



SPARK PLUGS & COILS & WIRE SETS GLOW PLUGS & CONTROL UNITS

2019
—
2020

CATCM1803

A LEADING QUALITY RANGE



IGNITION

Champion is highly regarded for its top quality spark plugs. Now, we also offer revolutionary glow plug technologies, glow control units, coils and wire sets. This means Champion carries a wide range of high-quality ignition components for diesel and petrol engines alike.



FILTERS

Champion **oil, fuel, air and cabin filters** are designed to meet the stringent OE requirements. For all filter types, we offer you a **comprehensive range**. And each one will provide the quality performance and ease of installation Champion customers are accustomed to.



WIPERS

Champion has 3 brands in its wiper range:

High quality Aerovantage wipers match OE design and technology offering 98%* vehicle parc coverage.

Our compact Easyvision can service 95%* of the vehicle parc, including flat blade equipped cars thanks to the patented Multi Clip system.

The brand new Rainy Day offers 85% parc coverage in an ultra compact range at a great price.



LIGHTING

An outstanding lighting range. A reverse indicator. A cool interior light. Or perfectly processed halogen headlights and Xenon headlights for increased brightness, making you shine like you own the night.



BRAKES

If you get a quick start, you'll want a safe stop. That's why Champion now offers brakes, too. Pads, discs and shoe kits for the front and rear of the car, we've got them. So, Champion provides a matched solution with these simple-to-change brakes who will save you a lot of time.



BATTERIES

Start your engine. Designed to last and deliver optimal power, you can rely on Champion batteries to start your engine time after time. Champion offers a wide range of standard batteries & advanced EFB & AGM batteries for cars equipped with start/stop and brake regeneration systems.











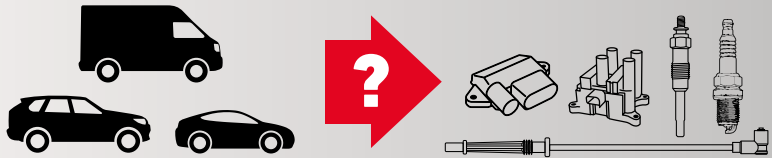

Technical Code → Short Code

| Technical Code | Short Code |
|----------------|------------|
| A6GC | OE112 |
| C11YCC | OE057 |
| C9YC | OE003 |
| CJ6 | CJ6 |
| CJ7Y | CJ7Y |
| CJ8 | CJ8 |
| D16 | D16 |
| DJ8J | DJ8J |
| J17LM | J17LM |
| J19LM | J19LM |
| J8C | J8C |
| KA4ZPYPB4 | OE215 |
| KA6ZPHPB-1 | OE244 |
| KA8ZYCC-1 | OE247 |
| KC10PYPB4 | OE191 |
| KC6PYPB | OE214 |
| KC6PYPBX | OE222 |
| KC6ZWYPB | OE260 |
| KC7PYPBX | OE209 |
| KC7ZPMPBX4 | OE234 |
| KC7ZPYPB4 | OE213 |
| KC7ZTMC4 | OE235 |
| KC8PYP4 | OE228 |
| KC8WYPB4 | OE181 |
| KC8ZMCC | OE177 |
| KC8ZPYPB4 | OE176 |
| KEC4PYPB | OE210 |
| KEC4PYPBF | OE219 |
| KEC4PYPBF-1 | OE220 |
| KEC6WYPB-1 | OE246 |
| KER4PYPB | OE229 |
| L77JC4 | L77JC4 |
| L78C | L78C |
| L82C | L82C |
| L82YC | OE038 |
| L86C | CCH306C |
| L86C | OE037 |
| L87YC | OE007 |
| L92YC | OE059 |
| N11YC | OE065 |
| N12YC | OE015 |
| N3C | OE068 |
| N3G | OE078 |
| N4C | OE079 |
| N5C | OE074 |
| N6YC | OE087 |
| N7BYC | OE012 |
| N7YC | OE010 |
| N9BYC | OE044 |
| N9YC | OE001 |
| P-RA7HC | P-RA7HC |
| P-RG4HCC | P-RG4HCC |
| P-RG6HCC | P-RG6HCC |
| P-RG7C | P-RG7C |
| P-RZ7HC | P-RZ7HC |
| P-RZ9HC | P-RZ9HC |
| QCJ6Y | QCJ6Y |
| QCJ8Y | QCJ8Y |
| QL77JC4 | QL77JC4 |
| RA2PYPB | OE208 |
| RA4HC | OE073 |
| RA4HCX | OE052 |
| RA4YC | OE230 |
| RA6HC | OE083 |
| RA7PYPB4 | OE226 |

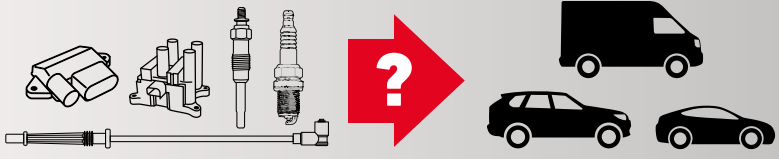
| Technical Code | Short Code |
|----------------|------------|
| RA7WHPB | OE187 |
| RA7YC | OE199 |
| RA8MCX4 | OE196 |
| RA8YCX4 | OE186 |
| RC10DMC | OE019 |
| RC10MCC | OE198 |
| RC10WMPB2 | OE184 |
| RC10WYPB4 | OE180 |
| RC10YC4 | OE063 |
| RC10YCC | OE016 |
| RC11LCC4 | OE114 |
| RC11PYPB4 | OE138 |
| RC12LC4 | OE128 |
| RC12LYC | OE041 |
| RC12MCC4 | OE154 |
| RC12WMPB4 | OE194 |
| RC12WYPB4 | OE193 |
| RC12YC | OE013 |
| RC6WYPBX | OE264 |
| RC6YCC | OE094 |
| RC7BMC | OE216 |
| RC7BYC | OE237 |
| RC7BYC | OE254 |
| RC7BYC4 | OE077 |
| RC7DYC | OE217 |
| RC7QMC | OE257 |
| RC7YCC | OE014 |
| RC87YCL | OE033 |
| RC89PYC | OE145 |
| RC89TMC | OE120 |
| RC89WYPB4 | OE182 |
| RC89YCC | OE093 |
| RC8BYC | OE030 |
| RC8DMC | OE026 |
| RC8PMPB | OE227 |
| RC8PYP | OE136 |
| RC8PYPB4 | OE146 |
| RC8QMC | OE218 |
| RC8TYC | OE123 |
| RC8VTYC4 | OE032 |
| RC8WMPB4 | OE188 |
| RC8WYPB4 | OE179 |
| RC8YCL | OE034 |
| RC8ZPYPB4 | OE239 |
| RC9MCC4 | OE089 |
| RC9QMP | OE223 |
| RC9YC | OE005 |
| RC9YC4 | OE039 |
| RC9YCC | OE002 |
| RCJ8 | RCJ8 |
| REA10WYPB | OE261 |
| REA12WMB4 | OE240 |
| REA4PMPB4 | OE233 |
| REA6PYPB | OE225 |
| REA6YC | OE231 |
| REA8MX | OE130 |
| REA8PMPB5 | OE207 |
| REA8WYPB | OE256 |
| REA8WYPB4 | OE253 |
| REC10PYC4 | OE175 |
| REC10WYPB4 | OE190 |
| REC10YC4 | OE148 |
| REC6TMC | OE236 |
| REC7PMPB4 | OE238 |
| REC7QMC | OE262 |

| Technical Code | Short Code |
|----------------|------------|
| REC8PYB | OE206 |
| REC8PYPB | OE224 |
| REC9MCLX | OE178 |
| REC9YCL | OE035 |
| RER12WMPB | OE263 |
| RER2PYPB | OE232 |
| RER3WYPB | OE248 |
| RER6DMC | OE211 |
| RER6YC | OE212 |
| RER8MC | OE201 |
| RER8WMPB | OE249 |
| RER8WYPB | OE250 |
| RER8YC | OE197 |
| RERX4PMPB | OE205 |
| RERX4ZWYPB | OE245 |
| RERX5PMPB | OE242 |
| RERX5ZPYPB | OE243 |
| RERX6PMPB4 | OE204 |
| RERX8PMPBX4 | OE203 |
| RES10TMC4 | OE255 |
| RES9PYP4 | OE029 |
| RES9WYPB5 | OE189 |
| RES9YCC4 | OE031 |
| RET4WYPBX | OE258 |
| RF7YC | OE054 |
| RG4HCX | OE241 |
| RG4PHP | OE122 |
| RG6YC | RG6YC |
| RG6YCA | RG6YCA |
| RJ17LM | RJ17LM |
| RJ19LM | RJ19LM |
| RJ19LMC | RJ19LMC |
| RL78C | RL78C |
| RL82C | OE086 |
| RL82YC | OE064 |
| RN10PYP4 | OE192 |
| RN10VTYC4 | OE027 |
| RN11YC | OE051 |
| RN11YC4 | OE049 |
| RN12YC | OE042 |
| RN14PMP5 | OE105 |
| RN1C | RN1C |
| RN2C | OE091 |
| RN3C | OE108 |
| RN4C | OE098 |
| RN7YC | OE018 |
| RN7YCC | OE008 |
| RN8VTYC4 | OE025 |
| RN8WYPB | OE195 |
| RN9YC | OE006 |
| RN9YC4 | OE048 |
| RN9YCC | OE004 |
| RS8WYPB5 | OE183 |
| RS9PYP4 | OE131 |
| RS9YC | OE011 |
| RV15YC4 | RV15YC4 |
| RV8C | RV8C |
| RX12ZYC | RX12ZYC |
| RY4C | RY4C |
| RZ7C | RZ7C |
| S12YC | OE099 |
| S9YC | OE009 |
| X | CCH425 |
| Z9Y | Z9Y |

Table of contents

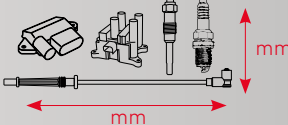
| | | |
|---|---|------------|
|  |  | II |
|  |  HOW TO USE THIS CATALOGUE | XIV |
|  |  | 1 |
|  |  | 338 |
|  |   | 382 |
|  |   | 471 |

CHAMPION IS LEADING IN SPARK PLUGS GLOBALLY, COVERING 95%* OF THE EUROPEAN CAR PARC

Our catalogue includes iridium, platinum and double copper spark plugs, as well as EON TITAN compact plugs featuring Thermal Contour and Poly-V technology. Each of these high-quality spark plugs is designed to optimise engine performance, resist erosion and minimise wear.



Recent New Product Innovations include:

- Bi-Hex plugs for PSA and BMW/Mini
- 'Sidefire' plugs for VW OEM
- 'Cup Terminal' plugs for VW OEM
- New plugs for small-engine applications

* Source : FMPI/TecDoc : Parc Coverage Summary : of cars equipped with a Glow Plug Control Unit (for more info : www.tecalliance.net/en/company) 2018

EON TITAN: THE RELIABLE TECHNOLOGY FOR A GREAT PERFORMANCE



Formula 1 Ceramic technology for anti-flashover.

EON TITAN brings Champion's ribless F1 technology to the road: physically and dielectrically stronger and it ensures a maximum flashover protection.

FISS suppressor for a smooth balanced idling.

Fired in Suppressor Seal (FISS) construction maintains a consistent spark plug voltage for smoother idling and also contributes to cooling.

Thin walled copper core centre electrode for great heat dissipation.

The thin walls bring the copper nearer to the surface. The firing end retains heat longer under light engine loads to reduce cold fouling, while improving heat dissipation at high rpm to cut wear and extend spark plug life.

Longer core nose/broader seat for wider heat range.

The long core nose -more resistant to fouling- and increased seat diameter contribute to the turbo cooling effect around the core nose.

Gapped for performance.

Eon Titan gives that 'just new' acceleration feel throughout its full life and a superb combustion efficiency that cuts both fuel consumption and emissions.

Copper core.

- Machined thermal contour centre electrode (CET1-9) for precious-metal performance on naturally aspirated engines.
- Platinum fine-wire centre electrode (CET10P-18P) for maximum performance on turbo engines.

Titanium alloy poly-v ground electrode :

Filigree poly-v shape requires lower voltage for greater ignition reliability & better flame front propagation, nickel-titanium alloy provides high erosion resistance



Wired for success

The longevity of a car is determined by the quality of the OE in its engine and even more so, by the quality of the spare parts. Champion Wire Sets offer a price/quality performance of high order. We make sure that clients only pay for the required quality.

Matching the high aftermarket production quality

Champion's product range matches high aftermarket production quality. All three conductive cores are well protected by EPDM or XLPE inner insulation and the silicone outer jacket.

Carbon Core

- Carbon impregnated conductor
- RFI suppression created by resistance in carbon conductor (7 to 30 kOhms/m)

Wire Wound Core

- Wirewound conductor based on ferrite
- RFI suppression created by magnetic field

Copper Core

- Nickel plated copper conductor 1mm² (19 x 0.25mm²)
- RFI suppression created by resistors in the boots



Built for benefits

- **RESISTANT:** Ability to resist high temperatures
- **DURABLE:** Excellent resistance to the effects of salt, water, oil, petrol and acids
- **SAFE:** Secure radio interference suppression



Champion Ignition Coils: The decisive spark for every driving experience

Champion offers a new range of ignition coils, developed to match your vehicle.

- **Pencil Coils** in high-value material, available with electronics module.
- **Plug Top Coils** with electronics module and interference suppressed spark plug connector.
- **Ignition Coil Rails** with double and single spark technology.
- **Block Ignition Coils** for static high voltage distribution. Single and double spark coils available with and without integrated electronics modules for 4, 5 and 6 cylinders.
- **Coils for Ignition Systems with Ignition Distributors** for transistor ignitions, with mounted or integrated electronics module.
- **Canister Type Ignition Coils** for rotating high voltage distribution in older vehicles with contact-controlled battery ignition.

A GLOWING SUCCESS: RELIABLE INNOVATIONS FOR DIESEL ENGINES

Champion's Integrated Pressure Sensor Glow Plug,
Ceramic Glow Plug and Instant Start System

Champion has a long history of introducing new technologies for its range of ignition components. Three of the most groundbreaking ones are for glow plugs. They all ensure an ultra-fast warm-up for fast starting diesel engines, even in cold conditions.

By maintaining high temperatures after the engine has started, Champion's glow plugs keep engines running smoothly from the start as well as help lowering emissions.





Champion Integrated Pressure Sensor Glow Plug

By installing pressure sensor glow plugs higher peak pressures can be implemented in today's smaller engines, standard and future combustion processes can be pushed even further to their limits, and constantly stable emissions control can be obtained throughout the engine's entire service life. In each cylinder, the pressure sensor plug measures the rapidly changing pressure in the combustion chamber during each combustion cycle and transmits this information continuously to the engine control electronics.

The engine can be operated within the optimum window between maximum power and minimum exhaust gases.

- Combustion noise can be reduced.
- Enables constant stability of the combustion process.
- Effective compensation for injector ageing.

Champion Ceramic Glow Plug

The hardness and strength of the materials used for the plugs, withstand temperatures up to 1,100 °C. The short heat-up times, at the tip of the ceramic element, require less energy to generate the proper temperature to start the engine. That also means it needs less fuel.



Instant Start System

Instant reliability at the turn of a key

The Instant Start System for diesel engines with direct injection combines an electronic control unit and optimized glow plugs to reach temperatures up to 1,100 °C in 1 to 2 seconds. Even in temperatures as low as -25 °C. The usual glow plug needs about 5 seconds. Each glow plug can be controlled by a separate power semiconductor within the system. This allows separate monitoring of the current and individual diagnostics.



CHAMPION GLOW CONTROL UNITS NEVER MISS A START

Glow Control Units are the latest addition to the ever-expanding range of Champion's ignition technologies. As is the case with most of our ignition components, these units are produced using all proven technologies and industry-first innovations. They require the same quality standards as OE equipment and are tested accordingly.

Furthermore, and more importantly, this is an addition to a range of products made for each other. Champion Glow Control Units secure the optimum support to cold-start operations for every diesel engine.

With Champion's consistently developed range of Glow Control Units, you're guaranteed a long-term collaboration. That's real support.

26 SKUs - 90% European car parc coverage*
Champion Glow Plug Control Units fit 63 Mio cars in Europe, including Russia*



* Source : FMPI/TecDoc : Parc Coverage Summary : of cars equipped with a Glow Plug Control Unit (for more info : www.tecalliance.net/en/company) 2018



SPARK PLUGS: Chazelles*

- A **production facility right around the corner**
- **Quality** swiftly delivered
- **Short lead time**
- **Reduced customs duty** for export customers
- A **perfect location** for customer and Federal-Mogul training sessions or visits



GLOW PLUGS: Ludwigsburg**

- All-wheel **roller test bench**
- **Ceramics Competence Centre**
- Central **vibration test laboratory**
- Laboratories for **ignition system components and sensors**
- **Endurance** test area
- **Electromagnetic compatibility department** to test behavior of various electrical and electronic components
- **Conventional and special engine test benches** for fully automatic endurance and cold-start tests

IS*
NY

Ludwigsburg**
GERMANY

Carpi*
ITALY

Bhiwadi*
INDIA

Qingdao
CHINA

All OE applications manufacturers

AC | ACURA | ALFA ROMEO | ALPINA | ALPINE | AMERICAN MOTORS | ARO | ASIA MOTORS | ASTON MARTIN
| AUDI | AUSTIN | AUSTIN-HEALEY | AUTO UNION | AUTOBIANCHI | AVIA | BAOLONG | BARKAS | BEDFORD |
BENTLEY | BERTONE | BITTER | BMW | BORGWARD | BUGATTI | BUICK | CADILLAC | CARBODIES | CATER-
HAM | CHENGLONG | CHERY | CHEVROLET | CHRYSLER | CITROËN | DACIA | DADI | DAEWOO | DAF |
DAIHATSU | DAIMLER | DALLAS | DE TOMASO | DODGE | EAGLE | EUNOS | FERRARI | FIAT | FORD | FORD
OTOSAN | FOTON | FSO | GAZ | GEELY | GEO | GINETTA | GLAS | GOLDEN DRAGON | GREAT WALL |
HOLDEN | HONDA | HUMMER | HYUNDAI | INFINITI | INNOCENTI | IRMSCHER | ISUZU | IVECO | JAGUAR |
JEEP | KIA | LADA | LAMBORGHINI | LANCIA | LAND ROVER | LANDWIND (JMC) | LDV | LEXUS | LOTUS | LTI |
MAHINDRA | MARUTI | MASERATI | MAZDA | MERCEDES-BENZ | METROCAB | MG | MINI | MITSUBISHI |
MITSUOKA | MORGAN | MORRIS | MOSKVICH | NISSAN | NSU | OLCIT | OPEL | PANTHER | PEUGEOT |
PIAGGIO | PININFARINA | PLYMOUTH | PONTIAC | PORSCHE | PROTON | PUCH | RANGER | RAYTON FISSORE
| RELIANT | RENAULT | ROLLS-ROYCE | ROVER | SAAB | SANTANA | SEAT | SKODA | SMART | SSANGYONG |
SUBARU | SUZUKI | TALBOT | TATA (TELCO) | TOYOTA | TRABANT | TRIUMPH | TVR | UAZ | VAUXHALL |
VOLVO | VW | WARTBURG | WESTFIELD | WIESMANN | WOLSELEY | YUGO | YULON | ZASTAVA | ZAZ

* Marked plants are Federal-Mogul Powertrain plants ** Ludwigsburg is a BorgWarner plant

GB - IMPORTANT

Reproduction of this catalogue or parts thereof is only allowed with our explicit permission in writing. Pictorial representations and design are copyrighted. Claims for damages, of any form whatsoever, resulting from details made in this catalogue or from incorrect use, application, storage or handling, are explicitly excluded. Contractual rights and any resulting or related claims based thereon, irrespective of form, initially come into being on the basis of a separate written agreement, in particular on the basis of our general terms of sale and delivery. All former statements lose their validity with the publication of this catalogue. The catalogue is not an operating manual for the use and installation of the ignition products. It does not contain any advice in a legal sense. The catalogue neither replaces the constantly applicable technical regulations – particularly for tolerances – nor the installation and maintenance stipulations of the individual vehicle manufacturer. Also, it is not possible to forego the expertise of those carrying out the installation and application. The individual references made in this catalogue for the installation and the application of the ignition products are instructions solely for the technically qualified specialist and are to be checked and verified by them for their suitability in each case. Federal-Mogul accepts no responsibility for application decisions. The contents of the catalogue are not intended to create or substitute any contractual agreement which has to be reserved exclusively to a separate agreement between 2 identified parties, whereby seller can be only one of our Federal-Mogul entities as mentioned on the back cover page. The right is retained to correct errors and alterations, particularly with regard to amendments in the vehicle manufacturer's details and stipulations.

DE - WICHTIGE HINWEISE

Nachdruck, auch auszugsweise, ist nur mit unserer ausdrücklichen schriftlichen Zustimmung gestattet. Die bildlichen Darstellungen und Ausstattungen sind geschützt. Ersatzansprüche, gleich welcher Art, aufgrund der Angaben in diesem Katalog oder auf Grund unsachgemäßem Umgang, unsachgemäßer Verwendung, Lagerung oder Handhabung der angebotenen Produkte, sind ausdrücklich ausgeschlossen. Vertragliche Ansprüche und daraus abgeleitete oder darauf beruhende Ansprüche, gleich welcher Art, kommen erst auf Grund einer besonderen schriftlichen Vereinbarung, insbesondere auf der Grundlage unserer allgemeinen Verkaufs- und Lieferbedingungen, zustande. Der Katalog ist keine Einbauanleitung für Zündungsteile. Er enthält keine Beratung im Rechtssinne. Der Katalog ersetzt weder die immer vorrangigen technischen Vorschriften, insbesondere für Toleranzen, sowie die Einbau- und Wartungsvorschriften des jeweiligen Automobilherstellers, noch kann auf das notwendige Fachwissen des die Montage und die Verwendung Durchführenden verzichtet werden. Die in diesem Katalog jeweils gegebenen Hinweise für Einbau und Verwendung der Zündungsteile sind Hinweise ausschließlich für den technisch ausgebildeten und versierten Fachmann, die von ihm im jeweiligen Anwendungsfall auf ihre Eignung geprüft und entschieden werden müssen. Eine Haftung wird von Federal-Mogul für Anwendungsentscheidungen nicht übernommen. Die Inhalte dieses Katalogs sind nicht dazu bestimmt eine vertragliche Verpflichtung zu begründen oder zu ersetzen, was ausschließlich einer gesonderten Vereinbarung zwischen 2 konkret bezeichneten Parteien vorbehalten bleibt, wobei der Verkäufer eine unserer Federal-Mogul Gesellschaften sein wird, wie auf der Rückseite des Kataloges. Die Korrektur von Irrtümern und Änderungen, insbesondere auf Grund von geänderten Angaben und Vorschriften der Automobilhersteller, bleibt vorbehalten.

FR - IMPORTANT

La reproduction de ce catalogue, même partielle, n'est autorisée qu'avec notre accord préalable et par écrit. Les illustrations graphiques et la présentation font l'objet d'un copyright. Nous excluons toutes réclamations ayant pour objet ce catalogue ou pouvant résulter de son incompréhension, portant sur de mauvaises utilisations, manipulations, manutentions ou mauvais stockage. Des droits contractuels et des droits dérivés, de quelque nature qu'ils soient, ne peuvent résulter que d'un accord écrit, particulièrement sur la base de nos conditions générales de ventes et de livraisons. Ce catalogue annule et remplace toute édition antérieure. Le catalogue n'est pas une notice d'utilisation et de montage des produits d'allumage et de préchauffage. Il ne contient pas de directives en tant que telles. Le catalogue ne remplace ni les prescriptions techniques, toujours prioritaires, particulièrement pour les tolérances, ni les prescriptions de montage et d'entretien des constructeurs automobiles. Il ne peut en aucun cas remplacer les connaissances professionnelles nécessaires pour le montage et l'utilisation. Les remarques données pour le montage et l'utilisation des produits d'allumage et de préchauffage sont exclusivement destinées au professionnel averti et de formation technique, à qui il appartiendra de vérifier la conformité des indications pour chaque cas. La responsabilité des décisions d'utilisation ne peut être prise en charge par Federal-Mogul. Le contenu de ce catalogue ne peut constituer ou remplacer un contrat qui doit faire l'objet d'un document séparé établi entre 2 parties, dont l'une doit être une entité légale de Federal-Mogul dont la liste figure sur la couverture arrière. Nous nous réservons le droit d'apporter des corrections d'erreurs et modifications, suite notamment à de nouvelles données fournies par les constructeurs.

ES - IMPORTANTE

Queda totalmente prohibida la reproducción, total o parcial, del contenido de este catálogo, salvo nuestra previa autorización por escrito. Están, asimismo, reservados todos los derechos sobre el diseño y representación pictórica del catálogo. No se aceptará ningún tipo de reclamación fundamentada en la interpretación de los datos contenidos en este catálogo, así como en el incorrecto uso, manipulación o almacenaje de nuestras piezas. Únicamente se aceptarán reclamaciones que estén basadas en derechos contractuales o en los motivos arriba indicados siempre que exista un acuerdo especial y por escrito, con base en nuestras condiciones generales de venta y suministro. Con la edición de este catálogo queda anulada toda la información contenida en publicaciones anteriores. El catálogo no es un manual para el uso e instalación de los productos de encendido, y no representa una asesoría técnica en el sentido legal. Los datos del catálogo no sustituyen, en ningún caso, a las especificaciones técnicas, tanto en lo que se refiere a tolerancias como a las instrucciones de instalación y mantenimiento indicadas por los fabricantes de vehículos, especificaciones que serán siempre prioritarias. Las indicaciones sobre uso y montaje de los productos de encendido contenidas en este catálogo están exclusivamente dirigidas a profesionales con la debida cualificación y formación técnica, que deben decidir en cada caso sobre la exactitud de las mismas. La responsabilidad de estas decisiones no puede ser, en ningún caso, atribuida a Federal-Mogul. La información facilitada en el catálogo no representa o sustituye ningún tipo de acuerdo, quedando a tal efecto el acuerdo por separado entre dos partes identificadas, donde la parte vendedora sólo puede ser una de las entidades de Federal-Mogul mencionadas en la contraportada del catálogo. Los datos e instrucciones contenidos en este catálogo podrán ser corregidos o modificados sin previo aviso.

NL - BELANGRIJK

Reproductie van deze catalogus of gedeelten daarvan is uitsluitend toegestaan met onze uitdrukkelijke schriftelijke toestemming. Er rusten auteursrechten op afbeeldingen en ontwerp. Vorderingen wegens schade, in elke vorm, ten gevolge van informatie in deze catalogus of door verkeerd gebruik, toepassing, opslag of transport, zijn nadrukkelijk uitgesloten. Contractuele rechten en elke resulterende of daaraan gerelateerde aanspraken op basis daarvan, onafhankelijk van de vorm, ontstaan in eerste instantie op basis van een aparte schriftelijke overeenkomst, in het bijzonder op basis van onze algemene verkoop- en leveringsvoorwaarden. Alle eerdere verklaringen verliezen hun geldigheid met de publicatie van deze catalogus. De catalogus is geen bedieningshandleiding voor het gebruik en de montage van de ontstekingsproducten. Hij bevat geen advies in juridische zin. De catalogus vormt geen vervanging van de permanent geldende technische voorschriften – in het bijzonder voor toleranties – of voor de bepalingen voor montage en onderhoud van de individuele autofabrikant. De kennis van degene die de montage en toepassing uitvoert, is ook onontbeerlijk. De individuele verwijzingen in deze catalogus voor de montage en toepassing van de ontstekingsproducten zijn louter instructies voor de daarvoor opgeleide technische specialist en door hen moet voor elk geval worden gecontroleerd en geverifieerd of zij geschikt zijn. Federal-Mogul accepteert geen verantwoordelijkheid voor de keuze van toepassing. De inhoud van de catalogus is niet bedoeld voor het opstellen of vervangen van een contractuele overeenkomst die uitsluitend moet worden gereserveerd tussen 2 geïdentificeerde partijen, waarbij de verkoper uitsluitend een van onze Federal-Mogul entiteiten kan zijn die op de achtercover worden vermeld. Wij behouden ons het recht voor om fouten en wijzigingen te corrigeren, in het bijzonder met betrekking tot wijzigingen in details en bepalingen van de autofabrikant.

IT - IMPORTANTE

La riproduzione di questo catalogo, anche parziale, è permessa soltanto in seguito ad una autorizzazione scritta. I grafici ed i disegni sono marchio depositato. Reclami per difetti, di qualsiasi natura essi siano, relativi al contenuto di questo catalogo, o all'uso improprio di esso, verranno respinti. Le pretese avanzate od i reclami dovranno essere in conformita' con le nostre condizioni generali di vendita. Il presente catalogo annulla e sostituisce tutte le edizioni precedenti. Il catalogo non è un manuale per l'utilizzo ed il montaggio dei prodotti di accensione. Non contiene indicazioni in questo senso. Esso non sostituisce le descrizioni tecniche, sempre prioritarie, in particolare per le tolleranze, né le istruzioni relative al montaggio ed alla manutenzione date dai costruttori. Non può in nessun caso essere paragonato alla conoscenza professionale necessaria per il montaggio e l'utilizzo. Le considerazioni sui prodotti di accensione fatte su questo catalogo, sono destinate esclusivamente a professionisti con formazione tecnica i quali verificheranno l'esattezza della informazioni, in ogni caso. Le responsabilità derivanti dall'utilizzo improprio dello stesso non potranno essere addebitate alla Federal-Mogul. I contenuti del catalogo non sostituiscono in alcun modo gli accordi contrattuali che sono riservati esclusivamente a due contraenti definiti, come venditore si intende una delle società Federal-Mogul menzionate sul retro del catalogo. Ci riserviamo di apportare correzioni e modifiche relative, in particolare a dati o istruzioni ricevute dai costruttori.

© Federal-Mogul Corporation 2015

The contents of this publication are the copyright of Federal-Mogul Corporation.

Unauthorized reproduction in whole or in part is expressly forbidden.

Champion is a trademark of Federal-Mogul Corporation

R ERX 8 PMPBX 4

| | |
|---|-------------------------|
| - | Non |
| K | 1-2 |
| Q | 0.1-0.14 |
| R | SAC9 6-15 FISS 3-10 |
| U | Booster Gap : Non |
| X | Dual 6-15 + 0.1-0.13 |

| | mm | mm | mm | mm | Nm | Cast Iron Head | Alu-minium Head |
|--------|-----------|-------------|-----------|--------|-------|----------------|-----------------|
| A | 16 | M12x1.25 mm | 19 | Gasket | 15-25 | 12-20 | |
| AX | 18 | M12x1.25 mm | 19 | Gasket | 15-25 | 12-20 | |
| C | 16 | M14x1.25 mm | 19 | Gasket | 20-35 | 15-30 | |
| CJ | 19 | M14x1.25 mm | 9.5 | Gasket | 20-35 | 15-30 | |
| D | 23 | M18x1.5 mm | 12.7 | Gasket | 30-45 | 20-35 | |
| DJ | 16 | M14x1.25 mm | 8.3 | Taper | 15-25 | 12-20 | |
| DZ | 16 | M10x1 mm | 12.7 | Taper | 11-12 | 11-12 | |
| EA | 14 | M12x1.25 mm | 26.5 | Gasket | 15-25 | 12-20 | |
| EC | 16 | M14x1.25 mm | 26.5 | Gasket | 20-35 | 15-30 | |
| ER | 16 | M12x1.25 mm | 26.5 | Gasket | 15-25 | 12-20 | |
| ERX | BI-HEX 14 | M12x1.25 mm | 26.5 | Gasket | 15-25 | 12-20 | |
| E / ES | 16 | M14x1.25 mm | 25 | Taper | 15-25 | 12-20 | |
| F | 21 | M18x1.5 mm | 11.7 | Taper | 15-30 | 15-25 | |
| FN | 16 | M14x1.25 mm | 19 | Gasket | 20-35 | 15-30 | |
| G | 16 | M10x1 mm | 19 | Gasket | 10-15 | 10-15 | |
| H | 21 | M14x1.25 mm | 11.1 | Gasket | 20-35 | 15-30 | |
| J | 21 | M14x1.25 mm | 9.5 | Gasket | 20-35 | 15-30 | |
| L | 21 | M14x1.25 mm | 12.7 | Gasket | 20-35 | 15-30 | |
| N | 21 | M14x1.25 mm | 19 | Gasket | 20-35 | 15-30 | |
| P | 18 | M12x1.25 mm | 12.5 | Gasket | 15-25 | 12-20 | |
| S | 16 | M14x1.25 mm | 18 | Taper | 15-25 | 12-20 | |
| V | 16 | M14x1.25 mm | 11.7 | Taper | 15-25 | 12-20 | |
| W | 24 | 7/8"-18 | 16 > 19 | Gasket | 67-74 | - | |
| X | 16 | M14x1.25 mm | 12.7 | Gasket | 20-35 | 15-30 | |
| Y | 16 | M10x1 mm | 6.4 > 9.5 | Gasket | 10-15 | 10-15 | |
| Z | 16 | M10x1 mm | 12.7 | Gasket | 10-15 | 10-15 | |
| ZF | 21 | M18x1.5 mm | 11.1 | Taper | 15-30 | 15-25 | |
| X PLUG | 24 | 1/2"-14 | 25.4 | Taper | | | |
| 7989 | 16 | M16x1.5 mm | 21.6 | Taper | | | |

| | | |
|----|----|----|
| 23 | | |
| 21 | | |
| 20 | | |
| 19 | 95 | |
| 19 | 95 | |
| 18 | 91 | |
| 17 | 90 | |
| 16 | | |
| 15 | | |
| 14 | | |
| 13 | | |
| 12 | 86 | |
| 11 | | |
| 10 | | |
| 9 | | |
| 8 | | |
| 7 | | |
| 6 | 85 | 63 |
| 5 | 82 | 61 |
| 4 | 81 | 59 |
| | 79 | |
| | 78 | |
| 3 | 77 | 57 |
| | 76 | |
| | 75 | |
| 2 | | 55 |
| 1 | | 54 |
| | | 53 |

| #Z.... | Skirted shell | | Z |
|--------|----------------|-------------------|---------------------|
| - | Nickel | Nickel | 1 non |
| A | Nickel | Nickel | 1 non A |
| B | Nickel | Nickel | 2 non |
| BMC | Copper | Nickel | 2 3.0 |
| BVC | Copper | Nickel | 2-3 1.5 |
| C | Copper | Nickel | 1 non |
| CC | Copper | Copper | 1 non |
| CX | Copper | Nickel | 1 non C |
| D | Nickel | Nickel | 1 8.4 |
| DMC | Copper | Nickel | 2 3.0 |
| DR | Nickel | Nickel | 1 non |
| DYC | Copper | Nickel | 2 1.5 |
| ECC | Copper | Copper | 1 7.4 |
| F | Copper | Nickel | 3 non |
| G | Gold Palladium | Nickel | 1 non |
| GC | Gold Palladium | Copper | 1 non |
| H | Nickel | Nickel | 1 0.8 |
| HC | Copper | Nickel | 1 0.8 |
| HCC | Copper | Copper | 1 0.8 |
| HGX | Copper | Nickel | 1 0.8 C |
| HX | Nickel | Nickel | 1 0.8 C |
| J | Nickel | Nickel | 1 non |
| JC | Copper | Nickel | 1 non |
| LC | Copper | Nickel | 1 2.3 |
| LCC | Copper | Copper | 1 2.3 |
| LM | Nickel | Nickel | 1 non |
| LMC | Steel | Copper | 1 non |
| LY | Nickel | Nickel | 1 5.1 |
| LYC | Copper | Nickel | 1 5.1 |
| MC | Copper | Nickel | 1 3.0 |
| MCC | Copper | Copper | 1 3.0 |
| MCLX | Copper | Copper | 1 3.0 RCN |
| MCX | Copper | 125 Nickel | 1 3.0 |
| MX | Copper | 125 Nickel | 1 3.0 |
| P | Platinum | Nickel / Platinum | 1 > 2 non |
| PEC | Platinum | Copper | 1 7.4 |
| PEP | Platinum | Platinum | 1 7.4 |
| PEPB | Platinum | Platinum | 1 7.4 B |
| PHP | Platinum | Platinum | 1 0.8 |
| PLP | Platinum | Platinum | 1 5.1 |
| PLPB | Platinum | Platinum | 1 5.1 B |
| PNC | Platinum | Copper | 1 3.0 |
| PMCB | Platinum | Copper | 1 3.0 B |
| PMP | Platinum | Platinum | 1 3.0 |
| PMPB | Platinum | Platinum | 1 3.0 B |
| PMPBX | Platinum | Platinum | 1+2 3.0 B & 1+2 |
| PP | Platinum | Platinum | 1 non |
| PYB | Platinum | Nickel | 1 1.5 |
| PYC | Platinum | Copper | 1 1.5 |
| PYCB | Platinum | Copper | 1 1.5 B |
| PYCBX | Platinum | Copper | 1 1.5 B & RCN |
| PYP | Platinum | Platinum | 1 1.5 |
| PYPB | Platinum | Platinum | 1 1.5 B |
| PYPBF | Platinum | Platinum | 1 1.5 F |
| PYPBX | Platinum | Platinum | 1 1.5 B & RCN / 1+2 |
| QMC | Copper | Nickel | 4 3.0 |
| QMP | Platinum | Nickel | 4 3.0 |
| R | Nickel | Nickel | 1 non |
| TMC | Copper | Nickel | 3 3.0 |
| TYC | Copper | Nickel | 3 1.5 |
| V | Nickel | non | non non V |
| VC | Copper | non | non non V |
| VPYC | Platinum | Copper | 1 1.5 |
| VTYC | Copper | Nickel | 3 1.5 |
| WEP | Iridium | Platinum | 1 7.4 B |
| WHPB | Iridium | Platinum | 1 0.8 B |
| WMPB | Iridium | Platinum | 1 3.0 B |
| WP | Iridium | Platinum | 1 non |
| WYCB | Iridium | Copper | 1 1.5 B |
| WYPB | Iridium | Platinum | 1 0.8 B |
| Y | Nickel | Nickel | 1 1.5 |
| YC | Copper | Nickel | 1 1.5 |
| YCC | Copper | Copper | 1 1.5 |
| YCL | Copper | Copper | 1 1.5 |
| YCX | Copper | 125 Nickel | 1 1.5 |
| YDR | Nickel | Nickel | 1 1.5 C |
| YX | Nickel | Nickel | 1 1.5 B |
| X plug | Nickel | Nickel | 1 non |
| 7989 | Platinum | Platinum | 1 1.4 |

| | |
|---|--------------|
| - | 0.7 - 0.9 mm |
| 2 | 0.6 mm |
| 3 | 0.9 mm |
| 4 | 1.0 mm |
| 5 | 1.3 mm |
| 6 | 1.5 mm |
| 8 | 2.0 mm |

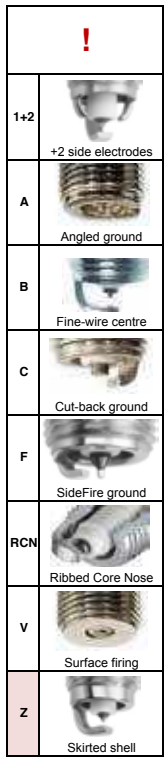

**Verwendungshinweis - Comment utiliser - Cómo usarlo - Hoe te gebruiken - Come si utilizzano -
 Основы использования - Jak korzystać z katalogu - Οδηγίες χρήσης - Como utilizar - Hogyan
 használd - Návod k použití**

| EN | D | F | ES | NL | I | RU | PL | GR | PT | HU | CZ |
|-----------------------------|-----------------------------|----------------------------|----------------------|----------------------|---------------------------------|--|--------------------------------------|------------------------|-----------------------|-----------------------|---------------------------|
| Resistor | Widerstand | Résistance | Resistencia | Weerstand | Resistenza | Резистор | Opornik | Αντίσταση | Resistência | Ellenállás | Odpor |
| Heatrange | Wärme- wert | Dégre thermique | Grado térmico | Warmte- graad | Grado termico | Калильное число | Ciepłota świecy | Θερμική διαβάθμιση | Índice térmico | Hőérték | Tepelná hodnota |
| Centre electrode | Mittel- elektrode | Electrode centrale | Electrodo central | Midden- elektrode | Elettrodo centrale | Цент- ральный электрод | Elektroda centralna | Κεντρικό Ηλεκτρόδιο | Eléctrodo central | Központi elektroda | Střední electroda |
| Ground electrode | Masse- elektrode | Electrode de masse | Electrodo lateral | Massa- elektrode | Elettrodo di masse | Боковой электрод | Elektroda boczna | Ηλεκτρόδιο Γείωσης | Eléctrodo de massa | Test elektroda | Boční electroda |
| Projection | Funken- lage | Projection | Proyec- ción | Projectie | Protezione | Высту- пание центр. электрода | Wysunięcie elektrody środkowej | Προεξοχή | Projeção | Kinyúlás | Vysunutí izolátoru |
| Feature | Bemer- kungen | Caracté- ristique | Caracte- rística | Kenmerk | Carat- terisitica | Описание | Cechy charaktery- styczne | Χαρακτη- ριστικά | Saliência | Tulajdon- ság | Charakte- ristika |
| Terminal | Anschluss | Embouts de connexion | Conexión | Aansluiting | Connettori | Контакт- ный терминал | Element przyłącze- niowy | Τερματική διάταξη | Conexão | Terminál | Konektor |
| Gap | Elek- troden- Abstand | Écarte- ment | Rango | Afstand | Distanza inter- elettrodi | Искровой зазор | Odstęp elektrod | Διάκενο | Folga | Rés | Elektrodová vzdálenost |
| Torque Nm | Anzugs- dreh- moment | Couple de serrage | Par de apriete | Aanhaal- moment | Coppia di serraggio | Момент затяжки | Moment dokręcenia | Ροπή Σύσφιξης | Torque de aperto | Meghúzási nyomaték | Utahovací moment |
| Cylinder head | Zylinder- kopf | Culasse | Culata | Cilinder- kop | Testa cilindro | Головка блока | Głowica cylindra | Κυλινδρο- κεφαλή | Cabeça de cilindro | Hengerfej | Hlava válců |
| Thread | Gewinde | Filetage | Rosca | Spoed | Filettatura | Резьба | Gwint | Σπειρωμα | Rosca | Menet | Závit |
| Iron | Eisen | Fer | Acero | IJzer | Ghisa | Чугун | Żeliwo | Σιδήρου | Ferro | Vas | Litina |
| Aluminium | Aluminium | Aluminium | Aluminio | Aluminium | Alluminio | Алюминий | Aluminium | Αλουμινίου | Alumínio | Alumínium | Lehká slitina |



| C3 | | | | | | | | | | |
|-------------|---|------------------------|--------|-------------|--------------------|-----|------|-------|--|--------|
| 1.4 Hybrid | 4 | KFV(TU3JP) | 54/72 | 05/05→ | OE034 | 0,9 | CET2 | OE179 | BAE946A ^[11] | |
| 1.6 | 4 | NFU(TU5JP4) | 80/107 | 05/03→ | OE035 | 0,9 | CET5 | OE190 | BAEA045E | CLS124 |
| C3 I | | | | | | | | | | |
| 1.1 i | 4 | HFX(TU1A); HFX(TU1JP) | 44/59 | 02/02→ | OE034 | 0,9 | CET2 | OE179 | BAE946A ^[11] →10/05 BAEA048E ^[7] 11/05→ | CLS124 |
| 1.4 16V | 4 | KFU(ET3J4) | 65/87 | 12/03→ | OE130 | 0,9 | CET4 | | BAEA472 | |
| 1.4 16V HDi | 4 | 8HY(DV4TED4) | 66/89 | 02/02→ | | | | | CCU149 ^[301] | |
| 1.4 Bioflex | 4 | KFV(TU3JP) | 60/80 | 01/09→ | OE034 | 0,9 | CET2 | OE179 | BAE946A ^[11] →07/12 | |
| 1.4 HDi | 4 | 8HX(DV4TD); 8HZ(DV4TD) | 50/67 | 02/02→ | CH201 RP.10227→ | 11v | | | CCU149 ^[301] | |
| 1.4 HDi | 4 | 8HZ(DV4TD) | 52/70 | 07/03→02/11 | CH201 | 11v | | | | |
| 1.4 HDi | 4 | 8HX(DV4TD) | 55/74 | 05/05→ | CH201 | 11v | | | CCU147 | |

- EN**
- 1 Model
 - 6 Spark plug
 - 11 Spark plug Iridium
 - 2 Cylinders
 - 7 Glow plug
 - 12 Ignition coil
 - 3 Engine code
 - 8 Electrode Gap
 - 13 Glow plug control unit
 - 4 KiloWatt / Horsepower
 - 9 Voltage
 - 14 Ignition leads
 - 5 Model year
 - 10 EON Titan

- DE**
- 1 Modell
 - 6 Zündkerze
 - 11 Iridium Zündkerze
 - 2 Zylinder
 - 7 Glühkerze
 - 12 Zündspule
 - 3 Motorkennung
 - 8 Elektrodenabstand
 - 13 Zündmodul
 - 4 kW / PS
 - 9 Spannung
 - 14 Zündkabelsatz
 - 5 Modelljahr
 - 10 EON Titan

- FR**
- 1 Modèle
 - 6 Bougie d'allumage
 - 11 Bougie d'allumage Iridium
 - 2 Cylindres
 - 7 Bougie de préchauffage
 - 12 Bobine d'allumage
 - 3 Code moteur
 - 8 Écartement des électrodes
 - 13 Module d'allumage
 - 4 Kilowatt/Nombre de chevaux
 - 9 Tension
 - 14 Faisceaux
 - 5 Année du modèle
 - 10 EON Titan

- NL**
- 1 Model
 - 6 Bougies
 - 11 Iridium bougie
 - 2 Cilinder
 - 7 Gloeibougies
 - 12 Bobines
 - 3 Motortype
 - 8 Elektrodenafstand
 - 13 Ontstekingsmodule
 - 4 kW/pk
 - 9 Volt
 - 14 Ontstekingskabelsets
 - 5 Bouwjaar
 - 10 EON Titan

- ES**
- 1 Modelo
 - 6 Bujía de encendido
 - 11 Bujía de encendido Iridium
 - 2 Cilindros
 - 7 Calentador
 - 12 Bobina de encendido
 - 3 Código de motor
 - 8 Distancia entre electrodos
 - 13 Módulo de encendido
 - 4 Kilovatio/Potencia
 - 9 Tensión
 - 14 Juegos de cables
 - 5 Año de modelo
 - 10 EON Titan

- IT**
- 1 Modello
 - 6 Candele d'accensione
 - 11 Candele d'accensione Iridium
 - 2 Cilindro
 - 7 Candele di preriscaldamento
 - 12 Bobine
 - 3 N. motore
 - 8 Distanza degli elettrodi
 - 13 Moduli di accensione
 - 4 kW/CV
 - 9 Volt
 - 14 Cavi di accensione
 - 5 Anno di costr.
 - 10 EON Titan



**Control Unit,
Glow Plug System**

CCU106

CCU154



Glow Plug

CCGP010

CH302



Spark Plug

OE242

OE243

OE244

OE245

OE246

OE247

OE248

OE249

OE250

OE253

OE254

OE255

OE256

OE258

OE260

OE261

OE263

OE264

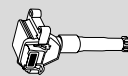

Ignition Coil

| | | | |
|----------|----------|----------|---------|
| BAEA009E | BAEA126E | BAEA199E | BAEA409 |
| BAEA012E | BAEA131E | BAEA242 | BAEA410 |
| BAEA013E | BAEA132E | BAEA243 | BAEA426 |
| BAEA014 | BAEA137E | BAEA246 | BAEA428 |
| BAEA016 | BAEA140E | BAEA247 | BAEA432 |
| BAEA017 | BAEA143E | BAEA252 | BAEA433 |
| BAEA019E | BAEA144E | BAEA254 | BAEA434 |
| BAEA029E | BAEA145E | BAEA255 | BAEA446 |
| BAEA030 | BAEA146E | BAEA264 | BAEA448 |
| BAEA031E | BAEA147E | BAEA267 | BAEA449 |
| BAEA032E | BAEA149E | BAEA269 | BAEA453 |
| BAEA033E | BAEA150E | BAEA296 | BAEA474 |
| BAEA037E | BAEA152E | BAEA298 | BAEA475 |
| BAEA041 | BAEA153E | BAEA299 | BAEA476 |
| BAEA041E | BAEA154E | BAEA302 | BAEA477 |
| BAEA042E | BAEA159E | BAEA304 | BAEA479 |
| BAEA043 | BAEA163E | BAEA306 | BAEA480 |
| BAEA043E | BAEA169E | BAEA324 | BAEA482 |
| BAEA044E | BAEA170E | BAEA326 | BAEA486 |
| BAEA046E | BAEA171E | BAEA337 | BAEA489 |
| BAEA048E | BAEA173E | BAEA339 | BAEA501 |
| BAEA051E | BAEA174E | BAEA345 | BAEA521 |
| BAEA052E | BAEA178E | BAEA347 | BAEA531 |
| BAEA055E | BAEA180E | BAEA348 | BAEA536 |
| BAEA056E | BAEA181E | BAEA351 | BAEA540 |
| BAEA059E | BAEA182E | BAEA352 | BAEA543 |
| BAEA061E | BAEA183E | BAEA354 | BAEA546 |
| BAEA062E | BAEA184E | BAEA359 | BAEA547 |
| BAEA063E | BAEA185E | BAEA365 | BAEA548 |
| BAEA065E | BAEA186E | BAEA367 | BAEA549 |
| BAEA066E | BAEA189E | BAEA368 | BAEA554 |
| BAEA067E | BAEA190E | BAEA377 | BAEA555 |
| BAEA068E | BAEA191E | BAEA378 | BAEA556 |
| BAEA069E | BAEA192E | BAEA383 | BAEA557 |
| BAEA073E | BAEA193E | BAEA384 | BAEA560 |
| BAEA077 | BAEA194E | BAEA385 | BAEA561 |
| BAEA084E | BAEA195E | BAEA386 | |
| BAEA085 | BAEA196E | BAEA388 | |
| BAEA095 | BAEA198E | BAEA394 | |



kW/BHP



eon TITAN

IRIDIUM

**ABARTH****500 / 595 / 695**

| | | | | | | | | |
|-----|---|----------------------|---------|--------|---------------------------|-----|--------------------------|-----------------------------|
| 1.4 | 4 | 312A1.000 | 99/133 | 08/08→ | OE208 →Prod.22.01.2013 | 0,8 | CET1 →Prod.22.01.2013 | BAEA095 →Prod.19.11.2014 |
| 1.4 | 4 | 312A3.000 | 103/138 | 05/10→ | OE208 →Prod.22.01.2013 | 0,8 | CET1 →Prod.22.01.2013 | BAEA095 →Prod.19.11.2014 |
| 1.4 | 4 | 312A1.000; 312A3.000 | 118/158 | 08/08→ | OE208 →Prod.22.01.2013 | 0,8 | CET1 →Prod.22.01.2013 | BAEA095 →Prod.19.11.2014 |
| 1.4 | 4 | 312A1.000; 312A3.000 | 119/160 | 01/14→ | | | | BAEA095 →Prod.19.11.2014 |
| 1.4 | 4 | 312A1.000; 312A3.000 | 132/177 | 08/08→ | OE208 →Prod.22.01.2013 | 0,8 | CET1 →Prod.22.01.2013 | BAEA095 →Prod.19.11.2014 |
| 1.4 | 4 | 312A1.000; 312A9.000 | 139/186 | 06/15→ | OE208 →Prod.22.01.2013 | 0,8 | CET1 →Prod.22.01.2013 | BAEA095 →Prod.19.11.2014 |
| 1.4 | 4 | 312A1.000 | 140/188 | 08/08→ | OE208 →Prod.22.01.2013 | 0,8 | CET1 →Prod.22.01.2013 | BAEA095 →Prod.19.11.2014 |

500C / 595C / 695C

| | | | | | | | | |
|-----|---|----------------------|---------|--------|---------------------------|-----|--------------------------|-----------------------------|
| 1.4 | 4 | 312A1.000 | 99/133 | 01/11→ | OE208 →Prod.22.01.2013 | 0,8 | CET1 →Prod.22.01.2013 | BAEA095 →Prod.19.11.2014 |
| 1.4 | 4 | 312A1.000; 312A3.000 | 103/138 | 09/09→ | OE208 →Prod.22.01.2013 | 0,8 | CET1 →Prod.22.01.2013 | BAEA095 →Prod.19.11.2014 |
| 1.4 | 4 | 312A1.000; 312A3.000 | 118/158 | 05/11→ | OE208 →Prod.22.01.2013 | 0,8 | CET1 →Prod.22.01.2013 | BAEA095 →Prod.19.11.2014 |
| 1.4 | 4 | 312A1.000; 312A3.000 | 119/160 | 01/14→ | | | | BAEA095 →Prod.19.11.2014 |
| 1.4 | 4 | 312A3.000 | 132/177 | 06/10→ | OE208 →Prod.22.01.2013 | 0,8 | CET1 →Prod.22.01.2013 | BAEA095 →Prod.19.11.2014 |

GRANDE PUNTO

| | | | | | | | | |
|-----|---|----------------------|---------|-------------|-------|-----|--|---------|
| 1.4 | 4 | 199A8.000 | 114/153 | 12/07→06/10 | OE208 | 0,8 | | BAEA095 |
| 1.4 | 4 | 199A8.000 | 132/177 | 12/07→12/12 | OE208 | 0,8 | | BAEA095 |
| 1.4 | 4 | 955A8.000 | 132/177 | 12/07→12/12 | | | | BAEA095 |
| 1.4 | 4 | 955A8.000 | 120/161 | 03/12→ | OE208 | 0,8 | | |
| 1.4 | 4 | 199A8.000; 955A8.000 | 132/177 | 03/12→ | OE208 | 0,8 | | |

AC**ACE**

| | | | | | | | | |
|-------------------|---|-----|---------|-------------|---------|-----|------|--|
| 4.6 | 8 | | 240/322 | 10/98→ | | | CET9 | |
| 4.9 | 8 | 99E | 179/240 | 10/98→ | RV15YC4 | 1,0 | | |
| 4.9 | 8 | 99E | 191/256 | 01/95→10/98 | RV15YC4 | 1,0 | | |
| 4.9 Super Charger | 8 | 99E | 239/320 | 10/98→ | RV15YC4 | 1,0 | | |

ACECA

| | | | | | | | | |
|-------------------|---|-----|---------|-------------|---------|-----|--|--|
| 4.9 | 8 | 99E | 179/240 | 09/93→12/97 | RV15YC4 | 1,0 | | |
| 4.9 Super Charger | 8 | 99E | 239/320 | 10/98→12/01 | RV15YC4 | 1,0 | | |

COBRA Mk IV

| | | | | | | | | |
|-------------------|---|-----|---------|-------------|---------|-----|--|--|
| 4.9 Roadster | 8 | 99H | 168/225 | 09/97→08/99 | RV15YC4 | 1,0 | | |
| 4.9 Super Charger | 8 | 99F | 239/320 | 10/97→ | RV15YC4 | 1,0 | | |

ACURA**NSX**

| | | | | | | | | |
|-----|---|-------|---------|-------------|-------|-----|--------|-------|
| 3.2 | 6 | C32B2 | 206/276 | 08/97→12/05 | OE146 | 1,0 | CET12P | OE179 |
|-----|---|-------|---------|-------------|-------|-----|--------|-------|

RL

| | | | | | | | | |
|-----|---|-------|---------|-------------|-------|-----|------|-------|
| 3.5 | 6 | C35A2 | 151/202 | 10/95→09/00 | OE154 | 1,0 | CET2 | OE194 |
| 3.5 | 6 | C35A5 | 153/205 | 10/00→09/04 | OE154 | 1,0 | CET2 | OE194 |

RSX

| | | | | | | | | |
|----------------|---|-------|---------|--------|--|--|--|----------|
| 2.0 | 4 | K20A3 | 114/153 | 10/05→ | | | | BAEA169E |
| 2.0 Sport | 4 | K20A3 | 118/158 | 10/01→ | | | | BAEA169E |
| 2.0 Vtec Sport | 4 | K20A | 162/217 | 10/01→ | | | | BAEA169E |

SLX

| | | | | | | | | |
|---------|---|------|---------|-------------|--|--|--------|-------|
| 3.2 4WD | 6 | 6VD1 | 140/188 | 11/95→09/99 | | | CET12P | OE180 |
|---------|---|------|---------|-------------|--|--|--------|-------|

ACURA



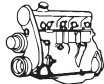

kW/BHP



eon TITAN

IRIDIUM

**...ACURA****...SLX**

| | | | | | | | | | | |
|---------|---|-------|---------|-------------|-------|-----|------|-------|--|--|
| 3.5 4WD | 6 | C35A5 | 151/202 | 11/97→09/99 | OE154 | 1,0 | CET2 | OE194 | | |
|---------|---|-------|---------|-------------|-------|-----|------|-------|--|--|

AIXAM**500**

| | | | | | | | | | | |
|-----|---|--------|-------|-------------|-------|-----|------|--|--|--|
| 0.5 | 2 | LGW523 | 15/20 | 09/03→07/05 | OE016 | 0,9 | CET2 | | | |
|-----|---|--------|-------|-------------|-------|-----|------|--|--|--|

A.751

| | | | | | | | | | | |
|-----|---|--------|-------|-------------|-------|-----|------|--|--|--|
| 0.5 | 2 | LGW523 | 15/20 | 07/05→03/10 | OE016 | 0,9 | CET2 | | | |
|-----|---|--------|-------|-------------|-------|-----|------|--|--|--|

CROSSLINE

| | | | | | | | | | | |
|-----|---|--------|-------|--------|-------|-----|------|--|--|--|
| 0.5 | 2 | LGW523 | 15/20 | 02/07→ | OE016 | 0,9 | CET2 | | | |
|-----|---|--------|-------|--------|-------|-----|------|--|--|--|

SCOUTY

| | | | | | | | | | | |
|-----|---|--------|-------|-------------|-------|-----|------|--|--|--|
| 0.5 | 2 | LGW523 | 15/20 | 08/07→07/12 | OE016 | 0,9 | CET2 | | | |
|-----|---|--------|-------|-------------|-------|-----|------|--|--|--|

ALFA ROMEO**4C**

| | | | | | | | | | | |
|-----|---|-----------|---------|--------|--|--|--|-------|--|--|
| 1.8 | 4 | 960A1.000 | 177/237 | 03/13→ | | | | OE256 | | |
|-----|---|-----------|---------|--------|--|--|--|-------|--|--|

4C SPIDER

| | | | | | | | | | | |
|-----|---|-----------|---------|--------|--|--|--|-------|--|--|
| 1.8 | 4 | 960A1.000 | 177/237 | 10/14→ | | | | OE256 | | |
|-----|---|-----------|---------|--------|--|--|--|-------|--|--|

145

| | | | | | | | | | | |
|----------|---|---------|-------|-------------|-------|-----|------|--|---------|--|
| 1.4 i.e. | 4 | AR33501 | 66/89 | 07/94→12/96 | OE087 | 0,9 | CET8 | | BAE800B | |
|----------|---|---------|-------|-------------|-------|-----|------|--|---------|--|

| | | | | | | | | | | |
|-------------------|---|------------------|--------|-------------|------------|-----|--|------------|----------------------------------|--------|
| 1.4 i.e. 16V T.S. | 4 | AR33503; AR38501 | 76/102 | 12/96→01/01 | OE122 [27] | 0,7 | | OE179 [28] | BAEA309 02/99→ Ch.3174688→ | CLS055 |
|-------------------|---|------------------|--------|-------------|------------|-----|--|------------|----------------------------------|--------|

OE223 [28]

1,6

| | | | | | | | | | | |
|--------------|---|---------|--------|-------------|------------|-----|--|------------|-------------------|--|
| 1.6 16V T.S. | 4 | AR32102 | 82/110 | 09/97→12/00 | OE122 [27] | 0,7 | | OE179 [28] | BAEA309 02/99→ | |
|--------------|---|---------|--------|-------------|------------|-----|--|------------|-------------------|--|

OE223 [28]

1,6

| | | | | | | | | | | |
|----------|---|---------|--------|-------------|-------|-----|------|--|---------|--|
| 1.6 i.e. | 4 | AR33201 | 76/102 | 10/94→12/96 | OE087 | 0,9 | CET8 | | BAEA234 | |
|----------|---|---------|--------|-------------|-------|-----|------|--|---------|--|

| | | | | | | | | | | |
|-------------------|---|------------------|--------|-------------|------------|-----|--|------------|----------------------------------|--------|
| 1.6 i.e. 16V T.S. | 4 | AR38201; AR67601 | 88/118 | 12/96→01/01 | OE122 [27] | 0,7 | | OE179 [28] | BAEA309 02/99→ Ch.3174688→ | CLS055 |
|-------------------|---|------------------|--------|-------------|------------|-----|--|------------|----------------------------------|--------|

OE223 [28]

1,6

| | | | | | | | | | | |
|--------------|---|---------|--------|-------------|-------|-----|------|--|---------|--|
| 1.7 i.e. 16V | 4 | AR33401 | 95/127 | 10/94→12/96 | OE094 | 0,9 | CET2 | | BAEA234 | |
|--------------|---|---------|--------|-------------|-------|-----|------|--|---------|--|

| | | | | | | | | | | |
|--------------|---|---------|---------|-------------|------------|-----|--|------------|-------------------|--------|
| 1.8 i.e. 16V | 4 | AR32201 | 106/142 | 03/98→01/01 | OE122 [27] | 0,7 | | OE179 [28] | BAEA309 02/99→ | CLS055 |
|--------------|---|---------|---------|-------------|------------|-----|--|------------|-------------------|--------|

OE223 [28]

1,6

| | | | | | | | | | | |
|-------------------|---|------------------------------|---------|-------------|------------|-----|--|------------|--|--|
| 1.8 i.e. 16V T.S. | 4 | AR38401; AR67106; AR67199 | 103/138 | 12/96→12/98 | OE122 [27] | 0,7 | | OE179 [28] | | |
|-------------------|---|------------------------------|---------|-------------|------------|-----|--|------------|--|--|

OE223 [28]

1,6

| | | | | | | | | | | |
|---------|---|---------|--------|-------------|-----------------------|-----|--|--|--|--|
| 1.9 JTD | 4 | AR32302 | 77/103 | 02/99→01/01 | CH222 Eng.1716459→ | 11v | | | | |
|---------|---|---------|--------|-------------|-----------------------|-----|--|--|--|--|

| | | | | | | | | | | |
|--------|---|------------------|-------|-------------|-------|-----|--|--|--|--|
| 1.9 TD | 4 | AR33601; AR67501 | 66/89 | 10/94→02/99 | CH189 | 11v | | | | |
|--------|---|------------------|-------|-------------|-------|-----|--|--|--|--|

| | | | | | | | | | | |
|---------|---|---------|---------|-------------|------------|-----|--|------------|---------|--------|
| 2.0 16V | 4 | AR32301 | 114/153 | 03/98→01/01 | OE122 [27] | 0,7 | | OE179 [28] | BAEA309 | CLS055 |
|---------|---|---------|---------|-------------|------------|-----|--|------------|---------|--------|

OE223 [28]

1,6

| | | | | | | | | | | |
|--------------|---|---------|---------|-------------|------------|-----|--|------------|--|--------|
| 2.0 16V T.S. | 4 | AR67204 | 110/148 | 10/95→01/01 | OE122 [27] | 0,7 | | OE179 [28] | | CLS055 |
|--------------|---|---------|---------|-------------|------------|-----|--|------------|--|--------|

OE223 [28]

1,6

146

| | | | | | | | | | | |
|----------|---|---------|-------|-------------|-------|-----|------|--|---------|--|
| 1.4 i.e. | 4 | AR33501 | 66/89 | 12/94→12/96 | OE087 | 0,9 | CET8 | | BAE800B | |
|----------|---|---------|-------|-------------|-------|-----|------|--|---------|--|

| | | | | | | | | | | |
|-------------------|---|------------------|--------|-------------|------------|-----|--|------------|----------------------------------|------------------|
| 1.4 i.e. 16V T.S. | 4 | AR33503; AR38501 | 76/102 | 11/96→01/01 | OE122 [27] | 0,7 | | OE179 [28] | BAEA309 02/99→ Ch.0165088→ | CLS055 02/99→ |
|-------------------|---|------------------|--------|-------------|------------|-----|--|------------|----------------------------------|------------------|

OE223 [28]

1,6

| | | | | | | | | | | |
|--------------|---|---------|--------|-------------|------------|-----|--|------------|-------------------|--|
| 1.6 16V T.S. | 4 | AR32102 | 82/110 | 09/97→12/00 | OE122 [27] | 0,7 | | OE179 [28] | BAEA309 02/99→ | |
|--------------|---|---------|--------|-------------|------------|-----|--|------------|-------------------|--|

OE223 [28]

1,6

| | | | | | | | | | | |
|----------|---|---------|--------|-------------|-------|-----|------|--|---------|--|
| 1.6 i.e. | 4 | AR33201 | 76/102 | 12/94→12/96 | OE087 | 0,9 | CET8 | | BAEA234 | |
|----------|---|---------|--------|-------------|-------|-----|------|--|---------|--|

CHAMPION

ACURA

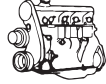

kW/BHP

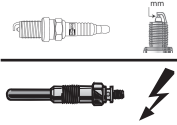

eon TITAN

IRIDIUM

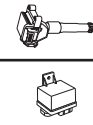
**...ALFA ROMEO****...146**

| | | | | | | | | | | |
|-------------------|---|------------------|---------|-------------|--|------------|------|-----------------------|----------------------------------|------------------|
| 1.6 i.e. 16V T.S. | 4 | AR38201; AR67601 | 88/118 | 11/96→10/01 | OE122 ^[27] OE223 ^[28] | 0,7 1,6 | | OE179 ^[28] | BAEA309 02/99→ Ch.0165088→ | CLS055 |
| 1.7 i.e. 16V | 4 | AR33401 | 95/127 | 12/94→12/96 | OE094 | 0,9 | CET2 | | BAEA234 | |
| 1.8 i.e. 16V T.S. | 4 | AR38401; AR67106 | 103/138 | 11/96→01/01 | OE122 ^[27] OE223 ^[28] | 0,7 1,6 | | OE179 ^[28] | | |
| 1.8 i.e. 16V T.S. | 4 | AR32201 | 106/142 | 03/98→01/01 | OE122 ^[27] OE223 ^[28] | 0,7 1,6 | | OE179 ^[28] | BAEA309 02/99→ | CLS055 02/99→ |
| 1.9 JTD | 4 | AR32302 | 77/103 | 02/99→01/01 | CH222 Eng.1716459→ | 11v | | | | |
| 1.9 TD | 4 | AR33601; AR67501 | 66/89 | 12/94→02/99 | CH189 | 11v | | | | |
| 2.0 16V | 4 | AR32301 | 114/153 | 03/97→10/01 | OE122 ^[27] OE223 ^[28] | 0,7 1,6 | | OE179 ^[28] | BAEA309 02/99→ | CLS055 02/99→ |
| 2.0 16V T.S. | 4 | AR67204 | 110/148 | 10/95→01/01 | OE122 ^[27] OE223 ^[28] | 0,7 1,6 | | OE179 ^[28] | | CLS055 |

147

| | | | | | | | | | | |
|---------------------|---|----------------------|---------|-------------|--|------------|--------|-----------------------|--------------------------|--------|
| 1.6 16V T.SPARK | 4 | AR32104 | 88/118 | 01/01→03/10 | OE122 ^[27] OE223 ^[28] | 0,7 1,6 | | OE179 ^[28] | | CLS055 |
| 1.6 16V T.SPARK ECO | 4 | AR37203 | 77/103 | 01/01→03/10 | OE077 ^[28] OE122 ^[27] | 1,0 0,7 | | OE179 ^[28] | | CLS055 |
| 1.9 JTD | 4 | 182B9.000 | 74/99 | 06/03→03/10 | CH222 ^[57] CH269 ^[59] | 11v 11v | | | CCU150 | |
| 1.9 JTD, 1.9 JTDM | 4 | 937A2.000; 939A7.000 | 85/114 | 04/01→03/10 | CH222 ^[57] CH269 ^[59] | 11v 11v | | | CCU150 | |
| 1.9 JTD 16V | 4 | 937A4.000 | 93/125 | 09/03→09/04 | CH224 | 11v | | | CCU150 | |
| 1.9 JTD 16V | 4 | 192B1.000 | 100/134 | 10/04→03/10 | CH224 | 11v | | | CCU150 | |
| 1.9 JTD 16V | 4 | 192A5.000 | 103/138 | 11/02→03/10 | CH224 | 11v | | | CCU150 | |
| 1.9 JTDM 8V | 4 | 937A3.000 | 88/118 | 07/05→03/10 | CH222 ^[57] CH269 ^[59] | 11v 11v | | | CCU150 | |
| 1.9 JTDM 16V | 4 | 937A5.000 | 110/148 | 09/04→03/10 | CH224 | 11v | | | CCU150 | |
| 1.9 JTDM 16V | 4 | 937A6.000 | 125/168 | 06/08→03/10 | | | | | CCU150 | |
| 2.0 | 4 | 937A1.000 | 121/162 | 07/02→05/05 | OE122 ^[27] OE123 | 0,7 0,7 | CET2 | OE179 | | |
| 2.0 16V T.SPARK | 4 | AR32310 | 110/148 | 01/01→03/10 | OE122 ^[27] OE223 ^[28] | 0,7 1,6 | | OE179 ^[28] | | CLS055 |
| 3.2 GTA | 6 | 932A.000 | 184/247 | 02/03→03/10 | OE146 | 1,0 | CET12P | OE179 | BAEA428 ^[277] | |

155

| | | | | | | | | | | |
|--------------|---|------------------|---------|-------------|--|------------|--|-----------------------|---------|--|
| 1.6 16V T.S. | 4 | AR67601 | 88/118 | 05/96→12/97 | OE122 ^[27] OE223 ^[28] | 0,7 1,6 | | OE179 ^[28] | | |
| 1.7 T.S. | 4 | AR67103 | 83/111 | 04/93→04/96 | | | | | BAEA234 | |
| 1.7 T.S. | 4 | AR67105 | 85/114 | 04/93→04/96 | | | | | BAEA234 | |
| 1.7 T.S. 16V | 4 | AR67106 | 103/138 | 05/96→12/97 | OE122 ^[27] OE223 ^[28] | 0,7 1,6 | | OE179 ^[28] | | |
| 1.9 TD | 4 | AR67501 | 66/89 | 04/93→12/97 | CH189 | 11v | | | | |
| 2.0 T.S. 16V | 4 | AR67204; AR67299 | 110/148 | 03/95→12/97 | OE122 ^[27] OE223 ^[28] | 0,7 1,6 | | OE179 ^[28] | | |
| 2.5 TD | 4 | VM07B; VM31B | 92/123 | 04/93→12/97 | CH189 →04/95 CH181 05/95→ | 11v 11v | | | | |

ALFA ROMEO





kW/BHP



eon TITAN

IRIDIUM



...ALFA ROMEO

156

| | | | | | | | | | | |
|-----------------------------------|---|---------------------------|---------|-------------|----------------------------|-----|---------|------------|-------------------|--------|
| 1.6 16V T.SPARK | 4 | AR32102 | 82/110 | 09/97→09/05 | OE122 [27] | 0,7 | | OE179 [28] | BAEA309 →09/00 | |
| | | | | | OE223 [28] | 1,6 | | | | |
| 1.6 16V T.SPARK. | 4 | AR32103 | 81/109 | 07/00→07/05 | OE122 [27] | 0,7 | | OE179 [28] | | |
| | | | | | OE223 [28] | 1,6 | | | | |
| 1.6 16V T.SPARK, 1.6 16V T.SPARK. | 4 | AR32103; AR32104; AR67601 | 88/118 | 09/97→05/06 | OE122 [27] | 0,7 | | OE179 [28] | | CLS055 |
| | | | | | OE223 [28] | 1,6 | | | | |
| 1.6 16V T.SPARK, 1.6 16V T.SPARK. | 4 | AR32102 | 88/118 | 09/97→05/06 | OE122 [27] | 0,7 | | OE179 [28] | BAEA309 →09/00 | CLS055 |
| | | | | | OE223 [28] | 1,6 | | | | |
| 1.8 16V T.SPARK | 4 | AR32205 | 103/138 | 02/97→05/06 | OE122 [27] | 0,7 | | OE179 [28] | | CLS055 |
| | | | | | OE223 [28] | 1,6 | | | | |
| 1.8 16V T.SPARK | 4 | AR32201 | 106/142 | 09/97→10/00 | OE122 [27] | 0,7 | | OE179 [28] | | CLS055 |
| | | | | | OE223 [28] | 1,6 | | | | |
| 1.9 JTD | 4 | AR32302 | 77/103 | 09/97→10/00 | CH222 [55] Eng.1716459→ | 11v | | | | |
| 1.9 JTD | 4 | AR37101 | 81/109 | 10/00→05/01 | CH222 [56] Eng.1716459→ | 11v | | | | |
| 1.9 JTD | 4 | 937A2.000 | 85/114 | 05/01→05/06 | CH222 | 11v | | | CCU150 | |
| 1.9 JTD | 4 | 937A4.000 | 93/125 | 11/03→05/06 | CH224 | 11v | | | CCU150 | |
| 1.9 JTD | 4 | 192B1.000 | 100/134 | 11/02→11/04 | CH224 | 11v | | | CCU150 | |
| 1.9 JTD, 1.9 JTD 16V 4WD | 4 | 937A5.000 | 110/148 | 07/04→05/06 | CH224 | 11v | | | CCU150 | |
| 1.9 JTD 16V | 4 | 192A5.000 | 103/138 | 11/02→05/06 | CH224 | 11v | | | CCU150 [57] | |
| 2.0 16V T.SPARK | 4 | AR32310 | 110/148 | 10/00→03/02 | OE122 [27] | 0,7 | | OE179 [28] | | CLS055 |
| | | | | | OE223 [28] | 1,6 | | | | |
| 2.0 16V T.SPARK | 4 | AR32301; AR32310 | 114/153 | 09/97→06/02 | OE122 [27] | 0,7 | | OE179 [28] | BAEA309 | CLS055 |
| | | | | | OE223 [28] | 1,6 | | | | |
| 2.0 JTS | 4 | 932A2.000 | 119/160 | 01/02→05/06 | OE122 [27] | 0,7 | CET2 | OE179 [28] | BAEA309 | |
| | | | | | OE123 | 0,7 | | OE179 | | |
| | | | | | OE223 [28] | 1,6 | | | | |
| 2.0 JTS | 4 | 937A1.000 | 122/164 | 03/02→05/06 | OE123 | 0,7 | CET2 | OE179 | | |
| 2.4 JTD | 5 | AR32501 | 100/134 | 09/97→09/03 | CH222 [56] Eng.1713819→ | 11v | | | | |
| 2.4 JTD | 5 | 839A6.000 | 103/138 | 10/00→05/06 | CH222 [56] Eng.1713819→ | 11v | | | | |
| 2.4 JTD | 5 | 841C000 | 110/148 | 03/02→05/06 | CH222 | 11v | | | CCU150 | |
| 2.4 JTD | 5 | 841M.000; 841N.000 | 120/161 | 06/03→05/06 | CH224 | 11v | | | CCU150 | |
| 2.4 JTD | 5 | 841G.000 | 129/173 | 10/03→05/06 | CH224 | 11v | | | CCU150 [287] | |
| 2.5 V6 24V | 6 | AR32401; AR32402 | 140/188 | 02/97→08/03 | OE136 | 0,8 | CET1 2P | OE179 | BAEA428 [277] | |
| 2.5 V6 24V | 6 | AR32405 | 141/189 | 02/97→05/06 | OE136 | 0,8 | CET1 2P | OE179 | BAEA428 [277] | |
| 3.2 GTA | 6 | 932A.000 | 184/247 | 03/02→05/06 | OE146 | 1,0 | CET1 2P | OE179 | BAEA428 [277] | |
| 159 | | | | | | | | | | |
| 1.8 MPI | 4 | 939A4.000 | 103/138 | 06/05→11/11 | OE089 | 1,0 | CET2 | OE188 | BAEA427 | |
| 1.8 TBi | 4 | 939B1.000 | 147/197 | 05/09→12/12 | | | | OE256 | BAEA427 | |
| 1.9 JTDM 8V | 4 | 937A7.000; 939A7.000 | 85/114 | 09/05→11/11 | CH222 →Eng.5115898 | 11v | | | CCU150 | |
| | | | | | CH269 Eng.5115898→ | 11v | | | | |
| 1.9 JTDM 8V | 4 | 939A1.000 | 88/118 | 09/05→11/11 | CH222 →Eng.5115898 | 11v | | | CCU150 | |
| | | | | | CH269 Eng.5115898→ | 11v | | | | |
| 1.9 JTDM 16V | 4 | 937A8.000; 939A8.000 | 100/134 | 09/05→11/11 | CH224 | 11v | | | CCU150 | |
| 1.9 JTDM 16V | 4 | 939A2.000 | 110/148 | 09/05→11/11 | CH224 | 11v | | | CCU150 | |
| 1.9 JTS | 4 | 939A6.000 | 118/158 | 09/05→11/11 | OE136 | 0,8 | CET1 2P | OE179 | | |
| 2.2 JTS | 4 | 939A5.000 | 136/182 | 09/05→11/11 | OE136 | 0,8 | CET1 2P | OE179 | BAEA149E | |
| 2.4 JTDM | 5 | 939A3.000 | 147/197 | 09/05→11/11 | CH224 | 11v | | | CCU150 | |

CHAMPION

ALFA ROMEO



kW/BHP

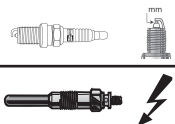

eon TITAN

IRIDIUM

**...ALFA ROMEO****...159**

| | | | | | | | | | |
|------------------------|---|-----------|---------|-------------|-------|-----|--------|-------|----------|
| 2.4 JTDM, 2.4 JTDM 4WD | 5 | 939A9.000 | 154/207 | 05/07→12/12 | | | | | CCU150 |
| 3.2 JTS, 3.2 JTS 4WD | 6 | 939A.000 | 191/256 | 12/05→11/11 | OE029 | 1,0 | CET17P | OE189 | BAEA174E |

164

| | | | | | | | | | |
|------------------|---|------------------------------|---------|-------------|-------|-----|--------|-------|--------------------------|
| 3.0 | 6 | AR64399 | 145/194 | 10/94→08/97 | OE136 | 0,8 | CET12P | OE179 | BAEA428 ^[277] |
| 3.0 | 6 | AR64304 | 156/209 | 09/93→12/95 | OE136 | 0,8 | CET12P | | BAEA428 ^[277] |
| 3.0 | 6 | AR66306 | 157/211 | 03/95→10/97 | OE136 | 0,8 | CET12P | OE179 | BAEA428 ^[277] |
| 3.0 | 6 | AR64304 | 168/225 | 04/93→02/95 | OE136 | 0,8 | CET12P | OE179 | BAEA428 ^[277] |
| 3.0, 3.0 24V 4WD | 6 | AR64304; AR64307; AR64308 | 170/228 | 02/94→09/98 | OE136 | 0,8 | CET12P | OE179 | BAEA428 ^[277] |
| 3.0 24V | 6 | AR66302 | 154/207 | 03/95→10/97 | OE136 | 0,8 | CET12P | OE179 | BAEA428 ^[277] |

166

| | | | | | | | | | |
|-------------|---|---------|---------|-------------|-----------------------|-----|------|-----------------------|---------|
| 2.0 V6 | 6 | AR34102 | 151/202 | 09/98→10/00 | OE087 | 0,9 | CET8 | | |
| 2.0 T.Spark | 4 | AR36301 | 110/148 | 10/00→06/07 | OE122 ^[27] | 0,7 | | OE179 ^[28] | CLS055 |
| | | | | | OE223 ^[28] | 1,6 | | | |
| 2.0 T.Spark | 4 | AR34103 | 114/153 | 09/98→10/00 | OE122 ^[27] | 0,7 | | OE179 ^[28] | BAEA309 |
| | | | | | OE223 ^[28] | 1,6 | | | CLS055 |

| | | | | | | | | | |
|------------|---|--------------------|---------|-------------|-----------------------|-----|--------|-------|--------------------------|
| 2.4 JTD | 5 | AR34202 | 100/134 | 09/98→10/00 | CH222 ^[56] | 11v | | | |
| | | | | | Eng.1713819→ | | | | |
| 2.4 JTD | 5 | 839A6.000 | 103/138 | 10/00→06/07 | CH222 ^[56] | 11v | | | CCU150 ^[57] |
| | | | | | Eng.1713819→ | | | | |
| 2.4 JTD | 5 | 841C000 | 110/148 | 04/02→06/07 | CH222 | 11v | | | CCU150 |
| 2.4 JTD | 5 | 841M.000; 841N.000 | 120/161 | 10/03→06/07 | CH224 | 11v | | | CCU150 |
| 2.4 JTD | 5 | 841G.000; 841H.000 | 129/173 | 10/03→06/07 | CH224 | 11v | | | CCU150 |
| 2.4 JTD | 5 | 841M.000 | 132/177 | 07/06→06/07 | CH224 | 11v | | | CCU150 |
| 2.4 JTD | 5 | 841M.000 | 136/182 | 07/05→06/07 | CH224 | 11v | | | CCU150 |
| 2.4 JTD | 5 | 936B.000 | 136/182 | 07/05→06/07 | | | | | CCU150 |
| 2.5 V6 24V | 6 | AR36201 | 138/185 | 10/00→06/07 | OE146 | 1,0 | CET12P | OE179 | BAEA428 ^[277] |
| 2.5 V6 24V | 6 | AR34201 | 140/188 | 09/98→12/06 | OE136 | 0,8 | CET12P | OE179 | BAEA428 ^[277] |
| 3.0 V6 24V | 6 | AR36101 | 162/217 | 10/00→06/07 | OE146 | 1,0 | CET12P | OE179 | BAEA428 ^[277] |
| 3.0 V6 24V | 6 | AR34301; AR34302 | 166/223 | 09/98→06/07 | OE136 | 0,8 | CET12P | OE179 | BAEA428 ^[277] |
| 3.2 V6 24V | 6 | 936A.000 | 176/236 | 10/03→06/07 | OE146 | 1,0 | CET12P | OE179 | BAEA428 ^[277] |

BRERA

| | | | | | | | | | |
|----------------------|---|-----------|---------|-------------|-------|-----|--------|-------|----------|
| 1.8 Tbi | 4 | 939B1.000 | 147/197 | 05/09→06/10 | | | | OE256 | |
| 2.2 JTS | 4 | 939A5.000 | 136/182 | 01/06→05/11 | OE136 | 0,8 | CET12P | OE179 | BAEA149E |
| 2.4 JTDM 20V | 5 | 939A3.000 | 147/197 | 01/06→06/10 | CH224 | 11v | | | CCU150 |
| 2.4 JTDM 20V | 5 | 939A9.000 | 154/207 | 05/07→06/10 | | | | | CCU150 |
| 3.2 JTS, 3.2 JTS 4WD | 6 | 939A.000 | 191/256 | 01/06→05/11 | OE029 | 1,0 | CET17P | OE189 | BAEA174E |

GIULIETTA

| | | | | | | | | | |
|--------------------|---|----------------------|---------|-------------|-------|-----|--|-------|---------|
| 1.4 BiFuel, 1.4 TB | 4 | 198A4.000; 940B7.000 | 88/118 | 04/10→ | OE208 | 0,8 | | | BAEA095 |
| 1.4 TB | 4 | 940B1.000; 940B8.000 | 77/103 | 04/11→ | OE208 | 0,8 | | | BAEA095 |
| 1.4 TB | 4 | 940A6.000 | 85/114 | 04/10→ | OE208 | 0,8 | | | BAEA095 |
| 1.4 TB | 4 | 940A2.000; 940C2.000 | 110/148 | 09/14→ | | | | | BAEA095 |
| 1.4 TB | 4 | 955A8.000 | 120/161 | 04/10→ | OE208 | 0,8 | | | |
| 1.4 TB | 4 | 940A2.000 | 125/168 | 04/10→ | OE208 | 0,8 | | | |
| 1.8 Tbi | 4 | 940A1.000 | 169/227 | 04/10→09/13 | | | | OE256 | |
| 1.8 Tbi | 4 | 940A1.000 | 173/232 | 04/10→ | | | | OE256 | |
| 1.8 Tbi | 4 | 940B2.000; 960A1.000 | 177/237 | 09/13→ | | | | OE256 | |

GT

| | | | | | | | | | |
|---------|---|----------------------|---------|-------------|-----------------------|-----|------|-----------------------|--------|
| 1.8 TS | 4 | AR32205 | 103/138 | 11/03→09/10 | OE122 ^[27] | 0,7 | | OE179 ^[28] | |
| | | | | | OE223 ^[28] | 1,6 | | | |
| 1.9 JTD | 4 | 937A5.000 | 110/148 | 11/03→09/10 | CH224 | 11v | | | CCU150 |
| 1.9 JTD | 4 | 937A6.000 | 125/168 | 05/08→09/10 | | | | | CCU150 |
| 2.0 JTS | 4 | 932A2.000 | 119/160 | 12/06→09/10 | OE123 | 0,7 | CET2 | OE179 | |
| 2.0 JTS | 4 | 932A2.000; 937A1.000 | 121/162 | 11/03→09/10 | OE123 | 0,7 | CET2 | OE179 | |

ALFA ROMEO



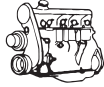

kW/BHP



eon TITAN

IRIDIUM

**...ALFA ROMEO****...GT**

| | | | | | | | | | |
|---------|---|----------|---------|-------------|-------|-----|--------|-------|--------------------------|
| 3.2 GTA | 6 | 936A.000 | 176/236 | 11/03→09/10 | OE146 | 1,0 | CET12P | OE179 | BAEA428 ^[277] |
|---------|---|----------|---------|-------------|-------|-----|--------|-------|--------------------------|

GTV

| | | | | | | | | | | |
|---------|---|---------|---------|-------------|-----------------------|-----|--|-----------------------|---------|--------|
| 1.8 16V | 4 | AR32201 | 106/142 | 05/98→10/05 | OE122 ^[27] | 0,7 | | OE179 ^[28] | BAEA309 | CLS055 |
|---------|---|---------|---------|-------------|-----------------------|-----|--|-----------------------|---------|--------|

OE223^[28]

1,6

| | | | | | | | | | | |
|--------------|---|---------|---------|-------------|-------|-----|------|--|--|--------|
| 2.0 V6 Turbo | 6 | AR16202 | 148/198 | 06/95→09/98 | OE087 | 0,9 | CET8 | | | CLS235 |
|--------------|---|---------|---------|-------------|-------|-----|------|--|--|--------|

| | | | | | | | | | | |
|---------|---|-----------|---------|-------------|-------|-----|------|-------|--|--|
| 2.0 JTS | 4 | 937A1.000 | 121/162 | 04/03→10/05 | OE123 | 0,7 | CET2 | OE179 | | |
|---------|---|-----------|---------|-------------|-------|-----|------|-------|--|--|

| | | | | | | | | | | |
|-----------------|---|------------------|---------|-------------|-----------------------|-----|--|-----------------------|--|--------|
| 2.0 T.SPARK 16V | 4 | AR16201; AR32310 | 110/148 | 06/95→10/05 | OE122 ^[27] | 0,7 | | OE179 ^[28] | | CLS055 |
|-----------------|---|------------------|---------|-------------|-----------------------|-----|--|-----------------------|--|--------|

OE223^[28]

1,6

| | | | | | | | | | | |
|-----------------|---|-------|---------|-------------|--|--|--|--|---------|--|
| 2.0 T.SPARK 16V | 4 | 16201 | 110/148 | 06/95→10/05 | | | | | BAEA309 | |
|-----------------|---|-------|---------|-------------|--|--|--|--|---------|--|

→04/98

| | | | | | | | | | | |
|-----------------|---|---------|---------|-------------|-----------------------|-----|--|-----------------------|---------|--------|
| 2.0 T.SPARK 16V | 4 | AR32301 | 114/153 | 09/97→03/03 | OE122 ^[27] | 0,7 | | OE179 ^[28] | BAEA309 | CLS055 |
|-----------------|---|---------|---------|-------------|-----------------------|-----|--|-----------------------|---------|--------|

OE223^[28]

1,6

| | | | | | | | | | |
|------------|---|---------|---------|-------------|-------|-----|--------|-------|--------------------------|
| 3.0 V6 24V | 6 | AR16105 | 160/215 | 10/00→10/05 | OE136 | 0,8 | CET12P | OE179 | BAEA428 ^[277] |
|------------|---|---------|---------|-------------|-------|-----|--------|-------|--------------------------|

| | | | | | | | | | |
|------------|---|---------|---------|-------------|-------|-----|--------|-------|--------------------------|
| 3.0 V6 24V | 6 | AR16102 | 162/217 | 10/96→10/00 | OE136 | 0,8 | CET12P | OE179 | BAEA428 ^[277] |
|------------|---|---------|---------|-------------|-------|-----|--------|-------|--------------------------|

| | | | | | | | | | |
|------------|---|-----------|---------|-------------|-------|-----|--------|-------|--------------------------|
| 3.2 V6 24V | 6 | 936A6.000 | 176/236 | 04/03→10/05 | OE146 | 1,0 | CET12P | OE179 | BAEA428 ^[277] |
|------------|---|-----------|---------|-------------|-------|-----|--------|-------|--------------------------|

MITO

| | | | | | | | | | | |
|-----|---|-----------|-------|--------|-------|-----|--------|--|--|--|
| 0.9 | 2 | 199B6.000 | 74/99 | 12/13→ | OE232 | 0,7 | CET15P | | | |
|-----|---|-----------|-------|--------|-------|-----|--------|--|--|--|

| | | | | | | | | | | |
|-------------|---|-----------|-------|--------|-------|-----|--------|--|--|--|
| 0.9 TwinAir | 2 | 312A2.000 | 63/84 | 07/11→ | OE232 | 0,7 | CET15P | | | |
|-------------|---|-----------|-------|--------|-------|-----|--------|--|--|--|

| | | | | | | | | | | |
|-------------|---|-----------|--------|--------|-------|-----|--------|--|--|--|
| 0.9 TwinAir | 2 | 199B6.000 | 77/103 | 04/13→ | OE232 | 0,7 | CET15P | | | |
|-------------|---|-----------|--------|--------|-------|-----|--------|--|--|--|

| | | | | | | | | | | |
|--------------|---|----------------------|-------|--------|--|--|--|--|------------------------|--|
| 1.3 MultiJet | 4 | 199A3.000; 955B2.000 | 66/89 | 09/08→ | | | | | CCU150 ^[53] | |
|--------------|---|----------------------|-------|--------|--|--|--|--|------------------------|--|

| | | | | | | | | | | |
|--------------|---|----------------------|-------|--------|--|--|--|--|------------------------|--|
| 1.3 MultiJet | 4 | 199B1.000; 330A1.000 | 70/94 | 10/09→ | | | | | CCU150 ^[53] | |
|--------------|---|----------------------|-------|--------|--|--|--|--|------------------------|--|

| | | | | | | | | | | |
|-----|---|-----------|-------|--------|-------|-----|------|--|---------|--|
| 1.4 | 4 | 955A9.000 | 51/68 | 05/11→ | OE196 | 1,0 | CET1 | | BAE940A | |
|-----|---|-----------|-------|--------|-------|-----|------|--|---------|--|

| | | | | | | | | | | |
|-----|---|-----------|-------|--------|-------|-----|------|--|---------|--|
| 1.4 | 4 | 955A1.000 | 57/76 | 03/11→ | OE196 | 1,0 | CET1 | | BAE403C | |
|-----|---|-----------|-------|--------|-------|-----|------|--|---------|--|

| | | | | | | | | | | |
|-----|---|-----------|-------|--------|-------|-----|------|--|---------|--------|
| 1.4 | 4 | 350A1.000 | 57/76 | 03/11→ | OE196 | 1,0 | CET1 | | BAE403C | CLS082 |
|-----|---|-----------|-------|--------|-------|-----|------|--|---------|--------|

| | | | | | | | | | | |
|-----|---|-----------|-------|--------|-------|-----|------|--|---------|--|
| 1.4 | 4 | 955A1.000 | 58/78 | 08/08→ | OE196 | 1,0 | CET1 | | BAE403C | |
|-----|---|-----------|-------|--------|-------|-----|------|--|---------|--|

| | | | | | | | | | | |
|-----|---|-----------|-------|--------|-------|-----|------|--|---------|--|
| 1.4 | 4 | 199A6.000 | 70/94 | 09/08→ | OE196 | 1,0 | CET1 | | BAE403C | |
|-----|---|-----------|-------|--------|-------|-----|------|--|---------|--|

| | | | | | | | | | | |
|----------------------|---|-----------|--------|--------|-------|-----|--|--|---------|--|
| 1.4 Bifuel, 1.4 TJet | 4 | 198A4.000 | 88/118 | 08/08→ | OE208 | 0,8 | | | BAEA095 | |
|----------------------|---|-----------|--------|--------|-------|-----|--|--|---------|--|

| | | | | | | | | | | |
|--------------|---|-----------|--------|--------|-------|-----|------|--|--|--|
| 1.4 MultiAir | 4 | 955A6.000 | 77/103 | 09/09→ | OE196 | 1,0 | CET1 | | | |
|--------------|---|-----------|--------|--------|-------|-----|------|--|--|--|

| | | | | | | | | | | |
|--------------|---|-----------|---------|--------|-------|-----|--|--|--|--|
| 1.4 MultiAir | 4 | 940A2.000 | 125/168 | 09/09→ | OE208 | 0,8 | | | | |
|--------------|---|-----------|---------|--------|-------|-----|--|--|--|--|

| | | | | | | | | | | |
|--------|---|-----------|---------|--------|-------|-----|--|--|--|--|
| 1.4 TB | 4 | 955B1.000 | 103/138 | 12/13→ | OE208 | 0,8 | | | | |
|--------|---|-----------|---------|--------|-------|-----|--|--|--|--|

| | | | | | | | | | | |
|----------|---|-----------|---------|--------|-------|-----|--|--|---------|--|
| 1.4 TJet | 4 | 198A1.000 | 110/148 | 09/08→ | OE208 | 0,8 | | | BAEA095 | |
|----------|---|-----------|---------|--------|-------|-----|--|--|---------|--|

| | | | | | | | | | | |
|----------|---|-----------|---------|--------|-------|-----|--|--|---------|--|
| 1.4 TJet | 4 | 199A8.000 | 114/153 | 08/08→ | OE208 | 0,8 | | | BAEA095 | |
|----------|---|-----------|---------|--------|-------|-----|--|--|---------|--|

| | | | | | | | | | | |
|--------------------|---|----------------------|--------|--------|-------|-----|--|--|--|--|
| 1.4 Turbo MultiAir | 4 | 955A2.000; 955A7.000 | 99/133 | 10/09→ | OE208 | 0,8 | | | | |
|--------------------|---|----------------------|--------|--------|-------|-----|--|--|--|--|

| | | | | | | | | | | |
|--------------------|---|-----------|---------|--------|-------|-----|--|--|--|--|
| 1.4 Turbo MultiAir | 4 | 955A8.000 | 120/161 | 10/09→ | OE208 | 0,8 | | | | |
|--------------------|---|-----------|---------|--------|-------|-----|--|--|--|--|

| | | | | | | | | | | |
|----------|---|-----------|--------|--------|--|--|--|--|------------------------|--|
| 1.6 JTDM | 4 | 955A4.000 | 85/114 | 09/08→ | | | | | CCU150 ^[53] | |
|----------|---|-----------|--------|--------|--|--|--|--|------------------------|--|

| | | | | | | | | | | |
|----------|---|----------------------|--------|--------|--|--|--|--|------------------------|--|
| 1.6 JTDM | 4 | 198A2.000; 955A3.000 | 88/118 | 08/08→ | | | | | CCU150 ^[53] | |
|----------|---|----------------------|--------|--------|--|--|--|--|------------------------|--|

SPIDER

| | | | | | | | | | | |
|---------|---|---------|---------|-------------|-----------------------|-----|--|-----------------------|---------|--------|
| 1.8 16V | 4 | AR32201 | 106/142 | 05/98→04/05 | OE122 ^[27] | 0,7 | | OE179 ^[28] | BAEA309 | CLS055 |
|---------|---|---------|---------|-------------|-----------------------|-----|--|-----------------------|---------|--------|

OE223^[28]

1,6

| | | | | | | | | | | |
|---------|---|-----------|---------|-------------|--|--|--|-------|--|--|
| 1.8 TBi | 4 | 939B1.000 | 147/197 | 05/09→03/11 | | | | OE256 | | |
|---------|---|-----------|---------|-------------|--|--|--|-------|--|--|

| | | | | | | | | | | |
|--------------|---|---------|---------|-------------|-------|-----|------|-------|--|--------|
| 2.0 V6 Turbo | 6 | AR16202 | 148/198 | 05/98→04/05 | OE006 | 0,9 | CET8 | OE195 | | CLS235 |
|--------------|---|---------|---------|-------------|-------|-----|------|-------|--|--------|

→12/00

| | | | | | | | | | | |
|---------|---|-----------|---------|-------------|-------|-----|------|-------|--|--|
| 2.0 JTS | 4 | 937A1.000 | 121/162 | 04/03→04/05 | OE123 | 0,7 | CET2 | OE179 | | |
|---------|---|-----------|---------|-------------|-------|-----|------|-------|--|--|

| | | | | | | | | | | |
|-----------------|---|---------|---------|-------------|-----------------------|-----|--|-----------------------|--|--------|
| 2.0 T.SPARK 16V | 4 | AR32310 | 110/148 | 06/95→04/05 | OE122 ^[27] | 0,7 | | OE179 ^[28] | | CLS055 |
|-----------------|---|---------|---------|-------------|-----------------------|-----|--|-----------------------|--|--------|

OE223^[28]

1,6

| | | | | | | | | | | |
|-----------------|---|---------|---------|-------------|-----------------------|-----|--|-----------------------|---------|--------|
| 2.0 T.SPARK 16V | 4 | AR16201 | 110/148 | 06/95→04/05 | OE122 ^[27] | 0,7 | | OE179 ^[28] | BAEA309 | CLS055 |
|-----------------|---|---------|---------|-------------|-----------------------|-----|--|-----------------------|---------|--------|

→04/98

OE223^[28]

1,6

| | | | | | | | | | | |
|-----------------|---|---------|---------|-------------|-----------------------|-----|--|-----------------------|---------|--------|
| 2.0 T.SPARK 16V | 4 | AR32301 | 114/153 | 05/98→08/00 | OE122 ^[27] | 0,7 | | OE179 ^[28] | BAEA309 | CLS055 |
|-----------------|---|---------|---------|-------------|-----------------------|-----|--|-----------------------|---------|--------|

OE223^[28]

1,6

| | | | | | | | | | | |
|---------|---|-----------|---------|-------------|-------|-----|--------|-------|----------|--|
| 2.2 JTS | 4 | 939A5.000 | 136/182 | 03/06→03/11 | OE136 | 0,8 | CET12P | OE179 | BAEA149E | |
|---------|---|-----------|---------|-------------|-------|-----|--------|-------|----------|--|

| | | | | | | | | | | |
|----------|---|-----------|---------|-------------|-------|-----|--|--|--------|--|
| 2.4 JTDM | 5 | 939A3.000 | 147/197 | 04/07→06/10 | CH224 | 11v | | | CCU150 | |
|----------|---|-----------|---------|-------------|-------|-----|--|--|--------|--|

| | | | | | | | | | | |
|----------|---|-----------|---------|-------------|-------|-----|--|--|--------|--|
| 2.4 JTDM | 5 | 939A3.000 | 154/207 | 03/08→06/10 | CH224 | 11v | | | CCU150 | |
|----------|---|-----------|---------|-------------|-------|-----|--|--|--------|--|

CHAMPION

ALFA ROMEO



kW/BHP

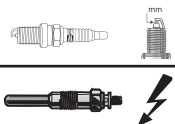

eon TITAN

IRIDIUM

**...ALFA ROMEO****...SPIDER**

| | | | | | | | | | |
|----------------------|---|-----------|---------|-------------|----------------|------------|--------|-------|--------------------------|
| 3.0 V6 | 6 | AR16101 | 141/189 | 04/95→04/05 | OE008 OE018 | 0,9 1,0 | CET8 | OE195 | |
| 3.0 V6 | 6 | AR16105 | 160/215 | 09/94→04/05 | OE146 | 1,0 | CET12P | OE179 | BAEA428 ^[277] |
| 3.0 V6 24V | 6 | AR16102 | 162/217 | 01/99→10/03 | OE136 | 0,8 | CET12P | OE179 | BAEA428 ^[277] |
| 3.2 V6 24V | 6 | 936A6.000 | 176/236 | 04/03→04/05 | OE146 | 1,0 | CET12P | OE179 | BAEA428 ^[277] |
| 3.2 JTS, 3.2 JTS 4WD | 6 | 939A.000 | 191/256 | 03/06→03/11 | OE029 | 1,0 | CET17P | OE189 | BAEA174E |

ALPINA**B3**

| | | | | | | | | | |
|--------------|---|---------------------------------|---------|-------------|-------|-----|--------|-------|--|
| 3.2 | 6 | M60B30(308S); M60B30(308S6K) | 195/261 | 04/96→04/99 | OE026 | 0,9 | CET2 | OE179 | |
| 3.3, 3.3 4WD | 6 | M52B28(286S); M52B28(286S7T) | 206/276 | 03/99→01/05 | OE223 | 1,6 | CET12P | | |
| 3.4 S | 6 | M52B28(286ST5) | 224/300 | 08/02→01/06 | OE223 | 1,6 | CET12P | | |

B5

| | | | | | | | | | |
|-----|---|-----------|---------|-------------|-------|-----|--------|-------|--|
| 4.4 | 8 | N62B44A19 | 368/493 | 03/05→09/10 | OE136 | 0,8 | CET12P | OE179 | |
|-----|---|-----------|---------|-------------|-------|-----|--------|-------|--|

B7

| | | | | | | | | | |
|------------------------------|---|-----------|---------|-------------|--|--|--|--|---------|
| 4.4 | 8 | N62B44A19 | 368/493 | 12/03→06/08 | | | | | BAEA324 |
| 4.4 BITURBO, 4.4 BITURBO 4WD | 8 | N63M10A | 373/500 | 03/09→06/12 | | | | | BAEA143 |

B8

| | | | | | | | | | |
|-----|---|----------------|---------|-------------|-------|-----|------|-------|--|
| 4.6 | 8 | M62B46(468S4K) | 245/329 | 01/95→03/98 | OE026 | 0,9 | CET2 | OE179 | |
|-----|---|----------------|---------|-------------|-------|-----|------|-------|--|

B10

| | | | | | | | | | |
|--------|---|----------------|---------|-------------|-------|-----|--------|-------|--|
| 3.2 | 6 | M60B30(308S6K) | 191/256 | 08/97→12/98 | OE026 | 0,9 | CET2 | OE179 | |
| 3.3 | 6 | M52B28(286S7T) | 206/276 | 01/99→10/03 | OE223 | 1,6 | CET12P | | |
| 4.6 V8 | 8 | M62B46(468S72) | 250/335 | 12/96→10/98 | OE026 | 0,9 | CET2 | OE179 | |
| 4.6 V8 | 8 | M62B46(468S72) | 255/342 | 10/98→09/02 | OE223 | 1,6 | CET12P | | |

B12

| | | | | | | | | | |
|-----|----|----------------|---------|-------------|-------|-----|--------|-------|--|
| 5.7 | 12 | M70B57(5714K2) | 285/382 | 12/95→09/98 | OE026 | 0,9 | CET2 | OE179 | |
| 6.0 | 12 | M73B54(5412AG) | 316/424 | 07/99→07/01 | OE223 | 1,6 | CET12P | | |

D10

| | | | | | | | | | |
|---------------|---|----------------|---------|-------------|-------|-----|--|--|--|
| 3.0 D Biturbo | 6 | M57D30(306DE1) | 180/241 | 04/00→10/03 | CH207 | 11v | | | |
|---------------|---|----------------|---------|-------------|-------|-----|--|--|--|

ROADSTER V8

| | | | | | | | | | |
|--------|---|---------------|---------|-------------|-------|-----|--------|--|---------|
| 4.8 V8 | 8 | M62B48(488S2) | 280/375 | 06/02→10/03 | OE223 | 1,6 | CET12P | | BAEA302 |
|--------|---|---------------|---------|-------------|-------|-----|--------|--|---------|

ROADSTER S

| | | | | | | | | | |
|-----|---|------|---------|-------------|-------|-----|--------|--|--|
| 3.3 | 6 | E5/2 | 221/296 | 07/03→12/05 | OE223 | 1,6 | CET12P | | |
|-----|---|------|---------|-------------|-------|-----|--------|--|--|

ARO**10**

| | | | | | | | | | |
|----------------|---|------|-------|-------------|-------|-----|--|--|--|
| 1.9 1.9 TD 4WD | 4 | F8QT | 69/93 | 06/97→10/06 | CH189 | 11v | | | |
|----------------|---|------|-------|-------------|-------|-----|--|--|--|

SPARTANA

| | | | | | | | | | |
|-----|---|--------|-------|-------------|-------|-----|------|-------|--|
| 1.2 | 4 | C3G702 | 40/54 | 01/99→10/06 | OE001 | 0,9 | CET8 | OE195 | |
|-----|---|--------|-------|-------------|-------|-----|------|-------|--|

ASTON MARTIN**DB7**

| | | | | | | | | | |
|-----|----|-------|---------|-------------|-------|-----|--------|-------|--|
| 3.2 | 6 | AJ6HT | 233/312 | 05/94→06/99 | OE014 | 0,9 | CET2 | OE179 | |
| 3.2 | 6 | AJ6HT | 250/335 | 01/94→10/03 | | | CET2 | OE179 | |
| 5.9 | 12 | AM2 | 298/400 | 07/99→10/03 | OE131 | 1,0 | CET18P | OE183 | |
| 6.0 | 12 | AM2 | 309/414 | 03/99→10/03 | OE131 | 1,0 | CET18P | OE183 | |
| 6.0 | 12 | AM2 | 320/429 | 10/02→10/03 | OE029 | 1,0 | CET17P | OE189 | |

DB9

| | | | | | | | | | |
|--------------|----|-----|---------|-------------|-------|-----|--------|-------|---------|
| 6.0, 6.0 V12 | 12 | AM3 | 331/444 | 01/04→10/16 | OE131 | 1,0 | CET18P | OE183 | BAEA426 |
| 6.0 V12 | 12 | AM3 | 350/469 | 09/05→07/12 | OE131 | 1,0 | CET18P | OE183 | |

ASTON MARTIN





kW/BHP



eon TITAN

IRIDIUM

**...ASTON MARTIN****DBS**

| | | | | | | | | | | |
|---------|----|-------|---------|--------|-------|-----|--------|-------|--|--|
| 6.0 V12 | 12 | AM4R9 | 380/510 | 09/07→ | OE131 | 1,0 | CET18P | OE183 | | |
|---------|----|-------|---------|--------|-------|-----|--------|-------|--|--|

RAPIDE

| | | | | | | | | | | |
|-----|----|-------------|---------|-------------|-------|-----|--------|-------|--|--|
| 6.0 | 12 | AM4R9; AM16 | 350/469 | 03/10→09/13 | OE131 | 1,0 | CET18P | OE183 | | |
|-----|----|-------------|---------|-------------|-------|-----|--------|-------|--|--|

| | | | | | | | | | | |
|-------|----|------|---------|--------|--|--|--|--|----------|--|
| 6.0 S | 12 | AM29 | 412/552 | 08/14→ | | | | | BAEA068E | |
|-------|----|------|---------|--------|--|--|--|--|----------|--|

→06/15

BAEA137E

06/15→

VANQUISH

| | | | | | | | | | | |
|---------|----|-------|---------|-------------|-------|-----|--------|-------|--|--|
| 6.0 V12 | 12 | AM702 | 338/453 | 05/01→08/07 | OE131 | 1,0 | CET18P | OE183 | | |
|---------|----|-------|---------|-------------|-------|-----|--------|-------|--|--|

| | | | | | | | | | | |
|-------|----|-------------|---------|-------------|-------|-----|--------|-------|--|--|
| 6.0 S | 12 | AM4R9; AM06 | 388/520 | 11/04→08/07 | OE131 | 1,0 | CET18P | OE183 | | |
|-------|----|-------------|---------|-------------|-------|-----|--------|-------|--|--|

VANTAGE

| | | | | | | | | | | |
|---------|----|------|---------|-------------|-------|-----|--------|-------|--|--|
| 6.0 V12 | 12 | AM10 | 380/510 | 09/09→12/13 | OE131 | 1,0 | CET18P | OE183 | | |
|---------|----|------|---------|-------------|-------|-----|--------|-------|--|--|

VIRAGE

| | | | | | | | | | | |
|-----|---|-------|---------|-------------|-------|-----|------|-------|--|--|
| 5.3 | 8 | 40HTE | 261/350 | 12/95→12/00 | OE002 | 0,9 | CET2 | OE179 | | |
|-----|---|-------|---------|-------------|-------|-----|------|-------|--|--|

| | | | | | | | | | | |
|-----|----|-------|---------|-------------|-------|-----|--------|-------|--|--|
| 6.0 | 12 | AM4R9 | 365/489 | 06/11→08/12 | OE131 | 1,0 | CET18P | OE183 | | |
|-----|----|-------|---------|-------------|-------|-----|--------|-------|--|--|

AUDI**80**

| | | | | | | | | | | |
|-------|---|-----|-------|-------------|-------|-----|------|-------|----------|--------|
| 1.6 E | 4 | ADA | 74/99 | 06/93→01/96 | OE025 | 1,0 | CET8 | OE195 | BAE851AE | CLS042 |
|-------|---|-----|-------|-------------|-------|-----|------|-------|----------|--------|

[261] [292]

| | | | | | | | | | | |
|---------|---|-----|--------|-------------|-------|-----|------|-------|--|--|
| 2.0 4WD | 4 | ADW | 79/106 | 11/93→01/96 | OE025 | 1,0 | CET8 | OE195 | | |
|---------|---|-----|--------|-------------|-------|-----|------|-------|--|--|

| | | | | | | | | | | |
|-------------|---|-----|---------|-------------|-------|-----|--------|--|--------------------------|--|
| 2.2 RS2 4WD | 5 | ADU | 232/311 | 03/94→05/95 | OE136 | 0,8 | CET11P | | BAEA043 ^[277] | |
|-------------|---|-----|---------|-------------|-------|-----|--------|--|--------------------------|--|

| | | | | | | | | | | |
|------------|---|-----|---------|-------------|-------|-----|--------|--|--------------------------|--|
| 2.2 S2 4WD | 5 | ABY | 169/227 | 02/93→07/95 | OE136 | 0,8 | CET11P | | BAEA043 ^[277] | |
|------------|---|-----|---------|-------------|-------|-----|--------|--|--------------------------|--|

100

| | | | | | | | | | | |
|-----|---|-----|---------|-------------|-------|-----|------|-------|----------|--------|
| 2.6 | 6 | ACZ | 102/137 | 07/93→06/94 | OE032 | 1,0 | CET2 | OE179 | BAEA007E | CLS001 |
|-----|---|-----|---------|-------------|-------|-----|------|-------|----------|--------|

| | | | | | | | | | | |
|-----------|---|-----|---------|-------------|-------|-----|------|-------|----------|--|
| 2.6 E 4WD | 6 | ACZ | 102/137 | 08/93→07/94 | OE032 | 1,0 | CET2 | OE179 | BAEA007E | |
|-----------|---|-----|---------|-------------|-------|-----|------|-------|----------|--|

A1

| | | | | | | | | | | |
|----------|---|------|-------|-------------|--|--|--|-------|---------------------------|--------|
| 1.2 TFSI | 4 | CBZA | 63/84 | 05/10→04/15 | | | | OE260 | BAE907AE ^[262] | CLS090 |
|----------|---|------|-------|-------------|--|--|--|-------|---------------------------|--------|

ModelYear→2014

| | | | | | | | | | | |
|---------|---|------|-------|-------------|---------|------|--|--|--|--|
| 1.4 TDI | 3 | CUSB | 66/89 | 11/14→10/18 | CP5G007 | 4.4v | | | | |
|---------|---|------|-------|-------------|---------|------|--|--|--|--|

| | | | | | | | | | | |
|----------|---|------------|--------|-------------|-------|-----|--|--|----------|--|
| 1.4 TFSI | 4 | CAXA; CNVA | 90/121 | 05/10→04/15 | OE213 | 0,9 | | | BAE408AE | |
|----------|---|------------|--------|-------------|-------|-----|--|--|----------|--|

ModelYear→2014

| | | | | | | | | | | |
|----------|---|------|--------|-------------|-------|-----|--|--|---------------------------|--|
| 1.4 TFSI | 4 | CZCA | 92/123 | 11/14→10/18 | OE244 | 0,8 | | | BAEA067E ^[240] | |
|----------|---|------|--------|-------------|-------|-----|--|--|---------------------------|--|

| | | | | | | | | | | |
|----------|---|------|--------|-------------|-------|-----|--|--|--|--|
| 1.4 TFSI | 4 | CZDD | 92/123 | 11/14→10/18 | OE244 | 0,8 | | | | |
|----------|---|------|--------|-------------|-------|-----|--|--|--|--|

| | | | | | | | | | | |
|----------|---|------|---------|-------------|-------|-----|--|--|---------------------------------|--|
| 1.4 TFSI | 4 | CPTA | 103/138 | 04/12→04/15 | OE244 | 0,8 | | | BAEA067E ^{[240] [275]} | |
|----------|---|------|---------|-------------|-------|-----|--|--|---------------------------------|--|

| | | | | | | | | | | |
|----------|---|------------------|---------|-------------|-------|-----|--|--|----------|--|
| 1.4 TFSI | 4 | CAVG; CTHG; CTJA | 136/182 | 01/11→04/15 | OE213 | 0,9 | | | BAE408AE | |
|----------|---|------------------|---------|-------------|-------|-----|--|--|----------|--|

→Prod.13.02.2011

| | | | | | | | | | | |
|---------|---|------|---------|-------------|-------|-----|--|--|---------------------------|--|
| 1.4 TSI | 4 | CZEA | 110/148 | 11/14→10/18 | OE244 | 0,8 | | | BAEA067E ^[240] | |
|---------|---|------|---------|-------------|-------|-----|--|--|---------------------------|--|

| | | | | | | | | | | |
|---------|---|------|-------|-------------|--|--|--|--|--------|--|
| 1.6 TDI | 4 | CAYB | 66/89 | 03/11→04/15 | | | | | CCU152 | |
|---------|---|------|-------|-------------|--|--|--|--|--------|--|

| | | | | | | | | | | |
|---------|---|------|--------|-------------|--|--|--|--|--------|--|
| 1.6 TDI | 4 | CAYC | 77/103 | 05/10→04/15 | | | | | CCU152 | |
|---------|---|------|--------|-------------|--|--|--|--|--------|--|

| | | | | | | | | | | |
|---------|---|------|--------|-------------|---------|------|--|--|--------|--|
| 1.6 TDI | 4 | CXMA | 85/114 | 11/14→10/18 | CP5G007 | 4.4v | | | CCU152 | |
|---------|---|------|--------|-------------|---------|------|--|--|--------|--|

| | | | | | | | | | | |
|----------|---|------|---------|-------------|--|--|--|-------|----------|--|
| 1.8 TFSI | 4 | DAJB | 141/189 | 02/15→10/18 | | | | OE246 | BAEA068E | |
|----------|---|------|---------|-------------|--|--|--|-------|----------|--|

→02/16

| | | | | | | | | | | |
|------------|---|------|---------|-------------|--|--|--|-------|----------|--|
| 2.0 S1 4WD | 4 | CWZA | 170/228 | 03/14→10/18 | | | | OE246 | BAEA068E | |
|------------|---|------|---------|-------------|--|--|--|-------|----------|--|

| | | | | | | | | | | |
|---------|---|------|---------|-------------|--|--|--|--|--------|--|
| 2.0 TDI | 4 | CFHB | 100/134 | 05/12→04/15 | | | | | CCU152 | |
|---------|---|------|---------|-------------|--|--|--|--|--------|--|

| | | | | | | | | | | |
|---------|---|------|---------|-------------|--|--|--|--|--------|--|
| 2.0 TDI | 4 | CFHD | 105/141 | 09/11→04/15 | | | | | CCU152 | |
|---------|---|------|---------|-------------|--|--|--|--|--------|--|

| | | | | | | | | | | |
|--------------|---|------|---------|-------------|-------|-----|--------|--|-------------------------|--|
| 2.0 TFSI 4WD | 4 | CDLH | 188/252 | 03/12→11/12 | OE214 | 0,7 | CET11P | | BAEA033E ^[7] | |
|--------------|---|------|---------|-------------|-------|-----|--------|--|-------------------------|--|

A2

| | | | | | | | | | | |
|---------|---|-----|-------|-------------|-------|-----|--|--|--|--|
| 1.2 TDI | 3 | ANY | 45/60 | 03/01→08/05 | CH181 | 11v | | | | |
|---------|---|-----|-------|-------------|-------|-----|--|--|--|--|

| | | | | | | | | | | |
|-----|---|-----|-------|-------------|-------|-----|------|-------|---------------------------|--------|
| 1.4 | 4 | AUA | 55/74 | 02/00→08/05 | OE032 | 1,0 | CET2 | OE179 | BAE907AE ^[262] | CLS260 |
|-----|---|-----|-------|-------------|-------|-----|------|-------|---------------------------|--------|

| | | | | | | | | | | |
|-----|---|-----|-------|-------------|-------|-----|------|-------|----------|--|
| 1.4 | 4 | BBY | 55/74 | 02/00→08/05 | OE032 | 1,0 | CET2 | OE179 | BAE408AE | |
|-----|---|-----|-------|-------------|-------|-----|------|-------|----------|--|

| | | | | | | | | | | |
|---------|---|----------|-------|-------------|-------|-----|--|--|--|--|
| 1.4 TDI | 3 | AMF; BHC | 55/74 | 02/00→08/05 | CH181 | 11v | | | | |
|---------|---|----------|-------|-------------|-------|-----|--|--|--|--|

| | | | | | | | | | | |
|---------|---|-----|--------|-------------|--|--|--|--|----------|--|
| 1.6 FSI | 4 | BAD | 81/109 | 05/02→08/05 | | | | | BAE408AE | |
|---------|---|-----|--------|-------------|--|--|--|--|----------|--|





kW/BHP



eon TITAN

IRIDIUM

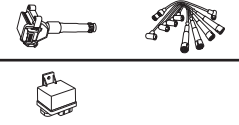

...AUDI

A3

| | | | | | | | | | | |
|--------------------------------|---|------------------|---------|-------------|-----------------------------|------|---------------|--------------|--|--|
| 1.2 TFSI | 4 | CJZA | 77/103 | 03/10→ | OE244 [226] [305] | 0,8 | | | BAEA067E [240] | |
| | | | | | | | | | BAEA126E [249] | |
| 1.2 TFSI | 4 | CYVB | 81/109 | 05/14→ | OE244 [226] [305] | 0,8 | | | BAEA067E [240] | |
| 1.2 TFSI, 1.2 TSI | 4 | CBZB | 77/103 | 03/10→ | | | | OE260 | BAE907AE [262] | CLS090 |
| 1.4 TFSI | 4 | CZCC | 85/114 | 02/16→ | OE244 [221] [303] | 0,8 | | | | |
| 1.4 TFSI | 4 | CMBA | 90/121 | 04/12→ | | | | | BAEA067E [240] | |
| | | | | | | | | | BAEA126E [249] | |
| 1.4 TFSI | 4 | CXSA | 90/121 | 04/12→ | OE244 [222] [304] | 0,8 | | | BAEA067E [240] | |
| | | | | | | | | | BAEA126E [249] | |
| 1.4 TFSI | 4 | CAXC; CMSA | 92/123 | 09/07→ | OE213 | 0,9 | | | BAE408AE | |
| 1.4 TFSI | 4 | CXSB; CZCA | 92/123 | 09/07→ | OE244 [222] [304] | 0,8 | | | BAEA067E [240] | |
| | | | | | OE244 [221] [303] | 0,8 | | | | |
| 1.4 TFSI | 4 | CPTA | 103/138 | 03/13→ | OE244 [222] [304] | 0,8 | | | BAEA067E [240] | |
| | | | | | OE244 [221] [303] | 0,8 | | | BAEA068E | |
| | | | | | | | | | BAEA126E [249] | |
| 1.4 TFSI e-tron | 4 | CUKB | 110/148 | 05/14→ | OE244 [222] [304] | 0,8 | | | BAEA067E [240] | |
| 1.4 TFSI e-tron | 4 | CXUA | 150/201 | 05/14→ | OE244 [222] [304] | 0,8 | | | | |
| 1.4 TFSI e-tron, 1.4 TFSI Flex | 4 | CWLA; CXUA | 110/148 | 05/14→ | OE244 [222] [304] | 0,8 | | | | |
| 1.4 TFSI g-tron | 4 | CPWA | 81/109 | 11/13→ | OE244 [222] [304] | 0,8 | | | BAEA067E [240] | |
| 1.4 TSI | 4 | CZEA | 110/148 | 05/14→ | OE244 [222] [304] | 0,8 | | | BAEA067E [240] | |
| | | | | | OE244 [221] [303] | 0,8 | | | | |
| 1.6 | 4 | AEH; AKL; APF | 74/99 | 09/96→05/03 | OE032 | 1,0 | CET2 | OE179 | BAE907AE [262] | CLS139 |
| 1.6 | 4 | AVU; BFQ | 75/101 | 08/00→03/13 | OE032 | 1,0 | CET2 | OE179 | BAE907AE [262] | CLS048 |
| 1.6 | 4 | BGU; BSE; BSF | 75/101 | 08/00→03/13 | OE032 | 1,0 | CET2 | OE179 | BAE907AE [262] | CLS017 CLS048 |
| 1.6 E-Power | 4 | CCSA; CMXA | 75/101 | 01/11→03/13 | OE032 | 1,0 | CET2 | OE179 | BAE907AE [262] | |
| 1.6 FSI | 4 | BAG; BLF; BLP | 85/114 | 08/03→09/07 | | | | | BAE408AE | |
| 1.6 TDI | 4 | CAYB | 66/89 | 05/09→03/13 | | | | | CCU152 | |
| 1.6 TDI | 4 | CLHA | 77/103 | 05/09→ | | | | | CCU151 | |
| 1.6 TDI | 4 | CAVC | 77/103 | 05/09→ | | | | | CCU152 | |
| 1.6 TDI | 4 | CRKB; CXXB; DBKA | 81/109 | 09/13→ | CPSG007 [44] | 4.4v | | | CCU151 | |
| 1.6 TDI | 4 | DDYA | 85/114 | 02/17→ | CPSG007 | 4.4v | | | | |
| 1.6 TDI 4WD | 4 | CXXB | 81/109 | 05/15→ | CPSG007 [44] | 4.4v | | | | |
| 1.8 | 4 | AGN | 92/123 | 09/96→05/03 | OE032 | 1,0 | | | BAE907AE [262] | CLS177 →Ch. 8L-V-140000 CLS140 Ch. 8L-V-140001→ |
| 1.8 | 4 | APG | 92/123 | 09/96→05/03 | OE032 | 1,0 | | | BAE907AE [262] | CLS140 Ch. 8L-V-140001→ |
| 1.8 S3 4WD | 4 | AMK; APY; AUL | 154/207 | 03/99→04/02 | OE136 | 0,8 | CET12P | OE179 | BAEA009E ModelYear→2000 BAEA043E ModelYear2001→ | |
| 1.8 S3 4WD | 4 | BAM | 165/221 | 10/01→05/03 | OE136 | 0,8 | CET12P | OE179 | BAEA043E | |
| 1.8 T | 4 | BPU | 110/148 | 12/96→08/12 | OE136 | 0,8 | CET12P | OE179 | | |
| 1.8 T | 4 | AQA; ARZ | 110/148 | 12/96→08/12 | OE136 | 0,8 | CET12P | OE179 | BAEA009E | |
| 1.8 T, 1.8 T 4WD | 4 | AGU | 110/148 | 12/96→08/12 | OE136 | 0,8 | CET12P | OE179 | BAEA043E BAEA016 ModelYear→2000 | |

AUDI





kW/BHP



eon TITAN

IRIDIUM



...AUDI

...A3

| | | | | | | | | | |
|---------------------------------------|---|--------------------|---------|--------------|--|------|--------|-------|--|
| 1.8 T, 1.8 T 4WD | 4 | ARY; AUQ | 132/177 | 10/98 →05/03 | OE136 | 0,8 | CET12P | OE179 | BAEA043E |
| 1.8 T, 1.8 T 4WD | 4 | AJQ; APP | 132/177 | 10/98 →05/03 | OE136 | 0,8 | CET12P | OE179 | BAEA009E |
| 1.8 T, 1.8 T 4WD | 4 | ARX; AUM | 110/148 | 12/96 →08/12 | OE136 | 0,8 | CET12P | OE179 | BAEA043E |
| 1.8 T 4WD | 4 | AQA | 110/148 | 12/96 →05/03 | OE136 | 0,8 | CET12P | OE179 | BAEA009E ModelYear →2000 |
| 1.8 TFSI | 4 | CNSB | 125/168 | 11/13 → | | | | OE246 | BAEA068E |
| 1.8 TFSI, 1.8 TFSI 4WD | 4 | BYT; BZB; CDAA | 118/158 | 11/06 →05/13 | OE214 | 0,7 | CET11P | | BAEA033E [7] [249] [275] |
| 1.8 TFSI, 1.8 TFSI 4WD | 4 | CJSA; CJSB | 132/177 | 04/12 → | | | | OE246 | BAEA068E |
| 1.9 TDI | 4 | AGR; ALH | 66/89 | 09/96 →07/01 | CH271 | 11v | | | CCU081 |
| 1.9 TDI | 4 | ATD; AXR | 74/99 | 10/00 →05/03 | CH271 | 11v | | | CCU081 |
| 1.9 TDI | 4 | BLS | 77/103 | 05/03 →05/10 | | | | | CCU151 →05/06 →Ch.BP-5A200000 BP-5B050000 |
| 1.9 TDI | 4 | BXE | 77/103 | 05/03 →05/10 | | | | | CCU152 Ch.BP-6A000001 BP-6B000001 → |
| 1.9 TDI | 4 | AHF; ASV | 81/109 | 08/97 →07/01 | CH271 | 11v | | | CCU152 05/08 → |
| 1.9 TDI, 1.9 TDI 4WD | 4 | ASZ | 96/129 | 08/00 →05/03 | CH271 | 11v | | | CCU081 |
| 2.0 FSI | 4 | AXW; BLR; BLX; BVY | 110/148 | 05/03 →06/08 | OE234 | 1,0 | CET3 | | BAEA033E [7] |
| 2.0 FSI | 4 | BLY; BMB | 110/148 | 05/03 →06/08 | | | | | BAEA033E [7] |
| 2.0 FSI | 4 | BVZ | 110/148 | 05/03 →06/08 | | | CET3 | | BAEA033E [7] |
| 2.0 S3 4WD | 4 | BZC; CDLC | 188/252 | 02/07 →03/13 | OE214 | 0,7 | CET11P | | BAEA033E [7] [249] [275] |
| 2.0 S3 4WD | 4 | BHZ; CDLA | 195/261 | 11/06 →03/13 | OE214 | 0,7 | CET11P | | BAEA033E [7] [249] [275] |
| 2.0 S3 4WD | 4 | CJXB | 206/276 | 02/13 → | | | | OE246 | BAEA068E |
| 2.0 S3 4WD | 4 | CJXF | 210/282 | 03/14 → | | | | OE246 | BAEA068E |
| 2.0 S3 4WD | 4 | CJXC | 221/296 | 11/12 → | | | | OE246 | BAEA068E |
| 2.0 TDI | 4 | CRFA; DEJB | 81/109 | 01/13 → | | | | | CCU151 |
| 2.0 TDI | 4 | CRBD | 100/134 | 05/03 → | | | | | CCU151 |
| 2.0 TDI | 4 | CRLC | 100/134 | 05/03 → | CPSG007 ^[44] | 4.4v | | | CCU151 |
| 2.0 TDI | 4 | CBAA; CFFA | 100/134 | 05/03 → | | | | | CCU152 |
| 2.0 TDI | 4 | CRFC | 105/141 | 09/12 → | | | | | CCU151 |
| 2.0 TDI | 4 | CRUA; DEJA | 110/148 | 04/12 → | CPSG007 | 4.4v | | | CCU151 |
| 2.0 TDI | 4 | DBGA | 110/148 | 04/12 → | CPSG007 ^[44] ModelYear →2016 | 4.4v | | | CCU151 |
| 2.0 TDI | 4 | DCYA | 110/148 | 04/12 → | CPSG007 ^[44] | 4.4v | | | CCU151 |
| 2.0 TDI | 4 | BUY | 120/161 | 06/06 →06/08 | CCGP003 | 7v | | | CCU152 Ch.BP-6A000001 BP-6B000001 → |
| 2.0 TDI, 2.0 TDI 4WD | 4 | BMM | 103/138 | 06/05 →05/13 | CCGP002 →Ch.BP-6A138000 BP-6B019000 | 7v | | | CCU151 →05/06 →Ch.BP-5A200000 BP-5B050000 |
| 2.0 TDI, 2.0 TDI 4WD | 4 | CRBC | 110/148 | 04/12 → | | | | | CCU152 Ch.BP-6A000001 BP-6B000001 → |
| 2.0 TDI, 2.0 TDI 4WD | 4 | CRLB | 110/148 | 04/12 → | CPSG007 ^[44] | 4.4v | | | CCU151 |
| 2.0 TDI, 2.0 TDI 4WD | 4 | BMN | 125/168 | 03/06 →03/13 | CCGP003 | 7v | | | CCU152 |
| 2.0 TDI, 2.0 TDI 4WD | 4 | CBBB | 125/168 | 03/06 →03/13 | | | | | CCU151 |
| 2.0 TDI, 2.0 TDI 4WD | 4 | CUNA; DGCA | 135/181 | 12/12 → | CPSG007 ^[44] | 4.4v | | | CCU151 |
| 2.0 TDI, 2.0 TDI 16V, 2.0 TDI 16V 4WD | 4 | CBAB; CFFB | 103/138 | 05/03 →05/13 | | | | | CCU152 |
| 2.0 TFSI | 4 | CBFA; CCTA | 147/197 | 09/04 →05/13 | | | | | BAEA033E [7] [249] [275] |



kW/BHP

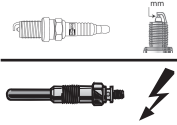

eon TITAN

IRIDIUM

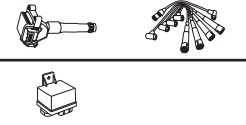

...AUDI

...A3

| | | | | | | | | | |
|------------------------|---|--------------------------------|---------|-------------|-------|-----|--------|-------|-----------------------------|
| 2.0 TFSI, 2.0 TFSI 4WD | 4 | CZPB | 140/188 | 05/16→ | | | | | BAEA137E |
| 2.0 TFSI, 2.0 TFSI 4WD | 4 | AXX; BPY; BWA; CAWB; CCA; CCZA | 147/197 | 09/04→05/13 | OE214 | 0,7 | CET11P | | BAEA033E [7] [249] [275] |
| 2.0 TFSI 4WD | 4 | CNTC | 162/217 | 11/13→ | | | | OE246 | BAEA068E |
| 2.5 RS3 4WD | 5 | CEPA | 250/335 | 01/11→12/12 | OE219 | 0,7 | | | BAEA033E [7] |
| 3.2 V6 4WD | 6 | BDB; BMJ; BUB | 184/247 | 07/03→05/09 | OE215 | 0,9 | | | BAEA044E [356] |

A4

| | | | | | | | | | | |
|------------------------|---|--------------------|---------|-------------|--|------|--------|-------|-----------------------------|--------|
| 1.6 | 4 | AHL; ANA; ARM | 74/99 | 11/94→09/01 | OE032 | 1,0 | CET2 | OE179 | BAE907AE [262] | CLS048 |
| 1.6 | 4 | ADP | 74/99 | 11/94→09/01 | OE032 | 1,0 | CET2 | OE179 | | CLS047 |
| 1.6 | 4 | ALZ | 75/101 | 07/00→06/08 | OE032 | 1,0 | CET2 | OE179 | BAE907AE [262] | CLS048 |
| 1.8 | 4 | ADR; APT; ARG | 92/123 | 11/94→09/01 | OE032 | 1,0 | | | BAEA162E | CLS057 |
| 1.8, 1.8 4WD | 4 | AFY | 85/114 | 04/95→09/01 | OE032 | 1,0 | CET2 | OE179 | BAEA162E | CLS057 |
| 1.8, 1.8 4WD | 4 | ADR; APT; ARG; AVV | 92/123 | 11/94→09/01 | OE032 | 1,0 | | | BAEA162E | CLS057 |
| 1.8 T | 4 | AWT | 110/148 | 01/95→05/10 | OE136 | 0,8 | CET12P | OE179 | BAEA043E | |
| 1.8 T | 4 | BFB | 120/161 | 07/02→03/09 | OE136 | 0,8 | CET12P | OE179 | BAEA043E | |
| 1.8 T, 1.8 T 4WD | 4 | AVJ | 110/148 | 01/95→05/10 | OE136 | 0,8 | CET12P | OE179 | BAEA043E | |
| 1.8 T, 1.8 T 4WD | 4 | AEB; ANB; APU; ARK | 110/148 | 01/95→05/10 | OE136 | 0,8 | CET12P | OE179 | BAEA016 | |
| 1.8 T, 1.8 T 4WD | 4 | AMB | 125/168 | 01/95→10/05 | OE136 | 0,8 | CET12P | OE179 | BAEA043E | |
| 1.8 T, 1.8 T 4WD | 4 | AJL | 132/177 | 12/97→09/01 | OE136 | 0,8 | CET12P | OE179 | BAEA016 | |
| 1.8 T, 1.8 T 4WD | 4 | BEX | 140/188 | 11/02→12/04 | OE136 | 0,8 | CET12P | OE179 | BAEA043E | |
| 1.8 T 4WD | 4 | AWT | 110/148 | 01/95→07/02 | OE136 | 0,8 | CET12P | OE179 | | |
| 1.8 T 4WD | 4 | ARX | 110/148 | 01/95→07/02 | | | | | BAEA016 | |
| 1.8 T 4WD | 4 | BFB | 120/161 | 07/02→03/09 | OE136 | 0,8 | CET12P | OE179 | BAEA043E | |
| | | | | | | | | | BAEA051E | |
| 1.8 TFSI | 4 | CABA; CDHA | 88/118 | 01/08→12/15 | OE214 | 0,7 | CET11P | | BAEA033E [7] [249] [275] | |
| 1.8 TFSI, 1.8 TFSI 4WD | 4 | CABB; CDHB | 118/158 | 11/07→03/12 | OE214 | 0,7 | CET11P | | BAEA033E [7] [249] [275] | |
| 1.8 TFSI, 1.8 TFSI 4WD | 4 | CJEB | 125/168 | 11/11→12/15 | | | | OE246 | BAEA137E | |
| 1.9 DUO, 1.9 TDI | 4 | IZ; AHH; AHU | 66/89 | 01/95→09/01 | CH271 | 11v | | | | |
| 1.9 TDI | 4 | AFF | 55/74 | 12/95→09/01 | CH271 | 11v | | | | |
| 1.9 TDI | 4 | AVB | 74/99 | 05/01→12/04 | CH271 | 11v | | | | |
| 1.9 TDI | 4 | BKE | 85/114 | 03/00→06/08 | | | | | CCU151 →Ch.8E-5-070250 | |
| 1.9 TDI | 4 | BRB | 85/114 | 03/00→06/08 | CCGP002 Ch.8E-5-400001→ | 7v | | | CCU151 Ch.8E-6-132001→ | |
| 1.9 TDI, 1.9 TDI 4WD | 4 | AFN; AVG | 81/109 | 10/95→09/01 | CH271 | 11v | | | | |
| 1.9 TDI, 1.9 TDI 4WD | 4 | AJM; ATJ | 85/114 | 03/00→06/08 | CH271 | 11v | | | | |
| 1.9 TDI, 1.9 TDI 4WD | 4 | AVF; AWX | 96/129 | 11/00→12/04 | CH271 | 11v | | | | |
| 2.0 | 4 | ALT | 96/129 | 11/00→06/08 | | | | | BAEA043E | |
| | | | | | | | | | BAEA051E | |
| 2.0 FSI | 4 | AWA | 110/148 | 07/02→12/04 | OE234 Ch.8E-1-000001→ Ch.8E-5-400000 | 1,0 | CET3 | | BAEA032E [13] | |
| 2.0 TDI | 4 | CAGC; CICC | 88/118 | 06/08→12/15 | | | | | CCU151 | |
| 2.0 TDI | 4 | BVG | 89/119 | 09/05→09/06 | CCGP003 | 7v | | | CCU151 | |
| 2.0 TDI | 4 | DEUC | 90/121 | 04/16→ | CPSG007 [44] [196] | 4.4v | | | CCU152 | |
| | | | | | CPSG007 [197] | 4.4v | | | | |
| 2.0 TDI | 4 | BVF | 93/125 | 11/05→11/06 | CCGP003 | 7v | | | CCU151 | |
| 2.0 TDI | 4 | BRC | 100/134 | 11/04→ | CCGP002 | 7v | | | CCU151 | |
| 2.0 TDI | 4 | BRF | 100/134 | 11/04→ | CCGP003 Ch.8E-5-400001→ | 7v | | | CCU151 | |
| 2.0 TDI | 4 | CAGB; CJC; CSUB | 100/134 | 11/04→ | | | | | CCU151 | |
| 2.0 TDI | 4 | DEUB | 100/134 | 11/04→ | CPSG007 [44] [196] | 4.4v | | | CCU152 | |
| | | | | | CPSG007 [197] | 4.4v | | | | |

AUDI



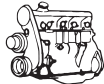

kW/BHP



eon TITAN

IRIDIUM



...AUDI

...A4

| | | | | | | | | | | |
|--|---|------------------------|---------|-------------|---|------|---------------|--------------|--|----------------------------------|
| 2.0 TDI | 4 | CZHA; DEUA | 110/148 | 05/13→ | CPSG007 [44][196] | 4.4v | | | | CCU152 |
| | | | | | CPSG007 ^[197] | 4.4v | | | | |
| 2.0 TDI | 4 | CMFB; CSUA | 110/148 | 05/13→ | CPSG007 [44][209] | 4.4v | | | | |
| 2.0 TDI | 4 | CAHB; CGLD; CNHC | 120/161 | 06/06→12/15 | | | | | | CCU151 |
| 2.0 TDI, 2.0 TDI 4WD | 4 | BPW | 103/138 | 11/04→03/09 | CCGP002 | 7v | | | | CCU151 |
| 2.0 TDI, 2.0 TDI 4WD | 4 | CAGA; CJCA; CMEA; CMFA | 105/141 | 11/07→12/15 | | | | | | CCU151 |
| 2.0 TDI, 2.0 TDI 4WD | 4 | CJCD; CSUA | 110/148 | 05/13→ | CPSG007 [44][209] | 4.4v | | | | CCU151 |
| 2.0 TDI, 2.0 TDI 4WD | 4 | BVA | 120/161 | 06/06→ | CCGP003 | 7v | | | | |
| 2.0 TDI, 2.0 TDI 4WD | 4 | BRD | 125/168 | 06/06→03/12 | CCGP003 | 7v | | | | CCU151 |
| 2.0 TDI, 2.0 TDI 4WD | 4 | CAHA | 125/168 | 06/06→03/12 | | | | | | CCU151 |
| 2.0 TDI, 2.0 TDI 4WD | 4 | CGLC; CMGB | 130/174 | 11/11→12/15 | | | | | | CCU151 |
| 2.0 TDI, 2.0 TDI 4WD | 4 | CNHA | 140/188 | 09/13→ | CPSG007 [44][209] | 4.4v | | | | CCU151 |
| 2.0 TDI, 2.0 TDI 4WD | 4 | DESA; DETA; DFVA | 140/188 | 09/13→ | CPSG007 [44][196] | 4.4v | | | | CCU152 |
| | | | | | CPSG007 ^[197] | 4.4v | | | | |
| 2.0 TDI 4WD | 4 | DEUA | 110/148 | 05/13→ | CPSG008 →Prod.17.07.2017 [44][210] | 4.4v | | | | |
| | | | | | CPSG008 ^[197] →Prod.17.07.2017 | 4.4v | | | | |
| 2.0 TDI 4WD | 4 | DETB | 120/161 | 06/06→ | CPSG008 →Prod.17.07.2017 [44][210] | 4.4v | | | | |
| | | | | | CPSG008 ^[197] →Prod.17.07.2017 | 4.4v | | | | |
| 2.0 TDI 16V | 4 | BRE | 103/138 | 11/04→ | CCGP003 Ch.8E-5-400001→ | 7v | | | | CCU151 |
| 2.0 TFSI | 4 | BPJ | 125/168 | 10/06→06/08 | OE214 | 0,7 | CET11P | | | |
| 2.0 TFSI | 4 | CVKB; DBPA; DEMA | 140/188 | 05/15→ | | | | OE246 | | BAEA137E |
| 2.0 TFSI | 4 | CAEB; CDNC | 155/208 | 06/08→05/13 | OE214 | 0,7 | CET11P | | | BAEA033E [7][249][275] |
| 2.0 TFSI | 4 | BUL | 162/217 | 06/05→12/15 | OE214 | 0,7 | CET11P | | | BAEA033E [7][275] |
| 2.0 TFSI, 2.0 TFSI 4WD | 4 | CNCD | 165/221 | 05/13→12/15 | | | | OE246 | | BAEA068E |
| 2.0 TFSI, 2.0 TFSI 4WD | 4 | CYRC | 183/245 | 11/15→ | | | | OE246 | | BAEA068E →02/16 |
| 2.0 TFSI, 2.0 TFSI 4WD | 4 | CYMC; CYRB; DDWA | 185/248 | 05/15→ | | | | OE246 | | BAEA068E →02/16 |
| 2.0 TFSI, 2.0 TFSI 4WD | 4 | BUL; CAED | 162/217 | 06/05→12/15 | OE214 | 0,7 | CET11P | | | BAEA033E ^[7] |
| 2.0 TFSI, 2.0 TFSI 4WD, 2.0 TFSI 4WD, 2.0 TFSI 16V | 4 | BPG; BWT | 147/197 | 11/04→03/09 | | | | | | BAEA033E ^[7] |
| 2.0 TFSI, 2.0 TFSI 4WD, 2.0 TFSI 16V | 4 | BGB; BWE | 147/197 | 11/04→03/09 | OE214 | 0,7 | CET11P | | | BAEA033E ^[7] |
| 2.0 TFSI, 2.0 TFSI flexible fuel, 2.0 TFSI flexible fuel 4WD | 4 | CAEA; CDNB; CFKA | 132/177 | 06/08→12/15 | OE214 | 0,7 | CET11P | | | BAEA033E [7][249][275] |
| 2.0 TFSI 4WD | 4 | CFKA | 132/177 | 11/09→03/12 | OE214 | 0,7 | CET11P | | | BAEA033E [7][249] |
| 2.0 TFSI 4WD | 4 | CPMA | 155/208 | 06/08→12/15 | OE214 | 0,7 | CET11P | | | |
| 2.0 TFSI 4WD | 4 | CAEB; CDNC | 155/208 | 06/08→12/15 | OE214 | 0,7 | CET11P | | | BAEA033E [7][249][275] |
| | | | | | | | | | | BAEA033E ^[7] |
| 2.0 TFSI 4WD | 4 | CAED; CPMB | 162/217 | 06/05→12/15 | OE214 | 0,7 | CET11P | | | BAEA033E [7][249][275] |
| 2.0 TFSI g-tron | 4 | CVLA | 125/168 | 11/16→ | | | | | | BAEA137E |
| 2.4 | 6 | AFM | 110/148 | 07/95→07/97 | OE032 | 1,0 | CET2 | OE179 | | CLS001 |
| 2.4 | 6 | AJG; AMM | 120/161 | 08/97→12/05 | OE237 | 1,6 | CET2 | OE179 | | BAEA154E |
| 2.4 | 6 | BDV | 125/168 | 09/01→12/05 | OE237 | 1,6 | CET2 | OE179 | | BAEA154E CLS046 |
| 2.4, 2.4 4WD | 6 | APZ | 120/161 | 08/97→12/05 | OE237 | 1,6 | CET2 | OE179 | | BAEA154E CLS001 |



kW/BHP

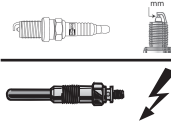

eon TITAN

IRIDIUM

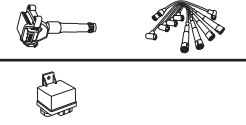

...AUDI

...A4

| | | | | | | | | | | |
|----------------------|---|------------------------------------|---------|-------------|--|------|--------|-------|--------------------------|--------------------------------------|
| 2.4, 2.4 4WD | 6 | AGA; ALF; AML; APS; ARJ | 121/162 | 03/97→09/01 | OE237 | 1,6 | CET2 | OE179 | BAEA154E | CLS046 |
| 2.4 4WD | 6 | AJG | 120/161 | 08/97→09/01 | OE237 | 1,6 | CET2 | OE179 | | CLS001 |
| 2.4 4WD | 6 | AML | 121/162 | 03/97→09/01 | OE237 | 1,6 | CET2 | OE179 | BAEA154E | CLS001 |
| 2.5 TDI | 6 | AYM | 114/153 | 08/01→07/02 | CH215 | 12v | | | | |
| 2.5 TDI | 6 | BCZ; BDG; BFC | 120/161 | 07/02→05/06 | CH215 | 12v | | | | |
| 2.5 TDI, 2.5 TDI 4WD | 6 | AFB; AKN | 110/148 | 09/97→09/01 | CH215 | 12v | | | | |
| 2.5 TDI 4WD | 6 | AKE; BAU; BDH | 132/177 | 11/00→12/04 | CH215 | 12v | | | | |
| 2.6 | 6 | ACZ | 102/137 | 01/96→07/97 | OE032 | 1,0 | CET2 | OE179 | | |
| 2.6, 2.6 4WD | 6 | ABC | 110/148 | 01/95→09/01 | OE032 | 1,0 | | | | CLS001 →07/97 CLS046 07/97→ |
| 2.7 Bi Turbo 4WD | 6 | APB | 187/251 | 08/98→12/98 | | | | | BAEA154E | |
| 2.7 RS4 4WD | 6 | ASJ; AZR | 280/375 | 05/00→09/01 | OE136 | 0,8 | CET12P | OE179 | BAEA016 | |
| 2.7 S4 4WD | 6 | AGB; AZB | 195/261 | 09/97→09/01 | OE136 | 0,8 | CET12P | OE179 | BAEA016 | |
| 2.7 Turbo 4WD | 6 | AJK | 169/227 | 02/99→09/00 | OE136 | 0,8 | CET12P | OE179 | BAEA154E | |
| 2.8 | 6 | AHA | 142/190 | 10/96→09/01 | OE237 | 1,6 | CET2 | OE179 | BAEA154E | |
| 2.8, 2.8 4WD | 6 | AAH | 128/172 | 01/95→07/97 | OE032 | 1,0 | | | | CLS001 |
| 2.8, 2.8 4WD | 6 | ATX | 140/188 | 03/99→10/00 | OE237 | 1,6 | CET2 | OE179 | BAEA154E | |
| 2.8, 2.8 4WD | 6 | ACK; ALG; AMX; APR; AQD | 142/190 | 10/96→09/01 | OE237 | 1,6 | CET2 | OE179 | BAEA154E | CLS046 |
| 2.8, 2.8 4WD | 6 | AHA; ATQ | 142/190 | 10/96→09/01 | OE237 | 1,6 | CET2 | OE179 | | |
| 2.8 4WD | 6 | ARP | 142/190 | 10/96→09/01 | | | | | BAEA154E | |
| 3.0, 3.0 4WD | 6 | BBJ | 160/215 | 04/01→07/06 | OE237 | 1,6 | CET2 | OE179 | BAEA051E | |
| 3.0, 3.0 4WD | 6 | ASN | 162/217 | 11/00→12/05 | OE237 | 1,6 | CET2 | OE179 | BAEA051E | |
| 3.0, 3.0 4WD | 6 | AVK | 162/217 | 11/00→12/05 | | | | | BAEA051E | |
| 3.0 S4 4WD | 6 | CAKA; CCBA; CGWC; CGXC; CREC; CTUB | 245/329 | 11/08→12/15 | OE214 | 0,7 | CET11P | | BAEA032E ^[13] | |
| 3.0 S4 4WD | 6 | CWGD | 260/349 | 05/16→ | | | | | BAEA137E | |
| 3.0 TDI 4WD | 6 | CCLA | 176/236 | 11/07→03/12 | CPSG007 ^[43] | 4.4v | | | | |
| 3.0 TDI 4WD | 6 | CKVB | 180/241 | 11/11→12/15 | CPSG007 ^[38] →Prod.23.06.2014 | 4.4v | | | | |
| 3.0 TDI 4WD | 6 | CKVC | 180/241 | 11/11→12/15 | CPSG007 ^[38] →Prod.23.06.2014 | 4.4v | | | | |
| 3.0 TDI 4WD | 6 | CRTC | 200/268 | 05/15→ | CPSG008 Prod.23.06.2014→ | 4.4v | | | | |
| 3.0 TDI 4WD | 6 | CRTC | 200/268 | 05/15→ | CCGP010 ^[71] | 6.2v | | | | |
| 3.0 TFSI 4WD | 6 | CMUA; CRED | 200/268 | 02/12→12/15 | | | | | BAEA032E ^[13] | |
| 3.2 FSI, 3.2 FSI 4WD | 6 | AUK; BKH | 188/252 | 01/05→03/09 | OE209 | 0,8 | CET11P | | BAEA032E ^[13] | |
| 3.2 FSI, 3.2 FSI 4WD | 6 | CALA | 195/261 | 11/07→03/12 | OE146 | 1,0 | CET12P | OE179 | BAEA032E ^[13] | |
| 4.2 RS4 4WD | 8 | BNS | 309/414 | 09/05→03/09 | OE214 | 0,7 | CET11P | | | |
| 4.2 RS4 4WD | 8 | CFSA | 331/444 | 05/12→08/15 | OE214 | 0,7 | CET11P | | BAEA033E ^[7] | |
| 4.2 S4 4WD | 8 | BBK | 253/339 | 03/03→03/09 | | | | | BAEA061E | |
| A4 Allroad | | | | | | | | | | |
| 2.0 TDI 4WD | 4 | CAGB; CJCB; CSUB | 100/134 | 09/09→ | | | | | CCU151 | |
| 2.0 TDI 4WD | 4 | DEUB | 100/134 | 09/09→ | CPSG008 →Prod.17.07.2017 [44] [210] | 4.4v | | | | |
| 2.0 TDI 4WD | 4 | DEUB | 100/134 | 09/09→ | CPSG008 ^[197] →Prod.17.07.2017 | 4.4v | | | | |
| 2.0 TDI 4WD | 4 | CAGA; CJCA | 105/141 | 09/09→05/16 | | | | | CCU151 | |
| 2.0 TDI 4WD | 4 | CJCD; CSUA | 110/148 | 05/13→ | CPSG007 [44] [209] | 4.4v | | | CCU151 | |
| 2.0 TDI 4WD | 4 | DEUA | 110/148 | 05/13→ | CPSG008 →Prod.17.07.2017 [44] [210] | 4.4v | | | | |
| 2.0 TDI 4WD | 4 | CAHB; CGLD; CNHC | 120/161 | 04/09→ | CPSG008 ^[197] →Prod.17.07.2017 | 4.4v | | | CCU151 | |

AUDI

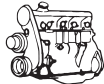

kW/BHP

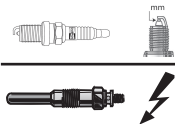

eon TITAN

IRIDIUM



...AUDI

...A4 Allroad

| | | | | | | | | | |
|--------------|---|------------------|---------|-------------|---|--------------|---------------|--------------|------------------------------------|
| 2.0 TDI 4WD | 4 | DETB | 120/161 | 04/09→ | CPSG007 [44] [201] | 4.4v | | | |
| 2.0 TDI 4WD | 4 | CAHA | 125/168 | 04/09→05/16 | | | | | CCU151 |
| 2.0 TDI 4WD | 4 | CGLC | 130/174 | 11/11→05/16 | | | | | CCU151 |
| 2.0 TDI 4WD | 4 | CNHA | 140/188 | 09/13→ | CPSG007 [44] [209] | 4.4v | | | CCU151 |
| 2.0 TDI 4WD | 4 | DESA; DETA; DFVA | 140/188 | 09/13→ | CPSG007 [44] [201] | 4.4v | | | |
| 2.0 TFSI 4WD | 4 | CDNC; CPMA | 155/208 | 04/09→05/16 | OE214 | 0,7 | CET11P | | BAEA033E [7] [249] [275] |
| 2.0 TFSI 4WD | 4 | CPMB | 162/217 | 05/13→05/16 | OE214 | 0,7 | CET11P | | BAEA033E [7] [249] [275] |
| 2.0 TFSI 4WD | 4 | CNCD | 165/221 | 05/13→05/16 | | | | OE246 | BAEA068E |
| 2.0 TFSI 4WD | 4 | CYRC | 183/245 | 05/16→ | | | | OE246 | |
| 2.0 TFSI 4WD | 4 | CYMC; CYRB; DDWA | 185/248 | 01/16→ | | | | OE246 | |
| 3.0 TDI 4WD | 6 | CSWB | 160/215 | 01/16→ | CPSG007 [203] | 4.4v | | | |
| 3.0 TDI 4WD | 6 | CKVB; CKVC | 180/241 | 01/12→05/16 | CPSG007 [215] | 4.4v | | | |
| 3.0 TDI 4WD | 6 | CRTC | 200/268 | 01/16→ | CCGP010 [71] CPSG007 [203] | 6.2v 4.4v | | | |

A5

| | | | | | | | | | |
|------------------------|---|------------------------|---------|-------------|--|------|---------------|--------------|---|
| 1.8 TFSI | 4 | CJED | 106/142 | 09/14→01/17 | | | | OE246 | BAEA137E |
| 1.8 TFSI | 4 | CDHB | 118/158 | 05/09→03/12 | OE214 | 0,7 | CET11P | | BAEA033E [7] [249] [275] |
| 1.8 TFSI | 4 | CABD | 125/168 | 10/07→01/17 | OE214 | 0,7 | CET11P | | BAEA033E [7] [249] [275] |
| 1.8 TFSI | 4 | CJEB | 125/168 | 10/07→01/17 | | | | OE246 | BAEA137E [275] BAEA137E |
| 1.8 TFSI | 4 | CJEE | 130/174 | 05/15→01/17 | | | | OE246 | BAEA137E |
| 2.0 TDI | 4 | CAGB; CJCB; CSUB | 100/134 | 09/09→ | | | | | CCU151 |
| 2.0 TDI | 4 | CAGA; CJCA; CMEA; CMFA | 105/141 | 09/09→01/17 | | | | | CCU151 |
| 2.0 TDI | 4 | CJCD; CSUA | 110/148 | 05/13→ | CPSG007 →Prod.27.04.2014 [44] [209] | 4.4v | | | CCU151 |
| | | | | | CPSG007 →Prod.28.04.2014 [44] [209] | 4.4v | | | |
| 2.0 TDI | 4 | CMFB | 110/148 | 05/13→ | CPSG007 →Prod.27.04.2014 [44] [209] | 4.4v | | | CCU151 |
| 2.0 TDI | 4 | DEUA | 110/148 | 05/13→ | CPSG007 [25] [44] [195] | 4.4v | | | |
| 2.0 TDI | 4 | CAHB; CGLD; CNHC | 120/161 | 08/08→01/17 | | | | | CCU151 |
| 2.0 TDI, 2.0 TDI 4WD | 4 | CAHA | 125/168 | 08/08→03/12 | | | | | CCU151 |
| 2.0 TDI, 2.0 TDI 4WD | 4 | CGLC | 130/174 | 10/11→01/17 | | | | | CCU151 |
| 2.0 TDI, 2.0 TDI 4WD | 4 | CNHA | 140/188 | 09/13→ | CPSG007 →Prod.27.04.2014 [44] [209] | 4.4v | | | CCU151 |
| | | | | | CPSG007 →Prod.28.04.2014 [44] [209] | 4.4v | | | |
| 2.0 TFSI | 4 | CAEA | 132/177 | 11/08→06/14 | OE214 | 0,7 | CET11P | | BAEA033E [7] [249] [275] |
| 2.0 TFSI | 4 | CDNB | 132/177 | 11/08→06/14 | OE214 | 0,7 | CET11P | | BAEA033E [7] [249] [275] BAEA033E [7] |
| 2.0 TFSI | 4 | CVKB; DEMA | 140/188 | 09/16→ | | | | | BAEA137E |
| 2.0 TFSI | 4 | CAEB | 155/208 | 06/08→06/14 | OE214 | 0,7 | CET11P | | BAEA033E [7] [249] [275] |
| 2.0 TFSI | 4 | CAED | 162/217 | 05/13→12/14 | OE214 | 0,7 | CET11P | | BAEA068E |
| 2.0 TFSI, 2.0 TFSI 4WD | 4 | CNCD | 165/221 | 05/13→05/16 | | | CET11P | OE246 | BAEA068E |
| 2.0 TFSI, 2.0 TFSI 4WD | 4 | CNCE | 169/227 | 08/15→01/17 | | | | OE246 | BAEA137E |

CHAMPION



kW/BHP

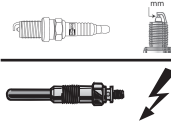

eon TITAN

IRIDIUM

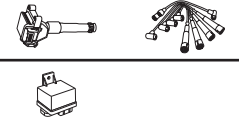

...AUDI

...A5

| | | | | | | | | | | |
|------------------------|---|------------------------------|---------|-------------|---|------|------------------|-------|-----------------------------|--------|
| 2.0 TFSI, 2.0 TFSI 4WD | 4 | CAEB; CDNC | 155/208 | 06/08→01/17 | OE214 | 0,7 | CET11P | | BAEA033E [7] [249] [275] | |
| | | | | | | | | | BAEA033E [7] | |
| 2.0 TFSI 4WD | 4 | CPMA | 155/208 | 06/08→01/17 | OE214 | 0,7 | CET11P | | BAEA033E [7] | |
| 2.0 TFSI 4WD | 4 | CAED | 162/217 | 03/12→01/17 | OE214 | 0,7 | CET11P | | BAEA033E [7] | |
| 2.0 TFSI 4WD | 4 | CPMB | 162/217 | 03/12→01/17 | OE214 | 0,7 | CET11P | | BAEA033E [7] [249] | |
| 2.0 TFSI g-tron | 4 | CVLA | 125/168 | 02/17→ | | | | | BAEA137E | |
| 3.0 S5 4WD | 6 | CAKA; CCBA | 245/329 | 06/09→01/17 | OE214 | 0,7 | CET11P | | BAEA032E [13] | |
| 3.0 S5 4WD | 6 | CGWC; CGXC; CREC; CTDA; CTUB | 245/329 | 06/09→01/17 | | | CET11P | | BAEA032E [13] | |
| 3.0 S5 4WD | 6 | CWGD | 260/349 | 07/16→ | | | | | BAEA137E | |
| 3.0 TDI 4WD | 6 | CKVD | 160/215 | 05/15→ | CPSG008 [38] [275] | 4.4v | | | | |
| 3.0 TDI 4WD | 6 | CKVB; CKVC | 180/241 | 10/11→01/17 | CPSG007 →Prod.23.06.2014 [38] [215] | 4.4v | | | | |
| | | | | | CPSG008 [215] Prod.23.06.2014→ | 4.4v | | | | |
| 3.0 TDI 4WD | 6 | CRTC | 200/268 | 02/17→ | CCGP010 [71] | 6.2v | | | | |
| 3.0 TDI 4WD | 6 | DCPC | 210/282 | 11/16→ | CCGP010 [71] | 6.2v | | | | |
| 3.0 TFSI 4WD | 6 | CHMB; CMUA; CRED | 200/268 | 11/11→01/17 | OE214 | 0,7 | CET11P | | BAEA032E [13] | |
| 3.2 FSI, 3.2 FSI 4WD | 6 | CALA | 195/261 | 06/07→03/12 | OE146 | 1,0 | CET11P CET12P | OE179 | BAEA032E [13] | |
| 4.2 RS5 4WD | 8 | CFSA | 331/444 | 03/10→08/15 | OE214 | 0,7 | CET11P | | BAEA033E [7] | |
| 4.2 S5 4WD | 8 | CAUA | 260/349 | 06/07→03/12 | OE209 | 0,8 | CET11P | | BAEA033E [7] | |
| A6 | | | | | | | | | | |
| 1.8 | 4 | AFY | 85/114 | 05/97→01/05 | OE032 | 1,0 | CET2 | OE179 | BAEA162E →12/00 | CLS057 |
| 1.8 | 4 | ANQ | 92/123 | 12/95→01/05 | OE032 | 1,0 | CET2 | OE179 | | |
| 1.8 | 4 | AJP | 92/123 | 12/95→01/05 | OE032 | 1,0 | CET2 | OE179 | BAEA009E →07/99 | |
| 1.8 | 4 | AQE; ARH | 92/123 | 12/95→01/05 | OE032 | 1,0 | CET2 | OE179 | BAEA009E 01/99→04/01 | |
| 1.8, 1.8 4WD | 4 | ADR | 92/123 | 12/95→01/05 | OE032 | 1,0 | | | BAEA162E | CLS057 |
| 1.8 T | 4 | AWL | 110/148 | 01/97→01/05 | OE136 | 0,8 | CET12P | OE179 | | |
| 1.8 T | 4 | AEB; ANB; APU; ARK | 110/148 | 01/97→01/05 | OE136 | 0,8 | CET12P | OE179 | BAEA016 | |
| 1.8 T, 1.8 T 4WD | 4 | AWT | 110/148 | 01/97→01/05 | OE136 | 0,8 | CET12P | OE179 | BAEA043E 06/00→ | |
| 1.8 T, 1.8 T 4WD | 4 | AJL | 132/177 | 12/97→01/05 | OE136 | 0,8 | CET12P | OE179 | BAEA016 | |
| 1.8 T 4WD | 4 | AEB; ANB; APU; ARK | 110/148 | 02/97→01/05 | OE136 | 0,8 | CET12P | OE179 | BAEA016 | |
| 1.8 TFSI | 4 | CYGA | 140/188 | 09/14→ | | | | OE246 | BAEA137E [275] | |
| | | | | | | | | | BAEA137E | |
| 1.9 TDI | 4 | 1Z; AHU | 66/89 | 06/94→12/97 | CH271 | 11v | | | | |
| 1.9 TDI | 4 | AFN; AVG | 81/109 | 04/97→04/01 | CH271 | 11v | | | | |
| 1.9 TDI | 4 | AJM | 85/114 | 07/00→01/05 | CH271 | 11v | | | | |
| 1.9 TDI | 4 | AVF; AWX | 96/129 | 08/01→01/05 | CH271 | 11v | | | | |
| 2.0 | 4 | AAE | 74/99 | 06/94→12/97 | OE025 | 1,0 | CET8 | OE195 | | CLS180 |
| 2.0 | 4 | ADW | 79/106 | 06/94→07/96 | OE025 | 1,0 | CET8 | OE195 | | |
| 2.0 | 4 | ABK | 85/114 | 06/94→12/97 | OE025 | 1,0 | CET8 | OE195 | | CLS180 |
| 2.0 | 4 | ALT | 96/129 | 08/01→01/05 | | | | | BAEA043E | |
| 2.0 16V | 4 | ACE | 103/138 | 06/94→12/97 | OE032 | 1,0 | CET2 | OE179 | | |
| 2.0 16V 4WD | 4 | ACE | 103/138 | 06/94→12/97 | OE032 | 1,0 | CET12P | OE179 | | |
| | | | | | OE136 | 0,8 | CET2 | | | |
| 2.0 TDI | 4 | BVG | 89/119 | 09/05→06/06 | CCGP003 | 7v | | | CCU151 | |
| 2.0 TDI | 4 | BRF | 100/134 | 07/04→ | CCGP003 | 7v | | | CCU151 | |
| 2.0 TDI | 4 | CAGB | 100/134 | 07/04→ | | | | | CCU151 | |

AUDI





kW/BHP



eon TITAN

IRIDIUM



...AUDI

...A6

| | | | | | | | | | | |
|---|---|------------------|---------|-------------|--|------|---------------|--------------|-----------------|--|
| 2.0 TDI | 4 | CGLE | 100/134 | 07/04→ | CPSG007 [44] [209] | 4.4v | | | | CCU151 |
| | | | | | CPSG007 ModelYear→2014 [44] [209] | 4.4v | | | | |
| 2.0 TDI | 4 | CSUE | 100/134 | 07/04→ | CPSG007 [44] [209] | 4.4v | | | | CCU151 |
| | | | | | CPSG007 [44] ModelYear2015→ | 4.4v | | | | |
| 2.0 TDI | 4 | DDCA | 100/134 | 07/04→ | | | | | | CCU151 |
| 2.0 TDI | 4 | BRE | 103/138 | 07/04→10/08 | CCGP003 Ch.4F-5-000001→ | 7v | | | | CCU151 |
| 2.0 TDI | 4 | CSUD; DDCB | 110/148 | 09/14→ | CPSG007 [44] | 4.4v | | | | CCU151 |
| | | | | | CPSG007 ModelYear→2014 [44] [209] | 4.4v | | | | |
| | | | | | CPSG007 [44] ModelYear2015→ | 4.4v | | | | |
| 2.0 TDI | 4 | CAHB | 120/161 | 04/09→ | | | | | | CCU151 |
| 2.0 TDI | 4 | CGLD | 120/161 | 04/09→ | CPSG007 [44] ModelYear2015→ | 4.4v | | | | CCU151 |
| 2.0 TDI | 4 | CAHA | 125/168 | 10/08→08/11 | | | | | | CCU151 |
| 2.0 TDI | 4 | CGLC; CMGB | 130/174 | 03/11→ | CPSG007 [44] ModelYear2015→ | 4.4v | | | | CCU151 |
| 2.0 TDI | 4 | CNHA; CZJA; DDDA | 140/188 | 11/13→ | CPSG007 ModelYear→2014 [44] [209] | 4.4v | | | | CCU151 |
| | | | | | CPSG007 [44] ModelYear2015→ | 4.4v | | | | |
| 2.0 TDI 4WD | 4 | CNHA; DDDA | 140/188 | 04/15→ | CPSG007 ModelYear→2014 [44] [209] | 4.4v | | | | CCU151 |
| | | | | | CPSG007 [44] ModelYear2015→ | 4.4v | | | | |
| 2.0 TFSI | 4 | BPJ | 125/168 | 06/05→08/11 | OE214 | 0,7 | CET11P | | | BAEA033E [7] |
| 2.0 TFSI | 4 | BYK | 125/168 | 06/05→08/11 | | | | | | BAEA033E [7] |
| 2.0 TFSI | 4 | CDNB | 132/177 | 05/11→ | OE214 | 0,7 | CET11P | | | BAEA033E [7] [249] [275] |
| 2.0 TFSI | 4 | CYNB; CYPA | 185/248 | 09/14→ | | | | OE246 | | BAEA068E →06/15 BAEA137E 06/15→ |
| 2.0 TFSI, 2.0 TFSI 4WD | 4 | CAED | 162/217 | 05/13→ | OE214 | 0,7 | CET11P | | | BAEA033E [7] [249] [275] |
| 2.0 TFSI, 2.0 TFSI 4WD, 2.0 TFSI hybrid | 4 | CAEB; CHJA | 155/208 | 03/11→ | OE214 | 0,7 | CET11P | | | BAEA033E [7] [249] [275] |
| 2.0 TFSI 4WD | 4 | CYPB | 183/245 | 05/15→ | | | | OE246 | | BAEA068E →06/15 BAEA137E 06/15→ |
| 2.0 TFSI 4WD | 4 | CYNB | 185/248 | 05/14→ | | | | OE246 | | BAEA068E →06/15 BAEA137E 06/15→ |
| 2.0 TFSI 4WD | 4 | CYPA | 185/248 | 05/14→ | | | | OE246 | | BAEA068E →06/15 BAEA137E |
| 2.2 S6 Turbo 4WD | 5 | AAN | 169/227 | 06/94→12/97 | OE136 | 0,8 | CET11P | | | BAEA043 [277] |
| 2.3, 2.3 4WD | 5 | AAR | 98/131 | 06/94→12/95 | OE027 | 1,0 | CET8 | OE195 | | |
| 2.4 | 6 | ALW | 100/134 | 07/98→01/05 | OE237 | 1,6 | CET2 | OE179 | BAEA154E | CLS046 |
| 2.4 | 6 | ARN | 100/134 | 07/98→01/05 | OE237 | 1,6 | CET2 | OE179 | BAEA154E | CLS001 |
| 2.4 | 6 | ASM | 100/134 | 07/98→01/05 | | | | | BAEA154E | |
| 2.4 | 6 | AFM | 110/148 | 07/95→12/97 | OE032 | 1,0 | CET2 | OE179 | BAEA007E | |
| 2.4 | 6 | APC | 115/154 | 02/97→01/05 | OE237 | 1,6 | CET2 | OE179 | BAEA154E | CLS001 |



kW/BHP



eon TITAN

IRIDIUM

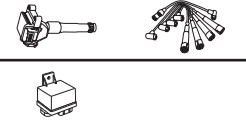

...AUDI

...A6

| | | | | | | | | | | |
|----------------------|---|-------------------------|---------|-------------|---|------|--------|-------|--------------------------|--------|
| 2.4 | 6 | AMM | 120/161 | 02/97→01/05 | | | | | BAEA154E | |
| 2.4, 2.4 4WD | 6 | APZ | 120/161 | 02/97→01/05 | | | | | BAEA154E | CLS001 |
| 2.4, 2.4 4WD | 6 | AJG | 120/161 | 02/97→01/05 | OE237 | 1,6 | CET2 | OE179 | BAEA154E | |
| 2.4, 2.4 4WD | 6 | AGA; ALF | 121/162 | 02/97→01/05 | OE237 | 1,6 | CET2 | OE179 | BAEA154E | CLS046 |
| 2.4, 2.4 4WD | 6 | AML; APS; ARJ | 121/162 | 02/97→01/05 | | | | | BAEA154E | CLS046 |
| 2.4, 2.4 4WD | 6 | BDV | 125/168 | 08/01→01/05 | OE237 | 1,6 | CET2 | OE179 | BAEA154E | CLS046 |
| 2.4, 2.4 4WD | 6 | BDW | 130/174 | 05/04→10/08 | OE146 | 1,0 | CET12P | OE179 | BAEA032E ^[13] | |
| 2.4 4WD | 6 | APC | 115/154 | 08/98→05/01 | OE237 | 1,6 | CET2 | OE179 | BAEA154E | |
| 2.4 4WD | 6 | AML | 121/162 | 02/97→01/05 | | | | | BAEA154E | CLS001 |
| 2.5 TDI | 5 | AAT | 84/113 | 01/95→12/97 | CH271 | 11v | | | | |
| 2.5 TDI | 5 | AAT | 85/114 | 06/94→12/97 | CH271 | 11v | | | | |
| 2.5 TDI | 6 | AYM | 114/153 | 08/01→01/05 | CH215 | 12v | | | | |
| 2.5 TDI | 6 | BCZ; BDG; BFC | 120/161 | 07/02→01/05 | CH215 | 12v | | | | |
| 2.5 TDI, 2.5 TDI 4WD | 5 | AEL | 103/138 | 08/94→12/97 | CH271 | 11v | | | | |
| 2.5 TDI, 2.5 TDI 4WD | 6 | AFB; AKN | 110/148 | 07/97→01/05 | CH215 | 12v | | | | |
| 2.5 TDI, 2.5 TDI 4WD | 6 | AKE; BAU; BDH; BND | 132/177 | 02/00→01/05 | CH215 | 12v | | | | |
| 2.6 | 6 | ACZ | 102/137 | 06/94→10/97 | OE032 | 1,0 | CET2 | OE179 | BAEA007E | CLS001 |
| 2.6, 2.6 4WD | 6 | ABC | 110/148 | 06/94→12/97 | OE032 | 1,0 | CET2 | OE179 | BAEA007E | CLS001 |
| 2.7, 2.7 4WD | 6 | APB; BEL | 187/251 | 05/01→07/04 | OE136 | 0,8 | | | BAEA016 | |
| 2.7 4WD | 6 | BEL | 195/261 | 11/03→07/04 | OE136 | 0,8 | CET12P | OE179 | BAEA043E | |
| 2.7 T, 2.7 T 4WD | 6 | AJK; AZA | 169/227 | 12/97→01/05 | OE136 | 0,8 | CET12P | OE179 | BAEA016 | |
| 2.7 T 4WD | 6 | BES | 184/247 | 08/01→01/05 | OE136 | 0,8 | CET12P | OE179 | BAEA043E | |
| 2.7 T 4WD | 6 | ARE | 184/247 | 08/01→01/05 | OE136 | 0,8 | CET12P | OE179 | BAEA016 | |
| 2.8 | 6 | AEJ | 120/161 | 06/94→07/96 | OE032 | 1,0 | CET2 | OE179 | BAEA007E | |
| 2.8 | 6 | AGE | 132/177 | 10/97→05/00 | OE237 | 1,6 | CET2 | OE179 | BAEA154E | CLS046 |
| 2.8, 2.8 4WD | 6 | AFC | 128/172 | 06/94→12/97 | OE032 | 1,0 | CET2 | OE179 | | |
| 2.8, 2.8 4WD | 6 | AAH | 128/172 | 06/94→12/97 | OE032 | 1,0 | CET2 | OE179 | BAEA007E | CLS001 |
| 2.8, 2.8 4WD | 6 | AEJ | 128/172 | 06/94→12/97 | | | | | BAEA007E | CLS001 |
| 2.8, 2.8 4WD | 6 | ATX | 140/188 | 07/99→01/05 | OE237 | 1,6 | CET2 | OE179 | BAEA154E | |
| 2.8, 2.8 4WD | 6 | AHA | 142/190 | 12/95→01/05 | OE237 | 1,6 | CET2 | OE179 | | CLS046 |
| 2.8, 2.8 4WD | 6 | ACK; ALG; AMX; APR; AQD | 142/190 | 12/95→01/05 | OE237 | 1,6 | CET2 | OE179 | BAEA154E | CLS046 |
| 2.8 4WD | 6 | AGE | 132/177 | 01/98→04/00 | OE237 | 1,6 | CET2 | OE179 | BAEA154E | |
| 2.8 FSI, 2.8 FSI 4WD | 6 | CCDA | 140/188 | 10/08→08/11 | OE146 | 1,0 | CET12P | OE179 | BAEA032E ^[13] | |
| 2.8 FSI, 2.8 FSI 4WD | 6 | CHVA | 150/201 | 11/10→04/15 | | | CET12P | OE181 | BAEA032E ^[13] | |
| 2.8 FSI, 2.8 FSI 4WD | 6 | BDX | 154/207 | 11/06→10/08 | OE146 | 1,0 | CET12P | OE179 | BAEA032E ^[13] | |
| 2.8 FSI, 2.8 FSI 4WD | 6 | CCEA | 162/217 | 10/08→ | OE146 | 1,0 | CET12P | OE179 | BAEA032E ^[13] | |
| 3.0, 3.0 4WD | 6 | BBJ | 160/215 | 06/01→05/06 | OE237 | 1,6 | CET2 | OE179 | BAEA051E | |
| 3.0, 3.0 4WD | 6 | ASN | 162/217 | 08/01→12/05 | OE237 | 1,6 | CET2 | OE179 | BAEA051E | |
| 3.0 TDI 4WD | 6 | CPNB | 176/236 | 10/08→ | CPSG007 ^[38] →Prod.03.03.2014 | 4.4v | | | | |
| | | | | | CPSG008 ^[38] Prod.03.03.2014→ | 4.4v | | | | |
| 3.0 TDI 4WD | 6 | CKVC | 180/241 | 03/11→ | CPSG007 ^[38] →Prod.03.03.2014 | 4.4v | | | | |
| | | | | | CPSG008 ^[38] Prod.03.03.2014→ | 4.4v | | | | |
| 3.0 TDI 4WD | 6 | CKVB | 180/241 | 03/11→ | CPSG007 ^[38] | 4.4v | | | | |
| 3.0 TFSI 4WD | 6 | CAJA | 213/286 | 10/08→08/11 | OE214 | 0,7 | CET11P | | BAEA032E ^[13] | |
| 3.0 TFSI 4WD | 6 | CCAA; CGWB | 220/295 | 10/08→05/12 | OE214 | 0,7 | CET11P | | BAEA032E ^[13] | |
| 3.0 TFSI 4WD | 6 | CGWD; CGXB; CTUA | 228/306 | 03/11→ | | | | | BAEA032E ^[13] | |
| 3.0 TFSI 4WD | 6 | CREC | 245/329 | 09/14→ | | | | | BAEA032E ^[13] | |
| 3.2 FSI | 6 | CALA | 195/261 | 05/09→03/11 | OE146 | 1,0 | CET12P | OE179 | BAEA032E ^[13] | |
| 3.2 FSI, 3.2 FSI 4WD | 6 | AUK | 188/252 | 05/04→05/09 | OE209 | 0,8 | CET11P | | BAEA032E ^[13] | |
| 3.2 FSI, 3.2 FSI 4WD | 6 | BKH | 188/252 | 05/04→05/09 | | | CET11P | | BAEA032E ^[13] | |
| 3.2 FSI 4WD | 6 | BYU | 183/245 | 09/06→10/08 | OE209 | 0,8 | CET11P | | BAEA032E ^[13] | |

AUDI

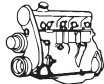

kW/BHP



eon TITAN

IRIDIUM



...AUDI

...A6

| | | | | | | | | | |
|----------------------------|----|------------|---------|-------------|--------------------------|-----|--------|-------|--------------------------|
| 3.7, 3.7 4WD | 8 | AQG | 191/256 | 03/99→01/05 | OE223 | 1,6 | CET12P | OE188 | BAEA009E |
| 4.0 RS6 4WD | 8 | CRDB; CWUB | 412/552 | 01/13→ | OE220 | 0,7 | | | |
| 4.0 S6 4WD | 8 | CEUC | 309/414 | 02/12→ | OE220 Ch.4H-A-000001→ | 0,7 | | | |
| 4.2 4WD | 8 | ASG | 220/295 | 11/98→01/05 | | | | | BAEA009E 06/00→ |
| 4.2 4WD | 8 | ARS | 220/295 | 11/98→01/05 | | | | | BAEA009E 04/99→05/01 |
| 4.2 4WD | 8 | BAT | 246/330 | 05/04→05/06 | | | | | BAEA061E |
| 4.2 FSI 4WD | 8 | BVJ | 257/345 | 06/06→08/11 | OE209 Ch.4F-7-000001→ | 0,8 | CET11P | | BAEA032E ^[13] |
| 4.2 RS6 4WD | 8 | BCY | 331/444 | 07/02→01/05 | OE136 | 0,8 | CET12P | OE179 | BAEA009E |
| 4.2 RS6 plus 4WD | 8 | BRV | 353/473 | 04/04→01/05 | OE136 | 0,8 | CET12P | OE179 | BAEA009E |
| 4.2 S6 4WD | 8 | AQJ | 250/335 | 09/99→01/05 | OE218 | 1,6 | CET2 | OE179 | BAEA009E →05/01 |
| 4.2 S6 4WD | 8 | ANK | 250/335 | 09/99→01/05 | OE218 | 1,6 | CET2 | OE179 | BAEA009E 09/00→ |
| 4.2 S6 4WD, 4.2 S6 4.2 4WD | 8 | AEC | 213/286 | 06/94→12/97 | OE011 | 0,9 | CET9 | OE183 | |
| 4.2 S6 Plus 4WD | 8 | AHK | 240/322 | 04/96→12/97 | OE009 | 0,9 | CET9 | OE183 | BAEA016 |
| 5.0 RS6 4WD | 10 | BUH | 426/571 | 04/08→08/10 | OE136 | 0,8 | CET12P | | BAEA032E ^[13] |
| 5.2 S6 4WD | 10 | BXA | 320/429 | 03/06→08/11 | OE209 | 0,8 | CET11P | | BAEA032E ^[13] |

A6 Allroad

| | | | | | | | | | |
|--------------|---|------|---------|-------------|-------------------------|------|--------|--|--------------------------|
| 3.0 TDI 4WD | 6 | CKVC | 180/241 | 01/12→06/16 | CPSG007 ^[38] | 4.4v | | | |
| 3.0 TFSI 4WD | 6 | CAJA | 213/286 | 10/08→08/11 | OE214 | 0,7 | CET11P | | BAEA032E ^[13] |
| 3.0 TFSI 4WD | 6 | CGWD | 228/306 | 01/12→12/14 | OE214 | 0,7 | CET11P | | BAEA032E ^[13] |
| 3.0 TFSI 4WD | 6 | CREC | 245/329 | 09/14→09/18 | | | | | BAEA032E ^[13] |
| 3.2 FSI 4WD | 6 | AUK | 188/252 | 05/06→10/08 | OE209 | 0,8 | CET11P | | BAEA032E ^[13] |
| 4.2 FSI 4WD | 8 | BVJ | 257/345 | 05/06→12/10 | OE209 | 0,8 | CET11P | | BAEA032E ^[13] |

A7

| | | | | | | | | | |
|----------------------|---|-----------------------|---------|-------------|---|------|--------|-------|--|
| 1.8 TFSI | 4 | CYGA | 140/188 | 04/15→05/18 | | | | OE246 | BAEA137E |
| 2.0 TFSI | 4 | CYPA | 185/248 | 09/14→05/18 | | | | OE246 | BAEA068E →04/15 BAEA137E 04/15→ |
| 2.0 TFSI 4WD | 4 | CYPB | 183/245 | 05/15→05/18 | | | | OE246 | |
| 2.0 TFSI 4WD | 4 | CYNB; CYPA | 185/248 | 05/15→05/18 | | | | OE246 | BAEA137E |
| 2.5 FSI | 6 | CLXB | 150/201 | 09/12→03/15 | | | | | BAEA032E ^[13] |
| 2.8 FSI, 2.8 FSI 4WD | 6 | CHVA; CNYA | 150/201 | 10/10→03/15 | | | CET12P | OE181 | BAEA032E ^[13] |
| 3.0 TDI 4WD | 6 | CPNB | 176/236 | 05/13→06/17 | CPSG007 ^[38] →Prod.03.03.2014 | 4.4v | | | |
| | | | | | CPSG008 ^[38] Prod.03.03.2014→ | 4.4v | | | |
| 3.0 TDI 4WD | 6 | CKVC | 180/241 | 10/10→06/16 | CPSG007 ^[38] →Prod.03.03.2014 | 4.4v | | | |
| | | | | | CPSG008 ^[38] Prod.03.03.2014→ | 4.4v | | | |
| 3.0 TDI 4WD | 6 | CKVB | 180/241 | 10/10→06/16 | CPSG007 ^[38] | 4.4v | | | |
| 3.0 TFSI 4WD | 6 | CGWB; CHMA | 220/295 | 10/10→05/12 | OE214 | 0,7 | CET11P | | BAEA032E ^[13] |
| 3.0 TFSI 4WD | 6 | CGWD; CGXB; CTA; CTUA | 228/306 | 01/11→03/15 | OE214 | 0,7 | CET11P | | BAEA032E ^[13] |
| 3.0 TFSI 4WD | 6 | CREC | 245/329 | 05/14→05/18 | | | | | BAEA032E ^[13] |
| 4.0 RS7 4WD | 8 | CRDB; CWUB | 412/552 | 10/13→04/18 | OE220 | 0,7 | | | |
| 4.0 S7 4WD | 8 | CEUC | 309/414 | 02/12→03/15 | OE220 | 0,7 | | | |
| 2.0 TFSI 4WD | 4 | CYPA | 185/248 | 09/16→ | | | | | BAEA137E |
| 2.0 TFSI hybrid | 4 | CHJA | 155/208 | 02/12→ | OE214 | 0,7 | CET11P | | BAEA033E ^[7] |
| 2.5 TDI, 2.5 TDI 4WD | 6 | AFB; AKN | 110/148 | 01/97→04/00 | CH215 | 12v | | | |
| 2.5 TDI, 2.5 TDI 4WD | 6 | AKE | 132/177 | 09/00→09/02 | CH215 | 12v | | | |
| 2.5 TFSI | 6 | CPAA; CVBA | 150/201 | 07/12→ | | | | | BAEA032E ^[13] |

CHAMPION



kW/BHP

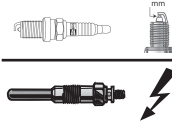

eon TITAN

IRIDIUM

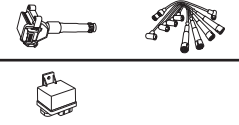

...AUDI

...A8

| | | | | | | | | | | |
|--|----|-------------------------|---------|-------------|---|------|--------|-------|--|--------|
| 2.8, 2.8 4WD | 6 | AEJ | 120/161 | 07/95→03/96 | OE019 | 0,9 | CET2 | OE184 | | CLS001 |
| 2.8, 2.8 4WD | 6 | AAH | 128/172 | 03/94→03/96 | OE032 | 1,0 | CET2 | OE179 | | CLS001 |
| 2.8, 2.8 4WD | 6 | ACK; ALG; AMX; APR; AQD | 142/190 | 04/96→09/02 | OE237 | 1,6 | CET2 | OE179 | BAEA154E | CLS046 |
| 2.8 4WD | 6 | AMX; APR; AQD | 142/190 | 04/96→09/02 | | | | | BAEA154E | CLS046 |
| 2.8 FSI | 6 | BDX | 154/207 | 08/07→07/10 | OE146 | 1,0 | CET12P | OE179 | BAEA032E ^[13] | |
| 3.0 | 6 | BBJ | 160/215 | 07/03→05/06 | OE237 | 1,6 | CET2 | OE179 | BAEA051E | |
| 3.0 | 6 | ASN | 162/217 | 07/03→05/05 | OE237 | 1,6 | CET2 | OE179 | BAEA051E | |
| 3.0 50 TDI 4WD, 3.0 50 TDI Mild Hybrid 4WD | 6 | ; DDVC | 210/282 | 06/17→ | CGP010 ^[71] ^[207] | 6.2v | | | | |
| 3.0 TDI 4WD | 6 | CPNA | 176/236 | 11/12→ | CPSG007 ^[38] | 4.4v | | | | |
| 3.0 TDI 4WD | 6 | CMHA | 184/247 | 07/10→ | CPSG007 ^[38] | 4.4v | | | | |
| 3.0 TFSI 4WD | 6 | CGXA; CREG | 213/286 | 07/10→ | OE214 | 0,7 | CET11P | | | |
| 3.0 TFSI 4WD | 6 | CGWA | 213/286 | 07/10→ | OE214 | 0,7 | CET11P | | BAEA032E ^[13] | |
| 3.0 TFSI 4WD | 6 | CREA | 228/306 | 11/11→ | OE214 | 0,7 | CET11P | | | |
| 3.0 TFSI 4WD | 6 | CGWD | 228/306 | 11/11→ | OE214 | 0,7 | CET11P | | BAEA032E ^[13] | |
| 3.0 TFSI 4WD | 6 | CREC; CTDA | 245/329 | 06/10→ | OE214 | 0,7 | CET11P | | | |
| 3.0 TFSI 4WD | 6 | CGXC; CMDA; CTUB | 245/329 | 06/10→ | OE214 | 0,7 | CET11P | | BAEA032E ^[13] | |
| 3.2 FSI, 3.2 FSI 4WD | 6 | BPK | 191/256 | 06/05→07/10 | OE209 | 0,8 | CET11P | | BAEA032E ^[13] | |
| 3.3 TDI 4WD | 8 | AKF | 165/221 | 06/00→09/02 | CH215 | 12v | | | | |
| 3.7, 3.7 4WD | 8 | AEW; AKJ | 169/227 | 07/95→12/98 | OE011 | 0,9 | CET9 | OE183 | BAEA016 ^[275] BAEA017 ^[275] | |
| 3.7, 3.7 4WD | 8 | AKC; AQG | 191/256 | 11/98→09/02 | OE223 | 1,6 | CET12P | OE188 | BAEA009E | |
| 3.7 4WD | 8 | BFL | 206/276 | 10/02→05/06 | | | | | BAEA061E | |
| 4.0 S8 4WD | 8 | CGTA; CTFA | 382/512 | 04/12→ | OE220 Ch.4H-A-000001→ | 0,7 | | | | |
| 4.0 TDI 4WD | 8 | ASE | 202/271 | 05/03→07/05 | CH215 | 12v | | | | |
| 4.0 TFSI 4WD | 8 | CEUA | 309/414 | 03/12→ | OE220 | 0,7 | | | | |
| 4.2 4WD | 8 | ARU | 175/235 | 02/99→04/00 | | | | | BAEA009E | |
| 4.2 4WD | 8 | AEM | 180/241 | 03/94→07/96 | OE011 | 0,9 | CET9 | OE183 | BAEA016 Ch.4D-T-000221→ | |
| 4.2 4WD | 8 | AGH | 210/282 | 07/95→09/98 | OE011 | 0,9 | CET9 | OE183 | BAEA016 Ch.4D-T-000221→ | |
| 4.2 4WD | 8 | ABZ; AKG | 220/295 | 03/94→11/98 | OE011 | 0,9 | CET9 | OE183 | BAEA016 ^[275] Ch.4D-T-000221→ BAEA017 ^[275] Ch.4D-T-000221→ | |
| 4.2 4WD | 8 | AQF | 228/306 | 11/98→09/02 | | | | | BAEA009E →02/01 | |
| 4.2 4WD | 8 | BFM | 246/330 | 10/02→07/10 | | | | | BAEA061E | |
| 4.2 FSI 4WD | 8 | BJV | 257/345 | 06/06→07/10 | OE209 | 0,8 | CET11P | | BAEA032E ^[13] | |
| 4.2 FSI 4WD | 8 | CDRA | 273/366 | 11/09→ | OE209 | 0,8 | CET11P | | BAEA032E ^[13] | |
| 4.2 S8 4WD | 8 | AHC; AKH | 250/335 | 07/96→06/99 | OE011 | 0,9 | CET9 | OE183 | BAEA016 Ch.4D-T-000221→ | |
| 4.2 S 8 4WD | 8 | AVP | 265/355 | 06/99→09/02 | OE218 | 1,6 | CET2 | OE188 | BAEA009E 09/00→ | |
| 4.2 S 8 4WD | 8 | AQH | 265/355 | 06/99→09/02 | OE218 | 1,6 | CET2 | OE188 | BAEA009E →02/01 | |
| 4.2 S 8 4WD | 8 | BCS | 265/355 | 06/99→09/02 | OE218 | 1,6 | CET2 | OE188 | | |
| 4.2 TDI 4WD | 8 | BMC | 235/315 | 01/05→06/05 | | | | | CCU151 | |
| 4.2 TDI 4WD | 8 | BVN | 240/322 | 07/05→07/10 | | | | | CCU151 | |
| 4.2 TDI 4WD | 8 | CDSB | 258/346 | 11/09→ | | | | | CCU151 ^[353] | |
| 5.2 S8 4WD | 10 | BSM | 331/444 | 06/06→07/10 | OE209 | 0,8 | CET11P | | BAEA032E ^[13] | |
| 6.0 W12 4WD | 12 | AZC | 309/414 | 01/01→09/02 | OE176 | 1,0 | CET3 | | BAEA031E ^[277] | |
| 6.0 W12 4WD | 12 | BHT; BSB; BTE | 331/444 | 12/03→07/10 | OE176 | 1,0 | CET3 | | BAEA031E ^[277] | |
| ALLROAD | | | | | | | | | | |
| 2.5 TDI 4WD | 6 | BCZ | 120/161 | 05/03→08/05 | CH215 | 12v | | | | |
| 2.5 TDI 4WD | 6 | AKE; BAU | 132/177 | 05/00→08/05 | CH215 | 12v | | | | |

AUDI



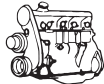

kW/BHP



eon TITAN

IRIDIUM



...AUDI

...ALLROAD

| | | | | | | | | | |
|------------|---|-----|---------|---------------|-------|-----|---------|-------|---------------------------|
| 2.7 4WD | 6 | BEL | 187/251 | 09/00 → 08/05 | OE136 | 0,8 | CET1 2P | OE179 | BAEA043E |
| 2.7 4WD | 6 | APB | 187/251 | 09/00 → 08/05 | OE136 | 0,8 | CET1 2P | OE179 | BAEA016 |
| 2.7 T 4WD | 6 | BES | 184/247 | 05/00 → 08/05 | OE136 | 0,8 | CET1 2P | OE179 | |
| 2.7 T 4WD | 6 | ARE | 184/247 | 05/00 → 08/05 | OE136 | 0,8 | CET1 2P | OE179 | BAEA016 |
| 4.2 V8 4WD | 8 | BAS | 220/295 | 07/02 → 08/05 | | | | | BAEA062E ^[277] |

CABRIOLET

| | | | | | | | | | | |
|---------|---|---------|---------|---------------|-------|-----|------|-------|---------------------------------|--------|
| 1.8 | 4 | ADR | 92/123 | 01/97 → 08/00 | OE032 | 1,0 | | | BAEA162E | CLS057 |
| 1.9 TDI | 4 | 1Z; AHU | 66/89 | 06/95 → 08/00 | CH271 | 11v | | | | |
| 2.0 16V | 4 | ACE | 103/138 | 06/95 → 07/96 | OE032 | 1,0 | CET2 | OE179 | BAE851AE ^{[261] [292]} | |
| 2.0 E | 4 | ABK | 85/114 | 01/93 → 07/98 | OE025 | 1,0 | CET8 | OE195 | BAE851AE ^{[261] [292]} | CLS180 |
| 2.6 | 6 | ACZ | 102/137 | 05/95 → 08/00 | OE032 | 1,0 | CET2 | OE188 | | CLS001 |
| 2.6 | 6 | ABC | 110/148 | 06/93 → 08/00 | OE032 | 1,0 | CET2 | OE179 | BAEA007E | CLS001 |

Q2

| | | | | | | | | | | |
|----------------------|---|------------|---------|---------|-------------------------|------|--|--|--|--|
| 1.4 TSI | 4 | CZEA | 110/148 | 06/16 → | OE244 | 0,8 | | | | |
| 1.6 TDI | 4 | DDYA | 85/114 | 06/16 → | CPSG007 ^[44] | 4.4v | | | | |
| 2.0 TDI, 2.0 TDI 4WD | 4 | DCYA; DFCA | 110/148 | 09/16 → | CPSG007 ^[44] | 4.4v | | | | |
| 2.0 TDI 4WD | 4 | DFHA | 140/188 | 07/16 → | CPSG007 ^[44] | 4.4v | | | | |

Q3

| | | | | | | | | | | |
|------------------------|---|------------------|---------|---------|---|------|---------|-------|-------------------------------------|--|
| 1.4 TFSI | 4 | CZDB | 92/123 | 07/16 → | OE244 | 0,8 | | | | |
| 1.4 TSI | 4 | CHPB; CZDA; CZEA | 110/148 | 10/13 → | OE244 | 0,8 | | | BAEA067E ^[240] | |
| 2.0 TDI | 4 | CUVD; DFTC | 88/118 | 03/15 → | CPSG007 ^{[44] [204] [275] [309]} | 4.4v | | | CCU152 | |
| 2.0 TDI | 4 | CFFA; CUVB; DFTB | 100/134 | 09/11 → | CPSG007 ^{ModelYear2015 → [44] [204] [275] [309]} | 4.4v | | | CCU152 | |
| 2.0 TDI, 2.0 TDI 4WD | 4 | CFFB; CLJA | 103/138 | 09/11 → | CPSG007 ^{ModelYear2015 → [44] [204] [275] [309]} | 4.4v | | | CCU152 | |
| 2.0 TDI, 2.0 TDI 4WD | 4 | CUVC; DBBA; DFTA | 110/148 | 11/14 → | CPSG007 ^{[44] [204] [275] [309]} | 4.4v | | | CCU152 | |
| 2.0 TDI, 2.0 TDI 4WD | 4 | CFGC; CLLB | 130/174 | 06/11 → | CPSG007 ^{ModelYear2015 → [44] [204] [275] [309]} | 4.4v | | | CCU152 | |
| 2.0 TDI, 2.0 TDI 4WD | 4 | CUWA; CYLA; DFUA | 135/181 | 11/14 → | CPSG007 ^{[44] [204] [275] [309]} | 4.4v | | | CCU152 | |
| 2.0 TDI 4WD | 4 | CFGD | 120/161 | 06/11 → | CPSG007 ^{ModelYear2015 → [44] [204] [275] [309]} | 4.4v | | | CCU152 | |
| 2.0 TFSI, 2.0 TFSI 4WD | 4 | CULB | 132/177 | 11/14 → | | | | OE246 | BAEA068E ^{→05/16} | |
| 2.0 TFSI 4WD | 4 | CCZC | 125/168 | 06/11 → | OE214 | 0,7 | CET1 1P | | BAEA033E ^{[7] [249] [275]} | |
| 2.0 TFSI 4WD | 4 | CPSA | 155/208 | 06/11 → | OE214 | 0,7 | CET1 1P | | BAEA033E ^{[7] [249] [275]} | |
| 2.5 RS 4WD | 5 | CTSA | 228/306 | 10/13 → | OE219 ^{→12/15} | 0,7 | | | BAEA033E ^{[7] [249] [275]} | |
| 2.5 RS 4WD | 5 | CZGA | 250/335 | 05/13 → | | | | | BAEA033E ^{[7] [249]} | |

Q5

| | | | | | | | | | | |
|---------|---|------------|---------|---------|-------------------------------|------|--|--|--------|--|
| 2.0 TDI | 4 | DEUB | 100/134 | 11/10 → | CPSG007 ^{[44] [211]} | 4.4v | | | | |
| 2.0 TDI | 4 | CJCA | 105/141 | 11/10 → | | | | | CCU151 | |
| 2.0 TDI | 4 | CJCD; CSUA | 110/148 | 05/13 → | CPSG007 ^[44] | 4.4v | | | CCU151 | |

CHAMPION



kW/BHP

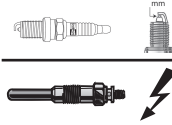

eon TITAN

IRIDIUM

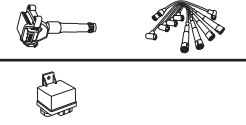
**...AUDI****...Q5**

| | | | | | | | | | | |
|-----------------------------------|---|------------------------|---------|-------------|--|--------------|---------------|--------------|--|--|
| 2.0 TDI | 4 | DEUA | 110/148 | 05/13→ | CPSG007 [44] [211] | 4.4v | | | | |
| 2.0 TDI | 4 | CNHA | 140/188 | 09/15→ | CPSG007 [44] | 4.4v | | | | CCU151 |
| 2.0 TDI, 2.0 TDI 4WD | 4 | CAGB; CJCB; CSUB | 100/134 | 08/09→ | | | | | | CCU151 |
| 2.0 TDI 4WD | 4 | CAGA; CJCA | 105/141 | 08/09→ | | | | | | CCU151 |
| 2.0 TDI 4WD | 4 | CJCD; CSUA | 110/148 | 05/13→ | CPSG007 [44] [209] | 4.4v | | | | CCU151 |
| 2.0 TDI 4WD | 4 | CAHB; CGLA; CGLD; CNHC | 120/161 | 11/08→ | | | | | | CCU151 |
| 2.0 TDI 4WD | 4 | DETB | 120/161 | 11/08→ | CPSG007 [44] [211] | 4.4v | | | | |
| 2.0 TDI 4WD | 4 | CAHA; CGLB; CMGA | 125/168 | 11/08→ | | | | | | CCU151 |
| 2.0 TDI 4WD | 4 | CGLC; CMGB | 130/174 | 06/12→ | | | | | | CCU151 |
| 2.0 TDI 4WD | 4 | CNHA | 140/188 | 11/13→ | CPSG007 [44] | 4.4v | | | | CCU151 |
| 2.0 TDI 4WD | 4 | DESA; DETA | 140/188 | 11/13→ | CPSG007 [44] [211] | 4.4v | | | | |
| 2.0 TFSI 4WD | 4 | CDNB | 132/177 | 08/09→ | OE214 | 0,7 | CET11P | | | BAEA033E [7] [249] [275] |
| 2.0 TFSI 4WD | 4 | CNCB | 132/177 | 08/09→ | | | | OE246 | | BAEA033E [7] [249] [275] |
| 2.0 TFSI 4WD | 4 | CPMA | 155/208 | 11/08→ | OE214 | 0,7 | CET11P | | | |
| 2.0 TFSI 4WD | 4 | CPMB | 162/217 | 05/13→ | OE214 | 0,7 | CET11P | | | BAEA033E [7] |
| 2.0 TFSI 4WD | 4 | CNCD | 165/221 | 06/12→ | | | | OE246 | | BAEA068E [253] →06/15 BAEA137E 06/15→ |
| 2.0 TFSI 4WD | 4 | CNCE | 169/227 | 08/15→ | | | | OE246 | | BAEA068E →05/16 BAEA137E 05/16→ |
| 2.0 TFSI 4WD, 2.0 TFSI hybrid 4WD | 4 | CAEB; CDNC; CHJA | 155/208 | 11/08→ | OE214 | 0,7 | CET11P | | | BAEA033E [7] [249] [275] |
| 3.0 SQ5 TFSI 4WD | 6 | CTUD; CTXA | 260/349 | 05/13→ | | | | | | BAEA032E [13] |
| 3.0 SQ5 TFSI 4WD | 6 | CWGD | 260/349 | 05/13→ | | | | | | BAEA137E |
| 3.0 TDI 4WD | 6 | CPNB | 176/236 | 11/08→ | CPSG007 [38] →Prod.03.03.2014 CPSG008 [38] Prod.03.03.2014→ | 4.4v 4.4v | | | | |
| 3.0 TDI 4WD | 6 | DCPC | 210/282 | 07/17→ | CCGP010 [24] [71] [208] CPSG007 [23] [228] | 6.2v 4.4v | | | | |
| 3.0 TFSI 4WD | 6 | CTUC; CTVA | 200/268 | 06/12→ | OE214 | 0,7 | CET11P | | | BAEA032E [13] |
| 3.2 FSI 4WD | 6 | CALB | 199/267 | 11/08→ | OE146 | 1,0 | CET12P | OE179 | | BAEA032E [13] |
| Q7 | | | | | | | | | | |
| 2.0 TFSI 4WD | 4 | CYMC; CYRB | 185/248 | 08/15→ | | | | OE246 | | BAEA068E →01/16 BAEA137E 01/16→ |
| 3.0 TDI 4WD | 6 | CZZB | 155/208 | 03/06→ | CCGP010 [71] [190] CPSG007 [23] [189] | 6.2v 4.4v | | | | |
| 3.0 TDI 4WD | 6 | CRTE; CZZA | 160/215 | 05/15→ | CCGP010 [71] [190] CPSG007 [23] [189] | 6.2v 4.4v | | | | |
| 3.0 TDI 4WD | 6 | CATA | 165/221 | 06/09→05/12 | CPSG007 [43] [212] | 4.4v | | | | |
| 3.0 TDI 4WD | 6 | CCMA | 176/236 | 11/07→08/15 | CPSG007 [43] [212] | 4.4v | | | | |

AUDI



kW/BHP

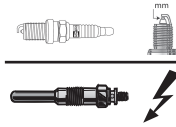

eon TITAN

IRIDIUM

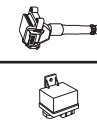

...AUDI

...Q7

| | | | | | | | | | |
|---------------------------------|----|-----------------------|---------|-------------|---|------|---------------|--------------|---|
| 3.0 TDI 4WD | 6 | CNRB | 176/236 | 11/07→08/15 | CPSG007 ^[215] →Prod.12.05.2014 | 4.4v | | | |
| | | | | | CPSG007 Prod.12.05.2014→ [26][216] | 4.4v | | | |
| | | | | | CPSG008 Prod.12.05.2014→ [24][217] | 4.4v | | | |
| 3.0 TDI 4WD | 6 | CLZB | 180/241 | 05/11→08/15 | CPSG007 ^[215] →Prod.12.05.2014 | 4.4v | | | |
| | | | | | CPSG007 Prod.12.05.2014→ [26][216] | 4.4v | | | |
| | | | | | CPSG008 Prod.12.05.2014→ [24][217] | 4.4v | | | |
| 3.0 TDI 4WD | 6 | CVMD | 183/245 | 06/15→ | CCGP010 [71][190] | 6.2v | | | |
| | | | | | CPSG007 [23][189] | 4.4v | | | |
| 3.0 TDI 4WD | 6 | CRTC | 200/268 | 06/15→ | CCGP010 [71][190] | 6.2v | | | |
| | | | | | CPSG007 [23][189] | 4.4v | | | |
| 3.0 TDI 4WD, 3.0 TDI e-tron 4WD | 6 | CUEA; CVZA; DDEA | 190/255 | 08/15→ | CCGP010 [71][190] | 6.2v | | | |
| | | | | | CPSG007 [23][189] | 4.4v | | | |
| 3.0 TFSI 4WD | 6 | CJTC; CJWC | 200/268 | 05/10→08/15 | OE214 | 0,7 | CET11P | | BAEA032E ^[13] |
| 3.0 TFSI 4WD | 6 | CJWE; CTWB | 206/276 | 05/11→08/15 | OE214 | 0,7 | CET11P | | BAEA032E ^[13] |
| 3.0 TFSI 4WD | 6 | CREC | 245/329 | 05/10→ | | | | | BAEA032E ^[13] |
| 3.0 TFSI 4WD | 6 | CJTB; CJWB; CNA; CTWA | 245/329 | 05/10→ | OE214 | 0,7 | CET11P | | BAEA032E ^[13] |
| 3.6 FSI 4WD | 6 | BHK | 206/276 | 08/06→05/10 | | | | | BAEA041E [277][324] |
| 4.2 FSI 4WD | 8 | BAR | 257/345 | 03/06→05/10 | OE209 | 0,8 | CET11P | | BAEA032E ^[13] |
| 4.2 TDI 4WD | 8 | BTR | 240/322 | 03/07→06/09 | | | | | CCU151 |
| 4.2 TDI 4WD | 8 | CCFA | 250/335 | 05/09→08/15 | | | | | CCU151 |
| R8 | | | | | | | | | |
| 4.2 FSI 4WD | 8 | BYH | 309/414 | 04/07→09/10 | OE209 | 0,8 | CET11P | | BAEA032E ^[13] |
| 4.2 FSI 4WD | 8 | CNDA | 316/424 | 07/10→07/15 | OE209 | 0,8 | CET11P | | BAEA032E ^[13] |
| 5.2 FSI 4WD | 10 | BUJ; CTYA | 386/518 | 04/09→ | OE214 | 0,7 | CET11P | | BAEA032E ^[13] |
| 5.2 FSI 4WD | 10 | CTPA | 404/542 | 05/12→07/15 | OE214 | 0,7 | CET11P | | BAEA032E ^[13] |
| 5.2 FSI 4WD | 10 | CMPA | 412/552 | 11/10→07/15 | OE214 | 0,7 | CET11P | | BAEA033E ^[7] |
| 5.2 FSI 4WD | 10 | CTPB | 419/562 | 07/14→07/15 | OE214 | 0,7 | | | BAEA032E ^[13] |
| TT | | | | | | | | | |
| 1.8 T | 4 | AUM | 110/148 | 01/01→06/06 | OE136 | 0,8 | CET12P | OE179 | BAEA043E 01/03→ BAEA043E 01/03→ Ch.8N-1-010001→ |
| 1.8 T | 4 | BVP | 120/161 | 09/05→06/06 | OE136 | 0,8 | CET12P | OE179 | BAEA043E |
| 1.8 T | 4 | ATC | 132/177 | 10/98→06/06 | OE136 | 0,8 | CET12P | OE179 | |
| 1.8 T | 4 | AJQ | 132/177 | 10/98→06/06 | OE136 | 0,8 | CET12P | OE179 | BAEA009E |
| 1.8 T | 4 | APP | 132/177 | 10/98→06/06 | OE136 | 0,8 | CET12P | OE179 | BAEA009E →09/00 Ch.8N-1-010001→ |
| | | | | | | | | | BAEA009E |
| 1.8 T | 4 | AUQ | 132/177 | 10/98→06/06 | OE136 | 0,8 | CET12P | OE179 | BAEA009E 09/00→ →Ch.8N-1-010000 |
| | | | | | | | | | BAEA043E 01/03→ |
| 1.8 T, 1.8 T 4WD | 4 | BVR | 140/188 | 09/05→06/06 | OE136 | 0,8 | CET12P | OE179 | BAEA043E |





kW/BHP

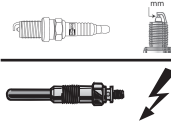

eon TITAN

IRIDIUM

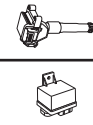
**...AUDI**

| ...TT | | | | | | | | | |
|-------------------------|---|----------------------|---------|-------------|-------------------------|------|--------|-------|--|
| 1.8 T 4WD | 4 | AJQ | 132/177 | 10/98→06/06 | OE136 | 0,8 | CET12P | OE179 | BAEA009E BAEA016 |
| 1.8 T 4WD | 4 | ARY; AUQ | 132/177 | 10/98→06/06 | OE136 | 0,8 | CET12P | OE179 | BAEA043E 01/03→ |
| 1.8 T 4WD | 4 | APX; BAM | 165/221 | 10/98→06/06 | OE136 | 0,8 | CET12P | OE179 | BAEA009E →Ch.8N-1-010000 BAEA043E Ch.8N-1-010001→ |
| 1.8 T 4WD | 4 | BFV | 176/236 | 03/05→06/06 | OE136 | 0,8 | CET12P | OE179 | BAEA043E |
| 1.8 TFSI | 4 | CDA | 118/158 | 06/08→06/14 | OE214 | 0,7 | CET11P | | BAEA033E [7] [249] [275] |
| 1.8 TFSI | 4 | CJSA; CJSB | 132/177 | 08/15→ | | | | OE246 | BAEA068E →06/16 |
| 2.0 TDI | 4 | CUNA | 135/181 | 07/14→ | CP5G007 ^[44] | 4.4v | | | CCU151 |
| 2.0 TDI 4WD | 4 | CBBB; CFGB | 125/168 | 06/08→06/14 | | | | | CCU151 |
| 2.0 TDI 4WD | 4 | CUNA | 135/181 | 01/17→ | CP5G007 ^[44] | 4.4v | | | |
| 2.0 TFSI, 2.0 TFSI 4WD | 4 | BPY; BWA; CCTA; CCZA | 147/197 | 08/06→06/10 | OE214 | 0,7 | CET11P | | BAEA033E [7] [249] [275] BAEA033E ^[7] |
| 2.0 TFSI, 2.0 TFSI 4WD | 4 | CESA; CETA | 155/208 | 05/10→06/14 | OE214 | 0,7 | CET11P | | BAEA033E [7] [249] [275] BAEA033E ^[7] |
| 2.0 TFSI, 2.0 TFSI 4WD | 4 | CHHC | 169/227 | 07/14→ | | | | OE246 | BAEA068E |
| 2.0 TFSI 4WD | 4 | BWA | 147/197 | 06/08→06/10 | OE214 | 0,7 | CET11P | | BAEA033E [7] [249] [275] |
| 2.0 TTS 4WD | 4 | CDLA; CDMA | 195/261 | 05/08→06/14 | OE214 | 0,7 | CET11P | | BAEA033E [7] [249] [275] |
| 2.0 TTS 4WD | 4 | CDLB | 200/268 | 05/08→06/14 | OE214 | 0,7 | CET11P | | BAEA033E [7] [249] [275] BAEA033E ^[7] |
| 2.0 TTS 4WD | 4 | CJXF | 210/282 | 02/15→ | | | | OE246 | BAEA068E →06/16 |
| 2.0 TTS 4WD | 4 | CJXG | 228/306 | 11/14→ | | | | OE246 | BAEA068E |
| 2.5 RS 4WD | 5 | CEPA | 250/335 | 07/09→06/14 | OE219 | 0,7 | | | BAEA033E ^[7] |
| 2.5 RS 4WD | 5 | CEPB | 265/355 | 05/11→06/14 | OE219 | 0,7 | | | BAEA033E ^[7] |
| 2.5 RS 4WD | 5 | DAZA | 294/394 | 10/16→ | | | | | BAEA137E |
| 3.2 V6 4WD, 3.2 VR6 4WD | 6 | BHE; BPF; BUB | 184/247 | 07/03→06/10 | OE215 | 0,9 | | | BAEA044E ^[356] BAEA044E [275] [356] |

V8

| | | | | | | | | | |
|---------|---|----|---------|-------------|-------|-----|------|-------|--|
| 3.6 4WD | 8 | PT | 180/241 | 04/93→02/94 | OE009 | 0,9 | CET9 | OE183 | |
|---------|---|----|---------|-------------|-------|-----|------|-------|--|

AUDI (FAW)**A3**

| | | | | | | | | | |
|-------------|---|----------------|---------|--------|--|-----|--|--|--|
| 1.4 35 TFSI | 4 | CSS; CSSA; DBW | 110/148 | 09/14→ | OE244 Prod.06.07.2015→ [218] [308] | 0,8 | | | |
|-------------|---|----------------|---------|--------|--|-----|--|--|--|

Q3

| | | | | | | | | | |
|-------------|---|-----|---------|--------|-------|-----|--|--|--|
| 1.4 30 TFSI | 4 | CSS | 110/148 | 04/14→ | OE244 | 0,8 | | | |
|-------------|---|-----|---------|--------|-------|-----|--|--|--|

BAOLONG**PEGASUS**

| | | | | | | | | | |
|-----|---|------|--------|-------------|-------|-----|------|-------|--|
| 2.0 | 4 | 4G63 | 84/113 | 12/03→12/06 | OE063 | 1,0 | CET2 | OE180 | |
| 2.4 | 4 | 4G64 | 97/130 | 12/03→12/06 | OE063 | 1,0 | CET2 | OE180 | |

BENTLEY**ARNAGE**

| | | | | | | | | | |
|----------|---|---------|---------|-------------|-------|-----|--------|-------|--|
| 6.7 V8 | 8 | L410IT | 298/400 | 09/99→08/03 | OE002 | 0,9 | CET2 | OE179 | |
| 6.7 V8 T | 8 | L410MTS | 336/451 | 02/02→10/09 | OE146 | 1,0 | CET12P | OE179 | |

BENTLEY





kW/BHP

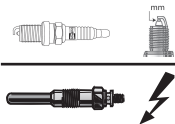

eon TITAN

IRIDIUM



...BENTLEY

AZURE

| | | | | | | | | |
|-----------------|---|----------|---------|-------------|-------|-----|------|--|
| 6.8 V8 | 8 | L410MIT | 286/384 | 09/95→08/99 | OE051 | 0,9 | CET8 | |
| 6.8 V8 | 8 | L410MIT2 | 300/402 | 08/99→06/06 | OE051 | 0,9 | CET8 | |
| 6.8 V8 Mulliner | 8 | L410MIT3 | 313/420 | 08/99→06/06 | OE051 | 0,9 | CET8 | |

CONTINENTAL

| | | | | | | | | |
|-----------------------|----|-------------------|---------|-------------|----------------|------------|----------------|---------------------------|
| 6.0 4WD | 12 | BEB; BWR | 412/552 | 06/03→ | OE051 OE136 | 0,9 0,8 | CET12P CET8 | BAEA031E ^[277] |
| 6.0 4WD | 12 | MTBHT | 412/552 | 06/03→ | OE136 | 0,8 | CET12P | BAEA031E ^[277] |
| 6.0 4WD | 12 | CKHB; CVAB | 423/567 | 11/10→ | | | | BAEA031E ^[277] |
| 6.0 4WD | 12 | BWRA; MTBHT | 449/602 | 08/07→ | | | | BAEA031E ^[277] |
| 6.0 4WD, 6.0 FLEX 4WD | 12 | BWRB; CKHA; MTBHT | 463/621 | 02/08→ | | | | BAEA031E ^[277] |
| 6.0 4WD, 6.0 FLEX 4WD | 12 | CVAC | 467/626 | 05/14→ | | | | BAEA031E ^[277] |
| 6.0 CS ISR 4WD | 12 | CKHE; CVAC | 471/632 | 03/11→ | | | | BAEA031E ^[277] |
| 6.8 V8 R | 8 | L410MIT2 | 300/402 | 08/99→10/02 | OE051 | 0,9 | CET8 | |
| 6.8 V8 S | 8 | L410MIT | 286/384 | 05/94→12/95 | OE051 | 0,9 | CET8 | |
| 6.8 V8 T Mulliner | 8 | L410MIT3 | 313/420 | 08/99→10/02 | OE051 | 0,9 | CET8 | |

CONTINENTAL FLYING SPUR

| | | | | | | | | |
|--------------|----|-----------------|---------|--------|-------|-----|------|---------------------------|
| 6.0 4WD | 12 | BEB; BWR; MTBHT | 412/552 | 03/05→ | OE051 | 0,9 | CET8 | BAEA031E ^[277] |
| 6.0 FLEX 4WD | 12 | BWRA; CKHC | 449/602 | 09/08→ | | | | BAEA031E ^[277] |
| 6.0 4WD | 12 | CVAA; DBDB | 460/617 | 03/13→ | | | | BAEA031E ^[277] |

BMW

1 (E81)

| | | | | | | | | |
|-----------|---|-------------------|---------|-------------|-------|-----|--|--|
| 1.6 116 i | 4 | N45B16A | 85/114 | 04/07→12/11 | OE120 | 0,6 | | BAEA324 →06/09 BAEA143 07/09→ |
| 1.6 116 i | 4 | N43B16A | 85/114 | 04/07→12/11 | | | | BAEA144E |
| 1.6 116 i | 4 | N43B16A; N43B16AA | 89/119 | 08/07→11/11 | | | | BAEA144E |
| 1.6 116 i | 4 | N45B16A | 90/121 | 03/07→11/11 | | | | BAEA324 →06/09 BAEA143 07/09→ |
| 1.6 116 i | 4 | N43B16A | 90/121 | 03/07→11/11 | | | | BAEA144E |
| 2.0 116 d | 4 | N47D20A; N47D20C | 66/89 | 01/11→12/11 | | | | CCU105 |
| 2.0 116 d | 4 | N47D20A; N47D20C | 85/114 | 11/08→12/11 | | | | CCU105 |
| 2.0 116 i | 4 | N43B20A | 90/121 | 11/08→12/11 | | | | BAEA144E 03/09→ |
| 2.0 118 d | 4 | N47D20A; N47D20C | 100/134 | 09/06→12/11 | | | | CCU105 |
| 2.0 118 d | 4 | N47D20A; N47D20C | 105/141 | 09/06→12/11 | | | | CCU105 |
| 2.0 118 i | 4 | N46B20B | 100/134 | 09/06→12/11 | | | | BAEA143 |
| 2.0 118 i | 4 | N43B20A | 105/141 | 09/06→12/11 | | | | BAEA144E 05/07→ |
| 2.0 120 d | 4 | N47D20A; N47D20C | 120/161 | 03/07→12/11 | | | | CCU105 |
| 2.0 120 d | 4 | N47D20A; N47D20C | 130/174 | 03/07→12/11 | | | | CCU105 |
| 2.0 120 i | 4 | N46B20B; N46B20C | 115/154 | 09/06→10/11 | | | | BAEA143 |
| 2.0 120 i | 4 | N43B20A | 120/161 | 09/06→12/11 | | | | BAEA144E 05/07→ |
| 2.0 120 i | 4 | N43B20A | 125/168 | 01/07→09/12 | | | | BAEA144E 05/07→ |
| 2.0 123 d | 4 | N47D20B; N47D20D | 150/201 | 03/07→12/11 | | | | CCU105 |
| 3.0 130 i | 6 | N52B30B; N52B30BF | 190/255 | 09/06→12/11 | OE238 | 1,0 | | |
| 3.0 130 i | 6 | N52B30A | 190/255 | 09/06→12/11 | OE238 | 1,0 | | BAEA143 09/09→ |
| 3.0 130 i | 6 | N52B30B; N52B30BF | 195/261 | 09/06→12/11 | OE238 | 1,0 | | |
| 3.0 130 i | 6 | N52B30A | 195/261 | 09/06→12/11 | OE238 | 1,0 | | BAEA143 11/07→08/09 |



kW/BHP

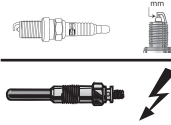

eon TITAN

IRIDIUM

**...BMW****1 Coupe (E82)**

| | | | | | | | | | |
|-----------|---|----------------------------|---------|-------------|-------|-----|--|-------|--------------------|
| 2.0 118 d | 4 | N47D20C | 100/134 | 09/09→10/13 | | | | | CCU105 |
| 2.0 118 d | 4 | N47D20C | 105/141 | 09/09→10/13 | | | | | CCU105 |
| 2.0 120 d | 4 | N47D20A; N47D20C | 120/161 | 09/07→10/13 | | | | | CCU105 |
| 2.0 120 d | 4 | N47D20A; N47D20C | 130/174 | 09/07→10/13 | | | | | CCU105 |
| 2.0 120 i | 4 | N46B20B | 115/154 | 09/09→10/13 | | | | OE188 | BAEA143 |
| 2.0 120 i | 4 | N46B20BD; N46B20C; N46B20E | 115/154 | 09/09→10/13 | | | | OE188 | |
| 2.0 120 i | 4 | N43B20A | 125/168 | 10/07→10/13 | | | | | BAEA144E →02/12 |
| 2.0 123 d | 4 | N47D20B; N47D20D | 150/201 | 10/07→10/13 | | | | | CCU105 |
| 3.0 125 i | 6 | N52B30A | 160/215 | 10/07→10/13 | OE238 | 1,0 | | | BAEA143 03/08→ |
| 3.0 128 i | 6 | N51B30A; N52B30A | 172/231 | 10/07→10/13 | | | | | BAEA143 |
| 3.0 135 i | 6 | N55B30A | 225/302 | 10/07→10/13 | OE242 | 0,8 | | | |
| 3.0 135 i | 6 | N54B30A | 225/302 | 10/07→10/13 | | | | | BAEA143 |
| 3.0 M | 6 | N54B30A | 250/335 | 04/11→06/12 | | | | | BAEA143 |

1 (E87)

| | | | | | | | | | |
|----------------------|---|--------------------------------------|---------|-------------|-------|-----|--|-------|--|
| 1.6 116 i | 4 | N45B16A | 85/114 | 11/03→06/11 | OE120 | 0,6 | | | BAEA324 →06/09 BAEA143 07/09→ |
| 1.6 116 i | 4 | N43B16A | 89/119 | 03/07→06/11 | | | | | BAEA144E |
| 1.6 116 i | 4 | N43B16A | 90/121 | 03/07→06/11 | | | | | BAEA144E |
| 2.0 116 d | 4 | N47D20C | 66/89 | 01/11→12/11 | | | | | CCU105 |
| 2.0 116 d | 4 | N47D20A | 85/114 | 12/08→09/12 | | | | | CCU105 |
| 2.0 116 i | 4 | N43B20A | 90/121 | 01/09→06/11 | | | | | BAEA144E |
| 2.0 118 d | 4 | M47D20(204D4) | 90/121 | 11/03→02/07 | | | | | CCU105 ^[48] |
| 2.0 118 d | 4 | M47 | 90/121 | 11/03→02/07 | | | | | CCU101 ^[47] |
| 2.0 118 d | 4 | M47D20(204D4) | 100/134 | 09/06→06/11 | | | | | CCU101 ^[47] |
| 2.0 118 d | 4 | N47D20A; N47D20C | 100/134 | 09/06→06/11 | | | | | CCU105 ^[48] |
| 2.0 118 d | 4 | M47D20(204D4) | 105/141 | 09/06→06/11 | | | | | CCU101 ^[47] |
| 2.0 118 d | 4 | N47D20A; N47D20C | 105/141 | 09/06→06/11 | | | | | CCU105 ^[48] |
| 2.0 118 i | 4 | N46B20B | 95/127 | 07/04→02/07 | | | | OE188 | BAEA143 |
| 2.0 118 i | 4 | N46B20B | 100/134 | 10/06→06/11 | | | | OE188 | BAEA143 03/07→ |
| 2.0 118 i | 4 | N43B20A | 105/141 | 09/06→06/11 | | | | | BAEA144E |
| 2.0 118 i, 2.0 120 i | 4 | N43B20A | 125/168 | 09/06→06/11 | | | | | BAEA144E |
| 2.0 120 d | 4 | M47D20(204D4) | 120/161 | 03/03→06/11 | | | | | CCU105 ^[48] |
| 2.0 120 d | 4 | M47 | 120/161 | 03/03→06/11 | | | | | CCU101 ^[47] |
| 2.0 120 d | 4 | N47D20A; N47D20C | 120/161 | 03/03→06/11 | | | | | CCU105 ^[48] |
| 2.0 120 d | 4 | M47 | 130/174 | 09/06→06/11 | | | | | CCU101 ^[47] |
| 2.0 120 d | 4 | N47D20A; N47D20C | 130/174 | 09/06→06/11 | | | | | CCU105 ^[48] |
| 2.0 120 i | 4 | N46B20B; N46B20BD; N46B20C; N46B20CC | 110/148 | 11/03→06/11 | | | | | BAEA143 |
| 2.0 120 i | 4 | N46B20B; N46B20BD; N46B20C; N46B20CC | 115/154 | 11/03→06/11 | | | | OE188 | BAEA143 |
| 2.0 120 i | 4 | N46B20A | 115/154 | 11/03→06/11 | | | | OE188 | |
| 2.0 120 i | 4 | N46B20CD | 115/154 | 11/03→06/11 | | | | | BAEA143 |
| 2.0 120 i | 4 | N43B20A | 120/161 | 09/06→06/11 | | | | | BAEA144E |
| 2.0 123 d | 4 | N47D20B; N47D20C; N47D20D | 150/201 | 03/07→09/12 | | | | | CCU105 |
| 3.0 130 i | 6 | N52B30A; N52B30AF; N52B30B; N52B30BF | 190/255 | 03/05→09/12 | OE238 | 1,0 | | | BAEA143 09/09→06/11 |
| 3.0 130 i | 6 | N52B30A; N52B30AF; N52B30B; N52B30BF | 195/261 | 03/05→09/12 | OE238 | 1,0 | | | BAEA145E →04/06 BAEA143 04/06→08/09 |

BMW



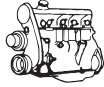

kW/BHP

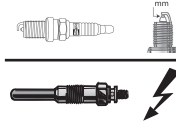

eon TITAN

IRIDIUM

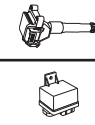

...BMW

1 Convertible (E88)

| | | | | | | | | |
|-----------|---|------------------------------|---------|---------------|-------|-----|-------|--------------------|
| 2.0 118 d | 4 | N47D20A; N47D20C | 100/134 | 09/08 → 12/13 | | | | CCU105 |
| 2.0 118 d | 4 | N47D20A; N47D20C | 105/141 | 09/08 → 12/13 | | | | CCU105 |
| 2.0 118 i | 4 | N46B20B | 100/134 | 09/08 → 12/13 | | | OE188 | BAEA143 |
| 2.0 118 i | 4 | N43B20A | 105/141 | 03/08 → 12/13 | | | | BAEA144E →02/12 |
| 2.0 120 d | 4 | N47D20A; N47D20C | 120/161 | 03/08 → 12/13 | | | | CCU105 |
| 2.0 120 d | 4 | N47D20A; N47D20C | 130/174 | 03/08 → 12/13 | | | | CCU105 |
| 2.0 120 d | 4 | N47D20C | 145/194 | 03/08 → 12/13 | | | | CCU105 |
| 2.0 120 i | 4 | N46B20B; N46B20C; N46B20E | 115/154 | 03/08 → 12/13 | | | OE188 | BAEA143 |
| 2.0 120 i | 4 | N43B20A | 120/161 | 03/08 → 12/13 | | | | BAEA144E →02/12 |
| 2.0 120 i | 4 | N43B20A | 125/168 | 03/08 → 12/13 | | | | BAEA144E →02/12 |
| 2.0 123 d | 4 | N47D20B; N47D20D | 150/201 | 09/08 → 12/13 | | | | CCU105 |
| 3.0 125 i | 6 | N52B30A | 160/215 | 03/08 → 12/13 | OE238 | 1,0 | | BAEA143 |
| 3.0 135 i | 6 | N55B30A | 225/302 | 03/08 → 12/13 | OE242 | 0,8 | | |
| 3.0 135 i | 6 | N54B30A | 225/302 | 03/08 → 12/13 | | | | BAEA143 |
| 3.0 135 i | 6 | N55B30A | 240/322 | 03/08 → 12/13 | OE242 | 0,8 | | BAEA143 |

1 (F20)

| | | | | | | | | |
|------------------------------|---|---------|---------|---------|-------|-----|--------|------------------------|
| 1.5 114 d | 3 | B37D15A | 70/94 | 06/15 → | | | | CCU106 |
| 1.5 116 d | 3 | B37D15A | 85/114 | 03/15 → | | | | CCU106 |
| 1.5 116 i | 3 | B38B15A | 80/107 | 03/15 → | | | OE245 | BAEA538 |
| 1.5 118 i | 3 | B38B15A | 100/134 | 03/15 → | | | OE245 | BAEA538 |
| 1.6 114 d | 4 | N47D16A | 70/94 | 10/12 → | | | | CCU106 |
| 1.6 114 i | 4 | N13B16A | 75/101 | 11/11 → | OE205 | 0,7 | CET16P | BAEA143 |
| 1.6 116 d | 4 | N47D16A | 85/114 | 11/12 → | | | | CCU106 ^[47] |
| 1.6 116 i | 4 | N13B16A | 100/134 | 12/10 → | OE205 | 0,7 | CET16P | BAEA143 |
| 1.6 118 i | 4 | N13B16A | 100/134 | 03/15 → | | | | BAEA143 |
| 1.6 118 i | 4 | N13B16A | 125/168 | 11/10 → | OE205 | 0,7 | CET16P | BAEA143 |
| 1.6 120 i | 4 | N13B16A | 130/174 | 03/15 → | OE205 | 0,7 | | BAEA143 |
| 2.0 116 d | 4 | N47D20C | 85/114 | 12/10 → | | | | CCU106 |
| 2.0 118 d | 4 | N47D20C | 100/134 | 12/10 → | | | | CCU106 |
| 2.0 118 d, 2.0 118 d 4WD | 4 | N47D20C | 105/141 | 12/10 → | | | | CCU106 |
| 2.0 120 d | 4 | N47D20C | 120/161 | 12/10 → | | | | CCU106 |
| 2.0 120 d, 2.0 120 d 4WD | 4 | N47D20C | 135/181 | 12/10 → | | | | CCU106 |
| 2.0 120 d, 2.0 120 d 4WD | 4 | N47D20C | 147/197 | 01/11 → | | | | CCU106 |
| 2.0 120 i | 4 | B48B20A | 135/181 | 09/15 → | | | OE245 | BAEA538 →06/17 |
| 2.0 125 d | 4 | N47D20D | 155/208 | 08/11 → | | | | CCU106 ^[47] |
| 2.0 125 d | 4 | N47D20D | 160/215 | 08/11 → | | | | CCU106 ^[47] |
| 2.0 125 i | 4 | N20B20A | 160/215 | 08/11 → | OE243 | 0,8 | | BAEA143 |
| 2.0 125 i | 4 | B48B20B | 165/221 | 09/15 → | | | OE245 | BAEA538 |
| 2.0 125 i | 4 | N20B20A | 175/235 | 03/13 → | OE243 | 0,8 | | BAEA143 |
| 3.0 M 135 i, 3.0 M 135 i 4WD | 6 | N55B30A | 235/315 | 11/11 → | OE242 | 0,8 | | BAEA143 |
| 3.0 M 135 i, 3.0 M 135 i 4WD | 6 | N55B30A | 240/322 | 03/15 → | OE242 | 0,8 | | BAEA143 |
| 3.0 M 140 i, 3.0 M 140 i 4WD | 6 | B58B30A | 250/335 | 09/15 → | | | OE245 | BAEA538 →06/17 |

1 (F21)

| | | | | | | | | |
|-----------|---|---------|---------|---------|-------|-----|--------|---------|
| 1.5 114 d | 3 | B37D15A | 70/94 | 06/15 → | | | | CCU106 |
| 1.5 116 d | 3 | B37D15A | 85/114 | 03/15 → | | | | CCU106 |
| 1.5 116 i | 3 | B38B15A | 80/107 | 03/15 → | | | OE245 | BAEA538 |
| 1.5 118 i | 3 | B38B15A | 100/134 | 03/15 → | | | OE245 | BAEA538 |
| 1.6 114 d | 4 | N47D16A | 70/94 | 07/12 → | | | | CCU106 |
| 1.6 114 i | 4 | N13B16A | 75/101 | 12/11 → | OE205 | 0,7 | CET16P | BAEA143 |

CHAMPION

BMW



kW/BHP

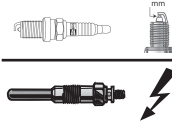

eon TITAN

IRIDIUM

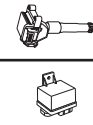
**...BMW****...1 (F21)**

| | | | | | | | | |
|------------------------------|---|---------|---------|--------|-------|-----|--------|------------------------|
| 1.6 116 d | 4 | N47D16A | 85/114 | 12/11→ | | | | CCU106 ^[47] |
| 1.6 116 i | 4 | N13B16A | 100/134 | 12/11→ | OE205 | 0,7 | CET16P | BAEA143 |
| 1.6 118 i | 4 | N13B16A | 100/134 | 03/15→ | | | | BAEA143 |
| 1.6 118 i | 4 | N13B16A | 125/168 | 07/12→ | OE205 | 0,7 | CET16P | BAEA143 |
| 1.6 120 i | 4 | N13B16A | 130/174 | 03/15→ | OE205 | 0,7 | | BAEA143 |
| 2.0 116 d | 4 | N47D20C | 85/114 | 01/12→ | | | | CCU106 |
| 2.0 118 d | 4 | N47D20C | 100/134 | 12/11→ | | | | CCU106 |
| 2.0 118 d, 2.0 118 d 4WD | 4 | N47D20C | 105/141 | 12/11→ | | | | CCU106 |
| 2.0 120 d | 4 | N47D20C | 120/161 | 07/12→ | | | | CCU106 |
| 2.0 120 d, 2.0 120 d 4WD | 4 | N47D20C | 135/181 | 02/12→ | | | | CCU106 |
| 2.0 120 d, 2.0 120 d 4WD | 4 | N47D20C | 147/197 | 01/12→ | | | | CCU106 |
| 2.0 120 i | 4 | B48B20B | 135/181 | 10/15→ | | | OE245 | BAEA538 →06/17 |
| 2.0 125 d | 4 | N47D20D | 155/208 | 12/11→ | | | | CCU106 ^[47] |
| 2.0 125 d | 4 | N47D20D | 160/215 | 12/11→ | | | | CCU106 ^[47] |
| 2.0 125 i | 4 | N20B20A | 160/215 | 12/11→ | OE243 | 0,8 | | BAEA143 |
| 2.0 125 i | 4 | B48B20B | 165/221 | 10/15→ | | | OE245 | BAEA538 →06/17 |
| 2.0 125 i | 4 | N20B20A | 175/235 | 03/13→ | OE243 | 0,8 | | BAEA143 |
| 3.0 M 135 i, 3.0 M 135 i 4WD | 6 | N55B30A | 235/315 | 12/11→ | OE242 | 0,8 | | BAEA143 |
| 3.0 M 135 i, 3.0 M 135 i 4WD | 6 | N55B30A | 240/322 | 03/15→ | OE242 | 0,8 | | BAEA143 |
| 3.0 M 140 i, 3.0 M 140 i 4WD | 6 | B58B30A | 250/335 | 09/15→ | | | OE245 | BAEA538 →06/17 |

2 Active Tourer (F45)

| | | | | | | | | |
|---------------------------|---|---------|---------|-------------|--|--|-------|---------|
| 1.5 216 i | 3 | B38A15A | 75/101 | 02/15→02/18 | | | OE245 | BAEA538 |
| 1.5 218 i, 1.5 225 xe 4WD | 3 | B38A15A | 100/134 | 11/13→ | | | OE245 | BAEA538 |
| 1.5 225 xe 4WD | 3 | B38A15A | 165/221 | 11/14→ | | | OE245 | BAEA538 |
| 2.0 220 i | 4 | B48A20A | 141/189 | 03/14→ | | | OE245 | BAEA538 |
| 2.0 225 i, 2.0 225 i 4WD | 4 | B48A20B | 170/228 | 11/13→ | | | OE245 | BAEA538 |

2 Coupe (F22, F87)

| | | | | | | | | |
|------------------------------|---|------------------|---------|-------------|-------|-----|-------|-------------------|
| 1.5 218 i | 3 | B38B15A | 100/134 | 03/15→ | | | OE245 | BAEA538 |
| 2.0 218 d | 4 | N47D20C | 105/141 | 01/14→ | | | | CCU106 |
| 2.0 220 d | 4 | N47D20C | 135/181 | 10/12→11/14 | | | | CCU106 |
| 2.0 220 d | 4 | N47D20C | 147/197 | 10/12→11/14 | | | | CCU106 |
| 2.0 220 i | 4 | N20B20B | 135/181 | 10/13→ | OE243 | 0,8 | | BAEA143 |
| 2.0 220 i | 4 | B48B20A | 135/181 | 10/13→ | | | OE245 | BAEA538 →06/17 |
| 2.0 225 d | 4 | N47D20D | 160/215 | 01/14→ | | | | CCU106 |
| 2.0 228 i | 4 | N20B20A; N26B20A | 180/241 | 07/14→ | OE243 | 0,8 | | BAEA143 |
| 2.0 230 i | 4 | B48B20B | 185/248 | 09/15→ | | | OE245 | BAEA538 →06/17 |
| 3.0 M 235 i, 3.0 M 235 i 4WD | 6 | N55B30A | 240/322 | 10/13→ | OE242 | 0,8 | | BAEA143 |
| 3.0 M 240 i | 6 | B58B30A | 250/335 | 09/15→ | | | | BAEA538 →06/17 |
| 3.0 M 240 i 4WD | 6 | B58B30A | 250/335 | 09/15→ | | | OE245 | BAEA538 →06/17 |

2 Convertible (F23)

| | | | | | | | | |
|------------------------------|---|---------|---------|--------|-------|-----|-------|-------------------|
| 1.5 218 i | 3 | B38B15A | 100/134 | 03/15→ | | | OE245 | BAEA538 |
| 2.0 220 i | 4 | N20B20B | 135/181 | 04/14→ | OE243 | 0,8 | | |
| 2.0 220 i | 4 | B48B20A | 135/181 | 04/14→ | | | OE245 | BAEA538 →06/17 |
| 2.0 228 i | 4 | N20B20A | 180/241 | 11/14→ | OE243 | 0,8 | | |
| 2.0 230 i | 4 | B48B20B | 185/248 | 09/15→ | | | OE245 | BAEA538 →06/17 |
| 3.0 M 235 i, 3.0 M 235 i 4WD | 6 | N55B30A | 240/322 | 11/14→ | OE242 | 0,8 | | |
| 3.0 M 240 i, 3.0 M 240 i 4WD | 6 | B58B30A | 250/335 | 09/15→ | | | OE245 | BAEA538 →06/17 |

BMW



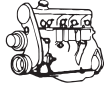

kW/BHP

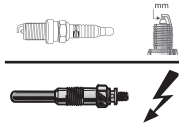

eon TITAN

IRIDIUM

**...BMW****2 Gran Tourer (F46)**

| | | | | | | | | | |
|-----------|---|---------|---------|-------------|--|--|--|-------|---------|
| 1.5 216 i | 3 | B38A15A | 75/101 | 09/14→02/18 | | | | OE245 | BAEA538 |
| 1.5 218 i | 3 | B38A15A | 100/134 | 07/14→ | | | | OE245 | BAEA538 |
| 2.0 220 i | 4 | B48A20A | 141/189 | 07/14→ | | | | OE245 | BAEA538 |

3 (E36)

| | | | | | | | | | | |
|------------|---|---------------|---------|-------------|-----------------|-----|------|-------|-------------------|--------|
| 1.8 318 is | 4 | M42B18(184S1) | 103/138 | 03/93→02/98 | OE026 | 0,9 | CET2 | OE188 | BAEA014 →09/93 | CLS036 |
| | | | | | OE216 LPG [278] | 0,8 | | | BAEA307 | |

3 /Compact/Convertible/Coupe/Touring (E36)

| | | | | | | | | | |
|-----------------------|---|---------------|---------|-------------|-----------------|-----|------|-------|---------|
| 2.0 320 i | 6 | M52B20(206S3) | 110/148 | 01/95→10/99 | OE026 | 0,9 | CET2 | OE188 | BAEA302 |
| | | | | | OE216 LPG [278] | 0,8 | | | |
| 2.5 323 i, 2.5 323 ti | 6 | M52B25(256S3) | 125/168 | 03/95→08/00 | OE026 | 0,9 | CET2 | OE188 | BAEA302 |
| | | | | | OE216 LPG [278] | 0,8 | | | |
| 2.8 328 i | 6 | M52B28(286S1) | 142/190 | 08/94→12/99 | OE026 | 0,9 | CET2 | OE188 | BAEA302 |
| | | | | | OE216 LPG [278] | 0,8 | | | |

3 /Compact/Coupe (E36)

| | | | | | | | | | | |
|------------------------|---|---------------|---------|-------------|-----------------|-----|------|-------|---------|--------|
| 1.8 318 ti | 4 | M42B18(184S1) | 103/138 | 11/94→08/95 | OE026 | 0,9 | CET2 | OE188 | BAEA307 | CLS036 |
| | | | | | OE216 LPG [278] | 0,8 | | | | |
| 1.9 318 is, 1.9 318 ti | 4 | M44B19(194S1) | 103/138 | 07/95→08/00 | OE026 | 0,9 | CET2 | OE188 | BAEA307 | CLS036 |
| | | | | | OE216 LPG [278] | 0,8 | | | | |

3 /Compact/Touring (E36)

| | | | | | | | | | |
|-------------|---|---------------|---------|-------------|-------|-----|--|--|--|
| 1.7 318 ids | 4 | M41D17(174T1) | 66/89 | 03/94→05/01 | CH189 | 11v | | | |
| 2.5 325 ids | 6 | M51D25(256T1) | 105/141 | 05/93→10/99 | CH189 | 11v | | | |

3 /Convertible/Coupe (E36)

| | | | | | | | | | |
|--------------------|---|---------------|---------|-------------|--|--|--------|-------|---------|
| 3.0 M3 | 6 | S50B30(306S1) | 217/291 | 01/95→10/95 | | | CET10P | OE187 | BAEA014 |
| 3.2 M3, 3.2 M3 3.2 | 6 | S50B32(326S1) | 236/316 | 09/95→04/99 | | | CET10P | OE187 | BAEA302 |

3 /Convertible/Touring (E36)

| | | | | | | | | | | |
|-----------|---|---------------|--------|-------------|-----------------|-----|------|-------|---------|--------|
| 1.8 318 i | 4 | M43B18(184E2) | 85/114 | 10/93→10/99 | OE026 | 0,9 | CET2 | OE188 | BAEA307 | CLS054 |
| | | | | | OE216 LPG [278] | 0,8 | | | | |

3 Compact (E36)

| | | | | | | | | | | |
|-----------|---|---------------|--------|-------------|-------|-----|--------|-------|---------|--------|
| 1.9 316 i | 4 | M43B19(194E1) | 77/103 | 12/98→08/00 | OE223 | 1,6 | CET12P | OE188 | BAEA307 | CLS054 |
|-----------|---|---------------|--------|-------------|-------|-----|--------|-------|---------|--------|

3 Convertible (E36)

| | | | | | | | | | |
|-----------|---|---------------|---------|-------------|-----------------|-----|------|-------|---------|
| 2.5 325 i | 6 | M50B25(256S2) | 141/189 | 03/93→12/95 | OE026 | 0,9 | CET2 | OE188 | BAEA014 |
| | | | | | OE216 LPG [278] | 0,8 | | | |

3 (E46)

| | | | | | | | | | |
|-----------|---|---------------|---------|-------------|------------|-----|--|--|--------------|
| 2.0 318 d | 4 | M47D20(204D1) | 85/114 | 09/01→02/05 | CH203 | 11v | | | |
| 2.0 318 d | 4 | M47N | 85/114 | 09/01→02/05 | | | | | CCU101 |
| 2.0 320 d | 4 | M47D20(204D1) | 95/127 | 02/98→08/01 | CH203 [93] | 11v | | | CCU101 [334] |
| 2.0 320 d | 4 | M47D20(204D1) | 100/134 | 04/98→09/01 | CH203 | 11v | | | |

3 /Compact (E46)

| | | | | | | | | | |
|-----------------------|---|---------|--------|-------------|-------|-----|--------|-------|---------|
| 1.6 316 i, 1.6 316 ti | 4 | N40B16A | 85/114 | 06/02→02/05 | OE223 | 1,6 | CET12P | OE188 | BAEA324 |
| 1.6 316 ti | 4 | N40B16A | 77/103 | 06/02→02/05 | OE223 | 1,6 | CET12P | OE188 | BAEA324 |

3 /Compact/Convertible/Coupe/Touring (E46)

| | | | | | | | | | |
|-------------------------------------|---|------------------|---------|-------------|-------|-----|--------|-------|--|
| 1.6 316 Ci, 1.6 316 i, 1.6 316 4 ti | | N45B16A | 85/114 | 06/02→07/06 | | | CET12P | OE188 | BAEA143 |
| 1.8 316 i, 1.8 316 ti | 4 | N46B18A | 85/114 | 06/01→02/05 | | | CET12P | OE188 | BAEA143 |
| 2.0 318 Ci | 4 | N46B20A; N46B20B | 110/148 | 02/05→12/07 | | | CET12P | OE188 | BAEA143 |
| 2.0 318 Ci, 2.0 318 i, 2.0 318 4 ti | 4 | N42B20A | 105/141 | 12/00→12/07 | OE223 | 1,6 | CET12P | OE188 | BAEA324 →03/03 BAEA143 03/03→ |
| 2.0 318 Ci, 2.0 318 i, 2.0 318 4 ti | 4 | N46B20A; N46B20C | 105/141 | 12/00→12/07 | | | CET12P | OE188 | BAEA143 03/03→ |





kW/BHP

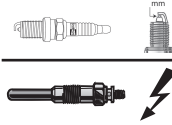

eon TITAN

IRIDIUM

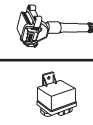
**...BMW****...3 /Compact/Convertible/Coupe/Touring (E46)**

| | | | | | | | | | | |
|---|---|---------------------------------|---------|-------------|-------|-----|--------|-------|---|--------|
| 2.0 318 Ci, 2.0 318 ti | 4 | N42B20A | 100/134 | 12/00→08/06 | OE223 | 1,6 | CET12P | OE188 | BAEA324 →03/03 BAEA143 03/03→ | |
| 2.2 320 Ci, 2.2 320 i | 6 | M54B22(226S1) | 120/161 | 01/00→05/06 | OE223 | 1,6 | CET12P | OE188 | BAEA302 →09/02 BAEA143 09/02→ BAEA324 09/02→ | |
| 2.2 320 Ci, 2.2 320 i | 6 | M54B22(226S1) | 125/168 | 01/00→12/07 | OE223 | 1,6 | CET12P | OE188 | BAEA302 →09/02 BAEA143 09/02→ BAEA324 09/02→ | |
| 2.5 325 Ci, 2.5 325 i, 2.5 325 xi 4WD | 6 | M54B25(256S5) | 137/184 | 09/00→12/06 | OE223 | 1,6 | CET12P | OE188 | BAEA302 →09/02 BAEA143 09/02→ BAEA324 09/02→ | |
| 2.5 325 Ci, 2.5 325 i, 2.5 325 xi 4WD, 2.5 325 ti | 6 | M54B25(256S5) | 141/189 | 09/00→12/07 | OE223 | 1,6 | CET12P | OE188 | BAEA302 →09/02 BAEA143 09/02→ BAEA324 09/02→ | |
| 3.0 330 Ci, 3.0 330 i | 6 | M54B30(306S3) | 168/225 | 06/00→12/06 | OE223 | 1,6 | CET12P | OE188 | BAEA302 →09/02 BAEA143 09/02→ BAEA324 09/02→ | |
| 3.0 330 Ci, 3.0 330 i, 3.0 330 xi 4WD | 6 | M54B30(306S3) | 170/228 | 06/00→12/07 | OE223 | 1,6 | CET12P | OE188 | BAEA302 →09/02 BAEA143 09/02→ BAEA324 09/02→ | |
| 3 /Compact/Coupe (E46) | | | | | | | | | | |
| 2.0 318 td | 4 | M47D20(204D4) | 85/114 | 03/03→02/05 | | | | | CCU101 →09/04 | |
| 2.0 320 Cd, 2.0 320 d | 4 | M47D20(204D4) | 110/148 | 09/01→07/06 | | | | | CCU101 →09/04 | |
| 3 /Compact/Touring (E46) | | | | | | | | | | |
| 1.8 316 i, 1.8 316 ti | 4 | N42B18A | 85/114 | 06/01→02/05 | OE223 | 1,6 | CET12P | OE188 | BAEA143 BAEA324 | |
| 2.0 318 i | 4 | N42B20A | 100/134 | 09/01→02/05 | OE223 | 1,6 | CET12P | OE188 | BAEA143 BAEA324 | |
| 3.0 330 xi 4WD | 6 | M54B30(306S3) | 168/225 | 09/04→04/05 | OE223 | 1,6 | CET12P | OE188 | BAEA143 BAEA324 | |
| 3 /Convertible/Coupe/Touring (E46) | | | | | | | | | | |
| 2.0 320 Ci, 2.0 320 i | 6 | M52B20(206S4) | 110/148 | 03/98→08/01 | OE223 | 1,6 | CET12P | OE188 | BAEA302 | |
| 2.5 323 Ci, 2.5 323 i | 6 | M52B25(256S4) | 120/161 | 03/98→09/00 | OE223 | 1,6 | CET12P | OE188 | BAEA302 | |
| 2.5 323 Ci, 2.5 323 i | 6 | M52B25(256S3); M52B25(256S4) | 125/168 | 03/98→12/00 | OE223 | 1,6 | CET12P | OE188 | BAEA302 | |
| 2.5 323 i | 6 | M52B25(256S4) | 127/170 | 04/99→12/00 | OE223 | 1,6 | CET12P | OE188 | BAEA302 | |
| 2.8 328 Ci, 2.8 328 i | 6 | M52B28(286S2) | 142/190 | 02/98→06/00 | OE223 | 1,6 | CET12P | OE188 | BAEA302 | |
| 2.8 328 i | 6 | M52B28(286S2) | 144/193 | 09/98→12/00 | OE223 | 1,6 | CET12P | OE188 | BAEA302 | |
| 3 /Coupe/Touring (E46) | | | | | | | | | | |
| 1.6 316 Ci, 1.6 316 i | 4 | M43B16(164E3) | 77/103 | 04/00→07/06 | OE223 | 1,6 | CET12P | OE188 | BAEA307 | CLS054 |

BMW



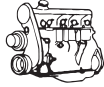

kW/BHP

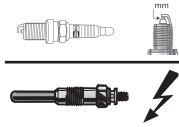

eon TITAN

IRIDIUM

**...BMW****...3 /Coupe/Touring (E46)**

| | | | | | | | | | | |
|-----------------------|---|---------------|--------|--------------|-------|-----|--------|-------|---------|--------|
| 1.9 316 i | 4 | M43B19(194E1) | 77/103 | 09/98 →02/05 | OE223 | 1,6 | CET12P | OE188 | BAEA307 | CLS054 |
| 1.9 318 Ci, 1.9 318 i | 4 | M43B19(194E1) | 85/114 | 10/99 →09/01 | OE223 | 1,6 | CET12P | OE188 | BAEA307 | CLS054 |
| 1.9 318 Ci, 1.9 318 i | 4 | M43B19(194E1) | 87/117 | 02/98 →09/01 | OE223 | 1,6 | CET12P | OE188 | BAEA307 | CLS054 |

3 /Touring (E46)

| | | | | | | | | | | |
|---------------------------|---|---------------|---------|--------------|-------|-----|--|--|-------------------------|--|
| 3.0 330 d, 3.0 330 xd 4WD | 6 | M57D30(306D1) | 135/181 | 10/99 →02/05 | CH203 | 11v | | | CCU102 ^[336] | |
| 3.0 330 d, 3.0 330 xd 4WD | 6 | M57D30(306D2) | 150/201 | 08/02 →05/05 | | | | | CCU102 ^[336] | |

3 Compact/Convertible (E46)

| | | | | | | | | | | |
|------------------------|---|---------------|---------|--------------|--|--|--|--|--------|--|
| 2.0 320 Cd, 2.0 320 td | 4 | M47D20(204D4) | 110/148 | 09/01 →12/07 | | | | | CCU101 | |
|------------------------|---|---------------|---------|--------------|--|--|--|--|--------|--|

3 Compact/Convertible/Coupe (E46)

| | | | | | | | | | | |
|------------------------|---|---------|---------|--------------|--|--|--------|-------|---|--|
| 2.0 318 Ci, 2.0 318 ti | 4 | N46B20A | 100/134 | 12/00 →08/06 | | | CET12P | OE188 | BAEA324 →03/03 BAEA143 03/03 → | |
|------------------------|---|---------|---------|--------------|--|--|--------|-------|---|--|

3 Convertible (E46)

| | | | | | | | | | | |
|------------|---|---------------|---------|--------------|-------|-----|--------|-------|---------|--|
| 2.2 320 Ci | 6 | M54B22(226S1) | 120/161 | 01/06 →12/07 | OE223 | 1,6 | CET12P | OE188 | BAEA143 | |
|------------|---|---------------|---------|--------------|-------|-----|--------|-------|---------|--|

3 Convertible/Coupe (E46)

| | | | | | | | | | | |
|--------------------|---|---------------|---------|--------------|--|--|--------|-------|--------------------|--|
| 3.0 330 Cd | 6 | M57D30(306D2) | 150/201 | 03/03 →12/07 | | | | | CCU102 | |
| 3.2 M3 | 6 | S54B32(326S4) | 235/315 | 09/00 →12/06 | | | CET10P | OE187 | BAEA143 BAEA324 | |
| 3.2 M3 | 6 | S54B32(326S4) | 248/333 | 09/00 →12/06 | | | CET10P | OE187 | BAEA143 BAEA324 | |
| 3.2 M3 | 6 | S54B32(326S4) | 265/355 | 06/03 →07/06 | | | CET10P | OE187 | BAEA143 BAEA324 | |
| 3.2 M3, 3.2 M3 3.2 | 6 | S54B32(326S4) | 252/338 | 06/00 →12/07 | | | CET10P | OE187 | BAEA143 BAEA324 | |

3 Touring (E46)

| | | | | | | | | | | |
|-----------|---|---------------|---------|--------------|------------------------|-----|--|--|-------------------------|--|
| 2.0 318 d | 4 | M47D20(204D4) | 85/114 | 10/02 →02/05 | | | | | CCU101 ^[334] | |
| 2.0 318 d | 4 | M47D20(204D1) | 85/114 | 10/02 →02/05 | CH203 ^[333] | 11v | | | CCU101 ^[334] | |
| 2.0 320 d | 4 | M47D20(204D1) | 100/134 | 03/00 →09/01 | CH203 ^[333] | 11v | | | | |
| 2.0 320 d | 4 | M47D20(204D4) | 110/148 | 09/01 →02/05 | | | | | CCU101 ^[334] | |

3 (E90)

| | | | | | | | | | | |
|-----------|---|-------------------|---------|--------------|-----------------------------------|------|--------|-------|-----------------------------|--|
| 1.6 316 i | 4 | N45B16A; N45B16AC | 85/114 | 09/05 →10/11 | | | | OE188 | BAEA143 | |
| 1.6 316 i | 4 | N43B16A; N43B16AA | 90/121 | 09/07 →10/11 | | | | | BAEA144E | |
| 2.0 316 d | 4 | N47D20C | 85/114 | 07/09 →12/11 | CCGP001 ^{[92][240][344]} | 5.4v | | | CCU105 ^[343] | |
| | | | | | | | | | CCU106 ^{[48][344]} | |
| 2.0 318 d | 4 | M47D20(204D4) | 90/121 | 03/05 →08/07 | | | | | CCU101 | |
| 2.0 318 d | 4 | N47D20A | 100/134 | 02/07 →03/10 | CCGP001 ^{[92][240][344]} | 5.4v | | | CCU105 ^[343] | |
| | | | | | | | | | CCU106 ^{[48][344]} | |
| 2.0 318 d | 4 | N47D20A; N47D20C | 105/141 | 02/07 →10/11 | CCGP001 ^{[92][240][344]} | 5.4v | | | CCU105 ^[343] | |
| | | | | | | | | | CCU106 ^{[48][344]} | |
| 2.0 318 i | 4 | N46B20B | 95/127 | 03/05 →08/07 | OE216 ^{LPG [278]} | 0,8 | CET12P | OE188 | BAEA143 | |
| 2.0 318 i | 4 | N46B20B | 100/134 | 03/07 →10/11 | | | | | BAEA143 ^[275] | |
| 2.0 318 i | 4 | N43B20A | 105/141 | 02/07 →10/11 | | | | | BAEA144E | |
| 2.0 320 d | 4 | M47D20(204D4) | 110/148 | 12/04 →09/07 | | | | | CCU101 | |
| 2.0 320 d | 4 | M47D20(204D4) | 115/154 | 12/04 →09/07 | | | | | CCU101 | |
| 2.0 320 d | 4 | M47D20(204D4) | 120/161 | 12/04 →12/11 | | | | | CCU101 ^[333] | |
| 2.0 320 d | 4 | N47D20C | 120/161 | 12/04 →12/11 | | | | | CCU105 ^[343] | |
| | | | | | | | | | CCU106 ^{[48][344]} | |

CHAMPION

BMW



kW/BHP

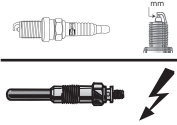

eon TITAN

IRIDIUM

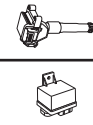
**...BMW****...3 (E90)**

| | | | | | | | | | |
|--|---|---|---------|-------------|----------------------------|-----|--------|-------|--|
| 2.0 320 d, 2.0 320 d 4WD | 4 | N47D20A; N47D20C | 130/174 | 09/07→03/10 | | | | | CCU105 ^[343] CCU106 ^{[48] [344]} |
| 2.0 320 d, 2.0 320 d 4WD | 4 | N47D20C | 135/181 | 03/10→12/11 | | | | | CCU105 ^[343] CCU106 ^{[48] [344]} |
| 2.0 320 d 4WD | 4 | N47D20C | 120/161 | 09/08→10/11 | | | | | CCU105 ^{[48] [343]} CCU106 ^{[48] [344]} |
| 2.0 320 i | 4 | N46B20B; N46B20BD; N46B20C; N46B20CB | 110/148 | 06/04→09/07 | OE216 ^{UPG [278]} | 0,8 | CET12P | OE188 | BAEA143 ^[247] BAEA324 |
| 2.0 320 i | 4 | N46B20B; N46B20C; N46B20CC; N46B20CD; N46B20E | 115/154 | 02/07→12/11 | | | | | BAEA143 ^[247] BAEA324 |
| 2.0 320 i | 4 | N43B20A | 125/168 | 03/07→12/11 | | | | | BAEA144E |
| 2.0 320 si | 4 | N45B20A | 127/170 | 09/05→08/06 | | | | | BAEA143 ^[247] BAEA324 |
| 2.0 320 xd 4WD | 4 | | 130/174 | 09/07→12/11 | | | | | CCU105 ^{[48] [343]} CCU106 ^{[48] [344]} |
| 2.5 323 i | 6 | N52B25A; N52B25B; N52B25BE; N52B25BF | 130/174 | 09/05→02/07 | OE238 | 1,0 | | | BAEA145E →04/06 |
| 2.5 323 i | 6 | N52B25A; N52B25BF | 140/188 | 03/07→12/11 | OE238 | 1,0 | | | BAEA143 |
| 2.5 325 i | 6 | N52B25A | 155/208 | 01/06→12/11 | OE238 | 1,0 | | | BAEA143 05/06→ |
| 2.5 325 i | 6 | N52B25A; N52B25B; N52B25BF | 160/215 | 01/05→10/11 | OE238 | 1,0 | | | BAEA145E →04/06 BAEA143 05/06→ |
| 2.5 325 xi 4WD | 6 | N52B25A | 160/215 | 03/05→10/11 | OE238 | 1,0 | | | BAEA145E 09/05→04/06 BAEA143 04/06→ |
| 3.0 325 d | 6 | M57D30(306D3) | 145/194 | 09/06→02/10 | | | | | CCU102 |
| 3.0 325 d | 6 | N57D30A | 150/201 | 03/10→10/11 | | | | | CCU108 |
| 3.0 325 i, 3.0 325 i 4WD | 6 | N53B30A | 160/215 | 03/07→12/11 | | | | | BAEA144E |
| 3.0 325 xi 4WD | 6 | N53B30A | 160/215 | 03/07→06/08 | | | | | BAEA144E ^[242] |
| 3.0 328 i 4WD | 6 | N51B30A; N52B30A | 172/231 | 09/08→12/10 | | | | | BAEA143 |
| 3.0 330 d | 6 | M57D30(306D3) | 155/208 | 09/05→12/11 | | | | | CCU102 ^[47] |
| 3.0 330 d | 6 | N57D30A | 155/208 | 09/05→12/11 | | | | | CCU108 ^[48] |
| 3.0 330 d | 6 | M57D30(306D3) | 170/228 | 09/05→09/08 | | | | | CCU102 |
| 3.0 330 d, 3.0 330 d 4WD | 6 | N57D30A | 180/241 | 09/08→12/11 | | | | | CCU108 |
| 3.0 330 i, 3.0 330 i 4WD, 3.0 330 xi 4WD | 6 | N53B30A | 200/268 | 09/07→12/11 | | | | | BAEA144E |
| 3.0 330 i, 3.0 330 xi 4WD | 6 | N52B30A; N52B30B; N52B30BF | 190/255 | 12/04→08/07 | OE238 | 1,0 | | | BAEA145E →04/06 BAEA143 05/06→ |
| 3.0 330 xd 4WD | 6 | M57D30(306D3) | 170/228 | 09/05→08/08 | | | | | CCU102 |
| 3.0 335 d | 6 | M57D30(306D5) | 210/282 | 09/06→12/11 | | | | | CCU102 |
| 3.0 335 i | 6 | N55B30A | 220/295 | 03/06→12/11 | OE242 | 0,8 | | | |
| 3.0 335 i | 6 | N54B30A | 220/295 | 03/06→12/11 | OE242 | 0,8 | | | BAEA143 |
| 3.0 335 i | 6 | N54B30A | 224/300 | 03/06→12/11 | OE242 | 0,8 | | | BAEA143 |
| 3.0 335 i, 3.0 335 i 4WD, 3.0 335 xi 4WD | 6 | N55B30A | 225/302 | 03/06→12/11 | OE242 | 0,8 | | | |
| 3.0 335 i, 3.0 335 i 4WD, 3.0 335 xi 4WD | 6 | N54B30A | 225/302 | 03/06→12/11 | | | | | BAEA143 |

BMW





kW/BHP



eon TITAN

IRIDIUM

**...BMW****...3 (E90)**

3.0 335 i 4WD, 3.0 335 xi 4WD 6 N54B30A 224/300 09/06 → 10/11

BAEA143

3 Touring (E91)

1.6 316 i 4 N43B16A 90/121 05/08 → 05/12

BAEA144E
09/08 → 02/12

2.0 316 d 4 N47D20C 85/114 09/09 → 06/12 CCGP001 → 02/11 [92] [240] 5.4v

CCU106 [48]

2.0 318 d 4 M47D20(204D4) 90/121 09/05 → 08/07

CCU101

2.0 318 d 4 N47D20C 100/134 07/07 → 06/12 CCGP001 → 02/11 [92] [240] 5.4v

CCU105 [343]

CCU106
[48] [344]

2.0 318 d 4 N47D20A; N47D20C 105/141 09/07 → 06/12 CCGP001 [92] [240] [344] 5.4v

CCU105 [343]

CCU106
[48] [344]

2.0 318 i 4 N46B20B 95/127 01/06 → 08/07 OE216 LPG [278] 0,8 CET12P OE188 BAEA143 [247]

2.0 318 i 4 N46B20B 100/134 09/07 → 03/12 OE188 BAEA143

2.0 318 i 4 N43B20A 105/141 05/07 → 05/12 BAEA144E → 02/12

2.0 320 d 4 M47N204D4 110/148 12/04 → 08/07 CCU101

2.0 320 d 4 M47D20(204D4) 120/161 12/04 → 06/12 CCU101 [333]

2.0 320 d 4 N47D20C 120/161 12/04 → 06/12 CCU105 [343]

2.0 320 d, 2.0 320 d 4WD 4 N47D20A; N47D20C 130/174 02/07 → 12/10 CCU105 [343]

CCU106
[48] [344]

2.0 320 d, 2.0 320 d 4WD 4 N47D20C 135/181 03/10 → 05/12 CCU105 [343]

CCU106
[48] [344]

2.0 320 d, 2.0 320 d 4WD 4 N47D20A; N47D20C 145/194 02/07 → 02/10 CCU106 [48]

2.0 320 d, 2.0 320 d 4WD 4 N47D20C 147/197 03/10 → 05/12 CCU106 [48]

2.0 320 d 4WD 4 N47D20C 120/161 07/09 → 06/12 CCU105 [343]

CCU106
[48] [344]

2.0 320 d ed 4 120/161 10/10 → 05/12 CCU106 [48]

2.0 320 i 4 N46B20B; N46B20C 110/148 09/05 → 06/12 OE216 LPG [278] 0,8 CET12P OE188 BAEA143 [247]

2.0 320 i 4 N46B20B; N46B20BD; N46B20C 115/154 09/05 → 06/12 BAEA144E

2.0 320 i 4 N43B20A 125/168 02/07 → 12/12 BAEA144E → 02/12

2.5 323 i 6 N52B25A 130/174 04/06 → 06/07 OE238 1,0 BAEA143

2.5 323 i 6 N52B25A 140/188 09/06 → 07/08 OE238 1,0 BAEA143

2.5 325 i 6 N52B25A 160/215 12/04 → 12/12 OE238 1,0 BAEA145E → 04/06

BAEA143
11/07 →

2.5 325 xi 4WD 6 N52B25A 160/215 08/05 → 08/11 OE238 1,0 BAEA145E → 06/06

BAEA143
05/06 →

3.0 325 d 6 M57306D3 145/194 09/06 → 06/12 CCU102

3.0 325 d 6 N57D30A 150/201 02/10 → 06/12 CCU108

3.0 325 i 6 N53B30A 155/208 09/07 → 06/12 BAEA144E

3.0 325 i, 3.0 325 i 4WD 6 N53B30A 160/215 09/07 → 06/12 BAEA144E → 02/12

3.0 325 xi 4WD 6 N53B30A 160/215 09/07 → 06/12 BAEA144E → 08/08

3.0 330 d 6 M57D30(306D3) 155/208 12/04 → 05/12 CCU102 [47]

3.0 330 d 6 N57D30A 155/208 12/04 → 05/12 CCU108 [48]

3.0 330 d 6 M57D30(306D3) 170/228 12/04 → 08/08 CCU102

BMW





kW/BHP

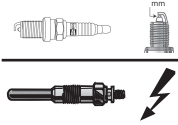

eon TITAN

IRIDIUM



...BMW

...3 Touring (E91)

| | | | | | | | | | | |
|--|---|---------------|---------|---------------|-------|-----|--|--|--|--------------------|
| 3.0 330 d, 3.0 330 d 4WD | 6 | N57D30A | 180/241 | 02/08 → 06/12 | | | | | | CCU108 |
| 3.0 330 i, 3.0 330 i 4WD | 6 | N53B30A | 200/268 | 09/07 → 06/12 | | | | | | BAEA144E →02/12 |
| 3.0 330 i, 3.0 330 xi 4WD | 6 | N52B30A | 190/255 | 08/05 → 08/07 | OE238 | 1,0 | | | | BAEA145E →04/06 |
| 3.0 330 xi 4WD | 6 | N53B30A | 200/268 | 09/07 → 06/12 | | | | | | BAEA144E →08/08 |
| 3.0 330 xd 4WD | 6 | M57D30(306D3) | 170/228 | 09/05 → 06/12 | | | | | | CCU102 |
| 3.0 335 d | 6 | M57D30(306D5) | 210/282 | 09/06 → 06/12 | | | | | | CCU102 |
| 3.0 335 i, 3.0 335 i 4WD, 3.0 335 xi 4WD | 6 | N55B30A | 225/302 | 09/06 → 06/12 | OE242 | 0,8 | | | | |
| 3.0 335 i, 3.0 335 i 4WD, 3.0 335 xi 4WD | 6 | N54B30A | 225/302 | 09/06 → 06/12 | | | | | | BAEA143 |

3 Coupe (E92)

| | | | | | | | | | | |
|--|---|--------------------------------------|---------|---------------|----------------------------|-----|--------|-------|--|--|
| 1.6 316 i | 4 | N43B16A | 90/121 | 09/07 → 12/13 | | | | | | BAEA144E |
| 2.0 318 i | 4 | N43B20A | 105/141 | 03/10 → 12/13 | | | | | | BAEA144E →02/12 |
| 2.0 320 d | 4 | N47D20A; N47D20C | 120/161 | 03/07 → 06/13 | | | | | | CCU105 ^[47] CCU106 ^[48] |
| 2.0 320 d, 2.0 320 d 4WD | 4 | N47D20C | 135/181 | 03/10 → 06/13 | | | | | | CCU106 ^[48] |
| 2.0 320 d, 2.0 320 d 4WD | 4 | N47D20C | 147/197 | 03/10 → 06/13 | | | | | | CCU106 ^[48] |
| 2.0 320 d, 2.0 320 d 4WD, 2.0 320 xd 4WD | 4 | N47D20A; N47D20C | 130/174 | 09/06 → 02/10 | | | | | | CCU105 ^[47] CCU106 ^[48] |
| 2.0 320 d, 2.0 320 d 4WD, 2.0 320 xd 4WD | 4 | N47D20A; N47D20C | 145/194 | 09/06 → 02/10 | | | | | | CCU106 ^[48] |
| 2.0 320 d 4WD, 2.0 320 xd 4WD | 4 | N47D20A; N47D20C | 120/161 | 03/08 → 06/13 | | | | | | CCU106 ^[48] |
| 2.0 320 i | 4 | | 110/148 | 11/06 → 06/07 | OE216 LPG ^[278] | 0,8 | CET12P | OE188 | | BAEA143 |
| 2.0 320 i | 4 | N46B20B | 115/154 | 06/07 → 12/13 | | | CET12P | OE188 | | |
| 2.0 320 i | 4 | N43B20A | 115/154 | 06/07 → 12/13 | | | | | | BAEA144E |
| 2.0 320 i | 4 | N43B20A | 120/161 | 01/07 → 12/13 | | | | | | BAEA144E |
| 2.0 320 i | 4 | N43B20A | 125/168 | 03/07 → 12/13 | | | | | | BAEA144E →02/12 |
| 2.5 323 i | 6 | N52N825A | 130/174 | 06/06 → 02/12 | | | | | | BAEA143 |
| 2.5 325 i | 6 | N52B25A; N52B25AF; N52B25BF | 155/208 | 03/10 → 06/13 | | | | | | BAEA143 |
| 2.5 325 i | 6 | N52B25AF; N52B25BF | 160/215 | 11/05 → 02/10 | OE238 | 1,0 | | | | |
| 2.5 325 i | 6 | N52B25A | 160/215 | 11/05 → 02/10 | OE238 | 1,0 | | | | BAEA143 11/07 → |
| 2.5 325 xi 4WD | 6 | N52B25A | 160/215 | 09/06 → 02/10 | OE238 | 1,0 | | | | BAEA143 11/07 → 08/08 |
| 3.0 325 d | 6 | M57D30(306D3) | 145/194 | 02/07 → 02/10 | | | | | | CCU102 |
| 3.0 325 d | 6 | N57D30A | 150/201 | 09/09 → 12/13 | | | | | | CCU108 |
| 3.0 325 d | 6 | M57D30(306D3) | 155/208 | 02/07 → 02/10 | | | | | | CCU102 |
| 3.0 325 i | 6 | N53B30A | 155/208 | 03/10 → 06/13 | | | | | | BAEA144E |
| 3.0 325 i, 3.0 325 i 4WD | 6 | N53B30A | 160/215 | 03/07 → 12/13 | | | | | | BAEA144E →02/12 |
| 3.0 325 xi 4WD | 6 | N53B30A | 160/215 | 09/07 → 02/10 | | | | | | BAEA144E →08/08 |
| 3.0 330 d, 3.0 330 d 4WD, 3.0 330 xd 4WD | 6 | N57D30A | 180/241 | 03/08 → 12/13 | | | | | | CCU108 |
| 3.0 330 d, 3.0 330 xd 4WD | 6 | M57D30(306D3) | 170/228 | 03/06 → 08/08 | | | | | | CCU102 |
| 3.0 330 i | 6 | N52B30A | 190/255 | 09/06 → 02/10 | OE238 | 1,0 | | | | BAEA143 11/07 → |
| 3.0 330 i | 6 | N52B30A; N52B30AF; N52B30B; N52B30BF | 200/268 | 09/06 → 06/13 | | | | | | BAEA143 09/07 → |
| 3.0 330 i | 6 | N52B30A; N52B30AF; N52B30B; N52B30BF | 200/268 | 09/06 → 06/13 | | | | | | BAEA144E 09/07 → |
| 3.0 330 i 4WD | 6 | N53B30A | 200/268 | 03/10 → 06/13 | | | | | | BAEA144E →02/12 |

BMW





kW/BHP

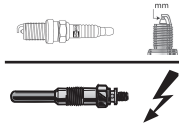

eon TITAN

IRIDIUM

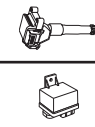

...BMW

...3 Coupe (E92)

| | | | | | | | | | |
|--|---|---------------|---------|---------------|--------------|-----|--|--|---------------------------|
| 3.0 330 xi 4WD | 6 | N52B30A | 190/255 | 09/06 → 08/07 | OE238 | 1,0 | | | BAEA143 |
| 3.0 330 xi 4WD | 6 | N52B30A | 200/268 | 09/06 → 02/10 | OE238 | 1,0 | | | BAEA143 |
| 3.0 335 d | 6 | M57D30(306D5) | 210/282 | 03/06 → 03/13 | | | | | CCU102 |
| 3.0 335 i | 6 | N54B30A | 225/302 | 11/05 → 06/13 | | | | | BAEA143 → 02/10 |
| 3.0 335 i, 3.0 335 i 4WD, 3.0 335 xi 4WD | 6 | N55B30A | 225/302 | 11/05 → 12/13 | OE242 | 0,8 | | | |
| 3.0 335 i 4WD, 3.0 335 xi 4WD | 6 | N54B30A | 225/302 | 03/07 → 12/13 | | | | | BAEA143 |

3 Convertible (E93)

| | | | | | | | | | |
|-----------|---|---|---------|---------------|---|------------|---------------|--------------|--|
| 2.0 318 i | 4 | N43B20A | 105/141 | 03/10 → 12/13 | | | | | BAEA144E → 02/12 |
| 2.0 320 d | 4 | N47D20C | 120/161 | 01/08 → 12/13 | | | | | CCU105 ^[47] CCU106 ^[48] |
| 2.0 320 d | 4 | N47D20A; N47D20C | 130/174 | 09/07 → 02/10 | | | | | CCU105 ^[47] CCU106 ^[48] |
| 2.0 320 d | 4 | N47D20C | 135/181 | 03/10 → 10/13 | | | | | CCU106 ^[48] |
| 2.0 320 d | 4 | N47D20A; N47D20C | 145/194 | 09/07 → 02/10 | | | | | CCU106 ^[48] |
| 2.0 320 d | 4 | N47D20C | 147/197 | 03/10 → 10/13 | | | | | CCU106 ^[48] |
| 2.0 320 i | 4 | | 110/148 | 01/07 → 08/13 | OE120 OE216 LPG ^[278] | 0,6 0,8 | CET2 | OE188 | BAEA143 |
| 2.0 320 i | 4 | N46B20B | 115/154 | 01/07 → 08/13 | | | CET12P | OE188 | BAEA324 → 06/09 BAEA143 07/09 → |
| 2.0 320 i | 4 | N43B20A | 115/154 | 01/07 → 08/13 | | | | | BAEA144E |
| 2.0 320 i | 4 | N43B20A | 120/161 | 09/06 → 10/13 | | | | | BAEA144E |
| 2.0 320 i | 4 | N43B20A | 125/168 | 09/06 → 10/13 | | | | | BAEA144E → 02/12 |
| 2.5 323 i | 6 | N52NB25A | 130/174 | 03/07 → 09/11 | | | | | BAEA143 |
| 2.5 325 i | 6 | N52B25A | 160/215 | 03/07 → 12/13 | OE238 | 1,0 | | | BAEA143 11/07 → |
| 3.0 325 d | 6 | M57D30(306D3) | 145/194 | 03/07 → 12/10 | | | | | CCU102 ^[47] CCU108 ^[48] |
| 3.0 325 d | 6 | N57D30A | 150/201 | 09/09 → 09/13 | | | | | CCU108 |
| 3.0 325 d | 6 | M57D30(306D3) | 155/208 | 03/07 → 12/10 | | | | | CCU102 |
| 3.0 325 i | 6 | N53B30A | 155/208 | 10/06 → 12/13 | | | | | BAEA144E 03/07 → 09/13 |
| 3.0 325 i | 6 | N53B30A | 160/215 | 03/07 → 12/13 | | | | | BAEA144E → 02/12 |
| 3.0 330 d | 6 | M57D30(306D3) | 170/228 | 03/07 → 12/13 | | | | | CCU102 ^[47] CCU108 ^[48] |
| 3.0 330 d | 6 | N57D30A | 180/241 | 01/09 → 12/13 | | | | | CCU108 |
| 3.0 330 i | 6 | N52B30A; N52B30AF; N52B30B; N52B30BF | 190/255 | 03/07 → 12/13 | | | | | BAEA143 11/07 → 01/13 |
| 3.0 330 i | 6 | N53B30A | 200/268 | 03/07 → 12/13 | | | | | BAEA143 → 02/12 BAEA144E → 02/12 |
| 3.0 335 i | 6 | N55B30A | 225/302 | 05/06 → 10/13 | OE242 | 0,8 | | | |
| 3.0 335 i | 6 | N54B30A; N54B30B | 225/302 | 05/06 → 10/13 | | | | | BAEA143 → 02/10 |

3 (F30, F80)

| | | | | | | | | | |
|-----------|---|---------|---------|---------------|------------------------------|------|---------------|--------------|-----------------------------|
| 1.5 318 i | 3 | B38B15A | 100/134 | 03/15 → | | | | OE245 | BAEA538 |
| 1.6 316 i | 4 | N13B16A | 100/134 | 10/12 → 08/16 | OE205 | 0,7 | CET16P | | BAEA143 |
| 1.6 320 i | 4 | N13B16A | 125/168 | 04/12 → 06/16 | OE205 | 0,7 | CET16P | | BAEA143 |
| 2.0 316 d | 4 | B47D20A | 85/114 | 05/11 → | CCGP001 [92] [240] | 5.4v | | | |
| 2.0 316 d | 4 | N47D20C | 85/114 | 05/11 → | CCGP001 [92] [240] | 5.4v | | | CCU106 [47] [344] |



BMW



kW/BHP

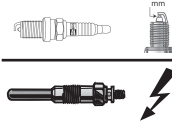

eon TITAN

IRIDIUM

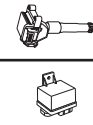

...BMW

...3 (F30, F80)

| | | | | | | | | | |
|-------------------------------------|---|------------------------------|---------|-------------|----------------------------|------|--------|---------------------------------|-------------------------|
| 2.0 318 d | 4 | B47D20A | 100/134 | 05/11→ | CCGP001 [92] [240] | 5.4v | | | |
| 2.0 318 d | 4 | N47D20C | 100/134 | 05/11→ | CCGP001 [92] [240] | 5.4v | | | CCU106 [47] [344] |
| 2.0 318 d, 2.0 318 d 4WD | 4 | N47D20C | 105/141 | 05/11→06/15 | CCGP001 [92] [240] | 5.4v | | | CCU106[47] |
| 2.0 320 d | 4 | B47D20A | 140/188 | 10/14→ | CCGP001 [47] [240] | 5.4v | | | |
| 2.0 320 d | 4 | N47D20C | 147/197 | 03/11→03/16 | CCGP001 [92] [240] | 5.4v | | | CCU106 |
| 2.0 320 d, 2.0 320 d 4WD | 4 | B47D20A | 120/161 | 04/11→ | CCGP001 [92] [240] | 5.4v | | | |
| 2.0 320 d, 2.0 320 d 4WD | 4 | N47D20C | 120/161 | 04/11→ | CCGP001 [92] [240] | 5.4v | | | CCU106[344] |
| 2.0 320 d, 2.0 320 d 4WD | 4 | N47D20C | 135/181 | 03/11→03/16 | CCGP001 [92] [240] | 5.4v | | | CCU106 |
| 2.0 320 d 4WD | 4 | N47D20C | 147/197 | 05/11→06/15 | CCGP001 [47] [240] | 5.4v | | | CCU106 |
| 2.0 320 i | 4 | N20B20D | 135/181 | 04/11→ | | | | | BAEA143 |
| 2.0 320 i, 2.0 320 i 4WD | 4 | N20B20A; N20B20B | 135/181 | 04/11→ | OE243 | 0,8 | | | BAEA143 |
| 2.0 320 i, 2.0 320 i 4WD, 2.0 330 e | 4 | B48B20A | 135/181 | 04/11→ | | | | OE245 ^[48] 07/15→ | BAEA538 →07/15 |
| 2.0 325 d | 4 | N47D20D | 155/208 | 07/12→02/16 | CCGP001 [47] [240] | 5.4v | | | CCU106 |
| 2.0 325 d | 4 | N47D20D | 160/215 | 07/12→02/16 | CCGP001 [92] [240] | 5.4v | | | CCU106 |
| 2.0 328 i, 2.0 328 i 4WD | 4 | N20B20A; N26B20A | 180/241 | 04/11→07/16 | OE243 | 0,8 | | | BAEA143 |
| 2.0 330 e | 4 | B48B20A | 185/248 | 02/15→ | | | | OE245 ^[48] 07/15→ | BAEA538 →07/15 |
| 2.0 330 i | 4 | B46B20B; B48B20A; B48B20B | 185/248 | 09/14→ | | | | OE245 ^[48] 07/15→ | BAEA538 07/15→06/17 |
| 2.0 330 i 4WD | 4 | B48B20A; B48B20B | 185/248 | 10/14→ | | | | OE245 ^[48] 07/15→ | BAEA538 07/15→ |
| 3.0 330 d, 3.0 330 d 4WD | 6 | N57D30A | 190/255 | 01/12→ | CCGP001 [92] [240] | 5.4v | | | |
| 3.0 330 d, 3.0 330 d 4WD | 6 | N57D30A | 210/282 | 01/12→ | CCGP001 ^[240] | 5.4v | | | |
| 3.0 335 d 4WD | 6 | N57D30B | 230/308 | 11/12→ | CCGP001 [47] [92] [240] | 5.4v | | | |
| 3.0 335 i | 6 | N55B30A | 250/335 | 07/13→ | OE242 | 0,8 | | | |
| 3.0 335 i, 3.0 335 i 4WD | 6 | N55B30A | 225/302 | 04/11→07/15 | OE242 | 0,8 | | | |
| 3.0 335 i, 3.0 335 i 4WD | 6 | N55B30A | 225/302 | 04/11→07/15 | | | | | BAEA143 |
| 3.0 335 i, 3.0 335 i 4WD | 6 | N55B30A | 240/322 | 04/11→07/13 | OE242 | 0,8 | | | BAEA143 |
| 3.0 335 i 4WD, 3.0 ActiveHybrid | 6 | N55B30A | 250/335 | 11/11→ | OE242 | 0,8 | | | BAEA143 |
| 3.0 340 i, 3.0 340 i 4WD | 6 | B58B30A | 240/322 | 10/14→ | | | | OE245 ^[48] 07/15→ | BAEA538 07/15→07/16 |
| 3.0 340 i, 3.0 340 i 4WD | 6 | B58B30A | 265/355 | 10/14→ | | | | OE245 ^[48] 07/15→ | BAEA538 07/15→07/16 |
| 3.0 ActiveHybrid | 6 | N55B30A | 225/302 | 11/11→05/15 | OE242 | 0,8 | | | BAEA143 |
| 3.0 M3 | 6 | S55B30A | 317/425 | 04/12→ | | | | | BAEA143 |
| 3 Touring (F31) | | | | | | | | | |
| 1.5 318 i | 3 | B38B15A | 100/134 | 01/15→ | | | | OE245 07/15→ | BAEA538 07/16→ |
| 1.6 316 i | 4 | N13B16A | 100/134 | 03/12→08/16 | OE205 | 0,7 | CET16P | | BAEA143 |
| 2.0 316 d | 4 | N47D20C | 85/114 | 02/12→ | | | | | CCU106 [47] [344] |
| 2.0 318 d | 4 | N47D20C | 100/134 | 07/11→ | | | | | CCU106 [47] [344] |
| 2.0 318 d, 2.0 318 d 4WD | 4 | N47D20C | 105/141 | 07/11→06/15 | | | | | CCU106 ^[47] |
| 2.0 320 d | 4 | B47D20A | 120/161 | 07/11→ | CCGP001 [48] [92] [240] | 5.4v | | | |
| 2.0 320 d | 4 | N47D20C | 120/161 | 07/11→ | CCGP001 [48] [92] [240] | 5.4v | | | CCU106 ^[344] |
| 2.0 320 d | 4 | N47D20C | 135/181 | 07/11→02/16 | CCGP001 [48] [92] [240] | 5.4v | | | CCU106 |

BMW



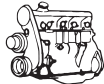

kW/BHP



eon TITAN

IRIDIUM



...BMW

...3 Touring (F31)

| | | | | | | | | |
|--------------------------|---|------------------|---------|-------------|----------------------------|------|-----------------|-------------------------|
| 2.0 320 d | 4 | N47D20C | 147/197 | 07/11→02/16 | CCGP001 [48] [92] [240] | 5.4v | | CCU106 |
| 2.0 320 d 4WD | 4 | N47D20C | 120/161 | 01/12→ | | | | CCU106 ^[344] |
| 2.0 320 d 4WD | 4 | N47D20C | 135/181 | 01/12→06/15 | | | | CCU106 |
| 2.0 320 d 4WD | 4 | N47D20C | 147/197 | 01/12→06/15 | | | | CCU106 |
| 2.0 320 i, 2.0 320 i 4WD | 4 | N20B20B | 135/181 | 01/12→ | OE243 | 0,8 | | BAEA143 |
| 2.0 320 i, 2.0 320 i 4WD | 4 | B48B20A | 135/181 | 01/12→ | | | OE245 07/15→ | |
| 2.0 325 d | 4 | N47D20D | 155/208 | 09/12→02/16 | CCGP001 [48] [240] | 5.4v | | CCU106 |
| 2.0 325 d | 4 | N47D20D | 160/215 | 09/12→02/16 | CCGP001 [48] [92] [240] | 5.4v | | CCU106 |
| 2.0 328 i, 2.0 328 i 4WD | 4 | N20B20A | 180/241 | 01/12→06/16 | OE243 | 0,8 | | BAEA143 |
| 2.0 330 i, 2.0 330 i 4WD | 4 | B48B20A; B48B20B | 185/248 | 09/14→ | | | OE245 07/15→ | BAEA538 07/16→ |
| 3.0 330 d, 3.0 330 d 4WD | 6 | N57D30A | 190/255 | 01/12→ | CCGP001 [48] [92] [240] | 5.4v | | |
| 3.0 330 d, 3.0 330 d 4WD | 6 | N57D30A | 210/282 | 01/12→ | CCGP001 ^[240] | 5.4v | | |
| 3.0 335 i, 3.0 335 i 4WD | 6 | N55B30A | 225/302 | 07/12→06/15 | OE242 | 0,8 | | BAEA143 |
| 3.0 335 i, 3.0 335 i 4WD | 6 | N55B30A | 240/322 | 07/12→07/13 | OE242 | 0,8 | | BAEA143 |
| 3.0 335 i, 3.0 335 i 4WD | 6 | N55B30A | 250/335 | 07/13→06/15 | OE242 | 0,8 | | BAEA143 |
| 3.0 340 i, 3.0 340 i 4WD | 6 | B58B30A | 240/322 | 10/14→ | | | OE245 07/15→ | BAEA538 →07/16 |
| 3.0 340 i, 3.0 340 i 4WD | 6 | B58B30A | 265/355 | 10/14→ | | | OE245 07/15→ | BAEA538 →07/16 |

3 Gran Turismo (F34)

| | | | | | | | | |
|--------------------------|---|------------------|---------|-------------|-----------------------|------|-----------------|------------------------|
| 2.0 318 d | 4 | N47D20C | 100/134 | 03/13→ | CCGP001 [92] [240] | 5.4v | | CCU106 |
| 2.0 318 d | 4 | N47D20C | 105/141 | 03/13→ | CCGP001 [92] [240] | 5.4v | | CCU106 |
| 2.0 320 d | 4 | N47D20C | 147/197 | 05/13→07/15 | CCGP001 [92] [240] | 5.4v | | CCU106 ^[47] |
| 2.0 320 d, 2.0 320 d 4WD | 4 | B47D20A; N47D20C | 120/161 | 03/13→ | CCGP001 [92] [240] | 5.4v | | CCU106 |
| 2.0 320 d, 2.0 320 d 4WD | 4 | N47D20C | 135/181 | 03/13→07/15 | CCGP001 [92] [240] | 5.4v | | CCU106 |
| 2.0 320 d 4WD | 4 | N47D20C | 147/197 | 05/13→07/15 | CCGP001 [92] [240] | 5.4v | | CCU106 |
| 2.0 320 i, 2.0 320 i 4WD | 4 | B48B20A | 135/181 | 07/12→ | | | OE245 07/16→ | BAEA538 07/16→06/17 |
| 2.0 320 i, 2.0 320 i 4WD | 4 | N20B20A; N20B20B | 135/181 | 07/12→ | | | | BAEA143 |
| 2.0 325 d | 4 | N47D20D | 155/208 | 07/13→ | CCGP001 [92] [240] | 5.4v | | CCU106 |
| 2.0 325 d | 4 | N47D20D | 160/215 | 03/13→ | CCGP001 [92] [240] | 5.4v | | CCU106 ^[47] |
| 2.0 328 i, 2.0 328 i 4WD | 4 | N20B20A; N26B20A | 180/241 | 08/12→07/16 | OE242 | 0,8 | | BAEA143 |
| 2.0 330 i, 2.0 330 i 4WD | 4 | B48B20B | 185/248 | 10/15→ | | | OE245 07/16→ | BAEA538 07/16→06/17 |
| 3.0 335 i, 3.0 335 i 4WD | 6 | N55B30A | 225/302 | 03/13→ | OE242 | 0,8 | | BAEA143 |
| 3.0 335 i, 3.0 335 i 4WD | 6 | N55B30A | 240/322 | 03/13→03/14 | OE242 | 0,8 | | BAEA143 |
| 3.0 335 i, 3.0 335 i 4WD | 6 | N55B30A | 250/335 | 07/13→ | OE242 | 0,8 | | BAEA143 |
| 3.0 340 i, 3.0 340 i 4WD | 6 | B58B30A | 240/322 | 10/15→ | | | OE245 07/16→ | BAEA538 07/16→06/17 |
| 3.0 340 i, 3.0 340 i 4WD | 6 | B58B30A | 265/355 | 09/15→ | | | OE245 07/16→ | BAEA538 07/16→06/17 |

4 Coupe (F32, F82)

| | | | | | | | | |
|--------------------------|---|------------------|---------|-------------|-----------------------|------|-------|-------------------------|
| 1.5 418 i | 3 | B38B15A | 100/134 | 02/16→ | | | OE245 | BAEA538 →06/17 |
| 2.0 420 d, 2.0 420 d 4WD | 4 | N47D20C | 120/161 | 07/13→ | | | | CCU106 ^[344] |
| 2.0 420 d, 2.0 420 d 4WD | 4 | N47D20C | 135/181 | 07/13→03/15 | CCGP001 [92] [240] | 5.4v | | CCU106 |
| 2.0 420 d, 2.0 420 d 4WD | 4 | N47D20C | 147/197 | 07/13→03/15 | CCGP001 [92] [240] | 5.4v | | CCU106 |
| 2.0 420 i, 2.0 420 i 4WD | 4 | N20B20A; N20B20B | 135/181 | 11/13→ | OE243 | 0,8 | | BAEA143 |





kW/BHP

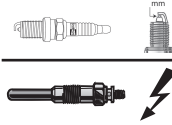

eon TITAN

IRIDIUM

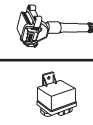

...BMW

...4 Coupe (F32, F82)

| | | | | | | | | | |
|--------------------------|---|------------------|---------|--------|--|------|--|-------|------------------------|
| 2.0 420 i, 2.0 420 i 4WD | 4 | B48B20A | 135/181 | 11/13→ | | | | OE245 | BAEA538 →06/17 |
| 2.0 425 d | 4 | N47D20D | 155/208 | 01/14→ | CCGP001 ^[240] | 5.4v | | | CCU106 |
| 2.0 425 d | 4 | N47D20D | 160/215 | 01/14→ | CCGP001 ^[92] ^[240] | 5.4v | | | CCU106 ^[47] |
| 2.0 428 i, 2.0 428 i 4WD | 4 | N20B20A; N26B20A | 180/241 | 07/13→ | OE243 | 0,8 | | | BAEA143 |
| 2.0 430 i, 2.0 430 i 4WD | 4 | B48B20A; B48B20B | 185/248 | 03/16→ | | | | OE245 | BAEA538 →06/17 |
| 3.0 435 i, 3.0 435 i 4WD | 6 | N55B30A | 225/302 | 07/13→ | OE242 | 0,8 | | | BAEA143 |
| 3.0 435 i, 3.0 435 i 4WD | 6 | N55B30A | 250/335 | 07/13→ | OE242 | 0,8 | | | BAEA143 |
| 3.0 440 i, 3.0 440 i 4WD | 6 | B58B30A | 240/322 | 03/16→ | | | | OE245 | BAEA538 →06/17 |
| 3.0 440 i, 3.0 440 i 4WD | 6 | B58B30A | 265/355 | 03/16→ | | | | OE245 | BAEA538 →06/17 |
| 3.0 M4 | 6 | S55B30A | 317/425 | 01/14→ | | | | | BAEA143 |

4 Convertible (F33, F83)

| | | | | | | | | | |
|--------------------------|---|------------------|---------|-------------|--|------|--|-------|-------------------------|
| 2.0 420 d | 4 | N47D20C | 120/161 | 10/13→ | | | | | CCU106 ^[344] |
| 2.0 420 d | 4 | N47D20C | 135/181 | 10/13→07/15 | CCGP001 ^[92] ^[240] | 5.4v | | | CCU106 |
| 2.0 420 d | 4 | N47D20C | 147/197 | 10/13→07/15 | CCGP001 ^[92] ^[240] | 5.4v | | | CCU106 ^[47] |
| 2.0 420 i | 4 | N20B20B | 135/181 | 07/14→ | OE243 | 0,8 | | | BAEA143 |
| 2.0 420 i | 4 | B48B20A | 135/181 | 07/14→ | | | | OE245 | BAEA538 →06/17 |
| 2.0 425 d | 4 | N47D20D | 155/208 | 07/14→ | CCGP001 ^[240] | 5.4v | | | CCU106 |
| 2.0 425 d | 4 | N47D20D | 160/215 | 07/14→ | CCGP001 ^[92] ^[240] | 5.4v | | | CCU106 ^[47] |
| 2.0 428 i, 2.0 428 i 4WD | 4 | N20B20A; N26B20A | 180/241 | 10/13→ | OE243 | 0,8 | | | BAEA143 |
| 2.0 430 i, 2.0 430 i 4WD | 4 | B48B20B | 185/248 | 03/16→ | | | | OE245 | BAEA538 →06/17 |
| 3.0 435 d 4WD | 6 | N57D30B | 230/308 | 07/14→ | CCGP001 ^[92] ^[240] | 5.4v | | | |
| 3.0 435 i, 3.0 435 i 4WD | 6 | N55B30A | 225/302 | 10/13→ | OE242 | 0,8 | | | BAEA143 |
| 3.0 435 i, 3.0 435 i 4WD | 6 | N55B30A | 250/335 | 10/13→ | OE242 | 0,8 | | | BAEA143 |
| 3.0 440 i, 3.0 440 i 4WD | 6 | B58B30A | 240/322 | 03/16→ | | | | OE245 | BAEA538 →06/17 |
| 3.0 440 i, 3.0 440 i 4WD | 6 | B58B30A | 265/355 | 03/16→ | | | | OE245 | BAEA538 →06/17 |
| 3.0 M4 | 6 | S55B30A | 317/425 | 07/14→ | | | | | BAEA143 |

4 Gran Coupe (F36)

| | | | | | | | | | |
|--------------------------|---|------------------|---------|-------------|--|------|--|-------|-------------------------|
| 1.5 418 i | 3 | B38B15A | 100/134 | 07/15→ | | | | OE245 | BAEA538 →06/17 |
| 2.0 418 d | 4 | N47D20C | 100/134 | 03/14→ | | | | | CCU106 ^[344] |
| 2.0 418 d | 4 | N47D20C | 105/141 | 03/14→ | CCGP001 ^[92] ^[240] | 5.4v | | | CCU106 |
| 2.0 420 d, 2.0 420 d 4WD | 4 | N47D20C | 120/161 | 03/14→ | | | | | CCU106 ^[344] |
| 2.0 420 d, 2.0 420 d 4WD | 4 | N47D20C | 135/181 | 03/14→03/15 | CCGP001 ^[92] ^[240] | 5.4v | | | CCU106 |
| 2.0 420 d, 2.0 420 d 4WD | 4 | N47D20C | 147/197 | 03/14→03/15 | CCGP001 ^[92] ^[240] | 5.4v | | | CCU106 |
| 2.0 420 i, 2.0 420 i 4WD | 4 | N20B20B | 135/181 | 03/14→ | OE243 | 0,8 | | | BAEA143 |
| 2.0 420 i, 2.0 420 i 4WD | 4 | B48B20A | 135/181 | 03/14→ | | | | OE245 | BAEA538 →06/17 |
| 2.0 428 i, 2.0 428 i 4WD | 4 | N20B20A; N26B20A | 180/241 | 03/14→ | OE243 | 0,8 | | | BAEA143 |
| 2.0 430 i, 2.0 430 i 4WD | 4 | B48B20B | 185/248 | 03/16→ | | | | OE245 | BAEA538 →06/17 |
| 3.0 435 d 4WD | 6 | N57D30B | 230/308 | 07/14→ | CCGP001 ^[92] ^[240] | 5.4v | | | |
| 3.0 435 i, 3.0 435 i 4WD | 6 | N55B30A | 225/302 | 03/14→ | OE242 | 0,8 | | | BAEA143 |
| 3.0 435 i, 3.0 435 i 4WD | 6 | N55B30A | 250/335 | 03/14→ | OE242 | 0,8 | | | BAEA143 |
| 3.0 440 i, 3.0 440 i 4WD | 6 | B58B30A | 240/322 | 03/16→ | | | | OE245 | BAEA538 →06/17 |

BMW





kW/BHP

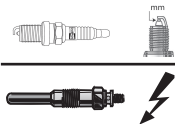

eon TITAN

IRIDIUM

**...BMW****...4 Gran Coupe (F36)**

3.0 440 i, 3.0 440 i 4WD 6 B58B30A 265/355 03/16→

OE245

BAEA538

→06/17

5 /Touring (E34)

2.5 525 td 6 M51D25(256T1) 85/114 03/93→01/97 CH189 11v

5 Touring (E34)

1.8 518 g 4 M43B18(184E2) 85/114 11/95→06/96 OE026 0,9 CET2 OE188 BAEA307

OE216 LPG [278]

0,8

1.8 518 i 4 M43B18(184E2) 83/111 03/93→09/94 OE026 0,9 CET2 OE188

4.0 540 i 8 M60B40(408S1) 210/282 09/93→01/97 OE026 0,9 CET2 OE188 BAEA014

→12/96

OE216 LPG [278]

0,8

5 (E39)

2.2 520 i 6 M54B22(226S1) 125/168 09/00→06/03 OE223 1,6 CET1 2P OE188 BAEA302

→09/02

BAEA143^[247]

10/02→

BAEA324

10/02→

2.8 528 i 6 M52B28(286S1); M52B28(286S2) 142/190 11/95→09/00 OE026 0,9 CET2 OE188 BAEA302

→09/98

OE216 LPG [278]

0,8

→09/98

OE223

1,6

09/98→

3.0 530 i 6 M54B30(306S3) 170/228 09/00→06/03 OE223 1,6 CET1 2P OE188 BAEA302

→09/02

BAEA143^[247]

10/02→

BAEA324

10/02→

3.5 535 i 8 M62B35(358S1); M62B35(358S2) 173/232 04/96→03/99 OE026 0,9 CET1 2P OE188 BAEA302

→09/98

OE216 LPG [278]

0,8

→09/98

OE223

1,6

09/98→

5 /Touring (E39)

2.0 520 d 4 M47D20(204D1) 100/134 02/00→09/03 CH203 11v

2.0 520 i 6 M52B20(206S3) 100/134 04/99→06/03 OE223 1,6 CET1 2P OE188 BAEA302

2.0 520 i 6 M52B20(206S3); M52B20(206S4) 110/148 01/96→06/03 OE026 0,9 CET1 2P OE188 BAEA302

→09/98

→08/98

OE216 LPG [278]

0,8

→09/98

OE223

1,6

09/98→

2.5 523 i 6 M52B25(256S3) 125/168 11/95→09/00 OE026 0,9 CET1 2P OE188 BAEA302

→09/98

→08/98

OE216 LPG [278]

0,8

→09/98

OE223

1,6

09/98→

2.5 525 d 6 M57D25(256D1) 120/161 02/00→05/04 CH203 11v

2.5 525 i 6 M54B25(256S5) 141/189 09/00→05/04 OE223 1,6 CET1 2P OE188 BAEA302

→09/02

2.5 525 td 6 M51D25(256T1) 85/114 01/97→06/03 CH189 11v

2.5 525 tds 6 M51D25(256T1) 105/141 01/96→05/04 CH189 11v

2.8 528 i 6 M52B28(286S1); M52B28(286S2) 142/190 01/97→09/00 OE223 1,6 CET1 2P OE188 BAEA302

3.0 530 d 6 M57D30(306D1) 135/181 08/98→09/00 CH203 11v

3.0 530 d 6 M57D30(306D1) 142/190 09/98→05/04 CH203 11v

3.5 535 i 8 M62B35(358S2) 180/241 04/99→06/03 OE223 1,6 CET1 2P OE188 BAEA302

BMW





kW/BHP

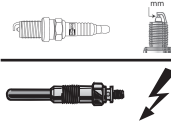

eon TITAN

IRIDIUM

**...BMW****...5 /Touring (E39)**

| | | | | | | | | | |
|-----------|---|---------------------------------|---------|-------------|--|-------------------|-------------------------|--------------|----------------|
| 4.4 540 i | 8 | M62B44(448S1); M62B44(448S2) | 210/282 | 04/96→05/04 | OE026 →09/98 OE216 LPG [278] →09/98 OE223 09/98→ | 0,9 0,8 1,6 | CET12P →08/98 | OE188 | BAEA302 |
| 4.9 M5 | 8 | S62B50(508S1) | 294/394 | 10/98→06/03 | OE223 | 1,6 | CET12P | OE188 | BAEA302 |

5 Touring (E39)

| | | | | | | | | | |
|-----------|---|---------------------------------|---------|-------------|--|------------|---------------|--------------|--|
| 2.0 520 i | 6 | M52B20(206S3) | 100/134 | 04/99→05/04 | OE223 | 1,6 | CET12P | | BAEA302 |
| 2.2 520 i | 6 | M54B22(226S1) | 125/168 | 09/00→05/04 | OE223 | 1,6 | CET12P | OE188 | BAEA302 →09/02 BAEA324 10/02→ |
| 2.5 523 i | 6 | M52B25(256S3); M52B25(256S4) | 125/168 | 09/96→08/00 | OE026 OE216 LPG [278] | 0,9 0,8 | CET12P | OE188 | BAEA302 |
| 3.0 530 i | 6 | M54B30(306S3) | 170/228 | 09/00→05/04 | OE223 | 1,6 | CET12P | OE188 | BAEA302 →09/02 BAEA324 10/02→ BAEA143 [247] |

5 (E60)

| | | | | | | | | | |
|---|---|-------------------------------|---------|-------------|--------------|-----|---------------|--------------|---|
| 2.0 520 d | 4 | M47D20(204D4) | 110/148 | 02/05→02/08 | | | | | CCU101 |
| 2.0 520 d | 4 | M47D20(204D4) | 120/161 | 02/05→02/08 | | | | | CCU105 [48] [343] |
| 2.0 520 d | 4 | M47 | 120/161 | 02/05→02/08 | | | | | CCU101 |
| 2.0 520 d | 4 | N47D20A; N47D20C | 130/174 | 04/06→12/09 | | | | | CCU105 |
| 2.0 520 i | 4 | N46B20B | 115/154 | 04/06→12/09 | | | | OE188 | BAEA324 →06/09 BAEA143 07/09→ |
| 2.0 520 i | 4 | N43B20A | 120/161 | 12/06→03/10 | | | | | BAEA143 |
| 2.0 520 i | 4 | N43B20A | 125/168 | 09/07→03/10 | | | | | BAEA144E |
| 2.2 520 i | 6 | M54B22(226S1) | 125/168 | 07/03→03/10 | OE223 | 1,6 | CET12P | OE188 | BAEA324 →06/09 BAEA143 [247] |
| 2.5 523 i | 6 | N52B25A; N52B25B; N52B25BE | 130/174 | 10/04→02/07 | OE238 | 1,0 | | | BAEA145E [242] →04/06 BAEA143 [247] |
| 2.5 523 i | 6 | N52B25A | 140/188 | 01/07→03/10 | OE238 | 1,0 | | | BAEA144E |
| 2.5 525 d | 6 | M57D25(256D1) | 120/161 | 12/04→03/10 | | | | | CCU102 |
| 2.5 525 d | 6 | M57D25(256D2) | 130/174 | 06/04→03/10 | | | | | CCU102 |
| 2.5 525 i | 6 | M54B25(256S5) | 141/189 | 09/03→03/10 | OE223 | 1,6 | CET12P | OE188 | BAEA324 →06/09 BAEA143 [247] |
| 2.5 525 i | 6 | N52B25B; N52B25BF | 160/215 | 10/04→12/09 | OE238 | 1,0 | | | BAEA145E →04/06 BAEA143 04/06→ |
| 2.5 525 i | 6 | N52B25A | 160/215 | 10/04→12/09 | OE238 | 1,0 | | | BAEA145E →04/06 [86] [242] BAEA143 04/06→ [87] [242] |
| 2.5 525 xi 4WD | 6 | N52B25A | 160/215 | 07/05→03/10 | OE238 | 1,0 | | | BAEA145E →04/06 [86] [242] BAEA143 04/06→ [87] [242] |
| 3.0 525 d, 3.0 525 d 4WD, 3.0 525 xd 4WD | 6 | M57D30(306D3) | 145/194 | 11/06→03/10 | | | | | CCU102 |
| 3.0 525 i, 3.0 525 i 4WD | 6 | N53B30A | 160/215 | 01/07→03/10 | | | | | BAEA144E |
| 3.0 525 xi 4WD | 6 | N53B30A | 160/215 | 01/07→03/10 | | | | | BAEA144E →12/08 [88] [242] |

BMW



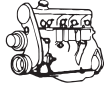

kW/BHP

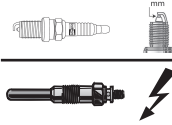

eon TITAN

IRIDIUM

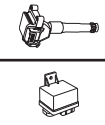

...BMW

...5 (E60)

| | | | | | | | | | |
|---|---|---------------------------------|---------|-------------|----------------------------|-----|--------|-------|---|
| 3.0 530 d | 6 | M57D30(306D2); M57D30(306D3) | 155/208 | 09/02→12/09 | | | | | CCU102 |
| 3.0 530 d | 6 | M57D30(306D2) | 160/215 | 09/02→09/05 | | | | | CCU102 |
| 3.0 530 d, 3.0 530 d 4WD, 3.0 530 xd 4WD | 6 | M57D30(306D3) | 173/232 | 02/07→12/09 | | | | | CCU102 |
| 3.0 530 d, 3.0 530 xd 4WD | 6 | M57D30(306D3) | 170/228 | 02/05→02/07 | | | | | CCU102 |
| 3.0 530 i | 6 | M54B30(306S3) | 170/228 | 12/01→02/05 | OE223 | 1,6 | CET12P | OE188 | BAEA143 ^[247] BAEA324 |
| 3.0 530 i | 6 | N52B30A | 187/251 | 03/05→03/10 | | | | | BAEA145E →03/06 BAEA143 04/06→ |
| 3.0 530 i | 6 | N52B30A; N52B30B; N52B30BF | 190/255 | 09/04→02/07 | OE238 | 1,0 | | | BAEA145E →04/06 BAEA143 04/06→ [87] [242] |
| 3.0 530 i, 3.0 530 i 4WD, 3.0 530 xi 4WD | 6 | N53B30A | 200/268 | 09/06→12/09 | | | | | BAEA144E |
| 3.0 530 xi 4WD | 6 | N52B30A | 190/255 | 09/04→02/07 | OE238 | 1,0 | | | BAEA145E →04/06 BAEA143 05/06→ |
| 3.0 535 d | 6 | M57D30(306D4) | 200/268 | 09/04→03/10 | | | | | CCU102 |
| 3.0 535 d | 6 | M57D30(306D5) | 210/282 | 01/07→03/10 | | | | | CCU102 |
| 3.0 535 i | 6 | N54B30A | 224/300 | 09/07→03/10 | | | | | BAEA143 |
| 3.0 535 i | 6 | N54B30A | 225/302 | 04/06→12/09 | | | | | BAEA324 →06/09 BAEA143 07/09→ |
| 4.0 540 i | 8 | N62B40A | 225/302 | 07/05→03/10 | OE216 LPG ^[278] | 0,8 | CET12P | OE188 | BAEA143 BAEA324 |
| 4.4 545 i | 8 | N62B44A | 245/329 | 09/03→03/10 | OE223 | 1,6 | CET12P | OE188 | BAEA324 →06/09 BAEA143 ^[87] 07/09→ |
| 4.8 550 i | 8 | N62B48A; N62B48B | 270/362 | 07/05→03/10 | OE216 LPG ^[278] | 0,8 | CET12P | OE188 | BAEA143 |
| 5 Touring (E61) | | | | | | | | | |
| 2.0 520 d | 4 | M47D20(204D4) | 110/148 | 04/05→02/08 | | | | | CCU101 ^[91] CCU105 [48] [343] |
| 2.0 520 d | 4 | M47D20(204D4) | 120/161 | 04/05→02/08 | | | | | CCU101 ^[91] CCU105 [48] [343] |
| 2.0 520 d | 4 | N47D20A; N47D20C | 130/174 | 03/07→05/10 | | | | | CCU105 |
| 2.0 520 i | 4 | N43B20A | 120/161 | 07/07→08/10 | | | | | BAEA144E [88] [242] |
| 2.0 520 i | 4 | N43B20A | 125/168 | 09/07→12/10 | | | | | BAEA144E →08/10 |
| 2.5 523 i | 6 | N52B25A; N52B25B; N52B25BE | 130/174 | 10/04→02/07 | OE238 | 1,0 | | | BAEA145E ^[242] →04/06 BAEA143 ^[247] |
| 2.5 523 i | 6 | N52B25A | 140/188 | 01/07→12/10 | OE238 →12/09 | 1,0 | | | BAEA144E |
| 2.5 525 d | 6 | M57D25(256D2) | 120/161 | 03/04→03/07 | | | | | CCU102 |
| 2.5 525 d | 6 | M57D25(256D2) | 130/174 | 03/04→03/07 | | | | | CCU102 |
| 2.5 525 i | 6 | M54B25(256S5) | 141/189 | 06/04→12/10 | OE223 | 1,6 | CET12P | OE188 | BAEA324 →06/09 BAEA143 ^[247] |
| 2.5 525 i | 6 | N52B25A; N52B25B; N52B25BF | 160/215 | 10/04→03/10 | OE238 | 1,0 | | | BAEA145E ^[242] →04/06 BAEA143 ^[247] |

BMW

CHAMPION



kW/BHP

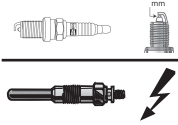

eon TITAN

IRIDIUM

**...BMW****...5 Touring (E61)**

| | | | | | | | | | |
|---|---|---|---------|-------------|--|------|---------------|--------------|---|
| 2.5 525 xi 4WD | 6 | N52B25A | 160/215 | 07/05→12/10 | OE238 | 1,0 | | | BAEA145E →04/06 |
| 3.0 525 d, 3.0 525 d 4WD, 3.0 525 xd 4WD | 6 | M57D30(306D3) | 145/194 | 03/07→05/10 | | | | | CCU102 |
| 3.0 525 i, 3.0 525 i 4WD | 6 | N53B30A | 160/215 | 01/07→12/10 | | | | | BAEA144E →08/10 |
| 3.0 525 xi 4WD | 6 | N53B30A | 160/215 | 01/07→12/10 | | | | | BAEA144E →08/08 |
| 3.0 530 d | 6 | M57D30(306D2); M57D30(306D3) | 155/208 | 03/04→05/10 | | | | | CCU102 |
| 3.0 530 d | 6 | M57D30(306D2) | 160/215 | 03/04→09/05 | | | | | CCU102 |
| 3.0 530 d, 3.0 530 d 4WD, 3.0 530 xd 4WD | 6 | M57D30(306D3) | 173/232 | 01/07→05/10 | | | | | CCU102 |
| 3.0 530 d, 3.0 530 xd 4WD | 6 | M57D30(306D3) | 170/228 | 02/05→02/07 | | | | | CCU102 |
| 3.0 530 i | 6 | N52B30A; N52B30B; N52B30BF | 190/255 | 09/04→02/07 | OE238 | 1,0 | | | BAEA145E ^[242] →04/06 BAEA143 ^[247] |
| 3.0 530 i | 6 | N53B30A | 200/268 | 09/06→12/10 | | | | | BAEA143 →08/10 BAEA144E →08/10 |
| 3.0 530 i 4WD | 6 | N53B30A | 200/268 | 09/08→05/10 | | | | | BAEA144E |
| 3.0 530 xi 4WD | 6 | N52B30A | 190/255 | 04/05→02/07 | OE238 | 1,0 | | | BAEA145E |
| 3.0 530 xi 4WD | 6 | N52B30A | 200/268 | 09/06→05/10 | | | | | BAEA144E →08/08 |
| 3.0 535 d | 6 | M57D30(306D4) | 200/268 | 09/04→12/10 | | | | | CCU102 |
| 3.0 535 d | 6 | M57D30(306D5) | 210/282 | 01/07→12/10 | | | | | CCU102 |
| 4.4 545 i | 8 | N62B44A | 245/329 | 06/04→12/10 | OE223 | 1,6 | CET12P | OE188 | BAEA324 →06/09 |
| 4.8 550 i | 8 | N62B48A; N62B48B | 270/362 | 07/05→12/10 | OE216 ^{UPG [278]} | 0,8 | CET12P | OE188 | BAEA143 |
| 5 (F10) | | | | | | | | | |
| 1.6 520 i | 4 | N20B16A | 125/168 | 07/13→10/16 | OE243 | 0,8 | | | |
| 2.0 518 d | 4 | N47D20C | 100/134 | 02/13→06/14 | | | | | CCU106 ^[48] |
| 2.0 518 d | 4 | N47D20C | 105/141 | 02/13→06/14 | | | | | CCU106 ^[48] |
| 2.0 520 d | 4 | N47D20C | 120/161 | 01/09→10/16 | | | | | CCU106 ^[344] |
| 2.0 520 d, 2.0 520 d 4WD | 4 | N47D20C | 100/134 | 01/13→06/14 | | | | | CCU106 |
| 2.0 520 d, 2.0 520 d 4WD | 4 | N47D20C | 135/181 | 03/10→06/14 | | | | | CCU106 |
| 2.0 520 d, 2.0 520 d 4WD | 4 | N47D20C | 147/197 | 01/13→06/14 | | | | | CCU106 |
| 2.0 520 i | 4 | N20B20A | 120/161 | 10/10→10/16 | OE243 | 0,8 | | | BAEA143 |
| 2.0 520 i | 4 | N20B20B | 120/161 | 10/10→10/16 | | | | | BAEA143 |
| 2.0 520 i | 4 | N20B20A; N20B20B | 135/181 | 10/10→10/16 | OE243 | 0,8 | | | BAEA143 |
| 2.0 525 d, 2.0 525 d 4WD | 4 | N47D20D | 155/208 | 01/11→10/16 | | | | | CCU106 |
| 2.0 525 d, 2.0 525 d 4WD | 4 | N47D20D | 160/215 | 01/11→10/16 | | | | | CCU106 |
| 2.0 528 i, 2.0 528 i 4WD | 4 | N20B20A | 180/241 | 10/10→10/16 | OE243 | 0,8 | | | BAEA143 →05/13 |
| 2.5 523 i | 6 | N52B25A; N52B25AF; N52B25B; N52B25BF | 150/201 | 01/09→08/11 | OE238 | 1,0 | | | BAEA143 |
| 3.0 523 i | 6 | N53B30A | 150/201 | 06/09→08/11 | | | | | BAEA144E |
| 3.0 525 d | 6 | N57D30A | 150/201 | 03/10→08/11 | | | | | CCU108 |
| 3.0 528 i | 6 | N53B30A | 190/255 | 01/09→08/11 | | | | | BAEA143 BAEA144E |
| 3.0 530 d | 6 | N57D30A | 180/241 | 01/09→08/11 | CCGP001 ^{[47] [92] [240] [346]} | 5.4v | | | CCU108 ^[357] |
| 3.0 530 d | 6 | N57D30A | 190/255 | 01/11→10/16 | CCGP001 →01/12 ^{[47] [92] [240] [346]} | 5.4v | | | CCU108 ^[357] |
| 3.0 530 d | 6 | N57D30A | 210/282 | 09/10→10/16 | CCGP001 →01/12 ^{[47] [92] [240] [346]} | 5.4v | | | CCU108 ^[357] |

BMW





kW/BHP

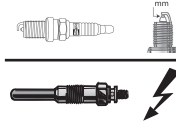

eon TITAN

IRIDIUM

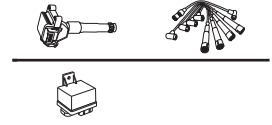

...BMW

...5 (F10)

| | | | | | | | | |
|---------------------------------|---|---------|---------|-------------|--------------------------------------|------|--|----------------------|
| 3.0 530 d 4WD | 6 | N57D30A | 190/255 | 03/11→10/16 | CCGP001 →01/12 [47] [92] [240] | 5.4v | | CCU108 [47] [345] |
| 3.0 530 d 4WD | 6 | N57D30A | 210/282 | 09/10→10/16 | CCGP001 →01/12 [47] [92] [240] | 5.4v | | CCU108[48] |
| 3.0 530 i | 6 | N53B30A | 200/268 | 05/11→06/13 | | | | BAEA144E →02/12 |
| 3.0 535 d | 6 | N57D30B | 220/295 | 03/10→08/11 | CCGP001 [47] [92] [240] [348] | 5.4v | | CCU108[347] |
| | | | | | CCGP001 [48] [92] [240] | 5.4v | | |
| 3.0 535 d | 6 | N57D30B | 225/302 | 03/10→08/11 | CCGP001 [47] [92] [240] [348] | 5.4v | | CCU108[347] |
| | | | | | CCGP001 [48] [92] [240] | 5.4v | | |
| 3.0 535 d | 6 | N57D30B | 230/308 | 01/11→10/16 | CCGP001 [47] [92] [240] [348] | 5.4v | | CCU108[347] |
| | | | | | CCGP001 [48] [92] [240] | 5.4v | | |
| 3.0 535 i | 6 | N55B30A | 225/302 | 01/09→10/16 | OE242 | 0,8 | | BAEA143 →05/13 |
| 3.0 535 i, 3.0 535 i 4WD | 6 | N55B30A | 240/322 | 07/13→10/16 | OE242 | 0,8 | | BAEA143 |
| 3.0 535 i 4WD, 3.0 ActiveHybrid | 6 | N55B30A | 225/302 | 03/10→10/16 | OE242 | 0,8 | | BAEA143 |
| 3.0 ActiveHybrid | 6 | N55B30A | 250/335 | 09/10→08/16 | OE242 | 0,8 | | BAEA143 |
| 3.0 M 550 d 4WD | 6 | N57D30C | 280/375 | 07/11→10/16 | CCGP001 [92] [240] | 5.4v | | |
| 4.4 550 i | 8 | N63B44B | 300/402 | 01/09→06/13 | OE242 | 0,8 | | |
| 4.4 550 i, 4.4 550 i 4WD | 8 | N63B44A | 300/402 | 01/09→06/13 | OE242 | 0,8 | | BAEA143 |
| 4.4 550 i, 4.4 550 i 4WD | 8 | N63B44B | 330/443 | 08/12→10/16 | OE243 | 0,8 | | BAEA143 |
| 4.4 M5 | 8 | S63B44B | 412/552 | 10/10→10/16 | | | | BAEA143[87] |
| 4.4 M5 Competition | 8 | S63B44B | 423/567 | 02/13→10/16 | | | | BAEA143 |
| 4.4 M5 Edition 30 | 8 | S63B44B | 441/591 | 07/14→10/16 | | | | BAEA143 |

5 Touring (F11)

| | | | | | | | | |
|--------------------------|---|---------|---------|-------------|--|------|--|----------------------|
| 2.0 518 d | 4 | N47D20C | 100/134 | 10/12→ | | | | CCU106 [48] [344] |
| 2.0 518 d | 4 | N47D20C | 105/141 | 10/12→07/14 | | | | CCU106[48] |
| 2.0 520 d, 2.0 520 d 4WD | 4 | N47D20C | 135/181 | 11/09→10/16 | | | | CCU106 |
| 2.0 520 d, 2.0 520 d 4WD | 4 | N47D20C | 147/197 | 11/09→10/16 | | | | CCU106 |
| 2.0 520 d 4WD | 4 | N47D20C | 100/134 | 07/13→07/14 | | | | CCU106 |
| 2.0 520 i | 4 | N20B20A | 120/161 | 09/11→02/17 | OE243 | 0,8 | | |
| 2.0 520 i | 4 | N20B20A | 135/181 | 10/10→ | OE243 | 0,8 | | BAEA143 |
| 2.0 520 i | 4 | N20B20B | 135/181 | 10/10→ | | | | BAEA143 |
| 2.0 525 d, 2.0 525 d 4WD | 4 | N47D20D | 155/208 | 02/11→ | | | | CCU106 |
| 2.0 525 d, 2.0 525 d 4WD | 4 | N47D20D | 160/215 | 02/11→ | | | | CCU106 |
| 2.0 528 i | 4 | N20B20A | 180/241 | 10/10→ | OE243 | 0,8 | | BAEA143 |
| 2.0 528 i 4WD | 4 | N20B20A | 180/241 | 03/11→ | | | | BAEA143 |
| 2.5 523 i | 6 | N52B25A | 150/201 | 11/09→08/11 | | | | BAEA143 09/10→ |
| 3.0 523 i | 6 | N53B30A | 150/201 | 11/09→08/11 | | | | BAEA144E |
| 3.0 525 d | 6 | N57D30A | 150/201 | 11/09→08/11 | | | | CCU108 |
| 3.0 528 i | 6 | N53B30A | 190/255 | 11/09→08/11 | | | | BAEA143 BAEA144E |
| 3.0 530 d | 6 | N57D30A | 180/241 | 11/09→08/11 | CCGP001 [47] [92] [240] [346] | 5.4v | | CCU108[357] |
| 3.0 530 d | 6 | N57D30A | 190/255 | 02/11→ | CCGP001 →01/12 [47] [92] [240] [346] | 5.4v | | CCU108[357] |
| 3.0 530 d | 6 | N57D30A | 210/282 | 09/11→ | CCGP001 →01/12 [47] [92] [240] [346] | 5.4v | | CCU108[357] |

CHAMPION

BMW



kW/BHP

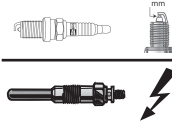

eon TITAN

IRIDIUM

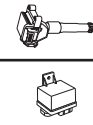
**...BMW****...5 Touring (F11)**

| | | | | | | | | |
|--------------------------|---|---------|---------|-------------|---|------|--|-----------------------------|
| 3.0 530 d 4WD | 6 | N57D30A | 190/255 | 07/10→ | CCGP001 →01/12 [47] [92] [240] | 5.4v | | |
| 3.0 530 d 4WD | 6 | N57D30A | 210/282 | 09/11→ | CCGP001 →01/12 [47] [92] [240] | 5.4v | | CCU108 [48] |
| 3.0 530 i | 6 | N53B30A | 200/268 | 07/11→06/13 | | | | BAEA144E →02/12 |
| 3.0 535 d | 6 | N57D30B | 220/295 | 03/10→08/11 | CCGP001 [47] [92] [240] [348] | 5.4v | | CCU108 [47] [347] |
| 3.0 535 d | 6 | N57D30B | 225/302 | 03/10→08/11 | CCGP001 [47] [92] [240] [348] | 5.4v | | CCU108 [347] |
| | | | | | CCGP001 [48] [92] [240] | 5.4v | | |
| 3.0 535 d | 6 | N57D30B | 230/308 | 03/11→ | CCGP001 [47] [92] [240] [348] | 5.4v | | CCU108 [347] |
| | | | | | CCGP001 [48] [92] [240] | 5.4v | | |
| 3.0 535 i, 3.0 535 i 4WD | 6 | N55B30A | 225/302 | 11/09→ | OE242 | 0,8 | | BAEA143 |
| 3.0 535 i 4WD | 6 | N55B30A | 240/322 | 07/13→ | OE242 | 0,8 | | |
| 3.0 M 550 d 4WD | 6 | N57D30C | 280/375 | 10/10→ | CCGP001 [92] [240] | 5.4v | | |
| 4.4 550 i | 8 | N63B44A | 300/402 | 09/10→06/13 | OE242 | 0,8 | | BAEA143 |
| 4.4 550 i | 8 | N63B44B | 330/443 | 08/12→ | OE243 | 0,8 | | BAEA143 |

5 (G30, F90)

| | | | | | | | | |
|--|---|------------------|---------|--------|--|--|--|---------------------------------------|
| 2.0 530 e iPerformance | 4 | B48B20B | 135/181 | 03/17→ | | | | OE245 BAEA538 →06/17 |
| 2.0 530 e iPerformance, 2.0 530 i, 2.0 530 i 4WD | 4 | B46B20B; B48B20B | 185/248 | 09/16→ | | | | OE245 BAEA538 →06/17 |
| 3.0 530 d | 6 | B57D30A | 195/261 | 09/16→ | | | | BAEA538 →06/17 |
| 3.0 540 i, 3.0 540 i 4WD | 6 | B58B30A | 250/335 | 09/16→ | | | | OE245 BAEA538 →06/17 |
| 3.0 540 i, 3.0 540 i 4WD | 6 | B58B30A | 265/355 | 09/16→ | | | | OE245 BAEA538 →06/17 |

5 Gran Turismo (F07)

| | | | | | | | | |
|---------------|---|---------|---------|-------------|---|------|--|---------------------|
| 2.0 520 d | 4 | N47D20C | 100/134 | 10/12→02/17 | | | | CCU106 |
| 2.0 520 d | 4 | N47D20C | 120/161 | 04/11→02/17 | | | | CCU106 |
| 2.0 520 d | 4 | N47D20C | 135/181 | 04/11→02/17 | | | | CCU106 |
| 2.0 528 i | 4 | N20B20A | 180/241 | 07/13→02/17 | OE243 | 0,8 | | BAEA143 |
| 3.0 530 d | 6 | N57D30A | 155/208 | 09/10→06/12 | CCGP001 →01/12 [47] [92] [240] [346] | 5.4v | | CCU108 [357] |
| 3.0 530 d | 6 | N57D30A | 180/241 | 08/09→06/12 | CCGP001 →01/12 [47] [92] [240] [346] | 5.4v | | CCU108 [357] |
| 3.0 530 d | 6 | N57D30A | 190/255 | 07/12→02/17 | | | | CCU108 [357] |
| 3.0 530 d 4WD | 6 | N57D30A | 180/241 | 06/10→06/12 | CCGP001 →01/12 [47] [92] [240] | 5.4v | | CCU108 [48] |
| 3.0 530 d 4WD | 6 | N57D30A | 190/255 | 07/12→02/17 | | | | CCU108 [48] |
| 3.0 535 d | 6 | N57D30B | 220/295 | 03/10→06/12 | CCGP001 [47] [92] [240] [348] | 5.4v | | CCU108 [347] |
| | | | | | CCGP001 [48] [92] [240] | 5.4v | | |
| 3.0 535 d | 6 | | 225/302 | 05/09→06/12 | CCGP001 [47] [92] [240] [348] | 5.4v | | CCU108 [347] |
| | | | | | CCGP001 [48] [92] [240] | 5.4v | | |
| 3.0 535 d | 6 | N57D30B | 230/308 | 07/12→02/17 | CCGP001 [47] [92] [240] [348] | 5.4v | | CCU108 [347] |
| | | | | | CCGP001 [48] [92] [240] | 5.4v | | |
| 3.0 535 d 4WD | 6 | N57D30B | 220/295 | 03/10→06/12 | | | | CCU108 [347] |
| 3.0 535 d 4WD | 6 | | 225/302 | 05/09→06/12 | | | | CCU108 [347] |

BMW



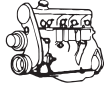

kW/BHP

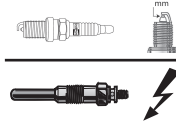

eon TITAN

IRIDIUM

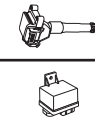
**...BMW****...5 Gran Turismo (F07)**

| | | | | | | | | | | |
|--------------------------|---|---------|---------|-------------|-------|-----|--|--|--|-------------------------|
| 3.0 535 d 4WD | 6 | N57D30B | 230/308 | 07/12→02/17 | | | | | | CCU108 ^[347] |
| 3.0 535 i, 3.0 535 i 4WD | 6 | N55B30A | 225/302 | 01/09→02/17 | OE242 | 0,8 | | | | BAEA143 |
| 4.4 550 i | 8 | N63B44B | 298/400 | 10/09→06/12 | OE016 | 0,9 | | | | BAEA143 |
| 4.4 550 i 4WD | 8 | N63B44A | 298/400 | 06/10→06/12 | | | | | | BAEA143 |
| 4.4 550 i, 4.4 550 i 4WD | 8 | N63B44A | 300/402 | 08/09→06/12 | OE016 | 0,9 | | | | BAEA143 |
| 4.4 550 i, 4.4 550 i 4WD | 8 | N63B44B | 330/443 | 07/12→02/17 | OE243 | 0,8 | | | | BAEA143 |

6 (E63)

| | | | | | | | | | | |
|------------|---|-------------------|---------|-------------|----------------------------|-----|---------|-------|--|---|
| 3.0 630 i | 6 | N52B30A; N52B30BF | 190/255 | 02/04→07/07 | OE238 | 1,0 | | | | BAEA145E →04/06 BAEA143 04/06→ |
| 3.0 630 i | 6 | N53B30A | 200/268 | 07/07→07/10 | | | | | | BAEA144E |
| 3.0 635 d | 6 | M57D30(306D5) | 210/282 | 07/07→07/10 | | | | | | CCU102 |
| 4.4 645 Ci | 8 | N62B44A | 245/329 | 01/04→08/05 | OE223 | 1,6 | CET1 2P | OE188 | | BAEA324 |
| 4.8 650 i | 8 | N62B48B | 270/362 | 07/05→07/10 | OE216 ^{LPG [278]} | 0,8 | CET1 2P | OE188 | | BAEA143 |

6 Convertible (E64)

| | | | | | | | | | | |
|------------|---|-------------------------------|---------|-------------|----------------------------|-----|---------|-------|--|---|
| 3.0 630 i | 6 | N52B30A; N52B30B; N52B30BF | 190/255 | 03/04→07/07 | OE238 | 1,0 | | | | BAEA145E →04/06 BAEA143 04/06→ |
| 3.0 630 i | 6 | N53B30A | 200/268 | 07/07→07/10 | | | | | | BAEA144E |
| 3.0 635 d | 6 | M57D30(306D5) | 210/282 | 07/07→07/10 | | | | | | CCU102 |
| 4.4 645 Ci | 8 | N62B44A | 245/329 | 04/04→08/05 | OE223 | 1,6 | CET1 2P | OE188 | | BAEA324 |
| 4.8 650 i | 8 | N62B48B | 270/362 | 07/05→07/10 | OE216 ^{LPG [278]} | 0,8 | CET1 2P | OE188 | | BAEA143 |

6 Convertible (F12)

| | | | | | | | | | | |
|--------------------------|---|------------------|---------|-------------|-------------------------------|------|--|--|--|-------------------------|
| 3.0 640 d, 3.0 640 d 4WD | 6 | N57D30B | 230/308 | 09/11→ | CCGP001 ^{[92] [240]} | 5.4v | | | | |
| 3.0 640 i | 6 | N55B30A | 235/315 | 03/11→ | OE242 | 0,8 | | | | BAEA143 →05/13 |
| 3.0 640 i 4WD | 6 | N55B30A | 235/315 | 01/13→ | OE242 | 0,8 | | | | BAEA143 |
| 4.4 650 i | 8 | N63B44A | 298/400 | 09/11→12/12 | OE242 | 0,8 | | | | BAEA143 →06/12 |
| 4.4 650 i | 8 | N63B44A | 300/402 | 03/11→ | OE242 | 0,8 | | | | BAEA143 →06/12 |
| 4.4 650 i 4WD | 8 | N63B44A | 298/400 | 09/11→ | | | | | | BAEA143 |
| 4.4 650 i 4WD | 8 | N63B44A | 300/402 | 06/11→ | OE242 | 0,8 | | | | BAEA143 ^[87] |
| 4.4 650 i, 4.4 650 i 4WD | 8 | N63B44A; N63B44B | 330/443 | 10/11→ | OE243 | 0,8 | | | | |
| 4.4 650 i, 4.4 650 i 4WD | 8 | N63B44A; N63B44B | 330/443 | 10/11→ | OE243 | 0,8 | | | | BAEA143 ^[87] |
| 4.4 M6 | 8 | S63B44B | 412/552 | 01/12→ | | | | | | BAEA143 |
| 4.4 M6 | 8 | S63B44B | 423/567 | 02/14→ | | | | | | BAEA143 |

6 Coupe (F13)

| | | | | | | | | | | |
|--------------------------|---|---------|---------|-------------|-------------------------------|------|--|--|--|-------------------------|
| 3.0 640 d, 3.0 640 d 4WD | 6 | N57D30B | 230/308 | 11/10→ | CCGP001 ^{[92] [240]} | 5.4v | | | | |
| 3.0 640 i, 3.0 640 i 4WD | 6 | N55B30A | 235/315 | 11/10→ | OE242 | 0,8 | | | | BAEA143 |
| 4.4 650 i | 8 | N63B44A | 298/400 | 09/11→12/12 | OE242 | 0,8 | | | | BAEA143 |
| 4.4 650 i | 8 | N63B44A | 300/402 | 11/10→ | OE242 | 0,8 | | | | BAEA143 ^[87] |
| 4.4 650 i 4WD | 8 | N63B44A | 298/400 | 09/11→ | | | | | | BAEA143 |
| 4.4 650 i 4WD | 8 | N63B44A | 300/402 | 06/11→ | OE242 | 0,8 | | | | BAEA143 |
| 4.4 650 i, 4.4 650 i 4WD | 8 | N63B44B | 330/443 | 10/11→ | OE243 | 0,8 | | | | BAEA143 ^[87] |
| 4.4 M6 | 8 | S63B44B | 412/552 | 01/12→ | | | | | | BAEA143 ^[87] |
| 4.4 M6 | 8 | S63B44B | 423/567 | 02/14→ | | | | | | BAEA143 |

6 Gran Coupe (F06)

| | | | | | | | | | | |
|--------------------------|---|---------|---------|--------|-------------------------------|------|--|--|--|-------------------------|
| 3.0 640 d, 3.0 640 d 4WD | 6 | N57D30B | 230/308 | 09/11→ | CCGP001 ^{[92] [240]} | 5.4v | | | | |
| 3.0 640 i, 3.0 640 i 4WD | 6 | N55B30A | 235/315 | 09/11→ | OE242 | 0,8 | | | | BAEA143 |
| 4.4 650 i, 4.4 650 i 4WD | 8 | N63B44B | 330/443 | 11/11→ | OE243 | 0,8 | | | | BAEA143 ^[87] |
| 4.4 M6 | 8 | S63B44B | 412/552 | 12/12→ | | | | | | BAEA143 ^[87] |





kW/BHP

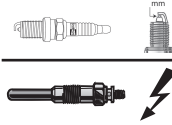

eon TITAN

IRIDIUM

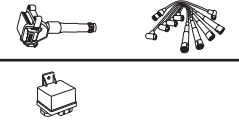

...BMW

...6 Gran Coupe (F06)

| | | | | | | | | | |
|--------|---|---------|---------|---------|--|--|--|--|---------|
| 4.4 M6 | 8 | S63B44B | 423/567 | 02/14 → | | | | | BAEA143 |
|--------|---|---------|---------|---------|--|--|--|--|---------|

7 (E38)

| | | | | | | | | | |
|-------------|---|---------------|---------|---------------|-------|-----|--|--|--|
| 2.5 725 tds | 6 | M51D25(256T1) | 105/141 | 04/96 → 11/01 | CH189 | 11v | | | |
|-------------|---|---------------|---------|---------------|-------|-----|--|--|--|

| | | | | | | | | | |
|--------------|---|---------------|---------|---------------|------------------|-----|--------|-------|-----------------------|
| 2.8 728i 4WD | 6 | M52B28(286S1) | 142/190 | 11/95 → 09/01 | OE223 09/98 → | 1,6 | CET12P | OE188 | BAEA302 [83] [242] |
|--------------|---|---------------|---------|---------------|------------------|-----|--------|-------|-----------------------|

| | | | | | | | | | |
|---------------|---|---------------------------------|---------|---------------|------------------|-----|------|-------|---------|
| 2.8 728 i, iL | 6 | M52B28(286S1); M52B28(286S2) | 142/190 | 08/95 → 11/01 | OE026 → 09/98 | 0,9 | CET2 | OE188 | BAEA302 |
|---------------|---|---------------------------------|---------|---------------|------------------|-----|------|-------|---------|

| | | | | | | | | | |
|--|--|--|--|--|----------------------------|-----|--|--|--|
| | | | | | OE216 LPG [278] → 09/98 | 0,8 | | | |
|--|--|--|--|--|----------------------------|-----|--|--|--|

| | | | | | | | | | |
|--|--|--|--|--|------------------|-----|--|--|--|
| | | | | | OE223 09/98 → | 1,6 | | | |
|--|--|--|--|--|------------------|-----|--|--|--|

| | | | | | | | | | |
|-----------|---|---------------|---------|---------------|-------|-----|--|--|--|
| 3.0 730 d | 6 | M57D30(306D1) | 135/181 | 08/98 → 04/00 | CH203 | 11v | | | |
|-----------|---|---------------|---------|---------------|-------|-----|--|--|--|

| | | | | | | | | | |
|-----------|---|---------------|---------|---------------|-------|-----|--|--|--|
| 3.0 730 d | 6 | M57D30(306D1) | 142/190 | 04/00 → 11/01 | CH203 | 11v | | | |
|-----------|---|---------------|---------|---------------|-------|-----|--|--|--|

| | | | | | | | | | |
|---------------|---|---------------|---------|---------------|------------------|-----|--------|-------|--------------------|
| 3.0 730 i, iL | 8 | M60B30(308S1) | 155/208 | 10/94 → 11/01 | OE026 → 09/98 | 0,9 | CET12P | OE188 | BAEA014 → 12/96 |
|---------------|---|---------------|---------|---------------|------------------|-----|--------|-------|--------------------|

| | | | | | | | | | |
|--|--|--|--|--|----------------------------|-----|--|--|--|
| | | | | | OE216 LPG [278] → 09/98 | 0,8 | | | |
|--|--|--|--|--|----------------------------|-----|--|--|--|

| | | | | | | | | | |
|---------------|---|---------------|---------|---------------|------------------|-----|--------|-------|--------------------|
| 3.0 730 i, iL | 8 | M60B30(308S1) | 160/215 | 10/94 → 11/01 | OE026 → 09/98 | 0,9 | CET12P | OE188 | BAEA014 → 12/96 |
|---------------|---|---------------|---------|---------------|------------------|-----|--------|-------|--------------------|

| | | | | | | | | | |
|--|--|--|--|--|----------------------------|-----|--|--|--|
| | | | | | OE216 LPG [278] → 09/98 | 0,8 | | | |
|--|--|--|--|--|----------------------------|-----|--|--|--|

| | | | | | | | | | |
|---------------|---|---------------|---------|---------------|------------------|-----|-------------------|-------|---------|
| 3.5 735 i, iL | 8 | M62B35(358S1) | 173/232 | 01/96 → 12/98 | OE026 → 09/98 | 0,9 | CET12P → 05/96 | OE188 | BAEA302 |
|---------------|---|---------------|---------|---------------|------------------|-----|-------------------|-------|---------|

| | | | | | | | | | |
|--|--|--|--|--|----------------------------|-----|--|--|--|
| | | | | | OE216 LPG [278] → 09/98 | 0,8 | | | |
|--|--|--|--|--|----------------------------|-----|--|--|--|

| | | | | | | | | | |
|-----------|---|---------------|---------|---------------|-------|-----|--|--|--|
| 3.9 740 d | 8 | M67D39(398D1) | 180/241 | 05/99 → 11/01 | CH207 | 11v | | | |
|-----------|---|---------------|---------|---------------|-------|-----|--|--|--|

| | | | | | | | | | |
|---------------|---|---------------|---------|---------------|------------------|-----|-------------------|-------|--------------------|
| 4.0 740 i, iL | 8 | M60B40(408S1) | 210/282 | 10/94 → 11/01 | OE026 → 09/98 | 0,9 | CET12P → 08/98 | OE188 | BAEA014 → 06/96 |
|---------------|---|---------------|---------|---------------|------------------|-----|-------------------|-------|--------------------|

| | | | | | | | | | |
|--|--|--|--|--|----------------------------|-----|--|--|--|
| | | | | | OE216 LPG [278] → 09/98 | 0,8 | | | |
|--|--|--|--|--|----------------------------|-----|--|--|--|

| | | | | | | | | | |
|---------------|---|---------------------------------|---------|---------------|------------------|-----|--------|-------|---------|
| 4.4 740 i, iL | 8 | M62B44(448S1); M62B44(448S2) | 210/282 | 01/96 → 11/01 | OE026 → 09/98 | 0,9 | CET12P | OE188 | BAEA302 |
|---------------|---|---------------------------------|---------|---------------|------------------|-----|--------|-------|---------|

| | | | | | | | | | |
|--|--|--|--|--|----------------------------|-----|--|--|--|
| | | | | | OE216 LPG [278] → 09/98 | 0,8 | | | |
|--|--|--|--|--|----------------------------|-----|--|--|--|

| | | | | | | | | | |
|---------------|----|---------------------------------|---------|---------------|-------|-----|--------|-------|---------|
| 5.4 750 i, iL | 12 | M73B54(54121); M73B54(54122) | 240/322 | 09/94 → 11/01 | OE223 | 1,6 | CET12P | OE184 | BAEA302 |
|---------------|----|---------------------------------|---------|---------------|-------|-----|--------|-------|---------|

| | | | | | | | | | |
|---------------------|---|---------|---------|---------------|-------|-----|--|--|---|
| 7 (E65, E66) | | | | | | | | | |
| 3.0 730 i, Li | 6 | N52B30A | 184/247 | 03/05 → 07/08 | OE238 | 1,0 | | | BAEA145E → 03/06 BAEA143 04/06 → |

| | | | | | | | | | |
|--------------------------|---|---------------------------------|---------|---------------|--|--|--|--|--------|
| 7 (E65, E66, E67) | | | | | | | | | |
| 3.0 730 d | 6 | M57D30(306D2); M57D30(306D3) | 155/208 | 10/02 → 07/08 | | | | | CCU102 |

| | | | | | | | | | |
|-----------|---|---------------|---------|---------------|--|--|--|--|--------|
| 3.0 730 d | 6 | M57D30(306D2) | 160/215 | 06/02 → 02/05 | | | | | CCU102 |
|-----------|---|---------------|---------|---------------|--|--|--|--|--------|

| | | | | | | | | | |
|---------------|---|---------------|---------|---------------|-------|-----|--------|-------|-------------------------------------|
| 3.0 730 i, Li | 6 | M54B30(306S3) | 170/228 | 03/03 → 07/08 | OE223 | 1,6 | CET12P | OE188 | BAEA143 ^[247] BAEA324 |
|---------------|---|---------------|---------|---------------|-------|-----|--------|-------|-------------------------------------|

| | | | | | | | | | |
|---------------|---|---------|---------|---------------|-------|-----|--|--|---|
| 3.0 730 i, Li | 6 | N52B30A | 190/255 | 03/05 → 07/08 | OE238 | 1,0 | | | BAEA145E → 04/06 BAEA143 11/07 → |
|---------------|---|---------|---------|---------------|-------|-----|--|--|---|

| | | | | | | | | | |
|------------|---|---------------|---------|---------------|--|--|--|--|--------|
| 3.0 730 Ld | 6 | M57D30(306D3) | 170/228 | 07/05 → 08/08 | | | | | CCU102 |
|------------|---|---------------|---------|---------------|--|--|--|--|--------|

| | | | | | | | | | |
|---------------|---|---------|---------|---------------|-------|-----|--------|-------|---------|
| 3.6 735 i, Li | 8 | N62B36A | 200/268 | 11/01 → 02/05 | OE223 | 1,6 | CET12P | OE188 | BAEA324 |
|---------------|---|---------|---------|---------------|-------|-----|--------|-------|---------|

| | | | | | | | | | |
|-----------|---|---------|---------|---------------|-------|-----|------|-------|---------|
| 4.0 735 i | 8 | N62B40A | 225/302 | 03/05 → 12/09 | OE120 | 0,6 | CET2 | OE188 | BAEA143 |
|-----------|---|---------|---------|---------------|-------|-----|------|-------|---------|

| | | | | | | | | | |
|---------------|---|---------|---------|---------------|-----------------|-----|--------|-------|--------------------------|
| 4.0 740 i, Li | 8 | N62B40A | 225/302 | 07/05 → 07/08 | OE216 LPG [278] | 0,8 | CET12P | OE188 | BAEA143 ^[247] |
|---------------|---|---------|---------|---------------|-----------------|-----|--------|-------|--------------------------|

| | | | | | | | | | |
|---------------|---|---------|---------|---------------|-------|-----|--------|-------|---------|
| 4.4 745 i, Li | 8 | N62B44A | 245/329 | 11/01 → 07/08 | OE223 | 1,6 | CET12P | OE188 | BAEA324 |
|---------------|---|---------|---------|---------------|-------|-----|--------|-------|---------|

| | | | | | | | | | |
|---------------|---|---------|---------|---------------|-----------------|-----|--------|-------|---------|
| 4.8 750 i, Li | 8 | N62B48B | 270/362 | 07/05 → 07/08 | OE216 LPG [278] | 0,8 | CET12P | OE188 | BAEA143 |
|---------------|---|---------|---------|---------------|-----------------|-----|--------|-------|---------|

| | | | | | | | | | |
|---------------|----|---------|---------|---------------|-------|-----|--------|-------|--------------------------|
| 6.0 760 i, Li | 12 | N73B60A | 327/439 | 01/03 → 07/08 | OE223 | 1,6 | CET12P | OE188 | BAEA143 ^[247] |
|---------------|----|---------|---------|---------------|-------|-----|--------|-------|--------------------------|

| | | | | | | | | | |
|-------------------------------|---|---------|---------|---------------|----------------------------|------|--|--|------------------------|
| 7 (F01, F02, F03, F04) | | | | | | | | | |
| 3.0 730 d | 6 | N57D30A | 180/241 | 02/08 → 07/12 | CCGP001 [48] [92] [240] | 5.4v | | | CCU108 ^[47] |

BMW





kW/BHP

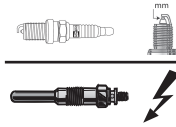

eon TITAN

IRIDIUM

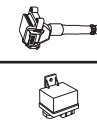

...BMW

...7 (F01, F02, F03, F04)

| | | | | | | | | | |
|--|----|-------------------|---------|---------------|----------------------------|------|--|--|-------------------------|
| 3.0 730 d, 3.0 730 d 4WD | 6 | N57D30A | 155/208 | 02/08 → 05/15 | CCGP001 [48] [92] [240] | 5.4v | | | CCU108 ^[47] |
| 3.0 730 d, 3.0 730 d 4WD | 6 | N57D30A | 190/255 | 11/11 → 05/15 | CCGP001 [48] [92] [240] | 5.4v | | | |
| 3.0 730 i, Li | 6 | N52B30A; N52B30BF | 190/255 | 06/08 → 12/15 | OE238 | 1,0 | | | BAEA143 |
| 3.0 740 d, 3.0 740 d 4WD | 6 | N57D30B | 225/302 | 09/09 → 12/15 | CCGP001 [48] [92] [240] | 5.4v | | | CCU108 ^[47] |
| 3.0 740 d, 3.0 740 d 4WD | 6 | N57D30B | 230/308 | 07/12 → 12/15 | CCGP001 [48] [92] [240] | 5.4v | | | |
| 3.0 740 i | 6 | N54B30A | 240/322 | 10/08 → 12/15 | | | | | BAEA143 →06/12 |
| 3.0 740 i, Li, 3.0 740 i, Li 4WD, 3.0 ActiveHybrid | 6 | N55B30A | 235/315 | 05/11 → 12/15 | OE242 | 0,8 | | | BAEA143 |
| 3.0 750 d 4WD | 6 | N57D30C | 280/375 | 07/12 → 12/15 | CCGP001 [92] [240] | 5.4v | | | |
| 3.0 ActiveHybrid | 6 | N55B30A | 260/349 | 05/11 → 05/15 | OE242 | 0,8 | | | BAEA143 |
| 4.4 750 i, 4.4 750 i 4WD | 8 | N63B44A; N63B44B | 300/402 | 10/08 → 12/15 | OE242 | 0,8 | | | BAEA143 →06/12 |
| 4.4 750 i, 4.4 750 i 4WD | 8 | N63B44B | 330/443 | 10/12 → 12/15 | OE243 | 0,8 | | | BAEA143 ^[87] |
| 4.4 ActiveHybrid | 8 | N63B44A | 330/443 | 09/09 → 06/12 | OE242 | 0,8 | | | BAEA143 |
| 4.4 ActiveHybrid | 8 | N63B44B | 339/455 | 09/09 → 06/12 | | | | | BAEA143 |
| 4.4 ActiveHybrid | 8 | N63B44A | 342/459 | 09/09 → 06/12 | OE242 | 0,8 | | | BAEA143 |
| 6.0 760 i | 12 | N74B60A | 400/536 | 09/09 → 12/15 | OE242 | 0,8 | | | BAEA143 |

7 (G11, G12)

| | | | | | | | | | |
|---|---|---------|---------|---------|--|--|-------|--|-------------------|
| 2.0 730 i, Li, 2.0 740 e, Le, 2.0 740 e, Le 4WD | 4 | B48B20B | 190/255 | 02/16 → | | | OE245 | | BAEA538 →06/17 |
| 2.0 740 e, Le, 2.0 740 e, Le 4WD | 4 | B48B20B | 240/322 | 04/16 → | | | OE245 | | BAEA538 →06/17 |
| 3.0 740 i, Li, 3.0 740 i, Li 4WD | 6 | B58B30A | 240/322 | 09/15 → | | | OE245 | | BAEA538 →06/17 |

8 (E31)

| | | | | | | | | | |
|------------|----|---------------|---------|---------------|-------------------------------------|------------|--------|-------|---------|
| 4.0 840 i | 8 | M60B40(408S1) | 210/282 | 02/93 → 02/96 | OE026 OE216 LPG ^[278] | 0,9 0,8 | CET2 | OE188 | BAEA014 |
| 4.4 840 Ci | 8 | M62B44(448S1) | 210/282 | 01/96 → 12/99 | OE026 OE216 LPG ^[278] | 0,9 0,8 | CET2 | OE188 | BAEA302 |
| 5.4 850 Ci | 12 | M73B54(54121) | 240/322 | 09/94 → 12/99 | OE223 | 1,6 | CET12P | OE184 | BAEA302 |

X1 (E84)

| | | | | | | | | | |
|--------------------------------------|---|---------|---------|---------------|---------------------------------------|------|--------|-------|--|
| 1.6 sDrive 16 i | 4 | N20B16A | 105/141 | 03/13 → 06/15 | OE243 | 0,8 | | | BAEA143 |
| 2.0 sDrive 16 d | 4 | N47D20C | 85/114 | 04/12 → 06/15 | | | | | CCU106 ^[344] |
| 2.0 sDrive 18 d, 2.0 xDrive 18 d 4WD | 4 | N47D20C | 100/134 | 03/09 → 06/15 | CCGP001 →02/11 [92] [240] [344] | 5.4v | | | CCU105 ^[343] CCU106 ^[344] |
| 2.0 sDrive 18 d, 2.0 xDrive 18 d 4WD | 4 | N47D20C | 105/141 | 10/09 → 06/15 | CCGP001 →02/11 [92] [240] [344] | 5.4v | | | CCU105 ^[343] CCU106 ^[344] |
| 2.0 sDrive 18 i | 4 | N46B20B | 100/134 | 03/09 → 06/15 | OE216 LPG ^[278] | 0,8 | CET12P | OE188 | BAEA143 |
| 2.0 sDrive 18 i | 4 | N46B20B | 110/148 | 01/10 → 06/15 | OE216 LPG ^[278] | 0,8 | | OE188 | BAEA143 |
| 2.0 sDrive 20 d, 2.0 xDrive 20 d 4WD | 4 | N47D20C | 120/161 | 03/10 → 06/15 | | | | | CCU105 ^[343] CCU106 ^[344] |
| 2.0 sDrive 20 d, 2.0 xDrive 20 d 4WD | 4 | N47D20C | 130/174 | 10/09 → 06/15 | | | | | CCU105 ^[343] CCU106 ^[344] |
| 2.0 sDrive 20 d, 2.0 xDrive 20 d 4WD | 4 | N47D20C | 135/181 | 07/12 → 06/15 | | | | | CCU105 ^[343] CCU106 ^[344] |
| 2.0 sDrive 20 i | 4 | N20B20A | 135/181 | 09/11 → 06/15 | OE243 | 0,8 | | | BAEA143 →05/13 |



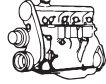

kW/BHP

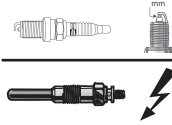

eon TITAN

IRIDIUM

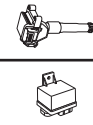
**...BMW****...X1 (E84)**

| | | | | | | | | |
|---------------------|---|---------|---------|-------------|--------------|-----|--|--------------------------------|
| 2.0 xDrive 20 i 4WD | 4 | N20B20A | 135/181 | 09/11→06/15 | OE243 | 0,8 | | BAEA143 |
| 2.0 xDrive 23 d 4WD | 4 | N47D20D | 150/201 | 10/09→06/15 | | | | CCU105 |
| 2.0 xDrive 25 d 4WD | 4 | N47D20D | 160/215 | 10/09→06/15 | | | | CCU106 ^[344] |
| 2.0 xDrive 28 i 4WD | 4 | N20B20A | 180/241 | 04/11→06/15 | OE243 | 0,8 | | BAEA143 →05/13 |
| 3.0 xDrive 25 i 4WD | 6 | N52B30A | 160/215 | 01/10→06/15 | OE238 | 1,0 | | BAEA143 |
| 3.0 xDrive 28 i 4WD | 6 | N52B30A | 190/255 | 10/09→06/15 | OE238 | 1,0 | | BAEA143 →08/11 |

X1 (F48)

| | | | | | | | | |
|--------------------------------------|---|---------------------------|---------|-------------|--|--|--------------|----------------|
| 1.5 sDrive 18 i | 3 | B38A15A | 100/134 | 11/14→05/17 | | | OE245 | BAEA538 |
| 2.0 sDrive 20 i, 2.0 xDrive 20 i 4WD | 4 | B48A20A; B48A20B | 141/189 | 11/14→ | | | OE245 | BAEA538 |
| 2.0 xDrive 25 i 4WD | 4 | B46A20B; B48A20A; B48A20B | 170/228 | 11/14→ | | | OE245 | BAEA538 |

X2 (F39)

| | | | | | | | | |
|---------------------|---|---------|---------|--------|--|--|--------------|----------------|
| 2.0 sDrive 20 i | 4 | B48A20A | 141/189 | 11/17→ | | | | BAEA538 |
| 2.0 xDrive 28 i 4WD | 4 | B46A20B | 170/228 | 11/17→ | | | OE245 | BAEA538 |

X3 (E83)

| | | | | | | | | |
|--------------------------------|---|------------------|---------|-------------|----------------------------------|-----|---------------|--|
| 2.0 d 4WD | 4 | M47D20(204D4) | 110/148 | 11/03→08/07 | | | | CCU101 |
| 2.0 d 4WD, 2.0 xDrive 20 d 4WD | 4 | N47D20A; N47D20C | 130/174 | 03/07→08/10 | | | | CCU105 |
| 2.0 i 4WD | 4 | N46B20B | 110/148 | 07/05→08/08 | OE216 ^[PG 278] | 0,8 | CET12P | OE188 BAEA143 ^[247] |
| 2.0 xDrive 18 d 4WD | 4 | N47D20C | 100/134 | 04/09→12/11 | | | | CCU105 |
| 2.0 xDrive 18 d 4WD | 4 | N47D20C | 105/141 | 09/08→12/11 | | | | CCU105 |
| 2.0 xDrive 20 d 4WD | 4 | N47D20C | 120/161 | 09/07→08/10 | | | | CCU105 |
| 2.0 xDrive 20 i 4WD | 4 | N46B20B | 110/148 | 09/08→08/11 | | | OE188 | BAEA143 |
| 2.5 i 4WD | 6 | M54B25(256S5) | 141/189 | 01/04→08/06 | OE223 | 1,6 | CET12P | OE188 BAEA143 ^[247] |
| 2.5 i 4WD | 6 | M54256S5; M54B25 | 141/189 | 01/04→08/06 | | | | BAEA324 |
| 2.5 si 4WD | 6 | N52B25A | 155/208 | 07/06→12/08 | OE238 | 1,0 | | BAEA143 09/06→08/08 |
| 2.5 si 4WD | 6 | N52B25A | 160/215 | 09/06→08/08 | OE238 | 1,0 | | BAEA143 |
| 2.5 xDrive 25 i 4WD | 6 | N52B25A | 160/215 | 09/08→12/11 | OE238 | 1,0 | | BAEA143 →08/10 |
| 3.0 d 4WD | 6 | M57D30(306D2) | 150/201 | 01/04→08/05 | | | | CCU102 |
| 3.0 d 4WD, 3.0 xDrive 30 d 4WD | 6 | M57D30(306D3) | 160/215 | 09/05→08/10 | | | | CCU102 |
| 3.0 i 4WD | 6 | M54B30(306S3) | 170/228 | 01/04→08/06 | OE223 | 1,6 | CET12P | OE188 BAEA143 ^[247] |
| 3.0 i 4WD | 6 | M54306S3; M54B30 | 170/228 | 01/04→08/06 | | | | BAEA324 |
| 3.0 sd 4WD | 6 | M57D30(306D5) | 210/282 | 09/06→08/08 | | | | CCU102 |
| 3.0 si 4WD | 6 | N52B30A | 200/268 | 09/06→08/08 | OE238 | 1,0 | | BAEA143 |
| 3.0 xDrive 28 i 4WD | 6 | N52B30A | 171/229 | 09/08→12/10 | | | | BAEA143 |
| 3.0 xDrive 30 d 4WD | 6 | M57D30(306D3) | 155/208 | 09/08→08/10 | | | | CCU102 |
| 3.0 xDrive 30 i 4WD | 6 | N52B30A | 160/215 | 03/06→07/10 | | | | BAEA143 |
| 3.0 xDrive 30 i 4WD | 6 | N52B30A | 200/268 | 09/08→12/11 | OE238 | 1,0 | | BAEA143 →08/10 |

X3 (F25)

| | | | | | | | | |
|--------------------------------------|---|-----------------------------|---------|--------|--------------|-----|--|--------------------------|
| 2.0 sDrive 18 d | 4 | N47D20C | 100/134 | 08/11→ | | | | CCU106 |
| 2.0 sDrive 18 d | 4 | N47D20C | 105/141 | 08/11→ | | | | CCU106 |
| 2.0 sDrive 20 i, 2.0 xDrive 20 i 4WD | 4 | N20B20A | 135/181 | 09/11→ | OE243 | 0,8 | | BAEA143 |
| 2.0 xDrive 20 d 4WD | 4 | N47D20C | 120/161 | 09/10→ | | | | CCU106 |
| 2.0 xDrive 20 d 4WD | 4 | N47D20C | 135/181 | 09/10→ | | | | CCU106 |
| 2.0 xDrive 28 i 4WD | 4 | N20B20A | 180/241 | 08/11→ | OE243 | 0,8 | | BAEA143 →05/13 |
| 3.0 xDrive 28 i 4WD | 6 | N52B30A; N52B30AF; N52B30BF | 190/255 | 04/11→ | OE238 | 1,0 | | BAEA143 →03/12 |

BMW





kW/BHP

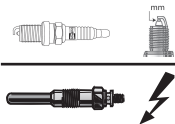

eon TITAN

IRIDIUM



...BMW

...X3 (F25)

| | | | | | | | | | |
|---------------------|---|---------|---------|--------|--------------------------------|------|--|--|-------------------|
| 3.0 xDrive 30 d 4WD | 6 | N57D30A | 190/255 | 05/11→ | CCGP001 →01/12 [92][240] | 5.4v | | | |
| 3.0 xDrive 35 d 4WD | 6 | N57D30B | 230/308 | 09/11→ | CCGP001 [92][240] | 5.4v | | | |
| 3.0 xDrive 35 i 4WD | 6 | N55B30A | 225/302 | 09/10→ | OE242 | 0,8 | | | BAEA143 →05/13 |

X4 (F26)

| | | | | | | | | | |
|---------------------|---|---------|---------|-------------|----------------------|------|--|--|---------|
| 2.0 xDrive 20 i 4WD | 4 | N20B20A | 135/181 | 04/14→03/18 | OE243 | 0,8 | | | BAEA143 |
| 2.0 xDrive 28 i 4WD | 4 | N20B20A | 180/241 | 04/14→03/18 | OE243 | 0,8 | | | BAEA143 |
| 3.0 xDrive 35 d 4WD | 6 | N57D30B | 230/308 | 04/14→03/18 | CCGP001 [92][240] | 5.4v | | | |
| 3.0 xDrive 35 i 4WD | 6 | N55B30A | 225/302 | 04/14→03/18 | | | | | BAEA143 |

X5 (E53)

| | | | | | | | | | |
|------------|---|-----------------|---------|-------------|----------------------------|-----|--------|-------|--|
| 3.0 d 4WD | 6 | M57D30(306D1) | 135/181 | 05/01→12/03 | CH203 | 11v | | | CCU102 ^[336] |
| 3.0 d 4WD | 6 | M57D30(306D2) | 155/208 | 09/03→12/06 | | | | | CCU102 ^[336] |
| 3.0 d 4WD | 6 | M57D30(306D2) | 160/215 | 12/03→12/06 | | | | | CCU102 ^[336] |
| 3.0 i 4WD | 6 | M54B30(306S3) | 170/228 | 05/00→12/06 | OE223 | 1,6 | CET12P | OE188 | BAEA302 →10/02 BAEA143 ^[247] 10/02→ BAEA324 10/02→ |
| 4.4 i 4WD | 8 | M62B44(448S2) | 210/282 | 05/00→12/03 | OE223 | 1,6 | CET12P | OE188 | BAEA302 |
| 4.4 i 4WD | 8 | N62B44; N62B44A | 235/315 | 12/03→09/06 | OE223 | 1,6 | CET12P | OE188 | BAEA324 |
| 4.6 is 4WD | 8 | M62B46(468S1) | 255/342 | 02/02→12/03 | OE223 | 1,6 | CET12P | OE188 | BAEA302 |
| 4.8 is 4WD | 8 | N62B48A | 265/355 | 04/04→09/06 | OE216 ^{LPG [278]} | 0,8 | CET12P | OE188 | BAEA324 |

X5 (E70)

| | | | | | | | | | |
|---------------------|---|---|---------|-------------|----------------------------|------|--------|-------|--|
| 3.0 d 4WD | 6 | M57D30(306D3) | 155/208 | 02/07→09/08 | | | | | CCU102 |
| 3.0 d 4WD | 6 | M57D30(306D3) | 173/232 | 02/07→09/08 | | | | | CCU102 |
| 3.0 M 50 d 4WD | 6 | N57D30C | 280/375 | 08/11→06/13 | CCGP001 [92][240] | 5.4v | | | |
| 3.0 sd 4WD | 6 | M57D30(306D5) | 210/282 | 10/07→03/10 | | | | | CCU102 |
| 3.0 si 4WD | 6 | N52B30A; N52B30AF; N52B30B; N52B30BF | 200/268 | 02/06→09/08 | OE238 | 1,0 | | | BAEA143 11/07→ |
| 3.0 xDrive 30 d 4WD | 6 | M57D30(306D3); N57D30A | 155/208 | 10/08→07/13 | | | | | CCU102 ^[47] CCU108 ^[48] |
| 3.0 xDrive 30 d 4WD | 6 | M57D30(306D3) | 173/232 | 10/08→03/10 | | | | | CCU102 ^[47] CCU108 ^[48] |
| 3.0 xDrive 30 d 4WD | 6 | N57D30A | 180/241 | 04/10→07/13 | | | | | CCU102 ^[47] CCU108 ^[48] |
| 3.0 xDrive 30 i 4WD | 6 | N52B30A | 200/268 | 09/08→03/10 | OE238 | 1,0 | | | BAEA143 |
| 3.0 xDrive 35 d 4WD | 6 | M57D30(306D5) | 210/282 | 09/08→06/13 | | | | | CCU108 |
| 3.0 xDrive 35 i 4WD | 6 | N55B30A | 225/302 | 09/10→06/13 | OE242 | 0,8 | | | BAEA143 →05/13 |
| 3.0 xDrive 35 i 4WD | 6 | N55B30A | 235/315 | 02/12→06/13 | OE242 | 0,8 | | | BAEA143 |
| 3.0 xDrive 40 d 4WD | 6 | N57D30B | 225/302 | 09/10→06/13 | | | | | CCU108 ^[48] |
| 4.4 M 4WD | 8 | S63B44A | 408/547 | 09/09→06/13 | OE242 | 0,8 | | | BAEA143 |
| 4.4 xDrive 50 i 4WD | 8 | N63B44A | 298/400 | 09/09→06/13 | | | | | BAEA143 |
| 4.4 xDrive 50 i 4WD | 8 | N63B44A | 300/402 | 07/09→06/13 | OE242 | 0,8 | | | BAEA143 |
| 4.8 i 4WD | 8 | N62B48B | 261/350 | 02/07→09/08 | OE216 ^{LPG [278]} | 0,8 | CET12P | OE188 | BAEA143 |
| 4.8 xDrive 48 i 4WD | 8 | N62B48B | 261/350 | 09/08→06/13 | OE227 | 0,6 | | | BAEA143 |

X5 (F15, F85)

| | | | | | | | | | |
|--------------------------------------|---|---------|---------|--------|-------|-----|--|--|--------|
| 2.0 sDrive 25 d, 2.0 xDrive 25 d 4WD | 4 | N47D20D | 155/208 | 11/13→ | | | | | CCU106 |
| 2.0 sDrive 25 d, 2.0 xDrive 25 d 4WD | 4 | N47D20D | 160/215 | 11/13→ | | | | | CCU106 |
| 2.0 xDrive 40e 4WD | 4 | N20B20A | 180/241 | 09/15→ | OE243 | 0,8 | | | |

BMW





kW/BHP



eon TITAN

IRIDIUM



...BMW

...X5 (F15, F85)

| | | | | | | | | | |
|---------------------|---|---------|---------|--------|-----------------------|------|--|--|-------------------|
| 3.0 M 50 d 4WD | 6 | N57D30C | 280/375 | 07/13→ | CCGP001 [92] [240] | 5.4v | | | |
| 3.0 xDrive 35 i 4WD | 6 | N55B30A | 225/302 | 11/13→ | OE242 | 0,8 | | | BAEA143 |
| 3.0 xDrive 35 i 4WD | 6 | N55B30A | 240/322 | 11/13→ | OE242 | 0,8 | | | |
| 3.0 xDrive 40 d 4WD | 6 | N57D30B | 230/308 | 12/13→ | CCGP001 [92] [240] | 5.4v | | | |
| 4.4 M 4WD | 8 | S63B44B | 423/567 | 12/14→ | | | | | BAEA143 →01/15 |
| 4.4 xDrive 50 i 4WD | 8 | N63B44B | 330/443 | 07/13→ | OE243 | 0,8 | | | BAEA143 |

X6 (E71, E72)

| | | | | | | | | | |
|---|---|---------------|---------|-------------|-----------------------|------|--|--|------------------------|
| 3.0 M 50 d 4WD | 6 | N57D30C | 280/375 | 08/11→06/14 | CCGP001 [92] [240] | 5.4v | | | |
| 3.0 xDrive 30 d 4WD | 6 | N57D30A | 155/208 | 07/09→06/14 | | | | | CCU108 |
| 3.0 xDrive 30 d 4WD | 6 | M57D30(306D3) | 173/232 | 09/07→06/14 | | | | | CCU108 ^[90] |
| 3.0 xDrive 30 d 4WD | 6 | N57D30A | 180/241 | 04/09→06/14 | | | | | CCU108 |
| 3.0 xDrive 35 d 4WD | 6 | M57D30(306D5) | 210/282 | 06/07→03/10 | | | | | CCU102 |
| 3.0 xDrive 35 i 4WD | 6 | N55B30A | 225/302 | 06/07→06/14 | OE242 | 0,8 | | | |
| 3.0 xDrive 35 i 4WD | 6 | N54B30A | 225/302 | 06/07→06/14 | | | | | BAEA143 |
| 3.0 xDrive 35 i 4WD | 6 | N55B30A | 235/315 | 07/09→06/14 | OE242 | 0,8 | | | BAEA143 |
| 3.0 xDrive 35 i 4WD | 6 | N54B30A | 240/322 | 06/07→03/10 | | | | | BAEA143 |
| 3.0 xDrive 40 d 4WD | 6 | N57D30B | 225/302 | 07/09→06/14 | | | | | CCU108 |
| 4.4 ActiveHybrid 4WD | 8 | N63B44A | 357/479 | 01/09→10/11 | OE242 | 0,8 | | | BAEA143 |
| 4.4 ActiveHybrid 4WD, 4.4 xDrive 50 i 4WD | 8 | N63B44A | 300/402 | 10/07→06/14 | OE242 | 0,8 | | | BAEA143 |
| 4.4 M 4WD | 8 | S63B44A | 408/547 | 07/08→06/14 | OE242 | 0,8 | | | BAEA143 |
| 4.4 xDrive 50 i 4WD | 8 | N63B44A | 298/400 | 10/07→06/14 | | | | | BAEA143 |
| 4.4 xDrive 50 i 4WD | 8 | N63B44A | 330/443 | 10/07→06/14 | OE242 | 0,8 | | | BAEA143 |

X6 (F16, F86)

| | | | | | | | | | |
|---------------------|---|---------|---------|--------|-----------------------|------|--|--|------------------------------------|
| 3.0 M 50 d 4WD | 6 | N57D30C | 280/375 | 08/14→ | CCGP001 [92] [240] | 5.4v | | | |
| 3.0 xDrive 35 i 4WD | 6 | N55B30A | 225/302 | 12/14→ | OE242 | 0,8 | | | BAEA143 |
| 3.0 xDrive 35 i 4WD | 6 | N55B30A | 240/322 | 02/15→ | OE242 | 0,8 | | | BAEA143 |
| 4.4 M 4WD | 8 | S63B44B | 423/567 | 12/14→ | | | | | BAEA143 ^[275] →01/15 |
| 4.4 xDrive 50 i 4WD | 8 | N63B44B | 330/443 | 08/14→ | OE243 | 0,8 | | | BAEA143 11/14→ |

Z3 Coupe (E36)

| | | | | | | | | | |
|-------|---|---------------------------------|---------|-------------|-------|-----|--------|-------|-------------------|
| 2.8 i | 6 | M52B28(286S1) | 142/190 | 07/97→06/00 | OE223 | 1,6 | CET12P | OE188 | BAEA302 |
| 3.0 i | 6 | M54B30(306S3) | 170/228 | 06/00→06/03 | OE223 | 1,6 | CET12P | OE188 | BAEA302 →12/02 |
| 3.2 M | 6 | S50B32(326S1); S50B32(326S3) | 236/316 | 02/98→06/01 | | | CET10P | OE187 | BAEA302 →12/00 |
| 3.2 M | 6 | S54B32(326S4) | 239/320 | 06/01→06/03 | | | CET10P | OE187 | |
| 3.2 M | 6 | S54326S4; S54B32 | 239/320 | 06/01→06/03 | | | | | BAEA324 |

Z3 Roadster (E36)

| | | | | | | | | | | |
|-------|---|---------------|---------|-------------|-------------------------------------|------------|--------|-------|-------------------|--------|
| 1.8 i | 4 | M43B18(184E2) | 85/114 | 10/95→10/98 | OE026 OE216 ^{LPG [278]} | 0,9 0,8 | CET2 | OE188 | BAEA307 | CLS054 |
| 1.9 i | 4 | M43B19(194E1) | 85/114 | 01/99→01/03 | OE223 | 1,6 | CET12P | OE188 | BAEA307 | CLS054 |
| 1.9 i | 4 | M43B19(194E1) | 87/117 | 07/98→01/03 | OE223 09/98→ | 1,6 | CET12P | OE188 | BAEA307 | CLS054 |
| 1.9 i | 4 | M44B19(194S1) | 103/138 | 10/95→03/99 | OE026 OE216 ^{LPG [278]} | 0,9 0,8 | | | BAEA307 | CLS036 |
| 2.0 i | 6 | M52B20(206S4) | 110/148 | 04/99→01/03 | OE223 | 1,6 | CET12P | OE188 | BAEA302 | |
| 2.2 i | 6 | M54B22(226S1) | 125/168 | 08/00→01/03 | OE223 | 1,6 | CET12P | OE188 | BAEA302 →09/02 | |

BMW



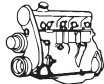

kW/BHP



eon TITAN

IRIDIUM



...BMW

...Z3 Roadster (E36)

| | | | | | | | | | |
|-------|---|---------------------------------|---------|-------------|----------------------------------|-----|---------------|--------------|--------------------------|
| 2.8 i | 6 | M52B28(286S1) | 142/190 | 04/97→06/00 | OE026 →09/98 | 0,9 | CET2 | OE188 | BAEA302 |
| | | | | | OE216 LPG [278] →09/98 | 0,8 | | | |
| | | | | | OE223 09/98→ | 1,6 | | | |
| 2.8 i | 6 | M52B28(286S1); M52B28(286S2) | 143/192 | 01/96→07/00 | OE026 | 0,9 | CET2 | | BAEA302 11/96→ |
| 3.0 i | 6 | M54B30(306S3) | 170/228 | 06/00→01/03 | OE223 | 1,6 | CET12P | OE188 | BAEA302 →12/02 |
| 3.2 M | 6 | S50B32(326S1) | 236/316 | 03/97→06/01 | | | CET10P | OE187 | BAEA302 →12/00 |
| 3.2 M | 6 | S54B32(326S4) | 239/320 | 06/01→01/03 | | | CET10P | OE187 | |
| 3.2 M | 6 | S54B32; S54B32(326S4) | 239/320 | 06/01→01/03 | | | | | BAEA324 |

Z4 Coupe (E86)

| | | | | | | | | | |
|--------|---|------------------|---------|-------------|--------------|-----|---------------|--------------|--|
| 3.0 si | 6 | N52B30A | 195/261 | 03/06→01/09 | OE238 | 1,0 | | | BAEA145E →04/06 BAEA143 11/07→08/08 |
| 3.2 M | 6 | S54B32(326S4) | 252/338 | 03/06→01/09 | | | CET10P | OE187 | |
| 3.2 M | 6 | S54326S4; S54B32 | 252/338 | 03/06→01/09 | | | | | BAEA143 [247] BAEA324 |

Z4 Roadster (E85)

| | | | | | | | | | |
|--------|---|-------------------|---------|-------------|------------------------|-----|---------------|--------------|--|
| 2.0 i | 4 | N46B20A | 110/148 | 03/05→02/09 | OE216 LPG [278] | 0,8 | CET12P | OE188 | BAEA143 [247] BAEA324 |
| 2.0 i | 4 | N46B20B | 110/148 | 03/05→02/09 | OE216 LPG [278] | 0,8 | CET12P | OE188 | BAEA143 [247] |
| 2.0 i | 4 | N46B20 | 110/148 | 03/05→02/09 | | | | | BAEA324 |
| 2.2 i | 6 | M54B22(226S1) | 125/168 | 10/03→10/05 | OE223 | 1,6 | CET12P | OE188 | BAEA143 [247] BAEA324 |
| 2.5 i | 6 | N52B25A | 130/174 | 09/05→02/09 | OE238 | 1,0 | | | BAEA145E →04/06 BAEA143 11/07→ |
| 2.5 i | 6 | M54B25(256S5) | 141/189 | 02/03→12/05 | OE223 | 1,6 | CET12P | OE188 | BAEA143 [247] BAEA324 |
| 2.5 si | 6 | N52B25A | 160/215 | 09/05→02/09 | OE238 | 1,0 | | | BAEA145E →04/06 BAEA143 11/07→ |
| 3.0 i | 6 | M54B30(306S3) | 170/228 | 02/03→10/05 | OE223 | 1,6 | CET12P | OE188 | BAEA143 [89] [247] [275] BAEA324 [84] [275] |
| 3.0 si | 6 | N52B30A; N52B30BF | 195/261 | 01/06→12/08 | OE238 | 1,0 | | | BAEA145E →04/06 BAEA143 11/07→08/08 |
| 3.2 M | 6 | S54B32(326S4) | 252/338 | 03/06→02/09 | | | CET10P | OE187 | BAEA143 [247] BAEA324 |

Z4 Roadster (E89)

| | | | | | | | | | |
|------------------|---|---------|---------|--------|--------------|-----|--|--|--------------------------|
| 2.0 sDrive 18 i | 4 | N20B20A | 115/154 | 04/13→ | OE243 | 0,8 | | | BAEA143 →05/13 |
| 2.0 sDrive 20 i | 4 | N20B20A | 135/181 | 09/11→ | OE243 | 0,8 | | | BAEA143 |
| 2.0 sDrive 28 i | 4 | N20B20A | 180/241 | 09/11→ | OE243 | 0,8 | | | BAEA143 →05/13 |
| 2.5 sDrive 23 i | 6 | N52B25A | 150/201 | 05/09→ | OE238 | 1,0 | | | BAEA143 →08/11 |
| 3.0 sDrive 30 i | 6 | N52B30A | 190/255 | 05/09→ | OE238 | 1,0 | | | BAEA143 →08/11 |
| 3.0 sDrive 35 i | 6 | N54B30A | 225/302 | 05/09→ | | | | | BAEA143 |
| 3.0 sDrive 35 is | 6 | N54B30A | 250/335 | 09/10→ | | | | | BAEA143 |

CHAMPION

BMW



kW/BHP

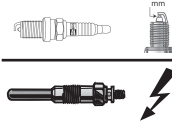

eon TITAN

IRIDIUM

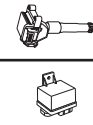
**...BMW****Z8 Roadster (E52)**

| | | | | | | | | | |
|-----|---|---------------|---------|-------------|-------|-----|--------|-------|---------|
| 4.9 | 8 | S62B50(508S1) | 294/394 | 06/00→06/03 | OE223 | 1,6 | CET12P | OE188 | BAEA302 |
|-----|---|---------------|---------|-------------|-------|-----|--------|-------|---------|

BRISTOL**411**

| | | | | | | | | | |
|--------------|---|-------------|---------|--------|-------|-----|------|--|--|
| 5.9 Series 6 | 8 | LA-360(E59) | 287/385 | 06/10→ | OE042 | 0,9 | CET8 | | |
|--------------|---|-------------|---------|--------|-------|-----|------|--|--|

BYD**F3**

| | | | | | | | | | |
|-----|---|------|-------|-------------|-------|-----|------|-------|--|
| 1.6 | 4 | 4G18 | 74/99 | 09/05→12/10 | OE063 | 1,0 | CET2 | OE180 | |
|-----|---|------|-------|-------------|-------|-----|------|-------|--|

CADILLAC**BLS**

| | | | | | | | | | |
|-----------------|---|--------------------|---------|--------|-------|-----|--------|-------|--|
| 1.9 D | 4 | Z19DTH | 110/148 | 04/06→ | CH224 | 11v | | | |
| 2.0 T | 4 | B207L; LK9; Z20NET | 129/173 | 04/06→ | OE136 | 0,8 | CET12P | OE179 | |
| 2.0 T | 4 | B207R; LK9 | 154/207 | 04/06→ | OE136 | 0,8 | CET12P | OE179 | |
| 2.0 T | 4 | Z20NER | 154/207 | 04/06→ | OE089 | 1,0 | CET2 | OE188 | |
| 2.0 T Flexpower | 4 | Z20LER | 147/197 | 12/07→ | OE089 | 1,0 | CET2 | OE188 | |
| 2.8 T | 6 | B284L; Z28NET | 188/252 | 04/06→ | | | CET14P | OE190 | |

CTS

| | | | | | | | | | |
|-----|---|-----|---------|-------------|--|--|--------|-------|---------------------------------------|
| 2.8 | 6 | LP1 | 155/208 | 01/08→ | | | | | BAEA174E |
| 2.8 | 6 | LP1 | 158/212 | 03/05→09/07 | | | CET14P | OE190 | BAEA174E |
| 3.2 | 6 | LA3 | 160/215 | 03/02→09/07 | | | | | BAEA152E 09/02→08/04 [36] [277] |

| | | | | | | | | | |
|--------------|---|-----|---------|-------------|--|--|--|--|---------------------------------------|
| 3.6 | 6 | LY7 | 189/253 | 03/05→09/07 | | | | | BAEA153E 09/02→08/04 [42] [277] |
| 3.6, 3.6 4WD | 6 | LLT | 199/267 | 01/10→ | | | | | BAEA174E |
| 3.6, 3.6 4WD | 6 | LLT | 229/307 | 01/08→ | | | | | BAEA174E |
| 3.6, 3.6 4WD | 6 | LLT | 237/318 | 09/11→ | | | | | BAEA174E |
| 5.7 V8 | 8 | LS6 | 294/394 | 03/05→09/07 | | | | | BAEA159E |
| 6.2, 6.2 V | 8 | LSA | 415/557 | 01/08→ | | | | | BAEA159E |

ESCALADE

| | | | | | | | | | |
|--|---|---------------|---------|-------------|--|--|--|--|----------|
| 6.0 HYBRID, 6.0 HYBRID 4WD | 8 | LZ1 | 248/333 | 09/10→12/13 | | | | | BAEA159E |
| 6.2, 6.2 4WD, 6.2 Flex, 6.2 Flex 4WD, 6.2 FLEXFUEL, 6.2 FLEXFUEL 4WD | 8 | L9H; L92; L94 | 301/404 | 09/06→ | | | | | BAEA159E |

SRX

| | | | | | | | | | |
|--------------|---|-----|---------|-------------|--|--|--|--|----------|
| 3.6, 3.6 4WD | 6 | LY7 | 190/255 | 01/04→12/08 | | | | | BAEA174E |
|--------------|---|-----|---------|-------------|--|--|--|--|----------|

STS

| | | | | | | | | | |
|--------------|---|-----|---------|-------------|--|--|--|--|----------|
| 3.6 | 6 | LY7 | 189/253 | 05/05→12/07 | | | | | BAEA174E |
| 3.6, 3.6 4WD | 6 | LLT | 229/307 | 10/09→12/12 | | | | | BAEA174E |

CATERHAM**21**

| | | | | | | | | | |
|------------------|---|-------|---------|-------------|-------|-----|------|-------|--|
| 1.6 i Supersport | 4 | 16K4F | 103/138 | 01/96→12/98 | OE005 | 0,9 | CET2 | OE180 | |
|------------------|---|-------|---------|-------------|-------|-----|------|-------|--|

SEVEN

| | | | | | | | | | |
|----------|---|--|---------|--------|--|--|--------|--|--|
| 2.0 R500 | 4 | | 196/263 | 09/04→ | | | CET17P | | |
|----------|---|--|---------|--------|--|--|--------|--|--|

CHENGLONG**FUTURE**

| | | | | | | | | | |
|-----|---|------|--------|--------|-------|-----|------|-------|--|
| 2.0 | 4 | 4G63 | 93/125 | 03/01→ | OE063 | 1,0 | CET2 | OE180 | |
| 2.4 | 4 | 4G64 | 97/130 | 03/01→ | OE063 | 1,0 | CET2 | OE180 | |

CHENGLONG





kW/BHP

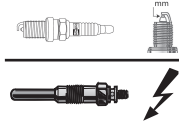

eon TITAN

IRIDIUM

**CHERY****A1**

1.3 4 SQR473F 61/82 04/07→12/14 OE005 0,9 CET2 OE179

A3

1.6 4 SQR481F; SQR481FD 88/118 09/08→12/10 OE005 0,9 CET2 OE179

2.0 4 SQR484F 102/137 04/09→08/10 OE005 0,9 CET2 OE179

A5

1.6 LPG 4 SQR481F 88/118 01/06→01/09 OE005 0,9 CET2 OE179

2.0 4 SQR484F 99/133 01/06→12/12 OE005 0,9 CET2 OE179

COWIN

1.3 4 60/80 09/06→12/10 OE005 0,9 CET2 OE179

1.5 4 SQR477F 80/107 07/08→05/10 OE005 0,9 CET2 OE179

1.6 4 SQR480 65/87 08/03→12/08 OE005 0,9 CET2 OE179

COWIN 2

1.5 4 SQR477F 80/107 05/10→12/14 OE005 0,9 CET2 OE179

COWIN 3

1.5 4 SQR477F 80/107 05/10→12/14 OE005 0,9 CET2 OE179

1.8 4 SQR481FC 97/130 05/10→12/12 OE005 0,9 CET2 OE179

2.0 4 SQR484F 102/137 05/10→12/12 OE005 0,9 CET2 OE179

COWIN 5

1.8 4 SQR481FC 97/130 03/12→12/15 OE005 0,9 CET2 OE179

E5

1.5 4 SQR477F; SQR46G15 80/107 07/11→ OE005 0,9 CET2 OE179

EASTAR CROSS

2.0 4 SQE484F 100/134 06/07→ OE005 0,9 CET2 OE179

FULWIN

1.5 4 SQR477F 80/107 04/06→ OE005 0,9 CET2 OE179

QQ3

0.8 3 SQR372 38/51 03/04→12/12 OE005 0,9 CET2 OE179

1.1 4 F11A; LJ465Q-1ANE1 39/52 06/03→ OE005 0,9 CET2 OE179

1.1 4 SQR472 50/67 06/06→12/10 OE005 0,9 CET2 OE179

QQ6

1.1 4 39/52 09/06→ OE005 0,9 CET2 OE179

TIGGO

1.6 4 SQR481F 80/107 07/06→12/10 OE005 0,9 CET2 OE179

1.6 4 SQR481F 88/118 09/06→12/14 OE005 0,9 CET2 OE179

1.8 4 SQR481FC 97/130 05/07→12/14 OE005 0,9 CET2 OE179

2.0 4 4G63-S4M 92/123 03/05→12/08 OE063 1,0 CET2 OE180

2.0 4 SQR484F 95/127 09/06→12/08 OE005 0,9 CET2 OE179

2.0 4 SQR484F 101/135 01/10→ OE005 0,9 CET2 OE179

2.0, 2.0 4WD 4 SQR484F 102/137 09/06→12/14 OE005 0,9 CET2 OE179

2.4, 2.4 4WD 4 4G64-S4M 95/127 03/05→12/08 OE063 1,0 CET2 OE180

TIGGO 3

1.6 4 SQR481F 80/107 05/07→ OE005 0,9 CET2 OE179

2.0, 2.0 4WD 4 SQR484F 102/137 05/07→12/10 OE005 0,9 CET2 OE179

TIGGO DR

1.8 4 SQR481FC 97/130 12/09→12/13 OE005 0,9 CET2 OE179

V5

2.0 4 SQR484F 99/133 06/06→06/07 OE005 0,9 CET2 OE179

2.4 4 4G64S4M 95/127 06/06→06/07 OE063 1,0 CET2 OE180

X1

1.3 4 SQR473 61/82 01/10→ OE005 0,9 CET2 OE179

CHERY





kW/BHP

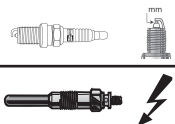

eon TITAN

IRIDIUM

**CHEVROLET****ALERO**

| | | | | | | | | | | |
|-----|---|-----|---------|-------------|-------|-----|------|-------|--|--|
| 2.2 | 4 | L61 | 104/139 | 12/01→09/04 | OE031 | 1,0 | CET7 | OE189 | | |
|-----|---|-----|---------|-------------|-------|-----|------|-------|--|--|

ASTRA

| | | | | | | | | | | |
|----------------------|---|----------|---------|-------------|-------------|-----|------|-------|--|--|
| 2.0, 2.0 GL | 4 | ; C20SEJ | 82/110 | 10/98→07/02 | OE019 | 0,9 | CET2 | OE184 | | |
| 2.0, 2.0 GL | 4 | ; C20NE | 85/114 | 02/96→12/11 | OE019 | 0,9 | CET2 | OE184 | | |
| 2.0, 2.0 GLS | 4 | X20XEV | 94/126 | 03/99→07/02 | OE019 | 0,9 | CET2 | OE184 | | |
| 2.0, 2.0 GLS | 4 | C20SEL | 100/134 | 02/96→12/11 | OE019 | 0,9 | CET2 | OE184 | | |
| 2.0 DTi, 2.0 DTi GLS | 4 | Y20DTH | 74/99 | 08/02→12/11 | CH231 [275] | 11v | | | | |

AVALANCHE

| | | | | | | | | | | |
|-------------------|---|-----|---------|-------------|--|--|--|--|--|----------|
| 5.3 Flex-Fuel | 8 | LY5 | 235/315 | 06/05→07/07 | | | | | | BAEA159E |
| 5.3 Flex-Fuel 4WD | 8 | | 231/310 | 01/07→ | | | | | | BAEA159E |

AVERO

| | | | | | | | | | | |
|-----------|---|-------------------|---------|-------------|-----------------|-----|------|-------|---------------------------|------------------|
| 1.2 | 4 | A12XEL | 51/68 | 03/11→ | OE198 | 0,9 | CET2 | OE184 | BAEA185E | CLS144 |
| 1.2 | 4 | B12S1; F12S3; LY4 | 53/71 | 03/05→ | OE006 | 0,9 | CET8 | OE195 | BAEA447A | CLS085 |
| 1.2 | 4 | B12D1 | 55/74 | 01/08→ | OE199 | 0,9 | CET1 | OE187 | BAEA447A ^[110] | CLS085 |
| | | | | | OE230 LPG [278] | 0,9 | | | BAEA447A | |
| 1.2 | 4 | LMU | 55/74 | 01/08→ | OE199 | 0,9 | CET1 | OE187 | BAEA447A ^[110] | CLS085 |
| | | | | | OE230 LPG [278] | 0,9 | | | | |
| 1.2 | 4 | B12D1; LMU | 62/83 | 01/08→ | OE199 | 0,9 | CET1 | OE187 | BAEA447A ^[110] | CLS085 |
| | | | | | OE230 LPG [278] | 0,9 | | | | |
| 1.2 | 4 | A12XER | 63/84 | 03/11→ | OE198 | 0,9 | CET2 | OE184 | BAEA185E | CLS144 |
| 1.2 LPG | 4 | B12D1; LMU | 62/83 | 04/08→ | OE230 | 0,9 | | | BAEA447A ^[110] | CLS085 |
| 1.2 LPG | 4 | A12XER | 63/84 | 11/12→ | OE198 | 0,9 | CET2 | OE184 | BAEA185E | |
| 1.4 | 4 | F14S3 | 61/82 | 03/05→ | OE006 | 0,9 | CET8 | OE195 | BAEA447A ^[110] | |
| 1.4 | 4 | F14D3; L14 | 69/93 | 03/05→12/07 | OE005 | 0,9 | CET2 | OE179 | BAEA447A ^[110] | CLS086 CLS196 |
| 1.4 | 4 | F14D4 | 74/99 | 04/08→ | OE039 | 1,0 | CET2 | OE179 | BAEA447A | CLS086 |
| | | | | | OE198 | 0,9 | | OE184 | | |
| 1.4 | 4 | LDT | 74/99 | 04/08→ | OE198 | 0,9 | CET2 | OE184 | BAEA447A | CLS086 |
| 1.4 | 4 | A14XER | 74/99 | 04/08→ | OE198 | 0,9 | CET2 | OE184 | BAEA447A | |
| 1.4 Turbo | 4 | LUJ; LUV | 103/138 | 08/13→ | | | | | BAEA185E | |
| 1.5 | 4 | F15S3; LX6 | 62/83 | 05/05→ | OE006 | 0,9 | CET8 | OE195 | BAEA447A | |
| 1.6 | 4 | F16D3; LXV | 76/102 | 05/05→ | OE039 | 1,0 | CET2 | OE179 | | |
| 1.6 | 4 | F16D4 | 85/114 | 03/11→ | OE198 | 0,9 | CET2 | OE184 | BAEA199E | |

AVERO / KALOS

| | | | | | | | | | | |
|---------|---|-------------|--------|-------------|-------|-----|------|-------|---------------------------|--|
| 1.4 | 4 | F14S3 | 61/82 | 03/05→05/08 | OE006 | 0,9 | CET8 | OE195 | BAEA447A ^[110] | CLS020 |
| 1.4 | 4 | F14D3 | 69/93 | 05/03→01/07 | OE005 | 0,9 | CET2 | OE179 | BAEA447A ^[275] | |
| 1.4 16V | 4 | F14D3 | 69/93 | 03/05→05/08 | OE005 | 0,9 | CET2 | OE179 | BAEA447A ^[110] | CLS020 [275] CLS086 [275] CLS196 |
| 1.5 | 4 | F15S3 | 62/83 | 01/05→05/08 | OE006 | 0,9 | CET8 | | BAEA447A | |
| 1.6 | 4 | A16DMS; LXT | 77/103 | 09/03→12/08 | OE039 | 1,0 | CET2 | OE179 | | |

C1500

| | | | | | | | | | | |
|----------|---|-----|---------|-------------|-------------|-----|--|--|--|--|
| 6.5 TDiC | 8 | L56 | 135/181 | 10/96→12/00 | CH189 [275] | 11v | | | | |
|----------|---|-----|---------|-------------|-------------|-----|--|--|--|--|

C3500

| | | | | | | | | | | |
|------------------------|---|-------|---------|-------------|-------------|-----|--|--|--|--|
| 6.5 TDiC, 6.5 TDiC 4WD | 8 | ; L56 | 135/181 | 10/93→09/96 | CH189 [275] | 11v | | | | |
|------------------------|---|-------|---------|-------------|-------------|-----|--|--|--|--|

CAMARO

| | | | | | | | | | | |
|-----|---|-----|---------|--------|--|--|--|--|----------|--|
| 6.2 | 8 | L99 | 298/400 | 09/09→ | | | | | BAEA159E | |
| 6.2 | 8 | LS3 | 318/426 | 09/09→ | | | | | BAEA159E | |

CAPRICE

| | | | | | | | | | | |
|-----|---|-----------|---------|-------------|-------------------|-----|--|--|--|--|
| 5.7 | 8 | LTI(5.7L) | 194/260 | 10/93→09/96 | RV15YC4 →12/93 | 1,0 | | | | |
| 5.7 | 8 | LTI(5.7L) | 207/278 | 10/93→09/96 | RV15YC4 →12/93 | 1,0 | | | | |

CHEVROLET



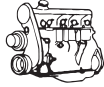

kW/BHP

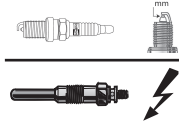

eon TITAN

IRIDIUM

**...CHEVROLET****...CAPRICE**

| | | | | | | | | | |
|--------|---|-----------|---------|-------------|-------------------|-----|--|--|--|
| 5.7 LS | 8 | LT1(5.7L) | 183/245 | 10/93→09/96 | RV15YC4 →12/93 | 1,0 | | | |
|--------|---|-----------|---------|-------------|-------------------|-----|--|--|--|

CAPTIVA

| | | | | | | | | | |
|----------------------|---|------------|---------|--------|-------|-----|--------|-------|---------------------------|
| 2.4, 2.4 4WD | 4 | Z24SED | 100/134 | 06/06→ | OE019 | 0,9 | CET2 | OE184 | BAEA447A ^[110] |
| 2.4, 2.4 4WD | 4 | A24XE; LE5 | 123/165 | 03/11→ | | | CET17P | OE189 | |
| 2.4 LPG, 2.4 LPG 4WD | 4 | Z24SED | 100/134 | 01/07→ | | | | | BAEA447A ^[110] |
| 3.2 4WD | 6 | 10HM | 169/227 | 06/06→ | OE029 | 1,0 | CET17P | OE189 | |

COBALT

| | | | | | | | | | |
|-----|---|-----|---------|--------|-------|-----|------|-------|--|
| 2.2 | 4 | L61 | 108/145 | 04/04→ | OE031 | 1,0 | CET7 | OE189 | |
|-----|---|-----|---------|--------|-------|-----|------|-------|--|

CORSA

| | | | | | | | | | |
|---------|---|-------|-------|-------------|-------|-----|------|-------|--|
| 1.4 GLS | 4 | C14NZ | 44/59 | 08/94→07/97 | OE006 | 0,9 | CET8 | OE195 | |
|---------|---|-------|-------|-------------|-------|-----|------|-------|--|

CORVETTE

| | | | | | | | | | |
|---------|---|------------|---------|--------|--|--|--|--|----------|
| 6.0 | 8 | LS2 | 298/400 | 09/04→ | | | | | BAEA159E |
| 6.2 | 8 | LS3 | 321/430 | 02/08→ | | | | | BAEA159E |
| 6.2 ZR1 | 8 | LS9(6, 2L) | 476/638 | 09/08→ | | | | | BAEA159E |
| 7.0 Z06 | 8 | LS7 | 371/498 | 03/06→ | | | | | BAEA159E |
| 7.0 Z06 | 8 | LS3; LS7 | 377/506 | 03/06→ | | | | | BAEA159E |

CRUZE

| | | | | | | | | | |
|--------------|---|-----------------|---------|-------------|-------|-----|--------|-------|----------------------------------|
| 1.3, 1.3 4WD | 4 | M13A | 61/82 | 07/00→09/08 | OE039 | 1,0 | CET2 | OE179 | |
| 1.4 | 4 | A14XER; LDD | 74/99 | 07/13→ | | | | | BAEA185E |
| 1.4 | 4 | LUJ | 103/138 | 09/10→ | | | | | BAEA185E |
| 1.5, 1.5 4WD | 4 | M15A | 73/98 | 08/03→09/08 | | | CET12P | OE179 | |
| 1.6 | 4 | F16D3; LXV | 80/107 | 05/09→ | OE039 | 1,0 | CET2 | OE179 | BAEA447A ^[110] CLS196 |
| 1.6 | 4 | LXT | 80/107 | 05/09→ | OE039 | 1,0 | CET2 | OE179 | BAEA447A ^[110] CLS196 |
| | | | | | | | | | BAEA447A |
| 1.6 | 4 | F16D4 | 83/111 | 05/09→ | OE198 | 0,9 | CET2 | OE184 | BAEA447A ^[110] CLS020 |
| 1.6 | 4 | LDE | 86/115 | 12/12→ | OE198 | 0,9 | CET2 | | |
| 1.6 | 4 | F16D4; LDE | 91/122 | 05/09→ | OE198 | 0,9 | CET2 | OE184 | BAEA447A |
| 1.8 | 4 | F18D4; LUW; LWE | 103/138 | 11/09→ | OE198 | 0,9 | CET2 | OE184 | |
| 1.8 | 4 | 2H0; F18D4 | 104/139 | 05/09→ | OE198 | 0,9 | CET2 | OE184 | CLS020 |
| 1.8 LPG | 4 | 2H0; F18D4 | 104/139 | 06/11→ | OE198 | 0,9 | CET2 | OE184 | |

EPICA

| | | | | | | | | | |
|-----|---|--------|---------|-------------|-------|-----|--------|-------|---------------------------|
| 2.0 | 4 | C20SED | 94/126 | 01/05→12/06 | OE019 | 0,9 | CET2 | OE184 | BAEA447A ^[275] |
| 2.0 | 4 | | 96/129 | 08/06→ | OE019 | 0,9 | CET2 | OE184 | |
| 2.0 | 4 | T20SED | 98/131 | 01/05→12/06 | OE019 | 0,9 | CET2 | OE184 | |
| 2.0 | 6 | X20D1 | 105/141 | 06/06→ | OE146 | 1,0 | CET12P | OE179 | |
| 2.5 | 6 | LF4 | 115/154 | 09/03→ | OE146 | 1,0 | CET12P | OE179 | |

EVANDA

| | | | | | | | | | |
|-----|---|--------|--------|--------|-------|-----|------|-------|---------------------------------------|
| 2.0 | 4 | X20SED | 96/129 | 03/05→ | OE019 | 0,9 | CET2 | OE184 | BAEA025E ^[275] BAEA447A |
|-----|---|--------|--------|--------|-------|-----|------|-------|---------------------------------------|

HHR

| | | | | | | | | | |
|-----|---|-----|---------|-------------|-------|-----|--------|-------|--|
| 2.2 | 4 | L61 | 108/145 | 01/06→12/11 | OE031 | 1,0 | CET7 | OE189 | |
| 2.4 | 4 | LE5 | 125/168 | 10/07→12/11 | | | CET17P | OE189 | |
| 2.4 | 4 | LE5 | 128/172 | 01/06→12/11 | | | CET17P | OE189 | |

KALOS

| | | | | | | | | | |
|---------|---|-------|--------|-------------|-------------------------------------|------------|------|-------|--|
| 1.2 | 4 | B12S1 | 53/71 | 03/05→ | OE049 OE006 ^{LPG [279]} | 1,0 0,9 | CET8 | OE195 | BAEA447A ^[110] CLS085 |
| 1.2 | 4 | F12S3 | 53/71 | 03/05→ | OE006 | 0,9 | CET8 | OE195 | BAEA447A ^[110] |
| 1.4 16V | 4 | F14D3 | 69/93 | 03/05→ | OE005 | 0,9 | CET2 | OE179 | BAEA447A ^[110] CLS020 ^[275] CLS086 ^[275] CLS196 |
| 1.6 | 4 | L91 | 77/103 | 06/06→05/08 | OE006 | 0,9 | CET8 | OE195 | |

CHAMPION**CHEVROLET**



kW/BHP

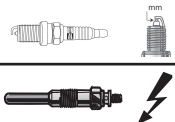

eon TITAN

IRIDIUM

**...CHEVROLET****LACETTI**

| | | | | | | | | | | |
|---------|---|--------|--------|--------|-------|-----|------|-------|-------------------------------------|--------|
| 1.4 | 4 | F14D3 | 70/94 | 03/05→ | OE005 | 0,9 | CET2 | OE179 | | |
| 1.4 16V | 4 | F14D3 | 70/94 | 03/05→ | OE005 | 0,9 | CET2 | OE179 | BAEA543 | CLS196 |
| 1.6 | 4 | F16D3 | 80/107 | 03/05→ | OE039 | 1,0 | CET2 | OE179 | BAEA543 | CLS196 |
| 1.8 | 4 | F18D3 | 89/119 | 08/05→ | OE026 | 0,9 | CET2 | OE188 | BAEA447A ^[110] | |
| 1.8 | 4 | T18SED | 89/119 | 08/05→ | OE026 | 0,9 | CET2 | | | |
| 1.8 | 4 | T18SED | 90/121 | 05/03→ | OE026 | 0,9 | CET2 | OE188 | BAEA447A ^[110] →02/06 | |
| | | | | | OE077 | 1,0 | | | BAEA508 02/06→ | |

LANOS

| | | | | | | | | | | |
|-----|---|--------|-------|--------|-------|-----|------|-------|----------|--------|
| 1.5 | 4 | A15SMS | 63/84 | 11/05→ | OE006 | 0,9 | CET8 | OE195 | BAEA447A | CLS025 |
|-----|---|--------|-------|--------|-------|-----|------|-------|----------|--------|

LUMINA APV

| | | | | | | | | | | |
|-----|---|-----|---------|-------------|-------|-----|------|-------|--|--|
| 2.3 | 4 | LD2 | 101/135 | 10/93→07/96 | OE039 | 1,0 | CET2 | OE180 | | |
|-----|---|-----|---------|-------------|-------|-----|------|-------|--|--|

MALIBU

| | | | | | | | | | | |
|---------|---|-----|---------|--------|-------|-----|--------|-------|--|--|
| 2.0 | 4 | LTD | 104/139 | 02/12→ | OE019 | 0,9 | CET2 | OE184 | | |
| 2.0 LPG | 4 | LTD | 101/135 | 02/12→ | OE019 | 0,9 | CET2 | OE184 | | |
| 2.4 | 4 | LE9 | 123/165 | 01/12→ | | | CET17P | OE189 | | |
| 2.4 | 4 | LE9 | 125/168 | 01/12→ | | | CET17P | OE189 | | |

MATIZ

| | | | | | | | | | | |
|--------------|---|-------|-------|--------|-----------------|-----|------|-------|---------------------------|--------|
| 0.8, 0.8 LPG | 3 | F8CV | 38/51 | 03/05→ | OE048 | 1,0 | CET8 | OE195 | BAEA539 | |
| 1.0 | 4 | B10S | 47/63 | 03/05→ | OE049 →12/10 | 1,0 | CET8 | OE195 | BAEA447A ^[110] | CLS085 |
| | | | | | OE006 LPG [279] | 0,9 | | | | |
| 1.0 | 4 | LA2 | 48/64 | 01/07→ | OE006 | 0,9 | CET8 | OE195 | | |
| 1.0 | 4 | B10S1 | 49/66 | 03/05→ | OE006 | 0,9 | CET8 | OE195 | BAEA447A ^[110] | CLS085 |
| 1.0 LPG | 4 | B10S1 | 49/66 | 03/05→ | OE230 | 0,9 | | | BAEA447A ^[110] | CLS085 |

NIVA

| | | | | | | | | | | |
|---------|---|-------|--------|-------------|-------|-----|------|-------|---------|--|
| 1.7 4WD | 4 | | 59/79 | 09/02→ | OE006 | 0,9 | CET8 | OE195 | BAEA395 | |
| 1.7 4WD | 4 | | 61/82 | 01/10→ | OE006 | 0,9 | CET8 | OE195 | | |
| 1.8 4WD | 4 | Z18XE | 92/123 | 01/07→12/09 | OE198 | 0,9 | CET2 | OE184 | | |

NUBIRA

| | | | | | | | | | | |
|-----|---|---------|--------|-------------|----------------|------------|------|-------|-------------------------------------|---------|
| 1.4 | 4 | F14D3 | 69/93 | 01/05→12/07 | OE005 OE039 | 0,9 1,0 | CET2 | OE179 | BAEA543 | |
| 1.4 | 4 | F14D3 | 70/94 | 01/06→12/08 | OE005 | 0,9 | CET2 | OE179 | BAEA543 | CLS196 |
| 1.6 | 4 | F16D3 | 80/107 | 03/05→12/11 | OE039 | 1,0 | CET2 | OE179 | BAEA543 | CLS196 |
| 1.8 | 4 | F18D3 | 89/119 | 08/05→12/11 | OE077 OE198 | 1,0 0,9 | CET2 | OE184 | BAEA447A ^[110] | |
| 1.8 | 4 | T18SED | 90/121 | 03/05→12/09 | OE019 OE077 | 0,9 1,0 | CET2 | OE184 | BAEA447A ^[110] →02/06 | BAEA508 |
| 2.0 | 4 | ; F20D2 | 88/118 | 01/05→09/07 | OE019 | 0,9 | CET2 | OE184 | | |

OPTRA

| | | | | | | | | | | |
|--------------|---|--------|--------|-------------|-------|-----|------|-------|---------------------------|--|
| 1.6 | 4 | LXT | 78/105 | 08/03→11/12 | OE039 | 1,0 | CET2 | OE179 | | |
| 1.6 | 4 | F16D3 | 80/107 | 08/03→12/08 | OE039 | 1,0 | CET2 | OE179 | | |
| 1.8, 1.8 SRV | 4 | T18SED | 90/121 | 08/03→ | | | | | BAEA508 | |
| 2.0 | 4 | X20SED | 98/131 | 06/99→07/03 | OE019 | 0,9 | CET2 | OE184 | BAEA447A ^[275] | |

ORLANDO

| | | | | | | | | | | |
|--------------|---|------------|---------|--------|-------|-----|------|-------|----------|--|
| 1.4 | 4 | LUJ | 103/138 | 06/12→ | | | | | BAEA185E | |
| 1.8, 1.8 LPG | 4 | 2H0; F18D4 | 104/139 | 02/11→ | OE198 | 0,9 | CET2 | OE184 | | |
| 2.0 LPG | 4 | LTD | 103/138 | 02/12→ | OE019 | 0,9 | CET2 | OE184 | | |

REZZO

| | | | | | | | | | | |
|-----|---|--------|--------|--------|-------|-----|------|-------|---------------------------|--------|
| 1.6 | 4 | A16DMS | 77/103 | 03/05→ | OE039 | 1,0 | CET2 | OE195 | BAEA447A ^[110] | CLS020 |
| 1.6 | 4 | A16DMS | 79/106 | 08/05→ | | | CET8 | OE195 | BAEA447A ^[110] | CLS020 |

CHEVROLET





kW/BHP



eon TITAN

IRIDIUM

**...CHEVROLET****...REZZO**

| | | | | | | | | | |
|-----|---|--------|--------|--------|-------|-----|------|-------|---------------------------|
| 2.0 | 4 | T20SED | 89/119 | 03/05→ | OE019 | 0,9 | CET2 | OE184 | BAEA447A ^[110] |
| 2.0 | 4 | T20SED | 90/121 | 08/05→ | OE019 | 0,9 | CET2 | OE184 | BAEA447A ^[110] |

SILVERADO 1500

| | | | | | | | | | |
|---------------------------|---|----------|---------|--------|--|--|--|--|----------|
| 5.3 4WD, 5.3 FlexFuel 4WD | 8 | LH6; LMG | 232/311 | 01/07→ | | | | | BAEA159E |
|---------------------------|---|----------|---------|--------|--|--|--|--|----------|

SPARK

| | | | | | | | | | |
|-----|---|-------|-------|-------------|-------|-----|------|-------|----------------------------------|
| 0.8 | 3 | F8CV | 37/50 | 05/05→ | OE048 | 1,0 | CET8 | OE195 | BAEA539 |
| 0.8 | 3 | F8CV | 38/51 | 09/00→12/04 | OE048 | 1,0 | CET8 | | |
| 1.0 | 4 | B10D1 | 50/67 | 03/10→ | OE199 | 0,9 | CET1 | OE187 | BAEA447A ^[110] CLS144 |

| | | | | | | | | | |
|---------|---|-------|-------|--------|----------------------------|-----|--|--|-----------------|
| 1.0 LPG | 4 | B10D1 | 50/67 | 03/10→ | OE230 ^{LPG [278]} | 0,9 | | | BAEA447A CLS144 |
|---------|---|-------|-------|--------|----------------------------|-----|--|--|-----------------|

| | | | | | | | | | |
|--------|---|-----|-------|--------|-------|-----|------|-------|--|
| 1.0 SX | 4 | LA2 | 44/59 | 06/09→ | OE006 | 0,9 | CET8 | OE195 | |
|--------|---|-----|-------|--------|-------|-----|------|-------|--|

| | | | | | | | | | |
|--------|---|-----------|-------|--------|-------|-----|------|-------|--|
| 1.0 SX | 4 | B10S; LA2 | 46/62 | 05/05→ | OE006 | 0,9 | CET8 | OE195 | |
|--------|---|-----------|-------|--------|-------|-----|------|-------|--|

| | | | | | | | | | |
|--------|---|-------|-------|--------|-------|-----|------|-------|----------|
| 1.0 SX | 4 | B10S1 | 49/66 | 05/05→ | OE049 | 1,0 | CET8 | OE195 | BAEA447A |
|--------|---|-------|-------|--------|-------|-----|------|-------|----------|

| | | | | | | | | | |
|-----|---|------------|-------|--------|-------|-----|------|-------|----------------------------------|
| 1.2 | 4 | B12D1; LMU | 60/80 | 03/10→ | OE199 | 0,9 | CET1 | OE187 | BAEA447A ^[110] CLS144 |
|-----|---|------------|-------|--------|-------|-----|------|-------|----------------------------------|

| | | | | | | | | | |
|---------|---|------------|-------|--------|----------------------------|-----|--|--|-----------------|
| 1.2 LPG | 4 | B12D1; LMU | 60/80 | 03/10→ | OE230 ^{LPG [278]} | 0,9 | | | BAEA447A CLS144 |
|---------|---|------------|-------|--------|----------------------------|-----|--|--|-----------------|

TAHOE

| | | | | | | | | | |
|--------------|---|-----|---------|-------------|---------|-----|--|--|--|
| 5.7, 5.7 4WD | 8 | L05 | 147/197 | 10/94→09/95 | RV15YC4 | 1,0 | | | |
|--------------|---|-----|---------|-------------|---------|-----|--|--|--|

| | | | | | | | | | |
|--------------|---|--|---------|-------------|---------|-----|--|--|--|
| 5.7, 5.7 4WD | 8 | | 184/247 | 10/95→09/96 | RV15YC4 | 1,0 | | | |
|--------------|---|--|---------|-------------|---------|-----|--|--|--|

| | | | | | | | | | |
|--------------------|---|-----|---------|-------------|---------|-----|--|--|--|
| 5.7 V8, 5.7 V8 4WD | 8 | L31 | 190/255 | 10/94→09/96 | RV15YC4 | 1,0 | | | |
|--------------------|---|-----|---------|-------------|---------|-----|--|--|--|

TRAILBLAZER

| | | | | | | | | | |
|---------|---|-----|---------|-------------|-------|-----|--------|-------|--|
| 4.2 4WD | 6 | LL8 | 201/270 | 09/01→09/08 | OE029 | 1,0 | CET17P | OE189 | |
|---------|---|-----|---------|-------------|-------|-----|--------|-------|--|

| | | | | | | | | | |
|---------|---|-----|---------|-------------|--|--|--|--|----------|
| 6.0 4WD | 8 | LS2 | 295/396 | 08/05→09/08 | | | | | BAEA159E |
|---------|---|-----|---------|-------------|--|--|--|--|----------|

TRAX

| | | | | | | | | | |
|--------------|---|------------------|---------|--------|--|--|--|--|----------|
| 1.4, 1.4 4WD | 4 | A14NET; LUJ; LUV | 103/138 | 12/12→ | | | | | BAEA185E |
|--------------|---|------------------|---------|--------|--|--|--|--|----------|

| | | | | | | | | | |
|-----|---|------------|--------|--------|-------|-----|------|-------|----------|
| 1.6 | 4 | F16D4; LDE | 85/114 | 12/12→ | OE198 | 0,9 | CET2 | OE184 | BAEA198E |
|-----|---|------------|--------|--------|-------|-----|------|-------|----------|

| | | | | | | | | | |
|--------------|---|------------|---------|--------|-------|-----|------|--|----------|
| 1.8, 1.8 4WD | 4 | 2H0; F18D4 | 103/138 | 03/13→ | OE198 | 0,9 | CET2 | | BAEA199E |
|--------------|---|------------|---------|--------|-------|-----|------|--|----------|

VECTRA

| | | | | | | | | | |
|-----|---|--------------|--------|-------------|-------|-----|------|-------|--|
| 2.0 | 4 | Z0NEJ; C20NE | 81/109 | 03/96→12/05 | OE019 | 0,9 | CET2 | OE184 | |
|-----|---|--------------|--------|-------------|-------|-----|------|-------|--|

| | | | | | | | | | |
|-----|---|--------|---------|-------------|-------|-----|------|-------|--|
| 2.0 | 4 | C20SEL | 100/134 | 03/96→04/98 | OE019 | 0,9 | CET2 | OE184 | |
|-----|---|--------|---------|-------------|-------|-----|------|-------|--|

| | | | | | | | | | |
|-----|---|-------|---------|-------------|-------|-----|--------|-------|--|
| 2.2 | 4 | Z22SE | 108/145 | 04/02→04/04 | OE255 | 1,0 | CET17P | OE189 | |
|-----|---|-------|---------|-------------|-------|-----|--------|-------|--|

| | | | | | | | | | |
|-----|---|-------|---------|-------------|-------|-----|------|-------|--|
| 2.2 | 4 | Z22YH | 114/153 | 01/05→07/06 | OE120 | 0,6 | CET2 | OE188 | |
|-----|---|-------|---------|-------------|-------|-----|------|-------|--|

| | | | | | | | | | |
|-----|---|--------|---------|--------|--|--|--------|-------|--------------------|
| 2.8 | 6 | Z28NET | 184/247 | 10/06→ | | | CET14P | OE190 | BAEA174E →08/08 |
|-----|---|--------|---------|--------|--|--|--------|-------|--------------------|

| | | | | | | | | | |
|-----|---|--------|---------|-------------|--|--|--------|-------|----------|
| 2.8 | 6 | Z28NET | 188/252 | 11/05→09/06 | | | CET14P | OE190 | BAEA174E |
|-----|---|--------|---------|-------------|--|--|--------|-------|----------|

VIVA

| | | | | | | | | | |
|-----|---|-------|--------|-------------|-------|-----|------|-------|--|
| 1.8 | 4 | Z18XE | 90/121 | 09/03→03/08 | OE198 | 0,9 | CET2 | OE184 | |
|-----|---|-------|--------|-------------|-------|-----|------|-------|--|

VIVANT

| | | | | | | | | | |
|-----|---|--------|--------|--------|-------|-----|------|-------|--|
| 1.6 | 4 | A16DMS | 77/103 | 01/05→ | OE039 | 1,0 | CET2 | OE179 | |
|-----|---|--------|--------|--------|-------|-----|------|-------|--|

| | | | | | | | | | |
|-----|---|--------|--------|--------|-------|-----|------|-------|--|
| 1.6 | 4 | A16DMS | 78/105 | 08/01→ | OE039 | 1,0 | CET2 | OE179 | |
|-----|---|--------|--------|--------|-------|-----|------|-------|--|

| | | | | | | | | | |
|-----|---|--------|--------|--------|-------|-----|------|-------|---------------------------|
| 2.0 | 4 | X20SED | 89/119 | 08/00→ | OE019 | 0,9 | CET2 | OE184 | BAEA447A ^[275] |
|-----|---|--------|--------|--------|-------|-----|------|-------|---------------------------|

| | | | | | | | | | |
|--------|---|--------|--------|--------|-------|-----|------|-------|--|
| 2.0 CX | 4 | T20SED | 89/119 | 01/05→ | OE019 | 0,9 | CET2 | OE184 | |
|--------|---|--------|--------|--------|-------|-----|------|-------|--|

VOLT

| | | | | | | | | | |
|------------|---|-----|---------|--------|--|--|--|--|----------|
| 1.4 EV 150 | 4 | LUU | 111/149 | 11/11→ | | | | | BAEA185E |
|------------|---|-----|---------|--------|--|--|--|--|----------|

ZAFIRA

| | | | | | | | | | |
|-----|---|-------|--------|-------------|-------|-----|------|-------|--|
| 2.0 | 4 | C20NE | 85/114 | 04/01→07/04 | OE019 | 0,9 | CET2 | OE184 | |
|-----|---|-------|--------|-------------|-------|-----|------|-------|--|

| | | | | | | | | | |
|-----|---|-------|--------|-------------|-------|-----|------|-------|--|
| 2.0 | 4 | X20XE | 89/119 | 08/04→12/12 | OE019 | 0,9 | CET2 | OE184 | |
|-----|---|-------|--------|-------------|-------|-----|------|-------|--|

| | | | | | | | | | |
|-----|---|--------|---------|-------------|-------|-----|------|-------|--|
| 2.0 | 4 | C20SEL | 100/134 | 04/01→07/12 | OE019 | 0,9 | CET2 | OE184 | |
|-----|---|--------|---------|-------------|-------|-----|------|-------|--|

| | | | | | | | | | |
|-----|---|-------|---------|--------|-------|-----|------|-------|-------------------------|
| 2.2 | 4 | Z22YH | 110/148 | 09/01→ | OE120 | 0,6 | CET2 | OE188 | BAEA149E 09/05→08/06 |
|-----|---|-------|---------|--------|-------|-----|------|-------|-------------------------|

CHEVROLET





kW/BHP



eon TITAN

IRIDIUM

**CHEVROLET**

| | | | | | | | | | | |
|----------------|---|-----|---------|-------------|---------|-----|--|--|--|--------------------------|
| ASTRO | | | | | | | | | | |
| 4.3 | 6 | LB4 | 127/170 | 10/94→09/95 | RV15YC4 | 1,0 | | | | |
| EXPRESS | | | | | | | | | | |
| 5.3 Flex-Fuel | 8 | L59 | 216/290 | 01/07→ | | | | | | BAEA159E ^[96] |
| G20 | | | | | | | | | | |
| 5.7 4WD | 8 | | 136/182 | 01/94→09/94 | RV15YC4 | 1,0 | | | | |

CHRYSLER

| | | | | | | | | | | |
|---------------------|---|------------|---------|-------------|-------|-----|--------|-------|-------------------|---|
| 300 C | | | | | | | | | | |
| 2.7 | 6 | EES | 130/174 | 01/07→11/12 | | | | | | BAEA453 ^[275] BAEA453 ^[68] |
| 2.7 | 6 | 2.7FX; EER | 142/190 | 09/04→11/12 | | | | | | BAEA453 01/06→ |
| 3.5 | 6 | EGG | 183/245 | 09/04→11/12 | | | | | | BAEA453 ^[275] 08/05→01/08 BAEA432 ^[277] |
| 3.5, 3.5 4WD | 6 | EEG; EGG | 183/245 | 09/04→11/12 | | | | | | BAEA453 ^[275] 01/06→ BAEA432 ^[277] |
| 300 M | | | | | | | | | | |
| 3.5 V6 24V | 6 | EGG | 185/248 | 08/00→09/04 | | | | | | BAEA432 ^[277] |
| 3.5 V6 24V | 6 | EGG | 187/251 | 07/98→08/00 | | | | | | BAEA432 ^[277] |
| CIRRUS | | | | | | | | | | |
| 2.0 LX | 4 | ECB | 96/129 | 05/94→09/97 | OE005 | 0,9 | CET2 | OE180 | | |
| 2.0 LX | 4 | ECB | 98/131 | 10/97→09/00 | OE005 | 0,9 | CET2 | OE180 | | |
| 2.5 LX | 6 | EEB | 120/161 | 10/94→09/00 | OE063 | 1,0 | CET2 | OE180 | | |
| CONCORDE | | | | | | | | | | |
| 3.5 LX | 6 | EWZ | 174/233 | 10/97→09/03 | | | | | | BAEA432 ^[277] |
| 3.5 LX Supercharged | 6 | EWZ | 186/249 | 10/97→09/03 | | | | | | BAEA432 ^[277] |
| CROSSFIRE | | | | | | | | | | |
| 3.2 | 6 | EGX | 160/215 | 07/03→12/08 | | | CET12P | OE180 | BAEA297 | CLS064 |
| 3.2 SRT-6 | 6 | EGZ | 246/330 | 09/04→12/07 | OE191 | 1,0 | CET12P | OE180 | BAEA297 | |
| DELTA | | | | | | | | | | |
| 1.4 | 4 | 198A4.000 | 88/118 | 08/11→ | OE208 | 0,8 | | | | |
| 1.4 16V | 4 | 198A7.000 | 103/138 | 08/11→ | OE208 | 0,8 | | | | |
| NEON | | | | | | | | | | |
| 1.8 16V | 4 | EBD | 85/114 | 09/97→08/99 | OE002 | 0,9 | CET2 | OE180 | | |
| 2.0 16V | 4 | 420H | 98/131 | 05/94→08/99 | OE005 | 0,9 | CET2 | OE180 | | |
| 2.0 16V | 4 | ECC | 107/143 | 06/94→08/99 | OE005 | 0,9 | CET2 | OE180 | | |
| 2.0 16V | 4 | 420T | 109/146 | 04/96→08/99 | OE005 | 0,9 | CET2 | OE180 | | |
| NEON II | | | | | | | | | | |
| 1.6 | 4 | EJD | 85/114 | 11/01→12/06 | OE089 | 1,0 | CET2 | OE184 | | |
| 1.8 | 4 | EBD | 91/122 | 01/00→12/01 | OE002 | 0,9 | CET2 | OE180 | | |
| 2.0 16V | 4 | ECB | 97/130 | 10/02→12/06 | OE005 | 0,9 | CET2 | OE180 | BAEA380 →12/03 | |
| 2.0 16V | 4 | 420H; ECB | 98/131 | 08/99→12/06 | OE005 | 0,9 | CET2 | OE180 | | |
| 2.0 16V R/T | 4 | ECH | 110/148 | 10/01→12/06 | OE005 | 0,9 | CET2 | OE180 | BAEA380 →12/03 | |
| NEW YORKER | | | | | | | | | | |
| 3.5 i 24V | 6 | F01 | 155/208 | 04/93→09/98 | OE041 | 0,9 | | | | CLS062 |
| PACIFICA | | | | | | | | | | |
| 3.5 | 6 | EGN | 186/249 | 08/03→12/06 | | | | | | BAEA432 ^[277] |
| 3.5 4WD | 6 | EGN | 186/249 | 08/03→12/06 | | | | | | BAEA432 ^[275] BAEA453 ^[275] |

CHRYSLER

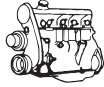

kW/BHP

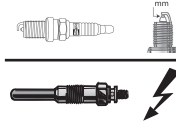

eon TITAN

IRIDIUM

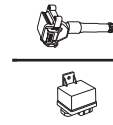
**...CHRYSLER****PT CRUISER**

| | | | | | | | | | | |
|--------|---|-----|---------|-------------|-------|-----|------|-------|---------|--------|
| 1.6 | 4 | EJD | 85/114 | 11/01→12/10 | OE089 | 1,0 | CET2 | OE184 | | |
| 2.0 | 4 | ECC | 104/139 | 06/00→09/04 | | | | | BAEA380 | CLS241 |
| 2.4 | 4 | EDZ | 105/141 | 03/04→12/10 | | | | | BAEA380 | CLS241 |
| 2.4 | 4 | EDZ | 110/148 | 06/00→12/10 | | | | | BAEA380 | CLS241 |
| 2.4 GT | 4 | EDV | 164/220 | 08/03→12/10 | | | | | BAEA380 | 12/03→ |

SEBRING

| | | | | | | | | | | |
|--------------|---|----------|---------|-------------|-------|-----|------|-------|--------------------------|--------|
| 2.0 | 4 | ECC | 104/139 | 05/95→06/07 | | | | | BAEA380 | CLS241 |
| 2.0 VVT | 4 | ECN | 115/154 | 07/07→12/10 | OE154 | 1,0 | CET2 | OE194 | | |
| 2.4 VVT | 4 | ED3; EDG | 125/168 | 07/07→12/10 | OE154 | 1,0 | CET2 | OE194 | | |
| 2.5 LE | 6 | EEB | 120/161 | 05/95→12/96 | OE063 | 1,0 | CET2 | OE180 | | |
| 2.7, 2.7 VVT | 6 | EER | 137/184 | 07/07→12/10 | | | | | BAEA453 ^[275] | |
| 2.7 VVT | 6 | EER | 141/189 | 09/06→12/10 | | | | | BAEA453 ^[275] | |
| 3.5 4WD | 6 | EGF; EGG | 175/235 | 09/07→12/10 | | | | | BAEA453 ^[275] | |

STRATUS

| | | | | | | | | | | |
|-----------|---|-----------|---------|-------------|-------|-----|--------|-------|---------|--|
| 2.0 16V | 4 | ECB | 98/131 | 12/95→04/01 | OE005 | 0,9 | CET2 | OE180 | | |
| 2.0 LE | 4 | 420X; COO | 96/129 | 12/95→04/01 | OE005 | 0,9 | CET2 | OE180 | BAEA380 | |
| 2.5 V6 | 6 | HOO | 125/168 | 12/95→04/01 | OE063 | 1,0 | CET2 | OE180 | | |
| 2.5 LX | 6 | 625H | 120/161 | 04/96→04/01 | | | CET12P | OE180 | | |
| 2.5 LX V6 | 6 | EEB; HOO | 120/161 | 12/95→04/01 | OE063 | 1,0 | CET2 | OE180 | | |

VIPER

| | | | | | | | | | | |
|-----|----|-----|---------|-------------|-------|-----|--|--|--|--|
| 8.0 | 10 | EPD | 282/378 | 07/98→12/98 | OE041 | 0,9 | | | | |
|-----|----|-----|---------|-------------|-------|-----|--|--|--|--|

VISION

| | | | | | | | | | | |
|---------|---|---------------|---------|-------------|-------|-----|--|--|--|--|
| 3.5 TSi | 6 | EGE; F00; F01 | 155/208 | 09/93→12/97 | OE041 | 0,9 | | | | |
|---------|---|---------------|---------|-------------|-------|-----|--|--|--|--|

VOYAGER / GRAND VOYAGER III

| | | | | | | | | | | |
|--------------|---|-----------------|---------|-------------|-------|-----|------|-------|---------|--------|
| 2.0 i | 4 | COO | 98/131 | 01/95→03/01 | OE002 | 0,9 | CET2 | OE180 | BAEA380 | |
| 2.4 i | 4 | B00 | 111/149 | 01/95→03/01 | | | | | BAEA380 | CLS190 |
| 2.5 TD | 4 | 425CLIRS/X; ENC | 85/114 | 01/95→03/01 | CH181 | 11v | | | | |
| 2.5 TDiC 4WD | 4 | ENC | 85/114 | 10/95→03/01 | CH181 | 11v | | | | |
| 3.0 | 6 | EFA | 112/150 | 01/95→03/01 | OE042 | 0,9 | CET8 | | | |
| 3.3 i | 6 | ROO | 116/156 | 01/95→03/01 | OE105 | 1,3 | | | | CLS062 |
| 3.8 i 4WD | 6 | LOO | 122/164 | 01/95→03/01 | OE105 | 1,3 | | | | CLS062 |
| 3.8 i 4WD | 6 | EGH | 131/176 | 01/95→03/01 | OE105 | 1,3 | | | | CLS062 |

VOYAGER IV

| | | | | | | | | | | |
|--------------|---|----------|---------|-------------|-------|-----|--|--|---------|--------|
| 2.4 | 4 | EDZ | 108/145 | 02/00→12/08 | | | | | BAEA380 | |
| 2.5 CRD | 4 | EDK | 88/118 | 08/05→12/08 | CH180 | 11v | | | | |
| 2.5 CRD | 4 | ENC | 105/141 | 02/00→12/08 | CH180 | 11v | | | | |
| 2.8 CRD | 4 | ENR | 110/148 | 06/04→12/08 | CH180 | 11v | | | | |
| 3.3, 3.3 4WD | 6 | EGA; EGM | 128/172 | 02/00→12/08 | | | | | | CLS193 |
| 3.8, 3.8 4WD | 6 | EGH | 160/215 | 02/00→12/08 | | | | | | CLS193 |

YPSILON

| | | | | | | | | | | |
|-------------|---|-----------|-------|--------|-------|-----|--------|--|--|--|
| 0.9 Twinair | 2 | 312A2.000 | 63/84 | 05/11→ | OE232 | 0,7 | CET15P | | | |
| 1.2 | 4 | 169A4.000 | 51/68 | 05/11→ | OE196 | 1,0 | CET1 | | | |

CITROËN**AX**

| | | | | | | | | | | |
|----------|---|----------------------|-------|-------------|-------|-----|--|--|--|--|
| 1.5 15 D | 4 | VJY(TUD5) | 40/54 | 08/94→12/97 | CH185 | 11v | | | | |
| 1.5 15 D | 4 | VJY(TUD5); VJZ(TUD5) | 43/58 | 08/94→12/97 | CH185 | 11v | | | | |

BERLINGO

| | | | | | | | | | | |
|-----|---|--------------|-------|--------|----------------------------|-----|------|-------|----------|--|
| 1.6 | 4 | NFR(TU5JP4B) | 66/89 | 04/08→ | OE035 | 0,9 | CET5 | OE190 | BAEA045E | |
| | | | | | OE224 ^{LPG [279]} | 0,8 | | | | |



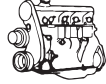

kW/BHP

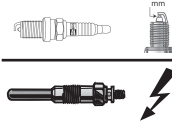

eon TITAN

IRIDIUM

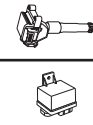

...CITROËN

...BERLINGO

| | | | | | | | | | |
|----------------|---|--------------------------------|--------|-------------|-------------------------------------|------------|--------|-------|----------|
| 1.6 | 4 | NFU(TU5JP4) | 80/107 | 04/08→ | OE035 OE224 ^{IPG [279]} | 0,9 0,8 | CET5 | OE190 | BAEA045E |
| 1.6 HDi 75 16V | 4 | 9HT(DV6BTED4) | 55/74 | 04/08→ | CH201 | 11v | | | |
| 1.6 HDi 90 | 4 | 9HX(DV6ATED4) | 66/89 | 04/08→ | CH201 | 11v | | | |
| 1.6 HDi 90 | 4 | 9HJ(DV6DTEDM); 9HP(DV6DTED) | 68/91 | 07/10→ | CH201 | 11v | | | |
| 1.6 HDi 110 | 4 | 9HZ(DV6TED4) | 80/107 | 04/08→ | CH201 | 11v | | | CCU147 |
| 1.6 VTi 95 | 4 | 5FK(EP6CB) | 72/97 | 07/10→ | OE205 | 0,7 | CET16P | | BAEA143 |
| 1.6 VTi 120 | 4 | 5FS(EP6C) | 88/118 | 11/09→ | OE205 | 0,7 | CET16P | | BAEA143 |
| 1.9 D | 4 | DJY(XUD9A) | 51/68 | 07/96→10/99 | CH189 | 11v | | | |

BERLINGO / BERLINGO FIRST

| | | | | | | | | | | |
|-------------------------|---|-----------------------------|--------|-------------|-------------------------------------|------------|------|-------|--------------------------------------|--------|
| 1.1 i | 4 | HDZ(TU1M) | 44/59 | 07/96→05/08 | OE034 | 0,9 | CET2 | OE179 | | CLS262 |
| 1.1 i | 4 | HFX(TU1JP) | 44/59 | 07/96→05/08 | OE034 | 0,9 | CET2 | OE179 | BAE946A 01/01→08/05 [10] [275] | CLS262 |
| 1.4 | 4 | KFW(TU3JP) | 53/71 | 11/02→10/05 | OE034 | 0,9 | CET2 | OE179 | BAE946A ^[10] | |
| 1.4 bivalent | 4 | KFW(TU3JP) | 48/64 | 11/02→12/11 | OE005 OE034 | 0,9 0,9 | CET2 | OE179 | BAEA048E ^[7] | |
| 1.4 i | 4 | KFW(TU3JP) | 55/74 | 07/96→12/11 | OE034 *to be adjusted | 0,7* | CET2 | OE179 | BAE946A [10] [275] | CLS262 |
| 1.4 i | 4 | KFX(TU3JP) | 55/74 | 07/96→12/11 | OE034 *to be adjusted | 0,7* | CET2 | OE179 | | CLS262 |
| 1.4 i bivalent | 4 | KFW(TU3JP) | 55/74 | 04/03→10/08 | OE034 | 0,9 | CET2 | OE179 | BAE946A ^[10] | |
| 1.6 16V | 4 | NFU(TU5JP4) | 80/107 | 10/00→12/11 | OE035 OE224 ^{IPG [279]} | 0,9 0,8 | CET5 | OE190 | BAEA045E | |
| 1.6 16V | 4 | NFU(TU5JP4) | 81/109 | 11/02→10/08 | OE035 | 0,9 | CET5 | OE190 | BAEA045E | |
| 1.6 HDi 75 | 4 | 9HW(DV6BTED4); DV6B | 55/74 | 07/05→12/11 | CH201 06/06→ | 11v | | | CCU147 | |
| 1.6 HDi 90 | 4 | 9HX(DV6ATED4) | 66/89 | 07/05→05/08 | CH201 03/06→ RP.10689→ | 11v | | | CCU147 | |
| 1.8 D | 4 | A9A(XUD7) | 43/58 | 07/98→10/02 | CH189 | 11v | | | | |
| 1.8 i | 4 | LFX(XU7JB) | 66/89 | 05/97→10/02 | OE034 | 0,9 | CET2 | OE179 | | CLS123 |
| 1.8 i 4WD | 4 | LFX(XU7JB) | 66/89 | 04/97→10/01 | OE034 | 0,9 | CET2 | OE179 | | |
| 1.9 D | 4 | D9B(XUD9A/L); DJY(XUD9A) | 50/67 | 07/96→12/03 | CH189 | 11v | | | | |
| 1.9 D, 1.9 D 4WD | 4 | WJZ(DW8) | 51/68 | 07/98→10/05 | CH185 | 11v | | | | |
| 1.9 D, 1.9 D 4WD | 4 | WJY(DW8B) | 51/68 | 07/98→10/05 | CH185 | 11v | | | CCU149 ^[318] | |
| 2.0 HDi 4WD, 2.0 HDi 90 | 4 | RHY(DW10TD) | 66/89 | 12/99→10/05 | CH170 | 11v | | | CCU149 ^[359] | |

C1

| | | | | | | | | | |
|---------|---|------------|-------|-------------|----------------|------------|------|-------|----------|
| 1.0 | 3 | CFB(1KR) | 50/67 | 06/05→09/14 | OE035 OE178 | 0,9 0,9 | CET5 | OE190 | BAEA164E |
| 1.4 HDi | 4 | 8HT(DV4TD) | 40/54 | 06/05→09/14 | CH201 | 11v | | | CCU147 |

C1 II

| | | | | | | | | | |
|------------|---|----------|-------|--------|--|--|--|--|----------|
| 1.0 VTi 68 | 3 | CFB(1KR) | 51/68 | 04/14→ | | | | | BAEA164E |
|------------|---|----------|-------|--------|--|--|--|--|----------|

C2

| | | | | | | | | | |
|---------|---|------------------------|--------|--------|-------------------------------------|------------|------|-------|-----------------------------------|
| 1.1 | 4 | HFX(TU1JP) | 44/59 | 09/03→ | OE034 | 0,9 | CET2 | OE179 | BAE946A ^[10] |
| 1.4 | 4 | KFV(TU3JP) | 54/72 | 09/03→ | OE034 | 0,9 | CET2 | OE179 | BAE946A ^[10] →02/05 |
| 1.4 | 4 | KFV(TU3JP) | 55/74 | 10/06→ | OE034 | 0,9 | CET2 | OE179 | BAE946A ^[10] |
| 1.4 16V | 4 | KFU(ET3J4) | 65/87 | 06/06→ | OE130 | 0,9 | CET4 | | BAEA472 |
| 1.4 HDi | 4 | 8HX(DV4TD); 8HZ(DV4TD) | 50/67 | 09/03→ | | | | | CCU149 ^[318] |
| 1.6 | 4 | NFU(TU5JP4) | 80/107 | 09/03→ | OE035 OE224 ^{IPG [279]} | 0,9 0,8 | CET5 | OE190 | BAEA045E |
| 1.6 HDi | 4 | 9HZ(DV6TED4) | 80/107 | 09/05→ | CH201 07/07→ | 11v | | | CCU147 |
| 1.6 VTS | 4 | NFS(TU5JP4S) | 90/121 | 01/05→ | OE035 | 0,9 | CET5 | OE190 | BAEA045E |

CITROËN



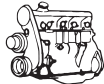

kW/BHP



eon TITAN

IRIDIUM

**...CITROËN****C3**

| | | | | | | | | | | |
|------------|---|-------------|--------|--------|--|------------|-------------|--------------|--|---------------|
| 1.4 | 4 | KFV(TU3JP) | 54/72 | 05/03→ | OE034 | 0,9 | CET2 | OE179 | BAE946A ^[10] →10/12 | |
| 1.4 HDi | 4 | 8HX(DV4TD) | 50/67 | 04/04→ | CH201 RP.10221→ | 11v | | | CCU147 | |
| 1.4 Hybrid | 4 | KFV(TU3JP) | 54/72 | 05/05→ | OE034 | 0,9 | CET2 | OE179 | BAE946A ^[10] | |
| 1.6 | 4 | NFU(TU5JP4) | 80/107 | 05/03→ | OE035 OE224 LPG [279] | 0,9 0,8 | CET5 | OE190 | BAEA045E | CLS124 |

C3 I

| | | | | | | | | | | |
|----------------|---|------------------------|--------|-------------|--|------------|-------------|--------------|--|---------------|
| 1.1 i | 4 | HFX(TU1A); HFX(TU1JP) | 44/59 | 02/02→ | OE034 | 0,9 | CET2 | OE179 | BAE946A ^[10] →10/05 BAEA048E ^[7] 11/05→ | CLS124 |
| 1.4 16V | 4 | KFU(ET3J4) | 65/87 | 12/03→ | OE130 | 0,9 | CET4 | | BAEA472 | |
| 1.4 16V HDi | 4 | 8HY(DV4TED4) | 66/89 | 02/02→ | | | | | CCU149 ^[318] | |
| 1.4 Bioflex | 4 | KFV(TU3JP) | 60/80 | 01/09→ | OE034 | 0,9 | CET2 | OE179 | BAE946A ^[10] →07/12 | |
| 1.4 HDi | 4 | 8HX(DV4TD); 8HZ(DV4TD) | 50/67 | 02/02→ | CH201 RP.10227→ | 11v | | | CCU149 ^[318] | |
| 1.4 HDi | 4 | 8HZ(DV4TD) | 52/70 | 07/03→02/11 | CH201 | 11v | | | | |
| 1.4 HDi | 4 | 8HX(DV4TD) | 55/74 | 05/05→ | CH201 | 11v | | | CCU147 | |
| 1.4 i | 4 | KFV(TU3A); KFV(TU3JP) | 54/72 | 02/02→ | OE034 | 0,9 | CET2 | OE179 | BAE946A ^[10] →10/05 BAEA048E ^[7] 11/05→ | |
| 1.4 i Bivalent | 4 | KFV(TU3JP) | 54/72 | 02/02→ | OE034 | 0,9 | CET2 | OE179 | BAE946A ^[10] | CLS124 |
| 1.6 16V | 4 | NFU(TU5JP4) | 80/107 | 02/02→ | OE035 OE224 LPG [279] | 0,9 0,8 | CET5 | OE190 | BAEA045E | CLS124 |
| 1.6 16V | 4 | NFU(TU5JP4) | 81/109 | 05/03→09/05 | OE035 | 0,9 | CET5 | | BAEA045E | |
| 1.6 16V HDi | 4 | 9HX(DV6ATED4) | 66/89 | 10/05→ | CH201 RP.10784→ | 11v | | | | |
| 1.6 16V HDi | 4 | 9HZ(DV6TED4) | 80/107 | 09/05→ | CH201 RP.10784→ | 11v | | | CCU147 | |
| 1.6 Bioflex | 4 | NFU(TU5JP4) | 83/111 | 06/05→ | | | | | BAEA045E | |

C3 II

| | | | | | | | | | | |
|---------------------|---|----------------------|--------|--------|--------------|-----|---------------|--------------|--------------------------------|--|
| 1.0 VTi 68 | 3 | ZMZ(EB0) | 50/67 | 08/12→ | | | | OE263 | | |
| 1.1 | 4 | HFX(TU1JP) | 44/59 | 11/09→ | OE034 | 0,9 | CET2 | OE179 | BAEA048E ^[7] | |
| 1.1 BiFuel | 4 | HFX(TU1A) | 44/59 | 11/10→ | OE034 | 0,9 | CET2 | OE179 | | |
| 1.2 THP 110 | 3 | HNZ(EB2DT) | 81/109 | 10/14→ | | | | | BAEA557 | |
| 1.2 VTi 82 | 3 | HMZ(EB2F) | 60/80 | 06/12→ | | | | OE263 | | |
| 1.4 | 4 | KFT(TU3A); KFV(TU3A) | 54/72 | 11/09→ | OE034 | 0,9 | CET2 | OE179 | BAEA048E ^[7] | |
| 1.4 HDi 70 | 4 | 8HR(DV4C) | 50/67 | 11/09→ | CH201 | 11v | | | | |
| 1.4 HDi 70 | 4 | 8HZ(DV4TD) | 50/67 | 11/09→ | CH201 | 11v | | | CCU147 | |
| 1.4 LPG, 1.4 VTi 95 | 4 | 8FN(EP3); 8FP(EP3) | 70/94 | 11/09→ | OE203 | 1,0 | | | BAEA143 | |
| 1.4 VTi | 4 | 8FR(EP3) | 72/97 | 11/09→ | | | | | BAEA143 | |
| 1.6 HDi 90 | 4 | 9HX(DV6ATED4) | 66/89 | 11/09→ | CH201 | 11v | | | | |
| 1.6 VTi 120 | 4 | 5FS(EP6C) | 88/118 | 11/09→ | OE205 | 0,7 | CET16P | | BAEA143 | |

C3 Picasso

| | | | | | | | | | | |
|----------------------------|---|---------------------------------|--------|--------|--------------|-----|---------------|--|----------------|--|
| 1.2 THP 110 | 3 | HNZ(EB2DT) | 81/109 | 01/15→ | | | | | BAEA557 | |
| 1.4 VTi 95, 1.4 VTi 95 LPG | 4 | 8FN(EP3); 8FP(EP3); 8FS(EP3) | 70/94 | 02/09→ | OE203 | 1,0 | | | BAEA143 | |
| 1.6 HDi | 4 | 9HX(DV6ATED4) | 66/89 | 02/09→ | CH201 | 11v | | | | |
| 1.6 HDi | 4 | 9HZ(DV6TED4) | 80/107 | 02/09→ | CH201 | 11v | | | CCU147 | |
| 1.6 VTi 120 | 4 | 5FS(EP6C); 5FW(EP6) | 88/118 | 02/09→ | OE205 | 0,7 | CET16P | | BAEA143 | |

C4

| | | | | | | | | | | |
|---------|---|-------------|--------|-------------|--|------------|-------------|--------------|-----------------|--|
| 1.4 16V | 4 | KFU(ET3J4) | 65/87 | 11/04→07/11 | OE130 | 0,9 | CET4 | | BAEA472 | |
| 1.6 16V | 4 | NFU(TU5JP4) | 80/107 | 11/04→07/11 | OE035 OE224 LPG [279] | 0,9 0,8 | CET5 | OE190 | BAEA045E | |

CHAMPION**CITROËN**

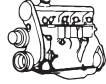

kW/BHP

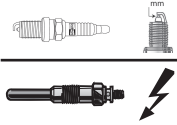

eon TITAN

IRIDIUM

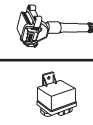
**...CITROËN****...C4**

| | | | | | | | | | |
|-------------|---|-------------------------------|---------|-------------|--------------------|-----|--------|--|-------------------|
| 1.6 HDi | 4 | 9HX(DV6ATED4) | 66/89 | 11/04→07/11 | CH201 RP.10784→ | 11v | | | |
| 1.6 HDi | 4 | 9HY(DV6TED4); 9HZ(DV6TED4) | 80/107 | 11/04→07/11 | CH201 →RP.10784 | 11v | | | CCU147 |
| | | | | | CH201 RP.10784→ | 11v | | | |
| 1.6 THP 150 | 4 | 5FX(EP6DT) | 110/148 | 07/08→07/11 | OE205 | 0,7 | CET16P | | BAEA143 |
| 1.6 VTi 120 | 4 | 5FW(EP6) | 88/118 | 07/08→07/11 | OE205 | 0,7 | CET16P | | BAEA143 →07/10 |
| 2.0 16V | 4 | RFN(EW10J4) | 100/134 | 11/04→07/07 | OE178 | 0,9 | CET5 | | BAEA348 |
| 2.0 16V | 4 | RFJ(EW10A) | 103/138 | 07/06→ | OE178 | 0,9 | CET5 | | BAEA352 |
| 2.0 16V | 4 | RFK(EW10J4S) | 130/174 | 11/04→12/10 | OE178 | 0,9 | CET5 | | BAEA351 |
| | | | | | OE224 UPG [279] | 0,8 | | | |
| 2.0 HDi | 4 | RHR(DW10BTD4) | 100/134 | 11/04→12/10 | CH268 | 11v | | | CCU147 |
| 2.0 HDi | 4 | RHF(DW10BTD4) | 103/138 | 06/07→07/11 | CH268 | 11v | | | CCU147 |

C4 AIRCROSS

| | | | | | | | | | |
|-----|---|------|--------|--------|--|--|--------|-------|---------|
| 1.6 | 4 | 4A92 | 86/115 | 04/12→ | | | CET14P | OE190 | BAEA547 |
|-----|---|------|--------|--------|--|--|--------|-------|---------|

C4 CACTUS

| | | | | | | | | | |
|-------------|---|------------|--------|--------|--|--|--|--|---------|
| 1.2 THP 110 | 3 | HNZ(EB2DT) | 81/109 | 09/14→ | | | | | BAEA557 |
|-------------|---|------------|--------|--------|--|--|--|--|---------|

C4 Grand Picasso I

| | | | | | | | | | |
|-------------|---|-------------------------------|---------|--------|-------|-----|--------|--|---------|
| 1.6 16V | 4 | 5FT(EP6DT) | 103/138 | 07/08→ | OE205 | 0,7 | CET16P | | BAEA143 |
| 1.6 16V | 4 | 5FX(EP6DT) | 110/148 | 10/08→ | OE205 | 0,7 | CET16P | | BAEA143 |
| 1.6 HDi | 4 | 9HY(DV6TED4); 9HZ(DV6TED4) | 80/107 | 10/06→ | CH201 | 11v | | | CCU147 |
| 1.6 THP 155 | 4 | 5FV(EP6CDT) | 115/154 | 09/10→ | OE205 | 0,7 | CET16P | | BAEA143 |
| 1.6 VTi 120 | 4 | 5FW(EP6) | 88/118 | 07/08→ | OE205 | 0,7 | CET16P | | BAEA143 |
| 1.8 i 16V | 4 | 6FY(EW7A) | 92/123 | 10/06→ | OE178 | 0,9 | CET5 | | BAEA352 |
| 2.0 HDi 138 | 4 | RHR(DW10BTD4) | 100/134 | 10/06→ | CH170 | 11v | | | CCU147 |
| 2.0 HDi 138 | 4 | RHJ(DW10BTD4) | 100/134 | 10/06→ | | | | | CCU147 |
| 2.0 i 16V | 4 | RFJ(EW10A) | 103/138 | 10/06→ | OE178 | 0,9 | CET5 | | BAEA352 |
| 2.0 i 16V | 4 | RFJ(EW10A) | 105/141 | 01/10→ | OE178 | 0,9 | CET5 | | |

C4 Grand Picasso II

| | | | | | | | | | |
|-------------|---|-------------|---------|--------|-------|-----|--------|--|---------|
| 1.2 THP 130 | 3 | HNY(EB2DTS) | 96/129 | 04/14→ | | | | | BAEA557 |
| 1.6 THP 155 | 4 | 5FV(EP6CDT) | 115/154 | 09/13→ | OE205 | 0,7 | CET16P | | |
| 1.6 VTi 120 | 4 | 5FS(EP6C) | 88/118 | 09/13→ | OE205 | 0,7 | CET16P | | BAEA143 |

C4 I

| | | | | | | | | | |
|---------------------------|---|-------------------------------|---------|-------------|--------------------|-----|--------|-------|-------------------|
| 1.4 16V | 4 | KFU(ET3J4) | 65/87 | 11/04→07/11 | OE130 | 0,9 | CET4 | | BAEA472 |
| 1.6 16V, 1.6 16V Bio-Flex | 4 | NFU(TU5JP4) | 80/107 | 11/04→07/11 | OE035 | 0,9 | CET5 | OE190 | BAEA045E |
| | | | | | OE224 UPG [279] | 0,8 | | | |
| 1.6 Flex | 4 | | 81/109 | 02/09→07/11 | OE035 | 0,9 | CET5 | | BAEA045E |
| 1.6 HDi | 4 | 9HX(DV6ATED4) | 66/89 | 11/04→07/11 | CH201 RP.10784→ | 11v | | | CCU147 |
| 1.6 HDi | 4 | 9HY(DV6TED4); 9HZ(DV6TED4) | 80/107 | 11/04→07/11 | CH201 RP.10784→ | 11v | | | CCU147 |
| 1.6 THP 140 | 4 | 5FT(EP6DT) | 103/138 | 07/08→07/11 | OE205 | 0,7 | CET16P | | BAEA143 |
| 1.6 THP 150 | 4 | 5FX(EP6DT) | 110/148 | 07/08→07/11 | OE205 | 0,7 | CET16P | | BAEA143 |
| 1.6 VTi 120 | 4 | 5FW(EP6) | 88/118 | 07/08→07/11 | OE205 | 0,7 | CET16P | | BAEA143 →09/10 |
| 2.0 16V | 4 | RFN(EW10J4) | 100/134 | 11/04→07/07 | OE178 | 0,9 | CET5 | | BAEA348 |
| 2.0 16V | 4 | RFJ(EW10A) | 103/138 | 11/04→07/11 | OE178 | 0,9 | CET5 | | BAEA352 |
| 2.0 16V | 4 | RFK(EW10J4S) | 130/174 | 11/04→07/08 | OE178 | 0,9 | CET5 | | BAEA351 |
| | | | | | OE224 UPG [279] | 0,8 | | | |
| 2.0 HDi | 4 | RHR(DW10BTD4) | 100/134 | 11/04→07/11 | CH268 | 11v | | | CCU147 |
| 2.0 HDi | 4 | RHF(DW10BTD4) | 103/138 | 07/08→07/11 | CH268 | 11v | | | CCU147 |

CITROËN



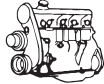

kW/BHP



eon TITAN

IRIDIUM

**...CITROËN****C4 II**

| | | | | | | | | | | | | |
|-----------------|---|-------------|---------|--------|-------|-----|--------|--|--|--|--|-------------------|
| 1.2 THP 130 | 3 | HNY(EB2DTS) | 96/129 | 04/14→ | | | | | | | | BAEA557 |
| 1.4 VTi 95 | 4 | 8FP(EP3) | 70/94 | 11/09→ | OE203 | 1,0 | | | | | | BAEA143 |
| 1.6 THP 155 | 4 | 5FV(EP6CDT) | 115/154 | 11/09→ | OE205 | 0,7 | CET16P | | | | | BAEA143 |
| 1.6 VTi 120 | 4 | 5FS(EP6C) | 88/118 | 11/09→ | OE205 | 0,7 | CET16P | | | | | BAEA143 09/10→ |
| 1.6 VTi 120 LPG | 4 | 5FS(EP6C) | 88/118 | 09/11→ | OE205 | 0,7 | CET16P | | | | | BAEA143 |

C4 Picasso I

| | | | | | | | | | | | | |
|-------------|---|---------------------------------|---------|-------------|-------|-----|--------|--|--|--|--|---------|
| 1.6 16V | 4 | 5FX(EP6DT) | 110/148 | 07/08→08/13 | OE205 | 0,7 | CET16P | | | | | BAEA143 |
| 1.6 HDi | 4 | 9HY(DV6TED4); 9HZ(DV6TED4) | 80/107 | 02/07→08/13 | CH201 | 11v | | | | | | CCU147 |
| 1.6 THP 140 | 4 | 5FT(EP6DT) | 103/138 | 07/08→08/13 | OE205 | 0,7 | CET16P | | | | | BAEA143 |
| 1.6 THP 155 | 4 | 5FV(EP6CDT) | 115/154 | 09/10→08/13 | OE205 | 0,7 | CET16P | | | | | BAEA143 |
| 1.6 VTi 120 | 4 | 5FW(EP6) | 88/118 | 07/08→08/13 | OE205 | 0,7 | CET16P | | | | | BAEA143 |
| 1.8 i 16V | 4 | 6FY(EW7A) | 92/123 | 02/07→12/11 | OE178 | 0,9 | CET5 | | | | | BAEA352 |
| 2.0 HDi 138 | 4 | RHJ(DW10BTD4); RHR(DW10BTD4) | 100/134 | 10/06→08/13 | CH268 | 11v | | | | | | CCU147 |
| 2.0 i 16V | 4 | RFJ(EW10A) | 103/138 | 02/07→08/13 | OE178 | 0,9 | CET5 | | | | | BAEA352 |

C4 Picasso II

| | | | | | | | | | | | | |
|-------------|---|-------------|---------|--------|-------|-----|--------|--|--|--|--|---------|
| 1.2 THP 130 | 3 | HNY(EB2DTS) | 96/129 | 04/14→ | | | | | | | | BAEA557 |
| 1.6 THP 155 | 4 | 5FV(EP6CDT) | 115/154 | 02/13→ | OE205 | 0,7 | CET16P | | | | | |
| 1.6 VTi 120 | 4 | 5FS(EP6C) | 88/118 | 02/13→ | OE205 | 0,7 | CET16P | | | | | |
| 1.6 VTi 120 | 4 | 5FS(EP6C) | 88/118 | 02/13→ | | | | | | | | BAEA143 |

C5 I

| | | | | | | | | | | | | |
|--------------|---|---------------------------------|---------|-------------|---|------------|--------|-------|--|--|--|--------------------------------------|
| 1.8 16V | 4 | 6FZ(EW7J4) | 85/114 | 03/01→08/04 | OE178 | 0,9 | CET5 | | | | | BAEA348 |
| 2.0 16V | 4 | RFN(EW10J4) | 100/134 | 03/01→08/04 | OE178 | 0,9 | CET5 | | | | | BAEA348 |
| 2.0 16V HPI | 4 | RLZ(EW10D) | 103/138 | 03/01→08/04 | | | | | | | | BAEA348 |
| 2.0 HDi | 4 | RHY(DW10TD) | 66/89 | 03/01→08/04 | CH170 | 11v | | | | | | CCU149 ^[359] →RP.09701 |
| 2.0 HDi | 4 | RHS(DW10ATED); RHZ(DW10ATED) | 79/106 | 03/01→08/04 | CH170 | 11v | | | | | | CCU149 ^[359] →RP.09820 |
| 2.0 HDi | 4 | RHZ(DW10ATED) | 80/107 | 03/01→08/04 | CH170 | 11v | | | | | | CCU149 ^[359] →RP.09820 |
| 2.2 HDi | 4 | 4HX(DW12TED4/FAP) | 98/131 | 03/01→08/04 | CH170 ^[134] CH268 ^[136] [252] | 11v 11v | | | | | | CCU149 ^[359] |
| 3.0 Carlsson | 6 | XFX(ES9J4S) | 173/232 | 09/03→08/04 | OE175 | 1,0 | CET14P | OE190 | | | | BAEA347 |
| 3.0 V6 | 6 | XFX(ES9J4S) | 152/204 | 03/01→08/04 | OE175 | 1,0 | CET14P | OE190 | | | | BAEA347 |

C5 II

| | | | | | | | | | | | | |
|---------|---|---------------------------------|---------|--------|--|------------|--------|-------|--|--|--|---------|
| 1.6 HDi | 4 | 9HY(DV6TED4); 9HZ(DV6TED4) | 80/107 | 09/04→ | CH201 RP.10784→ | 11v | | | | | | CCU147 |
| 1.8 16V | 4 | 6FZ(EW7J4) | 85/114 | 09/04→ | OE178 | 0,9 | CET5 | | | | | BAEA348 |
| 1.8 16V | 4 | 6FY(EW7A) | 92/123 | 09/05→ | OE178 | 0,9 | CET5 | | | | | |
| 2.0 16V | 4 | RFJ(EW10A) | 103/138 | 09/04→ | OE178 | 0,9 | CET5 | | | | | BAEA352 |
| 2.0 HDi | 4 | RHR(DW10BTD4) | 100/134 | 09/04→ | CH268 | 11v | | | | | | CCU147 |
| 2.2 HDi | 4 | 4HX(DW12TED4/FAP) | 98/131 | 09/04→ | CH170 ^[134] CH268 ^[136] | 11v 11v | | | | | | CCU147 |
| 2.2 HDi | 4 | 4HP(DW12BTD4); 4HR(DW12BTD4) | 120/161 | 05/06→ | | | | | | | | CCU147 |
| 2.2 HDi | 4 | 4HT(DW12BTD4) | 125/168 | 04/06→ | | | | | | | | CCU147 |
| 3.0 | 6 | XFX(ES9J4S) | 173/232 | 09/04→ | OE175 | 1,0 | CET14P | OE190 | | | | BAEA347 |
| 3.0 V6 | 6 | XFU(ES9A); XFX(ES9J4S) | 152/204 | 09/04→ | OE175 | 1,0 | CET14P | OE190 | | | | BAEA347 |

C5 III

| | | | | | | | | | | | | |
|--------------------------|---|--------------|---------|--------|-------|-----|--------|--|--|--|--|---------|
| 1.6 HDi 110 | 4 | 9HZ(DV6TED4) | 80/107 | 02/08→ | CH201 | 11v | | | | | | CCU147 |
| 1.6 THP 150 | 4 | 5FN(EP6CDT) | 110/148 | 04/09→ | OE205 | 0,7 | CET16P | | | | | |
| 1.6 THP 155 | 4 | 5FV(EP6CDT) | 115/154 | 04/09→ | OE205 | 0,7 | CET16P | | | | | BAEA143 |
| 1.6 VTi 120, 1.6 VTi 120 | 4 | 5FS(EP6C) | 88/118 | 07/10→ | OE205 | 0,7 | CET16P | | | | | BAEA143 |

CHAMPION



kW/BHP

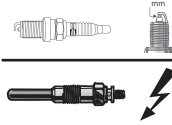

eon TITAN

IRIDIUM

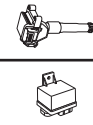
**...CITROËN****...C5 III**

| | | | | | | | | | |
|--------------------------|---|---------------------------------|---------|--------|-------|-----|--------|-------|---------|
| 1.8 16V | 4 | 6FY(EW7A) | 92/123 | 02/08→ | OE178 | 0,9 | CET5 | | |
| 2.0 16V, 2.0 16V BioFlex | 4 | RFJ(EW10A) | 103/138 | 02/08→ | OE178 | 0,9 | CET5 | | BAEA352 |
| 2.0 HDi | 4 | RHF(DW10BTE4); RHR(DW10BTE4) | 100/134 | 02/08→ | CH268 | 11v | | | CCU147 |
| 2.0 HDi 140 | 4 | RHF(DW10BTE4) | 103/138 | 04/09→ | CH268 | 11v | | | CCU147 |
| 2.2 HDi | 4 | 4HT(DW12BTE4) | 125/168 | 02/08→ | | | | | CCU147 |
| 2.2 HDi 165 | 4 | 4HP(DW12BTE4) | 120/161 | 02/08→ | | | | | CCU147 |
| 2.7 HDi | 6 | DT17ED4; UHZ(DT17BTE4) | 150/201 | 02/08→ | CH240 | 11v | | | |
| 3.0 V6 | 6 | XFU(ES9A); XFX(ES9A) | 155/208 | 02/08→ | OE175 | 1,0 | CET14P | OE190 | BAEA347 |

C6

| | | | | | | | | | |
|---------|---|------------------------|---------|--------|-------|-----|--------|-------|-------------------|
| 2.2 HDi | 4 | 4HP(DW12BTE4) | 120/161 | 06/06→ | | | | | CCU147 |
| 2.2 HDi | 4 | 4HT(DW12BTE4) | 125/168 | 06/06→ | | | | | CCU147 |
| 2.7 HDi | 6 | DT17ED4; UHZ(DT17BTE4) | 150/201 | 09/05→ | CH240 | 11v | | | |
| 3.0 V6 | 6 | XFX(ES9A); XFX(ES9J4S) | 155/208 | 09/05→ | OE175 | 1,0 | CET14P | OE190 | BAEA347 12/05→ |

C8

| | | | | | | | | | |
|-------------|---|-----------------------------------|---------|--------|----------------------------------|-----|--------|-------|---------|
| 2.0 | 4 | RFN(EW10J4) | 100/134 | 07/02→ | OE178 | 0,9 | CET5 | | BAEA348 |
| 2.0 16V | 4 | RFJ(EW10A) | 103/138 | 09/05→ | OE178 | 0,9 | CET5 | | BAEA352 |
| 2.0 16V | 4 | RFJ(EW10A) | 104/139 | 09/05→ | OE178 | 0,9 | CET5 | | |
| 2.0 HDi | 4 | RHM(DW10ATED4); RHT(DW10ATED4) | 79/106 | 07/02→ | CH170 ^[134] | 11v | | | CCU149 |
| | | | | | CH268 ^[136] | 11v | | | |
| 2.0 HDi | 4 | RHW(DW10ATED4) | 80/107 | 07/02→ | CH170 →RP.09666 | 11v | | | CCU149 |
| | | | | | CH268 RP.09667→ | 11v | | | |
| 2.0 HDi | 4 | RHK(DW10ATED4) | 88/118 | 07/06→ | CH268 | 11v | | | CCU147 |
| 2.0 HDi 135 | 4 | RHR(DW10ATED4) | 100/134 | 03/06→ | CH268 | 11v | | | |
| 2.0 HDi 135 | 4 | DW10ATED4 | 100/134 | 03/06→ | | | | | CCU147 |
| 2.2 | 4 | 3FZ(EW12J4) | 116/156 | 07/02→ | OE178 | 0,9 | CET5 | | BAEA351 |
| 2.2 HDi | 4 | 4HW(DW12TED4) | 94/126 | 07/02→ | CH170 ^[134] →04/03 | 11v | | | CCU149 |
| | | | | | CH268 ^[136] 05/03→ | 11v | | | |
| 2.2 HDi | 4 | 4HP(DW12BTE4); 4HR(DW12BTE4) | 120/161 | 06/07→ | | | | | CCU147 |
| 2.2 HDi | 4 | 4HT(DW12BTE4) | 125/168 | 06/06→ | | | | | CCU147 |
| 3.0 V6 | 6 | XFX(ES9J4S) | 150/201 | 07/02→ | OE175 | 1,0 | CET14P | OE190 | BAEA347 |

C-CROSSER

| | | | | | | | | | |
|--------------|---|---------------|---------|--------|--|--|--------|-------|--------|
| 2.0, 2.0 4WD | 4 | 4B11 | 108/145 | 11/10→ | | | CET12P | OE182 | |
| 2.2 HDi 4WD | 4 | 4HN(DW12MTE4) | 115/154 | 02/07→ | | | | | CCU147 |
| 2.4 16V 4WD | 4 | SFZ(4B12-MMC) | 125/168 | 08/08→ | | | CET12P | OE180 | |

C-ELYSEE

| | | | | | | | | | |
|-------------|---|----------|--------|--------|-------|-----|------|--|--|
| 1.6 VTi 115 | 4 | NFP(EC5) | 85/114 | 11/12→ | OE035 | 0,9 | CET5 | | |
|-------------|---|----------|--------|--------|-------|-----|------|--|--|

DS3

| | | | | | | | | | |
|----------------------------|---|-------------------------|---------|-------------|-------|-----|--------|--|---------|
| 1.2 THP 110 | 3 | HNZ(EB2DT) | 81/109 | 10/14→07/15 | | | | | BAEA557 |
| 1.4 VTi 95, 1.4 VTi 95 LPG | 4 | 8FN(EP3); 8FP(EP3) | 70/94 | 04/10→07/15 | OE203 | 1,0 | | | BAEA143 |
| 1.4 VTi 98 | 4 | 8FR(EP3) | 72/97 | 11/09→07/15 | OE203 | 1,0 | | | BAEA143 |
| 1.6 THP 150 | 4 | 5FN(EP6CDT); 5FX(EP6DT) | 110/148 | 01/10→07/15 | OE205 | 0,7 | CET16P | | |
| 1.6 THP 155 | 4 | 5FR(EP6DT); 5FV(EP6CDT) | 115/154 | 04/10→07/15 | OE205 | 0,7 | CET16P | | BAEA143 |
| 1.6 VTi 120 | 4 | 5FS(EP6C) | 88/118 | 04/10→07/15 | OE205 | 0,7 | CET16P | | BAEA143 |

DS4

| | | | | | | | | | |
|-------------|---|-------------|---------|-------------|-------|-----|--------|--|---------|
| 1.2 THP 130 | 3 | HNY(EB2DTS) | 96/129 | 07/14→07/15 | | | | | BAEA557 |
| 1.6 THP 155 | 4 | 5FV(EP6CDT) | 115/154 | 04/11→07/15 | OE205 | 0,7 | CET16P | | |
| 1.6 THP 160 | 4 | 5FM(EP6DT) | 120/161 | 04/12→07/15 | OE205 | 0,7 | CET16P | | |

CITROËN





kW/BHP



eon TITAN

IRIDIUM



...CITROËN

...DS4

| | | | | | | | | | |
|-------------|---|-------------------------|---------|-------------|-------|-----|--------|--|---------|
| 1.6 THP 165 | 4 | 5FM(EP6DT); 5GZ(EP6FDT) | 121/162 | 01/12→07/15 | OE205 | 0,7 | CET16P | | |
| 1.6 THP 200 | 4 | 5FU(EP6DTX) | 147/197 | 04/11→07/15 | OE205 | 0,7 | | | |
| 1.6 VTi 120 | 4 | 5FS(EP6C) | 88/118 | 04/11→07/15 | OE205 | 0,7 | CET16P | | BAEA143 |

DS5

| | | | | | | | | | |
|-------------|---|-------------------------|---------|-------------|-------|-----|--------|--|--|
| 1.6 THP 155 | 4 | 5FV(EP6CDT) | 115/154 | 11/11→07/15 | OE205 | 0,7 | CET16P | | |
| 1.6 THP 165 | 4 | 5FM(EP6DT); 5GZ(EP6FDT) | 121/162 | 01/12→07/15 | OE205 | 0,7 | CET16P | | |
| 1.6 THP 200 | 4 | 5FU(EP6DTX) | 147/197 | 11/11→07/15 | OE205 | 0,7 | | | |

EVASION

| | | | | | | | | | |
|----------------------|---|----------------------------------|---------|-------------|-------|-----|------|-------|------------------------|
| 1.8 | 4 | LFZ(XU7JP) | 73/98 | 05/97→07/02 | OE034 | 0,9 | CET2 | OE179 | |
| 1.8 | 4 | | 76/102 | 02/96→12/96 | OE034 | 0,9 | CET2 | OE179 | BAEA232 09/96→ |
| 1.9 TD | 4 | D8B(XUD9TF); DHX(XUD9TF/BTF) | 66/89 | 11/94→07/02 | CH189 | 11v | | | CCU149 ^[51] |
| 1.9 TD | 4 | D8B(XUD9TF) | 68/91 | 10/95→12/98 | CH189 | 11v | | | CCU149 ^[51] |
| 2.0 | 4 | RFU(XU10J2/C) | 89/119 | 06/94→07/02 | OE034 | 0,9 | CET2 | OE179 | CLS005 |
| 2.0 16V | 4 | RFV(XU10J4R) | 97/130 | 05/98→04/00 | OE034 | 0,9 | CET2 | OE179 | |
| 2.0 16V | 4 | RFN(EW10J4) | 100/134 | 05/00→07/02 | OE178 | 0,9 | CET5 | | BAEA348 |
| 2.0 HDi, 2.0 HDi 16V | 4 | RHW(DW10ATED4); RHZ(DW10ATED) | 80/107 | 08/99→07/02 | CH170 | 11v | | | CCU149 |
| 2.0 Turbo C.T. | 4 | RGX(XU10J2TE) | 108/145 | 06/94→07/02 | OE034 | 0,9 | CET2 | OE179 | CLS005 |
| 2.1 TD | 4 | P8C(XUD11BTE) | 80/107 | 05/96→07/02 | CH189 | 11v | | | |

JUMPY

| | | | | | | | | | | |
|----------------|---|--|---------|-------------|-------|-----|----------------|-------|---|--------|
| 1.6 | 4 | 1580SPI | 58/78 | 10/95→08/00 | | | CET2 →09/99 | OE179 | BAEA234 | CLS123 |
| 1.6 | 4 | 220A2.000 | 58/78 | 10/95→08/00 | | | | | BAEA234 | CLS123 |
| 1.6 HDi 90 16V | 4 | 9HU(DV6UTED4) | 66/89 | 01/07→ | CH201 | 11v | | | CCU147 | |
| 1.9 D | 4 | D9B(XUD9A/U) | 51/68 | 10/95→08/98 | CH189 | 11v | | | | |
| 1.9 D 70 | 4 | WJY(DW8B); WJZ(DW8) | 51/68 | 04/98→11/03 | CH185 | 11v | | | | |
| 1.9 TD | 4 | DHX(XUD9TF/BTF) | 66/89 | 10/95→08/00 | CH189 | 11v | | | CCU149 ^[51] →Prod.03.05.1998 →RP.07846 | |
| 1.9 TD | 4 | D8B(XUD9TF) | 68/91 | 04/96→11/03 | CH189 | 11v | | | CCU149 ^[51] →Prod.03.05.1998 →RP.07846 | |
| 2.0 | 4 | RFN(EW10J4) | 100/134 | 04/00→12/06 | OE178 | 0,9 | CET5 | | BAEA348 09/00→ | |
| 2.0 HDi 95 | 4 | RHX(DW10BTED) | 69/93 | 10/99→10/06 | CH170 | 11v | | | CCU149 | |
| 2.0 HDi 110 | 4 | RHW(DW10ATED4); RHZ(DW10ATED); RHZ(DW10BTED); RHZ(DW10BTED+); RHZ(DW10CTED); RHZ(DW10CTED+) | 80/107 | 03/00→10/06 | CH170 | 11v | | | CCU149 | |
| 2.0 HDi 120 | 4 | RHK(DW10UTED4) | 88/118 | 01/07→ | CH268 | 11v | | | CCU147 | |
| 2.0 HDi 140 | 4 | RHR(DW10BTED4) | 100/134 | 01/07→ | CH268 | 11v | | | CCU149 | |
| 2.0 i | 4 | RFH(EW10A) | 103/138 | 01/07→ | OE178 | 0,9 | CET5 | | BAEA352 | |
| 2.0 i 16V | 4 | RFN(EW10J4) | 102/137 | 03/00→10/06 | OE178 | 0,9 | CET5 | | BAEA348 01/04→ | |

NEMO

| | | | | | | | | | | |
|---------|---|----------------------|-------|--------|-------|-----|------|-------|-------------------------|--|
| 1.4 | 4 | KFT(TU3A); KVF(TU3A) | 54/72 | 04/09→ | OE034 | 0,9 | CET2 | OE179 | BAEA048E ^[7] | |
| 1.4 HDi | 4 | 8HS(DV4TED) | 50/67 | 04/09→ | CH201 | 11v | | | CCU147 | |

SAXO

| | | | | | | | | | | |
|-----------|---|-----------|-------|-------------|--------------------------|------|------|-------|--|--------|
| 1.0 X | 4 | CDZ(TU9M) | 33/44 | 05/96→11/98 | OE034 *to be adjusted | 0,8* | CET2 | OE179 | | CLS262 |
| 1.0 X | 4 | CDZ(TU9M) | 37/50 | 05/98→06/03 | OE034 | 0,9 | CET2 | OE179 | | |
| 1.1 X, SX | 4 | HDZ(TU1M) | 40/54 | 05/96→09/03 | OE034 | 0,9 | CET2 | OE179 | BAE946A ^[10] 06/00→12/02 | CLS262 |
| 1.1 X, SX | 4 | HDZ(TU1M) | 44/59 | 05/96→09/03 | OE034 *to be adjusted | 0,8* | CET2 | OE179 | | CLS262 |



CITROËN



kW/BHP



eon TITAN

IRIDIUM

**...CITROËN****...SAXO**

| | | | | | | | | | | |
|--------------|---|-------------|--------|-------------|-------------------------------------|------------|------|-------|-------------------------------------|--------|
| 1.1 X, SX | 4 | HFX(TU1JP) | 44/59 | 05/96→09/03 | OE034 *to be adjusted | 0,8* | CET2 | OE179 | BAE946A ^[10] 09/00→ | CLS262 |
| 1.4 VTS | 4 | KFX(TU3JP) | 55/74 | 05/96→06/03 | OE034 | 0,9 | CET2 | OE179 | | CLS262 |
| 1.4 VTS | 4 | KFW(TU3JP) | 55/74 | 05/96→06/03 | OE034 | 0,9 | CET2 | OE179 | BAE946A ^[10] 06/00→ | CLS262 |
| 1.5 D | 4 | VJY(TUD5) | 40/54 | 09/96→09/03 | CH185 | 11v | | | | |
| 1.5 D | 4 | VJZ(TUD5) | 42/56 | 09/96→06/01 | CH185 | 11v | | | | |
| 1.5 D | 4 | VJZ(TUD5) | 43/58 | 07/01→04/04 | CH185 | 11v | | | | |
| 1.6 | 4 | NFZ(TU5JP) | 66/89 | 02/96→06/03 | OE034 | 0,9 | CET2 | OE179 | | CLS262 |
| 1.6 | 4 | NFT(TU5JP) | 74/99 | 02/01→04/04 | OE034 | 0,9 | CET2 | OE179 | BAE946A ^[10] | |
| 1.6 | 4 | NFX(TU5JP4) | 88/118 | 02/96→04/04 | OE035 OE218 LPG ^[278] | 0,9 1,6 | CET5 | OE190 | BAEA046E ^[277] | |
| 1.6 VTL, VTR | 4 | NFZ(TU5JP) | 65/87 | 05/96→06/03 | OE034 | 0,9 | CET2 | OE179 | | CLS262 |
| 1.6 VTS | 4 | NFT(TU5JP) | 72/97 | 09/00→09/03 | OE034 | 0,9 | CET2 | OE179 | BAE946A ^[10] | |
| 1.6 VTS | 4 | NFX(TU5JP4) | 87/117 | 06/96→09/03 | OE035 OE218 LPG ^[278] | 0,9 1,6 | CET5 | OE190 | BAEA046E ^[277] 01/01→ | |

XANTIA

| | | | | | | | | | | |
|-------------------|---|---|---------|-------------|-------------------------------------|-------------|------|----------------|-------------------------|--------|
| 1.6 i | 4 | BFZ(XU5JP) | 65/87 | 03/93→03/01 | OE034 *to be adjusted | 0,8* | CET2 | OE179 | | CLS123 |
| 1.8 i | 4 | LFZ(XU7JB) | 66/89 | 04/97→04/03 | OE034 | 0,9 | CET2 | OE179 | | CLS123 |
| 1.8 i | 4 | LFZ(XU7JP) | 74/99 | 03/93→01/98 | OE034 | 0,9 | CET2 | OE179 | | CLS123 |
| 1.8 i 16V | 4 | LFY(XU7JP4) | 81/109 | 06/95→04/03 | OE034 *to be adjusted OE034 | 0,8* 0,9 | CET2 | OE179 | BAEA256 →RP.7608 | |
| 1.9 D | 4 | DJZ(XUD9Y) | 50/67 | 06/94→01/98 | CH189 | 11v | | | | |
| 1.9 D | 4 | D9B(XUD9A/L) | 51/68 | 06/94→01/98 | CH189 | 11v | | | | |
| 1.9 SD | 4 | DHW(XUD9SD) | 55/74 | 02/96→04/03 | CH189 | 11v | | | | |
| 1.9 Turbo D | 4 | D8B(XUD9TF); DHX(XUD9TF/BTF); DHY(XUD9TE/Y) | 66/89 | 05/93→04/03 | CH189 | 11v | | | CCU149 ^[315] | |
| 2.0 HDI 90 | 4 | RHY(DW10TD) | 66/89 | 03/99→04/03 | CH170 | 11v | | | CCU149 | |
| 2.0 HDI 109 | 4 | RHZ(DW10ATED) | 80/107 | 02/99→04/03 | CH170 | 11v | | | CCU149 | |
| 2.0 i | 4 | RFX(XU10J2C) | 89/119 | 03/93→04/03 | OE005 OE034 | 0,9 0,9 | CET2 | OE179 OE180 | | CLS005 |
| 2.0 i 16V | 4 | RFV(XU10J4R) | 97/130 | 06/95→04/03 | OE034 *to be adjusted OE034 | 0,8* 0,9 | CET2 | OE179 | BAE700AK 03/97→ | CLS005 |
| 2.0 i 16V | 4 | RFT(XU10J4/Z) | 110/148 | 06/94→01/98 | OE014 OE034 | 0,9 0,9 | CET2 | OE179 | BAE700AK 03/97→ | CLS005 |
| 2.0 i 16V | 4 | RFY(XU10J4/Z) | 112/150 | 03/93→01/98 | OE014 OE034 | 0,9 0,9 | CET2 | OE179 | BAE700AK 06/95→ | CLS005 |
| 2.0 Turbo | 4 | RGX(XU10J2TE) | 108/145 | 06/95→04/03 | OE034 | 0,9 | CET2 | OE179 | | CLS005 |
| 2.1 Turbo D 12V | 4 | P8C(XUD11BTE) | 80/107 | 06/95→02/99 | CH189 | 11v | | | | |
| 3.0 i 24V, 3.0 V6 | 6 | XFZ(ES9J4) | 140/188 | 01/97→04/03 | OE026 OE218 LPG ^[278] | 0,9 1,6 | CET2 | OE188 | | |

XM

| | | | | | | | | | | |
|-----------|---|-----------------------------------|---------|-------------|-------|-----|------|-------|-------------------------|--------|
| 2.0 i 16V | 4 | RFV(XU10J4R) | 97/130 | 05/94→10/00 | OE034 | 0,9 | CET2 | OE179 | BAEA256 →08/97 | CLS005 |
| 2.0 Turbo | 4 | RGX(XU10J2TE); RGY(XU10J2TE/Z) | 108/145 | 05/94→10/00 | OE034 | 0,9 | CET2 | OE179 | | CLS005 |
| 2.5 TD | 4 | THY(DKSATE) | 95/127 | 05/94→10/00 | CH189 | 11v | | | CCU149 ^[315] | |
| 3.0 V6 | 6 | XFZ(ES9J4) | 140/188 | 04/97→10/00 | OE026 | 0,9 | CET2 | OE188 | | |

XSARA

| | | | | | | | | | | |
|---------|---|------------|-------|-------------|--|--|--|--|-------------------------|--|
| 1.4 HDi | 4 | 8HX(DV4TD) | 50/67 | 01/03→08/05 | | | | | CCU149 ^[359] | |
|---------|---|------------|-------|-------------|--|--|--|--|-------------------------|--|

CITROËN



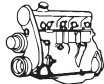

kW/BHP



eon TITAN

IRIDIUM

**...CITROËN****...XSARA**

| | | | | | | | | | | |
|------------------------|---|-----------------------|---------|-------------|------------------------|-----|-------------|--------------|---|---------------|
| 1.4 i | 4 | KFW(TU3JP) | 55/74 | 04/97→08/05 | OE034 | 0,9 | CET2 | OE179 | BAE946A ^[10] 09/00→ | CLS262 |
| | | | | | OE216 LPG [278] | 0,8 | | | | |
| 1.4 i | 4 | KFX(TU3JP) | 55/74 | 04/97→08/05 | OE034 | 0,9 | CET2 | OE179 | BAEA232 →06/98 | CLS262 |
| | | | | | OE216 LPG [278] | 0,8 | | | | |
| 1.5 D | 4 | VJZ(TUD5) | 42/56 | 04/97→09/00 | CH185 | 11v | | | | |
| 1.6 16V | 4 | NFU(TU5JP4) | 80/107 | 09/00→08/05 | OE035 | 0,9 | CET5 | OE190 | BAEA045E | |
| | | | | | OE224 LPG [279] | 0,8 | | | | |
| 1.6 i | 4 | NFZ(TU5JP) | 65/87 | 04/97→09/00 | OE034 | 0,9 | CET2 | OE179 | BAEA232 →06/98 | |
| 1.8 D | 4 | 161A(XUD7); A9A(XUD7) | 43/58 | 04/97→09/00 | CH189 | 11v | | | | |
| 1.8 i | 4 | LFX(XU7JB) | 66/89 | 04/97→09/00 | OE034 | 0,9 | CET2 | OE179 | | CLS123 |
| 1.8 i | 4 | LFZ(XU7JP) | 74/99 | 02/98→09/00 | OE034 | 0,9 | CET2 | OE179 | BAEA232 | |
| 1.8 i 16V, 1.8 LPG | 4 | LFY(XU7JP4) | 81/109 | 04/97→09/00 | OE034 | 0,9 | CET2 | OE179 | | CLS123 |
| 1.8 i Aut. | 4 | LFZ(XU7JP) | 74/99 | 04/97→09/00 | OE034 | 0,9 | CET2 | OE179 | | CLS123 |
| 1.9 D | 4 | DJY(XUD9A) | 50/67 | 04/97→09/00 | CH189 | 11v | | | | |
| 1.9 D | 4 | WJZ(DW8) | 51/68 | 07/98→08/05 | CH185 | 11v | | | | |
| 1.9 D | 4 | WJY(DW8B) | 51/68 | 07/98→08/05 | CH185 | 11v | | | CCU149 ^[314] | |
| 1.9 D, 1.9 SD | 4 | DHV(XUD9BSD) | 55/74 | 01/98→09/00 | CH189 | 11v | | | CCU149 ^[315] | |
| 1.9 TD | 4 | DHY(XUD9TE/Y) | 66/89 | 04/97→09/00 | CH189 | 11v | | | | |
| 2.0 16V | 4 | RFV(XU10J4R) | 97/130 | 07/98→09/00 | OE034 | 0,9 | CET2 | OE179 | | |
| 2.0 16V | 4 | RFN(EW10J4) | 100/134 | 09/00→08/05 | OE178 | 0,9 | CET5 | | BAEA348 | |
| 2.0 16V | 4 | RFS(XU10J4RS) | 120/161 | 04/97→09/00 | OE026 | 0,9 | CET2 | OE179 | | |
| | | | | | OE216 LPG [278] | 0,8 | | | | |
| 2.0 HDi 90, 2.0 HDi 90 | 4 | RHY(DW10TD) | 66/89 | 02/99→08/05 | CH170 | 11v | | | CCU149 ^[359] →RP.09701 | |
| 2.0 HDi 109 | 4 | RHZ(DW10ATED) | 80/107 | 05/01→08/05 | CH170 | 11v | | | CCU149 ^[359] →RP.09820 | |
| 2.0 i 16V | 4 | RFS(XU10J4RS) | 120/161 | 02/98→03/05 | OE034 | 0,9 | CET2 | OE179 | | |
| | | | | | OE216 LPG [278] | 0,8 | | | | |

XSARA PICASSO

| | | | | | | | | | | |
|------------|---|-------------------------------|---------|-------------|------------------------|-----|-------------|--------------|---|--|
| 1.6 | 4 | NFZ(TU5JP) | 65/87 | 12/99→ | OE034 | 0,9 | CET2 | OE179 | | |
| 1.6 | 4 | NFZ(TU5JP) | 67/90 | 06/02→ | OE005 | 0,9 | CET2 | OE179 | | |
| | | | | | OE034 | 0,9 | | | | |
| 1.6 | 4 | NFV(TU5JP) | 70/94 | 12/99→ | OE034 | 0,9 | CET2 | OE179 | BAE946A 01/00→04/10 [10] [250] | |
| 1.6 16V | 4 | NFU(TU5JP4) | 80/107 | 09/05→ | OE035 | 0,9 | CET5 | OE190 | BAEA045E | |
| | | | | | OE224 LPG [279] | 0,8 | | | | |
| 1.6 16V | 4 | NFU(TU5JP4) | 81/109 | 06/05→09/06 | OE035 | 0,9 | CET5 | | | |
| 1.6 Chrono | 4 | NFV(TU5JP) | 74/99 | 04/01→10/04 | OE034 | 0,9 | CET2 | | BAE946A ^[10] | |
| 1.6 HDi | 4 | 9HX(DV6ATED4) | 66/89 | 09/05→ | CH201 03/06→ | 11v | | | CCU147 | |
| 1.6 HDi | 4 | 9HY(DV6TED4); 9HZ(DV6TED4) | 80/107 | 05/04→ | CH201 03/06→ | 11v | | | CCU147 | |
| 1.8 16V | 4 | 6FZ(EW7J4) | 85/114 | 02/00→ | OE148 | 1,0 | CET5 | | BAEA348 | |
| | | | | | OE178 | 0,9 | | | | |
| 2.0 16V | 4 | RFN(EW10J4) | 100/134 | 01/03→ | OE178 | 0,9 | CET5 | | BAEA348 | |
| 2.0 HDi | 4 | RHY(DW10TD) | 66/89 | 12/99→ | CH170 | 11v | | | CCU149 ^[359] →RP.09820 | |
| 2.0 HDi | 4 | | 80/107 | 12/99→ | CH170 | 11v | | | CCU149 ^[359] →RP.09820 | |

ZX

| | | | | | | | | | | |
|-------|---|-----------------------|--------|-------------|--------------|-------|-------------|--------------|--|---------------|
| 1.4 D | 4 | K9Y(TUD3Y) | 37/50 | 07/94→10/97 | CH147 | 11.5v | | | | |
| 1.6 | 4 | BDY(XU5M); BFZ(XU5JP) | 66/89 | 07/94→10/97 | OE034 | 0,9 | CET2 | | | CLS123 |
| 1.8 | 4 | LFZ(XU7JP) | 76/102 | 07/94→10/97 | OE034 | 0,9 | CET2 | OE179 | | CLS123 |

CHAMPION**CITROËN**

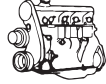

kW/BHP

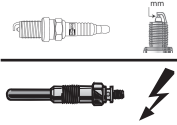

eon TITAN

IRIDIUM

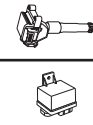

...CITROËN

...ZX

| | | | | | | | | | | |
|-----------|---|-----------------------------|---------|-------------|-----------------|------|------|-------|----------|--------|
| 1.8 | 4 | LFY(XU7JP4) | 82/110 | 04/96→10/97 | OE034 | 0,9 | CET2 | OE179 | BAEA256 | |
| 1.8 D | 4 | 161A(XUD7) | 44/59 | 06/93→10/97 | CH189 | 11v | | | | |
| 1.8 i 16V | 4 | LFY(XU7JP4) | 81/109 | 01/96→02/98 | OE034 | 0,9 | CET2 | OE179 | BAEA256 | |
| | | | | | OE034 | 0,8* | | | | |
| | | | | | *to be adjusted | | | | | |
| 1.9 D | 4 | D9B(XUD9A/U); DJY(XUD9A) | 50/67 | 07/93→10/97 | CH189 | 11v | | | | |
| 1.9 DT | 4 | DHY(XUD9TE/Y) | 65/87 | 07/94→10/97 | CH189 | 11v | | | | |
| 2.0 | 4 | RFX(XU10J2C) | 90/121 | 07/94→10/97 | OE005 | 0,9 | CET2 | | | |
| 2.0 | 4 | RFS(XU10J4RS) | 122/164 | 09/96→10/97 | OE034 | 0,9 | CET2 | | | |
| 2.0 i 16V | 4 | RFT(XU10J4/Z) | 110/148 | 06/94→06/97 | | | CET2 | OE179 | BAE700AK | CLS005 |
| 2.0 i 16V | 4 | RFS(XU10J4RS) | 120/161 | 05/96→06/97 | OE034 | 0,8* | CET2 | OE179 | | |
| | | | | | *to be adjusted | | | | | |

CITROËN

BERLINGO

| | | | | | | | | | | |
|----------------|---|---|--------|-------------|----------------------------|-----|--------|-------|----------|--|
| 1.4 CNG | 4 | KFW(TU3JP) | 48/64 | 11/02→03/08 | OE034 | 0,9 | CET2 | OE179 | | |
| 1.6 | 4 | NFR(TU5JP4B) | 66/89 | 04/08→ | OE035 | 0,9 | CET5 | OE190 | BAEA045E | |
| | | | | | OE224 ^{UPG [279]} | 0,8 | | | | |
| 1.6 | 4 | NFU(TU5JP4) | 80/107 | 04/08→ | OE035 | 0,9 | CET5 | OE190 | BAEA045E | |
| | | | | | OE224 ^{UPG [279]} | 0,8 | | | | |
| 1.6 HDi 75 | 4 | 9HT(DV6BTED4); 9HT(DV6BUTED4) | 55/74 | 04/08→ | CH201 | 11v | | | CCU147 | |
| 1.6 HDi 90 16V | 4 | 9HS(DV6TED4BU); 9HX(DV6ATED4); 9HX(DV6AUTED4) | 66/89 | 04/08→ | CH201 | 11v | | | | |
| 1.6 HDi 110 | 4 | 9HZ(DV6TED4) | 80/107 | 04/08→ | CH201 | 11v | | | CCU147 | |
| 1.6 VTi 95 | 4 | 5FK(EP6CB) | 72/97 | 07/10→ | OE205 | 0,7 | CET16P | | BAEA143 | |
| 1.6 VTi 120 | 4 | 5FS(EP6C) | 88/118 | 11/09→ | OE205 | 0,7 | CET16P | | BAEA143 | |

BERLINGO / BERLINGO FIRST

| | | | | | | | | | | |
|----------------------------|---|---------------------|--------|-------------|----------------------------|------|------|-------|-------------------------|--------|
| 1.1 i | 4 | HDZ(TU1M) | 44/59 | 07/96→03/08 | OE034 | 0,9 | CET2 | OE179 | | CLS262 |
| 1.1 i | 4 | HFX(TU1JP) | 44/59 | 07/96→03/08 | OE034 | 0,9 | CET2 | OE179 | BAE946A | CLS262 |
| | | | | | | | | | 01/01→08/05 | |
| | | | | | | | | | [10] [275] | |
| 1.4 bivalent | 4 | KFW(TU3JP) | 48/64 | 11/02→12/11 | OE034 | 0,9 | CET2 | OE179 | BAE946A | |
| | | | | | | | | | →03/10 | |
| | | | | | | | | | [10] [275] | |
| 1.4 i | 4 | KFX(TU3JP) | 55/74 | 07/96→12/11 | OE034 | 0,9 | CET2 | OE179 | | CLS262 |
| 1.4 i | 4 | KFW(TU3JP) | 55/74 | 07/96→12/11 | OE034 | 0,9 | CET2 | OE179 | BAE946A | CLS262 |
| | | | | | | | | | →03/10 | |
| | | | | | | | | | [10] [275] | |
| 1.4 i bivalent | 4 | KFW(TU3JP) | 55/74 | 04/03→10/05 | OE034 | 0,7* | CET2 | OE179 | BAE946A ^[10] | |
| | | | | | *to be adjusted | | | | | |
| 1.6 16V | 4 | NFU(TU5JP4) | 80/107 | 10/00→03/08 | OE035 | 0,9 | CET5 | OE190 | BAEA045E | |
| | | | | | OE224 ^{UPG [279]} | 0,8 | | | 12/02→ | |
| 1.6 16V | 4 | NFU(TU5JP4) | 81/109 | 08/05→12/07 | OE035 | 0,9 | CET5 | | | |
| 1.6 HDI 75 | 4 | 9HW(DV6BTED4); DV6B | 55/74 | 07/05→12/11 | CH201 | 11v | | | CCU147 | |
| | | | | | 07/06→ | | | | | |
| 1.6 HDI 90 | 4 | 9HX(DV6ATED4) | 66/89 | 07/05→12/11 | CH201 | 11v | | | CCU147 | |
| | | | | | 03/06→ | | | | | |
| | | | | | RP.10689→ | | | | | |
| 1.8 D | 4 | A9A(XUD7) | 43/58 | 07/96→10/02 | CH189 | 11v | | | | |
| 1.8 i | 4 | LFX(XU7JB) | 66/89 | 08/99→10/02 | OE034 | 0,9 | CET2 | OE179 | | CLS123 |
| 1.9 D | 4 | DJY(XUD9A) | 51/68 | 07/96→12/03 | CH189 | 11v | | | | |
| 1.9 D 70, 1.9 D 70 4WD | 4 | WJZ(DW8) | 51/68 | 07/98→12/11 | CH185 | 11v | | | | |
| 1.9 D 70, 1.9 D 70 4WD | 4 | WJY(DW8B) | 51/68 | 07/98→12/11 | CH185 | 11v | | | CCU149 ^[318] | |
| 2.0 HDI 90, 2.0 HDI 90 4WD | 4 | RHY(DW10TD) | 66/89 | 12/99→12/11 | CH170 | 11v | | | CCU149 ^[359] | |

CITROËN





kW/BHP

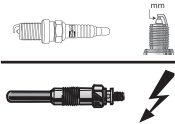

eon TITAN

IRIDIUM

**...CITROËN****C2 ENTERPRISE**

| | | | | | | | | | | |
|---------|---|------------|-------|--------|--|--|--|--|--|-------------------------|
| 1.4 HDi | 4 | 8HX(DV4TD) | 50/67 | 04/09→ | | | | | | CCU149 ^[318] |
|---------|---|------------|-------|--------|--|--|--|--|--|-------------------------|

C15

| | | | | | | | | | | |
|-------|---|-----------|-------|-------------|-------|-----|--|--|--|--------|
| 1.9 D | 4 | WJX(DW8B) | 44/59 | 12/00→12/05 | CH189 | 11v | | | | CCU149 |
| 1.9 D | 4 | WJY(DW8B) | 51/68 | 10/00→10/02 | CH185 | 11v | | | | CCU149 |

C-CROSSER ENTERPRISE

| | | | | | | | | | | |
|-------------|---|----------------|---------|--------|--|--|--------|-------|--|--------|
| 2.2 HDi 4WD | 4 | 4HN(DW12MTED4) | 115/154 | 01/09→ | | | | | | CCU147 |
| 2.4 16V 4WD | 4 | 4B12 | 125/168 | 01/09→ | | | CET12P | OE182 | | |

JUMPER

| | | | | | | | | | | |
|--------------------------------|---|----------------------------------|---------|-------------|--|-------|------|-------|--|--------|
| 1.9 D | 4 | DJY(XUD9A) | 50/67 | 07/99→04/02 | CH189 | 11v | | | | |
| 1.9 D | 4 | D9B(XUD9A/U) | 51/68 | 02/94→04/02 | CH189 | 11v | | | | |
| 1.9 TD | 4 | D8C(XUD9UTF); DHX(XUD9TF/BTF) | 66/89 | 03/94→04/02 | CH189 | 11v | | | | |
| 1.9 TD, 1.9 TD 4WD | 4 | D8C(XUD9UTF) | 68/91 | 02/94→04/02 | CH189 | 11v | | | | |
| 2.0 | 4 | XU10J2 | 81/109 | 04/02→ | OE034 | 0,9 | CET2 | OE179 | | CLS123 |
| 2.0, 2.0 4WD | 4 | RFW(XU10J2U) | 80/107 | 02/94→04/02 | OE034 | 0,9 | CET2 | OE179 | | CLS123 |
| 2.0 bivalent | 4 | XU10J2 | 81/109 | 02/03→ | OE034 | 0,9 | CET2 | OE179 | | |
| 2.0 HDi | 4 | RHV(DW10TD) | 62/83 | 04/02→ | | | | | | CCU149 |
| 2.0 HDi, 2.0 HDi | 4 | RHV(DW10TD); RHV(DW10UTD) | 62/83 | 11/01→ | CH170 | 11v | | | | CCU149 |
| 2.2 HDi | 4 | 4HY(DW12UTED) | 74/99 | 02/02→ | CH170 ^[135] →04/03 CH268 ^[136] 05/03→ | 11v | | | | CCU149 |
| 2.2 HDi 100 | 4 | 4HV(P22DTE) | 74/99 | 04/06→ | CH229 | 11.5v | | | | |
| 2.2 HDi 120 | 4 | 4HU(P22DTE) | 88/118 | 04/06→ | CH229 | 11.5v | | | | |
| 2.5 D, 2.5 D 4WD | 4 | T9A(DJ5) | 63/84 | 03/94→04/02 | CH189 | 11v | | | | |
| 2.5 DT 4WD, 2.5 TD, 2.5 TD 4WD | 4 | T8A(DJ5T); THZ(DJ5T) | 76/102 | 03/94→04/02 | CH189 | 11v | | | | |
| 2.8 D | 4 | 8140.63(F28D) | 64/86 | 01/99→02/02 | CH216 | 11v | | | | |
| 2.8 HDi | 4 | | 93/125 | 10/00→01/02 | CH216 | 11v | | | | CCU149 |
| 2.8 HDi | 4 | 8140.43N | 107/143 | 05/04→ | CH216 | 11v | | | | CCU149 |
| 2.8 HDi, 2.8 HDi 4WD | 4 | 8140.43S; F28TDCR | 94/126 | 09/00→ | CH216 | 11v | | | | CCU149 |
| 3.0 HDi 145 | 4 | F1CE3481N(F30DTE) | 107/143 | 07/10→ | CH270 | 11v | | | | |
| 3.0 HDi 155 | 4 | F1CE0481D(F30DT) | 115/154 | 07/10→ | CH270 | 11v | | | | |
| 3.0 HDi 160 | 4 | F1CE0481D(F30DT) | 116/156 | 09/06→ | CH270 | 11v | | | | |
| 3.0 HDi 180 | 4 | F1CE3481E(F30DTE) | 130/174 | 07/11→ | CH270 | 11v | | | | |

JUMPY

| | | | | | | | | | | |
|----------------|---|---------------------|---------|-------------|-------|-----|----------------|-------|--|---|
| 1.6 HDi 90 16V | 4 | 9HU(DV6UTED4) | 66/89 | 01/07→ | CH201 | 11v | | | | CCU147 |
| 1.6 i | 4 | 220A2.000 | 58/78 | 10/95→08/00 | | | CET2 →09/99 | | | BAEA234 |
| 1.6 i | 4 | 1580SPI | 58/78 | 10/95→08/00 | | | CET2 →09/99 | OE179 | | BAEA234 |
| 1.9 D | 4 | D9B(XUD9A/U) | 51/68 | 10/95→08/98 | CH189 | 11v | | | | |
| 1.9 D 70 | 4 | WJY(DW8B); WJZ(DW8) | 51/68 | 04/98→10/06 | CH185 | 11v | | | | CCU149 |
| 1.9 DT | 4 | | 65/87 | 10/95→08/00 | CH189 | 11v | | | | CCU149 ^[51] →Prod.03.05.1998 →RP.07846 |
| 1.9 TD | 4 | DHX(XUD9TF/BTF) | 66/89 | 10/95→08/00 | CH189 | 11v | | | | CCU149 ^[51] →Prod.03.05.1998 →RP.07846 |
| 1.9 TD | 4 | D8B(XUD9TF) | 68/91 | 10/99→10/06 | CH189 | 11v | | | | |
| 2.0 | 4 | RFN(EW10J4) | 100/134 | 04/00→10/06 | OE178 | 0,9 | CET5 | | | BAEA348 |
| 2.0 HDi 95 | 4 | RHX(DW10BTED) | 69/93 | 10/99→10/06 | CH170 | 11v | | | | CCU149 |



CITROËN



kW/BHP

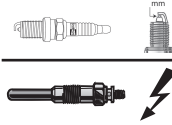

eon TITAN

IRIDIUM

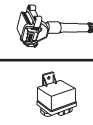
**...CITROËN****...JUMPY**

| | | | | | | | | | |
|------------------------------|---|--|---------|-------------|-------|-----|------|--|---------|
| 2.0 HDi 110, 2.0 HDi 110 16V | 4 | RHW(DW10ATED4); RHZ(DW10ATED); RHZ(DW10BTED); RHZ(DW10BTED+); RHZ(DW10CTED); RHZ(DW10CTED+) | 80/107 | 10/01→10/06 | CH170 | 11v | | | CCU149 |
| 2.0 HDi 120 | 4 | RHK(DW10ATED4) | 88/118 | 01/07→ | CH268 | 11v | | | CCU147 |
| 2.0 HDi 120 4WD | 4 | RHK(DW10ATED4) | 88/118 | 01/10→ | | | | | CCU147 |
| 2.0 HDi 140 | 4 | RHR(DW10BTED4) | 100/134 | 01/07→ | CH268 | 11v | | | CCU149 |
| 2.0 i | 4 | RFH(EW10A) | 103/138 | 01/07→ | OE178 | 0,9 | CET5 | | BAEA352 |
| 2.0 i 16V | 4 | RFN(EW10J4) | 102/137 | 03/00→10/06 | OE178 | 0,9 | CET5 | | BAEA348 |

NEMO

| | | | | | | | | | |
|---------|---|-------------|-------|--------|-------|-----|------|-------|-------------------------|
| 1.4 | 4 | KFV(TU3A) | 54/72 | 02/08→ | OE034 | 0,9 | CET2 | OE179 | BAEA048E ^[7] |
| 1.4 HDi | 4 | 8HS(DV4TED) | 50/67 | 02/08→ | CH201 | 11v | | | CCU147 |

XSARA

| | | | | | | | | | |
|---------|---|-------------|-------|-------------|-------|-----|--|--|--------------------------------------|
| 2.0 HDi | 4 | RHY(DW10TD) | 66/89 | 09/00→03/05 | CH170 | 11v | | | CCU149 ^[359] →RP.09701 |
|---------|---|-------------|-------|-------------|-------|-----|--|--|--------------------------------------|

DACIA**1309**

| | | | | | | | | | |
|-----|---|--|-------|-------------|--|--|--|--|---------|
| 1.6 | 4 | | 53/71 | 12/94→08/01 | | | | | BAEA234 |
|-----|---|--|-------|-------------|--|--|--|--|---------|

1310

| | | | | | | | | | |
|------------------|---|--|-------|-------------|-------|-----|--|--|---------|
| 1.4, 1.4 Classic | 4 | | 46/62 | 01/95→07/04 | OE007 | 0,9 | | | |
| 1.5 | 4 | | 46/62 | 01/95→07/04 | | | | | BAEA354 |

DOKKER

| | | | | | | | | | |
|--------------|---|----------------|--------|--------|-------|-----|------|-------|----------------|
| 1.2 TCe | 4 | H5F402 | 85/114 | 11/12→ | | | | OE261 | BAEA131E |
| 1.6 | 4 | K7M812; K7M828 | 61/82 | 11/12→ | | | CET2 | OE179 | BAEA354 CLS088 |
| 1.6, 1.6 LPG | 4 | | 75/101 | 04/15→ | | | | | BAEA354 |
| 1.6 LPG | 4 | K7M812; K7M828 | 61/82 | 11/13→ | OE033 | 0,9 | CET2 | OE179 | BAEA354 CLS088 |

DUSTER

| | | | | | | | | | |
|--|---|---|--------|--------|----------------------|-----|------|-------|--|
| 1.2 TCe 125, 1.2 TCe 125 4WD | 4 | H5F404; H5F410 | 92/123 | 10/13→ | | | | OE261 | BAEA131E |
| 1.5 dCi | 4 | K9K796; K9K830 | 63/84 | 04/10→ | CH271 | 11v | | | |
| 1.5 dCi | 4 | K9K884; K9K892 | 66/89 | 10/10→ | CH271 ^[9] | 11v | | | |
| 1.5 dCi | 4 | K9K896 | 79/106 | 06/10→ | | | | | CCU147 ^[11] ^[352] |
| 1.5 dCi 4WD | 4 | K9K658; K9K858 | 80/107 | 08/13→ | CH271 ^[9] | 11v | | | |
| 1.5 dCi 4WD | 4 | K9K898 | 81/109 | 10/10→ | | | | | CCU147 ^[11] ^[352] |
| 1.6 16V, 1.6 16V 4WD, 1.6 16V Hi-Flex, 1.6 16V LPG | 4 | K4M606; K4M690; K4M696 | 77/103 | 04/10→ | OE033 | 0,9 | CET2 | OE179 | BAE409A |
| 1.6 SCe 115, 1.6 SCe 115 4WD, 1.6 SCe 115 LPG | 4 | H4M430; H4M438; H4M730; H4M738; H4M740 | 84/113 | 06/15→ | | | | | BAEA131E ^[105] ^[375] |

LOGGY

| | | | | | | | | | |
|-------------|---|----------------|--------|--------|--|------------|------|-------|--|
| 1.2 TCe | 4 | H5F402 | 85/114 | 03/12→ | | | | OE261 | BAEA131E |
| 1.6 | 4 | K7M812; K7M828 | 61/82 | 03/12→ | OE026 OE216 ^{LPG} ^[278] | 0,9 0,8 | CET2 | OE179 | BAEA354 CLS088 |
| 1.6 LPG | 4 | K7M812; K7M828 | 61/82 | 11/13→ | OE033 | 0,9 | CET2 | OE179 | BAEA354 CLS088 |
| 1.6 LPG | 4 | | 75/101 | 04/15→ | | | | | BAEA354 |
| 1.6 SCe 115 | 4 | H4M740 | 75/101 | 06/15→ | | | | | BAEA131E ^[105] ^[375] |

LOGAN

| | | | | | | | | | |
|-------------|---|--------|-------|--------|-------|-----|------|--|--------------------|
| 1.2 16V | 4 | D4F732 | 55/74 | 02/06→ | OE130 | 0,9 | CET4 | | BAE947A BAEA325 |
| 1.2 16V LPG | 4 | D4F734 | 55/74 | 02/06→ | OE130 | 0,9 | CET4 | | |

DACIA





kW/BHP

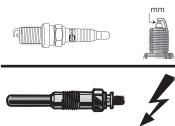

eon TITAN

IRIDIUM

**...DACIA****...LOGAN**

| | | | | | | | | | | |
|----------------------------|---|---|--------|--------|--|-------------------|-------------|--------------|-----------------------------|--|
| 1.4 | 4 | K7J710 | 55/74 | 09/04→ | OE026 OE216 LPG [278] | 0,9 0,8 | CET2 | OE179 | BAEA354 | CLS076 |
| 1.4 MPI LPG | 4 | K7J710; K7J714 | 55/74 | 02/06→ | OE026 OE216 LPG [278] | 0,9 0,8 | CET2 | OE179 | BAEA354 | CLS076 |
| 1.5 dCi | 4 | K9K790 | 48/64 | 09/05→ | CH271 | 11v | | | CCU147 [11] [352] | |
| 1.5 dCi | 4 | K9K792 | 50/67 | 01/06→ | CH271 | 11v | | | | |
| 1.5 dCi | 4 | K9K892 | 55/74 | 05/10→ | CH271 [9] | 11v | | | | |
| 1.5 dCi | 4 | K9K796 | 63/84 | 09/07→ | CH271 | 11v | | | | |
| 1.5 dCi | 4 | K9K892 | 65/87 | 05/10→ | CH271 [9] | 11v | | | | |
| 1.6 | 4 | K7M710 | 64/86 | 09/04→ | OE026 OE033 OE216 LPG [278] | 0,9 0,9 0,8 | CET2 | OE179 | BAEA354 | CLS019 →Eng.050317 CLS076 Eng.050318→ Eng.090920 CLS088 Eng.090921→ |
| 1.6 16V, 1.6 16V Flexifuel | 4 | K4M690; K4M694; K4M696; K4M697; K4M698 | 77/103 | 02/06→ | OE033 | 0,9 | CET2 | OE179 | BAE409A | |
| 1.6 Bifuel, 1.6 MPI 85 | 4 | K7M718; K7M800 | 62/83 | 05/10→ | OE026 OE216 LPG [278] | 0,9 0,8 | CET2 | OE179 | BAEA354 | CLS019 →Eng.050317 CLS076 Eng.050318→ Eng.090920 CLS088 Eng.090921→ |

LOGAN II

| | | | | | | | | | | |
|----------------|---|----------------|-------|--------|--------------|-----|-------------|--------------|----------------------------------|--|
| 0.9 TCe 90 | 3 | H4B400; H4B408 | 66/89 | 10/12→ | | | | OE261 | BAEA131E | |
| 0.9 TCe 90 LPG | 3 | H4B405; H4B410 | 66/89 | 09/15→ | | | | | BAEA131E | |
| 1.2, 1.2 LPG | 4 | D4F732; D4F734 | 55/74 | 10/12→ | OE130 | 0,9 | CET4 | | BAE947A BAEA325 | |

LOGAN MCV

| | | | | | | | | | | |
|--------------------------|---|----------------|--------|--------|--|------------|-------------|--------------|----------------|--|
| 1.4 | 4 | K7J710 | 55/74 | 02/07→ | OE026 OE216 LPG [278] | 0,9 0,8 | CET2 | OE179 | BAEA354 | CLS076 |
| 1.5 dCi | 4 | K9K792 | 50/67 | 02/07→ | CH271 | 11v | | | | |
| 1.5 dCi | 4 | K9K796 | 63/84 | 09/07→ | CH271 | 11v | | | | |
| 1.5 dCi | 4 | K9K892 | 65/87 | 05/10→ | CH271 [9] | 11v | | | | |
| 1.6, 1.6 Bifuel | 4 | K7M710 | 64/86 | 02/07→ | OE026 OE216 LPG [278] | 0,9 0,8 | CET2 | OE179 | BAEA354 | CLS019 →Eng.050317 CLS076 Eng.050318→ Eng.090920 CLS088 Eng.090921→ |
| 1.6 16V | 4 | K4M697 | 77/103 | 02/07→ | OE033 | 0,9 | CET2 | OE179 | | |
| 1.6 16V, 1.6 16V Hi-Flex | 4 | K4M690; K4M696 | 77/103 | 02/07→ | OE033 | 0,9 | CET2 | OE179 | BAE409A | |
| 1.6 MPI 85 | 4 | K7M800 | 62/83 | 05/10→ | OE026 OE216 LPG [278] | 0,9 0,8 | CET2 | OE179 | BAEA354 | CLS019 →Eng.050317 CLS076 Eng.050318→ Eng.090920 CLS088 Eng.090921→ |

LOGAN MCV II

| | | | | | | | | | | |
|----------------------------|---|-----------------------------------|-------|--------|--------------|-----|-------------|--------------|-----------------|-----------------------------------|
| 0.9 TCe 90, 0.9 TCe 90 LPG | 3 | H4B400; H4B405; H4B408; H4B410 | 66/89 | 02/13→ | | | | OE261 | BAEA131E | |
| 1.2 | 4 | D4F732 | 54/72 | 05/15→ | | | | | | CLS084 [296] Eng.15622→ |
| 1.2 | 4 | D4F732 | 55/74 | 02/13→ | OE130 | 0,9 | CET4 | | BAEA325 | CLS084 [296] Eng.15622→ |



kW/BHP

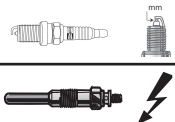

eon TITAN

IRIDIUM

**...DACIA****...LOGAN MCV II**

| | | | | | | | | | | |
|---------|---|--------|-------|--------|-------|-----|------|--|--|----------------------------|
| 1.2 LPG | 4 | D4F734 | 55/74 | 02/13→ | OE130 | 0,9 | CET4 | | | CLS084 [296] Eng.15622→ |
|---------|---|--------|-------|--------|-------|-----|------|--|--|----------------------------|

NOVA

| | | | | | | | | | | |
|-----|---|-----|-------|-------------|----------------|------------|--|--|--|--|
| 1.4 | 4 | C2J | 48/64 | 04/96→03/01 | OE007 OE064 | 0,9 0,9 | | | | |
|-----|---|-----|-------|-------------|----------------|------------|--|--|--|--|

| | | | | | | | | | | |
|-----|---|--|-------|-------------|-------|-----|--|--|---------|--|
| 1.6 | 4 | | 53/71 | 04/96→03/03 | OE051 | 0,9 | | | BAEA234 | |
|-----|---|--|-------|-------------|-------|-----|--|--|---------|--|

PICK UP

| | | | | | | | | | | |
|-----|---|--|-------|-------------|--|--|--|--|-------------------|--|
| 1.6 | 4 | | 53/71 | 04/96→08/01 | | | | | BAEA234 02/97→ | |
|-----|---|--|-------|-------------|--|--|--|--|-------------------|--|

SANDERO

| | | | | | | | | | | |
|---------|---|--------|-------|--------|-------|-----|------|--|--------------------|--------------|
| 1.2 16V | 4 | D4F732 | 55/74 | 11/08→ | OE130 | 0,9 | CET4 | | BAE947A BAEA325 | CLS084 [296] |
|---------|---|--------|-------|--------|-------|-----|------|--|--------------------|--------------|

| | | | | | | | | | | |
|-------------|---|--------|-------|--------|-------|-----|------|--|--------------------------|--|
| 1.2 16V LPG | 4 | D4F732 | 55/74 | 11/08→ | OE130 | 0,9 | CET4 | | BAE947A BAEA325 [323] | |
|-------------|---|--------|-------|--------|-------|-----|------|--|--------------------------|--|

| | | | | | | | | | | |
|-----|---|--------|-------|--------|--------------------------|------------|------|-------|---------|--------|
| 1.4 | 4 | K7J710 | 55/74 | 06/08→ | OE026 OE216 LPG [278] | 0,9 0,8 | CET2 | OE179 | BAEA354 | CLS076 |
|-----|---|--------|-------|--------|--------------------------|------------|------|-------|---------|--------|

| | | | | | | | | | | |
|-------------|---|--------|-------|--------|--------------------------|------------|------|-------|---------|--------|
| 1.4 MPI LPG | 4 | K7J714 | 53/71 | 01/09→ | OE026 OE216 LPG [278] | 0,9 0,8 | CET2 | OE179 | BAEA354 | CLS076 |
|-------------|---|--------|-------|--------|--------------------------|------------|------|-------|---------|--------|

| | | | | | | | | | | |
|---------|---|--------|-------|--------|-------|-----|--|--|--|--|
| 1.5 dCi | 4 | K9K792 | 50/67 | 11/08→ | CH271 | 11v | | | | |
|---------|---|--------|-------|--------|-------|-----|--|--|--|--|

| | | | | | | | | | | |
|---------|---|--------|-------|--------|-------|-----|--|--|--|--|
| 1.5 dCi | 4 | K9K796 | 63/84 | 11/08→ | CH271 | 11v | | | | |
|---------|---|--------|-------|--------|-------|-----|--|--|--|--|

| | | | | | | | | | | |
|-----|---|--------|-------|--------|--------------------------|------------|------|-------|---------|---|
| 1.6 | 4 | K7M710 | 64/86 | 06/08→ | OE026 OE216 LPG [278] | 0,9 0,8 | CET2 | OE179 | BAEA354 | CLS019 →Eng.050317 CLS076 Eng.050318→ Eng.090920 CLS088 Eng.090921→ |
|-----|---|--------|-------|--------|--------------------------|------------|------|-------|---------|---|

| | | | | | | | | | | |
|-------------------------|---|----------------|--------|--------|-------|-----|------|-------|---------|--|
| 1.6 16V, 1.6 16V Bifuel | 4 | K4M690; K4M696 | 77/103 | 01/11→ | OE033 | 0,9 | CET2 | OE179 | BAE409A | |
|-------------------------|---|----------------|--------|--------|-------|-----|------|-------|---------|--|

| | | | | | | | | | | |
|----------------|---|----------------|--------|--------|-------|-----|------|-------|--|--|
| 1.6 16V Bifuel | 4 | K4M690; K4M694 | 77/103 | 01/11→ | OE033 | 0,9 | CET2 | OE179 | | |
|----------------|---|----------------|--------|--------|-------|-----|------|-------|--|--|

| | | | | | | | | | | |
|------------|---|--------|-------|--------|--------------------------|------------|------|-------|---------|---|
| 1.6 MPI 85 | 4 | K7M800 | 62/83 | 05/10→ | OE026 OE216 LPG [278] | 0,9 0,8 | CET2 | OE179 | BAEA354 | CLS019 →Eng.050317 CLS076 Eng.050318→ Eng.090920 CLS088 Eng.090921→ |
|------------|---|--------|-------|--------|--------------------------|------------|------|-------|---------|---|

SANDERO II

| | | | | | | | | | | |
|------------|---|--------|-------|--------|--|--|--|------------------------------------|----------|--|
| 0.9 TCe 90 | 3 | H4B400 | 66/89 | 10/12→ | | | | OE261 Eng.130429→ Eng.140609 | BAEA131E | |
|------------|---|--------|-------|--------|--|--|--|------------------------------------|----------|--|

| | | | | | | | | | | |
|----------------|---|--|-------|--------|--|--|--|--|----------|--|
| 0.9 TCe 90 LPG | 3 | | 66/89 | 09/15→ | | | | | BAEA131E | |
|----------------|---|--|-------|--------|--|--|--|--|----------|--|

| | | | | | | | | | | |
|--------------|---|--------|-------|--------|-------|-----|------|--|--------------------------|--|
| 1.2, 1.2 LPG | 4 | D4F732 | 55/74 | 10/12→ | OE130 | 0,9 | CET4 | | BAE947A BAEA325 [323] | |
|--------------|---|--------|-------|--------|-------|-----|------|--|--------------------------|--|

SOLENZA

| | | | | | | | | | | |
|-----|---|--------|-------|--------|--------------------------|------------|------|-------|---------|--|
| 1.4 | 4 | E7J262 | 55/74 | 02/03→ | OE026 OE216 LPG [278] | 0,9 0,8 | CET2 | OE179 | BAEA354 | |
|-----|---|--------|-------|--------|--------------------------|------------|------|-------|---------|--|

| | | | | | | | | | | |
|-------|---|--------|-------|--------|----------------|------------|--|--|--------------|--|
| 1.9 D | 4 | F8Q636 | 46/62 | 02/03→ | CH217 CH233 | 11v 11v | | | CCU129 [338] | |
|-------|---|--------|-------|--------|----------------|------------|--|--|--------------|--|

SUPERNOVA

| | | | | | | | | | | |
|-----|---|--------|-------|-------------|-------|-----|------|-------|---------|--|
| 1.4 | 4 | E7J262 | 55/74 | 04/00→03/03 | OE005 | 0,9 | CET2 | OE179 | BAEA354 | |
|-----|---|--------|-------|-------------|-------|-----|------|-------|---------|--|

DACIA**DOKKER Express**

| | | | | | | | | | | |
|-------------|---|--------|--------|--------|--|--|--|--|----------|--|
| 1.2 TCe 115 | 4 | H5F402 | 84/113 | 12/12→ | | | | | BAEA131E | |
|-------------|---|--------|--------|--------|--|--|--|--|----------|--|

| | | | | | | | | | | |
|-------------|---|--|--------|--------|--|--|--|-------|----------|--|
| 1.2 TCe 115 | 4 | | 85/114 | 07/15→ | | | | OE261 | BAEA131E | |
|-------------|---|--|--------|--------|--|--|--|-------|----------|--|

| | | | | | | | | | | |
|--------------|---|----------------|-------|--------|-------|-----|------|-------|---------|--------|
| 1.6, 1.6 LPG | 4 | K7M812; K7M828 | 61/82 | 12/12→ | OE033 | 0,9 | CET2 | OE179 | BAEA354 | CLS088 |
|--------------|---|----------------|-------|--------|-------|-----|------|-------|---------|--------|

| | | | | | | | | | | |
|--------------|---|--|--------|--------|--|--|--|--|---------|--|
| 1.6, 1.6 LPG | 4 | | 75/101 | 04/15→ | | | | | BAEA354 | |
|--------------|---|--|--------|--------|--|--|--|--|---------|--|

DACIA





kW/BHP



eon TITAN

IRIDIUM

**...DACIA****DUSTER**

| | | | | | | | | | |
|------------------------------|---|----------------|--------|---------|--------------------|-----|--|-------|----------|
| 1.2 TCe 125 4WD | 4 | H5F404 | 92/123 | 10/13 → | | | | OE261 | BAEA131E |
| 1.5 dCi 4WD | 4 | K9K658; K9K858 | 80/107 | 04/13 → | CH271 [9] [337] | 11v | | | |
| 1.6 SCe 115, 1.6 SCe 115 4WD | 4 | | 84/113 | 06/15 → | | | | | BAE409A |

LOGAN

| | | | | | | | | | |
|------------|---|--------|-------|---------|-----------------|-----|------|-------|--------------------------------------|
| 1.4 | 4 | K7J710 | 55/74 | 03/09 → | OE026 | 0,9 | CET2 | OE179 | BAEA354 |
| | | | | | OE216 LPG [278] | 0,8 | | | |
| 1.5 dCi | 4 | K9K792 | 50/67 | 03/09 → | CH271 [9] | 11v | | | |
| 1.5 dCi | 4 | K9K796 | 63/84 | 03/09 → | CH271 | 11v | | | |
| 1.6 | 4 | K7M710 | 64/86 | 03/09 → | OE026 | 0,9 | CET2 | OE179 | BAEA354 |
| | | | | | OE216 LPG [278] | 0,8 | | | CLS019 → Eng.050317 |
| | | | | | | | | | CLS076 Eng.050318 → Eng.090920 |
| | | | | | | | | | CLS088 Eng.090921 → |
| 1.6 MPI 85 | 4 | K7M800 | 62/83 | 05/10 → | OE026 | 0,9 | CET2 | OE179 | BAEA354 |
| | | | | | OE216 LPG [278] | 0,8 | | | CLS019 → Eng.050317 |
| | | | | | | | | | CLS076 Eng.050318 → Eng.090920 |
| | | | | | | | | | CLS088 Eng.090921 → |

DADI**CITY COURSER**

| | | | | | | | | | |
|--------------|---|---------|--------|---------------|-------------|-----|------|-------|--|
| 2.2, 2.2 4WD | 4 | 491QE | 76/102 | 09/01 → | OE006 | 0,9 | CET8 | OE195 | |
| 2.4 4WD | 4 | 4G64S4M | 97/130 | 09/04 → 12/12 | OE063 | 1,0 | CET2 | OE180 | |
| 2.8 TD | 4 | 4JB1T | 74/99 | 09/04 → | CH306 [275] | 11v | | | |

ELEGANTEST

| | | | | | | | | | |
|---------|---|---------|--------|---------|-------|-----|------|-------|--|
| 2.3 4WD | 4 | 4G64S4M | 97/130 | 05/03 → | OE063 | 1,0 | CET2 | OE180 | |
|---------|---|---------|--------|---------|-------|-----|------|-------|--|

DADI**PICK UP**

| | | | | | | | | | |
|--------|---|-------|-------|---------|-------------|-----|--|--|--|
| 2.8 TD | 4 | 4JB1T | 74/99 | 02/01 → | CH306 [275] | 11v | | | |
|--------|---|-------|-------|---------|-------------|-----|--|--|--|

DAEWOO**ARANOS**

| | | | | | | | | | |
|-----|---|-------|--------|---------------|-------|-----|------|-------|--|
| 2.0 | 4 | C20LE | 77/103 | 01/95 → 11/97 | OE006 | 0,9 | CET8 | OE195 | |
|-----|---|-------|--------|---------------|-------|-----|------|-------|--|

BROUGHAM

| | | | | | | | | | |
|-----|---|--------|---------|---------------|-------|-----|------|-------|--|
| 2.0 | 4 | | 81/109 | 08/94 → 12/97 | OE019 | 0,9 | CET2 | OE184 | |
| 2.0 | 4 | X20XEV | 100/134 | 08/94 → 12/97 | OE019 | 0,9 | CET2 | OE184 | |

CIELO

| | | | | | | | | | |
|-----|---|------|-------|---------------|-------|-----|------|-------|---------|
| 1.5 | 4 | Y15L | 55/74 | 04/95 → 07/97 | OE006 | 0,9 | CET8 | OE195 | |
| 1.5 | 4 | V15L | 66/89 | 06/94 → 07/98 | OE006 | 0,9 | CET8 | OE195 | BAEA554 |

ESPERO

| | | | | | | | | | |
|---------|---|-------|--------|---------------|-------|-----|------|-------|---------|
| 1.5 16V | 4 | A15MF | 65/87 | 10/93 → 09/94 | OE039 | 1,0 | CET2 | OE180 | |
| 1.5 16V | 4 | A15MF | 66/89 | 02/95 → 06/99 | OE039 | 1,0 | CET2 | OE180 | BAEA554 |
| 1.8 | 4 | C18LE | 66/89 | 02/95 → 09/99 | OE006 | 0,9 | CET8 | OE195 | BAEA554 |
| 1.8 | 4 | C18LE | 70/94 | 02/95 → 06/99 | OE006 | 0,9 | CET8 | OE195 | BAEA554 |
| 2.0 | 4 | C20LE | 77/103 | 02/95 → 06/99 | | | CET8 | OE195 | BAEA554 |
| 2.0 | 4 | C20LE | 81/109 | 10/93 → 09/94 | | | CET8 | OE195 | |

EVANDA

| | | | | | | | | | |
|-----|---|--------|--------|---------|-------|-----|------|-------|----------|
| 2.0 | 4 | L88 | 96/129 | 08/02 → | OE019 | 0,9 | CET2 | OE184 | |
| 2.0 | 4 | X20SED | 96/129 | 08/02 → | OE019 | 0,9 | CET2 | OE184 | BAEA447A |





kW/BHP

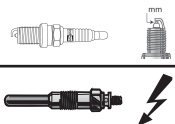

eon TITAN

IRIDIUM

**...DAEWOO****GENTRA**

| | | | | | | | | | | |
|--------------|---|-------|--------|--------|-------|-----|------|-------|--|--|
| 1.6 E-Tec LS | 4 | F16D3 | 77/103 | 05/05→ | OE039 | 1,0 | CET2 | OE179 | | |
|--------------|---|-------|--------|--------|-------|-----|------|-------|--|--|

KALOS

| | | | | | | | | | | |
|-----|---|--------------|-------|--------|-------|-----|------|-------|----------|--------|
| 1.2 | 4 | B12S1; F12S3 | 53/71 | 04/03→ | OE049 | 1,0 | CET8 | OE195 | BAEA447A | CLS085 |
|-----|---|--------------|-------|--------|-------|-----|------|-------|----------|--------|

| | | | | | | | | | | |
|-----|---|-------|-------|--------|-------|-----|------|-------|----------|--------|
| 1.4 | 4 | F14S3 | 61/82 | 09/02→ | OE006 | 0,9 | CET8 | OE195 | BAEA447A | CLS025 |
|-----|---|-------|-------|--------|-------|-----|------|-------|----------|--------|

| | | | | | | | | | | |
|-----|---|-------|-------|-------------|-------|-----|------|-------|----------|------------------|
| 1.4 | 4 | F14D3 | 69/93 | 05/03→12/04 | OE005 | 0,9 | CET2 | OE179 | BAEA447A | CLS020 CLS196 |
|-----|---|-------|-------|-------------|-------|-----|------|-------|----------|------------------|

| | | | | | | | | | | |
|---------|---|-------|-------|--------|-------|-----|------|-------|----------|--|
| 1.4 16V | 4 | F14D3 | 69/93 | 04/03→ | OE005 | 0,9 | CET2 | OE179 | BAEA447A | CLS020 [275] CLS086 [275] CLS196 |
|---------|---|-------|-------|--------|-------|-----|------|-------|----------|--|

| | | | | | | | | | | |
|-----|---|------|-------|-------------|-------|-----|------|-------|----------|--|
| 1.5 | 4 | F15S | 62/83 | 11/02→12/04 | OE006 | 0,9 | CET8 | OE195 | BAEA447A | |
|-----|---|------|-------|-------------|-------|-----|------|-------|----------|--|

KORANDO

| | | | | | | | | | | |
|-------------|---|----------|--------|--------|-------|-----|------|-------|---------|--|
| 2.0 16V 4WD | 4 | M161.950 | 94/126 | 02/99→ | OE019 | 0,9 | CET2 | OE184 | BAEA340 | |
|-------------|---|----------|--------|--------|-------|-----|------|-------|---------|--|

| | | | | | | | | | | |
|---------|---|----------|---------|--------|-------|-----|------|-------|---------|--|
| 2.3 4WD | 4 | M161.970 | 105/141 | 01/99→ | OE005 | 0,9 | CET2 | OE180 | BAEA340 | |
|---------|---|----------|---------|--------|-------|-----|------|-------|---------|--|

| | | | | | | | | | | |
|-----------|---|----------|-------|--------|-------|-------|--|--|--|--|
| 2.9 D 4WD | 5 | MB-OM662 | 72/97 | 01/99→ | CH176 | 11.5v | | | | |
|-----------|---|----------|-------|--------|-------|-------|--|--|--|--|

| | | | | | | | | | | |
|------------|---|--------------|--------|--------|-------|-------|--|--|--|--|
| 2.9 TD 4WD | 5 | MB-OM60129TD | 88/118 | 01/99→ | CH176 | 11.5v | | | | |
|------------|---|--------------|--------|--------|-------|-------|--|--|--|--|

| | | | | | | | | | | |
|---------|---|----------|---------|--------|-------|-----|------|-------|---------|--|
| 3.2 4WD | 6 | M104.995 | 156/209 | 01/99→ | OE005 | 0,9 | CET2 | OE180 | BAEA340 | |
|---------|---|----------|---------|--------|-------|-----|------|-------|---------|--|

LACETTI

| | | | | | | | | | | |
|-----|---|-------|-------|--------|-------|-----|------|-------|---------|------------------|
| 1.4 | 4 | F14D3 | 70/94 | 02/04→ | OE005 | 0,9 | CET2 | OE179 | BAEA543 | CLS020 CLS196 |
|-----|---|-------|-------|--------|-------|-----|------|-------|---------|------------------|

| | | | | | | | | | | |
|-----|---|-------|--------|--------|-------|-----|------|-------|---------|--------|
| 1.6 | 4 | F16D3 | 80/107 | 02/04→ | OE039 | 1,0 | CET2 | OE179 | BAEA543 | CLS196 |
|-----|---|-------|--------|--------|-------|-----|------|-------|---------|--------|

| | | | | | | | | | | |
|-----|---|--------|--------|--------|-------|-----|------|-------|---|--------|
| 1.8 | 4 | T18SED | 90/121 | 02/04→ | OE019 | 0,9 | CET2 | OE188 | BAEA447A →02/06 BAEA508 02/06→ | CLS107 |
|-----|---|--------|--------|--------|-------|-----|------|-------|---|--------|

| | | | | | | | | | | |
|---------|---|-------|-------|-------------|--|--|--|--|---------|--|
| 1.8 CDX | 4 | F18D2 | 67/90 | 08/03→12/04 | | | | | BAEA508 | |
|---------|---|-------|-------|-------------|--|--|--|--|---------|--|

| | | | | | | | | | | |
|---------|---|--------|--------|-------------|--|--|--------|-------|---------|--|
| 1.8 CDX | 4 | T18SED | 90/121 | 08/03→12/04 | | | CET12P | OE184 | BAEA508 | |
|---------|---|--------|--------|-------------|--|--|--------|-------|---------|--|

| | | | | | | | | | | |
|-----|---|--------|--------|-------------|-------|-----|------|-------|--|--|
| 2.0 | 4 | C20SED | 81/109 | 06/99→07/03 | OE019 | 0,9 | CET2 | OE184 | | |
|-----|---|--------|--------|-------------|-------|-----|------|-------|--|--|

| | | | | | | | | | | |
|-----|---|--------|--------|-------------|-------|-----|------|-------|----------------------------------|--|
| 2.0 | 4 | X20SED | 98/131 | 06/99→07/03 | OE019 | 0,9 | CET2 | OE184 | BAEA025E [275] BAEA447A [275] | |
|-----|---|--------|--------|-------------|-------|-----|------|-------|----------------------------------|--|

LANOS

| | | | | | | | | | | |
|-----|---|----------------|-------|--------|-------|-----|------|-------|------------------------|--------|
| 1.3 | 4 | A13SMS; A14SMS | 55/74 | 05/97→ | OE006 | 0,9 | CET8 | OE195 | BAEA447A Ch.590906→ | CLS025 |
|-----|---|----------------|-------|--------|-------|-----|------|-------|------------------------|--------|

| | | | | | | | | | | |
|-----|---|--------|-------|--------|-------|-----|------|-------|------------------------------------|--------|
| 1.5 | 4 | A15SMS | 63/84 | 05/97→ | OE006 | 0,9 | CET8 | OE195 | BAEA025E BAEA447A Ch.590906→ | CLS025 |
|-----|---|--------|-------|--------|-------|-----|------|-------|------------------------------------|--------|

| | | | | | | | | | | |
|-----|---|--------|-------|-------------|-------|-----|------|-------|----------|--|
| 1.5 | 4 | A15DMS | 73/98 | 10/97→06/99 | OE006 | 0,9 | CET8 | OE195 | BAEA447A | |
|-----|---|--------|-------|-------------|-------|-----|------|-------|----------|--|

| | | | | | | | | | | |
|---------|---|--------|--------|--------|-------|-----|------|-------|----------------------------------|--------|
| 1.6 16V | 4 | A16DMS | 78/105 | 02/97→ | OE039 | 1,0 | CET2 | OE179 | BAEA025E [275] BAEA447A [275] | CLS020 |
|---------|---|--------|--------|--------|-------|-----|------|-------|----------------------------------|--------|

LEGANZA

| | | | | | | | | | | |
|--------|---|-------|-------|-------------|-------|-----|------|-------|--|--|
| 1.8 CD | 4 | C18LE | 70/94 | 06/97→07/03 | OE006 | 0,9 | CET8 | OE195 | | |
|--------|---|-------|-------|-------------|-------|-----|------|-------|--|--|

| | | | | | | | | | | |
|---------|---|--------|--------|-------------|-------|-----|------|-------|----------------------------------|--|
| 2.0 16V | 4 | T20SED | 93/125 | 07/00→04/04 | OE019 | 0,9 | CET2 | OE184 | BAEA025E [275] BAEA447A [275] | |
|---------|---|--------|--------|-------------|-------|-----|------|-------|----------------------------------|--|

| | | | | | | | | | | |
|---------|---|--------|--------|-------------|-------|-----|------|-------|----------------------------------|--|
| 2.0 16V | 4 | X20SED | 98/131 | 06/97→12/02 | OE019 | 0,9 | CET2 | OE184 | BAEA025E [275] BAEA447A [275] | |
|---------|---|--------|--------|-------------|-------|-----|------|-------|----------------------------------|--|

| | | | | | | | | | | |
|---------|---|--------|---------|-------------|-------|-----|------|-------|----------------------------------|--|
| 2.2 16V | 4 | T22SED | 100/134 | 04/99→12/02 | OE026 | 0,9 | CET2 | OE188 | BAEA025E [275] BAEA447A [275] | |
|---------|---|--------|---------|-------------|-------|-----|------|-------|----------------------------------|--|

MAGNUS

| | | | | | | | | | | |
|-----|---|--------|--------|--------|-------|-----|------|-------|----------------------------------|--|
| 2.0 | 4 | X20SED | 96/129 | 07/99→ | OE019 | 0,9 | CET2 | OE184 | BAEA025E [275] BAEA447A [275] | |
|-----|---|--------|--------|--------|-------|-----|------|-------|----------------------------------|--|

| | | | | | | | | | | |
|-----|---|-------|---------|-------------|-------|-----|--------|-------|--|--|
| 2.5 | 6 | X25D1 | 115/154 | 08/03→12/04 | OE146 | 1,0 | CET12P | OE179 | | |
|-----|---|-------|---------|-------------|-------|-----|--------|-------|--|--|

DAEWOO



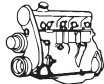

kW/BHP

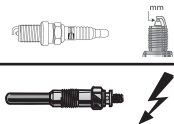

eon TITAN

IRIDIUM



...DAEWOO

MATIZ

| | | | | | | | | | | |
|-----|---|------|-------|--------|-------|-----|------|-------|--|------------------------|
| 0.8 | 3 | F8CV | 38/51 | 09/98→ | OE048 | 1,0 | CET8 | OE195 | BAEA540 →09/00 →Ch.577030 BAEA539 10/00→ | CLS013 [292] →12/01 |
| 1.0 | 4 | B10S | 47/63 | 01/03→ | OE006 | 0,9 | CET8 | OE195 | BAEA447A | CLS085 |

MUSSO

| | | | | | | | | | | |
|------------|---|--------------|---------|-------------|-------|-------|------|-------|---------|------------------|
| 2.2 TD 4WD | 4 | MBOM601 | 74/99 | 09/99→ | CH176 | 11.5v | | | | |
| 2.3 4WD | 4 | M111.970 | 103/138 | 01/99→ | OE003 | 0,9 | CET2 | OE180 | BAEA340 | CLS063 CLS071 |
| 2.9 D 4WD | 5 | MB-OM662 | 73/98 | 01/99→09/99 | CH176 | 11.5v | | | | |
| 2.9 TD 4WD | 5 | MB-OM60129TD | 88/118 | 01/99→ | CH176 | 11.5v | | | | |
| 3.2 4WD | 6 | M104.992 | 162/217 | 01/99→ | OE005 | 0,9 | CET2 | OE180 | BAEA340 | |

NEXIA

| | | | | | | | | | | |
|---------|---|-------|--------|-------------|--------------------------|------|------|-------|--------------------|--|
| 1.5 | 4 | G15MF | 44/59 | 08/96→08/97 | OE006 *to be adjusted | 0,7* | CET8 | OE195 | BAEA554 | |
| 1.5 | 4 | G15MF | 52/70 | 02/95→08/97 | | | CET8 | OE195 | BAEA554 | |
| 1.5 | 4 | G15MF | 55/74 | 02/95→08/97 | OE006 | 0,9 | CET8 | OE195 | BAEA554 | |
| 1.5 | 4 | Y15L | 59/79 | 08/97→ | OE006 | 0,9 | CET8 | OE195 | BAEA554 | |
| 1.5 16V | 4 | A15MF | 66/89 | 02/95→08/97 | OE039 | 1,0 | CET2 | OE180 | BAEA554 | |
| 1.6 | 4 | F16D3 | 80/107 | 08/97→ | OE039 | 1,0 | CET2 | OE179 | BAEA543 BAEA554 | |

NUBIRA

| | | | | | | | | | | |
|---------|---|--------------|--------|-------------|----------------|------------|------|----------------|--|--------|
| 1.4 | 4 | F14D3 | 69/93 | 10/03→12/04 | OE005 | 0,9 | CET2 | OE179 | BAEA543 | CLS020 |
| 1.5 SE | 4 | A15DMS | 81/109 | 06/99→07/03 | OE039 | 1,0 | CET2 | OE179 | | |
| 1.6 | 4 | A16DMS | 76/102 | 08/02→07/03 | OE019 | 0,9 | CET2 | OE184 | BAEA447A | |
| 1.6 | 4 | F16D3 | 80/107 | 07/03→ | OE039 | 1,0 | CET2 | OE179 | BAEA543 | CLS196 |
| 1.6 16V | 4 | A16SMS | 66/89 | 06/97→ | OE039 | 1,0 | CET2 | | BAEA025E ^[275] BAEA447A ^[275] | |
| 1.6 16V | 4 | A16DMS | 76/102 | 07/00→ | OE019 OE039 | 0,9 1,0 | CET2 | OE179 OE184 | BAEA447A | CLS020 |
| 1.6 16V | 4 | A16DMS | 78/105 | 05/97→ | OE019 | 0,9 | CET2 | OE184 | BAEA025E ^[275] BAEA447A ^[275] | CLS020 |
| 1.8 | 4 | C18LE | 70/94 | 06/04→ | OE006 | 0,9 | CET8 | OE195 | | |
| 1.8 | 4 | T18SED | 90/121 | 07/03→ | OE019 | 0,9 | CET2 | OE184 | BAEA447A →02/06 BAEA508 | |
| 2.0 | 4 | C20SED | 81/109 | 06/99→07/03 | OE019 | 0,9 | CET2 | OE184 | BAEA025E ^[275] BAEA447A ^[275] | |
| 2.0 16V | 4 | T20SED | 93/125 | 12/00→ | OE019 | 0,9 | CET2 | OE184 | BAEA447A | |
| 2.0 16V | 4 | X20SED; Z20L | 98/131 | 05/97→ | OE019 | 0,9 | CET2 | OE184 | BAEA025E ^[275] BAEA447A ^[275] | |

PRINCE

| | | | | | | | | | | |
|-----|---|---------------|---------|-------------|-------|-----|------|-------|--|--|
| 2.0 | 4 | C20LE; C20NED | 85/114 | 08/94→12/98 | OE006 | 0,9 | CET8 | OE195 | | |
| 3.0 | 6 | C30NE | 130/174 | 08/94→07/97 | OE064 | 0,9 | | | | |

REXTON

| | | | | | | | | | | |
|------------|---|-----------|---------|--------|-------|-------|------|-------|---------|--|
| 2.9 TD 4WD | 5 | OM662.983 | 88/118 | 04/02→ | CH176 | 11.5v | | | | |
| 3.2 V6 4WD | 6 | M162.992 | 162/217 | 04/02→ | OE005 | 0,9 | CET2 | OE180 | BAEA340 | |

REZZO

| | | | | | | | | | | |
|--------|---|--------|--------|-------------|-------|-----|------|-------|----------|--------|
| 1.6 | 4 | A16DMS | 77/103 | 09/00→ | OE039 | 1,0 | CET2 | OE195 | BAEA447A | CLS020 |
| 1.6 SX | 4 | A16SMS | 66/89 | 08/01→12/04 | OE039 | 1,0 | CET2 | | BAEA447A | CLS020 |
| 1.8 | 4 | F18D2 | 67/90 | 09/00→ | OE006 | 0,9 | CET8 | OE195 | BAEA447A | |
| 1.8 | 4 | A18DMS | 72/97 | 09/00→ | OE006 | 0,9 | CET8 | OE195 | BAEA447A | |
| 1.8 | 4 | F18S2 | 74/99 | 09/00→ | OE006 | 0,9 | CET8 | OE195 | BAEA447A | |

CHAMPION

DAEWOO



kW/BHP

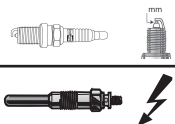

eon TITAN

IRIDIUM

**...DAEWOO****...REZZO**

| | | | | | | | | | |
|-----|---|--------|--------|-------------|-------|-----|------|-------|----------|
| 2.0 | 4 | X20SED | 89/119 | 09/01→12/04 | OE019 | 0,9 | CET2 | OE184 | BAEA447A |
| 2.0 | 4 | T20SED | 94/126 | 09/00→ | OE019 | 0,9 | CET2 | OE184 | BAEA447A |

SUPER SALOON

| | | | | | | | | | |
|------------|---|-------|---------|-------------|-------|-----|--|--|--|
| 3.0 Luxury | 6 | C30NE | 130/174 | 08/94→08/95 | OE064 | 0,9 | | | |
|------------|---|-------|---------|-------------|-------|-----|--|--|--|

TICO

| | | | | | | | | | |
|-----|---|------|-------|-------------|-------|-----|------|-------|---------|
| 0.8 | 3 | F8C | 35/47 | 02/95→12/00 | OE049 | 1,0 | CET8 | | BAEA539 |
| 0.8 | 3 | F8CV | 38/51 | 01/96→12/00 | OE048 | 1,0 | CET8 | OE195 | BAEA540 |

TOSCA

| | | | | | | | | | |
|---------------|---|-------|---------|--------|-------|-----|--------|-------|--|
| 2.0 XT | 6 | X20D1 | 105/141 | 02/06→ | OE146 | 1,0 | CET12P | OE179 | |
| 2.5 Executive | 6 | X25D1 | 115/154 | 02/06→ | OE146 | 1,0 | CET12P | OE179 | |

WINSTORM

| | | | | | | | | | |
|--------------------|---|--------|---------|--------|-------|-----|------|-------|--|
| 2.4, 2.4 4WD | 4 | Z24XED | 104/139 | 12/06→ | OE019 | 0,9 | CET2 | OE184 | |
| 2.4 LS, 2.4 LT 4WD | 4 | Z24XED | 103/138 | 12/06→ | OE019 | 0,9 | CET2 | OE184 | |

DAEWOO**MATIZ**

| | | | | | | | | | |
|-----|---|------|-------|-------------|--|--|--|--|--|
| 0.8 | 3 | F8CV | 38/51 | 08/98→08/02 | | | | | BAEA540 →Ch.577030 BAEA539 Ch.577031→ |
|-----|---|------|-------|-------------|--|--|--|--|--|

DAIHATSU**ALTIS**

| | | | | | | | | | |
|------------------------------|---|--------|---------|-------------|-------|-----|--------|-------|--|
| 2.2 4WD, 2.2 SL, 2.2 SL 4WD | 4 | 5S-FE | 103/138 | 10/96→07/01 | OE039 | 1,0 | CET2 | OE179 | |
| 2.4, 2.4 4WD | 4 | 2AZ-FE | 112/150 | 08/01→12/05 | | | CET12P | OE182 | |
| 2.4 VVTi SX, 2.4 VVTi SX 4WD | 4 | 2AZ-FE | 116/156 | 01/06→12/10 | | | CET12P | OE182 | |

APPLAUSE II

| | | | | | | | | | |
|---------|---|------|-------|-------------|-------|-----|------|-------|--|
| 1.6 16V | 4 | HD-E | 73/98 | 07/97→05/00 | OE039 | 1,0 | CET2 | OE180 | |
|---------|---|------|-------|-------------|-------|-----|------|-------|--|

BOON

| | | | | | | | | | |
|--------------|---|--------|-------|--------|--|--|--------|-------|--|
| 1.0, 1.0 4WD | 3 | 1KR-FE | 51/68 | 01/10→ | | | CET14P | OE190 | |
|--------------|---|--------|-------|--------|--|--|--------|-------|--|

CHARADE

| | | | | | | | | | |
|---------|---|--------|-------|--------|--|--|--|--|----------|
| 1.3 16V | 4 | 1NR-FE | 73/98 | 05/11→ | | | | | BAEA172E |
|---------|---|--------|-------|--------|--|--|--|--|----------|

CHARADE IV

| | | | | | | | | | |
|-----------|---|---------|--------|-------------|-------|-----|--------|-------|--|
| 1.0 | 3 | CB22 | 38/51 | 09/94→03/96 | OE048 | 1,0 | CET8 | OE195 | |
| 1.3 | 4 | HC | 44/59 | 09/96→11/99 | OE039 | 1,0 | CET2 | OE180 | |
| 1.3 16V | 4 | HCE | 55/74 | 05/96→11/99 | | | CET2 | OE179 | |
| 1.3 i 16V | 4 | HC; HCE | 62/83 | 01/93→09/00 | OE039 | 1,0 | CET2 | OE180 | |
| 1.5 16V | 4 | HEE | 55/74 | 10/94→01/01 | OE039 | 1,0 | CET2 | OE180 | |
| 1.5 i 16V | 4 | HEEG | 66/89 | 06/94→11/99 | | | CET2 | OE179 | |
| 1.5 i 16V | 4 | HEE | 66/89 | 06/94→11/99 | OE030 | 0,9 | CET2 | OE179 | |
| 1.6 GTi | 4 | HD-E | 77/103 | 03/93→11/99 | | | CET12P | OE179 | |

COO

| | | | | | | | | | |
|-----|---|-------|-------|--------|-------|-----|------|-------|--|
| 1.0 | 3 | EJ-VE | 43/58 | 10/06→ | OE019 | 0,9 | CET2 | OE184 | |
|-----|---|-------|-------|--------|-------|-----|------|-------|--|

COPEN

| | | | | | | | | | |
|-----|---|------------|-------|-------------|--|--|--------|-------|----------|
| 0.7 | 4 | JB; JB-DET | 50/67 | 09/03→12/07 | | | CET12P | OE179 | |
| 1.3 | 4 | K3-VE | 64/86 | 03/06→09/12 | | | CET12P | OE179 | BAEA194E |

CUORE IV

| | | | | | | | | | |
|-----|---|------|-------|-------------|-------|-----|------|-------|--|
| 0.8 | 3 | ED20 | 31/42 | 11/96→10/98 | OE006 | 0,9 | CET8 | OE195 | |
| 0.8 | 3 | ED20 | 32/43 | 01/95→08/98 | OE006 | 0,9 | CET8 | OE195 | |

CUORE V

| | | | | | | | | | |
|----------|---|--------------|-------|-------------|-------|-----|------|-------|----------|
| 1.0 DVVT | 3 | EJ-VE | 43/58 | 10/00→02/03 | OE019 | 0,9 | CET2 | OE184 | |
| 1.0 i | 3 | EJ-DE; EJ-VE | 41/55 | 10/98→05/03 | OE026 | 0,9 | CET2 | OE188 | BAEA180E |

DAIHATSU



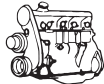

kW/BHP



eon TITAN

IRIDIUM

**...DAIHATSU****CUORE VI**

| | | | | | | | | | | |
|-----|---|-------|-------|--------|----------------|------------|------|----------------|--|--|
| 1.0 | 3 | EJ-VE | 43/58 | 03/03→ | OE019 OE026 | 0,9 0,9 | CET2 | OE184 OE188 | | |
|-----|---|-------|-------|--------|----------------|------------|------|----------------|--|--|

CUORE VII

| | | | | | | | | | | |
|-----|---|--------|-------|--------|--|--|--------|-------|----------|--|
| 1.0 | 3 | 1KR-FE | 51/68 | 04/07→ | | | CET14P | OE190 | BAEA164E | |
|-----|---|--------|-------|--------|--|--|--------|-------|----------|--|

GRAN MOVE

| | | | | | | | | | | |
|---------|---|------|-------|-------------|--|--|--------|-------|--|--|
| 1.5 16V | 4 | HEEG | 66/89 | 10/96→07/98 | | | CET12P | OE179 | | |
| 1.6 16V | 4 | HDEP | 67/90 | 05/98→ | | | CET12P | OE179 | | |

HIJET

| | | | | | | | | | | |
|-------|---|------|-------|-------------|-------|-----|------|-------|--|--|
| 1.0 | 3 | CB42 | 35/47 | 10/94→05/98 | OE006 | 0,9 | CET8 | OE195 | | |
| 1.2 D | 4 | | 27/36 | 01/96→03/98 | CH189 | 11v | | | | |

MATERIA

| | | | | | | | | | | |
|------------------|---|--------|--------|--------|-------|-----|--------|-------|----------|--|
| 1.0 DVVT | 3 | EJ-VE | 43/58 | 10/06→ | OE019 | 0,9 | CET2 | OE184 | | |
| 1.3 | 4 | K3-VE | 67/90 | 10/06→ | | | CET10P | OE187 | BAEA194E | |
| 1.5, 1.5 ECO 4WD | 4 | 3SZ-VE | 76/102 | 10/06→ | | | CET10P | OE187 | BAEA194E | |

MOVE

| | | | | | | | | | | |
|-------|---|-------|-------|-------------|-------|-----|------|-------|----------|--|
| 0.8 | 3 | ED20 | 31/42 | 01/97→11/99 | OE048 | 1,0 | CET8 | OE195 | | |
| 1.0 i | 3 | EJ-DE | 41/55 | 10/98→09/02 | OE026 | 0,9 | CET2 | OE188 | BAEA180E | |

SIRION

| | | | | | | | | | | |
|------------------|---|--------|--------|-------------|-------|-----|--------|-------|----------|--|
| 1.0 | 3 | 1KR-FE | 51/68 | 01/05→ | | | CET14P | OE190 | BAEA164E | |
| 1.0 DVVT 4WD | 3 | 1KR-FE | 51/68 | 04/05→ | | | CET14P | OE190 | | |
| 1.0 i | 3 | EJ-VE | 43/58 | 09/00→01/05 | OE026 | 0,9 | CET2 | OE188 | BAEA180E | |
| 1.0 i, 1.0 i 4WD | 3 | EJ-DE | 41/55 | 04/98→09/00 | OE026 | 0,9 | CET2 | OE188 | BAEA180E | |
| 1.0 i 4WD | 3 | EJ-VE | 43/58 | 09/00→01/05 | OE026 | 0,9 | CET2 | OE188 | | |
| 1.3 | 4 | K3-VE | 64/86 | 01/05→ | | | CET12P | OE179 | BAEA194E | |
| 1.3, 1.3 4WD | 4 | K3-VE | 67/90 | 03/08→ | OE199 | 0,9 | CET1 | | BAEA194E | |
| 1.3 4WD | 4 | K3-VE | 64/86 | 04/05→ | OE089 | 1,0 | CET2 | OE188 | BAEA194E | |
| 1.3 Sport | 4 | K3-VE2 | 75/101 | 08/00→01/05 | | | CET2 | OE182 | BAEA194E | |
| 1.3 Sport 4WD | 4 | K3-VE2 | 75/101 | 08/00→03/05 | | | CET2 | OE182 | | |
| 1.5 | 4 | 3SZ-VE | 76/102 | 03/08→ | OE199 | 0,9 | CET1 | | BAEA194E | |

TERIOS

| | | | | | | | | | | |
|---------------|---|--------|--------|-------------|--------------------------|------------|--------|-------|----------|--------|
| 1.3, 1.3 4WD | 4 | K3-VE | 63/84 | 10/00→10/05 | | | | OE188 | | |
| 1.3 4WD | 4 | HC-EJ | 61/82 | 10/97→10/00 | OE026 OE216 LPG (278) | 0,9 0,8 | CET2 | OE188 | | CLS163 |
| 1.3 VVT-i 4WD | 4 | K3-VE | 63/84 | 11/05→ | OE089 | 1,0 | CET2 | OE188 | BAEA194E | |
| 1.5 4WD | 4 | 3SZ-VE | 77/103 | 05/06→ | | | CET10P | OE187 | BAEA194E | |
| 1.5 VVT-i 4WD | 4 | 3SZ-VE | 75/101 | 09/10→ | OE199 | 0,9 | CET1 | | | |

TREVIS

| | | | | | | | | | | |
|-----|---|-------|-------|--------|-------|-----|------|-------|--|--|
| 1.0 | 3 | EJ-VE | 43/58 | 06/06→ | OE026 | 0,9 | CET2 | OE188 | | |
|-----|---|-------|-------|--------|-------|-----|------|-------|--|--|

YRV

| | | | | | | | | | | |
|--------------|---|--------|--------|--------|-------|-----|--------|-------|--|--|
| 1.0 | 3 | EJ-VE | 43/58 | 02/01→ | OE026 | 0,9 | CET2 | OE188 | | |
| 1.3, 1.3 4WD | 4 | K3-VE | 64/86 | 02/01→ | | | | OE188 | | |
| 1.3 GTi | 4 | K3-VET | 95/127 | 07/02→ | OE136 | 0,8 | CET12P | OE179 | | |

DAIHATSU**EXTOL**

| | | | | | | | | | | |
|-----|---|-------|-------|-------------|--|--|--|-------|--|--|
| 1.3 | 4 | K3-VE | 63/84 | 07/00→11/11 | | | | OE188 | | |
|-----|---|-------|-------|-------------|--|--|--|-------|--|--|

HIJET

| | | | | | | | | | | |
|-----------|---|-------|-------|-------------|-------|-----|------|-------|--|--|
| 0.5 | 2 | AB30 | 20/27 | 10/94→12/95 | OE006 | 0,9 | CET8 | OE195 | | |
| 1.0 i | 3 | CB42 | 35/47 | 07/94→05/98 | OE006 | 0,9 | CET8 | OE195 | | |
| 1.2 D | 4 | LDW12 | 26/35 | 05/95→03/98 | CH189 | 11v | | | | |
| 1.3 i 16V | 4 | HCE | 48/64 | 05/98→ | OE039 | 1,0 | CET2 | OE180 | | |

CHAMPION

DAIHATSU



kW/BHP

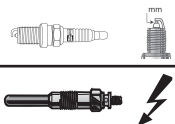

eon TITAN

IRIDIUM

**DAIMLER****DAIMLER XJ**

| | | | | | | | | | |
|------------------|----|--------|---------|-------------|-------|-----|--------|-------|--------------------------|
| 4.0 V8 Super 4.0 | 8 | DC | 267/358 | 07/97→06/03 | OE146 | 1,0 | CET12P | OE179 | BAEA368 ^[277] |
| 4.0 Long | 8 | AJ-V8 | 216/290 | 10/97→06/03 | OE002 | 0,9 | CET2 | | |
| 4.0 Six | 6 | 9JPF8B | 177/237 | 10/94→06/03 | OE002 | 0,9 | CET2 | OE179 | |
| 4.0 Six | 8 | BC | 209/280 | 07/97→12/02 | OE136 | 0,8 | CET12P | OE179 | BAEA368 ^[277] |
| 6.0 Double Six | 12 | 8E | 229/307 | 10/94→06/03 | OE011 | 0,9 | CET9 | OE183 | |

XJ 40, 81

| | | | | | | | | | |
|----------------|----|----|---------|-------------|-------|-----|------|-------|--|
| 6.0 Double Six | 12 | 8C | 229/307 | 02/93→09/94 | OE011 | 0,9 | CET9 | OE183 | |
|----------------|----|----|---------|-------------|-------|-----|------|-------|--|

DALLAS**FUN**

| | | | | | | | | | |
|-------|---|-----------|-------|-------------|-------|-----|--|--|--|
| 1.8 D | 4 | 161(XUD7) | 43/58 | 01/94→12/98 | CH189 | 11v | | | |
|-------|---|-----------|-------|-------------|-------|-----|--|--|--|

DE TOMASO**BIGUA**

| | | | | | | | | | |
|-----|---|--|---------|-------------|--|--|------|--|--|
| 4.6 | 8 | | 237/318 | 01/96→12/02 | | | CET9 | | |
|-----|---|--|---------|-------------|--|--|------|--|--|

GUARA

| | | | | | | | | | |
|-----|---|--|---------|-------------|-------|-----|------|-------|--|
| 4.0 | 8 | | 208/279 | 01/93→12/04 | OE030 | 0,9 | CET2 | OE179 | |
|-----|---|--|---------|-------------|-------|-----|------|-------|--|

DODGE**AVENGER**

| | | | | | | | | | |
|-----|---|----------|---------|--------|-------|-----|------|-------|-------------------------|
| 2.0 | 4 | ECN | 115/154 | 06/07→ | OE154 | 1,0 | CET2 | OE194 | |
| 2.4 | 4 | EDG | 125/168 | 06/07→ | OE154 | 1,0 | CET2 | OE194 | |
| 2.4 | 4 | ED3; EDG | 129/173 | 06/07→ | OE154 | 1,0 | CET2 | OE194 | |
| 2.7 | 6 | EER | 137/184 | 06/07→ | | | | | BAEA453 ^[68] |

CALIBER

| | | | | | | | | | |
|--------------|---|-----|---------|-------------|-------|-----|------|-------|--|
| 1.8 | 4 | EBA | 110/148 | 06/06→12/09 | OE154 | 1,0 | CET2 | OE194 | |
| 2.0 | 4 | ECN | 115/154 | 06/06→ | OE154 | 1,0 | CET2 | OE194 | |
| 2.4 | 4 | ED3 | 125/168 | 10/06→ | OE154 | 1,0 | CET2 | OE194 | |
| 2.4 | 4 | ED3 | 126/169 | 10/06→ | OE154 | 1,0 | CET2 | | |
| 2.4 4WD | 4 | ED3 | 125/168 | 10/06→ | OE154 | 1,0 | CET2 | | |
| 2.4 SRT4 4WD | 4 | ED4 | 223/299 | 10/06→ | OE154 | 1,0 | CET2 | OE194 | |
| 2.4 Turbo | 4 | ED4 | 217/291 | 12/07→ | OE154 | 1,0 | CET2 | OE194 | |

CARAVAN

| | | | | | | | | | |
|------------------|---|-----|---------|-------------|-------|-----|------|-------|--|
| 2.0 i | 4 | | 98/131 | 01/95→03/01 | OE002 | 0,9 | CET2 | OE180 | |
| 2.5 TD | 4 | ENC | 85/114 | 01/95→03/01 | CH189 | 11v | | | |
| 3.0 | 6 | EFA | 112/150 | 01/95→03/01 | OE042 | 0,9 | CET8 | | |
| 3.3 i | 6 | EGP | 116/156 | 01/95→03/01 | OE105 | 1,3 | | | |
| 3.8 i, 3.8 i 4WD | 6 | EGH | 122/164 | 01/95→03/01 | OE105 | 1,3 | | | |
| 3.8 i, 3.8 i 4WD | 6 | EGH | 131/176 | 01/95→03/01 | OE105 | 1,3 | | | |

CHALLENGER

| | | | | | | | | | |
|----------|---|-----|---------|--------|--|--|--------|-------|--|
| 6.4 SRT8 | 8 | ESH | 346/464 | 08/11→ | | | CET17P | OE189 | |
| 6.4 SRT8 | 8 | ESG | 351/471 | 01/11→ | | | CET17P | OE189 | |

CHARGER

| | | | | | | | | | |
|----------|---|-----|---------|-------------|--|--|--------|-------|--------------------------|
| 2.7 | 6 | EER | 141/189 | 04/06→12/10 | | | | | BAEA453 |
| 3.5 | 6 | EGG | 186/249 | 06/05→12/10 | | | | | BAEA432 ^[277] |
| 6.4 SRT8 | 8 | ESG | 351/471 | 09/11→ | | | CET17P | OE189 | |

DAKOTA

| | | | | | | | | | |
|------------------|---|-----|---------|-------------|-------|-----|------|-------|--|
| 2.5 | 4 | EDM | 88/118 | 10/95→09/03 | OE013 | 0,8 | CET2 | | |
| 3.9 4WD, 3.9 SLT | 6 | EHC | 128/172 | 10/95→09/03 | OE128 | 1,0 | | | |
| 4.7, 4.7 4WD | 8 | EVA | 172/231 | 09/99→ | OE154 | 1,0 | CET2 | OE194 | |
| 5.9 | 8 | EML | 184/247 | 10/00→09/03 | OE128 | 1,0 | | | |

DODGE



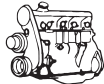

kW/BHP



eon TITAN

IRIDIUM

**...DODGE****DART**

| | | | | | | | | | |
|-------|---|-----|---------|--------|-------|-----|------|-------|---------|
| 1.4 T | 4 | EAF | 119/160 | 04/12→ | | | | | BAE403C |
| 2.4 | 4 | ED6 | 137/184 | 04/12→ | OE154 | 1,0 | CET2 | OE194 | |

DURANGO

| | | | | | | | | | |
|--------------|---|-----|---------|-------------|-------|-----|------|-------|--|
| 3.7, 3.7 4WD | 6 | EKG | 157/211 | 11/03→12/10 | OE089 | 1,0 | CET2 | | |
| 4.7 4WD | 8 | EVA | 172/231 | 11/03→12/09 | OE154 | 1,0 | CET2 | OE194 | |

INTREPID

| | | | | | | | | | |
|--------|---|----------|---------|-------------|-------|-----|--|--|--------------------------|
| 3.2 | 6 | EGW; EKK | 168/225 | 04/98→09/04 | | | | | BAEA432 ^[277] |
| 3.3 | 6 | EGD | 120/161 | 01/95→12/98 | OE105 | 1,3 | | | |
| 3.5 ES | 6 | EGG | 187/251 | 04/98→09/04 | | | | | BAEA432 ^[277] |

JOURNEY

| | | | | | | | | | |
|---------------|---|----------|---------|--------|-------|-----|--------|-------|-------------------------|
| 2.4 | 4 | ED3; EDG | 129/173 | 09/08→ | OE154 | 1,0 | CET2 | OE194 | |
| 2.4, 2.4 ECO+ | 4 | ED3; EDG | 125/168 | 01/09→ | OE154 | 1,0 | CET2 | OE194 | |
| 3.5, 3.5 4WD | 6 | EGF | 173/232 | 06/08→ | | | CET17P | OE189 | BAEA453 ^[68] |

NEON

| | | | | | | | | | |
|-----------------------|---|-----|---------|-------------|-------|-----|------|-------|-------------------|
| 2.0 16V | 4 | ECC | 107/143 | 06/94→08/99 | OE005 | 0,9 | CET2 | OE180 | BAEA380 |
| 2.0 16V | 4 | ECC | 109/146 | 04/96→08/99 | OE005 | 0,9 | CET2 | OE180 | BAEA380 |
| 2.0 16V | 4 | ECC | 112/150 | 04/96→08/99 | OE005 | 0,9 | CET2 | OE180 | BAEA380 |
| 2.0 16V, 2.0 Highline | 4 | ECB | 98/131 | 01/94→09/99 | OE005 | 0,9 | CET2 | OE180 | BAEA380 →06/97 |

NEON II

| | | | | | | | | | |
|---------|---|-----|---------|--------|-------|-----|------|-------|--|
| 2.0 16V | 4 | ECB | 98/131 | 08/99→ | OE005 | 0,9 | CET2 | OE180 | |
| 2.0 16V | 4 | ECH | 112/150 | 08/99→ | OE005 | 0,9 | CET2 | OE180 | |

NITRO

| | | | | | | | | | |
|--------------|---|-----|---------|-------------|-------|-----|------|-------|-------------------------|
| 3.7, 3.7 4WD | 6 | EKG | 157/211 | 09/06→12/12 | OE089 | 1,0 | CET2 | | |
| 3.7 V6 | 6 | | 154/207 | 06/07→12/12 | OE089 | 1,0 | CET2 | | |
| 3.7 V6 4WD | 6 | EKG | 151/202 | 06/07→12/12 | OE089 | 1,0 | CET2 | OE184 | |
| 4.0 4WD | 6 | EGS | 191/256 | 09/06→12/07 | | | | | BAEA453 ^[68] |

RAM 1500

| | | | | | | | | | |
|--------------|----|-----|---------|-------------|-------|-----|------|--|--|
| 3.7 | 6 | EKG | 157/211 | 06/01→09/08 | OE089 | 1,0 | CET2 | | |
| 3.9 | 6 | EHC | 128/172 | 01/93→05/01 | OE128 | 1,0 | | | |
| 3.9 | 6 | EHC | 130/174 | 01/93→08/02 | OE128 | 1,0 | | | |
| 4.7, 4.7 4WD | 8 | EVA | 172/231 | 06/01→09/08 | OE154 | 1,0 | CET2 | | |
| 4.7, 4.7 4WD | 8 | EVC | 175/235 | 08/01→09/08 | OE154 | 1,0 | CET2 | | |
| 5.2 | 8 | ELF | 172/231 | 01/93→09/01 | OE128 | 1,0 | | | |
| 5.9, 5.9 4WD | 8 | EML | 180/241 | 06/01→09/08 | OE128 | 1,0 | | | |
| 5.9, 5.9 4WD | 8 | EML | 184/247 | 01/93→09/01 | OE128 | 1,0 | | | |
| 8.3 SRT-10 | 10 | EWC | 373/500 | 09/03→12/06 | OE041 | 0,9 | | | |

RAM 2500

| | | | | | | | | | |
|--------------|----|-----|---------|-------------|-------|-----|------|--|--|
| 5.9, 5.9 4WD | 8 | EML | 184/247 | 01/93→09/01 | OE128 | 1,0 | | | |
| 8.0 4WD | 10 | EWA | 228/306 | 01/02→12/09 | | | CET2 | | |
| 8.0, 8.0 4WD | 10 | EWA | 221/296 | 01/93→05/01 | | | CET2 | | |

RAMCHARGER II

| | | | | | | | | | |
|---------|---|-----|---------|-------------|-------|-----|--|--|--|
| 5.2 4WD | 8 | ELN | 164/220 | 01/99→12/01 | OE128 | 1,0 | | | |
| 5.9 4WD | 8 | EML | 183/245 | 01/99→12/01 | OE128 | 1,0 | | | |

STRATUS

| | | | | | | | | | |
|---------|---|-----|---------|-------------|-------|-----|--------|-------|--|
| 2.0 16V | 4 | ECB | 98/131 | 12/95→04/01 | OE005 | 0,9 | CET2 | OE180 | |
| 2.5 V6 | 6 | EEB | 125/168 | 12/95→04/01 | | | CET12P | OE180 | |

VIPER

| | | | | | | | | | |
|--------------|----|-------|---------|-------------|-------|-----|--|--|--|
| 8.0 RT10 ACR | 10 | EWB | 335/449 | 10/97→09/02 | OE041 | 0,9 | | | |
| 8.3 SRT-10 | 10 | ; EWC | 372/499 | 09/02→ | OE041 | 0,9 | | | |

DODGE





kW/BHP

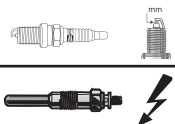

eon TITAN

IRIDIUM

**DODGE****RAM**

| | | | | | | | | |
|---------|---|-----|---------|-------------|-------|-----|--|--|
| 3.9 | 6 | EHC | 128/172 | 08/93→09/03 | OE128 | 1,0 | | |
| 5.2 | 8 | ELF | 172/231 | 08/93→09/03 | OE128 | 1,0 | | |
| 5.2 CNG | 8 | | 165/221 | 08/99→09/03 | OE128 | 1,0 | | |
| 5.9 | 8 | EML | 184/247 | 01/93→09/03 | OE128 | 1,0 | | |

EMGRAND (GEELY)**EC 7**

| | | | | | | | | |
|-----|---|--------------------|---------|-------------|-------|-----|------|-------|
| 1.8 | 4 | JL4G18 | 94/126 | 07/09→ | OE034 | 0,9 | CET2 | OE179 |
| 1.8 | 4 | JLC-4G18; JLY-4G18 | 98/131 | 07/09→12/15 | OE034 | 0,9 | CET2 | OE179 |
| 1.8 | 4 | JL4G18 | 102/137 | 07/09→12/14 | OE034 | 0,9 | CET2 | OE179 |

EC 7 RV

| | | | | | | | | |
|-----|---|--------|---------|-------------|-------|-----|------|-------|
| 1.8 | 4 | JL4G18 | 102/137 | 07/09→12/14 | OE034 | 0,9 | CET2 | OE179 |
|-----|---|--------|---------|-------------|-------|-----|------|-------|

EUNOS**500**

| | | | | | | | | |
|-----|---|------|--------|-------------|-------|-----|------|-------|
| 1.6 | 4 | B6EW | 79/106 | 04/94→10/99 | OE063 | 1,0 | CET2 | OE180 |
|-----|---|------|--------|-------------|-------|-----|------|-------|

FERRARI**348**

| | | | | | | | | |
|-----|---|------|---------|-------------|-------|-----|--|-------------------|
| 3.4 | 8 | | 221/296 | 03/93→12/95 | | | | BAEA234 →04/94 |
| 3.4 | 8 | V834 | 235/315 | 03/93→12/95 | OE073 | 0,8 | | BAEA234 →04/94 |

348 tb/GTB

| | | | | | | | | |
|-----|---|----------|---------|-------------|-------|-----|--|---------|
| 3.4 | 8 | F119D040 | 235/315 | 10/93→04/94 | OE073 | 0,8 | | BAEA234 |
|-----|---|----------|---------|-------------|-------|-----|--|---------|

348 ts/GTS

| | | | | | | | | |
|-----|---|----------|---------|-------------|-------|-----|--|---------|
| 3.4 | 8 | F119D040 | 235/315 | 10/93→12/95 | OE073 | 0,8 | | BAEA234 |
|-----|---|----------|---------|-------------|-------|-----|--|---------|

360

| | | | | | | | | |
|------------------------|---|---------|---------|-------------|-------|-----|--|--|
| 3.6, 3.6 Modena | 8 | F131B40 | 294/394 | 03/99→03/05 | OE122 | 0,7 | | |
| 3.6 Challenge | 8 | F131B44 | 305/409 | 05/01→03/05 | OE122 | 0,7 | | |
| 3.6 Challenge Stradale | 8 | | 313/420 | 05/03→03/05 | OE122 | 0,7 | | |
| 3.6 Modena | 8 | F131B44 | 316/424 | 01/02→03/05 | OE122 | 0,7 | | |

612 SCAGLIETTI

| | | | | | | | | |
|-----|----|---------|---------|-------------|-------|-----|--|--|
| 5.7 | 12 | F118B42 | 397/532 | 04/04→06/11 | OE073 | 0,8 | | |
|-----|----|---------|---------|-------------|-------|-----|--|--|

ENZO FERRARI

| | | | | | | | | |
|-----|----|---------|---------|-------------|-------|-----|--|--|
| 6.0 | 12 | F140B49 | 485/650 | 10/02→12/03 | OE122 | 0,7 | | |
|-----|----|---------|---------|-------------|-------|-----|--|--|

F355

| | | | | | | | | |
|-----|---|----------|---------|-------------|--------------------------|------|--|---------|
| 3.5 | 8 | F129B/40 | 280/375 | 07/95→12/00 | OE122 *to be adjusted | 0,6* | | BAEA234 |
|-----|---|----------|---------|-------------|--------------------------|------|--|---------|

F355 Berlinetta

| | | | | | | | | |
|-----|---|----------|---------|-------------|--------------------------|------|--|---------|
| 3.5 | 8 | F129B/40 | 280/375 | 05/94→03/99 | OE122 *to be adjusted | 0,6* | | BAEA234 |
|-----|---|----------|---------|-------------|--------------------------|------|--|---------|

F430

| | | | | | | | | |
|-----|---|---------|---------|-------------|-------|-----|--|--|
| 4.3 | 8 | F131B43 | 360/483 | 03/05→12/09 | OE122 | 0,7 | | |
|-----|---|---------|---------|-------------|-------|-----|--|--|

FIAT**500**

| | | | | | | | | |
|----------------|---|----------------------|--------|--------|-------|-----|--------|----------------|
| 0.9 | 2 | 312A4.000; 312A6.000 | 44/59 | 12/13→ | OE232 | 0,7 | CET15P | BAE403C |
| 0.9 | 2 | 312A4.000 | 48/64 | 09/12→ | OE232 | 0,7 | CET15P | BAE403C |
| 0.9 | 2 | 312A5.000 | 59/79 | 12/13→ | OE232 | 0,7 | CET15P | BAE403C |
| 0.9 | 2 | 312A2.000 | 63/84 | 07/10→ | OE232 | 0,7 | CET15P | BAEA090 |
| 0.9 | 2 | 199B6.000 | 77/103 | 10/13→ | OE232 | 0,7 | CET15P | |
| 1.2, 1.2 LPG | 4 | 169A4.000 | 51/68 | 10/07→ | OE196 | 1,0 | CET1 | BAE940A CLS082 |
| 1.3 D Multijet | 4 | 169A1.000 | 55/74 | 10/07→ | | | | CCU150 |

FIAT



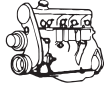

kW/BHP

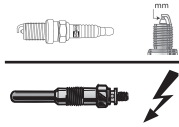

eon TITAN

IRIDIUM

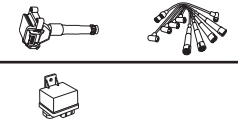

FIAT

| ...FIAT | | | | | | | | | |
|-------------------|---|----------------|---------|-------------|--|-----|----------------|--------------|------------------------------------|
| ...500 | | | | | | | | | |
| 1.4 | 4 | 169A3.000 | 74/99 | 10/07→ | OE196 | 1,0 | | | BAE403C |
| | | | | | OE230 LPG [278] | 0,9 | | | |
| 1.4 | 4 | 169A3.000 | 75/101 | 09/08→ | OE196 | 1,0 | | | BAE403C |
| | | | | | OE230 LPG [278] | 0,9 | | | |
| 1.4, 1.4 Flex | 4 | 169A3.000 | 77/103 | 02/09→ | OE196 | 1,0 | | | BAE403C |
| | | | | | OE230 LPG [278] | 0,9 | | | |
| 1.4 Flex | 4 | 169A3.000 | 79/106 | 07/13→ | OE196 | 1,0 | | | BAE403C |
| | | | | | OE230 LPG [278] | 0,9 | | | |
| 1.4 Turbo | 4 | EAF | 101/135 | 09/13→ | OE196 | 1,0 | | | BAE403C |
| | | | | | OE230 LPG [278] | 0,9 | | | |
| 500 C | | | | | | | | | |
| 0.9 | 2 | 312A4.000 | 48/64 | 09/12→ | OE232 | 0,7 | CET1 5P | | BAE403C |
| 0.9 | 2 | 312A2.000 | 63/84 | 09/09→ | OE232 | 0,7 | CET1 5P | | BAEA090 |
| 0.9 | 2 | 199B6.000 | 77/103 | 12/13→ | OE232 | 0,7 | CET1 5P | | |
| 1.2 | 4 | 169A4.000 | 51/68 | 09/09→ | OE196 | 1,0 | CET1 | | BAE940A CLS082 |
| 1.3 D Multijet | 4 | 169A1.000 | 55/74 | 09/09→ | | | | | CCU150 |
| 1.4 | 4 | 169A3.000 | 74/99 | 09/09→ | OE196 | 1,0 | | | BAE403C |
| | | | | | OE230 LPG [278] | 0,9 | | | |
| 1.4 | 4 | 169A3.000; EAB | 75/101 | 09/11→ | OE196 | 1,0 | | | BAE403C |
| | | | | | OE230 LPG [278] | 0,9 | | | |
| 1.4 | 4 | 169A3.000 | 77/103 | 08/11→ | OE196 | 1,0 | | | BAE403C |
| | | | | | OE230 LPG [278] | 0,9 | | | |
| 1.4 Flex | 4 | 169A3.000 | 79/106 | 08/11→ | OE196 | 1,0 | | | BAE403C |
| | | | | | OE230 LPG [278] | 0,9 | | | |
| 500X | | | | | | | | | |
| 1.4 | 4 | 55263624 | 103/138 | 09/14→ | OE208 | 0,8 | | | |
| 500L | | | | | | | | | |
| 0.9 | 2 | 199B6.000 | 77/103 | 09/12→ | OE232 | 0,7 | CET1 5P | | BAEA090 |
| 0.9 Natural Power | 2 | 312A2.000 | 63/84 | 03/13→ | OE232 | 0,7 | CET1 5P | | BAEA090 |
| 1.4 | 4 | 843A1.000 | 70/94 | 09/12→ | OE196 | 1,0 | | | BAE403C |
| | | | | | OE230 LPG [278] | 0,9 | | | |
| 1.4 | 4 | | 93/125 | 05/14→ | | | | | BAEA095 →Prod.19.11.2014 |
| 1.4 | 4 | 312A1.000 | 118/158 | 09/13→ | | | | | BAEA095 →Prod.19.11.2014 |
| 1.4 | 4 | EAM | 119/160 | 09/13→ | | | | | BAEA095 →Prod.19.11.2014 |
| 1.4, 1.4 LPG | 4 | 940B7.000 | 88/118 | 10/13→ | | | | | BAEA095 →Prod.19.11.2014 |
| 1.4 Flex | 4 | 843A1.000 | 65/87 | 11/14→ | OE196 | 1,0 | | | BAE403C |
| | | | | | OE230 LPG [278] | 0,9 | | | |
| BARCETTA | | | | | | | | | |
| 1.8 16V | 4 | 188A6.000 | 96/129 | 04/95→05/05 | OE016 | 0,9 | CET2 | OE180 | |
| 1.8 16V | 4 | 183A1.000 | 96/129 | 04/95→05/05 | OE016 | 0,9 | CET2 | OE180 | BAEA549 →05/98 |
| 1.8 16V | 4 | 183A1000 | 96/129 | 04/95→05/05 | OE216 LPG [278] | 0,8 | | | |
| BRAVA | | | | | | | | | |
| 1.2 16V | 4 | 182B2.000 | 64/86 | 12/98→12/02 | OE186 | 1,0 | CET1 | | BAEA234 CLS044 |
| 1.2 16V 80 | 4 | 188A5.000 | 59/79 | 10/00→10/01 | OE196 | 1,0 | CET1 | | BAEA234 CLS044 |
| 1.2 16V 80 | 4 | 182B2.000 | 60/80 | 12/98→12/02 | OE186 | 1,0 | CET1 | | BAEA234 CLS044 |
| | | | | | OE230 LPG [278] Eng.1945438→ | 0,9 | | | |
| 1.4 | 4 | 182A5.000 | 55/74 | 10/95→10/01 | OE216 LPG [278] →10/98 | 0,8 | CET2 | OE179 | BAEA234 CLS136 |
| 1.4 12 V | 4 | 182A3.000 | 59/79 | 10/95→08/98 | OE216 LPG [278] | 0,8 | CET2 | OE179 | BAEA234 CLS136 |





kW/BHP

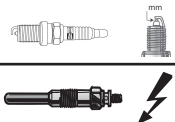

eon TITAN

IRIDIUM



...FIAT

...BRAVA

| | | | | | | | | | | |
|--------------|---|-----------|---------|-------------|---|-----|------|-------|------------------------|--------|
| 1.6 16V | 4 | 182A6.000 | 66/89 | 10/95→10/01 | OE216 LPG [278] →10/98 | 0,8 | CET2 | OE179 | BAE920AX | CLS137 |
| 1.6 16V | 4 | 182A4.000 | 76/102 | 02/96→12/02 | OE216 LPG [278] →10/98 | 0,8 | CET2 | OE179 | BAE920AX | CLS137 |
| 1.6 16V | 4 | 182B6.000 | 76/102 | 02/96→12/02 | OE030 | 0,9 | CET2 | OE179 | BAE920AX | CLS137 |
| 1.8 GT 16V | 4 | 182A2.000 | 83/111 | 10/95→08/01 | | | CET2 | OE188 | BAEA549 →07/99 | |
| 1.9 D | 4 | 160A7.000 | 48/64 | 10/95→10/01 | CH189 | 11v | | | | |
| 1.9 JTD | 4 | 182B9.000 | 74/99 | 09/00→10/01 | CH222 | 11v | | | CCU150 ^[57] | |
| 1.9 JTD | 4 | 182B4.000 | 79/106 | 01/01→12/02 | CH222 | 11v | | | CCU150 ^[57] | |
| 1.9 JTD 105 | 4 | 182B4.000 | 77/103 | 12/98→10/01 | CH222 Eng.1716459→ Prod.15.11.1999→ | 11v | | | CCU150 ^[57] | |
| 1.9 TD 75 S | 4 | 182A8.000 | 55/74 | 03/96→10/01 | CH167 | 11v | | | CCU153 | |
| 1.9 TD 100 S | 4 | 182A7.000 | 74/99 | 03/96→10/01 | CH167 | 11v | | | | |
| 2.0 | 5 | 182B7.000 | 113/152 | 09/98→08/00 | OE216 LPG [278] | 0,8 | CET2 | OE179 | | |

BRAVO I

| | | | | | | | | | | |
|--------------|---|-----------|---------|-------------|---|-----|------|-------|------------------------|--------|
| 1.2 16V 80 | 4 | 188A5.000 | 59/79 | 10/00→10/01 | OE196 | 1,0 | CET1 | | BAEA234 | CLS044 |
| 1.2 16V 80 | 4 | 182B2.000 | 60/80 | 12/98→10/00 | OE186 | 1,0 | CET1 | | BAEA234 | CLS044 |
| | | | | | OE230 LPG [278] Eng.1945438→ | 0,9 | | | | |
| 1.2 16V 80 | 4 | 182B2.000 | 64/86 | 12/98→10/01 | OE186 →07/99 | 1,0 | CET1 | | BAEA234 | CLS044 |
| 1.4 | 4 | 182A5.000 | 55/74 | 10/95→10/01 | OE216 LPG [278] →10/98 | 0,8 | CET2 | OE179 | BAEA234 | CLS136 |
| 1.4 | 4 | 182A3.000 | 59/79 | 10/95→10/01 | OE216 LPG [278] →10/98 | 0,8 | CET2 | OE179 | BAEA234 | CLS136 |
| 1.6 | 4 | 182B6.000 | 76/102 | 09/00→10/01 | OE030 | 0,9 | CET2 | OE179 | BAE920AX | CLS137 |
| 1.6 16V | 4 | 182A6.000 | 66/89 | 10/95→10/01 | OE216 LPG [278] | 0,8 | CET2 | OE179 | BAE920AX | CLS137 |
| 1.6 16V | 4 | 182A4.000 | 76/102 | 03/96→10/01 | OE216 LPG [278] →10/98 | 0,8 | CET2 | OE179 | BAE920AX | CLS137 |
| 1.8 GT | 4 | 182A2.000 | 83/111 | 10/95→10/01 | OE216 LPG [278] →07/99 →Eng.1945438 | 0,8 | CET2 | OE188 | BAEA549 →07/99 | |
| 1.9 D | 4 | 160A7.000 | 48/64 | 10/95→10/01 | CH189 | 11v | | | | |
| 1.9 JTD | 4 | 182B9.000 | 74/99 | 09/00→10/01 | CH222 | 11v | | | CCU150 ^[57] | |
| 1.9 JTD 105 | 4 | 182B4.000 | 77/103 | 12/98→10/01 | CH222 Eng.1716459→ Prod.15.11.1999→ | 11v | | | CCU150 ^[57] | |
| 1.9 TD 75 S | 4 | 182A8.000 | 55/74 | 03/96→10/01 | CH167 | 11v | | | CCU153 | |
| 1.9 TD 100 S | 4 | 182A7.000 | 74/99 | 03/96→10/01 | CH167 | 11v | | | | |
| 2.0 HGT 20V | 5 | 182A1.000 | 108/145 | 10/95→07/98 | OE216 LPG [278] | 0,8 | CET2 | OE179 | | |
| 2.0 HGT 20V | 5 | 182B7.000 | 113/152 | 07/98→10/01 | OE216 LPG [278] | 0,8 | CET2 | OE179 | | |

BRAVO II

| | | | | | | | | | | |
|----------------|---|----------------------|---------|-------------|-----------------|-----|------|--|------------------------|--|
| 1.4 | 4 | 192B2.000 | 66/89 | 04/07→12/14 | OE196 | 1,0 | CET1 | | BAE403C | |
| | | | | | OE230 LPG [278] | 0,9 | | | | |
| 1.4 16V | 4 | 198A7.000 | 103/138 | 03/08→ | OE208 | 0,8 | | | BAE403C [131] [275] | |
| 1.4 LPG | 4 | 192B2.000 | 66/89 | 12/08→12/14 | OE196 | 1,0 | CET1 | | BAE403C | |
| 1.4 T-Jet | 4 | 198A4.000 | 88/118 | 09/07→ | OE208 | 0,8 | | | BAEA095 | |
| 1.4 T-Jet | 4 | 198A1.000 | 110/148 | 09/07→12/14 | OE208 | 0,8 | | | BAEA095 | |
| 1.9 D Multijet | 4 | 192B5.000 | 66/89 | 04/07→12/08 | CH269 | 11v | | | CCU150 | |
| 1.9 D Multijet | 4 | 192A1.000; 192B4.000 | 85/114 | 11/06→ | CH269 →12/09 | 11v | | | CCU150 | |
| 1.9 D Multijet | 4 | 192A8.000 | 88/118 | 04/07→ | CH269 | 11v | | | CCU150 | |
| 1.9 D Multijet | 4 | 937A5.000 | 110/148 | 04/07→ | CH224 | 11v | | | CCU150 | |

CINQUECENTO

| | | | | | | | | | | |
|--------------|---|-----------|-------|-------------|-------|-----|------|-------|---------|--------|
| 0.7 i | 2 | 170A.046 | 22/30 | 07/94→01/98 | OE004 | 0,9 | CET8 | OE195 | BAE800B | |
| 1.1 Sporting | 4 | 176B2.000 | 40/54 | 10/94→01/98 | OE002 | 0,9 | CET2 | OE180 | BAE800B | CLS261 |

FIAT



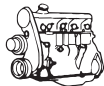

kW/BHP

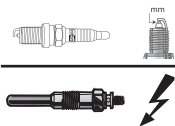

eon TITAN

IRIDIUM

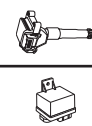

...FIAT

COUPE

| | | | | | | | | | |
|---------------|---|-----------|---------|---------------|-----------------|------------|--------|-------|-------------------|
| 1.8 16V | 4 | 183A1.000 | 96/129 | 03/96 → 08/00 | OE216 LPG [278] | 0,8 | CET2 | OE179 | BAEA549 →05/98 |
| 2.0 16V | 4 | 836A3.000 | 102/137 | 11/93 → 08/96 | OE008 OE018 | 0,9 1,0 | CET8 | OE195 | |
| 2.0 16V Turbo | 4 | 175A1.000 | 140/188 | 11/93 → 08/96 | OE012 | 0,8 | CET8 | OE195 | BAE800B |
| 2.0 20V | 5 | 182A1.000 | 108/145 | 08/96 → 09/98 | OE216 LPG [278] | 0,8 | CET2 | OE179 | |
| 2.0 20V | 5 | 182B3.000 | 113/152 | 04/98 → 08/00 | OE216 LPG [278] | 0,8 | CET2 | OE179 | |
| 2.0 20V Turbo | 5 | 175A3.000 | 162/217 | 08/96 → 08/00 | OE136 | 0,8 | CET12P | OE179 | |

CROMA

| | | | | | | | | | |
|----------------|---|-----------|---------|---------------|------------------------|-----|--------|-------|---------|
| 1.8 16V | 4 | 939A4.000 | 103/138 | 12/05 → | OE089 | 1,0 | CET2 | OE188 | BAEA427 |
| 1.9 D Multijet | 4 | 939A7.000 | 85/114 | 06/05 → | CH222 →Eng.5115898 | 11v | | | CCU150 |
| 1.9 D Multijet | 4 | 939A1.000 | 88/118 | 06/05 → 12/11 | CH269 Eng.5115898 → | 11v | | | |
| 1.9 D Multijet | 4 | 939A1.000 | 88/118 | 06/05 → 12/11 | CH222 →Eng.5115898 | 11v | | | CCU150 |
| 1.9 D Multijet | 4 | 939A8.000 | 100/134 | 12/05 → | CH269 Eng.5115898 → | 11v | | | CCU150 |
| 1.9 D Multijet | 4 | 939A2.000 | 110/148 | 06/05 → 12/11 | CH224 | 11v | | | CCU150 |
| 2.2 16V | 4 | 194A1.000 | 108/145 | 06/05 → | CH224 | 11v | | | CCU150 |
| 2.4 D Multijet | 5 | 939A3.000 | 147/197 | 06/05 → | OE255 | 1,0 | CET17P | OE189 | |
| 2.5 2500 V6 | 6 | 834G.000 | 119/160 | 06/93 → 08/96 | CH224 | 11v | | | CCU150 |
| | | | | | OE018 | 1,0 | CET8 | OE195 | |

DOBLO

| | | | | | | | | | | |
|------------------------|---|----------------------|--------|---------------|-----------------|-----|------|-------|----------------------|--------|
| 1.2 | 4 | 223A5.000 | 48/64 | 03/01 → | OE016 | 0,9 | CET2 | OE180 | BAE800B | CLS067 |
| 1.3 D Multijet | 4 | 223A9.000 | 62/83 | 10/05 → | | | | | CCU150 | |
| 1.3 D Multijet | 4 | 199A3.000; 263A2.000 | 66/89 | 02/10 → | | | | | CCU150 [22] [298] | |
| 1.3 JTD | 4 | 199A2.000 | 55/74 | 05/05 → | | | | | CCU150 | |
| 1.3 JTD 16V | 4 | 188A9.000 | 51/68 | 12/04 → 05/05 | | | | | CCU150 | |
| 1.4 | 4 | 350A1.000 | 57/76 | 10/05 → | OE196 | 1,0 | CET1 | | BAE940A | CLS082 |
| 1.4 | 4 | 843A1.000 | 70/94 | 02/10 → | OE196 | 1,0 | CET1 | | BAE403C | |
| | | | | | OE230 LPG [278] | 0,9 | | | | |
| 1.4, 1.4 Natural Power | 4 | 198A4.000 | 88/118 | 02/10 → | OE208 | 0,8 | | | BAEA095 | |
| 1.6 | 4 | 182B6.000 | 68/91 | 09/02 → | OE030 | 0,9 | CET2 | OE179 | BAE920AX | |
| 1.6 16V | 4 | 182B6.000 | 76/102 | 10/01 → | OE016 | 0,9 | CET2 | OE180 | BAE403B | |
| 1.6 Natural Power | 4 | 182B6.000 | 76/102 | 09/02 → | OE030 | 0,9 | CET2 | OE179 | BAE920AX | |
| 1.9 D | 4 | 223A6.000 | 46/62 | 03/01 → | CH209 | 11v | | | | |
| 1.9 D Multijet | 4 | 186A9.000 | 88/118 | 10/05 → | CH269 | 11v | | | CCU150 | |
| 1.9 JTD | 4 | 182B9.000; 223B2.000 | 74/99 | 10/01 → | CH222 | 11v | | | CCU150 | |
| 1.9 JTD | 4 | 223A7.000; 223B1.000 | 77/103 | 07/03 → | CH222 | 11v | | | CCU150 | |

ELBA

| | | | | | | | | | |
|-----|---|----------------------|-------|---------------|-------|-----|------|-------|--|
| 1.6 | 4 | 146C6.000; 146D6.000 | 69/93 | 01/94 → 12/96 | OE018 | 1,0 | CET8 | OE195 | |
|-----|---|----------------------|-------|---------------|-------|-----|------|-------|--|

FIORINO Pick up

| | | | | | | | | | |
|--------|---|-----------|-------|---------------|-------|-----|------|-------|--------------------|
| 1.4 | 4 | 146D5.000 | 49/66 | 05/94 → 05/01 | | | CET8 | OE195 | BAE504D BAEA234 |
| 1.6 | 4 | 146C6.000 | 55/74 | 01/94 → 05/01 | OE018 | 1,0 | CET8 | OE195 | BAE504D |
| 1.6 | 4 | 146D6.000 | 55/74 | 01/94 → 05/01 | OE018 | 1,0 | CET8 | OE195 | BAEA234 |
| 1.7 D | 4 | 146B2.000 | 42/56 | 10/93 → 10/99 | CH189 | 11v | | | |
| 1.7 TD | 4 | 146D7.000 | 46/62 | 01/97 → 05/01 | CH189 | 11v | | | CCU153 |

FREEMONT

| | | | | | | | | | |
|--------------|---|----------|---------|---------|-------|-----|------|-------|-------------------------|
| 2.4 | 4 | ED3; EDG | 125/168 | 08/11 → | OE154 | 1,0 | CET2 | OE194 | |
| 3.6, 3.6 4WD | 6 | ERB | 206/276 | 08/11 → | | | | | BAEA453 ^[68] |

GRANDE PUNTO

| | | | | | | | | | | |
|-----|---|-----------|-------|---------|-------|-----|------|--|---------|--------|
| 1.2 | 4 | 199A4.000 | 48/64 | 10/05 → | OE196 | 1,0 | CET1 | | BAE940A | CLS082 |
|-----|---|-----------|-------|---------|-------|-----|------|--|---------|--------|

FIAT





kW/BHP

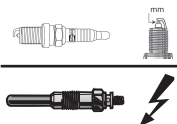

eon TITAN

IRIDIUM

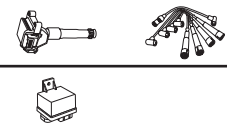

...FIAT

...GRANDE PUNTO

| | | | | | | | | | | |
|---------------------------------|---|-----------|---------|-------------|-------|-----|------|--|---|--------|
| 1.2 | 4 | 169A4.000 | 51/68 | 09/10→ | OE196 | 1,0 | CET1 | | BAE940A | CLS082 |
| 1.2 LPG | 4 | 199A4.000 | 51/68 | 07/08→ | OE196 | 1,0 | CET1 | | | |
| 1.3 D Multijet | 4 | 199B2.000 | 51/68 | 07/08→ | | | | | CCU150 ^[53] | |
| 1.3 D Multijet | 4 | 199A2.000 | 55/74 | 10/05→ | | | | | CCU150 Ch.0456091→ Prod.15.10.2008→ | |
| 1.3 D Multijet | 4 | 199A2.000 | 56/75 | 06/09→ | | | | | CCU150 | |
| 1.3 D Multijet | 4 | 199B4.000 | 62/83 | 04/10→ | | | | | CCU150 | |
| 1.3 D Multijet | 4 | 223A9.000 | 62/83 | 04/10→ | | | | | CCU150 | |
| 1.3 D Multijet | 4 | 199A3.000 | 66/89 | 10/05→ | | | | | CCU150 Ch.0456091→ Prod.15.10.2008→ | |
| 1.4 | 4 | 199A7.000 | 55/74 | 10/05→07/07 | OE196 | 1,0 | CET1 | | BAE940A | |
| 1.4, 1.4 LPG, 1.4 Natural Power | 4 | 350A1.000 | 57/76 | 06/05→ | OE196 | 1,0 | CET1 | | BAE940A | CLS082 |
| 1.4 16V | 4 | 199A6.000 | 70/94 | 10/05→ | OE196 | 1,0 | CET1 | | BAE403C | |
| 1.4 16V | 4 | 198A1.000 | 112/150 | 09/07→07/12 | OE208 | 0,8 | | | BAEA095 | |
| 1.4 T-Jet | 4 | 198A4.000 | 88/118 | 09/07→ | OE208 | 0,8 | | | BAEA095 | |
| 1.6 D Multijet | 4 | 955A3.000 | 88/118 | 07/08→ | | | | | CCU150 ^[53] | |
| 1.9 D Multijet | 4 | 939A7.000 | 85/114 | 06/06→12/09 | CH269 | 11v | | | CCU150 | |
| 1.9 D Multijet | 4 | 939A1.000 | 88/118 | 10/05→ | CH269 | 11v | | | CCU150 | |
| 1.9 D Multijet | 4 | 199A5.000 | 96/129 | 10/05→ | CH269 | 11v | | | CCU150 | |

IDEA

| | | | | | | | | | | |
|----------------|---|-------------|--------|-------------|-------------------------------------|------------|------|--|---------|--------|
| 1.2 16V | 4 | 188A5.000 | 59/79 | 01/04→ | OE196 OE230 LPG ^[278] | 1,0 0,9 | CET1 | | BAE403C | |
| 1.3 D Multijet | 4 | 188A9.000 | 51/68 | 01/04→ | | | | | CCU150 | |
| 1.3 D Multijet | 4 | 199A3.000 | 66/89 | 10/05→ | | | | | CCU150 | |
| 1.3 D Multijet | 4 | 199B1.000 | 70/94 | 05/08→12/12 | | | | | CCU150 | |
| 1.4 | 4 | 192B2.000 | 66/89 | 12/03→ | OE196 OE230 LPG ^[278] | 1,0 0,9 | CET1 | | BAE403C | |
| 1.4, 1.4 LPG | 4 | 350A1.000 | 57/76 | 10/05→ | OE196 | 1,0 | CET1 | | BAE940A | CLS082 |
| 1.4 16V | 4 | 843A1.000 | 70/94 | 01/04→ | OE196 OE230 LPG ^[278] | 1,0 0,9 | CET1 | | BAE403C | |
| 1.8 | 4 | 93313090-7U | 81/109 | 01/08→07/10 | OE089 | 1,0 | CET2 | | | |
| 1.9 JTD | 4 | 188B2.000 | 74/99 | 01/04→ | CH222 | 11v | | | CCU150 | |

LINEA

| | | | | | | | | | | |
|----------------|---|-----------|--------|--------|-------|-----|------|--|---------|--------|
| 1.3 D Multijet | 4 | 199A3.000 | 66/89 | 06/07→ | | | | | CCU150 | |
| 1.4 | 4 | 350A1.000 | 57/76 | 06/07→ | OE196 | 1,0 | CET1 | | BAE940A | CLS082 |
| 1.4 T-Jet | 4 | 198A4.000 | 88/118 | 09/07→ | OE208 | 0,8 | | | BAEA095 | |
| 1.9 16V | 4 | | 94/126 | 07/08→ | OE002 | 0,9 | CET2 | | | |

MAREA

| | | | | | | | | | | |
|---------------------|---|----------------------|--------|-------------|--|-----|------|-------|-------------------|--------|
| 1.2 16V | 4 | 182B2.000 | 60/80 | 10/98→05/02 | OE186 | 1,0 | CET1 | | BAEA234 | CLS044 |
| 1.4 80 12V | 4 | 182A3.000 | 59/79 | 09/96→05/02 | OE216 LPG ^[278] | 0,8 | CET2 | OE179 | BAEA234 | CLS136 |
| 1.6 | 4 | 185A3.000 | 68/91 | 03/99→08/00 | OE016 | 0,9 | CET2 | OE180 | BAE920AX | |
| 1.6 | 4 | 182B6.000 | 76/102 | 09/00→08/02 | OE030 | 0,9 | CET2 | OE179 | BAE920AX | CLS137 |
| 1.6 16V | 4 | 185A3.000 | 75/101 | 04/97→02/99 | OE026 | 0,9 | CET2 | OE179 | BAE920AX | CLS137 |
| 1.6 100 16V | 4 | 182A4.000 | 76/102 | 09/96→05/02 | OE216 LPG ^[278] →03/99 | 0,8 | CET2 | OE179 | BAE920AX | CLS137 |
| 1.6 100 16V Bipower | 4 | 185A3.000; 186A4.000 | 76/102 | 04/99→05/02 | OE016 | 0,9 | CET2 | OE180 | BAE920AX | CLS137 |
| 1.6 SX | 4 | 182B5.098 | 72/97 | 09/00→08/02 | OE016 | 0,9 | CET2 | | BAE920AX | |
| 1.8 115 16V | 4 | 182A2.000 | 83/111 | 09/96→05/02 | OE216 LPG ^[278] →07/99 →Eng.1945438 | 0,8 | CET2 | OE188 | BAEA549 →01/99 | |
| 1.9 JTD | 4 | 182B4.000; 182B9.000 | 79/106 | 01/01→12/07 | CH222 | 11v | | | | |

FIAT



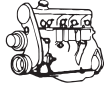

kW/BHP

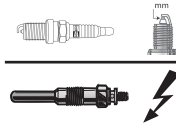

eon TITAN

IRIDIUM

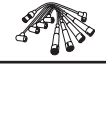
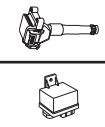

...FIAT

...MAREA

| | | | | | | | | | |
|-------------|---|----------------------|---------|-------------|---|-----|------|------------------------|--|
| 1.9 JTD 105 | 4 | 182B4.000 | 77/103 | 12/98→12/02 | CH222 Eng.1713819→ Prod.15.11.1999→ | 11v | | | |
| 1.9 JTD 110 | 4 | 186A6.000 | 81/109 | 09/00→08/02 | CH222 | 11v | | CCU150 ^[57] | |
| 1.9 TD 75 | 4 | 182A8.000 | 55/74 | 09/96→05/02 | CH167 | 11v | | CCU153 | |
| 1.9 TD 100 | 4 | 182A7.000; 182B9.000 | 74/99 | 05/96→06/03 | CH167 | 11v | | | |
| 2.0 150 20V | 5 | 182A1.000 | 108/145 | 09/96→04/99 | OE216 LPG [278] | 0,8 | CET2 | OE179 | |
| 2.0 150 20V | 5 | 185A8.000 | 110/148 | 01/01→05/02 | OE216 LPG [278] | 0,8 | CET2 | OE179 | |
| 2.0 155 20V | 5 | 182B7.000 | 113/152 | 04/99→02/03 | OE216 LPG [278] | 0,8 | CET2 | OE188 | |
| 2.4 JTD 130 | 5 | 185A6.000; 839A5.000 | 96/129 | 04/99→05/02 | CH222 Eng.1713819→ Prod.15.11.1999→ | 11v | | | |
| 2.4 TD 125 | 5 | 185A2.000 | 91/122 | 09/96→04/99 | CH167 | 11v | | | |

MULTIPLA

| | | | | | | | | | |
|---------------------------|---|----------------------|--------|-------------|---|-----|------|-------|------------------------|
| 1.6 | 4 | 182B6.000 | 68/91 | 05/04→08/05 | OE030 | 0,9 | CET2 | OE179 | BAE920AX |
| 1.6 | 4 | 182B6.000 | 74/99 | 03/01→08/05 | OE030 | 0,9 | CET2 | OE179 | BAE920AX |
| 1.6, 1.6 100 16V | 4 | 182A4.000; 182B6.000 | 76/102 | 04/99→06/10 | OE030 | 0,9 | CET2 | OE179 | BAE920AX CLS137 |
| 1.6 16V, 1.6 16V Blupower | 4 | 182B6.000; 186A3.000 | 70/94 | 04/99→06/10 | OE016 | 0,9 | CET2 | OE180 | BAE920AX CLS137 |
| 1.6 16V Bipower | 4 | 182B6.000; 186A4.000 | 76/102 | 04/99→06/10 | OE016 | 0,9 | CET2 | OE180 | BAE920AX CLS137 |
| 1.6 16V GPL | 4 | 182B6.000 | 76/102 | 10/01→06/10 | | | | | BAE920AX |
| 1.9 JTD | 4 | 186A9.000 | 88/118 | 04/02→06/10 | CH269 10/05→ | 11v | | | CCU150 ^[59] |
| 1.9 JTD 105 | 4 | 182B4.000 | 77/103 | 04/99→06/10 | CH222 Eng.1692991→ Prod.15.11.1999→ | 11v | | | |
| 1.9 JTD 110 | 4 | 186A6.000 | 81/109 | 03/01→07/02 | CH222 | 11v | | | CCU150 ^[57] |
| 1.9 JTD 115 | 4 | 186A8.000 | 85/114 | 07/02→06/10 | CH222 | 11v | | | CCU150 ^[58] |

PALIO

| | | | | | | | | | |
|-------------------|---|------------------------------------|-------|-------------|-----------------------------------|-------------------|--------------|-------|--------------------------------|
| 1.0 | 4 | 178A1.000 | 45/60 | 04/96→10/03 | OE018 | 1,0 | CET8 | OE195 | BAE800B |
| 1.0 | 4 | 178A1.000 | 56/75 | 04/96→10/03 | OE018 | 1,0 | CET8 | OE195 | BAE800B |
| 1.2 | 4 | 178B7.045 | 44/59 | 07/97→10/04 | OE196 | 1,0 | CET1 | | BAE800B CLS067 |
| 1.2 | 4 | 178C4.066 | 44/59 | 07/97→10/04 | OE016 OE196 | 0,9 1,0 | CET1 CET2 | OE180 | BAE800B CLS067 |
| 1.2 | 4 | 188A4.000 | 44/59 | 07/97→10/04 | OE016 OE196 OE230 LPG [278] | 0,9 1,0 0,9 | CET1 CET2 | OE180 | BAE800B CLS067 |
| 1.2 | 4 | 178E2.000 | 50/67 | 06/99→10/02 | OE063 OE216 LPG [278] | 1,0 0,8 | CET2 | OE180 | BAE800B CLS067 CLS261 |
| 1.2 | 4 | 178B5.000 | 53/71 | 07/01→06/05 | | | | | BAE800B |
| 1.2 | 4 | 176A8.000; 178B5.000; 178E2.000 | 54/72 | 04/96→ | OE063 OE216 LPG [278] | 1,0 0,8 | CET2 | OE180 | BAE800B CLS007 →Eng.7672018 |
| 1.2 | 4 | 188A5.000 | 59/79 | 09/01→ | OE196 OE230 LPG [278] | 1,0 0,9 | CET1 | | BAEA234 |
| 1.2 Biopower | 4 | 178E9.011 | 52/70 | 01/04→12/05 | OE196 | 1,0 | CET1 | | BAE800B |
| 1.2 Flex, 1.2 LPG | 4 | 188A4.000 | 44/59 | 07/97→08/02 | OE196 | 1,0 | CET1 | | BAE800B |
| 1.4 | 4 | 178B2.000 | 51/68 | 04/96→10/02 | OE019 | 0,9 | CET2 | OE179 | BAE800B |
| 1.4 | 4 | 199A1.000 | 57/76 | 10/05→ | OE196 | 1,0 | CET1 | | |
| 1.4 | 4 | 834A1.000 | 70/94 | 06/03→ | OE196 | 1,0 | CET1 | | |
| 1.4 Biopower | 4 | 310A2.011 | 63/84 | 02/05→ | OE196 | 1,0 | CET1 | | |
| 1.4 Cat | 4 | 178B2.016 | 51/68 | 04/96→08/01 | | | CET2 | OE179 | BAE800B |
| 1.5 | 4 | | 57/76 | 04/96→12/00 | OE014 | 0,9 | CET2 | OE179 | BAE920AX |
| 1.5 | 4 | 178E5.022 | 62/83 | 02/02→ | OE005 | 0,9 | CET2 | OE179 | BAE800B |
| 1.6 | 4 | 178D2.011 | 70/94 | 07/97→ | | | | | BAE920AX 03/00→09/01 |
| 1.6 16V | 4 | 178C7.098; 178D2.011 | 68/91 | 07/97→10/03 | OE016 | 0,9 | CET2 | | BAE920AX |

CHAMPION



kW/BHP

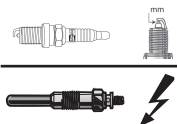

eon TITAN

IRIDIUM

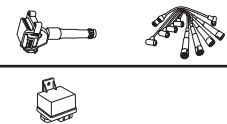

...FIAT

...PALIO

| | | | | | | | | | | |
|---------|---|-----------|--------|-------------|-------|-----|------|-------|----------|--------|
| 1.6 16V | 4 | 178B3.000 | 74/99 | 04/96→12/05 | OE016 | 0,9 | CET2 | OE180 | BAE920AX | CLS137 |
| 1.6 16V | 4 | 182B6.000 | 76/102 | 02/01→ | OE016 | 0,9 | CET2 | OE180 | BAE920AX | CLS137 |
| 1.7 TD | 4 | 176A3.000 | 51/68 | 04/96→01/12 | CH189 | 11v | | | CCU153 | |
| 1.9 D | 4 | 223A6.000 | 46/62 | 09/00→ | CH209 | 11v | | | | |
| 1.9 JTD | 4 | 188A2.000 | 59/79 | 09/01→ | CH222 | 11v | | | CCU150 | |

PANDA

| | | | | | | | | | | |
|------------------------------------|---|----------------------|-------|-------------|------------------------------------|------------|----------------------------------|-----------------|--------------------|------------------------|
| 0.9 | 2 | 312A4.000; 312A6.000 | 44/59 | 12/13→ | OE232 | 0,7 | CET15P | | BAEA090 | |
| 0.9 | 2 | 312A4.000 | 48/64 | 02/12→ | OE232 | 0,7 | CET15P | | BAEA090 | |
| 0.9 | 2 | 312A2.000; 312A7.000 | 57/76 | 02/12→ | OE232 | 0,7 | CET15P | | BAEA090 | |
| 0.9, 0.9 4WD, 0.9 Natural Power | 2 | 312A2.000 | 63/84 | 02/12→ | OE232 | 0,7 | CET15P | | BAEA090 | |
| 0.9, 0.9 Natural Power | 2 | 312A2.000; 312A5.000 | 59/79 | 12/13→ | OE232 | 0,7 | CET15P | | BAEA090 | |
| 0.9 4WD | 2 | 312A2.000; 312A7.000 | 66/89 | 06/14→ | OE232 | 0,7 | CET15P | | BAEA090 | |
| 1.1 | 4 | 187A1.000 | 40/54 | 09/03→ | OE016 →12/04 OE196 01/05→ | 0,9 1,0 | CET2 →12/04 CET1 01/05→ | OE180 →12/04 | BAE800B | CLS261 |
| 1.1 1100, 1.1 1100 4WD | 4 | 176B2.000; 187A1.000 | 40/54 | 02/95→07/04 | OE016 | 0,9 | CET2 | OE180 | BAE800B | CLS067 |
| 1.2 | 4 | 188A4.000 | 44/59 | 09/03→ | OE016 →09/04 OE196 10/04→ | 0,9 1,0 | CET2 →09/04 CET1 10/04→ | OE180 →09/04 | BAE800B | CLS261 |
| 1.2 | 4 | 169A4.000 | 51/68 | 03/10→ | OE196 | 1,0 | CET1 | | BAE403C BAE940A | CLS082 |
| 1.2 4WD | 4 | 188A4.000 | 44/59 | 10/04→ | OE196 | 1,0 | CET1 | | BAE800B | CLS261 |
| 1.2 4WD | 4 | 169A4.000 | 51/68 | 11/09→ | OE196 | 1,0 | CET1 | | BAE940A | CLS082 |
| 1.2 LPG | 4 | 169A4.000 | 51/68 | 11/10→ | OE196 | 1,0 | CET1 | | BAE403C BAE800B | |
| 1.2 LPG, 1.2 Natural Power | 4 | 188A4.000 | 44/59 | 01/07→ | OE196 | 1,0 | CET1 | | BAE800B | CLS067 →Eng.2888158 |
| 1.3 D Multijet | 4 | 169A1.000; 169A5.000 | 55/74 | 06/06→ | | | | | CCU150 | |
| 1.3 D Multijet, 1.3 D Multijet 4WD | 4 | 188A8.000 | 51/68 | 09/03→ | | | | | CCU150 | |
| 1.3 D Multijet 4WD | 4 | 169A1.000 | 55/74 | 09/10→ | | | | | CCU150 | |
| 1.3 D Multijet 4WD | 4 | 169A5.000 | 55/74 | 09/10→ | | | | | CCU150 | |
| 1.4 | 4 | 169A3.000 | 74/99 | 10/06→ | OE196 OE230 LPG [278] | 1,0 0,9 | CET1 | | BAE403C | |
| 1.4 Natural Power | 4 | 350A1.000 | 51/68 | 01/10→ | OE196 | 1,0 | CET1 | | | |
| 1.4 Natural Power | 4 | 350A1.000 | 57/76 | 09/10→ | OE196 | 1,0 | CET1 | | BAE940A | |

PREMIO

| | | | | | | | | | | |
|----------|---|----------------------|-------|-------------|-------|-----|------|-------|---------|--|
| 1.6 i.e. | 4 | 146B7.011; 160A2.011 | 60/80 | 08/93→12/96 | OE018 | 1,0 | CET8 | OE195 | BAE800B | |
|----------|---|----------------------|-------|-------------|-------|-----|------|-------|---------|--|

PUNTO

| | | | | | | | | | | |
|-------------------------------|---|----------------------|--------|-------------|--------------------------|------------|--------|-------|---------|--------|
| 0.9 | 2 | 199B6.000; 199B7.000 | 74/99 | 12/13→ | OE232 | 0,7 | CET15P | | BAEA090 | |
| 0.9 | 2 | 199B6.000 | 77/103 | 07/13→ | OE232 | 0,7 | CET15P | | BAEA090 | |
| 0.9 Bifuel, 0.9 Twinair Turbo | 2 | 312A2.000 | 63/84 | 03/12→ | OE232 | 0,7 | CET15P | | BAEA090 | |
| 1.1 55 | 4 | 176A6.000; 176B2.000 | 40/54 | 09/93→09/99 | OE002 | 0,9 | CET2 | OE180 | BAE800B | CLS261 |
| 1.2 | 4 | 199B9.000 | 49/66 | 02/14→ | OE196 | 1,0 | CET1 | | BAE940A | |
| 1.2 | 4 | 169A4.000 | 51/68 | 03/12→ | OE196 | 1,0 | CET1 | | BAE940A | CLS082 |
| 1.2 16V, 1.2 85 16V | 4 | 176B9.000 | 63/84 | 04/97→06/00 | OE186 | 1,0 | CET1 | | BAE800B | CLS035 |
| 1.2 16V 80 | 4 | 188A5.000 | 59/79 | 09/99→12/06 | OE196 OE230 LPG [278] | 1,0 0,9 | CET1 | | BAEA234 | CLS044 |
| 1.2 60 | 4 | 176A7.000 | 43/58 | 01/94→06/00 | OE002 | 0,9 | CET2 | OE180 | BAE800B | CLS261 |
| 1.2 60 | 4 | 176B1.000; 176B4.000 | 44/59 | 09/93→12/10 | OE002 | 0,9 | CET2 | OE180 | BAE800B | CLS261 |

FIAT



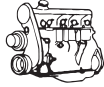

kW/BHP

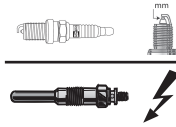

eon TITAN

IRIDIUM

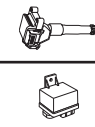

...FIAT

...PUNTO

| | | | | | | | | | | |
|------------------------------------|---|----------------------|--------|-------------|--|------------|----------------------------------|-----------------|------------------------|--|
| 1.2 60 | 4 | 188A4.000 | 44/59 | 09/93→12/10 | OE016 →09/04 OE196 10/04→ | 0,9 1,0 | CET2 →09/04 CET1 10/04→ | OE180 →09/04 | BAE800B | CLS261 →01/03 CLS067 02/03→ →Eng.2935743 |
| 1.2 75 | 4 | 176A8.000 | 54/72 | 10/93→09/99 | OE002 | 0,9 | CET2 | OE180 | BAE800B | CLS261 |
| 1.2 Bifuel | 4 | 188A4.000 | 44/59 | 08/07→03/12 | OE196 | 1,0 | CET1 | | BAE800B | CLS082 CLS067 Eng.C10491→ →Eng.2935743 |
| 1.2 Natural Power | 4 | 188A4.000 | 44/59 | 09/03→03/12 | OE016 →09/04 OE196 10/04→ | 0,9 1,0 | CET2 →09/04 CET1 10/04→ | OE180 →09/04 | BAE800B | CLS067 →Eng.2935743 |
| 1.3 D Multijet | 4 | 199A2.000; 199A9.000 | 55/74 | 03/12→ | | | | | CCU150 ^[21] | |
| 1.3 D Multijet | 4 | 199B8.000 | 59/79 | 12/13→ | | | | | CCU150 ^[53] | |
| 1.3 D Multijet | 4 | 199B4.000 | 62/83 | 03/12→ | | | | | CCU150 ^[21] | |
| 1.3 D Multijet | 4 | 199B1.000; 330A1.000 | 70/94 | 03/12→ | | | | | CCU150 ^[21] | |
| 1.3 JTD 16V | 4 | 188A9.000 | 51/68 | 06/03→03/12 | | | | | CCU150 | |
| 1.4 | 4 | 199A7.000 | 55/74 | 03/12→ | | | | | BAE940A | |
| 1.4 | 4 | 843A1.000 | 70/94 | 09/03→03/12 | OE196 OE230 LPG [278] | 1,0 0,9 | CET1 | | BAE403C | |
| 1.4 | 4 | 199A6.000 | 71/95 | 11/05→03/12 | OE196 | 1,0 | CET1 | | BAE403C | |
| 1.4, 1.4 Bifuel, 1.4 Natural Power | 4 | 350A1.000 | 57/76 | 03/12→ | OE196 | 1,0 | CET1 | | BAE940A | |
| 1.4 GT Turbo | 4 | 176B6.000 | 96/129 | 09/96→07/99 | OE077 | 1,0 | CET2 | OE179 | BAEA234 | |
| 1.4 GT Turbo | 4 | 176A4.000 | 98/131 | 10/93→03/97 | OE077 | 1,0 | CET2 | OE179 | BAEA234 | |
| 1.4 Multi Air | 4 | 955A6.000 | 77/103 | 03/12→ | OE196 | 1,0 | CET1 | | | |
| 1.4 Turbo Multi Air | 4 | 955A2.000 | 99/133 | 03/12→ | OE208 | 0,8 | | | | |
| 1.6 | 4 | 176A9.000 | 65/87 | 01/94→04/97 | | | CET2 | OE179 | BAEA234 | |
| 1.6 90 | 4 | 176A9.000 | 65/87 | 04/94→04/97 | | | CET2 | OE179 | | |
| 1.7 D | 4 | 176B3.000 | 42/56 | 04/94→09/97 | CH189 | 11v | | | | |
| 1.7 TD | 4 | 176B7.000 | 46/62 | 09/96→09/99 | CH189 | 11v | | | CCU153 | |
| 1.7 TD | 4 | 176A3.000 | 51/68 | 01/94→09/99 | CH189 →09/96 | 11v | | | CCU153 | |
| 1.7 TD | 4 | 176A5.000 | 52/70 | 01/94→09/99 | CH189 | 11v | | | CCU153 | |
| 1.8 130 HGT | 4 | 183A1.000; 188A6.000 | 96/129 | 09/99→03/12 | OE016 | 0,9 | CET2 | OE180 | | |
| 1.9 DS 60 | 4 | 188A3.000 | 44/59 | 09/99→03/12 | CH209 | 11v | | | | |
| 1.9 JTD | 4 | 188A7.000 | 63/84 | 10/01→03/12 | CH222 [47] [310] CH269 [48] [311] | 11v 11v | | | CCU150 | |
| 1.9 JTD | 4 | 188B2.000 | 74/99 | 06/03→03/12 | CH222 | 11v | | | | |
| 1.9 JTD 80 | 4 | 188A2.000 | 59/79 | 09/99→03/12 | CH222 | 11v | | | CCU150 | |
| PUNTO EVO | | | | | | | | | | |
| 1.2 | 4 | 199A4.000 | 48/64 | 10/09→02/12 | OE196 | 1,0 | CET1 | | BAE940A | CLS082 |
| 1.2 | 4 | 169A4.000 | 51/68 | 10/09→02/12 | OE196 | 1,0 | CET1 | | BAE940A | CLS082 |
| 1.3 D Multijet | 4 | 199B2.000 | 51/68 | 07/08→02/12 | | | | | CCU150 ^[53] | |
| 1.3 D Multijet | 4 | 199A2.000; 199A9.000 | 55/74 | 10/09→02/12 | | | | | CCU150 ^[53] | |
| 1.3 D Multijet | 4 | 199B4.000; 223A9.000 | 62/83 | 10/09→02/12 | | | | | CCU150 ^[53] | |
| 1.3 D Multijet | 4 | 199A3.000 | 66/89 | 10/09→ | | | | | CCU150 ^[53] | |
| 1.3 D Multijet | 4 | 199B1.000 | 70/94 | 10/09→02/12 | | | | | CCU150 ^[53] | |
| 1.4 | 4 | 199A7.000 | 55/74 | 07/09→02/12 | OE196 | 1,0 | CET1 | | BAE940A | |
| 1.4 | 4 | 350A1.000 | 57/76 | 10/09→02/12 | OE196 | 1,0 | CET1 | | BAE940A | CLS082 |
| 1.4 16V | 4 | 955A6.000 | 77/103 | 10/09→02/12 | OE196 | 1,0 | CET1 | | | |
| 1.4 16V | 4 | 955A2.000 | 99/133 | 10/09→02/12 | OE208 | 0,8 | | | | |
| 1.4 LPG, 1.4 Natural Power | 4 | 350A1.000 | 57/76 | 06/09→02/12 | OE196 | 1,0 | CET1 | | BAE940A | |

FIAT





kW/BHP

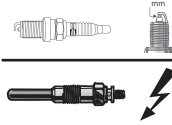

eon TITAN

IRIDIUM

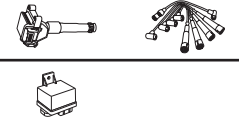

...FIAT

QUBO

| | | | | | | | | | |
|-------------------|---|----------------------|-------|--------|-------|-----|------|-------|-------------------------|
| 1.3 D Multijet | 4 | 199A2.000; 199A9.000 | 55/74 | 02/08→ | | | | | CCU150 ^[267] |
| 1.3 D Multijet | 4 | 199B1.000 | 70/94 | 07/10→ | | | | | CCU150 ^[267] |
| 1.4 | 4 | KFT; KFV | 54/72 | 02/08→ | OE034 | 0,9 | CET2 | OE179 | BAEA048E ^[7] |
| 1.4 Natural Power | 4 | 350A1.000 | 57/76 | 10/09→ | OE196 | 1,0 | CET1 | | BAE940A |

SCUDO

| | | | | | | | | | | |
|------------------------------------|---|---------------------|---------|-------------|--|-----|------|-------|------------------------|-------------------------------------|
| 1.6 | 4 | 220A2.000 | 58/78 | 02/96→12/06 | | | CET2 | OE179 | BAEA234 | CLS135 |
| 1.6 D Multijet | 4 | 9HU | 66/89 | 01/07→ | CH201 | 11v | | | CCU147 ^[21] | |
| 1.9 D | 4 | WJZ(DW8) | 51/68 | 02/96→12/06 | CH185 | 11v | | | | |
| 1.9 D | 4 | D9B | 51/68 | 02/96→12/06 | CH189 | 11v | | | | |
| 1.9 TD | 4 | D8B | 68/91 | 02/96→12/06 | CH189 | 11v | | | CCU149 | 12/99→ Ch.0008420→ [52] [319] |
| 1.9 TD Eco | 4 | DHX(XUD9TF/L) | 66/89 | 02/96→12/06 | CH189 | 11v | | | CCU149 | 12/99→ Ch.0008420→ [52] [319] |
| 2.0 16V | 4 | RFN(EW10J4) | 100/134 | 06/00→12/06 | OE178 | 0,9 | CET5 | | BAEA348 | |
| 2.0 D Multijet | 4 | RHR | 100/134 | 01/07→ | CH268 | 11v | | | CCU147 | |
| 2.0 D Multijet | 4 | RH02; RHH | 120/161 | 07/10→ | CH268 | 11v | | | CCU147 | |
| 2.0 D Multijet, 2.0 D Multijet 4WD | 4 | RHK | 88/118 | 01/07→ | CH268 | 11v | | | CCU147 | |
| 2.0 D Multijet, 2.0 D Multijet 4WD | 4 | RH02 | 94/126 | 04/11→ | CH268 | 11v | | | CCU147 | |
| 2.0 JTD | 4 | RHX | 69/93 | 01/04→12/06 | CH170 | 11v | | | | |
| 2.0 JTD, 2.0 JTD 16V | 4 | RHW(DW10ATED4); RHZ | 80/107 | 05/99→12/06 | CH170 ^[172] CH268 ^[173] | 11v | | | | |

SEDICI

| | | | | | | | | | | |
|------------------------------------|---|-------|--------|-------------|-------|-----|------|-------|----------|--------|
| 1.6 16V | 4 | M16A | 79/106 | 06/06→10/14 | OE016 | 0,9 | | | BAEA181E | CLS167 |
| | | | | | | | | | →06/09 | →06/09 |
| 1.6 16V | 4 | M16A | 88/118 | 06/06→10/14 | OE016 | 0,9 | CET2 | | BAEA181E | CLS167 |
| | | | | | | | | | →06/09 | →06/09 |
| 1.6 16V 4WD | 4 | M16A | 79/106 | 06/06→10/14 | OE016 | 0,9 | CET2 | OE180 | BAEA181E | CLS167 |
| | | | | | | | | | →06/09 | →06/09 |
| 1.6 16V 4WD | 4 | M16A | 88/118 | 06/06→10/14 | OE016 | 0,9 | CET2 | OE180 | BAEA181E | CLS167 |
| | | | | | | | | | →06/09 | →06/09 |
| 1.9 D Multijet, 1.9 D Multijet 4WD | 4 | D19AA | 88/118 | 06/06→10/11 | CH222 | 11v | | | | |

SEICENTO / 600

| | | | | | | | | | | |
|-----|---|----------------------|-------|-------------|------------------------------------|------------|----------------------------------|-----------------|---------|--------|
| 0.9 | 4 | 1170A1.046 | 29/39 | 11/97→12/08 | OE004 | 0,9 | CET8 | OE195 | BAE800B | CLS003 |
| 1.1 | 4 | 176B2.000; 187A1.000 | 40/54 | 01/98→01/10 | OE002 →10/04 OE196 11/04→ | 0,9 1,0 | CET2 →10/04 CET1 11/04→ | OE180 →10/04 | BAE800B | CLS261 |

SIENA

| | | | | | | | | | | |
|-------------|---|-----------|-------|-------------|-------------------------------------|-----|------|-------|---------|-------------|
| 1.2 | 4 | 178C4.066 | 44/59 | 09/01→12/12 | OE016 | 0,9 | CET2 | OE180 | BAE800B | CLS067 |
| 1.2 | 4 | 188A4.000 | 44/59 | 09/01→12/12 | OE016 OE230 LPG ^[278] | 0,9 | CET2 | OE180 | BAE800B | CLS067 |
| 1.2 | 4 | 178E9.011 | 52/70 | 06/04→12/09 | | | | | BAE800B | |
| 1.2 | 4 | 178B5.000 | 54/72 | 09/98→12/09 | OE016 | 0,9 | CET2 | OE180 | BAE800B | |
| 1.2 | 4 | 188A5.000 | 59/79 | 09/01→12/09 | OE196 | 1,0 | CET1 | | BAEA234 | CLS044 |
| 1.2 Flex | 4 | 178E9.011 | 52/70 | 03/04→05/05 | OE196 | 1,0 | CET1 | | | |
| 1.3 JTD | 4 | 188A9.000 | 51/68 | 09/03→ | | | | | CCU150 | |
| 1.4 | 4 | 178B2.000 | 51/68 | 04/96→12/09 | OE002 | 0,9 | CET2 | OE180 | BAE800B | 03/00→06/01 |
| 1.4 | 4 | 350A1.000 | 57/76 | 01/07→ | OE196 | 1,0 | CET1 | | BAE940A | |
| 1.4 | 4 | 178F3.011 | 57/76 | 01/07→ | OE196 | 1,0 | CET1 | | BAE940A | |
| 1.4 Bipower | 4 | 178F3.011 | 60/80 | 06/04→10/07 | OE196 | 1,0 | CET1 | | | |

FIAT





kW/BHP

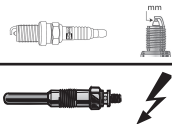

eon TITAN

IRIDIUM



...FIAT

...SIENA

| | | | | | | | | | | |
|-------------|---|-------------|--------|-------------|-------|-----|------|-------|------------------------|--------|
| 1.4 Cat | 4 | 178B2.016 | 51/68 | 04/96→12/09 | OE019 | 0,9 | CET2 | OE184 | BAE800B 05/98→06/01 | |
| 1.6 | 4 | 182B6.000 | 76/102 | 11/00→12/09 | OE030 | 0,9 | CET2 | OE179 | BAE920AX | CLS137 |
| 1.6 16V | 4 | 178B3.000 | 78/105 | 10/97→12/09 | OE016 | 0,9 | CET2 | OE180 | BAE920AX | |
| 1.7 TD | 4 | 176A3.000 | 51/68 | 02/06→12/09 | CH189 | 11v | | | CCU153 | |
| 1.8 Bipower | 4 | 93313090-7U | 81/109 | 06/04→12/09 | OE089 | 1,0 | CET2 | | | |

STILO

| | | | | | | | | | | |
|----------------|---|----------------------|---------|-------------|--------------------------|------------|------|-------|-------------------|--|
| 1.2 16V | 4 | 188A5.000 | 59/79 | 02/02→11/06 | OE196 OE230 LPG [278] | 1,0 0,9 | CET1 | | BAE403C | |
| 1.4 16V | 4 | 192B2.000 | 66/89 | 03/05→08/08 | OE196 OE230 LPG [278] | 1,0 0,9 | CET1 | | BAE403C | |
| 1.4 16V | 4 | 843A1.000 | 70/94 | 01/04→08/08 | OE196 OE230 LPG [278] | 1,0 0,9 | CET1 | | BAE403C | |
| 1.6 16V | 4 | 182B6.000 | 76/102 | 10/01→08/08 | OE016 | 0,9 | CET2 | OE180 | BAE403B | |
| 1.6 16V | 4 | 192B3.000 | 77/103 | 03/05→12/07 | OE089 | 1,0 | CET2 | OE188 | BAEA427 | |
| 1.8 16V | 4 | 192A4.000 | 98/131 | 10/01→08/08 | OE016 | 0,9 | CET2 | OE180 | | |
| 1.9 D, 1.9 JTD | 4 | 192B5.000 | 66/89 | 09/04→08/08 | CH269 | 11v | | | CCU150 | |
| 1.9 D Multijet | 4 | 192A9.000 | 74/99 | 09/05→08/08 | CH222 | 11v | | | CCU150 | |
| 1.9 D Multijet | 4 | 192A8.000 | 88/118 | 09/05→08/08 | CH269 | 11v | | | | |
| 1.9 D Multijet | 4 | 937A5.000 | 110/148 | 09/05→08/08 | CH224 | 11v | | | CCU150 | |
| 1.9 JTD | 4 | 192A3.000 | 59/79 | 02/02→08/08 | CH222 | 11v | | | CCU150 | |
| 1.9 JTD | 4 | 192A1.000; 937A7.000 | 85/114 | 10/01→08/08 | CH222 | 11v | | | CCU150 | |
| 1.9 JTD | 4 | 937A4.000 | 93/125 | 09/03→08/08 | CH224 | 11v | | | CCU150 | |
| 1.9 JTD | 4 | 192B1.000 | 100/134 | 04/04→08/08 | CH224 | 11v | | | | |
| 1.9 JTD | 4 | 192A5.000 | 103/138 | 01/04→08/08 | CH224 | 11v | | | CCU150 | |
| 2.4 20V | 5 | 192A2.000 | 125/168 | 10/01→04/07 | OE216 LPG [278] | 0,8 | CET2 | OE179 | BAE403D →12/03 | |

STRADA

| | | | | | | | | | | |
|----------------|---|-----------|-------|-------------|---|-------------------|----------------------------------|-----------------|----------------------|--------|
| 1.2 | 4 | 188A4.000 | 44/59 | 04/03→ | OE016 →09/04 OE196 10/04→ OE230 LPG [278] | 0,9 1,0 0,9 | CET2 →09/04 CET1 10/04→ | OE180 →09/04 | BAE800B | CLS067 |
| 1.2 | 4 | 178B5.000 | 54/72 | 06/99→12/06 | OE063 | 1,0 | CET2 | OE180 | BAE800B | CLS261 |
| 1.3 D Multijet | 4 | 223A9.000 | 62/83 | 05/06→ | | | | | CCU150 [59] [295] | |
| 1.7 TD | 4 | 176A3.000 | 51/68 | 06/99→12/06 | CH189 | 11v | | | CCU153 | |
| 1.9 D | 4 | 223A6.000 | 46/62 | 12/00→ | CH209 | 11v | | | | |
| 1.9 JTD | 4 | 188A2.000 | 59/79 | 04/03→ | CH222 | 11v | | | | |

TEMPRA

| | | | | | | | | | | |
|----------|---|-----------|--------|-------------|-------|-----|------|-------|---------|--------|
| 1.6 i.e. | 4 | 159B9.000 | 63/84 | 06/94→08/96 | | | CET2 | OE179 | | CLS135 |
| 1.6 i.e. | 4 | 159B9.000 | 66/89 | 06/94→08/96 | | | CET2 | OE179 | BAEA234 | CLS135 |
| 1.8 i.e. | 4 | 835C4.000 | 66/89 | 09/93→08/96 | OE018 | 1,0 | CET8 | OE195 | BAE800B | |
| 1.8 i.e. | 4 | 836A5.000 | 74/99 | 10/94→08/96 | OE018 | 1,0 | CET8 | OE195 | BAE800B | |
| 1.8 i.e. | 4 | 835C2.000 | 76/102 | 09/93→08/96 | OE018 | 1,0 | CET8 | OE195 | BAE800B | |
| 2.0 | 4 | 159A6.046 | 81/109 | 05/94→12/98 | | | | | BAE800B | |

TIPO

| | | | | | | | | | | |
|--------------------|---|------------------------------------|---------|-------------|-------|-----|------|-------|--------------|--------|
| 1.6 | 4 | 159A3.046; 159A3.048; 835C1.000 | 56/75 | 03/93→10/95 | OE005 | 0,9 | CET2 | | BAEA234[139] | |
| 1.8 i.e | 4 | 836A5.000 | 71/95 | 03/93→04/95 | OE018 | 1,0 | CET8 | OE195 | BAE800B | |
| 1.8 i.e. | 4 | 835C4.000 | 66/89 | 09/93→04/95 | OE018 | 1,0 | CET8 | OE195 | BAE800B | CLS002 |
| 1.8 i.e. | 4 | 159A4.000; 836A5.000 | 74/99 | 10/94→10/95 | OE018 | 1,0 | CET8 | OE195 | BAE800B | |
| 1.8 i.e. | 4 | 835C2.000 | 76/102 | 04/93→04/95 | OE018 | 1,0 | CET8 | OE195 | BAE800B | |
| 2.0 | 4 | 836A3.011 | 104/139 | 03/93→04/95 | OE018 | 1,0 | CET8 | | | |
| 2.0 i.e. 16V Sport | 4 | 836A3.000 | 102/137 | 03/93→04/95 | OE018 | 1,0 | CET8 | OE195 | | |

CHAMPION



kW/BHP

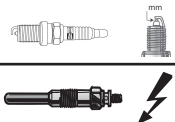

eon TITAN

IRIDIUM

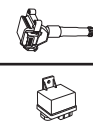

...FIAT

ULYSSE

| | | | | | | | | | |
|----------------------|---|---------------------|---------|-------------|-----------------|-----|--------|-------|-------------------------|
| 1.8 | 4 | LFW | 73/98 | 05/97→08/02 | OE019 | 0,9 | CET2 | OE184 | CLS005 |
| 1.9 TD | 4 | DHX(XUD9TF/L) | 66/89 | 02/95→08/02 | CH189 | 11v | | | |
| 2.0 | 4 | RFU(XU10J2C) | 89/119 | 06/94→08/02 | OE014 | 0,9 | CET2 | OE179 | CLS005 |
| 2.0, 2.0 16V | 4 | RFN(EW10J4) | 100/134 | 09/00→06/11 | OE178 | 0,9 | CET5 | | BAEA348 |
| 2.0 16V | 4 | RFV | 97/130 | 05/98→09/00 | OE014 | 0,9 | CET2 | OE179 | |
| 2.0 D Multijet | 4 | RHK | 88/118 | 05/06→06/11 | CH268 [173] | 11v | | | |
| 2.0 D Multijet | 4 | RHR | 100/134 | 05/06→06/11 | CH268 | 11v | | | |
| 2.0 JTD | 4 | RHM(DW10ATED4) | 79/106 | 05/03→08/06 | CH170 [172] | 11v | | | |
| | | | | | CH268 [173] | 11v | | | |
| 2.0 JTD | 4 | RHZ | 80/107 | 10/99→08/06 | CH170 | 11v | | | |
| 2.0 JTD, 2.0 JTD 16V | 4 | RHW(DW10ATED4) | 80/107 | 05/99→08/06 | CH170 [172] | 11v | | | |
| | | | | | CH268 [173] | 11v | | | |
| 2.0 Turbo | 4 | RGX(XU10J2CTE) | 108/145 | 06/94→08/02 | OE034 →05/00 | 0,9 | CET2 | OE188 | CLS005 |
| 2.1 TD | 4 | P8C | 80/107 | 03/96→10/99 | CH189 | 11v | | | |
| 2.2 D Multijet | 4 | 4HS; 4HT(DW12BTED4) | 125/168 | 03/08→06/11 | | | | | CCU147 ^[285] |
| 2.2 JTD | 4 | 4HW(DW12ATED4) | 94/126 | 08/02→08/06 | CH170 [172] | 11v | | | CCU147 ^[285] |
| | | | | | CH268 [173] | 11v | | | |
| 2.2 JTD | 4 | 4HP; 4HR | 120/161 | 03/08→06/11 | | | | | CCU147 ^[285] |
| 3.0 | 6 | XFW | 150/201 | 08/02→06/11 | OE175 | 1,0 | CET14P | OE190 | BAEA347 |

UNO

| | | | | | | | | | |
|--------|---|-----------|-------|-------------|-------|-----|------|-------|--------------------------|
| 1.0 iE | 4 | 156A2.246 | 34/46 | 05/98→08/00 | OE005 | 0,9 | CET2 | OE180 | BAE506D ^[292] |
| 1.7 D | 4 | 146B2.000 | 43/58 | 11/94→08/00 | CH189 | 11v | | | |

FIAT

DOBLO

| | | | | | | | | | | |
|----------------------|---|----------------------|--------|-------------|----------------------------|-----|------|---------|---------------------------------|--------|
| 1.2 | 4 | 223A5.000 | 48/64 | 03/01→ | OE016 | 0,9 | CET2 | OE180 | BAE800B | CLS067 |
| 1.3 D Multijet | 4 | 263A6.000 | 55/74 | 10/05→ | | | | | CCU150 ^{[22] [298]} | |
| 1.3 D Multijet | 4 | 199A2.000 | 55/74 | 10/05→ | | | | | CCU150 | |
| 1.3 D Multijet | 4 | 199A3.000; 263A2.000 | 66/89 | 02/10→ | | | | | CCU150 ^{[22] [298]} | |
| 1.3 JTD 16V | 4 | 188A8.000; 188A9.000 | 51/68 | 05/04→12/06 | | | | | CCU150 | |
| 1.3 JTD 16V Multijet | 4 | 223A9.000 | 62/83 | 08/06→ | | | | | CCU150 | |
| 1.4 | 4 | 350A1.000 | 57/76 | 10/05→ | OE196 | 1,0 | CET1 | BAE940A | CLS082 | |
| 1.4 | 4 | 843A1.000 | 70/94 | 02/10→ | OE196 | 1,0 | CET1 | BAE403C | | |
| | | | | | OE230 LPG ^[278] | 0,9 | | | | |
| 1.4 | 4 | 198A4.000 | 88/118 | 10/11→ | OE208 | 0,8 | | BAE403C | | |
| 1.4 Natural Power | 4 | 198A4.000 | 88/118 | 06/10→ | OE208 | 0,8 | | BAEA095 | | |
| 1.6 16V | 4 | 182B6.000 | 76/102 | 10/01→ | OE016 | 0,9 | CET2 | OE180 | BAE403B | |
| 1.6 Natural Power | 4 | 182B6.000 | 76/102 | 09/02→ | OE016 | 0,9 | CET2 | OE180 | BAE920AX | |
| 1.9 D | 4 | 223A6.000 | 46/62 | 03/01→ | CH209 | 11v | | | | |
| 1.9 JTD | 4 | 182B9.000 | 74/99 | 10/01→ | CH222 | 11v | | | CCU150 | |
| 1.9 JTD | 4 | 223A7.000; 223B1.000 | 77/103 | 07/03→ | CH222 | 11v | | | CCU150 | |
| 1.9 JTD Multijet | 4 | 186A9.000 | 88/118 | 12/06→ | CH269 →12/10 | 11v | | | CCU150 | |

DUCATO

| | | | | | | | | | | |
|------------------------------|---|----------------------|--------|-------------|-------|-----|------|-------|---------|--------|
| 1.9 D | 4 | D9B; D9B(XUD9A); DJY | 50/67 | 04/98→04/02 | CH185 | 11v | | | | |
| 1.9 TD | 4 | DHX(XUD9TF/L) | 66/89 | 04/98→04/02 | CH189 | 11v | | | | |
| 1.9 TD CAT, 1.9 TD Combinato | 4 | 230A4.000 | 59/79 | 08/94→04/02 | CH189 | 11v | | | | |
| 2.0, 2.0 Bipower | 4 | RFL(XU10J2U) | 81/109 | 04/02→ | OE002 | 0,9 | CET2 | OE180 | BAEA232 | CLS123 |
| 2.0, 2.0 Panorama/Combinato | 4 | RFW | 80/107 | 03/94→04/02 | OE002 | 0,9 | CET2 | OE180 | CLS123 | |
| 2.0 4WD | 4 | RFW | 80/107 | 11/94→04/02 | OE002 | 0,9 | CET2 | OE179 | BAEA232 | CLS123 |
| 2.0 4WD | 4 | RFL(XU10J2U) | 81/109 | 05/02→07/06 | OE002 | 0,9 | CET2 | OE179 | BAEA232 | |
| | | | | | | | | OE180 | | |

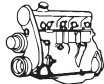

kW/BHP

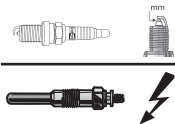

eon TITAN

IRIDIUM



...FIAT

...DUCATO

| | | | | | | | | | |
|--|---|--|---------|-------------|-------|-------|------|-------|---------|
| 2.0 JTD | 4 | RHV(DW10) | 62/83 | 07/01→ | CH170 | 11v | | | |
| 2.2 100 Multijet 2, 2 D | 4 | 4HV(P22DTE) | 74/99 | 07/06→ | CH229 | 11.5v | | | |
| 2.3 110 Multijet 2, 3 D | 4 | F1AE3481G | 83/111 | 10/11→ | CH270 | 11v | | | |
| 2.3 120 Multijet 2, 3 D, 2.3 120 Multijet 2, 3 D 4WD | 4 | F1AE0481D; FPT | 88/118 | 07/06→ | CH270 | 11v | | | |
| 2.3 130 Multijet 2, 3 D | 4 | F1AE0481T | 93/125 | 08/06→ | CH270 | 11v | | | |
| 2.3 130 Multijet 2, 3 D | 4 | F1AE0481N; F1AE3481D; F1AGL411D; F1AGL411M | 96/129 | 07/06→ | CH270 | 11v | | | |
| 2.3 150 Multijet 2, 3 D | 4 | F1AE3481E | 109/146 | 06/11→ | CH270 | 11v | | | |
| 2.3 JTD | 4 | F1AE0481C | 81/109 | 04/02→ | CH270 | 11v | | | CCU150 |
| 2.5 D, 2.5 D 4WD, 2.5 D Combinato | 4 | 8140.67 | 62/83 | 03/94→04/02 | CH147 | 11.5v | | | |
| 2.8 D, 2.8 D 4WD, 2.8 TD 4WD | 4 | 8140.63 | 64/86 | 02/98→04/02 | CH216 | 11v | | | |
| 2.8 iDTD 4WD, 2.8 TD 4WD, 2.8 TDI, 2.8 TDI 4WD | 4 | 8140.43 | 90/121 | 10/97→07/06 | CH216 | 11v | | | |
| 2.8 JTD, 2.8 JTD 4WD | 4 | 8140.43S | 94/126 | 11/00→ | CH216 | 11v | | | |
| 2.8 JTD, 2.8 JTD Power | 4 | 8140.43N | 107/143 | 04/04→ | CH216 | 11v | | | |
| 3.0 140 Natural Power | 4 | F1CE0441A; F1CFA401A | 100/134 | 04/09→ | OE077 | 1,0 | CET2 | OE179 | BAE403C |
| 3.0 150 Multijet 3, 0 D | 4 | F1CE3481N | 107/143 | 04/10→ | CH270 | 11v | | | |
| 3.0 160 Multijet 3, 0 D | 4 | F1CE0481D; F1CE3481M | 115/154 | 07/06→ | CH270 | 11v | | | |
| 3.0 160 Multijet 3, 0 D | 4 | F1CE0481D | 116/156 | 07/06→ | CH270 | 11v | | | |
| 3.0 180 Multijet 3, 0 D | 4 | F1CE3481E | 130/174 | 06/11→ | CH270 | 11v | | | |

FIORINO

| | | | | | | | | | |
|-----------------------|---|----------------------|-------|-------------|-------|-----|------|-------|---|
| 1.3 D Multijet | 4 | 199A2.000; 199A9.000 | 55/74 | 11/07→ | | | | | CCU150 ^[267] |
| 1.3 D Multijet | 4 | 199B1.000; 330A1.000 | 70/94 | 07/09→ | | | | | CCU150 ^[267] |
| 1.4 | 4 | KFT; KFV | 54/72 | 11/07→ | OE034 | 0,9 | CET2 | OE179 | BAEA048E ^[7] |
| 1.4 70 i.e. | 4 | 146C5.000; 146D5.000 | 49/66 | 05/94→05/01 | OE006 | 0,9 | CET8 | OE195 | BAE506F ^[292] →05/95 BAE234 06/95→ BAE504D |
| 1.4 Natural Power | 4 | 350A1.000 | 57/76 | 06/08→ | OE196 | 1,0 | CET1 | | BAE940A |
| 1.6 75 i.e. | 4 | 146C6.000; 146D6.000 | 55/74 | 10/93→05/01 | OE008 | 0,9 | CET8 | OE195 | BAE234 06/95→ BAE504D |
| | | | | | OE018 | 1,0 | | | |
| 1.7 65 1.7 TD, 1.7 TD | 4 | 146D7.000 | 46/62 | 11/96→05/01 | CH189 | 11v | | | CCU153 |

PANDA

| | | | | | | | | | |
|----------------------------|---|-----------|-------|-------------|-------------------------------------|------------|--------------|-------|-------------------|
| 1.1 | 4 | 187A1.000 | 40/54 | 09/00→ | OE016 OE196 | 0,9 1,0 | CET1 CET2 | OE180 | BAE800B |
| 1.1 4WD | 4 | 187A1.000 | 40/54 | 09/00→02/04 | | | | | BAE800B |
| 1.2, 1.2 4WD | 4 | 188A4.000 | 44/59 | 09/04→ | OE196 | 1,0 | CET1 | | BAE800B CLS261 |
| 1.2, 1.2 4WD | 4 | 169A4.000 | 51/68 | 09/10→ | OE196 | 1,0 | CET1 | | CLS082 |
| 1.2 LPG | 4 | 169A4.000 | 51/68 | 09/10→ | OE196 | 1,0 | CET1 | | |
| 1.2 LPG, 1.2 Natural Power | 4 | 188A4.000 | 44/59 | 01/07→ | OE196 | 1,0 | CET1 | | BAE800B |
| 1.3 D Multijet | 4 | 188A8.000 | 51/68 | 03/04→ | | | | | CCU150 |
| 1.3 D Multijet | 4 | 169A1.000 | 55/74 | 01/06→ | | | | | CCU150 |
| 1.3 D Multijet 4WD | 4 | 169A1.000 | 55/74 | 01/06→ | | | | | CCU150 |
| 1.4 Natural Power | 4 | 350A1.000 | 57/76 | 10/09→ | OE196 OE230 ^{LPG [278]} | 1,0 0,9 | CET1 | | BAE403C |

PANDA VAN

| | | | | | | | | | |
|---------------------------------|---|----------------------|-------|--------|-------|-----|--------|--|---------|
| 0.9 | 2 | 312A4.000 | 48/64 | 02/12→ | OE232 | 0,7 | CET15P | | BAEA090 |
| 0.9, 0.9 4WD, 0.9 Natural Power | 2 | 312A2.000 | 63/84 | 02/12→ | OE232 | 0,7 | CET15P | | BAEA090 |
| 0.9, 0.9 Natural Power | 2 | 312A2.000; 312A5.000 | 59/79 | 12/13→ | OE232 | 0,7 | CET15P | | BAEA090 |
| 1.2, 1.2 LPG | 4 | 169A4.000 | 51/68 | 02/12→ | OE196 | 1,0 | CET1 | | BAE403C |





kW/BHP

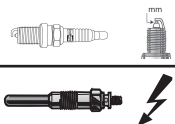

eon TITAN

IRIDIUM

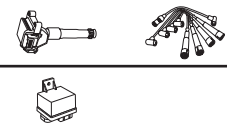

...FIAT

PUNTO

| | | | | | | | | | | |
|----------------------------|---|-----------|-------|-------------|--|----------------|--------|-------|------------------------|--|
| 0.9 Twinair Turbo | 2 | 312A2.000 | 63/84 | 03/12→ | OE232 | 0,7 | CET15P | | | |
| 1.1 | 4 | 176B2.000 | 40/54 | 04/96→02/00 | OE002 | 0,9 | CET2 | OE180 | BAE800B | CLS261 |
| 1.2 60 | 4 | 188A4.000 | 44/59 | 02/00→10/09 | OE016 | 0,9 | CET2 | OE180 | BAE800B | CLS261 →01/03 CLS067 02/03→ →Eng.2935743 |
| 1.3 D Multijet | 4 | 199B4.000 | 62/83 | 03/12→ | | | | | CCU150 ^[21] | |
| 1.3 D Multijet | 4 | 199B1.000 | 70/94 | 03/09→ | | | | | CCU150 ^[53] | |
| 1.4 | 4 | 350A1.000 | 57/76 | 02/06→ | OE196 | 1,0 | CET1 | | BAE940A | CLS082 |
| 1.4 LPG, 1.4 Natural Power | 4 | 350A1.000 | 57/76 | 03/09→ | OE196 | 1,0 | CET1 | | BAE940A | |
| 1.7 D | 4 | 176B3.000 | 42/56 | 04/96→02/00 | CH189 | 11v | | | CCU153 | |
| 1.7 TD | 4 | 176B7.000 | 46/62 | 09/96→09/99 | CH189 | 11v | | | | |
| 1.7 TD | 4 | 176A5.000 | 52/70 | 04/96→02/00 | CH189 | 11v | | | CCU153 | |
| 1.9 D 60 | 4 | 188A3.000 | 44/59 | 02/00→10/09 | CH209 | 11v | | | | |
| 1.9 JTD | 4 | 188A7.000 | 63/84 | 02/00→10/09 | CH222 [47] [310] CH269 [48] [311] | 11v 11v | | | CCU150 | |

SCUDO

| | | | | | | | | | | |
|------------------------------------|---|--|---------|-------------|------------------------|-----|------|-------|---|--------|
| 1.6 | 4 | 220A2.000 | 58/78 | 02/96→12/06 | | | CET2 | OE179 | BAEA234 | CLS135 |
| 1.6 D Multijet | 4 | 9HU | 66/89 | 01/07→ | CH201 | 11v | | | CCU147 ^[21] | |
| 1.9 D | 4 | WJY(DW8B); WJZ(DW8) | 51/68 | 02/96→12/06 | CH185 | 11v | | | | |
| 1.9 D | 4 | D9B | 51/68 | 02/96→12/06 | CH189 | 11v | | | | |
| 1.9 TD | 4 | DHX(XUD9TF/L) | 66/89 | 02/96→12/06 | CH189 | 11v | | | CCU149 12/99→ Ch.0008420→ [52] [319] | |
| 1.9 TD | 4 | D8B | 68/91 | 09/96→12/06 | CH189 | 11v | | | CCU149 12/99→ Ch.0008420→ [52] [319] | |
| 2.0 | 4 | RFN(EW10J4) | 100/134 | 05/00→12/06 | OE178 | 0,9 | CET5 | | BAEA348 | |
| 2.0 D Multijet | 4 | RH02 | 94/126 | 05/11→ | CH268 | 11v | | | CCU147 | |
| 2.0 D Multijet | 4 | DW10BTED4; RHR | 100/134 | 01/07→ | CH268 | 11v | | | CCU147 | |
| 2.0 D Multijet | 4 | RH02; RHH | 120/161 | 07/10→ | CH268 | 11v | | | CCU147 | |
| 2.0 D Multijet, 2.0 D Multijet 4WD | 4 | RHK | 88/118 | 01/07→ | CH268 | 11v | | | CCU147 | |
| 2.0 JTD | 4 | RHX | 69/93 | 10/99→12/06 | CH170 | 11v | | | | |
| 2.0 JTD | 4 | RHZ | 80/107 | 12/02→12/06 | CH170 | 11v | | | | |
| 2.0 JTD 16V | 4 | RHK(DW10UTED4); RHM(DW10ATED4); RHW(DW10ATED4) | 80/107 | 05/99→12/06 | CH170 ^[172] | 11v | | | | |
| | | | | | CH268 ^[173] | 11v | | | | |

SEICENTO / 600

| | | | | | | | | | | |
|-----|---|------------|-------|-------------|-------|-----|------|-------|---------|--------|
| 0.9 | 4 | 1170A1.046 | 29/39 | 01/98→01/10 | OE004 | 0,9 | CET8 | OE195 | BAE800B | CLS003 |
| 1.1 | 4 | 176B2.000 | 40/54 | 01/98→01/10 | OE002 | 0,9 | CET2 | OE180 | BAE800B | CLS067 |

FORD

BANTAM

| | | | | | | | | | | |
|-----|---|------|-------|-------------|-------|-----|--------|--|---------|--|
| 1.3 | 4 | A9JD | 55/74 | 11/94→ | | | | | BAEA422 | |
| 1.6 | 4 | | 70/94 | 09/06→ | | | | | BAEA422 | |
| 1.6 | 4 | | 74/99 | 09/01→08/06 | OE029 | 1,0 | CET17P | | | |

B-MAX

| | | | | | | | | | | |
|---------|---|------------|--------|--------|-------|-----|--------|-------|---------|--|
| 1.4 | 4 | SPJD; SPJE | 66/89 | 10/12→ | OE131 | 1,0 | CET18P | OE183 | BAEA387 | |
| 1.4 LPG | 4 | RTJC | 64/86 | 08/13→ | OE031 | 1,0 | CET7 | | | |
| 1.4 LPG | 4 | RTJC | 66/89 | 08/13→ | OE031 | 1,0 | CET7 | | | |
| 1.6 Ti | 4 | IQJA | 77/103 | 10/12→ | OE131 | 1,0 | CET18P | OE183 | BAEA387 | |

FORD



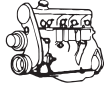

kW/BHP

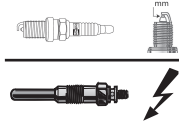

eon TITAN

IRIDIUM

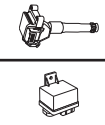

FORD

| ...FORD | | | | | | | | | | |
|-----------------------|---|------------------------------|---------|-------------|--------------------------|------------|--------|-------|--|--|
| C-MAX | | | | | | | | | | |
| 1.6 | 4 | HWDA; HWDB; SHDA; SHDB; SHDC | 74/99 | 02/07→09/10 | OE031 | 1,0 | CET7 | OE189 | BAEA387 →07/10 | CLS077 →Prod.26.03.2007 CLS089 Prod.26.03.2007→ |
| 1.6 | 4 | HXDA; HXDB; SIDA | 85/114 | 04/07→09/10 | | | | | BAEA387 | CLS089 |
| 1.6 TDCi | 4 | HHDA; HHDB | 66/89 | 02/07→09/10 | CH201 | 11v | | | | |
| 1.6 TDCi | 4 | G8DC; MTDA | 74/99 | 02/07→09/10 | CH201 →07/10 | 11v | | | | |
| 1.6 TDCi | 4 | G8DA; G8DB; G8DD | 80/107 | 02/07→09/10 | CH201 | 11v | | | | |
| 1.8 | 4 | QQDC | 90/121 | 02/07→09/10 | | | CET18P | OE183 | BAEA408 | |
| 1.8, 1.8 Flexifuel | 4 | Q7DA; QQDA; QQDB | 92/123 | 02/07→09/10 | OE131 | 1,0 | CET18P | OE183 | BAEA408 | |
| 1.8 TDCi | 4 | KKDA | 85/114 | 02/07→09/10 | CH196 | 10v | | | | |
| 2.0, 2.0 CNG, 2.0 LPG | 4 | AODA; AODB; AODE; SYDA | 107/143 | 02/07→09/10 | OE131 | 1,0 | CET18P | OE183 | BAEA408 | |
| 2.0 TDCi | 4 | IXDA | 81/109 | 02/08→09/10 | CH268 | 11v | | | | |
| 2.0 TDCi | 4 | G6DC; G6DE; G6DF | 98/131 | 02/07→09/10 | CH268 | 11v | | | | |
| 2.0 TDCi | 4 | G6DA; G6DB; G6DD; G6DG | 100/134 | 02/07→09/10 | CH268 | 11v | | | | |
| C-MAX II | | | | | | | | | | |
| 1.6 EcoBoost | 4 | JQDA; JQDB | 110/148 | 12/10→ | | | | | BAEA387 | |
| 1.6 EcoBoost | 4 | JTDA; JTDB | 134/180 | 12/10→ | | | | | BAEA387 | |
| 1.6 Flexifuel | 4 | MUDA | 88/118 | 02/11→ | | | | | BAEA387 | |
| 1.6 Ti | 4 | XTDA | 63/84 | 12/10→ | OE131 | 1,0 | CET18P | OE183 | | |
| 1.6 Ti | 4 | IQDA; IQDB | 77/103 | 12/10→ | OE031 | 1,0 | CET7 | OE189 | BAEA387 →05/11 | CLS089 |
| 1.6 Ti | 4 | PNDA | 92/123 | 12/10→ | OE031 | 1,0 | CET7 | OE189 | BAEA387 →05/11 | CLS089 |
| COUGAR | | | | | | | | | | |
| 2.0 16V | 4 | EDBA; EDBB; EDBC; EDBD | 96/129 | 08/98→12/01 | OE029 OE031 | 1,0 1,0 | CET17P | OE189 | BAEA350 | CLS016 [275] |
| 2.5 V6 24V | 6 | LCBB; LCBC; LCBE | 125/168 | 08/98→12/01 | OE131 | 1,0 | CET18P | OE183 | | CLS156 09/00→ |
| 2.5 V6 24V | 6 | LCBA | 125/168 | 08/98→12/01 | OE131 | 1,0 | CET18P | OE183 | BAEA372 10/00→ | CLS156 09/00→ |
| 2.5 ST 200 | 6 | SGA | 151/202 | 01/00→12/01 | OE131 | 1,0 | CET18P | OE183 | | CLS156 09/00→ |
| ECOSPORT | | | | | | | | | | |
| 2.0 4WD | 4 | | 105/141 | 04/04→ | | | | | BAEA422 | |
| ESCORT CLASSIC | | | | | | | | | | |
| 1.6 16V | 4 | L1E | 66/89 | 10/98→07/00 | OE029 | 1,0 | CET17P | OE189 | BAEA281 | CLS111 |
| 1.8 TD | 4 | RFD; RFK | 66/89 | 10/98→07/00 | CH147 | 11.5v | | | | |
| ESCORT VI | | | | | | | | | | |
| 1.4 | 4 | F4B; FUH | 55/74 | 08/93→01/95 | | | CET2 | OE179 | BAEA281 [275] BAEA281 | CLS122 |
| 1.4 i | 4 | F4B | 55/74 | 07/93→01/95 | | | CET2 | OE179 | BAEA281 01/94→ | CLS122 |
| 1.6 i 16V | 4 | L1H | 65/87 | 01/94→01/95 | OE029 | 1,0 | CET17P | OE189 | BAEA281 | CLS111 |
| 1.8 TD | 4 | RFD; RFK | 66/89 | 02/93→01/95 | CH147 | 11.5v | | | | |
| 1.8 TD | 4 | RFS | 66/89 | 02/93→01/95 | CH205 | 10v | | | | |
| ESCORT VII | | | | | | | | | | |
| 1.3 | 4 | J4B | 44/59 | 01/95→02/99 | OE131 | 1,0 | CET18P | OE183 | BAEA281 →08/98 BAEA350 09/98→ | CLS121 |
| 1.3 | 4 | J6A | 44/59 | 01/95→02/99 | OE011 *to be adjusted | 0,7* | CET9 | OE183 | BAEA281 →08/98 BAEA350 09/98→ | CLS121 |
| 1.4 | 4 | F4B; FUH | 55/74 | 01/95→02/99 | | | CET2 | OE179 | BAEA281 | CLS122 |
| 1.6 | 4 | | 70/94 | 01/01→08/02 | | | | | BAEA422 | |





kW/BHP

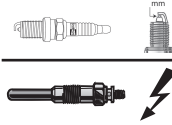

eon TITAN

IRIDIUM

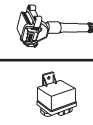
**...FORD****...ESCORT VII**

| | | | | | | | | | | |
|---|---|---------------|---------|-------------|-------|-------|--------|-------|-------------------|--------|
| 1.6 16V, 1.6 16V 4WD, 1.6 16V XR3i, 1.6 i 16V | 4 | L1E; L1K | 66/89 | 01/95→09/99 | OE029 | 1,0 | CET17P | OE189 | BAEA281 | CLS111 |
| 1.6 16V XR3i, 1.6 i 16V | 4 | L1H | 65/87 | 01/95→12/96 | OE029 | 1,0 | CET17P | OE189 | BAEA281 | CLS111 |
| 1.8 16V, 1.8 16V XR3i | 4 | RDA | 77/103 | 01/95→08/98 | OE029 | 1,0 | CET17P | OE189 | BAEA281 | CLS111 |
| 1.8 16V, 1.8 16V XR3i | 4 | RKC | 85/114 | 01/95→02/99 | OE029 | 1,0 | CET17P | OE189 | BAEA281 | CLS111 |
| 1.8 16V XR3i | 4 | RQB | 96/129 | 02/95→08/00 | OE029 | 1,0 | CET17P | OE189 | BAEA281 | CLS111 |
| 1.8 D | 4 | RTE; RTF; RTH | 44/59 | 01/95→02/99 | CH147 | 11.5v | | | | |
| 1.8 TD | 4 | RFD; RFK | 66/89 | 01/95→02/99 | CH147 | 11.5v | | | | |
| 1.8 Turbo D | 4 | RVA | 51/68 | 12/95→08/99 | CH205 | 10v | | | | |
| 2.0 RS 2000, 2.0 RS 2000 4WD | 4 | N7A | 110/148 | 02/95→10/98 | OE039 | 1,0 | CET2 | OE180 | BAEA308 →08/96 | |

FIESTA

| | | | | | | | | | | |
|------------|---|--|-------|-------------|--|--|--|--|---------|--|
| 1.0 | 4 | | 49/66 | 05/02→03/08 | | | | | BAEA422 | |
| 1.0 | 4 | | 70/94 | 09/04→12/06 | | | | | BAEA422 | |
| 1.0 Street | 4 | | 48/64 | 10/01→08/04 | | | | | BAEA422 | |
| 1.6 Street | 4 | | 70/94 | 03/02→03/10 | | | | | BAEA422 | |

FIESTA III

| | | | | | | | | | | |
|-----------|---|-----|-------|-------------|-------|-------|------|-------|---------|--------|
| 1.6 i 16V | 4 | L1G | 65/87 | 01/94→12/95 | OE031 | 1,0 | CET7 | OE189 | BAEA281 | CLS111 |
| 1.8 TD | 4 | RFL | 55/74 | 03/93→12/95 | CH147 | 11.5v | | | | |

FIESTA IV

| | | | | | | | | | | |
|------------------|---|-----------------------------------|--------|-------------|----------------|------------|----------------|-------|--|--|
| 1.0 i | 4 | ZH10JRB | 38/51 | 02/97→09/99 | OE011 | 0,9 | CET9 | OE183 | | |
| 1.0 i | 4 | | 48/64 | 09/99→01/02 | OE011 | 0,9 | CET9 | OE183 | BAEA422 | |
| 1.3 | 4 | | 42/56 | 04/96→08/99 | OE131 | 1,0 | CET18P | OE183 | | |
| 1.3 1.25 i 16V | 4 | DHA; DHB; DHC; DHD; DHE; DHF; DHG | 55/74 | 08/95→01/02 | OE031 | 1,0 | CET7 | OE189 | BAEA281 →04/98 BAEA350 05/98→ | CLS032 →04/98 CLS077 05/98→ CLS015 |
| 1.3 i | 4 | JJA; JJC; JJE; JJJ; JJK; JJM | 37/50 | 08/95→01/02 | OE131 | 1,0 | CET18P | OE183 | BAEA281 →08/98 | CLS033 [275] →08/98 CLS066 [275] 09/98→ |
| 1.3 i | 4 | JBC | 44/59 | 08/95→01/02 | OE131 | 1,0 | CET18P | OE183 | BAEA281 →08/98 | CLS033 [275] →08/98 CLS066 [275] 09/98→ |
| 1.3 i | 4 | J4C; J4J; J4L; J4Q; J4R; J4T | 44/59 | 08/95→01/02 | OE011 OE131 | 0,9 1,0 | CET18P CET9 | OE183 | BAEA281 BAEA422 | CLS033 [275] →08/98 CLS066 [275] 09/98→ |
| 1.4 i 16V | 4 | FHA; FHE | 66/89 | 04/96→01/02 | OE031 | 1,0 | CET7 | OE189 | BAEA281 →04/98 BAEA350 05/98→ | CLS111 →05/98 CLS015 |
| 1.6 16V Sport | 4 | L1V; L1T | 76/102 | 02/00→01/02 | OE031 | 1,0 | CET7 | OE189 | BAEA281 | CLS111 |
| 1.8 D | 4 | RTJ; RTK | 44/59 | 08/95→04/00 | CH205 | 10v | | | | |
| 1.8 DI | 4 | RTN; RTP; RTQ | 55/74 | 04/00→01/02 | CH196 | 10v | | | | |
| FIESTA V | | | | | | | | | | |
| 1.0 | 4 | | 49/66 | 05/02→03/08 | OE031 | 1,0 | CET7 | | BAEA422 →08/06 | |
| 1.0 Supercharger | 4 | | 70/94 | 05/02→12/06 | | | | | BAEA422 | |
| 1.3 | 4 | BAJA | 44/59 | 11/01→06/08 | OE031 | 1,0 | CET7 | OE189 | BAEA350 [274] | CLS092 |
| 1.3 | 4 | A9JA; A9JB | 51/68 | 11/01→06/08 | OE031 | 1,0 | CET7 | OE189 | BAEA350 [274] →08/07 BAEA387 09/07→ | CLS092 |
| 1.3 16V | 4 | M7JA; M7JB | 51/68 | 03/03→06/08 | OE029 | 1,0 | CET17P | OE189 | BAEA387 03/05→ | CLS077 |

FORD



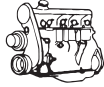

kW/BHP

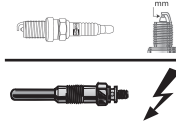

eon TITAN

IRIDIUM

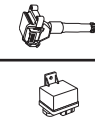

FORD

| ...FORD | | | | | | | | | | |
|------------------------------------|---|------------------------------|---------|-------------|----------------------------------|-----|--------|-------|--|--|
| ...FIESTA V | | | | | | | | | | |
| 1.3 16V | 4 | FUJA; FUJB | 55/74 | 05/02→06/08 | OE029 | 1,0 | CET17P | OE189 | BAEA422 →02/05 BAEA387 03/05→ | CLS077 |
| 1.4 16V | 4 | FXJA; FXJB | 59/79 | 11/01→06/08 | OE029 | 1,0 | CET17P | OE189 | BAEA350 →02/05 BAEA387 03/05→ | CLS077 |
| 1.4 TDCi | 4 | F6JA; F6JB | 50/67 | 11/01→06/08 | CH201 ^[124] 08/04→ | 11v | | | CCU147 | |
| 1.6 | 4 | | 70/94 | 11/01→12/04 | | | | | BAEA422 | |
| 1.6 | 4 | | 72/97 | 05/02→06/08 | | | | | BAEA422 | |
| 1.6 16V | 4 | FYJA; FYJB | 74/99 | 11/01→06/08 | OE031 | 1,0 | CET7 | OE189 | BAEA350 →02/05 BAEA387 03/05→ | CLS077 |
| 1.6 TDCi | 4 | HHJA; HHJB | 66/89 | 11/04→06/08 | CH201 06/06→ | 11v | | | CCU147 →Prod.30.01.2006 | |
| 2.0 ST150 | 4 | N4JB | 110/148 | 03/05→06/08 | OE131 | 1,0 | CET18P | OE183 | BAEA448 ^[275] | CLS074 |
| FIESTA VI | | | | | | | | | | |
| 1.3 | 4 | STJA; STJB; STJC | 44/59 | 06/08→ | OE031 | 1,0 | CET7 | OE189 | BAEA387 | CLS089 |
| 1.3 | 4 | SNJA; SNJB; SNJC; SNJD | 60/80 | 06/08→ | OE031 | 1,0 | CET7 | OE189 | BAEA387 | CLS089 |
| 1.4 | 4 | SPJA; SPJC | 71/95 | 06/08→ | OE031 | 1,0 | CET7 | OE189 | BAEA387 | CLS077 |
| 1.4 LPG | 4 | RTJA; RTJB | 68/91 | 01/09→ | OE131 | 1,0 | CET18P | OE183 | BAEA387 | |
| 1.4 LPG | 4 | RTJA; RTJB | 71/95 | 01/09→ | OE131 | 1,0 | CET18P | OE183 | BAEA387 | |
| 1.4 TDCi | 4 | F6JB; F6JD | 50/67 | 01/09→ | CH201 | 11v | | | | |
| 1.4 TDCi | 4 | F6JD | 51/68 | 07/10→ | CH201 | 11v | | | | |
| 1.6 ST | 4 | JTJA; JTJB | 134/180 | 03/13→ | | | CET17P | OE189 | | |
| 1.6 TDCi | 4 | HHJF; UBJA | 55/74 | 06/08→ | CH201 | 11v | | | | |
| 1.6 TDCi | 4 | HHJC; HHJD; HHJE | 66/89 | 06/08→ | CH201 | 11v | | | | |
| 1.6 Ti | 4 | IQJA; IQJC | 77/103 | 09/12→ | OE131 | 1,0 | CET18P | OE183 | BAEA387 | |
| 1.6 Ti | 4 | HXJA; HXJB | 88/118 | 06/08→ | OE031 | 1,0 | CET7 | OE189 | BAEA387 | CLS089 |
| 1.6 Ti | 4 | U5JA | 99/133 | 12/10→ | | | CET17P | OE189 | BAEA387 | CLS089 |
| FOCUS | | | | | | | | | | |
| 1.4 16V | 4 | FXDA; FXDB; FXDC; FXDD | 55/74 | 10/98→11/04 | OE031 | 1,0 | CET7 | OE189 | BAEA350 | CLS077 |
| 1.6 16V | 4 | FYDA; FYDB; FYDC; FYDD; FYDH | 74/99 | 10/98→11/04 | OE031 | 1,0 | CET7 | OE189 | BAEA350 | CLS077 |
| 1.6 16V Flexifuel | 4 | FYDH | 75/101 | 01/02→11/04 | OE031 | 1,0 | CET7 | OE189 | BAEA350 | CLS077 |
| 1.8 16V | 4 | EYDB; EYDC; EYDD; EYDE; EYDF | 85/114 | 10/98→11/04 | OE029 | 1,0 | CET17P | OE189 | BAEA350 →07/04 | CLS016 ^[275] |
| 1.8 16V | 4 | EYDG; EYDI; EYDJ; EYDL | 85/114 | 10/98→11/04 | OE029 | 1,0 | CET17P | OE189 | BAEA350 →07/04 | |
| 1.8 BiFuel | 4 | EYDL | 82/110 | 02/03→01/05 | | | | | BAEA350 | |
| 1.8 DI / TDDi, 1.8 Turbo DI / TDDi | 4 | BHDA; BHDB | 55/74 | 08/99→03/05 | CH196 | 10v | | | | |
| 1.8 TDCi | 4 | FFDA | 74/99 | 08/02→11/04 | CH196 | 10v | | | | |
| 1.8 TDCi | 4 | F9DA; F9DB | 85/114 | 03/01→11/04 | CH196 | 10v | | | | |
| 1.8 Turbo DI / TDDi | 4 | C9DA; C9DB; C9DC | 66/89 | 10/98→11/04 | CH196 | 10v | | | | |
| 2.0 16V | 4 | EDDB; EDCC; EDDD; EDDF | 96/129 | 10/98→11/04 | OE029 | 1,0 | CET17P | OE189 | BAEA350 →07/04 | CLS016 ^[275] |
| 2.0 RS | 4 | HMDA | 158/212 | 10/02→11/04 | OE029 | 1,0 | CET17P | OE189 | BAEA350 | CLS016 ^[275] |
| 2.0 ST170 | 4 | ALDA | 127/170 | 03/02→11/04 | OE029 | 1,0 | CET17P | OE189 | BAEA350 | CLS016 ^[275] |
| FOCUS C-MAX | | | | | | | | | | |
| 1.6 | 4 | HWDA; HWDB; SHDA; SHDB; SHDC | 74/99 | 10/03→03/07 | OE031 | 1,0 | CET7 | OE189 | BAEA422 →02/05 BAEA387 03/05→ | CLS077 →Prod.26.03.2007 CLS089 Prod.26.03.2007→ |
| 1.6 TDCi | 4 | HHDA; HHDB | 66/89 | 02/05→03/07 | CH201 ^[124] | 11v | | | CCU147 | |
| 1.6 TDCi | 4 | G8DA; G8DB | 80/107 | 10/03→03/07 | CH201 ^[124] | 11v | | | CCU147 | |





kW/BHP

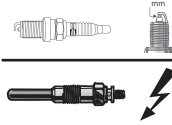

IRIDIUM

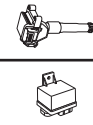

...FORD

...FOCUS C-MAX

| | | | | | | | | | | |
|---------------|---|------------------------|---------|-------------|-----------------|-----|--------|-----------------|--|--------|
| 1.6 Ti | 4 | HXDA; SIDA | 85/114 | 08/04→03/07 | OE031 | 1,0 | | | BAEA422 →02/05 BAEA387 03/05→ | CLS077 |
| 1.8 | 4 | CSDA; CSDB | 88/118 | 10/03→03/07 | OE131 →08/05 | 1,0 | CET18P | OE183 | BAEA408 | |
| 1.8 | 4 | QQDC | 90/121 | 09/05→03/07 | | | | OE183 | BAEA408 | |
| 1.8 | 4 | QQDB | 92/123 | 04/04→03/07 | OE131 →08/05 | 1,0 | CET18P | OE183 09/05→ | BAEA408 | |
| 1.8 | 4 | QQDA | 92/123 | 04/04→03/07 | OE131 →08/05 | 1,0 | | OE183 09/05→ | BAEA408 | |
| 1.8 | 4 | Q7DA | 92/123 | 04/04→03/07 | | | | | BAEA408 | |
| 1.8 Flexifuel | 4 | Q7DA | 92/123 | 01/06→03/07 | | | CET18P | OE183 | BAEA408 | |
| 1.8 TDCi | 4 | KKDA; KKDB | 85/114 | 01/05→03/07 | CH196 | 10v | | | | |
| 2.0 | 4 | AODA; AODB | 107/143 | 03/04→03/07 | OE131 →01/05 | 1,0 | CET18P | OE183 02/05→ | BAEA408 | |
| 2.0 | 4 | AODE; SYDA | 107/143 | 03/04→03/07 | | | CET18P | | BAEA408 | |
| 2.0 TDCi | 4 | G6DC; G6DE; G6DF | 98/131 | 10/03→03/07 | CH268 | 11v | | | | |
| 2.0 TDCi | 4 | G6DA; G6DB; G6DD; G6DG | 100/134 | 10/03→03/07 | CH268 | 11v | | | CCU147 | |

FOCUS II

| | | | | | | | | | | |
|-----------------------|---|------------------------------|---------|-------------|-------------|-----|----------------|-------|--|--|
| 1.4 | 4 | ASDA; ASDB | 59/79 | 07/04→09/12 | OE031 | 1,0 | CET7 | OE189 | BAEA422 →02/05 BAEA387 | CLS016 [275] |
| 1.6 | 4 | HWDA; HWDB | 74/99 | 07/04→09/12 | OE031 | 1,0 | CET7 | OE189 | BAEA422 →02/05 BAEA387 | CLS077 →Prod.26.03.2007 CLS089 Prod.26.03.2007→ |
| 1.6 | 4 | SHDA; SHDB; SHDC | 74/99 | 07/04→09/12 | OE031 | 1,0 | CET7 | OE189 | BAEA387 | CLS077 →Prod.26.03.2007 CLS089 Prod.26.03.2007→ |
| 1.6 LPG | 4 | SIDA | 85/114 | 10/09→09/12 | OE031 | 1,0 | CET18P CET7 | OE183 | BAEA387 | |
| 1.6 TDCi | 4 | GPDA; GPDB; GPDC; HHDA; HHDB | 66/89 | 07/04→09/12 | CH201 [124] | 11v | | | CCU147 | |
| 1.6 TDCi | 4 | G8DC; MTD | 74/99 | 07/04→09/12 | CH201 [124] | 11v | | | CCU147 | |
| 1.6 TDCi | 4 | G8DA; G8DB; G8DD; G8DE; G8DF | 80/107 | 07/04→09/12 | CH201 [124] | 11v | | | CCU147 | |
| 1.6 TDCi | 4 | G8DA | 81/109 | 12/07→09/12 | CH201 [124] | 11v | | | CCU147 | |
| 1.6 Ti | 4 | HXDA; HXDB | 85/114 | 07/04→09/12 | OE031 | 1,0 | CET7 | OE189 | BAEA422 →02/05 BAEA387 | CLS077 →03/07 CLS089 03/07→ CLS016 [275] |
| 1.6 Ti | 4 | SIDA | 85/114 | 07/04→09/12 | OE031 | 1,0 | CET7 | OE189 | BAEA422 →02/05 BAEA387 03/05→ | CLS077 →03/07 CLS089 03/07→ |
| 1.8, 1.8 Flexifuel | 4 | Q7DA; QQDA; QQDB | 92/123 | 01/06→09/12 | OE131 | 1,0 | CET18P | OE183 | BAEA408 | |
| 1.8 Flexifuel | 4 | ; QQDD | 96/129 | 12/05→01/08 | OE131 | 1,0 | CET18P | OE183 | | |
| 1.8 TDCi | 4 | KKDA | 85/114 | 07/04→09/12 | CH196 | 10v | | | CCU147 →Prod.15.01.2008 | |
| 2.0 | 4 | | 104/139 | 06/05→ | OE131 | 1,0 | CET18P | | BAEA422 | |
| 2.0, 2.0 CNG, 2.0 LPG | 4 | AODA; AODB; AODE; SYDA | 107/143 | 07/04→09/12 | OE131 | 1,0 | CET18P | OE183 | BAEA408 | |
| 2.0 Flex | 4 | SYDA | 107/143 | 10/08→03/10 | | | | | BAEA422 | |
| 2.0 TDCi | 4 | IXDA | 81/109 | 02/08→07/11 | CH268 | 11v | | | | |
| 2.0 TDCi | 4 | G6DE; G6DF | 98/131 | 07/04→01/08 | CH268 | 11v | | | | |
| 2.0 TDCi | 4 | G6DA; G6DB; G6DD; G6DG | 100/134 | 07/04→09/12 | CH268 | 11v | | | CCU147 | |
| 2.5 RS | 5 | JZDA | 224/300 | 01/09→07/11 | | | CET14P | OE190 | BAEA055E | |
| 2.5 RS 500 | 5 | JZDA | 257/345 | 05/10→07/11 | | | CET14P | OE190 | BAEA055E | |

FORD



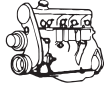

kW/BHP

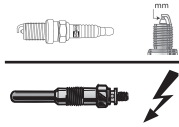

eon TITAN

IRIDIUM

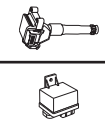
**...FORD****...FOCUS II**

| | | | | | | | | | | |
|--------|---|------|---------|-------------|--|------------|---------------|--------------|-----------------|--|
| 2.5 ST | 5 | HYDA | 166/223 | 10/05→09/12 | OE206 OE224 LPG [279] | 0,7 0,8 | CET14P | OE190 | BAEA055E | |
|--------|---|------|---------|-------------|--|------------|---------------|--------------|-----------------|--|

FOCUS III

| | | | | | | | | | | |
|---------------|---|------------------------|---------|--------|--------------|-----|---------------|--------------|----------------|---------------|
| 1.6 EcoBoost | 4 | JQDA; JQDB; YUDA | 110/148 | 07/10→ | | | | | BAEA387 | |
| 1.6 Flexifuel | 4 | MUDA | 88/118 | 07/10→ | OE031 | 1,0 | CET7 | OE189 | BAEA387 | CLS089 |
| 1.6 LPG | 4 | MUDA | 88/118 | 02/12→ | OE031 | 1,0 | CET7 | | | |
| 1.6 Ti | 4 | XTDA | 63/84 | 08/11→ | OE031 | 1,0 | CET7 | OE189 | BAEA387 | |
| 1.6 Ti | 4 | IQDB | 77/103 | 07/10→ | OE031 | 1,0 | CET7 | OE189 | BAEA387 | CLS089 |
| 1.6 Ti | 4 | PNDA | 92/123 | 07/10→ | OE031 | 1,0 | CET7 | OE189 | BAEA387 | CLS089 |
| 1.6 Ti | 4 | PNDD | 92/123 | 07/10→ | OE031 | 1,0 | CET7 | OE189 | BAEA387 | |
| 2.0 ST | 4 | R9DA; R9DB; R9DC; R9DD | 184/247 | 07/12→ | | | CET17P | | | |

FUSION

| | | | | | | | | | | |
|----------|---|------------|-------|-------------|--|-----|-------------|--------------|--|-------------------------|
| 1.3 | 4 | FUJA; FUJB | 55/74 | 08/04→12/12 | OE031 | 1,0 | CET7 | OE189 | BAEA350 →02/05 BAEA387 03/05→ | CLS077 |
| 1.4 | 4 | FXJA; FXJB | 59/79 | 08/02→12/12 | OE031 | 1,0 | CET7 | OE189 | BAEA350 →02/05 BAEA387 03/05→ | CLS077 |
| 1.4 | 4 | FXJC | 59/79 | 08/02→12/12 | OE031 | 1,0 | CET7 | OE189 | BAEA350 →02/05 BAEA387 03/05→ | |
| 1.4 LPG | 4 | UTJA | 59/79 | 01/10→12/12 | OE031 | 1,0 | CET7 | OE189 | BAEA387 →06/12 | CLS089 →06/12 |
| 1.4 TDCi | 4 | F6JA; F6JB | 50/67 | 08/02→12/12 | CH201 [124] Prod.08.01.2004→ | 11v | | | CCU147 | |
| 1.6 | 4 | FYJA; FYJB | 74/99 | 08/02→11/08 | OE031 | 1,0 | CET7 | OE189 | BAEA350 →02/05 BAEA387 03/05→ | CLS077 |
| 1.6 | 4 | FYJC | 74/99 | 08/02→11/08 | OE031 | 1,0 | CET7 | OE189 | BAEA350 →02/05 BAEA387 03/05→ | |

GALAXY

| | | | | | | | | | | |
|---------------|---|--------------|---------|-------------|--|------------|---------------|--------------|--------------------------|---------------------|
| 1.8 TDCi | 4 | FFWA | 74/99 | 05/06→06/15 | CH196 | 10v | | | | |
| 1.8 TDCi | 4 | QYWA | 92/123 | 05/06→06/15 | CH196 | 10v | | | | |
| 1.9 TDI | 4 | IZ; AHU; ANU | 66/89 | 03/95→05/06 | CH271 →Prod.31.10.2001 CH181 Prod.01.11.2001→ | 11v 11v | | | | |
| 1.9 TDI | 4 | AFN; AVG | 81/109 | 08/97→04/00 | CH271 | 11v | | | | |
| 1.9 TDI | 4 | AUY | 85/114 | 04/00→05/06 | CH271 →Prod.31.10.2001 CH181 Prod.01.11.2001→ | 11v 11v | | | | |
| 1.9 TDI | 4 | ASZ | 96/129 | 02/03→05/06 | CH181 | 11v | | | | |
| 1.9 TDI | 4 | BTB | 110/148 | 05/05→05/06 | CH181 | 11v | | | | |
| 2.0 | 4 | AOWA; AOWB | 107/143 | 05/06→06/15 | | | CET18P | OE183 | BAEA408 | |
| 2.0 EcoBoost | 4 | TNWB | 146/196 | 07/10→06/15 | | | CET17P | | | |
| 2.0 EcoBoost | 4 | TNWA | 149/200 | 03/10→06/15 | | | CET17P | | | |
| 2.0 Flexifuel | 4 | TBWA; TBWB | 107/143 | 05/06→06/15 | | | | | BAEA408 | |
| 2.0 i | 4 | NSE | 85/114 | 11/95→05/06 | OE136 | 0,8 | CET12P | OE179 | BAEA422 01/01→ | CLS049 |
| 2.0 i | 4 | ZVSA | 85/114 | 11/95→05/06 | OE136 | 0,8 | CET12P | OE179 | BAEA422 01/01→ | CLS243 [275] |
| 2.0 TDCi | 4 | KLWA | 85/114 | 11/07→06/15 | CH268 →02/10 | 11v | | | | |
| 2.0 TDCi | 4 | AZWA | 96/129 | 05/06→06/15 | CH268 | 11v | | | | |

FORD





kW/BHP

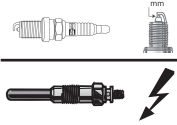

eon TITAN

IRIDIUM

**...FORD****...GALAXY**

| | | | | | | | | | | |
|------------------------|---|------------------|---------|---------------|-------|-------|--------|-------|--|--------|
| 2.0 TDCi | 4 | AZWC | 100/134 | 05/06 → 06/15 | CH268 | 11v | | | | |
| 2.0 TDCi | 4 | QXWA; QXWB; QXWC | 103/138 | 05/06 → 06/15 | CH229 | 11.5v | | | | |
| 2.3 | 4 | SEWA | 118/158 | 09/07 → 06/15 | | | CET18P | OE183 | | |
| 2.3 4WD, 2.3 16V | 4 | YSB | 107/143 | 09/96 → 05/06 | OE146 | 1,0 | CET12P | OE179 | BAEA308 ^[41] →Prod.30.03.2000 | |
| 2.3 16V | 4 | E5SB | 103/138 | 09/01 → 05/06 | OE146 | 1,0 | CET12P | OE179 | BAEA365 BAEA422 | |
| 2.3 16V | 4 | E5SA | 107/143 | 01/97 → 05/06 | OE146 | 1,0 | CET12P | OE179 | BAEA365 Prod.01.04.2000 → BAEA422 Prod.01.04.2000 → | |
| 2.8 i V6, 2.8 i V6 4WD | 6 | AAA; AMY | 128/172 | 11/95 → 04/00 | | | CET12P | OE180 | BAEA004E | CLS240 |
| 2.8 V6 | 6 | AYL | 150/201 | 04/00 → 05/06 | OE176 | 1,0 | CET3 | | BAEA063E | |

GRAND C-MAX

| | | | | | | | | | | |
|--------------|---|------------|---------|---------|-------|-----|------|-------|-------------------|--------|
| 1.6 EcoBoost | 4 | JQDA; JQDB | 110/148 | 12/10 → | | | | | BAEA387 | |
| 1.6 EcoBoost | 4 | JTDA; JTDB | 134/180 | 12/10 → | | | | | BAEA387 | |
| 1.6 Ti | 4 | IQDA; IQDB | 77/103 | 12/10 → | OE031 | 1,0 | CET7 | OE189 | BAEA387 →05/11 | CLS089 |
| 1.6 Ti | 4 | PNDA | 92/123 | 12/10 → | OE031 | 1,0 | CET7 | OE189 | BAEA387 →05/11 | CLS089 |

KA

| | | | | | | | | | | |
|-------|---|---------------------------------|-------|---------------|-------------------------------------|------------|--------|-------|--|--|
| 1.0 i | 4 | ZHTOJRB | 38/51 | 07/97 → 09/99 | OE011 | 0,9 | CET9 | OE183 | | |
| 1.0 i | 4 | | 48/64 | 09/99 → 11/08 | OE011 | 0,9 | CET9 | OE183 | BAEA422 | |
| 1.2 | 4 | 169A4000; AAAA; FP4 | 51/68 | 10/08 → | OE196 OE230 LPG ^[278] | 1,0 0,9 | CET1 | | BAE940A | |
| 1.3 i | 4 | JJD; JJF; JJG; JJH; JJJ | 36/48 | 06/98 → 11/08 | OE131 | 1,0 | CET18P | OE183 | BAEA350 10/02 → 07/07 | CLS033 ^[275] →09/98 CLS066 ^[275] 09/98 → |
| 1.3 i | 4 | JJB | 37/50 | 09/96 → 10/02 | OE131 | 1,0 | CET18P | OE183 | BAEA350 ^[274] 09/98 → | CLS033 ^[275] →08/98 CLS066 ^[275] 09/98 → |
| 1.3 i | 4 | J4D; J4K; J4M; J4N; J4P; J4S | 44/59 | 09/96 → 11/08 | OE131 | 1,0 | CET18P | OE183 | BAEA281 →08/98 BAEA350 ^[274] 09/98 → | CLS033 ^[275] →08/98 CLS066 ^[275] 09/98 → |
| 1.3 i | 4 | BAA | 44/59 | 09/96 → 11/08 | OE031 | 1,0 | CET7 | OE189 | BAEA281 →08/98 BAEA350 ^[274] 09/98 → | CLS033 ^[275] →08/98 CLS066 ^[275] 09/98 → CLS091 10/02 → |
| 1.3 i | 4 | A9A; A9B | 51/68 | 08/02 → 11/08 | OE031 | 1,0 | CET7 | OE189 | BAEA350 →02/07 | CLS091 |
| 1.6 | 4 | CDB; CDC | 70/94 | 09/00 → | OE031 | 1,0 | CET7 | | | |
| 1.6 i | 4 | CDB; CDC | 70/94 | 02/01 → 11/08 | OE029 | 1,0 | CET17P | OE189 | BAEA350 →07/07 BAEA387 08/07 → | CLS091 |

KUGA I

| | | | | | | | | | | |
|------------------------|---|-----------------|---------|---------------|-------|-----|--------|-------|----------|--|
| 2.0 TDCi, 2.0 TDCi 4WD | 4 | G6DG | 100/134 | 03/08 → 11/12 | CH268 | 11v | | | | |
| 2.5, 2.5 4WD | 5 | HYDB; HYDC | 147/197 | 03/09 → | | | CET14P | OE190 | | |
| 2.5 4WD | 5 | DuratecST-Motor | 147/197 | 03/09 → | | | | | BAEA055E | |

KUGA II

| | | | | | | | | | | |
|----------|---|------------|--------|---------|--|--|--|--|---------|--|
| 2.0 TDCi | 4 | XRMA; XRMB | 88/118 | 09/14 → | | | | | BAEA143 | |
|----------|---|------------|--------|---------|--|--|--|--|---------|--|

MAVERICK

| | | | | | | | | | | |
|-------------|---|------|---------|---------------|-------|-----|--------|-------|---------|-------------------------|
| 2.0 16V 4WD | 4 | YF | 91/122 | 02/01 → | OE029 | 1,0 | CET17P | OE189 | BAEA350 | CLS016 ^[275] |
| 2.3 16V 4WD | 4 | GZ | 110/148 | 03/04 → | | | CET18P | OE183 | BAEA408 | |
| 2.4 i 4WD | 4 | KA24 | 85/114 | 09/96 → 04/98 | OE089 | 1,0 | CET2 | OE184 | | |

FORD



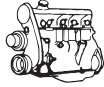

kW/BHP

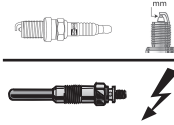

eon TITAN

IRIDIUM

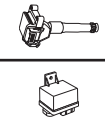

...FORD

...MAVERICK

| | | | | | | | | | | |
|----------------|---|-------|---------|---------------|-------|-----|--------|-------|--------------------------|--|
| 2.4 i 4WD | 4 | KA24 | 87/117 | 09/96 → 04/98 | OE089 | 1,0 | CET2 | OE184 | | |
| 2.4 i 4WD | 4 | KA24E | 91/122 | 02/93 → 08/96 | OE089 | 1,0 | CET2 | OE184 | | |
| 2.7 TD 4WD | 4 | TD27 | 74/99 | 02/93 → 08/96 | CH186 | 11v | | | | |
| 3.0 V6 24V 4WD | 6 | AJ | 145/194 | 02/01 → | | | CET18P | OE183 | BAEA410 ^[277] | |
| 3.0 V6 24V 4WD | 6 | AJ | 149/200 | 03/04 → | | | CET18P | OE183 | | |

MONDEO I

| | | | | | | | | | | |
|--------------------------|---|----------|---------|---------------|-------|-------|--------|-------|---------|--------|
| 1.6 i 16V | 4 | L1J | 65/87 | 07/94 → 08/96 | OE029 | 1,0 | CET17P | OE189 | BAEA281 | CLS111 |
| 1.6 i 16V | 4 | L1F | 66/89 | 02/93 → 08/96 | OE029 | 1,0 | CET17P | OE189 | BAEA281 | CLS111 |
| 1.8 i 16V | 4 | RKB | 82/110 | 01/94 → 08/96 | OE029 | 1,0 | CET17P | OE189 | BAEA281 | CLS111 |
| 1.8 i 16V, 1.8 i 16V 4WD | 4 | RKA | 85/114 | 02/93 → 08/96 | OE029 | 1,0 | CET17P | OE189 | BAEA281 | CLS111 |
| 1.8 TD | 4 | RFM; RFN | 65/87 | 06/93 → 08/96 | CH147 | 11.5v | | | | |
| 1.8 TD | 4 | RFM; RFN | 66/89 | 10/95 → 08/96 | CH147 | 11.5v | | | | |
| 2.0 i 16V | 4 | NGA | 97/130 | 01/93 → 08/96 | OE029 | 1,0 | CET17P | OE189 | | CLS111 |
| 2.0 i 16V, 2.0 i 16V 4WD | 4 | NGA | 100/134 | 02/93 → 08/96 | OE029 | 1,0 | CET17P | OE189 | BAEA281 | CLS111 |
| 2.0 i 16V 4WD | 4 | NGA | 97/130 | 12/94 → 08/96 | OE029 | 1,0 | CET17P | OE189 | BAEA281 | CLS111 |
| 2.5 i 24V | 6 | SEA | 125/168 | 07/94 → 08/96 | OE131 | 1,0 | CET18P | OE183 | | |

MONDEO II

| | | | | | | | | | | |
|----------------|---|-------------------------|---------|---------------|-------|-----|--------|-------|--------------------|------------------------------------|
| 1.6 i | 4 | L1J | 66/89 | 08/96 → 09/00 | OE029 | 1,0 | CET17P | OE189 | BAEA281 → 08/98 | CLS111 → 08/98 |
| | | | | | | | | | BAEA350 09/98 → | CLS016 ^[275] 09/98 → |
| 1.6 i 16V | 4 | L1L; L1N; L1Q | 70/94 | 05/98 → 09/00 | OE029 | 1,0 | CET17P | OE189 | BAEA281 → 08/98 | CLS111 → 08/98 |
| | | | | | | | | | BAEA350 09/98 → | CLS016 ^[275] 09/98 → |
| 1.8 i | 4 | RKB; RKF; RKH; RKJ; RKK | 85/114 | 08/96 → 09/00 | OE029 | 1,0 | CET17P | OE189 | BAEA281 → 08/98 | CLS111 → 08/98 |
| | | | | | | | | | BAEA350 09/98 → | CLS016 ^[275] 09/98 → |
| 1.8 TD | 4 | RFN | 66/89 | 08/96 → 09/00 | CH205 | 10v | | | | |
| 2.0 i | 4 | NGA; NGB; NGC; NGD | 96/129 | 08/96 → 09/00 | OE029 | 1,0 | CET17P | OE189 | BAEA281 → 08/98 | CLS111 → 08/98 |
| | | | | | | | | | BAEA350 09/98 → | CLS016 ^[275] 09/98 → |
| 2.5 2.5 ST 200 | 6 | SGA | 151/202 | 05/99 → 09/00 | OE131 | 1,0 | CET18P | OE183 | | |
| 2.5 24V | 6 | LCBD; SEA; SEB; SEC | 125/168 | 08/96 → 09/00 | OE131 | 1,0 | CET18P | OE183 | | |

MONDEO III

| | | | | | | | | | | |
|--------------------------|---|------------------------|---------|---------------|-------|-------|--------|-------|-------------------------------------|--------|
| 1.8 16V | 4 | CGBA; CGBB | 81/109 | 10/00 → 03/07 | OE131 | 1,0 | CET18P | OE183 | BAEA365 → 02/05 | CLS074 |
| | | | | | | | | | BAEA448 ^[275] 03/05 → | |
| 1.8 16V | 4 | CHBA; CHBB | 92/123 | 10/00 → 03/07 | OE131 | 1,0 | CET18P | OE183 | BAEA365 → 02/05 | CLS074 |
| | | | | | | | | | BAEA448 ^[275] 03/05 → | |
| 1.8 SGi | 4 | CFBA | 96/129 | 06/03 → 03/07 | | | CET18P | OE183 | BAEA422 → 02/05 | CLS074 |
| 2.0 16V | 4 | CJBA; CJBB | 107/143 | 10/00 → 03/07 | OE131 | 1,0 | CET18P | OE183 | BAEA365 → 02/05 | CLS074 |
| | | | | | | | | | BAEA448 ^[275] 03/05 → | |
| 2.0 16V DI / TDDi / TDGi | 4 | D5BA | 66/89 | 10/00 → 03/07 | CH229 | 11.5v | | | | |
| 2.0 16V TDDi / TDGi | 4 | D6BA; HJBA; HJBB; HJBC | 85/114 | 10/00 → 03/07 | CH229 | 11.5v | | | | |
| 2.0 TDGi | 4 | FMBA; N7BA | 96/129 | 10/01 → 03/07 | CH229 | 11.5v | | | | |
| 2.2 TDGi | 4 | QJBC; QJBD | 110/148 | 09/04 → 03/07 | CH229 | 11.5v | | | | |
| 2.2 TDGi | 4 | QJBA; QJBB | 114/153 | 09/04 → 03/07 | CH229 | 11.5v | | | | |
| 2.5 V6 24V | 6 | LCBD | 125/168 | 10/00 → 03/07 | OE131 | 1,0 | CET18P | OE183 | BAEA372 | CLS156 |
| 3.0 V6 24V | 6 | REBA | 150/201 | 09/04 → 03/07 | OE131 | 1,0 | CET18P | OE183 | BAEA372 | |
| 3.0 ST220 | 6 | MEBA | 166/223 | 04/02 → 03/07 | OE131 | 1,0 | CET18P | OE183 | BAEA372 | |

FORD





kW/BHP

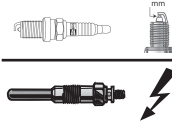

eon TITAN

IRIDIUM

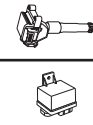

...FORD

MONDEO IV

| | | | | | | | | | | |
|--------------------|---|------------------------|---------|-------------|--------------------------|------------|--------|-------|-------------------|--------|
| 1.6 Ti | 4 | RHBA | 81/109 | 03/07→01/15 | OE031 | 1,0 | CET7 | OE189 | BAEA387 →08/10 | |
| 1.6 Ti | 4 | KGBA | 88/118 | 03/10→01/15 | OE031 | 1,0 | CET7 | OE189 | BAEA387 | |
| 1.6 Ti | 4 | PNBA | 92/123 | 03/07→01/15 | OE031 | 1,0 | CET7 | OE189 | BAEA387 →08/10 | CLS077 |
| 1.8 TDCi | 4 | FFBA | 74/99 | 03/07→01/15 | CH196 | 10v | | | | |
| 1.8 TDCi | 4 | KHBA; QYBA | 92/123 | 06/07→01/15 | CH196 | 10v | | | | |
| 2.0, 2.0 Flexifuel | 4 | AOBA; AOBC; TBBA; TBBB | 107/143 | 03/07→01/15 | | | CET18P | OE183 | BAEA408 | |
| 2.0 EcoBoost | 4 | TPBA | 176/236 | 03/10→01/15 | | | CET17P | | | |
| 2.0 LPG | 4 | TBBA | 107/143 | 07/09→01/15 | | | | | BAEA408 | |
| 2.0 SCTi | 4 | TNBA | 149/200 | 03/10→01/15 | | | CET17P | | | |
| 2.0 TDCi | 4 | KLBA; LPBA | 85/114 | 11/07→01/15 | CH268 | 11v | | | | |
| 2.0 TDCi | 4 | AZBA | 96/129 | 03/07→01/15 | CH268 | 11v | | | | |
| 2.0 TDCi | 4 | AZBC | 100/134 | 03/07→01/15 | CH268 →02/10 | 11v | | | | |
| 2.3 | 4 | SEBA | 118/158 | 07/07→01/15 | | | CET18P | OE183 | | |
| 2.5 | 5 | HUBA | 162/217 | 03/07→01/15 | OE206 OE224 LPG [279] | 0,7 0,8 | CET14P | | BAEA055E | |

PUMA

| | | | | | | | | | | |
|-------------------|---|----------|---------|-------------|-------|-----|--------|-------|--|--------------------------------------|
| 1.4 16V | 4 | FHD; FHF | 66/89 | 11/97→10/00 | OE031 | 1,0 | CET7 | OE189 | BAEA281 →05/98 BAEA350 05/98→ | CLS032 →05/98 CLS077 05/98→ |
| 1.6 16V | 4 | L1W | 76/102 | 08/00→06/02 | OE031 | 1,0 | CET7 | OE189 | BAEA350 | CLS077 |
| 1.7 16V | 4 | MHA; MHB | 92/123 | 03/97→06/02 | OE029 | 1,0 | CET17P | OE189 | BAEA281 →04/00 BAEA350 05/00→ | CLS032 →04/00 CLS077 05/00→ |
| 1.7 Racing ST 160 | 4 | MHA | 114/153 | 06/99→06/02 | OE029 | 1,0 | CET17P | OE189 | | |

RANGER

| | | | | | | | | | | |
|------------------------|---|---------------------|---------|-------------|-----------------|-----|--------|-------|--|--|
| 2.2 | 4 | | 78/105 | 03/02→09/05 | OE039 | 1,0 | CET2 | | | |
| 2.5 D, 2.5 D 4WD | 4 | WL | 57/76 | 10/99→04/02 | CH242 →09/01 | 11v | | | | |
| 2.5 i 4WD | 4 | GBVAF; GBVAK; GBVAL | 122/164 | 11/11→ | | | CET17P | OE189 | | |
| 2.5 TD | 4 | MD25TI | 80/107 | 06/05→05/07 | CH242 | 11v | | | | |
| 2.5 TD, 2.5 TD 4WD | 4 | WL-T | 62/83 | 04/02→06/06 | CH242 | 11v | | | | |
| 2.5 TD 4WD | 4 | WL-T | 80/107 | 10/99→06/06 | CH242 →09/01 | 11v | | | | |
| 2.5 TDCi 4WD, 2.5 TDdi | 4 | WLAA | 105/141 | 05/06→07/12 | CH242 | 11v | | | | |
| 2.5 TDdi, 2.5 TDdi 4WD | 4 | | 86/115 | 04/02→09/05 | CH242 | 11v | | | | |
| 2.9 D | 4 | D29UYT | 70/94 | 06/99→02/02 | CH242 [187] | 11v | | | | |

SCORPIO I

| | | | | | | | | | | |
|--------|---|-----|--------|-------------|-------|-----|--|--|--|--|
| 2.5 TD | 4 | SCB | 85/114 | 08/93→09/94 | CH189 | 11v | | | | |
|--------|---|-----|--------|-------------|-------|-----|--|--|--|--|

SCORPIO II

| | | | | | | | | | | |
|-----------|---|-----|---------|-------------|--------------------------|------|--------|-------|-------------------|------------------------|
| 2.0 i | 4 | NSD | 85/114 | 10/94→08/98 | OE136 | 0,8 | CET12P | OE179 | | CLS022 |
| 2.0 i 16V | 4 | N3A | 100/134 | 10/94→08/98 | OE136 | 0,8 | CET12P | OE179 | BAEA308 →04/96 | CLS022 |
| 2.3 i 16V | 4 | Y5A | 108/145 | 06/96→08/98 | | | CET12P | OE182 | BAEA308 | CLS022 [292] CLS187 |
| 2.5 TD | 4 | SCC | 85/114 | 10/94→08/98 | CH181 | 11v | | | | |
| 2.5 TD | 4 | VM | 92/123 | 09/96→08/98 | CH181 | 11v | | | | |
| 2.9 i | 6 | BRG | 110/148 | 02/95→08/98 | OE011 *to be adjusted | 1,0* | CET9 | OE183 | | |
| 2.9 i 24V | 6 | BOB | 152/204 | 10/94→08/98 | | | CET12P | OE180 | | |

S-MAX

| | | | | | | | | | | |
|----------|---|------|--------|-------------|-------------|-----|--|--|--|--|
| 1.8 TDCi | 4 | FFWA | 74/99 | 01/07→12/10 | CH196 | 10v | | | | |
| 1.8 TDCi | 4 | QYWA | 92/123 | 05/06→12/14 | CH196 [322] | 10v | | | | |

FORD



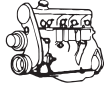

kW/BHP

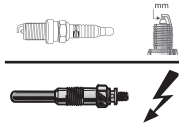

eon TITAN

IRIDIUM

**...FORD****...S-MAX**

| | | | | | | | | | | |
|--------------------|---|------------------------|---------|---------------|-----------------|-----|--------|-------|----------|--|
| 2.0, 2.0 Flexifuel | 4 | AOWA; AOWB; TBWA; TBWB | 107/143 | 05/06 → 12/14 | | | CET18P | OE183 | BAEA408 | |
| 2.0 EcoBoost | 4 | TNWB | 146/196 | 07/10 → 12/14 | | | CET17P | | | |
| 2.0 EcoBoost | 4 | TNWA | 149/200 | 03/10 → 12/14 | | | CET17P | | BAEA408 | |
| 2.0 EcoBoost | 4 | TPWA | 176/236 | 07/10 → | | | CET17P | | | |
| 2.0 TDCi | 4 | KLWA | 85/114 | 11/07 → 12/14 | CH268 | 11v | | | | |
| 2.0 TDCi | 4 | AZWA | 96/129 | 05/06 → 12/14 | CH268 | 11v | | | | |
| 2.0 TDCi | 4 | AZWC | 100/134 | 05/06 → 12/14 | CH268 | 11v | | | | |
| | | | | | →02/10 | | | | | |
| 2.3 | 4 | SEWA | 118/158 | 07/07 → 12/14 | | | CET18P | OE183 | | |
| 2.5 ST | 5 | HUWA | 162/217 | 05/06 → 12/14 | OE206 | 0,7 | CET14P | | BAEA055E | |
| | | | | | OE224 LPG [279] | 0,8 | | | | |

STREET KA

| | | | | | | | | | | |
|-----|---|------------|-------|---------------|-------|-----|------|-------|--------------------------|--------|
| 1.6 | 4 | CDRA; CDRB | 70/94 | 05/03 → 07/05 | OE031 | 1,0 | CET7 | OE189 | BAEA350 ^[274] | CLS092 |
|-----|---|------------|-------|---------------|-------|-----|------|-------|--------------------------|--------|

TOURNEO CONNECT

| | | | | | | | | | | |
|----------------------|---|--|--------|---------------|-------|-----|--------|-------|---------|--|
| 1.8 16V | 4 | EYPA; EYPC; EYPD | 85/114 | 06/02 → 12/13 | OE029 | 1,0 | CET17P | OE189 | BAEA350 | |
| 1.8 TDCi | 4 | HCPA; HCPB; P9PA; P9PB; P9PC; P9PD; R3PA; RWPE; RWPF | 66/89 | 06/02 → 12/13 | CH196 | 10v | | | | |
| 1.8 TDCi | 4 | RWPA; RWPC; RWPD | 81/109 | 08/06 → 12/13 | CH196 | 10v | | | | |
| 1.8 TDCi / TDDi / DI | 4 | BHPA; P7PA; P7PB; R2PA | 55/74 | 06/02 → 12/13 | CH196 | 10v | | | | |

FORD**B-MAX**

| | | | | | | | | | | |
|--------|---|------|--------|---------|-------|-----|------|--|--|--|
| 1.4 | 4 | SPJD | 66/89 | 10/12 → | OE031 | 1,0 | CET7 | | | |
| 1.6 Ti | 4 | IQJA | 77/103 | 10/12 → | OE031 | 1,0 | CET7 | | | |

ESCORT '95

| | | | | | | | | | | |
|-------------|---|----------|-------|---------------|-------|-------|------|-------|---------|--------|
| 1.4 | 4 | F4B | 54/72 | 01/95 → 08/00 | | | CET2 | OE179 | BAEA281 | CLS122 |
| 1.8 D | 4 | RTF; RTH | 44/59 | 01/95 → 08/00 | CH147 | 11.5v | | | | |
| 1.8 TD | 4 | RFD; RFK | 66/89 | 01/95 → 08/00 | CH147 | 11.5v | | | | |
| 1.8 TD | 4 | RFS | 66/89 | 01/95 → 08/00 | CH205 | 10v | | | | |
| 1.8 Turbo D | 4 | RVA | 51/68 | 12/95 → 06/01 | CH205 | 10v | | | | |

FIESTA

| | | | | | | | | | | |
|----------------|---|---------------|-------|---------------|--------|-----|--------|-------|---------|--------|
| 1.4 i | 4 | FHA | 66/89 | 04/96 → 10/99 | OE131 | 1,0 | CET18P | OE183 | BAEA281 | CLS015 |
| 1.8 DI, 1.8 TD | 4 | RTN; RTP; RTQ | 55/74 | 07/93 → 08/03 | CH196 | 10v | | | | |
| | | | | | →12/02 | | | | | |

FIESTA V

| | | | | | | | | | | |
|----------|---|------------|-------|---------------|------------------------|-----|------|-------|--------------------------|--------|
| 1.3 | 4 | A9JA; A9JB | 51/68 | 10/03 → 07/05 | OE031 | 1,0 | CET7 | OE189 | BAEA350 ^[274] | CLS092 |
| 1.4 TDCi | 4 | F6JA; F6JB | 50/67 | 10/03 → 12/10 | CH201 ^[124] | 11v | | | CCU147 | |
| | | | | | 08/04 → | | | | | |

FIESTA VI

| | | | | | | | | | | |
|----------|---|------------------|-------|---------|-------|-----|------|-------|---------|--------|
| 1.3 | 4 | SNJA; SNJB | 60/80 | 01/09 → | OE031 | 1,0 | CET7 | OE189 | BAEA387 | CLS089 |
| 1.4 TDCi | 4 | F6JB; F6JD | 50/67 | 01/09 → | CH201 | 11v | | | | |
| 1.4 TDCi | 4 | F6JD | 51/68 | 07/10 → | CH201 | 11v | | | | |
| 1.6 TDCi | 4 | HHJC; HHJD; HHJE | 66/89 | 01/09 → | CH201 | 11v | | | | |

KA Van

| | | | | | | | | | | |
|-------|---|------------------------------|-------|---------------|--|--|--------|-------|--------------------------|---------|
| 1.3 i | 4 | BAA | 44/59 | 05/02 → 05/05 | | | CET17P | OE189 | BAEA422 | 10/02 → |
| 1.3 i | 4 | J4D; J4K; J4M; J4N; J4P; J4S | 44/59 | 05/02 → 05/05 | | | CET17P | OE189 | BAEA281 ^[275] | →10/02 |
| | | | | | | | | | BAEA422 ^[275] | →10/02 |

TRANSIT

| | | | | | | | | | | |
|---------|---|----------|--------|---------------|-------|-------|------|-------|--|--------|
| 2.0 | 4 | NSF; NSG | 84/113 | 06/94 → 03/06 | OE014 | 0,9 | CET2 | OE179 | | CLS022 |
| 2.0 CNG | 4 | NSH | 84/113 | 06/94 → 03/00 | | | CET2 | OE179 | | |
| 2.0 DI | 4 | D3FA | 55/74 | 08/00 → 05/06 | CH229 | 11.5v | | | | |

FORD



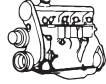

kW/BHP

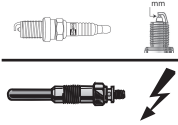

eon TITAN

IRIDIUM

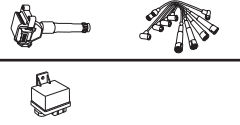

...FORD

...TRANSIT

| | | | | | | | | | |
|------------------------|---|--|---------|-------------|--|----------------|--------|-------|--------------------|
| 2.0 DI | 4 | F3FA | 63/84 | 08/00→05/06 | CH229 | 11.5v | | | |
| 2.0 DI | 4 | ABFA | 74/99 | 08/00→05/06 | CH229 | 11.5v | | | |
| 2.0 TDCi | 4 | F1FA | 92/123 | 08/02→05/06 | CH229 | 11.5v | | | |
| 2.2 TDCi | 4 | P8FA; P8FB | 63/84 | 04/06→08/14 | CH229 [362] | 11.5v | | | |
| 2.2 TDCi | 4 | DRF5; DRFF; DRFG; DRR5 | 74/99 | 10/11→ | CH229 [362] →Prod.30.12.2014 | 11.5v | | | |
| 2.2 TDCi | 4 | DRFA; DRFB; DRFC; DRFD; DRFE; DRR4; DRRB; DRRC | 74/99 | 10/11→ | CH229 [362] | 11.5v | | | |
| 2.2 TDCi | 4 | QVFA | 81/109 | 04/06→08/14 | CH229 [362] | 11.5v | | | |
| 2.2 TDCi | 4 | SRFA; SRFB; SRFC; SRFD; SRFE | 85/114 | 10/08→08/14 | CH229 [362] | 11.5v | | | |
| 2.2 TDCi | 4 | QWFA | 96/129 | 04/06→08/14 | CH229 [362] | 11.5v | | | |
| 2.2 TDCi | 4 | UHR5 | 99/133 | 08/13→ | CH229 [362] →Prod.30.12.2014 | 11.5v | | | |
| 2.2 TDCi | 4 | USRA; USRB | 100/134 | 09/11→08/14 | CH229 [362] | 11.5v | | | |
| 2.2 TDCi | 4 | PGFA; PGFB; UHFA; UHFB; UHFC | 103/138 | 10/07→08/14 | CH229 [362] | 11.5v | | | |
| 2.2 TDCi | 4 | CVRA; CVRB; CVRC | 114/153 | 10/11→ | CH229 [362] CH229 [362] →Prod.30.12.2014 | 11.5v 11.5v | | | |
| 2.2 TDCi, 2.2 TDCi 4WD | 4 | CY14; CY24; CYF5; CYFG; CYR5; USF6; USR6 | 92/123 | 10/11→ | CH229 [362] →Prod.30.12.2014 | 11.5v | | | |
| 2.2 TDCi, 2.2 TDCi 4WD | 4 | CYFA; CYFB; CYFC; CYFD; CYRA; CYRB; CYRC | 92/123 | 10/11→ | CH229 [362] | 11.5v | | | |
| 2.2 TDCi, 2.2 TDCi 4WD | 4 | CV24; CVF5; CVR5; UYR6 | 114/153 | 10/11→ | CH229 [362] →Prod.30.12.2014 | 11.5v | | | |
| 2.3 | 4 | E5FC | 105/141 | 03/01→03/06 | | | | | BAEA308 |
| 2.3 | 4 | E5FA | 107/143 | 08/00→03/06 | | | | | BAEA308 |
| 2.3 16V | 4 | GZFA; GZFB; GZFC | 107/143 | 08/00→08/14 | | CET18P | | | BAEA408 |
| 2.3 16V | 4 | E5FA; E5FC | 107/143 | 08/00→08/14 | OE136 | 0,8 | CET12P | OE179 | BAEA308 |
| 2.4 DI | 4 | D4FA | 88/118 | 01/00→05/06 | CH229 | 11.5v | | | |
| 2.4 DI, 2.4 TD | 4 | F4FA | 55/74 | 01/00→05/06 | CH229 | 11.5v | | | |
| 2.4 DI, 2.4 TDdi | 4 | D2FA; D2FB; D2FE | 66/89 | 01/00→05/06 | CH229 | 11.5v | | | |
| 2.4 TDCi | 4 | PHFA; PHFC | 74/99 | 04/06→08/14 | CH229 | 11.5v | | | |
| 2.4 TDCi | 4 | H9FA | 101/135 | 03/04→05/06 | CH229 | 11.5v | | | |
| 2.4 TDCi, 2.4 TDCi 4WD | 4 | H9FB; H9FD | 103/138 | 04/06→ | CH229 | 11.5v | | | |
| 2.4 TDCi, 2.4 TDE | 4 | FXFA; JXFA; JXFC | 85/114 | 03/04→08/14 | CH229 | 11.5v | | | |
| 2.4 TDE | 4 | DOFA | 92/123 | 07/01→05/06 | CH229 | 11.5v | | | |
| 3.2 TDCi | 5 | SAFA; SAFB | 147/197 | 09/07→08/14 | CH229 | 11.5v | | | |
| TRANSIT CONNECT | | | | | | | | | |
| 1.8 16V | 4 | EYPA; EYPC; EYPD | 85/114 | 06/02→12/13 | OE029 | 1,0 | CET17P | OE189 | BAEA350 BAEA365 |
| 1.8 16V LPG | 4 | EYPC | 85/114 | 06/02→12/13 | OE029 | 1,0 | CET17P | OE189 | BAEA281 |
| 1.8 Di | 4 | BHPA; P7PA; P7PB; R2PA | 55/74 | 06/02→12/13 | CH196 | 10v | | | |
| 1.8 TDCi | 4 | HCPA; HCPB; P9PA; P9PB; P9PC; P9PD; R3PA; RWPE; RWPF | 66/89 | 06/02→12/13 | CH196 | 10v | | | |
| 1.8 TDCi | 4 | RWPA; RWPC; RWPD | 81/109 | 08/06→12/13 | CH196 | 10v | | | |
| TRANSIT CUSTOM | | | | | | | | | |
| 2.2 TDCi | 4 | DRF4; DRFF; DRFG | 74/99 | 04/12→ | CH229 [362] →Prod.30.12.2014 | 11.5v | | | |
| 2.2 TDCi | 4 | CYF4; CYFF | 92/123 | 04/12→ | CH229 [362] →Prod.30.12.2014 | 11.5v | | | |
| 2.2 TDCi | 4 | CVFF | 114/153 | 04/12→ | CH229 [362] →Prod.30.12.2014 | 11.5v | | | |
| TRANSIT TOURNEO | | | | | | | | | |
| 2.0 | 4 | NSF; NSG; NSH | 84/113 | 11/94→12/00 | OE014 | 0,9 | CET2 | OE179 | |
| 2.2 TDCi | 4 | QVFA | 81/109 | 07/06→08/14 | CH229 [362] | 11.5v | | | |

FORD



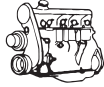

kW/BHP

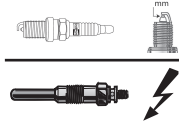

eon TITAN

IRIDIUM

**...FORD****...TRANSIT TOURNEO**

| | | | | | | | | |
|----------|---|---------------------------------|---------|-------------|-------------|-------|--|--|
| 2.2 TDCi | 4 | SRFA; SRFB; SRFC; SRFD; SRFE | 85/114 | 10/08→08/14 | CH229 [362] | 11.5v | | |
| 2.2 TDCi | 4 | QWFA | 96/129 | 07/06→08/14 | CH229 [362] | 11.5v | | |
| 2.2 TDCi | 4 | PGFA; PGFB; UHFA; UHFB; UHFC | 103/138 | 10/07→08/14 | CH229 [362] | 11.5v | | |

FORD ASIA / OCEANIA**FALCON**

| | | | | | | | | |
|---------------|---|----------|---------|--------|-------|-----|--------|-------|
| 4.0, 4.0 Ghia | 6 | BARRA182 | 182/244 | 09/02→ | OE191 | 1,0 | CET12P | OE180 |
|---------------|---|----------|---------|--------|-------|-----|--------|-------|

IKON

| | | | | | | | | |
|-----|---|--|-------|--------|--|--|--|---------|
| 1.6 | 4 | | 67/90 | 06/99→ | | | | BAEA422 |
|-----|---|--|-------|--------|--|--|--|---------|

LASER / LASER LIDEA

| | | | | | | | | |
|-----|---|------|-------|-------------|-------|-----|------|-------|
| 1.6 | 4 | B6GP | 66/89 | 06/94→05/99 | OE039 | 1,0 | CET2 | OE179 |
|-----|---|------|-------|-------------|-------|-----|------|-------|

FORD ASIA / OZEAANIA**FESTIVA**

| | | | | | | | | |
|---------|---|------------|--------|-------------|-------|-----|------|-------|
| 1.8 GLX | 4 | BPE4; BPE5 | 85/114 | 05/94→08/98 | OE034 | 0,9 | CET2 | OE179 |
|---------|---|------------|--------|-------------|-------|-----|------|-------|

LIATA

| | | | | | | | | |
|---------|---|------------|--------|-------------|-------|-----|------|-------|
| 1.8 GLX | 4 | BPE3; BPE5 | 85/114 | 05/94→06/97 | OE034 | 0,9 | CET2 | OE179 |
|---------|---|------------|--------|-------------|-------|-----|------|-------|

TELSTAR

| | | | | | | | | |
|-----|---|------|--------|-------------|-------|-----|------|-------|
| 1.8 | 4 | BPE5 | 85/114 | 05/94→10/00 | OE034 | 0,9 | CET2 | OE179 |
|-----|---|------|--------|-------------|-------|-----|------|-------|

TIERRA

| | | | | | | | | |
|-----|---|------|--------|-------------|-------|-----|------|-------|
| 1.6 | 4 | B6EW | 79/106 | 05/98→09/03 | OE063 | 1,0 | CET2 | OE180 |
|-----|---|------|--------|-------------|-------|-----|------|-------|

FORD ASIA / OZEAANIA**FREDA**

| | | | | | | | | |
|-----|---|--------|-------|-------------|-------|-----|------|-------|
| 2.0 | 4 | HCL580 | 59/79 | 10/94→10/01 | OE063 | 1,0 | CET2 | OE180 |
|-----|---|--------|-------|-------------|-------|-----|------|-------|

| | | | | | | | | |
|-----|---|--------|-------|-------------|-------|-----|------|-------|
| 2.5 | 4 | HCR589 | 62/83 | 10/94→10/01 | OE063 | 1,0 | CET2 | OE180 |
|-----|---|--------|-------|-------------|-------|-----|------|-------|

FORD AUSTRALIA**COUGAR**

| | | | | | | | | |
|-----|---|------|---------|-------------|-------|-----|--------|--|
| 2.5 | 6 | LCBC | 125/168 | 10/99→03/03 | OE131 | 1,0 | CET18P | |
|-----|---|------|---------|-------------|-------|-----|--------|--|

COURIER

| | | | | | | | | |
|------------------|---|----|-------|-------------|-------|-----|--|--|
| 2.5 D, 2.5 D 4WD | 4 | WL | 63/84 | 05/96→02/99 | CH242 | 11v | | |
|------------------|---|----|-------|-------------|-------|-----|--|--|

ESCAPE

| | | | | | | | | |
|---------|---|----|---------|-------------|--|--|--------|--|
| 3.0 4WD | 6 | AJ | 149/200 | 03/01→03/04 | | | CET18P | |
|---------|---|----|---------|-------------|--|--|--------|--|

EXPLORER

| | | | | | | | | |
|---------|---|--|---------|-------------|--|--|------|--|
| 4.6 4WD | 8 | | 178/239 | 11/01→01/08 | | | CET9 | |
|---------|---|--|---------|-------------|--|--|------|--|

F150

| | | | | | | | | |
|--------|---|--|---------|-------------|--|--|------|--|
| 4.6 V8 | 8 | | 154/207 | 05/97→08/98 | | | CET9 | |
|--------|---|--|---------|-------------|--|--|------|--|

| | | | | | | | | |
|--------|---|--|---------|-------------|--|--|------|--|
| 4.6 V8 | 8 | | 164/220 | 09/98→10/01 | | | CET9 | |
|--------|---|--|---------|-------------|--|--|------|--|

| | | | | | | | | |
|------------|---|--|---------|-------------|--|--|------|--|
| 4.6 V8 4WD | 8 | | 248/333 | 10/03→09/07 | | | CET9 | |
|------------|---|--|---------|-------------|--|--|------|--|

| | | | | | | | | |
|--------------------|---|--|---------|-------------|--|--|------|--|
| 4.6 V8, 4.6 V8 4WD | 8 | | 162/217 | 10/96→09/98 | | | CET9 | |
|--------------------|---|--|---------|-------------|--|--|------|--|

| | | | | | | | | |
|--------------------|---|-------|---------|-------------|--|--|------|--|
| 4.6 V8, 4.6 V8 4WD | 8 | ; 99W | 170/228 | 10/98→09/07 | | | CET9 | |
|--------------------|---|-------|---------|-------------|--|--|------|--|

| | | | | | | | | |
|--------|---|--|---------|-------------|--|--|--------|--|
| 5.4 V8 | 8 | | 280/375 | 05/01→11/03 | | | CET18P | |
|--------|---|--|---------|-------------|--|--|--------|--|

F250

| | | | | | | | | |
|--------------------|---|--|---------|-------------|--|--|------|--|
| 4.6 V8, 4.6 V8 4WD | 8 | | 162/217 | 10/96→09/98 | | | CET9 | |
|--------------------|---|--|---------|-------------|--|--|------|--|

| | | | | | | | | |
|--------------------|---|--|---------|-------------|--|--|------|--|
| 4.6 V8, 4.6 V8 4WD | 8 | | 170/228 | 10/98→11/03 | | | CET9 | |
|--------------------|---|--|---------|-------------|--|--|------|--|

F350

| | | | | | | | | |
|--------------------|---|--|---------|-------------|--|--|--------|--|
| 5.4 V8, 5.4 V8 4WD | 8 | | 191/256 | 10/96→11/03 | | | CET18P | |
|--------------------|---|--|---------|-------------|--|--|--------|--|

FALCON

| | | | | | | | | |
|--------------|---|---------|---------|-------------|-------|-----|--------|--|
| 5.4 i V8 XR8 | 8 | Boss260 | 260/349 | 01/03→04/08 | OE131 | 1,0 | CET18P | |
|--------------|---|---------|---------|-------------|-------|-----|--------|--|

FORD





kW/BHP

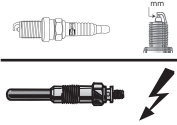

eon TITAN

IRIDIUM

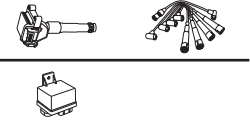
**...FORD AUSTRALIA****...FALCON**

| | | | | | | | | | |
|--------------|---|---------|---------|-------------|-------|-----|--------|--|--|
| 5.4 i V8 XR8 | 8 | Boss290 | 290/389 | 02/08→12/14 | OE131 | 1,0 | CET18P | | |
|--------------|---|---------|---------|-------------|-------|-----|--------|--|--|

FIESTA

| | | | | | | | | | |
|-------|---|------|-------|-------------|-------|-----|--------|-------|--|
| 1.4 i | 4 | SPJA | 71/95 | 10/09→12/10 | OE029 | 1,0 | CET17P | OE189 | |
|-------|---|------|-------|-------------|-------|-----|--------|-------|--|

| | | | | | | | | | |
|----------|---|------|-------|-------------|-------|-----|--|--|--|
| 1.6 TDCi | 4 | HHJD | 66/89 | 01/09→12/10 | CH201 | 11v | | | |
|----------|---|------|-------|-------------|-------|-----|--|--|--|

FOCUS

| | | | | | | | | | |
|-------|---|------|--------|-------------|--|--|--|--|---------|
| 1.8 i | 4 | EYDE | 85/114 | 09/02→04/05 | | | | | BAEA422 |
|-------|---|------|--------|-------------|--|--|--|--|---------|

| | | | | | | | | | |
|-------|---|------|--------|-------------|--|--|--|--|---------|
| 2.0 i | 4 | EDDB | 96/129 | 09/02→04/05 | | | | | BAEA422 |
|-------|---|------|--------|-------------|--|--|--|--|---------|

| | | | | | | | | | |
|-------------|---|------|---------|-------------|--|--|--|--|---------|
| 2.0 i ST170 | 4 | ALDA | 127/170 | 04/03→04/05 | | | | | BAEA422 |
|-------------|---|------|---------|-------------|--|--|--|--|---------|

| | | | | | | | | | |
|----------|---|------|---------|-------------|-------|-----|--|--|--|
| 2.0 TDCi | 4 | G6DA | 100/134 | 04/07→08/11 | CH268 | 11v | | | |
|----------|---|------|---------|-------------|-------|-----|--|--|--|

KA

| | | | | | | | | | |
|-----|---|----------|-------|-------------|-------|-----|--------|-------|--|
| 1.3 | 4 | J4D; J4F | 44/59 | 11/99→12/03 | OE131 | 1,0 | CET18P | OE183 | |
|-----|---|----------|-------|-------------|-------|-----|--------|-------|--|

MONDEO

| | | | | | | | | | |
|-----|---|--|--------|-------------|--|--|--|--|---------|
| 2.0 | 4 | | 94/126 | 12/96→04/01 | | | | | BAEA422 |
|-----|---|--|--------|-------------|--|--|--|--|---------|

| | | | | | | | | | |
|-----|---|-----|--------|-------------|-------|-----|--------|-------|--|
| 2.0 | 4 | NGA | 96/129 | 07/95→02/00 | OE029 | 1,0 | CET17P | OE189 | |
|-----|---|-----|--------|-------------|-------|-----|--------|-------|--|

| | | | | | | | | | |
|-------|---|-----|--------|-------------|-------|-----|--------|-------|--|
| 2.0 i | 4 | NGA | 97/130 | 07/95→12/99 | OE029 | 1,0 | CET17P | OE189 | |
|-------|---|-----|--------|-------------|-------|-----|--------|-------|--|

| | | | | | | | | | |
|----------|---|------|---------|-------------|-------|-----|--|--|--|
| 2.0 TDCi | 4 | AZBA | 103/138 | 03/07→01/15 | CH201 | 11v | | | |
|----------|---|------|---------|-------------|-------|-----|--|--|--|

MUSTANG

| | | | | | | | | | |
|--------|---|--|---------|-------------|--|--|------|--|--|
| 4.6 V8 | 8 | | 160/215 | 11/95→05/99 | | | CET9 | | |
|--------|---|--|---------|-------------|--|--|------|--|--|

| | | | | | | | | | |
|--------|---|--|---------|-------------|--|--|------|--|--|
| 4.6 V8 | 8 | | 165/221 | 11/95→05/99 | | | CET9 | | |
|--------|---|--|---------|-------------|--|--|------|--|--|

| | | | | | | | | | |
|--------|---|--|---------|-------------|--|--|------|--|--|
| 4.6 V8 | 8 | | 192/257 | 06/99→10/00 | | | CET9 | | |
|--------|---|--|---------|-------------|--|--|------|--|--|

| | | | | | | | | | |
|--------|---|--|---------|--------|--|--|------|--|--|
| 4.6 V8 | 8 | | 224/300 | 12/04→ | | | CET9 | | |
|--------|---|--|---------|--------|--|--|------|--|--|

| | | | | | | | | | |
|--------|---|--|---------|-------------|--|--|------|--|--|
| 4.6 V8 | 8 | | 225/302 | 11/95→05/99 | | | CET9 | | |
|--------|---|--|---------|-------------|--|--|------|--|--|

| | | | | | | | | | |
|--------|---|--|---------|-------------|--|--|------|--|--|
| 4.6 V8 | 8 | | 236/316 | 06/99→09/03 | | | CET9 | | |
|--------|---|--|---------|-------------|--|--|------|--|--|

| | | | | | | | | | |
|--------|---|--|---------|--------|--|--|--------|--|--|
| 5.4 V8 | 8 | | 355/476 | 01/06→ | | | CET18P | | |
|--------|---|--|---------|--------|--|--|--------|--|--|

RANGER

| | | | | | | | | | |
|----------|---|-----------|---------|-------------|-------|-----|--|--|--|
| 2.5 TDDi | 4 | WLAT(16V) | 105/141 | 11/06→11/11 | CH242 | 11v | | | |
|----------|---|-----------|---------|-------------|-------|-----|--|--|--|

TAURUS

| | | | | | | | | | |
|-------|---|--|---------|-------------|--|--|--------|--|--|
| 3.0 i | 6 | | 149/200 | 03/96→09/98 | | | CET18P | | |
|-------|---|--|---------|-------------|--|--|--------|--|--|

FORD AUSTRALIA**COURIER**

| | | | | | | | | | |
|------------------|---|----|-------|-------------|-------|-----|--|--|--|
| 2.5 D, 2.5 D 4WD | 4 | WL | 64/86 | 05/96→02/99 | CH242 | 11v | | | |
|------------------|---|----|-------|-------------|-------|-----|--|--|--|

TRANSIT

| | | | | | | | | | |
|--------|---|------|--------|-------------|------------------------|-------|--|--|--|
| 2.2 TD | 4 | QVFA | 81/109 | 09/06→12/14 | CH229 ^[362] | 11.5v | | | |
|--------|---|------|--------|-------------|------------------------|-------|--|--|--|

| | | | | | | | | | |
|--------|---|------------------|--------|-------------|------------------------|-------|--|--|--|
| 2.2 TD | 4 | CYFA; CYFB; CYFC | 92/123 | 01/12→12/14 | CH229 ^[362] | 11.5v | | | |
|--------|---|------------------|--------|-------------|------------------------|-------|--|--|--|

| | | | | | | | | | |
|----------|---|------------------------------|--------|-------------|------------------------|-------|--|--|--|
| 2.2 TDCi | 4 | SRFA; SRFB; SRFC; SRFD; SRFE | 85/114 | 01/10→12/14 | CH229 ^[362] | 11.5v | | | |
|----------|---|------------------------------|--------|-------------|------------------------|-------|--|--|--|

| | | | | | | | | | |
|----------|---|------------------|---------|--------|------------------------|-------|--|--|--|
| 2.2 TDCi | 4 | CVRA; CVRB; CVRC | 114/153 | 10/11→ | CH229 ^[362] | 11.5v | | | |
|----------|---|------------------|---------|--------|------------------------|-------|--|--|--|

| | | | | | | | | | |
|-------|---|------|-------|-------------|-------|-------|--|--|--|
| 2.4 D | 4 | D2FA | 66/89 | 01/00→09/06 | CH229 | 11.5v | | | |
|-------|---|------|-------|-------------|-------|-------|--|--|--|

| | | | | | | | | | |
|-------|---|------|--------|--------|-------|-------|--|--|--|
| 2.4 D | 4 | FXFA | 85/114 | 03/04→ | CH229 | 11.5v | | | |
|-------|---|------|--------|--------|-------|-------|--|--|--|

| | | | | | | | | | |
|-------|---|------|--------|-------------|-------|-------|--|--|--|
| 2.4 D | 4 | D4FA | 88/118 | 01/00→09/06 | CH229 | 11.5v | | | |
|-------|---|------|--------|-------------|-------|-------|--|--|--|

| | | | | | | | | | |
|-------|---|------|--------|-------------|-------|-------|--|--|--|
| 2.4 D | 4 | DOFA | 92/123 | 07/01→09/06 | CH229 | 11.5v | | | |
|-------|---|------|--------|-------------|-------|-------|--|--|--|

| | | | | | | | | | |
|-------|---|------|---------|-------------|-------|-------|--|--|--|
| 2.4 D | 4 | H9FA | 101/135 | 03/04→09/06 | CH229 | 11.5v | | | |
|-------|---|------|---------|-------------|-------|-------|--|--|--|

| | | | | | | | | | |
|--------|---|------|---------|--------|-------|-------|--|--|--|
| 2.4 TD | 4 | H9FB | 103/138 | 07/06→ | CH229 | 11.5v | | | |
|--------|---|------|---------|--------|-------|-------|--|--|--|

TRANSIT CUSTOM

| | | | | | | | | | |
|----------|---|------------|--------|--------|--|-------|--|--|--|
| 2.2 TDCi | 4 | CYF4; CYFF | 92/123 | 09/13→ | CH229 ^[362] →Prod.30.12.2014 | 11.5v | | | |
|----------|---|------------|--------|--------|--|-------|--|--|--|

FORD USA**CROWN VICTORIA**

| | | | | | | | | | |
|-----|---|-----|---------|-------------|--|--|------|--|--|
| 4.6 | 8 | 99W | 167/224 | 09/02→12/07 | | | CET9 | | |
|-----|---|-----|---------|-------------|--|--|------|--|--|

FORD USA

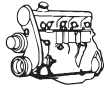

kW/BHP



eon TITAN

IRIDIUM



FORD USA

| ...FORD USA | | | | | | | | | |
|-------------------------|---|-------|---------|-------------|----------------------------|-----|--------|-------|--------------------------|
| ECOSPORT | | | | | | | | | |
| 1.0 XL Supercharged | 4 | | 70/94 | 06/02→ | | | | | BAEA422 |
| 1.6 | 4 | | 72/97 | 10/07→ | | | | | BAEA422 |
| 2.0 XLT 4WD | 4 | | 105/141 | 06/02→ | | | | | BAEA422 |
| ESCAPE | | | | | | | | | |
| 3.0 4WD | 6 | | 145/194 | 01/01→04/04 | | | CET18P | | BAEA410 ^[277] |
| EXPEDITION | | | | | | | | | |
| 4.6 4WD | 8 | 99W | 158/212 | 08/96→09/02 | | | CET9 | | |
| 4.6, 4.6 4WD | 8 | 99W | 173/232 | 09/01→02/06 | | | CET9 | | |
| 5.4 4WD, 5.4 XLT | 8 | | 194/260 | 08/96→02/06 | | | CET18P | | |
| EXPLORER | | | | | | | | | |
| 4.0, 4.0 4WD | 6 | 99X | 150/201 | 10/99→12/01 | | | CET9 | | |
| 4.0 V6 4WD | 6 | | 115/154 | 03/95→12/01 | | | CET18P | OE183 | |
| 4.0 V6 4WD | 6 | | 121/162 | 01/93→12/94 | | | CET18P | OE183 | |
| 4.0 V6 4WD | 6 | | 150/201 | 10/98→12/01 | | | CET9 | OE183 | |
| 4.0 V6 4WD | 6 | | 152/204 | 10/96→12/01 | | | CET18P | OE183 | |
| 4.6, 4.6 4WD | 8 | | 178/239 | 09/01→12/05 | | | CET9 | | |
| 5.0 4WD | 8 | | 157/211 | 01/96→12/01 | | | CET18P | OE183 | |
| F150 | | | | | | | | | |
| 4.6 | 8 | | 164/220 | 09/98→10/01 | | | CET9 | | |
| 4.6 Lariat Supercab 4WD | 8 | | 248/333 | 10/03→09/07 | | | CET9 | | |
| 4.6 XL Styleside | 8 | 99W | 170/228 | 10/03→09/07 | | | CET9 | | |
| F-150 | | | | | | | | | |
| 4.6 | 8 | | 154/207 | 05/97→08/98 | | | CET9 | | |
| 4.6, 4.6 4WD | 8 | | 162/217 | 10/96→09/98 | | | CET9 | | |
| 4.6, 4.6 4WD | 8 | ; 99W | 170/228 | 10/98→09/07 | | | CET9 | | |
| 5.4 | 8 | | 280/375 | 05/01→11/03 | | | CET18P | | |
| F250 | | | | | | | | | |
| 4.6, 4.6 4WD | 8 | | 162/217 | 10/96→09/98 | | | CET9 | | |
| 4.6, 4.6 4WD | 8 | | 170/228 | 10/98→11/03 | | | CET9 | | |
| FIVE HUNDRED | | | | | | | | | |
| 3.0 | 6 | | 151/202 | 08/04→ | | | CET18P | | BAEA410 ^[277] |
| MUSTANG | | | | | | | | | |
| 4.6 | 8 | | 160/215 | 11/95→05/99 | | | CET9 | | |
| 4.6 | 8 | 99W | 165/221 | 11/95→05/99 | | | CET9 | | |
| 4.6 | 8 | | 192/257 | 09/98→12/04 | | | CET9 | | |
| 4.6 | 8 | | 225/302 | 11/95→05/99 | | | CET9 | | |
| 4.6 | 8 | | 228/306 | 11/95→05/99 | | | CET9 | | |
| 4.6 | 8 | | 236/316 | 06/99→09/03 | | | CET9 | | |
| 5.4 V8 | 8 | | 355/476 | 01/06→ | | | CET18P | OE183 | |
| PROBE II | | | | | | | | | |
| 2.0 16V | 4 | FS | 85/114 | 10/93→03/98 | OE089 | 1,0 | CET2 | OE184 | |
| 2.5 V6 24V | 6 | KL | 119/160 | 10/93→03/98 | OE089 | 1,0 | CET2 | OE184 | |
| | | | | | OE216 ^{LPG [278]} | 0,8 | | | |
| 2.5 V6 24V | 6 | KL | 120/161 | 12/94→03/98 | OE089 | 1,0 | CET2 | OE184 | |
| | | | | | OE216 ^{LPG [278]} | 0,8 | | | |
| TAURUS | | | | | | | | | |
| 3.0 | 6 | | 95/127 | 11/98→12/99 | | | CET18P | | |
| 3.0, 3.0 Flex-Fuel | 6 | | 108/145 | 09/95→12/99 | | | CET18P | | |
| 3.0 24V | 6 | | 130/174 | 09/95→12/99 | | | CET18P | | |
| 3.0 24V | 6 | | 149/200 | 06/95→12/03 | | | CET18P | | |
| 3.0 V6 | 6 | | 115/154 | 01/96→12/99 | | | CET18P | | |





kW/BHP

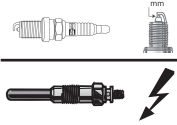

eon TITAN

IRIDIUM

**...FORD USA****THUNDERBIRD**

4.6 8 99W 151/202 01/93→12/97

CET9

WINDSTAR

3.0 V6 6 108/145 01/95→12/00

CET18P

3.0 V6 6 109/146 03/95→02/99

CET18P

FORD USA**E SERIES**

4.6 8 99W 167/224 10/01→09/07

CET9

FOTON**SURF**

2.2 4 4YME 76/102 06/99→08/03

OE048

1,0

CET8

OE195

2.8 TD 4 4JB1T 74/99 02/00→08/03

CH306 (275)

11v

SURFING

2.2 4 491EQ1 76/102 09/03→

OE006

0,9

CET8

OE195

FOTON**ALPHA**

2.2, 2.2 DLX 4 4YME 76/102 08/02→

OE048

1,0

CET8

OE195

2.2 DX 4 4YE 68/91 08/02→

OE048

1,0

CET8

OE195

SEA LION

2.2 DLX 4 4YE 68/91 08/98→03/02

OE048

1,0

CET8

OE195

2.2 DLX 4 4YME 76/102 06/01→

OE048

1,0

CET8

OE195

SUP

2.2 4 BJ491EQ1 76/102 08/03→

OE006

0,9

CET8

OE195

VIEW

2.2 4 BJ491EQ1 76/102 08/02→08/14

OE006

0,9

CET8

OE195

FSO**LANOS**

1.4 4 A13SM 55/74 05/04→10/08

OE006

0,9

CET8

OE195

BAEA447A

1.5 4 A15SM 63/84 05/04→10/08

OE006

0,9

CET8

OE195

1.6 16V 4 A16DMS 78/105 05/04→10/08

OE039

1,0

CET2

OE179

BAEA025E

GAZ**VOLGA**

2.3 4 ZMZ-4062.10 96/129 02/93→12/10

OE051

0,9

CET8

2.3 4 ZMZ-4062.10 107/143 01/07→12/10

OE051

0,9

CET8

2.4 4 ZMZ-4021.10 59/79 02/93→12/10

OE059

0,8

2.4 4 ZMZ-4021.10 66/89 01/97→12/10

OE059

0,8

2.4 4 ZMZ-4021.10 74/99 01/97→12/10

OE059

0,8

GAZ**GAZELLE**

2.3 4 ZMZ-4063.10 72/97 09/01→12/02

OE051

0,9

2.3 4 ZMZ-4062.10 96/129 10/93→08/01

OE051

0,9

CET8

2.3, 2.3 4WD 4 ZMZ-4063.10 104/139 01/03→01/10

OE051

0,9

2.3 4WD 4 ZMZ-4063.10 112/150 01/08→01/10

OE051

0,9

2.4 4 ZMZ-4027.10 63/84 01/03→03/13

OE059

0,8

2.4, 2.4 4WD 4 ; ZMZ-402.10; ZMZ-4025.10 66/89 10/93→03/13

OE059

0,8

2.9 4 UMZ-4215.10 75/101 01/03→01/10

OE006

0,9

CET8

OE195

2.9, 2.9 4WD 4 UMZ4216 78/105 01/05→03/13

OE006

0,9

CET8

OE195

2.9, 2.9 4WD 4 UMZ4216 79/106 01/07→03/13

OE006

0,9

CET8

OE195

GAZ





kW/BHP

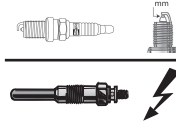

eon TITAN

IRIDIUM

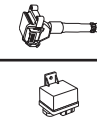
**...GAZ****SOBOL (2217)**

| | | | | | | | | |
|-----|---|-------------|-------|-------------|-------|-----|--|--|
| 2.3 | 4 | ZMZ-4063.10 | 72/97 | 09/97→04/13 | OE051 | 0,9 | | |
| 2.4 | 4 | ZMZ-402.10 | 66/89 | 01/97→ | OE059 | 0,8 | | |

SOBOL (2310)

| | | | | | | | | |
|-----|---|------------|-------|-------------|-------|-----|--|--|
| 2.4 | 4 | ZMZ-402.10 | 66/89 | 09/97→04/13 | OE059 | 0,8 | | |
|-----|---|------------|-------|-------------|-------|-----|--|--|

SOBOL (2752)

| | | | | | | | | |
|-----|---|-------------|-------|-------------|-------|-----|--|--|
| 2.3 | 4 | ZMZ-4063.10 | 72/97 | 09/97→04/13 | OE051 | 0,9 | | |
| 2.4 | 4 | ZMZ-402.10 | 66/89 | 01/97→ | OE059 | 0,8 | | |

GEELY**BL**

| | | | | | | | | |
|-----|---|---------|-------|--------|-------|-----|------|-------|
| 1.3 | 4 | MR479Q | 63/84 | 09/05→ | OE034 | 0,9 | CET2 | OE179 |
| 1.5 | 4 | MR479QA | 69/93 | 09/05→ | OE034 | 0,9 | CET2 | OE179 |

CK

| | | | | | | | | |
|-----|---|----------------|--------|--------|-------|-----|------|-------|
| 1.3 | 4 | 8A-FE; MR479Q | 63/84 | 04/05→ | OE034 | 0,9 | CET2 | OE179 |
| 1.5 | 4 | 5A-FE; MR479QA | 69/93 | 09/05→ | OE034 | 0,9 | CET2 | OE179 |
| 1.6 | 4 | MR481QA | 79/106 | 09/05→ | OE034 | 0,9 | CET2 | OE179 |

GC2

| | | | | | | | | |
|-----|---|--------|-------|--------|-------|-----|------|-------|
| 1.3 | 4 | MR479Q | 63/84 | 12/14→ | OE034 | 0,9 | CET2 | OE179 |
|-----|---|--------|-------|--------|-------|-----|------|-------|

HAOQING

| | | | | | | | | |
|-----|---|-----------------|-------|-------------|-------|-----|------|-------|
| 1.0 | 3 | JL376QE; TJ376Q | 37/50 | 05/98→08/01 | OE006 | 0,9 | CET8 | OE195 |
|-----|---|-----------------|-------|-------------|-------|-----|------|-------|

HISOON

| | | | | | | | | |
|-----|---|---------|-------|-------------|-------|-----|------|-------|
| 1.3 | 4 | MR479Q | 63/84 | 07/04→ | OE034 | 0,9 | CET2 | OE179 |
| 1.5 | 4 | MR479QA | 69/93 | 07/04→12/09 | OE034 | 0,9 | CET2 | OE179 |

HQ

| | | | | | | | | |
|-----|---|---------|-------|--------|-------|-----|------|-------|
| 1.0 | 3 | JL376QE | 38/51 | 09/05→ | OE006 | 0,9 | CET8 | OE195 |
| 1.1 | 3 | JL378QE | 40/54 | 09/05→ | OE006 | 0,9 | CET8 | OE195 |
| 1.3 | 4 | MR479Q | 63/84 | 09/05→ | OE034 | 0,9 | CET2 | OE179 |

MARINDO

| | | | | | | | | |
|-----|---|---------|-------|--------|-------|-----|------|-------|
| 1.5 | 4 | MR479QA | 69/93 | 03/05→ | OE034 | 0,9 | CET2 | OE179 |
|-----|---|---------|-------|--------|-------|-----|------|-------|

MEIRI

| | | | | | | | | |
|-----|---|-------|-------|-------------|-------|-----|------|-------|
| 1.3 | 4 | 8A-FE | 63/84 | 06/99→08/04 | OE034 | 0,9 | CET2 | OE179 |
|-----|---|-------|-------|-------------|-------|-----|------|-------|

MK

| | | | | | | | | |
|-----|---|---------|-------|--------|-------|-----|------|-------|
| 1.5 | 4 | MR479QA | 69/93 | 06/05→ | OE034 | 0,9 | CET2 | OE179 |
|-----|---|---------|-------|--------|-------|-----|------|-------|

MR

| | | | | | | | | |
|-----|---|---------|-------|--------|-------|-----|------|-------|
| 1.0 | 3 | JL376QE | 38/51 | 09/05→ | OE006 | 0,9 | CET8 | OE195 |
| 1.1 | 3 | JL378QE | 40/54 | 09/05→ | OE006 | 0,9 | CET8 | OE195 |
| 1.3 | 4 | MR479Q | 63/84 | 09/05→ | OE034 | 0,9 | CET2 | OE179 |
| 1.5 | 4 | MR479QA | 69/93 | 09/05→ | OE034 | 0,9 | CET2 | OE179 |

PU

| | | | | | | | | |
|-----|---|---------|-------|--------|-------|-----|------|-------|
| 1.0 | 3 | JL376QE | 38/51 | 09/05→ | OE006 | 0,9 | CET8 | OE195 |
| 1.1 | 3 | JL378QE | 40/54 | 09/05→ | OE006 | 0,9 | CET8 | OE195 |
| 1.3 | 4 | MR479Q | 63/84 | 09/05→ | OE034 | 0,9 | CET2 | OE179 |

SL

| | | | | | | | | |
|-----|---|--------|--------|--------|-------|-----|------|-------|
| 1.8 | 4 | JL4G18 | 93/125 | 09/11→ | OE034 | 0,9 | CET2 | OE179 |
|-----|---|--------|--------|--------|-------|-----|------|-------|

URBAN NANNY

| | | | | | | | | |
|-----|---|------------------|-------|--------|-------|-----|------|-------|
| 1.0 | 3 | JL376QE | 38/51 | 05/04→ | OE006 | 0,9 | CET8 | OE195 |
| 1.1 | 3 | JL378QE; JT378QE | 40/54 | 05/04→ | OE006 | 0,9 | CET8 | OE195 |
| 1.3 | 4 | MR479Q | 63/84 | 05/04→ | OE034 | 0,9 | CET2 | OE179 |

VISION

| | | | | | | | | |
|-----|---|---------|--------|--------|-------|-----|------|-------|
| 1.5 | 4 | JL4G15D | 78/105 | 05/09→ | OE034 | 0,9 | CET2 | OE179 |
|-----|---|---------|--------|--------|-------|-----|------|-------|

GAZ





kW/BHP

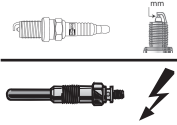

eon TITAN

IRIDIUM

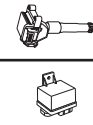
**...GEELY****...VISION**

1.8 4 JL4G18 103/138 08/06→12/12 OE034 0,9 CET2 OE179

GINETTA**G34**

2.0 4 B204FT 140/188 01/95→12/98 OE018 1,0 CET8 OE195

GMC**SAVANA 2500**

5.3 4WD 8 LM7 220/295 09/04→12/05 BAE538

GOLDEN DRAGON**XML**

2.2 4 491Q 68/91 06/99→08/02 OE006 0,9 CET8 OE195

2.2 4 491QME 76/102 08/01→ OE006 0,9 CET8 OE195

GREAT WALL**FENGJUN 5**

2.4 4 4G69S4N 93/125 01/13→ OE063 1,0 CET2 OE180

HOVER H3

2.0 4 4G63S4M 85/114 05/09→ OE063 1,0 CET2 OE180

2.0 4 4G63S4M 90/121 05/09→ OE063 1,0 CET2 OE180

PEGASUS

2.2 RHG Royale, 2.2 RHN Royale 4WD 4 491QE 74/99 02/04→12/08 OE006 0,9 CET8 OE195

STEED

2.2 4 GW491Q-E 78/105 01/12→ OE006 0,9 CET8 OE195

GREAT WALL**DEER**

2.2 4 GA491QE 76/102 02/00→08/03 OE006 0,9 CET8 OE195

SAILING

2.2 4 491Q 74/99 06/01→08/02 OE006 0,9 CET8 OE195

2.2 4WD 4 4YME 76/102 09/02→08/03 OE048 1,0 CET8 OE195

HOLDEN**ADVENTRA**

3.6 i V6 4WD 6 H7 195/261 05/06→07/09 BAE174E

APOLLO

3.0 i 6 3VZ-FE 136/182 03/93→05/97 OE191 1,0 CET12P OE180

ASTRA

1.6 CD 4 X16XEL; Z16XE 74/99 08/95→09/98 OE198 0,9 CET2 OE184

1.8 i 4 X18XE1 85/114 09/96→08/00 BAE342

1.8 i 4 Z18XE 92/123 09/00→03/08 OE198 0,9 CET2 OE184 BAE342

1.8 i 4 Z18XER 103/138 04/07→03/10 OE198 0,9 CET2 OE184

1.9 CDTI 4 Z19DTH 110/148 06/06→03/10 CH224 11v

2.0 i Turbo 4 Z20LER; Z20LET 147/197 06/02→03/10 OE019 0,9 CET2 OE184

2.0 VXR 4 A20NFT 206/276 12/14→ CET17P OE189
*to be adjusted

2.2 4 Z22YH 110/148 12/06→03/08 OE120 0,6 CET2 OE188

2.2 i 4 Z22SE 108/145 09/00→12/06 OE029 1,0 CET17P OE184
OE198 0,9 CET2 OE189**BARINA**

1.4 Efi 4 Z14XEP 66/89 01/04→02/05 OE198 0,9 CET2 OE184

1.8 SRi 4 Z18XE 92/123 09/00→02/05 OE198 0,9 CET2 OE184 BAE342

HOLDEN



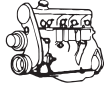

kW/BHP

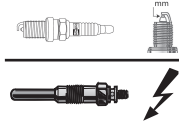

eon TITAN

IRIDIUM

**...HOLDEN****CAPRICE**

3.6 i V6 6 H7 190/255 08/04 → 07/06

BAEA174E

CAPTIVA

2.4 i, 2.4 i 4WD 4 Z24XED 103/138 12/09 → 12/11

OE019

0,9

CET2

OE184

COMMODORE

3.6 i V6 6 HN 180/241 09/04 →

BAEA174E

3.6 i V6 6 HV 210/282 09/07 → 10/13

BAEA174E

3.6 i V6, 3.6 i V6 6 H7; HV; LY7 195/261 07/06 → 10/13

BAEA174E

3.6 i V6, 3.6 i V6 4WD 6 H7; HV 190/255 09/04 → 05/13

BAEA174E

3.6 i V6, 3.6 i V6 Dual Fuel LPG 6 HB 175/235 09/04 → 10/13

BAEA174E

CREWMAN

3.6 i V6 6 HN 180/241 09/06 → 12/07

BAEA174E

3.6 i V6 4WD 6 HB 175/235 11/05 → 12/07

BAEA174E

INSIGNIA

2.8 VXR 4WD 6 A28NER 239/320 01/15 →

OE238

1,0

HOLDEN

RODEO

3.0 TD 4 4JH1-TC 96/129 12/01 → 01/07

CH306

11v

STATESMAN

3.6 i V6 6 LY7 195/261 07/06 → 12/10

BAEA174E

3.6 VVT 6 H7 190/255 08/04 → 07/06

BAEA174E

TIGRA

1.8 4 Z18XE 92/123 09/05 → 12/07

OE198

0,9

CET2

OE184

TRAX

1.8 4 2H0; F18D4 103/138 10/13 →

OE198

0,9

CET2

BAEA199E

VECTRA

2.2 i 4 Z22SE 108/145 04/02 → 12/06

OE029

1,0

CET17P

OE189

VIVA

1.8 i 4 F18D3 89/119 03/05 → 12/09

OE198

0,9

CET2

OE184

BAEA342

ZAFIRA

2.2 i 4 Z22SE 108/145 06/01 → 02/06

OE029

1,0

CET17P

OE189

HOLDEN**COMBO**

1.4 i 4 Z14XEP 66/89 04/05 → 12/12

OE198

0,9

CET2

OE184

BAEA338

ONE TONNER

3.6 i V6, 3.6 i V6 4WD 6 HB 175/235 08/03 → 12/05

BAEA174E

HONDA**ACCORD V**

1.9 i 4 F18A3 85/114 02/96 → 10/98

OE089

1,0

CET2

OE184

OE216 LPG [278]

0,8

2.0, 2.0 i LS 16V 4 F20B3 100/134 09/93 → 02/98

OE089

1,0

CET2

OE184

BAEA275^[292]

OE216 LPG [278]

0,8

2.0 i 4 F20Z2 85/114 03/93 → 01/96

OE089

1,0

CET2

OE184

BAEA275^[292]

OE216 LPG [278]

0,8

2.0 i LS 4 F20Z1 96/129 02/96 → 10/98

OE089

1,0

CET2

OE184

OE216 LPG [278]

0,8

2.0 i S 4 F20Z1 96/129 03/93 → 01/96

OE089

1,0

CET2

OE184

BAEA275^[292]

OE216 LPG [278]

0,8

2.0 TDi 4 20T2N 77/103 04/96 → 10/98

CH169

11v

2.2 4 F22B1 107/143 10/93 → 12/97

BAEA275^[292]**CHAMPION**



kW/BHP

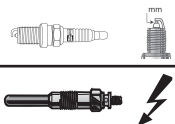

eon TITAN

IRIDIUM

**...HONDA****...ACCORD V**

| | | | | | | | | | |
|------------|---|-------|---------|-------------|--|------------|-------------|--------------|---------------------------------|
| 2.2 i ES | 4 | F22B5 | 110/148 | 09/93→02/98 | OE089 OE216 LPG [278] | 1,0 0,8 | CET2 | OE184 | BAEA275 ^[292] |
| 2.2 i VTEC | 4 | F22Z2 | 110/148 | 02/96→10/98 | OE089 OE216 LPG [278] | 1,0 0,8 | CET2 | OE184 | |
| 2.3 i SR | 4 | H23A3 | 116/156 | 03/93→01/96 | OE089 OE216 LPG [278] | 1,0 0,8 | CET2 | OE184 | BAEA275 ^[292] |

ACCORD VI

| | | | | | | | | | |
|-----------------------|---|-------|---------|-------------|---|-------------|---------------|--------------|---------------------------------|
| 1.6 | 4 | A16A5 | 65/87 | 10/98→12/02 | OE039 | 1,0 | CET2 | OE179 | |
| 1.6 i | 4 | D16B6 | 85/114 | 10/98→12/02 | OE089 OE216 LPG [278] | 1,0 0,8 | CET2 | OE184 | |
| 1.8 i | 4 | F18B2 | 100/134 | 10/98→12/02 | OE089 OE216 LPG [278] | 1,0 0,8 | CET2 | OE184 | |
| 2.0 | 4 | F20B6 | 108/145 | 12/99→12/02 | OE089 | 1,0 | CET2 | OE184 | |
| 2.0 i | 4 | F20B6 | 108/145 | 10/98→01/01 | OE089 OE216 LPG [278] | 1,0 0,8 | CET2 | OE184 | |
| 2.0 i 16V | 4 | F20B7 | 108/145 | 02/98→06/03 | OE089 | 1,0 | CET2 | OE184 | BAEA275 ^[292] |
| 2.0 i 16V | 4 | F20B5 | 108/145 | 02/98→06/03 | OE089 OE216 LPG [278] | 1,0 0,8 | CET2 | OE184 | BAEA275 ^[292] |
| 2.0 TDi, 2.0 Turbo DI | 4 | 20T2N | 77/103 | 02/99→12/02 | CH169 | 11v | | | |
| 2.2 Type-R | 4 | H22A7 | 156/209 | 02/99→12/02 | | | CET12P | OE179 | BAEA275 ^[292] |
| 2.3 | 4 | F23A1 | 113/152 | 11/00→06/03 | | | CET2 | OE184 | |
| 2.3 | 4 | F23Z5 | 113/152 | 11/00→06/03 | OE089 *to be adjusted OE216 LPG [278] | 0,9* 0,8 | CET2 | OE184 | |
| 2.3 16 V | 4 | F23A7 | 118/158 | 02/98→12/02 | OE089 | 1,0 | CET2 | OE184 | |
| 3.0 V6 24V | 6 | J30A1 | 147/197 | 02/98→06/03 | OE089 OE216 LPG [278] | 1,0 0,8 | CET2 | OE184 | |

ACCORD VII

| | | | | | | | | | |
|---------|---|-------------|---------|-------------|--|------------|-------------|--------------|----------------------------------|
| 2.0 | 4 | K20A6 | 114/153 | 02/03→05/08 | OE089 OE216 LPG [278] | 1,0 0,8 | CET2 | OE184 | BAEA169E ^[125] |
| 2.0 4WD | 4 | K20A6 | 114/153 | 02/03→05/08 | OE089 OE216 LPG [278] | 1,0 0,8 | CET2 | OE184 | BAEA169E |
| 2.4 | 4 | K24A; K24A3 | 140/188 | 02/03→05/08 | OE239 | 1,1 | CET3 | | BAEA169E ^[125] |

ACCORD VIII

| | | | | | | | | | |
|-------|---|-------|---------|--------|--------------|-----|-------------|--|-----------------|
| 2.0 i | 4 | R20A4 | 110/148 | 07/08→ | OE239 | 1,1 | CET3 | | |
| 2.0 i | 4 | R20A3 | 115/154 | 06/08→ | OE239 | 1,1 | CET3 | | BAEA182E |

CAPA

| | | | | | | | | | |
|----------|---|------|---------|-------------|--------------|-----|-------------|--------------|--|
| 1.5 16V | 4 | D15B | 72/97 | 04/98→09/02 | OE089 | 1,0 | CET2 | OE184 | |
| 1.6 Vtec | 4 | B16A | 125/168 | 01/98→09/02 | OE014 | 0,9 | CET2 | OE179 | |

CITY

| | | | | | | | | | |
|------------------------|---|-------|-------|-------------|--------------|-----|-------------|--------------|---|
| 1.3 i-DSI 4WD, 1.3 SES | 4 | L13A1 | 63/84 | 09/01→09/05 | OE039 | 1,0 | CET2 | OE179 | BAEA175E ^{[12] [28]} BAEA176E ^{[7] [27]} |
|------------------------|---|-------|-------|-------------|--------------|-----|-------------|--------------|---|

CIVIC V

| | | | | | | | | | |
|------------|---|---------------------|--------|-------------|--|------------|-------------|--------------|---|
| 1.5 | 4 | D15B2 | 66/89 | 10/93→12/95 | OE039 | 1,0 | CET2 | OE180 | BAEA275 ^[292] CLS128 ^[292] CLS129 |
| 1.5 | 4 | D15B7 | 67/90 | 10/93→12/95 | | | | | BAEA275 ^[292] |
| 1.5 | 4 | D15B2; D15B7; D15Z1 | 74/99 | 10/93→12/95 | OE039 | 1,0 | CET2 | OE180 | |
| 1.5 iLSi | 4 | D15B7 | 74/99 | 08/93→11/95 | OE089 OE216 LPG [278] | 1,0 0,8 | CET2 | OE184 | BAEA275 ^[292] CLS128 ^[292] |
| 1.6 i | 4 | D16Y7 | 77/103 | 01/94→11/95 | OE039 | 1,0 | CET2 | OE180 | BAEA275 ^[292] CLS129 |
| 1.6 i Vtec | 4 | D16Y6; D16Z9 | 92/123 | 01/94→03/96 | OE039 | 1,0 | CET2 | OE180 | CLS012 |

HONDA



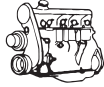

kW/BHP

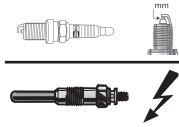

eon TITAN

IRIDIUM



...HONDA

...CIVIC V

| | | | | | | | | | | |
|------------|---|-------|---------|-------------|-------|-----|------|-------|--------------------------|--|
| 1.6 i Vtec | 4 | B16A2 | 118/158 | 01/94→11/95 | OE005 | 0,9 | CET2 | OE180 | BAEA275 ^[292] | |
|------------|---|-------|---------|-------------|-------|-----|------|-------|--------------------------|--|

CIVIC VI

| | | | | | | | | | | |
|-----|---|-------|-------|-------------|--|--|--|--|--------------------------|--|
| 1.4 | 4 | D14A4 | 55/74 | 11/95→10/98 | | | | | BAEA275 ^[292] | |
|-----|---|-------|-------|-------------|--|--|--|--|--------------------------|--|

| | | | | | | | | | | |
|---------|---|-------|-------|-------------|-------|-----|------|-------|--|--------|
| 1.4 16V | 4 | D14A7 | 55/74 | 04/98→02/01 | OE089 | 1,0 | CET2 | OE184 | | CLS012 |
|---------|---|-------|-------|-------------|-------|-----|------|-------|--|--------|

| | | | | | | | | | | |
|--|--|--|--|--|----------------------------|-----|--|--|--|--|
| | | | | | OE216 LPG ^[278] | 0,8 | | | | |
|--|--|--|--|--|----------------------------|-----|--|--|--|--|

| | | | | | | | | | | |
|---------|---|-------|-------|-------------|-------|-----|------|-------|--------------------------|--------|
| 1.4 16V | 4 | D14A8 | 66/89 | 04/98→02/01 | OE089 | 1,0 | CET2 | OE180 | BAEA275 ^[292] | CLS012 |
|---------|---|-------|-------|-------------|-------|-----|------|-------|--------------------------|--------|

| | | | | | | | | | | |
|--|--|--|--|--|----------------------------|-----|--|--|--|--|
| | | | | | OE216 LPG ^[278] | 0,8 | | | | |
|--|--|--|--|--|----------------------------|-----|--|--|--|--|

| | | | | | | | | | | |
|-------|---|---------------------|-------|-------------|-------|-----|------|-------|--|-------------------------|
| 1.4 i | 4 | D14A5; D14A7; D14Z3 | 55/74 | 09/95→02/01 | OE016 | 0,9 | CET2 | OE180 | | CLS128 ^[292] |
|-------|---|---------------------|-------|-------------|-------|-----|------|-------|--|-------------------------|

| | | | | | | | | | | |
|-------|---|--------------|-------|-------------|-------|-----|------|-------|--------------------------|--------|
| 1.4 i | 4 | D14A3; D14Z1 | 55/74 | 09/95→02/01 | OE016 | 0,9 | CET2 | OE180 | BAEA275 ^[292] | CLS129 |
|-------|---|--------------|-------|-------------|-------|-----|------|-------|--------------------------|--------|

| | | | | | | | | | | |
|--|--|--|--|--|-------|-----|--|-------|--|--|
| | | | | | OE089 | 1,0 | | OE184 | | |
|--|--|--|--|--|-------|-----|--|-------|--|--|

| | | | | | | | | | | |
|-------|---|---------------------|-------|-------------|-------|-----|------|-------|--|-------------------------|
| 1.4 i | 4 | D14A2; D14A6; D14A8 | 66/89 | 06/95→02/01 | OE016 | 0,9 | CET2 | OE180 | | CLS128 ^[292] |
|-------|---|---------------------|-------|-------------|-------|-----|------|-------|--|-------------------------|

| | | | | | | | | | | |
|-------|---|-------|-------|-------------|-------|-----|------|-------|--|-------------------------|
| 1.4 i | 4 | D14Z4 | 66/89 | 06/95→02/01 | OE016 | 0,9 | CET2 | OE180 | | CLS128 ^[292] |
|-------|---|-------|-------|-------------|-------|-----|------|-------|--|-------------------------|

| | | | | | | | | | | |
|--|--|--|--|--|-------|-----|--|-------|--|--------|
| | | | | | OE089 | 1,0 | | OE184 | | CLS129 |
|--|--|--|--|--|-------|-----|--|-------|--|--------|

| | | | | | | | | | | |
|-------|---|-------|-------|-------------|-------|-----|------|-------|--|--------|
| 1.4 i | 4 | D14A4 | 66/89 | 06/95→02/01 | OE016 | 0,9 | CET2 | OE180 | | CLS129 |
|-------|---|-------|-------|-------------|-------|-----|------|-------|--|--------|

| | | | | | | | | | | |
|--|--|--|--|--|-------|-----|--|-------|--|--|
| | | | | | OE089 | 1,0 | | OE184 | | |
|--|--|--|--|--|-------|-----|--|-------|--|--|

| | | | | | | | | | | |
|-------|---|-------|-------|-------------|-------|-----|------|-------|--------------------------|--------|
| 1.4 i | 4 | D14Z2 | 66/89 | 06/95→02/01 | OE016 | 0,9 | CET2 | OE180 | BAEA275 ^[292] | CLS129 |
|-------|---|-------|-------|-------------|-------|-----|------|-------|--------------------------|--------|

| | | | | | | | | | | |
|--|--|--|--|--|-------|-----|--|-------|--------|--|
| | | | | | OE089 | 1,0 | | OE184 | 12/98→ | |
|--|--|--|--|--|-------|-----|--|-------|--------|--|

| | | | | | | | | | | |
|---------|---|---------------------|-------|-------------|-------|-----|------|-------|--------------------------|--------|
| 1.4 i S | 4 | D14A4; D14Z2; D14Z4 | 66/89 | 11/95→02/01 | OE016 | 0,9 | CET2 | OE180 | BAEA275 ^[292] | CLS129 |
|---------|---|---------------------|-------|-------------|-------|-----|------|-------|--------------------------|--------|

| | | | | | | | | | | |
|--|--|--|--|--|-------|-----|--|-------|--|--|
| | | | | | OE089 | 1,0 | | OE184 | | |
|--|--|--|--|--|-------|-----|--|-------|--|--|

| | | | | | | | | | | |
|-----|---|-------|-------|-------------|-------|-----|------|-------|--------------------------|--|
| 1.5 | 4 | D15Z3 | 66/89 | 11/95→12/96 | OE089 | 1,0 | CET2 | OE184 | BAEA275 ^[292] | |
|-----|---|-------|-------|-------------|-------|-----|------|-------|--------------------------|--|

| | | | | | | | | | | |
|--|--|--|--|--|-------|-----|--|--|--|--|
| | | | | | OE216 | 0,8 | | | | |
|--|--|--|--|--|-------|-----|--|--|--|--|

| | | | | | | | | | | |
|---------|---|-------|--------|-------------|-------|-----|------|-------|--|--------|
| 1.5 16V | 4 | D15Z8 | 84/113 | 01/97→02/01 | OE089 | 1,0 | CET2 | OE184 | | CLS012 |
|---------|---|-------|--------|-------------|-------|-----|------|-------|--|--------|

| | | | | | | | | | | |
|--|--|--|--|--|----------------------------|-----|--|--|--|--|
| | | | | | OE216 LPG ^[278] | 0,8 | | | | |
|--|--|--|--|--|----------------------------|-----|--|--|--|--|

| | | | | | | | | | | |
|-------|---|-------|--------|-------------|-------|-----|------|-------|--------------------------|--------|
| 1.5 i | 4 | D15Z6 | 84/113 | 11/95→02/01 | OE089 | 1,0 | CET2 | OE184 | BAEA275 ^[292] | CLS129 |
|-------|---|-------|--------|-------------|-------|-----|------|-------|--------------------------|--------|

| | | | | | | | | | | |
|--|--|--|--|--|----------------------------|-----|--|--|--|--|
| | | | | | OE216 LPG ^[278] | 0,8 | | | | |
|--|--|--|--|--|----------------------------|-----|--|--|--|--|

| | | | | | | | | | | |
|--------------|---|-------|-------|-------------|-------|-----|------|-------|--------------------------|--------|
| 1.5 i Vtec-E | 4 | D15Z3 | 66/89 | 09/94→01/97 | OE089 | 1,0 | CET2 | OE184 | BAEA275 ^[292] | CLS129 |
|--------------|---|-------|-------|-------------|-------|-----|------|-------|--------------------------|--------|

| | | | | | | | | | | |
|--|--|--|--|--|----------------------------|-----|--|--|--|--|
| | | | | | OE216 LPG ^[278] | 0,8 | | | | |
|--|--|--|--|--|----------------------------|-----|--|--|--|--|

| | | | | | | | | | | |
|-----|---|-------|--------|-------------|--|--|--|--|--------------------------|--|
| 1.6 | 4 | D16Y7 | 79/106 | 09/95→12/00 | | | | | BAEA275 ^[292] | |
|-----|---|-------|--------|-------------|--|--|--|--|--------------------------|--|

| | | | | | | | | | | |
|-----|---|-------|--------|-------------|--|--|--|--|--------------------------|--|
| 1.6 | 4 | D16Y2 | 93/125 | 10/95→12/00 | | | | | BAEA275 ^[292] | |
|-----|---|-------|--------|-------------|--|--|--|--|--------------------------|--|

| | | | | | | | | | | |
|---------|---|-------|--------|-------------|-------|-----|------|-------|--------------------------|--------|
| 1.6 16V | 4 | D16B2 | 85/114 | 01/97→02/01 | OE089 | 1,0 | CET2 | OE180 | BAEA275 ^[292] | CLS012 |
|---------|---|-------|--------|-------------|-------|-----|------|-------|--------------------------|--------|

| | | | | | | | | | | |
|--|--|--|--|--|----------------------------|-----|--|--|--|--------|
| | | | | | OE216 LPG ^[278] | 0,8 | | | | CLS129 |
|--|--|--|--|--|----------------------------|-----|--|--|--|--------|

| | | | | | | | | | | |
|-------|---|-------|--------|-------------|-------|-----|------|-------|--------------------------|--------|
| 1.6 i | 4 | D16Y7 | 77/103 | 03/96→03/00 | OE039 | 1,0 | CET2 | OE180 | BAEA275 ^[292] | CLS129 |
|-------|---|-------|--------|-------------|-------|-----|------|-------|--------------------------|--------|

| | | | | | | | | | | |
|--|--|--|--|--|--------|--|--|--|--|--|
| | | | | | →12/98 | | | | | |
|--|--|--|--|--|--------|--|--|--|--|--|

| | | | | | | | | | | |
|--|--|--|--|--|-------|-----|--|--|--|--|
| | | | | | OE089 | 1,0 | | | | |
|--|--|--|--|--|-------|-----|--|--|--|--|

| | | | | | | | | | | |
|--|--|--|--|--|--------|--|--|--|--|--|
| | | | | | 01/99→ | | | | | |
|--|--|--|--|--|--------|--|--|--|--|--|

| | | | | | | | | | | |
|--|--|--|--|--|----------------------------|-----|--|--|--|--|
| | | | | | OE216 LPG ^[278] | 0,8 | | | | |
|--|--|--|--|--|----------------------------|-----|--|--|--|--|

| | | | | | | | | | | |
|-------|---|-------|--------|-------------|-------|-----|------|-------|--|-------------------------|
| 1.6 i | 4 | D16Y3 | 83/111 | 09/94→01/97 | OE002 | 0,9 | CET2 | OE180 | | CLS128 ^[292] |
|-------|---|-------|--------|-------------|-------|-----|------|-------|--|-------------------------|

| | | | | | | | | | | |
|-------|---|-------|--------|-------------|-------|-----|------|-------|--|--|
| 1.6 i | 4 | D16Y5 | 84/113 | 11/95→02/01 | OE089 | 1,0 | CET2 | OE184 | | |
|-------|---|-------|--------|-------------|-------|-----|------|-------|--|--|

| | | | | | | | | | | |
|--|--|--|--|--|----------------------------|-----|--|--|--|--|
| | | | | | OE216 LPG ^[278] | 0,8 | | | | |
|--|--|--|--|--|----------------------------|-----|--|--|--|--|

| | | | | | | | | | | |
|------------|---|-------|--------|-------------|----------------------------|-----|------|-------|--------------------------|--------|
| 1.6 i Vtec | 4 | D16Y8 | 92/123 | 11/95→02/01 | OE216 LPG ^[278] | 0,8 | CET2 | OE180 | BAEA275 ^[292] | CLS012 |
|------------|---|-------|--------|-------------|----------------------------|-----|------|-------|--------------------------|--------|

| | | | | | | | | | | |
|--|--|--|--|--|--------|--|--|--|--|--|
| | | | | | 01/98→ | | | | | |
|--|--|--|--|--|--------|--|--|--|--|--|

| | | | | | | | | | | |
|--|--|--|--|--|-------|-----|--|--|--|--|
| | | | | | OE089 | 1,0 | | | | |
|--|--|--|--|--|-------|-----|--|--|--|--|

| | | | | | | | | | | |
|--|--|--|--|--|--------|--|--|--|--|--|
| | | | | | 01/99→ | | | | | |
|--|--|--|--|--|--------|--|--|--|--|--|

| | | | | | | | | | | |
|--|--|--|--|--|-------|-----|--|--|--|--|
| | | | | | OE039 | 1,0 | | | | |
|--|--|--|--|--|-------|-----|--|--|--|--|

| | | | | | | | | | | |
|------------|---|-------|--------|-------------|-------|-----|------|-------|--------------------------|--------|
| 1.6 i Vtec | 4 | D16Y6 | 92/123 | 11/95→02/01 | OE039 | 1,0 | CET2 | OE180 | BAEA275 ^[292] | CLS012 |
|------------|---|-------|--------|-------------|-------|-----|------|-------|--------------------------|--------|

| | | | | | | | | | | |
|------------|---|-------|--------|-------------|-------|-----|------|-------|--------------------------|--------|
| 1.6 i Vtec | 4 | D16Y2 | 93/125 | 09/94→01/97 | OE002 | 0,9 | CET2 | OE180 | BAEA275 ^[292] | CLS129 |
|------------|---|-------|--------|-------------|-------|-----|------|-------|--------------------------|--------|

| | | | | | | | | | | |
|------------|---|-------|---------|-------------|-------|-----|------|-------|--------------------------|--|
| 1.6 i Vtec | 4 | B16A2 | 118/158 | 04/99→12/00 | OE034 | 0,9 | CET2 | OE179 | BAEA275 ^[292] | |
|------------|---|-------|---------|-------------|-------|-----|------|-------|--------------------------|--|

| | | | | | | | | | | |
|---------|---|-------|---------|-------------|--|--|------|-------|--------------------------|--|
| 1.6 VTi | 4 | B16A2 | 118/158 | 11/95→02/01 | | | CET2 | OE179 | BAEA275 ^[292] | |
|---------|---|-------|---------|-------------|--|--|------|-------|--------------------------|--|

| | | | | | | | | | | |
|---------|---|-------|---------|-------------|--|--|------|-------|--------------------------|--|
| 1.8 16V | 4 | B18C4 | 124/166 | 01/97→02/01 | | | CET2 | OE179 | BAEA275 ^[292] | |
|---------|---|-------|---------|-------------|--|--|------|-------|--------------------------|--|

| | | | | | | | | | | |
|-------------------|---|-------|-------|-------------|-------|-----|--|--|--|--|
| 2.0 i D, 2.0 TDiC | 4 | 20T2N | 74/99 | 04/98→02/01 | CH169 | 11v | | | | |
|-------------------|---|-------|-------|-------------|-------|-----|--|--|--|--|

| | | | | | | | | | | |
|-------------------|---|-------|--------|-------------|-------|-----|--|--|--|--|
| 2.0 i D, 2.0 TDiC | 4 | 20T2N | 77/103 | 04/98→02/01 | CH169 | 11v | | | | |
|-------------------|---|-------|--------|-------------|-------|-----|--|--|--|--|

| | | | | | | | | | | |
|----------|---|-------|-------|-------------|-------|-----|--|--|--|--|
| 2.0 i TD | 4 | 20T2R | 63/84 | 01/97→02/01 | CH169 | 11v | | | | |
|----------|---|-------|-------|-------------|-------|-----|--|--|--|--|

HONDA





kW/BHP

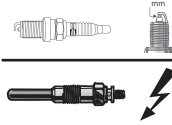

eon TITAN

IRIDIUM

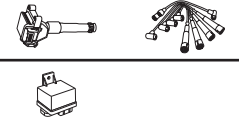

...HONDA

CIVIC VII

| | | | | | | | | | | |
|-------------------|---|--------------|---------|-------------|-----------------|-----|--------|-------|--|---|
| 1.2 i-DSI | 4 | L12A1 | 58/78 | 04/01→10/04 | | | | | | BAEA175E [12] [28] BAEA176E [7] [27] |
| 1.3 Hybrid | 4 | LDA1 | 69/93 | 09/02→12/05 | | | CET12P | OE180 | | BAEA175E [12] [28] BAEA176E [7] [27] |
| 1.3 IMA | 4 | LDA1 | 61/82 | 10/03→09/05 | | | CET12P | OE180 | | BAEA175E [12] [28] BAEA176E [7] [27] |
| 1.4, 1.4 iS | 4 | D14Z5; D14Z6 | 66/89 | 12/00→09/05 | OE089 | 1,0 | CET2 | OE184 | | BAEA170E |
| | | | | | OE216 LPG [278] | 0,8 | | | | |
| 1.4 i | 4 | D14Z6 | 55/74 | 02/01→09/05 | OE089 | 1,0 | CET2 | OE184 | | BAEA170E |
| | | | | | OE216 LPG [278] | 0,8 | | | | |
| 1.6 | 4 | R16A1 | 84/113 | 02/01→09/05 | | | | | | BAEA182E |
| 1.6, 1.6 i | 4 | D16V1; D16W7 | 81/109 | 02/01→12/05 | OE089 | 1,0 | CET2 | OE180 | | BAEA170E |
| | | | | | OE216 LPG [278] | 0,8 | | | | |
| 1.7 | 4 | D17A6 | 85/114 | 02/01→09/05 | OE089 | 1,0 | CET2 | OE184 | | BAEA170E |
| 1.7 | 4 | D17A6 | 92/123 | 01/00→08/05 | | | | | | BAEA170E [275] |
| 1.7 i | 4 | D17A8 | 88/118 | 05/01→12/05 | OE089 | 1,0 | CET2 | OE184 | | BAEA170E |
| | | | | | OE216 LPG [278] | 0,8 | | | | |
| 1.7 i VTEC | 4 | D17A9 | 92/123 | 05/01→12/05 | OE089 | 1,0 | CET2 | OE184 | | BAEA170E |
| | | | | | OE216 LPG [278] | 0,8 | | | | |
| 1.7 i VTEC | 4 | D17A5 | 92/123 | 05/01→12/05 | OE089 | 1,0 | CET2 | OE184 | | BAEA170E |
| 2.0 | 4 | K20A3 | 118/158 | 10/03→09/05 | OE146 | 1,0 | CET12P | OE179 | | BAEA169E |
| | | | | | OE216 LPG [278] | 0,8 | | | | |
| 2.0 i Sport | 4 | K20A3 | 118/158 | 09/01→09/05 | OE089 | 1,0 | CET2 | OE184 | | BAEA169E [125] |
| | | | | | OE216 LPG [278] | 0,8 | | | | |
| 2.0 Type-R | 4 | K20A2 | 147/197 | 09/01→09/05 | | | CET12P | OE179 | | BAEA169E [125] |
| CIVIC VIII | | | | | | | | | | |
| 1.3 Hybrid | 4 | LDA2 | 70/94 | 01/06→ | | | CET14P | OE190 | | BAEA176E [7] |
| 1.3 Hybrid | 4 | LDA2 | 85/114 | 01/10→02/12 | | | CET14P | OE190 | | BAEA176E [7] |
| 1.4 | 4 | L13A7 | 61/82 | 09/05→ | | | CET12P | OE179 | | BAEA175E [12] [28] BAEA176E [7] [27] |
| 1.6 | 4 | R16A1 | 84/113 | 09/05→ | OE239 | 1,1 | CET3 | | | BAEA182E |
| 1.6 | 4 | R16A1 | 92/123 | 09/05→ | | | | | | BAEA182E 06/06→03/12 |
| 1.8 | 4 | R18A1; R18A2 | 103/138 | 09/05→ | OE239 | 1,1 | CET3 | | | BAEA182E |
| 2.0 | 4 | K20A3 | 114/153 | 02/06→02/12 | OE146 | 1,0 | CET12P | OE179 | | BAEA169E |
| | | | | | OE216 LPG [278] | 0,8 | | | | |
| 2.0 Type R | 4 | K20Z4 | 148/198 | 09/06→ | | | CET12P | OE179 | | BAEA169E [125] |
| CIVIC IX | | | | | | | | | | |
| 1.4 i-VTEC | 4 | L13Z4 | 73/98 | 02/12→ | OE239 | 1,1 | CET3 | | | |
| CR-V I | | | | | | | | | | |
| 2.0 4WD | 4 | B20Z1 | 98/131 | 04/99→02/02 | OE089 | 1,0 | CET2 | OE188 | | BAEA275 [292] |
| 2.0 16V 4WD | 4 | B20B | 94/126 | 10/95→12/01 | OE089 | 1,0 | CET2 | OE184 | | BAEA275 [292] |
| | | | | | OE216 LPG [278] | 0,8 | | | | |
| 2.0 16V 4WD | 4 | B20Z1 | 108/145 | 01/99→02/02 | OE089 | 1,0 | CET2 | OE184 | | BAEA275 [292] |
| | | | | | OE216 LPG [278] | 0,8 | | | | |
| CR-V II | | | | | | | | | | |
| 2.0 4WD | 4 | K20A | 110/148 | 09/01→03/07 | OE089 | 1,0 | CET2 | OE184 | | |
| 2.0 4WD | 4 | K20A4 | 110/148 | 09/01→03/07 | OE216 LPG [278] | 0,8 | | | | BAEA169E [125] |

HONDA



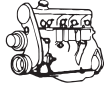

kW/BHP

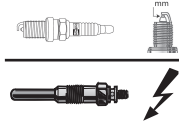

eon TITAN

IRIDIUM



HONDA

...HONDA

...CR-V II

| | | | | | | | | | |
|--------------|---|-------|---------|-------------|-------|-----|------|-------|--|
| 2.0 4WD | 4 | K20A5 | 112/150 | 03/02→09/06 | OE089 | 1,0 | | | |
| 2.4 Vtec 4WD | 4 | K24A | 118/158 | 09/01→09/06 | OE089 | 1,0 | CET2 | OE184 | |

CR-V III

| | | | | | | | | | |
|----------------|---|--------------|---------|--------|-------|-----|------|-------|----------|
| 2.0 i 4WD | 4 | R20A2 | 110/148 | 01/07→ | OE239 | 1,1 | CET3 | | BAEA182E |
| 2.4 | 4 | K24A1 | 125/168 | 04/07→ | OE089 | 1,0 | CET2 | OE184 | BAEA169E |
| 2.4 4WD | 4 | K24A; K24Z1 | 124/166 | 09/06→ | OE089 | 1,0 | CET2 | OE184 | |
| 2.4 i-VTEC 4WD | 4 | K24Z1 | 118/158 | 10/06→ | OE239 | 1,1 | CET3 | | BAEA169E |
| 2.4 i-VTEC 4WD | 4 | K24Z1; K24Z4 | 122/164 | 09/09→ | OE239 | 1,1 | CET3 | | BAEA169E |
| 2.4 i-Vtec 4WD | 4 | K24Z1 | 125/168 | 04/07→ | OE239 | 1,1 | CET3 | | |

CR-V IV

| | | | | | | | | | |
|--------------|---|-------|---------|--------|-------|-----|------|--|--|
| 2.0, 2.0 4WD | 4 | R20A9 | 114/153 | 10/12→ | OE239 | 1,1 | CET3 | | |
| 2.4 4WD | 4 | K24Z9 | 140/188 | 01/12→ | OE239 | 1,1 | CET3 | | |

CR-Z

| | | | | | | | | | |
|------------|---|------|--------|--------|-------|-----|------|--|--|
| 1.5 Hybrid | 4 | LEA1 | 84/113 | 06/10→ | OE239 | 1,1 | CET3 | | |
|------------|---|------|--------|--------|-------|-----|------|--|--|

DOMANI

| | | | | | | | | | |
|-----|---|-------|---------|-------------|-------|-----|------|-------|--|
| 1.4 | 4 | B13B | 67/90 | 11/94→12/97 | OE014 | 0,9 | CET2 | OE179 | |
| 1.8 | 4 | B18B6 | 103/138 | 10/94→09/00 | OE089 | 1,0 | CET2 | OE188 | |

ELEMENT

| | | | | | | | | | |
|------------------------|---|-------|---------|-------------|--|--|--------|-------|--|
| 2.4 Vtec, 2.4 Vtec 4WD | 4 | K24A6 | 118/158 | 07/02→12/11 | | | CET12P | OE194 | |
|------------------------|---|-------|---------|-------------|--|--|--------|-------|--|

ELYSION

| | | | | | | | | | |
|------------|---|-------|---------|--------|-------|-----|------|--|--|
| 3.0 i-VTEC | 6 | J30A4 | 184/247 | 05/04→ | OE239 | 1,1 | CET3 | | |
| 3.5 i-VTEC | 6 | | 221/296 | 05/04→ | OE239 | 1,1 | CET3 | | |

FR-V

| | | | | | | | | | |
|---------|---|-------|---------|-------------|-----------------|-----|------|-------|---------------------------|
| 1.7 | 4 | D17A2 | 92/123 | 08/04→ | OE089 | 1,0 | CET2 | OE184 | BAEA170E |
| | | | | | OE216 LPG [278] | 0,8 | | | |
| 1.8 | 4 | R18A1 | 103/138 | 01/07→ | OE239 | 1,1 | CET3 | | BAEA182E |
| 2.0 | 4 | K20A9 | 110/148 | 02/05→ | OE089 | 1,0 | CET2 | OE184 | BAEA169E ^[125] |
| | | | | | OE216 LPG [278] | 0,8 | | | |
| 2.0 | 4 | K20A9 | 114/153 | 08/04→09/06 | OE089 | 1,0 | CET2 | OE184 | BAEA169E |
| | | | | | OE216 LPG [278] | 0,8 | | | |
| 2.0 4WD | 4 | K20A9 | 114/153 | 08/04→09/06 | OE089 | 1,0 | CET2 | OE184 | |
| | | | | | OE216 LPG [278] | 0,8 | | | |

HR-V

| | | | | | | | | | | |
|----------------------|---|-------|--------|--------|-----------------|-----|------|-------|--------------------------|--------|
| 1.6 16V, 1.6 16V 4WD | 4 | D16W1 | 77/103 | 03/99→ | OE089 | 1,0 | CET2 | OE184 | BAEA275 ^[292] | CLS129 |
| | | | | | OE216 LPG [278] | 0,8 | | | | |
| 1.6 16V 4WD | 4 | D16W5 | 91/122 | 10/99→ | OE089 | 1,0 | CET2 | OE184 | BAEA275 ^[292] | CLS129 |
| | | | | | OE216 LPG [278] | 0,8 | | | →12/05 | |

INSIGHT

| | | | | | | | | | |
|------------|---|------|-------|-------------|--|--|--------|-------|--|
| 1.0 Hybrid | 3 | ECA1 | 56/75 | 04/00→12/06 | | | CET14P | OE190 | |
| 1.3 Hybrid | 4 | LDA3 | 65/87 | 04/09→ | | | CET14P | OE190 | |
| 1.3 Hybrid | 4 | LDA3 | 73/98 | 04/09→ | | | CET14P | OE190 | |

INSPIRE

| | | | | | | | | | |
|--------|---|------|---------|-------------|-------|-----|--------|-------|--|
| 3.2 GX | 6 | C32A | 155/208 | 06/95→08/98 | OE136 | 0,8 | CET12P | OE179 | |
|--------|---|------|---------|-------------|-------|-----|--------|-------|--|

INTEGRA

| | | | | | | | | | |
|----------------|---|-------|---------|-------------|-----------------|-----|--------|-------|--------------------------|
| 1.8 SiR | 4 | B18C | 132/177 | 09/93→08/01 | | | | | BAEA275 ^[292] |
| 1.8 Type-R | 4 | B18C6 | 140/188 | 11/97→10/01 | | | CET12P | OE180 | BAEA275 ^[292] |
| 1.8 VtiR | 4 | B18C1 | 127/170 | 07/93→11/99 | | | | | BAEA275 ^[292] |
| 2.0 | 4 | K20A3 | 118/158 | 02/02→ | OE089 | 1,0 | CET12P | OE179 | BAEA169E |
| | | | | | →07/06 | | | | |
| | | | | | OE216 LPG [278] | 0,8 | | | |
| 2.0 16V Type-R | 4 | K20Z1 | 162/217 | 02/02→ | | | CET12P | OE179 | |





kW/BHP

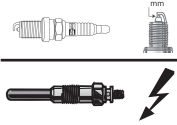

eon TITAN

IRIDIUM

**...HONDA**

| ...HONDA | | | | | | | | | |
|-------------------|---|--------------|---------|-------------|--------------------------|------------|--------|-------|---|
| JAZZ | | | | | | | | | |
| 1.3 | 4 | L13A1 | 63/84 | 05/03→07/08 | OE039 | 1,0 | CET2 | OE179 | BAEA175E [12] [28] BAEA176E [7] [27] |
| 1.5 i-DSI | 4 | L15A2 | 66/89 | 12/02→07/08 | OE039 | 1,0 | CET2 | OE179 | |
| 1.5 i-DSI | 4 | L15A2 | 81/109 | 10/04→07/08 | OE039 | 1,0 | CET2 | OE179 | |
| JAZZ II | | | | | | | | | |
| 1.2 i-DSI | 4 | L12A1; L12A4 | 57/76 | 03/02→07/08 | OE039 | 1,0 | CET2 | OE179 | BAEA175E [12] [28] BAEA176E [7] [27] |
| 1.3 | 4 | L13A1 | 61/82 | 03/02→07/08 | OE039 | 1,0 | CET2 | OE179 | BAEA175E [12] [28] BAEA176E [7] [27] |
| 1.3 iDSi | 4 | L13A1 | 63/84 | 03/02→09/07 | OE039 | 1,0 | CET2 | OE179 | BAEA175E [12] [28] BAEA176E [7] [27] |
| 1.4 | 4 | L13A1 | 59/79 | 12/06→10/08 | OE039 | 1,0 | CET2 | OE179 | BAEA175E [12] [28] BAEA176E [7] [27] |
| 1.5 | 4 | L15A | 81/109 | 04/02→07/08 | OE039 | 1,0 | | | |
| JAZZ III | | | | | | | | | |
| 1.2 | 4 | L12B1 | 66/89 | 07/08→ | OE239 | 1,1 | CET3 | | BAEA175E [12] [28] BAEA176E [7] [27] |
| 1.3 HYBRID | 4 | LDA3 | 65/87 | 04/11→ | | | CET14P | OE190 | |
| 1.5 i-VTEC | 4 | L15A3; L15A7 | 88/118 | 07/08→ | OE239 | 1,1 | CET3 | | |
| LAGREAT | | | | | | | | | |
| 3.5 EX | 6 | J35A | 151/202 | 11/98→06/02 | OE239 | 1,1 | CET3 | | |
| 3.5 EXi Vtec | 6 | J35A8 | 182/244 | 09/05→ | | | CET12P | OE194 | |
| LEGEND III | | | | | | | | | |
| 3.5 i 24V | 6 | C35A2 | 151/202 | 02/96→10/97 | | | CET12P | OE180 | |
| 3.5 VTEC V6 | 6 | C35A8 | 221/296 | 10/04→06/09 | OE154 | 1,0 | CET2 | OE194 | |
| LEGEND IV | | | | | | | | | |
| 3.5 V6 4WD | 6 | C35A8; J35A8 | 217/291 | 05/06→12/12 | OE239 | 1,1 | CET3 | | |
| LOGO | | | | | | | | | |
| 1.3 | 4 | D13B7 | 48/64 | 03/99→03/02 | OE089 OE216 LPG [278] | 1,0 0,8 | CET2 | OE184 | BAEA275 ^[292] CLS129 |
| NSX I | | | | | | | | | |
| 3.2 24V Vtec | 6 | C32B2 | 206/276 | 01/97→09/05 | OE146 | 1,0 | CET12P | OE179 | |
| ODYSSEY | | | | | | | | | |
| 3.5 | 6 | J35A | 171/229 | 07/02→08/04 | OE239 | 1,1 | CET3 | | |
| 3.5 | 6 | J35A8 | 182/244 | 09/04→ | OE239 | 1,1 | CET3 | | |
| PRELUDE IV | | | | | | | | | |
| 2.2 i 16V Vtec | 4 | H22A2 | 136/182 | 02/93→09/96 | OE089 OE216 LPG [278] | 1,0 0,8 | CET12P | OE179 | BAEA275 ^[292] |
| PRELUDE V | | | | | | | | | |
| 2.0 16V | 4 | F20A4 | 98/131 | 10/96→10/00 | OE089 OE216 LPG [278] | 1,0 0,8 | CET2 | OE184 | BAEA275 ^[292] |
| 2.2 16V | 4 | H22A2; H22A5 | 136/182 | 10/96→10/00 | | | CET12P | OE179 | BAEA275 ^[292] |
| 2.2 16V | 4 | H22A5 | 147/197 | 10/96→10/00 | | | CET12P | OE179 | BAEA275 ^[292] |

HONDA



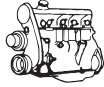

kW/BHP

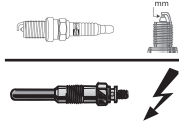

eon TITAN

IRIDIUM



HONDA

| ...HONDA | | | | | | | | | |
|------------------|---|----------|---------|-------------|----------------------------|-----|--------|-------|---------------------------------|
| RIDGELINE | | | | | | | | | |
| 3.5 4WD | 6 | J35A9 | 188/252 | 03/05→12/14 | OE239 | 1,1 | CET3 | | |
| S2000 | | | | | | | | | |
| 2.0 | 4 | F20CVTEC | 177/237 | 06/99→ | OE136 | 0,8 | CET12P | OE179 | BAEA169E |
| 2.2 Vtec | 4 | F22C1 | 176/236 | 10/03→ | | | | | BAEA169E |
| SHUTTLE | | | | | | | | | |
| 2.2 16V | 4 | F22B8 | 110/148 | 10/94→02/98 | OE089 | 1,0 | CET2 | OE184 | BAEA275 ^[292] |
| | | | | | OE216 ^{LPG [278]} | 0,8 | | | |
| 2.3 16V | 4 | F23A7 | 110/148 | 10/97→06/04 | OE089 | 1,0 | CET2 | OE184 | BAEA275 ^[292] |
| | | | | | OE216 ^{LPG [278]} | 0,8 | | | |
| SMX | | | | | | | | | |
| 2.0 Lowdown | 4 | B20B1 | 103/138 | 10/99→09/02 | OE089 | 1,0 | CET2 | OE188 | |
| STEPWGN | | | | | | | | | |
| 2.0, 2.0 4WD | 4 | K20A9 | 118/158 | 10/00→09/05 | OE089 | 1,0 | CET2 | OE184 | |
| | | | | | OE216 ^{LPG [278]} | 0,8 | | | |
| STREAM | | | | | | | | | |
| 1.7 16V | 4 | D17A2 | 92/123 | 05/01→ | OE089 | 1,0 | CET2 | OE184 | BAEA170E |
| | | | | | OE216 ^{LPG [278]} | 0,8 | | | |
| 2.0 16V | 4 | K20A1 | 115/154 | 05/01→ | OE089 | 1,0 | CET2 | OE184 | BAEA169E ^[125] |
| | | | | | OE216 ^{LPG [278]} | 0,8 | | | |
| HUMMER | | | | | | | | | |
| HUMMER H3 | | | | | | | | | |
| 3.5 4WD | 5 | L52 | 162/217 | 04/05→ | | | CET17P | OE189 | |
| HYUNDAI | | | | | | | | | |
| ACCENT | | | | | | | | | |
| 1.3 | 4 | G4EH | 44/59 | 10/94→01/00 | OE063 | 1,0 | CET2 | OE180 | BAEA264 CLS023 |
| 1.3 | 4 | G4EH | 55/74 | 10/94→01/00 | OE063 | 1,0 | CET2 | OE180 | BAEA264 CLS023 |
| 1.3 i 12V | 4 | G4EH | 62/83 | 10/94→01/00 | OE063 | 1,0 | CET2 | OE180 | BAEA264 CLS023 |
| | | | | | | | | | →07/99 |
| 1.5 | 4 | G4EK | 63/84 | 10/94→07/99 | | | | | BAEA264 |
| 1.5 i 12V | 4 | G4EK | 65/87 | 10/94→01/00 | OE063 | 1,0 | CET2 | OE180 | BAEA264 CLS024 |
| 1.5 i 16V | 4 | G4ER | 73/98 | 10/95→01/00 | OE063 | 1,0 | CET2 | OE180 | BAEA264 CLS023 |
| ACCENT I | | | | | | | | | |
| 1.3 | 4 | G4EH | 44/59 | 10/94→01/00 | OE063 | 1,0 | CET2 | OE180 | BAEA264 CLS023 |
| 1.3 | 4 | G4EH | 55/74 | 10/94→01/00 | OE063 | 1,0 | CET2 | OE180 | BAEA264 CLS023 |
| 1.3 i 12V | 4 | G4EH | 62/83 | 10/94→01/00 | OE063 | 1,0 | CET2 | OE180 | BAEA264 CLS023 |
| 1.5 i 12V | 4 | G4EK | 65/87 | 10/94→01/00 | OE063 | 1,0 | CET2 | OE180 | BAEA264 CLS023 ^[367] |
| | | | | | | | | | CLS024 ^[320] |
| 1.5 i 16V | 4 | G4ER | 73/98 | 12/95→01/00 | OE063 | 1,0 | CET2 | OE180 | BAEA264 CLS023 ^[367] |
| | | | | | | | | | CLS024 ^[320] |
| ACCENT II | | | | | | | | | |
| 1.3 | 4 | G4EA | 55/74 | 01/00→11/05 | OE063 | 1,0 | CET2 | OE180 | BAEA479 CLS023 |
| | | | | | | | | | →07/00 |
| | | | | | | | | | CLS072 |
| | | | | | | | | | 07/00→ |
| 1.3 | 4 | G4EA | 61/82 | 01/00→11/05 | OE063 | 1,0 | CET2 | OE180 | BAEA479 CLS023 |
| | | | | | | | | | →07/00 |
| | | | | | | | | | CLS072 |
| | | | | | | | | | 07/00→ |
| 1.3 | 4 | G4EH | 62/83 | 08/02→11/05 | OE063 | 1,0 | CET2 | OE180 | BAEA479 CLS072 |
| 1.3 | 4 | G4EA | 63/84 | 01/00→11/05 | OE063 | 1,0 | CET2 | OE180 | BAEA479 ^[117] CLS023 |
| | | | | | | | | | →07/00 |
| | | | | | | | | | BAEA479 CLS072 |
| | | | | | | | | | 07/00→ |





kW/BHP

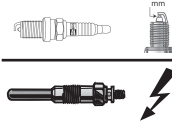

eon TITAN

IRIDIUM

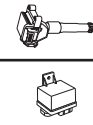

...HYUNDAI

...ACCENT II

| | | | | | | | | | | |
|----------|---|--------|--------|-------------|-------|-----|------|-------|---------|--------|
| 1.5 | 4 | G4EB | 66/89 | 01/00→11/05 | OE063 | 1,0 | CET2 | OE180 | BAEA479 | CLS072 |
| 1.5 | 4 | G4FK | 73/98 | 09/99→10/02 | OE063 | 1,0 | | | BAEA479 | |
| 1.5 | 4 | G4EC-G | 75/101 | 09/99→11/05 | OE063 | 1,0 | CET2 | OE180 | BAEA479 | CLS024 |
| 1.5 | 4 | G4FK | 75/101 | 09/99→11/05 | OE063 | 1,0 | CET2 | OE180 | BAEA483 | |
| 1.5 CRDi | 3 | D3EA | 60/80 | 01/02→11/05 | CH226 | 11v | | | | |
| 1.6 | 4 | G4ED-G | 77/103 | 12/02→11/05 | OE063 | 1,0 | CET2 | OE180 | BAEA483 | |

ACCENT III

| | | | | | | | | | | |
|---------|---|------|--------|-------------|-------|-----|------|-------|--|--------|
| 1.4 GL | 4 | G4EE | 71/95 | 11/05→11/10 | | | CET2 | OE179 | | CLS024 |
| 1.6 GLS | 4 | G4ED | 82/110 | 11/05→11/10 | OE063 | 1,0 | CET2 | OE180 | | |

ACCENT IV

| | | | | | | | | | | |
|-----|---|------|--------|-------------|-------|-----|------|-------|---|--|
| 1.4 | 4 | G4LC | 74/99 | 11/10→ | | | | OE248 | | |
| 1.4 | 4 | G4FA | 79/106 | 11/10→ | OE201 | 0,9 | CET6 | | BAEA475 ^[275] | |
| 1.4 | 4 | G4FA | 80/107 | 11/10→12/14 | OE201 | 0,9 | CET6 | | BAEA475 ^[326] Prod.20.01.2011→ Prod.25.10.2013 | |
| 1.6 | 4 | G4FC | 90/121 | 11/10→ | OE201 | 0,9 | CET6 | | BAEA475 ^[275] | |
| 1.6 | 4 | G4FC | 91/122 | 11/10→ | OE201 | 0,9 | CET6 | | BAEA475 ^[275] | |

ASLAN

| | | | | | | | | | | |
|---------|---|------|---------|-------------|--|--|--------|-------|--|--|
| 3.3 GDi | 6 | G6DH | 216/290 | 06/14→08/16 | | | CET14P | OE190 | | |
|---------|---|------|---------|-------------|--|--|--------|-------|--|--|

ATOS

| | | | | | | | | | | |
|-------|---|--------|-------|-------------|-------|-----|------|-------|-----------------------------------|--------------------------------------|
| 1.0 i | 4 | G4HC | 40/54 | 02/98→12/00 | OE063 | 1,0 | CET2 | OE180 | BAEA266 ^[17] 08/00→ | CLS021 |
| 1.0 i | 4 | G4HC | 41/55 | 02/98→03/02 | OE063 | 1,0 | CET2 | | BAEA266 08/00→ | |
| 1.0 i | 4 | G4HC-E | 43/58 | 03/01→07/03 | OE063 | 1,0 | CET2 | OE180 | BAEA266 ^[18] | CLS093 →04/03 CLS023 05/03→ |
| 1.1 | 4 | G4HD | 43/58 | 08/03→12/08 | OE063 | 1,0 | CET2 | OE180 | BAEA266 [112] [275] | |
| 1.1 | 4 | G4HG | 45/60 | 06/03→12/10 | OE063 | 1,0 | CET2 | OE180 | | |
| 1.1 | 4 | G4HG | 46/62 | 08/03→12/08 | OE063 | 1,0 | CET2 | OE180 | | CLS073 |

ATOS PRIME

| | | | | | | | | | | |
|-------|---|------|-------|--------|-------|-----|------|-------|-----------------------------------|------------------|
| 1.0 i | 4 | G4HC | 40/54 | 08/99→ | OE063 | 1,0 | CET2 | OE180 | BAEA266 ^[17] 08/00→ | CLS093 08/00→ |
|-------|---|------|-------|--------|-------|-----|------|-------|-----------------------------------|------------------|

COUPE

| | | | | | | | | | | |
|------------------|---|--------|---------|-------------|-------|-----|--------|-------|--|--------------------------------------|
| 1.6 16V | 4 | G4ED-G | 77/103 | 03/02→08/09 | OE063 | 1,0 | CET2 | OE180 | BAEA483 | CLS024 |
| 1.6 16V | 4 | G4ED-G | 79/106 | 03/02→08/09 | OE063 | 1,0 | CET2 | OE180 | BAEA483 | CLS024 |
| 1.6 16V | 4 | G4GR | 85/114 | 03/98→04/02 | OE063 | 1,0 | CET2 | OE180 | BAEA267 →05/00 BAEA483 09/01→ | CLS130 →05/00 CLS024 05/00→ |
| 1.6 i 16V | 4 | G4GR | 84/113 | 12/96→04/02 | OE063 | 1,0 | CET2 | OE180 | BAEA267 →12/00 | CLS130 |
| 1.8 SX | 4 | G4GM | 94/126 | 07/96→04/02 | OE063 | 1,0 | CET2 | OE180 | | |
| 2.0 | 4 | G4GC-G | 100/134 | 08/01→08/09 | | | CET12P | OE180 | BAEA482 08/02→12/06 | CLS094 |
| 2.0 | 4 | G4DF | 101/135 | 08/99→01/02 | OE063 | 1,0 | CET2 | OE180 | BAEA267 →08/01 | CLS130 |
| 2.0 | 4 | G4GC-G | 102/137 | 03/02→08/09 | | | CET12P | OE180 | BAEA482 08/02→12/06 | |
| 2.0 16V | 4 | G4DF | 99/133 | 03/01→04/02 | OE063 | 1,0 | CET2 | OE180 | BAEA267 →08/01 | CLS094 |
| 2.0 16V | 4 | G4GF | 102/137 | 08/96→04/02 | OE063 | 1,0 | CET2 | OE180 | BAEA267 →12/00 | CLS130 |
| 2.0 F2 Evolution | 4 | G4GF | 115/154 | 01/99→12/01 | OE063 | 1,0 | CET2 | OE180 | BAEA267 | |
| 2.0 GLS | 4 | G4GC-G | 105/141 | 02/03→08/09 | | | CET12P | OE180 | BAEA482 | CLS094 |
| 2.7 V6 | 6 | G6BA-G | 121/162 | 01/01→08/09 | OE191 | 1,0 | CET12P | OE180 | | |

HYUNDAI



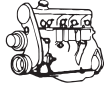

kW/BHP

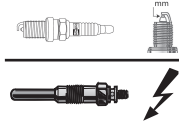

eon TITAN

IRIDIUM

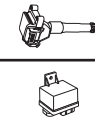

...HYUNDAI

...COUPE

| | | | | | | | | | | |
|--------|---|--------|---------|-------------|--|--|--------|-------|--|--------|
| 2.7 V6 | 6 | G6BA-G | 123/165 | 03/02→08/09 | | | CET12P | OE180 | | CLS189 |
|--------|---|--------|---------|-------------|--|--|--------|-------|--|--------|

ELANTRA

| | | | | | | | | | | |
|----------|---|------------|---------|-------------|-----------------|-----|----------------|-----------------|-------------------|--------|
| 1.5 D | 4 | D4FA | 82/110 | 06/00→07/06 | CH226 | 11v | | | | |
| 1.6 | 4 | G4GR | 66/89 | 06/00→07/06 | OE063 | 1,0 | CET2 | OE180 | BAEA483 | CLS024 |
| 1.6 | 4 | G4ED-G | 77/103 | 05/03→07/06 | OE063 | 1,0 | CET2 | OE180 | BAEA483 | CLS024 |
| 1.6 | 4 | G4ED-G | 79/106 | 06/00→07/06 | OE063 | 1,0 | CET2 | OE180 | BAEA483 | CLS024 |
| 1.6 | 4 | G4GA | 82/110 | 09/03→07/06 | OE063 | 1,0 | CET2 | OE180 | | |
| 1.6 | 4 | G4FG | 94/126 | 06/11→ | OE201 | 0,9 | CET6 | | | |
| 1.6 | 4 | G4FG | 97/130 | 06/11→ | OE201 | 0,9 | | | BAEA475 | |
| 1.6 CVT | 4 | G4FC | 90/121 | 06/06→06/11 | OE063 →12/08 | 1,0 | CET2 | OE180 →12/08 | BAEA474 | |
| | | | | | OE201 01/09→ | 0,9 | CET6 | | | |
| 1.8 | 4 | G4BB | 79/106 | 06/00→07/03 | OE063 | 1,0 | CET2 | OE180 | BAEA482 09/02→ | |
| 1.8 | 4 | G4BB; G4GB | 97/130 | 03/98→07/06 | OE063 | 1,0 | CET2 | OE180 | BAEA482 09/02→ | CLS094 |
| 1.8 | 4 | G4GB | 98/131 | 11/02→07/06 | OE063 | 1,0 | CET2 | OE180 | BAEA482 | |
| 1.8 | 4 | G4NB | 110/148 | 09/10→ | OE201 | 0,9 | | OE249 | | |
| 2.0 | 4 | G4GC-G | 102/137 | 06/00→07/06 | OE063 | 1,0 | CET2 | OE180 | BAEA482 09/02→ | CLS094 |
| 2.0 | 4 | G4GC | 104/139 | 06/00→07/06 | OE063 | 1,0 | CET2 | OE180 | BAEA482 09/02→ | CLS094 |
| 2.0 | 4 | G4GC | 105/141 | 10/03→07/06 | OE063 | 1,0 | CET12P CET2 | OE180 | BAEA482 | CLS094 |
| 2.0 CRDi | 4 | D4EA | 83/111 | 04/01→07/06 | CH226 | 11v | | | | |
| 2.0 CVT | 4 | G4GC | 103/138 | 06/06→05/10 | OE063 | 1,0 | CET2 | | BAEA482 | |
| 2.0 CVT | 4 | G4GC | 105/141 | 06/06→06/11 | OE063 | 1,0 | CET2 | OE180 | | CLS130 |

EQUUS / CENTENNIAL

| | | | | | | | | | | |
|---------|---|------|---------|-------------|-------|-----|--------|-------|---------|--|
| 3.5 | 6 | G6CU | 155/208 | 10/99→03/09 | | | CET12P | OE188 | | |
| 4.5 | 8 | 8A80 | 195/261 | 10/99→09/03 | OE146 | 1,0 | CET12P | OE179 | BAEA548 | |
| 4.6 V8 | 8 | G8BA | 269/361 | 03/09→ | | | | | BAEA548 | |
| 5.0 GDi | 8 | G8BE | 316/424 | 03/09→ | | | | | BAEA548 | |

GALLOPER II

| | | | | | | | | | | |
|------------------------|---|------------|---------|-------------|-------|-----|--------|-------|--|--|
| 2.5 TGi D 4WD | 4 | D4BH | 77/103 | 08/98→12/03 | CH256 | 11v | | | | |
| 2.5 TD 4WD | 4 | D4BA; D4BF | 65/87 | 08/98→12/03 | CH256 | 11v | | | | |
| 2.5 TD intercooler 4WD | 4 | D4BH | 73/98 | 08/98→12/03 | CH256 | 11v | | | | |
| 2.6 TD 4WD | 4 | D4BB | 63/84 | 08/98→06/03 | CH256 | 11v | | | | |
| 3.0 V6 4WD | 6 | G6AT | 104/139 | 08/98→12/03 | | | CET12P | OE180 | | |

GENESIS

| | | | | | | | | | | |
|----------------------|---|------|---------|-------------|--|--|--------|-------|---------|--|
| 2.0 T | 4 | G4KF | 157/211 | 01/08→12/12 | | | | | BAEA548 | |
| 2.0 T | 4 | G4KF | 204/274 | 04/12→02/14 | | | | | BAEA548 | |
| 3.3 24V | 6 | G6DB | 171/229 | 06/08→12/14 | | | CET12P | OE180 | | |
| 3.3 24V | 6 | G6DH | 221/296 | 01/08→12/14 | | | CET14P | OE190 | | |
| 3.3 GDI, 3.3 GDI 4WD | 6 | G6DH | 207/278 | 08/14→ | | | CET14P | OE190 | | |
| 3.8 V6 | 6 | G6DA | 223/299 | 01/08→02/14 | | | | | BAEA531 | |

GETZ

| | | | | | | | | | | |
|-------|---|------|-------|-------------|-------|-----|------|-------|--------------------------|--------------------------------------|
| 1.1 | 4 | G4HD | 46/62 | 09/02→09/05 | OE063 | 1,0 | CET2 | OE180 | BAEA480 ^[111] | CLS023 →04/03 CLS073 04/03→ |
| 1.1 | 4 | G4HD | 49/66 | 09/05→06/09 | OE063 | 1,0 | CET2 | OE180 | BAEA480 | CLS093 |
| 1.3 | 4 | G4EA | 61/82 | 09/04→06/09 | OE063 | 1,0 | CET2 | OE180 | BAEA479 | CLS072 |
| 1.3 | 4 | G4EA | 63/84 | 09/03→09/05 | OE063 | 1,0 | CET2 | OE180 | BAEA479 | CLS072 |
| 1.3 i | 4 | G4EA | 60/80 | 09/02→03/04 | OE063 | 1,0 | CET2 | OE180 | BAEA479 ^[117] | CLS072 |

HYUNDAI





kW/BHP

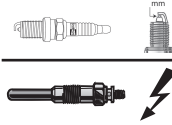

eon TITAN

IRIDIUM

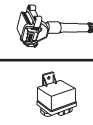

...HYUNDAI

...GETZ

| | | | | | | | | | | |
|----------|---|--------|--------|-------------|-------|-----|------|-------|-------------------|--------|
| 1.4 i | 4 | G4EE | 71/95 | 08/05→12/10 | OE063 | 1,0 | CET2 | OE180 | BAEA483 11/06→ | CLS024 |
| 1.5 CRDi | 3 | D3EA | 60/80 | 03/03→09/05 | CH226 | 11v | | | | |
| 1.5 i | 4 | G4ER | 73/98 | 03/03→09/05 | OE063 | 1,0 | CET2 | OE180 | | |
| 1.6 | 4 | G4ED-G | 77/103 | 09/02→09/05 | OE063 | 1,0 | CET2 | OE180 | BAEA483 | CLS024 |
| 1.6 | 4 | G4ED-G | 78/105 | 06/05→12/06 | OE063 | 1,0 | CET2 | OE180 | BAEA483 | |

GRANDEUR

| | | | | | | | | | | |
|----------|---|------|---------|-------------|-------|-----|--------|-------|---------|--|
| 2.2 CRDi | 4 | D4EB | 110/148 | 06/06→12/11 | CH226 | 11v | | | | |
| 2.2 CRDi | 4 | D4EB | 114/153 | 06/06→10/10 | CH226 | 11v | | | | |
| 2.7 | 6 | G6BA | 141/189 | 05/06→ | | | CET14P | OE190 | | |
| 3.3 | 6 | G6DB | 173/232 | 04/05→12/10 | | | CET12P | OE180 | BAEA531 | |
| 3.3 | 6 | G6DB | 191/256 | 11/10→12/11 | | | CET12P | OE180 | | |
| 3.3 | 6 | G6DB | 194/260 | 09/10→12/11 | | | CET12P | OE180 | | |
| 3.3 | 6 | G6DB | 196/263 | 09/09→12/10 | | | CET12P | OE180 | | |
| 3.3 | 6 | G6DB | 198/266 | 02/07→ | | | CET12P | OE180 | | |
| 3.3 | 6 | G6DH | 218/292 | 09/11→ | | | CET14P | OE190 | | |
| 3.3 Flex | 6 | G6DB | 177/237 | 01/07→11/11 | | | CET12P | OE180 | | |
| 3.8 | 6 | G6DA | 195/261 | 06/05→12/11 | | | CET14P | OE190 | | |

GRAND SANTA FÉ

| | | | | | | | | | | |
|----------------------|---|------|---------|--------|--|--|--------|-------|--|--|
| 3.3 GDi, 3.3 GDi 4WD | 6 | G6DH | 216/290 | 07/13→ | | | CET14P | OE190 | | |
| 3.3 GDi 4WD | 6 | G6DH | 210/282 | 07/13→ | | | CET14P | OE190 | | |

H-1 / STAREX

| | | | | | | | | | | |
|------------------------|---|------|---------|-------------|------------------------|-----|------|-------|--------------------------|--|
| 2.4 | 4 | G4JS | 101/135 | 02/03→04/04 | OE048 | 1,0 | CET8 | OE195 | BAEA502E ^[13] | |
| 2.4 | 4 | G4JS | 107/143 | 11/01→04/04 | OE048 | 1,0 | CET8 | OE195 | BAEA502E ^[13] | |
| 2.4, 2.4 4WD | 4 | G4CS | 82/110 | 06/97→04/04 | OE048 | 1,0 | CET8 | OE195 | | |
| 2.4 4WD | 4 | G4JS | 99/133 | 06/01→04/04 | OE048 | 1,0 | CET8 | OE195 | BAEA502E ^[13] | |
| 2.5 CRDi | 4 | D4CB | 81/109 | 06/06→12/07 | CH234 | 11v | | | | |
| 2.5 CRDi | 4 | D4CB | 85/114 | 06/97→04/04 | CH234 | 11v | | | | |
| 2.5 CRDi | 4 | D4CB | 120/161 | 12/02→04/04 | CH234 | 11v | | | | |
| 2.5 CRDi, 2.5 CRDi 4WD | 4 | D4CB | 103/138 | 12/02→ | CH234 | 11v | | | | |
| 2.5 D | 4 | D4BF | 57/76 | 10/97→04/04 | CH225 ^[275] | 11v | | | | |
| | | | | | CH256 ^[275] | 11v | | | | |
| 2.5 D | 4 | D4BF | 62/83 | 10/97→04/04 | CH225 ^[275] | 11v | | | | |
| | | | | | CH256 ^[275] | 11v | | | | |
| 2.5 TGi, 2.5 TD 4WD | 4 | D4BH | 73/98 | 10/97→12/07 | CH225 ^[275] | 11v | | | | |
| | | | | | CH256 ^[275] | 11v | | | | |
| 2.5 TGi, 2.5 TD 4WD | 4 | D4BH | 74/99 | 11/01→12/07 | CH225 ^[275] | 11v | | | | |
| | | | | | CH256 ^[275] | 11v | | | | |
| 2.5 TD, 2.5 TD 4WD | 4 | D4BF | 59/79 | 06/97→04/04 | CH225 ^[275] | 11v | | | | |
| | | | | | CH256 ^[275] | 11v | | | | |
| 2.6 TDiC | 4 | D4BB | 63/84 | 10/97→04/04 | CH234 | 11v | | | | |

H100

| | | | | | | | | | | |
|-------|---|------|-------|-------------|-------|-----|--|--|--|--|
| 2.5 D | 4 | D4BA | 57/76 | 05/96→10/01 | CH225 | 11v | | | | |
|-------|---|------|-------|-------------|-------|-----|--|--|--|--|

i10

| | | | | | | | | | | |
|-----|---|------|-------|-------------|-------|-----|------|-------|-----------------------------|--------|
| 1.0 | 3 | G3LA | 49/66 | 08/13→ | | | | | BAEA476 →Prod.17.09.2016 | |
| 1.0 | 3 | G3LA | 51/68 | 01/11→12/17 | OE197 | 0,9 | CET6 | | | |
| 1.1 | 4 | G4HG | 48/64 | 12/07→12/13 | OE063 | 1,0 | CET2 | OE180 | | CLS093 |
| 1.1 | 4 | G4HG | 49/66 | 01/08→12/13 | OE063 | 1,0 | CET2 | OE180 | BAEA477 | CLS093 |
| 1.1 | 4 | G4HG | 51/68 | 04/11→12/13 | OE063 | 1,0 | CET2 | OE180 | BAEA477 | CLS093 |
| 1.2 | 4 | G4LA | 57/76 | 11/08→12/11 | OE197 | 0,9 | CET6 | | BAEA536 ^[114] | |
| 1.2 | 4 | G4LA | 63/84 | 04/11→12/13 | OE197 | 0,9 | CET6 | | BAEA536 | |
| 1.2 | 4 | G4LA | 64/86 | 12/13→ | | | | | BAEA536 | |

HYUNDAI



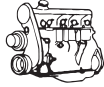

kW/BHP

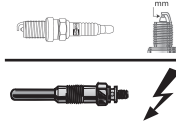

eon TITAN

IRIDIUM

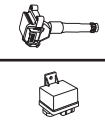

HYUNDAI

...HYUNDAI

| i20 | | | | | | | | | |
|-----------------------------------|---|--------------|---------|--------------|-----------------------|-----|--------|-----------------|--|
| 1.0 T-GDI | 3 | G3LC | 74/99 | 01/16 → | | | | OE248 | |
| 1.0 T-GDI | 3 | G3LC | 88/118 | 01/16 → | | | | OE248 | |
| 1.2 | 4 | G4LA | 57/76 | 09/08 →12/12 | OE197 | 0,9 | CET6 | | BAEA536 |
| 1.2 | 4 | G4LA | 62/83 | 01/13 → | OE197 | 0,9 | CET6 | | |
| 1.2 | 4 | G4LA | 63/84 | 03/12 →12/15 | OE197 | 0,9 | CET6 | | BAEA536 |
| 1.4 | 4 | G4FA | 74/99 | 09/08 → | OE201 | 0,9 | CET6 | | BAEA475 ^[275] |
| 1.4 | 4 | G4LC | 74/99 | 09/08 → | | | | OE248 | |
| 1.6 | 4 | G4FC | 91/122 | 12/08 → | OE201 07/09 →03/12 | 0,9 | | | BAEA475 |
| 1.6 | 4 | G4FC | 93/125 | 09/08 →12/12 | OE063 →12/08 | 1,0 | CET2 | OE180 →12/08 | BAEA475 ^[275] |
| | | | | | OE201 01/09 → | 0,9 | CET6 | | |
| i30 | | | | | | | | | |
| 1.4 | 4 | G4FA | 73/98 | 12/11 → | OE201 | 0,9 | CET6 | | BAEA475 ^[275] BAEA475 |
| 1.4 | 4 | G4LC | 74/99 | 12/14 → | | | | OE248 | BAEA475 |
| 1.4 | 4 | G4FA | 77/103 | 10/07 →06/12 | OE063 →12/08 | 1,0 | CET2 | OE180 →12/08 | BAEA474 |
| | | | | | OE201 | 0,9 | CET6 | | |
| 1.4 | 4 | G4FA | 80/107 | 10/07 →06/12 | OE063 →12/08 | 1,0 | CET2 | OE180 →12/08 | BAEA474 ^[120] BAEA475 ^[275] |
| | | | | | OE201 | 0,9 | CET6 | | |
| 1.6 | 4 | G4FC | 85/114 | 10/07 →06/12 | OE063 →12/08 | 1,0 | CET2 | OE180 →12/08 | BAEA475 ^[121] |
| | | | | | OE201 01/09 → | 0,9 | CET6 | | |
| 1.6 | 4 | G4FC | 88/118 | 01/12 → | OE201 | 0,9 | CET6 | | BAEA475 |
| 1.6 | 4 | G4FG | 88/118 | 01/12 → | OE201 | 0,9 | | | BAEA475 |
| 1.6 | 4 | G4FC | 90/121 | 10/07 →06/12 | OE063 →12/08 | 1,0 | CET2 | OE180 →12/08 | BAEA475 ^[121] |
| | | | | | OE201 01/09 → | 0,9 | CET6 | | |
| 1.6 | 4 | G4FC | 93/125 | 02/08 →06/12 | OE063 →12/08 | 1,0 | CET2 | OE180 →12/08 | BAEA475 ^[121] |
| | | | | | OE201 01/09 → | 0,9 | CET6 | | |
| 1.6 | 4 | G4FG | 95/127 | 12/11 →12/15 | OE201 | 0,9 | | | BAEA475 |
| 2.0 | 4 | G4GC; G4GC-G | 105/141 | 10/07 →06/12 | | | CET12P | OE180 | CLS094 |
| 2.0 CRDi | 4 | D4EA-F | 100/134 | 10/07 →06/12 | CH226 | 11v | | | |
| 2.0 CRDi | 4 | D4EA-F | 103/138 | 10/07 →06/12 | CH226 | 11v | | | |
| i40 | | | | | | | | | |
| 2.0 GDi | 4 | G4NC | 121/162 | 12/14 → | | | | OE249 | |
| 2.0 GDI | 4 | G4NC | 130/174 | 07/11 → | | | | OE249 | |
| 2.0 GDI | 4 | G4NC | 131/176 | 03/12 → | | | | OE249 | |
| ix20 | | | | | | | | | |
| 1.4 | 4 | G4FA | 66/89 | 11/10 → | OE201 | 0,9 | CET6 | | BAEA475 ^[275] |
| 1.4 | 4 | G4FA | 74/99 | 11/10 → | OE201 | 0,9 | | | |
| 1.6 | 4 | G4FC | 92/123 | 11/10 → | OE201 | 0,9 | CET6 | | BAEA475 ^[275] |
| ix35 | | | | | | | | | |
| 2.0 | 4 | G4KD | 122/164 | 01/10 → | OE148 | 1,0 | CET5 | OE190 | BAEA548 |
| 2.0, 2.0 4WD | 4 | G4KD | 120/161 | 01/10 → | OE148 | 1,0 | CET5 | OE190 | BAEA548 |
| 2.0 CVT 4WD, 2.0 GDi, 2.0 GDi 4WD | 4 | G4KD; G4NC | 122/164 | 08/09 → | | | | OE249 | |
| 2.4 4WD | 4 | G4KE | 130/174 | 01/10 → | OE148 | 1,0 | CET5 | OE190 | |
| 2.4 DCVVT-I 4WD | 4 | G4KE | 128/172 | 07/10 →12/13 | OE148 | 1,0 | CET5 | OE190 | |





kW/BHP

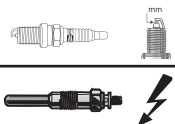

eon TITAN

IRIDIUM

**...HYUNDAI****LANTRA II**

| | | | | | | | | | | |
|---------|---|------|---------|-------------|-------|------|------|-------|---------|--------|
| 1.5 12V | 4 | G4EK | 65/87 | 12/96→10/00 | OE063 | 1,0 | CET2 | OE180 | BAEA264 | |
| 1.6 16V | 4 | G4GR | 84/113 | 11/95→10/00 | OE063 | 1,0 | CET2 | OE180 | BAEA267 | CLS130 |
| 1.6 i | 4 | G4GR | 66/89 | 11/95→10/00 | OE063 | 1,0 | CET2 | OE180 | BAEA267 | CLS130 |
| 1.8 16V | 4 | G4GM | 94/126 | 11/95→10/00 | OE063 | 1,0 | CET2 | OE180 | BAEA267 | CLS130 |
| 1.9 D | 4 | DJY | 50/67 | 03/98→10/00 | CH189 | 11v | | | | |
| 2.0 | 4 | G4JP | 100/134 | 04/97→05/00 | | | | | BAEA483 | |
| 2.0 16V | 4 | G4GF | 102/137 | 11/95→10/00 | OE063 | 0,7* | CET2 | OE180 | BAEA267 | CLS130 |

*to be adjusted

MATRIX

| | | | | | | | | | | |
|----------|---|--------|--------|-------------|-------|-----|------|-------|--------------------------|--------|
| 1.5 CRDi | 3 | D3EA | 60/80 | 10/01→08/10 | CH226 | 11v | | | | |
| 1.6 | 4 | G4ED-L | 66/89 | 01/02→12/05 | OE063 | 1,0 | CET2 | OE180 | BAEA483 | |
| 1.6 | 4 | G4ED-G | 76/102 | 06/01→08/10 | OE063 | 1,0 | CET2 | OE180 | BAEA483 | CLS024 |
| 1.8 | 4 | G4GB-G | 90/121 | 06/01→08/10 | OE063 | 1,0 | CET2 | OE180 | BAEA482 ^[118] | |

PORTER

| | | | | | | | | | | |
|----------|---|------|---------|-------------|-------|-----|------|--|--|--|
| 2.4 | 4 | G4CS | 82/110 | 03/96→04/04 | OE049 | 1,0 | CET8 | | | |
| 2.5 CRDi | 4 | D4CB | 103/138 | 02/03→04/04 | CH234 | 11v | | | | |
| 2.5 TD | 4 | D4BA | 57/76 | 07/94→04/04 | CH225 | 11v | | | | |
| 2.5 TD | 4 | D4BH | 73/98 | 07/94→04/04 | CH221 | 11v | | | | |
| 2.6 TD | 4 | D4BB | 63/84 | 07/94→04/04 | CH256 | 11v | | | | |

SANTA FÉ I

| | | | | | | | | | | |
|------------------------|---|--------|---------|-------------|--------|-----|--------|-------|--------------------------|--------|
| 2.0 | 4 | G4JP | 99/133 | 08/01→03/06 | | | CET12P | OE180 | BAEA502E ^[13] | |
| 2.0 CRDi, 2.0 CRDi 4WD | 4 | D4EA | 83/111 | 04/01→03/06 | CH226 | 11v | | | | |
| 2.0 CRDi 4WD | 4 | D4EA-V | 92/123 | 08/03→03/06 | CH226 | 11v | | | | |
| 2.0 CRDi 4WD | 4 | D4EA-F | 107/143 | 11/03→02/06 | CH226 | 11v | | | | |
| | | | | | →12/05 | | | | | |
| 2.4 16V, 2.4 16V 4WD | 4 | G4JS-G | 100/134 | 02/01→03/06 | OE192 | 1,0 | CET8 | OE195 | BAEA502E ^[13] | |
| 2.4 16V, 2.4 16V 4WD | 4 | G4JS-G | 107/143 | 02/01→03/06 | OE192 | 1,0 | CET8 | OE195 | BAEA502E ^[13] | |
| 2.7 | 6 | G6EA | 129/173 | 08/04→03/06 | | | CET14P | OE190 | | |
| 2.7 4WD | 6 | G6EA | 132/177 | 11/00→03/06 | | | CET14P | OE190 | | |
| 2.7 V6 4WD | 6 | G6BA-G | 127/170 | 02/01→03/06 | | | CET12P | OE180 | | CLS189 |

SANTA FÉ II

| | | | | | | | | | | |
|--------------------------------|---|------|---------|-------------|------------------|-----|--------|-------|--------------------------|--------------------------|
| 2.2 CRDi, 2.2 CRDi 4WD | 4 | D4EB | 102/137 | 03/06→12/12 | CH226 | 11v | | | | |
| | | | | | →Prod.23.09.2009 | | | | | |
| 2.2 CRDi, 2.2 CRDi 4WD | 4 | D4EB | 114/153 | 03/06→12/09 | CH226 | 11v | | | | |
| | | | | | →Prod.23.09.2009 | | | | | |
| 2.2 CRDi, 2.2 CRDi 4WD | 4 | D4HB | 145/194 | 01/09→12/12 | CH226 | 11v | | | | |
| | | | | | →Prod.23.09.2009 | | | | | |
| 2.2 CRDi GLS, 2.2 CRDi GLS 4WD | 4 | D4EB | 110/148 | 03/06→12/09 | CH226 | 11v | | | | |
| | | | | | →Prod.23.09.2009 | | | | | |
| 2.4, 2.4 4WD | 4 | G4KE | 128/172 | 07/10→12/12 | OE148 | 1,0 | CET5 | OE190 | BAEA531 ^[275] | BAEA548 ^[275] |
| 2.7, 2.7 4WD | 6 | G6BA | 125/168 | 03/06→12/12 | | | CET12P | OE180 | | |
| 2.7 V6 GLS, 2.7 V6 GLS 4WD | 6 | G6EA | 139/186 | 03/06→12/09 | | | CET14P | OE190 | | |
| 3.3, 3.3 4WD | 6 | G6DB | 180/241 | 03/06→12/09 | | | CET12P | OE180 | | |
| 3.3 Dynamic 4WD | 6 | G6DB | 173/232 | 03/06→12/12 | | | CET12P | OE180 | | |

SANTA FÉ III

| | | | | | | | | | | |
|--------------|---|------|---------|-------------|--|--|--------|-------|---------|--|
| 2.4, 2.4 4WD | 4 | G4KJ | 141/189 | 09/12→12/15 | | | | | BAEA548 | |
| 3.3, 3.3 4WD | 6 | G6DH | 216/290 | 09/12→ | | | CET14P | OE190 | | |

SANTAMO

| | | | | | | | | | | |
|----------------------|---|--------------|---------|-------------|--|--|------|-------|--------------------------|--|
| 2.0 16V, 2.0 16V 4WD | 4 | G4CP-D, G4JP | 102/137 | 05/99→12/02 | | | CET8 | OE195 | BAEA521 ^[275] | |
|----------------------|---|--------------|---------|-------------|--|--|------|-------|--------------------------|--|

SONATA III

| | | | | | | | | | | |
|---------|---|------|-------|-------------|-------|-----|------|-------|--|--|
| 1.8 GLS | 4 | G4DM | 63/84 | 07/96→05/98 | OE048 | 1,0 | CET8 | | | |
| 1.8 i | 4 | G4CM | 72/97 | 05/93→06/98 | OE048 | 1,0 | CET8 | OE195 | | |
| 2.0 i | 4 | G4EP | 70/94 | 08/96→06/98 | OE006 | 0,9 | CET8 | OE195 | | |

HYUNDAI



kW/BHP



eon TITAN

IRIDIUM

**...HYUNDAI****...SONATA III**

| | | | | | | | | | |
|-----------|---|---------|---------|-------------|-------|-----|------|-------|--|
| 2.0 i | 4 | G4CP | 77/103 | 06/94→08/96 | | | CET8 | OE195 | |
| 2.0 i 16V | 4 | G4CP-DM | 92/123 | 06/96→06/98 | OE048 | 1,0 | CET8 | OE195 | |
| 2.0 i 16V | 4 | G4CP-D | 102/137 | 05/93→06/98 | OE048 | 1,0 | CET8 | OE195 | |
| 3.0 i V6 | 6 | G6AT | 107/143 | 05/93→06/98 | OE192 | 1,0 | CET8 | OE195 | |

SONATA IV

| | | | | | | | | | |
|------------------|---|---------|---------|-------------|-------|-----|--------|-------|------------------------------------|
| 2.0 16V | 4 | G4JP-EG | 96/129 | 10/01→11/04 | OE191 | 1,0 | CET12P | OE180 | BAEA502E ^[13] |
| 2.0 16V | 4 | G4JP-G | 100/134 | 06/98→10/01 | OE048 | 1,0 | CET8 | OE195 | BAEA502E ^[13] |
| 2.0 16V | 4 | | 106/142 | 10/01→11/04 | OE048 | 1,0 | CET8 | | BAEA502E ^[13] |
| 2.0 CRDi Dynamic | 4 | D4EA | 103/138 | 10/01→11/04 | CH226 | 11v | | | |
| 2.0 Flex | 4 | G4JP | 98/131 | 04/01→11/04 | | | | | BAEA502E ^[13] |
| 2.2 CRDi | 4 | D4EB | 110/148 | 06/02→11/04 | CH226 | 11v | | | |
| 2.4 16V | 4 | G4BS | 105/141 | 03/98→10/01 | OE192 | 1,0 | CET8 | OE195 | BAEA502E ^[13] →03/01 |
| 2.5 V6 24V | 6 | G6BV-G | 118/158 | 06/98→10/01 | | | CET12P | OE180 | BAEA269 |
| 2.7 i V6 | 6 | G6BA-Y | 132/177 | 10/01→05/05 | | | CET14P | OE190 | |
| 2.7 V6 | 6 | G6BA-G | 127/170 | 10/01→11/04 | | | CET12P | OE180 | BAEA269 ^[361] CLS189 |
| 2.7 V6 | 6 | G6BA | 129/173 | 11/02→11/04 | | | CET12P | OE188 | |

SONATA V

| | | | | | | | | | |
|--------------|---|--------|---------|-------------|-------|-----|--------|-------|--|
| 2.0 CRDi | 4 | D4EA-F | 100/134 | 02/06→12/10 | CH226 | 11v | | | |
| 2.0 CRDi | 4 | D4EA-F | 103/138 | 02/06→12/10 | CH226 | 11v | | | |
| 2.0 CRDi | 4 | D4EA-F | 110/148 | 03/09→12/10 | CH226 | 11v | | | |
| 2.0 VVTi GLS | 4 | G4KA | 106/142 | 05/05→12/10 | OE063 | 1,0 | CET2 | OE180 | BAEA531 |
| 2.0 VVTi GLS | 4 | G4KD | 121/162 | 01/08→12/10 | OE148 | 1,0 | CET5 | OE190 | BAEA548 |
| 2.4 | 4 | G4KC | 119/160 | 01/05→12/10 | OE063 | 1,0 | CET2 | OE180 | BAEA531 ^[275] →11/07 BAEA548 ^[275] 12/07→ |
| 2.4 | 4 | G4KC | 125/168 | 06/08→12/09 | | | | | BAEA502E ^[13] |
| 2.4 | 4 | G4KE | 128/172 | 06/08→12/10 | OE148 | 1,0 | CET5 | OE190 | BAEA531 BAEA548 |
| 3.3 | 6 | G6DB | 171/229 | 01/05→12/10 | | | CET12P | OE180 | BAEA531 |
| 3.3 | 6 | G6DB | 173/232 | 06/05→12/10 | | | CET12P | OE180 | BAEA531 |
| 3.3 | 6 | G6DB | 175/235 | 09/05→12/06 | | | CET12P | OE180 | |
| 3.3 | 6 | G6DB | 184/247 | 01/08→12/10 | | | CET12P | OE180 | BAEA531 |
| 3.3 | 6 | G6DB | 186/249 | 09/07→12/08 | | | CET12P | OE180 | |

SONATA VI

| | | | | | | | | | |
|-------|---|------|---------|-------------|-------|-----|------|-------|---------|
| 2.0 | 4 | G4KD | 110/148 | 01/09→06/14 | OE148 | 1,0 | CET5 | OE190 | BAEA548 |
| 2.0 i | 4 | G4KD | 121/162 | 01/11→06/14 | OE148 | 1,0 | CET5 | OE190 | |
| 2.4 | 4 | G4KC | 128/172 | 01/09→11/10 | OE148 | 1,0 | CET5 | OE190 | BAEA548 |
| 2.4 | 4 | G4KC | 131/176 | 01/09→12/15 | OE148 | 1,0 | CET5 | OE190 | BAEA548 |

TERRACAN

| | | | | | | | | | |
|------------------------|---|------|---------|-------------|-------|-----|--------|-------|--|
| 2.5 D | 4 | D4BH | 59/79 | 06/01→10/03 | CH225 | 11v | | | |
| 2.5 D, 2.5 TD 4WD | 4 | D4BH | 74/99 | 06/01→12/06 | CH225 | 11v | | | |
| 2.9 CRDi, 2.9 CRDi 4WD | 4 | J3 | 110/148 | 11/01→12/06 | CH256 | 11v | | | |
| 2.9 CRDi 4WD | 4 | J3 | 120/161 | 11/03→12/06 | CH256 | 11v | | | |
| 3.5 i V6 4WD | 6 | G6CU | 143/192 | 12/01→12/06 | | | CET12P | OE180 | |
| 3.5 i V6 4WD | 6 | G6CU | 147/197 | 12/01→12/06 | | | CET12P | OE180 | |

TIBURON

| | | | | | | | | | |
|---------|---|--------|---------|-------------|-------|-----|------|-------|--------------------------|
| 1.6 CVT | 4 | G4ED-G | 78/105 | 10/06→12/08 | OE063 | 1,0 | CET2 | OE180 | |
| 2.0 CVT | 4 | G4GC | 105/141 | 10/06→12/08 | OE039 | 1,0 | CET2 | OE179 | BAEA502E ^[13] |

HYUNDAI





kW/BHP



eon TITAN

IRIDIUM

**...HYUNDAI****TRAJET**

| | | | | | | | | | | |
|----------|---|--------|---------|-------------|-------|-----|--------|-------|--|------------------|
| 2.0 | 4 | G4JP-G | 100/134 | 03/00→07/08 | OE191 | 1,0 | CET12P | OE180 | BAEA502E ^[13] →02/04 BAEA482 ^[118] 02/04→ | CLS094 02/04→ |
| 2.0 | 4 | G4GC-G | 103/138 | 03/01→07/08 | | | CET12P | OE180 | BAEA502E ^[13] →02/04 BAEA482 ^[118] 02/04→ | CLS094 02/04→ |
| 2.0 | 4 | G4CP-D | 103/138 | 03/01→07/08 | | | | | BAEA502E ^[13] | |
| 2.0 | 4 | G4GC | 104/139 | 11/03→07/08 | OE063 | 1,0 | CET2 | OE180 | BAEA502E ^[13] →02/04 BAEA482 ^[118] 02/04→ | CLS094 02/04→ |
| 2.0 CRDi | 4 | D4EA | 83/111 | 04/01→07/08 | CH226 | 11v | | | | |
| 2.0 CRDi | 4 | D4EA | 92/123 | 08/05→07/08 | CH226 | 11v | | | | |
| 2.7 V6 | 6 | G6BA-G | 127/170 | 09/00→07/08 | | | CET12P | OE180 | | |

TUCSON

| | | | | | | | | | | |
|------------------------|---|--------|---------|-------------|-------|-----|--------|-------|--------------------------|--------|
| 2.0, 2.0 4WD | 4 | G4GC | 104/139 | 08/04→ | | | CET12P | OE180 | BAEA482 ^[122] | CLS094 |
| 2.0, 2.0 4WD | 4 | G4GC | 105/141 | 07/05→01/12 | | | | | BAEA482 | |
| 2.0 CRDi, 2.0 CRDi 4WD | 4 | D4EA | 83/111 | 08/04→03/10 | CH226 | 11v | | | | |
| 2.0 CRDi, 2.0 CRDi 4WD | 4 | D4EA-F | 88/118 | 01/07→03/10 | CH226 | 11v | | | | |
| 2.0 CRDi, 2.0 CRDi 4WD | 4 | D4EA-F | 100/134 | 01/06→ | CH226 | 11v | | | | |
| 2.0 CRDi, 2.0 CRDi 4WD | 4 | D4EA-F | 103/138 | 01/06→03/10 | CH226 | 11v | | | | |
| 2.0 CRDi, 2.0 CRDi 4WD | 4 | D4EA-F | 110/148 | 01/09→03/10 | CH226 | 11v | | | | |
| 2.7 4WD | 6 | G6BA-G | 129/173 | 08/04→ | | | CET12P | OE180 | BAEA555 | |

VELOSTER

| | | | | | | | | | | |
|-----------|---|------|---------|--------|-------|-----|--|-------|---------|--|
| 1.6 | 4 | G4FG | 94/126 | 06/11→ | OE201 | 0,9 | | | | |
| 1.6 MPI | 4 | G4FG | 97/130 | 04/11→ | OE201 | 0,9 | | | BAEA475 | |
| 1.6 T-GDI | 4 | G4FJ | 137/184 | 10/12→ | | | | OE250 | | |

XG

| | | | | | | | | | | |
|---------|---|--------|---------|-------------|--|--|--------|-------|--|--|
| 2.5 250 | 6 | G6BV | 120/161 | 12/98→12/05 | | | CET12P | OE180 | | |
| 3.0 30 | 6 | G6CT-G | 138/185 | 12/98→12/05 | | | CET12P | OE180 | | |
| 3.5 350 | 6 | G6CU | 145/194 | 10/02→12/05 | | | CET12P | OE180 | | |

HYUNDAI**GRACE**

| | | | | | | | | | | |
|--------|---|------|-------|-------------|-------|-----|--|--|--|--|
| 2.5 D | 4 | D4BA | 55/74 | 07/93→06/94 | CH221 | 11v | | | | |
| 2.5 TD | 4 | D4BF | 59/79 | 06/98→10/01 | CH221 | 11v | | | | |

H-1

| | | | | | | | | | | |
|--------------------|---|--------------|---------|-------------|--|-----|------|-------|---------|--|
| 2.4 | 4 | G4CS | 82/110 | 03/00→04/04 | OE048 ^[2] | 1,0 | CET8 | OE195 | | |
| 2.4 i | 4 | G4KC | 126/169 | 02/08→ | | | | | BAEA548 | |
| 2.4 i | 4 | G4KC | 129/173 | 02/08→ | | | | | BAEA548 | |
| 2.5 CRDi | 4 | D4CB | 81/109 | 07/01→ | CH234 ^[130] →04/11 CH234 | 11v | | | | |
| 2.5 CRDi | 4 | D4CB | 85/114 | 01/09→ | CH234 | 11v | | | | |
| 2.5 CRDi | 4 | D4CB | 103/138 | 12/02→ | CH234 | 11v | | | | |
| 2.5 CRDi | 4 | D4CB; D4CB-L | 120/161 | 02/08→ | CH234 | 11v | | | | |
| 2.5 CRDi | 4 | D4CB | 125/168 | 02/08→ | CH234 | 11v | | | | |
| 2.5 CRDi, 2.5 CRDi | 4 | D4CB; D4CB-W | 100/134 | 07/08→ | CH234 | 11v | | | | |
| 2.5 D, 2.5 TD | 4 | D4BH | 73/98 | 03/00→10/05 | CH225 ^[275] CH256 ^[275] | 11v | | | | |
| 2.5 TD | 4 | D4BF | 59/79 | 03/00→09/00 | CH225 ^[275] CH256 ^[275] | 11v | | | | |
| 2.5 TD | 4 | D4BH | 74/99 | 10/01→08/07 | CH225 ^[275] CH256 ^[275] | 11v | | | | |

HYUNDAI



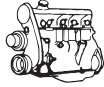

kW/BHP

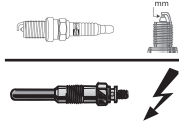

eon TITAN

IRIDIUM

**...HYUNDAI****H100**

| | | | | | | | | | |
|-------------------------|---|------------|--------|-------------|-------|-----|------|-------|--|
| 2.4 | 4 | G4CS | 82/110 | 10/97→12/04 | OE049 | 1,0 | CET8 | | |
| 2.4 | 4 | G4CS | 84/113 | 05/96→10/03 | OE048 | 1,0 | CET8 | OE195 | |
| 2.4 | 4 | G4CS | 90/121 | 07/93→03/00 | OE048 | 1,0 | CET8 | OE195 | |
| 2.5 D | 4 | D4BA; D4BX | 55/74 | 07/93→12/94 | CH225 | 11v | | | |
| 2.5 D | 4 | D4BA | 57/76 | 07/93→03/00 | CH225 | 11v | | | |
| 2.5 D, 2.5 TD, 2.5 TDiC | 4 | D4BF | 59/79 | 07/93→10/03 | CH225 | 11v | | | |

HIGHWAY VAN

| | | | | | | | | | |
|------------|---|------|---------|-------------|--|--|--------|-------|--------------------------|
| 2.0 16V | 4 | G4JP | 100/134 | 03/00→03/04 | | | CET12P | OE180 | BAEA502E ^[13] |
| 2.7 V6 24V | 6 | G6BA | 125/168 | 03/00→03/04 | | | CET12P | OE180 | |

PORTER

| | | | | | | | | | |
|----------|---|------|---------|-------------|----------------|------------|------|-------|--|
| 2.4 | 4 | G4CS | 82/110 | 03/96→04/04 | OE006 OE049 | 0,9 1,0 | CET8 | OE195 | |
| 2.5 CRDi | 4 | D4CB | 103/138 | 02/03→ | CH234 | 11v | | | |
| 2.5 TGi | 4 | D4BH | 74/99 | 05/04→ | CH221 | 11v | | | |
| 2.5 TD | 4 | D4BA | 57/76 | 07/94→04/04 | CH225 | 11v | | | |
| 2.5 TD | 4 | D4BH | 73/98 | 07/94→04/04 | CH221 | 11v | | | |
| 2.6 TD | 4 | D4BB | 63/84 | 07/94→04/04 | CH256 | 11v | | | |

INFINITI**EX**

| | | | | | | | | | |
|-------------|---|--------|---------|--------|---------|----|--|--|----------|
| 3.0 30d 4WD | 6 | V9X | 175/235 | 04/10→ | CCGP007 | 7v | | | |
| 3.5 35 4WD | 6 | VQ35HR | 221/296 | 10/08→ | | | | | BAEA158E |

FX

| | | | | | | | | | |
|--------------------|---|--------|---------|-------------|---------|----|--------|-------|---------------------------|
| 3.0 30d 4WD | 6 | V9X | 175/235 | 04/10→ | CCGP007 | 7v | | | |
| 3.5 35, 3.5 35 4WD | 6 | VQ35DE | 206/276 | 01/03→12/08 | | | CET14P | OE190 | BAEA132E ^[277] |
| 4.5 45, 4.5 45 4WD | 8 | VK45DE | 232/311 | 01/03→12/08 | | | CET14P | OE190 | |
| 5.0 50 4WD | 8 | VK50VE | 287/385 | 10/08→ | | | | | BAEA088E |
| 5.0 50 4WD | 8 | VK50VE | 309/414 | 06/13→ | | | | | BAEA088E |

G

| | | | | | | | | | |
|--------|---|--------|---------|--------|--|--|--------|-------|---------------------------|
| 2.5 25 | 6 | VQ25HR | 163/219 | 01/11→ | | | | | BAEA158E |
| 3.5 35 | 6 | VQ35DE | 191/256 | 10/02→ | | | CET14P | OE190 | BAEA132E ^[277] |

I30

| | | | | | | | | | |
|-----|---|--------|---------|--------|-------|-----|------|-------|----------------------------------|
| 3.0 | 6 | VQ30DE | 142/190 | 01/97→ | OE063 | 1,0 | CET2 | OE180 | BAEA073E →12/99 [32] [277] |
|-----|---|--------|---------|--------|-------|-----|------|-------|----------------------------------|

M

| | | | | | | | | | |
|---------|---|--------|---------|--------|---------|----|--|--|----------|
| 3.0 30d | 6 | V9X | 175/235 | 03/10→ | CCGP007 | 7v | | | |
| 3.5 35h | 6 | VQ35HR | 225/302 | 04/11→ | | | | | BAEA158E |

M35

| | | | | | | | | | |
|----------------------------|---|--------|---------|--------|--|--|--------|-------|---------------------------|
| 3.5 Luxury, 3.5 Luxury 4WD | 6 | VQ35DE | 206/276 | 01/05→ | | | CET14P | OE190 | BAEA132E ^[277] |
| 3.5 Luxury Hybrid | 6 | VQ35HR | 268/359 | 01/10→ | | | | | BAEA158E |

M45

| | | | | | | | | | |
|------------|---|--------|---------|--------|--|--|--------|-------|--|
| 4.5 Luxury | 8 | VK45DE | 250/335 | 01/05→ | | | CET14P | OE190 | |
|------------|---|--------|---------|--------|--|--|--------|-------|--|

Q45 I

| | | | | | | | | | |
|-----|---|--------|---------|-------------|--|--|--------|-------|--|
| 4.1 | 8 | VH41DE | 205/275 | 01/93→12/96 | | | CET12P | OE180 | |
|-----|---|--------|---------|-------------|--|--|--------|-------|--|

Q45 II

| | | | | | | | | | |
|-----|---|--------|---------|-------------|-------|-----|--------|--|--|
| 4.1 | 8 | VH41DE | 205/275 | 01/97→01/01 | OE138 | 1,0 | CET12P | | |
|-----|---|--------|---------|-------------|-------|-----|--------|--|--|

Q45 III

| | | | | | | | | | |
|-----|---|--------|---------|--------|--|--|--------|-------|--|
| 4.5 | 8 | VK45DE | 250/335 | 02/01→ | | | CET14P | OE190 | |
|-----|---|--------|---------|--------|--|--|--------|-------|--|

Q50

| | | | | | | | | | |
|----------------------------------|---|--------|---------|--------|--|--|--|--|----------|
| 3.5 50 Hybrid, 3.5 50 Hybrid 4WD | 6 | VQ35HR | 268/359 | 04/13→ | | | | | BAEA158E |
|----------------------------------|---|--------|---------|--------|--|--|--|--|----------|

HYUNDAI



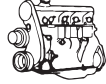

kW/BHP

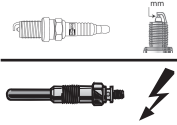

eon TITAN

IRIDIUM

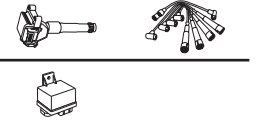
**...INFINITI****Q70**

| | | | | | | | | |
|-----|---|-----|---------|--------|---------|----|--|--|
| 3.0 | 6 | V9X | 175/235 | 03/13→ | CCGP007 | 7v | | |
|-----|---|-----|---------|--------|---------|----|--|--|

QX4

| | | | | | | | | |
|---------|---|-------|---------|--------|-------|-----|------|-------|
| 3.3 4WD | 6 | VG33E | 125/168 | 01/97→ | OE063 | 1,0 | CET2 | OE180 |
|---------|---|-------|---------|--------|-------|-----|------|-------|

QX50

| | | | | | | | | |
|-------------|---|-----|---------|--------|---------|----|--|--|
| 3.0 30d 4WD | 6 | V9X | 175/235 | 08/13→ | CCGP007 | 7v | | |
|-------------|---|-----|---------|--------|---------|----|--|--|

QX70

| | | | | | | | | |
|-------------|---|-----|---------|--------|---------|----|--|--|
| 3.0 30d 4WD | 6 | V9X | 175/235 | 08/13→ | CCGP007 | 7v | | |
|-------------|---|-----|---------|--------|---------|----|--|--|

| | | | | | | | | |
|------------|---|--------|---------|--------|--|--|--|----------|
| 5.0 50 4WD | 8 | VK50VE | 287/385 | 08/13→ | | | | BAEA088E |
|------------|---|--------|---------|--------|--|--|--|----------|

INNOCENTI**ELBA**

| | | | | | | | | |
|----------|---|----------------------|-------|-------------|-------|-----|------|-------|
| 1.4 i.e. | 4 | 146C5.000; 146D5.000 | 49/66 | 09/94→12/96 | OE018 | 1,0 | CET8 | OE195 |
|----------|---|----------------------|-------|-------------|-------|-----|------|-------|

| | | | | | | | | |
|----------|---|----------------------|-------|-------------|-------|-----|------|-------|
| 1.6 i.e. | 4 | 146C6.000; 146D6.000 | 55/74 | 09/94→12/96 | OE018 | 1,0 | CET8 | OE195 |
|----------|---|----------------------|-------|-------------|-------|-----|------|-------|

ISUZU**ASCENDER**

| | | | | | | | | |
|---------|---|-----|---------|--------|--|--|--------|-------|
| 4.2 4WD | 6 | LL8 | 217/291 | 03/03→ | | | CET17P | OE189 |
|---------|---|-----|---------|--------|--|--|--------|-------|

ASKA III

| | | | | | | | | |
|-----|---|------|-------|-------------|-------|-----|------|-------|
| 2.3 | 4 | 4ZD1 | 71/95 | 10/97→09/01 | OE006 | 0,9 | CET8 | OE195 |
|-----|---|------|-------|-------------|-------|-----|------|-------|

D-MAX I

| | | | | | | | | |
|-------|---|--|---------|-------------|----------------------|-----|--|--|
| 3.0 D | 4 | | 107/143 | 01/04→06/12 | CH306 [158] [275] | 11v | | |
|-------|---|--|---------|-------------|----------------------|-----|--|--|

| | | | | | | | | |
|------------------|---|-----------|--------|-------------|----------------------|-----|--|--|
| 3.0 D, 3.0 D 4WD | 4 | ; 4JH1-TC | 88/118 | 06/03→10/04 | CH306 [158] [275] | 11v | | |
|------------------|---|-----------|--------|-------------|----------------------|-----|--|--|

| | | | | | | | | |
|------------------------|---|---------|---------|-------------|----------------------|-----|--|--|
| 3.0 DiTD, 3.0 DiTD 4WD | 4 | 4JJ1-TC | 120/161 | 01/07→06/12 | CH306 [158] [275] | 11v | | |
|------------------------|---|---------|---------|-------------|----------------------|-----|--|--|

| | | | | | | | | |
|--------------|---|---------|--------|-------------|----------------------|-----|--|--|
| 3.0 DiTD 4WD | 4 | 4JH1-TC | 96/129 | 05/02→06/12 | CH306 [158] [275] | 11v | | |
|--------------|---|---------|--------|-------------|----------------------|-----|--|--|

| | | | | | | | | |
|--------------|---|--|---------|-------------|----------------------|-----|--|--|
| 3.0 DiTD 4WD | 4 | | 100/134 | 06/03→06/12 | CH306 [158] [275] | 11v | | |
|--------------|---|--|---------|-------------|----------------------|-----|--|--|

| | | | | | | | | |
|--------------|---|---------|---------|-------------|----------------------|-----|--|--|
| 3.0 DiTD 4WD | 4 | 4JH1-TC | 114/153 | 06/05→06/07 | CH306 [158] [275] | 11v | | |
|--------------|---|---------|---------|-------------|----------------------|-----|--|--|

| | | | | | | | | |
|--------------|---|---------|---------|-------------|----------------------|-----|--|--|
| 3.0 DiTD 4WD | 4 | 4JH1-TC | 114/153 | 06/05→06/07 | CH306 [158] [275] | 11v | | |
|--------------|---|---------|---------|-------------|----------------------|-----|--|--|

| | | | | | | | | |
|--------------|---|---------|---------|-------------|----------------------|-----|--|--|
| 3.0 DiTD 4WD | 4 | 4JH1-TC | 114/153 | 06/05→06/07 | CH306 [158] [275] | 11v | | |
|--------------|---|---------|---------|-------------|----------------------|-----|--|--|

KB

| | | | | | | | | |
|------------------------|---|------|-------|-------------|-------|-----|--|--|
| 2.5 DiTD, 2.5 DiTD 4WD | 4 | 4JA1 | 56/75 | 07/02→06/04 | CH306 | 11v | | |
|------------------------|---|------|-------|-------------|-------|-----|--|--|

| | | | | | | | | |
|--------------------------|---|---------|--------|--------|-------|-----|--|--|
| 2.5 D-TEQ, 2.5 D-TEQ 4WD | 4 | 4JK1-TC | 85/114 | 10/08→ | CH306 | 11v | | |
|--------------------------|---|---------|--------|--------|-------|-----|--|--|

| | | | | | | | | |
|--------------------------|---|---------|---------|--------|-------|-----|--|--|
| 3.0 D-TEQ, 3.0 D-TEQ 4WD | 4 | 4JJ1-TC | 120/161 | 08/10→ | CH306 | 11v | | |
|--------------------------|---|---------|---------|--------|-------|-----|--|--|

TROOPER III

| | | | | | | | | |
|----------------|---|------|---------|-------------|--|--|--------|-------|
| 3.5 V6 24V 4WD | 6 | 6VE1 | 158/212 | 04/00→08/04 | | | CET12P | OE180 |
|----------------|---|------|---------|-------------|--|--|--------|-------|

VEHICROSS

| | | | | | | | | |
|---------|---|------|---------|-------------|-------|-----|------|-------|
| 3.2 4WD | 6 | 6VD1 | 158/212 | 04/97→12/00 | OE063 | 1,0 | CET2 | OE179 |
|---------|---|------|---------|-------------|-------|-----|------|-------|

WIZARD

| | | | | | | | | |
|---------|---|------|---------|-------------|-------|-----|------|-------|
| 3.2 4WD | 6 | 6VD1 | 158/212 | 06/98→08/02 | OE063 | 1,0 | CET2 | OE179 |
|---------|---|------|---------|-------------|-------|-----|------|-------|

ISUZU**D-MAX I**

| | | | | | | | | |
|-------|---|---------|---------|-------------|----------------------|-----|--|--|
| 3.0 D | 4 | 4JJ1-TC | 120/161 | 01/07→06/12 | CH306 [158] [275] | 11v | | |
|-------|---|---------|---------|-------------|----------------------|-----|--|--|

| | | | | | | | | |
|-----------|---|---------|---------|-------------|----------------------|-----|--|--|
| 3.0 D 4WD | 4 | 4JJ1-TC | 120/161 | 01/07→06/12 | CH306 [158] [275] | 11v | | |
|-----------|---|---------|---------|-------------|----------------------|-----|--|--|

IVECO**MASSIF**

| | | | | | | | | |
|-------------|---|------------|---------|-------------|-------|-----|--|--|
| 3.0 HPI 4WD | 4 | F1CE0481FA | 107/143 | 10/08→02/11 | CH270 | 11v | | |
|-------------|---|------------|---------|-------------|-------|-----|--|--|

| | | | | | | | | |
|-------------|---|------------|---------|-------------|-------|-----|--|--|
| 3.0 HPT 4WD | 4 | F1CE0481HA | 130/174 | 10/08→02/11 | CH270 | 11v | | |
|-------------|---|------------|---------|-------------|-------|-----|--|--|

IVECO



kW/BHP

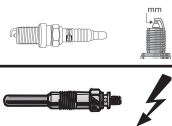

eon TITAN

IRIDIUM

**IVECO****DAILY C14G**3.0 50C14G Natural Power 4 100/134 10/15→10/16 **OE254** 0,5**DAILY II**2.8 30-8, 2.8 30-8 V, 2.8 35-8, 2.8 35-8 K 4 8140.63 62/83 09/98→05/99 **CH216** 11v**DAILY III**2.3 29 L 10, 2.3 29 L 10 V, 2.3 35 C 10 V, 35 S 10 V, 2.3 35 S 10 4 F1AE0481A 70/94 09/02→07/07 **CH270** 11v2.3 29 L 12, 2.3 29 L 12 V, 2.3 35 C 12, 35 S 12, 2.3 35 C 12 V, 35 S 12 V 4 F1AE0481B 85/114 09/02→07/07 **CH270** 11v2.3 29 L 14, 2.3 35 C 14, 35 S 14, 2.3 40 C 14 4 F1AE0481M 100/134 01/05→04/06 **CH270** 11v2.8 29 L 9, 2.8 29 L 9 V, 2.8 35 S 9, 35 C 9, 2.8 35 S 9 V, 35 C 9 V 4 8140.63 62/83 05/99→07/07 **CH216** 11v2.8 29 L 13, 2.8 35 S 13, 35 C 13, 2.8 35 S 13 V, 35 C 13 V, 2.8 40 C 13, 2.8 50 C 13 4 8140.43S 92/123 05/99→07/07 **CH216** 11v2.8 35 C 15, 2.8 35 S 15 V, 35 C 15 V, 2.8 40 C 15, 2.8 50 C 15, 2.8 65 C 15 4 8140.43N 107/143 01/01→07/07 **CH216** 11v2.8 50 C 11 Natural Power (CNG), 2.8 CNG 4 8149.03 78/105 05/99→07/07 **OE254** 0,53.0 35 C 14, 3.0 40 C 14, 3.0 45 C 14, 3.0 50 C 14, 3.0 65 C 14 4 F1CE0481A 100/134 07/99→04/06 **CH270** 11v3.0 35 C 17, 35 S 17, 3.0 40 C 17, 40 S 17, 3.0 50 C 17, 3.0 65 C 17 4 F1CE0481B 122/164 09/04→04/06 **CH270** 11v**DAILY IV**2.3 29L10, 2.3 29L10 V, 2.3 35C10, 35S10, 2.3 35C10 K, 2.3 40C10, 2.3 40C10 V 4 F1AE0481FA 70/94 05/06→08/11 **CH270** 11v2.3 29L12, 2.3 29L12 V, 29L12 V/P, 2.3 35C12, 2.3 35C12, 35S12, 2.3 35C12 V, 35C12 V/P, 35S12 V, 35S12 V/P, 2.3 40C12, 2.3 40C12 V, 40C14 V/P 4 F1AE0481GA 85/114 05/06→08/11 **CH270** 11v2.3 29L14, 2.3 29L14 C, 29L14 C/P, 29L14 V, 29L14 V/P, 2.3 35C14, 35S14, 35S14 /P, 2.3 35S14, 35S14 /P, 2.3 35S14 C, 35S14 C/P, 35S14 V, 35S14 V/P, 35C14 V, 35C14 V/P, 2.3 35S14 K, 35S14 DK 4 F1AE0481HA 100/134 05/06→08/11 **CH270** 11v2.3 35C11, 35S11, 35S11 D, 35S11 /P, 2.3 35C11 V, 35S11 V, 2.3 35C11 K, 35C11 DK, 35S11 K, 35S11 DK, 2.3 40C11, 40C11 D, 2.3 40C11 V 4 F1AE0481FA 78/105 07/07→08/11 **CH270** 11v2.3 35C13, 35C13 /P, 35S13 D, 35S13, 35S13 /P, 2.3 35C13 V, 35C13 V/P, 35S13 V, 35S13 V/P, 2.3 35C13 K, 35C13 DK, 35S13 K, 35S13 DK, 2.3 40C13, 40C13 /P, 2.3 40C13 V, 40C13 V/P 4 F1AE0481GA 93/125 07/07→08/11 **CH270** 11v

IVECO





kW/BHP

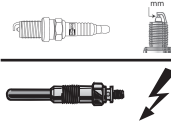

eon TITAN

IRIDIUM

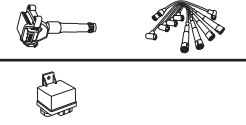
**...IVECO****...DAILY IV**

| | | | | | | |
|---|---|------------------------|---------|-------------|--------------|-----|
| 3.0 35C14, 35C14 /P, 35S14, 35S14 /P, 35S14 D, 35S14 D/P, 3.0 35C14 V, 35C14 V/P, 35S14 V, 35S14 V/P, 3.0 35C14 K, 35C14 DK, 35S14 K, 35S14 DK, 3.0 40C14, 40C14 /P, 3.0 40C14 V, 40C14 V/P, 3.0 40C14 K, 40C14 DK, 3.0 45C14, 45C14 /P, 3.0 50C... | 4 | FICE3481LC | 103/138 | 07/07→08/11 | CH270 | 11v |
| 3.0 35C14 G, 35C14 G/P, 35S14 G, 35S14 G/P, 35C14 GD, 35S14 GD, 3.0 35C14 GV, 35C14 GV/P, 35S14 GV, 35S14 GV/P, 3.0 35S14 G, 3.0 40C14 G, 40C14 G/P, 3.0 40C14 GV, 40C14 GV/P, 3.0 50C14 G, 50C14 G/P, 50C14 GD, 50C14 GD/P, 3.0 50C14 GV, 50C14... | 4 | FICE0441A | 100/134 | 07/07→08/11 | OE254 | 0,5 |
| 3.0 35C15, 3.0 35C15 V, 35C15 V/P, 3.0 40C15, 3.0 40C15 V, 40C15 V/P, 3.0 45C15, 3.0 45C15 V, 3.0 50C15, 3.0 50C15 V, 50C15 V/P, 3.0 60C15, 3.0 60C15 V/P, 60C15 /P, 60C15 D, 60C15 D/P, 3.0 60C15 V, 3.0 65C15, 3.0 65C15, 65C15 /P, 65C15 D, 65C15... | 4 | FICE0481FA | 107/143 | 05/06→08/11 | CH270 | 11v |
| 3.0 35C17, 35C17 /P, 35S17, 35S17 /P, 35S17 D, 3.0 35C17 V, 35C17 V/P, 35S17 V, 35S17 V/P, 3.0 35C17 K, 35C17 DK, 35S17 K, 35S17 DK, 3.0 35S17 W, 35S17 WD 4WD, 3.0 40C17, 40C17 /P, 3.0 40C17 V, 40C17 V/P, 3.0 40C17 K, 40C17 DK, 3.0 45C17, 4... | 4 | FICE0481HA | 125/168 | 07/07→08/11 | CH270 | 11v |
| 3.0 35C18, 3.0 35C18, 35S18, 3.0 35C18 V, 35C18 V/P, 35S18 V, 35S18 V/P, 3.0 40C18, 3.0 40C18 V, 40C18 V/P, 3.0 45C18, 3.0 45C18, 45C18 /P, 45C18 D, 45C18 D/P, 3.0 50C18, 3.0 50C18 V, 50C18 V/P, 3.0 60C18, 3.0 65C18 | 4 | FICE0481HA; FICE0481HC | 130/174 | 05/06→08/11 | CH270 | 11v |
| 3.0 35S15 | 4 | FICE0481L | 110/148 | 06/06→08/11 | CH270 | 11v |
| DAILY V | | | | | | |
| 2.3 26L11, 26L11D, 35C11D, 35S11, 40C11, 2.3 29L11 V, 35C11 V, 35S11 V, 40C11 V, 2.3 35C11K, 35S11DKP | 4 | FIAE3481A | 78/105 | 09/11→02/14 | CH270 | 11v |
| 2.3 29L13, 29L13D, 35C13D, 40C13, 2.3 29L13 V, 35C13 V, 35S13 V, 40C13 V, 40S13 V, 2.3 35C13K, 35C13DKP | 4 | FIAE3481B | 93/125 | 09/11→02/14 | CH270 | 11v |
| 2.3 29L15 V, 35C15L V, 40C15L V, 50C15L V | 4 | FIAE3481C | 107/143 | 09/11→02/14 | CH270 | 11v |
| 3.0 35C15, 35C15D, 35S15, 40C15, 45C15, 50C15, 60C15, 70C15, 3.0 35C15 V, 40C15 V, 3.0 35C15K, 35S15DKP, 50C15K, 60C15K, 65C15DK, 70C15K | 4 | FICE3481J; FICE3481L | 107/143 | 09/11→02/14 | CH270 | 11v |

IVECO

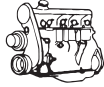

kW/BHP

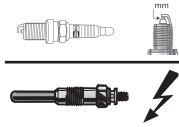

eon TITAN

IRIDIUM

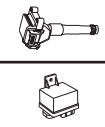

...IVECO

...DAILY V

| | | | | | | | | | |
|--|---|----------------------|---------|-------------|-------|-----|--|--|--|
| 3.0 35C17, 35C17D, 35S17, 40C17, 45C17, 50C17, 60C17, 70C17, 3.0 35C17 V, 35S17 V, 40C17 V, 45C17 V, 50C17 V, 60C17 V, 3.0 35C17K, 35S17DKP, 50C17K, 65C17DK, 70C17K | 4 | F1CE3481C; F1CE3481K | 125/168 | 09/11→02/14 | CH270 | 11v | | | |
| 3.0 35C21, 35S21, 40C21, 45C21, 50C21, 60C21, 70C21, 3.0 35C21 V, 35S21 V, 40C21 V, 45C21 V, 50C21 V, 3.0 35S21DKP | 4 | F1CE3481D | 150/201 | 09/11→02/14 | CH270 | 11v | | | |
| 3.0 35 S 14 | 4 | F1CE3481L | 110/148 | 04/12→02/14 | CH270 | 11v | | | |

DAILY VI

| | | | | | | | | | |
|---|---|------------------------|---------|--------|-----------------|-----|--|--|--|
| 3.0 Natural Power 35S14, 35C14, 40C14, 50C14, 3.0 Natural Power 35S14, 35C14, 40C14, 50C14, 65C14, 70C14, 3.0 NaturalPower 35S14, 35C14, 40C14, 50C14, 65C14, 70C14, 72C1 | 4 | ; F1CFA401A; F1CFA401B | 100/134 | 03/14→ | OE254 →12/16 | 0,5 | | | |
|---|---|------------------------|---------|--------|-----------------|-----|--|--|--|

DAILY LINE

| | | | | | | | | | |
|-------------------------|---|-----------|---------|--------|-----------------|-----|--|--|--|
| 3.0 50C14 Natural Power | 4 | F1CFA401A | 100/134 | 06/14→ | OE254 →12/16 | 0,5 | | | |
|-------------------------|---|-----------|---------|--------|-----------------|-----|--|--|--|

MASSIF

| | | | | | | | | | |
|-------------|---|------------|---------|-------------|-------|-----|--|--|--|
| 3.0 HPI 4WD | 4 | F1CE0481FA | 107/143 | 10/08→02/11 | CH270 | 11v | | | |
| 3.0 HPT 4WD | 4 | F1CE0481HA | 130/174 | 10/08→02/11 | CH270 | 11v | | | |

JAGUAR

S-TYPE

| | | | | | | | | | |
|------------------|---|-----------------|---------|-------------|-------|-----|--------|-------|---|
| 2.5 V6 | 6 | AJ25; JB(AJ-V6) | 147/197 | 04/02→10/07 | OE131 | 1,0 | CET18P | OE183 | |
| 2.7 D | 6 | AJD | 152/204 | 06/04→10/07 | CH240 | 11v | | | |
| 3.0 V6 | 6 | AJ-V6; FB | 175/235 | 01/99→10/07 | OE131 | 1,0 | CET18P | OE183 | BAEA367 |
| 4.0 V8 | 8 | AJ-V8 | 203/272 | 01/99→04/02 | OE146 | 1,0 | CET12P | OE179 | BAEA368 ^[277] →Ch.M45254 BAEA196E ^[275] Ch.M45255→ |
| 4.0 V8 | 8 | AJ-V8 | 209/280 | 09/99→12/02 | OE146 | 1,0 | CET12P | | |
| 4.2 V8 | 8 | AJ8FT | 219/294 | 04/02→10/07 | | | CET12P | OE180 | BAEA196E ^[275] BAEA368 ^[275] |
| 4.2 R 4, 2 V8 | 8 | AJ8FT | 291/390 | 04/02→10/07 | | | CET12P | OE180 | BAEA368 ^[277] →Ch.M45254 BAEA196E ^[275] Ch.M45255→ |
| 4.2 Supercharged | 8 | AJ8FT | 298/400 | 11/01→12/08 | | | CET12P | OE180 | |

XF

| | | | | | | | | | |
|----------------|---|-------|---------|-------------|-----------------|-----|--------|-------|---------------------------|
| 2.0 | 4 | 204PT | 177/237 | 06/12→ | | | CET17P | | |
| 2.7 D | 6 | AJD | 152/204 | 03/08→04/15 | CH240 →02/09 | 11v | | | |
| 3.0 | 6 | AJ6WG | 175/235 | 03/08→04/15 | OE131 | 1,0 | CET18P | OE183 | |
| 3.0, 3.0 4WD | 6 | 306PS | 250/335 | 03/12→ | | | | | BAEA196E ^[275] |
| 4.2 | 8 | SV82G | 219/294 | 03/08→04/15 | | | CET12P | OE180 | BAEA196E ^[275] |
| 4.2 Kompressor | 8 | SV8TS | 306/410 | 03/08→04/15 | | | CET12P | OE180 | BAEA196E ^[275] |

XJ

| | | | | | | | | | |
|-------|---|-------|---------|-------------|-------|-----|--------|-------|---------------------------|
| 2.0 | 4 | 204PT | 177/237 | 05/12→ | | | CET17P | | |
| 2.7 D | 6 | AJD | 152/204 | 10/05→03/09 | CH240 | 11v | | | |
| 3.0 | 6 | AJ-V6 | 175/235 | 05/03→ | OE131 | 1,0 | CET18P | OE183 | |
| 3.0 | 6 | AJ-V6 | 179/240 | 04/04→01/07 | OE131 | 1,0 | CET18P | OE183 | |
| 3.0 | 6 | 306PS | 250/335 | 03/12→ | | | | | BAEA196E ^[275] |



kW/BHP

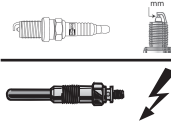

eon TITAN

IRIDIUM

**...JAGUAR****...XJ**

| | | | | | | | | | |
|---------------------|----|---------------|---------|-------------|------------------------------------|------------|--------|-------|---------------------------|
| 3.2 | 8 | | 174/233 | 07/97→05/03 | OE136 →09/98 OE146 10/98→ | 0,8 1,0 | CET12P | OE179 | BAEA368 ^[277] |
| 3.2 6 | 6 | 9JPCRB | 155/208 | 11/94→07/97 | OE005 | 0,9 | CET2 | OE180 | |
| 3.6 | 8 | RG(AJ-V8) | 190/255 | 05/03→03/09 | | | CET12P | OE180 | BAEA196E ^[275] |
| 4.0 | 6 | 9LPFRB | 171/229 | 07/94→03/96 | OE013 | 0,8 | CET2 | OE193 | |
| 4.0 | 8 | BC | 209/280 | 07/97→05/03 | OE136 →09/98 OE146 10/98→ | 0,8 1,0 | CET12P | OE179 | BAEA368 ^[277] |
| 4.0 | 8 | AJ-V8 | 216/290 | 10/97→04/03 | OE146 | 1,0 | CET12P | | |
| 4.0 | 8 | DC | 267/358 | 07/97→05/03 | OE146 | 1,0 | CET12P | OE179 | BAEA368 ^[277] |
| 4.0 6 Sovereign | 6 | 9JPCRB | 177/237 | 09/94→07/97 | OE002 | 0,9 | CET2 | OE180 | |
| 4.0 R Super Charged | 6 | 9KPDRB | 235/315 | 11/94→07/97 | OE014 | 0,9 | CET2 | OE179 | |
| 4.2 | 8 | AJ8FT | 219/294 | 05/03→03/09 | | | CET12P | OE180 | BAEA196E ^[275] |
| 4.2 R | 8 | AJ8FT | 291/390 | 03/03→03/09 | | | CET12P | OE180 | BAEA196E ^[275] |
| 6.0 | 12 | 8D | 222/298 | 05/93→03/96 | OE011 | 0,9 | CET9 | OE183 | |
| 6.0 12, 6.0 V12 | 12 | 8C(92-94); 8E | 229/307 | 03/93→09/97 | OE011 | 0,9 | CET9 | OE183 | |

XJSC

| | | | | | | | | | |
|-----|----|--------|---------|-------------|-------|-----|------|-------|--|
| 4.0 | 6 | 9LPFRB | 171/229 | 07/94→03/96 | OE013 | 0,8 | CET2 | OE193 | |
| 6.0 | 12 | 8D | 222/298 | 05/93→03/96 | OE011 | 0,9 | CET9 | OE183 | |

XK

| | | | | | | | | | |
|---------|---|-----------|---------|-------------|--|--|--------|-------|---------------------------|
| 3.6 | 8 | RG(AJ-V8) | 190/255 | 07/07→07/14 | | | CET12P | OE180 | BAEA196E ^[275] |
| 4.2 XK8 | 8 | AJ8FT | 219/294 | 03/06→07/14 | | | CET12P | OE180 | BAEA196E ^[275] |
| 4.2 XKR | 8 | AJ8FT | 291/390 | 03/06→07/14 | | | CET12P | OE180 | BAEA196E |
| 4.2 XKR | 8 | SV8TS | 306/410 | 03/06→07/14 | | | CET12P | OE180 | BAEA196E ^[275] |
| 4.2 XKR | 8 | SV8TS | 313/420 | 08/06→07/14 | | | CET12P | OE180 | |

XK 8

| | | | | | | | | | |
|------------|---|--------------------|---------|-------------|-------|-----|--------|-------|---------------------------|
| 4.0 | 8 | AJ26; AJ27; CC; CE | 209/280 | 03/96→07/05 | OE136 | 0,8 | CET12P | OE179 | |
| 4.0 | 8 | AJ26; AJ-V8 | 216/290 | 05/96→07/05 | OE136 | 0,8 | CET12P | OE179 | |
| 4.0 | 8 | EC | 267/358 | 02/98→07/05 | OE136 | 0,8 | CET12P | | |
| 4.0 XKR | 8 | AJ27S | 276/370 | 05/98→07/05 | OE136 | 0,8 | CET12P | OE180 | |
| 4.2 | 8 | AJ8FT | 219/294 | 08/02→12/06 | | | CET12P | OE180 | BAEA196E ^[275] |
| 4.2 R 4, 2 | 8 | AJ8FT | 291/390 | 08/02→12/06 | | | CET12P | OE180 | BAEA196E ^[275] |

X-TYPE

| | | | | | | | | | |
|---------------------|---|---------------------|---------|-------------|-------|-------|--------|-------|--|
| 2.0 D | 4 | FMBA; FMBB; R4-X404 | 96/129 | 07/03→12/09 | CH229 | 11.5v | | | |
| 2.1 V6 | 6 | YB(AJ-V6) | 115/154 | 03/02→11/09 | OE131 | 1,0 | CET18P | OE183 | |
| 2.2 D | 4 | LJ46G | 107/143 | 01/07→12/09 | CH229 | 11.5v | | | |
| 2.2 D | 4 | LJ46G | 110/148 | 10/05→12/09 | CH229 | 11.5v | | | |
| 2.2 D | 4 | LJ46G | 114/153 | 10/05→12/09 | CH229 | 11.5v | | | |
| 2.5 4WD, 2.5 V6 4WD | 6 | XB(AJ-V6) | 144/193 | 06/01→12/09 | OE131 | 1,0 | CET18P | OE183 | |
| 3.0 4WD, 3.0 V6 4WD | 6 | AJ-V6 | 169/227 | 06/01→12/09 | OE131 | 1,0 | CET18P | OE183 | |

JEEP**CHEROKEE**

| | | | | | | | | | |
|---------------------|---|----------|---------|-------------|----------------------------|-----|------|-------|-------------------|
| 2.4 4WD, 2.4 Laredo | 4 | ED1 | 108/145 | 09/01→01/08 | | | | | BAEA380 →12/03 |
| 2.5 CRD 4WD | 4 | R425DOHC | 105/141 | 09/01→01/08 | CH180 | 11v | | | |
| 2.8 CRD 4WD | 4 | ENR | 110/148 | 11/02→01/08 | CH180 | 11v | | | |
| 2.8 CRD 4WD | 4 | ENR | 120/161 | 11/04→01/08 | CH180 | 11v | | | |
| 3.7 4WD | 6 | EKG | 155/208 | 09/01→01/08 | OE089 | 1,0 | CET2 | OE184 | |
| | | | | | OE216 ^{LPG [278]} | 0,8 | | | |
| 3.7 4WD, 3.7 Laredo | 6 | EKG | 150/201 | 10/01→01/08 | OE089 | 1,0 | CET2 | OE184 | |
| | | | | | OE216 ^{LPG [278]} | 0,8 | | | |

JEEP





kW/BHP



eon TITAN

IRIDIUM



...JEEP

...CHEROKEE

| | | | | | | | | | |
|--------------------|---|-----|---------|-------------|--|------------|-------------|--------------|--------------------------------|
| 3.7 V6, 3.7 V6 4WD | 6 | EKG | 157/211 | 01/08→ | OE089 OE216 LPG [278] | 1,0 0,8 | CET2 | OE184 | |
| 3.7 V6 4WD | 6 | EKG | 151/202 | 01/08→ | OE089 OE216 LPG [278] | 1,0 0,8 | CET2 | OE184 | |
| 4.0 i 4WD | 6 | ERH | 127/170 | 07/98→09/01 | OE041 | 0,9 | | | |
| 4.0 i 4WD | 6 | ERH | 131/176 | 01/95→09/01 | OE041 | 0,9 | | | BAEA394 [292] →09/98 |

COMMANDER

| | | | | | | | | | |
|------------|---|-----|---------|-------------|--|------------|-------------|--------------|--|
| 3.7 V6 4WD | 6 | EKG | 157/211 | 09/05→12/10 | OE089 OE216 LPG [278] | 1,0 0,8 | CET2 | OE184 | |
| 4.7 V8 4WD | 8 | EVA | 170/228 | 09/05→12/10 | OE154 | 1,0 | CET2 | OE194 | |

COMPASS

| | | | | | | | | | |
|--------------|---|-----|---------|--------|--------------|-----|-------------|--------------|--|
| 2.4, 2.4 4WD | 4 | ED3 | 125/168 | 08/06→ | OE154 | 1,0 | CET2 | OE194 | |
|--------------|---|-----|---------|--------|--------------|-----|-------------|--------------|--|

GRAND CHEROKEE I

| | | | | | | | | | |
|-----------------|---|----------|---------|-------------|--------------|-----|-------------|--------------|--------------------------------|
| 2.5 TD 4WD | 4 | M51; M52 | 85/114 | 10/95→04/99 | CH181 | 11v | | | |
| 4.0 i 4WD | 6 | S01 | 130/174 | 10/95→04/99 | OE041 | 0,9 | | | BAEA394 [292] →12/97 |
| 4.0 Laredo | 6 | ERH | 131/176 | 10/96→09/98 | OE041 | 0,9 | | | BAEA394 [275] [292] |
| 5.2 4WD | 8 | Y01 | 156/209 | 10/95→04/99 | OE013 | 0,8 | CET2 | OE193 | |
| 5.2, 5.2 4WD | 8 | ELF | 164/220 | 10/96→09/98 | OE128 | 1,0 | | | BAEA394 [292] →12/97 |
| 5.2 Limited 4WD | 8 | ELF | 136/182 | 10/96→09/98 | OE128 | 1,0 | | | BAEA394 [292] →12/97 |
| 5.9 i 4WD | 8 | | 177/237 | 08/97→04/99 | OE128 | 1,0 | | | |

GRAND CHEROKEE II

| | | | | | | | | | |
|--------------|---|-----|---------|-------------|--------------|-----|-------------|--------------|--|
| 3.1 TD 4WD | 5 | EXA | 103/138 | 04/99→12/01 | CH181 | 11v | | | |
| 4.0, 4.0 4WD | 6 | ERH | 140/188 | 10/98→09/05 | OE041 | 0,9 | | | |
| 4.7 V8 4WD | 8 | EVA | 162/217 | 04/99→08/00 | OE154 | 1,0 | CET2 | OE194 | |
| 4.7 V8 4WD | 8 | EVA | 164/220 | 04/99→09/05 | OE154 | 1,0 | CET2 | OE194 | |
| 4.7 V8 4WD | 8 | EVA | 167/224 | 06/03→09/05 | OE154 | 1,0 | CET2 | OE194 | |
| 4.7 V8 4WD | 8 | EVC | 190/255 | 10/01→09/05 | OE154 | 1,0 | CET2 | OE194 | |

GRAND CHEROKEE III

| | | | | | | | | | |
|----------------------|---|-----|---------|-------------|--|------------|-------------|--------------|---------------------|
| 3.0 CRD, 3.0 CRD 4WD | 6 | EXL | 160/215 | 06/05→12/10 | | | | | CCU114 [275] |
| 3.0 CRD 4WD | 6 | EXL | 155/208 | 05/06→12/10 | | | | | CCU114 [275] |
| 3.7 V6 4WD | 6 | EKG | 148/198 | 01/08→12/10 | OE089 OE216 LPG [278] | 1,0 0,8 | CET2 | OE184 | |
| 3.7 V6 4WD | 6 | EKG | 157/211 | 10/04→12/10 | OE089 OE216 LPG [278] | 1,0 0,8 | CET2 | OE184 | |
| 4.7 V8 4WD | 8 | EVA | 170/228 | 06/05→12/10 | OE154 | 1,0 | CET2 | OE194 | |

GRAND CHEROKEE IV

| | | | | | | | | | |
|--------------|---|-----|---------|--------|--|--|---------------|--------------|--|
| 6.4 SRT8 4WD | 8 | ESG | 344/461 | 03/11→ | | | CET17P | OE189 | |
|--------------|---|-----|---------|--------|--|--|---------------|--------------|--|

PATRIOT

| | | | | | | | | | |
|-----------------------------|---|-----|---------|--------|--------------|-----|-------------|--------------|--|
| 2.4, 2.4 4WD, 2.4 Eco + 4WD | 4 | ED3 | 125/168 | 01/08→ | OE154 | 1,0 | CET2 | OE194 | |
|-----------------------------|---|-----|---------|--------|--------------|-----|-------------|--------------|--|

RENEGADE

| | | | | | | | | | |
|-----|---|---------------|---------|--------|--------------|-----|--|--|--|
| 1.4 | 4 | 55263624; EAM | 103/138 | 07/14→ | OE208 | 0,8 | | | |
|-----|---|---------------|---------|--------|--------------|-----|--|--|--|

WRANGLER II

| | | | | | | | | | |
|-----------------|---|-----|---------|-------------|--------------|-----|--|--|----------------|
| 2.4 4WD | 4 | ED1 | 105/141 | 11/02→04/07 | | | | | BAEA380 |
| 2.5 4WD | 4 | P00 | 87/117 | 08/96→04/07 | OE041 | 0,9 | | | |
| 4.0 4WD | 6 | | 124/166 | 06/98→04/07 | OE041 | 0,9 | | | |
| 4.0 4WD | 6 | S01 | 130/174 | 08/96→04/07 | OE041 | 0,9 | | | |
| 4.0 Rubicon 4WD | 6 | ERH | 128/172 | 08/03→04/07 | OE041 | 0,9 | | | |

CHAMPION



kW/BHP



eon TITAN

IRIDIUM



JENSEN

S-V8

4.6 8 243/326 10/98→05/07

CET9

KIA

AVELLA

1.3 4 B3 55/74 11/95→12/01

OE048

1,0

CET8

1.5 4 55/74 02/97→12/01

OE048

1,0

CET8

OE195

CADENZA I

3.3 GDI 6 G6DH 216/290 01/10→

CET14P

OE190

3.3 GDI 6 G6DH 218/292 09/13→

CET14P

OE190

3.5 CVT 6 G6DC 213/286 01/10→

OE191

1,0

CET12P

CARENS I

1.8 i 4 T8 81/109 11/00→07/02

OE063

1,0

CET2

OE180

BAEA433

CLS173

CARENS II

1.6 4 GA6D 77/103 07/02→

OE063

1,0

CET2

OE180

BAEA486^[275]

CLS256

1.8 4 TB 93/125 07/02→

OE063

1,0

CET2

OE180

BAEA433

CLS173

2.0 CRDi 4 D4EA 83/111 07/02→

CH226

11v

2.0 CRDi 4 D4EA-F 103/138 11/05→

CH226

11v

2.0 CVT 4 G4GC 102/137 08/04→

CET12P

OE180

BAEA482

CLS094

CARENS III

1.6 CVT 4 G4FC 93/125 10/10→

OE201

0,9

CET6

BAEA475

1.6 CVT 4 G4FC 97/130 08/09→

OE201

0,9

CET6

BAEA475

2.0 CRDi 115 4 D4EA 85/114 05/07→

CH226

11v

2.0 CRDi 135 4 D4EA 100/134 08/09→

CH226

11v

2.0 CRDi 140 4 D4EA-F 103/138 09/06→

CH226

11v

2.0 CVT 4 G4KA 106/142 09/06→

OE063

1,0

CET2

OE180

BAEA531

CARENS IV

2.0 GDi 4 G4NC 122/164 03/13→

OE249

2.0 GDi 4 G4NC 130/174 03/13→

OE249

CARNIVAL / GRAND CARNIVAL III

2.7 V6 6 G6EA 139/186 06/06→

CET14P

OE190

3.8 6 G6DA 182/244 01/10→

CET14P

OE190

2.5 V6 6 KRV6 121/162 08/99→10/01

OE136

0,8

CET12P

OE179

OE216^{UPG [278]}

0,8

2.9 TD 4 J3 93/125 08/99→10/01

CH226

11v

CARNIVAL II

2.4 4 109/146 12/01→10/06

OE048

1,0

CET8

OE195

2.5 V6 6 K5 110/148 10/01→06/06

OE136

0,8

CET12P

OE179

OE216^{UPG [278]}

0,8

2.9 CRDi 4 J3 106/142 10/01→06/06

CH226

11v

2.9 TD 4 J3 93/125 01/99→09/07

CH226

11v

3.5 6 G6CU 143/192 07/02→04/06

CET12P

OE180

CEE'D

1.0 T-GDI 3 G3LC 74/99 07/15→

OE248

1.0 T-GDI 3 G3LC 88/118 07/15→

OE248

1.4 4 G4FA 77/103 12/06→12/12

OE201

0,9

CET6

BAEA475

1.4 4 G4FA 80/107 12/06→12/12

OE063

1,0

CET2

OE180

→12/08

BAEA475

02/09→

OE201

0,9

CET6

BAEA474

01/09→

1.4 CVT 4 G4FA 66/89 07/09→

OE201

0,9

CET6

BAEA475

1.4 CVT 4 G4FA 73/98 05/12→

OE201

0,9

CET6

BAEA475

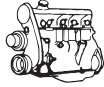

kW/BHP

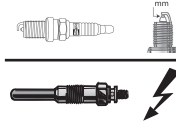

eon TITAN

IRIDIUM

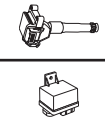

KIA

| ...KIA | | | | | | | | | | |
|--------------|---|---------|---------|-------------|------------------------------------|------------|--------------|-----------------|--|--------|
| ...CEE'D | | | | | | | | | | |
| 1.6 | 4 | G4FC | 85/114 | 09/07→12/12 | OE063 →12/08 OE201 01/09→ | 1,0 0,9 | CET2 CET6 | OE180 →12/08 | BAEA474 →04/09 BAEA475 04/09→ | |
| 1.6 | 4 | G4FC | 90/121 | 12/06→12/12 | OE063 →12/08 OE201 01/09→ | 1,0 0,9 | CET2 CET6 | OE180 →12/08 | BAEA474 →03/09 BAEA475 04/09→ | |
| 1.6 | 4 | G4FC | 93/125 | 09/07→12/12 | OE063 →12/08 OE201 01/09→ | 1,0 0,9 | CET2 CET6 | OE180 →12/08 | BAEA474 →03/09 BAEA475 04/09→ | |
| 1.6 CVT | 4 | G4FC | 92/123 | 06/09→ | OE201 | 0,9 | CET6 | | BAEA475 BAEA475 [275][342] | |
| 1.6 CVT | 4 | G4FC | 95/127 | 01/13→ | | | | | BAEA475 [275][342] | |
| 1.6 CVT | 4 | G4FC | 96/129 | 11/14→ | | | | | BAEA475 [275][342] | |
| 2.0 | 4 | G4GC | 105/141 | 12/06→12/12 | | | CET12P | OE180 | CLS094 | |
| 2.0 CRDi | 4 | D4EA | 100/134 | 06/07→12/12 | CH226 | 11v | | | | |
| 2.0 CRDi 140 | 4 | D4EA-F | 103/138 | 09/07→12/12 | CH226 | 11v | | | | |
| CERATO | | | | | | | | | | |
| 1.5 CRDi | 4 | D4FA | 75/101 | 07/05→ | CH226 | 11v | | | | |
| 1.6 | 4 | | 75/101 | 04/04→12/09 | | | | | BAEA483 →Prod.19.10.2006 BAEA474 Prod.04.09.2006→ Prod.25.01.2008 BAEA475 Prod.10.06.2008→ | |
| 1.6 | 4 | G4ED | 77/103 | 04/04→ | OE063 | 1,0 | CET2 | OE180 | BAEA483 ^[119] →10/06 BAEA474 ^[120] 11/06→ | CLS024 |
| 1.6 | 4 | G4FC | 90/121 | 04/04→ | OE063 →12/08 OE201 01/09→ | 1,0 0,9 | CET2 CET6 | OE180 →12/08 | BAEA474 →01/08 BAEA475 02/08→ | |
| 1.6 MPi | 4 | G4FC | 96/129 | 06/13→ | OE201 | 0,9 | | | BAEA475 | |
| 1.8 | 4 | T8 | 85/114 | 10/01→07/04 | OE063 | 1,0 | CET2 | | BAEA433 | |
| 1.8 | 4 | G4GB | 93/125 | 09/01→ | OE063 | 1,0 | CET2 | OE180 | | |
| 2.0 | 4 | G4GC | 105/141 | 04/04→ | OE063 | 1,0 | CET2 | OE180 | BAEA482 ^[118] | CLS094 |
| 2.0 CRDi | 4 | D4EA | 83/111 | 04/04→ | CH226 | 11v | | | | |
| CERATO II | | | | | | | | | | |
| 1.6 | 4 | G4FC | 90/121 | 01/10→ | OE201 | 0,9 | CET6 | | BAEA475 | |
| 1.6 | 4 | G4FC | 91/122 | 02/09→ | OE201 | 0,9 | | | | |
| 1.6 | 4 | G4FC | 93/125 | 01/10→ | OE201 | 0,9 | CET6 | | BAEA475 | |
| 1.6 CVT | 4 | G4FC | 91/122 | 02/09→ | OE201 | 0,9 | CET6 | | BAEA475 | |
| 2.0 | 4 | G4KD | 115/154 | 01/09→ | OE148 | 1,0 | CET5 | OE190 | BAEA548 ^[275] | |
| CERATO KOUP | | | | | | | | | | |
| 1.6 CVT | 4 | G4FC | 91/122 | 10/09→ | OE201 | 0,9 | CET6 | | BAEA475 | |
| 2.0 | 4 | G4KD | 115/154 | 01/09→ | OE148 | 1,0 | CET5 | OE190 | BAEA548 ^[275] | |
| CLARUS | | | | | | | | | | |
| 1.8 i 16V | 4 | T8 | 85/114 | 07/96→ | OE063 | 1,0 | CET2 | OE180 | BAEA433 | CLS173 |
| 2.0 i 16V | 4 | FE(16V) | 98/131 | 07/96→ | OE039 | 1,0 | CET2 | OE180 | | |
| JOICE | | | | | | | | | | |
| 2.0 | 4 | G4CP | 88/118 | 09/01→ | OE006 | 0,9 | CET8 | OE195 | BAEA521 ^[277] →02/03 | |
| 2.0 | 4 | G4CP | 102/137 | 02/00→ | OE006 | 0,9 | CET8 | OE195 | BAEA521 ^[277] | |





kW/BHP

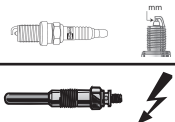

eon TITAN

IRIDIUM



...KIA

MAGENTIS

| | | | | | | | | | | |
|----------|---|--------|---------|-------------|-------|-----|--------|-------|--------------------------|--------|
| 2.0 | 4 | G4JP | 100/134 | 05/01→09/05 | OE048 | 1,0 | CET8 | OE195 | BAEA502E ^[13] | |
| 2.0 | 4 | G4KA | 106/142 | 11/05→ | | | CET12P | OE180 | BAEA531 | |
| | | | | | | | | | BAEA548 ^[275] | |
| 2.0 | 4 | G4KD | 121/162 | 07/09→ | OE148 | 1,0 | CET5 | OE190 | BAEA548 | |
| 2.0 CRDi | 4 | D4EA | 100/134 | 11/05→12/08 | CH226 | 11v | | | | |
| 2.0 CRDi | 4 | D4EA-F | 103/138 | 04/06→ | CH226 | 11v | | | | |
| 2.0 CRDi | 4 | D4EA-F | 110/148 | 04/06→ | CH226 | 11v | | | | |
| 2.5 V6 | 6 | G6BV | 124/166 | 05/01→ | | | CET12P | OE180 | BAEA269 | CLS189 |
| 2.7 | 6 | G6EA | 138/185 | 11/05→ | | | CET14P | OE190 | | |
| 2.7 V6 | 6 | G6EA | 142/190 | 07/09→ | | | CET14P | OE190 | | |

OPIRUS

| | | | | | | | | | | |
|--------|---|------|---------|--------|--|--|--------|-------|---------|--|
| 2.7 | 6 | G6EA | 139/186 | 10/06→ | | | CET14P | OE190 | | |
| 3.3 | 6 | | 173/232 | 10/06→ | | | CET12P | OE180 | | |
| 3.5 | 6 | G6CU | 149/200 | 09/03→ | | | CET12P | OE180 | | |
| 3.8 V6 | 6 | G6DA | 196/263 | 10/06→ | | | CET12P | OE180 | BAEA531 | |

OPTIMA

| | | | | | | | | | | |
|----------------|---|------|---------|--------|-------|-----|--|-------|--------------------------|--|
| 2.0 | 4 | G4KD | 125/168 | 03/12→ | | | | OE249 | BAEA548 | |
| 2.0 | 4 | G4KH | 204/274 | 03/12→ | | | | | BAEA548 ^[275] | |
| 2.0 CVL | 4 | G4KD | 121/162 | 03/12→ | | | | OE249 | BAEA548 | |
| 2.0 CVT Hybrid | 4 | G4NE | 110/148 | 03/12→ | | | | | BAEA548 | |
| 2.4 | 4 | G4KJ | 132/177 | 03/12→ | OE148 | 1,0 | | | BAEA548 | |

PICANTO

| | | | | | | | | | | |
|--------------|---|--------|-------|-------------|-------|-----|------|-------|--|--------|
| 1.0 | 3 | G3LA | 51/68 | 05/11→ | OE197 | 0,9 | CET6 | | BAEA476 ^[116] | |
| 1.0 | 4 | G4HE | 45/60 | 04/04→ | OE063 | 1,0 | CET2 | OE180 | BAEA477 ^[113] →Prod.31.10.2007 | CLS093 |
| 1.0 | 4 | G4HE | 46/62 | 09/07→ | OE063 | 1,0 | CET2 | OE180 | BAEA477 ^[113] →Prod.31.10.2007 | CLS093 |
| 1.0, 1.0 LPG | 4 | ; G4HC | 53/71 | 04/04→04/11 | | | | | BAEA477 ^[113] →Prod.31.10.2007 | |
| 1.0 Bi-Fuel | 3 | B3LA | 60/80 | 05/11→ | | | | | BAEA476 ^[116] | |
| 1.1 | 4 | G4HG | 48/64 | 04/04→ | OE063 | 1,0 | CET2 | OE180 | BAEA477 ^[113] →Prod.31.10.2007 | CLS093 |
| 1.2 | 4 | G4LA | 63/84 | 09/11→ | OE197 | 0,9 | CET6 | | | |

PRIDE

| | | | | | | | | | | |
|------------|---|------|--------|-------------|-------|-----|------|-------|--|--------|
| 1.3 | 4 | B3A5 | 47/63 | 08/99→05/01 | OE006 | 0,9 | CET8 | OE195 | | |
| 1.3 | 4 | | 54/72 | 05/94→05/97 | OE006 | 0,9 | CET8 | | | CLS258 |
| 1.3 16V | 4 | B3 | 47/63 | 10/96→05/01 | OE006 | 0,9 | CET8 | OE195 | | CLS258 |
| 1.4 LX | 4 | G4EE | 71/95 | 03/05→12/11 | | | CET2 | OE179 | | CLS197 |
| 1.6 CVT LX | 4 | G4ED | 82/110 | 03/05→12/11 | OE063 | 1,0 | CET2 | OE180 | | |

PRO CEE'D

| | | | | | | | | | | |
|-----------|---|------|--------|-------------|-----------------|-----|------|-----------------|--------------------------|--|
| 1.0 T-GDI | 3 | G3LC | 74/99 | 07/15→ | | | | OE248 | | |
| 1.0 T-GDI | 3 | G3LC | 88/118 | 07/15→ | | | | OE248 | | |
| 1.4 | 4 | G4FA | 77/103 | 02/08→09/12 | OE201 | 0,9 | CET6 | | BAEA475 ^[275] | |
| 1.4 | 4 | G4FA | 80/107 | 02/08→09/12 | OE063 →12/08 | 1,0 | CET2 | OE180 →12/08 | BAEA474 | |
| | | | | | OE201 01/09→ | 0,9 | CET6 | | | |
| 1.4 CVT | 4 | G4FA | 66/89 | 06/10→09/12 | OE201 | 0,9 | CET6 | | BAEA475 | |
| 1.4 CVT | 4 | G4FA | 73/98 | 03/13→ | OE201 | 0,9 | CET6 | | BAEA475 | |
| 1.6 | 4 | G4FC | 90/121 | 02/08→09/12 | OE063 →12/08 | 1,0 | CET2 | OE180 →12/08 | BAEA474 →03/09 | |
| | | | | | OE201 01/09→ | 0,9 | CET6 | | BAEA475 ^[275] | |
| 1.6 | 4 | G4FC | 93/125 | 02/08→09/12 | OE063 →12/08 | 1,0 | CET2 | OE180 →12/08 | BAEA474 →03/09 | |
| | | | | | OE201 01/09→ | 0,9 | CET6 | | BAEA475 ^[275] | |

KIA



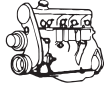

kW/BHP

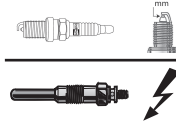

eon TITAN

IRIDIUM

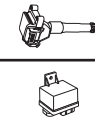

...KIA

...PRO CEE'D

| | | | | | | | | | | |
|--------------|---|--------|---------|---------------|-------|-----|--------|-------|--------------------------|--------|
| 1.6 CVT | 4 | G4FC | 92/123 | 10/10 → 02/13 | OE201 | 0,9 | CET6 | | BAEA475 ^[275] | |
| 1.6 GDI | 4 | G4FD | 99/133 | 03/13 → | | | | | BAEA475 | |
| 1.6 GT | 4 | G4FJ | 150/201 | 06/13 → | | | | | BAEA475 | |
| 2.0 | 4 | G4GC | 105/141 | 02/08 → 09/12 | OE063 | 1,0 | CET2 | OE180 | | CLS094 |
| 2.0 CRDi 140 | 4 | D4EA-F | 103/138 | 02/08 → 09/12 | CH226 | 11v | | | | |
| 2.0 LPG | 4 | G4GC | 105/141 | 01/09 → 12/09 | OE191 | 1,0 | CET12P | | | CLS094 |

QUORIS

| | | | | | | | | | | |
|-----|---|--|---------|---------|--|--|--------|-------|--|--|
| 3.3 | 6 | | 221/296 | 11/12 → | | | CET14P | OE190 | | |
|-----|---|--|---------|---------|--|--|--------|-------|--|--|

RETONA

| | | | | | | | | | | |
|-------------|---|---------|--------|---------|-------|-----|------|-------|--------------------------|--|
| 2.0 16V 4WD | 4 | FE(16V) | 94/126 | 05/00 → | OE039 | 1,0 | CET2 | OE180 | BAEA434 ^[277] | |
| 2.0 TD 4WD | 4 | RF | 61/82 | 06/99 → | CH242 | 11v | | | | |

RIO

| | | | | | | | | | | |
|---------|---|-----|-------|---------------|-----------------|------|------|-------|---------|--------|
| 1.3 | 4 | A3E | 55/74 | 08/00 → 02/05 | OE089 | 1,0 | CET2 | OE184 | BAEA561 | CLS009 |
| 1.3 | 4 | A3E | 60/80 | 08/00 → 02/05 | OE006 | 0,9 | CET8 | OE195 | BAEA561 | |
| | | | | | OE049 | 1,0 | | | | |
| | | | | | OE006 | 0,9 | | | | |
| | | | | | LPG [266] [279] | | | | | |
| 1.5 | 4 | A5D | 70/94 | 09/02 → 02/05 | OE039 | 1,0 | CET2 | | BAEA486 | CLS256 |
| 1.5 16V | 4 | A5D | 71/95 | 09/02 → 02/05 | | | CET2 | OE179 | BAEA486 | CLS256 |
| 1.5 16V | 4 | A5D | 72/97 | 08/00 → 02/05 | OE034 | 0,8* | CET2 | OE179 | BAEA486 | CLS256 |
| | | | | | *to be adjusted | | | | | |

RIO II

| | | | | | | | | | | |
|------------------|---|------|--------|---------|-------|-----|------|-------|---------------|--------|
| 1.4 16V | 4 | G4EE | 71/95 | 03/05 → | | | CET2 | OE179 | BAEA483 | CLS197 |
| | | | | | | | | | 04/05 → 12/06 | |
| 1.6 16V, 1.6 CVT | 4 | G4ED | 82/110 | 03/05 → | OE063 | 1,0 | CET2 | OE180 | BAEA483 | CLS256 |
| | | | | | | | | | 04/05 → 12/06 | |

RIO III

| | | | | | | | | | | |
|------------------|---|------|--------|---------|------------------|-----|------------------|--|--------------------------|--|
| 1.2 CVT | 4 | G4LA | 62/83 | 11/14 → | | | | | BAEA536 ^[115] | |
| 1.3 CVT | 4 | G4LA | 65/87 | 06/11 → | OE197 | 0,9 | CET6 | | | |
| | | | | | →Prod.20.05.2012 | | →Prod.20.05.2012 | | | |
| 1.3 CVT, 1.3 LPG | 4 | G4LA | 63/84 | 09/11 → | OE197 | 0,9 | CET6 | | | |
| | | | | | →Prod.20.05.2012 | | →Prod.20.05.2012 | | | |
| 1.4 CVT | 4 | G4FA | 79/106 | 06/11 → | OE201 | 0,9 | CET6 | | BAEA475 ^[275] | |
| | | | | | | | | | BAEA475 | |
| 1.4 CVT | 4 | G4FA | 80/107 | 09/11 → | OE201 | 0,9 | CET6 | | BAEA475 ^[275] | |
| 1.6 CVT | 4 | G4FC | 90/121 | 06/12 → | OE201 | 0,9 | | | BAEA475 ^[366] | |
| | | | | | | | | | BAEA475 | |

ROADSTER

| | | | | | | | | | | |
|-----|---|--|---------|---------|-------|-----|------|-------|--|--|
| 1.8 | 4 | | 100/134 | 08/99 → | OE048 | 1,0 | CET8 | OE195 | | |
|-----|---|--|---------|---------|-------|-----|------|-------|--|--|

SEDONA

| | | | | | | | | | | |
|---------|---|------|---------|---------|--|--|--------|-------|--|--|
| 3.3 | 6 | G6DF | 196/263 | 01/15 → | | | CET14P | OE190 | | |
| 3.3 GDI | 6 | G6DH | 206/276 | 09/14 → | | | CET14P | OE190 | | |

SEPHIA

| | | | | | | | | | | |
|-----------|---|--------------|--------|---------------|-------|-----|------|-------|---------|--------|
| 1.5 i | 4 | B5 | 59/79 | 02/96 → 10/97 | OE006 | 0,9 | CET8 | OE195 | | CLS131 |
| 1.6 i | 4 | B6 | 59/79 | 09/93 → 10/97 | OE048 | 1,0 | CET8 | OE195 | | CLS131 |
| 1.8 i 16V | 4 | OK24N; OK26Y | 82/110 | 01/95 → 10/97 | OE005 | 0,9 | CET2 | OE179 | BAEA433 | CLS173 |

SHUMA

| | | | | | | | | | | |
|-----------|---|------------|--------|---------------|-------|-----|------|-------|---------|--------|
| 1.5 | 4 | OK280 | 59/79 | 03/96 → 12/98 | OE005 | 0,9 | CET2 | OE180 | | CLS131 |
| | | | | | OE039 | 1,0 | | | | |
| 1.5 i 16V | 4 | BFD; ZY-VE | 65/87 | 10/97 → 10/01 | | | CET8 | OE195 | | CLS157 |
| 1.6 | 4 | GA6D | 75/101 | 01/01 → 12/01 | OE005 | 0,9 | CET2 | OE180 | BAEA486 | |
| | | | | | OE063 | 1,0 | | | | |
| 1.8 GX | 4 | | 85/114 | 05/99 → 10/01 | OE063 | 1,0 | CET2 | OE180 | | |
| 1.8 i 16V | 4 | T8 | 81/109 | 10/97 → 03/01 | | | CET8 | OE195 | BAEA433 | CLS173 |

CHAMPION



kW/BHP

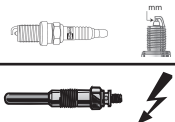

eon TITAN

IRIDIUM



...KIA

SHUMA II

| | | | | | | | | | | |
|-----|---|------|--------|-------------|--------------------------|------------|------|-------|---------|--------|
| 1.6 | 4 | GA6D | 75/101 | 05/01→08/04 | OE063 *to be adjusted | 0,7* | CET2 | OE180 | BAEA486 | CLS256 |
| 1.8 | 4 | T8 | 81/109 | 05/01→06/04 | OE063 | 1,0 | CET2 | | | |
| 1.8 | 4 | T8 | 84/113 | 04/03→08/04 | OE005 OE063 | 0,9 1,0 | CET2 | OE180 | BAEA433 | CLS173 |

SORENTO I

| | | | | | | | | | | |
|--------------|---|------|---------|-------------|-------|-----|--------|-------|--------------------------|--|
| 2.4 4WD | 4 | G4JS | 102/137 | 08/02→ | OE192 | 1,0 | CET8 | OE195 | BAEA502E ^[13] | |
| 2.5 CRDi | 4 | D4CB | 131/176 | 09/06→ | CH234 | 11v | | | | |
| 2.5 CRDi 4WD | 4 | D4CB | 103/138 | 08/02→ | CH234 | 11v | | | | |
| 2.5 CRDi 4WD | 4 | D4CB | 120/161 | 05/06→ | CH234 | 11v | | | | |
| 2.5 CRDi 4WD | 4 | D4CB | 125/168 | 12/06→ | CH234 | 11v | | | | |
| 3.3 | 6 | G6DB | 182/244 | 09/08→12/09 | | | CET12P | OE180 | | |
| 3.3, 3.3 4WD | 6 | G6DB | 180/241 | 09/07→12/09 | | | CET12P | OE180 | | |
| 3.3 V6 4WD | 6 | | 177/237 | 12/06→ | | | CET12P | OE180 | | |
| 3.3 V6 4WD | 6 | G6DB | 182/244 | 02/07→ | | | CET12P | OE180 | BAEA531 | |
| 3.5 V6 4WD | 6 | G6CU | 143/192 | 08/02→ | | | CET12P | OE180 | | |

SORENTO II

| | | | | | | | | | | |
|----------------------|---|------|---------|--------|-------|-----|--------|-------|--------------------------|--|
| 2.4 CVT, 2.4 CVT 4WD | 4 | G4KE | 128/172 | 11/09→ | OE148 | 1,0 | CET5 | OE190 | BAEA548 | |
| 2.4 CVT, 2.4 CVT 4WD | 4 | | 141/189 | 10/12→ | | | | | BAEA548 | |
| 2.4 GDI, 2.4 GDI 4WD | 4 | G4KJ | 141/189 | 10/12→ | | | | | BAEA548 ^[275] | |
| 3.3 GDI, 3.3 GDI 4WD | 6 | G6DH | 216/290 | 09/13→ | | | CET14P | OE190 | | |

SORENTO III

| | | | | | | | | | | |
|---------|---|--|---------|--------|--|--|--------|-------|--|--|
| 3.3 4WD | 6 | | 196/263 | 01/15→ | | | CET14P | OE190 | | |
|---------|---|--|---------|--------|--|--|--------|-------|--|--|

SOUL

| | | | | | | | | | | |
|---------|---|------|--------|-------------|-------|-----|------|--|--------------------------|--|
| 1.6 | 4 | G4FG | 91/122 | 09/09→12/10 | | | | | BAEA475 | |
| 1.6 CVT | 4 | G4FC | 77/103 | 02/09→ | OE201 | 0,9 | CET6 | | BAEA475 ^[275] | |
| 1.6 CVT | 4 | G4FC | 93/125 | 02/09→ | OE201 | 0,9 | CET6 | | BAEA475 ^[121] | |
| 1.6 CVT | 4 | G4FC | 95/127 | 03/12→ | OE201 | 0,9 | CET6 | | BAEA475 | |

SOUL II

| | | | | | | | | | | |
|---------|---|------|---------|--------|--|--|--|-------|--|--|
| 1.6 GDI | 4 | G4FD | 97/130 | 02/14→ | | | | OE250 | | |
| 2.0 CVT | 4 | G4NA | 113/152 | 02/14→ | | | | OE249 | | |

SPORTAGE

| | | | | | | | | | | |
|------------------------|---|---------|---------|-------------|--------------------------|------|--------|-------|---|--------|
| 2.0, 2.0 4WD | 4 | FE(16V) | 87/117 | 10/00→08/03 | | | CET2 | OE179 | BAEA434 ^[277] | |
| 2.0 16V 4WD, 2.0 i 16V | 4 | G4GC | 104/139 | 09/04→ | | | CET12P | OE180 | | CLS094 |
| 2.0 CRDi, 2.0 CRDi 4WD | 4 | D4EA | 83/111 | 09/04→ | CH226 | 11v | | | | |
| 2.0 CRDi, 2.0 CRDi 4WD | 4 | D4EA | 100/134 | 01/06→ | CH226 | 11v | | | | |
| 2.0 CRDi, 2.0 CRDi 4WD | 4 | D4EA-F | 103/138 | 01/06→ | CH226 | 11v | | | | |
| 2.0 CRDi, 2.0 CRDi 4WD | 4 | D4EA-F | 110/148 | 09/07→ | CH226 | 11v | | | | |
| 2.0 CVT | 4 | G4KD | 122/164 | 07/10→ | OE148 | 1,0 | CET5 | OE190 | BAEA548 | |
| 2.0 CVT, 2.0 CVT 4WD | 4 | G4KD | 120/161 | 07/10→ | OE148 | 1,0 | CET5 | OE190 | BAEA548 | |
| 2.0 CVT 4WD | 4 | G4KD | 110/148 | 06/10→12/13 | | | | | BAEA548 | |
| 2.0 CVT 4WD | 4 | G4KD | 122/164 | 07/10→ | OE148 | 1,0 | | | BAEA548 ^[275] | |
| 2.0 i 4WD | 4 | FE(8V) | 70/94 | 04/94→08/99 | OE005 *to be adjusted | 0,7* | CET2 | OE180 | BAEA234 | |
| 2.0 i 16V | 4 | FE(16V) | 94/126 | 10/99→08/03 | | | CET2 | OE179 | BAEA434 ^[277] | |
| 2.0 i 16V 4WD | 4 | FE(16V) | 94/126 | 04/94→08/03 | | | CET2 | OE179 | BAEA234 →11/98 BAEA434 ^[277] 12/98→ | |
| 2.0 TD 4WD | 4 | RF | 61/82 | 10/97→08/03 | CH242 →10/98 | 11v | | | | |
| 2.2 D 4WD | 4 | | 52/70 | 08/94→04/99 | CH242 →10/98 | 11v | | | | |
| 2.4 i 4WD | 4 | G4KE | 130/174 | 08/10→ | OE148 | 1,0 | CET5 | OE190 | | |
| 2.7 V6 4WD | 6 | G6BA | 129/173 | 09/04→ | | | CET12P | OE180 | BAEA555 | |

KIA



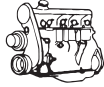

kW/BHP

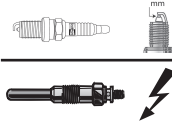

eon TITAN

IRIDIUM



...KIA

VENGA

| | | | | | | | | |
|---------|---|------|--------|--------|-------|-----|------|--------------------------|
| 1.4 CVT | 4 | G4FA | 66/89 | 02/10→ | OE201 | 0,9 | CET6 | BAEA475 ^[275] |
| 1.6 CVT | 4 | G4FC | 92/123 | 02/10→ | OE201 | 0,9 | CET6 | BAEA475 ^[275] |

KIA

K2500

| | | | | | | | | |
|-------|---|------|-------|--------|-----------------|-----|--|--|
| 2.5 D | 4 | D4BH | 69/93 | 01/03→ | CH256 →08/03 | 11v | | |
| | | | | | CH225 09/03→ | 11v | | |

K2700

| | | | | | | | | |
|-------|---|----|-------|--------|-------|-----|--|--|
| 2.7 D | 4 | J2 | 59/79 | 10/99→ | CH242 | 11v | | |
| 2.7 D | 4 | J2 | 61/82 | 03/97→ | CH242 | 11v | | |

PREGIO

| | | | | | | | | |
|-----------|---|------|-------|-------------|-----------------|-----|--|--|
| 2.5 D | 4 | D4BH | 69/93 | 08/95→09/04 | CH256 →11/03 | 11v | | |
| 2.5 TGi D | 4 | D4BH | 69/93 | 09/02→ | CH256 →08/03 | 11v | | |
| | | | | | CH225 08/03→ | 11v | | |
| 2.7 D | 4 | J2 | 60/80 | 10/97→ | CH242 | 11v | | |

PRIDE Van

| | | | | | | | | |
|---------|---|----|-------|-------------|-------|-----|------|--|
| 1.3 16V | 4 | B3 | 47/63 | 10/96→06/99 | OE006 | 0,9 | CET8 | |
|---------|---|----|-------|-------------|-------|-----|------|--|

LADA

110

| | | | | | | | | |
|------------|---|-----------|---------|-------------|---|-------------|------|----------------------------|
| 1.5 | 4 | BA32111 | 52/70 | 06/96→09/04 | OE006 | 0,9 | CET8 | OE195 |
| 1.5 | 4 | ; BA32111 | 54/72 | 01/95→12/12 | OE006 | 0,9 | CET8 | OE195 |
| 1.5 | 4 | VAZ-2111 | 56/75 | 10/00→12/05 | OE006 | 0,9 | CET8 | OE195 |
| 1.5 | 4 | VAZ-2111 | 57/76 | 01/95→12/05 | OE048 | 1,0 | CET8 | OE195 |
| 1.5 16V | 4 | VAZ-2112 | 67/90 | 10/00→12/10 | OE039 | 1,0 | CET2 | OE180 |
| 1.5 16V | 4 | VAZ-2112 | 70/94 | 01/95→12/05 | OE006 →09/00 *to be adjusted OE039 | 0,7* 1,0 | CET2 | OE180 |
| 1.6 | 4 | VAZ-21114 | 60/80 | 01/00→12/12 | OE048 | 1,0 | CET8 | OE195 BAEA395 01/05→ |
| 1.6 | 4 | VAZ-21124 | 66/89 | 01/00→04/07 | OE039 | 1,0 | CET2 | OE179 |
| 2.0 i | 4 | C20XE | 110/148 | 08/96→07/00 | OE019 | 0,9 | CET2 | OE184 |
| 2.6 Wankel | 2 | VAZ-415 | 88/118 | 06/97→09/04 | OE091 | 0,7 | | |

111

| | | | | | | | | |
|---------|---|-----------|-------|-------------|---|-------------|------|------------------|
| 1.5 | 4 | BA32111 | 52/70 | 01/97→12/03 | OE048 ^[313] | 1,0 | | |
| 1.5 | 4 | VAZ-2111 | 56/75 | 10/00→12/05 | OE006 | 0,9 | CET8 | OE195 |
| 1.5 | 4 | VAZ-2111 | 57/76 | 01/96→12/05 | OE048 | 1,0 | CET8 | OE195 |
| 1.5 | 4 | VAZ-2111 | 58/78 | 10/00→09/04 | OE048 | 1,0 | CET8 | OE195 |
| 1.5 16V | 4 | VAZ-2112 | 67/90 | 10/00→12/05 | OE006 | 0,9 | CET8 | OE195 |
| 1.5 16V | 4 | VAZ-2112 | 70/94 | 01/95→08/02 | OE006 →09/00 *to be adjusted OE039 | 0,7* 1,0 | CET2 | OE180 |
| 1.6 | 4 | VAZ-21114 | 60/80 | 09/04→12/13 | OE039 | 1,0 | CET2 | OE179 BAEA395 |
| 1.6 | 4 | VAZ-21124 | 66/89 | 09/04→ | OE039 | 1,0 | CET2 | OE179 BAEA395 |

112

| | | | | | | | | |
|---------|---|----------|-------|-------------|-------|-----|------|-------|
| 1.5 | 4 | VAZ-2111 | 54/72 | 01/95→10/00 | OE006 | 0,9 | CET8 | OE195 |
| 1.5 | 4 | VAZ-2111 | 56/75 | 10/00→12/05 | OE006 | 0,9 | CET8 | OE195 |
| 1.5 | 4 | VAZ-2111 | 57/76 | 01/95→09/04 | OE048 | 1,0 | CET8 | OE195 |
| 1.5 16V | 4 | VAZ-2112 | 67/90 | 10/00→12/05 | OE006 | 0,9 | CET8 | OE195 |

CHAMPION



kW/BHP

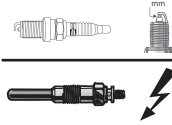

eon TITAN

IRIDIUM

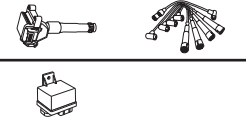
**...LADA****...112**

| | | | | | | | | | |
|---------|---|-----------|-------|-------------|----------------|------------|------|-------|--|
| 1.5 16V | 4 | VAZ-2112 | 70/94 | 01/95→09/00 | OE006 OE039 | 0,9 1,0 | CET2 | OE180 | |
| 1.6 | 4 | VAZ-21114 | 60/80 | 01/05→12/11 | OE039 | 1,0 | CET2 | OE179 | |
| 1.6 | 4 | VAZ-21124 | 66/89 | 03/06→12/08 | OE039 | 1,0 | CET2 | OE179 | |

GRANTA

| | | | | | | | | | |
|-----|---|-----------|-------|--------|----------------|------------|------|-------|--------------------------|
| 1.6 | 4 | VAZ-11183 | 60/80 | 10/11→ | OE039 | 1,0 | CET2 | OE179 | BAEA395 ^[275] |
| 1.6 | 4 | VAZ-11186 | 64/86 | 10/11→ | OE039 OE048 | 1,0 1,0 | CET2 | OE179 | BAEA395 ^[275] |
| 1.6 | 4 | VAZ-21126 | 72/97 | 10/11→ | OE039 | 1,0 | CET2 | OE179 | |

GRANTA (2349)

| | | | | | | | | | |
|-----|---|-----------|-------|--------|-------|-----|------|--|--|
| 1.6 | 4 | VAZ-11186 | 64/86 | 10/11→ | OE039 | 1,0 | CET2 | | |
|-----|---|-----------|-------|--------|-------|-----|------|--|--|

KALINA

| | | | | | | | | | |
|-------------|---|-----------|-------|-------------|----------------|------------|--------------|----------------|--------------------------|
| 1.4 16V | 4 | VAZ-11194 | 66/89 | 11/08→12/13 | OE039 | 1,0 | CET2 | OE179 | |
| 1.4 16V LPG | 4 | VAZ-11194 | 65/87 | 11/08→ | OE039 | 1,0 | CET2 | OE179 | |
| 1.6 | 4 | VAZ-21124 | 60/80 | 10/04→ | OE039 | 1,0 | CET2 | OE179 | |
| 1.6 | 4 | VAZ-21114 | 60/80 | 10/04→ | OE039 OE048 | 1,0 1,0 | CET2 CET8 | OE179 OE195 | BAEA395 |
| 1.6 | 4 | VAZ1110 | 62/83 | 01/10→ | OE039 | 1,0 | CET2 | OE179 | BAEA395 ^[275] |
| 1.6 | 4 | VAZ-11186 | 64/86 | 06/13→ | OE039 | 1,0 | CET2 | OE179 | |
| 1.6 | 4 | VAZ-11186 | 66/89 | 10/04→ | OE039 OE048 | 1,0 1,0 | CET2 CET8 | OE179 OE195 | BAEA395 |
| 1.6 | 4 | VAZ-21126 | 72/97 | 10/04→ | OE039 | 1,0 | CET2 | OE179 | |

LARGUS

| | | | | | | | | | |
|-----|---|---------|--------|--------|----------------|------------|------|-------|---------|
| 1.6 | 4 | VAZ-K7M | 62/83 | 03/12→ | OE048 | 1,0 | CET8 | OE195 | BAEA354 |
| 1.6 | 4 | VAZ-K4M | 77/103 | 03/12→ | OE033 OE034 | 0,9 0,9 | CET2 | OE179 | |

NADESHDA

| | | | | | | | | | |
|-----------|---|------------|-------|-------------|-------|-----|------|-------|--------|
| 1.7 4WD | 4 | VAZ-2121.3 | 60/80 | 12/97→12/06 | OE048 | 1,0 | CET8 | OE195 | CLS147 |
| 1.7 i 4WD | 4 | BA321214 | 59/79 | 12/97→12/06 | OE048 | 1,0 | CET8 | OE195 | |
| 1.8 4WD | 4 | VAZ-2130 | 60/80 | 12/97→12/06 | OE048 | 1,0 | CET8 | OE195 | CLS147 |
| 1.8 i 4WD | 4 | VAZ-2130.1 | 67/90 | 12/97→12/06 | OE048 | 1,0 | CET8 | OE195 | |

NIVA

| | | | | | | | | | | |
|---------------------|---|----------------------|-------|-------------|-------|-----|------|-------|---------|--------|
| 1.7 1700 i 4WD | 4 | BA321214; VAZ-2121.3 | 59/79 | 06/96→12/06 | OE048 | 1,0 | CET8 | OE195 | BAEA395 | CLS147 |
| 1.7 1700 i 4WD | 4 | BA321214 | 60/80 | 10/00→12/10 | OE006 | 0,9 | CET8 | OE195 | BAEA395 | CLS147 |
| 1.7 1700 i 4WD | 4 | BA321214 | 61/82 | 09/10→ | OE006 | 0,9 | CET8 | OE195 | BAEA395 | CLS147 |
| 1.9 1900 Diesel 4WD | 4 | XUD9A | 48/64 | 01/93→08/99 | CH189 | 11v | | | | |
| 1.9 1900 Diesel 4WD | 4 | XUD9SD | 55/74 | 01/99→12/06 | CH189 | 11v | | | | |

NIVA II

| | | | | | | | | | | |
|-------------|---|----------|-------|--------|-------|-----|------|-------|---------|--------|
| 1.7 4WD | 4 | BA321214 | 59/79 | 09/02→ | OE006 | 0,9 | CET8 | OE195 | BAEA395 | |
| 1.7 4WD | 4 | BA321214 | 61/82 | 08/04→ | OE006 | 0,9 | CET8 | OE195 | BAEA395 | CLS147 |
| 1.7 LPG 4WD | 4 | BA321214 | 57/76 | 09/02→ | OE006 | 0,9 | CET8 | OE195 | BAEA395 | |

NOVA

| | | | | | | | | | | |
|------------------------------|---|---------|-------|-------------|-------|-----|------|-------|---------|-----------|
| 1.5 1500 | 4 | BA32103 | 49/66 | 05/93→04/12 | OE001 | 0,9 | CET8 | OE195 | BAEA115 | [8] [275] |
| 1.7 1700, 1.7 1700 i Classic | 4 | B032123 | 62/83 | 08/94→04/12 | OE001 | 0,9 | CET8 | OE195 | BAEA234 | |

OKA

| | | | | | | | | | | |
|-----|---|--|-------|-------------|-------|-----|--|--|--|--|
| 0.8 | 2 | | 24/32 | 08/96→09/07 | OE003 | 0,9 | | | | |
|-----|---|--|-------|-------------|-------|-----|--|--|--|--|

PRIORA

| | | | | | | | | | | |
|-----|---|-----------|-------|-------------|-------|-----|------|-------|--------------------------|--|
| 1.6 | 4 | | 60/80 | 12/08→12/13 | OE048 | 1,0 | CET8 | OE195 | BAEA395 | |
| 1.6 | 4 | VAZ-21116 | 66/89 | 01/11→12/13 | | | | | BAEA395 ^[275] | |
| 1.6 | 4 | VAZ-21126 | 72/97 | 04/07→ | OE039 | 1,0 | CET2 | OE179 | | |

LADA





kW/BHP



eon TITAN

IRIDIUM



LADA

...LADA**...PRIORA**

| | | | | | | | | | |
|---------|---|-----------|-------|---------|-------|-----|------|-------|--|
| 1.6 LPG | 4 | VAZ-21126 | 71/95 | 12/08 → | OE048 | 1,0 | CET8 | OE195 | |
|---------|---|-----------|-------|---------|-------|-----|------|-------|--|

SAMARA

| | | | | | | | | | |
|----------|---|----------|-------|---------------|---|------|------|-------|--|
| 1.1 1100 | 4 | BA321081 | 43/58 | 02/96 → 08/99 | OE006 <small>*to be adjusted</small> | 0,7* | CET8 | OE195 | |
|----------|---|----------|-------|---------------|---|------|------|-------|--|

| | | | | | | | | | |
|----------|---|----------|-------|---------------|--|-------------|------|-------|---|
| 1.3 1300 | 4 | BA321115 | 50/67 | 02/96 → 12/06 | OE001 OE006 <small>*to be adjusted</small> | 0,9 0,7* | CET8 | OE195 | BAEA115 ^[8] BAEA115 ^[8] ^[275] |
|----------|---|----------|-------|---------------|--|-------------|------|-------|---|

| | | | | | | | | | |
|-----|---|----------|-------|---------------|-------|-----|------|-------|--|
| 1.5 | 4 | BA321083 | 53/71 | 08/03 → 12/13 | OE006 | 0,9 | CET8 | OE195 | |
|-----|---|----------|-------|---------------|-------|-----|------|-------|--|

| | | | | | | | | | |
|-----|---|----------|-------|---------------|-------|-----|------|-------|--|
| 1.5 | 4 | VAZ-2111 | 56/75 | 04/96 → 12/13 | OE006 | 0,9 | CET8 | OE195 | |
|-----|---|----------|-------|---------------|-------|-----|------|-------|--|

| | | | | | | | | | |
|-----|---|----------|-------|---------------|-------|-----|------|-------|--|
| 1.5 | 4 | VAZ-2111 | 57/76 | 01/00 → 12/06 | OE006 | 0,9 | CET8 | OE195 | |
|-----|---|----------|-------|---------------|-------|-----|------|-------|--|

| | | | | | | | | | |
|-----|---|------------|-------|---------------|-------|-----|------|-------|--|
| 1.5 | 4 | ; VAZ-2111 | 59/79 | 08/03 → 12/06 | OE006 | 0,9 | CET8 | OE195 | |
|-----|---|------------|-------|---------------|-------|-----|------|-------|--|

| | | | | | | | | | |
|----------|---|----------|-------|---------------|----------------|------------|------|-------|--|
| 1.5 1500 | 4 | BA321111 | 52/70 | 11/94 → 12/06 | OE001 OE048 | 0,9 1,0 | CET8 | OE195 | |
|----------|---|----------|-------|---------------|----------------|------------|------|-------|--|

| | | | | | | | | | |
|-----|---|----------|-------|---------------|-------|-----|--|--|--|
| 1.6 | 4 | BA311183 | 60/80 | 02/09 → 12/13 | OE048 | 1,0 | | | |
|-----|---|----------|-------|---------------|-------|-----|--|--|--|

| | | | | | | | | | |
|-----|---|--|-------|---------------|--|--|--|--|--------------------------|
| 1.6 | 4 | | 60/80 | 02/09 → 12/13 | | | | | BAEA395 ^[275] |
|-----|---|--|-------|---------------|--|--|--|--|--------------------------|

XRAY

| | | | | | | | | | |
|-----|---|-----------|--------|---------|--|--|--|--|----------|
| 1.6 | 4 | VAZ-21129 | 78/105 | 02/16 → | | | | | BAEA131E |
|-----|---|-----------|--------|---------|--|--|--|--|----------|

| | | | | | | | | | |
|-----|---|-------------|--------|---------|--|--|--|--|----------|
| 1.6 | 4 | H4M; HR16DE | 81/109 | 02/16 → | | | | | BAEA131E |
|-----|---|-------------|--------|---------|--|--|--|--|----------|

| | | | | | | | | | |
|-----|---|-----------|--------|---------|--|--|--|--|----------|
| 1.8 | 4 | VAZ-21179 | 90/121 | 02/16 → | | | | | BAEA131E |
|-----|---|-----------|--------|---------|--|--|--|--|----------|

LADA**LARGUS**

| | | | | | | | | | |
|-----|---|---------|-------|---------|-------|-----|------|-------|--------------------------|
| 1.6 | 4 | VAZ-K7M | 62/83 | 03/12 → | OE048 | 1,0 | CET8 | OE195 | BAEA354 ^[275] |
|-----|---|---------|-------|---------|-------|-----|------|-------|--------------------------|

| | | | | | | | | | |
|-----|---|---------|--------|---------|----------------|------------|------|-------|---------|
| 1.6 | 4 | VAZ-K4M | 77/103 | 03/12 → | OE033 OE034 | 0,9 0,9 | CET2 | OE179 | BAE409A |
|-----|---|---------|--------|---------|----------------|------------|------|-------|---------|

LAMBORGHINI**DIABLO**

| | | | | | | | | | |
|--------|----|--|---------|---------------|--|--|--|--|---------|
| 5.7 SE | 12 | | 386/518 | 01/94 → 12/96 | | | | | BAE800B |
|--------|----|--|---------|---------------|--|--|--|--|---------|

GALLARDO

| | | | | | | | | | |
|---------|----|------|---------|---------|-------|-----|--------|-------|---|
| 5.0 4WD | 10 | L510 | 368/493 | 08/03 → | OE136 | 0,8 | CET12P | OE179 | BAEA032E ^[13] ^[275] |
|---------|----|------|---------|---------|-------|-----|--------|-------|---|

| | | | | | | | | | |
|---------|----|--|---------|---------|-------|-----|--------|-------|---|
| 5.0 4WD | 10 | | 382/512 | 07/05 → | OE136 | 0,8 | CET12P | OE179 | BAEA032E ^[13] ^[275] |
|---------|----|--|---------|---------|-------|-----|--------|-------|---|

| | | | | | | | | | |
|-----------------|----|------|---------|---------|--|--|--|--|--|
| 5.2 LP560-4 4WD | 10 | CMPA | 412/552 | 06/08 → | | | | | BAEA033E ^[7] ^[275] |
|-----------------|----|------|---------|---------|--|--|--|--|--|

GALLARDO SPYDER

| | | | | | | | | | |
|---------|----|--|---------|---------|-------|-----|--------|-------|---|
| 5.0 4WD | 10 | | 382/512 | 08/05 → | OE136 | 0,8 | CET12P | OE179 | BAEA032E ^[13] ^[275] |
|---------|----|--|---------|---------|-------|-----|--------|-------|---|

| | | | | | | | | | |
|-----------------|----|------|---------|---------|--|--|--|--|--|
| 5.2 LP560-4 4WD | 10 | CMPA | 412/552 | 11/08 → | | | | | BAEA033E ^[7] ^[275] |
|-----------------|----|------|---------|---------|--|--|--|--|--|

LANCIA**DEDRA**

| | | | | | | | | | |
|-----|---|-----------|-------|---------------|-------|-----|------|-------|--|
| 1.6 | 4 | 159B9.000 | 66/89 | 10/94 → 07/99 | OE014 | 0,9 | CET2 | OE179 | |
|-----|---|-----------|-------|---------------|-------|-----|------|-------|--|

| | | | | | | | | | |
|---------|---|-----------|--------|---------------|----------------------------|-----|------|-------|-----------------|
| 1.6 16V | 4 | 182A4.000 | 76/102 | 01/96 → 07/99 | OE216 ^{LPG [278]} | 0,8 | CET2 | OE179 | BAE920AX CLS137 |
|---------|---|-----------|--------|---------------|----------------------------|-----|------|-------|-----------------|

| | | | | | | | | | |
|----------|---|-----------|-------|---------------|-------|-----|------|-------|-------------------|
| 1.6 i.e. | 4 | 835C1.000 | 55/74 | 04/93 → 07/99 | OE014 | 0,9 | CET2 | OE179 | BAEA234 →10/94 |
|----------|---|-----------|-------|---------------|-------|-----|------|-------|-------------------|

| | | | | | | | | | |
|------------|---|-----------|-------|---------------|-------|-----|------|-------|---------|
| 1.6 LE Cat | 4 | 159B9.000 | 66/89 | 07/94 → 07/99 | OE014 | 0,9 | CET2 | OE179 | BAEA234 |
|------------|---|-----------|-------|---------------|-------|-----|------|-------|---------|

| | | | | | | | | | |
|------------|---|-----------|--------|---------------|----------------------------|-----|------|-------|---------|
| 1.8 16V LE | 4 | 182A2.000 | 83/111 | 03/96 → 07/99 | OE216 ^{LPG [278]} | 0,8 | CET2 | OE188 | BAEA549 |
|------------|---|-----------|--------|---------------|----------------------------|-----|------|-------|---------|

| | | | | | | | | | |
|------------|---|-----------|--------|---------------|-------------------------------------|------------|------|-------|---------|
| 1.8 GT 16V | 4 | 183A1.000 | 96/129 | 03/96 → 07/99 | OE016 OE216 ^{LPG [278]} | 0,9 0,8 | CET2 | OE180 | BAEA549 |
|------------|---|-----------|--------|---------------|-------------------------------------|------------|------|-------|---------|

| | | | | | | | | | |
|----------|---|-----------|-------|---------------|----------------|------------|------|-------|--|
| 1.8 i.e. | 4 | 835C5.000 | 66/89 | 08/93 → 07/99 | OE008 OE018 | 0,9 1,0 | CET8 | OE195 | |
|----------|---|-----------|-------|---------------|----------------|------------|------|-------|--|

| | | | | | | | | | |
|----------|---|-----------|-------|---------------|--|--|------|-------|---------|
| 1.8 i.e. | 4 | 836A5.000 | 74/99 | 07/94 → 07/99 | | | CET2 | OE179 | BAE800B |
|----------|---|-----------|-------|---------------|--|--|------|-------|---------|





kW/BHP



eon TITAN

IRIDIUM

**...LANCIA****...DEDRA**

| | | | | | | | | | | |
|------------------|---|-----------|---------|-------------|----------------|------------|------|-------|--|--|
| 2.0 4WD, 2.0 16V | 4 | 836A3.000 | 102/137 | 07/94→07/99 | OE008 OE018 | 0,9 1,0 | CET8 | OE195 | | |
|------------------|---|-----------|---------|-------------|----------------|------------|------|-------|--|--|

DELTA I

| | | | | | | | | | | |
|--------------------|---|----------------------|---------|-------------|-------|-----|------|-------|---------|--|
| 2.0 16V HF Evo 4WD | 4 | 831E5.000; 831E5.046 | 155/208 | 06/93→01/94 | OE012 | 0,8 | CET8 | OE195 | BAE800B | |
|--------------------|---|----------------------|---------|-------------|-------|-----|------|-------|---------|--|

DELTA II

| | | | | | | | | | | |
|----------|---|-----------|-------|-------------|--------------------------|------|------|-------|---------|--------------|
| 1.4 i.e. | 4 | 160A1.046 | 51/68 | 10/94→08/99 | OE002 *to be adjusted | 0,8* | CET2 | OE180 | BAE504D | CLS002 [341] |
|----------|---|-----------|-------|-------------|--------------------------|------|------|-------|---------|--------------|

CLS135 [340]

| | | | | | | | | | | |
|----------|---|-----------|-------|-------------|--------------------------|------|------|-------|---------|--------------|
| 1.4 i.e. | 4 | 836A4.000 | 51/68 | 10/94→08/99 | OE002 *to be adjusted | 0,8* | CET2 | OE180 | BAE504D | CLS002 [341] |
|----------|---|-----------|-------|-------------|--------------------------|------|------|-------|---------|--------------|

BAEA234
CLS135 [340]

| | | | | | | | | | | |
|----------|---|-----------|-------|-------------|-------|-----|------|-------|---------|--------|
| 1.6 i.e. | 4 | 835C1.000 | 55/74 | 06/93→08/99 | OE014 | 0,9 | CET2 | OE179 | BAEA234 | CLS135 |
|----------|---|-----------|-------|-------------|-------|-----|------|-------|---------|--------|

| | | | | | | | | | | |
|----------|---|-----------|-------|-------------|-----------------|-----|------|-------|----------|--------|
| 1.6 i.e. | 4 | 182A6.000 | 66/89 | 03/96→08/99 | OE216 LPG [278] | 0,8 | CET2 | OE179 | BAE920AX | CLS137 |
|----------|---|-----------|-------|-------------|-----------------|-----|------|-------|----------|--------|

| | | | | | | | | | | |
|--------------|---|-----------|--------|-------------|-----------------|-----|------|-------|----------|--------|
| 1.6 i.e. 16V | 4 | 182A4.000 | 76/102 | 01/96→08/99 | OE216 LPG [278] | 0,8 | CET2 | OE179 | BAE920AX | CLS137 |
|--------------|---|-----------|--------|-------------|-----------------|-----|------|-------|----------|--------|

| | | | | | | | | | | |
|----------|---|------------------------------------|-------|-------------|-------|-----|------|-------|---------|--|
| 1.8 i.e. | 4 | 835C4.000; 836A6.000; 836C4.000 | 66/89 | 07/94→08/99 | OE018 | 1,0 | CET8 | OE195 | BAE800B | |
|----------|---|------------------------------------|-------|-------------|-------|-----|------|-------|---------|--|

| | | | | | | | | | | |
|----------|---|-----------|--------|-------------|----------------|------------|------|-------|---------|--------|
| 1.8 i.e. | 4 | 835C2.000 | 76/102 | 06/93→08/99 | OE008 OE018 | 0,9 1,0 | CET8 | OE195 | BAE800B | CLS005 |
|----------|---|-----------|--------|-------------|----------------|------------|------|-------|---------|--------|

| | | | | | | | | | | |
|--------------|---|-----------|--------|-------------|-----------------|-----|------|-------|---------|--|
| 1.8 i.e. 16V | 4 | 182A2.000 | 83/111 | 03/96→08/99 | OE216 LPG [278] | 0,8 | CET2 | OE188 | BAEA549 | |
|--------------|---|-----------|--------|-------------|-----------------|-----|------|-------|---------|--|

| | | | | | | | | | | |
|-----------------|---|-----------|--------|-------------|--------------------------|------------|------|-------|-------------------|--|
| 1.8 i.e. 16V GT | 4 | 183A1.000 | 96/129 | 03/96→08/99 | OE016 OE216 LPG [278] | 0,9 0,8 | CET2 | OE180 | BAEA549 →07/99 | |
|-----------------|---|-----------|--------|-------------|--------------------------|------------|------|-------|-------------------|--|

| | | | | | | | | | | |
|--------|---|----------------------|-------|-------------|--|--|--|--|--------|--|
| 1.9 TD | 4 | 160D1.000; 835A4.000 | 66/89 | 10/94→08/99 | | | | | CCU153 | |
|--------|---|----------------------|-------|-------------|--|--|--|--|--------|--|

| | | | | | | | | | | |
|---------|---|-----------|---------|-------------|-------|-----|------|-------|--|--|
| 2.0 16V | 4 | 836A3.000 | 102/137 | 06/93→08/99 | OE018 | 1,0 | CET8 | OE195 | | |
|---------|---|-----------|---------|-------------|-------|-----|------|-------|--|--|

| | | | | | | | | | | |
|---------------|---|-----------|---------|-------------|-------|-----|------|-------|---------|--|
| 2.0 16V Turbo | 4 | 836A2.000 | 137/184 | 06/93→08/99 | OE012 | 0,8 | CET8 | OE195 | BAE800B | |
|---------------|---|-----------|---------|-------------|-------|-----|------|-------|---------|--|

| | | | | | | | | | | |
|---------------|---|-----------|---------|-------------|-------|-----|------|-------|---------|--|
| 2.0 16V Turbo | 4 | 175A4.000 | 142/190 | 07/96→08/99 | OE012 | 0,8 | CET8 | OE195 | BAE800B | |
|---------------|---|-----------|---------|-------------|-------|-----|------|-------|---------|--|

DELTA III

| | | | | | | | | | | |
|-----|---|-----------|---------|-------------|-------|-----|--|--|---------|--|
| 1.4 | 4 | 198A1.000 | 110/148 | 09/08→08/14 | OE208 | 0,8 | | | BAEA095 | |
|-----|---|-----------|---------|-------------|-------|-----|--|--|---------|--|

| | | | | | | | | | | |
|-----------------|---|-----------|--------|-------------|-------|-----|--|--|---------|--|
| 1.4, 1.4 Bifuel | 4 | 198A4.000 | 88/118 | 09/08→08/14 | OE208 | 0,8 | | | BAEA095 | |
|-----------------|---|-----------|--------|-------------|-------|-----|--|--|---------|--|

| | | | | | | | | | | |
|---------|---|-----------|---------|-------------|-------|-----|--|--|--|--|
| 1.4 16V | 4 | 198A7.000 | 103/138 | 07/10→08/14 | OE208 | 0,8 | | | | |
|---------|---|-----------|---------|-------------|-------|-----|--|--|--|--|

FLAVIA

| | | | | | | | | | | |
|-----|---|-----|---------|-------------|-------|-----|------|-------|--|--|
| 2.4 | 4 | EDG | 125/168 | 03/12→12/14 | OE154 | 1,0 | CET2 | OE194 | | |
|-----|---|-----|---------|-------------|-------|-----|------|-------|--|--|

| | | | | | | | | | | |
|-----|---|-----|---------|-------------|-------|-----|------|-------|--|--|
| 2.4 | 4 | EDG | 129/173 | 03/12→12/14 | OE154 | 1,0 | CET2 | OE194 | | |
|-----|---|-----|---------|-------------|-------|-----|------|-------|--|--|

KAPPA

| | | | | | | | | | | |
|---------------|---|-----------|---------|-------------|-------|-----|------|-------|---------|--|
| 2.0 16V Turbo | 4 | 838A4.000 | 151/202 | 02/95→10/01 | OE012 | 0,8 | CET8 | OE195 | BAEA234 | |
|---------------|---|-----------|---------|-------------|-------|-----|------|-------|---------|--|

| | | | | | | | | | | |
|---------|---|-----------|---------|-------------|-------|-----|------|-------|--|--|
| 2.0 20V | 5 | 838A1.000 | 107/143 | 10/94→10/01 | OE030 | 0,9 | CET2 | OE179 | | |
|---------|---|-----------|---------|-------------|-------|-----|------|-------|--|--|

| | | | | | | | | | | |
|---------|---|-----------|---------|-------------|-------|-----|------|-------|--|--|
| 2.0 20V | 5 | 838A6.000 | 114/153 | 07/96→10/01 | OE030 | 0,9 | CET2 | OE179 | | |
|---------|---|-----------|---------|-------------|-------|-----|------|-------|--|--|

| | | | | | | | | | | |
|---------------|---|-----------|---------|-------------|-------|-----|--------|-------|--|--|
| 2.0 20V Turbo | 5 | 175A3.000 | 162/217 | 06/98→10/01 | OE136 | 0,8 | CET12P | OE179 | | |
|---------------|---|-----------|---------|-------------|-------|-----|--------|-------|--|--|

| | | | | | | | | | | |
|---------|---|----------------------|---------|-------------|--------------------------|------------|------|-------|--|--|
| 2.4 20V | 5 | 838A2.000; 838A2.027 | 129/173 | 08/94→10/01 | OE030 OE216 LPG [278] | 0,9 0,8 | CET2 | OE179 | | |
|---------|---|----------------------|---------|-------------|--------------------------|------------|------|-------|--|--|

| | | | | | | | | | | |
|---------|---|-----------|---------|-------------|---|-----|--|--|--|--|
| 2.4 JTD | 5 | 838A8.000 | 100/134 | 06/98→10/01 | CH222 Eng.1713819→ Prod.15.11.1999→ | 11v | | | | |
|---------|---|-----------|---------|-------------|---|-----|--|--|--|--|

| | | | | | | | | | | |
|----------|---|----------------------|--------|-------------|-------|-----|--|--|--|--|
| 2.4 T.DS | 5 | 838A3.000; 838A7.000 | 91/122 | 08/94→10/01 | CH167 | 11v | | | | |
|----------|---|----------------------|--------|-------------|-------|-----|--|--|--|--|

| | | | | | | | | | | |
|---------|---|----------|---------|-------------|-------|-----|------|--|---------------|--|
| 3.0 24V | 6 | 838B.000 | 150/201 | 08/94→10/01 | OE094 | 0,9 | CET2 | | BAEA428 [277] | |
|---------|---|----------|---------|-------------|-------|-----|------|--|---------------|--|

LYBRA

| | | | | | | | | | | |
|-----|---|-----------|--------|-------------|-------|-----|------|-------|----------|--|
| 1.6 | 4 | 182B6.000 | 76/102 | 10/00→10/05 | OE030 | 0,9 | CET2 | OE179 | BAE920AX | |
|-----|---|-----------|--------|-------------|-------|-----|------|-------|----------|--|

| | | | | | | | | | | |
|---------|---|-----------|--------|-------------|--------------------------|------------|------|-------|----------|--------|
| 1.6 16V | 4 | 182A4.000 | 76/102 | 07/99→10/05 | OE030 OE216 LPG [278] | 0,9 0,8 | CET2 | OE179 | BAE920AX | CLS137 |
|---------|---|-----------|--------|-------------|--------------------------|------------|------|-------|----------|--------|

| | | | | | | | | | | |
|---------|---|------------------------------------|--------|-------------|--------------------------|------------|------|-------|--|--|
| 1.8 16V | 4 | 839A4.000; 839A7.000; 839A9.000 | 96/129 | 07/99→10/05 | OE016 OE216 LPG [278] | 0,9 0,8 | CET2 | OE180 | | |
|---------|---|------------------------------------|--------|-------------|--------------------------|------------|------|-------|--|--|

| | | | | | | | | | | |
|---------|---|---------|--------|-------------|--|-----|--|--|--|--|
| 1.9 JTD | 4 | AR32302 | 77/103 | 07/99→09/01 | CH222 [55] Eng.1713819→ Prod.15.11.1999→ | 11v | | | | |
|---------|---|---------|--------|-------------|--|-----|--|--|--|--|

LANCIA



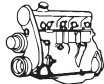

kW/BHP



eon TITAN

IRIDIUM

**...LANCIA****...LYBRA**

| | | | | | | | | | |
|---------|---|--------------------|---------|-------------|----------------------------------|-----|------|-------|------------------------|
| 1.9 JTD | 4 | AR37101 | 81/109 | 09/00→05/01 | CH222 | 11v | | | CCU150 ^[57] |
| 1.9 JTD | 4 | 937A2.000 | 85/114 | 05/01→10/05 | CH222 | 11v | | | CCU150 ^[57] |
| 2.0 20V | 5 | 185A8.000 | 110/148 | 09/00→10/05 | OE030 | 0,9 | CET2 | OE179 | |
| | | | | | OE216 ^{LPG [278]} | 0,8 | | | |
| 2.0 20V | 5 | 182B7.000 | 113/152 | 07/99→09/00 | OE030 | 0,9 | CET2 | OE179 | |
| | | | | | OE216 ^{LPG [278]} | 0,8 | | | |
| 2.4 20V | 5 | 192A2.000 | 125/168 | 10/01→10/05 | OE030 | 0,9 | CET2 | | |
| 2.4 JTD | 5 | 839A5.000; AR32501 | 99/133 | 07/99→02/01 | CH222 | 11v | | | |
| | | | | | Eng.1713819→ Prod.15.11.1999→ | | | | |
| 2.4 JTD | 5 | 839A6.000 | 103/138 | 09/00→10/05 | CH222 | 11v | | | CCU150 ^[57] |
| 2.4 JTD | 5 | 841C.000 | 110/148 | 05/02→10/05 | CH222 | 11v | | | CCU150 ^[57] |

MUSA

| | | | | | | | | | |
|----------------|---|-----------|-------|-------------|----------------------------|-----|------|--|------------------------|
| 1.3 D Multijet | 4 | 188A9.000 | 51/68 | 10/04→09/12 | | | | | CCU150 |
| 1.3 D Multijet | 4 | 199A3.000 | 66/89 | 09/06→09/12 | | | | | CCU150 |
| 1.3 D Multijet | 4 | 199B1.000 | 70/94 | 03/09→09/12 | | | | | CCU150 ^[53] |
| 1.4 | 4 | 192B2.000 | 66/89 | 10/07→09/12 | OE196 | 1,0 | CET1 | | BAE403C |
| | | | | | OE230 ^{LPG [278]} | 0,9 | | | |
| 1.4 | 4 | 843A1.000 | 70/94 | 10/04→09/12 | OE196 | 1,0 | CET1 | | BAE403C |
| 1.4, 1.4 LPG | 4 | 350A1.000 | 57/76 | 09/05→09/12 | OE196 | 1,0 | CET1 | | BAE940A CLS082 |
| 1.9 D Multijet | 4 | 188B2.000 | 74/99 | 10/04→09/12 | CH222 | 11v | | | CCU150 |

PHEDRA

| | | | | | | | | | |
|----------------|---|-----------------|---------|-------------|------------------------|-----|--------|-------|------------------------------|
| 2.0 | 4 | RFN(EW10J4) | 100/134 | 09/02→11/10 | OE178 | 0,9 | CET5 | | |
| 2.0 D Multijet | 4 | RHR(DW10BTED4) | 100/134 | 07/06→11/10 | CH268 | 11v | | | |
| 2.0 JTD | 4 | RHM(DW10ATED4) | 79/106 | 07/03→11/10 | CH170 ^[172] | 11v | | | |
| | | | | | CH268 ^[173] | 11v | | | |
| 2.0 JTD | 4 | RHW(DW10ATED4) | 80/107 | 09/02→11/10 | CH170 ^[172] | 11v | | | |
| | | | | | CH268 ^[173] | 11v | | | |
| 2.0 JTD | 4 | RHK(DW10OUTED4) | 88/118 | 06/06→11/10 | CH170 ^[172] | 11v | | | |
| | | | | | CH268 ^[173] | 11v | | | |
| 2.2 D Multijet | 4 | 4HS; 4HT | 125/168 | 03/08→11/10 | | | | | CCU147 ^{[21] [285]} |
| 2.2 JTD | 4 | 4HW(DW12ATED4) | 94/126 | 09/02→11/10 | CH170 ^[172] | 11v | | | CCU147 ^{[21] [285]} |
| | | | | | CH268 ^[173] | 11v | | | |
| 2.2 JTD | 4 | 4HP; 4HR | 120/161 | 04/06→11/10 | | | | | CCU147 ^{[21] [285]} |
| 3.0 V6 | 6 | ES9J4S | 150/201 | 09/02→11/10 | OE175 | 1,0 | CET14P | OE190 | BAEA347 |

THEISIS

| | | | | | | | | | |
|----------------|---|--------------------|---------|-------------|-------|-----|--------|-------|--------------------------|
| 2.4 | 5 | 841D.000 | 125/168 | 07/02→07/09 | OE005 | 0,9 | CET2 | OE180 | |
| 2.4 D Multijet | 5 | 841P.000 | 136/182 | 04/06→07/09 | CH224 | 11v | | | CCU150 |
| 2.4 JTD | 5 | 841C.000 | 110/148 | 07/02→07/09 | CH222 | 11v | | | CCU150 |
| 2.4 JTD | 5 | 841M.000; 841N.000 | 120/161 | 09/03→07/09 | CH224 | 11v | | | CCU150 |
| 2.4 JTD | 5 | 841G.000 | 129/173 | 05/03→07/09 | CH224 | 11v | | | CCU150 |
| 3.0 V6 | 6 | 841A.000 | 158/212 | 07/02→07/09 | OE136 | 0,8 | CET12P | OE179 | BAEA428 ^[277] |
| 3.2 V6 | 6 | 841L.000 | 169/227 | 05/03→07/09 | OE136 | 0,8 | CET11P | | BAEA428 ^[277] |

Y

| | | | | | | | | | |
|---------|---|-----------|-------|-------------|-------|-----|------|-------|----------------|
| 1.1 | 4 | 176B2.000 | 40/54 | 11/95→09/03 | OE002 | 0,9 | CET2 | OE180 | BAE800B CLS261 |
| 1.2 | 4 | 840A3.000 | 44/59 | 03/96→09/03 | OE002 | 0,9 | CET2 | OE180 | BAE800B CLS261 |
| 1.2 | 4 | 188A4.000 | 44/59 | 03/96→09/03 | OE002 | 0,9 | CET2 | OE180 | BAE800B CLS067 |
| 1.2 16V | 4 | 188A5.000 | 59/79 | 10/00→09/03 | OE186 | 1,0 | CET1 | | BAEA234 CLS044 |
| 1.2 16V | 4 | 176B9.000 | 63/84 | 04/97→09/03 | OE186 | 1,0 | CET1 | | BAE800B CLS035 |
| 1.4 12V | 4 | 840A4.000 | 55/74 | 03/96→09/03 | OE030 | 0,9 | CET2 | OE179 | BAEA234 CLS136 |
| 1.4 12V | 4 | 840A2.000 | 59/79 | 10/96→09/03 | OE030 | 0,9 | CET2 | OE179 | BAEA234 CLS136 |

CHAMPION

LANCIA



kW/BHP

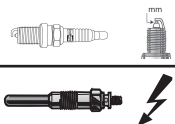

eon TITAN

IRIDIUM

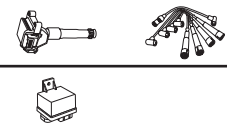

...LANCIA

Y10

| | | | | | | | | | | |
|------------------------|---|-----------|-------|-------------|-------|-----|------|-------|---------|--------|
| 1.1 Fire, 1.1 Fire 4WD | 4 | 176B2.000 | 40/54 | 01/95→12/95 | OE002 | 0,9 | CET2 | OE180 | BAEA234 | CLS112 |
|------------------------|---|-----------|-------|-------------|-------|-----|------|-------|---------|--------|

YPSILON

| | | | | | | | | | | |
|----------------------|---|-----------|-------|--------|-------|-----|--------|--|---------|--|
| 0.9 CNG, 0.9 TwinAir | 2 | 312A2.000 | 63/84 | 05/11→ | OE232 | 0,7 | CET15P | | BAEA090 | |
|----------------------|---|-----------|-------|--------|-------|-----|--------|--|---------|--|

| | | | | | | | | | | |
|-------------|---|----------------------|-------|--------|-------|-----|--------|--|--|--|
| 0.9 TwinAir | 2 | 312A2.000; 312A5.000 | 59/79 | 12/13→ | OE232 | 0,7 | CET15P | | | |
|-------------|---|----------------------|-------|--------|-------|-----|--------|--|--|--|

| | | | | | | | | | | |
|-----|---|-----------|-------|-------------|-------|-----|------|--|---------|--------|
| 1.2 | 4 | 188A4.000 | 44/59 | 10/03→12/11 | OE196 | 1,0 | CET1 | | BAE800B | CLS067 |
|-----|---|-----------|-------|-------------|-------|-----|------|--|---------|--------|

| | | | | | | | | | | |
|-----|---|-----------|-------|--------|-------|-----|------|--|-------------------------|--------|
| 1.2 | 4 | 169A4.000 | 51/68 | 08/10→ | OE196 | 1,0 | CET1 | | BAE800B ^[21] | CLS082 |
|-----|---|-----------|-------|--------|-------|-----|------|--|-------------------------|--------|

| | | | | | | | | | | |
|--|--|--|--|--|--|--|--|--|-------------------------|--|
| | | | | | | | | | BAE940A ^[22] | |
|--|--|--|--|--|--|--|--|--|-------------------------|--|

| | | | | | | | | | | |
|-----|---|-----------|-------|-------------|-------|-----|------|--|---------|--|
| 1.2 | 4 | 188A5.000 | 59/79 | 10/03→12/11 | OE196 | 1,0 | CET1 | | BAE403C | |
|-----|---|-----------|-------|-------------|-------|-----|------|--|---------|--|

| | | | | | | | | | | |
|------------|---|-----------|-------|--------|-------|-----|------|--|-------------------------|--------|
| 1.2 Bifuel | 4 | 169A4.000 | 49/66 | 05/11→ | OE196 | 1,0 | CET1 | | BAE800B ^[21] | CLS082 |
|------------|---|-----------|-------|--------|-------|-----|------|--|-------------------------|--------|

| | | | | | | | | | | |
|--|--|--|--|--|--|--|--|--|-------------------------|--|
| | | | | | | | | | BAE940A ^[22] | |
|--|--|--|--|--|--|--|--|--|-------------------------|--|

| | | | | | | | | | | |
|----------------|---|-----------|-------|-------------|--|--|--|--|--------|--|
| 1.3 D Multijet | 4 | 199A2.000 | 55/74 | 09/06→12/11 | | | | | CCU150 | |
|----------------|---|-----------|-------|-------------|--|--|--|--|--------|--|

| | | | | | | | | | | |
|----------------|---|-----------|-------|-------------|--|--|--|--|--------|--|
| 1.3 D Multijet | 4 | 199A3.000 | 66/89 | 09/06→12/11 | | | | | CCU150 | |
|----------------|---|-----------|-------|-------------|--|--|--|--|--------|--|

| | | | | | | | | | | |
|----------------|---|-----------|--------|-------------|--|--|--|--|--------|--|
| 1.3 D Multijet | 4 | 199A3.000 | 77/103 | 05/07→12/11 | | | | | CCU150 | |
|----------------|---|-----------|--------|-------------|--|--|--|--|--------|--|

| | | | | | | | | | | |
|---------|---|-----------|-------|-------------|--|--|--|--|--------|--|
| 1.3 JTD | 4 | 188A9.000 | 51/68 | 10/03→12/11 | | | | | CCU150 | |
|---------|---|-----------|-------|-------------|--|--|--|--|--------|--|

| | | | | | | | | | | |
|--------------|---|-----------|-------|-------------|-------|-----|------|--|---------|--------|
| 1.4, 1.4 LPG | 4 | 350A1.000 | 57/76 | 02/06→12/11 | OE196 | 1,0 | CET1 | | BAE940A | CLS082 |
|--------------|---|-----------|-------|-------------|-------|-----|------|--|---------|--------|

| | | | | | | | | | | |
|---------|---|-----------|-------|-------------|-------|-----|------|--|---------|--|
| 1.4 16V | 4 | 843A1.000 | 70/94 | 10/03→12/11 | OE196 | 1,0 | CET1 | | BAE403C | |
|---------|---|-----------|-------|-------------|-------|-----|------|--|---------|--|

ZETA

| | | | | | | | | | | |
|---------|---|--------------|--------|-------------|-------|-----|------|-------|--|--|
| 2.0 16V | 4 | RFV(XU10J4R) | 97/130 | 05/98→07/00 | OE019 | 0,9 | CET2 | OE184 | | |
|---------|---|--------------|--------|-------------|-------|-----|------|-------|--|--|

| | | | | | | | | | | |
|---------|---|-----|---------|-------------|-------|-----|------|--|--|--|
| 2.0 16V | 4 | RFN | 100/134 | 07/00→09/02 | OE178 | 0,9 | CET5 | | | |
|---------|---|-----|---------|-------------|-------|-----|------|--|--|--|

| | | | | | | | | | | |
|----------------------|---|-------------------------------|--------|-------------|-------|-----|--|--|--|--|
| 2.0 JTD, 2.0 JTD 16V | 4 | RHW(DW10ATED4); RHZ(DW10ATED) | 80/107 | 09/99→09/02 | CH170 | 11v | | | | |
|----------------------|---|-------------------------------|--------|-------------|-------|-----|--|--|--|--|

| | | | | | | | | | | |
|-----------|---|---------------|---------|-------------|-------|-----|------|-------|--|--------|
| 2.0 Turbo | 4 | RGX(XU10J2TE) | 108/145 | 05/95→09/02 | OE034 | 0,9 | CET2 | OE188 | | CLS005 |
|-----------|---|---------------|---------|-------------|-------|-----|------|-------|--|--------|

| | | | | | | | | | | |
|--------|---|-----|--------|-------------|-------|-----|--|--|--|--|
| 2.1 TD | 4 | P8C | 80/107 | 05/96→09/99 | CH189 | 11v | | | | |
|--------|---|-----|--------|-------------|-------|-----|--|--|--|--|

LAND ROVER

DEFENDER

| | | | | | | | | | | |
|-------------|---|-------|--------|-------------|-------|-------|--|--|--|--|
| 2.4 Td4 4WD | 4 | DT244 | 90/121 | 05/07→02/16 | CH229 | 11.5v | | | | |
|-------------|---|-------|--------|-------------|-------|-------|--|--|--|--|

| | | | | | | | | | | |
|-------------|---|---------------|--------|-------------|-----------------|-------|--|--|--|--|
| 2.5 Td5 4WD | 5 | 10P; 14P; 15P | 90/121 | 06/98→02/16 | CH178 →12/98 | 11.5v | | | | |
|-------------|---|---------------|--------|-------------|-----------------|-------|--|--|--|--|

| | | | | | | | | | | |
|--|--|--|--|--|-----------------|-----|--|--|--|--|
| | | | | | CH272 01/99→ | 11v | | | | |
|--|--|--|--|--|-----------------|-----|--|--|--|--|

| | | | | | | | | | | |
|---------|---|--------|---------|-------------|-------|-----|------|-------|--|--|
| 2.8 4WD | 6 | M52B28 | 140/188 | 11/98→09/03 | OE026 | 0,9 | CET2 | OE188 | | |
|---------|---|--------|---------|-------------|-------|-----|------|-------|--|--|

| | | | | | | | | | | |
|---------|---|-----|---------|-------------|-------|-----|------|--|--|--|
| 3.9 4WD | 8 | 37L | 134/180 | 04/98→09/00 | OE051 | 0,9 | CET8 | | | |
|---------|---|-----|---------|-------------|-------|-----|------|--|--|--|

| | | | | | | | | | | |
|------------|---|-----|---------|-------------|-------|-----|------|--|--|--|
| 3.9 V8 4WD | 8 | 37L | 136/182 | 11/98→02/16 | OE051 | 0,9 | CET8 | | | |
|------------|---|-----|---------|-------------|-------|-----|------|--|--|--|

DISCOVERY I

| | | | | | | | | | | |
|-----------|---|---------------|--------|-------------|-------|-------|--|--|--|--|
| 2.5 D 4WD | 4 | 17L; 19L; 22L | 90/121 | 06/93→10/98 | CH178 | 11.5v | | | | |
|-----------|---|---------------|--------|-------------|-------|-------|--|--|--|--|

| | | | | | | | | | | |
|---------|---|----------|---------|-------------|-------|-----|------|--|----------------------|--|
| 4.0 4WD | 8 | 35D; 36D | 134/180 | 09/93→10/98 | OE051 | 0,9 | CET8 | | BAEA115 [8] [275] | |
|---------|---|----------|---------|-------------|-------|-----|------|--|----------------------|--|

DISCOVERY II

| | | | | | | | | | | |
|-------------|---|----------|---------|-------------|-------|-----|--|--|--|--|
| 2.5 Td5 4WD | 5 | 10P; 15P | 102/137 | 11/98→06/04 | CH272 | 11v | | | | |
|-------------|---|----------|---------|-------------|-------|-----|--|--|--|--|

| | | | | | | | | | | |
|------------|---|---------------|---------|-------------|-------|-----|--------|-------|---------|--|
| 4.0 V8 4WD | 8 | 35D; 56D; 94D | 136/182 | 11/98→06/04 | OE138 | 1,0 | CET12P | OE180 | BAEA234 | |
|------------|---|---------------|---------|-------------|-------|-----|--------|-------|---------|--|

DISCOVERY III

| | | | | | | | | | | |
|------------|---|-------|---------|-------------|-------|-----|--|--|--|--|
| 2.7 TD 4WD | 6 | 276DT | 140/188 | 07/04→09/09 | CH240 | 11v | | | | |
|------------|---|-------|---------|-------------|-------|-----|--|--|--|--|

| | | | | | | | | | | |
|---------|---|-------|---------|-------------|--|--|--------|-------|---------------------------|--|
| 4.4 4WD | 8 | 448PN | 220/295 | 07/04→09/09 | | | CET12P | OE180 | BAEA196E ^[275] | |
|---------|---|-------|---------|-------------|--|--|--------|-------|---------------------------|--|

DISCOVERY IV

| | | | | | | | | | | |
|------------|---|-------|---------|--------|-------|-----|--|--|--|--|
| 2.7 TD 4WD | 6 | 276DT | 140/188 | 09/09→ | CH240 | 11v | | | | |
|------------|---|-------|---------|--------|-------|-----|--|--|--|--|

DISCOVERY SPORT

| | | | | | | | | | | |
|---------|---|-------|---------|--------|--|--|--------|--|--|--|
| 2.0 4WD | 4 | 204PT | 177/237 | 11/14→ | | | CET17P | | | |
|---------|---|-------|---------|--------|--|--|--------|--|--|--|

FREELANDER

| | | | | | | | | | | |
|---------|---|-------|--------|-------------|--|--|--|--|---------|--|
| 1.8 4WD | 4 | 18K4F | 86/115 | 10/00→10/06 | | | | | BAEA501 | |
|---------|---|-------|--------|-------------|--|--|--|--|---------|--|

| | | | | | | | | | | |
|-------------|---|-------|--------|-------------|-------|-----|--------|-------|-------------------------|--------|
| 1.8 16V 4WD | 4 | 18K4F | 86/115 | 11/00→10/06 | OE146 | 1,0 | CET12P | OE179 | BAEA501 →Ch.5A000001 | CLS045 |
|-------------|---|-------|--------|-------------|-------|-----|--------|-------|-------------------------|--------|

| | | | | | | | | | | |
|--|--|--|--|--|--|--|--|--|-------------------------|--|
| | | | | | | | | | BAEA469 Ch.1A000001→ | |
|--|--|--|--|--|--|--|--|--|-------------------------|--|

LAND ROVER





kW/BHP

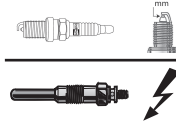

eon TITAN

IRIDIUM

**...LAND ROVER****...FREELANDER**

| | | | | | | | | | | |
|---------------|---|-------|--------|---------------|----------------|------------|--------|-------|--|--------|
| 1.8 i 16V 4WD | 4 | 18K4F | 88/118 | 02/98 → 10/06 | OE136 OE146 | 0,8 1,0 | CET12P | OE179 | BAEA469 [185] [275] BAEA501 [275] BAEA469 [185] Ch.1A000001 → BAEA501 Ch.5A000001 → | CLS155 |
|---------------|---|-------|--------|---------------|----------------|------------|--------|-------|--|--------|

| | | | | | | | | | | |
|-------------|---|------------|---------|---------------|-------|-----|--------|-------|--|--|
| 2.0 DI 4WD | 4 | 20T2N | 72/97 | 02/98 → 10/06 | CH169 | 11v | | | | |
| 2.0 Td4 4WD | 4 | 204D3 | 80/107 | 03/01 → 10/06 | CH203 | 11v | | | | |
| 2.0 Td4 4WD | 4 | 204D3; M47 | 82/110 | 11/00 → 10/06 | CH203 | 11v | | | | |
| 2.5 V6 4WD | 6 | 25K4F | 130/174 | 11/00 → 10/06 | OE146 | 1,0 | CET12P | OE179 | | |

FREELANDER 2

| | | | | | | | | | | |
|-------------|---|--------|---------|---------------|--|--|--------|-------|--|--|
| 2.0 Si4 4WD | 4 | 204PT | 177/237 | 10/11 → 10/14 | | | CET17P | | | |
| 3.2 4WD | 6 | B6324S | 171/229 | 10/06 → 10/14 | | | CET14P | OE190 | | |

RANGE ROVER EVOQUE

| | | | | | | | | | | |
|---------|---|-------|---------|---------|--|--|--------|--|--|--|
| 2.0 4WD | 4 | 204PT | 177/237 | 06/11 → | | | CET17P | | | |
|---------|---|-------|---------|---------|--|--|--------|--|--|--|

RANGE ROVER II

| | | | | | | | | | | |
|-----------|---|-----------|---------|---------------|------------------|-----|----------------|------------------|---------|--|
| 2.5 D 4WD | 4 | 19L; 22L | 83/111 | 08/94 → 03/02 | CH189 | 11v | | | | |
| 2.5 D 4WD | 6 | 256T(BMW) | 100/134 | 07/94 → 03/02 | CH189 | 11v | | | | |
| 3.9 4WD | 8 | 42D | 140/188 | 07/94 → 03/02 | OE051 | 0,9 | CET8 | | BAEA234 | |
| 4.0 4WD | 8 | 42D | 136/182 | 01/95 → 03/02 | OE138 | 1,0 | CET12P | OE180 | BAEA234 | |
| 4.6 4WD | 8 | 60D | 160/215 | 06/98 → 03/02 | OE138 | 1,0 | CET12P | OE180 | BAEA234 | |
| 4.6 4WD | 8 | 46D | 165/221 | 07/94 → 03/02 | OE138 01/99 → | 1,0 | CET12P CET8 | OE180 01/99 → | BAEA234 | |
| 4.6 4WD | 8 | 46D | 168/225 | 09/95 → 03/02 | OE138 | 1,0 | CET12P | | BAEA234 | |

RANGE ROVER III

| | | | | | | | | | | |
|-----------|---|--------|---------|---------------|-------|-----|--------|-------|----------------|--|
| 3.0 D 4WD | 6 | 306D1 | 130/174 | 03/02 → 08/12 | CH203 | 11v | | | | |
| 3.6 D 4WD | 8 | 368DT | 200/268 | 04/06 → 08/12 | CH240 | 11v | | | | |
| 4.2 4WD | 8 | 428PS | 291/390 | 05/05 → 08/12 | | | CET12P | OE180 | BAEA196E [275] | |
| 4.4 4WD | 8 | M62B44 | 210/282 | 03/02 → 08/05 | OE223 | 1,6 | | | BAEA302 | |
| 4.4 4WD | 8 | 448PN | 220/295 | 08/04 → 08/12 | | | CET12P | OE180 | | |
| 4.4 4WD | 8 | 448PN | 225/302 | 05/05 → 08/12 | | | CET12P | | BAEA196E [275] | |
| 4.4 4WD | 8 | AJ | 225/302 | 05/05 → 08/12 | | | | OE180 | | |

RANGE ROVER SPORT

| | | | | | | | | | | |
|-----------|---|-------|---------|---------------|-------|-----|--------|-------|----------------|--|
| 2.7 D 4WD | 6 | 276DT | 140/188 | 02/05 → 03/13 | CH240 | 11v | | | | |
| 3.6 D 4WD | 8 | 368DT | 200/268 | 04/06 → 03/13 | CH240 | 11v | | | | |
| 4.2 4WD | 8 | 428PS | 287/385 | 02/05 → 03/13 | | | CET12P | OE180 | BAEA196E [275] | |
| 4.4 4WD | 8 | 448PN | 220/295 | 02/05 → 03/13 | | | CET12P | OE180 | BAEA196E [275] | |

LANDWIND (JMC)**LANDWIND**

| | | | | | | | | | | |
|------------|---|----------|--------|---------|-------|-----|------|-------|--|--|
| 2.0 4WD | 4 | 4G63-S4M | 84/113 | 09/05 → | OE063 | 1,0 | CET2 | OE180 | | |
| 2.4 4WD | 4 | 4G64-S4M | 92/123 | 09/05 → | OE063 | 1,0 | CET2 | OE180 | | |
| 2.8 TD 4WD | 4 | JX493ZQ | 68/91 | 09/05 → | CH306 | 11v | | | | |

LDV**CONVOY**

| | | | | | | | | | | |
|----------------|---|-----------|-------|---------------|-------|-------|--|--|--|--|
| 2.4 D | 4 | D2FA | 66/89 | 03/02 → 04/09 | CH229 | 11.5v | | | | |
| 2.5 D | 4 | EN55 | 53/71 | 04/96 → 02/02 | CH189 | 11v | | | | |
| 2.5 D | 4 | 4HB | 55/74 | 10/97 → 04/09 | CH189 | 11v | | | | |
| 2.5 D | 4 | ET70 | 71/95 | 04/96 → 06/06 | CH189 | 11v | | | | |
| 2.5 D, 2.5 TDI | 4 | 4EB; ET70 | 74/99 | 10/97 → 04/09 | CH189 | 11v | | | | |
| 2.5 DI | 4 | EN55 | 56/75 | 10/98 → 04/09 | CH189 | 11v | | | | |



LAND ROVER



kW/BHP

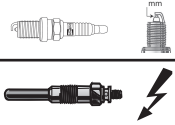

eon TITAN

IRIDIUM

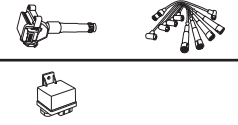

...LDV

CUB

| | | | | | | | | | |
|-------|---|------|-------|---------------|-------|-----|--|--|--|
| 2.3 D | 4 | LD23 | 53/71 | 08/98 → 09/01 | CH186 | 11v | | | |
|-------|---|------|-------|---------------|-------|-----|--|--|--|

MAXUS

| | | | | | | | | | |
|-------|---|------------------------|--------|---------------|------------------------|-----|--|--|--|
| 2.5 D | 4 | VM39C; VM40C; VMR425 | 70/94 | 02/05 → 12/08 | CH180 ^[275] | 11v | | | |
| 2.5 D | 4 | | 78/105 | 04/07 → 12/09 | CH180 ^[275] | 11v | | | |
| 2.5 D | 4 | BS580VM; VM39C; VMR425 | 88/118 | 02/05 → 12/09 | CH180 ^[275] | 11v | | | |
| 2.5 D | 4 | BS582VM | 99/133 | 02/06 → 12/09 | CH180 ^[275] | 11v | | | |

PILOT

| | | | | | | | | | |
|-------|---|------|-------|---------------|-------|-----|--|--|--|
| 1.9 D | 4 | XUD9 | 52/70 | 04/96 → 10/05 | CH189 | 11v | | | |
|-------|---|------|-------|---------------|-------|-----|--|--|--|

LEXUS

CT

| | | | | | | | | | |
|----------|---|------------------|-------|---------|--|--|--|--|----------|
| 1.8 200h | 4 | 2ZR-FXE; 5ZR-FXE | 73/98 | 12/10 → | | | | | BAEA184E |
|----------|---|------------------|-------|---------|--|--|--|--|----------|

ES

| | | | | | | | | | |
|--------------|---|---------|---------|---------------|-------|-----|--------|-------|----------|
| 2.5 250 | 4 | 2AR-FE | 135/181 | 06/12 → | | | CET14P | OE190 | BAEA192E |
| 2.5 300h | 4 | 2AR-FXE | 118/158 | 06/12 → | | | | | BAEA192E |
| 3.0 | 6 | 1MZ-FE | 140/188 | 10/96 → 07/01 | | | CET12P | OE182 | |
| 3.0 | 6 | 1MZ-FE | 157/211 | 08/01 → 10/06 | OE136 | 0,8 | CET12P | OE179 | |
| 3.0 | 6 | 1MZ-FE | 158/212 | 10/01 → 06/08 | OE136 | 0,8 | CET12P | OE179 | |
| 3.3 | 6 | 3MZ-FE | 168/225 | 06/03 → 10/06 | | | CET12P | OE182 | |
| 3.5, 3.5 350 | 6 | 2GR-FE | 204/274 | 05/06 → | | | CET14P | OE190 | |

GS

| | | | | | | | | | |
|-------------------------|---|---------|---------|---------------|-------|-----|--------|-------|---------------------------|
| 2.5 250 | 6 | 4GR-FSE | 154/207 | 01/12 → | | | CET14P | OE190 | BAEA192E |
| 2.5 300h | 4 | 2AR-FSE | 133/178 | 10/13 → | | | | | BAEA192E |
| 2.5 GS 250 | 6 | 4GR-FSE | 158/212 | 01/12 → | | | CET14P | OE190 | |
| 3.0 300 | 6 | 2JZ-GE | 156/209 | 01/93 → 08/97 | OE026 | 0,9 | CET2 | OE188 | BAEA445 ^[275] |
| 3.0 300 | 6 | 2JZ-GE | 161/216 | 10/00 → 12/04 | OE026 | 0,9 | CET2 | OE188 | |
| 3.0 300 | 6 | 2JZ-GE | 163/219 | 08/97 → 10/00 | OE026 | 0,9 | CET2 | OE188 | |
| 3.0 300 | 6 | 3GR-FE | 170/228 | 04/05 → 11/11 | | | CET14P | OE190 | BAEA192E |
| 3.0 300 | 6 | 3GR-FSE | 183/245 | 04/05 → 11/11 | | | CET14P | OE190 | BAEA192E |
| 3.5 350 | 6 | 2GR-FSE | 232/311 | 05/08 → | | | CET14P | OE190 | |
| 3.5 350, 3.5 350 4WD | 6 | 2GR-FSE | 226/303 | 04/08 → 11/11 | | | CET14P | OE190 | |
| 3.5 350 4WD | 6 | 2GR-FSE | 232/311 | 05/08 → | | | CET14P | OE190 | BAEA192E |
| 3.5 350 4WD, 3.5 GS 350 | 6 | 2GR-FSE | 234/314 | 12/11 → | | | CET14P | OE190 | BAEA192E |
| 3.5 450h | 6 | 2GR-FXE | 215/288 | 01/12 → | | | | | BAEA192E |
| 3.5 450h | 6 | 2GR-FSE | 218/292 | 02/06 → 11/11 | | | CET14P | OE190 | BAEA192E |
| 3.5 450h | 6 | 2GR-FSE | 254/341 | 02/06 → 11/11 | | | CET14P | OE190 | BAEA192E |
| 4.0 400 | 8 | 1UZ-FE | 216/290 | 12/97 → 11/00 | OE136 | 0,8 | CET12P | OE179 | |
| 4.3 430 | 8 | 3UZ-FE | 208/279 | 11/00 → 11/11 | | | CET12P | OE182 | BAEA172E ^[161] |
| 4.3 VVTi | 8 | 3UZ-FE | 221/296 | 04/05 → 11/11 | | | CET12P | OE182 | |
| 4.6 460 | 8 | 1UR-FSE | 255/342 | 09/07 → 11/11 | | | CET14P | OE190 | |

GX

| | | | | | | | | | |
|-------------|---|--------|---------|---------------|--|--|--------|-------|----------|
| 4.6 470 4WD | 8 | 1UR-FE | 218/292 | 11/09 → | | | CET14P | OE190 | BAEA192E |
| 4.6 470 4WD | 8 | 1UR-FE | 225/302 | 01/10 → | | | CET14P | OE190 | |
| 4.7 470 4WD | 8 | 2UZ-FE | 175/235 | 11/01 → 11/09 | | | CET12P | OE182 | |
| 4.7 470 4WD | 8 | 2UZ-FE | 199/267 | 11/01 → 11/09 | | | CET12P | OE182 | |

HS

| | | | | | | | | | |
|----------|---|---------|---------|---------|--|--|--------|-------|--|
| 2.4 250h | 4 | 2AZ-FXE | 110/148 | 07/09 → | | | CET12P | OE182 | |
|----------|---|---------|---------|---------|--|--|--------|-------|--|

IS

| | | | | | | | | | |
|---------|---|--------|---------|---------------|-------|-----|--------|-------|---------------------------|
| 2.0 200 | 6 | 1G-FE | 114/153 | 10/02 → 10/05 | | | CET12P | OE182 | BAEA172E ^[161] |
| 3.0 300 | 6 | 2JZ-GE | 157/211 | 10/01 → 10/05 | OE136 | 0,8 | CET12P | OE179 | |

IS C

| | | | | | | | | | |
|---------|---|---------|---------|---------|--|--|--------|-------|----------|
| 2.5 250 | 6 | 4GR-FSE | 153/205 | 04/09 → | | | CET14P | OE190 | BAEA192E |
|---------|---|---------|---------|---------|--|--|--------|-------|----------|

LEXUS



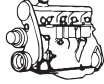

kW/BHP

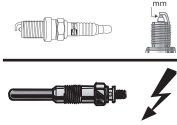

eon TITAN

IRIDIUM



...LEXUS

IS I

| | | | | | | | | | |
|---------|---|--------|---------|-------------|-------|-----|--------|-------|---------------------------|
| 2.0 200 | 6 | 1G-FE | 114/153 | 04/99→07/05 | | | CET12P | OE182 | BAEA172E ^[161] |
| 3.0 300 | 6 | 2JZ-GE | 157/211 | 09/01→07/05 | OE136 | 0,8 | CET12P | OE179 | |

IS II

| | | | | | | | | | |
|----------------------|---|---------|---------|-------------|--|--|--------|-------|---------------------------|
| 2.5 250, 2.5 250 4WD | 6 | 4GR-FSE | 153/205 | 08/05→03/13 | | | CET14P | OE190 | BAEA192E |
| 2.5 250, 2.5 250 4WD | 6 | 4GR-FSE | 158/212 | 11/10→03/13 | | | CET14P | OE190 | |
| 3.5 350 | 6 | 2GR-FSE | 234/314 | 01/08→03/13 | | | CET14P | OE190 | |
| 3.5 350, 3.5 350 4WD | 6 | 2GR-FSE | 228/306 | 10/05→03/13 | | | CET14P | OE190 | |
| 5.0 IS F | 8 | 2UR-GSE | 311/417 | 11/07→03/13 | | | CET14P | OE190 | BAEA167E ^[166] |

IS III

| | | | | | | | | | |
|----------|---|---------|---------|--------|--|--|--------|-------|----------|
| 2.5 250 | 6 | 4GR-FSE | 153/205 | 04/13→ | | | CET14P | OE190 | |
| 2.5 300h | 4 | 2AR-FSE | 133/178 | 04/13→ | | | | | BAEA192E |

LS

| | | | | | | | | | |
|----------------------|---|---------|---------|-------------|----------------------------|-----|--------|-------|---------------------------|
| 4.0 400 | 8 | 1UZ-FE | 194/260 | 12/94→08/97 | OE136 | 0,8 | CET12P | OE179 | BAEA445 |
| | | | | | OE218 ^{LPG [278]} | 1,6 | | | |
| 4.0 400 | 8 | 1UZ-FE | 203/272 | 09/98→10/00 | OE136 | 0,8 | CET12P | OE179 | BAEA445 |
| 4.0 400 | 8 | 1UZ-FE | 209/280 | 09/97→10/00 | OE136 | 0,8 | CET12P | OE179 | BAEA445 |
| 4.0 400 | 8 | 1UZ-FE | 216/290 | 10/97→07/00 | OE136 | 0,8 | CET12P | | |
| 4.3 430 | 8 | 3UZ-FE | 207/278 | 10/00→08/06 | | | CET12P | OE182 | BAEA172E ^[161] |
| 4.3 430 | 8 | 3UZ-FE | 208/279 | 10/00→08/06 | | | CET12P | OE182 | |
| 4.6 460 | 8 | 1UR-FE | 255/342 | 05/08→ | | | CET14P | OE190 | BAEA192E |
| 4.6 460 | 8 | 1UR-FSE | 270/362 | 10/09→ | | | CET14P | OE190 | |
| 4.6 460 | 8 | 1UR-FSE | 280/375 | 04/06→ | | | CET14P | OE190 | BAEA192E |
| 4.6 460 | 8 | 1UR-FSE | 285/382 | 09/12→ | | | CET14P | OE190 | BAEA192E |
| 4.6 460 4WD | 8 | 1UR-FSE | 270/362 | 12/08→ | | | CET14P | OE190 | BAEA192E |
| 4.6 460 4WD | 8 | 1UR-FSE | 272/365 | 09/12→ | | | CET14P | OE190 | BAEA192E |
| 4.6 460, 4.6 460 4WD | 8 | 1UR-FSE | 283/380 | 12/08→ | | | CET14P | OE190 | |
| 5.0 600h 4WD | 8 | 2UR-FSE | 290/389 | 08/07→ | | | CET14P | OE190 | BAEA192E |

LX

| | | | | | | | | | |
|-------------|---|--------|---------|-------------|--|--|--------|-------|----------|
| 4.7 470 4WD | 8 | 2UZ-FE | 170/228 | 05/98→03/08 | | | CET12P | OE182 | BAEA172E |
| 4.7 470 4WD | 8 | 2UZ-FE | 173/232 | 05/98→03/08 | | | CET12P | OE182 | |
| 4.7 470 4WD | 8 | 2UZ-FE | 197/264 | 05/98→10/02 | | | CET12P | OE182 | |
| 4.7 470 4WD | 8 | 2UZ-FE | 202/271 | 08/02→03/08 | | | CET12P | OE182 | |
| 5.7 570 4WD | 8 | 3UR-FE | 270/362 | 11/07→ | | | CET14P | OE190 | BAEA192E |
| 5.7 570 4WD | 8 | 3UR-FE | 282/378 | 11/07→ | | | CET14P | OE190 | |

RX

| | | | | | | | | | |
|------------------------|---|-----------------|---------|-------------|--|--|--------|-------|---------------------------|
| 2.7 270 | 4 | 1AR-FE | 138/185 | 12/08→10/15 | | | CET14P | OE190 | BAEA192E |
| 3.0 300 | 6 | 1MZ-FE | 148/198 | 01/98→02/03 | | | CET12P | OE182 | BAEA173E |
| 3.0 300 4WD | 6 | 1MZ-FE | 148/198 | 10/00→05/03 | | | CET12P | OE182 | BAEA173E ^[162] |
| 3.0 300 4WD | 6 | 1MZ-FE | 150/201 | 05/03→12/08 | | | CET12P | OE182 | BAEA173E ^[162] |
| 3.0 300 4WD | 6 | 1MZ-FE | 164/220 | 01/98→02/03 | | | CET12P | OE182 | BAEA173E |
| 3.3 330, 3.3 330 4WD | 6 | 3MZ-FE | 171/229 | 04/03→12/08 | | | CET12P | OE182 | |
| 3.3 400h, 3.3 400h 4WD | 6 | 3MZ-FE | 155/208 | 09/04→12/08 | | | CET12P | OE182 | |
| 3.5 350, 3.5 350 4WD | 6 | 2GR-FE | 203/272 | 01/06→12/08 | | | CET14P | OE190 | |
| 3.5 350, 3.5 350 4WD | 6 | 2GR-FE | 206/276 | 12/08→10/15 | | | CET14P | OE190 | |
| 3.5 350 4WD | 6 | 2GR-FE; 2GR-FXE | 204/274 | 12/08→08/15 | | | CET14P | OE190 | |
| 3.5 450h, 3.5 450h 4WD | 6 | 2GR-FXE | 183/245 | 12/08→10/15 | | | CET14P | OE190 | |
| 3.5 450h, 3.5 450h 4WD | 6 | | 220/295 | 12/08→10/15 | | | CET14P | OE190 | |

SC

| | | | | | | | | | |
|---------|---|--------|---------|-------------|--|--|--------|-------|-------------------------------------|
| 4.3 430 | 8 | 3UZ-FE | 210/282 | 05/01→07/10 | | | CET12P | OE182 | BAEA172E ^[161] →07/03 |
| 4.3 430 | 8 | 3UZ-FE | 215/288 | 01/01→07/10 | | | CET12P | OE188 | |
| 4.3 430 | 8 | 3UZ-FE | 244/327 | 05/01→07/10 | | | CET12P | OE188 | |

LEXUS



kW/BHP

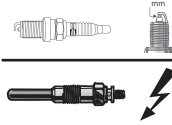

eon TITAN

IRIDIUM

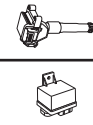
**LIFAN****320**

1.3 4 LF479Q3 65/87 07/06→ OE005 0,9 CET2 OE179

520

1.3 4 LF479Q1; LF479Q3; LF479Q4 65/87 07/06→12/15 OE005 0,9 CET2 OE179

1.6 4 LF481Q3 78/105 04/06→12/12 OE005 0,9 CET2 OE179

1.6 4 T16b3 85/114 04/06→ OE005 0,9 CET2 OE179

620

1.6 4 LF481Q3 78/105 06/08→ OE005 0,9 CET2 OE179

X60

1.8 i 4WD 4 LFB479Q 98/131 01/11→ OE005 0,9 CET2 OE179

LIGIER**AMBRA**

0.5 2 LGW523 14/19 12/96→12/06 OE016 0,9 CET2

BE UP

0.5 2 LGW523 14/19 08/02→12/06 OE016 0,9 CET2

NOVA

0.1 400 1 5/7 08/02→ OE016 0,9 CET2

0.5 650 2 LGW523 14/19 08/02→ OE016 0,9 CET2

LINCOLN**CONTINENTAL TOWN CAR**

4.6 8 V99V 209/280 01/94→12/02 CET9

4.6 Signature 8 157/211 01/94→10/99 CET9

LS

3.0 V6 24V 6 140/188 05/98→ OE131 1,0 CET18P OE183 BAEA367

3.9 V8 32V 8 180/241 05/98→ BAEA368^[277]**TOWN CAR III**

4.6 8 160/215 10/97→12/03 CET9

LOTUS**ELISE**1.8 4 18K4F 88/118 08/95→11/00 OE146 1,0 CET12P OE179 CLS061^[292]
OE218^{UPG [278]} 1,61.8 4 18K4F 90/121 11/00→08/05 OE146 1,0 CET12P OE179 CLS061^[292]

1.8 4 1ZZ-FE 99/133 10/03→ OE089 1,0 CET2

1.8 4 18K4G 101/135 11/98→12/03 OE146 1,0 CET12P

1.8 4 18K4K 118/158 11/98→ OE146 1,0 CET12P

1.8 4 2ZZ-GE 118/158 11/98→ OE146 1,0 CET12P OE179 CLS061^[292]

1.8 4 2ZZ-GE 140/188 11/02→ CET12P OE182

1.8 4 2ZZ-GE 141/189 01/04→ CET12P OE182

1.8 111 S 4 18K4K 107/143 03/99→11/00 OE146 1,0 CET12P OE179

ELISE 340 R

1.8 4 132/177 03/00→02/01 OE146 1,0 CET12P OE179

ESPRIT S4

2.2 4 221/296 05/93→07/96 OE018 1,0 CET8

2.2 4 222/298 11/94→07/96 OE018 1,0 CET8

3.5 V8 32V Turbo 8 618 260/349 02/96→06/03 OE030 0,9 CET2 OE179

OE216^{UPG [278]} 0,8**EUROPA S**

2.0 Turbo 4 Z20LER 147/197 07/06→ OE019 0,9 CET2 OE184

LOTUS





kW/BHP

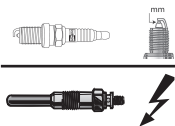

eon TITAN

IRIDIUM

**...LOTUS****EXIGE**

| | | | | | | | | |
|-----------|---|--------|---------|-------------|-------|-----|---------|-------|
| 1.8 16V | 4 | 2ZZ-GE | 132/177 | 05/00→07/08 | OE014 | 0,9 | CET2 | OE179 |
| 1.8 16V | 4 | 2ZZ-GE | 141/189 | 09/01→07/08 | | | CET1 2P | OE182 |
| 1.8 16V | 4 | 2ZZ-GE | 163/219 | 04/06→06/12 | | | CET1 2P | OE182 |
| 1.8 265 E | 4 | 2ZZ-GE | 197/264 | 08/06→06/12 | | | CET1 2P | OE182 |

LTI**TX**

| | | | | | | | | |
|---------|---|----------|--------|--------|-------------|-------|--|--|
| 2.4 TDi | 4 | D2FA | 66/89 | 10/02→ | CH229 | 11.5v | | |
| 2.5 TD | 4 | R425DOHC | 75/101 | 01/06→ | CH180 [275] | 11v | | |
| 2.7 TD | 4 | TD27 | 60/80 | 01/97→ | CH221 | 11v | | |

MARCOS**MANTA RAY**

| | | | | | | | | |
|-----|---|--|---------|-------------|--|--|------|--|
| 4.6 | 8 | | 261/350 | 08/97→09/02 | | | CET9 | |
|-----|---|--|---------|-------------|--|--|------|--|

MANTIS

| | | | | | | | | |
|-----|---|--|---------|--------|--|--|------|--|
| 4.6 | 8 | | 261/350 | 01/97→ | | | CET9 | |
|-----|---|--|---------|--------|--|--|------|--|

MASERATI**3200 GT**

| | | | | | | | | |
|--------------------|---|-------|---------|-------------|-------|------|--|--|
| 3.2 Biturbo V8 32V | 8 | AM585 | 271/363 | 10/98→03/02 | OE122 | 0,6* | | |
|--------------------|---|-------|---------|-------------|-------|------|--|--|

*to be adjusted

4200 GT

| | | | | | | | | |
|-----|---|------|---------|-------------|-------|-----|--|--|
| 4.2 | 8 | M138 | 287/385 | 03/02→11/07 | OE122 | 0,7 | | |
|-----|---|------|---------|-------------|-------|-----|--|--|

4200 GT SPYDER

| | | | | | | | | |
|-----|---|------|---------|--------|-------|-----|--|--|
| 4.2 | 8 | M138 | 287/385 | 10/01→ | OE122 | 0,7 | | |
|-----|---|------|---------|--------|-------|-----|--|--|

QUATTROPORTE IV

| | | | | | | | | |
|-------------|---|---------------|---------|-------------|-------|-----|------|----------|
| 2.0 Biturbo | 6 | 24VDOHC | 211/283 | 03/94→09/98 | | | | BAE700AK |
| 2.8 Biturbo | 6 | AM574; AM574A | 209/280 | 03/94→09/98 | OE087 | 0,9 | CET8 | BAE700AK |
| 3.2 V8 32V | 8 | AM578 | 247/331 | 12/95→05/01 | OE122 | 0,7 | | |

QUATTROPORTE V

| | | | | | | | | |
|-----|---|-------|---------|--------|-------------|-----|--|--|
| 4.2 | 8 | M139A | 295/396 | 03/04→ | OE122 [290] | 0,7 | | |
|-----|---|-------|---------|--------|-------------|-----|--|--|

MAYBACH**57**

| | | | | | | | | |
|--------------|----|----------|---------|-------------|--|--|---------|-------|
| 5.5, 5.5 V12 | 12 | M285.950 | 405/543 | 09/02→12/12 | | | CET1 2P | OE188 |
| 6.0 | 12 | M285.980 | 463/621 | 01/11→12/12 | | | CET1 2P | OE188 |
| 6.0 | 12 | M285.980 | 471/632 | 06/09→12/12 | | | CET1 2P | OE188 |
| 6.0 S | 12 | M285.980 | 450/603 | 09/05→12/12 | | | CET1 2P | OE188 |

MAZDA**2 Saloon (DE_)**

| | | | | | | | | |
|-------|---|-------|--------|-------------|--|--|--|---------|
| 1.5 i | 4 | ZY-DE | 76/102 | 05/10→06/15 | | | | BAEA489 |
|-------|---|-------|--------|-------------|--|--|--|---------|

2 (DE_, DH_3)

| | | | | | | | | |
|------------|---|--------------|--------|-------------|-------|-----|---------|-------|
| 1.3 | 4 | ZJ-VE | 55/74 | 10/07→06/15 | | | CET1 2P | OE180 |
| 1.3 | 4 | ZJ-VE | 63/84 | 10/07→06/15 | | | CET1 2P | OE180 |
| 1.3 MZR | 4 | ZJ-VE | 62/83 | 01/10→06/15 | | | CET1 2P | OE180 |
| 1.4 MZR-CD | 4 | Y404 | 50/67 | 01/08→06/15 | CH201 | 11v | | |
| 1.5 | 4 | ZY-DE; ZY-VE | 76/102 | 10/07→06/15 | | | CET1 2P | OE180 |
| 1.5 MZR | 4 | ZY05; ZY66 | 75/101 | 06/11→06/15 | | | CET1 2P | OE180 |
| 1.6 MZ-CD | 4 | Y406; Y646 | 66/89 | 10/08→06/15 | CH201 | 11v | | |

2 (DL, DJ)

| | | | | | | | | |
|-----|---|--|-------|--------|--|--|--|-------------|
| 1.5 | 4 | P5X0; P5X2; P5Y5; P5Y8; P5Z7; P5Z8; P5Z9 | 55/74 | 08/14→ | | | | OE253 [294] |
|-----|---|--|-------|--------|--|--|--|-------------|





kW/BHP



eon TITAN

IRIDIUM

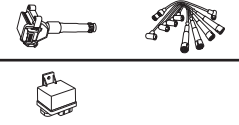

...MAZDA

...2 (DL, DJ)

| | | | | | | | | | | |
|-----|---|--|--------|--------|--|--|--|------------------------|--|--|
| 1.5 | 4 | P5X0; P5X2; P5Y5; P5Y6; P5Y8; P5Z2; P5Z3; P5Z7; P5Z8; P5Z9 | 66/89 | 08/14→ | | | | OE253 ^[294] | | |
| 1.5 | 4 | P5X0; P5X2; P5Y5; P5Z3; P5Z7; P5Z8; P5Z9 | 85/114 | 08/14→ | | | | OE253 ^[294] | | |

2 (DY)

| | | | | | | | | | | |
|--------|---|------------|--------|-------------|-------|-----|------|-------|---|--------|
| 1.2 | 4 | FUJA | 55/74 | 02/03→06/07 | OE031 | 1,0 | CET7 | OE189 | BAEA350 | |
| 1.3 | 4 | FUJA | 55/74 | 04/03→06/07 | OE031 | 1,0 | CET7 | OE189 | BAEA350 →02/05 | CLS077 |
| 1.4 | 4 | FXJA | 59/79 | 02/03→06/07 | OE031 | 1,0 | CET7 | OE189 | BAEA350 →02/05 BAEA422 →02/05 BAEA387 02/05→ | CLS077 |
| 1.4 CD | 4 | F6JA; F6JB | 50/67 | 04/03→06/07 | | | | | CCU147 | |
| 1.5 | 4 | ZY-VE | 82/110 | 04/03→06/07 | OE063 | 1,0 | CET2 | OE180 | BAEA489 | |
| 1.6 | 4 | FYJA | 74/99 | 02/03→06/07 | OE031 | 1,0 | CET7 | OE189 | BAEA350 | CLS077 |

3 (BK)

| | | | | | | | | | | |
|--------------------|---|--------------------------------------|---------|-------------|-------|-----|--------|-------|-------------------|--|
| 1.4 | 4 | FXJA | 59/79 | 02/04→06/09 | | | CET12P | OE180 | BAEA489 | |
| 1.4 | 4 | ZJ-VE | 62/83 | 10/03→06/09 | | | CET12P | OE180 | BAEA489 | |
| 1.6 MZ-CD | 4 | Y406 | 66/89 | 06/06→12/09 | CH201 | 11v | | | | |
| 2.0 | 4 | LF50; LF72; LF-DE; LFN7; LFN8; LF-VE | 110/148 | 10/03→12/09 | | | CET18P | OE183 | BAEA422 →02/06 | |
| 2.3 DiSi Turbo MPS | 4 | L3YH | 184/247 | 06/06→06/09 | | | CET17P | | | |
| 2.3 MPS Turbo | 4 | L3N9; L3-VDT | 191/256 | 12/06→06/09 | | | CET17P | | | |
| 2.3 MZR | 4 | L3-VE | 115/154 | 03/04→03/09 | | | CET18P | OE183 | | |
| 2.3 MZR Sport | 4 | L3Y5; L3YT | 126/169 | 10/03→06/09 | | | CET18P | OE183 | | |

3 /Saloon (BK)

| | | | | | | | | | | |
|-----|---|----------|--------|-------------|--|--|--------|-------|-------------------|--|
| 1.6 | 4 | B6ZE; Z6 | 77/103 | 10/03→06/09 | | | CET12P | OE180 | BAEA489 03/06→ | |
|-----|---|----------|--------|-------------|--|--|--------|-------|-------------------|--|

3 Saloon (BK)

| | | | | | | | | | | |
|-----|---|--------------------------------------|---------|-------------|--|--|--------|-------|--|--|
| 2.0 | 4 | LF17 | 104/139 | 04/04→06/06 | | | CET18P | OE183 | BAEA408 | |
| 2.0 | 4 | LF50; LF72; LF-DE; LFN7; LFN8; LF-VE | 110/148 | 10/03→12/09 | | | CET18P | OE183 | BAEA422 →02/06 BAEA489 03/06→ | |

3 (BL)

| | | | | | | | | | | |
|---------------|---|--------------|---------|-------------|--|--|--------|--|---------|--|
| 1.6 MZR | 4 | Z6 | 79/106 | 01/10→12/13 | | | | | BAEA489 | |
| 2.3 MPS Turbo | 4 | L3KG; L3-VDT | 191/256 | 06/09→09/14 | | | CET17P | | | |

3 /Saloon (BL)

| | | | | | | | | | | |
|--------------|---|-------------|---------|-------------|------------------------|-----|--------|-------|---------|--|
| 1.6 MZR | 4 | Z6 | 77/103 | 12/08→09/14 | | | CET12P | OE180 | BAEA489 | |
| 1.6 MZR CD | 4 | Y601; Y642 | 80/107 | 12/08→05/13 | CH201 ^[288] | 11v | | | | |
| 1.6 MZR CD | 4 | Y650; Y655 | 85/114 | 09/10→05/13 | CH201 ^[288] | 11v | | | | |
| 2.0 MZR | 4 | LF17; LF-DE | 110/148 | 01/09→09/14 | | | CET17P | OE189 | | |
| 2.0 MZR DISI | 4 | LF-Z2 | 111/149 | 12/08→05/13 | | | CET17P | OE189 | | |
| 2.5 | 4 | L5-VE | 122/164 | 03/09→09/14 | | | CET17P | OE189 | | |

3 /Saloon (BM, BN)

| | | | | | | | | | | |
|-----|---|------------|---------|--------|--|--|--|-------|---------|--|
| 1.5 | 4 | P5Y1 | 74/99 | 09/13→ | | | | OE253 | | |
| 1.5 | 4 | P5Y1 | 88/118 | 10/13→ | | | | OE253 | | |
| 1.6 | 4 | Z6Y1; Z6Y3 | 77/103 | 09/13→ | | | | | BAEA489 | |
| 2.0 | 4 | PEY7 | 88/118 | 09/13→ | | | | OE253 | | |
| 2.0 | 4 | PEY7 | 110/148 | 11/13→ | | | | OE253 | | |
| 2.0 | 4 | PEX2; PEY7 | 121/162 | 09/13→ | | | | OE253 | | |

5 (CR19)

| | | | | | | | | | | |
|-----|---|------|--------|-------------|--|--|--------|-------|--|--|
| 1.8 | 4 | L823 | 85/114 | 02/05→05/10 | | | CET18P | OE183 | | |
|-----|---|------|--------|-------------|--|--|--------|-------|--|--|

MAZDA



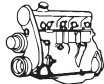

kW/BHP



eon TITAN

IRIDIUM

**...MAZDA****...5 (CR19)**

2.0 4 LFF7 107/143 02/05→05/10

CET17P

OE183

CET18P

OE189

5 (CW)

1.8 MZR 4 L850 85/114 09/10→

CET18P

OE183

2.0 4 LF-ZB 110/148 09/10→

CET17P

OE189

6 Hatchback (GG)

3.0 6 AJ 162/217 01/04→12/07 OE131 1,0

CET18P

OE183

3.0 6 AJ 164/220 01/05→12/07 OE131 1,0

CET18P

OE183

6 Hatchback/Saloon (GG)

1.8 4 L813; L823; L828 88/118 08/02→08/07

CET18P

OE183

BAEA556

CLS075

2.0 4 LF17; LF18 104/139 06/02→08/07

CET18P

OE183

BAEA556

CLS075

2.0 4 LFF7 108/145 03/05→08/07

CET17P

OE183

CLS075

CET18P

OE189

2.3 4 L3C1 122/164 06/02→08/07

CET18P

OE183

BAEA422

CLS075

→02/05

BAEA556^[275]

03/05→

6 Saloon (GG)

2.3 MPS Turbo 4WD 4 L3KG 191/256 12/05→08/07

CET17P

6 Estate (GH)

1.8 MZR 4 L813 88/118 02/08→07/13

CET18P

OE183

6 Estate/Hatchback (GH)

2.0 MZR 4 LF17 108/145 08/07→07/13 OE031 1,0

→12/12

CET17P

OE189

2.0 MZR 4 LF-DE 114/153 01/10→07/13 OE031 1,0

→12/12

CET17P

OE189

6 Estate/Hatchback/Saloon (GH)

2.0 MZR 4 LF-DE 114/153 01/10→12/12

CET17P

OE189

2.5 MZR 4 L5-VE 125/168 08/07→07/13

CET17P

OE189

6 Hatchback/Saloon (GH)

1.8 MZR 4 L813 88/118 08/07→07/13

CET18P

OE183

BAEA556

6 Saloon (GH)

2.0 MZR 4 LF17 108/145 08/07→12/12 OE031 1,0

CET17P

OE189

6 Estate/Saloon (GJ, GL)

2.0 4 PEXB; PEXL; PEY5; PEY7 107/143 01/13→

OE253

2.0 4 PEXB; PEXL; PEY5; PEY7 121/162 01/13→

OE253

2.5 4 PYY1; PY-Y8; PY-ZA 141/189 12/12→

OE253

6 Station Wagon (GY)

1.8 4 L813 88/118 08/02→08/07

CET18P

OE183

BAEA556

CLS075

2.0 4 LF17; LF18 104/139 08/02→08/07

CET18P

OE183

BAEA556

CLS075

2.0 4 LFF7 108/145 03/05→08/07

CET17P

OE183

CLS075

CET18P

OE189

2.3 4 L3C1 122/164 01/02→02/08

CET18P

OE183

BAEA422

CLS075

→02/05

BAEA556^[275]

03/05→

2.3 4WD 4 L3C1 119/160 11/02→08/07

CET18P

OE183

BAEA556

→02/05

121 II (DB)

1.5 i 4 B5C4 62/83 01/94→05/97 OE063 1,0

CET2

OE180

121 III (JASM, JBSM)

1.3 4 JJK; JJM 37/50 03/96→04/03 OE131 1,0

CET18P

OE183

BAEA350

CLS033^[275]CLS066^[275]

MAZDA





kW/BHP

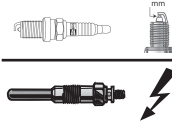

eon TITAN

IRIDIUM

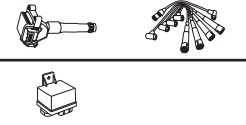
**...MAZDA****...121 III (JASM, JBSM)**

| | | | | | | | | | | |
|-----|---|----------|-------|-------------|-------|-----|--------|-------|---------|--|
| 1.3 | 4 | J4R; J4T | 44/59 | 03/96→04/03 | OE039 | 1,0 | CET2 | OE180 | BAEA350 | CLS033 [275] CLS066 [275] |
| 1.3 | 4 | DHF; DHG | 55/74 | 03/96→04/03 | OE029 | 1,0 | CET17P | OE189 | BAEA350 | CLS032 →04/98 CLS016 [275] 05/98→ |

| | | | | | | | | | | |
|-------|---|----------|-------|-------------|-------|-----|--|--|--|--|
| 1.8 D | 4 | RTJ; RTK | 44/59 | 03/96→04/03 | CH205 | 10v | | | | |
|-------|---|----------|-------|-------------|-------|-----|--|--|--|--|

323 C IV (BG)

| | | | | | | | | | | |
|-------------------|---|---------|---------|-------------|-------|-----|------|-------|--|--|
| 1.6 | 4 | B67K | 66/89 | 09/93→09/00 | OE005 | 0,9 | CET2 | OE179 | | |
| 1.8 16V Turbo 4WD | 4 | BPTurbo | 136/182 | 01/93→07/94 | OE005 | 0,9 | CET2 | OE180 | | |

323 C V (BA)

| | | | | | | | | | | |
|---------|---|---------|--------|-------------|-------|-----|--------|-------|---------------|--------|
| 1.3 16V | 4 | B3(16V) | 54/72 | 08/94→09/98 | OE039 | 1,0 | CET2 | OE180 | BAEA560 [275] | CLS131 |
| 1.5 16V | 4 | Z5-DE | 65/87 | 08/94→09/98 | OE039 | 1,0 | CET2 | OE180 | | CLS031 |
| 1.8 16V | 4 | BP-ZE | 84/113 | 08/94→09/98 | | | CET12P | OE179 | | |

323 F V (BA)

| | | | | | | | | | | |
|---------|---|-------|---------|-------------|-------|-----|--------|-------|--|--------|
| 1.5 16V | 4 | Z5-DE | 65/87 | 07/94→09/98 | OE063 | 1,0 | CET2 | OE180 | | CLS031 |
| 1.8 16V | 4 | BP-ZE | 84/113 | 08/94→09/98 | OE039 | 1,0 | CET2 | OE179 | | |
| 2.0 24V | 6 | KF | 106/142 | 08/94→09/98 | | | CET12P | OE179 | | |

323 F VI (BJ)

| | | | | | | | | | | |
|------------|---|------------|--------|-------------|-----------------|-----|------|-------|----------|--------|
| 1.4 | 4 | B3(16V) | 53/71 | 01/01→05/04 | OE063 | 1,0 | CET2 | OE180 | BAEA560 | |
| 1.4 16V | 4 | B3ME | 54/72 | 09/98→01/01 | OE063 | 1,0 | CET2 | OE180 | | |
| 1.5 16V | 4 | ZL05 | 65/87 | 09/98→01/01 | OE005 | 0,9 | CET2 | OE180 | BAEA190E | CLS183 |
| 1.5 16V | 4 | ZL06 | 65/87 | 09/98→01/01 | OE005 | 0,9 | CET2 | OE180 | BAEA190E | CLS257 |
| 1.6 | 4 | ZM | 70/94 | 01/01→05/04 | OE089 | 1,0 | CET2 | OE184 | BAEA190E | CLS257 |
| | | | | | OE216 LPG [278] | 0,8 | | | | |
| 1.6 | 4 | ZM | 72/97 | 01/01→05/04 | OE089 | 1,0 | CET2 | OE184 | BAEA190E | CLS257 |
| | | | | | OE216 LPG [278] | 0,8 | | | | |
| 1.8 Astina | 4 | BP(DOHC) | 92/123 | 09/98→05/04 | | | | | BAEA083E | CLS198 |
| | | | | | | | | | 10/00→ | 10/00→ |
| 1.9 16V | 4 | FP; FP55 | 84/113 | 09/98→01/01 | OE063 | 1,0 | CET2 | OE180 | BAEA083E | CLS198 |
| | | | | | | | | | 10/00→ | 10/00→ |
| 2.0 | 4 | FS7E; FS7G | 96/129 | 01/01→05/04 | OE089 | 1,0 | CET2 | OE184 | BAEA083E | CLS198 |

323 P V (BA)

| | | | | | | | | | | |
|---------|---|---------|-------|-------------|-------|-----|------|-------|---------------|--------|
| 1.3 16V | 4 | B3(16V) | 54/72 | 10/96→09/98 | OE005 | 0,9 | CET2 | OE180 | BAEA560 [275] | CLS131 |
| 1.5 16V | 4 | Z5-DE | 65/87 | 10/96→09/98 | OE063 | 1,0 | CET2 | OE180 | | CLS031 |

323 S V (BA)

| | | | | | | | | | | |
|---------|---|---------|--------|-------------|-------------|-----|--------|-------|---------------|--------|
| 1.3 16V | 4 | B3(16V) | 54/72 | 08/94→09/98 | OE039 | 1,0 | CET2 | OE180 | BAEA560 [275] | CLS131 |
| 1.5 16V | 4 | Z5-DE | 65/87 | 08/94→09/98 | OE063 | 1,0 | CET2 | OE180 | | CLS031 |
| 1.6 TD | 4 | 4EE1-T | 60/80 | 05/94→09/98 | CH242 [186] | 11v | | | | |
| 1.8 16V | 4 | BP-ZE | 84/113 | 08/94→09/98 | | | CET12P | OE179 | | |
| 2.0 D | 4 | RF1G | 52/70 | 10/96→09/98 | CH242 [186] | 11v | | | | |

323 S VI (BJ)

| | | | | | | | | | | |
|-------------|---|----------------|--------|-------------|-----------------|-----|------|-------|----------|--------|
| 1.4 | 4 | B3(16V) | 53/71 | 01/01→05/04 | OE039 | 1,0 | CET2 | OE180 | | |
| 1.4 16V | 4 | B3ME | 54/72 | 09/98→01/01 | OE063 | 1,0 | CET2 | OE180 | | |
| 1.5 | 4 | | 80/107 | 05/98→05/04 | OE063 | 1,0 | CET2 | OE180 | | |
| 1.5 16V | 4 | ZL05 | 65/87 | 09/98→01/01 | OE063 | 1,0 | CET2 | OE180 | BAEA190E | CLS183 |
| 1.5 16V | 4 | ZL06 | 65/87 | 09/98→01/01 | OE063 | 1,0 | CET2 | OE180 | BAEA190E | CLS257 |
| 1.6 | 4 | ZM | 70/94 | 01/01→05/04 | OE089 | 1,0 | CET2 | OE184 | BAEA190E | CLS257 |
| | | | | | OE216 LPG [278] | 0,8 | | | | |
| 1.6 | 4 | ZM | 72/97 | 01/01→05/04 | OE089 | 1,0 | CET2 | OE184 | BAEA190E | CLS257 |
| | | | | | OE216 LPG [278] | 0,8 | | | | |
| 1.8 Protege | 4 | BP(DOHC); FP55 | 92/123 | 05/98→05/04 | | | | | BAEA083E | CLS198 |
| | | | | | | | | | 10/00→ | 10/00→ |

MAZDA



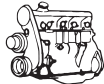

kW/BHP

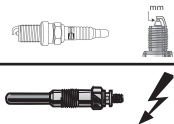

eon TITAN

IRIDIUM

**...MAZDA****...323 S VI (BJ)**

| | | | | | | | | | | |
|---------|---|------------|--------|-------------|-------|-----|------|-------|--------------------|------------------|
| 1.9 16V | 4 | FP; FP55 | 84/113 | 09/98→05/04 | OE063 | 1,0 | CET2 | OE180 | BAEA083E 10/00→ | CLS198 10/00→ |
| 2.0 | 4 | FS7E; FS7G | 96/129 | 01/01→05/04 | OE005 | 0,9 | CET2 | OE179 | BAEA083E | CLS198 |

626 III Station Wagon (GV)

| | | | | | | | | | | |
|---------------|---|-------|-------|-------------|-------|-----|--|--|--|--|
| 2.0 D | 4 | RF65 | 60/80 | 11/94→09/97 | CH242 | 11v | | | | |
| 2.0 D Complex | 4 | RF-CX | 55/74 | 05/93→11/96 | CH242 | 11v | | | | |

626 IV (GE)

| | | | | | | | | | | |
|-------|---|------|--------|-------------|-------|-----|------|--|--|--|
| 1.8 i | 4 | FP | 78/105 | 05/94→06/97 | OE005 | 0,9 | CET2 | | | |
| 2.0 D | 4 | RF55 | 56/75 | 05/94→06/97 | CH242 | 11v | | | | |

626 IV /Hatchback (GE)

| | | | | | | | | | | |
|------------|---|----------|-------|-------------|-------|-----|------|-------|--|--------|
| 1.8, 1.8 i | 4 | ; FP01LP | 66/89 | 08/94→04/97 | OE005 | 0,9 | CET2 | OE180 | | CLS229 |
|------------|---|----------|-------|-------------|-------|-----|------|-------|--|--------|

626 IV Hatchback (GE)

| | | | | | | | | | | |
|-------------------|---|------|---------|-------------|--------------------------|------------|------|-------|--|--|
| 2.0 D GLX Complex | 4 | RF55 | 55/74 | 01/93→04/97 | CH242 →12/95 | 11v | | | | |
| 2.5 24V | 6 | KL | 120/161 | 08/94→04/97 | OE089 OE216 LPG [278] | 1,0 0,8 | CET2 | OE184 | | |

626 V (GF)

| | | | | | | | | | | |
|-----|---|------|---------|-------------|-------|-----|------|-------|---------|--------|
| 2.0 | 4 | FS | 85/114 | 05/97→10/02 | OE005 | 0,9 | CET2 | OE180 | | CLS239 |
| 2.0 | 4 | FS2C | 100/134 | 04/98→10/02 | OE005 | 0,9 | CET2 | OE180 | BAEA281 | |

626 V /Hatchback (GF)

| | | | | | | | | | | |
|-----|---|----------|-------|-------------|-------|-----|------|-------|---------------|--------|
| 1.8 | 4 | FPY3 | 66/89 | 05/97→12/99 | OE039 | 1,0 | CET2 | OE180 | BAEA281 [275] | CLS239 |
| 1.8 | 4 | FP; FP9A | 74/99 | 12/99→10/02 | OE005 | 0,9 | CET2 | OE180 | BAEA281 [275] | CLS239 |

626 V Hatchback (GF)

| | | | | | | | | | | |
|----------|---|------|---------|-------------|-------|-----|------|-------|---------|--------|
| 2.0 | 4 | FS | 85/114 | 05/97→10/02 | OE005 | 0,9 | CET2 | OE180 | BAEA281 | CLS239 |
| 2.0 H.P. | 4 | FS2C | 100/134 | 02/98→10/02 | OE005 | 0,9 | CET2 | OE180 | BAEA354 | CLS239 |

626 V Station Wagon (GW)

| | | | | | | | | | | |
|----------|---|------|---------|-------------|-------|-----|------|-------|---------------|--------|
| 1.8 | 4 | FPY3 | 66/89 | 02/98→01/00 | OE039 | 1,0 | CET2 | OE180 | BAEA281 [275] | CLS239 |
| 1.8 | 4 | FP9A | 74/99 | 01/00→10/02 | OE005 | 0,9 | CET2 | OE180 | BAEA281 [275] | CLS239 |
| 2.0 | 4 | FS | 85/114 | 02/98→10/02 | OE005 | 0,9 | CET2 | OE180 | BAEA281 | CLS239 |
| 2.0 H.P. | 4 | FS2C | 100/134 | 02/98→10/02 | OE005 | 0,9 | CET2 | OE180 | BAEA281 [275] | |

B-SERIE (UF)

| | | | | | | | | | | |
|---------|---|--|-------|-------------|-------|-----|------|--|--|--|
| 2.2 12V | 4 | | 68/91 | 04/96→01/99 | OE039 | 1,0 | CET2 | | | |
|---------|---|--|-------|-------------|-------|-----|------|--|--|--|

B-SERIE /Platform/Chassis (UF)

| | | | | | | | | | | |
|-------------------|---|------|-------|-------------|-------|-----|--|--|--|--|
| 2.5 D, 2.5 D 4WD | 4 | | 63/84 | 02/96→06/99 | CH242 | 11v | | | | |
| 2.5 D 4WD, 2.5 TD | 4 | WL-T | 64/86 | 04/96→02/99 | CH242 | 11v | | | | |

B-SERIE (UN)

| | | | | | | | | | | |
|-------------|---|------|--------|-------------|--------------------------|------------|------|-------|--|--|
| 2.2 | 4 | F2R4 | 68/91 | 11/99→08/02 | OE039 | 1,0 | CET2 | | | |
| 2.2 4WD | 4 | R5A2 | 60/80 | 02/99→11/06 | OE039 | 1,0 | CET2 | | | |
| 2.2 8V 4WD | 4 | JL22 | 68/91 | 06/99→11/06 | OE051 | 0,9 | CET8 | | | |
| 2.6 12V 4WD | 4 | JK26 | 90/121 | 06/99→11/06 | | | CET2 | OE188 | | |
| 2.6 12V 4WD | 4 | G6 | 90/121 | 06/99→11/06 | OE089 OE216 LPG [278] | 1,0 0,8 | | | | |

B-SERIE /Platform/Chassis (UN)

| | | | | | | | | | | |
|-------------------|---|------------|--------|-------------|-------|-----|--|--|--|--|
| 2.5 D, 2.5 D 4WD | 4 | MD25NA | 57/76 | 06/99→11/06 | CH242 | 11v | | | | |
| 2.5 D, 2.5 D 4WD | 4 | WLE7 | 61/82 | 11/99→12/01 | CH242 | 11v | | | | |
| 2.5 D, 2.5 D 4WD | 4 | WLE7 | 62/83 | 12/02→11/06 | CH242 | 11v | | | | |
| 2.5 D 4WD | 4 | WLE9 | 65/87 | 11/99→07/02 | CH242 | 11v | | | | |
| 2.5 D 4WD, 2.5 TD | 4 | WLF5; WL-T | 86/115 | 02/99→03/05 | CH242 | 11v | | | | |
| 2.5 TD 4WD | 4 | MD25TI | 80/107 | 06/99→07/06 | CH242 | 11v | | | | |

CX-3 (DK)

| | | | | | | | | | | |
|-----|---|------------|--------|--------|--|--|--|-------|--|--|
| 2.0 | 4 | PEX3; PEXB | 88/118 | 05/15→ | | | | OE253 | | |
|-----|---|------------|--------|--------|--|--|--|-------|--|--|

MAZDA





kW/BHP

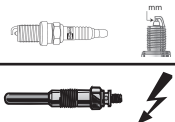

eon TITAN

IRIDIUM

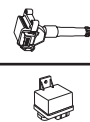
**...MAZDA****...CX-3 (DK)**

2.0 4WD 4 PEX3; PEXB 110/148 05/15→ OE253

CX-5 (KE, GH)

2.0 4 PEY4; PEY5 114/153 07/12→12/18 OE253

2.0 4 PEY6; PEY7 121/162 11/11→02/17 OE253

02/12→ Ch.KE9132624→

2.0 4WD 4 PEY6; PEY7 118/158 11/11→02/17 OE253

08/12→ Ch.KE132624→

2.5 4WD 4 PYY1 141/189 02/15→02/17 OE253

CX-7 (ER)

2.3 MZR DISI Turbo 4WD 4 L3-VDT 175/235 06/06→12/14 CET17P

2.3 MZR DISI Turbo 4WD 4 L3-VDT 190/255 10/07→08/09 CET17P

2.3 MZR DISI Turbo 4WD 4 L3-VDT 191/256 06/09→03/13 CET17P

2.5 MZR 4 L5-VE 120/161 07/09→03/13 CET17P OE189

CX-9 (TB)

3.5, 3.5 4WD 6 CYC4 193/259 09/06→ CET17P OE189

3.7, 3.7 4WD 6 CA; CAY1; CAY5; CAY6 204/274 01/07→ CET17P

DEMIO (DW)

1.3 16V 4 B3ME 46/62 08/98→07/03 OE063 1,0 CET2 OE180 CLS168

1.3 i 16V 4 B3(16V) 53/71 08/98→04/00 OE063 1,0 CET2 OE180 CLS168

1.5 16V 4 B5E 55/74 04/00→07/03 OE063 1,0 CET2 OE180

E-SERIE MPV (SG)

2.0 i 4 FE(12V) 74/99 06/95→10/01 OE063 1,0 CET2

2.5 i 4 96/129 08/99→10/01 OE063 1,0 CET2

2.5 TD, 2.5 TD 4WD 4 WL-T 92/123 06/95→10/01 CH242 11v

MPV I (LV)

2.5 TD 4 WL-T 85/114 05/96→09/99 CH242 11v

3.0 i V6 6 JE94 113/152 03/95→09/99 OE089 1,0 CET2 OE184

OE216 LPG [278] 0,8

MPV II (LW)

2.0 4 FS 88/118 08/00→07/02 OE089 1,0 CET2 OE184 BAEA281 [275]

2.0 4 FS-DS 90/121 09/99→08/00 OE089 1,0 CET2 OE184 CLS198

OE216 LPG [278] 0,8

2.3 4 L3 104/139 07/02→02/06 CET18P OE183 BAEA556

MPV III (LY)

2.3, 2.3 4WD 4 L3-VE 120/161 02/06→ CET18P OE183

MX-3 (EC)

1.6 i 4 B6D 79/106 01/94→10/97 CET12P OE179 CLS031 [275]

1.8 i V6 6 K838 95/127 01/94→10/97 OE063 1,0 CET2 OE180

MX-5 I (NA)

1.6 4 8AN1 66/89 01/95→04/98 OE039 1,0 CET2 OE180 CLS056 [275]

1.8 4 BP(DOHC) 96/129 01/93→04/98 CET2 OE179 BAEA195E CLS056 [275]

1.8 4 BPF1 96/129 01/93→04/98 OE039 1,0 CET2 OE179 BAEA195E CLS056 [275]

MX-5 II (NB)

1.6 16V 4 B6D 81/109 05/98→10/05 OE063 1,0 CET2 OE180 CLS056

1.8 4 BPD 103/138 01/98→07/02 OE039 1,0 CET2 OE179 BAEA084E [277] CLS056

08/00→

→07/00

CLS159

08/00→

1.8 4 BP6J 107/143 08/02→10/05 OE063 1,0 CET2 BAEA084E [277] CLS159

1.8 16V 4 BPD 102/137 11/00→10/05 OE063 1,0 CET2 OE180 BAEA084E [277] CLS159

MAZDA



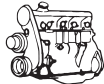

kW/BHP



eon TITAN

IRIDIUM

**...MAZDA****...MX-5 II (NB)**

| | | | | | | | | | | |
|-------------|---|------------|---------|-------------|--------------|-----|---------------|--------------|--|---|
| 1.8 16V | 4 | BP-ZE | 103/138 | 05/98→10/05 | OE063 | 1,0 | CET2 | OE180 | BAEA084E ^[277] 08/00→ | CLS056 →07/00 CLS159 ^[275] 08/00→ |
| 1.8 16V | 4 | BPD; BP-ZE | 107/143 | 11/00→10/05 | OE063 | 1,0 | CET2 | OE180 | BAEA084E ^[277] | CLS159 |
| 1.8 i Turbo | 4 | BPTurbo | 136/182 | 04/02→10/05 | | | CET12P | OE180 | BAEA084E ^[277] | CLS159 |

MX-5 III (NC)

| | | | | | | | | | | |
|-----|---|------------------------------|---------|-------------|--|--|---------------|--------------|-----------------|--|
| 1.8 | 4 | L8-DE; L828 | 93/125 | 03/05→12/14 | | | CET18P | OE183 | BAEA195E | |
| 2.0 | 4 | LFG7; LFG8; LFY7; LFYK; LFZ8 | 118/158 | 07/05→12/14 | | | CET17P | OE189 | | |

MX-5 IV (ND)

| | | | | | | | | | | |
|-----|---|--------|--------|--------|--|--|--|--------------|--|--|
| 1.5 | 4 | P5-VPR | 96/129 | 06/15→ | | | | OE253 | | |
|-----|---|--------|--------|--------|--|--|--|--------------|--|--|

MX-6 (GE)

| | | | | | | | | | | |
|-----------|---|----|---------|-------------|---|------------|-------------|--------------|--|--|
| 2.5 i 24V | 6 | KL | 120/161 | 08/94→02/97 | OE089 OE216 LPG ^[278] | 1,0 0,8 | CET2 | OE184 | | |
|-----------|---|----|---------|-------------|---|------------|-------------|--------------|--|--|

PREMACY (CP)

| | | | | | | | | | | |
|-----|---|------------|---------|-------------|---|--------------------------|--------------------------------|------------------------------|-----------------|---------------|
| 1.9 | 4 | FP | 74/99 | 07/99→03/05 | OE039 Ch.100001→ Ch.151176 OE063 Ch.100001→ Ch.151176 OE089 Ch.151177→ OE216 LPG ^[278] Ch.151177→ | 1,0 1,0 1,0 0,8 | CET2 | OE180 | BAEA083E | CLS198 |
| 1.9 | 4 | FP | 84/113 | 07/99→03/05 | OE039 Ch.100001→ Ch.151176 OE063 Ch.10001→ Ch.151176 OE089 Ch.151177→ OE216 LPG ^[278] Ch.151177→ | 1,0 1,0 1,0 0,8 | CET2 | OE180 | BAEA083E | CLS198 |
| 2.0 | 4 | FS7E; FS7G | 96/129 | 11/01→03/05 | OE039 Ch.300001→ | 1,0 | CET2 | OE180 | BAEA083E | CLS198 |
| 2.0 | 4 | LFF7 | 107/143 | 02/05→03/05 | | | CET17P CET18P | OE183 OE189 | | |

TRIBUTE (EP)

| | | | | | | | | | | |
|----------------|---|-------|---------|-------------|--------------|-----|---------------|--------------|---------------------------------|--------------------------------|
| 2.0 | 4 | YF | 91/122 | 03/00→05/08 | OE029 | 1,0 | CET17P | OE189 | BAEA350 →12/05 | CLS016 ^[275] |
| 2.0 4WD | 4 | YF | 91/122 | 03/00→05/08 | OE029 | 1,0 | CET17P | OE189 | BAEA350 →12/03 | CLS016 ^[275] |
| 2.3 4WD | 4 | L3-VE | 110/148 | 04/04→05/08 | | | CET18P | OE183 | BAEA408 | |
| 3.0 V6 4WD | 6 | AJ | 149/200 | 04/04→05/08 | | | CET18P | OE183 | BAEA410 ^[277] | |
| 3.0 V6 24V 4WD | 6 | AJ | 145/194 | 03/00→05/08 | | | CET18P | OE183 | BAEA410 ^[277] | |

XEDOS 6 (CA)

| | | | | | | | | | | |
|---------|---|----------|---------|-------------|--------------|-----|---------------|--------------|--|--|
| 1.6 16V | 4 | B6(DOHC) | 79/106 | 06/94→10/99 | OE063 | 1,0 | CET2 | OE180 | | |
| 2.0 V6 | 6 | KF1 | 103/138 | 06/94→10/99 | | | CET12P | OE179 | | |

XEDOS 9 (TA)

| | | | | | | | | | | |
|---------|---|--------|---------|-------------|---|------------|---------------|--------------|--|--|
| 2.0 24V | 6 | KF | 105/141 | 08/93→01/00 | | | CET12P | OE179 | | |
| 2.3 24V | 6 | KJ-ZEM | 155/208 | 02/95→01/00 | OE089 | 1,0 | CET2 | OE184 | | |
| 2.5 24V | 6 | KL | 123/165 | 07/93→07/00 | OE089 OE216 LPG ^[278] | 1,0 0,8 | CET2 | OE184 | | |
| 2.5 V6 | 6 | KL | 120/161 | 07/00→09/02 | OE005 | 0,9 | CET2 | OE180 | | |

MAZDA



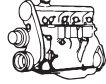

kW/BHP

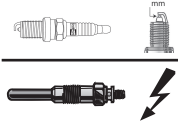

eon TITAN

IRIDIUM

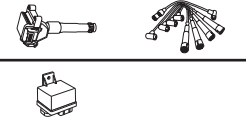

MAZDA

B-SERIE /Platform/Chassis (UN)

2.5 TD 4 WL-T 86/115 02/99→03/05 CH242 11v

E-SERIE Platform/Chassis (SD1)

2.2 E2200 D 4 R2 52/70 04/97→07/99 CH242 11v

E-SERIE Box (SR2)

2.0 E2000 4 FE(8V) 70/94 06/94→05/03 OE039 1,0 CET2 OE180

2.2 E2200 D, 2.2 E2200 D 4WD 4 R2 52/70 02/97→05/03 CH242 11v

2.5 E2500 D 4 WLE2 61/82 08/97→05/03 CH242 11v

2.5 E2500 TD 4 84/113 09/99→07/04 CH242 11v

MEGA

CLUB II

1.4 i 4 TU3FMC2 55/74 06/99→ OE034 0,9 CET2

MONTE CARLO

6.0 V12 12 290/389 01/98→ OE057 0,9 CET2

MERCEDES-BENZ

A-CLASS (W168)

1.4 A 140 4 M166.940 60/80 07/97→08/04 OE032 1,0 CET2 OE179 BAEA146E

1.6 A 140 4 M166.960 60/80 01/01→08/04 BAEA146E

1.6 A 160 4 M166.960 75/101 07/97→08/04 OE032 1,0 CET2 OE179 BAEA146E

1.7 A 160 CDI 4 OM668.941 44/59 07/98→02/01 CH219 11v CCU140

1.7 A 160 CDI 4 OM668.940 55/74 02/01→08/04 CH219 11v CCU140

1.7 A 170 CDI 4 OM668.940 66/89 07/98→02/01 CH219 11v CCU140

1.7 A 170 CDI 4 OM668.942 70/94 02/01→08/04 CH219 11v CCU140

1.9 A 190 4 M166.990 92/123 03/99→08/04 BAEA146E

1.9 A 190 Twin Engine 4 184/247 04/99→02/01 OE120 0,6 CET2

2.1 A 210 4 M166.995 103/138 12/01→08/04 BAEA146E

A-CLASS (W169)

1.5 A 150, 1.5 A 160 4 M266.920 70/94 09/04→06/12 CET12P OE180 BAEA297 CLS078

1.7 A 170, 1.7 A 180 4 M266.940 85/114 09/04→06/12 CET12P OE180 BAEA297 CLS078

2.0 A 160 CDI 4 OM640.942 60/80 09/04→06/12 CCU156 [21] [271]

2.0 A 180 CDI 4 OM640.940 80/107 09/04→06/12 CCU156 [21] [271]

2.0 A 200 4 M266.960 100/134 09/04→06/12 CET12P OE180 BAEA297 CLS078

2.0 A 200 CDI 4 OM640.941 100/134 09/04→06/12 CCU156 [21] [271]

2.0 A 200 CDI 4 OM640.941 103/138 09/04→06/12 CCU156 [21] [271]

2.0 A 200 TURBO 4 M266.980 142/190 09/05→06/12 CET12P OE181 BAEA297

2.0 A 200 TURBO 4 M266.980 142/190 09/05→06/12 CET12P OE181 BAEA297

2.0 A 200 TURBO 4 M266.980 142/190 09/05→06/12 CET12P OE181 BAEA297

B-CLASS (W245)

1.5 B 150, 1.5 B 160 4 M266.920 70/94 03/05→11/11 CET12P OE180 BAEA297 CLS078

1.7 B 170, 1.7 B 180 4 M266.940 85/114 03/05→11/11 CET12P OE180 BAEA297 CLS078

2.0 B 170 NGT 4 M266.960 85/114 04/08→11/11 OE005 0,9 CET2 OE179 BAEA297 [174]

2.0 B 180 CDI 4 OM640.940 80/107 03/05→11/11 CCU156 [21] [271]

2.0 B 180 NGT 4 M266.960 85/114 04/08→11/11 OE005 0,9 CET2 OE179 BAEA297

2.0 B 200 4 M266.960 100/134 03/05→11/11 CET12P OE180 BAEA297 CLS078

2.0 B 200 CDI 4 OM640.941 100/134 03/05→11/11 CCU156 [21] [271]

2.0 B 200 CDI 4 OM640.941 103/138 03/05→11/11 CCU156 [21] [271]

2.0 B 200 TURBO 4 M266.980 142/190 03/05→11/11 CET12P OE181 BAEA297

2.0 B 200 TURBO 4 M266.980 142/190 03/05→11/11 CET12P OE181 BAEA297

2.0 B 200 TURBO 4 M266.980 142/190 03/05→11/11 CET12P OE181 BAEA297

C-CLASS Coupe (C204)

1.8 C 180 4 M271.820 115/154 06/11→ OE229 0,8 CET15P BAEA077

MERCEDDES-BENZ





kW/BHP

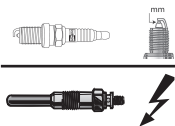

eon TITAN

IRIDIUM



...MERCEDES-BENZ

...C-CLASS Coupe (C204)

| | | | | | | | | | |
|--------------------------|---|----------|---------|--------|-------|-----|---------|--|----------|
| 1.8 C 200 CGI | 4 | M271.860 | 135/181 | 06/11→ | OE229 | 0,8 | CET1 5P | | |
| 1.8 C 250 | 4 | M271.860 | 150/201 | 06/11→ | OE229 | 0,8 | CET1 5P | | BAEA077 |
| 3.5 C 350, 3.5 C 350 4WD | 6 | M276.957 | 225/302 | 06/11→ | | | | | BAEA093E |
| 6.2 C 63 AMG | 8 | M156.985 | 336/451 | 06/11→ | OE233 | 1,0 | | | |
| 6.2 C 63 AMG | 8 | M156.985 | 358/480 | 01/12→ | OE233 | 1,0 | | | |
| 6.2 C 63 AMG | 8 | M156.985 | 373/500 | 11/12→ | OE233 | 1,0 | | | |
| 6.2 C 63 AMG | 8 | M156.985 | 380/510 | 01/12→ | OE233 | 1,0 | | | |

C-CLASS Coupe (CL203)

| | | | | | | | | | |
|---------------------------------|---|-----------|---------|-------------|--|-----|--|-------|--|
| 1.8 C 160 Kompressor | 4 | M271.921 | 90/121 | 05/02→05/08 | OE224 →11/06 →Eng.30853899 | 0,8 | CET1 4P | | BAEA053 →11/06 →Eng.30853899 |
| | | | | | OE229 12/06→ Eng.30853900→ | 0,8 | CET1 5P | | BAEA077 11/06→ Eng.30853900→ BAEA077 08/07→ Eng.30099999→ |
| 1.8 C 180 Kompressor | 4 | M271.946 | 105/141 | 05/02→05/08 | OE229 [232] | 0,8 | CET1 5P [232] | | BAEA053 →Eng.30853899 →Prod.30.11.2006 |
| | | | | | OE224 →Eng.30853899 →Prod.30.11.2006 | 0,8 | CET1 4P →Eng.30853899 →Prod.30.11.2006 | | BAEA077 Eng.30853900→ Prod.30.11.2006→ |
| | | | | | OE229 Eng.30853900→ Prod.30.11.2006→ | 0,8 | CET1 5P Eng.30853900→ Prod.30.11.2006→ | | |
| 1.8 C 200 CGI Kompressor | 4 | M271.942 | 125/168 | 03/03→05/08 | OE229 [232] | 0,8 | CET1 5P [232] | | BAEA053 →Eng.30853899 →Prod.30.11.2006 |
| | | | | | OE224 →Eng.30853899 →Prod.30.11.2006 | 0,8 | CET1 4P →Eng.30853899 →Prod.30.11.2006 | | BAEA077 Eng.30853900→ Prod.30.11.2006→ |
| | | | | | OE229 Eng.30853900→ Prod.30.11.2006→ | 0,8 | CET1 5P Eng.30853900→ Prod.30.11.2006→ | | |
| 1.8 C 200 Kompressor, 1.8 C 220 | 4 | M271.940 | 120/161 | 05/02→05/08 | OE229 [232] | 0,8 | CET1 5P [232] | | BAEA053 →Eng.30853899 →Prod.30.11.2006 |
| | | | | | OE224 →Eng.30853899 →Prod.30.11.2006 | 0,8 | CET1 4P →Eng.30853899 →Prod.30.11.2006 | | BAEA077 Eng.30853900→ Prod.30.11.2006→ |
| | | | | | OE229 Eng.30853900→ Prod.30.11.2006→ | 0,8 | CET1 5P Eng.30853900→ Prod.30.11.2006→ | | |
| 1.8 C 230 Kompressor | 4 | M271.948 | 141/189 | 05/02→05/08 | OE229 [232] | 0,8 | CET1 5P [232] | | BAEA053 →Eng.30853899 →Prod.30.11.2006 |
| | | | | | OE224 →Eng.30853899 →Prod.30.11.2006 | 0,8 | CET1 4P →Eng.30853899 →Prod.30.11.2006 | | BAEA077 Eng.30853900→ Prod.30.11.2006→ |
| | | | | | OE229 Eng.30853900→ Prod.30.11.2006→ | 0,8 | CET1 5P Eng.30853900→ Prod.30.11.2006→ | | |
| 2.0 C 180 | 4 | M111.951 | 95/127 | 03/01→05/02 | | | CET1 2P | OE181 | BAEA041 |
| 2.0 C 200 Kompressor | 4 | M111.955 | 120/161 | 03/01→05/02 | OE146 | 1,0 | CET1 2P | OE181 | BAEA041 |
| 2.2 C 200 CDI | 4 | OM646.962 | 90/121 | 03/03→05/08 | | | | | CCU140 |
| 2.2 C 220 CDI | 4 | OM611.962 | 100/134 | 03/01→01/04 | | | | | CCU140 |
| 2.2 C 220 CDI | 4 | OM611.962 | 105/141 | 03/01→01/04 | | | | | CCU140 |
| 2.2 C 220 CDI | 4 | OM646.963 | 110/148 | 02/04→05/08 | | | | | CCU140 |
| 2.3 C 230 Kompressor | 4 | M111.981 | 145/194 | 03/01→05/02 | | | CET1 2P | OE181 | BAEA041 |
| 2.5 C 230 | 6 | M272.920 | 150/201 | 01/05→05/08 | OE229 | 0,8 | CET1 5P | | BAEA077 08/07→ Eng.30099999→ BAEA140E |

MERCEDES-BENZ





kW/BHP



eon TITAN

IRIDIUM

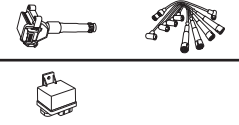

...MERCEDES-BENZ

...C-CLASS Coupe (CL203)

| | | | | | | | | | | |
|-------------------------|---|-----------|---------|-------------|-------------|-----|--------|-------|------------------------------------|--------|
| 3.0 C 30 CDI AMG | 5 | OM612.990 | 170/228 | 09/02→05/08 | CH704 [275] | 5v | | | CCU104 | |
| 3.2 C 32 AMG Kompressor | 6 | M112.961 | 260/349 | 05/02→05/08 | | | CET12P | OE180 | BAEA077 08/07→ Eng.30099999→ | |
| | | | | | | | | | BAEA297 | |
| 3.2 C 320 | 6 | M112.946 | 160/215 | 09/02→05/08 | OE191 | 1,0 | CET12P | OE180 | BAEA077 08/07→ Eng.30099999→ | CLS064 |
| | | | | | | | | | BAEA297 | |
| 3.5 C 350 | 6 | M272.960 | 200/268 | 01/05→05/08 | OE229 | 0,8 | CET15P | | BAEA077 08/07→ Eng.30099999→ | |
| | | | | | | | | | BAEA140E | |

C-CLASS T-Model (S202)

| | | | | | | | | | | |
|------------------------|---|-----------|---------|-------------|--|-------|--------|-----------------|-------------|---------------------------------------|
| 1.8 C 180 T | 4 | M111.920 | 90/121 | 06/96→09/00 | OE057 →06/97 | 0,9 | CET2 | OE180 →06/97 | BAEA313 | CLS106 [229] →Eng.045966 017110 |
| | | | | | OE032 07/97→ | 1,0 | | OE179 07/97→ | | CLS065 [230] Eng.045967 017111→ |
| 1.8 C 180 T | 4 | M111.921 | 90/121 | 06/96→09/00 | OE057 →06/97 | 0,9 | CET2 | OE180 →06/97 | BAEA340 | CLS138 [35] |
| | | | | | OE032 07/97→ | 1,0 | | OE179 07/97→ | | |
| 2.0 C 180 T | 4 | M111.952 | 95/127 | 09/00→03/01 | | | CET12P | OE181 | BAEA041 | |
| 2.0 C 200 T | 4 | M111.945 | 100/134 | 06/96→03/01 | OE057 →06/97 | 0,9 | CET2 | OE180 →06/97 | BAEA340[41] | CLS138 [35] |
| | | | | | OE032 07/97→ | 1,0 | | OE179 07/97→ | | |
| 2.0 C 200 T | 4 | M111.941 | 100/134 | 06/96→03/01 | OE057 →06/97 | 0,9 | CET2 | OE180 →06/97 | BAEA313 | CLS106 [229] →Eng.000765 000704 |
| | | | | | OE032 07/97→ | 1,0 | | OE179 07/97→ | | CLS065 [230] Eng.000766 000705→ |
| 2.0 C 200 T D | 4 | OM604.915 | 65/87 | 10/96→03/01 | CH177 [293] | 11.5v | | | CCU140 | |
| 2.0 C 200 T Kompressor | 4 | M111.956 | 120/161 | 09/00→03/01 | | | CET12P | OE181 | BAEA041 | |
| 2.0 C 200 T Kompressor | 4 | M111.944 | 141/189 | 11/96→03/01 | OE032 | 1,0 | CET2 | OE179 | BAEA340[41] | CLS138 [35] |
| 2.2 C 200 T CDI | 4 | OM611.960 | 75/101 | 03/98→03/01 | | | | | CCU140 | |
| 2.2 C 220 T CDI | 4 | OM611.960 | 92/123 | 09/97→03/01 | | | | | CCU140 | |
| 2.2 C 220 T D | 4 | OM604.910 | 55/74 | 06/96→03/01 | CH177 [293] | 11.5v | | | CCU140 | |
| 2.2 C 220 T D | 4 | OM604.910 | 70/94 | 06/96→09/98 | CH175 [175] [275] [297] CH177 [176] [275] [293] | 11.5v | | | CCU140 | |
| 2.3 C 230 T | 4 | M111.974 | 110/148 | 06/96→06/98 | OE057 | 0,9 | CET2 | OE180 | BAEA340[41] | CLS138 [35] |
| 2.3 C 230 T Kompressor | 4 | M111.975 | 142/190 | 06/97→09/00 | OE136 | 0,8 | CET12P | OE179 | BAEA340[41] | CLS138 [35] |
| 2.4 C 240 T | 6 | M112.910 | 125/168 | 06/97→09/00 | OE191 | 1,0 | CET12P | OE180 | BAEA297 | CLS064 |
| 2.5 C 250 T Turbo-D | 5 | OM605.960 | 110/148 | 06/96→03/01 | CH177 [293] | 11.5v | | | CCU141 | |
| 2.6 C 240 T | 6 | M112.915 | 125/168 | 09/00→03/01 | OE191 | 1,0 | CET12P | OE180 | BAEA297 | CLS064 |
| 2.8 C 280 T | 6 | M112.920 | 145/194 | 06/97→03/01 | OE191 | 1,0 | CET12P | OE180 | BAEA297 | CLS064 |
| 4.3 C 43 AMG | 8 | M113.944 | 225/302 | 08/97→03/01 | OE191 | 1,0 | CET12P | OE180 | BAEA297 | |

C-CLASS T-Model (S203)

| | | | | | | | | | | |
|----------------------|---|----------|---------|-------------|--|-----|---|--|--|--|
| 1.8 C 180 Kompressor | 4 | M271.946 | 105/141 | 05/02→08/07 | OE229 [232] | 0,8 | CET15P [232] | | BAEA053 →Eng.30853899 →Prod.30.11.2006 | |
| | | | | | OE224 →Eng.30853899 →Prod.30.11.2006 | 0,8 | CET14P →Eng.30853899 →Prod.30.11.2006 | | BAEA077 Eng.30853900→ Prod.30.11.2006→ | |
| | | | | | OE229 Eng.30853900→ Prod.30.11.2006→ | 0,8 | CET15P Eng.30853900→ Prod.30.11.2006→ | | | |

MERCEDES-BENZ



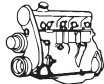

kW/BHP



eon TITAN

IRIDIUM

**...MERCEDES-BENZ****...C-CLASS T-Model (S203)**

| | | | | | | | | | |
|-------------------------------|---|----------------------|---------|-------------|---|-----|--|--------------|---|
| 1.8 C 200 CGI Kompressor | 4 | M271.942 | 125/168 | 07/03→08/07 | OE229 [232] | 0,8 | CET15P [232] | | BAEA053 →Eng.30853899 →Prod.30.11.2006 |
| | | | | | OE224 →Eng.30853899 →Prod.30.11.2006 | 0,8 | CET14P →Eng.30853899 →Prod.30.11.2006 | | BAEA077 Eng.30853900→ Prod.30.11.2006→ |
| | | | | | OE229 Eng.30853900→ Prod.30.11.2006→ | 0,8 | CET15P Eng.30853900→ Prod.30.11.2006→ | | |
| 1.8 C 200 Kompressor | 4 | M271.940 | 120/161 | 05/02→08/07 | OE229 [232] | 0,8 | CET15P [232] | | BAEA053 →Eng.30853899 →Prod.30.11.2006 |
| | | | | | OE224 →Eng.30853899 →Prod.30.11.2006 | 0,8 | CET14P →Eng.30853899 →Prod.30.11.2006 | | BAEA077 Eng.30853900→ Prod.30.11.2006→ |
| | | | | | OE229 Eng.30853900→ Prod.30.11.2006→ | 0,8 | CET15P Eng.30853900→ Prod.30.11.2006→ | | |
| 1.8 C 230 Kompressor | 4 | M271.948 | 141/189 | 02/04→08/07 | OE229 [232] | 0,8 | CET15P [232] | | BAEA053 →Eng.30853899 →Prod.30.11.2006 |
| | | | | | OE224 →Eng.30853899 →Prod.30.11.2006 | 0,8 | CET14P →Eng.30853899 →Prod.30.11.2006 | | BAEA077 Eng.30853900→ Prod.30.11.2006→ |
| | | | | | OE229 Eng.30853900→ Prod.30.11.2006→ | 0,8 | CET15P Eng.30853900→ Prod.30.11.2006→ | | |
| 2.0 C 180 | 4 | M111.951 | 95/127 | 03/01→05/02 | | | CET12P | OE181 | BAEA041 |
| 2.0 C 200 Kompressor | 4 | M111.955 | 120/161 | 03/01→05/02 | | | CET12P | OE181 | BAEA041 |
| 2.2 C 200 CDI | 4 | OM611.962; OM646.962 | 75/101 | 03/01→08/07 | | | | | CCU140 |
| 2.2 C 200 CDI | 4 | OM611.962 | 85/114 | 03/01→08/07 | | | | | CCU140 |
| 2.2 C 200 CDI | 4 | OM646.962; OM646.963 | 90/121 | 04/03→08/07 | | | | | CCU140 |
| 2.2 C 220 CDI | 4 | OM646.963 | 100/134 | 08/06→08/07 | | | | | CCU140 |
| 2.2 C 220 CDI | 4 | OM611.962 | 105/141 | 03/01→08/07 | | | | | CCU140 |
| 2.2 C 220 CDI | 4 | OM646.963 | 110/148 | 02/04→08/07 | | | | | CCU140 |
| 2.5 C 230 | 6 | M272.920 | 150/201 | 01/05→08/07 | OE229 | 0,8 | CET15P | | BAEA140E |
| 2.6 C 240 | 6 | M112.912 | 125/168 | 03/01→08/07 | OE191 | 1,0 | CET12P | OE180 | BAEA297 CLS064 |
| 2.6 C 240 4WD | 6 | M112.916 | 125/168 | 07/02→08/07 | OE191 | 1,0 | CET12P | OE180 | BAEA297 CLS064 →01/04 |
| 2.7 C 270 CDI | 5 | OM612.962 | 125/168 | 03/01→08/07 | | | | | CCU141 |
| 3.0 C 30 CDI AMG | 5 | OM612.990 | 170/228 | 01/03→08/07 | CH704 [275] | 5v | | | CCU104 |
| 3.0 C 280, 3.0 C 280 4WD | 6 | M272.940; M272.941 | 170/228 | 01/05→08/07 | OE229 | 0,8 | CET15P | | BAEA140E |
| 3.0 C 320 CDI | 6 | OM642.910 | 165/221 | 06/05→08/07 | | | | | CCU114 [180] [275] |
| 3.2 C 32 AMG Kompressor | 6 | M112.961 | 260/349 | 03/01→08/07 | | | CET12P | OE180 | BAEA297 CLS064 →01/04 |
| 3.2 C 320, 3.2 C 320 4WD | 6 | M112.946; M112.953 | 160/215 | 03/01→08/07 | OE191 | 1,0 | CET12P | OE180 | BAEA297 CLS064 |
| 3.5 C 350, 3.5 C 350 4WD | 6 | M272.960; M272.970 | 200/268 | 01/05→08/07 | OE229 | 0,8 | CET15P | | BAEA140E |
| 5.4 C 55 AMG | 8 | M113.988 | 270/362 | 02/04→08/07 | | | CET12P | OE180 | BAEA297 CLS064 |
| C-CLASS T-Model (S204) | | | | | | | | | |
| 1.6 C 180 Kompressor | 4 | M271.910 | 115/154 | 01/08→08/14 | OE229 | 0,8 | CET15P | | BAEA077 |
| 1.8 C 180 CGI | 4 | M271.820 | 115/154 | 11/09→08/14 | OE229 | 0,8 | CET15P | | BAEA077 |
| 1.8 C 180 Kompressor | 4 | M271.952 | 115/154 | 08/07→08/14 | OE229 | 0,8 | CET15P | | BAEA077 Eng.30853900→ |
| 1.8 C 200 CGI | 4 | M271.820; M271.860 | 135/181 | 08/07→08/14 | OE229 | 0,8 | CET15P | | BAEA077 |
| 1.8 C 200 Kompressor | 4 | M271.950 | 135/181 | 08/07→08/14 | OE229 | 0,8 | CET15P | | BAEA077 Eng.30853900→ |
| 1.8 C 250 CGI | 4 | M271.860 | 150/201 | 07/09→08/14 | OE229 | 0,8 | CET15P | | BAEA077 |
| 2.1 C 200 CDI | 4 | OM646.811 | 100/134 | 08/07→08/14 | | | | | CCU110 |
| 2.1 C 220 CDI | 4 | OM646.811 | 120/161 | 08/07→08/14 | | | | | CCU110 |
| 2.1 C 220 CDI | 4 | OM646.811 | 125/168 | 08/07→08/14 | | | | | CCU110 |
| 2.5 C 230 | 6 | M272.921 | 150/201 | 08/07→08/14 | OE229 | 0,8 | CET15P | | BAEA140E |

MERCEDES-BENZ





kW/BHP

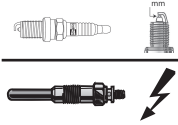

eon TITAN

IRIDIUM



...MERCEDES-BENZ

...C-CLASS T-Model (S204)

| | | | | | | | | | | |
|----------------------------------|---|----------------------|---------|-------------|-------|-----|--------|--|-----------------------|--|
| 3.0 C 280 | 6 | M272.947 | 170/228 | 08/07→08/14 | OE229 | 0,8 | CET15P | | BAEA140E | |
| 3.0 C 300 | 6 | M272.947 | 170/228 | 08/07→08/14 | OE229 | 0,8 | CET15P | | | |
| 3.0 C 320 CDI, 3.0 C 320 CDI 4WD | 6 | OM642.960; OM642.961 | 165/221 | 08/07→08/14 | | | | | CCU114 [180] [275] | |
| 3.0 C 350 CDI | 6 | OM642.830 | 165/221 | 08/07→08/14 | | | | | CCU116[275] | |
| 3.0 C 350 CDI | 6 | OM642.834 | 195/261 | 06/11→08/14 | | | | | CCU116[275] | |
| 3.0 C 350 CDI, 3.0 C 350 CDI 4WD | 6 | OM642.830; OM642.832 | 170/228 | 10/09→08/14 | | | | | CCU116[275] | |
| 3.5 C 350 | 6 | M272.961 | 200/268 | 08/07→08/14 | OE229 | 0,8 | CET15P | | BAEA140E | |
| 3.5 C 350 CGI | 6 | M276.957 | 225/302 | 06/11→08/14 | | | | | BAEA093E | |
| 6.2 C 63 AMG | 8 | M156.985 | 336/451 | 02/08→08/14 | OE233 | 1,0 | | | | |
| 6.2 C 63 AMG | 8 | M156.985 | 358/480 | 01/12→08/14 | OE233 | 1,0 | | | | |
| 6.2 C 63 AMG | 8 | M156.985 | 373/500 | 06/13→08/14 | OE233 | 1,0 | | | | |

C-CLASS (W202)

| | | | | | | | | | | |
|----------------------|---|-----------|---------|-------------|----------------------------|-------|--------|-----------------|-------------|---------------------------------------|
| 1.8 C 180 | 4 | M111.921 | 89/119 | 11/94→05/00 | OE057 →06/97 | 0,9 | CET2 | OE180 →06/97 | BAEA340[41] | CLS138 [35] |
| | | | | | OE032 07/97→ | 1,0 | | OE179 07/97→ | | |
| 1.8 C 180 | 4 | M111.921 | 90/121 | 03/93→05/00 | OE057 →06/97 | 0,9 | CET2 | OE180 →06/97 | BAEA340[41] | CLS138 [35] |
| | | | | | OE032 07/97→ | 1,0 | | OE179 07/97→ | | |
| 1.8 C 180 | 4 | M111.920 | 90/121 | 03/93→05/00 | OE057 →06/97 | 0,9 | CET2 | OE180 →06/97 | BAEA313 | CLS106 [229] →Eng.045966 017110 |
| | | | | | OE032 07/97→ | 1,0 | | OE179 07/97→ | | CLS065 [230] Eng.045967 017111→ |
| 2.0 C 200 | 4 | M111.945 | 100/134 | 01/94→05/00 | OE057 →06/97 | 0,9 | CET2 | OE180 →06/97 | BAEA340[41] | CLS138 [35] |
| | | | | | OE032 07/97→ | 1,0 | | OE179 07/97→ | | |
| 2.0 C 200 | 4 | M111.941 | 100/134 | 01/94→05/00 | OE057 →06/97 | 0,9 | CET2 | OE180 →06/97 | BAEA313 | CLS106 [229] →Eng.000765 000704 |
| | | | | | OE032 07/97→ | 1,0 | | OE179 07/97→ | | CLS065 [230] Eng.000766 000705→ |
| 2.0 C 200 D | 4 | OM601.913 | 55/74 | 03/93→05/00 | CH176 | 11.5v | | | | |
| 2.0 C 200 D | 4 | OM604.915 | 65/87 | 10/96→05/00 | CH177 [293] | 11.5v | | | CCU140 | |
| 2.0 C 200 Kompressor | 4 | M111.944 | 132/177 | 10/95→05/00 | OE032 | 1,0 | CET2 | OE179 | BAEA340[41] | CLS138 [35] |
| 2.0 C 200 Kompressor | 4 | M111.944 | 141/189 | 11/96→05/00 | OE032 | 1,0 | CET2 | OE179 | BAEA340[41] | CLS138 [35] |
| 2.2 C 200 CDI | 4 | OM611.960 | 75/101 | 03/98→05/00 | | | | | CCU140 | |
| 2.2 C 220 | 4 | M111.961 | 110/148 | 03/93→05/00 | OE057 | 0,9 | CET2 | OE180 | BAEA313 | |
| 2.2 C 220 CDI | 4 | OM611.960 | 92/123 | 09/97→05/00 | | | | | CCU140 | |
| 2.2 C 220 D | 4 | OM604.910 | 55/74 | 07/96→05/00 | CH175 [175] [275] [297] | 11.5v | | | CCU140 | |
| | | | | | CH177 [176] [275] [293] | 11.5v | | | | |
| 2.2 C 220 D | 4 | OM604.910 | 70/94 | 08/93→05/00 | CH175 [175] [275] [297] | 11.5v | | | CCU140 | |
| | | | | | CH177 [176] [275] [293] | 11.5v | | | | |
| 2.3 C 230 | 4 | M111.974 | 110/148 | 06/96→06/97 | OE057 | 0,9 | CET2 | OE180 | BAEA340[41] | CLS138 [35] |
| 2.3 C 230 Kompressor | 4 | M111.975 | 142/190 | 10/95→05/00 | OE136 | 0,8 | CET12P | OE179 | BAEA340[41] | CLS138 [35] |
| 2.4 C 240 | 6 | M112.910 | 125/168 | 06/97→05/00 | OE191 | 1,0 | CET12P | OE180 | BAEA297 | CLS064 |
| 2.5 C 250 D | 5 | OM605.910 | 83/111 | 05/93→05/00 | CH175 [175] [275] [297] | 11.5v | | | | |
| | | | | | CH177 [176] [275] [293] | 11.5v | | | | |
| 2.5 C 250 Turbo-D | 5 | OM605.960 | 110/148 | 10/95→05/00 | CH177 [293] | 11.5v | | | CCU141 | |

MERCEDES-BENZ



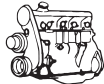

kW/BHP

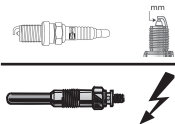

eon TITAN

IRIDIUM

**...MERCEDES-BENZ****...C-CLASS (W202)**

| | | | | | | | | | | |
|--------------|---|-------------------|---------|-------------|--------------|-----|---------------|--------------|----------------|--|
| 2.8 C 280 | 6 | M104.941 | 142/190 | 05/93→05/00 | OE057 | 0,9 | CET2 | OE180 | BAEA340 | CLS252 →08/95 CLS254 09/95→ |
| 2.8 C 280 | 6 | M112.920 | 145/194 | 06/97→05/00 | OE191 | 1,0 | CET12P | OE180 | BAEA297 | CLS064 |
| 3.6 C 36 AMG | 6 | M104.941 (AMG3.6) | 206/276 | 05/94→05/00 | OE057 | 0,9 | CET2 | OE180 | BAEA340 | |
| 4.3 C 43 AMG | 8 | M113.944 | 205/275 | 09/97→12/98 | OE191 | 1,0 | CET12P | OE180 | | |
| 4.3 C 43 AMG | 8 | M113.944 | 225/302 | 08/97→05/00 | OE191 | 1,0 | CET12P | OE180 | BAEA297 | |

C-CLASS (W203)

| | | | | | | | | | | |
|--------------------------|---|----------------------|---------|-------------|---|-----|--|---|---|------------------------------|
| 1.8 C 180 Kompressor | 4 | M271.946 | 105/141 | 05/02→02/07 | OE229 [232] | 0,8 | CET15P [232] | | BAEA053 →Eng.30853899 →Prod.30.11.2006 | |
| | | | | | OE224 →Eng.30853899 →Prod.30.11.2006 | 0,8 | CET14P →Eng.30853899 →Prod.30.11.2006 | BAEA077 Eng.30853900→ Prod.30.11.2006→ | | |
| | | | | | OE229 Eng.30853900→ Prod.30.11.2006→ | 0,8 | CET15P Eng.30853900→ Prod.30.11.2006→ | | | |
| 1.8 C 200 CGI Kompressor | 4 | M271.942 | 125/168 | 07/03→02/07 | OE229 [232] | 0,8 | CET15P [232] | | BAEA053 →Eng.30853899 →Prod.30.11.2006 | |
| | | | | | OE224 →Eng.30853899 →Prod.30.11.2006 | 0,8 | CET14P →Eng.30853899 →Prod.30.11.2006 | BAEA077 Eng.30853900→ Prod.30.11.2006→ | | |
| | | | | | OE229 Eng.30853900→ Prod.30.11.2006→ | 0,8 | CET15P Eng.30853900→ Prod.30.11.2006→ | | | |
| 1.8 C 200 Kompressor | 4 | M271.940 | 120/161 | 05/02→02/07 | OE229 [232] | 0,8 | CET15P [232] | | BAEA053 →Eng.30853899 →Prod.30.11.2006 | |
| | | | | | OE224 →Eng.30853899 →Prod.30.11.2006 | 0,8 | CET14P →Eng.30853899 →Prod.30.11.2006 | BAEA077 Eng.30853900→ Prod.30.11.2006→ | | |
| | | | | | OE229 Eng.30853900→ Prod.30.11.2006→ | 0,8 | CET15P Eng.30853900→ Prod.30.11.2006→ | | | |
| 1.8 C 230 Kompressor | 4 | M271.948 | 141/189 | 02/04→02/07 | OE229 [232] | 0,8 | CET15P [232] | | BAEA053 →Eng.30853899 →Prod.30.11.2006 | |
| | | | | | OE224 →Eng.30853899 →Prod.30.11.2006 | 0,8 | CET14P →Eng.30853899 →Prod.30.11.2006 | BAEA077 Eng.30853900→ Prod.30.11.2006→ | | |
| | | | | | OE229 Eng.30853900→ Prod.30.11.2006→ | 0,8 | CET15P Eng.30853900→ Prod.30.11.2006→ | | | |
| 2.0 C 180 | 4 | M111.951 | 95/127 | 10/00→05/02 | | | CET12P | OE181 | BAEA041 | |
| 2.0 C 200 Kompressor | 4 | M111.955 | 120/161 | 05/00→06/02 | | | CET12P | OE181 | BAEA041 | |
| 2.2 C 200 CDI | 4 | OM611.962 | 75/101 | 02/01→02/07 | | | | | | CCU140 |
| 2.2 C 200 CDI | 4 | OM611.962 | 85/114 | 09/00→02/07 | | | | | | CCU140 |
| 2.2 C 200 CDI | 4 | OM646.962; OM646.963 | 90/121 | 04/03→02/07 | | | | | | CCU140 |
| 2.2 C 220 CDI | 4 | OM611.962 | 100/134 | 05/00→02/07 | | | | | | CCU140 |
| 2.2 C 220 CDI | 4 | OM611.962; OM646.963 | 105/141 | 05/00→02/07 | | | | | | CCU140 |
| 2.2 C 220 CDI | 4 | OM646.963 | 110/148 | 02/03→02/07 | | | | | | CCU140 |
| 2.5 C 230 | 6 | M272.920 | 150/201 | 01/05→02/07 | OE229 | 0,8 | CET15P | | | BAEA140E |
| 2.6 C 240, 2.6 C 240 4WD | 6 | M112.912; M112.916 | 125/168 | 05/00→02/07 | OE191 | 1,0 | CET12P | OE180 | BAEA297 | CLS064 |
| 2.7 C 270 CDI | 5 | OM612.962 | 125/168 | 12/00→02/07 | | | | | | CCU141 |
| 3.0 C 30 CDI AMG | 5 | OM612.990 | 170/228 | 01/03→02/07 | CH704 [275] | 5v | | | | CCU104 |
| 3.0 C 280, 3.0 C 280 4WD | 6 | M272.940; M272.941 | 170/228 | 01/05→02/07 | OE229 | 0,8 | CET15P | | | BAEA140E |
| 3.0 C 320 CDI | 6 | OM642.910 | 165/221 | 01/05→02/07 | | | | | | CCU114 [180] [275] |
| 3.2 C 32 AMG Kompressor | 6 | M112.961 | 260/349 | 02/01→02/07 | | | CET12P | OE180 | BAEA297 09/02→ | CLS064 |
| 3.2 C 320, 3.2 C 320 4WD | 6 | M112.946; M112.953 | 160/215 | 05/00→02/07 | OE191 | 1,0 | CET12P | OE180 | BAEA297 | CLS064 |

MERCEDES-BENZ





kW/BHP

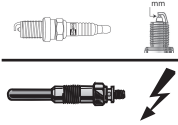

eon TITAN

IRIDIUM

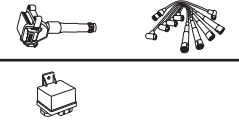

...MERCEDES-BENZ

...C-CLASS (W203)

| | | | | | | | | | | |
|--------------------------|---|--------------------|---------|---------------|-------|-----|--------|----------------|----------|--------|
| 3.5 C 350, 3.5 C 350 4WD | 6 | M272.960; M272.970 | 200/268 | 01/05 → 02/07 | OE229 | 0,8 | CET15P | | BAEA140E | |
| 5.4 C 55 AMG | 8 | M113.988 | 270/362 | 02/04 → 02/07 | | | CET12P | OE180 OE181 | BAEA297 | CLS242 |

C-CLASS (W204)

| | | | | | | | | | | |
|--|---|----------------------|---------|---------------|-------|-----|--------|--|---------------------------|--|
| 1.6 C 180 Kompressor | 4 | M271.910 | 115/154 | 01/08 → 01/14 | | | | | BAEA077 | |
| 1.8 C 180 CGI | 4 | M271.820 | 115/154 | 01/07 → 01/14 | OE229 | 0,8 | CET15P | | BAEA077 | |
| 1.8 C 180 Kompressor | 4 | M271.952 | 115/154 | 01/07 → 01/14 | OE229 | 0,8 | CET15P | | BAEA077 Eng.30853900 → | |
| 1.8 C 200 | 4 | M271.820 | 137/184 | 05/11 → 01/14 | OE229 | 0,8 | CET15P | | BAEA077 | |
| 1.8 C 200 CGI | 4 | M271.820; M271.860 | 135/181 | 01/07 → 01/14 | OE229 | 0,8 | CET15P | | BAEA077 | |
| 1.8 C 200 Kompressor | 4 | M271.950 | 135/181 | 01/07 → 01/14 | OE229 | 0,8 | CET15P | | BAEA077 Eng.30853900 → | |
| 1.8 C 250 CGI | 4 | M271.860 | 150/201 | 07/09 → 01/14 | OE229 | 0,8 | CET15P | | BAEA077 | |
| 2.1 C 200 CDI | 4 | OM646.811; OM646.812 | 100/134 | 01/07 → 01/14 | | | | | CCU110 | |
| 2.1 C 220 CDI | 4 | OM646.811 | 120/161 | 01/07 → 01/14 | | | | | CCU110 | |
| 2.1 C 220 CDI | 4 | OM646.811 | 125/168 | 01/07 → 01/14 | | | | | CCU110 | |
| 2.5 C 230, 2.5 C 230 4WD | 6 | M272.911; M272.921 | 150/201 | 01/07 → 01/14 | OE229 | 0,8 | CET15P | | BAEA140E | |
| 3.0 C 280, 3.0 C 280 4WD, 3.0 C 300, 3.0 C 300 4WD | 6 | M272.947; M272.948 | 170/228 | 01/07 → 01/14 | OE229 | 0,8 | CET15P | | BAEA140E | |
| 3.0 C 300 CDI 4WD, 3.0 C 350 CDI, 3.0 C 350 CDI 4WD | 6 | OM642.830; OM642.832 | 170/228 | 10/09 → 01/14 | | | | | CCU116 ^[275] | |
| 3.0 C 320 CDI, 3.0 C 320 CDI 4WD, 3.0 C 350 CDI, 3.0 C 350 CDI 4WD | 6 | OM642.960; OM642.961 | 165/221 | 01/07 → 01/14 | | | | | CCU114 [180] [275] | |
| 3.0 C 350 CDI | 6 | OM642.834 | 195/261 | 06/11 → 01/14 | | | | | CCU116 ^[275] | |
| 3.5 C 300, 3.5 C 300 4WD | 6 | M276.957 | 185/248 | 02/11 → 01/14 | | | | | BAEA093E | |
| 3.5 C 350, 3.5 C 350 4WD | 6 | M272.961; M272.971 | 200/268 | 01/07 → 01/14 | OE229 | 0,8 | CET15P | | BAEA140E | |
| 3.5 C 350, 3.5 C 350 4WD | 6 | M276.957 | 225/302 | 01/11 → 01/14 | | | | | BAEA093E | |
| 3.5 C 350 CGI | 6 | M272.982 | 215/288 | 09/08 → 01/14 | | | | | BAEA140E | |
| 6.2 C 63 AMG | 8 | M156.985 | 336/451 | 02/08 → 01/14 | OE233 | 1,0 | | | | |
| 6.2 C 63 AMG | 8 | M156.985 | 358/480 | 02/08 → 01/14 | OE233 | 1,0 | | | | |
| 6.2 C 63 AMG | 8 | M156.985 | 373/500 | 02/08 → 01/14 | OE233 | 1,0 | | | | |

CITAN Combi (415)

| | | | | | | | | | | |
|---------|---|----------|--------|---------|--|--|--|-------|----------|--|
| 1.2 112 | 4 | M200.711 | 84/113 | 06/13 → | | | | OE261 | BAEA131E | |
|---------|---|----------|--------|---------|--|--|--|-------|----------|--|

CLC-CLASS (CL203)

| | | | | | | | | | | |
|------------------------|---|-----------|---------|---------------|--|-----|---|--|--|--|
| 1.6 CLC 160 | 4 | M271.911 | 95/127 | 02/09 → 06/11 | OE229 | 0,8 | CET15P | | BAEA077 | |
| 1.8 CLC 180 Kompressor | 4 | M271.946 | 105/141 | 05/08 → 06/11 | OE229 ^[232] | 0,8 | CET15P ^[232] | | BAEA053 → Eng.30853899 → Prod.30.11.2006 | |
| | | | | | OE224 → Eng.30853899 → Prod.30.11.2006 | 0,8 | CET14P → Eng.30853899 → Prod.30.11.2006 | | BAEA077 Eng.30853900 → Prod.30.11.2006 → | |
| | | | | | OE229 Eng.30853900 → Prod.30.11.2006 → | 0,8 | CET15P Eng.30853900 → Prod.30.11.2006 → | | | |
| 1.8 CLC 200 Kompressor | 4 | M271.957 | 135/181 | 05/08 → 06/11 | OE229 | 0,8 | CET15P | | BAEA077 | |
| 2.1 CLC 200 CDI | 4 | OM646.962 | 90/121 | 05/08 → 06/11 | | | | | CCU140 | |
| 2.1 CLC 220 CDI | 4 | OM646.963 | 110/148 | 05/08 → 06/11 | | | | | CCU140 | |
| 2.5 CLC 230 | 6 | M272.920 | 150/201 | 05/08 → 06/11 | OE229 | 0,8 | CET15P | | BAEA140E | |
| 3.5 CLC 350 | 6 | M272.960 | 200/268 | 05/08 → 06/11 | OE229 | 0,8 | CET15P | | BAEA140E | |

CLK Convertible (A208)

| | | | | | | | | | | |
|--------------------|---|----------|---------|---------------|-----------------------|-----|--------|-----------------------|-------------------------|------------------------|
| 2.0 200 | 4 | M111.941 | 100/134 | 03/98 → 03/02 | | | | OE179 | | |
| 2.0 200 | 4 | M111.945 | 100/134 | 03/98 → 03/02 | OE057 → Eng.052061 | 0,9 | | OE179 → Eng.052061 | BAEA340 ^[41] | CLS138 ^[35] |
| 2.0 200 Kompressor | 4 | M111.956 | 120/161 | 06/00 → 03/02 | | | CET12P | OE181 | BAEA041 | |
| 2.0 200 Kompressor | 4 | M111.944 | 141/189 | 03/98 → 06/00 | OE032 | 1,0 | CET2 | OE179 | BAEA340 ^[41] | CLS138 ^[35] |

MERCEDES-BENZ



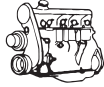

kW/BHP

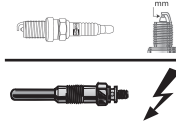

eon TITAN

IRIDIUM

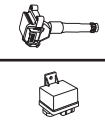
**...MERCEDES-BENZ****...CLK Convertible (A208)**

| | | | | | | | | | | |
|--------------------|---|--------------------|---------|--------------|--------------|-----|----------------|--------------|--------------------------------|-------------------------------|
| 2.3 230 Kompressor | 4 | M111.975 | 142/190 | 03/98 →06/00 | OE032 | 1,0 | CET2 | OE179 | BAEA340 ^[41] | CLS138 ^[35] |
| 2.3 230 Kompressor | 4 | M111.973 | 142/190 | 03/98 →06/00 | | | CET2 | | BAEA340 ^[41] | |
| 2.3 230 Kompressor | 4 | M111.982 | 145/194 | 06/00 →03/02 | | | CET1 2P | OE181 | BAEA041 | |
| 3.2 320 | 6 | M112.940 | 160/215 | 03/98 →03/02 | OE191 | 1,0 | CET1 2P | OE180 | BAEA297 | CLS064 |
| 4.3 430 | 8 | M113.943 | 205/275 | 09/98 →03/02 | OE191 | 1,0 | CET1 2P | OE180 | BAEA297 | CLS242 |
| 5.4 55 AMG | 8 | M113.981; M113.984 | 255/342 | 01/00 →03/02 | OE191 | 1,0 | CET1 2P | OE180 | BAEA297 | CLS242 |

CLK Convertible (A209)

| | | | | | | | | | | |
|-----------------|---|----------|---------|--------------|---|-----|---|--|---|--|
| 1.8 CLK 200 CGI | 4 | M271.942 | 125/168 | 07/03 →03/10 | OE229 ^[232] | 0,8 | CET1 5P ^[232] | | BAEA053 →Eng.30853899 →Prod.30.11.2006 | |
| | | | | | OE224 →Eng.30853899 →Prod.30.11.2006 | 0,8 | CET1 4P →Eng.30853899 →Prod.30.11.2006 | | BAEA077 Eng.30853900 → Prod.30.11.2006 → | |
| | | | | | OE229 Eng.30853900 → Prod.30.11.2006 → | 0,8 | CET1 5P Eng.30853900 → Prod.30.11.2006 → | | | |

| | | | | | | | | | | |
|------------------------|---|----------|---------|--------------|---|-----|---|--|---|--|
| 1.8 CLK 200 Kompressor | 4 | M271.940 | 120/161 | 02/03 →03/10 | OE229 ^[232] | 0,8 | CET1 5P ^[232] | | BAEA053 →Eng.30853899 →Prod.30.11.2006 | |
| | | | | | OE224 →Eng.30853899 →Prod.30.11.2006 | 0,8 | CET1 4P →Eng.30853899 →Prod.30.11.2006 | | BAEA077 Eng.30853900 → Prod.30.11.2006 → | |
| | | | | | OE229 Eng.30853900 → Prod.30.11.2006 → | 0,8 | CET1 5P Eng.30853900 → Prod.30.11.2006 → | | | |

| | | | | | | | | | | |
|------------------------|---|----------|---------|--------------|---|-----|----------------|--|----------------------------------|--|
| 1.8 CLK 200 Kompressor | 4 | M271.955 | 135/181 | 10/06 →03/10 | OE224 →08/07 →Eng.30099998 | 0,8 | CET1 5P | | BAEA053 →Eng.30853899 | |
| | | | | | OE229 08/07 → Eng.30099999 → | 0,8 | | | BAEA077 Eng.30853900 → | |

| | | | | | | | | | | |
|-----------------|---|-----------|---------|--------------|--------------|-----|----------------|--------------|---|---------------|
| 2.6 CLK 240 | 6 | M112.912 | 125/168 | 02/03 →03/10 | OE191 | 1,0 | CET1 2P | OE180 | BAEA297 | CLS064 |
| 3.0 CLK 280 | 6 | M272.940 | 170/228 | 01/05 →03/10 | OE229 | 0,8 | CET1 5P | | BAEA140E | |
| 3.0 CLK 320 CDI | 6 | OM642.910 | 165/221 | 03/05 →03/10 | | | | | CCU114 ^{[180] [275]} | |
| 3.2 CLK 320 | 6 | M112.955 | 160/215 | 02/03 →03/10 | OE191 | 1,0 | CET1 2P | OE180 | BAEA297 | CLS064 |
| 3.5 CLK 350 | 6 | M272.960 | 200/268 | 01/05 →03/10 | OE229 | 0,8 | CET1 5P | | BAEA140E | |
| 5.0 CLK 500 | 8 | M113.968 | 215/288 | 09/03 →12/05 | OE191 | 1,0 | CET1 2P | OE180 | | |
| 5.0 CLK 500 | 8 | M113.968 | 225/302 | 02/03 →03/10 | OE191 | 1,0 | CET1 2P | OE180 | BAEA297 | CLS242 |
| 5.4 CLK AMG DTM | 8 | M113.994 | 428/574 | 06/04 →03/10 | | | CET1 4P | OE190 | BAEA297 | |
| 5.5 CLK 55 AMG | 8 | M113.987 | 270/362 | 02/03 →03/10 | | | CET1 2P | OE180 | BAEA297 | CLS242 |
| 5.5 CLK 500 | 8 | M273.967 | 285/382 | 06/06 →03/10 | OE229 | 0,8 | CET1 5P | | BAEA140E | |
| 6.2 CLK 63 AMG | 8 | M156.982 | 354/475 | 04/06 →03/10 | OE233 | 1,0 | | | | |

CLK (C208)

| | | | | | | | | | | |
|--------------------|---|--------------------|---------|--------------|-----------------------------|-----|----------------|--------------|--------------------------------|-------------------------------|
| 2.0 200 | 4 | M111.945 | 100/134 | 06/97 →06/02 | OE057 →Eng.052061 | 0,9 | | OE179 | BAEA340 ^[41] | CLS138 ^[35] |
| 2.0 200 Kompressor | 4 | M111.956 | 120/161 | 06/00 →06/02 | | | CET1 2P | OE181 | BAEA041 | |
| 2.0 200 Kompressor | 4 | M111.944 | 141/189 | 06/97 →06/00 | OE032 | 1,0 | CET2 | OE179 | BAEA340 ^[41] | CLS138 ^[35] |
| 2.3 230 Kompressor | 4 | M111.975 | 142/190 | 06/97 →06/00 | OE032 | 1,0 | CET2 | OE179 | BAEA340 ^[41] | CLS138 ^[35] |
| 2.3 230 Kompressor | 4 | M111.973 | 142/190 | 06/97 →06/00 | | | CET2 | | BAEA340 ^[41] | |
| 2.3 230 Kompressor | 4 | M111.982 | 145/194 | 06/00 →06/02 | | | CET1 2P | OE181 | BAEA041 | |
| 3.2 320 | 6 | M112.940 | 160/215 | 06/97 →06/02 | OE191 | 1,0 | CET1 2P | OE180 | BAEA297 | CLS064 |
| 4.3 430 | 8 | M113.943 | 205/275 | 07/98 →06/02 | OE191 | 1,0 | CET1 2P | OE180 | BAEA297 | CLS242 |
| 5.4 | 8 | M113.984 | 260/349 | 10/98 →07/02 | OE191 | 1,0 | CET1 2P | OE180 | | |
| 5.4 55 AMG | 8 | M113.981; M113.984 | 255/342 | 08/99 →06/02 | OE191 | 1,0 | CET1 2P | OE180 | BAEA297 | CLS242 |

MERCEDES-BENZ





kW/BHP

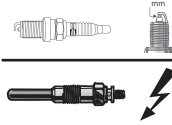

eon TITAN

IRIDIUM

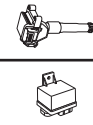
**...MERCEDES-BENZ****CLK (C209)**

| | | | | | | | | | | |
|--|---|--|---------|-------------|---|-----|--|--------------|--|---------------|
| 1.8 200 CGI | 4 | M271.942 | 125/168 | 07/03→05/09 | OE229 [232] | 0,8 | CET15P [232] | | BAEA053 →Eng.30853899 →Prod.30.11.2006 | |
| | | | | | OE224 →Eng.30853899 →Prod.30.11.2006 | 0,8 | CET14P →Eng.30853899 →Prod.30.11.2006 | | BAEA077 Eng.30853900→ Prod.30.11.2006→ | |
| | | | | | OE229 Eng.30853900→ Prod.30.11.2006→ | 0,8 | CET15P Eng.30853900→ Prod.30.11.2006→ | | | |
| 1.8 200 Kompressor | 4 | M271.940 | 120/161 | 09/02→05/09 | OE229 [232] | 0,8 | CET15P [232] | | BAEA053 →Eng.30853899 →Prod.30.11.2006 | |
| | | | | | OE224 →Eng.30853899 →Prod.30.11.2006 | 0,8 | CET14P →Eng.30853899 →Prod.30.11.2006 | | BAEA077 Eng.30853900→ Prod.30.11.2006→ | |
| | | | | | OE229 Eng.30853900→ Prod.30.11.2006→ | 0,8 | CET15P Eng.30853900→ Prod.30.11.2006→ | | | |
| 1.8 200 Kompressor | 4 | M271.955 | 135/181 | 10/06→05/09 | OE229 | 0,8 | CET15P | | BAEA053 →Eng.30853899 BAEA077 Eng.30853900→ | |
| 2.2 220 CDI | 4 | OM646.966 | 100/134 | 01/05→05/09 | | | | | CCU140 | |
| 2.2 220 CDI | 4 | OM646.966 | 110/148 | 01/05→05/09 | | | | | CCU140 | |
| 2.6 240 | 6 | M112.912 | 120/161 | 06/02→05/09 | OE191 | 1,0 | CET12P | OE180 | BAEA297 | |
| 2.6 240 | 6 | M112.912 | 125/168 | 06/02→05/09 | OE191 | 1,0 | CET12P | OE180 | BAEA297 | CLS064 |
| 2.7 270 CDI | 5 | OM612.967 | 120/161 | 02/03→06/05 | | | | | CCU141 | |
| 2.7 270 CDI | 5 | OM612.962; OM612.967 | 125/168 | 10/02→05/09 | | | | | CCU141 | |
| 3.0 280 | 6 | M272.940 | 170/228 | 01/05→05/09 | OE229 | 0,8 | CET15P | | BAEA140E | |
| 3.0 320 CDI | 6 | OM642.910 | 165/221 | 01/05→05/09 | | | | | CCU114 [180] [275] | |
| 3.2 320 | 6 | M112.955 | 160/215 | 06/02→05/09 | OE191 | 1,0 | CET12P | OE180 | BAEA297 | CLS064 |
| 3.5 350 | 6 | M272.960 | 200/268 | 01/05→05/09 | OE229 | 0,8 | CET15P | | BAEA140E | |
| 5.0 500 | 8 | M113.968 | 215/288 | 09/02→12/05 | OE191 | 1,0 | CET12P | OE180 | | |
| 5.0 500 | 8 | M113.968 | 225/302 | 06/02→05/09 | OE191 | 1,0 | CET12P | OE180 | BAEA297 | CLS242 |
| 5.4 55 AMG | 8 | M113.987 | 270/362 | 09/02→05/09 | | | CET12P | OE180 | BAEA297 | CLS242 |
| 5.4 DTM AMG | 8 | M113.994 | 428/574 | 06/04→05/09 | | | CET14P | OE190 | BAEA297 | |
| 5.5 500 | 8 | M273.965 | 285/382 | 06/06→05/09 | OE229 | 0,8 | CET15P | | BAEA140E | |
| 6.2 63 AMG | 8 | M156.982 | 354/475 | 04/06→05/09 | OE233 | 1,0 | | | | |
| 6.2 63 AMG | 8 | M156.982 | 373/500 | 05/07→05/09 | OE233 | 1,0 | | | | |
| CLS (C218) | | | | | | | | | | |
| 3.0 CLS 350 BlueTEC / d, 3.0 CLS 350 BlueTEC / d 4WD | 6 | OM642.852; OM642.853; OM642.854; OM642.858 | 185/248 | 11/12→ | | | | | CCU116 [275] | |
| 3.0 CLS 350 CDI / d, 3.0 CLS 350 CDI / d 4WD | 6 | OM642.852; OM642.853; OM642.854; OM642.858 | 195/261 | 01/11→ | | | | | CCU116 [275] | |
| 3.5 CLS 350 | 6 | M276.952 | 225/302 | 01/11→ | | | | | BAEA093E | |
| 4.7 CLS 500, 4.7 CLS 500 4WD | 8 | M278.922 | 300/402 | 02/11→ | | | | | BAEA093E | |
| 5.5 CLS 63 AMG | 8 | M157.980; M157.981 | 386/518 | 02/11→ | | | | | BAEA093E | |
| 5.5 CLS 63 AMG, 5.5 CLS 63 AMG 4WD | 8 | M157.980; M157.981 | 410/550 | 01/11→ | | | | | BAEA093E | |
| 5.5 CLS 63 AMG, 5.5 CLS 63 AMG 4WD | 8 | M157.981 | 430/577 | 02/13→ | | | | | BAEA093E | |
| CLS (C219) | | | | | | | | | | |
| 3.0 CLS 280, 3.0 CLS 300 | 6 | M272.943 | 170/228 | 07/08→12/10 | OE229 | 0,8 | CET15P | | BAEA140E | |
| 3.0 CLS 320 CDI | 6 | OM642.920 | 155/208 | 01/05→12/10 | | | | | CCU114 [180] [273] [275] [281] | |
| | | | | | | | | | CCU116 [239] [275] [284] | |

MERCEDES-BENZ





kW/BHP

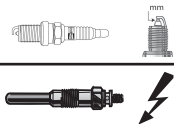

eon TITAN

IRIDIUM

**...MERCEDES-BENZ****...CLS (C219)**

| | | | | | | | | | | |
|----------------------------------|---|-----------|---------|-------------|-------|-----|--------|-------|----------|---|
| 3.0 CLS 320 CDI, 3.0 CLS 350 CDI | 6 | OM642.920 | 165/221 | 01/05→12/10 | | | | | | CCU114 [180] [273] [275] [281] |
| | | | | | | | | | | CCU116 [239] [275] [284] |
| 3.0 CLS 350 CDI | 6 | OM642.920 | 200/268 | 04/09→12/10 | | | | | | CCU114 [180] [273] [275] [281] |
| | | | | | | | | | | CCU116 [239] [275] [284] |
| 3.5 CLS 350 | 6 | M272.964 | 200/268 | 10/04→12/10 | OE229 | 0,8 | CET15P | | | BAEA140E |
| 3.5 CLS 350 | 6 | M272.985 | 215/288 | 04/06→12/10 | | | | | | BAEA140E [275] →10/06 →Eng.30417696 |
| 3.5 CLS 350 CGI | 6 | M272.985 | 215/288 | 04/09→12/10 | | | | | | BAEA140E [275] |
| 5.0 CLS 500 | 8 | M113.967 | 218/292 | 09/05→12/06 | OE191 | 1,0 | CET12P | OE180 | | |
| 5.0 CLS 500 | 8 | M113.967 | 225/302 | 10/04→12/10 | OE191 | 1,0 | CET12P | OE180 | BAEA297 | CLS064 |
| 5.4 CLS 55 AMG | 8 | M113.990 | 350/469 | 01/05→12/10 | | | CET14P | OE190 | BAEA297 | |
| 5.5 CLS 500 | 8 | M273.960 | 285/382 | 04/06→12/10 | OE229 | 0,8 | CET15P | | BAEA140E | |
| 6.2 CLS 63 AMG | 8 | M156.983 | 378/507 | 04/06→12/10 | OE233 | 1,0 | | | | |

CLS Shooting Brake (X218)

| | | | | | | | | | | |
|--|---|---------------------------------|---------|--------|--|--|--|--|--|--------------|
| 3.0 CLS 350 CDI / d, 3.0 CLS 350 CDI / d 4WD | 6 | OM642.852; OM642.853; OM642.854 | 195/261 | 10/12→ | | | | | | CCU116 [275] |
| 3.5 CLS 350 | 6 | M276.952 | 225/302 | 10/12→ | | | | | | BAEA093E |
| 4.7 CLS 500, 4.7 CLS 500 4WD | 8 | M278.922 | 300/402 | 10/12→ | | | | | | BAEA093E |
| 5.5 CLS 63 AMG | 8 | M157.981 | 386/518 | 10/12→ | | | | | | BAEA093E |
| 5.5 CLS 63 AMG, 5.5 CLS 63 AMG 4WD | 8 | M157.981 | 410/550 | 05/13→ | | | | | | BAEA093E |
| 5.5 CLS 63 AMG, 5.5 CLS 63 AMG 4WD | 8 | M157.981 | 430/577 | 02/13→ | | | | | | BAEA093E |

E-CLASS Convertible (A124)

| | | | | | | | | | | |
|--------------|---|------------------|---------|-------------|-------|-----|------|-------|---------|--|
| 2.0 E 200 | 4 | M111.940 | 100/134 | 06/93→03/98 | OE057 | 0,9 | CET2 | OE180 | BAEA313 | CLS106 [229] →Eng.040193 017707 CLS065 [230] Eng.040194 017708→ |
| 2.2 E 220 | 4 | M111.960 | 110/148 | 06/93→03/98 | OE057 | 0,9 | CET2 | OE180 | BAEA313 | CLS106 [229] →Eng.024563 049833 CLS065 [230] Eng.024564 049834→ |
| 3.2 E 320 | 6 | M104.992 | 162/217 | 06/93→03/98 | OE057 | 0,9 | CET2 | OE180 | BAEA340 | CLS252 →08/95 CLS254 09/95→ |
| 3.6 E 36 AMG | 6 | M104.992(AMG3.6) | 200/268 | 05/94→03/98 | OE057 | 0,9 | CET2 | OE180 | BAEA340 | CLS252 →08/95 CLS254 09/95→ |

E-CLASS Convertible (A207)

| | | | | | | | | | | |
|-------------------|---|--------------------|---------|--------|-------|-----|--------|--|----------|--------------|
| 1.8 E 200 CGI | 4 | M271.820; M271.860 | 135/181 | 01/10→ | OE229 | 0,8 | CET15P | | BAEA077 | |
| 1.8 E 250 CGI | 4 | M271.860 | 150/201 | 01/10→ | OE229 | 0,8 | CET15P | | BAEA077 | |
| 3.0 E 350 BlueTEC | 6 | OM642.838 | 185/248 | 06/13→ | | | | | | CCU116 [275] |
| 3.0 E 350 CDI | 6 | OM642.836 | 170/228 | 01/10→ | | | | | | CCU116 [275] |
| 3.0 E 350 CDI | 6 | OM642.838 | 195/261 | 04/11→ | | | | | | CCU116 [275] |
| 3.5 E 300 | 6 | M276.957 | 185/248 | 04/11→ | | | | | | BAEA093E |
| 3.5 E 350 | 6 | M276.957 | 225/302 | 04/11→ | | | | | | BAEA093E |
| 4.7 E 500 | 8 | M278.922 | 300/402 | 09/11→ | | | | | | BAEA093E |
| 5.5 E 500 | 8 | M273.966 | 285/382 | 01/10→ | OE229 | 0,8 | CET15P | | BAEA140E | |





kW/BHP

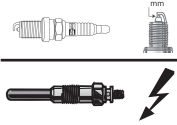

eon TITAN

IRIDIUM

**...MERCEDES-BENZ****E-CLASS Coupe (C124)**

| | | | | | | | | | | |
|--------------|---|------------------|---------|-------------|-------|-----|------|-------|---------|--|
| 2.0 E 200 | 4 | M111.940 | 100/134 | 06/93→06/97 | OE057 | 0,9 | CET2 | OE180 | BAEA313 | CLS106 [229] →Eng.040193 017707 CLS065 [230] Eng.040194 017708→ |
| 2.2 E 220 | 4 | M111.960 | 110/148 | 06/93→06/97 | OE057 | 0,9 | CET2 | OE180 | BAEA313 | CLS106 [229] →Eng.024563 049833 CLS065 [230] Eng.024564 049834→ |
| 3.2 E 320 | 6 | M104.992 | 162/217 | 06/93→06/97 | OE057 | 0,9 | CET2 | OE180 | BAEA340 | CLS252 →08/95 CLS254 09/95→ |
| 3.6 E 36 AMG | 6 | M104.992(AMG3.6) | 195/261 | 06/93→04/95 | OE057 | 0,9 | CET2 | OE180 | BAEA340 | CLS254 |
| 3.6 E 36 AMG | 6 | M104.992(AMG3.6) | 200/268 | 05/94→06/97 | OE057 | 0,9 | CET2 | OE180 | BAEA340 | CLS252 →08/95 CLS254 09/95→ |

E-CLASS Coupe (C207)

| | | | | | | | | | | |
|--------------------------|---|--------------------|---------|--------|-------|-----|--------|--|-------------|--|
| 1.8 E 200 CGI | 4 | M271.820; M271.860 | 135/181 | 01/10→ | OE229 | 0,8 | CET15P | | BAEA077 | |
| 1.8 E 250 CGI | 4 | M271.860 | 150/201 | 01/09→ | OE229 | 0,8 | CET15P | | BAEA077 | |
| 3.0 E 350 BlueTEC | 6 | OM642.838 | 185/248 | 03/13→ | | | | | CCU116[275] | |
| 3.0 E 350 CDI | 6 | OM642.836 | 170/228 | 01/09→ | | | | | CCU116[275] | |
| 3.0 E 350 CDI | 6 | OM642.838 | 195/261 | 04/11→ | | | | | CCU116[275] | |
| 3.5 E 300 | 6 | M276.957 | 185/248 | 04/11→ | | | | | BAEA093E | |
| 3.5 E 350 | 6 | M272.961; M272.988 | 200/268 | 05/11→ | OE229 | 0,8 | CET15P | | BAEA140E | |
| 3.5 E 350, 3.5 E 350 4WD | 6 | M276.957 | 225/302 | 04/11→ | | | | | BAEA093E | |
| 4.7 E 500 | 8 | M278.922 | 300/402 | 09/11→ | | | | | BAEA093E | |
| 5.5 E 500 | 8 | M273.966 | 285/382 | 01/09→ | OE229 | 0,8 | CET15P | | BAEA140E | |

E-CLASS T-Model (S124)

| | | | | | | | | | | |
|---------------------|---|-----------|---------|-------------|--|--------------------|------|-------|--------------|--|
| 2.0 E 200 T | 4 | M111.940 | 100/134 | 06/93→06/96 | OE057 | 0,9 | CET2 | OE180 | BAEA313 | CLS106 [229] →Eng.040193 017707 CLS065 [230] Eng.040194 017708→ |
| 2.2 E 220 T | 4 | M111.960 | 110/148 | 06/93→06/96 | OE057 | 0,9 | CET2 | OE180 | BAEA313 | CLS106 [229] →Eng.024563 049833 CLS065 [230] Eng.024564 049834→ |
| 2.5 E 250 TD | 5 | OM605.911 | 83/111 | 06/93→06/96 | CH175 [297] | 11.5v | | | | |
| 2.5 E 250 Turbo D | 5 | OM602.962 | 93/125 | 06/93→06/96 | CH176 | 11.5v | | | | |
| 2.8 E 280 T | 6 | M104.942 | 142/190 | 06/93→06/96 | OE057 | 0,9 | CET2 | OE180 | BAEA340 | CLS252 →08/95 CLS254 09/95→ |
| 2.8 E 280 T | 6 | M104.942 | 145/194 | 06/93→06/96 | OE057 | 0,9 | CET2 | OE180 | BAEA340 | CLS252 →08/95 CLS254 09/95→ |
| 3.0 E 300 T 4WD | 6 | M103.985 | 132/177 | 06/93→06/96 | OE011 | 0,9 | CET9 | OE183 | BAEA296[292] | CLS250 →08/95 CLS254 09/95→ |
| 3.0 E 300 TD | 6 | OM606.910 | 100/134 | 06/93→06/96 | CH175 [297] →05/95 CH177 [293] 06/95→ | 11.5v 11.5v | | | | |
| 3.0 E 300 TE-24 AMG | 6 | M104.980 | 162/217 | 06/93→06/96 | OE057 | 0,9 | CET2 | OE180 | | |

MERCEDES-BENZ





kW/BHP

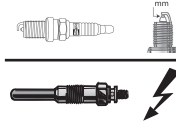

eon TITAN

IRIDIUM

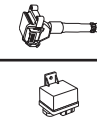

...MERCEDES-BENZ

...E-CLASS T-Model (S124)

| | | | | | | | | | | |
|--|---|----------------------|---------|-------------|-------|-------|------|-------|---------|--------------------------------------|
| 3.0 E 300 T Turbo-D, 3.0 E 300 T Turbo-D 4WD | 6 | OM603.960; OM603.963 | 108/145 | 06/93→06/96 | CH176 | 11.5v | | | | |
| 3.2 E 320 T | 6 | M104.992 | 162/217 | 06/93→06/96 | OE057 | 0,9 | CET2 | OE180 | BAEA340 | CLS252 →08/95 CLS254 09/95→ |
| 3.6 E 36 T AMG | 6 | M104.992(AMG3.6) | 200/268 | 05/94→06/96 | OE057 | 0,9 | CET2 | OE180 | BAEA340 | CLS252 →08/95 CLS254 09/95→ |

E-CLASS T-Model (S210)

| | | | | | | | | | | |
|------------------------------|---|-----------|---------|-------------|------------------------|-------|--------|-------|-------------------------|--|
| 2.0 E 200 T | 4 | M111.942 | 100/134 | 06/96→08/00 | OE032 | 1,0 | CET2 | OE179 | BAEA340 ^[41] | CLS138 ^[35] |
| 2.0 E 200 T Kompressor | 4 | M111.957 | 120/161 | 08/00→03/03 | | | CET12P | OE181 | BAEA041 | |
| 2.0 E 200 T Kompressor | 4 | M111.947 | 137/184 | 06/97→03/03 | OE032 | 1,0 | CET2 | OE179 | BAEA340 ^[41] | CLS063 ^[35] CLS071 ^[35] |
| 2.1 E 220 T CDI | 4 | OM611.961 | 100/134 | 05/99→03/03 | | | | | CCU140 | |
| 2.2 E 220 T CDI | 4 | OM611.961 | 92/123 | 06/98→07/99 | | | | | CCU140 | |
| 2.2 E 220 T CDI | 4 | OM611.961 | 105/141 | 07/99→03/03 | | | | | CCU140 | |
| 2.3 E 230 T | 4 | M111.970 | 110/148 | 06/96→06/97 | OE057 | 0,9 | CET2 | OE180 | BAEA340 ^[41] | |
| 2.4 E 240 T | 6 | M112.911 | 125/168 | 06/97→03/03 | OE191 | 1,0 | CET12P | OE180 | BAEA297 | CLS064 |
| 2.5 E 250 T D | 5 | OM605.912 | 83/111 | 06/96→07/99 | CH177 ^[293] | 11.5v | | | CCU141 | |
| 2.5 E 250 T Turbo-D | 5 | OM605.962 | 110/148 | 06/97→07/99 | CH177 ^[293] | 11.5v | | | CCU141 | |
| 2.6 E 240 T | 6 | M112.914 | 125/168 | 08/00→03/03 | OE191 | 1,0 | CET12P | OE180 | BAEA297 | CLS064 |
| 2.7 E 270 T CDI | 5 | OM612.961 | 120/161 | 02/00→03/03 | | | | | CCU141 | |
| 2.7 E 270 T CDI | 5 | OM612.961 | 125/168 | 07/99→03/03 | | | | | CCU141 | |
| 2.8 E 280 T, 2.8 E 280 T 4WD | 6 | M112.921 | 150/201 | 12/96→03/03 | OE191 | 1,0 | CET12P | OE180 | BAEA297 | CLS064 |
| 2.9 E 290 T Turbo-D | 5 | OM602.982 | 95/127 | 06/96→07/99 | CH204 | 11.5v | | | CCU141 | |
| 3.0 E 300 T Turbo-D | 6 | OM606.962 | 130/174 | 12/96→07/99 | CH177 ^[293] | 11.5v | | | CCU141 | |
| 3.2 E 320 | 6 | M112.941 | 160/215 | 09/97→12/98 | OE191 | 1,0 | CET12P | OE180 | | |
| 3.2 E 320 T, 3.2 E 320 T 4WD | 6 | M112.941 | 165/221 | 12/96→03/03 | OE191 | 1,0 | CET12P | OE180 | BAEA297 | CLS064 |
| 3.2 E 320 T CDI | 6 | OM613.961 | 145/194 | 07/99→03/03 | | | | | CCU141 | |
| 4.2 E 420 T | 8 | M119.985 | 205/275 | 06/96→06/97 | | | CET12P | OE179 | | CLS219 |
| 4.3 E 430 T, 4.3 E 430 T 4WD | 8 | M113.940 | 205/275 | 06/97→03/03 | OE191 | 1,0 | CET12P | OE180 | BAEA297 | CLS242 |
| 5.4 E 55 T AMG | 8 | M113.980 | 260/349 | 08/97→03/03 | OE191 | 1,0 | CET12P | OE180 | BAEA297 | CLS242 |
| 5.4 E 55 T AMG 4WD | 8 | M113.980 | 260/349 | 03/01→03/03 | OE191 | 1,0 | CET12P | OE180 | BAEA297 | |

E-CLASS T-Model (S211)

| | | | | | | | | | | |
|------------------------|---|-----------|---------|-------------|--|-----|---|--|--|--|
| 1.8 E 200 Kompressor | 4 | M271.956 | 135/181 | 04/06→07/09 | OE224 →11/06 →Eng.30853899 | 0,8 | CET14P | | BAEA053 →11/06 →Eng.30853899 | |
| | | | | | OE229 12/06→ Eng.30853900→ | 0,8 | CET15P | | BAEA077 11/06→ Eng.30853900→ | |
| 1.8 E 200 T Kompressor | 4 | M271.941 | 120/161 | 03/03→07/09 | OE229 ^[232] | 0,8 | CET15P ^[232] | | BAEA053 →Eng.30853899 →Prod.30.11.2006 | |
| | | | | | OE224 →Eng.30853899 →Prod.30.11.2006 | 0,8 | CET14P →Eng.30853899 →Prod.30.11.2006 | | BAEA077 Eng.30853900→ Prod.30.11.2006→ | |
| | | | | | OE229 Eng.30853900→ Prod.30.11.2006→ | 0,8 | CET15P Eng.30853900→ Prod.30.11.2006→ | | | |
| 2.1 E 200 CDI | 4 | OM646.821 | 100/134 | 04/06→07/09 | | | | | CCU110 | |
| 2.1 E 220 CDI | 4 | OM646.961 | 100/134 | 03/03→07/09 | | | | | CCU140 ^[233] | |
| 2.1 E 220 T CDI | 4 | OM646.961 | 110/148 | 03/03→07/09 | | | | | CCU140 ^[233] | |
| 2.1 E 220 T CDI | 4 | OM646.821 | 120/161 | 03/03→07/09 | | | | | CCU110 ^[269] CCU140 ^[233] | |
| 2.1 E 220 T CDI | 4 | OM646.821 | 125/168 | 04/06→07/09 | | | | | CCU110 ^[269] CCU140 ^[233] | |



MERCEDES-BENZ



kW/BHP

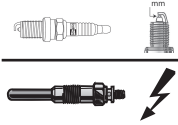

eon TITAN

IRIDIUM

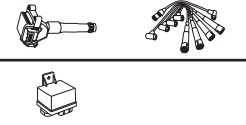

...MERCEDES-BENZ

...E-CLASS T-Model (S211)

| | | | | | | | | | | |
|---|---|---------------------------------|---------|-------------|-------|-----|--------|-------|--------------------------------------|--------|
| 2.5 E 230 T | 6 | M272.922 | 150/201 | 05/07→07/09 | OE229 | 0,8 | CET15P | | BAEA140E | |
| 2.6 E 240 T | 6 | M112.913 | 130/174 | 03/03→07/09 | OE191 | 1,0 | CET12P | OE180 | BAEA297 | CLS064 |
| 2.6 E 240 T 4WD | 6 | M112.917 | 130/174 | 07/03→07/09 | OE191 | 1,0 | CET12P | OE180 | BAEA297 | |
| 2.7 E 270 T CDI | 5 | OM647.961 | 120/161 | 03/03→07/09 | | | | | CCU141 | |
| 2.7 E 270 T CDI | 5 | OM647.961 | 130/174 | 03/03→07/09 | | | | | CCU141 | |
| 3.0 E 280 T, 3.0 E 280 T 4WD | 6 | M272.943; M272.944 | 170/228 | 03/05→07/09 | OE229 | 0,8 | CET15P | | BAEA140E | |
| 3.0 E 280 T CDI, 3.0 E 280 T CDI 4WD | 6 | OM642.920; OM642.921 | 140/188 | 03/05→07/09 | | | | | CCU114 [180] [273] [275] [281] | |
| | | | | | | | | | CCU116 [239] [275] [284] | |
| 3.0 E 320 T CDI, 3.0 E 320 T CDI 4WD | 6 | OM642.920; OM642.921 | 165/221 | 03/05→07/09 | | | | | CCU114 [180] [273] [275] [281] | |
| | | | | | | | | | CCU116 [239] [275] [284] | |
| 3.2 E 280 T CDI | 6 | OM648.961 | 130/174 | 05/04→07/09 | | | | | CCU113 [231] [283] | |
| | | | | | | | | | CCU141 [268] [280] | |
| 3.2 E 320 T, 3.2 E 320 T 4WD | 6 | M112.949; M112.954 | 165/221 | 03/03→07/09 | OE191 | 1,0 | CET12P | OE180 | BAEA297 | CLS064 |
| 3.2 E 320 T CDI | 6 | OM648.961 | 150/201 | 03/03→07/09 | | | | | CCU113 [231] [283] | |
| | | | | | | | | | CCU141 [268] [280] | |
| 3.5 E 350 T, 3.5 E 350 T 4WD | 6 | M272.964; M272.972 | 200/268 | 03/05→07/09 | OE229 | 0,8 | CET15P | | BAEA140E | |
| 5.0 E 500 T | 8 | M113.967 | 225/302 | 10/03→07/09 | OE191 | 1,0 | CET12P | OE180 | BAEA297 | CLS242 |
| 5.0 E 500 T 4WD | 8 | M113.969 | 225/302 | 10/03→07/09 | OE191 | 1,0 | CET12P | OE180 | BAEA297 | |
| 5.4 E 55 T AMG Kompressor | 8 | M113.990 | 350/469 | 07/03→07/09 | OE224 | 0,8 | CET14P | | BAEA297 | CLS242 |
| 5.5 E 500 T, 5.5 E 500 T 4WD | 8 | M273.960; M273.962 | 285/382 | 04/06→07/09 | OE229 | 0,8 | CET15P | | BAEA140E | |
| 6.2 E 63 AMG | 8 | M156.983 | 378/507 | 03/06→07/09 | OE233 | 1,0 | | | | |
| E-CLASS T-Model (S212) | | | | | | | | | | |
| 1.8 E 200 CGI | 4 | M271.860 | 135/181 | 11/09→ | OE229 | 0,8 | CET15P | | BAEA077 | |
| 1.8 E 250 CGI | 4 | M271.860 | 150/201 | 11/09→ | OE229 | 0,8 | CET15P | | BAEA077 | |
| 3.0 E 300 | 6 | M272.952 | 170/228 | 11/09→ | OE229 | 0,8 | CET15P | | | |
| 3.0 E 300 CDI | 6 | OM642.850 | 150/201 | 12/09→12/10 | | | | | CCU116 ^[275] | |
| 3.0 E 300 CDI / BlueTEC, 3.0 E 350 CDI, 3.0 E 350 CDI 4WD | 6 | OM642.850; OM642.852; OM642.856 | 170/228 | 11/09→ | | | | | CCU116 ^[275] | |
| 3.0 E 350 BlueTEC | 6 | OM642.850 | 155/208 | 11/09→ | | | | | CCU116 ^[275] | |
| 3.0 E 350 BlueTEC, 3.0 E 350 BlueTEC 4WD | 6 | OM642.852; OM642.858 | 185/248 | 11/12→ | | | | | CCU116 ^[275] | |
| 3.0 E 350 CDI, 3.0 E 350 CDI 4WD | 6 | OM642.852; OM642.858 | 195/261 | 07/11→ | | | | | CCU116 ^[275] | |
| 3.5 E 300, 3.5 E 300 4WD | 6 | M276.952 | 185/248 | 07/11→ | | | | | BAEA093E | |
| 3.5 E 350, 3.5 E 350 4WD | 6 | M276.952 | 225/302 | 09/11→ | | | | | BAEA093E | |
| 3.5 E 350, 3.5 E 350 4WD | 6 | M272.977; M272.980 | 200/268 | 08/09→ | OE229 | 0,8 | CET15P | | BAEA140E | |
| 4.7 E 500 4WD | 8 | M278.922 | 300/402 | 09/11→ | | | | | BAEA093E | |
| 5.5 E 63 AMG | 8 | M157.981 | 386/518 | 02/11→ | | | | | BAEA093E | |
| 5.5 E 63 AMG | 8 | M157.981 | 410/550 | 02/11→ | | | | | BAEA093E | |
| 5.5 E 63 AMG 4WD | 8 | M157.981 | 410/550 | 02/11→ | | | | | BAEA093E 08/12→ | |
| 5.5 E 63 AMG, 5.5 E 63 AMG 4WD | 8 | M157.981 | 430/577 | 02/13→ | | | | | BAEA093E | |
| 5.5 E 500 | 8 | M273.971 | 285/382 | 11/09→ | OE229 | 0,8 | CET15P | | BAEA140E | |
| 6.2 E 63 AMG | 8 | M156.985 | 386/518 | 08/09→ | OE233 | 1,0 | | | | |

MERCEDES-BENZ



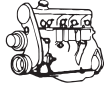

kW/BHP

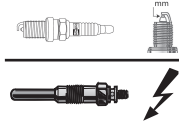

eon TITAN

IRIDIUM

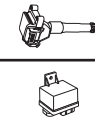

...MERCEDES-BENZ

E-CLASS (W124)

| | | | | | | | | | | |
|--|---|----------------------|---------|-------------|--|------------|--------|-------|--|--|
| 2.0 E 200 | 4 | M111.940 | 100/134 | 06/93→06/95 | OE057 | 0,9 | CET2 | OE180 | BAEA313 | CLS106 [229] →Eng.040193 017707 CLS065 [230] Eng.040194 017708→ |
| 2.0 E 200 D | 4 | OM601.912 | 55/74 | 06/93→06/95 | CH176 | 11.5v | | | | |
| 2.2 E 220 | 4 | M111.960 | 110/148 | 06/93→06/95 | OE057 | 0,9 | CET2 | OE180 | BAEA313 | CLS106 [229] →Eng.024563 049833 CLS065 [230] Eng.024564 049834→ |
| 2.5 E 250 D | 5 | OM605.911 | 83/111 | 07/93→06/95 | CH175 [297] | 11.5v | | | | |
| 2.5 E 250 Turbo-D | 5 | OM602.962 | 93/125 | 06/93→06/95 | CH176 | 11.5v | | | | |
| 2.8 E 280 | 6 | M104.942 | 142/190 | 06/93→06/95 | OE057 | 0,9 | CET2 | OE180 | BAEA340 | CLS252 |
| 2.8 E 280 | 6 | M104.942 | 145/194 | 06/93→06/95 | OE003 | 0,9 | CET2 | OE180 | BAEA340 | CLS252 |
| 3.0 E 300 4WD | 6 | M103.985 | 132/177 | 06/93→06/95 | OE011 | 0,9 | CET9 | OE183 | BAEA296[292] | CLS250 |
| 3.0 E 300 D | 6 | OM606.910 | 100/134 | 07/93→06/95 | CH175 [297] | 11.5v | | | | |
| 3.0 E 300 Turbo-D, 3.0 E 300 Turbo-D 4WD | 6 | OM603.960; OM603.963 | 108/145 | 06/93→06/95 | CH176 | 11.5v | | | | |
| 3.2 E 320 | 6 | M104.992 | 162/217 | 06/93→06/95 | OE057 | 0,9 | CET2 | OE180 | BAEA340 | CLS252 |
| 3.6 E 36 AMG | 6 | M104.992(AMG3.6) | 200/268 | 07/94→01/95 | OE057 | 0,9 | CET2 | OE180 | BAEA340 | |
| 4.2 E 420 | 8 | M119.975 | 205/275 | 06/93→06/95 | OE057 | 0,9 | CET2 | OE180 | BAEA298 [29][292] BAEA299 [46][292] | CLS219 |
| 5.0 E 500 | 8 | M119.974 | 235/315 | 06/93→06/95 | OE057 | 0,9 | CET2 | OE180 | BAEA296[292] | CLS219 |
| 6.0 E 60 AMG | 8 | M119.974(AMG6.0) | 280/375 | 05/94→06/95 | OE057 | 0,9 | CET2 | OE180 | BAEA296[292] | |
| E-CLASS (W210) | | | | | | | | | | |
| 2.0 E 200 | 4 | M111.942 | 100/134 | 06/95→08/00 | OE032 | 1,0 | CET2 | OE179 | BAEA340[41] | CLS138 [35] |
| 2.0 E 200 D | 4 | OM604.917 | 65/87 | 01/96→03/02 | CH177 [293] | 11.5v | | | CCU140 | |
| 2.0 E 200 Kompressor | 4 | M111.957 | 120/161 | 08/00→03/02 | | | CET12P | OE181 | BAEA041 | |
| 2.0 E 200 Kompressor | 4 | M111.947 | 137/184 | 06/97→03/02 | OE032 | 1,0 | CET2 | OE179 | BAEA340[41] | CLS063 [35] CLS071 [35] |
| 2.2 E 200 CDI | 4 | OM611.961 | 75/101 | 06/98→03/02 | | | | | CCU140 | |
| 2.2 E 200 CDI | 4 | OM611.961 | 85/114 | 07/99→03/02 | | | | | CCU140 | |
| 2.2 E 220 CDI | 4 | OM611.961 | 92/123 | 06/98→07/99 | | | | | CCU140 | |
| 2.2 E 220 CDI | 4 | OM611.961 | 100/134 | 07/99→03/02 | | | | | CCU140 | |
| 2.2 E 220 CDI | 4 | OM611.961 | 105/141 | 07/99→03/02 | | | | | CCU140 | |
| 2.2 E 220 D | 4 | OM604.912 | 55/74 | 05/96→03/02 | CH177 [293] | 11.5v | | | CCU140 | |
| 2.2 E 220 D | 4 | OM604.912 | 70/94 | 06/95→07/99 | CH177 [293] | 11.5v | | | CCU140 | |
| 2.3 E 230 | 4 | M111.970 | 110/148 | 06/95→06/97 | OE057 →Eng.052061 OE032 Eng.052062→ | 0,9 1,0 | CET2 | OE179 | BAEA340[41] | CLS063 [35] CLS071 [35] |
| 2.4 E 240 | 6 | M112.911 | 125/168 | 06/97→08/00 | OE191 | 1,0 | CET12P | OE180 | BAEA297 →06/99 | CLS064 |
| 2.5 E 250 D | 5 | OM605.912 | 83/111 | 06/95→07/99 | CH177 [293] | 11.5v | | | CCU141 | |
| 2.5 E 250 Turbo-D | 5 | OM605.962 | 110/148 | 06/97→07/99 | CH177 [293] | 11.5v | | | CCU141 | |
| 2.6 E 240 | 6 | M112.914 | 125/168 | 08/00→03/02 | OE191 | 1,0 | CET12P | OE180 | BAEA297 | CLS064 |
| 2.7 E 270 CDI | 5 | OM612.961 | 120/161 | 07/99→03/02 | | | | | CCU141 | |
| 2.7 E 270 CDI | 5 | OM612.961 | 125/168 | 07/99→03/02 | | | | | CCU141 | |
| 2.8 E 280 | 6 | M104.945 | 142/190 | 01/96→06/97 | OE057 | 0,9 | CET2 | OE180 | BAEA340 | CLS252 |
| 2.8 E 280 | 6 | M112.921 | 150/201 | 12/96→03/02 | OE191 | 1,0 | CET12P | OE180 | BAEA297 | CLS064 |
| 2.8 E 280 4WD | 6 | M112.921 | 150/201 | 12/96→03/02 | OE191 | 1,0 | CET12P | OE180 | BAEA297 →06/99 | CLS064 |
| 2.9 E 290 Turbo-D | 5 | OM602.982 | 95/127 | 03/96→07/99 | CH204 | 11.5v | | | CCU141 | |
| 3.0 E 300 D | 6 | OM606.912 | 100/134 | 06/95→06/97 | CH177 [293] | 11.5v | | | | |

MERCEDES-BENZ





kW/BHP

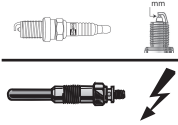

eon TITAN

IRIDIUM

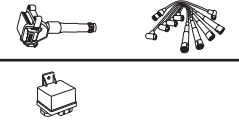

...MERCEDES-BENZ

...E-CLASS (W210)

| | | | | | | | | | | |
|--------------------------|---|------------------|---------|-------------|-------------|-------|--------|-------|---------|--------------------------------------|
| 3.0 E 300 Turbo-D | 6 | OM606.962 | 130/174 | 12/96→07/99 | CH177 [293] | 11.5v | | | CCU141 | |
| 3.2 E 320 | 6 | M104.995 | 162/217 | 06/95→06/97 | OE057 | 0,9 | CET2 | OE180 | BAEA340 | CLS252 →08/95 CLS254 09/95→ |
| 3.2 E 320, 3.2 E 320 4WD | 6 | M112.941 | 160/215 | 09/97→12/98 | OE191 | 1,0 | CET12P | OE180 | | |
| 3.2 E 320, 3.2 E 320 4WD | 6 | M112.941 | 165/221 | 06/97→03/02 | OE191 | 1,0 | CET12P | OE180 | BAEA297 | CLS064 |
| 3.2 E 320 CDI | 6 | OM613.961 | 145/194 | 07/99→03/02 | | | | | CCU141 | |
| 3.6 E 36 AMG | 6 | | 200/268 | 04/96→01/98 | OE057 | 0,9 | CET2 | OE180 | | |
| 4.2 E 420 | 8 | M119.985 | 205/275 | 01/96→06/97 | OE057 | 0,9 | CET2 | OE180 | | CLS219 |
| 4.3 E 430, 4.3 E 430 4WD | 8 | M113.940 | 205/275 | 06/97→03/02 | OE191 | 1,0 | CET12P | OE180 | BAEA297 | CLS242 |
| 5.0 E 50 AMG | 8 | M119.985(AMG5.0) | 255/342 | 02/96→08/97 | OE057 | 0,9 | CET2 | OE180 | | |
| 5.4 E 55 AMG | 8 | M113.980 | 255/342 | 09/97→02/02 | OE191 | 1,0 | CET12P | OE180 | | |
| 5.4 E 55 AMG | 8 | M113.980 | 260/349 | 08/97→03/02 | OE191 | 1,0 | CET12P | OE180 | BAEA297 | CLS242 |
| 5.4 E 55 AMG 4WD | 8 | M113.980 | 260/349 | 03/01→03/02 | OE191 | 1,0 | CET12P | OE180 | BAEA297 | |

E-CLASS (W211)

| | | | | | | | | | | |
|-------------------------------------|---|------------------------------------|---------|-------------|--|-----|---|-------|---|--------|
| 1.8 E 200 Kompressor | 4 | M271.956 | 135/181 | 04/06→12/08 | OE224 →11/06 →Eng.30853899 | 0,8 | CET14P | | BAEA053 →11/06 →Eng.30853899 | |
| | | | | | OE229 12/06→ Eng.30853900→ | 0,8 | CET15P | | BAEA077 11/06→ Eng.30853900→ | |
| 1.8 E 200 Kompressor, 1.8 E 200 NGT | 4 | M271.941 | 120/161 | 11/02→12/08 | OE229 [232] | 0,8 | CET15P [232] | | BAEA053 →Eng.30853899 →Prod.30.11.2006 | |
| | | | | | OE224 →Eng.30853899 →Prod.30.11.2006 | 0,8 | CET14P →Eng.30853899 →Prod.30.11.2006 | | BAEA077 Eng.30853900→ Prod.30.11.2006→ | |
| | | | | | OE229 Eng.30853900→ Prod.30.11.2006→ | 0,8 | CET15P Eng.30853900→ Prod.30.11.2006→ | | | |
| 2.1 E 200 CDI | 4 | OM646.820 | 100/134 | 04/06→12/08 | | | | | CCU110[269] CCU140[233] | |
| 2.1 E 220 CDI | 4 | OM646.961 | 100/134 | 03/02→12/08 | | | | | CCU140[233] | |
| 2.1 E 220 CDI | 4 | OM646.961 | 110/148 | 03/02→12/08 | | | | | CCU140[233] | |
| 2.1 E 220 CDI | 4 | OM646.821 | 120/161 | 03/03→12/08 | | | | | CCU110[269] CCU140[233] | |
| 2.1 E 220 CDI | 4 | OM646.821 | 125/168 | 04/06→12/08 | | | | | CCU110[269] CCU140[233] | |
| 2.2 E 200 CDI | 4 | OM646.951 | 75/101 | 07/02→12/08 | | | | | CCU140 | |
| 2.2 E 200 CDI | 4 | OM646.951 | 90/121 | 07/02→12/08 | | | | | CCU140 | |
| 2.5 E 230 | 6 | M272.922 | 150/201 | 09/07→12/08 | OE229 | 0,8 | CET15P | | BAEA140E | |
| 2.6 E 240, 2.6 E 240 4WD | 6 | M112.913; M112.917 | 130/174 | 03/02→12/08 | OE191 | 1,0 | CET12P | OE180 | BAEA297 | CLS064 |
| 2.7 E 270 CDI | 5 | OM647.961 | 120/161 | 03/02→12/08 | | | | | CCU141 | |
| 2.7 E 270 CDI | 5 | OM647.961 | 130/174 | 03/02→12/08 | | | | | CCU141 | |
| 3.0 E 280, 3.0 E 280 4WD | 6 | M272.943; M272.944 | 170/228 | 03/05→12/08 | OE229 | 0,8 | CET15P | | BAEA140E | |
| 3.0 E 280 CDI, 3.0 E 280 CDI 4WD | 6 | OM642.920; OM642.921 | 140/188 | 03/05→12/08 | | | | | CCU114 [180] [273] [275] [281] CCU116 [239] [275] [284] | |
| 3.0 E 300 BlueTEC | 6 | OM642.920 | 155/208 | 09/07→12/08 | | | | | CCU114 [180] [273] [275] [281] CCU116 [239] [275] [284] | |
| 3.0 E 320 CDI, 3.0 E 320 CDI 4WD | 6 | OM642.910; OM642.920; OM642.921 | 165/221 | 03/05→12/08 | | | | | CCU114 [180] [273] [275] [281] CCU116 [239] [275] [284] | |

MERCEDES-BENZ



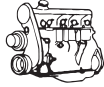

kW/BHP

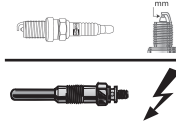

eon TITAN

IRIDIUM

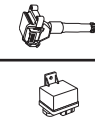
**...MERCEDES-BENZ****...E-CLASS (W211)**

| | | | | | | | | | | | |
|--------------------------|---|--------------------|---------|-------------|-------|-----|--------|-------|----------|--|--|
| 3.2 E 280 CDI | 6 | OM648.961 | 130/174 | 05/04→12/08 | | | | | | CCU113 [231] [283] CCU141 [268] [280] | |
| 3.2 E 320 | 6 | M112.949 | 165/221 | 03/02→12/08 | OE191 | 1,0 | CET12P | OE180 | BAEA297 | CLS064 | |
| 3.2 E 320 4WD | 6 | M112.954 | 165/221 | 03/03→12/08 | OE191 | 1,0 | CET12P | OE180 | BAEA297 | | |
| 3.2 E 320 CDI | 6 | OM648.961 | 150/201 | 11/02→12/08 | | | | | | CCU113 [231] [283] CCU141 [268] [280] | |
| 3.5 E 350, 3.5 E 350 4WD | 6 | M272.964; M272.972 | 200/268 | 03/05→12/08 | OE229 | 0,8 | CET15P | | BAEA140E | | |
| 4.0 E 420 CDI | 8 | OM629.910 | 231/310 | 01/06→12/08 | | | | | CCU118 | | |
| 5.0 E 500 | 8 | M113.967 | 215/288 | 09/02→12/05 | OE191 | 1,0 | CET12P | OE180 | | | |
| 5.0 E 500 | 8 | M113.967 | 225/302 | 03/02→12/08 | OE191 | 1,0 | CET12P | OE180 | BAEA297 | CLS242 | |
| 5.0 E 500 4WD | 8 | M113.969 | 225/302 | 10/03→12/08 | OE191 | 1,0 | CET12P | OE180 | BAEA297 | | |
| 5.5 E 55 AMG Kompressor | 8 | M113.990 | 350/469 | 10/02→12/08 | OE224 | 0,8 | CET14P | | BAEA297 | CLS242 | |
| 5.5 E 500, 5.5 E 500 4WD | 8 | M273.960; M273.962 | 285/382 | 04/06→12/08 | OE229 | 0,8 | CET15P | | BAEA140E | | |
| 6.2 E 63 AMG | 8 | M156.983 | 378/507 | 03/06→12/08 | OE233 | 1,0 | | | | | |

E-CLASS (W212)

| | | | | | | | | | | | |
|---|---|---------------------------------|---------|-------------|-------|-----|--------|--|--------------------|--|--|
| 1.8 E 200 CGI | 4 | M271.820; M271.860 | 135/181 | 08/09→ | OE229 | 0,8 | CET15P | | BAEA077 | | |
| 1.8 E 200 NGT | 4 | M271.958 | 120/161 | 03/11→ | OE229 | 0,8 | CET15P | | BAEA077 | | |
| 1.8 E 250 CGI | 4 | M271.860 | 150/201 | 01/09→ | OE229 | 0,8 | CET15P | | BAEA077 | | |
| 3.0 E 300 | 6 | M272.952 | 170/228 | 01/09→ | OE229 | 0,8 | CET15P | | BAEA140E | | |
| 3.0 E 300 CDI | 6 | OM642.850 | 150/201 | 12/09→12/10 | | | | | CCU116 [275] | | |
| 3.0 E 300 CDI / BlueTEC, 3.0 E 350 CDI, 3.0 E 350 CDI 4WD | 6 | OM642.850; OM642.852; OM642.856 | 170/228 | 01/09→ | | | | | CCU116 [275] | | |
| 3.0 E 350 BlueTEC | 6 | OM642.850 | 155/208 | 01/09→ | | | | | CCU116 [275] | | |
| 3.0 E 350 BlueTEC, 3.0 E 350 BlueTEC 4WD | 6 | OM642.852; OM642.858 | 185/248 | 11/12→ | | | | | CCU116 [275] | | |
| 3.0 E 350 CDI, 3.0 E 350 CDI 4WD | 6 | OM642.852; OM642.858 | 195/261 | 03/11→ | | | | | CCU116 [275] | | |
| 3.5 E 300, 3.5 E 300 4WD | 6 | M276.952 | 185/248 | 07/11→ | | | | | BAEA093E | | |
| 3.5 E 350, 3.5 E 350 4WD | 6 | M276.952 | 225/302 | 09/11→ | | | | | BAEA093E | | |
| 3.5 E 350, 3.5 E 350 4WD | 6 | M272.977; M272.980 | 200/268 | 01/09→ | OE229 | 0,8 | CET15P | | BAEA140E | | |
| 4.7 E 500, 4.7 E 500 4WD | 8 | M278.922 | 300/402 | 09/11→ | | | | | BAEA093E | | |
| 5.5 E 63 AMG | 8 | M157.980; M157.981 | 386/518 | 02/11→ | | | | | BAEA093E | | |
| 5.5 E 63 AMG | 8 | M157.981 | 410/550 | 02/11→ | | | | | BAEA093E 04/11→ | | |
| 5.5 E 63 AMG 4WD | 8 | M157.981 | 410/550 | 02/11→ | | | | | BAEA093E 08/12→ | | |
| 5.5 E 63 AMG, 5.5 E 63 AMG 4WD | 8 | M157.981 | 430/577 | 02/13→ | | | | | BAEA093E | | |
| 5.5 E 500, 5.5 E 500 4WD | 8 | M273.970; M273.971 | 285/382 | 01/09→ | OE229 | 0,8 | CET15P | | BAEA140E | | |
| 6.2 E 63 AMG | 8 | M156.985 | 386/518 | 12/09→ | OE233 | 1,0 | | | | | |

G-CLASS (W461)

| | | | | | | | | | | | |
|--------------------------------------|---|----------------------|---------|-------------|----------------------|-------|------|-------|-----------------------|--------|--|
| 2.3 230 GE 4WD | 4 | M102.996; M102.997 | 92/123 | 06/93→07/00 | OE009 | 0,9 | CET9 | OE183 | | CLS098 | |
| 2.7 G 270 CDI 4WD | 5 | OM612.966 | 115/154 | 01/03→ | | | | | CCU141 | | |
| 2.9 290 GD/G 290 D 4WD | 5 | OM602.942 | 70/94 | 06/93→07/00 | CH176 | 11.5v | | | | | |
| 2.9 G 290 TD 4WD | 5 | OM602.983 | 88/118 | 07/97→ | CH204 [177] [275] | 11.5v | | | CCU141 | | |
| 3.0 G 280 CDI 4WD, 3.0 G 300 CDI 4WD | 6 | OM642.884; OM642.975 | 135/181 | 04/09→ | | | | | CCU114 [180] [275] | | |

G-CLASS (W463)

| | | | | | | | | | | | |
|-------------------|---|------------------|---------|-------------|-------|-----|--------|-------|---------------|--|--|
| 2.7 G 270 CDI 4WD | 5 | OM612.965 | 115/154 | 10/01→ | | | | | CCU141 | | |
| 3.6 G 36 AMG 4WD | 6 | M104.996(AMG3.6) | 200/268 | 01/95→07/98 | OE057 | 0,9 | CET2 | OE180 | BAEA340 [41] | | |
| 5.0 500 GE 4WD | 8 | M117.965 | 177/237 | 09/93→12/94 | OE001 | 0,9 | CET8 | OE195 | BAEA298 [292] | | |
| 5.0 G 500 4WD | 8 | M113.962 | 215/288 | 09/04→12/05 | OE191 | 1,0 | CET12P | OE180 | | | |

CHAMPION

MERCEDES-BENZ



kW/BHP

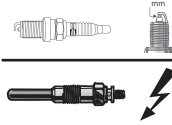

eon TITAN

IRIDIUM

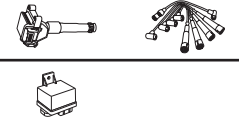

...MERCEDES-BENZ

...G-CLASS (W463)

| | | | | | | | | | | |
|------------------|----|--------------------|---------|--------|-------|-----|--------|-------|----------|--------|
| 5.0 G 500 4WD | 8 | M113.962 | 218/292 | 04/98→ | OE191 | 1,0 | CET12P | OE180 | BAEA297 | CLS242 |
| 5.4 G 55 AMG 4WD | 8 | M113.993 | 350/469 | 06/04→ | | | CET14P | OE190 | BAEA297 | |
| 5.4 G 55 AMG 4WD | 8 | M113.993 | 368/493 | 08/06→ | OE224 | 0,8 | CET14P | | BAEA297 | CLS242 |
| 5.5 G 55 AMG 4WD | 8 | M113.982 | 260/349 | 04/99→ | OE191 | 1,0 | CET12P | OE180 | BAEA297 | |
| 5.5 G 55 AMG 4WD | 8 | M113.993 | 373/500 | 08/08→ | OE224 | 0,8 | CET14P | | BAEA297 | CLS242 |
| 5.5 G 63 AMG 4WD | 8 | M157.984 | 400/536 | 05/12→ | | | | | BAEA093E | |
| 5.5 G 500 4WD | 8 | M273.963; M273.969 | 285/382 | 05/08→ | OE229 | 0,8 | CET15P | | | |
| 6.0 G 65 AMG 4WD | 12 | M279.982 | 450/603 | 05/12→ | | | CET12P | OE180 | | |

G-CLASS /Cabrio (W463)

| | | | | | | | | | | |
|-------------------------------|---|-----------|---------|-------------|------------------------|-------|--------|-------|-------------------------|--------------------------------------|
| 3.0 G 300 TD 4WD | 6 | OM606.964 | 130/174 | 08/96→07/00 | CH177 ^[293] | 11.5v | | | CCU141 | |
| 3.0 G 320 CDI 4WD | 6 | OM642.970 | 165/221 | 09/06→ | | | | | CCU116 ^[275] | |
| 3.0 G 350 CDI 4WD | 6 | OM642.886 | 155/208 | 07/11→ | | | | | CCU116 ^[275] | |
| 3.2 320 GE 4WD, 3.2 G 320 4WD | 6 | M104.996 | 155/208 | 09/94→12/97 | OE057 | 0,9 | CET2 | OE180 | BAEA340 ^[41] | CLS252 →08/95 CLS254 09/95→ |
| 3.2 G 320 4WD | 6 | M112.945 | 158/212 | 07/97→ | OE191 | 1,0 | CET12P | OE180 | BAEA297 | CLS064 |

G-CLASS Cabrio (W463)

| | | | | | | | | | | |
|---------------|---|--------------------|---------|--------|-------|-----|--------|-------|-------------------|--------|
| 5.0 G 500 4WD | 8 | M113.962 | 218/292 | 04/98→ | OE191 | 1,0 | CET12P | OE180 | BAEA297 →09/05 | CLS242 |
| 5.5 G 500 4WD | 8 | M273.963; M273.969 | 285/382 | 12/09→ | OE229 | 0,8 | CET15P | | BAEA140E | |

GL-CLASS (X164)

| | | | | | | | | | | |
|--|---|-----------|---------|-------------|-------|-----|--------|--|--|--|
| 3.0 GL 320 CDI / 350 BlueTEC 4WD | 6 | OM642.820 | 155/208 | 12/09→ | | | | | CCU116 ^[275] | |
| 3.0 GL 320 CDI 4WD | 6 | OM642.940 | 165/221 | 09/06→05/09 | | | | | CCU114 [180] [275] [280] CCU116 [275] [283] | |
| 3.0 GL 350 CDI 4WD | 6 | OM642.940 | 165/221 | 05/09→ | | | | | CCU114 [180] [275] [280] CCU116 [275] [283] | |
| 3.0 GL 350 CDI 4WD | 6 | OM642.822 | 195/261 | 10/10→ | | | | | CCU116 ^[275] | |
| 4.0 GL 420 CDI 4WD, 4.0 GL 450 CDI 4WD | 8 | OM629.912 | 225/302 | 09/06→ | | | | | CCU118 | |
| 4.7 GL 450 4WD | 8 | M273.923 | 250/335 | 09/06→ | OE229 | 0,8 | CET15P | | BAEA140E | |
| 5.5 GL 500 4WD | 8 | M273.963 | 285/382 | 09/06→ | OE229 | 0,8 | CET15P | | BAEA140E | |

GL-CLASS (X166)

| | | | | | | | | | | |
|------------------------------|---|-----------|---------|--------|--|--|--|--|-------------------------|--|
| 3.0 GL 350 CDI / BlueTec 4WD | 6 | OM642.826 | 190/255 | 07/12→ | | | | | CCU116 ^[275] | |
| 4.7 GL 500 4WD | 8 | M278.928 | 320/429 | 07/12→ | | | | | BAEA093E | |
| 5.5 GL 63 AMG 4WD | 8 | M157.982 | 410/550 | 07/12→ | | | | | BAEA093E | |

GLK-CLASS (X204)

| | | | | | | | | | | |
|----------------------|---|--------------------|---------|-------------|-------|-----|--------|--|---------------------------|--|
| 3.0 280 4WD | 6 | M272.948 | 170/228 | 06/08→06/09 | OE229 | 0,8 | CET15P | | BAEA140E ^[179] | |
| 3.0 300 4WD | 6 | M272.948 | 170/228 | 07/09→04/11 | OE229 | 0,8 | CET15P | | BAEA140E | |
| 3.0 320 CDI 4WD | 6 | OM642.961 | 165/221 | 06/08→06/15 | | | | | CCU114 [180] [275] | |
| 3.0 350 CDI 4WD | 6 | OM642.832 | 165/221 | 07/09→01/10 | | | | | CCU116 ^[275] | |
| 3.0 350 CDI 4WD | 6 | OM642.832 | 170/228 | 02/10→05/10 | | | | | CCU116 ^[275] | |
| 3.0 350 CDI 4WD | 6 | OM642.835 | 195/261 | 07/12→06/15 | | | | | CCU116 ^[275] | |
| 3.5 350, 3.5 350 4WD | 6 | M272.971; M272.991 | 200/268 | 06/08→06/15 | OE229 | 0,8 | CET15P | | BAEA140E | |
| 3.5 350 4WD | 6 | M276.957 | 225/302 | 06/08→06/15 | | | | | BAEA093E 06/11→ | |

M-CLASS (W163)

| | | | | | | | | | | |
|--------------------|---|-----------|---------|-------------|-------|-----|------|-------|-------------------------|--|
| 2.3 ML 230 4WD | 4 | M111.977 | 110/148 | 02/98→06/05 | OE032 | 1,0 | CET2 | OE179 | BAEA340 ^[41] | CLS063 ^[35] CLS071 ^[35] |
| 2.7 ML 270 CDI 4WD | 5 | OM612.963 | 120/161 | 12/99→06/05 | | | | | CCU141 | |

MERCEDES-BENZ



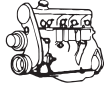

kW/BHP

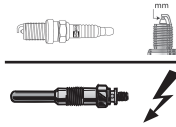

eon TITAN

IRIDIUM

**...MERCEDES-BENZ****...M-CLASS (W163)**

| | | | | | | | | | | |
|-------------------|---|--------------------|---------|---------------|-------|-----|--------|-------|---------|--------|
| 3.2 ML 320 4WD | 6 | M112.942 | 160/215 | 02/98 → 08/02 | OE191 | 1,0 | CET12P | OE180 | BAEA297 | CLS064 |
| 3.7 ML 350 4WD | 6 | M112.970 | 173/232 | 02/03 → 06/05 | OE191 | 1,0 | CET12P | OE180 | BAEA297 | CLS064 |
| 3.7 ML 350 4WD | 6 | M112.970 | 180/241 | 08/02 → 06/05 | OE191 | 1,0 | CET12P | OE180 | BAEA297 | CLS064 |
| 4.3 ML 430 4WD | 8 | M113.942 | 200/268 | 02/98 → 06/05 | OE191 | 1,0 | CET12P | OE180 | BAEA297 | CLS242 |
| 5.0 ML 500 4WD | 8 | M113.964; M113.965 | 215/288 | 09/01 → 06/05 | OE191 | 1,0 | CET12P | OE180 | BAEA297 | CLS242 |
| 5.4 ML 55 AMG 4WD | 8 | M113.981 | 255/342 | 02/00 → 06/05 | OE191 | 1,0 | CET12P | OE180 | BAEA297 | CLS242 |

M-CLASS (W164)

| | | | | | | | | | | |
|--|---|-----------|---------|---------------|-------|-----|--------|-------|-----------------------------|--|
| 3.0 ML 280 CDI 4WD, 3.0 ML 300 CDI 4WD | 6 | OM642.940 | 140/188 | 07/05 → 12/11 | | | | | CCU114 [180] [275] [280] | |
| 3.0 ML 300 CDI 4WD | 6 | OM642.820 | 150/201 | 02/10 → 12/11 | | | | | CCU116 [275] [283] | |
| 3.0 ML 320 CDI 4WD, 3.0 ML 350 CDI 4WD | 6 | OM642.940 | 165/221 | 07/05 → 12/11 | | | | | CCU114 [180] [275] [280] | |
| 3.0 ML 350 CDI 4WD | 6 | OM642.820 | 155/208 | 09/09 → 12/11 | | | | | CCU116 [275] [283] | |
| 3.0 ML 350 CDI 4WD | 6 | OM642.820 | 170/228 | 02/10 → 12/11 | | | | | CCU116 [275] [283] | |
| 3.5 ML 350 4WD | 6 | M272.967 | 200/268 | 02/05 → 12/11 | OE229 | 0,8 | CET15P | | BAEA140E | |
| 4.0 ML 420 CDI 4WD, 4.0 ML 450 CDI 4WD | 8 | OM629.912 | 225/302 | 02/06 → 12/11 | | | | | CCU118 | |
| 5.0 ML 500 4WD | 8 | M113.964 | 218/292 | 09/05 → 12/06 | OE191 | 1,0 | CET12P | OE180 | | |
| 5.0 ML 500 4WD | 8 | M113.964 | 225/302 | 07/05 → 12/11 | OE191 | 1,0 | CET12P | OE180 | BAEA297 | |
| 5.5 ML 500 4WD | 8 | M273.963 | 285/382 | 12/07 → 12/11 | OE229 | 0,8 | CET15P | | BAEA140E | |
| 6.2 ML 63 AMG 4WD | 8 | M156.980 | 375/503 | 01/06 → 12/11 | OE233 | 1,0 | | | | |

M-CLASS (W166)

| | | | | | | | | | | |
|------------------------|---|----------------------|---------|---------------|--|--|--|--|--------------|--|
| 3.0 ML 350 BlueTEC 4WD | 6 | OM642.826; OM642.864 | 190/255 | 06/11 → 02/15 | | | | | CCU116 [275] | |
| 3.5 ML 300 4WD | 6 | M276.955 | 185/248 | 08/12 → 02/15 | | | | | BAEA093E | |
| 3.5 ML 350 4WD | 6 | M276.955 | 225/302 | 06/11 → 12/15 | | | | | BAEA093E | |
| 4.7 ML 500 4WD | 8 | M278.928 | 300/402 | 02/12 → 02/15 | | | | | BAEA093E | |
| 5.5 ML 63 AMG 4WD | 8 | M157.982 | 386/518 | 11/11 → 02/15 | | | | | BAEA093E | |
| 5.5 ML 63 AMG 4WD | 8 | M157.982 | 410/550 | 11/11 → 02/15 | | | | | BAEA093E | |

R-CLASS (W251, V251)

| | | | | | | | | | | |
|--|---|----------------------|---------|---------------|-------|-----|--------|-------|-----------------------------|--------|
| 3.0 R 280, 3.0 R 300 | 6 | M272.945 | 170/228 | 01/07 → | OE229 | 0,8 | CET15P | | BAEA140E | |
| 3.0 R 280 4WD | 6 | M272.945 | 170/228 | 05/07 → | OE229 | 0,8 | CET15P | | BAEA140E Eng.30417697 → | |
| 3.0 R 280 CDI, 3.0 R 280 CDI 4WD, 3.0 R 300 CDI, 3.0 R 300 CDI 4WD | 6 | OM642.950 | 140/188 | 05/06 → | | | | | CCU114 [180] [275] [280] | |
| 3.0 R 280 CDI, 3.0 R 300 CDI | 6 | OM642.870; OM642.872 | 140/188 | 05/06 → | | | | | CCU116 [275] [283] | |
| 3.0 R 320 CDI 4WD, 3.0 R 350 CDI 4WD | 6 | OM642.870; OM642.950 | 155/208 | 01/06 → | | | | | CCU116 [275] [283] | |
| 3.0 R 320 CDI 4WD, 3.0 R 350 CDI 4WD | 6 | OM642.950 | 165/221 | 01/06 → | | | | | CCU114 [180] [275] [280] | |
| 3.0 R 350 CDI 4WD | 6 | OM642.872 | 195/261 | 08/10 → | | | | | CCU116 [275] | |
| 3.5 R 350, 3.5 R 350 4WD | 6 | M272.967 | 200/268 | 01/06 → | OE229 | 0,8 | CET15P | | BAEA140E | |
| 3.5 R 350 CGI 4WD | 6 | M276.958 | 225/302 | 01/06 → | | | | | BAEA093E 06/11 → | |
| 5.0 R 500 4WD | 8 | M113.971 | 218/292 | 01/06 → 12/06 | OE191 | 1,0 | CET12P | OE180 | | |
| 5.0 R 500 4WD | 8 | M113.960; M113.971 | 225/302 | 01/06 → | OE191 | 1,0 | CET12P | OE180 | BAEA297 | CLS242 |
| 5.5 R 500 4WD | 8 | M273.963 | 285/382 | 01/07 → | OE229 | 0,8 | CET15P | | BAEA140E | |

MERCEDES-BENZ





kW/BHP

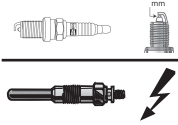

IRIDIUM

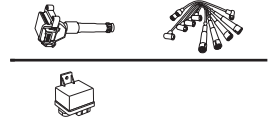

...MERCEDES-BENZ

...R-CLASS (W251, V251)

| | | | | | | | | | | |
|------------------|---|----------|---------|--------|--------------|-----|--|--|--|--|
| 6.2 R 63 AMG 4WD | 8 | M156.980 | 375/503 | 02/06→ | OE233 | 1,0 | | | | |
|------------------|---|----------|---------|--------|--------------|-----|--|--|--|--|

S-CLASS Coupe (C140)

| | | | | | | | | | | |
|----------------|---|----------|---------|-------------|---|-----|--|---|----------------------|---------------|
| 4.2 SEC/CL 420 | 8 | M119.981 | 205/275 | 10/94→02/99 | OE057 [270] →Eng.12/52, 22/62011673 | 0,9 | CET2 [270] →Eng.12/52, 22/62011673 | OE180 [270] →Eng.12/52, 22/62011673 | BAEA299 [292] | CLS219 |
| | | | | | OE228 Eng.12/52, 22/62011674→ | 1,0 | CET12P Eng.12/52, 22/62011674→ | OE181 Eng.12/52, 22/62011674→ | | |

| | | | | | | | | | | |
|----------------|---|----------|---------|-------------|--------------|-----|-------------|--------------|----------------------|---------------|
| 4.2 SEC/CL 420 | 8 | M119.971 | 205/275 | 10/94→02/99 | OE057 | 0,9 | CET2 | OE180 | BAEA299 [292] | CLS219 |
|----------------|---|----------|---------|-------------|--------------|-----|-------------|--------------|----------------------|---------------|

S-CLASS Coupe (C215)

| | | | | | | | | | | |
|--------------------------|----|----------|---------|-------------|--------------|-----|---------------|--------------|----------------|---------------|
| 5.0 CL 500 | 8 | M113.960 | 225/302 | 03/99→03/06 | OE191 | 1,0 | CET12P | OE180 | BAEA297 | CLS242 |
| 5.4 CL 55 AMG | 8 | M113.986 | 265/355 | 10/99→03/06 | OE191 | 1,0 | CET12P | OE180 | BAEA297 | CLS242 |
| 5.5 CL 55 AMG Kompressor | 8 | M113.991 | 368/493 | 06/02→03/06 | OE224 | 0,8 | CET14P | | BAEA297 | |
| 5.5 CL 600 | 12 | M275.950 | 368/493 | 09/02→03/06 | | | CET12P | OE188 | | |
| 5.8 CL 600 | 12 | M137.970 | 270/362 | 03/99→03/06 | | | CET12P | OE181 | | |
| 6.0 CL 65 AMG | 12 | M275.980 | 450/603 | 09/03→03/06 | | | CET12P | OE188 | | |

S-CLASS Coupe (C216)

| | | | | | | | | | | |
|----------------------------|----|--------------------|---------|-------------|--------------|-----|---------------|--------------|---------------------------|--|
| 4.7 CL 500, 4.7 CL 500 4WD | 8 | M278.920 | 320/429 | 02/11→12/13 | | | | | BAEA093E | |
| 5.5 CL 63 AMG | 8 | M157.980 | 400/536 | 02/11→12/13 | | | | | BAEA093E | |
| 5.5 CL 63 AMG | 8 | M157.980 | 420/563 | 01/10→12/13 | | | | | BAEA093E 09/11→ | |
| 5.5 CL 500, 5.5 CL 500 4WD | 8 | M273.961; M273.968 | 285/382 | 06/06→12/13 | OE229 | 0,8 | CET15P | | BAEA140E | |
| 5.5 CL 600 | 12 | M275.953 | 380/510 | 05/06→12/13 | | | CET12P | OE188 | | |
| 6.0 CL 65 AMG | 12 | M275.982 | 450/603 | 10/06→12/10 | | | CET12P | OE188 | | |
| 6.0 CL 65 AMG | 12 | M275.982 | 463/621 | 02/11→12/13 | | | CET12P | OE188 | | |
| 6.2 CL 63 AMG | 8 | M156.984 | 386/518 | 10/06→12/13 | OE233 | 1,0 | | | | |

S-CLASS Coupe (C217)

| | | | | | | | | | | |
|--------------|----|----------|---------|--------|--|--|---------------|--------------|--|--|
| 6.0 S 65 AMG | 12 | M279.980 | 463/621 | 07/14→ | | | CET12P | OE188 | | |
|--------------|----|----------|---------|--------|--|--|---------------|--------------|--|--|

S-CLASS (W140)

| | | | | | | | | | | |
|------------|---|----------|---------|-------------|--------------|-----|-------------|--------------|---------------------|--|
| 2.8 300 SE | 6 | M104.944 | 145/194 | 01/93→10/98 | OE057 | 0,9 | CET2 | OE180 | BAEA340 [41] | CLS252 →08/95 CLS254 09/95→ |
| 2.8 S 280 | 6 | M104.944 | 142/190 | 02/93→10/98 | OE057 | 0,9 | CET2 | OE180 | BAEA340 [41] | CLS252 →08/95 CLS254 09/95→ |

| | | | | | | | | | | |
|-------------------|---|-----------|---------|-------------|--------------------|-------|--|--|---------------|--|
| 3.0 S 300 Turbo-D | 6 | OM606.961 | 130/174 | 05/96→10/98 | CH177 [293] | 11.5v | | | CCU141 | |
|-------------------|---|-----------|---------|-------------|--------------------|-------|--|--|---------------|--|

| | | | | | | | | | | |
|-------------------|---|-----------|---------|-------------|--------------|-------|--|--|--|--|
| 3.4 S 350 Turbo-D | 6 | OM603.971 | 110/148 | 01/93→10/98 | CH176 | 11.5v | | | | |
|-------------------|---|-----------|---------|-------------|--------------|-------|--|--|--|--|

| | | | | | | | | | | |
|-----------|---|----------|---------|-------------|--------------|-----|-------------|--|--|---------------|
| 4.2 S 420 | 8 | M119.971 | 205/275 | 01/93→10/98 | OE057 | 0,9 | CET2 | | BAEA296 [30] [292] BAEA339 [31] [292] | CLS219 |
|-----------|---|----------|---------|-------------|--------------|-----|-------------|--|--|---------------|

| | | | | | | | | | | |
|-----------|---|----------|---------|-------------|--------------|-----|-------------|--------------|--|--|
| 5.0 S 500 | 8 | M119.970 | 235/315 | 01/93→10/98 | OE057 | 0,9 | CET2 | OE180 | | |
|-----------|---|----------|---------|-------------|--------------|-----|-------------|--------------|--|--|

| | | | | | | | | | | |
|-----------|---|----------|---------|-------------|---|-----|--|---|----------------|---------------|
| 5.0 S 500 | 8 | M119.980 | 235/315 | 01/93→10/98 | OE057 [270] →Eng.12/52, 22/62021034 | 0,9 | CET2 [270] →Eng.12/52, 22/62021034 | OE180 [270] →Eng.12/52, 22/62021034 | BAEA296 | CLS219 |
| | | | | | OE228 Eng.12/52, 22/62021035→ | 1,0 | CET12P Eng.12/52, 22/62021035→ | OE181 Eng.12/52, 22/62021035→ | BAEA339 | |

| | | | | | | | | | | |
|-----------|---|----------|---------|-------------|--|--|--|--|--|---------------|
| 5.0 S 500 | 8 | M119.970 | 235/315 | 01/93→10/98 | | | | | BAEA296 [30] [292] BAEA339 [31] [292] | CLS219 |
|-----------|---|----------|---------|-------------|--|--|--|--|--|---------------|

| | | | | | | | | | | |
|-----------|----|----------|---------|-------------|-----------------------------------|-----|----------------------------------|-----------------------------------|---------------------------|--|
| 6.0 S 600 | 12 | M120.982 | 290/389 | 01/93→10/98 | OE057 [270] →Eng.008359 | 0,9 | CET2 [270] →Eng.008359 | OE180 [270] →Eng.008359 | BAEA298 [31] [292] | |
| | | | | | OE228 Eng.008360→ | 1,0 | CET12P Eng.008360→ | OE181 Eng.008360→ | BAEA299 [30] [292] | |

| | | | | | | | | | | |
|-----------|----|----------|---------|-------------|--------------|-----|-------------|--------------|--|--|
| 6.0 S 600 | 12 | M120.980 | 290/389 | 01/93→10/98 | OE057 | 0,9 | CET2 | OE180 | BAEA298 [31] [292] BAEA299 [30] [292] | |
|-----------|----|----------|---------|-------------|--------------|-----|-------------|--------------|--|--|

S-CLASS (W220)

| | | | | | | | | | | |
|-----------|---|----------|---------|-------------|--------------|-----|---------------|--------------|----------------|---------------|
| 2.8 S 280 | 6 | M112.922 | 150/201 | 10/98→08/05 | OE191 | 1,0 | CET12P | OE180 | BAEA297 | CLS064 |
|-----------|---|----------|---------|-------------|--------------|-----|---------------|--------------|----------------|---------------|

MERCEDES-BENZ



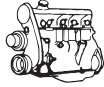

kW/BHP

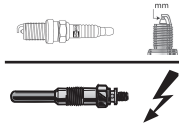

eon TITAN

IRIDIUM

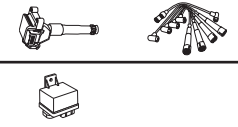

...MERCEDES-BENZ

...S-CLASS (W220)

| | | | | | | | | | | |
|--------------------------|----|--------------------|---------|---------------|-------|-----|--------|-------|---------|--------|
| 3.2 S 320 | 6 | M112.944 | 165/221 | 10/98 → 08/05 | OE191 | 1,0 | CET12P | OE180 | BAEA297 | CLS064 |
| 3.2 S 320 CDI | 6 | OM613.960 | 145/194 | 08/99 → 09/02 | | | | | CCU141 | |
| 3.2 S 320 CDI | 6 | OM648.960 | 150/201 | 09/02 → 08/05 | | | | | CCU141 | |
| 3.7 S 350, 3.7 S 350 4WD | 6 | M112.972; M112.975 | 180/241 | 09/02 → 08/05 | OE191 | 1,0 | CET12P | OE180 | BAEA297 | CLS064 |
| 4.3 S 430, 4.3 S 430 4WD | 8 | M113.941; M113.948 | 205/275 | 10/98 → 08/05 | OE191 | 1,0 | CET12P | OE180 | BAEA297 | CLS242 |
| 5.0 S 500 | 8 | M113.960 | 220/295 | 10/98 → 12/03 | OE191 | 1,0 | CET12P | OE180 | | |
| 5.0 S 500, 5.0 S 500 4WD | 8 | M113.960; M113.966 | 225/302 | 10/98 → 08/05 | OE191 | 1,0 | CET12P | OE180 | BAEA297 | CLS242 |
| 5.5 S 55 AMG | 8 | M113.986 | 265/355 | 04/99 → 08/05 | OE191 | 1,0 | CET12P | OE180 | BAEA297 | CLS242 |
| 5.5 S 55 AMG Kompressor | 8 | M113.991 | 368/493 | 06/02 → 08/05 | OE224 | 0,8 | CET14P | | BAEA297 | CLS242 |
| 5.5 S 600 | 12 | M275.950 | 368/493 | 09/02 → 12/06 | | | CET12P | OE188 | | |
| 5.8 S 600 | 12 | M137.970 | 270/362 | 01/00 → 08/05 | | | CET12P | OE181 | | |
| 6.0 S 65 AMG | 12 | M275.980 | 450/603 | 03/04 → 08/05 | | | CET12P | OE188 | | |

S-CLASS (W221)

| | | | | | | | | | | |
|---|----|----------------------|---------|---------------|-------|-----|--------|-------|-------------------------|--|
| 3.0 S 280, 3.0 S 300 | 6 | M272.946 | 170/228 | 08/06 → 12/13 | OE229 | 0,8 | CET15P | | BAEA140E | |
| 3.0 S 320 CDI | 6 | OM642.930 | 173/232 | 12/05 → 06/09 | | | | | CCU114 ^[275] | |
| 3.0 S 320 CDI, 3.0 S 320 CDI 4WD, 3.0 S 350 CDI | 6 | OM642.930; OM642.932 | 155/208 | 10/05 → 12/13 | | | | | CCU114 ^[275] | |
| 3.0 S 320 CDI 4WD, 3.0 S 350 CDI | 6 | OM642.930; OM642.932 | 173/232 | 10/06 → 12/13 | | | | | CCU114 ^[275] | |
| 3.0 S 350 BlueTec, 3.0 S 350 BlueTEC 4WD | 6 | OM642.862; OM642.868 | 190/255 | 04/11 → 12/13 | | | | | CCU116 ^[275] | |
| 3.5 S 350, 3.5 S 350 4WD | 6 | M272.965; M272.975 | 200/268 | 10/05 → 12/13 | OE229 | 0,8 | CET15P | | BAEA140E | |
| 3.5 S 350 CGI, 3.5 S 350 CGI 4WD | 6 | M276.950 | 225/302 | 04/11 → 12/13 | | | | | BAEA093E | |
| 3.5 S 400 Hybrid | 6 | M272.974 | 205/275 | 01/09 → 12/13 | OE229 | 0,8 | CET15P | | BAEA140E | |
| 4.0 S 420 CDI | 8 | OM629.911 | 235/315 | 10/06 → 12/09 | | | | | CCU118 | |
| 4.7 S 450, 4.7 S 450 4WD | 8 | M273.922; M273.924 | 250/335 | 12/05 → 12/13 | OE229 | 0,8 | CET15P | | BAEA140E | |
| 4.7 S 500 CGI, 4.7 S 500 CGI 4WD | 8 | M278.932 | 320/429 | 03/11 → 12/13 | | | | | BAEA093E | |
| 5.5 S 63 AMG | 8 | M157.980 | 400/536 | 03/11 → 12/13 | | | | | BAEA093E | |
| 5.5 S 63 AMG | 8 | M157.980 | 420/563 | 02/12 → 12/13 | | | | | BAEA093E | |
| 5.5 S 500, 5.5 S 500 4WD | 8 | M273.961; M273.968 | 285/382 | 10/05 → 12/13 | OE229 | 0,8 | CET15P | | BAEA140E | |
| 5.5 S 600 | 12 | M275.953 | 380/510 | 12/05 → 12/13 | | | CET12P | OE188 | | |
| 6.0 S 65 AMG | 12 | M275.982 | 450/603 | 12/05 → 12/13 | | | CET12P | OE188 | | |
| 6.0 S 65 AMG | 12 | M275.982 | 463/621 | 04/11 → 12/13 | | | CET12P | OE188 | | |
| 6.2 S 63 AMG | 8 | M156.984 | 386/518 | 10/06 → 12/13 | OE233 | 1,0 | | | | |

S-CLASS (W222, V222, X222)

| | | | | | | | | | | |
|--|----|----------------------|---------|---------|--|--|--------|-------|-------------------------|--|
| 3.0 S 350 BlueTEC / d, 3.0 S 350 BlueTEC / d 4WD | 6 | OM642.861; OM642.867 | 190/255 | 05/13 → | | | | | CCU116 ^[275] | |
| 3.0 S 350 BlueTEC 4WD | 6 | OM642.867 | 185/248 | 02/14 → | | | | | CCU116 ^[275] | |
| 3.5 S 400 Hybrid / h | 6 | M276.960 | 225/302 | 05/13 → | | | | | BAEA093E | |
| 4.7 S 500, 4.7 S 500 4WD | 8 | M278.929 | 335/449 | 05/13 → | | | | | BAEA093E | |
| 5.5 S 63 AMG, 5.5 S 63 AMG 4WD | 8 | M157.985 | 430/577 | 05/13 → | | | | | BAEA093E | |
| 6.0 S 65 AMG | 12 | M279.980 | 463/621 | 02/14 → | | | CET12P | OE188 | | |
| 6.0 S 600, 6.0 S 600 Maybach | 12 | M277.980 | 390/523 | 02/14 → | | | CET12P | OE188 | | |

SL (R129)

| | | | | | | | | | | |
|---------|---|----------|---------|---------------|------------------|-----|--------|------------------|-------------------------|-------------------|
| 2.8 280 | 6 | M104.943 | 142/190 | 08/93 → 10/01 | OE057 →05/97 | 0,9 | CET2 | OE180 →05/97 | BAEA340 ^[41] | CLS252 →08/95 |
| | | | | | OE032 06/97 → | 1,0 | | OE179 06/97 → | | CLS254 09/95 → |
| 2.8 280 | 6 | M112.923 | 150/201 | 05/98 → 10/01 | OE191 | 1,0 | CET12P | OE180 | BAEA297 | CLS064 |
| 3.2 320 | 6 | M112.943 | 165/221 | 05/98 → 10/01 | OE191 | 1,0 | CET12P | OE180 | BAEA297 | CLS064 |
| 3.2 320 | 6 | M104.991 | 170/228 | 09/93 → 10/01 | OE057 →06/97 | 0,9 | CET2 | OE180 →06/97 | BAEA340 ^[41] | CLS252 →08/95 |
| | | | | | OE032 07/97 → | 1,0 | | OE179 07/97 → | | CLS254 09/95 → |





kW/BHP

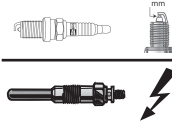

eon TITAN

IRIDIUM

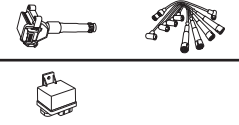

...MERCEDES-BENZ

...SL (R129)

| | | | | | | | | | | |
|---------------|----|---------------------------------------|---------|-------------|---|-----|--|---|----------------|---------------|
| 5.0 500 | 8 | M113.961 | 225/302 | 05/98→10/01 | OE191 | 1,0 | CET12P | OE180 | BAEA297 | CLS242 |
| 5.5 55 AMG | 8 | M113.985 | 260/349 | 03/00→10/01 | OE191 | 1,0 | CET12P | OE180 | | |
| 6.0 60 AMG | 8 | M119.982 | 280/375 | 05/97→10/01 | OE057 [270] →Eng.12/52, 22/62012118 | 0,9 | CET2 [270] →Eng.12/52, 22/62012118 | OE180 [270] →Eng.12/52, 22/62012118 | | |
| 6.0 60 AMG | 8 | M119.972(AMG6.0); M119.982(AMG6.0) | 280/375 | 05/97→10/01 | OE228 Eng.12/52, 22/62012119→ | 1,0 | CET12P Eng.12/52, 22/62012119→ | OE181 Eng.12/52, 22/62012119→ | | |
| 6.0 SL 60AMG | 8 | M119.982(AMG6.0) | 284/381 | 09/96→12/99 | OE057 →Eng.12/52, 22/62012118 | 0,9 | CET2 →Eng.12/52, 22/62012118 | OE180 →Eng.12/52, 22/62012118 | | |
| | | | | | OE228 Eng.12/52, 22/62012119→ | 1,0 | CET12P Eng.12/52, 22/62012119→ | OE181 Eng.12/52, 22/62012119→ | | |
| 7.3 SL 73 AMG | 12 | M120.981 | 386/518 | 01/99→12/01 | OE057 | 0,9 | CET2 | OE180 | | |
| 7.3 SL 73 AMG | 12 | M120.983 | 386/518 | 01/99→12/01 | OE057 [270] →Eng.002262 | 0,9 | CET2 [270] →Eng.002262 | OE180 [270] →Eng.002262 | | |
| | | | | | OE228 Eng.002263→ | 1,0 | CET12P Eng.002263→ | OE181 Eng.002263→ | | |

SL (R230)

| | | | | | | | | | | |
|-----------------------|----|----------|---------|-------------|--------------|-----|---------------|--------------|-----------------|---------------|
| 3.0 280, 3.0 300 | 6 | M272.949 | 170/228 | 03/08→01/12 | OE229 | 0,8 | CET15P | | BAEA140E | |
| 3.5 350 | 6 | M272.966 | 200/268 | 03/06→01/12 | OE229 | 0,8 | CET15P | | BAEA140E | |
| 3.5 350 | 6 | M272.968 | 232/311 | 04/08→01/12 | OE229 | 0,8 | CET15P | | BAEA140E | |
| 3.7 350 | 6 | M112.973 | 180/241 | 03/03→01/12 | OE191 | 1,0 | CET12P | OE180 | BAEA297 | CLS064 |
| 5.0 500 | 8 | M113.963 | 215/288 | 09/02→12/05 | OE191 | 1,0 | CET12P | OE180 | | |
| 5.0 500 | 8 | M113.963 | 225/302 | 10/01→01/12 | OE191 | 1,0 | CET12P | OE180 | BAEA297 | CLS242 |
| 5.4 55 AMG | 8 | M113.992 | 350/469 | 10/01→06/02 | OE224 | 0,8 | CET14P | | BAEA297 | CLS242 |
| 5.4 55 AMG | 8 | M113.995 | 380/510 | 03/06→01/12 | OE224 | 0,8 | CET14P | | BAEA297 | |
| 5.5 55 AMG Kompressor | 8 | M113.992 | 368/493 | 06/02→01/12 | OE224 | 0,8 | CET14P | | BAEA297 | CLS242 |
| 5.5 500 | 8 | M273.965 | 285/382 | 03/06→01/12 | OE229 | 0,8 | CET15P | | BAEA140E | |
| 5.5 600 | 12 | M275.951 | 368/493 | 04/03→01/12 | | | CET12P | OE188 | | |
| 5.5 600 | 12 | M275.954 | 380/510 | 03/06→01/12 | | | CET12P | OE188 | | |
| 6.0 65 AMG | 12 | M275.981 | 450/603 | 03/04→01/12 | | | CET12P | OE188 | | |
| 6.2 63 AMG | 8 | M156.981 | 386/518 | 03/08→01/12 | OE233 | 1,0 | | | | |

SL (R231)

| | | | | | | | | | | |
|------------|----|----------|---------|--------|--|--|---------------|--------------|---------------------------|--|
| 3.5 350 | 6 | M276.954 | 225/302 | 02/12→ | | | | | BAEA093E | |
| 4.7 500 | 8 | M278.927 | 320/429 | 01/12→ | | | | | BAEA093E | |
| 5.5 63 AMG | 8 | M157.983 | 395/530 | 01/12→ | | | | | BAEA093E | |
| 5.5 63 AMG | 8 | M157.983 | 415/557 | 01/12→ | | | | | BAEA093E 02/12→ | |
| 6.0 65 AMG | 12 | M279.981 | 463/621 | 05/12→ | | | CET12P | OE180 | | |

SLK (R170)

| | | | | | | | | | | |
|-----------------------|---|----------|---------|-------------|------------------------|-----|---------------|--------------|---------------------|--|
| 2.0 200 | 4 | M111.946 | 100/134 | 09/96→03/00 | OE057 →06/97 | 0,9 | CET2 | OE180 | BAEA340 [41] | CLS138 [35] |
| 2.0 200 Kompressor | 4 | M111.958 | 120/161 | 03/00→04/04 | | | CET12P | OE181 | BAEA041 | CLS063 [35] CLS071 [35] |
| 2.0 200 Kompressor | 4 | M111.943 | 141/189 | 10/96→03/00 | OE032 | 1,0 | CET2 | OE179 | BAEA340 [41] | CLS138 [35] |
| 2.3 230 Kompressor | 4 | M111.973 | 142/190 | 09/96→03/00 | OE032 | 1,0 | CET2 | OE179 | BAEA340 [41] | CLS138 [35] |
| 2.3 230 Kompressor | 4 | M111.983 | 145/194 | 03/00→04/04 | | | CET12P | OE181 | BAEA041 | |
| 3.2 32 AMG Kompressor | 6 | M112.960 | 260/349 | 03/01→04/04 | | | CET12P | OE180 | BAEA297 | CLS064 |
| 3.2 320 | 6 | M112.947 | 160/215 | 03/00→04/04 | OE191 | 1,0 | CET12P | OE180 | BAEA297 | CLS064 |

SLK (R171)

| | | | | | | | | | | |
|--------------------|---|----------|---------|-------------|---|-----|--|--|---|--|
| 1.8 200 Kompressor | 4 | M271.944 | 120/161 | 03/04→02/11 | OE229 [232] | 0,8 | CET15P [232] | | BAEA053 →Eng.30853899 →Prod.30.11.2006 | |
| | | | | | OE224 →Eng.30853899 →Prod.30.11.2006 | 0,8 | CET14P →Eng.30853899 →Prod.30.11.2006 | | BAEA077 Eng.30853900→ Prod.30.11.2006→ | |
| | | | | | OE229 Eng.30853900→ Prod.30.11.2006→ | 0,8 | CET15P Eng.30853900→ Prod.30.11.2006→ | | | |
| 1.8 200 Kompressor | 4 | M271.954 | 135/181 | 01/08→02/11 | OE229 | 0,8 | CET15P | | BAEA077 Eng.30853900→ | |

MERCEDES-BENZ





kW/BHP



eon TITAN

IRIDIUM



...MERCEDES-BENZ

...SLK (R171)

| | | | | | | | | | | |
|------------------|---|----------|---------|---------------|-------|-----|--------|-------|----------|--------|
| 3.0 280, 3.0 300 | 6 | M272.942 | 170/228 | 01/05 → 02/11 | OE229 | 0,8 | CET15P | | BAEA140E | |
| 3.5 350 | 6 | M272.963 | 200/268 | 06/04 → 02/11 | OE229 | 0,8 | CET15P | | BAEA140E | |
| 3.5 350 | 6 | M272.969 | 224/300 | 01/08 → 02/11 | OE229 | 0,8 | CET15P | | BAEA140E | |
| 5.5 55 AMG | 8 | M113.989 | 265/355 | 06/04 → 02/11 | | | CET12P | OE180 | BAEA297 | CLS242 |
| 5.5 55 AMG | 8 | M113.989 | 294/394 | 06/06 → 02/11 | OE191 | 1,0 | CET12P | | BAEA297 | |

SLK (R172)

| | | | | | | | | | | |
|------------|---|--------------------|---------|---------|-------|-----|--------|--|----------|--|
| 1.8 200 | 4 | M271.860 | 135/181 | 02/11 → | OE229 | 0,8 | CET15P | | | |
| 1.8 200 | 4 | M271.861 | 135/181 | 02/11 → | OE229 | 0,8 | CET15P | | BAEA077 | |
| 1.8 250 | 4 | M271.860; M271.861 | 150/201 | 02/11 → | OE229 | 0,8 | CET15P | | BAEA077 | |
| 3.5 350 | 6 | M276.956 | 225/302 | 02/11 → | | | | | BAEA093E | |
| 5.5 55 AMG | 8 | M152.980 | 310/416 | 01/12 → | | | | | BAEA093E | |

SLR (R199)

| | | | | | | | | | | |
|-----------------|---|----------|---------|---------|-------|-----|--------|--|---------|--|
| 5.4 | 8 | M155.980 | 460/617 | 04/04 → | OE224 | 0,8 | CET14P | | BAEA297 | |
| 5.4 722 Edition | 8 | M155.980 | 478/641 | 10/06 → | OE224 | 0,8 | CET14P | | BAEA297 | |

SLR Roadster (R199)

| | | | | | | | | | | |
|-----|---|----------|---------|---------|-------|-----|--------|--|---------|--|
| 5.4 | 8 | M155.980 | 460/617 | 04/07 → | OE224 | 0,8 | CET14P | | BAEA297 | |
| 5.4 | 8 | M155.980 | 478/641 | 10/06 → | OE224 | 0,8 | CET14P | | BAEA297 | |

VANEO (414)

| | | | | | | | | | | |
|---------|---|-----------|--------|---------------|-------|-----|--|--|----------|--|
| 1.6 | 4 | M166.961 | 60/80 | 02/02 → 07/05 | | | | | BAEA146E | |
| 1.6 | 4 | M166.961 | 75/101 | 02/02 → 07/05 | | | | | BAEA146E | |
| 1.7 CDI | 4 | OM668.914 | 55/74 | 02/02 → 07/05 | CH219 | 11v | | | CCU140 | |
| 1.7 CDI | 4 | OM668.914 | 67/90 | 02/02 → 07/05 | CH219 | 11v | | | CCU140 | |
| 1.9 | 4 | M166.991 | 92/123 | 02/02 → 07/05 | | | | | BAEA146E | |

V-CLASS (638/2)

| | | | | | | | | | | |
|---------------|---|--------------------|---------|---------------|-------|-------|------|-------|-------------------------|------------------------|
| 2.0 V 200 | 4 | M111.948; M111.950 | 95/127 | 02/97 → 07/03 | | | | | BAEA340 ^[41] | CLS138 ^[35] |
| 2.2 V 200 CDI | 4 | OM611.980 | 75/101 | 03/99 → 07/03 | | | | | CCU140 | |
| 2.2 V 220 CDI | 4 | OM611.980 | 90/121 | 03/99 → 07/03 | | | | | CCU140 | |
| 2.3 V 230 | 4 | M111.978; M111.980 | 105/141 | 10/96 → 07/03 | OE019 | 0,9 | CET2 | OE184 | BAEA340 ^[41] | CLS138 ^[35] |
| 2.3 V 230 TD | 4 | OM601.970 | 72/97 | 09/96 → 07/03 | CH176 | 11.5v | | | | |
| 2.8 V 280 | 6 | M104.900 | 128/172 | 08/97 → 07/03 | | | | | BAEA004E | |

VIANO (W639)

| | | | | | | | | | | |
|----------------------|---|----------------------|---------|---------------|-------|-----|--------|-------|-------------------------------|--------|
| 2.0 CDI | 4 | OM646.982 | 85/114 | 08/05 → | | | | | CCU140 | |
| 2.0 CDI, 2.0 CDI 4WD | 4 | OM646.982 | 80/107 | 09/03 → | | | | | CCU140 | |
| 2.0 CDI 4WD | 4 | OM646.982 | 85/114 | 03/06 → | | | | | CCU140 ^[235] | |
| 2.2 CDI, 2.2 CDI 4WD | 4 | OM646.980; OM646.982 | 110/148 | 09/03 → | | | | | CCU140 | |
| 3.0 CDI | 6 | OM642.990 | 150/201 | 03/06 → | | | | | CCU114 ^{[180] [275]} | |
| 3.0 CDI | 6 | OM642.890 | 165/221 | 07/10 → | | | | | CCU114 ^{[180] [275]} | |
| 3.2 | 6 | M112.951 | 160/215 | 09/03 → | OE191 | 1,0 | CET12P | OE180 | BAEA297 | CLS064 |
| 3.2 3,0 | 6 | M112.951 | 140/188 | 09/03 → | OE191 | 1,0 | CET12P | OE180 | BAEA297 | CLS064 |
| 3.5 | 6 | M272.978 | 190/255 | 09/07 → | OE229 | 0,8 | CET15P | | BAEA140E | |
| 3.7 | 6 | M112.976 | 165/221 | 06/04 → 07/07 | OE191 | 1,0 | CET12P | OE180 | BAEA297 | |
| 3.7 | 6 | M112.976 | 170/228 | 06/04 → | OE191 | 1,0 | CET12P | OE180 | BAEA297 | |

MERCEDES-BENZ

100 Box/Bus/Platform/Chassis (631)

| | | | | | | | | | | |
|-------|---|-----------|-------|---------------|-------|-------|--|--|--|--|
| 2.0 D | 4 | OM615.970 | 45/60 | 09/93 → 04/96 | CH176 | 11.5v | | | | |
|-------|---|-----------|-------|---------------|-------|-------|--|--|--|--|

CITAN Box (415)

| | | | | | | | | | | |
|---------|---|----------|--------|---------|--|--|--|-------|----------|--|
| 1.2 112 | 4 | M200.711 | 84/113 | 06/13 → | | | | OE261 | BAEA131E | |
|---------|---|----------|--------|---------|--|--|--|-------|----------|--|

SPRINTER 2-t Box (901, 902)

| | | | | | | | | | | |
|---------|---|----------|---------|---------------|-------|-----|------|-------|-------------------------|------------------------|
| 2.3 214 | 4 | M111.979 | 105/141 | 02/95 → 05/06 | OE057 | 0,9 | CET2 | OE180 | BAEA340 ^[41] | CLS138 ^[35] |
|---------|---|----------|---------|---------------|-------|-----|------|-------|-------------------------|------------------------|





kW/BHP

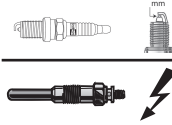

eon TITAN

IRIDIUM

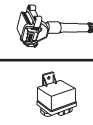

...MERCEDES-BENZ

...SPRINTER 2-t Box (901, 902)

| | | | | | | | | | | |
|---------|---|----------|---------|-------------|-------|-----|------|-------|-------------------------|--|
| 2.3 214 | 4 | M111.984 | 105/141 | 02/95→05/06 | OE032 | 1,0 | CET2 | OE179 | BAEA340 ^[41] | CLS063 ^[35] CLS071 ^[35] |
|---------|---|----------|---------|-------------|-------|-----|------|-------|-------------------------|--|

SPRINTER 2-t Box/Bus/Platform/Chassis (901, 902)

| | | | | | | | | | | |
|-------------|---|--------------------|---------|-------------|---|-----------------------|--------|-------|-------------------------|--|
| 2.1 208 CDI | 4 | OM611.987 | 60/80 | 04/00→05/06 | | | | | CCU140 | |
| 2.1 211 CDI | 4 | OM611.981 | 80/107 | 04/00→05/06 | | | | | CCU140 | |
| 2.1 213 CDI | 4 | OM611.981 | 95/127 | 04/00→05/06 | | | | | CCU140 | |
| 2.3 208 D | 4 | OM601.943 | 58/78 | 01/95→04/00 | CH176 | 11.5v | | | | |
| 2.3 208 D | 4 | OM601.943 | 60/80 | 09/96→04/00 | CH176 | 11.5v | | | | |
| 2.3 214 NGT | 4 | M111.979; M111.984 | 95/127 | 02/95→05/06 | OE146 | 1,0 | CET12P | OE179 | BAEA340 ^[41] | CLS063 ^[35] CLS071 ^[35] |
| 2.7 216 CDI | 5 | OM612.981 | 115/154 | 04/00→05/06 | | | | | CCU141 | |
| 2.9 210 D | 5 | OM602.980 | 75/101 | 01/97→04/00 | CH204 | 11.5v | | | CCU141 | |
| 2.9 212 D | 5 | OM602.980 | 90/121 | 02/95→04/00 | CH189 →Eng.9849 CH204 ^[285] Eng.137→ CH204 ^[287] Eng.9850→ | 11v 11.5v 11.5v | | | CCU141 | |

SPRINTER 2-t Bus/Platform/Chassis (901, 902)

| | | | | | | | | | | |
|---------|---|----------|---------|-------------|--|--|--|-------|-------------------------|------------------------|
| 2.3 214 | 4 | M111.979 | 105/141 | 02/95→05/06 | | | | OE180 | BAEA340 ^[41] | CLS138 ^[35] |
| 2.3 214 | 4 | M111.984 | 105/141 | 02/95→05/06 | | | | | BAEA340 ^[41] | CLS138 ^[35] |

SPRINTER 3,5-t Box (906)

| | | | | | | | | | | |
|---------|---|----------|---------|-------------|-------|-----|--------|--|--------------------------------------|--|
| 3.5 324 | 6 | M272.979 | 190/255 | 06/06→12/13 | OE229 | 0,8 | CET15P | | BAEA140E BAEA077 Eng.30099999→ | |
|---------|---|----------|---------|-------------|-------|-----|--------|--|--------------------------------------|--|

SPRINTER 3,5-t Box/Bus/Platform/Chassis (906)

| | | | | | | | | | | |
|--|---|---------------------------------|---------|-------------|-------|-----|--------|--|---|--|
| 1.8 316, 1.8 316 NGT | 4 | M271.951 | 115/154 | 09/08→ | OE229 | 0,8 | CET15P | | BAEA053 →10/10 →Eng.30853899 BAEA077 11/10→ Eng.30853900→ | |
| 1.8 316 LGT | 4 | M271.951 | 115/154 | 09/08→ | OE229 | 0,8 | CET15P | | BAEA077 Eng.30099999→ | |
| 2.1 309 CDI | 4 | OM646.984 | 65/87 | 06/06→12/09 | | | | | CCU140 | |
| 2.1 311 CDI, 2.1 311 CDI 4WD | 4 | OM646.985 | 80/107 | 06/06→12/09 | | | | | CCU140 | |
| 2.1 313 CDI | 4 | OM646.986 | 95/127 | 06/06→ | | | | | CCU140 | |
| 2.1 315 CDI, 2.1 315 CDI 4WD | 4 | OM646.986; OM646.989; OM646.990 | 110/148 | 06/06→ | | | | | CCU140 | |
| 3.0 318 CDI, 3.0 318 CDI 4WD | 6 | OM642.993 | 135/181 | 06/06→12/09 | | | | | CCU114 ^[275] | |
| 3.0 318 CDI, 3.0 318 CDI 4WD | 6 | OM642.992 | 135/181 | 06/06→12/09 | | | | | CCU114 ^[275] →Eng.41694476 | |
| 3.0 318 CDI, 3.0 318 CDI 4WD | 6 | OM642.896 | 135/181 | 06/06→12/09 | | | | | CCU116 [272] [275] CCU114 →Eng.41330713 [272] [275] CCU116 →Eng.41689183 [234] [275] | |
| 3.0 319 CDI / BlueTEC, 3.0 319 CDI / BlueTEC 4WD | 6 | OM642.992 | 140/188 | 03/09→ | | | | | CCU114 ^[275] →Eng.41694476 →Prod.03.03.2015 | |

MERCEDES-BENZ





kW/BHP



eon TITAN

IRIDIUM

**...MERCEDES-BENZ****...SPRINTER 3,5-t Box/Bus/Platform/Chassis (906)**

3.0 319 CDI / BlueTEC, 3.0 319 CDI / BlueTEC 4WD 6 OM642.896; OM642.898 140/188 03/09→

CCU116 [272] [275]

CCU114

→Eng.41330713
→Prod.15.06.2012
[272] [275]

CCU116

→Eng.41689183
→Prod.17.02.2015
[234] [275]**SPRINTER 3,5-t Bus/Platform/Chassis (906)**

3.5 324 6 M272.979 190/255 06/06→12/13 OE229 0,8 CET15P BAEA140E

SPRINTER 3-t Box (903)

2.3 314 4 M111.979 105/141 02/95→05/06 OE057 0,9 CET2 OE180 BAEA340[41] CLS138 [35]

2.9 310 D 5 OM602.980 75/101 02/95→04/00 CH204 11.5v CCU141
01/97→**SPRINTER 3-t Box/Bus/Platform/Chassis (903)**

2.1 308 CDI 4 OM611.987 60/80 04/00→05/06 CCU140

2.1 311 CDI, 2.1 311 CDI 4 OM611.981 80/107 04/00→05/06 CCU140
4WD2.1 313 CDI, 2.1 313 CDI 4 OM611.981 95/127 04/00→05/06 CCU140
4WD

2.3 308 D 4 OM601.943 58/78 02/95→04/00 CH176 11.5v

2.3 308 D 4 OM601.943 60/80 02/95→04/00 CH176 11.5v

2.3 314, 2.3 314 4WD 4 M111.984 105/141 02/95→05/06 OE032 1,0 CET2 OE179 BAEA340[41] CLS063 [35]
CLS071 [35]

2.3 314 4WD 4 M111.979 105/141 08/02→05/06 OE057 0,9 OE180

2.3 314 NGT 4 M111.979; M111.984 95/127 02/95→05/06 OE146 1,0 CET12P OE179 BAEA340[41] CLS063 [35]
CLS071 [35]2.7 316 CDI, 2.7 316 CDI 5 OM612.981 115/154 04/00→05/06 CCU141
4WD2.9 312 D, 2.9 312 D 2.9 5 OM602.980 90/121 02/95→08/02 CH189 11v CCU141
4WD

→Eng.9849

CH204 [285] 11.5v

Eng.137→

CH204 [287] 11.5v

Eng.9850→

SPRINTER 3-t Bus (903)2.9 310 D 5 OM602.980 75/101 01/97→12/99 CH204 [177] 11.5v
Eng.98502.9 310 D 4WD 5 OM602.980 75/101 05/97→08/02 CH204 11.5v CCU141
137→

→03/00

SPRINTER 3-t Bus/Platform/Chassis (903)2.3 314 4 M111.979 105/141 02/95→05/06 OE057 0,9 CET2 OE180 BAEA340[41] CLS063 [35]
CLS071 [35]**SPRINTER 3-t Platform/Chassis (903)**

2.9 310 D 5 OM602.980 75/101 01/97→04/00 CH204 11.5v CCU141

2.9 312 D 5 OM602.980 85/114 12/98→09/01 CH204 [177] 11.5v CCU141
Eng.9850

137→

SPRINTER 3-t Box (906)1.8 216 4 M271.951 115/154 09/08→ OE229 0,8 CET15P BAEA077
Eng.030099999→**SPRINTER 3-t Box/Bus/Platform/Chassis (906)**

2.1 209 CDI 4 OM646.984 65/87 06/06→12/09 CCU140

2.1 211 CDI 4 OM646.985 80/107 06/06→12/09 CCU140

2.1 213 CDI 4 OM646.986 95/127 06/06→ CCU140

MERCEDES-BENZ





kW/BHP

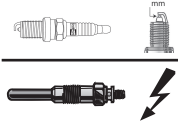

eon TITAN

IRIDIUM

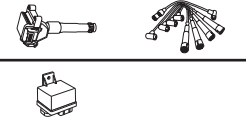

...MERCEDES-BENZ

...SPRINTER 3-t Box/Bus/Platform/Chassis (906)

| | | | | | | | | |
|-------------|---|---------------------------------|---------|-------------|--|--|--|---------------|
| 2.1 215 CDI | 4 | OM646.986; OM646.989; OM646.990 | 110/148 | 06/06→12/09 | | | | CCU140 |
|-------------|---|---------------------------------|---------|-------------|--|--|--|---------------|

| | | | | | | | | |
|---------|---|----------|---------|--------|--------------|-----|---------------|-----------------|
| 3.5 224 | 6 | M272.979 | 190/255 | 06/06→ | OE229 | 0,8 | CET15P | BAEA140E |
|---------|---|----------|---------|--------|--------------|-----|---------------|-----------------|

SPRINTER 3-t Box/Platform/Chassis (906)

| | | | | | | | | |
|-------------|---|-----------|---------|-------------|--|--|--|---|
| 3.0 218 CDI | 6 | OM642.992 | 135/181 | 06/06→12/09 | | | | CCU114 ^[275] →Eng.41694476 |
|-------------|---|-----------|---------|-------------|--|--|--|---|

| | | | | | | | | |
|-------------|---|-----------|---------|-------------|--|--|--|------------------------------|
| 3.0 218 CDI | 6 | OM642.896 | 135/181 | 06/06→12/09 | | | | CCU116 [272] [275] |
|-------------|---|-----------|---------|-------------|--|--|--|------------------------------|

| | | | | | | | | |
|--|--|--|--|--|--|--|--|--------------------------------|
| | | | | | | | | CCU114 →Eng.41330713 |
|--|--|--|--|--|--|--|--|--------------------------------|

| | | | | | | | | |
|--|--|--|--|--|--|--|--|-------------|
| | | | | | | | | [272] [275] |
|--|--|--|--|--|--|--|--|-------------|

| | | | | | | | | |
|--|--|--|--|--|--|--|--|--------------------------------|
| | | | | | | | | CCU116 →Eng.41689183 |
|--|--|--|--|--|--|--|--|--------------------------------|

| | | | | | | | | |
|--|--|--|--|--|--|--|--|-------------|
| | | | | | | | | [234] [275] |
|--|--|--|--|--|--|--|--|-------------|

| | | | | | | | | |
|-----------------------|---|-----------|---------|--------|--|--|--|---|
| 3.0 219 CDI / BlueTEC | 6 | OM642.992 | 140/188 | 03/09→ | | | | CCU114 ^[275] →Eng.41694476 |
|-----------------------|---|-----------|---------|--------|--|--|--|---|

| | | | | | | | | |
|--|--|--|--|--|--|--|--|------------------|
| | | | | | | | | →Prod.03.03.2015 |
|--|--|--|--|--|--|--|--|------------------|

| | | | | | | | | |
|-----------------------|---|-----------|---------|--------|--|--|--|------------------------------|
| 3.0 219 CDI / BlueTEC | 6 | OM642.896 | 140/188 | 03/09→ | | | | CCU116 [272] [275] |
|-----------------------|---|-----------|---------|--------|--|--|--|------------------------------|

| | | | | | | | | |
|--|--|--|--|--|--|--|--|--------------------------------|
| | | | | | | | | CCU114 →Eng.41330713 |
|--|--|--|--|--|--|--|--|--------------------------------|

| | | | | | | | | |
|--|--|--|--|--|--|--|--|------------------|
| | | | | | | | | →Prod.15.06.2012 |
|--|--|--|--|--|--|--|--|------------------|

| | | | | | | | | |
|--|--|--|--|--|--|--|--|-------------|
| | | | | | | | | [272] [275] |
|--|--|--|--|--|--|--|--|-------------|

| | | | | | | | | |
|--|--|--|--|--|--|--|--|--------------------------------|
| | | | | | | | | CCU116 →Eng.41689183 |
|--|--|--|--|--|--|--|--|--------------------------------|

| | | | | | | | | |
|--|--|--|--|--|--|--|--|------------------|
| | | | | | | | | →Prod.17.02.2015 |
|--|--|--|--|--|--|--|--|------------------|

| | | | | | | | | |
|--|--|--|--|--|--|--|--|-------------|
| | | | | | | | | [234] [275] |
|--|--|--|--|--|--|--|--|-------------|

| | | | | | | | | |
|--|--|--|--|--|--|--|--|--|
| | | | | | | | | |
|--|--|--|--|--|--|--|--|--|

SPRINTER 3-t Bus (906)

| | | | | | | | | |
|---------|---|----------|---------|--------|--------------|-----|---------------|---------------------------------|
| 1.8 216 | 4 | M271.951 | 115/154 | 09/08→ | OE229 | 0,8 | CET15P | BAEA077 Eng.30099999→ |
|---------|---|----------|---------|--------|--------------|-----|---------------|---------------------------------|

SPRINTER 3-t Platform/Chassis (906)

| | | | | | | | | |
|---------|---|----------|---------|-------------|--------------|-----|---------------|----------------|
| 1.8 216 | 4 | M271.951 | 115/154 | 09/08→05/16 | OE229 | 0,8 | CET15P | BAEA077 |
|---------|---|----------|---------|-------------|--------------|-----|---------------|----------------|

| | | | | | | | | |
|-------------|---|-----------|---------|-------------|--|--|--|--------------------------------|
| 3.0 218 CDI | 6 | OM642.993 | 135/181 | 06/06→12/09 | | | | CCU114 ^[275] |
|-------------|---|-----------|---------|-------------|--|--|--|--------------------------------|

SPRINTER 4,6-t Box/Platform/Chassis (906)

| | | | | | | | | |
|-------------|---|-----------|--------|-------------|--|--|--|---------------|
| 2.1 411 CDI | 4 | OM646.985 | 80/107 | 06/09→12/09 | | | | CCU140 |
|-------------|---|-----------|--------|-------------|--|--|--|---------------|

| | | | | | | | | |
|-------------|---|-----------|--------|--------|--|--|--|---------------|
| 2.1 413 CDI | 4 | OM646.986 | 95/127 | 06/06→ | | | | CCU140 |
|-------------|---|-----------|--------|--------|--|--|--|---------------|

| | | | | | | | | |
|-------------|---|---------------------------------|---------|--------|--|--|--|---------------|
| 2.1 415 CDI | 4 | OM646.986; OM646.989; OM646.990 | 110/148 | 06/06→ | | | | CCU140 |
|-------------|---|---------------------------------|---------|--------|--|--|--|---------------|

| | | | | | | | | |
|-------------|---|-----------|---------|-------------|--|--|--|---|
| 3.0 418 CDI | 6 | OM642.992 | 135/181 | 06/09→05/16 | | | | CCU114 ^[275] →Eng.41694476 |
|-------------|---|-----------|---------|-------------|--|--|--|---|

| | | | | | | | | |
|--|--|--|--|--|--|--|--|------------------|
| | | | | | | | | →Prod.03.03.2015 |
|--|--|--|--|--|--|--|--|------------------|

| | | | | | | | | |
|-------------|---|-----------|---------|-------------|--|--|--|------------------------------|
| 3.0 418 CDI | 6 | OM642.896 | 135/181 | 06/09→05/16 | | | | CCU116 [272] [275] |
|-------------|---|-----------|---------|-------------|--|--|--|------------------------------|

| | | | | | | | | |
|--|--|--|--|--|--|--|--|--------------------------------|
| | | | | | | | | CCU114 →Eng.41330713 |
|--|--|--|--|--|--|--|--|--------------------------------|

| | | | | | | | | |
|--|--|--|--|--|--|--|--|------------------|
| | | | | | | | | →Prod.15.06.2012 |
|--|--|--|--|--|--|--|--|------------------|

| | | | | | | | | |
|--|--|--|--|--|--|--|--|-------------|
| | | | | | | | | [272] [275] |
|--|--|--|--|--|--|--|--|-------------|

| | | | | | | | | |
|--|--|--|--|--|--|--|--|--------------------------------|
| | | | | | | | | CCU116 →Eng.41689183 |
|--|--|--|--|--|--|--|--|--------------------------------|

| | | | | | | | | |
|--|--|--|--|--|--|--|--|------------------|
| | | | | | | | | →Prod.17.02.2015 |
|--|--|--|--|--|--|--|--|------------------|

| | | | | | | | | |
|--|--|--|--|--|--|--|--|-------------|
| | | | | | | | | [234] [275] |
|--|--|--|--|--|--|--|--|-------------|

| | | | | | | | | |
|-------------|---|-----------|---------|--------|--|--|--|---|
| 3.0 419 CDI | 6 | OM642.992 | 140/188 | 03/09→ | | | | CCU114 ^[275] →Eng.41694476 |
|-------------|---|-----------|---------|--------|--|--|--|---|

| | | | | | | | | |
|--|--|--|--|--|--|--|--|------------------|
| | | | | | | | | →Prod.03.03.2015 |
|--|--|--|--|--|--|--|--|------------------|

| | | | | | | | | |
|-------------|---|----------------------|---------|--------|--|--|--|------------------------------|
| 3.0 419 CDI | 6 | OM642.896; OM642.898 | 140/188 | 03/09→ | | | | CCU116 [272] [275] |
|-------------|---|----------------------|---------|--------|--|--|--|------------------------------|

| | | | | | | | | |
|--|--|--|--|--|--|--|--|--------------------------------|
| | | | | | | | | CCU114 →Eng.41330713 |
|--|--|--|--|--|--|--|--|--------------------------------|

| | | | | | | | | |
|--|--|--|--|--|--|--|--|------------------|
| | | | | | | | | →Prod.15.06.2012 |
|--|--|--|--|--|--|--|--|------------------|

| | | | | | | | | |
|--|--|--|--|--|--|--|--|-------------|
| | | | | | | | | [272] [275] |
|--|--|--|--|--|--|--|--|-------------|

| | | | | | | | | |
|--|--|--|--|--|--|--|--|--------------------------------|
| | | | | | | | | CCU116 →Eng.41689183 |
|--|--|--|--|--|--|--|--|--------------------------------|

| | | | | | | | | |
|--|--|--|--|--|--|--|--|------------------|
| | | | | | | | | →Prod.17.02.2015 |
|--|--|--|--|--|--|--|--|------------------|

| | | | | | | | | |
|--|--|--|--|--|--|--|--|-------------|
| | | | | | | | | [234] [275] |
|--|--|--|--|--|--|--|--|-------------|

| | | | | | | | | |
|---------|---|----------|---------|-------------|--------------|-----|---------------|-----------------|
| 3.5 424 | 6 | M272.979 | 190/255 | 06/06→12/13 | OE229 | 0,8 | CET15P | BAEA140E |
|---------|---|----------|---------|-------------|--------------|-----|---------------|-----------------|

MERCEDES-BENZ



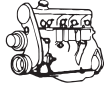

kW/BHP

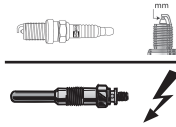

eon TITAN

IRIDIUM

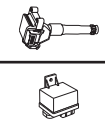

MERCEDES-BENZ

...MERCEDES-BENZ

SPRINTER 4,6-t Platform/Chassis (906)

| | | | | | | | | | |
|-------------|---|----------------------|---------|--------------|--|--|--|--|--|
| 2.1 415 CDI | 4 | OM646.986; OM646.989 | 110/148 | 06/06 → | | | | | CCU140 |
| 3.0 418 CDI | 6 | OM642.993 | 135/181 | 06/06 →12/09 | | | | | CCU114 [275] |
| 3.0 418 CDI | 6 | OM642.992 | 135/181 | 06/06 →12/09 | | | | | CCU114 [275] →Eng.41694476 |
| 3.0 418 CDI | 6 | OM642.896 | 135/181 | 06/06 →12/09 | | | | | CCU116 [272] [275] CCU114 →Eng.41330713 [272] [275] CCU116 →Eng.41689183 [234] [275] |

SPRINTER 4-t Box (904)

| | | | | | | | | | |
|---------------|---|-----------|--------|--------------|--|--|--|--|------------------------------|
| 2.9 414 D 4WD | 5 | OM602.980 | 90/121 | 05/97 →05/06 | | | | | CCU140 [237] CCU141 [238] |
|---------------|---|-----------|--------|--------------|--|--|--|--|------------------------------|

SPRINTER 4-t Box/Bus/Platform/Chassis (904)

| | | | | | | | | | |
|------------------------------|---|-----------|---------|--------------|--|--|-------|--|--------------------------|
| 2.1 408 CDI | 4 | OM611.987 | 60/80 | 04/00 →05/06 | | | | | CCU140 |
| 2.1 411 CDI, 2.1 411 CDI 4WD | 4 | OM611.981 | 80/107 | 04/00 →05/06 | | | | | CCU140 |
| 2.1 413 CDI, 2.1 413 CDI 4WD | 4 | OM611.981 | 95/127 | 04/00 →05/06 | | | | | CCU140 |
| 2.3 414, 2.3 414 4WD | 4 | M111.979 | 105/141 | 02/95 →05/06 | | | OE180 | | BAEA340 [41] CLS138 [35] |
| 2.3 414, 2.3 414 4WD | 4 | M111.984 | 105/141 | 02/96 →05/06 | | | | | BAEA340 [41] CLS138 [35] |
| 2.7 416 CDI, 2.7 416 CDI 4WD | 5 | OM612.981 | 115/154 | 04/00 →05/06 | | | | | CCU141 |

SPRINTER 4-t Box/Platform/Chassis (904)

| | | | | | | | | | |
|--------------------------|---|-----------|--------|--------------|------------------------------------|-------|--|--|--------|
| 2.3 408 D | 4 | OM601.943 | 58/78 | 02/96 →05/06 | CH176 | 11.5v | | | |
| 2.9 410 D, 2.9 410 D 4WD | 5 | OM602.980 | 75/101 | 02/96 →05/06 | CH204 [285] →03/00 Eng.000137 → | 11.5v | | | CCU141 |
| | | | | | CH204 [287] →03/00 Eng.009850 → | 11.5v | | | |
| 2.9 412 D, 2.9 412 D 4WD | 5 | OM602.980 | 85/114 | 02/96 →05/06 | CH204 [285] →03/00 Eng.000137 → | 11.5v | | | CCU141 |
| | | | | | CH204 [287] →03/00 Eng.009850 → | 11.5v | | | |
| 2.9 412 D, 2.9 412 D 4WD | 5 | OM602.980 | 90/121 | 02/96 →05/06 | CH204 [285] →03/00 Eng.000137 → | 11.5v | | | CCU141 |
| | | | | | CH204 [287] →03/00 Eng.009850 → | 11.5v | | | |
| | | | | | CH189 →Eng.009850 000137 | 11v | | | |

SPRINTER 4-t Platform/Chassis (904)

| | | | | | | | | | |
|-----------|---|-----------|---------|--------------|------------------------------------|-------|--|--|---|
| 2.3 414 | 4 | M111.984 | 105/141 | 02/95 →05/06 | | | | | BAEA340 [41] CLS063 [35] CLS071 [35] |
| 2.9 412 D | 5 | OM602.980 | 85/114 | 02/96 →05/06 | CH204 [285] →03/00 Eng.000137 → | 11.5v | | | CCU141 |
| | | | | | CH204 [287] →03/00 Eng.009850 → | 11.5v | | | |

SPRINTER 5-t Bus

| | | | | | | | | | |
|-----------------------|---|-----------|---------|---------|--|--|--|--|---|
| 3.0 519 CDI / BlueTEC | 6 | OM642.992 | 140/188 | 03/09 → | | | | | CCU114 [275] →Eng.41694476 →Prod.03.03.2015 |
|-----------------------|---|-----------|---------|---------|--|--|--|--|---|





kW/BHP



eon TITAN

IRIDIUM

**...MERCEDES-BENZ****...SPRINTER 5-t Bus**

3.0 519 CDI / BlueTEC 6 OM642.896; OM642.898 140/188 03/09→

CCU116
→Eng.41689183
→Prod.17.02.2015
[234] [275]**SPRINTER 5-t Platform/Chassis (905)**

2.7 616 CDI 5 OM612.981 115/154 04/01→05/06

CCU141**SPRINTER 5-t Box/Platform/Chassis (906)**

2.1 509 CDI 4 OM646.984 65/87 06/06→12/09

CCU140

2.1 511 CDI, 2.1 511 CDI 4WD 4 OM646.985 80/107 06/06→12/09

CCU140

2.1 513 CDI 4 OM646.986 95/127 06/06→

CCU140

2.1 515 CDI, 2.1 515 CDI 4WD 4 OM646.986; OM646.989; OM646.990 110/148 06/06→

CCU140

3.0 518 CDI, 3.0 518 CDI 4WD 6 OM642.993 135/181 06/06→12/09

CCU114[275]

3.0 518 CDI, 3.0 518 CDI 4WD 6 OM642.992 135/181 06/06→12/09

CCU114[275]
→Eng.41694476

3.0 518 CDI, 3.0 518 CDI 4WD 6 OM642.896 135/181 06/06→12/09

CCU116
[272] [275]
CCU114
→Eng.41330713
[272] [275]
CCU116
→Eng.41689183
[234] [275]

3.0 519 CDI / BlueTEC, 3.0 519 CDI / BlueTEC 4WD 6 OM642.992 140/188 03/09→

CCU114[275]
→Eng.41694476
→Prod.03.03.2015

3.0 519 CDI / BlueTEC, 3.0 519 CDI / BlueTEC 4WD 6 OM642.896; OM642.898 140/188 03/09→

CCU116
[272] [275]
CCU114
→Eng.41330713
→Prod.15.06.2012
[272] [275]
CCU116
→Eng.41689183
→Prod.17.02.2015
[234] [275]3.5 524 6 M272.979 190/255 06/06→12/13 **OE229** 0,8 **CET15P****BAEA140E****SPRINTER 5-t Platform/Chassis (906)**

1.8 516 4 M271.951 115/154 09/08→

OE229 0,8 **CET15P****BAEA053**
→10/10
→Eng.30853899
BAEA077
11/10→
Eng.30853900→

1.8 516 NGT 4 M271.951 115/154 09/08→

OE229 0,8 **CET15P****BAEA053**
→Eng.30853899
BAEA077
Eng.30853900→**SPRINTER Dumptruck (905)**

2.7 616 CDI 5 OM612.981 115/154 04/01→

CCU141**SPRINTER CLASSIC 3,5-t Box (909)**

2.1 311 CDI 4 OM646.701 80/107 09/13→

CCU141[236]**SPRINTER CLASSIC 4,6-t Bus (909)**

2.1 411 CDI 4 OM646.701 80/107 09/13→

CCU141[236]**VARIO Box Body / Estate/Bus/Dumptruck/Platform/Chassis**2.9 512 D, 2.9 612 D, 2.9 812 D, 2.9 O 812 5 OM602.984; OM602.985 90/121 09/96→12/10 **CH204** 11.5v**VITO / MIXTO Box (W639)**

2.2 109 CDI 4 OM646.983 65/87 09/03→

CCU140

MERCEDES-BENZ



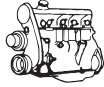

kW/BHP

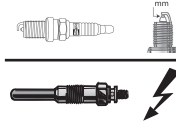

eon TITAN

IRIDIUM

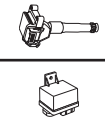

...MERCEDES-BENZ

...VITO / MIXTO Box (W639)

| | | | | | | | | | | |
|------------------------------|---|----------------------|---------|---------------|-------|-----|--------|-------|-----------------------|--------|
| 2.2 109 CDI | 4 | OM646.980; OM646.981 | 70/94 | 08/06 → | | | | | CCU140 | |
| 2.2 111 CDI | 4 | OM646.980; OM646.982 | 85/114 | 09/07 → | | | | | CCU140 | |
| 2.2 111 CDI, 2.2 111 CDI 4WD | 4 | OM646.982 | 80/107 | 09/03 → | | | | | CCU140 | |
| 2.2 115 CDI, 2.2 115 CDI 4WD | 4 | OM646.980; OM646.982 | 110/148 | 09/03 → | | | | | CCU140 | |
| 3.0 120 CDI | 6 | OM642.990 | 150/201 | 07/06 → | | | | | CCU114 [180] [275] | |
| 3.0 122 CDI | 6 | OM642.890 | 165/221 | 09/10 → | | | | | CCU116 [275] | |
| 3.2 119 | 6 | M112.951 | 140/188 | 09/03 → | OE191 | 1,0 | CET12P | OE180 | BAEA297 | CLS064 |
| 3.2 122 | 6 | M112.951 | 160/215 | 09/03 → | OE191 | 1,0 | CET12P | OE180 | BAEA297 | CLS064 |
| 3.5 126 | 6 | M272.978 | 190/255 | 09/07 → | OE229 | 0,8 | CET15P | | BAEA140E | |
| 3.7 123 | 6 | M112.976 | 165/221 | 06/04 → 07/08 | OE191 | 1,0 | CET12P | OE180 | BAEA297 | |
| 3.7 123 | 6 | M112.976 | 170/228 | 06/04 → 07/08 | OE191 | 1,0 | CET12P | OE180 | BAEA297 | |

VITO Box/Bus (638)

| | | | | | | | | | | |
|-----------------------|---|--------------------|---------|---------------|-------|-------|------|-------|--------------|-------------|
| 2.0 113 | 4 | M111.948; M111.950 | 95/127 | 02/96 → 07/03 | OE019 | 0,9 | CET2 | OE184 | BAEA340 [41] | CLS138 [35] |
| 2.2 108 CDI | 4 | OM611A(60KWCDI) | 60/80 | 03/99 → 07/03 | | | | | CCU140 | |
| 2.2 110 CDI | 4 | OM611LA(75KWCDI) | 75/101 | 03/99 → 07/03 | | | | | CCU140 | |
| 2.2 112 CDI | 4 | OM611.980 | 90/121 | 03/99 → 07/03 | | | | | CCU140 | |
| 2.3 108 D | 4 | OM601.942 | 58/78 | 02/96 → 07/03 | CH176 | 11.5v | | | | |
| 2.3 110 D, 2.3 110 TD | 4 | OM601.970 | 72/97 | 02/96 → 07/03 | CH176 | 11.5v | | | | |
| 2.3 114 | 4 | M111.978 | 105/141 | 12/96 → 07/03 | OE019 | 0,9 | CET2 | OE184 | BAEA340 [41] | CLS138 [35] |

VITO Bus (W639)

| | | | | | | | | | | |
|------------------------------|---|----------------------|---------|---------------|-------|-----|--------|-------|-----------------------|--|
| 2.2 109 CDI | 4 | OM646.983 | 65/87 | 09/03 → | | | | | CCU140 | |
| 2.2 109 CDI, 2.2 109 CDI 4WD | 4 | OM646.980; OM646.981 | 70/94 | 09/06 → | | | | | CCU140 | |
| 2.2 111 CDI | 4 | OM646.980 | 85/114 | 09/07 → | | | | | CCU140 | |
| 2.2 111 CDI, 2.2 111 CDI 4WD | 4 | OM646.982 | 80/107 | 09/03 → | | | | | CCU140 | |
| 2.2 115 CDI, 2.2 115 CDI 4WD | 4 | OM646.980; OM646.982 | 110/148 | 09/03 → | | | | | CCU140 | |
| 3.0 120 CDI | 6 | OM642.990 | 150/201 | 07/06 → | | | | | CCU114 [180] [275] | |
| 3.0 122 CDI | 6 | OM642.890 | 165/221 | 09/10 → | | | | | CCU116 [275] | |
| 3.2 119 | 6 | M112.951 | 140/188 | 09/03 → | OE191 | 1,0 | CET12P | OE180 | BAEA297 | |
| 3.2 122 | 6 | M112.951 | 160/215 | 09/03 → | OE191 | 1,0 | CET12P | OE180 | BAEA297 | |
| 3.5 126 | 6 | M272.978 | 190/255 | 09/07 → | OE229 | 0,8 | CET15P | | BAEA140E | |
| 3.7 123 | 6 | M112.976 | 165/221 | 06/04 → 07/08 | OE191 | 1,0 | CET12P | OE180 | BAEA297 | |
| 3.7 123 | 6 | M112.976 | 170/228 | 06/04 → | OE191 | 1,0 | CET12P | OE180 | BAEA297 | |

MERCEDES-BENZ (BBDC)

E-CLASS

| | | | | | | | | | | |
|-----------|---|----------|---------|---------------|--|-----|---|--|--|--|
| 1.8 E 200 | 4 | M271.941 | 120/161 | 11/05 → 12/06 | OE229 [232] | 0,8 | CET15P [232] | | BAEA053 → Eng.30853899 → Prod.30.11.2006 | |
| | | | | | OE224 → Eng.30853899 → Prod.30.11.2006 | 0,8 | CET14P → Eng.30853899 → Prod.30.11.2006 | | BAEA077 Eng.30853900 → Prod.30.11.2006 → | |
| | | | | | OE229 Eng.30853900 → Prod.30.11.2006 → | 0,8 | CET15P Eng.30853900 → Prod.30.11.2006 → | | | |

MERCURY

MOUNTAINEER

| | | | | | | | | | | |
|--------------|---|--|---------|---------------|--|--|------|--|--|--|
| 4.0, 4.0 4WD | 6 | | 152/204 | 10/00 → 12/05 | | | CET9 | | | |
|--------------|---|--|---------|---------------|--|--|------|--|--|--|



MERCEDES-BENZ



kW/BHP

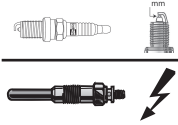

eon TITAN

IRIDIUM

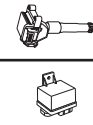
**METROCAB****TAXI**

2.4 TD 4 2L-T 66/89 01/01→05/06 CH154 11v

MG**MG 6**

1.8 T 4 18N4TI 118/158 11/10→ OE146 1,0 CET12P

MGF1.6 4 16K4F 82/110 02/00→03/02 OE146 1,0 CET12P OE179 BAEA469
→Ch.YD522572
[185] [260] CLS061 [292]
→Ch.YD522572BAEA501
Ch.YD522573→1.8 i, 8 i VVC 4 18K4K 118/158 10/01→03/02 OE146 1,0 CET12P OE179 CLS095
→Ch.YD5225721.8 i 16V 4 18K4F 88/118 03/95→03/02 OE146 1,0 CET12P OE179 BAEA469
→Ch.YD522572
[185] [260] CLS061 [292]
→Ch.YD522572BAEA501 [286]
Ch.YD522573→1.8 i VVC 4 18K4K 107/143 03/95→03/02 OE146 1,0 CET12P OE179 CLS095
→Ch.YD522572**MG TF**1.6 115 4 16K4F 85/114 03/02→12/09 OE146 1,0 CET12P OE179 BAEA469
→Ch.YD522572
[185] [260] CLS061 [292]
→Ch.YD5225721.8 120 4 18K4F 88/118 03/02→12/09 OE146 1,0 CET12P OE179 BAEA469
→Ch.YD522572
[185] [260] CLS061 [292]
→Ch.YD522572BAEA501
Ch.YD522573→1.8 135 4 18K4F 100/134 03/02→12/09 OE146 1,0 CET12P OE179 BAEA469
→Ch.YD522572
[185] [260] CLS061 [292]
→Ch.YD5225721.8 160 4 18K4K 118/158 03/02→12/09 OE146 1,0 CET12P OE179 CLS095
→Ch.YD522572**MG X-POWER**

4.6 SV 8 46K4F 230/308 01/03→04/08 CET9

MG ZR1.4 105 4 14K4F 76/102 06/01→04/05 OE146 1,0 CET12P OE179 BAEA469
→Ch.YD471564
[185] [260] CLS061 [292]
→Ch.YD471564BAEA501
Ch.YD471565→1.8 120 4 18K4F 86/115 06/01→04/05 OE146 1,0 CET12P OE179 BAEA469
→Ch.YD471564
[185] [260] CLS061 [292]
→Ch.YD471564BAEA501
Ch.YD471565→1.8 160 4 18K4K 118/158 06/01→04/05 OE146 1,0 CET12P OE179 CLS095
→Ch.YD471564

2.0 TD 4 20T2N 74/99 06/01→04/05 CH169 11v

2.0 TD 4 20T2N 83/111 12/02→04/05 CH169 11v

MG ZS

1.6 4 16K4F 79/106 11/01→04/05 OE146 1,0 CET12P OE179 BAEA501

1.6 4 16K4F 82/110 11/01→10/05 OE146 1,0 CET12P OE179

1.8 120 4 18K4F 86/115 07/01→10/05 OE146 1,0 CET12P OE179 BAEA501

2.0 TD 4 20T2N 74/99 01/04→10/05 CH169 11v

2.0 TD 4 20T2N 83/111 01/04→10/05 CH169 11v

2.5 180 6 25K4F 130/174 07/01→10/05 OE146 1,0 CET12P OE179 BAEA302
[245] [275]**MG ZT**

1.8 16V 4 18K4F 88/118 01/03→07/05 OE146 1,0 CET12P OE179 BAEA501



MG

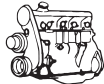

kW/BHP



eon TITAN

IRIDIUM



...MG

...MG ZT

| | | | | | | | | | |
|-----------------|---|-------|---------|-------------|-------|-----|--------|-------|---------|
| 1.8 T 16V | 4 | 18K4G | 118/158 | 01/03→07/05 | OE146 | 1,0 | CET12P | OE179 | BAEA501 |
| 2.0 CDTi | 4 | 204D2 | 85/114 | 06/02→09/03 | CH203 | 11v | | | |
| 2.0 CDTi | 4 | 204D2 | 96/129 | 11/02→07/05 | CH203 | 11v | | | |
| 2.5 160 | 6 | 25K4F | 118/158 | 06/01→07/05 | OE146 | 1,0 | CET12P | OE179 | |
| 2.5 180 | 6 | 25K4F | 130/174 | 02/04→10/05 | OE146 | 1,0 | CET12P | OE179 | |
| 2.5 190 | 6 | 25K4F | 140/188 | 06/01→07/05 | OE146 | 1,0 | CET12P | OE179 | |
| 4.6 260 | 8 | 99W | 191/256 | 10/03→07/05 | OE146 | 1,0 | CET12P | OE179 | |
| 4.6 X Power 385 | 8 | | 283/380 | 06/02→07/05 | | | CET9 | | |
| 4.6 X Power 500 | 8 | | 368/493 | 06/01→07/05 | | | CET9 | | |

MG ZT-

| | | | | | | | | | |
|-----------------|---|------------|---------|-------------|-------|-----|--------|-------|---------|
| 1.8 16V | 4 | 18K4F | 88/118 | 01/03→07/05 | OE146 | 1,0 | CET12P | OE179 | BAEA501 |
| 1.8 T 16V | 4 | 18K4G | 118/158 | 01/03→07/05 | OE146 | 1,0 | CET12P | OE179 | BAEA501 |
| 2.0 CDTi | 4 | 204D2 | 85/114 | 06/02→07/05 | CH203 | 11v | | | |
| 2.0 CDTi | 4 | 204D2 | 96/129 | 11/02→07/05 | CH203 | 11v | | | |
| 2.5 160 | 6 | 25K4F | 118/158 | 10/01→07/05 | OE146 | 1,0 | CET12P | OE179 | |
| 2.5 180 | 6 | 25K4F | 130/174 | 02/04→10/05 | OE146 | 1,0 | CET12P | OE179 | |
| 2.5 190 | 6 | 25K4F | 140/188 | 10/01→07/05 | OE146 | 1,0 | CET12P | OE179 | |
| 4.6 260 | 8 | 46F2F; 99W | 191/256 | 10/03→07/05 | OE146 | 1,0 | CET12P | OE179 | |
| 4.6 X Power 385 | 8 | | 283/380 | 06/02→07/05 | | | CET9 | | |

MG

EXPRESS

| | | | | | | | | | |
|---------|---|-------|---------|-------------|-------|-----|--------|-------|---|
| 1.4 | 4 | 14K4F | 76/102 | 03/03→05/05 | OE006 | 0,9 | CET8 | | BAEA469 [260] [275] BAEA501 [275] |
| 1.8 | 4 | 18K4F | 86/115 | 03/03→05/05 | OE146 | 1,0 | CET12P | OE179 | BAEA501 |
| 1.8 160 | 4 | 18K4K | 118/158 | 03/03→05/05 | OE146 | 1,0 | CET12P | | |
| 2.0 TD | 4 | 20T2N | 74/99 | 03/03→05/05 | CH169 | 11v | | | |

MINI

MINI

| | | | | | | | | | |
|---------------|---|----------------------|---------|-------------|-------|-----|--------|-----------------|------------------------|
| 1.2 One | 3 | B38A12A | 75/101 | 04/14→ | | | | OE245 | BAEA538 →06/17 |
| 1.2 One First | 3 | B38A12A | 55/74 | 06/14→10/17 | | | | OE245 →10/15 | BAEA538 →06/17 |
| 1.4 One | 4 | W10B14A | 55/74 | 04/03→03/10 | OE223 | 1,6 | CET12P | | BAEA382 |
| 1.4 One | 4 | N12B14A | 55/74 | 04/03→03/10 | OE204 | 1,0 | CET16P | | BAEA143 →02/10 |
| 1.4 One | 4 | N12B14A | 70/94 | 11/06→03/10 | OE204 | 1,0 | CET16P | | BAEA143 →02/10 |
| 1.5 Cooper | 3 | B36A15A; B38A15A | 100/134 | 09/13→ | | | | OE245 | BAEA538 →06/17 |
| 1.6 Cooper | 4 | W10B16A | 85/114 | 06/01→04/15 | OE223 | 1,6 | CET12P | OE188 | BAEA382 BAEA382[85] |
| 1.6 Cooper | 4 | N12B16A | 85/114 | 06/01→04/15 | OE204 | 1,0 | CET16P | | |
| 1.6 Cooper | 4 | N16B16A | 85/114 | 06/01→04/15 | OE204 | 1,0 | CET16P | | BAEA143 |
| 1.6 Cooper | 4 | N12B16A | 88/118 | 10/06→06/15 | OE204 | 1,0 | CET16P | | BAEA143 →08/10 |
| 1.6 Cooper | 4 | N12B16A; N16B16A | 90/121 | 09/09→06/15 | OE204 | 1,0 | CET16P | | BAEA143 |
| 1.6 Cooper D | 4 | 9HZ(DV6TED4); W16D16 | 80/107 | 11/06→09/10 | CH201 | 11v | | | |
| 1.6 Cooper S | 4 | N18B16A | 120/161 | 03/02→06/15 | OE205 | 0,7 | CET16P | | |
| 1.6 Cooper S | 4 | W11B16A | 120/161 | 03/02→06/15 | OE223 | 1,6 | CET12P | OE188 | BAEA382 CLS069 |
| 1.6 Cooper S | 4 | W11B16A | 125/168 | 07/04→12/08 | OE223 | 1,6 | CET12P | OE188 | BAEA382 CLS069 |
| 1.6 Cooper S | 4 | N14B16A; N14B16AB | 128/172 | 10/06→12/14 | OE205 | 0,7 | CET16P | | BAEA143 |
| 1.6 Cooper S | 4 | N18B16A | 135/181 | 02/10→06/15 | OE205 | 0,7 | CET16P | | BAEA143 |
| 1.6 Cooper S | 4 | N14B16A | 135/181 | 02/10→06/15 | OE205 | 0,7 | CET16P | | |





kW/BHP

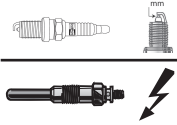

eon TITAN

IRIDIUM

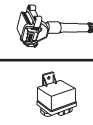
**...MINI****...MINI**

| | | | | | | | | | |
|---|---|------------------|---------|-------------|-------|-----|--------|---------|-------------------|
| 1.6 Cooper S, 1.6 Cooper S JCW | 4 | N18B16A | 147/197 | 02/10→06/15 | OE205 | 0,7 | CET16P | | |
| 1.6 John Cooper Works | 4 | N14B16C | 155/208 | 07/04→05/15 | OE205 | 0,7 | | BAEA143 | |
| 1.6 John Cooper Works | 4 | N18B16C | 155/208 | 07/04→05/15 | | | | BAEA143 | |
| 1.6 John Cooper Works, 1.6 John Cooper Works GP | 4 | N18B16C; W11B16A | 160/215 | 03/06→11/13 | OE205 | 0,7 | | | |
| 1.6 John Cooper Works, 1.6 Works | 4 | W11B16A | 155/208 | 11/03→05/15 | OE223 | 1,6 | CET2 | OE188 | BAEA382 |
| 1.6 One | 4 | N16B16A | 55/74 | 03/10→11/13 | OE204 | 1,0 | CET16P | | BAEA143 |
| 1.6 One | 4 | W10B16A | 66/89 | 06/01→11/07 | OE223 | 1,6 | CET12P | OE188 | BAEA382 |
| 1.6 One | 4 | N16B16A | 72/97 | 09/09→06/15 | OE204 | 1,0 | CET16P | | BAEA143 |
| 1.6 One D | 4 | 9HZ(DV6TED4) | 66/89 | 06/09→11/13 | CH201 | 11v | | | |
| 1.6 S Works | 4 | W11B16A | 149/200 | 11/03→06/05 | OE223 | 1,6 | CET2 | OE188 | BAEA382 |
| 2.0 Cooper S | 4 | B48A20A | 120/161 | 09/13→ | | | | OE245 | BAEA538 →06/17 |
| 2.0 Cooper S | 4 | B46A20A | 120/161 | 09/13→ | | | | OE245 | BAEA538 →06/17 |
| 2.0 Cooper S | 4 | B48A20A | 141/189 | 09/13→ | | | | OE245 | BAEA538 →06/17 |
| 2.0 Cooper S | 4 | B46A20A | 141/189 | 09/13→ | | | | OE245 | BAEA538 →06/17 |
| 2.0 John Cooper Works | 4 | B48A20B | 170/228 | 03/15→ | | | | OE245 | BAEA538 →06/17 |

MINI CLUBMAN

| | | | | | | | | | |
|--------------------------------|---|------------------|---------|-------------|-----------------|-----|--------|-----------------|-------------------|
| 1.4 One | 4 | N12B14A | 70/94 | 03/09→02/10 | OE204 | 1,0 | CET16P | | BAEA143 |
| 1.5 Cooper | 3 | B36A15A; B38A15A | 100/134 | 12/14→ | | | | OE245 →10/15 | BAEA538 →06/17 |
| 1.5 One | 3 | B38A15A | 75/101 | 02/15→ | | | | OE245 | BAEA538 →06/17 |
| 1.6 Cooper | 4 | N16B16A | 85/114 | 03/10→06/14 | OE204 | 1,0 | CET16P | | BAEA143 |
| 1.6 Cooper | 4 | N12B16A; N16B16A | 88/118 | 10/07→12/13 | OE204 | 1,0 | CET16P | | BAEA143 →07/10 |
| 1.6 Cooper | 4 | N16B16A | 90/121 | 03/10→06/14 | OE204 | 1,0 | CET16P | | BAEA143 |
| 1.6 Cooper D | 4 | 9HZ(DV6TED4) | 80/107 | 10/07→02/10 | CH201 | 11v | | | |
| 1.6 Cooper S | 4 | N14B16A | 120/161 | 10/07→02/10 | OE205 | 0,7 | CET16P | | BAEA143 |
| 1.6 Cooper S | 4 | N14B16AB | 128/172 | 10/07→02/10 | OE205 | 0,7 | CET16P | | BAEA143 |
| 1.6 Cooper S | 4 | N18B16A | 135/181 | 03/10→06/14 | OE205 | 0,7 | CET16P | | |
| 1.6 Cooper S | 4 | N18B16A | 147/197 | 03/10→06/14 | OE205 | 0,7 | CET16P | | |
| 1.6 John Cooper Works | 4 | N14B16C | 155/208 | 11/07→06/14 | OE205 05/08→ | 0,7 | | | BAEA143 |
| 1.6 John Cooper Works | 4 | N18B16C | 155/208 | 11/07→06/14 | | | | | BAEA143 |
| 1.6 One | 4 | N16B16A | 72/97 | 03/10→06/14 | OE204 | 1,0 | CET16P | | BAEA143 |
| 2.0 Cooper S | 4 | B46A20A; B48A20A | 141/189 | 11/14→ | | | | OE245 | BAEA538 →06/17 |
| 2.0 Cooper S, 2.0 Cooper S 4WD | 4 | B48A20A | 120/161 | 11/14→ | | | | OE245 →10/15 | BAEA538 →06/17 |
| 2.0 Cooper S 4WD | 4 | B48A20A | 141/189 | 04/15→ | | | | OE245 →10/15 | BAEA538 →06/17 |
| 2.0 John Cooper Works 4WD | 4 | B48A20B | 170/228 | 11/15→ | | | | OE245 | BAEA538 →06/17 |

MINI COUNTRYMAN

| | | | | | | | | | |
|----------------------------|---|------------------|---------|-------------|-------|-----|--------|-------|-------------------|
| 1.5 Cooper, 1.5 Cooper 4WD | 3 | B36A15A; B38A15A | 100/134 | 10/16→ | | | | OE245 | |
| 1.5 Cooper SE 4WD | 3 | B38A15A | 165/221 | 01/17→ | | | | OE245 | |
| 1.6 Cooper | 4 | N16B16A | 85/114 | 01/10→10/16 | OE204 | 1,0 | CET16P | | BAEA143 |
| 1.6 Cooper | 4 | N16B16A | 88/118 | 01/10→10/16 | | | | | BAEA143 |
| 1.6 Cooper | 4 | N16B16A | 90/121 | 01/10→10/16 | OE204 | 1,0 | CET16P | | BAEA143 09/10→ |
| 1.6 Cooper 4WD | 4 | N16B16A | 90/121 | 11/12→10/16 | | | | | BAEA143 |
| 1.6 Cooper S | 4 | N18B16A | 147/197 | 01/10→10/16 | OE205 | 0,7 | CET16P | | |

MINI



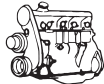

kW/BHP



eon TITAN

IRIDIUM



...MINI

...MINI COUNTRYMAN

| | | | | | | | | | |
|--------------------------------|---|------------------|---------|-------------|-------|-----|--------|-------|-------------------|
| 1.6 Cooper S, 1.6 Cooper S 4WD | 4 | N14B16A; N18B16A | 135/181 | 01/10→10/16 | OE205 | 0,7 | CET16P | | BAEA143 |
| 1.6 Cooper S 4WD | 4 | N18B16A | 120/161 | 01/10→10/16 | OE205 | 0,7 | CET16P | | |
| 1.6 John Cooper Works 4WD | 4 | N18B16A | 160/215 | 04/11→10/16 | OE205 | 0,7 | | | |
| 1.6 One | 4 | N16B16A | 72/97 | 01/10→09/16 | OE204 | 1,0 | CET16P | | BAEA143 |
| 2.0 Cooper S, 2.0 Cooper S 4WD | 4 | B46A20A; B48A20A | 120/161 | 10/16→ | | | | OE245 | BAEA538 →06/17 |
| 2.0 Cooper S, 2.0 Cooper S 4WD | 4 | B46A20A; B48A20A | 141/189 | 10/16→ | | | | OE245 | BAEA538 →06/17 |
| 2.0 John Cooper Works 4WD | 4 | B48A20B | 170/228 | 01/17→ | | | | OE245 | |

MINI PACEMAN

| | | | | | | | | | |
|--------------------------------|---|---------|---------|-------------|-------|-----|--------|--|---------|
| 1.6 Cooper | 4 | N16B16A | 88/118 | 04/12→09/16 | | | | | BAEA143 |
| 1.6 Cooper | 4 | N16B16A | 90/121 | 04/12→09/16 | OE204 | 1,0 | CET16P | | BAEA143 |
| 1.6 Cooper 4WD | 4 | N16B16A | 90/121 | 11/12→09/16 | | | | | BAEA143 |
| 1.6 Cooper S, 1.6 Cooper S 4WD | 4 | N18B16A | 135/181 | 03/12→09/16 | OE205 | 0,7 | CET16P | | |

MINI

MINI CLUBVAN

| | | | | | | | | | |
|------------|---|---------|--------|-------------|-------|-----|--------|--|---------|
| 1.6 Cooper | 4 | N16B16A | 90/121 | 12/12→06/14 | OE204 | 1,0 | CET16P | | BAEA143 |
| 1.6 One | 4 | N16B16A | 72/97 | 12/12→06/14 | OE204 | 1,0 | CET16P | | BAEA143 |

MITSUBISHI

380

| | | | | | | | | | |
|-------|---|------|---------|-------------|--|--|--------|-------|--|
| 3.8 i | 6 | 6G75 | 175/235 | 04/05→04/08 | | | CET12P | OE179 | |
|-------|---|------|---------|-------------|--|--|--------|-------|--|

ASX

| | | | | | | | | | |
|------------------|---|------|---------|--------|--|--|--------|-------|---------|
| 1.6 MIVEC | 4 | 4A92 | 85/114 | 05/10→ | | | CET14P | OE190 | BAEA547 |
| 1.6 MIVEC | 4 | 4A92 | 86/115 | 06/10→ | | | CET14P | OE190 | BAEA547 |
| 1.8, 1.8 4WD | 4 | 4B10 | 102/137 | 02/10→ | | | CET12P | OE179 | |
| 2.0 i, 2.0 i 4WD | 4 | 4B11 | 110/148 | 06/10→ | | | CET12P | OE182 | |
| 2.0 i, 2.0 i 4WD | 4 | 4B11 | 118/158 | 06/10→ | | | CET12P | OE182 | |

CARISMA

| | | | | | | | | | |
|---------------------------|---|---------------|---------|-------------|-----------------|-----|--------|-------|--------------------|
| 1.6 | 4 | 4G92(SOHC16V) | 66/89 | 07/95→06/06 | OE039 | 1,0 | CET2 | OE179 | BAEA179E 05/97→ |
| 1.6 | 4 | 4G92(SOHC16V) | 70/94 | 12/98→06/06 | OE039 | 1,0 | CET2 | OE179 | BAEA179E |
| 1.6 | 4 | 4G92(SOHC16V) | 73/98 | 05/97→06/06 | OE039 | 1,0 | CET2 | OE179 | BAEA179E |
| 1.6 | 4 | 4G92(SOHC16V) | 76/102 | 09/00→06/06 | OE039 | 1,0 | CET2 | OE179 | BAEA179E |
| 1.8 | 4 | 4G93(SOHC16V) | 85/114 | 07/95→09/97 | OE039 | 1,0 | CET2 | OE179 | BAEA179E 05/97→ |
| 1.8 16V GDI | 4 | 4G93(GDI) | 92/123 | 09/97→06/06 | OE227 | 0,6 | CET12P | OE188 | BAEA179E |
| | | | | | OE216 LPG [278] | 0,8 | | | |
| 1.8 GDI | 4 | 4G93(GDI) | 90/121 | 10/00→06/06 | OE227 | 0,6 | CET12P | OE188 | |
| | | | | | OE216 LPG [278] | 0,8 | | | |
| 1.8 MSX - 16V | 4 | 4G93(DOHC16V) | 103/138 | 07/95→07/97 | OE039 | 1,0 | CET2 | OE179 | |
| 1.9 DI-D | 4 | F9Q1 | 75/101 | 09/00→06/06 | CH271 | 11v | | | |
| 1.9 DI-D | 4 | F9Q2 | 85/114 | 09/00→06/06 | CH271 | 11v | | | |
| 1.9 TD | 4 | F8QT | 66/89 | 10/96→09/00 | CH260 | 11v | | | |
| 2.0 16V GT EVO VI/VII 4WD | 4 | 4G63Turbo | 206/276 | 11/99→06/06 | OE006 | 0,9 | CET8 | OE195 | |

COLT CZC

| | | | | | | | | | |
|-----------|---|-------|---------|-------------|-------|-----|------|-------|--|
| 1.5 | 4 | 4A91 | 80/107 | 05/06→07/09 | OE035 | 0,9 | CET5 | OE190 | |
| 1.5 Turbo | 4 | 4G15T | 110/148 | 05/06→07/09 | OE035 | 0,9 | CET5 | OE190 | |

COLT IV

| | | | | | | | | | |
|---------|---|---------------|--------|-------------|-------|-----|------|-------|--|
| 1.6 | 4 | 4G92(SOHC16V) | 66/89 | 02/94→04/96 | OE039 | 1,0 | CET2 | OE179 | |
| 1.6 4WD | 4 | 4G92(SOHC16V) | 84/113 | 08/93→08/95 | OE039 | 1,0 | CET2 | OE179 | |

CHAMPION



kW/BHP

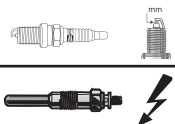

eon TITAN

IRIDIUM

**...MITSUBISHI****COLT V**

| | | | | | | | | | | |
|------------------|---|---------------|---------|-------------|-------|-----|------|-------|----------|--------|
| 1.3 | 4 | 4G19 | 66/89 | 08/02→09/03 | OE063 | 1,0 | CET2 | OE180 | | |
| 1.3 1300 | 4 | 4G13(16V) | 60/80 | 06/00→09/03 | OE039 | 1,0 | CET2 | OE179 | BAEA178E | CLS010 |
| 1.3 1300 GL, GLX | 4 | 4G13(12V) | 55/74 | 05/96→06/00 | OE048 | 1,0 | CET8 | OE195 | BAEA264 | CLS169 |
| 1.5 | 4 | 4G15(16V) | 81/109 | 09/95→09/03 | OE006 | 0,9 | CET8 | OE195 | | |
| 1.5 16V | 4 | 4G15(16V) | 69/93 | 10/99→09/03 | OE048 | 1,0 | CET8 | OE195 | | |
| 1.6 1600 | 4 | 4G92(SOHC16V) | 76/102 | 09/00→09/03 | OE039 | 1,0 | CET2 | OE179 | BAEA179E | |
| 1.6 1600 GLX | 4 | 4G92(SOHC16V) | 66/89 | 05/96→09/00 | OE039 | 1,0 | CET2 | OE179 | BAEA179E | |
| 1.8 | 4 | 4G93 | 109/146 | 11/97→07/01 | OE039 | 1,0 | CET2 | OE179 | | |

COLT VI

| | | | | | | | | | | |
|--------------|---|------------|---------|-------------|-----------------|-----|------|-------|-----------------------------|--|
| 1.1 | 3 | 3A91 | 55/74 | 10/04→06/12 | OE238 →06/10 | 1,0 | CET5 | OE190 | BAEA547 Prod.01.07.2010→ | |
| | | | | | OE035 | 0,9 | | | | |
| 1.1 LPG | 3 | 3A91 | 55/74 | 10/04→06/12 | OE034 | 0,9 | CET2 | OE179 | | |
| 1.3 | 4 | 4A90 | 70/94 | 06/04→06/12 | OE238 →06/10 | 1,0 | CET5 | OE190 | BAEA547 Prod.01.07.2010→ | |
| | | | | | OE035 | 0,9 | | | | |
| 1.3 LPG | 4 | 4A90 | 70/94 | 06/04→06/12 | OE238 | 1,0 | | | | |
| 1.5 | 4 | 4G15(16V) | 72/97 | 09/04→02/06 | OE048 | 1,0 | CET8 | OE195 | | |
| 1.5 | 4 | 4A91 | 80/107 | 06/04→06/12 | OE238 →06/10 | 1,0 | CET5 | OE190 | | |
| | | | | | OE035 | 0,9 | | | | |
| 1.5, 1.5 4WD | 4 | 4A91; 4G91 | 77/103 | 07/06→06/12 | OE035 | 0,9 | CET5 | OE190 | | |
| 1.5 CZT | 4 | 4G15T | 110/148 | 03/05→06/12 | OE035 | 0,9 | CET5 | OE190 | | |

COLT PLUS VII

| | | | | | | | | | | |
|---------|---|------|--------|--------|-------|-----|------|-------|--|--|
| 1.5 | 4 | 4A91 | 77/103 | 08/04→ | OE035 | 0,9 | CET5 | OE190 | | |
| 1.5 4WD | 4 | 4A91 | 75/101 | 08/04→ | OE035 | 0,9 | CET5 | OE190 | | |

DIAMANTE II

| | | | | | | | | | | |
|-----|---|---------------|---------|-------------|-------|-----|--------|-------|--|--|
| 2.5 | 6 | 6G73 | 147/197 | 09/99→08/04 | OE136 | 0,8 | CET12P | OE179 | | |
| 3.0 | 6 | 6G72(DOHC24V) | 140/188 | 06/99→09/02 | OE146 | 1,0 | CET12P | OE179 | | |
| 3.5 | 6 | 6G74(SOHC24V) | 157/211 | 10/02→11/05 | OE146 | 1,0 | CET12P | OE184 | | |

DION

| | | | | | | | | | | |
|-------------|---|------------|---------|-------------|-----------------|-----|--------|-------|--|--|
| 1.8 16V 4WD | 4 | 4G93T(GDI) | 121/162 | 12/99→12/05 | OE227 | 0,6 | CET12P | OE188 | | |
| | | | | | OE216 LPG [278] | 0,8 | | | | |

ECLIPSE

| | | | | | | | | | | |
|-----|---|---------------|---------|-------------|-------|-----|------|-------|--|--|
| 1.8 | 4 | 4G93(SOHC16V) | 102/137 | 04/94→04/99 | OE039 | 1,0 | CET2 | OE179 | | |
| 1.8 | 4 | 4G93 | 103/138 | 05/99→03/05 | OE039 | 1,0 | CET2 | OE179 | | |

ECLIPSE II

| | | | | | | | | | | |
|-----------------|---|-----------------|---------|-------------|-------|-----|------|-------|--|--|
| 2.0 2000 GS 16V | 4 | 4G63(DOHC16V) | 107/143 | 12/95→04/99 | OE006 | 0,9 | CET8 | OE195 | | |
| 2.0 2000 GT 16V | 4 | 4G63-T(DOHC16V) | 157/211 | 12/95→04/99 | OE006 | 0,9 | CET8 | OE195 | | |
| 2.4 2400 GS 16V | 4 | 4G64(16V) | 105/141 | 09/98→04/99 | OE039 | 1,0 | CET2 | OE180 | | |

ECLIPSE III

| | | | | | | | | | | |
|-----|---|---------------|---------|-------------|-------|-----|--------|-------|--|--|
| 3.0 | 6 | 6G72(DOHC24V) | 149/200 | 05/99→03/05 | OE146 | 1,0 | CET12P | OE179 | | |
|-----|---|---------------|---------|-------------|-------|-----|--------|-------|--|--|

ECLIPSE IV

| | | | | | | | | | | |
|--------|---|------|---------|-------------|--|--|--------|-------|--|--|
| 2.4 GS | 4 | 4G69 | 120/161 | 04/05→12/11 | | | CET14P | OE190 | | |
|--------|---|------|---------|-------------|--|--|--------|-------|--|--|

FTO

| | | | | | | | | | | |
|-----|---|---------------|--------|-------------|-------|-----|------|-------|--|--|
| 1.8 | 4 | 4G93(SOHC16V) | 92/123 | 09/94→07/01 | OE039 | 1,0 | CET2 | OE179 | | |
|-----|---|---------------|--------|-------------|-------|-----|------|-------|--|--|

GALANT

| | | | | | | | | | | |
|----------------------------------|---|-----------|---------|--------|--|--|--------|-------|--|--|
| 2.0 GDi G, 2.0 GDi V 4WD | 4 | 4G94(GDI) | 107/143 | 10/03→ | | | CET12P | OE184 | | |
| 2.4 GDi Sport, 2.4 GDi Sport 4WD | 4 | 4G69 | 121/162 | 10/03→ | | | CET14P | OE190 | | |
| 3.8 GDi, 3.8 GDi 4WD | 6 | 6G75 | 171/229 | 10/03→ | | | CET12P | OE179 | | |

GALANT V

| | | | | | | | | | | |
|-----|---|---------------|--------|-------------|-------|-----|------|-------|--|--|
| 1.8 | 4 | 4G93(SOHC16V) | 85/114 | 02/94→08/96 | OE039 | 1,0 | CET2 | OE179 | | |
|-----|---|---------------|--------|-------------|-------|-----|------|-------|--|--|

MITSUBISHI





kW/BHP



eon TITAN

IRIDIUM



...MITSUBISHI

GALANT VI

| | | | | | | | | | |
|------------|---|---------------|---------|-------------|--------------------------|------------|--------|-------|--------------------------|
| 1.8 GDi | 4 | 4G93(GDI) | 103/138 | 11/97→10/01 | OE227 OE216 LPG [278] | 0,6 0,8 | CET12P | OE188 | |
| 2.0 | 4 | 4G63(SOHC16V) | 98/131 | 09/00→10/04 | OE136 | 0,8 | CET12P | OE179 | BAEA179E ^[41] |
| 2.0 | 4 | 4G63(SOHC16V) | 100/134 | 09/96→09/00 | OE005 | 0,9 | CET2 | OE180 | BAEA179E ^[41] |
| 2.0 GDI | 4 | 4G94(GDI) | 107/143 | 01/97→10/04 | | | CET12P | OE184 | |
| 2.0 TDI | 4 | 4D68T | 66/89 | 09/96→10/04 | CH256 →02/00 | 11v | | | |
| 2.4 | 4 | 4G69 | 121/162 | 10/03→10/04 | | | CET14P | OE190 | |
| 2.4 GDI | 4 | 4G64(GDI) | 106/142 | 09/00→10/04 | | | CET12P | OE184 | |
| 2.4 GDI | 4 | 4G64(GDI) | 110/148 | 02/99→10/03 | | | CET12P | OE184 | CLS010 |
| 2.5 V6 24V | 6 | 6A13 | 118/158 | 09/00→10/04 | OE136 | 0,8 | CET12P | OE179 | |
| 2.5 V6 24V | 6 | 6A13 | 120/161 | 09/96→09/00 | OE136 | 0,8 | CET12P | OE179 | BAEA179E |

GALLOPER

| | | | | | | | | | |
|------------------------|---|------|---------|-------------|-----------------|-----|------|-------|--|
| 2.5 TD 4WD | 4 | D4BF | 65/87 | 09/98→12/03 | CH256 | 11v | | | |
| 2.5 TD intercooler 4WD | 4 | D4BH | 73/98 | 09/98→12/03 | CH256 →12/01 | 11v | | | |
| 3.0 V6 4WD | 6 | G6AT | 104/139 | 09/98→12/03 | OE039 | 1,0 | CET2 | OE180 | |

GRANDIS

| | | | | | | | | | |
|-----------|---|------|---------|-------------|--|--|--------|-------|--|
| 2.4 MIVEC | 4 | 4G69 | 121/162 | 04/04→12/11 | | | CET14P | OE190 | |
| 2.4 MIVEC | 4 | 4G69 | 130/174 | 04/04→12/11 | | | CET14P | OE190 | |

i

| | | | | | | | | | |
|---------|---|-------|-------|--------|-------|-----|--------|--|--|
| 0.7 | 3 | 3B20 | 38/51 | 01/10→ | OE229 | 0,8 | CET15P | | |
| 0.7 | 3 | 3B20T | 42/56 | 01/06→ | OE229 | 0,8 | CET15P | | |
| 0.7 4WD | 3 | 3B20T | 47/63 | 08/10→ | OE229 | 0,8 | CET15P | | |

KUDA

| | | | | | | | | | |
|-----|---|------|-------|-------------|-------|-----|------|-------|--|
| 1.8 | 4 | 4G37 | 66/89 | 06/98→04/03 | OE006 | 0,9 | CET8 | OE195 | |
|-----|---|------|-------|-------------|-------|-----|------|-------|--|

L 200

| | | | | | | | | | |
|------------|---|---------------|--------|-------------|----------------|------------|------|-------|--|
| 2.0 | 4 | 4G63(SOHC16V) | 90/121 | 06/96→12/07 | OE018 | 1,0 | CET8 | OE195 | |
| 2.4 4WD | 4 | 4G64(16V) | 97/130 | 06/96→12/07 | OE048 | 1,0 | CET8 | OE195 | |
| 2.5 TD | 4 | 4D56T | 66/89 | 08/01→11/05 | CH221 CH256 | 11v 11v | | | |
| 2.5 TD 4WD | 4 | 4D56TD | 73/98 | 06/96→12/07 | CH256 | 11v | | | |
| 2.5 TD 4WD | 4 | 4D56T | 85/114 | 09/01→12/07 | CH256 | 11v | | | |
| 2.5 TD 4WD | 4 | 4D56T | 98/131 | 08/01→12/07 | CH256 | 11v | | | |

LANCER V

| | | | | | | | | | |
|-----------------|---|---------------|---------|-------------|-----------------|-----|------|-------|--|
| 1.3 16V | 4 | 4G13(12V) | 55/74 | 09/97→10/99 | OE006 | 0,9 | CET8 | OE195 | |
| 1.6 | 4 | 4G92(SOHC16V) | 66/89 | 02/94→12/96 | OE039 | 1,0 | CET2 | OE179 | |
| 1.8 4WD, 1.8 i | 4 | 4G93 | 88/118 | 03/95→10/03 | OE039 | 1,0 | CET2 | OE179 | |
| 2.0 D | 4 | 4D68T | 65/87 | 03/95→10/03 | CH256 →05/96 | 11v | | | |
| 2.0 EVO II 4WD | 4 | 4G63Turbo | 192/257 | 01/94→07/95 | | | CET8 | OE195 | |
| 2.0 EVO III 4WD | 4 | 4G63Turbo | 198/266 | 08/95→07/96 | | | CET8 | OE195 | |

LANCER VI

| | | | | | | | | | |
|-------------|---|---------------|---------|-------------|--------------------------|------------|--------|-------|------------------|
| 1.3 12V | 4 | 4G13(12V) | 55/74 | 12/95→08/03 | OE048 | 1,0 | CET8 | OE195 | |
| 1.3 12V | 4 | 4G13 | 55/74 | 12/95→08/03 | | | | | CLS169 04/98→ |
| 1.5 16V | 4 | 4G15(12V) | 81/109 | 09/95→08/99 | OE048 | 1,0 | CET8 | OE195 | |
| 1.6 16V | 4 | 4G92(SOHC16V) | 66/89 | 12/95→08/03 | OE039 | 1,0 | CET2 | OE179 | |
| 1.8 | 4 | 4G93 | 91/122 | 09/95→08/03 | OE039 | 1,0 | CET2 | OE179 | |
| 1.8 16V | 4 | 4G93T | 151/202 | 09/95→08/03 | OE039 | 1,0 | CET2 | OE179 | |
| 1.8 GDI | 4 | 4G93(GDI) | 96/129 | 06/00→08/03 | OE227 OE216 LPG [278] | 0,6 0,8 | CET12P | OE188 | |
| 1.8 GDI 4WD | 4 | 4G93T(GDI) | 121/162 | 06/00→08/03 | OE227 OE216 LPG [278] | 0,6 0,8 | CET12P | OE188 | |





kW/BHP

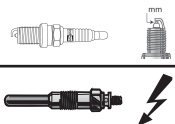

eon TITAN

IRIDIUM

**...MITSUBISHI****...LANCER VI**

| | | | | | | | | | | |
|----------------|---|-----------|---------|-------------|-------|-----|--------|-------|--|--|
| 2.0 | 4 | 4G94(GDI) | 92/123 | 09/95→08/03 | | | CET12P | OE184 | | |
| 2.0 D | 4 | 4D68 | 50/67 | 09/95→08/03 | CH256 | 11v | | | | |
| 2.0 EVO V 4WD | 4 | 4G63Turbo | 206/276 | 01/98→12/98 | | | CET8 | OE195 | | |
| 2.0 EVO VI 4WD | 4 | 4G63Turbo | 207/278 | 01/99→02/01 | | | CET8 | OE195 | | |

LANCER VII

| | | | | | | | | | | |
|------------------------|---|---------------|---------|-------------|--------------------------|------------|--------|-------|--------------------|--------|
| 1.3 | 4 | 4G13(16V) | 60/80 | 09/03→ | | | CET2 | OE179 | BAEA178E →04/10 | CLS010 |
| 1.6 | 4 | 4G18 | 72/97 | 09/03→ | | | CET2 | OE179 | BAEA178E | CLS010 |
| 1.8 GDi T | 4 | 4G93T(GDI) | 121/162 | 09/03→10/08 | OE227 OE216 LPG [278] | 0,6 0,8 | CET12P | OE188 | | |
| 1.8 SEi Limited | 4 | 4G93 | 91/122 | 09/03→03/07 | OE039 | 1,0 | CET2 | OE179 | | |
| 2.0 | 4 | 4G63(DOHC16V) | 85/114 | 08/03→ | | | | | BAEA193E | |
| 2.0 | 4 | 4G63(DOHC16V) | 99/133 | 09/03→ | | | CET8 | OE195 | BAEA193E | |
| 2.0 EVO VIII - 260 4WD | 4 | 4G63Turbo | 195/261 | 03/04→07/05 | | | CET8 | OE195 | BAEA193E | |
| 2.0 EVO IX 4WD | 4 | 4G63Turbo | 206/276 | 01/05→09/07 | | | CET8 | OE195 | | |
| 2.0 EVO IX 4WD | 4 | 4G63Turbo | 213/286 | 08/05→09/06 | | | CET8 | OE195 | | |
| 2.0 GDi | 4 | 4G94(GDI) | 92/123 | 09/03→ | | | CET12P | OE184 | | |

LANCER VIII

| | | | | | | | | | | |
|--|---|------|---------|--------|-------|-----|--------|-------|---------|--|
| 1.5 | 4 | 4A91 | 80/107 | 06/08→ | OE035 | 0,9 | CET5 | OE190 | BAEA547 | |
| 1.5 Bifuel | 4 | 4A91 | 80/107 | 02/10→ | OE035 | 0,9 | CET5 | OE190 | | |
| 1.6 MIVEC | 4 | 4A92 | 86/115 | 05/10→ | | | CET14P | OE190 | BAEA547 | |
| 1.8, 1.8 Bifuel | 4 | 4B10 | 105/141 | 02/08→ | | | CET12P | OE179 | | |
| 1.8, 1.8 Flex, 1.8 Flexfuel, 1.8 MIVEC | 4 | 4B10 | 103/138 | 03/09→ | | | CET12P | OE179 | | |
| 2.0 | 4 | 4B11 | 108/145 | 01/09→ | | | CET12P | OE182 | | |
| 2.0 | 4 | 4B11 | 115/154 | 04/08→ | | | CET12P | OE182 | | |
| 2.0 i | 4 | 4B11 | 113/152 | 10/07→ | | | CET12P | OE182 | | |

MAGNA

| | | | | | | | | | | |
|--|---|---------------|---------|-------------|-------|-----|--------|-------|--|--|
| 3.0 | 6 | 6G72(SOHC24V) | 150/201 | 08/00→07/02 | OE146 | 1,0 | CET12P | OE179 | | |
| 3.0 i | 6 | 6G72(SOHC24V) | 140/188 | 04/96→05/03 | OE146 | 1,0 | CET12P | OE179 | | |
| 3.5 | 6 | 6G74(SOHC24V) | 143/192 | 06/03→09/04 | OE146 | 1,0 | CET12P | OE184 | | |
| 3.5, 3.5 i | 6 | 6G74(SOHC24V) | 147/197 | 03/99→05/03 | OE146 | 1,0 | CET12P | OE184 | | |
| 3.5 i | 6 | 6G74(SOHC24V) | 155/208 | 08/00→07/05 | OE146 | 1,0 | CET12P | OE184 | | |
| 3.5 i | 6 | 6G74(SOHC24V) | 157/211 | 10/04→05/05 | OE146 | 1,0 | CET12P | OE184 | | |
| 3.5 i 4WD | 6 | 6G74(SOHC24V) | 159/213 | 06/03→05/05 | OE146 | 1,0 | CET12P | OE184 | | |
| 3.5 i Series II Raliant | 6 | 6G74(DOHC24V) | 180/241 | 08/02→05/05 | OE146 | 1,0 | CET12P | OE184 | | |
| 3.5 i Sport, 3.5 Series II Sports VR-X | 6 | 6G74(SOHC24V) | 163/219 | 08/00→05/05 | OE146 | 1,0 | CET12P | OE184 | | |

MIRAGE

| | | | | | | | | | | |
|---------|---|-----------|---------|-------------|-------|-----|------|-------|--|--|
| 1.5 | 4 | 4G15(12V) | 66/89 | 09/95→08/99 | OE048 | 1,0 | CET8 | OE195 | | |
| 1.5 | 4 | 4G15(16V) | 81/109 | 09/95→12/00 | OE048 | 1,0 | CET8 | OE195 | | |
| 1.8 4WD | 4 | 4G93T | 152/204 | 09/95→08/99 | OE039 | 1,0 | CET2 | OE179 | | |

MIRAGE V

| | | | | | | | | | | |
|-----|---|-----------|--------|-------------|-------|-----|------|-------|--|--|
| 1.5 | 4 | 4G15(12V) | 81/109 | 09/95→08/99 | OE048 | 1,0 | CET8 | OE195 | | |
|-----|---|-----------|--------|-------------|-------|-----|------|-------|--|--|

OUTLANDER I

| | | | | | | | | | | |
|------------------------|---|-----------------|---------|-------------|--|--|--------|-------|----------|--|
| 2.0, 2.0 4WD | 4 | 4G63(DOHC16V) | 100/134 | 05/03→10/06 | | | CET8 | OE195 | BAEA193E | |
| 2.0 4WD | 4 | 4G63(DOHC16V) | 93/125 | 05/03→10/06 | | | CET8 | OE195 | | |
| 2.0 Turbo 4WD | 4 | 4G63-T(DOHC16V) | 148/198 | 04/04→10/06 | | | CET8 | OE195 | BAEA193E | |
| 2.0 Turbo-R 4WD | 4 | 4G63Turbo | 177/237 | 01/02→10/06 | | | CET8 | OE195 | BAEA193E | |
| 2.4 4WD | 4 | 4G64(16V) | 102/137 | 05/03→10/06 | | | CET12P | OE180 | | |
| 2.4 4WD | 4 | 4G69 | 119/160 | 05/03→10/06 | | | CET14P | OE190 | | |
| 2.4 4WD, 2.4 HDD Mivec | 4 | 4G69 | 118/158 | 03/01→12/06 | | | CET14P | OE190 | | |

MITSUBISHI



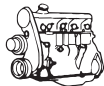

kW/BHP

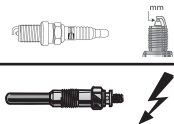

eon TITAN

IRIDIUM

**...MITSUBISHI****OUTLANDER II**

| | | | | | | | | | |
|----------------------------|---|----------|---------|---------------|-------|-----|--------|-------|--------|
| 2.0, 2.0 4WD | 4 | 4B11 | 108/145 | 11/06 → 11/12 | | | CET12P | OE182 | |
| 2.2 DI-D, 2.2 DI-D 4WD | 4 | 4N14 | 130/174 | 11/06 → 11/12 | | | | | CCU147 |
| 2.2 DI-D 4WD | 4 | 4N14 | 103/138 | 09/10 → 11/12 | | | | | CCU147 |
| 2.2 DI-D 4WD | 4 | 4HK; 4HN | 115/154 | 08/07 → 11/12 | | | | | CCU147 |
| 2.4, 2.4 4WD, 2.4 Flex 4WD | 4 | 4B12 | 125/168 | 11/06 → 11/12 | | | CET12P | OE180 | |
| 3.0, 3.0 4WD | 6 | 6B31 | 162/217 | 11/06 → 11/12 | OE229 | 0,8 | CET15P | | |
| 3.0 4WD | 6 | 6B31 | 177/237 | 10/09 → 11/12 | OE229 | 0,8 | CET15P | | |

OUTLANDER III

| | | | | | | | | | |
|----------------|---|----------------|---------|---------|--|--|--------|-------|--|
| 2.0, 2.0 4WD | 4 | 4J11 | 110/148 | 08/12 → | | | CET12P | OE179 | |
| 2.0, 2.0 4WD | 4 | 4B11; 4J11 | 107/143 | 10/12 → | | | CET12P | OE179 | |
| 2.0 Hybrid 4WD | 4 | 4B11; S61; Y61 | 89/119 | 12/12 → | | | CET12P | OE182 | |

PAJERO CLASSIC

| | | | | | | | | | |
|----------------------|---|-------|---------|---------|-------|-----|--------|-------|--|
| 2.5 TD 4WD | 4 | 4D56T | 85/114 | 07/01 → | CH256 | 11v | | | |
| 3.8 GDi, 3.8 GDi 4WD | 6 | 6G75 | 160/215 | 06/02 → | | | CET12P | OE179 | |

PAJERO II

| | | | | | | | | | |
|-----------------|---|---------------------------------|---------|---------------|--------------------------|------------|--------|-------|--|
| 1.8 1.8 GDI 4WD | 4 | 4G93(GDI) | 96/129 | 06/98 → 04/00 | OE227 OE216 LPG [278] | 0,6 0,8 | CET12P | OE188 | |
| 3.0 V6 24V 4WD | 6 | 6G72(SOHC24V) | 130/174 | 06/94 → 04/00 | OE039 | 1,0 | CET2 | OE180 | |
| 3.0 V6 24V 4WD | 6 | 6G72(SOHC24V) | 133/178 | 06/94 → 04/00 | OE039 | 1,0 | CET2 | OE180 | |
| 3.5 V6 24V 4WD | 6 | 6G74(DOHC24V); 6G74(SOHC24V) | 143/192 | 07/97 → 10/99 | OE146 | 1,0 | CET12P | OE184 | |
| 3.5 V6 24V 4WD | 6 | 6G74(DOHC24V); 6G74(SOHC24V) | 153/205 | 06/94 → 10/99 | OE146 | 1,0 | CET12P | OE184 | |

PAJERO III

| | | | | | | | | | |
|----------------------------|---|-----------------------------|---------|---------------|-------|-----|--------|-------|--|
| 2.5 TDi 4WD | 4 | 4D56T | 73/98 | 04/00 → 12/06 | CH256 | 11v | | | |
| 2.5 TDi 4WD | 4 | 4D56T | 85/114 | 09/01 → 12/06 | CH256 | 11v | | | |
| 3.0 4WD | 6 | 6G72(SOHC24V) | 125/168 | 10/01 → 12/06 | OE146 | 1,0 | CET12P | OE179 | |
| 3.2 Di-D 4WD | 4 | 4M41 | 129/173 | 04/00 → 01/07 | CH263 | 11v | | | |
| 3.2 Di-D 4WD, 3.2 DI-D 4WD | 4 | 4M41 | 118/158 | 04/00 → 12/06 | CH263 | 11v | | | |
| 3.2 Di-D 4WD, 3.2 DI-D 4WD | 4 | 4M41 | 121/162 | 04/00 → 12/06 | CH263 | 11v | | | |
| 3.5 4WD, 3.5 V6 GDI 4WD | 6 | 6G74(DOHC24V); 6G74(GDI) | 149/200 | 04/00 → 01/07 | OE146 | 1,0 | CET12P | OE184 | |

PAJERO IV

| | | | | | | | | | |
|------------|---|---------------|---------|---------|-------|-----|--------|-------|--|
| 3.0 4WD | 6 | 6G72(SOHC24V) | 131/176 | 02/07 → | OE146 | 1,0 | CET12P | OE179 | |
| 3.8 V6 4WD | 6 | 6G75 | 184/247 | 02/07 → | | | CET12P | OE179 | |

PAJERO PININ

| | | | | | | | | | |
|-------------|---|---------------|--------|---------------|-------------------------------------|------------|--------|-------|--------|
| 1.8 4WD | 4 | 4G93(SOHC16V) | 84/113 | 11/01 → 06/07 | OE039 | 1,0 | CET2 | OE179 | CLS010 |
| 1.8 GDI 4WD | 4 | 4G93(GDI) | 88/118 | 10/99 → 10/01 | OE227 → 06/00 OE216 LPG [278] | 0,6 0,8 | CET12P | OE188 | CLS010 |
| 2.0 GDI 4WD | 4 | 4G94(GDI) | 95/127 | 10/00 → 06/07 | | | CET12P | OE184 | |

PAJERO SPORT I

| | | | | | | | | | |
|-------------|---|---------------|---------|---------------|--------------------------|------------|--------|-------|--|
| 1.8 4WD | 4 | 4G93(SOHC16V) | 84/113 | 03/01 → 02/05 | OE039 | 1,0 | CET2 | OE179 | |
| 1.8 GDi 4WD | 4 | 4G93(GDI) | 88/118 | 05/99 → 02/01 | OE227 OE216 LPG [278] | 0,6 0,8 | CET12P | OE188 | |
| 2.0 GDi 4WD | 4 | 4G94(GDI) | 95/127 | 10/01 → 02/05 | | | CET12P | OE184 | |
| 2.5 TD 4WD | 4 | 4D56T | 73/98 | 11/98 → | CH256 | 11v | | | |
| 2.5 TD 4WD | 4 | 4D56T | 83/111 | 11/97 → 10/98 | CH256 08/98 → | 11v | | | |
| 2.5 TD 4WD | 4 | 4D56T | 85/114 | 07/02 → | CH256 | 11v | | | |
| 2.5 TD 4WD | 4 | 4D56T | 98/131 | 08/03 → | CH256 | 11v | | | |
| 3.0 V6 4WD | 6 | 6G72(DOHC24V) | 123/165 | 03/03 → | OE039 | 1,0 | CET2 | OE180 | |
| 3.0 V6 4WD | 6 | 6G72(SOHC24V) | 125/168 | 06/00 → | OE039 | 1,0 | CET2 | OE180 | |
| 3.0 V6 4WD | 6 | 6G72(SOHC24V) | 130/174 | 11/98 → | OE039 | 1,0 | CET2 | OE180 | |





kW/BHP

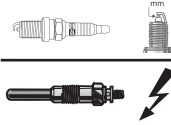

eon TITAN

IRIDIUM

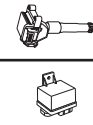
**...MITSUBISHI****...PAJERO SPORT I**

3.2 TDi 4WD 4 4M41 121/162 11/98 → CH263 11v

PAJERO SPORT II

3.0 4WD 6 6B31 162/217 09/08 → OE229 0,8 CET15P

3.5 V6 24V 4WD 6 6G74(SOHC24V) 153/205 09/08 → OE146 1,0 CET12P OE184

PROUDIA/DIGNITY

4.5 8 8A80 206/276 10/99 → 05/01 OE146 1,0 CET12P OE179

SANTAMO

2.0 16V, 2.0 16V 4WD 4 4G63(DOHC16V) 102/137 05/99 → 12/04 OE039 1,0 CET2 OE180 BAEA521 [277]

SPACE RUNNER

1.8, 1.8 4WD 4 4G93(SOHC16V) 85/114 06/96 → 08/99 OE039 1,0 CET2 OE179

2.0 4 4G63(SOHC16V) 98/131 05/00 → 08/02 OE063 1,0 CET2

2.0 4 4G63(SOHC16V) 100/134 08/99 → 08/02 OE063 1,0 CET2 OE180 BAEA179E [41]

2.0 16V 4 4G63(DOHC16V) 98/131 06/97 → 08/99 OE063 1,0 CET2 OE180

2.4 GDI 4 4G64(GDI) 110/148 08/99 → 01/03 CET12P OE184 CLS010

SPACE STAR

1.3 16V 4 4G13(16V) 60/80 09/00 → 12/04 OE063 1,0 CET2 OE180 BAEA178E CLS010

1.3 16V 4 4G13(16V) 61/82 12/98 → 12/04 OE063 1,0 CET2 OE180 BAEA178E CLS010

1.3 16V 4 4G13(16V) 63/84 06/98 → 12/04 OE063 1,0 CET2 OE180 BAEA178E CLS010

1.6 4 4G92(SOHC16V) 72/97 04/01 → 12/04 OE039 1,0 CET2 OE179

1.6 16V 4 4G18 72/97 01/01 → 12/04 OE063 1,0 CET2 OE180 BAEA178E CLS010

1.8 GDI 4 4G93(GDI) 87/117 06/98 → 12/04 OE227 0,6 CET12P OE188

1.8 GDI 4 4G93(GDI) 90/121 06/98 → 12/04 OE227 0,6 CET12P OE188

1.8 GDI 4 4G93(GDI) 90/121 06/98 → 12/04 OE227 0,6 CET12P OE188

1.8 MPI 4 4G93(DOHC16V) 82/110 10/02 → 12/04 OE227 0,6 CET2 OE179

1.8 MPI 4 4G93(DOHC16V) 82/110 10/02 → 12/04 OE227 0,6 CET2 OE179

1.8 MPI 4 4G93(DOHC16V) 82/110 10/02 → 12/04 OE227 0,6 CET2 OE179

1.8 MPI 4 4G93(DOHC16V) 82/110 10/02 → 12/04 OE227 0,6 CET2 OE179

1.9 DI-D 4 F9Q1 75/101 02/01 → 12/04 CH271 11v

1.9 DI-D 4 F9Q2 85/114 10/02 → 12/04 CH271 11v

SPACE WAGON

1.8 4 4G93 93/125 05/02 → 08/04 OE039 1,0 CET2 OE179

2.4 GDI 4 4G64(GDI) 108/145 09/00 → 12/04 CET12P OE184 CLS010

2.4 GDI, 2.4 GDI 4WD 4 4G64(GDI) 110/148 10/98 → 12/04 CET12P OE184 CLS010

2.4 GDI 4WD 4 4G64(GDI) 108/145 09/00 → 12/04 CET12P OE184

VERADA

3.5 i Series II 4WD 6 6G74(SOHC24V) 155/208 08/02 → 05/05 OE146 1,0 CET12P OE184

MITSUBISHI**L 300 III**

2.0 4 4G63(SOHC16V) 85/114 07/94 → 04/00 OE063 1,0 CET2 OE180

2.0, 2.0 4WD 4 4G63(SOHC16V) 82/110 06/94 → 05/03 OE063 1,0 CET2 OE180

2.0 i 4 4G63(SOHC16V) 83/111 06/94 → 10/98 OE063 1,0 CET2 OE180

2.4 4 4G64(SOHC16V) 94/126 09/97 → 05/03 OE048 1,0 CET8 OE195

3.0 4WD 6 6G72(DOHC24V) 136/182 10/00 → 05/03 OE146 1,0 CET12P OE179

L 400

1.6 4 4G32 51/68 06/96 → 10/02 OE051 0,9 CET8

2.0 4 4G63(SOHC16V) 83/111 12/94 → 10/02 OE063 1,0 CET2

2.0, 2.0 16V 4 4G63(SOHC16V) 85/114 05/95 → 03/01 OE063 1,0 CET2 OE180

2.4 i 4WD 4 4G64(16V) 97/130 05/95 → 05/00 OE063 1,0 CET2 OE180

2.5 2500 TD, 2.5 2500 TD 4WD 4 4D56T 64/86 05/95 → 06/05 CH256 11v

2.5 TD, 2.5 TD 4WD 4 4D56TD 73/98 05/95 → 05/00 CH256 11v

MITSUBISHI



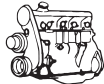

kW/BHP



eon TITAN

IRIDIUM

**...MITSUBISHI****PAJERO SPORT VAN I**

| | | | | | | | | | |
|------------|---|-------|--------|-------------|-------|-----|--|--|--|
| 2.5 TD 4WD | 4 | 4D56T | 85/114 | 12/99→01/08 | CH256 | 11v | | | |
|------------|---|-------|--------|-------------|-------|-----|--|--|--|

MITSUOKA**VIEWT**

| | | | | | | | | | |
|---------------|---|--------|-------|-------------|-------|-----|--------|-------|--|
| 1.2 Royal | 4 | CR12DE | 66/89 | 02/05→ | OE175 | 1,0 | CET14P | OE190 | |
| 1.3, 1.3 G | 4 | CG13DE | 55/74 | 05/96→08/01 | OE063 | 1,0 | CET2 | OE180 | |
| 1.4 Royal 4WD | 4 | CR14DE | 71/95 | 02/05→ | OE175 | 1,0 | CET14P | OE190 | |

YUGA

| | | | | | | | | | |
|--------------------------|---|--------|-------|--------|-------|-----|------|-------|--|
| 1.3 Royal, 1.3 Royal 4WD | 4 | CGA3DE | 63/84 | 06/99→ | OE063 | 1,0 | CET2 | OE180 | |
|--------------------------|---|--------|-------|--------|-------|-----|------|-------|--|

ZERO I

| | | | | | | | | | |
|-----------|---|------|---------|-------------|-------|-----|------|-------|--|
| 1.8 Turbo | 4 | BP28 | 120/161 | 06/96→08/00 | OE005 | 0,9 | CET2 | OE179 | |
|-----------|---|------|---------|-------------|-------|-----|------|-------|--|

MORGAN**AERO 8**

| | | | | | | | | | |
|-----|---|----------|---------|--------|-------|-----|--------|-------|--|
| 4.4 | 8 | M62448S2 | 210/282 | 10/00→ | OE223 | 1,6 | CET12P | OE188 | |
|-----|---|----------|---------|--------|-------|-----|--------|-------|--|

FOUR FOUR

| | | | | | | | | | |
|-------|---|-------|--------|-------------|-------|-----|--------|-------|--|
| 1.8 i | 4 | ZH18P | 92/123 | 01/93→01/05 | OE029 | 1,0 | CET17P | OE189 | |
|-------|---|-------|--------|-------------|-------|-----|--------|-------|--|

PLUS EIGHT

| | | | | | | | | | |
|-----|---|-----|---------|-------------|-------|-----|--------|-------|--|
| 4.6 | 8 | 46D | 164/220 | 01/96→10/01 | OE146 | 1,0 | CET12P | OE179 | |
|-----|---|-----|---------|-------------|-------|-----|--------|-------|--|

PLUS FOUR

| | | | | | | | | | |
|-------|---|------|---------|-------------|-------|-----|--------|-------|--|
| 1.8 i | 4 | RQB | 96/129 | 01/93→06/99 | OE029 | 1,0 | CET17P | OE189 | |
| 2.0 i | 4 | AODA | 106/142 | 01/04→06/14 | OE131 | 1,0 | CET18P | OE183 | |

ROADSTER

| | | | | | | | | | |
|-----------|---|------|---------|--------|-------|-----|--------|-------|--|
| 2.0 Plus4 | 4 | AODA | 106/142 | 01/04→ | OE131 | 1,0 | CET18P | OE183 | |
| 3.0 V6 | 6 | MEBA | 165/221 | 01/04→ | OE131 | 1,0 | CET18P | OE183 | |

MOSKVICH**2141**

| | | | | | | | | | |
|-----|---|--|-------|-------------|-------|-----|------|-------|--|
| 1.6 | 4 | | 56/75 | 11/97→12/01 | OE006 | 0,9 | CET8 | OE195 | |
| 1.6 | 4 | | 59/79 | 05/94→10/97 | OE006 | 0,9 | CET8 | OE195 | |
| 1.7 | 4 | | 63/84 | 03/95→12/01 | OE006 | 0,9 | CET8 | OE195 | |

2335

| | | | | | | | | | |
|-----|---|----------|-------|-------------|-------|-----|--|--|--|
| 1.7 | 4 | Y3AM3317 | 63/84 | 01/95→12/01 | OE068 | 0,7 | | | |
|-----|---|----------|-------|-------------|-------|-----|--|--|--|

NISSAN**100 NX**

| | | | | | | | | | |
|--------|---|--------|--------|-------------|-------|-----|------|-------|--|
| 1.6 SR | 4 | GA16DE | 75/101 | 09/93→10/94 | OE005 | 0,9 | CET2 | OE180 | |
|--------|---|--------|--------|-------------|-------|-----|------|-------|--|

200 SX

| | | | | | | | | | |
|-----------------|---|---------|---------|-------------|-------|-----|--------|-------|--|
| 2.0 i 16V | 4 | SR20DE | 118/158 | 10/93→12/99 | OE089 | 1,0 | CET2 | OE184 | |
| 2.0 i 16V Turbo | 4 | SR20DET | 147/197 | 10/93→12/99 | OE136 | 0,8 | CET12P | OE179 | |
| 2.0 Turbo | 4 | SR20DET | 162/217 | 04/94→09/99 | OE136 | 0,8 | CET12P | OE179 | |

240 SX

| | | | | | | | | | |
|-----|---|--------|---------|-------------|-------|-----|------|--|--|
| 2.4 | 4 | KA24DE | 112/150 | 05/94→08/97 | OE063 | 1,0 | CET2 | | |
|-----|---|--------|---------|-------------|-------|-----|------|--|--|

350 Z

| | | | | | | | | | |
|-----|---|--------|---------|-------------|-------|-----|--------|-------|---|
| 3.5 | 6 | VQ35DE | 206/276 | 10/03→12/07 | OE175 | 1,0 | CET14P | OE190 | BAEA158E 01/07→ BAEA132E ^[277] |
| 3.5 | 6 | VQ35DE | 214/287 | 10/03→01/07 | OE175 | 1,0 | CET14P | OE190 | |
| 3.5 | 6 | VQ35DE | 221/296 | 09/02→12/08 | OE175 | 1,0 | CET14P | OE190 | BAEA158E 01/07→ BAEA132E ^[277] |
| 3.5 | 6 | VQ35HR | 230/308 | 09/05→12/09 | | | | | BAEA158E 01/07→ |

CHAMPION

MITSUBISHI



kW/BHP

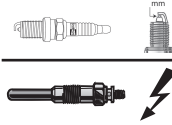

eon TITAN

IRIDIUM

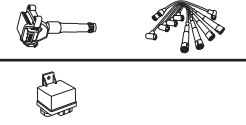

...NISSAN

AD Van

| | | | | | | | | | |
|-------|---|--------|--------|---------------|-------|-----|------|-------|--|
| 2.0 | 4 | SR20DE | 92/123 | 10/94 → 04/99 | OE063 | 1,0 | CET2 | OE180 | |
| 2.0 D | 4 | CD20 | 55/74 | 10/94 → 04/99 | CH600 | 11v | | | |

AD Wagon

| | | | | | | | | | |
|-----|---|--------|--------|---------------|-------|-----|------|-------|--|
| 1.5 | 4 | QG15DE | 66/89 | 05/99 → 08/04 | OE063 | 1,0 | CET2 | OE180 | |
| 2.0 | 4 | SR20DE | 92/123 | 05/99 → 08/01 | OE063 | 1,0 | CET2 | OE180 | |

ALMERA Classic

| | | | | | | | | | |
|---------|---|--------|--------|---------|-------|-----|------|-------|----------|
| 1.6 16V | 4 | QG16DE | 79/106 | 03/06 → | OE148 | 1,0 | CET5 | OE190 | BAEA081E |
|---------|---|--------|--------|---------|-------|-----|------|-------|----------|

ALMERA I

| | | | | | | | | | |
|---------------------------|---|--------|---------|---------------|------------------|-----|------|-------|--------|
| 1.4 | 4 | GA14DE | 64/86 | 09/95 → 07/00 | OE063 | 1,0 | CET2 | OE180 | |
| 1.4 GX, LX, 1.4 S, GX, LX | 4 | GA14DE | 55/74 | 09/95 → 07/00 | OE063 | 1,0 | CET2 | OE180 | |
| 1.6 | 4 | GA16DE | 73/98 | 09/95 → 07/00 | OE063 | 1,0 | CET2 | OE180 | |
| 1.6 | 4 | GA16DE | 75/101 | 07/95 → 03/00 | OE063 | 1,0 | CET2 | OE180 | |
| 1.6 SLX, 1.6 SR, SLX | 4 | GA16DE | 66/89 | 09/95 → 07/00 | OE063 | 1,0 | CET2 | OE180 | |
| 2.0 D | 4 | CD20 | 55/74 | 11/95 → 07/00 | CH600 → 04/96 | 11v | | | |
| 2.0 GTi | 4 | SR20DE | 105/141 | 07/96 → 03/00 | OE063 | 1,0 | CET2 | OE180 | CLS132 |

ALMERA II

| | | | | | | | | | |
|-------------|---|----------------|---------|---------------|---------------------------------------|-----|----------------|------------------|--|
| 1.5 | 4 | QG15DE | 66/89 | 03/00 → 11/06 | OE063 | 1,0 | CET2 | OE180 | BAEA081E ^[371] → 08/02 BAEA021E → 12/04 [7] [264] [328] |
| 1.5 | 4 | QG15DE | 72/97 | 10/02 → 09/06 | OE224 ^{UPG [279]} | 0,8 | CET5 | OE190 | BAEA021E → 12/04 [7] [264] [328] BAEA081E ^[371] |
| 1.5 | 4 | QC15DE | 72/97 | 10/02 → 09/06 | | | | OE190 | |
| 1.5 | 4 | GA15DE; QG15DE | 77/103 | 03/01 → | | | CET14P CET5 | OE190 | |
| 1.5 dCi | 4 | K9K722 | 60/80 | 01/03 → 09/06 | CH271 | 11v | | | CCU154 ^[82] |
| 1.5 XL | 4 | QG15DE | 77/103 | 03/01 → | OE148 | 1,0 | CET14P CET5 | OE190 | |
| 1.6 | 4 | GA16DE; QG16DE | 83/111 | 07/00 → 02/03 | OE063 | 1,0 | CET2 | OE180 | |
| 1.8 | 4 | QG18DE | 84/113 | 01/00 → 11/02 | OE224 ^{UPG [279]} 10/02 → | 0,8 | CET2 | OE180 | BAEA021E → 12/04 [7] [264] [328] BAEA081E ^[371] 10/00 → |
| 1.8 | 4 | QG18DE | 85/114 | 10/02 → 09/06 | OE224 ^{UPG [279]} | 0,8 | CET5 | OE190 | BAEA021E → 12/04 [7] [264] [328] BAEA081E ^[371] |
| 2.0 | 4 | SR20DE | 107/143 | 08/02 → | OE063 | 1,0 | CET2 | OE180 | |
| 2.2 dCi | 4 | YD22DDT | 82/110 | 09/03 → 09/06 | CH230 | 11v | | | |
| 2.2 dCi | 4 | YD22DDTi | 100/134 | 09/03 → 09/06 | CH230 | 11v | | | |
| 2.2 Di | 4 | YD22DDT | 81/109 | 03/00 → 04/03 | CH230 | 11v | | | |
| ALMERA TINO | | | | | | | | | |
| 1.8 | 4 | QG18DE | 84/113 | 08/00 → 02/06 | OE063 → 11/02 | 1,0 | CET2 | OE180 → 11/02 | BAEA021E → 11/00 [7] [264] BAEA081E 11/00 → |
| | | | | | OE224 ^{UPG [279]} 12/02 → | 0,8 | | | |
| 1.8 | 4 | QC18DE | 85/114 | 12/02 → 02/06 | | | | OE190 | |
| 1.8 | 4 | QG18DE | 85/114 | 12/02 → 02/06 | OE224 ^{UPG [279]} | 0,8 | CET5 | | BAEA081E |
| 2.0 | 4 | SR20DE | 100/134 | 08/00 → 01/03 | OE063 | 1,0 | CET2 | OE180 | |
| 2.2 dCi | 4 | YD22DDT | 82/110 | 09/03 → 02/06 | CH230 | 11v | | | |
| 2.2 dCi | 4 | YD22DDTi | 84/113 | 08/00 → 02/06 | CH230 | 11v | | | |

NISSAN



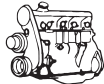

kW/BHP

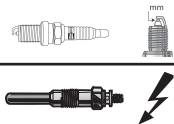

eon TITAN

IRIDIUM

**...NISSAN****...ALMERA TINO**

| | | | | | | | | | |
|---------|---|----------|---------|-------------|-------|-----|--|--|--|
| 2.2 dCi | 4 | YD22DDTi | 100/134 | 09/03→02/06 | CH230 | 11v | | | |
|---------|---|----------|---------|-------------|-------|-----|--|--|--|

ALTIMA

| | | | | | | | | | |
|-----|---|--------|---------|-------------|-------|-----|--------|-------|--------------------|
| 2.5 | 4 | QR25DE | 121/162 | 08/01→09/06 | OE148 | 1,0 | CET5 | OE190 | |
| 2.5 | 4 | QR25DE | 128/172 | 10/06→07/13 | OE207 | 1,1 | | | |
| 3.5 | 6 | VQ35DE | 180/241 | 08/01→09/06 | OE175 | 1,0 | CET14P | OE190 | |
| 3.5 | 6 | VQ35DE | 201/270 | 10/06→ | OE175 | 1,0 | CET14P | OE190 | BAEA158E →12/09 |

AVENIR

| | | | | | | | | | |
|--------------|---|--------|---------|-------------|-----------------|-----|------|-------|--|
| 1.6 | 4 | QG16DE | 80/107 | 11/97→12/05 | OE063 | 1,0 | CET2 | OE180 | |
| 1.8 | 4 | QG18DE | 92/123 | 11/97→12/05 | OE148 | 1,0 | CET5 | OE190 | |
| 2.0, 2.0 4WD | 4 | SR20DE | 107/143 | 11/97→12/05 | OE063 | 1,0 | CET2 | | |
| 2.0, 2.0 4WD | 4 | QR20DE | 110/148 | 09/01→12/05 | OE148 | 1,0 | CET5 | OE190 | |
| | | | | | OE224 LPG [279] | 0,8 | | | |

BASSARA

| | | | | | | | | | |
|-----|---|--------|---------|-------------|-------|-----|------|-------|--|
| 2.4 | 4 | KA24DE | 110/148 | 11/99→08/02 | OE063 | 1,0 | CET2 | | |
| 2.5 | 4 | QR25DE | 121/162 | 06/02→08/03 | OE148 | 1,0 | CET5 | OE190 | |

BLUEBIRD SYLPHY / SYLPHY III

| | | | | | | | | | |
|-----|---|--------|--------|--------|--|--|--|-----------------|--|
| 1.6 | 4 | HR16DE | 86/115 | 05/13→ | | | | OE240 08/14→ | |
|-----|---|--------|--------|--------|--|--|--|-----------------|--|

BLUEBIRD SYLPHY I

| | | | | | | | | | |
|-----|---|--------|---------|-------------|-------|-----|------|-------|--|
| 1.5 | 4 | QG15DE | 77/103 | 08/00→08/05 | OE063 | 1,0 | CET2 | OE180 | |
| 2.0 | 4 | SR20DE | 107/143 | 08/00→08/02 | OE063 | 1,0 | CET2 | | |

BLUEBIRD SYLPHY II

| | | | | | | | | | |
|--------------|---|--------|--------|-------------|-------|-----|--|-------|----------|
| 1.5, 1.5 4WD | 4 | HR15DE | 80/107 | 09/05→08/12 | | | | OE240 | BAEA088E |
| 2.0 | 4 | MR20DE | 98/131 | 09/05→08/12 | OE207 | 1,1 | | | |

CEDRIC

| | | | | | | | | | |
|-----|---|--------|---------|-------------|-------|-----|--------|-------|--|
| 2.5 | 6 | VQ25DE | 140/188 | 06/96→04/99 | OE191 | 1,0 | CET12P | OE180 | |
|-----|---|--------|---------|-------------|-------|-----|--------|-------|--|

CEFIRO I

| | | | | | | | | | |
|-----|---|--------|---------|-------------|-------|-----|--------|-------|--|
| 2.5 | 6 | VQ25DE | 154/207 | 01/00→09/03 | OE191 | 1,0 | CET12P | OE180 | |
| 3.5 | 6 | VQ35DE | 221/296 | 01/00→09/03 | OE175 | 1,0 | CET14P | OE190 | |

CEFIRO II

| | | | | | | | | | |
|-----|---|--------|---------|-------------|-------|-----|--------|-------|------------------------|
| 2.0 | 6 | VQ20DE | 103/138 | 10/94→12/99 | OE005 | 0,9 | CET2 | OE180 | BAEA073E [31] [277] |
| 2.5 | 6 | VQ25DE | 140/188 | 10/94→12/99 | OE191 | 1,0 | CET12P | OE180 | |
| 3.0 | 6 | VQ30DE | 142/190 | 10/94→12/99 | OE063 | 1,0 | CET2 | OE180 | BAEA073E [31] [275] |

CEFIRO III

| | | | | | | | | | |
|-----|---|--------|---------|-------------|-------|-----|------|-------|--|
| 2.0 | 6 | VQ20DE | 103/138 | 01/00→09/03 | OE005 | 0,9 | CET2 | OE180 | |
| 3.0 | 6 | VQ30DE | 147/197 | 01/00→09/03 | OE063 | 1,0 | CET2 | OE180 | |

CUBE

| | | | | | | | | | |
|--------------|---|----------------|--------|-------------|-------|-----|----------------|-------|----------|
| 1.3 | 4 | CG13DE | 55/74 | 03/98→08/00 | OE063 | 1,0 | CET2 | OE180 | |
| 1.3, 1.3 4WD | 4 | CGA3DE | 63/84 | 09/00→12/02 | OE063 | 1,0 | CET2 | OE180 | |
| 1.3, 1.3 4WD | 4 | CGA3DE | 74/99 | 09/00→12/02 | OE063 | 1,0 | CET2 | OE180 | |
| 1.4, 1.4 4WD | 4 | CR14DE | 72/97 | 01/03→09/05 | OE175 | 1,0 | CET14P | OE190 | BAEA188E |
| 1.5, 1.5 4WD | 4 | HR15DE; QG15DE | 80/107 | 01/03→09/05 | | | CET14P CET5 | OE190 | |
| 1.6 16V | 4 | HR16DE | 81/109 | 03/10→ | | | | OE240 | BAEA056E |

ELGRAND

| | | | | | | | | | |
|--------------|---|--------|---------|-------------|-------|-----|--------|-------|--|
| 2.5, 2.5 4WD | 4 | QR25DE | 125/168 | 11/10→ | OE207 | 1,1 | | | |
| 3.5, 3.5 4WD | 6 | VQ35DE | 177/237 | 08/00→12/10 | OE175 | 1,0 | CET14P | OE190 | |

GLORIA

| | | | | | | | | | |
|-----|---|--------|---------|-------------|-------|-----|--------|-------|--|
| 2.5 | 6 | VQ25DE | 140/188 | 06/96→04/99 | OE191 | 1,0 | CET12P | OE180 | |
|-----|---|--------|---------|-------------|-------|-----|--------|-------|--|



NISSAN



kW/BHP

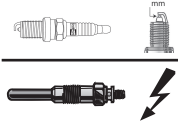

eon TITAN

IRIDIUM

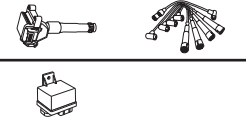

...NISSAN

GLORIA XI

2.4 4 KA24DE 112/150 05/99→08/04 OE063 1,0 CET2

JUKE

1.2 DIG-T 4 HRA2DDT 85/114 05/14→ OE261^[103] BAEA131E

1.6 4 HR16DE 69/93 01/13→ BAEA088E

1.6 4 HR16DE 86/115 06/10→ BAEA088E

KUBISTAR

1.2 4 D7F764 44/59 08/03→10/09 OE026 0,9 CET2 OE188 BAE409A

1.2 16V 4 D4F712 55/74 04/06→10/09 OE130 0,9 CET4 BAE409A

1.4 4 K7J700 55/74 08/03→10/09 BAE409A

1.5 dCi 4 K9K710; K9K714 42/56 08/03→10/09 CH271 11v CCU154

1.5 dCi 4 K9K710; K9K714 45/60 08/05→10/09 CH271 11v CCU154

1.5 dCi 4 K9K704 48/64 08/03→10/09 CH271 11v CCU154

1.5 dCi 4 K9K722 60/80 08/03→10/09 CH271 11v CCU154

1.5 dCi 70 4 K9K700; K9K716 50/67 04/06→10/09 CH271 11v CCU154

1.5 dCi 85 4 K9K276 62/83 04/06→10/09 CH271 11v CCU154

1.6 16V 4 K4M752 70/94 08/03→10/09 OE019 0,9 CET2 OE184 BAE409A

LAFESTA

2.0 CVTC 4 MR20DE 101/135 07/05→ OE207 1,1

LEOPARD

2.4 4 KA24DE 112/150 10/95→08/01 OE063 1,0 CET2

LIVINA / GRAND LIVINA

1.6 4 HR16DE 80/107 02/07→ OE207 1,1

LUCINO

1.6 4 GA16DE 73/98 11/95→01/00 OE063 1,0 CET2 OE180

2.0 D 4 CD20 55/74 11/97→01/00 CH600 11v

MAXIMA / MAXIMA QX IV

2.0, 2.0 QX 6 VQ20DE 103/138 02/95→12/00 OE005 0,9 CET2 OE180 BAEA073E

2.5 V6 24V 6 VQ25DE 140/188 02/95→12/00 CET12P OE180

3.0, 3.0 QX 6 VQ30DE 142/190 03/94→12/00 OE063 1,0 CET2 OE180 BAEA073E

^[31]^[277]

^[31]^[277]

MAXIMA / MAXIMA QX V

2.0 V6 24V 6 VQ20DE 103/138 03/00→11/03 OE063 1,0 CET2 OE180

2.5 V6 24V 6 VQ25DE 154/207 03/00→11/03 OE191 1,0 CET12P OE180

3.0 V6 24V 6 VQ30DE 147/197 03/00→11/03 OE063 1,0 CET2 OE180

3.5 6 VQ35DE 188/252 08/01→02/03 OE175 1,0 CET14P OE190 BAEA079E

3.5 6 VQ35DE 190/255 03/03→11/03 OE175 1,0 CET14P OE190 BAEA079E

3.5 6 VQ35DE 170/228 10/03→11/03 OE175 1,0 CET14P OE190 BAEA079E

MICRA C+C III

1.4 16V 4 CR14DE 65/87 08/05→ OE175 1,0 CET14P OE190 BAEA188E

1.6 160 SR 4 HR16DE 81/109 08/05→ OE207^[6] 1,1 BAEA056E

01/07→

MICRA II

1.0 i 16V 4 CG10DE 44/59 09/00→02/03 OE063 1,0 CET2 OE180 BAEA337

→10/02

1.4 i 16V 4 CGA3DE 60/80 09/00→02/03 OE063 1,0 CET2 OE180 BAEA337

→10/02

1.5 D 4 TD15 42/56 02/98→02/03 CH185 11v

MICRA III

1.0 16V 4 CG10DE 48/64 01/03→06/10 OE175 1,0 CET14P OE190 BAEA188E

1.2 16V 4 CG12DE; CR12DE 48/64 01/03→06/10 OE175 1,0 CET14P OE190 BAEA188E

1.2 16V 4 CG12DE; CR12DE 59/79 01/03→06/10 OE175 1,0 CET14P OE190 BAEA188E

NISSAN





kW/BHP



eon TITAN

IRIDIUM

**...NISSAN****...MICRA III**

| | | | | | | | | | |
|------------|---|--------|--------|-------------|--------------------------------|-----|--------|-------|---------------------------------------|
| 1.4 16V | 4 | CR14DE | 65/87 | 01/03→06/10 | OE175 | 1,0 | CET14P | OE190 | BAEA188E |
| 1.5 dCi | 4 | K9K704 | 48/64 | 01/03→06/10 | CH271 | 11v | | | CCU154 ^[82] 03/03→05/05 |
| 1.5 dCi | 4 | K9K708 | 50/67 | 06/05→06/10 | CH271 | 11v | | | |
| 1.5 dCi | 4 | K9K722 | 60/80 | 09/03→06/10 | CH271 | 11v | | | CCU154 ^[82] →05/05 |
| 1.5 dCi | 4 | K9K276 | 63/84 | 06/05→06/10 | CH271 | 11v | | | |
| 1.6 160 SR | 4 | HR16DE | 81/109 | 05/05→06/10 | OE207 ^[6] 01/07→ | 1,1 | | | BAEA056E |

MICRA IV

| | | | | | | | | | |
|-----------|---|---------|--------|--------|--|--|--|-------|----------|
| 1.2 | 3 | HR12DE | 56/75 | 05/10→ | | | | OE240 | BAEA088E |
| 1.2 | 3 | HR12DE | 59/79 | 05/10→ | | | | OE240 | BAEA088E |
| 1.2 DIG-S | 3 | HR12DDR | 72/97 | 04/11→ | | | | OE240 | BAEA088E |
| 1.5 | 4 | HR15DE | 75/101 | 11/10→ | | | | OE240 | |

MICRA V

| | | | | | | | | | |
|----------|---|-----------------|-------|--------|--|--|--|-------|--|
| 0.9 IG-T | 3 | H4B408; HR09DET | 66/89 | 12/16→ | | | | OE261 | |
|----------|---|-----------------|-------|--------|--|--|--|-------|--|

MURANO I

| | | | | | | | | | |
|---------|---|--------|---------|-------------|-------|-----|--------|-------|----------|
| 3.5 4WD | 6 | VQ35DE | 172/231 | 08/03→09/08 | OE175 | 1,0 | CET14P | OE190 | BAEA079E |
|---------|---|--------|---------|-------------|-------|-----|--------|-------|----------|

MURANO II

| | | | | | | | | | |
|--------------|---|----------|---------|-------------|---------|----|--|--|----------|
| 2.5 dCi 4WD | 4 | YD25DDTi | 140/188 | 01/10→09/14 | CCGP007 | 7v | | | |
| 3.5, 3.5 4WD | 6 | VQ35DE | 195/261 | 11/07→09/14 | | | | | BAEA158E |
| 3.5 4WD | 6 | VQ35DE | 188/252 | 10/08→09/14 | | | | | BAEA158E |

NOTE

| | | | | | | | | | |
|-----------|---|---------|--------|-------------|------------------------|-----|--------|-----------------|--|
| 1.2 | 3 | HR12DE | 59/79 | 06/13→ | | | | OE240 | BAEA088E |
| 1.2 DIG-S | 3 | HR12DDR | 72/97 | 06/13→ | | | | OE240 | |
| 1.4 | 4 | CR14DE | 65/87 | 03/06→06/12 | OE175 | 1,0 | CET14P | OE190 | BAEA188E |
| 1.5 dCi | 4 | K9K700 | 50/67 | 03/06→06/12 | CH271 →10/10 | 11v | | | |
| 1.5 dCi | 4 | K9K276 | 63/84 | 03/06→06/12 | CH271 →10/10 | 11v | | | |
| 1.5 dCi | 4 | K9K292 | 76/102 | 07/08→06/12 | CH271 →10/10 | 11v | | | |
| 1.6 | 4 | HR16DE | 81/109 | 03/06→ | OE207 ^[358] | 1,1 | | OE240 08/10→ | BAEA056E →12/08 BAEA088E 08/10→ |

NP300 NAVARA

| | | | | | | | | | |
|----------------------|---|----------|---------|--------|--|-----|--|--|--|
| 2.5 dCi | 4 | YD25DDTi | 120/161 | 10/06→ | CH230 →01/10 | 11v | | | |
| | | | | | CCGP007 ^[81] 01/10→11/13 | 7v | | | |
| 2.5 dCi, 2.5 dCi 4WD | 4 | YD25DDTi | 106/142 | 07/05→ | CH230 →01/10 | 11v | | | |
| | | | | | CCGP007 ^[81] 01/10→11/13 | 7v | | | |
| 2.5 dCi, 2.5 dCi 4WD | 4 | YD25DDTi | 128/172 | 07/05→ | CH230 →01/10 | 11v | | | |
| | | | | | CCGP007 ^[81] 01/10→11/13 | 7v | | | |
| 2.5 dCi 4WD | 4 | YD25DDTi | 126/169 | 10/06→ | CH230 →01/10 | 11v | | | |
| | | | | | CCGP007 ^[81] 01/10→11/13 | 7v | | | |
| 2.5 dCi 4WD | 4 | YD25DDTi | 140/188 | 12/09→ | CH230 →01/10 | 11v | | | |
| | | | | | CCGP007 ^[81] 01/10→11/13 | 7v | | | |
| 3.0 dCi 4WD | 6 | V9X | 170/228 | 02/10→ | CCGP007 | 7v | | | |

NP300 PICKUP

| | | | | | | | | | |
|----------------------|---|----------|--------|--------|-------|-----|--|--|--|
| 2.5 dCi, 2.5 dCi 4WD | 4 | YD25DDTi | 98/131 | 04/08→ | CH230 | 11v | | | |
|----------------------|---|----------|--------|--------|-------|-----|--|--|--|

CHAMPION

NISSAN



kW/BHP



eon TITAN

IRIDIUM

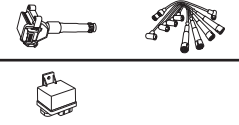

...NISSAN

PATHFINDER II

| | | | | | | | | | |
|------------|---|---------|---------|-------------|-------|-----|------|-------|--------------------|
| 2.7 TD 4WD | 4 | TD27ETi | 96/129 | 09/97→12/04 | CH221 | 11v | | | |
| 3.3 V6 4WD | 6 | VG33E | 110/148 | 03/98→10/00 | OE013 | 0,8 | CET2 | OE193 | |
| 3.3 V6 4WD | 6 | VG33E | 125/168 | 09/97→12/04 | OE013 | 0,8 | CET2 | OE193 | |
| 3.5 V6 4WD | 6 | VQ35 | 162/217 | 11/00→12/04 | | | CET5 | OE190 | BAEA079E 01/03→ |

PATHFINDER III

| | | | | | | | | | |
|----------------------|---|----------|---------|--------|--|-----|------|-------|--|
| 2.5 dCi, 2.5 dCi 4WD | 4 | YD25DDTi | 128/172 | 01/05→ | CH230 →01/10 | 11v | | | |
| | | | | | CCGP007 ^[81] 01/10→11/13 | 7v | | | |
| 2.5 dCi 4WD | 4 | YD25DDTi | 120/161 | 01/05→ | CH230 →01/10 | 11v | | | |
| | | | | | CCGP007 ^[81] 01/10→11/13 | 7v | | | |
| 2.5 dCi 4WD | 4 | YD25DDTi | 126/169 | 10/06→ | CH230 →01/10 | 11v | | | |
| | | | | | CCGP007 ^[81] 01/10→11/13 | 7v | | | |
| 2.5 dCi 4WD | 4 | YD25DDTi | 140/188 | 08/10→ | CCGP007 ^[81] →11/13 | 7v | | | |
| 3.0 dCi 4WD | 6 | V9X | 170/228 | 08/10→ | CCGP007 | 7v | | | |
| 4.0 4WD | 6 | VQ40DE | 198/266 | 09/05→ | OE148 | 1,0 | CET5 | OE190 | |

PATROL GR V

| | | | | | | | | | |
|-----------|---|-------|---------|--------|-------|-----|------|-------|--|
| 4.5 i 4WD | 6 | TB45E | 147/197 | 06/97→ | OE048 | 1,0 | CET8 | OE195 | |
|-----------|---|-------|---------|--------|-------|-----|------|-------|--|

PATROL III

| | | | | | | | | | |
|---------|---|--------|---------|--------|-------|-----|--|--|--|
| 5.6 4WD | 8 | VK56VD | 298/400 | 04/10→ | OE233 | 1,0 | | | |
|---------|---|--------|---------|--------|-------|-----|--|--|--|

PICK UP

| | | | | | | | | | |
|------------------|---|----------|---------|-------------|--------------------------|------|------|-------|--|
| 2.4 | 4 | KA24DE | 110/148 | 01/03→04/05 | OE063 | 1,0 | CET2 | | |
| 2.4, 2.4 i 4WD | 4 | KA24DE | 98/131 | 11/01→04/05 | OE063 | 1,0 | CET2 | | |
| 2.4 i, 2.4 i 4WD | 4 | KA24E | 88/118 | 02/98→04/05 | OE089 *to be adjusted | 0,8* | CET2 | OE184 | |
| 2.5 D 4WD | 4 | | 96/129 | 01/97→04/05 | CH230 | 11v | | | |
| 2.5 Di | 4 | YD25DDTi | 98/131 | 03/02→12/10 | CH230 | 11v | | | |

PIXO

| | | | | | | | | | |
|-----|---|------|-------|--------|-----------------|-----|--------|--|--|
| 1.0 | 3 | K10B | 50/67 | 06/09→ | OE226 | 1,1 | CET10P | | |
| | | | | | OE230 LPG [278] | 0,9 | | | |

PRIMERA

| | | | | | | | | | |
|----------------|---|--------|---------|-------------|-----------------|-----|------|-------|---|
| 1.6 | 4 | QG16DE | 78/105 | 03/02→08/08 | OE148 | 1,0 | CET5 | OE190 | BAEA081E →06/10 |
| 1.6, 1.6 Visia | 4 | QG16DE | 80/107 | 01/02→04/06 | OE148 | 1,0 | CET5 | OE190 | BAEA081E →06/10 |
| 1.6 16V | 4 | GA16DE | 66/89 | 09/96→07/02 | OE033 | 0,9 | CET2 | OE179 | CLS059 [292] |
| 1.6 16V | 4 | GA16DE | 73/98 | 09/96→07/02 | OE033 | 0,9 | CET2 | OE179 | CLS059 [292] |
| 1.6 16V | 4 | QG16DE | 78/105 | 06/96→07/02 | OE063 | 1,0 | CET2 | OE180 | BAEA081E CLS059 [292] |
| 1.6 16V | 4 | QG16DE | 80/107 | 04/98→12/01 | OE063 | 1,0 | CET2 | OE180 | |
| 1.8 | 4 | QG18DE | 85/114 | 03/02→10/08 | OE224 LPG [279] | 0,8 | CET5 | OE190 | BAEA081E |
| 1.8 16V | 4 | QG18DE | 84/113 | 08/99→07/02 | OE063 | 1,0 | CET2 | OE180 | BAEA021E →09/00 [7] [264] BAEA081E 09/00→ |
| 1.9 dCi | 4 | F9Q | 85/114 | 08/02→10/07 | CH271 | 11v | | | CCU154 |
| 1.9 dCi | 4 | F9Q | 88/118 | 04/03→ | CH271 | 11v | | | CCU154 |
| 2.0 | 4 | QR20DE | 103/138 | 03/02→ | OE224 LPG [279] | 0,8 | CET5 | OE190 | BAEA080E |
| 2.0 16V | 4 | SR20DE | 96/129 | 09/96→07/02 | OE089 | 1,0 | CET2 | OE184 | CLS132 |
| 2.0 16V | 4 | SR20DE | 103/138 | 08/99→07/02 | OE089 | 1,0 | CET2 | OE184 | CLS132 |
| 2.0 16V | 4 | SR20DE | 110/148 | 09/96→07/02 | OE089 | 1,0 | CET2 | OE184 | CLS132 |
| 2.0 16V | 4 | SR20VE | 140/188 | 06/96→05/99 | OE002 | 0,9 | CET2 | | |

NISSAN



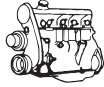

kW/BHP

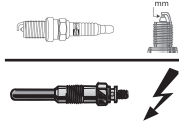

eon TITAN

IRIDIUM



...NISSAN

...PRIMERA

| | | | | | | | | |
|---------|---|---------|---------|--------------|----------------|------------|------|-------|
| 2.0 i | 4 | SR20DE | 92/123 | 01/95 →06/96 | OE005 | 0,9 | CET2 | OE180 |
| 2.0 TD | 4 | CD20T | 66/89 | 09/96 →07/02 | CH600 | 11v | | |
| 2.2 dCi | 4 | YD22DDT | 102/137 | 04/03 → | CH230 | 11v | | |
| 2.2 Di | 4 | YD22DDT | 93/125 | 03/02 →05/07 | CH230 | 11v | | |
| 2.5 | 4 | QG25DD | 125/168 | 01/02 → | OE207 | 1,1 | | |
| 2.5 | 4 | QR25DE | 125/168 | 01/02 → | OE148 OE207 | 1,0 1,1 | CET5 | OE190 |

PULSAR

| | | | | | | | | |
|-----------|---|---------|--------|---------|--|--|--|----------|
| 1.2 DIG-T | 4 | HR12DDT | 85/114 | 10/14 → | | | | OE261 |
| 1.2 DIG-T | 4 | HRA2DDT | 85/114 | 10/14 → | | | | BAEA131E |

QASHQAI / QASHQAI +2 I

| | | | | | | | | |
|----------------------|---|----------------|---------|--------------|----------------------|-----|--|--|
| 1.5 dCi | 4 | K9K282; K9K292 | 76/102 | 07/08 →12/13 | CH271 | 11v | | |
| 1.5 dCi | 4 | K9K282; K9K292 | 78/105 | 02/07 →12/13 | CH271 | 11v | | |
| 1.6 | 4 | HR16DE | 81/109 | 02/07 →12/13 | OE207 [104] [358] | 1,1 | | OE240 BAEA056E |
| 1.6 | 4 | HR16DE | 84/113 | 02/07 →12/13 | OE207 [104] [358] | 1,1 | | OE240 BAEA056E →01/10 BAEA088E 09/10 → |
| 1.6 | 4 | HR16DE | 86/115 | 11/10 →12/13 | OE207 [104] [358] | 1,1 | | OE240 BAEA056E [20] [109] [298] BAEA088E [22] [106] [294] |
| 2.0, 2.0 4WD | 4 | MR20DE | 104/139 | 02/07 →12/13 | OE207 | 1,1 | | BAEA088E |
| 2.0 dCi, 2.0 dCi 4WD | 4 | MTD; M9R | 110/148 | 02/07 →12/13 | CCGP007 | 7v | | |

QASHQAI II

| | | | | | | | | |
|-----------|---|---------|--------|---------|--|--|--|----------------------|
| 1.2 DIG-T | 4 | HR12DDT | 85/114 | 11/13 → | | | | OE261 [102] |
| 1.2 DIG-T | 4 | HRA2DDT | 85/114 | 11/13 → | | | | OE261 [102] BAEA131E |

QUEST

| | | | | | | | | |
|-----|---|--------|---------|---------|-------|-----|--------|-------|
| 3.5 | 6 | VQ35DE | 176/236 | 05/03 → | OE175 | 1,0 | CET14P | OE190 |
|-----|---|--------|---------|---------|-------|-----|--------|-------|

SENTRA V

| | | | | | | | | |
|-----|---|--------|---------|--------------|-------|-----|------|-------|
| 2.5 | 4 | QR25DE | 129/173 | 06/02 →08/06 | OE148 | 1,0 | CET5 | OE190 |
|-----|---|--------|---------|--------------|-------|-----|------|-------|

SENTRA VII

| | | | | | | | | |
|-----|---|--------|--------|---------|--|--|--|-------|
| 1.6 | 4 | HR16DE | 83/111 | 05/13 → | | | | OE240 |
| 1.6 | 4 | HR16DE | 85/114 | 05/13 → | | | | OE240 |
| 1.6 | 4 | HR16DE | 86/115 | 08/14 → | | | | OE240 |

SERENA

| | | | | | | | | |
|----------------------|---|--------|---------|--------------|-------|-----|------|-------|
| 1.6 | 4 | GA16DE | 71/95 | 02/93 →09/01 | OE033 | 0,9 | CET2 | OE179 |
| 1.6 | 4 | GA16DE | 75/101 | 10/94 →08/00 | OE063 | 1,0 | CET2 | |
| 2.0, 2.0 4WD | 4 | MR20DE | 108/145 | 04/05 →07/16 | OE207 | 1,1 | | |
| 2.0 SGX, 2.0 SGX 4WD | 4 | SR20DE | 107/143 | 09/00 →09/05 | OE063 | 1,0 | CET2 | |
| 2.3 D | 4 | LD23 | 55/74 | 01/95 →09/01 | CH186 | 11v | | |

SKYLINE

| | | | | | | | | |
|---------|---|--------|---------|--------------|-------|-----|--------|-------|
| 3.5 4WD | 6 | VQ35DE | 206/276 | 08/03 →08/07 | OE175 | 1,0 | CET14P | OE190 |
|---------|---|--------|---------|--------------|-------|-----|--------|-------|

STAGEA

| | | | | | | | | |
|---------------|---|---------|---------|--------------|-------|-----|--------|-------|
| 2.5, 2.5 4WD | 6 | RB25DE | 140/188 | 09/96 →10/01 | | | CET12P | OE188 |
| 2.5 Turbo 4WD | 6 | RB25DET | 173/232 | 09/96 →10/01 | | | CET12P | OE188 |
| 2.5 Turbo 4WD | 6 | VQ25DET | 206/276 | 10/01 →06/03 | OE191 | 1,0 | CET12P | OE180 |
| 3.5, 3.5 4WD | 6 | VQ35DE | 200/268 | 04/06 →12/07 | OE175 | 1,0 | CET14P | OE190 |

SUNNY III

| | | | | | | | | |
|-----|---|--------|--------|--------------|-------|-----|------|--|
| 1.6 | 4 | GA16DE | 75/101 | 07/95 →03/00 | OE063 | 1,0 | CET2 | |
|-----|---|--------|--------|--------------|-------|-----|------|--|

SUNNY IV

| | | | | | | | | |
|-----|---|--------|-------|--------------|-------|-----|------|-------|
| 1.3 | 4 | QG13DE | 64/86 | 09/97 →03/00 | OE063 | 1,0 | CET2 | OE180 |
|-----|---|--------|-------|--------------|-------|-----|------|-------|

NISSAN

CHAMPION



kW/BHP

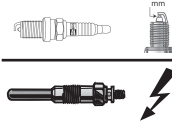

eon TITAN

IRIDIUM

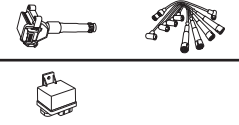

...NISSAN

...SUNNY IV

| | | | | | | | | | |
|-----|---|--------|---------|-------------|-------|-----|------|-------|--|
| 1.5 | 4 | QG15DE | 77/103 | 09/97→08/03 | OE063 | 1,0 | CET2 | OE180 | |
| 2.0 | 4 | SR20DE | 110/148 | 01/00→05/02 | OE063 | 1,0 | CET2 | | |

SYLPHY III

| | | | | | | | | | |
|-----|---|--------|--------|--------|--|--|--|-------|--|
| 1.6 | 4 | HR16DE | 85/114 | 08/12→ | | | | OE240 | |
|-----|---|--------|--------|--------|--|--|--|-------|--|

TEANA I

| | | | | | | | | | |
|-----|---|--------|---------|-------------|-------|-----|--------|-------|-------------------------------------|
| 2.0 | 4 | QR20DE | 103/138 | 10/03→06/08 | | | CET5 | OE190 | BAEA080E |
| 2.3 | 6 | VQ23DE | 127/170 | 10/03→06/08 | OE175 | 1,0 | CET14P | OE190 | BAEA079E ^[108] 03/07→ |
| 3.5 | 6 | VQ35DE | 170/228 | 10/03→06/08 | OE175 | 1,0 | CET14P | OE190 | BAE940A |

TEANA II

| | | | | | | | | | |
|-----|---|--------|---------|-------------|-------|-----|--|--|----------|
| 2.5 | 6 | VQ25DE | 134/180 | 07/08→09/13 | OE207 | 1,1 | | | BAEA158E |
| 3.5 | 6 | VQ35DE | 183/245 | 07/08→09/13 | | | | | BAEA158E |

TERRANO II

| | | | | | | | | | |
|---------------|---|--------|---------|-------------|-------|-----|--------|-------|--|
| 2.4 4WD | 4 | KA24E | 85/114 | 05/96→01/02 | OE089 | 1,0 | CET2 | OE184 | |
| 2.4 4WD | 4 | KA24E | 87/117 | 05/96→09/07 | OE089 | 1,0 | CET2 | OE184 | |
| 2.4 i 12V 4WD | 4 | KA24E | 91/122 | 02/93→12/97 | OE089 | 1,0 | CET2 | OE184 | |
| 3.5 4WD | 6 | VQ35DE | 177/237 | 10/94→06/03 | OE175 | 1,0 | CET14P | OE190 | |

TIIDA

| | | | | | | | | | |
|--------------|---|-------------|--------|-------------|------------------------|-----|--|-------|----------|
| 1.5, 1.5 4WD | 4 | HR15DE | 80/107 | 05/04→06/13 | | | | OE240 | BAEA088E |
| 1.5 dCi | 4 | K9K; K9K278 | 76/102 | 01/07→12/12 | CH271 | 11v | | | |
| 1.5 dCi | 4 | K9K; K9K278 | 78/105 | 09/07→12/12 | CH271 | 11v | | | |
| 1.6 | 4 | HR16DE | 78/105 | 09/12→09/16 | | | | OE240 | |
| 1.6 | 4 | HR16DE | 79/106 | 09/16→ | | | | OE240 | |
| 1.6 | 4 | HR16DE | 80/107 | 05/06→06/13 | OE207 ^[358] | 1,1 | | OE240 | |
| 1.6 | 4 | HR16DE | 81/109 | 09/07→12/12 | OE207 ^[358] | 1,1 | | OE240 | BAEA056E |
| 1.6 | 4 | HR16DE | 87/117 | 08/05→06/13 | OE207 ^[358] | 1,1 | | OE240 | |
| 1.8 | 4 | MR18DE | 78/105 | 01/07→06/11 | OE207 | 1,1 | | | BAEA056E |
| 1.8 | 4 | MR18DE | 93/125 | 09/07→ | OE207 | 1,1 | | | BAEA056E |
| 1.8 | 4 | MR18DE | 95/127 | 08/06→12/12 | | | | | BAEA056E |
| 1.8, 1.8 4WD | 4 | HR18DE | 81/109 | 05/04→02/07 | OE207 | 1,1 | | | |

XTERRA

| | | | | | | | | | |
|---------|---|--------|---------|--------|-------|-----|--|--|--|
| 4.0 4WD | 6 | VQ40DE | 198/266 | 01/05→ | OE175 | 1,0 | | | |
|---------|---|--------|---------|--------|-------|-----|--|--|--|

X-TRAIL

| | | | | | | | | | |
|----------------------|---|-------------------|---------|-------------|------------------------|-----|----------------|-------|--------------------|
| 2.0 | 4 | MR20DE | 103/138 | 07/01→11/13 | OE207 →07/10 | 1,1 | | | BAEA056E |
| 2.0 | 4 | MR20DE | 104/139 | 03/07→ | OE207 →07/10 | 1,1 | | | BAEA056E |
| 2.0, 2.0 4WD | 4 | QR20DE | 103/138 | 07/01→11/13 | OE224 ^[279] | 0,8 | CET5 | OE190 | BAEA080E |
| 2.0, 2.0 4WD | 4 | QR20DE | 110/148 | 09/01→01/13 | OE224 ^[279] | 0,8 | CET5 | OE190 | BAEA080E →01/07 |
| 2.0 4WD | 4 | MR20DE | 101/135 | 06/07→11/13 | OE207 | 1,1 | | | BAEA056E |
| 2.0 4WD | 4 | MR20DE | 103/138 | 07/01→11/13 | OE207 | 1,1 | | | BAEA056E |
| 2.0 4WD | 4 | MR20DE | 104/139 | 06/07→11/13 | OE207 | 1,1 | | | BAEA056E |
| 2.0 4WD | 4 | SR20VET | 206/276 | 06/01→01/13 | OE148 | 1,0 | CET14P CET5 | OE190 | |
| 2.0 4WD | 4 | QR20DE | 206/276 | 06/01→01/13 | | | | | BAEA080E →01/07 |
| 2.0 dCi, 2.0 dCi 4WD | 4 | M9R | 110/148 | 06/07→11/13 | CCGP007 | 7v | | | |
| 2.0 dCi 4WD | 4 | M9R760 | 127/170 | 06/07→11/13 | CCGP007 | 7v | | | |
| 2.2 dCi, 2.2 dCi 4WD | 4 | YD22DDTi | 100/134 | 12/03→01/13 | CH230 | 11v | | | |
| 2.2 dCi, 2.2 Di 4WD | 4 | YD22DDTi; YD22ETi | 84/113 | 06/01→01/13 | CH230 | 11v | | | |
| 2.5 4WD | 4 | QR25DE | 121/162 | 09/02→01/13 | OE224 ^[279] | 0,8 | CET5 | OE190 | BAEA080E |
| 2.5 4WD | 4 | QR25DE | 124/166 | 09/04→ | | | | | BAEA056E |

NISSAN



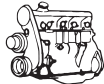

kW/BHP



eon TITAN

IRIDIUM

**...NISSAN****...X-TRAIL**

| | | | | | | | | | |
|---------|---|--------|---------|--------|---------------------------------|-----|-------------|--------------|--|
| 2.5 4WD | 4 | QR25DE | 132/177 | 11/02→ | OE224 LPG [266] [279] | 0,8 | CET5 | OE190 | BAEA080E ^[107] →01/07 |
|---------|---|--------|---------|--------|---------------------------------|-----|-------------|--------------|--|

NISSAN**CABSTAR**

| | | | | | | | | | |
|-------------------------------------|---|----------|--------|-------------|--------------------------|-----|--|--|--|
| 2.5 28.11 DCI, 32.11 DCI, 35.11 DCI | 4 | YD25DDTi | 81/109 | 09/06→12/13 | CH230 →10/11 | 11v | | | |
| | | | | | CCGP007 10/11→ | 7v | | | |
| 2.5 35.13 DCI, 45.13 DCI | 4 | YD25DDTi | 96/129 | 09/06→12/12 | CH230 →10/11 | 11v | | | |
| | | | | | CCGP007 10/11→ | 7v | | | |

CARAVAN

| | | | | | | | | | |
|-----|---|--------|--------|-------------|--------------|-----|-------------|--------------|--|
| 2.0 | 4 | KA20DE | 88/118 | 10/00→09/02 | OE063 | 1,0 | CET2 | OE180 | |
|-----|---|--------|--------|-------------|--------------|-----|-------------|--------------|--|

INTERSTAR

| | | | | | | | | | |
|-------------|---|------------------------|---------|-------------|--------------|-----|--|--|--|
| 1.9 dCi 80 | 4 | F9Q772; F9Q774 | 60/80 | 04/02→08/06 | CH271 | 11v | | | |
| 2.2 dCi 90 | 4 | G9T722 | 66/89 | 07/02→ | CH232 | 11v | | | |
| 2.5 dCi 100 | 4 | G9U720; G9U754 | 73/98 | 11/03→ | CH232 | 11v | | | |
| 2.5 dCi 100 | 4 | G9U650; G9U720; G9U754 | 74/99 | 04/06→ | CH232 | 11v | | | |
| 2.5 dCi 120 | 4 | G9U720; G9U724; G9U750 | 84/113 | 04/02→ | CH232 | 11v | | | |
| 2.5 dCi 120 | 4 | G9U650 | 88/118 | 08/06→ | CH232 | 11v | | | |
| 2.5 dCi 150 | 4 | G9U632 | 107/143 | 08/06→ | CH232 | 11v | | | |

KUBISTAR

| | | | | | | | | | |
|---------|---|----------------|-------|--------|--------------|-----|-------------|--------------|----------------------------------|
| 1.2 | 4 | D7F764 | 44/59 | 08/03→ | OE026 | 0,9 | CET2 | OE188 | BAE409A |
| 1.2 16V | 4 | D4F712 | 55/74 | 04/06→ | OE130 | 0,9 | CET4 | | BAE947A BAEA325 |
| 1.5 dCi | 4 | K9K710; K9K714 | 45/60 | 08/05→ | CH271 | 11v | | | |
| 1.5 dCi | 4 | K9K704 | 48/64 | 08/03→ | CH271 | 11v | | | |
| 1.5 dCi | 4 | K9K722 | 60/80 | 08/03→ | CH271 | 11v | | | |
| 1.6 16V | 4 | K4M752 | 70/94 | 08/03→ | OE033 | 0,9 | CET2 | OE179 | BAE409A |

NP300 NAVARA

| | | | | | | | | | |
|-------------|---|----------|---------|--------|---|-----|--|--|--|
| 2.5 dCi 4WD | 4 | YD25DDTi | 106/142 | 08/08→ | CH230 →01/10 | 11v | | | |
| | | | | | CCGP007 ^[81] 01/10→11/13 | 7v | | | |
| 2.5 dCi 4WD | 4 | YD25DDTi | 126/169 | 08/08→ | CH230 →01/10 | 11v | | | |
| | | | | | CCGP007 ^[81] 01/10→11/13 | 7v | | | |
| 2.5 dCi 4WD | 4 | YD25DDTi | 140/188 | 03/10→ | CCGP007 ^[81] →11/13 | 7v | | | |
| 3.0 dCi 4WD | 6 | V9X | 170/228 | 03/10→ | CCGP007 | 7v | | | |

NV200

| | | | | | | | | | |
|---------|---|------------------------|--------|--------|------------------------------|-----|--|--|-----------------|
| 1.5 dci | 4 | K9K400; K9K608; K9K628 | 63/84 | 02/10→ | CH271 ^[21] | 11v | | | |
| 1.5 dci | 4 | K9K892 | 66/89 | 04/11→ | CH271 ^[21] | 11v | | | |
| 1.6 16V | 4 | HR16DE | 81/109 | 02/10→ | OE207 | 1,1 | | | BAEA056E |

NV200 / EVALIA

| | | | | | | | | | |
|---------|---|------------------------|--------|--------|------------------------------|-----|--|--|-----------------|
| 1.5 dci | 4 | K9K400; K9K608; K9K628 | 63/84 | 07/10→ | CH271 ^[21] | 11v | | | |
| 1.5 dci | 4 | K9K892 | 66/89 | 04/11→ | CH271 ^[21] | 11v | | | |
| 1.6 16V | 4 | HR16DE | 81/109 | 07/10→ | OE207 | 1,1 | | | BAEA056E |

NV400

| | | | | | | | | | |
|-------------|---|---|--------|-------------|----------------|----|--|--|--|
| 2.3 dCi 100 | 4 | M9T670; M9T672; M9T676 | 74/99 | 11/11→06/14 | CCGP007 | 7v | | | |
| 2.3 dCi 125 | 4 | M9T670; M9T672; M9T676; M9T686; M9T690; M9T692; M9T696; M9T698; M9T870; M9T896 | 92/123 | 11/11→09/16 | CCGP007 | 7v | | | |



NISSAN

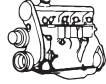

kW/BHP

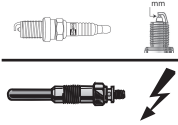

eon TITAN

IRIDIUM

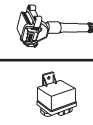

...NISSAN

...NV400

| | | | | | | | | | |
|--------------------------|---|--|---------|-------------|---------|----|--|--|--|
| 2.3 dCi 145 | 4 | M9T678; M9T680; M9T694; M9T696; M9T698; M9T706 | 107/143 | 11/11→06/16 | CCGP007 | 7v | | | |
| 2.3 dCi 160, 2.3 dCi 165 | 4 | M9T | 120/161 | 06/14→ | CCGP007 | 7v | | | |

PRIMASTAR

| | | | | | | | | | |
|--------------------------|---|----------------|---------|--------|---------|-----|------|-------|---------|
| 1.9 dCi 80 | 4 | F9Q762 | 60/80 | 03/01→ | CH271 | 11v | | | CCU154 |
| 1.9 dCi 100 | 4 | F9Q760 | 74/99 | 03/01→ | CH271 | 11v | | | CCU154 |
| 2.0 | 4 | F4R720; F4R722 | 88/118 | 03/01→ | | | CET2 | OE179 | BAE409A |
| 2.0 dCi 90 | 4 | M9R782 | 66/89 | 09/06→ | CCGP007 | 7v | | | |
| 2.0 dCi 115, 2.0 dCi 120 | 4 | M9R630; M9R780 | 84/113 | 09/06→ | CCGP007 | 7v | | | |
| 2.5 dCi 140 | 4 | G9U730 | 99/133 | 07/02→ | CH232 | 11v | | | CCU154 |
| 2.5 dCi 150 | 4 | G9U632 | 107/143 | 04/06→ | CH232 | 11v | | | CCU154 |

TRADE

| | | | | | | | | | |
|----------|---|---------|--------|-------------|-------|-----|--|--|--|
| 2.3 75 | 4 | LD23 | 55/74 | 05/97→12/00 | CH186 | 11v | | | |
| 3.0 D | 4 | BD30II | 63/84 | 04/93→12/98 | CH271 | 11v | | | |
| 3.0 TD | 4 | BD-30Ti | 81/109 | 11/98→09/04 | CH271 | 11v | | | |
| 3.0 TDiC | 4 | BD-30Ti | 78/105 | 06/96→10/01 | CH271 | 11v | | | |

URVAN

| | | | | | | | | | |
|-----|---|--------|---------|-------------|-------|-----|------|--|--|
| 2.4 | 4 | KA24DE | 103/138 | 05/01→11/10 | OE063 | 1,0 | CET2 | | |
|-----|---|--------|---------|-------------|-------|-----|------|--|--|

VANETTE CARGO

| | | | | | | | | | |
|-------|---|--------|-------|-------------|-------|-----|------|-------|--------|
| 1.6 i | 4 | GA16DE | 71/95 | 09/94→05/01 | OE089 | 1,0 | CET2 | OE184 | CLS153 |
| 1.6 i | 4 | GA16DE | 72/97 | 01/96→05/01 | OE089 | 1,0 | CET2 | OE184 | CLS153 |
| 2.3 D | 4 | LD23 | 55/74 | 09/94→05/02 | CH186 | 11v | | | |

OPEL

ADAM

| | | | | | | | | | |
|---------|---|----------------|--------|--------|-------|-----|------|-------|----------|
| 1.0 | 3 | B10XFL; F10XFL | 66/89 | 07/14→ | | | | OE258 | |
| 1.0 | 3 | B10XFT; F10XFT | 85/114 | 07/14→ | | | | OE258 | |
| 1.2 | 4 | A12XEL; B12XEL | 51/68 | 10/12→ | | | CET2 | OE184 | BAEA185E |
| 1.2 | 4 | | 69/93 | 07/13→ | | | | | BAEA185E |
| 1.4 | 4 | A14XEL; B14XEL | 64/86 | 10/12→ | OE198 | 0,9 | CET2 | OE184 | BAEA185E |
| 1.4 | 4 | A14XER; B14XER | 74/99 | 10/12→ | OE198 | 0,9 | CET2 | OE184 | BAEA185E |
| 1.4 LPG | 4 | A14XEL; B14XEL | 64/86 | 07/13→ | | | | | BAEA185E |

AGILA (A)

| | | | | | | | | | |
|------------------|---|--------|-------|-------------|-------|-----|------|-------|---------------------------------------|
| 1.0 | 3 | Z10XEP | 44/59 | 08/03→12/07 | OE198 | 0,9 | CET2 | OE184 | BAEA359 |
| 1.0 12V | 3 | Z10XE | 43/58 | 09/00→12/07 | OE198 | 0,9 | CET2 | OE184 | BAEA358 |
| 1.2 16V | 4 | Z12XE | 55/74 | 09/00→12/07 | OE019 | 0,9 | CET2 | OE184 | BAEA147E |
| 1.2 16V Twinport | 4 | Z12XEP | 59/79 | 07/04→12/07 | OE198 | 0,9 | CET2 | OE184 | BAEA338 |
| 1.3 CDTI | 4 | Z13DT | 51/68 | 08/03→12/07 | | | | | CCU142 ^[8] →Ch.4G999999 |

AGILA (B)

| | | | | | | | | | |
|--------------|---|--------------|-------|-------------|----------------------------|-----|--------|--|-----------------------|
| 1.0 | 3 | K10B | 50/67 | 07/11→07/14 | OE226 | 1,1 | CET10P | | BAEA189E |
| | | | | | OE230 ^{LPG [278]} | 0,9 | | | |
| 1.0, 1.0 LPG | 3 | K10B | 48/64 | 04/08→06/11 | OE226 | 1,1 | CET10P | | BAEA189E |
| | | | | | OE230 ^{LPG [278]} | 0,9 | | | |
| 1.2 | 4 | K12B | 69/93 | 04/10→10/14 | OE226 | 1,1 | CET10P | | BAEA189E |
| 1.2, 1.2 LPG | 4 | K12B | 63/84 | 04/08→10/12 | OE226 | 1,1 | CET10P | | BAEA189E |
| | | | | | OE230 ^{LPG [278]} | 0,9 | | | |
| 1.3 CDTI | 4 | D13A; Z13DTJ | 55/74 | 04/08→04/10 | | | | | CCU142 ^[8] |

AMPERA

| | | | | | | | | | |
|------------|---|--------|---------|-------------|--|--|--|--|----------|
| 1.4 EV 150 | 4 | A14XFL | 111/149 | 11/11→03/15 | | | | | BAEA185E |
|------------|---|--------|---------|-------------|--|--|--|--|----------|

ANTARA

| | | | | | | | | | |
|------------------------|---|-------|---------|-------------|--|--|--------|-------|--------|
| 2.2 CDTi, 2.2 CDTi 4WD | 4 | A22DM | 120/161 | 12/10→12/15 | | | | | CCU138 |
| 2.4, 2.4 4WD | 4 | A24XE | 123/165 | 12/10→ | | | CET17P | OE189 | |

OPEL



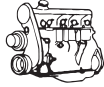

kW/BHP

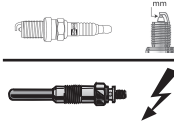

eon TITAN

IRIDIUM

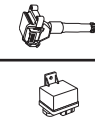

OPEL

| ...OPEL | | | | | | | | | | |
|------------------------------------|---|----------------|---------|-------------|----------------|------------|--------|-------|---------------------------|--|
| ...ANTARA | | | | | | | | | | |
| 2.4, 2.4 4WD, 2.4 LPG, 2.4 LPG 4WD | 4 | Z24XE | 103/138 | 08/06→ | OE019 | 0,9 | CET2 | OE184 | BAEA447A | |
| 2.4 4WD | 4 | Z24XE; Z24XED | 104/139 | 07/06→12/11 | OE019 | 0,9 | CET2 | OE184 | BAEA447A | |
| 3.0 4WD | 6 | A30XH | 190/255 | 11/10→12/15 | | | CET17P | OE189 | | |
| 3.2 V6 4WD | 6 | 10HM; Z32SEE | 167/224 | 07/06→12/11 | OE029 | 1,0 | CET17P | OE189 | | |
| ASTRA F | | | | | | | | | | |
| 1.4 i 16V | 4 | X14XE | 66/89 | 01/96→03/01 | OE019 | 0,9 | CET2 | OE184 | BAEA026E | CLS030 |
| 1.6 | 4 | 16LZ2 | 55/74 | 09/95→09/98 | OE019 | 0,9 | CET2 | OE184 | BAEA252 [275] [292] | |
| 1.6 | 4 | 16NZR | 55/74 | 09/95→09/98 | OE019 | 0,9 | CET2 | OE184 | BAEA026E ^[275] | |
| 1.6 i | 4 | X16SZ | 52/70 | 03/93→08/96 | OE019 | 0,9 | CET2 | OE184 | BAEA026E [275] [292] | CLS114 08/95→ Eng.028E6167→ |
| 1.6 i 16V | 4 | X16XEL | 74/99 | 08/94→09/98 | OE019 | 0,9 | CET2 | OE184 | BAEA026E | CLS029 |
| 1.7 TD | 4 | X17DTL | 50/67 | 11/94→09/98 | CH189 | 11v | | | | |
| 1.8 i 16V | 4 | 18SE | 82/110 | 09/95→09/96 | OE019 | 0,9 | CET2 | OE184 | | |
| 1.8 i 16V | 4 | C18SEL | 85/114 | 07/94→03/01 | OE019 | 0,9 | CET2 | OE184 | | |
| 1.8 i 16V | 4 | C18XEL; X18XE | 85/114 | 07/94→03/01 | OE019 | 0,9 | CET2 | OE184 | BAEA344 | CLS107 |
| 1.8 i 16V | 4 | C18XE | 92/123 | 06/93→01/98 | OE019 | 0,9 | CET2 | OE184 | BAEA344 | CLS107 |
| 2.0 i 16V | 4 | X20XEV | 100/134 | 02/95→09/98 | OE019 | 0,9 | CET2 | OE184 | BAEA344 | CLS107 |
| 2.0 i 16V | 4 | C20XE | 110/148 | 03/93→01/98 | OE019 | 0,9 | CET2 | OE184 | | |
| ASTRA F CLASSIC | | | | | | | | | | |
| 1.4 i | 4 | X14NZ | 44/59 | 01/98→01/05 | OE019 | 0,9 | CET2 | OE184 | BAEA253 ^[292] | CLS018 →Eng.028F1476 19241623 CLS141 Eng.028F1477 19241624→ |
| 1.6 i | 4 | X16SZR | 55/74 | 01/98→01/05 | OE019 | 0,9 | CET2 | OE184 | BAEA026E | CLS114 |
| 1.6 i 16V | 4 | X16XEL | 74/99 | 01/98→01/05 | OE019 | 0,9 | CET2 | OE184 | BAEA026E | CLS030 |
| ASTRA G | | | | | | | | | | |
| 1.2 16V | 4 | X12XE | 48/64 | 02/98→09/00 | OE019 | 0,9 | CET2 | OE184 | BAEA147E | |
| 1.2 16V | 4 | Z12XE | 55/74 | 09/00→01/05 | OE019 | 0,9 | CET2 | OE184 | BAEA147E →09/03 | |
| 1.4 | 4 | Z14XEP | 66/89 | 10/04→12/09 | OE198 OE089 | 0,9 1,0 | CET2 | OE184 | BAEA338 | |
| 1.4 16V | 4 | X14XE; Z14XE | 66/89 | 02/98→01/05 | OE019 | 0,9 | CET2 | OE184 | BAE965A | CLS030 |
| 1.6 | 4 | X16SZR | 55/74 | 02/98→09/00 | OE019 | 0,9 | CET2 | OE184 | BAEA026E | CLS176 |
| 1.6 | 4 | Z16SE | 62/83 | 09/00→01/05 | OE019 | 0,9 | CET2 | OE184 | | CLS114 |
| 1.6, 1.6 16V | 4 | Z16XEP | 76/102 | 03/00→12/09 | OE198 | 0,9 | CET2 | OE184 | BAEA427 | |
| 1.6 16V | 4 | C16SEL | 74/99 | 02/98→10/05 | OE198 | 0,9 | CET2 | OE184 | | |
| 1.6 16V | 4 | Z16XE | 74/99 | 02/98→10/05 | OE019 OE198 | 0,9 0,9 | CET2 | OE184 | BAE965A →Eng.41000000 | |
| 1.6 16V | 4 | X16XEL | 74/99 | 02/98→10/05 | OE019 OE198 | 0,9 0,9 | CET2 | OE184 | BAE965A | |
| 1.6 CNG | 4 | Z16YNG | 71/95 | 03/03→07/04 | OE136 | 0,8 | CET12P | OE179 | BAE965A | |
| 1.7 CDTI | 4 | Z17DTL | 59/79 | 04/03→12/09 | | | | | CCU143 ^[7] | |
| 1.7 DTI 16V | 4 | Y17DT | 55/74 | 02/00→01/05 | | | | | CCU143 ^[7] | |
| 1.7 TD | 4 | X17DTL | 50/67 | 02/98→08/00 | CH189 | 11v | | | CCU143 ^[7] | |
| 1.8 16V | 4 | X18XE1 | 85/114 | 02/98→10/00 | OE019 | 0,9 | CET2 | OE184 | BAEA342 | |
| 1.8 16V | 4 | Z18XE | 92/123 | 06/00→10/05 | OE198 | 0,9 | CET2 | OE184 | BAEA342 | |
| 2.0 16V | 4 | C20SEL; X20XEV | 100/134 | 02/98→01/05 | OE019 | 0,9 | CET2 | OE184 | BAEA344 | |





kW/BHP

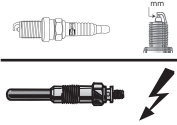

eon TITAN

IRIDIUM

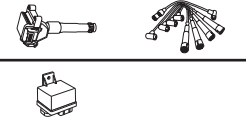
**...OPEL****...ASTRA G**

| | | | | | | | | | | |
|------------------------|---|----------------|---------|-------------|--|-----|---------------|--------------|------------------------------|---------------|
| 2.0 16V OPC | 4 | X20XER | 118/158 | 11/99→09/02 | OE019 | 0,9 | CET2 | OE184 | BAEA344 | CLS107 |
| 2.0 16V Turbo | 4 | Z20LET | 140/188 | 09/00→08/01 | OE019 | 0,9 | CET2 | OE184 | | |
| 2.0 16V Turbo, 2.0 OPC | 4 | Z20LET | 141/189 | 08/01→10/05 | OE019 | 0,9 | CET2 | OE184 | | |
| 2.0 16V Turbo, 2.0 OPC | 4 | Z20LET | 147/197 | 11/02→10/05 | OE019 | 0,9 | CET2 | OE184 | | |
| 2.0 DI | 4 | X20DTL; Y20DTL | 60/80 | 02/98→01/05 | CH207 | 11v | | | CCU143 ^[7] | |
| 2.0 DTI 16V | 4 | Y20DTH | 74/99 | 08/99→01/05 | CH231 09/02→ Ch.32000001 35000001 36000001 38000001 38000001 3H000001 46000001→ | 11v | | | CCU142 ^[8] | |
| 2.2 16V | 4 | Z22SE | 108/145 | 06/00→10/05 | OE255 | 1,0 | CET17P | OE189 | | |
| 2.2 DTI | 4 | Y22DTR | 86/115 | 09/02→01/05 | CH231 | 11v | | | CCU142 ^[8] | |
| 2.2 DTI | 4 | Y22DTR | 92/123 | 09/02→10/05 | CH231 | 11v | | | CCU142 ^[8] | |

ASTRA H

| | | | | | | | | | | |
|----------------------------|---|----------------|---------|-------------|--|-----|---------------|--------------|------------------------------|--|
| 1.2 | 4 | Z12XEP | 59/79 | 08/05→10/10 | OE198 | 0,9 | CET2 | OE184 | BAEA338 | |
| 1.3 CDTi, 1.3 CDTi | 4 | Z13DTH | 66/89 | 04/05→10/10 | | | | | CCU142 ^[8] | |
| 1.4 | 4 | Z14XEL | 55/74 | 04/04→10/10 | OE198 | 0,9 | CET2 | OE184 | | |
| 1.4 | 4 | Z14XEL | 59/79 | 04/04→10/04 | OE198 | 0,9 | CET2 | OE184 | | |
| 1.4, 1.4 LPG | 4 | Z14XEP | 66/89 | 03/04→10/10 | OE198 | 0,9 | CET2 | OE184 | BAEA338 | |
| 1.6 | 4 | Z16XE1; Z16XEP | 77/103 | 03/04→10/10 | OE198 | 0,9 | CET2 | OE184 | BAEA427 | |
| 1.6, 1.6 LPG | 4 | A16XER; Z16XER | 85/114 | 12/06→05/14 | OE198 | 0,9 | CET2 | OE184 | BAEA427 | |
| 1.6 Turbo | 4 | Z16LET | 132/177 | 02/07→10/10 | | | CET12P | OE188 | BAEA427 | |
| 1.7 CDTi | 4 | Z17DTL | 59/79 | 03/04→10/10 | | | | | CCU143 ^[7] | |
| 1.7 CDTi | 4 | A17DTR; Z17DTR | 92/123 | 02/07→05/14 | | | | | CCU143 ^[7] | |
| 1.7 CDTi, 1.7 CDTi | 4 | Z17DTH | 74/99 | 03/04→10/10 | | | | | CCU143 ^[7] | |
| 1.7 CDTi, 1.7 CDTi | 4 | A17DTJ; Z17DTJ | 81/109 | 02/07→05/14 | | | | | CCU143 ^[7] | |
| 1.8 | 4 | Z18XE | 92/123 | 01/04→10/10 | OE198 | 0,9 | CET2 | OE184 | BAEA342 | |
| 1.8 | 4 | A18XER; Z18XER | 103/138 | 08/05→10/10 | OE198 | 0,9 | CET2 | OE184 | BAEA427 | |
| 1.9 CDTi | 4 | Z19DTL | 74/99 | 09/05→10/10 | CH222 →Ch.72045139 75030986 78007391 76 | 11v | | | CCU142 ^[8] | |
| | | | | | CH269 Ch.72045140 75030987 78007392 88000001 76→ | 11v | | | CCU143 ^[7] | |
| 1.9 CDTi | 4 | Z19DT | 88/118 | 06/04→10/10 | CH222 →Ch.72045139 75030986 78007391 76 | 11v | | | CCU142 ^[8] | |
| | | | | | CH269 Ch.72045140 75030987 78007392 88000001 76→ | 11v | | | CCU143 ^[7] | |
| 1.9 CDTi, 1.9 CDTi | 4 | Z19DTH | 110/148 | 09/04→10/10 | CH224 | 11v | | | CCU142 ^[8] | |
| | | | | | | | | | CCU143 ^[7] | |
| 1.9 CDTi 16V, 1.9 CDTi 16V | 4 | Z19DTJ | 88/118 | 04/04→10/10 | CH224 | 11v | | | CCU142 ^[8] | |
| 2.0 Turbo | 4 | Z20LEL | 125/168 | 03/04→10/10 | OE136 | 0,8 | CET12P | OE179 | | |
| 2.0 Turbo | 4 | Z20LER | 147/197 | 09/04→10/10 | OE089 | 1,0 | CET2 | OE179 | | |
| 2.0 Turbo | 4 | Z20LEH | 177/237 | 03/05→10/10 | OE136 | 0,8 | CET12P | OE179 | | |

OPEL



kW/BHP



eon TITAN

IRIDIUM



...OPEL

ASTRA J

| | | | | | | | | | |
|-------------------------------|---|----------------|---------|-------------|--|------|--------|------------------------|--------------------------|
| 1.3 CDTI | 4 | A13DTE | 70/94 | 12/09→10/15 | CP5G003 ^[37] →Ch. B3999999 B8999999 BG999999 | 4.4v | | | CCU138 |
| 1.4 | 4 | A14XEL | 64/86 | 12/09→10/15 | | | CET2 | OE184 | BAEA185E |
| 1.4 | 4 | A14XER; B14XER | 74/99 | 12/09→10/15 | | | CET2 | OE184 | BAEA185E |
| 1.4, 1.4 LPG | 4 | A14NET; B14NET | 103/138 | 10/11→ | | | | | BAEA185E |
| 1.4, 1.4 Turbo | 4 | A14NEL; B14NEL | 88/118 | 10/10→ | | | | | BAEA185E |
| 1.4 Turbo | 4 | A14NET; B14NET | 103/138 | 12/09→ | | | | OE264 | BAEA185E |
| 1.6 | 4 | A16XER; B16XER | 85/114 | 12/09→ | OE198 | 0,9 | CET2 | OE184 | BAEA198E Ch.205D0232→ |
| 1.6, 1.6 Turbo, 1.6 Turbo 4WD | 4 | A16LET | 132/177 | 12/09→ | OE216 LPG [278] | 0,8 | CET12P | OE179 | BAEA199E |
| 1.6 LPG | 4 | A16XER | 84/113 | 10/12→10/15 | | | | | BAEA198E Ch.205D0232→ |
| 1.7 CDTI | 4 | A17DTL; A17DTN | 74/99 | 10/10→10/15 | | | | | CCU145 |
| 1.7 CDTI | 4 | A17DTJ | 81/109 | 09/09→10/15 | | | | | CCU145 |
| 1.7 CDTI | 4 | A17DTE | 81/109 | 09/09→10/15 | CP5G004 | 4.4v | | | CCU145 |
| 1.7 CDTI | 4 | A17DTR | 92/123 | 12/09→10/15 | | | | | CCU145 |
| 1.7 CDTI | 4 | A17DTF | 96/129 | 10/10→10/15 | CP5G004 | 4.4v | | | CCU145 |
| 1.7 CDTI | 4 | A17DTS | 96/129 | 10/10→10/15 | | | | | CCU145 |
| 1.8 | 4 | A18XER | 103/138 | 10/11→10/15 | OE198 | 0,9 | CET2 | OE184 | BAEA199E |
| 2.0 | 4 | A20NFT; B20NFT | 206/276 | 04/12→ | | | CET17P | OE189 *tobeadjusted | |
| 2.0 BiTurbo CDTI | 4 | A20DTR | 143/192 | 09/12→10/15 | CP5G006 | 4.4v | | | CCU138 |
| 2.0 CDTI | 4 | A20DTH | 118/158 | 09/09→10/15 | CP5G006 | 4.4v | | | CCU138 |
| 2.0 CDTI | 4 | A20DTH | 121/162 | 06/11→10/15 | CP5G006 | 4.4v | | | CCU138 |

ASTRA K

| | | | | | | | | | |
|-----------|---|----------------|---------|--------|--|--|--|-------|--|
| 1.0 Turbo | 3 | B10XFL; D10XFL | 77/103 | 06/15→ | | | | OE258 | |
| 1.4 Turbo | 4 | B14XFL | 92/123 | 06/15→ | | | | OE258 | |
| 1.4 Turbo | 4 | B14XFT | 103/138 | 07/17→ | | | | OE258 | |
| 1.4 Turbo | 4 | B14XFT | 110/148 | 06/15→ | | | | OE258 | |

CALIBRA A

| | | | | | | | | | | |
|--------------------------|---|--------------|---------|-------------|-------|-----|------|-------|---------|--------|
| 2.0 i 16V, 2.0 i 16V 4WD | 4 | X20XE | 100/134 | 02/94→07/97 | OE019 | 0,9 | CET2 | OE184 | BAEA344 | CLS107 |
| 2.5 i V6 | 6 | C25XE; X25XE | 125/168 | 04/93→07/97 | OE019 | 0,9 | CET2 | OE184 | | |

CAMPO

| | | | | | | | | | |
|----------------------|---|-----------|-------|-------------|-------|-----|------|-------|--|
| 2.3, 2.3 4WD | 4 | 4ZD1; 23P | 72/97 | 08/94→09/96 | OE006 | 0,9 | CET8 | OE195 | |
| 2.5 DTI, 2.5 DTI 4WD | 4 | 4JA1 | 74/99 | 07/01→12/01 | CH306 | 11v | | | |

CASCADA

| | | | | | | | | | |
|-----------|---|--------|---------|--------|---------|------|--|--|----------|
| 1.4 | 4 | A14NEL | 88/118 | 03/13→ | | | | | BAEA185E |
| 1.4 Turbo | 4 | A14NET | 103/138 | 03/13→ | | | | | BAEA185E |
| 2.0 CDTI | 4 | A20DTH | 121/162 | 03/13→ | CP5G006 | 4.4v | | | CCU138 |
| 2.0 CDTI | 4 | A20DTR | 143/192 | 03/13→ | CP5G006 | 4.4v | | | CCU138 |

COMBO

| | | | | | | | | | |
|--------------|---|--------|--------|-------------|-------|-----|--------|-------|---------|
| 1.4 | 4 | Z14XEP | 66/89 | 10/04→12/11 | OE198 | 0,9 | CET2 | OE184 | BAEA338 |
| 1.4 | 4 | A14FP | 70/94 | 02/12→ | OE199 | 0,9 | | | |
| 1.4, 1.4 CNG | 4 | A14FC | 88/118 | 02/12→ | | | | | BAEA095 |
| 1.6 | 4 | Z16SE | 64/86 | 10/01→09/06 | | | CET2 | OE188 | |
| 1.6 CNG | 4 | Z16YNG | 69/93 | 06/06→12/11 | OE136 | 0,8 | CET12P | OE179 | BAE965A |
| 1.6 CNG | 4 | Z16YNG | 71/95 | 04/05→01/11 | OE136 | 0,8 | CET12P | OE179 | BAE965A |
| 1.7 DI 16V | 4 | Y17DTL | 48/64 | 10/01→06/04 | CH189 | 11v | | | |

CORSA B

| | | | | | | | | | |
|-----------|---|-------|-------|-------------|-------|-----|------|-------|---------|
| 1.0 i 12V | 3 | X10XE | 40/54 | 11/96→09/00 | OE019 | 0,9 | CET2 | OE184 | BAEA358 |
|-----------|---|-------|-------|-------------|-------|-----|------|-------|---------|



kW/BHP



eon TITAN

IRIDIUM



...OPEL

...CORSA B

| | | | | | | | | | | |
|----------------------|---|--------------|--------|-------------|-----------------|------|------|-----------------|---|-----------------------------------|
| 1.2 i | 4 | C12NZ | 33/44 | 03/93→09/00 | OE019 08/95→ | 0,9 | CET2 | OE195 →07/95 | BAEA253 [275] [292] | CLS115 08/95→ Eng.19334657→ |
| | | | | | | | CET8 | OE184 08/95→ | | |
| 1.2 i | 4 | X12SZ | 33/44 | 03/93→09/00 | OE019 08/95→ | 0,9 | CET2 | OE195 →07/95 | BAEA026E [275] | CLS114 08/95→ Eng.028D0922→ |
| | | | | | | | CET8 | OE184 08/95→ | | |
| 1.2 i | 4 | 12NZ | 33/44 | 03/93→09/00 | OE019 08/95→ | 0,9 | CET2 | OE195 →07/95 | BAEA253 [292] | |
| | | | | | | | CET8 | OE184 08/95→ | | |
| 1.2 i 16V | 4 | X12XE | 48/64 | 03/98→09/00 | OE019 | 0,9 | CET2 | OE184 | BAEA147E | |
| 1.4 | 4 | C14SE | 54/72 | 04/93→08/94 | OE019 | 0,9 | CET2 | | BAEA026E | |
| 1.4 i | 4 | C14NZ; X14SZ | 40/54 | 03/93→09/00 | OE019 | 0,9 | CET2 | OE184 | | |
| 1.4 i | 4 | C14NZ | 44/59 | 03/93→09/00 | OE019 | 0,9 | CET2 | OE184 | BAEA253 [275] [292] | CLS115 08/95→ |
| 1.4 i | 4 | X14SZ | 44/59 | 03/93→09/00 | OE019 | 0,9 | CET2 | OE184 | BAEA026E [275] | CLS114 |
| 1.4 i 16V | 4 | C14SEL | 63/84 | 08/97→09/00 | OE019 | 0,9 | CET8 | | BAEA026E | CLS030 |
| 1.4 i 16V | 4 | X14XE | 66/89 | 09/94→12/02 | OE019 | 0,9 | CET2 | OE184 | BAEA026E | CLS030 |
| 1.4 i 16V | 4 | X14XE | 67/90 | 09/94→09/00 | OE019 | 0,9 | CET2 | OE184 | BAEA026E | CLS030 |
| 1.4 Si | 4 | C14SE | 60/80 | 03/93→09/00 | OE019 08/95→ | 0,9 | CET2 | OE195 →07/95 | BAEA026E [275] | CLS114 08/95→ Eng.028D0922→ |
| | | | | | | | CET8 | OE184 08/95→ | BAEA253 [275] [292] | |
| 1.6 GSI 16V | 4 | C16XE | 80/107 | 03/93→09/00 | OE019 | 0,9 | CET2 | OE184 | BAEA026E | CLS030 →Eng.20C71331 |
| 1.6 i 16V | 4 | C16SEL | 74/99 | 08/97→09/00 | OE019 | 0,9 | CET8 | | BAEA026E | CLS030 |
| 1.6 i 16V | 4 | X16XE | 78/105 | 09/94→09/00 | OE019 | 0,9 | CET2 | OE184 | BAEA026E | CLS030 |
| CORSA C | | | | | | | | | | |
| 1.0 | 3 | Z10XE | 43/58 | 09/00→06/03 | OE198 | 0,9 | CET2 | OE184 | BAEA358 | |
| 1.0 | 3 | Z10XEP | 44/59 | 06/03→12/09 | OE198 | 0,9 | CET2 | OE184 | BAEA359 | |
| 1.2 | 4 | Z12XE | 55/74 | 09/00→12/09 | OE019 | 0,9 | CET2 | OE184 | BAEA147E →Ch.36999999 BAEA338 Ch.37000000→ | |
| 1.2 Twinport | 4 | Z12XEP | 59/79 | 07/04→12/09 | OE198 | 0,9 | CET2 | OE184 | BAEA338 | |
| 1.3 CDTI | 4 | Z13DT | 51/68 | 06/03→12/09 | | | | | CCU142 [8] | |
| 1.4 | 4 | Z14XE | 66/89 | 09/00→12/09 | OE019 | 0,9 | CET2 | OE184 | BAE965A | |
| 1.4 Twinport | 4 | Z14XEP | 66/89 | 06/03→12/09 | OE198 | 0,9 | CET2 | OE184 | BAEA338 | |
| 1.7 CDTI | 4 | Z17DTH | 74/99 | 06/03→12/09 | | | | | CCU143 [7] | |
| 1.7 DI | 4 | Y17DTL | 48/64 | 09/00→12/09 | | | | | CCU143 [7] | |
| 1.7 DTI | 4 | Y17DT | 55/74 | 09/00→12/09 | | | | | CCU143 [7] | |
| 1.8 | 4 | Z18XE | 92/123 | 09/00→12/09 | OE198 | 0,9 | CET2 | OE184 | BAEA342 | |
| CORSA CLASSIC | | | | | | | | | | |
| 1.4 | 4 | Z14XE | 66/89 | 07/00→12/03 | OE019 | 0,9 | | | | |
| CORSA D | | | | | | | | | | |
| 1.0 | 3 | Z10XEP | 44/59 | 07/06→12/10 | OE198 | 0,9 | CET2 | OE184 | BAEA359 | |
| 1.0 | 3 | A10XEP | 48/64 | 12/09→08/14 | OE198 | 0,9 | CET2 | OE184 | | |
| 1.2 | 4 | A12XEL | 51/68 | 12/09→08/14 | | | CET2 | OE184 | BAEA185E | |
| 1.2 | 4 | Z12XEP | 59/79 | 07/06→08/14 | OE198 | 0,9 | CET2 | OE184 | BAEA338 | |
| 1.2, 1.2 LPG | 4 | A12XER | 63/84 | 12/09→08/14 | | | CET2 | OE184 | BAEA185E | |
| 1.2 LPG | 4 | Z12XEP | 59/79 | 08/06→08/14 | | | CET2 | OE184 | BAEA338 | |
| 1.2 LPG | 4 | A12XER | 61/82 | 06/11→08/14 | | | CET2 | OE184 | BAEA185E | |
| 1.3 CDTI | 4 | A13DTC | 55/74 | 07/06→08/14 | CPSG003 | 4.4v | | | CCU138 | |
| 1.3 CDTI | 4 | Z13DTJ | 55/74 | 07/06→08/14 | | | | | CCU144 | |

OPEL



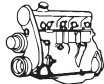

kW/BHP

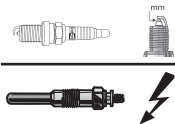

eon TITAN

IRIDIUM



...OPEL

...CORSA D

| | | | | | | | | | |
|--------------|---|------------------------|---------|---------------|-----------------|-----|--------|-------|----------|
| 1.3 CDTI | 4 | Z13DTH | 66/89 | 07/06 → 06/11 | | | | | CCU144 |
| 1.3 CDTI | 4 | A13DTE; A13DTR; Z13DTE | 70/94 | 06/09 → 08/14 | | | | | CCU138 |
| 1.4 | 4 | Z14XEP | 66/89 | 07/06 → 08/14 | OE198 | 0,9 | CET2 | OE184 | BAEA338 |
| 1.4 | 4 | A14XER | 74/99 | 12/09 → 08/14 | | | CET2 | OE184 | BAEA185E |
| 1.4 | 4 | A14NEL | 88/118 | 07/12 → 08/14 | | | | | BAEA185E |
| 1.4, 1.4 LPG | 4 | A14XEL | 64/86 | 09/09 → 08/14 | | | CET2 | OE184 | BAEA185E |
| 1.4 LPG | 4 | Z14XEP | 66/89 | 08/06 → 12/11 | | | CET2 | OE184 | BAEA338 |
| 1.6 Turbo | 4 | A16LEL; Z16LEL | 110/148 | 05/07 → 08/14 | OE216 LPG [278] | 0,8 | CET12P | OE179 | BAEA427 |
| 1.6 Turbo | 4 | B16LER | 141/189 | 11/06 → 08/14 | OE216 LPG [278] | 0,8 | CET12P | OE179 | |
| 1.6 Turbo | 4 | A16LER; Z16LER | 141/189 | 11/06 → 08/14 | OE216 LPG [278] | 0,8 | CET12P | OE179 | BAEA427 |
| 1.6 Turbo | 4 | A16LES | 155/208 | 06/11 → 08/14 | | | | OE188 | |
| 1.6 Turbo | 4 | A16LER; Z16LER | 155/208 | 06/11 → 08/14 | | | | | BAEA427 |
| 1.7 CDTI | 4 | Z17DTR | 92/123 | 08/06 → 12/11 | | | | | CCU145 |
| 1.7 CDTI | 4 | A17DTS | 96/129 | 12/09 → 08/14 | | | | | CCU145 |

CORSA E

| | | | | | | | | | |
|-----------|---|----------------|---------|---------|--|--|--|-------|----------|
| 1.0 | 3 | B10XFL; F10XFL | 66/89 | 09/14 → | | | | OE258 | |
| 1.0 | 3 | B10XFT; F10XFT | 85/114 | 09/14 → | | | | OE258 | |
| 1.2 | 4 | B12XEL; B12XER | 51/68 | 09/14 → | | | | | BAEA185E |
| 1.4 | 4 | B14XEL | 66/89 | 09/14 → | | | | | BAEA185E |
| 1.6 Turbo | 4 | B16LES | 152/204 | 03/15 → | | | | | BAEA199E |

CORSA Utility

| | | | | | | | | | |
|-----|---|-------|-------|---------------|-------|-----|--|--|---------|
| 1.4 | 4 | Z14XE | 66/89 | 07/00 → 12/10 | OE019 | 0,9 | | | BAE965A |
|-----|---|-------|-------|---------------|-------|-----|--|--|---------|

FRONTERA A

| | | | | | | | | | |
|-------------|---|---------------|---------|---------------|-------|-----|------|-------|--|
| 2.2 i 4WD | 4 | X22XE | 100/134 | 03/95 → 10/98 | OE019 | 0,9 | CET2 | OE184 | |
| 2.5 TDS 4WD | 4 | 25TDS(VM41B) | 85/114 | 09/96 → 10/98 | CH181 | 11v | | | |
| 2.8 TD 4WD | 4 | 28TDI(4JB1-T) | 83/111 | 03/95 → 10/98 | CH306 | 11v | | | |

FRONTERA B

| | | | | | | | | | |
|-------------|---|-------------|---------|---------------|-----------------------------------|-----|--------|-------|-----------|
| 2.2 DTI 4WD | 4 | X22DTH | 85/114 | 10/98 → 09/02 | CH207 → 07/00 | 11v | | | CCU143[7] |
| 2.2 DTI 4WD | 4 | Y22DTH | 85/114 | 10/98 → 09/02 | CH231 09/00 → Ch.1V500001 → | 11v | | | CCU143[7] |
| 2.2 DTI 4WD | 4 | Y22DTH | 88/118 | 09/02 → | CH231 | 11v | | | CCU143[7] |
| 2.2 i 4WD | 4 | Y22SE | 100/134 | 10/98 → | OE191 | 1,0 | CET12P | OE180 | BAEA025E |
| 2.2 i 4WD | 4 | X22SE | 100/134 | 10/98 → | OE019 | 0,9 | CET2 | OE184 | BAEA025E |
| 3.2 i 4WD | 6 | 6VD1; Y32NE | 151/202 | 10/98 → | OE191 | 1,0 | CET12P | OE180 | |

GT

| | | | | | | | | | |
|-----|---|-------------|---------|---------------|--|--|--------|-------|--|
| 2.0 | 4 | LNF; Z20NHH | 194/260 | 06/07 → 12/11 | | | CET17P | OE189 | |
|-----|---|-------------|---------|---------------|--|--|--------|-------|--|

INSIGNIA A

| | | | | | | | | | |
|--|---|----------------|---------|---------------|------------------------|------|--------|------------------------|--------------------------|
| 1.4, 1.4 LPG | 4 | A14NET; B14NET | 103/138 | 04/11 → 03/17 | | | | OE264 | BAEA185E |
| 1.6 | 4 | A16XER | 85/114 | 07/08 → 03/17 | OE089 → Ch.91999999 | 1,0 | CET2 | OE188 → Ch.91999999 | BAEA199E |
| | | | | | OE198 Ch.A1000001 → | 0,9 | | OE184 Ch.A1000001 → | |
| 1.6 SIDI | 4 | A16XHT; B16SHL | 125/168 | 03/13 → 03/17 | | | | OE258 | |
| 1.6 Turbo | 4 | A16LET | 132/177 | 07/08 → 03/17 | OE216 LPG [278] | 0,8 | CET12P | OE188 | BAEA427 → Ch.B1999999 |
| 1.8 | 4 | A18XER; B18XER | 103/138 | 07/08 → 03/17 | OE089 → Ch.91999999 | 1,0 | CET2 | OE188 → Ch.91999999 | BAEA199E |
| | | | | | OE198 Ch.A1000001 → | 0,9 | | OE184 Ch.A1000001 → | |
| 2.0 Biturbo CDTI, 2.0 Biturbo CDTI 4WD | 4 | A20DTR | 140/188 | 07/08 → 03/17 | CPSG006 | 4.4v | | | CCU138 |
| 2.0 Biturbo CDTI, 2.0 Biturbo CDTI 4WD | 4 | A20DTR | 143/192 | 01/12 → 03/17 | CPSG006 | 4.4v | | | CCU138 |
| 2.0 CDTI | 4 | A20DTC; A20DTL | 81/109 | 07/08 → 03/17 | CPSG006 | 4.4v | | | CCU138 |





kW/BHP

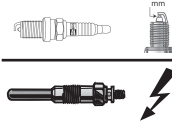

eon TITAN

IRIDIUM

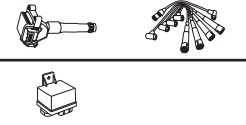
**...OPEL****...INSIGNIA A**

| | | | | | | | | | |
|--|---|----------------|---------|-------------|---------|------|--------------|-----------------------------|--------|
| 2.0 CDTI | 4 | A20DTE | 88/118 | 03/12→03/17 | CPSG006 | 4.4v | | | CCU138 |
| 2.0 CDTI | 4 | A20DT; A20DTJ | 96/129 | 07/08→03/17 | CPSG006 | 4.4v | | | CCU138 |
| 2.0 CDTI | 4 | A20DTE | 103/138 | 06/13→03/17 | CPSG006 | 4.4v | | | CCU138 |
| 2.0 CDTI, 2.0 CDTi, 2.0 CDTI 4WD, 2.0 CDTi 4WD | 4 | A20DTH | 120/161 | 07/13→03/17 | CPSG006 | 4.4v | | | CCU138 |
| 2.0 CDTI, 2.0 CDTI 4WD | 4 | A20DTH | 118/158 | 07/08→03/17 | CPSG006 | 4.4v | | | CCU138 |
| 2.0 E85 Turbo | 4 | A20NFT | 162/217 | 09/10→03/17 | | | CET17P [331] | OE189 *tobeadjusted | |
| | | | | | | | CET17P | OE189[331] *tobeadjusted | |
| 2.0 E85 Turbo, 2.0 Turbo, 2.0 Turbo 4WD | 4 | A20NHT | 162/217 | 07/08→03/17 | | | CET17P [331] | OE189[331] *tobeadjusted | |
| 2.0 Turbo | 4 | A20NHT; B20NHT | 184/247 | 04/14→03/17 | | | CET17P [331] | OE189[331] *tobeadjusted | |
| 2.0 Turbo 4WD | 4 | B20NHT | 184/247 | 07/11→03/17 | | | CET17P | OE189 *tobeadjusted | |
| 2.0 Turbo 4WD | 4 | A20NFT | 184/247 | 07/11→03/17 | | | CET17P [332] | OE189[332] *tobeadjusted | |
| | | | | | | | CET17P | OE189 *tobeadjusted | |
| 2.0 Turbo 4WD | 4 | A20NHT | 184/247 | 07/11→03/17 | | | CET17P [332] | OE189[332] *tobeadjusted | |
| | | | | | | | CET17P [331] | OE189 *tobeadjusted | |
| | | | | | | | CET17P | OE189[331] *tobeadjusted | |
| 2.0 Turbo E85 | 4 | A20NFT | 162/217 | 07/08→03/17 | | | CET17P | OE189 *tobeadjusted | |
| 2.8 V6 Turbo 4WD | 6 | A28NET | 191/256 | 07/08→03/17 | OE238 | 1,0 | | | |
| 2.8 V6 Turbo OPC 4WD | 6 | A28NER; B28NER | 239/320 | 07/09→03/17 | OE238 | 1,0 | | | |

INSIGNIA B

| | | | | | | | | | |
|-----|---|----------------|---------|--------|--|--|--|-------|--|
| 1.5 | 4 | B15SFL; D15SFL | 103/138 | 03/17→ | | | | OE258 | |
| 1.5 | 4 | B15SFT; D15SFT | 121/162 | 03/17→ | | | | OE258 | |

MERIVA A

| | | | | | | | | | |
|--|---|---------------|---------|-------------|-------|-----|--------|-------|-----------|
| 1.3 CDTI | 4 | Y13DT; Z13DT | 51/68 | 04/05→05/10 | | | | | CCU142[8] |
| 1.3 CDTI | 4 | Z13DTJ | 55/74 | 09/03→05/10 | | | | | CCU142[8] |
| 1.4 16V Twinport, 1.4 16V Twinport LPG | 4 | Z14XEP | 66/89 | 07/04→05/10 | OE198 | 0,9 | CET2 | OE184 | BAEA338 |
| 1.6 | 4 | Z16SE | 64/86 | 05/03→05/10 | OE019 | 0,9 | CET2 | OE184 | |
| 1.6 | 4 | Z16XEP | 77/103 | 01/06→05/10 | OE198 | 0,9 | CET2 | OE184 | BAEA427 |
| 1.6 16V | 4 | Z16XE | 74/99 | 05/03→01/06 | OE198 | 0,9 | CET2 | OE184 | BAE965A |
| 1.6 Turbo | 4 | Z16LET | 132/177 | 09/05→05/10 | | | CET12P | OE188 | BAEA427 |
| 1.7 CDTI | 4 | Z17DT; Z17DTH | 74/99 | 09/03→05/10 | | | | | CCU143[7] |
| 1.7 CDTI | 4 | Z17DTR | 92/123 | 09/06→05/10 | | | | | CCU143[7] |
| 1.7 DTI | 4 | Y17DT | 55/74 | 09/03→05/10 | | | | | CCU143[7] |
| 1.8 | 4 | Z18XE | 92/123 | 05/03→05/10 | OE019 | 0,9 | CET2 | OE184 | BAEA342 |

MERIVA B

| | | | | | | | | | |
|----------|---|----------------|---------|-------------|---------|------|------|-------|----------|
| 1.3 CDTI | 4 | A13DTC | 55/74 | 06/10→10/13 | CPSG003 | 4.4v | | | CCU138 |
| 1.3 CDTI | 4 | A13DTE | 70/94 | 06/10→11/14 | CPSG003 | 4.4v | | | CCU138 |
| 1.4 | 4 | A14XER; B14XER | 74/99 | 06/10→03/17 | OE198 | 0,9 | CET2 | OE184 | BAEA185E |
| 1.4 | 4 | A14NEL; B14NEL | 88/118 | 06/10→03/17 | | | | OE264 | BAEA185E |
| 1.4 | 4 | A14NET; B14NET | 103/138 | 06/10→03/17 | | | | | BAEA185E |
| 1.4 LPG | 4 | A14NEL; B14NEL | 88/118 | 06/11→03/17 | | | | | BAEA185E |
| 1.7 CDTI | 4 | A17DT | 74/99 | 06/10→01/17 | | | | | CCU145 |
| 1.7 CDTI | 4 | A17DTJ | 81/109 | 06/10→06/15 | | | | | CCU145 |
| 1.7 CDTI | 4 | A17DTS | 96/129 | 06/10→10/13 | | | | | CCU145 |

MOKKA

| | | | | | | | | | |
|--------------|---|--------|---------|--------|-------|-----|------|-------|----------|
| 1.8, 1.8 4WD | 4 | A18XER | 103/138 | 01/13→ | OE198 | 0,9 | CET2 | OE184 | BAEA199E |
|--------------|---|--------|---------|--------|-------|-----|------|-------|----------|

OPEL



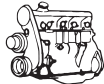

kW/BHP



eon TITAN

IRIDIUM



...OPEL

MOKKA / MOKKA X

| | | | | | | | | | | |
|------------------------|---|------------------------|---------|--------|-------------------|------|------|-------|----------|--|
| 1.4 | 4 | A14NET; B14NET; D14NET | 103/138 | 04/13→ | | | | OE264 | BAEA185E | |
| 1.4 4WD | 4 | B14XFT | 112/150 | 06/16→ | | | | OE258 | | |
| 1.4 4WD, 1.4 LPG | 4 | A14NET; B14NET; D14NET | 103/138 | 06/12→ | | | | | BAEA185E | |
| 1.6 | 4 | A16XER; B16XER | 85/114 | 06/12→ | OE198 | 0,9 | CET2 | OE184 | BAEA198E | |
| 1.7 CDTI, 1.7 CDTI 4WD | 4 | A17DTS | 96/129 | 06/12→ | CP5G004 →11/12 | 4.4v | | | CCU145 | |

MONTEREY B

| | | | | | | | | | | |
|----------------|---|------|---------|-------------|-------|-----|--------|-------|--|--|
| 3.5 V6 24V 4WD | 6 | 6VE1 | 158/212 | 07/98→08/99 | OE191 | 1,0 | CET12P | OE180 | | |
|----------------|---|------|---------|-------------|-------|-----|--------|-------|--|--|

OMEGA B

| | | | | | | | | | | |
|---------------|---|----------------------------|---------|-------------|-------|-----|------|-------|--|---|
| 2.0 | 4 | 20SE; X20SE | 85/114 | 03/94→12/00 | OE019 | 0,9 | CET2 | OE184 | | |
| 2.0 | 4 | XF20E | 90/121 | 05/94→05/99 | OE019 | 0,9 | CET2 | OE184 | | |
| 2.0 16V | 4 | X20XEV | 100/134 | 03/94→09/99 | OE019 | 0,9 | CET2 | OE184 | BAEA344 | CLS107 |
| 2.0 DTI 16V | 4 | X20DTH | 74/99 | 09/97→09/00 | | | | | CCU143 ^[7] | |
| 2.2 16V | 4 | Y22XE; Z22XE | 106/142 | 09/99→07/03 | OE019 | 0,9 | CET2 | OE184 | BAEA150E ^[277] | |
| 2.2 DTI 16V | 4 | Y22DTH | 81/109 | 09/00→07/03 | CH231 | 11v | | | CCU143 ^[7] | |
| 2.2 DTI 16V | 4 | Y22DTR | 86/115 | 01/01→07/03 | CH231 | 11v | | | | |
| 2.2 DTI 16V | 4 | Y22DTH | 88/118 | 09/00→07/03 | CH231 | 11v | | | CCU143 ^[7] | |
| 2.5 D, 2.5 TD | 6 | U25DT; U25TD; X25DT; X25TD | 96/129 | 04/94→07/03 | CH189 | 11v | | | | |
| 2.5 DTI | 6 | Y25DT; Y25TD | 110/148 | 09/01→07/03 | CH203 | 11v | | | | |
| 2.5 V6 | 6 | X25XE | 125/168 | 03/94→09/00 | OE019 | 0,9 | CET2 | OE184 | BAEA306 | CLS175 →Ch.08145499 CLS175 →Ch.8145499 |
| 2.6 V6 | 6 | Y26SE | 132/177 | 09/00→07/03 | | | CET2 | OE188 | BAEA152E ^[36] ^[277] BAEA153E ^[42] ^[277] | |
| 3.0 V6 | 6 | X30XE | 155/208 | 04/94→02/01 | OE019 | 0,9 | CET2 | OE184 | BAEA306 | CLS175 →Ch.08145499 |
| 3.2 V6 | 6 | Y32SE | 160/215 | 02/01→07/03 | | | CET2 | OE188 | BAEA152E ^[36] ^[277] BAEA153E ^[42] ^[277] | |

SIGNUM

| | | | | | | | | | | |
|--------------|---|--------|---------|-------------|--|-----|--------|-------|--|--|
| 1.8 | 4 | Z18XE | 90/121 | 05/03→07/05 | OE198 | 0,9 | CET2 | OE188 | BAEA342 | |
| 1.8 | 4 | Z18XER | 103/138 | 09/05→12/08 | OE198 | 0,9 | CET2 | OE188 | BAEA427 | |
| 1.9 CDTI | 4 | Z19DTL | 74/99 | 08/05→02/08 | CH222 →Ch.71021891 CH269 Ch.71021892→ | 11v | | | CCU143 ^[7] →Ch.61010105 CCU142 ^[8] Ch.61010106→ | |
| 1.9 CDTI | 4 | Z19DT | 88/118 | 04/04→02/08 | CH222 →Ch.71021891 CH269 Ch.71021892→ | 11v | | | CCU143 ^[7] →Ch.61010105 CCU142 ^[8] Ch.61010106→ | |
| 1.9 CDTI | 4 | Z19DTH | 110/148 | 04/04→02/08 | CH224 | 11v | | | CCU143 ^[7] →Ch.61010105 CCU142 ^[8] Ch.61010106→ | |
| 2.0 DTI | 4 | Y20DTH | 74/99 | 05/03→04/04 | CH231 | 11v | | | CCU143 ^[7] | |
| 2.0 Turbo | 4 | Z20NET | 129/173 | 05/03→12/08 | OE136 | 0,8 | CET12P | OE179 | | |
| 2.2 direct | 4 | Z22YH | 114/153 | 05/03→09/08 | | | CET2 | OE188 | BAEA149E | |
| 2.2 DTI | 4 | Y22DTR | 92/123 | 05/03→04/04 | CH231 | 11v | | | CCU143 ^[7] | |
| 2.2 DTI 16V | 4 | Y22DTR | 86/115 | 05/03→06/08 | CH231 | 11v | | | CCU143 ^[7] | |
| 2.8 V6 Turbo | 6 | Z28NEL | 169/227 | 09/05→12/08 | OE238 | 1,0 | | | BAEA174E | |
| 2.8 V6 Turbo | 6 | Z28NET | 184/247 | 01/06→12/08 | OE238 | 1,0 | | | BAEA174E | |
| 3.2 V6 | 6 | Z32SE | 155/208 | 05/03→07/05 | | | CET2 | OE188 | BAEA152E ^[36] ^[277] BAEA153E ^[42] ^[277] | |



OPEL



kW/BHP

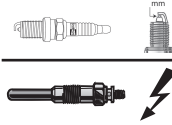

eon TITAN

IRIDIUM

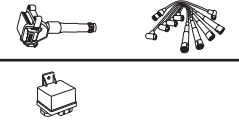

...OPEL

SINTRA

| | | | | | | | | | |
|-----------|---|--------|---------|-------------|-------|-----|------|-------|------------------------|
| 2.2 DTI | 4 | X22DTH | 85/114 | 07/97→04/99 | CH207 | 11v | | | CCU143 ^[7] |
| 2.2 i 16V | 4 | X22XE | 104/139 | 11/96→04/99 | OE019 | 0,9 | CET2 | OE184 | CLS107 |
| 3.0 i 24V | 6 | X30XE | 148/198 | 11/96→04/99 | OE019 | 0,9 | CET2 | OE184 | CLS175 →Ch.08145499 |

SPEEDSTER

| | | | | | | | | | |
|-----------|---|--------|---------|-------------|-------|-----|--------|-------|--|
| 2.0 Turbo | 4 | Z20LET | 147/197 | 08/02→08/06 | OE019 | 0,9 | CET2 | OE184 | |
| 2.2 | 4 | Z22SE | 108/145 | 06/00→08/05 | OE255 | 1,0 | CET17P | OE189 | |

TIGRA

| | | | | | | | | | |
|----------|---|--------|--------|-------------|-------|-----|------|----------|-----------------------|
| 1.3 CDTI | 4 | Z13DT | 51/68 | 06/04→12/10 | | | | | CCU142 ^[8] |
| 1.4 | 4 | Z14XEP | 66/89 | 06/04→12/10 | OE198 | 0,9 | CET2 | OE184 | BAEA338 |
| 1.4 16V | 4 | X14XE | 63/84 | 08/97→12/00 | | | CET2 | OE188 | BAEA026E CLS030 |
| 1.4 16V | 4 | X14XE | 66/89 | 07/94→12/00 | | | CET2 | OE188 | BAEA026E CLS030 |
| 1.6 16V | 4 | C16SEL | 74/99 | 08/97→08/98 | OE019 | 0,9 | CET8 | BAEA026E | CLS030 |
| 1.6 16V | 4 | X16XE | 78/105 | 07/94→08/98 | OE019 | 0,9 | CET2 | OE184 | BAEA026E CLS030 |
| 1.8 | 4 | Z18XE | 92/123 | 06/04→12/10 | OE198 | 0,9 | CET2 | OE184 | BAEA342 |

VECTRA A

| | | | | | | | | | |
|-----------------|---|--------|---------|-------------|----------------------------|-----|------|-------|----------------------------------|
| 1.6 i | 4 | X16SZ | 52/70 | 09/93→11/95 | OE019 | 0,9 | CET2 | OE184 | BAEA026E CLS114 ^[275] |
| 2.0 i Turbo 4WD | 4 | C20LET | 150/201 | 06/94→11/95 | OE089 | 1,0 | CET2 | OE188 | |
| | | | | | OE216 ^{LPG [278]} | 0,8 | | | |
| 2.5 V6 | 6 | C25XE | 125/168 | 02/93→11/95 | OE089 | 1,0 | CET2 | OE184 | |

VECTRA B

| | | | | | | | | | |
|-------------|---|----------------|---------|-------------|-------------|-----|------|-------|--|
| 1.6 GL | 4 | 16SV | 60/80 | 09/95→08/96 | OE006 | 0,9 | CET8 | OE195 | |
| 1.6 i | 4 | X16SZR | 55/74 | 10/95→07/03 | OE019 | 0,9 | CET2 | OE184 | BAEA026E CLS114 |
| 1.6 i | 4 | 16LZ2 | 55/74 | 10/95→07/03 | OE019 | 0,9 | CET2 | OE184 | BAEA253 ^[292] |
| 1.6 i 16V | 4 | X16XEL | 74/99 | 10/95→07/02 | OE019 | 0,9 | CET2 | OE184 | BAE965A CLS030 |
| | | | | | OE198 | 0,9 | | | BAE965A Ch.W1285447 W71544259→ |
| 1.6 i 16V | 4 | Y16XE; Z16XE | 74/99 | 10/95→07/02 | OE019 | 0,9 | CET2 | OE184 | BAE965A |
| | | | | | OE198 | 0,9 | | | BAE965A Ch.W1285447 W71544259→ |
| 1.8 i 16V | 4 | X18XE | 85/114 | 10/95→09/00 | OE019 | 0,9 | CET2 | OE184 | BAEA344 CLS107 |
| 1.8 i 16V | 4 | X18XE1 | 85/114 | 10/95→09/00 | OE019 | 0,9 | CET2 | OE184 | BAEA342 CLS107 |
| | | | | | | | | OE188 | |
| 1.8 i 16V | 4 | Z18XEL | 85/114 | 10/95→09/00 | OE019 | 0,9 | CET2 | OE184 | BAEA342 CLS107 |
| 1.8 i 16V | 4 | Z18XE | 92/123 | 09/00→07/03 | OE198 | 0,9 | CET2 | OE184 | BAEA342 |
| 2.0 DI 16V | 4 | X20DTL | 60/80 | 11/96→04/02 | CH207 | 11v | | | |
| 2.0 DTI 16V | 4 | X20DTH | 74/99 | 06/97→07/03 | CH207 | 11v | | | CCU143 ^[7] |
| | | | | | 03/98→06/00 | | | | Ch.W1000001 W5000001 W7000001 XL000001 WS WP→ |
| 2.0 DTI 16V | 4 | Y20DTH | 74/99 | 06/97→07/03 | CH231 | 11v | | | CCU143 ^[7] |
| | | | | | | | | | Ch.W1000001 W5000001 W7000001 XL000001 WS WP→ |
| 2.0 i | 4 | Z0NEJ | 82/110 | 10/95→04/02 | OE026 | 0,9 | CET2 | OE188 | |
| 2.0 i 16V | 4 | C20SEL; X20XEV | 100/134 | 10/95→09/00 | OE019 | 0,9 | CET2 | OE184 | BAEA344 CLS107 |

OPEL



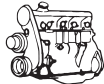

kW/BHP



eon TITAN

IRIDIUM



...OPEL

...VECTRA B

| | | | | | | | | | |
|-------------|---|--------|---------|-------------|---|------|--------|-------|---|
| 2.2 DTI 16V | 4 | Y22DTR | 88/118 | 09/00→04/02 | CH231 | 11v | | | CCU143 ^[7] Ch.W1000001 W5000001 W7000001 XL000001 WS WP→ |
| 2.2 DTI 16V | 4 | Y22DTR | 92/123 | 09/00→07/03 | CH231 | 11v | | | CCU143 ^[7] Ch.W1000001 W5000001 W7000001 XL000001 WS WP→ |
| 2.2 i 16V | 4 | Z22SE | 108/145 | 09/00→07/03 | OE255 | 1,0 | CET17P | OE189 | |
| 2.5 | 6 | X25XE | 144/193 | 10/99→06/00 | OE019 | 0,9 | CET2 | OE184 | |
| 2.5 i 500 | 6 | X25XE | 143/192 | 05/98→09/00 | OE089 <small>*to be adjusted</small> | 0,8* | CET2 | OE184 | |
| 2.5 i V6 | 6 | X25XE | 125/168 | 10/95→09/00 | OE019 | 0,9 | CET2 | OE184 | |
| 2.6 i V6 | 6 | Y26SE | 125/168 | 09/00→07/03 | | | CET2 | OE188 | BAEA152E [36] [277] BAEA153E [42] [277] |

VECTRA C

| | | | | | | | | | |
|--------------------------------|---|--------|---------|-------------|--|-----|--------|----------------|--|
| 1.6 | 4 | Z16XEP | 77/103 | 08/05→08/08 | OE198 | 0,9 | CET2 | OE184 OE188 | BAEA427 |
| 1.6, 1.6 16V | 4 | Z16XE | 74/99 | 06/04→09/08 | OE198 | 0,9 | CET2 | OE188 | BAE965A |
| 1.8 | 4 | Z18XEL | 81/109 | 04/02→07/08 | OE198 | 0,9 | CET2 | OE184 | BAEA342 |
| 1.8 | 4 | Z18XER | 103/138 | 08/05→08/08 | OE198 | 0,9 | CET2 | OE188 | BAEA427 |
| 1.8, 1.8 16V | 4 | Z18XE | 90/121 | 04/02→09/08 | OE198 | 0,9 | CET2 | OE188 | BAEA342 |
| 1.8 16V | 4 | Z18XEL | 81/109 | 08/02→12/06 | OE019 | 0,9 | CET2 | OE184 | |
| 1.9 CDTI | 4 | Z19DTL | 74/99 | 06/05→08/08 | CH222 →Ch.71021891 48999999 CH269 Ch.71021892 78→ | 11v | | | CCU143 ^[7] →Ch.61010105 48999999 CCU142 ^[8] Ch.61010106 68→ |
| 1.9 CDTI | 4 | Z19DT | 88/118 | 04/04→01/09 | CH222 →Ch.71021891 48999999 CH269 Ch.71021892 78→ | 11v | | | CCU143 ^[7] →Ch.61010105 48999999 CCU142 ^[8] Ch.61010106 68→ |
| 1.9 CDTI | 4 | Z19DTH | 110/148 | 04/04→08/08 | CH224 →03/07 | 11v | | | CCU143 ^[7] →Ch.61010105 48999999 CCU142 ^[8] Ch.61010106 68→ |
| 2.0 16V Turbo, 2.0 Turbo | 4 | Z20NET | 129/173 | 03/03→08/08 | OE136 | 0,8 | CET12P | OE179 | |
| 2.0 DTI, 2.0 DTI 16V | 4 | Y20DTH | 74/99 | 04/02→08/06 | CH231 | 11v | | | CCU143 ^[7] |
| 2.2 16V | 4 | Z22SE | 108/145 | 04/02→12/08 | OE255 | 1,0 | CET17P | OE188 OE189 | |
| 2.2 DGi, 2.2 direct | 4 | Z22YH | 114/153 | 10/03→08/08 | | | CET2 | OE188 | BAEA149E →10/08 |
| 2.2 DTI, 2.2 DTI 16V | 4 | Y22DTR | 86/115 | 04/02→06/08 | CH231 | 11v | | | CCU143 ^[7] |
| 2.2 DTI, 2.2 DTI 16V | 4 | Y22DTR | 92/123 | 04/02→07/06 | CH231 | 11v | | | CCU143 ^[7] |
| 2.8 V6 Turbo | 6 | Z28NEL | 169/227 | 08/05→10/08 | OE238 | 1,0 | | | BAEA174E |
| 2.8 V6 Turbo | 6 | Z28NET | 184/247 | 08/05→08/08 | OE238 | 1,0 | | | BAEA174E |
| 2.8 V6 Turbo | 6 | Z28NET | 188/252 | 08/05→09/08 | OE238 | 1,0 | | | BAEA174E |
| 2.8 V6 Turbo, 2.8 V6 Turbo OPC | 6 | Z28NET | 206/276 | 07/06→08/08 | OE238 | 1,0 | | | BAEA174E |

CHAMPION



kW/BHP

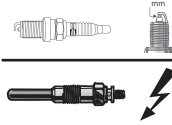

eon TITAN

IRIDIUM

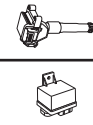

...OPEL

...VECTRA C

| | | | | | | | | | |
|--------|---|-------|---------|-------------|-------|-----|------|-------|--|
| 3.2 V6 | 6 | Z32SE | 155/208 | 08/02→07/06 | OE120 | 0,6 | CET2 | OE188 | BAEA152E [36] [277] BAEA153E [42] [277] |
|--------|---|-------|---------|-------------|-------|-----|------|-------|--|

ZAFIRA A

| | | | | | | | | | |
|-----|---|--------|--------|-------------|--|--|--|--|---------|
| 1.6 | 4 | Z16XEP | 76/102 | 10/03→06/05 | | | | | BAEA427 |
|-----|---|--------|--------|-------------|--|--|--|--|---------|

| | | | | | | | | | |
|---------|---|--------|-------|-------------|----------------|------------|------|-------|---------|
| 1.6 16V | 4 | X16XEL | 74/99 | 04/99→06/05 | OE019 OE198 | 0,9 0,9 | CET2 | OE184 | BAE965A |
|---------|---|--------|-------|-------------|----------------|------------|------|-------|---------|

| | | | | | | | | | |
|---------|---|-------|-------|-------------|----------------|------------|------|-------|--|
| 1.6 16V | 4 | Z16XE | 74/99 | 04/99→06/05 | OE019 OE198 | 0,9 0,9 | CET2 | OE184 | |
|---------|---|-------|-------|-------------|----------------|------------|------|-------|--|

| | | | | | | | | | |
|---------|---|--------|-------|-------------|--|--|--------|-------|-------------------|
| 1.6 CNG | 4 | Z16YNG | 71/95 | 09/01→06/05 | | | CET12P | OE179 | BAE965A CLS114 |
|---------|---|--------|-------|-------------|--|--|--------|-------|-------------------|

| | | | | | | | | | |
|---------|---|--------|--------|-------------|-------|-----|------|-------|---------|
| 1.8 16V | 4 | X18XE1 | 85/114 | 04/99→09/00 | OE019 | 0,9 | CET2 | OE184 | BAEA342 |
|---------|---|--------|--------|-------------|-------|-----|------|-------|---------|

| | | | | | | | | | |
|---------|---|-------|--------|-------------|-------|-----|------|-------|---------|
| 1.8 16V | 4 | Z18XE | 92/123 | 09/00→06/05 | OE198 | 0,9 | CET2 | OE184 | BAEA342 |
|---------|---|-------|--------|-------------|-------|-----|------|-------|---------|

| | | | | | | | | | |
|--------|---|--------|-------|-------------|---|-----|--|--|-----------------------|
| 2.0 DI | 4 | X20DTL | 63/84 | 07/99→06/00 | CH207 →Ch.22999999 25999999 26999999 28999999 28999999 2H999999 2G | 11v | | | CCU143 ^[7] |
|--------|---|--------|-------|-------------|---|-----|--|--|-----------------------|

| | | | | | | | | | |
|------------|---|--------|-------|-------------|---|-----|--|--|-----------------------|
| 2.0 DI 16V | 4 | X20DTL | 60/80 | 07/99→06/05 | CH207 →Ch.22999999 25999999 26999999 28999999 28999999 2H999999 2G | 11v | | | CCU143 ^[7] |
|------------|---|--------|-------|-------------|---|-----|--|--|-----------------------|

| | | | | | | | | | |
|-------------|---|--------|-------|-------------|---|-----|--|--|-----------------------|
| 2.0 DTI 16V | 4 | Y20DTH | 74/99 | 09/00→06/05 | CH207 →Ch.22999999 25999999 26999999 28999999 28999999 2H999999 2G | 11v | | | CCU142 ^[8] |
|-------------|---|--------|-------|-------------|---|-----|--|--|-----------------------|

| | | | | | | | | | |
|--|--|--|--|--|---|-----|--|--|--|
| | | | | | CH231 Ch.32000001 35000001 36000001 38000001 38000001 3H000001 4G000001→ | 11v | | | |
|--|--|--|--|--|---|-----|--|--|--|

| | | | | | | | | | |
|---------|---|--------|---------|-------------|-------|-----|------|-------|--|
| 2.0 OPC | 4 | Z20LET | 141/189 | 09/01→06/05 | OE019 | 0,9 | CET2 | OE184 | |
|---------|---|--------|---------|-------------|-------|-----|------|-------|--|

| | | | | | | | | | |
|---------|---|----------------|---------|-------------|-------|-----|------|-------|--|
| 2.0 OPC | 4 | Z20LER; Z20LET | 147/197 | 11/02→06/05 | OE019 | 0,9 | CET2 | OE184 | |
|---------|---|----------------|---------|-------------|-------|-----|------|-------|--|

| | | | | | | | | | |
|---------|---|-------|---------|-------------|-------|-----|--------|-------|--|
| 2.2 16V | 4 | Z22SE | 108/145 | 09/00→06/05 | OE255 | 1,0 | CET17P | OE189 | |
|---------|---|-------|---------|-------------|-------|-----|--------|-------|--|

| | | | | | | | | | |
|-------------|---|--------|--------|-------------|---|-----|--|--|-----------------------|
| 2.2 DTI 16V | 4 | Y22DTR | 86/115 | 01/02→06/05 | CH231 Ch.32000001 35000001 36000001 38000001 38000001 3H000001 4G000001→ | 11v | | | CCU142 ^[8] |
|-------------|---|--------|--------|-------------|---|-----|--|--|-----------------------|

| | | | | | | | | | |
|-------------|---|--------|--------|-------------|---|-----|--|--|-----------------------|
| 2.2 DTI 16V | 4 | Y22DTR | 92/123 | 01/02→06/05 | CH231 Ch.32000001 35000001 36000001 38000001 38000001 3H000001 4G000001→ | 11v | | | CCU142 ^[8] |
|-------------|---|--------|--------|-------------|---|-----|--|--|-----------------------|

ZAFIRA B

| | | | | | | | | | |
|-----|---|----------------|--------|-------------|-------|-----|------|-------|---------|
| 1.6 | 4 | Z16XE1; Z16XEP | 77/103 | 07/05→09/12 | OE198 | 0,9 | CET2 | OE184 | BAEA427 |
|-----|---|----------------|--------|-------------|-------|-----|------|-------|---------|

OPEL





kW/BHP



eon TITAN

IRIDIUM



...OPEL

...ZAFIRA B

| | | | | | | | | | |
|---------------|---|----------------|---------|-------------|-----------------------------------|-----|--------|-------|--|
| 1.6 | 4 | A16XER | 85/114 | 01/08→04/15 | OE198 | 0,9 | CET2 | OE184 | |
| 1.6 | 4 | Z16XER | 85/114 | 01/08→04/15 | OE198 | 0,9 | CET2 | OE184 | BAEA427 |
| 1.6 CNG | 4 | Z16YNG | 69/93 | 07/05→04/15 | OE136 | 0,8 | CET12P | OE179 | BAE965A |
| 1.6 CNG Turbo | 4 | A16XNT; Z16XNT | 110/148 | 02/09→04/15 | | | | | BAEA427 |
| 1.7 CDTi | 4 | A17DTJ; Z17DTJ | 81/109 | 01/08→04/15 | | | | | CCU143 ^[7] |
| 1.7 CDTi | 4 | A17DTR | 92/123 | 01/08→04/15 | | | | | CCU143 ^[7] |
| 1.8 | 4 | A18XER; Z18XER | 103/138 | 07/05→04/15 | OE198 | 0,9 | CET2 | OE184 | BAEA427 |
| 1.9 CDTi | 4 | Z19DTL | 74/99 | 07/05→12/10 | CH222 →Ch.62999999 6G999999 | 11v | | | CCU142 ^[8] |
| | | | | | CH269 Ch.72000001 7G000001→ | 11v | | | CCU143 ^[7] |
| 1.9 CDTi | 4 | Z19DT | 88/118 | 07/05→04/15 | CH222 →Ch.62999999 6G999999 | 11v | | | CCU142 ^[8] |
| | | | | | CH269 Ch.72000001 7G000001→ | 11v | | | CCU143 ^[7] |
| 1.9 CDTi | 4 | Z19DTH | 110/148 | 07/05→04/15 | CH224 | 11v | | | CCU142 ^[8] CCU143 ^[7] |
| 2.0 | 4 | Z20LER | 147/197 | 07/05→12/10 | OE089 | 1,0 | CET2 | OE184 | |
| 2.0 | 4 | Z20LEH | 177/237 | 01/06→12/10 | OE136 | 0,8 | CET12P | OE179 | |
| 2.2 | 4 | Z22YH | 110/148 | 07/05→12/12 | | | CET2 | OE188 | BAEA149E |

ZAFIRA TOURER C

| | | | | | | | | | |
|------------------|---|----------------|---------|--------|---|------|------|-------|----------|
| 1.4 | 4 | A14NEL; B14NEL | 88/118 | 10/11→ | | | | | BAEA185E |
| 1.4, 1.4 LPG | 4 | A14NET; B14NET | 103/138 | 10/11→ | | | | | BAEA185E |
| 1.6 CNG | 4 | A16XNT; B16XNT | 110/148 | 10/11→ | | | | | BAEA427 |
| 1.8 | 4 | A18XEL | 85/114 | 10/11→ | OE198 | 0,9 | CET2 | OE184 | BAEA199E |
| 1.8 | 4 | A18XER | 103/138 | 10/11→ | OE198 | 0,9 | CET2 | OE184 | BAEA199E |
| 1.8 LPG | 4 | A18XER | 101/135 | 10/11→ | OE198 | 0,9 | CET2 | OE184 | BAEA199E |
| 2.0 BiTurbo CDTi | 4 | A20DTR | 143/192 | 01/13→ | CPSG006 ^[287] | 4.4v | | | CCU138 |
| 2.0 CDTi | 4 | A20DTL | 81/109 | 10/11→ | CPSG006 ^[287] | 4.4v | | | CCU138 |
| 2.0 CDTi | 4 | A20DT | 96/129 | 10/11→ | CPSG006 ^[287] ^[298] | 4.4v | | | CCU138 |
| | | | | | CPSG006 ^[287] ^[294] | 4.4v | | | |
| 2.0 CDTi | 4 | Y20DTJ | 96/129 | 10/11→ | CPSG006 | 4.4v | | | CCU138 |
| 2.0 CDTi | 4 | Z20DTY | 96/129 | 10/11→ | CPSG006 | 4.4v | | | |
| 2.0 CDTi | 4 | Z20DTJ | 96/129 | 10/11→ | | | | | CCU138 |
| 2.0 CDTi | 4 | A20DTH | 118/158 | 10/11→ | CPSG006 | 4.4v | | | CCU138 |
| 2.0 CDTi | 4 | A20DTH | 121/162 | 10/11→ | CPSG006 | 4.4v | | | CCU138 |

OPEL

ARENA

| | | | | | | | | | |
|-------|---|----------------------------|-------|-------------|-------|-------|--|--|--|
| 1.9 D | 4 | 19DJ; 19DL; F8Q600; F8Q606 | 44/59 | 01/97→12/01 | CH217 | 11v | | | |
| 2.5 D | 4 | 25DG; 25DM | 55/74 | 01/97→12/01 | CH147 | 11.5v | | | |
| 2.5 D | 4 | S8U758; S8U780; S8U782 | 55/74 | 01/97→12/01 | CH189 | 11v | | | |

ASTRA F

| | | | | | | | | | | |
|----------|---|---------------|-------|-------------|-------|-----|------|-------|----------|-----------------------------------|
| 1.6 i | 4 | X16SZ | 52/70 | 02/93→07/96 | OE019 | 0,9 | CET2 | OE184 | BAEA026E | CLS114 08/95→ Eng.02BE6167→ |
| 1.6 i16V | 4 | X16XEL | 74/99 | 08/94→03/98 | OE019 | 0,9 | CET2 | OE184 | | |
| 1.7 TD | 4 | X17DTL | 50/67 | 08/94→01/99 | CH189 | 11v | | | | |
| 1.7 TD | 4 | X17DT(TC4EE1) | 60/80 | 03/95→02/98 | CH158 | 11v | | | | |

ASTRA G

| | | | | | | | | | | |
|-----|---|--------|-------|-------------|-------|-----|------|-------|----------|--------|
| 1.6 | 4 | X16SZR | 55/74 | 01/99→09/00 | OE019 | 0,9 | CET2 | OE184 | BAEA026E | CLS176 |
|-----|---|--------|-------|-------------|-------|-----|------|-------|----------|--------|





kW/BHP



eon TITAN

IRIDIUM



...OPEL

...ASTRA G

| | | | | | | | | | | |
|-------------|---|--------|--------|-------------|--------------|-----|-------------|--------------|------------------------------|---------------|
| 1.6 | 4 | Z16SE | 62/83 | 09/00→04/05 | OE019 | 0,9 | CET2 | OE184 | | CLS114 |
| 1.6 | 4 | Z16XEP | 76/102 | 10/04→04/05 | | | | | BAEA427 | |
| 1.7 DTI 16V | 4 | Y17DT | 55/74 | 02/00→04/05 | | | | | CCU143 ^[7] | |
| 1.7 TD | 4 | X17DTL | 50/67 | 01/99→04/05 | CH189 | 11v | | | CCU143 ^[7] | |
| 2.0 DI | 4 | X20DTL | 60/80 | 01/99→04/05 | CH207 | 11v | | | CCU143 ^[7] | |

ASTRA H

| | | | | | | | | | | |
|--------------|---|----------------|---------|-------------|--|-----|-------------|--|--|--|
| 1.3 CDTI | 4 | Z13DTH | 66/89 | 08/05→10/10 | | | | | CCU142 ^[8] | |
| 1.6 | 4 | Z16XEP | 76/102 | 02/04→11/04 | OE198 | 0,9 | CET2 | | BAEA427 | |
| 1.7 CDTI | 4 | Z17DTH | 74/99 | 03/04→10/10 | | | | | CCU143 ^[7] | |
| 1.7 CDTI | 4 | A17DTJ; Z17DTJ | 81/109 | 02/07→10/10 | | | | | CCU143 ^[7] | |
| 1.7 CDTI | 4 | A17DTR; Z17DTR | 92/123 | 02/07→10/10 | | | | | CCU143 ^[7] | |
| 1.9 CDTI | 4 | Z19DT | 88/118 | 09/05→10/10 | CH222 →Ch.72045139 75030986 78007391 7G | 11v | | | CCU142 ^[8] | |
| | | | | | CH269 Ch.72045140 75030987 78007392 88000001 7G→ | 11v | | | CCU143 ^[7] | |
| 1.9 CDTI | 4 | Z19DTH | 110/148 | 09/04→10/10 | CH224 | 11v | | | CCU142 ^[8] CCU143 ^[7] | |
| 1.9 CDTI 16V | 4 | Z19DTJ | 88/118 | 08/04→10/10 | CH224 | 11v | | | CCU142 ^[8] | |

COMBO

| | | | | | | | | | | |
|--------------|---|--------|--------|-------------|--------------|-----|---------------|--------------|---|--------------------------------|
| 1.2 | 4 | C12NZ | 33/44 | 07/94→10/01 | | | CET8 | OE195 | BAEA026E | |
| 1.2 | 4 | X12SZ | 33/44 | 07/94→10/01 | | | CET8 | OE195 | | CLS114 Eng.028D0922→ |
| 1.4 | 4 | C14NZ | 44/59 | 07/94→10/01 | | | CET8 | | BAEA253 →08/00 [275] [292] | CLS114 |
| 1.4 | 4 | X14SZ | 44/59 | 07/94→10/01 | | | CET8 | OE195 | BAEA026E ^[275] | CLS114 |
| 1.4 | 4 | C14SE | 60/80 | 07/94→10/01 | OE019 | 0,9 | CET2 | OE184 | BAEA026E | |
| 1.4, 1.4 CNG | 4 | A14FC | 88/118 | 02/12→ | | | | | BAEA095 | |
| 1.4 16V | 4 | Z14XEP | 66/89 | 08/99→ | OE198 | 0,9 | CET2 | OE184 | BAEA338 | |
| 1.4 16V | 4 | X14XE | 66/89 | 08/99→ | OE089 | 1,0 | CET2 | OE184 | BAEA026E | CLS030 |
| 1.6 | 4 | Z16SE | 64/86 | 10/01→ | OE019 | 0,9 | CET2 | OE188 | | |
| 1.6 CNG 16V | 4 | Z16YNG | 69/93 | 06/06→ | OE136 | 0,8 | CET12P | OE179 | BAE965A | |
| 1.6 CNG 16V | 4 | Z16YNG | 71/95 | 04/05→ | OE136 | 0,8 | CET12P | OE179 | BAE965A | |
| 1.7 DI 16V | 4 | Y17DTL | 48/64 | 10/01→ | CH189 | 11v | | | | |

CORSA B

| | | | | | | | | | | |
|-------|---|--------------|-------|-------------|--------------|-----|-------------|--------------|-----------------|---------------|
| 1.4 i | 4 | C14NZ; X14SZ | 44/59 | 08/99→09/00 | OE019 | 0,9 | CET2 | OE184 | BAEA026E | CLS114 |
|-------|---|--------------|-------|-------------|--------------|-----|-------------|--------------|-----------------|---------------|

CORSA C

| | | | | | | | | | | |
|--------------|---|--------|-------|--------|--------------|-----|-------------|--------------|---|--|
| 1.2 | 4 | Z12XEP | 59/79 | 07/05→ | OE198 | 0,9 | CET2 | OE184 | BAEA338 | |
| 1.2 16V | 4 | Z12XE | 55/74 | 09/00→ | OE019 | 0,9 | CET2 | OE184 | BAEA147E →Ch.36999999 BAEA338 Ch.37000000→ | |
| 1.3 CDTI 16V | 4 | Z13DT | 51/68 | 08/05→ | | | | | CCU142 ^[8] | |
| 1.4 | 4 | Z14XEP | 66/89 | 08/03→ | OE198 | 0,9 | CET2 | OE184 | BAEA338 | |
| 1.7 CDTi | 4 | Z17DTH | 74/99 | 08/03→ | | | | | CCU143 ^[7] | |
| 1.7 DI 16V | 4 | Y17DTL | 48/64 | 09/00→ | | | | | CCU143 ^[7] | |
| 1.7 DTI 16V | 4 | Y17DT | 55/74 | 09/00→ | | | | | CCU143 ^[7] | |

CORSA D

| | | | | | | | | | | |
|-----|---|--------|-------|--------|--|--|-------------|--------------|--|--|
| 1.0 | 3 | A10XEP | 44/59 | 07/06→ | | | CET2 | OE184 | | |
| 1.0 | 3 | A10XEP | 48/64 | 01/10→ | | | CET2 | OE184 | | |

OPEL



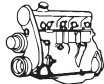

kW/BHP



eon TITAN

IRIDIUM



...OPEL

...CORSA D

| | | | | | | | | | |
|----------|---|------------------------|-------|--------|---------|------|------|-------|----------|
| 1.2 | 4 | A12XEL | 51/68 | 06/10→ | | | CET2 | OE184 | BAEA185E |
| 1.2 | 4 | Z12XEP | 59/79 | 07/09→ | OE198 | 0,9 | CET2 | OE184 | BAEA338 |
| 1.2 | 4 | A12XER | 63/84 | 06/10→ | | | CET2 | OE184 | BAEA185E |
| 1.3 CDTI | 4 | A13DTC | 55/74 | 07/06→ | CPSG003 | 4.4v | | | CCU138 |
| 1.3 CDTI | 4 | Z13DTJ | 55/74 | 07/06→ | | | | | CCU144 |
| 1.3 CDTI | 4 | Z13DTH | 66/89 | 07/06→ | | | | | CCU144 |
| 1.3 CDTI | 4 | A13DTE; A13DTR; Z13DTE | 70/94 | 06/10→ | | | | | CCU138 |

MOVANO

| | | | | | | | | | |
|------------------|---|--------------------------------|---------|-------------|-------|-------|--|--|-------------------------|
| 1.9 DTI | 4 | F9Q770 | 59/79 | 09/00→10/01 | CH271 | 11v | | | CCU129 ^[338] |
| 1.9 DTI | 4 | F9Q774 | 60/80 | 10/01→ | CH271 | 11v | | | |
| 1.9 DTI | 4 | F9Q772 | 60/80 | 10/01→ | CH271 | 11v | | | CCU154 |
| 2.2 DTI | 4 | G9T750 | 66/89 | 09/00→ | CH232 | 11v | | | |
| 2.2 DTI | 4 | G9T720; G9T722 | 66/89 | 09/00→ | CH232 | 11v | | | CCU154 |
| 2.5 CDTI | 4 | G9U754 | 73/98 | 10/03→12/06 | CH232 | 11v | | | |
| 2.5 CDTI | 4 | G9U650 | 74/99 | 10/03→ | CH232 | 11v | | | |
| 2.5 CDTI | 4 | G9U632; G9U650 | 88/118 | 10/03→ | CH232 | 11v | | | |
| 2.5 CDTI | 4 | G9U632; G9U650 | 107/143 | 10/03→ | CH232 | 11v | | | |
| 2.5 D | 4 | S8U770; S8U772 | 59/79 | 07/98→09/00 | CH147 | 11.5v | | | |
| 2.5 DTI | 4 | G9U720; G9U724; G9U750; G9U754 | 84/113 | 10/01→ | CH232 | 11v | | | CCU154 |
| 2.5 DTI, 2.5 DTi | 4 | G9U754 | 73/98 | 10/03→ | CH232 | 11v | | | CCU154 |
| 3.0 DTI, 3.0 DTi | 4 | ZD3200; ZD3202 | 100/134 | 10/03→ | | | | | CCU154 |

MOVANO B

| | | | | | | | | | |
|----------|---|--|---------|--------|---------------------------------|----|--|--|--|
| 2.3 CDTI | 4 | M9T670; M9T672; M9T676; M9T690; M9T692 | 74/99 | 05/10→ | CCGP007 | 7v | | | |
| 2.3 CDTI | 4 | M9T670; M9T672; M9T676; M9T680; M9T686; M9T690; M9T692; M9T696; M9T698; M9T876 | 92/123 | 05/10→ | CCGP007 | 7v | | | |
| 2.3 CDTI | 4 | M9T678; M9T680; M9T694; M9T696; M9T698 | 107/143 | 05/10→ | CCGP007 | 7v | | | |
| 2.3 CDTI | 4 | M9T694; M9T696; M9T698 | 110/148 | 01/13→ | CCGP007 | 7v | | | |
| 2.3 CDTI | 4 | M9T880 | 110/148 | 01/13→ | CCGP007 →06/13 [14] [171] | 7v | | | |

VIVARO A

| | | | | | | | | | |
|----------------|---|--------------------------------|---------|--------|---|-----|------|----------------|------------------------------|
| 1.9 DI, 1.9 Di | 4 | F9Q762 | 60/80 | 08/01→ | CH271 | 11v | | | CCU154 →Ch.6V699999 6Y |
| 1.9 DTI | 4 | F9Q760 | 74/99 | 08/01→ | CH271 | 11v | | | CCU154 →Ch.6V699999 6Y |
| 2.0 16V | 4 | F4R720 | 88/118 | 08/01→ | | | CET2 | OE179 | BAE409A |
| 2.0 CDTI | 4 | M9R630 | 66/89 | 01/06→ | CCGP007 ^[14] →12/11 | 7v | | | |
| 2.0 CDTI | 4 | M9R780; M9R782; M9R786 | 66/89 | 01/06→ | CCGP007 ^[14] Ch.C056227→ | 7v | | | |
| 2.0 CDTI | 4 | M9R630 | 84/113 | 08/06→ | CCGP007 ^[14] →Prod.12.12.2011 | 7v | | | |
| 2.0 CDTI | 4 | M9R780; M9R784; M9R786; M9R788 | 84/113 | 08/06→ | CCGP007 ^[14] Ch.C056227→ | 7v | | | |
| 2.0 ECOTEC | 4 | F4R820 | 86/115 | 08/06→ | OE019 | 0,9 | CET2 | OE179 OE184 | BAE409A |
| 2.5 CDTI | 4 | G9U630 | 84/113 | 08/06→ | CH232 | 11v | | | |
| 2.5 CDTI | 4 | G9MB6; G9U630 | 107/143 | 08/06→ | CH232 | 11v | | | |

CHAMPION



kW/BHP

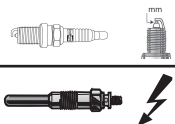

eon TITAN

IRIDIUM

**...OPEL****...VIVARO A**

| | | | | | | | | | |
|------------------|---|--------|--------|--------|-------|-----|--|--|------------------------------|
| 2.5 DTi, 2.5 DTi | 4 | G9U730 | 99/133 | 05/03→ | CH232 | 11v | | | CCU154 →Ch.6V699999 6Y |
|------------------|---|--------|--------|--------|-------|-----|--|--|------------------------------|

ZAFIRA B

| | | | | | | | | | |
|---------------|---|----------------|---------|-------------|-------|-----|------|-------|-----------------------|
| 1.6 CNG Turbo | 4 | A16XNT; Z16XNT | 110/148 | 02/09→04/15 | | | | | BAEA427 |
| 1.7 CDTi | 4 | A17DTJ; Z17DTJ | 81/109 | 01/08→04/15 | | | | | CCU143 ^[7] |
| 1.7 CDTi | 4 | A17DTR | 92/123 | 01/08→04/15 | | | | | CCU143 ^[7] |
| 1.8 | 4 | A18XER; Z18XER | 103/138 | 07/05→04/15 | OE198 | 0,9 | CET2 | OE184 | BAEA427 |

PANOZ**ROADSTER**

| | | | | | | | | | |
|-----|---|--|---------|-------------|--|--|--|------|--|
| 4.6 | 8 | | 227/304 | 06/96→12/00 | | | | CET9 | |
|-----|---|--|---------|-------------|--|--|--|------|--|

PEUGEOT**106 I**

| | | | | | | | | | | |
|-------|---|----------------------|--------|-------------|-------|-----|------|-------|---------------------|--------|
| 1.3 | 4 | TU2J2 | 72/97 | 10/93→04/96 | OE005 | 0,9 | CET2 | OE180 | BAEA231 | CLS262 |
| 1.5 D | 4 | VJY(TUD5) | 40/54 | 06/94→04/96 | CH185 | 11v | | | | |
| 1.5 D | 4 | VJY(TUD5); VJZ(TUD5) | 43/58 | 06/94→04/96 | CH185 | 11v | | | | |
| 1.6 | 4 | NFZ(TU5JP) | 65/87 | 06/93→04/96 | OE034 | 0,9 | CET2 | OE179 | BAEA231 →Ch.3200 | CLS262 |
| 1.6 | 4 | NFY(TU5J2) | 76/102 | 01/94→04/96 | OE034 | 0,9 | CET2 | OE179 | BAEA231 | CLS262 |

106 II

| | | | | | | | | | | |
|---------|---|---------------------------------|--------|-------------|-----------------|-----|------|-----------------|--|--------|
| 1.0 i | 4 | CDY(TU9M) | 33/44 | 05/96→10/99 | OE034 | 0,9 | CET2 | OE179 | BAEA232 | CLS262 |
| 1.0 i | 4 | CDZ(TU9M) | 37/50 | 01/97→03/01 | OE034 | 0,9 | CET2 | OE179 | BAEA232 | CLS262 |
| 1.1 i | 4 | HDY(TU1M) | 40/54 | 01/97→03/01 | OE034 | 0,9 | CET2 | OE179 | BAEA232 | CLS262 |
| 1.1 i | 4 | HDZ(TU1M) | 44/59 | 05/96→07/04 | OE034 | 0,9 | CET2 | OE179 | BAEA232 | CLS262 |
| 1.1 i | 4 | HFX(TU1JP) | 44/59 | 05/96→07/04 | OE034 | 0,9 | CET2 | OE179 | BAE946A ^[10] | CLS262 |
| 1.4 i | 4 | KFW(TU3JP); KFX(TU3JP) | 55/74 | 05/96→07/04 | OE034 | 0,9 | CET2 | OE179 | BAEA232 →02/98 BAE946A [10][19] | CLS262 |
| 1.5 D | 4 | VJY(TUD5) | 40/54 | 05/96→03/01 | CH185 | 11v | | | | |
| 1.5 D | 4 | VJX(TUD5); VJY(TUD5); VJZ(TUD5) | 42/56 | 04/98→07/04 | CH185 | 11v | | | | |
| 1.6 i | 4 | NFZ(TU5JP) | 65/87 | 05/96→10/99 | OE034 | 0,9 | CET2 | OE179 | BAEA232 →Ch.3200 | CLS262 |
| 1.6 i | 4 | NFW(TU5J2); NFY(TU5J2) | 74/99 | 05/96→01/01 | OE034 10/99→ | 0,9 | CET2 | OE179 10/99→ | BAEA231 | CLS262 |
| 1.6 S16 | 4 | NFX(TU5J4) | 87/117 | 05/96→07/04 | OE034 10/99→ | 0,9 | CET2 | OE179 10/99→ | BAEA046E ^[277] | |

107

| | | | | | | | | | |
|---------|---|---------------------|-------|-------------|-------|-----|------|-------|----------|
| 1.0 | 3 | CFA(384F); CFB(1KR) | 50/67 | 06/05→ | OE035 | 0,9 | CET5 | OE190 | BAEA164E |
| 1.4 HDi | 4 | 8HT(DV4TD) | 40/54 | 06/05→05/14 | CH201 | 11v | | | |

108

| | | | | | | | | | |
|---------|---|----------|-------|--------|--|--|--|--|----------|
| 1.0 VTi | 3 | CFB(1KR) | 51/68 | 05/14→ | | | | | BAEA164E |
|---------|---|----------|-------|--------|--|--|--|--|----------|

206

| | | | | | | | | | |
|-------------------------|---|------------------------|-------|-------------|--------------------|-----|------|-------|--|
| 1.1 | 4 | HFY(TU1JP) | 40/54 | 08/98→07/00 | OE034 | 0,9 | CET2 | OE179 | |
| 1.1, 1.1 i | 4 | HFX(TU1JP); HFZ(TU1JP) | 44/59 | 09/98→ | OE034 | 0,9 | CET2 | OE179 | BAE946A ^[10] |
| 1.4 | 4 | KFV(TU3A); KFW(TU3JP) | 55/74 | 07/02→ | OE034 | 0,9 | CET2 | OE179 | BAE946A ^[10] BAEA048E ^[7] |
| 1.4 16V | 4 | KFU(ET3J4) | 65/87 | 10/03→ | OE130 | 0,9 | CET4 | | BAEA472 |
| 1.4 HDi | 4 | 8HX(DV4TD) | 51/68 | 09/02→02/07 | CH201 Ch.10444→ | 11v | | | CCU149 ^[359] |
| 1.4 HDi, 1.4 HDi eco 70 | 4 | 8HX(DV4TD); 8HZ(DV4TD) | 50/67 | 09/01→ | CH201 RP.10444→ | 11v | | | CCU149 ^[359] |
| 1.4 i | 4 | KFW(TU3A); KFX(TU3JP) | 55/74 | 09/98→ | OE034 | 0,9 | CET2 | OE179 | |
| 1.4 i | 4 | KFW(TU3JP) | 55/74 | 09/98→ | OE034 | 0,9 | CET2 | OE179 | BAE946A ^[10] 06/00→ |

PEUGEOT

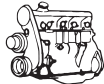

kW/BHP



eon TITAN

IRIDIUM



...PEUGEOT

...206

| | | | | | | | | | |
|---------------------|---|-------------------------------|---------|-------------|----------------------------|-----|----------------|-------|-------------------------|
| 1.4 LPG | 4 | KFV(TU3JP) | 55/74 | 07/02→ | OE034 | 0,9 | CET2 | OE179 | BAE946A ^[10] |
| 1.6 | 4 | NFU(TU5JP4) | 81/109 | 09/01→12/08 | OE035 | 0,9 | CET14P CET5 | OE190 | |
| 1.6 16V | 4 | NFU(TU5JP4) | 79/106 | 06/01→04/09 | OE148 | 1,0 | | | BAEA045E |
| 1.6 16V | 4 | NFU(TU5JP4) | 80/107 | 09/00→ | OE035 | 0,9 | CET5 | OE190 | BAEA045E |
| | | | | | OE224 ^{LPG [279]} | 0,8 | | | |
| 1.6 HDi 110 | 4 | 9HY(DV6TED4); 9HZ(DV6TED4) | 80/107 | 05/04→ | CH201 RP.10784→ | 11v | | | CCU147 |
| 1.6 i | 4 | NFZ(TU5JP) | 65/87 | 09/98→12/00 | OE034 | 0,9 | CET2 | OE179 | |
| 1.9 D | 4 | WJY(DW8B8); WJZ(DW8) | 51/68 | 09/98→11/01 | CH185 | 11v | | | CCU149 ^[315] |
| 2.0 16V, 2.0 S16 | 4 | RFN(EW10J4) | 100/134 | 06/99→ | OE178 | 0,9 | CET5 | | BAEA348 |
| 2.0 HDi, 2.0 HDI 90 | 4 | RHY(DW10TD) | 66/89 | 12/99→ | CH170 | 11v | | | CCU149 ^[359] |
| 2.0 RC | 4 | RFK(EW10J4S) | 130/174 | 07/03→ | OE178 | 0,9 | CET5 | | BAEA351 |
| | | | | | OE224 ^{LPG [279]} | 0,8 | | | |
| 2.0 S16 | 4 | RFR(EW10J4) | 99/133 | 04/99→10/00 | OE178 | 0,9 | CET5 | | BAEA348 |

206+

| | | | | | | | | | |
|----------------|---|--------------------------------------|-------|--------|--------------------|------------|------|-------|-------------------------|
| 1.1 | 4 | HFX(TU1A); TU1AE5 | 44/59 | 01/09→ | OE005 OE034 | 0,9 0,9 | CET2 | OE179 | BAEA048E ^[7] |
| 1.1 | 4 | HFX(TU1JP) | 44/59 | 01/09→ | OE034 | 0,9 | CET2 | OE179 | BAEA048E ^[7] |
| 1.4 HDi eco 70 | 4 | 8HR(DV4C); 8HX(DV4TD); 8HZ(DV4TD) | 50/67 | 01/09→ | CH201 RP.10444→ | 11v | | | CCU147 |
| 1.4 i | 4 | KFT(TU3A) | 54/72 | 09/10→ | OE034 | 0,9 | CET2 | OE179 | BAEA048E ^[7] |
| 1.4 i | 4 | KFV(TU3A); KFW(TU3A) | 55/74 | 01/09→ | OE034 | 0,9 | CET2 | OE179 | BAEA048E ^[7] |

207

| | | | | | | | | | |
|---------------|---|--|---------|-------------|----------------------------|-----|--------|-------|-------------------------|
| 1.4 | 4 | KFV(TU3A) | 53/71 | 02/06→ | OE034 | 0,9 | CET2 | OE179 | BAEA048E ^[7] |
| 1.4 | 4 | KFT(TU3A); KFV(TU3A) | 54/72 | 12/07→ | OE034 | 0,9 | CET2 | OE179 | BAEA048E ^[7] |
| 1.4 | 4 | KFV(TU3A); KFW(TU3A) | 55/74 | 08/08→ | OE034 | 0,9 | CET2 | OE179 | BAEA048E ^[7] |
| 1.4 16V | 4 | KFU(ET3J4) | 65/87 | 02/06→ | OE130 | 0,9 | CET4 | | BAEA472 |
| 1.4 16V | 4 | 8FS(EP3); EP3; EP3C | 70/94 | 06/07→ | OE203 | 1,0 | | | BAEA143 |
| 1.4 16V | 4 | 8FR(EP3) | 72/97 | 10/09→ | OE203 | 1,0 | | | BAEA143 |
| 1.4 Bioflex | 4 | KFW(TU3JP) | 60/80 | 08/08→ | OE034 | 0,9 | CET2 | OE179 | |
| 1.4 Bioflex | 4 | KFW(TU3A) | 60/80 | 08/08→ | OE034 | 0,9 | CET2 | OE179 | BAEA048E ^[7] |
| 1.4 HDi | 4 | 8HR(DV4C) | 50/67 | 02/06→ | CH201 | 11v | | | |
| 1.4 HDi | 4 | 8HZ(DV4TD) | 50/67 | 02/06→ | CH201 | 11v | | | CCU147 |
| 1.6 | 4 | | 90/121 | 09/07→12/13 | | | | | BAEA143 |
| 1.6 16V | 4 | NFU(TU5JP4) | 80/107 | 02/06→ | OE035 | 0,9 | CET5 | OE190 | BAEA045E |
| | | | | | OE224 ^{LPG [279]} | 0,8 | | | |
| 1.6 16V RC | 4 | 5FY(EP6DTS) | 128/172 | 02/07→ | OE205 | 0,7 | CET16P | | BAEA143 |
| 1.6 16V Turbo | 4 | 5FX(EP6DT) | 110/148 | 02/06→ | OE205 | 0,7 | CET16P | | BAEA143 |
| 1.6 16V Turbo | 4 | 5FR(EP6DT) | 115/154 | 10/09→ | OE205 | 0,7 | CET16P | | BAEA143 |
| 1.6 16V VTi | 4 | 5FS(EP6C); 5FW(EP6); EP6 | 88/118 | 02/07→ | OE205 | 0,7 | CET16P | | BAEA143 03/07→ |
| 1.6 Bioflex | 4 | N6A(TU5JP4) | 83/111 | 01/08→ | OE035 | 0,9 | CET5 | | BAEA045E |
| 1.6 HDi | 4 | 9HV(DV6TED4B); 9HV(DV6TED4BU); 9HX(DV6ATED4) | 66/89 | 02/06→10/13 | CH201 | 11v | | | CCU147 |
| 1.6 HDi | 4 | 9HY(DV6TED4); 9HZ(DV6TED4) | 80/107 | 02/06→ | CH201 | 11v | | | CCU147 |

207 CC

| | | | | | | | | | |
|---------------|---|--------------------------|---------|-------------|-------|-----|--------|--|---------|
| 1.6 | 4 | | 90/121 | 09/10→12/11 | | | | | BAEA143 |
| 1.6 16V | 4 | 5FS(EP6C); 5FW(EP6); EP6 | 88/118 | 02/07→ | OE205 | 0,7 | CET16P | | BAEA143 |
| 1.6 16V Turbo | 4 | 5FX(EP6DT) | 110/148 | 02/07→ | OE205 | 0,7 | CET16P | | BAEA143 |
| 1.6 16V Turbo | 4 | 5FR(EP6DT); 5FV(EP6CDT) | 115/154 | 10/09→ | OE205 | 0,7 | CET16P | | BAEA143 |
| 1.6 HDi | 4 | 9HZ(DV6TED4) | 80/107 | 02/07→ | CH201 | 11v | | | CCU147 |

CHAMPION

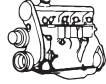

kW/BHP

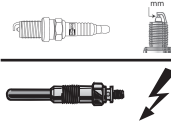

eon TITAN

IRIDIUM

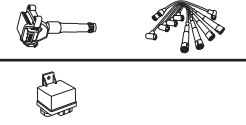

...PEUGEOT

| ...PEUGEOT | | | | | | | | | |
|------------------|---|-------------------------------|---------|-------------|--------------------------|------------|--------|-------|--|
| 207 SW | | | | | | | | | |
| 1.4 | 4 | KFT(TU3A); KfV(TU3A) | 54/72 | 06/07→ | OE034 | 0,9 | CET2 | OE179 | BAEA048E ^[7] |
| 1.4 16V | 4 | 8FS(EP3); EP3; EP3C | 70/94 | 06/07→ | OE203 | 1,0 | | | BAEA143 |
| 1.4 16V | 4 | 8FR(EP3) | 72/97 | 11/09→ | OE203 | 1,0 | | | BAEA143 |
| 1.6 16V | 4 | 5FS(EP6C); 5FW(EP6); EP6 | 88/118 | 06/07→ | OE205 | 0,7 | CET16P | | BAEA143 |
| 1.6 16V RC | 4 | 5FY(EP6DTS) | 128/172 | 02/07→ | OE205 | 0,7 | CET16P | | BAEA143 |
| 1.6 HDi | 4 | 9HV(DV6TED4B); 9HV(DV6TED4BU) | 66/89 | 06/07→12/12 | CH201 | 11v | | | |
| 1.6 HDi | 4 | 9HZ(DV6TED4) | 80/107 | 06/07→12/12 | CH201 | 11v | | | CCU147 |
| 208 | | | | | | | | | |
| 1.0 | 3 | ZMZ(EBO) | 50/67 | 03/12→ | | | | OE263 | |
| 1.2 | 3 | HMZ(EB2F) | 60/80 | 03/12→ | | | | OE263 | |
| 1.2 THP | 3 | HNZ(EB2DT) | 81/109 | 01/13→ | | | | | BAEA557 |
| 1.4 GPL, 1.4 VTi | 4 | 8FS(EP3); EP3C | 70/94 | 03/12→ | | | | | BAEA143 |
| 1.6 | 4 | 5FS(EP6C) | 88/118 | 03/12→ | OE205 | 0,7 | CET16P | | BAEA143 |
| 1.6 | 4 | 5FV(EP6CDT) | 115/154 | 03/12→ | OE205 | 0,7 | CET16P | | |
| 301 | | | | | | | | | |
| 1.6 VTi 115 | 4 | NFP(EC5) | 85/114 | 11/12→ | OE035 | 0,9 | CET5 | | |
| 306 | | | | | | | | | |
| 1.1 | 4 | HDZ(TU1M) | 44/59 | 05/93→05/01 | OE034 | 0,9 | CET2 | OE179 | BAEA231 ^[275] CLS124 BAEA232 ^[275] CLS262 |
| 1.4 | 4 | KDX(TU3MC) | 55/74 | 04/93→04/02 | OE034 | 0,9 | CET2 | OE179 | BAEA231 |
| 1.4 | 4 | KFW(TU3JP); KFX(TU3JP) | 55/74 | 04/93→04/02 | OE034 | 0,9 | CET2 | OE179 | BAEA232 CLS005 →RP.7874 |
| 1.4 | 4 | TU3MC | 55/74 | 04/93→04/02 | | | | | CLS124 |
| 1.4 SL | 4 | KDX(TU3MC) | 55/74 | 06/94→05/01 | OE034 *to be adjusted | 0,8* | CET2 | OE179 | BAEA231 CLS262 |
| 1.4 SL | 4 | KFW(TU3JP); KFX(TU3JP) | 55/74 | 06/94→05/01 | OE034 *to be adjusted | 0,8* | CET2 | OE179 | BAEA232 CLS262 →RP.7874 |
| 1.6 | 4 | NFZ(TU5JP) | 65/87 | 05/93→10/00 | OE034 | 0,9 | CET2 | OE179 | BAEA231 ^[47] CLS262 BAEA232 ^[48] →Prod.31.05.1998 →RP.07874 |
| 1.6 | 4 | | 66/89 | 07/00→05/01 | OE034 | 0,9 | CET2 | OE179 | |
| 1.6 | 4 | NFZ(TU5JP) | 66/89 | 07/00→05/01 | OE005 OE034 | 0,9 0,9 | CET2 | OE179 | |
| 1.6 | 4 | NFT(TU5JP) | 72/97 | 10/00→04/02 | OE034 | 0,9 | CET2 | OE179 | BAE946A ^[10] |
| 1.6 SR | 4 | NFZ(TU5JP) | 65/87 | 06/94→10/00 | OE034 07/95→ | 0,9 | CET2 | OE179 | BAEA231 ^[47] CLS262 BAEA232 ^[48] →Prod.31.05.1998 →RP.07874 |
| 1.8 | 4 | LFZ(XU7JP) | 74/99 | 05/93→04/02 | OE005 OE034 | 0,9 0,9 | CET2 | OE179 | BAEA232 CLS123 |
| 1.8, 1.8 ST | 4 | L6A(XU7JP); LFZ(XU7JP) | 74/99 | 05/93→04/02 | OE034 | 0,9 | CET2 | OE179 | BAEA232 CLS123 |
| 1.8 16V | 4 | LFY(XU7JP4) | 81/109 | 03/97→04/02 | OE034 | 0,9 | CET2 | OE179 | BAEA256 →RP.7608 |
| 1.8 D | 4 | A9A(XUD7) | 43/58 | 05/93→05/01 | CH189 | 11v | | | |
| 1.9 D | 4 | DJZ(XUD9Y) | 47/63 | 05/93→05/01 | CH189 | 11v | | | |
| 1.9 D | 4 | DJY(XUD9A) | 50/67 | 06/94→04/02 | CH189 | 11v | | | |
| 1.9 D | 4 | WJZ(DW8) | 51/68 | 04/93→04/02 | CH185 | 11v | | | |
| 1.9 D | 4 | WJY(DW8B) | 51/68 | 04/93→04/02 | CH185 | 11v | | | CCU149 ^[314] |
| 1.9 D | 4 | DHV(XUD9BSD) | 55/74 | 03/98→04/02 | CH189 | 11v | | | |
| 1.9 D | 4 | D8A(XUD9TE) | 68/91 | 01/93→12/97 | CH189 | 11v | | | CCU148 ^[61] →Prod.01.06.1994 CCU148 ^[49] →Prod.01.06.1995 |
| 1.9 D, 1.9 STD | 4 | D9B(XUD9A); DJY(XUD9A); XUD9 | 51/68 | 04/93→04/02 | CH189 | 11v | | | |

PEUGEOT





kW/BHP

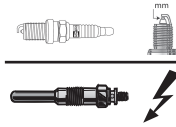

eon TITAN

IRIDIUM

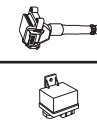

...PEUGEOT

...306

| | | | | | | | | | | |
|--------------------------|---|------------------------------|---------|-------------|------------------------------------|------|------|-----------------|--|--------|
| 1.9 DT, 1.9 SRDT, 1.9 TD | 4 | D8A(XUD9TE); DHY(XUD9TE) | 66/89 | 05/93→04/02 | CH189 | 11v | | | | |
| 1.9 SLD | 4 | DJZ(XUD9Y) | 47/63 | 06/94→05/01 | CH189 | 11v | | | | |
| 1.9 SLD | 4 | DJY(XUD9A) | 50/67 | 06/94→05/01 | CH189 | 11v | | | | |
| 2.0 | 4 | RFV(XU10J4R) | 97/130 | 03/97→04/02 | OE034 *to be adjusted | 0,8* | CET2 | OE179 | BAEA256 →Prod.07.09.1997 →RP.07608 | CLS005 |
| 2.0 | 4 | RFV(XU10J4R) | 99/133 | 05/97→06/00 | | | | | BAEA256 →Prod.07.09.1997 →RP.07608 | |
| 2.0, 2.0 ST, 2.0 XSi | 4 | RFX(XU10J2) | 89/119 | 05/93→04/02 | OE034 | 0,9 | CET2 | OE179 | BAEA232 | CLS005 |
| 2.0 16V | 4 | RFV(XU10J4R) | 97/130 | 03/97→04/02 | OE034 →03/01 *to be adjusted | 0,8* | CET2 | OE179 →03/01 | BAEA256 →Prod.07.09.1997 →RP.07608 | CLS005 |
| 2.0 16V | 4 | RFV(XU10J4R) | 99/133 | 03/97→04/02 | OE034 | 0,9 | CET2 | | BAEA256 →Prod.07.09.1997 →RP.07608 | |
| 2.0 HDI 90 | 4 | RHY(DW10TD) | 66/89 | 06/99→12/02 | CH170 | 11v | | | CCU149 | |
| 2.0 S16 | 4 | RFT(XU10J4); RFY(XU10J4Z) | 110/148 | 06/94→05/01 | OE034 *to be adjusted | 0,8* | CET2 | OE179 | BAE700AK | |
| 2.0 S16 | 4 | XU10J4TEZ | 110/148 | 06/94→05/01 | | | | | BAE700AK | |
| 2.0 S16 | 4 | RFY(XU10J4Z) | 112/150 | 05/93→05/01 | OE034 →09/99 | 0,9 | CET2 | OE179 | BAEA232 | |
| 2.0 S16 | 4 | RFS(XU10J4RS) | 120/161 | 07/96→05/01 | OE034 →09/99 *to be adjusted | 0,8* | CET2 | OE179 →09/99 | | |

307

| | | | | | | | | | | |
|--------------------------|---|---|---------|-------------|-------------------------------------|------------|------|-------|-------------------------|--|
| 1.4 | 4 | KFW(TU3JP) | 55/74 | 08/00→ | OE034 | 0,9 | CET2 | OE179 | BAE946A ^[10] | |
| 1.4 16V | 4 | KFU(ET3J4) | 65/87 | 11/03→ | OE130 | 0,9 | CET4 | | BAEA472 | |
| 1.4 HDi | 4 | 8HX(DV4TD); 8HZ(DV4TD) | 50/67 | 10/01→ | CH201 RP.10221→ | 11v | | | CCU149 ^[359] | |
| 1.4 HDi 70 | 4 | 8HZ(DV4TD) | 50/67 | 03/02→06/05 | | | | | CCU149 ^[359] | |
| 1.6 | 4 | NFU(TU5JP4) | 81/109 | 07/06→ | OE035 | 0,9 | CET5 | | | |
| 1.6 16V | 4 | NFU(TU5JP4) | 80/107 | 08/00→ | OE035 OE224 ^{LPG [279]} | 0,9 0,8 | CET5 | OE190 | BAEA045E | |
| 1.6 BioFlex | 4 | NFU(TU5JP4) | 80/107 | 09/07→ | OE035 | 0,9 | CET5 | OE190 | BAEA045E | |
| 1.6 HDi, 1.6 HDI 90 | 4 | 9HV(DV6TED4B); 9HV(DV6TED4BU); 9HX(DV6ATED4); 9HX(DV6AUTED4) | 66/89 | 04/05→ | CH201 RP.10784→ | 11v | | | | |
| 1.6 HDi 110, 1.6 HDI 110 | 4 | 9HY(DV6TED4); 9HZ(DV6TED4) | 80/107 | 02/04→ | CH201 RP.10784→ | 11v | | | CCU147 | |
| 2.0 | 4 | RFN(EW10J4) | 100/134 | 03/02→06/05 | OE178 | 0,9 | CET5 | | BAEA348 | |
| 2.0 16V | 4 | RFN(EW10J4) | 100/134 | 08/00→ | OE035 OE178 | 0,9 0,9 | CET5 | | BAEA348 | |
| 2.0 16V | 4 | RFJ(EW10A) | 103/138 | 12/04→ | OE178 | 0,9 | CET5 | | BAEA352 | |
| 2.0 16V | 4 | RFK(EW10J4S) | 130/174 | 10/03→ | OE178 OE224 ^{LPG [279]} | 0,9 0,8 | CET5 | | BAEA351 | |
| 2.0 HDi 90, 2.0 HDI 90 | 4 | RHY(DW10TD) | 66/89 | 08/00→ | CH170 | 11v | | | CCU149 ^[359] | |
| 2.0 HDi 110, 2.0 HDI 110 | 4 | RHS(DW10ATED) | 79/106 | 08/00→ | CH170 | 11v | | | CCU149 ^[359] | |
| 2.0 HDi 135 | 4 | RHR(DW10BTED4) | 100/134 | 10/03→ | CH268 | 11v | | | | |

308

| | | | | | | | | | | |
|---------|---|---------------|---------|--------|-------|-----|--------|--|---------|--|
| 1.4 16V | 4 | 8FS(EP3); EP3 | 70/94 | 09/07→ | OE203 | 1,0 | | | BAEA143 | |
| 1.4 16V | 4 | 8FR(EP3) | 72/97 | 12/09→ | OE203 | 1,0 | | | BAEA143 | |
| 1.6 | 4 | | 120/161 | 01/12→ | OE205 | 0,7 | CET16P | | | |
| 1.6 16V | 4 | 5FW(EP6); EP6 | 88/118 | 09/07→ | OE205 | 0,7 | CET16P | | BAEA143 | |
| 1.6 16V | 4 | 5FT(EP6DT) | 103/138 | 09/07→ | OE205 | 0,7 | CET16P | | BAEA143 | |
| 1.6 16V | 4 | 5FX(EP6DT) | 110/148 | 09/07→ | OE205 | 0,7 | CET16P | | BAEA143 | |

CHAMPION

PEUGEOT



kW/BHP

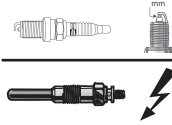

eon TITAN

IRIDIUM

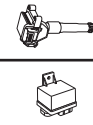
**...PEUGEOT****...308**

| | | | | | | | | | |
|-------------|---|--|---------|--------|-------|-----|--------|-------|---------|
| 1.6 16V | 4 | 5FV(EP6CDT) | 115/154 | 10/09→ | OE205 | 0,7 | CET16P | | BAEA143 |
| 1.6 16V | 4 | 5FY(EP6DTS) | 128/172 | 03/08→ | OE205 | 0,7 | CET16P | | BAEA143 |
| 1.6 BioFlex | 4 | NFU(TU5JP4) | 80/107 | 04/08→ | OE035 | 0,9 | CET5 | OE190 | |
| 1.6 GTi | 4 | EP6CDTX | 147/197 | 07/10→ | OE205 | 0,7 | | | BAEA143 |
| 1.6 HDi | 4 | 9HV(DV6TED4B); 9HV(DV6TED4BU); 9HX(DV6ATED4) | 66/89 | 09/07→ | CH201 | 11v | | | CCU147 |
| 1.6 HDi | 4 | 9HZ(DV6TED4) | 80/107 | 09/07→ | CH201 | 11v | | | CCU147 |
| 2.0 HDi | 4 | RHR(DW10BTED4); RHR(DW10CB) | 100/134 | 09/07→ | CH268 | 11v | | | |
| 2.0 HDi | 4 | RHR(DW10BTED4) | 103/138 | 07/10→ | CH268 | 11v | | | |

308 CC

| | | | | | | | | | |
|---------|---|----------------|---------|--------|-------|-----|--------|--|---------|
| 1.6 16V | 4 | EP6 | 88/118 | 06/09→ | OE205 | 0,7 | CET16P | | BAEA143 |
| 1.6 16V | 4 | 5FT(EP6DT) | 103/138 | 06/09→ | OE205 | 0,7 | CET16P | | BAEA143 |
| 1.6 16V | 4 | 5FX(EP6DT) | 110/148 | 06/09→ | OE205 | 0,7 | CET16P | | BAEA143 |
| 1.6 16V | 4 | 5FV(EP6CDT) | 115/154 | 06/09→ | OE205 | 0,7 | CET16P | | BAEA143 |
| 1.6 THP | 4 | EP6CDTX | 147/197 | 10/10→ | OE205 | 0,7 | | | |
| 2.0 HDi | 4 | RHR(DW10BTED4) | 100/134 | 04/09→ | CH268 | 11v | | | |
| 2.0 HDi | 4 | RHF(DW10BTED4) | 103/138 | 04/09→ | CH268 | 11v | | | |

308 II

| | | | | | | | | | |
|-------------|---|-------------|---------|--------|-------|-----|--------|--|---------|
| 1.2 THP 110 | 3 | HNZ(EB2DT) | 81/109 | 11/13→ | | | | | BAEA557 |
| 1.2 THP 130 | 3 | HNY(EB2DTS) | 96/129 | 11/13→ | | | | | BAEA557 |
| 1.6 | 4 | 5FV(EP6CDT) | 115/154 | 09/13→ | OE205 | 0,7 | CET16P | | |
| 1.6 THP 125 | 4 | 5FA(EP6CDT) | 92/123 | 09/13→ | OE205 | 0,7 | CET16P | | |

308 SW

| | | | | | | | | | |
|-------------|---|--|---------|--------|-------|-----|--------|-------|-------------------|
| 1.4 16V | 4 | 8FS(EP3) | 70/94 | 09/07→ | OE203 | 1,0 | | | BAEA143 |
| 1.4 16V | 4 | 8FR(EP3) | 72/97 | 12/09→ | OE203 | 1,0 | | | BAEA143 |
| 1.6 16V | 4 | 5FW(EP6); EP6 | 88/118 | 09/07→ | OE205 | 0,7 | CET16P | | BAEA143 05/08→ |
| 1.6 16V | 4 | 5FT(EP6DT) | 103/138 | 09/07→ | OE205 | 0,7 | CET16P | | BAEA143 |
| 1.6 16V | 4 | 5FX(EP6DT) | 110/148 | 09/07→ | OE205 | 0,7 | CET16P | | BAEA143 |
| 1.6 16V | 4 | 5FV(EP6CDT) | 115/154 | 10/09→ | OE205 | 0,7 | CET16P | | BAEA143 |
| 1.6 16V | 4 | 5FY(EP6DTS) | 128/172 | 03/08→ | OE205 | 0,7 | CET16P | | BAEA143 |
| 1.6 Bioflex | 4 | NFU(TU5JP4) | 82/110 | 03/09→ | OE035 | 0,9 | CET5 | OE190 | BAEA045E |
| 1.6 HDi | 4 | 9HV(DV6TED4B); 9HV(DV6TED4BU); 9HX(DV6ATED4) | 66/89 | 09/07→ | CH201 | 11v | | | |
| 1.6 HDi | 4 | 9HZ(DV6TED4) | 80/107 | 09/07→ | CH201 | 11v | | | CCU147 |
| 2.0 Bioflex | 4 | RFJ(EW10A) | 103/138 | 01/08→ | OE178 | 0,9 | CET5 | | |
| 2.0 HDi | 4 | RHR(DW10BTED4) | 100/134 | 09/07→ | CH268 | 11v | | | |
| 2.0 HDi | 4 | RHR(DW10BTED4) | 103/138 | 09/07→ | CH268 | 11v | | | |

308 SW II

| | | | | | | | | | |
|-------------|---|-------------|---------|--------|-------|-----|--------|--|---------|
| 1.2 THP 110 | 3 | HNZ(EB2DT) | 81/109 | 03/14→ | | | | | BAEA557 |
| 1.2 THP 130 | 3 | HNY(EB2DTS) | 96/129 | 03/14→ | | | | | BAEA557 |
| 1.6 THP 155 | 4 | 5FV(EP6CDT) | 115/154 | 03/14→ | OE205 | 0,7 | CET16P | | |

405 II

| | | | | | | | | | |
|---------|---|-------------|---------|-------------|-------|-----|------|-------|----------|
| 1.8 | 4 | LFZ(XU7JP) | 76/102 | 08/96→11/99 | OE034 | 0,9 | CET2 | OE179 | |
| 1.9 D | 4 | DJY(XUD9A) | 50/67 | 06/94→10/96 | CH189 | 11v | | | |
| 2.0 16V | 4 | RFT(XU10J4) | 110/148 | 06/94→10/95 | OE034 | 0,9 | CET2 | OE188 | BAE700AK |

406

| | | | | | | | | | |
|-----|---|------------------------|-------|-------------|-------|-----|------|-------|-------------------|
| 1.6 | 4 | BFZ(XU5JP) | 65/87 | 11/95→05/04 | OE034 | 0,9 | CET2 | OE179 | BAEA232 CLS123 |
| 1.8 | 4 | LFX(XU7JB) | 66/89 | 05/97→10/04 | OE034 | 0,9 | CET2 | OE179 | BAEA232 CLS123 |
| 1.8 | 4 | L6A(XU7JP); LFZ(XU7JP) | 74/99 | 10/96→03/99 | | | | | BAEA232 |

PEUGEOT





kW/BHP



eon TITAN

IRIDIUM



...PEUGEOT

...406

| | | | | | | | | | | |
|---------------------|---|-----------------------------------|---------|-------------|--|------------|--------|-------|---|--------|
| 1.8 16V | 4 | LFY(XU7JP4) | 81/109 | 11/95→10/00 | OE034 | 0,9 | CET2 | OE179 | BAEA256 →RP.7608 | |
| 1.8 16V | 4 | 6FZ(EW7J4) | 85/114 | 10/00→10/04 | OE178 | 0,9 | CET5 | | BAEA348 | |
| 1.9 D | 4 | DHW(XUD9SD) | 55/74 | 10/96→10/04 | CH189 | 11v | | | | |
| 1.9 TD | 4 | DHX(XUD9TE) | 66/89 | 01/96→10/04 | CH189 | 11v | | | CCU149 ^[315] | |
| 1.9 TD | 4 | DHY(XUD9TE) | 68/91 | 01/96→05/04 | CH189 | 11v | | | CCU149 ^[315] | |
| 1.9 TD | 4 | D8B(XUD9TE) | 69/93 | 10/95→10/97 | | | | | CCU149 ^[51] | |
| 2.0 | 4 | RGY(XU10J2TE) | 104/139 | 11/96→03/99 | OE034 | 0,9 | CET2 | OE179 | | |
| 2.0 16V | 4 | RFV(XU10J4R) | 97/130 | 11/95→12/04 | OE019 | 0,9 | CET2 | OE184 | BAEA256 →Prod.05.10.1997 →RP.07636 | CLS005 |
| 2.0 16V | 4 | RFR(EW10J4) | 99/133 | 01/99→09/04 | OE178 | 0,9 | CET5 | | BAEA348 | |
| 2.0 16V | 4 | RFV(XU10J4R) | 99/133 | 01/99→09/04 | | | | | BAEA256 →Prod.05.10.1997 →RP.07636 | |
| 2.0 16V | 4 | RFN(EW10J4) | 100/134 | 08/00→12/04 | OE178 | 0,9 | CET5 | | BAEA348 BAEA256 →Prod.05.10.1997 →RP.07636 | |
| 2.0 16V | 4 | RFV(XU10J4R) | 100/134 | 08/00→12/04 | OE178 | 0,9 | CET5 | | BAEA256 →Prod.05.10.1997 →RP.07636 | |
| 2.0 HDI 90 | 4 | RHY(DW10TD) | 66/89 | 02/99→10/04 | CH170 | 11v | | | CCU149 ^[359] →RP.09741 | |
| 2.0 HDi 110 | 4 | RHS(DW10ATED); RHZ(DW10ATED) | 79/106 | 08/01→10/04 | CH170 | 11v | | | CCU149 ^[359] →RP.09820 | |
| 2.0 HDI 110 | 4 | RHZ(DW10ATED) | 80/107 | 06/98→04/04 | CH170 | 11v | | | CCU149 ^[359] →RP.09820 | |
| 2.0 Turbo | 4 | RGX(XU10J2TE) | 108/145 | 04/96→10/04 | OE034 | 0,9 | CET2 | OE179 | BAEA232 | CLS005 |
| 2.1 TD 12V | 4 | P8C(XUD11BTE) | 80/107 | 01/96→10/04 | CH189 | 11v | | | | |
| 2.2 | 4 | 3FZ(EW12J4) | 116/156 | 07/00→12/04 | OE178 | 0,9 | CET5 | | BAEA351 | |
| 2.2 HDi, 2.2 HDI | 4 | 4HX(DW12TED4/FAP) | 98/131 | 03/00→12/04 | CH170 →RP.09666 CH268 RP.09667→ | 11v 11v | | | CCU149 ^[359] | |
| 3.0 24V, 3.0 V6 24V | 6 | XFZ(ES9J4) | 140/188 | 10/96→12/04 | OE026 | 0,9 | CET2 | OE188 | | |
| 3.0 V6 | 6 | AFX(ES9J4S) | 152/204 | 03/00→12/04 | OE175 | 1,0 | CET14P | OE190 | BAEA347 | |
| 407 | | | | | | | | | | |
| 1.6 HDi 110 | 4 | 9HZ(DV6TED4) | 80/107 | 05/04→ | CH201 RP.10784→ | 11v | | | CCU147 | |
| 1.8 | 4 | 6FZ(EW7J4) | 85/114 | 05/04→ | OE178 | 0,9 | CET5 | | BAEA348 BAEA351 | |
| 1.8 16V | 4 | 6FY(EW7A) | 92/123 | 09/05→ | OE178 | 0,9 | CET5 | | BAEA352 | |
| 2.0 | 4 | RFN(EW10J4) | 100/134 | 05/04→ | OE178 | 0,9 | CET5 | | BAEA348 | |
| 2.0 16V | 4 | RFJ(EW10A) | 103/138 | 09/05→ | OE178 | 0,9 | CET5 | | BAEA352 01/06→ | |
| 2.0 Bioflex | 4 | RFJ(EW10A) | 103/138 | 09/07→ | OE178 | 0,9 | CET5 | | | |
| 2.0 HDi | 4 | RHR(DW10BTED4) | 100/134 | 10/05→ | CH268 | 11v | | | | |
| 2.0 HDi | 4 | RHF(DW10BTED4); RHR(DW10BTED4) | 103/138 | 08/08→ | CH268 | 11v | | | | |
| 2.0 HDi 135 | 4 | RHR(DW10BTED4) | 100/134 | 05/04→ | CH268 | 11v | | | CCU147 | |
| 2.2 | 4 | 3FZ(EW12J4) | 116/156 | 05/04→ | OE178 | 0,9 | CET5 | | BAEA351 | |
| 2.2 16V | 4 | 3FY(EW12J4) | 120/161 | 09/05→ | OE178 | 0,9 | CET5 | | BAEA351 | |
| 2.7 HDi | 6 | UHZ(DT17) | 150/201 | 10/05→ | CH240 | 11v | | | | |
| 3.0, 3.0 V6 | 6 | XFV(ES9A) | 155/208 | 05/04→ | OE175 | 1,0 | CET14P | OE190 | BAEA347 | |
| 408 | | | | | | | | | | |
| 1.6 16V | 4 | | 80/107 | 02/10→ | OE205 | 0,7 | CET16P | | | |
| 1.6 Vti | 4 | SFS(EP6C) | 88/118 | 01/12→ | OE205 | 0,7 | CET16P | | BAEA143 | |

PEUGEOT





kW/BHP

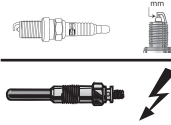

eon TITAN

IRIDIUM

**...PEUGEOT****508 I**

| | | | | | | | | | |
|---------|---|----------------------------------|---------|--------|-------|-----|--------|---------|--|
| 1.6 | 4 | 5GZ(EP6FDT) | 120/161 | 01/12→ | OE205 | 0,7 | CET16P | | |
| 1.6 THP | 4 | 5FN(EP6CDT) | 110/148 | 11/10→ | OE205 | 0,7 | CET16P | | |
| 1.6 THP | 4 | 5FV(EP6CDT) | 115/154 | 11/10→ | OE205 | 0,7 | CET16P | BAEA143 | |
| 1.6 VTi | 4 | 5FH(EP6C) | 85/114 | 11/10→ | OE205 | 0,7 | CET16P | BAEA143 | |
| 1.6 VTi | 4 | 5FS(EP6C) | 88/118 | 11/10→ | OE205 | 0,7 | CET16P | BAEA143 | |
| 2.0 HDi | 4 | RHR(DW10BTD4) | 100/134 | 11/10→ | CH268 | 11v | | | |
| 2.0 HDi | 4 | RHA(DW10CTED4); RHF(DW10BTD4) | 103/138 | 11/10→ | CH268 | 11v | | | |

508 SW I

| | | | | | | | | | |
|---------|---|----------------------------------|---------|--------|-------|-----|--------|---------|--|
| 1.6 THP | 4 | 5FX(EP6DT) | 110/148 | 11/10→ | OE205 | 0,7 | CET16P | | |
| 1.6 THP | 4 | 5FV(EP6CDT) | 115/154 | 11/10→ | OE205 | 0,7 | CET16P | BAEA143 | |
| 1.6 VTi | 4 | 5FH(EP6C) | 85/114 | 11/10→ | OE205 | 0,7 | CET16P | BAEA143 | |
| 1.6 VTi | 4 | 5FS(EP6C) | 88/118 | 11/10→ | OE205 | 0,7 | CET16P | BAEA143 | |
| 2.0 HDi | 4 | RHR(DW10BTD4) | 100/134 | 11/10→ | CH268 | 11v | | | |
| 2.0 HDi | 4 | RHA(DW10CTED4); RHF(DW10BTD4) | 103/138 | 11/10→ | CH268 | 11v | | | |

605

| | | | | | | | | | |
|------------------|---|---------------------------------|---------|-------------|--------------------------|------|------|-------|--|
| 2.0 16V | 4 | RFV(XU10J4R) | 97/130 | 07/94→09/99 | OE034 *to be adjusted | 0,8* | CET2 | OE179 | BAEA256 →Prod.07.09.1997 →RP.07608 |
| 2.1 TD 12V | 4 | P8C(XUD11BTE); PHZ(XUD11ATE) | 80/107 | 08/94→09/99 | CH189 | 11v | | | CCU148 |
| 2.5 Turbo Diesel | 4 | THY(DKSATE) | 95/127 | 07/94→09/99 | CH189 | 11v | | | CCU149 ^[315] |
| 3.0 V6 | 6 | XFZ(ES9J4) | 140/188 | 04/97→09/99 | OE026 | 0,9 | CET2 | OE188 | |

607

| | | | | | | | | | |
|-------------|---|------------------------|---------|-------------|--|-----|--------|-------|--------------------------------------|
| 2.0 | 4 | RFN(EW10J4) | 100/134 | 02/00→08/05 | OE178 | 0,9 | CET5 | | BAEA348 05/00→ |
| 2.0 HDi | 4 | RHS(DW10ATED) | 79/106 | 03/01→09/04 | CH170 | 11v | | | CCU149 ^[359] →RP.09820 |
| 2.0 HDI | 4 | RHZ(DW10ATED) | 80/107 | 05/00→09/05 | CH170 | 11v | | | CCU149 ^[359] →RP.09820 |
| 2.0 HDI | 4 | RHR(DW10BTD4) | 100/134 | 09/05→07/11 | CH268 | 11v | | | |
| 2.2 16V | 4 | 3FZ(EW12J4) | 116/156 | 02/00→08/05 | OE178 | 0,9 | CET5 | | BAEA351 05/00→ |
| 2.2 16V | 4 | 3FY(EW12J4) | 120/161 | 09/05→06/10 | OE178 | 0,9 | CET5 | | BAEA351 |
| 2.2 HDi | 4 | 4HX(DW12TED4/FAP) | 98/131 | 02/00→02/06 | CH170 →RP.09666 CH268 RP.09667→ | 11v | | | CCU149 ^[359] |
| 2.7 HDi 24V | 6 | DT17TED4 | 150/201 | 12/04→07/11 | CH240 | 11v | | | |
| 3.0 V6 24V | 6 | XFX(ES9J4S) | 152/204 | 02/00→07/04 | OE175 | 1,0 | CET14P | OE190 | BAEA347 |
| 3.0 V6 24V | 6 | XFV(ES9A); XFX(ES9J4S) | 155/208 | 03/04→07/11 | OE175 | 1,0 | CET14P | OE190 | BAEA347 10/04→ |

806

| | | | | | | | | | |
|----------------------|---|----------------------------------|---------|-------------|-------|-----|------|-------|-------------------------|
| 1.8 | 4 | LFW(XU7JP) | 73/98 | 07/95→08/02 | OE034 | 0,9 | CET2 | OE179 | BAEA232 |
| 1.9 TD | 4 | DHX(XUD9TE) | 66/89 | 07/95→08/02 | CH189 | 11v | | | CCU149 ^[315] |
| 1.9 TD | 4 | DHY(XUD9TE) | 68/91 | 05/97→08/02 | CH189 | 11v | | | CCU149 ^[315] |
| 2.0 | 4 | RFU(XU10J2) | 89/119 | 06/94→08/02 | OE034 | 0,9 | CET2 | OE179 | BAEA232 |
| 2.0 16V | 4 | RFV(XU10J4R) | 97/130 | 05/98→09/00 | OE034 | 0,9 | CET2 | OE179 | BAEA232 |
| 2.0 16V | 4 | RFN(EW10J4) | 100/134 | 09/00→08/02 | OE178 | 0,9 | CET5 | | BAEA348 →05/02 |
| 2.0 HDI, 2.0 HDI 16V | 4 | RHW(DW10ATED4); RHZ(DW10ATED) | 80/107 | 08/99→08/02 | CH170 | 11v | | | CCU149 |
| 2.0 Turbo | 4 | RGX(XU10J2TE) | 108/145 | 06/94→08/02 | OE034 | 0,9 | CET2 | OE179 | BAEA232 |
| 2.1 td 12V | 4 | P8C(XUD11BTE) | 80/107 | 06/96→08/99 | CH189 | 11v | | | CLS005 |

807

| | | | | | | | | | |
|-----|---|-------------|---------|--------|-------|-----|------|--|---------|
| 2.0 | 4 | RFN(EW10J4) | 100/134 | 06/02→ | OE178 | 0,9 | CET5 | | BAEA348 |
|-----|---|-------------|---------|--------|-------|-----|------|--|---------|

PEUGEOT



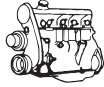

kW/BHP



eon TITAN

IRIDIUM



...PEUGEOT

...807

| | | | | | | | | | |
|---------|---|--|---------|--------|--------------------|-----|--------|-------|-------------------|
| 2.0 16V | 4 | RFJ(EW10A) | 103/138 | 09/05→ | OE178 | 0,9 | CET5 | | BAEA352 02/06→ |
| 2.0 HDi | 4 | RHM(DW10ATED4); RHT(DW10ATED4); RHW(DW10ATED4) | 79/106 | 06/02→ | CH170 →RP.09666 | 11v | | | CCU149 |
| | | | | | CH268 RP.09667→ | 11v | | | |
| 2.0 HDi | 4 | RHW(DW10ATED4) | 80/107 | 04/04→ | CH170 →RP.09666 | 11v | | | CCU149 |
| | | | | | CH268 RP.09667→ | 11v | | | |
| 2.0 HDi | 4 | RHK(DW10ATED4) | 88/118 | 02/06→ | CH268 | 11v | | | |
| 2.0 HDI | 4 | RHD(DW10ATED4); RHR(DW10ATED4) | 100/134 | 06/06→ | CH268 | 11v | | | |
| 2.2 | 4 | 3FZ(EW12J4) | 116/156 | 06/02→ | OE178 | 0,9 | CET5 | | BAEA351 |
| 2.2 HDi | 4 | 4HW(DW12ATED4); 4HW(DW12ATED4) | 94/126 | 06/02→ | CH170 →RP.09666 | 11v | | | CCU149 |
| | | | | | CH268 RP.09667→ | 11v | | | |
| 3.0 V6 | 6 | XFX(ES9J4S) | 150/201 | 06/02→ | OE175 | 1,0 | CET14P | OE190 | BAEA347 |

1007

| | | | | | | | | | |
|---------|---|------------------------|--------|--------|----------------------------|-----|------|-------|--|
| 1.4 | 4 | KFV(TU3A); KFV(TU3JP) | 54/72 | 04/05→ | OE034 | 0,9 | CET2 | OE179 | BAEA048E ^[7] 09/05→ BAE946A ^[10] |
| 1.4 16V | 4 | KFU(ET3J4) | 65/87 | 10/05→ | OE130 | 0,9 | CET4 | | BAEA472 |
| 1.4 HDi | 4 | 8HX(DV4TD); 8HZ(DV4TD) | 50/67 | 04/05→ | CH201 | 11v | | | CCU149 ^[318] |
| 1.6 16V | 4 | NFU(TU5JP4) | 80/107 | 04/05→ | OE035 | 0,9 | CET5 | OE190 | BAEA045E |
| | | | | | OE224 ^{LPG [279]} | 0,8 | | | |
| 1.6 HDi | 4 | 9HZ(DV6TED4) | 80/107 | 06/07→ | CH201 | 11v | | | CCU147 |

2008

| | | | | | | | | | |
|-------------|---|-------------|--------|--------|-------|-----|--------|-------|---------|
| 1.2 THP 110 | 3 | HNZ(EB2DT) | 81/109 | 01/15→ | | | | | BAEA557 |
| 1.2 THP 130 | 3 | HNY(EB2DTS) | 96/129 | 01/15→ | | | | | BAEA557 |
| 1.2 VTi | 3 | HMZ(EB2F) | 60/80 | 03/13→ | | | | OE263 | |
| 1.6 VTi | 4 | 5FS(EP6C) | 88/118 | 03/13→ | OE205 | 0,7 | CET16P | | BAEA143 |

3008

| | | | | | | | | | |
|---------|---|---|---------|--------|-------|-----|--------|--|---------|
| 1.2 | 3 | HNY(EB2DTS) | 96/129 | 01/15→ | | | | | BAEA557 |
| 1.6 HDi | 4 | 9HZ(DV6TED4) | 80/107 | 06/09→ | CH201 | 11v | | | CCU147 |
| 1.6 THP | 4 | 5FE(EP6CDTM); 5FE(EP6CDTMD); 5FX(EP6DT) | 110/148 | 06/09→ | OE205 | 0,7 | CET16P | | BAEA143 |
| 1.6 THP | 4 | 5FV(EP6CDT) | 115/154 | 06/09→ | OE205 | 0,7 | CET16P | | BAEA143 |
| 1.6 VTi | 4 | 5FS(EP6C); 5FW(EP6); EP6 | 88/118 | 06/09→ | OE205 | 0,7 | CET16P | | BAEA143 |

4007

| | | | | | | | | | |
|--------------|---|---------------------------------|---------|--------|--|--|--------|-------|--|
| 2.0, 2.0 4WD | 4 | 4B11 | 108/145 | 11/10→ | | | CET12P | OE182 | |
| 2.4 16V 4WD | 4 | SFY(4B12-MMC); SFZ(4B12-MMC) | 125/168 | 01/08→ | | | CET12P | OE180 | |

5008

| | | | | | | | | | |
|---------|---|--------------------------|---------|--------|-------|-----|--------|--|---------|
| 1.2 | 3 | HNY(EB2DTS) | 96/129 | 01/15→ | | | | | BAEA557 |
| 1.6 16V | 4 | 5FS(EP6C); 5FW(EP6); EP6 | 88/118 | 09/09→ | OE205 | 0,7 | CET16P | | BAEA143 |
| 1.6 16V | 4 | 5FV(EP6CDT) | 115/154 | 09/09→ | OE205 | 0,7 | CET16P | | BAEA143 |
| 1.6 HDi | 4 | 9HZ(DV6TED4) | 80/107 | 09/09→ | CH201 | 11v | | | CCU147 |

BIPPER Tepee

| | | | | | | | | | |
|---------|---|-------------|-------|--------|-------|-----|------|-------|-------------------------|
| 1.4 | 4 | KFV(TU3A) | 54/72 | 04/08→ | OE034 | 0,9 | CET2 | OE179 | BAEA048E ^[7] |
| 1.4 HDi | 4 | 8HS(DV4TED) | 50/67 | 04/08→ | CH201 | 11v | | | |

EXPERT

| | | | | | | | | | |
|-----|---|----------------|-------|-------------|-------|-----|------|-------|---------|
| 1.6 | 4 | 222A2(1580SPI) | 58/78 | 02/96→09/00 | OE014 | 0,9 | CET2 | OE179 | BAEA234 |
| 1.8 | 4 | LFZ(XU7JP) | 74/99 | 10/96→09/00 | OE034 | 0,9 | CET2 | OE179 | BAEA232 |

PEUGEOT



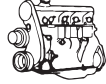

kW/BHP

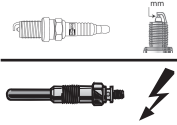

eon TITAN

IRIDIUM

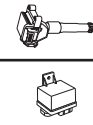
**...PEUGEOT****...EXPERT**

| | | | | | | | | | |
|----------------------|---|---|---------|-------------|--------------------|-----|------|--------------------------------------|---------|
| 1.9 D | 4 | WJZ(DW8) | 51/68 | 02/96→12/06 | CH185 | 11v | | | |
| 1.9 D | 4 | WJY(DW8B) | 51/68 | 02/96→12/06 | CH185 | 11v | | CCU149 | |
| 1.9 D | 4 | D9B(XUD9AU) | 51/68 | 02/96→12/06 | CH189 | 11v | | | |
| 1.9 TD | 4 | DHX(XUD9TE) | 66/89 | 02/96→09/00 | CH189 | 11v | | CCU149 ^[315] →RP.07846 | |
| 1.9 TD | 4 | D8B(XUD9TE) | 68/91 | 02/96→05/98 | CH189 | 11v | | CCU149 ^[315] →RP.07846 | |
| 2.0 | 4 | RFN(EW10J4) | 100/134 | 07/00→12/06 | OE178 | 0,9 | CET5 | | BAEA348 |
| 2.0 HDi | 4 | RHX(DW10BTD) | 69/93 | 10/00→10/06 | CH170 | 11v | | CCU149 | |
| 2.0 HDi, 2.0 HDi 16V | 4 | RHW(DW10ATED4); RHZ(DW10ATED); RHZ(DW10BTD); RHZ(DW10BTD+); RHZ(DW10CTED) | 80/107 | 07/00→12/06 | CH170 →RP.09666 | 11v | | CCU149 | |
| | | | | | CH268 RP.09667→ | 11v | | | |

EXPERT Tepee

| | | | | | | | | | |
|------------------------------|---|------------------------|---------|--------|-------|-----|------|--------|---------|
| 1.6 HDi 90 16V | 4 | 9HU(DV6UTED4) | 66/89 | 01/07→ | CH201 | 11v | | | |
| 2.0 16V | 4 | RFH(EW10A); RFJ(EW10A) | 103/138 | 01/07→ | OE178 | 0,9 | CET5 | | BAEA352 |
| 2.0 HDi 120, 2.0 HDi 120 4WD | 4 | RHK(DW10UTED4) | 88/118 | 01/07→ | CH268 | 11v | | | |
| 2.0 HDi 140 | 4 | RHR(DW10BTD4) | 100/134 | 01/07→ | CH268 | 11v | | CCU149 | |

PARTNER

| | | | | | | | | | | |
|----------------------|---|-----------------------------|--------|-------------|-------------------------------------|------------|------|-------|--|--------|
| 1.1 | 4 | HDZ(TU1M); HFX(TU1JP) | 44/59 | 06/96→10/02 | OE034 | 0,9 | CET2 | OE179 | BAEA232 | CLS262 |
| 1.4 | 4 | KFW(TU3JP) | 54/72 | 11/02→10/06 | OE034 | 0,9 | CET2 | OE179 | BAE946A ^[10] | |
| 1.4 | 4 | KFW(TU3A); KFX(TU3JP); TU32 | 55/74 | 06/96→12/15 | OE034 | 0,9 | CET2 | OE179 | BAEA048E ^[7] 09/05→ | CLS262 |
| 1.4 | 4 | KFW(TU3JP) | 55/74 | 06/96→12/15 | OE034 | 0,9 | CET2 | OE179 | BAEA048E ^[7] 09/05→ BAE946A ^[10] | CLS262 |
| 1.6 16V | 4 | NFU(TU5JP4) | 80/107 | 07/01→03/08 | OE035 OE224 ^{LPG [279]} | 0,9 0,8 | CET5 | OE190 | BAEA045E | |
| 1.6 HDi 75 | 4 | 9HW(DV6BTED4) | 55/74 | 02/06→12/13 | CH201 | 11v | | | | |
| 1.6 HDi 90 | 4 | 9HX(DV6ATED4) | 66/89 | 10/05→12/15 | CH201 RP.10784→ | 11v | | | | |
| 1.8 | 4 | LFX(XU7JB) | 66/89 | 05/97→12/03 | OE034 | 0,9 | CET2 | OE179 | BAEA232 | CLS123 |
| 1.9 D | 4 | DJY(XUD9A) | 50/67 | 06/96→12/02 | CH189 | 11v | | | | |
| 1.9 D | 4 | WJZ(DW8) | 51/68 | 05/96→07/08 | CH185 | 11v | | | | |
| 1.9 D | 4 | XUD9 | 51/68 | 05/96→07/08 | CH189 | 11v | | | | |
| 1.9 D, 1.9 D 4WD | 4 | WJY(DW8B) | 51/68 | 05/96→07/08 | CH185 | 11v | | | CCU149 ^[318] | |
| 2.0 HDi, 2.0 HDi 4WD | 4 | RHY(DW10TD) | 66/89 | 02/00→07/08 | CH170 | 11v | | | CCU149 ^[359] | |

PARTNER Tepee

| | | | | | | | | | | |
|-------------|---|----------------------------------|--------|--------|--------------------|-----|--------|-------|----------|--|
| 1.6 | 4 | NFR(TU5JP4B) | 66/89 | 04/08→ | OE035 | 0,9 | CET5 | OE190 | BAEA045E | |
| 1.6 | 4 | 5FK(EP6CB) | 72/97 | 08/10→ | OE205 | 0,7 | CET16P | | BAEA143 | |
| 1.6 | 4 | NFU(TU5JP4) | 80/107 | 04/08→ | OE035 | 0,9 | CET5 | OE190 | BAEA045E | |
| 1.6 | 4 | NFU(TU5JP4) | 81/109 | 09/08→ | OE035 | 0,9 | CET5 | | BAEA045E | |
| 1.6 | 4 | 5FS(EP6C) | 88/118 | 04/10→ | OE205 | 0,7 | CET16P | | BAEA143 | |
| 1.6 HDi | 4 | | 55/74 | 04/08→ | CH201 RP.10784→ | 11v | | | | |
| 1.6 HDi | 4 | 9HZ(DV6TED4) | 80/107 | 04/08→ | CH201 | 11v | | | CCU147 | |
| 1.6 HDi 16V | 4 | 9HV(DV6TED4B); 9HV(DV6TED4BU) | 66/89 | 04/08→ | CH201 | 11v | | | | |

RCZ

| | | | | | | | | | | |
|---------|---|-------------|---------|--------|-------|-----|--------|--|---------|--|
| 1.6 16V | 4 | 5FV(EP6CDT) | 115/154 | 03/10→ | OE205 | 0,7 | CET16P | | BAEA143 | |
| 1.6 16V | 4 | EP6CDTX | 147/197 | 06/10→ | OE205 | 0,7 | | | BAEA143 | |

PEUGEOT



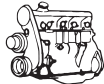

kW/BHP

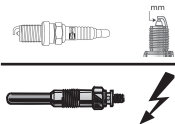

eon TITAN

IRIDIUM

**PEUGEOT****106 Van**

| | | | | | | | | | |
|-------|---|-----------|-------|---------------|-------|-----|--|--|--|
| 1.5 D | 4 | VJY(TUD5) | 40/54 | 05/96 → 03/01 | CH185 | 11v | | | |
| 1.5 D | 4 | VJX(TUD5) | 42/56 | 10/00 → 03/01 | CH185 | 11v | | | |

205

| | | | | | | | | | |
|------------|---|------------|-------|---------------|-------|-----|--|--|--|
| 1.7 Diesel | 4 | 161A(XUD7) | 44/59 | 03/94 → 05/97 | CH189 | 11v | | | |
|------------|---|------------|-------|---------------|-------|-----|--|--|--|

206 Van

| | | | | | | | | | |
|---------|---|------------------------|-------|---------------|---------------------|-----|--|--|-------------------------|
| 1.4 HDi | 4 | 8HX(DV4TD); 8HZ(DV4TD) | 50/67 | 09/01 → 03/09 | CH201 RP.10444 → | 11v | | | CCU149 ^[359] |
| 1.9 D | 4 | WJY(DW8B); WJZ(DW8) | 51/68 | 04/99 → 05/07 | CH185 | 11v | | | CCU149 ^[315] |

207

| | | | | | | | | | |
|---------|---|-----------------------------|-------|---------------|-------|-----|--|--|--------|
| 1.4 HDi | 4 | 8HZ(DV4TD) | 50/67 | 04/07 → | CH201 | 11v | | | CCU147 |
| 1.6 HDi | 4 | 9HV(DV6TED4); 9HX(DV6ATED4) | 66/89 | 04/07 → 10/12 | CH201 | 11v | | | |

306

| | | | | | | | | | |
|---------|---|------------|-------|---------------|-------|-----|--|--|--|
| 1.4 | 4 | KFW(TU3JP) | 55/74 | 03/96 → 07/01 | | | | | BAEA232 ^[275] → 06/98 |
| 1.9 D | 4 | XUD9TE | 69/93 | 02/94 → 04/99 | CH189 | 11v | | | CCU148 ^[61] → Prod.01.06.1994 CCU148 ^[49] → Prod.01.06.1995 |
| 1.9 STD | 4 | XUD9 | 51/68 | 02/94 → 05/99 | CH189 | 11v | | | |

BIPPER

| | | | | | | | | | |
|---------|---|-------------|-------|---------|-------|-----|------|-------|-------------------------|
| 1.4 | 4 | KFV(TU3A) | 54/72 | 02/08 → | OE034 | 0,9 | CET2 | OE179 | BAEA048E ^[7] |
| 1.4 HDi | 4 | 8HS(DV4TED) | 50/67 | 02/08 → | CH201 | 11v | | | |

BOXER

| | | | | | | | | | |
|-------------------------------|---|----------------------|---------|---------------|--|-------|------|-------|----------------|
| 1.9 D | 4 | DJY(XUD9A) | 50/67 | 07/99 → 04/02 | CH189 | 11v | | | |
| 1.9 D | 4 | D9B(XUD9AU) | 51/68 | 03/94 → 04/02 | CH189 | 11v | | | |
| 1.9 DT 4WD, 1.9 TD | 4 | XUD9TE | 66/89 | 06/94 → 04/02 | CH189 | 11v | | | |
| 1.9 TD | 4 | DHY(XUD9TE) | 66/89 | 06/94 → 04/02 | CH189 | 11v | | | |
| 1.9 TD, 1.9 TD 4WD | 4 | D8C(XUD9UTF); XUD9TE | 68/91 | 03/94 → 04/02 | CH189 | 11v | | | |
| 2.0 | 4 | RFL(XU10J2U) | 81/109 | 12/01 → | OE034 | 0,9 | CET2 | OE179 | BAEA232 CLS123 |
| 2.0 4WD | 4 | RFW(XU10J2) | 80/107 | 03/96 → 09/98 | OE034 | 0,9 | CET2 | | CLS123 |
| 2.0 HDi | 4 | RHV(DW10TD) | 62/83 | 04/02 → | CH170 | 11v | | | CCU149 |
| 2.0 HDi, 2.0 HDi | 4 | RHV(DW10UTD) | 62/83 | 08/01 → | CH170 | 11v | | | |
| 2.0 i, 2.0 i 4WD | 4 | RFW(XU10J2) | 80/107 | 03/94 → 04/02 | OE034 | 0,9 | CET2 | OE179 | BAEA232 CLS123 |
| 2.2 HDi | 4 | 4HY(DW12UTED) | 74/99 | 04/02 → | CH170 ^[134] → 04/03 CH268 ^[136] 05/03 → | 11v | | | CCU149 |
| 2.2 HDi 100 | 4 | 4HV(P22DTE) | 74/99 | 04/06 → | CH229 | 11.5v | | | |
| 2.2 HDi 120 | 4 | 4HU(P22DTE) | 88/118 | 04/06 → | CH229 | 11.5v | | | |
| 2.5 D, 2.5 D 4WD | 4 | T9A(DJ5) | 63/84 | 03/94 → 04/02 | CH189 | 11v | | | |
| 2.5 TD, 2.5 TD 4WD | 4 | T8A(DJ5T) | 76/102 | 03/94 → 04/02 | CH189 | 11v | | | |
| 2.8 D | 4 | 8140.63(F28D) | 64/86 | 01/99 → 02/02 | CH216 | 11v | | | |
| 2.8 HDi | 4 | 8140.43N | 107/143 | 04/04 → | CH216 | 11v | | | CCU149 |
| 2.8 HDi, 2.8 HDi, 2.8 HDi 4WD | 4 | 8140.43S(F28DTCR) | 94/126 | 10/00 → | CH216 | 11v | | | CCU149 |
| 2.8 HDi, 2.8 HDi 4WD | 4 | 8140.43S(F28DTCR) | 93/125 | 10/00 → 09/09 | CH216 | 11v | | | CCU149 |
| 3.0 HDi | 4 | F1CE0481D(F30DT) | 115/154 | 07/06 → | CH270 | 11v | | | |
| 3.0 HDi 145 | 4 | F1CE3481N(F30DTE) | 107/143 | 04/10 → | CH270 | 11v | | | |
| 3.0 HDi 160 | 4 | F1CE0481D(F30DT) | 116/156 | 04/06 → | CH270 | 11v | | | |
| 3.0 HDi 175 | 4 | F1CE3481E(F30DTE) | 130/174 | 03/11 → | CH270 | 11v | | | |

EXPERT

| | | | | | | | | | |
|----------------|---|----------------|-------|---------------|-------|-----|------|-------|---------|
| 1.6 | 4 | 222A2(1580SPI) | 58/78 | 02/96 → 09/00 | OE014 | 0,9 | CET2 | OE179 | BAEA234 |
| 1.6 HDi 90 16V | 4 | 9HU(DV6UTED4) | 66/89 | 01/07 → | CH201 | 11v | | | |
| 1.8 | 4 | LFZ(XU7JP) | 74/99 | 10/96 → 09/00 | OE034 | 0,9 | CET2 | OE179 | BAEA232 |





kW/BHP

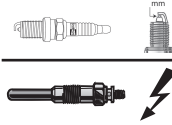

eon TITAN

IRIDIUM



...PEUGEOT

...EXPERT

| | | | | | | | | | |
|------------------------------|---|---|---------|-------------|--------------------|-----|------|--------------------------------------|--|
| 1.9 D | 4 | D9B(XUD9AU) | 51/68 | 02/96→09/01 | CH189 | 11v | | | |
| 1.9 D, 1.9 D 70 | 4 | WJZ(DW8) | 51/68 | 02/96→12/06 | CH185 | 11v | | | |
| 1.9 D, 1.9 D 70 | 4 | WJY(DW8B) | 51/68 | 02/96→12/06 | CH185 | 11v | | CCU149 | |
| 1.9 TD | 4 | DHX(XUD9TE) | 66/89 | 02/96→09/00 | CH189 | 11v | | CCU149 ^[315] →RP.07846 | |
| 1.9 TD | 4 | D8B(XUD9TE) | 68/91 | 02/96→05/98 | CH189 | 11v | | CCU149 ^[315] →RP.07846 | |
| 2.0 | 4 | RFN(EW10J4) | 100/134 | 09/02→12/06 | OE178 | 0,9 | CET5 | BAEA348 | |
| 2.0 16V | 4 | RFH(EW10A); RFJ(EW10A) | 103/138 | 01/07→ | OE178 | 0,9 | CET5 | BAEA352 | |
| 2.0 HDI | 4 | RHX(DW10BTD) | 69/93 | 07/00→12/06 | CH170 | 11v | | CCU149 | |
| 2.0 HDI, 2.0 HDi | 4 | RHW(DW10ATED4); RHZ(DW10ATED); RHZ(DW10BTD); RHZ(DW10BTD+); RHZ(DW10CTED) | 80/107 | 07/00→12/06 | CH170 →RP.09666 | 11v | | CCU149 | |
| | | | | | CH268 RP.09667→ | 11v | | | |
| 2.0 HDi 120, 2.0 HDi 120 4WD | 4 | RHK(DW10UTED4) | 88/118 | 01/07→ | CH268 | 11v | | | |
| 2.0 HDi 140 | 4 | RHR(DW10BTD4) | 100/134 | 01/07→ | CH268 | 11v | | CCU149 | |

PARTNER

| | | | | | | | | | | |
|--|---|-----------------------------------|--------|-------------|--------------------|-----|--------|-------|------------------------------------|--------|
| 1.1 | 4 | HDZ(TU1M) | 44/59 | 06/96→09/05 | OE034 | 0,9 | CET2 | OE179 | BAE946A ^[10] BAEA232 | CLS262 |
| 1.4 | 4 | KFV(TU3A) | 54/72 | 11/02→10/06 | OE034 | 0,9 | CET2 | OE179 | BAEA048E ^[7] | |
| 1.4 | 4 | KFX(TU3JP); TU32 | 55/74 | 06/96→12/15 | OE034 | 0,9 | CET2 | OE179 | | CLS262 |
| 1.4 BiFuel | 4 | KFW(TU3JP) | 55/74 | 04/03→10/06 | OE034 | 0,9 | CET2 | OE179 | BAE946A ^[10] | |
| 1.6 | 4 | NFR(TU5JP4B) | 66/89 | 04/08→ | OE035 | 0,9 | CET5 | OE190 | BAEA045E | |
| 1.6 | 4 | 5FK(EP6CB) | 72/97 | 11/10→ | OE205 | 0,7 | CET16P | | BAEA143 | |
| 1.6 | 4 | NFU(TU5JP4) | 80/107 | 09/00→ | OE035 | 0,9 | CET5 | | BAEA045E | |
| 1.6 | 4 | 5FS(EP6C) | 88/118 | 04/10→ | OE205 | 0,7 | CET16P | | BAEA143 | |
| 1.6 HDi | 4 | 9HT(DV6BTD4); 9HW(DV6BTD4) | 55/74 | 04/08→ | CH201 RP.10784→ | 11v | | | | |
| 1.6 HDi | 4 | 9HZ(DV6TED4) | 80/107 | 04/08→ | CH201 | 11v | | | CCU147 | |
| 1.6 HDi 16V | 4 | 9HS(DV6TED4BU); 9HX(DV6AUTED4) | 66/89 | 04/08→ | CH201 RP.10784→ | 11v | | | CCU147 | |
| 1.6 HDi 16V, 1.6 HDi 16V 4WD, 1.6 HDi 90 | 4 | 9HS(DV6TED4BU); 9HX(DV6ATED4) | 66/89 | 02/06→ | CH201 RP.10784→ | 11v | | | | |
| 1.6 HDi 75 | 4 | 9HW(DV6BTD4) | 55/74 | 08/05→07/08 | CH201 | 11v | | | | |
| 1.8 | 4 | LFX(XU7JB) | 66/89 | 03/97→08/00 | OE034 | 0,9 | CET2 | OE179 | | |
| 1.8 D | 4 | A9A(XUD7) | 43/58 | 06/96→12/02 | CH189 | 11v | | | | |
| 1.8 D | 4 | A9A(XUD7) | 44/59 | 11/96→02/98 | CH189 | 11v | | | | |
| 1.9 D | 4 | DJY(XUD9A) | 50/67 | 05/96→12/98 | CH189 | 11v | | | | |
| 1.9 D | 4 | WJZ(DW8) | 51/68 | 06/96→12/15 | CH185 | 11v | | | | |
| 1.9 D | 4 | DJY(XUD9A) | 51/68 | 06/96→12/15 | CH189 | 11v | | | | |
| 1.9 D, 1.9 D 4WD | 4 | WJY(DW8B) | 51/68 | 06/96→12/15 | CH185 | 11v | | | CCU149 ^[318] | |
| 2.0 HDi, 2.0 HDi 4WD | 4 | RHY(DW10TD) | 66/89 | 04/00→07/08 | CH170 | 11v | | | CCU149 ^[359] | |

PIAGGIO

PORTER

| | | | | | | | | | | |
|-------|---|----------|-------|-------------|----------------|------------|------|-------|--|--|
| 1.0 | 3 | CB41 | 33/44 | 02/93→06/04 | OE004 | 0,9 | CET8 | OE195 | | |
| 1.0 | 3 | CB42 | 35/47 | 07/94→ | OE004 OE006 | 0,9 0,9 | CET8 | OE195 | | |
| 1.2 D | 2 | | 47/63 | 01/11→ | CH229 | 11.5v | | | | |
| 1.2 D | 4 | LDW1204 | 26/35 | 05/95→ | CH189 | 11v | | | | |
| 1.3 | 4 | DA471QLR | 52/70 | 01/11→ | OE199 | 0,9 | | | | |
| 1.3 | 4 | DA471QLR | 53/71 | 01/11→ | OE199 | 0,9 | | | | |

PIAGGIO





kW/BHP



eon TITAN

IRIDIUM

**...PIAGGIO****...PORTER**

| | | | | | | | | | |
|---------------------------------|---|--------|-------|--------|-------|-----|------|-------|--|
| 1.3 16V, 1.3 16V 4WD, 1.3 i 16V | 4 | ; HCEL | 48/64 | 05/98→ | | | CET2 | OE188 | |
| 1.3 i 16V 4WD | 4 | | 48/64 | 05/98→ | OE120 | 0,6 | CET2 | OE188 | |

PLYMOUTH**BREEZE**

| | | | | | | | | | |
|---------|---|-----|--------|-------------|-------|-----|------|-------|--|
| 2.0 16V | 4 | ECB | 98/131 | 12/95→04/01 | OE002 | 0,9 | CET2 | OE179 | |
|---------|---|-----|--------|-------------|-------|-----|------|-------|--|

VOYAGER / GRAND VOYAGER

| | | | | | | | | | |
|----------------------|---|-----|---------|-------------|-----------------|-----|--|--|--|
| 2.5 TD | 4 | ENC | 85/114 | 01/95→03/01 | CH181 05/95→ | 11v | | | |
| 3.3 Flex-Fuel, 3.3 i | 6 | EGM | 116/156 | 01/95→03/01 | OE105 | 1,3 | | | |
| 3.8 i, 3.8 i 4WD | 6 | EGH | 122/164 | 01/95→03/01 | OE105 | 1,3 | | | |
| 3.8 i, 3.8 i 4WD | 6 | EGH | 131/176 | 01/95→03/01 | OE105 | 1,3 | | | |

PONTIAC**TRANS SPORT**

| | | | | | | | | | |
|-----|---|-----|---------|-------------|-------|-----|------|-------|--|
| 2.3 | 4 | LGO | 101/135 | 01/93→03/97 | OE005 | 0,9 | CET2 | OE180 | |
| 2.3 | 4 | LGO | 108/145 | 01/93→03/97 | OE005 | 0,9 | CET2 | OE180 | |

PORSCHE**911 (964)**

| | | | | | | | | | |
|-----------|---|--------|---------|-------------|-------|-----|------|-------|--|
| 3.6 Turbo | 6 | M64.50 | 265/355 | 01/93→09/93 | OE216 | 0,8 | CET2 | OE188 | |
|-----------|---|--------|---------|-------------|-------|-----|------|-------|--|

911 /Convertible (991)

| | | | | | | | | | |
|-----------------------------------|---|----------------|---------|--------|-------|-----|--|--|---------------------------|
| 3.8 Carrera 4S 4WD, 3.8 Carrera S | 6 | MA1.03; MAB.03 | 294/394 | 12/11→ | | | | | BAEA052E ^[277] |
| 3.8 Turbo 4WD | 6 | MA1.71 | 383/514 | 09/13→ | OE210 | 0,8 | | | |
| 3.8 Turbo S 4WD | 6 | MA1.71 | 412/552 | 09/13→ | OE210 | 0,8 | | | |

911 (993)

| | | | | | | | | | |
|----------------------------------|---|------------------|---------|-------------|-------|-----|------|-------|--------|
| 3.6 Carrera | 6 | M64.21; M64.22 | 210/282 | 08/95→09/97 | OE216 | 0,8 | CET2 | OE188 | CLS251 |
| 3.6 Carrera | 6 | M64.23; M64.24 | 210/282 | 08/95→09/97 | | | CET2 | OE188 | CLS251 |
| 3.6 Turbo 4WD | 6 | M64.60 | 300/402 | 03/95→09/97 | OE216 | 0,8 | CET2 | OE188 | CLS251 |
| 3.6 Turbo GT2, 3.6 Turbo GT2 4WD | 6 | M64.60R | 316/424 | 03/95→09/97 | OE216 | 0,8 | CET2 | OE188 | |
| 3.6 Turbo GT2 4WD | 6 | M64.60RS | 331/444 | 06/97→09/97 | OE026 | 0,9 | CET2 | OE188 | |
| 3.8 Carrera, 3.8 Carrera 4WD | 6 | M64.05S; M64.06S | 210/282 | 06/95→09/97 | OE216 | 0,8 | CET2 | | |
| 3.8 Carrera RS | 6 | M64.20 | 221/296 | 06/95→09/97 | OE094 | 0,9 | CET2 | | CLS251 |

911 /Convertible (993)

| | | | | | | | | | |
|------------------------------|---|------------------|---------|-------------|-------|-----|------|--|--|
| 3.8 Carrera, 3.8 Carrera 4WD | 6 | M64.05S; M64.06S | 210/282 | 06/95→09/97 | OE094 | 0,9 | CET2 | | |
| 3.8 Carrera, 3.8 Carrera 4WD | 6 | M64.21S | 221/296 | 08/95→09/97 | OE094 | 0,9 | CET2 | | |

911 /Convertible/Targa (993)

| | | | | | | | | | |
|------------------------------|---|--------------------------------|---------|-------------|-------|-----|------|-------|--------|
| 3.6 Carrera, 3.6 Carrera 4WD | 6 | M64.05; M64.06; M64.07; M64.08 | 200/268 | 10/93→08/95 | OE026 | 0,9 | CET2 | OE188 | CLS251 |
| 3.6 Carrera, 3.6 Carrera 4WD | 6 | M64.21; M64.22; M64.23; M64.24 | 210/282 | 08/95→09/97 | OE026 | 0,9 | CET2 | OE188 | CLS251 |

911 Targa (993)

| | | | | | | | | | |
|-------------|---|---------|---------|-------------|--|--|------|-------|--|
| 3.8 Carrera | 6 | M64.21S | 221/296 | 05/96→09/97 | | | CET2 | OE179 | |
|-------------|---|---------|---------|-------------|--|--|------|-------|--|

911 /Convertible (996)

| | | | | | | | | | |
|------------------------------|---|------------------------|---------|-------------|-------|-----|------|-------|--|
| 3.4 Carrera, 3.4 Carrera 4WD | 6 | M96.01; M96.02; M96.04 | 221/296 | 09/97→09/01 | OE218 | 1,6 | CET2 | OE188 | |
| 3.4 Carrera, 3.4 Carrera 4WD | 6 | M96.02 | 235/315 | 05/01→08/05 | OE218 | 1,6 | CET2 | OE188 | |
| 3.6 3.6 Turbo 4S 4WD, 3.6 S | 6 | M96.70 | 331/444 | 02/03→08/05 | OE216 | 0,8 | CET2 | OE179 | |
| 3.6 3.6 Turbo 4WD | 6 | M96.70 | 309/414 | 06/00→08/05 | OE216 | 0,8 | CET2 | OE188 | |
| 3.6 GT2 | 6 | M96.70 | 340/456 | 04/01→08/05 | OE216 | 0,8 | CET2 | OE188 | |
| 3.6 GT2 | 6 | M96.70 | 355/476 | 10/03→08/05 | OE216 | 0,8 | CET2 | OE188 | |
| 3.6 GT3 | 6 | M96.76 | 265/355 | 03/99→08/05 | OE216 | 0,8 | CET2 | OE188 | |

PIAGGIO





kW/BHP

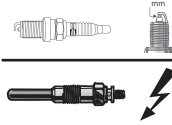

eon TITAN

IRIDIUM

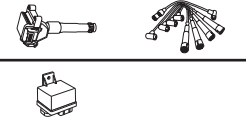
**...PORSCHE****...911 /Convertible (996)**

| | | | | | | | | |
|---------|---|--------|---------|-------------|--------------|-----|-------------|--------------|
| 3.6 GT3 | 6 | M96.79 | 280/375 | 03/03→08/05 | OE216 | 0,8 | CET2 | OE188 |
|---------|---|--------|---------|-------------|--------------|-----|-------------|--------------|

911 /Convertible/Targa (996)

| | | | | | | | | |
|-------------------------------------|---|--------|---------|-------------|--------------|-----|--|--|
| 3.6, 3.6 Carrera, 3.6 Carrera 4 4WD | 6 | M96.03 | 235/315 | 10/01→08/05 | OE257 | 0,5 | | |
|-------------------------------------|---|--------|---------|-------------|--------------|-----|--|--|

| | | | | | | | | |
|-----------------------------------|---|--------|---------|-------------|--------------|-----|--|--|
| 3.6 Carrera 4S 4WD, 3.6 Carrera S | 6 | M96.03 | 254/341 | 06/02→08/05 | OE257 | 0,5 | | |
|-----------------------------------|---|--------|---------|-------------|--------------|-----|--|--|

911 (997)

| | | | | | | | | |
|---------|---|--------|---------|-------------|--------------|-----|---------------|--|
| 3.6 GT3 | 6 | M97.76 | 305/409 | 03/06→12/09 | OE222 | 0,8 | CET11P | BAEA052E ^[277] ModelYear2009→ |
|---------|---|--------|---------|-------------|--------------|-----|---------------|--|

| | | | | | | | | |
|---------|---|--------|---------|-------------|--------------|-----|---------------|----------------------------------|
| 3.8 GT3 | 6 | M97.77 | 320/429 | 05/09→12/11 | OE222 | 0,8 | CET11P | BAEA052E ^[277] |
|---------|---|--------|---------|-------------|--------------|-----|---------------|----------------------------------|

| | | | | | | | | |
|------------|---|---------|---------|-------------|--------------|-----|---------------|----------------------------------|
| 3.8 GT3 RS | 6 | M97.77R | 331/444 | 08/09→12/11 | OE222 | 0,8 | CET11P | BAEA052E ^[277] |
|------------|---|---------|---------|-------------|--------------|-----|---------------|----------------------------------|

| | | | | | | | | |
|------------|---|--------|---------|-------------|--------------|-----|---------------|----------------------------------|
| 4.0 GT3 RS | 6 | M97.74 | 368/493 | 07/11→12/12 | OE222 | 0,8 | CET11P | BAEA052E ^[277] |
|------------|---|--------|---------|-------------|--------------|-----|---------------|----------------------------------|

911 /Convertible (997)

| | | | | | | | | |
|----------|---|---------|---------|-------------|--------------|-----|---------------|--|
| 3.6 GT 2 | 6 | M97.70S | 390/523 | 09/07→12/12 | OE222 | 0,8 | CET11P | |
|----------|---|---------|---------|-------------|--------------|-----|---------------|--|

| | | | | | | | | |
|------------|---|--------|---------|-------------|--------------|-----|---------------|--|
| 3.6 GT2 RS | 6 | M97.70 | 456/611 | 05/10→12/12 | OE222 | 0,8 | CET11P | |
|------------|---|--------|---------|-------------|--------------|-----|---------------|--|

| | | | | | | | | |
|---------------|---|--------|---------|-------------|--------------|-----|---------------|--|
| 3.6 Turbo 4WD | 6 | M97.70 | 353/473 | 03/06→12/09 | OE222 | 0,8 | CET11P | |
|---------------|---|--------|---------|-------------|--------------|-----|---------------|--|

| | | | | | | | | |
|---------------|---|--------|---------|-------------|--------------|-----|--|----------------------------------|
| 3.8 Turbo 4WD | 6 | MA1.70 | 368/493 | 09/09→12/12 | OE210 | 0,8 | | BAEA052E ^[277] |
|---------------|---|--------|---------|-------------|--------------|-----|--|----------------------------------|

| | | | | | | | | |
|---------------|---|--------|---------|-------------|--------------|-----|--|----------------------------------|
| 3.8 Turbo 4WD | 6 | MA1.70 | 373/500 | 09/10→12/11 | OE210 | 0,8 | | BAEA052E ^[277] |
|---------------|---|--------|---------|-------------|--------------|-----|--|----------------------------------|

| | | | | | | | | |
|-----------------|---|--------|---------|-------------|--------------|-----|--|----------------------------------|
| 3.8 Turbo S 4WD | 6 | MA1.70 | 390/523 | 02/10→12/12 | OE210 | 0,8 | | BAEA052E ^[277] |
|-----------------|---|--------|---------|-------------|--------------|-----|--|----------------------------------|

| | | | | | | | | |
|-----------------|---|--------|---------|-------------|--------------|-----|--|----------------------------------|
| 3.8 Turbo S 4WD | 6 | MA1.70 | 395/530 | 09/10→12/11 | OE210 | 0,8 | | BAEA052E ^[277] |
|-----------------|---|--------|---------|-------------|--------------|-----|--|----------------------------------|

911 /Convertible/Targa (997)

| | | | | | | | | |
|-------------|---|--------|---------|-------------|--------------|-----|--|--|
| 3.6 Carrera | 6 | M96.05 | 235/315 | 08/04→07/05 | OE257 | 0,5 | | |
|-------------|---|--------|---------|-------------|--------------|-----|--|--|

| | | | | | | | | |
|------------------------------|---|--------|---------|-------------|--------------|-----|--|--|
| 3.6 Carrera, 3.6 Carrera 4WD | 6 | M96.05 | 239/320 | 07/04→12/08 | OE257 | 0,5 | | |
|------------------------------|---|--------|---------|-------------|--------------|-----|--|--|

| | | | | | | | | |
|------------------------------|---|--------|---------|-------------|--------------|-----|--|--|
| 3.6 Carrera, 3.6 Carrera 4WD | 6 | M96.05 | 242/325 | 07/04→12/08 | OE257 | 0,5 | | |
|------------------------------|---|--------|---------|-------------|--------------|-----|--|--|

| | | | | | | | | |
|------------------------------|---|--------|---------|-------------|--|--|--|----------------------------------|
| 3.6 Carrera, 3.6 Carrera 4WD | 6 | MA1.02 | 254/341 | 06/08→12/12 | | | | BAEA052E ^[277] |
|------------------------------|---|--------|---------|-------------|--|--|--|----------------------------------|

| | | | | | | | | |
|--|---|--------|---------|-------------|--|--|--|----------------------------------|
| 3.8 Carrera 4 GTS 4WD, 3.8 Carrera GTS | 6 | MA1.01 | 300/402 | 06/09→12/12 | | | | BAEA052E ^[277] |
|--|---|--------|---------|-------------|--|--|--|----------------------------------|

| | | | | | | | | |
|-----------------------------------|---|--------|---------|-------------|--------------|-----|--|--|
| 3.8 Carrera 4S 4WD, 3.8 Carrera S | 6 | M97.01 | 261/350 | 07/04→12/08 | OE257 | 0,5 | | |
|-----------------------------------|---|--------|---------|-------------|--------------|-----|--|--|

| | | | | | | | | |
|-----------------------------------|---|--------|---------|-------------|--------------|-----|--|--|
| 3.8 Carrera 4S 4WD, 3.8 Carrera S | 6 | M97.01 | 264/354 | 07/04→12/10 | OE257 | 0,5 | | |
|-----------------------------------|---|--------|---------|-------------|--------------|-----|--|--|

| | | | | | | | | |
|-----------------------------------|---|---------|---------|-------------|--------------|-----|--|--|
| 3.8 Carrera 4S 4WD, 3.8 Carrera S | 6 | M97.01S | 280/375 | 08/05→12/08 | OE257 | 0,5 | | |
|-----------------------------------|---|---------|---------|-------------|--------------|-----|--|--|

| | | | | | | | | |
|-----------------------------------|---|--------|---------|-------------|--|--|--|----------------------------------|
| 3.8 Carrera 4S 4WD, 3.8 Carrera S | 6 | MA1.01 | 283/380 | 06/08→12/12 | | | | BAEA052E ^[277] |
|-----------------------------------|---|--------|---------|-------------|--|--|--|----------------------------------|

968

| | | | | | | | | |
|-------------|---|--|---------|-------------|--------------|-----|-------------|--------------|
| 3.0 Turbo S | 4 | | 224/300 | 03/93→11/95 | OE005 | 0,9 | CET2 | OE179 |
|-------------|---|--|---------|-------------|--------------|-----|-------------|--------------|

BOXSTER (986)

| | | | | | | | | |
|-----|---|--------|---------|-------------|--------------|-----|-------------|--------------|
| 2.5 | 6 | M96.20 | 150/201 | 09/96→08/99 | OE206 | 0,9 | CET2 | OE188 |
|-----|---|--------|---------|-------------|--------------|-----|-------------|--------------|

| | | | | | | | | |
|--|--|--|--|--|-----------------------------------|-----|--|--|
| | | | | | OE216 LPG ^[278] | 0,8 | | |
|--|--|--|--|--|-----------------------------------|-----|--|--|

| | | | | | | | | |
|-----|---|--|---------|-------------|--------------|-----|--|--|
| 2.7 | 6 | | 155/208 | 06/99→12/02 | OE218 | 1,6 | | |
|-----|---|--|---------|-------------|--------------|-----|--|--|

| | | | | | | | | |
|-----|---|--------|---------|-------------|--------------|-----|-------------|--------------|
| 2.7 | 6 | M96.22 | 162/217 | 08/99→07/02 | OE218 | 1,6 | CET2 | OE188 |
|-----|---|--------|---------|-------------|--------------|-----|-------------|--------------|

| | | | | | | | | |
|-----|---|--------|---------|-------------|--------------|-----|-------------|--------------|
| 2.7 | 6 | M96.23 | 168/225 | 07/02→12/04 | OE218 | 1,6 | CET2 | OE188 |
|-----|---|--------|---------|-------------|--------------|-----|-------------|--------------|

| | | | | | | | | |
|-------|---|--------|---------|-------------|--------------|-----|-------------|--------------|
| 3.2 S | 6 | M96.21 | 185/248 | 08/99→07/02 | OE218 | 1,6 | CET2 | OE188 |
|-------|---|--------|---------|-------------|--------------|-----|-------------|--------------|

| | | | | | | | | |
|-------|---|--------|---------|-------------|--------------|-----|-------------|--------------|
| 3.2 S | 6 | M96.24 | 196/263 | 01/04→12/04 | OE218 | 1,6 | CET2 | OE188 |
|-------|---|--------|---------|-------------|--------------|-----|-------------|--------------|

| | | | | | | | | |
|------------|---|--------|---------|-------------|--------------|-----|-------------|--------------|
| 3.2 S 3, 2 | 6 | M96.24 | 191/256 | 07/02→12/04 | OE218 | 1,6 | CET2 | OE188 |
|------------|---|--------|---------|-------------|--------------|-----|-------------|--------------|

BOXSTER (987)

| | | | | | | | | |
|-----|---|--------|---------|-------------|--------------|-----|--|--|
| 2.7 | 6 | M96.25 | 176/236 | 11/04→12/06 | OE257 | 0,5 | | |
|-----|---|--------|---------|-------------|--------------|-----|--|--|

| | | | | | | | | |
|-----|---|--------|---------|-------------|--------------|-----|--|--|
| 2.7 | 6 | M97.20 | 179/240 | 09/06→12/08 | OE257 | 0,5 | | |
|-----|---|--------|---------|-------------|--------------|-----|--|--|

| | | | | | | | | |
|-----|---|--------|---------|-------------|--------------|-----|--|--|
| 2.7 | 6 | M97.20 | 180/241 | 07/06→12/09 | OE257 | 0,5 | | BAEA052E ^[277] ModelYear2009→ |
|-----|---|--------|---------|-------------|--------------|-----|--|--|

| | | | | | | | | |
|--|--|--|--|--|--------------------------------|-----|--|--|
| | | | | | OE262 ModelYear2009→ | 1,4 | | |
|--|--|--|--|--|--------------------------------|-----|--|--|

| | | | | | | | | |
|-----|---|--------|---------|-------------|--|--|--|----------------------------------|
| 2.9 | 6 | MA1.20 | 188/252 | 06/09→12/11 | | | | BAEA052E ^[277] |
|-----|---|--------|---------|-------------|--|--|--|----------------------------------|

| | | | | | | | | |
|-------|---|--------|---------|-------------|--------------|-----|--|--|
| 3.2 S | 6 | M96.26 | 206/276 | 11/04→12/06 | OE257 | 0,5 | | |
|-------|---|--------|---------|-------------|--------------|-----|--|--|

PORSCHE





kW/BHP



eon TITAN

IRIDIUM

**...PORSCHE****...BOXSTER (987)**

| | | | | | | | | | |
|-------|---|--------|---------|---------------|----------------------------------|-----|--|--|--|
| 3.4 S | 6 | M97.21 | 217/291 | 07/06 → 12/09 | OE257 ModelYear → 2008 | 0,5 | | | BAEA052E ^[277] ModelYear 2009 → |
| | | | | | OE262 ModelYear 2009 → | 1,4 | | | |
| 3.4 S | 6 | M97.22 | 223/299 | 08/08 → 12/09 | OE257 ModelYear → 2008 | 0,5 | | | BAEA052E ^[277] ModelYear 2009 → |
| | | | | | OE262 ModelYear 2009 → | 1,4 | | | |
| 3.4 S | 6 | MA1.21 | 228/306 | 06/09 → 12/11 | OE262 | 1,4 | | | BAEA052E ^[277] |

BOXSTER Spyder (987)

| | | | | | | | | | |
|-----------|---|--------|---------|---------------|--------------|-----|--|--|--|
| 3.4 | 6 | MA1.21 | 235/315 | 06/10 → 12/11 | | | | | BAEA052E ^[277] |
| 3.4 RS 60 | 6 | M97.22 | 223/299 | 09/07 → 12/08 | OE257 | 0,5 | | | BAEA052E ^[277] ModelYear 2009 → |

CAYENNE (9PA)

| | | | | | | | | | |
|-----------------|---|---------|---------|---------------|---|-------------------|----------------------------------|--------------|---|
| 3.2 4WD | 6 | M02.2Y | 177/237 | 08/03 → 09/07 | | | | | BAEA044E ^[356] |
| 3.2 4WD | 6 | M02.2Y | 184/247 | 10/03 → 09/07 | OE215 | 0,9 | | | BAEA044E ^[356] |
| 3.6 4WD | 6 | M55.01 | 213/286 | 02/07 → 09/10 | | | | | BAEA044E ^[356] → 04/10 |
| 4.5 S 4WD | 8 | M48.00 | 250/335 | 09/02 → 09/07 | OE218 | 1,6 | CET2 | OE188 | BAEA012E ^[276] |
| 4.5 Turbo 4WD | 8 | M48.50 | 331/444 | 09/02 → 09/07 | OE136 OE222 OE257 ^[282] | 0,8 0,8 0,5 | CET1 1P CET1 2P | OE179 | BAEA012E ^[276] |
| 4.5 Turbo S 4WD | 8 | M48.50S | 368/493 | 01/04 → 09/07 | OE136 OE222 OE257 ^[282] | 0,8 0,8 0,5 | CET1 1P CET1 2P | OE179 | |
| 4.5 Turbo S 4WD | 8 | M48.50T | 383/514 | 03/06 → 09/07 | OE136 OE222 OE257 ^[282] | 0,8 0,8 0,5 | CET1 1P CET1 2P | OE179 | |
| 4.8 S 4WD | 8 | M48.01 | 283/380 | 02/07 → 09/10 | | | | | BAEA042E [13] [277] |
| 4.8 Turbo S 4WD | 8 | M48.51 | 368/493 | 02/07 → 09/10 | OE210 → 12/08 | 0,8 | | | BAEA042E [13] [277] |
| 4.8 Turbo S 4WD | 8 | M48.51 | 397/532 | 02/07 → 09/10 | OE210 → 12/08 | 0,8 | | | |
| 4.8 Turbo S 4WD | 8 | M48.51 | 404/542 | 08/08 → 09/10 | OE210 | 0,8 | | | |

CAYENNE (92A)

| | | | | | | | | | |
|--------------------|---|-------------------------------|---------|---------|--------------|-----|--|--------------|----------------------------------|
| 3.0 S E-Hybrid 4WD | 6 | M06.EC; MCG.E; MCG.EA; MCG.FA | 245/329 | 06/10 → | | | | | BAEA032E ^[13] |
| 3.0 S E-Hybrid 4WD | 6 | M06.EC; MCG.E; MCG.EA; MCG.FA | 306/410 | 10/14 → | | | | | BAEA032E ^[13] |
| 3.6 4WD | 6 | M55.02; MCE.YA | 220/295 | 06/10 → | | | | | BAEA044E ^[356] |
| 3.6 GTS 4WD | 6 | MCX.ZA | 324/434 | 02/15 → | | | | OE246 | BAEA163E |
| 3.6 S 4WD | 6 | MCU.RA | 309/414 | 10/14 → | | | | OE246 | BAEA163E |
| 4.8 GTS 4WD | 8 | M48.02 | 309/414 | 06/12 → | | | | | BAEA042E [13] [277] |
| 4.8 S 4WD | 8 | M48.02 | 294/394 | 06/10 → | | | | | BAEA042E [13] [277] |
| 4.8 Turbo 4WD | 8 | M48.52 | 368/493 | 06/10 → | OE210 | 0,8 | | | BAEA042E [13] [277] |
| 4.8 Turbo 4WD | 8 | MCF.TB | 382/512 | 10/14 → | OE210 | 0,8 | | | BAEA042E [13] [277] |
| 4.8 Turbo 4WD | 8 | M48.52 | 397/532 | 06/10 → | OE210 | 0,8 | | | BAEA042E [13] [277] |
| 4.8 Turbo S 4WD | 8 | M48.52 | 405/543 | 10/12 → | OE210 | 0,8 | | | BAEA042E [13] [277] |
| 4.8 Turbo S 4WD | 8 | MCY.XA | 419/562 | 01/15 → | OE210 | 0,8 | | | BAEA042E [13] [277] |

CAYMAN (987)

| | | | | | | | | | |
|-----|---|--------|---------|---------------|--------------|-----|--|--|--|
| 2.7 | 6 | M97.20 | 180/241 | 07/06 → 12/09 | OE257 | 0,5 | | | BAEA052E ^[277] ModelYear 2009 → |
|-----|---|--------|---------|---------------|--------------|-----|--|--|--|

PORSCHE





kW/BHP



eon TITAN

IRIDIUM

**...PORSCHE****...CAYMAN (987)**

| | | | | | | | | | | |
|------------------|---|--------|---------|-------------|--|------------|--|--|--|---|
| 2.9 | 6 | MA1.20 | 195/261 | 02/09→12/12 | | | | | | BAEA052E ^[277] |
| 3.4 R | 6 | MA1.21 | 243/326 | 11/10→12/12 | | | | | | BAEA052E ^[277] |
| 3.4 S | 6 | M97.21 | 217/291 | 11/05→12/09 | OE257 | 0,5 | | | | BAEA052E ^[277] ModelYear2009→ |
| 3.4 S | 6 | MA1.21 | 235/315 | 02/09→06/13 | | | | | | BAEA052E ^[277] |
| 3.4 S 3, 4 Sport | 6 | M97.22 | 223/299 | 08/08→12/12 | OE257 ModelYear→2008 OE262 ModelYear2009→ | 0,5 1,4 | | | | BAEA052E ^[277] ModelYear2009→ |

MACAN (95B)

| | | | | | | | | | | |
|---------------|---|----------------|---------|--------|--|--|--|-------|--|----------|
| 2.0 4WD | 4 | MCN.CC; MCY.NA | 174/233 | 07/14→ | | | | | | BAEA068E |
| 3.0 GTS 4WD | 6 | MDC.NA | 265/355 | 10/15→ | | | | OE246 | | |
| 3.0 S 4WD | 6 | MCT.MA | 250/335 | 02/14→ | | | | OE246 | | BAEA163E |
| 3.6 Turbo 4WD | 6 | MCT.LA | 294/394 | 02/14→ | | | | OE246 | | BAEA163E |

PANAMERA (970)

| | | | | | | | | | | |
|-------------------|---|----------------|---------|-------------|-------|-----|--|-------|--|---|
| 3.0 4S 4WD, 3.0 S | 6 | MCW.DA | 309/414 | 07/13→10/16 | | | | OE246 | | BAEA163E |
| 3.0 S E-Hybrid | 6 | MCG.EA; MCG.FA | 245/329 | 03/11→07/13 | | | | | | BAEA032E ^[13] |
| 3.0 S E-Hybrid | 6 | MCG.EA; MCG.FA | 279/374 | 03/11→07/13 | | | | | | BAEA032E ^[13] |
| 3.0 S E-Hybrid | 6 | MCG.EA; MCG.FA | 306/410 | 07/13→10/16 | | | | | | BAEA032E ^[13] |
| 3.6, 3.6 4WD | 6 | M46.20; M46.40 | 220/295 | 05/10→07/13 | | | | | | BAEA042E ^[13] ^[277] |
| 4.8 4S 4WD, 4.8 S | 8 | M48.20; M48.40 | 294/394 | 09/09→07/13 | | | | | | BAEA042E ^[13] ^[277] |
| 4.8 GTS 4WD | 8 | M48.40 | 316/424 | 01/12→07/13 | | | | | | BAEA042E ^[13] ^[277] |
| 4.8 GTS 4WD | 8 | MCX.PA; MCX.RA | 324/434 | 07/13→10/16 | | | | | | BAEA042E ^[13] ^[277] |
| 4.8 Turbo 4WD | 8 | M48.70 | 368/493 | 09/09→07/13 | OE210 | 0,8 | | | | BAEA042E ^[13] ^[277] |
| 4.8 Turbo 4WD | 8 | MCW.BA | 382/512 | 07/13→10/16 | OE210 | 0,8 | | | | |
| 4.8 Turbo 4WD | 8 | M48.70 | 397/532 | 08/10→07/13 | OE210 | 0,8 | | | | |
| 4.8 Turbo S 4WD | 8 | M48.70 | 404/542 | 05/11→07/13 | OE210 | 0,8 | | | | |
| 4.8 Turbo S 4WD | 8 | MCW.CA | 419/562 | 07/13→10/16 | OE210 | 0,8 | | | | |

PROTON**GEN 2**

| | | | | | | | | | | |
|-----|---|------|--------|--------|-------|-----|------|-------|--|---------|
| 1.3 | 4 | S4PE | 70/94 | 06/04→ | | | | | | BAEA234 |
| 1.6 | 4 | S4PH | 82/110 | 06/04→ | OE011 | 0,9 | CET9 | OE183 | | BAEA234 |

IMPIAN

| | | | | | | | | | | |
|-----|---|--------|--------|--------|-------|-----|------|-------|----------|--------|
| 1.6 | 4 | 4G18-P | 76/102 | 09/01→ | OE003 | 0,9 | CET2 | OE180 | BAEA179E | CLS010 |
|-----|---|--------|--------|--------|-------|-----|------|-------|----------|--------|

JUMBUCK

| | | | | | | | | | | |
|-----|---|------|-------|--------|-------|-----|------|--|---------|--|
| 1.5 | 4 | 4G15 | 64/86 | 05/02→ | OE051 | 0,9 | CET8 | | BAEA234 | |
|-----|---|------|-------|--------|-------|-----|------|--|---------|--|

PERSONA 300

| | | | | | | | | | | |
|------------------|---|------------|---------|-------------|-------|-----|------|-------|--|--|
| 1.3 | 4 | 4G13-M | 55/74 | 08/00→07/04 | OE051 | 0,9 | CET8 | | | |
| 1.3 313i | 4 | G13B | 55/74 | 03/96→01/00 | OE065 | 0,9 | CET8 | | | |
| 1.5 315 GLi/GLSi | 4 | 4G15M | 66/89 | 03/96→07/00 | OE065 | 0,9 | CET8 | | | |
| 1.5 315 GLSi | 4 | G15B | 64/86 | 09/96→07/00 | OE065 | 0,9 | CET8 | | | |
| 1.6 316 | 4 | 4G92 | 70/94 | 03/96→07/04 | OE039 | 1,0 | CET2 | OE180 | | |
| 1.6 316 GLXi | 4 | 4G92 | 83/111 | 03/96→07/00 | | | CET2 | OE179 | | |
| 1.8 318 16V GTI | 4 | 4G93(DOHC) | 99/133 | 03/96→07/00 | OE039 | 1,0 | CET2 | OE180 | | |
| 1.8 GTi | 4 | 4G93(DOHC) | 103/138 | 08/00→07/04 | OE039 | 1,0 | CET2 | OE179 | | |

PERSONA 400

| | | | | | | | | | | |
|--------------|---|--------|-------|-------------|-------|-----|------|--|--|--|
| 1.3 | 4 | 4G13M | 57/76 | 10/05→02/08 | OE051 | 0,9 | CET8 | | | |
| 1.3 413 | 4 | 4G13-P | 55/74 | 01/94→06/03 | OE065 | 0,9 | CET8 | | | |
| 1.3 413 GLSi | 4 | 4G13 | 55/74 | 01/94→01/00 | OE051 | 0,9 | CET8 | | | |
| 1.5 | 4 | 4G15M | 67/90 | 05/95→02/08 | OE051 | 0,9 | CET8 | | | |

PROTON



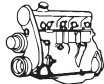

kW/BHP



eon TITAN

IRIDIUM

**...PROTON****...PERSONA 400**

| | | | | | | | | | |
|-----------------------|---|------------|--------|-------------|-------|-----|------|-------|--|
| 1.5 415 GLi/GLSi | 4 | 4G15 | 66/89 | 01/94→07/00 | OE048 | 1,0 | CET8 | OE195 | |
| 1.6 416 | 4 | 4G92 | 70/94 | 08/00→02/02 | OE039 | 1,0 | CET2 | OE179 | |
| 1.6 416 GLXi | 4 | 4G92 | 83/111 | 01/94→07/00 | OE039 | 1,0 | CET2 | OE180 | |
| 1.6 416 i | 4 | 4G92 | 70/94 | 12/95→07/00 | OE039 | 1,0 | CET2 | OE180 | |
| 1.8 | 4 | 4G93(DOHC) | 99/133 | 08/00→12/01 | OE039 | 1,0 | CET2 | OE179 | |
| 1.8 418, 1.8 418 GLXi | 4 | 4G93(DOHC) | 85/114 | 05/96→07/00 | | | CET2 | OE179 | |
| 2.0 420 D, 2.0 420 TD | 4 | 4D68T | 60/80 | 09/96→07/00 | CH256 | 11v | | | |
| 2.0 420 GLS D | 4 | 4D68 | 48/64 | 05/96→04/99 | CH256 | 11v | | | |

SAGA II

| | | | | | | | | | |
|---------|---|------|-------|--------|--|--|--|--|---------|
| 1.3 FLX | 4 | S4PE | 70/94 | 04/10→ | | | | | BAEA234 |
|---------|---|------|-------|--------|--|--|--|--|---------|

SATRIA

| | | | | | | | | | |
|-----|---|--------|-------|-------------|-------|-----|------|--|---------|
| 1.3 | 4 | 4G13-M | 55/74 | 07/96→05/06 | OE051 | 0,9 | CET8 | | |
| 1.3 | 4 | 4G13 | 55/74 | 07/96→05/06 | OE051 | 0,9 | CET8 | | BAEA234 |
| 1.5 | 4 | 4G15 | 64/86 | 07/00→05/06 | OE051 | 0,9 | CET8 | | |

SATRIA NEO

| | | | | | | | | | |
|-----|---|------|--------|-------------|--|--|--|--|---------|
| 1.3 | 4 | S4PE | 70/94 | 02/07→09/08 | | | | | BAEA234 |
| 1.6 | 4 | S4PH | 81/109 | 02/07→ | | | | | BAEA234 |

SAVVY

| | | | | | | | | | |
|-----|---|--|-------|--------|--|--|--|--|--------------------------|
| 1.2 | 4 | | 55/74 | 10/05→ | | | | | BAEA454 ^[149] |
|-----|---|--|-------|--------|--|--|--|--|--------------------------|

WIRA

| | | | | | | | | | |
|-----|---|-------------|--------|-------------|-------|-----|------|-------|---------|
| 1.3 | 4 | 4G13 | 55/74 | 08/00→ | OE051 | 0,9 | CET8 | | BAEA234 |
| 1.3 | 4 | 4G13M | 57/76 | 10/05→ | OE051 | 0,9 | CET8 | | |
| 1.5 | 4 | 4G15; 4G15M | 64/86 | 08/00→ | OE051 | 0,9 | CET8 | | BAEA234 |
| 1.5 | 4 | 4G15M | 67/90 | 10/05→ | OE051 | 0,9 | CET8 | | |
| 1.6 | 4 | 4G92 | 70/94 | 08/00→02/02 | OE039 | 1,0 | CET2 | OE179 | |
| 1.8 | 4 | 4G93(DOHC) | 99/133 | 08/00→12/01 | OE039 | 1,0 | CET2 | OE179 | |

PUCH**G-MODELL**

| | | | | | | | | | |
|------------------|---|-----------|---------|-------------|------------------------|-------|--------|-------|----------------|
| 2.9 G 290 TD 4WD | 5 | OM602.983 | 88/118 | 07/97→12/99 | CH176 | 11.5v | | | |
| 3.0 G 300 TD 4WD | 6 | OM606.964 | 130/174 | 08/96→12/99 | CH177 ^[293] | 11.5v | | | |
| 3.2 G 320 4WD | 6 | M104.996 | 155/208 | 09/94→12/97 | OE005 | 0,9 | CET2 | OE179 | BAEA340 |
| 5.0 G 500 4WD | 8 | M113.962 | 218/292 | 04/98→12/99 | OE191 | 1,0 | CET12P | OE180 | BAEA297 CLS242 |
| 5.5 G 55 AMG 4WD | 8 | M113.982 | 260/349 | 04/99→12/99 | OE191 | 1,0 | CET12P | OE180 | BAEA297 |

RELIANT**SCIMITAR SABRE**

| | | | | | | | | | |
|----------|---|-------|--------|-------------|-------|-----|------|-------|--|
| 1.4 1400 | 4 | | 55/74 | 01/93→08/93 | OE014 | 0,9 | CET2 | OE179 | |
| 1.4 i | 4 | 14K4E | 76/102 | 08/93→12/95 | OE005 | 0,9 | CET2 | OE180 | |

RENAULT**19 II**

| | | | | | | | | | |
|-----|---|----------------|-------|-------------|-------|-----|------|-------|--------------------------------|
| 1.4 | 4 | E6J700 | 57/76 | 05/93→12/98 | OE005 | 0,9 | CET2 | OE179 | BAEA251 ^{[265] [292]} |
| 1.4 | 4 | E6J706 | 60/80 | 10/96→06/01 | | | | | BAEA251 ^{[265] [292]} |
| 1.7 | 4 | F2N720; F2N721 | 68/91 | 01/93→08/95 | | | CET8 | OE195 | BAEA251 ^{[265] [292]} |
| 1.7 | 4 | F3N747 | 69/93 | 10/96→06/01 | OE087 | 0,9 | CET8 | | |

AVANTIME

| | | | | | | | | | |
|---------------|---|----------------|---------|-------------|-------|-----|--------|-------|------------------------|
| 2.0 16V Turbo | 4 | F4R760; F4R761 | 120/161 | 11/01→05/03 | | | CET12P | OE179 | BAE409A |
| 2.2 dCi | 4 | G9T712 | 110/148 | 05/02→05/03 | CH232 | 11v | | | CCU154 ^[10] |
| 3.0 V6 | 6 | L7X720; L7X721 | 152/204 | 09/01→05/03 | OE175 | 1,0 | CET14P | OE190 | BAEA347 |

CHAMPION

PROTON



kW/BHP

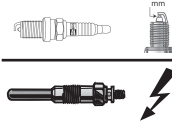

eon TITAN

IRIDIUM

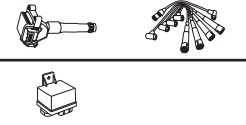
**...RENAULT****CAPTUR**

| | | | | | | | | | |
|-------------|---|----------------|--------|--------|--|--|--|---|-----------------|
| 0.9 TCe 90 | 3 | H4B400 | 66/89 | 06/13→ | | | | OE261 Eng.130429→ Eng.140609 | BAEA131E |
| 1.2 TCe 120 | 4 | H5F408; H5F412 | 87/117 | 01/16→ | | | | OE261 | BAEA131E |
| 1.2 TCe 120 | 4 | H5F403 | 88/118 | 06/13→ | | | | OE261 Eng.130429→ Eng.140609 | BAEA131E |

CLIO

| | | | | | | | | | | |
|----------------|---|----------------|--------|-------------|---------------------------|-----|-------------------|--------------|--------------------------|-------------------------------|
| 1.2 16V | 4 | D4F740 | 55/74 | 02/08→ | OE130 | 0,9 | CET13P [6] | | BAE947A →05/08 | CLS084 [296] 06/08→ |
| | | | | | OE225 [6] [254] | 0,7 | CET4 | | BAEA325 06/08→ | |
| 1.2 16V | 4 | D4F764 | 58/78 | 02/08→ | OE130 | 0,9 | CET4 | | BAE947A →05/08 | CLS084 [296] 06/08→ |
| | | | | | | | | | BAEA325 06/08→ | |
| 1.2 16V | 4 | D4F784 | 74/99 | 02/08→ | OE225 | 0,7 | CET13P | | BAE947A →05/08 | CLS084 [296] 06/08→ |
| | | | | | | | | | BAEA325 06/08→ | |
| | | | | | BAEA354 [275] | | | | | |
| 1.2 16V | 4 | D4F786 | 76/102 | 03/10→ | OE130 | 0,9 | CET13P | | BAEA354 | CLS084 [296] |
| | | | | | OE225 [6] [254] | 0,7 | | | | |
| 1.2 16VHi-Flex | 4 | D4F740 | 55/74 | 07/08→ | OE130 | 0,9 | CET13P [6] | | BAE947A | CLS084 [296] |
| | | | | | OE225 [6] [254] | 0,7 | CET4 | | BAEA325 | |
| 1.4 16V | 4 | K4J780 | 72/97 | 02/10→ | OE033 | 0,9 | CET2 | OE179 | BAE409A | |
| 1.5 dCi | 4 | K9K752 | 48/64 | 02/10→ | CH271 | 11v | | | CCU154 [10] | |
| 1.5 dCi | 4 | K9K714; K9K768 | 50/67 | 02/08→ | CH271 | 11v | | | CCU154 [10] | |
| 1.5 dCi | 4 | K9K770 | 55/74 | 08/10→ | CH271 | 11v | | | CCU154 [10] | |
| 1.5 dCi | 4 | K9K766 | 63/84 | 02/08→ | CH271 | 11v | | | CCU154 [10] | |
| 1.5 dCi | 4 | K9K770; K9K772 | 65/87 | 08/10→ | CH271 | 11v | | | CCU154 [10] | |
| 1.5 dCi | 4 | K9K772 | 76/102 | 02/08→ | CH271 | 11v | | | CCU154 [10] | |
| 1.5 dCi | 4 | K9K764; K9K774 | 78/105 | 02/08→12/12 | CH271 | 11v | | | CCU154 [10] | |
| 1.6 16V | 4 | K4M800; K4M801 | 82/110 | 02/08→ | OE033 | 0,9 | CET2 | OE179 | BAE409A | |
| 1.6 16V | 4 | K4M862 | 94/126 | 11/08→ | OE033 | 0,9 | CET2 | OE179 | BAE409A | |

CLIO I

| | | | | | | | | | | |
|--------------|---|-----------------------------------|---------|-------------|------------------------|-----|-------------|--------------|-------------------------------|--|
| 1.8 Rsi | 4 | F3P758 | 79/106 | 08/95→09/98 | OE006 →08/96 | 0,9 | CET8 | OE195 | BAEA251 [265] [292] | |
| 1.8 Rsi | 4 | F3P712 | 80/107 | 01/93→08/95 | OE006 | 0,9 | CET8 | OE195 | BAEA251 [265] [292] | |
| 1.9 D | 4 | F8Q678 | 40/54 | 01/97→09/98 | CH173 | 11v | | | | |
| 1.9 D | 4 | F8Q632; F8Q676; F8Q696; F8Q714 | 48/64 | 05/96→02/98 | CH206 | 11v | | | | |
| 2.0 Williams | 4 | F7R700 | 108/145 | 01/94→09/98 | | | CET2 | OE179 | BAEA251 [265] [292] | |

CLIO II

| | | | | | | | | | | |
|-----|---|---|-------|-------------|--------------|-----|-------------|--------------|---|-------------------------------|
| 1.0 | 4 | CG10DE | 40/54 | 02/00→05/01 | OE063 | 1,0 | CET2 | OE180 | BAEA354 | |
| 1.0 | 4 | | 52/70 | 06/01→04/05 | OE130 | 0,9 | CET4 | | | |
| 1.2 | 4 | D7F710; D7F722; D7F746; D7F764; D7F766 | 43/58 | 09/98→ | OE026 | 0,9 | CET2 | OE179 | BAEA345 →10/98 →Eng.981020 | |
| | | | | | | | | | BAEA354 11/98→ Eng.981021→ | |
| 1.2 | 4 | D7F720; D7F726 | 43/58 | 09/98→ | OE026 | 0,9 | CET2 | OE179 | BAEA345 →10/98 →Eng.981020 | CLS083 [275] 10/99→ |
| | | | | | | | | | BAEA354 11/98→ Eng.981021→ | |

RENAULT





kW/BHP

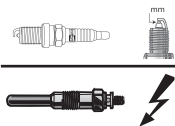

eon TITAN

IRIDIUM



...RENAULT

...CLIO II

| | | | | | | | | | | |
|-------------------|---|--|---------|---------------|--------------------------|------|--------|-------|-----------------------|---------------------------|
| 1.2 16V | 4 | D4F706; D4F712 | 54/72 | 06/06 → | OE130 | 0,9 | CET4 | | | |
| 1.2 16V | 4 | D4F706; D4F712; D4F714; D4F722; D4F728 | 55/74 | 06/01 → | OE130 | 0,9 | CET4 | | BAEA325 [151] [275] | CLS084 [296] |
| | | | | | | | | | BAEA454 [150] [275] | |
| 1.2 LPG | 4 | D7F764; D7F766 | 43/58 | 09/98 → 06/09 | OE026 | 0,9 | CET2 | OE179 | BAEA354 | CLS084 [152] [296] |
| | | | | | | | | | | CLS040 [275] → Eng.991002 |
| 1.2 LPG | 4 | D7F722 | 44/59 | 03/99 → 05/01 | OE026 | 0,9 | CET2 | OE179 | BAEA354 | CLS040 [275] → 09/99 |
| | | | | | | | | | | CLS083 [275] 10/99 → |
| 1.4 | 4 | E7J634; E7J780; K7J700 | 55/74 | 09/98 → 05/05 | OE033 *to be adjusted | 1,0* | CET2 | OE179 | BAEA242 [7] [37] | CLS019 |
| | | | | | | | | | BAEA243 [14] [39] | |
| 1.4 | 4 | E7J.6.34; E7J.6.35 | 55/74 | 09/98 → 05/05 | | | | | BAEA354 03/99 → | |
| 1.4 16V | 4 | K4J712; K4J713 | 70/94 | 10/99 → 09/04 | OE033 | 0,9 | CET2 | OE179 | BAE409A | |
| 1.4 16V | 4 | K4J710; K4J711; K4J712; K4J713; K4J715 | 72/97 | 08/00 → | OE033 | 0,9 | CET2 | OE179 | BAE409A | |
| 1.5 dCi | 4 | K9K704 | 42/56 | 06/01 → 12/06 | CH271 | 11v | | | CCU154 [10] | |
| 1.5 dCi | 4 | K9K740 | 47/63 | 06/05 → | CH271 | 11v | | | CCU154 [10] | |
| 1.5 dCi | 4 | K9K700; K9K704 | 48/64 | 06/01 → | CH271 | 11v | | | CCU154 [10] | |
| 1.5 dCi | 4 | K9K700; K9K714 | 50/67 | 08/04 → | CH271 | 11v | | | CCU154 [10] | |
| 1.5 dCi | 4 | K9K702 | 59/79 | 06/01 → 10/03 | CH271 | 11v | | | CCU154 [10] | |
| 1.5 dCi | 4 | K9K702 | 60/80 | 06/01 → | CH271 | 11v | | | CCU154 [10] | |
| 1.5 dCi | 4 | K9K718 | 62/83 | 02/07 → 06/09 | CH271 | 11v | | | CCU154 [10] | |
| 1.5 dCi | 4 | K9K712 | 74/99 | 01/04 → | CH271 | 11v | | | CCU154 [10] | |
| 1.6 | 4 | K7M744; K7M745; K7M746 | 66/89 | 09/98 → 05/05 | OE026 | 0,9 | CET2 | OE179 | BAE409A → 03/01 | CLS011 |
| | | | | | OE216 LPG [278] | 0,8 | | | BAEA354 09/99 → 12/02 | |
| | | | | | | | | | BAEA242 [7] [37] | |
| | | | | | | | | | BAEA243 [14] [39] | |
| 1.6, 1.6 Flex | 4 | K4M740; K4M748 | 81/109 | 05/00 → 02/09 | OE033 | 0,9 | CET2 | OE179 | | |
| 1.6, 1.6 Flex | 4 | K4M | 81/109 | 05/00 → 02/09 | | | | | BAE409A | |
| 1.6 16V | 4 | K4M708; K4M740; K4M742; K4M743; K4M744; K4M745; K4M748 | 79/106 | 09/98 → | OE033 | 0,9 | CET2 | OE179 | BAE409A | |
| 1.6 Hi-Flex | 4 | K4M748 | 86/115 | 01/05 → 02/10 | OE033 | 0,9 | CET2 | OE179 | BAE409A | |
| 1.9 D | 4 | F8Q630 | 47/63 | 09/98 → 05/05 | CH217 → 02/99 | 11v | | | CCU128 [329] | |
| | | | | | CH233 03/99 → | 11v | | | CCU129 [338] | |
| 1.9 D | 4 | F8Q630; F8Q632 | 48/64 | 02/00 → 05/01 | CH217 | 11v | | | CCU128 [329] | |
| | | | | | | | | | CCU129 [338] | |
| 1.9 dTi | 4 | F9Q780 | 59/79 | 12/99 → 05/05 | CH271 | 11v | | | CCU129 [338] | |
| 2.0 2.0 16V Sport | 4 | F4R730; F4R736 | 124/166 | 02/00 → | | | CET12P | OE179 | BAEA345 [275] 04/01 → | CLS194 |
| | | | | | | | | | BAEA354 [275] | |
| 2.0 16V Sport | 4 | F4R738 | 132/177 | 01/04 → | | | CET12P | OE179 | BAEA345 → 05/05 | CLS194 |
| 3.0 V6 Sport | 6 | L7X760 | 166/223 | 11/00 → 12/02 | OE175 | 1,0 | CET14P | OE190 | BAEA347 | |
| 3.0 V6 Sport | 6 | L7X762 | 187/251 | 12/02 → | OE175 | 1,0 | CET14P | OE190 | BAEA347 | |
| CLIO III | | | | | | | | | | |
| 1.2 | 4 | D4F764 | 57/76 | 10/05 → | OE130 | 0,9 | CET4 | | BAE947A | |
| | | | | | | | | | BAEA325 | |

RENAULT





kW/BHP

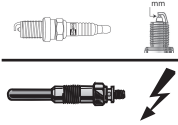

eon TITAN

IRIDIUM

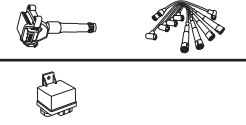

...RENAULT

...CLIO III

| | | | | | | | | | | |
|----------------------|---|------------------------|---------|-------------|---|-------------------|---|------------------------------------|--|-----------------------------------|
| 1.2 16V | 4 | D4F764 | 43/58 | 06/06→08/10 | | | | | BAE947A BAEA325 BAEA354 ^[275] | |
| 1.2 16V | 4 | D4F740 | 48/64 | 06/05→ | OE130 | 0,9 | CET13P ^[6] | | BAE947A →05/08 BAEA325 06/08→ | CLS084 ^[296] 06/08→ |
| 1.2 16V | 4 | D4F706; D4F740; D4F764 | 55/74 | 06/05→ | OE130 | 0,9 | CET13P ^[6] | | BAE947A →05/08 BAEA325 06/08→ | CLS084 ^[296] 06/08→ |
| 1.2 16V | 4 | D4F764 | 58/78 | 06/05→ | OE130 | 0,9 | CET4 | | BAE947A →05/08 BAEA325 06/08→ | CLS084 ^[296] 06/08→ |
| 1.2 16V | 4 | D4F784 | 74/99 | 05/07→ | OE225 | 0,7 | CET13P | | BAE947A →05/08 BAEA325 06/08→ BAEA354 ^[275] | CLS084 ^[296] 06/08→ |
| 1.2 16V | 4 | D4F786 | 76/102 | 09/10→ | OE130 | 0,9 | CET13P | | BAE947A BAEA325 | CLS084 ^[296] |
| 1.2 16VHi-Flex | 4 | D4F740; D4F742 | 55/74 | 07/08→ | OE130 | 0,9 | CET4 | | BAE947A BAEA325 | CLS084 ^[296] |
| 1.2 Ethanol | 4 | D4F742 | 55/74 | 07/08→ | OE130 | 0,9 | CET4 | | | |
| 1.4 16V | 4 | K4J780 | 72/97 | 06/05→ | OE033 | 0,9 | CET2 | OE179 | BAE409A | |
| 1.5 dCi | 4 | K9K752 | 47/63 | 06/05→ | CH271 | 11v | | | CCU154 ^[10] | |
| 1.5 dCi | 4 | K9K752 | 48/64 | 05/05→ | CH271 | 11v | | | CCU154 ^[10] | |
| 1.5 dCi | 4 | K9K714; K9K768 | 50/67 | 06/05→ | CH271 | 11v | | | CCU154 ^[10] | |
| 1.5 dCi | 4 | K9K770 | 55/74 | 08/10→ | CH271 | 11v | | | CCU154 ^[10] | |
| 1.5 dCi | 4 | K9K750 | 60/80 | 11/07→ | CH271 | 11v | | | CCU154 ^[10] | |
| 1.5 dCi | 4 | K9K766 | 63/84 | 06/05→ | CH271 | 11v | | | CCU154 ^[10] | |
| 1.5 dCi | 4 | K9K770 | 65/87 | 08/10→ | CH271 | 11v | | | CCU154 ^[10] | |
| 1.5 dCi | 4 | K9K772 | 76/102 | 06/05→ | CH271 | 11v | | | CCU154 ^[10] | |
| 1.5 dCi | 4 | K9K764; K9K774 | 78/105 | 06/05→ | CH271 | 11v | | | CCU154 ^[10] | |
| 1.6 16V | 4 | K4M804 | 65/87 | 06/05→ | OE033 | 0,9 | CET2 | OE179 | BAE409A | |
| 1.6 16V | 4 | K4M800; K4M801 | 82/110 | 06/05→ | OE033 | 0,9 | CET2 | OE179 | BAE409A | |
| 1.6 16V GT | 4 | K4M862 | 94/126 | 06/09→ | OE033 | 0,9 | CET2 | OE179 | BAE409A | |
| 2.0 16V | 4 | M4R700; M4R701 | 102/137 | 09/06→ | OE207 | 1,1 | | | BAEA056E | |
| 2.0 16V Sport | 4 | F4R830; F4R832 | 145/194 | 02/06→ | | | CET11P | OE179 | BAE409A | |
| 2.0 16V Sport | 4 | F4R832 | 148/198 | 09/08→ | OE033 | 0,9 | CET2 | OE179 | BAE409A | |
| CLIO IV | | | | | | | | | | |
| 0.9 TCe 90 | 3 | H4B400 | 66/89 | 11/12→ | | | | OE261 Eng.130429→ Eng.140609 | BAEA131E | |
| 0.9 TCe 90 LPG | 3 | H4B400 | 66/89 | 06/16→ | | | | OE261 | BAEA131E | |
| 1.2 16V | 4 | D4F728 | 54/72 | 11/12→ | OE225 | 0,7 | CET13P | | BAE947A BAEA325 ^[323] | CLS084 ^[296] |
| 1.2 16V | 4 | D4F740 | 54/72 | 11/12→ | OE130 OE225 OE225 ^[6] ^[254] | 0,9 0,7 0,7 | CET13P CET13P ^[6] CET4 | | BAE947A BAEA325 ^[323] | CLS084 ^[296] |
| 1.2 TCe 120 | 4 | H5F412 | 87/117 | 01/16→ | | | | OE261 | BAEA131E | |
| 1.2 TCe 120 | 4 | H5F403 | 88/118 | 03/13→ | | | | OE261 | BAEA131E | |
| DUSTER | | | | | | | | | | |
| 1.5 dCi | 4 | K9K796 | 63/84 | 02/12→ | CH271 ^[9] | 11v | | | CCU147 ^[11] | |
| 1.5 dCi, 1.5 dCi 4WD | 4 | K9K884 | 66/89 | 06/09→ | CH271 ^[9] | 11v | | | CCU147 ^[11] | |
| 1.5 dCi, 1.5 dCi 4WD | 4 | K9K856; K9K858; K9K898 | 80/107 | 09/13→ | CH271 ^[9] | 11v | | | CCU147 ^[11] | |

RENAULT





kW/BHP

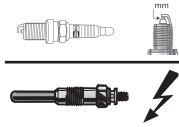

eon TITAN

IRIDIUM



...RENAULT

...DUSTER

| | | | | | | | | | |
|--------------------------------------|---|--|---------|-------------|----------------------|-----|------|-------|---------------------------------|
| 1.5 dCi, 1.5 dCi 4WD | 4 | ; K9K896 | 81/109 | 02/12→ | CH271 [9] | 11v | | | CCU147 [11] |
| 1.6 16V | 4 | K4M718 | 76/102 | 02/12→ | OE005 →Eng.140324 | 0,9 | CET2 | OE179 | BAE409A |
| | | | | | OE033 Eng.140325→ | 0,9 | | | |
| 1.6 16V | 4 | K4M616 | 77/103 | 06/11→ | OE005 →Eng.140324 | 0,9 | CET2 | OE179 | BAE409A |
| | | | | | OE033 Eng.140325→ | 0,9 | | | |
| 1.6 16V | 4 | K4M690 | 81/109 | 01/11→ | OE005 →Eng.140324 | 0,9 | CET2 | OE179 | BAE409A |
| | | | | | OE033 Eng.140325→ | 0,9 | | | |
| 1.6 16V, 1.6 16V 4WD | 4 | K4M616 | 75/101 | 06/11→ | OE005 →Eng.140324 | 0,9 | CET2 | OE179 | BAE409A |
| | | | | | OE033 Eng.140325→ | 0,9 | | | |
| 1.6 16V, 1.6 16V 4WD | 4 | K4M690 | 84/113 | 06/15→ | OE005 →Eng.140324 | 0,9 | CET2 | OE179 | BAE409A |
| | | | | | OE033 Eng.140325→ | 0,9 | | | |
| 1.6 Hi-Flex | 4 | K4M690 | 85/114 | 09/14→12/15 | OE005 →Eng.140324 | 0,9 | CET2 | OE179 | BAE409A |
| | | | | | OE033 Eng.140325→ | 0,9 | | | |
| 1.6 Hi-Flex | 4 | | 88/118 | 01/17→ | OE005 →Eng.140324 | 0,9 | CET2 | OE179 | BAE409A |
| | | | | | OE033 Eng.140325→ | 0,9 | | | |
| 2.0 | 4 | F4R403; F4R405 | 98/131 | 02/12→ | OE014 | 0,9 | CET2 | OE179 | BAE409A |
| | | | | | OE033 | 0,9 | | | |
| 2.0 | 4 | | 102/137 | 10/11→ | OE014 | 0,9 | CET2 | OE179 | BAE409A |
| | | | | | OE033 | 0,9 | | | |
| 2.0, 2.0 4WD | 4 | F4R400; F4R402; F4R404 | 101/135 | 01/11→ | OE014 | 0,9 | CET2 | OE179 | BAE409A |
| | | | | | OE033 | 0,9 | | | |
| 2.0, 2.0 4WD, 2.0 Flex, 2.0 Flex 4WD | 4 | F4R400; F4R402; F4R403; F4R408 | 105/141 | 10/11→ | OE014 | 0,9 | CET2 | OE179 | BAE409A |
| | | | | | OE033 | 0,9 | | | |
| 2.0 4WD | 4 | F4R | 99/133 | 02/12→ | OE014 | 0,9 | CET2 | OE179 | BAE409A |
| | | | | | OE033 | 0,9 | | | |
| 2.0 Flex, 2.0 Flex 4WD | 4 | F4R402; F4R403 | 109/146 | 01/16→ | OE014 | 0,9 | CET2 | OE179 | BAE409A |
| | | | | | OE033 | 0,9 | | | |
| 2.0 Hi-Flex, 2.0 Hi-Flex 4WD | 4 | F4R400; F4R402; F4R403; F4R404; F4R405; F4R408 | 104/139 | 01/11→ | OE014 | 0,9 | CET2 | OE179 | BAE409A |
| | | | | | OE033 | 0,9 | | | |
| ESPACE II | | | | | | | | | |
| 2.1 TD | 4 | J8S612 | 66/89 | 11/94→10/96 | CH189 | 11v | | | |
| ESPACE III | | | | | | | | | |
| 1.9 dTi | 4 | F9Q722 | 72/97 | 02/99→10/02 | CH271 | 11v | | | CCU129 [338] |
| 2.0 | 4 | F3R728; F3R729; F3R742; F3R768; F3R769 | 84/113 | 11/96→10/00 | | | CET8 | OE195 | CLS039 |
| | | | | | | | | | CLS052 |
| 2.0 | 4 | F4R700; F4R701 | 102/137 | 09/01→10/02 | OE033 | 0,9 | CET2 | OE179 | BAE409A |
| 2.0 16V | 4 | F4R700; F4R701 | 103/138 | 10/98→10/02 | OE033 | 0,9 | CET2 | OE179 | BAE409A |
| 2.2 12V TD | 4 | G8T714; G8T716; G8T760 | 83/111 | 11/96→10/00 | CH169 | 11v | | | |
| 2.2 D | 4 | G8T716 | 84/113 | 11/97→01/00 | CH169 | 11v | | | |
| 2.2 dCi | 4 | G9T710 | 85/114 | 07/00→10/02 | CH232 | 11v | | | CCU154 [10] |
| 2.2 dCi | 4 | G9T642; G9T710 | 95/127 | 10/00→10/02 | CH232 | 11v | | | CCU154 [10] |
| 3.0 | 6 | Z7X775 | 123/165 | 11/96→10/98 | OE033 | 0,9 | | OE179 | BAEA251 [265] [275] [292] [372] |





kW/BHP

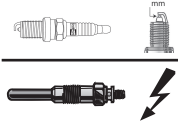

eon TITAN

IRIDIUM

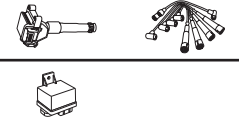

...RENAULT

| ...ESPACE III | | | | | | | | | |
|------------------------|---|--|---------|-------------|---|-----|---------------|--------------|--|
| 3.0 V6 24V | 6 | L7X727 | 140/188 | 10/98→10/02 | OE026 | 0,9 | CET2 | OE179 | |
| ESPACE IV | | | | | | | | | |
| 1.9 dCi | 4 | F9Q820 | 85/114 | 04/03→02/05 | CH271 | 11v | | | CCU154 →Eng.070828 [10] [360] CCU147 Eng.070829→ [11] [352] |
| 1.9 dCi | 4 | F9Q680; F9Q820; F9Q826 | 88/118 | 11/02→ | CH271 | 11v | | | CCU154 →Eng.070828 [10] [360] CCU147 Eng.070829→ [11] [352] |
| 2.0 | 4 | F4R790 | 98/131 | 11/02→02/05 | OE033 | 0,9 | CET2 | OE179 | BAE409A |
| 2.0 | 4 | F4R792 | 100/134 | 11/02→ | OE136 | 0,8 | CET12P | OE179 | BAE409A |
| 2.0 | 4 | F4R796; F4R797; F4R896; F4R897 | 125/168 | 04/05→ | OE136 | 0,8 | CET12P | OE179 | BAE409A |
| 2.0 dCi | 4 | M9R740; M9R750; M9R760; M9R761; M9R762; M9R763 | 96/129 | 01/06→ | CCGP007 Eng.060314 060904→ [14] [154] | 7v | | | |
| 2.0 dCi | 4 | M9R740; M9R750; M9R814; M9R815 | 110/148 | 01/06→ | CCGP007 Eng.060314 060904→ [14] [154] | 7v | | | |
| 2.0 dCi | 4 | M9R760; M9R761; M9R762; M9R763; M9R812; M9R815; M9R859 | 127/170 | 01/06→ | CCGP007 Eng.060314 060904→ [14] [154] | 7v | | | |
| 2.0 Turbo | 4 | F4R794; F4R795; F4R796; F4R797 | 120/161 | 11/02→ | OE136 | 0,8 | CET12P | OE179 | BAE409A |
| 2.2 dCi | 4 | G9T645 | 102/137 | 02/06→ | CH232 | 11v | | | CCU154 [10] |
| 2.2 dCi | 4 | G9T742; G9T743 | 110/148 | 11/02→ | CH232 | 11v | | | CCU154 [10] |
| 3.5 V6 | 6 | V4Y711; V4Y715 | 177/237 | 11/02→ | OE175 | 1,0 | CET14P | OE190 | BAEA079E |
| EXPRESS | | | | | | | | | |
| 1.9 D | 4 | F8Q640 | 40/54 | 07/95→10/97 | CH206 [287] [327] | 11v | | | |
| 1.9 D | 4 | F8Q724; F8Q776 | 47/63 | 07/95→10/99 | CH206 [287] [327] | 11v | | | |
| FLUENCE | | | | | | | | | |
| 1.6 | 4 | H4M729 | 86/115 | 01/13→ | | | | | BAEA131E [105] [375] |
| 1.6 16V | 4 | K4M838 | 78/105 | 02/10→ | | | | | BAE409A |
| 1.6 16V | 4 | K4M838; K4M839 | 81/109 | 02/10→ | OE207 | 1,1 | CET2 | | BAE409A |
| 1.6 16V | 4 | K4M | 81/109 | 02/10→ | OE033 | 0,9 | | OE179 | |
| 1.6 16V | 4 | K4M838 | 82/110 | 02/10→ | OE033 | 0,9 | CET2 | OE179 | BAE409A |
| 2.0 16V | 4 | M4R714; M4R751 | 103/138 | 02/10→ | OE207 | 1,1 | | | BAEA161E [300] |
| GRAND SCÉNIC II | | | | | | | | | |
| 1.5 dCi | 4 | K9K722 | 60/80 | 04/04→ | CH271 | 11v | | | |
| 1.5 dCi | 4 | K9K728 | 74/99 | 04/04→ | CH271 | 11v | | | |
| 1.5 dCi | 4 | K9K732 | 78/105 | 05/05→ | CH271 | 11v | | | |
| 1.6 | 4 | K4M788 | 77/103 | 06/06→ | OE033 | 0,9 | CET2 | OE179 | BAE409A |
| 1.6 | 4 | K4M812 | 82/110 | 06/06→11/08 | OE033 | 0,9 | CET2 | OE179 | BAE409A |
| 1.6 | 4 | K4M761; K4M782 | 83/111 | 04/04→ | OE033 | 0,9 | CET2 | OE179 | BAE409A |
| 1.6 Flex | 4 | K4M766 | 82/110 | 06/06→11/08 | | | | | BAE409A |
| 1.9 dCi | 4 | F9QE804 | 81/109 | 05/05→ | CH271 | 11v | | | |
| 1.9 dCi | 4 | F9Q803; F9Q804; F9Q812 | 85/114 | 05/05→01/09 | CH271 | 11v | | | |

RENAULT



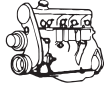

kW/BHP

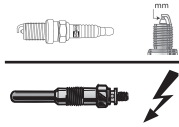

eon TITAN

IRIDIUM



...RENAULT

...GRAND SCÉNIC II

| | | | | | | | | | | |
|---------|---|--------------------------------------|---------|--------|--------------------------------------|-----|------|-------|---------|-------------------------------------|
| 1.9 dCi | 4 | F9Q812 | 88/118 | 04/04→ | CH271 | 11v | | | | CCU154 →Eng.050111 [10] [360] |
| 1.9 dCi | 4 | F9Q816; F9Q818; F9QEE804; F9QJ803 | 96/129 | 05/05→ | CH271 | 11v | | | | CCU147 Eng.050112→ [11] [352] |
| 2.0 | 4 | F4R770; F4R771 | 99/133 | 04/04→ | OE033 | 0,9 | CET2 | OE179 | BAE409A | |
| 2.0 | 4 | F4R776 | 120/161 | 04/04→ | OE033 | 0,9 | CET2 | OE179 | BAE409A | |
| 2.0 dCi | 4 | M9R700; M9R721; M9R722 | 110/148 | 09/05→ | CCGP007 Eng.061129→ [14] [154] | 7v | | | | |

GRAND SCÉNIC III

| | | | | | | | | | | |
|----------------|---|----------|---------|--------|-------------------------|-----|---------|-------|---------------------------|--|
| 1.2 TCe | 4 | H5F400 | 85/114 | 04/12→ | | | | OE261 | BAEA131E | |
| 1.2 TCe | 4 | H5F404 | 97/130 | 01/13→ | | | | OE261 | BAEA131E | |
| 1.4 16V | 4 | H4J700 | 96/129 | 02/09→ | OE225 | 0,7 | CET1 3P | | BAEA066E | |
| 1.6 16V | 4 | K4M858 | 81/109 | 02/09→ | OE033 | 0,9 | CET2 | OE179 | | |
| 1.6 16V | 4 | K4M.8.66 | 81/109 | 02/09→ | | | | | BAE409A 06/09→ | |
| 1.6 16V Bifuel | 4 | K4M866 | 81/109 | 02/09→ | OE033 | 0,9 | CET2 | OE179 | BAE409A | |
| 2.0 16V | 4 | M4R711 | 103/138 | 02/09→ | OE207 | 1,1 | | | BAEA161E ^[300] | |
| 2.0 dCi | 4 | M9R615 | 110/148 | 02/09→ | CCGP007 ^[14] | 7v | | | | |
| 2.0 dCi | 4 | M9R610 | 118/158 | 04/09→ | CCGP007 ^[14] | 7v | | | | |

GRAND SCÉNIC IV

| | | | | | | | | | | |
|-------------|---|--------|--------|--------|--|--|--|--|----------|--|
| 1.2 TCe 115 | 4 | H5F408 | 85/114 | 09/16→ | | | | | BAEA131E | |
| 1.2 TCe 130 | 4 | H5F408 | 96/129 | 09/16→ | | | | | BAEA131E | |

KADJAR

| | | | | | | | | | | |
|-------------|---|--------|--------|--------|--|--|--|-------|----------|--|
| 1.2 TCe 130 | 4 | H5F408 | 96/129 | 06/15→ | | | | OE261 | BAEA131E | |
|-------------|---|--------|--------|--------|--|--|--|-------|----------|--|

KANGOO

| | | | | | | | | | | |
|---------|---|---|-------|-------------|----------------------------|------|------|-------|------------------------------------|-----------------------------------|
| 1.2 | 4 | D7F710; D7F720; D7F722; D7F726; D7F744; D7F746 | 43/58 | 08/97→ | OE026 | 0,9 | CET2 | OE179 | BAEA345 →10/98 | CLS040 ^[275] →09/99 |
| | | | | | | | | | BAEA354 11/98→ | CLS083 ^[275] 10/99→ |
| 1.2 16V | 4 | D4F712; D4F714; D4F716; D4F730 | 55/74 | 06/01→ | OE130 *to be adjusted | 0,8* | CET4 | | BAEA345 ^[275] 03/03→ | CLS084 ^[296] |
| | | | | | | | | | BAE947A ^[275] 07/04→ | |
| | | | | | | | | | BAEA325 ^[275] 07/04→ | |
| | | | | | | | | | BAEA454 [150] [275] | |
| 1.4 | 4 | E7J634; E7J635 | 55/74 | 08/97→ | OE026 | 0,9 | CET2 | OE179 | BAEA354 09/98→12/07 | CLS117 →08/98 |
| 1.4 | 4 | E7J780 | 55/74 | 08/97→ | OE026 | 0,9 | CET2 | OE179 | BAEA242 [7] [37] | CLS011 |
| | | | | | | | | | BAEA243 [14] [39] | |
| 1.4 | 4 | K7J700; K7J701 | 55/74 | 08/97→ | OE026 | 0,9 | CET2 | OE179 | BAEA354 09/98→12/07 | CLS117 →08/98 |
| | | | | | OE216 ^{LPG [278]} | 0,8 | | | | |
| 1.5 dCi | 4 | K9K704 | 42/56 | 07/03→ | CH271 | 11v | | | CCU154 ^[10] | |
| 1.5 dCi | 4 | K9K700; K9K702 | 45/60 | 04/05→06/10 | CH271 | 11v | | | CCU154 ^[10] | |
| 1.5 dCi | 4 | K9K700; K9K704 | 48/64 | 12/01→ | CH271 | 11v | | | CCU154 ^[10] | |
| 1.5 dCi | 4 | K9K714 | 50/67 | 06/05→ | CH271 | 11v | | | CCU154 ^[10] | |
| 1.5 dCi | 4 | K9K702; K9K710 | 60/80 | 07/02→ | CH271 | 11v | | | CCU154 ^[10] | |

RENAULT

CHAMPION



kW/BHP

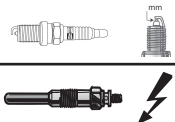

eon TITAN

IRIDIUM

**...RENAULT****...KANGOO**

| | | | | | | | | | |
|----------------------|---|-----------------------------------|-------|-------------|----------------------------|-----|------|-------|--|
| 1.5 dCi | 4 | K9K718 | 62/83 | 06/05→ | CH271 | 11v | | | CCU154 ^[10] |
| 1.6 | 4 | K7M746 | 66/89 | 09/99→06/01 | OE026 | 0,9 | CET2 | OE179 | BAEA354 |
| | | | | | OE216 ^{LPG [278]} | 0,8 | | | |
| 1.6 16V, 1.6 16V 4WD | 4 | K4M706; K4M750; K4M752; K4M753 | 70/94 | 06/01→ | OE033 | 0,9 | CET2 | OE179 | BAE409A |
| 1.6 16V bivalent | 4 | K4M850 | 60/80 | 06/05→ | OE033 | 0,9 | CET2 | OE179 | |
| 1.9 D 55 | 4 | F8Q662 | 40/54 | 08/97→ | CH217 →02/99 | 11v | | | CCU128 ^[329] |
| | | | | | CH233 03/99→ | 11v | | | CCU129 ^[338] |
| 1.9 D 65 | 4 | F8Q632 | 47/63 | 08/97→ | CH233 | 11v | | | CCU128 ^[329] CCU129 ^[338] |
| 1.9 D 65 | 4 | F8Q630 | 47/63 | 08/97→ | CH217 | 11v | | | CCU128 ^[329] CCU129 ^[338] |
| 1.9 dCi 4WD | 4 | F9Q790 | 62/83 | 10/03→ | CH271 | 11v | | | CCU129 ^[338] CCU154 ^[10] |
| 1.9 dCi 4WD, 1.9 dTi | 4 | F9Q780; F9Q782; F9Q790 | 59/79 | 02/00→ | CH271 | 11v | | | CCU129 ^[338] CCU154 ^[10] |
| 1.9 RXED | 4 | F8Q630; F8Q632 | 48/64 | 09/99→06/01 | CH217 | 11v | | | CCU128 ^[329] CCU129 ^[338] |

KANGOO / GRAND KANGOO

| | | | | | | | | | |
|-------------------------|---|-----------------------------------|--------|--------|----------------------------|-----|------|-------|---------------------------------|
| 1.2 TCe 115 | 4 | H5F400; H5F408; H5F412 | 84/113 | 07/13→ | | | | OE261 | BAEA131E |
| 1.6 | 4 | K7M750 | 64/86 | 02/08→ | OE026 | 0,9 | CET2 | OE179 | BAEA354 ^[101] CLS019 |
| | | | | | OE216 ^{LPG [278]} | 0,8 | | | |
| 1.6 16V | 4 | K4M.8.30 | 78/105 | 02/08→ | | | | | BAE409A |
| 1.6 16V, 1.6 16VHi-Flex | 4 | K4M830; K4M831; K4M834; K4M850 | 78/105 | 02/08→ | OE033 | 0,9 | CET2 | OE179 | |
| 1.6 16VHi-Flex | 4 | K4M.8.34 | 78/105 | 02/08→ | | | | | BAE409A 01/09→ |

KANGOO BE BOP

| | | | | | | | | | |
|-----|---|--------|--------|--------|-------|-----|------|-------|---------|
| 1.6 | 4 | K4M830 | 78/105 | 02/09→ | OE033 | 0,9 | CET2 | OE179 | BAE409A |
|-----|---|--------|--------|--------|-------|-----|------|-------|---------|

KAPTUR

| | | | | | | | | | |
|-----|---|----------------|--------|--------|--|--|--|--|-------------------------|
| 1.6 | 4 | H4M429; H4M438 | 84/113 | 03/16→ | | | | | BAEA131E [105] [375] |
|-----|---|----------------|--------|--------|--|--|--|--|-------------------------|

KOLEOS I

| | | | | | | | | | |
|----------------------|---|---|---------|--------|-------------------------|-----|--|--|----------|
| 2.0 dCi, 2.0 dCi 4WD | 4 | M9R832; M9R833; M9R834; M9R835; M9R836; M9R838; M9R850; M9R855; M9R856; M9R862; M9R865; M9R866 | 110/148 | 09/08→ | CCGP007 ^[14] | 7v | | | |
| 2.0 dCi 4WD | 4 | M9R830 | 127/170 | 09/08→ | CCGP007 ^[14] | 7v | | | |
| 2.5, 2.5 4WD | 4 | 2TR700; 2TR702; 2TR703 | 126/169 | 09/08→ | OE207 | 1,1 | | | BAEA088E |

LAGUNA

| | | | | | | | | | |
|---------------|---|--|---------|-------------|-------------------------|-----|------|-------|---------|
| 2.0 16V Turbo | 4 | F4R811; F4Ri811 | 125/168 | 09/08→12/15 | OE033 | 0,9 | CET2 | OE179 | BAE409A |
| 2.0 dCi | 4 | M9R744; M9R748; M9R754; M9R802; M9R805; M9R808; M9R814; M9R845; M9R854; M9R858 | 110/148 | 09/08→12/15 | CCGP007 [14] [154] | 7v | | | |
| 2.0 dCi | 4 | M9R800; M9R806; M9R809; M9R815; M9R849; M9R854; M9R857 | 127/170 | 09/08→12/15 | CCGP007 [14] [154] | 7v | | | |
| 2.0 dCi GT | 4 | M9R816; M9R820; M9R828 | 131/176 | 09/08→12/15 | CCGP007 [14] [154] | 7v | | | |
| 2.0 GT | 4 | F4R800 | 150/201 | 09/08→12/15 | OE033 | 0,9 | CET2 | OE179 | BAE409A |
| 3.0 dCi | 6 | V9X791; V9X891 | 173/232 | 09/08→12/15 | CCGP007 ^[14] | 7v | | | |
| 3.0 dCi | 6 | V9X891 | 177/237 | 01/12→12/15 | CCGP007 ^[14] | 7v | | | |

RENAULT



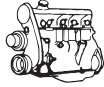

kW/BHP

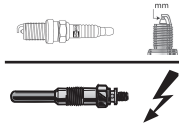

eon TITAN

IRIDIUM



...RENAULT

...LAGUNA

| | | | | | | | | | |
|--------|---|--------|---------|---------------|-------|-----|--|--|----------|
| 3.5 V6 | 6 | V4Y713 | 175/235 | 09/08 → 12/15 | OE207 | 1,1 | | | BAEA158E |
|--------|---|--------|---------|---------------|-------|-----|--|--|----------|

LAGUNA I

| | | | | | | | | | |
|---------|---|----------------|--------|---------------|-------|-----|------|-------|---------|
| 1.6 16V | 4 | K4M720; K4M724 | 79/106 | 11/97 → 03/01 | OE033 | 0,9 | CET2 | OE179 | BAE409A |
|---------|---|----------------|--------|---------------|-------|-----|------|-------|---------|

| | | | | | | | | | |
|-----|---|--------|-------|---------------|--|--|------|-------|--|
| 1.8 | 4 | F3P720 | 66/89 | 11/93 → 03/01 | | | CET8 | OE195 | |
|-----|---|--------|-------|---------------|--|--|------|-------|--|

| | | | | | | | | | |
|-----|---|--------|-------|---------------|--|--|------|-------|------------------------|
| 1.8 | 4 | F3P724 | 66/89 | 11/93 → 03/01 | | | CET8 | OE195 | BAEA251 [265] [292] |
|-----|---|--------|-------|---------------|--|--|------|-------|------------------------|

| | | | | | | | | | |
|-----|---|--------|-------|---------------|--|--|------|-------|--------------|
| 1.8 | 4 | F3P670 | 66/89 | 11/93 → 03/01 | | | CET8 | OE195 | CLS116 [292] |
|-----|---|--------|-------|---------------|--|--|------|-------|--------------|

| | | | | | | | | | |
|-----|---|--------|-------|---------------|--|--|------|-------|--|
| 1.8 | 4 | F3P678 | 66/89 | 11/93 → 03/01 | | | CET8 | OE195 | BAEA251 [265] [292] BAEA251 [265] [275] [292] |
|-----|---|--------|-------|---------------|--|--|------|-------|--|

| | | | | | | | | | |
|-----|---|--------|-------|---------------|--|--|--|--|------------------|
| 1.8 | 4 | F3P670 | 66/89 | 11/93 → 03/01 | | | | | CLS039 CLS052 |
|-----|---|--------|-------|---------------|--|--|--|--|------------------|

| | | | | | | | | | |
|-----|---|--------|-------|---------------|--|--|--|--|--------------|
| 1.8 | 4 | F3P720 | 66/89 | 11/93 → 03/01 | | | | | CLS116 [292] |
|-----|---|--------|-------|---------------|--|--|--|--|--------------|

| | | | | | | | | | |
|-----|---|--------|-------|---------------|--|--|------|-------|--|
| 1.8 | 4 | F3P674 | 69/93 | 06/95 → 03/01 | | | CET8 | OE195 | |
|-----|---|--------|-------|---------------|--|--|------|-------|--|

| | | | | | | | | | |
|-----|---|------------------------|-------|---------------|--|--|------|-------|------------------------------|
| 1.8 | 4 | F3P678; F3P720; F3P724 | 69/93 | 06/95 → 03/01 | | | CET8 | OE195 | BAEA251 [265] [275] [292] |
|-----|---|------------------------|-------|---------------|--|--|------|-------|------------------------------|

| | | | | | | | | | |
|-----|---|--------|-------|---------------|-------|-----|------|-------|--|
| 1.8 | 4 | F3P676 | 70/94 | 06/95 → 06/98 | OE006 | 0,9 | CET8 | OE195 | |
|-----|---|--------|-------|---------------|-------|-----|------|-------|--|

| | | | | | | | | | |
|---------|---|----------------|--------|---------------|-------|-----|------|-------|---------|
| 1.8 16V | 4 | F4P760; F4P770 | 88/118 | 04/98 → 03/01 | OE033 | 0,9 | CET2 | OE179 | BAE409A |
|---------|---|----------------|--------|---------------|-------|-----|------|-------|---------|

| | | | | | | | | | |
|---------|---|--------|--------|---------------|-------|-----|--|--|-----------------------------|
| 1.9 dCi | 4 | F9Q718 | 79/106 | 09/99 → 03/01 | CH271 | 11v | | | CCU129 [338] CCU154 [10] |
|---------|---|--------|--------|---------------|-------|-----|--|--|-----------------------------|

| | | | | | | | | | |
|---------|---|--------|-------|---------------|-------|-----|--|--|-----------------------------|
| 1.9 dTi | 4 | F9Q710 | 72/97 | 10/97 → 03/01 | CH271 | 11v | | | CCU129 [338] CCU154 [10] |
|---------|---|--------|-------|---------------|-------|-----|--|--|-----------------------------|

| | | | | | | | | | |
|---------|---|--------|-------|---------------|-------|-----|--|--|-----------------------------|
| 1.9 dTi | 4 | F9Q716 | 72/97 | 10/97 → 03/01 | CH169 | 11v | | | CCU129 [338] CCU154 [10] |
|---------|---|--------|-------|---------------|-------|-----|--|--|-----------------------------|

| | | | | | | | | | |
|---------|---|--------|-------|---------------|--|--|--|--|-----------------------------|
| 1.9 dTi | 4 | F9Q717 | 72/97 | 10/97 → 03/01 | | | | | CCU129 [338] CCU154 [10] |
|---------|---|--------|-------|---------------|--|--|--|--|-----------------------------|

| | | | | | | | | | |
|-----|---|--|-------|---------------|-------|-----|------|-------|--|
| 2.0 | 4 | | 70/94 | 11/93 → 03/01 | OE006 | 0,9 | CET8 | OE195 | |
|-----|---|--|-------|---------------|-------|-----|------|-------|--|

| | | | | | | | | | |
|-----|---|--------|--------|---------------|-------|-----|------|-------|------------------|
| 2.0 | 4 | F3R611 | 80/107 | 03/99 → 03/01 | OE006 | 0,9 | CET8 | OE195 | CLS039 CLS052 |
|-----|---|--------|--------|---------------|-------|-----|------|-------|------------------|

| | | | | | | | | | |
|-----|---|----------------|--------|---------------|--|--|------|-------|-----------------------------------|
| 2.0 | 4 | F3R722; F3R723 | 83/111 | 11/93 → 03/01 | | | CET8 | OE195 | BAEA251 01/96 → [265] [292] |
|-----|---|----------------|--------|---------------|--|--|------|-------|-----------------------------------|

| | | | | | | | | | |
|-----|---|--------|--------|---------------|--|--|------|-------|--|
| 2.0 | 4 | F3R722 | 84/113 | 06/95 → 02/01 | | | CET8 | OE195 | |
|-----|---|--------|--------|---------------|--|--|------|-------|--|

| | | | | | | | | | |
|-----|---|----------------|--------|---------------|--|--|------|-------|--------|
| 2.0 | 4 | F3R728; F3R768 | 84/113 | 06/95 → 02/01 | | | CET8 | OE195 | CLS039 |
|-----|---|----------------|--------|---------------|--|--|------|-------|--------|

| | | | | | | | | | |
|-----|---|--------|---------|---------------|-------|-----|------|-------|---------------|
| 2.0 | 4 | F4R780 | 102/137 | 09/99 → 02/01 | OE033 | 0,9 | CET2 | OE179 | BAE409A [275] |
|-----|---|--------|---------|---------------|-------|-----|------|-------|---------------|

| | | | | | | | | | |
|-----|---|----------------|---------|---------------|-------|-----|------|--|---|
| 2.0 | 4 | N7Q700; N7Q704 | 103/138 | 06/95 → 02/01 | OE120 | 0,6 | CET2 | | BAEA254 [7] [37] [275] BAEA255 [14] [39] [275] |
|-----|---|----------------|---------|---------------|-------|-----|------|--|---|

| | | | | | | | | | |
|---------|---|----------------|---------|---------------|-------|-----|------|-------|--|
| 2.0 16V | 4 | N7Q700; N7Q704 | 102/137 | 06/95 → 03/01 | OE120 | 0,6 | CET2 | OE179 | BAEA254 [7] [37] BAEA254 [7] [37] [275] BAEA255 [14] [39] BAEA255 [14] [39] [275] |
|---------|---|----------------|---------|---------------|-------|-----|------|-------|--|

| | | | | | | | | | |
|---------|---|--------|---------|---------------|-------|-----|------|-------|---------|
| 2.0 16V | 4 | F4R780 | 103/138 | 09/99 → 03/01 | OE033 | 0,9 | CET2 | OE179 | BAE409A |
|---------|---|--------|---------|---------------|-------|-----|------|-------|---------|

| | | | | | | | | | |
|-------|---|-----------------------------------|-------|---------------|-------|-----|--|--|--|
| 2.2 D | 4 | G8T706; G8T752; G8T790; G8T794 | 61/82 | 11/93 → 03/01 | CH169 | 11v | | | |
|-------|---|-----------------------------------|-------|---------------|-------|-----|--|--|--|

| | | | | | | | | | |
|--------|---|--------|--------|---------------|-------|-----|--|--|--|
| 2.2 dT | 4 | G8T760 | 83/111 | 03/96 → 03/01 | CH169 | 11v | | | |
|--------|---|--------|--------|---------------|-------|-----|--|--|--|

| | | | | | | | | | |
|-----|---|----------------|---------|---------------|--|--|------|-------|---------------------------------------|
| 3.0 | 6 | Z7X760; Z7X765 | 123/165 | 11/93 → 03/01 | | | CET2 | OE179 | BAEA251 [265] [275] [292] [372] |
|-----|---|----------------|---------|---------------|--|--|------|-------|---------------------------------------|

| | | | | | | | | | |
|---------|---|----------------|---------|---------------|--------------------------|------------|------|-------|--|
| 3.0 24V | 6 | L7X700; L7X701 | 140/188 | 03/97 → 03/01 | OE026 OE218 LPG [278] | 0,9 1,6 | CET2 | OE179 | |
|---------|---|----------------|---------|---------------|--------------------------|------------|------|-------|--|

LAGUNA II

| | | | | | | | | | |
|-----|---|--------|--------|---------------|-------|-----|--|--|---------|
| 1.6 | 4 | K4M710 | 76/102 | 03/01 → 10/05 | OE033 | 0,9 | | | BAE409A |
|-----|---|--------|--------|---------------|-------|-----|--|--|---------|

RENAULT





kW/BHP

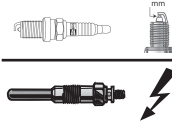

eon TITAN

IRIDIUM

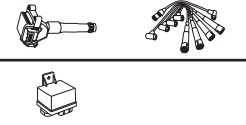

...RENAULT

...LAGUNA II

| | | | | | | | | | |
|--------------------------|---|--|---------|-------------|---|------------|--------|-------|--|
| 1.6 16V | 4 | K4M710; K4M714 | 79/106 | 03/01→12/07 | OE033 | 0,9 | CET2 | OE179 | BAE409A |
| 1.6 16V | 4 | K4M716 | 82/110 | 02/05→08/07 | OE033 | 0,9 | CET2 | OE179 | BAE409A |
| 1.6 FlexFuel | 4 | K4M718 | 76/102 | 06/01→10/03 | OE033 | 0,9 | CET2 | OE179 | |
| 1.6 LPG | 4 | K4M714 | 79/106 | 03/01→05/05 | | | | | BAE409A |
| 1.8 16V | 4 | F4P770; F4P771; F4P773; F4P774; F4P775 | 85/114 | 03/01→12/07 | OE033 | 0,9 | CET2 | OE179 | BAE409A |
| 1.8 16V | 4 | F4P770; F4P774 | 86/115 | 03/01→05/05 | OE033 | 0,9 | CET2 | OE179 | BAE409A |
| 1.8 16V | 4 | F4P770; F4P773 | 88/118 | 03/01→09/07 | OE033 | 0,9 | CET2 | OE179 | BAE409A |
| 1.8 16V | 4 | F4P770; F4P772; F4P774 | 89/119 | 03/01→05/05 | OE033 | 0,9 | CET2 | OE179 | BAE409A |
| 1.9 dCi | 4 | F9Q664 | 66/89 | 08/03→09/07 | CH271 | 11v | | | CCU154 ^[10] |
| 1.9 dCi | 4 | F9Q664 | 68/91 | 03/04→05/05 | CH271 | 11v | | | CCU154 ^[10] |
| 1.9 dCi | 4 | F9Q752; F9Q754 | 74/99 | 10/01→05/05 | CH271 | 11v | | | CCU154 ^[10] |
| 1.9 dCi | 4 | F9Q752 | 77/103 | 06/01→05/05 | CH271 | 11v | | | CCU154 ^[10] |
| 1.9 dCi | 4 | F9Q718; F9Q754 | 79/106 | 03/01→12/07 | CH271 | 11v | | | CCU154 ^[10] |
| 1.9 dCi | 4 | F9Q674; F9Q758 | 81/109 | 01/05→12/07 | CH271 | 11v | | | CCU154 ^[10] |
| 1.9 dCi | 4 | F9Q750; F9Q758; F9Q759 | 85/114 | 08/05→12/07 | CH271 | 11v | | | CCU154 ^[10] |
| 1.9 dCi | 4 | F9Q650; F9Q670; F9Q674; F9Q750 | 88/118 | 03/01→09/07 | CH271 | 11v | | | CCU154 ^[10] |
| 1.9 dCi | 4 | F9Q750 | 92/123 | 09/05→12/07 | CH271 | 11v | | | CCU154 ^[10] |
| 1.9 dCi | 4 | F9Q758; F9Q759 | 96/129 | 05/05→12/07 | CH271 | 11v | | | CCU154 ^[10] |
| 2.0 16V | 4 | F4R712; F4R713; F4R714; F4R715 | 98/131 | 08/02→09/07 | OE033 | 0,9 | CET2 | OE179 | BAE409A |
| 2.0 16V | 4 | F4R712; F4R713; F4R714; F4R715 | 99/133 | 08/02→12/07 | OE033 | 0,9 | CET2 | OE179 | BAE409A |
| 2.0 16V | 4 | F4R784; F4R786; F4R787 | 125/168 | 01/05→09/07 | OE033 | 0,9 | CET2 | OE179 | BAE409A |
| 2.0 16V | 4 | F4R886; F4R887 | 150/201 | 01/05→09/07 | OE033 | 0,9 | CET2 | OE179 | BAE409A →09/07 |
| 2.0 16V | 4 | F4R.784; F4R.786 | 150/201 | 01/05→09/07 | | | | | BAE409A |
| 2.0 16V IDE | 4 | F5R700 | 103/138 | 04/01→09/07 | OE175 | 1,0 | | | BAEA345 ^[275] |
| 2.0 16V IDE | 4 | F5R701 | 103/138 | 04/01→09/07 | OE175 | 1,0 | | | BAE409A BAEA345 ^[275] |
| 2.0 16V Turbo | 4 | F4R764; F4R765 | 120/161 | 01/03→08/05 | OE136 | 0,8 | CET12P | OE179 | BAE409A |
| 2.0 dCi | 4 | M9R740 | 110/148 | 08/05→08/06 | CH271 CCGP007 Eng.060904 061127→ [14] [154] | 11v 7v | | | CCU154 ^[10] |
| 2.0 dCi | 4 | M9R760 | 127/170 | 01/06→12/07 | CH271 CCGP007 Eng.060904 061127→ [14] [154] | 11v 7v | | | CCU154 ^[10] |
| 2.2 dCi | 4 | G9T600 | 85/114 | 04/04→10/05 | CH232 | 11v | | | CCU154 ^[10] |
| 2.2 dCi | 4 | G9T600; G9T605; G9T706; G9T707 | 102/137 | 05/05→12/07 | CH232 | 11v | | | CCU154 ^[10] |
| 2.2 dCi | 4 | G9T700; G9T702 | 110/148 | 10/01→08/06 | CH232 | 11v | | | CCU154 ^[10] |
| 3.0 V6 24V | 6 | L7X731 | 152/204 | 03/01→12/07 | OE175 | 1,0 | CET14P | OE190 | BAEA347 |
| LAGUNA III | | | | | | | | | |
| 1.5 dCi | 4 | K9K780; K9K782 | 81/109 | 10/07→12/15 | CH271 [289] [374] CH271 [9] [289] [337] | 11v 11v | | | |
| 1.6 16V | 4 | K4M824 | 81/109 | 10/07→12/15 | OE033 | 0,9 | CET2 | OE179 | BAE409A |
| 2.0 16V, 2.0 16V Hi-Flex | 4 | M4R704; M4R726 | 103/138 | 10/07→12/15 | OE207 | 1,1 | | | BAEA056E ^[275] BAEA161E [275] [300] |
| 2.0 16V Turbo | 4 | F4R811 | 125/168 | 10/07→12/15 | OE136 | 0,8 | CET12P | OE179 | BAE409A |

RENAULT





kW/BHP



eon TITAN

IRIDIUM

**...RENAULT****...LAGUNA III**

| | | | | | | | | | |
|------------|---|--|---------|-------------|-------------------------|-----|------|--|----------|
| 2.0 dCi | 4 | M9R742; M9R744; M9R802; M9R814; M9R854; M9R858 | 96/129 | 10/07→12/15 | CCGP007 [14][154] | 7v | | | |
| 2.0 dCi | 4 | M9R742; M9R744; M9R746; M9R748; M9R754; M9R802; M9R805; M9R808; M9R814; M9R845; M9R854; M9R858 | 110/148 | 10/07→12/15 | CCGP007 [14][154] | 7v | | | |
| 2.0 dCi | 4 | M9R800; M9R806; M9R809; M9R815; M9R849; M9R854; M9R857; M9R858 | 127/170 | 01/08→12/15 | CCGP007 [14][154] | 7v | | | |
| 2.0 dCi GT | 4 | M9R816; M9R820; M9R828 | 131/176 | 03/08→12/15 | CCGP007 [14][154] | 7v | | | |
| 2.0 GT | 4 | F4R800 | 150/201 | 03/08→12/15 | OE136 | 0,8 | CET2 | | BAE409A |
| 3.0 dCi | 6 | V9X791; V9X891 | 173/232 | 09/08→12/15 | CCGP007 ^[14] | 7v | | | |
| 3.5 V6 | 6 | V4Y713 | 175/235 | 04/08→12/15 | OE207 | 1,1 | | | BAEA158E |

LATITUDE

| | | | | | | | | | |
|--------------------------------|---|------------------------|---------|--------|-------------------------|-----|--|--|---------------------------|
| 2.0 16V, 2.0 16V eco2 Flexfuel | 4 | M4R746 | 103/138 | 02/11→ | OE207 | 1,1 | | | BAEA161E ^[300] |
| 2.0 dCi 150 | 4 | M9R824; M9R846 | 110/148 | 02/11→ | CCGP007 [14][154] | 7v | | | |
| 2.0 dCi 175 | 4 | M9R804; M9R817; M9R844 | 127/170 | 05/11→ | CCGP007 [14][154] | 7v | | | |
| 2.5 V6 | 6 | 2ZV604 | 130/174 | 05/11→ | OE207 | 1,1 | | | BAEA158E |
| 3.0 dCi 240 | 6 | V9X891 | 177/237 | 02/11→ | CCGP007 ^[14] | 7v | | | |

LOGAN I

| | | | | | | | | | | |
|---------|---|--|--------|-------------|---|---------------------------------|------|-------|---------|--------|
| 1.4 | 4 | K7J710 | 55/74 | 09/04→ | OE033 →04/05 OE026 05/05→ OE033 →Eng.050425 OE026 Eng.050425→ OE216 LPG ^[278] Eng.050425→ | 0,9 0,9 0,9 0,9 0,8 | CET2 | OE179 | BAEA354 | CLS076 |
| 1.5 dCi | 4 | K9K792 | 50/67 | 04/07→ | CH271 | 11v | | | | |
| 1.5 dCi | 4 | K9K796 | 63/84 | 02/08→06/15 | CH271 | 11v | | | | |
| 1.6 | 4 | K7M710 | 64/86 | 09/04→ | OE033 →04/05 OE026 OE216 LPG ^[278] | 0,9 0,9 0,8 | CET2 | OE179 | BAEA354 | CLS076 |
| 1.6 | 4 | K4M690; K4M694; K4M696; K4M697; K4M698 | 77/103 | 04/07→ | OE033 | 0,9 | CET2 | OE179 | BAE409A | |

LOGAN II

| | | | | | | | | | |
|-----|---|--------|--------|--------|-------|-----|--|--|---------|
| 1.6 | 4 | K7M812 | 60/80 | 04/14→ | OE026 | 0,9 | | | BAEA354 |
| 1.6 | 4 | K4M842 | 75/101 | 04/14→ | | | | | BAE409A |

MEGANE

| | | | | | | | | | | |
|---------|---|--------------------------------|--------|-------------|-------|-----|------|-------|-----------------------|--------|
| 1.4 i | 4 | E7J764 | 55/74 | 01/97→09/99 | OE033 | 0,9 | CET2 | OE179 | BAEA251 [265][292] | CLS117 |
| 1.6 16V | 4 | K4M700; K4M701; K4M704; K4M708 | 79/106 | 04/98→10/99 | OE033 | 0,9 | CET2 | OE179 | BAE409A | |

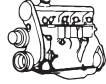

kW/BHP

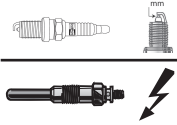

eon TITAN

IRIDIUM

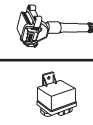
**...RENAULT****...MEGANE**

| | | | | | | | | | | |
|------------------|---|------------------------|---------|-------------|-----------------------|-----|--------|-------|---|---|
| 1.6 e | 4 | K7M702; K7M703 | 66/89 | 10/96→10/99 | OE033 | 0,9 | CET2 | OE179 | BAEA245 →03/97 [7] [37] BAEA246 →03/97 [14] [39] [275] BAEA242 04/97→ [7] [37] BAEA243 04/97→ [14] [39] [275] BAEA354 09/97→ | CLS014 →03/97 CLS011 04/97→06/98 CLS019 07/98→ |
| 1.6 i | 4 | K7M720 | 55/74 | 01/97→09/99 | OE033 | 0,9 | CET2 | OE179 | BAEA245 →03/97 [7] [37] BAEA246 →03/97 [14] [39] BAEA242 04/97→ [7] [37] BAEA243 04/97→ [14] [39] BAEA354 09/97→ | CLS014 →03/97 CLS011 04/97→06/98 CLS019 07/98→ |
| 1.9 D | 4 | F8Q790 | 47/63 | 03/97→09/99 | CH217 | 11v | | | | |
| 1.9 dT | 4 | F8Q784; F8Q786 | 66/89 | 01/97→09/99 | CH260 | 11v | | | | |
| 1.9 dTi | 4 | F9Q730; F9Q734 | 72/97 | 04/97→09/99 | CH169 | 11v | | | CCU129 ^[338] | |
| 2.0 i | 4 | F3R791; F3R796 | 80/107 | 01/99→09/99 | | | CET8 | OE195 | | CLS039 CLS052 |
| 2.0 i | 4 | F3R750; F3R751 | 84/113 | 01/97→09/99 | | | CET8 | OE195 | | CLS039 CLS052 |
| MEGANE CC | | | | | | | | | | |
| 1.2 TCe | 4 | H5F400 | 85/114 | 09/12→08/15 | | | | | BAEA131E | |
| 1.2 TCe | 4 | H5F404 | 97/130 | 01/13→ | | | | OE261 | BAEA131E | |
| 1.4 TCe | 4 | H4J700 | 96/129 | 06/10→ | OE225 | 0,7 | CET13P | | BAEA066E | |
| 1.6 16V | 4 | K4M858 | 81/109 | 06/10→ | OE033 | 0,9 | CET2 | OE179 | | |
| 1.6 16V | 4 | K4M.8.58 | 81/109 | 06/10→ | | | | | BAE409A | |
| 1.9 dCi | 4 | F9Q870 | 96/129 | 06/10→ | | | | | CCU129 ^[338] | |
| 2.0 CVT | 4 | M4R711; M4R713 | 103/138 | 06/10→ | OE207 | 1,1 | | | BAEA161E ^[300] | |
| 2.0 dCi | 4 | M9R610 | 118/158 | 06/10→ | CCGP007 [14] [154] | 7v | | | | |
| 2.0 TCe | 4 | F4R872 | 132/177 | 06/10→ | OE033 | 0,9 | CET2 | OE179 | BAE409A | |
| 2.0 TCe | 4 | F4R870 | 132/177 | 06/10→ | OE033 | 0,9 | CET2 | OE179 | | |
| 2.0 Turbo | 4 | F4R874 | 195/261 | 10/11→ | OE146 | 1,0 | CET12P | OE179 | BAE409A | |
| MEGANE I | | | | | | | | | | |
| 1.4 | 4 | E7J626 | 55/74 | 09/96→08/03 | OE033 | 0,9 | CET2 | OE179 | BAE409A BAEA354 | CLS019 CLS117 |
| 1.4 | 4 | E7J764 | 55/74 | 09/96→08/03 | OE033 | 0,9 | CET2 | OE179 | BAEA251 [265] [292] | CLS019 CLS117 |
| 1.4 16V | 4 | K4J700; K4J714; K4J750 | 70/94 | 03/99→08/03 | OE033 | 0,9 | CET2 | OE179 | BAE409A | |
| 1.4 e | 4 | E7J626 | 55/74 | 01/96→08/03 | OE033 | 0,9 | CET2 | OE179 | BAEA251 →02/99 [265] [292] BAE409A BAEA354 | CLS019 CLS117 |

RENAULT



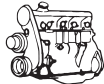

kW/BHP



eon TITAN

IRIDIUM



...RENAULT

...MEGANE I

| | | | | | | | | | | |
|---------|---|---|--------|-------------|-------|-----|------|-------|---|---|
| 1.4 e | 4 | E7J764 | 55/74 | 01/96→08/03 | OE033 | 0,9 | CET2 | OE179 | BAEA251 →02/99 [265] [292] BAEA354 02/99→ | CLS117 |
| 1.4 Eco | 4 | E7J624 | 52/70 | 01/96→03/99 | OE033 | 0,9 | CET2 | OE179 | BAEA251 [265] [292] | CLS117 |
| 1.6 16V | 4 | K4M700; K4M701; K4M706; K4M708; K4M709 | 79/106 | 03/99→08/03 | OE033 | 0,9 | CET2 | OE179 | BAE409A | |
| 1.6 e | 4 | K7M702; K7M703 | 66/89 | 01/96→08/03 | OE033 | 0,9 | CET2 | OE179 | BAEA245 →03/97 [7] [37] BAEA246 →03/97 [14] [39] BAEA242 04/97→ [7] [37] BAEA243 04/97→ [14] [39] BAEA354 BAEA354 ^[144] BAEA245 →Eng.970310 [7] [37] [145] BAEA246 →Eng.970310 [14] [39] [146] BAEA242 Eng.970310→ Eng.980708 [7] [37] [140] BAEA243 Eng.970310→ Eng.980708 [14] [39] [141] | CLS014 →03/97 CLS011 04/97→06/98 CLS019 |
| 1.6 e | 4 | K7M790 | 66/89 | 01/96→08/03 | OE033 | 0,9 | CET2 | OE179 | BAEA245 →03/97 [7] [37] BAEA246 →03/97 [14] [39] BAEA242 04/97→ [7] [37] BAEA243 04/97→ [14] [39] BAEA354 08/98→ | CLS014 →03/97 CLS011 04/97→06/98 CLS019 07/98→ |
| 1.6 i | 4 | K7M720 | 55/74 | 01/96→03/99 | OE033 | 0,9 | CET2 | OE179 | BAEA245 →03/97 [7] [37] BAEA246 →03/97 [14] [39] BAEA242 04/97→ [7] [37] BAEA243 04/97→ [14] [39] | CLS014 →03/97 CLS011 04/97→06/98 CLS019 07/98→ |
| 1.6 LPG | 4 | K4M704 | 80/107 | 10/00→08/02 | OE033 | 0,9 | CET2 | OE179 | BAE409A | |
| 1.8 16V | 4 | F4P720; F4P722 | 85/114 | 01/01→08/03 | OE033 | 0,9 | CET2 | OE179 | BAE409A | |

RENAULT





kW/BHP

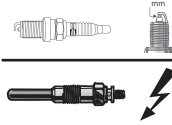

eon TITAN

IRIDIUM

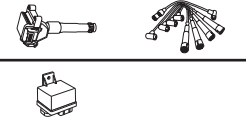
**...RENAULT****...MEGANE I**

| | | | | | | | | | |
|------------------|---|--|---------|-------------|--------------------------|------|------|-------|--|
| 1.9 D | 4 | F8Q622 | 47/63 | 09/96→08/03 | CH233 | 11v | | | CCU129 ^[338] CCU129 ^[338] →Eng.000400 CCU154 Eng.000401→ [10] [360] |
| 1.9 D | 4 | F8Q790 | 47/63 | 09/96→08/03 | CH233 | 11v | | | CCU129 ^[338] →Eng.000400 CCU154 Eng.000401→ [10] [360] |
| 1.9 D, 1.9 D Eco | 4 | F8Q620; F8Q622; F8Q624 | 47/63 | 01/96→08/03 | CH206 | 11v | | | CCU129 ^[338] |
| 1.9 D, 1.9 TDI | 4 | F8Q784 | 69/93 | 04/96→08/03 | CH260 | 11v | | | CCU129 ^[338] |
| 1.9 dCi | 4 | F9Q732; F9Q733; F9Q738 | 75/101 | 02/01→08/03 | CH271 | 11v | | | CCU129 ^[338] CCU154 ^[10] |
| 1.9 dCi, 1.9 dCi | 4 | F9Q732; F9Q733; F9Q738 | 77/103 | 03/99→08/03 | CH271 | 11v | | | CCU129 ^[338] |
| 1.9 dT | 4 | F8Q784; F8Q786 | 66/89 | 01/96→08/03 | CH260 | 11v | | | CCU129 ^[338] |
| 1.9 dTi | 4 | F9Q744 | 59/79 | 02/01→08/03 | CH271 | 11v | | | CCU129 ^[338] CCU154 ^[10] |
| 1.9 DTi | 4 | F9Q730 | 60/80 | 02/00→09/00 | CH169 | 11v | | | CCU129 ^[338] |
| 1.9 dTi | 4 | F9Q731; F9Q736 | 72/97 | 03/97→02/01 | CH271 | 11v | | | CCU129 ^[338] |
| 1.9 dTi | 4 | F9Q730; F9Q734 | 72/97 | 03/97→02/01 | CH169 | 11v | | | CCU129 ^[338] |
| 2.0 | 4 | F3R750; F3R751; F3R752; F3R791; F3R796; F3R797; F3R798 | 85/114 | 05/98→05/01 | OE006 | 0,9 | CET8 | | |
| 2.0, 2.0 i | 4 | F3R750; F3R752; F3R791; F3R796; F3R797; F3R798 | 84/113 | 01/96→08/03 | | | CET8 | OE195 | CLS039 CLS052 |
| 2.0 16V | 4 | F4R746; F4R770 | 102/137 | 01/02→08/03 | OE033 | 0,9 | CET2 | OE179 | BAE409A |
| 2.0 16V | 4 | F7R710; F7R714 | 108/145 | 03/96→08/03 | | | CET2 | OE179 | BAEA345 02/99→ BAE409A |
| 2.0 16V IDE | 4 | F5R740 | 103/138 | 11/99→08/03 | OE175 | 1,0 | | | BAEA345 CLS039 CLS052 |
| 2.0 i | 4 | F3R750; F3R751; F3R752; F3R797; F3R798 | 80/107 | 03/99→08/03 | OE006 *to be adjusted | 0,8* | CET8 | OE195 | CLS039 CLS052 |
| 2.0 i | 4 | F3R791; F3R796 | 80/107 | 03/99→08/03 | OE006 *to be adjusted | 0,8* | CET8 | OE195 | BAEA345 CLS039 CLS052 |
| 2.0 i | 4 | F3R750; F3R751; F3R798 | 84/113 | 01/96→08/03 | | | CET8 | OE195 | CLS039 CLS052 |
| 2.0 RT | 4 | F4R747; F5R740 | 103/138 | 03/01→08/03 | OE033 | 0,9 | | | BAE409A |
| MEGANE II | | | | | | | | | |
| 1.4, 1.4 16V | 4 | K4J732 | 60/80 | 09/03→ | OE033 | 0,9 | CET2 | OE179 | BAE409A |
| 1.4, 1.4 16V | 4 | K4J730; K4J740 | 72/97 | 11/02→ | OE033 | 0,9 | CET2 | OE179 | BAE409A |
| 1.5 dCi | 4 | K9K722 | 60/80 | 09/02→12/10 | CH271 | 11v | | | CCU154 →Eng.050116 [10] [360] CCU147 Eng.050117→ [11] [352] |
| 1.5 dCi | 4 | K9K724 | 63/84 | 05/05→12/10 | CH271 | 11v | | | CCU154 →Eng.050116 [10] [360] CCU147 Eng.050117→ [11] [352] |

RENAULT



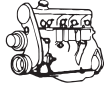

kW/BHP

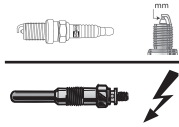

eon TITAN

IRIDIUM

**...RENAULT****...MEGANE II**

| | | | | | | | | | |
|---|---|--------------------------------|--------|-------------|-------|-----|------|-------|--|
| 1.5 dCi | 4 | K9K728; K9K729 | 74/99 | 10/03→12/10 | CH271 | 11v | | | CCU154 →Eng.050116 [10] [360] CCU147 Eng.050117→ [11] [352] |
| 1.5 dCi | 4 | K9K734 | 76/102 | 10/03→12/10 | CH271 | 11v | | | CCU147 [11] [352] CCU154 →Eng.050116 [10] [360] CCU147 Eng.050117→ [11] [352] |
| 1.5 dCi | 4 | K9K732 | 78/105 | 05/05→12/10 | CH271 | 11v | | | CCU147 [11] [352] CCU154 →Eng.050116 [10] [360] CCU147 Eng.050117→ [11] [352] |
| 1.6 | 4 | K4M768 | 75/101 | 09/03→ | OE033 | 0,9 | CET2 | OE179 | BAE409A |
| 1.6 | 4 | K4M762 | 77/103 | 05/05→ | OE033 | 0,9 | CET2 | OE179 | |
| 1.6 | 4 | K4M.7.64 | 77/103 | 05/05→ | | | | | BAE409A |
| 1.6 | 4 | K4M760; K4M761 | 81/109 | 09/03→11/08 | OE033 | 0,9 | CET2 | OE179 | |
| 1.6, 1.6 16V | 4 | K4M760; K4M761 | 83/111 | 11/02→ | OE033 | 0,9 | CET2 | OE179 | BAE409A |
| 1.6, 1.6 16V, 1.6 16VHi-Flex, 1.6 Flex-Fuel | 4 | K4M762; K4M788; K4M856 | 77/103 | 05/05→ | OE033 | 0,9 | CET2 | OE179 | BAE409A |
| 1.6 16V | 4 | K4M760; K4M761; K4M812; K4M813 | 82/110 | 01/06→ | OE033 | 0,9 | CET2 | OE179 | BAE409A |
| 1.6 Bifuel | 4 | K4M788 | 77/103 | 06/05→02/08 | OE033 | 0,9 | | | BAE409A |
| 1.6 Hi-Flex | 4 | K4M766 | 85/114 | 03/06→ | OE033 | 0,9 | CET2 | OE179 | BAE409A |
| 1.9 dCi | 4 | F9Q808 | 66/89 | 11/02→12/05 | CH271 | 11v | | | CCU154 →Eng.050111 [10] [360] CCU154 →Eng.050116 [10] [360] CCU147 [352] Eng.050112→ CCU147 Eng.050117→ [11] [352] |
| 1.9 dCi | 4 | F9Q808 | 68/91 | 03/04→ | CH271 | 11v | | | CCU154 →Eng.050111 [10] [360] CCU154 →Eng.050116 [10] [360] CCU147 [352] Eng.050112→ CCU147 Eng.050117→ [11] [352] |
| 1.9 dCi | 4 | F9Q804; F9Q818 | 81/109 | 05/05→ | CH271 | 11v | | | CCU154 →Eng.050111 [10] [360] CCU154 →Eng.050116 [10] [360] CCU147 [352] Eng.050112→ CCU147 Eng.050117→ [11] [352] |

RENAULT

CHAMPION



kW/BHP



eon TITAN

IRIDIUM

**...RENAULT****...MEGANE II**

| | | | | | | | | | |
|-------------------------|---|------------------------|---------|-------------|--------------------------------------|-----|--------|-------|---|
| 1.9 dCi | 4 | F9Q803; F9Q816 | 81/109 | 05/05→ | CH271 | 11v | | | CCU154 →Eng.050111 [10] [360] CCU147 ^[352] Eng.050112→ |
| 1.9 dCi | 4 | F9Q804; F9Q816; F9Q818 | 85/114 | 11/02→07/09 | CH271 | 11v | | | CCU154 →Eng.050111 [10] [360] CCU154 →Eng.050116 [10] [360] CCU147 ^[352] Eng.050112→ CCU147 Eng.050117→ [11] [352] |
| 1.9 dCi | 4 | F9Q800 | 88/118 | 11/02→ | CH271 | 11v | | | CCU154 →Eng.050111 [10] [360] CCU154 →Eng.050116 [10] [360] CCU147 ^[352] Eng.050112→ CCU147 Eng.050117→ [11] [352] |
| 1.9 dCi | 4 | F9Q816; F9Q818 | 96/129 | 05/05→ | CH271 | 11v | | | CCU154 →Eng.050116 [10] [360] CCU147 Eng.050117→ [11] [352] |
| 1.9 dCi | 4 | F9Q803; F9Q804 | 96/129 | 05/05→ | CH271 | 11v | | | CCU154 →Eng.050111 [10] [360] CCU154 →Eng.050116 [10] [360] CCU147 ^[352] Eng.050112→ CCU147 Eng.050117→ [11] [352] |
| 2.0 | 4 | F4R770; F4R771 | 102/137 | 09/03→01/11 | | | | | BAE409A |
| 2.0 | 4 | F4R774 | 169/227 | 08/06→02/08 | OE033 | 0,9 | CET2 | OE179 | BAE409A |
| 2.0, 2.0 16V | 4 | F4R770; F4R771 | 99/133 | 11/02→ | OE033 | 0,9 | CET2 | OE179 | BAE409A |
| 2.0 16V Turbo | 4 | F4R776 | 120/161 | 05/04→03/09 | OE136 | 0,8 | CET12P | OE179 | BAE409A |
| 2.0 dCi | 4 | M9R700; M9R722 | 110/148 | 09/05→ | CCGP007 Eng.061129→ [14] [154] | 7v | | | |
| 2.0 dCi | 4 | M9R724 | 127/170 | 01/07→02/08 | CCGP007 Eng.061129→ [14] [154] | 7v | | | |
| 2.0 Renault Sport | 4 | F4R774; F4R774 | 165/221 | 05/04→10/09 | | | CET11P | OE179 | BAE409A |
| MEGANE III | | | | | | | | | |
| 1.2 TCe | 4 | H5F400 | 85/114 | 03/12→ | | | | | BAEA131E |
| 1.2 TCe | 4 | H5F404 | 97/130 | 01/13→ | | | | OE261 | BAEA131E |
| 1.4 TCe | 4 | H4J700 | 96/129 | 04/09→ | OE225 | 0,7 | CET13P | | BAEA066E |
| 1.6 16V | 4 | K4M848 | 74/99 | 11/08→ | OE033 | 0,9 | CET2 | OE179 | BAE409A |
| 1.6 16V | 4 | K4M858; K4M866 | 82/110 | 11/08→ | OE033 | 0,9 | CET2 | | BAE409A |
| 1.6 16V | 4 | K4M | 82/110 | 11/08→ | | | | OE179 | |
| 1.6 16V, 1.6 16V Bifuel | 4 | K4M858; K4M866 | 81/109 | 11/08→ | OE033 | 0,9 | CET2 | OE179 | BAE409A |
| 2.0 | 4 | M4R710; M4R714 | 105/141 | 01/11→ | OE207 | 1,1 | | | BAEA161E ^[300] |

RENAULT



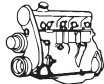

kW/BHP



eon TITAN

IRIDIUM



...RENAULT

...MEGANE III

| | | | | | | | | | | |
|-------------|---|----------------------------|---------|--------|-------------------------|-----|--------|-------|--|---------------------------|
| 2.0 CVT | 4 | M4R711; M4R713; M4RF713 | 103/138 | 02/09→ | OE207 | 1,1 | | | | BAEA161E ^[300] |
| 2.0 dCi | 4 | M9R615 | 110/148 | 04/09→ | CCGP007 ^[14] | 7v | | | | |
| 2.0 dCi | 4 | M9R610 | 118/158 | 04/09→ | CCGP007 ^[14] | 7v | | | | |
| 2.0 dCi | 4 | M9R610 | 120/161 | 07/12→ | CCGP007 ^[14] | 7v | | | | |
| 2.0 R.S. | 4 | F4R874 | 195/261 | 11/08→ | OE146 | 1,0 | CET12P | OE179 | | BAE409A |
| 2.0 R.S. | 4 | F4R874 | 201/270 | 07/14→ | OE146 | 1,0 | CET12P | OE179 | | BAE409A |
| 2.0 TCe | 4 | F4R870; F4R872 | 132/177 | 11/08→ | OE033 | 0,9 | CET2 | OE179 | | BAE409A |
| 2.0 TCe | 4 | F4R | 140/188 | 06/12→ | | | | | | BAE409A |
| 2.0 TCe | 4 | F4R874 | 162/217 | 09/12→ | OE146 | 1,0 | CET12P | OE179 | | BAE409A |
| 2.0 TCe | 4 | F4R | 162/217 | 09/12→ | | | | | | BAE409A |
| 2.0 TCe | 4 | F4R874 | 184/247 | 05/09→ | OE146 | 1,0 | CET12P | OE179 | | BAE409A |
| 2.0 TCe 220 | 4 | F4R874 | 162/217 | 11/13→ | OE146 | 1,0 | CET12P | OE179 | | BAE409A |

MEGANE IV

| | | | | | | | | | | |
|--------------|---|---|--------|--------|--|--|--|-------|--|------------------------------------|
| 1.2 TCe 100 | 4 | H5F408 | 74/99 | 11/15→ | | | | OE261 | | BAEA131E |
| 1.2 TCe 130 | 4 | H5F408 | 97/130 | 11/15→ | | | | OE261 | | BAEA131E |
| 1.2 Tce 130 | 4 | H5F408 | 97/130 | 10/16→ | | | | | | BAEA131E |
| 1.6 1.6 S Ce | 4 | | 84/113 | 10/16→ | | | | | | BAEA131E |
| 1.6 16V | 4 | H4M738; H4M748; H4M749; H4M750; H4M751 | 84/113 | 11/15→ | | | | | | BAEA131E ^{[105] [375]} |

MODUS / GRAND MODUS

| | | | | | | | | | | | |
|----------------------|---|-----------------------------------|--------|--------|--|------------|--------------------------------|-------|--|------------------------|-------------------------|
| 1.2 | 4 | D4F740 | 48/64 | 05/05→ | OE130 OE225 ^{[6] [254]} | 0,9 0,7 | CET1 3P ^[6] CET4 | | | BAE947A BAEA325 | CLS084 ^[296] |
| 1.2 | 4 | D4F764 | 58/78 | 12/04→ | OE130 | 0,9 | CET4 | | | BAE947A BAEA325 | CLS084 ^[296] |
| 1.2 | 4 | D4F786 | 76/102 | 04/11→ | OE130 | 0,9 | CET1 3P | | | BAEA354 | CLS084 ^[296] |
| 1.2, 1.2 16V Hi-Flex | 4 | D4F740 | 55/74 | 12/04→ | OE130 OE225 ^{[6] [254]} | 0,9 0,7 | CET1 3P ^[6] CET4 | | | BAE947A BAEA325 | CLS084 ^[296] |
| 1.2 16V | 4 | D4F784 | 74/99 | 05/07→ | OE225 | 0,7 | CET1 3P | | | BAEA354 | CLS084 ^[296] |
| 1.4 | 4 | K4J770; K4J780 | 72/97 | 12/04→ | OE033 | 0,9 | CET2 | OE179 | | BAE409A | |
| 1.5 dCi | 4 | K9K752; K9K768 | 48/64 | 12/04→ | CH271 | 11v | | | | CCU154 ^[10] | |
| 1.5 dCi | 4 | K9K768 | 50/67 | 12/04→ | CH271 | 11v | | | | CCU154 ^[10] | |
| 1.5 dCi | 4 | K9K750 | 60/80 | 09/04→ | CH271 | 11v | | | | CCU154 ^[10] | |
| 1.5 dCi | 4 | K9K760; K9K766 | 63/84 | 12/04→ | CH271 | 11v | | | | CCU154 ^[10] | |
| 1.5 dCi | 4 | K9K772 | 76/102 | 05/07→ | CH271 | 11v | | | | CCU154 ^[10] | |
| 1.5 dCi | 4 | K9K764 | 78/105 | 05/05→ | CH271 | 11v | | | | CCU154 ^[10] | |
| 1.5 dCi 75 | 4 | K9K770 | 55/74 | 10/10→ | CH271 | 11v | | | | CCU154 ^[10] | |
| 1.5 dCi 90 | 4 | K9K750; K9K770 | 65/87 | 10/10→ | CH271 | 11v | | | | CCU154 ^[10] | |
| 1.6 | 4 | K4M794 | 65/87 | 12/04→ | OE033 | 0,9 | CET2 | OE179 | | BAE409A | |
| 1.6 | 4 | K4M790; K4M791; K4M800; K4M801 | 82/110 | 12/04→ | OE033 | 0,9 | CET2 | OE179 | | BAE409A BAEA354 | |

SAFRANE I

| | | | | | | | | | | | |
|-----------------|---|----------------|---------|-------------|-------|-----|------|--|--|---|--|
| 2.1 dT | 4 | J8S760 | 65/87 | 11/93→07/96 | CH189 | 11v | | | | | |
| 3.0 | 6 | Z7X721; Z7X723 | 125/168 | 02/93→10/96 | | | | | | BAEA251 ^{[265] [275] [292] [372]} | |
| 3.0 Biturbo 4WD | 6 | Z7X726 | 193/259 | 02/93→07/96 | OE094 | 0,9 | CET2 | | | BAEA251 ^{[265] [275] [292] [372]} | |

SAFRANE II

| | | | | | | | | | | | |
|---------|---|----------------|---------|-------------|--|--|------|-------|--|--|--------|
| 2.0 16V | 4 | N7Q710; N7Q711 | 100/134 | 07/96→12/00 | | | CET2 | OE179 | | BAEA254 ^{[71] [37]} BAEA255 ^{[14] [39]} | CLS051 |
|---------|---|----------------|---------|-------------|--|--|------|-------|--|--|--------|





kW/BHP

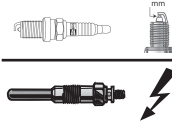

eon TITAN

IRIDIUM

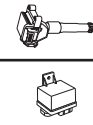
**...RENAULT****...SAFRANE II**

| | | | | | | | | | | |
|---------|---|----------------|---------|-------------|-----------------|-----|------|-------|---------------------------------------|--------|
| 2.2 dT | 4 | G8T740 | 83/111 | 07/96→12/00 | CH169 | 11v | | | | |
| 2.5 20V | 5 | N7U700; N7U701 | 121/162 | 07/96→12/00 | OE005 | 0,9 | CET2 | OE180 | BAEA037E [292] | CLS050 |
| 2.9 24V | 6 | L7X713 | 140/188 | 03/99→12/00 | OE026 | 0,9 | CET2 | OE179 | | |
| | | | | | OE218 LPG [278] | 1,6 | | | | |
| 3.0 V6 | 6 | Z7X755 | 123/165 | 07/96→12/00 | | | | OE179 | BAEA251 [265] [275] [292] [372] | |

SANDERO/STEPWAY I

| | | | | | | | | | | |
|-----|---|--------|--------|--------|-----------------|-----|------|-------|---------|--------|
| 1.4 | 4 | K7J710 | 55/74 | 02/09→ | OE026 | 0,9 | CET2 | OE179 | BAEA354 | CLS076 |
| | | | | | OE216 LPG [278] | 0,8 | | | | |
| 1.6 | 4 | K7M718 | 62/83 | 11/10→ | OE026 | 0,9 | CET2 | OE179 | BAEA354 | |
| | | | | | OE216 LPG [278] | 0,8 | | | | |
| 1.6 | 4 | K7M710 | 64/86 | 02/09→ | OE026 | 0,9 | CET2 | OE179 | BAEA338 | |
| | | | | | OE216 LPG [278] | 0,8 | | | | |
| 1.6 | 4 | K7M710 | 75/101 | 12/07→ | OE026 | 0,9 | CET2 | OE179 | BAEA354 | |
| | | | | | OE216 LPG [278] | 0,8 | | | | |
| 1.6 | 4 | K4M690 | 76/102 | 12/07→ | OE026 | 0,9 | CET2 | OE179 | BAE409A | |
| | | | | | OE216 LPG [278] | 0,8 | | | | |

SANDERO/STEPWAY II

| | | | | | | | | | | |
|-----|---|--|-------|--------|--|--|--|--|---------|--|
| 1.6 | 4 | | 61/82 | 11/13→ | | | | | BAEA354 | |
|-----|---|--|-------|--------|--|--|--|--|---------|--|

SCÉNIC I

| | | | | | | | | | | |
|----------------------|---|--|---------|-------------|--------------------------|------|------|-------|--------------|--|
| 1.4 16V | 4 | K4J714; K4J750 | 70/94 | 09/99→08/03 | OE033 *to be adjusted | 1,0* | CET2 | OE179 | BAE409A | |
| 1.6 | 4 | K4M708; K4M709 | 75/101 | 03/01→08/03 | OE033 | 0,9 | CET2 | OE179 | BAE409A | |
| 1.6 | 4 | K4M700; K4M701; K4M708 | 81/109 | 06/01→09/03 | OE033 | 0,9 | CET2 | OE179 | | |
| 1.6 | 4 | K4M | 81/109 | 06/01→09/03 | | | | | BAE409A | |
| 1.6, 1.6 BiFuel | 4 | K4M700; K4M704; K4M706; K4M707; K4M712; K4M776 | 79/106 | 09/99→09/03 | OE033 | 0,9 | CET2 | OE179 | BAE409A | |
| 1.6 16V | 4 | | 85/114 | 09/99→08/03 | OE026 | 0,9 | CET2 | OE179 | | |
| | | | | | OE216 LPG [278] | 0,8 | | | | |
| 1.8 4WD, 1.8 16V | 4 | F4P720; F4P722 | 85/114 | 07/00→08/03 | OE033 | 0,9 | CET2 | OE179 | BAE409A | |
| 1.9 D | 4 | F8Q788; F8Q790 | 47/63 | 09/99→03/01 | CH233 | 11v | | | | |
| 1.9 dCi, 1.9 dCi 4WD | 4 | F9Q732; F9Q733; F9Q740 | 75/101 | 09/99→08/03 | CH271 | 11v | | | CCU129 [338] | |
| 1.9 dCi 4WD | 4 | F9Q732; F9Q748; F9Q796 | 74/99 | 12/02→08/03 | CH271 | 11v | | | CCU129 [338] | |
| 1.9 dTi | 4 | F9Q744 | 59/79 | 02/01→08/03 | CH271 | 11v | | | CCU129 [338] | |
| 1.9 dTi | 4 | F9Q731; F9Q736 | 72/97 | 09/99→08/03 | CH271 | 11v | | | CCU129 [338] | |
| 1.9 dTi | 4 | F9Q734 | 72/97 | 09/99→08/03 | CH169 | 11v | | | CCU129 [338] | |
| 2.0 16V | 4 | F4R740; F4R741; F4R744; F4R747 | 103/138 | 09/99→08/03 | OE033 | 0,9 | CET2 | OE179 | BAE409A | |
| 2.0 16V, 2.0 16V 4WD | 4 | F4R740; F4R741; F4R744; F4R746 | 102/137 | 06/00→08/03 | OE033 | 0,9 | CET2 | OE179 | BAE409A | |

SCÉNIC II

| | | | | | | | | | | |
|---------|---|------------------------|-------|--------|-------|-----|------|-------|--|--|
| 1.4 | 4 | K4J730; K4J740; K4J770 | 72/97 | 06/03→ | OE033 | 0,9 | CET2 | OE179 | BAE409A | |
| 1.5 dCi | 4 | K9K722 | 60/80 | 06/03→ | CH271 | 11v | | | CCU154 →Eng.050116 [10] [360] CCU147 Eng.050117→ [11] [352] | |
| 1.5 dCi | 4 | K9K724 | 63/84 | 05/05→ | CH271 | 11v | | | CCU154 →Eng.050116 [10] [360] CCU147 Eng.050117→ [11] [352] | |

RENAULT





kW/BHP



eon TITAN

IRIDIUM

**...RENAULT****...SCÉNIC II**

| | | | | | | | | | | |
|---------------|---|------------------------------------|---------|-------------|--------------------------------------|-----|---------|-------|---------|--|
| 1.5 dCi | 4 | K9K728; K9K729 | 74/99 | 11/03→ | CH271 | 11v | | | | CCU154 →Eng.050116 [10] [360] CCU147 Eng.050117→ [11] [352] |
| 1.5 dCi | 4 | K9K734 | 76/102 | 01/07→ | CH271 | 11v | | | | CCU154 →Eng.050116 [10] [360] CCU147 Eng.050117→ [11] [352] |
| 1.5 dCi | 4 | K9K732 | 78/105 | 05/05→ | CH271 | 11v | | | | CCU154 →Eng.050116 [10] [360] CCU147 Eng.050117→ [11] [352] |
| 1.6 | 4 | K4M788 | 77/103 | 06/06→ | OE033 | 0,9 | CET2 | OE179 | BAE409A | |
| 1.6 | 4 | K4M761; K4M782 | 83/111 | 06/03→ | OE033 | 0,9 | CET2 | OE179 | BAE409A | |
| 1.6 16V | 4 | K4M706; K4M766; K4M812; K4M813 | 82/110 | 10/05→ | OE033 | 0,9 | CET2 | OE179 | BAE409A | |
| 1.6 Hi-Flex | 4 | K4M766 | 81/109 | 03/05→07/10 | | | | | BAE409A | |
| 1.9 D | 4 | F9Q812; F9QJ803 | 85/114 | 06/06→ | CH271 | 11v | | | | CCU154 →Eng.050111 [10] [360] CCU147 [352] Eng.050112→ |
| 1.9 dCi | 4 | F9Q804 | 81/109 | 05/05→ | CH271 | 11v | | | | CCU154 →Eng.050111 [10] [360] CCU147 [352] Eng.050112→ |
| 1.9 dCi | 4 | F9Q812 | 88/118 | 06/03→ | CH271 | 11v | | | | CCU154 →Eng.050111 [10] [360] CCU147 [352] Eng.050112→ |
| 1.9 dCi | 4 | F9Q804 | 92/123 | 06/03→ | CH271 | 11v | | | | CCU154 →Eng.050111 [10] [360] CCU147 [352] Eng.050112→ |
| 1.9 dCi | 4 | F9Q804; F9Q816; F9Q818; F9QJ803 | 96/129 | 05/05→ | CH271 | 11v | | | | CCU154 →Eng.050111 [10] [360] CCU147 [352] Eng.050112→ |
| 2.0 | 4 | F4R770; F4R771 | 99/133 | 06/03→ | OE033 | 0,9 | CET2 | OE179 | BAE409A | |
| 2.0 | 4 | F4R770 | 101/135 | 02/08→04/09 | | | | | BAE409A | |
| 2.0 16V Turbo | 4 | F4R776 | 120/161 | 05/04→ | OE136 | 0,8 | CET1 2P | OE179 | BAE409A | |
| 2.0 dCi | 4 | M9R700; M9R721; M9R722 | 110/148 | 09/05→ | CCGP007 Eng.061129→ [14] [154] | 7v | | | | |

SCÉNIC III

| | | | | | | | | | | |
|------------------|---|----------------------------|---------|--------|-------------------------|-----|---------|-------|----------|--|
| 1.2 TCe | 4 | H5F400 | 85/114 | 04/12→ | | | | OE261 | BAEA131E | |
| 1.2 TCe | 4 | H5F404; H5F408 | 97/130 | 01/13→ | | | | OE261 | BAEA131E | |
| 1.4 16V | 4 | H4J700 | 96/129 | 02/09→ | OE225 | 0,7 | CET1 3P | | BAEA066E | |
| 1.6 16V, 1.6 E85 | 4 | K4M858; K4M866; K4MR858 | 81/109 | 02/09→ | OE033 | 0,9 | CET2 | OE179 | BAE409A | |
| 2.0 16V | 4 | M4R713 | 103/138 | 02/09→ | OE207 | 1,1 | | | | |
| 2.0 16V | 4 | M4R710; M4R711 | 103/138 | 02/09→ | OE207 | 1,1 | | | BAEA161E | |
| 2.0 dCi | 4 | M9R615 | 110/148 | 02/09→ | CCGP007 ^[14] | 7v | | | | |
| 2.0 dCi | 4 | M9R610 | 118/158 | 04/09→ | CCGP007 ^[14] | 7v | | | | |

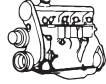

kW/BHP

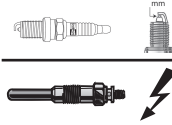

eon TITAN

IRIDIUM

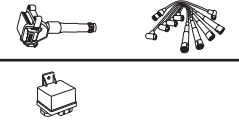

...RENAULT

SCÉNIC IV

| | | | | | | | | | | |
|-------------|---|--------|--------|--------|--|--|--|--------------|-----------------|--|
| 1.2 TCe 115 | 4 | H5F408 | 85/114 | 09/16→ | | | | | BAEA131E | |
| 1.2 TCe 130 | 4 | H5F408 | 96/129 | 09/16→ | | | | OE261 | BAEA131E | |

SPORT SPIDER

| | | | | | | | | | | |
|---------|---|--------|---------|-------------|--------------|-----|-------------|--------------|--|--|
| 2.0 16V | 4 | F7R710 | 110/148 | 03/95→10/99 | OE216 | 0,8 | CET2 | OE179 | | |
|---------|---|--------|---------|-------------|--------------|-----|-------------|--------------|--|--|

THALIA I

| | | | | | | | | | | |
|---------|---|------------------------|-------|-------------|--------------|-----|-------------|--------------|---------------------------------|--------------------------------|
| 1.2 | 4 | D7F744; D7F746 | 43/58 | 02/98→10/03 | OE026 | 0,9 | CET2 | OE179 | BAEA345 | |
| 1.2 16V | 4 | D4F706; D4F712; D4F728 | 55/74 | 04/02→ | OE130 | 0,9 | CET4 | | BAE947A ^[275] | CLS084 ^[296] |

| | | | | | | | | | | |
|--|--|--|--|--|--|--|--|--|--|--|
| | | | | | | | | | BAEA325 ^[275] | |
| | | | | | | | | | BAEA454 ^[150] ^[275] | |

| | | | | | | | | | | |
|-----|---|--------|-------|--------|-----------------------------------|-----|-------------|--------------|----------------|--|
| 1.4 | 4 | K7J700 | 55/74 | 08/00→ | OE026 | 0,9 | CET2 | OE179 | BAEA354 | |
| | | | | | OE216 ^{LPG [278]} | 0,8 | | | | |

| | | | | | | | | | | |
|---------|---|--------|-------|--------|--------------|-----|-------------|--------------|----------------|--|
| 1.4 16V | 4 | K4J712 | 72/97 | 08/00→ | OE033 | 0,9 | CET2 | OE179 | BAE409A | |
|---------|---|--------|-------|--------|--------------|-----|-------------|--------------|----------------|--|

| | | | | | | | | | | |
|---------|---|--------|-------|--------|--------------|-----|--|--|-------------------------------|--|
| 1.5 dCi | 4 | K9K740 | 47/63 | 06/05→ | CH271 | 11v | | | CCU154 ^[10] | |
|---------|---|--------|-------|--------|--------------|-----|--|--|-------------------------------|--|

| | | | | | | | | | | |
|---------|---|--------|-------|--------|--------------|-----|--|--|-------------------------------|--|
| 1.5 dCi | 4 | K9K700 | 48/64 | 04/02→ | CH271 | 11v | | | CCU154 ^[10] | |
|---------|---|--------|-------|--------|--------------|-----|--|--|-------------------------------|--|

| | | | | | | | | | | |
|---------|---|----------------|-------|--------|--------------|-----|--|--|-------------------------------|--|
| 1.5 dCi | 4 | K9K700; K9K714 | 50/67 | 02/03→ | CH271 | 11v | | | CCU154 ^[10] | |
|---------|---|----------------|-------|--------|--------------|-----|--|--|-------------------------------|--|

| | | | | | | | | | | |
|---------|---|--------|-------|--------|--------------|-----|--|--|-------------------------------|--|
| 1.5 dCi | 4 | K9K702 | 60/80 | 06/01→ | CH271 | 11v | | | CCU154 ^[10] | |
|---------|---|--------|-------|--------|--------------|-----|--|--|-------------------------------|--|

| | | | | | | | | | | |
|-----|---|--------|-------|--------|-----------------------------------|-----|-------------|--------------|----------------|--|
| 1.6 | 4 | K7M746 | 66/89 | 03/98→ | OE026 | 0,9 | CET2 | OE179 | BAEA354 | |
| | | | | | OE216 ^{LPG [278]} | 0,8 | | | | |

| | | | | | | | | | | |
|---------|---|--------|--------|--------|--------------|-----|-------------|--------------|----------------|--|
| 1.6 16V | 4 | K4M740 | 79/106 | 04/02→ | OE033 | 0,9 | CET2 | OE179 | BAE409A | |
|---------|---|--------|--------|--------|--------------|-----|-------------|--------------|----------------|--|

| | | | | | | | | | | |
|-------|---|--------|-------|-------------|--------------|-----|--|--|--|--|
| 1.9 D | 4 | F8Q630 | 48/64 | 02/98→05/01 | CH217 | 11v | | | | |
|-------|---|--------|-------|-------------|--------------|-----|--|--|--|--|

THALIA II

| | | | | | | | | | | |
|---------|---|--------|-------|--------|--------------|-----|-------------|--|----------------|--------------------------------|
| 1.2 16V | 4 | D4F728 | 55/74 | 09/08→ | OE130 | 0,9 | CET4 | | BAE947A | CLS084 ^[296] |
| | | | | | | | | | BAEA325 | |

| | | | | | | | | | | |
|---------|---|--------|-------|--------|--------------|-----|--|--|--|--|
| 1.5 dCi | 4 | K9K740 | 47/63 | 09/08→ | CH271 | 11v | | | | |
|---------|---|--------|-------|--------|--------------|-----|--|--|--|--|

| | | | | | | | | | | |
|---------|---|--------|-------|--------|--------------|-----|--|--|--|--|
| 1.5 dCi | 4 | K9K700 | 48/64 | 01/09→ | CH271 | 11v | | | | |
|---------|---|--------|-------|--------|--------------|-----|--|--|--|--|

| | | | | | | | | | | |
|---------|---|--------|-------|--------|--------------|-----|--|--|--|--|
| 1.5 dCi | 4 | K9K718 | 62/83 | 09/08→ | CH271 | 11v | | | | |
|---------|---|--------|-------|--------|--------------|-----|--|--|--|--|

| | | | | | | | | | | |
|---------|---|--------|--------|--------|--------------|-----|-------------|--------------|----------------|--|
| 1.6 16V | 4 | K4M743 | 77/103 | 09/08→ | OE033 | 0,9 | CET2 | OE179 | BAE409A | |
|---------|---|--------|--------|--------|--------------|-----|-------------|--------------|----------------|--|

THALIA III

| | | | | | | | | | | |
|---------|---|--|-------|--------|--|--|--|--|-----------------|--|
| 0.9 TCe | 3 | | 66/89 | 04/14→ | | | | | BAEA131E | |
|---------|---|--|-------|--------|--|--|--|--|-----------------|--|

TWINGO I

| | | | | | | | | | | |
|-----|---|----------------|-------|-------------|--------------|-----|-------------|--|----------------|---------------|
| 1.2 | 4 | C3G700; C3G702 | 40/54 | 03/93→03/07 | OE015 | 0,9 | CET8 | | BAE504L | CLS126 |
|-----|---|----------------|-------|-------------|--------------|-----|-------------|--|----------------|---------------|

| | | | | | | | | | | |
|-----|---|----------------|-------|-------------|-----------------------------------|-----|-------------|--------------|----------------|--------------------------------|
| 1.2 | 4 | D7F700; D7F701 | 40/54 | 03/93→03/07 | OE026 | 0,9 | CET2 | OE179 | BAEA345 | CLS040 ^[275] |
| | | | | | | | | | →10/98 | →11/99 |
| | | | | | OE216 ^{LPG [278]} | 0,8 | | | BAEA354 | CLS083 ^[275] |
| | | | | | | | | | 11/98→ | 12/99→ |

| | | | | | | | | | | |
|-----|---|--|-------|-------------|-----------------------------------|-----|-------------|--------------|----------------|--------------------------------|
| 1.2 | 4 | D7F700; D7F701; D7F702; D7F703; D7F704 | 43/58 | 05/96→06/07 | OE026 | 0,9 | CET2 | OE179 | BAEA345 | CLS040 ^[275] |
| | | | | | | | | | →10/98 | →11/99 |
| | | | | | OE216 ^{LPG [278]} | 0,8 | | | BAEA354 | CLS083 ^[275] |
| | | | | | | | | | 11/98→ | 12/99→ |
| | | | | | | | | | →Eng.981020 | |

| | | | | | | | | | | |
|--|--|--|--|--|--|--|--|--|----------------|--------------------------------|
| | | | | | | | | | BAEA354 | CLS083 ^[275] |
| | | | | | | | | | 11/98→ | 12/99→ |
| | | | | | | | | | →Eng.981021 | |

| | | | | | | | | | | |
|-----|---|------------------------|-------|-------------|--------------|-----|-------------|--------------|----------------|--|
| 1.2 | 4 | D7F702; D7F703; D7F704 | 44/59 | 09/98→08/00 | OE026 | 0,9 | CET2 | OE179 | BAEA345 | |
| | | | | | | | | | →Eng.981021 | |

| | | | | | | | | | | |
|--|--|--|--|--|--|--|--|--|---------------------------------|--|
| | | | | | | | | | BAEA354 ^[275] | |
| | | | | | | | | | Eng.981021→ | |
| | | | | | | | | | Eng.111215 | |

| | | | | | | | | | | |
|---------|---|--------|-------|-------------|--------------|-----|-------------|--|----------------|--------------------------------|
| 1.2 16V | 4 | D4F708 | 44/59 | 08/04→06/07 | OE130 | 0,9 | CET4 | | BAE947A | CLS084 ^[296] |
| | | | | | | | | | BAEA325 | |

| | | | | | | | | | | |
|---------|---|--------|-------|-------------|--------------|-----|-------------|--|---------------------------------|--|
| 1.2 16V | 4 | D4F702 | 55/74 | 01/01→06/07 | OE130 | 0,9 | CET4 | | BAEA454 ^[150] | |
| | | | | | | | | | →06/04 | |

| | | | | | | | | | | |
|--|--|--|--|--|--|--|--|--|---------------------------------|--|
| | | | | | | | | | BAE947A ^[156] | |
| | | | | | | | | | 07/04→ | |

| | | | | | | | | | | |
|--|--|--|--|--|--|--|--|--|---------------------------------|--|
| | | | | | | | | | BAEA325 ^[156] | |
| | | | | | | | | | 07/04→ | |

| | | | | | | | | | | |
|---------|---|----------------|-------|-------------|--------------|-----|-------------|--------------|--|--|
| 1.2 LPG | 4 | D7F702; D7F708 | 44/59 | 10/03→06/07 | OE026 | 0,9 | CET2 | OE179 | | |
|---------|---|----------------|-------|-------------|--------------|-----|-------------|--------------|--|--|

RENAULT





kW/BHP

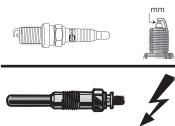

eon TITAN

IRIDIUM



...RENAULT

TWINGO II

| | | | | | | | | | | |
|-------------------|---|---|---------|--------|--------------------------------------|------------|---------------------|-------|--|--------------|
| 1.2 | 4 | D7F800 | 43/58 | 03/07→ | OE026 | 0,9 | CET2 | OE179 | BAEA354 | CLS083 [275] |
| 1.2 16V | 4 | D4F764; D4F770; D4F772 | 55/74 | 03/07→ | OE130 | 0,9 | CET4 | | BAE947A BAEA325 | CLS084 [296] |
| 1.2 16V | 4 | D4F772 | 56/75 | 03/07→ | OE130 | 0,9 | CET4 | | BAE947A BAEA325 | CLS084 [296] |
| 1.2 TCe 100 | 4 | D4F780; D4F782 | 75/101 | 02/11→ | OE130 OE225 [6] | 0,9 0,7 | CET1 3P [6] CET4 | | BAEA354 | |
| 1.2 Turbo | 4 | D4F780; D4F782 | 74/99 | 03/07→ | OE130 OE225 [6] | 0,9 0,7 | CET1 3P [6] CET4 | | BAEA354 | |
| 1.5 dCi | 4 | K9K740 | 47/63 | 03/07→ | CH271 | 11v | | | CCU147 [11] [352] CCU154 [10] [360] | |
| 1.5 dCi | 4 | K9K718 | 62/83 | 04/08→ | CH271 | 11v | | | CCU147 [11] [352] CCU154 [10] [360] | |
| 1.5 dCi 75 | 4 | K9K820 | 55/74 | 10/10→ | CH271 [9] [337] | 11v | | | CCU147 [11] [352] CCU154 [10] [360] | |
| 1.5 dCi 90 | 4 | K9K820 | 63/84 | 10/10→ | CH271 [9] [337] | 11v | | | CCU147 [11] [352] CCU154 [10] [360] | |
| 1.6 RS | 4 | K4M854 | 98/131 | 05/08→ | OE146 | 1,0 | CET12P | OE179 | BAE409A | |
| TWINGO III | | | | | | | | | | |
| 0.9 TCe 90 | 3 | H4B401 | 66/89 | 09/14→ | OE130 | 0,9 | CET4 | OE261 | BAEA131E | |
| 0.9 TCe 110 | 3 | H4B401 | 80/107 | 11/16→ | | | | OE261 | BAEA131E | |
| 1.0 SCe 70 | 3 | | 51/68 | 09/15→ | | | | | BAEA131E | |
| 1.0 SCe 70 | 3 | H4D400 | 52/70 | 09/14→ | OE130 | 0,9 | | | BAEA131E | |
| VEL SATIS | | | | | | | | | | |
| 2.0 16V Turbo | 4 | F4R762; F4R763 | 120/161 | 06/02→ | | | CET12P | OE179 | BAE409A | |
| 2.0 16 V Turbo | 4 | F4R766; F4R767 | 125/168 | 04/04→ | | | CET12P | OE179 | BAE409A | |
| 2.0 dCi | 4 | M9R760 | 110/148 | 08/05→ | CCGP007 Eng.060904→ [14] [154] | 7v | | | | |
| 2.0 dCi | 4 | M9R760; M9R762; M9R763 | 127/170 | 01/06→ | CCGP007 Eng.060904→ [14] [154] | 7v | | | | |
| 2.0 Turbo | 4 | F4R867 | 108/145 | 04/05→ | OE033 | 0,9 | CET2 | OE179 | BAE409A | |
| 2.2 dCi | 4 | G9T700; G9T702 | 83/111 | 12/04→ | CH232 | 11v | | | CCU154 →Eng.070828 [10] [360] CCU147 Eng.070829→ [11] [352] | |
| 2.2 dCi | 4 | G9T600; G9T702 | 85/114 | 04/04→ | CH232 | 11v | | | CCU154 →Eng.070828 [10] [360] CCU147 Eng.070829→ [11] [352] | |
| 2.2 dCi | 4 | G9T600; G9T606; G9T607; G9T700; G9T702 | 102/137 | 09/04→ | CH232 | 11v | | | CCU154 →Eng.070828 [10] [360] CCU147 Eng.070829→ [11] [352] | |

RENAULT



kW/BHP

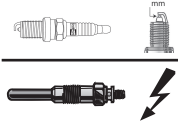

eon TITAN

IRIDIUM

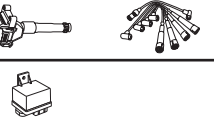

...RENAULT

...VEL SATIS

| | | | | | | | | | |
|-------------|---|------------------------|---------|--------|-------|-----|--------|-------|--|
| 2.2 dCi | 4 | G9T702; G9T703 | 110/148 | 06/02→ | CH232 | 11v | | | CCU154 →Eng.070828 [10] [360] CCU147 Eng.070829→ [11] [352] |
| 3.5 | 6 | V4Y715 | 170/228 | 10/04→ | OE175 | 1,0 | CET14P | OE190 | BAEA079E |
| 3.5 V6 | 6 | V4Y701; V4Y711; V4Y715 | 177/237 | 06/02→ | OE175 | 1,0 | CET14P | OE190 | BAEA079E |
| WIND | | | | | | | | | |
| 1.2 | 4 | D4F782 | 74/99 | 07/10→ | OE225 | 0,7 | CET13P | | BAEA354 CLS084 [296] |
| 1.2 TCe 100 | 4 | D4F780 | 75/101 | 02/11→ | OE225 | 0,7 | CET13P | | BAEA354 CLS084 [296] |
| 1.6 | 4 | K4M854 | 98/131 | 07/10→ | OE146 | 1,0 | CET12P | OE179 | BAE409A |

RENAULT

CLIO I

| | | | | | | | | | |
|---------|---|--------|-------|-------------|-------------|-----|--|--|--|
| 1.9 RND | 4 | F8Q678 | 40/54 | 04/96→02/98 | CH206 [275] | 11v | | | |
|---------|---|--------|-------|-------------|-------------|-----|--|--|--|

CLIO II

| | | | | | | | | | |
|---------|---|------------------------|-------|-------------|-------|-----|------|-------|--|
| 1.2 | 4 | D7F720 | 43/58 | 09/98→ | OE026 | 0,9 | CET2 | OE179 | BAEA345 →Eng.981021 BAEA354 [275] Eng.981021→ Eng.111215 CLS083 [275] 10/99→ |
| 1.2 | 4 | D7F726; D7F746 | 43/58 | 09/98→ | OE026 | 0,9 | CET2 | OE179 | BAEA345 →Eng.981021 BAEA354 [275] Eng.981021→ Eng.111215 |
| 1.2 | 4 | D7F722; D7F726; D7F746 | 44/59 | 03/99→10/03 | OE026 | 0,9 | CET2 | OE179 | BAEA354 CLS083 [275] |
| 1.5 dCi | 4 | K9K700; K9K704 | 48/64 | 06/01→ | CH271 | 11v | | | CCU154 [10] |
| 1.5 dCi | 4 | K9K714 | 50/67 | 04/04→ | CH271 | 11v | | | CCU154 [10] |
| 1.5 dCi | 4 | K9K702 | 59/79 | 06/01→10/04 | CH271 | 11v | | | CCU154 [10] |
| 1.5 dCi | 4 | K9K702; K9K710; K9K716 | 60/80 | 11/03→ | CH271 | 11v | | | CCU154 [10] |
| 1.9 D | 4 | F8Q630 | 47/63 | 09/98→ | CH217 | 11v | | | CCU128 [329] CCU129 [338] |
| 1.9 D | 4 | F8Q632 | 48/64 | 02/00→05/01 | CH217 | 11v | | | CCU128 [329] CCU129 [338] |
| 1.9 DTi | 4 | F9Q780 | 59/79 | 02/00→05/01 | CH271 | 11v | | | CCU129 [338] |

CLIO IV

| | | | | | | | | | |
|------------|---|----------------|-------|--------|--|--|--|-------|----------|
| 0.9 TCe 90 | 3 | H4B400; H4B408 | 66/89 | 01/14→ | | | | OE261 | BAEA131E |
|------------|---|----------------|-------|--------|--|--|--|-------|----------|

KANGOO

| | | | | | | | | | |
|-------------|---|--|--------|-------------|--------------------------|------|--------|-------|---|
| 1.0 | 4 | CG10DE | 40/54 | 07/03→ | OE175 | 1,0 | CET14P | OE190 | |
| 1.2 | 4 | D7F710; D7F720; D7F722; D7F726; D7F744; D7F746 | 43/58 | 08/97→ | OE026 | 0,9 | CET2 | OE179 | BAEA345 →10/98 BAEA354 11/98→ CLS040 [275] →09/99 CLS083 [275] 10/99→ |
| 1.2 | 4 | D7F710; D7F722; D7F744; D7F764; D7F766 | 44/59 | 07/98→07/01 | OE026 | 0,9 | CET2 | OE179 | BAEA345 Eng.981022→ |
| 1.2 16V | 4 | D4F712; D4F714; D4F730 | 55/74 | 10/01→ | OE130 *to be adjusted | 0,8* | CET4 | | BAEA345 [275] 03/03→ BAE947A [275] 06/08→ BAEA325 [275] 06/08→ BAEA454 [150] [275] CLS084 [296] |
| 1.2 BiFuel | 4 | D7F710; D7F744 | 43/58 | 07/98→07/01 | OE026 | 0,9 | CET2 | OE179 | BAEA354 Eng.981021→ |
| 1.2 TCe 115 | 4 | H5F400; H5F408; H5F412 | 84/113 | 07/13→ | | | | OE261 | BAEA131E |

RENAULT



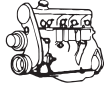

kW/BHP

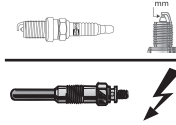

eon TITAN

IRIDIUM

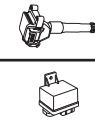

...RENAULT

...KANGOO

| | | | | | | | | | | |
|----------------------|---|-----------------------------------|--------|-------------|-------------------|-----|------|-------|---|---|
| 1.4 | 4 | E7J634; E7J635 | 55/74 | 08/97→06/08 | | | CET2 | OE179 | BAEA354 09/98→12/07 | CLS011 [142][287] CLS019 [143] |
| 1.4 | 4 | E7J780 | 55/74 | 08/97→06/08 | | | CET2 | OE179 | BAEA354 09/98→12/07 BAEA242 [7][37] BAEA243 [14][39] | CLS011 [142][287] CLS019 [143] |
| 1.4 | 4 | K7J700 | 55/74 | 08/97→06/08 | | | CET2 | OE179 | BAEA354 09/98→12/07 | |
| 1.4 | 4 | K7J701 | 55/74 | 08/97→06/08 | OE026 | 0,9 | CET2 | OE179 | BAEA354 09/98→12/07 | CLS019 [143] →Eng.050317 CLS076 [153] Eng.050318→ Eng.090920 CLS088 [157] Eng.090921→ Eng.150325 |
| | | | | | OE216 LPG [278] | 0,8 | | | | |
| 1.5 dCi | 4 | K9K704 | 42/56 | 12/02→ | CH271 | 11v | | | CCU154[10] | |
| 1.5 dCi | 4 | K9K716 | 45/60 | 10/05→ | CH271 | 11v | | | CCU154[10] | |
| 1.5 dCi | 4 | K9K700; K9K702; K9K704 | 48/64 | 12/01→ | CH271 | 11v | | | CCU154[10] | |
| 1.5 dCi | 4 | K9K714 | 50/67 | 06/05→ | CH271 | 11v | | | CCU154[10] | |
| 1.5 dCi | 4 | K9K702; K9K710 | 60/80 | 04/03→ | CH271 | 11v | | | CCU154[10] | |
| 1.5 dCi | 4 | K9K718 | 62/83 | 06/05→ | CH271 | 11v | | | CCU154[10] | |
| 1.6 | 4 | K7M750 | 64/86 | 02/08→ | OE026 | 0,9 | CET2 | OE179 | BAEA354 | |
| | | | | | OE216 LPG [278] | 0,8 | | | | |
| 1.6 16V | 4 | K4M830 | 78/105 | 02/08→ | OE033 | 0,9 | CET2 | OE179 | BAE409A | |
| 1.6 16V, 1.6 16V 4WD | 4 | K4M706; K4M750; K4M752; K4M753 | 70/94 | 10/01→ | OE033 | 0,9 | CET2 | OE179 | BAE409A | |
| 1.6 16V bivalent | 4 | K4M850 | 60/80 | 06/05→ | OE033 | 0,9 | CET2 | OE179 | BAE409A | |
| 1.6 16V LPG | 4 | K4M834 | 72/97 | 02/08→ | OE033 | 0,9 | CET2 | OE179 | BAE409A | |
| 1.9 D | 4 | F8Q632 | 48/64 | 09/99→06/03 | CH233 | 11v | | | CCU128[329] CCU129[338] | |
| 1.9 D 55 | 4 | F8Q662 | 40/54 | 08/97→ | CH217 →02/99 | 11v | | | CCU128[329] | |
| | | | | | CH233 03/99→ | 11v | | | CCU129[338] | |
| 1.9 D 65 | 4 | F8Q632 | 47/63 | 08/97→ | CH233 | 11v | | | CCU128[329] CCU129[338] | |
| 1.9 D 65 | 4 | F8Q630 | 47/63 | 08/97→ | CH217 | 11v | | | CCU128[329] CCU129[338] | |
| 1.9 dCi, 1.9 dCi 4WD | 4 | F9Q782; F9Q790 | 62/83 | 07/03→ | CH271 | 11v | | | CCU129[338] CCU154[10] | |
| 1.9 dCi 4WD, 1.9 dTi | 4 | F9Q780; F9Q782; F9Q790 | 59/79 | 02/00→ | CH271 | 11v | | | CCU129[338] CCU154[10] | |
| LOGAN EXPRESS | | | | | | | | | | |
| 1.5 dCi | 4 | K9K792 | 50/67 | 04/07→ | CH271 [9][337] | 11v | | | | |
| 1.6 | 4 | K7M710 | 64/86 | 04/07→ | OE026 | 0,9 | CET2 | OE179 | BAEA354 | |
| | | | | | OE216 LPG [278] | 0,8 | | | | |
| MASTER II | | | | | | | | | | |
| 1.9 dCi 80 | 4 | F9Q772; F9Q774 | 60/80 | 11/01→ | CH271 | 11v | | | CCU129[339] CCU154 [10][370] | |
| 1.9 dTi | 4 | F9Q770 | 59/79 | 09/00→ | CH271 | 11v | | | CCU129[339] CCU154 [10][370] | |
| 2.2 dCi 90 | 4 | G9T720; G9T722; G9T750 | 66/89 | 09/00→ | CH232 | 11v | | | CCU154[10] | |

RENAULT





kW/BHP

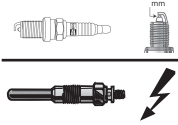

eon TITAN

IRIDIUM

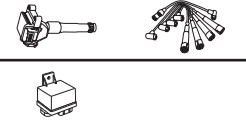

...RENAULT

...MASTER II

| | | | | | | | | | |
|-------------|---|--------------------------------|---------|-------------|-------|-----|--|--|------------------------|
| 2.5 dCi | 4 | G9U650; G9U754 | 74/99 | 08/06→ | CH232 | 11v | | | |
| 2.5 dCi | 4 | G9U650 | 88/118 | 08/06→ | CH232 | 11v | | | |
| 2.5 dCi | 4 | G9U632 | 107/143 | 08/06→ | CH232 | 11v | | | |
| 2.5 dCi 100 | 4 | G9U754 | 73/98 | 10/03→ | CH232 | 11v | | | |
| 2.5 dCi 120 | 4 | G9U720; G9U724; G9U750; G9U754 | 84/113 | 10/01→ | CH232 | 11v | | | CCU147 |
| 2.8 dTi | 4 | S9W702 | 84/113 | 07/98→10/01 | CH216 | 11v | | | |
| 3.0 dCi 120 | 4 | ZD3600 | 85/114 | 06/05→ | | | | | CCU154 ^[10] |
| 3.0 dCi 140 | 4 | ZD3200; ZD3202 | 100/134 | 10/03→ | | | | | CCU154 ^[10] |
| 3.0 dCi 160 | 4 | ZD3A604 | 115/154 | 06/05→ | | | | | CCU154 ^[10] |

MASTER III

| | | | | | | | | | |
|-------------|---|--|---------|--------|-------------------------------|----|--|--|--|
| 2.3 dCi 100 | 4 | M9T670; M9T672; M9T676; M9T690; M9T692; M9T870; M9T890 | 74/99 | 02/10→ | CCGP007 ^{[14] [154]} | 7v | | | |
| 2.3 dCi 125 | 4 | M9T670; M9T672; M9T676; M9T686; M9T690; M9T692; M9T696; M9T698; M9T870; M9T890; M9T896 | 92/123 | 02/10→ | CCGP007 ^{[14] [154]} | 7v | | | |
| 2.3 dCi 145 | 4 | M9T678; M9T680; M9T694; M9T696; M9T698; M9T706; M9T896 | 107/143 | 02/10→ | CCGP007 ^{[14] [154]} | 7v | | | |

RAPID

| | | | | | | | | | |
|-------|---|----------------|-------|-------------|-------|-----|------|-------|--------------------------------------|
| 1.1 | 4 | C1E762 | 35/47 | 09/93→04/95 | OE001 | 0,9 | CET8 | OE195 | |
| 1.2 | 4 | E7F708 | 48/64 | 05/95→11/98 | OE005 | 0,9 | CET2 | OE180 | |
| 1.4 | 4 | E7J728 | 58/78 | 01/94→03/98 | OE005 | 0,9 | CET2 | OE180 | BAEA251 ^{[265] [275] [292]} |
| 1.4 | 4 | E7J773 | 59/79 | 05/95→08/97 | OE005 | 0,9 | CET2 | OE179 | BAEA251 ^{[265] [275] [292]} |
| 1.9 D | 4 | F8Q640; F8Q682 | 40/54 | 09/94→03/98 | CH206 | 11v | | | |

TRAFIC

| | | | | | | | | | |
|------------------|---|----------------|-------|-------------|-------|-------|------|-------|--------------------------------------|
| 1.9 D | 4 | F8Q606 | 44/59 | 06/97→03/01 | CH217 | 11v | | | |
| 2.1 D | 4 | J8S620; J8S758 | 47/63 | 06/94→04/98 | CH189 | 11v | | | |
| 2.2, 2.2 4WD | 4 | J7T600 | 74/99 | 06/94→04/98 | OE011 | 0,9 | CET9 | OE183 | BAEA251 ^{[265] [275] [292]} |
| 2.5 D, 2.5 D 4WD | 4 | S8U758 | 58/78 | 09/94→01/99 | CH147 | 11.5v | | | |

TRAFIC II

| | | | | | | | | | |
|--------------------------|---|--------------------------------|--------|-------------|-------------------------------|-----|------|-------|--|
| 1.9 dCi | 4 | F9Q762 | 59/79 | 04/01→07/03 | CH271 | 11v | | | |
| 1.9 dCi | 4 | F9Q760 | 75/101 | 03/01→ | CH271 | 11v | | | CCU154 →Eng.060809 [10] [360] CCU147 Eng.060810→ [11] [352] |
| 1.9 dCi 80, 1.9 dCi 80 | 4 | F9Q760; F9Q762 | 60/80 | 03/01→ | CH271 | 11v | | | CCU154 →Eng.060809 [10] [360] CCU147 Eng.060810→ [11] [352] |
| 1.9 dCi 100, 1.9 dCi 100 | 4 | F9Q760 | 74/99 | 03/01→ | CH271 | 11v | | | CCU154 →Eng.060809 [10] [360] CCU147 Eng.060810→ [11] [352] |
| 2.0 | 4 | F4R720; F4R722 | 88/118 | 03/01→ | OE033 | 0,9 | CET2 | OE179 | BAE409A |
| 2.0 16V | 4 | F4R820 | 86/115 | 08/06→ | OE033 | 0,9 | CET2 | OE179 | BAE409A |
| 2.0 dCi 90 | 4 | M9R630; M9R780; M9R782 | 66/89 | 08/06→ | CCGP007 ^{[14] [154]} | 7v | | | |
| 2.0 dCi 115 | 4 | M9R692; M9R780; M9R782; M9R786 | 84/113 | 08/06→ | CCGP007 ^{[14] [154]} | 7v | | | |

RENAULT



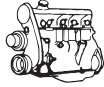

kW/BHP

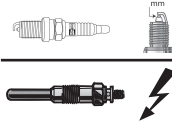

eon TITAN

IRIDIUM

**...RENAULT****...TRAFIC II**

| | | | | | | | | | |
|----------------------|---|--------|---------|--------|-------|-----|--|--|--|
| 2.5 dCi, 2.5 dCi 115 | 4 | G9U630 | 84/113 | 08/07→ | CH232 | 11v | | | |
| 2.5 dCi 135, 2.5 DTi | 4 | G9U730 | 99/133 | 03/01→ | CH232 | 11v | | | |
| 2.5 dCi 145 | 4 | G9U630 | 107/143 | 08/06→ | CH232 | 11v | | | |

TWINGO I

| | | | | | | | | | | |
|-----|---|-----------------------------------|-------|-------------|-------|-----|------|-------|--|------------------------|
| 1.2 | 4 | C3G700; C3G702 | 40/54 | 03/93→05/96 | OE015 | 0,9 | CET8 | | BAE504L | CLS126 |
| 1.2 | 4 | D7F700; D7F701 | 43/58 | 05/96→08/04 | OE026 | 0,9 | CET2 | OE179 | BAEA345 →Eng.981021 | CLS040 [275] →11/99 |
| | | | | | | | | | BAEA354 [275] Eng.981021→ Eng.111215 | CLS083 [275] 12/99→ |
| 1.2 | 4 | D7F702; D7F703; D7F704; D7F706 | 43/58 | 05/96→08/04 | OE026 | 0,9 | CET2 | OE179 | BAEA345 →Eng.981021 | CLS040 [275] →11/99 |
| | | | | | | | | | BAEA354 [275] Eng.981021→ Eng.111215 | |

RENAULT TRUCKS**MASCOTT**

| | | | | | | | | | |
|------------------------------------|---|-----------------------------------|---------|-------------|-------|-----|--|--|--|
| 2.8 130, 2.8 130.35, 2.8 130.55 | 4 | 8140.43.S.2585; 8140.43.S.3585 | 92/123 | 01/99→06/04 | CH216 | 11v | | | |
| 2.8 150.35, 2.8 150.55, 2.8 150.65 | 4 | 8140.43N.3585 | 107/143 | 10/01→06/04 | CH216 | 11v | | | |

ROLLS-ROYCE**CORNICHE IV**

| | | | | | | | | | |
|-----|---|-------|---------|-------------|-------|-----|------|--|--|
| 6.7 | 8 | L410I | 165/221 | 01/93→12/00 | OE051 | 0,9 | CET8 | | |
|-----|---|-------|---------|-------------|-------|-----|------|--|--|

CORNICHE V

| | | | | | | | | | |
|--------------|---|---------|---------|-------------|-------|-----|------|--|--|
| 6.7 V8 Turbo | 8 | L410MIT | 242/325 | 01/00→09/02 | OE006 | 0,9 | CET8 | | |
|--------------|---|---------|---------|-------------|-------|-----|------|--|--|

GHOST

| | | | | | | | | | |
|---------|----|---------|---------|--------|-------|-----|--|--|-------------------|
| 6.6 V12 | 12 | N74B66A | 420/563 | 08/08→ | OE242 | 0,8 | | | BAEA143 12/09→ |
| 6.6 V12 | 12 | N74B66A | 442/593 | 08/08→ | OE242 | 0,8 | | | |

PARK WARD

| | | | | | | | | | |
|-----|----|--------|---------|-------------|-------|-----|--------|--|--|
| 5.4 | 12 | M73B54 | 240/322 | 10/00→12/02 | OE223 | 1,6 | CET12P | | |
|-----|----|--------|---------|-------------|-------|-----|--------|--|--|

PHANTOM VII

| | | | | | | | | | |
|---------|----|---------|---------|--------|-------|-----|--------|--|------------------------|
| 6.8 | 12 | N73B68A | 338/453 | 08/02→ | OE223 | 1,6 | CET12P | | BAEA324 →02/09 |
| 6.8 V12 | 12 | N73B68A | 338/453 | 03/06→ | OE223 | 1,6 | CET12P | | BAEA324 06/07→02/09 |

SILVER SERAPH

| | | | | | | | | | |
|-----|----|--------|---------|-------------|-------|-----|--------|--|---------|
| 5.4 | 12 | M73B54 | 240/322 | 03/98→09/02 | OE223 | 1,6 | CET12P | | BAEA302 |
|-----|----|--------|---------|-------------|-------|-----|--------|--|---------|

WRAITH

| | | | | | | | | | |
|---------|----|---------|---------|--------|-------|-----|--|--|---------|
| 6.6 V12 | 12 | N74B66A | 465/624 | 07/13→ | OE242 | 0,8 | | | BAEA143 |
|---------|----|---------|---------|--------|-------|-----|--|--|---------|

ROVER**25**

| | | | | | | | | | | |
|--------------|---|-------|--------|-------------|-------|-----|--------|-------|--|------------------------------|
| 1.1 | 4 | | 44/59 | 11/99→05/05 | | | | | BAEA501 | |
| 1.1, 1.1 16V | 4 | 11K4F | 55/74 | 09/99→05/05 | OE146 | 1,0 | CET12P | OE179 | BAEA501 | |
| 1.4 16V | 4 | 14K4M | 62/83 | 10/99→05/05 | OE146 | 1,0 | CET12P | OE179 | BAEA469 →Ch.YD471564 [185] [260] | CLS061 [292] →Ch.YD471564 |
| 1.4 16V | 4 | 14K4F | 76/102 | 10/99→05/05 | OE146 | 1,0 | CET12P | OE179 | BAEA469 →Ch.YD471564 [185] [260] | CLS061 [292] →Ch.YD471564 |
| | | | | | | | | | BAEA501 Ch.YD471565→ | |



kW/BHP

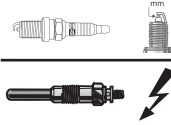

eon TITAN

IRIDIUM

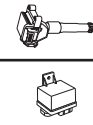

...ROVER

...25

| | | | | | | | | | | |
|---------|---|-------|---------|-------------|-------|-----|--------|-------|---|------------------------------|
| 1.6 16V | 4 | 16K4F | 80/107 | 10/99→05/05 | OE146 | 1,0 | CET12P | OE179 | BAEA469 →Ch.YD471564 [185] [260] BAEA501 Ch.YD471565→ | CLS061 [292] →Ch.YD471564 |
| 1.8 16V | 4 | 18K4F | 85/114 | 10/99→05/05 | OE146 | 1,0 | CET12P | OE179 | BAEA469 →Ch.YD471564 [185] [260] | CLS061 [292] →Ch.YD471564 |
| 1.8 16V | 4 | 18K4K | 107/143 | 02/00→05/05 | OE146 | 1,0 | CET12P | OE179 | | |
| 2.0 iDT | 4 | 20T2N | 74/99 | 10/99→05/05 | CH169 | 11v | | | | |
| 2.0 iDT | 4 | 20T2N | 83/111 | 01/02→12/04 | CH169 | 11v | | | | |

45

| | | | | | | | | | | |
|---------|---|-------|---------|-------------|-------|-----|--------|-------|-------------------------|--|
| 1.4 | 4 | 14K4F | 76/102 | 02/00→05/05 | OE146 | 1,0 | CET12P | OE179 | BAEA501 Ch.YD471064→ | |
| 1.6 | 4 | 16K4F | 80/107 | 02/00→05/05 | OE146 | 1,0 | CET12P | OE179 | BAEA501 Ch.YD471064→ | |
| 1.8 | 4 | 18K4F | 86/115 | 02/00→05/05 | OE146 | 1,0 | CET12P | OE179 | | |
| 2.0 V6 | 6 | 20K4F | 110/148 | 02/00→05/05 | OE146 | 1,0 | CET12P | OE179 | | |
| 2.0 iDT | 4 | 20T2N | 74/99 | 02/00→05/05 | CH169 | 11v | | | | |
| 2.0 iDT | 4 | 20T2N | 83/111 | 01/04→05/05 | CH169 | 11v | | | | |

75

| | | | | | | | | | | |
|-----------|---|---------------|---------|-------------|-------|-----|--------|-------|---------|--------|
| 1.8 | 4 | K1.8 | 88/118 | 02/99→05/05 | OE146 | 1,0 | CET12P | OE179 | BAEA501 | CLS045 |
| 1.8 | 4 | K1.8 | 88/118 | 02/99→05/05 | | | | | BAEA501 | |
| 1.8 Turbo | 4 | 18K4G | 110/148 | 05/03→05/05 | OE146 | 1,0 | CET12P | OE179 | BAEA501 | |
| 1.8 Turbo | 4 | 18K4G | 110/148 | 05/03→05/05 | | | | | BAEA501 | |
| 2.0 CDT | 4 | M47R | 85/114 | 02/99→05/05 | CH203 | 11v | | | | |
| 2.0 CDTi | 4 | 204D2 | 96/129 | 02/03→05/05 | CH203 | 11v | | | | |
| 2.0 V6 | 6 | 20K4F | 110/148 | 02/99→05/05 | OE146 | 1,0 | CET12P | OE179 | | |
| 2.5 V6 | 6 | KV6 | 129/173 | 02/99→10/01 | OE146 | 1,0 | CET12P | OE179 | | |
| 2.5 V6 | 6 | 25K4F; KV6 | 130/174 | 08/01→05/05 | OE146 | 1,0 | CET12P | OE179 | | |
| 4.6 V8 | 8 | 46F2F; V99WFH | 191/256 | 10/03→05/05 | | | CET9 | | | |

100

| | | | | | | | | | | |
|---------|---|--------------|--------|-------------|-------|-----|------|-------|------------------------|--|
| 1.1 111 | 4 | 11K2D | 44/59 | 04/94→10/97 | OE002 | 0,9 | CET2 | OE180 | BAEA469 [185] [260] | |
| 1.4 114 | 4 | 14K2A; 14K2D | 55/74 | 04/94→10/97 | OE002 | 0,9 | CET2 | OE180 | BAEA469 [185] [260] | |
| 1.4 114 | 4 | 14K4F | 75/101 | 03/97→10/98 | OE002 | 0,9 | CET2 | OE179 | BAEA469 [185] [260] | |

100 / METRO

| | | | | | | | | | | |
|-------------|---|-------|--------|-------------|-------|-----|------|-------|------------------------|--|
| 1.4 114 GSi | 4 | 14K4F | 76/102 | 10/94→10/95 | OE002 | 0,9 | CET2 | OE179 | BAEA469 [185] [260] | |
| 1.5 115 D | 4 | TUD5 | 42/56 | 12/94→12/98 | CH185 | 11v | | | | |

200

| | | | | | | | | | | |
|------------------|---|--------------|--------|-------------|-------|-----|------|-------|---|------------------------------|
| 1.1 211 | 4 | 11K2D | 44/59 | 01/98→03/00 | OE002 | 0,9 | CET2 | OE180 | BAEA469 [185] | |
| 1.4 214 | 4 | 14K2A; 14K2D | 55/74 | 09/93→12/95 | OE005 | 0,9 | CET2 | OE180 | BAEA115 [8] [275] | |
| 1.4 214 1.4i 16V | 4 | 14K4F | 76/102 | 01/93→11/99 | OE002 | 0,9 | CET2 | OE180 | BAEA469 [185] [260] | |
| 1.4 214 i | 4 | 14K2F | 55/74 | 11/95→03/00 | L82C | 0,6 | CET2 | OE180 | BAEA469 [185] [260] | CLS095 |
| | | | | | OE002 | 0,9 | | | | |
| 1.4 214 Si | 4 | 14K4F | 76/102 | 11/95→03/00 | OE002 | 0,9 | CET2 | OE180 | BAEA469 →Ch.YD471564 [185] [260] [275] BAEA501 [275] Ch.YD471565→ | CLS061 [292] →Ch.YD471564 |
| 1.6 216 1.6i 16V | 4 | 16K4F | 82/110 | 01/96→11/99 | OE002 | 0,9 | CET2 | OE180 | BAEA469 [185] [260] | CLS095 |

ROVER



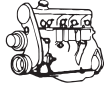

kW/BHP

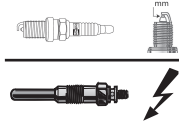

eon TITAN

IRIDIUM



...ROVER

...200

| | | | | | | | | | | |
|--------------|---|-------|---------|-------------|-------|-----|--------|-------|--------------------------------------|--------------|
| 1.6 216 Si | 4 | 16K4F | 82/110 | 11/95→06/99 | OE002 | 0,9 | CET2 | OE180 | BAEA469 →Ch.471564 [185] [260] | CLS061 [292] |
| 1.8 218 K Vi | 4 | 18K4K | 107/143 | 11/95→03/00 | OE146 | 1,0 | CET12P | OE179 | | |
| 1.8 218 Si | 4 | 18K4F | 88/118 | 08/99→03/00 | OE002 | 0,9 | CET2 | OE179 | | CLS095 |
| 2.0 220 D/SD | 4 | 20T2R | 63/84 | 11/95→03/00 | CH169 | 11v | | | | |
| 2.0 220 GSi | 4 | 20T4H | 100/134 | 05/94→06/99 | OE002 | 0,9 | CET2 | OE180 | BAEA115 [8] [275] | |
| 2.0 220 GTi | 4 | 20T4H | 100/134 | 01/93→10/95 | OE002 | 0,9 | CET2 | OE180 | | |
| 2.0 220 SDi | 4 | 20T2N | 77/103 | 11/95→03/00 | CH169 | 11v | | | | |

400

| | | | | | | | | | | |
|--------------------------|---|-------|---------|-------------|-------|-----|--------|-------|-------------------------------------|--|
| 1.4 414 | 4 | 14K2F | 55/74 | 03/96→12/99 | OE002 | 0,9 | CET2 | OE179 | BAEA469 BAEA469 [185] [260] | |
| 1.4 414 | 4 | 14K4C | 70/94 | 01/93→04/95 | OE002 | 0,9 | CET2 | OE180 | BAEA469 | |
| 1.4 414 Si | 4 | 14K4F | 76/102 | 05/95→03/00 | OE002 | 0,9 | CET2 | OE180 | BAEA469 [185] [260] | CLS095 |
| 1.6 416 Si | 4 | 16K4F | 82/110 | 05/95→03/00 | OE002 | 0,9 | CET2 | OE180 | BAEA469 →Ch.74464 [185] [260] | CLS095 |
| 1.6 416 Si | 4 | D16Y2 | 83/111 | 05/95→03/00 | | | CET2 | OE179 | BAEA469 →Ch.74464 | CLS095 |
| 1.6 416 Si | 4 | D16B2 | 85/114 | 05/95→03/00 | OE002 | 0,9 | CET2 | OE180 | | CLS095 |
| 1.6 i | 4 | D16Z2 | 82/110 | 05/94→11/98 | OE002 | 0,9 | CET2 | OE180 | BAEA469 [185] [260] | CLS095 →02/96 CLS129 [296] 02/96→ |
| 1.6 i | 4 | D16A8 | 90/121 | 05/94→11/98 | OE039 | 1,0 | CET2 | OE180 | BAEA469 [185] [260] | |
| 1.8 i | 4 | 18K4K | 107/143 | 06/96→11/98 | OE146 | 1,0 | CET12P | OE179 | | |
| 2.0 420 D | 4 | 20T2R | 63/84 | 11/95→03/00 | CH169 | 11v | | | | |
| 2.0 420 Di | 4 | 20T2N | 77/103 | 05/95→03/00 | CH169 | 11v | | | | |
| 2.0 420 GSi/SLI/GTi/Vite | 4 | 20T4H | 100/134 | 01/93→04/95 | OE002 | 0,9 | CET2 | OE180 | | |
| 2.0 420 Si Lux, 2.0 i | 4 | 20T4H | 100/134 | 05/94→03/00 | OE002 | 0,9 | CET2 | OE180 | BAEA231 | |
| 2.0 420 Turbo | 4 | 20T4G | 147/197 | 01/93→04/95 | OE002 | 0,9 | CET2 | OE180 | | |

600

| | | | | | | | | | | |
|--------------------|---|-------|---------|-------------|-----------------|-----|------|-------|-----------------------------|--|
| 1.9 618 i/Si | 4 | F18A3 | 85/114 | 03/96→02/99 | OE089 | 1,0 | CET2 | OE184 | | |
| | | | | | OE216 LPG [278] | 0,8 | | | | |
| 2.0 620 i | 4 | F20Z2 | 85/114 | 08/93→06/96 | OE089 | 1,0 | CET2 | OE184 | BAEA275 [292] →Ch.246796 | |
| | | | | | OE216 LPG [278] | 0,8 | | | | |
| 2.0 620 Sdi | 4 | 20T2N | 77/103 | 05/94→06/99 | CH169 | 11v | | | | |
| 2.0 620 Si | 4 | F20Z1 | 96/129 | 08/93→02/99 | OE089 | 1,0 | CET2 | OE184 | BAEA275 [292] →Ch.246796 | |
| | | | | | OE216 LPG [278] | 0,8 | | | | |
| 2.0 620 Ti Vitesse | 4 | 20T4G | 147/197 | 05/94→08/98 | OE002 | 0,9 | CET2 | OE180 | BAEA275 [292] | |
| 2.3 623 Si | 4 | H23A3 | 116/156 | 08/93→06/99 | OE089 | 1,0 | CET2 | OE184 | BAEA275 [292] | |
| | | | | | OE216 LPG [278] | 0,8 | | | | |

800

| | | | | | | | | | | |
|----------------------------|---|---------------------|---------|-------------|------------------------------------|----------------|------|-------|---------------------------------|--|
| 2.0 820 Sport | 4 | 20T4G | 145/194 | 04/94→03/96 | | | CET2 | OE179 | BAEA231 01/96→ Ch.230967→ | |
| 2.5, 2.5 Si | 6 | 25K4F | 129/173 | 02/96→10/98 | OE005 | 0,9 | CET2 | OE179 | | |
| 2.5 825 SD | 4 | 425SL1RR; 4924SHIRG | 87/117 | 09/93→02/99 | CH189 →04/95 CH181 05/95→ | 11v 11v | | | | |
| 2.5 825 Si, 2.5 825 Si Lux | 6 | 25K4F | 129/173 | 04/96→02/99 | | | CET2 | OE179 | | |

CHAMPION



kW/BHP

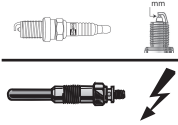

eon TITAN

IRIDIUM

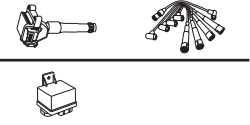
**...ROVER****CITYROVER**

| | | | | | | | | | |
|--------------|---|-------------|-------|-------------|-------|-----|------|-------|--------------------------|
| 1.4 Elegance | 4 | 14K2; 475Si | 62/83 | 09/03→12/05 | OE005 | 0,9 | CET2 | OE179 | BAEA232 ^[275] |
|--------------|---|-------------|-------|-------------|-------|-----|------|-------|--------------------------|

COUPE

| | | | | | | | | | | |
|----------|---|-------|--------|-------------|-------|-----|------|-------|-----------------------------------|--------|
| 1.6 16 V | 4 | 16K4F | 82/110 | 03/96→11/99 | OE002 | 0,9 | CET2 | OE180 | BAEA469 ^{[185] [260]} | CLS095 |
|----------|---|-------|--------|-------------|-------|-----|------|-------|-----------------------------------|--------|

| | | | | | | | | | |
|----------|---|-------|---------|-------------|-------|-----|--------|-------|--|
| 1.8 16 V | 4 | 18K4K | 107/143 | 03/96→11/99 | OE146 | 1,0 | CET12P | OE179 | |
|----------|---|-------|---------|-------------|-------|-----|--------|-------|--|

MINI

| | | | | | | | | | |
|-----|---|--|-------|-------------|-------|-----|------|--|--|
| 1.3 | 4 | | 63/84 | 11/96→05/01 | OE006 | 0,9 | CET8 | | |
|-----|---|--|-------|-------------|-------|-----|------|--|--|

| | | | | | | | | | |
|--------------|---|--|-------|-------------|-------|-----|------|--|--|
| 1.3 Cooper S | 4 | | 59/79 | 06/95→11/00 | OE006 | 0,9 | CET8 | | |
|--------------|---|--|-------|-------------|-------|-----|------|--|--|

| | | | | | | | | | |
|-------|---|-------|-------|-------------|-------|-----|------|--|-------------------------|
| 1.3 S | 4 | 12A2L | 46/62 | 02/98→05/01 | OE006 | 0,9 | CET8 | | BAEA231 Ch.BD134455→ |
|-------|---|-------|-------|-------------|-------|-----|------|--|-------------------------|

STREETWISE

| | | | | | | | | | |
|-----|---|-------|-------|-------------|-------|-----|--------|-------|---------|
| 1.4 | 4 | 14K4M | 62/83 | 08/03→05/05 | OE146 | 1,0 | CET12P | OE179 | BAEA501 |
|-----|---|-------|-------|-------------|-------|-----|--------|-------|---------|

| | | | | | | | | | |
|-----|---|-------|--------|-------------|-------|-----|--------|-------|---------|
| 1.4 | 4 | 14K4F | 76/102 | 08/03→05/05 | OE146 | 1,0 | CET12P | OE179 | BAEA501 |
|-----|---|-------|--------|-------------|-------|-----|--------|-------|---------|

| | | | | | | | | | |
|-----|---|-------|--------|-------------|-------|-----|--------|-------|---------|
| 1.6 | 4 | 16K4F | 80/107 | 01/04→05/05 | OE146 | 1,0 | CET12P | OE179 | BAEA501 |
|-----|---|-------|--------|-------------|-------|-----|--------|-------|---------|

| | | | | | | | | | |
|-----|---|-------|--------|-------------|-------|-----|--------|-------|---------|
| 1.8 | 4 | 18K4F | 86/115 | 08/03→05/05 | OE146 | 1,0 | CET12P | OE179 | BAEA501 |
|-----|---|-------|--------|-------------|-------|-----|--------|-------|---------|

| | | | | | | | | | |
|--------|---|-------|-------|-------------|-------|-----|--|--|--|
| 2.0 TD | 4 | 20T2N | 74/99 | 08/03→05/05 | CH169 | 11v | | | |
|--------|---|-------|-------|-------------|-------|-----|--|--|--|

SAAB**9-3**

| | | | | | | | | | |
|-------|---|-------|--------|-------------|-------|-----|------|-------|---------|
| 1.8 i | 4 | Z18XE | 90/121 | 01/04→02/15 | OE019 | 0,9 | CET2 | OE184 | BAEA342 |
|-------|---|-------|--------|-------------|-------|-----|------|-------|---------|

| | | | | | | | | | |
|---------|---|-------|--------|-------------|-----------------------------------|-----|--|--|--|
| 1.9 TiD | 4 | Z19DT | 88/118 | 09/04→02/15 | CH222 →Ch.71019398 76004481 | 11v | | | |
|---------|---|-------|--------|-------------|-----------------------------------|-----|--|--|--|

| | | | | | | | | | |
|--|--|--|--|--|-----------------------------------|-----|--|--|--|
| | | | | | CH269 Ch.71100001 76100001→ | 11v | | | |
|--|--|--|--|--|-----------------------------------|-----|--|--|--|

| | | | | | | | | | |
|---------|---|--------|---------|-------------|-------|-----|--|--|--|
| 1.9 TiD | 4 | Z19DTH | 110/148 | 09/04→02/15 | CH224 | 11v | | | |
|---------|---|--------|---------|-------------|-------|-----|--|--|--|

| | | | | | | | | | |
|-----------|---|-------|---------|-------------|-------|-----|----------------|-------|--|
| 2.0 1, 8t | 4 | B207E | 110/148 | 09/02→02/15 | OE136 | 0,8 | CET12P CET2 | OE179 | |
|-----------|---|-------|---------|-------------|-------|-----|----------------|-------|--|

| | | | | | | | | | |
|---|---|-------|---------|-------------|-------|-----|--------|-------|--|
| 2.0 1, 8t BioPower, 2.0 1.8t, 2.0 t, 2.0 t BioPower | 4 | B207E | 110/148 | 03/05→02/15 | OE136 | 0,8 | CET12P | OE179 | |
|---|---|-------|---------|-------------|-------|-----|--------|-------|--|

| | | | | | | | | | |
|---|---|-------|---------|-------------|-------|-----|--------|-------|--|
| 2.0 1, 8t BioPower, 2.0 t, 2.0 t BioPower | 4 | B207L | 129/173 | 09/02→02/15 | OE136 | 0,8 | CET12P | OE179 | |
|---|---|-------|---------|-------------|-------|-----|--------|-------|--|

| | | | | | | | | | |
|-------|---|-------|--------|-------------|--|--|------|-------|--------|
| 2.0 i | 4 | B204I | 96/129 | 02/98→08/03 | | | CET2 | OE182 | CLS150 |
|-------|---|-------|--------|-------------|--|--|------|-------|--------|

| | | | | | | | | | |
|--------------|---|-------|---------|-------------|--|--|------|-------|--|
| 2.0 SE Turbo | 4 | B204R | 147/197 | 02/98→08/03 | | | CET2 | OE179 | |
|--------------|---|-------|---------|-------------|--|--|------|-------|--|

| | | | | | | | | | |
|------------------|---|-------|---------|-------------|-------|-----|--------|-------|--|
| 2.0 t, 2.0 t 4WD | 4 | B207G | 120/161 | 01/07→02/15 | OE136 | 0,8 | CET12P | OE179 | |
|------------------|---|-------|---------|-------------|-------|-----|--------|-------|--|

| | | | | | | | | | |
|--|---|--------|---------|-------------|--|--|--------|------------------------|--|
| 2.0 t, 2.0 t 4WD, 2.0 t BioPower, 2.0 t BioPower, 2.0 t BioPower 4WD | 4 | A20NFT | 162/217 | 01/08→02/15 | | | CET17P | OE189 *tobeadjusted | |
|--|---|--------|---------|-------------|--|--|--------|------------------------|--|

| | | | | | | | | | |
|----------------------|---|-------|---------|-------------|-------|-----|--------|-------|--|
| 2.0 t, 2.0 Turbo 4WD | 4 | B207R | 154/207 | 09/02→02/15 | OE136 | 0,8 | CET12P | OE179 | |
|----------------------|---|-------|---------|-------------|-------|-----|--------|-------|--|

| | | | | | | | | | |
|-----------|---|-------|---------|-------------|-------|-----|--------|-------|--------|
| 2.0 Turbo | 4 | B205E | 110/148 | 03/99→08/03 | OE136 | 0,8 | CET12P | OE179 | CLS150 |
|-----------|---|-------|---------|-------------|-------|-----|--------|-------|--------|

| | | | | | | | | | |
|-----------|---|-------|---------|-------------|-------|-----|--------|-------|--------|
| 2.0 Turbo | 4 | B204E | 113/152 | 10/98→08/03 | OE136 | 0,8 | CET12P | OE179 | CLS150 |
|-----------|---|-------|---------|-------------|-------|-----|--------|-------|--------|

| | | | | | | | | | |
|-----------|---|---------------------|---------|-------------|-------|-----|--------|-------|--|
| 2.0 Turbo | 4 | B204L; B205E; B205L | 136/182 | 02/98→08/03 | OE136 | 0,8 | CET12P | OE179 | |
|-----------|---|---------------------|---------|-------------|-------|-----|--------|-------|--|

| | | | | | | | | | |
|-----------|---|-------|---------|-------------|-------|-----|--------|-------|--------|
| 2.0 Turbo | 4 | B205R | 151/202 | 10/99→08/03 | OE136 | 0,8 | CET12P | OE179 | CLS150 |
|-----------|---|-------|---------|-------------|-------|-----|--------|-------|--------|

| | | | | | | | | | |
|---------|---|---------------|--------|-------------|-------|-----|--|--|--|
| 2.2 TiD | 4 | D223L; X22DTH | 85/114 | 02/98→11/00 | CH207 | 11v | | | |
|---------|---|---------------|--------|-------------|-------|-----|--|--|--|

| | | | | | | | | | |
|---------|---|-------|--------|-------------|-------|-----|--|--|--|
| 2.2 TiD | 4 | D223L | 92/123 | 11/00→02/15 | CH231 | 11v | | | |
|---------|---|-------|--------|-------------|-------|-----|--|--|--|

| | | | | | | | | | |
|-----|---|-------|---------|-------------|-------|-----|--------|-------|--|
| 2.3 | 4 | B235R | 169/227 | 09/99→01/02 | OE136 | 0,8 | CET12P | OE179 | |
|-----|---|-------|---------|-------------|-------|-----|--------|-------|--|

| | | | | | | | | | |
|-------|---|-------|---------|-------------|--|--|------|-------|--|
| 2.3 i | 4 | B234I | 110/148 | 02/98→08/03 | | | CET2 | OE182 | |
|-------|---|-------|---------|-------------|--|--|------|-------|--|

| | | | | | | | | | |
|-----------|---|-------|---------|-------------|-------|-----|--------|-------|--|
| 2.3 Turbo | 4 | B235R | 165/221 | 10/98→08/03 | OE136 | 0,8 | CET12P | OE179 | |
|-----------|---|-------|---------|-------------|-------|-----|--------|-------|--|

| | | | | | | | | | |
|--------------|---|------------|---------|-------------|-------|-----|--|--|----------|
| 2.8 Turbo V6 | 6 | B284L; LP9 | 169/227 | 03/05→02/15 | OE238 | 1,0 | | | BAEA174E |
|--------------|---|------------|---------|-------------|-------|-----|--|--|----------|

| | | | | | | | | | |
|--------------|---|-----|---------|-------------|-------|-----|--|--|----------|
| 2.8 Turbo V6 | 6 | LP9 | 184/247 | 03/05→02/15 | OE238 | 1,0 | | | BAEA174E |
|--------------|---|-----|---------|-------------|-------|-----|--|--|----------|

| | | | | | | | | | |
|--------------|---|-------|---------|-------------|-------|-----|--|--|----------|
| 2.8 Turbo V6 | 6 | B284L | 188/252 | 12/07→02/15 | OE238 | 1,0 | | | BAEA174E |
|--------------|---|-------|---------|-------------|-------|-----|--|--|----------|

| | | | | | | | | | |
|--------------|---|--------------|---------|-------------|-------|-----|--|--|----------|
| 2.8 Turbo V6 | 6 | B284L; B284R | 203/272 | 04/08→02/15 | OE238 | 1,0 | | | BAEA174E |
|--------------|---|--------------|---------|-------------|-------|-----|--|--|----------|

| | | | | | | | | | |
|--------------------------------|---|-------|---------|-------------|-------|-----|--|--|----------|
| 2.8 Turbo V6, 2.8 Turbo V6 4WD | 6 | B284R | 206/276 | 05/08→02/15 | OE238 | 1,0 | | | BAEA174E |
|--------------------------------|---|-------|---------|-------------|-------|-----|--|--|----------|

SAAB



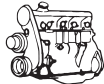

kW/BHP



eon TITAN

IRIDIUM

**...SAAB****9-3X**

| | | | | | | | | | |
|--------------------|---|--------|---------|-------------|--|--|--------|------------------------|--|
| 2.0 † BioPower 4WD | 4 | A20NFT | 162/217 | 01/11→12/12 | | | CET17P | OE189 *tobeadjusted | |
|--------------------|---|--------|---------|-------------|--|--|--------|------------------------|--|

9-4X

| | | | | | | | | | |
|---------------|---|----------|---------|-------------|-------|-----|--|--|--|
| 2.8 Turbo 4WD | 6 | LAU; LP9 | 224/300 | 02/11→12/11 | OE238 | 1,0 | | | |
|---------------|---|----------|---------|-------------|-------|-----|--|--|--|

9-5

| | | | | | | | | | |
|---------|---|--------|---------|-------------|-------|-----|--|--|--|
| 1.9 TiD | 4 | Z19DTH | 110/148 | 01/06→12/09 | CH224 | 11v | | | |
|---------|---|--------|---------|-------------|-------|-----|--|--|--|

| | | | | | | | | | |
|-----|---|--------|---------|-------------|--|--|--------|------------------------|--|
| 2.0 | 4 | A20NFT | 164/220 | 09/10→01/12 | | | CET17P | OE189 *tobeadjusted | |
|-----|---|--------|---------|-------------|--|--|--------|------------------------|--|

| | | | | | | | | | |
|-------|---|-------|---------|-------------|-------|-----|--------|-------|--|
| 2.0 † | 4 | B205L | 136/182 | 07/00→12/09 | OE136 | 0,8 | CET12P | OE179 | |
|-------|---|-------|---------|-------------|-------|-----|--------|-------|--|

| | | | | | | | | | |
|-----------------------|---|-------|---------|-------------|-------|-----|--------|-------|--|
| 2.0 †, 2.0 † BioPower | 4 | B205E | 110/148 | 09/97→12/09 | OE136 | 0,8 | CET12P | OE179 | |
|-----------------------|---|-------|---------|-------------|-------|-----|--------|-------|--|

| | | | | | | | | | |
|---------------------|---|-------|---------|-------------|-------|-----|--------|-------|--|
| 2.0 †, 2.0 Turbo SE | 4 | B205E | 141/189 | 10/98→07/00 | OE136 | 0,8 | CET12P | OE179 | |
|---------------------|---|-------|---------|-------------|-------|-----|--------|-------|--|

| | | | | | | | | | |
|----------------|---|--------|---------|-------------|--|--|--------|------------------------|--|
| 2.0 † BioPower | 4 | A20NFT | 162/217 | 05/10→01/12 | | | CET17P | OE189 *tobeadjusted | |
|----------------|---|--------|---------|-------------|--|--|--------|------------------------|--|

| | | | | | | | | | |
|--|---|--------|---------|-------------|--|--|--------------|-----------------------------|--|
| 2.0 † BioPower 4WD, 2.0 Turbo, 2.0 Turbo 4WD | 4 | A20NHT | 162/217 | 05/10→01/12 | | | CET17P [331] | OE189[331] *tobeadjusted | |
|--|---|--------|---------|-------------|--|--|--------------|-----------------------------|--|

| | | | | | | | | | |
|---------|---|-------|--------|-------------|-------|-----|--|--|--|
| 2.2 TiD | 4 | D223L | 88/118 | 03/02→12/09 | CH207 | 11v | | | |
|---------|---|-------|--------|-------------|-------|-----|--|--|--|

| | | | | | | | | | |
|-------|---|-------|---------|-------------|-------|-----|--------|-------|--|
| 2.3 † | 4 | B235E | 125/168 | 09/97→12/09 | OE136 | 0,8 | CET12P | OE179 | |
|-------|---|-------|---------|-------------|-------|-----|--------|-------|--|

| | | | | | | | | | |
|-----------------------|---|-------|---------|-------------|-------|-----|--------|-------|--|
| 2.3 †, 2.3 † BioPower | 4 | B235E | 136/182 | 01/01→12/09 | OE136 | 0,8 | CET12P | OE179 | |
|-----------------------|---|-------|---------|-------------|-------|-----|--------|-------|--|

| | | | | | | | | | |
|-----------|---|-------|---------|-------------|-------|-----|--------|-------|--|
| 2.3 Turbo | 4 | B235L | 162/217 | 07/03→12/09 | OE136 | 0,8 | CET12P | OE179 | |
|-----------|---|-------|---------|-------------|-------|-----|--------|-------|--|

| | | | | | | | | | |
|-----------|---|-------|---------|-------------|-------|-----|--------|-------|--|
| 2.3 Turbo | 4 | B235R | 169/227 | 10/99→09/01 | OE136 | 0,8 | CET12P | OE179 | |
|-----------|---|-------|---------|-------------|-------|-----|--------|-------|--|

| | | | | | | | | | |
|-----------|---|-------|---------|-------------|-------|-----|--------|-------|--|
| 2.3 Turbo | 4 | B235R | 184/247 | 09/01→12/09 | OE136 | 0,8 | CET12P | OE179 | |
|-----------|---|-------|---------|-------------|-------|-----|--------|-------|--|

| | | | | | | | | | |
|-----------|---|-------|---------|-------------|-------|-----|--------|-------|--|
| 2.3 Turbo | 4 | B235R | 191/256 | 11/05→12/09 | OE136 | 0,8 | CET12P | OE179 | |
|-----------|---|-------|---------|-------------|-------|-----|--------|-------|--|

| | | | | | | | | | |
|------------------|---|--------|---------|-------------|-------|-----|--|--|--|
| 2.8 Turbo V6 4WD | 6 | A28NER | 221/296 | 05/10→01/12 | OE238 | 1,0 | | | |
|------------------|---|--------|---------|-------------|-------|-----|--|--|--|

| | | | | | | | | | |
|---------|---|-------|---------|-------------|-------|-----|--------|-------|--|
| 3.0 V6† | 6 | B308E | 147/197 | 01/98→12/09 | OE136 | 0,8 | CET12P | OE179 | |
|---------|---|-------|---------|-------------|-------|-----|--------|-------|--|

9-7X

| | | | | | | | | | |
|---------|---|-----|---------|-------------|--|--|--------|-------|--|
| 4.2 4WD | 6 | LL8 | 213/286 | 12/05→07/12 | | | CET17P | OE189 | |
|---------|---|-----|---------|-------------|--|--|--------|-------|--|

900 I

| | | | | | | | | | |
|--------------|---|-------|---------|-------------|--|--|------|-------|--------|
| 2.0 Turbo-16 | 4 | B202L | 132/177 | 01/93→06/94 | | | CET2 | OE179 | CLS182 |
|--------------|---|-------|---------|-------------|--|--|------|-------|--------|

900 II

| | | | | | | | | | |
|---------------|---|-------|---------|-------------|--|--|------|-------|--------|
| 2.0 -16 Turbo | 4 | B204L | 136/182 | 07/93→02/98 | | | CET2 | OE179 | CLS150 |
|---------------|---|-------|---------|-------------|--|--|------|-------|--------|

| | | | | | | | | | |
|-------|---|-------|--------|-------------|-------|-----|------|-------|--------|
| 2.0 i | 4 | B204I | 96/129 | 12/93→02/98 | OE005 | 0,9 | CET2 | OE179 | CLS150 |
|-------|---|-------|--------|-------------|-------|-----|------|-------|--------|

| | | | | | | | | | |
|-------|---|-------|--------|-------------|-------|-----|------|-------|--------|
| 2.0 i | 4 | B206I | 98/131 | 07/93→07/94 | OE005 | 0,9 | CET2 | OE179 | CLS150 |
|-------|---|-------|--------|-------------|-------|-----|------|-------|--------|

| | | | | | | | | | |
|---------|---|-------|---------|-------------|-------|-----|------|-------|--------|
| 2.3 -16 | 4 | B234I | 110/148 | 07/93→02/98 | OE005 | 0,9 | CET2 | OE179 | CLS150 |
|---------|---|-------|---------|-------------|-------|-----|------|-------|--------|

| | | | | | | | | | |
|------------|---|-------|---------|-------------|-------|-----|--------|-------|--|
| 2.5 -24 V6 | 6 | B258I | 125/168 | 07/93→02/98 | OE223 | 1,6 | CET12P | OE184 | |
|------------|---|-------|---------|-------------|-------|-----|--------|-------|--|

9000

| | | | | | | | | | |
|------------------------|---|--------------|--------|-------------|-------|-----|------|-------|--------|
| 2.0 -16 CD, 2.0 -16 CS | 4 | B202I; B204I | 96/129 | 09/93→12/98 | OE005 | 0,9 | CET2 | OE179 | CLS150 |
|------------------------|---|--------------|--------|-------------|-------|-----|------|-------|--------|

| | | | | | | | | | |
|------------------------------|---|---------------------|---------|-------------|-------|-----|------|-------|--------|
| 2.0 -16 CD, 2.0 -16 ND Turbo | 4 | B202S; B204E; B204S | 110/148 | 09/93→12/98 | OE005 | 0,9 | CET2 | OE179 | CLS150 |
|------------------------------|---|---------------------|---------|-------------|-------|-----|------|-------|--------|

| | | | | | | | | | |
|-----------------|---|-------|---------|-------------|--|--|------|-------|--------|
| 2.3 -16 Aero CS | 4 | B234R | 162/217 | 02/93→12/98 | | | CET2 | OE179 | CLS150 |
|-----------------|---|-------|---------|-------------|--|--|------|-------|--------|

| | | | | | | | | | |
|-----------------|---|-------|---------|-------------|--|--|------|-------|--------|
| 2.3 -16 Aero CS | 4 | B234R | 165/221 | 02/93→12/98 | | | CET2 | OE179 | CLS150 |
|-----------------|---|-------|---------|-------------|--|--|------|-------|--------|

| | | | | | | | | | |
|-------------|---|-------|---------|-------------|--|--|------|-------|--------|
| 2.3 -16 CDE | 4 | B234I | 108/145 | 09/93→12/98 | | | CET2 | OE179 | CLS150 |
|-------------|---|-------|---------|-------------|--|--|------|-------|--------|

| | | | | | | | | | |
|--|---|-------|---------|-------------|--|--|------|-------|--------|
| 2.3 -16 CDE Eco-Power, 2.3 -16 CSE Eco Power | 4 | B234E | 125/168 | 09/93→12/98 | | | CET2 | OE179 | CLS150 |
|--|---|-------|---------|-------------|--|--|------|-------|--------|

| | | | | | | | | | |
|-------------|---|-------|---------|-------------|--|--|------|-------|--|
| 2.3 -16 CSE | 4 | B234I | 108/145 | 09/93→12/98 | | | CET2 | OE179 | |
|-------------|---|-------|---------|-------------|--|--|------|-------|--|

| | | | | | | | | | |
|-------------------|---|-------|---------|-------------|--|--|------|-------|--------|
| 2.3 -16 Turbo CSE | 4 | B234L | 147/197 | 09/93→12/98 | | | CET2 | OE179 | CLS150 |
|-------------------|---|-------|---------|-------------|--|--|------|-------|--------|

| | | | | | | | | | |
|--------------------------------------|---|-------|---------|-------------|-------|-----|------|-------|--|
| 3.0 -24 V6 CD/CDE, 3.0 -24 V6 CS/CSE | 6 | B308I | 155/208 | 07/94→12/98 | OE019 | 0,9 | CET2 | OE184 | |
|--------------------------------------|---|-------|---------|-------------|-------|-----|------|-------|--|

SANTANA**300/350**

| | | | | | | | | | |
|------------------------|---|----------|-------|--------|-------|-----|--|--|--|
| 1.6 D 4WD, 1.6 HDi 4WD | 4 | DV6ATED4 | 66/89 | 09/98→ | CH201 | 11v | | | |
|------------------------|---|----------|-------|--------|-------|-----|--|--|--|

PS10/ANIBAL

| | | | | | | | | | |
|-----------|---|----------|--------|--------|-------------|-----|--|--|--|
| 2.8 D 4WD | 4 | 8140.43P | 78/105 | 03/03→ | CH216 [275] | 11v | | | |
|-----------|---|----------|--------|--------|-------------|-----|--|--|--|



SAAB



kW/BHP

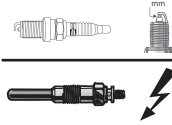

eon TITAN

IRIDIUM

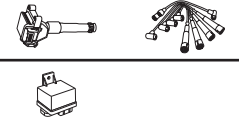

SEAT

ALHAMBRA

| | | | | | | | | | | |
|----------------------|---|---------------------------|---------|-------------|--|------|------------------------------|--------------|---|---------------|
| 1.4 TSI | 4 | CAVA; CNWB; CTHA | 110/148 | 06/10→ | OE244 ModelYear2016→ [25] [193] | 0,8 | | | BAE408AE | |
| 1.4 TSI | 4 | CZDA | 110/148 | 06/10→ | OE244 [25] [193] | 0,8 | | | | |
| 1.8 T 20V | 4 | AJH | 110/148 | 10/97→03/10 | OE032 | 1,0 | CET12P CET2 | OE179 | BAEA016 | |
| 1.8 T 20V | 4 | AWC | 110/148 | 10/97→03/10 | OE136 | 0,8 | CET12P CET2 | OE179 | BAEA009E | |
| 1.8 TSI | 4 | CDA | 118/158 | 11/12→ | OE214 | 0,7 | CET11P | | BAEA033E [7] | |
| 1.9 TDI | 4 | I2; AHU; ANU | 66/89 | 04/96→03/10 | CH271 | 11v | | | CCU152 [199] 05/05→04/08 CCU081 [198] | |
| 1.9 TDI | 4 | AFN; AVG | 81/109 | 08/96→06/00 | CH271 | 11v | | | CCU081 | |
| 1.9 TDI | 4 | ASZ | 96/129 | 11/02→11/08 | CH181 | 11v | | | CCU152 [199] 05/05→ CCU081 [198] | |
| 1.9 TDI | 4 | BTB | 110/148 | 05/05→05/07 | | | | | CCU081 [198] CCU152 [199] | |
| 1.9 TDI, 1.9 TDI 4WD | 4 | AUY; BVK | 85/114 | 06/00→03/10 | CH271 | 11v | | | CCU152 [199] 05/05→04/08 CCU081 [198] | |
| 2.0 i | 4 | ADY | 85/114 | 04/96→03/10 | OE032 | 1,0 | CET2 | OE179 | BAE851AE [261] [292] | CLS048 |
| 2.0 i | 4 | ATM | 85/114 | 04/96→03/10 | OE032 | 1,0 | CET2 | OE179 | BAE907AE [262] | CLS017 |
| 2.0 TDI | 4 | CFFE; CUVA | 85/114 | 05/11→ | | | | | CCU151 | |
| 2.0 TDI | 4 | CFFA | 100/134 | 06/10→05/11 | | | | | CCU151 | |
| 2.0 TDI | 4 | BRT | 103/138 | 11/05→ | CCGP002 | 7v | | | CCU152 →04/08 | |
| 2.0 TDI | 4 | CFGB | 125/168 | 06/10→ | | | | | CCU151 | |
| 2.0 TDI | 4 | CFGC | 130/174 | 11/12→ | | | | | CCU151 | |
| 2.0 TDI, 2.0 TDI 4WD | 4 | CFFB | 103/138 | 11/05→ | | | | | CCU151 | |
| 2.0 TDI, 2.0 TDI 4WD | 4 | CUVC; DFLA | 110/148 | 05/15→ | CP5G007 | 4.4v | | | | |
| 2.0 TDI, 2.0 TDI 4WD | 4 | CUWA; DFMA | 135/181 | 05/15→ | CP5G007 | 4.4v | | | | |
| 2.0 TSI | 4 | CCZA | 147/197 | 11/10→ | OE214 | 0,7 | CET11P | | BAEA033E [7] | |
| 2.0 TSI | 4 | DEDA | 162/217 | 05/15→ | | | | | BAEA068E →01/16 | |
| 2.8 V6, 2.8 V6 4WD | 6 | AUE; AYL | 150/201 | 06/00→03/10 | OE176 | 1,0 | CET3 | | BAEA063E | |
| ALTEA | | | | | | | | | | |
| 1.2 TSI | 4 | CBZB | 77/103 | 04/10→ | | | | OE260 | BAE907AE [262] | CLS090 |
| 1.4 16V | 4 | BXW; CGGB | 63/84 | 05/06→ | OE177 | 0,9 | CET3 | | BAE408AE | |
| 1.4 TSI | 4 | CAXC | 92/123 | 11/07→ | OE213 | 0,9 | | | BAE408AE | |
| 1.6 | 4 | BGU; BSE; BSF; CCSA; CMXA | 75/101 | 03/04→ | OE032 | 1,0 | CET2 | OE179 | BAE907AE [262] | CLS017 |
| 1.6 LPG | 4 | CHGA | 75/101 | 09/09→ | OE032 | 1,0 | CET2 | OE179 | BAE907AE [262] | CLS048 |
| 1.6 TDI | 4 | CAYB | 66/89 | 11/10→ | | | | | CCU152 | |
| 1.6 TDI | 4 | CAYC | 77/103 | 10/09→ | | | | | CCU152 | |
| 1.8 TFSI | 4 | BYT; BZB; CDA | 118/158 | 01/07→ | OE214 | 0,7 | CET11P | | BAEA033E [7] | |
| 1.9 TDI | 4 | BXF | 66/89 | 08/09→ | | | | | CCU152 | |
| 1.9 TDI | 4 | BKC | 77/103 | 04/04→ | | | | | CCU152 | |
| 1.9 TDI | 4 | BLS | 77/103 | 04/04→ | CCGP002 [183] [275] | 7v | | | CCU152 | |
| 1.9 TDI | 4 | BXE | 77/103 | 04/04→ | | | | | CCU152 Ch.5P-6-053001→ | |
| 2.0 FSI | 4 | BLR; BVY | 110/148 | 05/04→03/09 | OE234 | 1,0 | CET12P CET3 | | BAEA033E [7] | |
| 2.0 FSI | 4 | BLY; BVZ | 110/148 | 05/04→03/09 | OE146 | 1,0 | CET12P CET3 | OE179 | BAEA033E [7] | |

SEAT

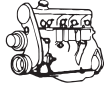

kW/BHP

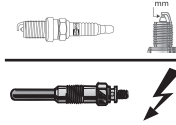

eon TITAN

IRIDIUM

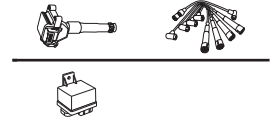

SEAT

| ...SEAT | | | | | | | | | |
|----------------------|---|----------------------|---------|-------------|-----------------------------------|-----|----------------|-------|---|
| ...ALTEA | | | | | | | | | |
| 2.0 TDI | 4 | AZV | 100/134 | 03/04→05/09 | | | | | CCU152 Ch.5P-6-053001→ |
| 2.0 TDI | 4 | BMM | 103/138 | 11/05→ | CCGP002 ModelYear→2010 | 7v | | | CCU152 |
| 2.0 TDI | 4 | BMN | 125/168 | 03/06→ | CCGP003 | 7v | | | CCU152 |
| 2.0 TDI | 4 | CEGA | 125/168 | 03/06→ | | | | | CCU152 |
| 2.0 TDI 16V | 4 | BKD | 103/138 | 03/04→ | | | | | CCU152 Ch.5P-6-053001→ |
| 2.0 TFSI | 4 | BWA | 147/197 | 04/06→05/09 | OE214 | 0,7 | CET11P | | BAEA033E ^[7] |
| ALTEA XL | | | | | | | | | |
| 1.2 TSI | 4 | CBZB | 77/103 | 04/10→ | | | | OE260 | BAE907AE ^[262] CLS090 |
| 1.4 16V | 4 | BXW; CGGB | 63/84 | 10/06→ | OE177 | 0,9 | CET3 | | BAE408AE |
| 1.4 TSI | 4 | CBZB | 89/119 | 09/09→12/12 | OE213 | 0,9 | | | |
| 1.4 TSI | 4 | CAXC | 92/123 | 11/07→ | OE213 | 0,9 | | | BAE408AE |
| 1.6 | 4 | BSE; BSF; CCSA; CMXA | 75/101 | 10/06→ | OE032 | 1,0 | CET2 | OE179 | BAE907AE ^[262] |
| 1.6 LPG | 4 | CHGA | 75/101 | 09/09→ | OE032 | 1,0 | CET2 | OE179 | BAE907AE ^[262] CLS048 |
| 1.6 Multifuel | 4 | CCSA | 75/101 | 10/06→ | | | | | BAE907AE ^[262] |
| 1.6 TDI | 4 | CAYB | 66/89 | 11/10→ | | | | | CCU152 |
| 1.6 TDI | 4 | CAYC | 77/103 | 10/09→ | | | | | CCU152 |
| 1.8 TFSI | 4 | BYT; BZB; CDAA | 118/158 | 01/07→ | OE214 | 0,7 | CET11P | | BAEA033E ^[7] |
| 1.9 TDI | 4 | BXF | 66/89 | 08/09→ | | | | | CCU152 |
| 1.9 TDI | 4 | BKC | 77/103 | 10/06→ | | | | | CCU152 |
| 1.9 TDI | 4 | BLS | 77/103 | 10/06→ | CCGP002 ^{[183] [275]} | 7v | | | CCU152 |
| 1.9 TDI | 4 | BXE | 77/103 | 10/06→ | | | | | CCU152 Ch.5P-6-053001→ |
| 1.9 TDI 4WD | 4 | BLS | 77/103 | 06/09→12/10 | CCGP002 ^{[183] [275]} | 7v | | | |
| 2.0 FSI | 4 | BVY | 110/148 | 10/06→03/09 | OE234 | 1,0 | CET12P CET3 | | BAEA033E ^[7] |
| 2.0 FSI | 4 | BVZ | 110/148 | 10/06→03/09 | OE146 | 1,0 | CET12P CET3 | OE179 | BAEA033E ^[7] |
| 2.0 TDI | 4 | AZV | 100/134 | 11/06→03/09 | | | | | CCU152 Ch.5P-6-053001→ |
| 2.0 TDI, 2.0 TDI 4WD | 4 | BMM | 103/138 | 10/06→ | CCGP002 ModelYear→2010 | 7v | | | CCU152 |
| 2.0 TDI, 2.0 TDI 4WD | 4 | BMN | 125/168 | 06/07→ | CCGP003 | 7v | | | CCU152 |
| 2.0 TDI, 2.0 TDI 4WD | 4 | CEGA | 125/168 | 06/07→ | | | | | CCU152 |
| 2.0 TDI 16V | 4 | BKD | 103/138 | 10/06→ | | | | | CCU152 Ch.5P-6-053001→ |
| 2.0 TFSI | 4 | BWA | 147/197 | 10/06→05/09 | OE214 | 0,7 | CET11P | | BAEA033E ^{[7] [249]} |
| 2.0 TFSI 4WD | 4 | BWA | 147/197 | 06/07→05/09 | OE214 | 0,7 | CET11P | | BAEA033E ^[7] |
| 2.0 TFSI 4WD | 4 | CCZB | 155/208 | 05/09→ | OE214 | 0,7 | CET11P | | BAEA033E ^[7] |
| AROSA | | | | | | | | | |
| 1.0 | 4 | AHT | 37/50 | 05/97→06/04 | OE136 | 0,8 | CET12P | OE179 | BAE961AE |
| 1.0 | 4 | AER; ALL | 37/50 | 05/97→06/04 | | | CET3 | | BAE851AE ^{[261] [275] [292]} CLS041 |
| | | | | | | | CET8 | | BAE961AE ^[275] |
| 1.0 | 4 | ALD; ANV | 37/50 | 05/97→06/04 | | | CET3 | | BAE907AE ^{[262] [275]} CLS038 |
| | | | | | | | CET8 | | BAE961AE ^[275] |
| 1.0 | 4 | AUC | 37/50 | 05/97→06/04 | | | CET3 | | BAE907AE ^{[262] [275]} CLS053 |
| | | | | | | | CET8 | | BAE961AE ^[275] |
| 1.0 | 4 | AER/ALL | 37/50 | 05/97→06/04 | OE025 | 1,0 | | OE195 | |
| 1.0 | 4 | ANV/ALD/AUC | 37/50 | 05/97→06/04 | OE176 | 1,0 | | | |





kW/BHP



eon TITAN

IRIDIUM

**...SEAT****...AROSA**

| | | | | | | | | | | |
|-------------|---|----------|-------|-------------|-----------------|-----|------|-------|---------------------------------|--------|
| 1.4 | 4 | AEX | 44/59 | 05/97→06/04 | OE027 | 1,0 | CET3 | | BAE851AE [261] [292] | CLS100 |
| | | | | | | | CET8 | | | |
| 1.4 | 4 | AKK | 44/59 | 05/97→06/04 | OE176 | 1,0 | CET3 | | BAE907AE [262] | |
| | | | | | | | CET8 | | | |
| 1.4 | 4 | AKV; APQ | 44/59 | 05/97→06/04 | OE027 | 1,0 | CET3 | | BAE851AE [261] [292] | CLS109 |
| | | | | | | | CET8 | | | |
| 1.4 | 4 | ANW; AUD | 44/59 | 05/97→06/04 | OE025 | 1,0 | CET3 | OE195 | BAE907AE [262] | CLS053 |
| | | | | | | | CET8 | | | |
| 1.4 1.4 TDI | 3 | AMF | 55/74 | 01/00→06/04 | CH271 →10/01 | 11v | | | CCU081 [127] →Ch.6H-3-007207 | |
| | | | | | CH181 11/01→ | 11v | | | | |
| 1.4 16V | 4 | AFK | 74/99 | 01/00→06/04 | OE032 | 1,0 | CET2 | OE179 | BAE907AE [262] | |
| 1.4 16V | 4 | AQQ | 74/99 | 01/00→06/04 | OE032 | 1,0 | CET2 | OE179 | | |
| 1.4 16V | 4 | AUB | 74/99 | 01/00→06/04 | OE032 | 1,0 | CET2 | OE179 | BAE907AE [262] | CLS260 |
| 1.4 16V | 4 | ANM | 74/99 | 01/00→06/04 | | | | | BAE907AE [262] | |
| 1.7 SDI | 4 | AKU | 44/59 | 08/97→06/04 | CH271 | 11v | | | CCU081 [127] →Ch.6H-3-007207 | |

ATECA

| | | | | | | | | | | |
|----------------------|---|------|---------|--------|---------------|------|--|--|--|--|
| 1.4 TSI, 1.4 TSI 4WD | 4 | CZEA | 110/148 | 06/16→ | OE244 | 0,8 | | | | |
| 1.6 TDI | 4 | DDYA | 85/114 | 04/16→ | CPSG007 [193] | 4.4v | | | | |
| 2.0 TDI, 2.0 TDI 4WD | 4 | DFFA | 110/148 | 04/16→ | CPSG007 [193] | 4.4v | | | | |
| 2.0 TDI 4WD | 4 | DFHA | 140/188 | 06/16→ | CPSG007 [193] | 4.4v | | | | |

CORDOBA

| | | | | | | | | | | |
|-----------|---|--------------------|-------|-------------|-------------|-----|------------|----------------|-------------------------|--------|
| 1.0 i | 4 | AER; ALD; ANV; AUC | 37/50 | 09/96→10/02 | OE027 | 1,0 | CET8 | | BAE851AE [261] [292] | CLS041 |
| 1.2 | 3 | AZQ; BME | 47/63 | 10/02→06/06 | OE177 | 0,9 | CET3 | | BAE408AE | |
| 1.2 12V | 3 | BXV | 51/68 | 05/06→11/09 | OE177 | 0,9 | CET3 | | BAE408AE | |
| 1.3 | 4 | 2G; AAV | 40/54 | 02/93→08/94 | OE012 | 0,8 | CET8 | OE195 | BAE851AE [261] [292] | |
| 1.4 | 4 | ANX | 40/54 | 12/97→04/99 | OE025 | 1,0 | CET8 | OE195 | BAE851AE [261] [292] | CLS028 |
| 1.4 16V | 4 | APE; AUA | 55/74 | 06/99→12/07 | OE032 | 1,0 | CET2 | OE179 OE188 | BAE907AE [262] | CLS260 |
| 1.4 16V | 4 | BBY | 55/74 | 06/99→12/07 | OE032 [287] | 1,0 | CET2 [287] | OE179 [287] | BAE408AE | |
| | | | | | OE176 [285] | 1,0 | CET3 [285] | | | |
| 1.4 16V | 4 | BKY | 55/74 | 06/99→12/07 | OE176 [285] | 1,0 | CET3 [287] | | BAE408AE | |
| | | | | | OE177 [287] | 0,9 | CET3 [285] | | | |
| 1.4 16V | 4 | BXW | 63/84 | 05/06→11/09 | OE177 | 0,9 | CET3 | | BAE408AE | |
| 1.4 16V | 4 | AUB; BBZ | 74/99 | 10/02→11/09 | OE032 | 1,0 | CET2 | OE188 | BAE408AE | |
| 1.4 i | 4 | ANX | 44/59 | 06/94→12/02 | OE025 | 1,0 | | OE195 | | |
| 1.4 i | 4 | ABD | 44/59 | 06/94→12/02 | OE027 | 1,0 | CET8 | | BAE851AE [261] [292] | CLS028 |
| 1.4 i | 4 | AEX | 44/59 | 06/94→12/02 | OE027 | 1,0 | CET8 | | BAE851AE [261] [292] | CLS109 |
| 1.4 i | 4 | AKK; ANW; AUD | 44/59 | 06/94→12/02 | | | CET8 | | BAE851AE [261] [292] | CLS109 |
| 1.4 i | 4 | AKV; APQ | 44/59 | 06/94→12/02 | OE025 | 1,0 | CET8 | OE195 | BAE851AE [261] [292] | CLS109 |
| 1.4 i 16V | 4 | AFH; AQQ; AUB | 74/99 | 09/96→10/02 | OE032 | 1,0 | CET2 | OE179 | BAE851AE [261] [292] | CLS178 |
| 1.4 TDI | 3 | BNM | 51/68 | 05/05→11/09 | CH181 | 11v | | | CCU081 | |
| 1.4 TDI | 3 | AMF | 55/74 | 10/02→12/05 | CH181 | 11v | | | CCU081 | |
| 1.4 TDI | 3 | BNV | 59/79 | 06/05→11/09 | CH181 | 11v | | | CCU081 | |
| 1.4 TDI | 3 | BMS | 59/79 | 06/05→11/09 | CCGP002 | 7v | | | | |
| 1.6 | 4 | BAH | 74/99 | 04/03→11/09 | OE235 | 1,0 | CET3 | | BAE907AE [262] | |

SEAT



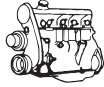

kW/BHP

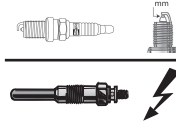

eon TITAN

IRIDIUM

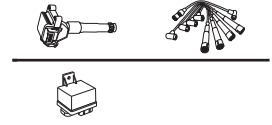

SEAT

...SEAT

...CORDOBA

| | | | | | | | | | | |
|-----------------|---|-------------------------|---------|-------------|----------------|------------|--------|-------|--|--------------|
| 1.6 16V | 4 | BTS | 77/103 | 11/06→11/09 | OE177 | 0,9 | CET3 | | BAE408AE | |
| 1.6 i | 4 | ABU | 55/74 | 02/93→12/02 | OE027 | 1,0 | CET8 | | BAE851AE [261] [292] | CLS099 |
| 1.6 i | 4 | AEE; ALM | 55/74 | 02/93→12/02 | OE027 | 1,0 | CET8 | | BAE851AE [261] [292] | CLS100 |
| 1.6 i | 4 | 1F | 55/74 | 02/93→12/02 | OE027 | 1,0 | CET8 | | BAE851AE [261] [292] | CLS079 [292] |
| 1.6 i | 4 | AEH; AFT; AKL; APF; AUR | 74/99 | 07/96→12/02 | OE032 | 1,0 | CET2 | OE179 | BAE851AE [261] [292] | CLS034 |
| 1.8 i | 4 | ABS | 66/89 | 02/93→09/02 | OE025 | 1,0 | CET8 | OE195 | BAE851AE [261] [292] | CLS027 |
| 1.8 i | 4 | ACC | 66/89 | 02/93→09/02 | OE025 | 1,0 | CET8 | OE195 | | |
| 1.8 i | 4 | ADZ | 66/89 | 02/93→09/02 | OE025 | 1,0 | CET8 | OE195 | | CLS110 [292] |
| 1.8 i 16V | 4 | ADL | 95/127 | 10/93→08/96 | OE032 | 1,0 | CET11P | | BAEA002E →Ch.6K-ZR132108 6K-ZR671000 [261] [292] BAE851AE Ch.6K-ZR132109 6K-ZR672000→ [261] [292] | CLS174 |
| 1.8 T 20V Cupra | 4 | AQX | 115/154 | 07/00→10/02 | OE032 | 1,0 | CET2 | OE179 | BAEA009E | |
| 1.8 T 20V Cupra | 4 | AYP | 115/154 | 07/00→10/02 | OE032 | 1,0 | CET2 | OE179 | BAEA043E | |
| 1.9 D | 4 | 1Y | 47/63 | 01/96→08/96 | CH260 | 11v | | | | |
| 1.9 D | 4 | 1Y | 50/67 | 02/93→08/96 | CH260 | 11v | | | | |
| 1.9 SDI | 4 | AEY | 47/63 | 08/96→11/09 | CH271 | 11v | | | CCU081 | |
| 1.9 SDI | 4 | ASY | 47/63 | 08/96→11/09 | CH181 | 11v | | | CCU081 | |
| 1.9 SDI | 4 | AGP; AQM | 50/67 | 06/99→12/02 | CH271 | 11v | | | CCU081 | |
| 1.9 TD | 4 | AAZ | 55/74 | 02/93→08/96 | CH260 | 11v | | | | |
| 1.9 TDI | 4 | 1Z; AGR; AHU; ALH | 66/89 | 08/96→12/02 | CH271 | 11v | | | CCU081 | |
| 1.9 TDI | 4 | ATD; AXR | 74/99 | 09/02→11/09 | CH181 | 11v | | | CCU081 | |
| 1.9 TDI | 4 | BMT | 74/99 | 09/02→11/09 | CCGP002 | 7v | | | CCU152 | |
| 1.9 TDI | 4 | AFN; ASK; ASV | 81/109 | 03/97→12/02 | CH271 | 11v | | | CCU081 | |
| 1.9 TDI | 4 | ASZ; BLT | 96/129 | 10/02→11/09 | CH181 | 11v | | | CCU081 | |
| 2.0 | 4 | AZL; BBX | 85/114 | 09/02→11/09 | OE032 | 1,0 | CET2 | OE179 | BAE907AE ^[262] | CLS017 |
| 2.0 i | 4 | AGG | 85/114 | 02/93→06/99 | OE025 | 1,0 | CET8 | OE195 | | |
| 2.0 i | 4 | 2E | 85/114 | 02/93→06/99 | OE025 | 1,0 | CET8 | OE195 | BAE851AE [261] [292] | CLS097 |
| 2.0 i 16V | 4 | ABF | 110/148 | 08/96→06/99 | OE032 | 1,0 | CET11P | | BAE851AE [261] [292] | CLS174 |
| EXEO | | | | | | | | | | |
| 1.6 | 4 | ALZ | 75/101 | 03/09→09/10 | OE032 | 1,0 | CET2 | OE179 | BAE907AE ^[262] | CLS048 |
| 1.8 T | 4 | CFMA | 110/148 | 12/08→05/10 | OE136 OE146 | 0,8 1,0 | CET12P | OE179 | BAEA043E | CLS048 |
| 1.8 TSI | 4 | CDHA | 88/118 | 09/10→ | OE214 | 0,7 | CET11P | | BAEA033E ^[7] | |
| 1.8 TSI | 4 | CDHB | 118/158 | 05/10→ | OE214 | 0,7 | CET11P | | BAEA033E ^[7] | |
| 2.0 TDI | 4 | CAGC; CJCC | 88/118 | 12/08→ | | | | | CCU151 | |
| 2.0 TDI | 4 | CAGA; CJCA | 105/141 | 12/08→ | | | | | CCU151 | |
| 2.0 TDI | 4 | CAHA; CGLB | 125/168 | 02/09→ | | | | | CCU151 | |
| 2.0 TFSI | 4 | BWE | 147/197 | 03/09→ | OE214 | 0,7 | CET11P | | BAEA033E ^[7] | |
| 2.0 TFSI | 4 | CDND | 155/208 | 05/10→ | OE214 | 0,7 | CET11P | | BAEA033E ^[7] | |
| IBIZA II | | | | | | | | | | |
| 1.0 | 4 | AAU | 33/44 | 03/93→09/96 | OE025 | 1,0 | CET8 | OE195 | BAE851AE [261] [292] | CLS109 |
| 1.0 16V | 4 | AST; AVZ | 51/68 | 10/99→02/02 | OE120 | 0,6 | CET2 | OE188 | BAE851AE [261] [292] | |
| 1.0 i | 4 | AER | 37/50 | 09/96→02/02 | OE027 | 1,0 | CET8 | | BAE851AE [261] [292] | CLS041 |



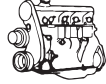

kW/BHP

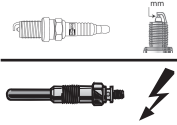

eon TITAN

IRIDIUM

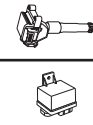

...SEAT

...IBIZA II

| | | | | | | | | | | |
|------------------|---|-------------------------|---------|-------------|--|------------|--|------------------------|---------------------------|-------------------------|
| 1.0 i | 4 | ALD; ANV; AUC | 37/50 | 09/96→02/02 | OE027 | 1,0 | CET8 | | BAE851AE [261] [292] | |
| 1.3 i | 4 | 2G | 40/54 | 03/93→08/99 | OE012 | 0,8 | CET8 | OE195 | BAEA002E [261] [292] | CLS109 |
| 1.3 i | 4 | AAV | 40/54 | 03/93→08/99 | OE012 | 0,8 | CET8 | OE195 | BAE851AE [261] [292] | CLS109 |
| 1.4 | 4 | ANX | 40/54 | 12/97→04/99 | OE025 | 1,0 | CET8 | OE195 | BAE851AE [261] [292] | |
| 1.4 16V | 4 | AUA | 55/74 | 05/00→02/02 | OE032 | 1,0 | CET2 | OE179 | BAE907AE ^[262] | |
| 1.4 16V | 4 | APE | 55/74 | 05/00→02/02 | OE032 | 1,0 | CET2 | OE179 | BAE907AE ^[262] | CLS260 |
| 1.4 i | 4 | AKK; ANW; AUD | 44/59 | 09/93→02/02 | OE027 | 1,0 | CET8 | | BAE851AE [261] [292] | |
| 1.4 i | 4 | ABD | 44/59 | 09/93→02/02 | OE027 | 1,0 | CET8 | | BAE851AE [261] [292] | CLS028 |
| 1.4 i | 4 | AEX; AKV | 44/59 | 09/93→02/02 | OE044 OE025 | 0,9 1,0 | CET8 | | BAE851AE [261] [292] | CLS109 |
| 1.4 i | 4 | APQ | 44/59 | 09/93→02/02 | OE027 OE025 | 1,0 1,0 | CET8 | | BAE851AE [261] [292] | |
| 1.4 i 16V | 4 | AFH; AQQ; AUB | 74/99 | 06/97→02/02 | OE027 | 1,0 | CET8 | | BAE851AE [261] [292] | CLS178 |
| 1.6 i | 4 | 1F; ABU | 55/74 | 03/93→02/02 | OE027 | 1,0 | CET8 | | BAE851AE [261] [292] | CLS099 |
| 1.6 i | 4 | ALM | 55/74 | 03/93→02/02 | OE027 | 1,0 | CET8 | | BAE851AE [261] [292] | CLS100 |
| 1.6 i | 4 | AEE | 55/74 | 03/93→02/02 | OE027 | 1,0 | CET8 | OE195 | BAE851AE [261] [292] | CLS100 |
| 1.6 i | 4 | AEH; AFT; AKL; APF; AUR | 74/99 | 04/96→02/02 | OE032 | 1,0 | CET2 | OE179 | BAE851AE [261] [292] | CLS034 |
| 1.8 i | 4 | ABS | 66/89 | 03/93→08/99 | OE025 | 1,0 | CET8 | OE195 | BAEA002E [261] [292] | CLS027 |
| 1.8 i | 4 | ACC; ADZ | 66/89 | 03/93→08/99 | OE025 | 1,0 | CET8 | OE195 | BAEA002E [261] [292] | CLS110 ^[292] |
| 1.8 i 16V | 4 | ADL | 95/127 | 11/93→08/96 | | | CET2 | OE188 | BAE851AE [261] [292] | CLS174 |
| 1.8 T 20V Cupra | 4 | AQX | 115/154 | 07/00→02/02 | OE032 | 1,0 | CET2 | OE179 | BAEA009E ^[74] | |
| 1.8 T 20V Cupra | 4 | AYP | 115/154 | 07/00→02/02 | OE032 | 1,0 | CET2 | OE179 | BAEA043E ^[73] | |
| 1.9 D | 4 | 1Y | 47/63 | 04/93→08/96 | CH260 | 11v | | | | |
| 1.9 D | 4 | 1Y | 50/67 | 10/94→08/96 | CH260 | 11v | | | | |
| 1.9 SDI | 4 | AEY | 47/63 | 08/96→08/99 | CH271 | 11v | | | CCU081 | |
| 1.9 SDI | 4 | AGP; AQM | 50/67 | 08/99→02/02 | CH271 | 11v | | | CCU081 [127] [365] | |
| 1.9 TD | 4 | AAZ | 55/74 | 03/93→08/96 | CH260 | 11v | | | | |
| 1.9 TDI | 4 | 1Z; AGR; AHU; ALH | 66/89 | 08/96→02/02 | CH271 | 11v | | | CCU081 | |
| 1.9 TDI | 4 | AFN; ASK; ASV | 81/109 | 02/97→02/02 | CH271 | 11v | | | CCU081 | |
| 2.0 i | 4 | 2E; AGG | 85/114 | 03/93→08/99 | OE025 | 1,0 | CET8 | OE195 | BAEA002E [261] [292] | |
| 2.0 i 16V | 4 | ABF | 110/148 | 08/96→08/99 | OE032 | 1,0 | CET11P | | BAE851AE [261] [292] | CLS174 |
| IBIZA III | | | | | | | | | | |
| 1.2 | 3 | BBM | 44/59 | 06/07→05/08 | OE177 | 0,9 | CET3 | | BAEA059E | |
| 1.2 | 3 | AZQ; BME | 47/63 | 02/02→06/06 | OE177 | 0,9 | CET3 | | BAE408AE | |
| 1.2 12V | 3 | BXV | 51/68 | 05/06→11/09 | OE177 | 0,9 | CET3 | | BAE408AE | |
| 1.4 16V | 4 | BBY | 55/74 | 02/02→12/07 | OE032 ^[287] OE176 ^[285] | 1,0 1,0 | CET2 ^[287] CET3 ^[285] | OE179 ^[287] | BAE408AE | CLS260 |
| 1.4 16V | 4 | BKY | 55/74 | 02/02→12/07 | OE176 ^[285] OE177 ^[287] | 1,0 0,9 | CET3 ^[287] CET3 ^[285] | | BAE408AE | CLS260 |
| 1.4 16V | 4 | BXW | 63/84 | 05/06→11/09 | OE177 | 0,9 | CET3 | | BAE408AE | |

SEAT



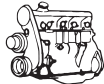

kW/BHP



eon TITAN

IRIDIUM



...SEAT

...IBIZA III

| | | | | | | | | | | |
|-----------------|---|----------|---------|-------------|---------|-----|--------|-------|---------------------------|--------|
| 1.4 16V | 4 | BBZ | 74/99 | 02/02→11/09 | OE032 | 1,0 | CET2 | OE188 | BAE408AE | |
| 1.4 16V | 4 | AUB | 74/99 | 02/02→11/09 | OE032 | 1,0 | CET2 | OE188 | BAE907AE ^[262] | CLS260 |
| 1.4 TDI | 3 | BNM | 51/68 | 05/05→11/09 | CH181 | 11v | | | CCU081 | |
| 1.4 TDI | 3 | AMF | 55/74 | 05/02→12/05 | CH181 | 11v | | | CCU081 | |
| 1.4 TDI | 3 | BNV | 59/79 | 06/05→11/09 | CH181 | 11v | | | CCU081 | |
| 1.4 TDI | 3 | BMS | 59/79 | 06/05→11/09 | CCGP002 | 7v | | | | |
| 1.6 | 4 | BAH | 74/99 | 02/03→11/09 | OE235 | 1,0 | CET3 | | BAE907AE ^[262] | |
| 1.6 16V | 4 | BTS | 77/103 | 11/06→11/09 | OE177 | 0,9 | CET3 | | BAE408AE | |
| 1.8 T Cupra R | 4 | BBU; BLZ | 132/177 | 01/04→02/08 | OE136 | 0,8 | CET12P | OE179 | BAEA043E | |
| 1.8 T FR | 4 | BKV | 110/148 | 12/03→05/08 | OE136 | 0,8 | CET12P | OE179 | | |
| 1.8 T FR | 4 | BJX | 110/148 | 12/03→05/08 | OE136 | 0,8 | CET12P | OE179 | BAEA043E | |
| 1.9 SDI | 4 | ASY | 47/63 | 02/02→12/05 | CH181 | 11v | | | CCU081 | |
| 1.9 TDI | 4 | ATD; AXR | 74/99 | 02/02→11/09 | CH181 | 11v | | | CCU081 | |
| 1.9 TDI | 4 | BMT | 74/99 | 02/02→11/09 | CCGP002 | 7v | | | CCU152 | |
| 1.9 TDI | 4 | ASZ; BLT | 96/129 | 02/02→11/09 | CH181 | 11v | | | CCU081 | |
| 1.9 TDI Cupra R | 4 | BPX; BUK | 118/158 | 03/04→02/08 | CH181 | 11v | | | CCU081 | |
| 2.0 | 4 | AZL; BBX | 85/114 | 04/02→11/09 | OE032 | 1,0 | CET2 | OE179 | BAE907AE ^[262] | CLS017 |

IBIZA IV

| | | | | | | | | | | |
|---------------|---|------------------------|---------|-------------|---------|------|------|-------|---------------------------|-------------------------------------|
| 1.0 | 3 | CHYB | 55/74 | 05/15→ | OE247 | 1,0 | | | BAEA067E ^[240] | |
| 1.0 TSI | 3 | CHZB | 70/94 | 05/15→ | | | | | BAEA067E ^[240] | |
| 1.0 TSI | 3 | CHZC | 81/109 | 05/15→ | | | | | BAEA067E ^[240] | |
| 1.2 | 3 | CGPB | 44/59 | 07/09→ | OE177 | 0,9 | CET3 | | BAE408AE | |
| 1.2 | 3 | BZG; CGPA; CJLB | 51/68 | 03/08→ | OE177 | 0,9 | CET3 | | BAE408AE | |
| 1.2 TDI | 3 | CFWA | 55/74 | 04/10→ | | | | | CCU152 | Prod.28.05.2013→ Prod.28.10.2013 |
| 1.2 TSI | 4 | CBZA | 63/84 | 08/12→ | | | | OE260 | BAE907AE ^[262] | CLS090 |
| 1.2 TSI | 4 | CJZC | 66/89 | 05/15→ | OE244 | 0,8 | | | BAEA067E ^[240] | |
| 1.2 TSI | 4 | CBZB | 77/103 | 09/10→ | | | | OE260 | BAE907AE ^[262] | CLS090 |
| 1.2 TSI | 4 | CJZD | 81/109 | 09/15→ | OE244 | 0,8 | | | | |
| 1.4 | 4 | BXW; CGGB | 63/84 | 03/08→ | OE177 | 0,9 | CET3 | | BAE408AE | |
| 1.4 TDI | 3 | CUSA | 55/74 | 05/15→ | CPSG007 | 4.4v | | | | |
| 1.4 TDI | 3 | BMS | 59/79 | 07/08→06/10 | CCGP002 | 7v | | | | |
| 1.4 TDI | 3 | CUSB | 66/89 | 05/15→ | CPSG007 | 4.4v | | | | |
| 1.4 TDI | 3 | CUTA; CYZA | 77/103 | 05/15→ | CPSG007 | 4.4v | | | | |
| 1.4 TSI | 4 | CPTA | 103/138 | 10/13→ | OE244 | 0,8 | | | BAEA067E ^[240] | |
| 1.4 TSI | 4 | CAVF; CNUB; CTHF; CTJB | 110/148 | 06/09→ | OE213 | 0,9 | | | BAE408AE | |
| 1.4 TSI | 4 | CZEA | 110/148 | 06/09→ | OE244 | 0,8 | | | | |
| 1.4 TSI Cupra | 4 | CAVE; CTHE; CTJC | 132/177 | 06/09→ | OE213 | 0,9 | | | BAE408AE | |
| 1.6 | 4 | BTS | 77/103 | 05/08→ | OE177 | 0,9 | CET3 | | BAE408AE | |
| 1.6 LPG | 4 | CNKA | 60/80 | 05/11→ | OE177 | 0,9 | CET3 | | BAE408AE | |
| 1.6 TDI | 4 | CAYB | 66/89 | 05/09→ | | | | | CCU152 | |
| 1.6 TDI | 4 | CAYC; CLNA | 77/103 | 05/09→ | | | | | CCU152 | |
| 1.8 TSI Cupra | 4 | DAJA | 141/189 | 11/15→ | | | | | BAEA068E | →01/16 |
| 1.9 TDI | 4 | BXJ | 66/89 | 07/08→06/10 | CCGP002 | 7v | | | CCU152 | |
| 1.9 TDI | 4 | BLS | 77/103 | 03/08→06/10 | CCGP002 | 7v | | | CCU152 | |
| 2.0 | 4 | CEKA | 85/114 | 10/08→ | OE032 | 1,0 | CET2 | OE179 | BAE907AE ^[262] | |
| 2.0 TDI | 4 | CFHD | 105/141 | 01/10→ | | | | | CCU152 | |

IBIZA V

| | | | | | | | | | | |
|-----|---|------|-------|--------|-------|-----|--|--|--|--|
| 1.0 | 3 | CHYB | 55/74 | 01/17→ | OE247 | 1,0 | | | | |
|-----|---|------|-------|--------|-------|-----|--|--|--|--|



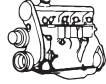

kW/BHP

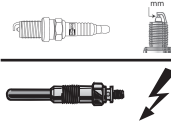

eon TITAN

IRIDIUM

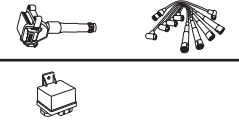

...SEAT

LEON

| | | | | | | | | | | |
|----------------------|---|------------------|---------|-------------|----------------------|------|--------|-------|-----------------------------------|--------|
| 1.2 TSI | 4 | CJZB; CYVA | 63/84 | 12/12→ | OE244 [223] [302] | 0,8 | | | BAEA126E →09/13 [249] [275] | |
| | | | | | | | | | BAEA067E [240] [275] | |
| 1.2 TSI | 4 | CJZA | 77/103 | 02/10→ | OE244 [223] [302] | 0,8 | | | BAEA126E →09/13 [249] [275] | |
| | | | | | | | | | BAEA067E [240] [275] | |
| 1.2 TSI | 4 | CBZB | 77/103 | 02/10→ | | | | OE260 | BAE907AE [262] | CLS090 |
| 1.2 TSI | 4 | CVVB | 81/109 | 04/14→ | OE244 [223] [302] | 0,8 | | | BAEA067E [240] | |
| 1.4 16V | 4 | BCA | 55/74 | 11/99→06/06 | OE032 | 1,0 | CET2 | OE188 | BAE408AE | |
| 1.4 16V | 4 | AHW; AXP | 55/74 | 11/99→06/06 | OE032 | 1,0 | CET2 | OE188 | BAE907AE [262] | CLS260 |
| 1.4 16V | 4 | APE | 55/74 | 11/99→06/06 | | | CET2 | | BAE907AE [262] | CLS260 |
| 1.4 16V | 4 | AUA | 55/74 | 11/99→06/06 | | | CET2 | | | |
| 1.4 16V | 4 | BXW; CGGB | 63/84 | 06/06→12/12 | OE177 | 0,9 | CET3 | | BAE408AE | |
| 1.4 TGI | 4 | CPWA | 81/109 | 02/13→ | OE244 [219] [306] | 0,8 | | | BAEA067E [240] | |
| 1.4 TSI | 4 | CMBA; CXSA | 90/121 | 11/12→ | OE244 [220] [307] | 0,8 | | | BAEA126E →09/13 [249] [275] | |
| | | | | | | | | | BAEA067E [240] [275] | |
| 1.4 TSI | 4 | CAXC | 92/123 | 11/07→ | OE213 | 0,9 | | | BAE408AE | |
| 1.4 TSI | 4 | CZCA | 92/123 | 11/07→ | OE244 [219] [306] | 0,8 | | | BAEA067E [240] | |
| 1.4 TSI | 4 | CHPA; CPTA | 103/138 | 09/12→ | OE244 [219] [306] | 0,8 | | | BAEA126E →09/13 [249] [275] | |
| | | | | | | | | | BAEA067E [240] [275] | |
| 1.4 TSI | 4 | CZDA; CZEA | 110/148 | 05/14→ | OE244 [219] [306] | 0,8 | | | BAEA067E [240] | |
| 1.6 | 4 | APF | 74/99 | 11/99→06/06 | OE032 | 1,0 | CET2 | OE179 | | |
| 1.6 | 4 | AEH; AKL | 74/99 | 11/99→06/06 | OE032 | 1,0 | CET2 | OE179 | BAE907AE [262] | CLS139 |
| 1.6 | 4 | BFQ | 75/101 | 07/05→12/12 | OE032 | 1,0 | CET2 | OE188 | BAE907AE [262] | |
| 1.6 | 4 | BGU | 75/101 | 07/05→12/12 | | | CET2 | OE188 | | |
| 1.6 | 4 | BSE; BSF | 75/101 | 07/05→12/12 | OE136 | 0,8 | CET12P | OE179 | BAE907AE [262] | CLS017 |
| 1.6 | 4 | CCSA; CMXA | 75/101 | 07/05→12/12 | OE136 | 0,8 | CET12P | OE179 | BAE907AE [262] | |
| 1.6 16 V | 4 | ATN | 77/103 | 09/00→06/06 | | | CET2 | | | |
| 1.6 16 V | 4 | AUS | 77/103 | 09/00→06/06 | OE032 →01/02 | 1,0 | CET2 | OE188 | BAE907AE [262] | CLS260 |
| 1.6 16 V | 4 | AZD; BCB | 77/103 | 09/00→06/06 | OE176 | 1,0 | CET2 | OE188 | BAE408AE | |
| 1.6 LPG | 4 | CHGA | 75/101 | 12/09→12/12 | | | | | BAE907AE [262] | |
| 1.6 MultiFuel | 4 | BSE; CMXA | 75/101 | 11/10→12/12 | OE032 | 1,0 | CET2 | OE179 | BAE907AE [262] | |
| 1.6 TDI | 4 | CLHB; CXXA; DDYB | 66/89 | 11/10→ | CPSG007 | 4.4v | | | CCU151 | |
| 1.6 TDI | 4 | CAYB | 66/89 | 11/10→ | | | | | CCU152 | |
| 1.6 TDI | 4 | CAYC | 77/103 | 02/10→ | | | | | CCU152 Ch.1P-6-075001→ | |
| 1.6 TDI, 1.6 TDI 4WD | 4 | CLHA | 77/103 | 02/10→ | CPSG007 | 4.4v | | | CCU151 | |
| 1.6 TDI, 1.6 TDI 4WD | 4 | CRKB; CXXB; DBKA | 81/109 | 09/13→ | CPSG007 | 4.4v | | | CCU151 | |
| 1.8 20V | 4 | AGN; APG | 92/123 | 11/99→06/06 | OE032 | 1,0 | CET2 | OE179 | BAE907AE [262] | CLS140 |
| 1.8 20V T | 4 | AUQ | 132/177 | 11/99→06/06 | OE136 | 0,8 | CET12P | OE179 | BAEA043E | |
| 1.8 20V T | 4 | APP | 132/177 | 11/99→06/06 | OE136 | 0,8 | CET12P | OE179 | BAEA009E | |
| 1.8 20V T 4WD | 4 | ARY | 132/177 | 11/99→06/06 | OE136 | 0,8 | CET12P | OE179 | | |
| 1.8 20V T 4WD | 4 | AJQ | 132/177 | 11/99→06/06 | OE136 | 0,8 | CET12P | OE179 | BAEA016 | |
| 1.8 T Cupra R | 4 | AMK | 154/207 | 02/02→06/06 | OE136 | 0,8 | CET12P | OE179 | BAEA043E | |
| 1.8 T Cupra R | 4 | BAM | 165/221 | 07/03→06/06 | OE136 | 0,8 | CET12P | OE179 | BAEA043E | |

SEAT



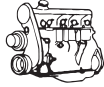

kW/BHP

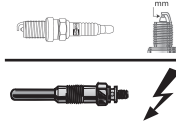

eon TITAN

IRIDIUM

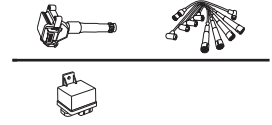

SEAT

...SEAT

...LEON

| | | | | | | | | |
|----------------------|---|------------------------|---------|-------------|---------|------|----------------|--|
| 1.8 TSI | 4 | BZB; CDA | 118/158 | 06/07→12/12 | OE214 | 0,7 | CET11P | BAEA033E ^[7] |
| 1.8 TSI | 4 | CJSA | 132/177 | 02/13→ | | | OE246 | BAEA068E |
| 1.8 TSI 4WD | 4 | CJSB | 132/177 | 11/14→ | | | OE246 | BAEA068E →01/16 |
| 1.9 SDI | 4 | AQM | 50/67 | 11/99→06/06 | CH271 | 11v | | CCU081 ^[364] |
| 1.9 TDI | 4 | AGR; ALH | 66/89 | 11/99→12/10 | CH271 | 11v | | CCU081 ^[364] |
| 1.9 TDI | 4 | BXF | 66/89 | 11/99→12/10 | | | | CCU152 Ch.1P-6-075001→ |
| 1.9 TDI | 4 | AXR | 74/99 | 10/05→06/06 | | | | CCU081 ^[364] |
| 1.9 TDI | 4 | BXE | 77/103 | 07/05→12/10 | | | | CCU152 Ch.1P-6-075001→ |
| 1.9 TDI | 4 | BLS | 77/103 | 07/05→12/10 | CCGP002 | 7v | | CCU152 Ch.1P-6-075001→ |
| 1.9 TDI | 4 | AHF; ASV | 81/109 | 11/99→06/06 | CH271 | 11v | | CCU081 ^[364] |
| 1.9 TDI | 4 | ASZ | 96/129 | 05/03→06/06 | CH181 | 11v | | CCU081 ^[364] |
| 1.9 TDI, 1.9 TDI 4WD | 4 | ARL | 110/148 | 09/00→06/06 | CH271 | 11v | | CCU081 ^[364] →Ch.1M-3-148000 |
| 2.0 Cupra | 4 | CJXE | 195/261 | 10/13→ | | | OE246 | BAEA068E →06/16 |
| 2.0 Cupra | 4 | CJXA | 206/276 | 10/13→ | | | OE246 | BAEA068E →06/16 |
| 2.0 Cupra | 4 | CJXH | 213/286 | 10/15→ | | | | BAEA068E →06/16 |
| 2.0 Cupra R | 4 | CDLA | 195/261 | 09/09→12/12 | OE214 | 0,7 | CET11P | BAEA033E ^[7] |
| 2.0 FSI | 4 | BLR; BVY | 110/148 | 07/05→05/10 | OE234 | 1,0 | CET12P CET3 | BAEA033E ^[7] |
| 2.0 FSI | 4 | BLY; BVZ | 110/148 | 07/05→05/10 | OE146 | 1,0 | CET12P CET3 | OE179 BAEA033E ^[7] |
| 2.0 TDI | 4 | CRVA | 81/109 | 02/13→ | CPSG007 | 4.4v | | CCU151 |
| 2.0 TDI | 4 | AZV | 100/134 | 07/05→05/10 | | | | CCU152 Ch.1P-6-075001→ |
| 2.0 TDI | 4 | BMM | 103/138 | 10/05→10/10 | | | | CCU152 |
| 2.0 TDI | 4 | CRVC | 105/141 | 05/13→ | CPSG007 | 4.4v | | CCU151 |
| 2.0 TDI | 4 | BMN | 125/168 | 05/06→12/12 | CCGP003 | 7v | | CCU152 |
| 2.0 TDI | 4 | CEGA; CFJA | 125/168 | 05/06→12/12 | | | | CCU152 |
| 2.0 TDI, 2.0 TDI 4WD | 4 | CKFC; CRBC; CRLB; CRMB | 110/148 | 10/12→ | CPSG007 | 4.4v | | CCU151 |
| 2.0 TDI, 2.0 TDI 4WD | 4 | CUNA; CUPA | 135/181 | 09/12→ | CPSG007 | 4.4v | | CCU151 |
| 2.0 TDI 16V | 4 | BKD | 103/138 | 07/05→12/12 | | | | CCU152 Ch.1P-6-075001→ |
| 2.0 TDI 16V | 4 | CFHC; CLCB | 103/138 | 07/05→12/12 | | | | CCU152 |
| 2.0 TFSI | 4 | BWA1 | 136/182 | 09/05→05/06 | OE214 | 0,7 | CET11P | BAEA033E ^[7] |
| 2.0 TFSI | 4 | BWA | 147/197 | 05/05→03/09 | OE214 | 0,7 | CET11P | BAEA033E ^[7] |
| 2.0 TFSI | 4 | CCZB | 155/208 | 06/09→12/12 | OE214 | 0,7 | CET11P | BAEA033E ^[7] |
| 2.0 TFSI | 4 | BWJ; CDLD | 177/237 | 11/06→05/11 | OE214 | 0,7 | CET11P | BAEA033E ^[7] |
| 2.8 | 6 | BDE | 150/201 | 05/02→06/04 | OE176 | 1,0 | CET3 | BAEA044E ^[356] |
| 2.8 Cupra 4WD | 6 | AUE | 150/201 | 02/01→06/06 | OE176 | 1,0 | CET3 | BAEA013E BAEA044E ^[356] |
| MARBELLA | | | | | | | | |
| 0.9 | 4 | 08NCB | 32/43 | 07/97→10/98 | OE042 | 0,9 | CET8 | CLS005 |
| 0.9 Cat | 4 | 08NCB | 30/40 | 11/96→10/98 | OE042 | 0,9 | CET8 | CLS005 |
| Mii | | | | | | | | |
| 1.0 | 3 | CHYA; DAFA | 44/59 | 10/11→ | OE247 | 1,0 | | BAEA126E →01/12 [249] [275] BAEA067E [240] [275] |



kW/BHP

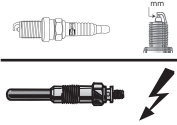

eon TITAN

IRIDIUM

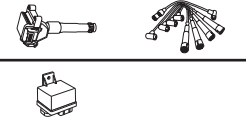
**...SEAT****...Mii**

| | | | | | | | | | | |
|-------------|---|------|-------|--------|-------|-----|--|--|--|--|
| 1.0 | 3 | CHYB | 55/74 | 10/11→ | OE247 | 1,0 | | | BAEA126E →01/12 [249] [275] | |
| | | | | | | | | | BAEA067E [240] [275] | |
| 1.0 EcoFuel | 3 | CPGA | 50/67 | 11/12→ | OE244 | 0,8 | | | BAEA067E [240] [275] | |
| | | | | | | | | | BAEA126E [249] [275] | |

TOLEDO I

| | | | | | | | | | | |
|-----------|---|----------|---------|-------------|-------|-----|--------|-------|---|---------------------|
| 1.6 i | 4 | 1F | 55/74 | 01/93→03/99 | OE027 | 1,0 | CET8 | | BAE851AE [261] [292] | CLS099 |
| 1.6 i | 4 | AFT | 74/99 | 11/96→03/99 | OE032 | 1,0 | CET2 | OE179 | BAE851AE [261] [292] | CLS034 |
| 1.8 i | 4 | ABS | 66/89 | 11/93→12/96 | OE025 | 1,0 | CET8 | OE195 | BAE851AE Ch.1L-ZR001001→ [261] [292] | CLS027 |
| | | | | | | | | | | CLS110 [292] |
| 1.8 i | 4 | ACC; ADZ | 66/89 | 11/93→12/96 | OE025 | 1,0 | CET8 | OE195 | BAE851AE Ch.1L-ZR001001→ [261] [292] | CLS110 [292] |
| 1.9 D | 4 | 1Y | 47/63 | 12/95→03/99 | CH260 | 11v | | | | |
| 1.9 TDI | 4 | 1Z; AHU | 66/89 | 08/95→03/99 | CH271 | 11v | | | CCU081 | |
| 1.9 TDI | 4 | AFN | 81/109 | 11/96→03/99 | CH271 | 11v | | | CCU081 | |
| 2.0 i 16V | 4 | ABF | 110/148 | 11/93→03/99 | OE032 | 1,0 | CET11P | | BAEA002E →Ch.1L-ZR001000 [261] [292] | CLS174 |
| | | | | | | | | | BAE851AE Ch.1L-ZR001001→ [261] [292] | |

TOLEDO II

| | | | | | | | | | | |
|------------|---|----------|---------|-------------|----------------------|-----|--------|-------|--|---------------|
| 1.4 16V | 4 | AHW | 55/74 | 01/00→05/02 | OE032 | 1,0 | CET2 | OE188 | BAE907AE [262] | CLS260 |
| 1.4 16V | 4 | AUA | 55/74 | 01/00→05/02 | | | CET2 | OE188 | | |
| 1.4 16V | 4 | APE; BCA | 55/74 | 01/00→05/02 | OE032 | 1,0 | CET2 | OE188 | | |
| 1.4 16V | 4 | AXP | 55/74 | 01/00→05/02 | OE032 | 1,0 | CET2 | OE188 | | CLS260 |
| 1.6 | 4 | APF | 74/99 | 10/98→07/04 | OE032 | 1,0 | CET2 | OE188 | | |
| 1.6 | 4 | AEH; AKL | 74/99 | 10/98→07/04 | OE032 | 1,0 | CET2 | OE188 | BAE907AE [262] | CLS139 |
| 1.6 | 4 | BFQ | 75/101 | 08/05→05/06 | | | | | BAE907AE [262] | |
| 1.6 16V | 4 | AUS | 77/103 | 06/00→05/06 | OE032 →12/01 | 1,0 | CET2 | OE188 | BAE907AE [262] | CLS260 |
| 1.6 16V | 4 | AZD | 77/103 | 06/00→05/06 | OE032 →12/01 | 1,0 | CET2 | OE188 | BAE408AE | |
| | | | | | OE176 01/02→07/04 | 1,0 | | | | |
| 1.6 16V | 4 | BCB | 77/103 | 06/00→05/06 | OE176 01/02→07/04 | 1,0 | CET2 | OE188 | BAE408AE | |
| 1.8 20V | 4 | AGN; APG | 92/123 | 10/98→07/04 | OE032 | 1,0 | CET2 | OE179 | BAE907AE [262] | CLS140 |
| 1.8 20VT | 4 | AUQ | 132/177 | 09/00→07/04 | OE136 | 0,8 | CET12P | OE179 | BAEA043E | |
| 1.8 20VT | 4 | APP | 132/177 | 09/00→07/04 | OE136 | 0,8 | CET12P | OE179 | BAEA009E | |
| 1.9 TDI | 4 | AGR; ALH | 66/89 | 03/99→07/04 | CH271 | 11v | | | CCU081 [364] | |
| 1.9 TDI | 4 | AHF; ASV | 81/109 | 10/98→07/04 | CH271 | 11v | | | CCU081 [364] | |
| 1.9 TDI | 4 | ASZ | 96/129 | 05/03→05/06 | CH181 | 11v | | | CCU081 [364] | |
| 1.9 TDI | 4 | ARL | 110/148 | 10/00→07/04 | CH271 | 11v | | | CCU081 [364] →Ch.1M-3-148000 | |
| 2.3 V5 | 5 | AGZ | 110/148 | 10/98→11/00 | | | CET2 | OE188 | BAEA037 | |
| 2.3 V5 20V | 5 | AQN | 125/168 | 09/00→11/03 | OE176 | 1,0 | CET3 | | BAEA063E | |

TOLEDO III

| | | | | | | | | | | |
|---------|---|---------------------|--------|-------------|-------|-----|------|-------|-----------------------|---------------|
| 1.4 16V | 4 | BXW | 63/84 | 05/06→05/09 | OE177 | 0,9 | CET3 | | BAE408AE | |
| 1.4 TSI | 4 | CAXC | 92/123 | 11/07→05/09 | OE213 | 0,9 | | | | |
| 1.6 | 4 | BGU; BSE; BSF; CCSA | 75/101 | 10/04→05/09 | OE026 | 0,9 | CET2 | OE188 | BAE907AE [262] | CLS017 |

SEAT



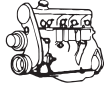

kW/BHP

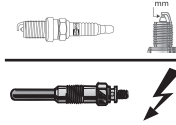

eon TITAN

IRIDIUM

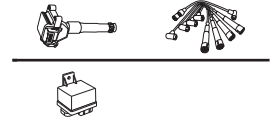
**...SEAT****...TOLEDO III**

| | | | | | | | | | |
|-------------|---|----------------|---------|-------------|----------------|-----|------------------------|--------------|----------------------------------|
| 1.8 TFSI | 4 | BYT; BZB; CDAA | 118/158 | 01/07→05/09 | OE214 | 0,7 | CET11P | | BAEA033E ^[7] |
| 1.9 TDI | 4 | BXE | 77/103 | 10/04→05/09 | | | | | CCU152 Ch.5P-6-053001→ |
| 1.9 TDI | 4 | BLS | 77/103 | 10/04→05/09 | CCGP002 | 7v | | | CCU152 Ch.5P-6-053001→ |
| 2.0 FSI | 4 | BLR; BVY | 110/148 | 10/04→05/09 | OE234 | 1,0 | CET12P CET3 | | BAEA033E ^[7] |
| 2.0 FSI | 4 | BLY; BVZ | 110/148 | 10/04→05/09 | OE146 | 1,0 | CET12P CET3 | OE179 | BAEA033E ^[7] |
| 2.0 TDI | 4 | AZV | 100/134 | 09/04→05/09 | | | | | CCU152 Ch.5P-6-053001→ |
| 2.0 TDI | 4 | BMM | 103/138 | 11/05→05/09 | CCGP002 | 7v | | | CCU152 |
| 2.0 TDI | 4 | BMN | 125/168 | 01/06→05/09 | CCGP003 | 7v | | | CCU152 |
| 2.0 TDI 16V | 4 | BKD | 103/138 | 04/04→05/09 | | | | | CCU152 Ch.5P-6-053001→ |
| 2.0 TFSI | 4 | BWA | 147/197 | 11/05→05/09 | OE214 | 0,7 | CET11P | | BAEA033E ^[7] |

TOLEDO IV

| | | | | | | | | | |
|---------|---|------------|--------|--------|----------------|------|-------------|--------------|--|
| 1.2 | 3 | CGPC | 55/74 | 07/12→ | OE177 | 0,9 | CET3 | | BAE408AE |
| 1.2 TSI | 4 | CBZA | 63/84 | 07/12→ | | | | OE260 | BAE907AE ^[262] CLS090 |
| 1.2 TSI | 4 | CJZC | 66/89 | 05/15→ | OE244 | 0,8 | | | |
| 1.2 TSI | 4 | CBZB | 77/103 | 07/12→ | | | | OE260 | BAE907AE ^[262] CLS090 |
| 1.2 TSI | 4 | | 78/105 | 09/12→ | | | | OE260 | |
| 1.2 TSI | 4 | CJZD | 81/109 | 05/15→ | OE244 | 0,8 | | | |
| 1.4 TDI | 3 | CUSB | 66/89 | 05/15→ | CPSG007 | 4.4v | | | |
| 1.4 TSI | 4 | CAXA | 90/121 | 07/12→ | OE213 | 0,9 | | | BAE408AE |
| 1.4 TSI | 4 | CZCA | 92/123 | 05/15→ | OE244 | 0,8 | | | |
| 1.6 | 4 | CFNA | 77/103 | 07/13→ | OE177 | 0,9 | CET3 | | BAE408AE |
| 1.6 TDI | 4 | CAYB | 66/89 | 06/13→ | | | | | CCU152 |
| 1.6 TDI | 4 | CAYC; CLNA | 77/103 | 07/12→ | | | | | CCU152 |
| 1.6 TDI | 4 | CXMA | 85/114 | 05/15→ | CPSG007 | 4.4v | | | |

SEAT**INCA**

| | | | | | | | | | |
|---------|---|---------------|-------|-------------|--------------|-----|-------------|--------------|---|
| 1.4 16V | 4 | AUA | 55/74 | 04/00→06/03 | OE032 | 1,0 | CET2 | OE179 | BAE907AE ^[262] |
| 1.4 i | 4 | AEX; AKV; APQ | 44/59 | 11/95→06/03 | OE027 | 1,0 | CET8 | | BAE851AE ^{[261] [292]} CLS109 |
| 1.4 i | 4 | AUD | 44/59 | 11/95→06/03 | OE025 | 1,0 | CET8 | OE195 | BAE907AE ^[262] CLS053 CLS109 |
| 1.6 i | 4 | 1F | 55/74 | 11/95→09/00 | OE027 | 1,0 | CET8 | | BAE851AE ^{[261] [292]} CLS099 |
| 1.6 i | 4 | AEE; ALM | 55/74 | 11/95→09/00 | OE027 | 1,0 | CET8 | | BAE851AE ^{[261] [292]} |
| 1.7 D | 4 | AHB | 42/56 | 09/96→06/03 | CH260 | 11v | | | CCU081 →Ch.9K-3-001600 |
| 1.9 D | 4 | 1Y | 47/63 | 11/95→06/03 | CH260 | 11v | | | |
| 1.9 SDI | 4 | AEY; AVQ | 47/63 | 11/95→06/03 | CH271 | 11v | | | CCU081 →Ch.9K-3-001600 |
| 1.9 TDI | 4 | ALH | 66/89 | 09/96→06/03 | CH271 | 11v | | | |

LEON

| | | | | | | | | | |
|---------|---|------------|---------|-------------|--|-----|--|--|--|
| 1.2 TSI | 4 | CJZB; CYVA | 63/84 | 01/13→ | OE244 ^{[223] [302]} | 0,8 | | | |
| 1.2 TSI | 4 | CYVB | 81/109 | 04/14→ | OE244 ^{[223] [302]} | 0,8 | | | |
| 1.4 TSI | 4 | CMBA; CXSA | 90/121 | 09/12→10/16 | OE244 ^{[220] [307]} | 0,8 | | | |
| 1.4 TSI | 4 | CHPA; CPTA | 103/138 | 09/12→10/16 | OE244 ^{[219] [306]} | 0,8 | | | |
| 1.4 TSI | 4 | CZEA | 110/148 | 05/14→ | OE244 ^{[219] [306]} | 0,8 | | | |

CHAMPION



kW/BHP



eon TITAN

IRIDIUM

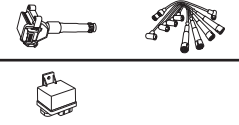

...SEAT

LEON ST

| | | | | | | | | | |
|---------|---|------------|---------|--------|----------------------|-----|--|--|--|
| 1.2 TSI | 4 | CJZB; CYVA | 63/84 | 01/13→ | OE244 [223] [302] | 0,8 | | | |
| 1.2 TSI | 4 | CYVB | 81/109 | 05/14→ | OE244 [223] [302] | 0,8 | | | |
| 1.4 TSI | 4 | CZDA; CZEA | 110/148 | 05/14→ | OE244 [219] [306] | 0,8 | | | |

SKODA

CITIGO

| | | | | | | | | | |
|---------|---|------|-------|--------|-------|-----|--|--|--|
| 1.0 | 3 | CHYA | 44/59 | 10/11→ | OE247 | 1,0 | | | BAEA067E [240] [275] BAEA126E [249] [275] |
| 1.0 | 3 | CHYB | 55/74 | 10/11→ | OE247 | 1,0 | | | BAEA067E [240] [275] BAEA126E [249] [275] |
| 1.0 CNG | 3 | CPGA | 50/67 | 11/12→ | OE244 | 0,8 | | | BAEA067E [240] |

FABIA I

| | | | | | | | | | |
|------------|---|---------------|--------|-------------|----------------------------|------------|--------------------------|-------------|--|
| 1.0 | 4 | AQV; ARV | 37/50 | 12/99→08/02 | OE032 | 1,0 | CET2 | OE188 | BAE961AE |
| 1.2 | 3 | AWY; BMD | 40/54 | 07/01→12/07 | OE177 | 0,9 | CET3 | | BAEA059E |
| 1.2 | 3 | AZQ; BME | 47/63 | 01/03→03/08 | OE177 | 0,9 | CET3 | | BAE408AE |
| 1.4 | 4 | AZE; AZF | 44/59 | 04/00→03/03 | OE145 | 0,8 | CET12P | OE182 | BAE961AE |
| 1.4 | 4 | AME; AQW; ATZ | 50/67 | 08/99→05/03 | OE145 | 0,8 | CET12P | OE182 | BAE961AE |
| 1.4 16V | 4 | AUA; BBY | 55/74 | 10/99→03/08 | OE032 [287] OE176 [285] | 1,0 1,0 | CET2 [287] CET3 [285] | OE179 [287] | BAE408AE [275] CLS260 BAE907AE [262] [275] BAE961AE [275] |
| 1.4 16V | 4 | BKY | 55/74 | 10/99→03/08 | OE176 [285] OE177 [287] | 1,0 0,9 | CET3 [285] CET3 [287] | | BAE408AE [275] CLS260 BAE907AE [262] [275] BAE961AE [275] |
| 1.4 16V | 4 | BUD | 59/79 | 04/06→12/07 | OE177 | 0,9 | CET3 | | BAE408AE |
| 1.4 16V | 4 | AUB; BBZ | 74/99 | 12/99→03/08 | OE032 | 1,0 | CET2 | OE179 | BAE408AE [275] CLS260 BAE907AE [262] [275] BAE961AE [275] |
| 1.4 TDI | 3 | BNM | 51/68 | 10/05→03/08 | CH181 | 11v | | | CCU081 →Ch.6Y-64648255 |
| 1.4 TDI | 3 | AMF | 55/74 | 04/03→03/08 | CH181 | 11v | | | CCU081 →Ch.6Y-64648255 |
| 1.4 TDI | 3 | BNV | 59/79 | 10/05→03/08 | CH181 | 11v | | | CCU081 →Ch.6Y-64648255 |
| 1.9 SDI | 4 | ASY | 47/63 | 11/99→03/08 | CH271 | 11v | | | CCU081 →Ch.6Y-64648255 |
| 1.9 TDI | 4 | ATD; AXR | 74/99 | 01/00→03/08 | CH271 | 11v | | | CCU081 →Ch.6Y-64648255 |
| 1.9 TDI RS | 4 | ASZ; BLT | 96/129 | 06/03→03/08 | CH181 | 11v | | | CCU081 →Ch.6Y-64648255 |
| 2.0 | 4 | AZL | 85/114 | 12/99→03/08 | OE032 | 1,0 | CET2 | OE179 | BAE907AE [262] CLS017 |

FABIA II

| | | | | | | | | | |
|---------|---|------------------|-------|-------------|--|------------|------|--|---|
| 1.2 | 3 | BBM; CHFA | 44/59 | 12/06→12/14 | OE177 | 0,9 | CET3 | | BAEA059E |
| 1.2 | 3 | CEVA; CGPA; CHTA | 51/68 | 01/07→12/14 | OE177 | 0,9 | CET3 | | BAE408AE |
| 1.2 | 3 | BZG | 51/68 | 01/07→12/14 | OE177 →Ch.SJ-83074394 OE177 →Ch.SJ-88501225 | 0,9 0,9 | CET3 | | BAE408AE |
| 1.2 12V | 3 | CGPB | 44/59 | 11/11→12/14 | OE177 | 0,9 | CET3 | | BAE408AE |
| 1.2 TDI | 3 | CFWA | 55/74 | 05/10→12/14 | | | | | CCU152 Prod.27.05.2013→ Prod.18.11.2013 |

SKODA



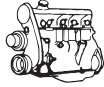

kW/BHP

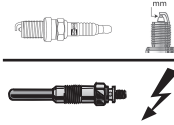

eon TITAN

IRIDIUM

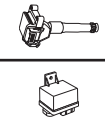

...SKODA

...FABIA II

| | | | | | | | | | | |
|------------|---|------------|---------|-------------|---------|-----|------|-------|---------------------------|--------|
| 1.2 TSI | 4 | CBZA | 63/84 | 03/10→12/14 | | | | OE260 | BAE907AE ^[262] | CLS090 |
| 1.2 TSI | 4 | CBZB | 77/103 | 03/10→12/14 | | | | OE260 | BAE907AE ^[262] | CLS090 |
| 1.4 | 4 | BXW; CGGB | 63/84 | 01/07→12/14 | OE177 | 0,9 | CET3 | | BAE408AE | |
| | | | | | | | | | Ch.5J-7-000001→ | |
| 1.4 TDI | 3 | BNM | 51/68 | 02/07→03/10 | CH181 | 11v | | | | |
| 1.4 TDI | 3 | BNV | 59/79 | 01/07→03/10 | CH181 | 11v | | | | |
| 1.4 TDI | 3 | BMS | 59/79 | 01/07→03/10 | CCGP002 | 7v | | | | |
| 1.4 TSI RS | 4 | CAVE | 132/177 | 05/10→12/14 | | | | | BAE408AE | |
| 1.6 | 4 | BTS | 77/103 | 04/07→12/14 | OE177 | 0,9 | CET3 | | BAE408AE | |
| | | | | | | | | | Ch.5J-7-000001→ | |
| 1.6 | 4 | CFNA; CLSA | 77/103 | 04/07→12/14 | OE177 | 0,9 | CET3 | | | |
| 1.6 TDI | 4 | CAYA | 55/74 | 04/10→12/14 | | | | | CCU152 | |
| 1.6 TDI | 4 | CAYB | 66/89 | 03/10→12/14 | | | | | CCU152 | |
| 1.6 TDI | 4 | CAYC | 77/103 | 03/10→12/14 | | | | | CCU152 | |
| 1.9 TDI | 4 | BLS | 77/103 | 04/07→03/10 | CCGP002 | 7v | | | CCU152 | |

FABIA III

| | | | | | | | | | | |
|---------|---|------|--------|--------|---------|------|--|--|---------------------------|--|
| 1.0 | 3 | CHYA | 44/59 | 08/14→ | OE247 | 1,0 | | | BAEA067E ^[240] | |
| 1.0 | 3 | CHYB | 55/74 | 08/14→ | OE247 | 1,0 | | | BAEA067E ^[240] | |
| 1.2 TSI | 4 | CJZC | 66/89 | 08/14→ | OE244 | 0,8 | | | BAEA067E ^[240] | |
| 1.2 TSI | 4 | CJZD | 81/109 | 08/14→ | OE244 | 0,8 | | | BAEA067E ^[240] | |
| 1.4 TDI | 3 | CUSA | 55/74 | 05/15→ | CPSG007 | 4.4v | | | | |
| 1.4 TDI | 3 | CUSB | 66/89 | 08/14→ | CPSG007 | 4.4v | | | | |
| 1.4 TDI | 3 | CUTA | 77/103 | 08/14→ | CPSG007 | 4.4v | | | | |

FAVORIT

| | | | | | | | | | | |
|-----|---|---------|-------|-------------|-------|-----|------|-------|--|--|
| 1.3 | 4 | 781.135 | 43/58 | 01/93→12/93 | OE005 | 0,9 | CET2 | OE180 | | |
|-----|---|---------|-------|-------------|-------|-----|------|-------|--|--|

FELICIA I

| | | | | | | | | | | |
|----------------------|---|-----------|-------|-------------|--------|-----|---------|--------|-----------------------------------|--------|
| 1.3 | 4 | 135B; AMG | 40/54 | 10/94→04/02 | OE013 | 0,8 | CET1 2P | OE182 | BAE851AE | |
| | | | | | OE145 | 0,8 | CET2 | OE193 | ^[261] ^[292] | |
| 1.3 | 4 | 135M | 40/54 | 10/94→04/02 | OE013 | 0,8 | CET1 2P | OE182 | BAE851AE | |
| | | | | | OE145 | 0,8 | CET2 | OE193 | ^[261] ^[292] | |
| 1.3 | 4 | AMJ | 43/58 | 10/94→04/02 | OE005 | 0,9 | CET2 | OE180 | BAE851AE | |
| | | | | | | | | | ^[261] ^[292] | |
| 1.3 | 4 | 135L | 43/58 | 10/94→04/02 | | | CET2 | | BAE851AE | |
| | | | | | | | | | ^[261] ^[292] | |
| 1.3 | 4 | 135L | 43/58 | 10/94→04/02 | OE013 | 0,8 | | OE193 | | |
| 1.3 | 4 | 136B; AMH | 50/67 | 10/94→04/02 | OE005 | 0,9 | CET1 2P | OE180 | BAE851AE | |
| | | | | | OE145 | 0,8 | CET2 | OE182 | ^[261] ^[292] | |
| 1.3 | 4 | 136M | 50/67 | 10/94→04/02 | OE005 | 0,9 | CET1 2P | OE180 | BAE851AE | |
| | | | | | OE145 | 0,8 | CET2 | OE182 | ^[261] ^[292] | |
| 1.3 LX | 4 | 135B; AMG | 40/54 | 08/95→03/98 | OE013 | 0,8 | CET1 2P | OE193 | BAE851AE | |
| | | | | | →08/96 | | CET2 | OE182 | ^[261] ^[292] | |
| | | | | | | | | 08/96→ | | |
| 1.3 LXI | 4 | 136B; AMH | 50/67 | 08/95→03/98 | OE005 | 0,9 | CET1 2P | OE180 | BAE851AE | |
| | | | | | →08/96 | | CET2 | OE182 | ^[261] ^[292] | |
| | | | | | | | | 08/96→ | | |
| 1.6, 1.6 GLX, 1.6 LX | 4 | AEE | 55/74 | 08/95→04/02 | OE025 | 1,0 | CET8 | OE195 | BAE851AE | CLS100 |
| | | | | | | | | | ^[261] ^[292] | |
| 1.9 D | 4 | AEF | 47/63 | 10/95→04/02 | CH260 | 11v | | | | |

FELICIA II

| | | | | | | | | | | |
|-----|---|-----|-------|-------------|-------|-----|---------|-------|-----------------------------------|--|
| 1.3 | 4 | AMG | 40/54 | 01/98→06/01 | OE145 | 0,8 | CET1 2P | OE182 | BAE851AE | |
| | | | | | | | | | ^[261] ^[292] | |
| | | | | | | | | | BAE960AE | |

SKODA





kW/BHP

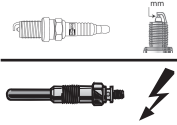

eon TITAN

IRIDIUM

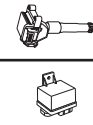
**...SKODA****...FELICIA II**

| | | | | | | | | | | |
|-----|---|-----|-------|-------------|-------|-----|--------|-------|-------------------------|--------|
| 1.3 | 4 | AMJ | 43/58 | 01/98→06/01 | OE005 | 0,9 | CET2 | OE180 | BAE960AE | |
| 1.3 | 4 | AMH | 50/67 | 01/98→06/01 | OE145 | 0,8 | CET12P | OE182 | BAE851AE [261] [292] | |
| | | | | | | | | | BAE960AE | |
| 1.6 | 4 | AEE | 55/74 | 01/98→06/01 | OE025 | 1,0 | CET8 | OE195 | BAE851AE [261] [292] | CLS109 |
| | | | | | | | | | BAE960AE | |

| | | | | | | | | | | |
|-------|---|-----|-------|-------------|-------|-----|--|--|--|--|
| 1.9 D | 4 | AEF | 47/63 | 01/98→06/01 | CH260 | 11v | | | | |
|-------|---|-----|-------|-------------|-------|-----|--|--|--|--|

KODIAQ

| | | | | | | | | | | |
|----------------------|---|-----------------|---------|--------|-----------------------------|------|--|--|----------|--|
| 2.0 TDI, 2.0 TDI 4WD | 4 | DBG; DBGC; DFGA | 110/148 | 10/16→ | CPSG007 →Prod.31.10.2017 | 4.4v | | | | |
| 2.0 TDI 4WD | 4 | DFHA | 140/188 | 10/16→ | CPSG007 →Prod.31.10.2017 | 4.4v | | | | |
| 2.0 TSI 4WD | 4 | CZPA | 132/177 | 10/16→ | | | | | BAEA137E | |

OCTAVIA I

| | | | | | | | | | | |
|----------------------|---|--------------------|---------|-------------|-----------------|-----|--------|-------|--|------------------|
| 1.4 | 4 | AMD | 44/59 | 04/99→03/01 | OE145 | 0,8 | CET12P | OE182 | BAE961AE | |
| 1.4 16V | 4 | AXP | 55/74 | 08/00→12/10 | OE032 [287] | 1,0 | CET2 | OE188 | BAE907AE →Prod.28.02.2002 [64] [262] [275] | CLS260 |
| | | | | | OE176 [285] | 1,0 | | | | |
| 1.4 16V | 4 | BCA | 55/74 | 08/00→12/10 | OE032 [287] | 1,0 | CET2 | OE188 | BAE408AE [65] [275] | CLS260 |
| | | | | | | | | | BAE907AE →Prod.28.02.2002 [64] [262] [275] | |
| 1.6 | 4 | AEE | 55/74 | 09/96→09/04 | OE025 | 1,0 | CET8 | OE195 | BAE851AE [261] [292] | CLS100 |
| 1.6 | 4 | AEH; AKL | 74/99 | 02/97→12/07 | OE032 | 1,0 | CET2 | OE179 | BAE907AE [262] | CLS139 |
| 1.6 | 4 | AVU; BFQ | 75/101 | 09/00→12/10 | OE032 | 1,0 | CET2 | OE188 | BAE907AE [262] | CLS048 |
| 1.8 | 4 | AGN | 92/123 | 09/96→07/00 | OE032 | 1,0 | CET2 | OE179 | BAE907AE [262] | CLS140 04/97→ |
| 1.8 20V | 4 | AGN | 92/123 | 07/98→07/00 | OE032 | 1,0 | CET2 | OE179 | BAE907AE [262] | CLS140 |
| 1.8 RS 1.8 T | 4 | AUQ | 132/177 | 05/01→01/06 | OE136 | 0,8 | CET12P | OE179 | BAEA043E | |
| 1.8 T | 4 | AGU | 110/148 | 08/97→12/10 | OE136 | 0,8 | CET12P | OE179 | BAEA016 | |
| 1.8 T | 4 | ARX; AUM | 110/148 | 08/97→12/10 | OE136 | 0,8 | CET12P | OE179 | BAEA043E ModelYear2001→ | |
| 1.8 T | 4 | ARZ | 110/148 | 08/97→12/10 | OE136 | 0,8 | CET12P | OE179 | BAEA009E ModelYear→2000 | |
| 1.8 T 4WD | 4 | ARX | 110/148 | 05/01→05/06 | OE136 | 0,8 | CET12P | OE179 | BAEA043E | |
| 1.9 SDI | 4 | AGP; AQM | 50/67 | 06/97→12/03 | CH271 | 11v | | | CCU081 | |
| 1.9 TDI | 4 | AHF; ASV | 81/109 | 08/97→01/06 | CH271 | 11v | | | CCU081 | |
| 1.9 TDI | 4 | ASZ | 96/129 | 09/02→09/04 | CH181 | 11v | | | CCU081 | |
| 1.9 TDI, 1.9 TDI 4WD | 4 | AGR; ALH | 66/89 | 09/96→03/10 | CH271 | 11v | | | CCU081 | |
| 1.9 TDI, 1.9 TDI 4WD | 4 | ATD; AXR | 74/99 | 08/00→12/10 | CH271 →11/01 | 11v | | | CCU081 | |
| | | | | | CH181 12/01→ | 11v | | | | |
| 2.0 | 4 | AZJ | 85/114 | 04/99→05/07 | OE032 | 1,0 | CET2 | OE179 | BAEA029E | |
| 2.0, 2.0 4WD | 4 | AEG; APK; AQY; AZH | 85/114 | 04/99→05/07 | OE032 | 1,0 | CET2 | OE179 | BAE907AE [262] | CLS017 |
| 2.0 4WD | 4 | AZJ | 85/114 | 08/00→09/04 | OE032 | 1,0 | CET2 | OE179 | BAEA029E | CLS070 |
| 2.0 4WD | 4 | ATF | 88/118 | 01/00→12/10 | OE176 | 1,0 | CET3 | | BAE907AE [262] | |

OCTAVIA II

| | | | | | | | | | | |
|---------|---|-----------|--------|-------------|-------|-----|------|-------|--------------------------|--------|
| 1.2 TSI | 4 | CBZB | 77/103 | 02/10→06/13 | | | | OE260 | BAE907AE [262] | CLS090 |
| 1.4 | 4 | BCA | 55/74 | 05/04→05/06 | OE032 | 1,0 | CET2 | OE179 | BAE408AE [275] | |
| | | | | | | | | OE188 | BAE408AE | |
| | | | | | | | | | BAE961AE [275] | |
| 1.4 | 4 | BUD; CGGA | 59/79 | 06/04→06/13 | OE177 | 0,9 | CET3 | OE188 | BAE408AE [275] →12/11 | |
| 1.4 TSI | 4 | CAXA | 90/121 | 11/08→06/13 | OE213 | 0,9 | | | BAE408AE | |

SKODA



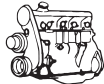

kW/BHP



eon TITAN

IRIDIUM



...SKODA

...OCTAVIA II

| | | | | | | | | | | |
|------------------------------|---|---------------------------|---------|-------------|-------------------|------------|----------------|-------|---------------------------|--------|
| 1.6 | 4 | BGU; BSE; BSF; CCSA; CMXA | 75/101 | 06/04→06/13 | OE026 OE032 | 0,9 1,0 | CET2 | OE188 | BAE907AE ^[262] | CLS048 |
| 1.6 FSI | 4 | BLF | 85/114 | 02/04→10/08 | | | | | BAE408AE | |
| 1.6 LPG, 1.6 MultiFuel | 4 | CCSA; CHGA | 75/101 | 01/08→06/13 | OE032 | 1,0 | CET2 | OE179 | BAE907AE ^[262] | CLS048 |
| 1.6 MultiFuel | 4 | CMXA | 75/101 | 01/08→06/13 | OE032 | 1,0 | CET2 | OE179 | | |
| 1.6 TDI, 1.6 TDI 4WD | 4 | CAYC | 77/103 | 06/09→04/13 | | | | | CCU152 | |
| 1.8 TSI | 4 | CDAB | 112/150 | 03/09→06/13 | OE214 | 0,7 | CET11P | | | |
| 1.8 TSI, 1.8 TSI 4WD | 4 | BZB; CDA | 118/158 | 06/07→04/13 | OE214 | 0,7 | CET11P | | BAEA033E ^[7] | |
| 1.8 TSI 4WD | 4 | CDAB | 112/150 | 03/09→02/13 | OE214 | 0,7 | CET11P | | BAEA033E ^[7] | |
| 1.9 TDI, 1.9 TDI 4WD | 4 | BLS; BXE | 77/103 | 06/04→12/10 | | | | | CCU152 03/06→ | |
| 2.0 FSI | 4 | BLR; BVY | 110/148 | 11/04→10/08 | OE234 | 1,0 | CET12P CET3 | | BAEA033E ^[7] | |
| 2.0 FSI | 4 | BLY; BVZ | 110/148 | 11/04→10/08 | OE146 | 1,0 | CET12P CET3 | OE179 | BAEA033E ^[7] | |
| 2.0 FSI 4WD | 4 | BLX; BVX | 110/148 | 11/04→10/08 | OE234 | 1,0 | CET3 | | BAEA033E ^[7] | |
| 2.0 RS | 4 | BWA; CCZA | 147/197 | 10/05→02/13 | OE214 | 0,7 | CET11P | | BAEA033E ^[7] | |
| 2.0 TDI | 4 | BMM | 103/138 | 11/05→05/10 | CCGP002 →12/05 | 7v | | | CCU152 | |
| 2.0 TDI, 2.0 TDI 4WD | 4 | CFHF; CLCA | 81/109 | 03/10→06/13 | | | | | CCU152 | |
| 2.0 TDI, 2.0 TDI 16V | 4 | AZV | 100/134 | 02/04→05/10 | | | | | CCU152 03/06→ | |
| 2.0 TDI 4WD | 4 | BMM | 103/138 | 07/06→05/10 | | | | | CCU152 | |
| 2.0 TDI 16V | 4 | BKD | 103/138 | 02/04→05/13 | | | | | CCU152 03/06→ | |
| 2.0 TDI 16V, 2.0 TDI 16V 4WD | 4 | CFHC; CLCB | 103/138 | 02/04→05/13 | | | | | CCU152 | |
| 2.0 TDI RS | 4 | BMN | 125/168 | 04/06→02/13 | CCGP003 | 7v | | | CCU152 | |
| 2.0 TDI RS | 4 | CEGA | 125/168 | 04/06→02/13 | | | | | CCU152 | |

OCTAVIA III

| | | | | | | | | | | |
|----------------------------------|---|------------------------|---------|--------|-------------------------|------|--|-------|--|--|
| 1.2 TSI | 4 | CJZB; CYVA | 63/84 | 11/12→ | OE244 | 0,8 | | | BAEA067E ^{[240] [275]} BAEA126E ^{[249] [275]} | |
| 1.2 TSI | 4 | CJZA | 77/103 | 11/12→ | OE244 | 0,8 | | | BAEA067E ^{[240] [275]} BAEA126E ^{[249] [275]} | |
| 1.2 TSI | 4 | CYVB | 81/109 | 05/15→ | OE244 | 0,8 | | | | |
| 1.4 TSI | 4 | CHPA | 103/138 | 11/12→ | OE244 | 0,8 | | | BAEA067E ^{[240] [275]} BAEA126E ^{[249] [275]} | |
| 1.4 TSI | 4 | CZDA | 110/148 | 08/14→ | OE244 | 0,8 | | | | |
| 1.4 TSI G-TEC | 4 | CPWA | 81/109 | 11/13→ | OE244 | 0,8 | | | BAEA067E ^[240] | |
| 1.6 | 4 | CWVA | 81/109 | 01/14→ | OE247 | 1,0 | | | BAEA067E ^[240] | |
| 1.6 TDI | 4 | CLHB; CXXA; DDYB | 66/89 | 11/12→ | CPSG007 ^[25] | 4.4v | | | CCU151 | |
| 1.6 TDI | 4 | CXXB; DBKA | 81/109 | 05/13→ | CPSG007 ^[25] | 4.4v | | | CCU151 | |
| 1.6 TDI | 4 | CRKB | 81/109 | 05/13→ | CPSG007 ^[22] | 4.4v | | | CCU151 | |
| 1.6 TDI | 4 | DDYA | 85/114 | 02/17→ | CPSG007 | 4.4v | | | | |
| 1.6 TDI, 1.6 TDI 4WD | 4 | CLHA | 77/103 | 11/12→ | CPSG007 ^[25] | 4.4v | | | CCU151 | |
| 1.6 TDI 4WD | 4 | CXXB | 81/109 | 05/15→ | CPSG007 ^[25] | 4.4v | | | | |
| 1.8 TSI | 4 | CJSA | 132/177 | 11/12→ | | | | OE246 | BAEA068E | |
| 1.8 TSI 4WD | 4 | CJSB | 132/177 | 11/12→ | | | | OE246 | BAEA068E | |
| 2.0 TDI | 4 | CKFB; CRVC | 105/141 | 11/12→ | CPSG007 ^[25] | 4.4v | | | CCU151 | |
| 2.0 TDI, 2.0 TDI 4WD | 4 | CKFC; CRMB; CYKA; DCYA | 110/148 | 11/12→ | CPSG007 ^[25] | 4.4v | | | CCU151 | |
| 2.0 TDI RS, 2.0 TDI / TDI RS 4WD | 4 | CUNA; CUPA; DJGA | 135/181 | 05/13→ | CPSG007 ^[25] | 4.4v | | | CCU151 | |
| 2.0 TSI RS | 4 | CHHB | 162/217 | 11/12→ | | | | OE246 | BAEA068E | |

CHAMPION

SKODA



kW/BHP

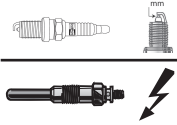

eon TITAN

IRIDIUM

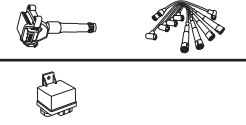
**...SKODA****...OCTAVIA III**

| | | | | | | | | | |
|------------|---|------|---------|--------|--|--|--|-------|--------------------|
| 2.0 TSI RS | 4 | CHHA | 169/227 | 05/15→ | | | | OE246 | BAEA068E →07/16 |
|------------|---|------|---------|--------|--|--|--|-------|--------------------|

RAPID

| | | | | | | | | | |
|---------|---|------------|--------|--------|---------|------|------|-------|--|
| 1.2 | 3 | CGPC | 55/74 | 07/12→ | OE177 | 0,9 | CET3 | | BAE408AE |
| 1.2 TSI | 4 | CBZA | 63/84 | 07/12→ | | | | OE260 | BAE907AE ^[262] CLS090 ^[66] →10/12 |
| 1.2 TSI | 4 | CJZC | 66/89 | 05/15→ | OE244 | 0,8 | | | |
| 1.2 TSI | 4 | CBZB | 77/103 | 07/12→ | | | | OE260 | BAE907AE ^[262] CLS090 ^[66] →10/12 |
| 1.2 TSI | 4 | CJZD | 81/109 | 05/15→ | OE244 | 0,8 | | | |
| 1.4 TDI | 3 | CUSB | 66/89 | 05/15→ | CP5G007 | 4.4v | | | |
| 1.4 TSI | 4 | CAXA | 90/121 | 07/12→ | OE213 | 0,9 | | | BAE408AE |
| 1.4 TSI | 4 | CZCA | 92/123 | 05/15→ | OE244 | 0,8 | | | |
| 1.6 | 4 | CFNA | 77/103 | 10/11→ | OE177 | 0,9 | CET3 | | BAE408AE |
| 1.6 | 4 | CLSA | 77/103 | 10/11→ | | | | | BAE408AE |
| 1.6 TDI | 4 | CAYB | 66/89 | 08/13→ | | | | | CCU152 |
| 1.6 TDI | 4 | CAYC; CLNA | 77/103 | 10/11→ | | | | | CCU152 |

ROOMSTER

| | | | | | | | | | |
|---------|---|-----------|--------|-------------|---------|-----|------|-------|---|
| 1.2 | 3 | BME | 47/63 | 05/06→01/07 | OE177 | 0,9 | CET3 | | BAE408AE |
| 1.2 | 3 | BZG; CGPA | 51/68 | 01/07→05/15 | OE177 | 0,9 | CET3 | | BAE408AE |
| 1.2 TDI | 3 | CFWA | 55/74 | 03/10→05/15 | | | | | CCU152 Prod.27.05.2013→ Prod.18.11.2013 |
| 1.2 TSI | 4 | CBZA | 63/84 | 03/10→05/15 | | | | OE260 | BAE907AE ^[262] CLS090 |
| 1.2 TSI | 4 | CBZB | 77/103 | 03/10→05/15 | | | | OE260 | BAE907AE ^[262] CLS090 |
| 1.4 | 4 | BXW; CGGB | 63/84 | 09/06→05/15 | OE177 | 0,9 | CET3 | | BAE408AE →12/11 |
| 1.4 TDI | 3 | BNM | 51/68 | 07/06→03/10 | CH181 | 11v | | | |
| 1.4 TDI | 3 | BNV | 59/79 | 09/06→03/10 | CH181 | 11v | | | |
| 1.4 TDI | 3 | BMS | 59/79 | 09/06→03/10 | CCGP002 | 7v | | | |
| 1.6 | 4 | BTS; CFNA | 77/103 | 09/06→05/15 | OE177 | 0,9 | CET3 | | BAE408AE →12/11 |
| 1.6 TDI | 4 | CAYB | 66/89 | 03/10→05/15 | | | | | CCU152 |
| 1.6 TDI | 4 | CAYC | 77/103 | 03/10→05/15 | | | | | CCU152 |
| 1.9 TDI | 4 | AXR | 74/99 | 03/06→05/06 | CH181 | 11v | | | |
| 1.9 TDI | 4 | BLS | 77/103 | 09/06→03/10 | CCGP002 | 7v | | | CCU152 |

SUPERB I

| | | | | | | | | | |
|---------|---|----------|---------|-------------|---------|-----|--------|-------|----------------------------------|
| 1.8 T | 4 | AWT | 110/148 | 12/01→03/08 | OE136 | 0,8 | CET12P | OE179 | BAEA043E |
| 1.9 TDI | 4 | AVB | 74/99 | 08/02→10/05 | CH181 | 11v | | | |
| 1.9 TDI | 4 | BSV | 77/103 | 10/05→05/07 | CCGP002 | 7v | | | CCU152 |
| 1.9 TDI | 4 | BPZ | 85/114 | 01/07→03/08 | CCGP002 | 7v | | | |
| 1.9 TDI | 4 | AVF; AWX | 96/129 | 12/01→03/08 | CH181 | 11v | | | |
| 2.0 | 4 | AZM | 85/114 | 12/01→03/08 | OE032 | 1,0 | CET2 | OE188 | BAE907AE ^[262] CLS017 |
| 2.0 TDI | 4 | BSS | 103/138 | 10/05→03/08 | CCGP002 | 7v | | | CCU152 |
| 2.5 TDI | 6 | AYM | 114/153 | 12/01→08/03 | CH215 | 12v | | | |
| 2.5 TDI | 6 | BDG | 120/161 | 06/03→03/08 | CH215 | 12v | | | |
| 2.8 V6 | 6 | BBG | 140/188 | 06/02→03/08 | OE237 | 1,6 | CET2 | OE179 | CLS046 |
| 2.8 V6 | 6 | AMX | 142/190 | 12/01→03/08 | OE237 | 1,6 | CET2 | OE179 | BAEA154E CLS046 |

SUPERB II

| | | | | | | | | | |
|----------------------|---|-----------|---------|-------------|---------|-----|--------|--|-----------------------------------|
| 1.4 TSI | 4 | CAXC | 92/123 | 07/08→05/15 | OE213 | 0,9 | | | BAE408AE |
| 1.6 TDI | 4 | CAYC | 77/103 | 09/10→05/15 | | | | | CCU152 |
| 1.8 TSI, 1.8 TSI 4WD | 4 | CDAB | 112/150 | 03/09→05/15 | OE214 | 0,7 | CET11P | | BAEA033E ^[7] |
| 1.8 TSI, 1.8 TSI 4WD | 4 | BZB; CDAA | 118/158 | 03/08→05/15 | OE214 | 0,7 | CET11P | | BAEA033E ^[7] 08/12→ |
| 1.9 TDI | 4 | BLS; BXE | 77/103 | 03/08→11/10 | | | | | CCU152 |
| 2.0 TDI | 4 | BMP | 103/138 | 03/08→05/10 | CCGP002 | 7v | | | CCU152 |

SKODA



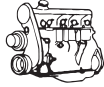

kW/BHP

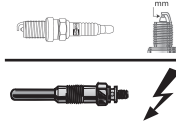

eon TITAN

IRIDIUM

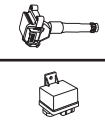
**...SKODA****...SUPERB II**

| | | | | | | | | | |
|------------------------------|---|------------|---------|---------------|-------|-----|--------|--|-------------------------|
| 2.0 TDI, 2.0 TDI 4WD | 4 | CBBB; CFGB | 125/168 | 07/08 → 05/15 | | | | | CCU152 |
| 2.0 TDI 16V | 4 | BKD | 103/138 | 01/09 → 05/15 | | | | | CCU152 |
| 2.0 TDI 16V, 2.0 TDI 16V 4WD | 4 | CFFB; CLJA | 103/138 | 01/09 → 05/15 | | | | | CCU152 |
| 2.0 TSI | 4 | CCZA | 147/197 | 05/10 → 05/15 | OE214 | 0,7 | CET11P | | |
| 3.6 FSI 4WD, 3.6 V6 4WD | 6 | CDVA | 191/256 | 11/08 → 05/15 | | | | | BAEA041E [277] [324] |

SUPERB III

| | | | | | | | | | |
|----------------------|---|------------------|---------|---------|---------|------|--|-------|--------------------|
| 1.4 TSI | 4 | CZCA | 92/123 | 03/15 → | OE244 | 0,8 | | | |
| 1.4 TSI, 1.4 TSI 4WD | 4 | CZDA; CZEZ | 110/148 | 03/15 → | OE244 | 0,8 | | | |
| 1.6 TDI | 4 | DCXA; DCZA | 88/118 | 03/15 → | CPSG007 | 4.4v | | | CCU151 |
| 1.8 TSI | 4 | CJSA; CJSC | 132/177 | 03/15 → | | | | OE246 | BAEA068E →01/16 |
| 2.0 TDI | 4 | CRGA | 130/174 | 03/15 → | CPSG007 | 4.4v | | | |
| 2.0 TDI, 2.0 TDI 4WD | 4 | CRLB; DFEA; DFGA | 110/148 | 03/15 → | CPSG007 | 4.4v | | | CCU151 |
| 2.0 TDI, 2.0 TDI 4WD | 4 | DDAA; DFCA | 140/188 | 03/15 → | CPSG007 | 4.4v | | | CCU151 |
| 2.0 TSI | 4 | CHHB | 162/217 | 03/15 → | | | | OE246 | BAEA068E →07/16 |
| 2.0 TSI 4WD | 4 | CJXA | 206/276 | 03/15 → | | | | | BAEA068E →07/16 |

YETI

| | | | | | | | | | |
|----------------------|---|------------------------------|---------|---------------|------------------------------|------|--------|-------|----------------------------------|
| 1.2 TSI | 4 | CBZB | 77/103 | 09/09 → 05/15 | | | | OE260 | BAE907AE ^[262] CLS090 |
| 1.2 TSI | 4 | CYVB | 81/109 | 05/15 → 12/17 | OE244 | 0,8 | | | |
| 1.4 TSI | 4 | CAXA | 90/121 | 06/10 → 05/15 | OE213 | 0,9 | | | BAE408AE |
| 1.4 TSI | 4 | CZCA | 92/123 | 05/15 → 12/17 | OE244 | 0,8 | | | |
| 1.4 TSI 4WD | 4 | CZDA | 110/148 | 05/15 → 12/17 | OE244 | 0,8 | | | |
| 1.6 | 4 | CWVA | 81/109 | 04/14 → 12/17 | OE247 | 1,0 | | | BAEA067E ^[240] |
| 1.6 TDI | 4 | CAYC | 77/103 | 11/10 → 05/15 | | | | | CCU152 |
| 1.8 TSI 4WD | 4 | CDAB | 112/150 | 11/09 → 12/17 | OE214 | 0,7 | CET11P | | BAEA033E ^[7] |
| 1.8 TSI 4WD | 4 | CDAZ | 118/158 | 05/09 → 12/17 | OE214 | 0,7 | CET11P | | BAEA033E ^[7] |
| 2.0 TDI, 2.0 TDI 4WD | 4 | CFHA; CFHF; CLCA; CUUA; DFSA | 81/109 | 11/09 → 12/17 | | | | | CCU152 |
| 2.0 TDI, 2.0 TDI 4WD | 4 | CUUB; DFSB | 110/148 | 05/15 → 12/17 | CPSG007 Prod.25.05.2015 → | 4.4v | | | CCU152 |
| 2.0 TDI, 2.0 TDI 4WD | 4 | CBDB; CFHC; CLCB | 103/138 | 05/09 → 12/17 | | | | | CCU152 |
| 2.0 TDI 4WD | 4 | CEGA; CFJA | 125/168 | 11/09 → 05/15 | | | | | CCU152 |

SKODA**FABIA I**

| | | | | | | | | | |
|---------|---|---------------|-------|---------------|-------|-----|--------|-------|---------------------------|
| 1.2 | 3 | AWY; BMD | 40/54 | 07/01 → 12/07 | OE177 | 0,9 | CET3 | | BAEA059E |
| 1.2 | 3 | AZQ; BME | 47/63 | 01/03 → 12/07 | OE177 | 0,9 | CET3 | | BAE408AE |
| 1.4 | 4 | AME; AQW; ATZ | 50/67 | 07/01 → 05/03 | OE145 | 0,8 | CET12P | OE182 | BAE961AE |
| 1.4 TDI | 3 | BNM | 51/68 | 10/05 → 12/07 | CH181 | 11v | | | CCU081 →Ch.6Y-64648255 |
| 1.9 SDI | 4 | ASY | 47/63 | 07/01 → 12/07 | CH271 | 11v | | | CCU081 →Ch.6Y-64648255 |

ROOMSTER Praktik

| | | | | | | | | | |
|---------|---|-----------|-------|---------------|---------|-----|------|-------|--|
| 1.2 | 3 | BZG; CGPA | 51/68 | 03/07 → 05/15 | OE177 | 0,9 | CET3 | | BAE408AE |
| 1.2 TDI | 3 | CFWA | 55/74 | 03/10 → 05/15 | | | | | CCU152 Prod.27.05.2013 → Prod.18.11.2013 |
| 1.2 TSI | 4 | CBZA | 63/84 | 03/10 → 05/15 | | | | OE260 | BAE907AE ^[262] CLS090 |
| 1.4 | 4 | BXW; CGGB | 63/84 | 03/07 → 05/15 | OE177 | 0,9 | CET3 | | BAE408AE →12/11 |
| 1.4 TDI | 3 | BNM | 51/68 | 03/07 → 03/10 | CH181 | 11v | | | |
| 1.4 TDI | 3 | BNV | 59/79 | 03/07 → 03/10 | CH181 | 11v | | | |
| 1.4 TDI | 3 | BMS | 59/79 | 03/07 → 03/10 | CCGP002 | 7v | | | |
| 1.6 TDI | 4 | CAYB | 66/89 | 03/10 → 05/15 | | | | | CCU152 |

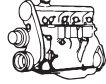

kW/BHP

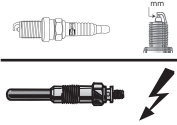

eon TITAN

IRIDIUM

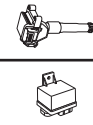
**SMART****CABRIO**

| | | | | | | | | | | |
|-----|---|-----------------------|-------|-------------|-------|-----|------|--|-------------------|--------|
| 0.6 | 3 | M160E6ALB03; M160.910 | 40/54 | 03/00→01/04 | OE217 | 0,6 | CET2 | | BAEA304 | CLS068 |
| 0.6 | 3 | M160E6ALB05; M160.910 | 45/60 | 01/01→01/04 | OE217 | 0,6 | CET2 | | BAEA304 →12/02 | CLS068 |
| 0.6 | 3 | M160.910 | 52/70 | 06/02→01/04 | OE217 | 0,6 | CET2 | | BAEA304 | CLS068 |
| 0.7 | 3 | M160.920 | 40/54 | 01/01→01/03 | OE217 | 0,6 | | | BAEA304 | |
| 0.7 | 3 | M160.920 | 45/60 | 01/03→01/04 | OE211 | 0,6 | | | BAEA304 | CLS068 |
| 0.7 | 3 | M160.920 | 55/74 | 01/03→01/04 | OE211 | 0,6 | | | BAEA304 | CLS068 |

CITY-COUPÉ

| | | | | | | | | | | |
|-----|---|-----------------------|-------|-------------|-------|-----|------|--|-------------------|------------------|
| 0.6 | 3 | M160E6ALB04; M160.910 | 33/44 | 07/98→01/04 | OE217 | 0,6 | CET2 | | BAEA304 | CLS068 |
| 0.6 | 3 | M160E6ALB03; M160.910 | 40/54 | 07/98→01/04 | OE217 | 0,6 | CET2 | | BAEA304 | CLS068 |
| 0.6 | 3 | M160E6ALB05; M160.910 | 45/60 | 01/01→01/04 | OE217 | 0,6 | CET2 | | BAEA304 →12/02 | CLS068 →12/02 |
| 0.6 | 3 | M160.910 | 52/70 | 06/02→01/04 | OE217 | 0,6 | CET2 | | BAEA304 | CLS068 |
| 0.7 | 3 | M160.920 | 33/44 | 07/98→01/04 | OE211 | 0,6 | | | BAEA304 | |
| 0.7 | 3 | M160.920 | 37/50 | 01/03→01/04 | OE211 | 0,6 | | | BAEA304 | CLS068 |
| 0.7 | 3 | M160.920 | 45/60 | 01/03→01/04 | OE211 | 0,6 | | | BAEA304 | CLS068 |
| 0.7 | 3 | M160.920 | 55/74 | 01/03→01/04 | OE211 | 0,6 | | | BAEA304 | CLS068 |

CROSSBLADE

| | | | | | | | | | | |
|-----|---|----------|-------|-------------|-------|-----|------|--|---------|--------|
| 0.6 | 3 | M160.910 | 52/70 | 06/02→12/03 | OE217 | 0,6 | CET2 | | | CLS068 |
| 0.6 | 3 | M160.920 | 52/70 | 06/02→12/03 | | | | | BAEA304 | |

FORFOUR

| | | | | | | | | | | |
|------------|---|-------------------|---------|-------------|-------|-----|------|-------|----------|--|
| 0.9 | 3 | H4B409; M281.910 | 66/89 | 11/14→ | | | | OE261 | BAEA131E | |
| 0.9 Brabus | 3 | M281.910 | 80/107 | 07/16→ | | | | OE261 | BAEA131E | |
| 1.0 | 3 | M281.920 | 45/60 | 11/14→ | OE130 | 0,9 | CET4 | | BAEA131E | |
| 1.0 | 3 | H4DA401; M281.920 | 52/70 | 07/14→ | OE130 | 0,9 | CET4 | | BAEA131E | |
| 1.1 | 3 | M134.911 | 47/63 | 02/05→06/06 | OE238 | 1,0 | | | | |
| 1.1 | 3 | M134.910 | 55/74 | 01/04→06/06 | OE238 | 1,0 | | | | |
| 1.3 | 4 | M135.930 | 70/94 | 01/04→06/06 | OE238 | 1,0 | | | | |
| 1.5 | 4 | M135.950 | 80/107 | 01/04→06/06 | OE238 | 1,0 | | | | |
| 1.5 | 4 | M135.950 | 90/121 | 01/04→06/06 | OE238 | 1,0 | | | | |
| 1.5 BRABUS | 4 | M122.950 | 130/174 | 05/05→06/06 | OE035 | 0,9 | CET5 | OE190 | | |

FORTWO

| | | | | | | | | | | |
|------------------|---|----------|--------|-------------|-------|-----|--------|-------|----------|--------|
| 0.6 | 3 | M160.910 | 45/60 | 01/04→02/07 | OE217 | 0,6 | CET2 | | | |
| 0.7 | 3 | M160.920 | 37/50 | 01/04→01/07 | OE211 | 0,6 | | | BAEA304 | CLS068 |
| 0.7 | 3 | M160.920 | 45/60 | 01/04→01/07 | OE211 | 0,6 | | | BAEA304 | CLS068 |
| 0.7 | 3 | M160.920 | 55/74 | 01/04→01/07 | OE211 | 0,6 | | | BAEA304 | CLS068 |
| 0.9 | 3 | M281.910 | 66/89 | 09/14→ | | | | OE261 | BAEA131E | |
| 0.9 Brabus | 3 | M281.910 | 80/107 | 07/16→ | | | | OE261 | BAEA131E | |
| 1.0 | 3 | M132.910 | 45/60 | 01/07→ | OE212 | 0,9 | CET15P | | | |
| 1.0 | 3 | M281.920 | 45/60 | 01/07→ | OE130 | 0,9 | CET4 | | BAEA131E | |
| 1.0 | 3 | M132.910 | 52/70 | 01/07→ | OE212 | 0,9 | CET15P | | | |
| 1.0 | 3 | M281.920 | 52/70 | 01/07→ | OE130 | 0,9 | CET4 | | BAEA131E | |
| 1.0 Brabus | 3 | M132.930 | 72/97 | 01/08→ | OE212 | 0,9 | CET15P | | | |
| 1.0 Brabus | 3 | M132.930 | 88/118 | 04/12→ | OE212 | 0,9 | CET15P | | | |
| 1.0 Turbo | 3 | M132.930 | 62/83 | 01/07→ | OE212 | 0,9 | CET15P | | | |
| 1.0 Turbo Brabus | 3 | M132.930 | 75/101 | 07/10→ | OE212 | 0,9 | CET15P | | | |

ROADSTER

| | | | | | | | | | | |
|------------|---|--------------------|-------|-------------|-------|-----|--|--|---------|--------|
| 0.7 | 3 | M160.921; M160.922 | 45/60 | 04/03→11/05 | OE211 | 0,6 | | | BAEA304 | CLS068 |
| 0.7 | 3 | M160.921; M160.922 | 60/80 | 04/03→11/05 | OE211 | 0,6 | | | BAEA304 | CLS068 |
| 0.7 Brabus | 3 | M160.923 | 74/99 | 12/03→11/05 | OE211 | 0,6 | | | BAEA304 | |

SMART





kW/BHP

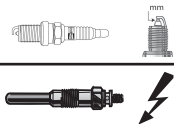

eon TITAN

IRIDIUM

**SSANGYONG****ACTYON I**

2.3, 2.3 4WD 4 G23D 110/148 11/06 →

BAEA340

KORANDO

2.0 4WD 4 E20 94/126 05/97 → 10/02

BAEA340
→ 10/01

2.3 4WD 4 ; M111.970 103/138 05/97 → 02/00

OE191

1,0

CET12P

OE180

BAEA340

2.3 4WD 4 105/141 01/99 → 11/06

BAEA340
→ 10/01

2.3 D 4WD 4 OM601.940 58/78 12/96 → 06/98

CH176

11.5v

2.9 D 4WD 5 MB-OM662 72/97 12/96 → 10/00

CH176

11.5v

2.9 D 4WD 5 MB-OM662 73/98 06/97 → 10/00

CH176

11.5v

2.9 TD 4WD 5 88/118 04/98 → 11/06

CH176

11.5v

3.2 4WD 6 M104.995 154/207 12/96 → 11/02

OE087

0,9

CET8

BAEA340

3.2 4WD 6 M104.995 156/209 01/99 → 11/02

OE005

0,9

CET2

OE179

BAEA340

KYRON

3.2 M320 4WD 6 G32D 162/217 03/08 →

OE057

0,9

CET2

OE180

BAEA340

MUSSO

2.0 4WD 4 E20 93/125 10/96 → 05/05

OE057

0,9

CET2

OE180

BAEA340

2.3 4WD 4 M111.970 103/138 10/96 → 11/02

OE003

0,9

CET2

OE180

BAEA340

CLS063
CLS071

2.3 4WD 4 110/148 04/03 → 08/06

BAEA340

2.3 D 4WD 4 OM661.940 58/78 03/93 → 04/97

CH176

11.5v

2.3 D 4WD 4 MB-OM661; OM601.940 59/79 10/95 → 04/99

CH176

11.5v

2.9 D 4WD 5 MB-OM662 73/98 03/96 → 11/98

CH176

11.5v

2.9 TD 4WD 5 88/118 04/98 → 09/07

CH176

11.5v

3.2 4WD 6 M104.992 162/217 06/96 → 09/04

OE016

0,9

CET2

OE180

BAEA340

REXTON

2.3 RX230 4WD 4 G23D 110/148 05/02 →

OE057

0,9

CET2

OE180

BAEA340

2.9 TD 4WD 5 88/118 04/02 →

CH176

11.5v

3.2 4WD 6 G32D 162/217 04/02 →

OE057

0,9

CET2

OE180

BAEA340

RODIUS

3.2, 3.2 4WD 6 G32D 162/217 05/05 →

OE057

0,9

CET2

OE180

BAEA340

SSANGYONG**ISTANA**

2.9 D 5 OM602.980 90/121 06/95 → 11/03

CH204 [285]
→ 03/00

Eng.137 →

CH204 [287]
→ 03/00

Eng.9850 →

11.5v

11.5v

SUBARU**FORESTER**

2.0 4WD 4 EJ202 90/121 08/97 → 09/02

OE063

1,0

CET2

OE180

BAEA191E

CLS170
→ 05/98
CLS192
06/98 →

2.0 4WD 4 EJ202 92/123 06/98 → 05/05

OE063

1,0

CET2

OE180

BAEA191E

CLS192

2.0 4WD 4 EJ201 92/123 06/98 → 05/05

OE063

1,0

CET2

OE180

BAEA191E

CLS080

2.0 4WD 4 EJ204 110/148 01/08 →

CET14P

OE190

2.0 X 4WD 4 EJ201; EJ204 116/156 06/05 → 05/08

OE136

0,8

CET12P

OE179

BAEA191E

CET14P

OE190

2.0 S Turbo 4WD 4 EJ205 125/168 06/98 → 04/01

OE136

0,8

CET12P

OE179

2.0 S Turbo 4WD 4 EJ205 130/174 04/01 → 05/05

OE136

0,8

CET12P

OE179

BAEA191E

CLS080

2.5 4WD 4 EJ25 126/169 01/09 →

CET14P

OE190

2.5 4WD 4 EJ25 155/208 12/03 → 05/05

OE146

1,0

CET12P

OE179

BAEA191E

CHAMPION



kW/BHP

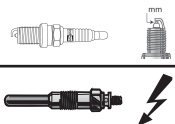

eon TITAN

IRIDIUM

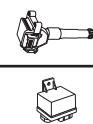
**...SUBARU****...FORESTER**

| | | | | | | | | | | |
|---------------------|---|-------|---------|---------------|--|--|--------|-------|----------|--|
| 2.5 4WD, 2.5 XT 4WD | 4 | EJ255 | 169/227 | 06/05 → 09/13 | | | CET14P | OE190 | | |
| 2.5 RX Nato 4WD | 4 | EJ25 | 115/154 | 11/02 → 12/08 | | | CET14P | OE190 | BAEA191E | |

IMPREZA

| | | | | | | | | | | |
|--|---|--------------------|---------|---------------|-------|-----|--------|-------|----------|--------|
| 1.5 4WD | 4 | EL15 | 77/103 | 05/06 → 03/07 | | | CET14P | OE190 | | |
| 1.5 4WD, 1.5 F | 4 | EL15 | 79/106 | 02/08 → | | | CET14P | OE190 | | |
| 1.6 4WD, 1.6 i, 1.6 i 4WD | 4 | EJ161 | 70/94 | 06/98 → 06/09 | OE063 | 1,0 | CET2 | OE180 | | |
| 2.0 4WD | 4 | EJ20E; EJ201 | 85/114 | 12/95 → 12/00 | OE136 | 0,8 | CET12P | OE179 | | |
| 2.0 4WD | 4 | EJ201 | 92/123 | 03/99 → 12/07 | OE063 | 1,0 | CET2 | OE180 | BAEA191E | CLS080 |
| 2.0 4WD | 4 | EJ205 | 184/247 | 10/05 → 03/07 | OE224 | 0,8 | CET14P | | BAEA191E | |
| 2.0 4WD | 4 | EJ20(Turbo) | 184/247 | 10/05 → 03/07 | OE224 | 0,8 | CET14P | | | |
| 2.0 4WD, 2.0 WRX STi 4WD | 4 | EJ205P; EJ207 | 206/276 | 09/98 → 12/08 | OE224 | 0,8 | CET14P | | | |
| 2.0 i | 4 | EJ201 | 92/123 | 09/98 → 09/00 | OE039 | 1,0 | CET2 | OE179 | BAEA191E | |
| 2.0 i 4WD | 4 | EJ20E; EJ201 | 85/114 | 10/95 → 12/00 | OE136 | 0,8 | CET12P | OE179 | | CLS170 |
| 2.0 i 4WD | 4 | EJ201 | 92/123 | 06/98 → 06/09 | OE063 | 1,0 | CET12P | OE179 | BAEA191E | CLS080 |
| | | | | | OE136 | 0,8 | CET2 | OE180 | | |
| 2.0 i 4WD, 2.0 R 4WD | 4 | EJ204 | 110/148 | 01/08 → | OE224 | 0,8 | CET14P | | | |
| 2.0 i 16V 4WD | 4 | EJ20E; EJ201 | 92/123 | 06/98 → 12/00 | OE136 | 0,8 | CET12P | OE179 | BAEA191E | |
| 2.0 i R 4WD | 4 | EJ204 | 118/158 | 09/05 → 06/07 | OE035 | 0,9 | CET14P | OE190 | BAEA191E | |
| | | | | | OE224 | 0,8 | CET5 | | | |
| 2.0 i Turbo 4WD, 2.0 Turbo 4WD, 2.0 Turbo GT 4WD | 4 | EJ20(Turbo); EJ20G | 155/208 | 03/94 → 12/00 | OE136 | 0,8 | CET12P | OE179 | | |
| 2.0 Turbo 4WD, 2.0 Turbo GT 4WD, 2.0 WRX Turbo 4WD | 4 | EJ205 | 160/215 | 06/98 → 12/05 | OE136 | 0,8 | CET12P | OE179 | | |
| 2.0 WRX STi 4WD | 4 | EJ207 | 195/261 | 11/01 → 07/05 | OE136 | 0,8 | CET12P | OE179 | | |
| 2.0 WRX STi 4WD | 4 | EJ207 | 235/315 | 02/04 → 07/05 | OE136 | 0,8 | CET12P | OE179 | | |
| 2.0 WRX Turbo 4WD | 4 | EJ205 | 165/221 | 12/02 → 03/07 | OE136 | 0,8 | CET12P | OE179 | | |
| 2.2 GX 4WD | 4 | EJ22E | 96/129 | 09/98 → 09/00 | | | | | BAEA191E | |
| 2.2 GX 4WD | 4 | EJ22 | 97/130 | 11/95 → 08/98 | | | | | BAEA191E | |
| 2.5 4WD | 4 | EJ251 | 130/174 | 03/01 → 09/05 | | | | | BAEA191E | |
| 2.5 4WD, 2.5 i WRX 4WD, 2.5 WRX 4WD | 4 | EJ255 | 169/227 | 09/05 → | OE224 | 0,8 | CET14P | | | |
| 2.5 4WD, 2.5 WRX STi 4WD | 4 | EJ257 | 221/296 | 10/05 → | OE224 | 0,8 | CET14P | | | |
| 2.5 i 4WD | 4 | EJ251 | 112/150 | 12/02 → 09/05 | | | | | BAEA191E | |
| 2.5 STi CS400 4WD | 4 | EJ257 | 294/394 | 04/10 → 08/13 | OE224 | 0,8 | CET14P | | | |
| 2.5 WRX STi 4WD | 4 | EJ257 | 206/276 | 09/05 → 12/07 | OE224 | 0,8 | CET14P | | | |

JUSTY II

| | | | | | | | | | | |
|------------|---|-------|-------|---------------|-------|-----|------|-------|--|--------|
| 1.3 4WD | 4 | G13BB | 63/84 | 04/01 → 11/03 | OE005 | 0,9 | CET2 | OE180 | | CLS026 |
| 1.3 GX 4WD | 4 | EF13 | 50/67 | 10/95 → 11/03 | OE006 | 0,9 | CET8 | OE195 | | |

JUSTY III

| | | | | | | | | | | |
|---------|---|------|-------|---------|--|--|--------|-------|----------|--|
| 1.3 4WD | 4 | M13A | 69/93 | 09/03 → | | | CET12P | OE179 | BAEA181E | |
| 1.5 4WD | 4 | M15A | 73/98 | 09/03 → | | | CET12P | OE179 | BAEA181E | |

JUSTY IV

| | | | | | | | | | | |
|-----|---|--------|-------|---------|--|--|--------|-------|----------|--|
| 1.0 | 3 | 1KR-FE | 51/68 | 01/07 → | | | CET14P | OE190 | BAEA164E | |
|-----|---|--------|-------|---------|--|--|--------|-------|----------|--|

LEGACY II

| | | | | | | | | | | |
|------------------|---|------------------------|---------|---------------|-------|-----|--------|-------|--|--|
| 2.0 i, 2.0 i 4WD | 4 | EJ20E; EJ20EMPI; EJ201 | 85/114 | 09/94 → 03/99 | OE063 | 1,0 | CET2 | OE180 | | |
| 2.2, 2.2 i 4WD | 4 | EJ22; EJ22EMPI | 94/126 | 02/94 → 03/99 | OE005 | 0,9 | CET2 | OE180 | | |
| 2.2 i 4WD | 4 | EJ22EMPI | 96/129 | 06/96 → 03/99 | OE005 | 0,9 | CET2 | OE180 | | |
| 2.5 i 4WD | 4 | EJ25D | 110/148 | 06/96 → 03/99 | OE146 | 1,0 | CET12P | OE179 | | |
| | | | | | | | | OE180 | | |

LEGACY III

| | | | | | | | | | | |
|---------|---|-------|---------|---------------|-------|-----|------|-------|----------|--------|
| 2.0 4WD | 4 | EJ201 | 92/123 | 12/98 → 08/03 | OE063 | 1,0 | CET2 | OE180 | BAEA191E | CLS080 |
| 2.5 4WD | 4 | EJ25 | 115/154 | 10/98 → 08/03 | OE063 | 1,0 | CET2 | OE180 | BAEA191E | CLS080 |

SUBARU



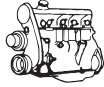

kW/BHP

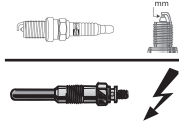

eon TITAN

IRIDIUM

**...SUBARU****LEGACY IV**

| | | | | | | | | | | |
|-----------|---|--------------|---------|-------------|--------------|-----|---------------|--------------|-----------------|--|
| 2.0 4WD | 4 | EJ202 | 101/135 | 09/03→10/05 | OE063 | 1,0 | CET2 | OE180 | | |
| 2.0 4WD | 4 | EJ20X; EJ204 | 121/162 | 06/05→04/09 | | | CET12P | OE180 | BAEA191E | |
| 2.0 4WD | 4 | EJ20Y | 132/177 | 06/05→04/09 | | | CET12P | OE180 | | |
| 2.0 4WD | 4 | EJ20Y | 140/188 | 06/05→04/09 | | | CET12P | OE180 | | |
| 2.0 R 4WD | 4 | EJ204 | 110/148 | 09/07→12/09 | OE224 | 0,8 | CET14P | | | |
| 2.5 4WD | 4 | EJ25 | 121/162 | 09/03→04/09 | OE146 | 1,0 | CET12P | OE179 | BAEA191E | |
| 2.5 i 4WD | 4 | EJ25 | 127/170 | 09/07→12/09 | | | CET12P | OE188 | | |
| 3.0 R 4WD | 6 | EZ30 | 180/241 | 09/03→06/09 | OE035 | 0,9 | CET5 | OE190 | | |

LEGACY V

| | | | | | | | | | | |
|------------|---|-------|---------|-------------|--------------|-----|---------------|--------------|--|--|
| 2.0 i 4WD | 4 | EJ204 | 110/148 | 09/09→12/14 | OE224 | 0,8 | CET14P | | | |
| 2.5 GT 4WD | 4 | EJ255 | 195/261 | 07/10→12/14 | | | CET14P | OE190 | | |
| 2.5 i 4WD | 4 | EJ253 | 123/165 | 09/09→12/14 | | | CET12P | OE180 | | |

LEGACY OUTBACK

| | | | | | | | | | | |
|------------|---|-------|---------|-------------|--------------|-----|---------------|--------------|-----------------|---------------|
| 2.5 4WD | 4 | EJ25D | 110/148 | 01/96→12/99 | OE063 | 1,0 | CET2 | OE180 | | |
| 2.0 4WD | 4 | EJ202 | 101/135 | 09/03→10/05 | | | CET12P | OE180 | | |
| 2.5 4WD | 4 | EJ25 | 115/154 | 10/00→08/03 | OE063 | 1,0 | CET2 | OE180 | BAEA191E | CLS080 |
| 2.5 4WD | 4 | EJ25D | 121/162 | 11/03→09/09 | OE146 | 1,0 | CET12P | OE179 | | |
| 2.5 4WD | 4 | EJ251 | 127/170 | 09/08→ | | | CET12P | OE188 | BAEA191E | |
| 2.5 i 4WD | 4 | EJ253 | 123/165 | 09/09→ | | | CET12P | OE180 | | |
| 3.0 4WD | 6 | EZ30 | 180/241 | 11/03→09/09 | OE035 | 0,9 | CET5 | OE190 | | |
| 3.0 H6 4WD | 6 | EZ30 | 154/207 | 10/00→08/03 | | | CET14P | OE190 | | |
| 3.6 R 4WD | 6 | EZ36D | 191/256 | 09/09→ | | | CET14P | OE190 | | |

SVX

| | | | | | | | | | | |
|---------------|---|----------|---------|-------------|--------------|-----|-------------|--------------|--|--|
| 3.3 i 24V 4WD | 6 | EG33DOHC | 162/217 | 09/94→12/97 | OE039 | 1,0 | CET2 | OE180 | | |
|---------------|---|----------|---------|-------------|--------------|-----|-------------|--------------|--|--|

TREZIA

| | | | | | | | | | | |
|-----|---|-----------------|-------|--------|--|--|--|--|-----------------|--|
| 1.3 | 4 | 1NR-FE; 1NR-FKE | 73/98 | 03/11→ | | | | | BAEA172E | |
|-----|---|-----------------|-------|--------|--|--|--|--|-----------------|--|

TRIBECA

| | | | | | | | | | | |
|---------|---|-------|---------|--------|--------------|-----|---------------|--------------|--|--|
| 3.0 4WD | 6 | EZ30 | 180/241 | 10/06→ | | | CET14P | OE190 | | |
| 3.0 4WD | 6 | EZ30 | 184/247 | 01/05→ | OE035 | 0,9 | CET5 | OE190 | | |
| 3.6 4WD | 6 | EZ36D | 190/255 | 09/07→ | | | CET14P | OE190 | | |

SUZUKI**ALTO (EF)**

| | | | | | | | | | | |
|-----|---|-------|-------|-------------|--------------|-----|-------------|--|--|--|
| 1.0 | 4 | G10BB | 39/52 | 09/94→09/98 | OE051 | 0,9 | CET8 | | | |
|-----|---|-------|-------|-------------|--------------|-----|-------------|--|--|--|

ALTO (FF)

| | | | | | | | | | | |
|-----|---|-------------|-------|-------------|------------------------------|------------|-------------|--------------|-----------------|---------------|
| 1.1 | 4 | F10D; F10DN | 46/62 | 09/04→12/08 | OE083 OE199 | 0,7 0,9 | CET1 | OE187 | BAEA181E | CLS026 |
|-----|---|-------------|-------|-------------|------------------------------|------------|-------------|--------------|-----------------|---------------|

ALTO (GF)

| | | | | | | | | | | |
|-----|---|------|-------|--------|--|------------|---------------|--|--|--|
| 1.0 | 3 | K10B | 50/67 | 01/09→ | OE226 OE230 LPG [278] | 1,1 0,9 | CET10P | | | |
|-----|---|------|-------|--------|--|------------|---------------|--|--|--|

ALTO (HA12, HA23)

| | | | | | | | | | | |
|-----|---|-------|-------|-------------|--------------|-----|-------------|--------------|--|--|
| 1.0 | 4 | G10BB | 43/58 | 01/00→06/02 | OE005 | 0,9 | CET2 | OE180 | | |
|-----|---|-------|-------|-------------|--------------|-----|-------------|--------------|--|--|

BALENO /Estate/Hatchback (EG)

| | | | | | | | | | | |
|--------------------------|---|------------------------------|--------|-------------|--------------|-----|-------------|--------------|-----------------|--|
| 1.3 | 4 | G13BA | 52/70 | 09/96→05/02 | OE005 | 0,9 | CET2 | OE180 | BAEA181E | |
| 1.3 16V, 1.3 i 16V | 4 | G13BB | 63/84 | 07/95→05/02 | OE005 | 0,9 | CET2 | OE180 | BAEA181E | |
| 1.6 i 16V, 1.6 i 16V 4WD | 4 | G16B | 72/97 | 07/95→05/02 | OE005 | 0,9 | CET2 | OE180 | BAEA181E | |
| 1.6 i 16V, 1.6 i 16V 4WD | 4 | G16B | 73/98 | 08/96→05/02 | OE005 | 0,9 | CET2 | OE180 | BAEA181E | |
| 1.8 GTX, 1.8 i 16V | 4 | J18A | 89/119 | 03/96→05/02 | OE039 | 1,0 | CET2 | OE180 | BAEA072E | |
| 1.9 TD | 4 | DHV(XUD9BSD); DHW(XUD9SD) | 55/74 | 04/98→05/02 | CH189 | 11v | | | | |

GRAND VITARA I (FT, HT)

| | | | | | | | | | | |
|---------|---|------|-------|-------------|--|--|---------------|--------------|-----------------|---------------|
| 1.6 4WD | 4 | G16B | 69/93 | 03/98→07/03 | | | CET12P | OE179 | BAEA136E | CLS026 |
|---------|---|------|-------|-------------|--|--|---------------|--------------|-----------------|---------------|





kW/BHP

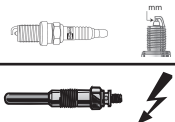

eon TITAN

IRIDIUM

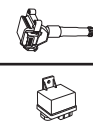
**...SUZUKI****...GRAND VITARA I (FT, HT)**

| | | | | | | | | | | |
|--------------------------------------|---|----------|---------|-------------|------------------------|-----|--------|-------|----------|--------|
| 1.6 4WD | 4 | G16B | 73/98 | 02/00→09/02 | OE039 | 1,0 | CET2 | | BAEA136E | CLS026 |
| 2.0 4WD | 4 | J20A | 94/126 | 03/98→07/03 | | | CET12P | OE179 | BAEA072E | |
| 2.0 4WD | 4 | J20A | 103/138 | 04/98→08/05 | | | | | BAEA072E | |
| 2.0 HDI 110 4WD, 2.0 HDI 110 16V 4WD | 4 | RHW; RHZ | 80/107 | 07/01→09/05 | CH170 ^[275] | 11v | | | | |
| | | | | | CH268 ^[275] | 11v | | | | |
| 2.0 TD 4WD | 4 | RFM | 63/84 | 04/00→09/05 | CH242 | 11v | | | | |
| 2.0 TD 4WD | 4 | RF | 64/86 | 03/98→07/03 | CH242 | 11v | | | | |
| 2.5 V6 24V 4WD | 6 | H25A | 106/142 | 04/98→07/03 | | | CET12P | OE179 | BAEA072E | |
| 2.5 V6 24V 4WD | 6 | H25A | 116/156 | 04/01→07/03 | | | CET12P | OE180 | BAEA072E | |
| 2.7 | 6 | H27A | 135/181 | 09/03→08/06 | | | CET12P | OE180 | | |
| 2.7 4WD | 6 | H27A | 127/170 | 09/01→07/03 | | | CET12P | OE180 | BAEA072E | |
| 2.7 4WD | 6 | H27A | 135/181 | 04/03→07/03 | | | CET12P | OE180 | BAEA072E | |

GRAND VITARA II (JT)

| | | | | | | | | | | |
|---------|---|------|-------|-------------|-------|-----|------|-------|----------|--------|
| 1.6 4WD | 4 | M16A | 73/98 | 09/05→02/15 | OE016 | 0,9 | CET2 | OE180 | BAEA181E | CLS167 |
|---------|---|------|-------|-------------|-------|-----|------|-------|----------|--------|

GRAND VITARA II (JT, TE, TD)

| | | | | | | | | | | |
|---------|---|------|---------|-------------|-------|-----|--------|-------|----------|--------|
| 1.6 4WD | 4 | M16A | 78/105 | 04/05→ | OE016 | 0,9 | CET2 | OE180 | BAEA181E | CLS167 |
| 2.0 4WD | 4 | J20A | 103/138 | 10/05→02/15 | OE191 | 1,0 | CET12P | OE180 | BAEA072E | |
| 2.4 4WD | 4 | J24B | 122/164 | 01/09→ | OE175 | 1,0 | CET14P | OE190 | | |
| 2.4 4WD | 4 | J24B | 124/166 | 01/09→ | OE175 | 1,0 | CET14P | OE190 | | |
| 3.2 4WD | 6 | N32A | 171/229 | 01/09→02/15 | | | CET17P | OE189 | | |

IGNIS I (FH)

| | | | | | | | | | | |
|--------------|---|------|-------|-------------|--|--|--------|-------|----------|--------|
| 1.3, 1.3 4WD | 4 | M13A | 61/82 | 10/00→09/03 | | | CET12P | OE180 | BAEA181E | CLS167 |
|--------------|---|------|-------|-------------|--|--|--------|-------|----------|--------|

IGNIS II (MH)

| | | | | | | | | | | |
|--------------|---|------|--------|--------|-------|-----|--------|-------|----------|--------|
| 1.3 | 4 | M13A | 69/93 | 09/03→ | | | CET12P | OE179 | BAEA181E | CLS167 |
| 1.3 4WD | 4 | M13A | 69/93 | 09/03→ | OE136 | 0,8 | CET12P | OE179 | BAEA181E | CLS167 |
| 1.5, 1.5 4WD | 4 | M15A | 73/98 | 09/03→ | | | CET12P | OE179 | BAEA181E | CLS167 |
| 1.5 Sport | 4 | M15A | 80/107 | 12/03→ | | | CET12P | OE179 | BAEA181E | CLS167 |

JIMNY (FJ)

| | | | | | | | | | | |
|---------|---|-------|-------|-------------|-------|-----|------|-------|----------|--------|
| 1.0 4WD | 4 | F10AC | 39/52 | 09/98→10/03 | OE006 | 0,9 | CET8 | OE195 | | |
| 1.3 4WD | 4 | M13A | 65/87 | 09/00→08/02 | OE005 | 0,9 | CET2 | OE180 | BAEA136E | CLS167 |

JIMNY Closed Off-Road Vehicle (SN)

| | | | | | | | | | | |
|----------------------|---|--------|-------|-------------|-------|-----|------|-------|---|--------|
| 1.3 | 4 | M13A | 63/84 | 08/04→ | OE039 | 1,0 | | | BAEA136E ^[275] →Ch.00200000 | |
| 1.3 4WD | 4 | G13BB | 63/84 | 09/98→08/00 | OE005 | 0,9 | CET2 | OE180 | BAEA136E | CLS026 |
| 1.3 16V, 1.3 16V 4WD | 4 | G13BB | 59/79 | 09/98→ | OE005 | 0,9 | CET2 | OE180 | BAEA136E | CLS026 |
| 1.3 16V, 1.3 16V 4WD | 4 | M13A | 60/80 | 02/01→ | OE005 | 0,9 | CET2 | OE180 | BAEA136E | CLS167 |
| 1.3 16V 4WD | 4 | M13A | 63/84 | 08/05→ | OE005 | 0,9 | CET2 | OE180 | BAEA136E | CLS167 |
| 1.5 DDiS 4WD | 4 | K9K700 | 48/64 | 12/03→ | CH271 | 11v | | | | |
| 1.5 DDiS 4WD | 4 | K9K266 | 63/84 | 08/05→ | CH271 | 11v | | | | |

KIZASHI (FR)

| | | | | | | | | | | |
|--------------|---|------|---------|--------|-------|-----|--------|-------|--|--|
| 2.4, 2.4 4WD | 4 | J24B | 131/176 | 10/10→ | OE175 | 1,0 | CET14P | OE190 | | |
| 2.4, 2.4 4WD | 4 | J24B | 138/185 | 04/12→ | OE175 | 1,0 | CET14P | OE190 | | |

LIANA Hatchback

| | | | | | | | | | | |
|----------------|---|------|--------|-------------|-------|-----|--------|-------|----------|--------|
| 1.3 | 4 | M13A | 66/89 | 07/01→12/07 | | | CET2 | OE179 | BAEA181E | CLS167 |
| 1.6 | 4 | M16A | 79/106 | 01/05→12/07 | OE016 | 0,9 | CET2 | OE180 | BAEA181E | CLS167 |
| 1.6, 1.6 4WD | 4 | M16A | 76/102 | 07/01→12/07 | | | CET2 | OE179 | BAEA181E | CLS167 |
| 1.6 4WD | 4 | M16A | 79/106 | 01/05→12/07 | OE136 | 0,8 | CET12P | OE179 | BAEA181E | CLS167 |
| 1.6 4WD, 1.6 i | 4 | M16A | 78/105 | 04/02→12/07 | | | CET2 | OE179 | BAEA181E | CLS167 |

LIANA Estate (ER)

| | | | | | | | | | | |
|-------|---|------|--------|-------------|-------|-----|------|-------|--|--|
| 1.8 i | 4 | M18A | 92/123 | 10/01→12/07 | OE014 | 0,9 | CET2 | OE179 | | |
|-------|---|------|--------|-------------|-------|-----|------|-------|--|--|

SUZUKI





kW/BHP

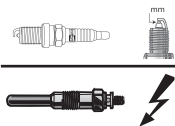

eon TITAN

IRIDIUM



...SUZUKI

LIANA (ER, RH)

| | | | | | | | | | | |
|----------------|---|------|--------|--------|-------|-----|------|-------|----------|--------|
| 1.3 | 4 | M13A | 66/89 | 03/02→ | | | CET2 | OE179 | BAEA181E | CLS167 |
| 1.6, 1.6 4WD | 4 | M16A | 76/102 | 03/02→ | | | CET2 | OE179 | BAEA181E | CLS167 |
| 1.6, 1.6 4WD | 4 | M16A | 79/106 | 01/05→ | OE016 | 0,9 | CET2 | OE180 | BAEA181E | CLS167 |
| 1.6 4WD, 1.6 i | 4 | M16A | 78/105 | 04/02→ | | | CET2 | OE179 | BAEA181E | CLS167 |

SAMURAI Closed Off-Road Vehicle (SJ)

| | | | | | | | | | | |
|------------|---|-------|-------|-------------|-------|-----|------|--|--|--|
| 1.3 4WD | 4 | G13BA | 59/79 | 01/00→12/04 | OE051 | 0,9 | CET8 | | | |
| 1.9 TD 4WD | 4 | XUD9 | 46/62 | 11/98→12/04 | CH189 | 11v | | | | |

SPLASH (EX)

| | | | | | | | | | | |
|---------|---|------|-------|--------|-----------------|-----|--------|--|----------|--|
| 1.0 | 3 | K10B | 48/64 | 01/08→ | OE226 | 1,1 | CET10P | | | |
| | | | | | OE230 LPG [278] | 0,9 | | | | |
| 1.0 | 3 | K10B | 50/67 | 06/11→ | OE226 | 1,1 | CET10P | | BAEA189E | |
| | | | | | OE230 LPG [278] | 0,9 | | | | |
| 1.2 | 4 | K12B | 63/84 | 01/08→ | OE226 | 1,1 | CET10P | | BAEA189E | |
| | | | | | OE230 LPG [278] | 0,9 | | | | |
| 1.2 VVT | 4 | K12B | 66/89 | 06/11→ | OE226 | 1,1 | CET10P | | BAEA189E | |
| | | | | | OE230 LPG [278] | 0,9 | | | | |
| 1.2 VVT | 4 | K12B | 69/93 | 09/10→ | OE226 | 1,1 | CET10P | | BAEA189E | |
| | | | | | OE230 LPG [278] | 0,9 | | | | |

SWIFT II Hatchback (EA, MA)

| | | | | | | | | | | |
|-------|---|-------|-------|-------------|-------|-----|------|-------|--|--|
| 1.0 i | 3 | G10A | 39/52 | 01/95→12/05 | OE006 | 0,9 | CET8 | OE195 | | |
| 1.3 | 4 | G13BB | 63/84 | 06/01→12/03 | | | CET8 | OE195 | | |

SWIFT III (MZ, EZ)

| | | | | | | | | | | |
|---------|---|------|--------|--------|-------|-----|--------|-------|----------|--------|
| 1.3 | 4 | M13A | 68/91 | 02/05→ | | | CET12P | OE179 | BAEA181E | CLS167 |
| 1.3 4WD | 4 | M13A | 66/89 | 01/06→ | | | CET12P | OE179 | BAEA181E | CLS167 |
| 1.3 4WD | 4 | M13A | 68/91 | 02/05→ | OE136 | 0,8 | CET12P | OE179 | BAEA181E | CLS167 |
| 1.5 | 4 | M15A | 75/101 | 02/05→ | | | CET12P | OE179 | BAEA181E | CLS167 |
| 1.5 4WD | 4 | M15A | 74/99 | 02/05→ | OE136 | 0,8 | CET12P | OE179 | BAEA181E | CLS167 |
| 1.6 | 4 | M16A | 92/123 | 05/06→ | | | CET12P | OE179 | BAEA181E | CLS167 |

SWIFT IV (FZ, NZ)

| | | | | | | | | | | |
|--------------|---|------|---------|--------|-----------------|-----|--------|-------|----------|--|
| 1.2, 1.2 4WD | 4 | K12B | 66/89 | 10/10→ | OE226 | 1,1 | CET10P | | | |
| | | | | | OE230 LPG [278] | 0,9 | | | | |
| 1.2, 1.2 4WD | 4 | K12B | 69/93 | 10/10→ | OE226 | 1,1 | CET10P | | BAEA189E | |
| | | | | | OE230 LPG [278] | 0,9 | | | | |
| 1.6 | 4 | M16A | 100/134 | 01/12→ | OE175 | 1,0 | CET14P | OE190 | BAEA181E | |

SX4 (EY, GY)

| | | | | | | | | | | |
|------------------------|---|-------|---------|-------------|-------|-----|--------|-------|----------|--------|
| 1.5 | 4 | M15A | 73/98 | 06/06→07/10 | OE016 | 0,9 | CET2 | OE180 | BAEA181E | CLS167 |
| 1.5 VVT | 4 | M15A | 82/110 | 07/10→ | OE016 | 0,9 | CET2 | OE180 | BAEA181E | CLS167 |
| 1.5 VVT 4WD | 4 | M15A | 82/110 | 07/10→ | | | | | BAEA181E | CLS167 |
| 1.6 DDIS | 4 | 9HX | 66/89 | 04/07→ | CH201 | 11v | | | | |
| 1.6 VVT, 1.6 VVT 4WD | 4 | M16A | 79/106 | 06/06→ | OE016 | 0,9 | CET2 | OE180 | BAEA181E | CLS167 |
| 1.6 VVT, 1.6 VVT 4WD | 4 | M16A | 88/118 | 07/09→ | OE016 | 0,9 | CET2 | OE180 | BAEA181E | CLS167 |
| 1.6 VVT 4WD | 4 | M16A | 82/110 | 07/09→ | OE016 | 0,9 | CET2 | OE180 | BAEA181E | CLS167 |
| 1.9 DDIS, 1.9 DDIS 4WD | 4 | D19AA | 88/118 | 06/06→ | CH222 | 11v | | | | |
| 2.0, 2.0 4WD | 4 | J20A | 107/143 | 06/06→ | OE175 | 1,0 | CET14P | OE190 | | |

SX4 /Saloon (GY)

| | | | | | | | | | | |
|-----|---|------|--------|--------|-------|-----|------|-------|----------|--------|
| 1.6 | 4 | M16A | 74/99 | 06/06→ | OE016 | 0,9 | CET2 | OE180 | BAEA181E | CLS167 |
| 1.6 | 4 | M16A | 88/118 | 10/07→ | OE016 | 0,9 | CET2 | OE180 | BAEA181E | CLS167 |

SX4 Saloon (GY)

| | | | | | | | | | | |
|-----|---|------|--------|--------|-------|-----|------|--|----------|--------|
| 1.6 | 4 | M16A | 79/106 | 10/07→ | OE016 | 0,9 | CET2 | | BAEA181E | CLS167 |
|-----|---|------|--------|--------|-------|-----|------|--|----------|--------|

SX4 S-Cross (JY)

| | | | | | | | | | | |
|--------------|---|------|--------|--------|-------|-----|------|-------|----------|--------|
| 1.6, 1.6 4WD | 4 | M16A | 86/115 | 12/13→ | OE016 | 0,9 | CET2 | OE180 | BAEA181E | CLS167 |
|--------------|---|------|--------|--------|-------|-----|------|-------|----------|--------|

CHAMPION

SUZUKI



kW/BHP

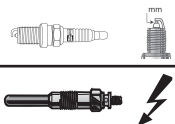

eon TITAN

IRIDIUM

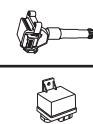
**...SUZUKI****...SX4 S-Cross (JY)**

| | | | | | | | | | | |
|--------------|---|------|--------|--------|-------|-----|------|-------|----------|--------|
| 1.6, 1.6 4WD | 4 | M16A | 88/118 | 08/13→ | OE016 | 0,9 | CET2 | OE180 | BAEA181E | CLS167 |
|--------------|---|------|--------|--------|-------|-----|------|-------|----------|--------|

VITARA (ET, TA)

| | | | | | | | | | | |
|------------|---|----|-------|-------------|-------|-----|--|--|--|--|
| 2.0 TD 4WD | 4 | RF | 52/70 | 12/94→03/98 | CH242 | 11v | | | | |
|------------|---|----|-------|-------------|-------|-----|--|--|--|--|

| | | | | | | | | | | |
|------------------------|---|----|-------|-------------|-------|-----|--|--|--|--|
| 2.0 TD Intercooler 4WD | 4 | RF | 64/86 | 12/95→03/98 | CH242 | 11v | | | | |
|------------------------|---|----|-------|-------------|-------|-----|--|--|--|--|

| | | | | | | | | | | |
|----------------|---|------|---------|-------------|-------|-----|------|-------|----------|--|
| 2.5 V6 24V 4WD | 6 | H25A | 118/158 | 12/95→03/98 | OE005 | 0,9 | CET2 | OE179 | BAEA072E | |
|----------------|---|------|---------|-------------|-------|-----|------|-------|----------|--|

VITARA /Cabrio (ET, TA)

| | | | | | | | | | | |
|-----------|---|-------|-------|-------------|-------|-----|--|--|--|--|
| 1.9 D 4WD | 4 | XUD9A | 50/67 | 01/95→03/98 | CH189 | 11v | | | | |
|-----------|---|-------|-------|-------------|-------|-----|--|--|--|--|

| | | | | | | | | | | |
|-----------|---|--------|-------|-------------|-------|-----|--|--|--|--|
| 1.9 D 4WD | 4 | XUD9SD | 55/74 | 08/96→03/99 | CH189 | 11v | | | | |
|-----------|---|--------|-------|-------------|-------|-----|--|--|--|--|

| | | | | | | | | | | |
|-------------|---|------|--------|-------------|-------|-----|------|-------|----------|--|
| 2.0 16V 4WD | 4 | J20A | 97/130 | 12/96→03/99 | OE005 | 0,9 | CET2 | OE180 | BAEA072E | |
|-------------|---|------|--------|-------------|-------|-----|------|-------|----------|--|

| | | | | | | | | | | |
|----------------|---|------|---------|-------------|-------|-----|------|-------|----------|--|
| 2.0 V6 24V 4WD | 6 | H20A | 100/134 | 12/94→03/98 | OE005 | 0,9 | CET2 | OE180 | BAEA072E | |
|----------------|---|------|---------|-------------|-------|-----|------|-------|----------|--|

WAGON R+ Hatchback (EM)

| | | | | | | | | | | |
|-----|---|------|-------|-------------|-------|-----|------|-------|--|--|
| 1.0 | 4 | K10A | 48/64 | 02/98→05/00 | OE083 | 0,7 | CET1 | OE187 | | |
|-----|---|------|-------|-------------|-------|-----|------|-------|--|--|

| | | | | | | | | | | |
|--------------|---|------|-------|-------------|-------|-----|------|-------|--|--|
| 1.2, 1.2 4WD | 4 | K12A | 51/68 | 02/98→05/00 | OE083 | 0,7 | CET1 | OE187 | | |
|--------------|---|------|-------|-------------|-------|-----|------|-------|--|--|

WAGON R+ (MM)

| | | | | | | | | | | |
|-----|---|------|-------|-------------|-------|-----|------|-------|--|--|
| 1.0 | 4 | K10A | 51/68 | 08/00→07/03 | OE083 | 0,7 | CET1 | OE187 | | |
|-----|---|------|-------|-------------|-------|-----|------|-------|--|--|

| | | | | | | | | | | |
|-----|---|------|-------|--------|-------|-----|--------|-------|--|--|
| 1.3 | 4 | M13A | 65/87 | 08/01→ | OE136 | 0,8 | CET12P | OE179 | | |
|-----|---|------|-------|--------|-------|-----|--------|-------|--|--|

WAGON R+ Hatchback (MM)

| | | | | | | | | | | |
|-----|---|------|-------|--------|--|--|--------|-------|----------|--------|
| 1.3 | 4 | M13A | 69/93 | 09/03→ | | | CET12P | OE179 | BAEA181E | CLS167 |
|-----|---|------|-------|--------|--|--|--------|-------|----------|--------|

| | | | | | | | | | | |
|--------------|---|-------|-------|--------|-------|-----|------|-------|----------|--------|
| 1.3, 1.3 4WD | 4 | G13BB | 56/75 | 05/00→ | OE005 | 0,9 | CET2 | OE180 | BAEA181E | CLS026 |
|--------------|---|-------|-------|--------|-------|-----|------|-------|----------|--------|

| | | | | | | | | | | |
|---------|---|------|-------|--------|-------|-----|--------|-------|----------|--------|
| 1.3 4WD | 4 | M13A | 69/93 | 09/03→ | OE136 | 0,8 | CET12P | OE179 | BAEA181E | CLS167 |
|---------|---|------|-------|--------|-------|-----|--------|-------|----------|--------|

WAGON R Hatchback

| | | | | | | | | | | |
|-----|---|------|-------|-------------|-------|-----|------|-------|--|--|
| 1.0 | 3 | G10A | 39/52 | 07/03→08/05 | OE006 | 0,9 | CET8 | OE195 | | |
|-----|---|------|-------|-------------|-------|-----|------|-------|--|--|

| | | | | | | | | | | |
|-----|---|--------|-------|-------------|-------|-----|------|-------|--|--|
| 1.0 | 3 | Z10XEP | 44/59 | 06/04→08/05 | OE198 | 0,9 | CET2 | OE184 | | |
|-----|---|--------|-------|-------------|-------|-----|------|-------|--|--|

| | | | | | | | | | | |
|-----|---|--------|-------|-------------|-------|-----|------|-------|---------|--|
| 1.2 | 4 | Z12XEP | 59/79 | 06/04→08/05 | OE198 | 0,9 | CET2 | OE184 | BAEA338 | |
|-----|---|--------|-------|-------------|-------|-----|------|-------|---------|--|

X-90 (EL)

| | | | | | | | | | | |
|--------------------------|---|------|-------|-------------|--|--|--------|-------|--|--------|
| 1.6 i 16V, 1.6 i 16V 4WD | 4 | G16B | 71/95 | 09/95→12/97 | | | CET12P | OE179 | | CLS230 |
|--------------------------|---|------|-------|-------------|--|--|--------|-------|--|--------|

SUZUKI**CARRY Box (FD)**

| | | | | | | | | | | |
|---------------|---|-------|-------|--------|-------|-----|------|-------|----------|--|
| 1.3, 1.3 16 V | 4 | G13BB | 58/78 | 03/99→ | OE005 | 0,9 | CET2 | OE180 | BAEA181E | |
|---------------|---|-------|-------|--------|-------|-----|------|-------|----------|--|

| | | | | | | | | | | |
|---------|---|-------|-------|-------------|-------|-----|------|-------|--|--|
| 1.3 4WD | 4 | G13BB | 56/75 | 02/99→09/04 | OE005 | 0,9 | CET2 | OE180 | | |
|---------|---|-------|-------|-------------|-------|-----|------|-------|--|--|

SUPER CARRY Bus (ED)

| | | | | | | | | | | |
|-----|---|------|-------|-------------|-------|-----|------|-------|--|--------|
| 1.0 | 4 | F10A | 30/40 | 09/94→03/99 | OE006 | 0,9 | CET8 | OE195 | | CLS225 |
|-----|---|------|-------|-------------|-------|-----|------|-------|--|--------|

TATA**INDICA**

| | | | | | | | | | | |
|-------|---|-------|-------|--------|-------|-----|--|--|--|--|
| 1.4 D | 4 | 475DL | 39/52 | 10/98→ | CH185 | 11v | | | | |
|-------|---|-------|-------|--------|-------|-----|--|--|--|--|

| | | | | | | | | | | |
|-------|---|-------|-------|--------|-------|-----|------|-------|--|--|
| 1.4 i | 4 | 475Si | 55/74 | 10/98→ | OE005 | 0,9 | CET2 | OE179 | | |
|-------|---|-------|-------|--------|-------|-----|------|-------|--|--|

| | | | | | | | | | | |
|-------|---|--|-------|-------------|-------|-----|------|-------|--|--|
| 1.4 L | 4 | | 44/59 | 06/98→09/02 | OE005 | 0,9 | CET2 | OE179 | | |
|-------|---|--|-------|-------------|-------|-----|------|-------|--|--|

INDIGO

| | | | | | | | | | | |
|-----|---|-------|-------|--------|-------|-----|------|-------|--|--|
| 1.4 | 4 | 475Si | 62/83 | 01/03→ | OE005 | 0,9 | CET2 | OE179 | | |
|-----|---|-------|-------|--------|-------|-----|------|-------|--|--|

LOADBETA

| | | | | | | | | | | |
|-------|---|---------|-------|-------------|-------|-----|--|--|--|--|
| 1.9 D | 4 | 483DL45 | 50/67 | 08/94→12/06 | CH189 | 11v | | | | |
|-------|---|---------|-------|-------------|-------|-----|--|--|--|--|

| | | | | | | | | | | |
|------------------|---|-------|-------|-------------|-------|-----|--|--|--|--|
| 1.9 D, 1.9 D 4WD | 4 | 483DL | 66/89 | 11/95→12/06 | CH189 | 11v | | | | |
|------------------|---|-------|-------|-------------|-------|-----|--|--|--|--|

SAFARI

| | | | | | | | | | | |
|-------------|---|-------|---------|--------|-------|-----|------|-------|--|--|
| 2.0 16V 4WD | 4 | 483PL | 101/135 | 06/99→ | OE005 | 0,9 | CET2 | OE179 | | |
|-------------|---|-------|---------|--------|-------|-----|------|-------|--|--|

TOFAS**DOGAN**

| | | | | | | | | | | |
|---------|---|--|-------|-------------|-------|-----|------|-------|--|--|
| 1.6 i.e | 4 | | 61/82 | 01/99→12/02 | OE018 | 1,0 | CET8 | OE195 | | |
|---------|---|--|-------|-------------|-------|-----|------|-------|--|--|

| | | | | | | | | | | |
|--------|---|--|-------|-------------|-------|-----|------|-------|--|--|
| 1.6 IE | 4 | | 66/89 | 01/97→07/02 | OE018 | 1,0 | CET8 | OE195 | | |
|--------|---|--|-------|-------------|-------|-----|------|-------|--|--|

TOFAS



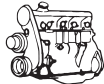

kW/BHP



eon TITAN

IRIDIUM

**...TOFAS****KARTAL**

1.6 IE 4 66/89 01/97→07/02 OE018 1,0 CET8 OE195

SAHIN

1.6 IE 4 63/84 01/97→07/02 OE018 1,0 CET8 OE195

TOYOTA**4 RUNNER**

2.7, 2.7 4WD 4 3RZ-FE 112/150 11/95→08/02 OE039 1,0 CET2

3.0 Turbo-D 4WD 4 1KZ-T 92/123 10/93→11/02 CH608 11v

3.4 6 5VZ-FE 136/182 11/95→07/02 OE019 0,9 CET2

ALLION I

1.5 4 1NZ-FE 80/107 06/01→04/05 OE093 1,0 CET2 OE182

1.8, 1.8 4WD 4 1ZZ-FE 97/130 06/01→06/07 OE093 1,0 CET2 OE182

2.0, 2.0 4WD 4 1AZ-FSE 114/153 06/01→06/07 CET12P OE182

ALLION II

1.5 4 1NZ-FE 81/109 07/07→11/12 CET14P OE190 BAEA167E

1.8 4 2ZR-FAE 106/142 07/07→ BAEA184E

1.8 4WD 4 2ZR-FAE 98/131 07/07→ BAEA184E

2.0 4 3ZR-FAE 116/156 07/07→ BAEA184E

ALPHARD

2.4, 2.4 4WD 4 2AZ-FE 117/157 09/03→04/08 CET12P OE182

3.0, 3.0 4WD 6 1MZ-FE 162/217 04/03→04/08 CET12P OE182

ALPHARD / VELLFIRE

2.4, 2.4 4WD 4 2AZ-FE 125/168 04/08→12/14 CET12P OE182

3.5 6 2GR-FE 202/271 04/08→ CET14P OE190

3.5, 3.5 4WD 6 2GR-FE 206/276 04/08→ CET14P OE190

ALTEZZA

2.0 6 1G-FE; 1G-GE 114/153 01/99→07/05 CET12P OE182

2.0 VVTi 4 3S-GE 147/197 02/99→07/05 OE136 0,8 CET12P

2.0 VVTi 6 1G-FE 118/158 01/99→07/05 CET12P OE182

3.0 6 2JZ-GE 157/211 07/01→07/05 OE191 1,0 CET12P OE180

ALTEZZA GITA

2.0, 2.0 4WD 6 1G-FE; 1G-GE 114/153 01/99→06/01 CET12P OE182

3.0 6 2JZ-GE 157/211 07/01→06/05 OE191 1,0 CET12P OE180

AQUA

1.5 Hybrid 4 1NZ-FXE 54/72 12/11→ CET12P

ARISTO

3.0 6 2JZ-GE 170/228 08/97→09/04 OE191 1,0 CET12P OE180

3.0 6 2JZ-GTE 206/276 08/97→09/04 OE136 0,8 CET12P

ASCENT

1.8 4 7A-FE 81/109 06/01→10/03 OE138 1,0 CET12P OE193

AURION

2.0 4 1AZ-FSE 114/153 03/06→07/09 CET12P OE182

3.5 6 2GR-FE 200/268 03/06→ CET14P OE190

3.5 6 2GR-FSE 235/315 03/06→09/11 CET14P OE190

AURIS

1.3 4 1NR-FE 73/98 10/12→ BAEA192E

1.3 Dual-VVTi 4 1NR-FE 73/98 01/10→09/12 BAEA172E

1.3 Dual-VVTi 4 1NR-FE 74/99 05/09→09/12 BAEA184E

1.4 4 4ZZ-FE 71/95 03/07→09/12 OE039 1,0 CET2 OE180 BAEA164E^[167]

1.5 4 1NZ-FE 80/107 10/12→ CET14P OE190

1.5 4 1NZ-FE 81/109 09/09→09/12 CET14P OE190

TOFAS





kW/BHP

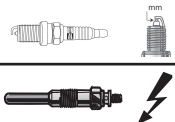

eon TITAN

IRIDIUM

**...TOYOTA****...AURIS**

| | | | | | | | | | |
|--------------|---|-----------------|---------|-------------|--|--|--------|-------|----------|
| 1.5 4WD | 4 | 1NZ-FE | 77/103 | 09/09→ | | | CET14P | OE190 | |
| 1.6 | 4 | 1ZR-FE | 91/122 | 03/07→09/12 | | | | | BAEA184E |
| 1.6 | 4 | 1ZR-FAE | 97/130 | 05/09→ | | | | | BAEA184E |
| 1.8 | 4 | 2ZR-FAE | 106/142 | 02/09→ | | | | | BAEA184E |
| 1.8 | 4 | 2ZR-FAE | 108/145 | 02/09→09/12 | | | | | BAEA184E |
| 1.8, 1.8 4WD | 4 | 2ZR-FAE; 2ZR-FE | 100/134 | 10/06→09/12 | | | | | BAEA184E |
| 1.8 Hybrid | 4 | 2ZR-FXE | 73/98 | 09/10→ | | | | | BAEA184E |

AURIS TOURING SPORTS

| | | | | | | | | | |
|------------|---|---------|--------|--------|--|--|--|--|----------|
| 1.6 | 4 | 1ZR-FAE | 97/130 | 07/13→ | | | | | BAEA184E |
| 1.8 Hybrid | 4 | 2ZR-FXE | 73/98 | 07/13→ | | | | | BAEA184E |

AVALON

| | | | | | | | | | |
|----------|---|--------|---------|-------------|-------|-----|--------|-------|--|
| 3.0 | 6 | 1MZ-FE | 137/184 | 08/01→04/05 | | | CET12P | OE182 | |
| 3.0 | 6 | 1MZ-FE | 140/188 | 03/95→05/05 | OE026 | 0,9 | CET2 | OE188 | |
| 3.0 | 6 | 1MZ-FE | 145/194 | 04/00→03/06 | | | CET12P | OE182 | |
| 3.0 | 6 | 1MZ-FE | 157/211 | 09/99→12/04 | | | CET12P | OE182 | |
| 3.5 VVTi | 6 | 2GR-FE | 206/276 | 01/05→09/12 | | | CET14P | OE190 | |

AVANZA

| | | | | | | | | | |
|-----|---|--------|--------|-------------|-------|-----|--------|-------|--|
| 1.3 | 4 | K3-VE | 63/84 | 12/03→10/11 | OE136 | 0,8 | CET12P | | |
| 1.3 | 4 | K3-VE | 67/90 | 08/06→12/11 | OE136 | 0,8 | CET12P | | |
| 1.5 | 4 | 3SZ-VE | 76/102 | 08/06→12/11 | | | CET10P | OE187 | |

AVENSIS

| | | | | | | | | | |
|----------------------|---|-----------------|---------|-------------|-----------------|-----|--------|-------|--|
| 1.6 | 4 | 4A-FE | 74/99 | 09/97→10/00 | OE138 | 1,0 | CET12P | OE193 | CLS058 [292] |
| | | | | | OE218 LPG [278] | 1,6 | | | |
| 1.6 | 4 | 4A-FE | 81/109 | 09/97→02/03 | OE218 LPG [278] | 1,6 | CET2 | OE179 | CLS058 [292] |
| 1.6 | 4 | 3ZZ-FE | 81/109 | 09/97→02/03 | OE093 | 1,0 | CET2 | OE182 | BAEA164E [167] |
| | | | | | OE218 LPG [278] | 1,6 | | | |
| 1.6 | 4 | 1ZR-FAE | 97/130 | 11/08→ | | | | | BAEA184E |
| 1.6 VVT-i | 4 | 3ZZ-FE | 81/109 | 10/00→11/08 | OE093 | 1,0 | CET2 | OE182 | BAEA164E [167] |
| 1.8 | 4 | 7A-FE | 81/109 | 09/97→10/00 | OE138 | 1,0 | CET12P | OE193 | |
| 1.8 | 4 | 2ZR-FAE | 108/145 | 11/08→ | | | | | BAEA184E |
| 1.8, 1.8 VVT-i | 4 | 1ZZ-FE | 95/127 | 10/00→11/08 | | | CET2 | OE182 | BAEA164E [167] |
| 2.0 | 4 | 3S-FE | 94/126 | 09/97→10/00 | OE026 | 0,9 | CET2 | OE188 | CLS171 |
| 2.0 | 4 | 1AZ-FSE | 108/145 | 03/03→11/08 | | | CET12P | OE188 | BAEA167E [275] BAEA171E [165] [275] |
| 2.0 | 4 | 3ZR-FAE; 3ZR-FE | 112/150 | 11/08→ | | | | | BAEA184E |
| 2.0, 2.0 VVT-i | 4 | 1AZ-FSE | 110/148 | 10/00→02/03 | | | CET12P | OE182 | BAEA167E [166] BAEA171E [165] |
| 2.0 D | 4 | 2C-T | 61/82 | 10/97→05/98 | CH302 | 11v | | | |
| 2.0 TD | 4 | 2C-TE | 66/89 | 09/97→02/03 | CH302 | 11v | | | |
| 2.0 VVTi | 4 | 1AZ-FE | 114/153 | 04/03→11/08 | OE136 | 0,8 | CET12P | OE179 | BAEA171E →09/05 OE182 BAEA167E 09/05→ |
| 2.4 | 4 | 2AZ-FSE | 120/161 | 10/03→10/08 | | | CET12P | OE188 | BAEA167E |
| 2.4 | 4 | 2AZ-FSE | 125/168 | 09/03→11/08 | | | CET12P | OE188 | BAEA167E |
| AVENSIS VERSO | | | | | | | | | |
| 2.0 | 4 | 1AZ-FE | 110/148 | 08/01→11/09 | | | CET12P | OE182 | BAEA167E [275] BAEA171E [169] [275] |
| 2.4, 2.4 4WD | 4 | 2AZ-FE | 115/154 | 08/01→08/07 | | | CET12P | OE182 | |

TOYOTA





kW/BHP

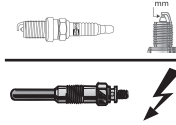

eon TITAN

IRIDIUM

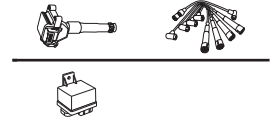
**...TOYOTA****AYGO**

| | | | | | | | | | |
|---------|---|--------|-------|--------|-------|-----|--------|-------|---|
| 1.0 | 3 | 1KR-FE | 50/67 | 07/05→ | OE035 | 0,9 | CET5 | OE190 | BAEA164E [167] [275] BAEA165E [275] |
| 1.0 | 3 | 1KR-FE | 51/68 | 05/14→ | | | CET14P | OE190 | BAEA164E |
| 1.0 GPL | 3 | 1KR-FE | 50/67 | 07/05→ | OE035 | 0,9 | CET5 | OE190 | |

bb I

| | | | | | | | | | |
|-----|---|--------|--------|-------------|-------|-----|------|-------|--|
| 1.5 | 4 | 1NZ-FE | 80/107 | 03/00→12/05 | OE093 | 1,0 | CET2 | OE182 | |
|-----|---|--------|--------|-------------|-------|-----|------|-------|--|

bb II

| | | | | | | | | | |
|--------------|---|-------|--------|--------|-------|-----|--------|-------|--|
| 1.3, 1.3 4WD | 4 | K3-VE | 68/91 | 12/05→ | OE136 | 0,8 | CET12P | | |
| 1.5 | 4 | 3S-VE | 80/107 | 12/05→ | | | CET10P | OE187 | |

BREVIS

| | | | | | | | | | |
|-----|---|---------|---------|-------------|--|--|--------|-------|--|
| 2.5 | 6 | 1JZ-FSE | 147/197 | 10/99→09/02 | | | CET12P | OE188 | |
| 3.0 | 6 | 2JZ-FSE | 162/217 | 10/99→06/07 | | | CET12P | OE188 | |

CALDINA

| | | | | | | | | | |
|---------|---|---------|---------|-------------|-------|-----|--------|-------|--|
| 1.8 | 4 | 7A-FE | 85/114 | 10/97→08/02 | OE138 | 1,0 | CET12P | OE193 | |
| 2.0 | 4 | 1AZ-FSE | 112/150 | 09/02→06/07 | | | CET12P | OE182 | |
| 2.0 4WD | 4 | 3S-GTE | 140/188 | 10/97→09/01 | OE136 | 0,8 | CET12P | | |
| 2.0 4WD | 4 | 3S-GTE | 192/257 | 02/00→09/01 | OE136 | 0,8 | CET12P | | |
| 2.0 TD | 4 | 2C | 56/75 | 06/94→09/97 | CH302 | 11v | | | |

CAMI

| | | | | | | | | | |
|--------------|---|--------------|---------|-------------|-------|-----|--------|-------|--|
| 1.3 | 4 | K3-VE; K3-VT | 66/89 | 06/99→12/05 | OE136 | 0,8 | CET12P | | |
| 1.3, 1.3 4WD | 4 | K3-VE | 63/84 | 02/01→12/05 | OE136 | 0,8 | CET12P | | |
| 1.3 4WD | 4 | HC-EJ | 61/82 | 05/99→09/00 | OE136 | 0,8 | CET12P | | |
| 1.3 4WD | 4 | K3-VT | 103/138 | 06/99→12/05 | | | CET12P | OE179 | |

CAMRY

| | | | | | | | | | |
|-----------------------------|---|---------|---------|-------------|-------|-----|--------|-------|---|
| 2.0 | 4 | 1AZ-FE | 109/146 | 09/11→ | | | CET12P | OE182 | BAEA167E 12/11→ |
| 2.0 | 4 | 1AZ-FE | 110/148 | 08/01→ | | | CET12P | OE182 | BAEA171E →09/05 BAEA167E 09/05→ |
| 2.0 4WD | 4 | 3S-FE | 100/134 | 08/93→09/97 | OE039 | 1,0 | CET2 | OE179 | |
| 2.0 TD | 4 | 2C-T | 66/89 | 08/96→09/99 | CH302 | 11v | | | |
| 2.0 VVT-i | 4 | 1AZ-FE | 108/145 | 01/06→09/11 | OE136 | 0,8 | CET12P | OE179 | BAEA167E |
| 2.2 | 4 | 5S-FE | 93/125 | 02/93→09/02 | OE026 | 0,9 | CET2 | OE179 | BAEA445 |
| | | | | | OE039 | 1,0 | | OE188 | |
| 2.2 | 4 | 5S-FE | 96/129 | 08/96→11/01 | OE026 | 0,9 | CET2 | OE188 | CLS259 |
| 2.4 | 4 | 2AZ-FE | 112/150 | 11/01→11/06 | | | CET12P | OE182 | BAEA167E [275] BAEA171E [169] [275] |
| 2.4 | 4 | 2AZ-FE | 116/156 | 01/06→09/11 | | | CET12P | OE182 | BAEA167E |
| 2.4 | 4 | 2AZ-FE | 123/165 | 01/06→09/11 | | | CET12P | OE182 | BAEA167E |
| 2.4 | 4 | 2AZ-FE | 127/170 | 01/02→09/11 | | | | | BAEA167E |
| 2.4 Hybrid, 2.4 VVTi Hybrid | 4 | 2AZ-FXE | 105/141 | 01/06→07/11 | | | CET12P | OE182 | |
| 2.4 VVT-i Hybrid | 4 | 2AZ-FXE | 110/148 | 01/06→09/11 | | | CET12P | OE182 | |
| 2.5 | 4 | 2AR-FE | 133/178 | 09/09→ | | | CET14P | OE190 | BAEA192E |
| 2.5 VVTi | 4 | 2AR-FE | 129/173 | 01/10→09/11 | | | CET14P | OE190 | BAEA192E |
| 3.0 | 6 | 1MZ-FE | 135/181 | 09/93→07/96 | OE026 | 0,9 | CET2 | OE188 | |
| 3.0 | 6 | 1MZ-FE | 137/184 | 08/01→11/06 | | | CET12P | OE182 | BAEA173E [163] [275] |
| 3.0 | 6 | 1MZ-FE | 141/189 | 09/02→11/06 | | | CET12P | OE182 | |
| 3.0 24V | 6 | 1MZ-FE | 140/188 | 08/96→11/01 | OE026 | 0,9 | CET2 | OE188 | BAEA173E [162] [275] |
| 3.0 V6 | 6 | 1MZ-FE | 135/181 | 08/96→11/01 | OE026 | 0,9 | CET2 | OE188 | BAEA173E [162] [275] |

TOYOTA





kW/BHP

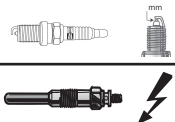

eon TITAN

IRIDIUM

**...TOYOTA****...CAMRY**

| | | | | | | | | | |
|-----|---|--------|---------|-------------|--|--|--------|-------|--|
| 3.3 | 6 | 3MZ-FE | 165/221 | 08/02→11/06 | | | CET12P | OE182 | |
| 3.5 | 6 | 2GR-FE | 204/274 | 01/08→ | | | CET14P | OE190 | |

CAMRY SOLARA

| | | | | | | | | | |
|-----|---|--------|---------|-------------|-------|-----|--------|-------|--|
| 2.2 | 4 | 5S-FE | 100/134 | 06/98→06/01 | OE039 | 1,0 | CET2 | OE179 | |
| 2.2 | 4 | 5S-FE | 101/135 | 02/00→11/02 | OE039 | 1,0 | CET2 | OE179 | |
| 3.0 | 6 | 1MZ-FE | 140/188 | 02/00→11/02 | | | CET12P | OE182 | |
| 3.0 | 6 | 1MZ-FE | 147/197 | 06/98→11/02 | OE026 | 0,9 | CET12P | OE182 | |
| | | | | | | | CET2 | OE188 | |
| 3.3 | 6 | 3MZ-FE | 155/208 | 07/03→11/08 | | | CET12P | OE182 | |
| 3.3 | 6 | 3MZ-FE | 165/221 | 07/03→11/08 | | | CET12P | OE182 | |

CARIBE

| | | | | | | | | | |
|---------|---|-------|--------|-------------|-------|-----|--------|-------|--|
| 1.3 | 4 | 4E-FE | 55/74 | 09/94→08/96 | OE063 | 1,0 | CET2 | OE180 | |
| 1.6 | 4 | 4A-FE | 84/113 | 09/94→08/03 | OE005 | 0,9 | CET2 | OE179 | |
| 1.8 4WD | 4 | 4S-FE | 85/114 | 09/94→08/03 | OE146 | 1,0 | CET12P | OE179 | |

CARINA E

| | | | | | | | | | |
|-----------------------|---|-------|---------|-------------|-----------------|-----|--------|-------|--------------|
| 1.6 | 4 | 4A-FE | 73/98 | 12/93→09/97 | OE063 | 1,0 | CET12P | OE193 | CLS058 [292] |
| | | | | | OE138 | 1,0 | CET2 | | |
| | | | | | OE218 LPG [278] | 1,6 | | | |
| 1.6, 1.6 16V | 4 | 4A-FE | 78/105 | 10/95→09/97 | OE138 | 1,0 | CET12P | OE193 | CLS058 [292] |
| | | | | | OE218 LPG [278] | 1,6 | | | |
| 1.6 16V | 4 | 4A-FE | 85/114 | 12/94→09/97 | OE138 | 1,0 | CET12P | OE193 | CLS058 [292] |
| | | | | | OE218 LPG [278] | 1,6 | | | |
| 1.6 i | 4 | 4A-FE | 73/98 | 02/95→09/97 | OE138 | 1,0 | CET12P | OE193 | CLS058 [292] |
| | | | | | OE218 LPG [278] | 1,6 | | | |
| 1.8, 1.8 i, 1.8 i 16V | 4 | 7A-FE | 79/106 | 01/95→09/97 | OE138 | 1,0 | CET12P | OE193 | CLS058 [292] |
| 1.8 GL | 4 | 7A-FE | 92/123 | 10/94→09/97 | OE138 | 1,0 | CET12P | | CLS058 [292] |
| 2.0 GTi 16V | 4 | 3S-GE | 129/173 | 03/94→09/97 | OE136 | 0,8 | CET12P | OE179 | |
| | | | | | OE218 LPG [278] | 1,6 | | | |
| 2.0 TD | 4 | 2C-T | 61/82 | 01/96→09/97 | CH302 | 11v | | | |

CELICA

| | | | | | | | | | |
|-----------------|---|--------|---------|-------------|-----------------|-----|--------|-------|----------------|
| 1.8 16V TS | 4 | 2ZZ-GE | 141/189 | 08/99→09/05 | | | CET12P | OE182 | BAEA168E [164] |
| 1.8 16V VT-i | 4 | 1ZZ-FE | 105/141 | 08/99→07/05 | | | CET2 | OE182 | BAEA164E [167] |
| | | | | | | | | | BAEA168E [164] |
| 1.8 i 16V | 4 | 7A-FE | 85/114 | 11/93→11/99 | | | CET2 | OE179 | |
| 2.0 GTi | 4 | 3S-GE | 129/173 | 08/94→08/99 | OE136 | 0,8 | CET12P | | |
| 2.0 i 16V | 4 | 3S-GE | 125/168 | 11/93→11/99 | OE136 | 0,8 | CET12P | OE179 | |
| | | | | | OE218 LPG [278] | 1,6 | | | |
| 2.0 i 16V | 4 | 3S-GE | 129/173 | 11/93→11/99 | OE136 | 0,8 | CET12P | OE179 | |
| | | | | | OE218 LPG [278] | 1,6 | | | |
| 2.0 i Turbo 4WD | 4 | 3S-GTE | 178/239 | 02/94→11/99 | OE136 | 0,8 | CET12P | OE179 | |
| | | | | | OE218 LPG [278] | 1,6 | | | |

CELSIOR

| | | | | | | | | | |
|---------|---|--------|---------|-------------|--|--|--------|-------|--|
| 4.3 VVi | 8 | 3UZ-FE | 208/279 | 09/00→08/06 | | | CET12P | OE182 | |
|---------|---|--------|---------|-------------|--|--|--------|-------|--|

CENTURY

| | | | | | | | | | |
|-----|----|--------|---------|--------|-------|-----|--------|--|--|
| 5.0 | 12 | 1GZ-FE | 206/276 | 04/97→ | OE146 | 1,0 | CET12P | | |
|-----|----|--------|---------|--------|-------|-----|--------|--|--|

CHASER

| | | | | | | | | | |
|---------|---|---------|---------|-------------|-------|-----|--------|-------|--|
| 2.5 VVi | 6 | 1JZ-GE | 147/197 | 10/96→05/01 | OE191 | 1,0 | CET12P | OE180 | |
| 2.5 VVi | 6 | 1JZ-GTE | 206/276 | 10/96→05/01 | OE136 | 0,8 | CET12P | OE179 | |
| 3.0 VVi | 6 | 2JZ-FSE | 162/217 | 10/96→05/01 | | | CET12P | OE188 | |

COROLLA

| | | | | | | | | | |
|-----|---|--------|-------|-------------|-------|-----|------|-------|----------|
| 1.3 | 4 | 2NZ-FE | 65/87 | 08/00→05/04 | OE093 | 1,0 | CET2 | OE182 | |
| 1.3 | 4 | 1NR-FE | 73/98 | 06/13→ | | | | | BAEA192E |

TOYOTA





kW/BHP

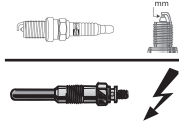

eon TITAN

IRIDIUM



...TOYOTA

...COROLLA

| | | | | | | | | | | |
|------------------------|---|-----------------|---------|-------------|-----------------|-----|----------------|-------------------------|--|--------------|
| 1.3 | 4 | 1NR-FE | 74/99 | 01/07→ | | | | | | BAEA192E |
| 1.3 VVTi | 4 | 8A-FE | 64/86 | 03/04→03/09 | OE063 | 1,0 | CET2 | OE180 | | |
| 1.3 XLI | 4 | 4E-FE | 55/74 | 08/95→04/97 | OE063 | 1,0 | CET2 | OE180 | | CLS231 [292] |
| 1.4 | 4 | 4E-FE | 63/84 | 04/97→02/00 | OE019 | 0,9 | CET2 | OE184 | | CLS096 |
| 1.4, 1.4 16V | 4 | 4ZZ-FE | 71/95 | 02/00→01/02 | OE039 | 1,0 | CET2 | OE180 | BAEA449 | |
| 1.4 VVT-i | 4 | 4ZZ-FE | 71/95 | 10/01→11/13 | OE039 | 1,0 | CET2 | OE180 | BAEA164E ^[167] BAEA164E ^[275] BAEA164E BAEA169E ^[167] ^[275] | |
| 1.5 | 4 | 1NZ-FE | 78/105 | 09/99→06/07 | OE093 | 1,0 | CET2 | OE182 | | |
| 1.5 | 4 | 1NZ-FE | 80/107 | 07/01→ | OE093 | 1,0 | CET14P CET2 | OE182 OE190 | | |
| 1.5 | 4 | 1NZ-FE | 81/109 | 03/01→ | OE093 | 1,0 | CET14P CET2 | OE190 | | |
| 1.5 4WD | 4 | 1NZ-FE | 76/102 | 05/12→ | | | CET14P | OE190 | | |
| 1.5 4WD | 4 | 1NZ-FE | 77/103 | 09/06→ | | | CET14P | OE190 | | |
| 1.5 G 4WD | 4 | 1NZ-FE | 80/107 | 11/01→05/04 | OE093 | 1,0 | CET2 | OE182 | | |
| 1.6 | 4 | 4A-FE | 81/109 | 04/97→03/09 | OE005 | 0,9 | CET2 | OE180 | | |
| 1.6 | 4 | 3ZZ-FE | 81/109 | 04/97→03/09 | OE093 | 1,0 | CET2 | OE182 | BAEA164E BAEA164E ^[167] | |
| 1.6 | 4 | 1ZR-FAE; 1ZR-FE | 97/130 | 01/09→ | | | | | BAEA184E | |
| 1.6 16V | 4 | 3ZZ-FE | 81/109 | 10/99→10/01 | OE093 | 1,0 | CET2 | OE182 | BAEA164E | |
| 1.6 Aut. | 4 | 4A-FE | 79/106 | 04/97→02/00 | OE005 | 0,9 | CET2 | OE179 OE180 OE182 | | |
| 1.6 Dual VVTi | 4 | 1ZR-FE | 91/122 | 01/07→ | | | | | BAEA184E | |
| 1.6 i | 4 | 4A-FE | 78/105 | 09/94→11/99 | OE063 | 1,0 | CET2 | | | |
| 1.6 VVTi | 4 | 1ZR-FE | 90/121 | 07/10→05/14 | | | | | BAEA184E | |
| 1.6 VVT-i | 4 | 3ZZ-FE | 81/109 | 08/01→06/13 | OE093 | 1,0 | CET2 | OE182 | BAEA164E ^[167] | |
| 1.8 | 4 | 1ZZ-FE | 92/123 | 09/01→03/09 | OE093 | 1,0 | CET2 | OE182 | BAEA164E | |
| 1.8 | 4 | 1ZZ-FE | 95/127 | 04/04→03/09 | OE093 | 1,0 | CET2 | OE182 | BAEA164E ^[167] BAEA168E ^[164] | |
| 1.8 | 4 | 1ZZ-FE | 96/129 | 03/01→07/05 | OE093 | 1,0 | CET2 | OE182 | BAEA164E | |
| 1.8 | 4 | 1ZZ-FE | 97/130 | 09/02→07/14 | OE063 | 1,0 | | | | |
| 1.8 | 4 | 2ZR-FE | 100/134 | 11/01→ | | | | | BAEA184E | |
| 1.8 | 4 | 2ZR-FAE | 106/142 | 09/06→ | | | | | BAEA184E | |
| 1.8 | 4 | | 108/145 | 01/09→ | | | | | BAEA184E | |
| 1.8, 1.8 4WD | 4 | 4S-FE | 92/123 | 08/95→03/09 | OE146 | 1,0 | CET12P | OE179 | | |
| 1.8, 1.8 4WD, 1.8 VVTi | 4 | 1ZZ-FE | 100/134 | 11/01→ | OE093 | 1,0 | CET2 | OE182 | BAEA164E | |
| 1.8 4WD | 4 | 7A-FE | 81/109 | 04/97→10/01 | | | CET12P | OE180 | | |
| 1.8 4WD | 4 | 2ZR-FAE | 98/131 | 09/06→ | | | | | BAEA184E | |
| 1.8 16V 4WD | 4 | 7A-FE | 81/109 | 09/95→04/97 | | | CET2 | OE179 | | |
| 1.8 VVTi | 4 | 1ZZ-FE | 101/135 | 11/06→ | OE063 →03/08 | 1,0 | | | | |
| 1.8 VVTi | 4 | 2ZR-FBE; 2ZR-FE | 103/138 | 08/10→ | | | | | BAEA184E | |
| 1.8 VVT-i | 4 | 1ZZ-FE | 99/133 | 12/01→05/04 | OE093 | 1,0 | CET2 | OE182 | BAEA164E ^[167] BAEA168E ^[164] | |
| 1.8 VVTi 4WD | 4 | 1ZZ-FE | 99/133 | 10/01→02/04 | OE093 | 1,0 | CET2 | OE182 | | |
| 1.8 VVTL-i TS | 4 | 2ZZ-GE | 141/189 | 01/02→02/07 | | | CET12P | OE182 | BAEA168E ^[164] | |
| 1.8 VVTL-i TS | 4 | 2ZZ-GE | 160/215 | 10/05→12/06 | | | CET12P | OE182 | BAEA168E | |
| 1.8 VVTL-i TS | 4 | 2ZZ-GE | 165/221 | 02/05→02/07 | | | CET12P | OE182 | BAEA168E ^[164] | |
| 1.9 D | 4 | 1WZ | 51/68 | 02/00→01/02 | CH185 | 11v | | | | |
| 2.2 TD | 4 | 3C-TE | 66/89 | 04/98→10/01 | CH608 | 11v | | | | |

TOYOTA





kW/BHP

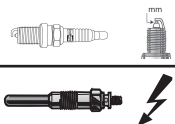

eon TITAN

IRIDIUM

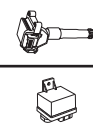
**...TOYOTA****COROLLA RUMION**

| | | | | | | | | | |
|---------|---|---------|---------|--------|--|--|--------|-------|----------|
| 1.5 | 4 | 1NZ-FE | 81/109 | 09/07→ | | | CET14P | OE190 | |
| 1.8 | 4 | 2ZR-FAE | 106/142 | 09/07→ | | | | | BAEA184E |
| 1.8 4WD | 4 | 2ZR-FAE | 100/134 | 09/07→ | | | | | BAEA184E |

CORONA

| | | | | | | | | | |
|--------|---|------|-------|-------------|-------|-----|--|--|--|
| 2.0 TD | 4 | 2C-T | 61/82 | 07/94→09/97 | CH302 | 11v | | | |
|--------|---|------|-------|-------------|-------|-----|--|--|--|

CRESTA

| | | | | | | | | | |
|--------------|---|--------|---------|-------------|-------|-----|--------|-------|--|
| 2.0 VVTi 24V | 6 | 1G-FE | 118/158 | 10/96→09/01 | OE136 | 0,8 | CET12P | OE179 | |
| 2.2 TD | 4 | 3C-TE | 66/89 | 10/96→09/01 | CH608 | 11v | | | |
| 2.5 VVTi | 6 | 1JZ-GE | 147/197 | 10/96→09/01 | OE191 | 1,0 | CET12P | OE180 | |
| 3.0 VVTi | 6 | 2JZ-GE | 162/217 | 10/96→09/01 | OE191 | 1,0 | CET12P | OE180 | |

CROWN

| | | | | | | | | | |
|--|---|---------|---------|-------------|-------|-----|--------|-------|--|
| 2.0 | 6 | 1GZ-EE | 132/177 | 08/96→07/02 | OE136 | 0,8 | CET12P | OE179 | |
| 2.5 | 6 | 1JZ-GTE | 206/276 | 09/99→08/03 | OE136 | 0,8 | CET12P | OE179 | |
| 2.5, 2.5 4WD | 6 | 1JZ-GE | 147/197 | 09/99→08/03 | OE191 | 1,0 | CET12P | OE180 | |
| 2.5 Athlete | 6 | 4GR-FSE | 158/212 | 09/03→02/08 | | | CET14P | OE190 | |
| 2.5 V6, 2.5 V6 4WD | 6 | 4GR-FSE | 149/200 | 02/08→11/12 | | | CET14P | OE190 | |
| 3.0 | 6 | 2JZ-FSE | 147/197 | 09/99→08/03 | | | CET12P | OE188 | |
| 3.5 Hybrid | 6 | 2GR-FSE | 218/292 | 02/08→11/12 | | | CET14P | OE190 | |
| 3.5 V6 | 6 | 2GR-FSE | 232/311 | 02/08→ | | | CET14P | OE190 | |
| 4.3 V8 4WD, 4.3 Royal Saloon, 4.3 Royal Saloon 4WD | 8 | 3UZ-FE | 206/276 | 09/03→11/12 | | | CET12P | OE182 | |

CURREN

| | | | | | | | | | |
|--------------|---|-------|---------|-------------|-------|-----|--------|-------|--|
| 1.8 | 4 | 7A-FE | 85/114 | 11/93→10/98 | OE138 | 1,0 | CET12P | OE193 | |
| 1.8 | 4 | 4S-FE | 92/123 | 10/95→10/98 | OE146 | 1,0 | CET12P | OE179 | |
| 2.0, 2.0 4WD | 4 | 3S-GE | 129/173 | 11/93→10/98 | OE136 | 0,8 | CET12P | | |
| 2.2 | 4 | 5S-FE | 100/134 | 10/95→10/98 | OE039 | 1,0 | CET2 | OE179 | |

DUET

| | | | | | | | | | |
|-----|---|-------|-------|-------------|-------|-----|------|--|--|
| 1.0 | 3 | EJ-VE | 43/58 | 09/98→04/04 | OE019 | 0,9 | CET2 | | |
|-----|---|-------|-------|-------------|-------|-----|------|--|--|

ECHO

| | | | | | | | | | |
|----------|---|--------|--------|-------------|-------|-----|------|-------|--|
| 1.5 VVTi | 4 | 1NZ-FE | 78/105 | 04/99→08/05 | OE093 | 1,0 | CET2 | OE182 | |
|----------|---|--------|--------|-------------|-------|-----|------|-------|--|

FJ CRUISER

| | | | | | | | | | |
|-------------------|---|--------|---------|-------------|-------|-----|------|-------|----------|
| 4.0, 4.0 VVTi 4WD | 6 | 1GR-FE | 178/239 | 01/06→10/10 | OE035 | 0,9 | CET5 | OE190 | |
| 4.0 4WD | 6 | 1GR-FE | 193/259 | 11/10→ | OE035 | 0,9 | CET5 | OE190 | |
| 4.0 4WD | 6 | 1GR-FE | 200/268 | 12/10→ | OE035 | 0,9 | CET5 | OE190 | |
| 4.0 4WD | 6 | 1GR-FE | 203/272 | 01/11→ | OE035 | 0,9 | CET5 | OE190 | BAEA192E |

FORTUNER

| | | | | | | | | | |
|--------------|---|--------|---------|-------------|-------|-----|------|-------|----------|
| 2.7 4WD | 4 | 2TR-FE | 118/158 | 06/04→05/15 | OE035 | 0,9 | CET5 | OE190 | |
| 2.7 Flexfuel | 4 | 2TR-FE | 120/161 | 01/12→05/15 | OE035 | 0,9 | CET5 | | |
| 2.7 VVTi | 4 | 2TR-FE | 118/158 | 06/04→05/15 | OE035 | 0,9 | CET5 | OE190 | BAEA167E |
| 4.0, 4.0 4WD | 6 | 1GR-FE | 173/232 | 07/05→ | OE035 | 0,9 | CET5 | | |

GAIA

| | | | | | | | | | |
|------------------------|---|---------|---------|-------------|-------|-----|--------|-------|--|
| 2.0 VVTi, 2.0 VVTi 4WD | 4 | 1AZ-FSE | 112/150 | 05/98→10/03 | | | CET12P | OE182 | |
| 2.2 TD | 4 | 3C-TE | 69/93 | 10/98→10/03 | CH608 | 11v | | | |

GRANVIA

| | | | | | | | | | |
|---------|---|--------|---------|-------------|-------|-----|------|-------|--|
| 2.7 | 4 | 3RZ-FE | 112/150 | 08/95→09/98 | OE039 | 1,0 | CET2 | | |
| 3.0 TDi | 4 | 1KZ-TE | 96/129 | 08/95→12/04 | CH608 | 11v | | | |
| 3.4 | 6 | 5VZ-FE | 140/188 | 08/95→12/04 | OE019 | 0,9 | CET2 | OE184 | |

HARRIER

| | | | | | | | | | |
|--------------|---|--------|---------|-------------|-------|-----|--------|-------|--|
| 2.2 4WD | 4 | 5S-FE | 103/138 | 03/98→01/03 | OE039 | 1,0 | CET2 | OE179 | |
| 2.4, 2.4 4WD | 4 | 2AZ-FE | 118/158 | 06/00→06/12 | | | CET12P | OE182 | |
| 3.0 4WD | 6 | 1MZ-FE | 150/201 | 10/03→12/08 | | | CET12P | OE182 | |

TOYOTA

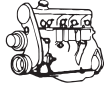

kW/BHP

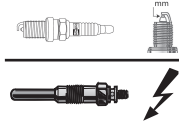

eon TITAN

IRIDIUM

**...TOYOTA****...HARRIER**

| | | | | | | | | |
|----------------|---|--------|---------|---------------|--|--|--------|-------|
| 3.0 4WD | 6 | 1MZ-FE | 164/220 | 03/98 → 01/03 | | | CET12P | OE182 |
| 3.3 4WD | 6 | 3MZ-FE | 171/229 | 10/03 → 12/08 | | | CET12P | OE182 |
| 3.3 Hybrid 4WD | 6 | 3MZ-FE | 155/208 | 04/05 → 05/12 | | | CET12P | OE182 |
| 3.5 4WD | 6 | 2GR-FE | 206/276 | 04/05 → 12/08 | | | CET14P | OE190 |

HIGHLANDER / KLUGER

| | | | | | | | | |
|----------------|---|--------|---------|---------------|--|--|--------|-------|
| 3.3 Hybrid 4WD | 6 | 3MZ-FE | 200/268 | 03/05 → 05/07 | | | CET12P | OE182 |
| 3.5 4WD | 6 | 2GR-FE | 201/270 | 05/07 → | | | CET14P | OE190 |

HILUX

| | | | | | | | | |
|--------------|---|--------|---------|---------------|-----------------|-----|------|-------|
| 2.7 | 4 | 3RZ-FE | 107/143 | 08/01 → 07/04 | OE005 | 0,9 | CET2 | OE179 |
| | | | | | OE218 LPG [278] | 1,6 | | |
| 3.0 TDiC 4WD | 4 | 1KZ-T | 92/123 | 08/93 → 07/97 | CH608 | 11v | | |
| 3.4 4WD | 6 | 5VZ-FE | 131/176 | 11/95 → 07/04 | OE019 | 0,9 | CET2 | OE184 |
| 3.4 4WD | 6 | 5VZ-FE | 136/182 | 11/95 → 07/00 | OE019 | 0,9 | CET2 | OE184 |

HILUX II

| | | | | | | | | |
|--------------|---|--------|---------|---------------|-------|-----|------|-------|
| 2.7, 2.7 4WD | 4 | 3RZ-FE | 110/148 | 08/94 → 07/00 | OE005 | 0,9 | CET2 | |
| 3.0 D | 4 | 5L | 67/90 | 08/02 → 07/04 | CH154 | 11v | | |
| 3.4, 3.4 4WD | 6 | 5VZ-FE | 131/176 | 08/01 → 07/05 | OE019 | 0,9 | CET2 | OE184 |

HILUX V

| | | | | | | | | |
|------------------|---|----|-------|---------------|-------|-----|--|--|
| 2.4 D, 2.4 D 4WD | 4 | 2L | 58/78 | 01/94 → 12/97 | CH154 | 11v | | |
|------------------|---|----|-------|---------------|-------|-----|--|--|

HILUX VI

| | | | | | | | | |
|------------|---|--------|---------|---------------|-----------------|-----|------|-------|
| 2.4 D | 4 | 2L | 55/74 | 08/97 → 04/05 | CH154 | 11v | | |
| 2.4 i 4WD | 4 | 2RZ-FE | 103/138 | 08/97 → 10/05 | OE002 | 0,9 | CET2 | OE180 |
| 2.4 TD 4WD | 4 | 2L-T | 66/89 | 08/98 → 01/02 | CH154 | 11v | | |
| 2.7 | 4 | 3RZ-FE | 107/143 | 01/98 → 07/04 | OE005 | 0,9 | CET2 | OE179 |
| | | | | | OE218 LPG [278] | 1,6 | | |
| 2.7 4WD | 4 | 3RZ-FE | 108/145 | 11/97 → 04/05 | OE005 | 0,9 | CET2 | |
| 2.8 D 4WD | 4 | 3L | 61/82 | 08/97 → 07/01 | CH154 | 11v | | |
| 3.0 D 4WD | 4 | 5L | 67/90 | 01/02 → 07/05 | CH154 | 11v | | |
| 3.0 TD 4WD | 4 | 1KZ-TE | 85/114 | 11/01 → 04/05 | CH608 | 11v | | |

HILUX VII

| | | | | | | | | |
|--------------|---|--------|---------|---------------|-------|-----|--------|----------------|
| 2.0 | 4 | 1TR-FE | 108/145 | 08/05 → 05/15 | | | CET12P | OE188 |
| 2.7, 2.7 4WD | 4 | 2TR-FE | 118/158 | 08/05 → 05/15 | OE035 | 0,9 | CET5 | OE190 |
| 4.0 | 6 | 1GR-FE | 175/235 | 08/05 → | OE035 | 0,9 | CET5 | OE190 |
| 4.0 4WD | 6 | 1GR-FE | 175/235 | 08/05 → | OE035 | 0,9 | CET5 | OE190 BAEA167E |

MARK II

| | | | | | | | | |
|----------|---|--------|---------|---------------|-------|-----|--------|-------|
| 2.0 VVTi | 6 | 1G-FE | 118/158 | 10/96 → 06/07 | OE136 | 0,8 | CET12P | OE179 |
| 2.2 | 4 | 5S-FE | 96/129 | 08/96 → 07/01 | OE039 | 1,0 | CET2 | OE179 |
| 3.0 | 6 | 2JZ-GE | 166/223 | 08/96 → 07/01 | OE191 | 1,0 | CET12P | OE180 |
| 3.0 VVTi | 6 | 2JZ-GE | 162/217 | 10/96 → 09/01 | OE191 | 1,0 | CET12P | OE180 |

MARK X I

| | | | | | | | | |
|------------------------|---|---------|---------|---------------|--|--|--------|----------------|
| 2.5 VVTi, 2.5 VVTi 4WD | 6 | 4GR-FSE | 158/212 | 03/04 → 09/09 | | | CET14P | OE190 BAEA192E |
| 3.0 VVTi | 6 | 3GR-FSE | 183/245 | 05/04 → 09/09 | | | | BAEA192E |

MARK X II

| | | | | | | | | |
|--------------|---|---------|---------|---------|--|--|--------|-------|
| 2.5, 2.5 4WD | 6 | 4GR-FSE | 149/200 | 10/09 → | | | CET14P | OE190 |
| 3.5 | 6 | 2GR-FSE | 234/314 | 10/09 → | | | CET14P | OE190 |

MARK X ZiO

| | | | | | | | | |
|--------------|---|--------|---------|---------|--|--|--------|-------|
| 2.4, 2.4 4WD | 4 | 2AZ-FE | 120/161 | 09/07 → | | | CET12P | OE182 |
| 3.5 | 6 | 2GR-FE | 206/276 | 09/07 → | | | CET14P | OE190 |

INNOVA I

| | | | | | | | | |
|-----|---|--------|---------|---------|-------|-----|------|--|
| 2.7 | 4 | 2TR-FE | 118/158 | 08/04 → | OE035 | 0,9 | CET5 | |
|-----|---|--------|---------|---------|-------|-----|------|--|

TOYOTA



kW/BHP

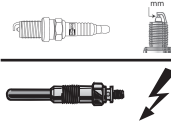

eon TITAN

IRIDIUM

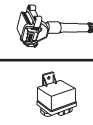
**...TOYOTA**

| IQ | | | | | | | | | |
|---------------------------|---|---------|---------|-------------|----------------------------|-----|--------|-------|--|
| 1.0 | 3 | 1KR-FE | 50/67 | 01/09→ | OE035 | 0,9 | CET5 | OE190 | BAEA165E ^[168] |
| 1.3 | 4 | 1NR-FE | 72/97 | 01/09→ | | | | | BAEA192E |
| ISIS | | | | | | | | | |
| 1.8 VVTi | 4 | 1ZZ-FE | 97/130 | 07/04→ | OE093 | 1,0 | CET2 | OE182 | |
| 1.8 VVTi | 4 | 2ZR-FAE | 106/142 | 04/07→ | | | | | BAEA184E |
| 1.8 VVTi 4WD | 4 | 2ZR-FAE | 98/131 | 04/07→ | | | | | BAEA184E |
| 2.0 VVTi | 4 | 3ZR-FAE | 116/156 | 04/07→ | | | | | BAEA184E |
| 2.0 VVTi, 2.0 VVTi 4WD | 4 | 1AZ-FSE | 114/153 | 07/04→ | | | CET12P | OE182 | |
| IST | | | | | | | | | |
| 1.3 VVTi | 4 | 2NZ-FE | 63/84 | 05/04→07/07 | OE093 | 1,0 | CET2 | OE182 | |
| 1.5 VVTi | 4 | 1NZ-FE | 80/107 | 05/04→07/07 | OE093 | 1,0 | CET2 | OE182 | |
| KLUGER | | | | | | | | | |
| 2.4, 2.4 4WD | 4 | 2AZ-FE | 115/154 | 06/00→05/07 | | | CET12P | OE182 | |
| 2.4, 2.4 4WD | 4 | 2AZ-FE | 118/158 | 06/00→05/07 | | | CET12P | OE182 | |
| 2.7 VVTi, 2.7 VVTi 4WD | 4 | 1AR-FE | 140/188 | 05/07→ | | | CET14P | OE190 | |
| 3.0, 3.0 4WD | 6 | 1MZ-FE | 164/220 | 06/00→05/07 | | | CET12P | OE182 | |
| 3.0 4WD | 6 | 1MZ-FE | 150/201 | 10/03→05/07 | | | CET12P | OE182 | |
| 3.3, 3.3 4WD | 6 | 3MZ-FE | 171/229 | 10/03→05/07 | | | CET12P | OE182 | |
| 3.3 Hybrid | 6 | 3MZ-FE | 200/268 | 03/05→05/07 | | | CET12P | OE182 | |
| 3.5 | 6 | 2GR-FE | 201/270 | 05/07→ | | | CET14P | OE190 | |
| LAND CRUISER | | | | | | | | | |
| 2.7 4WD | 4 | 3RZ-FE | 112/150 | 09/02→08/04 | OE005 | 0,9 | CET2 | OE179 | BAEA186E |
| | | | | | OE218 ^{LP6 [278]} | 1,6 | | | |
| 2.7 4WD | 4 | 2TR-FE | 120/161 | 11/03→02/10 | OE035 | 0,9 | CET5 | OE190 | BAEA167E |
| 3.0 TD 4WD | 4 | 1KZ-T | 92/123 | 05/93→05/96 | CH608 | 11v | | | |
| 4.6 V8 4WD | 8 | 1UR-FE | 227/304 | 09/10→ | | | CET14P | OE190 | BAEA192E |
| 5.7 V8 4WD | 8 | 3UR-FE | 268/359 | 09/11→ | | | CET14P | OE190 | |
| 5.7 V8 4WD | 8 | 3UR-FE | 284/381 | 08/07→ | | | CET14P | OE190 | |
| LAND CRUISER 90 | | | | | | | | | |
| 2.7 4WD | 4 | 3RZ-FE | 110/148 | 04/95→07/02 | OE005 | 0,9 | CET2 | | |
| 3.0 TD 4WD | 4 | 1KZ-TE | 92/123 | 04/96→12/02 | CH608 | 11v | | | |
| 3.0 TD 4WD | 4 | 1KZ-TE | 103/138 | 04/95→07/00 | CH608 | 11v | | | |
| 3.4 i 24V 4WD | 6 | 5VZ-FE | 131/176 | 03/96→12/02 | OE019 | 0,9 | CET2 | OE184 | |
| 4.7 4WD | 8 | 2UZ-FE | 175/235 | 08/02→ | | | CET12P | OE182 | |
| LAND CRUISER 100 | | | | | | | | | |
| 4.5 4WD | 6 | 1FZ-FE | 173/232 | 03/98→08/07 | OE019 | 0,9 | | | |
| 4.7 4WD | 8 | 2UZ-FE | 173/232 | 01/98→08/07 | | | CET12P | OE182 | BAEA172E ^[161] |
| 4.7 4WD | 8 | 2UZ-FE | 175/235 | 02/02→08/07 | | | CET12P | OE182 | BAEA172E |
| LAND CRUISER 150 | | | | | | | | | |
| 2.7 4WD | 4 | 2TR-FE | 120/161 | 01/10→ | OE035 | 0,9 | CET5 | | BAEA167E ^[275] BAEA171E ^[275] |
| LAND CRUISER 200 | | | | | | | | | |
| 4.6 V8 4WD | 8 | 1UR-FE | 234/314 | 01/12→ | | | CET14P | OE190 | BAEA192E |
| 4.7 V8 4WD | 8 | 2UZ-FE | 202/271 | 08/07→ | | | CET12P | OE182 | |
| 4.7 V8 4WD | 8 | 2UZ-FE | 212/284 | 01/08→ | OE136 | 0,8 | CET12P | OE179 | |
| LAND CRUISER PRADO | | | | | | | | | |
| 3.0 D-4D 4WD | 4 | 1KZ-TE | 92/123 | 09/02→07/09 | CH608 | 11v | | | |
| 3.4 4WD | 6 | 5VZ-FE | 136/182 | 09/02→08/04 | OE019 | 0,9 | CET2 | OE184 | |
| 4.0 4WD | 6 | 1GR-FE | 179/240 | 09/02→08/10 | OE035 | 0,9 | CET5 | OE190 | BAEA167E |
| 4.0 4WD | 6 | 1GR-FE | 183/245 | 12/02→12/09 | OE035 | 0,9 | CET5 | OE190 | BAEA167E ^[166] |

TOYOTA



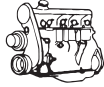

kW/BHP

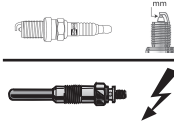

eon TITAN

IRIDIUM

**...TOYOTA****...LAND CRUISER PRADO**

| | | | | | | | | | |
|----------------------|---|--------|---------|--------|--|--|--------|-------|----------------------|
| 4.0 V6 Dual VVTi 4WD | 6 | 1GR-FE | 205/275 | 08/09→ | | | CET14P | OE190 | BAEA172E BAEA192E |
| 4.0 V6 VVTi 4WD | 6 | 1GR-FE | 183/245 | 01/10→ | | | CET14P | OE190 | |
| 4.0 V6 VVTi 4WD | 6 | 1GR-FE | 203/272 | 01/10→ | | | CET14P | OE190 | |
| 4.0 V6 VVT-i 4WD | 6 | 1GR-FE | 207/278 | 01/03→ | | | CET14P | OE190 | BAEA192E |

MAJESTA

| | | | | | | | | | |
|-----|---|--------|---------|-------------|-------|-----|--------|-------|--|
| 4.0 | 8 | 1UZ-FE | 206/276 | 09/99→08/03 | OE136 | 0,8 | CET12P | OE179 | |
|-----|---|--------|---------|-------------|-------|-----|--------|-------|--|

MATRIX

| | | | | | | | | | |
|----------|---|--------|--------|-------------|-------|-----|------|-------|--|
| 1.8 4WD | 4 | 1ZZ-FE | 91/122 | 01/02→02/04 | OE093 | 1,0 | CET2 | OE182 | |
| 1.8 VVTi | 4 | 1ZZ-FE | 96/129 | 01/02→02/04 | OE093 | 1,0 | CET2 | OE182 | |

MR 2 III

| | | | | | | | | | |
|--------------|---|--------|---------|-------------|-------|-----|------|-------|---------------------------|
| 1.8 16V VT-i | 4 | 1ZZ-FE | 103/138 | 10/99→06/07 | OE093 | 1,0 | CET2 | OE182 | BAEA164E ^[167] |
|--------------|---|--------|---------|-------------|-------|-----|------|-------|---------------------------|

NADIA

| | | | | | | | | | |
|---------|---|--------|---------|-------------|-------|-----|------|--|--|
| 2.0 | 4 | 3S-FE | 100/134 | 04/98→08/03 | OE026 | 0,9 | CET2 | | |
| 2.0 4WD | 4 | 3S-FSE | 107/143 | 04/98→08/03 | OE176 | 1,0 | CET3 | | |

NOAH/VOXY

| | | | | | | | | | |
|--------------|---|---------|---------|-------------|--|--|--------|-------|----------|
| 2.0 | 4 | 3ZR-FAE | 116/156 | 06/07→ | | | | | BAEA184E |
| 2.0, 2.0 4WD | 4 | 1AZ-FSE | 112/150 | 12/01→06/07 | | | CET12P | OE182 | |
| 2.0 4WD | 4 | 3ZR-FAE | 114/153 | 06/07→09/13 | | | | | BAEA184E |

OPA

| | | | | | | | | | |
|---------|---|---------|---------|-------------|-------|-----|--------|-------|--|
| 1.8 | 4 | 1ZZ-FE | 100/134 | 04/00→08/03 | OE093 | 1,0 | CET2 | OE182 | |
| 1.8 4WD | 4 | 1ZZ-FE | 92/123 | 04/00→08/03 | OE093 | 1,0 | CET2 | OE182 | |
| 2.0 | 4 | 1AZ-FSE | 112/150 | 08/00→04/05 | | | CET12P | OE182 | |

PASEO

| | | | | | | | | | |
|-----|---|-------|--------|-------------|-------|-----|------|-------|--|
| 1.5 | 4 | 5E-FE | 81/109 | 08/95→06/99 | OE063 | 1,0 | CET2 | OE180 | |
|-----|---|-------|--------|-------------|-------|-----|------|-------|--|

PASSO

| | | | | | | | | | |
|--------------|---|--------|--------|-------------|-------|-----|--------|-------|--|
| 1.0, 1.0 4WD | 3 | 1KR-FE | 51/68 | 06/05→ | OE035 | 0,9 | CET5 | OE190 | |
| 1.3 | 4 | K3-VE | 77/103 | 06/05→12/07 | OE136 | 0,8 | CET12P | | |

PASSO SETTE

| | | | | | | | | | |
|--------------|---|--------|--------|--------|--|--|--------|-------|--|
| 1.5, 1.5 4WD | 4 | 3SZ-VE | 80/107 | 12/08→ | | | CET10P | OE187 | |
|--------------|---|--------|--------|--------|--|--|--------|-------|--|

PICNIC

| | | | | | | | | | |
|---------|---|-------|---------|-------------|-------|-----|------|-------|--------|
| 2.0 | 4 | 3S-FE | 90/121 | 01/01→12/01 | OE026 | 0,9 | CET2 | OE188 | |
| 2.0 | 4 | 3S-FE | 100/134 | 05/96→04/01 | OE026 | 0,9 | CET2 | | |
| 2.0 16V | 4 | 3S-FE | 94/126 | 08/96→09/00 | OE026 | 0,9 | CET2 | OE188 | CLS232 |
| 2.2 D | 4 | 3C-TE | 66/89 | 08/97→12/01 | CH608 | 11v | | | |

PLATZ

| | | | | | | | | | |
|-------------------|---|--------|--------|-------------|-------|-----|------|-------|--|
| 1.0 | 4 | 1SZ-FE | 50/67 | 04/99→08/05 | OE093 | 1,0 | CET2 | OE182 | |
| 1.3, 1.3 VVTi 4WD | 4 | 2NZ-FE | 63/84 | 08/99→08/05 | OE093 | 1,0 | CET2 | OE182 | |
| 1.5, 1.5 VVTi 4WD | 4 | 1NZ-FE | 78/105 | 04/99→08/05 | OE093 | 1,0 | CET2 | OE182 | |

PORTE

| | | | | | | | | | |
|----------|---|--------|--------|-------------|-------|-----|--------|-------|--|
| 1.3 VVTi | 4 | 2NZ-FE | 64/86 | 07/04→07/12 | OE093 | 1,0 | CET2 | OE182 | |
| 1.5 4WD | 4 | 1NZ-FE | 77/103 | 07/04→07/12 | | | CET12P | OE182 | |
| 1.5 VVTi | 4 | 1NZ-FE | 81/109 | 07/04→07/12 | OE093 | 1,0 | CET2 | OE182 | |

PORTE II

| | | | | | | | | | |
|---------|---|--------|--------|--------|--|--|--------|-------|--|
| 1.5 | 4 | 1NZ-FE | 80/107 | 08/12→ | | | CET14P | OE190 | |
| 1.5 4WD | 4 | 1NZ-FE | 76/102 | 08/12→ | | | CET14P | OE190 | |

PREMIO

| | | | | | | | | | |
|---------|---|---------|---------|-------------|--|--|--------|-------|----------|
| 1.5 | 4 | 1NZ-FE | 81/109 | 07/07→ | | | CET14P | OE190 | |
| 1.8 | 4 | 2ZR-FAE | 106/142 | 12/01→11/12 | | | | | BAEA184E |
| 1.8 4WD | 4 | 2ZR-FAE | 98/131 | 07/07→ | | | | | BAEA184E |

TOYOTA





kW/BHP

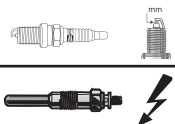

eon TITAN

IRIDIUM

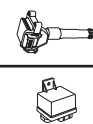

...TOYOTA

...PREMIO

2.0, 2.0 4WD 4 3ZR-FAE 116/156 07/07→ BAEA184E

PREVIA

2.0 4 3S-FE 94/126 10/00→08/03 OE026 0,9 CET2
 2.4 4 2AZ-FE 115/154 02/00→02/06 CET12P OE182 BAEA167E [275]
 BAEA171E [169] [275]

3.0, 3.0 4WD 6 1MZ-FE 162/217 02/00→12/05 CET12P OE182

PREVIA III

2.4 4 2AZ-FE 125/168 10/05→ CET12P OE182 BAEA171E

3.5, 3.5 4WD 6 2GR-FE 206/276 01/06→ CET14P OE190

PRIUS

1.5 4 1NZ-FXE 43/58 12/97→08/00 CET12P OE180 [160]
 OE193

1.5 4 1NZ-FXE 57/76 09/03→12/09 CET12P OE193 BAEA165E [168]

1.5 Hybrid 4 1NZ-FXE 53/71 05/00→01/04 CET12P OE180 [160]
 →04/03 BAEA165E [168]
 OE193

1.5 Hybrid 4 1NZ-FXE 85/114 09/00→12/03 CET12P OE180 [160]
 →04/03
 OE193

1.5 Hybrid 4 1NZ-FXE 107/143 09/03→03/09 CET12P OE193

1.8 Hybrid 4 2ZR-FXE 73/98 04/09→ BAEA184E

PRIUS C

1.5 Hybrid 4 1NZ-FXE 54/72 02/12→ CET12P BAEA165E

1.5 Hybrid 4 1NZ-FXE 74/99 09/11→ CET12P

PRIUS PLUS

1.8 Hybrid 4 2ZR-FXE 73/98 05/11→ BAEA184E

PROBOX/SUCCEED

1.3 VVTi 4 2NZ-FE 64/86 07/02→08/14 OE093 1,0 CET2 OE182

1.5 VVTi, 1.5 VVTi 4WD 4 1NZ-FE 80/107 07/02→08/14 OE093 1,0 CET2 OE182

1.5 VVTi 4WD 4 1NZ-FE 77/103 07/02→08/14 OE093 1,0 CET2

1.5 VVTi Hybrid 4 1NZ-FXE 68/91 07/02→08/14 OE191 1,0 CET12P OE180

PROGRES

2.5 6 1JZ-FSE 147/197 10/97→06/07 CET12P OE188

3.0 6 2JZ-FSE 162/217 10/97→06/07 CET12P OE188

RACTIS

1.3 4 2SZ-FE 64/86 09/05→08/10 OE093 1,0 CET2

1.5 VVTi 4 1NZ-FE 80/107 09/05→08/10 CET14P OE190

1.5 VVTi 4WD 4 1NZ-FE 76/102 09/05→08/10 CET14P OE190

RAUM

1.5 4 5E-FE 66/89 05/97→03/03 OE063 1,0 CET2 OE180

1.5 4 5E-FE 69/93 08/97→04/03 OE063 1,0 CET2 OE180

1.5 4 1NZ-FE 80/107 05/03→ OE093 1,0 CET2 OE182

1.5 4WD 4 5E-FE 67/90 08/97→04/03 OE063 1,0 CET2 OE180

1.5 4WD 4 1NZ-FE 77/103 05/03→ OE093 1,0 CET2 OE182

RAV 4 I

2.0 4 3S-FE 99/133 06/97→09/99 OE026 0,9 CET2

2.0 4WD 4 3S-FE 94/126 07/96→06/00 OE026 0,9 CET2 OE188 CLS233 [292]

2.0 4WD 4 3S-FE 95/127 06/94→06/00 OE026 0,9 CET2 OE188 CLS233 [292]

2.0 4WD 4 3S-FE 99/133 01/94→09/99 OE026 0,9 CET2 OE188

2.0 4WD 4 3S-GE 121/162 01/94→09/99 OE136 0,8 CET12P

TOYOTA



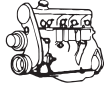

kW/BHP

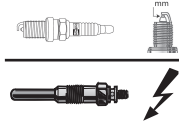

eon TITAN

IRIDIUM

**...TOYOTA****RAV 4 II**

| | | | | | | | | | |
|---------------|---|--------|---------|-------------|-------|-----|--------|-------|--|
| 1.8 | 4 | 1ZZ-FE | 92/123 | 08/00→11/05 | OE093 | 1,0 | CET2 | OE182 | BAEA164E ^[167] |
| 2.0 4WD | 4 | 1AZ-FE | 110/148 | 06/00→11/05 | | | CET12P | OE182 | BAEA167E ^[275] BAEA171E ^{[169] [275]} |
| 2.4 VVT-i 4WD | 4 | 2AZ-FE | 112/150 | 08/03→11/05 | | | CET12P | OE182 | BAEA167E |

RAV 4 III

| | | | | | | | | | |
|--------------------------|---|---------|---------|--------|--|--|--------|-------|--|
| 2.0, 2.0 4WD | 4 | 3ZR-FAE | 116/156 | 12/08→ | | | | | BAEA184E |
| 2.0 4WD | 4 | 1AZ-FE | 112/150 | 03/06→ | | | CET12P | OE182 | BAEA167E ^[275] BAEA171E ^{[169] [275]} |
| 2.0 VVT-i, 2.0 VVT-i 4WD | 4 | 3ZR-FAE | 109/146 | 03/09→ | | | | | BAEA184E |
| 2.4 | 4 | 2AZ-FE | 125/168 | 11/05→ | | | CET12P | OE182 | BAEA167E ^[275] BAEA171E ^{[169] [275]} |
| 2.4 VVT-i 4WD | 4 | 2AZ-FE | 125/168 | 11/05→ | | | CET12P | OE182 | BAEA171E |
| 3.5 4WD | 6 | 2GR-FE | 206/276 | 08/07→ | | | CET14P | OE190 | |
| 3.5 VVT-i 4WD | 6 | 2GR-FE | 201/270 | 11/05→ | | | CET14P | OE190 | |

RAV 4 IV

| | | | | | | | | | |
|---------------|---|---------|---------|--------|--|--|--------|-------|----------|
| 2.0 4WD | 4 | 3ZR-FAE | 111/149 | 12/12→ | | | | | BAEA184E |
| 2.0 VVT-i | 4 | 3ZR-FAE | 107/143 | 12/12→ | | | | | BAEA184E |
| 2.5 VVT-i 4WD | 4 | 2AR-FE | 132/177 | 12/12→ | | | CET14P | OE190 | BAEA192E |

RUSH

| | | | | | | | | | |
|--------------|---|--------|--------|--------|--|--|--------|-------|--|
| 1.5, 1.5 4WD | 4 | 3SZ-VE | 80/107 | 03/06→ | | | CET10P | OE187 | |
|--------------|---|--------|--------|--------|--|--|--------|-------|--|

SCEPTER

| | | | | | | | | | |
|-----|---|--------|---------|-------------|-------|-----|--------|-------|--|
| 2.5 | 6 | 4VZ-FE | 129/173 | 11/94→09/96 | OE146 | 1,0 | CET12P | OE179 | |
|-----|---|--------|---------|-------------|-------|-----|--------|-------|--|

SEQUOIA

| | | | | | | | | | |
|--------------|---|--------|---------|-------------|--|--|--------|-------|--|
| 4.7 4WD | 8 | 2UZ-FE | 204/274 | 05/00→11/07 | | | CET12P | OE182 | |
| 4.7 4WD | 8 | 2UZ-FE | 206/276 | 09/04→ | | | CET12P | OE182 | |
| 4.7, 4.7 4WD | 8 | 2UZ-FE | 175/235 | 05/00→11/07 | | | CET12P | OE182 | |
| 5.7 4WD | 8 | 3UR-FE | 284/381 | 11/07→ | | | CET14P | OE190 | |

SIENNA

| | | | | | | | | | |
|---------|---|--------|---------|-------------|-------|-----|--------|-------|--|
| 3.0 | 6 | 1MZ-FE | 143/192 | 08/97→12/02 | OE026 | 0,9 | CET2 | OE188 | |
| 3.0 | 6 | 1MZ-FE | 154/207 | 08/97→12/02 | OE026 | 0,9 | CET2 | OE188 | |
| 3.3 4WD | 6 | 3MZ-FE | 169/227 | 01/03→11/09 | | | CET12P | OE182 | |
| 3.5 4WD | 6 | 2GR-FE | 198/266 | 01/07→ | | | CET14P | OE190 | |

SIENTA

| | | | | | | | | | |
|--------------|---|--------|--------|-------------|-------|-----|------|-------|--|
| 1.5, 1.5 4WD | 4 | 1NZ-FE | 81/109 | 05/03→ | OE093 | 1,0 | CET2 | OE182 | |
| 1.5 4WD | 4 | 1NZ-FE | 77/103 | 05/03→05/15 | OE093 | 1,0 | CET2 | | |

SOLARA

| | | | | | | | | | |
|-----|---|--------|---------|-------------|-------|-----|--------|-------|--|
| 2.4 | 4 | 2AZ-FE | 117/157 | 07/03→11/08 | | | CET12P | OE182 | |
| 3.0 | 6 | 1MZ-FE | 140/188 | 06/98→06/01 | OE026 | 0,9 | CET2 | OE188 | |

SOLUNA VIOS

| | | | | | | | | | |
|-----|---|--|-------|-------------|-------|-----|------|--|--|
| 1.5 | 4 | | 68/91 | 07/02→08/13 | OE063 | 1,0 | CET2 | | |
|-----|---|--|-------|-------------|-------|-----|------|--|--|

SPADE

| | | | | | | | | | |
|---------|---|--------|--------|--------|--|--|--------|-------|--|
| 1.5 | 4 | 1NZ-FE | 80/107 | 08/12→ | | | CET14P | OE190 | |
| 1.5 4WD | 4 | 1NZ-FE | 76/102 | 08/12→ | | | CET14P | OE190 | |

SPRINTER

| | | | | | | | | | |
|---------|---|-------|--------|-------------|-------|-----|--------|-------|--|
| 1.8 4WD | 4 | 4S-FE | 92/123 | 04/95→11/02 | OE146 | 1,0 | CET12P | OE179 | |
| 2.2 TD | 4 | 3C-TE | 66/89 | 04/95→11/02 | CH608 | 11v | | | |

SPRINTER CARIB

| | | | | | | | | | |
|--------------|---|-------|--------|-------------|-------|-----|--------|-------|--|
| 1.6 | 4 | 4A-FE | 81/109 | 08/95→10/01 | OE005 | 0,9 | CET2 | OE179 | |
| 1.8, 1.8 4WD | 4 | 7A-FE | 85/114 | 08/95→10/01 | OE138 | 1,0 | CET12P | OE193 | |

TOYOTA





kW/BHP

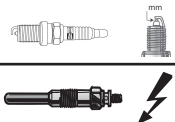

eon TITAN

IRIDIUM

**...TOYOTA****...SPRINTER CARIB**

| | | | | | | | | | |
|---------|---|-------|--------|-------------|-------|-----|--------|-------|--|
| 1.8 4WD | 4 | 4S-FE | 92/123 | 04/95→11/02 | OE146 | 1,0 | CET12P | OE179 | |
|---------|---|-------|--------|-------------|-------|-----|--------|-------|--|

SUPRA

| | | | | | | | | | |
|-----|---|--------|---------|-------------|--|--|--|--|---|
| 3.0 | 6 | 2JZ-GE | 165/221 | 05/93→07/02 | | | | | BAEA445 ^[316] →05/96 BAEA173E ^[317] →09/97 |
|-----|---|--------|---------|-------------|--|--|--|--|---|

3.0 i Bi-Turbo

| | | | | | | | | | |
|----------------|---|---------|---------|-------------|-------|-----|--------|-------|--|
| 3.0 i Bi-Turbo | 6 | 2JZ-GTE | 243/326 | 05/93→07/02 | OE136 | 0,8 | CET12P | OE179 | |
|----------------|---|---------|---------|-------------|-------|-----|--------|-------|--|

TACOMA

| | | | | | | | | | |
|--------------|---|--------|---------|-------------|--|--|--|--|--------------------|
| 2.7, 2.7 4WD | 4 | 3RZ-FE | 112/150 | 01/95→08/04 | | | | | BAEA186E 09/00→ |
|--------------|---|--------|---------|-------------|--|--|--|--|--------------------|

TERCEL

| | | | | | | | | | |
|-----|---|-------|-------|-------------|-------|-----|------|-------|--|
| 1.5 | 4 | 5E-FE | 70/94 | 11/94→09/99 | OE063 | 1,0 | CET2 | OE180 | |
|-----|---|-------|-------|-------------|-------|-----|------|-------|--|

TUNDRA

| | | | | | | | | | |
|--------------|---|--------|---------|-------------|-------|-----|------|--|--|
| 3.4, 3.4 4WD | 6 | 5VZ-FE | 140/188 | 04/99→07/03 | OE019 | 0,9 | CET2 | | |
|--------------|---|--------|---------|-------------|-------|-----|------|--|--|

| | | | | | | | | | |
|--------------|---|--------|---------|-------------|-------|-----|------|-------|--|
| 4.0, 4.0 4WD | 6 | 1GR-FE | 180/241 | 05/03→11/06 | OE035 | 0,9 | CET5 | OE190 | |
|--------------|---|--------|---------|-------------|-------|-----|------|-------|--|

| | | | | | | | | | |
|--------------|---|--------|---------|--------|--|--|--------|-------|--|
| 5.7, 5.7 4WD | 8 | 3UR-FE | 284/381 | 01/07→ | | | CET14P | OE190 | |
|--------------|---|--------|---------|--------|--|--|--------|-------|--|

URBAN CRUISER

| | | | | | | | | | |
|-----|---|--------|-------|--------|--|--|--|--|----------|
| 1.3 | 4 | 1NR-FE | 73/98 | 01/09→ | | | | | BAEA192E |
|-----|---|--------|-------|--------|--|--|--|--|----------|

| | | | | | | | | | |
|-----|---|--------|-------|--------|--|--|--|--|----------|
| 1.3 | 4 | 1NR-FE | 74/99 | 04/09→ | | | | | BAEA192E |
|-----|---|--------|-------|--------|--|--|--|--|----------|

| | | | | | | | | | |
|----------|---|--------|--------|--------|-------|-----|------|--|--|
| 1.5 VVTi | 4 | 1NZ-FE | 80/107 | 07/07→ | OE093 | 1,0 | CET2 | | |
|----------|---|--------|--------|--------|-------|-----|------|--|--|

| | | | | | | | | | |
|--------------|---|--------|--------|--------|-------|-----|------|--|--|
| 1.5 VVTi 4WD | 4 | 1NZ-FE | 76/102 | 07/07→ | OE093 | 1,0 | CET2 | | |
|--------------|---|--------|--------|--------|-------|-----|------|--|--|

VENZA

| | | | | | | | | | |
|--------------|---|--------|---------|--------|--|--|--------|-------|----------|
| 2.7, 2.7 4WD | 4 | 1AR-FE | 136/182 | 11/08→ | | | CET14P | OE190 | BAEA192E |
|--------------|---|--------|---------|--------|--|--|--------|-------|----------|

| | | | | | | | | | |
|--------------|---|--------|---------|--------|--|--|--------|-------|--|
| 3.5, 3.5 4WD | 6 | 2GR-FE | 200/268 | 11/08→ | | | CET14P | OE190 | |
|--------------|---|--------|---------|--------|--|--|--------|-------|--|

VEROSSA

| | | | | | | | | | |
|------------------------|---|-------|---------|-------------|--|--|--------|-------|--|
| 2.0 VVTi, 2.0 VVTi 4WD | 6 | 1G-FE | 118/158 | 10/00→11/03 | | | CET12P | OE182 | |
|------------------------|---|-------|---------|-------------|--|--|--------|-------|--|

| | | | | | | | | | |
|----------|---|---------|---------|-------------|--|--|--------|-------|--|
| 2.5 VVTi | 6 | 1JZ-FSE | 147/197 | 10/00→11/03 | | | CET12P | OE188 | |
|----------|---|---------|---------|-------------|--|--|--------|-------|--|

| | | | | | | | | | |
|----------|---|---------|---------|-------------|-------|-----|--------|--|--|
| 2.5 VVTi | 6 | 1JZ-GTE | 206/276 | 10/00→11/03 | OE136 | 0,8 | CET12P | | |
|----------|---|---------|---------|-------------|-------|-----|--------|--|--|

VERSO

| | | | | | | | | | |
|-----|---|---------|--------|--------|--|--|--|--|----------|
| 1.6 | 4 | 1ZR-FAE | 97/130 | 04/09→ | | | | | BAEA184E |
|-----|---|---------|--------|--------|--|--|--|--|----------|

| | | | | | | | | | |
|-----|---|---------|---------|--------|--|--|--|--|----------|
| 1.8 | 4 | 2ZR-FAE | 108/145 | 04/09→ | | | | | BAEA184E |
|-----|---|---------|---------|--------|--|--|--|--|----------|

VERSO S

| | | | | | | | | | |
|-----|---|--------|-------|-------------|--|--|--|--|----------|
| 1.3 | 4 | 1NR-FE | 70/94 | 11/10→10/16 | | | | | BAEA192E |
|-----|---|--------|-------|-------------|--|--|--|--|----------|

| | | | | | | | | | |
|-----|---|--------|-------|-------------|--|--|--|--|----------|
| 1.3 | 4 | 1NR-FE | 73/98 | 11/10→10/16 | | | | | BAEA192E |
|-----|---|--------|-------|-------------|--|--|--|--|----------|

| | | | | | | | | | |
|-----|---|--------|--------|-------------|--|--|--------|-------|--|
| 1.5 | 4 | 1NZ-FE | 80/107 | 11/10→04/14 | | | CET14P | OE190 | |
|-----|---|--------|--------|-------------|--|--|--------|-------|--|

| | | | | | | | | | |
|---------|---|--------|--------|-------------|--|--|--------|-------|--|
| 1.5 4WD | 4 | 1NZ-FE | 76/102 | 11/10→10/16 | | | CET14P | OE190 | |
|---------|---|--------|--------|-------------|--|--|--------|-------|--|

VIOS

| | | | | | | | | | |
|----------|---|-------|-------|-------------|-------|-----|------|-------|--|
| 1.3 VVTi | 4 | 8A-FE | 64/86 | 07/02→01/08 | OE063 | 1,0 | CET2 | OE180 | |
|----------|---|-------|-------|-------------|-------|-----|------|-------|--|

| | | | | | | | | | |
|-----|---|-------|-------|-------------|-------|-----|------|--|--|
| 1.5 | 4 | 5A-FE | 68/91 | 07/02→01/08 | OE063 | 1,0 | CET2 | | |
|-----|---|-------|-------|-------------|-------|-----|------|--|--|

| | | | | | | | | | |
|----------|---|--------|--------|-------------|-------|-----|------|--|--|
| 1.5 VVTi | 4 | 1NZ-FE | 78/105 | 07/02→01/08 | OE063 | 1,0 | CET2 | | |
|----------|---|--------|--------|-------------|-------|-----|------|--|--|

VIOS/YARIS

| | | | | | | | | | |
|-----|---|--------|-------|--------|-------|-----|------|-------|----------|
| 1.0 | 3 | 1KR-FE | 52/70 | 08/07→ | OE035 | 0,9 | CET5 | OE190 | BAEA164E |
|-----|---|--------|-------|--------|-------|-----|------|-------|----------|

| | | | | | | | | | |
|-----|---|--------|--------|--------|--|--|--------|-------|--|
| 1.5 | 4 | 1NZ-FE | 80/107 | 08/07→ | | | CET14P | OE190 | |
|-----|---|--------|--------|--------|--|--|--------|-------|--|

| | | | | | | | | | |
|-----|---|--------|--------|--------|-------|-----|------|-------|--|
| 1.5 | 4 | 1NZ-FE | 81/109 | 08/07→ | OE093 | 1,0 | CET2 | OE182 | |
|-----|---|--------|--------|--------|-------|-----|------|-------|--|

VISTA

| | | | | | | | | | |
|-----|---|--------|--------|-------------|-------|-----|------|-------|--|
| 1.8 | 4 | 1ZZ-FE | 96/129 | 06/98→08/03 | OE093 | 1,0 | CET2 | OE182 | |
|-----|---|--------|--------|-------------|-------|-----|------|-------|--|

| | | | | | | | | | |
|----------------------|---|-----------------|---------|-------------|--|--|--------|-------|--|
| 2.0, 2.0 D4 N200 4WD | 4 | 1AZ-FE; 1AZ-FSE | 112/150 | 06/98→08/03 | | | CET12P | OE182 | |
|----------------------|---|-----------------|---------|-------------|--|--|--------|-------|--|

| | | | | | | | | | |
|-----|---|--------|---------|-------------|--|--|--------|-------|--|
| 2.4 | 4 | 2AZ-FE | 112/150 | 06/01→08/03 | | | CET12P | OE182 | |
|-----|---|--------|---------|-------------|--|--|--------|-------|--|

| | | | | | | | | | |
|-----|---|--------|---------|-------------|-------|-----|------|-------|--|
| 3.0 | 6 | 1MZ-FE | 140/188 | 06/98→08/02 | OE026 | 0,9 | CET2 | OE188 | |
|-----|---|--------|---------|-------------|-------|-----|------|-------|--|

| | | | | | | | | | |
|-----|---|--------|---------|-------------|--|--|--------|-------|--|
| 3.3 | 6 | 3MZ-FE | 165/221 | 06/02→08/03 | | | CET12P | OE182 | |
|-----|---|--------|---------|-------------|--|--|--------|-------|--|

WILL CYPHA

| | | | | | | | | | |
|----------|---|--------|-------|-------------|-------|-----|------|-------|--|
| 1.3 VVTi | 4 | 2NZ-FE | 62/83 | 05/01→07/05 | OE093 | 1,0 | CET2 | OE182 | |
|----------|---|--------|-------|-------------|-------|-----|------|-------|--|

TOYOTA





kW/BHP

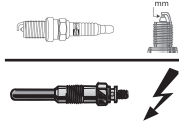

eon TITAN

IRIDIUM



TOYOTA

| ...TOYOTA | | | | | | | | | |
|------------------------|---|-----------------|---------|-------------|-------|-----|----------------|----------------|---|
| ...WILL CYPHA | | | | | | | | | |
| 1.5 VVTi 4WD | 4 | 1NZ-FE | 78/105 | 05/01→07/05 | OE093 | 1,0 | CET2 | OE182 | |
| WILL Vi | | | | | | | | | |
| 1.3 | 4 | 2NZ-FE | 64/86 | 01/00→12/01 | OE093 | 1,0 | CET2 | OE182 | |
| WILL VS | | | | | | | | | |
| 1.5 VVTi 4WD | 4 | 1NZ-FE | 81/109 | 03/01→04/04 | OE093 | 1,0 | CET2 | OE182 | |
| 1.8 VVTi, 1.8 VVTi 4WD | 4 | 1ZZ-FE | 100/134 | 03/01→04/04 | OE093 | 1,0 | CET2 | OE182 | |
| WINDOM | | | | | | | | | |
| 3.0 | 6 | 1MZ-FE | 155/208 | 10/96→07/01 | OE026 | 0,9 | CET2 | OE188 | |
| 3.0 VVTi G | 6 | 1MZ-FE | 158/212 | 08/01→07/04 | | | CET12P | OE182 | |
| WISH | | | | | | | | | |
| 1.8 Hi | 4 | 1ZZ-FE | 97/130 | 04/03→03/09 | OE093 | 1,0 | CET2 | OE182 | BAEA164E |
| 1.8 Hi 4WD | 4 | 1ZZ-FE | 92/123 | 04/03→03/09 | OE093 | 1,0 | CET2 | OE182 | BAEA164E |
| 2.0, 2.0 4WD | 4 | 3ZR-FAE | 116/156 | 04/09→ | | | | | BAEA184E |
| 2.0 Zi | 4 | 1AZ-FSE | 114/153 | 04/03→03/09 | | | CET12P | OE182 | |
| YARIS | | | | | | | | | |
| 1.0 | 4 | 1SZ-FE | 48/64 | 03/03→09/05 | | | CET2 | OE182 | BAEA165E ^[168] |
| 1.0 | 4 | 1SZ-FE | 50/67 | 04/99→09/05 | | | CET2 | OE182 | BAEA165E ^[168] |
| 1.0, 1.0 VVT-i | 3 | 1KR-FE | 51/68 | 01/05→ | OE035 | 0,9 | CET5 | OE190 | BAEA164E ^{[167][275]} BAEA165E ^[275] |
| 1.0 GPL | 3 | 1KR-FE | 51/68 | 01/06→ | OE035 | 0,9 | CET5 | OE190 | |
| 1.3 | 4 | 2NZ-FE | 63/84 | 11/99→ | | | CET2 | OE182 | BAEA165E ^[168] |
| 1.3 | 4 | 2SZ-FE | 64/86 | 04/02→09/05 | | | CET2 | OE182 | BAEA165E |
| 1.3 | 4 | 1NR-FE | 70/94 | 12/10→ | | | | | BAEA192E |
| 1.3, 1.3 VVT-i | 4 | 1NR-FE; 1NR-FKE | 73/98 | 07/10→ | | | | | BAEA192E |
| 1.3 4WD | 4 | 2NZ-FE; 2SZ-FE | 64/86 | 08/07→ | OE093 | 1,0 | CET2 | OE182 | |
| 1.3 VVT-i | 4 | 2NZ-FE; 2SZ-FE | 63/84 | 01/05→ | OE093 | 1,0 | CET2 | OE182 | BAEA165E |
| 1.3 VVT-i | 4 | 2SZ-FE | 64/86 | 08/05→ | | | CET2 | OE182 | BAEA165E ^[168] |
| 1.3 VVT-i | 4 | 1NR-FE | 74/99 | 11/08→ | | | | | BAEA192E |
| 1.5 | 4 | 1NZ-FE | 77/103 | 01/03→11/05 | | | CET2 | OE182 | BAEA165E ^[168] |
| 1.5 | 4 | 1NZ-FE | 78/105 | 04/01→ | | | CET2 | OE182 | BAEA165E ^[168] |
| 1.5 | 4 | 1NZ-FE | 80/107 | 11/05→ | OE093 | 1,0 | CET14P CET2 | OE182 OE190 | BAEA165E |
| 1.5 | 4 | 1NZ-FE | 110/148 | 03/00→07/05 | OE089 | 1,0 | CET2 | OE188 | BAEA165E ^[168] |
| 1.5 Hybrid | 4 | 1NZ-FXE | 54/72 | 04/15→ | | | CET12P | | |
| 1.5 Hybrid | 4 | 1NZ-FXE | 55/74 | 03/12→ | | | CET12P | | BAEA165E ^[168] |
| 1.8 VVTi | 4 | 1ZZ-FE | 97/130 | 11/05→ | OE093 | 1,0 | CET2 | OE182 | |
| 1.8 VVTi | 4 | 2ZR-FE | 98/131 | 01/07→12/11 | | | | | BAEA184E |
| YARIS / VIOS | | | | | | | | | |
| 1.3 | 4 | 2NZ-FE | 63/84 | 08/05→ | OE063 | 1,0 | | | |
| 1.3 | 4 | 2NZ-FE; 2SZ-FE | 64/86 | 09/05→04/14 | OE093 | 1,0 | CET2 | OE182 | BAEA165E |
| 1.3 4WD | 4 | 2NZ-FE | 64/86 | 08/07→ | OE093 | 1,0 | CET2 | OE182 | |
| YARIS VERSO | | | | | | | | | |
| 1.3 | 4 | 2NZ-FE | 62/83 | 11/02→09/05 | OE093 | 1,0 | CET2 | OE182 | BAEA165E ^[168] |
| 1.3 | 4 | 2NZ-FE | 63/84 | 08/99→10/02 | OE093 | 1,0 | CET2 | OE182 | BAEA165E ^[168] |
| 1.5 | 4 | 1NZ-FE | 77/103 | 03/00→09/05 | | | CET2 | OE182 | BAEA165E ^[168] |
| 1.5 | 4 | 1NZ-FE | 78/105 | 03/00→09/05 | | | CET2 | OE182 | BAEA165E ^[168] |
| 1.5 4WD | 4 | 1NZ-FE | 78/105 | 03/00→09/05 | OE093 | 1,0 | CET2 | | |
| ZELAS | | | | | | | | | |
| 2.5 VVT-i | 4 | 2AR-FE | 131/176 | 08/10→ | | | CET14P | OE190 | |





kW/BHP

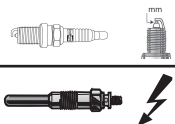

eon TITAN

IRIDIUM

**TOYOTA****COASTER**2.7 4 3RZ-FE 112/150 08/99→10/03 **OE039** 1,0 **CET2****DELIBOY**2.2 D 4 3C-TE 66/89 10/94→10/95 **CH608** 11v**DYNA**2.7 4 2TR-FE 109/146 09/06→ **OE035** 0,9 **CET5**3.0 D4d 4 5L 65/87 08/01→ **CH154** 11v**DYNA 150**3.0 D 4 5L 65/87 09/98→07/01 **CH154** 11v**DYNA 200**2.2 4 4Y 69/93 10/93→07/01 **OE006** 0,9 **CET8** **OE195****HIACE / COMMUTER V**2.7 4 2TR-FE 111/149 01/05→ **OE035** 0,9 **CET5****HIACE III**2.4 4 2RZ-E 85/114 08/95→08/04 **OE006** 0,9 **CET8** **OE195**3.0 D 4 5L 65/87 08/98→08/04 **CH154** 11v3.4, 3.4 4WD 6 5VZ-FE 131/176 08/95→08/01 **OE019** 0,9 **CET2** **OE184****HIACE IV**2.4, 2.4 4WD 4 2RZ-E 85/114 08/95→11/03 **OE006** 0,9 **CET8** **OE195**2.4 D 4 2L 55/74 08/95→08/01 **CH154** 11v2.4 D 4 2L 58/78 08/95→08/06 **CH154** 11v2.4 D 4 2L 61/82 08/95→08/06 **CH154** 11v2.4 i 4 2RZ-E 88/118 08/95→08/04 **OE006** 0,9 **CET8**2.4 TD, 2.4 TD 4WD 4 2L-T 66/89 08/95→08/06 **CH154** 11v2.7 4 3RZ-FE 106/142 11/01→12/06 **OE005** 0,9 **CET2** **OE180****OE218** LPG [278] 1,62.7, 2.7 4WD 4 3RZ-FE 105/141 04/98→08/06 **OE005** 0,9 **CET2** **OE180** **BAEA186E**

08/01→

OE218 LPG [278] 1,62.7 4WD 4 3RZ-FE 106/142 04/98→ **OE005** 0,9 **CET2** **OE180** **BAEA186E**

08/01→

OE218 LPG [278] 1,6**HIACE V**2.7 VVTi 4 2TR-FE 111/149 01/05→ **OE035** 0,9 **CET5** **BAEA171E****HILUX**2.7 4 3RZ-FE 107/143 08/97→08/05 **OE005** 0,9 **CET2****HILUX III**2.7 4 2TR-FE 118/158 02/05→ **OE035** 0,9 **CET5**4.0, 4.0 4WD 6 1GR-FE 175/235 02/05→ **OE035** 0,9 **CET5****LITEACE**1.8 4 1ZZ-FE 96/129 10/97→08/01 **OE093** 1,0 **CET2** **OE182**2.2 D 4 3C-TE 66/89 02/95→08/97 **CH608** 11v**TARAGO**2.4 4 2RZ-E 85/114 08/95→10/99 **OE006** 0,9 **CET8** **OE195**2.7 4 3RZ-FE 106/142 08/98→08/04 **OE005** 0,9 **CET2****TOWN ACE**2.4 4 2AZ-FE 115/154 10/03→07/07 **CET12P** **OE182**3.0 D 4 5L 65/87 10/01→07/07 **CH154** 11v**TOYOTA (FAW)****PRIUS**1.5 4 1NZ-FXE 57/76 01/06→12/09 **CET12P** **OE193**1.8 Hybrid 4 5ZR-FXE 73/98 02/12→ **CET12P** **OE193**

TOYOTA (FAW)



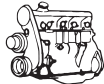

kW/BHP



eon TITAN

IRIDIUM



TVR

TVR

CERBERA

| | | | | | | | | | |
|--------|---|----------|---------|-------------|-------|-----|------|-------|--|
| 4.0 | 6 | AJA6 | 268/359 | 01/99→10/03 | OE083 | 0,7 | CET1 | OE187 | |
| 4.2 | 8 | AJP8 | 268/359 | 01/96→10/03 | OE026 | 0,9 | CET2 | OE184 | |
| 4.5 | 8 | AJP8-4.5 | 313/420 | 01/97→10/03 | OE026 | 0,9 | CET2 | OE184 | |
| 4.5 GT | 8 | AJP8-4.5 | 324/434 | 01/96→10/03 | OE026 | 0,9 | CET2 | OE184 | |

CHIMAERA

| | | | | | | | | | |
|-----|---|--------|---------|-------------|-------|-----|------|-------|----------------------|
| 3.9 | 8 | 39SE | 173/232 | 04/98→12/99 | | | | | BAEA115 [8] [275] |
| 3.9 | 8 | 39SE | 177/237 | 01/93→10/03 | OE006 | 0,9 | CET8 | OE195 | BAEA115 [8] [275] |
| 3.9 | 8 | 37A40P | 202/271 | 12/94→06/97 | | | | | BAEA115 [8] [275] |
| 4.3 | 8 | 40D | 206/276 | 01/93→12/93 | OE018 | 1,0 | CET8 | OE195 | |

GRIFFITH

| | | | | | | | | | |
|-----|---|---------------------|---------|-------------|-------|-----|------|-------|--|
| 5.0 | 8 | 37A50P; 47A50P; J8T | 243/326 | 01/93→03/02 | OE018 | 1,0 | CET8 | OE195 | |
|-----|---|---------------------|---------|-------------|-------|-----|------|-------|--|

TUSCAN II

| | | | | | | | | | |
|-----|---|------|---------|-------------|-------|-----|------|-------|--|
| 4.0 | 6 | AJA6 | 268/359 | 01/98→07/06 | OE083 | 0,7 | CET1 | OE187 | |
|-----|---|------|---------|-------------|-------|-----|------|-------|--|

UAZ

3160

| | | | | | | | | | |
|-----------|---|------------|--------|-------------|-------|-----|--|--|--|
| 2.4 i 4WD | 4 | UMZ4178.10 | 76/102 | 01/94→12/03 | OE037 | 0,6 | | | |
| 2.9 4WD | 4 | UMZ-4218 | 76/102 | 01/94→12/03 | OE007 | 0,9 | | | |
| 2.9 i 4WD | 4 | UMZ-421310 | 88/118 | 01/94→12/03 | OE007 | 0,9 | | | |

31512

| | | | | | | | | | |
|------------|---|------------|---------|--------|-------|-----|--|--|--|
| 4.3 V6 4WD | 6 | UMZ-417811 | 135/181 | 01/98→ | OE037 | 0,6 | | | |
|------------|---|------------|---------|--------|-------|-----|--|--|--|

HUNTER

| | | | | | | | | | |
|---------|---|------------|--------|--------|-------|-----|------|-------|--|
| 2.7 4WD | 4 | ZMZ-409.10 | 94/126 | 07/04→ | OE013 | 0,8 | CET2 | OE193 | |
|---------|---|------------|--------|--------|-------|-----|------|-------|--|

PATRIOT

| | | | | | | | | | |
|---------|---|------------|--------|--------|-------|-----|------|-------|--|
| 2.7 4WD | 4 | ZMZ-409210 | 82/110 | 07/04→ | OE013 | 0,8 | CET2 | OE193 | |
| 2.7 4WD | 4 | ZMZ-409.10 | 94/126 | 07/04→ | OE013 | 0,8 | CET2 | OE193 | |

SIMBIR (3162)

| | | | | | | | | | |
|-----------|---|------------|--------|--------|-------|-----|--|--|--|
| 2.9 i 4WD | 4 | UMZ-421310 | 88/118 | 01/97→ | OE007 | 0,9 | | | |
|-----------|---|------------|--------|--------|-------|-----|--|--|--|

UAZ

CARGO

| | | | | | | | | | |
|---------|---|------------|--------|--------|-------|-----|------|-------|--|
| 2.7 4WD | 4 | ZMZ-409.10 | 94/126 | 07/04→ | OE013 | 0,8 | CET2 | OE193 | |
|---------|---|------------|--------|--------|-------|-----|------|-------|--|

VAUXHALL

ADAM

| | | | | | | | | | |
|---------|---|------------------------|--------|--------|--|--|------|-------|----------|
| 1.0 | 3 | | 66/89 | 07/14→ | | | | OE258 | |
| 1.0 | 3 | B10XFT; F10XFT | 85/114 | 07/14→ | | | | OE258 | |
| 1.2 | 4 | A12XEL; B12XEL; B12XER | 51/68 | 10/12→ | | | CET2 | | BAEA185E |
| 1.4 | 4 | A14XEL; B14XER | 64/86 | 10/12→ | | | CET2 | | BAEA185E |
| 1.4 | 4 | A14XER | 74/99 | 10/12→ | | | CET2 | OE184 | BAEA185E |
| 1.4 LPG | 4 | | 64/86 | 07/13→ | | | CET2 | | |

AGILA Mk I (A)

| | | | | | | | | | |
|------------------|---|--------|-------|-------------|-------|-----|------|-------|---|
| 1.0 12V | 3 | Z10XE | 43/58 | 09/00→08/05 | OE198 | 0,9 | CET2 | OE184 | BAEA358 |
| 1.0 12V | 3 | Z10XEP | 44/59 | 02/00→11/06 | OE198 | 0,9 | CET2 | OE184 | BAEA359 |
| 1.2 16V | 4 | Z12XE | 55/74 | 09/00→03/08 | OE019 | 0,9 | CET2 | OE184 | BAEA147E ^[159] BAEA338 ^[170] |
| 1.2 16V Twinport | 4 | Z12XEP | 59/79 | 07/04→11/06 | OE198 | 0,9 | CET2 | OE184 | BAEA338 |

AGILA Mk II (B)

| | | | | | | | | | |
|---------|---|------|-------|-------------|-------|-----|--------|--|--|
| 1.0 12V | 3 | K10B | 48/64 | 01/08→11/14 | OE226 | 1,1 | CET10P | | |
| 1.0 i | 3 | K10B | 50/67 | 08/11→11/14 | OE226 | 1,1 | CET10P | | |

CHAMPION



kW/BHP

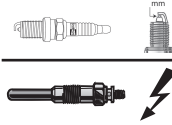

eon TITAN

IRIDIUM

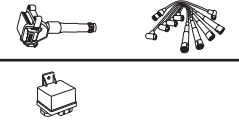

...VAUXHALL

...AGILA Mk II (B)

| | | | | | | | | | |
|-----------|---|--------------|-------|-------------|-------|-----|--------|-----------------------|--|
| 1.2 i 16V | 4 | K12B | 63/84 | 01/08→11/14 | OE226 | 1,1 | CET10P | BAEA189E | |
| 1.2 i 16V | 4 | K12B | 69/93 | 01/08→11/14 | OE226 | 1,1 | CET10P | BAEA189E | |
| 1.3 CDTi | 4 | D13A; Z13DTJ | 55/74 | 01/08→11/14 | | | | CCU142 ^[8] | |

AMPERA

| | | | | | | | | | |
|------------|---|---------------|---------|--------|--|--|--|----------|--|
| 1.4 EV 150 | 4 | 4ET50; A14XFL | 111/149 | 03/12→ | | | | BAEA185E | |
|------------|---|---------------|---------|--------|--|--|--|----------|--|

ANTARA

| | | | | | | | | | |
|------------------------|---|--------------|---------|-------------|-------|-----|--------|--------|----------|
| 2.2 CDTi, 2.2 CDTi 4WD | 4 | A22DM | 120/161 | 12/10→ | | | | CCU138 | |
| 2.2 CDTi 4WD | 4 | A22DMH | 135/181 | 12/10→ | | | | CCU138 | |
| 2.4, 2.4 4WD | 4 | A24XE; A24XF | 123/165 | 12/10→04/15 | | | CET17P | OE189 | |
| 2.4, 2.4 4WD | 4 | A24XE; A24XF | 126/169 | 11/10→04/15 | | | CET17P | OE189 | |
| 2.4 4WD | 4 | Z24XED | 103/138 | 08/06→04/15 | OE019 | 0,9 | CET2 | OE184 | BAEA447A |
| 3.0 4WD | 6 | A30XF; A30XH | 188/252 | 11/10→04/15 | | | CET17P | OE189 | |

ASTRA Mk III (F)

| | | | | | | | | | | |
|--------------------|---|---------------|---------|-------------|-------|-----|------|-------|----------|--|
| 1.4 i 16V | 4 | X14XE | 66/89 | 01/96→03/01 | OE019 | 0,9 | CET2 | OE184 | BAEA026E | CLS030 |
| 1.6 | 4 | C16SE | 74/99 | 03/94→08/95 | OE006 | 0,9 | CET8 | OE195 | | |
| 1.6 i | 4 | X16SZ | 52/70 | 02/93→02/98 | OE019 | 0,9 | CET2 | OE184 | BAEA026E | |
| 1.6 i 16V | 4 | X16XEL | 74/99 | 01/94→09/98 | OE019 | 0,9 | CET2 | OE184 | BAEA026E | CLS030 →Ch.20C17332 CLS029 Ch.20C17333→ |
| 1.7 TD | 4 | X17DTL | 50/67 | 01/94→09/98 | CH189 | 11v | | | | |
| 1.8 | 4 | C18XE | 92/123 | 09/94→08/96 | OE019 | 0,9 | CET2 | OE184 | | |
| 1.8 16V, 1.8 i 16V | 4 | C18XEL; X18XE | 85/114 | 01/94→03/01 | OE019 | 0,9 | CET2 | OE184 | BAEA344 | |
| 1.8 i 16V | 4 | 18SE | 82/110 | 09/95→02/98 | OE019 | 0,9 | CET2 | OE184 | | |
| 1.8 i 16V | 4 | C18XE | 92/123 | 06/93→02/98 | OE019 | 0,9 | CET2 | OE184 | BAEA344 | CLS107 |
| 2.0 i 16V | 4 | X20XEV | 100/134 | 01/94→09/98 | OE019 | 0,9 | CET2 | OE184 | BAEA344 | CLS107 |

ASTRA Mk IV (G)

| | | | | | | | | | | |
|------------------|---|-------------------------------|---------|-------------|-------|-----|------|-------|-----------------------|--------|
| 1.2 16V | 4 | X12XE | 48/64 | 02/98→09/00 | OE019 | 0,9 | CET2 | OE184 | BAEA147E | |
| 1.2 16V | 4 | Z12XE | 55/74 | 09/00→05/05 | OE019 | 0,9 | CET2 | OE184 | BAEA147E | |
| 1.4 16V | 4 | X14XE | 66/89 | 02/98→05/05 | OE019 | 0,9 | CET2 | OE184 | BAE965A | CLS030 |
| 1.4 16V | 4 | Z14XE | 66/89 | 02/98→05/05 | OE019 | 0,9 | CET2 | OE184 | BAE965A | |
| 1.6 | 4 | X16SZR | 55/74 | 02/98→04/04 | OE019 | 0,9 | CET2 | OE184 | BAEA026E | |
| 1.6 | 4 | Z16SE | 62/83 | 03/98→05/05 | OE019 | 0,9 | CET2 | OE184 | | CLS114 |
| 1.6, 1.6 16V | 4 | Z16XEP | 76/102 | 03/00→10/05 | OE198 | 0,9 | CET2 | OE184 | BAEA427 | |
| 1.6 16V | 4 | C16SEL; X16XEL; Z16XE; Z16XEP | 74/99 | 02/98→10/05 | OE019 | 0,9 | CET2 | OE184 | BAE965A | |
| | | | | | OE198 | 0,9 | | | | |
| 1.6 Dualfuel | 4 | Z16SE | 62/83 | 07/00→05/05 | OE019 | 0,9 | CET2 | OE184 | | |
| 1.6 Dualfuel | 4 | Z16SE | 63/84 | 03/98→05/05 | OE198 | 0,9 | CET2 | OE179 | BAE965A | |
| 1.7 CDTi 16V | 4 | Z17DTL | 59/79 | 04/03→05/05 | | | | | CCU143 ^[7] | |
| 1.7 DTI 16V | 4 | Y17DT | 55/74 | 02/00→05/05 | | | | | CCU143 ^[7] | |
| 1.7 TD | 4 | X17DTL | 50/67 | 02/98→08/00 | CH189 | 11v | | | CCU143 ^[7] | |
| 1.8 16V | 4 | X18XE1; Z18XEL | 85/114 | 02/98→08/05 | OE019 | 0,9 | CET2 | OE184 | BAEA342 | |
| 1.8 16V | 4 | Z18XE | 92/123 | 02/98→10/05 | OE198 | 0,9 | CET2 | OE184 | BAEA342 | |
| 1.8 16V Dualfuel | 4 | Z18XE | 87/117 | 02/98→08/05 | OE198 | 0,9 | CET2 | OE179 | BAEA342 | |
| 2.0 | 4 | X20XER | 118/158 | 10/99→08/00 | OE019 | 0,9 | CET2 | OE184 | BAEA344 | |
| 2.0 | 4 | Z20LER; Z20LET | 147/197 | 08/02→10/05 | OE019 | 0,9 | CET2 | OE184 | | |
| 2.0 16V | 4 | X20XEV | 100/134 | 02/98→05/05 | OE019 | 0,9 | CET2 | OE184 | BAEA344 | |
| 2.0 16V Turbo | 4 | Z20LET | 140/188 | 09/00→08/05 | OE019 | 0,9 | CET2 | OE184 | | |
| 2.0 DI | 4 | X20DTL; Y20DTL | 60/80 | 02/98→05/05 | CH207 | 11v | | | CCU143 ^[7] | |
| 2.0 DTI 16V | 4 | X20DTH | 74/99 | 02/98→05/05 | CH207 | 11v | | | | |

VAUXHALL



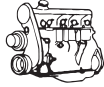

kW/BHP

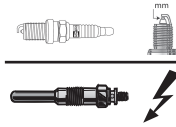

eon TITAN

IRIDIUM

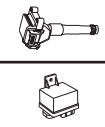

...VAUXHALL

...ASTRA Mk IV (G)

| | | | | | | | | | |
|--------------------------|---|--------|---------|-------------|---|-----|---------------|--------------|------------------------------|
| 2.0 DTI 16V | 4 | Y20DTH | 74/99 | 02/98→05/05 | CH231 Ch.3200001 3500001 3600001 3800001 3800001 3H00001 4G00001→ | 11v | | | CCU142 ^[8] |
| 2.0 SRI Turbo, 2.0 Turbo | 4 | Z20LET | 141/189 | 11/01→10/05 | OE019 | 0,9 | CET2 | OE184 | |
| 2.2 16V | 4 | Z22SE | 108/145 | 03/00→10/05 | OE255 | 1,0 | CET17P | OE189 | |
| 2.2 DTI | 4 | Y22DTR | 92/123 | 09/02→05/05 | CH231 | 11v | | | CCU142 ^[8] |

ASTRA Mk V (H)

| | | | | | | | | | |
|--------------------|---|----------------|---------|-------------|--|------------|---------------|------------------------------|--|
| 1.3 CDTi, 1.3 CDTi | 4 | Z13DTH | 66/89 | 01/04→11/10 | | | | | CCU142 ^[8] |
| 1.4 | 4 | Z14XEL | 55/74 | 08/04→10/10 | OE198 | 0,9 | CET2 | OE184 | |
| 1.4, 1.4 i 16V | 4 | Z14XEP | 66/89 | 01/04→11/10 | OE198 | 0,9 | CET2 | OE184 | BAEA338 |
| 1.6 | 4 | Z16XEP | 77/103 | 01/04→11/10 | OE198 | 0,9 | CET2 | OE184 | BAEA427 |
| 1.6 | 4 | A16XER; Z16XER | 85/114 | 01/04→05/09 | OE198 | 0,9 | CET2 | OE184 | BAEA427 12/05→ |
| 1.6 | 4 | Z16LET | 132/177 | 08/04→11/10 | | | CET12P | OE188 | BAEA427 |
| 1.6 i 16V | 4 | A16XER; Z16XER | 85/114 | 10/06→08/11 | OE198 | 0,9 | CET2 | OE184 | BAEA427 |
| 1.6 Turbo | 4 | Z16LET | 132/177 | 09/06→09/09 | | | CET12P | OE188 | BAEA427 |
| 1.7 CDTi | 4 | Z17DTL | 59/79 | 01/04→05/09 | | | | | CCU143 ^[7] |
| 1.7 CDTi | 4 | A17DTJ; Z17DTJ | 81/109 | 01/04→10/12 | | | | | CCU143 ^[7] |
| 1.7 CDTi, 1.7 CDTi | 4 | Z17DTH | 74/99 | 01/04→11/10 | | | | | CCU143 ^[7] |
| 1.8 | 4 | Z18XE | 92/123 | 01/04→11/10 | OE198 | 0,9 | CET2 | OE184 | BAEA342 |
| 1.8, 1.8 i 16V | 4 | A18XER; Z18XER | 103/138 | 01/04→11/10 | OE198 | 0,9 | CET2 | OE184 | BAEA427 |
| 1.9 CDTi | 4 | Z19DTL | 74/99 | 08/04→11/10 | CH222 →Ch.72045139 75030986 78007391 7G | 11v | | | CCU142 ^[8] |
| | | | | | CH269 Ch.72045140 75030987 78007392 88000001 7G→ | 11v | | | CCU143 ^[7] |
| 1.9 CDTi, 1.9 CDTi | 4 | Z19DT | 88/118 | 01/04→11/10 | CH222 →Ch.72045139 75030986 78007391 7G | 11v | | | CCU142 ^[8] |
| | | | | | CH269 Ch.72045140 75030987 78007392 88000001 7G→ | 11v | | | CCU143 ^[7] |
| 1.9 CDTi, 1.9 CDTi | 4 | Z19DTH | 110/148 | 01/04→11/10 | CH224 | 11v | | | CCU142 ^[8] CCU143 ^[7] |
| 1.9 CDTi 16V | 4 | Z19DTJ | 88/118 | 01/04→05/09 | CH224 | 11v | | | CCU142 ^[8] |
| 2.0, 2.0 Turbo | 4 | Z20LEL | 125/168 | 01/04→11/10 | OE136 | 0,8 | CET12P | OE179 | |
| 2.0 Turbo | 4 | Z20LER | 147/197 | 01/04→11/10 | OE089 OE198 | 1,0 0,9 | CET2 | OE179 OE184 | |
| 2.0 Turbo | 4 | Z20LEH | 177/237 | 01/04→05/09 | OE136 | 0,8 | CET12P | OE179 | |
| 2.0 VXR | 4 | Z20LEH | 176/236 | 02/09→11/10 | OE198 | 0,9 | CET2 | OE184 | |

ASTRA Mk VI (J)

| | | | | | | | | | |
|--------------------|---|--------|-------|--------|--|------|-------------|--------------|-----------------|
| 1.3 CDTi, 1.3 CDTi | 4 | A13DTE | 70/94 | 12/09→ | CPSG003 ^[37] →Ch.83999999 88999999 86999999 | 4.4v | | | CCU138 |
| 1.4 | 4 | A14XEL | 64/86 | 12/09→ | | | CET2 | OE184 | BAEA185E |

VAUXHALL





kW/BHP

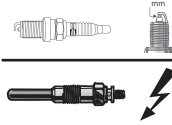

eon TITAN

IRIDIUM

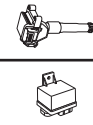

...VAUXHALL

...ASTRA Mk VI (J)

| | | | | | | | | | |
|--------------------|---|----------------|---------|--------|--------------------------|------------|--------|------------------------|--------------------------|
| 1.4 | 4 | A14XER; B14XER | 74/99 | 12/09→ | | | CET2 | OE184 | BAEA185E |
| 1.4, 1.4 Turbo | 4 | A14NEL; B14NEL | 88/118 | 10/10→ | | | | | BAEA185E |
| 1.4, 1.4 Turbo | 4 | A14NET; B14NET | 103/138 | 12/09→ | | | | | BAEA185E |
| 1.6 | 4 | A16XER; B16XER | 85/114 | 12/09→ | OE198 | 0,9 | CET2 | OE184 | BAEA198E Ch.205D0232→ |
| 1.6, 1.6 Turbo | 4 | A16LET | 132/177 | 12/09→ | OE146 OE216 LPG [278] | 1,0 0,8 | CET12P | OE179 | BAEA199E |
| 1.7 CDTi | 4 | A17DTR | 92/123 | 12/09→ | | | | | CCU145 |
| 1.7 CDTi, 1.7 CDTI | 4 | A17DTJ | 81/109 | 12/09→ | | | | | CCU145 |
| 1.7 CDTi, 1.7 CDTI | 4 | A17DTE | 81/109 | 12/09→ | CPSG004 | 4.4v | | | CCU145 |
| 1.7 CDTi, 1.7 CDTI | 4 | A17DTF | 96/129 | 06/11→ | CPSG004 | 4.4v | | | CCU145 |
| 1.7 CDTi, 1.7 CDTI | 4 | A17DTS | 96/129 | 06/11→ | | | | | CCU145 |
| 2.0 BiTurbo CDTI | 4 | ; A20DTR | 143/192 | 12/12→ | CPSG006 | 4.4v | | | CCU138 |
| 2.0 CDTi | 4 | A20DTH | 118/158 | 12/09→ | CPSG006 | 4.4v | | | CCU138 |
| 2.0 CDTi | 4 | A20DTH | 121/162 | 08/11→ | CPSG006 | 4.4v | | | CCU138 |
| 2.0 VXR | 4 | A20NFT; B20NFT | 206/276 | 04/12→ | | | CET17P | OE189 *tobendjusted | |

ASTRA Mk VII (K)

| | | | | | | | | | |
|-----------|---|----------------|---------|--------|--|--|--|-------|--|
| 1.0 | 3 | B10XFL; D10XFL | 77/103 | 07/15→ | | | | OE258 | |
| 1.4 Turbo | 4 | B14XFL | 92/123 | 07/15→ | | | | OE258 | |
| 1.4 Turbo | 4 | B14XFT | 110/148 | 07/15→ | | | | OE258 | |

BRAVA

| | | | | | | | | | |
|----------------------|---|------|-------|-------------|-------|-----|------|-------|--|
| 2.3, 2.3 4WD | 4 | 23P | 72/97 | 08/94→09/96 | OE006 | 0,9 | CET8 | OE195 | |
| 2.5 DTI, 2.5 DTI 4WD | 4 | 4JA1 | 74/99 | 08/01→12/02 | CH306 | 11v | | | |

CALIBRA

| | | | | | | | | | |
|----------|---|--------------|---------|-------------|-------|-----|------|-------|--|
| 2.5 i V6 | 6 | C25XE; X25XE | 125/168 | 04/93→07/97 | OE019 | 0,9 | CET2 | OE184 | |
|----------|---|--------------|---------|-------------|-------|-----|------|-------|--|

CASCADA

| | | | | | | | | | |
|----------|---|----------------|---------|--------|---------|------|--|--|----------|
| 1.4 | 4 | | 88/118 | 02/13→ | | | | | BAEA185E |
| 1.4 | 4 | A14NET; B14NET | 103/138 | 02/13→ | | | | | BAEA185E |
| 2.0 CDTI | 4 | A20DTH | 121/162 | 02/13→ | CPSG006 | 4.4v | | | CCU138 |
| 2.0 CDTI | 4 | A20DTR | 143/192 | 02/13→ | CPSG006 | 4.4v | | | CCU138 |

CAVALIER Mk III

| | | | | | | | | | |
|-------|---|-------|-------|-------------|-------|-----|------|-------|--------------------------------------|
| 1.6 i | 4 | X16SZ | 52/70 | 09/93→11/95 | OE019 | 0,9 | CET2 | OE184 | BAEA026E BAEA253 ^[292] |
|-------|---|-------|-------|-------------|-------|-----|------|-------|--------------------------------------|

COMBO TOUR Mk II (C)

| | | | | | | | | | |
|---------|---|--------|-------|-------------|-------|-----|--------|-------|---------|
| 1.4 | 4 | Z14XEP | 66/89 | 10/04→09/10 | OE198 | 0,9 | CET2 | OE184 | |
| 1.6 CNG | 4 | Z16YNG | 69/93 | 06/06→09/10 | OE136 | 0,8 | CET12P | OE179 | BAE965A |
| 1.6 CNG | 4 | Z16YNG | 71/95 | 04/05→02/12 | OE136 | 0,8 | CET12P | OE179 | BAE965A |

CORSA Mk I (B)

| | | | | | | | | | |
|-----------|---|--------------|-------|-------------|-----------------|-----|------|------------------------------------|--|
| 1.0 i 12V | 3 | X10XE | 40/54 | 11/96→09/00 | OE019 | 0,9 | CET2 | OE184 | BAEA358 |
| 1.2 i | 4 | C12NZ | 33/44 | 03/93→09/00 | OE019 08/95→ | 0,9 | CET2 | OE195 →07/95 OE184 08/95→ | BAEA253 ^[292] CLS114 CLS115 |
| 1.2 i | 4 | X12SZ | 33/44 | 03/93→09/00 | OE019 08/95→ | 0,9 | CET2 | OE195 →07/95 OE184 08/95→ | BAEA253 ^[292] |
| 1.2 i 16V | 4 | X12XE | 48/64 | 03/98→09/00 | OE019 | 0,9 | CET2 | OE184 | BAEA147E |
| 1.4 i | 4 | C14NZ; X14SZ | 44/59 | 03/93→09/00 | OE019 08/95→ | 0,9 | CET2 | OE195 →07/95 OE184 08/95→ | BAEA253 ^[292] CLS114 |
| 1.4 i 16V | 4 | X14XE | 66/89 | 09/94→09/00 | OE019 | 0,9 | CET2 | OE184 | BAEA026E CLS030 |

VAUXHALL





kW/BHP



eon TITAN

IRIDIUM

**...VAUXHALL****...CORSA Mk I (B)**

| | | | | | | | | | |
|-------------|---|--------------|--------|-------------|-----------------|-----|------|------------------------------------|----------|
| 1.4 iS | 4 | C14SE | 60/80 | 03/93→09/00 | OE019 08/95→ | 0,9 | CET2 | OE195 →07/95 OE184 08/95→ | BAEA026E |
| 1.6 GSI 16V | 4 | C16XE | 80/107 | 03/93→09/00 | OE019 | 0,9 | CET2 | OE184 | BAEA026E |
| 1.6 i 16V | 4 | C16XE; X16XE | 78/105 | 09/94→09/00 | OE019 | 0,9 | CET2 | OE184 | BAEA026E |

CORSA Mk II (C)

| | | | | | | | | | |
|------------------|---|--------|--------|-------------|-------|-----|--------|-------|---|
| 1.0 12V | 3 | Z10XE | 43/58 | 09/00→10/03 | OE198 | 0,9 | CET2 | OE184 | BAEA358 |
| 1.0 12V | 3 | Z10XEP | 44/59 | 11/03→10/06 | OE198 | 0,9 | CET2 | OE184 | BAEA359 |
| 1.2 16V | 4 | Z12XE | 55/74 | 09/00→10/06 | OE019 | 0,9 | CET2 | OE184 | BAEA147E →Eng.33999999 34999999 36999999 BAEA338 Eng.43000001 44000001 46000001→ |
| 1.2 16V Dualfuel | 4 | Z12XE | 55/74 | 08/01→10/06 | OE136 | 0,8 | CET12P | OE179 | BAEA147E →08/04 |
| 1.2 Twinport | 4 | Z12XEP | 59/79 | 07/04→10/06 | OE198 | 0,9 | CET2 | OE184 | BAEA338 |
| 1.3 CDTI 16V | 4 | Z13DT | 52/70 | 08/00→09/06 | | | | | CCU142 ^[8] |
| 1.4 16V | 4 | Z14XE | 66/89 | 09/00→10/06 | OE019 | 0,9 | CET2 | OE184 | BAE965A |
| 1.4 Twinport | 4 | Z14XEP | 66/89 | 06/03→10/06 | OE198 | 0,9 | CET2 | OE184 | BAEA338 |
| 1.7 CDTI 16V | 4 | Z17DTH | 74/99 | 08/00→09/06 | | | | | CCU143 ^[7] |
| 1.7 DI 16V | 4 | Y17DTL | 48/64 | 08/00→09/06 | | | | | CCU143 ^[7] |
| 1.7 DTI 16V | 4 | Y17DT | 55/74 | 08/00→09/06 | | | | | CCU143 ^[7] |
| 1.8 1.8 16V | 4 | Z18XE | 92/123 | 08/00→09/06 | OE198 | 0,9 | CET2 | OE184 | BAEA342 |

CORSA Mk III (D)

| | | | | | | | | | |
|--------------|---|------------------------|---------|-------------|----------------------------|------|--------|-------|----------|
| 1.0 | 3 | A10XEP | 44/59 | 11/06→08/14 | | | CET2 | OE184 | |
| 1.0 | 3 | Z10XEP | 44/59 | 11/06→08/14 | | | CET2 | OE184 | BAEA359 |
| 1.0 i 12V | 3 | A10XEP | 48/64 | 06/10→08/14 | | | CET2 | OE184 | |
| 1.2 | 4 | A12XEL | 51/68 | 06/10→08/14 | | | | | BAEA185E |
| 1.2 | 4 | Z12XEP | 59/79 | 11/06→08/14 | OE198 | 0,9 | CET2 | OE184 | BAEA338 |
| 1.2 i 16V | 4 | A12XER | 63/84 | 11/06→08/14 | | | CET2 | OE184 | BAEA185E |
| 1.2 LPG | 4 | A12XER | 63/84 | 08/11→08/14 | | | | | BAEA185E |
| 1.3 CDTI | 4 | A13DTC | 55/74 | 07/06→08/14 | CP5G003 | 4.4v | | | CCU138 |
| 1.3 CDTI | 4 | Z13DTJ | 55/74 | 07/06→08/14 | | | | | CCU144 |
| 1.3 CDTI | 4 | Z13DTH | 66/89 | 07/06→08/14 | | | | | CCU144 |
| 1.3 CDTI | 4 | A13DTE; A13DTR; Z13DTE | 70/94 | 06/10→08/14 | | | | | CCU138 |
| 1.4 | 4 | Z14XEP | 66/89 | 07/06→08/14 | OE198 | 0,9 | CET2 | OE184 | BAEA338 |
| 1.4 | 4 | A14XER | 74/99 | 07/10→08/14 | | | CET2 | OE184 | BAEA185E |
| 1.4 | 4 | A14NEL | 88/118 | 07/12→08/14 | | | | | BAEA185E |
| 1.4, 1.4 LPG | 4 | A14XEL | 64/86 | 09/09→08/14 | | | CET2 | OE184 | BAEA185E |
| 1.4 LPG | 4 | Z14XEP | 66/89 | 07/06→08/14 | OE198 | 0,9 | CET2 | OE184 | |
| 1.6 SRi | 4 | A16LEL | 110/148 | 05/07→08/14 | OE136 | 0,8 | CET12P | OE179 | BAEA427 |
| | | | | | OE216 ^{LPG [278]} | 0,8 | | | |
| 1.6 VXR | 4 | A16LER; B16LER; Z16LER | 141/189 | 12/13→08/14 | OE136 | 0,8 | CET12P | OE179 | BAEA427 |
| | | | | | OE216 ^{LPG [278]} | 0,8 | | | |
| 1.6 VXR | 4 | A16LES; Z16LER | 150/201 | 06/11→08/14 | | | CET12P | OE188 | BAEA427 |
| 1.7 CDTI | 4 | Z17DTR | 92/123 | 11/06→08/14 | | | | | CCU145 |
| 1.7 CDTI | 4 | A17DTS | 96/129 | 11/06→08/14 | | | | | CCU145 |

CORSA Mk IV (E)

| | | | | | | | | | |
|---------|---|------------------------|---------|--------|--|--|--|-------|----------|
| 1.0 | 3 | B10XFL; F10XFL | 66/89 | 08/14→ | | | | OE258 | |
| 1.0 | 3 | B10XFT; F10XFT | 85/114 | 08/14→ | | | | OE258 | |
| 1.4 | 4 | B14XEJ; B14XEL; B14XER | 66/89 | 08/14→ | | | | | BAEA185E |
| 1.6 VXR | 4 | B16LES | 151/202 | 04/15→ | | | | | BAEA199E |

VAUXHALL





kW/BHP



eon TITAN

IRIDIUM



...VAUXHALL

FRONTERA Mk I (A)

| | | | | | | | | | |
|------------|---|---------------|---------|-------------|-------|-----|------|-------|--|
| 2.0 4WD | 4 | C20NE; X20SE | 85/114 | 04/95→08/98 | OE019 | 0,9 | CET2 | OE184 | |
| 2.2 i 4WD | 4 | X22XE | 100/134 | 03/95→10/98 | OE019 | 0,9 | CET2 | OE184 | |
| 2.8 TD 4WD | 4 | 28TDI(4JB1-T) | 83/111 | 01/95→12/96 | CH306 | 11v | | | |

FRONTERA Mk II (B)

| | | | | | | | | | |
|-------------|---|--------------|---------|-------------|-----------------------|-----|--------|-------|-----------------------|
| 2.2 DTI 4WD | 4 | X22DTH | 85/114 | 10/98→09/04 | CH207 →Ch.YV699999 | 11v | | | CCU143 ^[7] |
| 2.2 DTI 4WD | 4 | Y22DTH | 85/114 | 10/98→09/04 | CH231 Ch.1V500001→ | 11v | | | CCU143 ^[7] |
| 2.2 i 4WD | 4 | X22SE; Y22SE | 100/134 | 10/98→10/04 | | | CET12P | OE180 | BAEA025E |
| 3.2 i 4WD | 6 | 6VD1; Y32NE | 151/202 | 10/98→10/04 | | | CET12P | OE180 | |

INSIGNIA Mk I (A)

| | | | | | | | | | |
|--------------|---|------------------|---------|-------------|-----------------------|-----|--------|-----------------------|----------|
| 1.4, 1.4 LPG | 4 | A14NET; B14NET | 103/138 | 04/11→05/17 | | | | OE264 | BAEA185E |
| 1.6 | 4 | A16XER | 85/114 | 07/08→07/12 | OE089 →Ch.91999999 | 1,0 | CET2 | OE188 →Ch.91999999 | |
| | | | | | OE198 Ch.A1000001→ | 0,9 | | OE184 Ch.A1000001→ | |
| 1.6 Turbo | 4 | ; A16XHT; B16SHL | 125/168 | 07/13→05/17 | | | | OE258 | |
| 1.6 Turbo | 4 | A16LET | 132/177 | 01/09→05/17 | OE216 LPG [278] | 0,8 | CET12P | OE188 | BAEA427 |
| 1.8 | 4 | A18XER; B18XER | 103/138 | 07/08→05/17 | OE089 →Ch.91999999 | 1,0 | CET2 | OE188 →Ch.91999999 | BAEA199E |
| | | | | | OE198 Ch.A1000001→ | 0,9 | | OE184 Ch.A1000001→ | |

| | | | | | | | | | |
|--|---|----------------|---------|-------------|---------|------|--------------|---|--------|
| 2.0 Biturbo CDTI, 2.0 Biturbo CDTI 4WD | 4 | A20DTR | 143/192 | 03/12→05/17 | CP5G006 | 4.4v | | | CCU138 |
| 2.0 CDTI | 4 | A20DTC; A20DTL | 81/109 | 07/08→05/17 | CP5G006 | 4.4v | | | CCU138 |
| 2.0 CDTI | 4 | A20DTE | 88/118 | 03/12→03/16 | CP5G006 | 4.4v | | | CCU138 |
| 2.0 CDTI | 4 | A20DT; A20DTJ | 96/129 | 07/08→12/14 | CP5G006 | 4.4v | | | CCU138 |
| 2.0 CDTI | 4 | A20DTE | 103/138 | 07/13→05/17 | CP5G006 | 4.4v | | | CCU138 |
| 2.0 CDTI, 2.0 CDTI 4WD | 4 | A20DTH | 118/158 | 07/08→05/17 | CP5G006 | 4.4v | | | CCU138 |
| 2.0 CDTI, 2.0 CDTI 4WD | 4 | A20DTR | 140/188 | 10/08→05/17 | CP5G006 | 4.4v | | | CCU138 |
| 2.0 CDTI, 2.0 CDTI 4WD | 4 | ; A20DTH | 120/161 | 07/13→05/17 | CP5G006 | 4.4v | | | CCU138 |
| 2.0 E85 Turbo | 4 | A20NFT | 162/217 | 09/10→05/17 | | | CET17P [332] | OE189 ^[332] *tobeadjusted | |
| | | | | | | | CET17P | OE189 *tobeadjusted | |
| 2.0 E85 Turbo | 4 | A20NHT | 162/217 | 09/10→05/17 | | | CET17P [332] | OE189 ^[332] *tobeadjusted | |
| | | | | | | | CET17P [331] | OE189 ^[331] *tobeadjusted | |
| 2.0 Turbo, 2.0 Turbo 4WD | 4 | A20NFT; A20NHT | 162/217 | 07/08→05/17 | | | CET17P [332] | OE189 ^[332] *tobeadjusted | |
| 2.0 Turbo, 2.0 Turbo 4WD | 4 | A20NFT; A20NHT | 184/247 | 09/11→05/17 | | | CET17P [332] | OE189 ^[332] *tobeadjusted | |
| 2.8 V6 Turbo 4WD | 6 | A28NET | 191/256 | 07/08→05/17 | OE238 | 1,0 | | | |
| 2.8 VXR 4WD | 6 | A28NER; B28NER | 239/320 | 07/09→05/17 | OE238 | 1,0 | | | |

INSIGNIA Mk II (B)

| | | | | | | | | | |
|-----|---|----------------|---------|--------|--|--|--|-------|--|
| 1.5 | 4 | B15SFL; D15SFL | 103/138 | 03/17→ | | | | OE258 | |
| 1.5 | 4 | B15SFT; D15SFT | 121/162 | 03/17→ | | | | OE258 | |

MERIVA Mk I (A)

| | | | | | | | | | |
|--------------------|---|---------------|---------|-------------|-------|-----|--------|-------|-----------------------|
| 1.3 CDTI | 4 | Z13DTJ | 55/74 | 01/03→10/09 | | | | | CCU142 ^[8] |
| 1.4 16V Twinport | 4 | Z14XEP | 66/89 | 01/03→06/10 | OE198 | 0,9 | CET2 | OE184 | BAEA338 |
| 1.6 i | 4 | Z16SE | 64/86 | 01/03→06/10 | OE019 | 0,9 | CET2 | OE184 | |
| 1.6 i 16V | 4 | Z16XE | 74/99 | 01/03→09/05 | OE198 | 0,9 | CET2 | OE184 | BAE965A |
| 1.6 i 16V Twinport | 4 | Z16XEP | 77/103 | 05/03→06/10 | OE198 | 0,9 | CET2 | OE184 | BAEA427 12/05→ |
| 1.6 Turbo | 4 | Z16LET | 132/177 | 05/06→06/10 | | | CET12P | OE188 | BAEA427 |
| 1.7 CDTi | 4 | Z17DT; Z17DTH | 74/99 | 09/03→06/10 | | | | | CCU143 ^[7] |
| 1.7 DTI | 4 | Y17DT | 55/74 | 06/03→06/10 | | | | | CCU143 ^[7] |

VAUXHALL



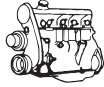

kW/BHP



eon TITAN

IRIDIUM

**...VAUXHALL****...MERIVA Mk I (A)**

| | | | | | | | | | |
|-----------|---|-------|--------|-------------|-------|-----|------|-------|---------|
| 1.8 i 16V | 4 | Z18XE | 92/123 | 05/03→06/10 | OE198 | 0,9 | CET2 | OE188 | BAEA342 |
|-----------|---|-------|--------|-------------|-------|-----|------|-------|---------|

MERIVA Mk II (B)

| | | | | | | | | | |
|--------------|---|----------------|---------|--------|---------|------|------|-------|----------|
| 1.3 CDTI | 4 | A13DTC | 55/74 | 06/10→ | CPSG003 | 4.4v | | | CCU138 |
| 1.3 CDTi | 4 | A13DTE | 70/94 | 06/10→ | CPSG003 | 4.4v | | | CCU138 |
| 1.4 | 4 | A14XER; B14XER | 74/99 | 06/10→ | OE198 | 0,9 | CET2 | OE184 | BAEA185E |
| 1.4 | 4 | A14NET; B14NET | 103/138 | 06/10→ | | | | | BAEA185E |
| 1.4, 1.4 LPG | 4 | A14NEL; B14NEL | 88/118 | 06/10→ | | | | | BAEA185E |
| 1.7 CDTI | 4 | A17DT | 74/99 | 06/10→ | | | | | CCU145 |
| 1.7 CDTi | 4 | A17DTI | 81/109 | 06/10→ | | | | | CCU145 |
| 1.7 CDTi | 4 | A17DTS | 96/129 | 06/10→ | | | | | CCU145 |

MOKKA / MOKKA X

| | | | | | | | | | |
|------------------------|---|------------------------|---------|--------|-------------------|------|------|-------|----------|
| 1.4, 1.4 4WD | 4 | A14NET; B14NET; D14NET | 103/138 | 06/12→ | | | | | BAEA185E |
| 1.4 4WD | 4 | B14XFT | 112/150 | 06/16→ | | | | OE258 | |
| 1.6 | 4 | A16XER; B16XER | 85/114 | 06/12→ | OE198 | 0,9 | CET2 | | BAEA198E |
| 1.7 CDTI, 1.7 CDTI 4WD | 4 | A17DTS | 96/129 | 06/12→ | CPSG004 →11/12 | 4.4v | | | CCU145 |

MONTEREY Mk II

| | | | | | | | | | |
|----------------|---|------|---------|-------------|--|--|--------|-------|--|
| 3.5 V6 24V 4WD | 6 | 6VE1 | 158/212 | 07/98→08/99 | | | CET12P | OE180 | |
|----------------|---|------|---------|-------------|--|--|--------|-------|--|

OMEGA (B)

| | | | | | | | | | |
|-------------|---|-------------------------------|---------|-------------|-------|-----|--------|-------|--|
| 2.0 | 4 | 20SE; X20SE | 85/114 | 03/94→09/99 | OE019 | 0,9 | CET2 | OE184 | |
| 2.0 16V | 4 | X20XEV | 100/134 | 03/94→07/01 | OE019 | 0,9 | CET2 | OE184 | BAEA344 |
| 2.0 DTI 16V | 4 | X20DTH | 74/99 | 01/98→09/00 | CH207 | 11v | | | CCU143 ^[7] |
| 2.2 16V | 4 | Y22XE; Z22XE | 106/142 | 01/94→06/03 | OE019 | 0,9 | CET17P | OE184 | BAEA150E ^[277] 09/99→ |
| | | | | | OE029 | 1,0 | CET2 | OE189 | |
| 2.2 DTI 16V | 4 | Y22DTH | 88/118 | 08/00→07/03 | CH231 | 11v | | | CCU143 ^[7] |
| 2.5 DTI 24V | 6 | Y25DT; Y25TD | 110/148 | 09/01→07/03 | CH203 | 11v | | | |
| 2.5 V6 | 6 | X25XE | 125/168 | 03/94→09/00 | OE019 | 0,9 | CET2 | OE184 | BAEA306 ^[275] CLS175 →Ch.08145499 |
| 2.5 TD | 6 | U25DT; U25TD; X25DT; X25TD | 96/129 | 04/94→07/01 | CH189 | 11v | | | |
| 2.6 V6 | 6 | Y26SE | 132/177 | 08/00→07/03 | OE120 | 0,6 | CET2 | OE188 | BAEA152E ^[36] ^[277] BAEA153E ^[42] ^[277] |
| 3.0 V6 | 6 | X30XE | 155/208 | 04/94→07/00 | OE019 | 0,9 | CET2 | OE184 | BAEA306 ^[275] |
| 3.2 V6 | 6 | Y32SE | 160/215 | 02/01→07/03 | OE120 | 0,6 | CET2 | OE188 | BAEA152E ^[36] ^[277] BAEA153E ^[42] ^[277] |

SIGNUM

| | | | | | | | | | |
|--------------|---|--------|---------|-------------|-----------------------|-----|--------|-------|---------------------------------------|
| 1.8 | 4 | Z18XE | 90/121 | 06/03→07/05 | OE198 | 0,9 | CET2 | OE184 | BAEA342 |
| 1.8 | 4 | Z18XER | 103/138 | 08/05→05/08 | OE198 | 0,9 | CET2 | OE184 | BAEA427 12/05→ |
| 1.9 CDTI | 4 | Z19DT | 88/118 | 04/04→03/08 | CH222 →Ch.71021891 | 11v | | | CCU143 ^[7] →Ch.61010105 |
| | | | | | CH269 Ch.71021892→ | 11v | | | CCU142 ^[8] Ch.61010106→ |
| 1.9 CDTI 16V | 4 | Z19DTH | 110/148 | 04/04→03/08 | CH224 | 11v | | | CCU143 ^[7] →Ch.61010105 |
| | | | | | | | | | CCU142 ^[8] Ch.61010106→ |
| 1.9 Turbo | 4 | Z19DTL | 74/99 | 01/05→05/08 | CH222 →Ch.71021891 | 11v | | | CCU142 ^[8] Ch.61010106→ |
| | | | | | CH269 Ch.71021892→ | 11v | | | |
| 2.0 DTI | 4 | Y20DTH | 74/99 | 05/03→05/08 | CH231 →09/05 | 11v | | | CCU143 ^[7] |
| 2.0 i Turbo | 4 | Z20NET | 129/173 | 03/03→10/08 | OE136 | 0,8 | CET12P | OE179 | |

VAUXHALL



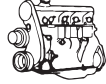

kW/BHP

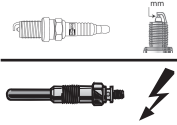

eon TITAN

IRIDIUM

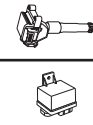
**...VAUXHALL****...SIGNUM**

| | | | | | | | | | |
|--------------|---|--------|---------|-------------|-------|-----|--------|-------|--|
| 2.2 DTI | 4 | Y22DTR | 92/123 | 05/03→05/08 | CH231 | 11v | | | CCU143 ^[7] |
| 2.2 i | 4 | Z22YH | 114/153 | 05/03→05/08 | OE120 | 0,6 | CET2 | OE188 | BAEA149E |
| 2.8 V6 Turbo | 6 | Z28NEL | 169/227 | 07/05→05/08 | | | CET14P | OE190 | BAEA174E |
| 2.8 V6 Turbo | 6 | Z28NET | 184/247 | 05/07→10/08 | | | | | BAEA174E |
| 3.2 V6 | 6 | Z32SE | 155/208 | 05/03→05/08 | OE120 | 0,6 | CET2 | OE188 | BAEA152E [36] [277] BAEA153E [42] [277] |

SINTRA

| | | | | | | | | | |
|------------|---|--------|---------|-------------|-------|-----|------|-------|-----------------------|
| 2.2 DTI | 4 | X22DTH | 85/114 | 07/97→04/99 | CH207 | 11v | | | CCU143 ^[7] |
| 2.2 i 16 V | 4 | X22XE | 104/139 | 11/96→04/99 | OE019 | 0,9 | CET2 | OE184 | CLS107 |
| 3.0 i 24V | 6 | X30XE | 148/198 | 11/96→04/99 | OE019 | 0,9 | CET2 | OE184 | |

SPEEDSTER

| | | | | | | | | | |
|-----|---|-------|---------|-------------|-------|-----|--|--|--|
| 2.2 | 4 | Z22SE | 108/145 | 03/01→09/06 | OE255 | 1,0 | | | |
|-----|---|-------|---------|-------------|-------|-----|--|--|--|

TIGRA

| | | | | | | | | | |
|----------|---|--------|--------|-------------|-------|-----|------|-------|-----------------------|
| 1.3 CDTI | 4 | Z13DT | 51/68 | 06/04→08/09 | | | | | CCU142 ^[8] |
| 1.4 | 4 | Z14XEP | 66/89 | 06/04→08/09 | OE198 | 0,9 | CET2 | OE184 | BAEA338 |
| 1.8 | 4 | Z18XE | 92/123 | 06/04→08/09 | OE198 | 0,9 | CET2 | OE184 | BAEA342 |

TIGRA Mk I

| | | | | | | | | | |
|---------|---|-------|--------|-------------|-------|-----|------|-------|--|
| 1.4 16V | 4 | X14XE | 66/89 | 07/94→12/00 | OE019 | 0,9 | CET2 | OE184 | BAEA026E CLS030 09/94→08/99 →Eng.20C17331 |
| 1.6 16V | 4 | X16XE | 78/105 | 07/94→12/00 | OE019 | 0,9 | CET2 | OE184 | BAEA026E |

VECTRA (B)

| | | | | | | | | | |
|--------------------------|---|----------------------|---------|-------------|---|-----|--------|-------|---|
| 1.6 i | 4 | X16SZR | 55/74 | 08/95→10/01 | OE019 | 0,9 | CET2 | OE184 | BAEA026E BAEA253 ^[292] |
| 1.6 i 16V | 4 | X16XEL; Y16XE; Z16XE | 74/99 | 08/95→10/01 | OE019 | 0,9 | CET2 | OE184 | BAE965A |
| 1.8 i 16V | 4 | X18XE; X18XE1 | 85/114 | 09/95→09/00 | OE019 | 0,9 | CET2 | OE184 | BAEA342 BAEA344 |
| 1.8 i 16V | 4 | Z18XE | 92/123 | 09/00→07/03 | OE198 | 0,9 | CET2 | OE184 | BAEA342 |
| 2.0 Di 16V, 2.0 Di 16V | 4 | X20DTL | 60/80 | 08/95→10/01 | CH207 Ch.W1000001 W5000001 W7000001 XL000001 WP WS→ | 11v | | | |
| 2.0 DTI 16V, 2.0 DTi 16V | 4 | X20DTH | 74/99 | 08/95→10/01 | CH207 03/98→ | 11v | | | CCU143 ^[7] Ch.W1000001 W5000001 W7000001 XL000001 WS WP→ |
| 2.0 DTI 16V, 2.0 DTi 16V | 4 | Y20DTH | 74/99 | 08/95→10/01 | CH231 | 11v | | | CCU143 ^[7] Ch.W1000001 W5000001 W7000001 XL000001 WS WP→ |
| 2.0 i 16V | 4 | X20XEV | 100/134 | 10/95→01/01 | OE019 | 0,9 | CET2 | OE184 | BAEA344 |
| 2.2 DTI 16V | 4 | Y22DTR | 92/123 | 08/95→10/01 | CH231 | 11v | | | CCU143 ^[7] Ch.W1000001 W5000001 W7000001 XL000001 WS WP→ |
| 2.2 i 16V | 4 | Z22SE | 108/145 | 08/95→07/03 | OE255 | 1,0 | CET17P | OE189 | |
| 2.5 i GSi | 6 | X25XE | 143/192 | 03/98→07/00 | OE019 | 0,9 | CET2 | OE184 | |

VAUXHALL



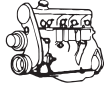

kW/BHP

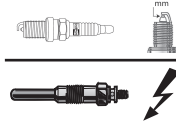

eon TITAN

IRIDIUM

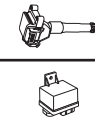

...VAUXHALL

...VECTRA (B)

| | | | | | | | | | |
|----------|---|-------|---------|---------------|-------|-----|------|-------|--|
| 2.5 i V6 | 6 | X25XE | 125/168 | 09/95 → 08/00 | OE019 | 0,9 | CET2 | OE184 | |
| 2.6 i V6 | 6 | Y26SE | 125/168 | 09/00 → 07/03 | OE120 | 0,6 | CET2 | OE188 | BAEA152E [36] [277] BAEA153E [42] [277] |

VECTRA Mk II (C)

| | | | | | | | | | |
|---------------------------|---|--------|---------|---------------|------------------------------------|-----|--------|-------|--|
| 1.8 | 4 | Z18XER | 103/138 | 01/06 → 07/08 | OE198 | 0,9 | CET2 | OE184 | BAEA427 |
| 1.8 16V, 1.8 16V Dualfuel | 4 | Z18XE | 90/121 | 04/02 → 07/08 | OE198 | 0,9 | CET2 | OE188 | BAEA342 |
| 1.9 CDTI | 4 | Z19DT | 88/118 | 04/02 → 09/08 | CH222 → Ch.71021891 48999999 | 11v | | | CCU143[7] → Ch.61010105 48999999 |
| | | | | | CH269 Ch.71021892 78 → | 11v | | | CCU142[8] Ch.61010106 68 → |
| 1.9 CDTI 16V | 4 | Z19DTH | 110/148 | 04/04 → 05/09 | CH224 | 11v | | | CCU143[7] → Ch.61010105 48999999 |
| | | | | | | | | | CCU142[8] Ch.61010106 68 → |
| 2.0 16V Turbo | 4 | Z20NET | 129/173 | 01/00 → 10/08 | OE136 | 0,8 | CET12P | OE179 | |
| 2.0 DTI 16V | 4 | Y20DTH | 74/99 | 04/02 → 10/08 | CH231 | 11v | | | CCU143[7] |
| 2.2 16V | 4 | Z22SE | 108/145 | 01/02 → 10/08 | OE255 | 1,0 | CET17P | OE189 | |
| 2.2 direct | 4 | Z22YH | 114/153 | 01/02 → 10/08 | OE120 | 0,6 | CET2 | OE188 | BAEA149E |
| 2.2 DTI 16V | 4 | Y22DTR | 92/123 | 04/02 → 10/08 | CH231 | 11v | | | CCU143[7] |
| 2.8 V6 Turbo | 6 | Z28NEL | 169/227 | 08/05 → 07/08 | OE238 | 1,0 | | | BAEA174E |
| 2.8 V6 Turbo | 6 | Z28NET | 184/247 | 08/06 → 07/08 | OE238 | 1,0 | | | BAEA174E |
| 2.8 V6 Turbo | 6 | Z28NET | 188/252 | 08/05 → 07/08 | OE238 | 1,0 | | | BAEA174E |
| 2.8 V6 Turbo | 6 | Z28NET | 206/276 | 08/06 → 07/08 | OE238 | 1,0 | CET14P | OE190 | BAEA174E |
| 3.2 V6 | 6 | Z32SE | 155/208 | 08/02 → 07/08 | OE120 | 0,6 | CET2 | OE188 | BAEA152E [36] [277] BAEA153E [42] [277] |

VX220

| | | | | | | | | | |
|-------------|---|--------|---------|---------------|-------|-----|--------|-------|--|
| 2.0 i Turbo | 4 | Z20LET | 147/197 | 03/01 → 07/05 | OE019 | 0,9 | CET2 | OE184 | |
| 2.2 i | 4 | Z22SE | 108/145 | 09/00 → 07/05 | OE255 | 1,0 | CET17P | OE189 | |

ZAFIRA Mk I (A)

| | | | | | | | | | |
|---------------|---|---------------|---------|---------------|----------------|------------|--------|-------|-----------|
| 1.6 16V | 4 | X16XEL; Z16XE | 74/99 | 04/99 → 08/05 | OE019 OE198 | 0,9 0,9 | CET2 | OE184 | BAE965A |
| 1.6 CNG | 4 | Z16YNG | 71/95 | 09/01 → 06/05 | OE136 | 0,8 | CET12P | OE179 | BAE965A |
| 1.6 Dualfuel | 4 | X16XEL; Z16XE | 74/99 | 11/98 → 08/05 | OE019 | 0,9 | CET2 | OE184 | BAE965A |
| 1.8 16V | 4 | X18XE1 | 85/114 | 05/99 → 08/00 | OE019 | 0,9 | CET2 | OE184 | BAEA342 |
| 1.8 16V | 4 | Z18XE | 92/123 | 09/00 → 08/05 | OE198 | 0,9 | CET2 | OE184 | BAEA342 |
| 1.8 Dualfuel | 4 | Z18XE | 92/123 | 09/00 → 08/05 | OE198 | 0,9 | CET2 | OE184 | |
| 2.0 | 4 | Z20LET | 147/197 | 06/02 → 06/05 | OE019 | 0,9 | CET2 | OE184 | |
| 2.0 DI 16V | 4 | X20DTL | 60/80 | 10/99 → 08/05 | CH207 | 11v | | | CCU143[7] |
| 2.0 DTI 16V | 4 | Y20DTH | 74/99 | 04/99 → 08/05 | CH207 | 11v | | | CCU142[8] |
| 2.0 GSI Turbo | 4 | Z20LET | 141/189 | 09/01 → 06/05 | OE019 | 0,9 | CET2 | OE184 | |
| 2.2 16V | 4 | Z22SE | 108/145 | 11/98 → 08/04 | OE255 | 1,0 | CET17P | OE189 | |
| 2.2 D | 4 | Y22DTR | 92/123 | 06/01 → 06/05 | CH231 | 11v | | | CCU142[8] |

ZAFIRA Mk II (B)

| | | | | | | | | | |
|---------------|---|----------------|---------|---------------|-------|-----|--------|-------|--------------------|
| 1.6 | 4 | Z16XE1; Z16XEP | 77/103 | 07/05 → 11/14 | OE198 | 0,9 | CET2 | OE184 | BAEA427 12/05 → |
| 1.6 | 4 | A16XER; Z16XER | 85/114 | 12/07 → 11/14 | OE198 | 0,9 | CET2 | OE184 | BAEA427 |
| 1.6 CNG | 4 | Z16YNG | 69/93 | 07/05 → 11/14 | OE136 | 0,8 | CET12P | OE179 | BAE965A |
| 1.6 CNG Turbo | 4 | A16XNT; Z16XNT | 110/148 | 02/09 → 11/14 | | | | | BAEA427 |
| 1.7 CDTI | 4 | A17DTJ; Z17DTJ | 81/109 | 04/09 → 11/14 | | | | | CCU143[7] |

VAUXHALL





kW/BHP

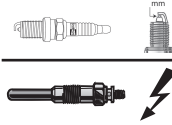

eon TITAN

IRIDIUM

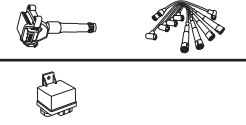

...VAUXHALL

...ZAFIRA Mk II (B)

| | | | | | | | | | |
|----------|---|----------------|---------|-------------|-----------------------------------|-----|--------|-------|--|
| 1.7 CDTi | 4 | A17DTR | 92/123 | 01/08→11/14 | | | | | CCU143 ^[7] |
| 1.8 | 4 | A18XEL | 88/118 | 04/13→11/14 | OE198 | 0,9 | | | |
| 1.8 | 4 | A18XER; Z18XER | 103/138 | 04/05→11/14 | OE198 | 0,9 | CET2 | OE184 | BAEA427 12/05→ |
| 1.9 CDTi | 4 | Z19DTL | 74/99 | 07/05→11/14 | CH222 →Ch.62999999 66999999 | 11v | | | CCU142 ^[8] |
| | | | | | CH269 Ch.72000001 76000001→ | 11v | | | CCU143 ^[7] |
| 1.9 CDTi | 4 | Z19DT | 88/118 | 07/05→11/14 | CH222 →Ch.62999999 66999999 | 11v | | | CCU142 ^[8] |
| | | | | | CH269 Ch.72000001 76000001→ | 11v | | | CCU143 ^[7] |
| 1.9 CDTi | 4 | Z19DTH | 110/148 | 07/05→11/14 | CH224 | 11v | | | CCU142 ^[8] CCU143 ^[7] |
| 2.0 | 4 | Z20LER | 147/197 | 07/05→11/14 | OE089 | 1,0 | CET2 | OE188 | |
| 2.0 | 4 | Z20LEH | 176/236 | 01/06→11/14 | OE136 | 0,8 | CET12P | OE179 | |
| 2.2 | 4 | Z22YH | 110/148 | 07/05→11/14 | OE120 | 0,6 | CET2 | OE188 | BAEA149E |

ZAFIRA Mk III

| | | | | | | | | | |
|------------------|---|----------------|---------|--------|--------------------------|------|------|-------|----------|
| 1.4 | 4 | A14NEL | 88/118 | 10/11→ | | | | | BAEA185E |
| 1.4 | 4 | A14NET; B14NET | 103/138 | 10/11→ | | | | | BAEA185E |
| 1.6 CNG | 4 | A16XNT; B16XNT | 110/148 | 10/11→ | | | | | BAEA427 |
| 1.8 | 4 | A18XEL | 85/114 | 10/11→ | OE198 | 0,9 | CET2 | OE184 | BAEA199E |
| 1.8 | 4 | | 88/118 | 10/11→ | OE198 | 0,9 | CET2 | OE184 | BAEA199E |
| 1.8 | 4 | A18XER | 103/138 | 10/11→ | OE198 | 0,9 | CET2 | OE184 | BAEA199E |
| 2.0 BiTurbo CDTi | 4 | A20DTR | 143/192 | 01/13→ | CP5G006 ^[287] | 4.4v | | | CCU138 |
| 2.0 CDTi | 4 | A20DTL | 81/109 | 10/11→ | CP5G006 ^[287] | 4.4v | | | CCU138 |
| 2.0 CDTi | 4 | A20DT | 96/129 | 10/11→ | CP5G006 [287] [298] | 4.4v | | | CCU138 |
| | | | | | CP5G006 [287] [294] | 4.4v | | | |
| 2.0 CDTi | 4 | Y20DTJ; Z20DTJ | 96/129 | 10/11→ | CP5G006 | 4.4v | | | CCU138 |
| 2.0 CDTi | 4 | A20DTH | 121/162 | 10/11→ | CP5G006 | 4.4v | | | CCU138 |

VAUXHALL

ARENA

| | | | | | | | | | |
|-------|---|------------------------|-------|-------------|-------|-----|--|--|--|
| 1.9 D | 4 | F8Q600; F8Q606 | 44/59 | 03/98→08/01 | CH217 | 11v | | | |
| 2.5 D | 4 | S8U758; S8U780; S8U782 | 55/74 | 03/98→08/01 | CH189 | 11v | | | |

ASTRAVAN Mk III (F)

| | | | | | | | | | |
|--------|---|--------|-------|-------------|-------|-----|------|-------|----------|
| 1.6 i | 4 | X16SZ | 52/70 | 02/94→10/96 | OE019 | 0,9 | CET2 | OE184 | BAEA026E |
| 1.7 TD | 4 | X17DTL | 50/67 | 01/94→08/98 | CH189 | 11v | | | |

ASTRAVAN Mk IV (G)

| | | | | | | | | | |
|-------------|---|--------|-------|-------------|-------|-----|------|-------|-----------------------|
| 1.6 i | 4 | X16SZR | 55/74 | 08/98→09/00 | OE019 | 0,9 | CET2 | OE184 | BAEA026E |
| 1.6 i | 4 | Z16SE | 62/83 | 09/00→08/06 | OE019 | 0,9 | CET2 | OE184 | CLS114 |
| 1.7 CDTi | 4 | Z17DTL | 59/79 | 04/04→08/06 | | | | | CCU143 ^[7] |
| 1.7 DTI 16V | 4 | Y17DT | 55/74 | 04/01→08/06 | | | | | CCU143 ^[7] |
| 1.7 TD | 4 | X17DTL | 50/67 | 08/98→08/06 | CH189 | 11v | | | CCU143 ^[7] |
| 2.0 DI | 4 | X20DTL | 60/80 | 08/98→08/06 | CH207 | 11v | | | CCU143 ^[7] |
| 2.0 DTI | 4 | Y20DTH | 74/99 | 04/04→08/06 | CH207 | 11v | | | CCU142 ^[8] |

ASTRAVAN Mk V (H)

| | | | | | | | | | |
|----------|---|----------------|--------|-------------|-------|-----|------|-------|-----------------------|
| 1.3 CDTi | 4 | Z13DTH | 66/89 | 08/05→ | | | | | CCU142 ^[8] |
| 1.4 i | 4 | Z14XEP | 66/89 | 03/05→ | OE198 | 0,9 | CET2 | OE184 | BAEA338 |
| 1.6 | 4 | Z16XE1; Z16XEP | 76/102 | 03/05→ | OE198 | 0,9 | CET2 | OE184 | BAEA427 |
| 1.7 CDTi | 4 | Z17DTL | 59/79 | 03/05→07/06 | | | | | CCU143 ^[7] |



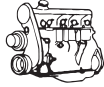

kW/BHP

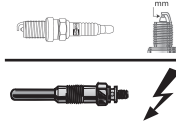

eon TITAN

IRIDIUM

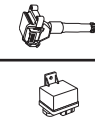

...VAUXHALL

...ASTRAVAN Mk V (H)

| | | | | | | | | | |
|----------|---|----------------|---------|-------------|---|-----|--|--|--|
| 1.7 CDTi | 4 | Z17DTH | 74/99 | 03/05→11/11 | | | | | CCU143 ^[7] |
| 1.7 CDTi | 4 | A17DTJ; Z17DTJ | 81/109 | 06/11→12/13 | | | | | CCU143 ^[7] |
| 1.7 CDTi | 4 | A17DTR; Z17DTR | 92/123 | 11/11→ | | | | | CCU143 ^[7] |
| 1.9 CDTi | 4 | Z19DT | 88/118 | 03/05→11/11 | CH222 →Ch.72045139 75030986 78007391 7G | 11v | | | CCU142 ^[8] |
| | | | | | CH269 Ch.72045140 75030987 78007392 88000001 7G→ | 11v | | | CCU143 ^[7] |
| 1.9 CDTi | 4 | Z19DTH | 110/148 | 03/05→11/11 | CH224 | 11v | | | CCU142 ^[8] CCU143 ^[7] |

COMBO Mk I (B)

| | | | | | | | | | |
|-----|---|--------------|-------|-------------|-------|-----|------|-------|--------------------------|
| 1.2 | 4 | C12NZ; X12SZ | 33/44 | 07/94→10/01 | | | | OE195 | |
| 1.4 | 4 | C14NZ | 44/59 | 07/94→10/01 | OE019 | 0,9 | CET2 | OE184 | BAEA253 ^[292] |
| 1.4 | 4 | C14SE | 60/80 | 07/94→10/01 | OE019 | 0,9 | CET2 | OE184 | BAEA253 ^[292] |

COMBO Mk II (C)

| | | | | | | | | | |
|-------------|---|--------|-------|-------------|-------|-----|--------|-------|---------|
| 1.4 16V | 4 | Z14XE | 66/89 | 10/01→05/07 | OE019 | 0,9 | CET2 | OE184 | BAE965A |
| 1.4 i 16V | 4 | Z14XEP | 66/89 | 01/04→11/11 | OE198 | 0,9 | CET2 | OE184 | BAEA338 |
| 1.6 | 4 | Z16SE | 62/83 | 09/01→10/04 | OE019 | 0,9 | CET2 | OE184 | CLS114 |
| 1.6 | 4 | Z16SE | 64/86 | 10/01→11/11 | OE019 | 0,9 | CET2 | OE184 | |
| 1.6 CNG 16V | 4 | Z16YNG | 69/93 | 06/06→02/12 | OE136 | 0,8 | CET12P | OE179 | BAE965A |
| 1.6 CNG 16V | 4 | Z16YNG | 71/95 | 04/05→02/12 | OE136 | 0,8 | CET12P | OE179 | BAE965A |
| 1.7 DI 16V | 4 | Y17DTL | 48/64 | 09/01→11/11 | CH189 | 11v | | | |

COMBO Mk III (D)

| | | | | | | | | | |
|---------|---|--|--------|--------|--|--|--|--|---------|
| 1.4 CNG | 4 | | 88/118 | 11/11→ | | | | | BAEA095 |
|---------|---|--|--------|--------|--|--|--|--|---------|

CORSAVAN Mk I (B)

| | | | | | | | | | |
|-------|---|-------|-------|-------------|-------|-----|------|-------|---------------------------------|
| 1.4 i | 4 | C14NZ | 44/59 | 01/94→09/00 | OE019 | 0,9 | CET2 | OE184 | BAEA253 ^[292] CLS114 |
| 1.5 D | 4 | 15D | 37/50 | 08/94→12/95 | CH158 | 11v | | | |

CORSAVAN Mk II (C)

| | | | | | | | | | |
|------------------|---|--------|-------|-------------|-------|-----|------|-------|-----------------------|
| 1.2 16V | 4 | Z12XE | 55/74 | 09/00→06/06 | OE019 | 0,9 | CET2 | OE184 | BAEA147E →08/04 |
| 1.2 16V Dualfuel | 4 | Z12XE | 55/74 | 08/01→06/06 | | | | | BAEA147E →08/04 |
| 1.3 CDTI 16V | 4 | Z13DT | 52/70 | 04/04→06/06 | | | | | CCU142 ^[8] |
| 1.4 | 4 | Z14XEP | 66/89 | 11/03→06/06 | OE198 | 0,9 | CET2 | OE184 | |
| 1.7 DI 16V | 4 | Y17DTL | 48/64 | 09/00→06/06 | | | | | CCU143 ^[7] |
| 1.7 DTI 16V | 4 | Y17DT | 55/74 | 09/00→06/06 | | | | | CCU143 ^[7] |

CORSAVAN Mk III (D)

| | | | | | | | | | |
|----------|---|--------------------------------|-------|--------|-------|-----|------|-------|----------|
| 1.2 | 4 | A12XEL | 51/68 | 01/10→ | | | CET2 | OE184 | BAEA185E |
| 1.2 | 4 | Z12XEP | 59/79 | 07/09→ | OE198 | 0,9 | CET2 | OE184 | BAEA338 |
| 1.3 CDTI | 4 | Z13DTJ | 55/74 | 07/06→ | | | | | CCU144 |
| 1.3 CDTI | 4 | A13DTC | 55/74 | 07/06→ | | | | | CCU138 |
| 1.3 CDTI | 4 | Z13DTH | 66/89 | 07/06→ | | | | | CCU144 |
| 1.3 CDTI | 4 | A13DTE; A13DTR; B13DTR; Z13DTE | 70/94 | 07/06→ | | | | | CCU138 |

MIDI II

| | | | | | | | | | |
|--------|---|-------|-------|-------------|------------------------|-----|--|--|--|
| 2.4 TD | 4 | 4FG1T | 56/75 | 09/94→08/97 | CH158 ^[275] | 11v | | | |
| 2.4 TD | 4 | 4FG1T | 69/93 | 10/94→08/97 | CH158 ^[275] | 11v | | | |

MOVANO Mk I (A)

| | | | | | | | | | |
|---------|---|--------|-------|-------------|-------|-----|--|--|-------------------------|
| 1.9 DTI | 4 | F9Q770 | 59/79 | 09/00→10/01 | CH271 | 11v | | | CCU129 ^[338] |
| 1.9 DTI | 4 | F9Q774 | 60/80 | 10/01→05/10 | CH271 | 11v | | | CCU129 ^[338] |

VAUXHALL





kW/BHP

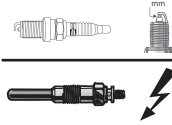

eon TITAN

IRIDIUM

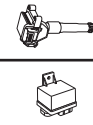

...VAUXHALL

...MOVANO Mk I (A)

| | | | | | | | | | | |
|------------------|---|--------------------------------|---------|-------------|-------|-----|--|--|--|--------|
| 2.2 DTI | 4 | G9T720; G9T722; G9T750 | 66/89 | 09/00→05/10 | CH232 | 11v | | | | CCU154 |
| 2.5 CDTI | 4 | G9U650 | 74/99 | 10/01→12/10 | CH232 | 11v | | | | |
| 2.5 CDTI | 4 | G9U632; G9U650 | 88/118 | 02/03→05/10 | CH232 | 11v | | | | |
| 2.5 CDTI | 4 | G9U632; G9U650 | 107/143 | 08/06→05/10 | CH232 | 11v | | | | |
| 2.5 D | 4 | S8U770; S8U772 | 59/79 | 10/98→08/02 | CH189 | 11v | | | | |
| 2.5 DTI | 4 | G9U720; G9U724; G9U750; G9U754 | 84/113 | 01/01→05/10 | CH232 | 11v | | | | |
| 2.8 DTI, 2.8 TDI | 4 | S9W702 | 84/113 | 10/98→10/01 | CH189 | 11v | | | | |

MOVANO Mk II (B)

| | | | | | | | | | | |
|----------|---|--|---------|--------|-------------------------|----|--|--|--|--|
| 2.3 CDTI | 4 | M9T670; M9T672; M9T676; M9T690; M9T692; M9T870 | 74/99 | 05/10→ | CCGP007 ^[14] | 7v | | | | |
| 2.3 CDTI | 4 | M9T670; M9T672; M9T676; M9T680; M9T686; M9T690; M9T692; M9T696; M9T698; M9T876; M9T898 | 92/123 | 05/10→ | CCGP007 ^[14] | 7v | | | | |
| 2.3 CDTI | 4 | M9T678; M9T680; M9T694; M9T696; M9T698 | 107/143 | 05/10→ | CCGP007 ^[14] | 7v | | | | |
| 2.3 CDTI | 4 | | 110/148 | 01/13→ | CCGP007 ^[14] | 7v | | | | |

VIVARO

| | | | | | | | | | | |
|-------------------|---|--------------------------------|---------|-------------|---|-----|------|-------|---------|------------------------------|
| 1.9 DI | 4 | F9Q762 | 59/79 | 08/01→07/14 | CH271 | 11v | | | | CCU154 →Ch.6Y 6V699999 |
| 1.9 DTI | 4 | F9Q760 | 74/99 | 08/01→12/06 | CH271 | 11v | | | | |
| 2.0 16V | 4 | F4R720 | 88/118 | 08/01→07/14 | OE034 | 0,9 | CET2 | OE179 | BAE409A | |
| 2.0 CDTI | 4 | M9R630 | 66/89 | 01/06→07/14 | CCGP007 ^[14] →Prod.12.12.2011 | 7v | | | | |
| 2.0 CDTI | 4 | M9R780; M9R782; M9R786 | 66/89 | 01/06→07/14 | CCGP007 ^[14] Ch.C056227→ | 7v | | | | |
| 2.0 CDTI | 4 | M9R630 | 84/113 | 08/06→07/14 | CCGP007 ^[14] →Prod.12.12.2011 | 7v | | | | |
| 2.0 CDTI | 4 | M9R780; M9R784; M9R786; M9R788 | 84/113 | 08/06→07/14 | CCGP007 ^[14] Ch.C056227→ | 7v | | | | |
| 2.0 ECOTEC | 4 | F4R820 | 86/115 | 08/06→07/14 | OE034 | 0,9 | CET2 | OE179 | BAE409A | |
| 2.5 CDTI | 4 | G9U630 | 107/143 | 01/06→07/14 | CH232 | 11v | | | | |
| 2.5 CDTI, 2.5 DTI | 4 | G9U730 | 99/133 | 04/03→07/14 | CH232 | 11v | | | | |

VOLVO

440 K

| | | | | | | | | | | |
|------------------|---|------|--------|-------------|-------|-----|--|--|--|------------------------|
| 1.9 Turbo-Diesel | 4 | D19T | 66/89 | 07/94→12/96 | CH260 | 11v | | | | |
| 2.0 | 4 | B20F | 80/107 | 08/93→07/96 | OE004 | 0,9 | | | | BAEA251 [265] [292] |

460 L

| | | | | | | | | | | |
|------------------|---|------|--------|-------------|-------|-----|--|--|--|------------------------|
| 1.9 Turbo-Diesel | 4 | D19T | 66/89 | 07/94→07/96 | CH260 | 11v | | | | |
| 2.0 | 4 | B20F | 80/107 | 08/93→07/96 | OE004 | 0,9 | | | | BAEA251 [265] [292] |

850

| | | | | | | | | | | |
|-------------|---|-----------------|---------|-------------|-------|-----|--------|-------|---------------------------|-------------------------|
| 2.0 | 5 | B5202S | 93/125 | 08/94→12/96 | OE120 | 0,6 | CET2 | OE188 | BAEA037E ^[292] | CLS050 08/95→ |
| 2.0 Turbo | 5 | B5204T2 | 132/177 | 09/93→10/97 | OE136 | 0,8 | CET12P | OE179 | BAEA037E ^[292] | CLS050 01/96→ |
| 2.0 Turbo | 5 | B5204FT; B5204T | 155/208 | 02/93→12/96 | OE136 | 0,8 | CET12P | OE179 | BAEA037E ^[292] | CLS050 08/95→ |
| 2.3 | 5 | B5234FS | 106/142 | 01/96→10/96 | OE136 | 0,8 | CET12P | OE179 | | |
| 2.3 T5 | 5 | B5234FT | 166/223 | 02/93→12/96 | OE136 | 0,8 | CET12P | OE179 | BAEA037E ^[292] | CLS050 08/95→ 09/94→ |
| 2.3 T5 R | 5 | B5234T2 | 176/236 | 04/96→10/96 | OE136 | 0,8 | CET12P | OE179 | | |
| 2.3 T5-R | 5 | B5234T4 | 184/247 | 08/95→12/96 | OE136 | 0,8 | CET12P | OE179 | BAEA037E ^[292] | CLS050 03/96→ |
| 2.3 Turbo R | 5 | B5234T5 | 177/237 | 06/95→10/97 | OE136 | 0,8 | CET12P | OE179 | | |
| 2.3 Turbo R | 5 | B5234T5 | 179/240 | 09/94→10/97 | OE136 | 0,8 | CET12P | OE179 | | |

VOLVO





kW/BHP



eon TITAN

IRIDIUM



...VOLVO

...850

| | | | | | | | | | | |
|---------|---|---------|---------|-------------|-------|-----|------|-------|-------------------------------------|--------|
| 2.4 | 5 | B5252FS | 106/142 | 08/94→12/96 | OE120 | 0,6 | CET2 | OE188 | BAEA037E ^[292] 08/95→ | CLS050 |
| 2.4 4WD | 5 | B5254T | 142/190 | 04/96→12/96 | | | CET2 | OE179 | BAEA037E ^[292] 09/96→ | CLS050 |
| 2.4 GLE | 5 | B5254T | 142/190 | 09/93→10/97 | OE014 | 0,9 | CET2 | OE179 | | |
| 2.5 TDI | 5 | D5252T | 103/138 | 08/95→12/96 | CH271 | 11v | | | | |

940 II

| | | | | | | | | | | |
|----------------|---|--------|---------|-------------|-------|-----|------|-------|--|--------|
| 2.0 | 4 | B200G | 89/119 | 11/94→12/95 | OE018 | 1,0 | CET8 | OE195 | | |
| 2.0 | 4 | B204FT | 102/137 | 10/94→05/97 | OE018 | 1,0 | CET8 | OE195 | | |
| 2.0 Turbo | 4 | B200FT | 114/153 | 04/96→10/98 | OE018 | 1,0 | CET8 | OE195 | | |
| 2.3 | 4 | B230FD | 85/114 | 08/94→07/95 | OE004 | 0,9 | CET8 | OE195 | | CLS236 |
| 2.3 | 4 | B230FB | 96/129 | 08/94→10/98 | OE004 | 0,9 | CET8 | OE195 | | CLS236 |
| 2.3 ti | 4 | B230FK | 99/133 | 01/95→10/98 | OE004 | 0,9 | CET8 | OE195 | | CLS236 |
| 2.3 Turbo | 4 | B230FT | 121/162 | 08/94→10/98 | OE004 | 0,9 | CET8 | OE195 | | CLS188 |
| 2.3 Turbo | 4 | B230FT | 126/169 | 01/95→12/98 | OE004 | 0,9 | CET8 | OE195 | | CLS188 |
| 2.4 TD Interc. | 6 | D24TIC | 90/121 | 08/94→10/98 | CH260 | 11v | | | | |

960 II

| | | | | | | | | | | |
|-----|---|--------|---------|-------------|-------|-----|------|-------|-------------------------|--|
| 2.5 | 6 | B6254S | 125/168 | 07/94→12/96 | OE120 | 0,6 | CET2 | OE188 | BAEA446 ^[97] | |
| 2.9 | 6 | B6304S | 150/201 | 07/94→12/96 | OE120 | 0,6 | CET2 | OE188 | BAEA446 ^[97] | |

C30

| | | | | | | | | | | |
|-------------------|---|-------------------|---------|-------------|----------------------------|-----|--------|-------|---------------------|--------|
| 1.6 | 4 | B4164S3 | 74/99 | 10/06→12/12 | OE031 | 1,0 | CET7 | OE189 | BAEA387 | CLS077 |
| 1.6 D | 4 | D4164T | 80/107 | 10/06→12/12 | CH201 Eng.16126→ | 11v | | | CCU147 →Ch.39039 | |
| 1.8, 1.8 FlexFuel | 4 | B4184S8; B4184S11 | 92/123 | 10/06→12/12 | OE131 | 1,0 | CET18P | OE183 | BAEA408 | |
| 2.0, 2.0 FlexFuel | 4 | B4204S3; B4204S4 | 107/143 | 10/06→12/12 | OE131 | 1,0 | CET18P | OE183 | BAEA408 | |
| 2.0 D | 4 | D4204T | 100/134 | 10/06→12/12 | CH268 | 11v | | | CCU147 →Ch.39039 | |
| 2.4 i | 5 | B5244S4 | 125/168 | 10/06→12/12 | OE236 | 1,7 | | | BAEA055E | |
| 2.5 T5 | 5 | B5254T3 | 162/217 | 10/06→12/12 | OE206 | 0,7 | CET14P | | BAEA055E →07/07 | |
| | | | | | OE224 LPG ^[279] | 0,8 | | | | |
| 2.5 T5 | 5 | B5254T7 | 169/227 | 03/07→12/12 | OE206 | 0,7 | CET14P | | BAEA055E | |
| | | | | | OE224 LPG ^[279] | 0,8 | | | | |

C70 I

| | | | | | | | | | | |
|---------|---|----------------|---------|-------------|-------|-----|--------|-------|-------------------------------------|------------------|
| 2.0 | 5 | B5204T2 | 132/177 | 03/97→10/05 | OE136 | 0,8 | CET12P | OE179 | BAEA037E ^[292] →07/98 | CLS050 |
| 2.0 T | 5 | B5204T4 | 120/161 | 03/00→10/05 | OE136 | 0,8 | CET12P | OE179 | BAEA019E | |
| 2.0 T | 5 | B5204T3 | 166/223 | 03/97→10/05 | | | CET2 | OE179 | BAEA037E ^[292] →07/98 | CLS050 |
| | | | | | | | | | BAEA019E 08/98→ | |
| 2.3 T5 | 5 | B5234T3 | 176/236 | 03/98→10/05 | OE136 | 0,8 | CET12P | OE179 | BAEA019E 09/98→ | CLS050 →08/98 |
| 2.3 T5 | 5 | B5234T9 | 180/241 | 07/02→10/05 | OE136 | 0,8 | CET12P | OE179 | BAEA019E | |
| 2.3 T-5 | 5 | B5234T3 | 176/236 | 03/97→09/02 | OE136 | 0,8 | CET12P | OE179 | BAEA037E ^[292] →07/98 | CLS050 →07/98 |
| | | | | | | | | | BAEA019E 08/98→ | |
| 2.4 | 5 | B5254S | 121/162 | 03/99→09/02 | OE120 | 0,6 | CET2 | OE188 | BAEA019E | |
| 2.4 | 5 | B5254S | 125/168 | 06/98→10/05 | OE120 | 0,6 | CET2 | OE188 | BAEA019E ^[126] 03/99→ | |
| | | | | | | | | | BAEA019E BAEA446 ^[97] | |
| 2.4 | 5 | B5244S | 125/168 | 06/98→10/05 | OE120 | 0,6 | CET2 | OE188 | BAEA019E | |
| 2.4 T | 5 | B5244T; B5254T | 142/190 | 03/97→10/05 | OE136 | 0,8 | CET12P | OE179 | BAEA037E ^[292] →07/98 | CLS050 →08/98 |
| | | | | | | | | | BAEA019E 08/98→ | |
| 2.4 T | 5 | B5244T7 | 147/197 | 07/02→10/05 | OE136 | 0,8 | CET12P | OE179 | BAEA019E | |

CHAMPION

VOLVO



kW/BHP



eon TITAN

IRIDIUM



...VOLVO

C70 II

| | | | | | | | | | |
|--------|---|---------|---------|-------------|------------------------|-----|---------------|--------------|----------------------------|
| 2.0 D | 4 | D4204T | 100/134 | 01/08→10/09 | CH268 | 11v | | | CCU147 →Ch.40042 |
| 2.4 | 5 | B5244S5 | 103/138 | 03/06→10/09 | OE236 | 1,7 | | | BAEA055E |
| 2.4 i | 5 | B5244S4 | 125/168 | 03/06→10/09 | OE236 | 1,7 | CET5 | OE190 | BAEA055E |
| 2.5 T5 | 5 | B5254T3 | 162/217 | 03/06→02/07 | OE206 | 0,7 | CET14P | | BAEA055E |
| | | | | | OE224 LPG [279] | 0,8 | | | |
| 2.5 T5 | 5 | B5254T7 | 169/227 | 03/07→10/09 | OE206 | 0,7 | CET14P | | BAEA055E |
| | | | | | OE224 LPG [279] | 0,8 | | | |

S40 I

| | | | | | | | | | | |
|-------------------|---|-------------------|---------|-------------|----------------------------|-----|---------------|--------------|---|---------------|
| 1.6 | 4 | B4164S | 77/103 | 09/95→08/99 | OE120 | 0,6 | CET2 | OE188 | BAEA254 [7] [37] BAEA255 [14] [39] | CLS051 |
| 1.6 | 4 | B4164S2 | 80/107 | 03/99→12/03 | OE120 | 0,6 | CET2 | OE188 | BAEA429 | CLS195 |
| 1.8 | 4 | B4184S; B4184S3 | 85/114 | 07/95→08/03 | OE120 | 0,6 | CET2 | OE188 | BAEA254 [7] [37] BAEA255 [14] [39] | CLS051 |
| 1.8 | 4 | B4184S2 | 85/114 | 07/95→08/03 | OE120 | 0,6 | CET2 | OE179 | BAEA429 | CLS195 |
| 1.8 | 4 | B4184S2 | 90/121 | 03/99→12/03 | OE120 | 0,6 | CET2 | OE188 | BAEA429 | CLS195 |
| 1.8 i | 4 | B4184SJ | 90/121 | 06/01→12/03 | OE227 | 0,6 | CET12P | OE188 | BAEA254 [7] [37] [137] BAEA255 [14] [39] [138] BAEA446 [97] | |
| | | | | | OE216 LPG [278] | 0,8 | | | | |
| 1.8 i | 4 | B4184SM | 92/123 | 03/98→12/03 | OE227 | 0,6 | CET12P | OE188 | | |
| | | | | | OE216 LPG [278] | 0,8 | | | | |
| 1.9 DI | 4 | D4192T2 | 70/94 | 03/99→07/00 | CH169 | 11v | | | | |
| 1.9 DI | 4 | D4192T4 | 75/101 | 07/00→12/03 | CH271 | 11v | | | | |
| 1.9 DI | 4 | D4192T3 | 85/114 | 07/00→12/03 | CH271 | 11v | | | | |
| 1.9 T4 | 4 | B4194T; B4194T2 | 147/197 | 05/97→07/00 | OE136 | 0,8 | CET12P | OE179 | BAEA429 | CLS195 |
| 1.9 TD | 4 | D4192T | 66/89 | 07/95→08/99 | CH260 | 11v | | | | |
| 2.0 | 4 | B4204S | 100/134 | 07/95→12/03 | OE120 | 0,6 | CET2 | OE188 | BAEA254 →12/99 [7] [37] BAEA255 →12/99 [14] [39] BAEA429 01/00→ | CLS195 |
| 2.0 | 4 | B4204S2 | 100/134 | 07/95→12/03 | OE120 | 0,6 | CET2 | OE188 | BAEA254 →12/99 [7] [37] BAEA255 →12/99 [14] [39] BAEA429 01/00→ | CLS195 |
| 2.0 | 4 | B4204S | 103/138 | 07/95→08/99 | OE120 | 0,6 | CET2 | OE188 | BAEA254 [7] [37] BAEA255 [14] [39] | CLS051 |
| 2.0 T | 4 | B4204T | 118/158 | 10/97→12/03 | OE136 | 0,8 | CET12P | OE179 | BAEA429 | CLS195 |
| 2.0 T | 4 | B4204T3 | 120/161 | 06/01→12/03 | OE136 | 0,8 | CET12P | OE179 | BAEA429 | CLS195 |
| 2.0 T | 4 | B4204T2; B4204T3 | 121/162 | 07/00→06/01 | OE136 | 0,8 | CET12P | OE179 | BAEA429 | CLS195 |
| 2.0 T4 | 4 | B4204T5 | 147/197 | 07/00→12/03 | OE136 | 0,8 | CET12P | OE179 | BAEA429 | CLS195 |
| S40 II | | | | | | | | | | |
| 1.6 | 4 | B4164S3 | 74/99 | 01/05→12/12 | OE031 | 1,0 | CET7 | OE189 | BAEA387 Ch.106167→ | CLS077 |
| 1.6 D | 4 | D4164T | 81/109 | 01/05→12/12 | CH201 Eng.16126→ | 11v | | | CCU147 →Ch.350231 | |
| 1.8, 1.8 FlexFuel | 4 | B4184S8; B4184S11 | 92/123 | 04/04→12/10 | OE131 | 1,0 | CET18P | OE183 | BAEA408 | |
| 2.0 | 4 | B4204S3 | 107/143 | 10/06→12/12 | OE131 | 1,0 | CET18P | OE183 | BAEA408 | |

VOLVO



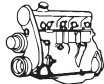

kW/BHP

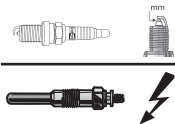

eon TITAN

IRIDIUM



...VOLVO

...S40 II

| | | | | | | | | | |
|--------------------|---|---------|---------|-------------|-----------------|-----|--------|-------|--|
| 2.0 D | 4 | D4204T | 100/134 | 01/04→12/10 | CH268 | 11v | | | CCU147 →Ch.350231 |
| 2.0 D4 | 4 | D4204T2 | 96/129 | 07/05→12/06 | CH268 | 11v | | | |
| 2.0 F | 4 | B4204S4 | 107/143 | 10/09→12/12 | | | CET18P | OE183 | BAEA408 |
| 2.4 | 5 | B5244S5 | 103/138 | 01/04→12/10 | OE236 | 1,7 | | | BAEA055E |
| 2.4 | 5 | B5244S4 | 125/168 | 01/04→12/12 | OE236 | 1,7 | | | BAEA055E ^[275] BAEA446 [97] [275] |
| 2.4 4WD | 5 | B5244S4 | 125/168 | 08/06→12/12 | OE035 | 0,9 | CET5 | OE190 | BAEA055E |
| 2.5 T5, 2.5 T5 4WD | 5 | B5254T3 | 162/217 | 01/04→12/07 | OE206 | 0,7 | CET14P | | BAEA055E →07/07 |
| | | | | | OE224 LPG [279] | 0,8 | | | |
| 2.5 T5, 2.5 T5 4WD | 5 | B5254T7 | 169/227 | 03/07→12/12 | OE206 | 0,7 | CET14P | | BAEA055E |
| | | | | | OE224 LPG [279] | 0,8 | | | |

S60 I

| | | | | | | | | | |
|------------------|---|----------|---------|-------------|---------------------------|-----|------------------|-----------------|--|
| 2.0 T | 5 | B5204T5 | 132/177 | 07/00→04/10 | OE136 →07/04 | 0,8 | CET12P →07/04 | OE179 →07/04 | BAEA019E →07/04 |
| | | | | | OE206 08/04→ | 0,7 | CET14P 08/04→ | | BAEA055E 08/04→ |
| | | | | | OE224 LPG [279] 08/04→ | 0,8 | | | |
| 2.3 T5 | 5 | B5234T3 | 184/247 | 07/00→04/10 | OE136 | 0,8 | CET12P | OE179 | BAEA019E |
| 2.3 T5 | 5 | B5234T7 | 195/261 | 07/00→09/02 | OE136 | 0,8 | CET12P | OE179 | BAEA019E |
| 2.4 | 5 | B5244S2 | 103/138 | 07/00→04/10 | OE120 | 0,6 | CET2 | OE188 | BAEA019E |
| 2.4 | 5 | B5244S | 125/168 | 11/00→04/10 | OE120 | 0,6 | CET2 | OE188 | BAEA019E |
| 2.4 | 5 | B5244T4 | 132/177 | 01/05→10/06 | OE136 | 0,8 | CET12P | OE179 | BAEA055E |
| 2.4 4WD | 5 | B5244T5 | 191/256 | 02/04→04/10 | OE136 | 0,8 | CET12P | OE179 | BAEA055E |
| 2.4 Bifuel (CNG) | 5 | B5244S6 | 103/138 | 07/01→04/10 | OE120 | 0,6 | CET12P | OE179 | BAEA019E |
| 2.4 Bifuel (LPG) | 5 | B5244S62 | 103/138 | 07/01→04/10 | OE120 | 0,6 | | | BAEA019E |
| 2.4 D | 5 | D5244T2 | 96/129 | 05/01→04/10 | CH240 | 11v | | | |
| 2.4 D5 | 5 | D5244T | 120/161 | 01/01→04/10 | CH240 | 11v | | | |
| 2.4 T | 5 | B5244T | 142/190 | 01/01→04/10 | OE136 | 0,8 | CET12P | OE179 | BAEA055E |
| 2.4 T | 5 | B5244T3 | 147/197 | 07/00→04/10 | OE136 →10/01 | 0,8 | CET12P →10/01 | OE179 →10/01 | BAEA019E →07/03 |
| | | | | | OE206 11/01→ | 0,7 | CET14P 11/01→ | | BAEA055E 08/03→ |
| 2.4 T 4WD | 5 | B5244T3 | 147/197 | 06/01→04/10 | OE206 | 0,7 | CET14P | | BAEA019E →07/03 BAEA055E 08/03→ |
| 2.4 T5 | 5 | B5244T5 | 191/256 | 04/04→04/10 | OE206 | 0,7 | CET14P | | BAEA055E |
| 2.5 R 2, 5 T 4WD | 5 | B5254T4 | 221/296 | 01/03→04/10 | OE206 | 0,7 | CET14P | | BAEA055E →07/07 |
| 2.5 T, 2.5 T 4WD | 5 | B5254T2 | 154/207 | 07/02→04/10 | OE136 | 0,8 | CET12P | OE179 | BAEA019E |

S60 II

| | | | | | | | | | |
|-----------------|---|-----------------|---------|-------------|--|--|--------|-------|----------|
| 1.6 T3 | 4 | B4164T3 | 110/148 | 04/10→12/15 | | | CET17P | OE189 | |
| 1.6 T4, 1.6 T4F | 4 | B4164T; B4164T2 | 132/177 | 04/10→12/15 | | | CET17P | OE189 | |
| 2.0 T | 4 | B4204T6 | 149/200 | 04/10→12/11 | | | CET17P | | |
| 2.0 T | 5 | B5204T8 | 132/177 | 05/12→12/15 | | | | | BAEA055E |
| 2.0 T5 | 4 | B4204T7 | 177/237 | 04/10→12/14 | | | CET17P | | |

S70

| | | | | | | | | | |
|-----------|---|-----------------|---------|-------------|-------|-----|--------|-------|--|
| 2.0 | 5 | B5202FS; B5202S | 93/125 | 01/97→11/00 | OE120 | 0,6 | CET2 | OE188 | BAEA037E ^[292] CLS050 |
| 2.0 | 5 | B5204F | 105/141 | 01/97→11/00 | OE120 | 0,6 | CET2 | OE188 | BAEA037E ^[292] CLS050 →07/98 |
| 2.0 | 5 | B5204T4 | 120/161 | 01/97→11/00 | OE136 | 0,8 | CET2 | OE179 | BAEA019E |
| 2.0 | 5 | B5204T2 | 132/177 | 01/97→11/00 | OE136 | 0,8 | CET12P | OE179 | BAEA037E ^[292] CLS050 →07/98 |
| 2.0 Turbo | 5 | B5204T | 155/208 | 01/97→11/00 | OE136 | 0,8 | CET12P | OE179 | BAEA037E ^[292] CLS050 →07/98 |

VOLVO





kW/BHP

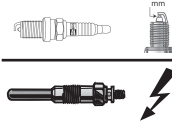

eon TITAN

IRIDIUM

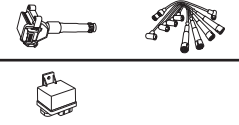

...VOLVO

...S70

| | | | | | | | | | | |
|--|---|------------------|---------|-------------|-------|-----|--------|-------|--------------------------|--------|
| 2.0 Turbo | 5 | B5204T3 | 166/223 | 01/97→11/00 | OE136 | 0,8 | CET12P | OE179 | BAEA019E | CLS050 |
| 2.3 | 5 | B5234T3 | 177/237 | 11/96→11/00 | | | | | BAEA019E | |
| 2.3 | 5 | B5234T7 | 195/261 | 04/99→09/00 | OE136 | 0,8 | CET12P | OE179 | BAEA019E | |
| 2.3 T-5 | 5 | B5234T3 | 176/236 | 01/97→11/00 | OE136 | 0,8 | CET12P | OE179 | BAEA037E [292] →07/98 | CLS050 |
| | | | | | | | | | BAEA019E 08/98→ | |
| 2.3 T5 4WD | 5 | B5234T3 | 177/237 | 11/96→09/98 | OE136 | 0,8 | CET12P | OE179 | BAEA019E | |
| 2.3 T5 4WD | 5 | B5234T4 | 184/247 | 07/97→09/00 | OE136 | 0,8 | CET12P | OE179 | | |
| 2.3 Turbo | 5 | B5234FT+ | 184/247 | 01/97→11/00 | OE136 | 0,8 | CET12P | OE179 | BAEA037E [292] →07/98 | CLS050 |
| 2.4 | 5 | B5252F5 | 106/142 | 01/97→11/00 | OE120 | 0,6 | CET2 | OE188 | BAEA037E [292] | CLS050 |
| 2.4 | 5 | B5254S | 121/162 | 06/98→11/00 | OE120 | 0,6 | CET2 | OE188 | BAEA037E [292] →07/98 | |
| | | | | | | | | | BAEA019E 08/98→ | |
| 2.4 | 5 | B5244S; B5254S | 125/168 | 01/97→11/00 | OE120 | 0,6 | CET2 | OE188 | BAEA037E [292] →07/98 | CLS050 |
| | | | | | | | | | BAEA019E 08/98→ | |
| 2.4, 2.4 4WD, 2.4 Bifuel, 2.4 Blu-Fuel | 5 | B5244S2; B5244SG | 103/138 | 07/97→11/00 | OE120 | 0,6 | CET2 | OE188 | BAEA019E | |
| 2.4 4WD | 5 | B5254S | 121/162 | 10/98→05/99 | OE120 | 0,6 | CET2 | | BAEA019E | |
| 2.4 4WD | 5 | B5244S | 125/168 | 04/99→09/00 | OE120 | 0,6 | CET2 | OE188 | BAEA019E | |
| 2.4 4WD, 2.4 Bifuel | 5 | B5252F5; GB5252S | 106/142 | 11/96→11/00 | OE120 | 0,6 | CET2 | OE188 | BAEA037E [292] | |
| 2.4 T5 4WD | 5 | B5254T | 142/190 | 11/96→04/99 | OE136 | 0,8 | CET12P | OE179 | BAEA019E 08/98→ | |
| 2.4 Turbo | 5 | B5244T; B5254T | 142/190 | 01/97→11/00 | OE136 | 0,8 | CET12P | OE179 | BAEA037E [292] →07/98 | CLS050 |
| | | | | | | | | | BAEA019E 08/98→ | |
| 2.5 TDI, 2.5 TDi 4WD | 5 | D5252T | 103/138 | 01/97→11/00 | CH271 | 11v | | | | |

S80 I

| | | | | | | | | | | |
|-------------------|---|----------|---------|-------------|---------------------------|-----|------------------|-----------------|--------------------|--|
| 2.0 | 5 | B5204T4 | 120/161 | 06/98→07/06 | OE136 | 0,8 | CET12P | OE179 | BAEA019E | |
| 2.0 T | 5 | B5204T5 | 132/177 | 12/99→07/06 | OE136 →07/04 | 0,8 | CET12P →07/04 | OE179 →07/04 | BAEA019E →07/04 | |
| | | | | | OE206 08/04→ | 0,7 | CET14P 08/04→ | | BAEA055E 08/04→ | |
| | | | | | OE224 LPG [279] 08/04→ | 0,8 | | | | |
| 2.0 T | 5 | B5204T3 | 166/223 | 06/98→07/06 | OE136 | 0,8 | CET12P | OE179 | BAEA019E | |
| 2.4 | 5 | B5244S2 | 103/138 | 01/99→07/06 | OE120 | 0,6 | CET2 | OE188 | BAEA019E | |
| 2.4 | 5 | B5244S | 125/168 | 01/99→07/06 | OE120 | 0,6 | CET2 | OE188 | BAEA019E | |
| 2.4 Bifuel (CNG) | 5 | B5244SG2 | 103/138 | 09/01→07/06 | OE120 | 0,6 | CET12P | OE179 | BAEA019E | |
| 2.4 Bifuel (LPG) | 5 | B5244SG | 103/138 | 09/01→07/06 | OE120 | 0,6 | | | BAEA019E | |
| 2.4 D | 5 | D5244T2 | 96/129 | 10/01→07/06 | CH240 | 11v | | | | |
| 2.4 D5 | 5 | D5244T | 120/161 | 08/01→07/06 | CH240 | 11v | | | | |
| 2.4 LTP | 5 | B5244T4 | 132/177 | 06/04→07/06 | OE136 | 0,8 | CET12P | OE179 | BAEA055E | |
| 2.4 T, 2.4 T5 4WD | 5 | B5244T3 | 147/197 | 04/00→07/06 | OE136 →10/01 | 0,8 | CET12P →10/01 | OE179 →10/01 | BAEA019E | |
| | | | | | OE206 11/01→ | 0,7 | CET14P 11/01→ | | | |
| 2.5 T, 2.5 T 4WD | 5 | B5254T2 | 154/207 | 03/03→07/06 | OE136 | 0,8 | CET12P | OE179 | BAEA019E | |
| 2.5 TDI | 5 | D5252T | 103/138 | 01/99→07/06 | CH271 | 11v | | | | |
| 2.8 T6 | 6 | B6284T | 200/268 | 05/98→07/06 | OE136 | 0,8 | CET12P | OE179 | BAEA019E | |
| 2.9 | 6 | B6294S | 147/197 | 03/99→07/06 | OE120 | 0,6 | CET2 | OE188 | BAEA019E | |
| 2.9 | 6 | B6304S3 | 150/201 | 05/98→07/06 | OE120 →12/99 | 0,6 | CET2 | OE188 | BAEA019E | |
| 3.0 | 6 | B6294S2 | 144/193 | 06/01→07/06 | OE120 | 0,6 | CET12P | OE179 | BAEA019E | |
| 3.0 T6 | 6 | B6294T | 200/268 | 06/01→07/06 | OE136 | 0,8 | CET12P | OE179 | BAEA019E | |

VOLVO



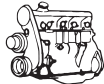

kW/BHP

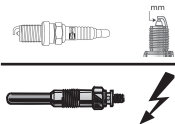

eon TITAN

IRIDIUM



...VOLVO

S80 II

| | | | | | | | | | | |
|-------------------|---|------------------|---------|-------------|-----------------|-----|--------|-------|----------|--|
| 1.6 D DRiVe | 4 | D4164T | 80/107 | 01/10→12/11 | CH201 | 11v | | | | |
| 1.6 T4, 1.6 T4F | 4 | B4164T; B4164T2 | 132/177 | 10/10→ | | | CET17P | OE189 | | |
| 2.0, 2.0 FlexFuel | 4 | B4204S3; B4204S4 | 107/143 | 01/08→09/12 | OE131 | 1,0 | CET18P | OE183 | BAEA408 | |
| 2.0 T | 4 | B4204T6 | 149/200 | 01/10→ | | | CET17P | | | |
| 2.0 T5 | 4 | B4204T7 | 177/237 | 10/10→ | | | CET17P | | | |
| 2.0 TDi | 4 | D4204T | 100/134 | 02/08→03/11 | CH268 | 11v | | | | |
| 2.5 T | 5 | B5254T6 | 147/197 | 03/06→12/11 | OE206 | 0,7 | CET14P | | BAEA055E | |
| | | | | | OE224 LPG [279] | 0,8 | | | | |
| 2.5 T | 5 | B5254T10 | 170/228 | 01/10→12/12 | | | CET14P | | BAEA055E | |
| 2.5 T FlexFuel | 5 | B5254T8 | 147/197 | 05/08→12/11 | | | CET14P | OE190 | BAEA055E | |
| 2.5 T FlexFuel | 5 | B5254T11 | 170/228 | 01/10→12/11 | | | CET14P | OE190 | BAEA055E | |
| 3.0 T6 4WD | 6 | B6304T2 | 210/282 | 01/07→12/10 | OE035 | 0,9 | CET5 | OE190 | | |
| 3.2 | 6 | B6324S | 175/235 | 03/06→ | OE206 | 0,7 | CET14P | | | |
| | | | | | OE224 LPG [279] | 0,8 | | | | |
| 3.2, 3.2 4WD | 6 | B6324S5 | 179/240 | 01/10→ | | | CET14P | | | |
| 3.2 4WD | 6 | B6324S | 175/235 | 01/07→12/10 | | | CET14P | OE190 | | |
| 4.4 V8 4WD | 8 | B8444S | 232/311 | 03/06→03/12 | | | CET12P | OE179 | | |

S90

| | | | | | | | | | | |
|-----|---|---------|---------|-------------|-------|-----|------|-------|-------------------------|--|
| 2.5 | 6 | B6254FS | 125/168 | 11/96→10/98 | OE120 | 0,6 | CET2 | OE188 | BAEA446 | |
| 2.5 | 6 | B6244FS | 132/177 | 11/96→10/97 | OE120 | 0,6 | CET2 | OE188 | | |
| 2.9 | 6 | B6304S2 | 132/177 | 01/97→05/98 | OE120 | 0,6 | CET2 | OE188 | BAEA446 ^[97] | |
| 2.9 | 6 | B6304GS | 150/201 | 01/97→05/98 | OE120 | 0,6 | CET2 | OE188 | BAEA446 ^[97] | |

V40

| | | | | | | | | | | |
|-------------|---|-----------------|---------|-------------|-----------------|-----|--------|-------|---|------------------|
| 1.6 | 4 | B4164S | 77/103 | 12/95→08/99 | OE120 | 0,6 | CET2 | OE188 | BAEA254 ^{[7] [37]} BAEA255 ^{[14] [39]} | CLS051 |
| 1.6 | 4 | B4164S2 | 80/107 | 03/99→06/04 | OE120 | 0,6 | CET2 | OE188 | BAEA429 | CLS195 |
| 1.6 T3 GTDi | 4 | B4164T3 | 110/148 | 03/12→ | | | CET17P | OE189 | | |
| 1.6 T4 GTDi | 4 | B4164T | 132/177 | 03/12→ | | | CET17P | OE189 | | |
| 1.8 | 4 | B4184S; B4184S3 | 85/114 | 07/95→08/99 | OE120 | 0,6 | CET2 | OE188 | BAEA254 ^{[7] [37]} BAEA255 ^{[14] [39]} | CLS051 |
| 1.8 | 4 | B4184S2 | 90/121 | 03/99→06/04 | OE120 | 0,6 | CET2 | OE188 | BAEA429 | CLS195 |
| 1.8 i | 4 | B4184SJ | 90/121 | 06/01→06/04 | OE227 | 0,6 | CET12P | OE188 | BAEA429 | CLS195 |
| | | | | | OE216 LPG [278] | 0,8 | | | | |
| 1.8 i | 4 | B4184SM | 92/123 | 03/98→06/04 | OE227 | 0,6 | CET12P | OE188 | BAEA245 ^{[7] [37]} BAEA246 ^{[14] [39]} | |
| | | | | | OE216 LPG [278] | 0,8 | | | | |
| 1.9 DI | 4 | D4192T2 | 70/94 | 03/99→07/00 | CH169 | 11v | | | | |
| 1.9 DI | 4 | D4192T4 | 75/101 | 07/00→06/04 | CH271 | 11v | | | | |
| 1.9 DI | 4 | D4192T3 | 85/114 | 07/00→06/04 | CH271 | 11v | | | | |
| 1.9 T4 | 4 | B4194T; B4194T2 | 147/197 | 05/97→07/00 | OE136 | 0,8 | CET12P | OE179 | BAEA429 | CLS195 |
| 1.9 TD | 4 | D4192T | 66/89 | 07/95→08/99 | CH260 | 11v | | | | |
| 2.0 | 4 | B4204S; B4204S2 | 100/134 | 07/95→06/04 | OE120 | 0,6 | CET2 | OE188 | BAEA245 ^{[7] [37]} BAEA246 ^{[14] [39]} | CLS051 →08/99 |
| 2.0 | 4 | B4204S | 103/138 | 07/95→08/99 | OE120 | 0,6 | CET2 | OE188 | BAEA254 ^{[7] [37]} BAEA255 ^{[14] [39]} | CLS051 |
| 2.0 T | 4 | B4204T | 118/158 | 10/97→07/00 | OE136 | 0,8 | CET12P | OE179 | BAEA429 | CLS195 |
| 2.0 T | 4 | B4204T3 | 120/161 | 06/01→06/04 | OE136 | 0,8 | CET12P | OE179 | BAEA429 | CLS195 |
| 2.0 T | 4 | B4204T2 | 121/162 | 07/99→ | OE136 | 0,8 | CET12P | OE179 | BAEA429 | CLS195 |



VOLVO



kW/BHP

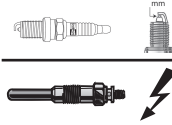

eon TITAN

IRIDIUM

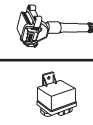
**...VOLVO****...V40**

| | | | | | | | | | | |
|--------------------|---|----------|---------|-------------|--------------|-----|---------------|--------------|-----------------|---------------|
| 2.0 T4 | 4 | B4204T5 | 147/197 | 07/00→06/04 | OE136 | 0,8 | CET12P | OE179 | BAEA429 | CLS195 |
| 2.0 T4, 2.0 T4 4WD | 5 | B5204T8 | 132/177 | 07/13→ | | | | | BAEA055E | |
| 2.0 T5, 2.0 T5 4WD | 5 | B5204T9 | 157/211 | 03/13→ | | | | | BAEA055E | |
| 2.5 T5, 2.5 T5 4WD | 5 | B5254T12 | 187/251 | 12/12→ | | | | | BAEA055E | |

V50

| | | | | | | | | | | |
|--------------------|---|-------------------|---------|-------------|----------------------------|-----|---------------|--------------|------------------------------|--|
| 1.6 | 4 | B4164S3 | 74/99 | 01/05→12/12 | OE031 | 1,0 | CET7 | OE189 | BAEA387 Ch.105440→ | |
| 1.6 D | 4 | D4164T | 81/109 | 01/05→12/11 | CH201 Eng.16126→ | 11v | | | CCU147 →Ch.367151 | |
| 1.8, 1.8 FlexFuel | 4 | B4184S8; B4184S11 | 92/123 | 04/04→12/10 | OE131 | 1,0 | CET18P | OE183 | BAEA408 | |
| 2.0, 2.0 FlexFuel | 4 | B4204S3; B4204S4 | 107/143 | 10/06→12/12 | OE131 | 1,0 | CET18P | OE183 | BAEA408 | |
| 2.0 D | 4 | D4204T | 100/134 | 04/04→12/10 | CH268 | 11v | | | CCU147 →Ch.367151 | |
| 2.4 | 5 | B5244S5 | 103/138 | 04/04→12/10 | OE236 | 1,7 | | | BAEA055E | |
| 2.4 | 5 | B5244S4 | 125/168 | 04/04→12/10 | OE236 | 1,7 | | | BAEA055E | |
| 2.4 4WD | 5 | B5244S4 | 125/168 | 08/06→12/09 | OE035 | 0,9 | CET5 | OE190 | BAEA055E | |
| 2.5 T5, 2.5 T5 4WD | 5 | B5254T3 | 162/217 | 04/04→12/07 | OE206 | 0,7 | CET14P | | BAEA055E →07/07 | |
| | | | | | OE224 LPG [279] | 0,8 | | | | |
| 2.5 T5, 2.5 T5 4WD | 5 | B5254T7 | 169/227 | 03/07→12/12 | OE206 | 0,7 | CET14P | | BAEA055E | |
| | | | | | OE224 LPG [279] | 0,8 | | | | |

V60

| | | | | | | | | | | |
|-----------------|---|-----------------|---------|-------------|--|--|---------------|--------------|-----------------|--|
| 1.6 T3 | 4 | B4164T3 | 110/148 | 09/10→12/15 | | | CET17P | OE189 | | |
| 1.6 T4, 1.6 T4F | 4 | B4164T; B4164T2 | 132/177 | 09/10→12/15 | | | CET17P | OE189 | | |
| 2.0 T | 4 | B4204T6 | 149/200 | 07/10→12/12 | | | CET17P | | | |
| 2.0 T5 | 4 | B4204T7 | 177/237 | 09/10→12/14 | | | CET17P | | | |
| 2.0 T5 | 5 | B5204T9 | 157/211 | 10/13→ | | | | | BAEA055E | |

V70 I

| | | | | | | | | | | |
|--------------------------|---|-------------------|---------|-------------|--------------|-----|---------------|--------------|---------------------------------|-------------------------|
| 2.0 | 5 | B5202FS; B5202S | 93/125 | 12/95→03/00 | OE120 | 0,6 | CET2 | OE188 | BAEA037E [292] | CLS050 |
| 2.0 | 5 | B5204F | 105/141 | 12/95→03/00 | OE120 | 0,6 | CET2 | OE188 | BAEA037E [292] →07/98 | CLS050 →08/98 |
| | | | | | | | | | BAEA019E 08/98→ | |
| 2.0 | 5 | B5204T4 | 120/161 | 01/97→12/00 | OE136 | 0,8 | CET2 | OE179 | BAEA019E | |
| 2.0 | 5 | B5204T2 | 132/177 | 11/96→03/00 | OE136 | 0,8 | CET12P | OE179 | BAEA037E [292] →07/98 | CLS050 →08/98 |
| 2.0 Turbo | 5 | B5204T | 155/208 | 12/95→03/00 | OE136 | 0,8 | CET12P | OE179 | BAEA037E [292] →07/98 | CLS050 |
| | | | | | | | | | BAEA019E 08/98→ | |
| 2.0 Turbo, 2.0 Turbo 4WD | 5 | B5204T3 | 166/223 | 11/96→12/00 | OE136 | 0,8 | CET12P | OE179 | BAEA037E [292] →07/98 | CLS050 |
| | | | | | | | | | BAEA019E 08/98→ | |
| 2.3 | 5 | B5234T3 | 177/237 | 11/96→11/00 | | | | | BAEA019E | |
| 2.3 4WD | 5 | B5234T3 | 177/237 | 04/97→09/98 | OE136 | 0,8 | CET12P | OE179 | BAEA019E | |
| 2.3 4WD | 5 | B5234T7; B5234T8 | 195/261 | 12/98→02/00 | OE136 | 0,8 | CET12P | OE179 | BAEA019E | |
| 2.3 T 4WD | 5 | B5234FT+; B5234T4 | 184/247 | 04/97→03/00 | OE136 | 0,8 | CET12P | OE179 | BAEA037E [292] →07/98 | CLS050 |
| 2.3 T-5, 2.3 T-5 4WD | 5 | B5234T3 | 176/236 | 11/96→12/00 | OE136 | 0,8 | CET12P | OE179 | BAEA037E [292] →07/98 | CLS050 |
| | | | | | | | | | BAEA019E 08/98→ | |
| 2.3 Turbo | 5 | B5234FT+ | 184/247 | 12/95→03/00 | OE136 | 0,8 | CET12P | OE179 | BAEA037E [292] | CLS050 |
| 2.4 | 5 | B5244S2; B5244S62 | 103/138 | 03/99→12/00 | OE120 | 0,6 | CET2 | OE188 | BAEA019E | |
| 2.4 | 5 | B5254S | 121/162 | 06/98→12/99 | OE120 | 0,6 | CET2 | OE188 | BAEA037E [292] →07/98 | |
| | | | | | | | | | BAEA019E 08/98→ | |

VOLVO



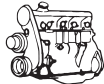

kW/BHP



eon TITAN

IRIDIUM



...VOLVO

...V70 I

| | | | | | | | | | | |
|--------------------------|---|-------------------------|---------|-------------|-------|-----|--------|-------|---|--------|
| 2.4 | 5 | B5244S; B5254FS; B5254S | 125/168 | 12/95→05/00 | OE120 | 0,6 | CET2 | OE188 | BAEA037E ^[292] →07/98 BAEA019E 08/98→ | CLS050 |
| 2.4, 2.4 Bifuel | 5 | B5252FS; GB5252S | 106/142 | 12/95→03/00 | OE120 | 0,6 | CET2 | OE188 | BAEA037E ^[292] | CLS050 |
| 2.4 4WD | 5 | B5254S | 121/162 | 06/98→12/99 | OE120 | 0,6 | CET2 | | BAEA019E | |
| 2.4 Bifuel | 5 | B5244SG | 103/138 | 08/99→12/00 | OE120 | 0,6 | CET12P | OE179 | BAEA019E | |
| 2.4 Turbo, 2.4 Turbo 4WD | 5 | B5244T; B5254T | 142/190 | 04/96→12/00 | OE136 | 0,8 | CET12P | OE179 | BAEA037E ^[292] →07/98 BAEA019E 08/98→ | CLS050 |
| 2.4 Turbo 4WD | 5 | B5244T2 | 195/261 | 03/99→12/00 | OE136 | 0,8 | CET12P | OE179 | BAEA019E | CLS050 |
| 2.5 TDi, 2.5 TDi 4WD | 5 | D5252T | 103/138 | 12/95→12/00 | CH271 | 11v | | | | |

V70 II

| | | | | | | | | | | |
|--------------------|---|-----------------------------|---------|-------------|--|---------------------------|--------------------------------------|-----------------|--|--|
| 2.0 T | 5 | B5204T5 | 132/177 | 11/99→08/07 | OE136 →07/04 OE206 08/04→ OE224 LPG ^[279] 08/04→ | 0,8 0,7 0,8 | CET12P →07/04 CET14P 08/04→ | OE179 →07/04 | BAEA019E →07/04 BAEA055E 08/04→ | |
| 2.3 | 5 | B5234T7 | 195/261 | 10/00→09/04 | OE136 | 0,8 | CET12P | OE179 | BAEA019E | |
| 2.3 4WD | 5 | B5234T7; B5234T8 | 195/261 | 10/00→09/04 | OE136 | 0,8 | CET12P | OE179 | | |
| 2.3 4WD | 5 | B5234T7 | 195/261 | 10/00→09/04 | | | | | BAEA019E | |
| 2.3 T5 | 5 | B5234T3 | 184/247 | 11/99→12/04 | OE136 | 0,8 | CET12P | OE179 | BAEA019E | |
| 2.4 | 5 | B5244S2 | 103/138 | 03/00→08/07 | OE120 | 0,6 | CET2 | OE188 | BAEA019E | |
| 2.4 | 5 | B5244S | 125/168 | 03/00→08/07 | OE120 | 0,6 | CET2 | OE188 | BAEA019E | |
| 2.4 Bifuel (CNG) | 5 | B5244SG | 103/138 | 09/01→08/07 | OE120 | 0,6 | CET12P | OE179 | BAEA019E | |
| 2.4 Bifuel (LPG) | 5 | B5244SG2 | 103/138 | 09/01→08/07 | OE120 | 0,6 | | | BAEA019E | |
| 2.4 D | 5 | D5244T2 | 96/129 | 07/01→08/07 | CH240 | 11v | | | | |
| 2.4 D5, 2.4 D5 4WD | 5 | D5244T; D5244T2; D5244T5 | 120/161 | 01/01→12/08 | CH240 | 11v | | | | |
| 2.4 T, 2.4 T 4WD | 5 | B5244T3 | 147/197 | 11/99→08/03 | OE136 →10/01 OE206 11/01→ | 0,8 0,7 | CET12P →10/01 CET14P 11/01→ | OE179 →10/01 | BAEA019E | |
| 2.4 T5 | 5 | B5244T5 | 191/256 | 04/04→08/07 | OE206 OE224 LPG ^[279] | 0,7 0,8 | CET14P | | BAEA055E →07/07 | |
| 2.5 4WD | 5 | B5254T2 | 155/208 | 09/02→12/04 | | | | | BAEA019E | |
| 2.5 R 2, 2.5 T 4WD | 5 | B5254T4 | 221/296 | 03/03→08/07 | OE206 OE224 LPG ^[279] | 0,7 0,8 | CET14P | | BAEA055E →07/07 | |
| 2.5 R Sport | 5 | B5254T4 | 221/296 | 12/02→08/07 | OE206 OE224 LPG ^[279] | 0,7 0,8 | CET14P | | BAEA055E | |
| 2.5 T, 2.5 T 4WD | 5 | B5254T2 | 154/207 | 07/01→08/07 | OE136 | 0,8 | CET12P | OE179 | BAEA019E | |
| 2.5 TDi | 5 | D5252T | 103/138 | 11/99→08/07 | CH271 | 11v | | | | |

V70 III

| | | | | | | | | | | |
|------------------------|---|--------------------|---------|-------------|-------|-----|--------|-------|----------|--|
| 1.6 D | 4 | D4164T | 80/107 | 07/09→12/11 | CH201 | 11v | | | | |
| 1.6 T4, 1.6 T4F | 4 | B4164T; B4164T2 | 132/177 | 10/10→12/15 | | | CET17P | OE189 | | |
| 2.0, 2.0 FlexiFuel | 4 | B4204S3; B4204S4 | 107/143 | 10/07→12/11 | OE131 | 1,0 | CET18P | OE183 | BAEA408 | |
| 2.0 D | 4 | D4204T | 100/134 | 10/07→12/15 | CH268 | 11v | | | CCU147 | |
| 2.0 T | 4 | B4204T6 | 149/200 | 09/09→12/11 | | | CET17P | | | |
| 2.0 T5 | 4 | B4204T7 | 177/237 | 01/10→12/14 | | | CET17P | | | |
| 2.5 T, 2.5 T FlexiFuel | 5 | B5254T6; B5254T8 | 147/197 | 08/07→12/09 | | | CET14P | OE190 | BAEA055E | |
| 2.5 T, 2.5 T FlexiFuel | 5 | B5254T10; B5254T11 | 170/228 | 04/09→12/12 | | | CET14P | OE190 | BAEA055E | |
| 3.0 T6 4WD | 6 | B6304T2 | 210/282 | 08/07→12/10 | | | CET14P | OE190 | | |
| 3.0 T6 4WD | 6 | B6304T4 | 224/300 | 01/10→12/15 | | | CET14P | OE190 | | |
| 3.2, 3.2 4WD | 6 | B6324S | 175/235 | 04/07→12/10 | | | CET14P | OE190 | | |

CHAMPION

VOLVO



kW/BHP

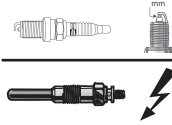

eon TITAN

IRIDIUM

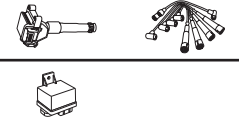

...VOLVO

...V70 III

| | | | | | | | | | |
|--------------|---|---------|---------|-------------|--|--|--------|-------|--|
| 3.2, 3.2 4WD | 6 | B6324S5 | 179/240 | 04/10→12/15 | | | CET14P | OE190 | |
|--------------|---|---------|---------|-------------|--|--|--------|-------|--|

V90

| | | | | | | | | | |
|-----|---|------------------|---------|-------------|-------|-----|------|-------|-------------------------|
| 2.5 | 6 | B6254FS | 125/168 | 11/96→10/98 | OE120 | 0,6 | CET2 | OE188 | BAEA446 |
| 2.5 | 6 | B6244FS | 132/177 | 11/96→10/97 | OE120 | 0,6 | CET2 | OE188 | |
| 2.9 | 6 | B6304S2 | 132/177 | 01/97→12/98 | OE120 | 0,6 | CET2 | OE188 | BAEA446 ^[97] |
| 2.9 | 6 | B6304FS; B6304GS | 150/201 | 01/97→12/98 | OE120 | 0,6 | CET2 | OE188 | BAEA446 ^[97] |

XC60

| | | | | | | | | | |
|------------|---|------------------|---------|-------------|----------------------------|-----|--------|--|------------------------------|
| 2.0 T | 4 | B4204T6 | 149/200 | 12/09→12/12 | | | CET17P | | |
| 2.0 T5 | 4 | B4204T7 | 177/237 | 09/10→12/14 | | | CET17P | | |
| 3.0 T6 4WD | 6 | B6304T2 | 210/282 | 05/08→12/10 | OE206 | 0,7 | CET14P | | |
| | | | | | OE224 ^{LPG [279]} | 0,8 | | | |
| 3.0 T6 4WD | 6 | B6304T3; B6304T4 | 242/325 | 04/14→12/15 | | | | | BAEA055E |
| 3.2 4WD | 6 | B6324S5 | 179/240 | 03/10→12/15 | | | | | BAEA115 ^{[8] [275]} |

XC70 CROSS COUNTRY

| | | | | | | | | | |
|------------|---|---------|---------|-------------|--------|-----|--------|--------|---------------------------|
| 2.0 T5 4WD | 5 | B5204T3 | 166/223 | 10/97→03/99 | | | | | BAEA037E ^[292] |
| 2.4 D5 4WD | 5 | D5244T | 120/161 | 09/02→08/07 | CH240 | 11v | | | |
| 2.4 T 4WD | 5 | B5254T | 142/190 | 11/97→09/02 | OE136 | 0,8 | CET12P | OE179 | BAEA037E ^[292] |
| 2.4 T 4WD | 5 | B5244T3 | 147/197 | 03/00→09/02 | OE136 | 0,8 | CET12P | OE179 | BAEA019E |
| | | | | | →10/01 | | →10/01 | →10/01 | |
| | | | | | OE206 | 0,7 | CET14P | | |
| | | | | | 11/01→ | | 11/01→ | | |
| 2.5 T 4WD | 5 | B5254T2 | 154/207 | 09/02→08/07 | OE136 | 0,8 | CET12P | OE179 | BAEA019E |

XC70 II

| | | | | | | | | | |
|------------|---|---------|---------|-------------|----------------------------|-----|--------|-------|--|
| 3.0 T6 4WD | 6 | B6304T2 | 210/282 | 01/08→ | OE206 | 0,7 | CET14P | | |
| | | | | | OE224 ^{LPG [279]} | 0,8 | | | |
| 3.2 4WD | 6 | B6324S | 175/235 | 08/07→12/11 | | | CET14P | OE190 | |

XC90 I

| | | | | | | | | | |
|------------|---|---------|---------|-------------|----------------------------|-----|--------|-------|----------|
| 2.4 D5 4WD | 5 | D5244T | 120/161 | 10/02→12/10 | CH240 | 11v | | | |
| 2.5 T 4WD | 5 | B5254T2 | 154/207 | 10/02→09/14 | OE136 | 0,8 | CET12P | OE179 | BAEA019E |
| 2.5 T 4WD | 5 | B5254T9 | 154/207 | 10/02→09/14 | | | | | BAEA019E |
| 2.9 T6 4WD | 6 | B6294T | 200/268 | 10/02→12/06 | OE136 | 0,8 | CET12P | OE179 | BAEA019E |
| 3.2 4WD | 6 | B6324S | 175/235 | 03/06→12/10 | OE206 | 0,7 | CET14P | | |
| | | | | | OE224 ^{LPG [279]} | 0,8 | | | |
| 4.4 V8 4WD | 8 | B8444S | 232/311 | 01/05→12/10 | | | CET12P | OE179 | |

VW

AMAROK

| | | | | | | | | | |
|--------------------------|---|------------|---------|--------|---------|------|--------|--|-------------------------|
| 2.0 BiTDI, 2.0 BiTDI 4WD | 4 | CDCA | 120/161 | 09/10→ | | | | | CCU152 |
| 2.0 BiTDI, 2.0 BiTDI 4WD | 4 | CNEA; CSHA | 132/177 | 11/11→ | | | | | CCU152 |
| 2.0 TDI, 2.0 TDI 4WD | 4 | CDBA; CNFA | 90/121 | 09/10→ | | | | | CCU152 |
| 2.0 TDI, 2.0 TDI 4WD | 4 | CNFB | 103/138 | 06/12→ | | | | | CCU152 |
| 2.0 TSI | 4 | CFPA | 118/158 | 12/10→ | OE214 | 0,7 | CET11P | | BAEA033E ^[7] |
| 3.0 TDI, 3.0 TDI 4WD | 6 | DDXA | 120/161 | 06/16→ | CPSG008 | 4.4v | | | |
| 3.0 TDI 4WD | 6 | DDXB | 150/201 | 06/16→ | CPSG008 | 4.4v | | | |
| 3.0 TDI 4WD | 6 | DDXC | 165/221 | 06/16→ | CPSG008 | 4.4v | | | |

BEETLE

| | | | | | | | | | |
|-------------|---|------------------------|---------|--------|--------------------------|------|--|-------|----------------------------------|
| 1.2 TSI | 4 | CBZB | 77/103 | 07/11→ | | | | OE260 | BAE907AE ^[262] CLS090 |
| 1.2 TSI 16V | 4 | CYVD | 77/103 | 12/14→ | OE244 | 0,8 | | | |
| 1.4 TSI | 4 | CZDA | 110/148 | 12/14→ | OE244 | 0,8 | | | BAEA067E ^[240] |
| 1.4 TSI | 4 | CAVD; CNWA; CTHD; CTKA | 118/158 | 10/11→ | | | | | BAE408AE |
| 1.6 TDI | 4 | CAYC | 77/103 | 10/11→ | | | | | CCU151 |
| 1.8 TSI | 4 | CPKA; CPRA | 125/168 | 12/13→ | | | | | BAEA068E |
| 2.0 TDI | 4 | CUUA | 81/109 | 06/14→ | CPSG007 ^[275] | 4.4v | | | |





kW/BHP



eon TITAN

IRIDIUM



...VW

...BEETLE

| | | | | | | | | | | |
|---------|---|------------------|---------|--------|--------------------------|------|--------|-------|--------------------|-------------------------|
| 2.0 TDI | 4 | CFFB | 103/138 | 04/11→ | | | | | | CCU151 |
| 2.0 TDI | 4 | CJAA | 103/138 | 04/11→ | CPSG007 | 4.4v | | | | |
| 2.0 TDI | 4 | CUUB; CVCA; DELA | 110/148 | 07/14→ | CPSG007 ^[275] | 4.4v | | | | |
| 2.0 TSI | 4 | CBFA; CCTA; CCZA | 147/197 | 04/11→ | OE214 | 0,7 | CET11P | | | |
| 2.0 TSI | 4 | CPLA; CPPA | 155/208 | 12/12→ | | | | OE246 | BAEA068E →11/13 | |
| 2.0 TSI | 4 | CULC | 162/217 | 12/14→ | | | | OE246 | BAEA068E | |
| 2.5 | 5 | CBTA; CBUA; CCCA | 125/168 | 04/11→ | OE177 | 0,9 | CET3 | | | BAEA033E ^[7] |

BORA

| | | | | | | | | | | |
|----------------------|---|---------------|---------|-------------|----------------------------------|-----|--------------|-------|---------------------------|-----------------------|
| 1.4 16V | 4 | BCA | 55/74 | 03/00→05/05 | OE032 | 1,0 | CET2 | OE188 | BAE408AE | |
| 1.4 16V | 4 | AKQ; APE | 55/74 | 03/00→05/05 | OE032 | 1,0 | CET2 | OE188 | BAE907AE ^[262] | CLS260 |
| 1.4 16V | 4 | AHW | 55/74 | 03/00→05/05 | OE032 | 1,0 | CET2 | OE188 | BAE408AE | CLS260 |
| | | | | | | | | | BAE907AE ^[262] | |
| 1.4 16V | 4 | AXP | 55/74 | 03/00→05/05 | OE176 ^[285] →07/02 | 1,0 | CET3 | | BAE408AE | CLS260 |
| | | | | | OE032 | 1,0 | | | BAE907AE ^[262] | |
| 1.6 | 4 | AEH; AKL; APF | 74/99 | 10/98→05/05 | OE032 | 1,0 | CET2 | OE179 | BAE907AE ^[262] | CLS139 |
| 1.6 | 4 | AVU; BFQ | 75/101 | 08/00→05/05 | OE032 | 1,0 | CET2 | OE179 | BAE907AE ^[262] | CLS048 |
| 1.6 | 4 | BJH | 75/101 | 08/00→05/05 | OE032 | 1,0 | CET2 | OE179 | BAE907AE ^[262] | |
| 1.6 | 4 | AWB | 78/105 | 06/02→10/04 | OE016 | 0,9 | CET2 | OE180 | | |
| 1.6 16V | 4 | ATN; AUS | 77/103 | 02/00→05/05 | OE032 | 1,0 | CET2 | OE188 | BAE907AE ^[262] | CLS260 |
| 1.6 16V | 4 | AZD/BCB | 77/103 | 02/00→05/05 | OE176 | 1,0 | CET3 | | | |
| 1.6 16V | 4 | AZD | 77/103 | 02/00→05/05 | OE176 | 1,0 | CET2 CET3 | OE188 | BAE408AE | CLS260 |
| 1.6 16V | 4 | BCB | 77/103 | 02/00→05/05 | OE176 | 1,0 | CET2 CET3 | OE188 | BAE408AE | |
| 1.6 FSI | 4 | BAD | 81/109 | 01/02→05/05 | | | | | BAE408AE | |
| 1.8 | 4 | BAF | 92/123 | 10/98→05/05 | OE032 | 1,0 | CET2 | OE179 | | |
| 1.8 | 4 | AGN | 92/123 | 10/98→05/05 | OE032 | 1,0 | CET2 | OE179 | BAE907AE ^[262] | CLS140 02/99→10/00 |
| 1.8 4WD | 4 | AGN | 92/123 | 02/99→05/05 | OE032 | 1,0 | CET2 | OE179 | BAE907AE ^[262] | CLS140 →10/00 |
| 1.8 T | 4 | AUM | 110/148 | 05/00→05/05 | OE136 | 0,8 | CET12P | OE179 | BAEA043E | |
| 1.8 T | 4 | ARX | 110/148 | 05/00→05/05 | | | CET12P | | | |
| 1.8 T | 4 | AGU | 110/148 | 05/00→05/05 | OE136 | 0,8 | CET2 | OE179 | BAEA016 | |
| 1.8 T | 4 | AWP | 132/177 | 03/02→05/05 | OE136 | 0,8 | CET12P | OE179 | | |
| 1.8 T | 4 | AUQ | 132/177 | 03/02→05/05 | OE136 | 0,8 | CET12P | OE179 | BAEA043E | |
| 1.9 SDI | 4 | AGP; AQM | 50/67 | 10/98→05/05 | CH271 | 11v | | | CCU081 | |
| 1.9 TDI | 4 | AHF; ASV | 81/109 | 10/98→06/01 | CH271 | 11v | | | CCU081 | |
| 1.9 TDI, 1.9 TDI 4WD | 4 | AGR; ALH | 66/89 | 10/98→05/05 | CH271 | 11v | | | CCU081 | |
| 1.9 TDI, 1.9 TDI 4WD | 4 | ATD; AXR | 74/99 | 09/00→05/05 | CH271 →Ch.1J-2-600000 | 11v | | | CCU081 | |
| | | | | | CH181 Ch.1J-2-600001→ | 11v | | | | |
| 1.9 TDI, 1.9 TDI 4WD | 4 | AJM; AUY | 85/114 | 12/98→01/02 | CH271 →Ch.1J-2-600000 | 11v | | | CCU081 | |
| 1.9 TDI, 1.9 TDI 4WD | 4 | ASZ | 96/129 | 11/00→05/05 | CH271 →Ch.1J-2-600000 | 11v | | | CCU081 | |
| | | | | | CH181 Ch.1J-2-600001→ | 11v | | | | |
| 1.9 TDI, 1.9 TDI 4WD | 4 | ARL | 110/148 | 05/00→05/05 | CH271 →Ch.1J-2-600000 | 11v | | | CCU081 | |
| | | | | | CH181 Ch.1J-2-600001→ | 11v | | | | |
| 2.0 | 4 | APK; AQY; AZH | 85/114 | 10/98→ | OE032 | 1,0 | CET2 | OE179 | BAE907AE ^[262] | CLS017 |
| 2.0 | 4 | AZG; AZJ | 85/114 | 10/98→ | OE176 | 1,0 | CET3 | | BAEA029E | CLS070 |
| 2.0 4WD | 4 | AZH | 85/114 | 04/00→05/05 | OE032 | 1,0 | CET2 CET3 | OE179 | BAE907AE ^[262] | CLS017 |

VW





kW/BHP



eon TITAN

IRIDIUM



...VW

| ...BORA | | | | | | | | | | |
|-----------------------|---|---------------|---------|-------------|----------------|------------|--------------|-------|--|--------|
| 2.0 4WD | 4 | AZJ | 85/114 | 04/00→05/05 | OE032 OE176 | 1,0 1,0 | CET2 CET3 | OE179 | BAEA029E | CLS070 |
| 2.3 V5, 2.3 V5 4WD | 5 | AGZ | 110/148 | 10/98→10/00 | | | CET2 | OE188 | BAEA037 | CLS184 |
| 2.3 V5, 2.3 V5 4WD | 5 | AQN | 125/168 | 10/00→05/05 | OE176 | 1,0 | CET3 | | BAEA063E | |
| 2.8 V6 4WD | 6 | AQP | 150/201 | 03/99→05/05 | OE176 | 1,0 | CET3 | | BAEA013E →04/01 →Ch.11-1-900000 | CLS185 |
| 2.8 V6 4WD | 6 | AUE | 150/201 | 03/99→05/05 | OE176 | 1,0 | CET3 | | BAEA013E →04/01 →Ch.11-1-900000 BAEA063E 05/01→ Ch.11-2-000001→ | CLS185 |
| 2.8 V6 4WD | 6 | BDE | 150/201 | 03/99→05/05 | OE176 | 1,0 | CET3 | | BAEA063E 05/01→ Ch.11-2-000001→ | CLS185 |
| 2.8 VR6 | 6 | AUE | 150/201 | 03/00→05/00 | OE176 | 1,0 | CET3 | | BAEA013E →Ch.11-1-900000 | CLS185 |
| CADDY ALLTRACK | | | | | | | | | | |
| 1.2 TSI | 4 | CYVC | 62/83 | 06/15→ | OE244 | 0,8 | | | | |
| 1.4 TSI | 4 | CZCB | 92/123 | 05/15→ | OE244 | 0,8 | | | | |
| 2.0 TDI | 4 | CUUF; DFSF | 55/74 | 05/15→ | CPSG007 | 4.4v | | | CCU152 | |
| 2.0 TDI | 4 | CUUD; DFSD | 75/101 | 05/15→ | CPSG007 | 4.4v | | | CCU152 | |
| 2.0 TDI, 2.0 TDI 4WD | 4 | CUUB; DFSB | 110/148 | 05/15→ | CPSG007 | 4.4v | | | CCU152 | |
| 2.0 TDI 4WD | 4 | CUUE; DFSE | 90/121 | 05/15→ | CPSG007 | 4.4v | | | CCU152 | |
| CADDY II | | | | | | | | | | |
| 1.4 | 4 | AEX; AKV; APQ | 44/59 | 11/95→01/04 | OE025 | 1,0 | CET8 | | BAE851AE [261] [292] | CLS109 |
| 1.4 | 4 | AUD | 44/59 | 11/95→01/04 | OE176 | 1,0 | | | BAE907AE [262] | CLS109 |
| 1.4 16V | 4 | AUA | 55/74 | 08/00→01/04 | OE032 | 1,0 | CET2 | OE179 | BAE907AE [262] | CLS260 |
| 1.6 | 4 | AEE | 55/74 | 11/95→12/00 | OE027 | 1,0 | CET8 | | BAE851AE [261] [292] | CLS109 |
| 1.6 | 4 | 1F | 55/74 | 11/95→12/00 | OE027 | 1,0 | CET8 | | BAE851AE [261] [292] | CLS099 |
| 1.7 SDI | 4 | AHB | 42/56 | 07/96→09/00 | CH271 | 11v | | | CCU081 | |
| 1.9 D | 4 | 1Y; AEF | 47/63 | 11/95→01/04 | CH260 | 11v | | | | |
| 1.9 SDI | 4 | AEY | 47/63 | 11/95→01/04 | CH271 | 11v | | | CCU081 | |
| 1.9 SDI | 4 | AYQ | 47/63 | 11/95→01/04 | | | | | CCU081 | |
| 1.9 TDI | 4 | AHU; ALE; ALH | 66/89 | 10/96→01/04 | CH271 | 11v | | | CCU081 | |
| CADDY III | | | | | | | | | | |
| 1.2 TSI | 4 | CBZA | 63/84 | 09/10→05/15 | | | | OE260 | BAE907AE [262] | CLS090 |
| 1.2 TSI | 4 | CBZB | 77/103 | 09/10→05/15 | | | | OE260 | BAE907AE [262] | CLS090 |
| 1.4 | 4 | BCA | 55/74 | 03/04→05/06 | OE032 | 1,0 | CET2 | OE179 | BAE408AE | |
| 1.4 | 4 | BUD | 59/79 | 05/06→08/10 | OE177 | 0,9 | CET3 | | BAE408AE →Ch.1K-8-281299 | |
| 1.6 | 4 | | 74/99 | 03/05→05/15 | OE005 | 0,9 | CET2 | OE179 | | |
| 1.6 | 4 | BGU; BSE; BSF | 75/101 | 04/04→05/15 | OE032 | 1,0 | CET2 | OE179 | BAE907AE [262] | CLS017 |
| 1.6 BiFuel | 4 | CHGA | 75/101 | 05/11→05/15 | OE032 | 1,0 | CET2 | OE179 | BAE907AE [262] | |
| 1.6 TDI | 4 | CAYE | 55/74 | 08/10→05/15 | | | | | CCU152 | |
| 1.6 TDI | 4 | CAYD | 75/101 | 08/10→05/15 | | | | | CCU152 | |
| 1.9 TDI | 4 | BSU | 55/74 | 09/05→08/10 | | | | | CCU152 Ch.2L-6-000001→ | |
| 1.9 TDI | 4 | BLS | 77/103 | 04/04→08/10 | | | | | CCU152 Ch.2L-6-000001→ | |
| 1.9 TDI 4WD | 4 | BLS | 77/103 | 05/08→08/10 | | | | | CCU152 | |
| 2.0 EcoFuel | 4 | BSX | 80/107 | 04/06→05/15 | | | CET2 | OE179 | BAEA029E | CLS070 |
| 2.0 SDI | 4 | BDJ; BST | 51/68 | 03/04→08/10 | | | | | CCU081 | |
| 2.0 TDI | 4 | BMM | 103/138 | 09/07→08/10 | | | | | CCU152 | |

VW





kW/BHP

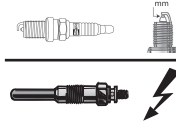

eon TITAN

IRIDIUM

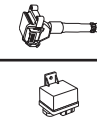

...VW

...CADDY III

| | | | | | | | | | |
|------------------------------|---|------------|---------|-------------|--|--|--|--|--------|
| 2.0 TDI | 4 | CFJA | 125/168 | 05/12→05/15 | | | | | CCU152 |
| 2.0 TDI, 2.0 TDI 4WD | 4 | CFHF; CLCA | 81/109 | 08/10→05/15 | | | | | CCU152 |
| 2.0 TDI 16V, 2.0 TDI 16V 4WD | 4 | CFHC; CLCB | 103/138 | 11/10→05/15 | | | | | CCU152 |

CADDY IV

| | | | | | | | | | |
|----------------------|---|------------|---------|--------|---------|------|--|--|---------------------------|
| 1.2 TSI | 4 | CYVC | 62/83 | 06/15→ | OE244 | 0,8 | | | BAEA067E ^[240] |
| 1.4 TGI CNG | 4 | CPWA | 81/109 | 06/15→ | | | | | BAEA067E ^[240] |
| 1.4 TSI | 4 | CZCB | 92/123 | 05/15→ | OE244 | 0,8 | | | BAEA067E ^[240] |
| 1.6 TDI | 4 | CAYE | 55/74 | 05/15→ | | | | | CCU152 |
| 1.6 TDI | 4 | CAYD | 75/101 | 05/15→ | | | | | CCU152 |
| 2.0 TDI | 4 | CUUF; DFSF | 55/74 | 05/15→ | CPSG007 | 4.4v | | | CCU152 |
| 2.0 TDI | 4 | CUUD; DFSD | 75/101 | 05/15→ | CPSG007 | 4.4v | | | CCU152 |
| 2.0 TDI, 2.0 TDI 4WD | 4 | CFHC; CLCB | 103/138 | 05/15→ | | | | | CCU152 |
| 2.0 TDI, 2.0 TDI 4WD | 4 | CUUB; DFSB | 110/148 | 05/15→ | CPSG007 | 4.4v | | | CCU152 |
| 2.0 TDI 4WD | 4 | CFHF | 81/109 | 05/15→ | | | | | CCU152 |
| 2.0 TDI 4WD | 4 | CUUE; DFSE | 90/121 | 05/15→ | CPSG007 | 4.4v | | | CCU152 |

CC

| | | | | | | | | | |
|----------------------------|---|------------|---------|-------------|---------|------|--------|--|---------------------------------|
| 1.4 TSI | 4 | CZDA | 110/148 | 05/15→12/16 | OE244 | 0,8 | | | BAEA067E ^[240] |
| 1.4 TSI, 1.4 TSI MultiFuel | 4 | CKMA; CTHD | 118/158 | 11/11→12/16 | | | | | BAE408AE |
| 1.8 TSI | 4 | CDAB | 112/150 | 11/11→12/16 | OE214 | 0,7 | CET11P | | |
| 1.8 TSI | 4 | CDA A | 118/158 | 11/11→12/16 | OE214 | 0,7 | CET11P | | |
| 2.0 TDI | 4 | CFFA | 100/134 | 11/11→12/16 | | | | | CCU151 |
| 2.0 TDI | 4 | CUVC | 110/148 | 05/15→12/16 | CPSG007 | 4.4v | | | |
| 2.0 TDI | 4 | CUWA | 135/181 | 05/15→12/16 | CPSG007 | 4.4v | | | |
| 2.0 TDI, 2.0 TDI 4WD | 4 | CFFB | 103/138 | 11/11→12/16 | | | | | CCU151 |
| 2.0 TDI, 2.0 TDI 4WD | 4 | CFGB; CLLA | 125/168 | 11/11→12/16 | | | | | CCU151 |
| 2.0 TDI, 2.0 TDI 4WD | 4 | CFG C | 130/174 | 12/12→12/16 | | | | | CCU151 |
| 2.0 TSI | 4 | CBFA; CCTA | 147/197 | 11/11→12/16 | OE214 | 0,7 | CET11P | | |
| 2.0 TSI | 4 | CCZB | 155/208 | 11/11→12/16 | OE214 | 0,7 | CET11P | | |
| 3.6 FSI 4WD | 6 | BWS | 220/295 | 11/11→12/16 | | | | | BAEA041E ^{[277] [324]} |

CORRADO

| | | | | | | | | | | |
|-------|---|---------|--------|-------------|-------|-----|------|-------|---------------------------------|--------|
| 2.0 i | 4 | 2E; ADY | 85/114 | 04/93→12/95 | OE025 | 1,0 | CET8 | OE195 | BAE851AE ^{[261] [292]} | CLS099 |
|-------|---|---------|--------|-------------|-------|-----|------|-------|---------------------------------|--------|

EOS

| | | | | | | | | | |
|-------------|---|----------------------------------|---------|-------------|-------|-----|--------|-------|---------------------------------|
| 1.4 TSI | 4 | CAXA | 90/121 | 11/07→08/15 | OE213 | 0,9 | | | BAE408AE |
| 1.4 TSI | 4 | CAVD; CTHD | 118/158 | 05/08→08/15 | | | | | BAE408AE |
| 1.6 FSI | 4 | BLF | 85/114 | 06/06→05/08 | | | | | BAE408AE |
| 2.0 FSI | 4 | BVY | 110/148 | 03/06→05/08 | OE234 | 1,0 | CET3 | | BAEA033E ^[7] |
| 2.0 FSI | 4 | BVZ | 110/148 | 03/06→05/08 | OE146 | 1,0 | CET12P | OE179 | BAEA033E ^[7] |
| 2.0 TDI | 4 | CFFA | 100/134 | 11/10→08/15 | | | | | CCU152 |
| 2.0 TDI | 4 | BMM | 103/138 | 06/06→05/08 | | | | | CCU152 |
| 2.0 TDI 16V | 4 | CBAB; CFFB | 103/138 | 05/08→08/15 | | | | | CCU152 |
| 2.0 TFSI | 4 | BPY; BWA; CAWB; CBFA; CCTA; CCZA | 147/197 | 03/06→08/15 | OE214 | 0,7 | CET11P | | BAEA033E ^[7] |
| 2.0 TSI | 4 | CCZB | 155/208 | 11/09→08/15 | OE214 | 0,7 | CET11P | | BAEA033E ^[7] |
| 3.2 V6 | 6 | BUB | 184/247 | 06/06→05/09 | OE215 | 0,9 | | | BAEA044E ^[356] |
| 3.6 V6 | 6 | CDVA | 191/256 | 05/09→11/10 | | | | | BAEA041E ^{[277] [324]} |

FOX

| | | | | | | | | | |
|---------|---|----------------|-------|--------|-------|-----|------|--|----------------------------------|
| 1.2 | 3 | BMD; CHFB | 40/54 | 04/05→ | OE177 | 0,9 | CET3 | | BAEA059E |
| 1.2 | 3 | CHFA | 44/59 | 09/10→ | OE177 | 0,9 | CET3 | | BAEA059E |
| 1.4 | 4 | BKR | 55/74 | 04/05→ | OE235 | 1,0 | CET3 | | BAE907AE ^[262] CLS081 |
| 1.4 TDI | 3 | BNM | 51/68 | 04/05→ | CH181 | 11v | | | CCU081 |
| 1.6 | 4 | BAH; BLH; CFZA | 74/99 | 10/03→ | OE235 | 1,0 | CET3 | | BAE907AE ^[262] |





kW/BHP

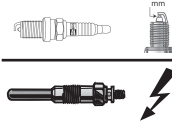

eon TITAN

IRIDIUM

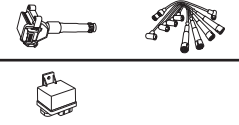

...VW

| ...FOX | | | | | | | | | | |
|----------------------|---|--------------------|---------|-------------|--------------------|------|------------------------------------|------------------------------------|----------------------|------------------|
| 1.6 | 4 | BPA; CCRA | 74/99 | 10/03→ | | | | | BAE907AE [262] | |
| 1.6 Total Flex | 4 | BJA | 74/99 | 10/03→ | | | CET12P | OE179 | | |
| 1.6 Total Flex | 4 | BPA; CCRA | 74/99 | 10/03→ | | | CET12P | OE179 | BAE907AE [262] | |
| GOLF ALLTRACK | | | | | | | | | | |
| 1.6 TDI 4WD | 4 | CRKB | 81/109 | 12/14→ | CPSG007 [194] | 4.4v | | | | |
| 1.6 TDI 4WD | 4 | CXXB | 81/109 | 12/14→ | CPSG007 [191] | 4.4v | | | | |
| 2.0 TDI 4WD | 4 | CRBC; CRLB; DCYA | 110/148 | 12/14→ | CPSG007 [25] [193] | 4.4v | | | | |
| 2.0 TDI 4WD | 4 | CUNA; DGCA | 135/181 | 12/14→ | CPSG007 [25] [193] | 4.4v | | | | |
| GOLF III | | | | | | | | | | |
| 1.6 | 4 | AFT | 74/99 | 07/94→04/99 | OE032 | 1,0 | CET2 | OE179 | BAE851AE [261] [292] | CLS034 CLS139 |
| 1.6 | 4 | AKS | 74/99 | 07/94→04/99 | OE123 | 0,7 | CET2 | OE179 | BAE851AE [261] [292] | CLS034 CLS139 |
| 1.6 | 4 | AEK | 74/99 | 07/94→04/99 | OE123 | 0,7 | CET2 | OE179 | BAE851AE [261] [292] | CLS043 CLS139 |
| 1.9 SDI | 4 | AEY | 47/63 | 07/95→04/99 | CH271 | 11v | | | CCU081 | |
| 1.9 TDI | 4 | 1Z; AHU; ALE | 66/89 | 09/93→04/99 | CH271 | 11v | | | CCU081 | |
| 1.9 TDI | 4 | AFN | 81/109 | 04/96→04/99 | CH271 | 11v | | | CCU081 | |
| 1.9 TDI 4WD | 4 | 1Z; AHU; ALE | 66/89 | 07/95→04/99 | CH271 | 11v | | | | |
| 2.0 | 4 | AEP | 79/106 | 08/95→04/96 | OE025 | 1,0 | CET8 | OE195 | | |
| 2.0 4WD | 4 | AGG | 85/114 | 08/95→04/99 | OE025 | 1,0 | CET8 | OE195 | BAE851AE [261] [292] | CLS099 |
| 2.0 GL | 4 | AEP | 79/106 | 08/95→09/97 | OE025 | 1,0 | CET8 | OE195 | BAE851AE [261] [292] | CLS079 [292] |
| 2.8 VR6 | 6 | AAA | 120/161 | 08/95→09/97 | | | CET12P | OE180 | BAEA004E | |
| 2.9 VR6 4WD | 6 | ABV | 140/188 | 10/94→04/99 | OE026 →06/95 | 0,9 | CET2 →06/95 CET12P 07/95→ | OE184 →06/95 OE180 07/95→ | BAEA004E | CLS199 |
| GOLF IV | | | | | | | | | | |
| 1.4 16V | 4 | AHW; AKQ; APE; AXP | 55/74 | 08/97→06/06 | OE032 | 1,0 | CET2 | | BAE907AE [262] | CLS260 |
| 1.4 16V | 4 | BCA | 55/74 | 08/97→06/06 | OE032 | 1,0 | CET2 CET3 | | BAE408AE | |
| 1.6 | 4 | BAH | 74/99 | 08/97→05/04 | OE235 | 1,0 | CET3 | | BAE907AE [262] | |
| 1.6 | 4 | AEH; AKL; APF | 74/99 | 08/97→05/04 | OE032 | 1,0 | CET2 | OE179 | BAE907AE [262] | CLS139 |
| 1.6 | 4 | AFT | 74/99 | 08/97→05/04 | OE032 | 1,0 | CET2 | OE179 | BAE851AE [261] [292] | CLS034 CLS139 |
| 1.6 | 4 | AKS | 74/99 | 08/97→05/04 | OE123 | 0,7 | CET2 | OE179 | BAE851AE [261] [292] | CLS034 CLS139 |
| 1.6 | 4 | AVU; BFQ | 75/101 | 08/00→06/06 | OE032 | 1,0 | CET2 | OE179 | BAE907AE [262] | CLS048 |
| 1.6 | 4 | BJH | 75/101 | 08/00→06/06 | OE032 | 1,0 | CET2 | OE179 | | |
| 1.6 | 4 | AWB | 78/105 | 08/03→06/05 | OE016 | 0,9 | CET2 | OE180 | | |
| 1.6 16V | 4 | ATN; AUS | 77/103 | 02/00→06/06 | OE032 | 1,0 | | | BAE907AE [262] | CLS260 |
| 1.6 16V | 4 | AZD | 77/103 | 02/00→06/06 | OE176 | 1,0 | CET3 | | BAE408AE | CLS260 |
| 1.6 16V | 4 | BCB | 77/103 | 02/00→06/06 | OE176 | 1,0 | CET3 | | BAE408AE | |
| 1.6 FSI | 4 | BAD | 81/109 | 01/02→06/06 | | | | | BAE408AE | |
| 1.8 | 4 | ANN | 55/74 | 06/98→06/02 | OE027 | 1,0 | CET8 | | BAE851AE [261] [292] | CLS027 |
| 1.8 | 4 | AAM | 55/74 | 06/98→06/02 | OE027 | 1,0 | CET8 | | BAE851AE [261] [292] | CLS079 [292] |
| 1.8 | 4 | ACC | 66/89 | 10/97→06/02 | OE025 | 1,0 | CET8 | OE195 | | |

VW





kW/BHP

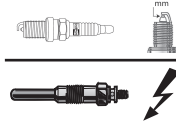

eon TITAN

IRIDIUM

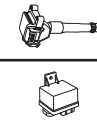

VW

| ...VW | | | | | | | | | | |
|----------------------|---|--------------------|---------|-------------|--------------------------|-----|--------|-------|-----------------------------|------------------|
| ...GOLF IV | | | | | | | | | | |
| 1.8 | 4 | ANP | 66/89 | 10/97→06/02 | OE025 | 1,0 | CET8 | OE195 | BAE851AE [261] [292] | CLS099 |
| 1.8 | 4 | ADZ | 66/89 | 10/97→06/02 | OE025 | 1,0 | CET8 | OE195 | BAE851AE [261] [292] | CLS110 [292] |
| 1.8 | 4 | BAF | 92/123 | 08/97→06/05 | OE032 | 1,0 | CET2 | OE179 | | |
| 1.8 | 4 | AGN | 92/123 | 08/97→06/05 | OE032 | 1,0 | CET2 | OE179 | BAE907AE[262] | CLS140 →10/00 |
| 1.8 4WD | 4 | AGN | 92/123 | 05/98→06/06 | OE032 | 1,0 | CET2 | OE179 | BAE907AE[262] | CLS140 |
| 1.8 T | 4 | AQA | 110/148 | 08/97→06/06 | OE136 | 0,8 | CET12P | OE179 | | |
| 1.8 T | 4 | ARZ | 110/148 | 08/97→06/06 | OE136 | 0,8 | CET12P | OE179 | BAEA009E | |
| 1.8 T | 4 | AGU | 110/148 | 08/97→06/06 | OE136 | 0,8 | CET12P | OE179 | BAEA016 | |
| 1.8 T | 4 | AWD | 110/148 | 08/97→06/06 | OE136 | 0,8 | CET12P | OE179 | BAEA009E →Ch.1J-Y-900000 | |
| 1.8 T | 4 | AUM | 110/148 | 08/97→06/06 | OE136 | 0,8 | CET12P | OE179 | BAEA043E Ch.1J-1-000001→ | |
| 1.8 T GTI | 4 | AUQ | 132/177 | 08/01→06/05 | OE136 | 0,8 | CET12P | OE179 | BAEA043E | |
| 1.9 SDI | 4 | AGP; AQM | 50/67 | 08/97→06/06 | CH271 | 11v | | | CCU081 [364] | |
| 1.9 TD | 4 | AAZ | 55/74 | 10/97→09/99 | CH260 | 11v | | | | |
| 1.9 TDI | 4 | AFN; AHF; ASV; AVG | 81/109 | 08/97→05/04 | CH271 | 11v | | | CCU081 [364] | |
| 1.9 TDI, 1.9 TDI 4WD | 4 | AGR; AHU; ALE; ALH | 66/89 | 10/97→05/06 | CH271 | 11v | | | CCU081 [364] | |
| 1.9 TDI, 1.9 TDI 4WD | 4 | ATD; AXR | 74/99 | 09/00→06/06 | CH271 →Ch.1J-2-545141 | 11v | | | CCU081 [364] | |
| | | | | | CH181 Ch.1J-2-545142→ | 11v | | | | |
| 1.9 TDI, 1.9 TDI 4WD | 4 | AJM; AUJ | 85/114 | 12/98→06/01 | CH271 | 11v | | | CCU081 [364] | |
| 1.9 TDI, 1.9 TDI 4WD | 4 | ASZ | 96/129 | 11/00→06/06 | CH271 →Ch.1J-2-600000 | 11v | | | CCU081 [364] | |
| | | | | | CH181 Ch.1J-2-600001→ | 11v | | | | |
| 1.9 TDI, 1.9 TDI 4WD | 4 | ARL | 110/148 | 02/00→06/06 | CH271 →Ch.1J-2-545141 | 11v | | | CCU081 [364] | |
| | | | | | CH181 Ch.1J-2-545142→ | 11v | | | | |
| 2.0 | 4 | APK; AQY | 85/114 | 06/98→06/06 | OE032 | 1,0 | CET2 | OE179 | BAE907AE[262] | CLS017 |
| 2.0 | 4 | BER | 85/114 | 06/98→06/06 | | | CET2 | OE179 | | |
| 2.0 | 4 | ATU; AWF; AWG | 85/114 | 06/98→06/06 | OE032 | 1,0 | CET2 | OE179 | | CLS034 |
| 2.0 | 4 | AGG; AKR | 85/114 | 06/98→06/06 | OE025 | 1,0 | CET8 | OE195 | BAE851AE [261] [292] | CLS099 |
| 2.0, 2.0 4WD | 4 | AZG; AZJ | 85/114 | 06/98→06/06 | OE176 | 1,0 | CET3 | OE179 | BAEA029E | CLS070 |
| 2.0 4WD | 4 | AZH | 85/114 | 10/00→06/06 | OE032 | 1,0 | CET2 | OE179 | BAE907AE[262] | CLS017 →06/01 |
| 2.0 Bi-Fuel | 4 | BEH | 85/114 | 02/02→06/06 | OE176 | 1,0 | CET3 | | BAEA029E | CLS070 |
| 2.3 V5 | 5 | AGZ | 110/148 | 08/97→06/06 | OE198 | 0,9 | CET2 | | BAEA037 | CLS181 →09/98 |
| | | | | | | | | | | CLS184 |
| 2.3 V5, 2.3 V5 4WD | 5 | AQN | 125/168 | 10/00→06/06 | OE176 | 1,0 | CET3 | | BAEA063E | |
| 2.3 V5 4WD | 5 | AGZ | 110/148 | 12/98→06/06 | OE198 | 0,9 | CET2 | | BAEA037 | CLS184 |
| 2.8 V6 4WD | 6 | AQP | 150/201 | 03/99→06/06 | OE176 | 1,0 | CET3 | | BAEA013E →04/01 | CLS185 |
| | | | | | | | | | →Ch.1J-1-900000 | |
| 2.8 V6 4WD | 6 | AUE | 150/201 | 03/99→06/06 | OE176 | 1,0 | CET3 | | BAEA013E →04/01 | CLS185 |
| | | | | | | | | | →Ch.1J-1-900000 | |
| | | | | | | | | | BAEA063E 05/01→ | |
| | | | | | | | | | Ch.1J-2-000001→ | |
| 2.8 V6 4WD | 6 | BDE | 150/201 | 03/99→06/06 | OE176 | 1,0 | CET3 | | BAEA063E 05/01→ | CLS185 |
| | | | | | | | | | Ch.1J-2-000001→ | |
| 3.2 R32 4WD | 6 | BFH; BML | 177/237 | 09/02→06/05 | OE215 | 0,9 | | | BAEA044E[356] | |





kW/BHP

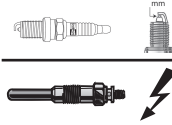

eon TITAN

IRIDIUM

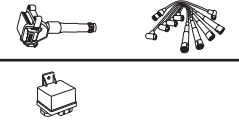

...VW

GOLF V

| | | | | | | | | | |
|----------------------|---|---------------------------------|---------|-------------|----------------------------------|------------|--------|----------------------------------|--|
| 1.4 | 4 | BUD | 59/79 | 06/07→07/09 | OE177 | 0,9 | CET3 | | BAE408AE →Ch.1K-8-281299 |
| 1.4 16V | 4 | BCA | 55/74 | 10/03→05/06 | OE032 | 1,0 | CET2 | OE179 | BAE408AE |
| 1.4 16V | 4 | BUD | 59/79 | 05/06→11/08 | OE177 | 0,9 | CET3 | | BAE408AE |
| 1.4 FSI | 4 | BKG; BLN | 66/89 | 10/03→07/06 | | | | | BAE408AE |
| 1.4 TSI | 4 | CAXA | 90/121 | 05/07→07/09 | | | | | BAE408AE |
| 1.4 TSI | 4 | BMV | 103/138 | 05/06→07/09 | | | | | BAE408AE |
| 1.4 TSI | 4 | CAVD | 118/158 | 07/08→07/09 | OE213 | 0,9 | | | BAE408AE |
| 1.4 TSI | 4 | BLG | 125/168 | 11/05→07/09 | | | | | BAE408AE |
| 1.6 | 4 | BGU; BSE; BSF; CCSA | 75/101 | 01/04→07/09 | OE032 | 1,0 | CET2 | OE179 | BAE907AE ^[262] CLS017 |
| 1.6 FSI | 4 | BAG; BLF; BLP | 85/114 | 10/03→07/08 | | | | | BAE408AE |
| 1.6 MultiFuel | 4 | CCSA | 75/101 | 10/07→07/09 | OE032 | 1,0 | CET2 | OE179 | BAE907AE ^[262] CLS048 |
| 1.9 TDI | 4 | BRU; BXF | 66/89 | 05/04→11/08 | | | | | CCU152 03/06→ |
| 1.9 TDI, 1.9 TDI 4WD | 4 | BKC; BXE | 77/103 | 10/03→07/09 | | | | | CCU152 03/06→ |
| 1.9 TDI, 1.9 TDI 4WD | 4 | BLS; BXE | 77/103 | 10/03→07/09 | | | | | CCU152 |
| 2.0 | 4 | BHY; CBPA | 85/114 | 08/06→11/08 | OE032 | 1,0 | CET2 | OE179 | BAE907AE ^[262] |
| 2.0 | 4 | BWA; CAWB; CCTA | 147/197 | 06/07→07/09 | OE214 | 0,7 | CET11P | | BAEA033E ^[7] |
| 2.0 FSI | 4 | BLY; BVZ | 110/148 | 01/04→11/08 | OE146 | 1,0 | CET12P | OE179 | BAEA033E ^[7] |
| 2.0 FSI, 2.0 FSI 4WD | 4 | AXW; BLR; BLX; BVX; BVY | 110/148 | 01/04→11/08 | OE234 | 1,0 | CET3 | | BAEA033E ^[7] |
| 2.0 GTI | 4 | AXX; BPY; BWA; CAWB; CBFÄ; CCTA | 147/197 | 10/04→02/09 | OE214 | 0,7 | CET11P | | BAEA033E ^[7] →Ch.1K-9W124420 |
| 2.0 GTI | 4 | BYD | 169/227 | 09/06→12/08 | OE214 | 0,7 | CET11P | | BAEA033E ^[7] |
| 2.0 SDI | 4 | BDK | 55/74 | 01/04→11/08 | | | | | CCU151 08/06→ |
| 2.0 TDI | 4 | AZV | 100/134 | 10/03→07/09 | | | | | CCU152 03/06→ |
| 2.0 TDI | 4 | BMN | 125/168 | 11/05→11/08 | CCGP003 Ch.1K-6-000001→ | 7v | | | CCU152 |
| 2.0 TDI, 2.0 TDI 4WD | 4 | BMM | 103/138 | 08/04→07/09 | | | | | CCU152 |
| 2.0 TDI 16V | 4 | BKD | 103/138 | 10/03→07/09 | | | | | CCU151 |
| 2.0 TDI 16V | 4 | CBDB | 103/138 | 10/03→07/09 | | | | | CCU152 |
| 2.0 TDI 16V 4WD | 4 | BKD | 103/138 | 08/04→11/08 | | | | | CCU151 08/06→ |
| 3.2, 3.2 R32 4WD | 6 | BUB | 184/247 | 09/05→11/08 | OE215 | 0,9 | | | BAEA044E ^[356] |
| 3.2 R32 4WD | 6 | BJS | 177/237 | 01/04→11/08 | OE215 | 0,9 | | | |
| 3.2 R32 4WD | 6 | CBRA | 184/247 | 11/05→11/08 | OE215 | 0,9 | | | |
| GOLF VI | | | | | | | | | |
| 1.2 TSI | 4 | CBZA | 63/84 | 05/10→07/13 | | | | OE260 | BAE907AE ^[262] CLS090 |
| 1.2 TSI | 4 | CBZB | 77/103 | 11/08→ | | | | OE260 OE260 ModelYear→2016 | BAE907AE ^[262] CLS090 |
| 1.2 TSI 16V | 4 | CYVD | 77/103 | 11/13→ | OE244 | 0,8 | | | BAEA067E ^[240] |
| 1.2 TSI 16V | 4 | CJZA | 77/103 | 11/13→ | | | | | BAEA067E ^[240] |
| 1.4 | 4 | CGGA | 59/79 | 10/08→07/13 | OE177 | 0,9 | CET3 | | BAE408AE BAE408AE Ch.1K-8-281300→ |
| 1.4 | 4 | BUD | 59/79 | 10/08→07/13 | OE177 | 0,9 | CET3 | | BAE408AE Ch.1K-8-281300→ |
| 1.4 TSI | 4 | CAXA | 90/121 | 10/08→ | OE213 OE213 ModelYear→2016 | 0,9 0,9 | | | BAE408AE |
| 1.4 TSI | 4 | CZCA | 92/123 | 11/13→ | OE244 | 0,8 | | | BAEA067E ^[240] |
| 1.4 TSI | 4 | CZDA | 110/148 | 11/13→ | OE244 | 0,8 | | | BAEA067E ^[240] |
| 1.4 TSI | 4 | CHPB | 110/148 | 11/13→ | OE244 | 0,8 | | | |
| 1.4 TSI | 4 | CAVD; CNWA; CTHD; CTKA | 118/158 | 10/08→ | OE213 →Prod.13.02.2011 | 0,9 | | | BAE408AE |

VW



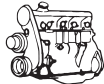

kW/BHP



eon TITAN

IRIDIUM



...VW

...GOLF VI

| | | | | | | | | | | |
|----------------------------|---|-------------------------|---------|---------------|----------------------------------|------|--------|-------|--|------------------|
| 1.6 | 4 | BSE; BSF; CCSA; CMXA | 75/101 | 10/08 → 07/13 | OE032 | 1,0 | CET2 | OE179 | BAE907AE ^[262] | CLS017 CLS048 |
| 1.6 BiFuel | 4 | CHGA | 75/101 | 03/09 → 11/12 | OE146 | 1,0 | CET12P | OE179 | BAE907AE ^[262] | CLS048 |
| 1.6 MultiFuel | 4 | CCSA; CMXA | 75/101 | 10/08 → 07/13 | OE032 | 1,0 | CET2 | OE179 | BAE907AE ^[262] | |
| 1.6 TDI | 4 | CAYB | 66/89 | 02/09 → 07/13 | | | | | CCU152 | |
| 1.6 TDI, 1.6 TDI 4WD | 4 | CAYC | 77/103 | 02/09 → | | | | | CCU152 | |
| 1.8 TSI | 4 | CDA A | 118/158 | 06/09 → 01/11 | OE214 | 0,7 | CET11P | | BAEA033E → 07/09 [7] [249] | |
| 2.0 GTI | 4 | CCZB | 155/208 | 11/11 → | OE214 | 0,7 | CET11P | | BAEA033E ^[7] | |
| 2.0 GTi | 4 | CCZB | 155/208 | 04/09 → 11/12 | OE214 | 0,7 | CET11P | | BAEA033E → 07/09 [7] [249] | |
| 2.0 GTi | 4 | CDLG | 173/232 | 05/11 → 11/12 | OE214 | 0,7 | CET11P | | BAEA033E ^[7] | |
| 2.0 GTi, 2.0 TSI | 4 | CBFA; CCTA; CCZA | 147/197 | 06/09 → 11/13 | OE214 | 0,7 | CET11P | | | |
| 2.0 R, 2.0 R 4WD | 4 | CDLA | 195/261 | 11/09 → | OE214 | 0,7 | CET11P | | BAEA033E ^[7] | |
| 2.0 R 4WD | 4 | CDLC; CRZA | 188/252 | 11/09 → 11/13 | OE214 | 0,7 | CET11P | | BAEA033E ^[7] | |
| 2.0 R 4WD | 4 | CDLF | 199/267 | 11/09 → 11/12 | OE214 | 0,7 | CET11P | | BAEA033E ^[7] | |
| 2.0 TDI | 4 | CBDC; CLCA | 81/109 | 10/08 → | | | | | CCU152 | |
| 2.0 TDI | 4 | CUUA | 81/109 | 10/08 → | CPSG007 | 4.4v | | | CCU152 | |
| 2.0 TDI | 4 | CBAA; CBDA; CFFA | 100/134 | 10/08 → 07/13 | | | | | CCU152 | |
| 2.0 TDI | 4 | CJAA | 103/138 | 10/08 → | CPSG007 | 4.4v | | | | |
| 2.0 TDI | 4 | CUUB | 110/148 | 11/13 → | CPSG007 | 4.4v | | | CCU152 | |
| 2.0 TDI | 4 | CBBB; CFGB | 125/168 | 04/09 → 11/12 | | | | | CCU152 | |
| 2.0 TDI, 2.0 TDI 4WD | 4 | CBAB; CBDDB; CFFB; CFHC | 103/138 | 10/08 → | | | | | CCU152 | |
| 2.0 TSI | 4 | CULC | 162/217 | 11/13 → | | | | OE246 | BAEA068E | |
| GOLF VII | | | | | | | | | | |
| 1.0 TSI | 3 | CHZD | 85/114 | 05/15 → | | | | | BAEA067E ^[240] | |
| 1.2 TSI | 4 | CJZB; CYVA | 63/84 | 08/12 → | OE244 | 0,8 | | | BAEA067E ^[240] BAEA126E ^[249] | |
| 1.2 TSI | 4 | CJZA | 77/103 | 11/12 → | OE244 | 0,8 | | | BAEA067E ^[240] BAEA126E ^[249] | |
| 1.2 TSI | 4 | CYVB | 81/109 | 04/14 → | OE244 | 0,8 | | | BAEA067E ^[240] | |
| 1.4 Flex, 1.4 TSI | 4 | ; CHPB | 110/148 | 05/14 → | OE244 | 0,8 | | | | |
| 1.4 GTE Hybrid, 1.4 TSI | 4 | CUKB; CZDA; CZE A | 110/148 | 05/14 → | OE244 | 0,8 | | | BAEA067E ^[240] | |
| 1.4 TGI CNG | 4 | CPWA | 81/109 | 06/13 → | | | | | BAEA067E ^[240] | |
| 1.4 TSI | 4 | CHPA; CPTA | 103/138 | 08/12 → | OE244 | 0,8 | | | BAEA067E ^[240] BAEA126E ^[249] | |
| 1.4 TSI, 1.4 TSI MultiFuel | 4 | CMBA; CPVA; CXSA | 90/121 | 11/12 → | OE244 | 0,8 | | | BAEA067E ^[240] BAEA126E ^[249] | |
| 1.4 TSI, 1.4 TSI MultiFuel | 4 | CPVB; CZCA; CZDD | 92/123 | 12/13 → | OE244 | 0,8 | | | BAEA067E ^[240] | |
| 1.6 | 4 | CWVA | 81/109 | 05/14 → | OE247 | 1,0 | | | BAEA067E ^[240] | |
| 1.6 TDI | 4 | CRKA | 66/89 | 04/13 → | | | | | CCU151 | |
| 1.6 TDI | 4 | CXXA; DDYB | 66/89 | 04/13 → | | | | | CCU151 | |
| 1.6 TDI | 4 | CLHB | 66/89 | 04/13 → | CPSG007 ^{[25] [193]} | 4.4v | | | CCU151 | |
| 1.6 TDI | 4 | DBKA | 81/109 | 01/13 → | | | | | CCU151 | |
| 1.6 TDI | 4 | DDYA | 85/114 | 11/16 → | CPSG007 ^[192] | 4.4v | | | | |
| 1.6 TDI, 1.6 TDI 4WD | 4 | CLHA | 77/103 | 08/12 → | CPSG007 ^{[25] [193]} | 4.4v | | | CCU151 | |
| 1.6 TDI, 1.6 TDI 4WD | 4 | CRKB | 81/109 | 01/13 → | CPSG007 ^[194] | 4.4v | | | CCU151 | |
| 1.6 TDI, 1.6 TDI 4WD | 4 | CXXB | 81/109 | 01/13 → | CPSG007 ^[191] | 4.4v | | | CCU151 | |
| 2.0 GTD | 4 | CUNA; DGCA | 135/181 | 04/13 → | CPSG007 ^{[25] [193]} | 4.4v | | | CCU151 | |
| 2.0 GTI | 4 | CHHB; CNTC; CXCB; CXDA | 162/217 | 04/13 → | | | | OE246 | BAEA068E | |
| 2.0 GTI | 4 | CHHA | 169/227 | 04/13 → | | | | OE246 | BAEA068E | |

VW



kW/BHP

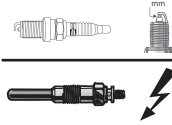

eon TITAN

IRIDIUM

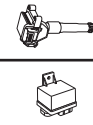
**...VW**

| ...GOLF VII | | | | | | | | | | |
|-----------------------|---|------------------------------|---------|-------------|---|------|---------------|--------------|------------------------------------|---------------|
| 2.0 GTI Clubsport | 4 | CJXE | 195/261 | 02/16→ | | | | OE246 | BAEA068E | |
| 2.0 GTI Clubsport S | 4 | CJXG | 228/306 | 09/16→ | | | | | BAEA068E | |
| 2.0 R 4WD | 4 | CJXB | 206/276 | 11/13→ | | | | OE246 | BAEA068E | |
| 2.0 R 4WD | 4 | CJXC | 221/296 | 11/13→ | | | | OE246 | BAEA068E | |
| 2.0 TDI | 4 | CRLD; CRVA; CYKB; DCYB; DEJB | 81/109 | 11/12→ | CPSG007 [25] [193] | 4.4v | | | CCU151 | |
| 2.0 TDI | 4 | CRBB; CRVC | 105/141 | 08/12→ | | | | | CCU151 | |
| 2.0 TDI, 2.0 TDI 4WD | 4 | CKFC; CRMB; CRUA; DCYA; DEJA | 110/148 | 11/12→ | | | | | CCU151 | |
| 2.0 TDI, 2.0 TDI 4WD | 4 | CRBC; CRLB | 110/148 | 11/12→ | CPSG007 [25] [193] | 4.4v | | | CCU151 | |
| GOLF PLUS | | | | | | | | | | |
| 1.2 TSI | 4 | CBZA | 63/84 | 05/10→12/13 | | | | OE260 | BAE907AE [262] | CLS090 |
| 1.2 TSI | 4 | CBZB | 77/103 | 11/09→12/13 | | | | OE260 | BAE907AE [262] | CLS090 |
| 1.4 16V | 4 | BCA | 55/74 | 01/05→11/06 | OE032 | 1,0 | CET2 | OE179 | BAE408AE | |
| 1.4 16V | 4 | BUD | 59/79 | 05/06→12/13 | OE177 | 0,9 | CET3 | | | |
| 1.4 16V | 4 | CGGA | 59/79 | 05/06→12/13 | OE177 | 0,9 | CET3 | | BAE408AE Ch.1K-9-400001→ | |
| 1.4 FSI | 4 | BLN | 66/89 | 07/05→11/06 | | | | | BAE408AE | |
| 1.4 TSI | 4 | CAXA | 90/121 | 06/07→12/13 | OE213 Ch.1KZ9-900001→ ModelYear2009→ | 0,9 | | | BAE408AE →Ch.1K-8-281299 | |
| 1.4 TSI | 4 | BMV | 103/138 | 05/06→06/08 | | | | | BAE408AE →Ch.1K-8-281299 | |
| 1.4 TSI | 4 | CAVD; CNWA | 118/158 | 06/08→12/13 | | | | | BAE408AE | |
| 1.4 TSI | 4 | BLG | 125/168 | 05/06→06/08 | | | | | BAE408AE →Ch.1K-8-281299 | |
| 1.6 | 4 | BSE | 75/101 | 05/05→12/13 | OE032 | 1,0 | CET2 | OE179 | BAE907AE [262] | CLS017 |
| 1.6 | 4 | BSF; CCSA; CMXA | 75/101 | 05/05→12/13 | | | CET2 | | BAE907AE [262] | CLS017 |
| 1.6 BiFuel | 4 | CHGA | 75/101 | 05/09→12/13 | OE032 | 1,0 | CET2 | OE179 | BAE907AE [262] | CLS048 |
| 1.6 FSI | 4 | BLF; BLP | 85/114 | 12/04→05/08 | | | | | BAE408AE | |
| 1.6 MultiFuel | 4 | CCSA; CMXA | 75/101 | 11/07→12/13 | OE146 | 1,0 | CET12P | OE179 | BAE907AE [262] | CLS048 |
| 1.6 TDI | 4 | CAYB | 66/89 | 02/09→12/13 | | | | | CCU152 | |
| 1.6 TDI | 4 | CAYC | 77/103 | 03/09→12/13 | | | | | CCU152 | |
| 1.9 TDI | 4 | BRU; BXF; BXJ | 66/89 | 05/05→12/08 | | | | | CCU081 | |
| 1.9 TDI | 4 | BKC; BXE | 77/103 | 01/05→01/09 | | | | | CCU081 [127] [363] | |
| 1.9 TDI | 4 | BLS | 77/103 | 01/05→01/09 | | | | | CCU081 [127] [363] | |
| | | | | | | | | | CCU152 Ch.5M-6-500001→ | |
| 2.0 FSI | 4 | BLR; BVY | 110/148 | 05/05→06/08 | OE234 | 1,0 | CET3 | | BAEA033E [7] | |
| 2.0 FSI | 4 | BLY; BVZ | 110/148 | 05/05→06/08 | OE146 | 1,0 | CET12P | OE179 | BAEA033E [7] | |
| 2.0 TDI | 4 | CBDC; CLCA | 81/109 | 01/09→12/13 | | | | | CCU152 | |
| 2.0 TDI | 4 | BEE | 96/129 | 05/05→05/07 | | | | | CCU081 | |
| 2.0 TDI | 4 | AZV | 100/134 | 05/05→12/13 | | | | | CCU081 [127] [363] | |
| 2.0 TDI | 4 | CBDA; CFHB | 100/134 | 05/05→12/13 | | | | | CCU152 Ch.1KZ-9W900001→ | |
| 2.0 TDI | 4 | BMM | 103/138 | 12/05→05/11 | | | | | CCU081 | |
| | | | | | | | | | CCU152 Ch.5M-6-500001→ | |
| 2.0 TDI 16V | 4 | BKD | 103/138 | 01/05→12/13 | | | | | CCU081 [127] [363] | |
| 2.0 TDI 16V | 4 | CBDB; CFHC | 103/138 | 01/05→12/13 | | | | | CCU152 Ch.1KZ-9W900001→ | |
| GOLF SPORTSVAN | | | | | | | | | | |
| 1.0 TSI | 3 | CHZD | 85/114 | 05/15→ | | | | | BAEA067E [240] | |
| 1.2 TSI | 4 | CVVA | 63/84 | 05/14→ | OE244 | 0,8 | | | BAEA067E [240] | |

VW





kW/BHP



eon TITAN

IRIDIUM



...VW

...GOLF SPORTSVAN

| | | | | | | | | | |
|----------------------------|---|------------------|---------|--------|----------------|------|--|--|---------------------------------|
| 1.2 TSI | 4 | CYVB | 81/109 | 04/14→ | OE244 | 0,8 | | | BAEA067E^[240] |
| 1.4 TSI | 4 | CZDA | 110/148 | 02/14→ | OE244 | 0,8 | | | BAEA067E^[240] |
| 1.4 TSI, 1.4 TSI MultiFuel | 4 | CPVB; CZCA | 92/123 | 04/14→ | OE244 | 0,8 | | | BAEA067E^[240] |
| 1.6 | 4 | CWVA | 81/109 | 05/14→ | OE247 | 1,0 | | | BAEA067E^[240] |
| 1.6 TDI | 4 | CRKA; CXXA; DDYB | 66/89 | 02/14→ | | | | | CCU151 |
| 1.6 TDI | 4 | CXXB | 81/109 | 02/14→ | | | | | CCU151 |
| 1.6 TDI | 4 | CRKB; DBKA | 81/109 | 02/14→ | | | | | CCU151 |
| 1.6 TDI | 4 | DDYA | 85/114 | 11/16→ | CPSG008 | 4.4v | | | |
| 2.0 TDI | 4 | CRLD; CRVA; DCYB | 81/109 | 05/14→ | | | | | CCU151 |
| 2.0 TDI | 4 | CRLB; DCYA | 110/148 | 02/14→ | CPSG007 | 4.4v | | | CCU151 |

GOL III

| | | | | | | | | | |
|-----|---|-----|-------|-------------|--|-----|-------------|--------------|--|
| 1.6 | 4 | UNF | 68/91 | 08/02→05/08 | OE235 <small>Ch.5W-9P050700 5W-9T061965→</small> | 1,0 | CET3 | | |
| 1.6 | 4 | BWX | 73/98 | 03/99→09/05 | OE032 | 1,0 | CET2 | OE179 | |

GOL IV

| | | | | | | | | | |
|------------|---|-----|-------|-------------|--|-----|-------------|--------------|---|
| 1.0 | 4 | BTY | 53/71 | 10/05→05/08 | OE016 | 0,9 | CET2 | OE180 | BAE907AE^[262] CLS081 |
| 1.6 Hybrid | 4 | UNF | 68/91 | 09/05→05/08 | OE235 <small>Ch.5W-9P050700 5W-9T061965→</small> | 1,0 | CET3 | | |

JETTA III

| | | | | | | | | | |
|---------------|---|---------------------------|---------|-------------|--------------------------------|------------|------------------------------|--------------|---|
| 1.4 TSI | 4 | CAXA | 90/121 | 05/07→10/10 | | | | | BAE408AE |
| 1.4 TSI | 4 | BMY | 103/138 | 07/06→10/10 | | | | | BAE408AE →Ch.1K-8-281299 |
| 1.4 TSI | 4 | CAVD | 118/158 | 07/08→10/10 | | | | | BAE408AE |
| 1.4 TSI | 4 | BLG | 125/168 | 07/06→10/10 | | | | | BAE408AE →Ch.1K-8-281299 |
| 1.6 | 4 | BSE; BSF; CCSA | 75/101 | 10/05→10/10 | OE032 | 1,0 | CET2 | OE179 | BAE907AE^[262] CLS017 |
| 1.6 | 4 | BGU | 75/101 | 10/05→10/10 | OE032 | 1,0 | CET2 | OE179 | |
| 1.6 FSI | 4 | BLF | 85/114 | 09/05→10/10 | | | | | BAE408AE Ch.1K-7-000000→ |
| 1.6 MultiFuel | 4 | CCSA | 75/101 | 01/08→10/10 | OE032 | 1,0 | CET2 | OE179 | BAE907AE^[262] CLS048 |
| 1.6 TDI | 4 | CAYC | 77/103 | 06/09→10/10 | | | | | CCU151 |
| 1.9 TDI | 4 | BKC; BXE | 77/103 | 08/05→10/10 | | | | | CCU152 |
| 1.9 TDI | 4 | BLS | 77/103 | 08/05→10/10 | CCGP002^[184] | 7v | | | CCU152 |
| 2.0 FSI | 4 | BLR; BVY | 110/148 | 08/05→10/10 | OE234 | 1,0 | CET3 | | BAEA033E^[7] |
| 2.0 FSI | 4 | BLX | 110/148 | 08/05→10/10 | | | | | BAEA033E^[7] |
| 2.0 FSI | 4 | BVZ | 110/148 | 08/05→10/10 | OE146 | 1,0 | CET12P | OE179 | BAEA033E^[7] |
| 2.0 FSI | 4 | BLY | 110/148 | 08/05→10/10 | OE146 OE234 | 1,0 1,0 | CET12P CET3 | OE179 | BAEA033E^[7] |
| 2.0 TDI | 4 | CBDA | 100/134 | 09/05→10/10 | | | | | CCU152 |
| 2.0 TDI | 4 | BMM | 103/138 | 10/05→10/10 | | | | | CCU152 |
| 2.0 TDI | 4 | BMN | 125/168 | 10/06→10/10 | CCGP003 | 7v | | | |
| 2.0 TDI | 4 | CEGA | 125/168 | 10/06→10/10 | | | | | CCU152 |
| 2.0 TDI 16V | 4 | CBDB | 103/138 | 08/05→10/10 | | | | | CCU152 |
| 2.0 TDI 16V | 4 | CJAA | 103/138 | 08/05→10/10 | CPSG007 | 4.4v | | | |
| 2.0 TFSI | 4 | CAWA | 125/168 | 07/08→10/10 | OE214 | 0,7 | CET11P | | BAEA033E^[7] |
| 2.0 TFSI | 4 | AXX; BPY; BWA; CAWB; CCTA | 147/197 | 10/05→10/10 | OE214 | 0,7 | CET11P | | BAEA033E^[7] |
| 2.0 TFSI | 4 | CBFA; CCZA | 147/197 | 10/05→10/10 | OE214 | 0,7 | CET11P | | |
| 2.5 | 5 | BGP; BTK | 110/148 | 01/06→10/10 | OE176 | 1,0 | CET3 | | |
| 2.5 | 5 | CBTA; CBUA; CCCA | 125/168 | 07/08→10/10 | | | CET3 | | BAEA033E^[7] |

JETTA IV

| | | | | | | | | | |
|-------------|---|------|--------|--------|--------------|-----|--|--------------|---|
| 1.2 TSI | 4 | CBZB | 77/103 | 10/10→ | | | | OE260 | BAE907AE^[262] CLS090 |
| 1.2 TSI 16V | 4 | CYVD | 77/103 | 08/14→ | OE244 | 0,8 | | | |
| 1.4 TSI | 4 | CAXA | 90/121 | 05/11→ | OE213 | 0,9 | | | BAE408AE |



VW



kW/BHP



eon TITAN

IRIDIUM

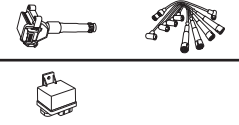

...VW

...JETTA IV

| | | | | | | | | | |
|-------------------|---|--------------------|---------|-------------|--|------|--------|--|--|
| 1.4 TSI | 4 | CMSB | 90/121 | 05/11→ | OE213 | 0,9 | | | |
| 1.4 TSI | 4 | CZCA | 92/123 | 08/14→ | OE244 | 0,8 | | BAEA067E [240] | |
| 1.4 TSI | 4 | CZDA; CZTA | 110/148 | 04/11→ | OE244 | 0,8 | | BAEA067E [240] | |
| 1.4 TSI | 4 | CAVA; CTHA | 110/148 | 04/11→ | | | | BAE408AE | |
| 1.4 TSI | 4 | CAVD | 118/158 | 04/11→ | | | | BAE408AE | |
| 1.4 TSI Hybrid | 4 | CNLA | 110/148 | 04/11→ | OE244 | 0,8 | | BAEA067E [240] [275] BAEA126E [249] [275] | |
| 1.4 TSI Hybrid | 4 | CRJA | 110/148 | 04/11→ | OE244 | 0,8 | | | |
| 1.6 | 4 | CFNB | 63/84 | 03/13→ | | | | BAE408AE | |
| 1.6 | 4 | CFNA; CLRA | 77/103 | 12/11→ | OE177 | 0,9 | CET3 | BAE408AE | |
| 1.6 TDI | 4 | CAYC | 77/103 | 04/10→07/14 | | | | CCU151 | |
| 1.8 TSI | 4 | CPKA; CPRA | 125/168 | 07/14→ | | | | BAEA068E | |
| 2.0 | 4 | CKJA | 85/114 | 06/10→ | OE177 | 0,9 | CET3 | BAEA029E | |
| 2.0 | 4 | CBPA | 85/114 | 06/10→ | OE177 | 0,9 | CET3 | BAE907AE [262] | |
| 2.0 TDI | 4 | CLCA | 81/109 | 10/10→ | | | | CCU151 | |
| 2.0 TDI | 4 | CFFB; CFHC; CLCB | 103/138 | 02/11→ | | | | CCU151 | |
| 2.0 TDI | 4 | CJAA | 103/138 | 02/11→ | CPSG007 | 4.4v | | | |
| 2.0 TDI | 4 | CUUB; DELA; DGMA | 110/148 | 08/14→ | CPSG007 [275] | 4.4v | | CCU151 | |
| 2.0 TSI | 4 | CBFA; CCTA; CCZA | 147/197 | 12/10→ | OE214 | 0,7 | CET11P | BAEA033E [7] | |
| 2.0 TSI | 4 | CPLA; CPPA | 155/208 | 12/12→ | | | | OE246 | BAEA068E →Prod.24.11.2013 |
| 2.5 | 5 | CBTA; CBUA; CCCA | 125/168 | 04/10→ | | | CET3 | | |
| LUPO | | | | | | | | | |
| 1.0 | 4 | AHT | 37/50 | 09/98→07/05 | OE136 | 0,8 | CET12P | OE179 | BAE961AE |
| 1.0 | 4 | AER/ALL | 37/50 | 09/98→07/05 | OE025 | 1,0 | CET8 | OE195 | |
| 1.0 | 4 | ANV/ALD/AUC | 37/50 | 09/98→07/05 | OE176 | 1,0 | CET3 | | |
| 1.0 | 4 | ALD; ANV | 37/50 | 09/98→07/05 | | | | | BAE907AE [262] [275] BAE961AE [275] |
| 1.0 | 4 | AER; ALL | 37/50 | 09/98→07/05 | | | | | BAE851AE [261] [275] [292] BAE961AE [275] |
| 1.0 | 4 | AUC | 37/50 | 09/98→07/05 | | | | | BAE907AE [262] [275] BAE961AE [275] |
| 1.2 TDI 3L | 3 | ANY; AYZ | 45/60 | 07/99→07/05 | CH271 →Ch.6X-2-005000 CH181 Ch.6X-2-005001→ | 11v | | | |
| 1.4 | 4 | AUD | 44/59 | 10/00→07/05 | OE176 | 1,0 | CET3 | BAE907AE [262] | CLS053 |
| 1.4 16V | 4 | AHW; AKQ; APE; AUA | 55/74 | 09/98→07/05 | OE032 | 1,0 | CET2 | OE179 | BAE907AE [262] |
| 1.4 16V | 4 | BBY | 55/74 | 09/98→07/05 | OE032 | 1,0 | CET2 | OE179 | BAE408AE |
| 1.4 16V | 4 | AFK; AUB | 74/99 | 08/99→07/05 | OE032 | 1,0 | CET2 | OE188 | BAE907AE [262] |
| 1.4 16V | 4 | AQQ | 74/99 | 08/99→07/05 | OE032 | 1,0 | CET2 | OE188 | BAE907AE [262] |
| 1.4 16V | 4 | ANM | 74/99 | 08/99→07/05 | | | | | BAE907AE [262] |
| 1.4 TDI | 3 | AMF | 55/74 | 01/99→07/05 | CH271 →Ch.6X-2-005000 CH181 Ch.6X-2-005001→ | 11v | | | CCU081 |
| 1.6 GTI | 4 | AVY | 92/123 | 09/00→07/05 | OE032 | 1,0 | CET2 | OE179 | BAE907AE [262] |
| 1.7 SDI | 4 | AKU | 44/59 | 09/98→07/05 | CH271 | 11v | | | CCU081 |
| MULTIVAN V | | | | | | | | | |
| 1.9 TDI | 4 | BRR | 62/83 | 01/06→11/09 | | | | | CCU151 |
| 1.9 TDI | 4 | AXC | 63/84 | 04/03→11/09 | CH181 | 11v | | | CCU151 |
| 1.9 TDI | 4 | BRS | 75/101 | 06/06→11/09 | | | | | CCU151 |

VW



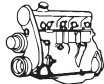

kW/BHP



eon TITAN

IRIDIUM



...VW

...MULTIVAN V

| | | | | | | | | | |
|--------------------------|---|------------|---------|-------------|---------|-----|--------|-------|---------------------------------|
| 1.9 TDI | 4 | AXB | 77/103 | 04/03→11/09 | CH181 | 11v | | | CCU151 |
| 2.0 | 4 | AXA | 85/114 | 11/03→08/15 | | | CET8 | OE195 | BAE907AE ^[262] |
| 2.0 BiTDI, 2.0 BiTDI 4WD | 4 | CFCA | 132/177 | 09/09→08/15 | | | | | CCU151 |
| 2.0 TDI | 4 | CAAA | 62/83 | 09/09→08/15 | | | | | CCU151 |
| 2.0 TDI | 4 | CAAB | 75/101 | 09/09→08/15 | | | | | CCU151 |
| 2.0 TDI | 4 | CAAD | 84/113 | 05/11→08/15 | | | | | CCU151 |
| 2.0 TDI, 2.0 TDI 4WD | 4 | CAAE; CCHB | 100/134 | 05/10→08/15 | | | | | CCU151 |
| 2.0 TDI, 2.0 TDI 4WD | 4 | CAAC; CCHA | 103/138 | 09/09→08/15 | | | | | CCU151 |
| 2.0 TSI | 4 | CJKB | 110/148 | 07/12→08/15 | OE214 | 0,7 | CET11P | | BAEA033E ^[7] |
| 2.0 TSI, 2.0 TSI 4WD | 4 | CJKA | 150/201 | 05/11→08/15 | OE214 | 0,7 | CET11P | | BAEA033E ^[7] |
| 2.5 TDI | 5 | BLJ | 120/161 | 11/03→11/09 | CH181 | 11v | | | |
| 2.5 TDI, 2.5 TDI 4WD | 5 | AXD | 96/129 | 04/03→11/09 | CH181 | 11v | | | |
| 2.5 TDI, 2.5 TDI 4WD | 5 | BNZ | 96/129 | 04/03→11/09 | CCGP002 | 7v | | | |
| 2.5 TDI, 2.5 TDI 4WD | 5 | AXE | 128/172 | 04/03→11/09 | CH181 | 11v | | | |
| 2.5 TDI, 2.5 TDI 4WD | 5 | BPC | 128/172 | 04/03→11/09 | CCGP002 | 7v | | | |
| 3.2 V6 | 6 | BDL | 170/228 | 02/04→06/04 | OE215 | 0,9 | | | BAEA044E ^[356] |
| 3.2 V6 | 6 | CFLA | 173/232 | 02/04→11/09 | | | | | BAEA044E ^{[275] [356]} |
| 3.2 V6, 3.2 V6 4WD | 6 | BKK; CFLA | 173/232 | 02/04→11/09 | OE215 | 0,9 | | | BAEA044E ^{[275] [356]} |

MULTIVAN VI

| | | | | | | | | | |
|----------------------|---|------------|---------|--------|---|------|--|--|-------------------------------|
| 2.0 TDI | 4 | CXGA | 62/83 | 04/15→ | CPSG007 | 4.4v | | | |
| 2.0 TDI | 4 | CXGB | 75/101 | 04/15→ | CPSG007 | 4.4v | | | |
| 2.0 TDI | 4 | CXGC; CXHB | 84/113 | 05/16→ | CPSG007 →Prod.03.07.2017 [67] [240] | 4.4v | | | |
| | | | | | CPSG008 →Prod.03.07.2017 [70] [241] | 4.4v | | | |
| 2.0 TDI, 2.0 TDI 4WD | 4 | CXFA; CXHA | 110/148 | 04/15→ | CPSG007 | 4.4v | | | |
| 2.0 TDI, 2.0 TDI 4WD | 4 | CXEB | 150/201 | 06/15→ | CPSG007 | 4.4v | | | |
| 2.0 TSI | 4 | CJKB | 110/148 | 04/15→ | | | | | BAEA033E ^{[7] [249]} |
| 2.0 TSI, 2.0 TSI 4WD | 4 | CJKA | 150/201 | 04/15→ | | | | | BAEA033E ^{[7] [249]} |

NEW BEETLE

| | | | | | | | | | |
|---------|---|--------------------|---------|-------------|------------------------------------|-----------|--------|-------|---------------------------------------|
| 1.4 | 4 | BCA | 55/74 | 11/01→09/10 | OE176 | 1,0 | CET3 | | BAE408AE |
| 1.6 | 4 | AWH | 74/99 | 10/99→09/00 | OE032 | 1,0 | CET2 | OE188 | BAE907AE ^[262] CLS260 |
| 1.6 | 4 | AYD | 75/101 | 06/00→09/10 | OE176 →07/01 OE032 07/01→ | 1,0 | CET2 | OE188 | BAE907AE ^[262] CLS048 |
| 1.6 | 4 | BFS | 75/101 | 06/00→09/10 | OE032 | 1,0 | CET2 | OE188 | BAE907AE ^[262] CLS048 |
| 1.8 T | 4 | AGU | 110/148 | 10/99→09/10 | OE136 | 0,8 | CET12P | OE179 | |
| 1.8 T | 4 | AVC; AWU; AWW; BKF | 110/148 | 10/99→09/10 | OE136 | 0,8 | CET12P | OE179 | BAEA043E |
| 1.8 T | 4 | APH | 110/148 | 10/99→09/10 | OE136 | 0,8 | CET12P | OE179 | BAEA009E |
| 1.8 T | 4 | AWP; BNU | 132/177 | 11/01→06/05 | OE136 | 0,8 | CET12P | OE179 | BAEA043E |
| 1.9 TDI | 4 | ALH | 66/89 | 01/98→06/04 | CH271 | 11v | | | CCU081 ^[364] |
| 1.9 TDI | 4 | ATD; AXR | 74/99 | 02/01→09/10 | CH181 | 11v | | | CCU081 ^[364] |
| 1.9 TDI | 4 | BEW | 74/99 | 02/01→09/10 | CCGP002 CH181 | 7v 11v | | | |
| 1.9 TDI | 4 | BSW | 77/103 | 07/05→09/10 | | | | | CCU081 ^[364] |
| 2.0 | 4 | AEG; APIK; AQY | 85/114 | 01/98→10/10 | OE032 | 1,0 | CET2 | OE179 | BAE907AE ^{[64] [262]} CLS017 |
| 2.0 | 4 | AZG | 85/114 | 01/98→10/10 | OE032 | 1,0 | CET2 | OE179 | BAEA029E ^[72] CLS070 |

CHAMPION



kW/BHP

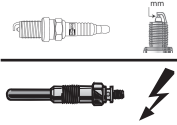

eon TITAN

IRIDIUM

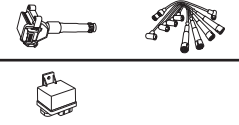

...VW

...NEW BEETLE

| | | | | | | | | | | |
|-----------------|---|-----------|---------|-------------|--|-------------------|-------------|--------------|---|---------------|
| 2.0 | 4 | AZJ; BEV | 85/114 | 01/98→10/10 | OE032 OE176 ^[258] OE177 ^[242] ModelYear2006→ | 1,0 1,0 0,9 | CET2 | OE179 | BAEA029E ^[72] BAEA029E | CLS070 |
| 2.0 | 4 | BDC; BGD | 85/114 | 01/98→10/10 | OE176 ^[258] | 1,0 | CET2 | OE179 | BAEA029E | CLS070 |
| 2.0 | 4 | AVH; BEJ | 85/114 | 01/98→10/10 | OE032 | 1,0 | CET2 | OE179 | BAEA029E ^[72] | |
| 2.0 | 4 | BHP | 85/114 | 01/98→10/10 | OE032 | 1,0 | CET2 | OE179 | BAE907AE ^{[64] [262]} BAEA029E ^[72] | |
| 2.0 | 4 | BER; CBPA | 85/114 | 01/98→10/10 | OE032 | 1,0 | CET2 | OE179 | BAE907AE ^{[64] [262]} | |
| 2.3 V5 | 5 | AQN | 125/168 | 10/00→09/10 | OE176 | 1,0 | CET3 | | BAEA063E | |
| 2.5 | 5 | BPR; BPS | 110/148 | 07/05→09/10 | OE177 | 0,9 | CET3 | | | |
| 3.2 RSI 3.2 4WD | 6 | AXJ | 165/221 | 04/00→05/01 | OE176 | 1,0 | CET3 | | BAEA013E BAEA063E | |

PARATI III

| | | | | | | | | | | |
|-----|---|-----|-------|--------|--------------|-----|-------------|--------------|--|--|
| 1.8 | 4 | UDH | 73/98 | 08/02→ | OE025 | 1,0 | CET8 | OE195 | | |
|-----|---|-----|-------|--------|--------------|-----|-------------|--------------|--|--|

PASSAT

| | | | | | | | | | | |
|---------------------------|---|---------------|---------|-------------|--|-------------------|---------------|--------------|---|--------------------------------|
| 1.4 GTE Hybrid | 4 | CUKC | 115/154 | 06/15→ | | | | | BAEA067E ^[240] | |
| 1.4 TSI | 4 | CAXA | 90/121 | 05/07→12/14 | OE213 | 0,9 | | | BAE408AE | |
| 1.4 TSI | 4 | CZCA | 92/123 | 11/14→ | OE244 | 0,8 | | | BAEA067E ^[240] | |
| 1.4 TSI | 4 | CTHD | 118/158 | 11/12→12/14 | OE213 ^[275] | 0,9 | | | BAE408AE | |
| 1.4 TSI, 1.4 TSI 4WD | 4 | CZDA; CZEA | 110/148 | 11/14→ | OE244 | 0,8 | | | BAEA067E ^[240] | |
| 1.4 TSI EcoFuel | 4 | CDGA | 110/148 | 01/09→12/14 | | | | | BAE408AE | |
| 1.4 TSI MultiFuel | 4 | CKMA | 118/158 | 11/10→12/14 | | | | | BAE408AE | |
| 1.6 | 4 | AHL; ANA; ARM | 74/99 | 07/94→11/00 | OE032 | 1,0 | CET2 | OE179 | BAE907AE ^[262] | CLS048 |
| 1.6 | 4 | AFT | 74/99 | 07/94→11/00 | OE032 | 1,0 | CET2 | OE179 | BAE851AE ^{[261] [292]} | CLS034 |
| 1.6 | 4 | ADP | 74/99 | 07/94→11/00 | OE032 | 1,0 | CET2 | OE179 | | CLS034 CLS047 |
| 1.6 | 4 | AEK | 74/99 | 07/94→11/00 | OE123 | 0,7 | CET2 | OE179 | BAE851AE ^{[261] [292]} | CLS043 |
| 1.6 | 4 | BSE; BSF | 75/101 | 11/00→11/10 | OE032 | 1,0 | CET2 | OE179 | BAE907AE ^[262] | CLS017 |
| 1.6 | 4 | ALZ | 75/101 | 11/00→11/10 | OE032 | 1,0 | CET2 | OE188 | BAE907AE ^[262] | CLS048 |
| 1.6 FSI | 4 | BLF | 85/114 | 03/05→06/08 | | | | | BAE408AE | |
| 1.6 TDI | 4 | CAYC | 77/103 | 08/09→12/14 | | | | | CCU151 | |
| 1.6 TDI | 4 | DCXA; DCZA | 88/118 | 08/14→ | CPSG007 | 4.4v | | | CCU151 | |
| 1.8 | 4 | AFY | 85/114 | 01/97→03/05 | OE032 | 1,0 | CET2 | OE179 | BAEA162E | CLS057 |
| 1.8 | 4 | ADR; APT; ARG | 92/123 | 10/96→11/00 | OE032 | 1,0 | CET2 | OE179 | BAE851AE ^{[261] [292]} BAEA162E ^[69] BAEA162E | CLS057 |
| 1.8 4WD | 4 | ADR; APT; ARG | 92/123 | 10/96→11/00 | OE032 | 1,0 | CET2 | OE179 | BAEA162E | CLS057 |
| 1.8 4WD, 1.8 T, 1.8 T 4WD | 4 | AWM | 125/168 | 02/01→08/05 | OE136 | 0,8 | CET12P | OE179 | BAEA043E | |
| 1.8 T, 1.8 T 4WD | 4 | AEB; ANB; APU | 110/148 | 10/96→11/00 | OE032 | 1,0 | CET2 | OE179 | BAEA016 | |
| 1.8 T 20V | 4 | AWL; AWT | 110/148 | 11/00→05/05 | OE136 | 0,8 | CET12P | OE179 | BAEA043E | |
| 1.8 TSI | 4 | CGYA | 112/150 | 11/09→12/14 | OE214 | 0,7 | CET11P | | BAEA033E ^[7] | |
| 1.8 TSI | 4 | CDAB | 112/150 | 11/09→12/14 | OE214 | 0,7 | CET11P | | | |
| 1.8 TSI | 4 | BZB; CDAA | 118/158 | 05/07→12/14 | OE214 | 0,7 | CET11P | | BAEA033E ^[7] | |
| 1.8 TSI | 4 | CJSA; CJSC | 132/177 | 02/15→ | | | | OE246 | | |
| 1.9 TDI | 4 | IZ; AHH; AHU | 66/89 | 10/93→11/00 | CH271 | 11v | | | CCU081 | |
| 1.9 TDI | 4 | AVB | 74/99 | 02/00→05/05 | CH271 CH271 →Ch.38-2-350000 CH181 Ch.38-2-350001→ | 11v 11v 11v | | | | |

VW

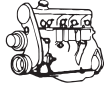

kW/BHP

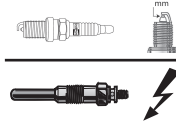

eon TITAN

IRIDIUM

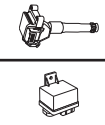

...VW

...PASSAT

| | | | | | | | | | | |
|----------------------|---|------------------------------------|---------|-------------|---|------|--------|-------|-----------------------------------|--------|
| 1.9 TDI | 4 | BKC; BXE | 77/103 | 03/05→11/10 | | | | | CCU151 →11/05 | |
| | | | | | | | | | CCU152 11/05→04/07 | |
| 1.9 TDI | 4 | BLS | 77/103 | 03/05→11/10 | CCGP002 ^[184] 05/07→05/08 | 7v | | | CCU151 →11/05 | |
| | | | | | | | | | CCU152 11/05→04/07 | |
| 1.9 TDI, 1.9 TDI 4WD | 4 | AFN; AVG | 81/109 | 03/96→11/00 | CH271 | 11v | | | CCU081 | |
| 1.9 TDI, 1.9 TDI 4WD | 4 | AJM; ATJ | 85/114 | 08/98→11/00 | CH271 | 11v | | | | |
| 1.9 TDI, 1.9 TDI 4WD | 4 | AVF; AWX | 96/129 | 11/00→05/05 | CH271 →Ch.3B-2-350000 | 11v | | | | |
| | | | | | CH181 Ch.3B-2-350001→ | 11v | | | | |
| 2.0 | 4 | AEP | 79/106 | 03/95→08/96 | OE025 | 1,0 | CET8 | OE195 | BAE851AE [261][292] | |
| 2.0 | 4 | ALT | 96/129 | 11/01→05/05 | | | CET2 | OE188 | BAEA043E | |
| 2.0, 2.0 4WD | 4 | ASU; AUZ | 88/118 | 04/00→11/00 | OE032 | 1,0 | CET2 | OE179 | | |
| 2.0 16V | 4 | ABF | 110/148 | 01/94→05/97 | OE032 | 1,0 | CET11P | | BAE851AE [261][292] | CLS174 |
| 2.0 BlueTDI | 4 | CBAC | 105/141 | 01/09→11/10 | | | | | CCU151 | |
| 2.0 FSI | 4 | BLY; BVZ | 110/148 | 03/05→11/10 | OE146 | 1,0 | CET12P | OE179 | BAEA033E ^[7] | |
| 2.0 FSI | 4 | CCTB | 125/168 | 08/07→07/10 | OE214 | 0,7 | CET11P | | BAEA033E ^[7] →09/08 | |
| 2.0 FSI | 4 | CBFA | 147/197 | 07/05→11/10 | OE214 | 0,7 | CET11P | | | |
| 2.0 FSI | 4 | AXX; BPY; BWA; CAWB; CCTA; CCZA | 147/197 | 07/05→11/10 | OE214 | 0,7 | CET11P | | BAEA033E ^[7] | |
| | | | | | | | | | BAEA033E [7][249] | |
| 2.0 FSI, 2.0 FSI 4WD | 4 | BLR; BLX; BLY; BVX; BVY | 110/148 | 03/05→11/10 | OE234 | 1,0 | CET3 | | BAEA033E ^[7] | |
| 2.0 TDI | 4 | CBDC | 81/109 | 11/08→ | | | | | CCU151 | |
| 2.0 TDI | 4 | BWV | 88/118 | 11/05→05/07 | CCGP003 | 7v | | | CCU152 | |
| 2.0 TDI | 4 | BVE | 90/121 | 08/05→07/06 | CCGP003 | 7v | | | CCU151 →11/05 | |
| | | | | | | | | | CCU152 11/05→ | |
| 2.0 TDI | 4 | BMA | 100/134 | 12/03→12/14 | CCGP003 →05/07 | 7v | | | CCU151 →11/05 | |
| | | | | | | | | | CCU152 11/05→04/07 | |
| 2.0 TDI | 4 | CFFA | 100/134 | 12/03→12/14 | | | | | CCU151 | |
| 2.0 TDI | 4 | CBAA | 100/134 | 12/03→12/14 | | | | | CCU151 →11/05 | |
| | | | | | | | | | CCU152 11/05→04/07 | |
| 2.0 TDI | 4 | BUZ | 120/161 | 08/05→05/09 | CCGP003 | 7v | | | CCU151 →11/05 | |
| | | | | | | | | | CCU152 11/05→04/07 | |
| 2.0 TDI | 4 | BMR | 125/168 | 08/05→12/14 | CCGP003 | 7v | | | CCU151 →11/05 | |
| | | | | | | | | | CCU152 11/05→04/07 | |
| 2.0 TDI | 4 | CBBB | 125/168 | 08/05→12/14 | | | | | CCU151 →11/05 | |
| | | | | | | | | | CCU152 11/05→04/07 | |
| 2.0 TDI | 4 | CUPA | 135/181 | 07/15→ | CPSP007 | 4.4v | | | CCU151 →Prod.06.03.2017 | |
| 2.0 TDI, 2.0 TDI 4WD | 4 | BMP | 103/138 | 03/05→06/15 | CCGP002 | 7v | | | CCU151 →11/05 | |
| | | | | | | | | | CCU152 11/05→04/07 | |
| 2.0 TDI, 2.0 TDI 4WD | 4 | CFFB | 103/138 | 03/05→06/15 | | | | | CCU151 | |

VW





kW/BHP

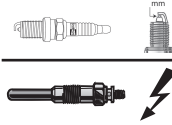

eon TITAN

IRIDIUM

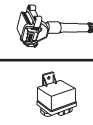

...VW

...PASSAT

| | | | | | | | | | | |
|--|---|------------------------------|---------|-------------|-------------------|------|------------------------------------|------------------------------------|----------------------------|--------|
| 2.0 TDI, 2.0 TDI 4WD | 4 | CRLB; DBGA; DFEA; DFGA | 110/148 | 06/14→ | CPSG007 | 4.4v | | | CCU151 | |
| 2.0 TDI, 2.0 TDI 4WD | 4 | CFGC | 130/174 | 12/12→ | | | | | CCU151 | |
| 2.0 TDI, 2.0 TDI 4WD | 4 | DDAA; DFCA | 140/188 | 11/14→ | CPSG007 | 4.4v | | | CCU151 | |
| 2.0 TDI, 2.0 TDI 4WD | 4 | CBBB; CFGB; CLLA | 125/168 | 08/05→12/14 | | | | | CCU151 | |
| 2.0 TDI 4WD | 4 | CUAA | 176/236 | 08/14→ | CPSG007 | 4.4v | | | CCU151 | |
| 2.0 TDI 16V | 4 | BKP | 103/138 | 03/05→11/10 | CCGP003 →05/07 | 7v | | | CCU151 →11/05 | |
| | | | | | | | | | CCU152 11/05→04/07 | |
| 2.0 TDI 16V, 2.0 TDI 16V 4WD | 4 | CBAB | 103/138 | 03/05→11/10 | | | | | CCU151 →11/05 | |
| | | | | | | | | | CCU152 11/05→04/07 | |
| 2.0 TDI 16V 4WD | 4 | BKP | 103/138 | 03/05→11/10 | CCGP003 →05/07 | 7v | | | CCU151 →11/05 | |
| | | | | | | | | | CCU152 11/05→04/07 | |
| 2.0 TSI | 4 | CCZB | 155/208 | 11/10→12/14 | OE214 | 0,7 | CET11P | | BAEA033E [7] | |
| 2.0 TSI | 4 | CHHB; CXDA | 162/217 | 02/15→ | | | | OE246 | BAEA068E | |
| 2.0 TSI 4WD | 4 | CJXA | 206/276 | 05/15→ | | | | OE246 | | |
| 2.3 V5, 2.3 V5 4WD, 2.3 VR5, 2.3 VR5 4WD | 5 | AZX | 125/168 | 11/00→05/05 | OE176 | 1,0 | CET3 | | BAEA065E | |
| 2.3 VR5, 2.3 VR5 4WD | 5 | AGZ | 110/148 | 10/96→11/00 | | | CET2 | OE188 | BAEA037 | CLS181 |
| 2.5 TDI | 6 | BDG | 120/161 | 05/03→05/05 | CH215 | 12v | | | | |
| 2.5 TDI, 2.5 TDI 4WD | 6 | AFB; AKN | 110/148 | 07/98→05/05 | CH215 | 12v | | | | |
| 2.5 TDI 4WD | 6 | BAU; BDH | 132/177 | 01/03→05/05 | CH215 | 12v | | | | |
| 2.8 4WD, 2.8 V6 | 6 | AGE | 132/177 | 05/97→09/99 | OE237 | 1,6 | CET2 | OE179 | | CLS046 |
| 2.8 4WD, 2.8 V6, 2.8 V6 4WD | 6 | ACK; ALG; AMX; APR; AQD; ATQ | 142/190 | 08/96→05/05 | OE237 | 1,6 | CET2 | OE179 | BAEA154E | CLS046 |
| 2.8 V6 | 6 | ATX | 140/188 | 09/99→11/00 | OE237 | 1,6 | CET2 | OE179 | BAEA154E | CLS046 |
| 2.8 V6, 2.8 V6 4WD | 6 | AHA | 142/190 | 08/96→11/00 | OE237 | 1,6 | CET2 | OE179 | | |
| 2.8 V6 4WD | 6 | ATX | 140/188 | 09/99→11/00 | OE237 | 1,6 | | | BAEA154E | CLS046 |
| 2.8 V6 4WD | 6 | AQP | 142/190 | 10/96→11/00 | | | | | | CLS046 |
| 2.9 VR6 4WD | 6 | ABV | 135/181 | 01/94→05/97 | OE026 →06/95 | 0,9 | CET2 →06/95 CET12P 07/95→ | OE184 →06/95 OE180 07/95→ | BAEA004E | CLS199 |
| 3.2 FSI 4WD | 6 | AXZ | 184/247 | 11/05→11/10 | | | | | BAEA041E [277] [324] | |
| 3.6 FSI, 3.6 FSI 4WD | 6 | BLV | 206/276 | 06/05→ | | | | | BAEA041E [277] [324] | |
| 3.6 FSI 4WD, 3.6 R36 4WD | 6 | BWS | 220/295 | 04/07→12/14 | | | | | BAEA041E [277] [324] | |
| 4.0 W8 4WD | 8 | BDN; BDP | 202/271 | 09/01→09/04 | OE026 | 0,9 | CET2 | OE188 | BAEA031E [277] | |
| PASSAT ALLTRACK | | | | | | | | | | |
| 1.4 TSI 4WD | 4 | CZEA | 110/148 | 05/15→ | OE244 | 0,8 | | | | |
| 1.8 TSI | 4 | CDAB | 112/150 | 01/12→12/14 | OE214 | 0,7 | CET11P | | | |
| 1.8 TSI | 4 | CDA A | 118/158 | 01/12→12/14 | OE214 | 0,7 | CET11P | | | |
| 2.0 TDI, 2.0 TDI 4WD | 4 | CFFB | 103/138 | 01/12→12/14 | | | | | CCU151 | |
| 2.0 TDI 4WD | 4 | CRLB; DFEA | 110/148 | 05/15→ | CPSG007 | 4.4v | | | CCU151 | |
| 2.0 TDI 4WD | 4 | CFGB | 125/168 | 01/12→12/14 | | | | | CCU151 | |
| 2.0 TDI 4WD | 4 | CFGC | 130/174 | 01/13→12/14 | | | | | CCU151 | |
| 2.0 TDI 4WD | 4 | CUPA | 135/181 | 07/15→ | CPSG007 | 4.4v | | | CCU151 →Prod.06.03.2017 | |
| 2.0 TDI 4WD | 4 | DDAA; DFCA | 140/188 | 05/15→ | CPSG007 | 4.4v | | | CCU151 | |
| 2.0 TDI 4WD | 4 | CUAA | 176/236 | 05/15→ | CPSG007 | 4.4v | | | CCU151 | |
| 2.0 TSI 4WD | 4 | CCZB | 155/208 | 01/12→12/14 | OE214 | 0,7 | CET11P | | | |
| 2.0 TSI 4WD | 4 | CHHB | 162/217 | 07/15→ | | | | OE246 | | |

VW



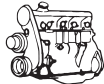

kW/BHP



eon TITAN

IRIDIUM



...VW

PASSAT CC

| | | | | | | | | | | |
|----------------------|---|------------------------|---------|-------------|-------|-----|--------|--|--|---------------------------------|
| 1.4 TSI MultiFuel | 4 | CKMA | 118/158 | 01/11→01/12 | | | | | | BAE408AE |
| 1.8 TSI | 4 | CDAB; CGYA | 112/150 | 11/08→05/10 | OE214 | 0,7 | CET11P | | | |
| 1.8 TSI | 4 | BZB; CDA | 118/158 | 06/08→01/12 | OE214 | 0,7 | CET11P | | | BAEA033E ^[7] |
| 2.0 BlueTDI | 4 | CBAC | 105/141 | 05/09→11/10 | | | | | | CCU151 |
| 2.0 TDI | 4 | CBAA; CFFA | 100/134 | 06/08→05/11 | | | | | | CCU151 |
| 2.0 TDI | 4 | CBBA | 120/161 | 05/08→05/11 | | | | | | CCU151 |
| 2.0 TDI, 2.0 TDI 4WD | 4 | CBAB; CFFB | 103/138 | 06/08→01/12 | | | | | | CCU151 |
| 2.0 TDI, 2.0 TDI 4WD | 4 | CBBB; CFGB; CLLA | 125/168 | 06/08→01/12 | | | | | | CCU151 |
| 2.0 TSI | 4 | CAWB; CBFA; CCTA; CCZA | 147/197 | 06/08→01/12 | OE214 | 0,7 | CET11P | | | BAEA033E ^[7] |
| 2.0 TSI | 4 | CCZB | 155/208 | 11/10→01/12 | OE214 | 0,7 | CET11P | | | BAEA033E ^[7] |
| 3.6 FSI, 3.6 FSI 4WD | 6 | BLV; CNNA | 206/276 | 06/08→01/12 | | | | | | BAEA041E ^{[277] [324]} |
| 3.6 FSI 4WD | 6 | BWS | 220/295 | 06/08→05/10 | | | | | | BAEA041E ^{[277] [324]} |

PHAETON

| | | | | | | | | | | |
|--------------------|----|------------|---------|-------------|-------|-----|------|-------|--|--|
| 3.2 V6, 3.2 V6 4WD | 6 | AYT; BKL | 177/237 | 04/02→11/08 | OE215 | 0,9 | | | | BAEA044E ^[356] |
| 3.2 V6 4WD | 6 | BRK | 177/237 | 02/04→11/08 | | | | | | BAEA044E ^[356] |
| 3.6 V6 4WD | 6 | CHNA; CMVA | 206/276 | 11/08→03/16 | | | | | | BAEA041E ^{[277] [324]} |
| 4.2 V8 4WD | 8 | BGH; BGJ | 246/330 | 05/03→03/16 | | | CET2 | OE188 | | BAEA062E ^[277] |
| 5.0 V10 TDI 4WD | 10 | AJS | 230/308 | 11/02→10/06 | CH181 | 11v | | | | |
| 6.0 W12 4WD | 12 | BAN | 309/414 | 04/02→12/05 | OE176 | 1,0 | CET3 | | | BAEA031E ^[277] Ch.3D-4-030001→ |
| 6.0 W12 4WD | 12 | BRN; BTT | 331/444 | 05/05→03/16 | OE176 | 1,0 | CET3 | | | BAEA031E ^[277] |

POINTER

| | | | | | | | | | | |
|--------|---|--|-------|-------------|-------|-----|--|--|--|--|
| 1.9 TD | 4 | | 55/74 | 08/95→09/97 | CH260 | 11v | | | | |
|--------|---|--|-------|-------------|-------|-----|--|--|--|--|

POLO

| | | | | | | | | | | |
|-------------|---|----------|--------|-------------|-------|-----|------|-------|--|--|
| 1.0 | 3 | CHYA | 44/59 | 01/14→ | OE247 | 1,0 | | | | BAEA067E ^[240] 03/15→ |
| 1.0 | 3 | CHYB | 55/74 | 01/14→ | OE247 | 1,0 | | | | BAEA067E ^[240] 03/15→ |
| 1.0 | 4 | ALD | 37/50 | 08/96→12/01 | OE176 | 1,0 | CET3 | | | BAE907AE ^[262] CLS038 |
| 1.0 | 4 | AUC | 37/50 | 08/96→12/01 | OE176 | 1,0 | CET3 | | | BAE907AE ^[262] CLS053 |
| 1.0 45 | 4 | AEV | 33/44 | 10/94→09/96 | OE025 | 1,0 | CET8 | OE195 | | BAE851AE ^{[261] [292]} CLS100 |
| 1.0 50 | 4 | AER; ALL | 37/50 | 09/96→10/99 | OE027 | 1,0 | CET8 | | | BAE851AE ^{[261] [292]} CLS041 |
| 1.0 TSI | 3 | CHZB | 70/94 | 11/14→ | | | | | | BAEA067E ^[240] 03/15→ |
| 1.0 TSI | 3 | CHZC | 81/109 | 11/14→ | | | | | | BAEA067E ^[240] 03/15→ |
| 1.2 | 3 | AWY; BMD | 40/54 | 01/02→05/07 | OE177 | 0,9 | CET3 | | | BAEA059E |
| 1.2 | 3 | BBM | 44/59 | 05/07→ | OE177 | 0,9 | CET3 | | | BAEA059E |
| 1.2 | 3 | CGPB | 44/59 | 05/07→ | OE177 | 0,9 | CET3 | | | BAE408AE Ch.6R-A-000001→ |
| 1.2 | 3 | CGPA | 51/68 | 06/09→ | OE177 | 0,9 | CET3 | | | BAE408AE Ch.6R-A-000001→ |
| 1.2 12V | 3 | AZQ; BME | 47/63 | 10/01→07/07 | OE177 | 0,9 | CET3 | | | BAE408AE |
| 1.2 12V | 3 | BZG | 51/68 | 05/07→11/09 | OE177 | 0,9 | CET3 | | | BAE408AE |
| 1.2 TSI | 4 | CBZC | 66/89 | 05/11→05/14 | | | | OE260 | | BAE907AE ^[262] CLS090 |
| 1.2 TSI | 4 | CBZB | 77/103 | 11/09→ | | | | OE260 | | BAE907AE ^[262] CLS090 |
| 1.2 TSI | 4 | CJZD | 81/109 | 01/14→ | OE244 | 0,8 | | | | BAEA067E ^[240] 03/15→ |
| 1.2 TSI 16V | 4 | CJZC | 66/89 | 02/14→ | OE244 | 0,8 | | | | BAEA067E ^[240] BAEA126E ^[249] |
| 1.3 55 | 4 | ADX | 40/54 | 10/94→07/95 | OE025 | 1,0 | CET8 | OE195 | | BAE851AE ^{[261] [292]} CLS100 |
| 1.4 | 4 | AKP; ANX | 40/54 | 12/98→09/01 | OE176 | 1,0 | CET3 | | | BAE907AE ^[262] |

CHAMPION



kW/BHP

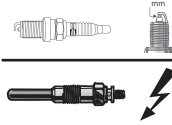

eon TITAN

IRIDIUM

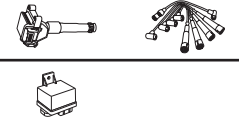

...VW

...POLO

| | | | | | | | | | | |
|---|---|--------------------|---------|-------------|--|------------|--|------------------------|---------------------------------------|------------------|
| 1.4 | 4 | AEX; AKV; ANX; APQ | 44/59 | 05/97→09/01 | OE027 | 1,0 | CET8 | | BAE851AE [261] [292] | CLS109 |
| 1.4 | 4 | AKK | 44/59 | 05/97→09/01 | OE176 | 1,0 | CET3 | | BAE907AE ^[262] | CLS053 CLS109 |
| 1.4 | 4 | ANW | 44/59 | 05/97→09/01 | OE176 | 1,0 | CET3 | | BAE851AE [261] [292] | CLS053 |
| 1.4 | 4 | BKY | 55/74 | 07/06→04/12 | OE176 ^[285] OE177 ^[287] | 1,0 0,9 | CET3 ^[287] CET3 ^[285] | | BAE408AE | |
| 1.4 | 4 | BLM | 61/82 | 08/02→11/09 | | | | | BAE408AE | |
| 1.4 | 4 | AGY | 62/83 | 05/96→07/02 | OE032 | 1,0 | CET2 | OE179 | | |
| 1.4 | 4 | CDDA; CGGB; CLPA | 63/84 | 12/03→ | OE177 | 0,9 | CET3 | | BAE408AE | |
| 1.4 | 4 | | 63/84 | 12/03→ | | | | | BAE907AE ^[262] | |
| 1.4 | 4 | BBZ | 74/99 | 11/03→ | OE032 | 1,0 | CET2 | OE188 | BAE408AE | |
| 1.4, 1.4 16V | 4 | BBY | 55/74 | 10/99→04/12 | OE032 ^[287] OE176 ^[285] | 1,0 1,0 | CET2 ^[287] CET3 ^[285] | OE179 ^[287] | BAE408AE | |
| 1.4 1.4 16V, 1.4 16V, 1.4 75 1.4 16V | 4 | AHW; APE; AUA | 55/74 | 10/99→05/08 | OE032 | 1,0 | CET2 | OE179 | BAE907AE ^[262] | CLS260 |
| 1.4, 1.4 60 | 4 | ANW; AUD | 44/59 | 07/95→09/01 | OE176 | 1,0 | CET3 | | BAE907AE ^[262] | CLS053 |
| 1.4 1.4 TDI | 3 | AMF | 55/74 | 10/99→09/01 | CH271 | 11v | | | CCU081 | |
| 1.4 16V | 4 | APE | 55/74 | 10/99→05/08 | OE032 | 1,0 | CET2 | OE179 | | CLS260 |
| 1.4 16V | 4 | AUA | 55/74 | 10/99→05/08 | OE032 | 1,0 | CET2 | OE179 | BAE907AE ^[262] | CLS260 |
| | | | | | OE032 ^[287] OE176 ^[285] | 1,0 1,0 | CET2 ^[287] CET3 ^[285] | OE179 ^[287] | | |
| 1.4 16V | 4 | BKY | 55/74 | 10/99→05/08 | OE176 ^[285] OE177 ^[287] | 1,0 0,9 | CET3 ^[285] CET3 ^[287] | | | |
| 1.4 16V | 4 | BUD | 59/79 | 05/06→11/09 | OE177 | 0,9 | CET3 | | BAE408AE | |
| 1.4 16V | 4 | AFK | 74/99 | 10/99→05/08 | OE032 | 1,0 | CET2 | OE179 | BAE907AE ^[262] | CLS178 CLS260 |
| 1.4 16V | 4 | AQQ | 74/99 | 10/99→05/08 | OE032 | 1,0 | CET2 | OE179 | | CLS178 CLS260 |
| 1.4 16V | 4 | AUB | 74/99 | 10/99→05/08 | OE032 | 1,0 | CET2 | OE179 | BAE408AE BAE907AE ^[262] | CLS178 CLS260 |
| 1.4 16V | 4 | BBZ | 74/99 | 10/99→05/08 | OE032 | 1,0 | CET2 | | BAE408AE | |
| 1.4 54 | 4 | ANX | 40/54 | 01/98→08/99 | OE025 | 1,0 | CET8 | OE195 | BAE851AE [261] [292] | |
| 1.4 55 | 4 | AEX | 40/54 | 08/95→10/99 | OE027 | 1,0 | CET8 | | BAE851AE [261] [292] | CLS109 |
| 1.4 60 | 4 | ANX | 44/59 | 07/95→09/01 | OE027 | 1,0 | CET8 | | BAE851AE [261] [292] | |
| 1.4 60 | 4 | AEX; AKV; APQ | 44/59 | 07/95→09/01 | OE025 OE027 | 1,0 1,0 | CET8 | | BAE851AE [261] [292] | CLS109 |
| 1.4 60 | 4 | AKK | 44/59 | 07/95→09/01 | OE176 | 1,0 | CET3 | | BAE907AE ^[262] | CLS109 |
| 1.4 100 1.4 16V | 4 | AFH | 74/99 | 04/96→10/99 | OE032 | 1,0 | CET2 | OE188 | BAE851AE [261] [292] | CLS178 |
| 1.4 BiFuel | 4 | CMAA | 60/80 | 03/10→01/11 | OE177 | 0,9 | CET3 | | BAE408AE | |
| 1.4 FSI | 4 | AXU | 63/84 | 02/02→07/06 | | | | | BAE408AE | |
| 1.4 GTI | 4 | CAVE; CTHE | 132/177 | 05/10→ | | | | | BAE408AE | |
| 1.4 TDI | 3 | BNM | 51/68 | 04/05→11/09 | CH181 | 11v | | | CCU081 | |
| 1.4 TDI | 3 | BWB | 51/68 | 04/05→11/09 | CCGP002 | 7v | | | | |
| 1.4 TDI | 3 | AMF; BAY | 55/74 | 10/01→ | CH181 | 11v | | | CCU081 | |
| 1.4 TDI | 3 | CUSA; CYZB | 55/74 | 10/01→ | CPSG007 | 4.4v | | | | |
| 1.4 TDI | 3 | BNV | 59/79 | 04/05→11/09 | CH181 | 11v | | | CCU081 | |
| 1.4 TDI | 3 | BMS | 59/79 | 04/05→11/09 | CCGP002 | 7v | | | | |
| 1.4 TDi | 3 | ATL | 66/89 | 01/00→10/00 | | | | | CCU081 | |
| 1.4 TDI | 3 | CUSB | 66/89 | 02/14→ | CPSG007 | 4.4v | | | | |

VW



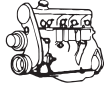

kW/BHP

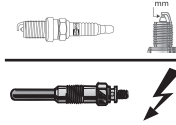

eon TITAN

IRIDIUM

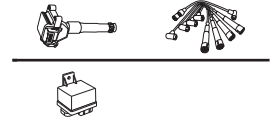

...VW

...POLO

| | | | | | | | | | | |
|------------------------------------|---|--------------------|---------|-------------|-------------------|-----|--------|-------|---------------------------|-------------------------|
| 1.4 TSI | 4 | CPTA | 103/138 | 10/12→ | OE244 | 0,8 | | | BAEA067E [240] [275] | |
| | | | | | | | | | BAEA126E [249] [275] | |
| 1.4 TSI | 4 | CZEA | 110/148 | 05/14→ | OE244 | 0,8 | | | BAEA067E ^[240] | |
| | | | | | | | | | 03/15→ | |
| 1.6 | 4 | ALM | 55/74 | 05/97→09/01 | OE027 | 1,0 | CET8 | | BAE851AE [261] [292] | CLS100 |
| 1.6 | 4 | CFNB | 63/84 | 05/10→ | OE177 | 0,9 | CET3 | | BAE408AE | |
| 1.6 | 4 | BAH | 74/99 | 05/97→ | OE235 | 1,0 | CET3 | | BAE907AE ^[262] | CLS081 |
| 1.6 | 4 | AEH; AKL; APF; AUR | 74/99 | 05/97→ | OE032 | 1,0 | CET2 | OE179 | BAE907AE ^[262] | CLS139 |
| | | | | | | | | | 09/99→ | |
| 1.6 | 4 | CCRA; CFZA | 74/99 | 05/97→ | OE235 | 1,0 | CET3 | | | |
| 1.6, 1.6 16V | 4 | BTS; CFNA; CLSA | 77/103 | 05/06→ | OE177 | 0,9 | CET3 | | BAE408AE | |
| 1.6 1.6 16V GTI | 4 | ARC; AVY | 92/123 | 10/99→09/01 | OE032 | 1,0 | CET2 | OE179 | BAE907AE ^[262] | |
| 1.6, 1.6 75 | 4 | AEA; AEE; AHS | 55/74 | 10/94→09/01 | OE025 | 1,0 | CET8 | OE195 | BAE851AE [261] [292] | CLS100 |
| 1.6, 1.6 100 | 4 | AFT | 74/99 | 12/95→ | OE032 | 1,0 | CET2 | OE179 | BAE851AE [261] [292] | CLS034 |
| 1.6 75 | 4 | 1F | 55/74 | 10/94→09/01 | OE027 | 1,0 | CET8 | | BAE851AE [261] [292] | CLS099 |
| 1.6 75 | 4 | AEE | 55/74 | 10/94→09/01 | OE025 | 1,0 | CET8 | OE195 | BAE851AE [261] [292] | CLS100 |
| | | | | | OE027 | 1,0 | | | | |
| 1.6 75 | 4 | ALM | 55/74 | 10/94→09/01 | OE027 | 1,0 | CET8 | | | CLS100 |
| 1.6 100 | 4 | AEH; AKL; APF; AUR | 74/99 | 12/95→09/01 | OE032 | 1,0 | CET2 | OE179 | BAE851AE [261] [292] | CLS139 |
| 1.6 120 1.6 16V GTI | 4 | AJV | 88/118 | 09/98→10/99 | OE032 | 1,0 | CET2 | OE179 | BAE907AE ^[262] | CLS260 |
| 1.6 BiFuel | 4 | CNKA | 60/80 | 01/11→ | OE177 | 0,9 | CET3 | | BAE408AE | |
| 1.6 TDI | 4 | CAYA | 55/74 | 06/09→ | | | | | CCU152 | |
| 1.6 TDI | 4 | CAYB | 66/89 | 06/09→ | | | | | CCU152 | |
| 1.6 TDI | 4 | CAYC; CLNA | 77/103 | 06/09→ | | | | | CCU152 | |
| 1.6 Total Flex | 4 | CCRA | 74/99 | 10/04→ | | | | | BAE907AE ^[262] | |
| 1.7 57 1.7 SDI, 1.7 SDI | 4 | AHG; AKW | 42/56 | 04/97→09/01 | CH271 | 11v | | | CCU081 | |
| 1.7 60 1.7 SDI, 1.7 SDI | 4 | AKU | 44/59 | 08/97→09/01 | CH271 | 11v | | | CCU081 | |
| 1.8 | 4 | ADZ | 66/89 | 05/97→09/01 | OE025 | 1,0 | CET8 | OE195 | BAE851AE [261] [292] | CLS110 ^[292] |
| 1.8 90 | 4 | ABS; ADZ | 66/89 | 01/97→09/01 | OE025 | 1,0 | CET8 | OE195 | BAE851AE [261] [292] | |
| 1.8 90 | 4 | ADD | 66/89 | 01/97→09/01 | OE025 | 1,0 | CET8 | OE195 | BAE851AE [261] [292] | CLS079 ^[292] |
| 1.8 GTI | 4 | BJX | 110/148 | 09/05→11/09 | OE136 | 0,8 | CET12P | OE179 | BAEA043E | |
| 1.8 GTI | 4 | DAJB | 141/189 | 11/14→ | | | | OE246 | BAEA068E →01/16 | |
| 1.8 GTI | 4 | DAJA | 141/189 | 11/14→ | | | | | BAEA068E →01/16 | |
| 1.8 GTi Cup Edition | 4 | BBU | 132/177 | 05/06→11/09 | OE136 | 0,8 | CET12P | OE179 | BAEA043E | |
| 1.9 64 1, 9 D, 1.9 64 1.9 D, 1.9 D | 4 | 1Y; AEF | 47/63 | 10/94→09/01 | CH260 | 11v | | | | |
| 1.9 64 1.9 SDI, 1.9 SDI | 4 | AEY; AGD; ASX; ASY | 47/63 | 12/95→ | CH271 | 11v | | | CCU081 | |
| 1.9 68 1.9 SDI, 1.9 SDI | 4 | AGP; AQM | 50/67 | 08/99→01/02 | CH271 | 11v | | | CCU081 | |
| 1.9 90 1.9 TDI, 1.9 TDI | 4 | AGR; AHU; ALE; ALH | 66/89 | 09/96→09/01 | CH271 | 11v | | | CCU081 | |
| 1.9 110 1.9 TDI, 1.9 TDI | 4 | AFN; ASV | 81/109 | 06/98→01/02 | CH271 | 11v | | | CCU081 | |
| 1.9 SDI | 4 | AEY | 48/64 | 06/96→09/01 | CH260 | 11v | | | CCU081 | |
| 1.9 TDI | 4 | AHU | 67/90 | 01/97→08/99 | CH271 | 11v | | | CCU081 | |
| 1.9 TDI | 4 | BMT | 74/99 | 10/01→12/10 | CCGP002 05/04→ | 7v | | | CCU152 | |
| 1.9 TDI | 4 | ASZ | 96/129 | 11/03→11/09 | | | | | CCU081 | |
| 1.9 TDI, 1.9 TDi | 4 | ATD; AXR | 74/99 | 10/01→ | CH181 | 11v | | | CCU081 | |
| 2.0 | 4 | BBX | 85/114 | 08/99→ | | | | | BAE907AE ^[262] | |
| | | | | | | | | | →06/11 | |



kW/BHP

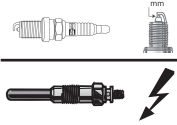

eon TITAN

IRIDIUM



...VW

...POLO

| | | | | | | | | |
|-----------|---|------|---------|--------|-------|-----|--------|-------------------------|
| 2.0 R WRC | 4 | CDLJ | 162/217 | 08/13→ | OE214 | 0,7 | CET11P | BAEA033E ^[7] |
|-----------|---|------|---------|--------|-------|-----|--------|-------------------------|

POLO VIVO

| | | | | | | | | |
|-----|---|------|-------|--------|--|--|--|----------|
| 1.4 | 4 | CLPB | 55/74 | 02/10→ | | | | BAE408AE |
|-----|---|------|-------|--------|--|--|--|----------|

| | | | | | | | | |
|-----|---|------|-------|--------|--|--|--|----------|
| 1.4 | 4 | CLPA | 63/84 | 02/10→ | | | | BAE408AE |
|-----|---|------|-------|--------|--|--|--|----------|

QUANTUM

| | | | | | | | | |
|--------|---|--|-------|-------------|-------|-----|--|--|
| 1.9 TD | 4 | | 55/74 | 10/93→06/97 | CH260 | 11v | | |
|--------|---|--|-------|-------------|-------|-----|--|--|

ROUTAN

| | | | | | | | | |
|-----|---|------|---------|-------------|--|--|--|-------------------------|
| 4.0 | 6 | CGVA | 187/251 | 09/08→11/10 | | | | BAEA453 ^[68] |
|-----|---|------|---------|-------------|--|--|--|-------------------------|

SANTANA

| | | | | | | | | |
|-------|---|-----|-------|-------------|-------|-----|------|--|
| 1.8 i | 4 | AFE | 72/97 | 01/95→09/12 | OE065 | 0,9 | CET8 | |
|-------|---|-----|-------|-------------|-------|-----|------|--|

SCIROCCO

| | | | | | | | | |
|---------|---|------------|--------|-------------|-------|-----|--|----------|
| 1.4 TSI | 4 | CAXA; CMSB | 90/121 | 08/08→11/17 | OE213 | 0,9 | | BAE408AE |
|---------|---|------------|--------|-------------|-------|-----|--|----------|

| | | | | | | | | |
|---------|---|------|--------|-------------|-------|-----|--|--|
| 1.4 TSI | 4 | CZCA | 92/123 | 11/13→11/17 | OE244 | 0,8 | | |
|---------|---|------|--------|-------------|-------|-----|--|--|

| | | | | | | | | |
|---------|---|------|--------|-------------|-------|-----|--|--|
| 1.4 TSI | 4 | CZDC | 96/129 | 07/15→11/17 | OE244 | 0,8 | | |
|---------|---|------|--------|-------------|-------|-----|--|--|

| | | | | | | | | |
|---------|---|------|---------|-------------|-------|-----|--|--|
| 1.4 TSI | 4 | CZDA | 110/148 | 07/15→11/17 | OE244 | 0,8 | | |
|---------|---|------|---------|-------------|-------|-----|--|--|

| | | | | | | | | |
|---------|---|------------------------|---------|-------------|--|--|--|----------|
| 1.4 TSI | 4 | CAVD; CNWA; CTHD; CTKA | 118/158 | 05/08→11/17 | | | | BAE408AE |
|---------|---|------------------------|---------|-------------|--|--|--|----------|

| | | | | | | | | |
|-------|---|------|---------|-------------|-------|-----|--------|-------------------------|
| 2.0 R | 4 | CDLC | 188/252 | 11/09→11/17 | OE214 | 0,7 | CET11P | BAEA033E ^[7] |
|-------|---|------|---------|-------------|-------|-----|--------|-------------------------|

| | | | | | | | | |
|-------|---|------|---------|-------------|-------|-----|--------|-------------------------|
| 2.0 R | 4 | CDLA | 195/261 | 11/09→11/17 | OE214 | 0,7 | CET11P | BAEA033E ^[7] |
|-------|---|------|---------|-------------|-------|-----|--------|-------------------------|

| | | | | | | | | |
|-------|---|------|---------|-------------|--|--|--|--|
| 2.0 R | 4 | CDLK | 206/276 | 05/14→11/17 | | | | BAEA033E ^[7] ^[249] |
|-------|---|------|---------|-------------|--|--|--|--|

| | | | | | | | | |
|---------|---|------|---------|-------------|--|--|--|--------|
| 2.0 TDI | 4 | CFHB | 100/134 | 11/10→11/17 | | | | CCU152 |
|---------|---|------|---------|-------------|--|--|--|--------|

| | | | | | | | | |
|---------|---|------------|---------|-------------|--|--|--|--------|
| 2.0 TDI | 4 | CBDB; CFHC | 103/138 | 08/08→11/17 | | | | CCU152 |
|---------|---|------------|---------|-------------|--|--|--|--------|

| | | | | | | | | |
|---------|---|------|---------|-------------|---------|------|--|--------|
| 2.0 TDI | 4 | CUUB | 110/148 | 11/13→11/17 | CP5G007 | 4.4v | | CCU152 |
|---------|---|------|---------|-------------|---------|------|--|--------|

| | | | | | | | | |
|---------|---|------------|---------|-------------|--|--|--|--------|
| 2.0 TDI | 4 | CBBB; CFGB | 125/168 | 05/09→11/17 | | | | CCU152 |
|---------|---|------------|---------|-------------|--|--|--|--------|

| | | | | | | | | |
|---------|---|------|---------|-------------|--|--|--|--------|
| 2.0 TDI | 4 | CFGC | 130/174 | 01/13→11/17 | | | | CCU152 |
|---------|---|------|---------|-------------|--|--|--|--------|

| | | | | | | | | |
|---------|---|------------|---------|-------------|---------|------|--|--------|
| 2.0 TDI | 4 | CUWA; CUXA | 135/181 | 05/14→11/17 | CP5G007 | 4.4v | | CCU152 |
|---------|---|------------|---------|-------------|---------|------|--|--------|

| | | | | | | | | |
|---------|---|------|---------|-------------|--|--|-----------------|--|
| 2.0 TSI | 4 | CULA | 132/177 | 11/13→11/17 | | | OE246 01/15→ | |
|---------|---|------|---------|-------------|--|--|-----------------|--|

| | | | | | | | | |
|---------|---|------|---------|-------------|-------|-----|--------|-------------------------|
| 2.0 TSI | 4 | CAWB | 147/197 | 05/08→11/09 | OE214 | 0,7 | CET11P | BAEA033E ^[7] |
|---------|---|------|---------|-------------|-------|-----|--------|-------------------------|

| | | | | | | | | |
|---------|---|------|---------|-------------|-------|-----|--------|-------------------------|
| 2.0 TSI | 4 | CCZB | 155/208 | 11/09→11/17 | OE214 | 0,7 | CET11P | BAEA033E ^[7] |
|---------|---|------|---------|-------------|-------|-----|--------|-------------------------|

| | | | | | | | | |
|---------|---|------|---------|-------------|--|--|-----------------|--|
| 2.0 TSI | 4 | CULC | 162/217 | 11/13→11/17 | | | OE246 01/15→ | |
|---------|---|------|---------|-------------|--|--|-----------------|--|

SHARAN

| | | | | | | | | |
|---------|---|------|---------|--------|-------|-----|--|---------------------------|
| 1.4 TSI | 4 | CZDA | 110/148 | 05/10→ | OE244 | 0,8 | | BAEA067E ^[240] |
|---------|---|------|---------|--------|-------|-----|--|---------------------------|

| | | | | | | | | |
|---------|---|------------------|---------|--------|--|--|--|----------|
| 1.4 TSI | 4 | CAVA; CNWB; CTHA | 110/148 | 05/10→ | | | | BAE408AE |
|---------|---|------------------|---------|--------|--|--|--|----------|

| | | | | | | | | |
|-----------|---|-----|---------|-------------|-------|-----|------|-------|
| 1.8 T 20V | 4 | AJH | 110/148 | 09/97→03/10 | OE032 | 1,0 | CET2 | OE179 |
|-----------|---|-----|---------|-------------|-------|-----|------|-------|

| | | | | | | | | |
|-----------|---|-----|---------|-------------|-------|-----|--------|-------|
| 1.8 T 20V | 4 | AWC | 110/148 | 09/97→03/10 | OE136 | 0,8 | CET12P | OE179 |
|-----------|---|-----|---------|-------------|-------|-----|--------|-------|

| | | | | | | | | |
|---------|---|-------|---------|--------|-------|-----|--------|--|
| 1.8 TSI | 4 | CDA A | 118/158 | 11/11→ | OE214 | 0,7 | CET11P | |
|---------|---|-------|---------|--------|-------|-----|--------|--|

| | | | | | | | | |
|---------|---|--------------|-------|-------------|-------|-----|--|--------|
| 1.9 TDI | 4 | 1Z; AHU; ANU | 66/89 | 09/95→03/10 | CH271 | 11v | | CCU081 |
|---------|---|--------------|-------|-------------|-------|-----|--|--------|

| | | | | | | | | |
|---------|---|----------|--------|-------------|-------|-----|--|--------|
| 1.9 TDI | 4 | AFN; AVG | 81/109 | 09/96→04/00 | CH271 | 11v | | CCU081 |
|---------|---|----------|--------|-------------|-------|-----|--|--------|

| | | | | | | | | |
|---------|---|-----|--------|-------------|-------|-----|--|--------|
| 1.9 TDI | 4 | ASZ | 96/129 | 11/02→03/10 | CH181 | 11v | | CCU081 |
|---------|---|-----|--------|-------------|-------|-----|--|--------|

| | | | | | | | | |
|---------|---|-----|---------|-------------|--|--|--|--------|
| 1.9 TDI | 4 | BTB | 110/148 | 06/05→03/10 | | | | CCU081 |
|---------|---|-----|---------|-------------|--|--|--|--------|

| | | | | | | | | |
|----------------------|---|----------|--------|-------------|--------------------------|-----|--|--------|
| 1.9 TDI, 1.9 TDI 4WD | 4 | AUY; BVK | 85/114 | 04/00→03/10 | CH271 →Ch.7M-2-030004 | 11v | | CCU081 |
|----------------------|---|----------|--------|-------------|--------------------------|-----|--|--------|

| | | | | | | | | |
|-----|---|-----|--------|-------------|-------|-----|------|-------|
| 2.0 | 4 | ADY | 85/114 | 09/95→03/10 | OE032 | 1,0 | CET2 | OE179 |
|-----|---|-----|--------|-------------|-------|-----|------|-------|

| | | | | | | | | |
|-----|---|-----|--------|-------------|-------|-----|------|-------|
| 2.0 | 4 | ATM | 85/114 | 09/95→03/10 | OE032 | 1,0 | CET2 | OE179 |
|-----|---|-----|--------|-------------|-------|-----|------|-------|

| | | | | | | | | |
|---------|---|--|---------|-------------|-------|-----|--------|-------|
| 2.0 16V | 4 | | 110/148 | 09/95→02/00 | OE136 | 0,8 | CET12P | OE179 |
|---------|---|--|---------|-------------|-------|-----|--------|-------|

| | | | | | | | | |
|---------|---|-----|--------|-------------|-------|-----|------|-------|
| 2.0 LPG | 4 | ATM | 85/114 | 04/06→03/10 | OE032 | 1,0 | CET2 | OE179 |
|---------|---|-----|--------|-------------|-------|-----|------|-------|

| | | | | | | | | |
|---------|---|------------------|--------|--------|--|--|--|--------|
| 2.0 TDI | 4 | CFFE; CUVA; DFLD | 85/114 | 05/11→ | | | | CCU151 |
|---------|---|------------------|--------|--------|--|--|--|--------|

| | | | | | | | | |
|---------|---|-----|---------|--------|---------|----|--|--|
| 2.0 TDI | 4 | BVH | 100/134 | 11/05→ | CCGP002 | 7v | | |
|---------|---|-----|---------|--------|---------|----|--|--|

VW



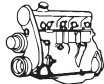

kW/BHP



eon TITAN

IRIDIUM



...VW

...SHARAN

| | | | | | | | | | | | |
|----------------------------|---|------------|---------|-------------|---------|------|--------|-----------------|--|-------------------------|-----------------------------------|
| 2.0 TDI | 4 | CFFA | 100/134 | 11/05→ | | | | | | CCU151 | |
| 2.0 TDI | 4 | BRT | 103/138 | 11/05→ | CCGP002 | 7v | | | | | |
| 2.0 TDI | 4 | CFGB | 125/168 | 08/10→ | | | | | | CCU151 | |
| 2.0 TDI | 4 | CFGC | 130/174 | 01/13→ | | | | | | CCU151 | |
| 2.0 TDI, 2.0 TDI 4WD | 4 | CFFB | 103/138 | 11/05→ | | | | | | CCU151 | |
| 2.0 TDI, 2.0 TDI 4WD | 4 | CUVC; DFLA | 110/148 | 05/15→ | CPSG007 | 4.4v | | | | | |
| 2.0 TDI, 2.0 TDI 4WD | 4 | CUWA; DFMA | 135/181 | 05/15→ | CPSG007 | 4.4v | | | | | |
| 2.0 TSI | 4 | CCZA | 147/197 | 12/10→ | OE214 | 0,7 | CET11P | | | BAEA033E ^[7] | |
| 2.0 TSI | 4 | DEDA | 162/217 | 05/15→ | | | | OE246 01/16→ | | | |
| 2.8 V6 24V, 2.8 V6 24V 4WD | 6 | AYL | 150/201 | 04/00→03/10 | OE176 | 1,0 | CET3 | | | BAEA063E | CLS185 |
| 2.8 VR6 | 6 | AAA | 128/172 | 09/95→04/00 | | | CET12P | OE180 | | BAEA004E | CLS240 →Ch.7M-V-060000 |
| 2.8 VR6 | 6 | AMY | 128/172 | 09/95→04/00 | | | CET12P | OE180 | | BAEA004E | |
| 2.8 VR6 4WD | 6 | AAA; AMY | 128/172 | 11/96→04/00 | | | CET12P | OE180 | | BAEA004E | CLS199 ^[292] CLS240 |

TARO

| | | | | | | | | | | | |
|------------------|---|----|-------|-------------|-------|-----|--|--|--|--|--|
| 2.4 D, 2.4 D 4WD | 4 | 2L | 58/78 | 07/94→03/97 | CH154 | 11v | | | | | |
|------------------|---|----|-------|-------------|-------|-----|--|--|--|--|--|

TIGUAN

| | | | | | | | | | | | |
|----------------------|---|------------------|---------|-------------|-------------------------|------|--------|-------|--|---------------------------|--|
| 1.4 TSI | 4 | CAXA | 90/121 | 08/10→ | OE213 ModelYear→2018 | 0,9 | | | | BAE408AE | |
| 1.4 TSI | 4 | CZDB | 92/123 | 05/15→ | OE244 | 0,8 | | | | BAEA067E ^[240] | |
| 1.4 TSI | 4 | CZCA | 92/123 | 05/15→ | OE244 | 0,8 | | | | | |
| 1.4 TSI | 4 | CZDA | 110/148 | 05/08→ | OE244 | 0,8 | | | | BAEA067E ^[240] | |
| 1.4 TSI, 1.4 TSI 4WD | 4 | BWK; CAVA; CTHA | 110/148 | 09/07→ | | | | | | BAE408AE | |
| 1.4 TSI, 1.4 TSI 4WD | 4 | CAVD; CTHD | 118/158 | 05/11→ | | | | | | BAE408AE | |
| 1.4 TSI, 1.4 TSI 4WD | 4 | CZDA; CZEA; DJVA | 110/148 | 09/07→ | OE244 | 0,8 | | | | | |
| 1.6 TDI | 4 | DGDB | 85/114 | 05/16→ | CPSG007 | 4.4v | | | | | |
| 2.0 TDI | 4 | CFFD; CUVE | 81/109 | 05/10→ | | | | | | CCU152 | |
| 2.0 TDI | 4 | CYKC | 81/109 | 05/10→ | CPSG007 | 4.4v | | | | | |
| 2.0 TDI | 4 | DFGC | 85/114 | 05/16→ | CPSG007 | 4.4v | | | | | |
| 2.0 TDI, 2.0 TDI 4WD | 4 | CBAB; CFFB; CLJA | 103/138 | 09/07→ | | | | | | CCU152 | |
| 2.0 TDI, 2.0 TDI 4WD | 4 | CUVC; DBGK; DFGA | 110/148 | 05/15→ | CPSG007 | 4.4v | | | | | |
| 2.0 TDI 4WD | 4 | CBAA; CFFA | 100/134 | 11/07→ | | | | | | CCU152 | |
| 2.0 TDI 4WD | 4 | CBBA | 120/161 | 02/08→08/09 | | | | | | CCU152 | |
| 2.0 TDI 4WD | 4 | CBBB; CFGB | 125/168 | 09/07→ | | | | | | CCU152 | |
| 2.0 TDI 4WD | 4 | CFGC | 130/174 | 11/12→ | | | | | | CCU152 | |
| 2.0 TDI 4WD | 4 | CUWA | 135/181 | 05/15→ | CPSG007 | 4.4v | | | | | |
| 2.0 TDI 4WD | 4 | DFHA | 140/188 | 04/16→ | CPSG007 | 4.4v | | | | | |
| 2.0 TDI 4WD | 4 | CUAA | 176/236 | 05/16→ | CPSG007 | 4.4v | | | | | |
| 2.0 TFSI 4WD | 4 | CAWA; CCZC | 125/168 | 09/07→ | OE214 | 0,7 | CET11P | | | BAEA033E ^[7] | |
| 2.0 TFSI 4WD | 4 | CAWB; CCTA; CCZA | 147/197 | 09/07→ | OE214 | 0,7 | CET11P | | | BAEA033E ^[7] | |
| 2.0 TSI 4WD | 4 | CCZD | 132/177 | 05/11→ | OE214 | 0,7 | CET11P | | | BAEA033E ^[7] | |
| 2.0 TSI 4WD | 4 | CZPA | 132/177 | 05/11→ | | | | OE246 | | BAEA137E | |
| 2.0 TSI 4WD | 4 | CCZB | 155/208 | 05/11→ | OE214 | 0,7 | CET11P | | | BAEA033E ^[7] | |
| 2.0 TSI 4WD | 4 | CHHB | 162/217 | 06/16→ | | | | OE246 | | | |

TIGUAN ALLSPACE

| | | | | | | | | | | | |
|----------------------|---|------------|---------|--------|--------------------------|------|--|--|--|--|--|
| 1.4 TSI | 4 | CZDA; CZEA | 110/148 | 04/17→ | OE244 | 0,8 | | | | | |
| 2.0 TDI, 2.0 TDI 4WD | 4 | DBGK; DFGA | 110/148 | 06/17→ | CPSG007 ^[275] | 4.4v | | | | | |
| 2.0 TDI 4WD | 4 | DFHA | 140/188 | 06/17→ | CPSG007 ^[275] | 4.4v | | | | | |
| 2.0 TDI 4WD | 4 | CUAA | 176/236 | 06/17→ | CPSG007 ^[275] | 4.4v | | | | | |

TOUAREG

| | | | | | | | | | | | |
|----------------|---|-----|---------|-------------|---------|-----|--|--|--|--------|--|
| 2.5 R5 TDI 4WD | 5 | BLK | 120/161 | 08/03→05/10 | CH181 | 11v | | | | CCU081 | |
| 2.5 R5 TDI 4WD | 5 | BPD | 120/161 | 08/03→05/10 | CCGP002 | 7v | | | | | |

CHAMPION

VW



kW/BHP

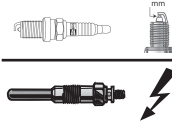

eon TITAN

IRIDIUM

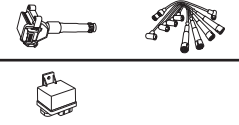

...VW

...TOUAREG

| | | | | | | | | | |
|-----------------------|----|------------------------------|---------|-------------|---------|------|--------|-------|---|
| 2.5 R5 TDI 4WD | 5 | BAC | 128/172 | 01/03→05/10 | CH181 | 11v | | | CCU081 |
| 2.5 R5 TDI 4WD | 5 | BPE | 128/172 | 01/03→05/10 | CCGP002 | 7v | | | |
| 3.0 V6 TDI 4WD | 6 | CATA | 165/221 | 11/04→ | CPSG007 | 4.4v | | | |
| 3.0 V6 TDI 4WD | 6 | CNRB | 176/236 | 11/07→ | CPSG008 | 4.4v | | | |
| 3.0 V6 TSI 4WD | 6 | CJTA | 213/286 | 08/10→ | | | | | BAEA032E [13] |
| 3.0 V6 TSI Hybrid 4WD | 6 | CGEA; CGFA | 245/329 | 04/10→ | OE214 | 0,7 | CET11P | | BAEA032E [13] |
| 3.2 V6 4WD | 6 | AZZ; BAA; BKJ; BMV; BMX; BRJ | 162/217 | 10/02→11/06 | OE215 | 0,9 | | | BAEA044E [356] →06/05 |
| 3.2 V6 4WD | 6 | BMV | 177/237 | 11/04→11/06 | OE215 | 0,9 | | | BAEA044E [356] |
| 3.6 V6 FSI 4WD | 6 | CMTA | 183/245 | 08/10→ | | | | | BAEA041E [277] [324] |
| 3.6 V6 FSI 4WD | 6 | BHK; BHL; CGRA | 206/276 | 10/05→ | | | | | BAEA041E [277] [324] |
| 4.2 V8 4WD | 8 | AXQ; BHX | 228/306 | 12/02→11/06 | | | CET2 | OE188 | BAEA062E [277] |
| 4.2 V8 FSI 4WD | 8 | BAR | 257/345 | 06/06→05/10 | OE209 | 0,8 | CET11P | | BAEA032E [13] [75] BAEA033E [7] [76] [275] |
| 4.2 V8 FSI 4WD | 8 | CGNA | 265/355 | 01/11→ | OE209 | 0,8 | CET11P | | BAEA032E [13] |
| 4.2 V8 TDI 4WD | 8 | CKDA | 250/335 | 01/10→ | | | | | CCU151 |
| 5.0 V10 TDI 4WD | 10 | AYH | 230/308 | 10/02→05/10 | CH181 | 11v | | | |
| 5.0 V10 TDI 4WD | 10 | BLE | 230/308 | 10/02→05/10 | CCGP002 | 7v | | | |
| 5.0 R50 TDI 4WD | 10 | CBWA | 257/345 | 08/07→05/10 | CCGP002 | 7v | | | |
| 6.0 W12 4WD | 12 | BJN; CFRA | 331/444 | 08/04→05/10 | OE176 | 1,0 | CET3 | | BAEA031E [277] |
| TOURAN | | | | | | | | | |
| 1.2 TSI | 4 | CBZB | 77/103 | 05/10→05/15 | | | | OE260 | BAE907AE [262] CLS090 |
| 1.2 TSI | 4 | CVVB | 81/109 | 05/15→ | OE244 | 0,8 | | | BAEA067E [240] |
| 1.2 TSI | 4 | CZDA | 81/109 | 05/15→ | | | | | BAEA067E [240] |
| 1.4 FSI, 1.4 TSI | 4 | BLG; CAVB; CTHB | 125/168 | 11/06→05/15 | | | | | BAE408AE |
| 1.4 TSI | 4 | CTHC | 103/138 | 02/06→05/15 | | | | | BAE408AE |
| 1.4 TSI | 4 | BMV | 103/138 | 02/06→05/15 | | | | | BAE408AE →Ch.1K-8-281299 |
| 1.4 TSI | 4 | CAVC | 103/138 | 02/06→05/15 | | | | | BAE408AE BAE408AE →Ch.1K-8-281299 |
| 1.4 TSI | 4 | CZDA | 110/148 | 05/15→ | OE244 | 0,8 | | | BAEA067E [240] |
| 1.4 TSI | 4 | CVVB | 110/148 | 05/15→ | | | | | BAEA067E [240] |
| 1.4 TSI EcoFuel | 4 | CDGA | 110/148 | 05/09→05/15 | | | | | BAE408AE |
| 1.6 | 4 | BGU; BSE; BSF | 75/101 | 07/03→05/10 | OE032 | 1,0 | CET2 | OE179 | BAE907AE [262] CLS017 |
| 1.6 FSI | 4 | BAG; BLF; BLP | 85/114 | 02/03→01/07 | | | | | BAE408AE |
| 1.6 TDI | 4 | CAYB | 66/89 | 05/10→05/15 | | | | | CCU152 |
| 1.6 TDI | 4 | CAYC | 77/103 | 05/10→05/15 | | | | | CCU152 |
| 1.6 TDI | 4 | CRKB | 81/109 | 05/15→05/16 | CPSG007 | 4.4v | | | |
| 1.6 TDI | 4 | DGDA | 85/114 | 05/16→ | CPSG007 | 4.4v | | | |
| 1.8 TSI | 4 | CJSA | 132/177 | 11/15→ | | | | OE246 | |
| 1.9 TDI | 4 | BXF | 66/89 | 11/04→05/10 | | | | | CCU152 |
| 1.9 TDI | 4 | BXE | 77/103 | 08/03→05/10 | | | | | CCU152 |
| 1.9 TDI | 4 | BLS | 77/103 | 08/03→05/10 | | | | | CCU152 Ch.1T-6-160001→ |
| 2.0 EcoFuel | 4 | BSX | 80/107 | 02/06→05/09 | | | CET2 | OE179 | BAEA029E CLS070 |
| 2.0 FSI | 4 | BJZ | 85/114 | 10/04→05/10 | OE176 | 1,0 | CET3 | | |
| 2.0 FSI | 4 | AXW; BLR; BLX; BVY | 110/148 | 10/03→01/07 | OE234 | 1,0 | CET3 | | BAEA033E [7] |
| 2.0 FSI | 4 | BLY; BVZ | 110/148 | 10/03→01/07 | OE146 | 1,0 | CET12P | OE179 | BAEA033E [7] |
| 2.0 TDI | 4 | CFHF; CLCA | 81/109 | 11/10→ | | | | | CCU152 |
| 2.0 TDI | 4 | AZV | 100/134 | 02/03→05/10 | | | | | CCU152 Ch.1T-6-160001→ |
| 2.0 TDI | 4 | BMM | 103/138 | 12/05→05/15 | | | | | CCU152 |

VW





kW/BHP

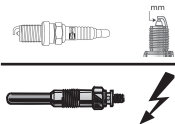

eon TITAN

IRIDIUM



...VW

...TOURAN

| | | | | | | | | | | |
|-------------|---|------------|---------|-------------|---------|------|--|--|--|---------------------------|
| 2.0 TDI | 4 | CFHC | 103/138 | 12/05→05/15 | | | | | | CCU152 |
| 2.0 TDI | 4 | DFEA; DFGA | 110/148 | 05/15→ | CP5G007 | 4.4v | | | | |
| 2.0 TDI | 4 | BMN | 125/168 | 12/05→01/13 | CCGP003 | 7v | | | | CCU152 |
| 2.0 TDI | 4 | CFJA | 125/168 | 12/05→01/13 | | | | | | CCU152 |
| 2.0 TDI | 4 | CFJB | 130/174 | 01/13→05/15 | | | | | | CCU152 |
| 2.0 TDI | 4 | DFHA | 140/188 | 11/15→ | CP5G007 | 4.4v | | | | |
| 2.0 TDI 16V | 4 | BKD | 103/138 | 08/03→05/10 | | | | | | CCU152 Ch.TT-6-160001→ |

UP

| | | | | | | | | | | |
|-------------|---|------------|-------|--------|-------|-----|--|--|--|--|
| 1.0 | 3 | CHYA; DAFA | 44/59 | 08/11→ | OE247 | 1,0 | | | | BAEA067E ^[240] BAEA126E ^[249] |
| 1.0 | 3 | CHYB | 55/74 | 08/11→ | OE247 | 1,0 | | | | BAEA067E ^[240] BAEA126E ^[249] |
| 1.0 EcoFuel | 3 | CPGA | 50/67 | 11/12→ | OE244 | 0,8 | | | | BAEA067E ^[240] ^[275] BAEA126E ^[249] ^[275] |

VENTO

| | | | | | | | | | | |
|---------|---|---------|--------|-------------|-------|-----|------|-------|--|--------|
| 1.2 | 4 | CBZB | 77/103 | 01/10→ | | | | OE260 | | |
| 1.6 | 4 | AFT | 74/99 | 10/94→09/98 | OE032 | 1,0 | CET2 | OE179 | BAE851AE →12/95 [261] ^[292] | CLS034 |
| 1.6 | 4 | AEK | 74/99 | 10/94→09/98 | OE123 | 0,7 | CET2 | OE179 | BAE851AE →12/95 [261] ^[292] | CLS043 |
| 1.9 SDI | 4 | AEY | 47/63 | 04/97→09/98 | CH271 | 11v | | | | CCU081 |
| 1.9 TDI | 4 | ALE | 66/89 | 09/93→09/98 | CH271 | 11v | | | | |
| 1.9 TDI | 4 | 1Z; AHU | 66/89 | 09/93→09/98 | CH271 | 11v | | | | CCU081 |
| 1.9 TDI | 4 | AFN | 81/109 | 04/96→09/98 | CH271 | 11v | | | | CCU081 |
| 2.0 GL | 4 | AEP | 79/106 | 05/96→12/97 | OE025 | 1,0 | CET8 | OE195 | | |

VOYAGE

| | | | | | | | | | | |
|----------|---|------|-------|-------------|-------|-----|------|-------|---------------------------|--|
| 1.4 | 4 | AGY | 62/83 | 05/96→07/02 | OE032 | 1,0 | CET2 | OE179 | | |
| 1.6 Flex | 4 | CFZA | 74/99 | 07/08→ | OE235 | 1,0 | CET3 | | BAE907AE ^[262] | |
| 1.9 TDi | 4 | 1Z | 66/89 | 09/99→09/01 | CH271 | 11v | | | | |

XLI

| | | | | | | | | | | |
|------------------|---|------|-------|--------|---------|------|--|--|--|--|
| 0.8 TDI E-Hybrid | 2 | CSCA | 35/47 | 02/14→ | CP5G007 | 4.4v | | | | |
|------------------|---|------|-------|--------|---------|------|--|--|--|--|

VW

AMAROK

| | | | | | | | | | | |
|----------------------|---|------------|---------|--------|--|--|--|--|--|--------|
| 2.0 TDI | 4 | CDBA; CNFA | 90/121 | 09/11→ | | | | | | CCU152 |
| 2.0 TDI | 4 | CNFB | 103/138 | 09/11→ | | | | | | CCU152 |
| 2.0 TDI, 2.0 TDI 4WD | 4 | CDCA | 120/161 | 09/11→ | | | | | | CCU152 |
| 2.0 TDI, 2.0 TDI 4WD | 4 | CNEA; CSHA | 132/177 | 09/11→ | | | | | | CCU152 |
| 2.0 TDI 4motion 4WD | 4 | CNFB | 103/138 | 09/11→ | | | | | | CCU152 |

CADDY ALLTRACK

| | | | | | | | | | | |
|----------------------|---|------------|---------|--------|---------|------|--|--|--|--------|
| 1.2 TSI | 4 | CYVC | 62/83 | 06/15→ | OE244 | 0,8 | | | | |
| 1.4 TSI | 4 | CZCB | 92/123 | 05/15→ | OE244 | 0,8 | | | | |
| 2.0 TDI | 4 | CUUF; DFSF | 55/74 | 05/15→ | CP5G007 | 4.4v | | | | CCU152 |
| 2.0 TDI | 4 | CUUD; DFSD | 75/101 | 05/15→ | CP5G007 | 4.4v | | | | CCU152 |
| 2.0 TDI, 2.0 TDI 4WD | 4 | CUUB; DFSB | 110/148 | 05/15→ | CP5G007 | 4.4v | | | | CCU152 |
| 2.0 TDI 4WD | 4 | CUUE; DFSE | 90/121 | 05/15→ | CP5G007 | 4.4v | | | | CCU152 |

CADDY II

| | | | | | | | | | | |
|--------|---|-----|-------|-------------|-------|-----|------|-------|---------------------------|--------|
| 1.4 | 4 | AUA | 55/74 | 08/00→01/04 | OE032 | 1,0 | CET2 | OE179 | BAE907AE ^[262] | CLS260 |
| 1.4 60 | 4 | AUD | 44/59 | 11/95→01/04 | OE176 | 1,0 | | | BAE907AE ^[262] | CLS053 |



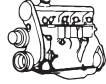

kW/BHP

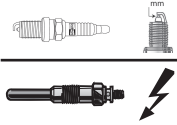

eon TITAN

IRIDIUM

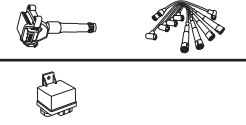

...VW

...CADDY II

| | | | | | | | | | | |
|---------|---|--------------|-------|-------------|-------|-----|------|--|-------------------------|--------|
| 1.4 60 | 4 | AEX; APQ | 44/59 | 11/95→01/04 | OE025 | 1,0 | CET8 | | BAE851AE [261] [292] | CLS109 |
| 1.6 75 | 4 | AEE | 55/74 | 11/95→09/00 | OE027 | 1,0 | CET8 | | BAE851AE [261] [292] | CLS109 |
| 1.6 75 | 4 | 1F | 55/74 | 11/95→09/00 | OE027 | 1,0 | CET8 | | BAE851AE [261] [292] | CLS099 |
| 1.7 SDI | 4 | AHB | 42/56 | 07/96→09/00 | CH271 | 11v | | | CCU081 | |
| 1.9 D | 4 | 1Y | 47/63 | 11/95→01/04 | CH260 | 11v | | | | |
| 1.9 SDI | 4 | AEY | 47/63 | 11/95→01/04 | CH271 | 11v | | | CCU081 | |
| 1.9 SDI | 4 | AYQ | 47/63 | 11/95→01/04 | | | | | CCU081 | |
| 1.9 TDI | 4 | AEY | 66/89 | 09/96→01/04 | CH271 | 11v | | | | |
| 1.9 TDI | 4 | 1Z; AHU; ALH | 66/89 | 09/96→01/04 | | | | | CCU081 | |

CADDY III

| | | | | | | | | | | |
|------------------------------|---|---------------|---------|-------------|-------|-----|------|-------|-----------------------------|--------|
| 1.2 TSI | 4 | CBZA | 63/84 | 09/10→05/15 | | | | OE260 | BAE907AE [262] | CLS090 |
| 1.2 TSI | 4 | CBZB | 77/103 | 09/10→05/15 | | | | OE260 | BAE907AE [262] | CLS090 |
| 1.4 | 4 | BCA | 55/74 | 03/04→05/06 | OE032 | 1,0 | CET2 | OE179 | BAE408AE | |
| 1.4 | 4 | BUD | 59/79 | 05/06→08/10 | OE177 | 0,9 | CET3 | | BAE408AE →Ch.1K-8-281299 | |
| 1.6 | 4 | BGU; BSE; BSF | 75/101 | 04/04→05/15 | OE032 | 1,0 | CET2 | OE179 | BAE907AE [262] | CLS017 |
| 1.6 BiFuel | 4 | CHGA | 75/101 | 05/11→05/15 | OE032 | 1,0 | CET2 | OE179 | BAE907AE [262] | |
| 1.6 TDI | 4 | CAYE | 55/74 | 08/10→05/15 | | | | | CCU152 | |
| 1.6 TDI | 4 | CAYD | 75/101 | 08/10→05/15 | | | | | CCU152 | |
| 1.9 TDI | 4 | BSU | 55/74 | 09/05→08/10 | | | | | CCU152 Ch.2K-6-000001→ | |
| 1.9 TDI | 4 | BLS | 77/103 | 04/04→08/10 | | | | | CCU152 Ch.2L-6-000001→ | |
| 1.9 TDI 4WD | 4 | BLS | 77/103 | 11/08→08/10 | | | | | CCU152 | |
| 2.0 EcoFuel | 4 | BSX | 80/107 | 04/06→05/15 | | | CET2 | OE179 | BAEA029E | CLS070 |
| 2.0 SDI | 4 | BDJ; BST | 51/68 | 03/04→08/10 | CH181 | 11v | | | CCU081 | |
| 2.0 TDI | 4 | BMM | 103/138 | 09/07→08/10 | | | | | CCU152 | |
| 2.0 TDI | 4 | CFJA | 125/168 | 05/12→05/15 | | | | | CCU152 | |
| 2.0 TDI, 2.0 TDI 4WD | 4 | CFHE | 62/83 | 11/10→05/15 | | | | | CCU152 | |
| 2.0 TDI, 2.0 TDI 4WD | 4 | CFHF; CLCA | 81/109 | 08/10→05/15 | | | | | CCU152 | |
| 2.0 TDI 16V, 2.0 TDI 16V 4WD | 4 | CFHC; CLCB | 103/138 | 11/10→05/15 | | | | | CCU152 | |

CADDY IV

| | | | | | | | | | | |
|----------------------|---|------------------|---------|--------|---------|------|--|--|----------------|--|
| 1.2 TSI | 4 | CYVC | 62/83 | 06/15→ | OE244 | 0,8 | | | BAEA067E [240] | |
| 1.4 TGI CNG | 4 | CPWA | 81/109 | 06/15→ | | | | | BAEA067E [240] | |
| 1.4 TSI | 4 | CZCB | 92/123 | 05/15→ | OE244 | 0,8 | | | BAEA067E [240] | |
| 1.6 TDI | 4 | CAYE | 55/74 | 05/15→ | | | | | CCU152 | |
| 1.6 TDI | 4 | CAYD | 75/101 | 05/15→ | | | | | CCU152 | |
| 2.0 TDI | 4 | CUUD; DFSD | 75/101 | 05/15→ | CPSG007 | 4.4v | | | CCU152 | |
| 2.0 TDI, 2.0 TDI 4WD | 4 | CUUF; DFSC; DFSF | 55/74 | 05/15→ | CPSG007 | 4.4v | | | CCU152 | |
| 2.0 TDI, 2.0 TDI 4WD | 4 | CFHC; CLCB | 103/138 | 05/15→ | | | | | CCU152 | |
| 2.0 TDI, 2.0 TDI 4WD | 4 | CUUB; DFSB | 110/148 | 05/15→ | CPSG007 | 4.4v | | | CCU152 | |
| 2.0 TDI 4WD | 4 | CFHF | 81/109 | 05/15→ | | | | | CCU152 | |
| 2.0 TDI 4WD | 4 | CUUE; DFSE | 90/121 | 05/15→ | CPSG007 | 4.4v | | | CCU152 | |

CRAFTER

| | | | | | | | | | | |
|---------|---|------|--------|--------|---|------|--|--|--|--|
| 2.0 TDI | 4 | DAUB | 75/101 | 10/16→ | CPSG007 →Prod.03.07.2017 [67] [240] | 4.4v | | | | |
| | | | | | CPSG008 →Prod.03.07.2017 [70] [241] | 4.4v | | | | |

VW



kW/BHP

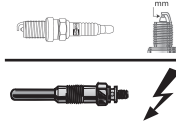

eon TITAN

IRIDIUM



...VW

...CRAFTER

| | | | | | | | | | |
|----------------------|---|------|---------|---------|--|------|--|--|--|
| 2.0 TDI | 4 | DAUA | 103/138 | 09/16 → | CPSG007 →Prod.03.07.2017 [67][240] | 4.4v | | | |
| | | | | | CPSG008 →Prod.03.07.2017 [701][241] | 4.4v | | | |
| 2.0 TDI, 2.0 TDI 4WD | 4 | DAVA | 130/174 | 09/16 → | CPSG007 →Prod.03.07.2017 [67][240] | 4.4v | | | |
| | | | | | CPSG008 →Prod.03.07.2017 [701][241] | 4.4v | | | |

CRAFTER 30-35

| | | | | | | | | | |
|----------------------|---|------------|---------|--------------|----------------|----|--|--|---------------|
| 2.0 TDI | 4 | CKTB; CSLA | 80/107 | 05/11 →12/16 | | | | | CCU152 |
| 2.0 TDI | 4 | CSLB | 84/113 | 11/13 →12/16 | | | | | CCU152 |
| 2.0 TDI | 4 | CKTC | 100/134 | 05/11 →12/16 | | | | | CCU152 |
| 2.0 TDI | 4 | CKUC | 105/141 | 10/11 →12/16 | | | | | CCU152 |
| 2.0 TDI, 2.0 TDI 4WD | 4 | CKUB; CSNA | 120/161 | 07/11 →12/16 | | | | | CCU152 |
| 2.5 TDI | 5 | BJJ; CEBA | 65/87 | 04/06 →07/11 | CCGP002 | 7v | | | |
| 2.5 TDI | 5 | BJK; CEBB | 80/107 | 04/06 →05/13 | CCGP002 | 7v | | | |
| 2.5 TDI | 5 | BJL; CECA | 100/134 | 04/06 →05/13 | CCGP002 | 7v | | | |
| 2.5 TDI | 5 | BJM; CECB | 120/161 | 04/06 →07/11 | CCGP002 | 7v | | | |

CRAFTER 30-50

| | | | | | | | | | |
|----------------------|---|------------|---------|--------------|----------------|----|--|--|---------------|
| 2.0 TDI | 4 | CKTB; CSLA | 80/107 | 05/11 →12/16 | | | | | CCU152 |
| 2.0 TDI | 4 | CSLB | 84/113 | 11/13 →12/16 | | | | | CCU152 |
| 2.0 TDI | 4 | CKTC | 100/134 | 05/11 →12/16 | | | | | CCU152 |
| 2.0 TDI | 4 | CSLC | 103/138 | 11/15 →12/16 | | | | | CCU152 |
| 2.0 TDI | 4 | CKUC | 105/141 | 10/11 →12/16 | | | | | CCU152 |
| 2.0 TDI, 2.0 TDI 4WD | 4 | CKUB; CSNA | 120/161 | 07/11 →12/16 | | | | | CCU152 |
| 2.5 TDI | 5 | BJJ; CEBA | 65/87 | 04/06 →07/11 | CCGP002 | 7v | | | |
| 2.5 TDI | 5 | BJK; CEBB | 80/107 | 04/06 →05/13 | CCGP002 | 7v | | | |
| 2.5 TDI | 5 | BJL; CECA | 100/134 | 04/06 →05/13 | CCGP002 | 7v | | | |
| 2.5 TDI | 5 | BJM; CECB | 120/161 | 04/06 →07/11 | CCGP002 | 7v | | | |

LOAD UP

| | | | | | | | | | |
|-----|---|------------|-------|---------|--------------|-----|--|--|--|
| 1.0 | 3 | CHYA; DAFA | 44/59 | 12/14 → | OE247 | 1,0 | | | |
|-----|---|------------|-------|---------|--------------|-----|--|--|--|

LT 28-35 II

| | | | | | | | | | |
|---------|---|----------|---------|--------------|--------------|-----|-------------|--------------|----------------|
| 2.3 | 4 | AGL | 105/141 | 05/96 →07/06 | OE026 | 0,9 | CET2 | OE188 | BAEA340 |
| 2.5 SDI | 5 | AGX | 55/74 | 07/96 →07/06 | CH271 | 11v | | | |
| 2.5 TDI | 5 | BBE | 61/82 | 05/01 →07/06 | CH271 | 11v | | | |
| 2.5 TDI | 5 | APA | 66/89 | 05/99 →07/06 | CH271 | 11v | | | |
| 2.5 TDI | 5 | BBF | 70/94 | 05/01 →07/06 | CH271 | 11v | | | |
| 2.5 TDI | 5 | AHD | 75/101 | 05/96 →08/99 | CH271 | 11v | | | |
| 2.5 TDI | 5 | ANJ; AVR | 80/107 | 05/99 →07/06 | CH271 | 11v | | | |

LT 28-46 II

| | | | | | | | | | |
|---------|---|----------|---------|--------------|--------------|-----|-------------|--------------|----------------|
| 2.3 | 4 | AGL | 105/141 | 05/96 →07/06 | OE026 | 0,9 | CET2 | OE188 | BAEA340 |
| 2.5 SDI | 5 | AGX | 55/74 | 09/96 →07/06 | CH271 | 11v | | | |
| 2.5 TDI | 5 | BBE | 61/82 | 05/01 →07/06 | CH271 | 11v | | | |
| 2.5 TDI | 5 | APA | 66/89 | 05/99 →07/06 | CH271 | 11v | | | |
| 2.5 TDI | 5 | BBF | 70/94 | 05/01 →07/06 | CH271 | 11v | | | |
| 2.5 TDI | 5 | AHD | 75/101 | 05/96 →08/99 | CH271 | 11v | | | |
| 2.5 TDI | 5 | ANJ; AVR | 80/107 | 05/99 →07/06 | CH271 | 11v | | | |

LT 40-55 I

| | | | | | | | | | |
|-------|---|----|-------|--------------|--------------|-----|-------------|------------------------|--|
| 2.4 i | 6 | 1E | 69/93 | 01/93 →06/96 | OE027 | 1,0 | CET8 | OE195 →08/93 | |
|-------|---|----|-------|--------------|--------------|-----|-------------|------------------------|--|

VW





kW/BHP

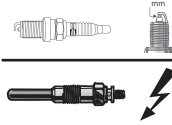

eon TITAN

IRIDIUM

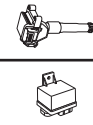

...VW

POLO Van

| | | | | | | | | | | |
|---------|---|----------|---------|-------------|---------|------|------|-------|-------------------------|--------|
| 1.0 | 3 | CHYA | 44/59 | 01/14→ | OE247 | 1,0 | | | | |
| 1.0 | 3 | CHYB | 55/74 | 01/14→ | OE247 | 1,0 | | | | |
| 1.0 | 4 | AEV | 33/44 | 10/94→12/99 | OE012 | 0,8 | CET8 | OE195 | BAE851AE [261] [292] | CLS109 |
| 1.2 TSI | 4 | CJZC | 66/89 | 02/14→ | OE244 | 0,8 | | | | |
| 1.2 TSI | 4 | CJZD | 81/109 | 01/14→ | OE244 | 0,8 | | | | |
| 1.4 | 4 | AEX; APQ | 44/59 | 08/97→12/99 | OE027 | 1,0 | CET8 | | BAE851AE [261] [292] | CLS109 |
| 1.4 TDI | 3 | CUSA | 55/74 | 03/14→ | CPSG007 | 4.4v | | | | |
| 1.4 TDI | 3 | CUSB | 66/89 | 02/14→ | CPSG007 | 4.4v | | | | |
| 1.4 TSI | 4 | CZEA | 110/148 | 05/14→ | OE244 | 0,8 | | | | |
| 1.7 SDI | 4 | AKU | 44/59 | 08/97→12/99 | CH271 | 11v | | | CCU081 | |
| 1.9 D | 4 | AEF | 47/63 | 10/94→12/99 | CH260 | 11v | | | | |
| 1.9 SDI | 4 | AEY | 47/63 | 07/96→12/99 | CH271 | 11v | | | CCU081 | |

TRANSPORTER IV

| | | | | | | | | | | |
|----------------------|---|--------------------|---------|-------------|-------|-----|--------|-------|-------------------------|--------|
| 2.4 D | 5 | AJA | 55/74 | 08/97→04/03 | CH260 | 11v | | | | |
| 2.5, 2.5 4WD | 5 | AET | 85/114 | 07/96→04/03 | OE027 | 1,0 | CET8 | | BAE851AE [261] [292] | CLS108 |
| 2.5, 2.5 4WD | 5 | APL; AVT | 85/114 | 07/96→04/03 | OE123 | 0,7 | CET2 | OE179 | BAE851AE [261] [292] | |
| 2.5 TDI | 5 | AJT; AYY | 65/87 | 05/98→04/03 | CH271 | 11v | | | CCU081 | |
| 2.5 TDI | 5 | AHY; AXG | 111/149 | 05/98→04/03 | CH271 | 11v | | | CCU081 | |
| 2.5 TDI, 2.5 TDI 4WD | 5 | ACV; AUF; AXL; AYC | 75/101 | 09/95→04/03 | CH271 | 11v | | | CCU081 | |
| 2.8 | 6 | AES | 103/138 | 05/96→05/00 | | | CET12P | OE180 | BAEA004E | |
| 2.8 VR6 | 6 | AMV | 150/201 | 04/00→04/03 | OE176 | 1,0 | CET3 | | BAEA004E | |
| 2.8 VR 6, 2.8 VR6 | 6 | AES | 103/138 | 11/95→05/00 | | | CET12P | OE180 | BAEA004E | CLS237 |
| 2.8 VR6 4WD | 6 | AES | 103/138 | 01/96→04/96 | | | CET12P | OE180 | | |

TRANSPORTER V

| | | | | | | | | | | |
|--------------------------|---|------|---------|-------------|-------|-----|------|-------|--|--|
| 1.9 TDI | 4 | BRR | 62/83 | 01/06→11/09 | | | | | CCU151 Ch.7H-6-080001 7H-6X022501 7J-6-022501→ | |
| 1.9 TDI | 4 | AXC | 63/84 | 04/03→11/09 | CH181 | 11v | | | CCU081 →Ch.7H-6-080000 7H-6X022500 7J-6-022500 CCU151 Ch.7H-6-080001 7H-6X022501 7J-6-022501→ | |
| 1.9 TDI | 4 | BRS | 75/101 | 06/06→11/09 | | | | | CCU151 Ch.7H-6-080001 7H-6X022501 7J-6-022501→ | |
| 1.9 TDI | 4 | AXB | 77/103 | 04/03→11/09 | CH181 | 11v | | | CCU081 →Ch.7H-6-080000 7H-6X022500 7J-6-022500 CCU151 Ch.7H-6-080001 7H-6X022501 7J-6-022501→ | |
| 2.0 | 4 | AXA | 85/114 | 11/03→08/15 | | | CET8 | OE195 | BAE907AE [262] | |
| 2.0 BiTDI, 2.0 BiTDI 4WD | 4 | CFCA | 132/177 | 09/09→08/15 | | | | | CCU151 ModelYear→2011 | |
| 2.0 TDI | 4 | CAAA | 62/83 | 09/09→08/15 | | | | | CCU151 ModelYear→2011 | |
| 2.0 TDI | 4 | CAAB | 75/101 | 09/09→08/15 | | | | | CCU151 ModelYear→2011 | |
| 2.0 TDI | 4 | CAAD | 84/113 | 05/11→08/15 | | | | | CCU151 ModelYear→2011 | |

VW



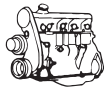

kW/BHP



eon TITAN

IRIDIUM



...VW

...TRANSPORTER V

| | | | | | | | | | |
|-----------------------------|---|------------|---------|-------------|---------|-----|--------|--|---|
| 2.0 TDI, 2.0 TDI 4WD | 4 | CAAE; CCHB | 100/134 | 05/10→08/15 | | | | | CCU151 ModelYear→2011 |
| 2.0 TDI, 2.0 TDI 4WD | 4 | CAAC; CCHA | 103/138 | 09/09→08/15 | | | | | CCU151 ModelYear→2011 |
| 2.0 TSI | 4 | CJKB | 110/148 | 07/12→08/15 | OE214 | 0,7 | CET11P | | BAEA033E ^[7] |
| 2.0 TSI, 2.0 TSI 4WD | 4 | CJKA | 150/201 | 05/11→08/15 | OE214 | 0,7 | CET11P | | BAEA033E ^[7] |
| 2.5 TDi | 5 | BLJ | 120/161 | 11/03→11/09 | CH181 | 11v | | | CCU081 →Ch.7H-6-080000 7H-6X022500 7J-6-022500 |
| 2.5 TDI, 2.5 TDI 4WD | 5 | AXD | 96/129 | 04/03→11/09 | CH181 | 11v | | | CCU081 →Ch.7H-6-080000 7H-6X022500 7J-6-022500 |
| 2.5 TDI, 2.5 TDI 4WD | 5 | BNZ | 96/129 | 04/03→11/09 | CCGP002 | 7v | | | |
| 2.5 TDI, 2.5 TDI 4WD | 5 | AXE | 128/172 | 04/03→11/09 | CH181 | 11v | | | CCU081 →Ch.7H-6-080000 7H-6X022500 7J-6-022500 |
| 2.5 TDI, 2.5 TDI 4WD | 5 | BPC | 128/172 | 04/03→11/09 | CCGP002 | 7v | | | |
| 3.2 4WD, 3.2 V6, 3.2 V6 4WD | 6 | BKK | 173/232 | 08/03→11/09 | OE215 | 0,9 | | | BAEA044E ^[356] |
| 3.2 4WD, 3.2 V6 4WD | 6 | CFLA | 173/232 | 11/03→11/09 | | | | | BAEA044E ^[356] |
| 3.2 V6 | 6 | BDL | 170/228 | 04/03→11/09 | OE215 | 0,9 | | | BAEA044E ^[356] |

TRANSPORTER VI

| | | | | | | | | | |
|----------------------|---|------------|---------|--------|---|--------------|--|--|----------------------|
| 2.0 TDI | 4 | CXGA | 62/83 | 04/15→ | CPSG007 | 4.4v | | | |
| 2.0 TDI | 4 | CXGB | 75/101 | 04/15→ | CPSG007 | 4.4v | | | |
| 2.0 TDI | 4 | CXGC; CXHB | 84/113 | 05/16→ | CPSG007 →Prod.03.07.2017 [67][240] | 4.4v | | | |
| | | | | | CPSG008 →Prod.03.07.2017 [70][241] | 4.4v | | | |
| 2.0 TDI, 2.0 TDI 4WD | 4 | CXFA; CXHA | 110/148 | 04/15→ | CPSG007 | 4.4v | | | |
| 2.0 TDI, 2.0 TDI 4WD | 4 | CXEB | 150/201 | 06/15→ | CPSG007 CPSG007 →Prod.03.07.2017 [67][240] | 4.4v 4.4v | | | |
| | | | | | CPSG008 →Prod.03.07.2017 [70][241] | 4.4v | | | |
| 2.0 TDI 4WD | 4 | CXHA | 110/148 | 08/15→ | CPSG007 CPSG007 →Prod.03.07.2017 [67][240] | 4.4v 4.4v | | | |
| | | | | | CPSG008 →Prod.03.07.2017 [70][241] | 4.4v | | | |
| 2.0 TSI | 4 | CJKB | 110/148 | 04/15→ | | | | | BAEA033E [7][249] |
| 2.0 TSI, 2.0 TSI 4WD | 4 | CJKA | 150/201 | 04/15→ | | | | | BAEA033E [7][249] |

VW (FAW)

GOLF SPORTSVAN

| | | | | | | | | | |
|-------------|---|-----|---------|--------|-------|-----|--|--|--|
| 1.2 T | 4 | CYA | 81/109 | 05/16→ | OE244 | 0,8 | | | |
| 1.4 280 TSI | 4 | CSS | 110/148 | 05/16→ | OE244 | 0,8 | | | |
| 1.4 T | 4 | CST | 96/129 | 05/16→ | OE244 | 0,8 | | | |

WESTFIELD

130

| | | | | | | | | | |
|--------|---|------|---------|--------|-------|-----|------|-------|--|
| 3.9 V8 | 8 | 35DL | 147/197 | 01/97→ | OE018 | 1,0 | CET8 | OE195 | |
| 3.9 V8 | 8 | 35DH | 201/270 | 01/97→ | OE018 | 1,0 | CET8 | OE195 | |

CHAMPION



kW/BHP

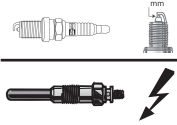

eon TITAN

IRIDIUM

**...WESTFIELD****SE / SEVEN**

2.0 4 184/247 01/05→12/09

CET17P

WIESMANN**MF3**

2.8 6 M52(286S1) 142/190 01/96→08/02 OE238 1,0

3.0 6 M54306S3 170/228 07/03→ CET2 OE188

3.2 6 S50326S1 236/316 01/96→08/01 CET10P OE187

3.2 6 S54326S4 252/338 07/03→ CET10P OE187

YULON**YULON**

1.8 i 4 CA18S 76/102 01/93→12/98 OE005 0,9 CET2

ZASTAVA**10**

1.2 60 4 188A4.000 44/59 10/05→ OE016 0,9 CET2 OE180

ZAZ**CHANCE**

1.3 4 ME307 52/70 10/04→ OE006 0,9 CET8 OE195

FORZA

1.5 4 SQR477F 80/107 01/13→ OE006 0,9 CET8 OE195

LANOS

1.4 4 A13SM 55/74 10/04→ OE006 0,9 CET8 OE195 BAEA025E

1.5 4 A15SM 63/84 10/04→ OE006 0,9 CET8 OE195 BAEA025E

1.6 16V 4 A16DMS 78/105 10/04→ OE006 0,9 CET8 OE195 BAEA025E

SENS

1.3 4 ME307 52/70 10/04→ OE006 0,9 CET8 OE195

SLAVUTA

1.1 4 MZ2471 38/51 03/95→10/01 OE006 0,9 CET8 OE195

1.2 4 VAZ217 43/58 10/01→ OE006 0,9 CET8 OE195

1.3 4 MENZ310 44/59 10/01→ OE006 0,9 CET8 OE195

TAVRIA

1.1 4 38/51 06/00→12/07 OE006 0,9 CET8 OE195

1.2 4 MZ2477 42/56 01/98→12/07 OE006 0,9 CET8 OE195

1.3 4 MEMZ32457 52/70 10/01→12/07 OE006 0,9 CET8 OE195

VIDA

1.4 4 F14D3 69/93 01/12→ OE005 0,9 CET2 OE179

1.5 4 F15S3 62/83 01/12→ OE006 0,9 CET8 OE195

1.5 4 SQR477F 80/107 01/12→ OE006 0,9 CET8 OE195

ZAZ**LANOS PICK-UP**

1.4 4 A13SM 55/74 10/04→ OE006 0,9 CET8 OE195

1.5 4 A15SM 63/84 10/04→ OE006 0,9 CET8 OE195

WESTFIELD



| L82C | ...OE001 | ...OE001 | ...OE002 |
|--|---|--|--|
| ALPINE 1300 BARKAS B 1000 BMW 503 CONVERTIBLE BORGWARD ISABELLA CITROËN ID FIAT 1000ER-SERIE, 1400, 1900, JAGST FORD TAUNUS 12M, TAUNUS '51 MERCEDES-BENZ 170 (W170), PONTON (W120) MOSKVICH 403 PORSCHE 356 CABRIOLET /SPEEDSTER /COUPE RENAULT 8 ROVER 200 SKODA 100, 110, OCTAVIA TALBOT SIMCA 1301 TRIUMPH TR 2, TR 3, TR 3A, TR 4A VW 1500, 1600, KAEFER, KARMANN GHIA, TRANSPORTER I, TRANSPORTER II, TRANSPORTER III WARTBURG 353 | BMW 02 /CONVERTIBLE (E10), 02 TOURING (E6), 3 (E21), 3 (E30), 3 /CONVERTIBLE /TOURING (E30), 5 (E12), 5 (E28), 5 (E34), 6 (E24), 7 (E23), 7 (E32), 1500-2000 (115, 116, 118, 121), 1600 GT COUPE, 2000-3.2 COUPE (E9), 2500-3.3 (E3), Z1 ROADSTER BOND EQUIPE, EQUIPE MK. II CITROËN C25, SM FIAT 125, 128, 130, 131, 132, 242-SERIE, 1500, 1500-2300, ARGENTA, DUCATO, ELBA, PREMIO, X 1/9 FORD CONSUL, CORSAIR, CORTINA, ESCORT I, ESCORT II, GRANADA, TAUNUS 15M, TAUNUS 17M, TAUNUS 20M, TAUNUS 20M XL, TRANSIT, ZEPHYR III, ZEPHYR IV, ZODIAC, ZODIAC FORD AUSTRALIA COURIER FORD OTOSAN ANADOL FSO 125P, 126P, 127P, 132P, POLONEZ I, POLONEZ II, POLONEZ III GINETTA G15, G21 GLAS 04, 1700, GT, V 8 HONDA CIVIC I INNOCENTI MINI JENSEN GT, HEALEY LADA 1200-1500, 1200-1600, NIVA, NOVA, SAMARA, TOSCANA MARCOS 2-3 LITRE, 1600 MAZDA 323 I /STATION WAGON (FA), 626 I (CB), 818 ESTATE, 1000, 1300 MERCEDES-BENZ /8 (W114), /8 (W115), /8 /COUPE (W114), COUPE (C123), G-CLASS (W460), G-CLASS (W463), HECKFLOSSE (W110), HECKFLOSSE (W111, W112), HENSCHEL 2-T, PONTON (W121), SALOON (W123), S-CLASS (W108, W109), S-CLASS (W116), S-CLASS (W126), S-CLASS COUPE (C126), SL (R107), SL (W121), SL COUPE (C107), T1 BOX (601, 611), T1 BUS /PLATFORM /CHASSIS (601), T2 /L BOX BODY / ESTATE /DUMPTRUCK /PLATFORM /CHASSIS, T2 /L MUNICIPAL VEHICLE MORRIS MARINA, MINI, MINOR MOSKVICH 412, 427 | NISSAN CHERRY (E10) I, CHERRY II, CHERRY III, DATSUN 100 A, DATSUN 120, DATSUN 120 Y, DATSUN 160 J, DATSUN 180 B, SUNNY NSU 1000, PRINZ, TTS PEUGEOT 404, 504, 505, J7 PUCH G-MODELL RENAULT 5, 9, 11, 12, 15, 16, 18, 19 I, 19 II, 21, FUEGO, MASTER I, RAPID, SUPER 5, TRAFIC ROVER 2000-3500 SAAB 90, 95, 96, 99, 900 I SEAT 128, RONDA TALBOT 1307-1510, HORIZON, SIMCA 1000, SIMCA 1100, SIMCA 1200 S, SIMCA SUNBEAM TOYOTA LAND CRUISER TRABANT 1.1 TRIUMPH 2.5 PI MK I, 1300, 1500, HERALD, SPITFIRE, TR 5, TR 6, VITESSE VOLVO 240, 340-360 VW CADDY I, GOLF I, GOL I, ILTIS, JETTA I, K 70, LT 28-35 I, LT 40-55 I, PASSAT, POLO, SANTANA, SCIROCCO WARTBURG 353 WOLSELEY 18/85, 1300, HORNET ZASTAVA 101 | LANCIA DELTA II, Y, Y10 LAND ROVER DISCOVERY I NISSAN PRIMERA PLYMOUTH BREEZE ROVER 100, 100 / METRO, 200, 400, 600, 800, COUPE SKODA FAVORIT TOYOTA CARINA E, HILUX VI OE003 BMW 3 (E30), 3 (E36), 3 /CONVERTIBLE /TOURING (E30), 3 TOURING (E30), 7 (E32), 8 (E31) CITROËN AX, BX, C15 DAEWOO MUSSO LADA OKA MERCEDES-BENZ E-CLASS (W124), SALOON (W124), SL (R129) OPEL OMEGA A PEUGEOT 205 I, 205 II, 305 II, 309 I, 309 II, 405 I, 605 PROTON IMPIAN SAAB 900 I, 9000 SEAT IBIZA I SSANGYONG MUSSO VAUXHALL CARLTON MK III OE004 ALFA ROMEO 155 BERTONE FREECLIMBER BMW 3 (E30), 5 (E28), 5 (E34) CHRYSLER SARATOGA, VOYAGER II DAIHATSU HIJET FIAT CINQUECENTO, PANDA, SEICENTO / 600 PIAGGIO PORTER |



...OE004

RENAULT
21
SUBARU
LEONE II
VOLVO
440 K, 460 L, 480 E, 740, 760, 940, 940 II, 960

OE005

ASTON MARTIN
VIRAGE
AUSTIN
MAESTRO, MONTEGO
AUTOBIANCHI
Y10
BITTER
TYPE 3
CATERHAM
21, SEVEN
CHERY
A1, A3, A5, COWIN, COWIN 2, COWIN 3, COWIN 5, E5, EASTAR CROSS, FULWIN, QQ3, QQ6, TIGGO, TIGGO 3, TIGGO DR, V5, X1
CHEVROLET
AVEO, AVEO / KALOS, KALOS, LACETTI, NUBIRA
CHRYSLER
CIRRUS, NEON, NEON II, STRATUS
CITROËN
BERLINGO / BERLINGO FIRST, BX, C15, XANTIA, XSARA PICASSO, ZX
DACIA
SUPERNOVA
DAEWOO
KALOS, KORANDO, LACETTI, MUSSO, NUBIRA, REXTON
DODGE
NEON, NEON II, STRATUS
FIAT
PALIO, PANDA, TIPO, UNO
FORD
ESCORT '81, ESCORT III, ESCORT IV, ESCORT V, FIESTA II, FIESTA III, ORION I, ORION II, ORION III, SCORPIO I, SIERRA
FSO
POLONEZ III
GEO
TRACKER
HONDA
CIVIC V
JAGUAR
XJ, XJSC
KIA
SEPHIA, SHUMA, SHUMA II, SPORTAGE
LANCIA
THESIS, Y10
LIFAN
320, 520, 620, X60
LOTUS
ELAN

...OE005

MAZDA
323 C IV (BG), 323 F IV (BG), 323 F VI (BJ), 323 III HATCHBACK (BF), 323 P V (BA), 323 S IV (BG), 323 S VI (BJ), 626 III /COUPE /HATCHBACK (GD), 626 III STATION WAGON (GV), 626 IV (GE), 626 IV /HATCHBACK (GE), 626 V (GF), 626 V /HATCHBACK (GF), 626 V STATION WAGON (GW), MPV I (LV), XEDOS 9 (TA)
MERCEDES-BENZ
B-CLASS (W245)
MITSUBISHI
GALANT VI
MITSUOKA
ZERO I
MORGAN
PLUS FOUR
NISSAN
100 NX, BLUEBIRD, CEFIRO II, CEFIRO III, MAXIMA / MAXIMA QX IV, PRIMERA, SUNNY III
OPEL
ASTRA F, KADETT E, OMEGA A
PEUGEOT
106 I, 205 II, 206+, 306, 309 I, 309 II, 405 I
PONTIAC
TRANS SPORT
PORSCHE
968
PUCH
G-MODELL
RELIANT
SCIMITAR SABRE
RENAULT
19 I, 19 II, CLIO I, DUSTER, RAPID, SAFRANE II
ROVER
200, 800, CITYROVER, MAESTRO, MONTEGO
SAAB
900 II, 9000
SKODA
FAVORIT, FELICIA I, FELICIA II
SSANGYONG
KORANDO
SUBARU
JUSTY II, LEGACY II
SUZUKI
ALTO (HA12, HA23), BALENO /ESTATE /HATCHBACK (EG), CARRY BOX (FD), JIMNY (FJ), JIMNY CLOSED OFF-ROAD VEHICLE (SN), VITARA (ET, TA), VITARA /CABRIO (ET, TA), WAGON R+ HATCHBACK (MM)
TATA
INDICA, INDIGO, SAFARI
TOYOTA
CARIBE, CARINA E, CARINA II, CELICA, COROLLA, CRESSIDA, CRESTA, CROWN, HIACE IV, HILUX, HILUX II, HILUX VI, LAND CRUISER, LAND CRUISER 90, SPRINTER, SPRINTER CARIB, SUPRA, TARAGO

...OE005

VAUXHALL
CARLTON MK III, SENATOR MK II (B)
VW
CADDY III
YULON
101 FEELING, YULON
ZAZ
VIDA
OE006
AC
ME
ALFA ROMEO
75, 90, 164, GTV, SPIDER
ALPINA
B3, B6, C1, C2
ASIA MOTORS
ROCSTA, TOWNER
AUDI
QUATTRO
AUSTIN
ALLEGRO, APACHE, MAESTRO, MAXI, MAXI II, METRO, MINI, MONTEGO, PRINCESS, PRINCESS 2
AUSTIN-HEALEY
3000 MK.III, SPRITE MK.III
AUTOBIANCHI
A 112, Y10
BEDFORD
ASTRAMAX, ASTRA VAN, MIDI, RASCAL
CHEVROLET
AVEO, AVEO / KALOS, CORSA, KALOS, LANOS, MATIZ, NIVA, SPARK
CHRYSLER
LE BARON
CITROËN
GS
DADI
CITY COURSER
DAEWOO
ARANOS, CIELO, ESPERO, KALOS, LANOS, LEGANZA, LEMANS, MATIZ, NEXIA, NUBIRA, PRINCE, REZZO, ROYALE, SUPER SALOON
DAIHATSU
55 WIDE, 1000, CUORE I, CUORE II, CUORE III, CUORE IV, HIJET, ROCKY HARD TOP, ROCKY SOFT TOP, RUGGER, SPARCAR
DAIMLER
2.8 - 5.3, COUPE, LANDAULETTE, LIMOUSINE
FIAT
126, 127, 128, 131, 132, 147, 238-SERIE, 900T/E PANORAMA, 900T/E PULMINO, ARGENTA, CAMPAGNOLA, DUCATO, DUNA, ELBA, FIORINO, FIORINO PICK UP, PANDA, PENNY, REGATA, RITMO, TALENTO, TEMpra, TIPO, UNO, X 1/9
FORD
CAPRI, CAPRI II, CAPRI III, CONSUL, CORSAIR, CORTINA, ECONOVAN, ESCORT I, GRANADA, SCORPIO I, SIERRA, TAUNUS, TAUNUS 15M, TAUNUS 17M, TAUNUS 20M, TAUNUS 20M XL

...OE006

FOTON
SUP, SURFING, VIEW
FSO
LANOS, POLONEZ I
GAZ
GAZELLE
GEELY
HAOQING, HQ, MR, PU, URBAN NANNY
GOLDEN DRAGON
XML
GREAT WALL
DEER, PEGASUS, SAILING, STEED
HOLDEN
SCURRY
HONDA
ACCORD I, ACTY, CIVIC III, PRELUDE I, PRELUDE II, QUINTET
HYUNDAI
PONY, PONY / EXCEL, PORTER, SONATA II, SONATA III, STELLAR
INNOCENTI
ELBA, KORAL, MINI, REGENT
ISUZU
ASKA I, ASKA III, CAMPO, MIDI, PICKUP, TROOPER I
JAGUAR
E-TYPE, E-TYPE 2+2, XJ
KIA
JOICE, PRIDE, PRIDE VAN, RIO, SEPHIA
LADA
110, 111, 112, 1200-1600, NIVA, NIVA II, NOVA, SAMARA
LANCIA
A 112, DEDRA, DELTA I, Y10
LAND ROVER
88/109, 90, 110/127, DEFENDER, DISCOVERY I, RANGE ROVER I
LDV
SHERPA
MASERATI
BORA, KHAMSIN, KYALAMI, MERAK, QUATTROPORTE III
MAZDA
121 II (DB), 323 I /STATION WAGON (FA), 323 II /HATCHBACK (BD), 323 III /HATCHBACK (BF), 323 III STATION WAGON (BW), 616, 626 I (CB), 626 II /COUPE /HATCHBACK (GC), 626 III /COUPE /HATCHBACK (GD), 929 I (LA), 929 II /COUPE (HB), 929 II ESTATE (HV), B-SERIE (UF), E-SERIE BOX (SR2)
MERCEDES-BENZ
/8 (W114)
MG
1300 MK.II, EXPRESS, METRO, MGB, MGB GT, MIDGET



| ...OE006 | ...OE006 | ...OE009 | ...OE011 |
|---|--|--|--|
| MITSUBISHI CARISMA, COLT I, COLT II, COLT III, COLT V, CORDIA, ECLIPSE, ECLIPSE I, ECLIPSE II, GALANT I, GALANT II, GALANT III, GALANT IV, KUDA, L 200, L 300 / DELICA II, L 300 III, LANCER CELESTE, LANCER F, LANCER I, LANCER II, LANCER III, LANCER IV, LANCER V, MIRAGE III, SAPPORO I, SAPPORO II, SPACE WAGON, TREDIA MORRIS ITAL, MARINA II MOSKVICH 2140, 2141, ALEKO, ASLK 2137, ASLK 2140 NISSAN 280 ZX,ZXT, BLUEBIRD, BOBBY, CHERRY II, LAUREL, PATROL III/1, PATROL III/2, PICK UP, PRAIRIE, SILVIA, STANZA, SUNNY I, SUNNY II, URVAN, VANETTE OPEL ASCONA B, ASCONA C, CAMPO, CORSA A, KADETT D, KADETT E, MANTA B, OMEGA A, REKORD E, VECTRA A, VECTRA B PEUGEOT J5, J9 PIAGGIO PORTER PININFARINA SPIDEREUROPA PORSCHE 911 / CONVERTIBLE, 924, 928, 944 / CONVERTIBLE PROTON AEROBAC, SALOON RENAULT 11, 19 I, 19 II, 21, CLIO I, LAGUNA I, MEGANE I, SUPER 5 RILEY KESTREL ROLLS-ROYCE CORNICHE V ROVER 2000-3500, MAESTRO, MINI, MINI-MOKE, MONTEGO SAAB 99, 900 I SANTANA SAMURAI SEAT 124, 127, 128, 131, 850, FURA, IBIZA I, MARBELLÁ, PANDA, RITMO, RONDA, TERRA SUBARU JUSTY I, JUSTY II, LEONE I, LEONE II, LIBERO, MV, REX II SUZUKI CARRY PICKUP, JIMNY (FJ), SUPER CARRY BUS (ED), SWIFT CONVERTIBLE (SF413), SWIFT I (AA), SWIFT II HATCHBACK (EA, MA), SWIFT II SALOON (AH, AJ), VITARA / CABRIO (ET, TA), WAGON R HATCHBACK TALBOT 1307-1510, AVENGER, SIMCA 1100, SIMCA SUNBEAM, SOLARA, TAGORA | TOYOTA CAMRY, CARINA II, CELICA, CHASER, COROLLA, COROLLA FX, CRESSIDA, CRESTA, CROWN, DYNA, DYNA 200, HIACE II, HIACE III, HIACE IV, HILUX IV, MARK II, LAND CRUISER, STARLET, STARLET 1000, STOUT, TARAGO, TOWN ACE, VISTA TRIUMPH 2000 MKII, 2500, ACCLAIM, STAG, TOLEDO TVR 350, 1600, 3000, CHIMAERA, TAIMAR VAUXHALL ASTRA, ASTRA MK II, ASTRA MK III (F), ASTRAMAX, BRAVA, CARLTON MK II, CARLTON MK III, CAVALIER MK II, CAVALIER MK III, CRESTA, MIDI, NOVA, NOVAVAN, RASCAL, VELOX, VENTORA, VICTOR, VISCOUNT VOLVO 240, 340-360, 440 K, 460 L, 740, 760, 940, 960 VW CADDY I, DERBY, GOLF I, JETTA I, LT 40-55 I, POLO, TARO YUGO 311 / 411, 511 / 513, SANA, TEMPO ZASTAVA 101, YUGO, YUGO FLORIDA ZAZ CHANCE, FORZA, LANOS, LANOS PICK-UP, SENS, SLAVUTA, TAVRIA, VIDA <div style="background-color: red; color: white; padding: 2px;">OE007</div> CITROËN C35 DACIA 1304, 1310, NOVA, PICK UP RENAULT 12, ESTAFETTE SKODA RAPID TRIUMPH HERALD, SPITFIRE UAZ 3160, SIMBIR (3162) VOLVO P 121, PV 544 <div style="background-color: red; color: white; padding: 2px;">OE008</div> ALFA ROMEO 155, SPIDER ALPINA B7, B10 FIAT COUPE, FIORINO, TIPO LANCIA DEDRA, DELTA II, THEMA RENAULT 19 II, 21 VOLVO 740, 940 <div style="background-color: red; color: white; padding: 2px;">OE009</div> ALPINE A310 | AUDI A6, V8 CITROËN AXEL, BX, CX I, CX II, DS, LNA, VISA DAIMLER 2.8 - 5.3 MERCEDES-BENZ 190 (W201), COUPE (C123), COUPE (C124), G-CLASS (W460), G-CLASS (W461), G-CLASS /CABRIO (W463), HECKFLÖSSE (W111, W112), KOMBI T-MODEL (S123), KOMBI T-MODEL (S124), SALOON (W123), SALOON (W124), SALOON (W124), T1 BOX (601, 611), T1 BOX (602), T1 BUS /PLATFORM /CHASSIS (601), T1 PLATFORM /CHASSIS (602), T1 /TN BOX BODY / ESTATE /PLATFORM /CHASSIS, T2 /L BOX BODY / ESTATE /DUMPTRUCK /PLATFORM /CHASSIS, T2 /LN1 BOX BODY / ESTATE /PLATFORM /CHASSIS OLTCIT 11 OPEL ASCONA B, MANTA B PEUGEOT 104, 204, 205 I, 205 II, 304, 305 I, 305 II, 309 I, 504, 505, 604 PUCH G-MODELL RENAULT 5, 14, 18, 20, 21, 25, 30, ESPACE II, FUEGO, MASTER I, SAFRANE I, TRAFIC TALBOT SAMBA, SIMCA SIM'4, TAGORA VOLVO 240, 260, 760, 780, 960 <div style="background-color: red; color: white; padding: 2px;">OE011</div> AUDI 100, A6, A8 AUSTIN AMBASSADOR, PRINCESS 2 DAIMLER DAIMLER XJ, XJ 40, 81 FORD ESCORT '81, ESCORT '86, ESCORT '91, ESCORT III, ESCORT IV, ESCORT V, ESCORT VI, ESCORT VII, FIESTA, FIESTA I, FIESTA II, FIESTA III, FIESTA IV, KA, ORION II, ORION III, SCORPIO I, SCORPIO II, SIERRA JAGUAR XJ, XJSC LANCIA THEMA MERCEDES-BENZ 190 (W201), COUPE (C124), E-CLASS (W124), E-CLASS T-MODEL (S124), G-CLASS (W463), G-CLASS /CABRIO (W463), KOMBI T-MODEL (S124), SALOON (W124), S-CLASS (W126), SL (R107), SL (R129) MORRIS ITAL | PEUGEOT 205 II PROTON GEN 2 PUCH G-MODELL RENAULT 18, 25, MASTER I, TRAFIC ROVER 2000-3500 TALBOT SAMBA TRIUMPH DOLOMITE TVR S VOLVO 260, 760 <div style="background-color: red; color: white; padding: 2px;">OE012</div> ALFA ROMEO 155, 164 AUDI 80, 90, 100, 200, COUPE, QUATTRO FIAT COUPE, CROMA, TIPO LANCIA DEDRA, DELTA I, DELTA II, KAPPA, THEMA PEUGEOT 505 PORSCHE 968 / CONVERTIBLE SEAT CORDOBA, IBIZA II VW CADDY I, CORRADO, GOLF I, GOLF II, JETTA I, JETTA II, LT 28-35 I, PASSAT, POLO, POLO VAN, SANTANA, SCIROCCO, TRANSPORTER III, TRANSPORTER IV <div style="background-color: red; color: white; padding: 2px;">OE013</div> CHEVROLET BERETTA DODGE DAKOTA, RAM, RAMCHARGER JAGUAR XJ, XJSC JEEP GRAND CHEROKEE I NISSAN PATHFINDER II SKODA FAVORIT, FELICIA I UAZ CARGO, HUNTER, PATRIOT <div style="background-color: red; color: white; padding: 2px;">OE014</div> ALFA ROMEO 75, 164 ASTON MARTIN DB7 AUDI 80 |



| | | | |
|---|---|--|--|
| <p>...OE014</p> <p>CATERHAM SEVEN</p> <p>CITROËN BX, XANTIA, ZX</p> <p>FIAT PALIO, ULYSSE, UNO</p> <p>FORD ESCORT '86, ESCORT III, TRANSIT, TRANSIT TOURNEO</p> <p>HONDA CAPA, CIVIC I, CIVIC II, DOMANI</p> <p>JAGUAR XJ</p> <p>LANCIA DEDRA, DELTA II</p> <p>LOTUS ELAN, EXIGE</p> <p>MORGAN FOUR FOUR</p> <p>NISSAN BLUEBIRD</p> <p>PANTHER KALLISTA</p> <p>PEUGEOT 205 II, 309 I, 405 I, EXPERT</p> <p>PORSCHE 911 SPEEDSTER (964), 911 TARGA (964)</p> <p>RELIANT SCIMITAR, SCIMITAR SABRE</p> <p>RENAULT DUSTER</p> <p>SAAB 9000</p> <p>SEAT MALAGA</p> <p>SUZUKI LIANA ESTATE (ER)</p> <p>TOYOTA CELICA, CORONA</p> <p>VOLVO 850</p> <p>OE015</p> <p>BMW 3 (E30), 5 (E28)</p> <p>FIAT PREMIO</p> <p>JAGUAR MK I, MK II, MK VII, MK VIII, MK IX, MK X, S-TYPE</p> <p>RENAULT 5, 18, 19 I, 19 II, CLIO I, FUEGO, RAPID, SUPER 5, TRAFIC, TWINGO I</p> <p>TOYOTA LAND CRUISER</p> <p>OE016</p> <p>AIXAM 500, A.751, CROSSLINE, SCOUTY</p> <p>BMW 5 GRAN TURISMO (F07)</p> | <p>...OE016</p> <p>CITROËN VISA</p> <p>FIAT BARCETTA, DOBLO, MAREA, MULTIPLA, PALIO, PANDA, PUNTO, SEDICI, SIENA, STILO, STRADA</p> <p>HONDA CIVIC VI</p> <p>LANCIA DEDRA, DELTA II, LYBRA</p> <p>LIGIER AMBRA, BE UP, NOVA</p> <p>SSANGYONG MUSSO</p> <p>SUZUKI GRAND VITARA II (JT), GRAND VITARA II (JT, TE, TD), LIANA (ER, RH _), LIANA HATCHBACK, SX4 (EY, GY), SX4 /SALOON (GY), SX4 SALOON (GY), SX4 S-CROSS (JY)</p> <p>VW BORA, GOLF IV, GOL IV</p> <p>ZASTAVA TO</p> <p>OE018</p> <p>ABARTH RITMO</p> <p>ALFA ROMEO 6, 75, 90, 155, 164, 1750-2000, A11 / A12, ALFETTA, ALFETTA GT, F11 / F12, GIULIA, GIULIETTA, GT, GTV, ROMEO 2, RZ, SPIDER, SZ</p> <p>ALPINE BERLINETTE</p> <p>ASTON MARTIN LAGONDA I, V8, ZAGATO</p> <p>AUDI 50, 80, 90, 100, COUPE, QUATTRO</p> <p>AUSTIN MAESTRO, MONTEGO</p> <p>AUTOBIANCHI A 112</p> <p>BMW 02 /CONVERTIBLE (E10), 02 TOURING (E6), 5 (E12), 1500-2000 (115, 116, 118, 121)</p> <p>CATERHAM SEVEN</p> <p>CITROËN AMI, GS</p> <p>FERRARI 208/308, MONDIAL</p> <p>FIAT 124, 127, 128, 131, 132, 241-SERIE, 850, ARGENTA, COUPE, CROMA, ELBA, FIORINO, FIORINO PICK UP, PALIO, PREMIO, REGATA, RITMO, TEMPRA, TIPO, UNO, X 1/9</p> <p>FORD ESCORT II</p> <p>FSO POLONEZ I, POLONEZ II</p> | <p>...OE018</p> <p>GINETTA G34</p> <p>INNOCENTI ELBA</p> <p>JAGUAR XJ</p> <p>JEEP CJ5 - CJ8</p> <p>LANCIA A 112, BETA, BETAH.P.E., BETA MONTE CARLO, DEDRA, DELTA I, DELTA II, FULVIA, GAMMA, PRISMA, THEMA, TREVI</p> <p>LOTUS ECLAT, ELITE, ESPRIT S2, ESPRIT S3, ESPRIT S4, EUROPA, EXCEL</p> <p>MASERATI GHIBLI, INDY, MEXICO</p> <p>MERCEDES-BENZ COUPE (C123), COUPE (W111), KOMBI T-MODEL (S123), PAGODE (W113), PONTON (W128), SALOON (W123), S-CLASS (W108, W109), SL (R107), SL COUPE (C107)</p> <p>MG MAESTRO, METRO, MONTEGO</p> <p>MITSUBISHI COLT II, COLT III, L 200, LANCER CELESTE, SAPPORO II</p> <p>MORGAN FOUR FOUR, PLUS FOUR</p> <p>MOSKVICH 407</p> <p>OPEL FRONTERA A</p> <p>PANTHER KALLISTA</p> <p>RELIANT SCIMITAR</p> <p>RENAULT 9, 11, 16, 17, 18, 19 I, 19 II, 20, 21, CLIO I, FUEGO, SUPER 5, TRAFIC</p> <p>ROVER 800, MONTEGO</p> <p>SAAB 99, 600</p> <p>SEAT 124, 131, 132, 133, RONDA</p> <p>SUBARU LEONE II, XT</p> <p>TALBOT 160, 180, 1307-1510, AVENGER, HORIZON, MATRA BAGHEERA, MURENA, RANCHO, SIMCA 1000, SIMCA 1100, SIMCA 1500, SIMCA 1501, SIMCA 1609/1610, SIMCA SUNBEAM</p> <p>TOFAS DOGAN, KARTAL, SAHIN</p> <p>TVR 280, 390, 400, 420, 450, 2500, CHIMAERA, GRIFFITH, SPEED EIGHT</p> | <p>...OE018</p> <p>VOLVO 240, 340-360, 440 K, 460 L, 480 E, 740, 760, 940, 940 II, 960</p> <p>VW DERBY, GOLF I, GOLF II, JETTA I, JETTA II, PASSAT, POLO, SANTANA, SCIROCCO</p> <p>WESTFIELD 130</p> <p>OE019</p> <p>AUDI A8</p> <p>CATERHAM SUPER SEVEN</p> <p>CHEVROLET ASTRA, CAPTIVA, EPICA, EVANDA, MALIBU, NUBIRA, OPTRA, ORLANDO, REZZO, VECTRA, VIVANT, ZAFIRA</p> <p>DAEWOO BROUGHAM, EVANDA, KORANDO, LACETTI, LEGANZA, MAGNUS, NUBIRA, PRINCE, REZZO, WINSTORM</p> <p>DAIHATSU COO, CUORE V, CUORE VI, MATERIA</p> <p>FIAT PALIO, SIENA, ULYSSE</p> <p>HOLDEN ASTRA, CAPTIVA</p> <p>LADA 110</p> <p>LANCIA ZETA</p> <p>LOTUS EUROPA S</p> <p>MERCEDES-BENZ V-CLASS (638/2), VITO BOX/BUS (638)</p> <p>NISSAN KUBISTAR</p> <p>OPEL AGILA (A), ANTARA, ASTRA F, ASTRA F CLASSIC, ASTRA G, CALIBRA A, COMBO, CORSA B, CORSA C, CORSA CLASSIC, CORSA UTILITY, FRONTERA A, FRONTERA B, KADETT E, MERIVA A, OMEGA B, SINTRA, SPEEDSTER, TIGRA, VECTRA A, VECTRA B, VECTRA C, VIVARO A, ZAFIRA A</p> <p>PEUGEOT 406</p> <p>SAAB 9-3, 9000</p> <p>TOYOTA 4 RUNNER, COROLLA, DUET, GRANVIA, HIACE III, HILUX, HILUX II, LAND CRUISER 90, LAND CRUISER 100, LAND CRUISER PRADO, TUNDRA</p> |
|---|---|--|--|

**...OE019****VAUXHALL**

AGILA MK I (A), ANTARA, ASTRA MK II, ASTRA MK III (F), ASTRA MK IV (G), ASTRAMAN MK III (F), ASTRAMAN MK IV (G), CALIBRA, CAVALIER MK II, CAVALIER MK III, COMBO MK I (B), COMBO MK II (C), CORSA MK I (B), CORSA MK II (C), CORSAVAN MK I (B), CORSAVAN MK II (C), FRONTERA MK I (A), MERIVA MK I (A), NOVA, OMEGA (B), SINTRA, TIGRA MK I, VECTRA (B), VX220, ZAFIRA MK I (A)

OE025**AUDI**

80, 100, A6, CABRIOLET, COUPE

SEAT

AROSA, CORDOBA, IBIZA II, INCA, TOLEDO I

SKODA

FELICIA I, FELICIA II, OCTAVIA I

VW

CADDY II, CORRADO, GOLF I, GOLF II, GOLF III, GOLF IV, JETTA II, LUPO, PARATI III, PASSAT, POLO, VENTO

OE026**ALPINA**

B3, B8, B10, B12

BERTONE

FREECLIMBER 2

BITTER

TYPE 3

BMW

3 (E30), 3 (E36), 3 /COMPACT /CONVERTIBLE/COUPE/TOURING (E36), 3 /COMPACT /COUPE (E36), 3 /COMPACT /COUPE /TOURING (E36), 3 CONVERTIBLE (E30), 3 CONVERTIBLE (E36), 3 /CONVERTIBLE/COUPE (E36), 3 /CONVERTIBLE/TOURING (E36), 3 COUPE (E36), 3 TOURING (E30), 5 (E34), 5 (E39), 5 /TOURING (E34), 5 TOURING (E34), 5 /TOURING (E39), 5 TOURING (E39), 7 (E32), 7 (E38), 8 (E31), Z3 ROADSTER (E36)

CATERHAM

SEVEN

CHEVROLET

LACETTI

CITROËN

XANTIA, XM, XSARA

DACIA

LOGDY, LOGAN, LOGAN MCV, SANDERO, SOLENZA

DAEWOO

LEGANZA

DAIHATSU

CUORE V, CUORE VI, MOVE, SIRION, TERIOS, TREVIS, YRV

FIAT

MAREA

IRMSCHER

SENATOR

LAND ROVER

DEFENDER

...OE026**LEXUS**

GS

NISSAN

KUBISTAR

OPEL

KADETT E, OMEGA A, VECTRA B

PEUGEOT

406, 605

PORSCHE

911 (993), 911 /CONVERTIBLE /TARGA (993), BOXSTER (986)

RENAULT

CLIO I, CLIO II, ESPACE III, KANGOO, KANGOO / GRAND KANGOO, LAGUNA I, LOGAN EXPRESS, LOGAN I, LOGAN II, SAFRANE II, SANDERO /STEPWAY I, SCËNIC I, THALIA I, TWINGO I, TWINGO II

SEAT

TOLEDO III

SKODA

OCTAVIA II

TOYOTA

AVALON, AVENSIS, CAMRY, CAMRY SOLARA, NADIA, PICNIC, PREVIA, RAV 4 I, SIENNA, SOLARA, VISTA, WINDOW

TVR

CERBERA

VAUXHALL

CALIBRA, CARLTON MK III, CAVALIER MK III

VW

CORRADO, GOLF III, LT 28-35 II, LT 28-46 II, PASSAT, VENTO

OE027**AUDI**

80, 100, 200, A6, CABRIOLET, COUPE

SEAT

AROSA, CORDOBA, IBIZA II, INCA, TOLEDO I

VW

CADDY II, GOLF I, GOLF II, GOLF III, GOLF IV, JETTA II, LT 28-35 I, LT 40-55 I, PASSAT, POLO, POLO VAN, SCIROCCO, TRANSPORTER IV, VENTO

OE029**ALFA ROMEO**

159, BRERA, SPIDER

ASTON MARTIN

DB7

CHEVROLET

CAPTIVA, TRAILBLAZER

FORD

BANTAM, COUGAR, ESCORT CLASSIC, ESCORT V, ESCORT VI, ESCORT VII, FIESTA V, FOCUS, KA, MAVERICK, MONDEO I, MONDEO II, ORION III, PUMA, TOURNEO CONNECT, TRANSIT CONNECT

FORD AUSTRALIA

FIESTA, MONDEO

HOLDEN

ASTRA, VECTRA, ZAFIRA

MAZDA

121 III (JASM, JBSM), TRIBUTE (EP)

...OE029**MORGAN**

FOUR FOUR, PLUS FOUR

OPEL

ANTARA

VAUXHALL

OMEGA (B)

OE030**DAIHATSU**

CHARADE IV

DE TOMASO

GUARA

FIAT

BRAVA, BRAVO I, DOBLO, MAREA, MULTIPLA, SIENA

LANCIA

KAPPA, LYBRA, Y

LOTUS

ESPRIT S4

OE031**CHEVROLET**

ALERO, COBALT, HHR

FORD

B-MAX, C-MAX, C-MAX II, COUGAR, FIESTA III, FIESTA IV, FIESTA V, FIESTA VI, FOCUS, FOCUS C-MAX, FOCUS II, FOCUS III, FUSION, GRAND C-MAX, KA, MONDEO IV, PUMA, STREET KA

MAZDA

2 (DY), 6 ESTATE /HATCHBACK (GH), 6 SALOON (GH)

VOLVO

C30, S40 II, V50

OE032**AUDI**

80, 100, 200, A2, A3, A4, A6, A8, CABRIOLET, COUPE

MERCEDES-BENZ

A-CLASS (W168), C-CLASS (W202), C-CLASS T-MODEL (S202), CLK (C208), CLK CONVERTIBLE (A208), E-CLASS (W210), E-CLASS T-MODEL (S210), M-CLASS (W163), SL (R129), SLK (R170), SPRINTER 2-T BOX (901, 902), SPRINTER 3-T BOX /BUS /PLATFORM /CHASSIS (903)

RENAULT

25

SEAT

ALHAMBRA, ALTEA, ALTEA XL, AROSA, CORDOBA, EXEO, IBIZA II, IBIZA III, IBIZA IV, INCA, LEON, TOLEDO I, TOLEDO II

SKODA

FABIA I, OCTAVIA I, OCTAVIA II, SUPERB I

VW

BORA, CADDY II, CADDY III, CORRADO, GOLF II, GOLF III, GOLF IV, GOLF V, GOLF VI, GOLF PLUS, GOL III, JETTA II, JETTA III, LUPO, NEW BEETLE, PASSAT, POLO, SHARAN, TOURAN, VENTO, VOYAGE

OE033**DACIA**

DOKKER, DOKKER EXPRESS, DUSTER, LODGY, LOGAN, LOGAN MCV, SANDERO

...OE033**LADA**

LARGUS

NISSAN

KUBISTAR, PRIMERA, SERENA

RENAULT

CLIO, CLIO II, CLIO III, DUSTER, ESPACE III, ESPACE IV, FLUENCE, GRAND SCËNIC II, GRAND SCËNIC III, KANGOO, KANGOO BE BOP, KANGOO / GRAND KANGOO, LAGUNA, LAGUNA I, LAGUNA II, LAGUNA III, LOGAN I, MEGANE, MEGANE CC, MEGANE I, MEGANE II, MEGANE III, MODUS / GRAND MODUS, SCËNIC I, SCËNIC II, SCËNIC III, THALIA I, THALIA II, TRAFIC II, VEL SATIS

OE034**CITROËN**

AX, BERLINGO, BERLINGO / BERLINGO FIRST, BX, C2, C3, C3 I, C3 II, C15, EVASION, JUMPER, NEMO, SAXO, XANTIA, XM, XSARA, XSARA PICASSO, ZX

EMGRAND

EC7, EC7-RV

EMGRAND (GEELY)

EC 7, EC 7 RV

FIAT

FIORINO, QUBO, TEMPRA, ULYSSE

FORD ASIA / OZEANIA

FESTIVA, LIATA, TELSTAR

GEELY

BL, CK, GC2, HISOON, HQ, MARINDO, MEIRI, MK, MR, PU, SL, URBAN NANNY, VISION

HONDA

CIVIC VI

KIA

RIO

LADA

LARGUS

LANCIA

ZETA

MEGA

CLUB, CLUB II

MITSUBISHI

COLT VI

NISSAN

BLUEBIRD

OPEL

ASTRA F

PEUGEOT

106 I, 106 II, 106 VAN, 205, 205 I, 205 II, 206, 206+, 207, 207 SW, 305 II, 306, 307, 309 I, 309 II, 405 I, 405 II, 406, 605, 806, 1007, BIPPER, BIPPER TEPEE, BOXER, EXPERT, PARTNER

ROVER

200, 400

SUBARU

REX III

VAUXHALL

VIVARO

VOLVO

850

**OE035****CITROËN**

BERLINGO, BERLINGO / BERLINGO FIRST, C1, C2, C3, C3 I, C4, C4 I, C-ELYSEE, SAXO, XSARA, XSARA PICASSO

MITSUBISHI

COLT CZC, COLT VI, COLT PLUS VII, LANCER VIII

PEUGEOT

107, 206, 207, 301, 307, 308, 308 SW, 1007, PARTNER, PARTNER TEEPEE

SMART**FORFOUR****SUBARU**

IMPREZA, LEGACY IV, OUTBACK, TRIBECA

TOYOTA

AYGO, DYNA, FJ CRUISER, FORTUNER, HIACE / COMMUTER V, HIACE V, HILUX III, HILUX VII, INNOVA I, IQ, LAND CRUISER, LAND CRUISER 150, LAND CRUISER PRADO, PASSO, TUNDRA, VIOS/YARIS, YARIS

VOLVO

S40 II, S80 II, V50

OE037**AUTO UNION**

DKW F11, DKW F12

BORGWARD

ISABELLA

CITROËN**ID****FORD**

TAUNUS 12M, TAUNUS 15M, TAUNUS 17M

MOSKVICHI

403, 423

OPEL

KADETT B, OLYMPIA REKORD

RENAULT

ESTAFETTE

SKODA

110

UAZ

3160, 31512

VW

181, 1500, 1600, KAEFER, KARMANN GHIA, TRANSPORTER I, TRANSPORTER III

WARTBURG

353

OE039**CHEVROLET**

AVEO, AVEO / KALOS, CRUZE, LACETTI, LUMINA APV, NUBIRA, OPTRA, REZZO, VIVANT

CITROËN

XM

DAEWOO

ESPERO, GENTRA, LACETTI, LANOS, NEXIA, NUBIRA, REZZO

DAIHATSU

ALTIS, APPLAUSE I, APPLAUSE II, CHARADE III, CHARADE IV, HIJET

...OE039**FORD**

ESCORT '86, ESCORT '91, ESCORT IV, ESCORT V, ESCORT VI, ESCORT VII, FIESTA II, FIESTA III, ORION II, ORION III, RANGER, SIERRA, TRANSIT

FORD ASIA / OCEANIA

LASER, LASER / LASER LIDEA

FORD AUSTRALIA

COURIER, TELSTAR

FSO

LANOS

HONDA

ACCORD III, ACCORD VI, CITY, CIVIC II, CIVIC IV, CIVIC V, CIVIC VI, CONCERTO, CRX II, CRX III, JAZZ, JAZZ II, LEGEND I

HYUNDAI

GALLOPER I, TIBURON

JEEP

CHEROKEE

KIA

CLARUS, RETONA, RIO, SHUMA

LADA

110, 111, 112, GRANTA, GRANTA (2349), KALINA, OKA, PRIORA

MAZDA

121 II (DB), 121 III (JASM, JBSM), 323 C IV (BG), 323 C V (BA), 323 F IV (BG), 323 F V (BA), 323 III /HATCHBACK (BF), 323 S IV (BG), 323 S V (BA), 323 S VI (BJ), 626 III /COUPE /HATCHBACK (GD), 626 III STATION WAGON (GV), 626 V /HATCHBACK (GF), 626 V STATION WAGON (GW), 929 III (HC), B-SERIE (UF), B-SERIE (UN), E-SERIE BOX (SR2), MX-5 I (NA), MX-5 II (NB), MX-6 (GE), PREMACY (CP)

MITSUBISHI

CARISMA, COLT IV, COLT V, ECLIPSE, ECLIPSE II, FTO, GALANT V, GALLOPER, LANCER IV, LANCER V, LANCER VI, LANCER VII, MIRAGE, PAJERO II, PAJERO PININ, PAJERO SPORT I, SANTAMO, SPACE RUNNER, SPACE STAR, SPACE WAGON

NISSAN

AVENIR, BLUEBIRD, PRAIRIE, PRAIRIE PRO, SKYLINE, STANZA, SUNNY II

PROTON

PERSONA 300, PERSONA 400, WIRA

ROVER

400, 800

SAAB

9000

SUBARU

IMPREZA, JUSTY I, LEGACY I, SVX

SUZUKI

BALENO /ESTATE /HATCHBACK (EG), GRAND VITARA I (FT, HT), JIMNY CLOSED OFF-ROAD VEHICLE (SN), SWIFT II HATCHBACK (EA, MA), SWIFT II SALOON (AH, AJ), VITARA (ET, TA)

...OE039**TOYOTA**

4 RUNNER, AURIS, CAMRY, CAMRY SOLARA, CARINA E, CARINA II, CELICA, COASTER, COROLLA, CURREN, GRANVIA, HARRIER, MARK II, MR 2 II, SCEPTER, VISTA

OE041**CHRYSLER**

NEW YORKER, VIPER, VISION

DODGE

INTREPID, RAM 1500, VIPER

FORD USA

PROBE I

JEEP

CHEROKEE, COMANCHE, GRAND CHEROKEE I, GRAND CHEROKEE II, WRANGLER I, WRANGLER II

OE042**BRISTOL**

411

CHRYSLER

DAYTONA, LE BARON, SARATOGA, VOYAGER / GRAND VOYAGER III

CITROËN

2 CV

DODGE

CARAVAN

GEO

METRO, STORM, TRACKER

JEEP

CJ5 - CJ8

RELIANT

KITTEN

RENAULT

19 II, RAPID

SEAT

MARBELLA, TERRA

TRIUMPH

2000 MK I, 2000 MKII

OE044**SEAT**

IBIZA II

VW

GOLF III, JETTA I, PASSAT, VENTO

OE048**ACURA**

INTEGRA

CHEVROLET

MATIZ, SPARK

DAEWOO

MATIZ, TICO

DAIHATSU

CHARADE II, CHARADE III, CHARADE IV, CHARMANT, CUORE II, MOVE

FOTON

ALPHA, SEA LION, SURF

GREAT WALL

SAILING

HONDA

ACCORD II, ACCORD III, CIVIC I, CIVIC III, CRX I, INTEGRA, PRELUDE II

...OE048**HYUNDAI**

H-1, H-1 / STAREX, H100, LANTRA I, PONY, PONY / EXCEL, S COUPE, SONATA II, SONATA III, SONATA IV

ISUZU

PIAZZA

KIA

AVELLA, CARNIVAL II, MAGENTIS, ROADSTER, SEPHIA

LADA

110, 111, 112, GRANTA, KALINA, LARGUS, NADESCHDA, NIVA, PRIORA, SAMARA, TOSCANA

MAZDA

323 C IV (BG), 323 II HATCHBACK (BD), 323 III /HATCHBACK (BF), 323 III STATION WAGON (BW), 626 II /HATCHBACK (GC), 626 III /COUPE /HATCHBACK (GD), 626 III STATION WAGON (GV)

MITSUBISHI

COLT II, COLT IV, COLT V, COLT VI, GALANT III, L 200, L 300 III, LANCER III, LANCER IV, LANCER V, LANCER VI, MIRAGE, MIRAGE II, MIRAGE V, SIGMA, SPACE WAGON, STARION

NISSAN

PATROL GR V, URVAN, VANETTE

OPEL

ASCONA C, KADETT E, VECTRA A

PROTON

PERSONA 400

RENAULT

19 II

ROVER

200

SUBARU

LEONE II, LIBERO, REX I, REX II

TOYOTA

COROLLA, COROLLA FX, LAND CRUISER 80, SPRINTER, STARLET

VAUXHALL

CAVALIER, CAVALIER CC, FIRENZA, VIVA

OE049**CHEVROLET**

KALOS, MATIZ, SPARK

CHRYSLER

LE BARON, VOYAGER I, VOYAGER II

DAEWOO

KALOS, TICO

DAIHATSU

CHARADE II, CHARADE III, CHARMANT, ROCKY HARD TOP, SKYWING

DAIMLER

2.8 - 5.3

GEO

METRO

HONDA

JAZZ I

HYUNDAI

H100, PORTER

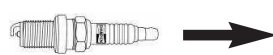

...OE049

KIA
RIO
MARUTI
800
MITSUBISHI
DEBONAIR, LANCER IV, LANCER V, PAJERO I, PAJERO II
NISSAN
CHERRY III, MICRA I, PATROL GR IV, SUNNY I, SUNNY II, URVAN
SUZUKI
ALTO (OS), ALTO HATCHBACK
TOYOTA
CAMRY, CARIBE, CARINA, COROLLA, CORONA, HIACE III, MODELL F, STARLET, TERCEL, TOWN ACE

OE051

ALFA ROMEO

6
AUSTIN
METRO, MINI
BENTLEY
AZURE, CONTINENTAL, CONTINENTAL FLYING SPUR
DACIA
NOVA
DAIHATSU
CHARADE I, CHARMANT, DELTA WIDE, ROCKY SOFT TOP, RUGGER, TAFT
GAZ
GAZELLE, SOBOL (2217), SOBOL (2752), VOLGA

HONDA

CIVIC I, CIVIC II

HYUNDAI

PONY

INNOCENTI

MINI

ISUZU

GEMINI

JAGUAR

E-TYPE, XJ

LAND ROVER

90, 110/127, DEFENDER, DISCOVERY I, RANGE ROVER I, RANGE ROVER II

LDV

SHERPA

MAZDA

121 I (DA), B-SERIE (PE), B-SERIE (UD), B-SERIE (UF), B-SERIE (UN), E-SERIE BOX, E-SERIE BOX (SR2), E-SERIE BUS (SR1)

MG

MGR V8, MIDGET

MITSUBISHI

CORDIA, L 200, L 300 / DELICA II, L 300 II, L 300 III, L 400, LANCER II, PAJERO I, TREDIA

MORGAN

PLUS EIGHT

...OE051

NISSAN
BLUEBIRD, BLUEBIRD (B610), CHERRY II, CHERRY III, DATSUN 160 J, DATSUN 180 B, LAUREL, MICRA I, PICK UP, PRAIRIE, SILVIA, SUNNY, SUNNY I, SUNNY II, VANETTE

PORSCHE

928

PROTON

AEROBACK, JUMBUCK, PERSONA 300, PERSONA 400, SALOON, SATRIA, WIRA

RENAULT

RAPID

ROLLS-ROYCE

CORNICHE IV, SILVER SPIRIT

SUZUKI

ALTO (EF), CARRY BOX (OS), LJ 80 (OL), SAMURAI CLOSED OFF-ROAD VEHICLE (SJ), SJ 410, SJ 410 CABRIO (OS), SJ 413 (OS), SUPER CARRY BUS (ED)

TOFAS

SAHIN

TOYOTA

1000, BLIZZARD, CAMRY, CARINA, CARINA II, CELICA, COASTER, COROLLA, COROLLA FX, CORONA, CRESSIDA, CRESTA, CROWN, DYNA, DYNA 100, DYNA 150, HIACE I, HIACE II, HILUX, HILUX I, HILUX II, HILUX III, HILUX IV, HILUX V, MARK II, LAND CRUISER, LITEACE, MASTER ACE SURF, MODELL F, STARLET, TOWN ACE, VISTA

TRIUMPH

DOLOMITE, SPITFIRE, TR 7

VW

LT 28-35 I, TARO

OE057

MEGA

MONTE CARLO, TRACK

MERCEDES-BENZ

CABRIOLET (A124), C-CLASS (W202), C-CLASS T-MODEL (S202), CLK (C208), CLK CONVERTIBLE (A208), COUPE (C124), E-CLASS (W124), E-CLASS (W210), E-CLASS CONVERTIBLE (A124), E-CLASS COUPE (C124), E-CLASS T-MODEL (S124), E-CLASS T-MODEL (S210), G-CLASS (W463), G-CLASS /CABRIO (W463), KOMBI T-MODEL (S124), SALOON (W124), S-CLASS (W140), S-CLASS COUPE (C140), SL (R129), SLK (R170), SPRINTER 2-T BOX (901, 902), SPRINTER 3-T BOX (903), SPRINTER 3-T BOX /BUS /PLATFORM /CHASSIS (903), SPRINTER 3-T BUS /PLATFORM /CHASSIS (903)

SSANGYONG

KYRON, MUSSO, REXTON, RODIUS

OE059

ARO

10

GAZ

GAZELLE, SOBOL (2217), SOBOL (2310), SOBOL (2752), VOLGA

LAND ROVER

RANGE ROVER I

...OE059

MG

MGB GT

RENAULT

4, 5, 6

ROVER

2000-3500

TRIUMPH

TR 8

UAZ

452, 469 B

OE063

BAOLONG

PEGASUS

BYD

F3

CHENGLONG

FUTURE

CHERY

TIGGO, V5

CHRYSLER

CIRRUS, SEBRING, STRATUS

DADI

CITY COURSER, ELEGANTEST

EUNOS

500

FIAT

PALIO, STRADA

FORD ASIA / OZEANIA

FREDA, TIERRA

GREAT WALL

FENGJUN 5, HOVER H3

HYUNDAI

ACCENT, ACCENT I, ACCENT II, ACCENT III, ATOS, ATOS PRIME, COUPE, ELANTRA, GETZ, I10, I20, I30, LANTRA II, MATRIX, S COUPE, SONATA V, STELLAR, TIBURON, TRAJET

INFINITI

I30, QX4

ISUZU

TROOPER II, VEHICROSS, WIZARD

KIA

CARENS I, CARENS II, CARENS III, CEE'D, CERATO, CLARUS, PICANTO, PRIDE, PRO CEE'D, RIO II, SHUMA, SHUMA II

LANDWIND (JMC)

LANDWIND

MAZDA

2 (DY), 121 I (DA), 121 II (DB), 323 F V (BA), 323 F VI (BJ), 323 III STATION WAGON (BW), 323 P V (BA), 323 S IV (BG), 323 S V (BA), 323 S VI (BJ), 626 IV /HATCHBACK (GE), 929 III (HC), DEMIO (DW), E-SERIE MPV (SG), MX-3 (EC), MX-5 II (NB), PREMACY (CP), XEDOS 6 (CA)

MITSUBISHI

COLT V, L 300 III, L 400, SPACE RUNNER, SPACE STAR

MITSUOKA

VIEWT, YUGA

...OE063

NISSAN

240 SX, AD VAN, AD WAGON, ALMERA I, ALMERA II, ALMERA TINO, AVENIR, BASSARA, BLUEBIRD, BLUEBIRD SYLPHY I, CARAVAN, CEDRIC, CEFIRO II, CEFIRO III, CUBE, GLORIA, GLORIA VIII, GLORIA XI, LEOPARD, LUCINO, MAXIMA / MAXIMA QX IV, MAXIMA / MAXIMA QX V, MICRA II, PICK UP, PRIMERA, SERENA, SUNNY II, SUNNY III, SUNNY IV, TERRANO I, URVAN

PORSCHE

356 CABRIOLET /SPEEDSTER /COUPE

RENAULT

CLIO II

SUBARU

FORESTER, IMPREZA, LEGACY I, LEGACY II, LEGACY III, LEGACY IV, LEGACY OUTBACK, OUTBACK

TOYOTA

4 RUNNER, CARIBE, CARINA E, CARINA II, CELICA, COROLLA, COROLLA FX, COROLLA LEVIN, CORONA, CORSA, CRESSIDA, CRESTA, CURREN, MR 2 I, PASEO, RAUM, SCEPTER, SOLUNA VIOS, SPRINTER, SPRINTER CARIB, STARLET, TERCEL, VIOS, VISTA, YARIS / VIOS

OE064

ARO

240-244

BEDFORD

BLITZ

DACIA

NOVA

DAEWOO

PRINCE, SUPER SALOON

FIAT

126, PANDA

FORD

TAUNUS 15M

OPEL

ADMIRAL A, ADMIRAL B, ASCONA A, ASCONA B, COMMODORE A, COMMODORE B, COMMODORE C, CORSA A, DIPLOMAT B, FRONTERA A, GT, KADETT A, KADETT B, KADETT C, KADETT D, KADETT E, KAPITAN, MANTA A, MANTA B, MONZA A, OLYMPIA A, OMEGA A, REKORD A, REKORD B, REKORD C, REKORD D, REKORD E, SENATOR A, SENATOR B

PORSCHE

356 CABRIOLET /SPEEDSTER /COUPE, 911 /TARGA

RANGER

REKORD

VAUXHALL

ASTRA, ASTRA MK II, CARLTON MK II, CARLTON MK III, CAVALIER, CAVALIER CC, FRONTERA MK I (A), NOVA, ROYALE, SENATOR, SENATOR MK II (B), VICEROY

OE065

ARO

10

JAGUAR

MK X



...OE065

PROTON
PERSONA 300, PERSONA 400
VW
SANTANA

OE068

ALFA ROMEO
ALFETTA, ALFETTA GT, GIULIETTA, GTV, SPIDER

BMW
600 (111), 700 (107), 700 COUPE

LAMBORGHINI
COUNTACH, ESPADA, JARAMA

MOSKVICH
2335

NSU
TT

PORSCHE
356 CABRIOLET /SPEEDSTER /COUPE

OE073

FERRARI
348, 348 TB/GTB, 348 TS/GTS, 612 SCAGLIETTI

LAMBORGHINI
LM-002

MASERATI
GHIBLI II, SHAMAL

OE077

ALFA ROMEO
147

CHEVROLET
LACETTI, NUBIRA

FIAT
DUCATO, PUNTO, UNO

MITSUBISHI
PAJERO II, SAPPORO III

NISSAN
280 ZX,ZXT

SUBARU
LEONE II, XT

OE083

BMW
5 (E34), 5 /TOURING (E34)

SUZUKI
ALTO (FF), CAPPUCINO (EE), WAGON R+ (MM), WAGON R+ HATCHBACK (EM)

TVR
CERBERA, TUSCAN II

OE087

ALFA ROMEO
33, 75, 145, 146, 164, 166, ALFASUD, ARNA, GIULIA, GT, GTA, GTV, MONTREAL

ALPINE
A310

AUDI
80, 100, COUPE, SUPER 90

FERRARI
365 GT 2+2, 365 GTB/4 DAYTONA, 365 GTS/4 DAYTONA, 400 I, 412 I, 512 BB, DINO GT, DINO GTS, MONDIAL

...OE087

FIAT
ARGENTA, DINO

FORD
CAPRI, ESCORT I

MASERATI
228, 420/430, BITURBO, KARIF, QUATTROPORTE I, QUATTROPORTE III, QUATTROPORTE IV

MERCEDES-BENZ
/8 COUPE (W114), CABRIOLET (W111), COUPE (W111), HECKFLOSSE (W111, W112), KOMBI T-MODEL (S123), SALOON (W123), S-CLASS (W108, W109), T2/L DUMPTRUCK

PEUGEOT
204, 304

PININFARINA
SPIDEREUROPA

PORSCHE
911 (964), 911 /TARGA, 911 TARGA, 924, 944 /CONVERTIBLE

RENAULT
9, 11, 19 I, 19 II, 21, SUPER 5

SSANGYONG
KORANDO

TALBOT
MATRA BAGHEERA, SIMCA 1000, SIMCA 1100, SIMCA SUNBEAM

TRIUMPH
VITESSE

VW
DERBY, GOLF I, JETTA I, PASSAT, SANTANA, SCIROCCO

OE089

ALFA ROMEO
159

CADILLAC
BLS

CHRYSLER
NEON II, PT CRUISER

DAIHATSU
SIRION, TERIOS

DODGE
DURANGO, NITRO, RAM 1500

FIAT
CROMA, IDEA, SIENA, STILO

FORD
MAVERICK

FORD USA
PROBE I, PROBE II

HONDA
ACCORD IV, ACCORD V, ACCORD VI, ACCORD VII, CAPA, CIVIC II, CIVIC V, CIVIC VI, CIVIC VII, CR-V I, CR-V II, CR-V III, DOMANI, FR-V, HR-V, INTEGRA, LOGO, PRELUDE IV, PRELUDE V, SHUTTLE, SMX, STEPWGN, STREAM

JEEP
CHEROKEE, COMMANDER, GRAND CHEROKEE III

KIA
RIO

...OE089

LOTUS
ELISE

MAZDA
323 F VI (BJ), 323 S VI (BJ), 626 III (GD), 626 IV HATCHBACK (GE), 929 III (HC), B-SERIE (UF), B-SERIE (UN), MPV I (LV), MPV II (LW), MX-6 (GE), PREMACY (CP), XEDOS 9 (TA)

NISSAN
100 NX, 200 SX, PICK UP, PRAIRIE PRO, PRIMERA, SUNNY III, TERRANO I, TERRANO II, VANETTE CARGO

OPEL
ASTRA G, ASTRA H, CALIBRA A, COMBO, INSIGNIA A, VECTRA A, VECTRA B, ZAFIRA B

ROVER
600, 800

TOYOTA
YARIS

VAUXHALL
ASTRA MK II, ASTRA MK V (H), CAVALIER MK III, INSIGNIA MK I (A), ZAFIRA MK II (B)

OE091

ALPINE
1300, 1600

FIAT
850

JAGUAR
XJ

LADA
110

LAMBORGHINI
MIURA

MERCEDES-BENZ
GULLWING (W198), SL (R198)

PORSCHE
356 COUPE, 911 /CONVERTIBLE /TARGA, 924

OE093

TOYOTA
ALLION I, AVENSIS, BB I, COROLLA, ECHO, ISIS, IST, LAND CRUISER, LAND CRUISER 80, LITEACE, MATRIX, MR 2 III, OPA, PLATZ, PORTE, PROBOX/SUCCEED, RACTIS, RAUM, RAV 4 II, SIENTA, URBAN CRUISER, VIOS/YARIS, VISTA, WILL CYPHA, WILL VI, WILL VS, WISH, YARIS, YARIS VERSO, YARIS / VIOS

OE094

ALFA ROMEO
33, 75, 145, 146, 164

ALPINE
A610

CITROËN
AX

LANCIA
KAPPA

PEUGEOT
205 II

PORSCHE
911 (993), 911 /CONVERTIBLE (993)

...OE094

RENAULT
21, SAFRANE I

SEAT
IBIZA I, MALAGA, TOLEDO I

VW
CORRADO, PASSAT, SCIROCCO

OE105

CHRYSLER
CONCORDE, VOYAGER / GRAND VOYAGER III

DODGE
CARAVAN, INTREPID

PLYMOUTH
VOYAGER / GRAND VOYAGER

OE120

BMW
1 (E81), 1 (E87), 3 (E30), 3 CONVERTIBLE (E93), 5 (E28), 7 (E65, E66, E67)

CHEVROLET
VECTRA, ZAFIRA

HOLDEN
ASTRA

MERCEDES-BENZ
A-CLASS (W168)

OPEL
VECTRA C

PIAGGIO
PORTER

RENAULT
LAGUNA I

SEAT
IBIZA II

VAUXHALL
OMEGA (B), SIGNUM, VECTRA (B), VECTRA MK II (C), ZAFIRA MK II (B)

VOLVO
850, 960, 960 II, C70 I, S40 I, S60 I, S70, S80 I, S90, V40, V70 I, V70 II, V90

OE122

ALFA ROMEO
145, 146, 147, 155, 156, 166, GT, GTV, SPIDER

FERRARI
360, ENZO FERRARI, F355, F355 BERLINETTA, F430

MASERATI
3200 GT, 4200 GT, 4200 GT SPYDER, QUATTROPORTE IV, QUATTROPORTE V

OE123

ALFA ROMEO
147, 156, GT, GTV, SPIDER

VW
GOLF III, GOLF IV, PASSAT, TRANSPORTER IV, VENTO

OE128

DODGE
DAKOTA, RAM, RAM 1500, RAM 2500, RAMCHARGER, RAMCHARGER II

JEEP
CHEROKEE, COMANCHE, GRAND CHEROKEE I





| | | | |
|---|---|--|---|
| <p>OE130 CITROËN C2, C3 I, C4, C4 I DACIA LOGAN, LOGAN II, LOGAN MCV II, SANDERO, SANDERO II NISSAN KUBISTAR PEUGEOT 206, 207, 307, 1007 RENAULT CLIO, CLIO II, CLIO III, CLIO IV, KANGOO, MODUS / GRAND MODUS, THALIA I, THALIA II, TWINGO I, TWINGO II, TWINGO III SMART FORFOUR, FORTWO</p> | <p>...OE136 HONDA INSPIRE, LEGEND II, NSX I, S2000 JAGUAR XJ, XK 8 KIA CARNIVAL I, CARNIVAL II LAMBORGHINI GALLARDO, GALLARDO SPYDER LANCIA KAPPA, THESIS LAND ROVER FREELANDER LEXUS ES, GS, IS, IS I, LS, SC MERCEDES-BENZ C-CLASS (W202), C-CLASS T-MODEL (S202) MITSUBISHI 3000 GT, DIAMANTE I, DIAMANTE II, GALANT V, GALANT VI, MAGNA, SIGMA NISSAN 180 SX, 200 SX, 300 ZX, SUNNY III OPEL ASTRA G, ASTRA H, COMBO, SIGNUM, VECTRA C, ZAFIRA B PORSCHE CAYENNE (9PA) RENAULT ESPACE IV, LAGUNA II, LAGUNA III, MEGANE II, SCÉNIC II SAAB 9-3, 9-5 SEAT ALHAMBRA, AROSA, EXEO, IBIZA III, LEON, TOLEDO II SKODA OCTAVIA I, SUPERB I SUBARU FORESTER, IMPREZA, LEGACY I SUZUKI IGNIS II (MH), LIANA HATCHBACK, SWIFT III (MZ, EZ), WAGON R+ (MM), WAGON R+ HATCHBACK (MM) TOYOTA ALTEZZA, ARISTO, AVANZA, AVENSIS, BB II, CALDINA, CAMI, CAMRY, CARINA E, CELICA, CELSIOR, CHASER, CRESTA, CROWN, CURREN, MARK II, LAND CRUISER 200, MAJESTA, MR 2 II, PASSO, RAV 4 I, SOARER, SUPRA, VEROSSA VAUXHALL ASTRA MK V (H), COMBO MK II (C), COMBO TOUR MK II (C), CORSA MK II (C), CORSA MK III (D), SIGNUM, VECTRA MK II (C), ZAFIRA MK I (A), ZAFIRA MK II (B) VOLVO 850, C70 I, S40 I, S60 I, S70, S80 I, V40, V70 I, V70 II, XC70 CROSS COUNTRY, XC90 I VW BORA, GOLF IV, LUPO, NEW BEETLE, PASSAT, POLO, SHARAN</p> | <p>OE138 INFINITI Q45 II LAND ROVER DISCOVERY II, RANGE ROVER II TOYOTA ASCENT, AVENSIS, CALDINA, CARINA E, COROLLA, CORONA, CURREN, SPRINTER, SPRINTER CARIB OE145 SKODA FABIA I, FELICIA I, FELICIA II, OCTAVIA I OE146 ACURA NSX ALFA ROMEO 147, 156, 166, GT, GTV, SPIDER AUDI A4, A5, A6, A8, Q5 BENTLEY ARNAGE CHEVROLET EPICA DAEWOO MAGNUS, TOSCA DAIMLER DAIMLER XJ FORD GALAXY HONDA CIVIC VII, CIVIC VIII, NSX I HYUNDAI EQUUS / CENTENNIAL INFINITI G20, M30 JAGUAR S-TYPE, XJ LAND ROVER FREELANDER LEXUS ES LOTUS ELISE, ELISE 340 R MERCEDES-BENZ C-CLASS COUPE (CL203), SPRINTER 2-T BOX /BUS /PLATFORM /CHASSIS (901, 902), SPRINTER 3-T BOX /BUS /PLATFORM /CHASSIS (903) MG EXPRESS, MG 6, MGF, MG TF, MG ZR, MG ZS, MG ZT, MG ZT- MITSUBISHI DIAMANTE I, DIAMANTE II, ECLIPSE III, L 300 III, MAGNA, PAJERO II, PAJERO III, PAJERO IV, PAJERO SPORT II, PROUDIA/DIGNITY, VERADA MORGAN PLUS EIGHT NISSAN CEDRIC RENAULT MEGANE CC, MEGANE III, TWINGO II, WIND</p> | <p>...OE146 ROVER 25, 45, 75, 200, 400, COUPE, STREETWISE SEAT ALTEA, ALTEA XL, EXEO, LEON, TOLEDO III SKODA OCTAVIA II SUBARU FORESTER, LEGACY II, LEGACY IV, OUTBACK TOYOTA CAMRY, CARIBE, CENTURY, COROLLA, CRESTA, CURREN, MARK II, PREVIA, SCEPTER, SPRINTER, SPRINTER CARIB, VISTA, WINDOM VAUXHALL ASTRA MK VI (J) VW EOS, GOLF V, GOLF VI, GOLF PLUS, JETTA III, PASSAT, TOURAN</p> |
| <p>OE131 ASTON MARTIN DB7, DB9, DBS, RAPIDE, VANQUISH, VANTAGE, VIRAGE FORD B-MAX, C-MAX, C-MAX II, COUGAR, ESCORT V, ESCORT VI, ESCORT VII, FIESTA, FIESTA IV, FIESTA V, FIESTA VI, FOCUS C-MAX, FOCUS II, KA, MONDEO I, MONDEO II, MONDEO III FORD AUSTRALIA COUGAR, FALCON, KA JAGUAR S-TYPE, XF, XJ, X-TYPE LINCOLN LS MAZDA 6 HATCHBACK (GG), 121 III (JASM, JBSM) MORGAN PLUS FOUR, ROADSTER VOLVO C30, S40 II, S80 II, V50, V70 III</p> | <p>OE136 ACURA LEGEND II, NSX ALFA ROMEO 156, 159, 164, 166, BRERA, GTV, SPIDER ALPINA B5 AUDI 80, 100, A3, A4, A6, ALLROAD, COUPE, QUATTRO, TT BENTLEY CONTINENTAL CADILLAC BLS DAIHATSU YRV DAIMLER DAIMLER XJ FIAT COUPE FORD GALAXY, SCORPIO II, TRANSIT</p> | <p>OE148 CITROËN XSARA PICASSO HYUNDAI IX35, SANTA FÉ II, SONATA V, SONATA VI KIA CERATO II, CERATO KOUP, MAGENTIS, OPTIMA, SORENTO II, SPÓRTAGE NISSAN ALMERA CLASSIC, ALMERA II, ALTIMA, AVENIR, BASSARA, PATHFINDER III, PRIMERA, SENTRA V, X-TRAIL PEUGEOT 206</p> | <p>OE148 CITROËN XSARA PICASSO HYUNDAI IX35, SANTA FÉ II, SONATA V, SONATA VI KIA CERATO II, CERATO KOUP, MAGENTIS, OPTIMA, SORENTO II, SPÓRTAGE NISSAN ALMERA CLASSIC, ALMERA II, ALTIMA, AVENIR, BASSARA, PATHFINDER III, PRIMERA, SENTRA V, X-TRAIL PEUGEOT 206</p> |
| <p>OE136 ACURA LEGEND II, NSX ALFA ROMEO 156, 159, 164, 166, BRERA, GTV, SPIDER ALPINA B5 AUDI 80, 100, A3, A4, A6, ALLROAD, COUPE, QUATTRO, TT BENTLEY CONTINENTAL CADILLAC BLS DAIHATSU YRV DAIMLER DAIMLER XJ FIAT COUPE FORD GALAXY, SCORPIO II, TRANSIT</p> | <p>OE136 ACURA LEGEND II, NSX ALFA ROMEO 156, 159, 164, 166, BRERA, GTV, SPIDER ALPINA B5 AUDI 80, 100, A3, A4, A6, ALLROAD, COUPE, QUATTRO, TT BENTLEY CONTINENTAL CADILLAC BLS DAIHATSU YRV DAIMLER DAIMLER XJ FIAT COUPE FORD GALAXY, SCORPIO II, TRANSIT</p> | <p>OE148 CITROËN XSARA PICASSO HYUNDAI IX35, SANTA FÉ II, SONATA V, SONATA VI KIA CERATO II, CERATO KOUP, MAGENTIS, OPTIMA, SORENTO II, SPÓRTAGE NISSAN ALMERA CLASSIC, ALMERA II, ALTIMA, AVENIR, BASSARA, PATHFINDER III, PRIMERA, SENTRA V, X-TRAIL PEUGEOT 206</p> | <p>OE148 CITROËN XSARA PICASSO HYUNDAI IX35, SANTA FÉ II, SONATA V, SONATA VI KIA CERATO II, CERATO KOUP, MAGENTIS, OPTIMA, SORENTO II, SPÓRTAGE NISSAN ALMERA CLASSIC, ALMERA II, ALTIMA, AVENIR, BASSARA, PATHFINDER III, PRIMERA, SENTRA V, X-TRAIL PEUGEOT 206</p> |

**...OE175****NISSAN**

350 Z, ALTIMA, CEFIRO I, CUBE, ELGRAND, MAXIMA / MAXIMA QX V, MAXIMA QX V, MICRA C+C III, MICRA III, MURANO I, NOTE, QUEST, SKYLINE, STAGEA, TEANA I, TERRANO II, XTERRA

PEUGEOT

406, 407, 607, 807

RENAULT

AVANTIME, CLIO II, ESPACE IV, KANGOO, LAGUNA II, MEGANE I, VEL SATIS

SUZUKI

GRAND VITARA II (JT, TE, TD), KIZASHI (FR), SWIFT IV (FZ, NZ), SX4 (EY, GY)

OE176**AUDI**

A8

FORD

GALAXY

SEAT

ALHAMBRA, AROSA, CORDOBA, IBIZA III, LEON, TOLEDO II

SKODA

FABIA I, OCTAVIA I

TOYOTA

NADIA

VW

BORA, CADDY II, GOLF IV, JETTA III, LUPO, NEW BEETLE, PASSAT, PHAETON, POLO, SHARAN, TOUAREG, TOURAN, TRANSPORTER IV

OE177**SEAT**

ALTEA, ALTEA XL, CORDOBA, IBIZA III, IBIZA IV, LEON, TOLEDO III, TOLEDO IV

SKODA

FABIA I, FABIA II, OCTAVIA II, RAPID, ROOMSTER, ROOMSTER PRAKTIK

VW

BEETLE, CADDY III, FOX, GOLF V, GOLF VI, GOLF PLUS, JETTA IV, NEW BEETLE, POLO

OE178**CITROËN**

C1, C4, C4 GRAND PICASSO I, C4 I, C4 PICASSO I, C5 I, C5 II, C5 III, C8, EVASION, JUMPY, XSARA, XSARA PICASSO

FIAT

SCUDO, ULYSSE

LANCIA

PHEDRA, ZETA

PEUGEOT

206, 307, 308 SW, 406, 407, 607, 806, 807, EXPÛRT, EXPÛRT TÛPEE

OE186**FIAT**

BRAVA, BRAVO I, MAREA, PUNTO

LANCIA

THEMA, Y

OE191**CHRYSLER**

CROSSFIRE

...OE191**FORD ASIA / OCEANIA**

FALCON

HOLDEN

APOLLO

HYUNDAI

COUPE, SONATA IV, TRAJET

KIA

CADENZA I, PRO CEE'D

MERCEDES-BENZ

C-CLASS (W202), C-CLASS (W203), C-CLASS COUPE (CL203), C-CLASS T-MODEL (S202), C-CLASS T-MODEL (S203), CLK (C208), CLK (C209), CLK CONVERTIBLE (A208), CLK CONVERTIBLE (A209), CLS (C219), E-CLASS (W210), E-CLASS (W211), E-CLASS T-MODEL (S210), E-CLASS T-MODEL (S211), G-CLASS (W463), G-CLASS /CABRIO (W463), G-CLASS CABRIO (W463), M-CLASS (W163), M-CLASS (W164), R-CLASS (W251, V251), S-CLASS (W220), S-CLASS COUPE (C215), SL (R129), SL (R230), SLK (R170), SLK (R171), VIANO (W639), VITO BUS (W639), VITO / MIXTO BOX (W639)

NISSAN

CEDRIC, CEFIRO I, CEFIRO II, GLORIA, MAXIMA / MAXIMA QX V, STAGEA

OPEL

FRONTERA B, MONTEREY A, MONTEREY B

PUCH

G-MODELL

SSANGYONG

KORANDO

SUZUKI

GRAND VITARA II (JT, TE, TD)

TOYOTA

ALTEZZA, ALTEZZA GITA, ARISTO, CHASER, CRESTA, CROWN, MARK II, PROBOX/SUCCEED, SOARER

VW

VENTO

OE192**HYUNDAI**

SANTA FÉ I, SONATA II, SONATA III, SONATA IV

KIA

SORENTO I

TOYOTA

CENTURY

OE196**ALFA ROMEO**

MITO

CHRYSLER

YPSILON

FIAT

500, 500 C, 500L, BRAVA, BRAVO I, BRAVO II, DOBLO, FIORINO, GRANDE PUNTO, IDEA, LINEA, PALIO, PANDA, PANDA VAN, PUNTO, PUNTO EVO, QUBO, SEICENTO / 600, SIENA, STILO, STRADA

FORD

KA

LANCIA

MUSA, YPSILON

OE197**HYUNDAI**

I10, I20

KIA

PICANTO, RIO III

OE198**CHEVROLET**

AVEO, CRUZE, NIVA, NUBIRA, ORLANDO, TRAX, VIVA

HOLDEN

ASTRA, BARINA, COMBO, TIGRA, TRAX, VIVA

OPEL

ADAM, AGILA (A), ASTRA G, ASTRA H, ASTRA J, COMBO, CORSA C, CORSA D, INSIGNIA A, MERIVA A, MERIVA B, MOKKA, MOKKA / MOKKA X, SIGNUM, TIGRA, VECTRA B, VECTRA C, ZAFIRA A, ZAFIRA B, ZAFIRA TOURER C

SUZUKI

WAGON R HATCHBACK

VAUXHALL

AGILA MK I (A), ASTRA MK IV (G), ASTRA MK V (H), ASTRA MK VI (J), ASTRAVAN MK V (H), COMBO MK II (C), COMBO TOUR MK II (C), CORSA MK II (C), CORSA MK III (D), CORSAVAN MK II (C), CORSAVAN MK III (D), INSIGNIA MK I (A), MERIVA MK I (A), MERIVA MK II (B), MOKKA / MOKKA X, SIGNUM, TIGRA, VECTRA (B), VECTRA MK II (C), ZAFIRA MK I (A), ZAFIRA MK II (B), ZAFIRA MK III

VW

GOLF IV

OE199**CHEVROLET**

AVEO, SPARK

DAIHATSU

SIRION, TERIOS

OPEL

COMBO

PIAGGIO

PORTER

SUZUKI

ALTO (FF)

OE201**HYUNDAI**

ACCENT IV, ELANTRA, I20, I30, IX20, VELOSTER

KIA

CARENS III, CEE'D, CERATO, CERATO II, CERATO KOUP, PRO CEE'D, RIO III, SOUL, VENZA

OE203**CITROËN**

C3 II, C3 PICASSO, C4 II, DS3

PEUGEOT

207, 207 SW, 308, 308 SW

OE204**MINI**

MINI, MINI CLUBMAN, MINI CLUBVAN, MINI COUNTRYMAN, MINI PACEMAN

OE205**BMW**

1 (F20), 1 (F21), 3 (F30, F80), 3 TOURING (F31)

CITROËN

BERLINGO, C3 II, C3 PICASSO, C4, C4 GRAND PICASSO I, C4 GRAND PICASSO II, C4 I, C4 II, C4 PICASSO I, C4 PICASSO II, C5 III, DS3, DS4, DS5

MINI

MINI, MINI CLUBMAN, MINI COUNTRYMAN, MINI PACEMAN

PEUGEOT

207, 207 CC, 207 SW, 208, 308, 308 CC, 308 II, 308 SW, 308 SW II, 408, 508 I, 508 SW I, 2008, 3008, 5008, PARTNER, PARTNER TEPEE, RCZ

OE206**FORD**

FOCUS II, MONDEO IV, S-MAX

VOLVO

C30, C70 II, S40 II, S60 I, S80 I, S80 II, V50, V70 II, XC60, XC70 CROSS COUNTRY, XC70 II, XC90 I

OE207**NISSAN**

ALTIMA, BLUEBIRD SYLPHY II, ELGRAND, LAFESTA, LIVINA / GRAND LIVINA, MICRA C+C III, MICRA III, NOTE, NV200, NV200 / EVALIA, PRIMERA, QASHQAI / QASHQAI +2 I, SERENA, TEANA II, TIIDA, X-TRAIL

RENAULT

CLIO III, FLUENCE, GRAND SCÉNIC III, KOLEOS I, LAGUNA, LAGUNA III, LATITUDE, MEGANE CC, MEGANE III, SCÉNIC III

OE208**ABARTH**

500 / 595 / 695, 500C / 595C / 695C, GRANDE PUNTO, PUNTO

ALFA ROMEO

GIULIETTA, MITO

CHRYSLER

DELTA

FIAT

500X, BRAVO II, DOBLO, GRANDE PUNTO, LINEA, PUNTO, PUNTO EVO

JEEP

RENEGADE

LANCIA

DELTA III

OE209**AUDI**

A4, A5, A6, A6 ALLROAD, A8, Q7, R8

VW

TOUAREG

OE210**PORSCHE**

911 / CONVERTIBLE (991), 911 / CONVERTIBLE (997), CAYENNE (9PA), CAYENNE (92A), PANAMERA (970)

OE211**SMART**

CABRIO, CITY-COUPÉ, FORTWO, ROADSTER



OE212

SMART
FORTWO

OE213

AUDI
A1, A3
SEAT
ALTEA, ALTEA XL, IBIZA IV, LEON, TOLEDO III, TOLEDO IV

SKODA
OCTAVIA II, RAPID, SUPERB II, YETI
VW

EOS, GOLF V, GOLF VI, GOLF PLUS, JETTA IV, PASSAT, SCIROCCO, TIGUAN

OE214

AUDI
A1, A3, A4, A4 ALLROAD, A5, A6, A6 ALLROAD, A7, A8, Q3, Q5, Q7, R8, TT

SEAT
ALHAMBRA, ALTEA, ALTEA XL, EXEO, LEON, TOLEDO III

SKODA
OCTAVIA II, SUPERB II, YETI

VW
AMAROK, BEETLE, CC, EOS, GOLF V, GOLF VI, JETTA III, JETTA IV, MULTIVAN V, PASSAT, PASSAT ALLTRACK, PASSAT CC, POLO, SCIROCCO, SHARAN, TIGUAN, TOUAREG, TRANSPORTER V

OE215

AUDI
A3, TT
PORSCHE
CAYENNE (9PA)

VW
EOS, GOLF IV, GOLF V, MULTIVAN V, PHAETON, TOUAREG, TRANSPORTER V

OE216

BMW
3 (E36), 3 (E90), 3 /COMPACT /CONVERTIBLE /COUPE /TOURING (E36), 3 /COMPACT /COUPE (E36), 3 /COMPACT /COUPE /TOURING (E36), 3 CONVERTIBLE (E36), 3 CONVERTIBLE (E93), 3 /CONVERTIBLE /COUPE (E36), 3 /CONVERTIBLE /TOURING (E36), 3 COUPE (E36), 3 COUPE (E92), 3 TOURING (E91), 5 (E34), 5 (E39), 5 (E60), 5 /TOURING (E34), 5 TOURING (E34), 5 /TOURING (E39), 5 TOURING (E39), 5 TOURING (E61), 6 (E63), 6 CONVERTIBLE (E64), 7 (E38), 7 (E65, E66, E67), 8 (E31), X1 (E84), X3 (E83), X5 (E53), X5 (E70), Z3 ROADSTER (E36), Z4 ROADSTER (E85)

CITROËN
XSARA
DACIA
LODGY, LOGAN, LOGAN MCV, SANDERO, SOLENZA
DAIHATSU
TERIOS
FIAT
BARCETTA, BRAVA, BRAVO I, COUPE, MAREA, PALIO, STILO

...OE216

FORD USA
PROBE II
HONDA
ACCORD IV, ACCORD V, ACCORD VI, ACCORD VII, CIVIC V, CIVIC VI, CIVIC VII, CIVIC VIII, CR-V I, CR-V II, FR-V, HR-V, INTEGRA, LOGO, PRELUDE IV, PRELUDE V, SHUTTLE, STEPWGN, STREAM

JEEP
CHEROKEE, COMMANDER, GRAND CHEROKEE III

KIA
CARNIVAL I, CARNIVAL II

LANCIA
DEDRA, DELTA II, KAPPA, LYBRA

LOTUS
ESPRIT S4
MAZDA

323 F VI (BJ), 323 S VI (BJ), 626 III STATION WAGON (GV), 626 IV HATCHBACK (GE), B-SERIE (UN), MPV I (LV), MPV II (LW), MX-6 (GE), PREMACY (CP), XEDOS 9 (TA)

MITSUBISHI
CARISMA, DION, GALANT VI, LANCER VI, LANCER VII, PAJERO II, PAJERO PININ, PAJERO SPORT I, SPACE STAR

OPEL
ASTRA J, CALIBRA A, CORSA D, INSIGNIA A, VECTRA A

PORSCHE
911 (964), 911 (993), 911 /CONVERTIBLE (996), BOXSTER (986)

RENAULT
CLIO II, KANGOO, KANGOO / GRAND KANGOO, LOGAN EXPRESS, LOGAN I, SANDERO /STEPWAY I, SCÉNIC I, SPORT SPIDER, THALIA I, TWINGO I

ROVER
600
VAUXHALL
ASTRA MK VI (J), CALIBRA, CAVALIER MK III, CORSA MK III (D), INSIGNIA MK I (A)

VOLVO
S40 I, V40

OE217
SMART
CABRIO, CITY-COUPE, CROSSBLADE, FORTWO

OE218

AUDI
A6, A8
CITROËN
C15, SAXO, XANTIA

LEXUS
LS

LOTUS
ELISE

PORSCHE
911 /CONVERTIBLE (996), BOXSTER (986), CAYENNE (9PA)

RENAULT
LAGUNA I, SAFRANE II

...OE218

TOYOTA
AVENSIS, CARINA E, CELICA, HIACE IV, HILUX, HILUX VI, LAND CRUISER, MR 2 II

OE219

AUDI
A3, Q3, TT

OE220

AUDI
A6, A7, A8

OE222

PORSCHE
911 (997), 911 /CONVERTIBLE (997), CAYENNE (9PA)

OE223

ALFA ROMEO
145, 146, 147, 155, 156, 166, GT, GTV, SPIDER

ALPINA
B3, B10, B12, ROADSTER V8, ROADSTER S

AUDI
A6, A8

BMW
3 COMPACT (E36), 3 /COMPACT (E46), 3 /COMPACT /CONVERTIBLE /COUPE /TOURING (E46), 3 /COMPACT /TOURING (E46), 3 CONVERTIBLE (E46), 3 /CONVERTIBLE /COUPE /TOURING (E46), 3 /COUPE /TOURING (E46), 5 (E39), 5 (E60), 5 /TOURING (E39), 5 TOURING (E39), 5 TOURING (E61), 6 (E63), 6 CONVERTIBLE (E64), 7 (E38), 7 (E65, E66, E67), 8 (E31), X3 (E83), X5 (E53), Z3 COUPE (E36), Z3 ROADSTER (E36), Z4 ROADSTER (E85), Z8 ROADSTER (E52)

LAND ROVER
RANGE ROVER III
MINI
MINI
MORGAN
AERO 8

ROLLS-ROYCE
PARK WARD, PHANTOM VII, SILVER SERAPH
SAAB
900 II

OE224

CITROËN
BERLINGO, BERLINGO / BERLINGO FIRST, C2, C3, C3 I, C4, C4 I, XSARA, XSARA PICASSO

FORD
FOCUS II, MONDEO IV, S-MAX

MERCEDES-BENZ
C-CLASS (W203), C-CLASS COUPE (CL203), C-CLASS T-MODEL (S203), CLC-CLASS (CL203), CLK (C209), CLK CONVERTIBLE (A209), E-CLASS (W211), E-CLASS T-MODEL (S211), G-CLASS (W463), S-CLASS (W220), S-CLASS COUPE (C215), SL (R230), SLK (R171), SLR (R199), SLR ROADSTER (R199)

MERCEDES-BENZ (BBDC)
E-CLASS

...OE224

NISSAN
ALMERA II, ALMERA TINO, AVENIR, PRIMERA, X-TRAIL

PEUGEOT
206, 207, 307, 1007, PARTNER

SUBARU
IMPREZA, LEGACY IV, LEGACY V

VOLVO
C30, C70 II, S40 II, S60 I, S80 I, S80 II, V50, V70 II, XC60, XC70 II, XC90 I

OE225

RENAULT
CLIO, CLIO III, CLIO IV, GRAND SCÉNIC III, MEGANE CC, MEGANE III, MODUS / GRAND MODUS, SCÉNIC III, TWINGO II, WIND

OE226

NISSAN
PIXO

OPEL
AGILA (B)

SUZUKI
ALTO (GF), SPLASH (EX), SWIFT IV (FZ, NZ)

VAUXHALL
AGILA MK II (B)

OE227

BMW
X5 (E70)

MITSUBISHI
CARISMA, DION, GALANT VI, LANCER VI, LANCER VII, PAJERO II, PAJERO PININ, PAJERO SPORT I, SPACE STAR

VOLVO
S40 I, V40

OE228

MERCEDES-BENZ
S-CLASS (W140), S-CLASS COUPE (C140), SL (R129)

OE229

MERCEDES-BENZ
C-CLASS (W203), C-CLASS (W204), C-CLASS COUPE (C204), C-CLASS COUPE (CL203), C-CLASS T-MODEL (S203), C-CLASS T-MODEL (S204), CLC-CLASS (CL203), CLK (C209), CLK CONVERTIBLE (A209), CLS (C219), E-CLASS (W211), E-CLASS (W212), E-CLASS CONVERTIBLE (A207), E-CLASS COUPE (C207), E-CLASS T-MODEL (S211), E-CLASS T-MODEL (S212), G-CLASS (W463), G-CLASS CABRIO (W463), GL-CLASS (X164), GLK-CLASS (X204), M-CLASS (W164), R-CLASS (W251, V251), S-CLASS (W221), S-CLASS COUPE (C216), SL (R230), SLK (R171), SLK (R172), SPRINTER 3,5-T BOX (906), SPRINTER 3,5-T BOX /BUS /PLATFORM /CHASSIS (906), SPRINTER 3,5-T BUS /PLATFORM /CHASSIS (906), SPRINTER 3-T BOX (906), SPRINTER 3-T BOX /BUS /PLATFORM /CHASSIS (906), SPRINTER 3-T BUS (906), SPRINTER 3-T PLATFORM /CHASSIS (906), SPRINTER 4,6-T BOX /PLATFORM /CHASSIS (906), SPRINTER 5-T BOX /PLATFORM /CHASSIS (906), SPRINTER 5-T PLATFORM /CHASSIS (906), VIANO (W639), VITO BUS (W639), VITO / MIXTO BOX (W639)



...OE229

MERCEDES-BENZ (BBDC)

E-CLASS

MITSUBISHI

I, OUTLANDER II, PAJERO SPORT II

OE230

CHEVROLET

AVEO, MATIZ, SPARK

FIAT

500, 500 C, 500L, BRAVA, BRAVO I, BRAVO II, DOBLO, IDEA, PALIO, PANDA, PUNTO, SIENA, STILO, STRADA

FORD

KA

LANCIA

MUSA

NISSAN

PIXO

OPEL

AGILA (B)

SUZUKI

ALTO (GF), SPLASH (EX), SWIFT IV (FZ, NZ)

OE232

ALFA ROMEO

MITO

CHRYSLER

YPSILON

FIAT

500, 500 C, 500L, PANDA, PANDA VAN, PUNTO

LANCIA

YPSILON

OE233

MERCEDES-BENZ

C-CLASS (W204), C-CLASS COUPE (C204), C-CLASS T-MODEL (S204), CLK (C209), CLK CONVERTIBLE (A209), CLS (C219), E-CLASS (W211), E-CLASS (W212), E-CLASS T-MODEL (S211), E-CLASS T-MODEL (S212), M-CLASS (W164), R-CLASS (W251, V251), S-CLASS (W221), S-CLASS COUPE (C216), SL (R230)

NISSAN

PATROL III

OE234

AUDI

A3, A4

SEAT

ALTEA, ALTEA XL, LEON, TOLEDO III

SKODA

OCTAVIA II

VW

EOS, GOLF V, GOLF PLUS, JETTA III, PASSAT, TOURAN

OE235

SEAT

CORDOBA, IBIZA III

VW

FOX, GOLF IV, GOL III, GOL IV, POLO, VOYAGE

OE236

VOLVO

C30, C70 II, S40 II, V50

OE237

AUDI

A4, A6, A8

SKODA

SUPERB I

VW

PASSAT

OE238

BMW

1 (E81), 1 (E87), 1 CONVERTIBLE (E88), 1 COUPE (E82), 3 (E90), 3 CONVERTIBLE (E93), 3 COUPE (E92), 3 TOURING (E91), 5 (E60), 5 (F10), 5 TOURING (E61), 6 (E63), 6 CONVERTIBLE (E64), 7 (E65, E66), 7 (E65, E66, E67), 7 (F01, F02, F03, F04), X1 (E84), X3 (E83), X3 (F25), X5 (E70), Z4 COUPE (E86), Z4 ROADSTER (E85), Z4 ROADSTER (E89)

HOLDEN

INSIGNIA

MITSUBISHI

COLT VI

OPEL

INSIGNIA A, SIGNUM, VECTRA C

SAAB

9-3, 9-4X, 9-5

SMART

FORFOUR

VAUXHALL

INSIGNIA MK I (A), VECTRA MK II (C)

WIESMANN

MF3

OE239

HONDA

ACCORD VII, ACCORD VIII, CIVIC VIII, CIVIC IX, CR-V III, CR-V IV, CR-Z, ELYSION, FR-V, JAZZ III, LAGREAT, LEGEND IV, ODYSSEY, RIDGELINE

OE242

BMW

1 (F20), 1 (F21), 1 CONVERTIBLE (E88), 1 COUPE (E82), 2 CONVERTIBLE (F23), 2 COUPE (F22, F87), 3 (E90), 3 (F30, F80), 3 CONVERTIBLE (E93), 3 COUPE (E92), 3 GRAN TURISMO (F34), 3 TOURING (E91), 3 TOURING (F31), 4 CONVERTIBLE (F33, F83), 4 COUPE (F32, F82), 4 GRAN COUPE (F36), 5 (F10), 5 GRAN TURISMO (F07), 5 TOURING (F11), 6 CONVERTIBLE (F12), 6 COUPE (F13), 6 GRAN COUPE (F06), 7 (F01, F02, F03, F04), X3 (F25), X5 (E70), X5 (F15, F85), X6 (E71, E72), X6 (F16, F86)

ROLLS-ROYCE

GHOST, WRAITH

OE243

BMW

1 (F20), 1 (F21), 2 CONVERTIBLE (F23), 2 COUPE (F22, F87), 3 (F30, F80), 3 TOURING (F31), 4 CONVERTIBLE (F33, F83), 4 COUPE (F32, F82), 4 GRAN COUPE (F36), 5 (F10), 5 GRAN TURISMO (F07), 5 TOURING (F11), 6 CONVERTIBLE (F12), 6 COUPE (F13), 6 GRAN COUPE (F06), 7 (F01, F02, F03, F04), X1 (E84), X3 (F25), X4 (F26), X5 (F15, F85), X6 (F16, F86), Z4 ROADSTER (E89)

OE244

AUDI

A1, A3, Q2, Q3

AUDI (FAW)

A3, Q3

SEAT

ALHAMBRA, ATECA, IBIZA IV, LEON, LEON ST, MII, TOLEDO IV

SKODA

CITIGO, FABIA III, OCTAVIA III, RAPID, SUPERB III, YETI

VW

BEETLE, CADDY ALLTRACK, CADDY IV, CC, GOLF VI, GOLF VII, GOLF SPORTSVAN, JETTA IV, PASSAT, PASSAT ALLTRACK, POLO, POLO VAN, SCIROCCO, SHARAN, TIGUAN, TIGUAN ALLSPACE, TOURAN, UP

VW (FAW)

GOLF SPORTSVAN

OE247

SEAT

IBIZA IV, IBIZA V, MII

SKODA

CITIGO, FABIA III, OCTAVIA III, YETI

VW

GOLF VII, GOLF SPORTSVAN, LOAD UP, POLO, POLO VAN, UP

OE254

IVECO

DAILY CITYS, DAILY III, DAILY IV, DAILY VI, DAILY LINE

OE255

CHEVROLET

VECTRA

FIAT

CROMA

OPEL

ASTRA G, SPEEDSTER, VECTRA B, VECTRA C, ZAFIRA A

VAUXHALL

ASTRA MK IV (G), SPEEDSTER, VECTRA (B), VECTRA MK II (C), VX220, ZAFIRA MK I (A)

OE257

PORSCHE

911 /CONVERTIBLE /TARGA (996), 911 /CONVERTIBLE /TARGA (997), BOXSTER (987), BOXSTER SPYDER (987), CAYENNE (9PA), CAYMAN (987)

OE262

PORSCHE

BOXSTER (987), CAYMAN (987)

RV15YC4

AC

ACE, ACECA, COBRA MK IV

CHEVROLET

ASTRO, BLAZER, BLAZER S10, C1500, C2500, CAMARO, CAPRICE, G20, S10, S10 PICK UP, SUBURBAN, TAHOE

PONTIAC

FIREBIRD, TRANS SPORT



eon TITAN



CET1

ABARTH
500 / 595 / 695, 500C / 595C / 695C

ALFA ROMEO
MITO

BMW
3 / CONVERTIBLE (E30), 5 (E28), 5 (E34), 5 / TOURING (E34), 6 (E24), M1 (E26)

CHEVROLET
AVEO, SPARK

CHRYSLER
YPSILON

DAIHATSU
SIRION, TERIOS

FERRARI
328 GTB, 328 GTS, 512 TR, MONDIAL, TESTAROSSA

FIAT
500, 500 C, BRAVA, BRAVO I, BRAVO II, DOBLO, FIORINO, GRANDE PUNTO, IDEA, LINEA, MAREA, PALIO, PANDA, PANDA VAN, PUNTO, PUNTO EVO, QUBO, SEICENTO / 600, SIENA, STILO, STRADA

FORD
KA

LANCIA
MUSA, THEMA, Y, YPSILON

SUZUKI
ALTO (FF), CAPPUCINO (EE), WAGON R+ (MM), WAGON R+ HATCHBACK (EM)

TVR
CERBERA, TUSCAN II

CET2

ACURA
RL, SLX

AIXAM
500, A.751, CROSSLINE, SCOUTY

ALFA ROMEO
33, 75, 145, 146, 147, 156, 159, 164, GT, GTV, SPIDER

ALPINA
B3, B8, B10, B12

ALPINE
A610

ASTON MARTIN
DB7, VIRAGE

AUDI
80, 90, 100, A2, A3, A4, A6, A8, CABRIOLET, COUPE

AUSTIN
MAESTRO, MONTEGO

AUTOBIANCHI
Y10

BAOLONG
PEGASUS

BENTLEY
ARNAGE

BERTONE
FREECLIMBER 2

BITTER
TYPE 3

...CET2

BMW
3 (E30), 3 (E36), 3 / COMPACT / CONVERTIBLE / COUPE / TOURING (E36), 3 / COMPACT / COUPE (E36), 3 / COMPACT / COUPE / TOURING (E36), 3 CONVERTIBLE (E30), 3 CONVERTIBLE (E36), 3 CONVERTIBLE (E93), 3 / CONVERTIBLE / COUPE (E36), 3 / CONVERTIBLE / TOURING (E30), 3 / CONVERTIBLE / TOURING (E36), 3 COUPE (E36), 3 TOURING (E30), 5 (E28), 5 (E34), 5 (E39), 5 / TOURING (E34), 5 TOURING (E34), 7 (E32), 7 (E38), 7 (E65, E66, E67), 8 (E31), Z3 ROADSTER (E36)

BYD
F3

CADILLAC
BLS

CATERHAM
21, SEVEN, SUPER SEVEN

CHENGLONG
FUTURE

CHERY
A1, A3, A5, COWIN, COWIN 2, COWIN 3, COWIN 5, E5, EASTAR CROSS, FULWIN, QQ3, QQ6, TIGGO, TIGGO 3, TIGGO DR, V5, X1

CHEVROLET
ASTRA, AVEO, AVEO / KALOS, BERETTA, CAPTIVA, CRUZE, EPICA, EVANDA, KALOS, LACETTI, LUMINA APV, MALIBU, NIVA, NUBIRA, OPTRA, ORLANDO, REZZO, TRAX, VECTRA, VIVA, VIVANT, ZAFIRA

CHRYSLER
CIRRUS, NEON, NEON II, PT CRUISER, SEBRING, STRATUS, VOYAGER / GRAND VOYAGER III

CITROËN
AX, BERLINGO, BERLINGO / BERLINGO FIRST, BX, C2, C3, C3 I, C3 II, C15, EVASION, JUMPER, JUMPY, NEMO, SAXO, VISA, XANTIA, XM, XSARA, XSARA PICASSO, ZX

DACIA
DOKKER, DOKKER EXPRESS, DUSTER, LODGY, LOGAN, LOGAN MCV, SANDERO, SOLENZA, SUPERNOVA

DADI
CITY COURSER, ELEGANTEST

DAEWOO
BROUGHAM, ESPERO, EVANDA, GENRA, KALOS, KORANDO, LACETTI, LANOS, LEGANZA, MAGNUS, MUSSO, NEXIA, NUBIRA, PRINCE, REXTON, REZZO, WINSTORM

DAIHATSU
ALTIS, APPLAUSE I, APPLAUSE II, CHARADE III, CHARADE IV, COO, CUORE V, CUORE VI, HIJET, MATERIA, MOVE, SIRION, TERIOS, TREVIS, YRV

DAIMLER
DAIMLER, DAIMLER XJ, XJ 40, 81

DE TOMASO
GUARA

...CET2

DODGE
AVENGER, CALIBER, CARAVAN, DAKOTA, DART, DURANGO, JOURNEY, NEON, NEON II, NITRO, RAM, RAM 1500, RAM 2500, RAMCHARGER, STRATUS

EMGRAND
EC7, EC7-RV

EMGRAND (GEELY)
EC 7, EC 7 RV

EUNOS
500

FIAT
BARCETTA, BRAVA, BRAVO I, CINQUECENTO, COUPE, CROMA, DOBLO, DUCATO, FIORINO, FREEMONT, IDEA, LINEA, MAREA, MULTIPLA, PALIO, PANDA, PUNTO, QUBO, SCUDO, SEDICI, SEICENTO / 600, SIENA, STILO, STRADA, TEMPRA, TIPO, ULYSSE, UNO

FORD
ESCORT '81, ESCORT '86, ESCORT '91, ESCORT '95, ESCORT III, ESCORT IV, ESCORT V, ESCORT VI, ESCORT VII, FIESTA I, FIESTA II, FIESTA III, MAVERICK, ORION I, ORION II, ORION III, RANGER, SCORPIO I, SIERRA, TRANSIT, TRANSIT TOURNEO

FORD ASIA / OCEANIA
LASER, LASER / LASER LIDEA

FORD ASIA / OZANIA
FESTIVA, FREDIA, LIATA, TELSTAR, TIERRA

FORD AUSTRALIA
COURIER, TELSTAR

FORD USA
PROBE I, PROBE II

FSO
LANOS, POLONEZ III

GEELY
BL, CK, GC2, HISOON, HQ, MARINDO, MEIRI, MK, MR, PU, SL, URBAN NANNY, VISION

GEORG
TRACKER

GREAT WALL
FENGJUN 5, HOVER H3

HOLDEN
ASTRA, BARINA, CAPTIVA, COMBO, TIGRA, TRAX, VIVA

HONDA
ACCORD III, ACCORD IV, ACCORD V, ACCORD VI, ACCORD VII, CAPA, CITY, CIVIC I, CIVIC II, CIVIC IV, CIVIC V, CIVIC VI, CIVIC VII, CONCERTO, CR-V I, CR-V II, CR-V III, CRX II, CRX III, DOMANI, FR-V, HR-V, JAZZ, JAZZ II, LEGEND I, LEGEND III, LOGO, PRELUDE III, PRELUDE IV, PRELUDE V, SHUTTLE, SMX, STEPWGN, STREAM

HYUNDAI
ACCENT, ACCENT I, ACCENT II, ACCENT III, ATOS, ATOS PRIME, COUPE, ELANTRA, GALLOPER I, GETZ, I10, I20, I30, LANTRA II, MATRIX, S COUPE, SONATA V, STELLAR, TIBURON, TRAJET

INFINITI
I30, QX4

...CET2

IRMSCHER
SENATOR

ISUZU
GEMINI, TROOPER II, VEHICROSS, WIZARD

JAGUAR
XJ, XJSC

JEEP
CHEROKEE, COMMANDER, COMPASS, GRAND CHEROKEE I, GRAND CHEROKEE II, GRAND CHEROKEE III, PATRIOT

KIA
CARENS I, CARENS II, CARENS III, CEE'D, CERATO, CLARUS, PICANTO, PRIDE, PRO CEE'D, RETONA, RIO, RIO II, SEPHIA, SHUMA, SHUMA II, SPORTAGE

LADA
110, 111, 112, GRANTA, GRANTA (2349), KALINA, LARGUS, OKA, PRIORA

LANCIA
DEDRA, DELTA II, FLAVIA, KAPPA, LYBRA, THESIS, Y, Y10, ZETA

LAND ROVER
DEFENDER, DISCOVERY I

LANDWIND (JMC)
LANDWIND

LEXUS
GS

LIFAN
320, 520, 620, X60

LIGIER
AMBRA, BE UP, NOVA

LOTUS
ELAN, ELISE, ESPRIT S4, EUROPA S, EXIGE

MAZDA
2 (DY), 121 I (DA), 121 II (DB), 121 III (JASM, JBSM), 323 C IV (BG), 323 C V (BA), 323 F IV (BG), 323 F V (BA), 323 F VI (BJ), 323 III / HATCHBACK (BF), 323 III HATCHBACK (BF), 323 III STATION WAGON (BW), 323 P V (BA), 323 S IV (BG), 323 S V (BA), 323 S VI (BJ), 626 III (GD), 626 III / COUPE / HATCHBACK (GD), 626 III STATION WAGON (GV), 626 IV (GE), 626 IV / HATCHBACK (GE), 626 IV HATCHBACK (GE), 626 V (GF), 626 V / HATCHBACK (GF), 626 V HATCHBACK (GF), 626 V STATION WAGON (GW), 929 III (HC), B-SERIE (UF), B-SERIE (UN), DEMIO (DW), E-SERIE BOX (SR2), E-SERIE MPV (SG), MPV I (LV), MPV II (LW), MX-3 (EC), MX-5 I (NA), MX-5 II (NB), MX-6 (GE), PREMACY (CP), XEDOS 6 (CA), XEDOS 9 (TA)

MEGA
CLUB, CLUB II, MONTE CARLO, TRACK



**...CET2****MERCEDES-BENZ**

A-CLASS (W168), B-CLASS (W245), CABRIOLET (A124), C-CLASS (W202), C-CLASS T-MODEL (S202), CLK (C208), CLK CONVERTIBLE (A208), COUPE (C124), E-CLASS (W124), E-CLASS (W210), E-CLASS CONVERTIBLE (A124), E-CLASS COUPE (C124), E-CLASS T-MODEL (S124), E-CLASS T-MODEL (S210), G-CLASS (W463), G-CLASS /CABRIO (W463), KOMBI T-MODEL (S124), M-CLASS (W163), SALOON (W124), S-CLASS (W108, W109), S-CLASS (W140), S-CLASS COUPE (C140), SL (R129), SLK (R170), SPRINTER 2-T BOX (901, 902), SPRINTER 3-T BOX (903), SPRINTER 3-T BOX /BUS /PLATFORM /CHASSIS (903), SPRINTER 3-T BUS /PLATFORM /CHASSIS (903), V-CLASS (638/2), VITO BOX /BUS (638)

MINI**MINI****MINI**

CARISMA, COLT IV, COLT V, COLT VI, ECLIPSE, ECLIPSE II, FTO, GALANT V, GALANT VI, GALLOPER, I 300 III, I 400, LANCER IV, LANCER V, LANCER VI, LANCER VII, MIRAGE, PAJERO II, PAJERO PININ, PAJERO SPORT I, SANTAMO, SPACE RUNNER, SPACE STAR, SPACE WAGON

MITSUBISHI

CARISMA, COLT IV, COLT V, COLT VI, ECLIPSE, ECLIPSE II, FTO, GALANT V, GALANT VI, GALLOPER, I 300 III, I 400, LANCER IV, LANCER V, LANCER VI, LANCER VII, MIRAGE, PAJERO II, PAJERO PININ, PAJERO SPORT I, SANTAMO, SPACE RUNNER, SPACE STAR, SPACE WAGON

MITSUBISHI

CARISMA, COLT IV, COLT V, COLT VI, ECLIPSE, ECLIPSE II, FTO, GALANT V, GALANT VI, GALLOPER, I 300 III, I 400, LANCER IV, LANCER V, LANCER VI, LANCER VII, MIRAGE, PAJERO II, PAJERO PININ, PAJERO SPORT I, SANTAMO, SPACE RUNNER, SPACE STAR, SPACE WAGON

MITSUBISHI

CARISMA, COLT IV, COLT V, COLT VI, ECLIPSE, ECLIPSE II, FTO, GALANT V, GALANT VI, GALLOPER, I 300 III, I 400, LANCER IV, LANCER V, LANCER VI, LANCER VII, MIRAGE, PAJERO II, PAJERO PININ, PAJERO SPORT I, SANTAMO, SPACE RUNNER, SPACE STAR, SPACE WAGON

CARISMA, COLT IV, COLT V, COLT VI, ECLIPSE, ECLIPSE II, FTO, GALANT V, GALANT VI, GALLOPER, I 300 III, I 400, LANCER IV, LANCER V, LANCER VI, LANCER VII, MIRAGE, PAJERO II, PAJERO PININ, PAJERO SPORT I, SANTAMO, SPACE RUNNER, SPACE STAR, SPACE WAGON

CARISMA, COLT IV, COLT V, COLT VI, ECLIPSE, ECLIPSE II, FTO, GALANT V, GALANT VI, GALLOPER, I 300 III, I 400, LANCER IV, LANCER V, LANCER VI, LANCER VII, MIRAGE, PAJERO II, PAJERO PININ, PAJERO SPORT I, SANTAMO, SPACE RUNNER, SPACE STAR, SPACE WAGON

CARISMA, COLT IV, COLT V, COLT VI, ECLIPSE, ECLIPSE II, FTO, GALANT V, GALANT VI, GALLOPER, I 300 III, I 400, LANCER IV, LANCER V, LANCER VI, LANCER VII, MIRAGE, PAJERO II, PAJERO PININ, PAJERO SPORT I, SANTAMO, SPACE RUNNER, SPACE STAR, SPACE WAGON

CARISMA, COLT IV, COLT V, COLT VI, ECLIPSE, ECLIPSE II, FTO, GALANT V, GALANT VI, GALLOPER, I 300 III, I 400, LANCER IV, LANCER V, LANCER VI, LANCER VII, MIRAGE, PAJERO II, PAJERO PININ, PAJERO SPORT I, SANTAMO, SPACE RUNNER, SPACE STAR, SPACE WAGON

CARISMA, COLT IV, COLT V, COLT VI, ECLIPSE, ECLIPSE II, FTO, GALANT V, GALANT VI, GALLOPER, I 300 III, I 400, LANCER IV, LANCER V, LANCER VI, LANCER VII, MIRAGE, PAJERO II, PAJERO PININ, PAJERO SPORT I, SANTAMO, SPACE RUNNER, SPACE STAR, SPACE WAGON

CARISMA, COLT IV, COLT V, COLT VI, ECLIPSE, ECLIPSE II, FTO, GALANT V, GALANT VI, GALLOPER, I 300 III, I 400, LANCER IV, LANCER V, LANCER VI, LANCER VII, MIRAGE, PAJERO II, PAJERO PININ, PAJERO SPORT I, SANTAMO, SPACE RUNNER, SPACE STAR, SPACE WAGON

CARISMA, COLT IV, COLT V, COLT VI, ECLIPSE, ECLIPSE II, FTO, GALANT V, GALANT VI, GALLOPER, I 300 III, I 400, LANCER IV, LANCER V, LANCER VI, LANCER VII, MIRAGE, PAJERO II, PAJERO PININ, PAJERO SPORT I, SANTAMO, SPACE RUNNER, SPACE STAR, SPACE WAGON

CARISMA, COLT IV, COLT V, COLT VI, ECLIPSE, ECLIPSE II, FTO, GALANT V, GALANT VI, GALLOPER, I 300 III, I 400, LANCER IV, LANCER V, LANCER VI, LANCER VII, MIRAGE, PAJERO II, PAJERO PININ, PAJERO SPORT I, SANTAMO, SPACE RUNNER, SPACE STAR, SPACE WAGON

CARISMA, COLT IV, COLT V, COLT VI, ECLIPSE, ECLIPSE II, FTO, GALANT V, GALANT VI, GALLOPER, I 300 III, I 400, LANCER IV, LANCER V, LANCER VI, LANCER VII, MIRAGE, PAJERO II, PAJERO PININ, PAJERO SPORT I, SANTAMO, SPACE RUNNER, SPACE STAR, SPACE WAGON

CARISMA, COLT IV, COLT V, COLT VI, ECLIPSE, ECLIPSE II, FTO, GALANT V, GALANT VI, GALLOPER, I 300 III, I 400, LANCER IV, LANCER V, LANCER VI, LANCER VII, MIRAGE, PAJERO II, PAJERO PININ, PAJERO SPORT I, SANTAMO, SPACE RUNNER, SPACE STAR, SPACE WAGON

CARISMA, COLT IV, COLT V, COLT VI, ECLIPSE, ECLIPSE II, FTO, GALANT V, GALANT VI, GALLOPER, I 300 III, I 400, LANCER IV, LANCER V, LANCER VI, LANCER VII, MIRAGE, PAJERO II, PAJERO PININ, PAJERO SPORT I, SANTAMO, SPACE RUNNER, SPACE STAR, SPACE WAGON

CARISMA, COLT IV, COLT V, COLT VI, ECLIPSE, ECLIPSE II, FTO, GALANT V, GALANT VI, GALLOPER, I 300 III, I 400, LANCER IV, LANCER V, LANCER VI, LANCER VII, MIRAGE, PAJERO II, PAJERO PININ, PAJERO SPORT I, SANTAMO, SPACE RUNNER, SPACE STAR, SPACE WAGON

CARISMA, COLT IV, COLT V, COLT VI, ECLIPSE, ECLIPSE II, FTO, GALANT V, GALANT VI, GALLOPER, I 300 III, I 400, LANCER IV, LANCER V, LANCER VI, LANCER VII, MIRAGE, PAJERO II, PAJERO PININ, PAJERO SPORT I, SANTAMO, SPACE RUNNER, SPACE STAR, SPACE WAGON

CARISMA, COLT IV, COLT V, COLT VI, ECLIPSE, ECLIPSE II, FTO, GALANT V, GALANT VI, GALLOPER, I 300 III, I 400, LANCER IV, LANCER V, LANCER VI, LANCER VII, MIRAGE, PAJERO II, PAJERO PININ, PAJERO SPORT I, SANTAMO, SPACE RUNNER, SPACE STAR, SPACE WAGON

CARISMA, COLT IV, COLT V, COLT VI, ECLIPSE, ECLIPSE II, FTO, GALANT V, GALANT VI, GALLOPER, I 300 III, I 400, LANCER IV, LANCER V, LANCER VI, LANCER VII, MIRAGE, PAJERO II, PAJERO PININ, PAJERO SPORT I, SANTAMO, SPACE RUNNER, SPACE STAR, SPACE WAGON

CARISMA, COLT IV, COLT V, COLT VI, ECLIPSE, ECLIPSE II, FTO, GALANT V, GALANT VI, GALLOPER, I 300 III, I 400, LANCER IV, LANCER V, LANCER VI, LANCER VII, MIRAGE, PAJERO II, PAJERO PININ, PAJERO SPORT I, SANTAMO, SPACE RUNNER, SPACE STAR, SPACE WAGON

CARISMA, COLT IV, COLT V, COLT VI, ECLIPSE, ECLIPSE II, FTO, GALANT V, GALANT VI, GALLOPER, I 300 III, I 400, LANCER IV, LANCER V, LANCER VI, LANCER VII, MIRAGE, PAJERO II, PAJERO PININ, PAJERO SPORT I, SANTAMO, SPACE RUNNER, SPACE STAR, SPACE WAGON

CARISMA, COLT IV, COLT V, COLT VI, ECLIPSE, ECLIPSE II, FTO, GALANT V, GALANT VI, GALLOPER, I 300 III, I 400, LANCER IV, LANCER V, LANCER VI, LANCER VII, MIRAGE, PAJERO II, PAJERO PININ, PAJERO SPORT I, SANTAMO, SPACE RUNNER, SPACE STAR, SPACE WAGON

CARISMA, COLT IV, COLT V, COLT VI, ECLIPSE, ECLIPSE II, FTO, GALANT V, GALANT VI, GALLOPER, I 300 III, I 400, LANCER IV, LANCER V, LANCER VI, LANCER VII, MIRAGE, PAJERO II, PAJERO PININ, PAJERO SPORT I, SANTAMO, SPACE RUNNER, SPACE STAR, SPACE WAGON

CARISMA, COLT IV, COLT V, COLT VI, ECLIPSE, ECLIPSE II, FTO, GALANT V, GALANT VI, GALLOPER, I 300 III, I 400, LANCER IV, LANCER V, LANCER VI, LANCER VII, MIRAGE, PAJERO II, PAJERO PININ, PAJERO SPORT I, SANTAMO, SPACE RUNNER, SPACE STAR, SPACE WAGON

CARISMA, COLT IV, COLT V, COLT VI, ECLIPSE, ECLIPSE II, FTO, GALANT V, GALANT VI, GALLOPER, I 300 III, I 400, LANCER IV, LANCER V, LANCER VI, LANCER VII, MIRAGE, PAJERO II, PAJERO PININ, PAJERO SPORT I, SANTAMO, SPACE RUNNER, SPACE STAR, SPACE WAGON

CARISMA, COLT IV, COLT V, COLT VI, ECLIPSE, ECLIPSE II, FTO, GALANT V, GALANT VI, GALLOPER, I 300 III, I 400, LANCER IV, LANCER V, LANCER VI, LANCER VII, MIRAGE, PAJERO II, PAJERO PININ, PAJERO SPORT I, SANTAMO, SPACE RUNNER, SPACE STAR, SPACE WAGON

CARISMA, COLT IV, COLT V, COLT VI, ECLIPSE, ECLIPSE II, FTO, GALANT V, GALANT VI, GALLOPER, I 300 III, I 400, LANCER IV, LANCER V, LANCER VI, LANCER VII, MIRAGE, PAJERO II, PAJERO PININ, PAJERO SPORT I, SANTAMO, SPACE RUNNER, SPACE STAR, SPACE WAGON

CARISMA, COLT IV, COLT V, COLT VI, ECLIPSE, ECLIPSE II, FTO, GALANT V, GALANT VI, GALLOPER, I 300 III, I 400, LANCER IV, LANCER V, LANCER VI, LANCER VII, MIRAGE, PAJERO II, PAJERO PININ, PAJERO SPORT I, SANTAMO, SPACE RUNNER, SPACE STAR, SPACE WAGON

CARISMA, COLT IV, COLT V, COLT VI, ECLIPSE, ECLIPSE II, FTO, GALANT V, GALANT VI, GALLOPER, I 300 III, I 400, LANCER IV, LANCER V, LANCER VI, LANCER VII, MIRAGE, PAJERO II, PAJERO PININ, PAJERO SPORT I, SANTAMO, SPACE RUNNER, SPACE STAR, SPACE WAGON

CARISMA, COLT IV, COLT V, COLT VI, ECLIPSE, ECLIPSE II, FTO, GALANT V, GALANT VI, GALLOPER, I 300 III, I 400, LANCER IV, LANCER V, LANCER VI, LANCER VII, MIRAGE, PAJERO II, PAJERO PININ, PAJERO SPORT I, SANTAMO, SPACE RUNNER, SPACE STAR, SPACE WAGON

CARISMA, COLT IV, COLT V, COLT VI, ECLIPSE, ECLIPSE II, FTO, GALANT V, GALANT VI, GALLOPER, I 300 III, I 400, LANCER IV, LANCER V, LANCER VI, LANCER VII, MIRAGE, PAJERO II, PAJERO PININ, PAJERO SPORT I, SANTAMO, SPACE RUNNER, SPACE STAR, SPACE WAGON

CARISMA, COLT IV, COLT V, COLT VI, ECLIPSE, ECLIPSE II, FTO, GALANT V, GALANT VI, GALLOPER, I 300 III, I 400, LANCER IV, LANCER V, LANCER VI, LANCER VII, MIRAGE, PAJERO II, PAJERO PININ, PAJERO SPORT I, SANTAMO, SPACE RUNNER, SPACE STAR, SPACE WAGON

CARISMA, COLT IV, COLT V, COLT VI, ECLIPSE, ECLIPSE II, FTO, GALANT V, GALANT VI, GALLOPER, I 300 III, I 400, LANCER IV, LANCER V, LANCER VI, LANCER VII, MIRAGE, PAJERO II, PAJERO PININ, PAJERO SPORT I, SANTAMO, SPACE RUNNER, SPACE STAR, SPACE WAGON

CARISMA, COLT IV, COLT V, COLT VI, ECLIPSE, ECLIPSE II, FTO, GALANT V, GALANT VI, GALLOPER, I 300 III, I 400, LANCER IV, LANCER V, LANCER VI, LANCER VII, MIRAGE, PAJERO II, PAJERO PININ, PAJERO SPORT I, SANTAMO, SPACE RUNNER, SPACE STAR, SPACE WAGON

...CET2**PLYMOUTH**

BREEZE

PONTIAC

TRANS SPORT

PORSCHE

356 CABRIOLET /SPEEDSTER /COUPE, 911 (964), 911 (993), 911 /CONVERTIBLE (964), 911 /CONVERTIBLE (993), 911 /CONVERTIBLE (996), 911 /CONVERTIBLE /TARGA (993), 911 SPEEDSTER (964), 911 TARGA (964), 911 TARGA (993), 968, BOXSTER (986), CAYENNE (9PA)

PROTON

IMPIAN, PERSONA 300, PERSONA 400, WIRA

PUCH

G-MODELL

RELIANT

SCIMITAR, SCIMITAR SABRE

RENAULT

19 I, 19 II, 21, 25, CLIO, CLIO I, CLIO II, CLIO III, DUSTER, ESPACE III, ESPACE IV, FLUENCE, GRAND SCÉNIC II, GRAND SCÉNIC III, KANGOO, KANGOO BE BOP, KANGOO / GRAND KANGOO, LAGUNA, LAGUNA I, LAGUNA II, LAGUNA III, LOGAN EXPRESS, LOGAN I, MEGANE, MEGANE CC, MEGANE I, MEGANE II, MEGANE III, MODUS / GRAND MODUS, RAPID, SAFRANE I, SAFRANE II, SANDERO/STEPWAY I, SCÉNIC I, SCÉNIC II, SCÉNIC III, SPORT SPIDER, THALIA I, THALIA II, TRAFIC II, TWINGO I, TWINGO II, VEL SATIS

ROVER

100, 100 / METRO, 200, 400, 600, 800, CITYROVER, COUPE, MAESTRO, MONTEGO

SAAB

9-3, 900 I, 900 II, 9000

SEAT

ALHAMBRA, ALTEA, ALTEA XL, AROSA, CORDOBA, EXEO, IBIZA I, IBIZA II, IBIZA III, IBIZA IV, INCA, LEON, MALAGA, RÓNDA, TOLEDO I, TOLEDO II, TOLEDO III

SKODA

FABIA I, FAVORIT, FELICIA I, FELICIA II, OCTAVIA I, OCTAVIA II, SUPERB I

SMART

CABRIO, CITY-COUPE, CROSSBLADE, FORTWO

SSANGYONG

KORANDO, KYRON, MUSSO, REXTON, RODIUS

SUBARU

FORESTER, IMPREZA, JUSTY I, JUSTY II, LEGACY I, LEGACY II, LEGACY III, LEGACY IV, LEGACY OUTBACK, OUTBACK, REX III, SVX

...CET2**SUZUKI**

ALTO (HA12, HA23), BALENO /ESTATE /HATCHBACK (EG), CARRY BOX (FD), GRAND VITARA I (FT, HT), GRAND VITARA II (JT), GRAND VITARA II (JT, TE, TD), JIMNY (FJ), JIMNY CLOSED OFF-ROAD VEHICLE (SN), LIANA (ER, RH), LIANA ESTATE (ER), LIANA HATCHBACK, SWIFT II HATCHBACK (EA, MA), SWIFT II SALOON (AH, AJ), SX4 (EY, GY), SX4 /SALOON (GY), SX4 SALOON (GY), SX4 S-CROSS (JY), VITARA (ET, TA), VITARA /CABRIO (ET, TA), WAGON R+ HATCHBACK (MM), WAGON R HATCHBACK

TATA

INDICA, INDIGO, SAFARI

TOYOTA

4 RUNNER, ALLION I, AURIS, AVALON, AVENSIS, BB I, CAMRY, CAMRY SOLARA, CARIBE, CARINA E, CARINA II, CELICA, COASTER, COROLLA, COROLLA FX, COROLLA LEVIN, CORONA, CORSA, CRESSIDA, CRESTA, CROWN, CURREN, DUET, ECHO, GRANVIA, HARRIER, HIACE III, HIACE IV, HILUX, HILUX II, HILUX VI, MARK II, ISIS, IST, LAND CRUISER, LAND CRUISER 80, LAND CRUISER 90, LAND CRUISER PRADO, LITEACE, MATRIX, MR 2 I, MR 2 II, MR 2 III, NADIA, OPA, PASEO, PICNIC, PLATZ, PORTE, PREVIA, PROBOX/SUCCEED, RACTIS, RAUM, RAV 4 I, RAV 4 II, SCEPTER, SIENNA, SIENTA, SOLARA, SOLUNA VIOS, SPRINTER, SPRINTER CARIB, STARLET, SUPRA, TARAGO, TERCEL, TUNDR, URBAN CRUISER, VIOS, VIOS/YARIS, VISTA, WILL CYPHA, WILL VI, WILL VS, WINDOM, WISH, YARIS, YARIS VERSO, YARIS / VIOS

TVR

CERBERA

UAZ

CARGO, HUNTER, PATRIOT

VAUXHALL

ADAM, AGILA MK I (A), ANTARA, ASTRA MK II, ASTRA MK III (F), ASTRA MK IV (G), ASTRA MK V (H), ASTRA MK VI (J), ASTRAVAN MK III (F), ASTRAVAN MK IV (G), ASTRAVAN MK V (H), CALIBRA, CARLTON MK III, CAVALIER MK II, CAVALIER MK III, COMBO MK I (B), COMBO MK II (C), COMBO TOUR MK II (C), CORSA MK I (B), CORSA MK II (C), CORSA MK III (D), CORSAVAN MK I (B), CORSAVAN MK II (C), CORSAVAN MK III (D), FRONTERA MK I (A), INSIGNIA MK I (A), MERIVA MK I (A), MERIVA MK II (B), MOKKA / MOKKA X, NOVA, OMEGA (B), SENATOR MK II (B), SIGNUM, SINTRA, TIGRA, TIGRA MK I, VECTRA (B), VECTRA MK II (C), VIVARO, VX220, ZAFIRA MK I (A), ZAFIRA MK II (B), ZAFIRA MK III

VOLVO

850, 960, 960 II, C70 I, S40 I, S60 I, S70, S80 I, S90, V40, V70 I, V70 II, V90

...CET2**VW**

BORA, CADDY II, CADDY III, CORRADO, GOLF II, GOLF III, GOLF IV, GOLF V, GOLF VI, GOLF PLUS, GOL III, GOL IV, JETTA II, JETTA III, LT 28-35 II, LT 28-46 II, LUPO, NEW BEETLE, PASSAT, PHAETON, POLO, SCIROCCO, SHARAN, TOUAREG, TOURAN, TRANSPORTER IV, VENTO, VOYAGE

WIEMANN

MF3

YULON

101 FEELING, YULON

ZASTAVA

10

ZAZ

VIDA

CET3**AUDI**

A3, A4, A8

FORD

GALAXY

HONDA

ACCORD VII, ACCORD VIII, CIVIC VIII, CIVIC IX, CR-V III, CR-V IV, CR-Z, ELYSION, FR-V, JAZZ III, LAGREAT, LEGEND IV, ODYSSEY, RIDGELINE

SEAT

ALHAMBRA, ALTEA, ALTEA XL, AROSA, CORDOBA, IBIZA III, IBIZA IV, LEON, TOLEDO II, TOLEDO III, TOLEDO IV

SKODA

FABIA I, FABIA II, OCTAVIA I, OCTAVIA II, RAPID, ROOMSTER, ROOMSTER PRAKTIK

TOYOTA

NADIA

VW

BEETLE, BORA, CADDY III, EOS, FOX, GOLF IV, GOLF V, GOLF VI, GOLF PLUS, GOL III, GOL IV, JETTA III, JETTA IV, LUPO, NEW BEETLE, PASSAT, PHAETON, POLO, SHARAN, TOUAREG, TOURAN, TRANSPORTER IV, VOYAGE

CET4**CITROËN**

C2, C3 I, C4, C4 I

DACIA

LOGAN, LOGAN II, LOGAN MCV II, SANDERO, SANDERO II

NISSAN

KUBISTAR

PEUGEOT

206, 207, 307, 1007

RENAULT

CLIO, CLIO II, CLIO III, CLIO IV, KANGOO, MODUS / GRAND MODUS, THALIA I, THALIA II, TWINGO I, TWINGO II, TWINGO III

SMART

FORFOUR, FORTWO



...CET5

CITROËN
BERLINGO, BERLINGO / BERLINGO FIRST, C1, C2, C3, C3 I, C4, C4 GRAND PICASSO I, C4 I, C4 PICASSO I, C5 I, C5 II, C5 III, C8, C-ELYSEE, EVASION, JUMPY, SAXO, XSARA, XSARA PICASSO

FIAT
SCUDO, ULYSSE

HYUNDAI
IX35, SANTA FÉ II, SONATA V, SONATA VI

KIA
CERATO II, CERATO KROUP, MAGENTIS, SORENTO II, SPORTAGE

LANCIA
PHEDRA, ZETA

MITSUBISHI
COLT CZC, COLT VI, COLT PLUS VII, LANCER VIII

NISSAN
ALMERA CLASSIC, ALMERA II, ALMERA TINO, ALTIMA, AVENIR, BASSARA, CUBE, PATHFINDER II, PATHFINDER III, PRIMERA, SENTRA V, TEANA I, X-TRAIL

PEUGEOT
107, 206, 207, 301, 307, 308, 308 SW, 406, 407, 607, 806, 807, 1007, EXPERT, EXPERT TEPÉE, PARTNER, PARTNER TEPÉE

SMART
FORFOUR

SUBARU
IMPREZA, LEGACY IV, OUTBACK, TRIBECA

TOYOTA
AYGO, DYNA, FI CRUISER, FORTUNER, HIACE / COMMUTER V, HIACE V, HILUX III, HILUX VII, INNOVA I, IQ, LAND CRUISER, LAND CRUISER 150, LAND CRUISER PRADO, PASSO, TUNDRA, VIOS/YARIS, YARIS

VOLVO

C70 II, S40 II, S80 II, V50

...CET6

HYUNDAI
ACCENT IV, ELANTRA, I10, I20, I30, IX20

KIA
CARENS III, CEE'D, CERATO, CERATO II, CERATO KROUP, PICANTO, PRO CEE'D, RIO III, SOUL, VENGA

...CET7

CHEVROLET
ALERO, COBALT, HHR

FORD
B-MAX, C-MAX, C-MAX II, FIESTA III, FIESTA IV, FIESTA V, FIESTA VI, FOCUS, FOCUS C-MAX, FOCUS II, FOCUS III, FUSION, GRAND C-MAX, KA, MONDEO IV, PUMA, STREET KA

MAZDA
2 (DY)

VOLVO
C30, S40 II, V50

...CET8

ABARTH
RITMO

...CET8

AC
ME

ACURA
INTEGRA

ALFA ROMEO
6, 33, 75, 90, 145, 146, 155, 164, 166, 1750-2000, A11 / A12, ALFASUD, ALFETTA, ALFETTA GT, ARNA, F11 / F12, GIULIA, GIULIETTA, GT, GTA, GTV, MONTREAL, ROMEO 2, RZ, SPIDER, SZ

ALPINA
B3, B6, B7, B9, B10, B11, C1, C2

ALPINE
A310, BERLINETTE

ARO
10, SPARTANA

ASIA MOTORS
ROCSTA, TOWNER

ASTON MARTIN
DB6, DBS, LAGONDA I, V8, ZAGATO

AUDI
50, 60, 75, 80, 90, 100, 200, A6, CABRIOLET, COUPE, QUATTRO, SUPER 90

AUSTIN
1000-SERIES MK II, ALLEGRO, APACHE, MAESTRO, MAXI, MAXI II, METRO, MINI, MONTEGÓ, PRINCESS, PRINCESS 2

AUSTIN-HEALEY
3000 MK.III, SPRITE MK.III, SPRITE MK.IV

AUTOBIANCHI
A 111, A 112, Y10

BEDFORD
ASTRAMAX, ASTRA VAN, MIDI, RASCAL

BENTLEY
AZURE, CONTINENTAL, CONTINENTAL FLYING SPUR

BMW
02 /CONVERTIBLE (E10), 02 TOURING (E6), 3 (E21), 3 (E30), 3 /CONVERTIBLE /TOURING (E30), 5 (E12), 5 (E28), 5 (E34), 6 (E24), 7 (E23), 7 (E32), 1500-2000 (115, 116, 118, 121), 1600 GT COUPE, 2000-3.2 COUPE (E9), 2500-3.3 (E3), Z1 ROADSTER

BOND
EQUIPE, EQUIPE MK. II

BRISTOL
411

CATERHAM
SEVEN

CHEVROLET
AVEO, AVEO / KALOS, CORSA, KALOS, LANOS, MATIZ, NIVA, REZZO, SPARK

CHRYSLER
DAYTONA, LE BARON, SARATOGA, VOYAGER / GRAND VOYAGER III, VOYAGER I, VOYAGER II

CITROËN
2 CV, AMI, C25, GS, SM

DADI
CITY COURSER

...CET8

DAEWOO
ARANOS, CIELO, ESPERO, KALOS, LANOS, LEGANZA, LEMANS, MATIZ, NEXIA, NUBIRA, PRINCE, REZZO, ROYALE, SUPER SALOON, TICO

DAIHATSU
55 WIDE, 1000, CHARADE I, CHARADE II, CHARADE III, CHARADE IV, CHARMANT, CUORE I, CUORE II, CUORE III, CUORE IV, DELTA WIDE, HIJET, MOVE, ROCKY HARD TOP, ROCKY SOFT TOP, RUGGER, SKYWING, SPARCAR, TAFT

DAIMLER
2.8 - 5.3, COUPE, LANDAULETTE, LIMOUSINE

DODGE
CARAVAN

FERRARI
208/308, 365 GT 2+2, 365 GTB/4 DAYTONA, 365 GTS/4 DAYTONA, 400 I, 412 I, 512 BB, DINO GT, DINO GT4, DINO GTS, MONDIAL

FIAT
124, 125, 126, 127, 128, 130, 131, 132, 147, 238-SERIE, 241-SERIE, 242-SERIE, 850, 900T/E PANORAMA, 900T/E PULMINO, 1500, 1500-2300, ARGENTA, CAMPAGNOLA, CINQUECENTO, COUPE, CROMA, DINO, DUCATO, DUNA, ELBA, FIORINO, FIORINO PICK UP, PALIO, PANDA, PENNY, PREMIO, REGATA, RITMO, SEICENTO / 600, TALENTO, TEMPRA, TIPO, UNO, X 1/9

FORD
CAPRI, CAPRI II, CAPRI III, CONSUL, CORSAIR, CORTINA, ECONOVAN, ESCORT I, ESCORT II, FIESTA I, GRANADA, SCORPIO I, SIERRA, TAUNUS, TAUNUS 12M, TAUNUS 15M, TAUNUS 17M, TAUNUS 20M, TAUNUS 20M XL, TAUNUS 26M XL, TAUNUS '80, TRANSIT, ZEPHYR III, ZEPHYR IV, ZODIAC, ZODIAC

FORD AUSTRALIA
COURIER

FORD OTOSAN
ANADOL

FOTON
ALPHA, SEA LION, SUP, SURF, SURFING, VIEW

FSO
125P, 126P, 127P, 132P, LANOS, POLÓNEZ I, POLÓNEZ II, POLÓNEZ III

GAZ
GAZELLE, VOLGA

GELY
HAOQING, HQ, MR, PU, URBAN NANNY

GEO
METRO, STORM, TRACKER

GINETTA
G15, G21, G34

GLAS
04, 1700, GT, V 8

GOLDEN DRAGON
XML

...CET8

GREAT WALL
DEER, PEGASUS, SAILING, STEED

HOLDEN
SCURRY

HONDA
ACCORD I, ACCORD II, ACCORD III, ACTY, CIVIC I, CIVIC II, CIVIC III, CIVIC IV, CRX I, INTEGRAL, JAZZ I, PRELUDE I, PRELUDE II, PRELUDE III, QUINTET

HYUNDAI
H-1, H-1 / STAREX, H100, LANTRA I, PONY, PONY / EXCEL, PORTER, SANTA FÉ I, SANTAMO, S COUPE, SONATA II, SONATA III, SONATA IV, STELLAR

INNOCENTI
ELBA, KORAL, MINI, REGENT

ISUZU
ASKA I, ASKA III, CAMPO, GEMINI, MIDI, PIAZZA, PICKUP, TROOPÉR I

JAGUAR
E-TYPE, E-TYPE 2+2, MK I, MK II, MK VII, MK VIII, MK IX, MK X, S-TYPE, XJ

JEEP
CJ5 - CJ8

JENSEN
GT, HEALEY

KIA
AVELLA, CARNIVAL II, JOICE, MAGENTIS, PRIDE, PRIDE VAN, RIO, ROADSTER, SEPHIA, SHUMA, SORENTO I

LADA
110, 111, 112, 1200-1500, 1200-1600, KALINA, LARGUS, NADESCHDA, NIVA, NIVA II, NOVA, PRIORA, SAMARA, TOSCANA

LANCIA
A 112, BETA, BETAH P.E., BETA MONTE CARLO, DEDRA, DELTA I, DELTA II, FLAMINIA, FLAVIA, FULVIA, GAMMA, KAPPA, PRISMA, THEMA, TREVI, Y10

LAND ROVER
88/109, 90, 110/127, DEFENDER, DISCOVERY I, RANGE ROVER I, RANGE ROVER II

LDV
SHERPA

LOTUS
ECLAT, ELITE, ESPRIT S2, ESPRIT S3, ESPRIT S4, EUROPA, EXCEL

MARCOS
2-3 LITRE, 1600

MARUTI
800

MASERATI
228, 420/430, BITURBO, BORA, GHIBLI, INDY, KARIF, KHAMZIN, KYALAMI, MERAH, MEXICO, QUATTROPORTE I, QUATTROPORTE III, QUATTROPORTE IV





...CET8

MAZDA

121 I (DA), 121 II (DB), 323 C IV (BG), 323 I /STATION WAGON (FA), 323 II /HATCHBACK (BD), 323 III /HATCHBACK (BF), 323 III HATCHBACK (BF), 323 III STATION WAGON (BW), 616, 626 I (CB), 626 II /COUPE /HATCHBACK (GC), 626 II /HATCHBACK (GC), 626 III /COUPE /HATCHBACK (GD), 626 III STATION WAGON (GV), 818 ESTATE, 929 I (LA), 929 II /COUPE (HB), 929 II ESTATE (HV), 1000, 1300, B-SERIE (PE), B-SERIE (UD), B-SERIE (UF), B-SERIE (UN), E-SERIE BOX, E-SERIE BOX (SR2), E-SERIE BUS (SR1)

MERCEDES-BENZ

/8 (W114), /8 (W115), /8 /COUPE (W114), /8 COUPE (W114), CABRIOLET (W111), COUPE (C123), COUPE (W111), G-CLASS (W460), G-CLASS (W463), HECKFLOSSE (W110), HECKFLOSSE (W111, W112), HENSCHEL 2-T, KOMBI T-MODEL (S123), PAGODE (W113), PONTON (W121), PONTON (W128), PULLMANN (W100), SALOON (W123), S-CLASS (W108, W109), S-CLASS (W116), S-CLASS (W126), S-CLASS COUPE (C126), SL (R107), SL (W121), SL COUPE (C107), T1 BOX (601, 611), T1 BUS /PLATFORM /CHASSIS (601), T2 /L BOX BODY / ESTATE /DUMPTRUCK /PLATFORM /CHASSIS, T2/L DUMPTRUCK, T2 /L MUNICIPAL VEHICLE

MG

1300 MK.II, EXPRESS, MAESTRO, METRO, MGB, MGB GT, MGR V8, MIDGET, MONTEGO

MINI

CARISMA, COLT I, COLT II, COLT III, COLT IV, COLT V, COLT VI, CORDIA, DEBONAIR, ECLIPSE, ECLIPSE I, ECLIPSE II, GALANT I, GALANT II, GALANT III, GALANT IV, KUDA, L 200, L 300 / DELICA II, L 300 II, L 300 III, L 400, LANCER CELESTE, LANCER F, LANCER I, LANCER II, LANCER III, LANCER IV, LANCER V, LANCER VI, LANCER VII, MIRAGE, MIRAGE II, MIRAGE III, MIRAGE V, OUTLANDER I, PAJERO I, PAJERO II, SAPPORO I, SAPPORO II, SAPPORO III, SIGMA, SPACE WAGON, STARION, TREDIA

MORGAN

FOUR FOUR, PLUS EIGHT, PLUS FOUR

MORRIS

ITAL, MARINA, MARINA II, MINI, MINOR

MOSKVICHI

407, 412, 427, 2140, 2141, ASLK 2137, ASLK 2140

NISSAN

280 ZX, ZXT, BLUEBIRD, BLUEBIRD (B610), BOBBY, CHERRY (E10) I, CHERRY II, CHERRY III, DATSUN 100 A, DATSUN 120, DATSUN 120 Y, DATSUN 160 J, DATSUN 180 B, LAUREL, LUCINO, MICRA I, PATROL GR IV, PATROL GR V, PATROL III/1, PATROL III/2, PICK UP, PRAIRIE, SÍLVIA, STANZA, SUNNY, SUNNY I, SUNNY II, URVAN, VANETTÉ

NSU

1000, PRINZ, TTS

...CET8

OPEL

ASCONA B, ASCONA C, ASTRA F, CALIBRA A, CAMPO, COMBO, CORSA A, CORSA B, FRONTERA A, KADETT D, KADETT E, MANTA B, OMEGA A, REKORD E, TIGRA, VECTRA A, VECTRA B

PANTHER

KALLISTA

PEUGEOT

204, 304, 404, 504, 505, J5, J7, J9

PIAGGIO

PORTER

PININFARINA

SPIDEREUROPA

PORSCHE

911 (964), 911 /CONVERTIBLE, 911 /TARGA, 911 TARGA, 924, 928, 944 /CONVERTIBLE, 968 /CONVERTIBLE

PROTON

AEROBACK, JUMBUCK, PERSONA 300, PERSONA 400, SALOON, SATHIA, WIRA

PUCH

G-MODELL

RELIANT

KITTEN, SCIMITAR

RENAULT

5, 9, 11, 12, 15, 16, 17, 18, 19 I, 19 II, 20, 21, CLIO I, ESPACE III, FUEGO, LAGUNA I, MASTER I, MEGANE, MEGANE I, RAPID, SUPER 5, TRAFIC, TWINGO I

RILEY

KESTREL

ROLLS-ROYCE

CORNICHE IV, CORNICHE V, SILVER SPIRIT

ROVER

200, 800, 2000-3500, MAESTRO, MINI, MINI-MOKE, MONTEGO

SAAB

90, 95, 96, 99, 600, 900 I

SANTANA

SAMURAI

SEAT

124, 127, 128, 131, 132, 133, 850, AROSA, CORDOBA, FURA, IBIZA I, IBIZA II, INCA, MARBELLA, PANDA, RITMO, RONDA, TERRA, TOLEDO I

SKODA

FELICIA I, FELICIA II, OCTAVIA I

SSANGYONG

KORANDO

SUBARU

JUSTY I, JUSTY II, LEONE I, LEONE II, LIBERO, MV, REX I, REX II, XT

SUZUKI

ALTO (OS), ALTO (EF), ALTO HATCHBACK, CARRY BOX (OS), CARRY PICKUP, JIMNY (FJ), LJ 80 (OL), SAMURAI CLOSED OFF-ROAD VEHICLE (SJ), SJ 410, SJ 410 CABRIO (OS), SJ 413 (OS), SUPER CARRY BUS (ED), SWIFT CONVERTIBLE (SF413), SWIFT I (AA), SWIFT II HATCHBACK (EA, MA), SWIFT II SALOON (AH, AJ), VITARA /CABRIO (ET, TA), WAGON R HATCHBACK

...CET8

TALBOT

160, 180, 1307-1510, AVENGER, HORIZON, MATRA BAGHEERA, MURENA, RANCHO, SIMCA 1000, SIMCA 1100, SIMCA 1200 S, SIMCA 1500, SIMCA 1501, SIMCA 1609/1610, SIMCA SUNBEAM, SOLARA, TAGORA

TOFAS

DOGAN, KARTAL, SAHIN

TOYOTA

1000, BLIZZARD, CAMRY, CARIBE, CARINA, CARINA II, CELICA, CENTURY, CHASER, COASTER, COROLLA, COROLLA FX, CORONA, CRESSIDA, CRESTA, CROWN, DYNA, DYNA 100, DYNA 150, DYNA 200, HIACE I, HIACE II, HIACE III, HIACE IV, HILUX, HILUX I, HILUX II, HILUX III, HILUX IV, HILUX V, MARK II, LAND CRUISER, LAND CRUISER 80, LITEACE, MASTER ACE SURF, MODELL F, SPRINTER, STARLET, STARLET 1000, STOUT, TARAGO, TERCEL, TOWN ACE, VISTA

TRABANT

1.1

TRIUMPH

2.5 PI MK I, 1300, 1500, 2000 MK I, 2000 MKII, 2500, ACCLAIM, DOLOMITE, HERALD, SPITFIRE, STAG, TOLEDO, TR 5, TR 6, TR 7, VITESSE

TVR

280, 350, 390, 400, 420, 450, 1600, 2500, 3000, CHIMAERA, GRIFFITH, SPEED EIGHT, TAIMAR

VAUXHALL

ASTRA, ASTRA MK II, ASTRA MK III (F), ASTRAMAX, BRAVA, CARLTON MK II, CARLTON MK III, CAVALIER, CAVALIER CC, CAVALIER MK II, CAVALIER MK III, CHEVETTE, CRESTA, FIRENZA, MIDI, NOVA, NOVAVAN, RASCAL, VELOX, VENTORA, VICTOR, VISCOUNT, VIVA

VOLVO

240, 340-360, 440 K, 460 L, 480 E, 740, 760, 940, 940 II, 960

VW

CADDY I, CADDY II, CORRADO, DERBY, GOLF I, GOLF II, GOLF III, GOLF IV, GOL I, ILTIS, JETTA I, JETTA II, K 70, LT 28-35 I, LT 40-55 I, LUPO, MULTIVAN V, PARATI III, PASSAT, POLO, POLO VAN, SANTANA, SCIROCCO, TARO, TRANSPORTER III, TRANSPORTER IV, TRANSPORTER V, VENTO

WARTBURG

353

WESTFIELD

130

WOLSELEY

18/85, 1300, HORNET

YUGO

311 / 411, 511 / 513, SANA, TEMPO

ZASTAVA

101, YUGO, YUGO FLORIDA

ZAZ

CHANCE, FORZA, LANOS, LANOS PICK-UP, SENS, SLAVUTA, TAVRIA, VIDA

CET9

AC

ACE

ALPINE

A310, V6

AUDI

100, A6, A8, V8

AUSTIN

AMBASSADOR, PRINCESS 2

CITROËN

AXEL, BX, CX I, CX II, DS, LNA, VISA

DAIMLER

2.8 - 5.3, DAIMLER XJ, XJ 40, 81

DE LOREAN

DMC-12

DE TOMASO

BIGUA

FORD

ESCORT '81, ESCORT '86, ESCORT '91, ESCORT III, ESCORT IV, ESCORT V, ESCORT VI, ESCORT VII, FIESTA, FIESTA I, FIESTA II, FIESTA III, FIESTA IV, KA, ORION II, ORION III, SCORPIO I, SCORPIO II, SIERRA

FORD AUSTRALIA

EXPLORER, F150, F250, MUSTANG

FORD USA

AEROSTAR, CROWN VICTORIA, E SERIES, EXPEDITION, EXPLORER, F150, F-150, F250, MUSTANG, PROBE I, THUNDERBIRD

JAGUAR

XJ, XJSC

JENSEN

S-V8

LANCIA

THEMA

LINCOLN

CONTINENTAL TOWN CAR, MARK VIII, TOWN CAR II, TOWN CAR III

MARCOS

MANTA RAY, MANTIS

MERCEDES-BENZ

190 (W201), COUPE (C123), COUPE (C124), E-CLASS (W124), E-CLASS T-MODEL (S124), G-CLASS (W460), G-CLASS (W461), G-CLASS (W463), G-CLASS /CABRIO (W463), HECKFLOSSE (W111, W112), KOMBI T-MODEL (S123), KOMBI T-MODEL (S124), SALOON (W123), SALOON (W124), SALOON (W124), S-CLASS (W126), SL (R107), SL (R129), T1 BOX (601, 611), T1 BOX (602), T1 BUS /PLATFORM /CHASSIS (601), T1 PLATFORM /CHASSIS (602), T1 /TN BOX BODY / ESTATE /PLATFORM /CHASSIS, T2 /L BOX BODY / ESTATE /DUMPTRUCK /PLATFORM /CHASSIS, T2 /LN1 BOX BODY / ESTATE /PLATFORM /CHASSIS

MERCURY

GRAND MARQUIS, MOUNTAINEER

MG

MG X-POWER, MG ZT, MG ZT-

MORRIS

ITAL

OLTCIT

11

**...CET9**

OPEL
ASCONA B, MANTA B
PANOZ
ROADSTER
PEUGEOT
104, 204, 205 I, 205 II, 304, 305 I, 305 II, 309 I, 504, 505, 604
PROTON
GEN 2
PUCH
G-MODELL
RENAULT
5, 14, 18, 20, 21, 25, 30, ESPACE I, ESPACE II, FUEGO, MASTER I, SAFRANE I, TRAFIC
ROVER
75, 2000-3500
TALBOT
SAMBA, SIMCA SIM'4, TAGORA
TRIUMPH
DOLOMITE
TVR
S
VOLVO
240, 260, 760, 780, 960

CET10P

BMW
3 /CONVERTIBLE /COUPE (E36), 3 CONVERTIBLE /COUPE (E46), Z3 COUPE (E36), Z3 ROADSTER (E36), Z4 COUPE (E86), Z4 ROADSTER (E85)
DAIHATSU
MATERIA, TERIOS
NISSAN
PIXO
OPEL
AGILA (B)
SUZUKI
ALTO (GF), SPLASH (EX), SWIFT IV (FZ, NZ)
TOYOTA
AVANZA, BB II, PASSO SETTE, RUSH
VAUXHALL
AGILA MK II (B)
WIESMANN
MF3

CET11P

AUDI
80, 100, 200, A1, A3, A4, A4 ALLROAD, A5, A6, A6 ALLROAD, A7, A8, COUPE, Q3, Q5, Q7, QUATTRO, R8, TT
LANCIA
THESIS
PORSCHE
911 (997), 911 /CONVERTIBLE (997), CAYENNE (9PA)
RENAULT
CLIO III, MEGANE II
SEAT
ALHAMBRA, ALTEA, ALTEA XL, CORDOBA, EXEO, IBIZA II, LEON, TOLEDO I, TOLEDO III

...CET11P

SKODA
OCTAVIA II, SUPERB II, YETI
VW
AMAROK, BEETLE, CC, EOS, GOLF III, GOLF V, GOLF VI, JETTA III, JETTA IV, MULTIVAN V, PASSAT, PASSAT ALLTRACK, PASSAT CC, POLO, SCIROCCO, SHARAN, TIGUAN, TOUAREG, TRANSPORTER V

CET12P

ACURA
LEGEND II, NSX, SLX
ALFA ROMEO
147, 156, 159, 164, 166, BRERA, GT, GTV, SPIDER
ALPINA
B3, B5, B10, B12, ROADSTER V8, ROADSTER S
AUDI
A3, A4, A5, A6, A7, A8, ALLROAD, Q5, TT
BENTLEY
ARNAGE, CONTINENTAL
BMW
3 (E90), 3 COMPACT (E36), 3 /COMPACT (E46), 3 COMPACT /CONVERTIBLE /COUPE (E46), 3 /COMPACT /CONVERTIBLE /COUPE /TOURING (E46), 3 /COMPACT /TOURING (E46), 3 CONVERTIBLE (E46), 3 CONVERTIBLE (E93), 3 /CONVERTIBLE /COUPE /TOURING (E46), 3 COUPE (E92), 3 /COUPE /TOURING (E46), 3 TOURING (E91), 5 (E39), 5 (E60), 5 /TOURING (E39), 5 TOURING (E39), 5 TOURING (E61), 6 (E63), 6 CONVERTIBLE (E64), 7 (E38), 7 (E65, E66, E67), 8 (E31), X1 (E84), X3 (E83), X5 (E53), X5 (E70), Z3 COUPE (E36), Z3 ROADSTER (E36), Z4 ROADSTER (E85), Z8 ROADSTER (E52)
CADILLAC
BLS
CHEVROLET
CRUZE, EPICA
CHRYSLER
CROSSFIRE, STRATUS
CITROËN
C-CROSSER, C-CROSSER ENTERPRISE, XM
DAEWOO
LACETTI, MAGNUS, TOSCA
DAIHATSU
ALTIS, APPLAUSE I, CHARADE III, CHARADE IV, COPEN, FERROZA HARD TOP, FERROZA SOFT TOP, GRAN MOVE, SIRION, YRV
DAIMLER
DAIMLER XJ
DODGE
STRATUS
FIAT
COUPE
FORD
GALAXY, SCORPIO II, TRANSIT
FORD ASIA / OCEANIA
FALCON
HOLDEN
APOLLO

...CET12P

HONDA
ACCORD IV, ACCORD VI, CIVIC II, CIVIC IV, CIVIC VII, CIVIC VIII, CONCERTO, CRX I, CRX II, CRX III, ELEMENT, INSPIRE, INTEGRA, LAGREAT, LEGEND I, LEGEND II, LEGEND III, NSX I, PRELUDE III, PRELUDE IV, PRELUDE V, S2000
HYUNDAI
COUPE, ELANTRA, EQUUS / CENTENNIAL, GALLOPER II, GENESIS, GRANDEUR, HIGHWAY VAN, I30, SANTA FÉ I, SANTA FÉ II, SONATA IV, SONATA V, TERRACAN, TRAJET, TUCSON, XG
INFINITI
G20, J30, M30, Q45 I, Q45 II
ISUZU
TROOPER III
JAGUAR
S-TYPE, XF, XJ, XK, XK 8
KIA
CADENZA I, CARENS II, CARNIVAL I, CARNIVAL II, CEE'D, MAGENTIS, OPIRUS, PRO CEE'D, SORENTO I, SPORTAGE
LAMBORGHINI
GALLARDO, GALLARDO SPYDER
LANCIA
KAPPA, THESIS
LAND ROVER
DISCOVERY II, DISCOVERY III, FREELANDER, RANGE ROVER II, RANGE ROVER III, RANGE ROVER SPORT
LEXUS
ES, GS, GX, HS, IS, IS I, LS, LX, RX, SC
LOTUS
ELISE, ELISE 340 R, EXIGE
MAYBACH
57
MAZDA
2 (DE, DH_3), 3 (BK), 3 /SALOON (BK), 3 /SALOON (BL), 323 C V (BA), 323 F V (BA), 323 S IV (BG), 323 S V (BA), 626 III /COUPE /HATCHBACK (GD), 626 III STATION WAGON (GV), 929 III (HC), MX-3 (EC), MX-5 II (NB), XEDOS 6 (CA), XEDOS 9 (TA)

...CET12P

MERCEDES-BENZ
A-CLASS (W169), B-CLASS (W245), C-CLASS (W202), C-CLASS (W203), C-CLASS COUPE (C203), C-CLASS T-MODEL (S202), C-CLASS T-MODEL (S203), CLK (C208), CLK (C209), CLK CONVERTIBLE (A208), CLK CONVERTIBLE (A209), CLS (C219), E-CLASS (W210), E-CLASS (W211), E-CLASS T-MODEL (S210), E-CLASS T-MODEL (S211), G-CLASS (W463), G-CLASS /CABRIO (W463), G-CLASS CABRIO (W463), M-CLASS (W163), M-CLASS (W164), R-CLASS (W251, V251), S-CLASS (W140), S-CLASS (W220), S-CLASS (W221), S-CLASS (W222, V222, X222), S-CLASS COUPE (C140), S-CLASS COUPE (C215), S-CLASS COUPE (C216), S-CLASS COUPE (C217), SL (R129), SL (R230), SL (R231), SLK (R170), SLK (R171), SPRINTER 2-T BOX /BUS /PLATFORM /CHASSIS (901, 902), SPRINTER 3-T BOX /BUS /PLATFORM /CHASSIS (903), VIANO (W639), VITO BUS (W639), VITO / MIXTO BOX (W639)
MG
EXPRESS, MG 6, MGF, MG TF, MG ZR, MG ZS, MG ZT, MG ZT-
MINI
MINI
MITSUBISHI
380, 3000 GT, ASX, CARISMA, DIAMANTE I, DIAMANTE II, DION, ECLIPSE III, GALANT, GALANT V, GALANT VI, L 300 III, LANCER VI, LANCER VII, LANCER VIII, MAGNA, OUTLANDER I, OUTLANDER II, OUTLANDER III, PAJERO CLASSIC, PAJERO II, PAJERO III, PAJERO IV, PAJERO PININ, PAJERO SPORT I, PAJERO SPORT II, PROUDIA/DIGNITY, SIGMA, SPACE RUNNER, SPACE STAR, SPACE WAGON, VERADA
MORGAN
AERO 8, PLUS EIGHT
NISSAN
180 SX, 200 SX, 300 ZX, BLUEBIRD, CEDRIC, CEFIRO I, CEFIRO II, GLORIA, LAUREL, MAXIMA III, MAXIMA / MAXIMA QX IV, MAXIMA / MAXIMA QX V, PRAIRIE, SKYLINE, STAGEA, SUNNY II, SUNNY III
OPEL
ASTRA G, ASTRA H, ASTRA J, COMBO, CORSA D, FRONTERA B, INSIGNIA A, MERIVA A, MONTEREY A, MONTEREY B, SIGNUM, VECTRA C, ZAFIRA A, ZAFIRA B
PEUGEOT
4007
PORSCHE
CAYENNE (9PA)
PUCH
G-MODELL
RENAULT
AVANTIME, CLIO II, ESPACE IV, LAGUNA II, LAGUNA III, MEGANE CC, MEGANE II, MEGANE III, SCENIC II, TWINGO II, VEL SATIS, WIND
ROLLS-ROYCE
PARK WARD, PHANTOM VII, SILVER SERAPH



...CET12P

ROVER

25, 45, 75, 200, 400, COUPE, STREETWISE

SAAB

9-3, 9-5, 900 II

SEAT

ALHAMBRA, ALTEA, ALTEA XL, AROSA, EXEO, IBIZA III, LEON, TOLEDO II, TOLEDO III

SKODA

FABIA I, FELICIA I, FELICIA II, OCTAVIA I, OCTAVIA II, SUPERB I

SSANGYONG

KORANDO

SUBARU

FORESTER, IMPREZA, JUSTY III, LEGACY I, LEGACY II, LEGACY IV, LEGACY V, OUTBACK, VIVIO

SUZUKI

GRAND VITARA I (FT, HT), GRAND VITARA II (JT, TE, TD), IGNIS I (FH), IGNIS II (MH), LIANA HATCHBACK, SWIFT II HATCHBACK (EA, MA), SWIFT III (MZ, EZ), VITARA (ET, TA), VITARA CABRIO (ET, TA), WAGON R+ (MM), WAGON R+ HATCHBACK (MM), X-90 (EL)

TOYOTA

ALLION I, ALPHARD, ALPHARD / VELLFIRE, ALTEZZA, ALTEZZA GITA, AQUA, ARISTO, ASCENT, AURION, AVALON, AVANZA, AVENSIS, AVENSIS VERSO, BB II, BREVIS, CALDINA, CAMI, CAMRY, CAMRY SOLARA, CARIBE, CARINA E, CELICA, CELSIOR, CENTURY, CHASER, COROLLA, CORONA, CRESTA, CROWN, CURREN, GAIA, HARRIER, HIGHLANDER / KLUGER, HILUX VII, MARK II, ISIS, KLUGER, LAND CRUISER 90, LAND CRUISER 100, LAND CRUISER 200, MAJESTA, MARK X ZIO, MR 2 I, MR 2 II, NOAH/VOXY, OPA, PASSO, PORTE, PREVIA, PREVIA III, PRIUS, PRIUS C, PROBOX/SUCCEED, PROGRES, RAV 4 I, RAV 4 II, RAV 4 III, SCEPTER, SEQUOIA, SIENNA, SOARER, SOLARA, SPRINTER, SPRINTER CARIB, SUPRA, TOWN ACE, VEROSSA, VISTA, WINDOM, WISH, YARIS

TOYOTA (FAW)

PRIUS

VAUXHALL

ASTRA MK V (H), ASTRA MK VI (J), COMBO MK II (C), COMBO TOUR MK II (C), CORSA MK II (C), CORSA MK III (D), FRONTERA MK II (B), INSIGNIA MK I (A), MERIVA MK I (A), MONTEREY, MONTEREY MK II, SIGNUM, VECTRA MK II (C), ZAFIRA MK I (A), ZAFIRA MK II (B)

VOLVO

850, C70 I, S40 I, S60 I, S70, S80 I, S80 II, V40, V70 I, V70 II, XC70 CROSS COUNTRY, XC90 I

VW

BORA, EOS, FOX, GOLF III, GOLF IV, GOLF V, GOLF VI, GOLF PLUS, JETTA III, LUPO, NEW BEETLE, PASSAT, POLO, SHARAN, TOURAN, TRANSPORTER IV, VENTO

CET13P

RENAULT

CLIO, CLIO III, CLIO IV, GRAND SCÉNIC III, MEGANE CC, MEGANE III, MODUS / GRAND MODUS, SCÉNIC III, TWINGO II, WIND

CET14P

CADILLAC

BLS, CTS

CHEVROLET

VECTRA

CITROËN

C4 AIRCROSS, C5 I, C5 II, C5 III, C6, C8

DAIHATSU

BOON, CUORE VII, SIRION

FIAT

ULYSSE

FORD

FOCUS II, KUGA I, MONDEO IV, S-MAX

HONDA

CIVIC VIII, INSIGHT, JAZZ III

HYUNDAI

ASLAN, GENESIS, GRANDEUR, GRAND SANTA FE, SANTA FE I, SANTA FE II, SANTA FE III, SONATA IV

INFINITI

FX, G, M35, M45, Q45 III

KIA

CADENZA I, CARINIVAL / GRAND CARINIVAL III, MAGENTIS, OPIRUS, QUORIS, SEDONA, SORENTO II, SORENTO III

LANCIA

PHEDRA

LAND ROVER

FREELANDER 2

LEXUS

ES, GS, GX, IS C, IS II, IS III, LS, LX, RX

MERCEDES-BENZ

C-CLASS (W203), C-CLASS COUPE (C1203), C-CLASS T-MODEL (S203), CLC-CLASS (C1203), CLK (C209), CLK CONVERTIBLE (A209), CLS (C219), E-CLASS (W211), E-CLASS T-MODEL (S211), G-CLASS (W463), S-CLASS (W220), S-CLASS COUPE (C215), SL (R230), SLK (R171), SLR (R199), SLR ROADSTER (R199)

MERCEDES-BENZ (BBDC)

E-CLASS

MITSUBISHI

ASX, ECLIPSE IV, GALANT, GALANT VI, GRANDIS, LANCER VIII, OUTLANDER I

MIITSUOKA

VIEWT

NISSAN

350 Z, ALMERA II, ALTIMA, CEFIRO I, CUBE, ELGRAND, MAXIMA / MAXIMA QX V, MAXIMA QX V, MICRA C+C III, MICRA III, MURANO I, NOTE, QUEST, SKYLINE, STAGEA, TEANA I, TERRANO II, X-TRAIL

PEUGEOT

206, 406, 407, 607, 807

RENAULT

AVANTIME, CLIO II, ESPACE IV, KANGOO, LAGUNA II, VEL SATIS

...CET14P

SUBARU

FORESTER, IMPREZA, JUSTY IV, LEGACY IV, LEGACY V, OUTBACK, TRIBECA

SUZUKI

GRAND VITARA II (JT, TE, TD), KIZASHI (FR), SWIFT IV (FZ, NZ), SX4 (EY, GY)

TOYOTA

ALLION II, ALPHARD / VELLFIRE, AURION, AURIS, AVALON, AYGO, CAMRY, COROLLA, COROLLA RUMION, CROWN, HARRIER, HIGHLANDER / KLUGER, KLUGER, LAND CRUISER, LAND CRUISER 200, LAND CRUISER PRADO, MARK X ZIO, PORTE II, PREMIO, PREVIA III, RACTIS, RAV 4 III, RAV 4 IV, SEQUOIA, SIENNA, SPADE, TUNDRA, VENZA, VERSO S, VIOS/YARIS, MARK X I, MARK X II, YARIS, ZELAS

VAUXHALL

SIGNUM, VECTRA MK II (C)

VOLVO

C30, C70 II, S40 II, S60 I, S80 I, S80 II, V50, V70 II, V70 III, XC60, XC70 CROSS COUNTRY, XC70 II, XC90 I

CET15P

ALFA ROMEO

MITO

CHRYSLER

YPSILON

FIAT

500, 500 C, 500L, PANDA, PANDA VAN, PUNTO

LANCIA

YPSILON

MERCEDES-BENZ

C-CLASS (W203), C-CLASS (W204), C-CLASS COUPE (C204), C-CLASS COUPE (C1203), C-CLASS T-MODEL (S203), C-CLASS T-MODEL (S204), CLC-CLASS (C1203), CLK (C209), CLK CONVERTIBLE (A209), CLS (C219), E-CLASS (W211), E-CLASS (W212), E-CLASS CONVERTIBLE (A207), E-CLASS COUPE (C207), E-CLASS T-MODEL (S211), E-CLASS T-MODEL (S212), G-CLASS (W463), G-CLASS CABRIO (W463), GL-CLASS (X164), GLK-CLASS (X204), M-CLASS (W164), R-CLASS (W251, V251), S-CLASS (W221), S-CLASS COUPE (C216), SL (R230), SLK (R171), SLK (R172), SPRINTER 3,5-T BOX (906), SPRINTER 3,5-T BOX /BUS /PLATFORM /CHASSIS (906), SPRINTER 3,5-T BUS /PLATFORM /CHASSIS (906), SPRINTER 3-T BOX (906), SPRINTER 3-T BOX /BUS /PLATFORM /CHASSIS (906), SPRINTER 3-T BUS (906), SPRINTER 3-T PLATFORM /CHASSIS (906), SPRINTER 4,6-T BOX /PLATFORM /CHASSIS (906), SPRINTER 5-T BOX /PLATFORM /CHASSIS (906), SPRINTER 5-T PLATFORM /CHASSIS (906), VIANO (W639), VITO BUS (W639), VITO / MIXTO BOX (W639)

MERCEDES-BENZ (BBDC)

E-CLASS

MITSUBISHI

I, OUTLANDER II, PAJERO SPORT II

SMART

FORTWO

CET16P

BMW

1 (F20), 1 (F21), 3 (F30, F80), 3 TOURING (F31)

CITROËN

BERLINGO, C3 II, C3 PICASSO, C4, C4 GRAND PICASSO I, C4 GRAND PICASSO II, C4 I, C4 II, C4 PICASSO I, C4 PICASSO II, C5 III, DS3, DS4, DS5

MINI

MINI, MINI CLUBMAN, MINI CLUBVAN, MINI COOPERMAN, MINI PACEMAN

PEUGEOT

207, 207 CC, 207 SW, 208, 308, 308 CC, 308 II, 308 SW, 308 SW II, 408, 508 I, 508 SW I, 2008, 3008, 5008, PARTNER, PARTNER TEPEE, RCZ

CET17P

ALFA ROMEO

159, BRERA, SPIDER

ASTON MARTIN

DB7

CATERHAM

SEVEN

CHEVROLET

CAPTIVA, HHR, MALIBU, TRAILBLAZER, VECTRA

DODGE

CHALLENGER, CHARGER, JOURNEY

FIAT

CROMA

FORD

BANTAM, COUGAR, ESCORT CLASSIC, ESCORT V, ESCORT VI, ESCORT VII, FIESTA V, FIESTA VI, FOCUS, FOCUS III, GALAXY, KA, KA VAN, MAVERICK, MONDEO I, MONDEO II, MONDEO IV, ORION III, PUMA, RANGER, S-MAX, TOURNEO CONNECT, TRANSIT CONNECT

FORD AUSTRALIA

FIESTA, MONDEO

HOLDEN

ASTRA, VECTRA, ZAFIRA

HUMMER

HUMMER H3

ISUZU

ASCENDER

JAGUAR

XF, XJ

JEEP

GRAND CHEROKEE IV

LAND ROVER

DISCOVERY SPORT, FREELANDER 2, RANGE ROVER EVOQUE

MAZDA

3 (BK), 3 (BL), 3 /SALOON (BL), 5 (CR19), 5 (CW), 6 ESTATE /HATCHBACK (GH), 6 ESTATE /HATCHBACK /SALOON (GH), 6 HATCHBACK /SALOON (GG), 6 SALOON (GG), 6 SALOON (GH), 6 STATION WAGON (GY), 121 III (JASM, JBSM), CX-7 (ER), CX-9 (TB), MX-5 III (NC), PREMACY (CP), TRIBUTE (EP)

MORGAN

FOUR FOUR, PLUS FOUR



eon TITAN



...CET17P

OPEL

ANTARA, ASTRA G, ASTRA J, GT, INSIGNIA A, SPEEDSTER, VECTRA B, VECTRA C, ZAFIRA A

SAAB

9-3, 9-3X, 9-5, 9-7X

SUZUKI

GRAND VITARA II (JT, TE, TD)

VAUXHALL

ANTARA, ASTRA MK IV (G), ASTRA MK VI (J), INSIGNIA MK I (A), OMEGA (B), VECTRA (B), VECTRA MK II (C), VX220, ZAFIRA MK I (A)

VOLVO

S60 II, S80 II, V40, V60, V70 III, XC60

WESTFIELD

SE / SEVEN

CET18P

ASTON MARTIN

DB7, DB9, DBS, RAPIDE, VANQUISH, VANTAGE, VIRAGE

FORD

B-MAX, C-MAX, C-MAX II, COUGAR, ESCORT V, ESCORT VI, ESCORT VII, FIESTA, FIESTA IV, FIESTA V, FIESTA VI, FOCUS C-MAX, FOCUS II, GALAXY, KA, MAVERICK, MONDEO I, MONDEO II, MONDEO III, MONDEO IV, S-MAX, TRANSIT

FORD AUSTRALIA

COUGAR, ESCAPE, F150, F350, FALCON, KA, MUSTANG, TAURUS

FORD USA

ESCAPE, EXPEDITION, EXPLORER, F-150, FIVE HUNDRED, MUSTANG, RANGER, TAURUS, WINDSTAR

JAGUAR

S-TYPE, XF, XJ, X-TYPE

LINCOLN

LS

MAZDA

3 (BK), 3 SALOON (BK), 5 (CR19), 5 (CW), 6 ESTATE (GH), 6 HATCHBACK (GG), 6 HATCHBACK /SALOON (GG), 6 HATCHBACK /SALOON (GH), 6 STATION WAGON (GY), 121 III (JASM, JBSM), MPV II (LW), MPV III (LY), MX-5 III (NC), PREMACY (CP), TRIBUTE (EP)

MORGAN

PLUS FOUR, ROADSTER

VOLVO

C30, S40 II, S80 II, V50, V70 III





IRIDIUM



OE179

ACURA
LEGEND II, NSX

ALFA ROMEO
145, 146, 147, 155, 156, 159, 164, 166, BRERA, GT, GTV, SPIDER

ALPINA
B3, B5, B8, B10, B12

ASTON MARTIN
DB7, VIRAGE

AUDI
80, 90, 100, A2, A3, A4, A5, A6, A8, ALLROAD, CABRIOLET, COUPE, Q5, TT

BENTLEY
ARNAGE

BITTER
TYPE 3

BMW
3 CONVERTIBLE (E30)

CADILLAC
BLS

CATERHAM
SEVEN

CHERY
A1, A3, A5, COWIN, COWIN 2, COWIN 3, COWIN 5, E5, EASTAR CROSS, FULWIN, QQ3, QQ6, TIGGO, TIGGO 3, TIGGO DR, V5, X1

CHEVROLET
AVEO, AVEO / KALOS, CRUZE, EPICA, KALOS, LACETTI, NUBIRA, OPTRA, VIVANT

CITROËN
AX, BERLINGO, BERLINGO / BERLINGO FIRST, BX, C2, C3, C3 I, C3 II, C15, EVASION, JUMPER, JUMPY, NEMO, SAXO, XANTIA, XM, XSARA, XSARA PICASSO, ZX

DACIA
DOKKER, DOKKER EXPRESS, DUSTER, LODGY, LOGAN, LOGAN MCV, SANDERO, SOLENZY, SUPERNOVA

DAEWOO
GENTRA, KALOS, LACETTI, LANOS, MAGNUS, NEXIA, NUBIRA, TOSCA

DAIHATSU
ALTIS, APPLAUSE I, CHARADE III, CHARADE IV, COPEN, FERENZA HARD TOP, FERENZA SOFT TOP, GRAN MOVE, SIRION, YRV

DAIMLER
DAIMLER XJ, XJ 40, 81

DE TOMASO
GUARA

EMGRAND
EC7, EC7-RV

EMGRAND (GEELY)
EC 7, EC 7 RV

FIAT
BRAVA, BRAVO I, COUPE, DOBLO, DUCATO, FIORINO, MAREA, MULTIPLA, PALIO, PANDA, PUNTO, QUBO, SCUDO, SIENA, STILO, TEMPRÀ, ULYSSÉ, UNO

...OE179

FORD
ESCORT '81, ESCORT '86, ESCORT '95, ESCORT III, ESCORT IV, ESCORT VI, ESCORT VII, FIESTA I, GALAXY, ORION III, SCORPIO I, SCORPIO II, TRANSIT, TRANSIT TOURNEO

FORD ASIA / OCEANIA
LASER, LASER / LASER LIDEA

FORD ASIA / OZEAANIA
FESTIVA, LIATA, TELSTAR

FSO
LANOS

GEELY
BL, CK, GC2, HISOON, HQ, MARINDO, MEIRI, MK, MR, PU, SL, URBAN NANNY, VISION

GEO
TRACKER

HONDA
ACCORD IV, ACCORD VI, CAPA, CITY, CIVIC I, CIVIC II, CIVIC IV, CIVIC V, CIVIC VI, CIVIC VII, CIVIC VIII, CONCERTO, CRX I, CRX II, CRX III, DOMANI, INSPIRE, INTEGRÀ, JAZZ, JAZZ II, LEGEND I, LEGEND II, NSX I, PRELUDE III, PRELUDE IV, PRELUDE V, S2000

HYUNDAI
ACCENT III, EQUUS / CENTENNIAL, GALLOPER I, TIBURON

INFINITI
G20, M30

ISUZU
GEMINI, TROOPER II, VEHICROSS, WIZARD

JAGUAR
S-TYPE, XJ, XK 8

KIA
CARNIVAL I, CARNIVAL II, PRIDE, RIO, RIO II, SEPHIA, SPORTAGE

LADA
110, 111, 112, GRANTA, KALINA, LARGUS, OKA, PRIORA

LAMBORGHINI
GALLARDO, GALLARDO SPYDER

LANCIA
DEDRA, DELTA II, KAPPA, LYBRA, THESIS, Y

LAND ROVER
FREELANDER

LEXUS
ES, GS, IS, IS I, LS

LIFAN
320, 520, 620, X60

LOTUS
ELAN, ELISE, ELISE 340 R, ESPRIT S4, EXIGE

MAZDA
323 C IV (BG), 323 C V (BA), 323 F IV (BG), 323 F V (BA), 323 III HATCHBACK (BF), 323 S IV (BG), 323 S V (BA), 323 S VI (BJ), 626 III /COUPE /HATCHBACK (GD), 626 III STATION WAGON (GV), 929 III (HC), MX-3 (EC), MX-5 I (NA), MX-5 II (NB), XEDOS 6 (CA), XEDOS 9 (TA)

...OE179

MERCEDES-BENZ
A-CLASS (W168), B-CLASS (W245), C-CLASS (W202), C-CLASS T-MODEL (S202), CLK (C208), CLK CONVERTIBLE (A208), E-CLASS (W210), E-CLASS T-MODEL (S210), M-CLASS (W163), S-CLASS (W140), S-CLASS COUPE (C140), SL (R129), SLK (R170), SPRINTER 2-T BOX (901, 902), SPRINTER 2-T BOX /BUS /PLATFORM /CHASSIS (901, 902), SPRINTER 3-T BOX /BUS /PLATFORM /CHASSIS (903)

MG
EXPRESS, MGF, MG TF, MG ZR, MG ZS, MG ZT, MG ZT-

MITSUBISHI
380, 3000 GT, ASX, CARISMA, COLT IV, COLT V, COLT VI, DIAMANTE I, DIAMANTE II, ECLIPSE, ECLIPSE III, FTO, GALANT, GALANT V, GALANT VI, L 300 III, LANCER IV, LANCER V, LANCER VI, LANCER VII, LANCER VIII, MAGNA, MIRAGE, OUTLANDER III, PAJERO CLASSIC, PAJERO III, PAJERO IV, PAJERO PININ, PAJERO SPORT I, PROUDIA/DIGNITY, SIGMA, SPACE RUNNER, SPACE STAR, SPACE WAGON

MIYUOKA
ZERO I

MORGAN
FOUR FOUR, PLUS EIGHT

NISSAN
180 SX, 200 SX, 300 ZX, AVENIR, BLUEBIRD, CEDRIC, KUBISTAR, MAXIMA III, PRAIRIE, PRAIRIE PRO, PRIMASTAR, PRIMERÀ, SERENA, SKYLINE, STANZA, SUNNY II, SUNNY III

OPEL
ASTRA G, ASTRA H, ASTRA J, COMBO, CORSA D, KADETT E, OMEGA A, SIGNUM, VECTRA C, VIVARO A, ZAFIRA A, ZAFIRA B

PANTHER
KALLISTA

PEUGEOT
106 I, 106 II, 106 VAN, 205, 205 I, 205 II, 206, 206+, 207, 207 SW, 305 II, 306, 307, 309 I, 309 II, 405 I, 405 II, 406, 605, 806, 1007, BIPPER, BIPPER TEPEE, BOXER, EXPERT, PARTNER

PLYMOUTH
BREEZE

PORSCHE
911 /CONVERTIBLE (964), 911 /CONVERTIBLE (996), 911 TARGA (993), 968, CAYENNE (9PA)

PROTON
PERSONA 300, PERSONA 400, WIRA

PUCH
G-MODELL

RELiant
SCIMITAR, SCIMITAR SABRE

...OE179

RENAULT
19 I, 19 II, 21, 25, AVANTIME, CLIO, CLIO I, CLIO II, CLIO III, DUSTER, ESPACE III, ESPACE IV, FLUENCE, GRAND SCÉNIC II, GRAND SCÉNIC III, KANGOO, KANGOO BE BOP, KANGOO / GRAND KANGOO, LAGUNA, LAGUNA I, LAGUNA II, LAGUNA III, LOGAN EXPRESS, LOGAN I, MEGANE, MEGANE CC, MEGANE I, MEGANE II, MEGANE III, MODUS / GRAND MODUS, RAPID, SAFRANE I, SAFRANE II, SANDERO/STEPWAY I, SCÉNIC I, SCÉNIC II, SCÉNIC III, SPORT SPIDER, THALIA I, THALIA II, TRAFIC II, TWINGO I, TWINGO II, VEL SATIS, WIND

ROVER
25, 45, 75, 100, 100 / METRO, 200, 400, 800, CITYROVER, COUPE, MAESTRO, MONTEGO, STREETWISE

SAAB
9-3, 9-5, 900 I, 900 II, 9000

SEAT
ALHAMBRA, ALTEA, ALTEA XL, AROSA, CORDOBA, EXEO, IBIZA I, IBIZA II, IBIZA III, IBIZA IV, INCA, LEON, MALAGA, RÓNDÀ, TOLEDO I, TOLEDO II, TOLEDO III

SKODA
FABIA I, OCTAVIA I, OCTAVIA II, SUPERB I

SSANGYONG
KORANDO

SUBARU
FORESTER, IMPREZA, JUSTY I, JUSTY III, LEGACY I, LEGACY II, LEGACY IV, OUTBACK, REX III, VIVIO

SUZUKI
GRAND VITARA I (FT, HT), IGNIS II (MH), LIANA (ER, RH, J), LIANA ESTATE (ER), LIANA HATCHBACK, SWIFT II HATCHBACK (EA, MA), SWIFT III (MZ, EZ), VITARA (ET, TA), VITARA CABRIO (ET, TA), WAGON R+ (MM), WAGON R+ HATCHBACK (MM), X-90 (EL)

TATA
INDICA, INDIGO, SAFARI

TOYOTA
ARISTO, AVENSIS, CAMI, CAMRY, CAMRY SOLARA, CARIBE, CARINA E, CARINA II, CELICA, CELSIOR, CHASER, COROLLA, COROLLA FX, CORONA, CRESSIDA, CRESTA, CROWN, CURREN, HARRIER, HILUX, HILUX VI, MARK II, LAND CRUISER, LAND CRUISER 200, MAJESTA, MR 2 I, MR 2 II, PREVIA, SCEPTER, SOARER, SPRINTER, SPRINTER CARIB, SUPRA, VISTA

VAUXHALL
ASTRA MK IV (G), ASTRA MK V (H), ASTRA MK VI (J), COMBO MK II (C), COMBO TOUR MK II (C), CORSA MK II (C), CORSA MK III (D), SIGNUM, VECTRA MK II (C), VIVARO, ZAFIRA MK I (A), ZAFIRA MK II (B)

VOLVO
850, C70 I, S40 I, S60 I, S70, S80 I, S80 II, V40, V70 I, V70 II, XC70 CROSS COUNTRY, XC90 I





IRIDIUM



...OE179

VW
BORA, CADDY II, CADDY III, CORRADO, EOS, FOX, GOLF II, GOLF III, GOLF IV, GOLF V, GOLF VI, GOLF PLUS, GOL III, JETTA II, JETTA III, LUPO, NEW BEETLE, PASSAT, POLO, SHARAN, TOURAN, TRANSPORTER IV, VENTO, VOYAGE

ZAZ
VIDA

OE180

ACURA
SLX

ASTON MARTIN
VIRAGE

AUSTIN
MAESTRO, MONTEGO

AUTOBIANCHI
Y10

BAOLONG
PEGASUS

BMW
3 (E30), 3 (E36), 3 /CONVERTIBLE /TOURING (E30), 3 TOURING (E30), 7 (E32), 8 (E31)

BYD
F3

CATERHAM
21, SEVEN

CHENGLONG
FUTURE

CHERY
TIGGO, V5

CHEVROLET
LUMINA APV

CHRYSLER
CIRRUS, CROSSFIRE, NEON, NEON II, SEBRING, STRATUS, VOYAGER / GRAND VOYAGER III

CITROËN
AX, BX, C15, C-CROSSER, VISA, XANTIA, XM, ZX

DADI
CITY COURSER, ELEGANTEST

DAEWOO
ESPERO, KORANDO, MUSSO, NEXIA, REXTON

DAIHATSU
APPLAUSE I, APPLAUSE II, CHARADE III, CHARADE IV, HIJET

DODGE
CARAVAN, NEON, NEON II, STRATUS

EUNOS
500

FIAT
BARCETTA, CINQUECENTO, DOBLO, DUCATO, MAREA, MULTIPLA, PALIO, PANDA, PUNTO, SEDICI, SEICENTO / 600, SIENA, STILO, STRADA, TEMPRA, TIPO, UNO

...OE180

FORD
ESCORT '86, ESCORT '91, ESCORT III, ESCORT IV, ESCORT V, ESCORT VI, ESCORT VII, FIESTA II, FIESTA III, GALAXY, ORION I, ORION II, ORION III, SCORPIO I, SCORPIO II, SIERRA, TRANSIT

FORD ASIA / OCEANIA
FALCON

FORD ASIA / OZEANIA
FREDA, TIERRA

FSO
POLONEZ III

GREAT WALL
FENGJUN 5, HOVER H3

HOLDEN
APOLLO

HONDA
ACCORD III, CIVIC II, CIVIC IV, CIVIC V, CIVIC VI, CIVIC VII, CONCERTO, CRX II, CRX III, INTEGRA, LEGEND I, LEGEND III

HYUNDAI
ACCENT, ACCENT I, ACCENT II, ACCENT III, ATOS, ATOS PRIME, COUPE, ELANTRA, GALLOPER II, GENESIS, GETZ, GRANDEUR, HIGHWAY VAN, I10, I20, I30, LANTRA II, MATRIX, SANTA FE I, SANTA FE II, S COUPE, SONATA IV, SONATA V, TERRACAN, TIBURON, TRAJET, TUCSON, XG

INFINITI
I30, J30, Q45 I, QX4

ISUZU
TROOPER III

JAGUAR
S-TYPE, XF, XJ, XJSC, XK, XK 8

JEEP
CHEROKEE

KIA
CARENS I, CARENS II, CARENS III, CARNIVAL II, CEE'D, CERATO, CLARUS, MAGENTIS, OPIRUS, PICANTO, PRIDE, PRO CEE'D, RETONA, RIO II, SHUMA, SHUMA II, SORENTO I, SPORTAGE

LADA
110, 111, 112

LANCIA
DEDRA, DELTA II, LYBRA, THESIS, Y, Y10

LAND ROVER
DISCOVERY I, DISCOVERY II, DISCOVERY III, RANGE ROVER II, RANGE ROVER III, RANGE ROVER SPORT

LANDWIND (JMC)
LANDWIND

LOTUS
ELAN

...OE180

MAZDA
2 (DE, DH_3), 2 (DY), 3 (BK), 3 /SALOON (BK), 3 /SALOON (BL), 121 I (DA), 121 II (DB), 121 III (JASM, JBSM), 323 C IV (BG), 323 C V (BA), 323 F IV (BG), 323 F V (BA), 323 F VI (BJ), 323 III /HATCHBACK (BF), 323 III STATION WAGON (BW), 323 P V (BA), 323 S IV (BG), 323 S V (BA), 323 S VI (BJ), 626 III /COUPE /HATCHBACK (GD), 626 III STATION WAGON (GV), 626 IV /HATCHBACK (GE), 626 V (GF), 626 V /HATCHBACK (GF), 626 V HATCHBACK (GF), 626 V STATION WAGON (GW), 929 III (HC), DEMIO (DW), E-SERIE BOX (SR2), MPV I (LV), MX-3 (EC), MX-5 I (NA), MX-5 II (NB), MX-6 (GE), PREMACY (CP), XEDOS 6 (CA), XEDOS 9 (TA)

MERCEDES-BENZ
A-CLASS (W169), B-CLASS (W245), CABRIOLET (A124), C-CLASS (W202), C-CLASS (W203), C-CLASS COUPE (CL203), C-CLASS T-MODEL (S202), C-CLASS T-MODEL (S203), CLK (C208), CLK (C209), CLK CONVERTIBLE (A208), CLK CONVERTIBLE (A209), CLS (C219), COUPE (C124), E-CLASS (W124), E-CLASS (W210), E-CLASS (W211), E-CLASS CONVERTIBLE (A124), E-CLASS COUPE (C124), E-CLASS T-MODEL (S124), E-CLASS T-MODEL (S210), E-CLASS T-MODEL (S211), G-CLASS (W463), G-CLASS /CABRIO (W463), G-CLASS CABRIO (W463), KOMBI T-MODEL (S124), M-CLASS (W163), M-CLASS (W164), R-CLASS (W251, V251), SALOON (W124), S-CLASS (W108, W109), S-CLASS (W140), S-CLASS (W220), S-CLASS COUPE (C140), S-CLASS COUPE (C215), SL (R129), SL (R230), SL (R231), SLK (R170), SLK (R171), SPRINTER 2-T BOX (901, 902), SPRINTER 2-T BUS /PLATFORM /CHASSIS (901, 902), SPRINTER 3-T BOX (903), SPRINTER 3-T BOX /BUS /PLATFORM /CHASSIS (903), SPRINTER 3-T BOX /PLATFORM /CHASSIS (903), SPRINTER 4-T BOX /BUS /PLATFORM /CHASSIS (904), VIANO (W639), VITO BUS (W639), VITO / MIXTO BOX (W639)

MINI
COLT V, ECLIPSE II, GALANT VI, GALLOPER, L 300 III, L 400, OUTLANDER I, OUTLANDER II, PAJERO II, PAJERO SPORT I, SANTAMO, SPACE RUNNER, SPACE STAR

MINI
VIEWT, YUGA

MORGAN
PLUS FOUR

NISSAN
100 NX, AD VAN, AD WAGON, ALMERA I, ALMERA II, ALMERA TINO, AVENIR, BLUEBIRD, BLUEBIRD SYLPHY I, CARAVAN, CEDRIC, CEFIRO I, CEFIRO II, CEFIRO III, CUBE, GLORIA, GLORIA VIII, LAUREL, LUCINO, MAXIMA / MAXIMA QX IV, MAXIMA / MAXIMA QX V, MICRA II, PRAIRIE PRO, PRIMERA, SERENA, SKYLINE, STAGEA, SUNNY II, SUNNY III, SUNNY IV, TERRANO I

...OE180

OPEL
FRONTERA B, MONTEREY A, MONTEREY B, OMEGA A

PEUGEOT
106 I, 205 I, 205 II, 305 II, 309 I, 309 II, 405 I, 605, 4007

PONTIAC
TRANS SPORT

PORSCHE
356 CABRIOLET /SPEEDSTER /COUPE

PROTON
IMPIAN, PERSONA 300, PERSONA 400

PUCH
G-MODELL

RELIANT
SCIMITAR SABRE

RENAULT
19 I, 19 II, CLIO I, CLIO II, RAPID, SAFRANE II

ROVER
100, 100 / METRO, 200, 400, 600, 800, COUPE

SAAB
900 I, 9000

SEAT
IBIZA I

SKODA
FAVORIT, FELICIA I, FELICIA II

SSANGYONG
KORANDO, KYRON, MUSSO, REXTON, RODIUS

SUBARU
FORESTER, IMPREZA, JUSTY I, JUSTY II, LEGACY I, LEGACY II, LEGACY III, LEGACY IV, LEGACY V, LEGACY OUTBACK, OUTBACK, SVX

SUZUKI
ALTO (HA12, HA23), BALENO /ESTATE /HATCHBACK (EG), CARRY BOX (FD), GRAND VITARA I (FT, HT), GRAND VITARA II (JT), GRAND VITARA II (JT, TE, TD), IGNIS I (FH), JIMNY (FJ), JIMNY CLOSED OFF-ROAD VEHICLE (SN), LIANA (ER, RH), LIANA HATCHBACK, SWIFT II HATCHBACK (EA, MA), SWIFT II SALOON (AH, AJ), SX4 (EY, GY), SX4 /SALOON (GY), SX4 S-CROSS (JY), VITARA (ET, TA), VITARA /CABRIO (ET, TA), WAGON R+ HATCHBACK (MM)

TOYOTA
4 RUNNER, ALTEZZA, ALTEZZA GITA, ARISTO, AURIS, CAMRY, CARIBE, CARINA E, CARINA II, CELICA, CHASER, COROLLA, COROLLA FX, CORONA, CORSA, CRESSIDA, CRESTA, CROWN, CURREN, HIACE IV, HILUX VI, MARK II, MR 2 I, PASEO, PREVIA, PRIUS, PROBOX/SUCCEED, RAUM, SCEPTER, SOARER, SPRINTER, SPRINTER CARIB, STARLET, SUPRA, TERCEL, VIOS, VISTA

VAUXHALL
CARLTON MK III, FRONTERA MK II (B), MONTEREY, MONTEREY MK II, SENATOR MK II (B)





IRIDIUM



...OE180

VW

BORA, GOLF III, GOLF IV, GOL IV, PASSAT, SHARAN, TRANSPORTER IV, VENTO

YULON

101 FEELING

ZASTAVA

10

OE181

AUDI

A6, A7

MERCEDES-BENZ

A-CLASS (W169), B-CLASS (W245), C-CLASS (W203), C-CLASS COUPE (CL203), C-CLASS T-MODEL (S202), C-CLASS T-MODEL (S203), CLK (C208), CLK CONVERTIBLE (A208), E-CLASS (W210), E-CLASS T-MODEL (S210), S-CLASS (W140), S-CLASS (W220), S-CLASS COUPE (C140), S-CLASS COUPE (C215), SL (R129), SLK (R170)

OE182

CITROËN

C-CROSSER, C-CROSSER ENTERPRISE

DAIHATSU

ALTIS, SIRION

FORD

SCORPIO II

LEXUS

ES, GS, GX, HS, IS, IS I, LS, LX, RX, SC

LOTUS

ELISE, EXIGE

mitsubishi

ASX, LANCER VIII, OUTLANDER II, OUTLANDER III

PEUGEOT

4007

SAAB

9-3

SKODA

FABIA I, FELICIA I, FELICIA II, OCTAVIA I

TOYOTA

ALLION I, ALPHARD, ALPHARD / VELLFIRE, ALTEZZA, ALTEZZA GITA, AURION, AVALON, AVENSIS, AVENSIS VERSO, BB I, CALDINA, CAMRY, CAMRY SOLARA, CELICA, CELSIOR, COROLLA, CROWN, ECHO, GAIA, HARRIER, HIGHLANDER / KLUGER, ISIS, IST, KLUGER, LAND CRUISER 80, LAND CRUISER 90, LAND CRUISER 100, LAND CRUISER 200, LITEACE, MARK X ZIO, MATRIX, MR 2 III, NOAH/VOXY, OPA, PLATZ, PORTE, PREVIA, PREVIA III, PROBOX/SUCCEED, RAUM, RAV 4 II, RAV 4 III, SEQUOIA, SIENNA, SIENNA, SOLARA, TOWN ACE, VEROSSA, VIOS/YARIS, VISTA, WILL CYPHA, WILL VI, WILL VS, WINDOM, WISH, YARIS, YARIS VERSO, YARIS / VIOS

OE183

ALPINE

A310

ASTON MARTIN

DB7, DB9, DBS, RAPIDE, VANQUISH, VANTAGE, VIRAGE

...OE183

AUDI

100, A6, A8, V8

AUSTIN

AMBASSADOR, PRINCESS 2

CITROËN

AXEL, BX, CX I, CX II, DS, LNA, VISA

DAIMLER

DAIMLER XJ, XJ 40, 81

FORD

B-MAX, C-MAX, C-MAX II, COUGAR, ESCORT '81, ESCORT '86, ESCORT '91, ESCORT III, ESCORT IV, ESCORT V, ESCORT VI, ESCORT VII, FIESTA, FIESTA I, FIESTA II, FIESTA III, FIESTA IV, FIESTA V, FIESTA VI, FOCUS C-MAX, FOCUS II, GALAXY, KA, MAVERICK, MONDEO I, MONDEO II, MONDEO III, MONDEO IV, ORION II, ORION III, SCORPIO I, SCORPIO II, SIERRA, S-MAX

FORD AUSTRALIA

KA

FORD USA

AEROSTAR, EXPLORER, MUSTANG, PROBE I

JAGUAR

S-TYPE, XF, XJ, XJSC, X-TYPE

LANCIA

THEMA

LINCOLN

LS

MAZDA

3 (BK), 3 SALOON (BK), 5 (CR19), 5 (CW), 6 ESTATE (GH), 6 HATCHBACK (GG), 6 HATCHBACK /SALOON (GG), 6 HATCHBACK /SALOON (GH), 6 STATION WAGON (GY), 121 III (JASM, JBSM), MPV II (LW), MPV III (LY), MX-5 III (NC), PREMACY (CP), TRIBUTE (EP)

MERCEDES-BENZ

190 (W201), COUPE (C123), COUPE (C124), E-CLASS (W124), E-CLASS T-MODEL (S124), G-CLASS (W460), G-CLASS (W461), G-CLASS (W463), G-CLASS /CABRIO (W463), HECKFLOSSE (W111, W112), KOMBI T-MODEL (S123), KOMBI T-MODEL (S124), SALOON (W123), SALOON (W124), S-CLASS (W126), SL (R107), SL (R129), T1 BOX (601, 611), T1 BUS /PLATFORM /CHASSIS (601), T1 PLATFORM /CHASSIS (602), T1 /TN BOX BODY / ESTATE /PLATFORM /CHASSIS, T2 /L BOX BODY / ESTATE /DUMPTRUCK /PLATFORM /CHASSIS, T2 /LNT BOX BODY / ESTATE /PLATFORM /CHASSIS

MORGAN

PLUS FOUR, ROADSTER

MORRIS

ITAL

OLTCIT

11

OPEL

ASCONA B, MANTA B

PEUGEOT

104, 204, 205 I, 205 II, 304, 305 I, 305 II, 309 I, 504, 505, 604

PROTON

GEN 2

...OE183

PUCH

G-MODELL

RENAULT

5, 14, 18, 20, 21, 25, 30, ESPACE II, FUEGO, MASTER I, SAFRANE I, TRAFIC

ROVER

2000-3500

TALBOT

SAMBA, SIMCA SIM'4, TAGORA

TRIUMPH

DOLOMITE

TVR

S

VOLVO

240, 260, 760, 780, 960, C30, S40 II, S80 II, V50, V70 III

OE184

AUDI

A8

BMW

7 (E38), 8 (E31)

CATERHAM

SUPER SEVEN

CHEVROLET

ASTRA, AVEO, CAPTIVA, CRUZE, EPICA, EVANDA, MALIBU, NIVA, NUBIRA, OPTRA, ORLANDO, REZZO, TRAX, VECTRA, VIVA, VIVANT, ZAFIRA

CHRYSLER

NEON II, PT CRUISER

DAEWOO

BROUGHAM, EVANDA, KORANDO, LACETTI, LEGANZA, MAGNUS, NUBIRA, PRINCE, REZZO, WINSTORM

DAIHATSU

COO, CUORE V, CUORE VI, MATERIA

DODGE

NITRO

FIAT

SIENA, ULYSSE

FORD

MAVERICK

FORD USA

PROBE I, PROBE II

HOLDEN

ASTRA, BARINA, CAPTIVA, COMBO, TIGRA, VIVA

HONDA

ACCORD IV, ACCORD V, ACCORD VI, ACCORD VII, CAPA, CIVIC V, CIVIC VI, CIVIC VII, CR-V I, CR-V II, CR-V III, FR-V, HR-V, LOGO, PRÉLUDE IV, PRÉLUDE V, SHUTTLE, STEPWGN, STREAM

JEOP

CHEROKEE, COMMANDER, GRAND CHEROKEE III

KIA

RIO

LADA

110

LANCIA

ZETA

...OE184

LOTUS

EUROPA S

MAZDA

323 F VI (BJ), 323 S VI (BJ), 626 IV HATCHBACK (GE), 929 III (HC), MPV I (LV), MPV II (LW), MX-6 (GE), XEDOS 9 (TA)

MERCEDES-BENZ

V-CLASS (638/2), VITO BOX/BUS (638)

MITSUBISHI

DIAMANTE I, DIAMANTE II, GALANT, GALANT VI, LANCER VI, LANCER VII, MAGNA, PAJERO II, PAJERO III, PAJERO PININ, PAJERO SPORT I, PAJERO SPORT II, SPACE RUNNER, SPACE WAGON, VERADA

NISSAN

100 NX, 200 SX, KUBISTAR, PICK UP, PRAIRIE PRO, PRIMERA, SUNNY III, TERRANO I, TERRANO II, VANETTE CARGO

OPEL

ADAM, AGILA (A), ANTARA, ASTRA F, ASTRA F CLASSIC, ASTRA G, ASTRA H, ASTRA J, CALIBRA A, COMBO, CORSA B, CORSA C, CORSA D, FRONTERA A, FRONTERA B, INSIGNIA A, KADETT E, MERIVA A, MERIVA B, MOKKA, MOKKA / MOKKA X, OMEGA B, SINTRA, SPEEDSTER, TIGRA, VECTRA A, VECTRA B, VECTRA C, VIVARO A, ZAFIRA A, ZAFIRA B, ZAFIRA TOURER C

PEUGEOT

406

ROVER

600, 800

SAAB

9-3, 900 II, 9000

SUZUKI

WAGON R HATCHBACK

TOYOTA

COROLLA, GRANVIA, HIACE III, HILUX, HILUX II, LAND CRUISER 90, LAND CRUISER PRADO

TVR

CERBERA

VAUXHALL

ADAM, AGILA MK I (A), ANTARA, ASTRA MK II, ASTRA MK III (F), ASTRA MK IV (G), ASTRA MK V (H), ASTRA MK VI (J), ASTRAMAN MK III (F), ASTRAMAN MK IV (G), ASTRAMAN MK V (H), CALIBRA, CAVALIER MK II, CAVALIER MK III, COMBO MK I (B), COMBO MK II (C), COMBO TOUR MK II (C), CORSA MK I (B), CORSA MK II (C), CORSA MK III (D), CORSAVAN MK I (B), CORSAVAN MK II (C), CORSAVAN MK III (D), FRONTERA MK I (A), INSIGNIA MK I (A), MERIVA MK I (A), MERIVA MK II (B), NOVA, OMEGA (B), SIGNUM, SINTRA, TIGRA, TIGRA MK I, VECTRA (B), VECTRA MK II (C), VX220, ZAFIRA MK I (A), ZAFIRA MK II (B), ZAFIRA MK III

VW

CORRADO, GOLF III, PASSAT, VENTO



IRIDIUM



OE187

BMW
3 /CONVERTIBLE (E30), 3 /CONVERTIBLE /COUPE (E36), 3 CONVERTIBLE /COUPE (E46), 5 (E28), 5 (E34), 5 /TOURING (E34), 6 (E24), Z3 COUPE (E36), Z3 ROADSTER (E36), Z4 COUPE (E86), Z4 ROADSTER (E85)

CHEVROLET
AVEO, SPARK

DAIHATSU
MATERIA, TERIOS

FERRARI
328 GTB, 328 GTS, 512 TR, MONDIAL, TESTAROSSA

SUZUKI
ALTO (FF), CAPPUCINO (EE), WAGON R+ (MM), WAGON R+ HATCHBACK (EM)

TOYOTA
AVANZA, BB II, PASSO SETTE, RUSH

TVR
CERBERA, TUSCAN II

WIESMANN
MF3

OE188

ALFA ROMEO
159

AUDI
A6, A8, CABRIOLET

BERTONE
FREECLIMBER 2

BITTER
TYPE 3

BMW
1 (E87), 1 CONVERTIBLE (E88), 1 COUPE (E82), 3 (E30), 3 (E36), 3 (E90), 3 COMPACT (E36), 3 /COMPACT (E46), 3 COMPACT /CONVERTIBLE /COUPE (E46), 3 /COMPACT /CONVERTIBLE /COUPE /TOURING (E36), 3 /COMPACT /CONVERTIBLE /COUPE /TOURING (E46), 3 /COMPACT /COUPE /TOURING (E36), 3 /COMPACT /COUPE /TOURING (E36), 3 /COMPACT /TOURING (E46), 3 CONVERTIBLE (E36), 3 CONVERTIBLE (E46), 3 CONVERTIBLE (E93), 3 /CONVERTIBLE /COUPE (E36), 3 /CONVERTIBLE /COUPE /TOURING (E46), 3 /CONVERTIBLE /TOURING (E36), 3 COUPE (E36), 3 COUPE (E92), 3 /COUPE /TOURING (E46), 3 TOURING (E30), 3 TOURING (E91), 5 (E28), 5 (E34), 5 (E39), 5 (E60), 5 /TOURING (E34), 5 TOURING (E34), 5 /TOURING (E39), 5 TOURING (E39), 5 TOURING (E61), 6 (E63), 6 CONVERTIBLE (E64), 7 (E32), 7 (E38), 7 (E65, E66, E67), 8 (E31), X1 (E84), X3 (E83), X5 (E53), X5 (E70), Z3 COUPE (E36), Z3 ROADSTER (E36), Z4 ROADSTER (E85), Z8 ROADSTER (E52)

CADILLAC
BLS

CATERHAM
SEVEN

CHEVROLET
LACETTI, VECTRA, ZAFIRA

...OE188

CITROËN
BX, XANTIA, XM

DAEWOO
LACETTI, LEGANZA

DAIHATSU
CUORE V, CUORE VI, EXTOL, MOVE, SIRION, TERIOS, TREVIS, YRV

FIAT
BRAVA, BRAVO I, CROMA, MAREA, STILO, ULYSSE

HOLDEN
ASTRA

HONDA
CIVIC II, CR-V I, DOMANI, SMX

HYUNDAI
EQUUS / CENTENNIAL, SONATA IV

IRMSCHER
SENATOR

LANCIA
DEDRA, DELTA II, ZETA

LAND ROVER
DEFENDER

LEXUS
GS, SC

MAYBACH
57

MAZDA
626 III (GD), B-SERIE (UN)

MERCEDES-BENZ
S-CLASS (W220), S-CLASS (W221), S-CLASS (W222, V222, X222), S-CLASS COUPE (C215), S-CLASS COUPE (C216), S-CLASS COUPE (C217), SL (R230)

MINI
MINI

MITSUBISHI
CARISMA, DION, GALANT V, GALANT VI, LANCER VI, LANCER VII, PAJERO II, PAJERO PININ, PAJERO SPORT I, SPACE STAR

MORGAN
AERO 8

NISSAN
KUBISTAR, STAGEA

OPEL
ASTRA H, CALIBRA A, COMBO, CORSA D, INSIGNIA A, KADETT E, MERIVA A, OMEGA A, OMEGA B, SIGNUM, TIGRA, VECTRA A, VECTRA B, VECTRA C, ZAFIRA B

PEUGEOT
309 II, 405 I, 405 II, 406, 605

PIAGGIO
PORTER

PORSCHE
911 (964), 911 (993), 911 /CONVERTIBLE (996), 911 /CONVERTIBLE /TARGA (993), BOXSTER (986), CAYENNE (9PA)

SEAT
CORDOBA, IBIZA II, IBIZA III, LEON, TOLEDO II, TOLEDO III

SKODA
FABIA I, OCTAVIA I, OCTAVIA II, SUPERB I

...OE188

SUBARU
LEGACY IV, OUTBACK

TOYOTA
ARISTO, AVALON, AVENSIS, BREVIS, CAMRY, CAMRY SOLARA, CHASER, CROWN, HILUX VII, PICNIC, PROGRES, RAV 4 I, SIENNA, SOLARA, VEROSSA, VISTA, WINDOM, YARIS

VAUXHALL
ASTRA MK V (H), CALIBRA, CARLTON MK III, CAVALIER MK III, CORSA MK III (D), INSIGNIA MK I (A), MERIVA MK I (A), OMEGA (B), SIGNUM, VECTRA (B), VECTRA MK II (C), ZAFIRA MK II (B)

VOLVO
850, 960, 960 II, C70 I, S40 I, S60 I, S70, S80 I, S90, V40, V70 I, V70 II, V90

VW
BORA, LT 28-35 II, LT 28-46 II, LUPO, NEW BEETLE, PASSAT, PHAETON, POLO, TOUAREG

WIESMANN
MF3

OE189

ALFA ROMEO
159, BRERA, SPIDER

ASTON MARTIN
DB7

CHEVROLET
ALERO, CAPTIVA, COBALT, HHR, MALIBU, TRAILBLAZER, VECTRA

DODGE
CHALLENGER, CHARGER, JOURNEY

FIAT
CROMA

FORD
C-MAX, C-MAX II, COUGAR, ESCORT CLASSIC, ESCORT V, ESCORT VI, ESCORT VII, FIESTA III, FIESTA IV, FIESTA V, FIESTA VI, FOCUS, FOCUS C-MAX, FOCUS II, FOCUS III, FUSION, GRAND C-MAX, KA, KA VAN, MAVERICK, MONDEO I, MONDEO II, MONDEO IV, ORION III, PUMA, RANGER, STREET KA, TOURNEO CONNECT, TRANSIT CONNECT

FORD AUSTRALIA
FIESTA, MONDEO

HOLDEN
ASTRA, VECTRA, ZAFIRA

HUMMER
HUMMER H3

ISUZU
ASCENDER

JEEP
GRAND CHEROKEE IV

MAZDA
2 (DY), 3 /SALOON (BL), 5 (CR19), 5 (CW), 6 ESTATE /HATCHBACK (GH), 6 ESTATE /HATCHBACK /SALOON (GH), 6 HATCHBACK /SALOON (GG), 6 SALOON (GH), 6 STATION WAGON (GY), 121 III (JASM, JBSM), CX-7 (ER), CX-9 (TB), MX-5 III (NC), PREMACY (CP), TRIBUTE (EP)

...OE189

MORGAN
FOUR FOUR, PLUS FOUR

OPEL
ANTARA, ASTRA G, ASTRA J, GT, INSIGNIA A, SPEEDSTER, VECTRA B, VECTRA C, ZAFIRA A

SAAB
9-3, 9-3X, 9-5, 9-7X

SUZUKI
GRAND VITARA II (JT, TE, TD)

VAUXHALL
ANTARA, ASTRA MK IV (G), ASTRA MK VI (J), INSIGNIA MK I (A), OMEGA (B), VECTRA (B), VECTRA MK II (C), VX220, ZAFIRA MK I (A)

VOLVO
C30, S40 II, S60 II, S80 II, V40, V50, V60, V70 III

OE190

CADILLAC
BLS, CTS

CHEVROLET
VECTRA

CITROËN
BERLINGO, BERLINGO / BERLINGO FIRST, C1, C2, C3, C3 I, C4, C4 AIRCROSS, C4 I, C5 I, C5 II, C5 III, C6, C8, SAXO, XSARA, XSARA PICASSO

DAIHATSU
BOON, CUORE VII, SIRION

FIAT
ULYSSE

FORD
FOCUS II, KUGA I

HONDA
CIVIC VIII, INSIGHT, JAZZ III

HYUNDAI
ASLAN, GENESIS, GRANDEUR, GRAND SANTA FÉ, IX35, SANTA FÉ I, SANTA FÉ II, SANTA FÉ III, SONATA IV, SONATA V, SONATA VI

INFINITI
FX, G, M35, M45, Q45 III

KIA
CADENZA I, CARNIVAL / GRAND CARNIVAL III, CERATO II, CERATO Koup, MAGENTIS, OPIRUS, QUORIS, SEDONA, SORENTO II, SORENTO III, SPORTAGE

LANCIA
PHEDRA

LAND ROVER
FREELANDER 2

LEXUS
ES, GS, GX, IS C, IS II, IS III, LS, LX, RX

MERCEDES-BENZ
CLK (C209), CLK CONVERTIBLE (A209), CLS (C219), G-CLASS (W463)

MITSUBISHI
ASX, COLT CZC, COLT VI, COLT PLUS VII, ECLIPSE IV, GALANT, GALANT VI, GRANDIS, LANCER VIII, OUTLANDER I

MIITSUOKA
VIEWT





IRIDIUM



...OE190

NISSAN

350 Z, ALMERA CLASSIC, ALMERA II, ALMERA TINO, ALTIMA, AVENIR, BASSARA, CEFIRO I, CUBE, ELGRAND, MAXIMA / MAXIMA QX V, MAXIMA QX V, MICRA C+C III, MICRA III, MURANO I, NOTE, PATHFINDER II, PATHFINDER III, PRIMERA, QUEST, SENTRA V, SKYLINE, STAGEA, TEANA I, TERRANO II, X-TRAIL

PEUGEOT

107, 206, 207, 307, 308, 308 SW, 406, 407, 607, 807, 1007, PARTNER, PARTNER TEPEE

RENAULT

AVANTIME, CLIO II, ESPACE IV, KANGOO, LAGUNA II, VEL SATIS

SMART

FORFOUR

SUBARU

FORESTER, IMPREZA, JUSTY IV, LEGACY IV, LEGACY V, OUTBACK, TRIBECA

SUZUKI

GRAND VITARA II (JT, TE, TD), KIZASHI (FR), SWIFT IV (FZ, NZ), SX4 (EY, GY)

TOYOTA

ALLION II, ALPHARD / VELLFIRE, AURION, AURIS, AVALON, AYGO, CAMRY, COROLLA, COROLLA RUMION, CROWN, FJ CRUISER, FORTUNER, HARRIER, HIGHLANDER / KLUGER, HILUX VII, IQ, KLUGER, LAND CRUISER, LAND CRUISER 200, LAND CRUISER PRADO, MARK X ZIO, PASSO, PORTE II, PREMIO, PREVIA III, RACTIS, RAV 4 III, RAV 4 IV, SEQUOIA, SIENNA, SPADE, TUNDRA, VENZA, VERSO S, VIOS/YARIS, MARK X I, MARK X II, YARIS, ZELAS

VAUXHALL

SIGNUM, VECTRA MK II (C)

VOLVO

C70 II, S40 II, S80 II, V50, V70 III, XC70 II

OE193

CHEVROLET

BERETTA

JAGUAR

XJ, XJSC

JEEP

GRAND CHEROKEE I

NISSAN

PATHFINDER II

SKODA

FAVORIT, FELICIA I

TOYOTA

ASCENT, AVENSIS, CALDINA, CARINA E, COROLLA, CORONA, CURREN, PRIUS, SPRINTER, SPRINTER CARIB

TOYOTA (FAW)

PRIUS

UAZ

CARGO, HUNTER, PATRIOT

OE194

ACURA

RL, SLX

CHRYSLER

SEBRING

...OE194

DODGE

AVENGER, CALIBER, DAKOTA, DART, DURANGO, JOURNEY

FIAT

FREEMONT

HONDA

ELEMENT, LAGREAT, LEGEND III

JEEP

COMMANDER, COMPASS, GRAND CHEROKEE II, GRAND CHEROKEE III, PATRIOT

LANCIA

FLAVIA

OE195

ABARTH

RITMO

AC

ME

ACURA

INTEGRA

ALFA ROMEO

6, 75, 90, 155, 164, 1750-2000, A11 / A12, ALFETTA, ALFETTA GT, F11 / F12, GIULIA, GIULIETTA, GT, GTV, ROMEO 2, RZ, SPIDER, SZ

ALPINA

B3, B6, B7, B9, B10, B11, C1, C2

ALPINE

BERLINETTE

ARO

10, SPARTANA

ASIA MOTORS

ROCSTA, TOWNER

ASTON MARTIN

DB6, DBS, LAGONDA I, V8, ZAGATO

AUDI

50, 60, 75, 80, 90, 100, 200, A6, CABRIOLET, COUPE, QUATTRO

AUSTIN

1000-SERIES MK II, ALLEGRO, MAESTRO, MAXI, MAXI II, METRO, MINI, MONTEGO, PRINCESS, PRINCESS 2

AUSTIN-HEALEY

SPRITE MK.IV

AUTOBIANCHI

A 111, A 112, Y10

BEDFORD

ASTRAMAX, ASTRA VAN, MIDI, RASCAL

BMW

02 /CONVERTIBLE (E10), 02 TOURING (E6), 3 (E21), 3 (E30), 3 /CONVERTIBLE /TOURING (E30), 5 (E12), 5 (E28), 5 (E34), 6 (E24), 7 (E23), 7 (E32), 1500-2000 (115, 116, 118, 121), 1600 GT COUPE, 2000-3.2 COUPE (E9), 2500-3.3 (E3), Z1 ROADSTER

CATERHAM

SEVEN

CHEVROLET

AVEO, AVEO / KALOS, CORSA, KALOS, LANOS, MATIZ, NIVA, REZZO, SPARK

...OE195

CHRYSLER

LE BARON, SARATOGA, VOYAGER II

CITROËN

AMI, C25, GS, SM

DADI

CITY COURSER

DAEWOO

ARANOS, CIELO, ESPERO, KALOS, LANOS, LEGANZA, LEMANS, MATIZ, NEXIA, NUBIRA, PRINCE, REZZO, ROYALE, SUPER SALOON, TICO

DAIHATSU

55 WIDE, 1000, CHARADE II, CHARADE III, CHARADE IV, CHARMANT, CUORE I, CUORE II, CUORE III, CUORE IV, HIJET, MOVE, ROCKY HARD TOP, ROCKY SOFT TOP, RUGGER, SPARCAR

DAIMLER

2.8 - 5.3, COUPE

FERRARI

208/308, MONDIAL

FIAT

124, 125, 126, 127, 128, 130, 131, 132, 147, 238-SERIE, 242-SERIE, 850, 900T/E PANORAMA, 900T/E PULMINO, 1500, 1500-2300, ARGENTA, CAMPAGNOLA, CINQUECENTO, COUPE, CROMA, DUCATO, DUNA, ELBA, FIORINO, FIORINO PICK UP, PALIO, PANDA, PREMIO, REGATA, RITMO, SEICENTO / 600, TALENTO, TEMPRA, TIPO, UNO, X 1/9

FORD

CAPRI, CAPRI II, CAPRI III, CONSUL, CORSAIR, CORTINA, ECONOVAN, ESCORT I, ESCORT II, FIESTA I, GRANADA, SCORPIO I, SIERRA, TAUNUS, TAUNUS 12M, TAUNUS 15M, TAUNUS 17M, TAUNUS 20M, TAUNUS 20M XL, TAUNUS 26M XL, TAUNUS '80, TRANSIT, ZEPHYR III, ZEPHYR IV, ZODIAC, ZODIAC

FORD OTOSAN

ANADOL

FOTON

ALPHA, SEA LION, SUP, SURF, SURFING, VIEW

FSO

125P, 126P, 127P, 132P, LANOS, POLONEZ I, POLONEZ II, POLONEZ III

GAZ

GAZELLE

GEELY

HAOQING, HQ, MR, PU, URBAN NANNY

GINETTA

G15, G21, G34

GLAS

04, 1700, GT, V 8

GOLDEN DRAGON

XML

GREAT WALL

DEER, PEGASUS, SAILING, STEED

HOLDEN

SCURRY

...OE195

HONDA

ACCORD I, ACCORD II, ACCORD III, ACTY, CIVIC I, CIVIC III, CIVIC IV, CRX I, INTEGRA, PRELUDE I, PRELUDE II, PRELUDE III, QUINTET

HYUNDAI

H-1, H-1 / STAREX, H100, LANTRA I, PONY, PONY / EXCEL, PORTER, SANTA FÉ I, SANTAMO, S COUPE, SONATA II, SONATA III, SONATA IV, STELLAR

INNOCENTI

ELBA, KORAL, MINI, REGENT

ISUZU

ASKA I, ASKA III, CAMPO, MIDI, PIAZZA, PICKUP, TROOPER I

JAGUAR

E-TYPE, E-TYPE 2+2, XJ

JEEP

CJ5 - CJ8

KIA

AVELLA, CARNIVAL II, JOICE, MAGENTIS, PRIDE, RIO, ROADSTER, SEPHIA, SHUMA, SORENTO I

LADA

110, 111, 112, 1200-1500, 1200-1600, KALINA, LARGUS, NADESCHA, NIVA, NIVA II, NOVA, PRIORA, SAMARA, TOSCANA

LANCIA

A 112, BETA, BETAH.P.E., BETA MONTE CARLO, DEDRA, DELTA I, DELTA II, FULVIA, GAMMA, KAPPA, PRISMA, THEMA, TREVI, Y10

LAND ROVER

88/109, 90, 110/127, DEFENDER, DISCOVERY I, RANGE ROVER I

LDV

SHERPA

LOTUS

ECLAT, ELITE, ESPRIT S2, ESPRIT S3, ESPRIT S4, EUROPA, EXCEL

MASERATI

BORA, GHIBLI, INDI, KHAMSI, KYALAMI, MERAK, MEXICO, QUATTROPORTE III

MAZDA

121 II (DB), 323 C IV (BG), 323 I /STATION WAGON (FA), 323 II /HATCHBACK (BD), 323 II HATCHBACK (BF), 323 III HATCHBACK (BF), 323 III STATION WAGON (BW), 616, 626 I (CB), 626 II /COUPE /HATCHBACK (GC), 626 II /HATCHBACK (GD), 626 III STATION WAGON (GV), 818 ESTATE, 929 I (LA), 929 II /COUPE (HB), 929 II ESTATE (HV), 1000, 1300, B-SERIE (UF), E-SERIE BOX (SR2)





IRIDIUM



...OE195

MERCEDES-BENZ
/8 (W114), /8 (W115), /8 /COUPE (W114), COUPE (C123), COUPE (W111), G-CLASS (W460), G-CLASS (W463), HECKFLOSSE (W110), HECKFLOSSE (W111, W112), HENSCHEL 2-T, KOMBI T-MODEL (S123), PAGODE (W113), PONTON (W121), PONTON (W128), PULLMANN (W100), SALOON (W123), S-CLASS (W108, W109), S-CLASS (W116), S-CLASS (W126), S-CLASS COUPE (C126), SL (R107), SL (W121), SL COUPE (C107), T1 BUS /PLATFORM /CHASSIS (601), T2 /L BOX BODY / ESTATE /DUMPTRUCK /PLATFORM /CHASSIS, T2 /L MUNICIPAL VEHICLE

MG
MAESTRO, METRO, MGB, MGB GT, MIDGET, MONTEGO

MITSUBISHI
CARISMA, COLT I, COLT II, COLT III, COLT IV, COLT V, COLT VI, CORDIA, ECLIPSE, ECLIPSE I, ECLIPSE II, GALANT I, GALANT II, GALANT III, GALANT IV, KUDA, L 200, L 300 / DELICA II, L 300 III, LANCER CELESTE, LANCER F, LANCER I, LANCER II, LANCER III, LANCER IV, LANCER V, LANCER VI, LANCER VII, MIRAGE, MIRAGE II, MIRAGE III, MIRAGE V, OUTLANDER I, PAJERO II, SAPPORO I, SAPPORO II, SAPPORO III, SIGMA, SPACE WAGON, STARION, TREDIA

MORGAN
FOUR FOUR, PLUS FOUR

MORRIS
ITAL, MARINA, MARINA II, MINI, MINOR

MOSKVICHI
407, 412, 427, 2140, 2141, ASLK 2137, ASLK 2140

NISSAN
280 ZX, ZXT, BLUEBIRD, BOBBY, CHERRY (E10) I, CHERRY II, CHERRY III, DATSUN 100 A, DATSUN 120, DATSUN 120 Y, DATSUN 160 J, DATSUN 180 B, LAUREL, LUCINO, PATROL GR V, PATROL III/1, PATROL III/2, PICK UP, PRAIRIE, SILVIA, STANZA, SUNNY, SUNNY I, SUNNY II, URVAN, VANETTE

NSU
1000, PRINZ, TTS

OPEL
ASCONA B, ASCONA C, ASTRA F, CALIBRA A, CAMPO, COMBO, CORSA A, CORSA B, FRONTERA A, KADETT D, KADETT E, MANTA B, OMEGA A, REKORD E, VECTRA A, VECTRA B

PANTHER
KALLISTA

PEUGEOT
304, 404, 504, 505, J5, J7, J9

PIAGGIO
PORTER

PININFARINA
SPIDEREUROPA

PORSCHE
911 /CONVERTIBLE, 924, 928, 944 /CONVERTIBLE, 968 /CONVERTIBLE

...OE195

PROTON
AEROBACK, PERSONA 400, SALOON

PUCH
G-MODELL

RELIANT
SCIMITAR

RENAULT
5, 9, 11, 12, 15, 16, 17, 18, 19 I, 19 II, 20, 21, CLIO I, ESPACE III, FUEGO, LAGUNA I, MASTER I, MEGANE, MEGANE I, RAPID, SUPER 5, TRAFIC

ROVER
200, 800, 2000-3500, MAESTRO, MINI, MINI-MOKE, MONTEGO

SAAB
90, 95, 96, 99, 600, 900 I

SANTANA
SAMURAI

SEAT
124, 127, 128, 131, 132, 133, 850, AROSA, CORDOBA, FURA, IBIZA I, IBIZA II, INCA, MARBELLA, PANDA, RITMO, RONDA, TERRA, TOLEDO I

SKODA
FELICIA I, FELICIA II, OCTAVIA I

SUBARU
JUSTY I, JUSTY II, LEONE I, LEONE II, LIBERO, MV, REX I, REX II, XT

SUZUKI
CARRY PICKUP, JIMNY (FJ), SUPER CARRY BUS (ED), SWIFT CONVERTIBLE (SF413), SWIFT I (AA), SWIFT II HATCHBACK (EA, MA), SWIFT II SALOON (AH, AJ), VITARA /CABRIO (ET, TA), WAGON R HATCHBACK

TALBOT
160, 180, 1307-1510, AVENGER, HORIZON, MATRA BAGHEERA, MURENA, RANCHO, SIMCA 1000, SIMCA 1100, SIMCA 1200 S, SIMCA 1500, SIMCA 1501, SIMCA 1609/1610, SIMCA SUNBEAM, SOLARA, TAGORA

TOFAS
DOGAN, KARTAL, SAHIN

TOYOTA
CAMRY, CARINA II, CELICA, CHASER, COROLLA, COROLLA FX, CRESSIDA, CRESTA, CROWN, DYNA 200, HIACE II, HIACE III, HIACE IV, HILUX IV, MARK II, LAND CRUISER, LAND CRUISER 80, SPRINTER, STARLET, STARLET 1000, STOUT, TARAGO, VISTA

TRABANT
1.1

TRIUMPH
2.5 PI MK I, 1300, 1500, 2000 MKII, 2500, ACCLAIM, HERALD, SPITFIRE, STAG, TOLEDO, TR 5, TR 6, VITESSE

TVR
280, 350, 390, 400, 420, 450, 1600, 2500, 3000, CHIMAERA, GRIFFITH, SPEED EIGHT, TAIMAR

...OE195

VAUXHALL
ASTRA, ASTRA MK II, ASTRA MK III (F), ASTRAMAX, ASTRAVAN MK III (F), BRAVA, CARLTON MK II, CARLTON MK III, CAVALIER, CAVALIER CC, CAVALIER MK II, CAVALIER MK III, CHEVETTE, COMBO MK I (B), CORSA MK I (B), CRESTA, FIRENZA, FRONTERA MK I (A), MIDI, NOVA, NOVAVAN, RASCAL, VELOX, VENTORA, VICTOR, VISCOUNT, VIVA

VOLVO
240, 340-360, 440 K, 460 L, 480 E, 740, 760, 940, 940 II, 960

VW
CADDY I, CORRADO, DERBY, GOLF I, GOLF II, GOLF III, GOLF IV, GOL I, ILTIS, JETTA I, JETTA II, K 70, LT 28-35 I, LT 40-55 I, LUPO, MULTIVAN V, PARATI III, PASSAT, POLO, POLO VAN, SANTANA, SCIROCCO, TARO, TRANSPORTER III, TRANSPORTER IV, TRANSPORTER V, VENTO

WARTBURG
353

WESTFIELD
130

WOLSELEY
18/85, 1300, HORNET

YUGO
311 / 411, 511 / 513, SANA, TEMPO

ZASTAVA
101, YUGO, YUGO FLORIDA

ZAZ
CHANCE, FORZA, LANOS, LANOS PICK-UP, SENS, SLAVUTA, TAVRIA, VIDA

OE240

NISSAN
BLUEBIRD SYLPHY II, BLUEBIRD SYLPHY / SYLPHY III, CUBE, MICRA IV, NOTE, QASHQAI / QASHQAI +2 I, SENTRA VII, SYLPHY III, TIIDA

OE245

BMW
1 (F20), 1 (F21), 2 ACTIVE TOURER (F45), 2 CONVERTIBLE (F23), 2 COUPE (F22, F87), 2 GRAN TOURER (F46), 3 (F30, F80), 3 GRAN TURISMO (F34), 3 TOURING (F31), 4 CONVERTIBLE (F33, F83), 4 COUPE (F32, F82), 4 GRAN COUPE (F36), 5 (G30, F90), 7 (G11, G12), X1 (F48), X2 (F39)

MINI
MINI, MINI CLUBMAN, MINI COUNTRYMAN

OE246

AUDI
A1, A3, A4 ALLROAD, A5, A6, A7, Q3, Q5, Q7, TT

PORSCHE
CAYENNE (92A), MACAN (95B), PANAMERA (970)

SEAT
LEON

SKODA
OCTAVIA III, SUPERB III

...OE246

VW
BEETLE, GOLF VI, GOLF VII, JETTA IV, PASSAT, PASSAT ALLTRACK, POLO, SCIROCCO, SHARAN, TIGUAN, TOURAN

OE248

HYUNDAI
ACCENT IV, I20, I30

KIA
CEE'D, PRO CEE'D

OE249

HYUNDAI
ELANTRA, I40, IX35

KIA
CARENS IV, OPTIMA, SOUL II

OE250

HYUNDAI
VELOSTER

KIA
SOUL II

OE253

MAZDA
2 (DL, DJ), 3 /SALOON (BM, BN), 6 ESTATE /SALOON (GJ, GL), CX-3 (DK), CX-5 (KE, GH), MX-5 IV (ND)

OE256

ALFA ROMEO
4C, 4C SPIDER, 159, BRERA, GIULIETTA, SPIDER

OE258

OPEL
ADAM, ASTRA K, CORSA E, INSIGNIA A, INSIGNIA B, MOKKA / MOKKA X

VAUXHALL
ADAM, ASTRA MK VII (K), CORSA MK IV (E), INSIGNIA MK I (A), INSIGNIA MK II (B), MOKKA / MOKKA X

OE260

AUDI
A1, A3

SEAT
ALTEA, ALTEA XL, IBIZA IV, LEON, TOLEDO IV

SKODA
FABIA II, OCTAVIA II, RAPID, ROOMSTER, ROOMSTER PRAKTIK, YETI

VW
BEETLE, CADDY III, GOLF VI, GOLF PLUS, JETTA IV, POLO, TOURAN, VENTO

OE261

DACIA
DOKKER, DOKKER EXPRESS, DUSTER, LODGY, LOGAN II, LOGAN MCV II, SANDERO II

MERCEDES-BENZ
CITAN BOX (415), CITAN COMBI (415)

NISSAN
JUKE, MICRA V, PULSAR, QASHQAI II





IRIDIUM



...OE261

RENAULT

CAPTUR, CLIO IV, GRAND SCÉNIC III,
KADJAR, KANGOO, KANGOO / GRAND
KANGOO, MEGANE CC, MEGANE III,
MEGANE IV, SCÉNIC III, SCÉNIC IV, TWINGO
III

SMART

FORFOUR, FORTWO

OE263

CITROËN

C3 II

PEUGEOT

208, 2008

OE264

OPEL

ASTRA J, INSIGNIA A, MERIVA B, MOKKA /
MOKKA X

VAUXHALL

INSIGNIA MK I (A)

**CCGP001**

BMW
3 (E90), 3 (F30, F80), 3 GRAN TURISMO (F34), 3 TOURING (E91), 3 TOURING (F31), 4 CONVERTIBLE (F33, F83), 4 COUPE (F32, F82), 4 GRAN COUPE (F36), 5 (F10), 5 GRAN TURISMO (F07), 5 TOURING (F11), 6 CONVERTIBLE (F12), 6 COUPE (F13), 6 GRAN COUPE (F06), 7 (F01, F02, F03, F04), X1 (E84), X3 (F25), X4 (F26), X5 (E70), X5 (F15, F85), X6 (E71, E72), X6 (F16, F86)

CCGP002

AUDI
A3, A4
SEAT
ALHAMBRA, ALTEA, ALTEA XL, CORDOBA, IBIZA III, IBIZA IV, LEON, TOLEDO III

SKODA
FABIA II, OCTAVIA II, ROOMSTER, ROOMSTER PRAKTIK, SUPERB I, SUPERB II

VW
CRAFTER 30-35, CRAFTER 30-50, JETTA III, MULTIVAN V, NEW BEETLE, PASSAT, POLO, SHARAN, TOUAREG, TRANSPORTER V

CCGP003

AUDI
A3, A4, A6
SEAT
ALTEA, ALTEA XL, LEON, TOLEDO III

SKODA
OCTAVIA II
VW
GOLF V, JETTA III, PASSAT, TOURAN

CCGP007

INFINITI
EX, FX, M, Q70, QX50, QX70
NISSAN
CABSTAR, MURANO II, NP300 NAVARA, NV400, PATHFINDER III, PRIMASTAR, QASHQAI / QASHQAI +2 I, X-TRAIL

OPEL
MOVANO B, VIVARO A
RENAULT
ESPACE IV, GRAND SCÉNIC II, GRAND SCÉNIC III, KOLEOS I, LAGUNA, LAGUNA II, LAGUNA III, LATITUDE, MASTER III, MEGANE CC, MEGANE II, MEGANE III, SCÉNIC II, SCÉNIC III, TRAFIC II, VEL SATIS

VAUXHALL
MOVANO MK II (B), VIVARO

CCGP010

AUDI
A4, A4 ALLROAD, A5, A8, Q5, Q7

CH147

CITROËN
AX, ZX

FIAT
DUCATO

FORD
ESCORT '86, ESCORT '91, ESCORT '95, ESCORT CLASSIC, ESCORT IV, ESCORT V, ESCORT VI, ESCORT VII, FIESTA, FIESTA III, MONDEO I, ORION II, ORION III, P 100 II, SIERRA

...CH147

IVECO
DAILY I, DAILY II
OPEL
ARENA, MOVANO
PEUGEOT
106 I
RENAULT
MASTER I, TRAFIC
ROVER
100 / METRO

CH154

METROCAB
TAXI
TOYOTA
4 RUNNER, CORSA, CRESSIDA, CROWN, DYNA, DYNA 150, HIACE I, HIACE II, HIACE III, HIACE IV, HILUX II, HILUX IV, HILUX V, HILUX VI, MARK II, LAND CRUISER, STARLET, TERCEL, TOWN ACE

VW
TARO

CH158

BEDFORD
MIDI
ISUZU
ASKA I, GEMINI, MIDI
OPEL
ASTRA F, CAMPO, CORSA A, KADETT E, MONTEREY A

VAUXHALL
ASTRA MK II, ASTRA MK III (F), BRAVA, CORSAVAN MK I (B), MIDI II, MONTEREY, NOVA

CH167

FIAT
BRAVA, BRAVO I, MAREA
LANCIA
KAPPA

CH169

CARBODIES
FL2, FX4, FX4R
HONDA
ACCORD V, ACCORD VI, CIVIC VI
LAND ROVER
FREELANDER

MG
EXPRESS, MG ZR, MG ZS
RENAULT
ESPACE III, LAGUNA I, MEGANE, MEGANE I, SAFRANE II, SCÉNIC I

ROVER
25, 45, 200, 400, 600, STREETWISE
VOLVO
S40 I, V40

CH170

CITROËN
BERLINGO / BERLINGO FIRST, C4 GRAND PICASSO I, C5 I, C5 II, C8, EVASION, JUMPER, JUMPY, XANTIA, XSARA, XSARA PICASSO

...CH170

FIAT
DUCATO, SCUDO, ULYSSE
LANCIA
PHEDRA, ZETA
PEUGEOT
206, 306, 307, 406, 607, 806, 807, BOXER, EXPERT, PARTNER
SUZUKI
GRAND VITARA I (FT, HT)

CH173

JEEP
CHEROKEE
RENAULT
9, 11, 19 I, 19 II, CLIO I, RAPID
VOLVO
340-360

CH175

MERCEDES-BENZ
C-CLASS (W202), C-CLASS T-MODEL (S202), E-CLASS (W124), E-CLASS T-MODEL (S124)

CH176

DAEWOO
KORANDO, MUSSO, REXTON

MERCEDES-BENZ
100 BOX (631), 100 BOX/BUS (631), 100 BOX /BUS /PLATFORM /CHASSIS (631), 190 (W201), C-CLASS (W202), E-CLASS (W124), E-CLASS T-MODEL (S124), G-CLASS (W460), G-CLASS (W461), G-CLASS (W463), G-CLASS /CABRIO (W463), KOMBI ESTATE (S124), KOMBI T-MODEL (S124), SALOON (W124), S-CLASS (W140), SPRINTER 2-T BOX /BUS /PLATFORM /CHASSIS (901, 902), SPRINTER 3-T BOX /BUS /PLATFORM /CHASSIS (903), SPRINTER 4-T BOX /PLATFORM /CHASSIS (904), T1 BOX (601, 611), T1 BOX /BUS /PLATFORM /CHASSIS (602), T1 BUS /PLATFORM /CHASSIS (601), T1 /TN BOX BODY / ESTATE /PLATFORM /CHASSIS, T2 /LN1 BOX BODY / ESTATE /DUMPTUCK, V-CLASS (638/2), VITO BOX/BUS (638)

MERCEDES-BENZ CV
UNIMOG

PUCH
G-MODELL
SSANGYONG
ISTANA, KORANDO, MUSSO, REXTON

CH177

MERCEDES-BENZ
C-CLASS (W202), C-CLASS T-MODEL (S202), E-CLASS (W210), E-CLASS T-MODEL (S124), E-CLASS T-MODEL (S210), G-CLASS /CABRIO (W463), S-CLASS (W140)

PUCH
G-MODELL

CH178

LAND ROVER
DEFENDER, DISCOVERY I, RANGE ROVER I

CH180

CHRYSLER
VOYAGER IV
JEEP
CHEROKEE
LDV
MAXUS
LTI
TX

CH181

ALFA ROMEO
155, 164
AUDI
A2
CHRYSLER
VOYAGER / GRAND VOYAGER III, VOYAGER II
FORD
GALAXY, SCORPIO II
JEEP
CHEROKEE, GRAND CHEROKEE I, GRAND CHEROKEE II

OPEL
FRONTERA A
PLYMOUTH
VOYAGER / GRAND VOYAGER

ROVER
800
SEAT
ALHAMBRA, AROSA, CORDOBA, IBIZA III, LEON, TOLEDO II

SKODA
FABIA I, FABIA II, OCTAVIA I, ROOMSTER, ROOMSTER PRAKTIK, SUPERB I
VAUXHALL
FRONTERA MK I (A)

VW
BORA, CADDY III, FOX, GOLF IV, LUPO, MULTIVAN V, NEW BEETLE, PASSAT, PHAETON, POLO, SHARAN, TOUAREG, TRANSPORTER V

CH185

CITROËN
AX, BERLINGO / BERLINGO FIRST, C15, JUMPY, SAXO, XSARA

FIAT
DUCATO, SCUDO

NISSAN
MICRA II

PEUGEOT
106 I, 106 II, 106 VAN, 206, 206 VAN, 306, EXPERT, PARTNER

ROVER
100 / METRO

TATA
INDICA

TOYOTA
COROLLA

CH186

FORD
MAVERICK



...CH186

LDV
CUB
NISSAN
SERENA, TERRANO I, TRADE, VANETTE
CARGO

CH189

ALFA ROMEO
145, 146, 155, 164, AR 6, AR 8

ARO
10, 240-244

AUSTIN
MAESTRO, MONTEGO

BEDFORD
ASTRAMAX, ASTRA VAN, BLITZ, MIDI

BERTONE
FREECLIMBER

BMW
3 /COMPACT /TOURING (E36), 3
/TOURING (E30), 5 (E28), 5 /TOURING
(E34), 5 /TOURING (E39), 7 (E38)

CARBODIES
FX4, FX4S, FX FAIRWAY

CHEVROLET
C1500, C3500

CHRYSLER
VOYAGER II

CITROËN
BERLINGO, BERLINGO / BERLINGO FIRST,
BX, C15, C25, C35, CX I, CX II, EVASION,
JUMPER, JUMPY, VISA, XANTIA, XM,
XSARA, ZX

DAF
400-SERIE

DAIHATSU
HIJET

DALLAS
FUN

DODGE
CARAVAN

FIAT
127, 131, 132, 147, 242-SERIE, ARGENTA,
BRAVA, BRAVO I, CAMPAGNOLA, CROMA,
DUCATO, DUNA, ELBA, FIORINO, FIORINO
PICK UP, PALIO, PANDA, PENNY, PUNTO,
REGATA, RITMO, SCUDO, SIENA, STRADA,
TALENTO, TEMPRA, TIPO, ULYSSE, UNO

FORD
GRANADA, SCORPIO I, SIERRA, TRANSIT

FSO
POLONEZ II, POLONEZ III

HYUNDAI
LANTRA II

INNOCENTI
ELBA

ISUZU
CAMPO, TFR/TFS

IVECO
DAILY I, DAILY II

JEEP
CHEROKEE, COMANCHE

...CH189

LADA
NIVA
LANCIA
DEDRA, DELTA I, PRISMA, THEMA, ZETA
LAND ROVER

88/109, 110/127, DEFENDER, RANGE
ROVER II

LDV
400, CONVOY, PILOT, SHERPA

MAHINDRA
CJ 3, CJ5

MERCEDES-BENZ
100 BOX (631), 100 BOX/BUS (631), 100
PLATFORM /CHASSIS (631), 190 (W201),
COUPE (C123), G-CLASS (W460), KOMBI
T-MODEL (S123), KOMBI T-MODEL (S124),
SALOON (W123), SALOON (W124),
SPRINTER 2-T BOX /BUS /PLATFORM
/CHASSIS (901, 902), SPRINTER 3-T BOX
/BUS /PLATFORM /CHASSIS (903),
SPRINTER 4-T BOX /PLATFORM /CHASSIS
(904), T1 BOX (601, 611), T1 BOX
/PLATFORM /CHASSIS (602), T1 BUS
/PLATFORM /CHASSIS (601), T1 /TN BOX
BODY / ESTATE /PLATFORM /CHASSIS, T2
/L BOX BODY / ESTATE /PLATFORM
/CHASSIS, T2 /LNT BOX BODY / ESTATE
/DUMPTRUCK /PLATFORM /CHASSIS

MERCEDES-BENZ CV
UNIMOG
OPEL
ARENA, ASCONA B, ASCONA C, ASTRA F,
ASTRA G, COMBO, FRONTERA A, KADETT D,
KADETT E, OMEGA A, OMEGA B, REKORD E,
SENATOR A, VECTRA A

PEUGEOT
205, 205 I, 205 II, 305 I, 305 II, 306, 309
I, 309 II, 405 I, 405 II, 406, 504, 505,
604, 605, 806, BOXER, EXPERT, J5, J7, J9,
PARTNER

PIAGGIO
PORTER

PUCH
G-MODELL

RAYTON FISSORE
MAGNUM

RENAULT
18, 19 I, 20, 21, 25, 30, ESPACE I, ESPACE
II, FUEGO, MASTER I, RAPID, SAFRANE I,
TRAFIC

RENAULT TRUCKS
B

ROVER
200, 400, 800, MAESTRO, MONTEGO

SEAT
131, 132, IBIZA I, MALAGA, RITMO,
RONDA

SUZUKI
BALENO /ESTATE /HATCHBACK (EG),
SAMURAI CLOSED OFF-ROAD VEHICLE (SJ),
VITARA /CABRIO (ET, TA)

TALBOT
180, EXPRESS 1000 -1500, EXPRESS 1000
-1800, HORIZON, SIMCA 1609/1610,
TAGORA

...CH189

TATA
LOADBETA
TOYOTA
LAND CRUISER
VAUXHALL

ARENA, ASTRA, ASTRA MK II, ASTRA MK III
(F), ASTRA MK IV (G), ASTRAMAX,
ASTRAVAN MK III (F), ASTRAVAN MK IV
(G), BRAVA, CARLTON MK II, CARLTON MK
III, CAVALIER MK II, CAVALIER MK III,
COMBO MK II (C), FRONTERA MK I (A),
MOVANO MK I (A), OMEGA (B), ROYALE,
SENATOR

CH196

FORD
C-MAX, FIESTA, FIESTA IV, FOCUS, FOCUS
C-MAX, FOCUS II, GALAXY, MONDEO IV,
S-MAX, TOURNEO CONNECT, TRANSIT
CONNECT

CH201

CITROËN
BERLINGO, BERLINGO / BERLINGO FIRST,
C1, C2, C3, C3 I, C3 II, C3 PICASSO, C4, C4
GRAND PICASSO I, C4 I, C4 PICASSO I, C5
II, C5 III, JUMPY, NEMO, XSARA PICASSO

FIAT
SCUDO

FORD
C-MAX, FIESTA V, FIESTA VI, FOCUS C-MAX,
FOCUS II, FUSION

FORD AUSTRALIA
FIESTA, MONDEO

MAZDA
2 (DE_, DH_3), 3 (BK), 3 /SALOON (BL)

MINI
MINI, MINI CLUBMAN

PEUGEOT
107, 206, 206+, 206 VAN, 207, 207 CC,
207 SW, 307, 308, 308 SW, 407, 1007,
3008, 5008, BIPPER, BIPPER TEPEE,
EXPERT, EXPERT TEPEE, PARTNER, PARTNER
TEPEE

SANTANA
300/350

SUZUKI
SX4 (EY, GY)

VOLVO
C30, S40 II, S80 II, V50, V70 III

CH203

BMW
3 (E46), 3 /TOURING (E46), 3 TOURING
(E46), 5 /TOURING (E39), 7 (E38), X5
(E53)

LAND ROVER
FREELANDER, RANGE ROVER III

MG
MG ZT, MG ZT-

OPEL
OMEGA B

ROVER
75

VAUXHALL
MIDI, OMEGA (B)

CH204

MERCEDES-BENZ
E-CLASS (W210), E-CLASS T-MODEL
(S210), G-CLASS (W461), SPRINTER 2-T
BOX /BUS /PLATFORM /CHASSIS (901,
902), SPRINTER 3-T BOX (903), SPRINTER
3-T BOX /BUS /PLATFORM /CHASSIS
(903), SPRINTER 3-T BUS (903), SPRINTER
3-T PLATFORM /CHASSIS (903), SPRINTER
4-T BOX /PLATFORM /CHASSIS (904),
SPRINTER 4-T PLATFORM /CHASSIS (904),
VARIO BOX BODY / ESTATE /BUS
/DUMPTRUCK /PLATFORM /CHASSIS

CH205

FORD
ESCORT '95, ESCORT VI, ESCORT VII,
FIESTA, FIESTA IV, MONDEO II

MAZDA
121 III (JASM, JBSM)

CH206

RENAULT
CLIO I, EXPRESS, MEGANE I, RAPID

CH207

ALPINA
D10

BMW
7 (E38)

OPEL
ASTRA G, FRONTERA B, SINTRA, VECTRA B,
ZAFIRA A

SAAB
9-3, 9-5

VAUXHALL
ASTRA MK IV (G), ASTRAVAN MK IV (G),
FRONTERA MK II (B), OMEGA (B), SINTRA,
VECTRA (B), ZAFIRA MK I (A)

CH209

FIAT
DOBLO, PALIO, PUNTO, STRADA

CH215

AUDI
A4, A6, A8, ALLROAD

SKODA
SUPERB I

VW
PASSAT

CH216

CITROËN
JUMPER

FIAT
DUCATO

IVECO
DAILY II, DAILY III

PEUGEOT
BOXER

RENAULT
MASTER II

RENAULT TRUCKS
MASCOTT

SANTANA
P510/ANIBAL



| | | | |
|--|---|--|--|
| CH217 DACIA SOLENZA OPEL ARENA RENAULT CLIO II, KANGOO, MEGANE, THALIA I, TRAFIC VAUXHALL ARENA | ...CH224 VAUXHALL ASTRA MK V (H), ASTRVAN MK V (H), SIGNUM, VECTRA MK II (C), ZAFIRA MK II (B) CH225 HYUNDAI H-1, H-1 / STAREX, H100, PORTER, TERRACAN KIA K2500, PREGIO CH226 HYUNDAI ACCENT II, ELANTRA, GETZ, GRANDEUR, I30, MATRIX, SANTA FE I, SANTA FE II, SONATA IV, SONATA V, TRAJET, TUCSON KIA CARENS II, CARENS III, CARNIVAL I, CARNIVAL II, CEE'D, CERATO, MAGENTIS, PRO CEE'D, SPORTAGE CH229 CITROËN JUMPER FIAT DUCATO FORD GALAXY, MONDEO III, TRANSIT, TRANSIT CUSTOM, TRANSIT TOURNEO FORD AUSTRALIA TRANSIT, TRANSIT CUSTOM JAGUAR X-TYPE LAND ROVER DEFENDER LDV CONVOY LTI TX PEUGEOT BOXER PIAGGIO PORTER CH230 NISSAN ALMERA II, ALMERA TINO, CABSTAR, NP300 NAVARA, NP300 PICKUP, PATHFINDER III, PICK UP, PRIMERA, X-TRAIL CH231 CHEVROLET ASTRA OPEL ASTRA G, FRONTERA B, OMEGA B, SIGNUM, VECTRA B, VECTRA C, ZAFIRA A SAAB 9-3 VAUXHALL ASTRA MK IV (G), FRONTERA MK II (B), OMEGA (B), SIGNUM, VECTRA (B), VECTRA MK II (C), ZAFIRA MK I (A) | ...CH232 OPEL MOVANO, VIVARO A RENAULT AVANTIME, ESPACE III, ESPACE IV, LAGUNA II, MASTER II, TRAFIC II, VEL SATIS VAUXHALL MOVANO MK I (A), VIVARO CH233 DACIA SOLENZA RENAULT CLIO II, KANGOO, MEGANE I, SCÉNIC I CH234 HYUNDAI H-1, H-1 / STAREX, PORTER KIA SORENTO I CH240 CITROËN C5 III, C6 JAGUAR S-TYPE, XF, XJ LAND ROVER DISCOVERY III, DISCOVERY IV, RANGE ROVER III, RANGE ROVER SPORT PEUGEOT 407, 607 VOLVO S60 I, S80 I, V70 II, XC70 CROSS COUNTRY, XC90 I CH242 FORD RANGER FORD AUSTRALIA COURIER, RANGER KIA BESTA, K2700, PREGIO, RETONA, SPORTAGE MAZDA 323 C IV (BG), 323 III /HATCHBACK (BF), 323 III STATION WAGON (BW), 323 P V (BA), 323 S IV (BG), 323 S V (BA), 626 II /HATCHBACK (GC), 626 III /HATCHBACK (GD), 626 III STATION WAGON (GV), 626 IV (GE), 626 IV HATCHBACK (GE), B-SERIE (PE), B-SERIE (UD), B-SERIE /PLATFORM /CHASSIS (UF), B-SERIE /PLATFORM /CHASSIS (UN), E-SERIE BOX (SR2), E-SERIE MPV (SG), E-SERIE PLATFORM /CHASSIS (SD1), MPV I (LV) SUZUKI GRAND VITARA I (FT, HT), VITARA (ET, TA) | ...CH256 MITSUBISHI GALANT V, GALANT VI, GALLOPER, L 200, L 300 / DELICA II, L 300 III, L 400, LANCER V, LANCER VI, PAJERO CLASSIC, PAJERO II, PAJERO III, PAJERO SPORT I, PAJERO SPORT VAN I, SPACE RUNNER, SPACE WAGON PROTON PERSONA 400 CH260 AUDI 80, 90, 100 BEDFORD BLITZ FORD TRANSIT MITSUBISHI CARISMA NISSAN BLUEBIRD, LAUREL, TRADE RENAULT 19 I, 19 II, MEGANE, MEGANE I SEAT CORDOBA, IBIZA II, INCA, TERRA, TOLEDO I SKODA FELICIA I, FELICIA II VOLVO 240, 440 K, 460 L, 740, 760, 780, 940, 940 II, 960, S40 I, V40 VW CADDY I, CADDY II, GOLF I, GOLF II, GOLF III, GOLF IV, ILTIS, JETTA I, JETTA II, LT 28-35 I, LT 40-55 I, PASSAT, POINTER, POLO, POLO VAN, QUANTUM, SANTANA, TRANSPORTER III, TRANSPORTER IV, VENTO CH263 MITSUBISHI PAJERO III, PAJERO SPORT I CH268 CITROËN C4, C4 I, C4 PICASSO I, C5 I, C5 II, C5 III, C8, JUMPER, JUMPY FIAT SCUDO, ULYSSE FORD C-MAX, FOCUS C-MAX, FOCUS II, GALAXY, KUGA I, MONDEO IV, S-MAX FORD AUSTRALIA FOCUS LANCIA PHEDRA PEUGEOT 307, 308, 308 CC, 308 SW, 406, 407, 508 I, 508 SW I, 607, 807, BOXER, EXPERT, EXPERT TEPEE SUZUKI GRAND VITARA I (FT, HT) VOLVO C30, C70 II, S40 II, S80 II, V50, V70 III CH269 ALFA ROMEO 147, 159 |
|--|---|--|--|

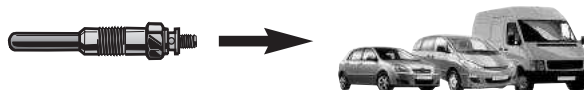

...CH269

FIAT

BRAVO II, CROMA, DOBLO, GRANDE PUNTO, MULTIPLA, PUNTO, STILO

OPEL

ASTRA H, SIGNUM, VECTRA C, ZAFIRA B

SAAB

9-3

VAUXHALL

ASTRA MK V (H), ASTRVAN MK V (H), SIGNUM, VECTRA MK II (C), ZAFIRA MK II (B)

CH270

CITROËN

JUMPER

FIAT

DUCATO

IVECO

DAILY III, DAILY IV, DAILY V, MASSIF

PEUGEOT

BOXER

CH271

AUDI

80, 100, A3, A4, A6, CABRIOLET

DACIA

DUSTER, LOGAN, LOGAN MCV, SANDERO

FORD

GALAXY

MITSUBISHI

CARISMA, SPACE STAR

NISSAN

ALMERA II, INTERSTAR, KUBISTAR, MICRA III, NOTE, NV200, NV200 / EVALIA, PRIMASTAR, PRIMERA, QASHQAI / QASHQAI +2 I, TIDA, TRADE

OPEL

MOVANO, VIVARO A

RENAULT

CLIO, CLIO II, CLIO III, DUSTER, ESPACE III, ESPACE IV, GRAND SCÉNIC II, KANGOO, LAGUNA I, LAGUNA II, LAGUNA III, LOGAN EXPRESS, LOGAN I, MASTER II, MEGANE I, MEGANE II, MODUS / GRAND MODUS, SCÉNIC I, SCÉNIC II, THALIA I, THALIA II, TRAFIC II, TWINGO II

SEAT

ALHAMBRA, AROSA, CORDOBA, IBIZA II, INCA, LEON, TOLEDO I, TOLEDO II

SKODA

FABIA I, OCTAVIA I

SUZUKI

JIMNY CLOSED OFF-ROAD VEHICLE (SN)

VAUXHALL

MOVANO MK I (A), VIVARO

VOLVO

850, S40 I, S70, S80 I, V40, V70 I, V70 II

VW

BORA, CADDY II, GOLF III, GOLF IV, LT 28-35 II, LT 28-46 II, LUPO, NEW BEETLE, PASSAT, POLO, POLO VAN, SHARAN, TRANSPORTER IV, VENTO, VOYAGE

CH272

LAND ROVER

DEFENDER, DISCOVERY II

CH302

DAIHATSU

CHARADE III

TOYOTA

AVENSIS, CALDINA, CAMRY, CARINA E, CARINA II, COROLLA, COROLLA FX, CORONA, DELIBOY, LAND CRUISER, LAND CRUISER 80, LITEACE, MASTER ACE SURF, MODELL F, SCEPTER, SPRINTER, TOWN ACE, VISTA

CH306

DADI

CITY COURSER, PICK UP

FOTON

SURF

HOLDEN

RODEO

ISUZU

D-MAX I, ELF, KB, TROOPER I

LANDWIND (JMC)

LANDWIND

OPEL

CAMPO, FRONTERA A

VAUXHALL

BRAVA, FRONTERA MK I (A)

CH600

NISSAN

AD VAN, ALMERA I, AVENIR, LUCINO, PRIMERA, SUNNY III

CH608

TOYOTA

4 RUNNER, COROLLA, CRESTA, DELIBOY, GAIA, GRANVIA, HILUX, HILUX VI, LAND CRUISER, LAND CRUISER 90, LAND CRUISER PRADO, LITEACE, PICNIC, SPRINTER

CH704

MERCEDES-BENZ

C-CLASS (W203), C-CLASS COUPE (CL203), C-CLASS T-MODEL (S203)

CPSG003

OPEL

ASTRA J, CORSA D, MERIVA B

VAUXHALL

ASTRA MK VI (J), CORSA MK III (D), MERIVA MK II (B)

CPSG004

OPEL

ASTRA J, MOKKA / MOKKA X

VAUXHALL

ASTRA MK VI (J), MOKKA / MOKKA X

CPSG006

OPEL

ASTRA J, CASCADA, INSIGNIA A, ZAFIRA TOURER C

VAUXHALL

ASTRA MK VI (J), CASCADA, INSIGNIA MK I (A), ZAFIRA MK III

CPSG007

AUDI

A1, A3, A4, A4 ALLROAD, A5, A6, A6 ALLROAD, A7, A8, Q2, Q3, Q5, Q7, TT

SEAT

ALHAMBRA, ATECA, IBIZA IV, LEON, TOLEDO IV

SKODA

FABIA III, KODIAQ, OCTAVIA III, RAPID, SUPERB III, YETI

VW

BEETLE, CADDY ALLTRACK, CADDY IV, CC, CRAFTER, GOLF ALLTRACK, GOLF VI, GOLF VII, GOLF SPORTSVAN, JETTA III, JETTA IV, MULTIVAN VI, PASSAT, PASSAT ALLTRACK, POLO, POLO VAN, SCIROCCO, SHARAN, TIGUAN, TIGUAN ALLSPACE, TOUAREG, TOURAN, TRANSPORTER VI, XLT

CPSG008

AUDI

A4, A4 ALLROAD, A5, A6, A7, Q5, Q7

VW

AMAROK, CRAFTER, GOLF SPORTSVAN, MULTIVAN VI, TOUAREG, TRANSPORTER VI

**BAE403B****FIAT**
DOBLO, STILO**BAE403C****ALFA ROMEO**
MITO
DODGE
DART**FIAT**
500, 500 C, 500L, BRAVO II, DOBLO,
DUCATO, GRANDE PUNTO, IDEA, PANDA,
PANDA VAN, PUNTO, STILO**LANCIA**
MUSA, YPSILON**BAE403D****FIAT**
STILO**BAE408AE****AUDI**
A1, A2, A3**SEAT**
ALHAMBRA, ALTEA, ALTEA XL, CORDOBA,
IBIZA III, IBIZA IV, LEON, TOLEDO II,
TOLEDO III, TOLEDO IV**SKODA**
FABIA I, FABIA II, OCTAVIA I, OCTAVIA II,
RAPID, ROOMSTÉR, ROOMSTER PRAKTIK,
SUPERB II, YETI**VW**
BEETLE, BORA, CADDY III, CC, EOS, GOLF
IV, GOLF V, GOLF VI, GOLF PLUS, JETTA III,
JETTA IV, LUPO, NEW BEETLE, PASSAT,
PASSAT CC, POLO, POLO VIVO, SCIROCCO,
SHARAN, TIGUAN, TOURAN**BAE409A****DACIA**
DUSTER, LOGAN, LOGAN MCV, SANDERO**LADA**
LARGUS**NISSAN**
KUBISTAR, PRIMASTAR**OPEL**
VIVARO A**RENAULT**
AVANTIME, CLIO, CLIO II, CLIO III, DUSTER,
ESPACE III, ESPACE IV, FLUENCE, GRAND
SCÉNIC II, GRAND SCÉNIC III, KANGOO,
KANGOO BE BOP, KANGOO / GRAND
KANGOO, LAGUNA, LAGUNA I, LAGUNA II,
LAGUNA III, LOGAN I, LOGAN II, MEGANE,
MEGANE CC, MEGANE I, MEGANE II,
MEGANE III, MODUS / GRAND MODUS,
SANDERO/STEPWAY I, SCÉNIC I, SCÉNIC II,
SCÉNIC III, THALIA I, THALIA II, TRAFIC II,
TWINGO II, VEL SATIS, WIND**VAUXHALL**
VIVARO**BAE504D****FIAT**
CROMA, FIORINO, FIORINO PICK UP,
TEMPRA, TIPO, UNO**LANCIA**
DEDRA, DELTA II, THEMA, Y10**BAE504I****RENAULT**
19 II, CLIO I, RAPID, TWINGO I**BAE506D****AUTOBIANCHI**
Y10**FIAT**
TEMPRA, TIPO, UNO**LANCIA**
Y10**ZASTAVA**
YUGO FLORIDA**BAE506F****FIAT**
CROMA, DUNA, FIORINO, FIORINO PICK
UP, PANDA, PENNY, REGATA, RITMO, TIPO,
UNO**LANCIA**
DELTA I, PRISMA, THEMA, Y10**BAE700AK****CITROËN**
XANTIA, ZX**MASERATI**
GHIBLI II, QUATTROPORTE IV**PEUGEOT**
306, 405 II**BAE800B****ALFA ROMEO**
33, 145, 146, 155**FIAT**
CINQUECENTO, COUPE, DOBLO, ELBA,
PALIO, PANDA, PREMIO, PUNTO, SEICENTO
/ 600, SIENA, STRADA, TEMPRA, TIPO**LAMBORGHINI**
DIABLO**LANCIA**
DEDRA, DELTA I, DELTA II, THEMA, Y,
YPSILON**BAE851AE****AUDI**
80, 100, CABRIOLET, COUPE**SEAT**
ALHAMBRA, AROSA, CORDOBA, IBIZA II,
INCA, TOLEDO I**SKODA**
FAVORIT, FELICIA I, FELICIA II, OCTAVIA I
VW
CADDY II, CORRADO, GOLF III, GOLF IV,
KAEFER, LUPO, PASSAT, POLO, POLO VAN,
SHARAN, TRANSPORTER IV, VENTO**BAE907AE****AUDI**
A1, A2, A3, A4**SEAT**
ALHAMBRA, ALTEA, ALTEA XL, AROSA,
CORDOBA, EXEO, IBIZA II, IBIZA III, IBIZA
IV, INCA, LEON, TOLEDO II, TOLEDO III,
TOLEDO IV**SKODA**
FABIA I, FABIA II, OCTAVIA I, OCTAVIA II,
RAPID, ROOMSTER, ROOMSTER PRAKTIK,
SUPERB I, YETI**...BAE907AE****VW**
BEETLE, BORA, CADDY II, CADDY III, FOX,
GOLF IV, GOLF V, GOLF VI, GOLF PLUS,
GOL IV, JETTA III, JETTA IV, LUPO,
MULTIVAN V, NEW BEETLE, PASSAT, POLO,
SHARAN, TOURAN, TRANSPORTER V,
VOYAGE**BAE920AX****FIAT**
BRAVA, BRAVO I, DOBLO, MAREA,
MULTIPLA, PALIO, SIENA**LANCIA**
DEDRA, DELTA II, LYBRA**BAE940A****ALFA ROMEO**
MITO**FIAT**
500, 500 C, DOBLO, FIORINO, GRANDE
PUNTO, IDEA, LINEA, PANDA, PUNTO,
PUNTO EVO, QUBO, SIENA**FORD**
KA**LANCIA**
MUSA, YPSILON**NISSAN**
TEANA I**BAE946A****CITROËN**
BERLINGO / BERLINGO FIRST, C2, C3, C3
I, SAXO, XSARA, XSARA PICASSO**PEUGEOT**
106 II, 206, 306, 307, 1007, PARTNER**BAE947A****DACIA**
LOGAN, LOGAN II, SANDERO, SANDERO II**NISSAN**
KUBISTAR**RENAULT**
CLIO, CLIO III, CLIO IV, KANGOO, MODUS /
GRAND MODUS, THALIA I, THALIA II,
TWINGO I, TWINGO II**BAE960AE****SKODA**
FELICIA II**BAE961AE****SEAT**
AROSA**SKODA**
FABIA I, OCTAVIA I, OCTAVIA II**VW**
LUPO**BAE965A****OPEL**
ASTRA G, COMBO, CORSA C, CORSA
UTILITY, MERIVA A, VECTRA B, VECTRA C,
ZAFIRA A, ZAFIRA B**VAUXHALL**
ASTRA MK IV (G), COMBO MK II (C),
COMBO TOUR MK II (C), CORSA MK II (C),
MERIVA MK I (A), VECTRA (B), ZAFIRA MK I
(A), ZAFIRA MK II (B)**BAEA002E****SEAT**
CORDOBA, IBIZA II, TOLEDO I
VW
PASSAT, POLO, TRANSPORTER IV, VENTO**BAEA004E****FORD**
GALAXY
MERCEDES-BENZ
V-CLASS (638/2)**VW**
CORRADO, GOLF III, PASSAT, SHARAN,
TRANSPORTER IV, VENTO**BAEA007E****AUDI**
80, 100, A6, CABRIOLET, COUPE**BAEA009E****AUDI**
A3, A6, A8, TT
SEAT
ALHAMBRA, CORDOBA, IBIZA II, LEON,
TOLEDO II**SKODA**
OCTAVIA I**VW**
GOLF IV, NEW BEETLE, SHARAN**BAEA012E****PORSCHE**
CAYENNE (9PA)**BAEA013E****SEAT**
LEON**VW**
BORA, GOLF IV, NEW BEETLE**BAEA014****BMW**
3 (E30), 3 (E36), 3 CONVERTIBLE (E36), 3
/CONVERTIBLE /COUPE (E36), 3 COUPE
(E36), 5 (E34), 5 /TOURING (E34), 5
TOURING (E34), 7 (E32), 7 (E38), 8 (E31)**BAEA016****AUDI**
A3, A4, A6, A8, ALLROAD, TT**SEAT**
ALHAMBRA, LEON**SKODA**
OCTAVIA I**VW**
BORA, GOLF IV, PASSAT, SHARAN**BAEA017****AUDI**
A8**BAEA019E****VOLVO**
C70 I, S60 I, S70, S80 I, V70 I, V70 II,
XC70 CROSS COUNTRY, XC90 I**BAEA021E****NISSAN**
ALMERA II, ALMERA TINO, PRIMERA

**BAEA025E**

CHEVROLET
EVANDA
DAEWOO
LACETTI, LANOS, LEGANZA, MAGNUS, NUBIRA
FSO
LANOS
OPEL
FRONTERA B
VAUXHALL
FRONTERA MK II (B)
ZAZ
LANOS

BAEA026E

OPEL
ASTRA F, ASTRA F CLASSIC, ASTRA G, COMBO, CORSA A, CORSA B, TIGRA, VECTRA A, VECTRA B
VAUXHALL
ASTRA MK III (F), ASTRA MK IV (G), ASTRAMAN MK III (F), ASTRAMAN MK IV (G), CAVALIER MK III, CORSA MK I (B), NOVA, TIGRA MK I, VECTRA (B)

BAEA029E

SKODA
OCTAVIA I
VW
BORA, CADDY III, GOLF IV, JETTA IV, NEW BEETLE, TOURAN

BAEA031E

AUDI
A8
BENTLEY
CONTINENTAL, CONTINENTAL FLYING SPUR, FLYING SPUR
VW
PASSAT, PHAETON, TOUAREG

BAEA032E

AUDI
A4, A5, A6, A6 ALLROAD, A7, A8, Q5, Q7, R8
LAMBORGHINI
GALLARDO, GALLARDO SPYDER
PORSCHE
CAYENNE (92A), PANAMERA (970)
VW
TOUAREG

BAEA033E

AUDI
A1, A3, A4, A4 ALLROAD, A5, A6, A8, Q3, Q5, R8, TT
LAMBORGHINI
GALLARDO, GALLARDO SPYDER
SEAT
ALHAMBRA, ALTEA, ALTEA XL, EXEO, LEON, TOLEDO III
SKODA
OCTAVIA II, SUPERB II, YETI

...BAEA033E

VW
AMAROK, BEETLE, EOS, GOLF V, GOLF VI, GOLF PLUS, JETTA III, JETTA IV, MULTIVAN V, MULTIVAN VI, PASSAT, PASSAT CC, POLO, SCIROCCO, SHARAN, TIGUAN, TOUAREG, TOURAN, TRANSPORTER V, TRANSPORTER VI

BAEA037

SEAT
TOLEDO II
VW
BORA, GOLF IV, PASSAT

BAEA037E

RENAULT
SAFRANE II
VOLVO
850, C70 I, S70, V70 I, XC70 CROSS COUNTRY

BAEA041

MERCEDES-BENZ
C-CLASS (W203), C-CLASS COUPE (CL203), C-CLASS T-MODEL (S202), C-CLASS T-MODEL (S203), CLK (C208), CLK CONVERTIBLE (A208), E-CLASS (W210), E-CLASS T-MODEL (S210), SLK (R170)

BAEA041E

AUDI
Q7
SKODA
SUPERB II
VW
CC, EOS, PASSAT, PASSAT CC, PHAETON, TOUAREG

BAEA042E

PORSCHE
CAYENNE (9PA), CAYENNE (92A), PANAMERA (970)

BAEA043

AUDI
80, 100, A6, COUPE

BAEA043E

AUDI
A3, A4, A6, ALLROAD, TT
SEAT
CORDOBA, EXEO, IBIZA II, IBIZA III, LEON, TOLEDO II
SKODA
OCTAVIA I, SUPERB I
VW
BORA, GOLF IV, NEW BEETLE, PASSAT, POLO

BAEA044E

AUDI
A3, TT
PORSCHE
CAYENNE (9PA), CAYENNE (92A)
SEAT
LEON
VW
EOS, GOLF IV, GOLF V, MULTIVAN V, PHAETON, TOUAREG, TRANSPORTER V

BAEA045E

CITROËN
BERLINGO, BERLINGO / BERLINGO FIRST, C2, C3, C3 I, C4, C4 I, XSARA, XSARA PICASSO
PEUGEOT
206, 207, 307, 308 SW, 1007, PARTNER, PARTNER TEPEE

BAEA046E

CITROËN
SAXO
PEUGEOT
106 II

BAEA048E

CITROËN
BERLINGO / BERLINGO FIRST, C3 I, C3 II, NEMO
FIAT
FIORINO, QUBO

PEUGEOT
206, 206+, 207, 207 SW, 1007, BIPPER, BIPPER TEPEE, PARTNER

BAEA051E

AUDI
A4, A6, A8
BAEA052E
PORSCHE
911 (997), 911 /CONVERTIBLE (991), 911 /CONVERTIBLE (997), 911 /CONVERTIBLE /TARGA (997), BOXSTER (987), BOXSTER SPYDER (987), CAYMAN (987)

BAEA053

MERCEDES-BENZ
C-CLASS (W203), C-CLASS COUPE (CL203), C-CLASS T-MODEL (S203), CLC-CLASS (CL203), CLK (C209), CLK CONVERTIBLE (A209), E-CLASS (W211), E-CLASS T-MODEL (S211), SLK (R171), SPRINTER 3.5-T BOX /BUS /PLATFORM /CHASSIS (906), SPRINTER 5-T PLATFORM /CHASSIS (906)

BAEA055E

FORD
FOCUS II, KUGA I, MONDEO IV, S-MAX
VOLVO
C30, C70 II, S40 II, S60 I, S60 II, S80 I, S80 II, V40, V50, V60, V70 II, V70 III, XC60

BAEA056E

NISSAN
CUBE, MICRA C+C III, MICRA III, NOTE, NV200, NV200 / EVÁLIA, QASHQAI / QASHQAI +2 I, TIIDA, X-TRAIL

RENAULT
CLIO III, LAGUNA III

BAEA059E

SEAT
IBIZA III
SKODA
FABIA I, FABIA II

...BAEA059E

VW
FOX, POLO

BAEA061E

AUDI
A4, A6, A8

BAEA062E

AUDI
ALLROAD
VW
PHAETON, TOUAREG

BAEA063E

FORD
GALAXY
SEAT
ALHAMBRA, TOLEDO II
VW
BORA, GOLF IV, NEW BEETLE, SHARAN

BAEA065E

VW
PASSAT

BAEA066E

RENAULT
GRAND SCÉNIC III, MEGANE CC, MEGANE III, SCÉNIC III

BAEA067E

AUDI
A1, A3, Q3
SEAT
IBIZA IV, LEON, MII
SKODA
CITIGO, FABIA III, OCTAVIA III, YETI
VW

BEETLE, CADDY IV, CC, GOLF VI, GOLF VII, GOLF SPORTSVAN, JETTA IV, PASSAT, POLO, SHARAN, TIGUAN, TOURAN, UP

BAEA068E

ASTON MARTIN
RAPIDE
AUDI
A1, A3, A4, A4 ALLROAD, A5, A6, A7, Q3, Q5, Q7, TT

PORSCHE
MACAN (95B)

SEAT
ALHAMBRA, IBIZA IV, LEON

SKODA

OCTAVIA III, SUPERB III
VW
BEETLE, GOLF VI, GOLF VII, JETTA IV, PASSAT, POLO

BAEA072E

SUZUKI
BALENO /ESTATE /HATCHBACK (EG), GRAND VITARA I (FT, HT), GRAND VITARA II (JT, TE, TD), VITARA (ET, TA), VITARA /CABRIO (ET, TA)

BAEA073E

INFINITI
I30
NISSAN
CEFIRO II, MAXIMA / MAXIMA QX IV

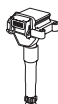

**BAEA077****MERCEDES-BENZ**

C-CLASS (W203), C-CLASS (W204), C-CLASS COUPE (C204), C-CLASS T-MODEL (CL203), C-CLASS T-MODEL (S203), C-CLASS T-MODEL (S204), CLC-CLASS (CL203), CLK (C209), CLK CONVERTIBLE (A209), E-CLASS (W211), E-CLASS (W212), E-CLASS CONVERTIBLE (A207), E-CLASS COUPE (C207), E-CLASS T-MODEL (S211), E-CLASS T-MODEL (S212), SLK (R171), SLK (R172), SPRINTER 3,5-T BOX (906), SPRINTER 3,5-T BOX /BUS /PLATFORM /CHASSIS (906), SPRINTER 3-T BOX (906), SPRINTER 3-T BUS (906), SPRINTER 3-T PLATFORM /CHASSIS (906), SPRINTER 5-T PLATFORM /CHASSIS (906)

MERCEDES-BENZ (BBDC)

E-CLASS

BAEA079E**NISSAN**

MAXIMA / MAXIMA QX V, MAXIMA QX V, MURANO I, PATHFINDER II, TEANA I

RENAULT

ESPACE IV, VEL SATIS

BAEA080E**NISSAN**

PRIMERA, TEANA I, X-TRAIL

BAEA081E**NISSAN**

ALMERA CLASSIC, ALMERA II, ALMERA TINO, PRIMERA

BAEA083E**MAZDA**

323 F VI (BJ), 323 S VI (BJ), PREMACY (CP)

BAEA084E**MAZDA**

MX-5 II (NB)

BAEA088E**INFINITI**

FX, QX70

NISSAN

BLUEBIRD SYLPHY II, JUKE, MICRA IV, NOTE, QASHQAI / QASHQAI +2 I, TIIDA

RENAULT

KOLEOS I

BAEA090**FIAT**

500, 500 C, 500L, PANDA, PANDA VAN, PUNTO

LANCIA

YPSILON

BAEA093E**MERCEDES-BENZ**

C-CLASS (W204), C-CLASS COUPE (C204), C-CLASS T-MODEL (S204), CLS (C218), CLS SHOOTING BRAKE (X218), E-CLASS (W212), E-CLASS CONVERTIBLE (A207), E-CLASS COUPE (C207), E-CLASS T-MODEL (S212), G-CLASS (W463), GL-CLASS (X166), GLK-CLASS (X204), M-CLASS (W166), R-CLASS (W251, V251), S-CLASS (W221), S-CLASS (W222, V222, X222), S-CLASS COUPE (C216), SL (R231), SLK (R172)

BAEA095**ABARTH**

500 / 595 / 695, 500C / 595C / 695C, GRANDE PUNTO

ALFA ROMEO

GIULIETTA, MITO

FIAT

500L, BRAVO II, DOBLO, GRANDE PUNTO, LINEA

LANCIA

DELTA III

OPEL

COMBO

VAUXHALL

COMBO MK III (D)

BAEA115**ALFA ROMEO**

33, 75, 90, ALFETTA, ALFETTA GT, GIULIA, GTV, SPIDER

AUDI

50, 60, 75, 80, 100, SUPER 90

AUSTIN

METRO, MINI

BEDFORD

RASCAL

BMW

3 (E21), 5 (E12), 6 (E24), 7 (E23), 2000-3.2 COUPE (E9), 2500-3.3 (E3)

CITROËN

AXEL, BX, C25, CX I, CX II, DS, GS, LNA, VISA

FIAT

CROMA, DUCATO, TALENTO

FORD

CAPRI, CAPRI II, CAPRI III, CORSAIR, CORTINA, ESCORT II, ESCORT III, TAUNUS, TAUNUS 12M, ZEPHYR IV, ZODIAC, ZODIAC

JAGUAR

XJ

LADA

1200-1500, 1200-1600, NIVA, NOVA, SAMARA, TOSCANA

LANCIA

DEDRA, DELTA I, PRISMA, THEMA

LAND ROVER

110/127, DEFENDER, DISCOVERY I, RANGE ROVER I

LDV

200

MERCEDES-BENZ

/8 /COUPE (W114), /8 COUPE (W114), G-CLASS (W460), G-CLASS (W461), PULLMANN (W100)

MG

MAESTRO, METRO, MGR V8, MONTEGO

NISSAN

COLT II, COLT III, CORDIA, GALANT I, GALANT II, GALANT III, GALANT IV, LANCER I, SAPPORO I, SAPPORO II

MORGAN

PLUS EIGHT

MOSKVIC

412, 2140, ASLK 2140

...BAEA115**NISSAN**

BLUEBIRD, CHERRY II, CHERRY III

PEUGEOT

205, 205 I, 205 II, 305 II, 309 I, 309 II, 405 I, 504, 505, J5, J9

PININFARINA

SPIDEREUROPA

PORSCHE

911 /TARGA, 911 TARGA, 924

RELIANT

SCIMITAR

RENAULT

9

ROVER

200, 400, 800, 2000-3500, MAESTRO, MINI, MINI-MOKE, MONTEGO

SAAB

99, 900 I, 9000

TALBOT

MATRA BAGHEERA, RANCHO, SAMBA

TRABANT

1.1

TVR

350, 450, CHIMAERA, GRIFFITH, SPEED EIGHT

VOLVO

164, 240, 340-360, 740, XC60

VW

CADDY I, DERBY, GOLF I, GOLF II, ILTIS, JETTA I, JETTA II, LT 28-35 I, LT 40-55 I, PASSAT, POLO, SANTANA, SCIROCCO

BAEA126E**AUDI**

A3

SEAT

LEON, MII

SKODA

CITIGO, OCTAVIA III

VW

GOLF VII, JETTA IV, POLO, UP

BAEA131E**DACIA**

DOKKER, DOKKER EXPRESS, DUSTER, LODGY, LOGAN II, LOGAN MCV II, SANDERO II

LADA

XRAY

MERCEDES-BENZ

CITAN BOX (415), CITAN COMBI (415)

NISSAN

JUKE, PULSAR, QASHQAI II

RENAULT

CAPTUR, CLIO IV, FLUENCE, GRAND SCÉNIC III, GRAND SCÉNIC IV, KADJAR, KANGOO, KANGOO / GRAND KANGOO, KAPTUR, MEGANE CC, MEGANE III, MEGANE IV, SCÉNIC III, SCÉNIC IV, THALIA III, TWINGO III

SMART

FORFOUR, FORTWO

BAEA132E**INFINITI**

FX, G, M35

NISSAN

350 Z

BAEA136E**SUZUKI**

GRAND VITARA I (FT, HT), JIMNY (FJ), JIMNY CLOSED OFF-ROAD VEHICLE (SN), SWIFT II HATCHBACK (EA, MA), SWIFT II SALOON (AH, AJ)

BAEA137E**ASTON MARTIN**

RAPIDE

AUDI

A3, A4, A5, A6, A7, A8, Q5, Q7, TT

SKODA

KODIAQ

TOYOTA

SPRINTER

VW

TIGUAN

BAEA140E**MERCEDES-BENZ**

C-CLASS (W203), C-CLASS (W204), C-CLASS COUPE (CL203), C-CLASS T-MODEL (S203), C-CLASS T-MODEL (S204), CLC-CLASS (CL203), CLK (C209), CLK CONVERTIBLE (A209), CLS (C219), E-CLASS (W211), E-CLASS (W212), E-CLASS CONVERTIBLE (A207), E-CLASS COUPE (C207), E-CLASS T-MODEL (S211), E-CLASS T-MODEL (S212), G-CLASS CABRIO (W463), GL-CLASS (X164), GLK-CLASS (X204), M-CLASS (W164), R-CLASS (W251, V251), S-CLASS (W221), S-CLASS COUPE (C216), SL (R230), SLK (R171), SPRINTER 3,5-T BOX (906), SPRINTER 3,5-T BUS /PLATFORM /CHASSIS (906), SPRINTER 3-T BOX /BUS /PLATFORM /CHASSIS (906), SPRINTER 4,6-T BOX /PLATFORM /CHASSIS (906), SPRINTER 5-T BOX /PLATFORM /CHASSIS (906), VIANO (W639), VITO BUS (W639), VITO / MIXTO BOX (W639)

BAEA143**ALPINA**

B7

...BAEA143
BMW

1 (E81), 1 (E87), 1 (F20), 1 (F21), 1 CONVERTIBLE (E88), 1 COUPE (E82), 2 COUPE (F22, F87), 3 (E90), 3 (F30, F80), 3 COMPACT / CONVERTIBLE / COUPE (E46), 3 / COMPACT / CONVERTIBLE / COUPE / TOURING (E46), 3 / COMPACT / TOURING (E46), 3 CONVERTIBLE (E46), 3 CONVERTIBLE (E93), 3 CONVERTIBLE / COUPE (E46), 3 COUPE (E92), 3 GRAN TURISMO (F34), 3 TOURING (E91), 3 TOURING (F31), 4 CONVERTIBLE (F33, F83), 4 COUPE (F32, F82), 4 GRAN COUPE (F36), 5 (E39), 5 (E60), 5 (F10), 5 GRAN TURISMO (F07), 5 TOURING (E39), 5 TOURING (E61), 5 TOURING (F11), 6 (E63), 6 CONVERTIBLE (E64), 6 CONVERTIBLE (F12), 6 COUPE (F13), 6 GRAN COUPE (F06), 7 (E65, E66), 7 (E65, E66, E67), 7 (F01, F02, F03, F04), X1 (E84), X3 (E83), X3 (F25), X4 (F26), X5 (E53), X5 (E70), X5 (F15, F85), X6 (E71, E72), X6 (F16, F86), Z4 COUPE (E86), Z4 ROADSTER (E85), Z4 ROADSTER (E89)

CITROËN

BERLINGO, C3 II, C3 PICASSO, C4, C4 GRAND PICASSO I, C4 GRAND PICASSO II, C4 I, C4 II, C4 PICASSO I, C4 PICASSO II, C5 III, DS3, DS4

FORD

KUGA II

MINI

MINI, MINI CLUBMAN, MINI CLUBVAN, MINI COUNTRYMAN, MINI PACEMAN

PEUGEOT

207, 207 CC, 207 SW, 208, 308, 308 CC, 308 SW, 408, 508 I, 508 SW I, 2008, 3008, 5008, PARTNER, PARTNER TEPEE, RCZ

ROLLS-ROYCE

GHOST, WRAITH

BAEA144E
BMW

1 (E81), 1 (E87), 1 CONVERTIBLE (E88), 1 COUPE (E82), 3 (E90), 3 CONVERTIBLE (E93), 3 COUPE (E92), 3 TOURING (E91), 5 (E60), 5 (F10), 5 TOURING (E61), 5 TOURING (F11), 6 (E63), 6 CONVERTIBLE (E64)

BAEA145E
BMW

1 (E87), 3 (E90), 3 TOURING (E91), 5 (E60), 5 TOURING (E61), 6 (E63), 6 CONVERTIBLE (E64), 7 (E65, E66), 7 (E65, E66, E67), Z4 COUPE (E86), Z4 ROADSTER (E85)

BAEA146E
MERCEDES-BENZ

A-CLASS (W168), Vaneo (414)

BAEA147E
OPEL

AGILA (A), ASTRA G, CORSA B, CORSA C

VAUXHALL

AGILA MK I (A), ASTRA MK IV (G), CORSA MK I (B), CORSA MK II (C), CORSAVAN MK II (C)

BAEA149E
ALFA ROMEO

159, BRERA, SPIDER

CHEVROLET

ZAFIRA

OPEL

SIGNUM, VECTRA C, ZAFIRA B

VAUXHALL

SIGNUM, VECTRA MK II (C), ZAFIRA MK II (B)

BAEA150E
OPEL

OMEGA B

VAUXHALL

OMEGA (B)

BAEA152E
CADILLAC

CTS

OPEL

OMEGA B, SIGNUM, VECTRA B, VECTRA C

VAUXHALL

OMEGA (B), SIGNUM, VECTRA (B), VECTRA MK II (C)

BAEA153E
CADILLAC

CTS

OPEL

OMEGA B, SIGNUM, VECTRA B, VECTRA C

VAUXHALL

OMEGA (B), SIGNUM, VECTRA (B), VECTRA MK II (C)

BAEA154E
AUDI

A4, A6, A8

SKODA

SUPERB I

VW

PASSAT

BAEA158E
INFINITI

EX, G, M, M35, Q50

NISSAN

350 Z, ALTIMA, MURANO II, TEANA II

RENAULT

LAGUNA, LAGUNA III, LATITUDE

BAEA159E
CADILLAC

CTS, ESCALADE

CHEVROLET

AVALANCHE, CAMARO, CORVETTE, EXPRESS, SILVERADO 1500, TRAILBLAZER

BAEA161E
RENAULT

FLUENCE, GRAND SCÉNIC III, LAGUNA III, LATITUDE, MEGANE CC, MEGANE III, SCÉNIC III

BAEA162E
AUDI

A4, A6, CABRIOLET

VW

PASSAT

BAEA163E
PORSCHE

CAYENNE (92A), MACAN (95B), PANAMERA (970)

BAEA164E
CITROËN

C1, C1 II

DAIHATSU

CUORE VII, SIRION

PEUGEOT

107, 108

SUBARU

JUSTY IV

TOYOTA

AURIS, AVENSIS, AYGO, CELICA, COROLLA, MR 2 III, RAV 4 II, VIOS/YARIS, WISH, YARIS

BAEA165E
TOYOTA

AYGO, IQ, PRIUS, PRIUS C, YARIS, YARIS VERSO, YARIS / VIOS

BAEA167E
LEXUS

IS II

TOYOTA

ALLION II, AVENSIS, AVENSIS VERSO, CAMRY, FORUNER, HILUX VII, LAND CRUISER, LAND CRUISER 150, LAND CRUISER PRADO, PREVIA, RAV 4 II, RAV 4 III

BAEA168E
TOYOTA

CELICA, COROLLA

BAEA169E
ACURA

RSX

HONDA

ACCORD VII, CIVIC VII, CIVIC VIII, CR-V II, CR-V III, FR-V, INTEGRÁ, S2000, STREAM

TOYOTA

COROLLA

BAEA170E
HONDA

CIVIC VII, FR-V, STREAM

BAEA171E
TOYOTA

AVENSIS, AVENSIS VERSO, CAMRY, HIACE V, LAND CRUISER 150, PREVIA, PREVIA III, RAV 4 II, RAV 4 III

BAEA172E
DAIHATSU

CHARADE

LEXUS

GS, IS, IS I, LS, LX, SC

SUBARU

TREZIA

TOYOTA

AURIS, LAND CRUISER 100, LAND CRUISER PRADO

BAEA173E
LEXUS

RX

...BAEA173E
TOYOTA

CAMRY, SUPRA

BAEA174E
ALFA ROMEO

159, BRERA, SPIDER

CADILLAC

CTS, SRX, STS

CHEVROLET

VECTRA

HOLDEN

ADVENTURA, CAPRICE, COMMODORE, CREWMAN, ONE TONNER, STATESMAN

OPEL

SIGNUM, VECTRA C

SAAB

9-3

VAUXHALL

SIGNUM, VECTRA MK II (C)

BAEA175E
HONDA

CITY, CIVIC VII, CIVIC VIII, JAZZ, JAZZ II, JAZZ III

BAEA176E
HONDA

CITY, CIVIC VII, CIVIC VIII, JAZZ, JAZZ II, JAZZ III

BAEA178E
MITSUBISHI

COLT V, LANCER VII, SPACE STAR

BAEA179E
MITSUBISHI

CARISMA, COLT V, GALANT VI, SPACE RUNNER, SPACE WAGON

PROTON

IMPIAN

BAEA180E
DAIHATSU

CUORE V, MOVE, SIRION

BAEA181E
FIAT

SEDICI

SUBARU

JUSTY III

SUZUKI

ALTO (FF), BALENO /ESTATE /HATCHBACK (EG), CARRY BOX (FD), GRAND VITARA II (JT), GRAND VITARA II (JT, TE, TD), IGNIS I (FH), IGNIS II (MH), LIANA (ER, RH...), LIANA HATCHBACK, SWIFT II SALOON (AH, AJ), SWIFT III (MZ, EZ), SWIFT IV (FZ, NZ), SX4 (EY, GY), SX4 /SALOON (GY), SX4 SALOON (GY), SX4 S-CROSS (JY), WAGON R+ HATCHBACK (MM)

BAEA182E
HONDA

ACCORD VIII, CIVIC VII, CIVIC VIII, CR-V III, FR-V

BAEA184E
LEXUS

CT

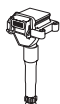

...BAEA184E

TOYOTA
ALLION II, AURIS, AURIS TOURING SPORTS, AVENSIS, COROLLA, COROLLA RUMION, ISIS, NOAH/VOXY, PREMIO, PRIUS, PRIUS PLUS, RAV 4 III, RAV 4 IV, VERSO, WISH, YARIS

BAEA185E

CHEVROLET
AVEO, CRUZE, ORLANDO, TRAX, VOLT

OPEL
ADAM, AMPERA, ASTRA J, CASCADA, CORSA D, CORSA E, INSIGNIA A, MERIVA B, MOKKA / MOKKA X, ZAFIRA TOURER C

VAUXHALL
ADAM, AMPERA, ASTRA MK VI (J), CASCADA, CORSA MK III (D), CORSA MK IV (E), CORSAVAN MK III (D), INSIGNIA MK I (A), MERIVA MK II (B), MOKKA / MOKKA X, ZAFIRA MK III

BAEA186E

TOYOTA
HIACE IV, LAND CRUISER, TACOMA

BAEA188E

NISSAN
CUBE, MICRA C+C III, MICRA III, NOTE

BAEA189E

OPEL
AGILA (B)
SUZUKI
SPLASH (EX), SWIFT IV (FZ, NZ)

VAUXHALL
AGILA MK II (B)

BAEA190E

MAZDA
323 F VI (BJ), 323 S VI (BJ)

BAEA191E

SUBARU
FORESTER, IMPREZA, LEGACY III, LEGACY IV, OUTBACK

BAEA192E

LEXUS
ES, GS, GX, IS C, IS II, IS III, LS, LX, RX

TOYOTA
AURIS, CAMRY, COROLLA, FJ CRUISER, IQ, LAND CRUISER, LAND CRUISER 200, LAND CRUISER PRADO, RAV 4 IV, URBAN CRUISER, VENZA, VERSO S, MARK X I, YARIS

BAEA193E

MITSUBISHI
LANCER VII, OUTLANDER I

BAEA194E

DAIHATSU
COPEN, MATERIA, SIRION, TERIOS

BAEA195E

MAZDA
MX-5 I (NA), MX-5 III (NC)

BAEA196E

JAGUAR
S-TYPE, XF, XJ, XK, XK 8

...BAEA196E

LAND ROVER
DISCOVERY III, RANGE ROVER III, RANGE ROVER SPORT

BAEA198E

CHEVROLET
TRAX
OPEL
ASTRA J, MOKKA / MOKKA X
VAUXHALL
ASTRA MK VI (J), MOKKA / MOKKA X

BAEA199E

CHEVROLET
AVEO, TRAX
HOLDEN
TRAX
OPEL
ASTRA J, CORSA E, INSIGNIA A, MOKKA, ZAFIRA TOURER C
VAUXHALL
ASTRA MK VI (J), CORSA MK IV (E), INSIGNIA MK I (A), ZAFIRA MK III

BAEA231

CITROËN
AX, ZX
PEUGEOT
106 I, 106 II, 106 VAN, 205 II, 306, 405 II

ROVER
400, 800, MINI

BAEA232

CITROËN
BX, EVASION, XSARA
FIAT
DUCATO
PEUGEOT
106 II, 205 I, 205 II, 306, 309 II, 405 I, 405 II, 406, 605, 806, BOXER, EXPERT, PARTNER
ROVER
CITYROVER

BAEA234

ALFA ROMEO
33, 145, 146, 155, 164
CITROËN
JUMPY
DACIA
1309, NOVA, PICK UP
FERRARI
348, 348 TB/GTB, 348 TS/GTS, F355, F355 BERLINETTA, MONDIAL
FIAT
BRAVA, BRAVO I, CROMA, FIORINO, FIORINO PICK UP, MAREA, PALIO, PUNTO, SCUDO, SIENA, TEMpra, TIPO, UNO
FSO
POLONEZ III
KIA
SPORTAGE
LADA
NOVA

...BAEA234

LANCIA
DEDRA, DELTA II, KAPPA, THEMA, Y, Y10

LAND ROVER
DISCOVERY II, RANGE ROVER II

PEUGEOT
EXPERT
PROTON
GEN 2, JUMBUCK, SAGA II, SATRIA, SATRIA NEO, WIRA

BAEA242

RENAULT
CLIO II, KANGOO, MEGANE, MEGANE I

BAEA243

RENAULT
CLIO II, KANGOO, MEGANE, MEGANE I

BAEA245

RENAULT
MEGANE, MEGANE I
VOLVO
V40

BAEA246

RENAULT
MEGANE, MEGANE I
VOLVO
V40

BAEA251

ALPINE
A610, V6
JEEP
CHEROKEE, WRANGLER I
RENAULT
9, 11, 18, 19 I, 19 II, 21, 25, CLIO I, ESPACE I, ESPACE II, ESPACE III, LAGUNA I, MASTER I, MEGANE, MEGANE I, RAPID, SAFRANE I, SAFRANE II, SUPER 5, TRAFIC

VOLVO
340-360, 440 K, 460 L, 480 E, 850

BAEA252

OPEL
ASCONA B, ASCONA C, ASTRA F, CORSA A, KADETT D, KADETT E, MANTA B, VECTRA A
VAUXHALL
ASTRA, ASTRA MK II, ASTRA MK III (F), ASTRAMAX, ASTRAVAN MK III (F), CAVALIER MK II, CAVALIER MK III, NOVA, NOVAVAN

BAEA253

OPEL
ASTRA F, ASTRA F CLASSIC, COMBO, CORSA A, CORSA B, KADETT, KADETT E, OMEGA A, VECTRA A, VECTRA B

VAUXHALL
ASTRA, ASTRA MK II, ASTRA MK III (F), ASTRAMAX, ASTRAVAN MK III (F), CARLTON MK III, CAVALIER MK III, COMBO MK I (B), CORSA MK I (B), CORSAVAN MK I (B), NOVA, VECTRA (B)

BAEA254

RENAULT
LAGUNA I, SAFRANE II
VOLVO
S40 I, V40

BAEA255

RENAULT
LAGUNA I, SAFRANE II
VOLVO
S40 I, V40

BAEA256

CITROËN
XANTIA, XM, ZX
PEUGEOT
306, 406, 605

BAEA264

HYUNDAI
ACCENT, ACCENT I, LANTRA II
MITSUBISHI
COLT V

BAEA266

HYUNDAI
ATOS, ATOS PRIME

BAEA267

HYUNDAI
COUPE, LANTRA II

BAEA269

HYUNDAI
SONATA IV
INFINITI
G20
KIA
MAGENTIS

BAEA275

HONDA
ACCORD IV, ACCORD V, ACCORD VI, CIVIC V, CIVIC VI, CR-V I, CRX III, HR-V, INTEGRA, LOGO, PRELUDE III, PRELUDE IV, PRELUDE V, SHUTTLE
ROVER
600

BAEA281

FORD
ESCORT '86, ESCORT '91, ESCORT '95, ESCORT CLASSIC, ESCORT IV, ESCORT V, ESCORT VI, ESCORT VII, FIESTA, FIESTA III, FIESTA IV, KA, KA VAN, MONDEO I, MONDEO II, ORION II, ORION III, PUMA, SCORPIO I, SIERRA, TRANSIT CONNECT

MAZDA
626 V (GF), 626 V /HATCHBACK (GF), 626 V HATCHBACK (GF), 626 V STATION WAGON (GW), MPV II (LW)

BAEA296

MERCEDES-BENZ
190 (W201), COUPE (C124), E-CLASS (W124), E-CLASS T-MODEL (S124), KOMBI T-MODEL (S124), SALOON (W124), S-CLASS (W126), S-CLASS (W140), SL (R129)

BAEA297

CHRYSLER
CROSSFIRE



...BAEA297

MERCEDES-BENZ

A-CLASS (W169), B-CLASS (W245), C-CLASS (W202), C-CLASS (W203), C-CLASS COUPE (CL203), C-CLASS T-MODEL (S202), C-CLASS T-MODEL (S203), CLK (C208), CLK (C209), CLK CONVERTIBLE (A208), CLK CONVERTIBLE (A209), CLS (C219), E-CLASS (W210), E-CLASS (W211), E-CLASS T-MODEL (S210), E-CLASS T-MODEL (S211), G-CLASS (W463), G-CLASS /CABRIO (W463), G-CLASS CABRIO (W463), M-CLASS (W163), M-CLASS (W164), R-CLASS (W251, V251), S-CLASS (W220), S-CLASS COUPE (C215), SL (R129), SL (R230), SLK (R170), SLK (R171), SLR (R199), SLR ROADSTER (R199), VIANO (W639), VITO BUS (W639), VITO / MIXTO BOX (W639)

PUCH

G-MODELL

BAEA298

MERCEDES-BENZ

CABRIOLET (A124), COUPE (C124), E-CLASS (W124), G-CLASS (W463), KOMBI T-MODEL (S124), SALOON (W124), S-CLASS (W126), S-CLASS (W140), S-CLASS COUPE (C126), S-CLASS COUPE (C140), SL (R129)

PORSCHE

959

BAEA299

MERCEDES-BENZ

E-CLASS (W124), SALOON (W124), S-CLASS (W140), S-CLASS COUPE (C140), SL (R107), SL (R129)

BAEA302

ALPINA

ROADSTER V8

BMW

3 /COMPACT /CONVERTIBLE /COUPE /TOURING (E36), 3 /COMPACT /CONVERTIBLE /COUPE /TOURING (E46), 3 /CONVERTIBLE /COUPE (E36), 3 /CONVERTIBLE /COUPE /TOURING (E46), 5 (E39), 5 /TOURING (E39), 5 TOURING (E39), 7 (E38), 8 (E31), X5 (E53), Z3 COUPE (E36), Z3 ROADSTER (E36), Z8 ROADSTER (E52)

LAND ROVER

RANGE ROVER III

MG

MG ZS

ROLLS-ROYCE

SILVER SERAPH

BAEA304

SMART

CABRIO, CITY-COUPÉ, CROSSBLADE, FORTWO, ROADSTER

BAEA306

OPEL

OMEGA B

VAUXHALL

OMEGA (B)

BAEA307

BMW

3 (E36), 3 COMPACT (E36), 3 /COMPACT /COUPE (E36), 3 /COMPACT /COUPE /TOURING (E36), 3 /CONVERTIBLE /TOURING (E36), 3 COUPE (E36), 3 /COUPE /TOURING (E46), 5 /TOURING (E34), 5 TOURING (E34), Z3 ROADSTER (E36)

BAEA308

FORD

ESCORT V, ESCORT VI, ESCORT VII, GALAXY, SCORPIO II, TRANSIT

BAEA309

ALFA ROMEO

145, 146, 156, 166, GTV, SPIDER

BAEA313

MERCEDES-BENZ

C-CLASS (W202), C-CLASS T-MODEL (S202), COUPE (C124), E-CLASS (W124), E-CLASS CONVERTIBLE (A124), E-CLASS COUPE (C124), E-CLASS T-MODEL (S124), KOMBI T-MODEL (S124), SALOON (W124)

BAEA324

ALPINA

B7

BMW

1 (E81), 1 (E87), 3 (E90), 3 /COMPACT (E46), 3 COMPACT /CONVERTIBLE /COUPE (E46), 3 /COMPACT /CONVERTIBLE /COUPE /TOURING (E46), 3 /COMPACT /TOURING (E46), 3 CONVERTIBLE (E93), 3 CONVERTIBLE /COUPE (E46), 5 (E39), 5 (E60), 5 TOURING (E39), 5 TOURING (E61), 6 (E63), 6 CONVERTIBLE (E64), 7 (E65, E66, E67), X3 (E83), X5 (E53), Z3 COUPE (E36), Z3 ROADSTER (E36), Z4 COUPE (E86), Z4 ROADSTER (E85)

ROLLS-ROYCE

PHANTOM VII

BAEA325

DACIA

LOGAN, LOGAN II, LOGAN MCV II, SANDERO, SANDERO II

NISSAN

KUBISTAR

RENAULT

CLIO, CLIO II, CLIO III, CLIO IV, KANGOO, MODUS / GRAND MODUS, THALIA I, THALIA II, TWINGO I, TWINGO II

BAEA337

NISSAN

MICRA II

BAEA338

HOLDEN

COMBO

OPEL

AGILA (A), ASTRA G, ASTRA H, COMBO, CORSA C, CORSA D, MERIVA A, TIGRA

RENAULT

SANDERO/STEPWAY I

SUZUKI

WAGON R HATCHBACK

...BAEA338

VAUXHALL

AGILA MK I (A), ASTRA MK V (H), ASTRAVAN MK V (H), COMBO MK II (C), CORSA MK II (C), CORSA MK III (D), CORSAVAN MK III (D), MERIVA MK I (A), TIGRA

BAEA339

MERCEDES-BENZ

190 (W201), COUPE (C124), G-CLASS (W463), G-CLASS /CABRIO (W463), KOMBI T-MODEL (S124), SALOON (W124), S-CLASS (W126), S-CLASS (W140), SL (R129)

BAEA340

DAEWOO

KORANDO, MUSSO, REXTON

MERCEDES-BENZ

C-CLASS (W202), C-CLASS T-MODEL (S202), CLK (C208), CLK CONVERTIBLE (A208), COUPE (C124), E-CLASS (W124), E-CLASS (W210), E-CLASS CONVERTIBLE (A124), E-CLASS COUPE (C124), E-CLASS T-MODEL (S124), E-CLASS T-MODEL (S210), G-CLASS (W463), G-CLASS /CABRIO (W463), KOMBI T-MODEL (S124), M-CLASS (W163), SALOON (W124), S-CLASS (W140), SL (R129), SLK (R170), SPRINTER 2-T BOX (901, 902), SPRINTER 2-T BOX /BUS /PLATFORM /CHASSIS (901, 902), SPRINTER 2-T BUS /PLATFORM /CHASSIS (901, 902), SPRINTER 3-T BOX (903), SPRINTER 3-T BOX /BUS /PLATFORM /CHASSIS (903), SPRINTER 3-T BUS /PLATFORM /CHASSIS (903), SPRINTER 4-T BOX /BUS /PLATFORM /CHASSIS (904), SPRINTER 4-T PLATFORM /CHASSIS (904), V-CLASS (638/2), VITO BOX /BUS (638)

PUCH

G-MODELL

SSANGYONG

ACTYON I, KORANDO, KYRON, MUSSO, REXTON, RODIUS

VW

LT 28-35 II, LT 28-46 II

BAEA342

HOLDEN

ASTRA, BARINA, VIVA

OPEL

ASTRA G, ASTRA H, CORSA C, MERIVA A, SIGNUM, TIGRA, VECTRA B, VECTRA C, ZAFIRA A

SAAB

9-3

VAUXHALL

ASTRA MK IV (G), ASTRA MK V (H), CORSA MK II (C), MERIVA MK I (A), SIGNUM, TIGRA, VECTRA (B), VECTRA MK II (C), ZAFIRA MK I (A)

BAEA344

OPEL

ASTRA F, ASTRA G, CALIBRA A, OMEGA B, VECTRA A, VECTRA B

...BAEA344

VAUXHALL

ASTRA MK III (F), ASTRA MK IV (G), CALIBRA, CAVALIER MK III, OMEGA (B), VECTRA (B)

BAEA345

RENAULT

CLIO I, CLIO II, KANGOO, LAGUNA II, MEGANE I, THALIA I, TWINGO I

BAEA347

CITROËN

C5 I, C5 II, C5 III, C6, C8

FIAT

ULYSSE

LANCIA

PHEDRA

PEUGEOT

406, 407, 607, 807

RENAULT

AVANTIME, CLIO II, LAGUNA II

BAEA348

CITROËN

C4, C4 I, C5 I, C5 II, C8, EVASION, JUMPY, XSARA, XSARA PICASSO

FIAT

SCUDO, ULYSSE

PEUGEOT

206, 307, 406, 407, 607, 806, 807, EXPERT

BAEA350

FORD

COUGAR, ESCORT VII, FIESTA, FIESTA IV, FIESTA V, FOCUS, FUSION, KA, MAVERICK, MONDEO II, PUMA, STREET KA, TOURNEO CONNECT, TRANSIT CONNECT

MAZDA

2 (DY), 121 III (JASM, JBSM), TRIBUTE (EP)

BAEA351

CITROËN

C4, C4 I, C8

PEUGEOT

206, 307, 406, 407, 607, 807

BAEA352

CITROËN

C4, C4 GRAND PICASSO I, C4 I, C4 PICASSO I, C5 II, C5 III, C8, JUMPY

PEUGEOT

307, 407, 807, EXPERT, EXPERT TEPEE

BAEA354

DACIA

1310, 1410, DOKKER, DOKKER EXPRESS, LODGY, LOGAN, LOGAN MCV, SANDERO, SOLENZA, SUPERNOVA

LADA

LARGUS

MAZDA

626 V HATCHBACK (GF)

NISSAN

KUBISTAR

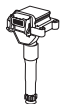
**...BAEA354****RENAULT**

CLIO, CLIO II, CLIO III, KANGOO, KANGOO / GRAND KANGOO, LOGAN EXPRESS, LOGAN I, LOGAN II, MEGANE, MEGANE I, MODUS / GRAND MODUS, SANDERO/STEPWAY I, SANDERO/STEPWAY II, THALIA I, TWINGO I, TWINGO II, WIND

BAEA358**OPEL**

AGILA (A), CORSA B, CORSA C

VAUXHALL

AGILA MK I (A), CORSA MK I (B), CORSA MK II (C)

BAEA359**OPEL**

AGILA (A), CORSA C, CORSA D

VAUXHALL

AGILA MK I (A), CORSA MK II (C), CORSA MK III (D)

BAEA365**FORD**

GALAXY, MONDEO III, TRANSIT CONNECT

BAEA367**JAGUAR**

S-TYPE

LINCOLN

LS

BAEA368**DAIMLER**

DAIMLER J1

JAGUAR

S-TYPE, XJ

LINCOLN

LS

BAEA372**FORD**

COUGAR, MONDEO III

BAEA380**CHRYSLER**

NEON II, PT CRUISER, SEBRING, STRATUS, VOYAGER / GRAND VOYAGER III, VOYAGER IV

DODGE

NEON

JEEP

CHEROKEE, WRANGLER II

BAEA382**MINI**

MINI

BAEA387**FORD**

B-MAX, C-MAX, C-MAX II, FIESTA V, FIESTA VI, FOCUS C-MAX, FOCUS II, FOCUS III, FUSION, GRAND C-MAX, KA, MONDEO IV

MAZDA

2 (DY)

VOLVO

C30, S40 II, V50

BAEA394**CHRYSLER**

DAYTONA, VOYAGER II

...BAEA394**JEEP**

CHEROKEE, COMANCHE, GRAND CHEROKEE I, WRANGLER I

BAEA395**CHEVROLET**

NIVA

LADA

110, 111, GRANTA, KALINA, NIVA, NIVA II, PRIORA, SAMARA

BAEA408**FORD**

C-MAX, FOCUS C-MAX, FOCUS II, GALAXY, MAVERICK, MONDEO IV, S-MAX, TRANSIT

MAZDA

3 SALOON (BK), TRIBUTE (EP)

VOLVO

C30, S40 II, S80 II, V50, V70 III

BAEA410**FORD**

MAVERICK

FORD USA

ESCAPE, FIVE HUNDRED

MAZDA

TRIBUTE (EP)

BAEA422**FORD**

BANTAM, ECOSPORT, ESCORT VII, FIESTA, FIESTA IV, FIESTA V, FOCUS C-MAX, FOCUS II, GALAXY, KA, KA VAN, MONDEO III

FORD ASIA / OCEANIA

IKON

FORD AUSTRALIA

FOCUS, MONDEO

FORD USA

ECOSPORT

MAZDA

2 (DY), 3 (BK), 3 SALOON (BK), 6 HATCHBACK/SALOON (GG), 6 STATION WAGON (GY)

BAEA426**ASTON MARTIN**

DB9

BAEA427**ALFA ROMEO**

159

FIAT

CROMA, STILO

OPEL

ASTRA G, ASTRA H, CORSA D, INSIGNIA A, MERIVA A, SIGNUM, VECTRA C, ZAFIRA A, ZAFIRA B, ZAFIRA TOURER C

VAUXHALL

ASTRA MK IV (G), ASTRA MK V (H), ASTRVAN MK V (H), CORSA MK III (D), INSIGNIA MK I (A), MERIVA MK I (A), SIGNUM, VECTRA MK II (C), ZAFIRA MK II (B), ZAFIRA MK III

BAEA428**ALFA ROMEO**

147, 156, 164, 166, GT, GTV, SPIDER

LANCIA

KAPPA, THESIS

BAEA429**VOLVO**

S40 I, V40

BAEA432**CHRYSLER**

300 C, 300 M, CONCORDE, PACIFICA

DODGE

CHARGER, INTREPID

BAEA433**KIA**

CARENS I, CARENS II, CERATO, CLARUS, SEPHIA, SHUMA, SHUMA II

BAEA434**KIA**

RETONA, SPORTAGE

BAEA445**LEXUS**

GS, LS

TOYOTA

4 RUNNER, CAMRY, LITEACE, MR 2 II, SUPRA

VW

TARO

BAEA446**VOLVO**

940, 960, 960 II, C70 I, S40 I, S40 II, S90, V90

BAEA447A**CHEVROLET**

AVEO, AVEO / KALOS, CAPTIVA, CRUZE, EPICA, EVANDA, KALOS, LACETTI, LANOS, MATIZ, NUBIRA, OPTRA, REZZO, SPARK, VIVANT

DAEWOO

EVANDA, KALOS, LACETTI, LANOS, LEGANZA, MAGNUS, MATIZ, NUBIRA, REZZO

FSO

LANOS

OPEL

ANTARA

VAUXHALL

ANTARA

BAEA448**FORD**

FIESTA V, MONDEO III

BAEA449**ROVER**

100 / METRO

TOYOTA

COROLLA

BAEA453**CHRYSLER**

300 C, PACIFICA, SEBRING

DODGE

AVENGER, CHARGER, JOURNEY, NITRO

FIAT

FREEMONT

VW

ROUTAN

BAEA454**PROTON**

SAVVY

RENAULT

CLIO II, KANGOO, THALIA I, TWINGO I

BAEA469**LAND ROVER**

FREELANDER

MG

EXPRESS, MGF, MG TF, MG ZR

ROVER

25, 100, 100 / METRO, 200, 400, COUPE

BAEA472**CITROËN**

C2, C3 I, C4, C4 I

PEUGEOT

206, 207, 307, 1007

BAEA474**HYUNDAI**

ELANTRA, I30

KIA

CEE'D, CERATO, PRO CEE'D

BAEA475**HYUNDAI**

ACCENT IV, ELANTRA, I20, I30, IX20, VELOSTER

KIA

CARENS III, CEE'D, CERATO, CERATO II, CERATO KOUP, PRO CEE'D, RIO III, SOUL, VENGA

BAEA476**HYUNDAI**

I10

KIA

PICANTO

BAEA477**HYUNDAI**

I10

KIA

PICANTO

BAEA479**HYUNDAI**

ACCENT II, GETZ

BAEA480**HYUNDAI**

GETZ

BAEA482**HYUNDAI**

COUPE, ELANTRA, MATRIX, TRAJET, TUCSON

KIA

CARENS II, CERATO

BAEA483**HYUNDAI**

ACCENT II, COUPE, ELANTRA, GETZ, LANTRA II, MATRIX

KIA

CERATO, RIO II

BAEA486**KIA**

CARENS II, RIO, SHUMA, SHUMA II

**BAEA489****MAZDA**

2 (DE_, DH_3), 2 (DY), 2 SALOON (DE_),
3 (BK), 3 (BL), 3 /SALOON (BK), 3
SALOON (BK), 3 /SALOON (BL), 3
/SALOON (BM, BN)

BAEA501**FSO**

POLONEZ III

LAND ROVER

FREELANDER

MG

EXPRESS, MGF, MG TF, MG ZR, MG ZS, MG
ZT, MG ZT-

ROVER

25, 45, 75, 200, STREETWISE

BAEA502E**HYUNDAI**

H-1 / STAREX, HIGHWAY VAN, SANTA FÉ I,
SONATA IV, SONATA V, TIBURON, TRAJET

KIA

MAGENTIS, SORENTO I

BAEA508**CHEVROLET**

LACETTI, NUBIRA, OPTRA

DAEWOO

LACETTI, NUBIRA

BAEA521**HYUNDAI**

SANTAMO

KIA

JOICE

MITSUBISHI

SANTAMO

BAEA531**HYUNDAI**

GENESIS, GRANDEUR, SANTA FÉ II, SONATA
V

KIA

CARENS III, MAGENTIS, OPIRUS, SORENTO I

BAEA536**HYUNDAI**

110, 120

KIA

RIO III

BAEA538**BMW**

1 (F20), 1 (F21), 2 ACTIVE TOURER (F45),
2 CONVERTIBLE (F23), 2 COUPE (F22,
F87), 2 GRAN TOURER (F46), 3 (F30,
F80), 3 GRAN TURISMO (F34), 3 TOURING
(F31), 4 CONVERTIBLE (F33, F83), 4
COUPE (F32, F82), 4 GRAN COUPE (F36),
5 (G30, F90), 7 (G11, G12), X1 (F48), X2
(F39)

GMC

SAVANA 2500

MINI

MINI, MINI CLUBMAN, MINI COUNTRYMAN

BAEA539**CHEVROLET**

MATIZ, SPARK

...BAEA539**DAEWOO**

MATIZ, TICO

BAEA540**DAEWOO**

MATIZ, TICO

BAEA543**CHEVROLET**

LACETTI, NUBIRA

DAEWOO

LACETTI, NEXIA, NUBIRA

BAEA547**CITROËN**

C4 AIRCROSS

MITSUBISHI

ASX, COLT VI, LANCER VIII

BAEA548**HYUNDAI**

EQUUS / CENTENNIAL, GENESIS, H-1,
IX35, SANTA FÉ II, SANTA FÉ III, SONATA V,
SONATA VI

KIA

CERATO II, CERATO KOUP, MAGENTIS,
OPTIMA, SORENTO II, SPORTAGE

BAEA549**FIAT**

BARCETTA, BRAVA, BRAVO I, COUPE,
MAREA

LANCIA

DEDRA, DELTA II

BAEA554**DAEWOO**

CIELO, ESPERO, NEXIA

BAEA555**HYUNDAI**

TUCSON

KIA

SPORTAGE

BAEA556**MAZDA**

6 HATCHBACK /SALOON (GG), 6
HATCHBACK /SALOON (GH), 6 STATION
WAGON (GY), MPV II (LW)

BAEA557**CITROËN**

C3 II, C3 PICASSO, C4 CACTUS, C4 GRAND
PICASSO II, C4 II, C4 PICASSO II, DS3, DS4

PEUGEOT

208, 308 II, 308 SW II, 2008, 3008, 5008

BAEA560**MAZDA**

121 I (DA), 121 II (DB), 323 C IV (BG),
323 C V (BA), 323 F IV (BG), 323 F VI
(BJ), 323 III /HATCHBACK (BF), 323 III
HATCHBACK (BF), 323 P V (BA), 323 S IV
(BG), 323 S V (BA)

BAEA561**KIA**

RIO



CCU081

AUDI
A3
SEAT
ALHAMBRA, AROSA, CORDOBA, IBIZA II, IBIZA III, INCA, LEON, TOLEDO I, TOLEDO II
SKODA
FABIA I, OCTAVIA I
VW
BORA, CADDY II, CADDY III, FOX, GOLF III, GOLF IV, GOLF PLUS, LUPO, NEW BEETLE, PASSAT, POLO, POLO VAN, SHARAN, TOURÈG, TRANSPORTER IV, TRANSPORTER V, VENTO

CCU101

BMW
1 (E87), 3 (E46), 3 (E90), 3 COMPACT / CONVERTIBLE (E46), 3 / COMPACT / COUPE (E46), 3 TOURING (E46), 3 TOURING (E91), 5 (E60), 5 TOURING (E61), 6 (E63), 6 CONVERTIBLE (E64), 7 (E65, E66, E67), X3 (E83), X5 (E53), X5 (E70), X6 (E71, E72)

CCU102

BMW
3 (E90), 3 CONVERTIBLE (E93), 3 CONVERTIBLE / COUPE (E46), 3 COUPE (E92), 3 / TOURING (E46), 3 TOURING (E91), 5 (E60), 5 TOURING (E61), 6 (E63), 6 CONVERTIBLE (E64), 7 (E65, E66, E67), X3 (E83), X5 (E53), X5 (E70), X6 (E71, E72)

CCU104

MERCEDES-BENZ
C-CLASS (W203), C-CLASS COUPE (CL203), C-CLASS T-MODEL (S203)

CCU105

BMW
1 (E81), 1 (E87), 1 CONVERTIBLE (E88), 1 COUPE (E82), 3 (E90), 3 CONVERTIBLE (E93), 3 COUPE (E92), 3 TOURING (E91), 5 (E60), 5 TOURING (E61), X1 (E84), X3 (E83)

CCU106

BMW
1 (F20), 1 (F21), 2 COUPE (F22, F87), 3 (E90), 3 (F30, F80), 3 CONVERTIBLE (E93), 3 COUPE (E92), 3 GRAN TURISMO (F34), 3 TOURING (E91), 3 TOURING (F31), 4 CONVERTIBLE (F33, F83), 4 COUPE (F32, F82), 4 GRAN COUPE (F36), 5 (F10), 5 GRAN TURISMO (F07), 5 TOURING (F11), X1 (E84), X3 (F25), X5 (F15, F85)

CCU108

BMW
3 (E90), 3 CONVERTIBLE (E93), 3 COUPE (E92), 3 TOURING (E91), 5 (F10), 5 GRAN TURISMO (F07), 5 TOURING (F11), 7 (F01, F02, F03, F04), X5 (E70), X6 (E71, E72)

CCU110

MERCEDES-BENZ
C-CLASS (W204), C-CLASS T-MODEL (S204), E-CLASS (W211), E-CLASS T-MODEL (S211)

CCU113

MERCEDES-BENZ
E-CLASS (W211), E-CLASS T-MODEL (S211)

CCU114

JEEP
GRAND CHEROKEE III
MERCEDES-BENZ
C-CLASS (W203), C-CLASS (W204), C-CLASS T-MODEL (S203), C-CLASS T-MODEL (S204), CLK (C209), CLK CONVERTIBLE (A209), CLS (C219), E-CLASS (W211), E-CLASS T-MODEL (S211), G-CLASS (W461), GL-CLASS (X164), GLK-CLASS (X204), M-CLASS (W164), R-CLASS (W251, V251), S-CLASS (W221), SPRINTER 3,5-T BOX / BUS / PLATFORM / CHASSIS (906), SPRINTER 3-T BOX / PLATFORM / CHASSIS (906), SPRINTER 4,6-T BOX / PLATFORM / CHASSIS (906), SPRINTER 4,6-T PLATFORM / CHASSIS (906), SPRINTER 5-T BOX / PLATFORM / CHASSIS (906), SPRINTER 5-T BUS, VIANO (W639), VITO BUS (W639), VITO / MIXTO BOX (W639)

CCU116

MERCEDES-BENZ
C-CLASS (W204), C-CLASS T-MODEL (S204), CLS (C218), CLS (C219), CLS SHOOTING BRAKE (X218), E-CLASS (W211), E-CLASS (W212), E-CLASS CONVERTIBLE (A207), E-CLASS COUPE (C207), E-CLASS T-MODEL (S211), E-CLASS T-MODEL (S212), G-CLASS / CABRIO (W463), GL-CLASS (X164), GL-CLASS (X166), GLK-CLASS (X204), M-CLASS (W164), M-CLASS (W166), R-CLASS (W251, V251), S-CLASS (W221), S-CLASS (W222, V222, X222), SPRINTER 3,5-T BOX / BUS / PLATFORM / CHASSIS (906), SPRINTER 3-T BOX / PLATFORM / CHASSIS (906), SPRINTER 4,6-T BOX / PLATFORM / CHASSIS (906), SPRINTER 4,6-T PLATFORM / CHASSIS (906), SPRINTER 5-T BOX / PLATFORM / CHASSIS (906), SPRINTER 5-T BUS, VITO BUS (W639), VITO / MIXTO BOX (W639)

CCU118

MERCEDES-BENZ
E-CLASS (W211), GL-CLASS (X164), M-CLASS (W164), S-CLASS (W221)

CCU128

RENAULT
CLIO II, KANGOO

CCU129

DACIA
SOLENZA

OPEL
MOVANO

RENAULT
CLIO II, ESPACE III, KANGOO, LAGUNA I, MASTER II, MEGANE, MEGANE CC, MEGANE I, SCÉNIC I

VAUXHALL
MOVANO MK I (A)

CCU138

OPEL
ANTARA, ASTRA J, CASCADA, CORSA D, INSIGNIA A, MERIVA B, ZAFIRA TOURER C

...CCU138

VAUXHALL
ANTARA, ASTRA MK VI (J), CASCADA, CORSA MK III (D), CORSAVAN MK III (D), INSIGNIA MK I (A), MERIVA MK II (B), ZAFIRA MK III

CCU140

MERCEDES-BENZ
A-CLASS (W168), C-CLASS (W202), C-CLASS (W203), C-CLASS COUPE (CL203), C-CLASS T-MODEL (S202), C-CLASS T-MODEL (S203), CLC-CLASS (CL203), CLK (C209), E-CLASS (W210), E-CLASS (W211), E-CLASS T-MODEL (S210), E-CLASS T-MODEL (S211), SPRINTER 2-T BOX / BUS / PLATFORM / CHASSIS (901, 902), SPRINTER 3,5-T BOX / BUS / PLATFORM / CHASSIS (906), SPRINTER 3-T BOX / BUS / PLATFORM / CHASSIS (903), SPRINTER 3-T BOX / BUS / PLATFORM / CHASSIS (906), SPRINTER 4,6-T BOX / PLATFORM / CHASSIS (906), SPRINTER 4-T BOX (904), SPRINTER 4-T BOX / BUS / PLATFORM / CHASSIS (904), SPRINTER 5-T BOX / PLATFORM / CHASSIS (906), VANO (414), V-CLASS (638/2), VIANO (W639), VITO BOX / BUS (638), VITO BUS (W639), VITO / MIXTO BOX (W639)

CCU141

MERCEDES-BENZ
C-CLASS (W202), C-CLASS (W203), C-CLASS T-MODEL (S202), C-CLASS T-MODEL (S203), CLK (C209), E-CLASS (W210), E-CLASS (W211), E-CLASS T-MODEL (S210), E-CLASS T-MODEL (S211), G-CLASS (W461), G-CLASS (W463), G-CLASS / CABRIO (W463), M-CLASS (W163), S-CLASS (W140), S-CLASS (W220), SPRINTER 2-T BOX / BUS / PLATFORM / CHASSIS (901, 902), SPRINTER 3-T BOX (903), SPRINTER 3-T BOX / BUS / PLATFORM / CHASSIS (903), SPRINTER 3-T PLATFORM / CHASSIS (903), SPRINTER 4-T BOX (904), SPRINTER 4-T BOX / BUS / PLATFORM / CHASSIS (904), SPRINTER 4-T BOX / PLATFORM / CHASSIS (904), SPRINTER 5-T PLATFORM / CHASSIS (905), SPRINTER CLASSIC 3,5-T BOX (909), SPRINTER CLASSIC 4,6-T BUS (909), SPRINTER DUMPTRUCK (905)

CCU142

OPEL
AGILA (A), AGILA (B), ASTRA G, ASTRA H, CORSA C, MERIVA A, SIGNUM, TIGRA, VECTRA C, ZAFIRA A, ZAFIRA B

VAUXHALL
AGILA MK II (B), ASTRA MK IV (G), ASTRA MK V (H), ASTRAMAN MK IV (G), ASTRAMAN MK V (H), CORSA MK II (C), CORSAVAN MK II (C), MERIVA MK I (A), SIGNUM, TIGRA, VECTRA MK II (C), ZAFIRA MK I (A), ZAFIRA MK II (B)

CCU143

OPEL
ASTRA G, ASTRA H, CORSA C, FRONTERA B, MERIVA A, OMEGA B, SIGNUM, SINTRA, VECTRA B, VECTRA C, ZAFIRA A, ZAFIRA B

...CCU143

VAUXHALL
ASTRA MK IV (G), ASTRA MK V (H), ASTRAMAN MK IV (G), ASTRAMAN MK V (H), CORSA MK II (C), CORSAVAN MK II (C), FRONTERA MK II (B), MERIVA MK I (A), OMEGA (B), SIGNUM, SINTRA, VECTRA (B), VECTRA MK II (C), ZAFIRA MK I (A), ZAFIRA MK II (B)

CCU144

OPEL
CORSA D
VAUXHALL
CORSA MK III (D), CORSAVAN MK III (D)

CCU145

OPEL
ASTRA J, CORSA D, MERIVA B, MOKKA / MOKKA X

VAUXHALL
ASTRA MK VI (J), CORSA MK III (D), MERIVA MK II (B), MOKKA / MOKKA X

CCU147

CITROËN
BERLINGO, BERLINGO / BERLINGO FIRST, C1, C2, C3, C3 I, C3 II, C3 PICASSO, C4, C4 GRAND PICASSO I, C4 I, C4 PICASSO I, C5 II, C5 III, C6, C8, C-CROSSER, C-CROSSER ENTERPRISE, JUMPY, NEMO, XSARA PICASSO

DACIA
DUSTER, LOGAN

FIAT
SCUDO, ULYSSE

FORD
FIESTA V, FOCUS C-MAX, FOCUS II, FUSION

LANCIA
PHEDRA

MAZDA
2 (DY)

MITSUBISHI
OUTLANDER II

PEUGEOT
206, 206+, 207, 207 CC, 207 SW, 307, 308, 308 SW, 407, 1007, 3008, 5008, PARTNER, PARTNER TEPEË

RENAULT
DUSTER, ESPACE IV, GRAND SCÉNIC II, MASTER II, MEGANÉ II, SCÉNIC II, TRAFIC II, TWINGO II, VEL SATIS

VOLVO
C30, C70 II, S40 II, V50, V70 III

CCU148

CITROËN
XM, ZX

PEUGEOT
306, 605

CCU149

CITROËN
BERLINGO / BERLINGO FIRST, C2, C2 ENTERPRISE, C3 I, C5 I, C8, C15, EVASION, JUMPER, JUMPY, XANTIA, XM, XSARA, XSARA PICASSO

FIAT
SCUDO

**...CCU149****PEUGEOT**

206, 206 VAN, 306, 307, 406, 605, 607, 806, 807, 1007, BOXER, EXPERT, EXPERT TEPEE, PARTNER

CCU150**ALFA ROMEO**

147, 156, 159, 166, BRERA, GT, MITO, SPIDER

FIAT

500, 500 C, BRAVA, BRAVO I, BRAVO II, CROMA, DOBLO, DUCATO, FIORINO, GRANDE PUNTO, IDEA, LINEA, MAREA, MULTIPLA, PALIO, PANDA, PUNTO, PUNTO EVO, QUBO, SIENA, STILO, STRADA

LANCIA

LYBRA, MUSA, THESIS, YPSILON

CCU151**AUDI**

A3, A4, A4 ALLROAD, A5, A6, A8, Q5, Q7, TT

SEAT

ALHAMBRA, EXEO, LEON

SKODA

OCTAVIA III, SUPERB III

VW

BEETLE, CC, GOLF V, GOLF VII, GOLF SPORTSVAN, JETTA III, JETTA IV, MULTIVAN V, PASSAT, PASSAT ALLTRACK, PASSAT CC, SHARAN, TOUAREG, TRANSPORTER V

CCU152**AUDI**

A1, A3, A4, Q3

SEAT

ALHAMBRA, ALTEA, ALTEA XL, CORDOBA, IBIZA III, IBIZA IV, LEON, TOLEDO III, TOLEDO IV

SKODA

FABIA II, OCTAVIA II, RAPID, ROOMSTER, ROOMSTER PRAKTIK, SUPERB I, SUPERB II, YETI

VW

AMAROK, CADDY ALLTRACK, CADDY III, CADDY IV, CRAFTER 30-35, CRAFTER 30-50, EOS, GOLF V, GOLF VI, GOLF PLUS, JETTA III, PASSAT, POLO, SCIROCCO, TIGUAN, TOURAN

CCU153**FIAT**

BRAVA, BRAVO I, FIORINO, FIORINO PICK UP, MAREA, PALIO, PUNTO, SIENA, STRADA, TEMPRA

LANCIA

DEDRA, DELTA II

CCU154**NISSAN**

ALMERA II, KUBISTAR, MICRA III, PRIMASTAR, PRIMERA

OPEL

MOVANO, VIVARO A

...CCU154**RENAULT**

AVANTIME, CLIO, CLIO II, CLIO III, ESPACE III, ESPACE IV, GRAND SCÉNIC II, KANGOO, LAGUNA I, LAGUNA II, MASTER II, MEGANE I, MEGANE II, MODUS / GRAND MODUS, SCÉNIC II, THALIA I, TRAFIC II, TWINGO II, VEL SATIS

VAUXHALL

MOVANO MK I (A), VIVARO

CCU156**MERCEDES-BENZ**

A-CLASS (W169), B-CLASS (W245)

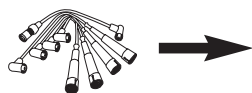

CLS001
AUDI
80, 100, A4, A6, A8, CABRIOLET, COUPE
CLS002
FIAT
TEMPRA, TIPO
LANCIA
DELTA II
CLS003
FIAT
CINQUECENTO, PANDA, SEICENTO / 600
CLS005
CITROËN
EVASION, XANTIA, XM, ZX
FIAT
ULYSSE
LANCIA
DELTA II, ZETA
PEUGEOT
306, 405 I, 405 II, 406, 806
SEAT
MARBELLA, TERRA
CLS007
FIAT
PALIO
CLS009
KIA
RIO
CLS010
MITSUBISHI
COLT V, GALANT VI, LANCER VII, PAJERO
PININ, SPACE RUNNER, SPACE STAR, SPACE
WAGON
PROTON
IMPIAN
CLS011
RENAULT
CLIO II, KANGOO, MEGANE, MEGANE I
CLS012
HONDA
CIVIC V, CIVIC VI
CLS013
DAEWOO
MATIZ
CLS014
RENAULT
MEGANE, MEGANE I
CLS015
FORD
FIESTA, FIESTA IV
CLS016
FORD
COUGAR, FOCUS, FOCUS II, MAVERICK,
MONDEO II
MAZDA
121 III (JASM, JBSM), TRIBUTE (EP)
CLS017
AUDI
A3

...CLS017
SEAT
ALHAMBRA, ALTEA, CORDOBA, IBIZA III,
LEON, TOLEDO III
SKODA
FABIA I, OCTAVIA I, SUPERB I
VW
BORA, CADDY III, GOLF IV, GOLF V, GOLF
VI, GOLF PLUS, JETTA III, NEW BEETLE,
PASSAT, SHARAN, TOURAN
CLS018
OPEL
ASTRA F, ASTRA F CLASSIC, CORSA A,
KADETT E
VAUXHALL
ASTRA MK II
CLS019
DACIA
LOGAN, LOGAN MCV, SANDERO
RENAULT
CLIO II, KANGOO, KANGOO / GRAND
KANGOO, MEGANE, MEGANE I
CLS020
CHEVROLET
AVEO / KALOS, CRUZE, KALOS, REZZO
DAEWOO
KALOS, LACETTI, LANOS, NUBIRA, REZZO
CLS021
HYUNDAI
ATOS
CLS022
FORD
SCORPIO II, SIERRA, TRANSIT
CLS023
HYUNDAI
ACCENT, ACCENT I, ACCENT II, ATOS, GETZ
CLS024
HYUNDAI
ACCENT, ACCENT I, ACCENT II, ACCENT III,
COUPE, ELANTRA, GETZ, MATRIX
KIA
CERATO
CLS025
CHEVROLET
LANOS
DAEWOO
KALOS, LANOS
CLS026
SUBARU
JUSTY II
SUZUKI
ALTO (FF), GRAND VITARA I (FT, HT),
JIMNY CLOSED OFF-ROAD VEHICLE (SN),
SWIFT II HATCHBACK (EA, MA), SWIFT II
SALOON (AH, AJ), WAGON R+ HATCHBACK
(MM)
CLS027
SEAT
CORDOBA, IBIZA II, TOLEDO I
VW
DERBY, GOLF II, GOLF III, GOLF IV, JETTA
II, PASSAT, POLO, TRANSPORTER IV, VENTO

CLS028
SEAT
CORDOBA, IBIZA II
VW
GOLF III
CLS029
OPEL
ASTRA F
VAUXHALL
ASTRA MK III (F)
CLS030
OPEL
ASTRA F, ASTRA F CLASSIC, ASTRA G,
COMBO, CORSA B, TIGRA, VECTRA B
VAUXHALL
ASTRA MK III (F), ASTRA MK IV (G), CORSA
MK I (B), TIGRA MK I
CLS031
MAZDA
323 C V (BA), 323 F V (BA), 323 P V (BA),
323 S V (BA), MX-3 (EC)
CLS032
FORD
FIESTA IV, PUMA
MAZDA
121 III (JASM, JBSM)
CLS033
FORD
FIESTA IV, KA
MAZDA
121 III (JASM, JBSM)
CLS034
SEAT
CORDOBA, IBIZA II, TOLEDO I
VW
GOLF III, GOLF IV, PASSAT, POLO, VENTO
CLS035
FIAT
PUNTO
LANCIA
Y
CLS036
BMW
3 (E36), 3 /COMPACT /COUPE (E36), 3
COUPE (E36), Z3 ROADSTER (E36)
CLS038
SEAT
AROSA
VW
LUPO, POLO
CLS039
RENAULT
ESPACE III, LAGUNA I, MEGANE, MEGANE I
CLS040
RENAULT
CLIO I, CLIO II, KANGOO, TWINGO I
CLS041
SEAT
AROSA, CORDOBA, IBIZA II
VW
LUPO, POLO

CLS042
AUDI
80, 100
VW
TRANSPORTER IV, VENTO
CLS043
VW
GOLF III, PASSAT, VENTO
CLS044
FIAT
BRAVA, BRAVO I, MAREA, PUNTO, SIENA
LANCIA
Y
CLS045
LAND ROVER
FREELANDER
ROVER
75
CLS046
AUDI
A4, A6, A8
SKODA
SUPERB I
VW
PASSAT
CLS047
AUDI
A4
VW
PASSAT
CLS048
AUDI
A3, A4
SEAT
ALHAMBRA, ALTEA, ALTEA XL, EXEO
SKODA
OCTAVIA I, OCTAVIA II
VW
BORA, GOLF IV, GOLF V, GOLF VI, GOLF
PLUS, JETTA III, NEW BEETLE, PASSAT,
SHARAN
CLS049
FORD
GALAXY
CLS050
RENAULT
SAFRANE II
VOLVO
850, C70 I, S70, V70 I
CLS051
RENAULT
LAGUNA I, SAFRANE II
VOLVO
S40 I, V40
CLS052
RENAULT
ESPACE III, LAGUNA I, MEGANE, MEGANE I
CLS053
SEAT
AROSA, INCA

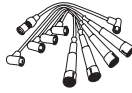

...CLS053

VW
CADDY II, LUPO, POLO

CLS054

BMW
3 COMPACT (E36), 3 /CONVERTIBLE /TOURING (E36), 3 /COUPE /TOURING (E46), 5 /TOURING (E34), Z3 ROADSTER (E36)

CLS055

ALFA ROMEO
145, 146, 147, 156, 166, GTV, SPIDER

CLS056

MAZDA
MX-5 I (NA), MX-5 II (NB)

CLS057

AUDI
A4, A6, CABRIOLET

VW

PASSAT

CLS058

TOYOTA
AVENSIS, CARINA E

CLS059

NISSAN
PRIMERA

CLS061

LOTUS
ELISE

MG

MGF, MG TF, MG ZR

ROVER

25, 200, 400

CLS062

CHRYSLER
NEW YORKER, VOYAGER / GRAND VOYAGER III, VOYAGER II

CLS063

DAEWOO
MUSSO

MERCEDES-BENZ

E-CLASS (W210), E-CLASS T-MODEL (S210), M-CLASS (W163), SLK (R170), SPRINTER 2-T BOX (901, 902), SPRINTER 2-T BOX /BUS /PLATFORM /CHASSIS (901, 902), SPRINTER 3-T BOX /BUS /PLATFORM /CHASSIS (903), SPRINTER 3-T BUS /PLATFORM /CHASSIS (903), SPRINTER 4-T PLATFORM /CHASSIS (904)

SSANGYONG

MUSSO

CLS064

CHRYSLER
CROSSFIRE

...CLS064

MERCEDES-BENZ

C-CLASS (W202), C-CLASS (W203), C-CLASS COUPE (CL203), C-CLASS T-MODEL (S202), C-CLASS T-MODEL (S203), CLK (C208), CLK (C209), CLK CONVERTIBLE (A208), CLK CONVERTIBLE (A209), CLS (C219), E-CLASS (W210), E-CLASS (W211), E-CLASS T-MODEL (S210), E-CLASS T-MODEL (S211), G-CLASS /CABRIO (W463), M-CLASS (W163), S-CLASS (W220), SL (R129), SL (R230), SLK (R170), VIANO (W639), VITO / MIXTO BOX (W639)

CLS065

MERCEDES-BENZ

C-CLASS (W202), C-CLASS T-MODEL (S202), COUPE (C124), E-CLASS (W124), E-CLASS CONVERTIBLE (A124), E-CLASS COUPE (C124), E-CLASS T-MODEL (S124), KOMBI T-MODEL (S124), SALOON (W124)

CLS066

FORD

FIESTA, FIESTA IV, KA

MAZDA

121 III (JASM, JBSM)

CLS067

FIAT

DOBLO, PALIO, PANDA, PUNTO, SEICENTO / 600, SIENA, STRADA

LANCIA

Y, YPSILON

CLS068

SMART

CABRIO, CITY-COUPÉ, CROSSBLADE, FORTWO, ROADSTER

CLS069

MINI

MINI

CLS070

SKODA

OCTAVIA I

VW

BORA, CADDY III, GOLF IV, NEW BEETLE, TOURAN

CLS071

DAEWOO

MUSSO

MERCEDES-BENZ

E-CLASS (W210), E-CLASS T-MODEL (S210), M-CLASS (W163), SLK (R170), SPRINTER 2-T BOX (901, 902), SPRINTER 2-T BOX /BUS /PLATFORM /CHASSIS (901, 902), SPRINTER 3-T BOX /BUS /PLATFORM /CHASSIS (903), SPRINTER 3-T BUS /PLATFORM /CHASSIS (903), SPRINTER 4-T PLATFORM /CHASSIS (904)

SSANGYONG

MUSSO

CLS072

HYUNDAI

ACCENT II, GETZ

CLS073

HYUNDAI

ATOS, GETZ

CLS074

FORD

FIESTA V, MONDEO III

CLS075

MAZDA

6 HATCHBACK /SALOON (GG), 6 STATION WAGON (GY)

CLS076

DACIA

LOGAN, LOGAN MCV, SANDERO

RENAULT

KANGOO, LOGAN I, SANDERO/STEPWAY I

CLS077

FORD

C-MAX, FIESTA IV, FIESTA V, FIESTA VI, FOCUS, FOCUS C-MAX, FOCUS II, FUSION, MONDEO IV, PUMA

MAZDA

2 (DY)

VOLVO

C30, S40 II

CLS078

MERCEDES-BENZ

A-CLASS (W169), B-CLASS (W245)

CLS079

SEAT

CORDOBA

VW

CADDY I, GOLF II, GOLF III, GOLF IV, PASSAT, POLO, VENTO

CLS080

SUBARU

FORESTER, IMPREZA, LEGACY III, OUTBACK

CLS081

VW

FOX, GOL IV, POLO

CLS082

ALFA ROMEO

MITO

FIAT

500, 500 C, DOBLO, GRANDE PUNTO, IDEA, LINEA, PANDA, PUNTO, PUNTO EVO

LANCIA

MUSA, YPSILON

CLS083

RENAULT

CLIO II, KANGOO, TWINGO I, TWINGO II

CLS084

DACIA

LOGAN MCV II, SANDERO

RENAULT

CLIO, CLIO II, CLIO III, CLIO IV, KANGOO, MODUS / GRAND MODUS, THALIA I, THALIA II, TWINGO I, TWINGO II, WIND

TALBOT

SIMCA 1000

CLS085

CHEVROLET

AVEO, KALOS, MATIZ

DAEWOO

KALOS, MATIZ

CLS086

CHEVROLET

AVEO, AVEO / KALOS, KALOS

DAEWOO

KALOS

CLS088

DACIA

DOKKER, DOKKER EXPRESS, LODGY, LOGAN, LOGAN MCV, SANDERO

RENAULT

KANGOO

CLS089

FORD

C-MAX, C-MAX II, FIESTA VI, FOCUS C-MAX, FOCUS II, FOCUS III, FUSION, GRAND C-MAX

CLS090

AUDI

A1, A3

SEAT

ALTEA, ALTEA XL, IBIZA IV, LEON, TOLEDO IV

SKODA

FABIA II, OCTAVIA II, RAPID, ROOMSTER, ROOMSTER PRAKTIK, YETI

VW

BEETLE, CADDY III, GOLF VI, GOLF PLUS, JETTA IV, POLO, TOURAN

CLS091

FORD

KA

CLS092

FORD

FIESTA V, STREET KA

CLS093

HYUNDAI

ATOS, ATOS PRIME, GETZ, I10

KIA

PICANTO

CLS094

HYUNDAI

COUPE, ELANTRA, I30, TRAJET, TUCSON

KIA

CARENS II, CEE'D, CERATO, PRO CEE'D, SPORTAGE

CLS095

MG

MGF, MG TF, MG ZR

ROVER

200, 400, COUPE

CLS096

TOYOTA

COROLLA

CLS097

AUDI

50, 80, 100

SEAT

CORDOBA, IBIZA I

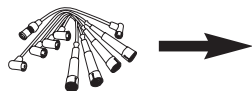
**...CLS097**

VW
CADDY I, DERBY, GOLF I, GOLF II, JETTA I, JETTA II, PASSAT, POLO, SANTANA, SCIROCCO, TRANSPORTER II, TRANSPORTER III

CLS098

MERCEDES-BENZ
190 (W201), COUPE (C123), COUPE (C124), G-CLASS (W460), G-CLASS (W461), G-CLASS /CABRIO (W463), KOMBI T-MODEL (S123), KOMBI T-MODEL (S124), SALOON (W123), SALOON (W124)

CLS099

AUDI
80, COUPE
SEAT
CORDOBA, IBIZA II, INCA, TOLEDO I

VW
CADDY I, CADDY II, CORRADO, GOLF I, GOLF II, GOLF III, GOLF IV, JETTA II, PASSAT, POLO, SANTANA, SCIROCCO, VENTO

WARTBURG
353

CLS100

SEAT
AROSA, CORDOBA, IBIZA II
SKODA
FELICIA I, OCTAVIA I

VW
GOLF I, GOLF II, GOLF III, POLO, SANTANA, TRANSPORTER IV

CLS106

MERCEDES-BENZ
C-CLASS (W202), C-CLASS T-MODEL (S202), COUPE (C124), E-CLASS (W124), E-CLASS CONVERTIBLE (A124), E-CLASS COUPE (C124), E-CLASS T-MODEL (S124), KOMBI T-MODEL (S124), SALOON (W124)

CLS107

DAEWOO
LACETTI
OPEL
ASTRA F, ASTRA G, CALIBRA A, OMEGA B, SINTRA, VECTRA A, VECTRA B
VAUXHALL
ASTRA MK III (F), SINTRA

CLS108

VW
TRANSPORTER IV

CLS109

SEAT
AROSA, CORDOBA, IBIZA II, INCA
SKODA
FELICIA II
VW
CADDY II, GOLF III, POLO, POLO VAN, VENTO

CLS110

SEAT
CORDOBA, IBIZA II, TOLEDO I

...CLS110

VW
GOLF III, GOLF IV, PASSAT, POLO, VENTO

CLS111

FORD
ESCORT CLASSIC, ESCORT V, ESCORT VI, ESCORT VII, FIESTA III, FIESTA IV, MONDEO I, MONDEO II, ORION III

CLS112

LANCIA
Y10

CLS114

OPEL
ASTRA F, ASTRA F CLASSIC, ASTRA G, COMBO, CORSA B, VECTRA A, VECTRA B, ZAFIRA A

VAUXHALL
ASTRA MK IV (G), ASTRAMAN MK IV (G), COMBO MK II (C), CORSA MK I (B), CORSAVAN MK I (B)

CLS115

OPEL
CORSA B
VAUXHALL
CORSA MK I (B)

CLS116

RENAULT
LAGUNA I

CLS117

RENAULT
19 II, CLIO I, KANGOO, MEGANE, MEGANE I, RAPID

CLS121

FORD
ESCORT '86, ESCORT '91, ESCORT IV, ESCORT V, ESCORT VI, ESCORT VII, FIESTA, FIESTA III, ORION II, ORION III

CLS122

FORD
ESCORT '91, ESCORT '95, ESCORT V, ESCORT VI, ESCORT VII, FIESTA II, FIESTA III, ORION II, ORION III

CLS123

CITROËN
BERLINGO / BERLINGO FIRST, JUMPER, JUMPY, XANTIA, XSARA, ZX

FIAT
DUCATO

PEUGEOT
205 I, 205 II, 306, 309 II, 405 II, 406, BOXER, PARTNER

CLS124

CITROËN
C3, C3 I

PEUGEOT
106 I, 306, 309 II

CLS126

RENAULT
SUPER 5, TWINGO I

VOLVO
340-360

CLS128

HONDA
CIVIC II, CIVIC IV, CIVIC V, CIVIC VI

ROVER
400

CLS129

HONDA
CIVIC V, CIVIC VI, CONCERTO, CRX III, HR-V, LOGO

ROVER
400

CLS130

HYUNDAI
COUPE, ELANTRA, LANTRA II

CLS131

KIA
SEPHIA, SHUMA
MAZDA

323 C IV (BG), 323 C V (BA), 323 F IV (BG), 323 III STATION WAGON (BW), 323 P V (BA), 323 S IV (BG), 323 S V (BA)

CLS132

NISSAN
100 NX, ALMERA I, PRIMERA

CLS135

FIAT
SCUDO, TEMPRA, TIPO

LANCIA
DELTA II

CLS136

FIAT
BRAVA, BRAVO I, MAREA
LANCIA
Y

CLS137

FIAT
BRAVA, BRAVO I, MAREA, MULTIPLA, PALIO, SIENA

LANCIA
DEDRA, DELTA II, LYBRA

CLS138

MERCEDES-BENZ
C-CLASS (W202), C-CLASS T-MODEL (S202), CLK (C208), CLK CONVERTIBLE (A208), E-CLASS (W210), E-CLASS T-MODEL (S210), SLK (R170), SPRINTER 2-T BOX (901, 902), SPRINTER 2-T BUS /PLATFORM /CHASSIS (901, 902), SPRINTER 3-T BOX (903), SPRINTER 4-T BOX /BUS /PLATFORM /CHASSIS (904), V-CLASS (638/2), VITO BOX/BUS (638)

CLS139

AUDI
A3

SEAT
LEON, TOLEDO II

SKODA
OCTAVIA I

VW
BORA, GOLF III, GOLF IV, POLO

CLS140

AUDI
A3

SEAT
LEON, TOLEDO II

SKODA
OCTAVIA I

VW
BORA, GOLF IV

CLS141

OPEL
ASTRA F, ASTRA F CLASSIC

CLS144

CHEVROLET
AVEO, SPARK

CLS147

LADA
NADESCHDA, NIVA, NIVA II

CLS150

SAAB
9-3, 900 I, 900 II, 9000

CLS153

NISSAN
VANETTE CARGO

CLS155

LAND ROVER
FREELANDER

CLS156

FORD
COUGAR, MONDEO III

CLS157

KIA
SHUMA

CLS159

MAZDA
MX-5 II (NB)

CLS163

DAIHATSU
TERIOS

CLS167

FIAT
SEDICI
SUZUKI

GRAND VITARA II (JT), GRAND VITARA II (JT, TE, TD), IGNIS I (FH), IGNIS II (MH), JIMNY (FJ), JIMNY CLOSED OFF-ROAD VEHICLE (SN), LIANA (ER, RH _), LIANA HATCHBACK, SWIFT III (MZ, EZ), SX4 (EY, GY), SX4 /SALOON (GY), SX4 SALOON (GY), SX4 S-CROSS (JY), WAGON R+ HATCHBACK (MM)

CLS168

MAZDA
DEMIO (DW)

CLS169

MITSUBISHI
COLT V, LANCER VI

CLS170

SUBARU
FORESTER, IMPREZA



CLS171
TOYOTA
AVENSIS

CLS173
KIA
CARENS I, CARENS II, CLARUS, SEPHIA, SHUMA, SHUMA II

CLS174
SEAT
CORDOBA, IBIZA II, TOLEDO I

VW
CORRADO, GOLF III, JETTA II, PASSAT, SCIROCCO

CLS175
OPEL
OMEGA B, SINTRA

VAUXHALL
OMEGA (B)

CLS176
OPEL
ASTRA G

CLS177
AUDI
A3

CLS178
SEAT
CORDOBA, IBIZA II

VW
POLO

CLS180
AUDI
80, 100, A6, CABRIOLET

CLS181
VW
GOLF IV, PASSAT

CLS182
SAAB
99, 900 I

CLS183
MAZDA
323 F VI (BJ), 323 S VI (BJ)

CLS184
VW
BORA, GOLF IV

CLS185
VW
BORA, GOLF IV, SHARAN

CLS187
FORD
SCORPIO II

CLS188
VOLVO
740, 940, 940 II

CLS189
HYUNDAI
COUPE, SANTA FÉ I, SONATA IV

KIA
MAGENTIS

CLS190
CHRYSLER
VOYAGER / GRAND VOYAGER III

CLS192
SUBARU
FORESTER

CLS193
CHRYSLER
VOYAGER IV

CLS194
RENAULT
CLIO II

CLS195
VOLVO
S40 I, V40

CLS196
CHEVROLET
AVEO, AVEO / KALOS, CRUZE, KALOS, LACETTI, NUBIRA

DAEWOO
KALOS, LACETTI, NUBIRA

CLS197
KIA
PRIDE, RIO II

CLS198
MAZDA
323 F VI (BJ), 323 S VI (BJ), MPV II (LW), PREMACY (CP)

CLS199
VW
CORRADO, GOLF III, PASSAT, SHARAN, VENTO

CLS219
MERCEDES-BENZ
E-CLASS (W124), E-CLASS (W210), E-CLASS T-MODEL (S210), SALOON (W124), S-CLASS (W140), S-CLASS COUPE (C140)

CLS225
FIAT
900T/E PANORAMA

FSO
125P, POLONEZ I

HYUNDAI
STELLAR

MITSUBISHI
GALANT IV, SPACE WAGON, TREDIA

OPEL
KADETT A, KADETT B

SEAT
133

SUZUKI
CARRY BOX (OS), SUPER CARRY BUS (ED)

CLS229
MAZDA
626 IV /HATCHBACK (GE), MX-6 (GE)

CLS230
SUZUKI
SWIFT II SALOON (AH, AJ), VITARA (ET, TA), VITARA CABRIO (ET, TA), X-90 (EL)

CLS231
TOYOTA
COROLLA

CLS232
TOYOTA
PICNIC

CLS233
TOYOTA
RAV 4 I

CLS235
ALFA ROMEO
164, GTV, SPIDER

CLS236
VOLVO
740, 760, 940, 940 II

CLS237
VW
TRANSPORTER IV

CLS238
VW
SHARAN

CLS239
MAZDA
626 V (GF), 626 V /HATCHBACK (GF), 626 V HATCHBACK (GF), 626 V STATION WAGON (GW)

CLS240
FORD
GALAXY

VW
GOLF III, PASSAT, SHARAN, VENTO

CLS241
CHRYSLER
PT CRUISER, SEBRING

CLS242
MERCEDES-BENZ
C-CLASS (W203), CLK (C208), CLK (C209), CLK CONVERTIBLE (A208), CLK CONVERTIBLE (A209), E-CLASS (W210), E-CLASS (W211), E-CLASS T-MODEL (S210), E-CLASS T-MODEL (S211), G-CLASS (W463), G-CLASS CABRIO (W463), M-CLASS (W163), R-CLASS (W251, V251), S-CLASS (W220), S-CLASS COUPE (C215), SL (R129), SL (R230), SLK (R171)

PUCH
G-MODELL

CLS243
FORD
GALAXY

CLS250
MERCEDES-BENZ
190 (W201), COUPE (C124), E-CLASS (W124), E-CLASS T-MODEL (S124), G-CLASS (W463), G-CLASS /CABRIO (W463), KOMBI T-MODEL (S124), SALOON (W124), S-CLASS (W126), SL (R107), SL (R129)

CLS251
PORSCHE
911 (993), 911 /CONVERTIBLE /TARGA (993)

CLS252
MERCEDES-BENZ
C-CLASS (W202), COUPE (C124), E-CLASS (W124), E-CLASS (W210), E-CLASS CONVERTIBLE (A124), E-CLASS COUPE (C124), E-CLASS T-MODEL (S124), G-CLASS /CABRIO (W463), KOMBI T-MODEL (S124), SALOON (W124), S-CLASS (W140), SL (R129)

CLS254
MERCEDES-BENZ
C-CLASS (W202), E-CLASS (W210), E-CLASS CONVERTIBLE (A124), E-CLASS COUPE (C124), E-CLASS T-MODEL (S124), G-CLASS /CABRIO (W463), S-CLASS (W140), SL (R129)

CLS256
KIA
CARENS II, RIO, RIO II, SHUMA II

CLS257
MAZDA
323 F VI (BJ), 323 S VI (BJ)

CLS258
FIAT
TEMPRA

KIA
PRIDE

CLS259
TOYOTA
CAMRY

CLS260
AUDI
A2

SEAT
AROSA, CORDOBA, IBIZA II, IBIZA III, LEON, TOLEDO II

SKODA
FABIA I, OCTAVIA I

VW
BORA, CADDY II, GOLF IV, LUPO, NEW BEETLE, POLO

CLS261
FIAT
CINQUECENTO, PALIO, PANDA, PUNTO, SEICENTO / 600, STRADA

LANCIA
Y

CLS262
CITROËN
AX, BERLINGO / BERLINGO FIRST, SAXO, XSARA, ZX

PEUGEOT
106 I, 106 II, 106 VAN, 306, PARTNER

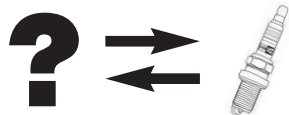

| ACCEL | CHAMPION |
|----------|----------|
| 112 | OE087 |
| 114 | OE001 |
| 115 | OE001 |
| 116 | OE065 |
| 142 | OE068 |
| 143 | OE079 |
| 146 | OE074 |
| 154 | L82C |
| 156 | OE037 |
| 196 | OE049 |
| 276 | RV15YC4 |
| 416 | OE013 |
| 442 | OE108 |
| 496 | OE042 |
| 514 | OE011 |
| 576 | RV15YC4 |
| ACDELCO | CHAMPION |
| 2500 | OE087 |
| 2503 | OE012 |
| 3500 | OE044 |
| 40XLS | OE087 |
| 41 F | OE087 |
| 41-103 | OE189 |
| 41-105 | OE189 |
| 41-106 | OE191 |
| 41-107 | OE189 |
| 41-2 XLS | OE087 |
| 41-602 | OE013 |
| 41-610 | OE013 |
| 41-617 | OE013 |
| 41-627 | OE013 |
| 41-8 XLS | OE001 |
| 41-802 | OE192 |
| 41-812 | OE011 |
| 41-813 | OE042 |
| 41-825 | OE191 |
| 41-828 | OE098 |
| 41-829 | OE039 |
| 41-905 | RV15YC4 |
| 41-907 | OE191 |
| 41-913 | OE191 |
| 41-954 | OE029 |
| 41-991 | OE183 |
| 41F | L78C |
| 42 | L82C |
| 42 F | L78C |
| 42 FF | L82C |
| 42 FS | OE038 |
| 42 LZ | L82C |
| 42 XLS | OE001 |
| 420 Z | L82C |
| 422 Z | L82C |

| ACDELCO | CHAMPION |
|----------|----------|
| 42-5 F | L82C |
| 425 Z | L82C |
| 42-6 FS | OE038 |
| 42CF | OE037 |
| 42CXLS | OE001 |
| 42F | L82C |
| 42LTS | OE011 |
| 42XL | OE068 |
| 42XLS | OE001 |
| 43 F | L82C |
| 43 FO | L82C |
| 43 FS | OE038 |
| 43 N | OE074 |
| 43 XLS | OE015 |
| 430 Z | L78C |
| 430Z | L82C |
| 43-5 XLS | OE015 |
| 43CLS | OE065 |
| 43CXLS | OE065 |
| 43N | OE079 |
| 43TS | RV15YC4 |
| 43XL | OE079 |
| 43XLS | OE001 |
| 44 | J8C |
| 44 F | L82C |
| 44 XL | OE074 |
| 44 XLS | OE001 |
| 440XLS | OE087 |
| 44-5 | J8C |
| 44-5Com | J8C |
| 445Z | L78C |
| 44CF | OE037 |
| 44Com | J8C |
| 44F | OE037 |
| 44FFS | OE059 |
| 44N | OE074 |
| 44XL | OE074 |
| 45 | J8C |
| 45 F | L82C |
| 45 XL | OE074 |
| 45 XLS | OE001 |
| 4500 | OE044 |
| 4501 | OE009 |
| 4502 | L82C |
| 4503 | OE094 |
| 45Com | J8C |
| 45F | OE037 |
| 45FFS | OE059 |
| 45XL | OE074 |
| 46 TS | OE054 |
| 46 XL | OE074 |
| 46 XLS | OE015 |
| 46F | OE037 |

| ACDELCO | CHAMPION |
|----------------|----------|
| 46FFS | OE059 |
| 46N | OE074 |
| 46XL | OE074 |
| 47 XL | OE074 |
| 47XL | OE074 |
| 56 | L82C |
| 6500 | OE044 |
| 6501 | OE009 |
| 6502 | OE015 |
| 7500 | OE057 |
| 7501 | OE009 |
| 7502 | OE038 |
| 83 TS | OE054 |
| 84 TS | OE054 |
| 85 TS | OE054 |
| 8500 | OE037 |
| 8501 | OE001 |
| 8502 | OE007 |
| 9500 | OE001 |
| B45 | J8C |
| C 41 CXLS | OE010 |
| C 42 CFS | OE038 |
| C 42 CXLS | OE010 |
| C 43 CXLS | OE001 |
| C 44 NS | OE010 |
| C 44 XL | OE074 |
| C42CXLS | OE001 |
| C42N | OE079 |
| C43N | OE074 |
| C44 | J8C |
| C44N | OE074 |
| C44NS | OE065 |
| C44XL | OE079 |
| CFR 1 CLS | OE005 |
| CFR 2 CLS | OE014 |
| CFR 3 CLS | OE005 |
| CFR1CLS | OE094 |
| CFR1CLS(black) | OE014 |
| CFR2CLS(black) | OE005 |
| CR 41 CXLS | OE087 |
| CR 42 CFS | OE064 |
| CR 42 CLTS | OE011 |
| CR 42 CXLSX | OE048 |
| CR 42 XLSX | OE048 |
| CR 425 FS | OE064 |
| CR41CXLS | OE018 |
| CR42CLTS | OE011 |
| CR42LTS | OE011 |
| CR42N | OE098 |
| CR42XLSX | OE048 |
| CR43CXLS | OE051 |
| CR43N | OE098 |
| CR43TS | RV15YC4 |

| ACDELCO | CHAMPION |
|-------------|----------|
| CR43TSM | RV15YC4 |
| CR44NS | OE065 |
| F8 | L82C |
| FL7 | OE068 |
| FL9 | OE074 |
| FR 1 LS | OE005 |
| FR 2 LS | OE039 |
| FR 3 CLS | OE005 |
| FR 3 LS | OE005 |
| FR 3 LS 6 | OE039 |
| FR1LS | OE005 |
| FR2CLS | OE005 |
| FR2LS | OE005 |
| FR2LSK | OE013 |
| FR3CLS | OE013 |
| FR3LM | OE041 |
| FR3LS | OE013 |
| FR3LSJ | OE013 |
| FR3LSK | OE013 |
| FR3LX | OE013 |
| FR4LE | OE041 |
| FR5LS | OE013 |
| M42FF | L82C |
| M44C | J8C |
| M45 | J8C |
| M45FF | OE037 |
| MR42FF | OE086 |
| MR43FF | OE037 |
| N 700 | OE038 |
| N 701 | L82C |
| N 705 | OE078 |
| R 2601 | OE094 |
| R 2603 | OE014 |
| R 3600 | OE018 |
| R 3601 | OE018 |
| R 41 CF | L78C |
| R 41 CXLS | OE087 |
| R 41-4 XLS | OE018 |
| R 42 CF | L78C |
| R 42 CFS | OE038 |
| R 42 CLTS | OE011 |
| R 42 CLTS 6 | OE011 |
| R 42 CXLS | OE006 |
| R 42 XLS | OE006 |
| R 42 XLS 6 | OE048 |
| R 42 XLS-11 | OE048 |
| R 42-6 FS | OE064 |
| R 43 CFS | OE064 |
| R 43 CXL | OE098 |
| R 44 CF | L82C |
| R 44 CXL | OE074 |
| R 44 XLS-11 | OE049 |
| R 4602 | OE014 |



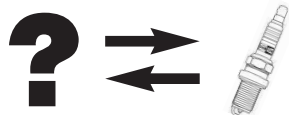

| ACDELCO | CHAMPION | ACDELCO | CHAMPION | AUTOLITE | CHAMPION | AUTOLITE | CHAMPION |
|----------|----------|-----------------|----------|----------|----------|--------------------|----------|
| R 4603 | OE094 | R44F | OE037 | 2616 | OE074 | 53 | OE001 |
| R 4604 | OE094 | R44LT | OE011 | 2635 | L78C | 535 | OE037 |
| R 4605 | OE038 | R44NS | OE042 | 2636 | L82C | 54 | OE065 |
| R 4606 | OE014 | R45NS | OE042 | 2652 | L78C | 5503 | OE005 |
| R 4607 | OE094 | R4606 | OE014 | 2653 | L78C | 62 | OE018 |
| R 5601 | OE077 | R46N | OE074 | 2654 | L82C | 64 | OE049 |
| R 5602 | OE026 | R46XL | OE074 | 2655 | L82C | 65 | OE042 |
| R 5603 | OE030 | R5602 | OE026 | 2656 | OE037 | 726 | RV15YC4 |
| R 5604 | OE039 | R5603 | OE030 | 2755 | OE083 | 893 | OE001 |
| R 5605 | OE033 | R5604 | OE039 | 294 | J8C | 935 | OE041 |
| R 5606 | OE032 | R5605 | OE034 | 295 | J8C | 94 | OE011 |
| R 5607 | OE025 | R5608 | OE002 | 315 | J8C | 985 | OE041 |
| R 5607 | OE027 | R5609 | OE039 | 3176 | OE074 | A5 | J8C |
| R 5609 | OE089 | R5610 | OE154 | 355 | J8C | A7 | J8C |
| R 5610 | OE089 | R6600 | OE004 | 356 | J8C | AE10 | OE074 |
| R 6600 | OE004 | R6601 | OE154 | 3895 | OE041 | AGPR22P | OE145 |
| R 6602 | OE011 | R6605 | OE063 | 3922 | OE039 | AGRF22D1 | OE131 |
| R 6603 | OE011 | R6606 | OE049 | 3923 | OE039 | AGRF22PP | OE131 |
| R 6604 | OE120 | R6608 | OE019 | 3924 | OE013 | AGSF22PPJ | OE131 |
| R 6605 | OE039 | R6609 | OE033 | 393 | OE068 | AN5 | J8C |
| R 6606 | OE049 | R6612 | OE148 | 394 | OE074 | AN7 | J8C |
| R 6607 | OE027 | R7600 | OE013 | 395 | OE074 | AP3923 | OE191 |
| R 6608 | OE019 | R7602 | OE019 | 396 | OE074 | AP646 | OE105 |
| R 6609 | OE033 | R8600 | OE042 | 397 | OE074 | APP3923 | OE191 |
| R 6612 | OE148 | R8601 | OE042 | 402 | OE091 | APP64 | OE192 |
| R 7600 | OE005 | S 41 F | L78C | 403 | OE108 | APP646 | OE105 |
| R 7601 | OE039 | S 44 F | L82C | 404 | OE098 | APP65 | OE192 |
| R 7602 | OE019 | S 44 XL | OE074 | 4055 | OE068 | AR5 | J8C |
| R 7603 | OE128 | S121XL | OE083 | 4056 | OE079 | AR8 | J8C |
| R 83 CTS | OE054 | S40F | L82C | 4092 | L78C | AT8 | J8C |
| R 84 TS | OE054 | S41F | L78C | 4093 | L82C | AWSF22FS | OE131 |
| R121XLS | OE083 | S41FR | L78C | 411 | L78C | XP3923 | OE180 |
| R2601 | OE014 | S41XLR | OE091 | 413 | L82C | BERU | CHAMPION |
| R41CLS | OE018 | S425Z | OE037 | 4132 | OE073 | 0001.330.702.00.01 | OE015 |
| R41CSL | OE108 | S42F | L82C | 4132 | OE083 | 0001.330.707.00.01 | OE003 |
| R41CXL | OE091 | S42FR | L82C | 4133 | OE083 | 0001.330.709.00.01 | OE044 |
| R41CXLS | OE018 | S42XL | OE068 | 414 | OE037 | 0001.330.725.00.01 | OE003 |
| R41XL | OE091 | S42XLR | OE108 | 4143 | OE083 | 0001.335.702.00.01 | OE001 |
| R41XLS | OE018 | S438XLS | OE087 | 415 | OE037 | 0001.335.709.00.01 | OE012 |
| R42CF | OE086 | S43XL | OE074 | 4152 | OE073 | 0001.335.714.00.01 | OE001 |
| R42CLTS | OE011 | S44 | J8C | 4153 | OE083 | 0001.340.702.00.01 | OE010 |
| R42CXL | OE108 | S44F | OE037 | 4162 | OE073 | 0001.340.706.00.01 | OE094 |
| R42F | OE086 | S44XL | OE074 | 4163 | OE083 | 0001.340.717.00.01 | OE094 |
| R42LTS | OE009 | S45F | OE037 | 4164 | OE083 | 0001.340.806.00.01 | OE014 |
| R42XL | OE108 | VF9 | J8C | 417 | OE037 | 0001.345.702.00.01 | OE087 |
| R42XLS6 | OE048 | AUTOLITE | CHAMPION | 4251 | OE087 | 0001.345.704.00.01 | OE012 |
| R43CTS | RV15YC4 | 103 | OE011 | 4253 | OE001 | 0001.430.701.00.01 | OE037 |
| R43CXL | OE098 | 16 | RV15YC4 | 4265 | OE042 | 0001.435.705.00.01 | L82C |
| R43CXLS | OE049 | 25 | RV15YC4 | 483 | OE011 | 0001.450.702.00.01 | L78C |
| R43TS | RV15YC4 | 2594 | OE068 | 4S-140 | J8C | 0001.630.700.00.01 | OE009 |
| R43TSK | RV15YC4 | 26 | RV15YC4 | 4S-165 | J8C | 0001.635.700.00.01 | OE009 |
| R43XLS | OE042 | 2615 | OE079 | 51 | OE087 | 0001.635.709.00.01 | OE009 |
| R44CXLS | OE051 | | | 5224 | OE013 | | |



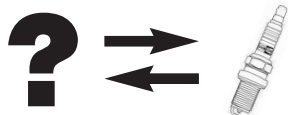

| BERU | CHAMPION |
|--------------------|----------|
| 0001.735.700.00.01 | OE054 |
| 0001.740.700.00.01 | OE054 |
| 0002.330.702.00.01 | OE049 |
| 0002.335.701.00.01 | OE006 |
| 0002.340.701.00.01 | OE018 |
| 0002.435.701.00.01 | OE064 |
| 0002.640.900.00.01 | OE029 |
| 0900.004.109.00.01 | OE029 |
| 0900.004.141.00.01 | OE031 |
| 0900.004.171.00.01 | OE146 |
| 0900.004.173.00.01 | OE136 |
| 10 FR-6 CPU03 | OE122 |
| 10 FR-7 KDUS | OE122 |
| 12 FR-6 DU | OE199 |
| 12 FR-6 DUT | OE199 |
| 12 FR-6 LUX | OE196 |
| 12 FR-7 DU | OE196 |
| 14 F-5 DPUR2T | OE136 |
| 14 F-6 DSR | OE014 |
| 14 F-6 DTU | OE094 |
| 14 F-6 DUOR | OE014 |
| 14 F-6 KPURW2 | OE181 |
| 14 F-7 DPUR02 | OE136 |
| 14 F-7 DPURU2 | OE146 |
| 14 F-7 DPURX2 | OE146 |
| 14 F-7 DUOR | OE014 |
| 14 F-7 HPURX2 | OE176 |
| 14 F-7 HUR2 | OE177 |
| 14 F-7 HURU02 | OE177 |
| 14 F-7 KPPRU2 | OE188 |
| 14 F-7 LDUR4 | OE026 |
| 14 F-8 DU0 | OE003 |
| 14 F-8 DU4 | OE057 |
| 14 F-8 DUR | OE005 |
| 14 F-8 LDUSR | OE019 |
| 14 F-8DU | OE003 |
| 14 FG-8 DTU | OE123 |
| 14 FGH-6 DTUR | OE094 |
| 14 FGH-7 DPURX2 | OE136 |
| 14 FGH-7 DTURX | OE032 |
| 14 FGH-7 DTURX0 | OE032 |
| 14 FGH-8 DTUR | OE123 |
| 14 FGH-8 DTURW | OE123 |
| 14 FGH-8 DTURX0 | OE032 |
| 14 FGHR-7 DTUU | OE077 |
| 14 FGHR-7 LDUW | OE019 |
| 14 FGR-7 CTU | OE077 |
| 14 FGR-8 MQPU | OE175 |
| 14 FR-5 DPPUX | OE136 |
| 14 FR-5 DPUX | OE136 |
| 14 FR-5 DTU | OE014 |
| 14 FR-5 DU | OE094 |
| 14 FR-5 DUU | OE094 |

| BERU | CHAMPION |
|----------------|----------|
| 14 FR-5 LPUOX | OE136 |
| 14 FR-6 DPOX | OE136 |
| 14 FR-6 DPU02S | OE136 |
| 14 FR-6 DPUW2 | OE136 |
| 14 FR-6 DPUX | OE136 |
| 14 FR-6 DPUX02 | OE136 |
| 14 FR-6 DPUX2 | OE136 |
| 14 FR-6 DU | OE014 |
| 14 FR-6 DUW | OE014 |
| 14 FR-6 DUW2 | OE014 |
| 14 FR-6 LDUW | OE030 |
| 14 FR-7 DPPUS2 | OE136 |
| 14 FR-7 DPPUW2 | OE146 |
| 14 FR-7 DPU3 | OE146 |
| 14 FR-7 DPUV02 | OE146 |
| 14 FR-7 DPUX02 | OE146 |
| 14 FR-7 DU | OE005 |
| 14 FR-7 DU2 | OE033 |
| 14 FR-7 DU2S | OE002 |
| 14 FR-7 DU2T | OE002 |
| 14 FR-7 DUW | OE005 |
| 14 FR-7 DUX | OE039 |
| 14 FR-7 HUX | OE089 |
| 14 FR-7 KDU | OE030 |
| 14 FR-7 KPPU | OE188 |
| 14 FR-7 KPU | OE227 |
| 14 FR-7 KPUV | OE188 |
| 14 FR-7 KPUX | OE188 |
| 14 FR-7 KPUX02 | OE188 |
| 14 FR-7 KUOX | OE089 |
| 14 FR-7 LDU | OE026 |
| 14 FR-7 LDUW | OE026 |
| 14 FR-7 LPU02 | OE227 |
| 14 FR-7 LPUT02 | OE188 |
| 14 FR-7 LPUX0 | OE146 |
| 14 FR-7 LPUX02 | OE188 |
| 14 FR-7 LUX | OE089 |
| 14 FR-7 LUX0 | OE039 |
| 14 FR-7 MU2 | OE035 |
| 14 FR-7 MUX2 | OE035 |
| 14 FR-7 NUX2 | OE178 |
| 14 FR-8 DPPUX | OE191 |
| 14 FR-8 DPU2 | OE145 |
| 14 FR-8 DPUX | OE191 |
| 14 FR-8 DU | OE005 |
| 14 FR-8 DUS | OE005 |
| 14 FR-8 DUW | OE039 |
| 14 FR-8 DUX | OE039 |
| 14 FR-8 HU | OE128 |
| 14 FR-8 HUT | OE128 |
| 14 FR-8 KUOU | OE063 |
| 14 FR-8 LDU3 | OE019 |
| 14 FR-8 LDUOX4 | OE019 |

| BERU | CHAMPION |
|----------------|----------|
| 14 FR-8 LPU0 | OE184 |
| 14 FR-8 LPU02 | OE184 |
| 14 FR-8 LPUX | OE184 |
| 14 FR-8 LU2 | OE198 |
| 14 FR-8 LU2T | OE198 |
| 14 FR-8 MPUX02 | OE175 |
| 14 FR-8 MPUX2 | OE175 |
| 14 FR-8 MU2 | OE148 |
| 14 FR-8 NQU23 | OE178 |
| 14 FR-9 KUX2 | OE154 |
| 14 G-8 DTU | OE027 |
| 14 GH-7 DTUR | OE025 |
| 14 GH-8 DTUR | OE027 |
| 14 GH-8 DTURX | OE027 |
| 14 GR-8 DTU | OE027 |
| 14 K-7 DU | OE009 |
| 14 K-7 DU0 | OE009 |
| 14 K-8 DU | OE009 |
| 14 K-8 DU0 | OE009 |
| 14 K-9 BU | RV15YC4 |
| 14 KG-8 DTU | OE009 |
| 14 KGR-7 KQU | OE011 |
| 14 KR-6 DPUV02 | OE131 |
| 14 KR-6 KPUV02 | OE183 |
| 14 KR-6 MUU | OE031 |
| 14 KR-7 DPUV | OE131 |
| 14 KR-7 DU | OE011 |
| 14 KR-7 DUX | OE011 |
| 14 KR-7 MPUV2 | OE189 |
| 14 KR-7 MPUX2 | OE029 |
| 14 KR-8 DPUX | OE131 |
| 14 KR-8 LQPU07 | OE183 |
| 14 KR-8 MPUV2 | OE029 |
| 14 KR-8 MPX | OE029 |
| 14 KR-8 MUV | OE031 |
| 14 KR-9 DPUX | OE131 |
| 14 KR-9 DUX | OE011 |
| 14 KR-9 LPUX | OE131 |
| 14 R-5 DU | OE087 |
| 14 R-6 DU | OE018 |
| 14 R-6 DUX | OE018 |
| 14 R-7 CU | OE098 |
| 14 R-7 DPU | OE195 |
| 14 R-7 DU | OE006 |
| 14 R-7 DUX | OE048 |
| 14 R-8 DPU | OE192 |
| 14 R-8 DPUU | OE192 |
| 14 R-8 DUX | OE049 |
| 14 R-9 KPUV2 | OE105 |
| 14 R-9 LPU1 | OE105 |
| 14 X-AU | L82C |
| 14 Z-4 AU | L78C |
| 14-4 DPO | OE078 |

| BERU | CHAMPION |
|-------------|----------|
| 14-5 AU | L82C |
| 14-5 DTU | OE012 |
| 14-5 DU | OE087 |
| 14-5 DU0 | OE087 |
| 14-6 DPO | OE008 |
| 14-6 DTU | OE012 |
| 14-7 AU | L82C |
| 14-7 CU | OE074 |
| 14-7 DTU | OE012 |
| 14-7 DU | OE001 |
| 14-7 DU0 | OE001 |
| 14-8 AU | OE037 |
| 14-8 DTU | OE044 |
| 14-8 LUR | OE004 |
| 14-9 DTU | OE027 |
| 14-9 DU | OE001 |
| A 7 | L82C |
| A 7 D | OE009 |
| FM 14-225/2 | OE087 |
| M 14-175 | L82C |
| M 14-225 | L78C |
| M14-175 | L82C |
| M14-225 | L78C |
| UPT1 | CET1 |
| UPT10P | CET10P |
| UPT11P | CET11P |
| UPT12P | CET12P |
| UPT13P | CET13P |
| UPT14P | CET14P |
| UPT15P | CET15P |
| UPT16P | CET16P |
| UPT17P | CET17P |
| UPT18P | CET18P |
| UPT2 | CET2 |
| UPT3 | CET3 |
| UPT4 | CET4 |
| UPT5 | CET5 |
| UPT6 | CET6 |
| UPT7 | CET7 |
| UPT8 | CET8 |
| UPT9 | CET9 |
| UXT1 | CET2 |
| UXT10 | CET12P |
| UXT11 | CET12P |
| UXT12 | CET11P |
| UXT13 | CET14P |
| UXT14 | CET11P |
| UXT15 | CET18P |
| UXT2 | CET8 |
| UXT3 | CET2 |
| UXT4 | CET9 |
| UXT5 | CET2 |
| UXT6 | CET8 |



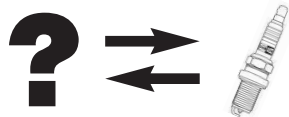

| BERU | CHAMPION | BERU | CHAMPION | BERU | CHAMPION | BERU | CHAMPION |
|--------|----------|--------|----------|--------|----------|--------|----------|
| UXT7 | CET17P | Z169 | OE015 | Z221SB | OE136 | Z255SB | OE039 |
| UXT8 | CET17P | Z16SB | OE039 | Z222 | OE255 | Z257 | OE026 |
| UXT9 | CET12P | Z17 | OE009 | Z223 | OE178 | Z257SB | OE026 |
| Z1 | OE015 | Z170 | OE146 | Z223SB | OE178 | Z27 | OE018 |
| Z10 | OE038 | Z170SB | OE146 | Z224 | OE146 | Z272 | OE177 |
| Z100 | OE057 | Z171 | OE146 | Z224SB | OE146 | Z273 | OE178 |
| Z100SB | OE057 | Z173 | OE198 | Z225 | OE089 | Z274 | OE225 |
| Z101 | OE019 | Z173SB | OE198 | Z226 | OE224 | Z275 | OE239 |
| Z103 | OE078 | Z174 | RV15YC4 | Z226SB | OE224 | Z277 | OE210 |
| Z104 | OE008 | Z176 | OE176 | Z227 | OE005 | Z278 | OE184 |
| Z105 | OE014 | Z176SB | OE176 | Z227SB | OE005 | Z279 | OE227 |
| Z10SB | OE038 | Z177 | OE031 | Z228 | OE146 | Z27SB | OE018 |
| Z11 | OE001 | Z17SB | OE009 | Z228SB | OE146 | Z28 | OE018 |
| Z116 | OE216 | Z18 | OE009 | Z229 | OE184 | Z280 | OE188 |
| Z116SB | OE216 | Z183 | OE148 | Z22SB | OE010 | Z282 | OE136 |
| Z117 | OE011 | Z183SB | OE148 | Z22SB | OE018 | Z284 | OE136 |
| Z118 | OE007 | Z184 | OE035 | Z23 | OE014 | Z285 | OE105 |
| Z118SB | OE007 | Z184SB | OE035 | Z230 | OE183 | Z286 | OE211 |
| Z11SB | OE001 | Z185 | OE222 | Z230SB | OE183 | Z287 | OE198 |
| Z12 | OE012 | Z188 | OE136 | Z233 | OE204 | Z288 | OE203 |
| Z120 | OE032 | Z188SB | OE136 | Z233SB | OE204 | Z28SB | OE018 |
| Z120SB | OE032 | Z18SB | OE009 | Z234 | OE196 | Z291 | OE230 |
| Z121 | OE032 | Z19 | OE064 | Z234SB | OE196 | Z292 | OE199 |
| Z121SB | OE032 | Z190 | OE019 | Z235 | OE238 | Z293 | OE196 |
| Z122 | OE228 | Z190SB | OE019 | Z235SB | OE238 | Z293SB | OE196 |
| Z122SB | OE228 | Z193 | OE034 | Z236 | OE234 | Z294 | OE236 |
| Z123 | OE030 | Z193SB | OE034 | Z236SB | OE234 | Z295 | OE209 |
| Z126 | OE123 | Z194 | OE217 | Z237 | OE223 | Z296 | OE131 |
| Z126SB | OE123 | Z194SB | OE217 | Z237SB | OE223 | Z297 | OE146 |
| Z127 | OE011 | Z19SB | OE064 | Z238 | OE145 | Z299 | OE039 |
| Z128 | OE123 | Z1SB | OE015 | Z238SB | OE145 | Z2SB | OE044 |
| Z129 | OE218 | Z2 | OE044 | Z23SB | OE014 | Z3 | OE004 |
| Z12SB | OE012 | Z20 | OE006 | Z24 | OE014 | Z30 | OE094 |
| Z13 | OE014 | Z200 | OE177 | Z240 | OE191 | Z301 | OE188 |
| Z130 | OE136 | Z200SB | OE177 | Z240SB | OE191 | Z302 | OE175 |
| Z13SB | OE014 | Z203 | OE198 | Z243 | OE130 | Z303 | OE035 |
| Z14 | OE026 | Z203SB | OE198 | Z243SB | OE130 | Z304 | OE077 |
| Z145 | OE237 | Z206 | OE136 | Z245 | OE030 | Z305 | OE031 |
| Z145SB | OE237 | Z206SB | OE136 | Z245SB | OE030 | Z306 | OE215 |
| Z149 | OE188 | Z207 | OE009 | Z246 | OE123 | Z307 | OE146 |
| Z14SB | OE026 | Z208 | OE019 | Z246SB | OE123 | Z308 | OE212 |
| Z15 | OE005 | Z209 | OE131 | Z247 | OE005 | Z309 | OE183 |
| Z150 | OE188 | Z209SB | OE131 | Z247SB | OE005 | Z30SB | OE094 |
| Z151 | OE227 | Z20SB | OE006 | Z248 | OE114 | Z310 | OE029 |
| Z152 | OE128 | Z21 | OE048 | Z248 | OE128 | Z310SB | OE029 |
| Z154 | OE093 | Z210 | OE122 | Z249 | OE063 | Z311 | OE192 |
| Z157 | OE089 | Z211 | OE175 | Z24SB | OE014 | Z312 | OE188 |
| Z157SB | OE089 | Z219 | OE175 | Z250 | OE002 | Z313 | OE136 |
| Z158 | OE089 | Z21SB | OE048 | Z251 | OE002 | Z314 | OE136 |
| Z158SB | OE089 | Z22 | OE010 | Z252 | OE014 | Z317 | OE136 |
| Z159 | OE136 | Z22 | OE018 | Z253 | OE094 | Z318 | OE205 |
| Z15SB | OE005 | Z220 | OE154 | Z254 | OE005 | Z32 | OE054 |
| Z16 | OE039 | Z221 | OE136 | Z255 | OE039 | Z320 | OE203 |

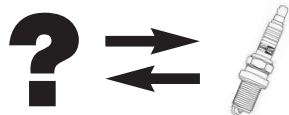

| BERU | CHAMPION |
|--------|----------|
| Z321 | OE188 |
| Z322 | OE181 |
| Z323 | OE136 |
| Z324 | OE019 |
| Z325 | OE207 |
| Z326 | OE206 |
| Z326SB | OE206 |
| Z33 | OE054 |
| Z332 | OE205 |
| Z333 | OE226 |
| Z335 | OE014 |
| Z336 | OE204 |
| Z337 | OE146 |
| Z338 | OE208 |
| Z339 | OE219 |
| Z340 | OE136 |
| Z340SB | OE136 |
| Z341 | OE122 |
| Z342 | OE189 |
| Z343 | OE191 |
| Z344 | OE235 |
| Z345 | OE220 |
| Z346 | OE188 |
| Z347 | OE214 |
| Z348 | OE246 |
| Z349 | OE213 |
| Z354 | OE136 |
| Z355 | OE233 |
| Z356 | OE029 |
| Z357 | OE232 |
| Z358 | OE199 |
| Z359 | OE229 |
| Z360 | OE077 |
| Z361 | OE197 |
| Z362 | OE201 |
| Z363 | OE242 |
| Z366 | OE245 |
| Z367 | OE246 |
| Z368 | OE247 |
| Z370 | OE253 |
| Z374 | OE256 |
| Z375 | OE257 |
| Z376 | OE258 |
| Z378 | OE260 |
| Z379 | OE261 |
| Z380 | OE262 |
| Z381 | OE263 |
| Z382 | OE264 |
| Z39 | L78C |
| Z3SB | OE004 |
| Z40 | L82C |
| Z400 | OE191 |
| Z401 | OE192 |

| BERU | CHAMPION |
|-------|----------|
| Z402 | OE131 |
| Z404 | OE195 |
| Z406 | OE131 |
| Z408 | OE184 |
| Z409 | OE131 |
| Z41 | OE038 |
| Z410 | OE105 |
| Z41SB | OE038 |
| Z42 | OE087 |
| Z42SB | OE087 |
| Z43 | OE087 |
| Z44 | OE012 |
| Z45 | OE014 |
| Z47 | OE087 |
| Z47SB | OE087 |
| Z48 | OE038 |
| Z5 | OE003 |
| Z50 | OE010 |
| Z51 | OE012 |
| Z52 | OE094 |
| Z53 | OE094 |
| Z57 | L82C |
| Z58 | OE074 |
| Z59 | OE098 |
| Z59SB | OE098 |
| Z5SB | OE003 |
| Z6 | OE009 |
| Z60 | OE077 |
| Z61 | OE001 |
| Z62 | OE001 |
| Z67 | OE011 |
| Z67SB | OE011 |
| Z68 | OE037 |
| Z69 | OE015 |
| Z6SB | OE009 |
| Z7 | OE009 |
| Z70 | OE015 |
| Z71 | OE003 |
| Z72 | OE005 |
| Z72SB | OE005 |
| Z73 | OE039 |
| Z73SB | OE039 |
| Z74 | OE019 |
| Z74SB | OE019 |
| Z75 | OE027 |
| Z76 | OE001 |
| Z76SB | OE001 |
| Z78 | OE027 |
| Z7SB | OE009 |
| Z8 | OE051 |
| Z80 | OE099 |
| Z85 | L82C |
| Z89 | OE094 |

| BERU | CHAMPION |
|---------------|----------|
| Z89SB | OE094 |
| Z9 | OE049 |
| Z90 | OE032 |
| Z90SB | OE032 |
| Z91 | OE025 |
| Z91SB | OE025 |
| Z92 | OE027 |
| Z92SB | OE027 |
| Z93 | OE027 |
| Z93SB | OE027 |
| Z94 | OE027 |
| Z94SB | OE027 |
| Z95 | OE011 |
| Z95SB | OE011 |
| Z97 | OE029 |
| Z98 | OE026 |
| Z98SB | OE026 |
| Z9SB | OE049 |
| ZM14-260 | L78C |
| BONON | CHAMPION |
| F5TC | OE065 |
| BOSCH | CHAMPION |
| 0 241 135 515 | OE247 |
| 0 241 140 519 | OE247 |
| 0 241 145 515 | OE244 |
| 0 241 219 543 | L82C |
| 0 241 219 891 | L82C |
| 0 241 225 012 | OE004 |
| 0 241 225 013 | OE001 |
| 0 241 225 544 | L82C |
| 0 241 225 545 | OE001 |
| 0 241 225 549 | L82C |
| 0 241 225 550 | OE001 |
| 0 241 225 556 | OE001 |
| 0 241 225 576 | OE027 |
| 0 241 229 059 | OE004 |
| 0 241 229 060 | OE044 |
| 0 241 229 061 | OE015 |
| 0 241 229 062 | OE015 |
| 0 241 229 565 | OE037 |
| 0 241 229 574 | OE015 |
| 0 241 229 578 | OE007 |
| 0 241 229 579 | OE074 |
| 0 241 229 588 | OE015 |
| 0 241 229 596 | OE015 |
| 0 241 229 600 | OE074 |
| 0 241 229 604 | OE037 |
| 0 241 229 612 | OE037 |
| 0 241 229 617 | OE009 |
| 0 241 229 619 | OE044 |
| 0 241 229 633 | OE044 |

| BOSCH | CHAMPION |
|---------------|----------|
| 0 241 229 634 | OE057 |
| 0 241 229 638 | OE044 |
| 0 241 229 641 | OE007 |
| 0 241 229 649 | OE009 |
| 0 241 229 650 | OE003 |
| 0 241 229 656 | OE026 |
| 0 241 229 658 | OE027 |
| 0 241 229 663 | OE027 |
| 0 241 229 665 | OE027 |
| 0 241 229 676 | OE032 |
| 0 241 229 685 | OE057 |
| 0 241 229 689 | OE228 |
| 0 241 229 704 | OE228 |
| 0 241 229 715 | OE015 |
| 0 241 229 716 | OE044 |
| 0 241 229 855 | OE007 |
| 0 241 229 857 | OE037 |
| 0 241 229 887 | OE037 |
| 0 241 229 918 | OE037 |
| 0 241 229 919 | OE007 |
| 0 241 229 923 | OE037 |
| 0 241 229 961 | OE057 |
| 0 241 235 001 | L82C |
| 0 241 235 089 | OE074 |
| 0 241 235 098 | OE074 |
| 0 241 235 102 | OE001 |
| 0 241 235 103 | OE001 |
| 0 241 235 515 | L82C |
| 0 241 235 536 | OE038 |
| 0 241 235 563 | OE001 |
| 0 241 235 564 | OE038 |
| 0 241 235 574 | OE074 |
| 0 241 235 585 | OE038 |
| 0 241 235 601 | L82C |
| 0 241 235 602 | OE001 |
| 0 241 235 607 | L82C |
| 0 241 235 609 | OE074 |
| 0 241 235 610 | OE001 |
| 0 241 235 633 | OE012 |
| 0 241 235 635 | OE009 |
| 0 241 235 636 | OE009 |
| 0 241 235 643 | OE012 |
| 0 241 235 666 | OE001 |
| 0 241 235 668 | OE009 |
| 0 241 235 675 | OE009 |
| 0 241 235 681 | OE009 |
| 0 241 235 682 | OE014 |
| 0 241 235 686 | OE026 |
| 0 241 235 690 | OE026 |
| 0 241 235 693 | OE001 |
| 0 241 235 697 | OE032 |
| 0 241 235 698 | OE025 |
| 0 241 235 705 | OE001 |



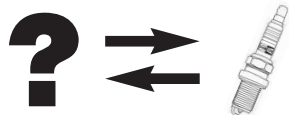

| BOSCH | CHAMPION | BOSCH | CHAMPION | BOSCH | CHAMPION | BOSCH | CHAMPION |
|---------------|-----------------|---------------|-----------------|---------------|-----------------|---------------|-----------------|
| 0 241 235 706 | OE032 | 0 242 129 521 | OE197 | 0 242 229 654 | OE019 | 0 242 235 542 | OE011 |
| 0 241 235 715 | OE176 | 0 242 129 801 | OE130 | 0 242 229 656 | OE051 | 0 242 235 544 | OE039 |
| 0 241 235 718 | OE176 | 0 242 132 800 | CET5 | 0 242 229 658 | OE027 | 0 242 235 547 | OE136 |
| 0 241 235 720 | OE136 | 0 242 132 801 | CET1 | 0 242 229 659 | OE016 | 0 242 235 549 | OE005 |
| 0 241 235 735 | OE177 | 0 242 135 501 | OE196 | 0 242 229 660 | OE039 | 0 242 235 551 | OE002 |
| 0 241 235 751 | OE026 | 0 242 135 509 | OE229 | 0 242 229 661 | OE255 | 0 242 235 566 | OE011 |
| 0 241 235 752 | OE032 | 0 242 135 510 | OE215 | 0 242 229 671 | OE019 | 0 242 235 567 | OE089 |
| 0 241 235 753 | OE009 | 0 242 135 515 | OE196 | 0 242 229 673 | OE005 | 0 242 235 587 | OE033 |
| 0 241 235 754 | OE038 | 0 242 135 515 | OE199 | 0 242 229 687 | OE049 | 0 242 235 589 | OE026 |
| 0 241 235 755 | OE001 | 0 242 135 515 | OE230 | 0 242 229 698 | OE198 | 0 242 235 592 | OE011 |
| 0 241 235 756 | OE012 | 0 242 135 524 | OE207 | 0 242 229 699 | OE198 | 0 242 235 597 | OE005 |
| 0 241 235 757 | OE025 | 0 242 135 527 | OE201 | 0 242 229 702 | OE035 | 0 242 235 602 | OE089 |
| 0 241 235 769 | OE177 | 0 242 135 529 | OE253 | 0 242 229 706 | OE032 | 0 242 235 607 | OE011 |
| 0 241 235 804 | OE038 | 0 242 135 545 | OE197 | 0 242 229 713 | OE191 | 0 242 235 609 | OE030 |
| 0 241 235 911 | OE001 | 0 242 135 802 | OE196 | 0 242 229 715 | OE198 | 0 242 235 610 | OE188 |
| 0 241 240 057 | OE010 | 0 242 140 512 | OE229 | 0 242 229 724 | OE016 | 0 242 235 615 | OE077 |
| 0 241 240 058 | OE010 | 0 242 140 530 | OE130 | 0 242 229 739 | OE189 | 0 242 235 617 | OE223 |
| 0 241 240 532 | OE038 | 0 242 145 515 | OE242 | 0 242 229 775 | OE011 | 0 242 235 624 | OE033 |
| 0 241 240 539 | OE010 | 0 242 145 518 | OE242 | 0 242 229 782 | OE019 | 0 242 235 636 | OE035 |
| 0 241 240 542 | OE014 | 0 242 145 541 | OE243 | 0 242 229 785 | OE031 | 0 242 235 640 | OE005 |
| 0 241 240 558 | OE012 | 0 242 219 516 | RV15YC4 | 0 242 229 796 | OE029 | 0 242 235 642 | OE237 |
| 0 241 240 564 | OE094 | 0 242 219 517 | RV15YC4 | 0 242 229 797 | OE178 | 0 242 235 643 | OE029 |
| 0 241 240 580 | OE014 | 0 242 222 801 | CET8 | 0 242 229 798 | OE002 | 0 242 235 644 | OE005 |
| 0 241 240 585 | OE014 | 0 242 222 802 | CET8 | 0 242 229 799 | OE032 | 0 242 235 656 | OE227 |
| 0 241 240 587 | OE014 | 0 242 222 803 | CET2 | 0 242 229 865 | OE019 | 0 242 235 658 | OE029 |
| 0 241 240 590 | OE094 | 0 242 222 804 | CET2 | 0 242 229 877 | OE031 | 0 242 235 663 | OE006 |
| 0 241 240 592 | OE094 | 0 242 225 534 | OE011 | 0 242 229 878 | OE019 | 0 242 235 664 | OE025 |
| 0 241 240 603 | L82C | 0 242 225 560 | RV15YC4 | 0 242 229 882 | OE027 | 0 242 235 665 | OE064 |
| 0 241 240 609 | OE094 | 0 242 225 573 | RV15YC4 | 0 242 229 883 | OE016 | 0 242 235 666 | OE005 |
| 0 241 242 802 | CET9 | 0 242 225 580 | OE198 | 0 242 229 884 | OE039 | 0 242 235 666 | OE034 |
| 0 241 243 501 | OE008 | 0 242 225 622 | RV15YC4 | 0 242 229 885 | OE049 | 0 242 235 667 | OE039 |
| 0 241 245 070 | OE012 | 0 242 229 530 | OE039 | 0 242 229 902 | OE031 | 0 242 235 668 | OE026 |
| 0 241 245 071 | OE087 | 0 242 229 555 | OE192 | 0 242 229 923 | OE035 | 0 242 235 690 | OE146 |
| 0 241 245 552 | OE087 | 0 242 229 566 | OE049 | 0 242 229 924 | OE032 | 0 242 235 692 | OE089 |
| 0 241 245 553 | OE038 | 0 242 229 568 | OE005 | 0 242 229 925 | OE191 | 0 242 235 699 | OE136 |
| 0 241 245 580 | L82C | 0 242 229 579 | OE184 | 0 242 229 995 | OE035 | 0 242 235 700 | OE131 |
| 0 241 245 599 | OE087 | 0 242 229 583 | OE041 | 0 242 230 500 | OE191 | 0 242 235 707 | OE048 |
| 0 241 245 602 | L82C | 0 242 229 586 | OE064 | 0 242 230 528 | OE180 | 0 242 235 715 | OE120 |
| 0 241 245 619 | OE038 | 0 242 229 587 | OE005 | 0 242 230 530 | OE189 | 0 242 235 733 | OE131 |
| 0 241 245 673 | OE246 | 0 242 229 590 | OE128 | 0 242 230 607 | OE035 | 0 242 235 740 | OE136 |
| 0 241 246 001 | OE087 | 0 242 229 591 | OE019 | 0 242 232 801 | CET2 | 0 242 235 743 | OE206 |
| 0 241 248 531 | L78C | 0 242 229 594 | OE005 | 0 242 232 802 | CET2 | 0 242 235 746 | OE029 |
| 0 241 248 540 | L78C | 0 242 229 598 | OE016 | 0 242 232 803 | CET8 | 0 242 235 748 | OE120 |
| 0 241 250 502 | OE078 | 0 242 229 605 | OE019 | 0 242 232 804 | CET8 | 0 242 235 749 | OE136 |
| 0 241 250 512 | OE078 | 0 242 229 606 | OE019 | 0 242 232 806 | CET9 | 0 242 235 749 | OE191 |
| 0 241 256 524 | OE108 | 0 242 229 613 | OE198 | 0 242 232 814 | CET7 | 0 242 235 756 | OE238 |
| 0 241 329 520 | OE054 | 0 242 229 615 | OE019 | 0 242 235 511 | OE006 | 0 242 235 758 | OE238 |
| 0 241 335 516 | OE054 | 0 242 229 626 | OE019 | 0 242 235 522 | OE064 | 0 242 235 764 | OE176 |
| 0 241 340 501 | OE054 | 0 242 229 630 | OE148 | 0 242 235 529 | OE006 | 0 242 235 766 | OE032 |
| 0 242 129 508 | OE130 | 0 242 229 634 | OE175 | 0 242 235 530 | OE048 | 0 242 235 767 | OE029 |
| 0 242 129 510 | OE130 | 0 242 229 635 | OE063 | 0 242 235 532 | OE098 | 0 242 235 776 | OE188 |
| 0 242 129 512 | OE205 | 0 242 229 648 | OE198 | 0 242 235 537 | OE006 | 0 242 235 788 | OE235 |
| 0 242 129 515 | OE201 | 0 242 229 650 | OE031 | 0 242 235 538 | OE011 | 0 242 235 791 | OE035 |

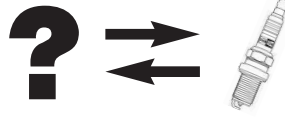

| BOSCH | CHAMPION |
|---------------|-----------------|
| 0 242 235 797 | OE035 |
| 0 242 235 894 | OE005 |
| 0 242 235 908 | OE011 |
| 0 242 235 909 | OE006 |
| 0 242 235 910 | OE025 |
| 0 242 235 911 | OE064 |
| 0 242 235 912 | OE005 |
| 0 242 235 913 | OE039 |
| 0 242 235 914 | OE026 |
| 0 242 235 915 | OE048 |
| 0 242 235 916 | OE029 |
| 0 242 235 918 | OE136 |
| 0 242 235 979 | OE011 |
| 0 242 235 981 | OE223 |
| 0 242 235 982 | OE136 |
| 0 242 235 985 | OE089 |
| 0 242 235 986 | OE089 |
| 0 242 235 987 | OE188 |
| 0 242 236 510 | OE190 |
| 0 242 236 510 | OE238 |
| 0 242 236 511 | OE136 |
| 0 242 236 512 | OE223 |
| 0 242 236 530 | OE177 |
| 0 242 236 539 | OE176 |
| 0 242 236 541 | OE089 |
| 0 242 236 542 | OE089 |
| 0 242 236 544 | OE188 |
| 0 242 236 558 | OE184 |
| 0 242 236 560 | OE011 |
| 0 242 236 562 | OE223 |
| 0 242 236 563 | OE131 |
| 0 242 236 564 | OE136 |
| 0 242 236 564 | OE146 |
| 0 242 236 565 | OE177 |
| 0 242 236 566 | OE176 |
| 0 242 236 572 | OE227 |
| 0 242 236 583 | OE146 |
| 0 242 240 511 | OE018 |
| 0 242 240 522 | OE131 |
| 0 242 240 523 | OE032 |
| 0 242 240 526 | OE014 |
| 0 242 240 528 | OE032 |
| 0 242 240 530 | OE227 |
| 0 242 240 531 | OE018 |
| 0 242 240 533 | OE180 |
| 0 242 240 548 | OE227 |
| 0 242 240 557 | OE216 |
| 0 242 240 566 | OE030 |
| 0 242 240 577 | OE014 |
| 0 242 240 584 | OE217 |
| 0 242 240 587 | OE218 |
| 0 242 240 606 | OE227 |
| 0 242 240 615 | OE136 |

| BOSCH | CHAMPION |
|---------------|-----------------|
| 0 242 240 619 | OE224 |
| 0 242 240 620 | OE183 |
| 0 242 240 621 | OE136 |
| 0 242 240 625 | OE136 |
| 0 242 240 627 | OE214 |
| 0 242 240 628 | OE222 |
| 0 242 240 635 | OE035 |
| 0 242 240 635 | OE236 |
| 0 242 240 637 | OE210 |
| 0 242 240 649 | OE146 |
| 0 242 240 650 | OE136 |
| 0 242 240 653 | OE179 |
| 0 242 240 665 | OE260 |
| 0 242 240 692 | OE181 |
| 0 242 240 849 | OE018 |
| 0 242 240 850 | OE014 |
| 0 242 242 801 | CET2 |
| 0 242 242 802 | CET8 |
| 0 242 245 515 | OE094 |
| 0 242 245 516 | OE087 |
| 0 242 245 536 | OE094 |
| 0 242 245 537 | OE087 |
| 0 242 245 539 | OE014 |
| 0 242 245 546 | OE136 |
| 0 242 245 548 | OE136 |
| 0 242 245 552 | OE087 |
| 0 242 245 556 | OE086 |
| 0 242 245 557 | OE098 |
| 0 242 245 559 | OE257 |
| 0 242 245 576 | OE214 |
| 0 242 245 581 | OE262 |
| 0 242 245 585 | OE246 |
| 0 242 245 812 | OE087 |
| 0 242 250 506 | L78C |
| 0 242 250 512 | OE087 |
| 0 242 260 001 | OE091 |
| 0 242 329 503 | OE054 |
| 0 242 329 504 | OE054 |
| 0 242 340 501 | OE054 |
| 4303 | OE191 |
| 4307 | OE192 |
| 4310 | OE192 |
| 4417 | OE180 |
| 4418 | OE194 |
| 4419 | OE193 |
| 4457 | OE183 |
| 4477 | OE195 |
| 4478 | OE195 |
| 4479 | OE195 |
| D6BC | OE054 |
| D7BC | OE054 |
| D8BC | OE054 |
| DR6BC | OE054 |

| BOSCH | CHAMPION |
|--------------|-----------------|
| DR7BC | OE054 |
| DR8BC | OE054 |
| F03DAR | OE005 |
| F03DAR | OE026 |
| F04DAR | OE013 |
| F04DAR | OE026 |
| F5DC | OE094 |
| F5DPOR | OE136 |
| F5DTC | OE094 |
| F5KPP332SBN | OE214 |
| F6DCOR | OE039 |
| F6DCO | OE014 |
| F6DCOR | OE014 |
| F6DP | OE145 |
| F6DPP332 | OE181 |
| F6DPX | OE145 |
| F6DSR | OE014 |
| F6DSR | OE039 |
| F6DTC | OE094 |
| F6DTC1 | OE039 |
| F6LTCR | OE032 |
| F6LTCR | OE094 |
| F6MPP33 | OE175 |
| F7DC | OE003 |
| F7DCO | OE003 |
| F7DCOR | OE039 |
| F7DCOR | OE014 |
| F7DPER | OE136 |
| F7DPP222T | OE136 |
| F7DTC | OE094 |
| F7HER2 | OE177 |
| F7HPP2 | OE176 |
| F7HPP22 | OE176 |
| F7HPP222 | OE176 |
| F7HPP222U | OE176 |
| F7KPP332U | OE188 |
| F7KTCR | OE032 |
| F7LDCR | OE026 |
| F7LTCR | OE032 |
| F8DC | OE057 |
| F8DCO | OE013 |
| F8DCOR | OE013 |
| F8DC4 | OE057 |
| F8DCO | OE003 |
| F8DER | OE005 |
| F8DPER | OE228 |
| F8DPP222U | OE228 |
| F8DPP33 | OE228 |
| F8DPP332 | OE228 |
| F8DPP33S | OE191 |
| F8KTCR | OE032 |
| F8KTCR | OE120 |
| F8LDCR | OE013 |

| BOSCH | CHAMPION |
|--------------|-----------------|
| F8LTCR | OE120 |
| F9DCO | OE057 |
| F9LCR2 | OE154 |
| FGR5KQE0 | OE257 |
| FGR5NQE04 | OE262 |
| FGR6KQC | OE218 |
| FGR6KQE | OE218 |
| FGR6NQE0 | OE236 |
| FGR7DQC | OE077 |
| FGR7DQE | OE120 |
| FGR7DQE+ | OE120 |
| FGR7DQE0 | OE013 |
| FGR7DQE0 | OE237 |
| FGR7DQI | OE223 |
| FGR7DQP | OE223 |
| FGR7DQP+ | OE223 |
| FGR7KQE | OE120 |
| FGR7KQE0 | OE120 |
| FGR8DQI | OE223 |
| FGR8KQC | OE198 |
| FGR8KQE | OE120 |
| FGR8KQE | OE198 |
| FGR8KQE0 | OE120 |
| FGR8KQE0 | OE198 |
| FGR8MQPE | OE175 |
| FL7HTCOR | OE235 |
| FLR7HTCO | OE235 |
| FLR8LDCU | OE019 |
| FLR8LDCU+ | OE019 |
| FLR8LDU+ | OE019 |
| FLR9LTE | OE013 |
| FQ5NPP332S | OE246 |
| FQR7ME | OE035 |
| FQR7ME | OE178 |
| FQR8DE | OE005 |
| FQR8LE2 | OE198 |
| FQR8LEU2 | OE198 |
| FR10DC | OE013 |
| FR10DCX | OE013 |
| FR10DX | OE013 |
| FR56 | CET2 |
| FR5DC | OE094 |
| FR5DCX | OE014 |
| FR5DP | OE136 |
| FR5DP1 | OE136 |
| FR5DP1X | OE136 |
| FR5DPP222 | OE146 |
| FR5DPP222U | OE146 |
| FR5DPP332 | OE146 |
| FR5DTC | OE014 |
| FR5DTC | OE026 |
| FR5KPP332S | OE214 |
| FR5NPP332S | OE246 |



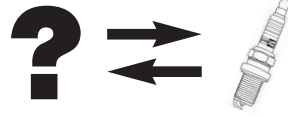

| BOSCH | | CHAMPION | BOSCH | | CHAMPION | BOSCH | | CHAMPION | BOSCH | | CHAMPION |
|------------|-------|----------|------------|-------|----------|-----------|---------|----------|------------|---------|----------|
| FR6D+ | OE014 | | FR7DPP33+ | OE191 | | FR8DII33X | OE193 | | HR10BCX | RV15YC4 | |
| FR6DC | OE014 | | FR7DPP332 | OE136 | | FR8DP | OE191 | | HR10BX | RV15YC4 | |
| FR6DC+ | OE014 | | FR7DPP332 | OE191 | | FR8DPP33 | OE191 | | HR5KI332S | OE183 | |
| FR6DC2 | OE014 | | FR7DPX | OE191 | | FR8DPP33+ | OE191 | | HR6DP | OE131 | |
| FR6DCP | OE191 | | FR7DTC | OE120 | | FR8DPX | OE191 | | HR6DPP33V | OE183 | |
| FR6DDC | OE026 | | FR7HC | OE177 | | FR8DS | OE016 | | HR6DS | OE011 | |
| FR6DP | OE191 | | FR7HC+ | OE177 | | FR8HC | OE041 | | HR6KI332S | OE183 | |
| FR6DP | OE227 | | FR7HCOX | OE089 | | FR8HC | OE128 | | HR78 | CET9 | |
| FR6DP1 | OE191 | | FR7HCOX | OE089 | | FR8HDC | OE019 | | HR78NX | CET7 | |
| FR6DP1 | OE227 | | FR7HE02 | OE177 | | FR8HDC+ | OE019 | | HR7D+ | OE011 | |
| FR6DPP22 | OE136 | | FR7HE2 | OE177 | | FR8HP | OE041 | | HR7DC | OE011 | |
| FR6DPP22U | OE136 | | FR7HPP22 | OE176 | | FR8HP0 | OE041 | | HR7DC+ | OE011 | |
| FR6DPP332S | OE222 | | FR7HPP22 | OE176 | | FR8HPX | OE041 | | HR7DC0 | OE011 | |
| FR6DPP332X | OE136 | | FR7HPP33+ | OE176 | | FR8KC+ | OE002 | | HR7DCX | OE011 | |
| FR6DPP33X | OE136 | | FR7HPP332W | OE176 | | FR8KCO | OE002 | | HR7DCX+ | OE011 | |
| FR6DPX | OE180 | | FR7KC | OE089 | | FR8KCU | OE039 | | HR7DCY+ | OE011 | |
| FR6DTC | OE032 | | FR7KC+ | OE089 | | FR8KDC | OE026 | | HR7DII33V | OE183 | |
| FR6DTCW | OE077 | | FR7KCW | OE089 | | FR8KII33X | OE193 | | HR7DP | OE131 | |
| FR6HI332 | OE213 | | FR7KCX | OE089 | | FR8KTC | OE032 | | HR7DPP22 | OE131 | |
| FR6KDO | OE217 | | FR7KCX+ | OE089 | | FR8KTC+ | OE032 | | HR7KPP33 | OE131 | |
| FR6KDE0 | OE217 | | FR7KPP33 | OE146 | | FR8LCX | OE089 | | HR7KPP33+ | OE131 | |
| FR6KI332S | OE179 | | FR7KPP33+ | OE136 | | FR8LDC | OE019 | | HR7MEW | OE031 | |
| FR6KPP33+ | OE136 | | FR7KPP332 | OE188 | | FR8LI332S | OE194 | | HR7MPP+ | OE029 | |
| FR6KPP332S | OE214 | | FR7KPP332U | OE146 | | FR8LPX | OE184 | | HR7MPP+V | OE029 | |
| FR6KPP332U | OE181 | | FR7KPP33U+ | OE188 | | FR8ME | OE035 | | HR7MPP22+ | OE029 | |
| FR6KPP33X+ | OE146 | | FR7KTC | OE032 | | FR8NEU | OE035 | | HR7MPP22U | OE029 | |
| FR6KTC | OE120 | | FR7LCX | OE089 | | FR8NII33W | OE190 | | HR7MPP22V | OE029 | |
| FR6LDC | OE030 | | FR7LCX+ | OE089 | | FR8SC | OE035 | | HR7MPP302X | OE029 | |
| FR6LDC | OE216 | | FR7LD+ | OE026 | | FR8SC+ | OE035 | | HR7NI332W | OE189 | |
| FR6LTC | OE120 | | FR7LDC | OE026 | | FR8SEO | OE035 | | HR8DPP22U | OE131 | |
| FR6MPP332 | OE224 | | FR7LDC+ | OE026 | | FR8SPP332 | OE175 | | HR8MCV+ | OE031 | |
| FR6NPP332 | OE210 | | FR7LDC4 | OE026 | | FR91 | CET2 | | HR8MEV | OE031 | |
| FR78 | CET2 | | FR7LDCU | OE026 | | FR91X | CET2 | | HR8MPV | OE029 | |
| FR78X | CET2 | | FR7LI332S | OE227 | | FR9DC | OE013 | | HR8NII332X | OE189 | |
| FR7D+ | OE005 | | FR7LPX | OE184 | | FR9LCX | OE198 | | HR8NPP302 | OE189 | |
| FR7DC | OE005 | | FR7LTC | OE120 | | FRDPP10 | OE136 | | HR91GX | RV15YC4 | |
| FR7DC+ | OE005 | | FR7ME | OE035 | | H10B | RV15YC4 | | HR9BC+ | RV15YC4 | |
| FR7DC2 | OE002 | | FR7ME | OE178 | | H56 | CET9 | | HR9BP | RV15YC4 | |
| FR7DC9 | OE005 | | FR7MPP10 | OE175 | | H6D | OE011 | | HR9BPX | RV15YC4 | |
| FR7DC0 | OE005 | | FR7MPP10 | OE206 | | H6DC0 | OE011 | | HR9DCX | OE011 | |
| FR7DCX | OE039 | | FR7NES | OE035 | | H7DC | OE009 | | MA175T7 | OE054 | |
| FR7DCX+ | OE039 | | FR7NI33 | OE190 | | H7DC0 | OE009 | | MA200T7 | OE054 | |
| FR7DE | OE005 | | FR7NI332S | OE190 | | H8DC | OE009 | | VR6NE | OE130 | |
| FR7DE2 | OE033 | | FR7NII35U | OE190 | | H8DC0 | OE009 | | VR7SPP33 | OE207 | |
| FR7DP | OE136 | | FR7NPP33 | OE238 | | H9BP | RV15YC4 | | VR8SC+ | OE130 | |
| FR7DPP | OE136 | | FR7NPP332 | OE238 | | H9BPX | RV15YC4 | | VR8SEW | OE130 | |
| FR7DPP+ | OE136 | | FR7SE | OE035 | | H9DC | OE099 | | W10A | L82C | |
| FR7DPP10 | OE136 | | FR7SE | OE238 | | H9DC0 | OE099 | | W10AC | L82C | |
| FR7DPP10 | OE191 | | FR8D+ | OE016 | | HGR7DQI | OE183 | | W10AC | OE037 | |
| FR7DPP22U | OE146 | | FR8DC | OE016 | | HGR7KQC | OE011 | | W125T1 | L82C | |
| FR7DPP22U | OE191 | | FR8DCX | OE063 | | HLR8STEX | OE255 | | W125T30 | OE001 | |
| FR7DPP33 | OE136 | | FR8DCX+ | OE063 | | HR10B | RV15YC4 | | W125T4 | L82C | |
| FR7DPP33 | OE191 | | FR8DE | OE016 | | HR10BC | RV15YC4 | | W145M1 | OE037 | |

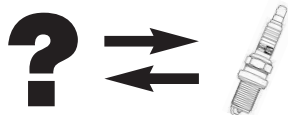

| BOSCH | CHAMPION |
|--------------|-----------------|
| W145M2 | OE074 |
| W145T1 | OE037 |
| W145T2 | OE074 |
| W145T30 | OE015 |
| W145T35 | OE007 |
| W145TR2 | OE098 |
| W175M2 | OE074 |
| W175T1 | L82C |
| W175T2 | OE074 |
| W175T27 | OE001 |
| W175T30 | OE001 |
| W175T35 | OE038 |
| W175T4 | J8C |
| W175TR2 | OE098 |
| W175TR35 | OE064 |
| W190M11S | L82C |
| W200RT27 | OE018 |
| W200RT30 | OE018 |
| W200T27 | OE010 |
| W200T30 | OE010 |
| W200T35 | OE038 |
| W215P21 | OE008 |
| W215T30 | OE010 |
| W225P11S | L82C |
| W225T1 | L82C |
| W225T2 | OE074 |
| W225T27 | OE087 |
| W225T28 | OE087 |
| W225T35 | OE038 |
| W225T7 | OE038 |
| W225TR30 | OE087 |
| W230T30 | OE087 |
| W240P11S | L78C |
| W240T1 | L78C |
| W240T2 | OE068 |
| W250P21 | OE078 |
| W250T1 | L78C |
| W260T1 | L78C |
| W260T1 | L82C |
| W260T2 | OE068 |
| W3D | OE087 |
| W3DP | OE087 |
| W3DP0 | OE087 |
| W4AC | L78C |
| W4AC | L82C |
| W4C1 | OE068 |
| W4C2 | OE068 |
| W4C3 | OE068 |
| W4CC | OE068 |
| W4CP | OE078 |
| W4CS | OE078 |
| W4DP | OE087 |
| W4DP0 | OE078 |

| BOSCH | CHAMPION |
|--------------|-----------------|
| W4DP0 | OE078 |
| W5A | L78C |
| W5AC | L82C |
| W5AS | L78C |
| W5BC | OE038 |
| W5C | OE079 |
| W5CC | OE068 |
| W5CS | OE078 |
| W5DC | OE087 |
| W5DCO | OE087 |
| W5DP0 | OE068 |
| W5DTC | OE012 |
| W6AC | L82C |
| W6AS | L82C |
| W6BC | OE038 |
| W6BP | L82C |
| W6CC | OE079 |
| W6D | OE001 |
| W6D1 | OE001 |
| W6DC | OE010 |
| W6DCO | OE010 |
| W6DP | OE001 |
| W6DP0 | OE001 |
| W6DP0 | OE008 |
| W6DTC | OE012 |
| W78X | CET8 |
| W7A | OE037 |
| W7AC | L82C |
| W7AC | OE037 |
| W7BC | OE038 |
| W7C | OE079 |
| W7CC | OE074 |
| W7CCO | OE079 |
| W7CCO | OE074 |
| W7CCX | OE098 |
| W7CX | OE079 |
| W7D | OE001 |
| W7D0 | OE001 |
| W7DC | OE001 |
| W7DCO | OE001 |
| W7DCO | OE001 |
| W7DCX | OE001 |
| W7DP | OE001 |
| W7DSR | OE001 |
| W7DTC | OE012 |
| W7DX | OE048 |
| W7EC | J8C |
| W7LTCR | OE025 |
| W8A | OE037 |
| W8AO | OE037 |
| W8AC | OE037 |
| W8AP | OE037 |
| W8AS | OE037 |

| BOSCH | CHAMPION |
|--------------|-----------------|
| W8BC | OE007 |
| W8BC | OE059 |
| W8C | OE074 |
| W8CO | OE074 |
| W8CC | OE074 |
| W8CD | OE074 |
| W8D | OE065 |
| W8DC | OE015 |
| W8DC | OE065 |
| W8DCO | OE001 |
| W8DCO | OE015 |
| W8DCX | OE015 |
| W8DCX | OE049 |
| W8DP | OE065 |
| W8DPX | OE065 |
| W8DTC | OE044 |
| W8DX | OE048 |
| W8E | J8C |
| W8LCR | OE004 |
| W8LDCR | OE027 |
| W8LTCR | OE027 |
| W95T1 | L82C |
| W95T2 | OE074 |
| W9A | OE037 |
| W9AC | L82C |
| W9AC | OE037 |
| W9ACO | OE037 |
| W9ACO | L82C |
| W9C | OE074 |
| W9CC | OE074 |
| W9CL | OE074 |
| W9DC | OE001 |
| W9DCO | OE001 |
| W9DTC | OE027 |
| W9LC | OE004 |
| WA125TR30 | OE011 |
| WA175T30 | OE009 |
| WGR7DQP | OE027 |
| WR175TR30 | OE006 |
| WR3CC | OE091 |
| WR3CTC | OE091 |
| WR4AC | L78C |
| WR4AC | OE086 |
| WR4CC | OE108 |
| WR4CP | OE108 |
| WR4DP0 | OE087 |
| WR56 | CET8 |
| WR5AC | OE086 |
| WR5AP | OE086 |
| WR5CC | OE108 |
| WR5CP | OE098 |
| WR6D+ | OE018 |
| WR6DC | OE018 |

| BOSCH | CHAMPION |
|--------------|-----------------|
| WR6DC+ | OE018 |
| WR6DC2 | OE008 |
| WR6DCX | OE077 |
| WR6DP | OE018 |
| WR6DTC | OE012 |
| WR6KI33S | OE195 |
| WR78 | CET8 |
| WR7B+ | OE064 |
| WR7BC | OE064 |
| WR7BC+ | OE064 |
| WR7CC | OE098 |
| WR7CCX | OE098 |
| WR7CP | OE098 |
| WR7CPX | OE098 |
| WR7D+ | OE006 |
| WR7DC | OE006 |
| WR7DC+ | OE006 |
| WR7DC2 | OE004 |
| WR7DCX | OE048 |
| WR7DCX+ | OE048 |
| WR7DP | OE004 |
| WR7DTC | OE044 |
| WR7KI33S | OE195 |
| WR7LC | OE004 |
| WR7LT+ | OE025 |
| WR7LTC+ | OE025 |
| WR8AC | OE037 |
| WR8D | OE042 |
| WR8D+ | OE051 |
| WR8DC | OE051 |
| WR8DC+ | OE051 |
| WR8DC4 | OE051 |
| WR8DCX | OE049 |
| WR8DCX+ | OE049 |
| WR8DP | OE192 |
| WR8LC | OE051 |
| WR8LC+ | OE051 |
| WR8LP | OE051 |
| WR8LT+ | OE027 |
| WR8LTC | OE027 |
| WR8LTC+ | OE027 |
| WR91 | CET8 |
| WR91V | OE105 |
| WR91V0 | OE105 |
| WR91X | CET8 |
| WR9D | OE051 |
| WR9D+ | OE051 |
| WR9DC | OE051 |
| WR9DC+ | OE051 |
| WR9DCX | OE049 |
| WR9DCX+ | OE049 |
| WR9DP | OE042 |
| WR9DPX | OE042 |



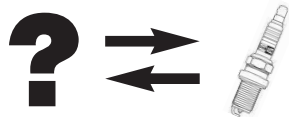



| BOSCH | | BOSNA | | BRIGGS & STRATTON | | CHAMPION | |
|--------------|-------|------------------------------|---------|------------------------------|---------|-----------------|-------|
| WR9DX | OE042 | FE55P | OE065 | 491055S | OE013 | C6BYC4/T10 | OE094 |
| X4C | OE083 | FE55PR | OE051 | 499608 | OE013 | C6VPC | OE032 |
| X4DC | OE083 | FE65CP | OE001 | 692051 | OE013 | C6VPC/103 | OE032 |
| X5DC | OE083 | FE65CPD | OE012 | 711252 | OE086 | C6YC | OE094 |
| X5DTC | OE083 | FE65CPR | OE006 | 797235 | OE051 | C6YCC | OE094 |
| XR2CS | OE073 | FE65P | OE001 | 798615 | OE065 | C6YCX | OE094 |
| XR4DC | OE083 | FE65PR | OE006 | BRISK | | C7YC | OE014 |
| XR5DC | OE083 | FE70 | OE074 | 1851 | OE240 | C7YC/184 | OE014 |
| Y5KPP332S | OE244 | FE70C | OE074 | DR15YC | OE005 | C7YCC | OE014 |
| Y6DC | OE083 | FE75 | OE079 | DR15YC1 | OE039 | C7YCC/093 | OE014 |
| Y6LERO2 | OE247 | FE75C | OE079 | DR15YCY | OE002 | C7YCX | OE014 |
| Y6NPP332 | OE229 | FE75CR | OE098 | DR15YP | OE145 | C9BMC | OE026 |
| Y7LERO2 | OE247 | FE75R | OE098 | DR15YP1 | OE145 | C9MCC | OE089 |
| YR5DDE | OE073 | FE80 | OE068 | DR15YP1 | OE145 | C9YCC | OE005 |
| YR6NPP332 | OE229 | FE80C | OE068 | DR15YPP | OE145 | C9YCC/033 | OE005 |
| YR78X | CET1 | FE80CR | OE108 | DR15YPP1 | OE145 | C9YCC/290 | OE002 |
| YR7DC | OE199 | FE80R | OE108 | DR15YS | OE002 | CCH3455 | OE204 |
| YR7DC+ | OE199 | FE85CP | OE087 | DR17YPP | OE191 | CCH450 | OE196 |
| YR7DE | OE073 | FE85CPD | OE012 | DR17YPP1 | OE191 | CCH455 | OE177 |
| YR7LPP332W | OE215 | FE85P | OE010 | DR17YS | OE016 | CCH460 | OE216 |
| YR7ME | OE197 | FE95CPR | OE087 | F 14 YC | OE054 | CCH461 | OE237 |
| YR7MPP33 | OE229 | FE95P | OE087 | F 15YC | OE054 | CCH464 | OE026 |
| YR7NE | OE201 | FE95PR | OE087 | CARLTON | | CCH465 | OE218 |
| YR7SEU | OE201 | FET65CP | OE099 | C8A | J8C | CCH488 | OE223 |
| YR8MEU | OE197 | FET65CPR | OE011 | SCR11C | OE051 | CCH7140 | OE215 |
| ZQR8S1302 | OE205 | FET75CP | OE009 | CHAMPION | | CCH7144 | OE210 |
| ZR5TPP33 | OE242 | FET75P | OE011 | 159010-03520 | OE037 | CCH7146 | OE219 |
| ZR5TPP330 | OE243 | FS50 | J8C | 159010-04120 | L82C | CCH7166 | OE214 |
| ZR5TPP33S | OE242 | FS50C | J8C | 425 | CCH425 | CCH7168 | OE222 |
| BOSNA | | FS70 | J8C | 730 | OE007 | CCH7175 | OE209 |
| F100 | L82C | FT25PR | RV15YC4 | A25 | CCH425 | CCH7190 | OE228 |
| F55CP | OE059 | FT45P | RV15YC4 | A4HC | OE073 | CCH7418 | OE238 |
| F55P | OE059 | FT45PR | RV15YC4 | A5YC | OE073 | CCH7422 | OE224 |
| F65CP | OE007 | MT65CP | OE054 | A6 | OE083 | CCH7426 | OE205 |
| F65P | OE007 | MT65P | OE054 | A6G | OE112 | CCH7428 | OE242 |
| F70 | L82C | SFE45CLR | OE041 | A6G/101 | OE112 | CCH7429 | OE243 |
| F70C | L82C | SFE45CPR | OE013 | A6HC | OE083 | CCH7445 | OE233 |
| F75C | OE037 | SFE55CPR10 | OE063 | A6Y | OE083 | CCH7600 | OE220 |
| F80 | L82C | SFE65CLR | OE089 | A6YC | OE083 | CCH7695 | OE208 |
| F80CR | OE086 | SFE65CLU | OE026 | BL13Y | RV15YC4 | CCH800 | OE212 |
| F85 | OE037 | SFE65CP | OE003 | BL15Y | RV15YC4 | CCH9069 | OE246 |
| F85CP | OE038 | SFE65CPDR | OE237 | BN89Y | OE011 | CCH9425 | OE245 |
| F85CPR | OE064 | SFE65CPDR10 | OE077 | BN9Y | OE011 | EON1/286 | CET2 |
| F85P | OE038 | SFE65CPR | OE005 | C10YCC | OE005 | EON10/286 | CET1 |
| FE100 | OE108 | SFE65CPUR | OE026 | C12YCC | OE013 | EON2/286 | CET2 |
| FE35CP | OE015 | SFE65P | OE014 | C279YC | OE014 | EON3/286 | CET9 |
| FE45CLR | OE004 | SFE85CP | OE094 | C281YC | OE003 | EON4/286 | CET7 |
| FE50 | OE074 | SFE85CPR | OE014 | C6BMC | OE094 | EON5/286 | CET8 |
| FE55CP | OE065 | SFE85CPR10 | OE014 | C6BMC/T10 | OE094 | EON6/286 | CET8 |
| FE55CP10 | OE049 | TWE65CPR | OE073 | C6BYC | OE094 | EON7/286 | CET3 |
| FE55CPD | OE044 | BRIGGS & STRATTON | | C6BYC/094 | OE094 | EON8/286 | CET4 |
| FE55CPR | OE051 | 491055 | OE013 | C6BYC4 | OE094 | EON9/286 | CET5 |
| | | | | | | F100S | L78C |

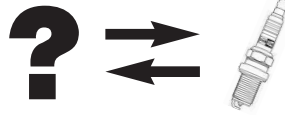



| CHAMPION |  |
|--------------|---|
| F50 | OE037 |
| F55PS | OE059 |
| F65PRS | OE064 |
| F65PS | OE007 |
| F70 | OE037 |
| F75S | L82C |
| F7Y | OE054 |
| F7YC | OE054 |
| F7YCC | OE054 |
| F805RS | OE086 |
| F80S | L82C |
| F85PS | OE007 |
| F95PS | OE007 |
| FE45P | OE015 |
| FE50 | OE074 |
| FE55LRS | OE004 |
| FE55LTXS | OE027 |
| FE55LXS | OE004 |
| FE55PRS | OE051 |
| FE55PS | OE015 |
| FE55PTS | OE044 |
| FE65LTXS | OE025 |
| FE65PP2 | OE004 |
| FE65PRP2 | OE006 |
| FE65PRS | OE006 |
| FE65PS | OE001 |
| FE65PTRS | OE012 |
| FE65PTS | OE012 |
| FE75RS | OE098 |
| FE75S | OE079 |
| FE80RS | OE108 |
| FE85PRS | OE018 |
| FE85PS | OE010 |
| FE85PTRS | OE012 |
| FE85PTS | OE012 |
| FET55PS | OE009 |
| FET65PRS | OE011 |
| FET65PS | OE009 |
| FUT55PRP2-13 | OE029 |
| J43 | J8C |
| J7 | J8C |
| J7J | J8C |
| J7JM | J8C |
| J8 | J8C |
| J8C/032 | J8C |
| J8C/053 | J8C |
| J8J | J8C |
| J8JM | J8C |
| KC11PYP | OE191 |
| L10S | L82C |
| L11S | L82C |
| L12Y | OE007 |
| L15Y | OE059 |

| CHAMPION |  |
|-----------|---|
| L287YC | OE007 |
| L288 | OE037 |
| L4J | L82C |
| L5 | L82C |
| L5J | L82C |
| L66Y | OE038 |
| L6G | L82C |
| L7 | L82C |
| L78 | L78C |
| L78C/053 | L78C |
| L78C/220 | L78C |
| L78C/R02 | L78C |
| L7J | L82C |
| L7Y | OE038 |
| L81 | L82C |
| L81Y | OE038 |
| L82 | L82C |
| L82C/053 | L82C |
| L82C/110 | L82C |
| L82C/R02 | L82C |
| L82Y | OE038 |
| L82YC/051 | OE038 |
| L82YCC | OE038 |
| L85 | L82C |
| L86 | OE037 |
| L86C/053 | OE037 |
| L86C/060 | OE037 |
| L86C/171 | OE037 |
| L86C/182 | OE037 |
| L86C/B01 | OE037 |
| L86C/R02 | OE037 |
| L86CC | OE037 |
| L87Y | OE007 |
| L87YC/051 | OE007 |
| L87YC/092 | OE007 |
| L87YCC | OE007 |
| L88 | OE037 |
| L88A | OE037 |
| L88YC | OE007 |
| L88YCC | OE007 |
| L89CM | OE037 |
| L92Y | OE059 |
| L95YC | OE059 |
| L95YC/T10 | OE059 |
| L9G | L82C |
| MT65PRS | OE054 |
| MT65PS | OE054 |
| MW5ES | OE015 |
| N10PY | OE065 |
| N10Y | OE065 |
| N10Y4 | OE049 |
| N11Y | OE065 |
| N11YC4 | OE049 |

| CHAMPION |  |
|------------|---|
| N11YCC | OE065 |
| N12Y | OE015 |
| N12YC/184 | OE015 |
| N12YCC | OE015 |
| N16YC | OE015 |
| N16YC/T10 | OE015 |
| N279YC | OE010 |
| N279YC/092 | OE010 |
| N281YC | OE001 |
| N281YC/T10 | OE001 |
| N288 | OE074 |
| N2C | OE091 |
| N3 | OE068 |
| N4 | OE079 |
| N4G | OE079 |
| N5 | OE074 |
| N5G | OE074 |
| N5M | OE074 |
| N6 | OE074 |
| N64Y | OE087 |
| N65Y | OE010 |
| N66Y | OE001 |
| N6BYC | OE012 |
| N6GY | OE087 |
| N6Y | OE087 |
| N6YCC | OE087 |
| N6YCX | OE087 |
| N7 | OE079 |
| N74C | OE001 |
| N79Y | OE010 |
| N7BMC | OE025 |
| N7BYC/033 | OE012 |
| N7BYC/094 | OE012 |
| N7BYC/184 | OE012 |
| N7BYC/C04 | OE012 |
| N7GY | OE010 |
| N7Y | OE010 |
| N7YCC | OE010 |
| N7YCX | OE010 |
| N8 | OE074 |
| N88 | OE079 |
| N89GY | OE001 |
| N89Y | OE001 |
| N8B | OE074 |
| N8GY | OE001 |
| N8Y | OE001 |
| N92Y | OE065 |
| N9BMC | OE027 |
| N9BYC4 | OE044 |
| N9Y | OE001 |
| N9YC/R17 | OE001 |
| N9YCC/033 | OE004 |
| N9YCX | OE001 |

| CHAMPION |  |
|-----------|---|
| NA10 | OE068 |
| NA8 | OE074 |
| OE001/U04 | OE001 |
| OE002/B04 | OE002 |
| OE002/T10 | OE002 |
| OE002/U04 | OE002 |
| OE003/017 | OE003 |
| OE003/R04 | OE002 |
| OE003/U04 | OE002 |
| OE004/U04 | OE004 |
| OE005/B04 | OE002 |
| OE005/R04 | OE002 |
| OE005/U04 | OE002 |
| OE006/U04 | OE006 |
| OE007/017 | OE007 |
| OE008/R04 | OE018 |
| OE008/U04 | OE018 |
| OE009/B04 | OE011 |
| OE009/R04 | OE011 |
| OE009/R17 | OE011 |
| OE010/B04 | OE018 |
| OE010/U04 | OE018 |
| OE011/B04 | OE011 |
| OE011/U04 | OE011 |
| OE012/B04 | OE012 |
| OE012/U04 | OE012 |
| OE014/R04 | OE014 |
| OE014/U04 | OE014 |
| OE015/B04 | OE015 |
| OE015/U04 | OE015 |
| OE016/U04 | OE016 |
| OE017 | OE014 |
| OE017/B04 | OE014 |
| OE017/R04 | OE014 |
| OE018/U04 | OE018 |
| OE019/U04 | OE019 |
| OE020 | OE011 |
| OE020/R04 | OE011 |
| OE020/U04 | OE011 |
| OE021/R04 | OE216 |
| OE022/T10 | OE004 |
| OE023 | OE005 |
| OE023/R04 | OE002 |
| OE023/U04 | OE002 |
| OE024 | OE039 |
| OE024/R04 | OE039 |
| OE024/U04 | OE039 |
| OE025/U04 | OE025 |
| OE026/017 | OE026 |
| OE027/U04 | OE027 |
| OE028 | OE044 |
| OE029/U04 | OE029 |
| OE030/R04 | OE030 |



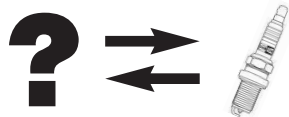

| CHAMPION | | CHAMPION | | CHAMPION | | CHAMPION | |
|-----------|-------|-----------|-------|--------------|---------|--------------|-------|
| OE031/U04 | OE031 | OE081 | OE034 | OE142 | OE073 | RC12LYC5 | OE041 |
| OE032/U04 | OE032 | OE084 | OE087 | OE142/T10 | OE073 | RC12MCC | OE154 |
| OE033/R04 | OE033 | OE085 | OE026 | OE143 | OE146 | RC12MCC/T10 | OE154 |
| OE034/O17 | OE034 | OE086/R02 | OE086 | OE144 | OE136 | RC12MCC4/T04 | OE154 |
| OE035/R04 | OE035 | OE087/R04 | OE087 | OE145/U04 | OE145 | RC12PYP | OE138 |
| OE036 | OE009 | OE088 | OE063 | OE147 | OE089 | RC12PYP/103 | OE138 |
| OE036/R04 | OE011 | OE089/R04 | OE089 | OE149 | OE191 | RC12YC/T06 | OE013 |
| OE038/R04 | OE064 | OE090/R04 | OE009 | OE149/T10 | OE191 | RC12YCC | OE013 |
| OE040 | OE091 | OE095 | OE025 | OE150 | OE122 | RC12YCC4 | OE013 |
| OE041/T04 | OE041 | OE095/R04 | OE025 | OE152 | OE034 | RC14E5 | OE041 |
| OE043 | OE014 | OE096 | OE037 | OE152/T04 | OE034 | RC6PYP | OE136 |
| OE043/T10 | OE014 | OE096/T10 | OE037 | OE152/T10 | OE034 | RC6YC | OE094 |
| OE043/U04 | OE014 | OE097 | OE004 | OE177/R04 | OE177 | RC7BMC/094 | OE216 |
| OE045/R04 | OE051 | OE100 | OE027 | OE186/R04 | OE186 | RC7BMC/290 | OE216 |
| OE045/T10 | OE051 | OE101 | OE049 | OE191/R04 | OE191 | RC7BYC | OE077 |
| OE045/U04 | OE051 | OE101/T10 | OE049 | ON11Y | OE049 | RC7YC | OE014 |
| OE046 | OE010 | OE102/T10 | OE217 | ON12Y | OE042 | RC7YC/092 | OE014 |
| OE046/T10 | OE010 | OE104 | OE038 | ON3 | OE108 | RC7YC4 | OE014 |
| OE047 | OE004 | OE106/T10 | OE065 | QL77J5 | OE086 | RC7YCC/033 | OE014 |
| OE047/R04 | OE048 | OE107 | OE077 | QN2 | OE091 | RC7YCC/093 | OE014 |
| OE047/U04 | OE048 | OE109 | OE012 | QN2C | OE091 | RC7YCC4 | OE014 |
| OE051/R04 | OE051 | OE109/T10 | OE012 | QN2G | OE091 | RC87PYC | OE136 |
| OE053 | OE054 | OE110 | OE094 | QN3 | OE108 | RC87PYC/113 | OE136 |
| OE053/T10 | OE054 | OE111 | OE051 | QN3C | OE108 | RC89PYC/113 | OE145 |
| OE054/U04 | OE054 | OE113 | OE049 | QN504YC | OE042 | RC8DMC/094 | OE026 |
| OE055 | OE015 | OE113/R04 | OE049 | R6 | OE083 | RC8DMC/C04 | OE026 |
| OE055/T10 | OE015 | OE116 | OE087 | R6G | OE083 | RC8MCC | OE089 |
| OE056 | OE014 | OE117 | OE018 | RA4GHC | OE073 | RC8MCC4 | OE089 |
| OE056/R04 | OE014 | OE118 | OE077 | RA4HCC | OE073 | RC8PYCB | OE146 |
| OE056/U04 | OE014 | OE118/T10 | OE077 | RA6 | OE083 | RC8PYX | OE034 |
| OE057/R04 | OE057 | OE119 | OE034 | RA6Y | OE083 | RC8YC | OE034 |
| OE058 | OE014 | OE119/T10 | OE034 | RA6YC | OE083 | RC8YC4 | OE034 |
| OE058/B04 | OE014 | OE120/U04 | OE120 | RBL13Y | RV15YC4 | RC8YCC | OE034 |
| OE058/R04 | OE014 | OE122/R04 | OE122 | RBL15Y | RV15YC4 | RC8YCC4 | OE034 |
| OE060 | OE004 | OE122/U04 | OE122 | RBL15Y4 | RV15YC4 | RC9BMC | OE026 |
| OE060/R04 | OE004 | OE124 | OE191 | RBN9GY | OE011 | RC9MCC | OE089 |
| OE061 | OE054 | OE124/T10 | OE191 | RBN9Y | OE011 | RC9MCC/093 | OE089 |
| OE061/T10 | OE054 | OE126 | OE136 | RC10DMC/C04 | OE019 | RC9TMC | OE120 |
| OE062 | OE016 | OE126/R04 | OE136 | RC10DMC4 | OE019 | RC9YC/092 | OE002 |
| OE062/T10 | OE016 | OE127 | OE034 | RC10ECC/052 | OE041 | RC9YC/C04 | OE002 |
| OE066 | OE089 | OE129 | OE032 | RC10PYC | OE191 | RC9YC/T04 | OE005 |
| OE066/R04 | OE089 | OE131/U04 | OE131 | RC10PYP4 | OE191 | RC9YC4/T04 | OE039 |
| OE069 | OE005 | OE132 | OE083 | RC10PYP4/T06 | OE191 | RC9YCC/033 | OE002 |
| OE070 | OE007 | OE132/T10 | OE083 | RC10VTYC4 | OE120 | RC9YCC/093 | OE002 |
| OE071 | OE064 | OE134 | OE138 | RC10YC | OE063 | RC9YCC/194 | OE002 |
| OE072 | OE011 | OE134/R04 | OE138 | RC10YC4/012 | OE063 | RC9YCC/290 | OE002 |
| OE075 | OE094 | OE135 | OE175 | RC10YCC/093 | OE016 | RC9YCC/C04 | OE002 |
| OE075/T10 | OE094 | OE136/R04 | OE136 | RC10YCC/290 | OE016 | RC9YCC4 | OE039 |
| OE076 | OE094 | OE136/U04 | OE136 | RC10YCC/C04 | OE016 | RC9YCC4/093 | OE039 |
| OE076/O17 | OE094 | OE137 | OE013 | RC10YCC4 | OE016 | RE7PYC5 | OE029 |
| OE076/R04 | OE094 | OE140 | OE089 | RC10YCL | OE033 | RE7PYC5/103 | OE029 |
| OE076/T10 | OE094 | OE140/T10 | OE089 | RC12ECC/T04 | OE041 | RE7YCC | OE031 |
| OE080 | OE014 | OE141 | OE191 | RC12LYC/T04 | OE041 | REA8MCL | OE130 |

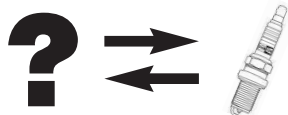

| CHAMPION | CHAMPION |
|--------------|----------|
| REC14PYC | OE175 |
| RES9PYP4/113 | OE029 |
| RES9YCC4/C04 | OE031 |
| RF7YC/092 | OE054 |
| RF7YCC | OE054 |
| RG2PHP | OE122 |
| RG4PHP/103 | OE122 |
| RG4PHP/113 | OE122 |
| RG6PP | OE122 |
| RL4J | OE086 |
| RL7J | OE086 |
| RL82 | OE086 |
| RL82C/051 | OE086 |
| RL82C/110 | OE086 |
| RL82Y | OE064 |
| RL82YC/053 | OE064 |
| RL82YC/C04 | OE064 |
| RL82YCC | OE064 |
| RL85 | OE086 |
| RN10GY | OE051 |
| RN10Y | OE051 |
| RN10Y4 | OE049 |
| RN10YC | OE051 |
| RN10YC4 | OE049 |
| RN11Y | OE051 |
| RN11YCC/093 | OE051 |
| RN11YCC4 | OE049 |
| RN12GY | OE042 |
| RN12Y | OE042 |
| RN14PMP5/T06 | OE105 |
| RN2 | OE091 |
| RN2C/053 | OE091 |
| RN2G | OE091 |
| RN3 | OE108 |
| RN3G | OE108 |
| RN4 | OE098 |
| RN4C/051 | OE098 |
| RN4G | OE098 |
| RN6GY | OE087 |
| RN6Y | OE087 |
| RN6YC | OE087 |
| RN74C | OE006 |
| RN77B | OE091 |
| RN7GY | OE018 |
| RN7LCC | OE004 |
| RN7Y | OE018 |
| RN7YC/092 | OE018 |
| RN7YC4 | OE018 |
| RN7YCC/033 | OE008 |
| RN7YCC4 | OE077 |
| RN8VTYC4/290 | OE025 |
| RN8VTYC4/C04 | OE025 |
| RN9GY | OE006 |

| CHAMPION | CHAMPION |
|-------------|----------|
| RN9LCC | OE004 |
| RN9Y | OE006 |
| RN9YC/092 | OE006 |
| RN9YC/290 | OE006 |
| RN9YC4/264 | OE048 |
| RN9YC4/290 | OE048 |
| RN9YCC/033 | OE004 |
| RN9YCC/093 | OE004 |
| RN9YCC4 | OE004 |
| RN9YCC4/093 | OE048 |
| RS9YC/092 | OE011 |
| RS9YC/290 | OE011 |
| RS9YC/C04 | OE011 |
| RS9YCC | OE011 |
| RS9YCC/033 | OE011 |
| RV15YC | RV15YC4 |
| RV15YC4/053 | RV15YC4 |
| RV15YC4/R02 | RV15YC4 |
| RV15YC4/T04 | RV15YC4 |
| S10YCC | OE011 |
| S12YCC | OE099 |
| S279YC/101 | OE009 |
| S7YC/C04 | OE009 |
| S9YCC | OE009 |
| S9YCC/093 | OE011 |
| SE12RCY | OE013 |
| SFE55LRS | OE198 |
| SFE55LXS | OE198 |
| SFE55PRS | OE005 |
| SFE55PS | OE003 |
| SFE55PTRS | OE032 |
| SFE55PTS | OE032 |
| SFE65LDRS | OE019 |
| SFE65LRS | OE089 |
| SFE65LTXS | OE032 |
| SFE65LXS | OE089 |
| SFE65PDRS | OE026 |
| SFE65PRS | OE005 |
| SFE65PS | OE003 |
| SFE65PTS | OE032 |
| SFE85LDRS | OE026 |
| SFE85LTRS | OE032 |
| SFE85PRS | OE014 |
| SFE85PTRS | OE014 |
| SFE85PTS | OE094 |
| TWE85PRS | OE073 |
| TWE85PS | OE083 |
| UBL13Y | RV15YC4 |
| UJ8 | J8C |
| UL12Y | OE007 |
| UL15Y | OE059 |
| UL82Y | OE038 |
| UN12Y | OE015 |

| CHAMPION | CHAMPION |
|----------|----------|
| UN79Y | OE010 |
| UN9Y | OE001 |
| X/T10 | CCH425 |
| XL10 | OE086 |
| XL10S | OE086 |
| XL7 | OE086 |
| XL85 | OE086 |
| XN10Y | OE049 |
| XN12Y | OE042 |
| XN3 | OE108 |
| XN4 | OE098 |
| XN9Y | OE006 |

| DENSO | CHAMPION |
|------------|----------|
| 16 | OE029 |
| 3121 | OE039 |
| 3329 | OE019 |
| 3374 | OE039 |
| 3395 | OE180 |
| 3427 | OE130 |
| 3443 | OE179 |
| 4711 | CET4 |
| 5067 | OE025 |
| D1 | OE025 |
| D110 | OE039 |
| D12 | OE005 |
| D14 | OE039 |
| D20 | OE019 |
| D21 | OE063 |
| D22 | OE002 |
| D4 | OE001 |
| D7 | OE011 |
| D76 | OE120 |
| DK20PR-D13 | OE239 |
| FK16HQR11 | OE190 |
| FK16HR11 | OE190 |
| FK20HBR11 | OE190 |
| FK20HR11 | OE190 |
| FXE16HR11 | OE240 |
| FXE20HE11 | OE240 |
| FXE20HR11 | OE240 |
| FXE22HR11 | OE233 |
| IK16 | OE145 |
| IK16 | OE180 |
| IK16TT | CET12P |
| IK20 | OE179 |
| IK20G | OE179 |
| IK20L | OE182 |
| IK20TT | CET11P |
| IK22 | OE179 |
| IK24 | OE214 |
| IKBH20TT | CET14P |
| IKH16 | OE190 |

| DENSO | CHAMPION |
|------------|----------|
| IKH16TT | CET14P |
| IKH20 | OE190 |
| IKH20TT | CET14P |
| IKH22 | OE210 |
| IKH24 | OE210 |
| IQ16TT | CET12P |
| IQ20TT | CET11P |
| IT16TT | CET18P |
| IT20 | OE183 |
| IT20TT | CET18P |
| ITV16 | OE189 |
| ITV16TT | CET17P |
| ITV20 | OE189 |
| ITV20TT | CET17P |
| IU22 | OE122 |
| IU27 | OE122 |
| IU27A | OE122 |
| IW16 | OE195 |
| IW16TT | CET8 |
| IW20 | OE195 |
| IW20TT | CET8 |
| IW22 | OE195 |
| IW24 | OE078 |
| IW24 | OE108 |
| IW27 | OE091 |
| IW31 | OE091 |
| IX24 | OE112 |
| IXEH20TT | CET4 |
| IXEH22TT | CET13P |
| IXU22 | OE187 |
| IXU24 | OE187 |
| IXU27 | OE208 |
| IXUH22I | OE263 |
| J16ARU11 | OE114 |
| J16CRU | OE004 |
| K16HPRU11 | OE148 |
| K16HPR-U11 | OE175 |
| K16HRU11 | OE148 |
| K16PR-U | OE016 |
| K16PRU11 | OE063 |
| K16PRZU11 | OE145 |
| K16PSRB8 | OE180 |
| K16RU | OE093 |
| K16RU11 | OE063 |
| K16TNR59 | OE026 |
| K16TNR-59 | OE019 |
| K16TR11 | OE019 |
| K16TT | CET2 |
| K20BRS10 | OE032 |
| K20CRL11 | OE089 |
| K20HRU11 | OE035 |
| K20HR-U11 | OE178 |
| K20PBR | OE120 |



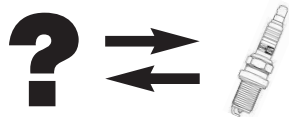

| DENSO | | CHAMPION | DENSO | | CHAMPION | DENSO | | CHAMPION | DENSO | | CHAMPION |
|--------------|-------|----------|-------------|-------|----------|-------------|---------|----------|-----------|-------|----------|
| K20PBR510 | OE032 | | PK20GR8 | OE176 | | SK20PRL9 | OE181 | | VXUH221 | OE263 | |
| K20PBR-S10 | OE120 | | PK20PR11 | OE146 | | SK20R11 | OE182 | | W14E | OE074 | |
| K20PRTPI1 | OE179 | | PK20PRL11 | OE146 | | SKJ16CRA8 | OE194 | | W14EP | OE015 | |
| K20PRU | OE005 | | PK20PRP8 | OE136 | | SKJ16CRL11 | OE176 | | W14EPRU | OE042 | |
| K20PR-U | OE002 | | PK20PTRS9 | OE136 | | SKJ16DRM11 | OE194 | | W14EXRU | OE042 | |
| K20PR-U | OE033 | | PK2OR11 | OE191 | | SKJ20CRA8 | OE213 | | W14EXU | OE015 | |
| K20PR-U11 | OE039 | | PK2OR13 | OE138 | | SKJ20DRM11 | OE239 | | W14FP | OE038 | |
| K20PRZU11 | OE191 | | PK22PR8 | OE136 | | SKJ20DRM11S | OE239 | | W14FPUL | OE059 | |
| K20PSRB8 | OE179 | | PKJ16CR8 | OE191 | | SVK20RZ11 | OE179 | | W14FU | L82C | |
| K20RU | OE089 | | PKJ16CR-L11 | OE176 | | SVK20RZ8 | OE179 | | W14FU | OE037 | |
| K20RU11 | OE089 | | PKJ20CR8 | OE213 | | SXU22HDR8 | OE250 | | W14U | J8C | |
| K20TNR | OE030 | | PKJ20CRL11 | OE146 | | SXU22PR9 | OE187 | | W14US | J8C | |
| K20TNRS | OE120 | | PT16VR13 | OE029 | | T16EPRU | OE011 | | W16EKRS11 | OE049 | |
| K20TNRS10 | OE120 | | PT16VR13 | OE031 | | T16EPR-U | OE099 | | W16EP | OE001 | |
| K20TNRS9 | OE120 | | Q14RU11 | OE039 | | T16EPRU15 | OE011 | | W16EPB10 | OE044 | |
| K20TR11 | OE026 | | Q16HRU | OE041 | | T16PRU11 | RV15YC4 | | W16EPRS11 | OE049 | |
| K20TT | CET2 | | Q16PRU11 | OE039 | | T16PU | RV15YC4 | | W16EPRU | OE051 | |
| K20TXR | OE026 | | Q16RU | OE013 | | T16TT | CET9 | | W16EPR-U | OE015 | |
| K20U11 | OE089 | | Q16RU11 | OE039 | | T16VRU10 | OE031 | | W16EPR-U | OE042 | |
| K22PB | OE094 | | Q16TT | CET2 | | T20EPRU | OE011 | | W16EPR-U | OE065 | |
| K22PBR7 | OE077 | | Q16U11 | OE057 | | T20EPR-U | OE009 | | W16EPRU10 | OE049 | |
| K22PBRS | OE077 | | Q20PRU | OE005 | | T20EPRU15 | OE011 | | W16EPRU11 | OE049 | |
| K22PRU | OE014 | | Q20PRU11 | OE039 | | T20EPU | OE009 | | W16EPU | OE065 | |
| K22PRZU | OE032 | | Q20PRZU11 | OE191 | | T20PU | OE054 | | W16EPU10 | OE049 | |
| K22PURZU11 | OE136 | | Q20PU | OE003 | | T20TT | CET9 | | W16EPZU | OE065 | |
| KH16TT | CET5 | | Q20PU11 | OE039 | | T20VRU10 | OE189 | | W16ESL | OE065 | |
| KH20TT | CET5 | | Q20RU | OE005 | | TU22 | OE122 | | W16ESL | OE074 | |
| KJ14CR11 | OE154 | | Q20RU11 | OE039 | | TV16TT | CET7 | | W16ESL11 | OE074 | |
| KJ14CRL11 | OE154 | | Q20TT | CET2 | | U22ETR | OE122 | | W16ESRL | OE051 | |
| KJ16CR11 | OE154 | | Q22PRU | OE014 | | U24ESRNZU | OE122 | | W16ESRL11 | OE049 | |
| KJ16CRL11 | OE089 | | Q22PRZU | OE191 | | VCH20 | OE253 | | W16ESU | OE074 | |
| KJ16CR-L11 | OE177 | | QJ16AARU | OE114 | | VFK20F | OE239 | | W16ETRS | OE027 | |
| KJ20CR-11 ND | OE089 | | QJ16ARU | OE128 | | VFKBH20 | OE190 | | W16EX | OE015 | |
| KJ20CRL | OE089 | | QJ16ARU11 | OE128 | | VFKH16 | OE190 | | W16EXRU | OE051 | |
| KJ20CRL11 | OE089 | | QJ16CR11 | OE154 | | VFXEH20 | OE240 | | W16EXRU11 | OE049 | |
| KJ20CR-L11 | OE089 | | QJ16HRU | OE041 | | VK16 | OE180 | | W16EXRU13 | OE049 | |
| KJ20CR-L11 | OE198 | | QJ6ARU11 | OE114 | | VK20 | OE179 | | W16EXRUA | OE051 | |
| KJ20DRM11 | OE089 | | S34 | OE180 | | VK20G | OE179 | | W16EXU | OE015 | |
| MA20PRU | OE054 | | S47 | OE179 | | VK20PRZ11 | OE179 | | W16EXU11 | OE049 | |
| P16 | OE029 | | SK16PR | OE193 | | VK20Y | OE181 | | W16EXU13 | OE049 | |
| P16PR11 | OE192 | | SK16PRA11 | OE193 | | VK22 | OE179 | | W16FPRU | OE059 | |
| P16R | OE042 | | SK16PR-A11 | OE180 | | VK22G | OE179 | | W16FPU | OE059 | |
| P16R13 | OE105 | | SK16PRE11 | OE193 | | VKB16 | OE184 | | W16FSU | OE037 | |
| P18 | OE131 | | SK16PRE13 | OE146 | | VKB20 | OE227 | | W16SU | J8C | |
| P20PR11 | OE191 | | SK16PRE13 | OE193 | | VKH16 | OE190 | | W16TT | CET8 | |
| P20PR13 | OE191 | | SK16PR-L11 | OE180 | | VKH20 | OE190 | | W17ES | OE074 | |
| P20PR8 | OE018 | | SK16R11 | OE193 | | VKH20Y | OE190 | | W17ESU | OE074 | |
| P20PRS11 | OE191 | | SK20BR11 | OE188 | | VKH22 | OE210 | | W17EV | OE074 | |
| P2OR11 | OE048 | | SK20PRA11 | OE179 | | VT20 | OE183 | | W17EWU | OE001 | |
| PK16PR-L11 | OE191 | | SK20PRA8 | OE179 | | VW16 | OE195 | | W17FU | OE037 | |
| PK16PR11 | OE191 | | SK20PRL11 | OE181 | | VW20 | OE195 | | W20EKRS11 | OE087 | |
| PK16PR-L11 | OE138 | | SK20PR-L11 | OE179 | | VXU22 | OE187 | | W20EP | OE001 | |
| PK16PRP11 | OE146 | | SK20PRL9 | OE136 | | VXU24 | OE187 | | W20EPB | OE044 | |

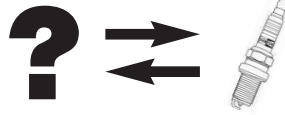

| DENSO | CHAMPION |
|-----------|----------|
| W20EPBR-S | OE025 |
| W20EPBR-S | OE027 |
| W20EPR-U | OE006 |
| W20EPRU10 | OE048 |
| W20EPRU10 | OE049 |
| W20EPRU11 | OE048 |
| W20EPRZU | OE004 |
| W20EPU | OE001 |
| W20EPU11 | OE049 |
| W20EPZU | OE001 |
| W20EPZU | OE079 |
| W20ESL | OE001 |
| W20ESL11 | OE079 |
| W20ESRL11 | OE048 |
| W20ESRL11 | OE098 |
| W20ESRU | OE098 |
| W20ESU | OE074 |
| W20ESZU | OE079 |
| W20ET | OE010 |
| W20ETL | OE027 |
| W20ETRL | OE027 |
| W20ETS | OE001 |
| W20EX | OE010 |
| W20EXRU | OE006 |
| W20EXRU11 | OE048 |
| W20EXRU13 | OE048 |
| W20EXU | OE001 |
| W20EXU11 | OE001 |
| W20EXU13 | OE001 |
| W20FP | OE038 |
| W20FPRU | OE064 |
| W20FPU | OE038 |
| W20FSU | L82C |
| W20FSZU | OE037 |
| W20TT | CET8 |
| W21ESRL11 | OE018 |
| W22EP | OE087 |
| W22EPB | OE012 |
| W22EPRS11 | OE049 |
| W22EPRU | OE018 |
| W22EPR-U | OE018 |
| W22EPRU11 | OE077 |
| W22EPU | OE087 |
| W22EPZU | OE068 |
| W22ESL11 | OE001 |
| W22ESRL | OE018 |
| W22ESRU | OE098 |
| W22ESR-U | OE079 |
| W22ESU | OE079 |
| W22ESU11 | OE079 |
| W22ESZU | OE008 |
| W22ESZU | OE079 |
| W22ETRL | OE025 |

| DENSO | CHAMPION |
|-----------|----------|
| W22EU | OE074 |
| W22EXRU | OE018 |
| W22FPRU | OE064 |
| W22FSR | OE086 |
| W22FSRU | OE086 |
| W22FSU | L82C |
| W22FSZU | OE037 |
| W22FU | OE037 |
| W22TT | CET8 |
| W24EPRU | OE087 |
| W24EPU | OE087 |
| W24ESR | OE108 |
| W24ESRU | OE108 |
| W24ESU | OE068 |
| W24ESU11 | OE068 |
| W24ESZU | OE078 |
| W24EU | OE068 |
| W24FPRU10 | OE064 |
| W24FSU | L78C |
| W24FSZU | L82C |
| W24FU | L82C |
| W25ECU | L78C |
| W27ESRU | OE091 |
| W27FSU10 | L78C |
| W27FSZU | L78C |
| W31EMRC | OE091 |
| W31ESRU | OE091 |
| WU14EU | OE074 |
| WU9EU | OE074 |
| X22EPU9 | OE083 |
| X24EPRU9 | OE083 |
| X24EPRZU9 | OE083 |
| X24EPZU9 | OE083 |
| X24ESRU | OE083 |
| X24ESU | OE083 |
| X24ESZU | OE112 |
| X24EU | OE083 |
| X24GPRU | OE083 |
| X27EPRU9 | OE073 |
| X27EPRZU9 | OE073 |
| X27EPRZU9 | OE083 |
| X27EPZU9 | OE083 |
| X31ESZU | OE073 |
| XE20HRU9 | OE130 |
| XE20HR-U9 | OE130 |
| XU22EPRU | OE083 |
| XU22EPR-U | OE199 |
| XU22EPU | OE083 |
| XU22HDR9 | OE201 |
| XU22HDR9 | OE212 |
| XU22PR9 | OE196 |
| XU22TT | CET1 |
| XU24EPRU | OE083 |

| DENSO | CHAMPION |
|-----------|----------|
| XU27EPRU | OE073 |
| XU27EPRZU | OE073 |
| XUH22TT | CET6 |
| ZK20R11 | OE182 |
| ZK20R13 | OE182 |
| ZT20EPR11 | OE183 |
| ZXE20HR13 | OE240 |
| ZXU20PR11 | OE226 |

| DUCELLIER | CHAMPION |
|-----------|----------|
| 599247 | OE087 |
| 599248 | OE010 |
| 599249 | OE010 |
| 599250 | OE001 |
| 599251 | OE015 |
| 599252 | OE001 |
| 599256 | OE038 |
| 599257 | L82C |
| 599258 | OE038 |
| 599301 | OE087 |
| 599302 | OE010 |
| 599303 | OE010 |
| 599304 | OE001 |
| 599305 | OE015 |
| 599306 | OE001 |
| 599310 | OE038 |
| 599311 | L82C |
| 599312 | OE038 |
| 599313 | OE054 |
| 599314 | OE001 |
| 599316 | L82C |
| 599323 | OE038 |
| 599330 | OE018 |
| 599331 | OE006 |
| 599528 | OE038 |

| EYQUEM | CHAMPION |
|---------------|----------|
| 0 001 355 783 | OE177 |
| 0 911 007 241 | OE014 |
| 0 911 007 303 | OE027 |
| 0 911 007 355 | OE178 |
| 0 911 007 383 | OE031 |
| 0 911 007 394 | OE191 |
| 0 911 007 395 | OE146 |
| 0 911 007 396 | OE184 |
| 0 911 007 397 | OE145 |
| 0 911 007 399 | OE234 |
| 0 911 007 400 | OE238 |
| 0 911 007 402 | OE223 |
| 0 911 007 404 | OE130 |
| 0 911 007 405 | OE204 |
| 0 911 007 406 | OE196 |
| 0 911 007 408 | OE122 |

| EYQUEM | CHAMPION |
|---------------|----------|
| 0 911 007 410 | OE203 |
| 1000 | L78C |
| 200 | L82C |
| 406 | OE037 |
| 4065 | OE037 |
| 500 | OE037 |
| 502 | OE037 |
| 550LS | OE001 |
| 550S | OE038 |
| 580L | OE074 |
| 580LS | OE015 |
| 580S | OE038 |
| 600L | OE074 |
| 600LS | OE001 |
| 600S | OE038 |
| 60L | OE074 |
| 60LS | OE015 |
| 700 | L82C |
| 705L | OE074 |
| 705S | OE038 |
| 707LS | OE010 |
| 707LSX | OE001 |
| 750 | L82C |
| 750LS | OE001 |
| 755 | L82C |
| 755LJS | OE009 |
| 755LS | OE087 |
| 755S | OE038 |
| 755SX | OE038 |
| 755X | L82C |
| 75806 | OE216 |
| 75LS | OE001 |
| 800LS | OE010 |
| 80266 | OE014 |
| 805LP | OE078 |
| 805LPA | OE078 |
| 80LS | OE010 |
| 850 | L82C |
| 850LS | OE087 |
| A100 | OE178 |
| A179 | OE031 |
| A183 | OE177 |
| A188 | OE184 |
| A189 | OE204 |
| A190 | OE196 |
| A191 | OE238 |
| A192 | OE234 |
| A193 | OE223 |
| A194 | OE145 |
| A195 | OE191 |
| A197 | OE130 |
| A199 | OE122 |
| A500 | OE203 |



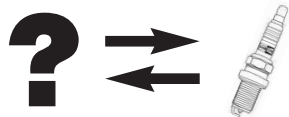





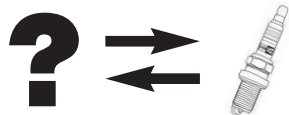



| ELYQUEM | CHAMPION | ELYQUEM | CHAMPION | ELYQUEM | CHAMPION | HIRIH | CHAMPION |
|--------------|----------|-------------|----------|---------------------------|----------|-----------------|----------|
| A71 | OE014 | RC72LS5 | OE018 | RFN62LZDP5 | OE136 | H14F9RTC | OE087 |
| C30LS | OE001 | RC82LS | OE087 | RKC52JS | OE054 | H14F9TC | OE087 |
| C32 | OE037 | RFC42HZDP5 | OE175 | RKC62JS | OE054 | H14F9TJC | OE012 |
| C32LS | OE001 | RFC42LS | OE005 | RWC52HSK | OE130 | H14K5RTC | OE013 |
| C32S | OE007 | RFC42LS2E | OE019 | RXC58HSEDP | OE203 | H14K6RFC | OE041 |
| C42 | L82C | RFC42LS5 | OE039 | RXC62HSEDP | OE204 | H14K6RLC-10 | OE114 |
| C42LJS3 | OE009 | RFC42LZ2E | OE019 | RZC58LS | OE196 | H14K6RTC | OE016 |
| C42S | OE038 | RFC42LZDP | OE184 | XKC62JS | OE054 | H14K6RTC-10 | OE063 |
| C52LJS | OE009 | RFC50LZ2E | OE019 | XRC52JS | OE054 | H14K6TC | OE057 |
| C52LS | OE001 | RFC52LS | OE005 | GPG GATEWAY | CHAMPION | H14K7RLC-10 | OE089 |
| C52LS3X | OE044 | RFC52LS2E | OE026 | 6082025 | L82C | H14K7RTC | OE005 |
| C62 | L82C | RFC52LS3 | OE120 | 8004025 | OE079 | H14K7RTC-10 | OE039 |
| C62LJS | OE009 | RFC52LS5 | OE039 | HERCULES | CHAMPION | H14K7TC | OE003 |
| C62LS | OE001 | RFC52LSP | OE146 | 029 808 70 06 | L82C | H14K8RTC | OE014 |
| C62LS3X | OE012 | RFC52LZDP | OE227 | 099 800 40 01 | L82C | H14K8RTJC | OE077 |
| C62S | OE038 | RFC52LZDP5 | OE188 | HERTH+BUSS ELPARTS | CHAMPION | H14K9RTC | OE094 |
| C72 | L78C | RFC58HZEDP5 | OE238 | LOPK 20R13 | OE188 | H14K9TC | OE094 |
| C72LS | OE010 | RFC58LS | OE014 | HIRIH | CHAMPION | H14P4RTC-10 | RV15YC4 |
| C72LS3X | OE012 | RFC58LS2E | OE026 | H12D6TC | OE083 | H14P5RTC | RV15YC4 |
| C82LS | OE087 | RFC58LS3 | OE077 | H12D8C | OE112 | H14P5RTC-10 | RV15YC4 |
| C82LS3X | OE012 | RFC58LS3X | OE077 | H12D8RTC | OE083 | H14P5TC | RV15YC4 |
| FC42LS | OE003 | RFC58LZ | OE002 | H12D8TTC | OE073 | H14Q6TC | OE009 |
| FC52LS | OE003 | RFC58LZ2 | OE030 | H12D8TC | OE073 | H14Q7RTC | OE011 |
| FC58LS3X | OE077 | RFC58LZ2E | OE026 | H12DK7RTC | OE073 | H14Q7RTC-15 | OE011 |
| FC62LS | OE014 | RFC58LZ3EX | OE032 | H14E11C | L78C | H14Q7TC | OE009 |
| FC62LS3X | OE094 | RFC58LZ5 | OE089 | H14E6TC | OE059 | H14Q7TC-15 | OE009 |
| FN42LZDPR5 | OE191 | RFC58LZDP | OE136 | H14E7RC | OE086 | H18T7TC | OE054 |
| FN52LS | OE003 | RFC58LZE5 | OE089 | H14E8C | L82C | H18T8TC | OE054 |
| FN62LZFDPR2A | OE234 | RFC58LZF5 | OE089 | H14E9C | L82C | HITACHI | CHAMPION |
| K450JS | OE054 | RFC58LZK | OE005 | H14E9RC | OE086 | L 44 P | OE087 |
| K550JS | OE054 | RFC58LZP | OE136 | H14F10RC | OE108 | L 45 PW | OE010 |
| KC52JS | OE054 | RFC58LZP4 | OE223 | H14F10RC | OE091 | L 45 PW-11 | OE001 |
| KC62JS | OE054 | RFC62LS | OE014 | H14F11RC | OE042 | L 45 PX | OE001 |
| N43 | OE038 | RFC62LS3 | OE077 | H14F5RTC | OE042 | L 45 W | OE074 |
| R850 | L78C | RFC62LS3X | OE094 | H14F5TC | OE065 | L 45 X | OE074 |
| RC42HJS3E5 | OE031 | RFC62LZ2 | OE237 | H14F6C | OE074 | L 46 X | OE074 |
| RC42S | OE064 | RFC62LZ3E | OE032 | H14F6RTC | OE051 | M 43 W | L78C |
| RC52LJS | OE011 | RFC62LZ3EX | OE094 | H14F6RTC-10 | OE049 | M 44 | L82C |
| RC52LJS5 | OE011 | RFC72LS | OE094 | H14F6TC | OE065 | M 44 P | OE038 |
| RC52LS5 | OE049 | RFC82LS | OE094 | H14F6TC-10 | OE049 | M 44 W | L82C |
| RC52LZ3EX | OE027 | RFC82LS3 | OE014 | H14F6TJC | OE044 | M 45 | L82C |
| RC52LZE | OE004 | RFN42LZG5 | OE128 | H14F7C | OE079 | M 45 PW | L82C |
| RC58LZ3EX | OE025 | RFN42LZP | OE145 | H14F7RC | OE098 | M 46 | L82C |
| RC62HJS6 | OE031 | RFN52HZ | OE148 | H14F7RLC | OE004 | ISOLATOR | CHAMPION |
| RC62HJSDP | OE029 | RFN52HZ3A | OE178 | H14F7RLC-10 | OE004 | FM.14-145/2 | OE065 |
| RC62HJSP | OE029 | RFN52LZ | OE016 | H14F7RTC-10 | OE048 | FM.14-175/2 | OE001 |
| RC62LJS | OE011 | RFN52LZDPF5 | OE176 | H14F7TC | OE001 | M.14-125 | OE037 |
| RC62LS | OE006 | RFN58HZ | OE035 | H14F7TJC | OE012 | M.14-145 | OE037 |
| RC62LS5 | OE048 | RFN58LZ | OE033 | H14F8RTC | OE018 | M.14-175 | OE037 |
| RC62S | OE038 | RFN58LZ | OE034 | H14F8RTC-10 | OE077 | M.14-225/2 | OE079 |
| RC72 | L78C | RFN58LZDP5 | OE146 | H14F9C | OE068 | M.14-240/2 | OE068 |
| RC72LJS | OE011 | RFN59HZ | OE035 | H14F9RC | OE108 | | |
| RC72LS | OE018 | RFN62LZ | OE014 | | | | |









| ISOLATOR  | |
|---|---|
| PM.14-145 | OE059 |
| JF |  |
| D8TC | OE083 |
| E7C | L82C |
| F7TC | OE001 |
| K6RTC | OE005 |
| K6TC | OE003 |
| K7DC | OE003 |
| KLG |  |
| F100 | L82C |
| F70 | L82C |
| F80 | L82C |
| FE100 | OE068 |
| FE50 | OE074 |
| FE70 | OE074 |
| FE80 | OE074 |
| TFS50 | J8C |
| KREIDLER |  |
| 08 1103 | L82C |
| 215 02 03 | L82C |
| LETRIKA |  |
| F 100 S | L78C |
| F 50 | OE037 |
| F 55 PS | OE007 |
| F 65 P | OE038 |
| F 65 PRS | OE064 |
| F 65 PS | OE038 |
| F 70 | L82C |
| F 70 | OE037 |
| F 80 S | L82C |
| F 85 PS | OE038 |
| F 95 PS | OE038 |
| F.70/M75 | OE037 |
| FE 45 P | OE001 |
| FE 55 P | OE001 |
| FE 55 PS | OE015 |
| FE 55 PTS | OE044 |
| FE 65 P | OE001 |
| FE 65 PRS | OE006 |
| FE 65 PS | OE001 |
| FE 65 PTS | OE012 |
| FE 75 RS | OE098 |
| FE 75 S | OE074 |
| FE 85 PRS | OE018 |
| FE 85 PS | OE010 |
| FE 85 PTS | OE012 |
| FET 55 PS | OE009 |
| FET 65 PRS | OE011 |
| FET 65 PS | OE009 |
| M.14-145 | OE037 |





| LETRIKA  | |
|--|---|
| M.14-225 | L82C |
| MT 65 RS | OE054 |
| SFE 55 PS | OE057 |
| SFE 65 PRS | OE005 |
| SFE 65 PS | OE001 |
| SFE 85 PRS | OE014 |
| SFE 85 PS | OE014 |
| SFE 85 PTS | OE094 |
| LODGE |  |
| 25HL | OE087 |
| 25HLD | OE094 |
| 25HLE | OE087 |
| 2HL | OE012 |
| 2HLDR | OE014 |
| 2HLE | OE079 |
| 2HLN | OE068 |
| 3HLNY | OE087 |
| 3HN | L82C |
| CAN | J8C |
| CB14 | OE074 |
| CL14 | OE074 |
| CLN | OE074 |
| CLN-H | OE074 |
| CLN-P | OE074 |
| H14 | L82C |
| H14S | L82C |
| HBLT | OE009 |
| HH14 | L82C |
| HHN | L82C |
| HL | OE001 |
| HL14 | OE074 |
| HLD | OE003 |
| HLN | OE074 |
| HLNP | OE074 |
| HN | L82C |
| HNP | L82C |
| L6Y | OE001 |
| RL47 | OE068 |
| MAGNETI MARELLI |  |
| 45LDC | OE057 |
| 6LC1R | OE063 |
| 6LDCR | OE016 |
| 7 LC | OE014 |
| 7 LCR | OE014 |
| 75LMCR | OE030 |
| 7LC | OE003 |
| 7LC1R | OE039 |
| 7LCR | OE005 |
| 8LCR | OE014 |
| 8LDC | OE014 |
| 9LC | OE094 |

| MAGNETI MARELLI  | |
|--|-------|
| 9LCR | OE094 |
| 9LMC | OE094 |
| CW 5 N | L82C |
| CW 55 N | L82C |
| CW 6 L | OE074 |
| CW 6 LP | OE015 |
| CW 6 N | L82C |
| CW 6 NP | OE038 |
| CW 7 LP | OE001 |
| CW 7 N | L78C |
| CW 7 NJ | L78C |
| CW 7 NP | OE038 |
| CW 78 LP | OE010 |
| CW 8 LP | OE087 |
| CW 8 LPS | OE087 |
| CW 8 N | L78C |
| CW 8 NP | OE038 |
| CW 89 LP | OE087 |
| CW5N | OE037 |
| CW78LPR | OE018 |
| CW8LPR | OE018 |
| CWP 7 L | OE010 |
| F 6 NC | OE038 |
| F 7 LCR | OE006 |
| F45LCR | OE051 |
| F4LCR | OE042 |
| F6LMC1R | OE027 |
| F75LMC1R | OE025 |
| F7LC | OE001 |
| F7LC1R | OE048 |
| F7LDCR | OE004 |
| F7LMC | OE044 |
| F7LSC | OE027 |
| F8LCR | OE018 |
| F8LDCR | OE008 |
| F8LNCR | OE004 |
| F8LSC | OE025 |
| F9LC | OE087 |
| F9LDCR | OE094 |
| FC7N | L82C |
| FC7NR | OE086 |
| FL7MCR | OE012 |
| FL8LCR | OE018 |
| L10BPCPR | OE122 |
| L10CR | OE073 |
| L10DCR | OE186 |
| L6LPYCR | OE136 |
| L6LSCR | OE019 |
| L75LMC1R | OE032 |
| L75LSCR | OE026 |
| L7LCR | OE005 |
| L7LDCR | OE002 |
| L8LCR | OE014 |

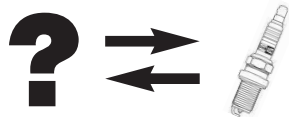
| MAGNETI MARELLI  | |
|--|---|
| L8LDC1R | OE014 |
| L8LDCR | OE014 |
| L9LPCPR | OE136 |
| L9LSPYC | OE032 |
| T7LC | OE009 |
| T7LCR | OE011 |
| T7LDCR | OE011 |
| TW7LP | OE009 |
| MIGHTY |  |
| M4E4 | OE037 |
| M4G22 | OE001 |
| M4G3 | OE074 |
| M4G32A | OE065 |
| M4G4 | OE074 |
| M4GR32 | OE049 |
| M4GR42 | OE042 |
| M4GR52 | OE042 |
| M4RF52 | RV15YC4 |
| MOPAR PARTS |  |
| 3874934 | RV15YC4 |
| 4091713 | OE042 |
| 4106122 | OE001 |
| 4106129 | OE051 |
| 4318130 | OE065 |
| 4318131 | OE049 |
| 4339413 | RV15YC4 |
| 4339491 | J8C |
| 4504278 | OE011 |
| 4504279 | OE039 |
| 4609040 | OE128 |
| 4671057 | OE005 |
| 4727114 | OE105 |
| 4796779 | OE191 |
| 4864462 | OE013 |
| 4864463 | OE049 |
| 5213693 | OE042 |
| 5234975 | OE011 |
| 5369556 | OE039 |
| 56006240 | OE013 |
| 56027275 | OE041 |
| 82300312 | OE108 |
| 82300313 | OE039 |
| MOTORCRAFT |  |
| 1Y00-18-110 | OE051 |
| 1Y03-18-110 | OE049 |
| 1Y07-18-110 | OE002 |
| 1Y09-18-110 | OE063 |
| 1Y0F-18-110 | OE083 |
| 1Y0G-18-110 | OE089 |
| 1Y0H-18-110 | OE089 |
| 1Y0K-18-110 | OE049 |





| MOTORCRAFT  | | MOTORCRAFT  | | MOTORCRAFT  | | MOTORCRAFT  | |
|--|---------|--|-------|--|-------|--|---------|
| 1YOL-18-110 | OE114 | AG1C | OE068 | AGPS 12 C | OE094 | AGSF22C | OE011 |
| 1YR1-18-110 | OE002 | AG1CX | OE068 | AGPS 12 C 1 | OE094 | AGSF22FCM | OE131 |
| 1YR7-18-110 | OE002 | AG1X | OE068 | AGPS 12 P 1 | OE136 | AGSF22FE13J | OE131 |
| 1YR9-18-110 | OE063 | AG2 | OE079 | AGPS 22 C | OE014 | AGSF22PP | OE131 |
| 1YRF-18-110 | OE083 | AG22 | OE001 | AGPS 32 C 1 | OE039 | AGSF22PPJ | OE131 |
| 1YRG-18-110 | OE089 | AG224 | OE001 | AGPS 44 F11J | OE176 | AGSF22WM | OE131 |
| 1YRH-18-110 | OE089 | AG22-4 | OE001 | AGPS22C | OE005 | AGSF32WM | OE183 |
| A5 | J8C | AG22C | OE001 | AGPS22CD | OE014 | AGSF32WM1 | OE183 |
| A5X | J8C | AG25 | OE001 | AGPS22P1 | OE136 | AGSP 092 P | OE136 |
| A7 | J8C | AG2C | OE079 | AGPS22PP1 | OE136 | AGSP 32 | OE014 |
| A7C | J8C | AG2X | OE079 | AGR 12 C | OE087 | AGSP 32 C | OE014 |
| A7CX | J8C | AG3 | OE074 | AGR 22 | OE006 | AGSP 33 C | OE089 |
| A7X | J8C | AG32 | OE065 | AGR 22 BC | OE018 | AGSP22C | OE013 |
| AE 2 | L78C | AG32A | OE065 | AGR 22 C | OE006 | AGSP22YE11 | OE182 |
| AE 22 | OE038 | AG32C | OE065 | AGR 22-3 C | OE018 | AGSP22YE13 | OE182 |
| AE 3 | L82C | AG3C | OE074 | AGR 252 C | OE006 | AGSP32 | OE013 |
| AE 32 | OE038 | AG3X | OE074 | AGR12 | OE018 | AGSP32C | OE013 |
| AE 4 | L82C | AG4 | OE074 | AGR12C | OE018 | AGSP33C | OE014 |
| AE 42 | OE038 | AG5 | OE074 | AGR1X | OE108 | AGSP52 | OE013 |
| AE 52 | L82C | AG7 | OE074 | AGR21 | OE098 | AGSP52C | OE013 |
| AE 6 | L82C | AG901C | OE068 | AGR2C | OE098 | AGSP54 | OE041 |
| AE 62 | L82C | AG902 | OE087 | AGR2X | OE098 | AGSP54C | OE041 |
| AE 82 | L82C | AGF22 | OE009 | AGR32 | OE049 | AJFS 32 CJ | OE031 |
| AE091 | L78C | AGF22C | OE009 | AGR32C | OE051 | ARF52 | RV15YC4 |
| AE1X | L78C | AGFS 22 C | OE011 | AGR42 | OE042 | ASF52 | RV15YC4 |
| AE2 | L82C | AGFS 22 C 1 | OE011 | AGR42C | OE042 | ASF52C | RV15YC4 |
| AE2X | L82C | AGFS 22 F 13J | OE183 | AGR52 | OE042 | ASWF32F | OE131 |
| AE3 | L82C | AGFS 22 IPJ | OE131 | AGRF 22 | OE011 | AT6 | J8C |
| AE3X | L82C | AGFS 32 C 1 | OE011 | AGRF 22 C | OE011 | AV1X | L78C |
| AE3XF | L82C | AGFS22CM1 | OE131 | AGRF 22 C 1 | OE011 | AV2X | L82C |
| AE4 | OE037 | AGN 42 | OE015 | AGRF 22 CD | OE011 | AV4 | OE037 |
| AE42 | OE059 | AGP 22 C | OE014 | AGRF 22 CD 1 | OE011 | AWRF 42 | OE011 |
| AE4C | OE037 | AGP 22 CD | OE014 | AGRF 32 C 1 | OE011 | AWSF 32 | OE009 |
| AE4X | OE037 | AGP22C | OE003 | AGRF2 | OE011 | AWSF 32 C | OE009 |
| AE6 | OE037 | AGPR 12 C | OE094 | AGRF22 | OE011 | AWSF 42 | OE011 |
| AE62 | OE059 | AGPR 12 C 1 | OE094 | AGRF22C | OE011 | AWSF 42 C | OE011 |
| AE8 | OE037 | AGPR 12 P | OE136 | AGRF22D1 | OE131 | AWSF 52 | OE011 |
| AER 32 | OE064 | AGPR 22 C | OE014 | AGRF22DD1 | OE131 | AWSF 52 C | OE011 |
| AER22 | OE086 | AGPR 22 CD | OE014 | AGRF22P1 | OE029 | AWSF22C | OE011 |
| AER2X | OE086 | AGPR 22 P 1 | OE136 | AGRF22PP | OE131 | AWSF22FS | OE131 |
| AF52 | RV15YC4 | AGPR 22 PP | OE136 | AGRF22PP1 | OE131 | AWSFA12C | OE011 |
| AF52C | RV15YC4 | AGPR 22 PPJ | OE136 | AGS 22 C | OE006 | AYFS 22 C | OE031 |
| AG 12 C | OE087 | AGPR 32 C | OE005 | AGS12 | OE018 | AYFS 22 CB | OE031 |
| AG 12 Racing | OE087 | AGPR 32 C 1 | OE039 | AGS12C | OE018 | AYFS 22 CJ | OE031 |
| AG 2 | OE074 | AGPR 32 CD | OE005 | AGS1C | OE108 | AYFS 22 F | OE029 |
| AG 22 | OE010 | AGPR 32 CD 1 | OE039 | AGS2C | OE098 | AYFS 22 FM | OE029 |
| AG 22 C | OE010 | AGPR 32 PD | OE198 | AGS32C | OE042 | AYFS 22 PP 1 | OE029 |
| AG 3 | OE074 | AGPR12C | OE014 | AGS42C | OE042 | AYFS 32 CJ | OE031 |
| AG 32 | OE001 | AGPR22C | OE005 | AGS52C | OE042 | AYFS092FEC | OE029 |
| AG 42 | OE001 | AGPR22CD | OE014 | AGSF 22 FE13J | OE131 | AYFS22C | OE031 |
| AG 52 | OE015 | AGPR22P | OE145 | AGSF 22 FSCM | OE131 | AYFS22CB | OE031 |
| AG091 | OE018 | AGPR32C1 | OE014 | AGSF 22 PPJ | OE131 | AYFS22F1 | OE029 |
| AG092C | OE087 | AGPR902C | OE094 | AGSF2 | OE011 | AYFS22PP | OE029 |



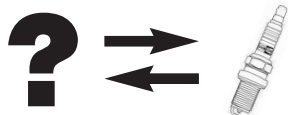

| MOTORCRAFT | CHAMPION |
|------------|----------|
| AYFS22PP1 | OE029 |
| AYFS32CJ | OE031 |
| AYRF 22 FF | OE029 |
| AYRF 22 PP | OE029 |
| AYRF22PP | OE029 |
| AZFS22C | OE031 |
| BF 22 | OE054 |
| BF 22 C | OE054 |
| BF 22 CX | OE054 |
| BF 32 | OE054 |
| BF 32 C | OE054 |
| BF 32 CX | OE054 |
| BF 42 | OE054 |
| BFS 22 C | OE054 |
| BFS 32 C | OE054 |
| BFS 32 C1 | OE054 |
| BRF 22 | OE054 |
| BRF 22 C | OE054 |
| BRF 22 CX | OE054 |
| BRF 22 X | OE054 |
| BRF 32 | OE054 |
| BRF 32 C | OE054 |
| BRF 32 CX | OE054 |
| BRF 32 X | OE054 |
| BRF 42 | OE054 |
| BRF 42 C | OE054 |
| BRF 42 X | OE054 |
| BSF 42 | OE054 |
| CYFS12VN4 | OE031 |
| HG2 | OE083 |
| HGS22C | OE083 |
| NCOSP | CHAMPION |
| D8TC | OE083 |
| E7C | L82C |
| F7TC | OE001 |
| K6RTC | OE005 |
| K6TC | OE003 |
| K7DC | OE003 |
| NEWSTAR | CHAMPION |
| D6TC | OE083 |
| D8C | OE112 |
| D8RTC | OE083 |
| D8TC | OE083 |
| DK7RTC | OE073 |
| E11C | L78C |
| E6C | OE037 |
| E6TC | OE059 |
| E7C | OE037 |
| E8C | L82C |
| E9C | L82C |
| E9RC | OE086 |

| NEWSTAR | CHAMPION |
|----------|----------|
| F10RC | OE108 |
| F11RC | OE091 |
| F5RTC | OE042 |
| F5RTC-15 | OE042 |
| F5TC | OE065 |
| F6C | OE074 |
| F6RTC | OE051 |
| F6RTC-10 | OE049 |
| F6TC | OE065 |
| F6TC-10 | OE065 |
| F6TJC | OE044 |
| F7C | OE079 |
| F7RC | OE098 |
| F7RLC | OE004 |
| F7RLC-10 | OE004 |
| F7RTC-10 | OE048 |
| F7TC | OE001 |
| F7TJC | OE044 |
| F8RTC | OE018 |
| F8RTC-10 | OE077 |
| F9C | OE068 |
| F9RC | OE108 |
| F9RTC | OE087 |
| F9TC | OE087 |
| F9TJC | OE012 |
| G5C | J8C |
| K5FC | OE041 |
| K5RTC | OE013 |
| K6RFC | OE041 |
| K6RLC-10 | OE114 |
| K6RTC-10 | OE063 |
| K6TC | OE057 |
| K7RLC-10 | OE089 |
| K7RTC | OE005 |
| K7RTC-10 | OE039 |
| K7RTJC | OE077 |
| K7TC | OE003 |
| K8RTC | OE014 |
| K9RTC | OE094 |
| K9TC | OE094 |
| P5RTC | RV15YC4 |
| P5RTC-10 | RV15YC4 |
| P5TC | RV15YC4 |
| Q6TC | OE099 |
| Q7RTC | OE011 |
| Q7RTC-15 | OE011 |
| Q7TC | OE009 |
| Q7TC-15 | OE009 |
| T8TC | OE054 |
| NGK | CHAMPION |
| 0005 | OE031 |
| 1041 | OE089 |

| NGK | CHAMPION |
|------|----------|
| 1052 | OE037 |
| 1086 | OE057 |
| 1091 | OE001 |
| 1092 | OE064 |
| 1094 | OE011 |
| 1095 | OE094 |
| 1098 | OE086 |
| 1111 | OE079 |
| 1127 | RV15YC4 |
| 1128 | OE018 |
| 1142 | OE018 |
| 1145 | OE016 |
| 1149 | OE018 |
| 1154 | OE049 |
| 1179 | OE186 |
| 1183 | OE011 |
| 1208 | OE238 |
| 1212 | OE048 |
| 1263 | OE012 |
| 1266 | OE016 |
| 1269 | OE005 |
| 1272 | OE014 |
| 1273 | OE063 |
| 1283 | OE014 |
| 1313 | OE180 |
| 1314 | OE179 |
| 1496 | OE179 |
| 1497 | OE195 |
| 1498 | OE180 |
| 1501 | OE190 |
| 1511 | OE189 |
| 1516 | OE183 |
| 1565 | OE184 |
| 1567 | OE120 |
| 1578 | OE201 |
| 1632 | OE146 |
| 1640 | OE190 |
| 1662 | OE063 |
| 1664 | OE176 |
| 1667 | OE016 |
| 1669 | OE148 |
| 1675 | OE214 |
| 1691 | OE196 |
| 1748 | OE188 |
| 1989 | OE250 |
| 2023 | OE018 |
| 203 | L82C |
| 204 | L82C |
| 2042 | OE009 |
| 2046 | OE078 |
| 205 | L78C |
| 206 | OE010 |
| 2074 | OE128 |

| NGK | CHAMPION |
|------|----------|
| 2075 | OE063 |
| 2077 | OE091 |
| 2078 | OE094 |
| 2081 | OE004 |
| 2087 | OE093 |
| 2095 | OE026 |
| 2097 | OE191 |
| 2127 | OE054 |
| 2129 | L82C |
| 214 | OE064 |
| 2145 | OE091 |
| 2164 | OE014 |
| 2171 | OE091 |
| 2175 | OE001 |
| 2197 | OE120 |
| 2202 | OE187 |
| 2213 | OE026 |
| 2215 | OE227 |
| 2251 | OE136 |
| 2262 | OE154 |
| 2268 | OE006 |
| 2285 | OE015 |
| 2287 | OE044 |
| 2288 | OE026 |
| 2300 | OE138 |
| 2316 | OE073 |
| 2317 | OE114 |
| 2330 | OE005 |
| 2341 | OE146 |
| 2347 | OE195 |
| 2355 | OE016 |
| 2357 | OE087 |
| 2358 | OE065 |
| 2363 | OE083 |
| 2364 | OE015 |
| 2382 | OE063 |
| 2397 | OE032 |
| 2412 | OE010 |
| 2412 | OE018 |
| 2417 | L82C |
| 2417 | OE037 |
| 2421 | L82C |
| 2423 | RV15YC4 |
| 2460 | OE063 |
| 2467 | OE029 |
| 2470 | OE027 |
| 2477 | OE194 |
| 2499 | OE089 |
| 2513 | OE223 |
| 2526 | OE093 |
| 2527 | RV15YC4 |
| 2528 | OE018 |
| 2530 | OE048 |



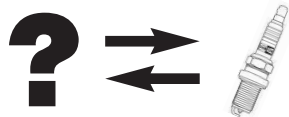

| NGK | CHAMPION | NGK | CHAMPION | NGK | CHAMPION | NGK | CHAMPION |
|------|----------|------|----------|------|----------|------|----------|
| 2550 | OE188 | 3232 | OE018 | 3789 | OE029 | 4424 | OE049 |
| 2563 | OE179 | 3236 | OE108 | 3811 | OE189 | 4435 | OE089 |
| 2609 | OE011 | 3243 | OE154 | 3812 | OE009 | 4457 | OE091 |
| 2621 | L78C | 3245 | OE091 | 3837 | OE188 | 4458 | OE190 |
| 2633 | OE064 | 3252 | OE091 | 3859 | OE002 | 4477 | OE183 |
| 2641 | OE073 | 3271 | OE188 | 3862 | OE044 | 4483 | OE019 |
| 2673 | OE004 | 3311 | OE038 | 3869 | OE089 | 4489 | OE054 |
| 2684 | OE146 | 3330 | OE094 | 3903 | OE195 | 4492 | OE108 |
| 2689 | OE091 | 3346 | OE011 | 3923 | OE087 | 4497 | OE145 |
| 2710 | OE054 | 3350 | OE188 | 3932 | OE196 | 4510 | L82C |
| 2726 | OE011 | 3355 | OE010 | 3933 | OE136 | 4510 | OE037 |
| 2743 | OE146 | 3355 | OE018 | 3967 | OE019 | 4511 | OE038 |
| 2756 | OE039 | 3356 | OE179 | 3971 | OE192 | 4528 | OE091 |
| 2761 | OE138 | 3377 | OE027 | 3972 | OE091 | 4553 | OE064 |
| 2789 | OE123 | 3384 | OE120 | 3975 | OE038 | 4555 | OE007 |
| 2792 | L82C | 3430 | OE078 | 3978 | OE136 | 4559 | OE031 |
| 2848 | OE026 | 3436 | OE042 | 3985 | OE054 | 4589 | OE188 |
| 2848 | OE030 | 3440 | OE191 | 3987 | OE042 | 4619 | OE033 |
| 2876 | OE012 | 3452 | OE026 | 4014 | OE146 | 4632 | OE038 |
| 2876 | OE025 | 3500 | OE136 | 4043 | OE154 | 4642 | OE138 |
| 2890 | OE198 | 3508 | OE180 | 4045 | OE136 | 4665 | OE011 |
| 2912 | OE087 | 3524 | OE063 | 4055 | OE195 | 4666 | OE009 |
| 2921 | OE074 | 3536 | OE003 | 4073 | OE089 | 4669 | OE015 |
| 2922 | OE054 | 3539 | OE136 | 4080 | OE184 | 4685 | OE136 |
| 2924 | RV15YC4 | 3540 | OE136 | 4095 | OE188 | 4691 | OE065 |
| 2941 | OE004 | 3544 | OE014 | 4111 | OE059 | 4696 | OE191 |
| 2950 | OE191 | 3546 | OE146 | 4120 | OE063 | 4696 | OE228 |
| 2975 | OE089 | 3566 | OE120 | 4122 | OE086 | 4704 | OE236 |
| 2978 | OE146 | 3570 | OE091 | 4129 | OE074 | 4717 | OE122 |
| 2989 | OE054 | 3573 | OE042 | 4157 | OE016 | 4729 | OE014 |
| 3000 | OE138 | 3577 | OE048 | 4179 | OE073 | 4741 | OE091 |
| 3014 | L78C | 3583 | OE026 | 4192 | OE004 | 4759 | OE187 |
| 3028 | OE049 | 3584 | OE237 | 4210 | OE037 | 4768 | OE013 |
| 3035 | OE091 | 3586 | OE176 | 4221 | OE091 | 4775 | OE175 |
| 3045 | OE032 | 3587 | OE029 | 4224 | OE049 | 4783 | OE063 |
| 3100 | OE136 | 3588 | OE224 | 4228 | OE048 | 4785 | OE049 |
| 3106 | OE195 | 3605 | OE187 | 4259 | OE122 | 4787 | OE026 |
| 3107 | OE180 | 3606 | OE187 | 4285 | OE257 | 4795 | OE196 |
| 3116 | OE227 | 3611 | OE038 | 4288 | OE229 | 4824 | OE048 |
| 3123 | OE083 | 3623 | OE011 | 4291 | OE089 | 4830 | OE073 |
| 3130 | OE108 | 3639 | OE108 | 4292 | OE191 | 4837 | OE049 |
| 3132 | OE039 | 3641 | OE187 | 4293 | OE002 | 4853 | OE146 |
| 3137 | OE001 | 3656 | OE190 | 4294 | OE188 | 4856 | OE005 |
| 3141 | OE138 | 3672 | OE148 | 4339 | OE073 | 4877 | OE146 |
| 3153 | OE044 | 3688 | OE146 | 4339 | OE199 | 4904 | OE190 |
| 3154 | OE049 | 3712 | OE009 | 4363 | OE184 | 4919 | OE179 |
| 3158 | OE039 | 3712 | OE099 | 4364 | OE146 | 4922 | OE098 |
| 3172 | OE012 | 3720 | OE089 | 4368 | OE089 | 4968 | OE131 |
| 3172 | OE025 | 3725 | OE064 | 4371 | OE146 | 4983 | OE196 |
| 3177 | OE011 | 3737 | OE005 | 4377 | OE146 | 4984 | OE018 |
| 3199 | OE223 | 3764 | OE179 | 4388 | OE026 | 4996 | OE180 |
| 3200 | OE195 | 3783 | OE005 | 4392 | OE011 | 5044 | OE108 |
| 3230 | OE091 | 3784 | OE011 | 4421 | OE013 | 5055 | OE029 |

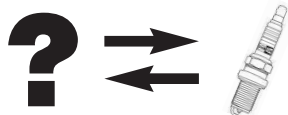

| NGK | CHAMPION |
|------|----------|
| 5084 | OE154 |
| 5110 | L82C |
| 5111 | OE038 |
| 5118 | OE207 |
| 5122 | OE098 |
| 5126 | L78C |
| 5135 | OE077 |
| 5156 | OE044 |
| 5165 | OE128 |
| 5165 | OE198 |
| 5195 | OE030 |
| 5208 | OE063 |
| 5214 | OE211 |
| 5216 | OE019 |
| 5236 | OE014 |
| 5259 | OE008 |
| 5271 | OE003 |
| 5275 | OE145 |
| 5282 | OE039 |
| 5328 | OE010 |
| 5339 | OE048 |
| 5343 | OE064 |
| 5344 | OE146 |
| 5399 | OE009 |
| 5422 | OE108 |
| 5428 | OE018 |
| 5459 | OE138 |
| 5461 | OE032 |
| 5464 | OE180 |
| 5476 | OE189 |
| 5492 | OE073 |
| 5510 | L78C |
| 5521 | OE012 |
| 5539 | L78C |
| 5542 | OE191 |
| 5547 | OE209 |
| 5555 | OE136 |
| 5567 | OE091 |
| 5572 | OE063 |
| 5584 | OE154 |
| 5585 | OE089 |
| 5592 | OE209 |
| 5598 | OE131 |
| 5621 | OE012 |
| 5627 | OE078 |
| 5637 | OE001 |
| 5648 | OE181 |
| 5649 | OE217 |
| 5685 | OE027 |
| 5688 | OE180 |
| 5689 | OE179 |
| 5690 | OE179 |
| 5691 | OE179 |

| NGK | CHAMPION |
|------|----------|
| 5692 | OE186 |
| 5703 | OE182 |
| 5705 | OE188 |
| 5724 | OE039 |
| 5730 | OE087 |
| 5742 | OE077 |
| 5743 | OE195 |
| 5756 | OE208 |
| 5757 | OE146 |
| 5758 | OE213 |
| 5760 | OE192 |
| 5773 | OE136 |
| 5788 | OE178 |
| 5809 | OE183 |
| 5811 | OE015 |
| 5823 | OE006 |
| 5832 | OE008 |
| 5838 | OE138 |
| 5839 | OE004 |
| 5843 | OE205 |
| 5847 | OE212 |
| 5851 | OE122 |
| 5860 | OE003 |
| 5874 | OE191 |
| 5881 | OE032 |
| 5887 | OE184 |
| 5932 | OE027 |
| 5942 | OE130 |
| 5948 | OE255 |
| 5960 | OE177 |
| 5987 | OE238 |
| 5992 | OE205 |
| 6002 | OE120 |
| 6043 | OE233 |
| 6046 | OE187 |
| 6096 | OE032 |
| 6097 | OE014 |
| 6098 | OE044 |
| 6129 | OE005 |
| 6129 | OE014 |
| 6130 | OE016 |
| 6161 | OE003 |
| 6194 | OE009 |
| 6203 | OE004 |
| 6211 | OE001 |
| 6223 | OE048 |
| 6234 | OE003 |
| 6240 | OE175 |
| 6289 | OE122 |
| 6290 | OE146 |
| 6313 | OE014 |
| 6314 | OE146 |
| 6323 | OE136 |

| NGK | CHAMPION |
|------|----------|
| 6326 | OE007 |
| 6341 | OE180 |
| 6342 | OE123 |
| 6343 | OE223 |
| 6344 | OE011 |
| 6345 | OE016 |
| 6368 | OE136 |
| 6376 | OE148 |
| 6378 | OE122 |
| 6410 | OE074 |
| 6411 | OE001 |
| 6418 | OE179 |
| 6422 | OE064 |
| 6427 | OE006 |
| 6436 | OE073 |
| 6437 | OE032 |
| 6441 | OE188 |
| 6458 | OE136 |
| 6464 | OE006 |
| 6465 | OE039 |
| 6466 | OE009 |
| 6481 | OE190 |
| 6502 | OE180 |
| 6511 | OE065 |
| 6546 | OE187 |
| 6597 | OE195 |
| 6637 | OE195 |
| 6643 | OE240 |
| 6644 | OE131 |
| 6645 | OE190 |
| 6648 | OE048 |
| 6651 | OE199 |
| 6664 | OE195 |
| 6677 | OE035 |
| 6684 | OE195 |
| 6687 | OE195 |
| 6711 | OE089 |
| 6714 | OE016 |
| 6717 | OE005 |
| 6717 | OE033 |
| 6723 | OE006 |
| 6741 | OE180 |
| 6799 | OE130 |
| 6837 | OE011 |
| 6838 | OE179 |
| 6840 | OE209 |
| 6853 | OE091 |
| 6858 | OE190 |
| 6872 | OE120 |
| 6883 | OE011 |
| 6893 | OE177 |
| 6895 | OE026 |
| 6895 | OE030 |

| NGK | CHAMPION |
|------|----------|
| 6903 | OE180 |
| 6921 | L82C |
| 6928 | OE065 |
| 6953 | OE063 |
| 6962 | OE005 |
| 6989 | OE131 |
| 6992 | OE077 |
| 6993 | OE019 |
| 7004 | OE122 |
| 7022 | OE064 |
| 7075 | OE042 |
| 7113 | OE035 |
| 7113 | OE148 |
| 7121 | OE039 |
| 7126 | OE054 |
| 7168 | OE186 |
| 7210 | OE039 |
| 7222 | OE051 |
| 7226 | OE018 |
| 7252 | OE041 |
| 7264 | OE027 |
| 7265 | OE018 |
| 7270 | OE195 |
| 7310 | OE074 |
| 7311 | OE049 |
| 7311 | OE065 |
| 7327 | OE015 |
| 7345 | OE004 |
| 7354 | OE026 |
| 7415 | OE187 |
| 7418 | OE180 |
| 7422 | OE051 |
| 7496 | OE063 |
| 7529 | OE001 |
| 7548 | OE091 |
| 7550 | OE184 |
| 7553 | OE032 |
| 7553 | OE120 |
| 7564 | OE002 |
| 7569 | OE131 |
| 7586 | OE029 |
| 7639 | OE001 |
| 7642 | OE016 |
| 7658 | OE179 |
| 7675 | OE032 |
| 7727 | OE001 |
| 7738 | OE008 |
| 7742 | OE234 |
| 7743 | OE176 |
| 7772 | OE136 |
| 7795 | OE073 |
| 7810 | OE063 |
| 7811 | OE001 |



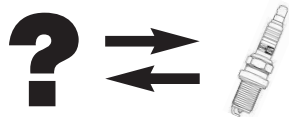

| NGK | CHAMPION | NGK | CHAMPION | NGK | CHAMPION | NGK | CHAMPION |
|-------|----------|-----------|----------|------------|----------|-------------|----------|
| 7822 | OE006 | 99404 | OE179 | B7HZ | L78C | BCPR6EP8 | OE136 |
| 7829 | OE007 | A7FS22C | OE029 | B8EG | OE078 | BCPR6EPN11 | OE145 |
| 7854 | OE180 | A7FS22PP1 | OE029 | B8EGP | OE078 | BCPR6EPN8 | OE145 |
| 7866 | OE180 | A8FS | OE054 | B8EGV | OE078 | BCPR6ER | OE026 |
| 7873 | OE094 | AP6FS | OE054 | B8EGV | OE078 | BCPR6ES | OE005 |
| 7877 | OE016 | AP6FSVP4 | OE054 | B8ES | OE068 | BCPR6ES11 | OE039 |
| 7912 | OE083 | AP6FVG | OE054 | B8EV | OE078 | BCPR6ESVP4 | OE005 |
| 7938 | OE063 | AP6FVG4 | OE054 | B8EVX | OE078 | BCPR6ET | OE120 |
| 7956 | OE019 | AP7FS | OE054 | B8H | L78C | BCPR6EY | OE002 |
| 7963 | OE136 | APR6FS | OE054 | B8HCS | L78C | BCPR6EY11 | OE089 |
| 7968 | OE176 | APR6FVG4 | OE054 | B8HS | L78C | BCPR6EYN11 | OE039 |
| 7980 | OE226 | B10SEGP | OE091 | B8HS10 | L78C | BCPR7E | OE014 |
| 7986 | OE108 | B10SEGV | OE091 | B9SEGV | OE091 | BCPR7EIX | OE179 |
| 7994 | OE039 | B4ES | OE074 | BCP4ES11 | OE057 | BCPR7EIX11 | OE179 |
| 7998 | OE120 | B5EB | OE074 | BCP5E | OE063 | BCPR7ER | OE013 |
| 8894 | OE198 | B5EB | OE074 | BCP5E11 | OE063 | BCPR7ER | OE013 |
| 90061 | OE261 | B5ES | OE074 | BCP5ES | OE063 | BCPR7ES | OE014 |
| 90117 | OE189 | B5EV | OE074 | BCP5ES11 | OE063 | BCPR7ES | OE094 |
| 90223 | OE205 | B5HS | OE037 | BCP5ESVP4 | OE063 | BCPR7ES11 | OE094 |
| 91015 | OE177 | B6E | OE074 | BCP5ET | OE063 | BCPR7ESVP4 | OE014 |
| 91039 | OE264 | B6EB | OE074 | BCP6E | OE003 | BCPR7ET | OE014 |
| 91432 | OE225 | B6EB11 | OE074 | BCP6E | OE003 | BCPR7EVG4 | OE014 |
| 91763 | OE154 | B6EBL | OE074 | BCP6ES | OE003 | BCPR7EY | OE014 |
| 92483 | OE201 | B6EFS | OE009 | BCP6ES11 | OE039 | BCPR9ES11 | OE094 |
| 93311 | OE208 | B6EM | OE074 | BCP6ESVP4 | OE003 | BCRE527Y | OE114 |
| 93607 | OE256 | B6EM | OE074 | BCP6ET | OE032 | BCRE527Y | OE128 |
| 94124 | OE253 | B6ES | OE074 | BCP6EV | OE136 | BCRE527YVG4 | OE114 |
| 94201 | OE245 | B6ES11 | OE079 | BCP6EVG4 | OE003 | BK5E | OE003 |
| 94460 | OE214 | B6EV | OE098 | BCP6EVX | OE136 | BK5E11 | OE003 |
| 94658 | OE183 | B6H | L82C | BCP6EY | OE003 | BK5ESZ | OE026 |
| 94716 | OE229 | B6HS | L82C | BCP7ET | OE094 | BK6E | OE003 |
| 94786 | OE232 | B6HS | OE037 | BCP7EV | OE014 | BKR4E | OE013 |
| 94833 | OE246 | B6HS10 | OE037 | BCP7EVX | OE014 | BKR5E | OE016 |
| 94951 | OE130 | B6HS5 | OE037 | BCPR4ES | OE013 | BKR5E | OE063 |
| 94968 | OE244 | B6HSA | OE037 | BCPR5E | OE016 | BKR5E11 | OE063 |
| 94977 | OE207 | B6HSA | OE037 | BCPR5E11 | OE063 | BKR5E11VG | OE063 |
| 95262 | OE213 | B6HV | OE037 | BCPR5E1X | OE180 | BKR5E11VG4 | OE063 |
| 95369 | OE189 | B6HVX | OE037 | BCPR5E1X11 | OE180 | BKR5E1X | OE180 |
| 95420 | OE011 | B6S | J8C | BCPR5EP11 | OE191 | BKR5E1X11 | OE180 |
| 95712 | OE238 | B6SVP1 | J8C | BCPR5EP8 | OE191 | BKR5EK | OE019 |
| 96463 | OE031 | B7E | OE074 | BCPR5EP8 | OE191 | BKR5EKB | OE019 |
| 96569 | OE197 | B7EB | OE079 | BCPR5ES | OE016 | BKR5EKB11 | OE019 |
| 96596 | OE247 | B7EB11 | OE079 | BCPR5ES11 | OE063 | BKR5EKC | OE019 |
| 96779 | OE190 | B7ECS | OE018 | BCPR5ESVP4 | OE016 | BKR5EKC | OE030 |
| 97153 | OE260 | B7ES | OE079 | BCPR5ET | OE077 | BKR5EKUP | OE198 |
| 97168 | OE232 | B7ES11 | OE068 | BCPR5EVG4 | OE016 | BKR5EN11 | OE039 |
| 97218 | OE238 | B7EV | OE079 | BCPR5EY | OE016 | BKR5EP | OE191 |
| 97237 | OE177 | B7EVX | OE079 | BCPR5EY11 | OE063 | BKR5EP11 | OE191 |
| 97439 | OE240 | B7H | L78C | BCPR5EY11 | OE063 | BKR5EQUB | OE120 |
| 97472 | OE196 | B7HC | L82C | BCPR5EYN11 | OE063 | BKR5EQUB | OE120 |
| 97506 | OE243 | B7HCS | L82C | BCPR6E | OE005 | BKR5EQUPA | OE120 |
| 97999 | OE263 | B7HCS | L82C | BCPR6E11 | OE039 | BKR5ES | OE063 |
| | | B7HS | L82C | BCPR6E1X | OE179 | BKR5ES11 | OE063 |
| | | B7HS10 | L82C | BCPR6E1X11 | OE179 | BKR5ES13 | OE063 |
| | | B7HV | L78C | BCPR6EP11 | OE188 | BKR5EY | OE016 |
| | | B7HV | L82C | BCPR6EP11 | OE191 | | |
| | | B7HVX | L82C | BCPR6EP13 | OE188 | | |

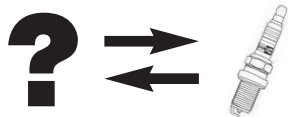

| NGK | CHAMPION |
|------------|----------|
| BKR5EY11 | OE016 |
| BKR5EYA | OE093 |
| BKR5EYA1 | OE093 |
| BKR5EYA11 | OE093 |
| BKR5EZ | OE016 |
| BKR6E | OE005 |
| BKR6E-11 | OE039 |
| BKR6E11VG | OE039 |
| BKR6E11VG4 | OE039 |
| BKR6EIX | OE179 |
| BKR6EIX11 | OE179 |
| BKR6EIXLPG | OE179 |
| BKR6EK | OE026 |
| BKR6EK11 | OE026 |
| BKR6EKB11 | OE026 |
| BKR6EKC | OE026 |
| BKR6EKC | OE030 |
| BKR6EKCVP4 | OE030 |
| BKR6EKE | OE026 |
| BKR6EKE | OE217 |
| BKR6EKPA | OE223 |
| BKR6EKP11 | OE026 |
| BKR6EKU | OE019 |
| BKR6EKUB | OE237 |
| BKR6EKVP4 | OE026 |
| BKR6EN11 | OE039 |
| BKR6EP | OE136 |
| BKR6EP11 | OE146 |
| BKR6EP13 | OE146 |
| BKR6EP13 | OE188 |
| BKR6EP8 | OE136 |
| BKR6EP8 | OE227 |
| BKR6EPN11 | OE191 |
| BKR6EQU | OE120 |
| BKR6EQUA | OE120 |
| BKR6EQUAP | OE120 |
| BKR6EQUP | OE223 |
| BKR6ES | OE005 |
| BKR6ES | OE014 |
| BKR6ES11 | OE039 |
| BKR6ET10 | OE032 |
| BKR6ETA10 | OE120 |
| BKR6ETUC | OE120 |
| BKR6EVG4 | OE002 |
| BKR6EVX | OE136 |
| BKR6EVX11 | OE136 |
| BKR6EVXA11 | OE179 |
| BKR6EVXA13 | OE179 |
| BKR6EY | OE002 |
| BKR6EY11 | OE089 |
| BKR6EYA | OE002 |
| BKR6EYA11 | OE089 |
| BKR6EYAVG4 | OE002 |

| NGK | CHAMPION |
|--------------|----------|
| BKR6EZ | OE033 |
| BKR6EZ | OE034 |
| BKR6EZB | OE002 |
| BKR7E | OE014 |
| BKR7E11 | OE014 |
| BKR7EKC | OE026 |
| BKR7EKN | OE026 |
| BKR7EKN11 | OE026 |
| BKR7EQU | OE032 |
| BKR7ESC11 | OE014 |
| BKR7EVX | OE014 |
| BKR7EVX11 | OE014 |
| BKR7EVX11 | OE136 |
| BKR8E | OE094 |
| BKR8E11 | OE094 |
| BKRUR6ET | OE120 |
| BKUR5EK | OE013 |
| BKUR5ET | OE120 |
| BKUR5ET | OE123 |
| BKUR5ET10 | OE032 |
| BKUR5ET10 | OE120 |
| BKUR5ETC10 | OE120 |
| BKUR6EK | OE026 |
| BKUR6ET | OE032 |
| BKUR6ET10 | OE032 |
| BKUR6ET10VP4 | OE032 |
| BKUR6ETB | OE077 |
| BKUR6ETB10 | OE032 |
| BKUR6ETB10 | OE077 |
| BKUR7ET | OE032 |
| BKUR7ET | OE094 |
| BKUR7ETVP4 | OE032 |
| BL6H | L82C |
| BP4ES | OE065 |
| BP4H | OE038 |
| BP4HS | OE007 |
| BP4HS | OE038 |
| BP4HS | OE059 |
| BP5E | OE015 |
| BP5EA | OE015 |
| BP5EAL | OE001 |
| BP5EAL11 | OE065 |
| BP5EAL11 | OE065 |
| BP5EFS | OE009 |
| BP5EFS | OE099 |
| BP5EKA | OE012 |
| BP5ES | OE065 |
| BP5ES11 | OE049 |
| BP5ES11 | OE065 |
| BP5ESA | OE015 |
| BP5ESVP4 | OE065 |

| NGK | CHAMPION |
|-----------|----------|
| BP5ESZ | OE065 |
| BP5ET | OE044 |
| BP5ET10 | OE044 |
| BP5ETVP4 | OE044 |
| BP5EV | OE065 |
| BP5EVG4 | OE001 |
| BP5EVX | OE001 |
| BP5EY | OE015 |
| BP5EY | OE065 |
| BP5EZ | OE015 |
| BP5HS | OE059 |
| BP6E | OE001 |
| BP6EF | OE009 |
| BP6EFS | OE009 |
| BP6EFS13 | OE009 |
| BP6EFSVP4 | OE009 |
| BP6EFG4 | OE009 |
| BP6EK | OE012 |
| BP6EKA | OE001 |
| BP6EKA | OE012 |
| BP6EQ13 | OE049 |
| BP6ES | OE001 |
| BP6ES11 | OE001 |
| BP6ES11 | OE048 |
| BP6ES13 | OE049 |
| BP6ESVP4 | OE001 |
| BP6ESZ | OE001 |
| BP6ET | OE012 |
| BP6ETVP4 | OE044 |
| BP6EV | OE001 |
| BP6EVG4 | OE001 |
| BP6EVX | OE004 |
| BP6EVX | OE008 |
| BP6EY | OE001 |
| BP6EY11 | OE048 |
| BP6EZ | OE001 |
| BP6H | OE038 |
| BP6HS | OE007 |
| BP6HS | OE038 |
| BP6HS10 | OE007 |
| BP6HVG | OE007 |
| BP7E | OE087 |
| BP7ES | OE010 |
| BP7ET | OE012 |
| BP7EVX | OE195 |
| BP7HS | OE007 |
| BP7HS | OE038 |
| BP7HS10 | OE007 |
| BP8ES | OE087 |
| BP8EV | OE087 |
| BPR4E | OE042 |
| BPR4E11 | OE042 |
| BPR4ES | OE051 |

| NGK | CHAMPION |
|-------------|----------|
| BPR4ES11 | OE049 |
| BPR4ESL11 | OE049 |
| BPR4EVX | OE042 |
| BPR4EY11 | OE049 |
| BPR4FS | RV15YC4 |
| BPR4FS11 | RV15YC4 |
| BPR5E | OE042 |
| BPR5E11 | OE049 |
| BPR5EA11 | OE049 |
| BPR5EAL | OE006 |
| BPR5EAL11 | OE048 |
| BPR5EGP | OE192 |
| BPR5EIX | OE195 |
| BPR5EQU | OE027 |
| BPR5EP11 | OE192 |
| BPR5ES | OE051 |
| BPR5ES11 | OE049 |
| BPR5ES13 | OE049 |
| BPR5ES15 | OE049 |
| BPR5ESVP4 | OE049 |
| BPR5EV10 | OE049 |
| BPR5EVG4 | OE049 |
| BPR5EVX | OE192 |
| BPR5EY11 | OE049 |
| BPR5EYV4 | OE049 |
| BPR5FS | RV15YC4 |
| BPR5FS11 | RV15YC4 |
| BPR6E | OE006 |
| BPR6E11 | OE048 |
| BPR6EF | OE011 |
| BPR6EF11 | OE011 |
| BPR6EF13 | OE011 |
| BPR6EFIX10 | OE183 |
| BPR6EFIX11 | OE183 |
| BPR6EFIX15 | OE183 |
| BPR6EFS | OE011 |
| BPR6EFS15 | OE011 |
| BPR6EFSVP4 | OE011 |
| BPR6EFG | OE011 |
| BPR6EFG4 | OE011 |
| BPR6EIX | OE195 |
| BPR6EIX11 | OE195 |
| BPR6EIXLPG | OE195 |
| BPR6EKN | OE018 |
| BPR6ES | OE006 |
| BPR6ES11 | OE048 |
| BPR6ES11VP4 | OE048 |
| BPR6ES13 | OE048 |
| BPR6ESN11 | OE048 |
| BPR6ESVP4 | OE004 |
| BPR6EV | OE004 |
| BPR6EVG | OE004 |
| BPR6EVG4 | OE004 |



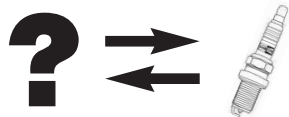

| NGK | CHAMPION | NGK | CHAMPION | NGK | CHAMPION | NGK | CHAMPION |
|-------------|----------|-----------|----------|--------------|----------|------------|----------|
| BPR6EVX | OE004 | BR9ECM | OE091 | DFH6B-11A | OE190 | IFR6D10 | OE181 |
| BPR6EY | OE006 | BR9ECS | OE091 | DILFR5A11 | OE190 | IFR6E11 | OE180 |
| BPR6EY11 | OE048 | BR9EG | OE091 | DILFR5C11 | OE190 | IFR6G-11K | OE179 |
| BPR6EY11VG4 | OE048 | BR9EGN8 | OE091 | DILFR7B10G | OE238 | IFR6J11 | OE179 |
| BPR6H | OE064 | BR9ES | OE091 | DILKAR7E11HS | OE240 | IFR6QG | OE181 |
| BPR6HS | OE064 | BR9ET | OE091 | DILZKAR6A11 | OE240 | IFR6S | OE179 |
| BPR6HS10 | OE064 | BR9EV | OE091 | DP7EA9 | OE083 | IFR6T11 | OE180 |
| BPR6HSA | OE038 | BR9EVX | OE091 | DP7EV9 | OE083 | IFR6T11 | OE182 |
| BPR7E | OE018 | BR9EYA | OE091 | DP8EV9 | OE083 | IFR6T11 | OE188 |
| BPR7EFS | OE011 | BRE527Y11 | OE114 | DP9EV9 | OE073 | IFR7X-7G | OE264 |
| BPR7EIX | OE195 | BU5EB11 | OE010 | DPR8EIX9 | OE187 | IGR6A11 | OE195 |
| BPR7EKN | OE008 | BU6EA11 | OE010 | DPR8EV9 | OE083 | IGR7A | OE195 |
| BPR7ES | OE018 | BU6EB11 | OE087 | DPR8EVX | OE083 | IGR7AG | OE195 |
| BPR7ES11 | OE018 | BU7EA11 | OE087 | DPR8EVX9 | OE083 | IKR6G11 | OE226 |
| BPR7ES11 | OE077 | BU8ET | OE001 | DPR9EV9 | OE073 | IKR7A | OE187 |
| BPR7EVG4 | OE008 | BUR5EB11 | OE018 | DPR9EVX9 | OE073 | IKR7B | OE187 |
| BPR7EY | OE018 | BUR5ET | OE027 | DPR9Z | OE073 | IKR7C | OE187 |
| BPR7EY11 | OE018 | BUR5ET10 | OE027 | DR7ES | OE083 | IKR7D | OE187 |
| BPR7HS | OE064 | BUR5ET10A | OE027 | FR2AD | OE013 | IKR9F8 | OE208 |
| BPR7HS10 | OE064 | BUR6EA11 | OE018 | FR4 | OE013 | IKR9J8 | OE208 |
| BPR8EIX | OE195 | BUR6EB11 | OE087 | FR51 | OE041 | ILFR5B11 | OE190 |
| BPR8ES | OE087 | BUR6EFSZ | OE011 | FR5AP10 | OE013 | ILFR5C | OE190 |
| BPR8EVX | OE087 | BUR6ET | OE025 | FR5AP11 | OE191 | ILFR5T11 | OE190 |
| BPR8HS | OE064 | BUR7EA11 | OE018 | FR5CP | OE136 | ILFR6A | OE190 |
| BPR9EIX | OE091 | BUR7EB11 | OE018 | FR5EI | OE180 | ILFR6A | OE224 |
| BPSESZ | OE065 | BZ8ES | OE091 | FR6AP10 | OE063 | ILFR6B | OE190 |
| BR527Y11 | OE049 | CR7EKC | OE122 | FR6F11K | OE039 | ILFR6D11 | OE190 |
| BR529Y11 | OE049 | CR9EIA9 | OE122 | GR4 | OE042 | ILFR6G | OE190 |
| BR6EB | OE006 | D7EA | OE083 | GR45 | OE049 | ILFR6J-11K | OE190 |
| BR6EB11 | OE048 | D7ES | OE083 | GR4VX | OE105 | ILFR6K8 | OE190 |
| BR6EF | OE011 | D7EV | OE112 | GR55 | OE048 | ILFR6T11 | OE190 |
| BR6ES | OE098 | D7EVX | OE112 | HB6AIX11P | OE182 | ILKAR7A7 | OE225 |
| BR7EB | OE098 | D8EV | OE112 | HB6BIX11P | OE188 | ILKAR7D6G | OE256 |
| BR7EB11 | OE098 | D8EVX | OE112 | IFR5A11 | OE180 | ILKAR7F7G | OE261 |
| BR7EF | OE011 | DCP7E | OE083 | IFR5D10 | OE191 | ILKAR7L11 | OE253 |
| BR7EFS | OE011 | DCPR7E | OE196 | IFR5D10 | OE228 | ILKR7B8 | OE250 |
| BR7EIX | OE195 | DCPR7EA9 | OE199 | IFR5E11 | OE039 | ILKR9G8 | OE232 |
| BR7ES | OE098 | DCPR7EIX | OE187 | IFR5E11 | OE180 | ILTR5A13G | OE189 |
| BR7ES11 | OE108 | DCPR7EN | OE196 | IFR5E13 | OE180 | ILTR5B | OE189 |
| BR7HS | OE086 | DCPR7EN10 | OE196 | IFR5G11 | OE180 | ILTR5B11 | OE189 |
| BR7HS10 | OE086 | DCPR7EVX | OE186 | IFR5G-11K | OE180 | ILTR5C | OE189 |
| BR8ECM | OE091 | DCPR8E | OE073 | IFR5J11 | OE180 | ILTR5D | OE189 |
| BR8ECMVX | OE091 | DCPR8EA | OE073 | IFR5L11 | OE180 | ILTR6A13G | OE029 |
| BR8ECS | OE091 | DCPR8EIX | OE187 | IFR5N10 | OE180 | ILTR6A13G | OE189 |
| BR8EG | OE108 | DCPR8EKC | OE186 | IFR5T11 | OE180 | ILTR6B | OE189 |
| BR8EIX | OE108 | DCPR8EKP | OE187 | IFR5T8N | OE180 | ILTR6E11 | OE189 |
| BR8ES | OE108 | DCPR8EN | OE186 | IFR6A | OE182 | ILZFR5B | OE190 |
| BR8ES11 | OE108 | DCPR9E | OE073 | IFR6A11 | OE182 | ILZFR6A11 | OE190 |
| BR8ESA | OE091 | DCPR9EIX | OE073 | IFR6A11T | OE188 | ILZFR6CK | OE190 |
| BR8ET | OE091 | DCPR9EVX | OE073 | IFR6B11 | OE180 | ILZFR6D11 | OE190 |
| BR8EV | OE108 | DCR7EIX | OE187 | IFR6BK | OE179 | ILZFR6D11 | OE238 |
| BR8EVX | OE108 | DCR8EIX | OE187 | IFR6C | OE181 | ILZKAR7A10 | OE233 |
| BR8HSA | L78C | DFH6B11A | OE190 | IFR6D10 | OE146 | ILZKBR7A8G | OE205 |

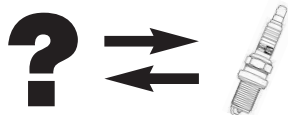

| NGK | CHAMPION |
|-------------|----------|
| ILZKBR7B8DG | OE205 |
| IRIMAC8 | OE187 |
| ITR6F13 | OE183 |
| IZFR5B | OE184 |
| IZFR5F11 | OE194 |
| IZFR5G | OE184 |
| IZFR5L11 | OE194 |
| IZFR6B | OE227 |
| IZFR6F11 | OE188 |
| IZFR6H11 | OE188 |
| IZFR6P7 | OE260 |
| KR7AI | OE187 |
| KR8B1 | OE187 |
| KR9C1 | OE073 |
| LFR5A11 | OE148 |
| LFR5AAA | OE035 |
| LFR5AGP | OE175 |
| LFR5AIX11 | OE190 |
| LFR5AP11 | OE175 |
| LFR5B | OE035 |
| LFR5B | OE148 |
| LFR5E11 | OE148 |
| LFR6A11 | OE148 |
| LFR6AIX11 | OE190 |
| LFR6B | OE035 |
| LFR6C-11 | OE035 |
| LFR6C-11 | OE178 |
| LFR6D | OE035 |
| LFR6D | OE236 |
| LKR6C | OE201 |
| LKR6C10E | OE201 |
| LKR6D10E | OE197 |
| LKR7B9 | OE212 |
| LKR8A | OE211 |
| LKR9C18 | OE232 |
| LPG1 | OE179 |
| LPG2 | OE195 |
| LPG3 | OE180 |
| LPG4 | OE189 |
| LPG5 | OE183 |
| LPG6 | OE184 |
| LPG7 | OE190 |
| LTR6B10T | OE255 |
| LZFR6A1 | OE148 |
| LZFR6AI | OE190 |
| LZFR6AP11GS | OE238 |
| LZKAR6AP11 | OE240 |
| LZKAR7A | OE130 |
| LZKAR7B | OE130 |
| LZKAR7D9D | OE130 |
| LZKR6AI10G | OE263 |
| LZKR6B-10E | OE201 |
| PFR5B | OE138 |

| NGK | CHAMPION |
|----------|----------|
| PFR5B11 | OE138 |
| PFR5B11B | OE138 |
| PFR5C11 | OE138 |
| PFR5G | OE138 |
| PFR5G11 | OE138 |
| PFR5G11E | OE138 |
| PFR5G13E | OE138 |
| PFR5J11 | OE138 |
| PFR5L11 | OE138 |
| PFR5N11 | OE138 |
| PFR5R11 | OE138 |
| PFR5R11 | OE191 |
| PFR6A11 | OE136 |
| PFR6B | OE136 |
| PFR6B11 | OE146 |
| PFR6B11C | OE146 |
| PFR6B9 | OE136 |
| PFR6B9 | OE146 |
| PFR6D10G | OE146 |
| PFR6E10 | OE146 |
| PFR6G | OE146 |
| PFR6G11 | OE136 |
| PFR6G11 | OE146 |
| PFR6G13 | OE146 |
| PFR6G13E | OE146 |
| PFR6G9 | OE146 |
| PFR6H10 | OE146 |
| PFR6J11 | OE146 |
| PFR6L-13 | OE138 |
| PFR6N11 | OE146 |
| PFR6Q | OE136 |
| PFR6T10G | OE191 |
| PFR6TG | OE146 |
| PFR6U11G | OE191 |
| PFR6WTG | OE209 |
| PFR6X11 | OE146 |
| PFR7B | OE146 |
| PFR7BD | OE146 |
| PFR7G | OE146 |
| PFR7G11 | OE146 |
| PFR7G11S | OE136 |
| PFR7G11S | OE146 |
| PFR7G9 | OE146 |
| PFR7H10 | OE136 |
| PFR7H10 | OE146 |
| PFR7M | OE146 |
| PFR7Q | OE136 |
| PFR7S8EG | OE214 |
| PFR7WT | OE209 |
| PFR7WTG | OE209 |
| PFR8S8EG | OE214 |
| PGR5A | OE042 |
| PGR5A11 | OE042 |

| NGK | CHAMPION |
|-------------|----------|
| PGR5C11 | OE192 |
| PGR6A | OE018 |
| PGR7A | OE195 |
| PKR7A | OE187 |
| PKR9B | OE073 |
| PLFR7A8EG | OE246 |
| PLFR5A | OE175 |
| PLFR5A11 | OE175 |
| PLFR6A | OE206 |
| PLKR7A | OE229 |
| PLKR7B8E | OE229 |
| PLKR9C8 | OE232 |
| PLTR6A10G | OE029 |
| PLZFR6A-11S | OE238 |
| PLZKAR6A-11 | OE207 |
| PLZKAR6A11D | OE207 |
| PLZKBR7AG | OE205 |
| PLZKBR7B8DG | OE205 |
| PMR7A | OE122 |
| PMR8A | OE122 |
| PMR8B | OE122 |
| PMR9B | OE122 |
| PTR5A10 | OE029 |
| PTR5A13 | OE029 |
| PTR5A13VP4 | OE029 |
| PTR5D10 | OE011 |
| PTR5D10 | OE131 |
| PTR5D13 | OE131 |
| PTR5F13 | OE131 |
| PTR6D13 | OE131 |
| PTR6D13G | OE131 |
| PTR6F | OE131 |
| PTR6F13 | OE131 |
| PZFR5D | OE176 |
| PZFR5D11 | OE176 |
| PZFR5F | OE184 |
| PZFR5F11 | OE184 |
| PZFR5J11 | OE176 |
| PZFR5N11T | OE176 |
| PZFR5N11T | OE234 |
| PZFR5N11TG | OE176 |
| PZFR5N11TG | OE234 |
| PZFR5Q11 | OE176 |
| PZFR6B | OE227 |
| PZFR6F | OE184 |
| PZFR6F | OE188 |
| PZFR6F11 | OE188 |
| PZFR6J11 | OE176 |
| PZFR6R | OE213 |
| PZKER7A8EGS | OE244 |
| R0179 | OE122 |
| R4118S8 | OE108 |
| R4118S9 | OE091 |

| NGK | CHAMPION |
|-------------|----------|
| R4118S9S | OE091 |
| R5672A8 | OE087 |
| R6021E8 | OE108 |
| R6021E9 | OE091 |
| R6021E9S | OE091 |
| R6252E9 | OE091 |
| R6918B8 | OE108 |
| R737610 | OE091 |
| SIFR6A11 | OE179 |
| SILTR6A7G | OE189 |
| SILZKBR8C8S | OE243 |
| SILZKBR8D8S | OE243 |
| SILZKGR8B8S | OE245 |
| T40227C-G08 | OE260 |
| TR4 | OE011 |
| TR55 | OE011 |
| TR55IX | OE183 |
| TR55VX | OE131 |
| TR5A10 | OE031 |
| TR5B | OE031 |
| TR5B13 | OE031 |
| TR5F13 | OE031 |
| TR5IX | OE183 |
| TR6AP13 | OE131 |
| TR6AP13 | OE183 |
| TR6AP13E | OE131 |
| TR6B10 | OE031 |
| UR4 | RV15YC4 |
| V29 | OE120 |
| V31 | OE120 |
| V32 | OE005 |
| V-Line 1 | OE025 |
| V-Line 10 | OE048 |
| V-Line 11 | OE039 |
| V-Line 12 | OE005 |
| V-Line 13 | OE048 |
| V-Line 14 | OE039 |
| V-Line 15 | OE004 |
| V-Line 16 | OE057 |
| V-Line 18 | OE038 |
| V-Line 19 | OE018 |
| V-Line 2 | OE006 |
| V-Line 20 | OE026 |
| V-Line 21 | OE027 |
| V-Line 22 | OE027 |
| V-Line 23 | OE019 |
| V-Line 24 | OE032 |
| V-Line 25 | OE029 |
| V-Line 26 | OE026 |
| V-Line 27 | OE032 |
| V-Line 28 | OE005 |
| V-Line 29 | OE123 |
| V-Line 3 | OE064 |



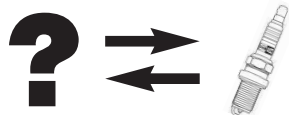

| NGK | CHAMPION |
|-------------|----------|
| V-Line 30 | OE223 |
| V-Line 31 | OE011 |
| V-Line 32 | OE005 |
| V-Line 33 | OE039 |
| V-Line 34 | OE176 |
| V-Line 35 | OE005 |
| V-Line 36 | OE005 |
| V-Line 37 | OE136 |
| V-Line 38 | OE033 |
| V-Line 39 | OE063 |
| V-Line 4 | OE001 |
| V-Line 5 | OE009 |
| V-Line 52 | OE213 |
| V-Line 7 | OE011 |
| V-Line 8 | OE015 |
| V-Line 9 | OE044 |
| ZFR4F11 | OE154 |
| ZFR5A11 | OE154 |
| ZFR5E11 | OE089 |
| ZFR5E11 | OE154 |
| ZFR5F | OE128 |
| ZFR5F | OE198 |
| ZFR5F11 | OE089 |
| ZFR5F11 | OE154 |
| ZFR5F11VP4 | OE154 |
| ZFR5FIX11 | OE194 |
| ZFR5J | OE154 |
| ZFR5J11 | OE089 |
| ZFR5J11 | OE154 |
| ZFR5P11 | OE177 |
| ZFR5PG | OE177 |
| ZFR6A11 | OE089 |
| ZFR6BP-G | OE188 |
| ZFR6F-11 | OE089 |
| ZFR6F11G | OE089 |
| ZFR6F11VP4 | OE089 |
| ZFR6FIX11 | OE188 |
| ZFR6FR | OE026 |
| ZFR6J | OE089 |
| ZFR6J11 | OE089 |
| ZFR6K | OE089 |
| ZFR6K11 | OE089 |
| ZFR6T11G | OE177 |
| ZFR6U11 | OE089 |
| ZFR6VG | OE198 |
| ZFR7F11 | OE089 |
| ZGR5A | OE004 |
| ZGR5AVG6 | OE004 |
| ZGR5B | OE004 |
| ZGR5BVG4 | OE004 |
| ZKER6A-10EG | OE247 |
| ZKR7A | OE196 |
| ZKR7A10 | OE196 |

| NGK | CHAMPION |
|----------------|----------|
| ZKR7B10 | OE196 |
| NHSP LD | CHAMPION |
| D7 | OE083 |
| EST | OE059 |
| E6C | OE037 |
| F5RTC | OE042 |
| F6REC4 | OE051 |
| F6RTC | OE051 |
| F6TC | OE065 |
| F6TJC | OE044 |
| F7TC | OE001 |
| F7TJC | OE012 |
| F9TC | OE087 |
| FEREPP | OE004 |
| G6 | J8C |
| K6EPPOR | OE191 |
| K6RKCCX | OE154 |
| K6RKDC | OE019 |
| K6RLCX | OE093 |
| K6RZC | OE114 |
| K6TC | OE003 |
| K7RLC | OE093 |
| K7RTC | OE005 |
| K7RTCX | OE039 |
| K7RTDC | OE026 |
| K7TC | OE003 |
| K7TJC | OE032 |
| K7YKJCR | OE120 |
| K7YRKDC | OE120 |
| K8RTJC | OE077 |
| KH6RK3 | OE148 |
| Q7TC | OE009 |
| PAL | CHAMPION |
| D 14 Y | OE014 |
| D 14 YC | OE014 |
| D 17 Y | OE057 |
| D 17 YC | OE057 |
| DR 14 YC | OE014 |
| DR 15 TC | OE145 |
| DR 15 YC | OE005 |
| DR 17 YC | OE005 |
| G 15 Y | OE009 |
| G 15 YC | OE009 |
| G 17 Y | OE009 |
| G 17 YC | OE009 |
| GR 15 YC | OE009 |
| L 12 Y | OE087 |
| L 12 YC | OE087 |
| L 14 Y | OE010 |
| L 14 YC | OE010 |
| L 15 | OE074 |

| PAL | CHAMPION |
|----------------------------|----------|
| L 15 C | OE074 |
| L 15 Y | OE001 |
| L 15 YC | OE001 |
| L 17 | OE074 |
| L 17 C | OE074 |
| L 17 Y | OE015 |
| L 17 YC | OE001 |
| L 19 C | OE074 |
| L 5 Y | OE001 |
| L 7 Y | OE015 |
| L 8 | OE074 |
| L 8 Y | OE087 |
| LR 14 YC | OE018 |
| LR 15 YC | OE006 |
| N 12 Y | OE038 |
| N 12 YC | OE038 |
| N 14 | L82C |
| N 14 C | L82C |
| N 15 | L82C |
| N 15 C | L82C |
| N 15 Y | OE038 |
| N 15 YC | OE038 |
| N 17 | L82C |
| N 17 C | L82C |
| N 17 Y | OE038 |
| N 17 YC | OE038 |
| N 7 | L82C |
| N 7 Y | OE038 |
| N 8 | L82C |
| N 8 Y | OE038 |
| NR 15 YC | OE064 |
| Super.G7Y | OE009 |
| Super.L7Y | OE065 |
| Super.N7 | OE037 |
| Super.N8 | L82C |
| PRESTOLITE ELECTRIC | CHAMPION |
| 12G2 | OE083 |
| 12G3 | OE083 |
| 14 E 22 | OE038 |
| 14 E 4 | L82C |
| 14 E 42 | OE038 |
| 14 G 2 | OE074 |
| 14 G 22 | OE010 |
| 14 G 32 | OE001 |
| 14 G 42 | OE015 |
| 14 G 52 | OE015 |
| 1400 | L82C |
| 140000 | OE037 |
| 14-4 | J8C |
| 14-5 | J8C |
| 14-7 | J8C |
| 14-7X | J8C |

| PRESTOLITE ELECTRIC | CHAMPION |
|---------------------|----------|
| 14E1 | L78C |
| 14F42 | RV15YC4 |
| 14F52 | RV15YC4 |
| 14G1 | OE068 |
| 14G12 | OE087 |
| 14G2 | OE079 |
| 14G22 | OE001 |
| 14G3 | OE074 |
| 14G32 | OE065 |
| 14G4 | OE074 |
| 14G5 | OE074 |
| 14G7 | OE074 |
| 14GR32 | OE049 |
| 14GR42 | OE042 |
| 14RF42 | RV15YC4 |
| 18 F 82 | OE054 |
| ROTAX | CHAMPION |
| 297 310 | L82C |
| 899 121 | L78C |
| 999 190 | L78C |
| 999 370 | L82C |
| SABO | CHAMPION |
| M802138 | OE051 |
| SAU11692 | OE013 |
| SACHS | CHAMPION |
| 0 265 156 004 | L78C |
| 0 265 156 015 | L78C |
| 0 298 087 002 | L82C |
| 0 298 087 003 | L82C |
| 0 298 087 006 | L82C |
| 0 298 087 008 | L78C |
| 0 298 087 009 | L78C |
| 0 298 087 011 | L78C |
| 0 298 087 012 | L78C |
| 0 965 155 000 | L82C |
| 0 998 004 000 | L82C |
| 0 998 004 001 | L82C |
| 2 765 045 000 | OE038 |
| 2 865 022 002 | OE038 |
| 80 480 305 | L82C |
| SAGEM | CHAMPION |
| 75806 | OE216 |
| RC 42 S | OE064 |
| RC 52 LJS | OE011 |
| RC 52 LJS 5 | OE011 |
| RC 62 HJSDP | OE029 |
| RC 62 LJS | OE011 |
| RC 72 LS | OE018 |
| RC 72 LS 5 | OE018 |
| RC 82 LS | OE087 |



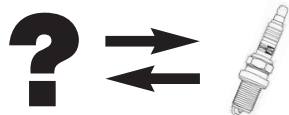

| SAGEM | | |
|--------------------|-------|--|
| RFC 82 LS | OE094 | |
| RFN 52 HZ | OE148 | |
| RFN 58 HZ | OE035 | |
| SEV-MARCHAL | | |
| 34 S | L78C | |
| 34HS | OE068 | |
| 34S | L82C | |
| 35 | L78C | |
| 35 B | L82C | |
| 35 S | L78C | |
| 35/1 | OE038 | |
| 35/1 B | OE038 | |
| 35/36 | OE038 | |
| 35/36 R | OE038 | |
| 36 | OE037 | |
| 36 B | L82C | |
| 36 HS | OE074 | |
| 37 S | L82C | |
| 4 N | L78C | |
| 4N | L82C | |
| 5 N | OE038 | |
| 5H | OE068 | |
| 5HA | OE001 | |
| 6 H | OE087 | |
| 6 N | L82C | |
| 6N | OE037 | |
| 7 H | OE087 | |
| 8 H | OE010 | |
| 9 H | OE001 | |
| 9H | OE001 | |
| GT 34 | OE038 | |
| GT 34 D | OE038 | |
| GT 34 H | OE087 | |
| GT 34 HD | OE087 | |
| GT 34.2 H | OE010 | |
| GT 34.5 | OE038 | |
| GT 34.5 H | OE001 | |
| GT 34.5 HA | OE001 | |
| GT 35 D | OE038 | |
| GT34 | OE001 | |
| GT35H | OE001 | |
| SOGEDAC | | |
| CC10 | OE009 | |
| CF10 | OE014 | |
| CP10 | OE001 | |
| XC10 | OE009 | |
| XP10 | OE001 | |
| XP4 | OE087 | |
| XPC7 | OE037 | |
| SPLITFIRE | | |
| SF265F | OE037 | |

| SPLITFIRE | | |
|------------------|---------|--|
| SF29E | J8C | |
| SF405D | OE068 | |
| SF405F | OE079 | |
| SF409B | L78C | |
| SF409C | L82C | |
| SF415B | OE073 | |
| SF415C | OE083 | |
| SF416B | OE073 | |
| SF425C | OE001 | |
| SF5C | OE001 | |
| SM29E | J8C | |
| SM2E | RV15YC4 | |
| SM40D | OE098 | |
| SM6E | OE042 | |
| STITT | | |
| 407L | OE086 | |
| 407XL | OE039 | |
| R407XL | OE039 | |
| TORCH | | |
| 8008 | OE042 | |
| 8010 | OE018 | |
| 8012 | OE011 | |
| 9007 | OE042 | |
| 9009 | OE018 | |
| D7C | OE083 | |
| D7CA | OE083 | |
| D7RC | OE083 | |
| D8C | OE073 | |
| D8RC | OE083 | |
| D8RTC | OE083 | |
| D8RTC-9 | OE083 | |
| D8TC | OE083 | |
| DK7RTC | OE083 | |
| DK8RTC | OE083 | |
| E5C | OE037 | |
| E5P | OE037 | |
| E7C | L82C | |
| E7RC | OE086 | |
| E8C | L78C | |
| E8RC | L78C | |
| E8RTC | L78C | |
| E8TC | L78C | |
| F4RF | OE042 | |
| F4RTC | OE042 | |
| F5C | OE074 | |
| F5RF | OE049 | |
| F5RF-11 | OE049 | |
| F5RTC | OE042 | |
| F6C | OE079 | |
| F6RC | OE098 | |
| F6RD | OE018 | |

| TORCH | | |
|--------------|---------|--|
| F6RDY | OE027 | |
| F6TC-11 | OE048 | |
| F6TJC | OE044 | |
| F6TP | OE001 | |
| F7RC | OE108 | |
| F7RTC | OE018 | |
| F7RTJC | OE018 | |
| F7TC | OE018 | |
| F7TJC | OE018 | |
| F8C | OE098 | |
| F8RC | OE098 | |
| F8RP | OE098 | |
| F8RTC | OE087 | |
| F8TC | OE087 | |
| F9RC | OE091 | |
| G6C | J8C | |
| K4RTC | OE013 | |
| K4RTC-11 | OE013 | |
| K4RTC3 | OE013 | |
| K4RTV | OE013 | |
| K5RD | OE019 | |
| K5RDY | OE013 | |
| K5RF-11 | OE013 | |
| K5RJY | OE120 | |
| K5RTC | OE013 | |
| K5RTC-11 | OE013 | |
| K5RTJY | OE013 | |
| K5TC | OE013 | |
| K6RD | OE026 | |
| K6RDY | OE026 | |
| K6RF-11 | OE039 | |
| K6RJY | OE120 | |
| K6RJY-10 | OE120 | |
| K6RTC | OE014 | |
| K6RTC-11 | OE039 | |
| K6RTJC | OE039 | |
| K6RTJY | OE032 | |
| K6RTMIP | OE190 | |
| K6RTP | OE191 | |
| K6RTP-11 | OE191 | |
| K6TC | OE003 | |
| K6TC-11 | OE003 | |
| K6TJC | OE003 | |
| K6TP | OE145 | |
| K6TP-11 | OE145 | |
| K7RF | OE014 | |
| K7RJY | OE032 | |
| K7RTC | OE039 | |
| K7RTJC | OE032 | |
| K7RTP | OE136 | |
| K7RTPF | OE136 | |
| K7TC | OE039 | |
| P4RTV | RV15YC4 | |

| TORCH | | |
|----------------|---------|--|
| P5RTP | RV15YC4 | |
| P5RTP-11 | RV15YC4 | |
| Q6RTC | OE011 | |
| Q6TC | OE011 | |
| Q7RC | OE011 | |
| T7TC | OE054 | |
| UNIPART | | |
| GSP 4154 | OE054 | |
| GSP 4352 | OE010 | |
| GSP 4356 | OE038 | |
| GSP 4362 | OE001 | |
| GSP 4366 | OE038 | |
| GSP 4382 | OE015 | |
| GSP 4462 | OE006 | |
| GSP 4652 | OE014 | |
| GSP 4662 | OE005 | |
| GSP 5658 | OE039 | |
| GSP 634 | OE039 | |
| GSP 664 | OE005 | |
| GSP 6662 | OE005 | |
| GSP 684 | OE014 | |
| GSP 685 | OE014 | |
| GSP 7664 | OE089 | |
| GSP 9652 | OE188 | |
| GSP130 | OE074 | |
| GSP131 | OE065 | |
| GSP141 | OE065 | |
| GSP151 | OE001 | |
| GSP160 | OE079 | |
| GSP163 | OE001 | |
| GSP171 | OE001 | |
| GSP191 | OE087 | |
| GSP2001 | OE002 | |
| GSP2003 | OE005 | |
| GSP2005 | OE039 | |
| GSP2006 | OE011 | |
| GSP2010 | OE012 | |
| GSP2011 | OE029 | |
| GSP2013 | OE004 | |
| GSP2015 | OE013 | |
| GSP2017 | OE019 | |
| GSP2018 | OE019 | |
| GSP2021 | OE054 | |
| GSP2023 | OE014 | |
| GSP2024 | OE087 | |
| GSP2025 | OE013 | |
| GSP2027 | OE011 | |
| GSP2028 | OE016 | |
| GSP2031 | OE044 | |
| GSP2032 | OE037 | |
| GSP2035 | OE003 | |
| GSP2036 | OE018 | |



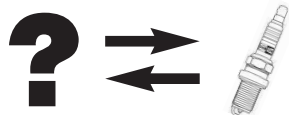

| UNIPART | CHAMPION | UNIPART | CHAMPION | VALEO | CHAMPION |
|---------|----------|--------------|----------|-------------|----------|
| GSP2038 | OE027 | GSP4342 | OE087 | 76H | OE001 |
| GSP2039 | OE049 | GSP4347 | OE012 | 76Hb | OE001 |
| GSP2040 | OE099 | GSP4357 | OE012 | 7H | OE087 |
| GSP2041 | OE120 | GSP4362 | OE001 | 84H | OE001 |
| GSP2044 | OE136 | GSP4367 | OE044 | 84Hb | OE001 |
| GSP2045 | OE013 | GSP4372 | OE065 | 8H | OE001 |
| GSP2046 | OE079 | GSP4376 | OE059 | 90 H | OE001 |
| GSP2048 | OE032 | GSP4452 | OE018 | 9H | OE065 |
| GSP2049 | OE037 | GSP44623 | OE027 | C 72 H | OE009 |
| GSP2050 | L82C | GSP4472 | OE051 | C68H | OE009 |
| GSP2051 | OE091 | GSP4482 | OE042 | C68Hb | OE009 |
| GSP2053 | OE026 | GSP4547 | OE094 | F 72 H | OE014 |
| GSP2055 | OE136 | GSP4562 | OE003 | F 72 H3E | OE094 |
| GSP2059 | OE120 | GSP4563 | OE009 | F 74 H | OE014 |
| GSP2065 | OE059 | GSP4573 | OE099 | F 80 H | OE014 |
| GSP2066 | OE030 | GSP461 | OE011 | F 82 H | OE003 |
| GSP2070 | OE030 | GSP4642 | OE094 | F 82 H | OE057 |
| GSP2071 | OE041 | GSP4652 | OE014 | F68H3 | OE094 |
| GSP2073 | OE120 | GSP46522 | OE026 | F80H | OE003 |
| GSP2074 | OE004 | GSP46523 | OE032 | F80Hb | OE003 |
| GSP2085 | OE014 | GSP4662 | OE005 | GC 68 N | OE054 |
| GSP2087 | OE039 | GSP46622 | OE019 | R 64 H | OE087 |
| GSP2090 | OE108 | GSP4663 | OE011 | R 70 H | OE018 |
| GSP2094 | OE099 | GSP531 | OE059 | R 70 H11 | OE018 |
| GSP2098 | OE001 | GSP540 | OE037 | R 76 H | OE006 |
| GSP2099 | OE065 | GSP550 | OE037 | R 76 H11 | OE048 |
| GSP2100 | OE003 | GSP560 | L82C | R 84 H11 | OE049 |
| GSP2101 | OE009 | GSP6382 | OE065 | R 88 N | OE064 |
| GSP2102 | OE009 | GSP6452 | OE008 | R76H11 | OE048 |
| GSP2103 | OE003 | GSP6462 | OE004 | RC 68 LPP | OE029 |
| GSP2106 | OE031 | GSP65721 | OE057 | RC 72 H | OE011 |
| GSP2108 | OE196 | GSP664 | OE013 | RC 72 H11 | OE011 |
| GSP2110 | OE013 | GSP665 | OE003 | RF 74 H | OE014 |
| GSP2112 | OE013 | GSP6651 | OE031 | RF 80 H | OE005 |
| GSP2114 | OE063 | GSP6652 | OE014 | RF 82 H | OE005 |
| GSP2115 | OE011 | GSP66527 | OE146 | RF74H | OE014 |
| GSP2116 | OE014 | GSP6658 | OE014 | RF74HZDC | OE034 |
| GSP2120 | OE011 | GSP6662 | OE002 | RF74LZD | OE178 |
| GSP2121 | OE099 | GSP6663 | OE011 | RF80H | OE005 |
| GSP2136 | OE120 | GSP684 | OE014 | RF82HZ2Y | OE019 |
| GSP2137 | OE035 | GSP9652 | OE136 | | |
| GSP2138 | OE035 | GSP981 | OE054 | | |
| GSP2149 | OE177 | | | YURA | CHAMPION |
| GSP2151 | OE187 | VALEO | CHAMPION | ELR11ISPC8+ | OE248 |
| GSP281 | OE018 | 246176 | OE005 | ELR9IQP9+ | OE249 |
| GSP30 | J8C | 246327 | OE048 | ELR9ISP8+ | OE250 |
| GSP331 | OE099 | 246487 | OE034 | ELR9QC10 | OE201 |
| GSP351 | OE099 | 246490 | OE019 | ELR9QC8 | OE201 |
| GSP361 | OE009 | 4N | L82C | | |
| GSP381 | OE011 | 64H | OE087 | | |
| GSP4154 | OE054 | 64Hb | OE087 | | |
| GSP4256 | L82C | 67HP | OE078 | | |
| GSP4266 | OE037 | 6N | OE037 | | |

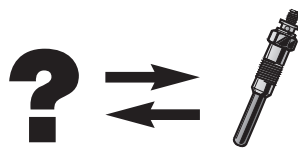

| ACDELCO | | |
|-------------------|-------|--|
| 102G | CH181 | |
| 103G | CH215 | |
| 104G | CH219 | |
| 106G | CH205 | |
| 109G | CH203 | |
| 110G | CH271 | |
| 114G | CH175 | |
| 116G | CH189 | |
| 117G | CH185 | |
| 118G | CH177 | |
| 120G | CH189 | |
| 128G | CH260 | |
| 138G | CH167 | |
| 148G | CH176 | |
| 149G | CH189 | |
| 230G | CH189 | |
| 239G | CH189 | |
| 241G | CH189 | |
| 242G | CH189 | |
| 243G | CH147 | |
| 244G | CH189 | |
| 245G | CH147 | |
| 246G | CH189 | |
| 247G | CH173 | |
| 28G | CH260 | |
| 30G | CH189 | |
| 500 GG/93893040 | CH260 | |
| 501 E | CH233 | |
| 503 E | CH216 | |
| 503 GG/93893043 | CH189 | |
| 507 GG/93893047 | CH189 | |
| 508 GG/93893048 | CH260 | |
| 51 GG/93893052 | CH189 | |
| 511 GG/93893051 | CH189 | |
| 518 GG/93893058 | CH221 | |
| 521 GG/93893061 | CH154 | |
| 522 GG/93893062 | CH260 | |
| 525 GG/93893065 | CH189 | |
| 526 GG/93893066 | CH189 | |
| 527 GG/93893067 | CH260 | |
| ASHIKA | | |
| B 120 | CH234 | |
| B065 | CH189 | |
| B071 | CH189 | |
| B081 | CH189 | |
| CP 72 | CH230 | |
| PM 168 | CH263 | |
| PN 139 | CH186 | |
| AUTO DELTA | | |
| GP2003/1 | CH189 | |
| GP4162 | CH158 | |

| AUTOLITE | | |
|-----------------|---------|--|
| 1101 | CH260 | |
| 1103 | CH189 | |
| 1104 | CH260 | |
| 1116 | CH271 | |
| BERU | | |
| 0 100 266 046 | CH704 | |
| 0 103 010 101 | CP5G004 | |
| 0 103 010 103 | CP5G004 | |
| 0 103 010 904 | CP5G006 | |
| 0 103 010 906 | CP5G006 | |
| 0 103 110 903 | CP5G003 | |
| 0 103 110 905 | CP5G003 | |
| 105MJ | CH189 | |
| 105MN | CH189 | |
| 141M | CH260 | |
| 141MJ | CH260 | |
| 151MJ | CH189 | |
| 161MJ | CH189 | |
| 162MJ | CH260 | |
| 276 010 | CH224 | |
| 601MJ | CH260 | |
| 602MJ | CH189 | |
| 603MJ | CH189 | |
| 604MJ | CH189 | |
| 605MJ | CH260 | |
| 607MJ | CH189 | |
| 609MJ | CH189 | |
| 613MJ | CH189 | |
| 633MJ | CH189 | |
| 636MJ | CH189 | |
| 642MJ | CH189 | |
| 651MJ | CH189 | |
| 661MJ | CH147 | |
| 663MJ | CH189 | |
| 666MJ | CH147 | |
| 673MJ | CH221 | |
| 687MJ | CH260 | |
| 688MJ | CH154 | |
| 689MJ | CH260 | |
| 691MJ | CH189 | |
| 719MJ | CH189 | |
| 724MJ | CH189 | |
| 727MJ | CH189 | |
| 783MJ | CH178 | |
| 798MJ | CH189 | |
| 844MJ | CH260 | |
| 852MJ | CH173 | |
| 853MJ | CH186 | |
| 854MJ | CH186 | |
| 855MJ | CH271 | |
| 857MJ | CH260 | |
| 858MJ | CH176 | |

| BERU | | |
|-------------|---------|--|
| 8631607 | CH240 | |
| 897MJ | CH302 | |
| 905MJ | CH169 | |
| 908MJ | CH189 | |
| 909MJ | CH189 | |
| 912MJ | CH185 | |
| 917MJ | CH189 | |
| 921MJ | CH221 | |
| 947MJ | CH158 | |
| 948MJ | CH177 | |
| 950MJ | CH271 | |
| 968MJ | CH154 | |
| 970MJ | CH167 | |
| 999MJ | CH169 | |
| CGP001 | CCGP001 | |
| CGP002 | CCGP002 | |
| CGP003 | CCGP003 | |
| CGP007 | CCGP007 | |
| CGP010 | CCGP010 | |
| GE104 | CH704 | |
| GE116 | CH704 | |
| GN005 | CH242 | |
| GN007 | CH181 | |
| GN008 | CH215 | |
| GN010 | CH219 | |
| GN012 | CH216 | |
| GN013 | CH189 | |
| GN016 | CH185 | |
| GN018 | CH271 | |
| GN019 | CH233 | |
| GN022 | CH205 | |
| GN024 | CH203 | |
| GN025 | CH207 | |
| GN026 | CH232 | |
| GN027 | CH170 | |
| GN030 | CH209 | |
| GN033 | CH231 | |
| GN035 | CH226 | |
| GN037 | CH270 | |
| GN039 | CH186 | |
| GN041 | CH222 | |
| GN043 | CH302 | |
| GN045 | CH240 | |
| GN046 | CH181 | |
| GN054 | CH268 | |
| GN055 | CH180 | |
| GN056 | CH201 | |
| GN057 | CH234 | |
| GN059 | CH224 | |
| GN061 | CH306 | |
| GN070 | CH263 | |
| GN097 | CH269 | |
| GN102 | CH600 | |

| BERU | | |
|-------------|---------|--|
| GN107 | CH256 | |
| GN109 | CH230 | |
| GN110 | CH608 | |
| GN853 | CH186 | |
| GN854 | CH186 | |
| GN855 | CH271 | |
| GN857 | CH260 | |
| GN858 | CH176 | |
| GN860 | CH175 | |
| GN905 | CH169 | |
| GN908 | CH189 | |
| GN909 | CH189 | |
| GN912 | CH185 | |
| GN917 | CH189 | |
| GN927 | CH147 | |
| GN939 | CH229 | |
| GN948 | CH177 | |
| GN954 | CH189 | |
| GN955 | CH225 | |
| GN959 | CH260 | |
| GN961 | CH204 | |
| GN963 | CH217 | |
| GN970 | CH167 | |
| GN985 | CH272 | |
| GN991 | CH206 | |
| GN992 | CH207 | |
| GN993 | CH196 | |
| GN999 | CH169 | |
| GV602 | CH189 | |
| GV603 | CH189 | |
| GV604 | CH260 | |
| GV636 | CH189 | |
| GV642 | CH189 | |
| GV661 | CH147 | |
| GV663 | CH189 | |
| GV666 | CH147 | |
| GV673 | CH221 | |
| GV688 | CH154 | |
| GV689 | CH260 | |
| GV691 | CH189 | |
| GV719 | CH189 | |
| GV724 | CH189 | |
| GV727 | CH189 | |
| GV783 | CH178 | |
| GV798 | CH167 | |
| GV844 | CH260 | |
| GV852 | CH173 | |
| GV897 | CH302 | |
| GV921 | CH221 | |
| GV947 | CH158 | |
| GV967 | CH302 | |
| GV968 | CH154 | |
| PSG003 | CP5G003 | |



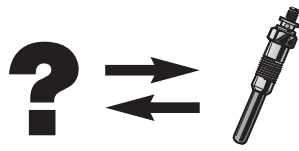

| BERU | CHAMPION |
|-------------|-----------------|
| PSG004 | CPSG004 |
| PSG006 | CPSG006 |
| PSG007 | CPSG007 |
| PSG008 | CPSG008 |

| BORGWARNER | CHAMPION |
|-------------------|-----------------|
| E2500033668A2 | CCGP001 |
| E2500033669A2 | CCGP002 |
| E2500033670A2 | CCGP003 |
| E2500033671A2 | CCGP007 |
| E2500043983A2 | CCGP010 |
| E2509671108A1 | CCGP002 |
| E2509671111A1 | CCGP007 |
| E2509671802A1 | CCGP003 |
| E2520026551A1 | CPSG008 |
| E2520028814A1 | CPSG007 |
| E2520033645A2 | CPSG003 |
| E2520033646A2 | CPSG004 |
| E2520033647A2 | CPSG006 |
| E2520033648A2 | CPSG007 |
| E2520033649A2 | CPSG008 |

| BOSCH | CHAMPION |
|---------------|-----------------|
| 0 250 001 782 | CH268 |
| 0 250 200 052 | CH260 |
| 0 250 200 054 | CH189 |
| 0 250 200 056 | CH189 |
| 0 250 200 057 | CH189 |
| 0 250 200 058 | CH189 |
| 0 250 200 059 | CH189 |
| 0 250 200 060 | CH189 |
| 0 250 200 061 | CH189 |
| 0 250 200 063 | CH260 |
| 0 250 200 064 | CH189 |
| 0 250 200 065 | CH189 |
| 0 250 200 066 | CH189 |
| 0 250 200 068 | CH189 |
| 0 250 200 069 | CH189 |
| 0 250 200 454 | CH189 |
| 0 250 200 456 | CH189 |
| 0 250 200 465 | CH189 |
| 0 250 200 468 | CH189 |
| 0 250 200 469 | CH189 |
| 0 250 201 001 | CH189 |
| 0 250 201 004 | CH260 |
| 0 250 201 005 | CH189 |
| 0 250 201 006 | CH189 |
| 0 250 201 008 | CH189 |
| 0 250 201 009 | CH189 |
| 0 250 201 010 | CH185 |
| 0 250 201 011 | CH260 |
| 0 250 201 015 | CH260 |
| 0 250 201 019 | CH189 |

| BOSCH | CHAMPION |
|---------------|-----------------|
| 0 250 201 020 | CH185 |
| 0 250 201 021 | CH260 |
| 0 250 201 026 | CH176 |
| 0 250 201 027 | CH189 |
| 0 250 201 029 | CH173 |
| 0 250 201 030 | CH189 |
| 0 250 201 031 | CH260 |
| 0 250 201 032 | CH260 |
| 0 250 201 033 | CH189 |
| 0 250 201 035 | CH175 |
| 0 250 201 036 | CH271 |
| 0 250 201 037 | CH189 |
| 0 250 201 038 | CH177 |
| 0 250 201 039 | CH189 |
| 0 250 201 040 | CH260 |
| 0 250 201 041 | CH176 |
| 0 250 201 042 | CH189 |
| 0 250 201 043 | CH173 |
| 0 250 201 043 | CH189 |
| 0 250 201 045 | CH189 |
| 0 250 201 046 | CH260 |
| 0 250 201 047 | CH176 |
| 0 250 201 048 | CH177 |
| 0 250 201 049 | CH205 |
| 0 250 201 050 | CH260 |
| 0 250 201 053 | CH209 |
| 0 250 201 054 | CH177 |
| 0 250 201 055 | CH176 |
| 0 250 201 405 | CH189 |
| 0 250 201 415 | CH260 |
| 0 250 201 469 | CH189 |
| 0 250 201 927 | CH189 |
| 0 250 201 929 | CH189 |
| 0 250 201 930 | CH260 |
| 0 250 201 932 | CH189 |
| 0 250 201 933 | CH260 |
| 0 250 201 935 | CH173 |
| 0 250 201 936 | CH189 |
| 0 250 201 937 | CH189 |
| 0 250 201 938 | CH260 |
| 0 250 201 940 | CH176 |
| 0 250 201 944 | CH260 |
| 0 250 201 945 | CH189 |
| 0 250 201 946 | CH176 |
| 0 250 201 950 | CH189 |
| 0 250 201 952 | CH189 |
| 0 250 201 953 | CH189 |
| 0 250 201 954 | CH176 |
| 0 250 202 001 | CH147 |
| 0 250 202 002 | CH216 |
| 0 250 202 003 | CH221 |
| 0 250 202 006 | CH154 |
| 0 250 202 009 | CH271 |

| BOSCH | CHAMPION |
|---------------|-----------------|
| 0 250 202 010 | CH260 |
| 0 250 202 018 | CH147 |
| 0 250 202 019 | CH189 |
| 0 250 202 020 | CH185 |
| 0 250 202 021 | CH206 |
| 0 250 202 022 | CH271 |
| 0 250 202 023 | CH181 |
| 0 250 202 024 | CH206 |
| 0 250 202 025 | CH169 |
| 0 250 202 026 | CH204 |
| 0 250 202 032 | CH170 |
| 0 250 202 033 | CH147 |
| 0 250 202 034 | CH167 |
| 0 250 202 035 | CH217 |
| 0 250 202 036 | CH222 |
| 0 250 202 038 | CH180 |
| 0 250 202 039 | CH207 |
| 0 250 202 040 | CH178 |
| 0 250 202 041 | CH219 |
| 0 250 202 042 | CH207 |
| 0 250 202 043 | CH231 |
| 0 250 202 046 | CH181 |
| 0 250 202 048 | CH268 |
| 0 250 202 052 | CH302 |
| 0 250 202 053 | CH154 |
| 0 250 202 058 | CH302 |
| 0 250 202 060 | CH221 |
| 0 250 202 065 | CH306 |
| 0 250 202 079 | CH302 |
| 0 250 202 087 | CH158 |
| 0 250 202 089 | CH242 |
| 0 250 202 090 | CH242 |
| 0 250 202 092 | CH256 |
| 0 250 202 093 | CH186 |
| 0 250 202 094 | CH221 |
| 0 250 202 095 | CH302 |
| 0 250 202 096 | CH154 |
| 0 250 202 102 | CH215 |
| 0 250 202 103 | CH203 |
| 0 250 202 124 | CH263 |
| 0 250 202 128 | CH232 |
| 0 250 202 129 | CH233 |
| 0 250 202 130 | CH229 |
| 0 250 202 131 | CH196 |
| 0 250 202 132 | CH269 |
| 0 250 202 135 | CH268 |
| 0 250 202 911 | CH271 |
| 0 250 203 001 | CH224 |
| 0 250 203 004 | CH240 |
| 0 250 203 009 | CH270 |
| 0 250 204 002 | CH201 |
| 0 250 212 006 | CH226 |
| 0 250 212 009 | CH271 |

| BOSCH | CHAMPION |
|---------------|-----------------|
| 0 250 251 471 | CH167 |
| 0 250 312 002 | CH600 |
| 0 250 312 007 | CH256 |
| 0 250 403 001 | CH240 |
| 0 250 603 001 | CCGP007 |
| 80006 | CH189 |
| 80007 | CH189 |
| 80008 | CH189 |
| 80009 | CH176 |
| 80010 | CH260 |
| 80011 | CH175 |
| 80012 | CH271 |
| 80013 | CH177 |
| 80031 | CH176 |
| F 002 G50 048 | CH270 |
| F 005 X04 828 | CH306 |
| F 005 X04 869 | CH600 |
| F 005 X12 978 | CH600 |
| F 005 X12 981 | CH186 |
| F 005 X13 002 | CH302 |
| GLP001 | CH189 |
| GLP002 | CH260 |
| GLP003 | CH271 |
| GLP004 | CH185 |
| GLP005 | CH189 |
| GLP006 | CH176 |
| GLP007 | CH222 |
| GLP009 | CH217 |
| GLP010 | CH147 |
| GLP011 | CH233 |
| GLP012 | CH205 |
| GLP013 | CH170 |
| GLP014 | CH169 |
| GLP015 | CH189 |
| GLP017 | CH177 |
| GLP019 | CH207 |
| GLP020 | CH206 |
| GLP023 | CH181 |
| GLP024 | CH196 |
| GLP025 | CH175 |
| GLP026 | CH167 |
| GLP030 | CH231 |
| GLP031 | CH215 |
| GLP034 | CH221 |
| GLP036 | CH260 |
| GLP038 | CH242 |
| GLP039 | CH256 |
| GLP040 | CH203 |
| GLP041 | CH216 |
| GLP042 | CH154 |
| GLP043 | CH224 |
| GLP045 | CH209 |
| GLP046 | CH158 |

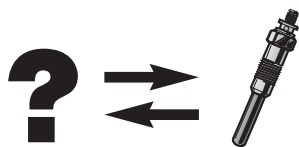

| BOSCH | | |
|--------------|----------------|--|
| GLP048 | CH178 | |
| GLP049 | CH186 | |
| GLP051 | CH229 | |
| GLP054 | CH256 | |
| GLP055 | CH268 | |
| GLP057 | CH232 | |
| GLP058 | CH189 | |
| GLP066 | CH269 | |
| GLP073 | CH271 | |
| GLP074 | CH302 | |
| GLP086 | CH260 | |
| GLP089 | CH189 | |
| GLP094 | CH201 | |
| GLP102 | CH219 | |
| GLP103 | CH306 | |
| GLP105 | CH600 | |
| GLP109 | CH180 | |
| GLP111 | CH268 | |
| GLP112 | CH271 | |
| GLP113 | CH170 | |
| GLP115 | CH240 | |
| GLP137 | CH263 | |
| GLP142 | CH302 | |
| GLP144 | CH240 | |
| GLP154 | CCGP007 | |
| GLP156 | CH242 | |
| GLP158 | CH176 | |
| GLP203 | CH226 | |
| GLP205 | CH270 | |
| GLP224 | CH271 | |
| BRISK | | |
| 01R447E | CH158 | |
| 01S355E | CH271 | |
| 01S405E | CH169 | |
| 01S412E | CH185 | |
| 01S439E | CH229 | |
| 01S492E | CH207 | |
| 01S507E | CH181 | |
| 01S508E | CH215 | |
| 01S510E | CH219 | |
| 01S512E | CH216 | |
| 01S527E | CH170 | |
| 01S533E | CH231 | |
| 01S541E | CH222 | |
| 11R173E | CH221 | |
| 11R421E | CH221 | |
| 11R468E | CH154 | |
| 11S505E | CH242 | |
| 11S543E | CH302 | |
| 21R136E | CH189 | |
| 21R21 | CH189 | |
| 21R352E | CH173 | |

| BRISK | | |
|-----------------|--------------|--|
| 21S357E | CH260 | |
| 21S358E | CH176 | |
| 21S427E | CH147 | |
| 21S448E | CH177 | |
| 21S461E | CH204 | |
| 21S522E | CH205 | |
| CHAMPION | | |
| AG60 | CH260 | |
| CH103 | CH154 | |
| CH133 | CH302 | |
| CH133/002 | CH302 | |
| CH137 | CH189 | |
| CH137/077 | CH189 | |
| CH137/181 | CH189 | |
| CH137/C02 | CH189 | |
| CH147/002 | CH147 | |
| CH147/C02 | CH147 | |
| CH147Y/002 | CH147 | |
| CH154/002 | CH154 | |
| CH155 | CH173 | |
| CH155/002 | CH173 | |
| CH156 | CH176 | |
| CH158/002 | CH158 | |
| CH159 | CH189 | |
| CH159/282 | CH189 | |
| CH160 | CH260 | |
| CH160/077 | CH260 | |
| CH160/272 | CH260 | |
| CH160/C02 | CH260 | |
| CH162 | CH221 | |
| CH162/002 | CH221 | |
| CH163 | CH189 | |
| CH163/077 | CH189 | |
| CH163/C02 | CH189 | |
| CH163F/002 | CH189 | |
| CH163Y/002 | CH189 | |
| CH164 | CH189 | |
| CH164/002 | CH189 | |
| CH167/002 | CH167 | |
| CH167Y/002 | CH167 | |
| CH168 | CH185 | |
| CH168/002 | CH185 | |
| CH168/077 | CH185 | |
| CH168/C02 | CH185 | |
| CH168F/002 | CH185 | |
| CH168Y/002 | CH185 | |
| CH169/002 | CH169 | |
| CH169/272 | CH169 | |
| CH169/C02 | CH169 | |
| CH169Y/002 | CH169 | |
| CH170/002 | CH170 | |
| CH170Y/002 | CH170 | |

| CHAMPION | | |
|-----------------|--------------|--|
| CH171 | CH271 | |
| CH171/272 | CH271 | |
| CH172 | CH169 | |
| CH172Y/002 | CH169 | |
| CH173/002 | CH173 | |
| CH173/102 | CH173 | |
| CH173/282 | CH173 | |
| CH173/C02 | CH173 | |
| CH173Y/002 | CH173 | |
| CH174 | CH189 | |
| CH175/002 | CH175 | |
| CH176/002 | CH176 | |
| CH176/102 | CH176 | |
| CH177/002 | CH177 | |
| CH178/002 | CH178 | |
| CH179 | CH260 | |
| CH179/077 | CH260 | |
| CH179/C02 | CH260 | |
| CH179Y/002 | CH260 | |
| CH180/002 | CH180 | |
| CH181/002 | CH181 | |
| CH181Y/002 | CH181 | |
| CH184 | CH271 | |
| CH184Y/002 | CH271 | |
| CH185/002 | CH185 | |
| CH185F/002 | CH185 | |
| CH185Y/002 | CH185 | |
| CH186/002 | CH186 | |
| CH187 | CH186 | |
| CH187/002 | CH186 | |
| CH189/102 | CH189 | |
| CH189/C02 | CH189 | |
| CH196/002 | CH196 | |
| CH196Y/002 | CH196 | |
| CH201/002 | CH201 | |
| CH203/002 | CH203 | |
| CH204/002 | CH204 | |
| CH205/002 | CH205 | |
| CH206/002 | CH206 | |
| CH206Y/002 | CH206 | |
| CH207/002 | CH207 | |
| CH209/002 | CH209 | |
| CH215/002 | CH215 | |
| CH216/002 | CH216 | |
| CH217/002 | CH217 | |
| CH217Y/002 | CH217 | |
| CH219/002 | CH219 | |
| CH219Y/002 | CH219 | |
| CH221/002 | CH221 | |
| CH222/002 | CH222 | |
| CH222Y/002 | CH222 | |
| CH224/002 | CH224 | |
| CH225/002 | CH225 | |

| CHAMPION | | |
|-----------------|--------------|--|
| CH226/002 | CH226 | |
| CH229/002 | CH229 | |
| CH230/002 | CH230 | |
| CH231/002 | CH231 | |
| CH232/002 | CH232 | |
| CH232Y/002 | CH232 | |
| CH233/002 | CH233 | |
| CH233Y/002 | CH233 | |
| CH234/002 | CH234 | |
| CH240/002 | CH240 | |
| CH242/002 | CH242 | |
| CH256/002 | CH256 | |
| CH260/002 | CH260 | |
| CH263/002 | CH263 | |
| CH268/002 | CH268 | |
| CH269/002 | CH269 | |
| CH270/002 | CH270 | |
| CH271/102 | CH271 | |
| CH271Y/002 | CH271 | |
| CH272/002 | CH272 | |
| CH302/002 | CH302 | |
| CH306/002 | CH306 | |
| CH60 | CH260 | |
| CH600/002 | CH600 | |
| CH608/002 | CH608 | |
| CH614/002 | CH242 | |
| CH63 | CH189 | |
| CH63Y/002 | CH189 | |
| CH68 | CH189 | |
| CH68Y/002 | CH189 | |
| CH69 | CH260 | |
| CH704/002 | CH704 | |
| CH87 | CH189 | |
| CH88 | CH189 | |
| CH94 | CH221 | |
| DELPHI | | |
| D 1 | CH189 | |
| D 10 | CH260 | |
| D 11 | CH205 | |
| D 12 | CH147 | |
| D 13 | CH271 | |
| D 14 | CH169 | |
| D 15 | CH271 | |
| D 16 | CH176 | |
| D 17 | CH207 | |
| D 18 | CH167 | |
| D 2 | CH173 | |
| D 21 | CH177 | |
| D 22 | CH181 | |
| D 24 | CH196 | |
| D 25 | CH158 | |
| D 26 | CH175 | |



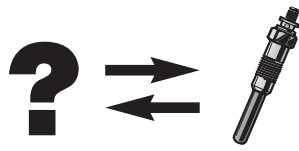

| DELPHI | | CHAMPION | | DENSO | | CHAMPION | | DENSO | | CHAMPION | |
|---------|-------|--------------|-----------------|-------------|-------|----------|-------|-------|--|----------|--|
| D 27 | CH170 | HDS342 | CH271 | 067100-1270 | CH154 | DG 180 | CH201 | | | | |
| D 28 | CH204 | HDS343 | CH260 | 067100-1330 | CH302 | DG 181 | CH268 | | | | |
| D 29 | CH232 | HDS346 | CH158 | 067100-1591 | CH306 | DG 182 | CH272 | | | | |
| D 3 | CH260 | HDS347 | CH173 | 067100-1630 | CH154 | DG 189 | CH234 | | | | |
| D 31 | CH222 | HDS348 | CH189 | 067100-1690 | CH302 | DG 192 | CH704 | | | | |
| D 33 | CH215 | HDS349 | CH189 | 067100-1710 | CH154 | DG 195 | CH270 | | | | |
| D 34 | CH209 | HDS350 | CH185 | 067100-1840 | CH154 | DG 196 | CH269 | | | | |
| D 36 | CH203 | HDS351 | CH189 | 067100-1841 | CH154 | DG 198 | CH221 | | | | |
| D 37 | CH229 | HDS352 | CH176 | 067100-1860 | CH302 | DG 211 | CH154 | | | | |
| D 39 | CH219 | HDS353 | CH189 | 067100-1861 | CH302 | DG 212 | CH154 | | | | |
| D 4 | CH189 | HDS354 | CH177 | DG 001 | CH189 | DG 214 | CH302 | | | | |
| D 40 | CH216 | HDS355 | CH169 | DG 002 | CH260 | DG 216 | CH302 | | | | |
| D 5 | CH233 | HDS356 | CH167 | DG 003 | CH185 | DG 218 | CH154 | | | | |
| D 6 | CH185 | HDS358 | CH186 | DG 004 | CH147 | DG 221 | CH154 | | | | |
| D 7 | CH217 | HDS359 | CH186 | DG 005 | CH271 | DG 232 | CH302 | | | | |
| D 8 | CH206 | HDS360 | CH207 | DG 006 | CH173 | DG 301 | CH256 | | | | |
| D 9 | CH169 | HDS361 | CH181 | DG 007 | CH205 | DG 304 | CH600 | | | | |
| HDS 360 | CH207 | HDS362 | CH205 | DG 008 | CH217 | DG 305 | CH608 | | | | |
| HDS 367 | CH170 | HDS363 | CH175 | DG 009 | CH206 | DG001 | CH189 | | | | |
| HDS 392 | CH263 | HDS366 | CH206 | DG 010 | CH176 | DG002 | CH260 | | | | |
| HDS 400 | CH306 | HDS367 | CH170 | DG 012 | CH260 | DG003 | CH185 | | | | |
| HDS 401 | CH600 | HDS368 | CH271 | DG 101 | CH169 | DG004 | CH147 | | | | |
| HDS 403 | CH256 | HDS369 | CH185 | DG 102 | CH167 | DG005 | CH271 | | | | |
| HDS 404 | CH240 | HDS370 | CH169 | DG 103 | CH260 | DG006 | CH173 | | | | |
| HDS 409 | CH224 | HDS371 | CH189 | DG 104 | CH158 | DG007 | CH205 | | | | |
| HDS 420 | CH234 | HDS372 | CH203 | DG 105 | CH221 | DG008 | CH217 | | | | |
| HDS211 | CH189 | HDS373 | CH204 | DG 106 | CH177 | DG009 | CH206 | | | | |
| HDS216 | CH189 | HDS374 | CH215 | DG 108 | CH306 | DG010 | CH176 | | | | |
| HDS217 | CH260 | HDS375 | CH216 | DG 109 | CH181 | DG012 | CH260 | | | | |
| HDS218 | CH189 | HDS376 | CH217 | DG 110 | CH204 | DG101 | CH169 | | | | |
| HDS221 | CH189 | HDS378 | CH219 | DG 111 | CH216 | DG102 | CH167 | | | | |
| HDS222 | CH260 | HDS379 | CH196 | DG 112 | CH233 | DG103 | CH260 | | | | |
| HDS229 | CH173 | HDS380 | CH209 | DG 115 | CH178 | DG104 | CH158 | | | | |
| HDS232 | CH221 | HDS382 | CH222 | DG 116 | CH170 | DG105 | CH221 | | | | |
| HDS234 | CH154 | HDS383 | CH229 | DG 118 | CH207 | DG106 | CH177 | | | | |
| HDS254 | CH260 | HDS384 | CH231 | DG 119 | CH175 | DG107 | CH271 | | | | |
| HDS255 | CH189 | HDS385 | CH233 | DG 120 | CH221 | DG108 | CH306 | | | | |
| HDS258 | CH260 | HDS391 | CH256 | DG 121 | CH196 | DG109 | CH181 | | | | |
| HDS262 | CH154 | HDS392 | CH263 | DG 122 | CH222 | DG110 | CH204 | | | | |
| HDS268 | CH302 | HDS394 | CH242 | DG 125 | CH189 | DG111 | CH216 | | | | |
| HDS273 | CH147 | HDS396 | CH232 | DG 126 | CH232 | DG112 | CH233 | | | | |
| HDS274 | CH189 | HDS397 | CH226 | DG 129 | CH209 | DG115 | CH178 | | | | |
| HDS275 | CH302 | HDS400 | CH306 | DG 130 | CH229 | DG116 | CH170 | | | | |
| HDS276 | CH221 | HDS401 | CH600 | DG 137 | CH186 | DG118 | CH207 | | | | |
| HDS295 | CH189 | HDS403 | CH256 | DG 142 | CH231 | DG119 | CH175 | | | | |
| HDS296 | CH189 | HDS404 | CH240 | DG 144 | CH215 | DG120 | CH221 | | | | |
| HDS297 | CH176 | HDS406 | CH268 | DG 145 | CH203 | DG121 | CH196 | | | | |
| HDS299 | CH189 | HDS407 | CH272 | DG 146 | CH242 | DG122 | CH222 | | | | |
| HDS303 | CH178 | HDS408 | CH180 | DG 155 | CH219 | DG125 | CH167 | | | | |
| HDS304 | CH189 | HDS409 | CH224 | DG 172 | CH225 | DG126 | CH232 | | | | |
| HDS337 | CH189 | HDS420 | CH234 | DG 173 | CH226 | DG129 | CH209 | | | | |
| HDS339 | CH147 | DENSO | CHAMPION | DG 174 | CH256 | DG130 | CH229 | | | | |
| HDS341 | CH260 | 0671001270 | CH154 | DG 176 | CH180 | DG137 | CH186 | | | | |

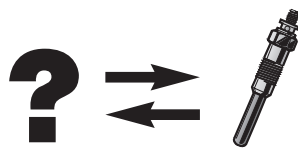

| DENSO | CHAMPION |
|---------------|----------|
| DG140 | CH240 |
| DG-140 | CH240 |
| DG142 | CH231 |
| DG144 | CH215 |
| DG145 | CH203 |
| DG146 | CH242 |
| DG155 | CH219 |
| DG170 | CH224 |
| DG-170 | CH224 |
| DG172 | CH225 |
| DG173 | CH226 |
| DG174 | CH256 |
| DG176 | CH180 |
| DG180 | CH201 |
| DG181 | CH268 |
| DG182 | CH272 |
| DG187 | CH263 |
| DG189 | CH234 |
| DG195 | CH270 |
| DG196 | CH269 |
| DG197 | CH230 |
| DG198 | CH221 |
| DG201 | CH154 |
| DG203 | CH154 |
| DG205 | CH302 |
| DG207 | CH302 |
| DG304 | CH600 |
| EYQUEM | CHAMPION |
| 0 911 101 138 | CH215 |
| 0 911 101 195 | CH242 |
| 0 911 101 196 | CH225 |
| 0 911 101 197 | CH221 |
| 0 911 101 199 | CH600 |
| 0 911 101 203 | CH201 |
| 0 911 101 233 | CH230 |
| 0 911 101 234 | CH234 |
| ACL588S | CH221 |
| CD566R | CH147 |
| CD659R | CH260 |
| CD660R | CH260 |
| CD661R | CH260 |
| CD670T | CH189 |
| CL580P | CH158 |
| CL588S | CH221 |
| CL588Y | CH154 |
| CL596V | CH302 |
| DD6120V | CH177 |
| DD659R | CH260 |
| DD665T | CH173 |
| DD668S | CH176 |
| DD670T | CH189 |
| DD671T | CH189 |

| EYQUEM | CHAMPION |
|--------|----------|
| DD678S | CH189 |
| DT584T | CH169 |
| DT589V | CH185 |
| DT592T | CH271 |
| G1 | CH242 |
| G20 | CH215 |
| G27 | CH173 |
| G30 | CH268 |
| G31 | CH225 |
| G32 | CH221 |
| G34 | CH185 |
| G38 | CH600 |
| G5 | CH240 |
| G54 | CH217 |
| G72 | CH201 |
| G76 | CH230 |
| G77 | CH234 |
| G9 | CH270 |
| KTB501 | CH147 |
| KTB601 | CH260 |
| KTB602 | CH260 |
| KTD602 | CH189 |
| KTD603 | CH189 |
| KTE601 | CH177 |
| KWE501 | CH185 |
| PTA601 | CH205 |
| PTB501 | CH147 |
| PTB601 | CH260 |
| PTB602 | CH260 |
| PTB603 | CH147 |
| PTC601 | CH176 |
| PTD501 | CH206 |
| PTD502 | CH167 |
| PTD601 | CH173 |
| PTD603 | CH189 |
| PTE502 | CH204 |
| PTE601 | CH175 |
| PTE603 | CH177 |
| PVC503 | CH221 |
| PWD501 | CH271 |
| PWD503 | CH271 |
| PWD504 | CH217 |
| PWD505 | CH222 |
| PWD506 | CH216 |
| PWD509 | CH196 |
| PWD510 | CH233 |
| PWE501 | CH185 |
| PWE502 | CH170 |
| PWE503 | CH178 |
| PWE506 | CH207 |
| PWF501 | CH219 |
| PWF502 | CH185 |
| PWF503 | CH181 |

| EYQUEM | CHAMPION |
|--------|----------|
| PWG501 | CH203 |
| PWG503 | CH215 |
| PWG504 | CH229 |
| STB502 | CH260 |
| SVA504 | CH158 |
| SVC504 | CH221 |
| SVE501 | CH302 |
| SVE503 | CH302 |
| SVG501 | CH154 |
| SVG502 | CH154 |
| FAE | CHAMPION |
| 7407 | CH189 |
| 7409 | CH173 |
| 74140 | CH189 |
| 74141 | CH260 |
| 74142 | CH147 |
| 74144 | CH176 |
| 74145 | CH271 |
| 74146 | CH206 |
| 74147 | CH175 |
| 74151 | CH185 |
| 74152 | CH181 |
| 74154 | CH204 |
| 74183 | CH229 |
| 74191 | CH233 |
| 7619 | CH221 |
| FAI | CHAMPION |
| FG100 | CH260 |
| FG101 | CH260 |
| FG103 | CH189 |
| FG104 | CH189 |
| FG106 | CH189 |
| FG107 | CH189 |
| FG108 | CH189 |
| FG109 | CH189 |
| FG110 | CH189 |
| FG111 | CH189 |
| FG114 | CH147 |
| FG117 | CH154 |
| FG121 | CH147 |
| FG124 | CH221 |
| FG125 | CH221 |
| FG128 | CH221 |
| FG129 | CH221 |
| FG132 | CH189 |
| FG133 | CH189 |
| FG135 | CH189 |
| FG137 | CH189 |
| FG146 | CH158 |
| FG147 | CH173 |
| FG150 | CH189 |

| FAI | CHAMPION |
|---------------|----------|
| FG153 | CH147 |
| FG154 | CH189 |
| FG155 | CH185 |
| GGP01 | CH260 |
| GGP02 | CH260 |
| GGP04 | CH189 |
| GGP09 | CH189 |
| GGP11 | CH147 |
| GGP14 | CH154 |
| GGP15 | CH189 |
| GGP16 | CH260 |
| GGP18 | CH147 |
| GGP26 | CH221 |
| GGP29 | CH189 |
| GGP30 | CH178 |
| GGP32 | CH189 |
| GGP33 | CH271 |
| GGP34 | CH189 |
| GGP35 | CH302 |
| GGP36 | CH186 |
| GGP38 | CH186 |
| GGP40 | CH158 |
| GGP41 | CH176 |
| GGP42 | CH173 |
| GGP43 | CH302 |
| GGP44 | CH260 |
| GGP46 | CH189 |
| GGP47 | CH185 |
| GGP49 | CH169 |
| GGP52 | CH154 |
| GGP53 | CH205 |
| GGP54 | CH181 |
| GGP56 | CH167 |
| GGP58 | CH204 |
| GGP59 | CH175 |
| GGP60 | CH177 |
| GGP61 | CH206 |
| GGP62 | CH169 |
| GGP65 | CH217 |
| GGP67 | CH170 |
| GGP68 | CH189 |
| GGP69 | CH189 |
| GGP72 | CH215 |
| GGP74 | CH203 |
| GGP75 | CH216 |
| GGP77 | CH219 |
| GGP79 | CH207 |
| GGP84 | CH271 |
| FEBI BILSTEIN | CHAMPION |
| 01002 | CH233 |
| 15949 | CH181 |
| 15953 | CH205 |



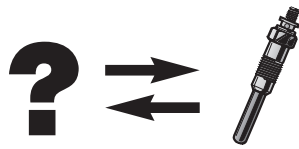

| | | | | | | | |
|---------------------------|-------|-----------------------------|-------|-------------------------|-------|-------------------------|-------|
| FEBI BILSTEIN | | HERTH+BUSS ELPARTS | | INTERMOTOR | | LUCAS ELECTRICAL | |
| 15956 | CH260 | 29 200 011 | CH189 | 80152 | CH260 | DS 001 | CH189 |
| 15957 | CH170 | 29 200 012 | CH260 | 80153 | CH260 | DS 003 | CH189 |
| 15959 | CH222 | 29 200 014 | CH189 | 80155 | CH189 | DS 006 | CH189 |
| 15961 | CH189 | 29 200 015 | CH260 | 80157 | CH167 | DS 007 | CH260 |
| 15962 | CH147 | J 571 2013 | CH608 | 80158 | CH169 | DS 014 | CH173 |
| 15963 | CH189 | J 5711023 | CH186 | 80161 | CH154 | DS 017 | CH221 |
| 15964 | CH175 | HERTH+BUSS JAKOPARTS | | JAPANPARTS | | DS 019 | CH154 |
| 15965 | CH189 | J 5711016 | CH600 | CP 22 | CH608 | DS 040 | CH189 |
| 15966 | CH177 | J 5711023 | CH186 | JAPCAR | | DS 043 | CH260 |
| 17700 | CH189 | J5711017 | CH186 | CP 02 | CH600 | DS 058 | CH147 |
| 17788 | CH207 | J5715000 | CH221 | CP 07 | CH256 | DS 122 | CH189 |
| 17979 | CH271 | HKT | | JKC 64031 | CH302 | DS 850 | CH147 |
| 17981 | CH169 | B040 | CH189 | LETRIKA | | HDS 211 | CH189 |
| 18404 | CH204 | CP02 | CH600 | 11 721 003 | CH260 | HDS 216 | CH189 |
| 18408 | CH219 | PD191 | CH302 | 11 721 004 | CH189 | HDS 218 | CH189 |
| 19099 | CH185 | PI49 | CH306 | LUCAS | | HDS 222 | CH260 |
| 19103 | CH154 | PI57 | CH158 | DS001 | CH189 | HDS 229 | CH173 |
| 19223 | CH176 | PI59 | CH158 | DS002 | CH260 | HDS 232 | CH221 |
| 19249 | CH217 | PM164 | CH256 | DS003 | CH189 | HDS 234 | CH154 |
| 19447 | CH196 | PM75 | CH221 | DS004 | CH260 | HDS 254 | CH260 |
| 19882 | CH203 | PN135 | CH221 | DS006 | CH189 | HDS 255 | CH189 |
| 21864 | CH229 | PN138 | CH186 | DS007 | CH260 | HDS 258 | CH260 |
| 21866 | CH232 | PN86 | CH189 | DS014 | CH173 | HDS 273 | CH147 |
| 21957 | CH209 | PN89 | CH260 | DS017 | CH221 | HDS 274 | CH189 |
| 24095 | CH240 | PT103 | CH154 | DS019 | CH154 | HDS 295 | CH189 |
| 24428 | CH231 | PT144 | CH154 | DS040 | CH189 | HDS 297 | CH176 |
| 24483 | CH224 | PT145 | CH302 | DS043 | CH260 | HDS 299 | CH189 |
| 24771 | CH226 | PT147 | CH154 | DS058 | CH147 | HDS 303 | CH178 |
| 24917 | CH242 | PT150 | CH302 | DS122 | CH189 | HDS 304 | CH167 |
| 26585 | CH302 | PT151 | CH154 | DS850 | CH147 | HDS 337 | CH189 |
| 27226 | CH181 | PT152 | CH302 | LP005 | CH147 | HDS 339 | CH147 |
| 31233 | CH186 | PZ38 | CH242 | LP021 | CH176 | HDS 341 | CH260 |
| 31248 | CH201 | PZ39 | CH242 | LP022 | CH260 | HDS 342 | CH271 |
| HELLA | | INTERMOTOR | | LP027 | CH271 | HDS 347 | CH173 |
| 8EG 008 497-501 | CH215 | 80000 | CH189 | LP033 | CH189 | HDS 348 | CH189 |
| 8EG 008 497-511 | CH219 | 80015 | CH189 | LP035 | CH189 | HDS 349 | CH189 |
| 8EG 008 497-521 | CH216 | 80021 | CH260 | LP037 | CH185 | HDS 358 | CH186 |
| 8EG 008 497-571 | CH203 | 80024 | CH271 | LP040 | CH177 | HDS 359 | CH186 |
| 8EG 008 497-581 | CH209 | 80026 | CH260 | LP045 | CH204 | HDS 371 | CH189 |
| 8EG 008-497-551 | CH271 | 80031 | CH189 | LP048 | CH205 | HDS 372 | CH203 |
| 8EG 008-497-561 | CH233 | 80034 | CH189 | LP050 | CH217 | HDS 373 | CH204 |
| 8EH 008 497-611 | CH196 | 80040 | CH260 | LP059 | CH207 | HDS 374 | CH215 |
| PO 750 | CH215 | 80044 | CH147 | LP062 | CH233 | HDS 375 | CH216 |
| PO 751 | CH219 | 80060 | CH173 | LP073 | CH271 | HDS 376 | CH217 |
| PO 752 | CH216 | 80100 | CH221 | LUCAS CAV | | HDS 379 | CH196 |
| PO 755 | CH271 | 80111 | CH260 | HDS 396 | CH232 | HDS 401 | CH600 |
| PO 756 | CH233 | 80121 | CH154 | HDS 420 | CH234 | HDS 403 | CH256 |
| PO 757 | CH203 | 80136 | CH158 | LUCAS ELECTRICAL | | MAGNETI MARELLI | |
| PO 758 | CH209 | 80140 | CH189 | 6415-4 | CH189 | TIX 2 A | CH189 |
| PO 761 | CH196 | 80142 | CH178 | | | TIX 4 A | CH189 |
| HERTH+BUSS ELPARTS | | 80144 | CH147 | | | TIX 6 A | CH189 |
| 29 200 010 | CH260 | | | | | TIX1A | CH260 |

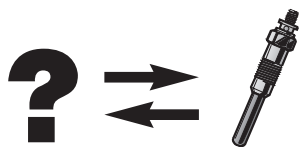

| MAGNETI MARELLI | CHAMPION |
|-----------------|----------|
| TIX2A | CH189 |
| TLX 2 A | CH189 |
| UC 12A | CH170 |
| UC 13A | CH217 |
| UC 14A | CH181 |
| UC 15A | CH185 |
| UC 16A | CH207 |
| UC 18A | CH219 |
| UC 3 A | CH271 |
| UC 4 A | CH167 |
| UC 7 A | CH185 |
| UC 8 A | CH169 |
| UC04F | CH704 |
| UC12A | CH170 |
| UC13A | CH169 |
| UC14A | CH181 |
| UC15A | CH185 |
| UC16A | CH207 |
| UC18A | CH219 |
| UC19A | CH222 |
| UC20A | CH271 |
| UC21A | CH217 |
| UC22A | CH196 |
| UC23A | CH221 |
| UC24A | CH178 |
| UC25A | CH186 |
| UC26A | CH203 |
| UC27A | CH229 |
| UC28A | CH231 |
| UC29A | CH232 |
| UC30A | CH233 |
| UC31A | CH271 |
| UC33A | CH226 |
| UC34A | CH256 |
| UC36A | CH186 |
| UC37A | CH216 |
| UC38A | CH302 |
| UC3A | CH271 |
| UC41A | CH268 |
| UC43A | CH269 |
| UC4A | CH167 |
| UC7A | CH185 |
| UC8A | CH169 |
| UC9A | CH158 |
| UX 11 A | CH147 |
| UX 13 A | CH176 |
| UX 14 A | CH173 |
| UX 15 A | CH189 |
| UX 16A | CH175 |
| UX 17A | CH177 |
| UX 18A | CH260 |
| UX 19A | CH205 |
| UX 20A | CH189 |

| MAGNETI MARELLI | CHAMPION |
|-----------------|----------|
| UX 21A | CH209 |
| UX 4 A | CH189 |
| UX 5 A | CH173 |
| UX 8 A | CH260 |
| UX11A | CH147 |
| UX13A | CH176 |
| UX14A | CH173 |
| UX15A | CH189 |
| UX16A | CH175 |
| UX17A | CH177 |
| UX18A | CH260 |
| UX19A | CH205 |
| UX20A | CH189 |
| UX21A | CH209 |
| UX22A | CH206 |
| UX23A | CH204 |
| UX24A | CH230 |
| UX2A | CH189 |
| UX4A | CH189 |
| UX8A | CH260 |
| UX9A | CH189 |
| UY3A | CH224 |
| UY4A | CH240 |
| UY5A | CH201 |
| UZ3A | CH600 |
| MONARK | CHAMPION |
| 90 505 052 | CH260 |
| 90 505 066 | CH260 |
| 90 505 907 | CH189 |
| 90 505 910 | CH260 |
| 90 905 063 | CH260 |
| MOPAR PARTS | CHAMPION |
| 4720600 | CH189 |
| 4863826 | CH181 |
| MOTORCRAFT | CHAMPION |
| ESD10 | CH260 |
| EZD 10 | CH260 |
| EZD 11 | CH189 |
| EZD 14 | CH189 |
| EZD 15 | CH189 |
| EZD 16 | CH189 |
| EZD 18 | CH221 |
| EZD 2 | CH189 |
| EZD 21 | CH154 |
| EZD 25 | CH260 |
| EZD 27 | CH260 |
| EZD 29 | CH173 |
| EZD 30 | CH189 |
| EZD 33 | CH271 |
| EZD 36 | CH181 |
| EZD 37 | CH196 |

| MOTORCRAFT | CHAMPION |
|------------|----------|
| EZD 38 | CH229 |
| EZD 39 | CH205 |
| EZD 4 | CH260 |
| EZD 41 | CH268 |
| EZD 5 | CH189 |
| EZD 8 | CH147 |
| EZD10 | CH260 |
| EZD11 | CH189 |
| EZD12 | CH189 |
| EZD14 | CH189 |
| EZD15 | CH189 |
| EZD16 | CH189 |
| EZD18 | CH221 |
| EZD2 | CH189 |
| EZD21 | CH154 |
| EZD4 | CH189 |
| EZD5 | CH189 |
| EZD8 | CH147 |
| EZDA | CH260 |
| EZDB | CH189 |
| EZDC | CH189 |
| EZDE | CH189 |
| EZDF | CH189 |
| EZDG | CH189 |
| EZDU | CH221 |
| EZDX | CH154 |
| NGK | CHAMPION |
| 1009 | CH185 |
| 1239 | CH260 |
| 1250 | CH189 |
| 1436 | CH233 |
| 1441 | CH170 |
| 1566 | CH242 |
| 1749 | CH204 |
| 2189 | CH221 |
| 2203 | CH178 |
| 2237 | CH189 |
| 2273 | CH169 |
| 2408 | CH271 |
| 2419 | CH217 |
| 2500 | CH230 |
| 2643 | CH189 |
| 2686 | CH225 |
| 2691 | CH203 |
| 2785 | CH176 |
| 2951 | CH154 |
| 3017 | CH600 |
| 3040 | CH263 |
| 3078 | CH219 |
| 3219 | CH189 |
| 3319 | CH232 |
| 3380 | CH189 |

| NGK | CHAMPION |
|------|----------|
| 3413 | CH222 |
| 3473 | CH189 |
| 3617 | CH147 |
| 3645 | CH189 |
| 3687 | CH158 |
| 3703 | CH231 |
| 3704 | CH260 |
| 3709 | CH234 |
| 3782 | CH302 |
| 3786 | CH215 |
| 3829 | CH260 |
| 3852 | CH216 |
| 3873 | CH147 |
| 3965 | CH173 |
| 4090 | CH229 |
| 4118 | CH205 |
| 4119 | CH178 |
| 4182 | CH260 |
| 4187 | CH215 |
| 4275 | CH175 |
| 4279 | CH185 |
| 4290 | CH147 |
| 4309 | CH272 |
| 4356 | CH189 |
| 4359 | CH170 |
| 4389 | CH167 |
| 4409 | CH217 |
| 4454 | CH176 |
| 4467 | CH158 |
| 4520 | CH196 |
| 4585 | CH189 |
| 4600 | CH203 |
| 4751 | CH147 |
| 4791 | CH147 |
| 4818 | CH169 |
| 4842 | CH219 |
| 4902 | CH217 |
| 4916 | CH206 |
| 4937 | CH221 |
| 4950 | CH189 |
| 4956 | CH260 |
| 4994 | CH256 |
| 5000 | CH207 |
| 5005 | CH185 |
| 5013 | CH226 |
| 5045 | CH177 |
| 5059 | CH209 |
| 5065 | CH181 |
| 5104 | CH169 |
| 5116 | CH242 |
| 5148 | CH205 |
| 5171 | CH206 |
| 5207 | CH201 |



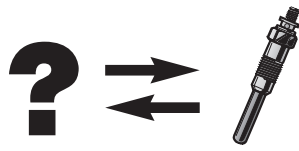

| NGK | CHAMPION | NGK | CHAMPION | NGK | CHAMPION | NGK | CHAMPION |
|-------|----------|-------|----------|------------|----------|------------|----------|
| 5264 | CH158 | 91766 | CH232 | DP41 | CH204 | D-Power 59 | CH263 |
| 5267 | CH189 | 93293 | CH230 | DP43 | CH209 | D-Power 6 | CH176 |
| 5287 | CH256 | 94629 | CH270 | DP5 | CH205 | D-Power 61 | CH230 |
| 5317 | CH173 | 94832 | CH229 | DP52 | CCGP002 | D-Power 64 | CH270 |
| 5376 | CH154 | 96037 | CH229 | DP55 | CCGP003 | D-Power 66 | CH232 |
| 5413 | CH173 | 96853 | CH270 | DP56 | CH268 | D-Power 7 | CH217 |
| 5486 | CH186 | 9810 | CCGP002 | DP59 | CH263 | D-Power 70 | CH269 |
| 5540 | CH222 | 9826 | CCGP002 | DP6 | CH176 | D-Power 73 | CH201 |
| 5568 | CH175 | 9835 | CCGP003 | DP61 | CH230 | D-Power 75 | CH229 |
| 5605 | CH271 | 9864 | CCGP003 | DP64 | CH270 | D-Power 9 | CH185 |
| 5700 | CH167 | 9974 | CH225 | DP66 | CH232 | Y1005J | CH268 |
| 5740 | CH177 | CY02 | CH600 | DP7 | CH217 | Y1007J | CH263 |
| 5906 | CH176 | CY07 | CH256 | DP70 | CH269 | Y1030J | CH269 |
| 5909 | CH271 | CY08 | CH186 | DP73 | CH201 | Y-115T | CH221 |
| 5979 | CH209 | CY52 | CH600 | DP75 | CH229 | Y-115TI | CH221 |
| 5986 | CH196 | CY57 | CH256 | DP9 | CH185 | Y-118T | CH154 |
| 5996 | CH206 | CY58 | CH186 | D-Power 1 | CH189 | Y-118TI | CH154 |
| 6003 | CH204 | CZ101 | CCGP002 | D-Power 10 | CH185 | Y-147T | CH302 |
| 6092 | CH224 | CZ104 | CCGP002 | D-Power 12 | CH233 | Y-154RS | CH306 |
| 6136 | CH260 | CZ301 | CCGP003 | D-Power 13 | CH256 | Y-204TS | CH260 |
| 6140 | CH186 | CZ304 | CCGP003 | D-Power 14 | CH207 | Y-204TS1 | CH260 |
| 6246 | CH170 | DP1 | CH189 | D-Power 15 | CH173 | Y-204V | CH260 |
| 6281 | CH185 | DP10 | CH185 | D-Power 16 | CH177 | Y-206T | CH189 |
| 6285 | CH260 | DP12 | CH233 | D-Power 17 | CH169 | Y-207T | CH260 |
| 6298 | CH231 | DP13 | CH256 | D-Power 19 | CH206 | Y-207TS | CH260 |
| 6416 | CH233 | DP14 | CH207 | D-Power 2 | CH260 | Y-208T | CH189 |
| 6586 | CH186 | DP15 | CH173 | D-Power 20 | CH181 | Y-501U | CH215 |
| 6592 | CH256 | DP16 | CH177 | D-Power 21 | CH256 | Y-502R | CH216 |
| 6599 | CH260 | DP17 | CH169 | D-Power 22 | CH169 | Y-503J | CH185 |
| 6649 | CH207 | DP18 | CH271 | D-Power 23 | CH147 | Y-503R | CH185 |
| 6704 | CH169 | DP19 | CH206 | D-Power 24 | CH170 | Y-504J | CH170 |
| 6848 | CH177 | DP2 | CH260 | D-Power 25 | CH260 | Y-504R | CH170 |
| 6892 | CH271 | DP20 | CH181 | D-Power 27 | CH196 | Y-506J | CH217 |
| 6897 | CH203 | DP21 | CH256 | D-Power 28 | CH158 | Y-506R | CH217 |
| 6900 | CH158 | DP22 | CH169 | D-Power 29 | CH167 | Y-507J | CH203 |
| 6943 | CH181 | DP23 | CH147 | D-Power 3 | CH147 | Y-507R | CH203 |
| 7464 | CH242 | DP24 | CH170 | D-Power 30 | CH175 | Y-508J | CH234 |
| 7493 | CH302 | DP25 | CH260 | D-Power 31 | CH215 | Y-509J | CH186 |
| 7503 | CH205 | DP27 | CH196 | D-Power 32 | CH203 | Y-515J | CH271 |
| 7545 | CH147 | DP28 | CH158 | D-Power 33 | CH147 | Y-516J | CH233 |
| 7782 | CH302 | DP29 | CH167 | D-Power 34 | CH178 | Y-517J | CH232 |
| 7794 | CH240 | DP3 | CH147 | D-Power 35 | CH229 | Y-519J | CH230 |
| 7906 | CH189 | DP30 | CH175 | D-Power 36 | CH222 | Y-523J | CH231 |
| 7947 | CH260 | DP31 | CH215 | D-Power 37 | CH231 | Y-524J | CH196 |
| 7957 | CH268 | DP32 | CH203 | D-Power 38 | CH219 | Y-525J | CH229 |
| 7992 | CH219 | DP33 | CH147 | D-Power 39 | CH242 | Y-530J | CH186 |
| 7995 | CH306 | DP34 | CH178 | D-Power 4 | CH271 | Y-532J | CH302 |
| 8902 | CH263 | DP35 | CH229 | D-Power 41 | CH204 | Y-534J | CH222 |
| 8939 | CH268 | DP36 | CH222 | D-Power 43 | CH209 | Y-548J | CH229 |
| 8944 | CH256 | DP37 | CH231 | D-Power 5 | CH205 | Y-605J | CH272 |
| 90002 | CH269 | DP38 | CH219 | D-Power 52 | CCGP002 | Y-701J | CH242 |
| 90828 | CH269 | DP39 | CH242 | D-Power 55 | CCGP003 | Y-701R | CH242 |
| 91322 | CH201 | DP4 | CH271 | D-Power 56 | CH268 | Y-703R | CH302 |

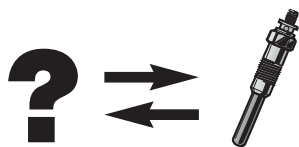

| NGK | CHAMPION |
|----------|----------|
| Y-707RS | CH221 |
| Y-711J | CH158 |
| Y-711RS | CH158 |
| Y-712RS | CH186 |
| Y-715R | CH154 |
| Y-719RS1 | CH158 |
| Y-721RS | CH158 |
| Y-722J | CH225 |
| Y-722JS | CH225 |
| Y-729U | CH178 |
| Y-730U | CH169 |
| Y-731U | CH185 |
| Y-732J | CH271 |
| Y-732U | CH271 |
| Y-733J | CH256 |
| Y-740 | CH169 |
| Y-740U | CH169 |
| Y-741U | CH181 |
| Y-743U | CH158 |
| Y-746J | CH219 |
| Y-746R | CH219 |
| Y-748U | CH207 |
| Y-749J | CH226 |
| Y-752M | CH189 |
| Y8005J | CH270 |
| Y-901R | CH260 |
| Y-902R | CH189 |
| Y-904M1 | CH306 |
| Y-908R | CH189 |
| Y-910J | CH147 |
| Y-910R | CH147 |
| Y-911J | CH147 |
| Y-911R | CH147 |
| Y-912M | CH173 |
| Y-912R | CH147 |
| Y-913J | CH173 |
| Y-913M | CH173 |
| Y-914U | CH189 |
| Y-916J | CH176 |
| Y-916R | CH176 |
| Y-917U | CH189 |
| Y-918J | CH260 |
| Y-918R | CH260 |
| Y-920R | CH189 |
| Y-922R | CH189 |
| Y-923U | CH189 |
| Y-924J | CH189 |
| Y-924U | CH189 |
| Y-925J | CH177 |
| Y-925R | CH177 |
| Y-927J | CH206 |
| Y-927R | CH206 |
| Y-928U | CH167 |

| NGK | CHAMPION |
|----------------|----------|
| Y-929U | CH204 |
| Y-930U | CH175 |
| Y-930Y | CH175 |
| Y-932R | CH260 |
| Y-933J | CH260 |
| Y-933R | CH260 |
| Y-935U | CH147 |
| Y-937J | CH205 |
| Y-937R | CH205 |
| Y-938R | CH189 |
| Y-939J | CH209 |
| YE05 | CH201 |
| YE07 | CH224 |
| YE12 | CH240 |
| NIPPARTS | CHAMPION |
| 5710501 | CH226 |
| J 5719002 | CH306 |
| J5174002 | CH169 |
| J5710301 | CH242 |
| J5710302 | CH234 |
| J5710400 | CH176 |
| J5710401 | CH176 |
| J5710500 | CH221 |
| J5710501 | CH226 |
| J5711009 | CH221 |
| J5711012 | CH186 |
| J5711016 | CH600 |
| J5711022 | CH221 |
| J5711026 | CH230 |
| J5711028 | CH185 |
| J5711031 | CH232 |
| J5712009 | CH302 |
| J5712013 | CH608 |
| J5712014 | CH154 |
| J5712016 | CH302 |
| J5712018 | CH154 |
| J5713000 | CH242 |
| J5713008 | CH242 |
| J5714000 | CH169 |
| J5715004 | CH256 |
| J5715008 | CH256 |
| J5715010 | CH263 |
| J5715012 | CH256 |
| J5715014 | CH271 |
| J5719003 | CH158 |
| J5719009 | CH158 |
| QUINTON HAZELL | CHAMPION |
| CH 306/002 | CH306 |
| QGP105 | CH260 |
| QGP107 | CH189 |
| QGP110 | CH189 |

| QUINTON HAZELL | CHAMPION |
|----------------|----------|
| QGP111 | CH189 |
| QGP112 | CH260 |
| QGP115 | CH189 |
| QGP117 | CH221 |
| QGP125 | CH154 |
| QGP131 | CH260 |
| QGP147 | CH147 |
| QGP148 | CH176 |
| QGP151 | CH189 |
| QGP154 | CH189 |
| QGP155 | CH271 |
| QGP165 | CH154 |
| QGP168 | CH221 |
| QGP169 | CH158 |
| QGP174 | CH178 |
| QGP175 | CH185 |
| QGP178 | CH205 |
| QGP179 | CH169 |
| QGP181 | CH260 |
| SWAG | CHAMPION |
| 70 91 5959 | CH222 |
| TEROSON | CHAMPION |
| CH 171 | CH271 |
| TOPRAN | CHAMPION |
| 207046 | CH232 |
| UNIPART | CHAMPION |
| GGP1 | CH189 |
| GGP12 | CH154 |
| GGP16 | CH158 |
| GGP17 | CH260 |
| GGP18 | CH189 |
| GGP2 | CH189 |
| GGP20 | CH221 |
| GGP22 | CH189 |
| GGP23 | CH185 |
| GGP24 | CH169 |
| GGP25 | CH271 |
| GGP26 | CH167 |
| GGP27 | CH175 |
| GGP28 | CH173 |
| GGP29 | CH189 |
| GGP30 | CH177 |
| GGP31 | CH178 |
| GGP32 | CH260 |
| GGP4 | CH260 |
| GGP7 | CH189 |
| GGP8 | CH147 |
| VALEO | CHAMPION |
| 344875 | CH189 |
| 344876 | CH260 |

| VALEO | CHAMPION |
|---------|----------|
| 344877 | CH189 |
| 344878 | CH189 |
| 344881 | CH176 |
| 344882 | CH147 |
| 344883 | CH189 |
| 344884 | CH189 |
| 344885 | CH147 |
| 344887 | CH189 |
| 344888 | CH189 |
| 344889 | CH173 |
| 344893 | CH271 |
| 344894 | CH189 |
| 344895 | CH185 |
| 344896 | CH189 |
| 344918 | CH158 |
| 344921 | CH169 |
| 344922 | CH189 |
| 344923 | CH189 |
| 344932 | CH189 |
| 344953 | CH189 |
| 344955 | CH205 |
| 344957 | CH175 |
| 344959 | CH177 |
| 344961 | CH217 |
| 344964 | CH207 |
| 344967 | CH169 |
| 344973 | CH271 |
| 344988 | CH219 |
| 344991 | CH203 |
| 344993 | CH232 |
| 345005 | CH196 |
| 345014 | CH221 |
| C 100 S | CH189 |
| C 101 S | CH189 |
| C 102 S | CH189 |
| C 105 S | CH147 |
| C 106 S | CH189 |
| C 107 S | CH189 |
| C 108 S | CH147 |
| C 110 S | CH189 |
| C 111 R | CH189 |
| C 112 R | CH260 |
| C 117 S | CH158 |
| C 118 S | CH260 |
| C 200 S | CH260 |
| C 201 S | CH176 |
| C 202 R | CH173 |
| C 203 R | CH147 |
| C 204 R | CH189 |
| C 205 R | CH271 |
| C 206 R | CH189 |
| C 207 R | CH185 |
| C 208 R | CH189 |

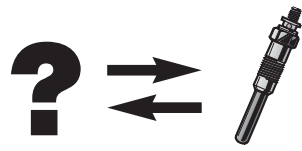

**VALEO**

| | |
|---------|-------|
| C 209 S | CH189 |
| C 210 S | CH169 |
| C100S | CH189 |
| C101S | CH189 |
| C102S | CH189 |
| C105S | CH147 |
| C106S | CH189 |
| C107S | CH189 |
| C108S | CH147 |
| C110S | CH189 |
| C111R | CH189 |
| C117S | CH158 |
| C118S | CH260 |
| C200S | CH260 |
| C201S | CH176 |
| C204R | CH189 |
| C205R | CH271 |
| C206R | CH189 |
| C207R | CH185 |
| C208R | CH189 |
| C210S | CH169 |
| C213S | CH169 |
| C215S | CH189 |
| C217S | CH205 |
| C219S | CH175 |
| C221S | CH177 |
| C223S | CH217 |
| C226S | CH207 |
| C228S | CH271 |
| C241S | CH203 |
| C243S | CH232 |
| C255S | CH196 |
| C264S | CH221 |

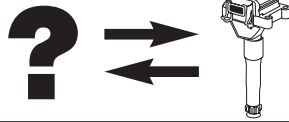

| AIRTEX | | |
|-----------------|----------|--|
| 5C 1071 | BAEA136E | |
| 5C 1166 | BAEA073E | |
| 5C 1208 | BAEA083E | |
| 5C 1287 | BAEA072E | |
| 5C 1394 | BAEA081E | |
| 5C 1403 | BAEA079E | |
| 5C 1430 | BAEA132E | |
| 5C 16127 | BAEA080E | |
| 5C1153 | BAEA521 | |
| 5C1317 | BAEA429 | |
| ANGLI | | |
| 15067 | BAE947A | |
| ASHIKA | | |
| 7801111 | BAEA188E | |
| 78-05-500 | BAEA179E | |
| 78-0W-W05 | BAEA543 | |
| ASHUKI | | |
| C980-05 | BAEA179E | |
| C980-050 | BAEA179E | |
| H595-03 | BAEA169E | |
| J840-03 | BAEA543 | |
| J840-05 | BAEA539 | |
| N84003 | BAEA188E | |
| AUTOMEGA | | |
| 3012080071 | BAEA344 | |
| 3012080306 | BAEA358 | |
| 3012080307 | BAE965A | |
| BBT | | |
| IC 03128 | BAEA137E | |
| IC 04114 | BAEA140E | |
| IC 07104 | BAEA026E | |
| IC 13100 | BAE800B | |
| IC 13116 | BAEA095 | |
| IC 16103 | BAEA073E | |
| IC 16109 | BAEA072E | |
| IC 16110 | BAEA433 | |
| IC 16112 | BAEA081E | |
| IC 16127 | BAEA080E | |
| IC 16128 | BAEA088E | |
| IC 17124 | BAEA083E | |
| IC0 3101 | BAE408AE | |
| IC0 3104 | BAE907AE | |
| IC01101 | BAEA055E | |
| IC03100 | BAE851AE | |
| IC03102 | BAEA043E | |
| IC03106 | BAEA016 | |
| IC03107 | BAEA017 | |
| IC03108 | BAEA154E | |
| IC03109 | BAEA002E | |
| IC03110 | BAEA033E | |

| BBT | | |
|------------|----------|--|
| IC03111 | BAEA032E | |
| IC03112 | BAEA031E | |
| IC03114 | BAE960AE | |
| IC03114 | BAE961AE | |
| IC03118 | BAEA063E | |
| IC03119 | BAEA029E | |
| IC03121 | BAEA051E | |
| IC03122 | BAEA059E | |
| IC03123 | BAEA044E | |
| IC03127 | BAEA067E | |
| IC03127 | BAEA126E | |
| IC03128 | BAEA068E | |
| IC04101 | BAEA313 | |
| IC04102 | BAEA340 | |
| IC04104 | BAEA339 | |
| IC04105 | BAEA298 | |
| IC04108 | BAEA340 | |
| IC04110 | BAEA146E | |
| IC04112 | BAEA053 | |
| IC04113 | BAEA077 | |
| IC04119 | BAEA093E | |
| IC07100 | BAEA344 | |
| IC07102 | BAE965A | |
| IC07103 | BAEA252 | |
| IC07105 | BAEA342 | |
| IC07106 | BAEA358 | |
| IC07107 | BAEA147E | |
| IC07109 | BAEA427 | |
| IC07112 | BAEA306 | |
| IC07116 | BAEA152E | |
| IC07117 | BAEA153E | |
| IC07121 | BAEA150E | |
| IC07122 | BAEA359 | |
| IC07124 | BAEA185E | |
| IC09100 | BAEA014 | |
| IC09102 | BAEA014 | |
| IC09103 | BAEA302 | |
| IC09107 | BAEA324 | |
| IC09108 | BAEA143 | |
| IC10101 | BAEA309 | |
| IC11101 | BAEA554 | |
| IC11102 | BAEA447A | |
| IC11103 | BAEA540 | |
| IC11104 | BAEA543 | |
| IC12101 | BAEA469 | |
| IC13101 | BAE506D | |
| IC13102 | BAE506F | |
| IC13105 | BAE920AX | |
| IC13106 | BAE403B | |
| IC15100 | BAE409A | |
| IC15101 | BAEA231 | |
| IC15103 | BAEA232 | |
| IC15105 | BAEA256 | |

| BBT | | |
|-------------|----------|--|
| IC15108 | BAEA242 | |
| IC15112 | BAE504L | |
| IC15116 | BAEA255 | |
| IC15117 | BAEA243 | |
| IC15119 | BAEA345 | |
| IC15120 | BAEA354 | |
| IC15125 | BAEA347 | |
| IC15126 | BAEA045E | |
| IC15127 | BAEA046E | |
| IC15128 | BAEA348 | |
| IC15129 | BAEA351 | |
| IC15130 | BAEA352 | |
| IC15138 | BAEA066E | |
| IC15142 | BAEA131E | |
| IC15144 | BAEA557 | |
| IC16100 | BAEA276 | |
| IC16101 | BAEA275 | |
| IC16108 | BAEA179E | |
| IC16113 | BAEA056E | |
| IC16117 | BAEA521 | |
| IC16118 | BAEA477 | |
| IC16119 | BAEA561 | |
| IC16125 | BAEA188E | |
| IC16131 | BAEA475 | |
| IC16132 | BAEA476 | |
| IC-16135 | BAEA170E | |
| IC16139 | BAEA182E | |
| IC16140 | BAEA181E | |
| IC1622 | BAEA486 | |
| IC17105 | BAEA173E | |
| IC17106 | BAEA168E | |
| IC17107 | BAEA172E | |
| IC17113 | BAEA165E | |
| IC17114 | BAEA502E | |
| IC17115 | BAEA167E | |
| IC17116 | BAEA269 | |
| IC17119 | BAEA480 | |
| IC17120 | BAEA479 | |
| IC17121 | BAEA483 | |
| IC17125 | BAEA084E | |
| IC17126 | BAEA489 | |
| IC-17131 | BAEA171E | |
| IC18100 | BAEA281 | |
| IC18101 | BAEA350 | |
| IC18105 | BAEA448 | |
| IC18106 | BAEA387 | |
| IC4102 | BAEA198E | |
| ZK15102 | BAE946A | |
| ZK15106 | BAE946A | |
| ZK15132 | BAEA048E | |
| BERU | | |
| 0040100015 | BAEA017 | |

| BERU | | |
|-------------|----------|--|
| 0040100060 | BAEA017 | |
| 0040100062 | BAEA043 | |
| 0040100293 | BAEA269 | |
| 0040102002 | BAEA012E | |
| 0040102004 | BAEA042E | |
| 0040102005 | BAEA052E | |
| 0040102006 | BAEA042E | |
| ZS009 | BAEA043 | |
| ZS014 | BAEA014 | |
| ZS016 | BAEA016 | |
| ZS017 | BAEA017 | |
| ZS029 | BAE920AX | |
| ZS037 | BAEA037 | |
| ZS041 | BAEA041 | |
| ZS043 | BAEA043 | |
| ZS052 | BAE409A | |
| ZS053 | BAEA053 | |
| ZS077 | BAEA077 | |
| ZS079 | BAE940A | |
| ZS090 | BAEA090 | |
| ZS095 | BAEA095 | |
| ZS110 | BAEA110 | |
| ZS115 | BAEA115 | |
| ZS231 | BAEA231 | |
| ZS232 | BAEA232 | |
| ZS234 | BAEA234 | |
| ZS242 | BAEA242 | |
| ZS243 | BAEA243 | |
| ZS244 | BAE506D | |
| ZS245 | BAEA245 | |
| ZS246 | BAEA246 | |
| ZS247 | BAEA247 | |
| ZS248 | BAE506F | |
| ZS250 | BAE504L | |
| ZS251 | BAEA251 | |
| ZS252 | BAEA252 | |
| ZS253 | BAEA253 | |
| ZS254 | BAEA254 | |
| ZS255 | BAEA255 | |
| ZS256 | BAEA256 | |
| ZS259 | BAE965A | |
| ZS264 | BAEA264 | |
| ZS266 | BAEA266 | |
| ZS267 | BAEA267 | |
| ZS269 | BAEA269 | |
| ZS275 | BAEA275 | |
| ZS276 | BAEA276 | |
| ZS281 | BAEA281 | |
| ZS283 | BAE800B | |
| ZS296 | BAEA296 | |
| ZS297 | BAEA297 | |
| ZS298 | BAEA298 | |
| ZS299 | BAEA299 | |



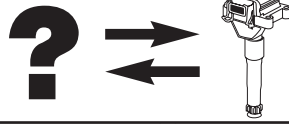

| BERU | CHAMPION |
|--------|----------|
| ZS302 | BAEA302 |
| ZS304 | BAEA304 |
| ZS306 | BAEA306 |
| ZS307 | BAEA307 |
| ZS308 | BAEA308 |
| ZS309 | BAEA309 |
| ZS313 | BAEA313 |
| ZS320 | BAE403B |
| ZS321 | BAE403D |
| ZS322 | BAE403C |
| ZS323 | BAE700AK |
| ZS324 | BAEA324 |
| ZS325 | BAEA325 |
| ZS337 | BAEA337 |
| ZS338 | BAEA338 |
| ZS339 | BAEA339 |
| ZS340 | BAEA340 |
| ZS342 | BAEA342 |
| ZS344 | BAEA344 |
| ZS345 | BAEA345 |
| ZS347 | BAEA347 |
| ZS348 | BAEA348 |
| ZS350 | BAEA350 |
| ZS351 | BAEA351 |
| ZS352 | BAEA352 |
| ZS354 | BAEA354 |
| ZS358 | BAEA358 |
| ZS359 | BAEA359 |
| ZS365 | BAEA365 |
| ZS367 | BAEA367 |
| ZS368 | BAEA368 |
| ZS372 | BAEA372 |
| ZS375 | BAE947A |
| ZS380 | BAEA380 |
| ZS382 | BAEA382 |
| ZS387 | BAEA387 |
| ZS394 | BAEA394 |
| ZS395 | BAEA395 |
| ZS408 | BAEA408 |
| ZS410 | BAEA410 |
| ZS422 | BAEA422 |
| ZS426 | BAEA426 |
| ZS427 | BAEA427 |
| ZS428 | BAEA428 |
| ZS429 | BAEA429 |
| ZS432 | BAEA432 |
| ZS433 | BAEA433 |
| ZS434 | BAEA434 |
| ZS445 | BAEA445 |
| ZS446 | BAEA446 |
| ZS447A | BAEA447A |
| ZS448 | BAEA448 |
| ZS449 | BAEA449 |

| BERU | CHAMPION |
|--------|----------|
| ZS453 | BAEA453 |
| ZS454 | BAEA454 |
| ZS469 | BAEA469 |
| ZS472 | BAEA472 |
| ZS474 | BAEA474 |
| ZS475 | BAEA475 |
| ZS476 | BAEA476 |
| ZS477 | BAEA477 |
| ZS479 | BAEA479 |
| ZS480 | BAEA480 |
| ZS482 | BAEA482 |
| ZS483 | BAEA483 |
| ZS486 | BAEA486 |
| ZS489 | BAEA489 |
| ZS501 | BAEA501 |
| ZS508 | BAEA508 |
| ZS521 | BAEA521 |
| ZS531 | BAEA531 |
| ZS536 | BAEA536 |
| ZS538 | BAEA538 |
| ZS539 | BAEA539 |
| ZS540 | BAEA540 |
| ZS543 | BAEA543 |
| ZS546 | BAEA546 |
| ZS547 | BAEA547 |
| ZS548 | BAEA548 |
| ZS549 | BAEA549 |
| ZS554 | BAEA554 |
| ZS555 | BAEA555 |
| ZS556 | BAEA556 |
| ZS557 | BAEA557 |
| ZS560 | BAEA560 |
| ZS561 | BAEA561 |
| ZSE001 | BAE851AE |
| ZSE002 | BAEA002E |
| ZSE003 | BAE907AE |
| ZSE004 | BAEA004E |
| ZSE007 | BAEA007E |
| ZSE009 | BAEA009E |
| ZSE012 | BAEA012E |
| ZSE013 | BAEA013E |
| ZSE019 | BAEA019E |
| ZSE021 | BAEA021E |
| ZSE025 | BAEA025E |
| ZSE026 | BAEA026E |
| ZSE029 | BAEA029E |
| ZSE030 | BAE408AE |
| ZSE031 | BAEA031E |
| ZSE032 | BAEA032E |
| ZSE033 | BAEA033E |
| ZSE037 | BAEA037E |
| ZSE039 | BAE960AE |
| ZSE040 | BAE961AE |

| BERU | CHAMPION |
|--------|----------|
| ZSE041 | BAEA041E |
| ZSE042 | BAEA042E |
| ZSE043 | BAEA043E |
| ZSE044 | BAEA044E |
| ZSE045 | BAEA045E |
| ZSE046 | BAEA046E |
| ZSE047 | BAE946A |
| ZSE048 | BAEA048E |
| ZSE051 | BAEA051E |
| ZSE052 | BAEA052E |
| ZSE053 | BAEA042E |
| ZSE055 | BAEA055E |
| ZSE056 | BAEA056E |
| ZSE059 | BAEA059E |
| ZSE061 | BAEA061E |
| ZSE062 | BAEA062E |
| ZSE063 | BAEA063E |
| ZSE065 | BAEA065E |
| ZSE066 | BAEA066E |
| ZSE067 | BAEA067E |
| ZSE068 | BAEA068E |
| ZSE072 | BAEA072E |
| ZSE073 | BAEA073E |
| ZSE079 | BAEA079E |
| ZSE080 | BAEA080E |
| ZSE081 | BAEA081E |
| ZSE083 | BAEA083E |
| ZSE084 | BAEA084E |
| ZSE088 | BAEA088E |
| ZSE093 | BAEA093E |
| ZSE126 | BAEA126E |
| ZSE131 | BAEA131E |
| ZSE132 | BAEA132E |
| ZSE136 | BAEA136E |
| ZSE137 | BAEA137E |
| ZSE140 | BAEA140E |
| ZSE143 | BAEA143 |
| ZSE144 | BAEA144E |
| ZSE145 | BAEA145E |
| ZSE146 | BAEA146E |
| ZSE147 | BAEA147E |
| ZSE149 | BAEA149E |
| ZSE150 | BAEA150E |
| ZSE152 | BAEA152E |
| ZSE153 | BAEA153E |
| ZSE154 | BAEA154E |
| ZSE158 | BAEA158E |
| ZSE159 | BAEA159E |
| ZSE161 | BAEA161E |
| ZSE162 | BAEA162E |
| ZSE163 | BAEA163E |
| ZSE164 | BAEA164E |
| ZSE165 | BAEA165E |

| BERU | CHAMPION |
|--------|----------|
| ZSE167 | BAEA167E |
| ZSE168 | BAEA168E |
| ZSE169 | BAEA169E |
| ZSE170 | BAEA170E |
| ZSE171 | BAEA171E |
| ZSE172 | BAEA172E |
| ZSE173 | BAEA173E |
| ZSE174 | BAEA174E |
| ZSE175 | BAEA175E |
| ZSE176 | BAEA176E |
| ZSE178 | BAEA178E |
| ZSE179 | BAEA179E |
| ZSE180 | BAEA180E |
| ZSE181 | BAEA181E |
| ZSE182 | BAEA182E |
| ZSE184 | BAEA184E |
| ZSE185 | BAEA185E |
| ZSE186 | BAEA186E |
| ZSE188 | BAEA188E |
| ZSE189 | BAEA189E |
| ZSE190 | BAEA190E |
| ZSE191 | BAEA191E |
| ZSE192 | BAEA192E |
| ZSE193 | BAEA193E |
| ZSE194 | BAEA194E |
| ZSE195 | BAEA195E |
| ZSE196 | BAEA196E |
| ZSE198 | BAEA198E |
| ZSE199 | BAEA199E |
| ZSE502 | BAEA502E |

| BORGWARNER | CHAMPION |
|---------------|----------|
| E 233 | BAEA380 |
| E2010025068A1 | BAEA539 |
| E2010025069A1 | BAEA179E |
| E2010025070A1 | BAEA543 |
| E2010026657A5 | BAEA181E |
| E2010028087A5 | BAEA185E |
| E2010028152A1 | BAEA489 |
| E2010028203A5 | BAEA186E |
| E2010028551A5 | BAEA188E |
| E2010031001A5 | BAEA189E |
| E2010031001B1 | BAEA189E |
| E2010031712A5 | BAEA548 |
| E2010031712B5 | BAEA548 |
| E2010032490A5 | BAEA549 |
| E2010032997A1 | BAEA554 |
| E2010033122A1 | BAEA191E |
| E2010033305A5 | BAEA192E |
| E2010033318A1 | BAEA555 |
| E2010033321A1 | BAEA193E |
| E2010033322A1 | BAEA556 |
| E2010033323A5 | BAEA557 |



| BORGWARNER | | |
|-------------------|-----------------|--|
| E2010034780A5 | BAEA194E | |
| E2010034782A1 | BAEA560 | |
| E2010034783A1 | BAEA561 | |
| E2010034784A1 | BAEA195E | |
| E2010034786A5 | BAEA196E | |
| E2010034787A1 | BAEA448 | |
| E2010037272A1 | BAEA198E | |
| E2010037273A1 | BAEA199E | |
| BOSCH | | |
| 0 221 102 031 | BAEA115 | |
| 0 221 102 036 | BAEA115 | |
| 0 221 102 046 | BAEA115 | |
| 0 221 102 051 | BAEA115 | |
| 0 221 102 060 | BAEA115 | |
| 0 221 102 069 | BAEA115 | |
| 0 221 102 072 | BAEA115 | |
| 0 221 102 081 | BAEA110 | |
| 0 221 119 009 | BAEA115 | |
| 0 221 119 016 | BAEA115 | |
| 0 221 119 017 | BAEA115 | |
| 0 221 119 021 | BAEA115 | |
| 0 221 119 022 | BAEA115 | |
| 0 221 119 031 | BAEA110 | |
| 0 221 119 036 | BAEA115 | |
| 0 221 119 037 | BAEA115 | |
| 0 221 119 038 | BAEA115 | |
| 0 221 119 044 | BAEA115 | |
| 0 221 119 355 | BAEA115 | |
| 0 221 122 319 | BAEA546 | |
| 0 221 501 003 | BAEA296 | |
| 0 221 501 007 | BAEA339 | |
| 0 221 501 374 | BAEA298 | |
| 0 221 501 376 | BAEA299 | |
| 0 221 502 429 | BAEA296 | |
| 0 221 502 431 | BAEA339 | |
| 0 221 502 433 | BAEA298 | |
| 0 221 502 435 | BAEA299 | |
| 0 221 503 003 | BAEA231 | |
| 0 221 503 005 | BAEA307 | |
| 0 221 503 005-7G8 | BAEA307 | |
| 0 221 503 006 | BAEA231 | |
| 0 221 503 012 | BAEA297 | |
| 0 221 503 014 | BAEA358 | |
| 0 221 503 015 | BAEA147E | |
| 0 221 503 017 | BAEA306 | |
| 0 221 503 022 | BAEA304 | |
| 0 221 503 024 | BAEA231 | |
| 0 221 503 025 | BAEA232 | |
| 0 221 503 026 | BAEA152E | |
| 0 221 503 027 | BAEA153E | |
| 0 221 503 031 | BAEA150E | |
| 0 221 503 033 | BAEA146E | |

| BOSCH | | |
|-------------------|-----------------|--|
| 0 221 503 035 | BAEA297 | |
| 0 221 503 407 | BAEA234 | |
| 0 221 503 421 | BAEA231 | |
| 0 221 503 457 | BAEA234 | |
| 0 221 503 469 | BAEA149E | |
| 0 221 503 471 | BAEA359 | |
| 0 221 503 472 | BAEA338 | |
| 0 221 503 485 | BAEA387 | |
| 0 221 503 487 | BAEA448 | |
| 0 221 503 489 | BAEA307 | |
| 0 221 503 489-7G8 | BAEA307 | |
| 0 221 503 490 | BAEA422 | |
| 0 221 504 004 | BAEA302 | |
| 0 221 504 017 | BAEA337 | |
| 0 221 504 020 | BAEA449 | |
| 0 221 504 024 | BAEA095 | |
| 0 221 504 029 | BAEA302 | |
| 0 221 504 030 | BAEA161E | |
| 0 221 504 035 | BAEA090 | |
| 0 221 504 100 | BAEA324 | |
| 0 221 504 410 | BAEA014 | |
| 0 221 504 456 | BAEA428 | |
| 0 221 504 460 | BAE403D | |
| 0 221 504 464 | BAEA324 | |
| 0 221 504 465 | BAEA145E | |
| 0 221 504 470 | BAEA143 | |
| 0 221 504 471 | BAEA144E | |
| 0 221 505 423 | BAEA308 | |
| 0 221 505 437 | BAEA313 | |
| 0 221 506 002 | BAEA340 | |
| 0 221 601 001 | BAEA002E | |
| 0 221 601 002 | BAEA002E | |
| 0 221 601 003 | BAE851AE | |
| 0 221 601 004 | BAE851AE | |
| 0 221 601 005 | BAE851AE | |
| 0 221 601 012 | BAEA037E | |
| 0 221 603 003 | BAEA162E | |
| 0 221 603 009 | BAE907AE | |
| 0 221 603 010 | BAE907AE | |
| 0 221 604 001 | BAEA019E | |
| 0 221 604 008 | BAEA019E | |
| 0 221 604 010 | BAEA055E | |
| 0 221 604 014 | BAEA056E | |
| 0 221 604 112 | BAEA174E | |
| 0 986 221 000 | BAE851AE | |
| 0 986 221 001 | BAE409A | |
| 0 986 221 002 | BAEA002E | |
| 0 986 221 003 | BAE920AX | |
| 0 986 221 004 | BAEA264 | |
| 0 986 221 005 | BAEA266 | |
| 0 986 221 007 | BAEA041 | |
| 0 986 221 008 | BAEA267 | |
| 0 986 221 009 | BAEA017 | |

| BOSCH | | |
|---------------|-----------------|--|
| 0 986 221 011 | BAEA016 | |
| 0 986 221 014 | BAEA043 | |
| 0 986 221 015 | BAEA004E | |
| 0 986 221 017 | BAEA037 | |
| 0 986 221 018 | BAEA502E | |
| 0 986 221 020 | BAEA269 | |
| 0 986 221 023 | BAE408AE | |
| 0 986 221 024 | BAEA043E | |
| 0 986 221 025 | BAEA242 | |
| 0 986 221 026 | BAEA243 | |
| 0 986 221 027 | BAE506D | |
| 0 986 221 028 | BAE506F | |
| 0 986 221 030 | BAEA254 | |
| 0 986 221 031 | BAEA255 | |
| 0 986 221 035 | BAE946A | |
| 0 986 221 036 | BAEA454 | |
| 0 986 221 039 | BAE965A | |
| 0 986 221 040 | BAEA053 | |
| 0 986 221 042 | BAE403B | |
| 0 986 221 043 | BAE403C | |
| 0 986 221 044 | BAEA501 | |
| 0 986 221 045 | BAE409A | |
| 0 986 221 049 | BAEA029E | |
| 0 986 221 051 | BAEA044E | |
| 0 986 221 052 | BAEA032E | |
| 0 986 221 056 | BAEA041E | |
| 0 986 221 057 | BAEA067E | |
| 0 986 221 060 | BAEA354 | |
| 0 986 221 062 | BAEA474 | |
| 0 986 221 063 | BAEA475 | |
| 0 986 221 069 | BAEA042E | |
| 0 986 221 070 | BAEA012E | |
| 0 986 221 079 | BAEA131E | |
| 0 986 221 092 | BAEA489 | |
| 0 986 221 098 | BAEA199E | |
| 0 986 JG1 211 | BAEA021E | |
| 0 986 JG1 212 | BAEA081E | |
| 0 986 JG1 213 | BAEA080E | |
| 0 986 JG1 214 | BAEA073E | |
| 0221 604 034 | BAEA093E | |
| 0221603010 | BAE907AE | |
| 0986221000 | BAE851AE | |
| 0986221023 | BAE408AE | |
| 0986221035 | BAE946A | |
| 0986221036 | BAE947A | |
| 0986221066 | BAEA077 | |
| 0986221096 | BAEA185E | |
| 1 227 030 062 | BAEA309 | |
| 9 220 081 505 | BAE504L | |
| F 000 ZSO 103 | BAE800B | |
| F 000 ZSO 111 | BAEA253 | |
| F 000 ZSO 112 | BAEA252 | |
| F 000 ZSO 114 | BAEA247 | |

| BOSCH | | |
|------------------|-----------------|--|
| F 000 ZSO 115 | BAEA251 | |
| F 000 ZSO 116 | BAEA275 | |
| F 000 ZSO 209 | BAE907AE | |
| F 000 ZSO 210 | BAE907AE | |
| F 000 ZSO 211 | BAEA395 | |
| F 000 ZSO 212 | BAEA281 | |
| F 000 ZSO 221 | BAEA354 | |
| ZS-K 1X1 | BAE504L | |
| ZS-K 1X2 | BAE800B | |
| ZS-K 2X2 | BAE907AE | |
| ZS-K-1X1PM | BAEA090 | |
| ZS-K-2X2 | BAEA422 | |
| BOUGICORD | | |
| 151401 | BAE947A | |
| 151401 | BAEA454 | |
| 151405 | BAE947A | |
| 154302 | BAE946A | |
| 15430200001 | BAE946A | |
| 154303 | BAEA048E | |
| 155003 | BAEA358 | |
| 155008 | BAEA365 | |
| 155010 | BAEA350 | |
| 155011 | BAEA281 | |
| 155013 | BAEA242 | |
| 155014 | BAEA243 | |
| 155016 | BAEA354 | |
| 155021 | BAEA347 | |
| 155026 | BAE851AE | |
| 155028 | BAEA165E | |
| 155031 | BAEA351 | |
| 155032 | BAEA045E | |
| 155039 | BAEA427 | |
| 155040 | BAEA352 | |
| 155043 | BAEA046E | |
| 155045 | BAEA359 | |
| 155048 | BAEA025E | |
| 155052 | BAEA026E | |
| 155053 | BAEA447A | |
| 155054 | BAEA044E | |
| 155057 | BAEA344 | |
| 155067 | BAEA469 | |
| 155074 | BAE940A | |
| 155075 | BAEA448 | |
| 155079 | BAEA540 | |
| 155080 | BAEA554 | |
| 155093 | BAEA479 | |
| 155095 | BAEA428 | |
| 155099 | BAEA502E | |
| 155100 | BAEA014 | |
| 155101 | BAEA031E | |
| 155103 | BAEA062E | |
| 155104 | BAEA059E | |

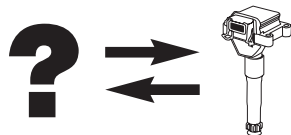

| BOUGICORD | CHAMPION | BOUGICORD | CHAMPION | BREMI | CHAMPION | BREMI | CHAMPION |
|------------------|-----------------|------------------|-----------------|--------------|-----------------|--------------|-----------------|
| 155106 | BAEA063E | 155450 | BAEA178E | 11882 | BAEA232 | 20155 | BAEA350 |
| 155109 | BAEA065E | 155452 | BAEA548 | 11883 | BAEA234 | 20155 | BAEA422 |
| 155110 | BAEA051E | 155456 | BAEA476 | 11886 | BAEA276 | 20157 | BAEA304 |
| 155111 | BAEA061E | 155465 | BAEA043 | 11891 | BAEA252 | 20160 | BAEA026E |
| 155112 | BAEA013E | 155473 | BAEA195E | 11892 | BAEA002E | 20161 | BAE946A |
| 155113 | BAEA483 | 155478 | BAEA190E | 11893 | BAE851AE | 20164 | BAEA479 |
| 155114 | BAEA560 | 155492 | BAEA132E | 11896 | BAEA252 | 20166 | BAEA447A |
| 155115 | BAEA539 | 155600 | BAEA017 | 11897 | BAE504D | 20167 | BAE947A |
| 155119 | BAEA477 | 155700 | BAEA014 | 11897 | BAE506F | 20167 | BAEA454 |
| 155121 | BAEA486 | 156100 | BAE907AE | 11898 | BAE506D | 20168 | BAEA037E |
| 155125 | BAEA188E | 156200 | BAE409A | 11899 | BAE800B | 20170 | BAEA264 |
| 155132 | BAEA429 | 156300 | BAE965A | 11900 | BAE504D | 20172 | BAEA501 |
| 155140 | BAEA164E | 156500 | BAEA256 | 11915 | BAEA275 | 20174 | BAEA309 |
| 155141 | BAEA171E | 156600 | BAE700AK | 11917 | BAE504L | 20176 | BAEA387 |
| 155142 | BAEA167E | 156800 | BAEA045E | 11918 | BAEA350 | 20179 | BAEA306 |
| 155146 | BAEA095 | 157000 | BAEA549 | 11922 | BAEA344 | 20180 | BAEA053 |
| 155152 | BAEA179E | 157200 | BAE960AE | 11923 | BAEA234 | 20183 | BAEA045E |
| 155153 | BAEA501 | 157300 | BAE403B | 11926 | BAEA234 | 20184 | BAEA147E |
| 155158 | BAEA561 | 157400 | BAE408AE | 11929 | BAE920AX | 20185 | BAEA077 |
| 155159 | BAEA073E | 157500 | BAEA043E | 11930 | BAEA245 | 20186 | BAEA019E |
| 155166 | BAEA543 | 157700 | BAEA032E | 11930 | BAEA254 | 20188 | BAEA296 |
| 155167 | BAEA434 | 157800 | BAEA031E | 11931 | BAEA246 | 20189 | BAEA338 |
| 155173 | BAEA368 | BRECAV | CHAMPION | 11931 | BAEA255 | 20190 | BAEA308 |
| 155175 | BAEA168E | 106.001 | BAE403B | 11935 | BAEA469 | 20190 | BAEA165E |
| 155176 | BAEA169E | 106.002 | BAE403C | 20110 | BAEA324 | 20191 | BAEA342 |
| 155177 | BAEA482 | 106.007 | BAE403D | 20111 | BAE409A | 20193 | BAEA146E |
| 155181 | BAEA380 | 109.001 | BAE965A | 20112 | BAEA031E | 20195 | BAEA146E |
| 155181 | BAEA382 | 110.004 | BAE700AK | 20113 | BAEA043E | 20198 | BAEA181E |
| 155184 | BAEA181E | 114.003 | BAE961AE | 20114 | BAEA032E | 20199 | BAEA299 |
| 155194 | BAEA489 | 124.001 | BAE960AE | 20115 | BAEA062E | 20300 | BAEA540 |
| 155200 | BAEA302 | BREMI | CHAMPION | 20116 | BAEA059E | 20301 | BAEA445 |
| 155204 | BAEA193E | 11720 | BAEA354 | 20117 | BAE408AE | 20303 | BAEA448 |
| 155214 | BAEA185E | 11722 | BAEA242 | 20119 | BAEA324 | 20304 | BAEA267 |
| 155215 | BAEA182E | 11723 | BAEA243 | 20120 | BAEA033E | 20306 | BAEA347 |
| 155224 | BAEA176E | 11731 | BAE907AE | 20121 | BAEA063E | 20307 | BAEA340 |
| 155229 | BAEA184E | 11732 | BAEA307 | 20122 | BAEA044E | 20312 | BAEA428 |
| 155231 | BAEA077 | 11803 | BAEA110 | 20124 | BAEA065E | 20314 | BAEA449 |
| 155237 | BAEA367 | 11821 | BAEA115 | 20125 | BAEA051E | 20315 | BAEA433 |
| 155244 | BAEA531 | 11855T | BAEA014 | 20126 | BAEA061E | 20318 | BAEA056E |
| 155248 | BAEA306 | 11856T | BAEA014 | 20129 | BAEA029E | 20319 | BAEA298 |
| 155251 | BAEA041E | 11857T | BAEA014 | 20130 | BAEA009E | 20320 | BAEA348 |
| 155253 | BAEA432 | 11860T | BAEA302 | 20131 | BAEA021E | 20321 | BAEA359 |
| 155258 | BAEA410 | 11866T | BAEA154E | 20132 | BAEA004E | 20322 | BAEA081E |
| 155287 | BAEA394 | 11869 | BAEA016 | 20133 | BAEA013E | 20326 | BAEA269 |
| 155309 | BAEA269 | 11871 | BAEA017 | 20134 | BAEA340 | 20328 | BAEA337 |
| 155310 | BAEA556 | 11873 | BAEA297 | 20135 | BAEA502E | 20331 | BAEA041E |
| 155313 | BAEA131E | 11875 | BAEA281 | 20136 | BAE965A | 20333 | BAEA170E |
| 155365 | BAEA298 | 11876 | BAEA253 | 20138 | BAEA025E | 20334 | BAEA352 |
| 155381 | BAEA547 | 11877 | BAEA251 | 20143 | BAEA266 | 20335 | BAEA358 |
| 155383 | BAEA192E | 11878 | BAEA247 | 20145 | BAEA041 | 20337 | BAEA080E |
| 155384 | BAEA475 | 11881 | BAEA231 | 20149 | BAEA073E | 20339 | BAEA483 |
| 155395 | BAEA521 | | | 20151 | BAEA072E | 20344 | BAEA482 |
| 155430 | BAEA186E | | | 20153 | BAEA313 | 20346 | BAEA186E |
| | | | | | | 20350 | BAEA543 |

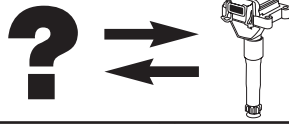

| BREMI | | |
|--------------|----------|--|
| 20353 | BAEA556 | |
| 20356 | BAEA394 | |
| 20364 | BAEA429 | |
| 20365 | BAEA153E | |
| 20366 | BAEA007E | |
| 20367 | BAEA554 | |
| 20368 | BAEA152E | |
| 20369 | BAEA434 | |
| 20370 | BAEA175E | |
| 20371 | BAE960AE | |
| 20372 | BAEA380 | |
| 20372 | BAEA382 | |
| 20374 | BAEA446 | |
| 20376 | BAEA477 | |
| 20377 | BAEA472 | |
| 20378 | BAEA474 | |
| 20379 | BAEA190E | |
| 20380 | BAE403B | |
| 20381 | BAEA395 | |
| 20383 | BAEA046E | |
| 20386 | BAEA168E | |
| 20396 | BAEA172E | |
| 20400 | BAEA169E | |
| 20403 | BAEA176E | |
| 20405 | BAEA432 | |
| 20412 | BAEA549 | |
| 20415 | BAEA180E | |
| 20424 | BAEA159E | |
| 20427 | BAEA174E | |
| 20428 | BAEA178E | |
| 20432 | BAEA531 | |
| 20433 | BAEA367 | |
| 20434 | BAEA410 | |
| 20438 | BAEA143 | |
| 20439 | BAEA167E | |
| 20441 | BAEA188E | |
| 20442 | BAEA132E | |
| 20443 | BAEA184E | |
| 20450 | BAE961AE | |
| 20453 | BAEA368 | |
| 20467 | BAEA193E | |
| 20469 | BAEA560 | |
| 20475 | BAEA555 | |
| 20476 | BAEA150E | |
| 20479 | BAEA084E | |
| 20487 | BAE403D | |
| 20490 | BAEA539 | |
| 20491 | BAE940A | |
| 20492 | BAE940A | |
| 20495 | BAEA475 | |
| 20496 | BAE947A | |
| 20496 | BAEA325 | |
| 20497 | BAEA185E | |

| BREMI | | |
|-------------------|----------|--|
| 20501 | BAEA548 | |
| 20503 | BAEA199E | |
| 20505 | BAEA067E | |
| 20515 | BAEA191E | |
| 20522 | BAEA182E | |
| 20524 | BAEA189E | |
| 20546 | BAEA194E | |
| 20547 | BAEA198E | |
| 20553 | BAE403C | |
| 20559 | BAEA561 | |
| 20561 | BAEA196E | |
| 20617 | BAE907AE | |
| BSG | | |
| BSG 30-835-002 | BAEA387 | |
| CHAMPION | | |
| AMC504D | BAE504D | |
| AMC504F | BAE504F | |
| AMC504L | BAE504L | |
| AMC506D | BAE506D | |
| AMC506F | BAE506F | |
| AMC700AK | BAE700AK | |
| AMC800B | BAE800B | |
| AMC920AX | BAE920AX | |
| BAE 947 A | BAEA325 | |
| BAE947A/245 | BAEA454 | |
| DELCO REMY | | |
| 3474221 | BAEA252 | |
| 3474232 | BAEA252 | |
| 3474282 | BAEA252 | |
| DELPHI | | |
| 19005252 | BAEA025E | |
| CE01841-12B1 | BAEA198E | |
| CE10000-12B1 | BAE965A | |
| CE10023-12B1 | BAE851AE | |
| CE10512-12B1 | BAEA501 | |
| CE20009-12B1 | BAEA427 | |
| CE20011-12B1 | BAE946A | |
| CE20018-12B1 | BAE947A | |
| CE20030-12B1 | BAE408AE | |
| CE20039-12B1 | BAEA309 | |
| CE20042-12B1 | BAEA365 | |
| CE20048-12B1 | BAEA354 | |
| CE20058-12B1 | BAE800B | |
| DS10000-12B1 | BAEA026E | |
| GN10018 | BAE907AE | |
| GN10204-12B1 | BAEA147E | |
| GN10230 | BAEA447A | |
| GN10234-12B1 | BAEA199E | |
| GN10235-12B1 | BAEA140E | |
| GN10239-12B1 | BAEA472 | |

| DELPHI | | |
|------------------|----------|--|
| GN10244 | BAEA158E | |
| GN10246 | BAEA132E | |
| GN10248 | BAEA176E | |
| GN10309-12B1 | BAEA174E | |
| GN10554-12B1 | BAEA195E | |
| GN10572-12B1 | BAEA143 | |
| GN10584-12B1 | BAEA557 | |
| GN10632-12B1 | BAEA068E | |
| DENSO | | |
| 029 700-8291 | BAE409A | |
| DIC-0102 | BAEA171E | |
| DIC-0103 | BAEA184E | |
| DIC-0106 | BAEA181E | |
| DIC-0107 | BAEA178E | |
| DIC-0110 | BAEA480 | |
| DIC-0113 | BAEA482 | |
| DIC-0116 | BAEA540 | |
| GCL 209 | BAEA501 | |
| MB 029700-8230 | BAEA501 | |
| DODUCO | | |
| 7402 | BAEA115 | |
| 7403 | BAEA110 | |
| DUCELLIER | | |
| 2526023 | BAEA251 | |
| 2526023 A | BAEA251 | |
| 2526049 A | BAEA253 | |
| 2526050 A | BAEA252 | |
| 520 073 A | BAEA247 | |
| 520064 | BAEA251 | |
| ELDOR | | |
| 78419001 | BAE409A | |
| EPS | | |
| 1.970.272 | BAEA344 | |
| 1.970.365 | BAEA345 | |
| 1.970.377 | BAEA354 | |
| 1.970.379 S | BAEA350 | |
| 1.970.380 S | BAEA365 | |
| 1.970.425 | BAEA062E | |
| 1.970.427 | BAEA032E | |
| 1.970.429 | BAEA043E | |
| 1.970.431 | BAEA059E | |
| 1.970.433 | BAEA061E | |
| 1.970.434 | BAEA044E | |
| 1.970.435 | BAEA063E | |
| 1.970.436 | BAEA051E | |
| 1.970.437 | BAEA065E | |
| ERA | | |
| 880001 | BAE851AE | |
| 880003 | BAE907AE | |

| ERA | | |
|------------|----------|--|
| 880006 | BAE408AE | |
| 880007 | BAEA043E | |
| 880008 | BAE800B | |
| 880009 | BAE409A | |
| 880010 | BAEA549 | |
| 880015 | BAEA344 | |
| 880027 | BAE504L | |
| 880030 | BAEA546 | |
| 880033 | BAE961AE | |
| 880035 | BAE946A | |
| 880036 | BAE947A | |
| 880036 | BAEA454 | |
| 880038 | BAE403B | |
| 880039 | BAE965A | |
| 880040 | BAEA026E | |
| 880044 | BAEA025E | |
| 880049 | BAEA350 | |
| 880052 | BAEA276 | |
| 880053 | BAEA275 | |
| 880056 | BAEA345 | |
| 880057 | BAEA469 | |
| 880058 | BAEA354 | |
| 880065 | BAEA032E | |
| 880066 | BAEA031E | |
| 880068 | BAE403C | |
| 880070 | BAEA540 | |
| 880071 | BAEA165E | |
| 880073 | BAEA348 | |
| 880074 | BAEA154E | |
| 880076 | BAEA021E | |
| 880078 | BAEA358 | |
| 880085 | BAEA045E | |
| 880087 | BAEA351 | |
| 880088 | BAE947A | |
| 880088 | BAEA325 | |
| 880089 | BAE700AK | |
| 880091 | BAE940A | |
| 880095 | BAEA347 | |
| 880098 | BAEA337 | |
| 880103 | BAEA387 | |
| 880103 | BAEA448 | |
| 880109 | BAEA234 | |
| 880112 | BAEA560 | |
| 880113 | BAEA554 | |
| 880114 | BAEA539 | |
| 880117 | BAEA048E | |
| 880118 | BAEA352 | |
| 880121 | BAEA046E | |
| 880122 | BAEA041E | |
| 880122 | BAEA044E | |
| 880124 | BAEA081E | |
| 880125 | BAEA359 | |
| 880129 | BAEA309 | |

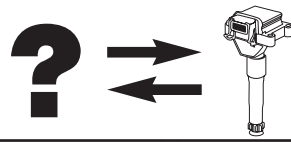

| ERA | CHAMPION | ERA | CHAMPION | FACET | CHAMPION | FACET | CHAMPION |
|--------|----------|------------------|----------|-------------|----------|----------|----------|
| 880131 | BAEA234 | 880278 | BAEA095 | 1.970.105 | BAEA247 | 470108 | BAE506D |
| 880132 | BAEA428 | 880294 | BAEA410 | 1.970.107 | BAEA251 | 470110 | BAEA252 |
| 880138 | BAEA266 | 880295 | BAEA372 | 1.970.108 | BAE506D | 470111 | BAEA252 |
| 880139 | BAEA264 | 880296 | BAEA281 | 1.970.110 | BAEA252 | 470135 | BAEA281 |
| 880140 | BAEA479 | 880297 | BAEA380 | 1.970.111 | BAEA252 | 470140 | BAEA253 |
| 880141 | BAEA267 | 880302 | BAEA080E | 1.970.135 | BAEA281 | 470146 | BAE800B |
| 880145 | BAEA502E | 880307 | BAEA445 | 1.970.140 | BAEA253 | 470158 | BAE506F |
| 880146 | BAEA269 | 880311 | BAEA193E | 1.970.146 | BAE800B | 470159 | BAEA002E |
| 880147 | BAEA561 | 880314 | BAEA531 | 1.970.158 | BAE506F | 470168 | BAEA234 |
| 880148 | BAEA486 | 880317 | BAEA178E | 1.970.159 | BAEA002E | 470174 | BAEA234 |
| 880150 | BAEA521 | 880318 | BAEA088E | 1.970.168 | BAEA234 | 470178 | BAEA296 |
| 880151 | BAEA447A | 880318 | BAEA158E | 1.970.174 | BAEA234 | 470188 | BAEA232 |
| 880152 | BAEA136E | 880320 | BAEA548 | 1.970.178 | BAEA296 | 470189 | BAEA231 |
| 880153 | BAEA427 | 880325 | BAEA453 | 1.970.178 | BAEA339 | 470213 | BAEA276 |
| 880155 | BAEA188E | 880326 | BAEA476 | 1.970.179 | BAEA298 | 470214 | BAEA275 |
| 880157 | BAEA306 | 880334 | BAEA184E | 1.970.188 | BAEA232 | 470228 | BAE504L |
| 880158 | BAEA073E | 880339 | BAEA126E | 1.970.189 | BAEA231 | 470299 S | BAEA281 |
| 880164 | BAEA477 | 880341 | BAEA043 | 1.970.213 | BAEA276 | 470307 | BAEA307 |
| 880165 | BAEA298 | 880345 | BAEA068E | 1.970.214 | BAEA275 | 470341 | BAEA252 |
| 880166 | BAEA059E | 880345 | BAEA137E | 1.970.228 | BAE504L | 470345 | BAE920AX |
| 880179 | BAEA299 | 880347 | BAEA199E | 1.970.299 S | BAEA281 | 470355 | BAEA245 |
| 880180 | BAEA340 | 880348 | BAEA140E | 1.970.307 | BAEA307 | 470355 | BAEA254 |
| 880184 | BAEA234 | 880348 | BAEA140E | 1.970.316 | BAEA340 | 470356 | BAEA246 |
| 880186 | BAEA433 | 880354 | BAEA185E | 1.970.316 | BAEA340 | 470356 | BAEA255 |
| 880186 | BAEA433 | 880358 | BAEA446 | 1.970.317 | BAEA313 | 470376 | BAEA242 |
| 880188 | BAEA483 | 880362 | BAEA555 | 1.970.341 | BAEA252 | 470378 | BAEA243 |
| 880189 | BAEA543 | 880368 | BAEA394 | 1.970.345 | BAE920AX | 470379 S | BAEA350 |
| 880190 | BAEA179E | 880373 | BAEA395 | 1.970.354 | BAEA016 | 470412 | BAEA014 |
| 880191 | BAEA501 | 880375 | BAEA090 | 1.970.355 | BAEA245 | 470417 | BAEA297 |
| 880193 | BAEA365 | 880376 | BAEA198E | 1.970.355 | BAEA254 | 490 423 | BAEA037E |
| 880196 | BAEA434 | 880377 | BAEA131E | 1.970.356 | BAEA246 | 490420 | BAE907AE |
| 880200 | BAEA143 | 880381 | BAEA432 | 1.970.356 | BAEA255 | 9.6002 | BAE506F |
| 880203 | BAEA480 | 880384 | BAEA190E | 1.970.376 | BAEA242 | 9.6005 | BAEA247 |
| 880213 | BAEA056E | 880385 | BAEA489 | 1.970.378 | BAEA243 | 9.6007 | BAEA251 |
| 880227 | BAEA368 | 880388 | BAEA084E | 1.970.378 | BAEA243 | 9.6008 | BAE506D |
| 880241 | BAEA173E | 880388 | BAEA084E | 1.970.379 S | BAEA350 | 9.6010 | BAEA252 |
| 880242 | BAEA192E | 880392 | BAEA189E | 1.970.387 | BAEA309 | 9.6011 | BAEA252 |
| 880242 | BAEA192E | 880392 | BAEA189E | 1.970.387 | BAEA309 | 9.6035 | BAEA281 |
| 880243 | BAEA164E | 880393 | BAEA191E | 1.970.412 | BAEA014 | 9.6040 | BAEA253 |
| 880243 | BAEA164E | 880393 | BAEA191E | 1.970.414 | BAEA304 | 9.6046 | BAE800B |
| 880244 | BAEA186E | 880396 | BAEA132E | 1.970.414 | BAEA304 | 9.6048 | BAE504D |
| 880244 | BAEA186E | 880399 | BAEA159E | 1.970.417 | BAEA297 | 9.6058 | BAE506F |
| 880245 | BAEA171E | 880400 | BAEA189E | 1.970.450 | BAEA427 | 9.6059 | BAEA002E |
| 880246 | BAEA474 | 880405 | BAEA556 | 1.990.420 | BAE907AE | 9.6062 | BAEA014 |
| 880247 | BAEA181E | 880407 | BAEA180E | 1.990.423 | BAEA037E | 9.6068 | BAEA234 |
| 880254 | BAEA367 | 880412 | BAEA182E | 470 178 | BAEA339 | 9.6074 | BAEA234 |
| 880255 | BAEA167E | 880439 | BAEA382 | 470 179 | BAEA298 | 9.6075 | BAEA115 |
| 880256 | BAEA172E | 880445 | BAEA557 | 470 316 | BAEA340 | 9.6076 | BAEA110 |
| 880257 | BAEA168E | | | 470 317 | BAEA313 | 9.6078 | BAEA296 |
| 880258 | BAEA169E | EUROCABLE | CHAMPION | 470 352 | BAEA302 | 9.6078 | BAEA339 |
| 880259 | BAEA475 | DC-1203 | BAEA486 | 470 354 | BAEA016 | 9.6079 | BAEA298 |
| 880264 | BAEA175E | DC-1225 | BAEA140E | 470 387 | BAEA309 | 9.6088 | BAEA232 |
| 880266 | BAEA170E | EYQUEM | CHAMPION | 470 450 | BAEA427 | 9.6089 | BAEA231 |
| 880272 | BAEA176E | B 6040 | BAEA232 | 470 414 | BAEA304 | | |
| 880273 | BAEA482 | FACET | CHAMPION | 470102 | BAE506F | | |
| 880274 | BAEA066E | 1.970.102 | BAE506F | 470105 | BAEA247 | | |
| 880277 | BAEA194E | | | 470107 | BAEA251 | | |

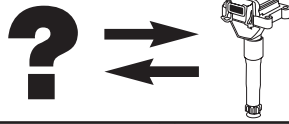

| FACET | CHAMPION |
|----------|----------|
| 9.6113 | BAEA276 |
| 9.6114 | BAEA275 |
| 9.6128 | BAE504L |
| 9.6172 | BAEA344 |
| 9.6199 S | BAEA281 |
| 9.6207 | BAEA307 |
| 9.6213 | BAEA428 |
| 9.6216 | BAEA340 |
| 9.6217 | BAEA313 |
| 9.6223 | BAEA173E |
| 9.6241 | BAEA252 |
| 9.6245 | BAE920AX |
| 9.6254 | BAEA016 |
| 9.6255 | BAEA245 |
| 9.6255 | BAEA254 |
| 9.6256 | BAEA246 |
| 9.6256 | BAEA255 |
| 9.6265 | BAEA345 |
| 9.6276 | BAEA242 |
| 9.6277 | BAEA354 |
| 9.6278 | BAEA243 |
| 9.6279 S | BAEA350 |
| 9.6280 S | BAEA365 |
| 9.6287 | BAEA309 |
| 9.6300 | BAEA147E |
| 9.6305 | BAE946A |
| 9.6312 | BAEA014 |
| 9.6314 | BAEA304 |
| 9.6317 | BAEA297 |
| 9.6319 | BAE947A |
| 9.6325 | BAEA062E |
| 9.6327 | BAEA032E |
| 9.6329 | BAEA043E |
| 9.6331 | BAEA059E |
| 9.6333 | BAEA061E |
| 9.6334 | BAEA044E |
| 9.6336 | BAEA051E |
| 9.6337 | BAEA065E |
| 9.6350 | BAEA427 |
| 9.6361 | BAEA164E |
| 9.6374 | BAE408AE |
| 9.6375 | BAEA143 |
| 9.6375 | BAEA145E |
| 9.6381 | BAEA387 |
| 9.6381 | BAEA448 |
| 9.6392 | BAEA531 |
| 9.6405 | BAEA547 |
| 9.6416 | BAEA489 |
| 9.6422 | BAEA182E |
| 9.6432 | BAEA422 |
| 9.6479 | BAEA536 |
| 9.6485 | BAEA543 |
| 9.8114 | BAE851AE |

| FACET | CHAMPION |
|---------------|----------|
| 9.8118 | BAEA025E |
| 9.8120 | BAE907AE |
| 9.8123 | BAEA037E |
| 96383 | BAEA472 |
| EPS 1.970.377 | BAEA354 |
| EPS 1.970.532 | BAEA422 |
| KW 470 377 | BAEA354 |
| KW 470 532 | BAEA422 |
| FAE | CHAMPION |
| 80209 | BAE965A |
| 80210 | BAEA026E |
| 80254 | BAEA501 |
| FARCOM | CHAMPION |
| 103006 | BAEA174E |
| 103011 | BAEA152E |
| 103013 | BAEA150E |
| FEBI BILSTEIN | CHAMPION |
| 17194 | BAE851AE |
| 19032 | BAE907AE |
| 19929 | BAE800B |
| 21109 | BAEA014 |
| 21524 | BAEA354 |
| 21525 | BAEA345 |
| 21526 | BAEA243 |
| 21527 | BAEA242 |
| 21528 | BAEA251 |
| 21569 | BAEA350 |
| 21666 | BAE409A |
| 22038 | BAE408AE |
| 22389 | BAE965A |
| 22581 | BAEA231 |
| 22697 | BAE920AX |
| 23187 | BAEA342 |
| 23258 | BAEA033E |
| 23260 | BAEA032E |
| 24106 | BAEA043E |
| 24108 | BAEA009E |
| 24435 | BAEA347 |
| 24500 | BAEA059E |
| 24997 | BAE946A |
| 26496 | BAE947A |
| 26869 | BAEA350 |
| 27132 | BAE907AE |
| 27168 | BAEA358 |
| 27470 | BAEA043E |
| 27522 | BAEA359 |
| 28108 | BAEA427 |
| 28487 | BAEA033E |
| 28533 | BAEA339 |
| 28538 | BAEA340 |
| 28548 | BAEA146E |

| FEBI BILSTEIN | CHAMPION |
|---------------|----------|
| 29147 | BAEA302 |
| 29319 | BAEA029E |
| 29412 | BAEA016 |
| 29859 | BAEA051E |
| 30261 | BAEA502E |
| 33666 | BAEA147E |
| 36080 | BAEA144E |
| 36100 | BAEA143 |
| 36113 | BAEA145E |
| 36358 | BAEA033E |
| 36999 | BAEA422 |
| FISPA | CHAMPION |
| 85 30292 | BAEA434 |
| 85 30368 | BAEA137E |
| 85.30006 | BAEA269 |
| 85.30020 | BAEA521 |
| 85.30027 | BAE504F |
| 85.30031 | BAE403D |
| 85.30032 | BAE506D |
| 85.30034 | BAE920AX |
| 85.30036 | BAE800B |
| 85.30040 | BAE504D |
| 85.30041 | BAE506F |
| 85.30042 | BAE504L |
| 85.30043 | BAE403B |
| 85.30044 | BAE700AK |
| 85.30045 | BAE403C |
| 85.30062 | BAE907AE |
| 85.30072 | BAEA051E |
| 85.30089 | BAEA017 |
| 85.30106 | BAE851AE |
| 85.30109 | BAE965A |
| 85.30110 | BAEA063E |
| 85.30111 | BAE946A |
| 85.30144 | BAE947A |
| 85.30153 | BAEA428 |
| 85.30163 | BAEA031E |
| 85.30164 | BAE409A |
| 85.30165 | BAE408AE |
| 85.30166 | BAEA026E |
| 85.30177 | BAEA031E |
| 85.30185 | BAE960AE |
| 85.30190 | BAE940A |
| 85.30194 | BAEA041E |
| 85.30195 | BAEA065E |
| 85.30196 | BAEA061E |
| 85.30197 | BAEA062E |
| 85.30205 | BAEA046E |
| 85.30222 | BAEA306 |
| 85.30237 | BAEA298 |
| 85.30238 | BAEA299 |
| 85.30250 | BAEA095 |

| FISPA | CHAMPION |
|-----------------|----------|
| 85.30251 | BAEA143 |
| 85.30257 | BAEA043 |
| 85.30267 | BAEA136E |
| 85.30279 | BAEA013E |
| 85.30307 | BAEA382 |
| 85.30323 | BAEA073E |
| 85.30335 | BAEA394 |
| 85.30347 | BAEA395 |
| 85.30366 | BAEA067E |
| 85.30366 | BAEA126E |
| 85.30368 | BAEA068E |
| 85.30373 | BAEA140E |
| 85.30393 | BAEA432 |
| 85.30425 | BAEA547 |
| 85.30428 | BAEA084E |
| 85.30441 | BAEA367 |
| 85.30444 | BAEA410 |
| 85.30453 | BAEA042E |
| 85.30454 | BAEA012E |
| 85.30457 | BAEA368 |
| 85.30460 | BAEA132E |
| 85.30503 | BAEA052E |
| HAVAM | CHAMPION |
| 1970272 | BAEA344 |
| 1970308 S | BAEA365 |
| 1970365 | BAEA345 |
| 1970377 | BAEA354 |
| HELLA | CHAMPION |
| 5DA 006 623 711 | BAE851AE |
| 5DA 006 623-621 | BAE851AE |
| 5DA 006 623-701 | BAEA002E |
| 5DA 749 245-291 | BAEA297 |
| 5DA 749 475-001 | BAE800B |
| 5DA 749 475-011 | BAEA231 |
| 5DA 749 475-021 | BAEA232 |
| 5DA 749 475-031 | BAEA354 |
| 5DA 749 475-041 | BAEA234 |
| 5DA 749 475-051 | BAEA307 |
| 5DA 749 475-061 | BAEA340 |
| 5DA 749 475-071 | BAEA313 |
| 5DA 749 475-091 | BAE920AX |
| 5DA 749 475-101 | BAEA245 |
| 5DA 749 475-101 | BAEA254 |
| 5DA 749 475-111 | BAEA242 |
| 5DA 749 475-121 | BAEA016 |
| 5DA 749 475-141 | BAEA021E |
| 5DA 749 475-151 | BAEA281 |
| 5DA 749 475-161 | BAE409A |
| 5DA 749 475-171 | BAE907AE |
| 5DA 749 475-191 | BAEA026E |
| 5DA 749 475-201 | BAEA255 |

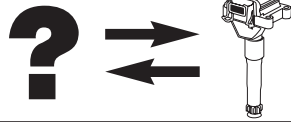

| HELLA | | |
|--------------------|----------|--|
| 5DA 749 475-211 | BAEA243 | |
| 5DA 749 475-221 | BAEA014 | |
| 5DA 749 475-231 | BAE965A | |
| 5DA 749 475-281 | BAEA304 | |
| 5DA 749 475-311 | BAEA302 | |
| 5DA 749 475-341 | BAEA309 | |
| 5DA 749 475-351 | BAEA162E | |
| 5DA 749 475-401 | BAEA308 | |
| 5DA 749 475-411 | BAEA387 | |
| 5DA 749 475-441 | BAEA342 | |
| 5DA 749 475-451 | BAEA358 | |
| 5DA 749 475-461 | BAEA045E | |
| 5DA 749 475-561 | BAEA501 | |
| 5DA 749 475-601 | BAEA352 | |
| 5DA 749 475-611 | BAEA351 | |
| 5DA 749 475-621 | BAEA256 | |
| 5DA 749 475-631 | BAEA338 | |
| 5DA 749 475-641 | BAE946A | |
| 5DA 749 475-671 | BAEA428 | |
| 5DA 749 475-691 | BAEA059E | |
| 5DA 749 475-701 | BAEA061E | |
| 5DA 749 475-771 | BAEA016 | |
| 5DA 749 475-781 | BAE409A | |
| 5DA 749 475-791 | BAEA053 | |
| 5DA 749 475-801 | BAEA077 | |
| 5DA 749 475-811 | BAE965A | |
| 5DA 749 475-821 | BAE907AE | |
| 5DA 749 475-831 | BAEA009E | |
| 5DA 749 475-851 | BAEA143 | |
| 5DA 749 475-851 | BAEA145E | |
| 5DA 749 475-861 | BAE408AE | |
| 5DA 749 475-871 | BAEA043E | |
| 5DA 749 475-941 | BAEA081E | |
| 5DA 749 475-951 | BAEA080E | |
| 5DA 749 475-971 | BAEA132E | |
| 5DA749475-661 | BAEA350 | |
| HERTH+BUSS ELPARTS | | |
| 19 050 028 | BAEA147E | |
| 19 050 031 | BAEA146E | |
| 19020001 | BAE851AE | |
| 19020002 | BAEA002E | |
| 19020005 | BAEA002E | |
| 19020007 | BAE907AE | |
| 19020008 | BAE800B | |
| 19020009 | BAEA422 | |
| 19020010 | BAE851AE | |
| 19020012 | BAEA281 | |
| 19020022 | BAEA344 | |
| 19020030 | BAEA354 | |
| 19020035 | BAEA387 | |
| 19020059 | BAEA422 | |
| 19050001 | BAEA043E | |

| HERTH+BUSS ELPARTS | | |
|---------------------------|----------|--|
| 19050002 | BAE946A | |
| 19050003 | BAE946A | |
| 19050004 | BAE408AE | |
| 19050005 | BAEA014 | |
| 19050007 | BAEA302 | |
| 19050008 | BAEA309 | |
| 19050010 | BAE409A | |
| 19050019 | BAE409A | |
| 19050020 | BAEA032E | |
| 19050022 | BAEA307 | |
| 19050025 | BAE965A | |
| 19050026 | BAEA313 | |
| 19050029 | BAEA358 | |
| 19050033 | BAEA055E | |
| 19050036 | BAEA347 | |
| 19050037 | BAEA045E | |
| 19050038 | BAEA046E | |
| 19050039 | BAEA348 | |
| 19050040 | BAEA351 | |
| 19050041 | BAEA352 | |
| 19050043 | BAEA048E | |
| 19050048 | BAEA051E | |
| 19050049 | BAEA427 | |
| HITACHI | | |
| 133849 | BAEA549 | |
| 133854 | BAEA472 | |
| 133891 | BAEA196E | |
| 134001 | BAEA410 | |
| 134006 | BAEA531 | |
| 134015 | BAEA198E | |
| 134019 | BAEA432 | |
| 134038 | BAEA192E | |
| 138743 | BAEA555 | |
| 138809 | BAEA448 | |
| 138823 | BAEA191E | |
| CM11-201D | BAEA009E | |
| CM11-205 | BAEA021E | |
| HOFFER | | |
| 8010315 | BAE965A | |
| 8010324 | BAE946A | |
| 8010326 | BAEA358 | |
| 8010328 | BAEA043E | |
| 8010329 | BAE408AE | |
| 8010334 | BAEA549 | |
| 8010336 | BAEA354 | |
| 8010372 | BAEA031E | |
| 8010373 | BAEA032E | |
| 8010378 | BAEA309 | |
| 8010384 | BAEA344 | |
| 8010395 | BAE940A | |
| 8010401 | BAEA502E | |

| HOFFER | | |
|---------------|----------|--|
| 8010405 | BAEA045E | |
| 8010409 | BAEA380 | |
| 8010414 | BAEA181E | |
| 8010418 | BAEA347 | |
| 8010419 | BAEA351 | |
| 8010420 | BAE947A | |
| 8010421 | BAEA048E | |
| 8010458 | BAEA521 | |
| 8010460 | BAEA059E | |
| 8010462 | BAEA387 | |
| 8010470 | BAEA046E | |
| 8010472 | BAEA352 | |
| 8010478 | BAE408AE | |
| 8010480 | BAEA427 | |
| 8010483 | BAEA359 | |
| 8010497 | BAEA051E | |
| 8010498 | BAEA063E | |
| 8010500 | BAEA056E | |
| 8010501 | BAEA031E | |
| 8010503 | BAEA065E | |
| 8010504 | BAEA061E | |
| 8010505 | BAEA062E | |
| 8010512 | BAEA136E | |
| 8010541 | BAEA095 | |
| 8010559 | BAEA186E | |
| 8010573 | BAEA395 | |
| 8010578 | BAEA066E | |
| 8010579 | BAEA194E | |
| 8010599 | BAEA067E | |
| 8010599 | BAEA126E | |
| 8010600 | BAEA140E | |
| 8010602 | BAEA137E | |
| 8010606 | BAEA185E | |
| 8010618 | BAEA531 | |
| 8010662 | BAEA547 | |
| 8010674 | BAEA190E | |
| 8010697 | BAEA042E | |
| 8010711 | BAEA180E | |
| 8010713 | BAEA131E | |
| 8010759 | BAEA189E | |
| 8810391 | BAEA348 | |
| HÜCO | | |
| 13 3809 | BAE965A | |
| 13 3812 | BAEA059E | |
| 13 3832 | BAEA427 | |
| 13 3852 | BAEA408 | |
| 13 3856 | BAEA153E | |
| 13 3860 | BAEA081E | |
| 13 3907 | BAEA080E | |
| 13 8814 | BAEA276 | |
| 133810 | BAEA342 | |
| 133814 | BAEA340 | |

| Hüco | | |
|-------------|----------|--|
| 133815 | BAEA358 | |
| 133830 | BAEA031E | |
| 133834 | BAEA051E | |
| 133837 | BAEA501 | |
| 133851 | BAEA446 | |
| 133854 | BAEA472 | |
| 133864 | BAEA174E | |
| 133867 | BAEA161E | |
| 133878 | BAEA172E | |
| 133902 | BAEA158E | |
| 133909 | BAEA188E | |
| 133930 | BAEA176E | |
| 133936 | BAEA489 | |
| 133941 | BAEA184E | |
| 133947 | BAEA181E | |
| 133951 | BAEA543 | |
| 134008 | BAEA186E | |
| 134017 | BAEA179E | |
| 134044 | BAEA182E | |
| 134048 | BAEA185E | |
| 134050 | BAEA178E | |
| 134058 | BAEA131E | |
| 138434 | BAEA004E | |
| 138435 | BAEA162E | |
| 138438 | BAEA029E | |
| 138708 | BAEA004E | |
| 138724 | BAEA486 | |
| 138828 | BAEA159E | |
| 138877 | BAEA469 | |
| 139910 | BAEA175E | |
| 2503909 | BAEA188E | |
| 2503910 | BAEA175E | |
| 2503930 | BAEA176E | |
| HUECO | | |
| 024-138811 | BAEA422 | |
| 13 3800 | BAE409A | |
| 13 3801 | BAE403C | |
| 13 3803 | BAEA347 | |
| 13 3805 | BAEA016 | |
| 13 3806 | BAEA043E | |
| 13 3807 | BAE408AE | |
| 13 3808 | BAEA033E | |
| 13 3811 | BAEA014 | |
| 13 3816 | BAEA147E | |
| 13 3822 | BAEA146E | |
| 13 3825 | BAEA324 | |
| 13 3827 | BAE403B | |
| 13 3847 | BAEA044E | |
| 13 3850 | BAEA429 | |
| 13 3855 | BAEA152E | |
| 13 3875 | BAEA143 | |
| 13 3876 | BAEA144E | |

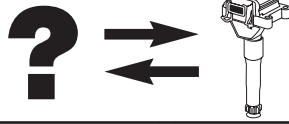





| HUECO | | |
|-------------------|----------|--|
| 13 3880 | BAEA150E | |
| 13 3901 | BAEA088E | |
| 13 3906 | BAEA132E | |
| 13 8416 | BAEA002E | |
| 13 8419 | BAE851AE | |
| 13 8425 | BAE907AE | |
| 13 8430 | BAEA026E | |
| 13 8437 | BAEA013E | |
| 13 8701 | BAEA002E | |
| 13 8702 | BAE851AE | |
| 13 8704 | BAE907AE | |
| 13 8709 | BAEA297 | |
| 13 8710 | BAEA304 | |
| 13 8730 | BAE800B | |
| 13 8751 | BAEA251 | |
| 13 8754 | BAEA247 | |
| 13 8756 | BAEA231 | |
| 13 8757 | BAEA254 | |
| 13 8758 | BAEA255 | |
| 13 8759 | BAEA242 | |
| 13 8760 | BAEA232 | |
| 13 8766 | BAEA243 | |
| 13 8780 | BAEA253 | |
| 13 8781 | BAEA252 | |
| 13 8803 | BAEA350 | |
| 13 8805 | BAEA025E | |
| 13 8808 | BAEA387 | |
| 13 8812 | BAEA275 | |
| 13 8817 | BAEA372 | |
| 133858 | BAEA021E | |
| 133911 | BAEA021E | |
| 138717 | BAEA395 | |
| 138811 | BAEA422 | |
| INTERMOTOR | | |
| 11150 | BAEA115 | |
| 11220 | BAEA115 | |
| 12200 | BAEA252 | |
| 12202 | BAEA252 | |
| 12203 | BAEA253 | |
| 12301 | BAEA251 | |
| 12302 | BAEA247 | |
| 12428 | BAEA372 | |
| 12589 | BAEA242 | |
| 12596 | BAEA354 | |
| 12602 | BAE506F | |
| 12606 | BAEA016 | |
| 12607 | BAEA243 | |
| 12608 | BAEA014 | |
| 12609 | BAEA302 | |
| 12613 | BAEA232 | |
| 12614 | BAEA281 | |
| 12616 | BAEA231 | |

| INTERMOTOR | | |
|-------------------|----------|--|
| 12618 | BAEA276 | |
| 12621 | BAEA002E | |
| 12622 | BAEA014 | |
| 12623 | BAEA234 | |
| 12626 | BAEA252 | |
| 12637 | BAEA234 | |
| 12639 | BAEA339 | |
| 12659 | BAEA275 | |
| 12678 | BAEA344 | |
| 12701 | BAEA254 | |
| 12702 | BAEA255 | |
| 12703 | BAEA281 | |
| 12705 | BAEA345 | |
| 12710 | BAEA307 | |
| 12714 | BAEA350 | |
| 12715 | BAEA365 | |
| 12717 | BAEA309 | |
| 12720 | BAE946A | |
| 12722 | BAEA358 | |
| 12723 | BAE965A | |
| 12724 | BAEA342 | |
| 12726 | BAEA029E | |
| 12731 | BAEA256 | |
| 12736 | BAEA340 | |
| 12739 | BAEA501 | |
| 12747 | BAEA348 | |
| 12749 | BAEA045E | |
| 12756 | BAEA351 | |
| 12758 | BAEA324 | |
| 12764 | BAEA345 | |
| 12766 | BAEA347 | |
| 12772 | BAEA387 | |
| 12778 | BAEA059E | |
| 12790 | BAEA044E | |
| 12812 | BAEA502E | |
| 12818 | BAEA055E | |
| 12832 | BAEA056E | |
| 12851 | BAEA154E | |
| 12859 | BAEA055E | |
| 12916 | BAE851AE | |
| 12919 | BAE907AE | |
| JANMOR | | |
| JM5011 | BAE408AE | |
| JM5028 | BAEA354 | |
| JM5070 | BAEA380 | |
| JM5084 | BAEA059E | |
| JM5085 | BAEA501 | |
| JM5093 | BAEA387 | |
| JM5108 | BAEA521 | |
| JM5111 | BAEA502E | |
| JM5253 | BAEA061E | |
| JM5254 | BAEA062E | |

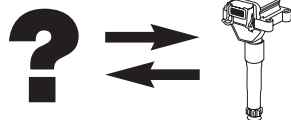

| JANMOR | | |
|-----------------|----------|--|
| JM5268 | BAEA065E | |
| JM5372 | BAEA088E | |
| JM5431 | BAEA140E | |
| ODM251 | BAE965A | |
| ODM253 | BAEA358 | |
| ODM258 | BAEA427 | |
| JP GROUP | | |
| 881208307 | BAE965A | |
| 905062001 | BAE907AE | |
| 905066001 | BAE408AE | |
| KAGER | | |
| 00-0911 | BAE961AE | |
| 00-0912 | BAE907AE | |
| 00-0914 | BAE408AE | |
| 00-0915 | BAEA043E | |
| 00-0916 | BAEA029E | |
| 60-0020 | BAEA043E | |
| 60-0035 | BAEA045E | |
| 60-0042 | BAEA354 | |
| 60-0061 | BAE408AE | |
| 60-0068 | BAE946A | |
| 60-0070 | BAEA348 | |
| 60-0076 | BAEA032E | |
| 60-0078 | BAEA351 | |
| 60-0079 | BAEA345 | |
| 60-0080 | BAE965A | |
| 60-0086 | BAEA358 | |
| 60-0094 | BAEA048E | |
| 60-0095 | BAEA352 | |
| 60-0098 | BAEA046E | |
| 60-0108 | BAEA359 | |
| 60-0109 | BAE940A | |
| 60-0113 | BAEA347 | |
| 60-0114 | BAEA427 | |
| 60-0121 | BAEA066E | |
| KW (KW) | | |
| 470 272 | BAEA344 | |
| 470 365 | BAEA345 | |
| 470 377 | BAEA354 | |
| 470 379 S | BAEA350 | |
| 470 380 S | BAEA365 | |
| 470 427 | BAEA032E | |
| 470 429 | BAEA043E | |
| 470 431 | BAEA059E | |
| 470 433 | BAEA061E | |
| 470 434 | BAEA044E | |
| 470 435 | BAEA063E | |
| 470 436 | BAEA051E | |
| LUCAS | | |
| DMB 1013 | BAEA434 | |



| LUCAS | | |
|-------------------------|----------|--|
| DMB 1026 | BAEA433 | |
| DMB 897 | BAEA387 | |
| DMB 984 | BAEA084E | |
| LUCAS ELECTRICAL | | |
| DLB 204 | BAEA251 | |
| DLB 205 | BAEA247 | |
| DLB 801 | BAE506F | |
| DMB 1102 | BAEA429 | |
| DMB 408 | BAEA354 | |
| DMB 808 | BAEA043E | |
| DMB 810 | BAEA365 | |
| DMB 816 | BAE965A | |
| DMB 851 | BAEA309 | |
| DMB 868 | BAEA045E | |
| DMB 875 | BAEA351 | |
| DMB 886 | BAEA046E | |
| DMB 893 | BAEA367 | |
| DMB 903 | BAE947A | |
| DMB 907 | BAEA059E | |
| DMB 910 | BAEA063E | |
| DMB 912 | BAEA044E | |
| DMB2027 | BAEA198E | |
| DMB2070 | BAEA547 | |
| DMB406 | BAEA345 | |
| DMB408 | BAEA354 | |
| LUO'S | | |
| L630310 | BAEA502E | |
| L740401 | BAE408AE | |
| L830106 | BAEA380 | |
| MAGNETI MARELLI | | |
| 0 60708038010 | BAE800B | |
| 0 60740303010 | BAE403C | |
| 0 60740304010 | BAE403D | |
| 0 60780002010 | BAE800B | |
| 0 60794001010 | BAE940A | |
| 0 60801012010 | BAEA427 | |
| 060705404010 | BAE504D | |
| 060705406010 | BAE504F | |
| 060705409010 | BAE504L | |
| 060705604010 | BAE506D | |
| 060705606010 | BAE506F | |
| 060705607010 | BAE506D | |
| 060707038010 | BAE700AK | |
| 060740302010 | BAE403B | |
| 060740303010 | BAE403C | |
| 060740304010 | BAE403D | |
| 060780002010 | BAE800B | |
| 060780003010 | BAE800B | |
| 060792001010 | BAE920AX | |
| 060796105010 | BAE961AE | |
| 060801008010 | BAE965A | |



| MAGNETI MARELLI  | |
|---|-----------------|
| 060810226010 | BAEA174E |
| 60705404 | BAE506F |
| 60705409 | BAE504L |
| 60705606 | BAE506F |
| 60707038 | BAE700AK |
| 60708038 | BAE800B |
| 60740303 | BAE403C |
| 60740304 | BAE403D |
| 60792001 | BAE920AX |
| BAE 403 B | BAE403B |
| BAE 403 C | BAE403C |
| BAE 403 D | BAE403D |
| BAE 504 L | BAE504L |
| BAE 506 | BAE506D |
| BAE 506 D | BAE506D |
| BAE 506 F | BAE506F |
| BAE 608 F | BAE965A |
| BAE 700 AK | BAE700AK |
| BAE 800 AK | BAE800B |
| BAE 800 B | BAE800B |
| BAE 800 DK | BAE800B |
| BAE 920 A | BAE920AX |
| BAE 920 AX | BAE920AX |
| BAE 9961 EA | BAE961AE |
| BAE504D | BAE506F |
| BAE506G | BAE506D |
| BAE680CF | BAEA174E |
| BAE800AK | BAE800B |
| BAE800BAM | BAE800B |
| MAPCO  | |
| 80042 | BAE800B |
| 80043 | BAE506D |
| 80100 | BAEA251 |
| 80103 | BAEA354 |
| 80402 | BAEA232 |
| 80563 | BAEA449 |
| 80571 | BAEA502E |
| 80613 | BAEA252 |
| 80616 | BAE965A |
| 80618 | BAEA358 |
| 80619 | BAEA147E |
| 80751 | BAEA281 |
| 80752 | BAEA350 |
| 80752 | BAEA422 |
| 80883 | BAEA043E |
| 80885 | BAE851AE |
| 80886 | BAE408AE |
| 80888 | BAE907AE |
| 80894 | BAEA051E |
| MEAT & DORIA  | |
| 0880190 | BAEA140E |

| MEAT & DORIA  | |
|---|-----------------|
| 10300 | BAE409A |
| 10302 | BAE800B |
| 10303 | BAE920AX |
| 10304 | BAE506F |
| 10305 | BAE506D |
| 10306 | BAEA002E |
| 10307 | BAE907AE |
| 10308 | BAE851AE |
| 10309 | BAE504F |
| 10311 | BAEA234 |
| 10314 | BAEA281 |
| 10315 | BAE965A |
| 10324 | BAE946A |
| 10325 | BAE947A |
| 10326 | BAEA358 |
| 10328 | BAEA043E |
| 10329 | BAE408AE |
| 10331 | BAE403B |
| 10333 | BAE961AE |
| 10336 | BAEA354 |
| 10339 | BAE403D |
| 10340 | BAE700AK |
| 10342 | BAEA016 |
| 10343 | BAEA232 |
| 10344 | BAEA275 |
| 10345 | BAEA242 |
| 10347 | BAEA243 |
| 10349 | BAEA234 |
| 10351 | BAEA324 |
| 10353 | BAEA014 |
| 10356 | BAE403D |
| 10362 | BAEA297 |
| 10366 | BAEA313 |
| 10372 | BAEA031E |
| 10373 | BAEA032E |
| 10374 | BAEA029E |
| 10375 | BAEA256 |
| 10378 | BAEA309 |
| 10380 | BAEA255 |
| 10382 | BAEA307 |
| 10388 | BAEA231 |
| 10391 | BAEA348 |
| 10394 | BAE960AE |
| 10395 | BAE940A |
| 10398 | BAEA342 |
| 10401 | BAEA502E |
| 10405 | BAEA045E |
| 10409 | BAEA380 |
| 10418 | BAEA347 |
| 10419 | BAEA351 |
| 10420 | BAE947A |
| 10439 | BAEA501 |
| 10458 | BAEA521 |

| MEAT & DORIA  | |
|---|-----------------|
| 10460 | BAEA059E |
| 10462 | BAEA387 |
| 10470 | BAEA046E |
| 10471 | BAEA048E |
| 10472 | BAEA352 |
| 10478 | BAE408AE |
| 10480 | BAEA427 |
| 10483 | BAEA359 |
| 10498 | BAEA063E |
| 10500 | BAEA056E |
| 10501 | BAEA031E |
| 10503 | BAEA065E |
| 10504 | BAEA061E |
| 10505 | BAEA062E |
| 10541 | BAEA095 |
| 10573 | BAEA395 |
| 10599 | BAEA067E |
| 10599 | BAEA126E |
| 10602 | BAEA137E |
| METZGER  | |
| 0880002 | BAE965A |
| 0880004 | BAEA342 |
| 0880007 | BAEA358 |
| 0880008 | BAEA147E |
| 0880012 | BAEA427 |
| 0880014 | BAEA143 |
| 0880040 | BAEA152E |
| 0880041 | BAEA153E |
| 0880047 | BAEA549 |
| 0880051 | BAEA340 |
| 0880052 | BAEA146E |
| 0880061 | BAEA004E |
| 0880063 | BAEA149E |
| 0880073 | BAEA387 |
| 0880076 | BAEA502E |
| 0880078 | BAEA051E |
| 0880090 | BAEA501 |
| 0880100 | BAE851AE |
| 0880101 | BAE408AE |
| 0880102 | BAEA043E |
| 0880103 | BAE907AE |
| 0880124 | BAEA181E |
| 0880130 | BAEA382 |
| 0880139 | BAEA144E |
| 0880157 | BAEA174E |
| 0880161 | BAEA145E |
| 0880172 | BAEA422 |
| 0880175 | BAEA449 |
| 0880180 | BAEA095 |
| 0880191 | BAEA150E |
| 0880197 | BAEA472 |
| 0880198 | BAEA126E |

| METZGER  | |
|--|-----------------|
| 0880200 | BAE409A |
| 0880204 | BAEA137E |
| 0880205 | BAEA161E |
| 0880250 | BAEA324 |
| 0880350 | BAE800B |
| 0880356 | BAE403B |
| 0880400 | BAEA019E |
| 0880401 | BAEA055E |
| 0880406 | BAEA090 |
| 0880431 | BAEA131E |
| VM-M308 | BAEA351 |
| WM-M003 | BAEA344 |
| WM-M102 | BAEA043E |
| WM-M301 | BAE946A |
| WM-M305 | BAEA045E |
| WM-M306 | BAEA046E |
| MEYLE  | |
| 014 158 0000 | BAEA340 |
| 014 885 0006 | BAEA146E |
| 100 885 0007 | BAEA051E |
| 100 885 0040 | BAE408AE |
| 100 905 0007 | BAE851AE |
| 100 905 0019 | BAEA043E |
| 100 905 0021 | BAE907AE |
| 161 488 50002 | BAE409A |
| 214 800 0000 | BAEA115 |
| 214 800 0001 | BAE800B |
| 214 885 0004 | BAE403B |
| 314 131 0000 | BAEA302 |
| 314 139 0000 | BAEA014 |
| 314 885 0000 | BAEA324 |
| 514 885 0004 | BAEA429 |
| 614 885 0004 | BAEA342 |
| 614 885 0006 | BAE965A |
| 614 885 0007 | BAEA427 |
| 614 885 0019 | BAEA174E |
| 714 885 0001 | BAEA387 |
| 714 885 0003 | BAEA422 |
| 7148850000 | BAEA350 |
| NGK  | |
| 48000 | BAE851AE |
| 48001 | BAEA350 |
| 48001 | BAEA365 |
| 48001 | BAEA422 |
| 48002 | BAE409A |
| 48003 | BAE408AE |
| 48004 | BAEA427 |
| 48005 | BAEA043E |
| 48006 | BAE965A |
| 48007 | BAEA454 |
| 48008 | BAEA016 |

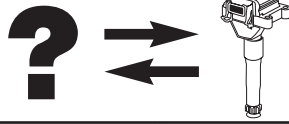

| NGK | CHAMPION |
|-------|----------|
| 48009 | BAEA302 |
| 48010 | BAE907AE |
| 48011 | BAEA342 |
| 48012 | BAEA026E |
| 48013 | BAE800B |
| 48014 | BAEA045E |
| 48015 | BAEA059E |
| 48016 | BAE946A |
| 48017 | BAEA146E |
| 48018 | BAEA340 |
| 48019 | BAEA242 |
| 48020 | BAEA243 |
| 48021 | BAEA281 |
| 48022 | BAEA358 |
| 48024 | BAEA297 |
| 48025 | BAEA234 |
| 48026 | BAEA354 |
| 48027 | BAEA387 |
| 48029 | BAEA252 |
| 48030 | BAEA232 |
| 48031 | BAEA347 |
| 48032 | BAEA348 |
| 48033 | BAEA324 |
| 48034 | BAE403B |
| 48035 | BAEA063E |
| 48036 | BAEA014 |
| 48037 | BAEA154E |
| 48038 | BAEA029E |
| 48039 | BAEA002E |
| 48040 | BAEA051E |
| 48041 | BAEA032E |
| 48042 | BAEA033E |
| 48043 | BAEA147E |
| 48044 | BAEA448 |
| 48047 | BAEA031E |
| 48048 | BAEA162E |
| 48050 | BAEA313 |
| 48051 | BAEA256 |
| 48052 | BAE920AX |
| 48054 | BAEA275 |
| 48055 | BAEA501 |
| 48056 | BAEA344 |
| 48057 | BAEA253 |
| 48058 | BAEA246 |
| 48058 | BAEA255 |
| 48059 | BAEA469 |
| 48061 | BAE403C |
| 48062 | BAEA247 |
| 48063 | BAEA408 |
| 48064 | BAE506D |
| 48065 | BAEA041E |
| 48065 | BAEA044E |
| 48067 | BAEA231 |

| NGK | CHAMPION |
|-------|----------|
| 48068 | BAEA245 |
| 48068 | BAEA254 |
| 48070 | BAEA025E |
| 48071 | BAEA352 |
| 48072 | BAEA351 |
| 48074 | BAEA048E |
| 48076 | BAEA046E |
| 48078 | BAEA345 |
| 48082 | BAEA009E |
| 48083 | BAEA338 |
| 48085 | BAEA304 |
| 48086 | BAEA372 |
| 48087 | BAEA004E |
| 48088 | BAEA061E |
| 48089 | BAEA041 |
| 48092 | BAEA251 |
| 48095 | BAEA165E |
| 48098 | BAEA276 |
| 48101 | BAEA013E |
| 48102 | BAEA549 |
| 48105 | BAEA445 |
| 48106 | BAEA306 |
| 48107 | BAEA164E |
| 48108 | BAE947A |
| 48108 | BAEA325 |
| 48114 | BAE961AE |
| 48115 | BAEA296 |
| 48115 | BAEA298 |
| 48115 | BAEA339 |
| 48116 | BAEA449 |
| 48119 | BAEA308 |
| 48120 | BAEA367 |
| 48122 | BAEA021E |
| 48123 | BAE504L |
| 48124 | BAEA472 |
| 48126 | BAEA359 |
| 48127 | BAEA019E |
| 48129 | BAEA540 |
| 48131 | BAEA053 |
| 48133 | BAEA307 |
| 48134 | BAEA502E |
| 48139 | BAEA081E |
| 48140 | BAEA055E |
| 48141 | BAEA554 |
| 48142 | BAEA447A |
| 48144 | BAEA368 |
| 48147 | BAEA144E |
| 48148 | BAEA560 |
| 48149 | BAEA309 |
| 48150 | BAEA037 |
| 48151 | BAEA149E |
| 48153 | BAEA539 |
| 48154 | BAEA428 |

| NGK | CHAMPION |
|-------|----------|
| 48155 | BAEA337 |
| 48156 | BAEA037E |
| 48157 | BAEA181E |
| 48159 | BAEA150E |
| 48160 | BAEA267 |
| 48162 | BAEA056E |
| 48163 | BAE700AK |
| 48165 | BAEA065E |
| 48167 | BAEA195E |
| 48169 | BAE940A |
| 48170 | BAEA266 |
| 48171 | BAEA429 |
| 48172 | BAE403D |
| 48173 | BAEA264 |
| 48174 | BAEA174E |
| 48178 | BAEA152E |
| 48179 | BAEA170E |
| 48183 | BAEA136E |
| 48184 | BAEA171E |
| 48185 | BAEA380 |
| 48192 | BAEA153E |
| 48201 | BAEA188E |
| 48204 | BAEA394 |
| 48206 | BAEA143 |
| 48206 | BAEA324 |
| 48207 | BAEA077 |
| 48208 | BAEA083E |
| 48209 | BAEA479 |
| 48216 | BAEA145E |
| 48223 | BAEA084E |
| 48225 | BAEA179E |
| 48226 | BAEA080E |
| 48230 | BAEA482 |
| 48234 | BAE960AE |
| 48235 | BAEA172E |
| 48237 | BAEA446 |
| 48239 | BAEA475 |
| 48240 | BAEA168E |
| 48241 | BAEA161E |
| 48242 | BAEA190E |
| 48244 | BAEA073E |
| 48245 | BAEA474 |
| 48254 | BAEA191E |
| 48258 | BAEA194E |
| 48259 | BAEA432 |
| 48266 | BAEA182E |
| 48267 | BAEA196E |
| 48269 | BAEA192E |
| 48273 | BAEA186E |
| 48274 | BAEA531 |
| 48276 | BAEA410 |
| 48278 | BAEA167E |
| 48281 | BAEA072E |

| NGK | CHAMPION |
|-------|----------|
| 48284 | BAEA066E |
| 48286 | BAEA095 |
| 48287 | BAEA483 |
| 48288 | BAEA486 |
| 48289 | BAEA543 |
| 48290 | BAEA477 |
| 48291 | BAEA434 |
| 48292 | BAEA175E |
| 48293 | BAEA176E |
| 48294 | BAEA433 |
| 48295 | BAEA169E |
| 48296 | BAEA561 |
| 48297 | BAEA173E |
| 48302 | BAEA115 |
| 48303 | BAEA115 |
| 48311 | BAEA299 |
| 48312 | BAEA395 |
| 48315 | BAEA480 |
| 48316 | BAEA521 |
| 48318 | BAEA508 |
| 48322 | BAEA453 |
| 48332 | BAEA079E |
| 48337 | BAEA140E |
| 48345 | BAEA546 |
| 48347 | BAEA088E |
| 48348 | BAEA158E |
| 48350 | BAEA132E |
| 48368 | BAEA382 |
| 48369 | BAEA556 |
| 48371 | BAEA269 |
| 48372 | BAEA555 |
| 48376 | BAEA193E |
| 48395 | BAEA184E |
| 48404 | BAEA185E |
| 48406 | BAEA199E |
| 48407 | BAEA198E |
| 48409 | BAEA137E |
| 48410 | BAEA131E |
| 49052 | BAEA548 |
| 49086 | BAE940A |
| U1001 | BAE851AE |
| U1002 | BAEA252 |
| U1003 | BAEA002E |
| U1004 | BAEA275 |
| U1005 | BAEA253 |
| U1006 | BAEA469 |
| U1007 | BAEA247 |
| U1008 | BAE506D |
| U1016 | BAEA276 |
| U1018 | BAEA445 |
| U1023 | BAEA296 |
| U1026 | BAE504L |
| U1028 | BAEA540 |



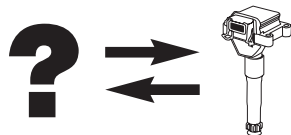

| | | | | | | | |
|------------|----------|------------|----------|------------|----------|-------------------------|----------|
| NGK | | NGK | | NGK | | NGK | |
| U1033 | BAEA560 | U3007 | BAEA255 | U5048 | BAE403D | U6027 | BAEA149E |
| U1035 | BAEA037E | U3009 | BAEA245 | U5049 | BAEA174E | U6028 | BAEA150E |
| U1065 | BAEA115 | U3009 | BAEA254 | U5051 | BAEA170E | U6029 | BAEA152E |
| U1066 | BAEA115 | U3010 | BAEA304 | U5052 | BAEA171E | U6030 | BAEA153E |
| U1074 | BAEA299 | U4001 | BAEA501 | U5055 | BAEA143 | U6033 | BAE960AE |
| U1086 | BAEA394 | U4005 | BAEA308 | U5055 | BAEA324 | U6035 | BAEA508 |
| U2001 | BAEA350 | U4006 | BAEA502E | U5056 | BAEA077 | U6036 | BAEA454 |
| U2001 | BAEA365 | U4007 | BAEA309 | U5058 | BAEA145E | U6037 | BAEA162E |
| U2001 | BAEA422 | U4009 | BAEA429 | U5061 | BAEA080E | U6041 | BAEA199E |
| U2003 | BAE907AE | U4010 | BAEA136E | U5065 | BAEA172E | U6042 | BAEA198E |
| U2004 | BAEA026E | U4011 | BAEA083E | U5066 | BAEA446 | U6055 | BAE940A |
| U2005 | BAEA281 | U4013 | BAEA084E | U5067 | BAEA475 | NIPPARTS | |
| U2006 | BAEA234 | U4020 | BAEA434 | U5068 | BAEA168E | J5368002 | BAEA072E |
| U2007 | BAEA354 | U4021 | BAEA433 | U5069 | BAEA161E | N5363006 | BAEA195E |
| U2008 | BAEA387 | U4026 | BAEA340 | U5071 | BAEA073E | N5366004 | BAEA180E |
| U2010 | BAEA154E | U5001 | BAE409A | U5072 | BAEA474 | NPS | |
| U2011 | BAEA029E | U5002 | BAE408AE | U5077 | BAEA194E | H536111 | BAEA502E |
| U2012 | BAEA448 | U5003 | BAEA043E | U5078 | BAEA432 | OPTIMAL | |
| U2014 | BAE920AX | U5004 | BAEA016 | U5082 | BAEA196E | SPE-116209 | BAE907AE |
| U2016 | BAEA344 | U5005 | BAEA302 | U5089 | BAEA410 | PEX | |
| U2017 | BAEA231 | U5006 | BAEA059E | U5090 | BAEA167E | 110.037 | BAE408AE |
| U2018 | BAEA025E | U5008 | BAEA347 | U5092 | BAEA072E | 110.044 | BAEA345 |
| U2019 | BAEA345 | U5009 | BAEA324 | U5094 | BAEA066E | 110026 | BAEA350 |
| U2023 | BAEA372 | U5010 | BAE403B | U5096 | BAEA095 | 111.034 | BAEA043E |
| U2024 | BAEA004E | U5011 | BAEA063E | U5097 | BAEA175E | 11720 | BAEA354 |
| U2026 | BAEA013E | U5012 | BAEA014 | U5098 | BAEA176E | QH INTERNATIONAL | |
| U2027 | BAEA306 | U5013 | BAEA051E | U5099 | BAEA169E | HP206641 | BAEA358 |
| U2028 | BAE947A | U5014 | BAEA032E | U5100 | BAEA173E | QUINTON HAZELL | |
| U2028 | BAEA325 | U5015 | BAEA033E | U5105 | BAEA453 | XIC 8200 | BAE408AE |
| U2030 | BAEA307 | U5017 | BAEA031E | U5112 | BAEA079E | XIC 8209 | BAEA428 |
| U2031 | BAEA447A | U5018 | BAE403C | U5117 | BAEA140E | XIC 8236 | BAE940A |
| U2033 | BAEA037 | U5019 | BAEA408 | U5119 | BAEA088E | XIC 8254 | BAEA427 |
| U2035 | BAEA267 | U5020 | BAEA044E | U5123 | BAEA132E | XIC 8263 | BAEA387 |
| U2037 | BAEA195E | U5022 | BAEA009E | U5128 | BAEA158E | XIC 8377 | BAEA434 |
| U2038 | BAE940A | U5024 | BAEA061E | U5154 | BAEA137E | XIC 8405 | BAEA433 |
| U2039 | BAEA266 | U5025 | BAEA041 | U6001 | BAEA427 | XIC 8448 | BAEA410 |
| U2040 | BAEA264 | U5027 | BAEA165E | U6002 | BAE965A | XIC8352 | BAEA472 |
| U2041 | BAEA380 | U5028 | BAEA549 | U6003 | BAEA342 | XIC8374 | BAEA174E |
| U2048 | BAEA479 | U5029 | BAEA164E | U6004 | BAEA045E | XIC8417 | BAEA161E |
| U2051 | BAEA482 | U5030 | BAEA449 | U6005 | BAE946A | SAGEM | |
| U2060 | BAEA483 | U5031 | BAEA367 | U6006 | BAEA146E | 21595273-2 | BAE409A |
| U2061 | BAEA486 | U5032 | BAEA021E | U6007 | BAEA358 | 21603121-9 | BAE409A |
| U2063 | BAEA477 | U5033 | BAEA019E | U6009 | BAEA348 | 2526015 | BAE506F |
| U2064 | BAEA561 | U5034 | BAEA053 | U6010 | BAEA147E | 2526015 A | BAE506F |
| U2065 | BAEA395 | U5036 | BAEA081E | U6012 | BAEA256 | 2526030 | BAE506D |
| U2066 | BAEA480 | U5037 | BAEA055E | U6013 | BAEA352 | 2526030 A | BAE506D |
| U2067 | BAEA521 | U5038 | BAEA368 | U6014 | BAEA351 | 2526034 | BAE504L |
| U3001 | BAE800B | U5039 | BAEA144E | U6015 | BAEA048E | 2526034 A | BAE504L |
| U3002 | BAEA242 | U5040 | BAEA428 | U6017 | BAEA046E | | |
| U3003 | BAEA243 | U5041 | BAEA337 | U6019 | BAEA338 | | |
| U3004 | BAEA297 | U5043 | BAEA056E | U6020 | BAE961AE | | |
| U3006 | BAEA313 | U5044 | BAE700AK | U6021 | BAEA472 | | |
| U3007 | BAEA246 | U5046 | BAEA065E | U6022 | BAEA359 | | |

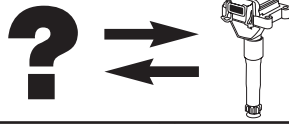

| SAGEM | CHAMPION |
|--------------|-----------------|
| 2526048 | BAEA251 |
| 2526048 A | BAEA251 |
| 2526049 | BAEA253 |
| 2526049 A | BAEA253 |
| 2526050 | BAEA252 |
| 2526050 A | BAEA252 |
| 2526051 | BAEA254 |
| 2526051 A | BAEA254 |
| 2526052 | BAEA255 |
| 2526052 A | BAEA255 |
| 2526055 A | BAEA344 |
| 2526059 | BAEA256 |
| 2526059 A | BAEA256 |
| 2526078 B | BAEA345 |
| 2526110 | BAEA245 |
| 2526110 A | BAEA245 |
| 2526111 | BAEA246 |
| 2526111 A | BAEA246 |
| 2526114 | BAEA242 |
| 2526114 A | BAEA242 |
| 2526115 | BAEA243 |
| 2526115 A | BAEA243 |
| 2526118 A | BAEA348 |
| 2526131 A | BAEA351 |
| 2526151 A | BAEA354 |
| 2526180 A | BAE409A |
| 2526182 A | BAEA045E |
| 2526182 B | BAEA045E |
| 2526210 | BAEA046E |
| 2526210 A | BAEA046E |
| 2528208 B | BAE946A |
| 520073 | BAEA247 |
| B 6039 | BAEA231 |
| B 6051 | BAEA254 |
| B 6052 | BAEA255 |
| B 6059 | BAEA256 |
| B 6110 | BAEA245 |
| B 6111 | BAEA246 |
| B 6114 | BAEA242 |
| B 6115 | BAEA243 |
| B 6162 | BAEA247 |
| B 6168 | BAE504L |
| B 6171 | BAEA251 |
| B 6172 | BAEA252 |
| B 6186 | BAE506D |
| B 6192 | BAEA253 |
| SIDAT | CHAMPION |
| 85.30273 | BAEA433 |
| 85.30292 | BAEA434 |
| 85.30368 | BAEA137E |
| 85.30001 | BAEA502E |
| 85.30006 | BAEA269 |

| SIDAT | CHAMPION |
|--------------|-----------------|
| 85.30020 | BAEA521 |
| 85.30027 | BAE504F |
| 85.30031 | BAE403D |
| 85.30032 | BAE506D |
| 85.30034 | BAE920AX |
| 85.30036 | BAE800B |
| 85.30040 | BAE504D |
| 85.30041 | BAE506F |
| 85.30042 | BAE504L |
| 85.30043 | BAE403B |
| 85.30044 | BAE700AK |
| 85.30045 | BAE403C |
| 85.30062 | BAE907AE |
| 85.30089 | BAEA017 |
| 85.30106 | BAE851AE |
| 85.30109 | BAE965A |
| 85.30110 | BAEA063E |
| 85.30111 | BAE946A |
| 85.30144 | BAE947A |
| 85.30153 | BAEA428 |
| 85.30163 | BAEA031E |
| 85.30164 | BAE409A |
| 85.30165 | BAE408AE |
| 85.30177 | BAEA031E |
| 85.30185 | BAE960AE |
| 85.30189 | BAE961AE |
| 85.30190 | BAE940A |
| 85.30194 | BAEA041E |
| 85.30195 | BAEA065E |
| 85.30196 | BAEA061E |
| 85.30197 | BAEA062E |
| 85.30205 | BAEA046E |
| 85.30222 | BAEA306 |
| 85.30237 | BAEA298 |
| 85.30238 | BAEA299 |
| 85.30250 | BAEA095 |
| 85.30251 | BAEA143 |
| 85.30257 | BAEA043 |
| 85.30268 | BAEA427 |
| 85.30275 | BAEA501 |
| 85.30279 | BAEA013E |
| 85.30307 | BAEA382 |
| 85.30323 | BAEA073E |
| 85.30335 | BAEA394 |
| 85.30347 | BAEA395 |
| 85.30366 | BAEA126E |
| 85.-30366 | BAEA067E |
| 85.30368 | BAEA068E |
| 85.30373 | BAEA140E |
| 85.30393 | BAEA432 |
| 85.30425 | BAEA547 |
| 85.30428 | BAEA084E |
| 85.30441 | BAEA367 |

| SIDAT | CHAMPION |
|-------------------|-----------------|
| 85.30444 | BAEA410 |
| 85.30445 | BAEA180E |
| 85.30453 | BAEA042E |
| 85.30454 | BAEA012E |
| 85.30457 | BAEA368 |
| 85.30460 | BAEA132E |
| 85.30503 | BAEA052E |
| SIDRA | CHAMPION |
| 60705604 | BAE506D |
| BBN0250 | BAE504L |
| BBN0283 | BAE800B |
| SIEMENS | CHAMPION |
| 5 WK9 0611 | BAEA344 |
| STANDARD | CHAMPION |
| 11490 | BAEA546 |
| 12100 | BAEA382 |
| 12101 | BAEA126E |
| 12102 | BAEA068E |
| 12102 | BAEA137E |
| 12103 | BAEA269 |
| 12105 | BAEA017 |
| 12106 | BAEA043 |
| 12108 | BAEA189E |
| 12117 | BAEA052E |
| 12118 | BAEA158E |
| 12119 | BAEA556 |
| 12125 | BAEA395 |
| 12126 | BAEA185E |
| 12129 | BAEA131E |
| 12133 | BAEA555 |
| 12144 | BAEA178E |
| 12145 | BAEA193E |
| 12149 | BAEA547 |
| 12153 | BAEA548 |
| 12154 | BAEA198E |
| 12157 | BAEA189E |
| 12163 | BAEA489 |
| 12164 | BAEA476 |
| 12182 | BAEA557 |
| 12271 | BAEA367 |
| 12400 | BAEA475 |
| 12401 | BAEA168E |
| 12403 | BAEA190E |
| 12405 | BAEA073E |
| 12406 | BAEA474 |
| 12411 | BAEA132E |
| 12417 | BAEA062E |
| 12423 | BAEA521 |
| 12424 | BAEA191E |
| 12428 Interomotor | BAEA372 |
| 12432 | BAEA194E |

| STANDARD | CHAMPION |
|-------------------|-----------------|
| 12433 | BAEA432 |
| 12441 | BAEA182E |
| 12442 | BAEA196E |
| 12446 | BAEA172E |
| 12446 | BAEA192E |
| 12454 | BAEA186E |
| 12457 | BAEA531 |
| 12459 | BAEA410 |
| 12469 | BAEA453 |
| 12473 | BAEA446 |
| 12481 | BAEA079E |
| 12498 | BAEA199E |
| 12601 | BAE506D |
| 12602 Interomotor | BAE506F |
| 12605 | BAE506F |
| 12605 Interomotor | BAE506F |
| 12619 | BAE800B |
| 12619 Interomotor | BAE800B |
| 12620 | BAE504D |
| 12621 Interomotor | BAEA002E |
| 12640 | BAEA298 |
| 12652 | BAEA445 |
| 12662 | BAE504L |
| 12662 Interomotor | BAE504L |
| 12667 | BAEA560 |
| 12678 Interomotor | BAEA344 |
| 12700 | BAE920AX |
| 12700 Interomotor | BAE920AX |
| 12707 | BAEA469 |
| 12711 | BAE409A |
| 12713 | BAEA306 |
| 12715 Interomotor | BAEA365 |
| 12720 Interomotor | BAE946A |
| 12722 Interomotor | BAEA358 |
| 12723 Interomotor | BAE965A |
| 12725 | BAEA454 |
| 12726 Interomotor | BAEA029E |
| 12727 Interomotor | BAE408AE |
| 12728 Interomotor | BAEA043E |
| 12729 | BAEA549 |
| 12736 Interomotor | BAEA340 |
| 12737 | BAE403B |
| 12737 Interomotor | BAE403B |
| 12739 | BAEA501 |
| 12749 Interomotor | BAEA045E |
| 12754 | BAEA037 |
| 12759 | BAEA150E |
| 12766 Interomotor | BAEA347 |
| 12767 | BAEA046E |
| 12769 | BAEA428 |
| 12772 Interomotor | BAEA387 |
| 12778 Interomotor | BAEA059E |
| 12779 | BAEA554 |

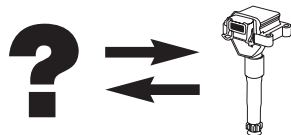

| STANDARD | CHAMPION | STANDARD | CHAMPION | STANDARD | CHAMPION | STANDARD | CHAMPION |
|------------------|----------|----------|----------|----------|----------|----------|----------|
| 12790 | BAEA041E | CP071 | BAEA555 | CU 1409 | BAEA132E | CU1372 | BAEA453 |
| 12791 | BAEA065E | CP079 | BAEA178E | CU 1489 | BAEA137E | CU1380 | BAEA189E |
| 12793 | BAEA539 | CP080 | BAEA193E | CU 1490 | BAEA126E | CU1403 | BAEA172E |
| 12798 | BAEA081E | CP083 | BAEA547 | CU 1509 | BAEA395 | CU1403 | BAEA192E |
| 12802 Intermotor | BAEA427 | CP087 | BAEA548 | CU1001 | BAEA306 | CU1422 | BAEA184E |
| 12807 | BAEA448 | CP088 | BAEA198E | CU1014 | BAEA367 | CU1424 | BAEA195E |
| 12809 | BAEA188E | CP090 | BAEA189E | CU1025 | BAEA017 | CU1425 | BAEA394 |
| 12810 | BAEA136E | CP094 | BAEA489 | CU1029 | BAEA037 | CU1430 | BAEA474 |
| 12818 Intermotor | BAEA055E | CP114 | BAEA190E | CU1031 | BAEA043 | CU1432 | BAEA168E |
| 12824 | BAEA184E | CP127 | BAEA062E | CU1052 | BAEA560 | CU1433 | BAEA084E |
| 12826 | BAEA195E | CP133 | BAEA521 | CU1061 | BAEA269 | CU1438 | BAEA521 |
| 12830 | BAEA031E | CP134 | BAEA191E | CU1069 | BAEA077 | CU1443 | BAEA190E |
| 12832 Intermotor | BAEA056E | CP142 | BAEA194E | CU1080 | BAEA543 | CU1449 | BAEA298 |
| 12840 | BAEA380 | CP143 | BAEA432 | CU1090 | BAEA549 | CU1455 | BAEA191E |
| 12842 | BAEA394 | CP151 | BAEA196E | CU1093 | BAEA486 | CU1463 | BAEA432 |
| 12843 | BAEA174E | CP153 | BAEA192E | CU1098 | BAEA150E | CU1489 | BAEA068E |
| 12846 | BAEA143 | CP160 | BAEA186E | CU1133 | BAEA428 | CU1495 | BAEA546 |
| 12850 | BAEA167E | CP163 | BAEA531 | CU1139 | BAEA454 | CU1500 | BAEA052E |
| 12851 | BAEA154E | CP165 | BAEA410 | CU1160 | BAEA031E | CU1503 | BAEA158E |
| 12853 | BAEA012E | CP171 | BAEA453 | CU1163 | BAEA540 | CU1504 | BAEA556 |
| 12856 | BAEA084E | CP175 | BAEA446 | CU1169 | BAEA013E | CU1510 | BAEA185E |
| 12857 | BAEA077 | CP217 | BAEA298 | CU1173 | BAEA012E | CU1511 | BAEA131E |
| 12858 | BAEA472 | CP226 | BAEA560 | CU1182 | BAEA179E | CU1518 | BAEA382 |
| 12864 | BAEA083E | CP245 | BAEA306 | CU1195 | BAEA434 | CU1521 | BAEA178E |
| 12865 | BAEA179E | CP250 | BAEA549 | CU1204 | BAEA046E | CU1522 | BAEA193E |
| 12867 | BAEA080E | CP260 | BAEA540 | CU1207 | BAEA154E | CU1526 | BAEA548 |
| 12877 | BAEA072E | CP269 | BAEA037 | CU1208 | BAEA065E | CU1530 | BAEA489 |
| 12884 | BAEA095 | CP273 | BAEA150E | CU1211 | BAEA041E | CU1536 | BAEA547 |
| 12887 | BAEA543 | CP279 | BAEA046E | CU1227 | BAEA198E | CU1539 | BAEA189E |
| 12888 | BAEA477 | CP281 | BAEA428 | CU1230 | BAEA448 | CU1558 | BAEA557 |
| 12889 | BAEA140E | CP283 | BAEA367 | CU1237 | BAEA539 | DMB813 | BAE946A |
| 12891 | BAEA434 | CP287 | BAEA554 | CU1241 | BAEA062E | IIS 022 | BAEA072E |
| 12893 | BAEA175E | CP292 | BAEA041E | CU1250 | BAEA561 | IIS 029 | BAEA073E |
| 12897 | BAEA169E | CP293 | BAEA065E | CU1253 | BAEA477 | IIS 058 | BAEA083E |
| 12898 | BAEA561 | CP295 | BAEA539 | CU1256 | BAEA143 | IIS 174 | BAEA081E |
| 12916 Intermotor | BAE851AE | CP308 | BAEA188E | CU1259 | BAEA554 | IIS 220 | BAEA136E |
| 12919 Intermotor | BAE907AE | CP321 | BAEA184E | CU1273 | BAEA172E | IIS 247 | BAEA084E |
| 12923 | BAEA013E | CP326 | BAEA031E | CU1274 | BAEA445 | IIS 252 | BAEA080E |
| CP012 | BAEA454 | CP336 | BAEA380 | CU1282 | BAEA482 | IIS 270 | BAEA095 |
| CP030 | BAEA448 | CP338 | BAEA394 | CU1288 | BAEA410 | IIS 289 | BAEA140E |
| CP033 | BAEA472 | CP339 | BAEA174E | CU1289 | BAEA472 | IIS 300 | BAEA132E |
| CP038 | BAEA199E | CP346 | BAEA154E | CU1291 | BAEA167E | IIS 349 | BAEA410 |
| CP039 | BAEA143 | CP348 | BAEA012E | CU1296 | BAEA380 | IIS 370 | BAEA079E |
| CP040 | BAEA185E | CP351 | BAEA084E | CU1306 | BAEA174E | IIS 389 | BAEA126E |
| CP042 | BAEA382 | CP352 | BAEA077 | CU1309 | BAEA199E | IIS 390 | BAEA137E |
| CP044 | BAEA068E | CP358 | BAEA179E | CU1313 | BAEA164E | IIS001 | BAEA043E |
| CP045 | BAEA269 | CP380 | BAEA543 | CU1315 | BAEA186E | IIS014 | BAEA428 |
| CP047 | BAEA017 | CP384 | BAEA434 | CU1329 | BAEA196E | IIS026 | BAEA170E |
| CP048 | BAEA043 | CP391 | BAEA561 | CU1334 | BAEA446 | IIS030 | BAEA165E |
| CP050 | BAEA189E | CP397 | BAEA013E | CU1339 | BAEA175E | IIS036 | BAEA501 |
| CP057 | BAEA052E | CP411 | BAEA557 | CU1348 | BAEA194E | IIS052 | BAEA031E |
| CP059 | BAEA556 | CU 1374 | BAEA095 | CU1354 | BAEA555 | IIS057 | BAEA190E |
| CP068 | BAEA131E | CU 1385 | BAEA140E | CU1355 | BAEA531 | IIS059 | BAEA549 |

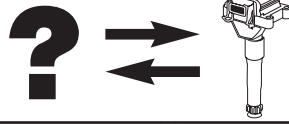





| STANDARD | CHAMPION |
|----------|----------|
| IIS064 | BAEA150E |
| IIS066 | BAEA046E |
| IIS068 | BAEA367 |
| IIS079 | BAEA469 |
| IIS-080 | BAEA365 |
| IIS081 | BAEA445 |
| IIS125 | BAEA041E |
| IIS134 | BAEA540 |
| IIS139 | BAEA546 |
| IIS141 | BAEA037 |
| IIS151 | BAEA448 |
| IIS166 | BAEA306 |
| IIS184 | BAEA013E |
| IIS194 | BAEA560 |
| IIS201 | BAEA188E |
| IIS212 | BAEA472 |
| IIS214 | BAEA539 |
| IIS216 | BAEA298 |
| IIS218 | BAEA143 |
| IIS225 | BAEA195E |
| IIS232 | BAEA065E |
| IIS235 | BAEA174E |
| IIS240 | BAEA380 |
| IIS242 | BAEA394 |
| IIS247 | BAEA084E |
| IIS250 | BAEA179E |
| IIS251 | BAEA077 |
| IIS261 | BAEA154E |
| IIS266 | BAEA454 |
| IIS272 | BAEA543 |
| IIS273 | BAEA477 |
| IIS275 | BAEA434 |
| IIS278 | BAEA175E |
| IIS283 | BAEA561 |
| IIS292 | BAEA475 |
| IIS306 | BAEA531 |
| IIS310 | BAEA521 |
| IIS311 | BAEA191E |
| IIS321 | BAEA194E |
| IIS323 | BAEA432 |
| IIS332 | BAEA196E |
| IIS336 | BAEA192E |
| IIS344 | BAEA186E |
| IIS349 | BAEA410 |
| IIS359 | BAEA453 |
| IIS363 | BAEA446 |
| IIS387 | BAEA199E |
| IIS388 | BAEA382 |
| IIS390 | BAEA068E |
| IIS391 | BAEA269 |
| IIS393 | BAEA017 |
| IIS394 | BAEA043 |
| IIS396 | BAEA189E |

| STANDARD | CHAMPION |
|------------|----------|
| IIS403 | BAEA062E |
| IIS416 | BAEA012E |
| IIS426 | BAEA052E |
| IIS427 | BAEA158E |
| IIS428 | BAEA556 |
| IIS435 | BAEA185E |
| IIS441 | BAEA555 |
| IIS443 | BAEA093E |
| IIS486 | BAEA184E |
| IIS493 | BAEA178E |
| IIS494 | BAEA193E |
| IIS504 | BAEA131E |
| IIS508 | BAEA547 |
| IIS511 | BAEA548 |
| IIS512 | BAEA198E |
| IIS515 | BAEA189E |
| IIS518 | BAEA489 |
| IIS533 | BAEA557 |
| IIS183 | BAEA554 |
| SWAG | CHAMPION |
| 10 92 8548 | BAEA146E |
| 20 92 1109 | BAEA014 |
| 20 93 6080 | BAEA144E |
| 20 93 6100 | BAEA143 |
| 20 93 6113 | BAEA145E |
| 26 92 2581 | BAEA231 |
| 30 91 7194 | BAE851AE |
| 30 91 9032 | BAE907AE |
| 30 92 2038 | BAE408AE |
| 30 92 4500 | BAEA059E |
| 30 92 9859 | BAEA051E |
| 32 92 3260 | BAEA032E |
| 40 92 3187 | BAE965A |
| 40 92 3187 | BAEA342 |
| 40 92 7168 | BAEA358 |
| 40 92 7522 | BAEA359 |
| 40 92 8108 | BAEA427 |
| 40 93 3666 | BAEA147E |
| 50926869 | BAEA350 |
| 60 92 1524 | BAEA354 |
| 60 92 1525 | BAEA345 |
| 60 92 1526 | BAEA243 |
| 60 92 1527 | BAEA242 |
| 60 92 1666 | BAE409A |
| 60 92 4435 | BAEA347 |
| 62 92 4997 | BAE946A |
| 70 91 9929 | BAE800B |
| 70 92 2697 | BAE920AX |
| 90 93 0261 | BAEA502E |
| TESLA | CHAMPION |
| CL 032 | BAEA137E |

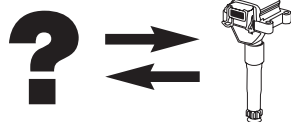



| TESLA | CHAMPION |
|------------|----------|
| CL 548 | BAEA434 |
| CL001 | BAE851AE |
| CL002 | BAE907AE |
| CL003 | BAE408AE |
| CL007 | BAE961AE |
| CL008 | BAE960AE |
| CL024 | BAEA065E |
| CL031 | BAEA126E |
| CL221 | BAEA427 |
| CL323 | BAEA095 |
| CL403 | BAEA387 |
| CL515 | BAEA502E |
| CL532 | BAEA521 |
| CL533 | BAEA136E |
| CL621 | BAEA140E |
| CL707 | BAEA429 |
| CL711 | BAEA501 |
| TOPRAN | CHAMPION |
| 109039 | BAE408AE |
| 109541 | BAEA043E |
| 206 642 | BAEA147E |
| 206638 | BAEA344 |
| 206640 | BAE965A |
| 206641 | BAEA358 |
| 207466 | BAEA427 |
| 302 104 | BAEA422 |
| 302104 | BAEA350 |
| 501401 | BAEA382 |
| 721405 | BAE946A |
| 721409 | BAEA347 |
| TRISCAN | CHAMPION |
| 8860 15014 | BAEA309 |
| 8860 15016 | BAEA428 |
| 8860 24011 | BAEA358 |
| 8860 24012 | BAE965A |
| 8860 28002 | BAE946A |
| 8860 28004 | BAEA045E |
| 8860 29020 | BAEA043E |
| 8860 29023 | BAEA032E |
| 8860 29024 | BAE408AE |
| 8860 43007 | BAEA502E |
| 886011012 | BAEA145E |
| 886011013 | BAEA143 |
| 886011014 | BAEA144E |
| 886013017 | BAEA449 |
| 8860-17009 | BAEA501 |
| 886023010 | BAEA146E |
| 886024009 | BAEA147E |
| 886024016 | BAEA149E |
| VALEO | CHAMPION |
| 138419 | BAE851AE |

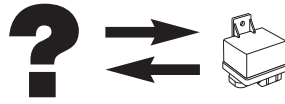

| VALEO | CHAMPION |
|-------------|----------|
| 2 526 037 A | BAEA232 |
| 2 526 040 | BAEA232 |
| 2 526 040 A | BAEA232 |
| 21597716-4 | BAEA352 |
| 21603121-9 | BAE409A |
| 245 040 | BAEA232 |
| 245000 | BAEA110 |
| 245027 | BAEA247 |
| 245041 | BAEA231 |
| 245042 | BAEA253 |
| 245043 | BAEA252 |
| 245046 | BAEA256 |
| 245049 | BAE506D |
| 245052 | BAE506F |
| 245054 | BAEA251 |
| 245057 | BAEA344 |
| 245058 | BAEA115 |
| 245062 | BAEA252 |
| 245066 | BAEA254 |
| 245067 | BAEA255 |
| 245068 | BAE504L |
| 245076 | BAEA245 |
| 245077 | BAEA246 |
| 245079 | BAEA345 |
| 245080 | BAEA296 |
| 245092 | BAE851AE |
| 245093 | BAEA002E |
| 245094 | BAEA347 |
| 245095 | BAEA045E |
| 245096 | BAEA046E |
| 245097 | BAE946A |
| 245098 | BAEA348 |
| 245100 | BAEA351 |
| 245101 | BAEA352 |
| 245103 | BAEA048E |
| 245104 | BAE409A |
| 245105 | BAEA354 |
| 245106 | BAEA242 |
| 245107 | BAEA243 |
| 245108 | BAEA342 |
| 245111 | BAE800B |
| 245116 | BAE403B |
| 245139 | BAEA350 |
| 245141 | BAE408AE |
| 245178 | BAEA164E |
| 245179 | BAEA026E |
| 2526015 | BAE506F |
| 2526023 | BAEA251 |
| 2526030 | BAE506D |
| 2526034 | BAE504L |
| 2526035 A | BAEA231 |
| 2526039 | BAEA231 |
| 2526048 | BAEA251 |



| VALEO |  | VEMO |  |
|---------------|---|---------------|---|
| 2526049 | BAEA253 | V10-70-0063 | BAEA044E |
| 2526050 | BAEA252 | V10-70-0064 | BAEA063E |
| 2526051 | BAEA254 | V10-70-0066 | BAEA065E |
| 2526052 | BAEA255 | V10-70-0067 | BAEA062E |
| 2526059 | BAEA256 | V10-70-0068 | BAEA061E |
| 2526062 | BAEA252 | V10-70-0069 | BAEA004E |
| 2526110 | BAEA245 | V10-70-0098 | BAEA067E |
| 2526111 | BAEA246 | V10-70-0098 | BAEA126E |
| 2526116A | BAEA342 | V10-70-0099 | BAEA137E |
| 520019 | BAEA110 | V20-70-0013 | BAEA143 |
| 520041 | BAEA115 | V20-70-0013 | BAEA144E |
| 520064 A | BAEA251 | V20-70-0013 | BAEA324 |
| B 6051 | BAEA254 | V20-70-0014 | BAEA324 |
| B 6052 | BAEA255 | V20-70-0017 | BAEA143 |
| B 6114 | BAEA242 | V24-70-0003 | BAE800B |
| CD 308 | BAEA247 | V24-70-0004 | BAE403B |
| CD 325 | BAEA251 | V24-70-0008 | BAEA428 |
| CD 331 | BAEA232 | V25-70-0001 | BAEA350 |
| CD 338 | BAEA253 | V25-70-0001 | BAEA422 |
| CD 339 | BAEA252 | V25-70-0001-1 | BAEA350 |
| CD 440 | BAEA344 | V25-70-0001-1 | BAEA422 |
| CD 443 | BAEA252 | V25-70-0003 | BAEA281 |
| VEMO |  | V25-70-0009 | BAEA387 |
| 10-70-0012 | BAE408AE | V26-70-0021 | BAEA175E |
| 10-70-0013 | BAEA043E | V30-70-0012 | BAEA340 |
| 10-70-0014 | BAEA002E | V30-70-0015 | BAEA146E |
| 10-70-0044 | BAE907AE | V40-70-0010 | BAEA026E |
| 10-70-0045 | BAEA016 | V40-70-0015 | BAEA342 |
| 10-70-0046 | BAEA029E | V40-70-0015-1 | BAEA342 |
| 10-70-0047 | BAE961AE | V40-70-0017 | BAEA427 |
| 10-70-0058 | BAEA031E | V40-70-0044 | BAEA358 |
| 20-70-0011 | BAEA014 | V40-70-0045 | BAEA147E |
| 20-70-0012 | BAEA302 | V40-70-0048 | BAEA359 |
| 20-70-0013 | BAEA324 | V40-70-0067 | BAEA150E |
| 20-70-0014 | BAEA324 | V40-70-0069 | BAEA152E |
| 25-70-0001 | BAEA350 | V40-70-0071 | BAEA149E |
| 25-70-0003 | BAEA281 | V40-70-0072 | BAEA153E |
| 30-70-0012 | BAEA340 | V40-70-0074 | BAEA174E |
| 40-70-0011 | BAEA253 | V42-70-0001 | BAE946A |
| 40-70-0015 | BAEA342 | V42-70-0012 | BAEA472 |
| 40-70-0016 | BAE965A | V46-70-0001 | BAE409A |
| V 37-70-0032 | BAEA395 | V46-70-0002 | BAEA354 |
| V10-70-0010 | BAE851AE | V49-70-0003 | BAEA501 |
| V10-70-0012 | BAE408AE | V52-70-0014 | BAEA536 |
| V10-70-0013 | BAEA043E | V64-70-0009 | BAEA136E |
| V10-70-0013-1 | BAEA043E | V70-70-0015 | BAEA449 |
| V10-70-0044 | BAE907AE | V95-70-0007 | BAEA429 |
| V10-70-0046 | BAEA029E | | |
| V10-70-0054 | BAEA032E | | |
| V10-70-0059 | BAEA059E | | |
| V10-70-0060 | BAEA033E | | |
| V10-70-0062 | BAEA051E | | |



| BERU |  |
|----------------------|---|
| 0 522 140 202 | CCU114 |
| 0 522 140 205 | CCU114 |
| 0 522 140 207 | CCU116 |
| 0 522 140 209 | CCU116 |
| 0 522 140 210 | CCU114 |
| GR081 | CCU081 |
| GSE101 | CCU101 |
| GSE102 | CCU102 |
| GSE104 | CCU104 |
| GSE105 | CCU105 |
| GSE106 | CCU106 |
| GSE108 | CCU108 |
| GSE110 | CCU110 |
| GSE113 | CCU113 |
| GSE114 | CCU114 |
| GSE116 | CCU116 |
| GSE118 | CCU118 |
| GSE128 | CCU128 |
| GSE129 | CCU129 |
| GSE138 | CCU138 |
| GSE140 | CCU140 |
| GSE141 | CCU141 |
| GSE142 | CCU142 |
| GSE143 | CCU143 |
| GSE144 | CCU144 |
| GSE145 | CCU145 |
| GSE147 | CCU147 |
| GSE148 | CCU148 |
| GSE149 | CCU149 |
| GSE150 | CCU150 |
| GSE151 | CCU151 |
| GSE152 | CCU152 |
| GSE153 | CCU153 |
| GSE154 | CCU154 |
| GSE156 | CCU156 |
| BORGWARNER |  |
| B2110017780A0 | CCU138 |
| E2110022364A0 | CCU118 |
| E2110022365A0 | CCU110 |
| E2110022366A0 | CCU113 |
| E2110022368A0 | CCU108 |
| E2110022583A1 | CCU152 |
| E2110022584A1 | CCU153 |
| E2110033672A0 | CCU154 |
| E6018815652A1 | CCU104 |
| DELPHI |  |
| HDC139 | CCU149 |
| HDC142 | CCU148 |
| FEBI BILSTEIN |  |
| 18342 | CCU149 |
| 38310 | CCU156 |

| HELLA |  |
|---------------|---|
| 4RV008188-271 | CCU148 |
| HÜCO |  |
| 132074 | CCU129 |
| 132079 | CCU128 |
| 132080 | CCU148 |
| 132088 | CCU149 |
| SWAG |  |
| 10938310 | CCU156 |
| 62918342 | CCU149 |



| BERU | CHAMPION | BERU | CHAMPION | BERU | CHAMPION | BERU | CHAMPION |
|-------------|-----------------|-------------|-----------------|-------------|-----------------|-------------|-----------------|
| ZEF765 | CLS001 | ZEF1190 | CLS179 | ZEF1539 | CLS074 | ZEF463 | CLS203 |
| ZEF1012 | CLS002 | ZEF1193 | CLS236 | ZEF1540 | CLS075 | ZEF466 | CLS098 |
| ZEF1015 | CLS003 | ZEF1194 | CLS180 | ZEF1545 | CLS193 | ZEF470 | CLS204 |
| ZEF1023 | CLS004 | ZEF1196 | CLS181 | ZEF1546 | CLS076 | ZEF471 | CLS205 |
| ZEF1044 | CLS005 | ZEF1197 | CLS237 | ZEF1549 | CLS077 | ZEF472 | CLS206 |
| ZEF1058 | CLS006 | ZEF1198 | CLS042 | ZEF1556 | CLS078 | ZEF487 | CLS207 |
| ZEF1066 | CLS007 | ZEF1199 | CLS043 | ZEF1557 | CLS079 | ZEF501 | CLS208 |
| ZEF1072 | CLS008 | ZEF1200 | CLS182 | ZEF1561 | CLS080 | ZEF520 | CLS249 |
| ZEF1076 | CLS009 | ZEF1201 | CLS044 | ZEF1572 | CLS081 | ZEF558 | CLS250 |
| ZEF1082 | CLS010 | ZEF1203 | CLS045 | ZEF1596 | CLS243 | ZEF561 | CLS099 |
| ZEF1094 | CLS011 | ZEF1219 | CLS046 | ZEF1598 | CLS082 | ZEF562 | CLS100 |
| ZEF1099 | CLS012 | ZEF1222 | CLS238 | ZEF1602 | CLS083 | ZEF567 | CLS210 |
| ZEF1103 | CLS168 | ZEF1223 | CLS047 | ZEF1604 | CLS084 | ZEF570 | CLS101 |
| ZEF1104 | CLS169 | ZEF1224 | CLS048 | ZEF1608 | CLS085 | ZEF571 | CLS166 |
| ZEF1105 | CLS013 | ZEF1226 | CLS049 | ZEF1609 | CLS086 | ZEF573 | CLS211 |
| ZEF1108 | CLS170 | ZEF1228 | CLS183 | ZEF1612 | CLS194 | ZEF574 | CLS212 |
| ZEF1111 | CLS171 | ZEF1230 | CLS184 | ZEF1625 | CLS195 | ZEF578 | CLS213 |
| ZEF1113 | CLS014 | ZEF1231 | CLS050 | ZEF1627 | CLS088 | ZEF579 | CLS214 |
| ZEF1114 | CLS015 | ZEF1232 | CLS051 | ZEF1628 | CLS089 | ZEF580 | CLS102 |
| ZEF1115 | CLS016 | ZEF1233 | CLS185 | ZEF1629 | CLS090 | ZEF581 | CLS103 |
| ZEF1117 | CLS017 | ZEF1236 | CLS186 | ZEF1633 | CLS091 | ZEF586 | CLS215 |
| ZEF1118 | CLS018 | ZEF1251 | CLS052 | ZEF1634 | CLS092 | ZEF597 | CLS216 |
| ZEF1127 | CLS172 | ZEF1252 | CLS239 | ZEF1635 | CLS196 | ZEF598 | CLS217 |
| ZEF1128 | CLS019 | ZEF1253 | CLS187 | ZEF1636 | CLS167 | ZEF601 | CLS251 |
| ZEF1129 | CLS020 | ZEF1255 | CLS053 | ZEF1638 | CLS093 | ZEF607 | CLS104 |
| ZEF1130 | CLS021 | ZEF1260 | CLS240 | ZEF1639 | CLS094 | ZEF612 | CLS105 |
| ZEF1131 | CLS022 | ZEF1262 | CLS188 | ZEF1640 | CLS197 | ZEF627 | CLS218 |
| ZEF1135 | CLS023 | ZEF1272 | CLS189 | ZEF1641 | CLS256 | ZEF635 | CLS219 |
| ZEF1136 | CLS024 | ZEF1327 | CLS241 | ZEF1642 | CLS257 | ZEF641 | CLS252 |
| ZEF1140 | CLS173 | ZEF1338 | CLS054 | ZEF1643 | CLS198 | ZEF642 | CLS106 |
| ZEF1142 | CLS025 | ZEF1340 | CLS190 | ZEF1644 | CLS095 | ZEF665 | CLS220 |
| ZEF1147 | CLS026 | ZEF1348 | CLS055 | ZEF1646 | CLS096 | ZEF670 | CLS253 |
| ZEF1148 | CLS174 | ZEF1360 | CLS056 | ZEF1652 | CLS144 | ZEF672 | CLS107 |
| ZEF1149 | CLS027 | ZEF1367 | CLS057 | ZEF1655 | CLS147 | ZEF707 | CLS108 |
| ZEF1150 | CLS028 | ZEF1370 | CLS058 | ZEF1656 | CLS148 | ZEF716 | CLS109 |
| ZEF1152 | CLS175 | ZEF1377 | CLS059 | ZEF1657 | CLS149 | ZEF717 | CLS110 |
| ZEF1159 | CLS029 | ZEF1391 | CLS060 | ZEF1661 | CLS153 | ZEF719 | CLS111 |
| ZEF1160 | CLS030 | ZEF1397 | CLS061 | ZEF1663 | CLS155 | ZEF720 | CLS112 |
| ZEF1161 | CLS176 | ZEF1399 | CLS191 | ZEF1664 | CLS156 | ZEF724 | CLS113 |
| ZEF1166 | CLS031 | ZEF1409 | CLS062 | ZEF1665 | CLS157 | ZEF725 | CLS114 |
| ZEF1168 | CLS150 | ZEF1412 | CLS063 | ZEF1667 | CLS159 | ZEF727 | CLS115 |
| ZEF1173 | CLS032 | ZEF1442 | CLS064 | ZEF1669 | CLS161 | ZEF731 | CLS116 |
| ZEF1175 | CLS177 | ZEF1450 | CLS065 | ZEF1671 | CLS163 | ZEF734 | CLS221 |
| ZEF1178 | CLS033 | ZEF1475 | CLS066 | ZEF298 | CLS199 | ZEF735 | CLS117 |
| ZEF1180 | CLS034 | ZEF1477 | CLS067 | ZEF303 | CLS244 | ZEF739 | CLS222 |
| ZEF1181 | CLS035 | ZEF1479 | CLS068 | ZEF304 | CLS245 | ZEF755 | CLS223 |
| ZEF1182 | CLS036 | ZEF1480 | CLS069 | ZEF309 | CLS246 | ZEF757 | CLS224 |
| ZEF1183 | CLS037 | ZEF1488 | CLS242 | ZEF363 | CLS247 | ZEF765 | CLS255 |
| ZEF1184 | CLS038 | ZEF1496 | CLS070 | ZEF364 | CLS200 | ZEF769 | CLS225 |
| ZEF1185 | CLS039 | ZEF1497 | CLS192 | ZEF406 | CLS201 | ZEF771 | CLS118 |
| ZEF1186 | CLS040 | ZEF1515 | CLS071 | ZEF408 | CLS248 | ZEF776 | CLS258 |
| ZEF1187 | CLS178 | ZEF1519 | CLS072 | ZEF432 | CLS097 | ZEF777 | CLS119 |
| ZEF1189 | CLS041 | ZEF1530 | CLS073 | ZEF437 | CLS202 | ZEF781 | CLS120 |



| BERU | |
|-------------|--------|
| ZEF783 | CLS121 |
| ZEF784 | CLS122 |
| ZEF787 | CLS261 |
| ZEF789 | CLS226 |
| ZEF793 | CLS123 |
| ZEF795 | CLS124 |
| ZEF796 | CLS125 |
| ZEF797 | CLS126 |
| ZEF802 | CLS227 |
| ZEF811 | CLS127 |
| ZEF813 | CLS262 |
| ZEF830 | CLS228 |
| ZEF839 | CLS128 |
| ZEF840 | CLS129 |
| ZEF850 | CLS130 |
| ZEF856 | CLS131 |
| ZEF859 | CLS229 |
| ZEF891 | CLS132 |
| ZEF895 | CLS133 |
| ZEF913 | CLS134 |
| ZEF915 | CLS230 |
| ZEF917 | CLS259 |
| ZEF934 | CLS231 |
| ZEF947 | CLS232 |
| ZEF949 | CLS233 |
| ZEF952 | CLS234 |
| ZEF967 | CLS135 |
| ZEF968 | CLS136 |
| ZEF983 | CLS137 |
| ZEF985 | CLS235 |
| ZEF987 | CLS254 |
| ZEF988 | CLS138 |
| ZEF989 | CLS139 |
| ZEF990 | CLS260 |
| ZEF991 | CLS140 |
| ZEF995 | CLS141 |

| BOSCH | |
|---------------|--------|
| 0 356 901 821 | CLS104 |
| 0 356 912 820 | CLS235 |
| 0 356 912 821 | CLS235 |
| 0 356 912 825 | CLS235 |
| 0 356 912 828 | CLS227 |
| 0 356 912 844 | CLS235 |
| 0 356 912 860 | CLS055 |
| 0 356 912 862 | CLS055 |
| 0 356 912 874 | CLS098 |
| 0 356 912 881 | CLS136 |
| 0 356 912 946 | CLS235 |
| 0 356 912 947 | CLS235 |
| 0 356 912 981 | CLS055 |
| 0 986 356 308 | CLS260 |
| 0 986 356 317 | CLS110 |

| BOSCH | |
|---------------|--------|
| 0 986 356 371 | CLS095 |
| 0 986 356 700 | CLS121 |
| 0 986 356 705 | CLS133 |
| 0 986 356 706 | CLS127 |
| 0 986 356 710 | CLS225 |
| 0 986 356 715 | CLS116 |
| 0 986 356 717 | CLS003 |
| 0 986 356 718 | CLS004 |
| 0 986 356 719 | CLS255 |
| 0 986 356 720 | CLS182 |
| 0 986 356 727 | CLS005 |
| 0 986 356 728 | CLS228 |
| 0 986 356 731 | CLS061 |
| 0 986 356 735 | CLS131 |
| 0 986 356 742 | CLS056 |
| 0 986 356 747 | CLS018 |
| 0 986 356 748 | CLS061 |
| 0 986 356 754 | CLS261 |
| 0 986 356 756 | CLS230 |
| 0 986 356 761 | CLS118 |
| 0 986 356 767 | CLS123 |
| 0 986 356 773 | CLS179 |
| 0 986 356 778 | CLS030 |
| 0 986 356 785 | CLS118 |
| 0 986 356 787 | CLS137 |
| 0 986 356 795 | CLS223 |
| 0 986 356 798 | CLS126 |
| 0 986 356 801 | CLS102 |
| 0 986 356 802 | CLS022 |
| 0 986 356 805 | CLS111 |
| 0 986 356 808 | CLS107 |
| 0 986 356 817 | CLS051 |
| 0 986 356 818 | CLS136 |
| 0 986 356 821 | CLS132 |
| 0 986 356 827 | CLS222 |
| 0 986 356 837 | CLS229 |
| 0 986 356 849 | CLS127 |
| 0 986 356 853 | CLS119 |
| 0 986 356 854 | CLS123 |
| 0 986 356 855 | CLS134 |
| 0 986 356 859 | CLS131 |
| 0 986 356 862 | CLS101 |
| 0 986 356 863 | CLS226 |
| 0 986 356 866 | CLS179 |
| 0 986 356 886 | CLS211 |
| 0 986 356 887 | CLS122 |
| 0 986 356 888 | CLS117 |
| 0 986 356 898 | CLS072 |
| 0 986 356 923 | CLS171 |
| 0 986 356 940 | CLS125 |
| 0 986 356 961 | CLS014 |
| 0 986 356 967 | CLS039 |
| 0 986 356 989 | CLS024 |

| BOSCH | |
|---------------|--------|
| 0 986 357 055 | CLS175 |
| 0 986 357 077 | CLS227 |
| 0 986 357 090 | CLS049 |
| 0 986 357 181 | CLS044 |
| 0 986 357 184 | CLS011 |
| 0 986 357 210 | CLS052 |
| 0 986 357 259 | CLS096 |
| 0 986 357 271 | CLS074 |
| B 271 | CLS074 |
| B 855 | CLS134 |

| BOUGICORD | |
|------------------|--------|
| 1420 | CLS116 |
| 1431 | CLS039 |
| 2451 | CLS221 |
| 2456 | CLS117 |
| 2457 | CLS019 |
| 3104 | CLS222 |
| 3395 | CLS223 |
| 3413 | CLS224 |
| 4003 | CLS255 |
| 4008 | CLS225 |
| 4020 | CLS118 |
| 4061 | CLS258 |
| 4081 | CLS119 |
| 4086 | CLS179 |
| 4102 | CLS027 |
| 4103 | CLS105 |
| 4110 | CLS098 |
| 4111 | CLS250 |
| 4113 | CLS027 |
| 4114 | CLS208 |
| 4115 | CLS204 |
| 4122 | CLS211 |
| 4123 | CLS101 |
| 4125 | CLS105 |
| 4147 | CLS120 |
| 4149 | CLS121 |
| 4150 | CLS122 |
| 4154 | CLS210 |
| 4155 | CLS174 |
| 4158 | CLS261 |
| 4162 | CLS136 |
| 4166 | CLS248 |
| 4204 | CLS035 |
| 4205 | CLS178 |
| 4206 | CLS044 |
| 4207 | CLS260 |
| 4304 | CLS226 |
| 4331 | CLS123 |
| 4334 | CLS124 |
| 4404 | CLS125 |
| 4405 | CLS126 |

| BOUGICORD | |
|------------------|--------|
| 6104 | CLS129 |
| 6202 | CLS227 |
| 6462 | CLS051 |
| 6469 | CLS050 |
| 6475 | CLS195 |
| 6812 | CLS133 |
| 7153 | CLS199 |
| 7155 | CLS098 |
| 7160 | CLS204 |
| 7162 | CLS201 |
| 7164 | CLS203 |
| 7168 | CLS250 |
| 7192 | CLS259 |
| 7214 | CLS061 |
| 7214 | CLS095 |
| 7219 | CLS127 |
| 7240 | CLS180 |
| 7241 | CLS102 |
| 7242 | CLS097 |
| 7243 | CLS097 |
| 7244 | CLS097 |
| 7245 | CLS027 |
| 7283 | CLS002 |
| 7284 | CLS135 |
| 7416 | CLS055 |
| 7418 | CLS111 |
| 7419 | CLS015 |
| 7420 | CLS052 |
| 7421 | CLS017 |
| 7423 | CLS140 |

| BRECAV | |
|---------------|--------|
| 06.5100 | CLS067 |
| 06.580 | CLS137 |
| 06.598 | CLS044 |
| 15.543 | CLS077 |
| CBR25100 | CLS067 |
| CBR2571 | CLS137 |
| CBR2598 | CLS044 |
| CBR2643 | CLS077 |

| BREMI | |
|--------------|--------|
| 203/200 | CLS054 |
| 205/200 | CLS181 |
| 205F200 | CLS184 |
| 206F200 | CLS017 |
| 206M200 | CLS048 |
| 206N200 | CLS070 |
| 206P200 | CLS048 |
| 210 | CLS107 |
| 212F200 | CLS240 |
| 220G200 | CLS260 |
| 220H200 | CLS260 |





| BREMI | CHAMPION |
|---------|----------|
| 221/200 | CLS048 |
| 221E200 | CLS048 |
| 221F200 | CLS048 |
| 221H200 | CLS048 |
| 222D200 | CLS177 |
| 222G200 | CLS140 |
| 223E200 | CLS139 |
| 223H200 | CLS139 |
| 225 | CLS216 |
| 225 | CLS254 |
| 226 | CLS252 |
| 226 | CLS254 |
| 227 | CLS106 |
| 229K200 | CLS237 |
| 231J100 | CLS041 |
| 233/200 | CLS046 |
| 236 | CLS180 |
| 251 | CLS001 |
| 255 | CLS172 |
| 257 | CLS204 |
| 258 | CLS098 |
| 259 | CLS207 |
| 260 | CLS208 |
| 260M200 | CLS017 |
| 261 | CLS205 |
| 262 | CLS206 |
| 263 | CLS250 |
| 264 | CLS217 |
| 266 | CLS219 |
| 267 | CLS027 |
| 270 | CLS027 |
| 271 | CLS027 |
| 280 | CLS216 |
| 281/100 | CLS036 |
| 287/200 | CLS037 |
| 295 | CLS028 |
| 296 | CLS027 |
| 296 B | CLS079 |
| 299 | CLS249 |
| 300/176 | CLS119 |
| 300/201 | CLS107 |
| 300/373 | CLS166 |
| 300/374 | CLS101 |
| 300/375 | CLS166 |
| 300/378 | CLS214 |
| 300/379 | CLS101 |
| 300/380 | CLS211 |
| 300/381 | CLS212 |
| 300/381 | CLS213 |
| 300/382 | CLS218 |
| 300/390 | CLS018 |
| 300/391 | CLS102 |
| 300/393 | CLS220 |

| BREMI | CHAMPION |
|----------|----------|
| 300/398 | CLS018 |
| 300/399 | CLS213 |
| 300/529 | CLS213 |
| 300/629 | CLS226 |
| 300/652 | CLS018 |
| 300/667 | CLS220 |
| 300/673 | CLS030 |
| 300/675 | CLS107 |
| 300/678 | CLS114 |
| 300/681 | CLS115 |
| 300/690 | CLS029 |
| 300/692 | CLS113 |
| 300/694 | CLS018 |
| 300/694 | CLS141 |
| 300/698 | CLS173 |
| 300/700 | CLS023 |
| 300/701 | CLS130 |
| 300/705 | CLS169 |
| 300/711 | CLS031 |
| 300/715 | CLS056 |
| 300/731 | CLS061 |
| 300/758 | CLS025 |
| 300/759 | CLS020 |
| 300/759 | CLS196 |
| 300/766 | CLS114 |
| 300/771 | CLS062 |
| 300/788 | CLS212 |
| 300/869 | CLS213 |
| 300/912 | CLS134 |
| 300/913 | CLS258 |
| 300/919 | CLS103 |
| 300/920 | CLS018 |
| 3A00/125 | CLS013 |
| 3A00/162 | CLS080 |
| 3A00/166 | CLS241 |
| 3A00/172 | CLS192 |
| 3A00/184 | CLS092 |
| 3A00/185 | CLS193 |
| 3A00/186 | CLS073 |
| 3A35/48 | CLS230 |
| 403 | CLS253 |
| 404 | CLS203 |
| 447 | CLS105 |
| 449A200 | CLS199 |
| 473/100 | CLS210 |
| 481 | CLS099 |
| 500/111 | CLS231 |
| 500/118 | CLS096 |
| 500/130 | CLS257 |
| 517/100 | CLS186 |
| 522 | CLS250 |
| 534 | CLS206 |
| 539 | CLS100 |

| BREMI | CHAMPION |
|---------|----------|
| 560 | CLS208 |
| 561 | CLS207 |
| 569/100 | CLS104 |
| 600/104 | CLS117 |
| 600/118 | CLS262 |
| 600/123 | CLS050 |
| 600/124 | CLS236 |
| 600/138 | CLS123 |
| 600/143 | CLS005 |
| 600/186 | CLS060 |
| 600/196 | CLS051 |
| 600/200 | CLS052 |
| 600/205 | CLS040 |
| 600/213 | CLS182 |
| 600/215 | CLS137 |
| 600/217 | CLS261 |
| 600/220 | CLS226 |
| 600/227 | CLS132 |
| 600/228 | CLS129 |
| 600/234 | CLS129 |
| 600/239 | CLS229 |
| 600/250 | CLS133 |
| 600/262 | CLS003 |
| 600/268 | CLS002 |
| 600/281 | CLS179 |
| 600/282 | CLS188 |
| 600/283 | CLS188 |
| 600/298 | CLS058 |
| 600/330 | CLS012 |
| 600/365 | CLS059 |
| 600/409 | CLS121 |
| 600/412 | CLS011 |
| 600/427 | CLS035 |
| 600/428 | CLS044 |
| 600/447 | CLS190 |
| 600/454 | CLS005 |
| 600/478 | CLS069 |
| 600/479 | CLS167 |
| 600/481 | CLS072 |
| 600/486 | CLS189 |
| 600/494 | CLS024 |
| 600/496 | CLS091 |
| 600/497 | CLS094 |
| 600-251 | CLS150 |
| 600-433 | CLS150 |
| 626 | CLS245 |
| 626 T | CLS245 |
| 778 RA | CLS097 |
| 793 | CLS098 |
| 797 | CLS204 |
| 800/175 | CLS066 |
| 800/179 | CLS033 |
| 800/190 | CLS016 |

| BREMI | CHAMPION |
|----------|----------|
| 800/198 | CLS049 |
| 800/203 | CLS022 |
| 800/210 | CLS120 |
| 800/210 | CLS122 |
| 800/211 | CLS033 |
| 800/212 | CLS022 |
| 800/213 | CLS111 |
| 800/215 | CLS032 |
| 912 | CLS055 |
| 913 | CLS235 |
| 919 | CLS108 |
| 923/100 | CLS109 |
| 924 | CLS110 |
| 925 | CLS110 |
| 931 | CLS042 |
| 933 | CLS064 |
| 939C200 | CLS053 |
| 954 | CLS174 |
| 958 | CLS100 |
| 959 | CLS034 |
| 962 | CLS043 |
| 963 | CLS034 |
| 964 | CLS238 |
| 968G100 | CLS260 |
| 974/200 | CLS054 |
| 977 | CLS178 |
| 979 | CLS136 |
| 983 | CLS138 |
| 990 | CLS042 |
| 992 | CLS174 |
| 998 | CLS047 |
| 9A04 | CLS242 |
| 9A09 | CLS172 |
| 9A15/200 | CLS081 |
| 9A16 | CLS063 |
| 9A30B200 | CLS090 |
| CHAMPION | CHAMPION |
| LS 01 | CLS255 |
| LS 103 | CLS018 |
| LS 11 | CLS101 |
| LS 123 | CLS116 |
| LS 130 | CLS230 |
| LS 135 | CLS112 |
| LS 14 | CLS127 |
| LS 16 | CLS213 |
| LS 173 | CLS137 |
| LS 175 | CLS136 |
| LS 20 | CLS119 |
| LS 200 | CLS210 |
| LS 201 | CLS099 |
| LS 204 | CLS100 |
| LS 205 | CLS099 |





| CHAMPION | | |
|-------------------|--------|--|
| LS 21 | CLS125 | |
| LS 219 | CLS098 | |
| LS 220 | CLS041 | |
| LS 221 | CLS099 | |
| LS 26 | CLS120 | |
| LS 27 | CLS122 | |
| LS 28 | CLS121 | |
| LS 31 | CLS128 | |
| LS 35 | CLS166 | |
| LS 36 | CLS018 | |
| LS 40 | CLS221 | |
| LS 47 | CLS126 | |
| LS 53 | CLS226 | |
| LS 71 | CLS117 | |
| LS 73 | CLS111 | |
| LS 77 | CLS125 | |
| LS 80 | CLS225 | |
| LS 81 | CLS004 | |
| LS 83 | CLS118 | |
| LS 94 | CLS030 | |
| LS 98 | CLS123 | |
| DELCO REMY | | |
| DRL 376 | CLS175 | |
| DRL 907 | CLS198 | |
| DRL690 | CLS008 | |
| DOWAL | | |
| 23 344 | CLS245 | |
| 23 379 | CLS099 | |
| 23 411 | CLS246 | |
| 23 655 | CLS248 | |
| FACET | | |
| 4.7006 | CLS085 | |
| 4.7013 | CLS167 | |
| 4.7059 | CLS195 | |
| 4.7230 | CLS084 | |
| 4.7235 | CLS093 | |
| 4.7246 | CLS084 | |
| 4.9385 | CLS094 | |
| 4.9614 | CLS074 | |
| 4.9680 | CLS086 | |
| 4.9720 | CLS081 | |
| 4.9729 | CLS257 | |
| 4.9809 | CLS080 | |
| 4.9880 | CLS096 | |
| 4.9888 | CLS095 | |
| FAE | | |
| 83563 | CLS086 | |
| 83588 | CLS096 | |
| 85481 | CLS195 | |
| 85765 | CLS095 | |

| FAE | | |
|-----------------------------|--------|--|
| 85806 | CLS167 | |
| HERTH+BUSS ELPARTS | | |
| 51 278 753 | CLS074 | |
| HERTH+BUSS JAKOPARTS | | |
| J5381002 | CLS133 | |
| J5383000 | CLS131 | |
| J5383008 | CLS229 | |
| J5383021 | CLS229 | |
| J5383026 | CLS239 | |
| J5387004 | CLS170 | |
| J5387009 | CLS170 | |
| J5387011 | CLS080 | |
| J5387019 | CLS192 | |
| HUECO | | |
| 134132 | CLS096 | |
| 134287 | CLS095 | |
| 134528 | CLS094 | |
| NGK | | |
| 0501 | CLS177 | |
| 0502 | CLS099 | |
| 0502 | CLS180 | |
| 0504 | CLS001 | |
| 0507 | CLS172 | |
| 0510 | CLS099 | |
| 0511 | CLS105 | |
| 0511 | CLS249 | |
| 0515 | CLS047 | |
| 0518 | CLS046 | |
| 0518 | CLS099 | |
| 0519 | CLS042 | |
| 0548 | CLS036 | |
| 0551 | CLS037 | |
| 0565 | CLS104 | |
| 0579 | CLS054 | |
| 0583 | CLS222 | |
| 0604 | CLS127 | |
| 0632 | CLS122 | |
| 0639 | CLS033 | |
| 0640 | CLS022 | |
| 0641 | CLS111 | |
| 0643 | CLS136 | |
| 0645 | CLS135 | |
| 0691 | CLS023 | |
| 0709 | CLS130 | |
| 0710 | CLS130 | |
| 0714 | CLS131 | |
| 0715 | CLS131 | |
| 0715 | CLS258 | |
| 0736 | CLS252 | |
| 0737 | CLS252 | |

| NGK | | |
|------------|--------|--|
| 0737 | CLS254 | |
| 0738 | CLS106 | |
| 0741 | CLS204 | |
| 0742 | CLS098 | |
| 0743 | CLS207 | |
| 0744 | CLS208 | |
| 0746 | CLS250 | |
| 0747 | CLS217 | |
| 0748 | CLS219 | |
| 0749 | CLS216 | |
| 0750 | CLS253 | |
| 0751 | CLS203 | |
| 0757 | CLS063 | |
| 0757 | CLS138 | |
| 0766 | CLS107 | |
| 0772 | CLS166 | |
| 0773 | CLS101 | |
| 0778 | CLS211 | |
| 0788 | CLS220 | |
| 0789 | CLS018 | |
| 0793 | CLS018 | |
| 0808 | CLS030 | |
| 0810 | CLS107 | |
| 0814 | CLS115 | |
| 0823 | CLS113 | |
| 0825 | CLS213 | |
| 0890 | CLS061 | |
| 0901 | CLS028 | |
| 0932 | CLS199 | |
| 0932 | CLS240 | |
| 0934 | CLS139 | |
| 0937 | CLS027 | |
| 0938 | CLS099 | |
| 0939 | CLS027 | |
| 0939 | CLS099 | |
| 0941 | CLS027 | |
| 0941 | CLS249 | |
| 0944 | CLS199 | |
| 0945 | CLS210 | |
| 0946 | CLS099 | |
| 0947 | CLS099 | |
| 0947 | CLS100 | |
| 0948 | CLS245 | |
| 0949 | CLS097 | |
| 0951 | CLS042 | |
| 0956 | CLS034 | |
| 0958 | CLS043 | |
| 0961 | CLS238 | |
| 0963 | CLS178 | |
| 0964 | CLS041 | |
| 0967 | CLS140 | |
| 0970 | CLS174 | |
| 1801 | CLS167 | |

| NGK | | |
|------------|--------|--|
| 2571 | CLS137 | |
| 2584 | CLS066 | |
| 2585 | CLS155 | |
| 2995 | CLS044 | |
| 2999 | CLS137 | |
| 4070 | CLS068 | |
| 44250 | CLS015 | |
| 44278 | CLS084 | |
| 4746 | CLS082 | |
| 5355 | CLS096 | |
| 5506 | CLS072 | |
| 6020 | CLS085 | |
| 6022 | CLS196 | |
| 6299 | CLS093 | |
| 6304 | CLS195 | |
| 6317 | CLS091 | |
| 6349 | CLS078 | |
| 6794 | CLS083 | |
| 7044 | CLS048 | |
| 7109 | CLS223 | |
| 7153 | CLS221 | |
| 7175 | CLS014 | |
| 7176 | CLS226 | |
| 7200 | CLS011 | |
| 7200 | CLS019 | |
| 7209 | CLS035 | |
| 7211 | CLS044 | |
| 7248 | CLS190 | |
| 7285 | CLS124 | |
| 7285 | CLS262 | |
| 7302 | CLS038 | |
| 7303 | CLS053 | |
| 7306 | CLS260 | |
| 7318 | CLS043 | |
| 7367 | CLS013 | |
| 7368 | CLS117 | |
| 7379 | CLS224 | |
| 7381 | CLS137 | |
| 8047 | CLS258 | |
| 8183 | CLS052 | |
| 8185 | CLS040 | |
| 8192 | CLS009 | |
| 8192 | CLS261 | |
| 8200 | CLS150 | |
| 8205 | CLS003 | |
| 8206 | CLS118 | |
| 8220 | CLS004 | |
| 8223 | CLS179 | |
| 8234 | CLS039 | |
| 8262 | CLS041 | |
| 8275 | CLS025 | |
| 8276 | CLS020 | |
| 8287 | CLS062 | |





| NGK | CHAMPION | NGK | CHAMPION | NGK | CHAMPION | NGK | CHAMPION |
|-----------|----------|-----------|----------|-----------|----------|-----------|----------|
| 8468 | CLS050 | RC-FD1203 | CLS187 | RC-MB202 | CLS252 | RC-RN603 | CLS040 |
| 8469 | CLS236 | RC-FD1205 | CLS066 | RC-MB202 | CLS254 | RC-RN606 | CLS039 |
| 8471 | CLS123 | RC-FD1207 | CLS074 | RC-MB203 | CLS106 | RC-RN620 | CLS060 |
| 8474 | CLS129 | RC-FD1210 | CLS091 | RC-MB206 | CLS204 | RC-RN620 | CLS126 |
| 8487 | CLS060 | RC-FD1217 | CLS015 | RC-MB207 | CLS098 | RC-RN623 | CLS116 |
| 8487 | CLS126 | RC-FD509 | CLS127 | RC-MB208 | CLS207 | RC-RN637 | CLS117 |
| 8493 | CLS116 | RC-FD531 | CLS111 | RC-MB209 | CLS208 | RC-RN640 | CLS224 |
| 8541 | CLS077 | RC-FD537 | CLS122 | RC-MB210 | CLS205 | RC-RN648 | CLS221 |
| 8542 | CLS016 | RC-FD538 | CLS121 | RC-MB211 | CLS250 | RC-RN652 | CLS014 |
| 8571 | CLS120 | RC-FD544 | CLS033 | RC-MB212 | CLS217 | RC-RN658 | CLS011 |
| 8573 | CLS128 | RC-FD545 | CLS022 | RC-MB213 | CLS219 | RC-RN658 | CLS019 |
| 8618 | CLS108 | RC-FD546 | CLS111 | RC-MB214 | CLS216 | RC-RV1201 | CLS155 |
| 8621 | CLS109 | RC-FD548 | CLS032 | RC-MB215 | CLS253 | RC-RV1301 | CLS069 |
| 8647 | CLS257 | RC-FD807 | CLS077 | RC-MB216 | CLS203 | RC-RV415 | CLS061 |
| 8650 | CLS128 | RC-FD808 | CLS016 | RC-MB222 | CLS063 | RC-SB605 | CLS150 |
| 8655 | CLS129 | RC-FD816 | CLS049 | RC-MB222 | CLS138 | RC-SE45 | CLS167 |
| 9262 | CLS067 | RC-FD819 | CLS022 | RC-NE09 | CLS133 | RC-SE77 | CLS258 |
| 9459 | CLS132 | RC-FD826 | CLS120 | RC-NX07 | CLS132 | RC-ST201 | CLS028 |
| 9618 | CLS259 | RC-FT1202 | CLS137 | RC-OP1101 | CLS029 | RC-ST901 | CLS053 |
| 9846 | CLS131 | RC-FT1203 | CLS044 | RC-OP201 | CLS107 | RC-TE43 | CLS259 |
| 9856 | CLS056 | RC-FT1208 | CLS067 | RC-OP402 | CLS166 | RC-TE51 | CLS096 |
| 9925 | CLS229 | RC-FT1209 | CLS082 | RC-OP403 | CLS101 | RC-VL1305 | CLS195 |
| RC-AD201 | CLS177 | RC-FT201 | CLS136 | RC-OP404 | CLS166 | RC-VL601 | CLS179 |
| RC-AD202 | CLS099 | RC-FT203 | CLS135 | RC-OP407 | CLS214 | RC-VL605 | CLS050 |
| RC-AD202 | CLS180 | RC-FT407 | CLS119 | RC-OP408 | CLS211 | RC-VL606 | CLS236 |
| RC-AD204 | CLS001 | RC-FT435 | CLS006 | RC-OP409 | CLS212 | RC-VW1105 | CLS081 |
| RC-AD207 | CLS172 | RC-FT444 | CLS023 | RC-OP410 | CLS218 | RC-VW201 | CLS199 |
| RC-AD210 | CLS099 | RC-FT601 | CLS009 | RC-OP415 | CLS018 | RC-VW201 | CLS240 |
| RC-AD211 | CLS105 | RC-FT601 | CLS261 | RC-OP416 | CLS102 | RC-VW202 | CLS048 |
| RC-AD211 | CLS249 | RC-FT604 | CLS003 | RC-OP418 | CLS220 | RC-VW203 | CLS017 |
| RC-AD215 | CLS047 | RC-FT605 | CLS118 | RC-OP419 | CLS018 | RC-VW203 | CLS139 |
| RC-AD218 | CLS046 | RC-FT623 | CLS137 | RC-OP423 | CLS018 | RC-VW204 | CLS237 |
| RC-AD218 | CLS099 | RC-FT632 | CLS035 | RC-OP424 | CLS213 | RC-VW206 | CLS027 |
| RC-AD219 | CLS042 | RC-FT633 | CLS044 | RC-OP428 | CLS213 | RC-VW207 | CLS099 |
| RC-AR903 | CLS055 | RC-HD1202 | CLS072 | RC-OP433 | CLS018 | RC-VW208 | CLS027 |
| RC-AR904 | CLS235 | RC-HD301 | CLS021 | RC-OP435 | CLS107 | RC-VW208 | CLS099 |
| RC-AR908 | CLS137 | RC-HD407 | CLS130 | RC-OP437 | CLS220 | RC-VW210 | CLS027 |
| RC-BW205 | CLS036 | RC-HD408 | CLS130 | RC-OP438 | CLS030 | RC-VW210 | CLS249 |
| RC-BW208 | CLS037 | RC-HE53 | CLS128 | RC-OP440 | CLS107 | RC-VW213 | CLS199 |
| RC-BW214 | CLS186 | RC-HE71 | CLS128 | RC-OP441 | CLS114 | RC-VW214 | CLS210 |
| RC-BW222 | CLS104 | RC-HE73 | CLS129 | RC-OP444 | CLS115 | RC-VW215 | CLS099 |
| RC-BW235 | CLS054 | RC-HE76 | CLS129 | RC-OP453 | CLS113 | RC-VW216 | CLS099 |
| RC-CR305 | CLS062 | RC-KA1204 | CLS073 | RC-OP454 | CLS018 | RC-VW216 | CLS100 |
| RC-CR601 | CLS123 | RC-KA1204 | CLS093 | RC-OP454 | CLS141 | RC-VW217 | CLS245 |
| RC-CR606 | CLS190 | RC-KA401 | CLS131 | RC-OP455 | CLS213 | RC-VW218 | CLS097 |
| RC-CT402 | CLS222 | RC-KA402 | CLS131 | RC-OP456 | CLS103 | RC-VW220 | CLS042 |
| RC-CT615 | CLS124 | RC-KA402 | CLS258 | RC-OP463 | CLS103 | RC-VW225 | CLS034 |
| RC-CT615 | CLS262 | RC-KA405 | CLS173 | RC-PG608 | CLS223 | RC-VW227 | CLS043 |
| RC-DW1202 | CLS085 | RC-LC1302 | CLS137 | RC-PG610 | CLS005 | RC-VW228 | CLS043 |
| RC-DW1203 | CLS196 | RC-LC604 | CLS004 | RC-PG615 | CLS226 | RC-VW229 | CLS034 |
| RC-DW301 | CLS025 | RC-MB1104 | CLS068 | RC-RN1204 | CLS083 | RC-VW230 | CLS238 |
| RC-DW302 | CLS020 | RC-MB1106 | CLS078 | RC-RN1311 | CLS084 | RC-VW232 | CLS178 |
| RC-DW304 | CLS013 | RC-MB201 | CLS252 | RC-RN601 | CLS052 | RC-VW233 | CLS041 |

**NGK** 

| | |
|----------|--------|
| RC-VW234 | CLS181 |
| RC-VW236 | CLS140 |
| RC-VW239 | CLS174 |
| RC-VW242 | CLS041 |
| RC-VW254 | CLS048 |
| RC-VW902 | CLS108 |
| RC-VW903 | CLS109 |
| RC-VW907 | CLS038 |
| RC-VW910 | CLS260 |
| RC-VW912 | CLS043 |
| RC-ZE07 | CLS131 |
| RC-ZE11 | CLS131 |
| RC-ZE21 | CLS056 |
| RC-ZE53 | CLS257 |
| RC-ZX29 | CLS229 |

NIPPARTS 

| | |
|-----------|--------|
| IC-K09 | CLS256 |
| J 5380514 | CLS094 |
| J 5382058 | CLS096 |
| J 5383028 | CLS198 |

PVL 

| | |
|--------|--------|
| 027 | CLS245 |
| 031 S | CLS246 |
| 067 SL | CLS099 |
| 072 | CLS200 |
| 121 R | CLS097 |
| 124 | CLS248 |
| 125 | CLS204 |
| 126 | CLS201 |
| 126 | CLS206 |
| 182 | CLS202 |
| 185 | CLS098 |
| 186 | CLS203 |
| 207 | CLS207 |
| 211 | CLS249 |
| 214 | CLS250 |
| 220 R | CLS097 |
| 221 | CLS099 |
| 231 | CLS191 |
| 70875 | CLS212 |

TESLA 

| | |
|---------|--------|
| T 382 B | CLS195 |
| T 711 B | CLS086 |
| T 888 B | CLS085 |

TRISCAN 

| | |
|------------|--------|
| 8860 10002 | CLS195 |
| 8860 16011 | CLS074 |



VALEO 





| | |
|--------|--------|
| 346089 | CLS175 |
| 346546 | CLS095 |

VALEO 







| | |
|--------|--------|
| 346558 | CLS096 |
|--------|--------|

OE ?

| AGRIA  | |
|---|-------|
| 031 150 | L82C |
| 031 160 | L82C |
| 031 170 | L78C |
| 1137 51 680 1 | L82C |
| 283 340 | L82C |
| 426 43 | L82C |
| 509 12 | OE038 |
| 516 80 | L82C |
| 599 99 | OE015 |
| ALFA ROMEO  | |
| 0046550992 | OE122 |
| 12NC | OE014 |
| 12NDK | OE030 |
| 462 29 251 | OE001 |
| 46449690 | OE223 |
| 46521529 | OE223 |
| 46521530 | OE122 |
| 46550991 | OE077 |
| 46550992 | OE122 |
| 55217232 | OE256 |
| 589 45 85 | OE018 |
| 589 45 86 | OE014 |
| 589 45 87 | OE006 |
| 589 45 88 | OE014 |
| 589 61 77 | OE026 |
| 598 40 36 | OE006 |
| 605 04 563 | OE087 |
| 605 12 929 | OE087 |
| 605 99 495 | OE122 |
| 60579903 | OE014 |
| 608 00 325 | OE018 |
| 608 10 689 | OE136 |
| 60810689 | OE014 |
| 717 116 38 | OE005 |
| 717 116 39 | OE018 |
| 717 116 40 | OE006 |
| 717 118 06 | OE005 |
| 717 412 08 | OE029 |
| 71736276 | OE014 |
| 71736282 | OE030 |
| 754 651 9 | OE005 |
| 755 443 6 | OE018 |
| 755 444 4 | OE006 |
| 755 444 5 | OE038 |
| 776 038 1 | OE018 |
| 776 038 2 | OE006 |
| 776 038 3 | OE005 |
| 776 038 4 | OE014 |
| 777 245 3 | OE014 |
| 915 170 018 0 | OE015 |
| 961 473 868 0 | OE026 |
| 961 962 458 0 | OE019 |

| ALFA ROMEO  | |
|---|-------|
| 962 800 028 0 | OE026 |
| ALLIS-CHALMERS  | |
| 4905797 | OE074 |
| 4907335 | J8C |
| 74905796 | OE074 |
| 74905798 | OE074 |
| 79001651 | OE074 |
| AUDI  | |
| 06H 905 601 A | OE214 |
| 06H 905 611 | OE214 |
| 06H 905 621 | OE214 |
| 06H 905 621 A | OE214 |
| 101 000 054 AC | OE227 |
| 101 905 631 | OE214 |
| AUTO UNION  | |
| 001 270 051 700 9 | OE010 |
| 009 33 02 331 009 | OE074 |
| 011 18 00 068 000 | L82C |
| 7821 700 10 10 000 | OE087 |
| N 017 811 1 | OE074 |
| N 017 811 19 | OE074 |
| N 017 811 20 | OE010 |
| N 017 811 23 | OE087 |
| N 017 812 13 | OE010 |
| BMW  | |
| 1 265 595 | OE001 |
| 12 12 0 030 548 | OE223 |
| 12 12 0 032 134 | OE227 |
| 12 12 0 032 135 | OE227 |
| 12 12 0 032 136 | OE120 |
| 12 12 0 032 137 | OE238 |
| 12 12 0 032 138 | OE238 |
| 12 12 0 034 098 | OE205 |
| 12 12 0 034 677 | OE204 |
| 12 12 0 035 915 | OE238 |
| 12 12 0 035 933 | OE204 |
| 12 12 0 037 580 | OE242 |
| 12 12 0 037 582 | OE242 |
| 12 12 0 037 607 | OE223 |
| 12 12 0 037 608 | OE223 |
| 12 12 0 038 894 | OE243 |
| 12 12 0 038 896 | OE243 |
| 12 12 0 039 664 | OE243 |
| 12 12 0 040 551 | OE245 |
| 12 12 0 040 581 | OE243 |
| 12 12 0 041 666 | OE245 |
| 12 12 0 141 871 | OE223 |
| 12 12 1 257 081 | OE010 |
| 12 12 1 257 082 | OE010 |
| 12 12 1 257 513 | OE001 |

| BMW  | |
|--|-------|
| 12 12 1 258 158 | OE001 |
| 12 12 1 258 159 | OE001 |
| 12 12 1 258 973 | OE001 |
| 12 12 1 262 360 | OE015 |
| 12 12 1 262 361 | OE015 |
| 12 12 1 263 070 | OE015 |
| 12 12 1 265 595 | OE001 |
| 12 12 1 267 485 | OE001 |
| 12 12 1 269 333 | OE001 |
| 12 12 1 276 283 | OE015 |
| 12 12 1 279 526 | OE015 |
| 12 12 1 286 682 | OE015 |
| 12 12 1 288 234 | OE015 |
| 12 12 1 334 315 | OE015 |
| 12 12 1 338 145 | OE010 |
| 12 12 1 338 146 | OE087 |
| 12 12 1 351 716 | OE074 |
| 12 12 1 353 286 | OE010 |
| 12 12 1 353 673 | OE001 |
| 12 12 1 435 955 | OE223 |
| 12 12 1 435 956 | OE223 |
| 12 12 1 714 751 | OE004 |
| 12 12 1 882 34 | OE001 |
| 12 12 2 158 165 | OE204 |
| 12 12 2 158 252 | OE188 |
| 12 12 2 158 253 | OE238 |
| 12 12 2 163 332 | OE205 |
| 12 12 2 293 697 | OE205 |
| 12 12 8 353 286 | OE010 |
| 12 12 8 636 155 | OE087 |
| 12 12 8 636 166 | OE010 |
| 12 12 8 636 167 | OE087 |
| 12 12 8 636 168 | OE010 |
| 12 12 8 636 169 | OE087 |
| 12 12 9 005 913 | OE015 |
| 12 12 9 005 914 | OE001 |
| 12 12 9 055 912 | OE001 |
| 12 12 9 056 446 | OE015 |
| 12 12 9 056 447 | OE015 |
| 12 12 9 057 189 | OE015 |
| 12 12 9 057 190 | OE015 |
| 12 12 9 057 749 | OE015 |
| 12 12 9 057 750 | OE015 |
| 12 12 9 057 992 | OE015 |
| 12 12 9 059 162 | OE026 |
| 12 12 9 059 794 | OE026 |
| 12 12 9 059 869 | OE004 |
| 12 12 9 061 383 | OE004 |
| 12 12 9 061 811 | OE026 |
| 12 12 9 061 869 | OE004 |
| 12 12 9 063 428 | OE026 |
| 12 12 9 064 619 | OE026 |
| 12 12 9 068 016 | OE154 |

| BMW  | |
|--|-------|
| 12 12 9 070 999 | OE154 |
| 12 12 9 071 003 | OE223 |
| 12 12 9 976 330 | L78C |
| 12 65 5 95 | OE001 |
| 12 79 5 264 | OE015 |
| 12121338145 | OE010 |
| 2 158 165 | OE204 |
| 7 749 743 | OE237 |
| BOMAG  | |
| 057 439 95 | L78C |
| CASE IH  | |
| A05999AB | J8C |
| TM20699 | OE037 |
| CATERPILLAR  | |
| 2W-9486 | OE001 |
| CHEVROLET  | |
| 92 06 7204 | OE029 |
| 96 307 729 | OE077 |
| 96 417 176 | OE077 |
| EC 229626 | OE019 |
| CHRYSLER  | |
| 4609076 | OE154 |
| 4727114 | OE105 |
| 4796779 | OE191 |
| 56027275 | OE128 |
| 56028189 | OE128 |
| 56028236 AA | OE154 |
| 56028236AA | OE154 |
| A1005N02 | OE004 |
| A1005N04 | OE049 |
| CITROËN  | |
| 5 403 277 | OE038 |
| 5 403 277 X | OE038 |
| 5 416 222 D | L82C |
| 5 417 768 | OE001 |
| 5 417 768 H | OE001 |
| 5 417 769 U | OE001 |
| 5 417 998 | OE001 |
| 5 417 998 H | OE001 |
| 5 425 202 | OE001 |
| 5 425 202 H | OE001 |
| 5 425 202 M | OE001 |
| 5 433 737 | OE038 |
| 5 433 737 J | OE038 |
| 5 433 738 | OE038 |
| 5 433 738 V | OE038 |
| 5 451 444 | OE038 |
| 5 451 444 B | OE038 |
| 5432 057 Y | OE015 |

OE ? ⇌



| CITROËN | CHAMPION |
|---------------|----------|
| 5960 14 | OE035 |
| 5960 54 | OE178 |
| 5960 73 | OE178 |
| 5960 75 | OE178 |
| 5960 84 | OE130 |
| 5960 90 | OE035 |
| 5960 91 | OE035 |
| 5960 92 | OE205 |
| 5960 97 | OE035 |
| 5960 98 | OE035 |
| 5960 E2 | OE205 |
| 5960 F7 | OE178 |
| 5960 H9 | OE205 |
| 5960 J3 | OE005 |
| 5960 K8 | OE035 |
| 5960 L2 | OE035 |
| 5960 L3 | OE203 |
| 5962 2T | OE030 |
| 5962 5C | OE035 |
| 5962 5G | OE034 |
| 5962 5M | OE035 |
| 5962 7E | OE175 |
| 5962 7S | OE034 |
| 5962 7W | OE035 |
| 5962 7X | OE035 |
| 5962 8A | OE175 |
| 5962 F0 | OE034 |
| 5962 H8 | OE039 |
| 5962 S9 | OE014 |
| 75 491 694 | OE010 |
| 75 491 695 | OE010 |
| 75 491 697 | OE010 |
| 75 492 437 | OE038 |
| 78 260 993 00 | OE001 |
| 91 517 001 | OE001 |
| 91 517 002 | OE001 |
| 91 517 007 | OE009 |
| 91 517 008 | OE009 |
| 95 496 692 | OE038 |
| 95 605 398 | L82C |
| 95 611 941 | OE009 |
| 95 618 380 | OE038 |
| 95 619 043 | OE001 |
| 95619038 | L82C |
| 96 009 090 | OE014 |
| 96 037 952 | OE057 |
| 96 040 824 | OE005 |
| 96 064 066 | OE014 |
| 96 070 663 | OE016 |
| 96 073 353 | OE077 |
| 96 088 669 | OE014 |
| 96 089 220 | OE002 |
| 96 145 071 | OE077 |

| CITROËN | CHAMPION |
|-------------------------|-----------------|
| 96.024.607 | OE014 |
| 9636393380 | OE035 |
| 9638127380 | OE034 |
| 9639814380 | OE034 |
| 9650889380 | OE178 |
| 97 535 383 | OE009 |
| A 212 7C | L78C |
| AM 212 207 A | L82C |
| AYB 212-7 | L78C |
| AZ 212 7A | L78C |
| DS 212 7G | OE038 |
| DV 212 207 A | OE038 |
| DX 212 7A | OE038 |
| DX 212 7B | L82C |
| DX 212 7C | OE038 |
| DY 212 207 A | OE038 |
| GX 06 188 06 1 | OE038 |
| GX 06 188 08 A | OE010 |
| GX 06 188 10 A | OE087 |
| MKP 000 73 | OE087 |
| MYC000006N | OE087 |
| MYC000006R | OE094 |
| MYC000007R | OE014 |
| ZA 3406 176 | OE010 |
| ZA 4233 922 | OE010 |
| ZB.9000.065.U | L82C |
| ZB9000062U | OE009 |
| ZB9000063U | OE014 |
| ZC 9456 074 U | L78C |
| ZC 9457 707 U | L78C |
| ZC 9852 109 U | L78C |
| ZC 9862 090 U | OE015 |
| ZC9862093U | OE001 |
| ZC9862095U | OE009 |
| ZCT 000 012 | OE010 |
| CITROËN/ PEUGEOT | CHAMPION |
| 96 762 881 80 | OE263 |
| 9673 806 380 | OE203 |
| DACIA | CHAMPION |
| 6001544293 | OE005 |
| 82 00 662 185 | OE130 |
| DAF | CHAMPION |
| 215206 | OE074 |
| 225190 | L82C |
| DAIHATSU | CHAMPION |
| 9004851106 | OE039 |
| 90048-51163 | OE089 |
| 90048-51164 | OE019 |
| 90048-51168-000 | OE077 |
| 90048-51196 | OE199 |

| DAIHATSU | CHAMPION |
|--------------------------|-----------------|
| 90048-51197 | OE196 |
| DUCATI | CHAMPION |
| 67040071A | OE073 |
| 67040081A | OE073 |
| 67040141A | OE083 |
| 67040171A | OE083 |
| 67040331A | OE073 |
| 67040351A | OE083 |
| 67040351A | OE186 |
| EZGO | CHAMPION |
| 25523-G5 | OE013 |
| FERRARI (FERRARI) | CHAMPION |
| 113538 | OE074 |
| FIAT | CHAMPION |
| 04NE | OE001 |
| 1 L 4 J | OE001 |
| 1 L 4 JR | OE006 |
| 1 L 45 J | OE010 |
| 1 L 45 JR | OE018 |
| 1 S 3 | L82C |
| 1 S 5 J | OE038 |
| 12NE | OE005 |
| 14NC | OE018 |
| 2284662 | OE010 |
| 2301710 | OE087 |
| 2301711 | OE010 |
| 3233922 | OE010 |
| 4113022 | L82C |
| 4170472 | OE087 |
| 4172173 | OE087 |
| 4249164 | OE010 |
| 4345041 | OE010 |
| 4346196 | OE006 |
| 4346796 | OE006 |
| 4346797 | OE018 |
| 4347776 | OE018 |
| 4359422 | OE001 |
| 4359423 | OE001 |
| 4359424 | OE006 |
| 4361799 | OE038 |
| 4361800 | OE038 |
| 4378107 | OE064 |
| 4401547 | OE038 |
| 4401549 | OE001 |
| 4401550 | OE006 |
| 4401551 | OE001 |
| 4401552 | OE018 |
| 4401586 | L82C |
| 4425057 | OE038 |
| 46417010 | OE039 |

| FIAT | CHAMPION |
|-----------|----------|
| 46461873 | OE196 |
| 46463801 | OE030 |
| 46471078 | OE120 |
| 46472021 | OE030 |
| 46480307 | OE026 |
| 46480362 | OE005 |
| 46480363 | OE005 |
| 46481273 | OE083 |
| 46531917 | OE186 |
| 46531918 | OE016 |
| 46531919 | OE186 |
| 46531935 | OE039 |
| 46541450 | OE136 |
| 46551935 | OE016 |
| 46750545 | OE196 |
| 46799928 | OE196 |
| 46823299 | OE196 |
| 55188857 | OE196 |
| 55190788 | OE196 |
| 55198201 | OE196 |
| 55210685 | OE208 |
| 55226083 | OE196 |
| 55229633 | OE232 |
| 55233997 | OE232 |
| 55249868 | OE208 |
| 5882087 | OE038 |
| 5894585 | OE008 |
| 5894586 | OE002 |
| 5894587 | OE004 |
| 5894588 | OE014 |
| 5896177 | OE026 |
| 5896824-1 | OE026 |
| 5984036 | OE006 |
| 60504563 | OE087 |
| 60512929 | OE087 |
| 60569957 | OE136 |
| 60800325 | OE018 |
| 60810689 | OE136 |
| 7 FYSSR | OE018 |
| 7 GBMSR | OE026 |
| 7 GYSSR | OE014 |
| 71711638 | OE005 |
| 71711639 | OE018 |
| 71711640 | OE006 |
| 71711806 | OE006 |
| 71719244 | OE016 |
| 71736275 | OE001 |
| 71736278 | OE018 |
| 71737139 | OE196 |
| 71739210 | OE029 |
| 71741208 | OE029 |
| 7546519 | OE005 |
| 7554419 | OE010 |



OE ? \Rightarrow







| FIAT | CHAMPION |
|------------|----------|
| 7554420 | OE001 |
| 7554421 | OE001 |
| 7554436 | OE018 |
| 7554437 | OE018 |
| 7554438 | OE087 |
| 7554444 | OE006 |
| 7554445 | OE038 |
| 7554447 | OE038 |
| 7554448 | OE038 |
| 7554449 | OE087 |
| 7554451 | OE006 |
| 7554452 | OE087 |
| 7554453 | OE010 |
| 7565476 | OE108 |
| 7565853 | OE094 |
| 7571541 | OE039 |
| 7686643 | OE008 |
| 7760381 | OE018 |
| 7760382 | OE004 |
| 7760383 | OE005 |
| 7760384 | OE014 |
| 7769243 | OE026 |
| 7772453 | OE014 |
| 7772515 | OE018 |
| 7782067 | OE077 |
| 7FYSR | OE018 |
| 7FYSSR | OE008 |
| 7GBYSR4 | OE077 |
| 9 FY | OE001 |
| 9 FYSR | OE006 |
| 9 FYSSR | OE006 |
| 9 GYSSR | OE033 |
| 9151700180 | OE015 |
| 9614738680 | OE026 |
| 9619624580 | OE019 |
| 9628000280 | OE026 |
| 9636393480 | OE148 |
| 9649464080 | OE178 |
| 9FYSR | OE018 |
| 9FYSSR | OE008 |
| 9GYSR | OE014 |
| 9GYSSR | OE014 |
| V 45 LSR | OE018 |
| FORD | CHAMPION |
| 01505812 | OE206 |
| 1 012 639 | OE011 |
| 1 023 706 | OE136 |
| 1 032 705 | OE198 |
| 1 088 847 | OE031 |
| 1 097 080 | OE031 |
| 1 120 170 | OE176 |
| 1 120 818 | OE054 |





| FORD | CHAMPION |
|---------------|----------|
| 1 128 053 | OE131 |
| 1 202 935 | OE031 |
| 1 204 572 | OE131 |
| 1 233 897 | OE031 |
| 1 240 5AD | OE054 |
| 1 240 5JE | OE054 |
| 1 255 464 | OE031 |
| 1 307 093 | OE131 |
| 1 315 691 | OE131 |
| 1 327 341 | OE031 |
| 1 335 367 | OE031 |
| 1 350 742 | OE031 |
| 1 362 012 | OE031 |
| 1 369 704 | OE183 |
| 1 379 739 | OE189 |
| 1 493 001 | OE031 |
| 1 505 812 | OE206 |
| 1 506 413 | OE010 |
| 1 506 415 | OE001 |
| 1 507 572 | OE054 |
| 1 518 878 | OE018 |
| 1 523 608 | OE006 |
| 1 542 499 | OE196 |
| 1 787 829 | OE031 |
| 1000996 | OE136 |
| 1086020 | OE146 |
| 1307093 | OE131 |
| 1369704 | OE183 |
| 1698597 | OE029 |
| 1787829 | OE031 |
| 1M50 12405 CA | OE031 |
| 1S7J 12405 DA | OE131 |
| 1S7J 12405 EB | OE131 |
| 2S7E 12405 AA | OE131 |
| 2S7E 12405 AB | OE131 |
| 2U7J 12405 AA | OE031 |
| 4 440 367 | OE131 |
| 4 454 955 | OE131 |
| 4M5G 12405 AA | OE031 |
| 4M5G 12405 XA | OE031 |
| 4M5G 12405 XB | OE031 |
| 4M5G 12405 XC | OE031 |
| 4M5G12405AA | OE031 |
| 5 099 295 | OE014 |
| 5 099 721 | OE005 |
| 5 099 727 | OE014 |
| 5 099 731 | OE054 |
| 5 099 732 | OE054 |
| 5 099 733 | OE054 |
| 5 099 735 | OE054 |
| 5 099 741 | OE011 |
| 5 099 846 | OE054 |
| 5 099 848 | OE054 |





| FORD | CHAMPION |
|-----------------|----------|
| 5 099 884 | OE006 |
| 5 099 885 | OE001 |
| 5 099 949 | OE087 |
| 5 099 950 | OE087 |
| 5 099 952 | OE014 |
| 5 099 961 | OE010 |
| 5 099 962 | OE018 |
| 5M5G 12405 AA | OE183 |
| 5M5G12405AA | OE183 |
| 6 073 379 | OE018 |
| 6 080 256 | OE014 |
| 6 173 150 | OE011 |
| 6 726 180 | OE029 |
| 6080256 | OE014 |
| 6M5J 12405 AA | OE206 |
| 6M8G 12405 BB | OE189 |
| 7 335 128 | OE136 |
| 73 OF 12405 AA | OE054 |
| 73 OF 12405 JA | OE014 |
| 730F 12405 AA | OE054 |
| 730F 12405 JA | OE014 |
| 78 HF 12405 AA | OE054 |
| 78 IF 12405 AA | OE087 |
| 78 TF 12405 BA | OE006 |
| 78GB 12405 CA | OE018 |
| 78GB 12405 HA | OE018 |
| 78HF 12405 AA | OE054 |
| 78IF 12405 AA | OE087 |
| 78IF 12405 BA | OE018 |
| 78TF 12405 AA | OE018 |
| 78TF 12405 BA | OE006 |
| 790F 12405 ACA | OE018 |
| 790F 12405 YA | OE018 |
| 80 GB 12405 AA | OE087 |
| 80 OF 12405 CA | OE094 |
| 80 OF 12405 DA | OE087 |
| 80 OF 12405 EA | OE087 |
| 80GB 12405 AA | OE087 |
| 800F 12405 CA | OE094 |
| 800F 12405 DA | OE087 |
| 800F 12405 EA | OE087 |
| 81 OF 12405 AAA | OE014 |
| 81 SF 12405 BA | OE014 |
| 81 SF 12405 DA | OE094 |
| 81GB 12405 AA | OE018 |
| 810F 12405 AAA | OE014 |
| 81SF 12405 BA | OE014 |
| 81SF 12405 DA | OE094 |
| 83 BB 12405 CA | OE054 |
| 83 OF | OE054 |
| 83 SF 12405 GA | OE094 |
| 83BB 12405 CA | OE054 |
| 830F | OE054 |



| FORD | CHAMPION |
|-----------------|----------|
| 83SF 12405 GA | OE094 |
| 840F 12405 JD | OE054 |
| 88 HF | OE054 |
| 88HF | OE054 |
| 920F 12405 EA | OE011 |
| 920F 12405EA | OE011 |
| 920F12405EA | OE011 |
| 959 F 12405 AA | OE136 |
| 96XF-12405-BB | OE146 |
| D 3 PF 12405 BA | OE087 |
| D3PF 12405 BA | OE087 |
| DZPF 12405 | OE054 |
| DZPF 12405 BUA | OE054 |
| XES4F 12405 DA | OE029 |
| XES4F12405DA | OE029 |
| XS6F 12405 BA | OE031 |
| XS6F 12405 CA | OE031 |
| YN2F 12405 AA | OE031 |
| YN2F-12405AA | OE031 |
| YN2J 12405 AA | OE031 |
| GENERAL MOTORS | CHAMPION |
| 12620540 | OE189 |
| 12637199 | OE258 |
| 12656517 | OE258 |
| 12673528 | OE258 |
| 12788884 | OE238 |
| 24538286 | OE199 |
| 25 324 618 | OE031 |
| 25193473 | OE198 |
| 55350481 | OE019 |
| 55490097 | OE258 |
| 55564748 | OE238 |
| 55564763 | OE188 |
| 55565219 | OE198 |
| 55576026 | OE264 |
| 90444723 | OE019 |
| 90542918 | OE019 |
| 91 95 868 | OE198 |
| 91 99 038 | OE031 |
| 91132086 | OE019 |
| 9146369 | OE019 |
| 9195109 | OE019 |
| 92 06 7204 | OE029 |
| 92 702 93 | OE136 |
| 93 175 994 | OE136 |
| 93 193 723 | OE226 |
| 93175880 | OE019 |
| 93175935 | OE019 |
| 93176801 | OE089 |
| 93180485 | OE198 |
| 95519055 | OE019 |
| 96130723 | OE039 |

OE ? ⇒

| GENERAL MOTORS  | |
|--|-------|
| 96464000 | OE199 |
| 96990231 | OE199 |
| GLAS  | |
| 156 | OE054 |
| 273 | OE038 |
| 274 | OE038 |
| 275 | OE038 |
| 284 | OE064 |
| 33 | OE054 |
| 34 | OE054 |
| 35 | OE054 |
| 393 | OE074 |
| 413 | L78C |
| 414 | L82C |
| 415 | L82C |
| 416 | L82C |
| 44 | OE054 |
| 53 | OE010 |
| 64 | OE048 |
| 745 | OE054 |
| 764 | OE011 |
| 765 | OE011 |
| GMC  | |
| 96 307 729 | OE077 |
| 96 417 176 | OE077 |
| HANOMAG  | |
| 151 123 014 | L82C |
| HANOMAG HENSCHEL  | |
| 151 123 014 | L82C |
| HOLDEN  | |
| 92 06 7204 | OE029 |
| HONDA  | |
| 12290-PNDA01 | OE136 |
| 12290-PNE004 | OE039 |
| 12290-RMX-003 | OE190 |
| 12290-RMX-004 | OE190 |
| 12290-RMX-013 | OE190 |
| 12290-RMX-014 | OE190 |
| 98079-5515V | OE180 |
| 98079-5517V | OE180 |
| 98079-55846 | OE006 |
| 98079-55871 | OE006 |
| 98079-55881 | OE006 |
| 98079-55946 | OE006 |
| 98079-5614E | OE039 |
| 98079-561-4G | OE089 |
| 98079-561-4P | OE089 |
| 98079-5615E | OE039 |
| 98079-5615V | OE179 |







| HONDA  | |
|--|-------|
| 98079-5617V | OE179 |
| 98079-56832 | OE006 |
| 98079-56846 | OE006 |
| 98079-56846-02 | OE006 |
| 98079-56946 | OE006 |
| 98079-571 BH | OE136 |
| 98079-5714H | OE136 |
| 9807B-5615P | OE039 |
| 9807B-5615W | OE179 |
| 9807B-5617P | OE089 |
| 9807B-5617W | OE179 |
| 9807-B5617W | OE136 |
| 9807B-561BW | OE239 |
| 9807B-561CW | OE239 |
| 9807B-56A7W | OE179 |
| HYUNDAI  | |
| 17710-12930 | OE180 |
| 18811-11061 | OE063 |
| 18813-11051 | OE192 |
| 18814-11051 | OE063 |
| 18817-11051 | OE191 |
| 18818-11051 | OE192 |
| 18822-11091 | OE048 |
| 18823-08101 | OE063 |
| 18823-11101 | OE063 |
| 18825-11101 | OE192 |
| 18826-11101 | OE146 |
| 18827-09080 | OE197 |
| 18829 11050 | OE089 |
| 18835-11161 | OE192 |
| 18843-10062 | OE197 |
| 18844-10060 | OE197 |
| 18854-09080 | OE201 |
| 18854-10080 | OE201 |
| 18855-10060 | OE201 |
| 18858-08090 | OE201 |
| 18858-10090 | OE201 |
| 18867-09095 | OE249 |
| 18868-08095 | OE250 |
| 18868-08115 | OE248 |
| 18869-09095 | OE249 |
| 27410-23700 | OE180 |
| 27410-3C000 | OE190 |
| 9803916 | OE248 |
| 9803943 | OE250 |
| IRAN KHODRO (IKCO)  | |
| IK00135680 | OE034 |
| K914563508A | OE034 |
| ISUZU  | |
| 97125969 | OE191 |



| IVECO  | |
|--|-------|
| 504209850 | OE254 |
| 5801436103 | OE254 |
| JAGUAR  | |
| C2A1535 | OE180 |
| C2S46895 | OE131 |
| EAC008584 | OE011 |
| EAC8916 | OE051 |
| EAC8917 | OE051 |
| EBC004021 | OE011 |
| EBC11480 | OE002 |
| EBC8143 | OE013 |
| EBL 11480 | OE005 |
| EBL 2230 | OE005 |
| NAB3850DA | OE011 |
| NCA3850DA/2 | OE136 |
| NCA3850HA2 | OE146 |
| XR842795 | OE131 |
| JEEP  | |
| 56027275 | OE128 |
| KHD  | |
| 345 9769 | L82C |
| 350 3132 | L82C |
| 419 11680 | L82C |
| KIA  | |
| 17710-12930 | OE180 |
| 18811-11061 | OE063 |
| 18813-11051 | OE192 |
| 18814-11051 | OE063 |
| 18817-11051 | OE191 |
| 18818-11051 | OE192 |
| 18822-11091 | OE048 |
| 18823-08101 | OE063 |
| 18823-11101 | OE063 |
| 18825-11101 | OE192 |
| 18826-11101 | OE146 |
| 18827-09080 | OE197 |
| 18829 11050 | OE089 |
| 18835-11161 | OE192 |
| 18843-10062 | OE197 |
| 18844-10060 | OE197 |
| 18854-09080 | OE201 |
| 18854-10080 | OE201 |
| 18855-10060 | OE201 |
| 18858-08090 | OE201 |
| 18867-09095 | OE249 |
| 18868-08095 | OE250 |
| 18868-08115 | OE248 |
| 27410-23700 | OE180 |
| 27410-3C000 | OE190 |

| KUBOTA  | |
|--|-------|
| 12268-6771-1 | OE001 |
| 12273-6771-1 | OE059 |
| 12392-6771-1 | OE015 |
| 12647-6771-1 | OE064 |
| 12691-6771-1 | OE057 |
| 12863-6771-1 | OE015 |
| 12866-6771-1 | OE015 |
| 12992-6771-1 | OE051 |
| 13078-6771-6 | OE001 |
| 13375-6774-0 | OE015 |
| 13451-6771-6 | L82C |
| 13581-6771-6 | L82C |
| 13582-6771-1 | L82C |
| 13901-6771-6 | OE007 |
| 13979-6771-1 | OE007 |
| LADA  | |
| 2112-3707010 | OE039 |
| LANCIA  | |
| 2 284 662 | OE010 |
| 2 301 710 | OE087 |
| 2 301 711 | OE010 |
| 4 170 472 | OE087 |
| 4 172 173 | OE087 |
| 4 233 922 | OE010 |
| 4 249 164 | OE010 |
| 4 345 040 | OE010 |
| 4 345 041 | OE010 |
| 46 229 251 | OE001 |
| 58 945 85 | OE018 |
| 58 945 86 | OE014 |
| 58 945 87 | OE006 |
| 58 961 77 | OE026 |
| 59 840 36 | OE006 |
| 60 504 563 | OE087 |
| 60 512 929 | OE087 |
| 60 800 325 | OE018 |
| 60 810 689 | OE136 |
| 71 711 638 | OE005 |
| 71 711 639 | OE018 |
| 71 711 640 | OE006 |
| 71 711 806 | OE006 |
| 75 444 44 | OE006 |
| 75 444 45 | OE038 |
| 75 465 19 | OE005 |
| 75 544 36 | OE018 |
| 77 603 81 | OE018 |
| 77 603 82 | OE006 |
| 77 603 83 | OE005 |
| 77 603 84 | OE014 |
| 77 724 53 | OE014 |
| 9151700180 | OE015 |



OE ? \Rightarrow

| LANCIA  | |
|--|-------|
| 96 147 386 80 | OE026 |
| 96 196 245 80 | OE019 |
| 9628000280 | OE026 |
| LAND ROVER  | |
| 4550157 | OE180 |
| ETC7244 | OE042 |
| LR001394 | OE190 |
| LR005253 | OE180 |
| LR005483 | OE190 |
| LR021006 | OE120 |
| RTC3569 | OE074 |
| RTC3571 | OE001 |
| RTC3573 | OE059 |
| RTC3812 | OE001 |
| MAN  | |
| 51 25923 0020 | OE010 |
| 51 25923 0022 | OE010 |
| 51 25923 0023 | OE010 |
| MARUTI SUZUKI  | |
| 9482M00567 | OE199 |
| MASSEY FERGUSON  | |
| 834225-MI | J8C |
| 834230-MI | J8C |
| 834234-MI | OE037 |
| 834245-MI | OE074 |
| 834247-MI | OE037 |
| MAZDA  | |
| 1A02-18-110 | OE196 |
| BP 01-18-110 | OE039 |
| BP 02-18-110 | OE039 |
| BP 03-18-110 | OE039 |
| BP 04-18-110 | OE039 |
| BP118110 | OE063 |
| C 401-18-110 | OE031 |
| C 402-18-110 A | OE031 |
| C 402-18-110A | OE031 |
| F 20118101 | OE089 |
| F 220-18-110 | OE039 |
| F 288 18110 | OE089 |
| F28518110 | OE089 |
| F28618110 | OE089 |
| F28718110 | OE089 |
| JE 41 18 110 | OE146 |
| KJ 14 18 110 | OE184 |
| L3G2-18-110 | OE029 |
| L3Y 2-18-110 | OE189 |
| L3Y1-18-110 | OE029 |
| L813 18 110 | OE183 |
| LFG 18-110 | OE189 |
| P51R-18110 | OE253 |

| MAZDA  | |
|--|-------|
| PE5R-18-110 | OE253 |
| PE5S-18-110 | OE253 |
| SKIT BKG 12020 | OE189 |
| SKIT BKG 18020 | OE189 |
| SKIT GG1 00F3 | OE189 |
| SKIT GG2 00F0 | OE189 |
| SKIT GG2 00F3 | OE189 |
| SKIT GGG 100F0 | OE189 |
| ZJ46-18-110 | OE146 |
| ZJY618110 | OE180 |
| ZJY6-18-110 | OE146 |
| MERCEDES-BENZ  | |
| 000 159 10 03 | OE001 |
| 000 159 12 03 | L82C |
| 000 159 15 03 | OE038 |
| 000 159 36 03 | L78C |
| 000 159 43 03 | OE038 |
| 000 159 54 03 | OE018 |
| 000 159 65 03 | OE038 |
| 000 159 68 03 | OE001 |
| 000 159 72 03 | OE038 |
| 000 159 79 03 | L82C |
| 000 159 94 03 | OE018 |
| 000 162 94 01 | OE009 |
| 001 158 88 03 | OE087 |
| 001 159 19 03 | OE087 |
| 001 159 27 03 | OE087 |
| 001 159 29 03 | L82C |
| 001 159 31 03 | OE087 |
| 001 159 34 03 | OE087 |
| 001 159 45 03 | OE087 |
| 001 159 47 03 | OE010 |
| 001 159 50 03 | OE087 |
| 001 159 51 03 | OE010 |
| 001 159 52 03 | OE087 |
| 001 159 53 03 | OE087 |
| 001 159 55 03 | OE087 |
| 001 159 60 03 | L82C |
| 001 159 61 03 | OE087 |
| 001 159 62 03 | OE087 |
| 001 159 65 03 | OE074 |
| 001 159 68 03 | OE010 |
| 001 159 69 03 | OE087 |
| 001 159 71 03 | OE010 |
| 001 159 76 03 | OE032 |
| 001 159 81 03 | OE001 |
| 001 159 82 03 | OE001 |
| 001 159 84 03 | OE010 |
| 001 159 84 04 | OE087 |
| 001 159 85 03 | OE010 |
| 001 159 87 03 | OE087 |
| 001 159 88 03 | OE087 |

| MERCEDES-BENZ  | |
|--|-------|
| 001 159 89 03 | OE087 |
| 001 159 93 03 | OE087 |
| 001 159 94 03 | OE010 |
| 001 159 95 03 | OE001 |
| 001 635 40 0 | OE009 |
| 002 159 04 03 | OE015 |
| 002 159 05 03 | OE015 |
| 002 159 06 03 | OE015 |
| 002 159 07 03 | OE015 |
| 002 159 08 03 | OE010 |
| 002 159 09 03 | OE010 |
| 002 159 10 03 | OE001 |
| 002 159 11 03 | OE001 |
| 002 159 14 03 | OE010 |
| 002 159 15 03 | OE010 |
| 002 159 16 03 | OE015 |
| 002 159 17 03 | OE015 |
| 002 159 18 03 | OE087 |
| 002 159 19 03 | OE001 |
| 002 159 20 03 | OE001 |
| 002 159 21 03 | OE001 |
| 002 159 24 03 | OE001 |
| 002 159 25 03 | OE001 |
| 002 159 26 03 | OE001 |
| 002 159 27 03 | OE087 |
| 002 159 28 03 | OE001 |
| 002 159 29 03 | OE001 |
| 002 159 30 03 | OE001 |
| 002 159 31 03 | OE001 |
| 002 159 35 03 | OE009 |
| 002 159 37 03 | OE009 |
| 002 159 41 03 | OE010 |
| 002 159 42 03 | OE010 |
| 002 159 47 03 | OE001 |
| 002 159 48 03 | OE015 |
| 002 159 49 03 | OE009 |
| 002 159 51 03 | OE087 |
| 002 159 54 03 | OE009 |
| 002 159 56 03 | OE009 |
| 002 159 57 03 | OE009 |
| 002 159 58 03 | OE009 |
| 002 159 59 03 | OE015 |
| 002 159 60 03 | OE015 |
| 002 159 61 03 | OE001 |
| 002 159 62 03 | OE087 |
| 002 159 63 03 | OE087 |
| 002 159 66 03 | OE009 |
| 002 159 72 03 | OE038 |
| 002 159 74 03 | OE074 |
| 002 159 78 03 | OE009 |
| 003 159 06 03 | OE009 |
| 003 159 10 03 | OE001 |
| 003 159 11 03 | OE015 |

| MERCEDES-BENZ  | |
|--|-------|
| 003 159 13 03 | OE010 |
| 003 159 14 03 | OE087 |
| 003 159 23 03 | OE009 |
| 003 159 24 03 | OE009 |
| 003 159 27 03 | OE001 |
| 003 159 28 03 | OE009 |
| 003 159 29 03 | OE015 |
| 003 159 30 03 | OE003 |
| 003 159 32 03 | OE087 |
| 003 159 35 03 | OE009 |
| 003 159 36 03 | OE009 |
| 003 159 41 03 | OE003 |
| 003 159 45 03 | OE001 |
| 003 159 46 03 | OE015 |
| 003 159 47 03 | OE001 |
| 003 159 53 03 | OE003 |
| 003 159 56 03 | OE087 |
| 003 159 57 03 | OE010 |
| 003 159 58 03 | OE010 |
| 003 159 62 03 | L82C |
| 003 159 65 03 | OE019 |
| 003 159 66 03 | OE191 |
| 003 159 67 03 | OE057 |
| 003 159 68 03 | OE057 |
| 003 159 71 03 | OE057 |
| 003 159 72 03 | OE032 |
| 003 159 75 03 | OE032 |
| 003 159 76 03 | OE032 |
| 003 159 78 03 | OE032 |
| 003 159 80 03 | OE136 |
| 003 159 81 03 | OE228 |
| 003 159 93 03 | OE146 |
| 003 159 94 03 | OE191 |
| 003 159 96 03 | OE191 |
| 003 159 96 03 | OE228 |
| 003 159 97 03 | OE181 |
| 003 159 97 03 26 | OE146 |
| 003 159 97 03 98 | OE146 |
| 004 159 07 03 | OE146 |
| 004 159 13 03 | OE224 |
| 004 159 14 03 | OE188 |
| 004 159 18 03 | OE229 |
| 004 159 19 03 | OE191 |
| 004 159 20 03 | OE136 |
| 004 159 23 03 | OE224 |
| 004 159 26 03 | OE005 |
| 004 159 30 03 | OE005 |
| 004 159 34 03 | OE229 |
| 004 159 36 03 | OE005 |
| 004 159 39 03 | OE233 |
| 004 159 43 03 | OE181 |
| 004 159 44 03 | OE229 |
| 004 159 45 03 | OE224 |



OE ? ⇌

| MERCEDES-BENZ | CHAMPION |
|--------------------|----------|
| 004 159 49 03 | OE229 |
| 004 159 50 03 | OE191 |
| 050 981 67 AA | OE191 |
| 102 159 00 03 | OE009 |
| 102 159 01 03 | OE009 |
| 102 159 03 03 | OE009 |
| 102 159 06 03 | OE009 |
| 102 159 11 03 | OE009 |
| 103 159 00 01 | OE009 |
| 103 159 00 03 | OE009 |
| 110 159 00 03 | OE010 |
| 116 159 00 03 | OE001 |
| 116 159 01 03 | OE015 |
| 116 159 02 03 | OE001 |
| 116 159 99 93 | OE001 |
| 132 159 00 03 | OE212 |
| A 001 159 76 03 | OE032 |
| A 003 159 14 03 | OE087 |
| A 003 159 35 03 | OE009 |
| A 003 159 36 03 | OE009 |
| A 003 159 41 03 | OE003 |
| A 003 159 45 03 | OE001 |
| A 003 159 46 03 | OE015 |
| A 003 159 56 03 | OE087 |
| A 003 159 57 03 | OE010 |
| A 003 159 65 03 | OE019 |
| A 003 159 66 03 | OE191 |
| A 003 159 67 03 | OE057 |
| A 003 159 67 03 26 | OE057 |
| A 003 159 68 03 | OE057 |
| A 003 159 71 03 | OE057 |
| A 003 159 75 03 | OE032 |
| A 003 159 76 03 | OE032 |
| A 003 159 80 03 | OE136 |
| A 003 159 81 03 | OE228 |
| A 003 159 93 03 | OE146 |
| A 003 159 94 03 | OE191 |
| A 003 159 96 03 | OE191 |
| A 003 159 96 03 | OE228 |
| A 003 159 97 03 | OE146 |
| A 003 159 97 03 26 | OE146 |
| A 003 159 97 03 98 | OE146 |
| A 004 159 07 03 | OE146 |
| A 004 159 13 03 | OE224 |
| A 004 159 18 03 | OE229 |
| A 004 159 19 03 | OE191 |
| A 004 159 19 03 26 | OE191 |
| A 004 159 20 03 | OE136 |
| A 004 159 23 03 | OE224 |
| A 004 159 26 03 | OE005 |
| A 004 159 30 03 | OE005 |
| A 004 159 30 03 26 | OE005 |
| A 004 159 34 03 | OE229 |

| MERCEDES-BENZ | CHAMPION |
|--------------------|----------|
| A 004 159 36 03 | OE005 |
| A 004 159 39 03 | OE233 |
| A 004 159 43 03 | OE181 |
| A 004 159 44 03 | OE229 |
| A 004 159 45 03 | OE224 |
| A 004 159 45 03 26 | OE224 |
| A 004 159 49 03 | OE229 |
| A 004 159 50 03 | OE191 |
| A 004 159 58 03 | OE229 |
| A 132 159 00 03 | OE212 |
| A 281 159 00 03 | OE261 |
| MINI | CHAMPION |
| 12 12 2 293 697 | OE205 |
| V 75 70 259 | OE204 |
| V 75 77 104 | OE204 |
| MITSUBISHI | CHAMPION |
| 1822A011 | OE250 |
| MA 848 593 | OE238 |
| MD 313 443 | OE146 |
| MD 360 019 | OE227 |
| MD 360 383 | OE184 |
| MN 128 362 | OE238 |
| MN 128 363 | OE238 |
| MN119487 | OE179 |
| MN119942 | OE120 |
| MN158596 | OE190 |
| MN163236 | OE179 |
| MN163807 | OE179 |
| MR984943 | OE179 |
| MS 851 183 | OE001 |
| MS 851 232 | OE006 |
| MS 851 233 | OE006 |
| MS 851 234 | OE087 |
| MS 851 237 | OE049 |
| MS 851 238 | OE048 |
| MS 851 335 | OE136 |
| MS 851 336 | OE146 |
| MS 851 357 | OE039 |
| MS 851 358 | OE039 |
| MS 851 412 | OE006 |
| MS 851 413 | OE087 |
| MS 851 473 | OE146 |
| MS 851 501 | OE136 |
| MS 851 502 | OE146 |
| MS 851 728 | OE039 |
| MS851368 | OE002 |
| MWM | CHAMPION |
| 6 0579 415 0007 | L78C |
| NISSAN | CHAMPION |
| 22101-AX015 | OE175 |

| NISSAN | CHAMPION |
|--------------|----------|
| 22401-01P15 | OE039 |
| 22401-01P16 | OE039 |
| 22401-10F16 | OE005 |
| 22401-1HC1B | OE240 |
| 22401-1KT1B | OE240 |
| 22401-1P116 | OE146 |
| 22401-20J05 | OE005 |
| 22401-20J06 | OE002 |
| 22401-20J06 | OE039 |
| 22401-27N66 | OE146 |
| 22401-2F200 | OE089 |
| 22401-53J06 | OE002 |
| 22401-53J13 | OE136 |
| 22401-53J66 | OE136 |
| 22401-58S16 | OE136 |
| 22401-70J13 | OE154 |
| 22401-70J17 | OE014 |
| 22401-70J19 | OE002 |
| 22401-70J22 | OE002 |
| 22401-74B00 | OE016 |
| 22401-74B07 | OE016 |
| 22401-74B11 | OE063 |
| 22401-74B18 | OE063 |
| 22401-8H315 | OE175 |
| 22401-8H514 | OE035 |
| 22401-8H514 | OE148 |
| 22401-8H515 | OE035 |
| 22401-8H516 | OE035 |
| 22401-8H516 | OE148 |
| 22401-99B17 | OE014 |
| 22401-99B22 | OE013 |
| 22401-AU015 | OE148 |
| 22401-AU075 | OE148 |
| 22401-AX015 | OE175 |
| 22401-AX075 | OE175 |
| 22401-BC01B | OE175 |
| 22401-BC05A | OE175 |
| 22401-CK81 B | OE207 |
| 22401-ED715 | OE240 |
| 22401-ED71B | OE240 |
| 22401-ED815 | OE240 |
| 22401-FU412 | OE013 |
| 22401-M7715 | OE001 |
| 22401-V5016 | OE039 |
| 22401-W8915 | OE065 |
| 22401-W8916 | OE001 |
| 22401-ZE01B | OE190 |
| 82000-46337 | OE136 |
| B2401-4A00A | OE226 |
| NSU | CHAMPION |
| 11 17 00 068 | L82C |
| 48 17 00 003 | L78C |

| OPEL | CHAMPION |
|-------------|----------|
| 09199038 | OE255 |
| 12 14 000 | OE019 |
| 12 14 003 | OE026 |
| 12 14 005 | OE019 |
| 12 14 007 | OE048 |
| 12 14 008 | OE048 |
| 12 14 009 | OE039 |
| 12 14 011 | OE120 |
| 12 14 012 | OE031 |
| 12 14 015 | OE019 |
| 12 14 016 | OE198 |
| 12 14 019 | OE038 |
| 12 14 020 | L82C |
| 12 14 021 | OE038 |
| 12 14 023 | OE038 |
| 12 14 025 | OE010 |
| 12 14 026 | OE136 |
| 12 14 027 | OE019 |
| 12 14 029 | OE136 |
| 12 14 031 | OE089 |
| 12 14 039 | OE010 |
| 12 14 041 | OE198 |
| 12 14 046 | L82C |
| 12 14 065 | OE238 |
| 12 14 066 | OE264 |
| 12 14 105 | OE258 |
| 12 14 108 | OE018 |
| 12 14 110 | OE010 |
| 12 14 112 | OE198 |
| 12 14 117 | OE019 |
| 12 14 119 | OE018 |
| 12 14 122 | OE018 |
| 12 14 128 | OE258 |
| 12 14 132 | OE018 |
| 12 14 139 | OE006 |
| 12 14 144 | OE005 |
| 12 14 145 | OE089 |
| 12 14 148 | OE039 |
| 12 14 149 | OE004 |
| 12 14 193 | OE006 |
| 12 14 455 | OE019 |
| 12 14 462 | OE191 |
| 12 14 527 | OE238 |
| 12 14 528 | OE188 |
| 12 14 702 | OE018 |
| 12 14 802 | OE018 |
| 12 14 803 | OE048 |
| 12 14 804 | OE005 |
| 12 14 805 | OE064 |
| 12 14 806 | OE018 |
| 12 14 807 | OE006 |
| 12 59 746 4 | OE189 |
| 12.141.49 | OE004 |

OE ? \rightleftharpoons

| OPEL | CHAMPION |
|--------------|----------|
| 12.144.62 | OE191 |
| 12.148.03 | OE077 |
| 1214013 | OE255 |
| 1214118 | OE255 |
| 25324618 | OE255 |
| 44 08 937 | OE146 |
| 44 10 220 | OE146 |
| 44 13 288 | OE146 |
| 44 32 200 | OE146 |
| 47 08 892 | OE226 |
| 48 05 484 | OE029 |
| 48 11 581 | OE189 |
| 90 350 018 | OE006 |
| 91 160 172 | OE146 |
| 92 063 303 | OE191 |
| 93 160 201 | OE146 |
| 93 161 199 | OE146 |
| 93 161 947 | OE146 |
| 93 190 948 | OE031 |
| 95519057 | OE255 |
| 97 125 696 | OE146 |
| 97 125 969 | OE191 |
| 97 170 268 | OE191 |
| 97125969 | OE191 |
| PEUGEOT | CHAMPION |
| 1105 693 600 | L82C |
| 5960 10 | OE001 |
| 5960 13 | OE035 |
| 5960 15 | OE034 |
| 5960 16 | OE035 |
| 5960 16 | OE178 |
| 5960 17 | OE035 |
| 5960 17 | OE148 |
| 5960 18 | OE026 |
| 5960 18 | OE030 |
| 5960 53 | OE178 |
| 5960 57 | OE178 |
| 5960 58 | OE178 |
| 5960 75 | OE178 |
| 5960 7X | OE035 |
| 5960 83 | OE130 |
| 5960 86 | OE178 |
| 5960 90 | OE035 |
| 5960 91 | OE035 |
| 5960 97 | OE035 |
| 5960 98 | OE035 |
| 5960 E1 | OE203 |
| 5960 E2 | OE203 |
| 5960 F0 | OE034 |
| 5960 F3 | OE035 |
| 5960 F7 | OE178 |
| 5960 G1 | OE130 |

| PEUGEOT | CHAMPION |
|---------|----------|
| 5960 G4 | OE205 |
| 5960 J2 | OE034 |
| 5960 K8 | OE035 |
| 5960 K9 | OE205 |
| 5960 L0 | OE205 |
| 5960 L2 | OE035 |
| 5960 L3 | OE203 |
| 5960 L5 | OE205 |
| 5961 07 | L78C |
| 5961 08 | L82C |
| 5961 09 | L82C |
| 5961 10 | L78C |
| 5961 12 | OE074 |
| 5961 15 | OE074 |
| 5961 19 | OE001 |
| 5961 20 | OE087 |
| 5961 23 | OE074 |
| 5961 26 | OE087 |
| 5961 27 | OE010 |
| 5961 29 | OE087 |
| 5961 41 | OE087 |
| 5961 42 | OE087 |
| 5961 43 | OE010 |
| 5961 47 | OE001 |
| 5961 48 | OE087 |
| 5961 93 | OE001 |
| 5961 96 | OE001 |
| 5962 05 | OE009 |
| 5962 11 | OE001 |
| 5962 13 | OE001 |
| 5962 15 | OE009 |
| 5962 16 | OE001 |
| 5962 16 | OE010 |
| 5962 19 | OE001 |
| 5962 21 | OE012 |
| 5962 2T | OE030 |
| 5962 44 | OE087 |
| 5962 45 | OE010 |
| 5962 47 | OE009 |
| 5962 48 | OE009 |
| 5962 51 | OE001 |
| 5962 52 | OE001 |
| 5962 58 | L82C |
| 5962 5C | OE035 |
| 5962 5E | OE035 |
| 5962 5M | OE035 |
| 5962 5M | OE148 |
| 5962 60 | OE001 |
| 5962 61 | OE009 |
| 5962 65 | OE001 |
| 5962 65 | OE010 |
| 5962 67 | L82C |
| 5962 68 | OE009 |

| PEUGEOT | CHAMPION |
|--------------|----------|
| 5962 6K | OE034 |
| 5962 6W | OE005 |
| 5962 70 | OE001 |
| 5962 71 | OE014 |
| 5962 72 | OE009 |
| 5962 7E | OE175 |
| 5962 7R | OE034 |
| 5962 7W | OE035 |
| 5962 7W | OE178 |
| 5962 88 | OE087 |
| 5962 89 | OE087 |
| 5962 8A | OE175 |
| 5962 96 | L82C |
| 5962 A0 | OE087 |
| 5962 A1 | OE010 |
| 5962 A2 | OE015 |
| 5962 A3 | OE038 |
| 5962 A4 | OE001 |
| 5962 C0 | OE009 |
| 5962 C5 | OE014 |
| 5962 E2 | OE057 |
| 5962 F6 | OE014 |
| 5962 H2 | OE014 |
| 5962 H4 | OE094 |
| 5962 H5 | OE059 |
| 5962 H6 | OE014 |
| 5962 H7 | OE077 |
| 5962 H8 | OE039 |
| 5962 H9 | OE005 |
| 5962 J1 | OE005 |
| 5962 J1 | OE016 |
| 5962 J3 | OE005 |
| 5962 K0 | OE005 |
| 5962 K1 | OE014 |
| 5962 K4 | OE005 |
| 5962 K7 | OE077 |
| 5962 R5 | OE077 |
| 5962 W9 | OE034 |
| 9151 400 080 | OE001 |
| 9151 700 080 | OE001 |
| 9151 700 380 | OE009 |
| 9151 700 680 | OE009 |
| 9151 873 580 | OE012 |
| 9151 944 680 | OE009 |
| 9151873580 | OE012 |
| 9152 106 780 | OE001 |
| 9456190680 | OE034 |
| 9561 837 880 | OE010 |
| 96363933 | OE035 |
| 9636393380 | OE035 |
| 9636419280 | OE034 |
| 9638127380 | OE217 |
| 9650684480 | OE035 |

| PEUGEOT | CHAMPION |
|----------------|----------|
| 9650889380 | OE178 |
| 9661959180 | OE035 |
| A0P | OE010 |
| CC 10 | OE009 |
| CP 10 | OE001 |
| Super 14-7 | L82C |
| Super 14-8 | L78C |
| Super 14-9 | L78C |
| PIAGGIO | CHAMPION |
| 438064 | OE077 |
| P4M | OE079 |
| P82M | L82C |
| P86M | OE037 |
| RP2M | OE091 |
| PORSCHE | CHAMPION |
| 905 071 4 | OE015 |
| 928 094 602 03 | OE001 |
| 95817022190 | OE214 |
| 999 020 802 10 | L82C |
| 999 170 023 90 | L82C |
| 999 170 050 90 | OE087 |
| 999 170 051 90 | OE087 |
| 999 170 052 90 | OE087 |
| 999 170 055 90 | OE087 |
| 999 170 056 90 | OE087 |
| 999 170 103 90 | OE222 |
| 999 170 111 90 | OE087 |
| 999 170 119 90 | OE001 |
| 999 170 122 90 | OE262 |
| 999 170 126 90 | OE001 |
| 999 170 130 90 | OE262 |
| 999 170 132 90 | OE015 |
| 999 170 133 90 | OE015 |
| 999 170 135 90 | OE087 |
| 999 170 136 90 | OE015 |
| 999 170 138 90 | OE010 |
| 999 170 139 90 | OE010 |
| 999 170 141 90 | OE006 |
| 999 170 142 90 | OE006 |
| 999 170 146 90 | OE001 |
| 999 170 148 90 | OE001 |
| 999 170 151 90 | OE262 |
| 999 170 156 90 | OE006 |
| 999 170 158 90 | OE006 |
| 999 170 165 90 | OE087 |
| 999 170 167 90 | OE038 |
| 999 170 168 90 | OE010 |
| 999 170 170 90 | OE015 |
| 999 170 182 90 | OE014 |
| 999 170 195 90 | OE216 |
| 999 170 201 90 | OE026 |

OE ? ⇔



| PORSCHE | | |
|----------------|--------------|--|
| 999 170 207 91 | OE218 | |
| 999 170 218 90 | OE218 | |
| 999 170 219 90 | OE218 | |
| 999 170 220 90 | OE216 | |
| 999 170 221 90 | OE222 | |
| 999 170 223 90 | OE257 | |
| 999 170 228 90 | OE210 | |
| 999 170 229 90 | OE210 | |
| 999 170 233 90 | OE246 | |
| 99917000290 | OE038 | |
| 99917020190 | OE026 | |
| 99917020490 | OE120 | |
| 99917020491 | OE120 | |
| 99917021890 | OE120 | |
| 99917021990 | OE120 | |
| 99917022190 | OE136 | |
| PROTON | | |
| MS851237E | OE039 | |
| PUCH | | |
| 905 0714 | OE015 | |
| RENAULT | | |
| 08 51 798 700 | L82C | |
| 08 51 798 800 | OE038 | |
| 08 54 407 100 | L82C | |
| 08 54 864 700 | L82C | |
| 08 55 800 600 | OE074 | |
| 08 55 836 400 | OE038 | |
| 08 55 836 500 | OE038 | |
| 08 55 939 100 | OE074 | |
| 22 40 123 31R | OE207 | |
| 22401-2047R | OE261 | |
| 224013682R | OE026 | |
| 224017726R | OE014 | |
| 224018651R | OE005 | |
| 224018760R | OE130 | |
| 515 | OE136 | |
| 60 01 040 356 | OE077 | |
| 60 01 040 357 | OE077 | |
| 60 01 040 543 | OE009 | |
| 60 01 544 293 | OE005 | |
| 6001544293 | OE033 | |
| 74 33 517 980 | OE005 | |
| 74 39 146 775 | OE077 | |
| 77 00 100 403 | OE026 | |
| 77 00 101 401 | OE005 | |
| 77 00 103 533 | OE019 | |
| 77 00 107 916 | OE019 | |
| 77 00 115 827 | OE026 | |
| 77 00 260 637 | OE014 | |
| 77 00 273 462 | OE005 | |
| 77 00 273 490 | OE005 | |



| RENAULT | | |
|----------------|--------------|--|
| 77 00 274 004 | OE005 | |
| 77 00 274 154 | OE033 | |
| 77 00 500 000 | OE001 | |
| 77 00 500 012 | OE001 | |
| 77 00 500 024 | OE087 | |
| 77 00 500 036 | OE078 | |
| 77 00 500 072 | OE009 | |
| 77 00 500 120 | OE018 | |
| 77 00 500 132 | OE077 | |
| 77 00 500 168 | OE026 | |
| 77 00 500 180 | OE005 | |
| 77 00 500 204 | OE009 | |
| 77 00 529 980 | OE038 | |
| 77 00 546 241 | OE038 | |
| 77 00 553 622 | OE001 | |
| 77 00 558 395 | OE038 | |
| 77 00 571 635 | OE038 | |
| 77 00 580 479 | OE038 | |
| 77 00 583 895 | OE001 | |
| 77 00 612 290 | OE001 | |
| 77 00 613 828 | OE015 | |
| 77 00 616 459 | OE038 | |
| 77 00 619 329 | L82C | |
| 77 00 621 029 | OE038 | |
| 77 00 647 263 | OE038 | |
| 77 00 647 265 | OE015 | |
| 77 00 647 267 | OE038 | |
| 77 00 647 269 | L82C | |
| 77 00 647 270 | OE038 | |
| 77 00 647 272 | OE001 | |
| 77 00 647 273 | OE010 | |
| 77 00 647 275 | L82C | |
| 77 00 647 276 | OE038 | |
| 77 00 647 278 | OE038 | |
| 77 00 647 279 | OE038 | |
| 77 00 647 280 | L82C | |
| 77 00 647 284 | L82C | |
| 77 00 647 285 | OE038 | |
| 77 00 647 286 | OE038 | |
| 77 00 659 130 | OE001 | |
| 77 00 659 152 | OE010 | |
| 77 00 659 262 | L82C | |
| 77 00 660 006 | OE001 | |
| 77 00 661 752 | OE015 | |
| 77 00 662 849 | OE038 | |
| 77 00 664 569 | OE064 | |
| 77 00 670 734 | OE015 | |
| 77 00 681 298 | OE006 | |
| 77 00 683 771 | OE015 | |
| 77 00 683 772 | OE038 | |
| 77 00 714 317 | OE011 | |
| 77 00 714 540 | OE011 | |
| 77 00 724 821 | OE015 | |





| RENAULT | | |
|----------------|--------------|--|
| 77 00 724 822 | OE015 | |
| 77 00 727 383 | OE006 | |
| 77 00 732 626 | OE087 | |
| 77 00 733 422 | OE007 | |
| 77 00 737 459 | OE087 | |
| 77 00 742 094 | OE018 | |
| 77 00 743 137 | OE057 | |
| 77 00 743 920 | OE015 | |
| 77 00 745 305 | OE014 | |
| 77 00 749 163 | OE057 | |
| 77 00 824 821 | OE015 | |
| 77 00 855 463 | OE094 | |
| 77 00 855 918 | OE009 | |
| 77 00 856 342 | OE094 | |
| 77 00 858 444 | OE077 | |
| 77 00 859 967 | OE001 | |
| 77 00 860 235 | OE001 | |
| 77 00 861 471 | OE010 | |
| 77 00 861 472 | OE001 | |
| 77 00 862 054 | OE015 | |
| 77 00 868 864 | OE018 | |
| 77 01 023 079 | OE001 | |
| 77 01 023 080 | OE001 | |
| 77 01 023 325 | OE015 | |
| 77 01 023 391 | OE038 | |
| 77 01 041 214 | OE015 | |
| 77 01 041 215 | OE009 | |
| 77 01 042 816 | OE005 | |
| 77 01 043 624 | OE216 | |
| 77 01 065 085 | OE207 | |
| 77 01 365 111 | OE087 | |
| 77 01 366 057 | OE038 | |
| 77 01 366 085 | OE078 | |
| 77 01 366 086 | OE010 | |
| 77 01 366 087 | OE010 | |
| 77 01 366 138 | OE010 | |
| 77 01 366 267 | OE038 | |
| 77 01 366 268 | OE010 | |
| 77 01 366 269 | OE001 | |
| 77 01 366 270 | OE009 | |
| 77 01 366 513 | OE007 | |
| 77 01 366 514 | OE009 | |
| 77 01 366 515 | OE038 | |
| 77 01 366 516 | OE001 | |
| 77 01 366 533 | OE037 | |
| 77 01 366 539 | OE001 | |
| 77 01 366 903 | OE001 | |
| 77 01 392 263 | L82C | |
| 77 01 414 022 | OE007 | |
| 77 01 414 023 | OE001 | |
| 77 01 414 024 | OE087 | |
| 77 01 414 026 | OE015 | |
| 77 01 414 030 | OE011 | |









| RENAULT | | |
|----------------|--------------|--|
| 77 01 414 031 | OE006 | |
| 77 01 414 036 | OE038 | |
| 77 01 414 037 | L82C | |
| 77 01 414 038 | OE009 | |
| 77 01 414 040 | OE005 | |
| 77 01 414 044 | OE010 | |
| 77 01 414 058 | OE009 | |
| 77 01 414 105 | OE001 | |
| 77 01 414 110 | OE005 | |
| 77 01 414 111 | OE005 | |
| 77 01 414 112 | OE005 | |
| 77 01 414 113 | OE006 | |
| 77 01 414 114 | OE012 | |
| 77 01 414 119 | OE012 | |
| 77 01 414 121 | OE054 | |
| 77 01 414 138 | OE011 | |
| 77 01 414 139 | OE005 | |
| 77 01 414 140 | OE012 | |
| 77 01 414 141 | OE014 | |
| 77 01 414 142 | OE006 | |
| 77 01 414 143 | OE018 | |
| 77 01 414 144 | OE038 | |
| 77 01 414 145 | OE005 | |
| 77 01 417 651 | OE009 | |
| 77 01 417 654 | OE087 | |
| 77 01 612 290 | OE001 | |
| 77 01 742 094 | OE018 | |
| 77 02 124 101 | OE015 | |
| 77 02 125 001 | OE038 | |
| 77 51 023 082 | OE001 | |
| 77.00.273.462 | OE016 | |
| 77.00.273.698 | OE191 | |
| 77.00.714.540 | OE011 | |
| 77.00.724.821 | OE001 | |
| 77.00.725.302 | OE042 | |
| 77.00.733.422 | OE059 | |
| 77.00.868.864 | OE008 | |
| 77.01.366.084 | OE078 | |
| 77.01.366.269 | OE001 | |
| 77.01.366.270 | OE009 | |
| 77.01.366.533 | OE037 | |
| 77.01.414.022 | OE059 | |
| 77.01.414.023 | OE001 | |
| 77.01.414.025 | OE001 | |
| 77.01.414.030 | OE011 | |
| 77.01.414.032 | OE042 | |
| 77.01.414.037 | L82C | |
| 77.01.414.038 | OE009 | |
| 77.01.414.040 | OE014 | |
| 77.01.414.056 | OE009 | |
| 77.01.414.065 | OE094 | |
| 7700 500 180 | OE033 | |
| 7700500024 | OE087 | |







OE ? ⇌

| RENAULT  | |
|--|-------|
| 7700500036 | OE078 |
| 7700500072 | OE011 |
| 7700500155 | OE033 |
| 7700500168 | OE026 |
| 7700500180 | OE005 |
| 7700500216 | OE011 |
| 7700714540 | OE011 |
| 7700724821 | OE001 |
| 7700725302 | OE042 |
| 7700732626 | OE087 |
| 7700733422 | OE059 |
| 7700868864 | OE008 |
| 7701366084 | OE078 |
| 7701366269 | OE001 |
| 7701366270 | OE009 |
| 7701366533 | OE037 |
| 7701414022 | OE059 |
| 7701414023 | OE001 |
| 7701414025 | OE001 |
| 7701414030 | OE011 |
| 7701414032 | OE042 |
| 7701414038 | OE009 |
| 7701414040 | OE014 |
| 7701414056 | OE009 |
| 7701414065 | OE094 |
| 82 00 030 765 | OE130 |
| 82 00 046 337 | OE146 |
| 82 00 209 310 | OE033 |
| 82 00 307 688 | OE146 |
| 82 00 363 384 | OE146 |
| 82 00 492 426 | OE136 |
| 82 00 587 901 | OE225 |
| 82 00 662 185 | OE130 |
| 8200020791 | OE033 |
| 8200020796 | OE033 |
| 8200021856 | OE033 |
| 8200033622 | OE033 |
| 8200046337 | OE136 |
| 83 04 504 277 | OE128 |
| 86 71 016 885 | OE006 |
| 8671019515 | OE136 |
| 89 33 003 862 | OE005 |
| 89.33.003.862 | OE005 |
| 8933003862 | OE005 |
| 96 26 195 980 | OE030 |
| 96 26 575 480 | OE030 |
| 96 36 415 880 | OE175 |
| 9636415880 | OE175 |
| ROVER  | |
| GSP 66527 | OE146 |
| GSP 9652 | OE146 |
| NLP000030 | OE120 |

| ROVER  | |
|--|-------|
| NLP000040 | OE136 |
| NLP10003 | OE002 |
| NLP10004 | OE014 |
| NLP100190 | OE136 |
| NLP100290 | OE146 |
| NLP100290L | OE146 |
| NLP100320 | OE138 |
| NLP1004 | OE014 |
| NPL 100190 | OE146 |
| SAAB  | |
| 23412600 | L82C |
| 23413800 | OE038 |
| 23415300 | OE038 |
| 75 05 142 | OE014 |
| 83 55 007 | OE001 |
| 9188681 | OE136 |
| 9399866 | OE136 |
| T 40 238 921 001 | OE001 |
| T 40 238 924 005 | OE001 |
| SEAT  | |
| 0003901171 | OE010 |
| 0003908857 | OE015 |
| 0003910649 | OE010 |
| 0003911398 | OE001 |
| 0004359424 | OE006 |
| 06H 905 601 A | OE214 |
| 06H 905 611 | OE214 |
| 06H 905 621 | OE214 |
| 06H 905 621 A | OE214 |
| 101 000 035 AH | OE198 |
| 101 000 040 AC | OE027 |
| 101 000 040 AD | OE025 |
| 101 905 603 B | OE177 |
| 101 905 609 | OE235 |
| 101 905 631 | OE214 |
| 101 905 631 B | OE214 |
| 101 905 631 H | OE214 |
| EA 919000 04 | OE074 |
| FH 919000 02 | OE001 |
| SKODA  | |
| 06H 905 601 A | OE214 |
| 06H 905 611 | OE214 |
| 06H 905 621 | OE214 |
| 06H 905 621 A | OE214 |
| 101 000 040 AD | OE025 |
| 101 000 049 AC | OE145 |
| 101 000 060 AA | OE145 |
| 101 905 603 B | OE177 |
| 101 905 631 | OE214 |
| 101 905 631 B | OE214 |
| 101 905 631 H | OE214 |

| SKODA  | |
|--|-------|
| 101000049AC | OE145 |
| 101000049AD | OE136 |
| 101000060AA | OE145 |
| BBC 057 008 | OE038 |
| BBC 057 009 | OE038 |
| BBC 057 011 | OE005 |
| BBC 057 012 | OE005 |
| BBC057010 | OE003 |
| BBC057012 | OE005 |
| SMART  | |
| 000 3085V005 | OE217 |
| 281 159 01 00 | OE130 |
| A 132 159 00 03 | OE212 |
| A 135 150 01 18 | OE238 |
| A 281 159 00 03 | OE261 |
| A 281 159 01 00 | OE130 |
| Q 000 3085V005 000 000 | OE217 |
| Q0012468V002000000 | OE211 |
| SOLO  | |
| 23 00 101 | L82C |
| 23 00 103 | L78C |
| 23 00 106 | L82C |
| 23 00 323 | L78C |
| 23 00 428 | OE038 |
| 23 00 441 | L82C |
| 23 00 500 | L78C |
| SSANGYONG  | |
| A 003 159 41 03 | OE003 |
| A 003 159 68 03 | OE057 |
| STEINBOCK  | |
| 014046 | L82C |
| 024153 | OE018 |
| STEYR  | |
| 23 733 | L78C |
| 902 0724 | L82C |
| 902 0726 | L82C |
| 902 0741 | L78C |
| 904 0784 | OE038 |
| 905 0702 | OE074 |
| 905 0703 | OE074 |
| 905 0711 | OE010 |
| STIHL  | |
| 0000 405 0101 | OE038 |
| 0000 405 0102 | L78C |
| 0000 405 0107 | L78C |
| 1107 400 7000 | L82C |
| SUBARU  | |
| 22401 AA 310 | OE227 |

| SUBARU  | |
|---|-------|
| 22401 AA 501 | OE188 |
| 22401 KA 210 | OE039 |
| 22401-AA371 | OE191 |
| 22401-AA731 | OE179 |
| SAB 330 NG 0608 | OE188 |
| SAB 330 NG 0611 | OE188 |
| SAB 330 NG 8608 | OE188 |
| SAB 330 NG 8611 | OE188 |
| SUZUKI  | |
| 09482-00527 | OE196 |
| 09482-00602 | OE226 |
| 09482-00602-A00 | OE226 |
| 09482-00603 | OE226 |
| 09482-00603-000 | OE226 |
| 09482-M00611 | OE226 |
| 90482-00448 | OE196 |
| 905 0712 | OE064 |
| 9482369 | OE196 |
| 96464000 | OE199 |
| TALBOT  | |
| 00 00 VSP 118 | OE006 |
| 00 00 VSP 120 | OE018 |
| 00 043 456 00 | OE010 |
| 00 044 629 00 | OE087 |
| 00 131 120 00 | OE010 |
| 00 136 956 00 | OE038 |
| 00 157 973 00 | OE001 |
| 00 165 081 00 | OE001 |
| 00 166 316 00 | OE010 |
| 00 429 049 00 | OE001 |
| 00 553 549 00 | OE001 |
| 00 553 552 00 | OE087 |
| 00 566 133 00 | OE001 |
| 00 792 270 42 | OE006 |
| 00 792 270 44 | OE018 |
| A 519 383 80 | OE012 |
| G 517 562 80 | OE001 |
| TOYOTA  | |
| 90048-51172 | OE188 |
| 90080-91194 | OE063 |
| 90910-01153 | OE013 |
| 90919-01020 | OE015 |
| 90919-01056 | OE015 |
| 90919-01059 | OE015 |
| 90919-01064 | OE051 |
| 90919-01083 | OE001 |
| 90919-01121 | OE136 |
| 90919-01122 | OE188 |
| 90919-01127 | OE188 |
| 90919-01128 | OE227 |
| 90919-01155 | OE128 |

OE ? ⇒



| TOYOTA | CHAMPION |
|-------------|----------|
| 90919-01164 | OE093 |
| 90919-01169 | OE188 |
| 90919-01176 | OE093 |
| 90919-01180 | OE227 |
| 90919-01182 | OE188 |
| 90919-01184 | OE089 |
| 90919-01191 | OE182 |
| 90919-01192 | OE019 |
| 90919-01193 | OE019 |
| 90919-01198 | OE026 |
| 90919-01210 | OE182 |
| 90919-01211 | OE188 |
| 90919-01226 | OE188 |
| 90919-01230 | OE188 |
| 90919-01235 | OE035 |
| 90919-01236 | OE035 |
| 90919-01237 | OE182 |
| 90919-01238 | OE188 |
| 90919-01247 | OE190 |
| 90919-01258 | OE035 |
| 90919-W1001 | OE035 |
| 90919-YZZAG | OE089 |

| VAG | CHAMPION |
|---------------|----------|
| 03F 905 600 | OE260 |
| 03F 905 600 A | OE260 |
| 04E 905 601 | OE244 |
| 04E 905 601 B | OE244 |
| 04E 905 612 | OE244 |
| 04E 905 612 C | OE244 |
| 101 905 626 | OE213 |

| VAUXHALL | CHAMPION |
|------------|----------|
| 092063308 | OE063 |
| 1214118 | OE255 |
| 90 509 739 | OE026 |
| 91132006 | OE019 |
| 92 06 7204 | OE029 |
| 93 175 935 | OE019 |
| 95519057 | OE255 |

| VOLVO | CHAMPION |
|-------------|----------|
| 000057007 | OE074 |
| 000057011 | OE001 |
| 000057015 | L82C |
| 000057022 | OE010 |
| 000057023 A | OE010 |
| 1150278 | OE179 |
| 1276056 | OE001 |
| 1276057 | OE087 |
| 1276058 | OE087 |
| 1276514 | OE010 |
| 1306604 | OE010 |
| 1306605 | OE001 |

| VOLVO | CHAMPION |
|-------------|----------|
| 1346541 | OE006 |
| 1357828 | OE038 |
| 135827 | OE038 |
| 1367015 | OE018 |
| 1367526 | OE001 |
| 1367528 | OE006 |
| 1367529 | OE018 |
| 1457826 | OE038 |
| 1467015 | OE018 |
| 22401 AA670 | OE179 |
| 2301710 | OE087 |
| 238624 | L78C |
| 238808 | L78C |
| 239446 | L82C |
| 241402 | OE038 |
| 241627 | OE038 |
| 241946 | OE038 |
| 270746-1 | OE006 |
| 270747-9 | OE018 |
| 271239 | OE227 |
| 271239-6 | OE227 |
| 271409 | OE006 |
| 271410 | OE038 |
| 271411 | OE038 |
| 271412 | OE038 |
| 271415-2 | OE018 |
| 271603-3 | OE014 |
| 271636-3 | OE005 |
| 271727-0 | OE005 |
| 272207 | OE120 |
| 272344 | OE136 |
| 273525 | OE038 |
| 273546 | OE010 |
| 273558 | OE038 |
| 273591 | OE010 |
| 273596 | OE010 |
| 298196 | OE006 |
| 30637385 | OE236 |
| 30650379 | OE206 |
| 30650843 | OE236 |
| 30731383 | OE179 |
| 30731425 | OE031 |
| 30731877 | OE031 |
| 30735760 | OE031 |
| 3104124 | L82C |
| 3104530 | OE038 |
| 3213327-4 | OE004 |
| 3343929-0 | OE087 |
| 3344315-1 | OE051 |
| 334444720 | OE004 |
| 3344472-0 | OE004 |
| 3344473 | OE004 |
| 3344473-8 | OE004 |

| VOLVO | CHAMPION |
|----------------|----------|
| 3344898-6 | OE004 |
| 3344899 | OE004 |
| 3344899-4 | OE004 |
| 3517629 | OE014 |
| 3517980 | OE005 |
| 3551943 | L78C |
| 3551945 | L78C |
| 3551946 | L78C |
| 3576753 | OE038 |
| 3576846 | OE038 |
| 3851859 | RV15YC4 |
| 3851861 | RV15YC4 |
| 460540 | OE038 |
| 463511 | OE001 |
| 463512 | OE010 |
| 463513 | OE087 |
| 570306 | L82C |
| 570334 | L78C |
| 7072153 | L82C |
| 72153 | L82C |
| 8642660 | OE120 |
| 8642661 | OE120 |
| 8670057 | OE136 |
| 8687 990 H 939 | OE179 |
| 8692070 | OE136 |
| 9146775 | OE120 |
| 917910 | OE136 |
| 9179100 | OE136 |
| 9202064 | OE120 |
| RF 80 H3 | OE120 |
| RF80H3 | OE120 |
| X 9146775 | OE120 |
| X9146775 | OE120 |

| VW | CHAMPION |
|---------------|----------|
| 000 057 001 | L82C |
| 000 057 001 A | L82C |
| 000 057 003 | L82C |
| 000 057 004 | L82C |
| 000 057 005 | OE074 |
| 000 057 006 | OE074 |
| 000 057 007 | OE074 |
| 000 057 011 | OE001 |
| 000 057 015 | L82C |
| 000 057 022 | OE010 |
| 000 057 023 A | OE010 |
| 000 057 066 A | OE044 |
| 000 057 067 A | OE012 |
| 04C 905 606 | OE247 |
| 04C 905 606 A | OE247 |
| 04C 905 616 | OE247 |
| 04C 905 616 A | OE247 |
| 06H 905 601 A | OE214 |

| VW | CHAMPION |
|----------------|----------|
| 06H 905 611 | OE214 |
| 06H 905 621 | OE214 |
| 06H 905 621 A | OE214 |
| 06K 905 601 B | OE246 |
| 06K 905 601 D | OE246 |
| 06K 905 611 C | OE246 |
| 06K 905 621 | OE246 |
| 079 905 626 B | OE219 |
| 079 905 626 D | OE220 |
| 079 905 626 E | OE219 |
| 079 905 626 G | OE220 |
| 101 000 000 AA | OE087 |
| 101 000 000 AB | OE001 |
| 101 000 000 AC | OE015 |
| 101 000 001 AA | OE012 |
| 101 000 001 AB | OE012 |
| 101 000 001 AC | OE012 |
| 101 000 001 AD | OE044 |
| 101 000 001 AE | OE044 |
| 101 000 002 AA | OE015 |
| 101 000 002 AB | OE001 |
| 101 000 002 AC | OE010 |
| 101 000 002 AD | OE087 |
| 101 000 002 AE | OE008 |
| 101 000 003 AA | OE094 |
| 101 000 003 AB | OE094 |
| 101 000 004 AA | OE094 |
| 101 000 005 AA | OE012 |
| 101 000 005 AB | OE012 |
| 101 000 005 AC | OE012 |
| 101 000 005 AD | OE044 |
| 101 000 005 AE | OE044 |
| 101 000 005 AF | OE027 |
| 101 000 006 AA | OE087 |
| 101 000 006 AB | OE010 |
| 101 000 006 AC | OE001 |
| 101 000 006 AD | OE015 |
| 101 000 006 AF | OE008 |
| 101 000 007 AA | OE012 |
| 101 000 007 AB | OE012 |
| 101 000 007 AC | OE044 |
| 101 000 007 AD | OE044 |
| 101 000 009 AA | OE074 |
| 101 000 012 AA | OE074 |
| 101 000 013 AA | OE014 |
| 101 000 014 AA | OE014 |
| 101 000 015 AA | OE009 |
| 101 000 015 AC | OE009 |
| 101 000 016 AA | OE136 |
| 101 000 017 AA | OE094 |
| 101 000 018 AA | OE015 |
| 101 000 019 AA | OE015 |
| 101 000 020 AA | OE015 |



OE ? \Rightarrow

| VW | CHAMPION | VW | CHAMPION | VW | CHAMPION | VW | CHAMPION |
|----------------|----------|----------------|----------|--------------|----------|--------------|----------|
| 101 000 026 AA | OE027 | 101 905 620 | OE136 | N 017 801 2 | L82C | N 017 811 70 | OE074 |
| 101 000 026 AB | OE025 | 101 905 620 | OE234 | N 017 801 3 | L78C | N 017 811 71 | OE087 |
| 101 000 027 AA | OE012 | 101 905 621 | OE209 | N 017 801 7 | L82C | N 017 811 72 | OE012 |
| 101 000 027 AB | OE044 | 101 905 621 A | OE209 | N 017 801 8 | L82C | N 017 811 73 | OE012 |
| 101 000 027 AC | OE044 | 101 905 621 B | OE209 | N 017 802 1 | L82C | N 017 811 74 | OE012 |
| 101 000 029 AB | OE011 | 101 905 621 C | OE209 | N 017 802 13 | L82C | N 017 811 75 | OE015 |
| 101 000 033 AA | OE032 | 101 905 631 | OE214 | N 017 803 9 | L82C | N 017 811 76 | OE087 |
| 101 000 033 AB | OE094 | 101 905 631 A | OE146 | N 017 811 1 | OE074 | N 017 811 77 | OE010 |
| 101 000 033 AC | OE123 | 101 905 631 B | OE214 | N 017 811 12 | OE010 | N 017 811 78 | OE001 |
| 101 000 033 AF | OE032 | 101 905 631 F | OE188 | N 017 811 13 | OE010 | N 017 811 79 | OE015 |
| 101 000 033 AG | OE019 | 101 905 631 G | OE214 | N 017 811 14 | OE010 | N 017 811 8 | OE074 |
| 101 000 033 AG | OE032 | 101 905 631 H | OE214 | N 017 811 17 | OE074 | N 017 812 1 | OE074 |
| 101 000 034 AA | OE001 | 101 905 640 D | OE209 | N 017 811 18 | OE010 | N 017 812 12 | OE010 |
| 101 000 035 AB | OE123 | 101 905 641 | OE219 | N 017 811 19 | OE074 | N 017 812 13 | OE010 |
| 101 000 035 AH | OE198 | 101.000.007.AA | OE012 | N 017 811 20 | OE010 | N 017 812 15 | OE074 |
| 101 000 035 HJ | OE237 | 101.000.007.AB | OE012 | N 017 811 21 | OE001 | N 017 812 18 | OE087 |
| 101 000 036 AA | OE025 | 101.000.017.AA | OE094 | N 017 811 22 | OE010 | N 017 812 19 | OE001 |
| 101 000 036 AB | OE027 | 101.905.611 | OE136 | N 017 811 23 | OE087 | N 017 812 20 | OE010 |
| 101 000 036 AC | OE027 | 101000005AB | OE044 | N 017 811 24 | OE074 | N 017 812 21 | OE087 |
| 101 000 038 AA | OE027 | 101000035AH | OE191 | N 017 811 25 | OE087 | N 017 812 22 | OE074 |
| 101 000 038 AB | OE027 | 101905600 | OE176 | N 017 811 26 | OE015 | N 017 812 23 | OE010 |
| 101 000 039 AA | OE027 | 101905600A | OE176 | N 017 811 27 | OE001 | N 017 812 24 | OE015 |
| 101 000 039 AB | OE027 | 101905601B | OE177 | N 017 811 28 | OE001 | N 017 812 25 | OE074 |
| 101 000 040 AC | OE027 | 101905601E | OE177 | N 017 811 30 | OE074 | N 017 812 27 | OE001 |
| 101 000 040 AD | OE025 | 101905601F | OE177 | N 017 811 31 | OE001 | N 017 812 30 | OE001 |
| 101 000 040 AE | OE027 | 101905603B | OE177 | N 017 811 32 | OE087 | N 017 812 34 | OE015 |
| 101 000 041 AC | OE032 | 101905617 | OE177 | N 017 811 36 | OE015 | N 017 812 35 | OE087 |
| 101 000 041 AE | OE094 | 101905620 | OE176 | N 017 811 39 | OE001 | N 017 812 36 | OE001 |
| 101 000 041 AF | OE123 | 191 905 450 | OE012 | N 017 811 40 | OE012 | N 017 812 37 | OE010 |
| 101 000 041 AG | OE032 | 191 905 450 A | OE012 | N 017 811 41 | OE010 | N 017 812 39 | OE087 |
| 101 000 045 AA | OE032 | 191 905 450 B | OE044 | N 017 811 47 | OE015 | N 017 812 4 | OE010 |
| 101 000 050 AA | OE027 | 191 905 450 C | OE012 | N 017 811 48 | OE015 | N 017 812 40 | OE010 |
| 101 000 050 AB | OE027 | 191 905 450 G | OE094 | N 017 811 49 | OE087 | N 017 812 41 | OE015 |
| 101 000 050 AC | OE025 | 191 905 450 H | OE012 | N 017 811 50 | OE010 | N 017 812 44 | OE087 |
| 101 000 051 AA | OE032 | 191 905 450 J | OE094 | N 017 811 51 | OE001 | N 017 812 46 | OE012 |
| 101 000 052 AA | OE011 | 191 905 450 K | OE044 | N 017 811 52 | OE010 | N 017 812 47 | OE012 |
| 101 000 055 AA | OE019 | 191 905 450 L | OE087 | N 017 811 53 | OE015 | N 017 812 48 | OE012 |
| 101 000 062 AB | OE176 | 191 905 450 M | OE010 | N 017 811 54 | OE012 | N 017 812 49 | OE012 |
| 101 000 063 AA | OE136 | 191 905 450 N | OE001 | N 017 811 55 | OE010 | N 017 812 50 | OE044 |
| 101 000 063 AC | OE136 | 191 905 450 P | OE015 | N 017 811 56 | OE044 | N 017 812 51 | OE012 |
| 101 000 065 AA | OE136 | 191 905 452 | OE087 | N 017 811 57 | OE012 | N 017 812 52 | OE012 |
| 101 905 600 | OE176 | 191 905 452 A | OE010 | N 017 811 58 | OE044 | N 017 812 56 | OE044 |
| 101 905 600 A | OE176 | 191 905 452 B | OE001 | N 017 811 59 | OE087 | N 017 812 57 | OE015 |
| 101 905 600 C | OE176 | 191 905 452 C | OE015 | N 017 811 6 | OE087 | N 017 812 58 | OE001 |
| 101 905 601 | OE176 | 191 905 452 D | OE012 | N 017 811 60 | OE012 | N 017 812 6 | OE087 |
| 101 905 601 B | OE177 | 191 905 452 E | OE012 | N 017 811 61 | OE012 | N 017 812 60 | OE087 |
| 101 905 601 F | OE177 | 191 905 452 F | OE012 | N 017 811 63 | OE001 | N 017 812 7 | OE012 |
| 101 905 603 B | OE177 | 191 905 452 G | OE044 | N 017 811 64 | OE012 | N 017 812 9 | OE087 |
| 101 905 609 | OE235 | 191 905 452 H | OE094 | N 017 811 65 | OE044 | N 017 813 1 | OE074 |
| 101 905 610 A | OE146 | N 012 812 36 | OE001 | N 017 811 66 | OE001 | N 017 813 10 | OE010 |
| 101 905 611 G | OE214 | N 017 801 1 | L82C | N 017 811 67 | OE012 | N 017 813 11 | OE015 |
| 101 905 617 | OE177 | N 017 801 11 | L82C | N 017 811 68 | OE012 | N 017 813 12 | OE010 |
| 101 905 617 C | OE177 | N 017 801 13 | L82C | N 017 811 69 | OE012 | N 017 813 13 | OE010 |

OE ? ⇌



| VW | CHAMPION |
|--------------|----------|
| N 017 813 14 | OE074 |
| N 017 813 15 | OE074 |
| N 017 813 16 | OE087 |
| N 017 813 17 | OE087 |
| N 017 813 18 | OE010 |
| N 017 813 19 | OE001 |
| N 017 813 20 | OE001 |
| N 017 813 24 | OE010 |
| N 017 813 26 | OE001 |
| N 017 813 3 | OE074 |
| N 017 813 30 | OE010 |
| N 017 813 32 | OE087 |
| N 017 813 33 | OE001 |
| N 017 813 39 | OE087 |
| N 017 813 40 | OE001 |
| N 017 813 42 | OE001 |
| N 017 813 43 | OE087 |
| N 017 813 45 | OE012 |
| N 017 813 46 | OE012 |
| N 017 813 47 | OE012 |
| N 017 813 50 | OE012 |
| N 017 813 53 | OE087 |
| N 017 813 54 | OE010 |
| N 017 813 55 | OE015 |
| N 017 813 6 | OE010 |
| N 017 813 7 | OE010 |
| N 017 813 8 | OE087 |
| N 017 813 9 | OE010 |
| N 017 821 1 | OE001 |
| N 017 832 1 | OE087 |
| N 017 832 2 | OE087 |
| N 100 807 02 | OE094 |
| N 100 807 1 | OE094 |
| N 101 172 01 | OE094 |
| N 101 251 05 | OE009 |
| Z 057 003 | L82C |
| Z 057 004 | OE074 |
| Z 057 005 | OE015 |
| Z 057 008 | OE074 |
| Z 057 011 | OE001 |
| Z 057 012 | OE087 |
| Z 057 020 | OE094 |
| Z 057 023 | OE010 |
| Z 057 037 | OE074 |
| Z 057 040 | OE010 |
| Z 057 056 | OE001 |
| Z 057 057 | OE074 |
| Z 057 058 | OE087 |
| Z 057 059 | OE074 |
| Z 057 060 | L82C |
| Z 057 062 | OE010 |
| Z 057 064 | L82C |
| Z 057 065 | OE074 |

| VW | CHAMPION |
|-----------------|-----------------|
| Z 057 066 | OE012 |
| Z 057 067 | OE012 |
| Z 057 068 | OE012 |
| Z 057 069 | OE044 |
| Z 057 073 | OE094 |
| Z 057 127 | OE015 |
| Z 057 128 | OE078 |
| Z 057 136 | OE015 |
| Z 057 140 | OE087 |
| Z 057 141 | OE010 |
| Z 057 142 | OE001 |
| Z 057 143 | OE015 |
| Z 057 145 | OE009 |
| Z 057 173 | OE014 |
| ZUENDAPP | CHAMPION |
| 247 07 106 | L82C |
| 250 07 604 | L82C |
| 265 07 101 | L82C |
| 276 07 106 | L78C |
| 280 07 140 | OE074 |
| 280 07 142 | OE001 |
| 280 07 143 | OE087 |

OE ? ⇒



| | | | | | | | |
|-------------------|---------|----------------|-------|-------------------------|-------|---------------|-------|
| ALFA ROMEO | | CITROËN | | CITROËN | | FIAT | |
| 46072001 | CH189 | 5960 66 | CH170 | 5962T1 | CH173 | 4754011 | CH189 |
| 46754154 | CH222 | 5960 67 | CH170 | 5962T2 | CH260 | 4774412 | CH189 |
| 472 95 95 | CH189 | 5960 69 | CH185 | 5962W2 | CH185 | 4774413 | CH189 |
| 55200817 | CH269 | 5960 77 | CH240 | 5962W8 | CH189 | 4781356 | CH189 |
| 605 96 245 | CH189 | 5960 78 | CH201 | 9 633 214 380 | CH189 | 4849406 | CH189 |
| 60596245 | CH189 | 5960 A4 | CH270 | 90 041 002 80 | CH147 | 500303569 | CH216 |
| 606 17 002 | CH181 | 5960 F4 | CH268 | 91 536 646 | CH189 | 500316493 | CH216 |
| 60617002 | CH181 | 5960.79 | CH201 | 91 538 910 99 | CH147 | 500351992 | CH270 |
| 60816139 | CH222 | 596064 | CH268 | 91536646 | CH189 | 5493206 | CH189 |
| 71735458 | CH222 | 596065 | CH268 | 95 493 206 | CH189 | 55187863 | CH224 |
| 71735465 | CH181 | 596069 | CH185 | 95 534 788 | CH189 | 55200817 | CH269 |
| AUDI | | 5960F9 | CH201 | 96 070 388 80 | CH147 | 5950464 | CH189 |
| 059 963 319 AC | CCGP010 | 5961 54 | CH189 | 96 076 258 | CH147 | 5951861 | CH189 |
| 059 963 319 T | CCGP010 | 5962 008 | CH189 | 96 076 258 | CH189 | 5951861(FU2B) | CH189 |
| 059963319A | CH215 | 5962 1R | CH189 | 96 141 678 | CH189 | 5951879 | CH189 |
| BMW | | 5962 1T | CH189 | 96 165 724 | CH189 | 5951881 | CH189 |
| 0 038 490 | CCGP001 | 5962 1V | CH189 | 96 236 383 | CH170 | 5951881(FU2A) | CH189 |
| 12 12 1 286 059 | CH189 | 5962 1W | CH147 | 96 316 589 80 | CH185 | 5951882 | CH189 |
| 12 12 1 288 161 | CH189 | 5962 1X | CH260 | 96 389 858 | CH170 | 5973752 | CH189 |
| 12 23 0 038 490 | CCGP001 | 5962 1Y | CH173 | 96141678 | CH189 | 5973753 | CH189 |
| 12 23 1 288 245 | CH189 | 5962 1Z | CH260 | 9631658980 | CH185 | 606 17 002 | CH181 |
| 12 23 2 240 255 | CH189 | 5962 2Z | CH185 | MKP 000 65 | CH189 | 60812292 | CH189 |
| 12 23 2 241 387 | CH189 | 5962 3C | CH170 | MKP 000 71 | CH260 | 71719015 | CH189 |
| 12 23 2 241 388 | CH189 | 5962 3E | CH170 | MKP00071 | CH260 | 71735458 | CH222 |
| 12 23 2 241 389 | CH189 | 5962 3H | CH189 | CITROEN/ PEUGEOT | | 71735459 | CH167 |
| 12 23 2 248 059 | CH203 | 5962 3J | CH189 | 5960 88 | CH229 | 71735460 | CH147 |
| 12 23 22 48 422 | CH207 | 5962 5A | CH216 | 5960 89 | CH229 | 71735461 | CH189 |
| 12 23 9 061 353 | CH189 | 5962 7F | CH170 | DAF | | 71735462 | CH216 |
| 12 23 9 061 354 | CH189 | 5962 7G | CH170 | 0192618 | CH189 | 71735464 | CH209 |
| 12231288245 | CH189 | 5962 J3 | CH147 | 105977 | CH189 | 762266740 | CH189 |
| 12232240255 | CH189 | 5962 J4 | CH189 | 1353958 | CH189 | 7702960 | CH189 |
| 12232241387 | CH189 | 5962 J7 | CH260 | DAIHATSU | | 7735920 | CH189 |
| 12232241389 | CH189 | 5962 R8 | CH189 | 1985054030000 | CH154 | 77359200 | CH189 |
| 12232248059 | CH203 | 5962 S8 | CH189 | 1985054030000 | CH154 | 7777837 | CH147 |
| 12239061353 | CH189 | 5962 T1 | CH173 | 1985054090000 | CH154 | 96 515 836 80 | CH268 |
| 12239061354 | CH189 | 5962 T1 | CH189 | 1985054090000 | CH154 | 9616472480 | CH189 |
| 7 810 858 | CCGP001 | 5962 T2 | CH260 | 1985054090000 | CH154 | 96165724 | CH189 |
| 7 810 858 01 | CCGP001 | 5962 W2 | CH185 | 1985054090000 | CH154 | 9623638380 | CH170 |
| 7 810 858 02 | CCGP001 | 5962 W8 | CH189 | 1985054090000 | CH154 | 9631658980 | CH185 |
| CHEVROLET | | 5962 X1 | CH189 | 1985054090000 | CH154 | 9633214380 | CH189 |
| 71735458 | CH222 | 5962008 | CH189 | 1985054090000 | CH154 | 9638985980 | CH170 |
| 89 417 515 81 | CH306 | 596203 | CH189 | 1985054090000 | CH154 | 9650100080 | CH201 |
| CHRYSLER | | 59621R | CH189 | 1985054090000 | CH154 | 9651029780 | CH170 |
| 05066840 AA | CH180 | 59621T | CH189 | 1985054090000 | CH154 | 9651029880 | CH185 |
| 05066840AA | CH180 | 59621V | CH189 | 1985054090000 | CH154 | 98462490 | CH189 |
| T0701 130 | CH189 | 59621W | CH147 | 1985054090000 | CH154 | 98498630 | CH147 |
| CITROËN | | 59621X | CH260 | 1985054090000 | CH154 | F 2 VB | CH189 |
| 5 962 58 | CH189 | 59621Y | CH173 | 1985054090000 | CH154 | F 4 VB | CH189 |
| 5960 64 | CH268 | 59621Z | CH260 | 1985054090000 | CH154 | F2VB | CH189 |
| 5960 65 | CH268 | 59622Z | CH185 | 1985054090000 | CH154 | FU 2 A | CH189 |
| | | 59623E | CH170 | 1985054090000 | CH154 | FU 4 A | CH189 |
| | | 59623J | CH189 | 1985054090000 | CH154 | FU2A | CH189 |
| | | 596258 | CH189 | 1985054090000 | CH154 | FU4A | CH189 |

OE ? ⇒



| FORD | CHAMPION |
|------------------|----------|
| 1 001 049 | CH205 |
| 1 008 792 | CH205 |
| 1 045 261 | CH205 |
| 1 079 401 | CH196 |
| 1 309 471 | CH229 |
| 1 313 809 | CH268 |
| 1 473 356 | CH268 |
| 1 587 444 | CH189 |
| 1 590 417 | CH260 |
| 1 952 464 | CH186 |
| 1008792 | CH205 |
| 1037204 | CH271 |
| 105 68 57 | CH205 |
| 1056857 | CH205 |
| 1079401 | CH196 |
| 1207068 | CH181 |
| 1313809 | CH268 |
| 1447128 | CH201 |
| 1536023 | CH242 |
| 1669977 | CH271 |
| 1690048 | CH181 |
| 1952464 | CH186 |
| 1M21-18B515-AA | CH181 |
| 2S6Q 6M090 BB | CH201 |
| 3M5Q 6M090AB | CH268 |
| 3M5Q 6M090AC | CH268 |
| 4 025 139 | CH242 |
| 4 612 191 | CH229 |
| 4U3Q-6M090-AA | CH240 |
| 4U3Q-6M090-AB | CH240 |
| 4U3Q-AA | CH240 |
| 4U3Q-AB | CH240 |
| 6 063 505 | CH189 |
| 6 075 812 | CH147 |
| 6 075 812 | CH260 |
| 6 154 593 | CH189 |
| 6 163 811 | CH147 |
| 6075812 | CH260 |
| 6154593 | CH189 |
| 7 072 673 | CH189 |
| 7 088 988 | CH147 |
| 7072673 | CH189 |
| 7088988 | CH147 |
| 78 GB 6 M 090 CA | CH189 |
| 785 F 6M090 BA | CH189 |
| 785 F 6M090 CB | CH189 |
| 786 B 6M090 CA | CH189 |
| 795 F 6M090 AA | CH260 |
| 795 F 6M090 CA | CH260 |
| 795F6M090AA | CH260 |
| 795F6M090CA | CH260 |
| 83 BB 6M090 A1A | CH189 |
| 83 BB 6M090 A2A | CH189 |

| FORD | CHAMPION |
|-----------------|----------|
| 83BB6M090A1A | CH189 |
| 83BB6M090A2A | CH189 |
| 84 BB 6M090 AA | CH189 |
| 84 FF 6M090 B2A | CH189 |
| 84BB6M090AA | CH189 |
| 89 FF 6M090 AA | CH147 |
| 89 FF 6M091 AA | CH147 |
| 89 FF 6M091 AA | CH189 |
| 89FF6M090AA | CH147 |
| 910 X 6M090 AA | CH173 |
| 910 X 6M090 BA | CH189 |
| 910X6M090AA | CH173 |
| 910X6M090BA | CH189 |
| 93 FF 6M090 AA | CH147 |
| 93FF6M090AA | CH147 |
| 94 DD 6M090 AA | CH189 |
| 95 DD 6M 090 AA | CH181 |
| 95VW-6M090-AA | CH271 |
| 95VW-6M090-AB | CH271 |
| 96 FF 6M090 AA | CH205 |
| 96 FF 6M090 AB | CH205 |
| 96 FF 6M090 BA | CH205 |
| 96 FF 6M090 BB | CH205 |
| 96 FF 6M090 CA | CH205 |
| 96FF6M090AA | CH205 |
| 96FF6M090AB | CH205 |
| 96FF6M090BA | CH205 |
| 96FF6M090BB | CH205 |
| 99 FF 6M090 AA | CH205 |
| 99FF6M090AA | CH205 |
| V94DX6M090AA | CH189 |
| XM 34 12A342 BA | CH242 |
| XS 7U 6M090 BA | CH229 |
| XS 7U 6M090 BB | CH229 |
| XS4U6M090AB | CH196 |
| FORD OTOSAN | CHAMPION |
| 1C10 6M090 AA | CH229 |
| GENERAL MOTORS | CHAMPION |
| 09118201 | CH207 |
| 55 233 532 | CPSG003 |
| 55 237 483 | CPSG003 |
| 55 565 634 | CPSG003 |
| 55 568 366 | CPSG004 |
| 55 577 419 | CPSG003 |
| 55 579 436 | CPSG006 |
| 55 580 403 | CPSG003 |
| 55 590 466 | CPSG004 |
| 55 590 467 | CPSG006 |
| 88 900 716 | CH181 |
| 88 900 717 | CH215 |
| 88 900 718 | CH219 |

| GENERAL MOTORS | CHAMPION |
|----------------|----------|
| 88 900 720 | CH205 |
| 88 900 721 | CH203 |
| 88 900 722 | CH271 |
| 88 900 723 | CH260 |
| 88 900 724 | CH175 |
| 88 900 728 | CH189 |
| 88 900 729 | CH167 |
| 88 900 730 | CH189 |
| 88 900 731 | CH189 |
| 88 900 734 | CH189 |
| 88 900 735 | CH147 |
| 88 900 736 | CH189 |
| 88 900 737 | CH147 |
| 88 900 741 | CH176 |
| 90 487 858 | CH189 |
| 90 569 338 | CH207 |
| 91 153 919 | CH181 |
| 91 182 01 | CH207 |
| 9111145 | CH147 |
| 9196669 | CH231 |
| 9201698 | CH232 |
| 93 190 433 | CH269 |
| 93161342 | CH232 |
| 93161489 | CH232 |
| 93178225 | CH231 |
| 93178411 | CH224 |
| 93180295 | CH222 |
| 93197244 | CH231 |
| 93198468 | CCGP007 |
| 94 133 759 | CH306 |
| 94 140 115 | CH306 |
| 94 175 158 | CH306 |
| 95508487 | CH224 |
| 95508488 | CH231 |
| 95508489 | CH222 |
| 95508493 | CH232 |
| 97 464 737 | CH231 |
| GLAS | CHAMPION |
| B 18 N | CH260 |
| B 19 N | CH189 |
| B 20 N | CH189 |
| B 22 N | CH189 |
| B 23 R | CH189 |
| B 26 SR | CH173 |
| B 27 SR | CH147 |
| B 29 SR | CH189 |
| B 30 SR | CH189 |
| B 31 SR | CH189 |
| B 32 R | CH189 |
| B 41 SR | CH176 |
| B 42 SR | CH147 |
| B 44 SR | CH189 |

| GLAS | CHAMPION |
|----------------|----------|
| B 48 R | CH173 |
| HONDA | CHAMPION |
| 12291P5TG02 | CH169 |
| 31812-ZG5-0030 | CH302 |
| HYUNDAI | CHAMPION |
| 36710-27000 | CH226 |
| 36710-27010 | CH226 |
| 36710-42000 | CH225 |
| 36710-42010 | CH225 |
| 36710-42020 | CH225 |
| 36710-42021 | CH225 |
| 36710-42060 | CH225 |
| 36710-42500 | CH256 |
| 36710-42510 | CH225 |
| 36710-4A000 | CH234 |
| 36710-4A100 | CH234 |
| IFA | CHAMPION |
| 834019 | CH260 |
| ISUZU | CHAMPION |
| 5-81410-040-0 | CH302 |
| 5-81410-057-3 | CH215 |
| 8 94133 759 2 | CH306 |
| 8 94133 759 3 | CH306 |
| 8 94133 759 5 | CH306 |
| 8 94133 759 6 | CH306 |
| 8 94140 153 | CH306 |
| 8 94175 158 0 | CH306 |
| 8 94481 972 0 | CH158 |
| 8-94133-759-0 | CH306 |
| 8-94133-759-1 | CH306 |
| 8-94133-759-4 | CH306 |
| 8-94133-759-7 | CH306 |
| 8944819720 | CH158 |
| 8-94751-581 | CH306 |
| 8-97073-641-0 | CH306 |
| IVECO | CHAMPION |
| 004 729 585 | CH189 |
| 27600323 | CH270 |
| 4841294 | CH189 |
| 98459883 | CH147 |
| JAGUAR | CHAMPION |
| 02 JD 61164 | CH229 |
| 02 JD 61604 | CH240 |
| JEEP | CHAMPION |
| 0 506 6840 AA | CH180 |
| 04 86 38 26 | CH181 |
| 04 86 38 26 AA | CH181 |



OE ? ⇒



| | | | | | | | |
|-------------------|-------|----------------------|---------|---------------|---------|-------------|---------|
| KHD | | MERCEDES-BENZ | | NISSAN | | OPEL | |
| 472 9585 | CH189 | 000 159 75 01 | CH189 | 11065-00Q00 | CH271 | 12 14 088 | CPSG004 |
| 478 1356 | CH189 | 000 159 77 01 | CH189 | 11065-00Q0A | CH232 | 12 14 101 | CPSG006 |
| KIA | | 000 159 81 01 | CH189 | 11065-00QAA | CH271 | 12 14 104 | CPSG004 |
| OK054-18140 | CH242 | 000 159 83 01 | CH189 | 11065-00QAF | CH271 | 12 14 304 | CH189 |
| OK710-18140 | CH242 | 000 159 96 01 | CH189 | 11065-00QAG | CH271 | 12 14 305 | CH231 |
| OK710-18140A | CH242 | 000 159 99 01 | CH189 | 11065-0W801 | CH186 | 12 14 306 | CH189 |
| OK71E-18140A | CH242 | 001 159 00 01 | CH176 | 11065-31N00 | CH186 | 12 14 307 | CH189 |
| OK75A-18140 | CH242 | 001 159 02 01 | CH189 | 11065-43G01 | CH221 | 12 14 310 | CH158 |
| OK75B-18140 | CH242 | 001 159 15 01 | CH175 | 11065-57J00 | CH600 | 12 14 317 | CH189 |
| 36710-27000 | CH226 | 001 159 16 01 | CH175 | 11065-5C900 | CH600 | 12 14 319 | CH189 |
| 36710-27010 | CH226 | 001 159 17 01 | CH176 | 11065-63G00 | CH221 | 12 14 320 | CH158 |
| 36710-42000 | CH225 | 001 159 21 01 | CH177 | 11065-65N01 | CH186 | 12 14 321 | CH306 |
| 36710-42010 | CH225 | 001 159 22 01 | CH189 | 11065-7C000 | CH186 | 12 14 323 | CH306 |
| 36710-42020 | CH225 | 001 159 26 01 | CH204 | 11065-9C600 | CH186 | 12 14 324 | CH189 |
| 36710-42021 | CH225 | 001 159 27 01 | CH219 | 11065-AD 200 | CH230 | 12 14 427 | CH181 |
| 36710-42060 | CH225 | 001 159 35 01 | CH189 | 11065-AD 201 | CH230 | 12 14 456 | CH207 |
| 36710-42500 | CH256 | 001 159 36 01 | CH176 | 11065-AD 20A | CH230 | 12 14 457 | CH207 |
| 36710-42510 | CH225 | 001 159 51 01 | CH704 | 11065-AD200 | CH230 | 1214033 | CH189 |
| 36710-4A000 | CH234 | 001 159 52 01 | CH704 | 11065-AD201 | CH230 | 121418 | CH203 |
| 36710-4A100 | CH234 | 001 159 75 01 | CH704 | 11065-AD210 | CH230 | 1214304 | CH189 |
| LANCIA | | A 000 159 75 01 | CH189 | 11065-AD220 | CH230 | 1214305 | CH189 |
| 46754154 | CH222 | A 000 159 81 01 | CH189 | 11065-BN701 | CH271 | 1214306 | CH189 |
| 60 812 292 | CH189 | A 000 159 83 01 | CH189 | 11065-G2400 | CH186 | 1214307 | CH189 |
| 606 17 002 | CH181 | A 001 159 15 01 | CH175 | 11065-HA300 | CH242 | 1214310 | CH158 |
| 71735458 | CH222 | A 001 159 16 01 | CH175 | 11065-V0700 | CH260 | 1214317 | CH189 |
| 77359200 | CH189 | A 001 159 20 01 | CH177 | 11065-V0710 | CH260 | 1214319 | CH189 |
| LAND ROVER | | A 001 159 21 01 | CH177 | 11065-Y 9703 | CH260 | 1214427 | CH181 |
| 1354289 | CH240 | A 001 159 26 01 | CH204 | 758 000 06-0 | CH189 | 1214457 | CH207 |
| ERR6066 | CH272 | A 001 159 27 01 | CH219 | OPEL | | 43 00 425 | CH306 |
| STC3103 | CH189 | A 001 159 51 01 | CH704 | 09 110 945 | CH217 | 43 00 615 | CH306 |
| LEYLAND | | A 001 159 52 01 | CH704 | 12 14 018 | CH203 | 44 02 724 | CH271 |
| 075 95 77 | CH167 | A 001 159 75 01 | CH704 | 12 14 020 | CH271 | 44 02 945 | CH217 |
| LOMBARDINI | | MITSUBISHI | | 12 14 033 | CH231 | 44 03 145 | CH147 |
| 21001110 | CH189 | 3671042500 | CH256 | 12 14 034 | CH224 | 44 09 469 | CH271 |
| MAN | | M 816 732 | CH260 | 12 14 040 | CH222 | 44 16 912 | CH271 |
| 000 159 8101 | CH189 | M 883 828 | CH271 | 12 14 042 | CH158 | 44 30 069 | CH232 |
| 000 159 83 01 | CH189 | MD 050 212 | CH221 | 12 14 044 | CH189 | 44 30 920 | CH232 |
| MAZDA | | MD 070 194 | CH221 | 12 14 054 | CH207 | 44 35 091 | CCGP007 |
| RF 1M-18-601 | CH242 | MD 077 167 | CH221 | 12 14 056 | CH231 | 4403145 | CH147 |
| RFG 1 18 601 | CH242 | MD 197511 | CH256 | 12 14 057 | CPSG003 | 45 06 155 | CH232 |
| RFN 1 18 601 | CH242 | MD 301950 | CH256 | 12 14 061 | CPSG003 | 55 187 863 | CH224 |
| RFN 1 18 601 A | CH242 | MD 344469 | CH256 | 12 14 064 | CH269 | 55568366 | CPSG004 |
| RFR 1 18 601 | CH242 | MD 354500 | CH256 | 12 14 071 | CH224 | 56 14 218 | CH189 |
| S 210 18 140 | CH242 | ME 203 539 | CH263 | 12 14 072 | CH231 | 5614216 | CH260 |
| VS01-18-601 | CH158 | ME203539 | CH263 | 12 14 073 | CH222 | 5614218 | CH189 |
| WL 01 18 601 | CH242 | MQ 901659 | CH242 | 12 14 074 | CH189 | 5614219 | CH260 |
| WL 03 18 601 | CH242 | MR 577131 | CH256 | 12 14 074 | CH189 | 88 900 716 | CH181 |
| WL 81-18-601 | CH242 | MRS77131 | CH256 | 12 14 080 | CH232 | 88 900 717 | CH215 |
| | | NISSAN | | 12 14 082 | CH271 | 88 900 718 | CH219 |
| | | 11065 00Q0C | CCGP007 | 12 14 084 | CH207 | 88 900 720 | CH205 |
| | | 11065 5X00A | CCGP007 | 12 14 085 | CH158 | 88 900 721 | CH203 |
| | | | | 12 14 086 | CPSG003 | 88 900 722 | CH271 |
| | | | | 12 14 087 | CPSG006 | 88 900 723 | CH260 |

OE ? ⇒



| OPEL | CHAMPION |
|------------|----------|
| 88 900 724 | CH175 |
| 88 900 725 | CH189 |
| 88 900 728 | CH189 |
| 88 900 729 | CH167 |
| 88 900 730 | CH189 |
| 88 900 731 | CH189 |
| 88 900 734 | CH189 |
| 88 900 735 | CH147 |
| 88 900 736 | CH189 |
| 88 900 737 | CH147 |
| 88 900 740 | CH173 |
| 88 900 741 | CH176 |
| 88900716 | CH181 |
| 88900717 | CH215 |
| 88900718 | CH219 |
| 88900720 | CH205 |
| 88900721 | CH203 |
| 88900722 | CH271 |
| 88900723 | CH260 |
| 88900724 | CH175 |
| 88900725 | CH189 |
| 88900726 | CH185 |
| 88900727 | CH177 |
| 88900728 | CH189 |
| 88900729 | CH167 |
| 88900731 | CH189 |
| 88900733 | CH189 |
| 88900734 | CH189 |
| 88900736 | CH189 |
| 88900737 | CH147 |
| 88900738 | CH189 |
| 88900740 | CH173 |
| 90 051 950 | CH189 |
| 90 093 867 | CH189 |
| 90 093 897 | CH189 |
| 90 166 155 | CH189 |
| 90 210 824 | CH189 |
| 90 487 858 | CH189 |
| 90 509 368 | CH189 |
| 90 510 924 | CH189 |
| 90 540 864 | CH189 |
| 90 569 338 | CH207 |
| 90051950 | CH189 |
| 90093867 | CH189 |
| 90093897 | CH189 |
| 90166155 | CH189 |
| 90210824 | CH189 |
| 90487858 | CH189 |
| 90569338 | CH207 |
| 91 10 724 | CH271 |
| 91 10 945 | CH217 |
| 91 111 45 | CH147 |
| 91 182 01 | CH207 |

| OPEL | CHAMPION |
|-------------|----------|
| 91153919 | CH181 |
| 9118201 | CH207 |
| 93 171 875 | CH203 |
| 93 178 411 | CH224 |
| 93 183 738 | CH158 |
| 93 183 740 | CH189 |
| 93 189 648 | CH271 |
| 93 197 242 | CH207 |
| 93171875 | CH203 |
| 94 387 612 | CH158 |
| 94 481 972 | CH158 |
| 94481972 | CH158 |
| 95 508 201 | CH207 |
| 95 508 487 | CH224 |
| 95 508 490 | CH189 |
| 95 508 494 | CH271 |
| 95 508 508 | CH158 |
| PERKINS | CHAMPION |
| 2666A004 | CH167 |
| K 166 AF 01 | CH189 |
| PEUGEOT | CHAMPION |
| 5960 64 | CH268 |
| 5960 65 | CH268 |
| 5960 66 | CH170 |
| 5960 67 | CH170 |
| 5960 76 | CH240 |
| 5960 79 | CH201 |
| 5960 A3 | CH270 |
| 5960 A4 | CH270 |
| 5960 F4 | CH268 |
| 5960 K4 | CH270 |
| 5960.78 | CH201 |
| 596064 | CH268 |
| 596065 | CH268 |
| 5960F9 | CH201 |
| 5961 39 | CH189 |
| 5961 40 | CH189 |
| 5961 53 | CH189 |
| 5961 54 | CH189 |
| 5961 57 | CH189 |
| 5961 58 | CH189 |
| 596139 | CH189 |
| 596140 | CH189 |
| 596153 | CH189 |
| 596157 | CH189 |
| 5962 03 | CH189 |
| 5962 1Z | CH260 |
| 5962 2Y | CH185 |
| 5962 35 | CH189 |
| 5962 3C | CH170 |
| 5962 3E | CH170 |

| PEUGEOT | CHAMPION |
|---------------|----------|
| 5962 3H | CH189 |
| 5962 3J | CH189 |
| 5962 4Z | CH216 |
| 5962 74 | CH189 |
| 5962 7A | CH189 |
| 5962 7F | CH170 |
| 5962 7G | CH170 |
| 5962 J2 | CH173 |
| 5962 J3 | CH147 |
| 5962 J3 | CH189 |
| 5962 J4 | CH189 |
| 5962 J5 | CH189 |
| 5962 J6 | CH189 |
| 5962 J7 | CH260 |
| 5962 K5 | CH189 |
| 5962 R8 | CH189 |
| 5962 S8 | CH189 |
| 5962 T1 | CH173 |
| 5962 T2 | CH260 |
| 5962 T7 | CH147 |
| 5962 W3 | CH185 |
| 5962 X1 | CH189 |
| 59622Y | CH185 |
| 596235 | CH189 |
| 59623C | CH170 |
| 59623H | CH189 |
| 596274 | CH189 |
| 5962J2 | CH173 |
| 5962J4 | CH189 |
| 5962J5 | CH189 |
| 5962J6 | CH189 |
| 5962J7 | CH260 |
| 5962K5 | CH189 |
| 5962R8 | CH189 |
| 5962S8 | CH189 |
| 5962T7 | CH147 |
| 5962W3 | CH185 |
| 7932 567 718 | CH189 |
| 7932567718 | CH189 |
| 9 633 214 380 | CH189 |
| 9150 860 280 | CH189 |
| 9150 861 080 | CH189 |
| 9150860280 | CH260 |
| 9150861080 | CH260 |
| 9152 184 980 | CH189 |
| 9152184980 | CH189 |
| 9153 664 680 | CH189 |
| 9153664680 | CH189 |
| 95 493 206 | CH189 |
| 95 534 788 | CH189 |
| 95 943 206 | CH189 |
| 95534788 | CH189 |
| 96 009 783 | CH147 |

| PEUGEOT | CHAMPION |
|---------------|----------|
| 96 009 783 | CH189 |
| 96 076 258 | CH189 |
| 96 141 678 | CH189 |
| 96 165 724 | CH189 |
| 96 236 383 | CH170 |
| 96 316 589 80 | CH185 |
| 96 389 858 | CH170 |
| 9616572480 | CH189 |
| MKP 000 065 | CH189 |
| MKP 000 65 | CH189 |
| MKP 000 71 | CH260 |
| PIAGGIO | CHAMPION |
| 438036 | CH260 |
| 493061 | CH189 |
| L2100097 | CH205 |
| RENAULT | CHAMPION |
| 50 01 001 587 | CH189 |
| 5001001587 | CH189 |
| 77 00 100 558 | CH217 |
| 77 00 100 586 | CH169 |
| 77 00 100 635 | CH233 |
| 77 00 103 674 | CH232 |
| 77 00 105 290 | CH206 |
| 77 00 111 323 | CH271 |
| 77 00 111 940 | CH233 |
| 77 00 662 199 | CH189 |
| 77 00 673 874 | CH189 |
| 77 00 701 130 | CH189 |
| 77 00 704 185 | CH189 |
| 77 00 715 768 | CH189 |
| 77 00 733 076 | CH189 |
| 77 00 734 956 | CH173 |
| 77 00 741 144 | CH189 |
| 77 00 854 538 | CH260 |
| 77 00 855 865 | CH189 |
| 77 00 856 238 | CH189 |
| 77 00 856 292 | CH260 |
| 77 00 858 208 | CH169 |
| 77 00 860 796 | CH169 |
| 77 00 861 906 | CH169 |
| 77 00 867 002 | CH206 |
| 77 00 867 617 | CH260 |
| 77 00 874 336 | CH206 |
| 77 01 029 762 | CH189 |
| 77 01 035 956 | CH189 |
| 77 01 039 387 | CH189 |
| 77 01 040 208 | CH147 |
| 77 01 069 730 | CH271 |
| 77 01 069 731 | CH189 |
| 77 01 349 475 | CH189 |
| 77 01 349 943 | CH189 |



OE ? ⇒



| RENAULT | | |
|----------------|--------------|--|
| 77 01 349 949 | CH260 | |
| 77 01 414 072 | CH189 | |
| 77 01 414 076 | CH189 | |
| 77 01 414 077 | CH260 | |
| 77 01 414 079 | CH189 | |
| 77 01 414 080 | CH189 | |
| 77 01 414 081 | CH147 | |
| 77 01 414 083 | CH147 | |
| 77 01 414 086 | CH189 | |
| 77 01 414 088 | CH260 | |
| 77 01 414 089 | CH147 | |
| 77 01 414 089 | CH189 | |
| 77 01 414 108 | CH189 | |
| 77 01 414 123 | CH189 | |
| 77 01 414 157 | CH176 | |
| 77 01 414 162 | CH189 | |
| 7700100558 | CH217 | |
| 7700100586 | CH169 | |
| 7700100635 | CH233 | |
| 7700105290 | CH206 | |
| 7700111940 | CH233 | |
| 7700701130 | CH189 | |
| 7700704185 | CH189 | |
| 7700715768 | CH189 | |
| 7700741144 | CH189 | |
| 7700854538 | CH260 | |
| 7700855865 | CH173 | |
| 7700856238 | CH173 | |
| 7700856292 | CH260 | |
| 7700860796 | CH169 | |
| 7700861906 | CH169 | |
| 7700867002 | CH206 | |
| 7700867617 | CH260 | |
| 7700874336 | CH206 | |
| 7701033403 | CH189 | |
| 7701035956 | CH189 | |
| 7701039387 | CH189 | |
| 7701040208 | CH147 | |
| 7701349475 | CH189 | |
| 7701349943 | CH173 | |
| 7701349949 | CH260 | |
| 7701414072 | CH189 | |
| 7701414076 | CH189 | |
| 7701414077 | CH260 | |
| 7701414080 | CH189 | |
| 7701414081 | CH147 | |
| 7701414086 | CH189 | |
| 7701414088 | CH260 | |
| 7701414107 | CH176 | |
| 7701414108 | CH189 | |
| 7701414123 | CH189 | |
| 7701414157 | CH176 | |
| 79 32 567 717 | CH189 | |

| RENAULT | | |
|-----------------|----------------|--|
| 82 00 012 099 | CH232 | |
| 82 00 090 817 | CH189 | |
| 82 00 421 091 | CH271 | |
| 82 00 423 224 | CH217 | |
| 82 00 423 227 | CH217 | |
| 82 00 434 855 | CH271 | |
| 82 00 445 627 | CH232 | |
| 82 00 464 077 | CH271 | |
| 82 00 490 950 | CH271 | |
| 82 00 517 313 | CH232 | |
| 82 00 561 251 | CCGP007 | |
| 82 00 787 721 | CH233 | |
| 82000012099 | CH232 | |
| 8200445627 | CH232 | |
| 8200787721 | CH233 | |
| 86 71 004 016 | CH260 | |
| 86 71 004 018 | CH189 | |
| ROVER | | |
| ERC 8450 | CH189 | |
| ERR 6066 | CH272 | |
| ETC 8847 | CH178 | |
| ETC8847 | CH178 | |
| NCC 100050 | CH169 | |
| NCC 100120 | CH203 | |
| NCC 100120 L | CH203 | |
| NCC100050 | CH169 | |
| NCC100120 | CH203 | |
| NCC100120L | CH203 | |
| SEAT | | |
| 0003940685 | CH189 | |
| N 105 792 01 | CH181 | |
| N 105 792 02 | CH181 | |
| SE 138919 000 A | CH189 | |
| SE138919000A | CH189 | |
| X 0396 550 20 | CH189 | |
| X03965520 | CH189 | |
| SUZUKI | | |
| 09900-HDI01 | CH170 | |
| 09900-RF001 | CH242 | |
| 09900-TD001 | CH189 | |
| 09900-TD001-000 | CH189 | |
| 18550-66G00 | CH189 | |
| 18550-66G00-000 | CH189 | |
| 1855067G00000 | CH170 | |
| 1855067G10000 | CH170 | |
| 18550-67G11 | CH268 | |
| 1855067G11000 | CH170 | |
| 18550-78E00 | CH242 | |
| 18550-78E10 | CH242 | |
| 18550-78E11 | CH242 | |
| 18550-79J50 | CH269 | |

| SUZUKI | | |
|-----------------|----------------|--|
| 18550-79J50 000 | CH269 | |
| 1855084A00000 | CH271 | |
| 1855084A50000 | CH271 | |
| 1855084A51000 | CH271 | |
| 18550-84A51-000 | CH271 | |
| 1855084CT0000 | CH233 | |
| TALBOT | | |
| 91 507 715 80 | CH189 | |
| 91 507 719 80 | CH189 | |
| TOYOTA | | |
| 19850-45030 | CH154 | |
| 19850-45031 | CH154 | |
| 19850-54030 | CH154 | |
| 19850-54031 | CH154 | |
| 19850-54090 | CH154 | |
| 19850-56010 | CH302 | |
| 19850-56012 | CH302 | |
| 19850-58010 | CH302 | |
| 19850-64020 | CH302 | |
| 19850-64030 | CH302 | |
| 19850-64031 | CH302 | |
| 19850-64031B | CH302 | |
| 19850-64050 | CH302 | |
| 19850-67020 | CH608 | |
| 19850-67030 | CH608 | |
| 19850-68010 | CH302 | |
| 19850-68040 | CH302 | |
| 19850-68050 | CH302 | |
| SU001-00351 | CH185 | |
| VAG | | |
| 03L 905 061 G | CPSG007 | |
| 03L 905 061 K | CPSG007 | |
| 059 905 061 E | CPSG008 | |
| 059 905 061 H | CPSG008 | |
| N 105 798 03 | CCGP003 | |
| N 105 798 05 | CCGP003 | |
| N 105 916 04 | CCGP002 | |
| N 105 916 08 | CCGP002 | |
| VAUXHALL | | |
| 900 33357 | CH189 | |
| 900 93897 | CH189 | |
| 902 10824 | CH189 | |
| VM | | |
| 46 072 007 F | CH180 | |
| VOLVO | | |
| 1257141 | CH260 | |
| 1257889 | CH260 | |
| 30 72 506 9 | CH268 | |
| 30862690 | CH169 | |

| VOLVO | | |
|---------------|--------------|--|
| 31216248 | CH201 | |
| 840643 | CH189 | |
| 86 53 698 | CH268 | |
| 8653698 | CH268 | |
| VW | | |
| 059 963 319 | CH215 | |
| 059 963 319 A | CH215 | |
| 059 963 319 H | CH215 | |
| 059963319 | CH215 | |
| 061905061 | CH260 | |
| 068 905 061 | CH260 | |
| 068905061 | CH260 | |
| N 019 081 1 | CH260 | |
| N 019 081 2 | CH260 | |
| N 019 081 4 | CH260 | |
| N 019 097 1 | CH260 | |
| N 019 100 01 | CH260 | |
| N 019 100 2 | CH260 | |
| N 019 100 5 | CH260 | |
| N 019 100 6 | CH260 | |
| N 101 401 01 | CH271 | |
| N 101 401 02 | CH271 | |
| N 101 401 03 | CH271 | |
| N 101 401 04 | CH271 | |
| N 101 401 05 | CH271 | |
| N 102 130 01 | CH260 | |
| N 102 130 02 | CH260 | |
| N 105 792 01 | CH181 | |
| N 105 792 02 | CH181 | |
| N0190811 | CH260 | |
| N0190812 | CH260 | |
| N0190814 | CH260 | |
| N0190971 | CH260 | |
| N0191001 | CH260 | |
| N0191002 | CH260 | |
| N0191005 | CH260 | |
| N0191006 | CH260 | |
| N10213001 | CH260 | |
| N10213002 | CH260 | |
| N10579202 | CH181 | |



OE ? ⇒



| ALFA ROMEO | |
|---------------------|-----------------|
| 116 55 65 079 00/00 | BAEA115 |
| 116 55 65 079 01/00 | BAEA115 |
| 46460582 | BAEA549 |
| 46469863 | BAEA309 |
| 55213613 | BAEA095 |
| 60558152 | BAEA234 |
| 60562701 | BAEA428 |
| 60586072 | BAEA234 |
| 60805420 | BAE800B |
| 60809492 | BAE800B |
| 60809606 | BAEA234 |
| 60810690 | BAEA428 |
| 71739725 | BAEA427 |
| 71741133 | BAEA174E |
| 71744369 | BAEA427 |
| 71751445 | BAEA174E |
| 71753911 | BAEA174E |
| 7648797 | BAEA234 |
| 76487970 | BAEA234 |
| ASTON MARTIN | |
| 4G4E-12A366-AA | BAEA426 |
| AUDI | |
| 058905101A | BAEA162E |
| 078 905 101 A | BAEA007E |
| BMW | |
| 0 495 289 | BAEA324 |
| 1 703 227 | BAEA302 |
| 1 703 359 | BAEA014 |
| 1 712 219 | BAEA324 |
| 1 712 223 | BAEA324 |
| 1 720 166 | BAEA014 |
| 1 720 877 | BAEA014 |
| 1 726 176 | BAEA014 |
| 1 726 177 | BAEA014 |
| 1 726 178 | BAEA014 |
| 1 726 178 B | BAEA014 |
| 1 730 765 | BAEA014 |
| 1 731 134 B | BAEA014 |
| 1 731 178 B | BAEA014 |
| 1 742 925 | BAEA014 |
| 1 748 394 | BAEA014 |
| 1 777 666 | BAEA014 |
| 12 13 0 148 594 | BAEA324 |
| 12 13 0 390 064 | BAEA324 |
| 12 13 0 495 289 | BAEA324 |
| 12 13 1 247 281 | BAEA307 |
| 12 13 1 273 216 | BAEA546 |
| 12 13 1 317 585 | BAEA014 |
| 12 13 1 326 684 | BAEA115 |
| 12 13 1 357 294 | BAEA115 |
| 12 13 1 357 295 | BAEA115 |

| BMW | |
|-----------------|-----------------|
| 12 13 1 402 440 | BAEA014 |
| 12 13 1 402 713 | BAEA014 |
| 12 13 1 703 227 | BAEA302 |
| 12 13 1 703 228 | BAEA302 |
| 12 13 1 703 359 | BAEA014 |
| 12 13 1 703 825 | BAEA302 |
| 12 13 1 712 219 | BAEA324 |
| 12 13 1 712 223 | BAEA324 |
| 12 13 1 720 166 | BAEA014 |
| 12 13 1 726 176 | BAEA014 |
| 12 13 1 726 177 | BAEA014 |
| 12 13 1 726 178 | BAEA014 |
| 12 13 1 727 108 | BAEA014 |
| 12 13 1 729 842 | BAEA014 |
| 12 13 1 730 765 | BAEA014 |
| 12 13 1 730 766 | BAEA014 |
| 12 13 1 731 134 | BAEA014 |
| 12 13 1 731 884 | BAEA014 |
| 12 13 1 748 017 | BAEA302 |
| 12 13 1 748 018 | BAEA302 |
| 12 13 1 748 394 | BAEA014 |
| 12 13 1 777 666 | BAEA014 |
| 12 13 7 523 345 | BAEA145E |
| 12 13 7 548 553 | BAEA145E |
| 12 13 7 550 012 | BAEA143 |
| 12 13 7 551 049 | BAEA143 |
| 12 13 7 551 260 | BAEA324 |
| 12 13 7 559 842 | BAEA144E |
| 12 13 7 562 744 | BAEA143 |
| 12 13 7 562 745 | BAEA144E |
| 12 13 7 571 643 | BAEA143 |
| 12 13 7 571 644 | BAEA144E |
| 12 13 7 575 010 | BAEA143 |
| 12 13 7 582 627 | BAEA144E |
| 12 13 7 594 596 | BAEA143 |
| 12 13 7 594 935 | BAEA144E |
| 12 13 7 594 936 | BAEA145E |
| 12 13 7 594 937 | BAEA143 |
| 12 13 7 594 938 | BAEA324 |
| 12 13 7 599 219 | BAEA302 |
| 12 13 7 619 385 | BAEA538 |
| 12 13 7 638 477 | BAEA144E |
| 12 13 7 703 359 | BAEA014 |
| 12 13 7 841 558 | BAEA324 |
| 12 13 8 616 153 | BAEA143 |
| 12 13 8 647 689 | BAEA143 |
| 12 13 8 678 438 | BAEA538 |
| 12 13 8 730 002 | BAEA115 |
| 12 13 9 066 468 | BAEA014 |
| 12 13 9 067 830 | BAEA302 |
| 1213 1 487 707 | BAEA382 |
| 1213 7510 738 | BAEA382 |
| 1247281 | BAEA307 |



| BMW | |
|------------------|-----------------|
| 1273216 | BAEA546 |
| 1404309 | BAEA302 |
| 1703825 | BAEA302 |
| 1748017 | BAEA302 |
| 1748018 | BAEA302 |
| 7 551 260 | BAEA324 |
| 7 599 218 | BAEA014 |
| 7 841 558 | BAEA324 |
| 9 066 468 | BAEA014 |
| BUICK | |
| 1 104 091 | BAEA472 |
| CHEVROLET | |
| 1115467 | BAEA554 |
| 25182496 | BAEA447A |
| 25186687 | BAEA198E |
| 96165049 | BAEA554 |
| 96253555 | BAEA447A |
| 96291054 | BAEA539 |
| 96336522 | BAEA540 |
| 96453420 | BAEA543 |
| 96476983 | BAEA199E |
| 96566260 | BAEA447A |
| CHRYSLER | |
| 0000K04557468 | BAEA380 |
| 00K 04609088 AG | BAEA432 |
| 00K 04609088 AI | BAEA432 |
| 00K 04797 293 AB | BAEA394 |
| 00K04606869AC | BAEA453 |
| 00K04606869AD | BAEA453 |
| 00K05234210 | BAEA394 |
| 04606869AB | BAEA453 |
| 04606869AC | BAEA453 |
| 04609088 AB | BAEA432 |
| 04609088 AC | BAEA432 |
| 04609088 AD | BAEA432 |
| 04609088 AE | BAEA432 |
| 04609088 AF | BAEA432 |
| 04797293AB | BAEA394 |
| 4797293 | BAEA394 |
| 5234210 | BAEA394 |
| 5252577 | BAEA394 |
| 5269670 | BAEA380 |
| 56032521 | BAEA380 |
| 56032521AB | BAEA380 |
| 56032521AC | BAEA380 |
| K 04609088 AF | BAEA432 |
| K 04609088 AH | BAEA432 |
| K04609103 | BAEA380 |
| K04609103AB | BAEA380 |
| K04609103AC | BAEA380 |
| K04797293 | BAEA394 |



| CHRYSLER | |
|--------------------------|-----------------|
| K05252577 | BAEA394 |
| T1031135 | BAEA251 |
| CITROËN | |
| 0000597075 | BAEA348 |
| 0000597077 | BAEA347 |
| 0000597078 | BAE946A |
| 0000597079 | BAE946A |
| 0000597084 | BAEA351 |
| 0000597087 | BAEA352 |
| 0000597090 | BAEA048E |
| 0000597094 | BAEA347 |
| 0000597097 | BAEA048E |
| 0000597098 | BAEA348 |
| 00005970A0 | BAEA352 |
| 00005970A5 | BAEA351 |
| 1607576780 | BAEA547 |
| 5 412 342 | BAEA110 |
| 5 412 977 | BAEA110 |
| 5 490 504 | BAEA115 |
| 5 491 302 | BAEA115 |
| 5 491 559 | BAEA115 |
| 5970-79 | BAE946A |
| 75 455 219 | BAEA115 |
| 96 062 288 | BAEA231 |
| 96 165 97 080 | BAEA231 |
| 96 211 048 | BAEA256 |
| 96 228 897 | BAEA232 |
| 96010513 | BAEA247 |
| 9611412080 | BAE700AK |
| 96341314 | BAEA348 |
| 9634131480 | BAEA348 |
| 96358649 | BAE946A |
| 9654347080 | BAEA048E |
| 97530780 | BAEA247 |
| MA 5455 219 | BAEA115 |
| CITROËN / PEUGEOT | |
| 59070 C1 | BAEA164E |
| 5970 53 | BAEA234 |
| 5970 64 | BAEA143 |
| 5970 76 | BAEA351 |
| 5970 80 | BAEA045E |
| 5970 85 | BAEA472 |
| 5970 88 | BAEA164E |
| 5970 99 | BAEA045E |
| 5970 C0 | BAEA164E |
| 96 753 909 80 | BAEA557 |
| 9651710680 | BAEA472 |
| 9806702780 | BAEA143 |
| DACIA | |
| 224332428R | BAEA131E |
| 224336134R | BAEA354 |

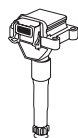



OE ? ⇒



| DACIA  | |
|--|-----------------|
| 6001543604 | BAEA354 |
| 77 00 274 008 | BAEA354 |
| 82 00 360 911 | BAEA325 |
| 82 00 702 693 | BAEA325 |
| DAEWOO  | |
| 0001587503 | BAEA340 |
| 1 104 091 | BAEA472 |
| 1115467 | BAEA554 |
| 19 017 110 | BAEA394 |
| 88921374 | BAEA025E |
| 96165049 | BAEA554 |
| 96253555 | BAEA447A |
| 96291054 | BAEA539 |
| 96336522 | BAEA540 |
| 96350585 | BAEA025E |
| 96453420 | BAEA543 |
| 96566260 | BAEA447A |
| E586A | BAEA025E |
| DAIHATSU  | |
| 19070-B1020 | BAEA194E |
| 90048-52125 | BAEA180E |
| 90048-52126 | BAEA180E |
| DUCATI  | |
| 285.2.015.2A | BAE800B |
| 380.4.010.1B | BAE800B |
| FERRARI (FERRARI)  | |
| 134386 | BAEA234 |
| FIAT  | |
| 0009633001580 | BAEA347 |
| 0009663278480 | BAEA347 |
| 04606869AC | BAEA453 |
| 187284R46772871 | BAE403D |
| 46446039 | BAE920AX |
| 46460582 | BAEA549 |
| 46469863 | BAEA309 |
| 46472440 | BAE920AX |
| 46480361 | BAE920AX |
| 46543562 | BAE800B |
| 46548037 | BAE800B |
| 46776830 | BAE403D |
| 46777286 | BAE403B |
| 46777287 | BAE403D |
| 46777288 | BAE403C |
| 46790073 | BAE800B |
| 55180004 | BAE403B |
| 55200112 | BAE940A |
| 55200486 | BAE940A |
| 55208723 | BAE940A |
| 55209603 | BAEA095 |
| 55213613 | BAEA095 |

| FIAT  | |
|---|-----------------|
| 55224494 | BAEA095 |
| 55231256 | BAEA090 |
| 55234131 | BAEA090 |
| 55234133 | BAEA090 |
| 60558152 | BAEA234 |
| 60562701 | BAEA428 |
| 60809606 | BAEA234 |
| 60810690 | BAEA428 |
| 60815150 | BAE800B |
| 71739725 | BAEA427 |
| 71741133 | BAEA174E |
| 71742420 | BAEA181E |
| 71744369 | BAEA427 |
| 71751445 | BAEA174E |
| 71753911 | BAEA174E |
| 7553120 | BAE506F |
| 7582152 | BAE506D |
| 7588435 | BAE506F |
| 7626232 | BAE800B |
| 7646974 | BAE506F |
| 7646975 | BAE504F |
| 7648797 | BAEA234 |
| 7663177 | BAE506D |
| 7672018 | BAE800B |
| 7698431 | BAE506D |
| 7746151 | BAE504D |
| 7746152 | BAE506D |
| 7746153 | BAE506F |
| 7746154 | BAE506D |
| 7753777 | BAE504F |
| 7789346 | BAE920AX |
| 96 228 897 80 | BAEA232 |
| 9634131380 | BAEA348 |
| A880093 | BAE403D |
| A88038 | BAE403B |
| A88068 | BAE403C |
| A88089 | BAE700AK |
| A8808M | BAE800B |
| A88094 | BAE960AE |
| FORD  | |
| 1008464 | BAEA004E |
| 1052492 | BAEA350 |
| 1053904 | BAEA350 |
| 1066102 | BAEA350 |
| 1067601 | BAEA350 |
| 1075786 | BAEA350 |
| 1111213 | BAEA422 |
| 1119835 | BAEA365 |
| 1130402 | BAEA350 |
| 1133237 | BAEA308 |
| 12029AB | BAEA350 |
| 12029AB | BAEA365 |

| FORD  | |
|---|-----------------|
| 12029AB | BAEA422 |
| 1224925 | BAEA408 |
| 1229419 | BAEA308 |
| 1314271 | BAEA408 |
| 1317972 | BAEA350 |
| 1319788 | BAEA365 |
| 1319929 | BAEA422 |
| 1322402 | BAEA408 |
| 1350562 | BAEA387 |
| 1371601 | BAEA055E |
| 1459278 | BAEA387 |
| 1517813 | BAEA422 |
| 1535713 | BAE940A |
| 1578771 | BAEA408 |
| 1619343 | BAEA365 |
| 1619343 | BAEA422 |
| 1671690 | BAE940A |
| 1727629 | BAEA387 |
| 1S7G-12029-AB | BAEA365 |
| 1S7G-12029-AC | BAEA365 |
| 1S7Z-12029AA | BAEA350 |
| 1S7Z-12029AA | BAEA365 |
| 1S7Z-12029AA | BAEA422 |
| 2W4E-12A366-AC | BAEA367 |
| 2W4E-12A366-AD | BAEA367 |
| 2W4E-12A366-BB | BAEA368 |
| 2W4E-12A366-BC | BAEA368 |
| 2W4E-12A366-BD | BAEA368 |
| 2W4E-12A366-BE | BAEA368 |
| 2W4Z-12029-B | BAEA368 |
| 2W4Z-12029-BC | BAEA368 |
| 2W4Z-12029-BD | BAEA368 |
| 4088000 | BAEA372 |
| 4093748 | BAEA410 |
| 4424413 | BAEA368 |
| 4448245 | BAEA410 |
| 448 298 | BAEA115 |
| 4586554 | BAEA368 |
| 4619092 | BAEA410 |
| 4667153 | BAEA368 |
| 4744015 | BAEA196E |
| 4751265 | BAEA372 |
| 4M5E12A366AA | BAEA408 |
| 4M5G-12029-ZA | BAEA387 |
| 4M5G-12029-ZB | BAEA387 |
| 4M5G12A366BA | BAEA408 |
| 4M5G12A366BB | BAEA408 |
| 4M5G-12A366-BC | BAEA408 |
| 4M5G12A366-BD | BAEA408 |
| 4M5U-12A366-BC | BAEA408 |
| 4S7G 12029 AB | BAEA448 |
| 5 008 049 | BAEA367 |
| 5008050 | BAEA368 |

| FORD  | |
|---|-----------------|
| 5008190 | BAEA372 |
| 5047437 | BAEA408 |
| 5F2E-12029-AA | BAEA372 |
| 5F2E-12029-AB | BAEA372 |
| 6485688 | BAEA308 |
| 6860288 | BAEA281 |
| 6M5G12029AA | BAEA055E |
| 6R83-12A366-AA | BAEA196E |
| 7053859 | BAE907AE |
| 7U2J-12029-AB | BAEA281 |
| 885F-12029-A2A | BAEA281 |
| 885F-12029-A2B | BAEA281 |
| 91XF 12029 AA | BAEA308 |
| 91XF-12029-BA | BAEA308 |
| 928F-12029-CA | BAEA281 |
| 95VW12029AA | BAEA004E |
| 95WF12029BA | BAE907AE |
| 988F12029AA | BAEA350 |
| 988F12029AB | BAEA350 |
| 988F12029AC | BAEA350 |
| 988F12029AD | BAEA350 |
| 988F-12029-BA | BAEA365 |
| 988F-12029-BA | BAEA422 |
| 988F12024AB | BAEA350 |
| 9L8E-12A366-AA | BAEA410 |
| 9S5 112 029 AA | BAE940A |
| 9S5 112 029 AB | BAE940A |
| AJ810445 | BAEA196E |
| AM5E-12A366-AA | BAEA408 |
| AM5E-12A366-AB | BAEA408 |
| CM5G-12029-FA | BAEA387 |
| CM5G-12029-FB | BAEA387 |
| E9TF-12029-AA | BAEA281 |
| YM2F 12029 AD | BAEA350 |
| YM2F-12024-AB | BAEA422 |
| YM2F-12024-AC | BAEA422 |
| YM2F-12029-AB | BAEA422 |
| GENERAL MOTORS  | |
| 03 474 233 | BAEA253 |
| 03474232 | BAEA252 |
| 03474282 | BAEA252 |
| 09 119 567 | BAEA342 |
| 10450424 | BAEA025E |
| 10458316 | BAEA427 |
| 10490192 | BAEA025E |
| 1104038 | BAEA025E |
| 1104091 | BAEA472 |
| 1115467 | BAEA554 |
| 12570616 | BAEA159E |
| 12611424 | BAEA159E |
| 12629037 | BAEA174E |
| 19005212 | BAE965A |



OE ? ⇒

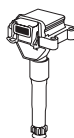

| GENERAL MOTORS | | CHAMPION |
|----------------|----------|----------|
| 25195107 | BAEA185E | |
| 25198623 | BAEA185E | |
| 3474233 | BAEA253 | |
| 55 575 499 | BAEA185E | |
| 55561655 | BAEA199E | |
| 55573735 | BAEA185E | |
| 55577898 | BAEA185E | |
| 55579072 | BAEA185E | |
| 55584404 | BAEA198E | |
| 55584745 | BAEA198E | |
| 90 449 740 | BAEA252 | |
| 90 458 250 | BAEA344 | |
| 90 510 387 | BAEA252 | |
| 90 536 194 | BAEA342 | |
| 90 541 062 | BAEA306 | |
| 90 563 160 | BAEA306 | |
| 90350929 | BAEA546 | |
| 90449739 | BAEA253 | |
| 90510386 | BAEA253 | |
| 90532618 | BAEA358 | |
| 90543059 | BAEA358 | |
| 90543253 | BAEA147E | |
| 9118114 | BAEA152E | |
| 9119567 | BAEA342 | |
| 93173708 | BAEA153E | |
| 93177212 | BAEA338 | |
| 93180806 | BAEA359 | |
| 93194165 | BAEA189E | |
| 95507901 | BAEA189E | |
| 96 415 010 | BAEA508 | |
| 96165049 | BAEA554 | |
| 96253555 | BAEA447A | |
| 96336522 | BAEA540 | |
| HONDA | | CHAMPION |
| 30500PM5A02 | BAEA276 | |
| 30500PM5A03 | BAEA276 | |
| 30510P73A01 | BAEA275 | |
| 30510P73A02 | BAEA275 | |
| 30510PT2006 | BAEA275 | |
| 30520 PDFE 00 | BAEA234 | |
| 30520-PGK-A01 | BAEA170E | |
| 30520-PNA-007 | BAEA169E | |
| 30520-PVF-A01 | BAEA170E | |
| 30520-PVJ-A01 | BAEA170E | |
| 30520-PWA-003 | BAEA175E | |
| 30520PWA013 | BAEA175E | |
| 30520PWAS01 | BAEA175E | |
| 30520-RAA-007 | BAEA169E | |
| 30520REAZ01 | BAEA175E | |
| 30520-RNA-A01 | BAEA182E | |
| 30520-RRA-007 | BAEA169E | |
| 30521-PWA-003 | BAEA176E | |

| HONDA | | CHAMPION |
|---------------|----------|----------|
| 30521PWA013 | BAEA176E | |
| 30521PWAS01 | BAEA176E | |
| 30521REAZ01 | BAEA176E | |
| 30521RLB003 | BAEA176E | |
| HYUNDAI | | CHAMPION |
| OK 247-18100 | BAEA433 | |
| OK0131 8100 | BAEA434 | |
| OK30A-18-10X | BAEA561 | |
| 27300-3F100 | BAEA548 | |
| 27301-02100 | BAEA480 | |
| 27301-02600 | BAEA266 | |
| 27301-02700 | BAEA477 | |
| 27301-02710 | BAEA477 | |
| 27301-03000 | BAEA536 | |
| 27301-03010 | BAEA536 | |
| 27301-03030 | BAEA536 | |
| 27301-04000 | BAEA476 | |
| 27301-22040 | BAEA264 | |
| 27301-22050 | BAEA264 | |
| 27301-22600 | BAEA479 | |
| 27301-23003 | BAEA267 | |
| 27301-23700 | BAEA482 | |
| 27301-26600 | BAEA483 | |
| 27301-28000 | BAEA474 | |
| 27301-28010 | BAEA475 | |
| 27301-33510 | BAEA521 | |
| 27301-33520 | BAEA521 | |
| 27301-37100 | BAEA269 | |
| 27301-37150 | BAEA555 | |
| 27301-38020 | BAEA502E | |
| 27301-3C000 | BAEA531 | |
| ISUZU | | CHAMPION |
| 8-01104-038-0 | BAEA025E | |
| IVECO | | CHAMPION |
| 464724400 | BAE920AX | |
| 467772871 | BAE403D | |
| 467772880 | BAE403C | |
| 500309816 | BAE920AX | |
| 504142675 | BAE403C | |
| JAGUAR | | CHAMPION |
| AJ81373 | BAEA368 | |
| AJ82545 | BAEA368 | |
| AJ86468 | BAEA368 | |
| C2542751 | BAEA367 | |
| XR814052 | BAEA367 | |
| XR816250 | BAEA367 | |
| XR827823 | BAEA368 | |
| XR842741 | BAEA367 | |
| KIA | | CHAMPION |
| OK 011-18-100 | BAEA234 | |

| KIA | | CHAMPION |
|-----------------|----------|----------|
| OK 247-18100 | BAEA433 | |
| OK 247-18100 A | BAEA433 | |
| OK0131 8100 | BAEA434 | |
| OK30A-18-10X | BAEA561 | |
| OK30E-18-10X | BAEA486 | |
| 27300-3F100 | BAEA548 | |
| 27301-02700 | BAEA477 | |
| 27301-02710 | BAEA477 | |
| 27301-04000 | BAEA476 | |
| 27301-23700 | BAEA482 | |
| 27301-26600 | BAEA483 | |
| 27301-28000 | BAEA474 | |
| 27301-28010 | BAEA475 | |
| 27301-37150 | BAEA555 | |
| 27301-3C000 | BAEA531 | |
| OK 011-18-100 | BAEA234 | |
| LADA | | CHAMPION |
| 21110370501000 | BAEA395 | |
| 21113705010 | BAEA395 | |
| LAMBORGHINI | | CHAMPION |
| 16004528 | BAE800B | |
| LANCIA | | CHAMPION |
| 46460582 | BAEA549 | |
| 46469863 | BAEA309 | |
| 55213613 | BAEA095 | |
| 7588435 | BAE504D | |
| 7663177 | BAE506D | |
| 82 281 560 | BAEA115 | |
| LAND ROVER | | CHAMPION |
| NEC000120 L | BAEA501 | |
| NEC100730 L | BAEA501 | |
| LOMBARDINI | | CHAMPION |
| 011200156719030 | BAE800B | |
| MAN | | CHAMPION |
| 51 25919 0016 | BAEA297 | |
| MASERATI | | CHAMPION |
| 477084200 | BAE504F | |
| 571.08.42.00 | BAE700AK | |
| 571084200 | BAE700AK | |
| MAZDA | | CHAMPION |
| 1E03-18-10X | BAEA350 | |
| 1E04-18-10X | BAEA350 | |
| 1E05-18-100B | BAEA350 | |
| 1E08-18-10X | BAEA350 | |
| 1E09-18-10X | BAEA350 | |
| B 542 18 10XA | BAEA560 | |
| BP6D-18-100A | BAEA084E | |
| BPE81810XC | BAEA195E | |

| MAZDA | | CHAMPION |
|----------------|----------|----------|
| C201-18-100 | BAEA350 | |
| C201-18-100A | BAEA350 | |
| C201-18-100B | BAEA350 | |
| FDS7-18-100 | BAEA281 | |
| FFY 118 100 | BAEA083E | |
| FP 85 18 100 A | BAEA083E | |
| FP 85 18 100 B | BAEA083E | |
| FP 85 18 100 C | BAEA083E | |
| FPY 118 100 | BAEA083E | |
| K 013-18-100 | BAEA434 | |
| K 247-18100 | BAEA433 | |
| L813-18-100 | BAEA556 | |
| YF091810X | BAEA350 | |
| ZJ20-18-100 | BAEA489 | |
| ZJ20-18100-A | BAEA489 | |
| ZL01-18-100-A | BAEA190E | |
| ZL01-18-100-B | BAEA190E | |
| MERCEDES-BENZ | | CHAMPION |
| 000 150 04 80 | BAEA313 | |
| 000 150 05 80 | BAEA313 | |
| 000 150 15 80 | BAEA053 | |
| 000 150 17 80 | BAEA041 | |
| 000 150 19 80 | BAEA140E | |
| 000 150 25 80 | BAEA077 | |
| 000 150 27 80 | BAEA140E | |
| 000 150 28 80 | BAEA041 | |
| 000 150 29 80 | BAEA053 | |
| 000 158 06 03 | BAEA115 | |
| 000 158 48 03 | BAEA296 | |
| 000 158 50 03 | BAEA339 | |
| 000 158 55 03 | BAEA299 | |
| 000 158 56 03 | BAEA298 | |
| 000 158 57 03 | BAEA299 | |
| 000 158 58 03 | BAEA298 | |
| 000 158 61 03 | BAEA296 | |
| 000 158 62 03 | BAEA339 | |
| 000 158 64 03 | BAEA298 | |
| 000 158 65 03 | BAEA299 | |
| 000 158 68 03 | BAEA313 | |
| 000 158 71 03 | BAEA340 | |
| 000 158 73 03 | BAEA297 | |
| 000 158 75 03 | BAEA340 | |
| 000 158 77 03 | BAEA304 | |
| 000 158 78 03 | BAEA297 | |
| 000150048081 | BAEA313 | |
| 003 158 50 01 | BAEA004E | |
| 160 158 77 03 | BAEA304 | |
| 272 150 02 80 | BAEA093E | |
| 272 906 00 60 | BAEA140E | |
| 276 150 00 80 | BAEA093E | |
| 276 906 01 60 | BAEA093E | |
| 276 906 02 59 | BAEA093E | |



OE ? ⇒

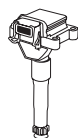

MERCEDES-BENZ

| | |
|-----------------|----------|
| 276 906 02 60 | BAEA093E |
| 276 906 35 00 | BAEA093E |
| 276 906 37 00 | BAEA093E |
| A 000 150 04 80 | BAEA313 |
| A 000 150 05 80 | BAEA313 |
| A 000 150 07 80 | BAEA146E |
| A 000 150 12 80 | BAEA146E |
| A 000 150 13 80 | BAEA146E |
| A 000 150 15 80 | BAEA053 |
| A 000 150 17 80 | BAEA041 |
| A 000 150 19 80 | BAEA140E |
| A 000 150 25 80 | BAEA077 |
| A 000 150 27 80 | BAEA140E |
| A 000 150 28 80 | BAEA041 |
| A 000 150 29 80 | BAEA053 |
| A 000 158 48 03 | BAEA296 |
| A 000 158 61 03 | BAEA296 |
| A 000 158 62 03 | BAEA339 |
| A 000 158 64 03 | BAEA298 |
| A 000 158 65 03 | BAEA299 |
| A 000 158 68 03 | BAEA313 |
| A 000 158 71 03 | BAEA340 |
| A 000 158 73 03 | BAEA297 |
| A 000 158 75 03 | BAEA340 |
| A 000 158 78 03 | BAEA297 |
| A 003 158 50 01 | BAEA004E |
| A 272 150 02 80 | BAEA093E |
| A 272 906 00 60 | BAEA140E |
| A 276 150 00 80 | BAEA093E |
| A 276 906 01 60 | BAEA093E |
| A 276 906 02 59 | BAEA093E |
| A 276 906 02 60 | BAEA093E |
| A 276 906 35 00 | BAEA093E |
| A 276 906 37 00 | BAEA093E |

MINI

| | |
|-----------------|---------|
| 12 13 7 619 385 | BAEA538 |
| 1213 1 487 707 | BAEA382 |
| 1213 7510 738 | BAEA382 |

MITSUBISHI

| | |
|------------|----------|
| 04609103AB | BAEA380 |
| 9311600 | BAEA395 |
| M04609103 | BAEA380 |
| M05269670 | BAEA380 |
| MD 003 820 | BAEA110 |
| MD 003 821 | BAEA110 |
| MD 363552 | BAEA193E |
| MD 623072 | BAEA193E |
| MD361710 | BAEA178E |
| MD362903 | BAEA178E |
| MD362907 | BAEA179E |
| MN195805 | BAEA547 |

MOTO GUZZI

| | |
|----------|---------|
| 57165300 | BAE800B |
| BAE800BG | BAE800B |

MV AGUSTA

| | |
|-----------|---------|
| 800091235 | BAE800B |
|-----------|---------|

NISSAN

| | |
|---------------|----------|
| 22433-8J115 | BAEA079E |
| 22433-8J11C | BAEA079E |
| 22448 1F700 | BAEA337 |
| 22448 4M500 | BAEA021E |
| 22448 4M50A | BAEA021E |
| 22448-00QAA | BAE409A |
| 22448-00QAC | BAEA354 |
| 22448-00QAD | BAEA454 |
| 22448-00QAE | BAE409A |
| 22448-00QAF | BAE947A |
| 22448-1KTOA | BAEA088E |
| 22448-31U00 | BAEA073E |
| 22448-31U01 | BAEA073E |
| 22448-6N000 | BAEA081E |
| 22448-6N002 | BAEA081E |
| 22448-6N010 | BAEA081E |
| 22448-6N011 | BAE409A |
| 22448-6N012 | BAEA081E |
| 22448-6N015 | BAEA081E |
| 22448-8H310 | BAEA080E |
| 22448-8H311 | BAEA080E |
| 22448-8H314 | BAEA080E |
| 22448-8H315 | BAEA080E |
| 224488J100 | BAEA079E |
| 224488J110 | BAEA079E |
| 224488J111 | BAEA079E |
| 224488J115 | BAEA079E |
| 22448-8J11C | BAEA079E |
| 22448-AL615 | BAEA132E |
| 22448-AL61C | BAEA132E |
| 22448AX001 | BAEA188E |
| 22448-ED00 0 | BAEA088E |
| 22448-ED800 | BAEA056E |
| 22448-ED800EP | BAEA056E |
| 22448ED80A | BAEA056E |
| 22448-JA00 A | BAEA088E |
| 22448-JA00 C | BAEA088E |
| 22448-JA10A | BAEA158E |
| 22448-JA10C | BAEA158E |

OPEL

| | |
|------------|----------|
| 03474283 | BAEA253 |
| 10 45 7075 | BAEA026E |
| 11 03 872 | BAEA026E |
| 11 03 905 | BAEA026E |
| 12 08 002 | BAEA252 |
| 12 08 003 | BAEA253 |

OPEL

| | |
|------------|----------|
| 12 08 004 | BAEA252 |
| 12 08 008 | BAEA342 |
| 12 08 012 | BAEA147E |
| 12 08 015 | BAEA115 |
| 12 08 015 | BAEA153E |
| 12 08 017 | BAEA115 |
| 12 08 020 | BAEA338 |
| 12 08 021 | BAEA427 |
| 12 08 028 | BAEA359 |
| 12 08 036 | BAEA252 |
| 12 08 039 | BAEA174E |
| 12 08 048 | BAEA252 |
| 12 08 054 | BAEA253 |
| 12 08 063 | BAEA026E |
| 12 08 070 | BAEA253 |
| 12 08 071 | BAEA344 |
| 12 08 075 | BAEA306 |
| 12 08 081 | BAEA174E |
| 12 08 086 | BAEA199E |
| 12 08 092 | BAEA185E |
| 12 08 093 | BAEA185E |
| 12 08 096 | BAEA185E |
| 12 08 098 | BAEA198E |
| 12 08 123 | BAEA185E |
| 12 08 209 | BAEA152E |
| 12 08 210 | BAEA153E |
| 12 08 213 | BAEA150E |
| 12 08 306 | BAEA358 |
| 12 08 307 | BAE965A |
| 1208051 | BAEA025E |
| 1208107 | BAEA095 |
| 1208307 | BAE965A |
| 12583514 | BAEA174E |
| 12629037 | BAEA174E |
| 12768422 | BAEA115 |
| 24 420 584 | BAEA338 |
| 24 420 622 | BAEA359 |
| 4408 389 | BAE409A |
| 4413 233 | BAE409A |
| 4701049 | BAEA189E |
| 4709290 | BAEA189E |
| 4711572 | BAEA189E |
| 4805507 | BAEA447A |
| 55213613 | BAEA095 |
| 62 35 124 | BAEA149E |
| 90 560 110 | BAEA147E |
| 90 564 334 | BAEA150E |
| 90510387 | BAEA252 |
| 90536194 | BAEA342 |
| 91 53 250 | BAEA149E |
| 91 95 819 | BAEA150E |
| 91159996 | BAE409A |

PEUGEOT

| | |
|---------|----------|
| 5940 29 | BAE504L |
| 5970 13 | BAEA110 |
| 5970 15 | BAEA110 |
| 5970 A3 | BAEA046E |
| 5970 A7 | BAEA256 |
| 5970 A8 | BAE946A |
| 5970.43 | BAEA247 |
| 5970.49 | BAEA231 |
| 5970.50 | BAE700AK |
| 5970.51 | BAEA256 |
| 5970.70 | BAEA232 |
| 5970.75 | BAEA348 |
| 5970.77 | BAEA347 |
| 5970.81 | BAEA046E |
| 5970.84 | BAEA351 |
| 5970.87 | BAEA352 |
| 5970.90 | BAEA048E |
| 5970.94 | BAEA347 |
| 5970.97 | BAEA048E |
| 5970.98 | BAEA348 |
| 5970.A0 | BAEA352 |
| 5970.A5 | BAEA351 |
| 597078 | BAE946A |
| 597079 | BAE946A |
| 597079 | BAE946A |
| 597083 | BAEA454 |

PIAGGIO

| | |
|------------|---------|
| 57165300 | BAE800B |
| 639187 | BAE800B |
| GU05716530 | BAE800B |

PONTIAC

| | |
|-----------|---------|
| 1 104 091 | BAEA472 |
|-----------|---------|

PORSCHE

| | |
|----------------|----------|
| 000 043 990 01 | BAEA052E |
| 901 602 102 01 | BAEA115 |
| 928 602 501 00 | BAEA115 |
| 946 602 104 00 | BAEA163E |
| 948 602 104 00 | BAEA012E |
| 948 602 104 01 | BAEA012E |
| 948 602 104 02 | BAEA042E |
| 948 602 104 03 | BAEA012E |
| 948 602 104 04 | BAEA042E |
| 948 602 104 05 | BAEA012E |
| 948 602 104 06 | BAEA042E |
| 948 602 104 07 | BAEA012E |
| 948 602 104 08 | BAEA012E |
| 948 602 104 09 | BAEA012E |
| 948 602 104 10 | BAEA042E |
| 948 602 104 11 | BAEA042E |
| 948 602 104 12 | BAEA042E |
| 948 602 104 13 | BAEA042E |

OE ? ⇒



| | | | | | | | |
|----------------|----------|----------------------|----------|------------------------|----------|-----------------|----------|
| PORSCHE | | RENAULT | | SKODA | | STANDARD | |
| 948 602 104 20 | BAEA012E | 82 00 360 911 | BAEA325 | 032 905 106 B | BAE907AE | IIS287 | BAEA167E |
| 955 602 101 03 | BAEA044E | 82 00 702 693 | BAE947A | 032 905 106B | BAE907AE | IIS293 | BAEA168E |
| 955 602 101 05 | BAEA044E | 82 00 702 693 | BAEA325 | 032 905 715 | BAE408AE | IIS295 | BAEA474 |
| 958 602 101 00 | BAEA044E | 82 00 726 341 | BAEA066E | 032 905 715A | BAE408AE | IIS336 | BAEA172E |
| 958 602 102 00 | BAEA032E | 82 00 959 964 | BAEA066E | 032 905 715C | BAE408AE | IIS519 | BAEA476 |
| 958 905 110 00 | BAEA068E | 8200025256 | BAEA454 | 032 905 715E | BAE408AE | SUBARU | |
| 9A1 602 104 00 | BAEA052E | 8200084401 | BAE947A | 047905104 | BAE960AE | 22433-AA570 | BAEA191E |
| 9A1 602 104 01 | BAEA052E | 8200084401 | BAEA454 | 047905104A | BAE961AE | SUZUKI | |
| 9A1 602 104 02 | BAEA052E | 8200154186 | BAE409A | 06A 905 097 | BAEA029E | 33400-51K10 | BAEA189E |
| 9A1 602 104 03 | BAEA052E | 8200154186A | BAE409A | 06A 905 097 A | BAEA029E | 33400-65G00 | BAEA181E |
| 9A1 602 104 04 | BAEA052E | 8200208611 | BAE409A | 357 905 104 | BAE851AE | 33410-66D00 | BAEA136E |
| 9A1 602 104 05 | BAEA052E | 8200380267 | BAE409A | 6 NO 905 104 | BAE851AE | 33410-66D00-000 | BAEA136E |
| 9A1 602 104 06 | BAEA052E | 8200405098 | BAE409A | 6N0905104 | BAE851AE | 33410-66D01 | BAEA136E |
| PROTON | | 8200568671 | BAE409A | 867 905 104 | BAE851AE | 33410-66D01-000 | BAEA136E |
| 8200051128 | BAEA454 | 8200672564 | BAE409A | 867 905 104A | BAE851AE | 33410-66D10 | BAEA136E |
| RENAULT | | 8200699627 | BAEA161E | BAE960AE010 | BAE960AE | 33410-66D10-000 | BAEA136E |
| 22 43 324 28R | BAEA131E | 8200765882 | BAE409A | SMART | | 33410-77E20 | BAEA072E |
| 22 43 361 34R | BAEA354 | 9633001580 | BAEA347 | 000 3100 V003 | BAEA304 | 33410-77E21 | BAEA072E |
| 22433 7085R | BAEA066E | 9664401880 | BAEA347 | 000 3100 V004 | BAEA304 | 33410-77E22 | BAEA072E |
| 224333529R | BAE409A | ROVER | | 000 3100 V005 | BAEA304 | TOYOTA | |
| 22448-ED00 0 | BAEA088E | ERR6045 | BAEA234 | A 281 906 00 00 | BAEA131E | 19080-46020 | BAEA173E |
| 22448-JA00 A | BAEA088E | GCL 195 | BAEA275 | C 000 3100 V003 | BAEA304 | 19080-46030 | BAEA445 |
| 22448-JA00 C | BAEA088E | GCL 307 | BAEA302 | C 000 3100 V004 | BAEA304 | 90080-19015 | BAEA164E |
| 2526180A | BAE409A | GCL161 | BAEA276 | C 000 3100 V005 | BAEA304 | 90080-19016 | BAEA173E |
| 60 00 581 617 | BAEA234 | NEC000120 | BAEA501 | Q 000 3100 V005 000000 | BAEA304 | 90080-19017 | BAEA449 |
| 7401275174 | BAEA037E | NEC100530 | BAEA275 | STANDARD | | 90080-19017 | BAEA449 |
| 77 00 100 589 | BAEA242 | NEC100630 | BAEA469 | 12143 | BAEA093E | 90080-1901700 | BAEA449 |
| 77 00 100 643 | BAEA243 | NEC100730 | BAEA501 | 12469 | BAEA453 | 90080-19019 | BAEA164E |
| 77 00 274 008 | BAEA354 | NEC101000 | BAEA302 | 12473 | BAEA446 | 90080-19021 | BAEA165E |
| 77 00 669 324 | BAEA110 | NEC101000SLP | BAEA302 | 12742 | BAEA540 | 90919-02197 | BAEA445 |
| 77 00 749 450 | BAE504L | NEC101010 | BAEA302 | 12774 | BAEA165E | 90919-02207 | BAEA173E |
| 77 00 858 138 | BAE504L | SAAB | | 12774 | BAEA165E | 90919-02227 | BAEA165E |
| 77 00 863 020 | BAEA254 | 73 09 859 | BAEA115 | 12825 | BAEA171E | 90919-02229 | BAEA165E |
| 77 00 863 021 | BAEA255 | 83 00 584 | BAEA115 | 12855 | BAEA170E | 90919-02230 | BAEA172E |
| 77 00 865 923 | BAEA254 | 85 02 098 | BAEA115 | 12866 | BAEA164E | 90919-02234 | BAEA173E |
| 77 00 872 834 | BAEA345 | 85 06 636 | BAEA115 | 12868 | BAEA172E | 90919-02237 | BAEA186E |
| 77 01 031 135 | BAEA251 | SAIC HUIZHONG | | 12874 | BAEA482 | 90919-02238 | BAEA168E |
| 77 01 041 607 | BAEA245 | NEC90012A | BAEA501 | 12886 | BAEA486 | 90919-02239 | BAEA164E |
| 77 01 041 608 | BAEA246 | SCANIA | | CP0020 | BAEA165E | 90919-02240 | BAEA165E |
| 77 02 218 697 | BAE504L | 1789358 | BAEA297 | CU1043 | BAEA170E | 90919-02243 | BAEA171E |
| 7700107177 | BAE409A | SEAT | | CU1119 | BAEA469 | 90919-02244 | BAEA171E |
| 7700113357 | BAE409A | 032 905 106 B | BAE907AE | CU1178 | BAEA165E | 90919-02247 | BAEA167E |
| 7700113357A | BAE409A | 82 00 584 | BAEA115 | CU1317 | BAEA171E | 90919-02248 | BAEA167E |
| 7700749450 | BAE504L | 85 02 098 | BAEA115 | CU1331 | BAEA475 | 90919-02250 | BAEA192E |
| 7700749450-D | BAE504L | 85 06 636 | BAEA115 | CU1337 | BAEA169E | 90919-02252 | BAEA184E |
| 7700858138 | BAE504L | SKODA | | CU1517 | BAEA093E | 90919-02256 | BAEA192E |
| 7700875000 | BAE409A | 004 050 016 | BAE851AE | CU1531 | BAEA476 | 90919-02257 | BAEA192E |
| 7701479027 | BAEA347 | 032 905 100A | BAE408AE | IIS004 | BAEA164E | 90919-02258 | BAEA184E |
| 7702218697 | BAE504L | 032 905 100B | BAE408AE | IIS234 | BAEA171E | 90919-02260 | BAEA167E |
| 82 00 141 149 | BAEA345 | 032 905 100C | BAE408AE | IIS259 | BAEA482 | 90919-02262 | BAEA164E |
| 82 00 360 911 | BAE947A | 032 905 100D | BAE408AE | IIS276 | BAEA486 | 90919-02265 | BAEA165E |
| | | 032 905 106 | BAE907AE | IIS282 | BAEA169E | 90919-A2001 | BAEA167E |

OE ? ⇒

| TOYOTA | CHAMPION |
|----------------|----------|
| 90919-C2002 | BAEA167E |
| 90919-T2002 | BAEA164E |
| TRACK MARSHALL | CHAMPION |
| ME 72-14 | BAEA408 |
| VAG | CHAMPION |
| 021 905 106 | BAEA004E |
| 021 905 106 A | BAEA004E |
| 022 905 100 B | BAEA044E |
| 022 905 100 E | BAEA044E |
| 022 905 100 H | BAEA044E |
| 022 905 100 L | BAEA044E |
| 022 905 100 P | BAEA044E |
| 022 905 100 S | BAEA044E |
| 022 905 100 T | BAEA044E |
| 022 905 715 | BAEA044E |
| 022 905 715 A | BAEA041E |
| 022 905 715 B | BAEA044E |
| 034 905 101 | BAEA043 |
| 034 905 105 | BAEA043 |
| 03D 905 115 | BAEA059E |
| 03D 905 115 A | BAEA059E |
| 03D 905 115 B | BAEA059E |
| 03D 905 115 C | BAEA059E |
| 03D 905 115 D | BAEA059E |
| 03D 905 115 E | BAEA059E |
| 03D 905 115 F | BAEA059E |
| 03D 905 115 G | BAEA059E |
| 03D 905 715 A | BAEA059E |
| 04C 905 110 A | BAEA067E |
| 04C 905 110 B | BAEA067E |
| 04C 905 110 D | BAEA067E |
| 04C 905 110 F | BAEA067E |
| 04C 905 110 H | BAEA067E |
| 04C 905 110 J | BAEA067E |
| 04C 905 110 K | BAEA067E |
| 04E 905 110 | BAEA126E |
| 04E 905 110 A | BAEA126E |
| 04E 905 110 B | BAEA126E |
| 04E 905 110 C | BAEA126E |
| 04E 905 110 E | BAEA126E |
| 058 905 101 | BAEA016 |
| 058 905 101 A | BAEA162E |
| 058 905 105 | BAEA016 |
| 058 905 105 | BAEA017 |
| 066 905 100 | BAEA065E |
| 066 905 100 B | BAEA065E |
| 066 905 100 C | BAEA065E |
| 066 905 100 D | BAEA065E |
| 066 905 100 G | BAEA065E |
| 06B 905 115 | BAEA009E |
| 06B 905 115 B | BAEA009E |

| VAG | CHAMPION |
|---------------|----------|
| 06B 905 115 E | BAEA009E |
| 06D 905 115 | BAEA032E |
| 06D 905 115 A | BAEA032E |
| 06D 905 115 C | BAEA032E |
| 06D 905 115 D | BAEA032E |
| 06D 905 115 F | BAEA032E |
| 06D 905 115 G | BAEA032E |
| 06D 905 115 J | BAEA032E |
| 06D 905 115 K | BAEA032E |
| 06E 905 115 | BAEA032E |
| 06E 905 115 A | BAEA032E |
| 06E 905 115 B | BAEA032E |
| 06E 905 115 C | BAEA032E |
| 06E 905 115 D | BAEA032E |
| 06E 905 115 E | BAEA032E |
| 06F 905 115 | BAEA033E |
| 06F 905 115 A | BAEA033E |
| 06F 905 115 B | BAEA033E |
| 06F 905 115 C | BAEA033E |
| 06F 905 115 D | BAEA033E |
| 06F 905 115 E | BAEA033E |
| 06F 905 115 F | BAEA033E |
| 06J 905 110 B | BAEA068E |
| 06J 905 110 C | BAEA068E |
| 06J 905 110 D | BAEA068E |
| 06J 905 110 E | BAEA068E |
| 06J 905 110 F | BAEA068E |
| 06J 905 110 G | BAEA068E |
| 06J 905 110 K | BAEA068E |
| 06K 905 110 G | BAEA137E |
| 06K 905 110 J | BAEA068E |
| 06K 905 110 K | BAEA068E |
| 06L 905 110 B | BAEA068E |
| 06L 905 110 C | BAEA068E |
| 06L 905 110 D | BAEA068E |
| 06L 905 110 E | BAEA068E |
| 06L 905 110 F | BAEA068E |
| 077 905 104 | BAEA017 |
| 078 905 104 | BAEA154E |
| 078 905 104 A | BAEA154E |
| 07C 905 115 | BAEA031E |
| 07C 905 115 C | BAEA031E |
| 07C 905 115 D | BAEA031E |
| 07C 905 115 E | BAEA031E |
| 07C 905 115 F | BAEA031E |
| 07C 905 115 H | BAEA031E |
| 07C 905 115 J | BAEA031E |
| 07C 905 715 | BAEA031E |
| 07C 905 715 A | BAEA031E |
| 07K 905 715 | BAEA033E |
| 07K 905 715 A | BAEA033E |
| 07K 905 715 B | BAEA033E |
| 07K 905 715 C | BAEA033E |

| VAG | CHAMPION |
|---------------|----------|
| 07K 905 715 D | BAEA033E |
| 07K 905 715 E | BAEA033E |
| 07K 905 715 F | BAEA033E |
| 171 905 115 | BAEA115 |
| 310 880 01 | BAEA004E |
| 6N0 905 104 | BAEA002E |
| 867 905 105 A | BAEA002E |
| VAUXHALL | CHAMPION |
| 55213613 | BAEA095 |
| 90458250 | BAEA344 |
| 9118115 | BAEA153E |
| VOLVO | CHAMPION |
| 1 275 602 | BAEA429 |
| 1207458 | BAEA115 |
| 1275174 | BAEA037E |
| 1275971 | BAEA446 |
| 241086 | BAEA115 |
| 30713416 | BAEA019E |
| 30713417 | BAEA055E |
| 30731416 | BAEA387 |
| 30731419 | BAEA387 |
| 30735759 | BAEA350 |
| 31216444 | BAEA350 |
| 31216444 | BAEA387 |
| 31359976 | BAEA350 |
| 3287677 | BAEA251 |
| 3287677-3 | BAEA251 |
| 70863020 | BAEA254 |
| 70863020-7 | BAEA245 |
| 70863021 | BAEA255 |
| 70863021-5 | BAEA246 |
| 826490 | BAEA115 |
| 841931 | BAEA115 |
| 8677837 | BAEA055E |
| 870909 | BAEA115 |
| 870943 | BAEA115 |
| 9125601 | BAEA019E |
| VW | CHAMPION |
| 021 905 106 B | BAEA013E |
| 021 905 106 C | BAEA013E |
| 022 905 100 A | BAEA063E |
| 022 905 100 D | BAEA063E |
| 022 905 100 G | BAEA063E |
| 022 905 100 K | BAEA063E |
| 022 905 100 N | BAEA063E |
| 022 905 715 C | BAEA063E |
| 032 905 106 B | BAE907AE |
| 032 905 106 D | BAE907AE |
| 032 905 106 E | BAE907AE |
| 032 905 106D | BAE907AE |
| 032905106B | BAE907AE |

| VW | CHAMPION |
|---------------|----------|
| 032905106D | BAE907AE |
| 036 905 100 A | BAE408AE |
| 036 905 100 B | BAE408AE |
| 036 905 100 C | BAE408AE |
| 036 905 100 D | BAE408AE |
| 036 905 715 | BAE408AE |
| 036 905 715 A | BAE408AE |
| 036 905 715 C | BAE408AE |
| 036 905 715 E | BAE408AE |
| 036 905 715 F | BAE408AE |
| 036 905 715 G | BAE408AE |
| 036905100A | BAE408AE |
| 036905100B | BAE408AE |
| 036905100C | BAE408AE |
| 036905100D | BAE408AE |
| 036905715 | BAE408AE |
| 036905715A | BAE408AE |
| 036905715C | BAE408AE |
| 036905715E | BAE408AE |
| 036905715F | BAE408AE |
| 047 905 104 | BAE960AE |
| 047 905 104 A | BAE961AE |
| 047 905 104 B | BAE961AE |
| 0489051051 | BAEA234 |
| 059 905 105 | BAEA115 |
| 059 905 105 B | BAEA115 |
| 06A 905 097 | BAEA029E |
| 06A 905 097 A | BAEA029E |
| 06A 905 104 | BAEA029E |
| 06A 905 115 | BAEA043E |
| 06A 905 115 A | BAEA043E |
| 06A 905 115 B | BAEA043E |
| 06A 905 115 C | BAEA043E |
| 06A 905 115 D | BAEA043E |
| 06B 905 115 D | BAEA043E |
| 06B 905 115 G | BAEA043E |
| 06B 905 115 H | BAEA043E |
| 06B 905 115 J | BAEA043E |
| 06B 905 115 L | BAEA043E |
| 06B 905 115 M | BAEA043E |
| 06B 905 115 N | BAEA043E |
| 06B 905 115 P | BAEA043E |
| 06B 905 115 Q | BAEA043E |
| 06B 905 115 R | BAEA043E |
| 06B 905 115 S | BAEA043E |
| 06C 905 115 A | BAEA051E |
| 06C 905 115 B | BAEA051E |
| 06C 905 115 C | BAEA043E |
| 06C 905 115 D | BAEA051E |
| 06C 905 115 E | BAEA051E |
| 06C 905 115 F | BAEA051E |
| 06C 905 115 G | BAEA051E |
| 06C 905 115 H | BAEA051E |

OE ? ⇔



| VW |  |
|----------------|---|
| 06C 905 115 K | BAEA051E |
| 06C 905 115 L | BAEA051E |
| 06C 905 115 M | BAEA051E |
| 06H 905 110 D | BAEA137E |
| 06H 905 110 E | BAEA137E |
| 06H 905 110F | BAEA137E |
| 071 905 106 | BAEA037 |
| 077 905 115 AA | BAEA062E |
| 077 905 115 B | BAEA061E |
| 077 905 115 C | BAEA061E |
| 077 905 115 E | BAEA061E |
| 077 905 115 F | BAEA061E |
| 077 905 115 G | BAEA062E |
| 077 905 115 H | BAEA061E |
| 077 905 115 J | BAEA062E |
| 077 905 115 K | BAEA061E |
| 077 905 115 M | BAEA062E |
| 077 905 115 P | BAEA061E |
| 077 905 115 Q | BAEA061E |
| 077 905 115 R | BAEA062E |
| 077 905 115 S | BAEA062E |
| 077 905 115 T | BAEA061E |
| 171 905 115 A | BAEA115 |
| 6N0905104 | BAE851AE |
| 6NO 905 104 | BAE851AE |
| 701 905 104 | BAEA002E |
| 701 905 104 A | BAEA002E |
| 867 905 104 A | BAE851AE |
| 867905104 A | BAE851AE |















| | |
|-------------------------|--------|
| BMW | |
| 12 21 7 786 821 | CCU101 |
| 12 21 7 788 327 | CCU102 |
| 12 21 7 798 000 | CCU105 |
| 12 21 7 800 156 | CCU108 |
| 12 21 7 801 200 | CCU101 |
| 12 21 7 801 201 | CCU102 |
| 12 21 7 810 856 | CCU106 |
| 12 21 8 519 471 | CCU106 |
| 12 21 8 570 087 | CCU106 |
| 12 21 8 591 723 | CCU105 |
| 12 21 8 591 724 | CCU108 |
| 7 786 821 | CCU101 |
| 7 788 327 | CCU102 |
| 7 801 200 | CCU101 |
| 7 801 201 | CCU102 |
| CHRYSLER | |
| 05175759AA | CCU114 |
| 05175759AB | CCU114 |
| 68013182AA | CCU114 |
| 68013182AB | CCU114 |
| 68013182AC | CCU114 |
| 68013182AD | CCU114 |
| CITROEN/ PEUGEOT | |
| 5981 16 | CCU148 |
| 5981 20 | CCU148 |
| 5981 31 | CCU149 |
| 5981 38 | CCU149 |
| 5981 40 | CCU147 |
| 9640469680 | CCU147 |
| FIAT | |
| 2374720 | CCU150 |
| 46414088 | CCU153 |
| 46432278 | CCU153 |
| 46438456 | CCU153 |
| 46772573 | CCU153 |
| 51233720 | CCU150 |
| 51888255 | CCU150 |
| 55199051 | CCU150 |
| 60812527 | CCU153 |
| 7735921 | CCU153 |
| 9615959448 | CCU153 |
| 9639912580 | CCU149 |
| FORD | |
| 1252609 | CCU147 |
| 3M5T-12A343-AA | CCU147 |
| GENERAL MOTORS | |
| 55563423 | CCU138 |
| 55574293 | CCU138 |
| 91167210 | CCU154 |
| 9201699 | CCU154 |





| | |
|-----------------------|--------|
| GENERAL MOTORS | |
| 992121 | CCU154 |
| LANCIA | |
| 46438456 | CCU153 |
| MERCEDES-BENZ | |
| 000 545 35 16 | CCU140 |
| 000 545 36 16 | CCU141 |
| 019 545 69 32 | CCU141 |
| 025 545 28 32 | CCU140 |
| 025 545 29 32 | CCU141 |
| 028 545 40 32 | CCU141 |
| 032 545 05 32 | CCU104 |
| 034 545 64 32 | CCU104 |
| 629 153 06 79 | CCU118 |
| 640 153 04 79 | CCU156 |
| 640 153 27 79 | CCU156 |
| 646 153 25 79 | CCU110 |
| 646 153 65 79 | CCU140 |
| 648 153 02 79 | CCU113 |
| 648 900 00 00 | CCU141 |
| A 000 545 35 16 | CCU140 |
| A 000 545 36 16 | CCU141 |
| A 019 545 69 32 | CCU141 |
| A 025 545 28 32 | CCU140 |
| A 025 545 29 32 | CCU141 |
| A 028 545 40 32 | CCU141 |
| A 032 545 05 32 | CCU104 |
| A 034 545 64 32 | CCU104 |
| A 629 153 06 79 | CCU118 |
| A 640 153 04 79 | CCU156 |
| A 640 153 27 79 | CCU156 |
| A 642 153 03 79 | CCU114 |
| A 642 153 19 79 | CCU114 |
| A 642 153 20 79 | CCU114 |
| A 642 153 37 79 | CCU116 |
| A 642 900 27 00 | CCU116 |
| A 642 900 28 00 | CCU114 |
| A 642 900 57 01 | CCU116 |
| A 642 900 58 01 | CCU114 |
| A 642 900 77 01 | CCU116 |
| A 642 900 78 01 | CCU114 |
| A 646 153 25 79 | CCU110 |
| A 646 153 65 79 | CCU140 |
| A 648 153 02 79 | CCU113 |
| A 648 900 00 00 | CCU141 |
| NISSAN | |
| 11067BN700 | CCU154 |
| OPEL | |
| 12 32 077 | CCU145 |
| 12 32 331 | CCU138 |
| 12 37 783 | CCU138 |







| | |
|----------------|--------|
| OPEL | |
| 1232076 | CCU144 |
| 44 09 990 | CCU154 |
| 45 06 156 | CCU154 |
| 55353011 | CCU142 |
| 55354141 | CCU143 |
| 55557760 | CCU144 |
| 55557761 | CCU145 |
| 6235240 | CCU142 |
| 6235303 | CCU143 |
| RENAULT | |
| 77 00 100 703 | CCU129 |
| 77 00 109 860 | CCU128 |
| 77 00 111 525 | CCU129 |
| 7700115078 | CCU154 |
| 9611751080 | CCU148 |
| VAG | |
| 038 907 281 B | CCU151 |
| 038 907 281 D | CCU152 |
| 04L 907 281 | CCU152 |
| 04L 907 282 | CCU151 |
| 357911253 | CCU081 |
| VOLVO | |
| 8692616 | CCU147 |

OE ? ⇒

| | |
|-------------------|---|
| ALFA ROMEO |  |
| 4646919 | CLS055 |
| 4646920 | CLS055 |
| 46755606 | CLS055 |
| BMW |  |
| 12 12 1 247 361 | CLS037 |
| 12 12 1 247 512 | CLS036 |
| 12 12 1 247 513 | CLS036 |
| 12 12 1 310 008 | CLS191 |
| 12 12 1 311 735 | CLS191 |
| 12 12 1 311 803 | CLS191 |
| 12 12 1 316 688 | CLS191 |
| 12 12 1 717 646 | CLS104 |
| 12 12 1 720 530 | CLS186 |
| 12 12 1 726 037 | CLS186 |
| 12 12 1 727 686 | CLS104 |
| CHEVROLET |  |
| 25 183 557 | CLS144 |
| 25 183 763 | CLS144 |
| 25 183 764 | CLS144 |
| 25 183 765 | CLS144 |
| 25 183 766 | CLS144 |
| 96 288 956 | CLS085 |
| 96 450 249 | CLS196 |
| 96 497 773 | CLS086 |
| CHRYSLER |  |
| 5013601 AB | CLS241 |
| 5018394 AA | CLS241 |
| 5018394 AC | CLS241 |
| 5018394 AD | CLS241 |
| 5018394 AG | CLS241 |
| 5019593 AA | CLS193 |
| DACIA |  |
| 82 00 506 297 | CLS076 |
| 82 00 943 801 | CLS088 |
| DAEWOO |  |
| 96 190 263 | CLS107 |
| 96 211 948 | CLS020 |
| 96 256 433 | CLS013 |
| 9A 418 150 B | CLS025 |
| DAIHATSU |  |
| 19901-87186-000 | CLS228 |
| 90048-58273-000 | CLS163 |
| 90048-58274-000 | CLS163 |
| FIAT |  |
| 1462110080 | CLS123 |
| 46413088 | CLS137 |
| 46425912 | CLS035 |
| 46474814 | CLS044 |



| | |
|-------------|---|
| FIAT |  |
| 46743086 | CLS044 |
| 46749624 | CLS067 |
| 55195775 | CLS082 |
| 55195776 | CLS082 |
| 60564150 | CLS235 |
| 60564151 | CLS235 |
| 60567866 | CLS235 |
| 60573733 | CLS235 |
| 60584943 | CLS235 |
| 71742423 | CLS167 |
| 7552294 | CLS118 |
| 7604907 | CLS118 |
| 7604977 | CLS006 |
| 7694366 | CLS003 |
| 7716092 | CLS002 |
| 7716094 | CLS004 |
| 7730698 | CLS008 |
| 7735397 | CLS135 |
| 7760523 | CLS136 |
| 7775810 | CLS009 |
| 7776810 | CLS261 |
| 9617237080 | CLS005 |
| FORD |  |
| 1004427 | CLS032 |
| 1004430 | CLS032 |
| 1004431 | CLS032 |
| 1004432 | CLS032 |
| 1012436 | CLS111 |
| 1063615 | CLS111 |
| 1063621 | CLS122 |
| 1071985 | CLS015 |
| 1071986 | CLS015 |
| 1071987 | CLS015 |
| 1071988 | CLS015 |
| 1110740 | CLS077 |
| 1110741 | CLS077 |
| 1110742 | CLS077 |
| 1110743 | CLS077 |
| 1111216 | CLS243 |
| 1111218 | CLS243 |
| 1111219 | CLS243 |
| 1111223 | CLS243 |
| 1119840 | CLS074 |
| 1119841 | CLS074 |
| 1119842 | CLS074 |
| 1119843 | CLS074 |
| 1214216 | CLS092 |
| 1319060 | CLS091 |
| 1319061 | CLS091 |
| 1319062 | CLS091 |
| 1319063 | CLS091 |
| 1335369 | CLS077 |





| | |
|-----------------------|---|
| FORD |  |
| 1335371 | CLS077 |
| 1335374 | CLS077 |
| 1335377 | CLS077 |
| 1502365 | CLS089 |
| 1502366 | CLS089 |
| 1502367 | CLS089 |
| 1502368 | CLS089 |
| 157E-12280-BC | CLS156 |
| 157E-12280-BE | CLS156 |
| 157E-12281-BC | CLS156 |
| 157E-12281-BE | CLS156 |
| 4138501 | CLS156 |
| 4138502 | CLS156 |
| 4155357 | CLS156 |
| 4335003 | CLS156 |
| 4454954 | CLS156 |
| 6592244 | CLS122 |
| 6592245 | CLS122 |
| 6592246 | CLS122 |
| 6592247 | CLS122 |
| 7053862 | CLS022 |
| 7053866 | CLS022 |
| 7262796 | CLS022 |
| 7262798 | CLS022 |
| 96MF-12283-BA | CLS032 |
| 96MF-12284-BA | CLS032 |
| 96MF-12286-BA | CLS032 |
| 96MF-12287-BA | CLS032 |
| YS6F-12283-A1A | CLS077 |
| YS6F-12283-B1A | CLS089 |
| YS6F-12284-A1A | CLS077 |
| YS6F-12284-B1A | CLS089 |
| YS6F-12286-A1A | CLS077 |
| YS6F-12286-B1A | CLS089 |
| YS6F-12287-A1A | CLS077 |
| YS6F-12287-B1A | CLS089 |
| GENERAL MOTORS |  |
| 96305387 | CLS025 |
| HONDA |  |
| 32700-P1J-E01 | CLS012 |
| 32722-P03-000 | CLS129 |
| 32722-P07-000 | CLS129 |
| 32722-P1K-E01 | CLS128 |
| 32722-P2A-003 | CLS129 |
| 32722-P2A-J00 | CLS129 |
| 32722-PM1-B01 | CLS128 |
| 32722-PM6-B00 | CLS128 |
| HYUNDAI |  |
| 27501-02A00 | CLS021 |
| 27501-02D00 | CLS023 |
| 27501-02H00 | CLS073 |





| | |
|-------------------|---|
| HYUNDAI |  |
| 27501-22B00 | CLS023 |
| 27501-22B10 | CLS072 |
| 27501-23A00 | CLS130 |
| 27501-23B70 | CLS094 |
| 27501-26A00 | CLS024 |
| 27501-26C00 | CLS024 |
| 27501-26D00 | CLS024 |
| 27501-37A00 | CLS189 |
| 27501-37B00 | CLS189 |
| KIA |  |
| OK2011 8140 | CLS131 |
| OK2011 8150A | CLS131 |
| OK2471 8160A | CLS173 |
| OK2471 8160B | CLS173 |
| OK2471 8180A | CLS173 |
| OK2471 8180B | CLS173 |
| OK2A31 8160A | CLS157 |
| OK2A31 8180A | CLS157 |
| OK30E1 8140 | CLS256 |
| 27420-02670 | CLS197 |
| 27420-23700 | CLS130 |
| 27430-23700 | CLS130 |
| 27440-23700 | CLS130 |
| 27450-23700 | CLS130 |
| 27501-02W00 | CLS093 |
| LADA |  |
| 2121 437 17080 | CLS147 |
| LANCIA |  |
| 46425912 | CLS035 |
| 7742005 | CLS112 |
| LAND ROVER |  |
| NGC500370 | CLS155 |
| NGC500380 | CLS155 |
| NGC500390 | CLS155 |
| NGC500400 | CLS155 |
| NGC500410 | CLS155 |
| MAZDA |  |
| 1E05-18-160 B | CLS075 |
| 1E05-18-170 B | CLS075 |
| 1E05-18-180 B | CLS075 |
| 1E05-18-190 B | CLS075 |
| 83M5-18-140 | CLS131 |
| B31R-18-140 | CLS168 |
| B6MC-18-160 B | CLS056 |
| B6MC-18-170 B | CLS056 |
| B6MC-18-180 B | CLS056 |
| B6MC-18-190 B | CLS056 |
| BP6D-18-140 A | CLS159 |
| BP6E-18-140 A | CLS159 |
| BPE8-18-140 A | CLS056 |











| MAZDA  | |
|--|--------|
| FP85-18-140 A | CLS198 |
| FP86-18-140 A | CLS198 |
| FSD7-18-140 B | CLS239 |
| Z501-18-140 A | CLS031 |
| ZL01-18-140 A | CLS257 |
| ZX18-18-140 | CLS131 |
| ZX19-18-140 | CLS131 |
| ZX29-18-140 | CLS229 |
| MERCEDES-BENZ  | |
| 102 150 19 18 | CLS098 |
| 102 150 20 18 | CLS098 |
| 102 150 21 18 | CLS098 |
| 102 150 28 18 | CLS098 |
| 102 150 29 18 | CLS098 |
| 110 150 40 18 | CLS207 |
| 110 150 63 18 | CLS208 |
| 110 150 69 18 | CLS208 |
| 110 150 70 18 | CLS208 |
| 110 150 71 18 | CLS208 |
| 110 150 72 18 | CLS208 |
| 110 150 73 18 | CLS208 |
| 110 150 74 18 | CLS208 |
| 112 150 01 18 | CLS064 |
| 112 150 02 18 | CLS064 |
| 112 150 03 18 | CLS242 |
| 112 150 04 18 | CLS242 |
| 114 150 00 18 | CLS200 |
| 116 150 00 18 | CLS201 |
| 116 150 01 18 | CLS206 |
| 116 150 12 19 | CLS203 |
| 116 150 13 19 | CLS203 |
| 116 150 46 18 | CLS201 |
| 266 150 01 18 | CLS078 |
| 266 150 02 18 | CLS078 |
| 266 150 06 18 | CLS078 |
| 266 150 07 18 | CLS078 |
| A 102 150 19 18 | CLS098 |
| A 102 150 20 18 | CLS098 |
| A 102 150 21 18 | CLS098 |
| A 102 150 28 18 | CLS098 |
| A 102 150 29 18 | CLS098 |
| A 110 150 40 18 | CLS207 |
| A 110 150 63 18 | CLS208 |
| A 110 150 69 18 | CLS208 |
| A 110 150 70 18 | CLS208 |
| A 110 150 71 18 | CLS208 |
| A 110 150 72 18 | CLS208 |
| A 110 150 73 18 | CLS208 |
| A 110 150 74 18 | CLS208 |
| A 112 150 01 18 | CLS064 |
| A 112 150 02 18 | CLS064 |
| A 112 150 03 18 | CLS242 |

| MERCEDES-BENZ  | |
|--|--------|
| A 112 150 04 18 | CLS242 |
| A 114 150 00 18 | CLS200 |
| A 116 150 00 18 | CLS201 |
| A 116 150 01 18 | CLS206 |
| A 116 150 12 19 | CLS203 |
| A 116 150 13 19 | CLS203 |
| A 116 150 46 18 | CLS201 |
| A 266 150 01 18 | CLS078 |
| A 266 150 02 18 | CLS078 |
| A 266 150 06 18 | CLS078 |
| A 266 150 07 18 | CLS078 |
| MINI  | |
| 12 12 7 513 032 | CLS069 |
| 12 12 7 513 033 | CLS069 |
| 12 12 7 513 034 | CLS069 |
| 12 12 7 513 035 | CLS069 |
| MITSUBISHI  | |
| MD332343 | CLS169 |
| MD365102 | CLS010 |
| NISSAN  | |
| 22440-1C710 | CLS153 |
| 22440-2J210 | CLS132 |
| 22440-86J10 | CLS059 |
| 22440-99B05 | CLS133 |
| OPEL  | |
| 12 82 153 | CLS030 |
| 12 82 154 | CLS030 |
| 12 82 155 | CLS030 |
| 12 82 156 | CLS030 |
| 12 82 163 | CLS176 |
| 12 82 164 | CLS176 |
| 12 82 165 | CLS176 |
| 12 82 166 | CLS176 |
| 16 12 400 | CLS166 |
| 16 12 429 | CLS166 |
| 16 12 430 | CLS218 |
| 16 12 434 | CLS101 |
| 16 12 436 | CLS166 |
| 16 12 447 | CLS214 |
| 16 12 458 | CLS211 |
| 16 12 459 | CLS212 |
| 16 12 476 | CLS218 |
| 16 12 477 | CLS213 |
| 16 12 479 | CLS213 |
| 16 12 509 | CLS018 |
| 16 12 523 | CLS103 |
| 16 12 527 | CLS103 |
| 16 12 533 | CLS018 |
| 16 12 536 | CLS102 |
| 16 12 537 | CLS102 |

| OPEL  | |
|--|--------|
| 16 12 541 | CLS018 |
| 16 12 542 | CLS103 |
| 16 12 545 | CLS103 |
| 16 12 551 | CLS220 |
| 16 12 556 | CLS018 |
| 16 12 561 | CLS029 |
| 16 12 598 | CLS107 |
| 16 12 603 | CLS175 |
| 16 12 606 | CLS115 |
| 16 12 607 | CLS141 |
| 16 12 608 | CLS114 |
| 16 12 609 | CLS113 |
| 16 12 619 | CLS175 |
| 16 12 639 | CLS115 |
| 90 008 241 | CLS212 |
| 90 491 944 | CLS175 |
| PEUGEOT  | |
| 5967 K9 | CLS226 |
| 5967 L0 | CLS123 |
| 5967 L3 | CLS005 |
| 5967 L6 | CLS005 |
| 5967 L7 | CLS123 |
| 5967 L8 | CLS005 |
| 5967 N1 | CLS005 |
| 5967.L5 | CLS262 |
| 5967.L9 | CLS262 |
| 5967.N6 | CLS262 |
| 9608885180 | CLS005 |
| 9609493380 | CLS123 |
| PORSCHE  | |
| 901 609 061 00 | CLS246 |
| 901 609 100 00 | CLS246 |
| 928 602 040 00 | CLS215 |
| 928 602 055 00 | CLS215 |
| 928 602 056 00 | CLS215 |
| 993 602 060 01 | CLS251 |
| 993 602 060 02 | CLS251 |
| 993 602 060 03 | CLS251 |
| 993 602 060 04 | CLS251 |
| 993 602 060 05 | CLS251 |
| 993 602 060 06 | CLS251 |
| 993 602 060 11 | CLS251 |
| 993 602 060 12 | CLS251 |
| 993 602 060 13 | CLS251 |
| 993 602 060 14 | CLS251 |
| 993 602 060 15 | CLS251 |
| 993 602 060 16 | CLS251 |
| RENAULT  | |
| 74 31 275 284 | CLS051 |
| 74 31 335 874 | CLS050 |
| 74 39 135 700 | CLS050 |

| RENAULT  | |
|---|--------|
| 77 00 106 221 | CLS039 |
| 77 00 107 662 | CLS040 |
| 77 00 114 549 | CLS083 |
| 77 00 273 226 | CLS011 |
| 77 00 273 826 | CLS019 |
| 77 00 742 835 | CLS117 |
| 77 00 749 521 | CLS126 |
| 77 00 866 923 | CLS014 |
| 77 00 874 109 | CLS040 |
| 77 00 874 564 | CLS052 |
| 77 01 025 483 | CLS149 |
| 77 01 349 467 | CLS149 |
| 82 00 334 440 | CLS194 |
| 82 00 486 877 | CLS084 |
| 82 00 506 297 | CLS076 |
| 82 00 713 680 | CLS084 |
| 82 00 805 133 | CLS083 |
| ROVER  | |
| GHT 252 | CLS161 |
| GHT 261 | CLS161 |
| GHT 263 | CLS148 |
| GHT 284 | CLS061 |
| GHT 291 | CLS045 |
| NGC 000 090 | CLS095 |
| NGC 000 094 | CLS061 |
| NGC104170L | CLS045 |
| SAAB  | |
| 9146895 | CLS150 |
| 9146903 | CLS150 |
| 9146911 | CLS150 |
| 9146929 | CLS150 |
| 9321910 | CLS150 |
| 9337346 | CLS182 |
| SMART  | |
| Q 000 2576 V002 000000 | CLS068 |
| SUBARU  | |
| 22451-AA630 | CLS170 |
| 22451-AA640 | CLS170 |
| 22451-AA720 | CLS080 |
| 22451-AA730 | CLS080 |
| 22451-AA800 | CLS080 |
| 22451-AA810 | CLS080 |
| SUZUKI  | |
| 33700-82011 | CLS258 |
| 33705-57B21 | CLS230 |
| 33705-66D00 | CLS026 |
| 33705-80G00 | CLS167 |
| 33705-83020 | CLS134 |
| 33705-86G00 | CLS167 |
| 33730-86G00 | CLS167 |



OE ? ⇌

SUZUKI

33740-86G00 **CLS167**

TOYOTA

6307 **CLS058**

90919-22319 **CLS259**

90919-22325 **CLS231**

90919-22370 **CLS233**

90919-22373 **CLS234**

90919-22386 **CLS171**

90919-22395 **CLS096**

90919-22400 **CLS171**

90998-99002 **CLS058**

VAG

021 905 409 **CLS199**

021 905 409 B **CLS199**

056 998 031 A **CLS097**

059 998 031 **CLS099**

06A 905 405 N **CLS070**

06A 905 409 M **CLS048**

06A 905 409 P **CLS048**

06B 905 431 A **CLS048**

06B 905 433 A **CLS048**

06B 905 435 A **CLS048**

06B 905 437 A **CLS048**

071 998 031 **CLS249**

078 905 113 **CLS046**

078 905 401 **CLS001**

111 998 031 **CLS245**

111 998 031 A **CLS245**

171 998 031 B **CLS097**

321 998 031 **CLS097**

321 998 031 A **CLS097**

477 998 031 **CLS248**

803 998 031 **CLS099**

N 101 902 02 **CLS172**

N 101 902 03 **CLS172**

N 101 902 04 **CLS172**

N 101 902 05 **CLS172**

N 101 903 02 **CLS172**

VOLVO

127528-4 **CLS051**

127560-3 **CLS195**

1306696-4 **CLS179**

1335874-2 **CLS050**

270800-6 **CLS179**

270898-0 **CLS179**

271483-0 **CLS236**

272193-4 **CLS179**

3073142-4 **CLS077**

3531277-6 **CLS236**

9135546-1 **CLS050**

9135700-4 **CLS050**

VOLVO

9146403-2 **CLS050**

9445258-8 **CLS050**

VW

021 905 409 AA **CLS237**

021 905 409 G **CLS237**

021 905 409 K **CLS237**

021 905 409 M **CLS237**

030 905 430 E **CLS041**

030 905 430 F **CLS041**

030 905 430 G **CLS041**

030 905 430 H **CLS041**

030 905 430 N **CLS053**

030 905 430 P **CLS053**

030 905 430 Q **CLS053**

030 905 430 R **CLS053**

032 905 409 B **CLS081**

032 905 430 K **CLS081**

032 905 430 L **CLS081**

032 905 430 M **CLS081**

032 905 430 N **CLS081**

036 905 409 K **CLS260**

036 905 483 G **CLS260**

037 905 409 B **CLS174**

037 905 409 D **CLS238**

037 905 483 C **CLS034**

03F 905 409 B **CLS090**

03F 905 409 C **CLS090**

03F 905 430 **CLS090**

03F 905 430 D **CLS090**

03F 905 430 E **CLS090**

03F 905 430 F **CLS090**

03F 905 430 G **CLS090**

03F 905 430 H **CLS090**

03F 905 430 J **CLS090**

03F 905 430 K **CLS090**

03F 905 430 L **CLS090**

06A 905 409 A **CLS139**

06A 905 409 D **CLS177**

06A 905 409 E **CLS139**

06A 905 409 F **CLS017**

06A 905 409 G **CLS140**

06A 905 409 L **CLS017**

06F 905 430 D **CLS090**

06F 905 430 E **CLS090**

06F 905 430 F **CLS090**

06F 905 430 G **CLS090**

071 905 409 C **CLS181**

071 905 409 G **CLS181**

071 905 409 J **CLS181**

078 905 531 A **CLS001**

078 905 532 A **CLS001**

078 905 533 A **CLS001**

VW

078 905 534 A **CLS001**

078 905 535 A **CLS001**

078 905 536 A **CLS001**

437 998 031 B **CLS105**

N 100 502 05 **CLS079**

N 100 529 04 **CLS109**

N 100 529 06 **CLS174**























N 100 529 07 **CLS079**

N 102 044 02 **CLS047**

























N 102 436 11 **CLS047**

N 104 529 11 **CLS178**



























| | | | | | |
|--|--|--|--|--|--|
| CCH306C  | CCH425 <p>No Image</p> | CET1  | CET2  | CET3  | CET4  |
| CET5  | CET6  | CET7  | CET8  | CET9  | CET10P  |
| CET11P  | CET12P  | CET13P  | CET14P  | CET15P  | CET16P  |
| CET17P  | CET18P  | CJ6  | CJ7Y  | CJ8  | D16  |

























| | | | | | |
|---|---|---|---|---|---|
| DJ8J  | J8C  | J17LM  | J19LM  | L77JC4  | L78C  |
| L82C  | OE001  | OE002  | OE003  | OE004  | OE005  |
| OE006  | OE007  | OE008  | OE009  | OE010  | OE011  |
| OE012  | OE013  | OE014  | OE015  | OE016  | OE018  |



























| | | | | | |
|---|---|---|---|---|---|
| OE019  | OE025  | OE026  | OE027  | OE029  | OE030  |
| OE031  | OE032  | OE033  | OE034  | OE035  | OE037  |
| OE038  | OE039  | OE041  | OE042  | OE044  | OE048  |
| OE049  | OE051  | OE052  | OE054  | OE057  | OE059  |



























| | | | | | |
|---|---|---|---|---|---|
| OE063  | OE064  | OE065  | OE068  | OE073  | OE074  |
| OE077  | OE078  | OE079  | OE083  | OE086  | OE087  |
| OE089  | OE091  | OE093  | OE094  | OE098  | OE099  |
| OE105  | OE108  | OE112  | OE114  | OE120  | OE122  |



























| | | | | | |
|---|---|---|---|---|---|
| OE123  | OE128  | OE130  | OE131  | OE136  | OE138  |
| OE145  | OE146  | OE148  | OE154  | OE175  | OE176  |
| OE177  | OE178  | OE179  | OE180  | OE181  | OE182  |
| OE183  | OE184  | OE186  | OE187  | OE188  | OE189  |

















| | | | | | |
|---|---|---|---|---|---|
| OE190  | OE191  | OE192  | OE193  | OE194  | OE195  |
| OE196  | OE197  | OE198  | OE199  | OE201  | OE203  |
| OE204  | OE205  | OE206  | OE207  | OE208  | OE209  |
| OE210  | OE211  | OE212  | OE213  | OE214  | OE215  |























| | | | | | |
|---|---|---|---|---|---|
| OE216  | OE217  | OE218  | OE219  | OE220  | OE222  |
| OE223  | OE224  | OE225  | OE226  | OE227  | OE228  |
| OE229  | OE230  | OE231  | OE232  | OE233  | OE234  |
| OE235  | OE236  | OE237  | OE238  | OE239  | OE240  |







| | | | | | |
|---|---|--|---|--|--|
| OE241  | OE242  | OE243  | OE244  | OE245  | OE246  |
| OE247 <p>No Image</p> | OE248  | OE249  | OE250  | OE253  | OE254 <p>No Image</p> |
| OE255  | OE256  | OE257 <p>No Image</p> | OE258 <p>No Image</p> | OE260 <p>No Image</p> | OE261 <p>No Image</p> |
| OE262 <p>No Image</p> | OE263 <p>No Image</p> | OE264 <p>No Image</p> | P-RA7HC  | P-RG4HCC  | P-RG6HCC  |









| | | | | | |
|---|---|---|---|---|--|
| P-RG7C  | P-RZ7HC  | P-RZ9HC  | QCJ6Y  | QCJ8Y  | QL77JC4  |
| RCJ8  | RG6YC  | RG6YCA  | RJ17LM  | RJ19LM  | RJ19LMC  |
| RL78C  | RN1C  | RV8C  | RV15YC4  | RX12ZYC  | RY4C  |
| RZ7C  | Z9Y  | | | | |



|  |  |  |  |  |
|--|---|---|---|---|
| CCH306C | L86C | 21 mm | M14x1,25 | 0,6 |
| CCH425 | X | 24 mm | 1/2"-14 | 0,7 |
| CJ6 | CJ6 | 19 mm | M14x1,25 | 0,5 |
| CJ7Y | CJ7Y | 19 mm | M14x1,25 | 0,5 |
| CJ8 | CJ8 | 19 mm | M14x1,25 | 0,6 |
| D16 | D16 | 23 mm | M18x1,5 | 0,6 |
| DJ8J | DJ8J | 16 mm | M14x1,25 | 0,7 |
| J8C | J8C | 21 mm | M14x1,25 | 0,8 |
| J17LM | J17LM | 21 mm | M14x1,25 | 0,8 |
| J19LM | J19LM | 21 mm | M14x1,25 | 0,7 |
| L77JC4 | L77JC4 | 21 mm | M14x1,25 | 0,8 |
| L78C | L78C | 21 mm | M14x1,25 | 0,6 |
| L82C | L82C | 21 mm | M14x1,25 | 0,6 |
| OE001 | N9YC | 21 mm | M14x1,25 | 0,9 |
| OE002 | RC9YCC | 16 mm | M14x1,25 | 0,9 |
| OE003 | C9YC | 16 mm | M14x1,25 | 0,9 |
| OE004 | RN9YCC | 21 mm | M14x1,25 | 0,9 |
| OE005 | RC9YC | 16 mm | M14x1,25 | 0,9 |
| OE006 | RN9YC | 21 mm | M14x1,25 | 0,9 |
| OE007 | L87YC | 21 mm | M14x1,25 | 0,9 |
| OE008 | RN7YCC | 21 mm | M14x1,25 | 0,9 |
| OE009 | S9YC | 16 mm | M14x1,25 | 0,9 |
| OE010 | N7YC | 21 mm | M14x1,25 | 0,9 |
| OE011 | RS9YC | 16 mm | M14x1,25 | 0,9 |
| OE012 | N7BYC | 21 mm | M14x1,25 | 0,8 |
| OE013 | RC12YC | 16 mm | M14x1,25 | 0,8 |
| OE014 | RC7YCC | 16 mm | M14x1,25 | 0,9 |
| OE015 | N12YC | 21 mm | M14x1,25 | 0,9 |
| OE016 | RC10YCC | 16 mm | M14x1,25 | 0,9 |
| OE018 | RN7YC | 21 mm | M14x1,25 | 1,0 |
| OE019 | RC10DMC | 16 mm | M14x1,25 | 0,9 |
| OE025 | RN8VTYC4 | 21 mm | M14x1,25 | 1,0 |
| OE026 | RC8DMC | 16 mm | M14x1,25 | 0,9 |
| OE027 | RN10VTYC4 | 21 mm | M14x1,25 | 1,0 |
| OE029 | RES9PYP4 | 16 mm | M14x1,25 | 1,0 |
| OE030 | RC8BYC | 16 mm | M14x1,25 | 0,9 |
| OE031 | RES9YCC4 | 16 mm | M14x1,25 | 1,0 |
| OE032 | RC8VTYC4 | 16 mm | M14x1,25 | 1,0 |
| OE033 | RC87YCL | 16 mm | M14x1,25 | 0,9 |
| OE034 | RC8YCL | 16 mm | M14x1,25 | 0,9 |
| OE035 | REC9YCL | 16 mm | M14x1,25 | 0,9 |
| OE037 | L86C | 21 mm | M14x1,25 | 0,6 |
| OE038 | L82YC | 21 mm | M14x1,25 | 0,9 |
| OE039 | RC9YC4 | 16 mm | M14x1,25 | 1,0 |
| OE041 | RC12LYC | 16 mm | M14x1,25 | 0,9 |
| OE042 | RN12YC | 21 mm | M14x1,25 | 0,9 |
| OE044 | N9BYC | 21 mm | M14x1,25 | 0,9 |
| OE048 | RN9YC4 | 21 mm | M14x1,25 | 1,0 |
| OE049 | RN11YC4 | 21 mm | M14x1,25 | 1,0 |
| OE051 | RN11YC | 21 mm | M14x1,25 | 0,9 |
| OE052 | RA4HCX | 16 mm | M12x1,25 | 0,9 |
| OE054 | RF7YC | 21 mm | M18x1,5 | 0,8 |
| OE057 | C11YCC | 16 mm | M14x1,25 | 0,9 |

|  |  |  |  |  |
|---|--|---|---|---|
| OE059 | L92YC | 21 mm | M14x1,25 | 0,8 |
| OE063 | RC10YC4 | 16 mm | M14x1,25 | 1,0 |
| OE064 | RL82YC | 21 mm | M14x1,25 | 0,9 |
| OE065 | N11YC | 21 mm | M14x1,25 | 0,9 |
| OE068 | N3C | 21 mm | M14x1,25 | 0,7 |
| OE073 | RA4HC | 16 mm | M12x1,25 | 0,8 |
| OE074 | N5C | 21 mm | M14x1,25 | 0,7 |
| OE077 | RC7BYC4 | 16 mm | M14x1,25 | 1,0 |
| OE078 | N3G | 21 mm | M14x1,25 | 0,5 |
| OE079 | N4C | 21 mm | M14x1,25 | 0,7 |
| OE083 | RA6HC | 16 mm | M12x1,25 | 0,7 |
| OE086 | RL82C | 21 mm | M14x1,25 | 0,6 |
| OE087 | N6YC | 21 mm | M14x1,25 | 0,9 |
| OE089 | RC9MCC4 | 16 mm | M14x1,25 | 1,0 |
| OE091 | RN2C | 21 mm | M14x1,25 | 0,7 |
| OE093 | RC89YCC | 16 mm | M14x1,25 | 1,0 |
| OE094 | RC6YCC | 16 mm | M14x1,25 | 0,9 |
| OE098 | RN4C | 21 mm | M14x1,25 | 0,6 |
| OE099 | S12YC | 16 mm | M14x1,25 | 0,9 |
| OE105 | RN14PMP5 | 21 mm | M14x1,25 | 1,3 |
| OE108 | RN3C | 21 mm | M14x1,25 | 0,7 |
| OE112 | A6GC | 16 mm | M12x1,25 | 0,7 |
| OE114 | RC11LCC4 | 16 mm | M14x1,25 | 1,0 |
| OE120 | RC89TMC | 16 mm | M14x1,25 | 0,6 |
| OE122 | RG4PHP | 16 mm | M10x1,0 | 0,7 |
| OE123 | RC8TYC | 16 mm | M14x1,25 | 0,7 |
| OE128 | RC12LC4 | 16 mm | M14x1,25 | 1,0 |
| OE130 | RE8MX | 14 mm | M12x1,25 | 0,9 |
| OE131 | RS9PYP4 | 16 mm | M14x1,25 | 1,0 |
| OE136 | RC8PYP | 16 mm | M14x1,25 | 0,8 |
| OE138 | RC11PYPB4 | 16 mm | M14x1,25 | 1,0 |
| OE145 | RC89PYC | 16 mm | M14x1,25 | 0,8 |
| OE146 | RC8PYPB4 | 16 mm | M14x1,25 | 1,0 |
| OE148 | REC10YC4 | 16 mm | M14x1,25 | 1,0 |
| OE154 | RC12MCC4 | 16 mm | M14x1,25 | 1,0 |
| OE175 | REC10PYC4 | 16 mm | M14x1,25 | 1,0 |
| OE176 | KC8ZPYPB4 | 16 mm | M14x1,25 | 1,0 |
| OE177 | KC8ZMCC | 16 mm | M14x1,25 | 0,9 |
| OE178 | REC9MCLX | 16 mm | M14x1,25 | 0,9 |
| OE186 | RA8YCX4 | 16 mm | M12x1,25 | 1,0 |
| OE191 | KC10PYPB4 | 16 mm | M14x1,25 | 1,0 |
| OE192 | RN10PYP4 | 21 mm | M14x1,25 | 1,0 |
| OE196 | RA8MCX4 | 16 mm | M12x1,25 | 1,0 |
| OE197 | RER8YC | 16 mm | M12x1,25 | 0,9 |
| OE198 | RC10MCC | 16 mm | M14x1,25 | 0,9 |
| OE199 | RA7YC | 16 mm | M12x1,25 | 0,9 |
| OE201 | RER8MC | 16 mm | M12x1,25 | 0,9 |
| OE203 | RERX8PMPBX4 | 14/bi-hex | M12x1,25 | 1,0 |
| OE204 | RERX6PMCB4 | 14/bi-hex | M12x1,25 | 1,0 |
| OE205 | RERX4PMPB | 14/bi-hex | M12x1,25 | 0,7 |
| OE206 | REC8PYB | 16 mm | M14x1,25 | 0,7 |
| OE207 | RE8PMPB5 | 14 mm | M12x1,25 | 1,1 |
| OE208 | RA2PYPB | 16 mm | M12x1,25 | 0,8 |





| CHAMPION | | | | |
|----------|-------------|-----------|----------|-----|
| OE209 | KC7PYPBX | 16 mm | M14x1,25 | 0,8 |
| OE210 | KEC4PYPB | 16 mm | M14x1,25 | 0,8 |
| OE211 | RER6DMC | 16 mm | M12x1,25 | 0,6 |
| OE212 | RER6YC | 16 mm | M12x1,25 | 0,9 |
| OE213 | KC7ZPYPB4 | 16 mm | M14x1,25 | 0,9 |
| OE214 | KC6PYPB | 16 mm | M14x1,25 | 0,7 |
| OE215 | KA4ZPYPB4 | 16 mm | M12x1,25 | 0,9 |
| OE216 | RC7BMC | 16 mm | M14x1,25 | 0,8 |
| OE217 | RC7DYC | 16 mm | M14x1,25 | 0,6 |
| OE218 | RC8QMC | 16 mm | M14x1,25 | 1,6 |
| OE219 | KEC4PYPBF | 16 mm | M14x1,25 | 0,7 |
| OE220 | KEC4PYPBF-1 | 16 mm | M14x1,25 | 0,7 |
| OE222 | KC6PYPBX | 16 mm | M14x1,25 | 0,8 |
| OE223 | RC9QMP | 16 mm | M14x1,25 | 1,6 |
| OE224 | REC8PYPB | 16 mm | M14x1,25 | 0,8 |
| OE225 | REA6PYPB | 14 mm | M12x1,25 | 0,7 |
| OE226 | RA7PYPB4 | 16 mm | M12x1,25 | 1,1 |
| OE227 | RC8PMPB | 16 mm | M14x1,25 | 0,6 |
| OE228 | KC8PYP4 | 16 mm | M14x1,25 | 1,0 |
| OE229 | KER4PYPB | 16 mm | M12x1,25 | 0,8 |
| OE230 | RA4YC | 16 mm | M12x1,25 | 0,9 |
| OE231 | REA6YC | 14 mm | M12x1,25 | 0,8 |
| OE232 | RER2PYPB | 16 mm | M12x1,25 | 0,7 |
| OE233 | REA4PMPB4 | 14 mm | M12x1,25 | 1,0 |
| OE234 | KC7ZPMPBX4 | 16 mm | M14x1,25 | 1,0 |
| OE235 | KC7ZTMC4 | 16 mm | M14x1,25 | 1,0 |
| OE236 | REC6TMC | 16 mm | M14x1,25 | 1,7 |
| OE237 | RC7BYC | 16 mm | M14x1,25 | 1,6 |
| OE238 | REC7PMPB4 | 16 mm | M14x1,25 | 1,0 |
| OE239 | RC8ZPYPB4 | 16 mm | M14x1,25 | 1,1 |
| OE241 | RG4HCX | 16 mm | M10x1,0 | 0,8 |
| OE242 | RERX5PMPB | 14/bi-hex | M12x1,25 | 0,8 |
| OE243 | RERX5ZPYPB | 14/bi-hex | M12x1,25 | 0,8 |
| OE244 | KA6ZPHPB-1 | 16 mm | M12x1,25 | 0,8 |
| OE247 | KA8ZYCC-1 | 16 mm | M12x1,25 | 1,0 |
| OE254 | RC7BYC | 16 mm | M14x1,25 | 0,5 |
| OE255 | REST10TMC4 | 16 mm | M14x1,25 | 1,0 |
| OE257 | RC7QMC | 16 mm | M14x1,25 | 0,5 |
| OE262 | REC7QMC | 16 mm | M14x1,25 | 1,4 |
| P-RA7HC | P-RA7HC | 18 mm | M12x1,25 | 0,9 |
| P-RG4HCC | P-RG4HCC | 16 mm | M10x1,0 | 0,9 |
| P-RG6HCC | P-RG6HCC | 16 mm | M10x1,0 | 0,8 |
| P-RG7C | P-RG7C | 16 mm | M10x1,0 | 0,7 |
| P-RZ7HC | P-RZ7HC | 16 mm | M10x1,0 | 0,7 |
| P-RZ9HC | P-RZ9HC | 16 mm | M10x1,0 | 0,7 |
| QCJ6Y | QCJ6Y | 19 mm | M14x1,25 | 0,7 |
| QCJ8Y | QCJ8Y | 19 mm | M14x1,25 | 0,7 |
| QL77JC4 | QL77JC4 | 21 mm | M14x1,25 | 0,8 |
| RCJ8 | RCJ8 | 19 mm | M14x1,25 | 0,8 |
| RG6YC | RG6YC | 16 mm | M10x1,0 | 0,8 |
| RG6YCA | RG6YCA | 16 mm | M10x1,0 | 0,6 |
| RJ17LM | RJ17LM | 21 mm | M14x1,25 | 0,8 |
| RJ19LM | RJ19LM | 21 mm | M14x1,25 | 0,8 |





| CHAMPION | | | | |
|----------|---------|-------|----------|-----|
| RJ19LMC | RJ19LMC | 21 mm | M14x1,25 | 0,5 |
| RL78C | RL78C | 21 mm | M14x1,25 | 0,5 |
| RN1C | RN1C | 21 mm | M14x1,25 | 0,5 |
| RV8C | RV8C | 16 mm | M14x1,25 | 1,0 |
| RV15YC4 | RV15YC4 | 16 mm | M14x1,25 | 1,0 |
| RX12ZYC | RX12ZYC | 16 mm | M14x1,25 | 0,7 |
| RY4C | RY4C | 16 mm | M10x1,0 | 0,7 |
| RZ7C | RZ7C | 16 mm | M10x1,0 | 0,7 |
| Z9Y | Z9Y | 16 mm | M10x1,0 | 0,7 |

| eon TITAN | | | | |
|-----------|--|-----------|----------|-----|
| CET1 | | 16 mm | M12x1,25 | 0,9 |
| CET2 | | 16 mm | M14x1,25 | 0,9 |
| CET3 | | 16 mm | M14x1,25 | 0,9 |
| CET4 | | 14 mm | M12x1,25 | 0,9 |
| CET5 | | 16 mm | M14x1,25 | 0,9 |
| CET6 | | 16 mm | M12x1,25 | 0,9 |
| CET7 | | 16 mm | M14x1,25 | 0,9 |
| CET8 | | 21 mm | M14x1,25 | 0,9 |
| CET9 | | 16 mm | M14x1,25 | 0,9 |
| CET10P | | 16 mm | M12x1,25 | 0,8 |
| CET11P | | 16 mm | M14x1,25 | 0,8 |
| CET12P | | 16 mm | M14x1,25 | 0,8 |
| CET13P | | 14 mm | M12x1,25 | 0,8 |
| CET14P | | 16 mm | M14x1,25 | 0,8 |
| CET15P | | 16 mm | M12x1,25 | 0,8 |
| CET16P | | 14/bi-hex | M12x1,25 | 0,8 |
| CET17P | | 16 mm | M14x1,25 | 0,8 |
| CET18P | | 16 mm | M14x1,25 | 0,8 |







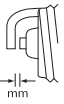

















| IRIDIUM | | | | |
|---------|------------|-----------|----------|-----|
| OE179 | RC8WYPB4 | 16 mm | M14x1,25 | 1,0 |
| OE180 | RC10WYPB4 | 16 mm | M14x1,25 | 1,0 |
| OE181 | KC8WYPB4 | 16 mm | M14x1,25 | 1,0 |
| OE182 | RC89WYPB4 | 16 mm | M14x1,25 | 1,0 |
| OE183 | RS8WYPB5 | 16 mm | M14x1,25 | 1,3 |
| OE184 | RC10WMPB2 | 16 mm | M14x1,25 | 0,6 |
| OE187 | RA7WHPB | 16 mm | M12x1,25 | 0,9 |
| OE188 | RC8WMPB4 | 16 mm | M14x1,25 | 1,0 |
| OE189 | RES9WYPB5 | 16 mm | M14x1,25 | 1,3 |
| OE190 | REC10WYPB4 | 16 mm | M14x1,25 | 1,0 |
| OE193 | RC12WYPB4 | 16 mm | M14x1,25 | 1,0 |
| OE194 | RC12WMPB4 | 16 mm | M14x1,25 | 1,0 |
| OE195 | RN8WYPB | 21 mm | M14x1,25 | 0,8 |
| OE240 | REA12WMB4 | 14 mm | M12x1,25 | 1,0 |
| OE245 | RERX4ZWYPB | 14/bi-hex | M12x1,25 | 0,8 |
| OE246 | KEC6WYPB-1 | 16 mm | M14x1,25 | 0,8 |





























|  IRIDIUM |  |  |  |  |
|--|---|---|---|---|
| OE248 | RER3WYPB | 16 mm | M12x1,25 | 0,8 |
| OE249 | RER8WMPB | 16 mm | M12x1,25 | 0,9 |
| OE250 | RER8WYPB | 16 mm | M16x1,25 | 0,8 |
| OE253 | REA8WYPB4 | 14 mm | M12x1,25 | 1,0 |
| OE256 | REA8WYPB | 14 mm | M12x1,25 | 0,7 |
| OE258 | RET4WYPBX | 14 mm | M12x1,25 | 0,7 |
| OE260 | KC6ZWYPB | 16 mm | M14x1,25 | 0,7 |
| OE261 | REA10WYPB | 14 mm | M12x1,25 | 0,7 |
| OE263 | RER12WMPB | 16 mm | M12x1,25 | 0,9 |
| OE264 | RC6WYPBX | 16 mm | M14x1,25 | 0,7 |



























| | | | | | |
|---|---|---|---|---|---|
| CH203  | CH204  | CH205  | CH206  | CH207  | CH209  |
| CH210  | CH215  | CH216  | CH217  | CH218  | CH219  |
| CH221  | CH222  | CH223  | CH224  | CH225  | CH226  |
| CH228  | CH229  | CH230  | CH231  | CH232  | CH233  |













| | | | | | |
|---|---|---|---|---|---|
| CH234  | CH240  | CH242  | CH252  | CH256  | CH258  |
| CH260  | CH263  | CH268  | CH269  | CH270  | CH271  |
| CH272  | CH273  | CH302  | CH306  | CH400  | CH401  |
| CH402  | CH403  | CH404  | CH405  | CH406  | CH407  |











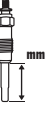

| | | | | | |
|---|---|---|---|---|---|
| CH408  | CH409  | CH410  | CH411  | CH600  | CH601  |
| CH603  | CH607  | CH608  | CH700  | CH701  | CH702  |
| CH704  | CH705  | CH709  | CH710  | CH711  | CH712  |
| CH713  | CH714  | CH715  | CH716  | CH717  | CH718  |

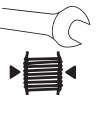

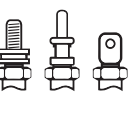







| | | | | | |
|--|--|--|--|--|---|
| CH719  | CH721  | CH722  | CH723  | CH724  | CH725  |
| CPSG003  | CPSG004  | CPSG006  | CPSG007  | CPSG008  | |
| | | | | | |
| | | | | | |

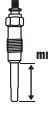



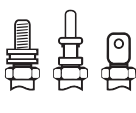
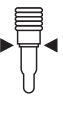







|  |  |  |  |  |  |  |  |  |  |  |
|---|---|---|---|---|---|---|--|---|---|---|
| | mm | mm | | mm | Nm | Nm Max. | | mm | V | A |
| CCGP001 | 134 | 29 | M10x1,0 | 10 mm | 15 | 20 | 4 mm | 63 | 5.4 | 45 |
| CCGP002 | 98.2 | 30 | M10x1,0 | 10 mm | 15 | 20 | 4 mm | 63 | 7 | 45 |
| CCGP003 | 118.5 | 30 | M8x1,0 | 8 mm | 8 | 10 | 4 mm | 93 | 7 | 45 |
| CCGP007 | 167.7 | 26 | M10x1,0 | 10 mm | 15 | 20 | 4 mm | 63 | 7 | 45 |
| CCGP010 | 130.7 | 28 | M10x1,0 | 10 mm | 15 | 20 | PIN | | 6.2 | |
| CH147 | 70 | 20.3 | M12x1,25 | 12 mm | 15 | 25 | M4 | | 11.5 | |
| CH154 | 95 | 32.1 | M10x1,25 | 12 mm | 15 | 20 | M4 | | 11 | |
| CH158 | 85 | 19 | M10x1,25 | 12 mm | 15 | 20 | M4 | 119 | 11 | 6 |
| CH167 | 71 | 25 | M12x1,25 | 12 mm | 15 | 25 | M4 | 63 | 11 | 14 |
| CH169 | 84 | 24.6 | M10x1,0 | 10 mm | 15 | 20 | M4 | | 11 | |
| CH170 | 107 | 28 | M10x1,0 | 10 mm | 15 | 20 | M4 | 63 | 11 | 18.5 |
| CH173 | 67 | 25 | M12x1,25 | 12 mm | 15 | 25 | M5 | 63 | 11 | 13.5 |
| CH175 | 119.5 | 28 | M12x1,25 | 12 mm | 15 | 25 | 5 mm | 63 | 11.5 | 12 |
| CH176 | 69 | 23 | M12x1,25 | 12 mm | 15 | 25 | M5 | 63 | 11.5 | 15.5 |
| CH177 | 115 | 28 | M12x1,25 | 12 mm | 15 | 25 | 4 mm | 63 | 11.5 | 15 |
| CH178 | 125 | 26 | M10x1,0 | 10 mm | 15 | 20 | M4 | 90 | 11.5 | 16 |
| CH180 | 129.5 | 25.8 | M10x1,0 | 10 mm | 15 | 20 | 4 mm | 63 | 11 | 14 |
| CH181 | 97 | 29.6 | M10x1,0 | 10 mm | 15 | 20 | 4 mm | | 11 | |
| CH185 | 89 | 29.6 | M10x1,0 | 10 mm | 15 | 20 | M4 | | 11 | |
| CH186 | 85 | 19.1 | M10x1,25 | 12 mm | 15 | 20 | M4 | | 11 | |
| CH189 | 72 | 24.3 | M12x1,25 | 12 mm | 15 | 25 | M5 | | 11 | |
| CH196 | 96 | 24.5 | M10x1,0 | 10 mm | 15 | 20 | M4 | 93 | 10 | 16.5 |
| CH200 | 118.5 | 28 | M8x1,0 | 8 mm | 8 | 10 | M4 | 123 | 11 | 11 |
| CH201 | 124.5 | 28 | M8x1,0 | 8 mm | 8 | 10 | 4 mm | 123 | 11 | 10 |
| CH203 | 106.5 | 33 | M10x1,0 | 10 mm | 15 | 20 | 4 mm | 63 | 11 | 15 |
| CH204 | 86 | 28 | M12x1,25 | 12 mm | 15 | 25 | 4 mm | 63 | 11.5 | 13 |
| CH205 | 62 | 18 | M12x1,25 | 12 mm | 15 | 25 | M5 | 63 | 10 | 18 |
| CH206 | 68 | 26 | M12x1,25 | 12 mm | 15 | 25 | M4 | 63 | 11 | 16 |
| CH207 | 133 | 28.6 | M10x1,0 | 10 mm | 15 | 20 | 4 mm | | 11 | |
| CH209 | 76 | 21 | M12x1,25 | 12 mm | 15 | 25 | 4 mm | 63 | 11 | 18 |
| CH210 | 119.5 | 31 | M10x1,25 | 12 mm | 15 | 20 | M4 | 119 | 11 | 14.5 |
| CH215 | 126 | 35 | M10x1,0 | 10 mm | 15 | 20 | 4 mm | 63 | 12 | 18 |
| CH216 | 75 | 25 | M10x1,0 | 10 mm | 15 | 20 | M4 | 63 | 11 | 15.5 |
| CH217 | 93 | 25 | M10x1,0 | 10 mm | 15 | 20 | M4 | 63 | 11 | 15.5 |
| CH218 | 130 | 28 | M10x1,0 | 10 mm | 15 | 20 | 4 mm | 63 | 11.5 | 13 |
| CH219 | 128 | 30.5 | M10x1,0 | 10 mm | 15 | 20 | M4 | 63 | 11 | 14 |
| CH221 | 87 | 21.85 | M10x1,25 | 12 mm | 15 | 20 | M4 | | 11 | |
| CH222 | 102.5 | 25 | M10x1,0 | 10 mm | 15 | 20 | 4 mm | 63 | 11 | 17.5 |
| CH223 | 119.4 | 28 | M8x1,0 | 8 mm | 8 | 10 | 4 mm | 93 | 11 | 13 |
| CH224 | 151.5 | 30 | M9x1,0 | 9 mm | 8 | 10 | 4 mm | 93 | 11 | 13 |
| CH225 | 95 | 22 | M10x1,25 | 12 mm | 15 | 20 | M4 | 119 | 11 | 20 |
| CH226 | 111.5 | 29.6 | M10x1,0 | 10 mm | 15 | 20 | M4 | 63 | 11 | 16 |
| CH228 | 121 | 40 | M10x1,0 | 10 mm | 15 | 20 | 4 mm | 63 | 11 | 14 |
| CH229 | 147 | 35 | M10x1,0 | 10 mm | 15 | 20 | M4 | 93 | 11.5 | 15.5 |
| CH230 | 179 | 20.8 | M10x1,0 | 12 mm | 15 | 20 | M4 | 119 | 11 | 11.7 |
| CH231 | 135 | 31 | M10x1,0 | 10 mm | 15 | 20 | 4 mm | 63 | 11 | 15.5 |
| CH232 | 151 | 25 | M10x1,0 | 10 mm | 15 | 20 | 4 mm | 63 | 11 | 17 |
| CH233 | 99 | 25 | M10x1,0 | 10 mm | 15 | 20 | 4 mm | 63 | 11 | 11 |
| CH234 | 153.5 | 31 | M10x1,25 | 12 mm | 15 | 20 | M4 | 120 | 11 | 14.5 |
| CH240 | 126.5 | 25 | M8x1,0 | 8 mm | 8 | 10 | 4 mm | 93 | 11 | 9 |
| CH242 | 87.5 | 22 | M10x1,25 | 12 mm | 15 | 20 | M4 | 120 | 11 | 13 |
| CH252 | 160 | 36 | M10x1,25 | 10 mm | 15 | 20 | M4 | 93 | 11 | 17.5 |
| CH256 | 84.5 | 18 | M10x1,25 | 12 mm | 15 | 20 | M4 | 123 | 11 | 17 |



|  |  |  |  |  |  |  |  |  |  |  |
|---|---|---|---|---|---|---|--|---|---|---|
| | mm | mm | | mm | Nm | Nm Max. | | | V | A |
| CH258 | 171 | 36.7 | M10x1,25 | 12 mm | 15 | 20 | M4 | 119 | 11 | 14.5 |
| CH260 | 62 | 21 | M12x1,25 | 12 mm | 15 | 25 | M5 | | 11 | |
| CH263 | 170 | 35 | M10x1,25 | 12 mm | 15 | 20 | M4 | 93 | 11 | 10 |
| CH268 | 118.4 | 27.75 | M10x1,0 | 10 mm | 15 | 20 | M4 | 63 | 11 | 18.5 |
| CH269 | 108 | 30 | M10x1,0 | 10 mm | 15 | 20 | 4 mm | 63 | 11 | 31 |
| CH270 | 152 | 40 | M8x1,0 | 8 mm | 8 | 10 | 4 mm | 93 | 11 | 11 |
| CH271 | 92 | 24.6 | M10x1,0 | 10 mm | 15 | 20 | 4 mm | | 11 | |
| CH272 | 106.5 | 25 | M10x1,0 | 10 mm | 15 | 20 | 4 mm | 63 | 11 | 15.5 |
| CH273 | 151 | 24.5 | M10x1,0 | 10 mm | 15 | 20 | 4 mm | 63 | 11 | 11 |
| CH302 | 97 | 28.1 | M10x1,25 | 12 mm | 15 | 20 | M4 | | 11 | |
| CH306 | 140 | 24 | M12x1,25 | 12 mm | 15 | 25 | M4 | 119 | 11 | 7 |
| CH400 | 148.5 | 27 | M8x1,0 | 8 mm | 8 | 10 | 4 mm | 93 | 11.5 | 13 |
| CH401 | 134.5 | 30 | M10x1,25 | 12 mm | 15 | 20 | M4 | 120 | 11 | 13 |
| CH402 | 97 | 28 | M8x1,0 | 8 mm | 8 | 10 | 4 mm | 123 | 11 | 11.5 |
| CH403 | 170 | 36.6 | M10x1,25 | 12 mm | 15 | 20 | M4 | 93 | 11 | 16 |
| CH404 | 156.5 | 35 | M9x1,0 | 9 mm | 8 | 10 | 4 mm | 93 | 11 | 20 |
| CH405 | 213 | 23 | M10x1,25 | 12 mm | 15 | 20 | M4 | 123 | 11 | 10 |
| CH406 | 161 | 31 | M10x1,25 | 12 mm | 15 | 20 | 4 mm | 119 | 11 | 10 |
| CH407 | 151.5 | 36 | M10x1,25 | 12 mm | 15 | 20 | M4 | 119 | 11 | 11 |
| CH408 | 160 | 28 | M10x1,25 | 10 mm | 15 | 20 | M4 | 93 | 11 | 10 |
| CH409 | 132 | 24 | M10x1,25 | 12 mm | 15 | 20 | M4 | 119 | 11 | 14.5 |
| CH410 | 160 | 28.3 | M10x1,25 | 10 mm | 15 | 20 | M4 | 93 | 11 | 8.5 |
| CH411 | 82 | 16 | M10x1,25 | 12 mm | 15 | 20 | M4 | 119 | 11 | 18 |
| CH600 | 94.5 | 18.5 | M10x1,25 | 10 mm | 15 | 20 | M4 | 123 | 11 | 17 |
| CH601 | 85 | 19 | M10x1,25 | 12 mm | 15 | 20 | M4 | 119 | 11 | 11.5 |
| CH603 | 143 | 24 | M10x1,25 | 12 mm | 15 | 20 | 4 mm | 119 | 11 | 15 |
| CH607 | 81 | 20 | M10x1,25 | 12 mm | 15 | 20 | M4 | 123 | 11 | 10 |
| CH608 | 101 | 25.4 | M10x1,25 | 12 mm | 15 | 20 | M4 | 93 | 11 | 10 |
| CH700 | 97 | 30 | M10x1,0 | 10 mm | 15 | 20 | 4 mm | 63 | 5 | 25 |
| CH701 | 106.5 | 33 | M10x1,0 | 10 mm | 15 | 20 | 4 mm | 63 | 5 | 25 |
| CH702 | 117 | 30 | M8x1,0 | 8 mm | 8 | 10 | 4 mm | 93 | 4.4 | 25 |
| CH704 | 133 | 31 | M10x1,0 | 10 mm | 15 | 20 | 4 mm | 63 | 5 | 25 |
| CH705 | 130 | 28 | M10x1,0 | 10 mm | 15 | 20 | 4 mm | 63 | 4.4 | 25 |
| CH709 | 148.5 | 27 | M8x1,0 | 8 mm | 8 | 10 | 4 mm | 93 | 4.4 | 25 |
| CH710 | 132 | 28 | M8x1,0 | 8 mm | 8 | 10 | 4 mm | 93 | 4.4 | 9 |
| CH711 | 156 | 26 | M10x1,25 | 10 mm | 15 | 20 | 4 mm | 119 | 4.4 | 8.5 |
| CH712 | 96.5 | 24.5 | M10x1,0 | 10 mm | 15 | 20 | 4 mm | 63 | 4.4 | 25 |
| CH713 | 90.5 | 24.5 | M10x1,0 | 10 mm | 15 | 20 | 4 mm | 63 | 4.4 | 25 |
| CH714 | 119.5 | 28 | M9x1,0 | 9 mm | 8 | 10 | 4 mm | 93 | 4.4 | 25 |
| CH715 | 156.5 | 35 | M9x1,0 | 9 mm | 8 | 10 | 4 mm | 93 | 4.4 | 25 |
| CH716 | 137.1 | 24 | M10x1,25 | 10 mm | 15 | 20 | 4 mm | 121 | 4.4 | 8.5 |
| CH717 | 134 | 29 | M10x1,0 | 10 mm | 15 | 20 | 4 mm | 63 | 4.4 | 8.5 |
| CH718 | 94 | 26 | M10x1,0 | 10 mm | 15 | 20 | 4 mm | 63 | 5 | 9 |
| CH719 | 112 | 28 | M8x1,0 | 8 mm | 8 | 10 | 4 mm | 123 | 5 | 30 |
| CH721 | 134 | 28 | M8x1,0 | 8 mm | 8 | 10 | 4 mm | 93 | 4.4 | 7.9 |
| CH722 | 162.7 | 26 | M10x1,0 | 10 mm | 15 | 20 | 4 mm | 93 | 4.6 | 10 |
| CH723 | 92.7 | 29.5 | M8x1,0 | 8 mm | 8 | 10 | 4 mm | 93 | 4.4 | 7.9 |
| CH724 | 146 | 31.4 | M10x1,0 | 10 mm | 15 | 20 | 4 mm | 93 | 4.4 | 8.1 |
| CH725 | 148.5 | 35.5 | M10x1,0 | 10 mm | 15 | 20 | M4 | 93 | 4.4 | 10 |
| CPSG003 | 132.2 | 28 | M9x1,0 | 12 mm | 8 | 10 | 4 mm PIN (PSG) | 93 | 4.4 | 8.5 |
| CPSG004 | 168 | 24 | M10x1,25 | 12 mm | 15 | 20 | 4 mm PIN (PSG) | 121 | 4.4 | 25 |
| CPSG006 | 179.95 | 35 | M9x1,0 | 12 mm | 8 | 10 | 4 mm PIN (PSG) | 93 | 4.4 | 8.5 |
| CPSG007 | 148.5 | 28 | M10x1,0 | 12 mm | 15 | 20 | 4 mm PIN (PSG) | 63 | 4.4 | |



| | | | | | | | | | | |
|---|---|---|---|---|---|---|--|---|---|---|
|  |  |  |  |  |  |  |  |  |  |  |
| CPSG008 | 165.1 | 28 | M10x1,0 | 12 mm | Nm | Nm Max. | 4 mm PIN (PSG) | 63 | 4.4 | |



BAE403B

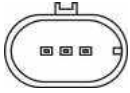

BAE403C

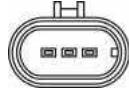

BAE403D

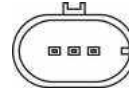

BAE408AE



BAE409A



BAE504D



BAE504F



BAE504L

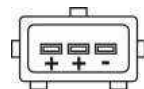

BAE506D

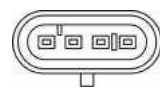

BAE506F



BAE700AK

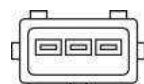

BAE800B

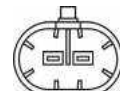



BAE850AK

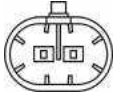

BAE851AE

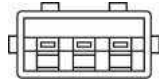

BAE907AE

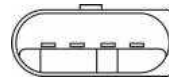

BAE920AX

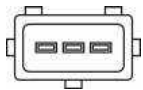

BAE940A

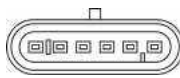

BAE946A



BAE947A

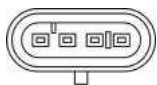

BAE960AE

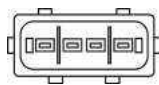

BAE961AE



BAE965A

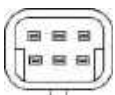













BAEA002E

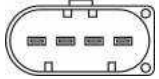
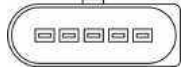
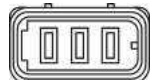
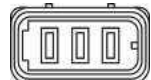
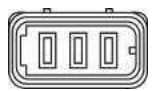
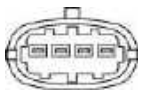

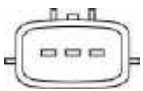

















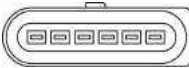

BAEA004E





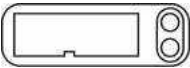













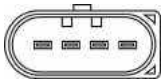

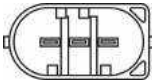





| | | |
|--|---|--|
| <p>BAEA007E</p>    | <p>BAEA009E</p> <p>No Image</p>  | <p>BAEA012E</p> <p>No Image</p>  |
| <p>BAEA013E</p> <p>No Image</p>  | <p>BAEA014</p> <p>No Image</p>  | <p>BAEA016</p> <p>No Image</p>  |
| <p>BAEA017</p> <p>No Image</p>  | <p>BAEA019E</p> <p>No Image</p>  | <p>BAEA021E</p>   |
| <p>BAEA025E</p>   | <p>BAEA026E</p>   | <p>BAEA029E</p> <p>No Image</p>  |



| | | |
|---|---|--|
| BAEA030 No Image   | BAEA031E No Image   | BAEA032E No Image   |
| BAEA033E No Image    | BAEA037 No Image   | BAEA037E No Image   |
| BAEA041 No Image   | BAEA041E No Image   | BAEA042E No Image  |
| BAEA043 No Image   | BAEA043E No Image  | BAEA044E No Image  |



| | | |
|--|--|--|
| <p>BAEA045E</p>   | <p>BAEA046E</p> <p>No Image</p>  | <p>BAEA048E</p> <p>No Image</p>  |
| <p>BAEA051E</p> <p>No Image</p>   | <p>BAEA052E</p> <p>No Image</p>   | <p>BAEA053</p>    |
| <p>BAEA055E</p> <p>No Image</p>   | <p>BAEA056E</p> <p>No Image</p>   | <p>BAEA059E</p> <p>No Image</p>   |
| <p>BAEA061E</p> <p>No Image</p>   | <p>BAEA062E</p> <p>No Image</p>   | <p>BAEA063E</p> <p>No Image</p>   |













| | | |
|--|---|--|
| <p>BAEA065E</p> <p>No Image</p>   | <p>BAEA066E</p> <p>No Image</p>   | <p>BAEA067E</p> <p>No Image</p>  |
| <p>BAEA068E</p> <p>No Image</p>  | <p>BAEA069E</p> <p>No Image</p>  | <p>BAEA072E</p>   |
| <p>BAEA073E</p> <p>No Image</p>  | <p>BAEA077</p> <p>No Image</p>   | <p>BAEA079E</p>   |
| <p>BAEA080E</p>   | <p>BAEA081E</p>   | <p>BAEA083E</p>   |



| | | |
|---|--|--|
| <p>BAEA084E</p> <p>No Image</p>  | <p>BAEA085</p> <p>No Image</p>   | <p>BAEA088E</p>   |
| <p>BAEA090</p>   | <p>BAEA093E</p>   | <p>BAEA095</p> <p>No Image</p>  |
| <p>BAEA110</p>   | <p>BAEA115</p> <p>No Image</p>  | <p>BAEA126E</p> <p>No Image</p>  |
| <p>BAEA131E</p> <p>No Image</p>  | <p>BAEA132E</p> <p>No Image</p>  | <p>BAEA136E</p>   |















| | | |
|--|---|--|
| <p>BAEA137E</p> <p>No Image</p>  | <p>BAEA140E</p> <p>No Image</p>   | <p>BAEA143</p> <p>No Image</p>  |
| <p>BAEA144E</p> <p>No Image</p>  | <p>BAEA145E</p> <p>No Image</p>  | <p>BAEA146E</p> <p>No Image</p>  |
| <p>BAEA147E</p> <p>No Image</p>  | <p>BAEA149E</p> <p>No Image</p>  | <p>BAEA150E</p> <p>No Image</p>  |
| <p>BAEA152E</p> <p>No Image</p>  | <p>BAEA153E</p> <p>No Image</p>  | <p>BAEA154E</p> <p>No Image</p> |















| | | |
|--|---|--|
| <p>BAEA158E</p>   | <p>BAEA159E</p> <p>No Image</p>  | <p>BAEA161E</p>   |
| <p>BAEA162E</p>  | <p>BAEA163E</p> <p>No Image</p>  | <p>BAEA164E</p>   |
| <p>BAEA165E</p>   | <p>BAEA167E</p>   | <p>BAEA168E</p>   |
| <p>BAEA169E</p> <p>No Image</p>  | <p>BAEA170E</p> <p>No Image</p>  | <p>BAEA171E</p> <p>No Image</p>  |



| | | |
|---|--|--|
| <p>BAEA172E</p>   | <p>BAEA173E</p> <p>No Image</p>  | <p>BAEA174E</p> <p>No Image</p>  |
| <p>BAEA175E</p>   | <p>BAEA176E</p>   | <p>BAEA178E</p> <p>No Image</p>  |
| <p>BAEA179E</p>    | <p>BAEA180E</p> <p>No Image</p>  | <p>BAEA181E</p> <p>No Image</p>  |
| <p>BAEA182E</p> <p>No Image</p>  | <p>BAEA183E</p> <p>No Image</p>  | <p>BAEA184E</p> <p>No Image</p>  |



| | | |
|--|---|--|
| <p>BAEA185E</p> <p>No Image</p>  | <p>BAEA186E</p> <p>No Image</p>  | <p>BAEA188E</p>   |
| <p>BAEA189E</p> <p>No Image</p>  | <p>BAEA190E</p> <p>No Image</p>  | <p>BAEA191E</p> <p>No Image</p>  |
| <p>BAEA192E</p> <p>No Image</p>  | <p>BAEA193E</p> <p>No Image</p> | <p>BAEA194E</p> <p>No Image</p>  |
| <p>BAEA195E</p> <p>No Image</p>  | <p>BAEA196E</p> <p>No Image</p>  | <p>BAEA198E</p> <p>No Image</p>  |



BAEA199E

No Image



BAEA231

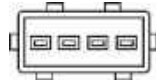

BAEA232

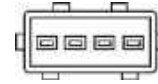

BAEA234

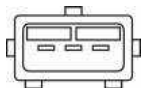

BAEA242

No Image

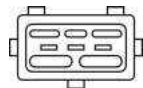

BAEA243

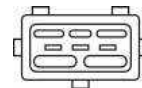

BAEA245

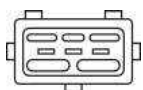

BAEA246

No Image

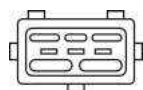

BAEA247

No Image

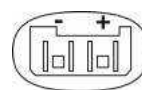

BAEA251

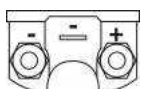

BAEA252

No Image

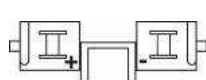

BAEA253

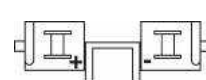



BAEA254

No Image

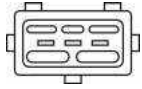

BAEA255

No Image

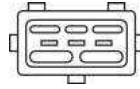

BAEA256

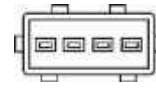

BAEA264

No Image

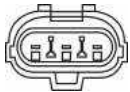

BAEA266



BAEA267

No Image

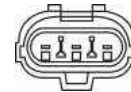

BAEA269

No Image



BAEA275

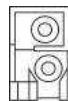

BAEA276

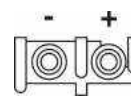

BAEA281

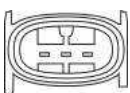

BAEA296







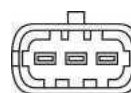





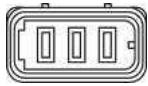







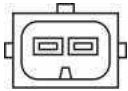

No Image

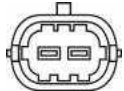



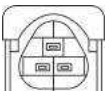

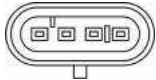





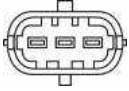

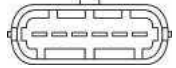







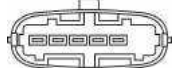



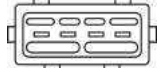

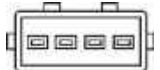

BAEA297





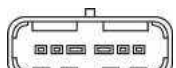

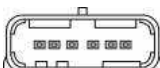







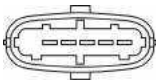

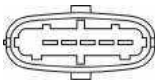

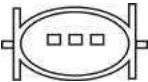

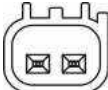

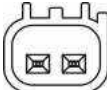

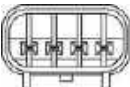

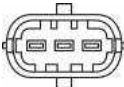

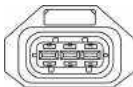
| | | |
|---|---|--|
| <p>BAEA298</p> <p>No Image</p>  | <p>BAEA299</p> <p>No Image</p>  | <p>BAEA302</p> <p>No Image</p>   |
| <p>BAEA304</p> <p>No Image</p>   | <p>BAEA306</p> <p>No Image</p>   | <p>BAEA307</p>    |
| <p>BAEA308</p>     | <p>BAEA309</p>  <p>Stecker ZLE 210</p>   | <p>BAEA313</p>   |
| <p>BAEA324</p> <p>No Image</p>   | <p>BAEA325</p>    | <p>BAEA326</p> <p>No Image</p>   |

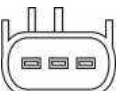









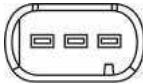

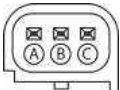

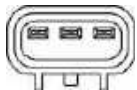

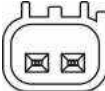

| | | |
|---|---|--|
| <p>BAEA337</p> <p>No Image</p>   | <p>BAEA338</p>    | <p>BAEA339</p> <p>No Image</p>  |
| <p>BAEA340</p>  <p>Stecker ZLE 234</p>    | <p>BAEA342</p>     | <p>BAEA344</p>    |
| <p>BAEA345</p> <p>No Image</p>   | <p>BAEA347</p> <p>No Image</p>   | <p>BAEA348</p> <p>No Image</p>   |
| <p>BAEA350</p>   | <p>BAEA351</p> <p>No Image</p>   | <p>BAEA352</p> <p>No Image</p>   |

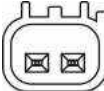

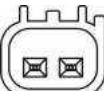













| | | |
|---|---|---|
| <p>BAEA354</p> <p>No Image</p>   | <p>BAEA358</p>    | <p>BAEA359</p> <p>No Image</p>   |
| <p>BAEA365</p> <p>No Image</p>   | <p>BAEA367</p> <p>No Image</p>   | <p>BAEA368</p> <p>No Image</p>   |
| <p>BAEA372</p>    | <p>BAEA377</p> <p>No Image</p>   | <p>BAEA378</p> <p>No Image</p>   |
| <p>BAEA380</p>    | <p>BAEA382</p>   | <p>BAEA383</p> <p>No Image</p>   |

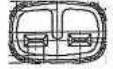

















| | | |
|---|--|---|
| <p>BAEA384</p> <p>No Image</p>   | <p>BAEA385</p> <p>No Image</p>   | <p>BAEA386</p> <p>No Image</p>  |
| <p>BAEA387</p>    | <p>BAEA388</p> <p>No Image</p>   | <p>BAEA394</p> <p>No Image</p>   |
| <p>BAEA395</p>   | <p>BAEA408</p>    | <p>BAEA409</p> <p>No Image</p>   |
| <p>BAEA410</p> <p>No Image</p>   | <p>BAEA422</p>   | <p>BAEA426</p> <p>No Image</p>  |



| | | |
|---|---|---|
| <p>BAEA427</p>   <p>No Image</p> | <p>BAEA428</p> <p>No Image</p>  | <p>BAEA429</p>   |
| <p>BAEA432</p> <p>No Image</p>  | <p>BAEA433</p> <p>No Image</p>    | <p>BAEA434</p> <p>No Image</p>  |
| <p>BAEA445</p>   | <p>BAEA446</p> <p>No Image</p>  | <p>BAEA447A</p>  |
| <p>BAEA448</p> <p>No Image</p>  | <p>BAEA449</p> <p>No Image</p>  | <p>BAEA453</p> <p>No Image</p>  |











| | | |
|---|--|---|
| BAEA454   | BAEA469   | BAEA472   |
| BAEA474 <p>No Image</p>  | BAEA475 <p>No Image</p>  | BAEA476 <p>No Image</p>  |
| BAEA477 <p>No Image</p>  | BAEA479   | BAEA480 <p>No Image</p>  |
| BAEA482 <p>No Image</p>  | BAEA483   | BAEA486 <p>No Image</p>  |











| | | |
|---|--|--|
| <p>BAEA489</p> <p>No Image</p>  | <p>BAEA501</p> <p>No Image</p>    | <p>BAEA502E</p>     |
| <p>BAEA508</p>   | <p>BAEA521</p> <p>No Image</p>  | <p>BAEA531</p> <p>No Image</p>  |
| <p>BAEA536</p> <p>No Image</p>  | <p>BAEA538</p>   | <p>BAEA539</p> <p>No Image</p>  |
| <p>BAEA540</p> <p>No Image</p>  | <p>BAEA543</p> <p>No Image</p>  | <p>BAEA546</p> <p>No Image</p> |

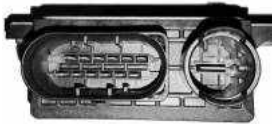

| | | |
|---|--|---|
| <p>BAEA547</p> <p>No Image</p>  | <p>BAEA548</p> <p>No Image</p>  | <p>BAEA549</p> <p>No Image</p>  |
| <p>BAEA554</p> <p>No Image</p>  | <p>BAEA555</p> <p>No Image</p>  | <p>BAEA556</p> <p>No Image</p> |
| <p>BAEA557</p> <p>No Image</p>  | <p>BAEA560</p> <p>No Image</p>  | <p>BAEA561</p> <p>No Image</p>  |
| | | |



















| | | |
|---|---|---|
| CCU081  12 3;4;5 | CCU101  12 4 | CCU102  12 6 |
| CCU104  12 5 | CCU105  12 4 | CCU106 No Image 12 3;4 |
| CCU108  12 6 | CCU110  12 4 | CCU113  12 6 |
| CCU114  12 6 | CCU116  12 6 | CCU118  12 8 |



| | | |
|---|---|---|
| CCU128  12 4 | CCU129  12 4 | CCU138 No Image 12 4 |
| CCU140  12 4 | CCU141  12 5;6 | CCU142  12 4 |
| CCU143  12 4 | CCU144  12 4 | CCU145  12 4 |
| CCU147  12 4 | CCU148  12 4 | CCU149  12 4 |



| | | | | | |
|---|--|--|---|---|--|
| <p>CCU150</p>  <p>CHAMPION E211002581A1</p> |  <p>12</p>  <p>4;5</p> | <p>CCU151</p>  |  <p>12</p>  <p>4;8</p> | <p>CCU152</p>  <p>CCU152 E211002581A1</p> |  <p>12</p>  <p>3;4</p> |
| <p>CCU153</p>  |  <p>12</p>  <p>4</p> | <p>CCU154</p> <p>No Image</p> |  <p>12</p>  <p>4</p> | <p>CCU156</p> <p>No Image</p> |  <p>12</p>  <p>4</p> |
| | | | | | |
| | | | | | |



CLS001



CLS002

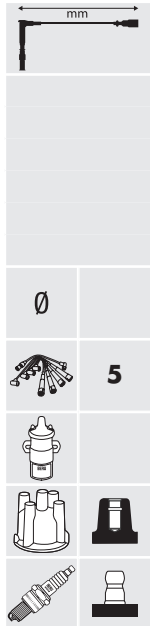

CLS003

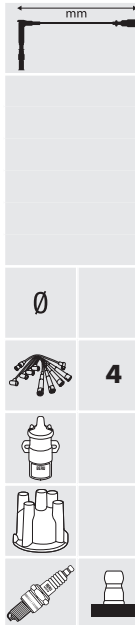

CLS004



CLS005



CLS006





CLS007

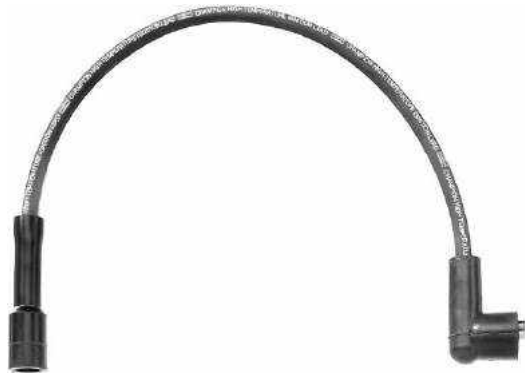

CLS008

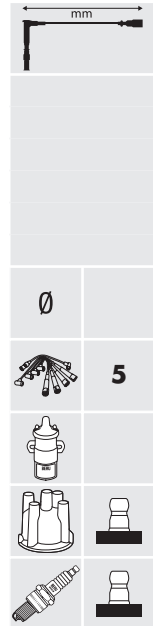
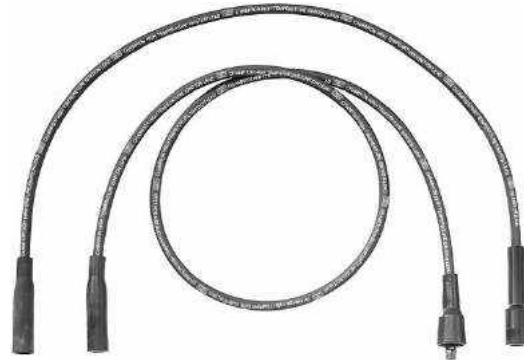

CLS009



CLS010

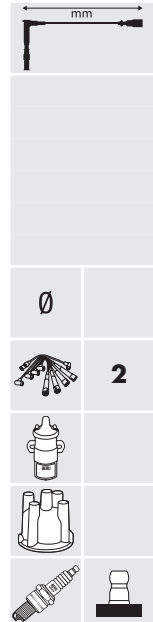

CLS011



CLS012



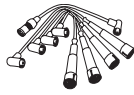

CLS013



CLS014

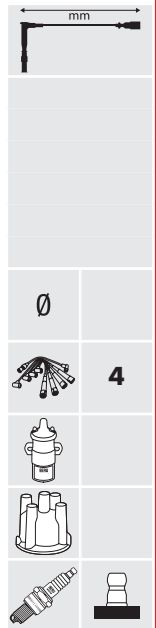

CLS015



CLS016

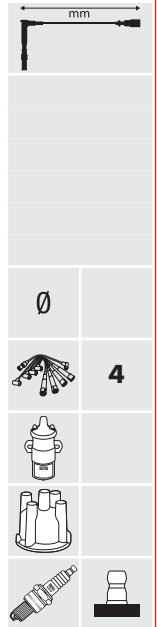

CLS017



CLS018

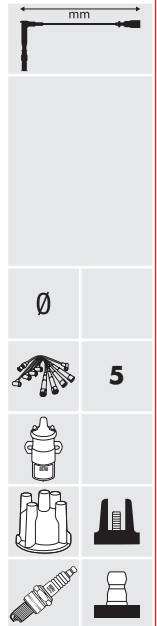



CLS019



CLS020

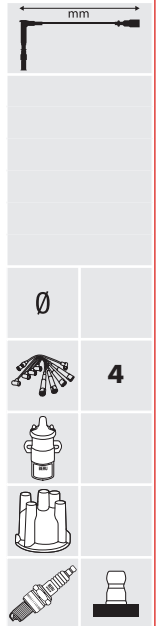

CLS021



CLS022

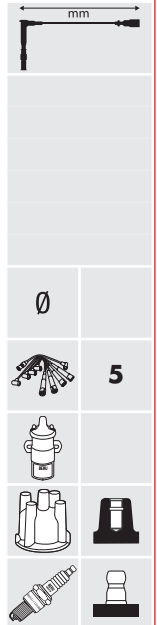

CLS023



CLS024

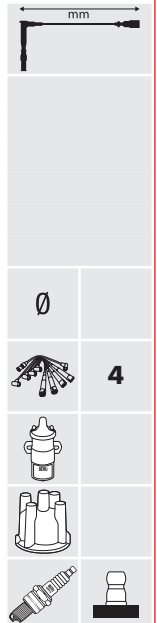

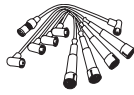

CLS025



CLS026



CLS027



CLS028



CLS029



CLS030





CLS031



CLS032

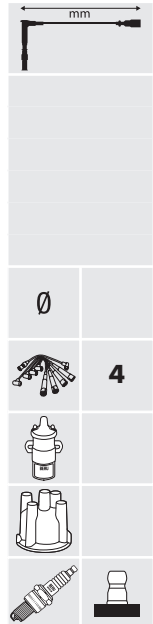

CLS033

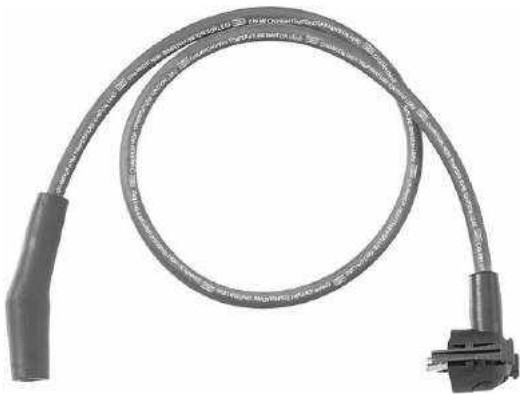

CLS034

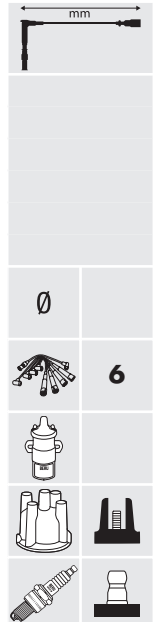

CLS035



CLS036



CHAMPION

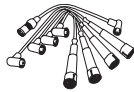

CLS037



CLS038



CLS039



CLS040



CLS041



CLS042





CLS043



CLS044

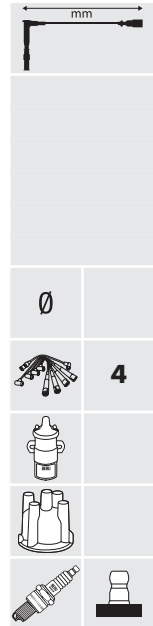

CLS045



CLS046

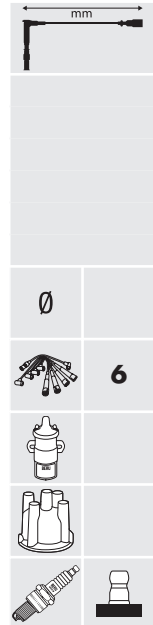

CLS047



CLS048





CLS049



CLS050



CLS051

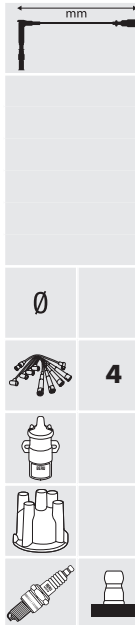

CLS052



CLS053



CLS054





CLS055



CLS056



CLS057



CLS058

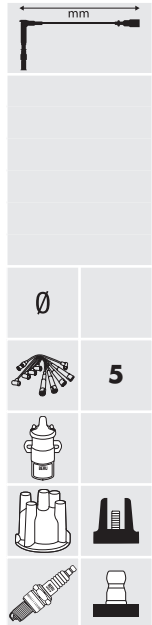

CLS059



CLS060

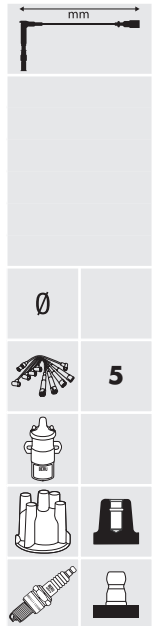

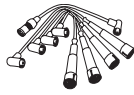

CLS061



| | |
|-------------|---|
| | |
| \emptyset | |
| | 5 |
| | |
| | |
| | |
| | |

CLS062



| | |
|-------------|---|
| | |
| \emptyset | |
| | 7 |
| | |
| | |
| | |
| | |

CLS063



| | |
|-------------|---|
| | |
| \emptyset | |
| | 2 |
| | |
| | |
| | |
| | |

CLS064



| | |
|-------------|----|
| | |
| \emptyset | |
| | 12 |
| | |
| | |
| | |
| | |

CLS065



| | |
|-------------|---|
| | |
| \emptyset | |
| | 4 |
| | |
| | |
| | |
| | |

CLS066



| | |
|-------------|---|
| | |
| \emptyset | |
| | 4 |
| | |
| | |
| | |
| | |



CLS067



CLS068

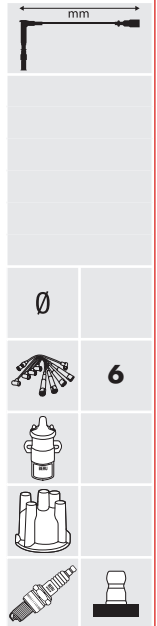
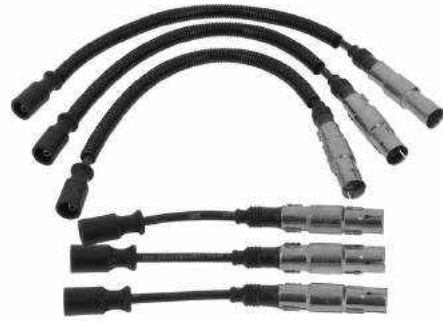

CLS069



CLS070

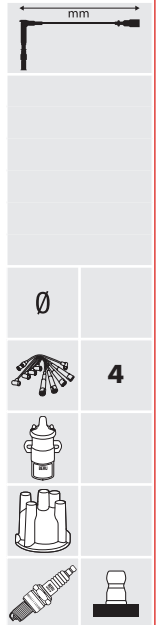

CLS071



CLS072

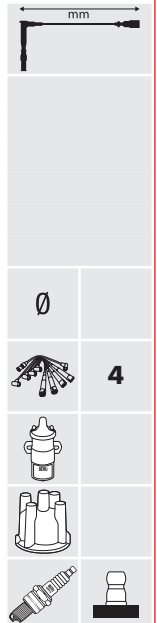

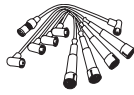

CLS073



| | |
|----|---|
| mm | |
| ∅ | |
| | 4 |
| | |
| | |
| | |

CLS074



| | |
|----|-----|
| mm | |
| ∅ | 8mm |
| | 4 |
| | |
| | |
| | |

CLS075



| | |
|----|---|
| mm | |
| ∅ | |
| | 4 |
| | |
| | |
| | |

CLS076



| | |
|----|---|
| mm | |
| ∅ | |
| | 4 |
| | |
| | |
| | |

CLS077



| | |
|----|-----|
| mm | |
| ∅ | 8mm |
| | 4 |
| | |
| | |
| | |

CLS078



| | |
|----|---|
| mm | |
| ∅ | |
| | 4 |
| | |
| | |
| | |



CLS079



CLS080

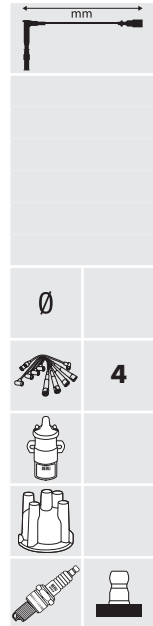

CLS081



CLS082

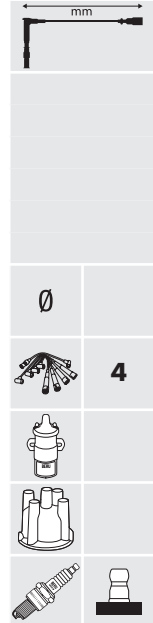

CLS083



CLS084



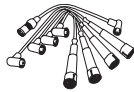

CLS085



| | |
|----|---|
| mm | |
| ∅ | |
| | 4 |
| | |
| | |
| | |

CLS086



| | |
|----|---|
| mm | |
| ∅ | |
| | 4 |
| | |
| | |
| | |

CLS087



| | |
|----|---|
| mm | |
| ∅ | |
| | 6 |
| | |
| | |
| | |

CLS088



| | |
|----|---|
| mm | |
| ∅ | |
| | 4 |
| | |
| | |
| | |

CLS089

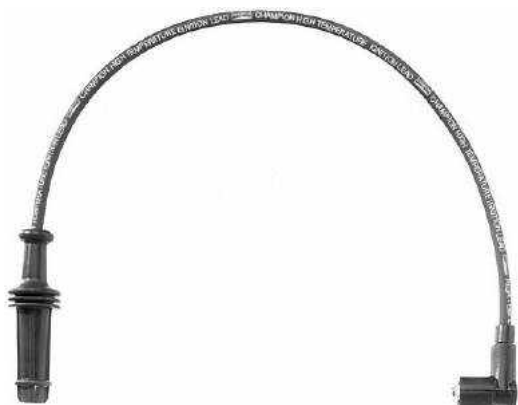

| | |
|-----|-----|
| mm | |
| 380 | |
| 320 | |
| 190 | |
| 140 | |
| ∅ | 8mm |
| | 4 |
| | |
| | |
| | |

CLS090



| | |
|----|---|
| mm | |
| ∅ | |
| | 4 |
| | |
| | |
| | |



CLS091



| | |
|-----|---|
| mm | |
| 200 | |
| 330 | |
| 370 | |
| 420 | |
| ∅ | |
| | 4 |
| | |
| | |
| | |

CLS092



| | |
|-----|---|
| mm | |
| 200 | |
| 330 | |
| 440 | |
| 460 | |
| ∅ | |
| | 4 |
| | |
| | |
| | |

CLS093



| | |
|-----|---|
| mm | |
| 280 | |
| 280 | |
| 380 | |
| 460 | |
| ∅ | |
| | 4 |
| | |
| | |
| | |

CLS094



| | |
|-----|---|
| mm | |
| 240 | |
| 330 | |
| 420 | |
| 540 | |
| ∅ | |
| | 4 |
| | |
| | |
| | |

CLS095



| | |
|-----|---|
| mm | |
| 460 | |
| 310 | |
| 340 | |
| 440 | |
| 510 | |
| ∅ | |
| | 5 |
| | |
| | |
| | |

CLS096



| | |
|-----|-----|
| mm | |
| 240 | |
| 290 | |
| 360 | |
| 460 | |
| ∅ | 5mm |
| | 4 |
| | |
| | |
| | |

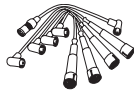

CLS097



CLS098



CLS099



CLS100



CLS101



CLS102

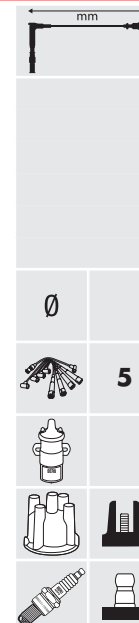



CLS103

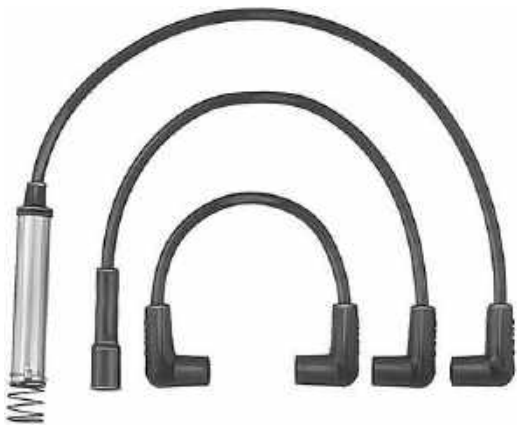

CLS104

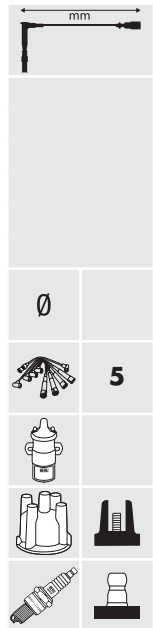
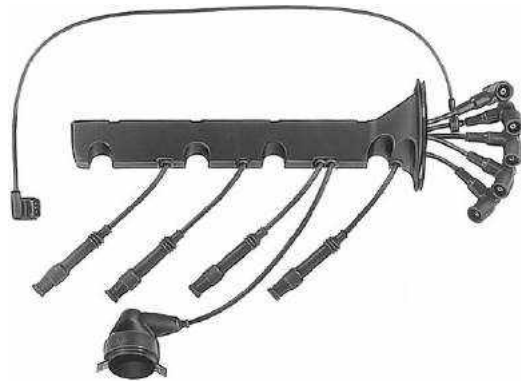

CLS105



CLS106

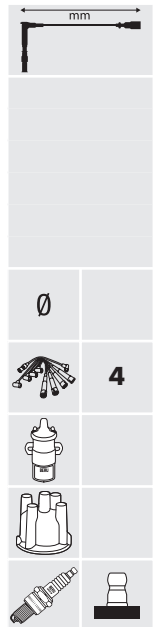

CLS107



CLS108

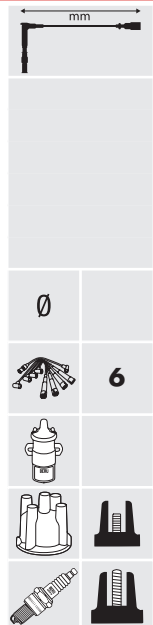

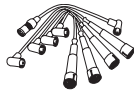

CLS109



CLS110



CLS111



CLS112



CLS113



CLS114

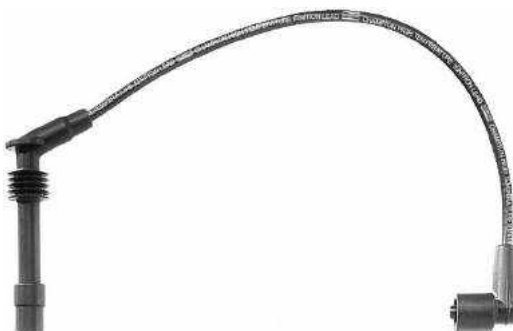



CLS115



CLS116



CLS117



CLS118



CLS119



CLS120



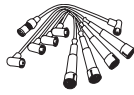

CLS121

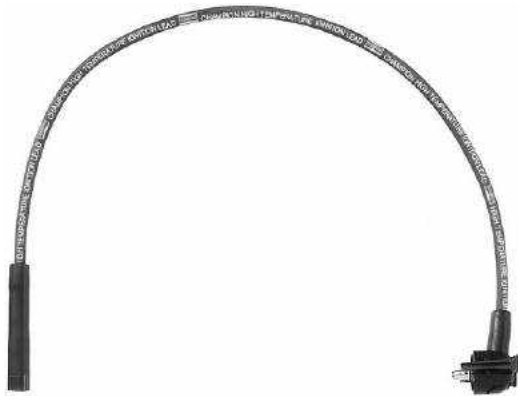

CLS122



CLS123



CLS124

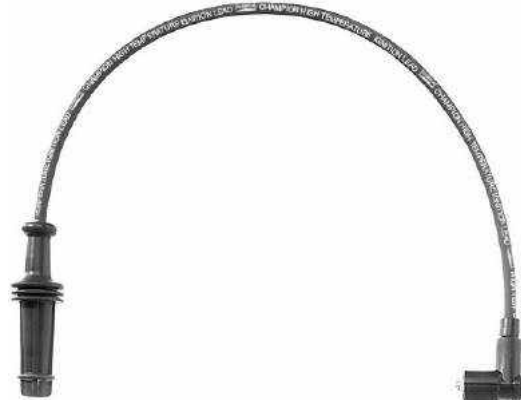

CLS125

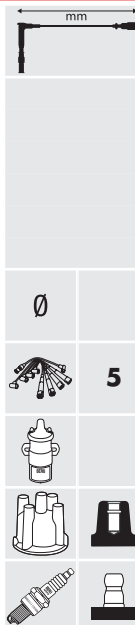

CLS126





CLS127

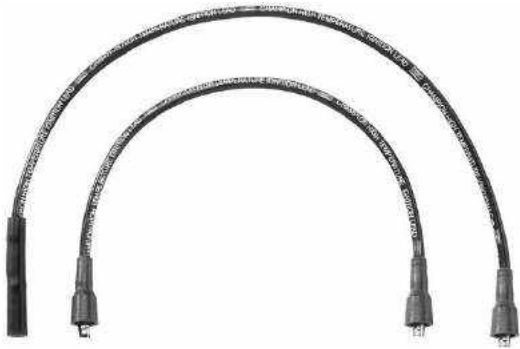

CLS128

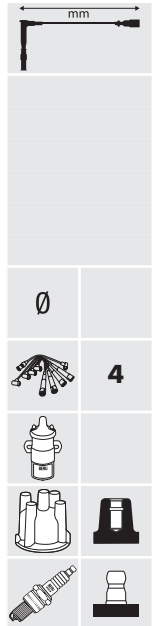

CLS129



CLS130

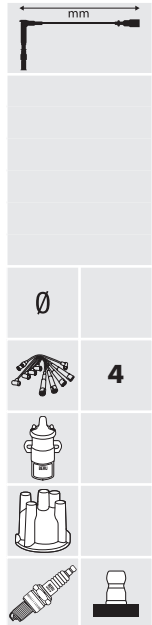

CLS131

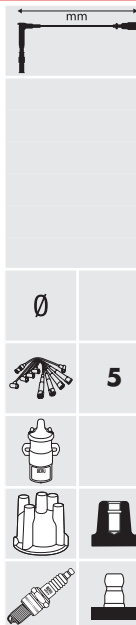

CLS132





CLS133



CLS134



CLS135



CLS136



CLS137



CLS138





CLS139



| | |
|----|----------|
| mm | |
| ∅ | |
| | 4 |
| | |
| | |
| | |

CLS140



| | |
|----|----------|
| mm | |
| ∅ | |
| | 4 |
| | |
| | |
| | |

CLS141



| | |
|----|----------|
| mm | |
| ∅ | |
| | 5 |
| | |
| | |
| | |

CLS144

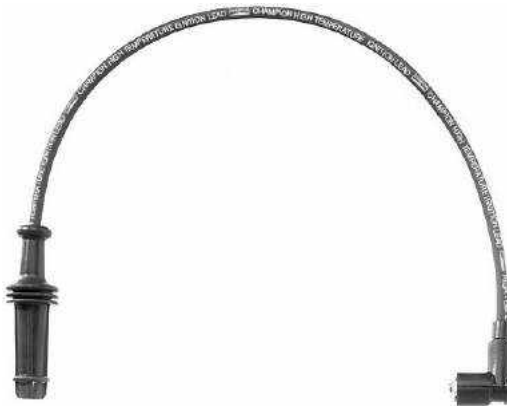

| | |
|----|------------|
| mm | |
| | 330 |
| | 390 |
| | 450 |
| | 230 |
| ∅ | |
| | 4 |
| | |
| | |
| | |

CLS147

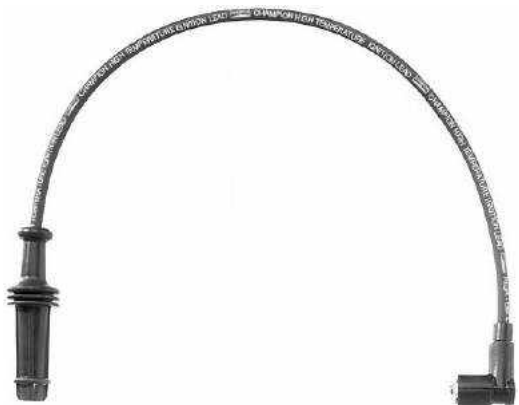

| | |
|----|------------|
| mm | |
| | 390 |
| | 290 |
| | 350 |
| | 380 |
| ∅ | |
| | 4 |
| | |
| | |
| | |

CLS148

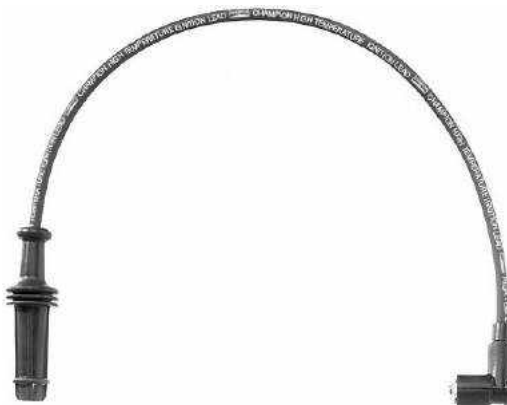

| | |
|----|------------|
| mm | |
| | 475 |
| | 475 |
| | 665 |
| | 705 |
| | 505 |
| ∅ | |
| | 5 |
| | |
| | |
| | |



CLS149

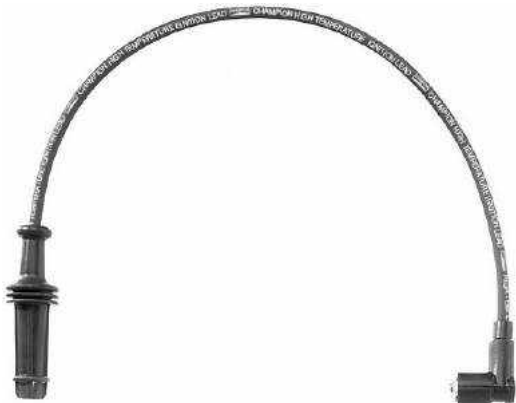

| mm | |
|-----|--|
| 340 | |
| 340 | |
| 380 | |
| 420 | |
| ∅ | |
| 4 | |
| | |
| | |
| | |
| | |

CLS150

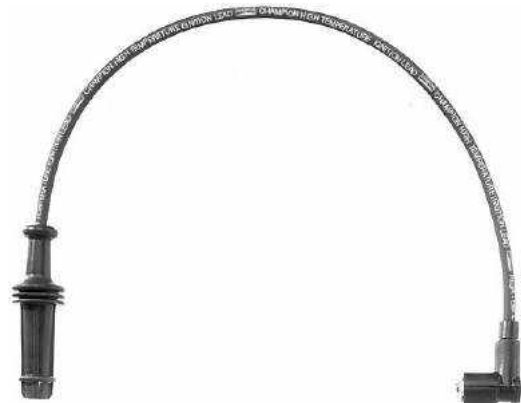

| mm | |
|-----|--|
| 665 | |
| 595 | |
| 455 | |
| 385 | |
| 305 | |
| ∅ | |
| 5 | |
| | |
| | |
| | |
| | |

CLS153

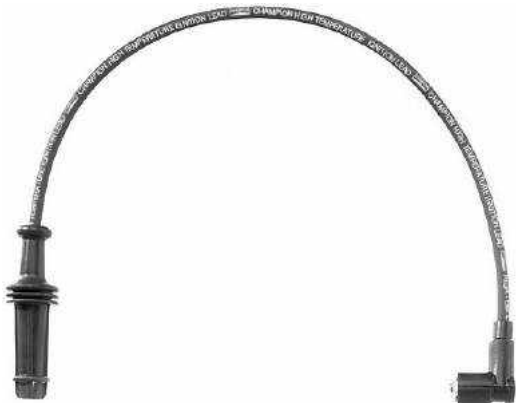

| mm | |
|-----|--|
| 425 | |
| 465 | |
| 605 | |
| 645 | |
| 885 | |
| ∅ | |
| 5 | |
| | |
| | |
| | |
| | |

CLS155

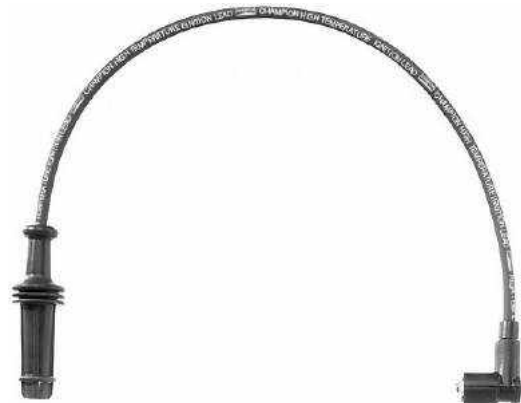

| mm | |
|-----|--|
| 600 | |
| 530 | |
| 430 | |
| 400 | |
| 210 | |
| ∅ | |
| 5 | |
| | |
| | |
| | |
| | |

CLS156

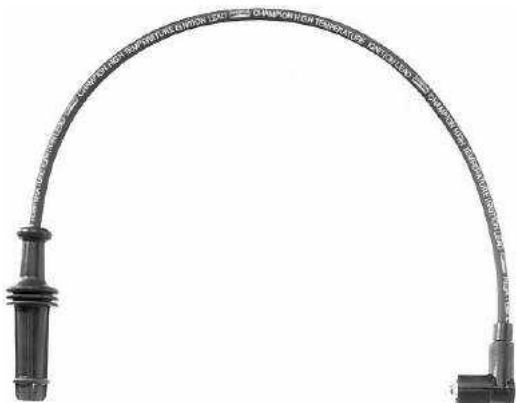

| mm | |
|------|--|
| 440 | |
| 400 | |
| 470 | |
| 900 | |
| 1035 | |
| 1100 | |
| ∅ | |
| 6 | |
| | |
| | |
| | |
| | |

CLS157

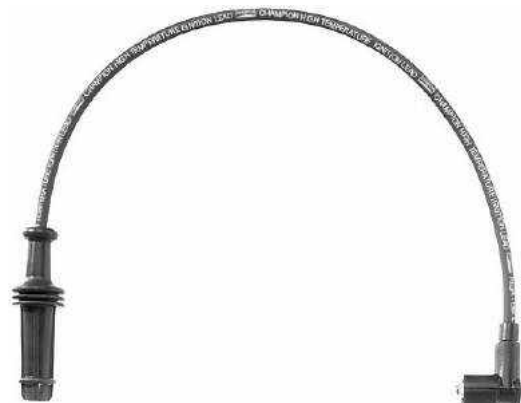

| mm | |
|-----|--|
| 335 | |
| 190 | |
| ∅ | |
| 2 | |
| | |
| | |
| | |
| | |

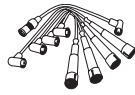

CLS159

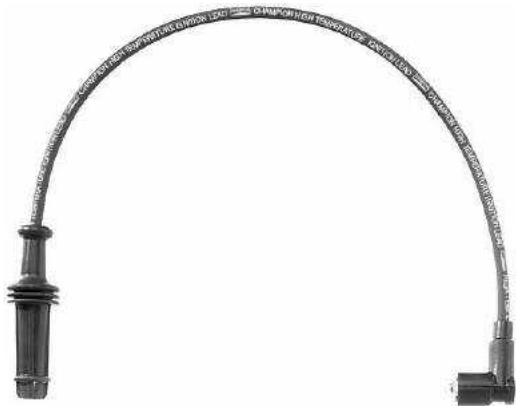

| | |
|-----|---|
| mm | |
| 180 | |
| 560 | |
| ∅ | |
| | 2 |
| | |
| | |
| | |

CLS161

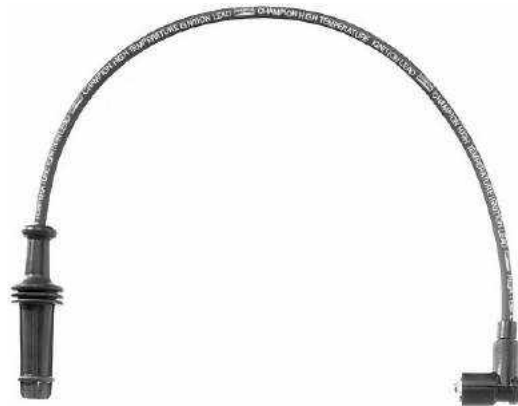

| | |
|-----|---|
| mm | |
| 390 | |
| 430 | |
| 530 | |
| 600 | |
| 795 | |
| ∅ | |
| | 5 |
| | |
| | |
| | |

CLS163

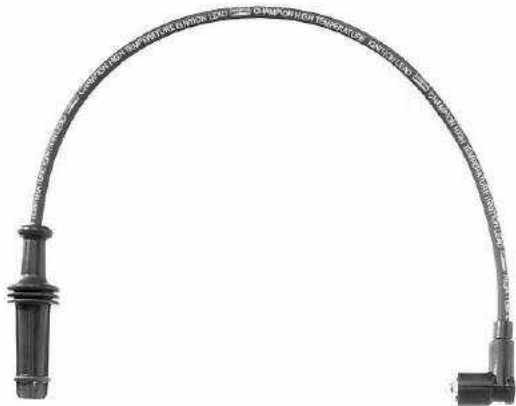

| | |
|-----|---|
| mm | |
| 400 | |
| 300 | |
| 300 | |
| 400 | |
| ∅ | |
| | 4 |
| | |
| | |
| | |

CLS166



| | |
|----|---|
| mm | |
| | |
| | |
| | |
| | |
| ∅ | |
| | 5 |
| | |
| | |
| | |

CLS167



| | |
|----|---|
| mm | |
| 90 | |
| 28 | |
| ∅ | |
| | 2 |
| | |
| | |
| | |

CLS168



| | |
|----|---|
| mm | |
| | |
| | |
| | |
| | |
| ∅ | |
| | 4 |
| | |
| | |
| | |

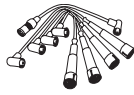

CLS169



CLS170

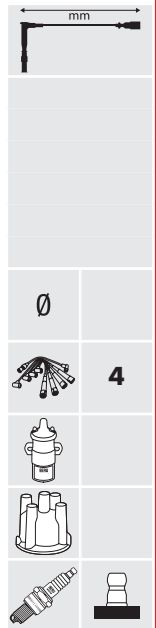

CLS171



CLS172

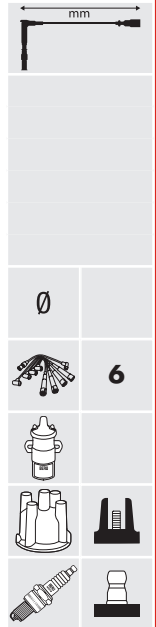

CLS173



CLS174

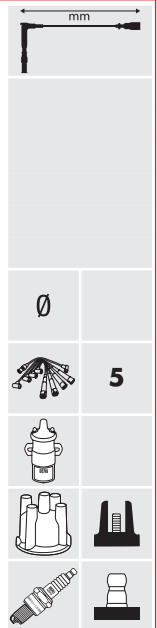



CLS175



CLS176



CLS177



CLS178

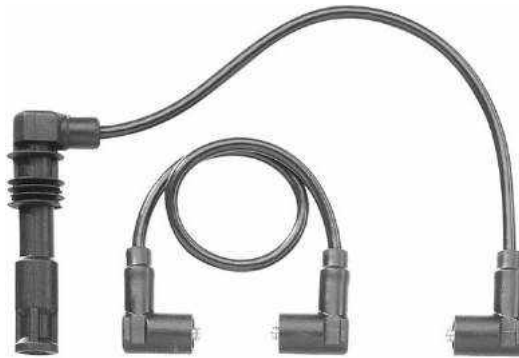

CLS179



CLS180



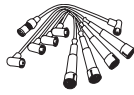

CLS181



CLS182



CLS183



CLS184



CLS185



CLS186

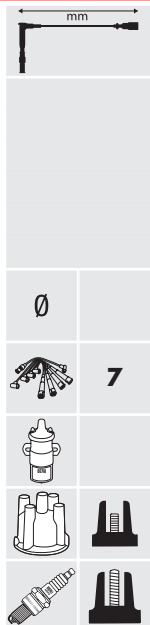



CLS187



| | |
|----|---|
| mm | |
| ∅ | |
| | 2 |
| | |
| | |
| | |

CLS188



| | |
|----|---|
| mm | |
| ∅ | |
| | 5 |
| | |
| | |
| | |

CLS189



| | |
|----|---|
| mm | |
| ∅ | |
| | 6 |
| | |
| | |
| | |

CLS190



| | |
|----|---|
| mm | |
| ∅ | |
| | 5 |
| | |
| | |
| | |

CLS191



| | |
|-----|---|
| mm | |
| 260 | |
| 360 | |
| 450 | |
| 560 | |
| 810 | |
| ∅ | |
| | 5 |
| | |
| | |
| | |

CLS192



| | |
|----|---|
| mm | |
| ∅ | |
| | 4 |
| | |
| | |
| | |



CLS193



| | |
|----|---|
| mm | |
| ∅ | |
| | 6 |
| | |
| | |
| | |

CLS194



| | |
|----|---|
| mm | |
| ∅ | |
| | 4 |
| | |
| | |
| | |

CLS195



| | |
|-----|-----|
| mm | |
| 360 | |
| 360 | |
| ∅ | 7mm |
| | 2 |
| | |
| | |
| | |

CLS196



| | |
|-----|---|
| mm | |
| 270 | |
| 410 | |
| 470 | |
| 530 | |
| ∅ | |
| | 4 |
| | |
| | |
| | |

CLS197



| | |
|-----|---|
| mm | |
| 230 | |
| 310 | |
| 410 | |
| 460 | |
| ∅ | |
| | 4 |
| | |
| | |
| | |

CLS198



| | |
|-----|-----|
| mm | |
| 250 | |
| 620 | |
| ∅ | 5mm |
| | 2 |
| | |
| | |
| | |



CLS199



CLS200

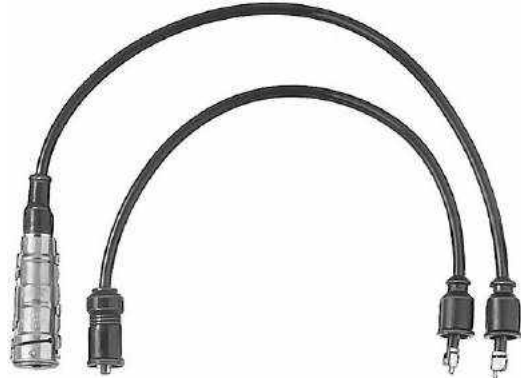

CLS201



CLS202

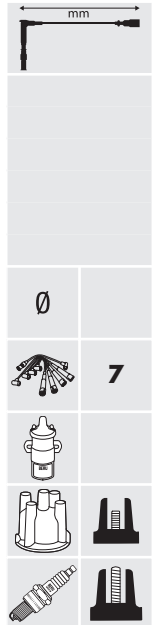

CLS203

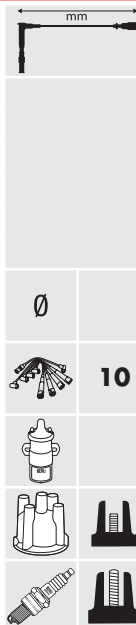
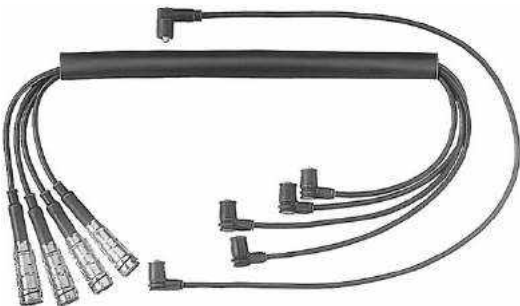

CLS204





CLS205

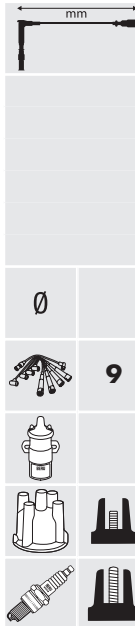

CLS206

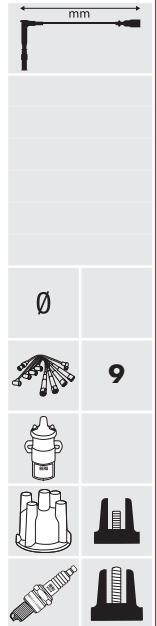

CLS207



CLS208

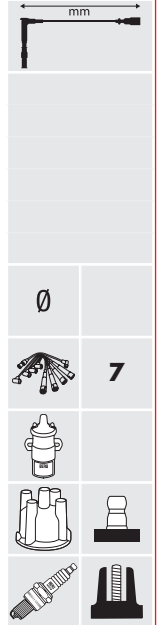

CLS210

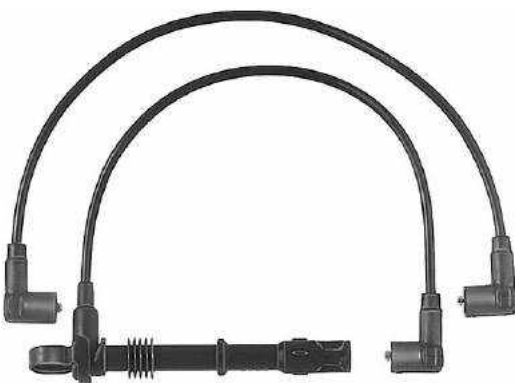

CLS211

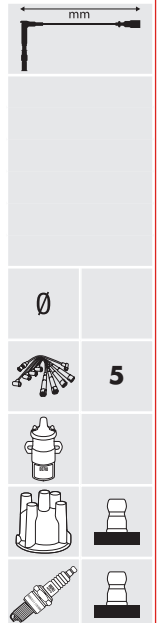



CLS212



CLS213



CLS214



CLS215

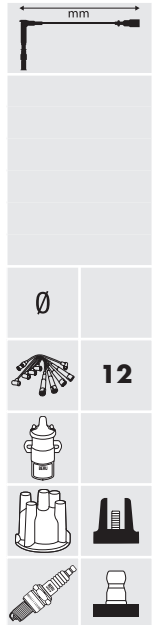
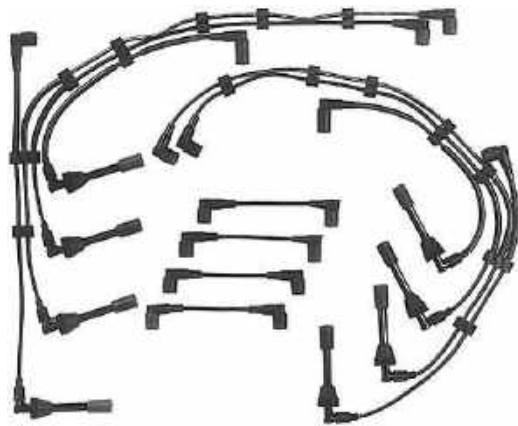

CLS216



CLS217

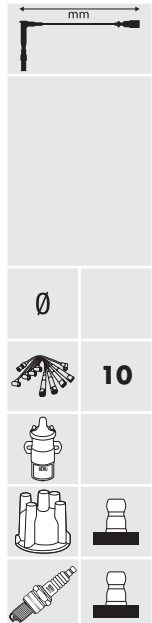

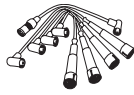

CLS218



CLS219

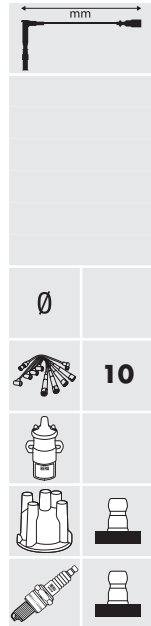

CLS220



CLS221

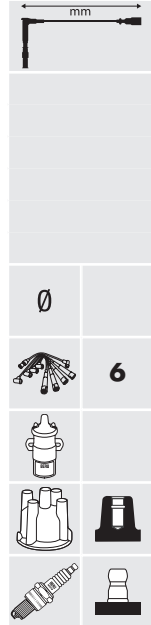
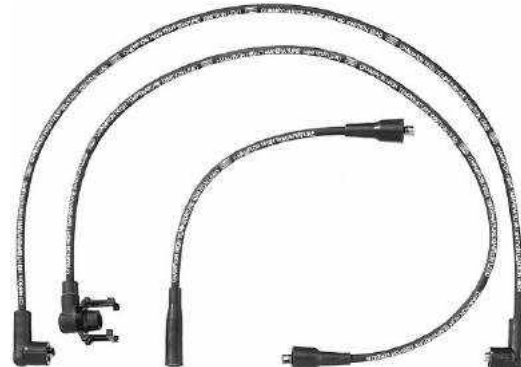

CLS222



CLS223

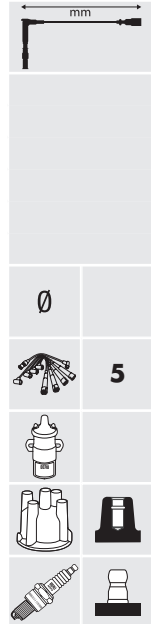
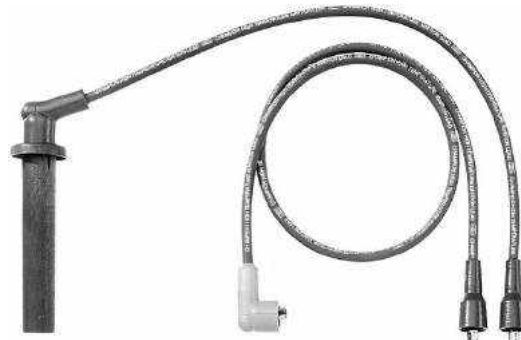



CLS224



CLS225

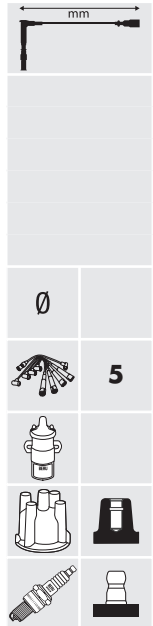
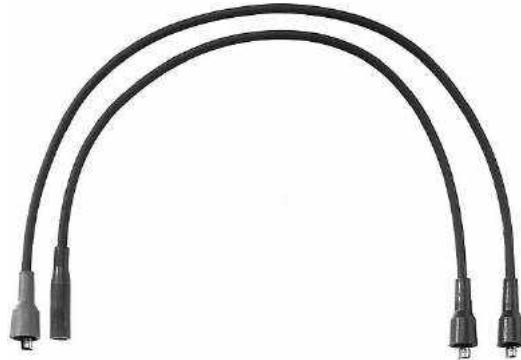

CLS226

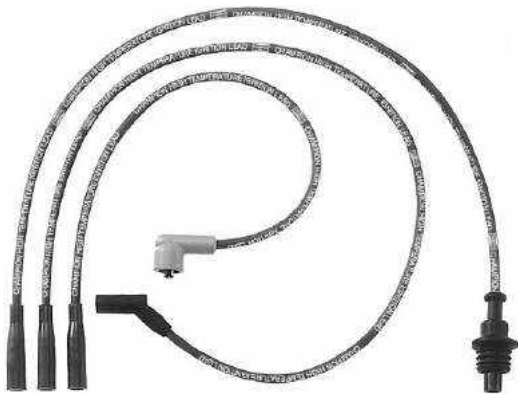

CLS227

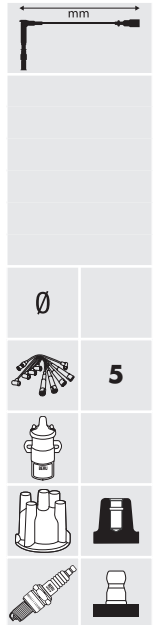

CLS228



CLS229

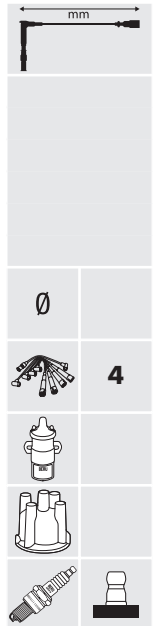

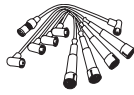

CLS230



CLS231



CLS232



CLS233



CLS234

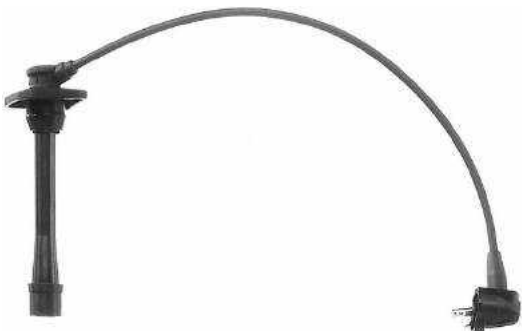

CLS235

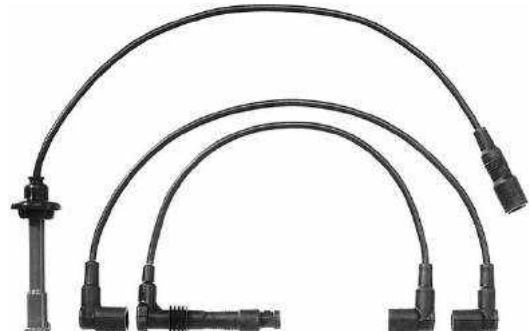



CLS236



CLS237



CLS238



CLS239



CLS240

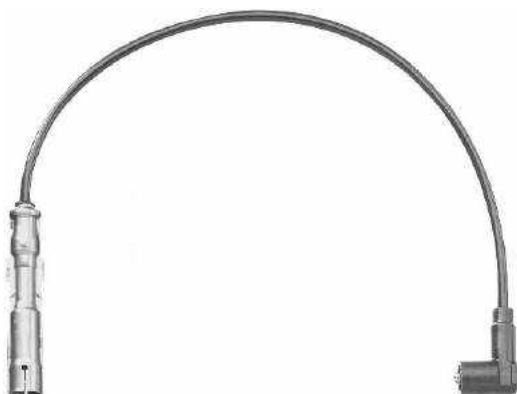

CLS241





CLS248

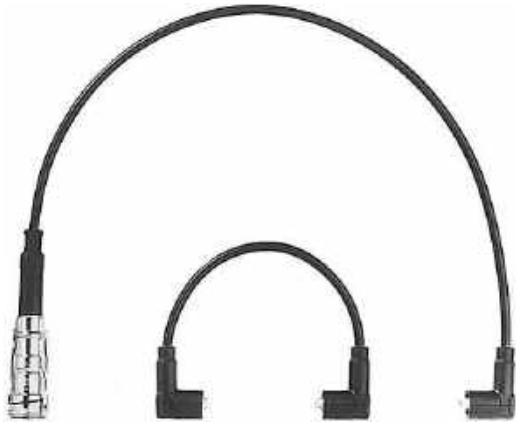

CLS249

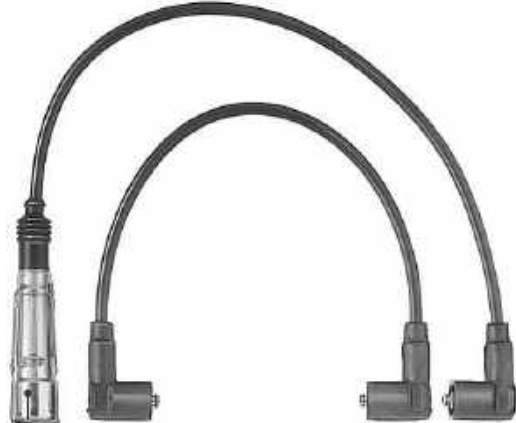

CLS250



CLS251



CLS252



CLS253





CLS254



| | |
|----|---|
| mm | |
| ∅ | |
| | 3 |
| | |
| | |
| | |

CLS255



| | |
|----|---|
| mm | |
| ∅ | |
| | 5 |
| | |
| | |
| | |

CLS256



| | |
|-----|---|
| mm | |
| 150 | |
| 250 | |
| 330 | |
| 390 | |
| ∅ | |
| | 4 |
| | |
| | |
| | |

CLS257



| | |
|-----|---|
| mm | |
| 370 | |
| 410 | |
| ∅ | |
| | 2 |
| | |
| | |
| | |

CLS258



| | |
|----|---|
| mm | |
| ∅ | |
| | 5 |
| | |
| | |
| | |

CLS259



| | |
|----|---|
| mm | |
| ∅ | |
| | 4 |
| | |
| | |
| | |



CLS260



CLS261



CLS262



TECHNICAL NOTES

TECHNISCHE HINWEISE
NOTES TECHNIQUES
TECHNISCHE NOTITIES
NOTAS TÉCNICAS

NOTE TECNICHE
ТЕХНИЧЕСКИЕ ПРИМЕЧАНИЯ
INFORMACJE TECHNICZNE
ΤΕΧΝΙΚΕΣ ΣΗΜΕΙΩΣΕΙΣ

MŰSZAKI FELJEGYZÉSEK
NOTAS TÉCNICAS
TECHNICKÉ POZNÁMKY

[309] tŽ āŁŃ; De9P, De9;
[310] tŽ āŁŃAn
[311] tŽ āŁŃBs
[312] tŽ āŁŃJüü
[313] tŽ āŁŃKüü
[314] tŽ āŁŃġH P ŽŽ2 P ā āŁŃXZZB; ; ;
[315] tŽ āŁŃġH P ŽŽ2 P ā āŁŃXZZNJ
[316] tŽ āŁŃġH o ŃeW
[317] tŽ āŁŃġH o ŃeWžqV4
[318] tŽ āŁŃXZZB; ; ; 7 ŰŁ ŃZmW
[319] tŽ āŁŃYDABC
[320] tŽ āŁŃYmaX
[321] tŽ āŁŃYqe
[322] tŽ āŁŃY ŰH nžqŃYB; K
[323] tŽ āŁŃZVALž; DA
[324] tŽ āŁŃŃH *P H Ž * _qb
[325] tŽ āŁŃ _mpf ZeZ
[326] tŽ āŁŃŃ Vf f V
[327] tŽ āŁŃŃcW R:WAR:VBR:WC
[328] tŽ āŁŃŃng
[329] tŽ āŁŃŃdAC
[330] tŽ āŁŃŃeXb
[331] tŽ āŁŃŃeYd
[332] tŽ āŁŃŃeYd7eas
[333] tŽ āŁŃŃf DL
[334] tŽ āŁŃŃf DLg
[335] tŽ āŁŃŃf DLgB
[336] tŽ āŁŃŃf JLg
[337] tŽ āŁŃŃf VAC
[338] tŽ āŁŃŃf YACžV VpZq
[339] tŽ āŁŃŃf YACžV VpZqRW ŽŽžž āž Ž Ń_A
[340] tŽ āŁŃŃf c
[341] tŽ āŁŃŃf f
[342] tŽ āŁŃŃžžž āŁŃP ĩ āhāŁ
[343] tŽ āŁŃŃg DL
[344] tŽ āŁŃŃg DLg
[345] tŽ āŁŃŃg JL
[346] tŽ āŁŃŃg JLg
[347] tŽ āŁŃŃg JLq
[348] tŽ āŁŃŃg JLx
[349] tŽ āŁŃŃg VAC
[350] tŽ āŁŃŃH ŽŽžž āž Ž ċpJ
[351] tŽ āŁŃŃg VACRW ŽŽžž āž Ž ċpJ7reD
[352] tŽ āŁŃŃg YAC
[353] tŽ āŁŃŃŰ ŃH ŃŃH P ŽŽ2 P ā āŁŃŽ HžJ
[354] tŽ āŁŃŃŰ žVCLV
[355] tŽ āŁŃŃŰ žVCLW
[356] tŽ āŁŃŃŰ ŃH *P H Ž * _qb
[357] tŽ āŁŃŃŰ žJLg
[358] tŽ āŁŃŃgr dž-K
[359] tŽ āŁŃŃqŰŁ ŃZmW
[360] tŽ āŁŃŃmAC
[361] tŽ āŁŃŃŰ: Ž ŁŰ āžžž ŃH žxqJBB
[362] tŽ āŁŃŃn P Ű
[363] tŽ āŁŃŃpžŰā ž-C:A; C
[364] tŽ āŁŃŃpžŰā ž-D:A; C
[365] tŽ āŁŃŃpžŰā ž-MA; C
[366] tŽ āŁŃŃqb žYžžpsqqlž

[367] tŽ āŁŃŃqmaX
[368] tŽ āŁŃŃH ŽŽžž āž Ž ċWC
[369] tŽ āŁŃŃH ŽŽžž āž Ž ċXJ
[370] tŽ āŁŃŃH ŽŽžž āž Ž ģndJ
[371] tŽ āŁŃŃs d
[372] tŽ āŁŃŃvr ALželgYZ
[373] tŽ āŁŃŃw8AAJrA
[374] tŽ āŁŃŃxaAC
[375] tŽ āŁŃŃxnAL

TECHNICAL NOTES

TECHNISCHE HINWEISE
NOTES TECHNIQUES
TECHNISCHE NOTITIES
NOTAS TÉCNICAS

NOTE TECNICHE
ТЕХНИЧЕСКИЕ ПРИМЕЧАНИЯ
INFORMACJE TECHNICZNE
ΤΕΧΝΙΚΕΣ ΣΗΜΕΙΩΣΕΙΣ

MŰSZAKI FELJEGYZÉSEK
NOTAS TÉCNICAS
TECHNICKÉ POZNÁMKY

[166] à *mZ8g P P Z ON; NAN8; BBDM
[167] à *mZ8g P P Z ON; NAN8; BBKB
[168] à *mZ8g P P Z ON; NAN8; BBKJ
[169] à *mZ8g P P Z ON; NAN8; BBKK
[170] à *mZ8g P P Z ONCALLBAB
[171] à *mZ8g P P Z ONGANNDKIM
[172] à *mZ8g P P Z ONKCNMNMNM
[173] à *mZ8g P P Z ONKJAJMCKM
[174] à *mZ8g P P Z OV*; ; *AJMLM; C
[175] à *mZ8g P P Z OV*; ; *AJN*AJ*; AV*; ; *AJN*AK
; A
[176] à *mZ8g P P Z OV*; ; *AJN*B*; AV*; ; *AJN*BA
; A
[177] à *mZ8g P P Z OV*; ; *AJN*BK*; A
[178] à *mZ8g P P Z OV*; ; *AJN*J*; AV*; ; *AJN*LA
; A
[179] à *mZ8g P P Z OV*BLB*N; K*; ; *K;
[180] à *mZ8g P P Z OV*KDB*N; ; *JM; A
[181] à *mZ8g P P Z Og *A; J*NAK*; BRg *A; J*NAK*; C
[182] à *mZ8g P P Z Og *A; J*NAK*; C
[183] à *mZ8g P P Z Og *A; J*NAK*; D
[184] à *mZ8g P P Z Og *A; J*NAK*; M
[185] à *mZ8g P P Z Og ZXA; ; KC;
[186] à *mZ8g P P Z Og BA; 8AMBAD; RjBA; 8AMBAD; *V
[187] à *mZ8g P P Z Of CD8ABVCDB8W
[188] à *np8g P P Z O; ``
[189] à *np8g P P Z O; d; *6*mqM6*Lf c7Lf s7Lf p
[190] à *np8g P P Z O; dC7; dD*6rqM7*Lt
[191] à *np8g P P Z OX_
[192] à *np8g P P Z OX_7Lf f
[193] à *np8g P P Z Olf f
[194] à *np8g P P Z Olf f 7Lf c
[195] à *np8g P P Z Olf f 7Lf c7LXn
[196] à *np8g P P Z Olf f Rlf cRlf u
[197] à *np8g P P Z Olf s
[198] à *np8g P P Z OYCG
[199] à *np8g P P Z OYLg
[200] à *np8g P P Z O nA
[201] à *np8g P P Z O nB6rYA
[202] à *np8g P P Z O nB6r_A
[203] à *np8g P P Z O nB6raA
[204] à *np8g P P Z Or; gRf Ab
[205] à *np8g P P Z Or DA
[206] à *np8g P P Z Or DAF_A
[207] à *np8g P P Z Or Lt
[208] à *np8g P P Z Or Lt *6LXn7LXq7Lf t
[209] à *np8g P P Z Or YA
[210] à *np8g P P Z Or YA6Lf f 7Lf c7Lf u
[211] à *np8g P P Z Or YA6Lf f 7Lf c7Lf u 7LXn
[212] à *np8g P P Z Or ZA
[213] à *np8g P P Z Or_A
[214] à *np8g P P Z Or_A
[215] à *np8g P P Z Or aA
[216] à *np8g P P Z Or aA6L` W
[217] à *np8g P P Z Or aA6Lf d
[218] à *np8g P P Z Or dM7raM
[219] à *np8g P P Z Or dM7raE
[220] à *np8g P P Z Or dM7raE7f J
[221] à *np8g P P Z Or eA7rdM

[222] à *np8g P P Z Or eA7rdM7f J7raM
[223] à *np8g P P Z Or eA7raN
[224] à *np8g P P Z Or eD
[225] à *np8g P P Z Or f D
[226] à *np8g P P Z Or nA
[227] à *np8g P P Z Or qM
[228] à *np8g P P Z Or qM6*Lf c
[229] à *qV*XHZZO; BA
[230] à *qV*XHZZO; BB
[231] à *qV*XHZZODND
[232] à *qV*XHZZOL; ;
[233] à *qV*XHZZOM CRM DRM JRM K
[234] à *qV*XHZZOND; dRNCndRM B
[235] à *qV*XHZZOf XAF XBF XCF nAF nBF nC
[236] à *qV*XHZZOf XB6f qN
[237] à *qV*XHZZOf oCF oDF oJ
[238] à *qV*XHZZOf oKf X;
[239] à *qV*XHZZOs DCRS MC
[240] aZ ZiiZ ZAl Ya Lji LjaOMzps
[241] aZ ZiiZ ZAl Ya Lji LjaOMw` u VpgZp
[242] aZ ZiiZ ZAl Ya Lji LjaOMw Ya
[243] aZ ZiiZ ZAl Ya Lji LjaOMwXaPYsXZeeZp
[244] aZ ZiiZ ZAl Ya Lji LjaOMw YaRvZ
[245] aZ ZiiZ ZAl Ya Lji LjaOWZP a
[246] aZ ZiiZ ZAl Ya Lji LjaOYZeXmpZf w
[247] aZ ZiiZ ZAl Ya Lji LjaOYZenab
[248] aZ ZiiZ ZAl Ya Lji LjaOY YZiiZ
[249] aZ ZiiZ ZAl Ya Lji LjaOZEYmp
[250] aZ ZiiZ ZAl Ya Lji LjaOZEZXrptk_t
[251] aZ ZiiZ ZAl Ya Lji LjaOZizu Hlj Ya
[252] aZ ZiiZ ZAl Ya Lji LjaO Ua Z aP aYaAlLH Z
[253] aZ ZiiZ ZAl Ya Lji LjaOabrVXab
[254] aZ ZiiZ ZAl Ya Lji LjaOmedVpLVL
[255] aZ ZiiZ ZAl Ya Lji LjaOesXVq
[256] aZ ZiiZ ZAl Ya Lji LjaOf VpZeeb
[257] aZ ZiiZ ZAl Ya Lji LjaOf VpZeePYsXZeeZp
[258] aZ ZiiZ ZAl Ya Lji LjaOg` d
[259] aZ ZiiZ ZAl Ya Lji LjaOqVZ
[260] aZ ZiiZ ZAl Ya Lji LjaOqV` Zf
[261] aZ ZiiZ ZAl Ya Lji LjaOq ZP *WmqXa
[262] aZ ZiiZ ZAl Ya Lji LjaOq ZP *WmqXa:r Zf tX
[263] aZ ZiiZ ZAl Ya Lji LjaOqwqr Zf *YsXZeeZp
[264] aZ ZiiZ ZAl Ya Lji LjaOq ZP *abrVXab
[265] aZ ZiiZ ZAl Ya Lji LjaOq ZP *VeZm
[266] aZ ZiiZ ZAl Ya Lji LjaOsgtZpWZf n_Zaesg`
[267] Ljfa` a` *VUau LH P OZ h*J
[268] Ljfa` a` *qV*XHZZODND
[269] Ljfa` a` *qV*XHZZOM CRM DRM JRM K
[270] Ljfa` a` *qV*XHZZOM M
[271] Ljfa` a` *qV*XHZZONBM
[272] Ljfa` a` *qV*XHZZOND; dRNCnd
[273] Ljfa` a` *qV*XHZZOs DCRS MC
[274] WZP Z u LjaOx LjZ o iZ` iJa` ZYa Zilz P
Za`Vlaj ZZ LjaZlZ` aZ ZiiZ * Z a iizLj
Ya`x LjZ o iZ`Lj * UP P ZlP a`ZP *h aajLi
aa` Z Yaaz`3mpY*ACAJLJC7BqK *ABVCLKVZ4
Z UU ZlqZ ZiiZLjqaz` a`az` ZU *ZZ
dU Ut U h`h` Zl Lja aZP` a` Lji aLjZ` 9
[275] WZP Z u LjaOZaLjZU` Z` *n hZ` u`P` *UP
Ua Z a`hZZ` *h h` UZ` aP` * Z`ZlP

[276] WZP Z u LjaOx gYdZpxZgu ZXaqZe
ZP oazai LjaOMZax LjZUz Zl ZYa ZlU
Ua Z aZlP` aq` ZYUz` LjZ o iZlP`Ua Z
aizara` Zaaz`q` ZYUz` *Z LjZ` Z Lj
LjZx LjZUz` ZlBq` ZYUz` aZ` *Z` ZlZ`ZlP`
[277] WZP Z u LjaOWZP Z u LjaOZP oazai LjaOxd_*A*
azaZ`x` Uza` ia` Z`
[278] ZP oahaiZlZ` *u` ZYa` ZiaLj` Uir`ZlP` 40B; ; ; ;
[279] ZP oahaiZlZ` *u` ZYa` ZiaLj` Uir`ZlP` 40C; ; ; ;
[280] tZ` uU` a` UZ` Ya` Lji LjaOV` Z` *sqV`
[281] tZ` uU` a` UZ` Ya` Lji LjaOV` Z` *sqV` LjZ`cUoUll
[282] tZ` uU` a` UZ` Ya` Lji LjaOXUllUzU
[283] tZ` uU` a` UZ` Ya` Lji LjaOs qV`
[284] tZ` uU` a` UZ` Ya` Lji LjaOs qV` LjZ`cUoUll
[285] ` Z` aZUzU` OV` HP U` aiaZ` aZUz`
[286] ` Z` aZUzU` OXtr8V` HP U` aiaZ` aZUz`*q` aZLjH` 4
[287] ` Z` aZUzU` OqYaU` aZ` aZUz`
[288] ` Z` aZUzU` OJ8` Ula` *Z` aZUz`
[289] ` Z` aZUzU` OK8` Ula` *Z` aZUz`
[290] ` Z` aZUzU` OaUuU` HP U` ai
[291] Ua` Z` aU` U` LjaOa` *Ua` Z` aZ`P` a`
dja` UllUaZ`
[292] Ua` Z` aU` U` LjaOa` *Ua` Z` aZ`P` a`
x` LjZ` Z` ZaZ`
[293] Ua` Z` aU` U` LjaOa` *Ua` Z` aZ`P` a`
u` Zaala` oZ` Z`
[294] Ua` Z` aU` U` LjaOa` *Ua` Z` aZ`P` a`
q` U` q` ho` *Lji` aLj`
[295] Ua` Z` aU` U` LjaOa` *Ua` Z` aZ`hAlZ`
nU` aiaZa` Z`
[296] Ua` Z` aU` U` LjaOa` *Ua` Z` aZ`hAlZ`
x` LjZ` Z` ZaZ`
[297] Ua` Z` aU` U` LjaOa` *Ua` Z` aZ`hAlZ`
u` Zaala` oZ` Z`
[298] Ua` Z` aU` U` LjaOa` *Ua` Z` aZ`hAlZ`
q` U` q` ho` *Lji` aLj`
[299] WZP Z u LjaOa` *Ua` Z` aZ`P` a`ABt
WZLZ` U`
[300] tZ` aLjO; BBAJ; D; C;
[301] tZ` aLjO; CeE
[302] tZ` aLjO; DZ97; DZ9W
[303] tZ` aLjO; DZ97; DZ9
[304] tZ` aLjO; DZ97; DZ97; DZ97; DZ9
[305] tZ` aLjO; DZ9W
[306] tZ` aLjO; DZ97; DZ9W
[307] tZ` aLjO; DZ97; DZ97; DZ9
[308] tZ` aLjO; DZ97; DZ9
[309] tZ` aLjO; De9P; De9;
[310] tZ` aLjOAn
[311] tZ` aLjOBs
[312] tZ` aLjOJUu
[313] tZ` aLjOKiu
[314] tZ` aLjOVUaU` Lj P` *XZB; ; ;
[315] tZ` aLjOVUaU` Lj P` *XZJW
[316] tZ` aLjO` Ua` Z` uOeW
[317] tZ` aLjO` Ua` Z` uOeW`*qV4
[318] tZ` aLjOXZB; ; ; ; hAlZ`ZmW
[319] tZ` aLjOYDABC
[320] tZ` aLjOYmaX
[321] tZ` aLjOYqe
[322] tZ` aLjOY` U` h` n` *qB` *B; K
[323] tZ` aLjOZVAL; DA
[324] tZ` aLjOa` *qBf` h` h` Zl



TECHNICAL NOTES

TECHNISCHE HINWEISE
NOTES TECHNIQUES
TECHNISCHE NOTITIES
NOTAS TÉCNICAS

NOTE TECNICHE
ΤΕΧΝΙΚΕΣ ΠΡΟΜΕΧΑΝΙΑ
INFORMACJE TECHNICZNE
ΤΕΧΝΙΚΕΣ ΣΗΜΕΙΩΣΕΙΣ

MŰSZAKI FELJEGYZÉSEK
NOTAS TÉCNICAS
TECHNICKÉ POZNÁMKY

- [325] t ž ħŨŦ_mpf Ze*Z
- [326] t ž ħŨŦ V f f V
- [327] t ž ħŨŦcW, RWARVBRVC
- [328] t ž ħŨŦcng
- [329] t ž ħŨŦddAC
- [330] t ž ħŨŦeXb
- [331] t ž ħŨŦeYd
- [332] t ž ħŨŦeYd7eas
- [333] t ž ħŨŦf DL
- [334] t ž ħŨŦf DLg
- [335] t ž ħŨŦf DLgB
- [336] t ž ħŨŦf JLg
- [337] t ž ħŨŦf VAC
- [338] t ž ħŨŦf YAC*gV VpZq
- [339] t ž ħŨŦf YAC*gV VpZqP ž žŨž*n_A
- [340] t ž ħŨŦf c
- [341] t ž ħŨŦf f
- [342] t ž ħŨŦf nb
- [343] t ž ħŨŦgDL
- [344] t ž ħŨŦgDLg
- [345] t ž ħŨŦgJL
- [346] t ž ħŨŦgJLg
- [347] t ž ħŨŦgJLq
- [348] t ž ħŨŦgJLx
- [349] t ž ħŨŦgVAC
- [350] t ž ħŨŦ ž žŨž*cpJ
- [351] t ž ħŨŦgVACP ž žŨž*cpJ7r eD
- [352] t ž ħŨŦgYAC
- [353] t ž ħŨŦgáá *á *VŨáŨ ŨH P *Z H*J
- [354] t ž ħŨŦŨáá *WCLV
- [355] t ž ħŨŦŨáá *WCLW
- [356] t ž ħŨŦŨáá *á *_qŨŨ H H žŨŨ
- [357] t ž ħŨŦŨáá *gJLg
- [358] t ž ħŨŦgr d*-K
- [359] t ž ħŨŦħŨŨž*ZmW
- [360] t ž ħŨŦmAC
- [361] t ž ħŨŦŨi ž ŨŨ á ž*á *xqJBB
- [362] t ž ħŨŦŨ P Ũ
- [363] t ž ħŨŦŨžŨŨ*- C:A; C
- [364] t ž ħŨŦŨžŨŨ*- D:A; C
- [365] t ž ħŨŦŨžŨŨ*- MA; C
- [366] t ž ħŨŦŨpsqqŨXaZq*Ũ Zpd
- [367] t ž ħŨŦŨmaX
- [368] t ž ħŨŦ ž žŨž*cWC
- [369] t ž ħŨŦ ž žŨž*cXJ
- [370] t ž ħŨŦ ž žŨž*ndJ
- [371] t ž ħŨŦŨsd
- [372] t ž ħŨŦŨvrAL*ŨŨYZ
- [373] t ž ħŨŦŨvBAAJrA
- [374] t ž ħŨŦŨxaAC
- [375] t ž ħŨŦŨxnAL



Short code → Tech code

| Short Code | Technical Code |
|------------|----------------|
| CCH306C | L86C |
| CCH425 | X |
| CJ6 | CJ6 |
| CJ7Y | CJ7Y |
| CJ8 | CJ8 |
| D16 | D16 |
| DJ8J | DJ8J |
| J17LM | J17LM |
| J19LM | J19LM |
| J8C | J8C |
| L77JC4 | L77JC4 |
| L78C | L78C |
| L82C | L82C |
| OE001 | N9YC |
| OE002 | RC9YCC |
| OE003 | C9YC |
| OE004 | RN9YCC |
| OE005 | RC9YC |
| OE006 | RN9YC |
| OE007 | L87YC |
| OE008 | RN7YCC |
| OE009 | S9YC |
| OE010 | N7YC |
| OE011 | RS9YC |
| OE012 | N7BYC |
| OE013 | RC12YC |
| OE014 | RC7YCC |
| OE015 | N12YC |
| OE016 | RC10YCC |
| OE018 | RN7YC |
| OE019 | RC10DMC |
| OE025 | RN8VTYC4 |
| OE026 | RC8DMC |
| OE027 | RN10VTYC4 |
| OE029 | RES9PYP4 |
| OE030 | RC8BYC |
| OE031 | RES9YCC4 |
| OE032 | RC8VTYC4 |
| OE033 | RC87YCL |
| OE034 | RC8YCL |
| OE035 | REC9YCL |
| OE037 | L86C |
| OE038 | L82YC |
| OE039 | RC9YC4 |
| OE041 | RC12LYC |
| OE042 | RN12YC |
| OE044 | N9BYC |
| OE048 | RN9YC4 |
| OE049 | RN11YC4 |
| OE051 | RN11YC |
| OE052 | RA4HCX |
| OE054 | RF7YC |
| OE057 | C11YCC |
| OE059 | L92YC |
| OE063 | RC10YC4 |
| OE064 | RL82YC |
| OE065 | N11YC |
| OE068 | N3C |
| OE073 | RA4HC |
| OE074 | N5C |
| OE077 | RC7BYC4 |
| OE078 | N3G |
| OE079 | N4C |
| OE083 | RA6HC |
| OE086 | RL82C |

| Short Code | Technical Code |
|------------|----------------|
| OE087 | N6YC |
| OE089 | RC9MCC4 |
| OE091 | RN2C |
| OE093 | RC89YCC |
| OE094 | RC6YCC |
| OE098 | RN4C |
| OE099 | S12YC |
| OE105 | RN14PMP5 |
| OE108 | RN3C |
| OE112 | A6GC |
| OE114 | RC11LCC4 |
| OE120 | RC89TMC |
| OE122 | RG4PHP |
| OE123 | RC8TYC |
| OE128 | RC12LC4 |
| OE130 | REA8MX |
| OE131 | RS9PYP4 |
| OE136 | RC8PYP |
| OE138 | RC11PYPB4 |
| OE145 | RC89PYC |
| OE146 | RC8PYPB4 |
| OE148 | REC10YC4 |
| OE154 | RC12MCC4 |
| OE175 | REC10PYC4 |
| OE176 | KC8ZPYPB4 |
| OE177 | KC8ZMCC |
| OE178 | REC9MCLX |
| OE179 | RC8WYPB4 |
| OE180 | RC10WYPB4 |
| OE181 | KC8WYPB4 |
| OE182 | RC89WYPB4 |
| OE183 | RS8WYPB5 |
| OE184 | RC10WMPB2 |
| OE186 | RA8YCX4 |
| OE187 | RA7WHPB |
| OE188 | RC8WMPB4 |
| OE189 | RES9WYPB5 |
| OE190 | REC10WYPB4 |
| OE191 | KC10PYPB4 |
| OE192 | RN10PYP4 |
| OE193 | RC12WYPB4 |
| OE194 | RC12WMPB4 |
| OE195 | RN8WYPB |
| OE196 | RA8MCX4 |
| OE197 | RER8YC |
| OE198 | RC10MCC |
| OE199 | RA7YC |
| OE201 | RER8MC |
| OE203 | RERX8PMPB4 |
| OE204 | RERX6PMC4 |
| OE205 | RERX4PMPB |
| OE206 | REC8PYB |
| OE207 | REA8PMPB5 |
| OE208 | RA2PYPB |
| OE209 | KC7PYPB4 |
| OE210 | KEC4PYPB |
| OE211 | RER6DMC |
| OE212 | RER6YC |
| OE213 | KC7ZPYPB4 |
| OE214 | KC6PYPB |
| OE215 | KA4ZPYPB4 |
| OE216 | RC7BMC |
| OE217 | RC7DYC |
| OE218 | RC8QMC |
| OE219 | KEC4PYPBF |

| Short Code | Technical Code |
|------------|----------------|
| OE220 | KEC4PYPBF-1 |
| OE222 | KC6PYPB4 |
| OE223 | RC9QMP |
| OE224 | REC8PYPB |
| OE225 | REA6PYPB |
| OE226 | RA7PYPB4 |
| OE227 | RC8PMPB |
| OE228 | KC8PYP4 |
| OE229 | KER4PYPB |
| OE230 | RA4YC |
| OE231 | REA6YC |
| OE232 | RER2PYPB |
| OE233 | REA4PMPB4 |
| OE234 | KC7ZPMPB4 |
| OE235 | KC7ZTMC4 |
| OE236 | REC6TMC |
| OE237 | RC7BYC |
| OE238 | REC7PMPB4 |
| OE239 | RC8ZPYPB4 |
| OE240 | REA12WMB4 |
| OE241 | RG4HCX |
| OE242 | RERX5PMPB |
| OE243 | RERX5ZPYPB |
| OE244 | KA6ZPHPB-1 |
| OE245 | RERX4ZWYPB |
| OE246 | KEC6WYPB-1 |
| OE247 | KA8ZYCC-1 |
| OE248 | RER3WYPB |
| OE249 | RER8WMPB |
| OE250 | RER8WYPB |
| OE253 | REA8WYPB4 |
| OE254 | RC7BYC |
| OE255 | RES10TMC4 |
| OE256 | REA8WYPB |
| OE257 | RC7QMC |
| OE258 | RET4WYPB4 |
| OE260 | KC6ZWYPB |
| OE261 | REA10WYPB |
| OE262 | REC7QMC |
| OE263 | RER12WMPB |
| OE264 | RC6WYPB4 |
| P-RA7HC | P-RA7HC |
| P-RG4HCC | P-RG4HCC |
| P-RG6HCC | P-RG6HCC |
| P-RG7C | P-RG7C |
| P-RZ7HC | P-RZ7HC |
| P-RZ9HC | P-RZ9HC |
| QCJ6Y | QCJ6Y |
| QCJ8Y | QCJ8Y |
| QL77JC4 | QL77JC4 |
| RCJ8 | RCJ8 |
| RG6YC | RG6YC |
| RG6YCA | RG6YCA |
| RJ17LM | RJ17LM |
| RJ19LM | RJ19LM |
| RJ19LMC | RJ19LMC |
| RL78C | RL78C |
| RN1C | RN1C |
| RV15YC4 | RV15YC4 |
| RV8C | RV8C |
| RX12ZYC | RX12ZYC |
| RY4C | RY4C |
| RZ7C | RZ7C |
| Z9Y | Z9Y |