

## Foam equipment

Eductors.....	204	Hand nozzles - Pok foam "QST".....	233
Eductors - Accessories .....	215	Hand nozzles - Long range water and air under pressure .	236
Eductors - High volume .....	217	Hand nozzles - Powder-foam.....	237
Self-educing attachments .....	218	Eductors - Powder .....	238
Branchpipes - Low expansion foam .....	219	Hand nozzles - Powder .....	238
Hand nozzles - Low expansion foam.....	223	Foam generators - Portable high expansion.....	239
Hand nozzles - Dual expansion foam .....	225	Foam generators - Fixed high expansion .....	242
Branchpipes - Medium expansion foam.....	226	Foam chambers.....	243
Hand nozzles - Medium expansion foam .....	229	Foam chambers.....	244
Foam units - Portable.....	230	Foam generators - Back-pressure .....	245
Foam units - Mobile .....	232	Discharge heads - Foam .....	246

Our range of eductors are made in aluminium alloy of first fusion and with heat treatment, red polyester coating or hard anodisation, in bronze or stainless steel, well adapted for a corrosive environment.

**All our eductors are equipped with couplings that conform to international norms:**



The foam eductors operate according to the Venturi principle and use the pressure created by the water to suction out a specific quantity of foam concentrate. Most of the types of eductors are therefore assembled between the water supply and the foam equipment, according to the schematic below.

The performance of the system will depend on the good use of the equipment according to requirements specific to each equipment. The inductors should be positioned such that there is about one meter of straight hose between water supply and the eductor and another meter of straight hose between eductor and the foam equipment. It is important to get an eductor that is adapted to the foam equipment, to take into account the pressure loss in the hoses and to foresee a pump that is powerful enough to get the right pressure at the inlet of the eductor and at the inlet of the foam equipment. The pressure loss between in and outlet of the eductor is 35 or 40%, depending on the model. The pressure loss in the hose between eductor and nozzle is function of the length of the hose and its diameter.

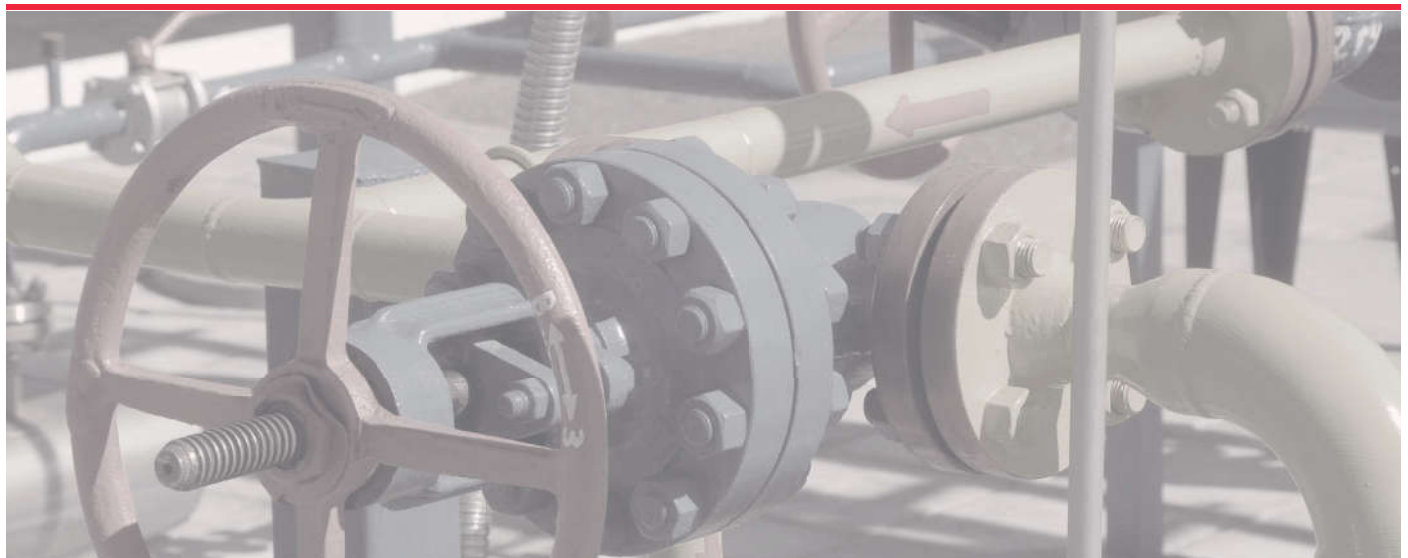
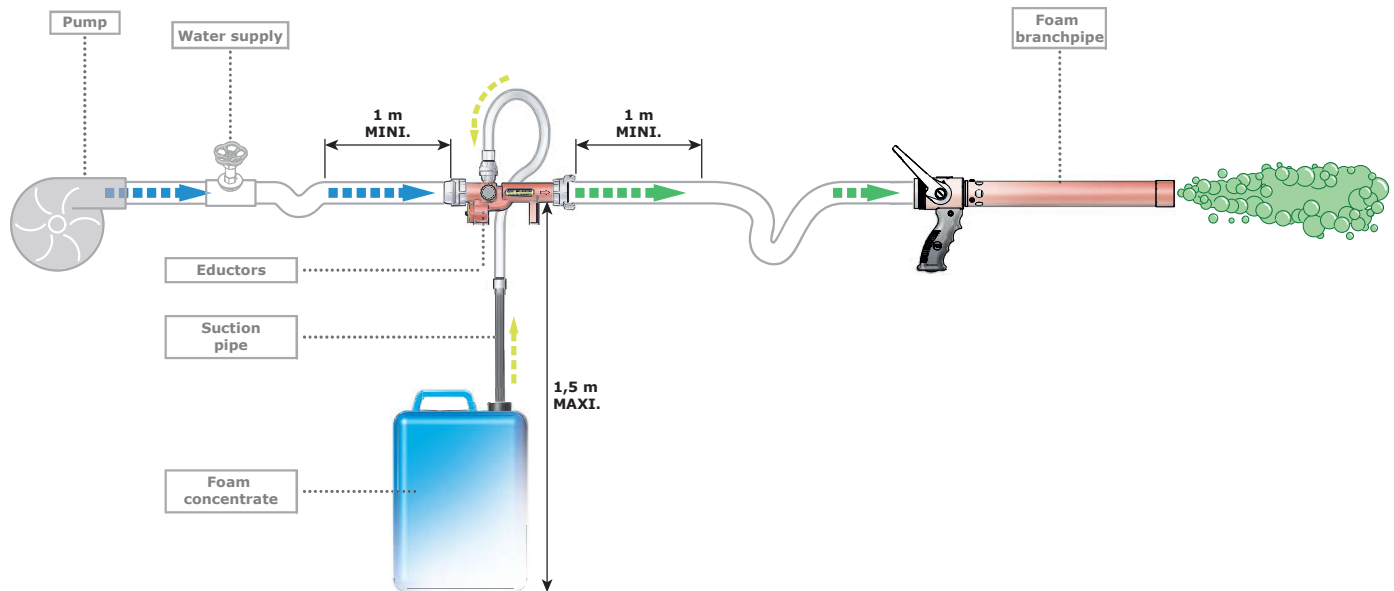

## "ULTRA-FOAM" eductors without bypass with calibrated orifices

**Compatibility**  
Equipment can be delivered with threads **NST/NH (NFPA 1963), BSP (ISO R 228)** or standardised couplings

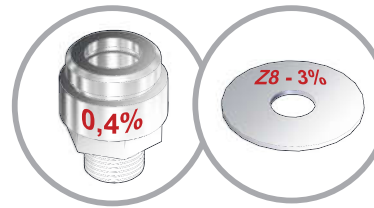

Calibrated orifices are supplied as standard and allow a precise foam concentrate percentage while having a non-return valve function. The suction percentages are: 0,4%, 1%, 3% or 6% depending on your requirement.



As an option, eductors can be equipped with metering devices to mount instead of calibrated orifices to allow to change the setting of the percentage during use, and having a non-return valve function.

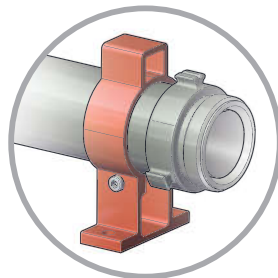

Other option: the foot in aluminium alloy for the 2.5" eductor model

**Maximum working pressure:** PN16  
**Material:** aluminium alloy  
**Surface treatment:** hard anodisation  
**Body type:** cut into bars  
**Non-return valve:** yes  
**Pressure loss:** 40%  
**Supplied with pick-up tube:** yes  
**Options:** metering device, fixation foot

Our range of "ULTRA-FOAM" eductors without bypass is made entirely in aluminium alloy hard anodised. Easy to use, the dosage is done using calibrated orifices (0.4%, 1%, 3% and 6% or 0.4%, 1% and 3%) that have a non-return valve function.

Our ultra-foam eductors are easily dismantled for a better cleaning and maintenance. Our range of eductors has flow rates from 35 to 750 lpm and various possible connections: threaded BSP or NST-NH, or standardised couplings.

Every product is furnished with a pick-up tube and a suction pipe.



Inlet	Outlet	Suction percentage adjustment	Flow rate / Working pressure				Dimensions (mm)	Weight (kg)	Ref.
			lpm	Bar	GPM	PSI			
1" NST-NH female	1" NST-NH male	0,4%, 1%, 3%, 6%	35	10	10	200	151 x 88 x 62	0,68	<b>13117</b>
1" NST-NH female	1" NST-NH male	0,4%, 1%, 3%, 6%	75	10	20	200	151 x 88 x 62	0,68	<b>12096</b>
1" NST-NH female	1" NST-NH male	0,4%, 1%, 3%, 6%	150	10	40	200	151 x 88 x 62	0,68	<b>13118</b>
1.5" NST-NH female	1.5" NST-NH male	0,4%, 1%, 3%, 6%	200	10	60	200	205 x 98 x 78	1,28	<b>12094</b>
1.5" NST-NH female	1.5" NST-NH male	0,4%, 1%, 3%	300	10	95	200	205 x 98 x 78	1,28	<b>13119</b>
1.5" NST-NH female	1.5" NST-NH male	0,4%, 1%, 3%	400	10	125	200	205 x 98 x 78	1,28	<b>13120</b>
2.5" NST-NH female	2.5" NST-NH male	0,4%, 1%, 3%, 6%	750	10	200	200	422 x 142 x 107	3,24	<b>25702</b>

## "ULTRA-FOAM" eductors without bypass, in bronze, with calibrated orifices

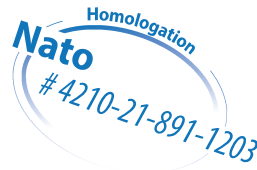

Maximum working pressure: PN16  
 Material: bronze  
 Surface treatment: untreated  
 Non-return valve: yes  
 Supplied with pick-up tube: yes

**Equips the "US Coast Guard"**  
**Equips the Canadian Navy**

These "ULTRA-FOAM" eductors without bypass are made entirely in bronze for a saline environment. The regulation of dosage is obtained by calibrated orifices having the function of non-return valve.

Our ultra-foam eductors are easily dismantled for a better cleaning and maintenance. Every product is furnished with a pick up tube and a suction pipe.

Inlet	Outlet	Flow rate / Working pressure				Dimensions (mm)	Weight (kg)	Ref.
		lpm	Bar	GPM	PSI			
1.5" NPSH female	1.5" NPSH male	225	10	60	200	290 x 62 x 128	2,35	<b>21867</b>
1.5" NPSH female	1.5" NPSH male			90	200	290 x 62 x 128	2,35	<b>21871</b>

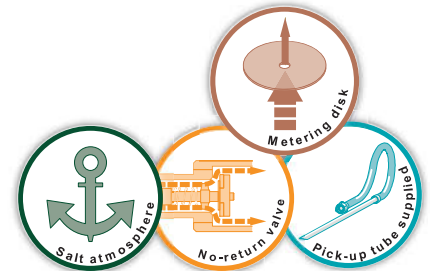

## "ULTRA-FOAM" eductors without bypass, in bronze, with metering device

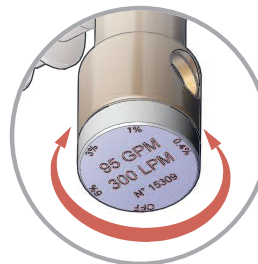

Adjustment of dosage done via the indexed metering device

Maximum working pressure: PN16  
 Material: bronze and stainless steel  
 Surface treatment: untreated  
 Suction percentage: 0.4, 1, 3 and 6%  
 Non-return valve: yes  
 Supplied with pick-up tube: yes

**Equips the Italian Navy**

These "ULTRA-FOAM" eductors without bypass are made entirely in bronze for a saline environment. The regulation of dosage during operation is obtained thanks to an indexed metering device.

Our ultra-foam eductors are easily dismantled for a better cleaning and maintenance. Every product is furnished with a pick up tube and a suction pipe.

Inlet	Outlet	Suction percentage adjustment	Flow rate / Working pressure				Dimensions (mm)	Weight (kg)	Ref.
			lpm	Bar	GPM	PSI			
M56 x 400 female (UNI 811)	M56 x 400 male (UNI 810)	0,4%, 1%, 3%, 6%	360	10	95	200	301 x 75 x 181	3,00	<b>21875</b>





## "ULTRA-LIGHT" eductors with bypass and calibrated orifices

**Compatibility**  
Equipment can be delivered with threads NST/NH (NFFA 1963), BSP (ISO R 228) or standardised couplings

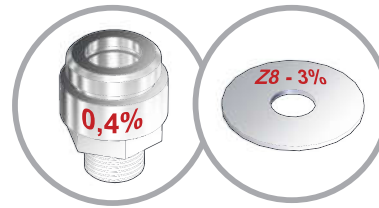

Calibrated orifices are supplied as standard and allow a precise foam concentrate percentage while having a non-return valve function. The suction percentages are: 0,4%, 1%, 3% or 6% depending on your requirement.



As an option, eductors can be equipped with metering devices to mount instead of calibrated orifices to allow to change the setting of the percentage during use, and having a non-return valve function.

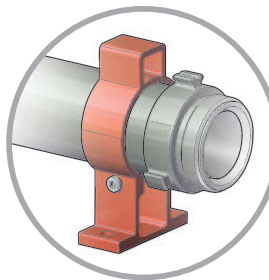

Other option: the foot in aluminium alloy for the 2.5" eductor model

**Maximum working pressure:** PN16  
**Material:** aluminium alloy  
**Surface treatment:** hard anodisation  
**Body type:** cut into bars  
**Non-return valve:** yes  
**Pressure loss:** 40%  
**Supplied with pick-up tube:** yes

**Options:** metering device, fixation foot.

Our range of "ULTRA-LIGHT" eductors with bypass is made entirely in aluminium alloy hard anodised. Our eductors are mounted in front of nozzles for operation with water or foam. The removable non-return valve with calibrated orifices allow for a dosage of 0.4, 1, 3 and 6%.

Our range of eductors are used with flow rates from 200 to 800 lpm and various possible connections: threaded BSP or NST-NH or standardised couplings. Every product is furnished with a pick up tube and a suction pipe.

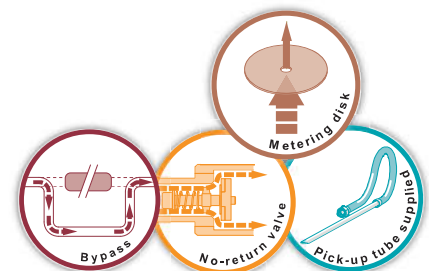

Inlet	Outlet	Suction percentage adjustment	Flow rate / Working pressure				Dimensions (mm)	Weight (kg)	Ref.
			lpm	Bar	GPM	PSI			
1.5" NST-NH female	1.5" NST-NH male	0,4%, 1%, 3%, 6%	200	10	60	200	159 x 100 x 75	0,99	<b>09949</b>
1.5" BSP female	1.5" BSP male	0,4%, 1%, 3%, 6%	200	10	60	200	159 x 100 x 75	0,99	<b>09949. BSP</b>
1.5" NST-NH female	1.5" NST-NH male	0,4%, 1%, 3%, 6%	300	10	95	200	159 x 100 x 75	0,99	<b>09950</b>
1.5" BSP female	1.5" BSP male	0,4%, 1%, 3%, 6%	300	10	95	200	159 x 100 x 75	0,99	<b>09950. BSP</b>
1.5" NST-NH female	1.5" NST-NH male	0,4%, 1%, 3%, 6%	400	10	125	200	159 x 100 x 75	0,99	<b>09951</b>
1.5" BSP female	1.5" BSP male	0,4%, 1%, 3%, 6%	400	10	125	200	159 x 100 x 75	0,99	<b>09951. BSP</b>
2.5" NST-NH female	2.5" NST-NH male	0,4%, 1%, 3%, 6%	750	10	200	200	271 x 142 x 108	2,28	<b>08918</b>
2.5" NST-NH female	2.5" NST-NH male	0,4%, 1%, 3%, 6%	800	10	200	200	271 x 142 x 108	2,28	<b>12483</b>
2.5" BSP female	2.5" BSP male	0,4%, 1%, 3%, 6%	800	10	250	200	271 x 142 x 108	2,28	<b>12481</b>
2.5" BSP male	2.5" BSP male	0,4%, 1%, 3%, 6%	800	10	250	200	271 x 142 x 108	2,08	<b>24485</b>

## Eductors "MIXY EDUCTOR" in aluminium alloy with metering device

With control valve and metering device

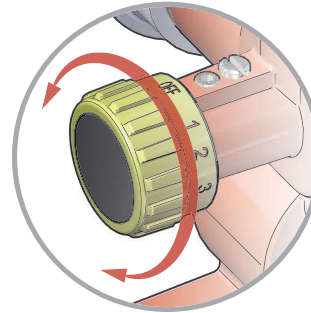

Setting of the dosing percentage via the indexed metering device

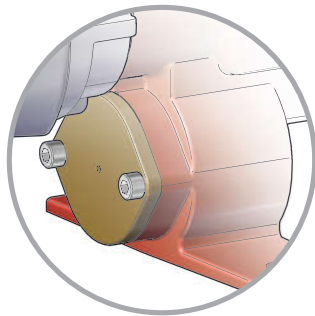

Control valve integrated to the eductor

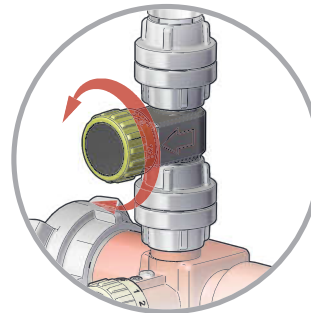

Optional: the eductors "MIXY EDUCTOR" of 200 and 400 lpm can be equipped with a metering device with suction percentages of 0,1%, 0,5% and 1%.

Our range of foam "MIXY EDUCTOR" operates according to the Venturi principle. As the pressurized water passes through the tip of the convergent pipe, a suction effect is created and the foam concentrated liquid is drawn up. The eductor is fitted with a non-return valve with a polyethylene ball valve, which prevents water from flowing back into the emulsifier tank. The metering orifice regulates the concentration flow and thus determines the percentage of the foam liquid from 0% to 6%.

The control valve allows a constant dosage while pressure varies.

Our range of eductors are used with flow rates from 200 to 800 lpm and various possible connections: threaded BSP or NST-NH or standardised couplings. Construction in aluminium alloy with red polyester coating.

**Maximum working pressure:** PN16  
**Material:** aluminium alloy  
**Surface treatment:** polyester coating  
**Body type:** moulded  
**Non-return valve:** yes  
**Control valve:** yes  
**Pressure loss:** 35%  
**Supplied with pick-up tube:** yes

**Options:** metering device 0,1%, 0,5% and 1% for 200 and 400 lpm eductors.

Inlet	Outlet	Suction percentage adjustment	Flow rate / Working pressure				Dimensions (mm)	Weight (kg)	Ref.
			lpm	Bar	GPM	PSI			
2" BSP male	2" BSP male	0, 1%, 2%, 3%, 4%, 5%, 6%	200	10	60	140	309 x 171 x 184	2,53	<b>16160</b>
Storz C/52	Storz C/52	0, 1%, 2%, 3%, 4%, 5%, 6%	200	10	60	140	378 x 171 x 176	3,13	<b>16272</b>
DSP DN40	DSP DN40	0, 1%, 2%, 3%, 4%, 5%, 6%	200	10	60	140	415 x 171 x 184	2,93	<b>18426</b>
1.5" NST-NH female	1.5" NST-NH male	0, 1%, 2%, 3%, 4%, 5%, 6%	200	10	60	140	372 x 171 x 184	2,90	<b>18749</b>
1.5" NST-NH female	1.5" NST-NH male	0, 0,4%, 1%, 3%, 6%	300	10	95	140	372 x 171 x 184	2,90	<b>18750</b>
2" BSP male	2" BSP male	0, 1%, 2%, 3%, 4%, 5%, 6%	400	10	125	140	309 x 171 x 184	2,50	<b>16215</b>
Storz C/52	Storz C/52	0, 1%, 2%, 3%, 4%, 5%, 6%	400	10	125	140	378 x 171 x 176	3,07	<b>16172</b>
Storz B/75	Storz B/75	0, 1%, 2%, 3%, 4%, 5%, 6%	400	10	125	140	384 x 171 x 176	4,88	<b>16173</b>
DSP DN40	DSP DN40	0, 1%, 2%, 3%, 4%, 5%, 6%	400	10	125	140	415 x 171 x 184	2,97	<b>18747</b>
DSP DN65	DSP DN65	0, 1%, 2%, 3%, 4%, 5%, 6%	400	10	125	140	410 x 171 x 184	3,22	<b>18410</b>
1.5" NST-NH female	1.5" NST-NH male	0, 0,4%, 1%, 3%, 6%	400	10	125	140	372 x 171 x 184	2,90	<b>18751</b>
2.5" NST-NH female	2.5" NST-NH male	0, 0,4%, 1%, 3%, 6%			150	140	536 x 197 x 225	5,32	<b>18752</b>
2.5" NST-NH female	2.5" NST-NH male	0, 0,4%, 1%, 3%, 6%			200	140	536 x 197 x 225	5,32	<b>18753</b>
2.5" BSP male	2.5" BSP male	0, 1%, 2%, 3%, 4%, 5%, 6%	800	10	250	140	454 x 197 x 225	4,65	<b>16174</b>
Storz C/52	Storz C/52	0, 1%, 2%, 3%, 4%, 5%, 6%	800	10	250	140			<b>16175</b>
Storz B/75	Storz B/75	0, 1%, 2%, 3%, 4%, 5%, 6%	800	10	250	140	529 x 197 x 217	5,50	<b>16176</b>
DSP DN65	DSP DN65	0, 1%, 2%, 3%, 4%, 5%, 6%	800	10	250	140	535 x 197 x 225	5,81	<b>18748</b>
2.5" NST-NH female	2.5" NST-NH male	0, 0,4%, 1%, 3%, 6%	800	10	250	140	536 x 197 x 225	5,32	<b>18754</b>

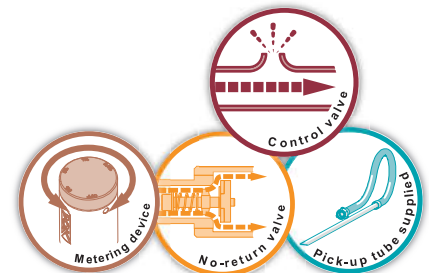

## Eductors "MIXY-EDUCTOR" in bronze with metering device

With control valve and metering device

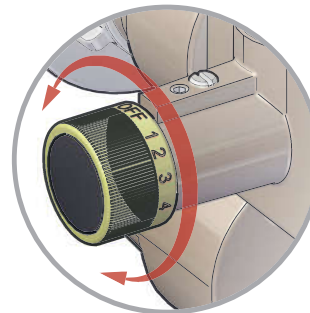

Setting of the dosing percentage via the indexed metering device

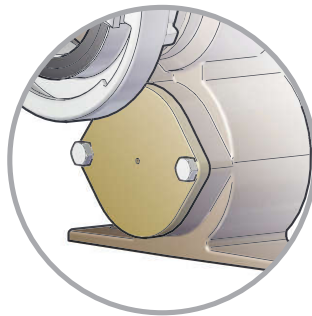

Control valve integrated to the eductor

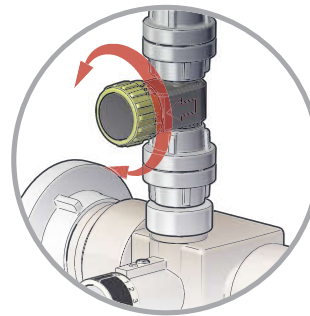

Optional: the eductors "MIXY EDUCTOR" of 200 and 400 lpm can be equipped with a metering device with suction percentages of 0,1%, 0,5% and 1%.

Our range of foam "MIXY EDUCTOR" operates according to the Venturi principle. As the pressurized water passes through the tip of the convergent pipe, a suction effect is created and the foam concentrated liquid is drawn up. The eductor is fitted with a non-return valve with a polyethylene ball valve, which prevents water from flowing back into the emulsifier tank. The metering orifice regulates the concentration flow and thus determines the percentage of the foam liquid from 0% to 6%.

The control valve allows a constant dosage while pressure varies.

Our range of eductors are used with flow rates from 200 to 800 lpm and various possible connections: threaded BSP or NST-NH or standardised couplings. Construction in bronze for the body and aluminium alloy for couplings.

**Maximum working pressure:** PN16  
**Material:** bronze  
**Body type:** moulded  
**Non-return valve:** yes  
**Control valve:** yes  
**Pressure loss:** 35%  
**Supplied with pick-up tube:** yes

**Options:** metering device 0,1%, 0,5% and 1% for 200 and 400 lpm eductors.

Inlet	Outlet	Suction percentage adjustment	Flow rate / Working pressure				Dimensions (mm)	Weight (kg)	Ref.
			lpm	Bar	GPM	PSI			
2" BSP male	2" BSP male	0, 1%, 2%, 3%, 4%, 5%, 6%	200	10	60	140	309 x 171 x 177	6,04	<b>18756</b>
Storz C/52	Storz C/52	0, 1%, 2%, 3%, 4%, 5%, 6%	200	10	60	140	378 x 171 x 177	6,62	<b>18755</b>
DSP DN40	DSP DN40	0, 1%, 2%, 3%, 4%, 5%, 6%	200	10	60	140	405 x 171 x 185	7,05	<b>18757</b>
Instantaneous BS336	Instantaneous BS336	0, 1%, 2%, 3%, 4%, 5%, 6%	200	10	60	140	406 x 171 x 192	8,61	<b>16083</b>
1.5" NST-NH female	1.5" NST-NH male	0, 0,4%, 1%, 3%, 6%	200	10	60	140	372 x 171 x 177	6,43	<b>18764</b>
1.5" NST-NH female	1.5" NST-NH male	0, 0,4%, 1%, 3%, 6%	300	10	95	140	372 x 171 x 177	6,43	<b>18765</b>
2" BSP male	2" BSP male	0, 1%, 2%, 3%, 4%, 5%, 6%	400	10	125	140	309 x 171 x 177	6,04	<b>18759</b>
Storz B/75	Storz B/75	0, 1%, 2%, 3%, 4%, 5%, 6%	400	10	125	140	384 x 171 x 177	8,39	<b>18758</b>
DSP DN65	DSP DN65	0, 1%, 2%, 3%, 4%, 5%, 6%	400	10	125	140	410 x 171 x 185	6,75	<b>18760</b>
Instantaneous BS336	Instantaneous BS336	0, 1%, 2%, 3%, 4%, 5%, 6%	400	10	125	140	405 x 171 x 195	6,96	<b>16084</b>
2.5" NST-NH female	2.5" NST-NH male	0, 0,4%, 1%, 3%, 6%			200	140			<b>18766</b>
2.5" BSP male	2.5" BSP male	0, 1%, 2%, 3%, 4%, 5%, 6%	800	10	250	140	453 x 198 x 225	9,25	<b>18762</b>
Storz B/75	Storz B/75	0, 1%, 2%, 3%, 4%, 5%, 6%	800	10	250	140	528 x 198 x 217	10,10	<b>18761</b>
DSP DN65	DSP DN65	0, 1%, 2%, 3%, 4%, 5%, 6%	800	10	250	140	535 x 198 x 225	9,87	<b>18763</b>

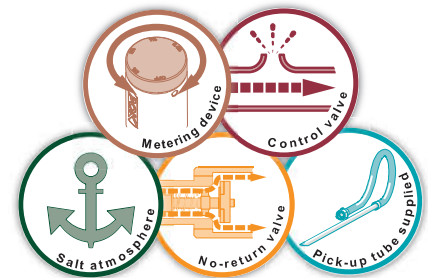

## "Around the pump" eductors

**Compatibility**  
Equipment can be delivered with threads  
**NST/NH (NFPA 1963),**  
**BSP (ISO R 228)**  
or standardised couplings

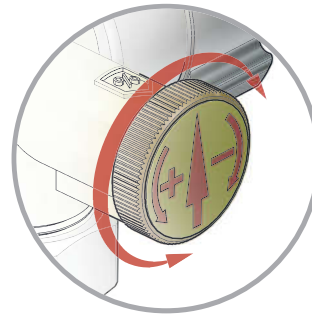

Setting of the dosing percentage via the indexed metering device

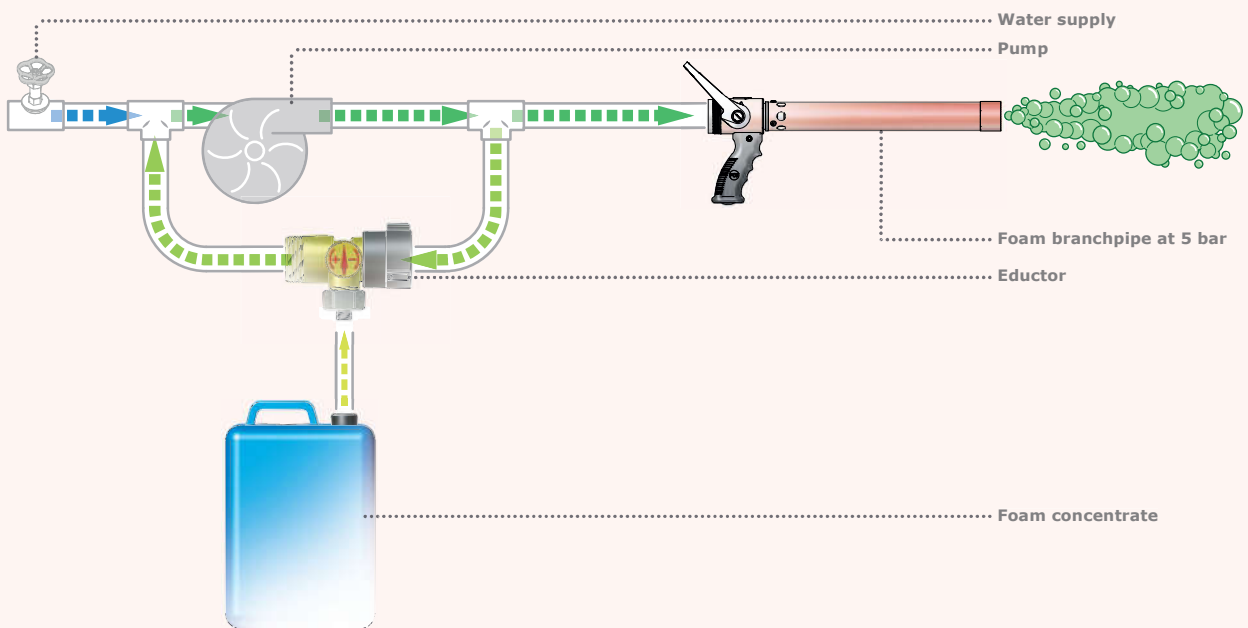

This equipment is used to deliver a premix with a low percentage of foam concentrate by placing it on a bypass allowing a portion of the water coming out of a pump to go through an eductor and inject the resulting premix at the entrance of the pump. The outgoing fluid is then at the nominal pressure of the pump with the premix percentage set at the metering device. This system enables having no pressure drop at the outlet of the pump (which would happen if one placed the eductor downstream of the pump).

**Maximum working pressure:** PN16  
**Material:** aluminium alloy and POM  
**Surface treatment:** hard anodisation on aluminium parts  
**Body type:** moulded  
**Suction percentage:** from 0,10% to 1,26% depending on product  
**Non-return valve:** yes  
**Supplied with pick-up tube:** yes

Inlet	Outlet	Suction percentage adjustment	Flow rate / Working pressure				Dimensions (mm)	Weight (kg)	Ref.
			lpm	Bar	GPM	PSI			
1"1/2 NST-NH female	1"1/2 NST-NH male	from 0,12% to 1,15%	200	6	60	90	135 x 182 x 104	0,80	<b>23462</b>
SG DN40	SG DN40 with lock	from 0,12% to 1,15%	200	6	60	90	215 x 181 x 95	1,01	<b>23466</b>
SG DN40	SG DN40 with lock	from 0,12% to 1,15%	400	6	125	90	215 x 181 x 95	1,01	<b>24952</b>





## Mini-eductors

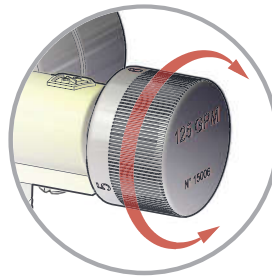

Suction percentage set with metering device for 0, 1, 2, 3, 4, 5 and 6%

**Maximum working pressure:** PN16  
**Material:** aluminium alloy and POM  
**Surface treatment:** hard anodisation on aluminium parts  
**Body type:** moulded  
**Suction percentage:** 0, 1, 2, 3, 4, 5 and 6%  
**Non-return valve:** yes  
**Supplied with pick-up tube:** yes

Our range of mini-eductors offers a compact size and a low weight. Made in aluminium alloy.

This range is available with two flow rates: 200 or 400 lpm. Various possible connections: threaded BSP or NST-NH, or standardised couplings. Delivered with pick-up tube.

Inlet	Outlet	Suction percentage adjustment	Flow rate / Working pressure				Dimensions (mm)	Weight (kg)	Ref.
			lpm	Bar	GPM	PSI			
1.5" NST-NH female	1.5" NST-NH male	0%, 1%, 2%, 3%, 4%, 5%, 6%	200	6	60	90	135 x 131 x 104	0,78	<b>18828</b>
1.5" NST-NH female	1.5" NST-NH male	0%, 1%, 2%, 3%, 4%, 5%, 6%	400	6	125	90	135 x 131 x 104	0,78	<b>15006</b>

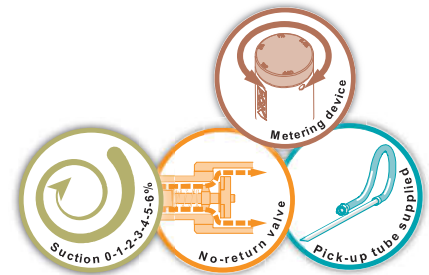

## High pressure eductor - PN40



Suction percentage set with metering device for 0, 1, 2, 3, 4, 5 and 6%

**Maximum working pressure:** PN40  
**Material:** aluminium alloy  
**Surface treatment:** hard anodisation  
**Body type:** cut into bars  
**Suction percentage:** 0, 0,4, 1, 3, and 6%  
**Non-return valve:** yes  
**Supplied with pick-up tube:** yes

Our range of high pressure eductors works at an operating pressure of 40 bar with inlet pressure of 40 bar, and outlet pressure of 26 bar. Made in aluminium alloy. This range is available with two flow rates: 75 or 150 lpm. Various possible connections: threaded BSP or NST-NH, or standardised couplings. Delivered with pick-up tube.

Inlet	Outlet	Suction percentage adjustment	Flow rate / Working pressure				Dimensions (mm)	Weight (kg)	Ref.
			lpm	Bar	GPM	PSI			
1" BSP male	1" BSP male	0%, 0,4%, 1%, 3%, 6%	75	40	20	580	219 x 70 x 171	1,40	<b>07248</b>
1" BSP male	1" BSP male	0%, 0,4%, 1%, 3%, 6%	150	40	40	580	219 x 70 x 171	1,40	<b>07249</b>



## Eductors for hose reel

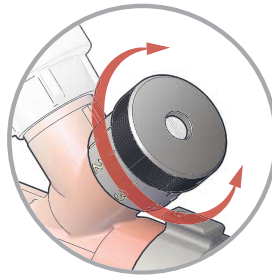

Suction percentage set with metering device for 1, 2, 3, 4, 5 and 6%

**Maximum working pressure:** PN16  
**Material:** aluminium alloy  
**Surface treatment:** polyester coating  
**Body type:** moulded  
**Suction percentage:** 0, 1, 2, 3, 4, 5 and 6%  
**Non-return valve:** yes  
**Supplied with pick-up tube:** yes

Our range of eductors for hose reels is made in aluminium alloy with red polyester coating. They equip the hose reels POK DN33, and allow to transform a simple hose reel into a hydro-foam hose reel system.

Our range can work with flow rates from 75 to 200 lpm and various possible connections: threaded BSP or NST-NH or standardised couplings.

Inlet	Outlet	Suction percentage adjustment	Flow rate / Working pressure				Dimensions (mm)	Weight (kg)	Ref.
			lpm	Bar	GPM	PSI			
1" BSP female	1" BSP male	0%, 1%, 2%, 3%, 4%, 5%, 6%	75	10					<b>01068</b>
1.5" BSP female	1.5" BSP male	0%, 1%, 2%, 3%, 4%, 5%, 6%	160	10			278 x 71 x 157	1,40	<b>03565</b>
1.5" NST-NH female	1.5" NST-NH male	0%, 1%, 2%, 3%, 4%, 5%, 6%	200	10			278 x 71 x 160	1,40	<b>07558</b>

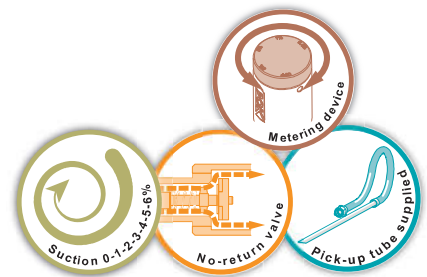

## Eductors with bypass and metering device

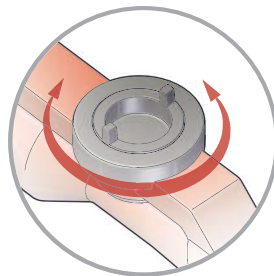

Stepless adjustment of the suction percentage from 0 to 6%

Certified by  
 The Ministry of Interior, Russia  
 n° 008112



**Maximum working pressure:** PN16  
**Material:** aluminium alloy  
**Surface treatment:** polyester coating  
**Body type:** moulded  
**Suction percentage:** from 0 to 6%  
**Non-return valve:** yes  
**Supplied with pick-up tube:** yes

Our range of eductors for hose reels is made in aluminium alloy with red polyester coating. Positioned upstream of a monitor to operate with water or foam.

Our eductor is equipped with a non-return valve.

The suction percentage can be adjusted from 0 to 6%.

The eductor has stabilising legs for a better positioning on the floor and comes with pick-up tube.

The eductors are working for a range of flow rates from 1,200 to 2,000 lpm.

The in and outlet are available threaded BSP or NST-NH, or standardised couplings.

Inlet	Outlet	Suction percentage adjustment	Flow rate / Working pressure				Dimensions (mm)	Weight (kg)	Ref.
			lpm	Bar	GPM	PSI			
AR DN100	AR DN100	from 0 to 6%	1200	10			739 x 306 x 190	8,51	<b>08153</b>
AR DN100	AR DN100	from 0 to 6%	1500	10			739 x 306 x 190	8,49	<b>07255</b>
AR DN100	AR DN100	from 0 to 6%	2000	10			739 x 306 x 190	8,45	<b>07256</b>

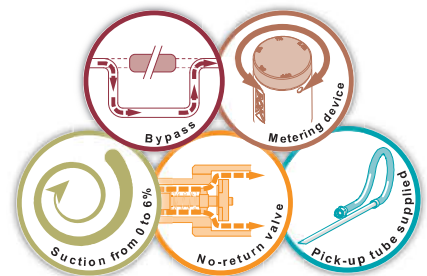

## Eductors in stainless steel with calibrated orifice



In compliance with norm  
 French: NF E 29-201 and NF E 29-203  
 German: DIN 201  
 American: ANSI B 16-5  
 International: ISO 2084

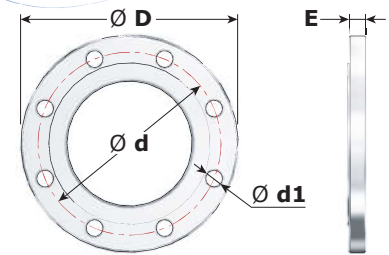

Description	Dimensions				
	D	d	E	d1 - Thread	Nbre of holes
ISO DN40 PN16	150	110	16	18 - M16	4
ISO DN50 PN16	165	125	18	18 - M16	4
ISO DN65 PN16	185	145	18	18 - M16	4
ISO DN80 PN16	200	160	20	18 - M16	8
ISO DN100 PN16	220	180	20	18 - M16	8
ISO DN150 PN16	285	240	22	22 - M20	8
3" ASA150	190,5	152,4	23,9	19 - M16	4
4" ASA150	228,6	190,5	23,9	19 - M16	8

Maximum working pressure: PN16  
 Material: stainless steel  
 Pressure loss: 40%  
 Suction percentage: 3 or 6%  
 Non-return valve: yes  
 Supplied with pick-up tube: yes

Our range of eductors with calibrated orifices is entirely made in stainless steel. The calibrated orifices allow a fixed suction of 3% or 6% (depending on your requirement). Our range of eductors works with flow rates going from 200 to 10,000 lpm and various connections: DN40 to DN150 (depending on the flow rate) PN16 or ASA150. Our eductors are delivered with pick-up tube.

Inlet flange	Outlet flange	Suction coupling	Flow rate / Working pressure				Dimensions (mm)	Weight (kg)	Ref.
			lpm	Bar	GPM	PSI			
DN40 PN16	DN40 PN16	3/8" BSP male	200	10			207 x 150 x 150		<b>07078</b>
DN50 PN16	DN50 PN16	1" BSP male	200	10			293 x 165 x 165	7,10	<b>07235</b>
DN50 PN16	DN50 PN16	1" BSP male	400	10			293 x 165 x 167	7,00	<b>21716</b>
DN65 PN16	DN65 PN16	1" BSP male	400	10			388 x 185 x 185		<b>07079</b>
DN65 PN16	DN65 PN16	1" BSP male	500	10			411 x 185 x 185		<b>07238</b>
DN65 PN16	DN65 PN16	1" BSP male	600	10			411 x 185 x 185		<b>07239</b>
DN65 PN16	DN65 PN16	1" BSP male	800	10			411 x 185 x 185	11,37	<b>07240</b>
DN80 PN16	DN80 PN16	1" BSP male	1000	10			487 x 200 x 200		<b>07241</b>
3" ASA150	3" ASA150	1" BSP male	1000	10			487 x 190 x 190	11,86	<b>21948</b>
DN100 PN16	DN100 PN16	1.5" BSP male	1200	10			807 x 220 x 220		<b>07242</b>
4" ASA150	4" ASA150	1.5" BSP male	1200	10			807 x 229 x 229		<b>21998</b>
DN100 PN16	DN100 PN16	1.5" BSP male	1500	10			807 x 220 x 220		<b>07243</b>
4" ASA150	4" ASA150	1.5" BSP male	1500	10			807 x 229 x 229		<b>21999</b>
DN100 PN16	DN100 PN16	1.5" BSP male	2000	10			807 x 220 x 220		<b>07244</b>
4" ASA150	4" ASA150	1.5" BSP male	2000	10			807 x 229 x 229		<b>22000</b>
DN100 PN16	DN100 PN16	1.5" BSP male	3000	10			807 x 220 x 220	23,47	<b>14782</b>
4" ASA150	4" ASA150	1.5" BSP male	3000	10			807 x 229 x 229		<b>22004</b>
DN150 PN16	DN150 PN16	Storz B/75	4000	10			1784 x 285 x 400	29,50	<b>22166</b>
DN150 PN16	DN150 PN16	Storz B/75	5000	10			1784 x 285 x 400		<b>22005</b>
DN150 PN16	DN150 PN16	2.5" BSP male	10000	14			1311 x 285 x 285	34,86	<b>30675</b>

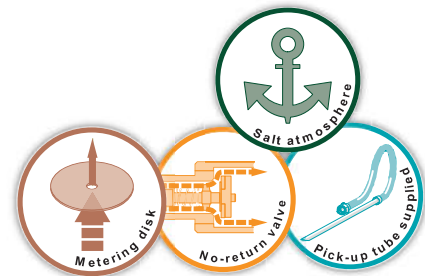

## Eductors in stainless steel, with metering device



Suction percentage set with metering device for 1, 2, 3, 4, 5 and 6%

In compliance with norm  
 French: NFE 29-201 and NFE 29-203  
 German: DIN 201  
 American: ANSI B 16-5  
 International: ISO 2084

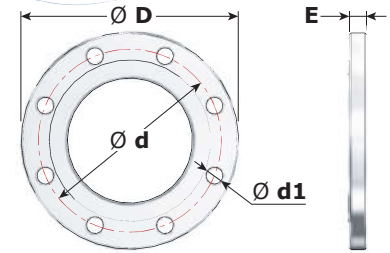

Description	Dimensions				
	D	d	E	d1 - Thread	# of holes
ISO DN40 PN16	150	110	16	18 - M16	4
ISO DN50 PN16	165	125	18	18 - M16	4
ISO DN65 PN16	185	145	18	18 - M16	4
ISO DN80 PN16	200	160	20	18 - M16	8
ISO DN100 PN16	220	180	20	18 - M16	8
ISO DN150 PN16	285	240	22	22 - M20	8
3" ASA150	190,5	152,4	23,9	19 - M16	4
4" ASA150	228,6	190,5	23,9	19 - M16	8

Maximum working pressure: PN16  
 Material: stainless steel  
 Pressure loss: 40%  
 Suction percentage: 0, 0.4, 1, 3 and 6%  
 Non-return valve: yes  
 Supplied with pick-up tube: yes

Our range of eductors with metering device is made entirely in stainless steel. The metering device allows to modify the suction percentage (0, 0.4, 1, 3 and 6%) during the use of the foam equipment. Our range of eductors works with flow rates going from 200 to 5,000 lpm and various connections: DN50 to DN150 (depending on the flow rate) PN16 or ASA150.

Inlet flange	Outlet flange	Suction coupling	Flow rate / Working pressure				Dimensions (mm)	Weight (kg)	Ref.
			lpm	Bar	GPM	PSI			
DN50 PN16	DN50 PN16	1/2" BSP female	200	10	60	140			22187
DN50 PN16	DN50 PN16	1/2" BSP female	400	10	125	140	293 x 165 x 232	8,00	21995
DN65 PN16	DN65 PN16	1/2" BSP female	400	10	125	140	388 x 185 x 242	9,63	22180
DN65 PN16	DN65 PN16	1" BSP male	800	10	250	140	411 x 185 x 293	11,94	22228
DN80 PN16	DN80 PN16	1" BSP male	1000	10	300	140	487 x 200 x 301	13,42	22006
3" ASA150	3" ASA150	1" BSP male	1000	10	300	140	487 x 190 x 296	14,10	22001
DN100 PN16	DN100 PN16	1.5" NPT female	1200	10			807 x 220 x 353		22007
4" ASA150	4" ASA150	1.5" NPT female	1200	10			807 x 229 x 357		22008
DN100 PN16	DN100 PN16	1.5" NPT female	1500	10	400	140	807 x 220 x 353		22169
4" ASA150	4" ASA150	1.5" NPT female	1500	10	400	140	807 x 229 x 357		22170
DN100 PN16	DN100 PN16	1.5" NPT female	2000	10	600	140	807 x 220 x 353		22183
4" ASA150	4" ASA150	1.5" NPT female	2000	10	600	140	807 x 229 x 357		22184
DN100 PN16	DN100 PN16	1.5" NPT female	3000	10	800	140	807 x 220 x 353		22185
4" ASA150	4" ASA150	1.5" NPT female	3000	10	800	140	807 x 229 x 357		22186
DN150 PN16	DN150 PN16	Storz B/75	4000	10			1784 x 285 x 421	32,78	21558
DN150 PN16	DN150 PN16	Storz B/75	5000	10			1784 x 285 x 421		22009





## Metering devices in aluminium alloy



Our range of metering devices is made entirely in aluminium alloy. Connected to the eductors and replacing the calibrated orifices, they allow to change the suction percentage (0, 0.4, 1, 3 and 6%) while the equipment is in use. These metering devices are equipped with a non-return valve and delivered with a pick-up tube. Our range works with flow rates from 35 (10 GPM) to 800 lpm (250 GPM).

**Maximum working pressure:** PN16  
**Material:** aluminium alloy  
**Surface treatment:** hard anodisation  
**Suction percentage:** 0, 0.4, 1, 3 and 6%  
**Non-return valve:** yes



Inlet	Outlet	Flow rate		Dimensions (mm)	Weight (kg)	Ref.
		lpm	GPM			
3/8" BSP male	3/4" BSP male	35	10	113 x 71 x 50	0,45	<b>13121</b>
3/8" BSP male	3/4" BSP male	75	20	113 x 71 x 50	0,45	<b>12639</b>
3/8" BSP male	3/4" BSP male	100	25	113 x 71 x 50	0,45	<b>17518</b>
3/8" BSP male	3/4" BSP male	150	40	113 x 71 x 50	0,45	<b>12640</b>
3/8" BSP male	3/4" BSP male	200	60	113 x 71 x 50	0,45	<b>12641</b>
3/8" BSP male	3/4" BSP male	300	95	113 x 71 x 50	0,45	<b>12642</b>
3/8" BSP male	3/4" BSP male	400	125	113 x 71 x 50	0,45	<b>12643</b>
GFR DN20 male	3/4" BSP male	750	200	149 x 108 x 58	0,82	<b>13122</b>
GFR DN20 male	3/4" BSP male	800	250	149 x 108 x 58	0,82	<b>13123</b>

## Metering devices in bronze and stainless steel



Our metering devices are entirely made of stainless steel and bronze. Connected to the eductors and replacing the calibrated orifices, they allow to change the suction percentage (0, 0.4, 1, 3 and 6%) while the equipment is in use without the need for disassembly. These metering devices are equipped with a non-return valve and delivered with a pick-up tube. Our range works with flow rates from 200 (60 GPM) to 3,000 lpm (800 GPM).

**Maximum working pressure:** PN16  
**Material:** bronze and stainless steel  
**Suction percentage:** 0, 0.4, 1, 3 and 6%  
**Non-return valve:** yes



Inlet	Outlet	Flow rate		Dimensions (mm)	Weight (kg)	Ref.
		lpm	GPM			
1/2" BSP female	1" BSP female	200	60	100 x Ø50	1,20	<b>15099</b>
1/2" BSP female	1" BSP female	300	95	100 x Ø50	1,20	<b>15309</b>
1/2" BSP female	1" BSP female	400	125	100 x Ø50	1,20	<b>15100</b>
1" BSP male	1" BSP female	600		144 x 90 x 60	2,42	<b>24792</b>
1" BSP male	1" BSP female	800	250	144 x 90 x 60	2,42	<b>22231</b>
1" BSP male	1" BSP female	1000	300	144 x 90 x 60	2,42	<b>19360</b>
1.5" NPT female	1.5" BSP female	1000	300	190 x 111 x 80	5,13	<b>21882</b>
1.5" NPT female	1.5" BSP female	1200		190 x 111 x 80	5,13	<b>30577</b>
1.5" NPT female	1.5" BSP female	1350		190 x 111 x 80	5,13	<b>24866</b>
1.5" NPT female	1.5" BSP female	1500		190 x 111 x 80	5,13	<b>21884</b>
1.5" NPT female	1.5" BSP female	2000	600	190 x 111 x 80	5,13	<b>14757</b>
1.5" NPT female	1.5" BSP female	2400		190 x 111 x 80	5,13	<b>28850</b>
1.5" NPT female	1.5" BSP female	2500		190 x 111 x 80	5,13	<b>20232</b>
1.5" NPT female	1.5" BSP female	3000	800	190 x 111 x 80	5,13	<b>14758</b>

## Metering devices for "MIXY EDUCTOR"



Option for "MIXY EDUCTOR" 200 and 400 lpm allowing to obtain the following percentages: 0.1, 0.5 and 1%. Simple use: simply remove the pick-up tube from the eductor with setting 6% and insert the metering device.

It has six positions: three positions 0.1, 0.5, and 1% dedicated to the "MIXY EDUCTOR" 200 lpm, three positions 0.1, 0.5, and 1% dedicated to "MIXY EDUCTOR" 400 lpm.

**Maximum working pressure:** PN16  
**Material:** aluminium alloy and brass  
**Suction percentage:** 0.1, 0.5 and 1%  
**Non-return valve:** yes



Inlet	Outlet	Flow rate		Dimensions (mm)	Weight (kg)	Ref.
		lpm	GPM			
Storz D/25	Storz D/25	200 - 400	60 - 125	115 x 95 x 55	0,56	<b>25272</b>
GFR DN20 female	GFR DN20 male	200 - 400	60 - 125	122 x 92 x 58	0,48	<b>25712</b>

## Pick-up tubes

Conform to the norm  
**EN 16712-2**



These pick-up tubes equip our eductors and self-educing foam nozzles.

The set consists of a crimped coupling on a rigid semi-transparent hose with metal coil, set on a tube of 1m length.

Our range goes from diameter 13 to 35 and 1 to 3 m length (depending on the model).

**Maximum working pressure:** PN16

Pick-up tube inside diameter (mm)	Inlet	Length(m)			Norm	Weight (kg)	Ref.
		Pick-up tube	Pick-up hose	Overall length			
13	3/8" BSP female	1	0,5	1,5			<b>26413</b>
20	3/8" BSP female	1	0,5	1,5		0,80	<b>12960</b>
25	GFR DN20 female	1	1	2		0,90	<b>16656</b>
25	GFR DN20 female	1,5	1	2,5		0,86	<b>09327</b>
25	GFR DN20 female	1	0,5	1,5	EN 16712-2	0,86	<b>40893</b>
25	GFR DN20 female	3	1	4		1,36	<b>16657</b>
25	GFR DN20 female	2	0,5	2,5	EN 16712-2	1,36	<b>40895</b>
25	Storz D/25	1,5	1	2,5		0,82	<b>09329</b>
25	Storz D/25	1	0,5	1,5	EN 16712-2	0,82	<b>40894</b>
25	Storz D/25	3	1	4		1,32	<b>16231</b>
25	Storz D/25	2	0,5	2,5	EN 16712-2	1,32	<b>40896</b>
35	SG DN40, with lock	3	1	4		3,20	<b>09328</b>
35	Storz C/52	3	1	4		3,20	<b>09330</b>

## Foot for "ULTRA-LIGHT" eductors



This foot in aluminium alloy serves to support the "ULTRA-LIGHT" of 2.5" and secures the eductor to the floor or to the wall. Internal diameter: 75mm.

**Material:** aluminium alloy  
**Surface treatment:** polyester coating

Description	Weight (kg)	Ref.
For 2.5" eductor, with fixation hole	0,32	<b>07308</b>

## High volume eductors for bladder tanks in stainless steel

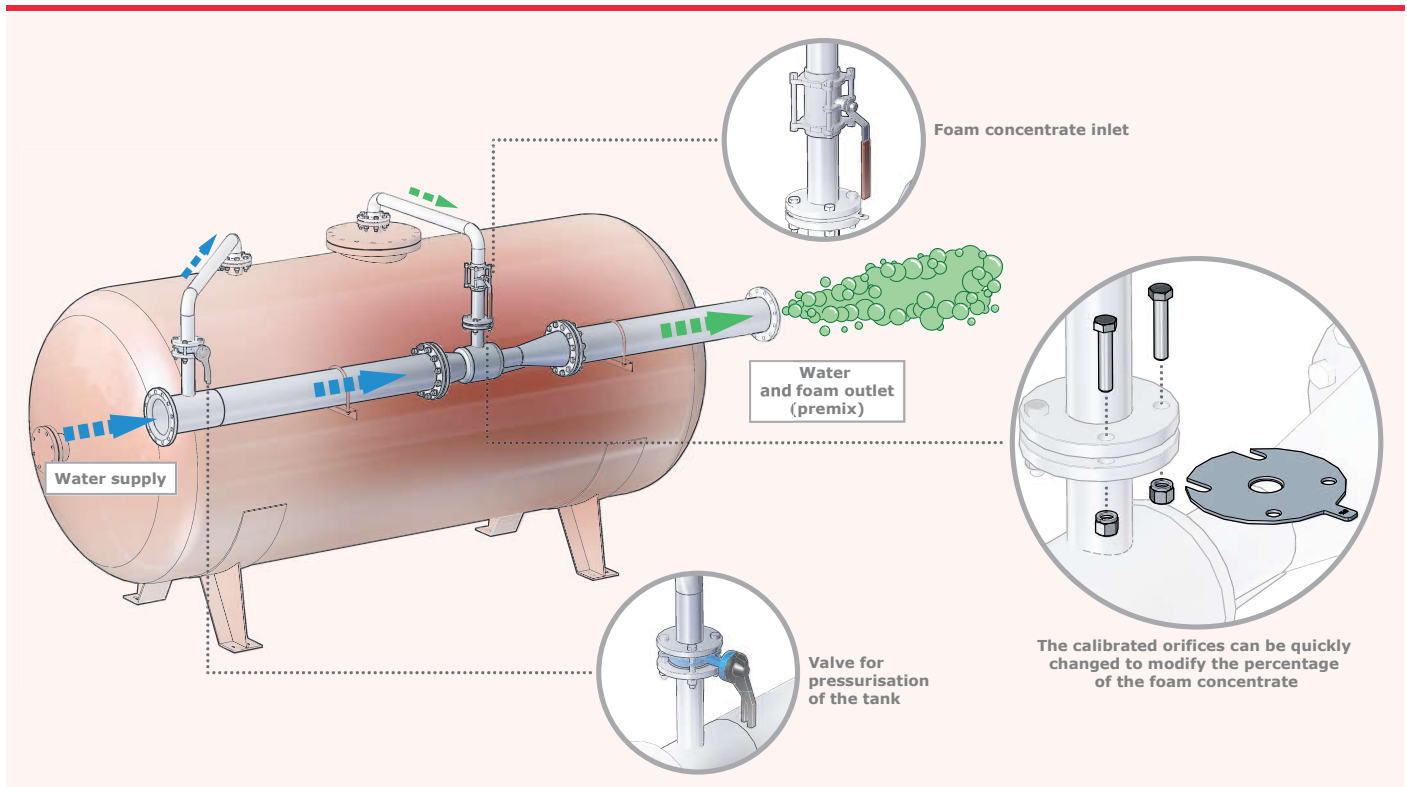

The high volume eductors mounted on tanks produce a constant percentage of foam over a wide flow rate range. These devices generate very low pressure losses: 2 to 5 % of the supply pressure, depending on the flow rate. Made entirely in stainless steel AISI 316L. They offer strength and durability. Our range is available in various models: DN100, DN125, DN150 and DN200.

Maximum working pressure: PN16  
Material: stainless steel

Water - inlet flange	Foam concentrate - inlet flange	Water / foam - outlet flange	Dimensions (mm)	Weight (kg)	Ref.
DN100 PN16	DN40 PN16	DN100 PN16	488 x 220 x 247	14,50	<b>27717</b>
DN125 PN16	DN65 PN16	DN125 PN16	545 x 250 x 308	18,80	<b>23002</b>
DN150 PN16	DN50 PN16	DN150 PN16	735 x 285 x 310	23,50	<b>23223</b>
DN200 PN16	DN65 PN16	DN200 PN16	968 x 340 x 416	35,00	<b>22434</b>

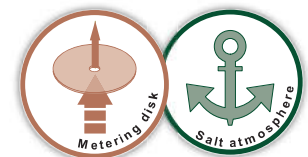

## Self-educing attachments for monitor diffusers

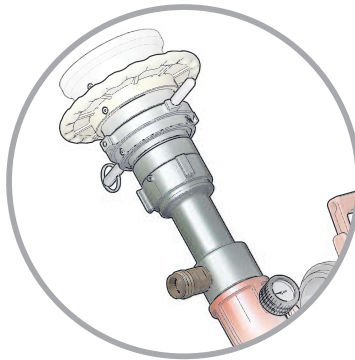

Example of the assembly of a self-educing device on a monitor "AZIMUTOR 3000" equipped with a nozzle "TURBOKADOR 3000"

**Maximum working pressure:** PN16  
**Material:** aluminium alloy  
**Surface treatment:** hard anodisation  
**Body type:** cut into bars  
**Non-return valve:** yes  
**Supplied with pick-up tube:** yes

Our range of self-educing attachments will make any diffuser mounted on a monitor turn into a self-educing foam equipment. Made in aluminium alloy with hard anodisation. This eductor allows to produce a premix at a specific flow rate: 750, 1,500, 2,000 and 3,000 lpm. It comes complete with a round thread at the suction, a long clear pick-up tube. This range of attachments comes in various threads and normalized couplings.

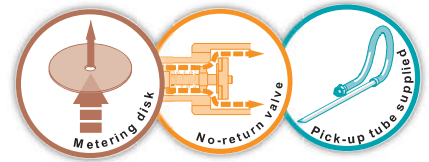

Inlet	Outlet	Flow rate (lpm)	Working pressure (bar)	Dimensions (mm)	Weight (kg)	Ref.
2.5" NST-NH male	1.5" NST-NH male	750	10	241 x 129 x 88	2,03	<b>12530</b>
1.5" BSP female	2.5" BSP male	1500	10	203 x 134 x 88	1,80	<b>14254</b>
2.5" BSP male	2.5" BSP male	2000	10	195 x 133 x 80	1,50	<b>14246</b>
2.5" BSP female	2.5" BSP male	3000	10	203 x 134 x 88	1,55	<b>14252</b>





## Foam branchpipes without shutoff, without suction of foam concentrate



Couplings conform to norms  
**DSP - NF S 61-701**  
**Storz - DIN 14307 & 14308**  
**BSP - ISO R 228**  
**NST / NH - NFPA 1963**

**Maximum working pressure:** PN16  
**Material:** aluminium alloy  
**Surface treatment:** polyester coating  
**Body type:** moulded  
**Expansion:** approx. x10



Our range of low expansion foam branchpipes without shutoff and without suction is made of aluminium alloy, hard anodised with red polyester coating. It offers an expansion of about 10 with a throwing range up to 28 meters at 800 lpm at 5 bar. The range of possible flow rates are from 75 to 800 lpm. Several connections are possible: threaded BSP or NST-NH or standardised couplings.

Inlet	Flow rate (lpm)	Working pressure (bar)	Average range (m)	Dimensions (mm)	Weight (kg)	Ref.
1" NST-NH female	75	5		363 x 50 x 50	0,40	<b>12669</b>
1.5" BSP male	225	5	18	550 x 62 x 144	1,14	<b>09042</b>
Storz C/52	225	5	18	584 x 98 x 144	1,43	<b>09043</b>
DSP DN40	225	5	18	563 x 72 x 144	1,18	<b>06801</b>
2" BSP male	400	5	22	692 x 80 x 160	1,45	<b>09044</b>
Storz C/52	400	5	22	726 x 98 x 160	1,74	<b>09045</b>
Storz B/75	400	5	22	729 x 126 x 160	2,64	<b>09046</b>
DSP DN40	400	5	22	745 x 80 x 160	1,69	<b>06803</b>
DSP DN65	475	5	23	742 x 107 x 160	1,82	<b>06804</b>
2.5" BSP male	800	5	28	824 x 82 x 160	2,26	<b>09047</b>
Storz B/75	800	5	28	839 x 126 x 160	3,23	<b>09048</b>
DSP DN65	800	5	28	852 x 107 x 160	2,41	<b>06806</b>

## Foam branchpipes without shutoff, with suction of foam concentrate



Couplings conform to norms  
**DSP - NF S 61-701**  
**Storz - DIN 14307 & 14308**  
**BSP - ISO R 228**  
**NST / NH - NFPA 1963**

**Maximum working pressure:** PN16  
**Material:** aluminium alloy  
**Surface treatment:** polyester coating  
**Body type:** moulded  
**Expansion:** approx. x10  
**Suction percentage:** 3 or 6%  
**Supplied with pick-up tube:** yes

Our range of low expansion foam branchpipes without shutoff and with suction orifice is made of aluminium alloy, hard anodised and with red polyester coating. It offers an expansion of about 10 with a throwing range up to 28 meters at 800 lpm at 5 bar. The range of flow rates possible are from 100 to 800 lpm. Several connections are possible: threaded BSP or NST-NH or standardised couplings. The equipment is delivered with pick-up tube.

Inlet	Flow rate (lpm)	Working pressure (bar)	Average range (m)	Dimensions (mm)	Weight (kg)	Ref.
SG DN20	100	5				<b>07590</b>
DSP DN40	200	5	18	590 x 104 x 134	0,95	<b>03403</b>
2" BSP male	400	5	22	762 x 123 x 135	1,64	<b>19477</b>
2.5" BSP male	800	5	28			<b>06831</b>
DSP DN65	800	5	28			<b>06832</b>

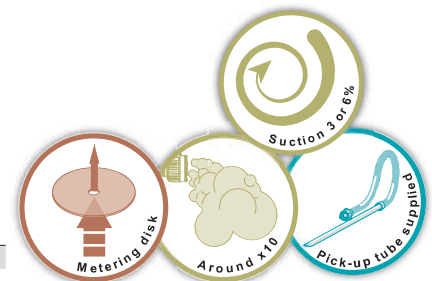

## Foam branchpipes with DIN shutoff, without suction of foam concentrate



Our range of low expansion foam branchpipes without suction is made in aluminium alloy, hard anodised and red polyester coating. Our branches are equipped with a "DIN" shutoff allowing opening and closing of the branch. They operate with flow rates ranging from 200 to 800 lpm and various connection are possible: threaded BSP or NST-NH or standardised couplings.



**Maximum working pressure:** PN16  
**Material:** aluminium alloy  
**Surface treatment:** polyester coating  
**Valve type:** ball valve  
**Operation:** by lever  
**Body type:** moulded  
**Expansion:** approx. x10

Inlet	Flow rate (lpm)	Working pressure (bar)	Average range (m)	Dimensions (mm)	Weight (kg)	Ref.
2" BSP male	200	5	18	502 x 60 x 144	1,17	<b>09049</b>
Storz C/52	200	5	18	533 x 98 x 162	1,45	<b>09050</b>
2" BSP male	400	5	22	646 x 67 x 174	1,70	<b>09051</b>
Storz C/52	400	5	22	678 x 98 x 188	1,98	<b>09052</b>
Storz B/75	400	5	22	681 x 126 x 202	2,88	<b>09053</b>
2.5" BSP male	800	5	28	884 x 82 x 217	2,74	<b>09054</b>
Storz B/75	800	5	28	918 x 126 x 217	3,92	<b>09055</b>



## Foam branchpipe with shutoff Gamma "Γ", without suction of foam concentrate



Our range of low expansion foam branchpipes without suction is made in aluminium alloy, hard anodised and red polyester coating. Our branches are equipped with a "Gamma Γ" shutoff allowing quick opening and closing of the branch. They operate with flow rates ranging from 200 to 400 lpm and various connection are possible: threaded BSP or NST-NH or standardised couplings.

**Maximum working pressure:** PN16  
**Material:** aluminium alloy  
**Surface treatment:** polyester coating  
**Valve type:** ball valve  
**Operation:** by handle  
**Body type:** moulded  
**Pistol grip type:** simple  
**Expansion:** approx. x10

Inlet	Flow rate (lpm)	Working pressure (bar)	Average range (m)	Dimensions (mm)	Weight (kg)	Ref.
2" BSP male	200	5	18	497 x 112 x 242	1,61	<b>15911</b>
Instantaneous 2.5" male	225	5	18	608 x 112 x 242	1,86	<b>16065</b>
2" BSP male	400	5	22	705 x 112 x 242	2,09	<b>16067</b>
Instantaneous 2.5" male	400	5	22	755 x 112 x 242	2,35	<b>16085</b>



## Foam branchpipes with shutoff, without suction of foam concentrate, without pistol grip



These foam branchpipes are without pistol grip to reduce the overall size. They are equipped with a shutoff allowing quick opening and closing of the branchpipe. Several inlet couplings are possible.

**Maximum working pressure:** PN16  
**Material:** aluminium alloy  
**Surface treatment:** polyester coating  
**Valve type:** ball valve  
**Operation:** by manoeuvre handle  
**Body type:** cut into bars  
**Expansion:** approx. x10

**Handle colour:**

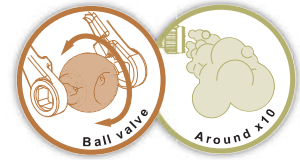

Inlet	Flow rate (lpm)	Working pressure (bar)	Average range (m)	Dimensions (mm)	Weight (kg)	Ref.
ISO M36 x 200 female (inlet thread normalized for DN33 hose reel)	225	5	18	479 x 110 x 136	1,36	<b>16000</b>
DSP DN40	225	5	18	521 x 110 x 136	1,44	<b>06811</b>

## Foam branchpipes with shutoff, without suction of foam concentrate, with pistol grip



These low expansion foam branchpipes are made in aluminium alloy, anodised and with red polyester coating. They are equipped with a shutoff allowing fast opening and closing of the branch.

Observed expansion is about 10 and flow rates range from 75 to 800 lpm. Various inlet connections are possible.

**Maximum working pressure:** PN16  
**Material:** aluminium alloy  
**Surface treatment:** polyester coating  
**Valve type:** ball valve  
**Operation:** by manoeuvre handle  
**Body type:** cut into bars  
**Pistol grip type:** simple  
**Expansion:** approx. x10

**Handle colour:**

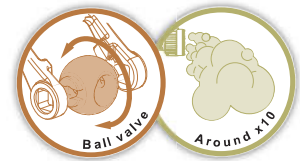

Inlet	Flow rate / Working pressure			Average range (m)	Dimensions (mm)	Weight (kg)	Ref.
	lpm	Bar	GPM				
1" BSP female	75	5			450 x 95 x 237	1,13	<b>16098</b>
DSP DN40	400	5		22	722 x 127 x 272	2,39	<b>06813</b>
DSP DN65	450	5		23	733 x 127 x 272	2,81	<b>06814</b>
DSP DN65	800	5		28	882 x 127 x 272	3,51	<b>06816</b>
1.5" NST-NH female			20				<b>09955</b>
1.5" NST-NH female			60	18			<b>09956</b>
1.5" NST-NH female			95	22	698 x 187 x 272	2,64	<b>09957</b>
1.5" NST-NH female			125	23	698 x 187 x 272	2,63	<b>09958</b>
2.5" NST-NH female			200	18	814 x 127 x 272	3,46	<b>02296</b>
2.5" NST-NH female			250	28	814 x 187 x 272	3,46	<b>09959</b>

## Foam branchpipe with shutoff, without suction of foam concentrate, with blabbermouth



These branches are mounted with a blabbermouth to adjust the shape and throw range.

They are equipped with a shutoff allowing the opening and closing of the branch. The flow rate is 400 lpm and various inlet connections are possible: threaded BSP or NST-NH or standardised couplings.

**Maximum working pressure:** PN16  
**Material:** aluminium alloy  
**Surface treatment:** polyester coating  
**Valve type:** ball valve  
**Operation:** by manoeuvre handle  
**Body type:** cut into bars  
**Expansion:** approx. x10

**Handle colour:**

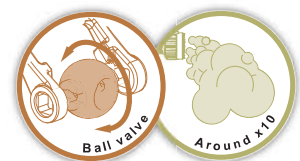

Inlet	Flow rate (lpm)	Working pressure (bar)	Average range (m)	Dimensions (mm)	Weight (kg)	Ref.
2" BSP male	400	5	22			<b>18813</b>
DSP DN40	400	5	22			<b>18815</b>
DSP DN65	400	5	22			<b>18814</b>

## "POWER FOAM" branchpipe with shutoff, without suction of foam concentrate (patented)



*Patented system*  
**POWER FOAM**  
*+ 30% performances*  
*Space divided by 2*

**Maximum working pressure:** PN16  
**Material:** aluminium alloy  
**Surface treatment:** polyester coating and hard anodisation  
**Valve type:** ball valve  
**Operation:** by manoeuvre handle  
**Body type:** moulded  
**Expansion:** approx. x10

**Handle colour:**

Our range of low expansion "POWER FOAM" branchpipes without suction is made according to a new patented technology making the device more compact with higher throw range performance. The branch is equipped with a ball valve and pistol grip.

The flow rate range, from 200 to 800 lpm and various inlet connections are possible. The branch is made of aluminium alloy, hard anodised and with red polyester coating.

Inlet	Flow rate (lpm)	Working pressure (bar)	Average range (m)	Dimensions (mm)	Weight (kg)	Ref.
2" BSP male	200	5	23	340 x 110 x 242	1,82	<b>23554</b>
2" BSP male	400	5	27	340 x 110 x 242	1,82	<b>23558</b>
2.5" BSP male	800	5	36	406 x 122 x 250	2,70	<b>25052</b>



## Foam branchpipe with suction of foam concentrate in aluminium alloy



**Maximum working pressure:** PN16  
**Material:** aluminium alloy  
**Surface treatment:** polyester coating and hard anodisation  
**Body type:** cut into bars  
**Valve type:** ball valve  
**Expansion:** approx. x10  
**Suction percentage:** 0.4, 1, 3 or 6%  
**Supplied with pick-up tube:** yes

**Handle colour:**

Our range of low expansion self educting branchpipes is made of aluminium alloy, hard anodised and with red polyester coating. The branch has a shutoff for quick opening and closing and a pick-up tube. Foam expansion is about 10. Flow rates range from 75 to 200 lpm and various possible inlets: threaded BSP or NST-NH or standardised couplings.

Inlet	Flow rate (lpm)	Working pressure (bar)	Dimensions (mm)	Weight (kg)	Ref.
1" BSP female	75	10	592 x 95 x 236	1,91	<b>09960</b>
Storz D/25	75	10			<b>16004</b>
SG DN20	75	10			<b>09358</b>
2" BSP male	200	7	661 x 95 x 236	1,80	<b>16005</b>
DSP DN40	200	7		1,64	<b>09359</b>
1.5" NST-NH female	200	7	648 x 95 x 236	1,80	<b>09961</b>

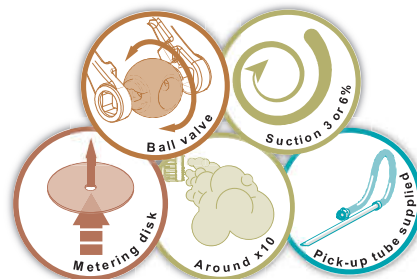

## Foam branchpipe with suction of foam concentrate, in bronze



**Maximum working pressure:** PN16  
**Material:** bronze and aluminium alloy  
**Surface treatment:** polyester coating  
**Body type:** moulded  
**Valve type:** ball valve  
**Expansion:** approx. x10  
**Suction percentage:** 3 or 6%  
**Supplied with pick-up tube:** yes

**Handle colour:**

Our range of low expansion self-educting foam branchpipe is made in bronze and stainless steel with polyester coating for corrosive environment.

The branch is equipped with a shutoff to open and close it and comes with a pick-up tube. Foam expansion is about 10.

Inlet	Flow rate (lpm)	Working pressure (bar)	Dimensions (mm)	Weight (kg)	Ref.
DSP DN65	400	5			<b>16186</b>
GOST	400	5		6	<b>18349</b>





## Dual-use

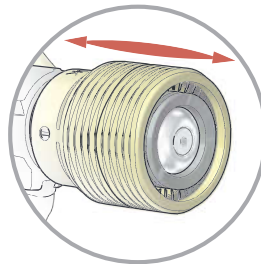

Passing from the water spray to foam is obtained by sliding the head

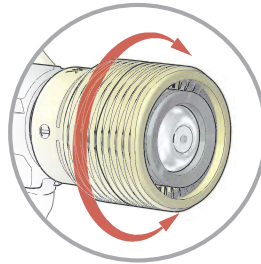

Changing from straight jet to spray is obtained by rotation of the head ring

**Maximum working pressure:** PN16  
**Shutoff:** with ball valve  
**Opening:** by operating handle  
**Expansion rate:** around x10  
**Material:** aluminium alloy  
**Surface treatment:** hard anodisation  
**Body type:** cut into bars  
**Head:** smooth  
**Pistol grip:** one  
**Option:** shutoff handle made in aluminium alloy  
**Bumper guard colours:**

The dual use nozzle is very light, robust and made of aluminium alloy hard anodised - PN16. To deliver foam, the nozzle must be supplied with a pre-mix solution. Choose between :

- position 1: water
- position 2: foam obtained by sliding the head ring

The operating handle enables a quick open/close of the nozzle.

Inlet	Flow rate	Working pressure	Dimensions (mm)	Weight (kg)	Ref
1.5" BSP female	250 lpm	6 bar	227 x 119 x 259	1,75	<b>32826</b>
Storz C/52 swivel	250 lpm	6 bar	291 x 119 x 259	2,20	<b>32826.Storz</b>

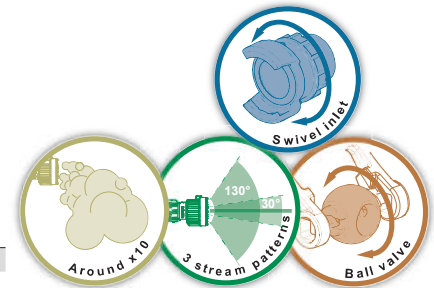

## Edupok

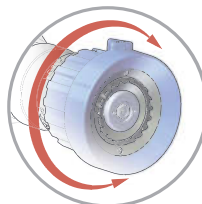

Stream pattern selection by rotation of the head ring

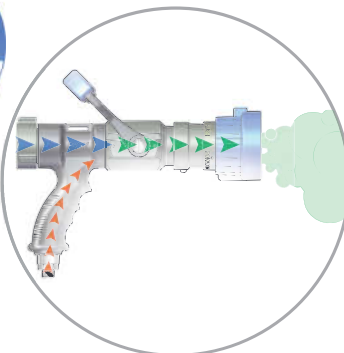

System of foam mix concentrate is integrated in the body of the nozzle

**Maximum working pressure:** PN16  
**Shutoff:** with ball valve  
**Opening:** by operating handle  
**Flush:** YES  
**Suction percentage:** 3%  
**Expansion rate:** around x10  
**Material:** aluminium alloy  
**Surface treatment:** hard anodisation  
**Body type:** cut into bars and moulded  
**Head:** spinning teeth  
**Pistol grip:** one  
**Options:** low expansion foam attachment, medium expansion foam attachment.  
**Bumper guard colours:**

Our self-educing nozzle "EDUPOK" 95 GPM has an ultra-compact mixing system integrated in the grip of the nozzle and does not require an external foam educator. The nozzle is made out of aluminium alloy hard anodised.

The bumper with tactile marks enables to select the different stream patterns (straight jet, flashover, wide angle spray).

The operating handle enables a quick open/close of the nozzle.

Inlet	Flow rate	Working pressure	Dimensions (mm)	Weight (kg)	Ref
1.5" NST-NH female	95 GPM	100 PSI	329 x 127 x 281	2,7	<b>32394</b>
Storz C/52 swivel	95 GPM	100 PSI	370 x 127 x 281	3	<b>32394.Storz</b>



## Self-educing foam branchpipe with spinning teeth nozzle

foam nozzle with spinning teeth  
Delivered with  
metering device  
and pick-up tube



Selection of the suction percentage with the metering device at 1 and 2%, the "Flush" position is used to clean the metering device.

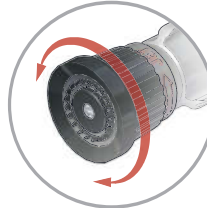

Nozzle tip with spinning teeth and selectable stream from straight jet to wide angle.

**Maximum working pressure:** PN16  
**Material:** aluminium alloy  
**Surface treatment:** hard anodisation  
**Valve type:** ball valve  
**Operation:** by manoeuvre handle  
**Body type:** cut into bars  
**Tip:** spinning teeth  
**Pistol grip type:** simple  
**Suction percentage:** 1 and 2%  
**Non-return valve:** yes  
**Supplied with pick-up tube:** yes

**Options:** foam tank with metering device

**Bumper guard colour:**

These foam nozzles are compact, with spinning teeth and come standard with metering device and pick-up tube.

The metering device allows to change the foam concentrate percentage during use and water pattern can be changed from straight jet to wide angle.

The nozzle is equipped with a shutoff for quick opening and closing. Several normalised couplings can be mounted: sym Guillemain, Storz, BSP, etc.

Inlet	Flow rate (lpm)	Working pressure (bar)	Dimensions (mm)	Weight (kg)	Ref.
1" BSP female	75	5		2,90	<b>17557</b>
1" NST-NH female	75	5			<b>18637</b>
SG DN20	75	5			<b>18638</b>
Storz D/25	75	5			<b>18639</b>

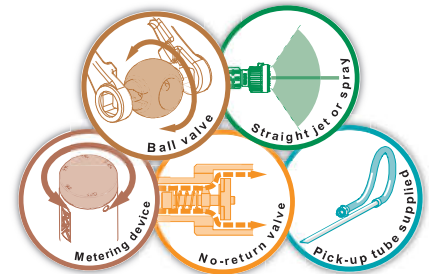

## Self-educing foam branchpipe

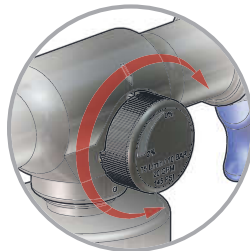

Selection of the suction percentage using the metering device from 0 to 2%.

**Maximum working pressure:** PN16  
**Material:** aluminium alloy and stainless steel  
**Surface treatment:** hard anodisation  
**Valve type:** ball valve  
**Operation:** by manoeuvre handle  
**Body type:** cut into bars  
**Tip:** spinning teeth  
**Pistol grip type:** simple  
**Suction percentage:** from 0 to 2%  
**Non-return valve:** yes  
**Supplied with pick-up tube:** yes

**Bumper guard colour:**

The self-educing foam branchpipe is equipped with a bottle allowing to have a reserve of foam concentrate directly on the nozzle.

The metering device allows to change the percentage of the foam concentration (0 to 2%) during operation and the stream pattern can be changed from straight jet to wide angle spray.

Several normalised couplings can be mounted on the nozzle: sym Guillemain, Storz, BSP, etc.

Inlet	Flow rate (lpm)	Working pressure (bar)	Dimensions (mm)	Weight (kg)	Ref.
1" BSP female	150	6			<b>29536</b>
Storz C/52	150	6	467 x 120 x 390	3,16	<b>29536.C52</b>

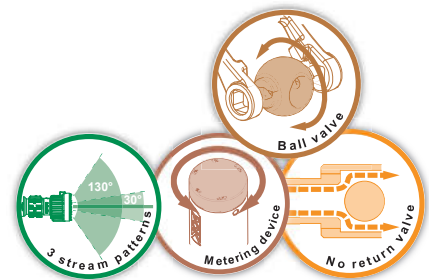

## Foam concentrate bottle for self-educing foam nozzle



Selection of the suction percentage using the metering device for 1% and 2%. The Flush position is used to clean the metering device.

**Maximum working pressure:** PN16  
**Suction percentage:** 1 and 2%  
**Non-return valve:** yes  
**Supplied with pick-up tube:** yes

This bottle with metering device replaces the pick-up tube which is no longer required. The operator can freely move with a foam concentrate supply attached to the nozzle.

Capacity (L)	Dimensions (mm)	Weight (kg)	Ref.
2	120 x 120 x 357	0,83	<b>21340</b>



## Dual expansion foam branchpipes (low and medium expansion)

Our dual expansion foam branchpipes 200 and 400 lpm are made in aluminium alloy. They are simple to use: the foam expansion can be changed by rotation of the ring for low or medium expansion.

At low expansion, the premix is going through the inner tube creating an expansion of about 10. At medium expansion, the premix is coming out of the four tips on the external tube creating homogeneous and dense foam of expansion about 70. The foam branchpipe works with a premix at 3 or 6% depending on the required foam results.

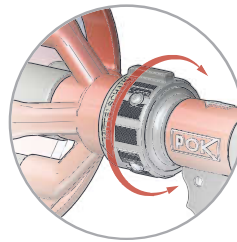

The rotation of the ring allows to go from expansion x10 to x70 (or x90)

**Maximum working pressure:** PN16  
**Material:** aluminium alloy  
**Surface treatment:** polyester coating and hard anodisation  
**Valve type:** ball valve  
**Operation:** by manoeuvre handle  
**Body type:** moulded  
**Pistol grip type:** simple  
**Expansion:** approx. x10 or x70

**Handle colour:**



**With pistol grip and "Gamma" handle. Foam expansion 10, in low expansion foam mode, and 70 in medium expansion foam mode.**

Inlet	Flow rate (lpm)	Working pressure (bar)	Dimensions (mm)	Weight (kg)	Ref.
Storz C/52	200	5	637 x 279 x 321	6,39	<b>29001</b>
Storz C/52	400	5	661 x 338 x 336	7,46	<b>29983</b>



**Model made for French Navy, with pistol grip and "Gamma" manoeuvre handle. Foam expansion 10, in low expansion foam mode, and 90 in medium expansion foam mode.**

Inlet	Flow rate (lpm)	Working pressure (bar)	Dimensions (mm)	Weight (kg)	Ref.
DSP DN40	200	4	668 x 338 x 366	7,09	<b>35102</b>



**With "DIN" valve, therefore without pistol grip. Expansion 10 in low expansion foam mode, and 70 in medium expansion foam mode.**

Inlet	Flow rate (lpm)	Working pressure (bar)	Dimensions (mm)	Weight (kg)	Ref.
Storz C/52	200	5	633 x 279 x 303	6,50	<b>34593</b>
Storz C/52	400	5	658 x 338 x 366	7,62	<b>37133</b>

## Foam branchpipe without shutoff, without manometer and stainless steel mesh



Couplings conform to norms  
 DSP - NF S 61-701  
 Storz - DIN 14307 & 14308  
 BSP - ISO R 228  
 NST / NH - NFPA 1963

Conform to the norm  
**Storz - DIN 14366**

**Maximum working pressure:** PN16  
**Material:** aluminium alloy and stainless steel  
**Surface treatment:** polyester coating  
**Expansion:** approx. x70  
**Lift handle:** yes

Our range of medium expansion foam branchpipes without shutoff is made in aluminium alloy and red polyester coating, and with a stainless steel mesh.

The expected foam expansion is 70. This range of foam branchpipes allows a flow rate going from 60 to 800 lpm as well as several inlet connections: threaded BSP or NST-NH or standardised couplings.



Inlet	Flow rate (lpm)	Working pressure (bar)	Dimensions (mm)	Weight (kg)	Ref.
1" NST-NH female	60	6			<b>12405</b>
2.5" BSP male	800	5	656 x 338 x 367	6,31	<b>09033</b>
Storz B/75	800	5	693 x 338 x 367	6,68	<b>09034</b>
DSP DN65, with lock	800	5	743 x 338 x 367	6,60	<b>01309</b>

## Foam branchpipe without shutoff, with manometer, with stainless steel mesh



Couplings conform to norms  
 DSP - NF S 61-701  
 Storz - DIN 14307 & 14308  
 BSP - ISO R 228  
 NST / NH - NFPA 1963

Conform to the norm  
**Storz - DIN 14366**

**Maximum working pressure:** PN16  
**Material:** aluminium alloy and stainless steel  
**Surface treatment:** polyester coating  
**Expansion:** approx. x70  
**Lift handle:** yes  
**Pressure gauge:** yes

Our range of medium expansion foam branchpipes without shutoff is made in aluminium alloy and red polyester coating and with a stainless steel mesh.

Expansion is about 70.

The flow rates go from 200 to 400 lpm and several inlet connections are possible: threaded BSP or NST-NH or standardised couplings.



Inlet	Flow rate (lpm)	Working pressure (bar)	Dimensions (mm)	Weight (kg)	Ref.
1.5" BSP male	200	5	441 x 228 x 259	2,21	<b>09028</b>
Storz C/52	200	5	474 x 228 x 259	2,49	<b>09029</b>
DSP DN40	200	5	484 x 228 x 259	2,37	<b>01305</b>
2" BSP male	400	5	436 x 279 x 311	2,75	<b>09030</b>
Storz C/52	400	5	471 x 279 x 311	3,03	<b>09031</b>
Storz B/75	400	5	474 x 279 x 311	3,05	<b>09032</b>
DSP DN40	400	5	489 x 279 x 311	2,97	<b>01307</b>



## Foam branchpipe with shutoff, with manometer, with stainless steel mesh



**Maximum working pressure:** PN16  
**Material:** aluminium alloy and stainless steel  
**Surface treatment:** polyester coating  
**Valve type:** ball valve  
**Operation:** by lever  
**Expansion:** approx. x70  
**Lift handle:** yes

Our range of medium expansion foam branchpipe with shutoff is made in aluminium alloy and red polyester coating, and equipped with a stainless steel mesh. This equipment provides an expansion of about 70 and throwing range up to 16 meters for a flow rate of 800 lpm at 5 bar.

These foam branchpipes work with flow rates from 200 to 800 lpm and several inlet connections are possible: threaded BSP or NST-NH or standardised couplings.



Inlet	Flow rate (lpm)	Working pressure (bar)	Dimensions (mm)	Weight (kg)	Ref.
2.5" BSP male	800	5	836 x 338 x 367	8,65	<b>09040</b>
Storz B/75	800	5	874 x 338 x 367	9,06	<b>09041</b>
DSP DN65, with lock	800	5	923 x 338 x 367	8,94	<b>01756</b>
2.5" NST-NH female	800	5	883 x 338 x 367	9,07	<b>09964</b>

## Foam branchpipe with shutoff, with manometer, with stainless steel mesh.



**Maximum working pressure:** PN16  
**Material:** aluminium alloy and stainless steel  
**Surface treatment:** polyester coating  
**Valve type:** ball valve  
**Operation:** by lever  
**Expansion:** approx. x70  
**Lift handle:** yes  
**Pressure gauge:** yes

Our range of medium foam expansion branchpipes with shutoff is made in aluminium alloy, hard anodised and equipped with a stainless steel mesh. These devices come with a manometer.

Inlet	Flow rate (lpm)	Working pressure (bar)	Dimensions (mm)	Weight (kg)	Ref.
1" NST-NH female	60	5			<b>13236</b>
2" BSP male	200	5	525 x 228 x 259	2,84	<b>09035</b>
Storz C/52	200	5	559 x 228 x 259	3,11	<b>09036</b>
Storz C/52	200	5,5	586 x 279 x 311	5,00	<b>29918*</b>
DSP DN40	200	5	575 x 228 x 259	2,07	<b>01306</b>
1.5" NST-NH female	200	5	557 x 228 x 259	3,09	<b>09962</b>
2" BSP male	400	5	518 x 279 x 311	3,37	<b>09037</b>
Storz C/52	400	5	550 x 279 x 311	3,65	<b>09038</b>
Storz C/52	400	5,5	788 x 279 x 311	5,80	<b>29921*</b>
Storz B/75	400	5	553 x 279 x 311	3,67	<b>09039</b>
DSP DN40	400	5	568 x 279 x 311	3,62	<b>01308</b>
1.5" NST-NH female	400	5	550 x 279 x 311	3,57	<b>09963</b>

\*Conform to the Polish standard, expansion x100 for 29918 and x88 for 29921, yellow handle

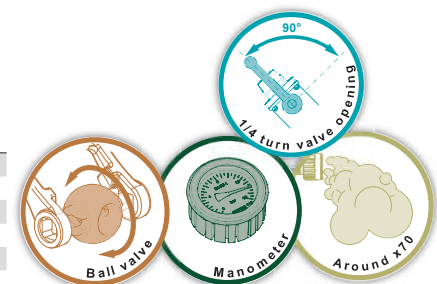

## "BLIZZARD 2000" foam branchpipe



Maximum working pressure: PN16  
 Material: aluminium alloy and stainless steel  
 Expansion: approx. x50

Our "BLIZZARD 2000" medium expansion foam branchpipe can be mounted on portable or fixed monitors, for a flow rate of 2,000 lpm at 10 bar. It is made in stainless steel and anodised aluminium. The branchpipe offers an expansion of 30 to 50 and throw range of 45 meters. The inlet connection is a 2.5" female thread and can be equipped with all types of couplings on demand.



Inlet	Flow rate (lpm)	Working pressure (bar)	Dimensions (mm)	Weight (kg)	Ref.
2.5" BSP female	2000	10		20,00	13129

## "BLIZZARD 200" foam branchpipe



High tech  
**Expansion x150**  
 30m<sup>3</sup> of foam per minute

Maximum working pressure: PN16  
 Material: aluminium alloy and resin  
 Surface treatment: polyester coating  
 Expansion: approx. x150  
 Lift handle: yes

The "BLIZZARD 200" medium expansion foam branchpipe is made in primary aluminium alloy with high strength thermic treatment. The mesh is in stainless steel and tube in polyester. With its robust construction and high technology the Blizzard 200 represents an evolution of our medium foam expansion branchpipe. Supplied with a premix of 3%, depending on the quality of the foam, the branchpipe produces an expansion of 150 or more, that is 30 m<sup>3</sup> per minute.



Inlet	Flow rate (lpm)	Working pressure (bar)	Dimensions (mm)	Weight (kg)	Ref.
DSP DN40	200	from 2 to 8	835 x 416 x 416	10,60	22612



## Medium expansion foam nozzles with shutoff



**Maximum working pressure:** PN16  
**Material:** aluminium alloy  
**Surface treatment:** polyester coating and hard anodisation  
**Body type:** cut into bars  
**Valve type:** ball valve  
**Expansion:** approx. x30  
**Suction percentage:** 0.4, 1, 3 or 6%  
**Supplied with pick-up tube:** yes

Handle colour:

Our range of self-educing medium expansion foam nozzles is made in aluminium alloy and with red polyester coating. The nozzles have a shutoff allowing open/close and are delivered with a pick-up tube. The foam expansion is about 30. The flow rates are going from 75 to 950 lpm and there are several possible inlet connections: threaded BSP or NST-NH, or standardised couplings.

Inlet	Flow rate (lpm)	Working pressure (bar)	Dimensions (mm)	Weight (kg)	Ref.
1" BSP female	75	5		3,23	<b>18632</b>
Storz D/25	75	5			<b>18633</b>
SG DN20	75	5			<b>18631</b>
1" NST-NH female	75	5	500 x 134 x 236	2,67	<b>08998</b>
1.5" NST-NH female	240	5			<b>13237</b>
1.5" NST-NH female	475	5			<b>13238</b>
2.5" NST-NH female	950	5			<b>13239</b>

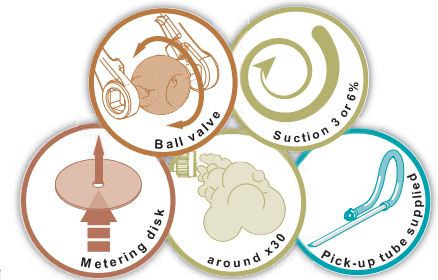

## Medium expansion foam nozzles with shutoff and bottle of foam concentrate



**Maximum working pressure:** PN16  
**Material:** aluminium alloy  
**Surface treatment:** polyester coating and hard anodisation  
**Body type:** cut into bars  
**Valve type:** ball valve  
**Expansion:** approx. x30  
**Suction percentage:** 3%

Handle colour:

Our range of self-educing medium expansion foam is made in aluminium alloy and red polyester coating. These nozzles have a shutoff for opening and closing and come with a bottle for foam concentrate. They offer an expansion of about 30. There are several possible inlet connections: threaded BSP or NST-NH, or standardised couplings.

Inlet	Flow rate (lpm)	Working pressure (bar)	Dimensions (mm)	Weight (kg)	Ref.
Storz D/25	75	5		4,02	<b>17581</b>
SG DN20	75	5			<b>18634</b>
1" BSP female	75	5			<b>18635</b>
1" NST-NH female	75	5			<b>18636</b>

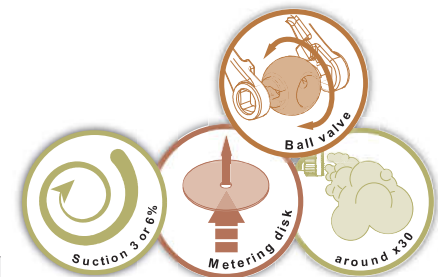

## "HANDY-FOAM" portable foam unit

Portable unit  
Great autonomy  
of the fireman  
Easy carrying  
Many options

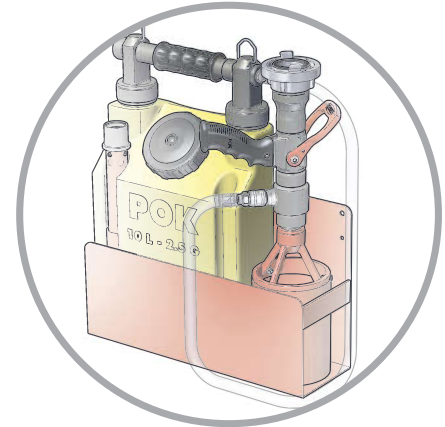

"Handy-foam" with carrier in aluminium alloy, equipped with a low and medium foam expansion branchpipe

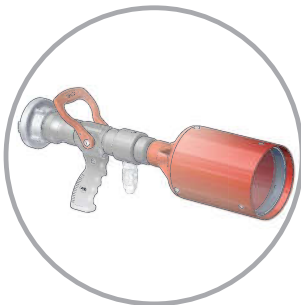

Self-educing foam branchpipe  
medium expansion of 75 lpm

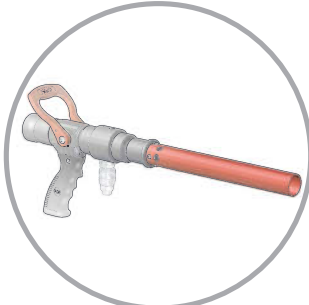

Self-educing foam branchpipe  
low expansion of 75 lpm

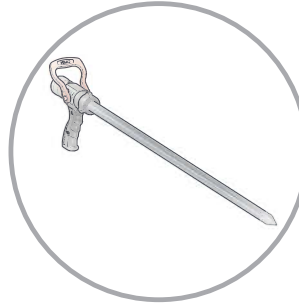

Belier piercing nozzle of 75 lpm

**Maximum working pressure:** PN16  
**Material:** aluminium alloy and polyethylene  
**Surface treatment:** polyester coating and hard anodisation  
**Valve type:** ball valve  
**Expansion:** approx. x10 or x70  
**Suction percentage:** 0,4, 1, 3 or 6%

**Handle colour:**

The "HANDY FOAM" portable foam unit is made of a reservoir in polyethylene with 10 liters capacity and carrying shoulder straps to facilitate the carrying.

It comes with low and medium expansion foam branchpipes that can be connected to the nozzle and exchanged depending on the use, and allowing possible percentages of foam concentrate thanks to calibrated orifices of 0.4, 1, 3 and 6%.

Various options are possible: self-educing low expansion foam branchpipe of 75 lpm, self-educing medium expansion foam branchpipe of 75 lpm, self-educing low expansion foam branchpipe of 200 lpm, Belier piercing nozzle of 75 lpm, shutoff, low expansion foam head, medium expansion foam head, nozzle tip of 75 lpm, reservoir, pick-up tube, carrier, extra metering orifices.

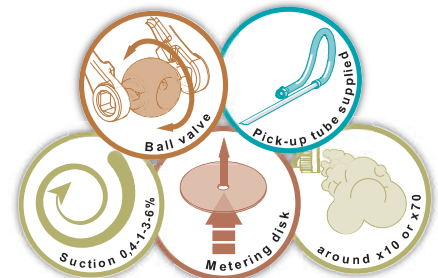

Description	Capacity (liter)	Flow rate (lpm)	Inlet	Dimensions (mm)	Weight (kg)	Ref.
Portable foam unit with low and medium expansion foam branchpipes and carrying shoulder straps	10	75			5,90	<b>08997</b>
Portable foam unit with low and medium expansion foam branchpipes and harness	20	75			6,20	<b>25098</b>
Self-educing low expansion foam branchpipe		75	1" BSP female	952 x 95 x 236	1,91	<b>09960</b>
Self-educing medium expansion foam branchpipe		75	1" BSP female	500 x 134 x 236	2,67	<b>08998</b>
Self-educing low expansion foam branchpipe		200	1.5" NST-NH female	648 x 95 x 236	1,80	<b>09961</b>
Belier piercing nozzle		75	1" NST-NH female	1099 x Ø64	1,88	<b>12789</b>
Shutoff valve with self-educing system		75	1" NST-NH female	247 x 95 x 236	1,45	<b>12678</b>
Low expansion foam head		60	1" NST-NH female	363 x Ø50	0,40	<b>12669</b>
Medium expansion foam head		60	1" NST-NH female	266 x Ø134	1,22	<b>12405</b>
Nozzle tip		75	1" NST-NH female	100 x Ø50	0,27	<b>12749</b>
Reservoir with pick-up tube, filter and straps	10					<b>08999</b>
Pick-up tube of 3 meters length						<b>12791</b>
Aluminium alloy support				493 x 133 x 303	1,12	<b>11716</b>
Metering orifices (precise the flow rate and percentage when ordering)				35 x Ø30	0,03	<b>09823</b>



## Portable foam unit in stainless steel



Portable foam unit in stainless steel. It is composed of a 12 liters reservoir and 60 lpm eductor with shutoff valve. It comes with a low expansion foam branchpipe and pick-up tube. Several inlet connections are possible: threaded BSP or NST-NH, or standardised couplings.

Inlet	Flow rate (lpm)	Capacity (liter)	Dimensions (mm)	Weight (kg)	Ref.
SG DN20	60	12			<b>09174</b>
GFR DN20 female	60	12			<b>09176</b>
DSP DN40	60	12			<b>09180</b>

Maximum working pressure: PN16  
Material: stainless steel

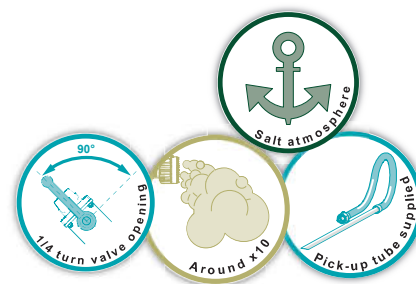

## Mobile foam units with reservoir

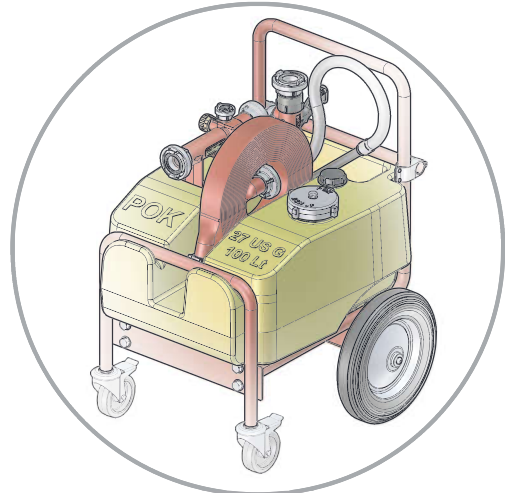

Mobile foam unit with 100 liters tank, "MIXY EDUCTOR" 200 lpm and low expansion foam nozzle 200 lpm

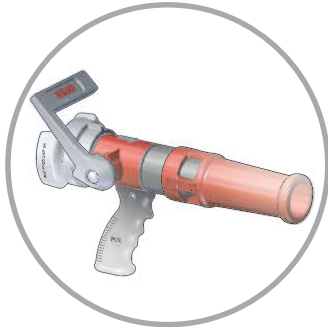

Supplied with low or medium expansion of 200 or 400 lpm

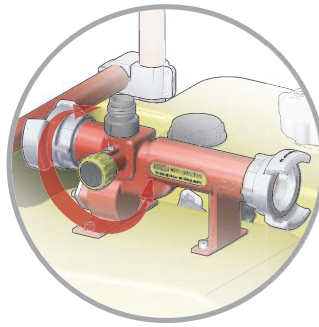

Supplied with "MIXY EDUCTOR" 200 or 400 lpm, with control valve and metering device

**Maximum working pressure:** PN16  
**Material:** aluminium alloy and polyethylene  
**Surface treatment:** polyester coating and hard anodisation  
**Valve type:** ball valve  
**Operation:** by handle  
**Expansion:** approx. x10 or x70  
**Suction percentage:** 0, 1, 2, 3, 4, 5 and 6%  
**Non-return valve:** yes  
**Control valve:** yes  
**Supplied with pick-up tube:** yes

Our mobile foam units are available in 100 liters or 150 liters. Equipped with a tank in polyethylene yellow colour, mounted on chassis and two rear wheels of 400 mm, two front and rotating wheels with a locking device.

The foam unit is delivered with accessories: Mixy eductor of 200 or 400 lpm and pick-up tube, a 20m long flat hose of diameter 45 or 70, a low or medium foam expansion nozzle of 200 or 400 lpm (depending on the model). Several inlet connections are possible: threaded BSP or NST-NH or standardised couplings.

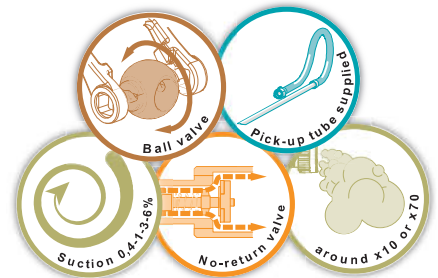

Description	Capacity (liter)	Flow rate (lpm)	Inlet	Dimensions (mm)	Weight (kg)	Ref.
Mobile foam unit with low expansion foam branchpipe and eductor 200 lpm	100	200	DSP DN40	790 x 745 x 922	49	<b>07949</b>
Mobile foam unit with medium expansion foam branchpipe and eductor 200 lpm	100	200	DSP DN40	790 x 745 x 922	54	<b>07950</b>
Mobile foam unit with low expansion foam branchpipe and eductor 200 lpm	100	200	Storz C/52	790 x 745 x 922	54	<b>09024</b>
Mobile foam unit with medium expansion foam branchpipe and eductor 200 lpm	100	200	Storz C/52	790 x 745 x 922	54	<b>09025</b>
Mobile foam unit with low expansion foam branchpipe and eductor 400 lpm	150	400	DSP DN65	800 x 760 x 992	62	<b>07951</b>
Mobile foam unit with medium expansion foam branchpipe and eductor 400 lpm	150	400	DSP DN65	800 x 760 x 992	64	<b>07952</b>
Mobile foam unit with low expansion foam branchpipe and eductor 400 lpm	150	400	Storz B/75	800 x 760 x 992	64	<b>09026</b>
Mobile foam unit with medium expansion foam branchpipe and eductor 400 lpm	150	400	Storz B/75	800 x 760 x 992	64	<b>09027</b>
Mobile foam unit with low expansion foam branchpipe and eductor 400 lpm	150	400	Instantaneous 2.5" male	800 x 760 x 992	63	<b>16064</b>
Mobile foam unit with low expansion foam branchpipe and eductor 200 lpm - without hose	150	200	DSP DN40	800 x 760 x 992	42	<b>16081</b>
Mobile foam unit with low expansion foam branchpipe and eductor 400 lpm - without hose	150	400	Storz C/52	800 x 760 x 992	49	<b>15860</b>
Mobile foam unit with low expansion foam branchpipe and eductor 400 lpm - without hose	150	400	Instantaneous 2.5" male	800 x 760 x 992	48	<b>16086</b>

## POK FOAM "QST" Quick Stick Technology 100 lpm

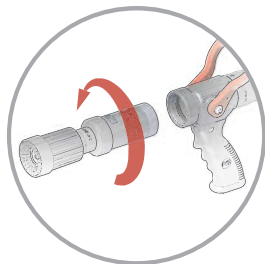

Replacing the stick is easy:  
1 - unscrew the soap box

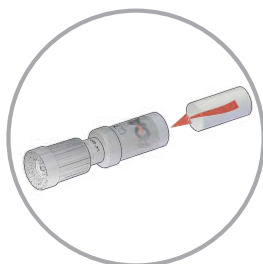

2 - insert a quick stick

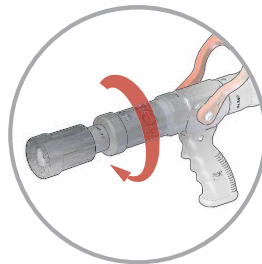

3 - screw the soap box  
tightly

Maximum working pressure: PN16  
Material: aluminium alloy  
Surface treatment: hard anodisation  
Valve type: ball valve  
Operation: by lever

Bumper guard colour:

POK Quick Stick Technology features the use of a small easy to use solid stick of wetting agent, type A or AFFF/AR. The water passing through the mixing tube dissolves the stick. Eliminates the drawbacks of liquid foams: weight, size, transfer problems. The nozzle offers a flow rate of 100 lpm at the operating pressure of 6 bar.

Several inlet connections are possible: threaded BSP or NST-NH or standardised couplings.



Inlet	Flow rate (lpm)	Working pressure (bar)	Dimensions (mm)	Weight (kg)	Ref.
3/4" BSP female	100	6	345 x 95 x 236	1,47	18673

## Soap box for POK FOAM "QST" 100 lpm



Inlet	Outlet	Dimensions (mm)	Weight (kg)	Ref.
3/4" GHT female	3/4" GHT male	140 x Ø54	0,32	18806

## Transparent soap box for POK FOAM "QST" 100 lpm



Inlet	Outlet	Dimensions (mm)	Weight (kg)	Ref.
3/4" GHT female	3/4" GHT male	145 x Ø59	0,15	22252

## Soap refill for POK FOAM "QST" 100 lpm



Description	Weight (kg)	Ref.
Soap refill - mini Eco green		16265
Soap refill - mini Turbo red		16266
Soap refill - mini Clean white		16267

## POK FOAM "QST" Quick Stick Technology 250 lpm - Gamma shutoff handle



Replacing the stick is easy:

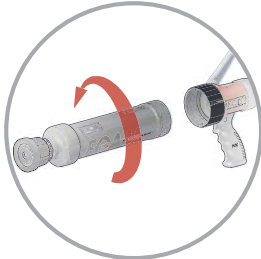

1 - unscrew the soap box

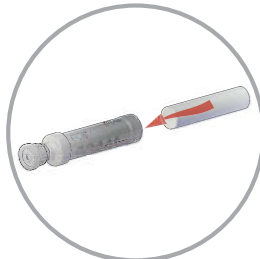

2 - insert a quick stick

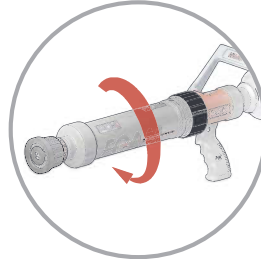

3 - screw the soap box tightly

**Maximum working pressure:** PN16  
**Material:** aluminium alloy  
**Surface treatment:** hard anodisation and polyester coating  
**Valve type:** ball valve  
**Operation:** by handle

POK Quick Stick Technology features the use of a small easy to use solid stick of wetting agent, type A AFFF/AR. The water passing through the mixing tube dissolves the stick. Eliminates the drawbacks of liquid foams: weight, size, transfer problems. The nozzle with Gamma shutoff handle offers a flow rate of 250 lpm at the operating pressure of 6 bar. Several inlet connections are possible: threaded BSP or NST-NH or standardised couplings.

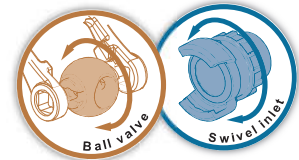

Inlet	Flow rate (lpm)	Working pressure (bar)	Dimensions (mm)	Weight (kg)	Ref.
Storz C/52	250	6	572 x 110 x 242	2,85	13677

## POK FOAM "QST" Quick Stick Technology 250 lpm - nozzle trigger

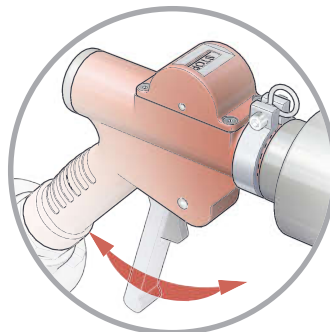

Nozzle with trigger and four positions: MAXI - 2/3 - 1/3 - Stop

**Maximum working pressure:** PN16  
**Material:** aluminium alloy  
**Surface treatment:** hard anodisation and polyester coating  
**Valve type:** with slide valve  
**Operation:** by trigger

POK Quick Stick Technology features the use of a small easy to use solid stick of wetting agent, type A AFFF/AR. The water passing through the mixing tube dissolves the stick. Eliminates the drawbacks of liquid foams: weight, size, transfer problems. The nozzle with slide valve and trigger offers a flow rate of 250 lpm at the operating pressure of 6 bar. Several inlet connections are possible: threaded BSP or NST-NH or standardised couplings.



Inlet	Flow rate (lpm)	Working pressure (bar)	Dimensions (mm)	Weight (kg)	Ref.
2.5" NST-NH female	250	6	813 x 93 x 215		13615



## Soap box for POK FOAM "QST" 250 lpm



Inlet	Outlet	Dimensions (mm)	Weight (kg)	Ref.
1.5" NST-NH female	1" NST-NH male	355 x Ø85	1,22	<b>18801</b>
1.5" NST-NH female	1" NPSH male	355 x Ø85	1,22	<b>18802</b>
1.5" NST-NH female	1.5" NST-NH male	376 x Ø85	1,25	<b>18803</b>

## Transparent soap box for POK FOAM "QST" 250 lpm



Inlet	Outlet	Dimensions (mm)	Weight (kg)	Ref.
1.5" NST-NH female	1.5" NST-NH male	328 x Ø87	0,49	<b>22267</b>

## Soap refill for POK FOAM "QST" 250 lpm



Description	Weight (kg)	Ref.
Soap refill - maxi Eco green		<b>16262</b>
Soap refill - maxi Turbo red		<b>16263</b>
Soap refill - maxi Clean white		<b>16264</b>

## Self-educing "QST" Quick Stick Technology with by-pass



**Maximum working pressure:** PN16  
**Material:** aluminium alloy  
**Surface treatment:** hard anodisation and polyester coating  
**Valve type:** ball valve  
**Operation:** by hand  
**Flush:** YES

Pre-mixed POK Quick Stick Technology "QST" features the use of a small, easy to use, solid stick of wetting agent, Type A AFFF/AR. The water passing through the mixing tube dissolves the stick. The use of solid cartridges eliminates the drawbacks of using liquid foams (weight, size, transfer problems). The pre-mixer is equipped with a bypass function which facilitates the change of the cartridge (so you can use the device with or without the pre-mixer) and it features a flush valve. Several inlet connections are possible: threaded BSP or NST, or standardised couplings.



Inlet	Outlet	Flow rate (lpm)	Working pressure (bar)	Dimensions (mm)	Weight (kg)	Ref.
1.5" BSP female	1.5" BSP female	250	6	829 x 288 x 303	12,22	<b>21758</b>

## Long range jet spray nozzle

High throw range  
Operation  
WATER - AIR



**Maximum working pressure:** PN16  
**Material:** aluminium alloy  
**Surface treatment:** polyester coating and hard anodisation  
**Body type:** moulded  
**Valve type:** ball valve  
**Operation:** by lever  
**Pistol grip type:** yes

Our long range jet spray nozzle allows a water jet spray distance longer than other devices. The working principle is as follows: coating of air under pressure by a water jet. At a certain distance of the nozzle, the forces which maintain the water around the air release, and the compressed air blow up this water jet into small droplets, which absorb the fire heat, to cool it down fast.

The advantage of this device is that the operation is continuous with an extremely fast effect. The advantage compared to a classic nozzle is to get a longer range of the jet spray.

Thanks to its jet spray allowing the absorption of the fire heat, our long range jet spray nozzle allows to solve one of the problems encountered by firefighters when they have to approach close to a fire.



Inlets	Flow rate water (lpm)	Flow rate air (m <sup>3</sup> /h)	Dimensions (mm)	Weight (kg)	Ref.
2x 1.5" NST-NH female	400	200	297 x 126 x 315	3,35	16051
2x 1.5" NPSH female	400	200	329 x 126 x 315	3,68	16052
2x Storz DN38 / 1.5"	400	200	290 x 126 x 315	3,22	16053
2x SG DN40	400	200	334 x 126 x 315	2,91	16054
2x 2" BSP male	400	200	256 x 126 x 315	2,92	16055



## "COMBIPOWDER" powder-foam nozzle (patented)

Product used  
By the French Navy



**Maximum working pressure:** PN16  
**Material:** aluminium alloy  
**Surface treatment:** polyester coating and hard anodisation  
**Body type:** moulded  
**Valve type:** ball valve  
**Operation:** by lever  
**Pistol grip type:** yes  
**Expansion:** approx. x10  
**Range:** 27m (measure made by the French Navy)

Our range of "COMBIPOWDER" powder foam nozzle is made entirely in aluminium alloy. This nozzle combines two functions: a powder nozzle with flow rate of 5 Kg/s and a 400 lpm foam nozzle.

The combination of the two devices operating simultaneously has the advantage of significantly improving the distance of the powder nozzle and generates unsurpassed efficiency in extinguishing oil fires.

A large number of inlet connections can be provided: threaded BSP or NST-NH or standardised couplings.



Inlets	Flow rate water (lpm)	Flow rate powder (kg/s)	Working pressure (bar)	Dimensions (mm)	Weight (kg)	Ref.
2x 2" BSP male	400	5	6	341 x 126 x 315	3,36	<b>14966</b>
2x 1" NST-NH female	400	5	6	401 x 126 x 315	4,15	<b>16028</b>
2x 1.5" NST-NH female	400	5	6	373 x 126 x 315	3,80	<b>16029</b>
2x 1" NPSH female	400	5	6	401 x 126 x 315	4,15	<b>16030</b>
2x 1.5" NPSH female	400	5	6	405 x 126 x 315	4,14	<b>16031</b>
2x Storz DN38	400	5	6	365 x 126 x 315	3,67	<b>16032</b>
2x SG DN40 swivel, in bronze	400	5	6	447 x 126 x 315	5,09	<b>16033</b>



### Powder eductors

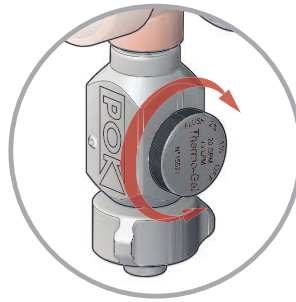

**Metering device 4 positions :**  
OFF - 1% - 2% - FLUSH

**Maximum working pressure:** PN16  
**Material:** aluminium alloy  
**Surface treatment:** polyester coating and hard anodisation  
**Body type:** moulded

This eductor allows to throw powder to extinguish specific fires. Entirely made of stainless steel with polyester coating or hard anodisation. The metering device is used to change the percentage of powder from 1 to 2%.

A large number of inlet connections can be provided: threaded BSP or NST-NH or standardised couplings.



Inlet	Flow rate (lpm)	Working pressure (bar)	Dimensions (mm)	Weight (kg)	Ref.
Storz C/52	400	6	349 x 98 x 205	1,48	<b>18973</b>

### Powder nozzles



**Maximum working pressure:** PN16  
**Material:** aluminium alloy  
**Surface treatment:** hard anodisation  
**Body type:** cut into bars  
**Shutoff:** ball valve  
**Operation:** by lever  
**Pistol grip type:** yes

This range of powder nozzles is made in aluminium alloy. They can be mounted on a large number of inlet connections: threaded BSP or NST-NH or standardised couplings. The flow rates range from 2 to 5 kg/s.



Inlet	Flow rate (kg/s)	Dimensions (mm)	Weight (kg)	Ref.
DSP DN40	2	291 x 127 x 272	1,62	<b>28693</b>
Storz C/52	5	340 x 127 x 272	1,90	<b>13930</b>

### Powder nozzle CRI-CRI



**Maximum working pressure:** PN16  
**Material:** aluminium alloy  
**Surface treatment:** hard anodisation  
**Body type:** moulded  
**Valve type:** cylindrical valve  
**Operation:** by lever  
**Pistol grip type:** yes

This powder nozzle features a direct full bore spray. It has an easy cleaning function from the inside by a rigid swab without dismantling.

Its "pistol" handle is ergonomic and is equipped with a safety feature that protects the user's hand against shock and friction.

The full diameter passage is 19mm (3/4") and offers a flow rate of 5 kg/s at an operating pressure of 8 bar.

Inlet	Flow rate (kg/s)	Dimensions (mm)	Weight (kg)	Ref.
3/4" BSP female	5	280 x 283 x 78	1,72	<b>31338</b>



## High expansion foam generators MISTRAL - DN300

**Adjustable equipment**  
**3 functions**  
 High expansion foam generator  
 Misting and ventilation  
 Discharge of fumes and smoke

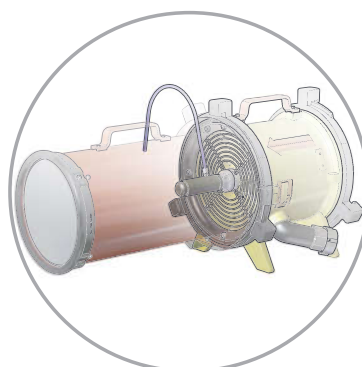

Example of use with self-educing device and foam expansion with mesh

**Maximum working pressure:** PN16  
**Material:** aluminium alloy  
**Surface treatment:** polyester coating  
**Lift handle:** yes

**Options:** self educating device, foam expansion with mesh

Our foam generator "MISTRAL 300" is made primarily of aluminium alloy. The stainless steel turbine can operate for more than twelve hours without interruption. It is usually not the case of similar models equipped with plastic turbines. The water supply is protected by a filter of high resistance and to protect the turbine against anything that could damage it. With self-educing function and foam tube (optional) the "MISTRAL 300" is a foam generator of high expansion (about 200) with a throw range higher than 10 meters at an operating pressure of 7 bar.

Inlet ventilation coupling: ZAG DN300 (norm NF S 61-707) in aluminium alloy.



Inlet	Outlet	Working pressure (bar)	Expansion	Dimensions (mm)	Weight (kg)	Ref.
1.5" NST-NH female	1.5" NST-NH male	7	200	338 x 407 x 409	17,70	<b>11521</b>

## Self-educing device



Inlet	Dimensions (mm)	Weight (kg)	Ref.
Storz D/25	164 x 55 x 68	0,49	<b>13024</b>

## Foam expansion with mesh



Inlet	Dimensions (mm)	Weight (kg)	Ref.
ZAG DN300	518 x 368 x 367	5,65	<b>12742</b>

## High expansion foam generator DN500

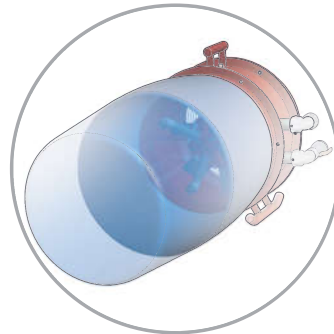

Generator with net to optimize expansion

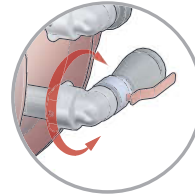

In and outlet with swivel elbow. 1/4 valve at the inlet.

**Maximum working pressure:** PN16  
**Material:** aluminium alloy and stainless steel  
**Surface treatment:** polyester coating and hard anodisation  
**Expansion:** about x500 or from x500 to x1200

Our high expansion portable foam generator DN500 is made entirely in aluminium alloy. It is used either as high expansion foam generator or without its extractor function as simple fan. It comes in two versions: 500 expansion or variable expansion from 500 to 1,200. The flow rate is 225 lpm at 6-7 bar. The foam concentrate is introduced in the device via a pick-up tube. A large number of inlet connections can be provided: threaded BSP or NST-NH or standardised couplings. This generator offers high performance and is easily transportable.



Inlet	Outlet	Expansion	Working pressure (bar)	Dimensions (mm)	Weight (kg)	Ref.
2" BSP male	2" BSP male	500	6-7			<b>07592</b>
2" BSP male	2" BSP male	500 to 1200	6-7			<b>01487</b>

## "SNOW COAT" DN500 high expansion foam generator

**Approved by Russian Navy**

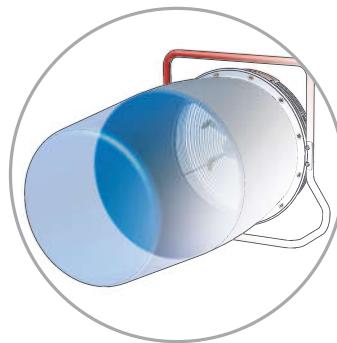

Generator with net to optimize the expansion

**Maximum working pressure:** PN16  
**Material:** aluminium alloy, stainless steel and brass  
**Surface treatment:** polyester coating  
**Expansion:** approx. x350

This generator has six injectors that bring the device into rotation similar to rotating fan blades, thus blowing the premix through the net. It offers a flow rate of 220 lpm at 6 bar.

It allows a premix of 3% and expansion rate of 350.

A large number of inlet connections can be provided: threaded BSP or NST-NH or standardised couplings.



Inlet	Flow rate (lpm)	Working pressure (bar)	Expansion	Dimensions (mm)	Weight (kg)	Ref.
DSP DN40	220	6-7	350	617 x 227 x 667	17,70	<b>18020</b>

## DN800 portable high expansion foam generator



Maximum working pressure: PN16  
Expansion: from x500 to x1000  
Lift handle: yes

This DN800 high expansion foam generator is portable by two people. It is equipped with a fan driven by a turbine with incorporated injector and water collector on the turbine. It offers a selectable expansion from 500 to 1,000. This unit is fully explosion proof. It offers a flow rate of 225 lpm. A large number of inlet connections can be provided: threaded BSP or NST-NH, or standardised couplings. The foam concentrate is drawn through a pick-up tube.



Inlet	Outlet	Expansion	Flow rate (lpm)	Working pressure (bar)	Dimensions (mm)	Weight (kg)	Ref.
DSP DN40	DSP DN40	500 to 1000	225	7	927 x 495 x 902	55	<b>07591</b>

## Portable foam generator in stainless steel



Maximum working pressure: PN16  
Material: stainless steel and brass  
Expansion: about x250  
Lift handle: yes

Our portable foam generator is made of stainless steel with elements in brass. The dimensions are optimised in order to easily transport the apparatus in the passageways of a ship. It is equipped with a central nozzle and 6 eccentric nozzles operating as fan blades and blowing premix through the stainless steel mesh. It offers a flow rate of 200 lpm at 4 bar and an expansion rate of 250. The standard inlet coupling is DSP DN40 with lock.



Inlet	Flow rate (lpm)	Working pressure (bar)	Expansion	Dimensions (mm)	Weight (kg)	Ref.
DSP DN40	200	4	250	860 x 553 x 603	36	<b>35226</b>

## "GYROFOAM" foam generators

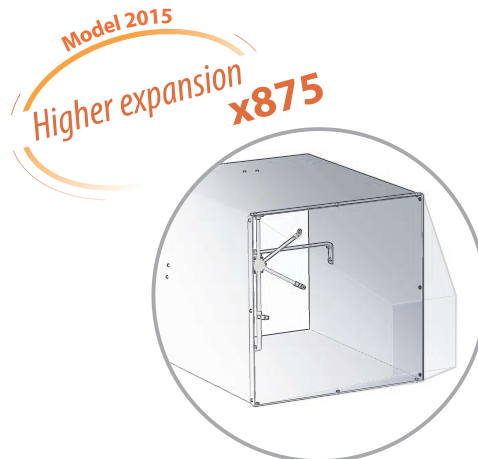

2015 Model with trapezoidal mesh for higher expansion

**Maximum working pressure:** PN16  
**Material:** stainless steel and brass  
**Surface treatment:** untreated  
**Expansion:** approx. x400 or approx. x875

Our high expansion foam generators "GYROFOAM" for fixed installations are made in stainless steel with the couplings in brass.

These units have six injectors which bring the device into rotation similar to rotating fan blades, thus blowing the premix through the stainless steel mesh.

The version called L2 offers a flow rate of 200 lpm at 7 bar and foam flow rate of 80 m<sup>3</sup> per minute (expansion 400). The new version of 2015 offers a flow rate of 250 lpm at 7 bar and foam flow rate of 175 m<sup>3</sup> per minute (expansion 875). A large number of inlet connections can be provided: threaded BSP or NST-NH, or standardised couplings.



Inlet	Expansion	Flow rate (lpm)	Working pressure (bar)	Dimensions (cm)	Weight (kg)	Ref.
1.5" BSP female	400	200	6	60 x 80 x 80	39	<b>14918</b>
1.5" BSP female	875	200	5	170 x 82 x 82	58	<b>35415</b>





The POK foam discharge systems are used to protect storage tanks with floating roof and with vertical opening, containing flammable or combustible liquids. They consist of two integrated components: a generator for generating the foam expansion, and a spillway to guide the foam to the bottom of the tank wall at the joint surface. Each foam generator operates by transferring a pressurized foam solution through a calibrated stainless steel orifice. Air is drawn through louvers into the generator and thoroughly mixed; and the foam thus produced passes through the weir and is projected outward. The foam then falls on the tray and extends over the area around the seal of the tank. POK Foam Tank Seal Generators are available in four sizes with nominal flow capacities of foam from 300 to 2400 lpm, in increments of 100 lpm. The foam generation of these devices depends on the quality of the foam concentrate as well as the operating conditions. With a good quality foam concentrate and a pressure of 7 bar at the inlet of the generator, the expansion rate is about 8. Tank Seal systems are suitable for use with all low expansion foam agents and for all types of fire hazard applications including oil and refrigerated solvent. The shape of the system is made to avoid foam projections that would be counterproductive in case of solvent fires.

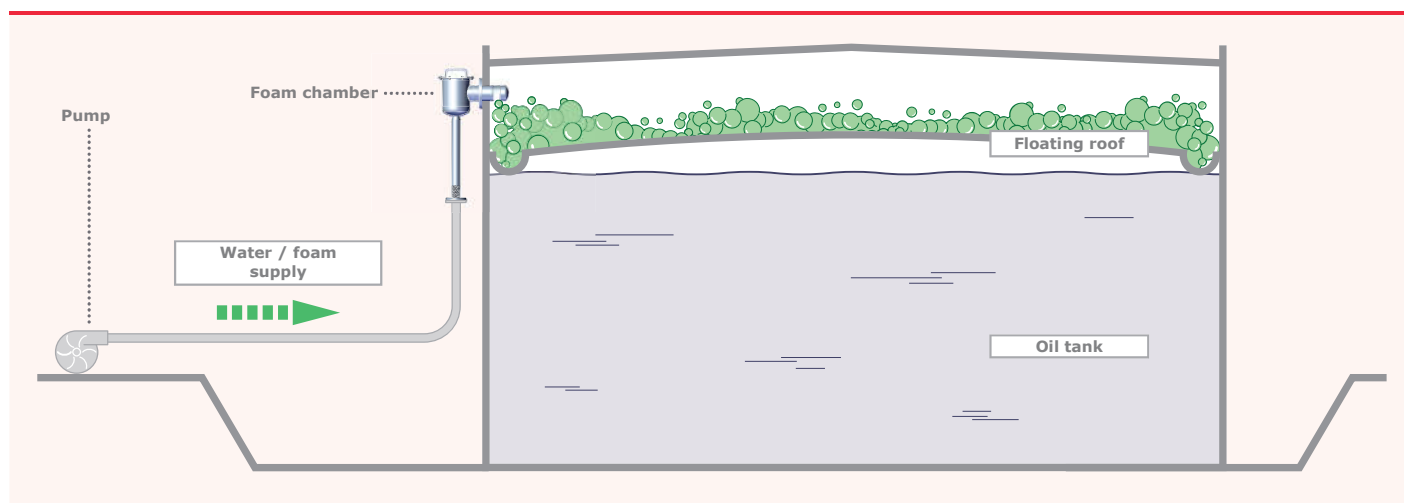

To ensure maximum protection of the tank seal, the foam will form a circular ring around the floating roof. Thus, it is recommended to design a circular barrier of an anti-corrosion material. The foam is thus guided into this corridor with a sufficient depth. For optimum security, we recommend a minimum volume of 0.3m x 0.3m and a maximum volume of 0.6m x 0.6m. This will provide perfect drainage of the foam around the floating roof. The drainage grooves rain water to flow away, which favors the production of foam. In case of fire, a rapid response is required. To accomplish this, a sensing system will instantly trigger the overflow foam, thus avoiding consequential damages.

## Foam chambers



Maximum working pressure: PN16  
Material: stainless steel

Our family of foam chambers is entirely made in stainless steel (standard model) and covers a large range of flow rates. All components of this product is the result of work of the metal workshop following strict procedures and knowledge. Our range is available in various models: DN50, DN80, DN100 and DN150. The inlet coupling is a flange ASA150 from 2 to 6" depending on the required flow rate (available with ISO type flange).



Inlet	Flow rate lpm	Dimensions (mm)	Weight (kg)	Ref.
Flange 2" ASA150	300	536 x 268 x 1007	17	<b>20473</b>
Flange 3" ASA150	600	582 x 280 x 1065	41	<b>13550</b>
Flange 4" ASA150	1200	723 x 334 x 1333	69	<b>15221</b>
Flange 6" ASA150	2400	899 x 434 x 1688	106	<b>15246</b>

## Foam chambers



**Maximum working pressure:** PN16  
**Material:** stainless steel

Our range of horizontal flow foam chamber is made entirely in stainless steel. It can be obtained in two versions depending on the required flow rate: DN50 or DN80.

Inlet	Dimensions (mm)	Weight (kg)	Ref.
Flange 2" ASA150	1128 x 170 x 248	11,60	<b>20439</b>
Flange 3" ASA150	2335 x 283 x 407	40,80	<b>21886</b>



## Trapezoidal foam chambers

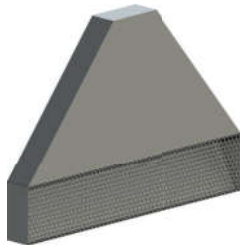

**Maximum working pressure:** PN16  
**Material:** stainless steel

Our foam chamber is entirely manufactured in stainless steel. It exists in a version DN50 with 2" BSP female thread. It offers a dispersion and an optimum expansion on the wall thanks to its trapezoidal shape.

Inlet	Dimensions (mm)	Weight (kg)	Ref.
2" BSP female	223 x 1003 x 702	18,80	<b>14356</b>



## Foam chamber



**Maximum working pressure:** PN16  
**Material:** stainless steel

Our range of foam chambers is entirely manufactured in stainless steel. Flow rates and inlet flanges can be adapted to your needs.

Inlet	Flow rate (lpm)	Working pressure (bar)	Dimensions (mm)	Weight (kg)	Ref.
Flange 4" ASA150	2000	7	447 x 618 x 1168	15,50	<b>27218</b>
Flange 4" ASA150	3000	7	497 x 923 x 1170	18,60	<b>27235</b>



## FOR THE PROTECTION OF OIL TANKS

Supplied with pre-mix, the foam generator produces a foam under pressure with a density of about 0.2 kg/L. This foam introduced at the base of a tank passes through the oil slick and extends to the liquid surface, depriving it of oxygen.

Advantages: extinction is very fast. The unit installed at the base of the tank is protected from gas explosions.

Supply pressure: from 7 to 16 bar. Flow rate up to 2200 lpm pre-mix at 7 bar. Contraindications: oil viscosity greater than 440 centistokes. In this case, it is necessary to use foam chambers.

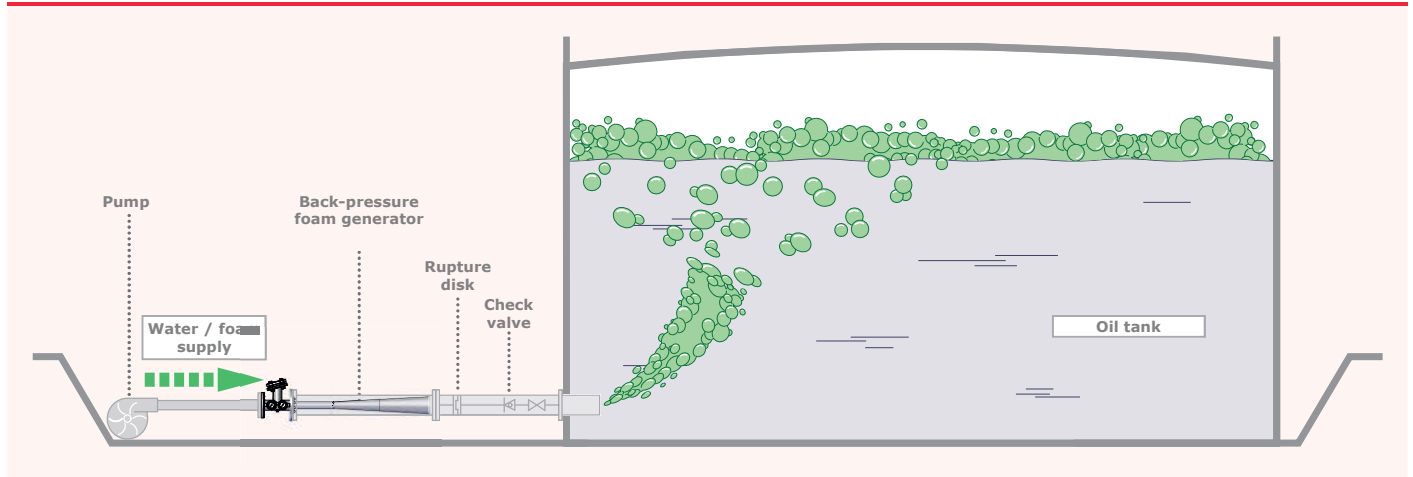

## Back-pressure foam generator



*Certified*  
By Russian authorities  
n° 0370411  
n° 8424.20.000



Our range of back pressure foam generator are made for the protection of oil tanks. Supplied with pre-mix, the generator produces foam under pressure with density of 0.2 kg/L. This foam introduced at the base of a tank passes through the oil slick and extends to the liquid surface, depriving it of oxygen. Advantages: extinction is very fast. The unit installed at the base of the tank is protected from gas explosions. The unit is made entirely of stainless steel or in aluminium alloy (depending on your preference). Different versions are available: 900, 1,400, 1,900 and 2,200 lpm.

Maximum working pressure: PN16  
Material: stainless steel



Inlet	Outlet	Flow rate (lpm)	Working pressure (bar)	Dimensions (mm)	Weight (kg)	Ref.
3" BSP female	3" BSP male	900	7	1129 x 164 x 292	8,30	<b>13904</b>
Flange 4" ASA150	Flange 6" ASA150	1400	7	1502 x 386 x 279	68,00	<b>13917</b>
Flange 4" ASA150	Flange 6" ASA150	1900	7	1502 x 386 x 279	68,00	<b>13188</b>
Flange 4" ASA150	Flange 6" ASA150	2200	7	1502 x 386 x 279	68,00	<b>13919</b>

## Foam discharge heads



*Equips the frigates  
of the Singapore Navy  
of the French Navy  
of the Italian Navy*

**Maximum working pressure:** PN16  
**Material:** stainless steel and bronze  
**Surface treatment:** Untreated  
**Expansion:** approx. x20 to x30

These discharge heads for fixed installations are made in stainless steel and bronze to resist to a corrosive environment. The mesh in stainless steel allows an expansion of 20 or 30.

Inlet	Water flow rate (lpm)	Working pressure	Dimensions (mm)	Weight (kg)	Ref.
1/2" BSP female	20	6	90 x Ø61	0,68	<b>14018</b>
3/4" BSP female	75	6	115 x Ø76	0,67	<b>12371</b>

