

SEGA®

DERBY OWNERS CLUB WORLD EDITION

US Horseshoe Version

Owner's Manual



SEGA AMUSEMENTS USA, INC.

MANUAL NO. 999-2200

GAME CODE: DOC

VISIT OUR WEBSITE!

SEGA SERVICE Sega Amusements USA Inc.
45133 Industrial Dr.
Fremont, CA 94538
(415) 701-6580

Google™ Search SEUService.com Site Search

Home	Whats New	Manuals	Bulletins	Assemblies	Graphics	
Search	Bulletin Sign-Up	Staff		Warranty Policy	Return Policy	Corporate Info

The NEW I/R Gun Protect Bd !!



(Click here for details)



If you have any questions or comments about this site please E-Mail to Dave.Cantrelle@seu.sega.com



Now with a new look to make your experience that much easier.

BEFORE USING THE PRODUCT, BE SURE TO READ THE FOLLOWING:

To maintain the safety:

To ensure the safe usage of the product, be sure to read the following before using the product. The following instructions are intended for the users, operators and the personnel in charge of the operation of the product. After carefully reading and sufficiently understanding the warning displays and cautions, handle the product appropriately. Be sure to keep this manual nearby the product or elsewhere convenient for referring to it when necessary.

Herein, explanations which require special attention are enclosed with dual lines. Depending on the potentially hazardous degrees, the terms of WARNING, CAUTION, etc. are used. Be sure to understand the contents of the displays before reading the text.



Indicates that mishandling the product by disregarding this warning will cause a potentially hazardous situation which can result in death or serious injury.



Indicates that mishandling the product by disregarding this caution will cause a slight hazardous situation which can result in personal injury and or material damage.

For the safe usage of the product, the following pictographs are used:



Indicates “HANDLE WITH CARE.” In order to protect the human body an equipment, this display is attached to places where the Owner’s Manual and or Service Manual should be referred to.

- **Perform work in accordance with the instructions herein stated.**
Instructions for work are explained by paying attention to the aspect of accident prevention. Failing to perform work as per the instructions can cause accidents. In the case where only those who have technical expertise should perform the work to avoid hazardous situation, the instructions herein state that the serviceman should perform such work.
- **Be sure to turn off power before working on the machine.**
To prevent electric shock, be sure to turn off power before starting the work in which the worker touches the interior of the product. If the work is to be performed in the power-on status, the Instruction Manual herein always states to that effect.
- **Be sure to ground the Earth Terminal** (this, however, is not required in the case where a power cord with earth is used).
This product is equipped with the Earth Terminal. When installing the product, Connect the Earth Terminal to the “accurately grounded indoor earth terminal” by using an earth wire. Unless the product is grounded appropriately, the user can be subject to electric shock. After performing repair, etc. for the Control equipment, ensure that the Earth Wire is firmly connected to the Control equipment.
- **Ensure that the Power Supply used is equipped with an Earth Leakage Breaker.**
This product does not incorporate the Earth Leakage Breaker. Using a power supply which is not equipped with the Earth Leakage Breaker can cause a fire when earth leakage occurs.
- **Be sure to use fuses which meet the specified rating.** (only for the machines which use fuses).
Using fuses exceeding the specified rating can cause a fire and electric shock.

- **Specification changes (removal of equipment, conversion and addition) not designated by SEGA are not allowed.**
The parts of the product include warning labels for safety, covers for personal protection, etc. It is very hazardous to operate the product by removing parts and or modifying the circuits. Should doors, lids and protective parts be damaged or lost, refrain from operating the product, and contact where the product was purchased from or the office herein stated. SEGA shall not be held responsible for any accidents, compensation for damage to a third party, resulting from the specifications not designated by SEGA.
 - **Ensure that the product meets the requirements of appropriate Electrical Specifications.**
Before installing the product, check for Electrical Specifications. SEGA products have a nameplate on which Electrical Specifications are described. Ensure that the product is compatible with the power supply voltage and frequency requirements of the location. Using any Electrical Specifications different from the designated Specifications can cause a fire and electric shock.
 - **Install and operate the product in places where appropriate lighting is available, allowing warning labels to be clearly read.**
To ensure safety for the customers, labels and printed instructions describing potentially hazardous situation are applied to places where accidents can be caused. Ensure that where the product is operated has sufficient lighting allowing the warnings to be read. If any label is peeled off, apply it again immediately. Please place an order with where the product was purchased from or the office herein stated.
 - **When handling the Monitor, be very careful. (Applies only to the product w/monitor.)**
Some of the monitor (TV) parts are subject to high tension voltage. Even after running off power, some portions are still subject to high tension voltage sometimes. Monitor repair and replacement should be performed only by those technical personnel who have knowledge of electricity and technical expertise.
 - **Be sure to adjust the monitor (projector) properly. (Applies only to the product w/monitor.)**
Do not operate the product leaving on-screen flickering or blurring as it is. Using the product with the monitor not properly adjusted may cause dizziness or a headache to an operator, a player, or the customers.
 - **When transporting or reselling this product, be sure to attach this manual to the product.**
In the case where commercially available monitors and printers are used in this product, only the contents relating to this product are explained herein. Some commercially available equipment has functions and reactions not stated in this manual. Read this manual together with the specific Instruction Manual of such equipment.
- Descriptions herein contained may be subject to improvement changes without notice.
 - The contents described herein are fully prepared with due care. However, should any question arise or errors be found, please contact SEGA.

INSPECTIONS IMMEDIATELY AFTER TRANSPORTING THE PRODUCT TO THE LOCATION.

Normally, at the time of shipment, SEGA products are in a status allowing for usage immediately after transporting to the location. Nevertheless, an irregular situation may occur during transportation. Before turning on power, check the following points to ensure that the product has been transported in a satisfactory status.

- Are there any dented portions or defects (cuts, etc.) on the external surfaces of the cabinet?
- Are Casters and Adjusters, damaged?
- Do the power supply voltage and frequency requirements meet with those of the location?
- Are all wiring connectors correctly and securely connected? Unless connected in the correct direction, connector connections can not be made accurately. Do not insert connectors forcibly.
- Do power cords have cuts and dents?
- Do the fuses used meet specified rating? Is the Circuit Protector in an energized status?
- Are all accessories available?
- Can all Doors and Lids be opened with the Accessory keys? Can Doors and Lids be firmly closed?

TABLE OF CONTENTS

BEFORE USING THE PRODUCT, BE SURE TO READ THE FOLLOWING:

TABLE OF CONTENTS

INTRODUCTION OF THE OWNER'S MANUAL

1. HANDLING PRECAUTIONS	1
2. PRECAUTIONS CONCERNING INSTALLATION LOCATION	2 - 3
3. OPERATION	4 - 7
4. ACCESSORIES	8 - 10
5. ASSEMBLING AND INSTALLATION	11 - 18
6. PRECAUTIONS TO BE HEDED WHEN MOVING THE MACHINE	19
7. CONTENTS OF GAME	20 - 24
8. EXPLANATION OF TEST AND DATA DISPLAY	25 - 52
8 - 1 SWITCH UNIT AND COIN METER	27 - 28
8 - 2 SYSTEM TEST MODE	29 - 41
8 - 3 GAME TEST MODE	42 - 52
9. CONTROL PANEL (ASSY HANDLE MECHA)	53 - 57
9 - 1 ADJUSTING/REPLACING THE V.R.	53 - 55
9 - 2 GREASING	56
10. SPEED SHIFTER (SHIFT LEVER).....	57 - 59
10 - 1 REMOVING THE 4-SPEED SHIFTER	57 - 58
10 - 2 REPLACING THE SWITCH	59
11. PEDAL DUAL	60 - 61
11 - 1 ADJUSTING AND REPLACING THE V.R.	60 - 61
11 - 2 GREASING	61
12. COIN SELECTOR	62 - 65
13. REPLACING THE FLOURESCENT LAMP, AND LAMPS	66 - 67
14. PERIODIC INSPECTION TABLE	68
15. TROUBLESHOOTING	69 - 70
16. GAME BOARD	71 - 74
16 - 1 REMOVING THE GAME BOARD	72 - 73
16 - 2 COMPOSITION OF GAME BOARD	74
17. COMMUNICATION PLAY	75 - 80
17 - 1 INSTALLATION PRECAUTIONS	75 - 76
17 - 2 CONNECTING THE COMMUNICATION CABLE	76 - 78
17 - 3 SETTING FOR COMMUNICATION PLAY	79 - 80
18. DESIGN RELATED PARTS	81 - 82
19. PARTS LIST	83 - 97
20. WIRE COLOR CODE TABLE	98
21. WIRING DIAGRAM	XXX

SPECIFICATIONS

Installation Space	: 111 inches width X 90.5 inches deep
Height	: 85 inches
Width	: 82.5 inches
Length	: 91 inches
Weight	: 1240 lbs
Power, maximum current	: 1200 W 10 A (AC 120V 60 Hz AREA)
MONITOR	: (4) 17 inch Flat Panels supplied by Samsung model # LTM170E6-L04 Happ # 49-2160-10 Alternate 17 in Flat Panel supplied by Wells Garner model # WGF0003 60 inch LCD Projector supplied by LG model # RU60SZ30 2.3A Bulb: Zenith Part #6912V00006C SEGA Part # 998-0219

INTRODUCTION OF THE OWNERS MANUAL

This Owner's Manual is intended to provide detailed descriptions together with all the necessary information covering the general operation of electronic assemblies, electromechanicals, servicing control, spare parts, etc. as regards the product,

DERBY OWNERS CLUB WORLD EDITION US "HORSESHOE" TYPE.

This manual is intended for the owners, personnel and managers in charge of operation of the product. Operate the product after carefully reading and sufficiently understanding the instructions. If the product fails to function satisfactorily, non-technical personnel should under no circumstances touch the internal system. Please contact where the product was purchased from.

Use of this product is unlikely to cause physical injuries or damages to property. However, where special attention is required this is indicated by a thick line, the word "IMPORTANT" and its sign in this manual.



Indicates that mishandling the product by disregarding this display can cause the product's intrinsic performance not to be obtained, resulting in malfunctioning.

IMPORTANT!

SEGA AMUSEMENTS USA, INC. / CUSTOMER SERVICE

45133 Industrial Drive, Fremont, California 94538, U.S.A.

Phone : (415) 701-6580

Fax : (415) 701-6594

◆ PRODUCTION DATE ◆

This SEGA product was produced in the year of:

2004

This signifies that this work was disclosed in 2004.

DEFINITION OF LOCATION MAINTENANCE MAN AND SERVICEMAN



Non-technical personnel who do not have technical knowledge and expertise should refrain from performing such work that this manual requires the location's maintenance man or a serviceman to carry out, or work which is not explained in this manual. Failing to comply with this instruction can cause a severe accident such as electric shock.

Ensure that parts replacement, servicing & inspections, and troubleshooting are performed by the location's maintenance man or the serviceman. It is instructed herein that particularly hazardous work should be performed by the serviceman who has technical expertise and knowledge.

The location's maintenance man and serviceman are herein defined as follows:

"Location's Maintenance Man" :

Those who have experience in the maintenance of amusement equipment and vending machines, etc., and also participate in the servicing and control of the equipment through such routine work as equipment assembly and installation, servicing and inspections, replacement of units and consumables, etc. within the Amusement Facilities and or locations under the management of the Owner and Owner's Operators of the product.

Activities of Location's Maintenance Man :

Assembly & installation, servicing & inspections, and replacement of units & consumables as regards amusement equipment, vending machines, etc.

Serviceman :

Those who participate in the designing, manufacturing, inspections and maintenance service of the equipment at an amusement equipment manufacturer.

Those who have technical expertise equivalent to that of technical high school graduates as regards electricity, electronics and or mechanical engineering, and daily take part in the servicing & control and repair of amusement equipment.

Serviceman's Activities :

Assembly & installation and repair & adjustments of electrical, electronic and mechanical parts of amusement equipment and vending machines.

LISTED



AMUSEMENT MACHINE

Notes:

1. HANDLING PRECAUTIONS

When installing or inspecting the machine, be very careful of the following points and pay attention to ensure that the player can enjoy the game safely.

Non-compliance with the following points or inappropriate handling running counter to the cautionary matters herein stated can cause personal injury or damage to the machine.



- Before performing work, be sure to turn power off. Performing the work without turning power off can cause an electric shock or short circuit. In the case work should be performed in the status of power on, this manual always states to that effect.
- To avoid electric shock or short circuit, do not plug in or unplug quickly.
- To avoid electric shock, do not plug in or unplug with a wet hand.
- Do not expose Power Cords and Earth Wires on the surface, (floor, passage, etc.). If exposed, the Power Cords and Earth Wires are susceptible to damage. Damaged cords and wires can cause electric shock or short circuit.
- To avoid causing a fire or electric shock, do not put things on or damage Power Cords.
- When or after installing the product, do not unnecessarily pull the power cord. If damaged, the power cord can cause a fire or electric shock.
- In case the power cord is damaged, ask for replacement through where the product was purchased from or the office herein stated. Using the cord as is damaged can cause fire, electric shock or leakage.
- Be sure to perform grounding appropriately. Inappropriate grounding can cause an electric shock.
- Be sure to use fuses meeting specified rating. Using fuses exceeding the specified rating can cause a fire or electric shock.
- Completely make connector connections for IC BD and others. Insufficient insertion can cause an electric shock.
- Specification changes, removal of equipment, conversion and/or addition, not designated by SEGA are not permitted.
 - Failure to observe this may cause a fire or an electric shock. Non-compliance with this instruction can have a bad influence upon physical conditions of the players or the lookers-on, or result in injury during play.
 - SEGA shall not be held responsible for damage, compensation for damage to a third party, caused by specification changes not designated by SEGA.
- Be sure to perform periodic maintenance inspections herein stated.
- There is no master switch to simultaneously turn off all electrical power to this product. Turning the main projector switch to OFF does not interrupt individual satellite power supplies, and caution is therefore required.



IMPORTANT!

- For the IC board circuit inspections, only the logic tester is allowed. The use of a multiple-purpose tester is not permitted, so be careful in this regard.
- When cleaning the CRT surfaces, use a soft, dry cloth. Do not apply chemicals such as thinner, benzine, etc.
- The electronic parts on the IC Board could be damaged due to human body's static electricity. Before performing IC Board related work, be sure to discharge physically accumulated statics by touching grounded metallic surfaces, etc.
- The Projector is employed for this machine. The Projector's screen is susceptible to damage, therefore, be very careful when cleaning the screen. For details, refer to PROJECTOR.
- Some parts are the ones designed and manufactured not specifically for this game machine. The manufacturers may discontinue, or change the specifications of, such general-purpose parts. If this is the case, Sega cannot repair or replace a failed game machine whether or not a warranty period has expired.

2. PRECAUTIONS CONCERNING INSTALLATION LOCATION



This product is an indoor game machine. Do not install it outside. Even indoors, avoid installing in places mentioned below so as not to cause a fire, electric shock, injury and or malfunctioning.

- Places subject to rain or water leakage, or places subject to high humidity in the proximity of an indoor swimming pool and or shower, etc.
- Places subject to direct sunlight, or places subject to high temperatures in the proximity of heating units, etc.
- Places filled with inflammable gas or vicinity of highly inflammable/volatile chemicals or hazardous matter.
- Dusty places.
- Sloped surfaces.
- Places subject to any type of violent impact.
- Vicinity of anti-disaster facilities such as fire exits and fire extinguishers.
- The operating (ambient) temperature range is from 5° to 30°.

LIMITATIONS OF USAGE REQUIREMENTS



- Be sure to check the Electrical Specifications.
Ensure that this product is compatible with the location's power supply, voltage and frequency requirements.
A plate describing Electrical Specifications is attached to the product.
Non-compliance with the Electrical Specifications can cause a fire and electric shock.
- This product requires the Breaker and Earth Mechanisms as part of the location facilities. Using them in a manner not independent can cause a fire and electric shock.
- Ensure that the indoor wiring for the power supply is rated at 15A or higher (AC single phase 100 ~ 120V area), and 8A or higher (AC 220 ~ 240V area). Non-compliance with the Electrical Specifications can cause a fire and electric shock.
- Be sure to independently use the power supply equipped with the Earth Leakage Breaker. Using a power supply without the Earth Leakage Breaker can cause an out-break of fire when earth leakage occurs.
- Putting many loads on one electrical outlet can cause generation of heat and a fire resulting from overload.
- When using an extension cord, ensure that the cord is rated at ?A or higher (AC 100 ~ 120V area) and ?A or higher (AC 220 ~ 240V area). Using a cord rated lower than the specified rating can cause a fire and electric shock.

Electric Current Consumption

MAIN UNIT

MAX. 10 A(AC 120V 60 Hz)

OPERATION AREA



- For the operation of this machine, secure a minimum area of 90.5 inches (W) × 111 inches (D). In order to prevent injury resulting from the falling down accident during game play, be sure to secure the minimum area for operation.

- The operating area needed for each station seat is a minimum of 31.5 inches in width by 20 inches in depth. This specified operating area is an absolute requirement for safe operation.

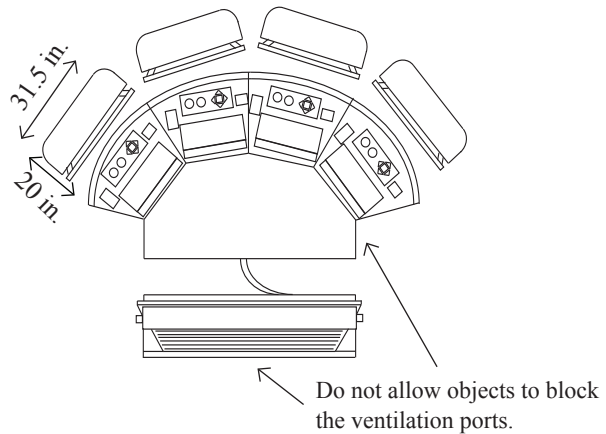

- Be sure to provide sufficient space so as to allow this product's ventilation fan to function efficiently. To avoid machine malfunctioning and a fire, do not place any obstacles near the ventilation opening.
- SEGA shall not be held responsible for damage, compensation for damage to a third party, resulting from the failure to observe this instruction.
- Do not allow objects to block the ventilation ports. It can cause generation of heat and a fire.
- The minimum ceiling height needed for the placement of this product is 89 in (the height of the product plus an additional 4in). A ceiling of less than the specified height could result in the buildup of excess heat and the outbreak of fire.



For transporting the machine into the location's building, the minimum necessary dimensions of the opening (of doors, etc.) are 30.5 inches (W) and 45 inches (H).

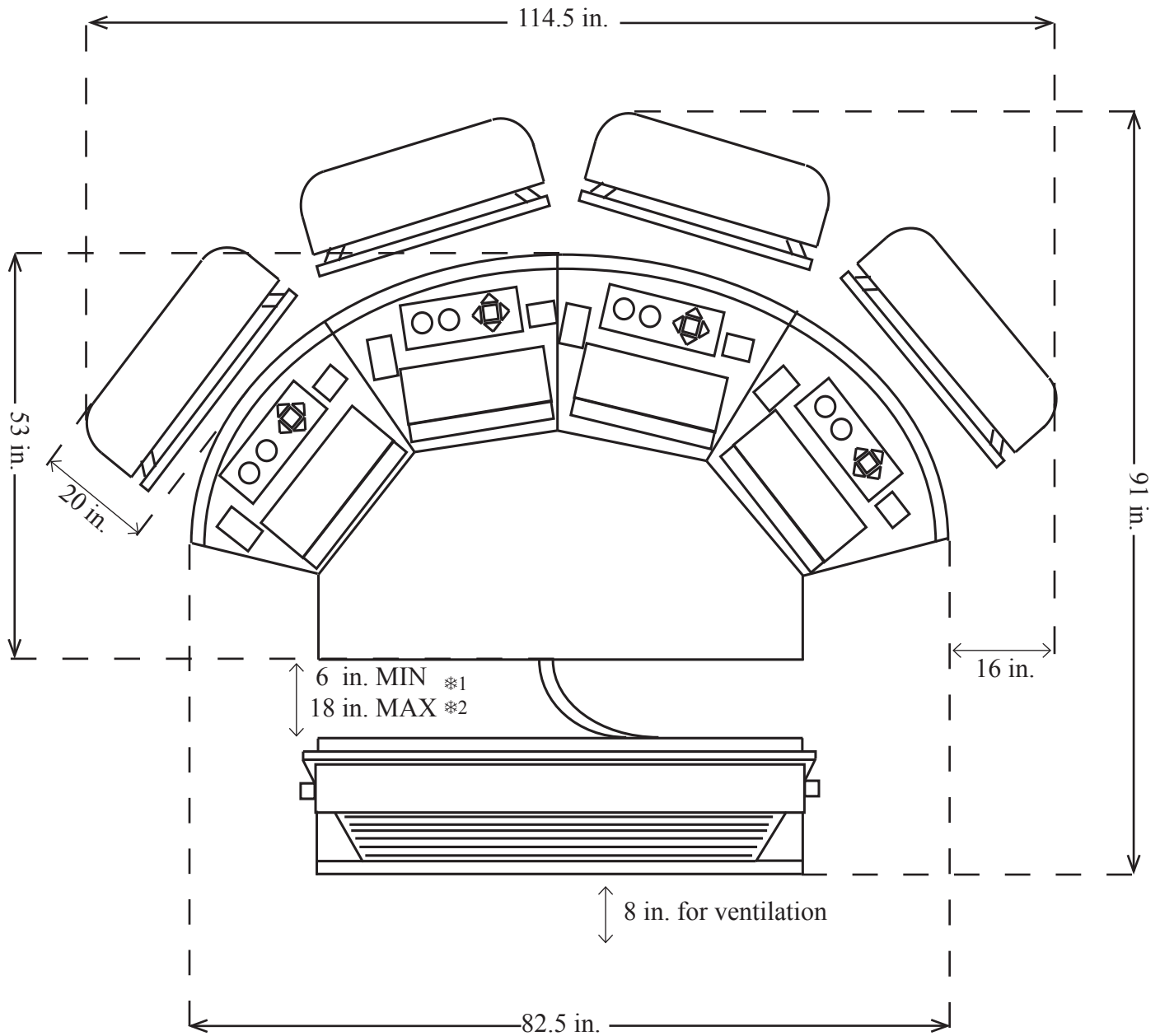

FIG. 2

Figure 2 is an example. Adjustments may be necessary, depending on placement location conditions.

- *1: The specified distance of 18 inches between the main projection unit and the satellites is calculated based on the recommended angle of vision for the projectors. Please allow for this specified distance to the greatest extent possible. Otherwise, the projected screen will appear at an angle and will be difficult to see.
- *2: There is a minimum and maximum value of 6 in. and 1.5 ft. for the main display distance from the player unit. This distance is limited by the length of the umbilical cord between the two units and the connectors projection distance from the body of the units. Please do not attempt to exceed or reduce this distance as damage will occur to your game.

3. OPERATION

PRECAUTIONS TO BE HEEDED BEFORE STARTING THE OPERATION

To avoid injury and trouble, be sure to constantly give careful attention to the behavior and manner of the visitors and players.



In order to avoid accidents, check the following before starting the operation:

- To ensure maximum safety for the players and the customers, ensure that where the product is operated has sufficient lighting to allow any warnings to be read. Operation under insufficient lighting can cause bodily contact with each other, hitting accident, and or trouble between customers.
- Be sure to perform appropriate adjustment of the monitor (projector). For operation of this machine, do not leave monitor's flickering or deviation as is. Failure to observe this can have a bad influence upon the players' or the customers' physical conditions.
- Check if all of the adjusters are in contact with the surface. If they are not, the Cabinet can move and cause an accident.

MAIN PROJECTION UNIT

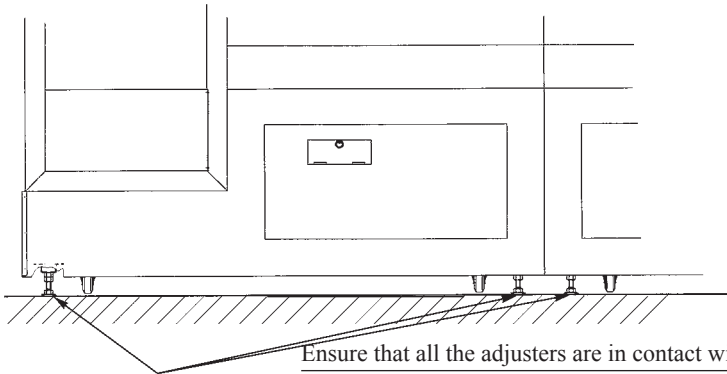

Ensure that all the adjusters are in contact with the floor.

STATIONS



Ensure that all the adjusters are in contact with the floor.

***NOTE: Stations do not look as they do in this image. This is for representation of adjuster settings.



- Do not put any heavy item on this product. Placing any heavy item on the product can cause a falling down accident or parts damage.
- Do not climb on the product. Climbing on the product can cause falling down accidents. To check the top portion of the product, use a step.
- To avoid electric shock, check to see if door & cover parts are damaged or omitted.
- To avoid electric shock, short circuit and or parts damage, do not put the following items on or in the periphery of the product.
Flower vases, flowerpots, cups, water tanks, cosmetics, and receptacles/containers/ vessels containing chemicals and water.



- To avoid injury, be sure to provide sufficient space by considering the potentially crowded situation at the installation location. Insufficient installation space can cause making bodily contact with each other, hitting accidents, and or trouble between customers.

PRECAUTIONS TO BE HEHEDED DURING OPERATION (PAYING ATTENTION TO CUSTOMERS)

To avoid injury and trouble, be sure to constantly give careful attention to the behavior and manner of the visitors and players.



- To avoid injury and accidents, those who fall under the following categories are not allowed to play the game.
 - Those who need assistance such as the use of an apparatus when walking.
 - Those who have high blood pressure or a heart problem.
 - Those who have experienced muscle convulsion or loss of consciousness when playing video game, etc.
 - Those who have a trouble in the neck and or spinal cord.
 - Intoxicated persons.
 - Pregnant women or those who are in the likelihood of pregnancy.
 - Persons susceptible to motion sickness.
 - Persons whose act runs counter to the product's warning displays.
- A player who has never been adversely affected by light stimulus might experience dizziness or headache depending on his physical condition when playing the game. Especially, small children can be subject to those conditions. Caution guardians of small children to keep watch on their children during play.
- It is suggested to ensure a space allowing the players who feel sick while playing the game to take a rest.
- Instruct those who feel sick during play to have a medical examination.
- To avoid injury resulting from falling down and electric shock due to spilled drinks, instruct the player not to place heavy items or drinks on the product.
- To avoid electric shock and short circuit, do not allow customers to put hands and fingers or extraneous matter in the openings of the product or small openings in or around the doors.
- To avoid falling down and injury resulting from falling down, immediately stop the customer's leaning against or climbing on the product, etc.
- To avoid electric shock and short circuit, do not allow the customers to unplug the power plug without a justifiable reason.



- Immediately stop such violent acts as hitting and kicking the product. Such violent acts can cause parts damage or falling down, resulting in injury due to fragments and falling down.
- Be sure to use seats of sufficient sturdiness and safety with this product. Unstable and/or unsafe seats could result in injury to customers.



Note: Actual unit will differ from image.



- If Head Cleaning Mode is displayed when the power is switched on, follow the instructions on the screen to perform head cleaning. Head Cleaning Mode cannot be exited and the game cannot be readied for play until head cleaning has been performed.
- Seats are required for the operation of this product. Seats of sufficient sturdiness and safety should be placed together with this product.
- The height of the satellite seats should be about 25.25 in. Seats of an appropriate height should be used.

4. NAME OF PARTS

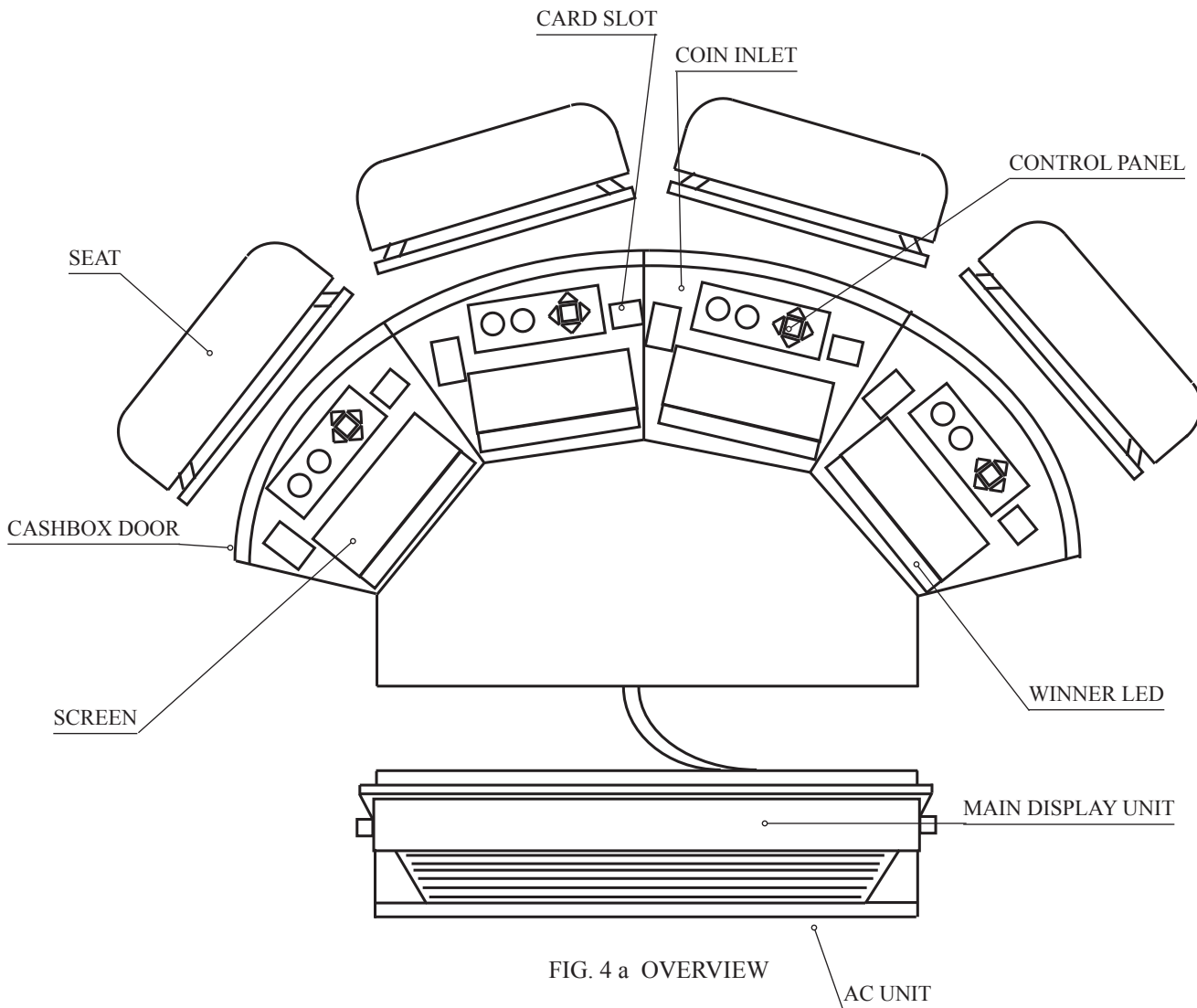

FIG. 4 a OVERVIEW

TABLE 4 Dimensions and Weights

Items	Width × Depth × Height (in)	Weight(lbs)
ASSY PROJECTION STAND	51 × 20 × 31	220
LCD PROJECTION DISPLAY	56.5 × 17 × 41	140
STATION PEDESTAL	58.5 × 27.5 × 40	160
(2) STATIONS	60.5 × 30 × 45	290
(4) SEATS	31.5 × 15 × 25.25	15
Marquee	63 × 11.5 × 13	70
ASSEMBLED	94.5 × 91 × 85	1240

5. ACCESSORIES

When transporting the machine, make sure that the following parts are supplied.

Magnetic cards for the recording of play results, cleaning kits for cleaning the head of the card reader/writer, and game instruction pamphlets are sold separately. Initial supplies are shipped with the product, as noted in the accompanying table. Subsequent purchases of these items can be made by contacting the office listed on this Owner's Manual or the dealer from whom the product was originally purchased. Be sure to provide the part number(s), name(s), and required number of items.

- Magnetic Cards
601-10879-01 CARD PACKAGE DOC 500 ENG: Package of 500 Magnetic Cards
- Cleaning Kit
601-10878-01 CLEANING KIT 8 SHEETS: 30 Pack Cleaning Kit (each pack contains 8 sheets)

TABLE 5 ACCESSORIES

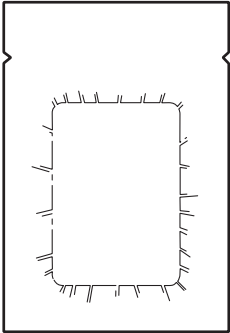
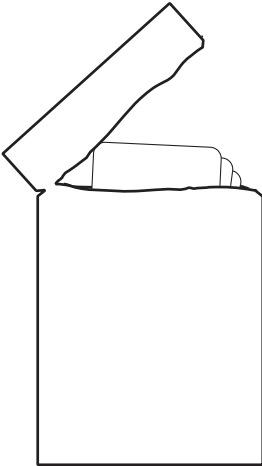
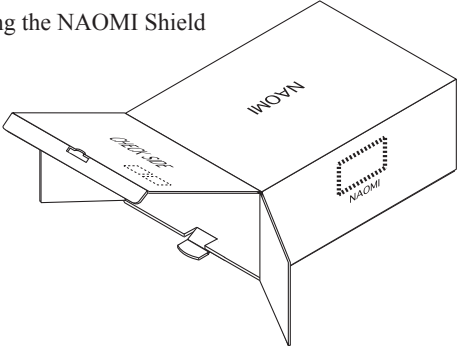
<p>DESCRIPTION Part No. (Qty.) Note Figures If Part No. has no description, the Number has not been registered or can not be registered. Such a part may not be obtainable even if the customer desires to purchase it. Therefore, ensure that the part is in safekeeping with you.</p>	<p>OWNER'S MANUAL 999-2200 (1)</p>	<p>KEY MASTER (2) For opening/closing the doors</p>	<p>KEY (2)×4 For the CASHBOX DOOR and the DBA Cover.</p>
<p>MAGNETIC CARD 601-10879-01 500 cards per bundle</p>	<p>CLEANING KIT 601-10878-01 30 packs per set (8 cleaning cards in one pack)</p>	<p>REMOTE CONTROLLER (see Section 12.) (1)</p>	<p>SERVICE MANUAL NAOMI ENG 420-6455-01 (1) Instruction Manual for the Game Board</p>
			

HOW TO USE THE CARTON BOX



When requesting for the replacement/repair of this product's Game Board (NAOMI BOARD), follow the instructions below. Transporting the Game Board in an undesignated status is unacceptable. An erroneous handling can cause parts damage.

- Put the Game Board in the Carton Box together with the Shield Case. Do not unnecessarily disassemble nor remove parts.
- By paying careful attention to the following Figure and the direction shown by on-Carton-Box printing, put the Shield Case in the Carton Box.
- When putting the Shield Case in the Carton Box, do not remove Leg Brackets.
- The projected portions of the packing material is intended for cushioning. Therefore, do not bend the projected portions.

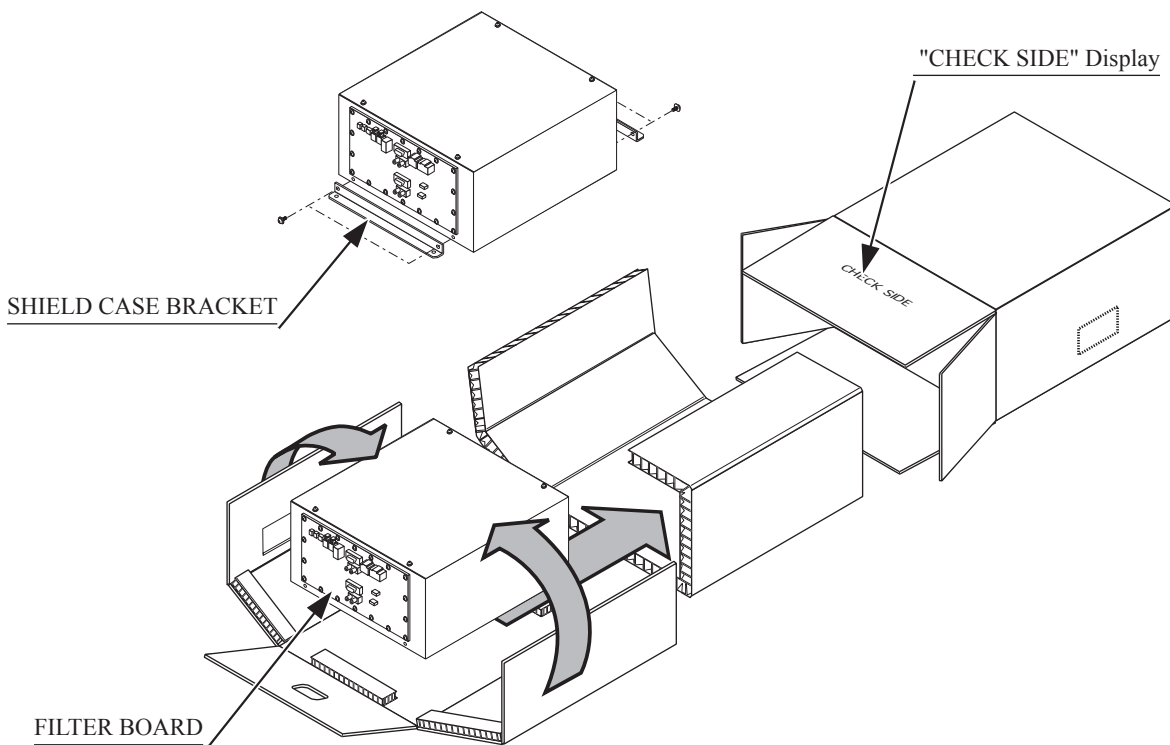

FIG. 5 a

Fold the packing material, and wrap the Shield Case with the packing material and put it in the Carton Box as shown. Putting it upside down or packing otherwise in the manner not shown can damage the Game Board and the parts.

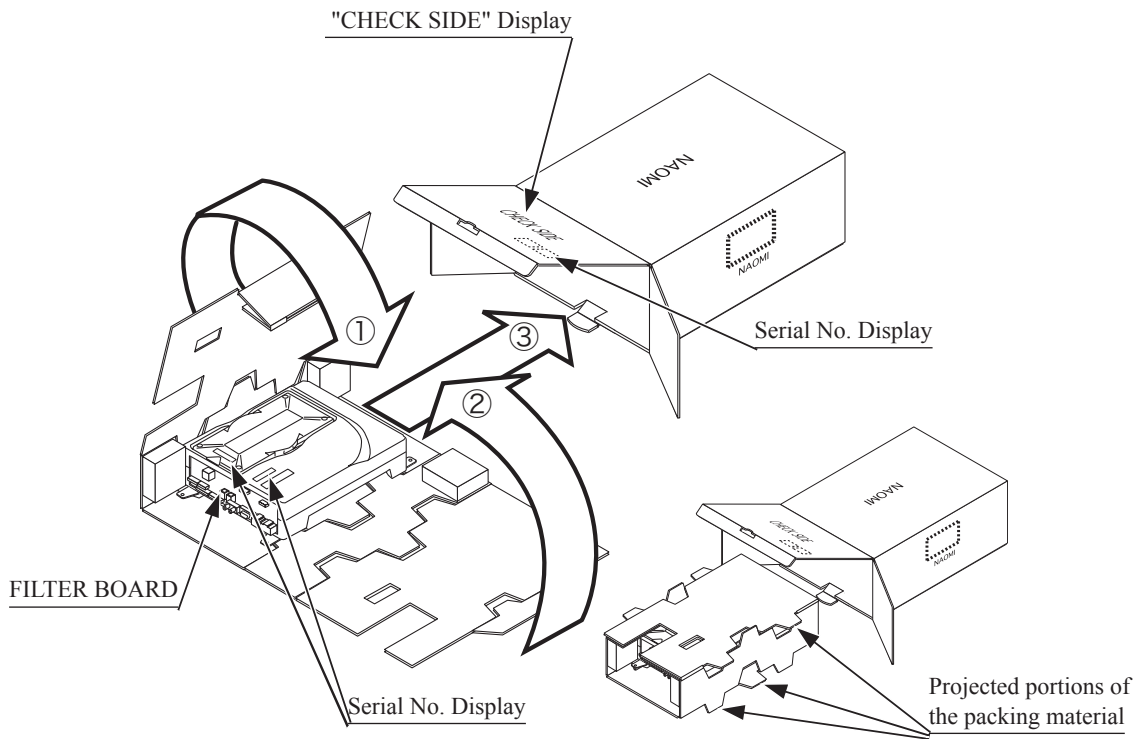

FIG. 5 b

Fold the packing material, and wrap the Shield Case with the packing material and put it in the Carton Box as shown. Putting it upside down or packing otherwise in the manner not shown can damage the Game Board and the parts.

OPTIONS



Be sure to use seats of sufficient sturdiness and safety with this product. Unstable and/or unsafe seats could result in injury to customers.

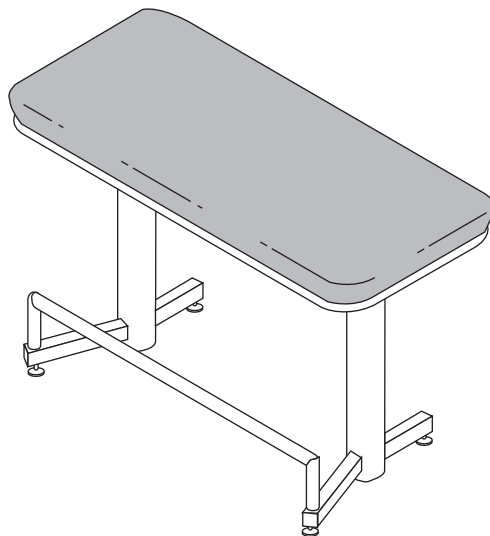

6. ASSEMBLING AND INSTALLATION



- Perform assembly work by following the procedure herein stated. Failing to comply with the instructions can cause electric shock hazard.
- Perform assembling as per this manual. Since this is a complex machine, erroneous assembling can cause an electric shock, machine damage and or not functioning as per specified performance.
- When assembling, be sure to use plural persons. Depending on the assembly work, there are some cases in which working by one person alone can cause personal injury or parts damage.
- Ensure that connectors are accurately connected. Incomplete connections can cause electric shock hazard.
- This work should be performed by maintenance or service personnel. Attempts to perform this work by unqualified personnel could result in electrical shock or other serious accidents. Furthermore, work not performed according to the instructions in this Owner's Manual could result in electrical shock to customers or other serious accidents. If no qualified personnel are available, please contact the dealer from which this product was purchased or the office shown on this Owner's Manual to request service. This is to ensure safety.
- Be careful not to damage the wiring. Damage to wiring could cause electrical shock or shorting.
- Do not expose power cables, earth wires, or fiber optic cables in passageways, etc. Exposure could lead to damage, possibly causing electrical shock or shorting. Be sure to use protective cable covers if cables must be laid on floors. (Cable diameters: Approx. 1/8" for power cables, Approx. 1/5" for optic fiber cables.)



- In order to ensure safe and reliable work, be sure to provide a stable step or stepladder. Performing work without a step or stepladder can lead to slips and falls.
- Work should be performed in a flat area measuring at least 12 ft square. Accidents may occur in a workspace that is smaller than this requirement, or that is on an incline, is uneven, or has channels in the floor. The work itself will also be more difficult to perform if this requirement is compromised.

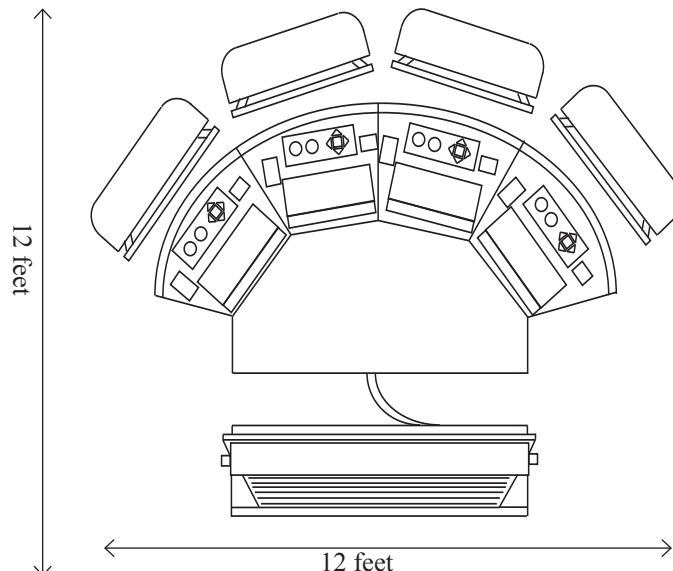



- Appropriate work clothes should be worn when performing work. Gloves and safety shoes should be worn in order to prevent accidents and injuries.
- If protective cable covers are used for cables on the floor, these should be of a shape and material that will not cause passersby to trip. Covers likely to induce tripping can cause accidents.

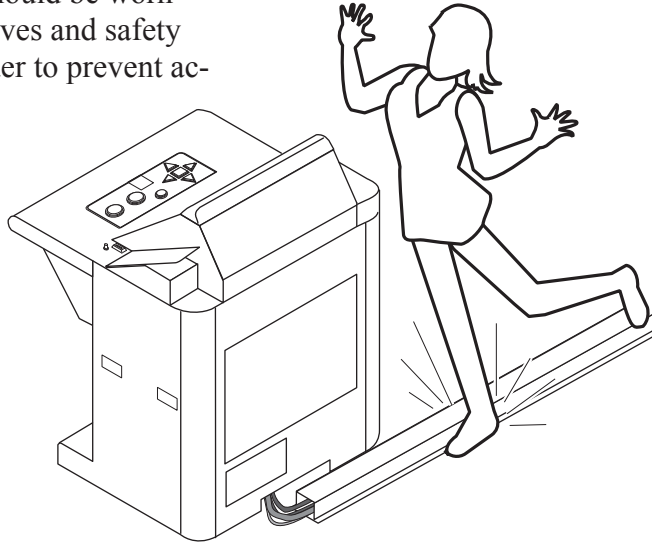

- Be sure to exercise caution in handling the projector screen, as it is easily damaged. Damaged screens cannot be repaired; they must be replaced.
- Because the screen is difficult to view at an angle, be sure to carefully consider the positioning of the satellites.

When carrying out the assembling and installation, follow the following 8-item sequence.

- 1 ASSEMBLING AND POSITIONING THE MAIN PROJECTION UNIT
- 2 SECURING THE STATIONS
- 3 POWER SUPPLY, AND EARTH CONNECTION
- 4 COMMUNICATION CONNECTIONS
- 5 SETTING THE CARDS
- 6 TURNING POWER ON

Tools required for the work

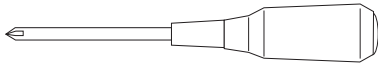

Phillips Type Screwdriver

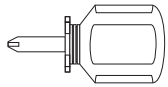

Phillips Type Screwdriver (Short)

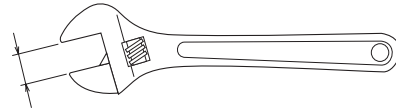

Crescent Wrench for Bolts

T15 Tamper Proff Bit
T25 Tamper Proff Bit
T27 Tamper Proff Bit
T35 Tamper Proff Bit
Bit Driver



Socket Wrench (for hexagon bolts and nuts)
Ratchet Handle

1

ASSEMBLING AND POSITIONING THE MAIN PROJECTION UNIT

Follow the steps outlined in the following procedural diagrams.

Place monitor upon the monitor stand having a care that the cords do not end up underneath the monitor when placing it upon the stand.

Also have a care to line the monitor up left to right so it fits centered upon the stand.

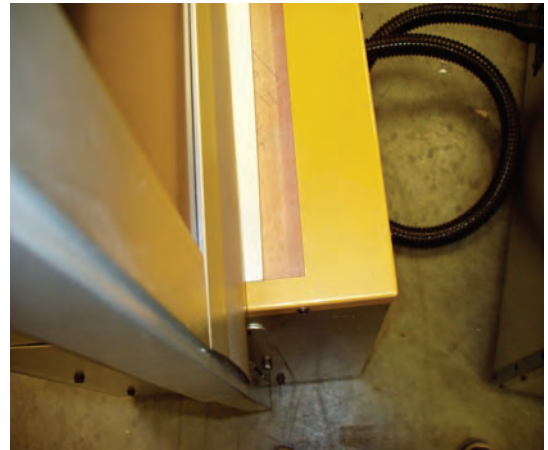

Slide the monitor fully forward on the stand being sure that it is fully under the front bracket as shown in the image to the right. If the monitor is not fully under the lip then the rear mounting bracket will not align properly with the holes in the monitor stand.



Secure the monitor to the monitor stand with the Monitor mounting bracket supplied with your unit. There are 3 screws that go in the back of the monitor and 5 screws that secure the bracket to the monitor stand.



Plug the DB15 plug to the video out female DB15 in the back of the monitor. Also be sure to connect the Bulb Fan connector then run the monitor power cord into the cabinet in the back right corner.



Place the cord cover inside the monitor plug area and secure to the monitor base with two screws. Then place the rear formed bracket on the back of the stand to cover the cords securing it to the monitor base with six screws in the back and one on each side of the bracket.



Place and secure the triangle brackets on each side of the monitor with two screws each to the monitor base.



Insert the Marquee Poles into the pole mounting brackets located to either side of the Monitor. The right side pole has power and audio that needs to be ran through the pole before securing the poles with 3 bolts.



Be sure to get help with placing the marquee on the marquee poles. Also be sure to connect the power and audio wires in the right pole to the marquee before placing the marquee in the pole. Then secure the marquee to the pole with two bolts each.



Power Plug

Open the service door on the front of the monitor base and plug the Monitor Power Cord into the Power Plug located on the upper board in the Monitor base.

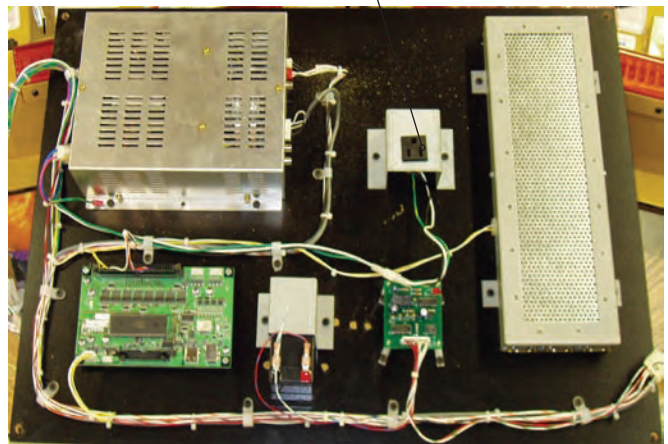

Be sure to connect the Monitor Fan Battery before running your unit. This comes disconnected when the unit is received, and if it is not connected your bulb in your monitor will die. Close the Service Door after these last two operations.

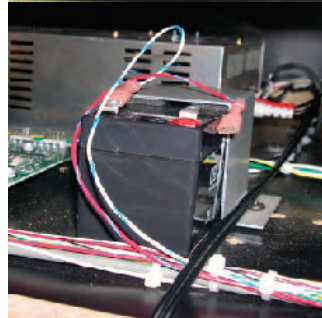

The recommended placement of the monitor to the stations pedestal is 18 inches away and centered.

Be sure to lower the leg adjusters to the ground to stop monitor movement.

2

SECURING THE STATIONS



Be sure that all adjusters are placed against the floor. Failure to place the adjusters against the floor could lead to accidents caused by cabinet movement.

Connect the fiber optic and power harness from the Montior Base to the Station Pedestal. Each side of the Harness is secured with 4 screws.



For each Station Set: Connect the power cable for the 2 stations and the 1 fiber optic connector. Then slide the station set into the pedestal having a care the cables are not pinched between the pedestal and the station set.

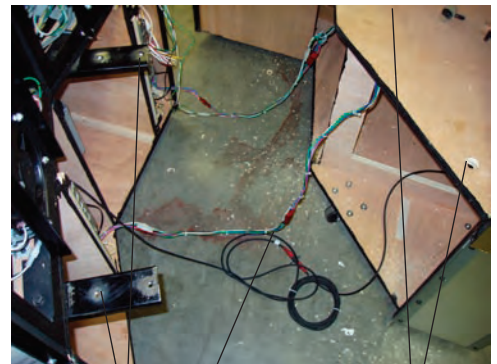

Bracket

Holes

Connections

Opening the right Station Hood on the right station set, and the left Station Hood on the left station set, reaching through the back , Place the 4 bolts through the pedestal holes into the station brackets which will secure the stations to the station pedestal.

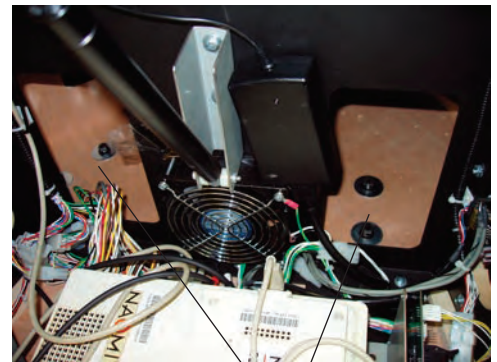

Station Bolts

Run the fiber optic cable from the Left station of the Right Station Set through the Station Portal into the Right station of the Left Station set. Then plug the fiber optic cable into the proper port on the Naomi Filter Board.

Station Portal



Secure the (6) Pem Studs between the Left Station Set and the Right Station Set. There are 3 in the front and 3 in the rear of the Station Sets.

(6) Pem Studs

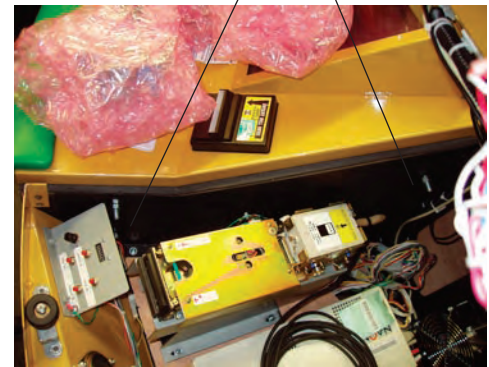

Place on the Unit the (3) brackets to the front and sides of the Station Sets. The front bracket takes Phillips screws where as the side brackets take tamper proof screws.

Front Center



Left and Right Sides



3

POWER SUPPLY, AND EARTH CONNECTION



- Be sure to independently use the power supply socket outlet equipped with an Earth Leakage Breaker. Using a power supply without an Earth Leakage Breaker can cause a fire when electric leakage occurs.
- This product is designed for an electrical outlet with an earth element. The power cord incorporates an earth wire. Improper grounding could result in electrical shock to customers, damage to components, and/or malfunctioning.
- If an electrical outlet with an earth element is not available and a commercially distributed conversion adapter is used, make sure that the product's earth terminal is connected to a grounded terminal using an earth wire. Improper grounding could result in electrical shock to customers, damage to components, and/or malfunctioning.
- Ensure that the power cord and earth wire are not exposed on the surface (passage, etc.). If exposed, they can be caught and are susceptible to damage. If damaged, the cord and wire can cause electric shock and short circuit accidents. Ensure that the wiring position is not in the customer's passage way or the wiring has protective covering.

The AC unit for the main projection unit is located at the back of the cabinet. The AC unit features a main switch, a circuit protector, an earth terminal, and an inlet for connecting the power cord.



Main SW off



FIG. 6. 3 b AC UNIT OF THE MAIN PROJECTION UNIT

**IMPORTANT!**

The communication cables are fiber optic type cables, and should be handled carefully. Improper handling may result in damage (such as from folding) that would render them unusable.

- Do not place heavy objects on the cables or step on them.
- When connecting or disconnecting the cables and connectors, always hold the connectors. Do not hold the cables.
- Be careful not to allow the connection surfaces at the ends of the communication cables to become dirty.
- Be careful not to bend the communication cables too much. The tightest permissible bend radius is 2.5 cm.
- Always carefully confirm the direction when connecting the connectors.

The RX and TX connectors are used to connect the communication cables to the shield case in the main projection unit and the Naomi shield cases inside the satellites. All the shield cases must be linked, using fiber optic cable to connect the RX connector for the shield case in the main projection unit to the TX connector for each Naomi shield case in each satellite, and using other communication cables to connect the RX connector in each satellite with the TX connectors in the shield cases for each of the other satellites. The connector at one end of each communication cable is red, and the connector at the other end is black. The connectors for the shield case communication cables are designated "RX" and "TX". Connect "RX" to the red connector and "TX" to the black connector.

5

SETTING THE CARDS

STOP
IMPORTANT!

- Please be sure to use the proprietary cards for this product. Usage of other cards could cause malfunctioning or breakdown.
- Be sure to set the cards in accordance with the specified procedure, direction, and number. Incorrect setting could cause equipment breakdown or other problems.
- Up to 100 cards may be set at a time. Do not set more than 100 cards, as this could cause problems such as jamming.
- Use new, freshly opened cards. Use of deformed or degraded cards can cause problems.
- Do not mix with cards that have been creased, bent, or previously used.

The card reader/writer, in which the cards are to be set, is to the left of the monitor screen, as seen when facing the satellite. Cards can be set regardless of whether the power is switched to ON or OFF.

- ① Release and open the RW cover to reveal the card reader/writer. The card reader/writer contains a card dispenser.



Card Reader/Writer



Release

Dispenser

- ② Remove the dispenser by pulling straight up from the card reader/writer.

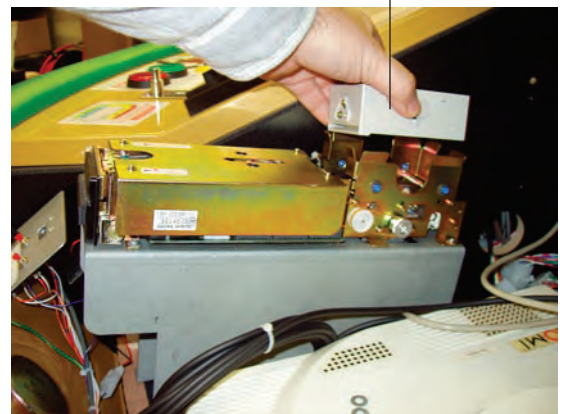

- ③ Place the cards in the dispenser in accordance with the instructions on the sticker that appears on the dispenser. Be careful not to place the cards backwards or upside down. The number of cards that can be placed in the dispenser at any one time is 100. In order to avoid problems such as jamming, be sure not exceed this limit. Use new packages of 100 cards, or else carefully count the number of cards before placing them in the dispenser.

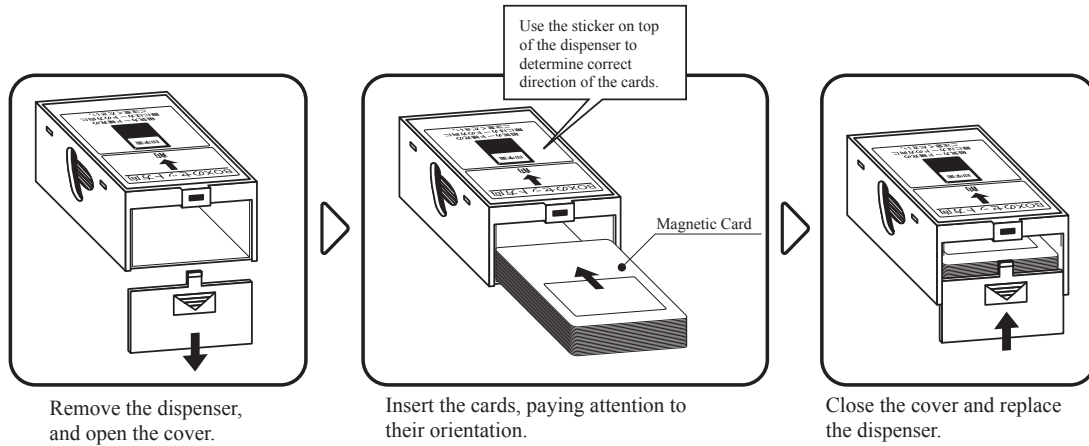
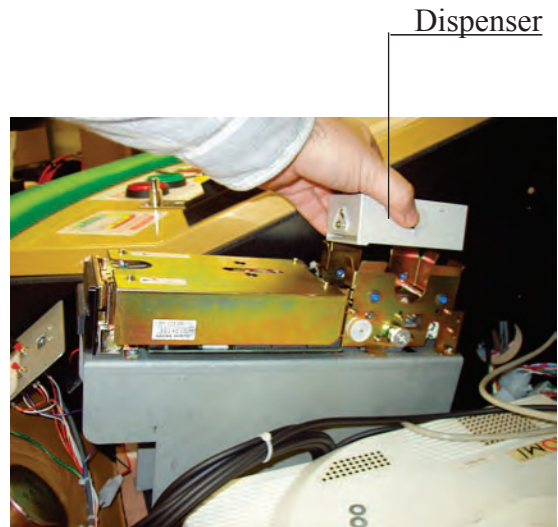

FIG. 6.5

- ④ Place the cover on the dispenser.
- ⑤ Place the dispenser back into the card reader/writer. The dispenser is designed to fit only in its correct orientation.
- ⑥ Close and lock the RW cover.



6

TURNING POWER ON

To turn on the power, turn the AC unit main switch in the main projection unit to ON, as well the power switches in all of the satellite AC units.

Unless all of the power switches are turned to ON, an error will be detected in the network check that is automatically carried out after powering up.

After power is turned on, the main projection unit billboard, the side frame fluorescent lamps on the right and left, and all the satellite fluorescent lamps will be illuminated.

Following display of the Naomi system startup screens on the main projection and satellite monitors, the network check will be displayed. After network check completion, advertising screens will appear.

In the event of communication connection problems or other errors, each monitor will alternate between the network check and Naomi logo screens, and the advertising screens will not appear.

If the advertising screens fail to appear, please refer to the Service Manual included with the product in order to identify and resolve the error.

Note that when power to this product is interrupted, marginal coins (i.e., those that do not represent a full credit) and bonus adder data will be lost. As long as power is supplied and the game is running, it will repeat the total of 16 seasons and 96 races. When power has been interrupted, the game will start with the first race of the season in progress at the time of the interruption. For example, if power is turned off during the 4th race of the 10th season, the game will resume from the 1st race of the 10th season after power is restored.



***Note: Image Differs From Actual Unit.

FIG. 6. 6 a NETWORK CHECKING SCREEN

7

ASSEMBLY CHECK

Please read the Service Manual accompanying the product, utilize the test modes for each station and the main projection unit, and check the various input/output devices and screen settings. Every possible check is conducted prior to shipping the product from the factory, but the passage of time and/or vibration experienced during transport may result in the need for further adjustments.

7. PRECAUTIONS TO BE HEEDED WHEN MOVING THE MACHINE



- When moving the machine, be sure to pull out the plug from the power supply. Moving the machine with the plug as is inserted can cause the power cord to be damaged, resulting in a fire and or electric shock.
- When moving the machine on the floor, retract the Adjusters and ensure that Casters make contact with the floor. During transportation, pay careful attention so that Casters do not tread power cords and earth wires. Damaging the power cords can cause an electric shock and/or short circuit.
- When lifting the cabinet, be sure to hold the catch portions or bottom part. Lifting the cabinet by holding other portions can damage parts and installation portions due to the empty weight of the cabinet, and cause personal injury.



- Do not use a forklift to move this product. This could cause breakage of components, and the pieces could cause injury.
- Do not push on glass or molded parts. This could cause breakage of components, and the pieces could cause injury.
- Do not move the stations by pulling or pushing on the armrests. This could cause breakage, and workers could suffer injury from the pieces.



- When transporting the product in places with steps, disassemble into each unit before transporting. Inclining the product in an as is assembled condition or placing the cabinet in places with steps can damage the unit's joining portions.
- To protect surface, do not directly apply a rope to the surfaces of product. Use protective materials to the places the rope is applied to.

On level surfaces, move the machine by causing the casters to make contact with the surface.

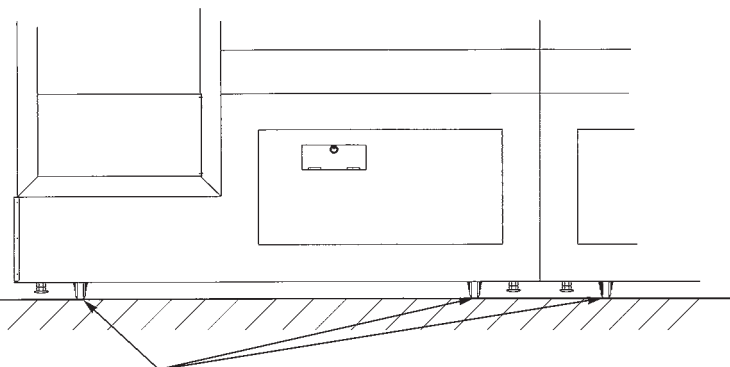

FIG. 7 a Casters of the main projection unit

8. CARD READER/WRITER



The card reader/writer features dip switches in three locations. These should not be changed from their factory settings. Changes to these settings could cause malfunctioning.

DIP SW 1 represents the communication setting.

- 1 OFF
- 2 ON
- 3 ON
- 4 OFF
- 5 OFF
- 6 ON
- 7 ON
- 8 OFF

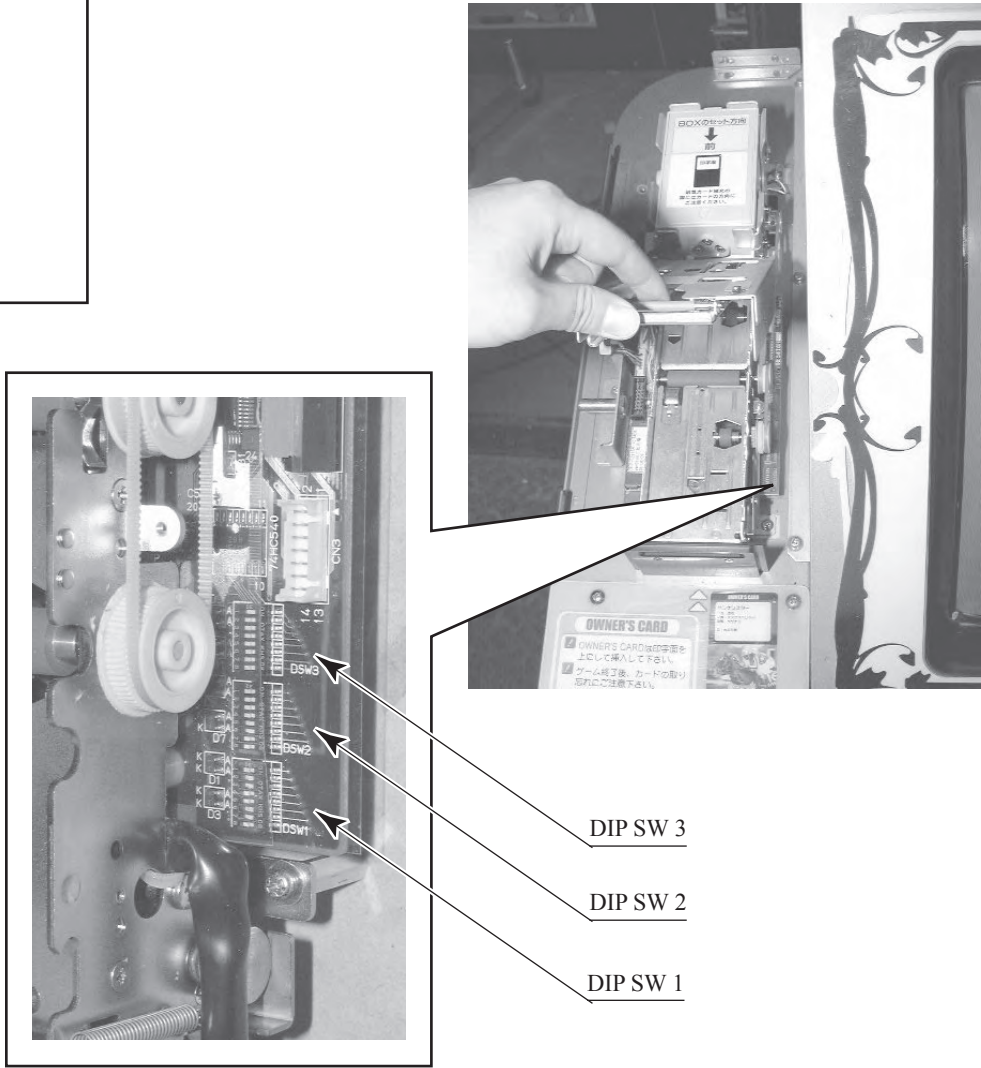

PHOTO 8

DIP SW 2 and 3 are for minute adjustments prior to final shipping. The settings of each card reader/writer may vary. Changes can result in malfunctions such as a slight divergence in the printing position.

8 - 1 SETTING THE CARDS



- Please be sure to use the proprietary cards for this product. Usage of other cards could cause malfunctioning or breakdown.
- Be sure to set the cards in accordance with the specified procedure, direction, and number. Incorrect setting could cause equipment breakdown or other problems.
- Up to 100 cards may be set at a time. Do not set more than 100 cards, as this could cause problems such as jamming.
- Use new, freshly opened cards. Use of deformed or degraded cards can cause problems.
- Do not mix with cards that have been creased, bent, or previously used.

The card reader/writer, in which the cards are to be set, is to the left of the monitor screen, as seen when facing the satellite. Cards can be set regardless of whether the power is switched to ON or OFF.

- 1 Release and open the RW cover to reveal the card reader/writer. The card reader/writer contains a card dispenser.



Card Reader/Writer

- 2 Remove the dispenser by pulling straight up from the card reader/writer.



Release

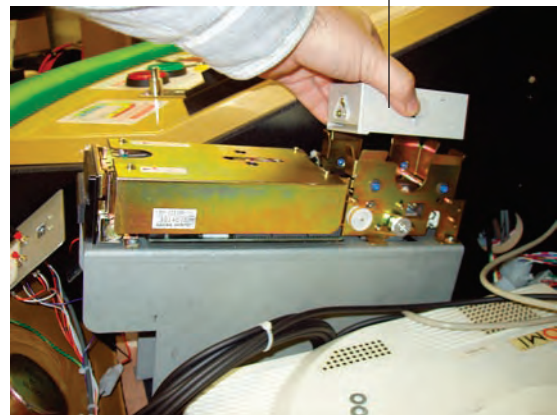

Dispenser

- ③ Place the cards in the dispenser in accordance with the instructions on the sticker that appears on the dispenser. Be careful not to place the cards backwards or upside down. The number of cards that can be placed in the dispenser at any one time is 100. In order to avoid problems such as jamming, be sure not exceed this limit. Use new packages of 100 cards, or else carefully count the number of cards before placing them in the dispenser.

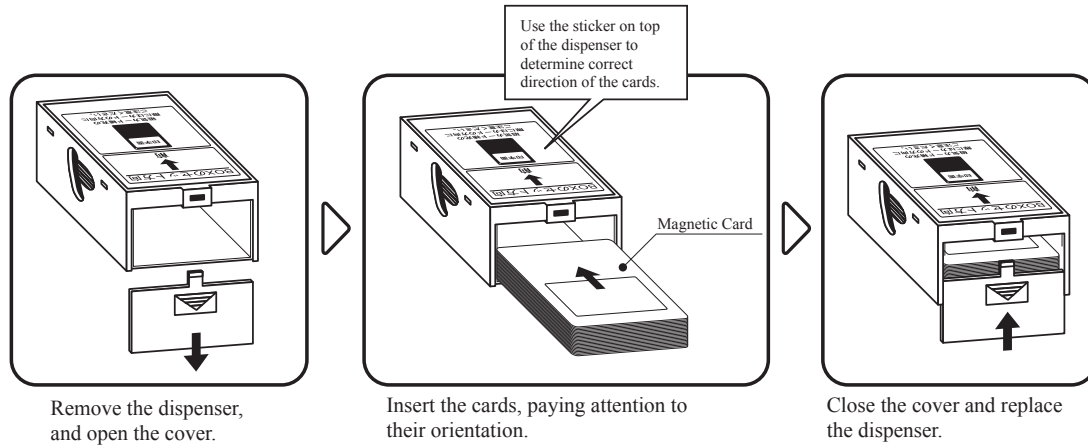
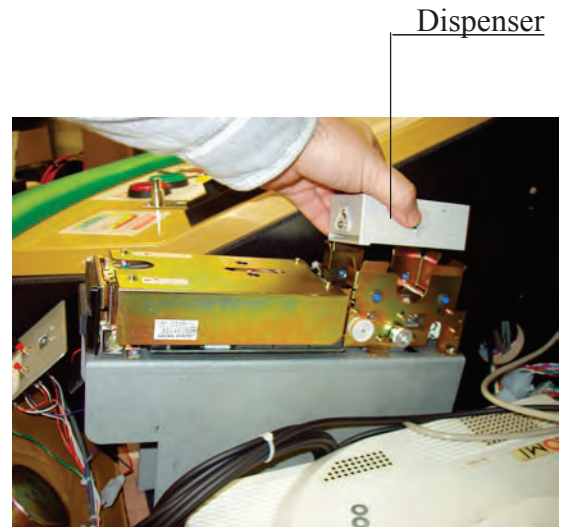

FIG. 6.5

- ④ Place the cover on the dispenser.
- ⑤ Place the dispenser back into the card reader/writer. The dispenser is designed to fit only in its correct orientation.
- ⑥ Close and lock the RW cover.





When the head cleaning mode is performed manually, never touch any places other than the specified parts. Doing so could cause an electric shock and/or short circuit.



- If the head cleaning mode is entered while the power is on, use the head cleaning procedure according to the instructions on the screen. The head cleaning mode cannot be quitted for being ready for starting the game unless the head cleaning is completed.
- Be sure to use dedicated cleaning cards. Use of ones other than such dedicated cleaning cards may cause a malfunction or failure of the machine.
- Cleaning cards are disposable. They must not be used more than once.
- Use cleaning cards immediately after opening the seal. If the cleaning cards become dry, they will lose their effectiveness. Keep unused cleaning cards tightly wrapped.
- Never conduct cleaning other than as described in this Owner's Manual. Doing so could result in printing errors, malfunctioning, and/or breakdown.
- Cards should be in the card reader/writer dispenser when head cleaning is performed. When there are no cards in the dispenser, the component that holds down the cards will come into contact with the roller of the card reader/writer, and this can cause unusual noise.

<Recommendations>

When Head Cleaning Mode is displayed by a station, it is best to proceed with cleaning of the other stations, even if they do not show Head Cleaning Mode. Head cleaning can be performed as an option in Test Mode or Check Mode (please refer to the Service Manual).
Cleaning cards come in packages of eight. The cards will begin to dry out after opening, so it is more effective and economical to perform cleaning on all the stations at the same time.

This product keeps a count of the number of times each card reader/writer is used. When power is turned off after the count surpasses 100, Head Cleaning Mode will automatically be displayed the next time that power is turned on. Follow the instructions on the screen using proprietary cleaning cards to perform cleaning. Head Cleaning Mode cannot be exited and the game cannot be readied for play until head cleaning has been performed. The reason that the cleaning card is placed upside down the second time in the procedure described below is that the printing head is on the top side when the cards are inserted in the card reader/writer, while the magnetic head is on the bottom.
Head cleaning can be manually performed as an option in Test Mode or Check Mode. Performing a head cleaning automatically returns the above-noted usage count to zero. Please refer to the Service Manual for details.

- ① Following the instructions displayed on the screen, insert the cleaning card into the card insertion opening. The card will be automatically pulled in.



PHOTO 8. 2

- ② The screen display shows that cleaning is taking place.
- ③ Following the instructions displayed on the screen, perform cleaning securely.

Optimum card reader operation depends on keeping the reader clean. Sega recommends, on top of the regular card cleaning method, a thorough cleaning of the reader transport area. Observe the following procedure to assure your reader stays as clean as possible:

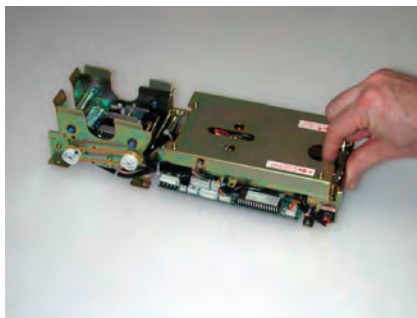

- 1- Access the transport area by releasing the top door stay mechanism. (Green Bar)



- 3- Continue by thoroughly wiping down the upper transport area.

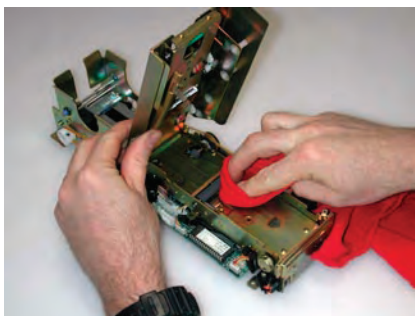

- 2- Using a red shop rag and denatured alcohol, thoroughly wipe down lower transport area.

8 - 3 TAKING ACTION AGAINST CARD JAMMING

If card jamming occurs, the error is shown on the satellite screen. Use the procedure to take action against the trouble.

- ① Release and open the card reader/write cover.



Release

PHOTO 8. 3 a

- ② Release the hatch by drawing the green shaft attached to the top cover on the card reader/writer. While drawing the shaft, open the cover up.

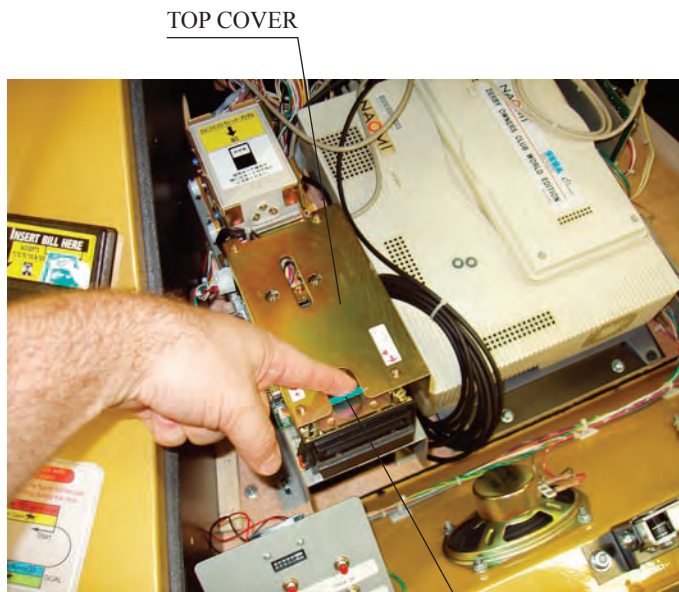

PHOTO 8. 3 b

Open the cover up while drawing the green shaft.

- ③ Remove the card jammed in the card reader/writer.
- ④ While drawing the shaft, close the cover. With the top cover closed, release the green shaft. Check that the top cover has been locked securely.

Remove the card jammed.



PHOTO 8. 3 c



PHOTO 8. 3 d

9. COIN SELECTOR



Be sure to perform this operation with the power switched off. Failure to do so could cause electrical shock or shorting.



- Use a soft cloth to clean the coin selector. When especially dirty, wipe it with a cloth that has been dampened with either hot or cold water. Never use chemical cleansers or solvents.
- When the coin selector has been removed, be sure to confirm that it works correctly after replacing it.
- The coin selector is a piece of precision equipment. Careless handling can cause breakage of components, poor connections in the electronic circuitry, etc.

9 - 1 REMOVING THE SELECTOR

- ① Turn off the power.
- ② Release and open the service door.
- ③ Flip the two spring loaded catches and remove the selector up and out sideways from the bracket.



Release

FIG. 9. 1

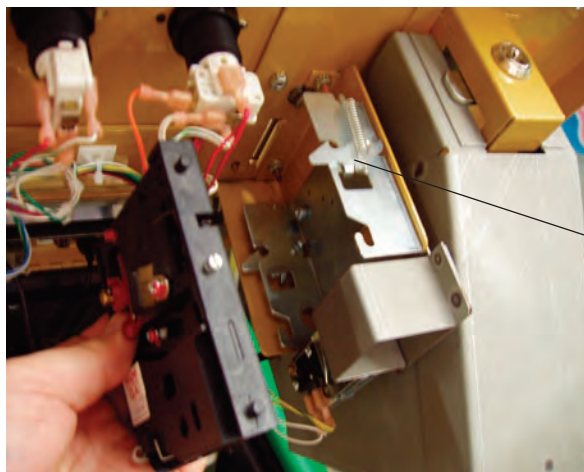

Catches

PHOTO 9.1 a

9 - 2 HANDLING THE COIN JAM

If the coin is not rejected when the REJECT button is pressed, open the coin chute door and open the selector gate. After removing the jammed coin, put a normal coin in and check to see that the selector correctly functions.

9- 3 CLEANING THE COIN SELECTOR



- Remove and clean smears by using a soft cloth dipped in water or diluted chemical detergent and then squeezed dry.
- Never apply machine oil, etc. to the Coin Selector.
- After cleaning the Coin Selector, insert a regular coin in the normal working status and ensure that the Selector correctly functions.

The coin selector should be cleaned once every 3 months. When cleaning, follow the procedure below:

- ① Turn the power for the machine OFF. Open the coin chute door.
- ② Remove the coin selector from the coin chute door.
- ③ Open the gate and dust off by using a soft brush (made of wool, etc.).
- ④ Remove and clean smears by using a soft cloth dipped in water or diluted chemical detergent and then squeezed dry.
- ⑤ Remove the CRADLE.
When removing the retaining ring (E ring), be very careful so as not to bend the rotary shaft.
- ⑥ Remove stain from the rotary shaft and shaft receiving portions by wiping off with a soft cloth, etc.
- ⑦ After wiping off as per above, further apply a dry cloth, etc. to cause the coin selector to dry completely.

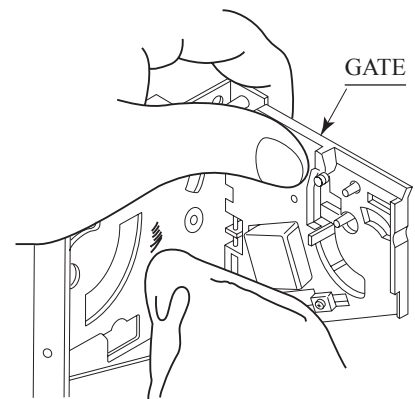

FIG. 9. 3 a

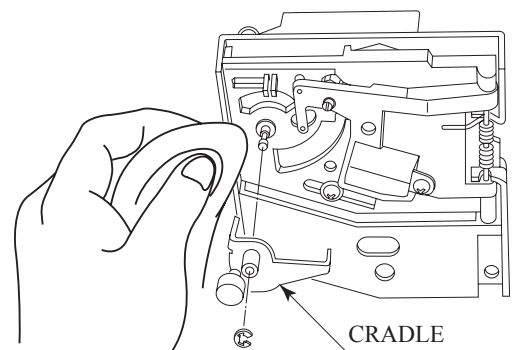
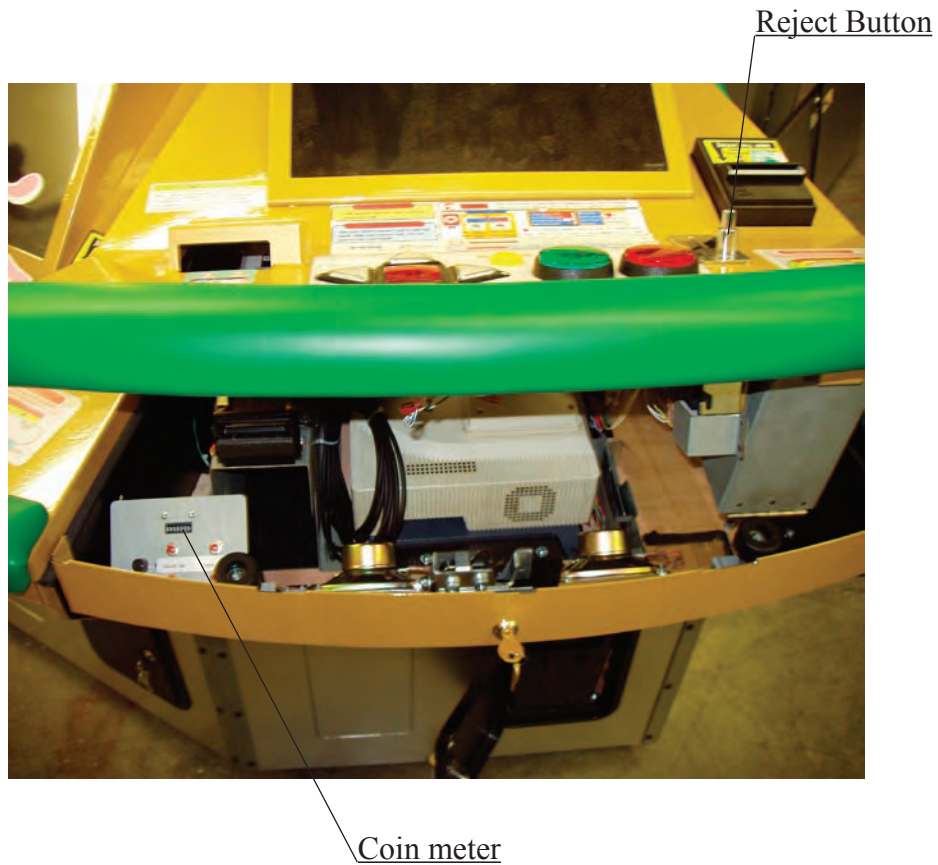

FIG. 9. 3 b

9 - 4 COIN INSERTION TEST

Once every month, when performing the Coin SW Test, simultaneously check the following:

- Does the Coin Meter count satisfactorily?
- Does the coin drop into the Cashbox correctly?
- Is the coin rejected when inserted while keeping the Reject Button pressed down?



10. LCD PROJECTOR



CAUTION!

Since the LCD Projector has been adjusted at the time of shipment, avoid making further adjustments without good reason.

10 - 1 CLEANING THE SCREEN



CAUTION!

Since the Projector screen is susceptible to damage, pay careful attention to its handling. When cleaning, refrain from using water or volatile chemicals.

When the screen surface becomes dirty with dust, etc., clean it by using a soft cloth such as gauze. When water, and volatile chemicals such as benzine, thinner, etc., spill on the screen surface, it may be subject to damage, therefore, do not use them. Also, since the surfaces are susceptible to damage, refrain from rubbing them with a hard material or using a duster.



PIC. 10. 1

10 - 2 ADJUSTING THE LCD PROJECTOR



WARNING!

Be sure that the monitors are appropriately adjusted. Do not operate the product when screen flickering or distortion is visible. Improperly adjusted screen images can cause players or other customers to experience headaches or other health-related symptoms.

11. MONITOR

11 - 1 REPLACING MONITORS



- Prior to connecting or disconnecting monitor connectors in conjunction with installation or removal of monitors, always disconnect the power connector (plug) first. Failure to do so can cause electrical shock or breakdown.
- Work must be performed by qualified personnel with a thorough knowledge of electrical systems. Work by inexperienced persons can result in electrical shock, etc.
- Proceed with work in accordance with the procedures described in this Owner's Manual. Electrical shock may occur if these instructions are not followed.
- To ensure safety, be sure to provide sufficient space in which to work. Working in confined areas can cause accidents and mistakes.
- Be careful not to damage wiring. Damaged wiring can cause electrical shock or shorting.
- Do not touch components, etc. unless directed to do so. Electrical shock or shorting can result.

- ① After turning the AC unit power switch to OFF, disconnect the power plug from the outlet.
- ② Release and open the Station Lid.
- ③ Unhook the DB15 VGA Connector from the monitor board and the Power connector.
- ④ Undo the 4 11/16ths Nuts from the monitor bracket and remove the brackets from your monitor.
- ⑤ Reverse these steps to put in your new monitor.



Release the lock.

PHOTO 11. 4 a

Undo VGA and Power.

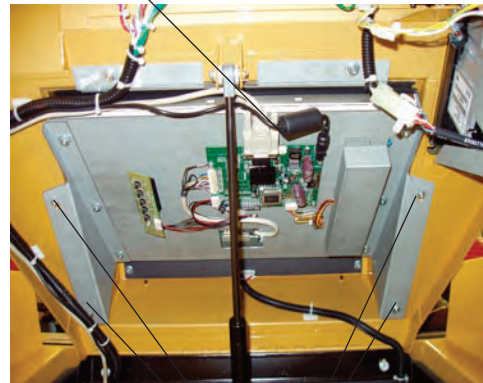

Remove (4) nuts.

12. REPLACING THE FLUORESCENT LAMP, AND LAMPS



- When performing work, be sure to turn power off. Working with power on can cause electric shock and short circuit hazards.
- The Fluorescent Lamp, when it gets hot, can cause burn. Be very careful when replacing the Fluorescent Lamp.
- Be sure to use lamps of the designated rating. Using lamps of undesigned rating can cause a fire or malfunctioning.



- To perform work safely and securely, be sure to prepare a step which is in a secure and stable condition. Performing work without using the step can cause violent falling down accidents.
- Be careful when handling the plastic made parts. Failure to observe this may cause injury due to damage or fragments resulting from damage.

FLUORESCENT LAMPS INSIDE THE BILLBOARD

There are 1 fluorescent lamps inside the main projection unit billboard. Use a step or stepladder for safety when changing the 1 lamps on the top.

- ① Turn the main switch in the main projection AC unit to OFF.
- ② Remove the 4 screws to remove the marquee top bracket, then remove the marquee plex, allowing replacement of the fluorescent lamp inside the billboard.



(4) Machine screws



FLUORESCENT LAMP F30T12/CW/RE
CoolWhite

LIGHTS IN THE CONTROL PANEL BUTTONS

All of the buttons on the control panel have LEDs inside them.

- ① Turn the power switch in the satellite AC unit to OFF.
- ② Release the Station Lid.
- ③ Squeeze tightly on both sides of switch at the base of the button, and pull out from the button (Figure 12).
- ④ To replace, pull the LED lamp straight out without turning.



Release the lock.

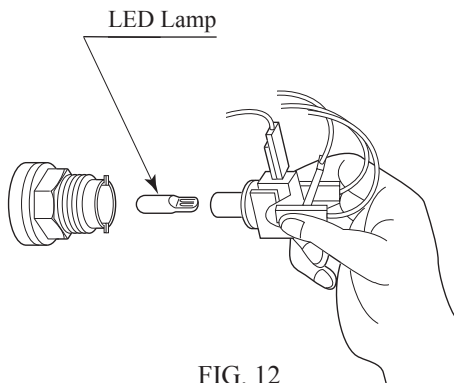

FIG. 12



Disconnect the connector.

PHOTO 12 1

13. PERIODIC INSPECTION TABLE

The items listed below require periodic check and maintenance to retain the performance of this machine and to ensure safe business operation.



- Be sure to check once a year to see if Power Cords are damaged, the plug is securely inserted, dust is accumulated between the Socket Outlet and the Power Plug, etc. Using the product with dust as is accumulated can cause fire and electric shock hazards.
- Never use a water jet, etc. to clean inside and outside the cabinet. If wetness occurs for any reason, do not use the product until it has completely dried.
- Periodically once a year, request the place of contact herein stated or the Distributor, etc. where the product was purchased from, as regards the internal cleaning. Using the product with dust as is accumulated in the interior without cleaning can cause a fire or accident. Note that cleaning the interior parts can be performed on a pay-basis.



Clearing the data in Test Mode will also return the card reader/writer usage count to zero. Note that if data is cleared frequently, Head Cleaning Mode will not be displayed even when the requisite number of usages has been reached.

TABLE 13

	Item	Interval	Reference
CABINET	Check Adjusters' contact with surface.	Daily	3
CARD READER/WRITER	Head cleaning	At the display of the head cleaning mode.	8-2
CONTOROL PANEL	Check SW, Lamp.	Monthly	Service manual
COIN SELECTOR	Check COIN SW.	Monthly	Service manual
	Cleaning of the coin selector.	Monthly	9-3
	Coin insertion test.	Monthly	9-4
PROJECTOR	SCREEN cleaning.	Weekly	10-1
	Check adjustments.	Monthly or when moving.	Service manual
MONITOR	Cleaning of LCD surfaces.	Weekly	11-2
GAME BD	MEMORY TEST.	Monthly	Service manual
	Check settings.	Monthly	Service manual
POWER SUPPLY PLUG	Inspection and cleaning	Annually	See above.
INTERIOR	Cleaning		
CABINET SURFACES	Cleaning	As necessary.	Next Page.

CLEANING THE CABINET SURFACES

When the cabinet surfaces are badly soiled, remove stains with a soft cloth dipped in water or diluted (with water) chemical detergent and squeezed dry. To avoid damaging surface finish, do not use such solvents as thinner, benzine, etc. other than ethyl alcohol, or abrasives, bleaching agent and chemical dustcloth.

14. TROUBLESHOOTING



- In order to prevent electric shock and short circuit, be sure to turn power off before performing work.
- Be careful so as not to damage wirings. Damaged wiring can cause electric shock or short circuit.
- After removing the cause of the functioning of the Circuit Protector, reinstate the Circuit Protector. Depending on the cause of the functioning, using the Circuit Protector as is without removing the cause can cause generation of heat and fire hazard.
- In the event that a problem cannot be resolved by employing the procedures listed in this Owner's Manual, please request service from the office shown on this Owner's Manual or the dealer from whom the product was originally purchased. Attempts to employ procedures other than those specified in this Owner's Manual can cause electrical shock, shorting, or fire.
- In the event of a problem that is not described here, please contact the office shown on this Owner's Manual or the dealer from whom the product was originally purchased. Careless attempts at repair can result in electrical shock, shorting, or fire.

If a problem occurs, first check to make sure that the wiring connectors are properly connected. This product automatically performs a self-check when the power is turned on or Test Mode is completed. If a problem is detected, an error message is displayed. An error message is also displayed if a problem is detected in the card reader/writer. Please refer to the service manual for instructions on how to deal with error messages.

TABLE 14 a

PROBLEMS	CAUSE	COUNTERMEASURES
When the main SW in the main projection unit is turned ON, the PTV is not activated.	The power is not ON.	Firmly insert the plug into the outlet.
	Incorrect power source/voltage.	Make sure that the power supply/voltage are correct.

TABLE 14 b

PROBLEMS	CAUSE	COUNTERMEASURES
Sound is not emitted.	Sound volume adjustment is not correct.	Adjust the SWITCH UNIT's sound adjustment volume control. (See Service Manual)
	Malfunctioning BD. and Amp.	Perform SOUND TEST. (See Service Manual)
When the power SW of the satellite is turned ON, the satellite is not activated.	The power is not ON.	Firmly insert the plug into the outlet.
	Incorrect power source/voltage.	Make sure that the power supply/voltage are correct.
Printing on cards is too light.	The card reader/writer head is dirty.	Perform head cleaning. (See Service Manual)
Fluorescent lamp doesn't light up.	Fluorescent lamp need replacement.	Replace the fluorescent lamp. (See Section 12)
Lamp doesn't light up.	Lamp need replacement.	Replace the lamp. (See Section 12)

FUSE REPLACEMENT



- In case fuse replacements other than those stated in this manual are necessary, contact where you purchased the product from for inquiries regarding this matter.
- Fuse replacements other than those specified can cause accidents and are strictly forbidden.
- In order to prevent an electric shock, be sure to turn power off and unplug from the socket outlet before performing work by touching the internal parts of the product.
- Be careful so as not to damage wirings. Damaged wiring can cause electric shock and short circuit accidents.
- Be sure to use fuses meeting specified rating. Using fuses exceeding the specified rating can cause fire and electric shock accidents.
- After eliminating the cause of the blowing of fuse, replace the fuse. Depending on the cause of fuse blowing, continued use with the fuse as is blown can cause generation of heat and fire hazard.

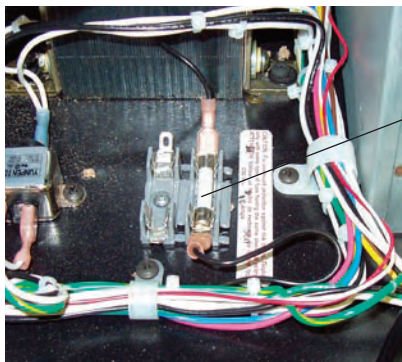

Fuse 250V 10A

15. GAME BOARD



- In order to prevent electric shock and short circuit hazards, be sure to turn power off before performing work.
- Be careful so as not to damage wirings. Damaged wiring can cause fire, electric shock and short circuit hazards.
- Do not expose the Game BD, etc. without a good reason. Failure to observe this can cause electric shock hazard or malfunctioning.



The electronic parts on the IC Board could be damaged due to human body's static electricity. Before performing IC Board related work, be sure to discharge physically accumulated statics by touching grounded metallic surfaces, etc.



- Put the Game Board in the Carton Box (an accessory) together with the Shield Case when requesting for the replacement or repair. Transporting the Game Board in an undesignated status for replacement/repair is unacceptable.
- DIP switch settings are NOT used to perform functional adjustments to this project. Use the factory settings for the dip switches on the IC board and elsewhere. Incorrect dip switch settings can cause malfunctioning.

Repairs to the game board will be performed by Sega. If game board breakdown or malfunctioning is suspected, replacement and/or repair of the entire shield case containing the game board should be requested. Accordingly, removal of the shield case is described in this Owner's Manual. The component structure of the game board itself is not presented here.

15 - 1 REMOVING THE GAME BOARD

To remove the shield case containing the game board, the entire wooden base on which the shield case is mounted should be removed from the main projection unit.

- ① Turn the main switch in the main projection AC unit to OFF.
- ② Remove the 2 screws from, release with key , and remove maintenance door from the front main monitor pedestal unit.
- ③ Disconnect all the connectors going to the lower board area.
- ④ Disconnect all other connectors from the shield case to other devices.
- ⑤ Remove the 2 screws securing the base to allow removal of the shield case mounted on its base. Be careful not to damage the wiring during removal.
- ⑥ Remove the 4 screws to remove the shield case from the base.

DIP SW SETTING

In this product, set all of the DIP switches to OFF.

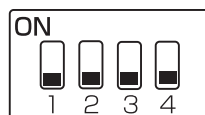

FIG. 15. 1 b

15 - 2 REMOVING THE NAOMI SHIELD CASES

- ① Turn the power switch in the satellite AC unit to OFF.
- ② Release and open the lid of the station.
- ③ Disconnect all the connectors from the shield case filter board.
- ④ Remove the 4 screws to remove the Naomi shield case from its base.



Release the lock.

Remove (4) screws



15 - 3 COMPOSITION OF NAOMI SHIELD CASE

ASSY CASE NAO DOC WE (840-0088D)

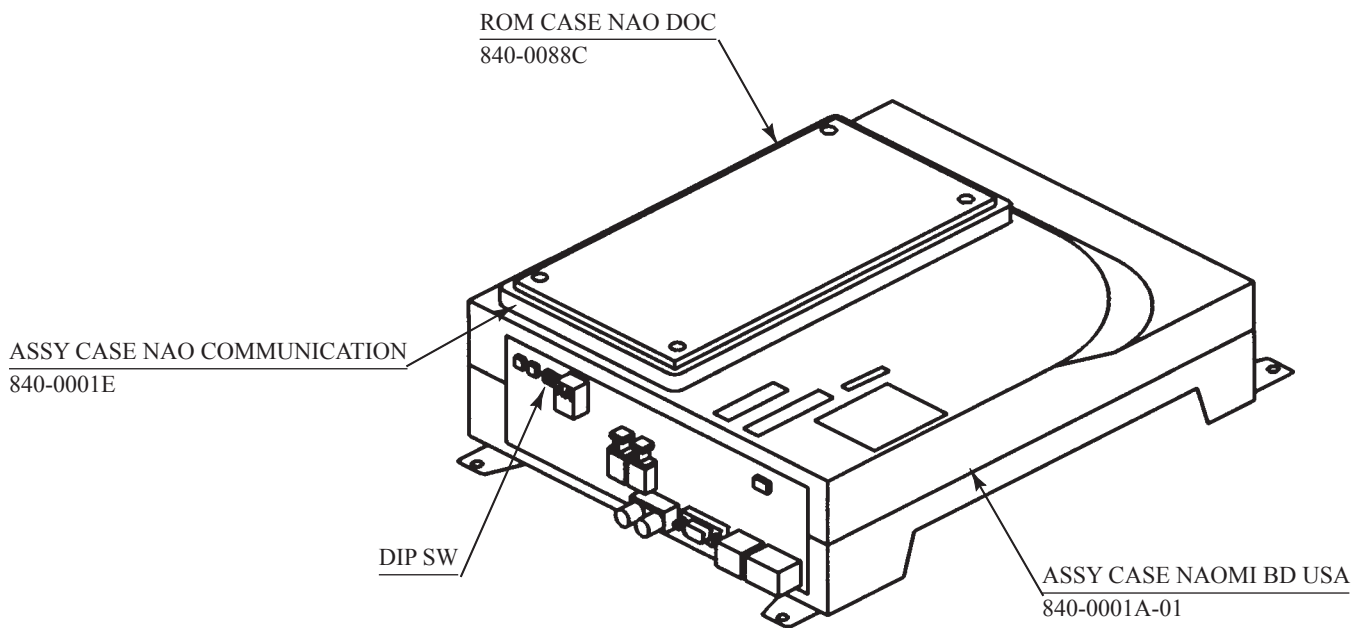

FIG. 15. 3 a

DIP SW SETTING

In this product, set all of the DIP switches to OFF.

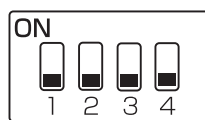

FIG. 15. 3 b

15 - 4 CARD READER/WRIter INTERFACE BOARD

The IC card, located inside the satellite on the left side facing the front, controls the connection between the card reader/writer and the Naomi shield case.

RS422/RS232C BD DOC
838-13661

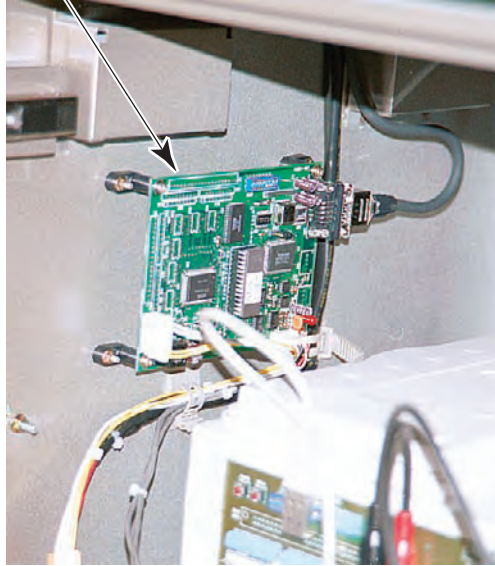

PHOTO 15. 4

DIP SW SETTING

Use the following DIP switch setting on this board.

1 ~ 4 ••• OFF
5, 6 ••• ON
7, 8 ••• OFF

16. DESIGN RELATED PARTS



17. PARTS

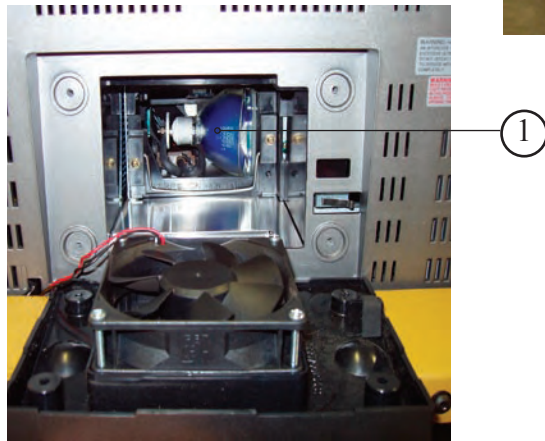

ITEM NO.	PART NO.	DESCRIPTION	NOTE
1	998-0219	LG 60" Halogen Monitor Lamp	Zenith#6912v00006C
2	999-2222	Monitor Right Projector Trim	
3	999-2216	Monitor Mounting Bracket	
4	999-2217	Left Marquee Mounting Pole	
5	999-2218	Right Marquee Mounting Pole	
6	999-2221	Monitor Connector Cover	
7	999-2220	Monitor Rear Projector Trim	
8	999-2010	Monitor Pedestal Fan Grill 4 Hole	
9	999-2219	Monitor Left Projector Trim	

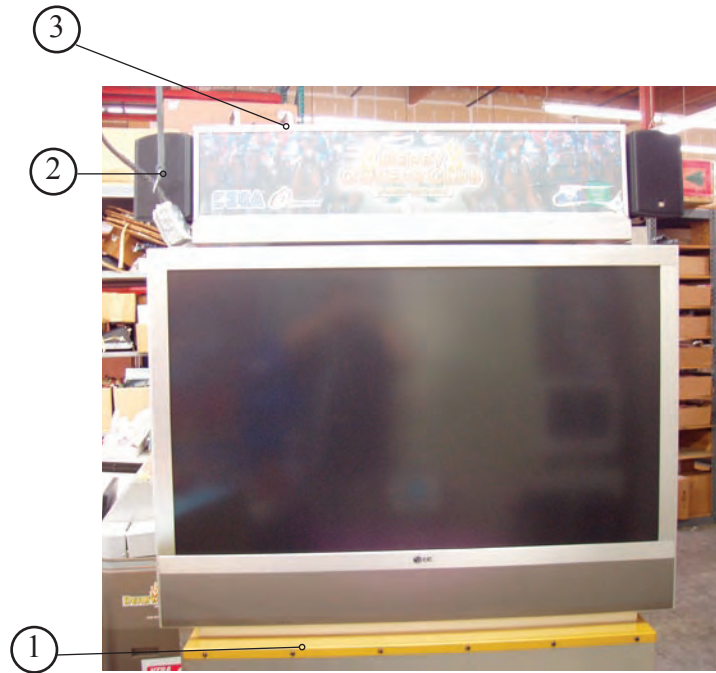

ITEM NO.	PART NO.	DESCRIPTION	NOTE
1	999-2223	Monitor Front Projector Trim	
2	999-2202	Speaker Marquee DOC	
3	999-2224	Marquee Upper Bracket DOC	

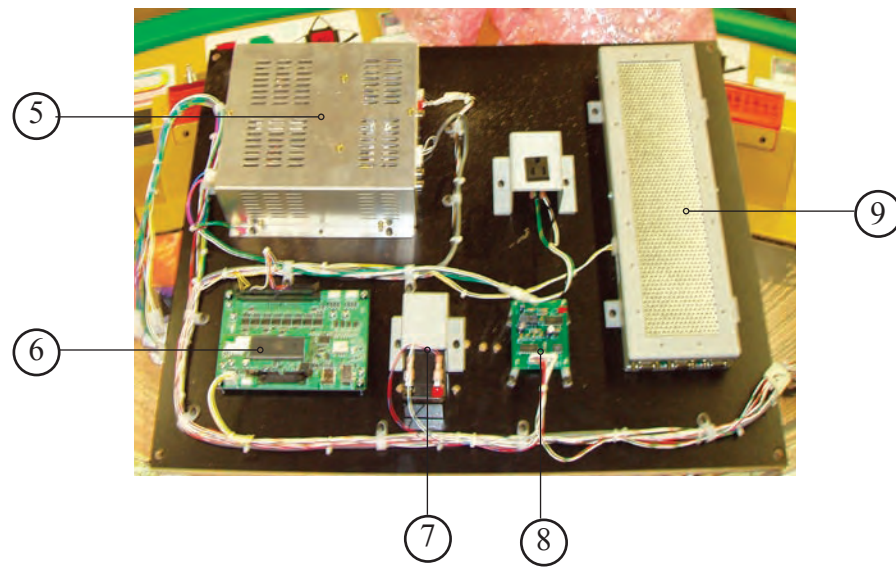
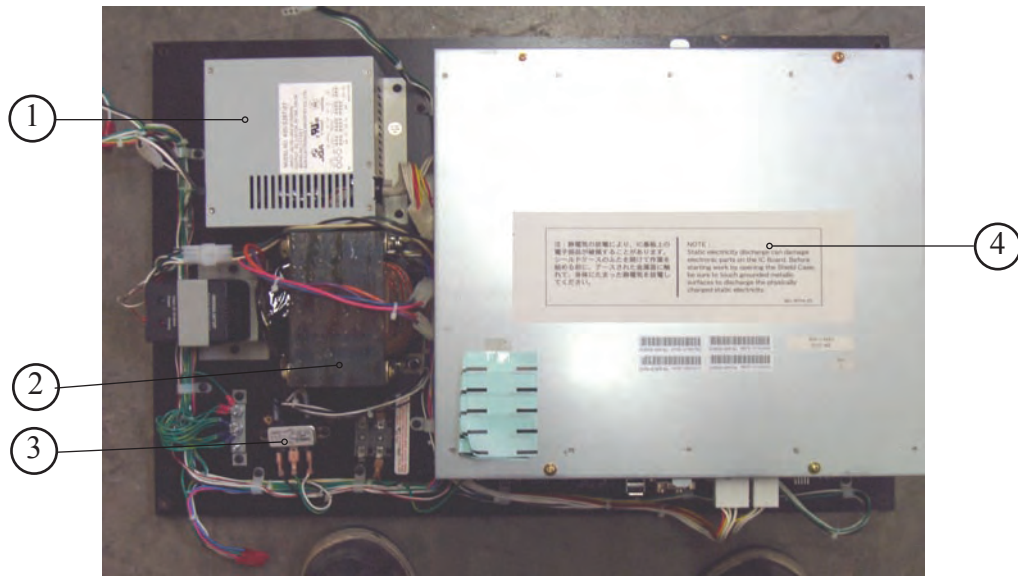

ITEM NO.	PART NO.	DESCRIPTION	NOTE
1	400-5397	SW Regu for JVS	
2	998-0229	Power Transformer	
3	998-0159	Line Filter	
4	DOC-4700	DOC Main Unit	
5	601-10369	Stereo Power Amplifier	
6	837-13551-92	I/O Control Board for JVS	
7	998-0231	Monitor Fan Battery	
8	998-0232	Random PCB	
9	998-0233	Video Combiner Board	

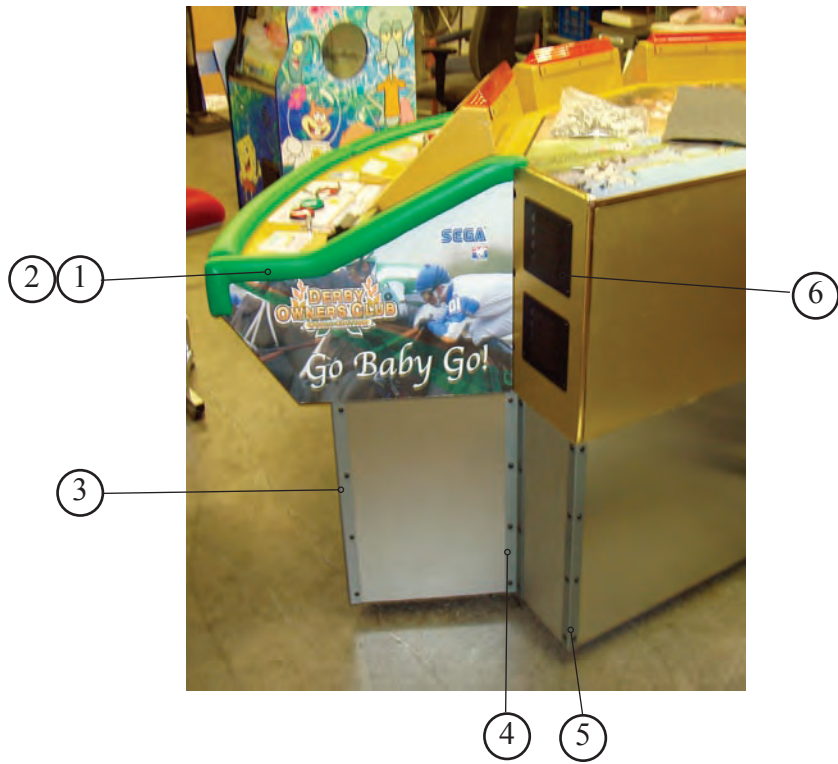

ITEM NO.	PART NO.	DESCRIPTION	NOTE
1	999-2213	Arm Rest Right Side	
2	999-2212	Arm Rest Left Side	
3	999-2226	Angle Bracket Outside Edges	
4	999-2227	Angle Bracket Reverse Inside	
5	999-2228	Angle Bracket Back Edges	
6	999-1065	Fan Grill	
7	Local Purchase	Coin Door	Happ # 40-0057-00
8	999-2211	Arm Rest Station	
9	999-2258	Angle Bracket Front Edges	
10	999-0169	Caster	
11	999-2225	Leg Leveler	
12	999-1177	Cash Box	



ITEM NO.	PART NO.	DESCRIPTION	NOTE
1	999-2229	Winner Lamp Cover Orange Plex	
2	999-2230	Winner Lamp Cover Bracket	
3	998-0234	Winner Lamp LED Board	
4	999-2231	Coin Inlet DOC	
5	999-2242	Button Red Whip Round	
6	999-2243	Button Green Slow Down Round	
7	999-2244	Button Yellow Start	
8	999-2245	Button White Triangle	
9	999-2246	Button Red Square OK	
10	999-2206	Station Lid Gold	
11	999-2232	Monitor Glass Tempered 14 5/8 x 11 3/4	
12	999-2210	Button Plate	
13	Local Purchase	Dollar Bill Acceptor (Not Included in Game) Mars AE-2631-D5E	

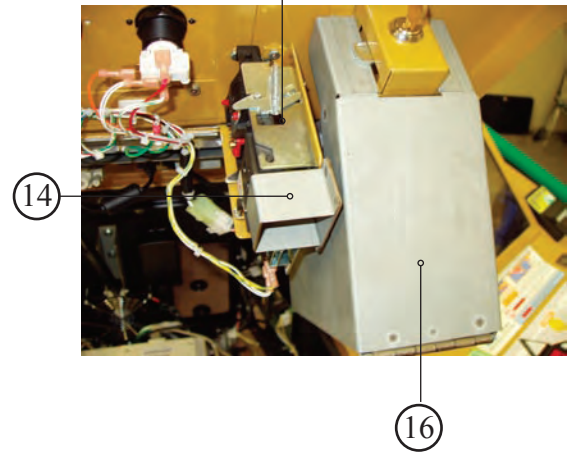
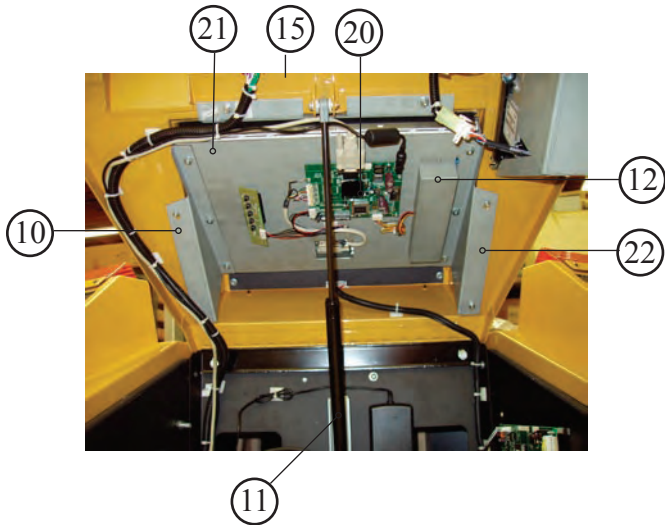
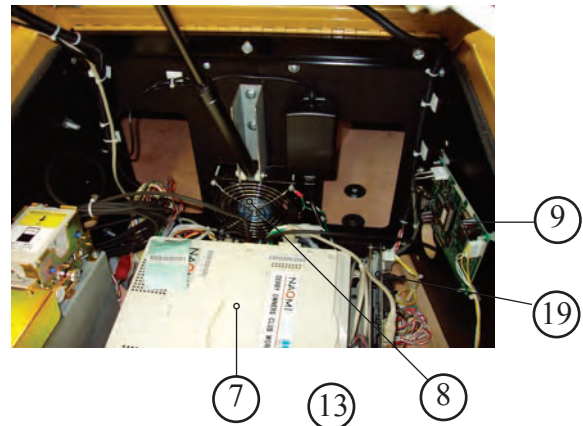
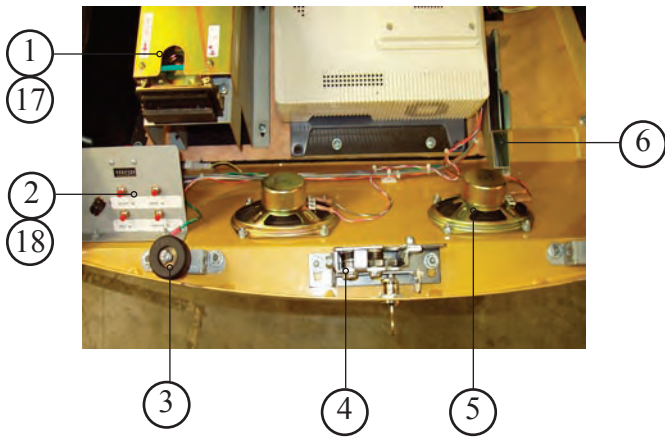

ITEM NO.	PART NO.	DESCRIPTION	NOTE
1	601-11082	Card Reader/Writer	
2	999-2233	Coin Meter Bracket	
3	999-2209	Stopper/Bumper	
4	999-2260	Station Latch Bottom	
5	999-2203	Speaker	
6	999-2237	Coin Chute	
7	840-0088D	Game Board DOC	
8	999-1596	Fan DOC	
9	838-13661	Card Reader/Writer Board	
10	999-2234	Monitor Bracket Left	
11	999-2207	Station Lid Strut	
12	999-2238	Inverter Cover	
13	999-2239	Coin Mech Mounting Bracket	
14	999-2240	Coin Mech Coin Deflector Guide	
15	999-2259	Station Latch Top	
16	999-2241	DBA Locking Bracket Box	
17	DOC-1328	Card Guide	
18	999-1899	Coin Meter	
19	837-13551-92	I/O Control Board for JVS	
20	998-0230	OSD PCB	
21	999-2235	Monitor Bracket	
22	999-2236	Monitor Bracket Right	

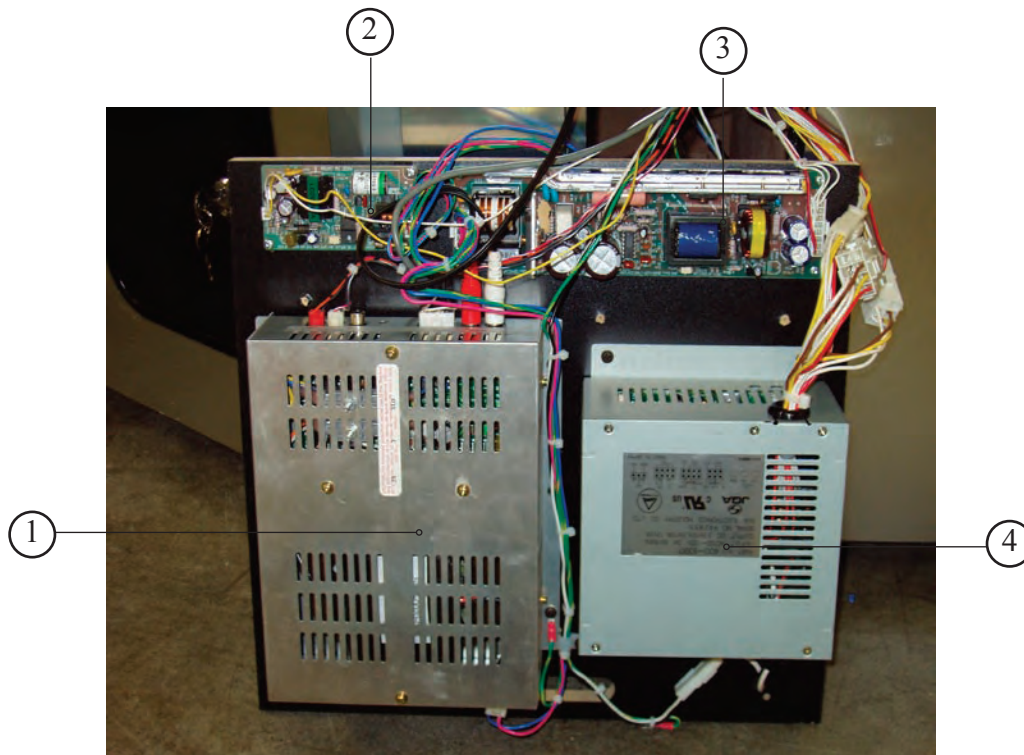

ITEM NO.	PART NO.	DESCRIPTION	NOTE
1	601-10369	Audio Amplifier	
2	400-5421-01005	Some Strange Board	
3	400-5421-10012	Some Other Strange Board	
4	400-5397	SW Regu for JVS	

17. WIRE COLOR CODE TABLE

THE WIRE COLOR CODE is as follow:

- A PINK
- B SKY BLUE
- C BROWN
- D PURPLE
- E LIGHT GREEN

Wires other than those of any of the above 5 single colors will be displayed by 2 alphanumeric characters.

- 1 RED
- 2 BLUE
- 3 YELLOW
- 4 GREEN
- 5 WHITE
- 7 ORANGE
- 8 BLACK
- 9 GRAY

If the right-hand side numeral of the code is 0, then the wire will be of a single color shown by the left-hand side numeral (see the above).

Note 1: If the right-hand side alphanumeric is not 0, that particular wire has a spiral color code. The left-hand side character shows the base color and the right-hand side one, the spiral color.

<Example> 51 WHITE / RED

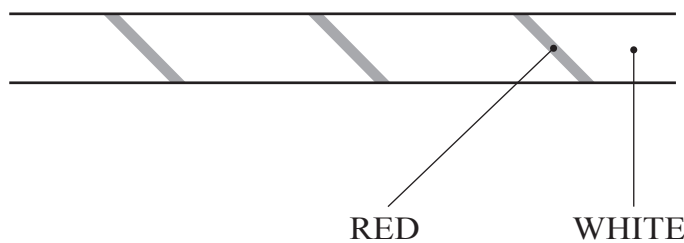

Note 2: The character following the wire color code indicates the size of the wire.

- U: AWG16
- K: AWG18
- L: AWG20
- None: AWG22

Warranty

Your new Sega Product is covered for a period of 90 days from the date of shipment. This certifies that the Printed Circuit Boards, Power Supplies and Monitor are to be free of defects in workmanship or materials under normal operating conditions. This also certifies that all Interactive Control Assemblies are to be free from defects in workmanship and materials under normal operating conditions. No other product in this machine is hereby covered.

Sellers sole liability in the event a warranted part described above fails shall be, at its option, to replace or repair the defective part during the warranty period. For Warranty claims, contact your Sega Distributor.

Should the Seller determine, by inspection that the product was caused by Accident, Misuse, Neglect, Alteration, Improper Repair, Installation or Testing, the warranty offered will be null and void.

Under no circumstances is the Seller responsible for any loss of profits, loss of use, or other damages.

This shall be the exclusive written Warranty of the original purchaser expressed in lieu of all other warranties expressed or implied. Under no circumstance shall it extend beyond the period of time listed above.



SEGA AMUSEMENTS USA, INC.

45133 Industrial Drive
Fremont, CA 94538
(415) 701-6580 phone
(415) 701-6594 fax