

DELAVAL



A Transamerica Company

APPROVED
DUKE POWER CO.
DATE **MAY 07 1979**
C. WYLLIE
CHIEF ENGINEER
By: **ELECTRICAL DIVISION**

DOCUMENT CONTROL DATE
MAY 3 1979
DUKE POWER COMPANY
DESIGN ENGINEERING

INSTRUCTION MANUAL

Volume I

C N M 1301.00-237 vol I

MODEL DSRV-16-4 DIESEL ENGINE-GENERATOR SET
SERIAL Nos. 75017-2761
75018-2762
75019-2763
75020-2764

DUKE POWER COMPANY
CATAWBA POWER STATION

ENGINE AND COMPRESSOR DIVISION NUCLEAR SAFETY RELATED

B405020170 B40502
PDR ADDCK 05000413
PDR

Dop 3L



Transamerica Delaval Inc.
 Engine and Compressor Division
 550 85th Avenue
 P.O. Box 2161
 Oakland, California 94621

Engine Data Sheet

Manufactured for	DUKE POWER COMPANY P.O. BOX 1339 CHARLOTTE, NC 28201	Sales Order Number 75017-75020
For Installation	CATAWBA NUCLEAR STATION	Purchase Order Number C-20660

ENGINE DATA

Model DSRV-16-4	Serial No(s). 75017-2761, 75018-2762, 75019-2763, 75020-2764					
<input checked="" type="checkbox"/> Stationary <input type="checkbox"/> Marine <input checked="" type="checkbox"/> Nuclear Standby <input checked="" type="checkbox"/> Diesel <input type="checkbox"/> Dual Fuel <input type="checkbox"/> Heavy Fuel <input checked="" type="checkbox"/> V type <input type="checkbox"/> Inline						
No. Cylinders 16	Bore 17 IN.	Stroke 21 IN.	Cycles 4	Total Displacement 76,266 CU-IN.	Controls RIGHT HAND	
BMEP 225 PSI	BHP 9770 @ 450 RPM	Crankshaft Rotation CLOCKWISE WHEN VIEWED FROM FLYWHEEL END			Starting System PILOT AIR, GEAR DRIVEN DISTRIB.	
Firing Order 1L-8R-4L-5R-7L-2R-3L-6R-8L-1R-5L-4R-2L-7R-6L-3R						
Fuel Injection Timing 22° LEFT BANK, 21° RIGHT BANK BEFORE TOP DEAD CENTER, SET 13.06 IN. LEFT BANK, 12.46 IN. RIGHT BANK BTDC ON A 68 IN. DIAMETER FLYWHEEL						
Fuel Injection Pump Rack at full load 37 MM						
Valve Clearance - Cold Engine INTAKE; 0.030 IN. EXHAUST; 0.030 IN.						

FACTORY TEST RESULTS (Average Full Load Data)

Item	Diesel	Dual Fuel	
EXHAUST TEMPERATURE	977° F		
AIR MANIFOLD PRESSURE	48.5 IN.-HG		
AIR MANIFOLD TEMPERATURE	128° F		
AMBIENT TEMPERATURE	71° F		
BAROMETRIC PRESSURE	29.70 IN.-HG		

NOTE: Exhaust temperatures are the average for all cylinders during factory test under LOCAL AMBIENT CONDITIONS. Temperatures in the field, therefore, may exceed this average temperature. Always include serial numbers when communicating with DELAVAL Engine and Compressor Division concerning engine performance, or when ordering spare or replacement parts.

Power Engines



Transamerica Delaval Inc.
Engine and Compressor Division
550 85th Avenue
P.O. Box 2161
Oakland, California 94621

GUARANTEE

Unless otherwise specifically stated, all machinery and equipment purchased hereunder is subject to the following warranty: Transamerica Delaval Inc., Engine and Compressor Division (hereinafter called Company) warrants that machinery and equipment manufactured by Company and furnished and delivered to the Purchaser hereunder shall be of the kind and quality described in the Company's specifications, and no other warranty or guaranty except of title is made or shall be implied. If any part of said machinery and equipment thus manufactured by the Company fails because of defective workmanship or material within one year from the date of starting the engine after delivery, but not exceeding fifteen months from the date of shipment, the Company will, provided such machinery and equipment has been used for the purpose and in the manner intended and the Company's examination shall disclose to its satisfaction that such parts are defective, replace such defective parts free of charge, f.o.b. cars at its warehouse in Oakland, California, but the Company will not be liable for repairs or alterations unless the same are made with its written consent or approval. The Company will not be liable for damages or delays caused by such defective material or workmanship, and it is agreed that the Company's liability under all guaranties or warranties, either express or implied, is expressly limited to the replacing of parts failing through defective workmanship or material within the times and in the manner aforesaid. Parts claimed to be defective are to be returned to the Company at its option, transportation prepaid. The Company makes no guaranties or warranties whatsoever in respect to products other than that manufactured by the Company as they are sold under the regular warranties of the respective manufacturers, copies of which will be furnished if requested. All warranties and guaranties as to efficiency and capacity are based upon shop tests when operating under specified conditions, but do not apply to any condition varying from the foregoing. The liability of the Company (except as to title) arising out of the supplying of said machinery or equipment or its use, whether on warranties or otherwise, shall not in any case exceed the cost of correcting defects in the machinery or equipment as herein provided, and upon the expiration of said warranty, as herein provided, all such liability shall terminate.

PRODUCT IMPROVEMENTS

The Company reserves the right, where possible, to include changes in design or material which are improvements. Also reserved is the right to furnish equipment of design modifications best suited to a particular installation, location, or operating condition, as long as such modification exceeds Purchaser's design specifications. The Company cannot be responsible for including improvements made after start of production on Purchaser's equipment.

Instruction Manual

TABLE OF CONTENTS

SECTION 1 – INTRODUCTION

Purpose	1-1
Scope of Manual	1-1
Notes, Cautions and Warnings	1-1
Customer Assistance	1-1
Parts Manual	1-2
Associated Publications Manual	1-2
General Engine Description	1-2

SECTION 2 – INSTALLATION

General	2-1
Foundation Drawing	2-1
Installation Drawing	2-1
System Schematic Drawings	2-1
Handling and Shipment	2-1
Foundation	2-2
Foundation Bolt Assemblies	2-2
Preparation For Installation	2-3
Placing Engine Over Foundation	2-3
Mounting Flywheel and Connecting Shaft	2-5
Grouting	2-5
Piping Systems	2-6
Treatment of Piping	2-6
Jacket Water System	2-7
Cooling Water System	2-8
Fuel Oil System	2-9
Lubricating Oil System	2-10
Flow Principle	2-10
Keep Warm Circuit	2-10
Placing Lubricating Oil System In Service	2-10A
Intake System	2-11
Exhaust System	2-12
Starting Air System	2-13

SECTION 3 – OPERATING PRINCIPLES

PART A – GENERAL

Working Principle	3-A-1
Intake Stroke	3-A-1
Compression Stroke	3-A-1
Power Stroke	3-A-1
Exhaust Stroke	3-A-1

PART B – LUBRICATING OIL SYSTEM

General	3-B-1
Pressure Regulating Valve	3-B-1
Filters and Strainers	3-B-2

Instruction Manual

SECTION 3 – OPERATING PRINCIPLES (Continued)

PART C – CONTROL SYSTEM

General	3-C-1
References	3-C-1
Drawings	3-C-1
Operating Modes	3-C-1
Control Options – Remote and Local	3-C-1
Panel Electrical Control	3-C-2
Automatic Safety Shutdown System	3-C-4
Local Engine Control Panel	3-C-4

SECTION 4 – ENGINE OPERATION

General	4-1
Pre-Start Procedure	4-2
Remote Manual Start	4-2
Local Manual Start	4-3
Start Diesel Signal	4-3
Remote Control Room Emergency	4-3
Normal Stop	4-4
Emergency Stop	4-4
Starting, Stopping and Operating Precautions	4-4

SECTION 5 – MAINTENANCE

General	5-1
Maintenance Concept	5-1
Record Keeping	5-1
Maintenance Schedules	5-3
Preserving Engine For Shipment or Storage	5-5
Specifications For Protective Materials	5-5
Preservation Equipment	5-6
Torque Wrench Tightening Procedures and Values	5-6
Procedure	5-6
Torque Values	5-6
Pre-Stressed Studs	5-6

Instruction Manual

SECTION 6 – DISASSEMBLY, INSPECTION AND REPAIR

PART A – GENERAL

Rotation and Cylinder Designation	6-A-1
Assembly of Parts	6-A-1
Use of Assembly Drawings	6-A-1
Special Tools	6-A-2
Cleanliness	6-A-2
Torquing	6-A-2

PART B – CYLINDER HEADS AND VALVES

Cylinder Head Removal	6-B-1
Inspection	6-B-1
Valves	6-B-2
Valve Spring Replacement	6-B-2
Valve Removal From Cylinder Head	6-B-2
Valve Inspection and Reconditioning	6-B-3
Cylinder Head Installation	6-B-3

PART C – PISTONS AND RODS

General	6-C-1
Connecting Rod Bearing Shell Replacement	6-C-1
Link Rod and Piston Removal	6-C-2
Piston and Master Rod Removal	6-C-3
Removal of a Seized Stud	6-C-4
Disassembly	6-C-5
Inspection	6-C-5
Piston Ring Replacement	6-C-6
Piston Ring Gap and Side Clearances	6-C-7
Piston Pin Bushing Replacement	6-C-7
Link Pin Bushing Replacement	6-C-7
Piston and Rod Assembly	6-C-8
Piston and Master Rod Installation	6-C-9
Piston and Link Rod Installation	6-C-10
Cylinder Liners	6-C-10
Liner Removal	6-C-10
Liner Installation	6-C-10

PART D – CRANKSHAFT AND BEARINGS

Main Bearings	6-D-1
Bearing Cap Removal	6-D-1
Bearing Shell Replacement	6-D-2
Bearing Cap Installation	6-D-2
Crankshaft Alignment and Thrust Clearance	6-D-4
Checking Thrust Clearance	6-D-4
Crankshaft Web Deflection	6-D-5
Deflection Standards	6-D-5
Corrective Action	6-D-5

PART E – CAMS, CAMSHAFTS AND BEARINGS

General	6-E-1
Camshaft Bearing Replacement	6-E-1
Cam Replacement	6-E-1
Timing Gears	6-E-3
Inspection	6-E-4
Assembly	6-E-4
Camshaft Timing	6-E-5

Instruction Manual

SECTION 6 – DISASSEMBLY, INSPECTION AND REPAIR (Continued)

PART F – FUEL SYSTEM

Fuel Injection Equipment	6-F-1
Fuel Injection Nozzles	6-F-1
Nozzle Adjustment	6-F-2
Fuel Injection Pumps	6-F-2
Description of Operation	6-F-3
Malfunctioning Pump	6-F-4
Pump Removal	6-F-4
Pump Disassembly	6-F-4
Pump Assembly	6-F-5
Pump Installation and Timing	6-F-6

DOCUMENT CONTROL DATE
JAN 21 1980
DUKE POWER COMPANY
DESIGN ENGINEERING

PART G – ENGINE CONTROLS

Overspeed Trip	6-G-1
Overspeed Trip Adjustment	6-G-2
Governor Drive Element Replacement	6-G-3
Logic Board Trouble Shooting	6-G-4
Checking Logic Elements	6-G-4

PART H – ENGINE BALANCING

General	6-H-1
Cylinder Balance	6-H-1
Fuel Injection Equipment	6-H-1
Engine Out of Tune	6-H-1
Preventive Maintenance	6-H-2
Trouble Shooting	6-H-2

PART I – STARTING AIR SYSTEM

General	6-I-1
Air Supply	6-I-1
Operation	6-I-1
Starting Air Valve Removal	6-I-2
Valve Disassembly	6-I-2
Valve Assembly	6-I-2
Valve Installation	6-I-2
Timing Starting Air Distributor	6-I-3
Air Filter Inspection	6-I-3
Strainers	6-I-3
Starting Air Distributor Data	6-I-6

PART J – COOLING WATER SYSTEMS

General	6-J-1
Operation	6-J-1
Treatment of Jacket Water	6-J-1
Water Softeners	6-J-2
Cleaning The Jacket Water System	6-J-2
Environmental Restrictions	6-J-2
Water Pump	6-J-3
Pump Repair Procedures	6-J-5
Partial Disassembly of Pump – Procedure "A"	6-J-5
Major Overhaul of Pump – Procedure "B"	6-J-6

PART K – LUBRICATING OIL SYSTEM

Filters and Strainers	6-K-1
Lubricating Oil Pump	6-K-2
Removing Pump	6-K-2
Pump Disassembly	6-K-3
Pump Reassembly	6-K-3
Oil Pump Gear Carrier Assembly	6-K-4
Disassembly and Assembly of Gear Carrier Assembly	6-K-4

SECTION 6 – DISASSEMBLY, INSPECTION AND REPAIR (Continued)

PART L – MISCELLANEOUS

Manometer	6-L-1
Measuring Vacuum	6-L-1
Operation and Maintenance	6-L-1
Crankcase Pressure	6-L-2
Crankcase Ventilation System	6-L-2
Crankcase Vacuum	6-L-2

SECTION 7 – TROUBLE SHOOTING

General	7-1
Records	7-1

SECTION 8 – APPENDICES

Appendix I – Torsional Stress and Critical Speeds	8-2
Appendix II – Operating Pressures and Temperatures	8-3
Appendix III – Table of Clearances	8-4
Appendix IV – Torque Values	8-5
Appendix V – Timing Diagram	8-6
Appendix VI – Lubricating Oil Recommendations	8-7
Appendix VII – Alarms and Safety Shutdowns	8-8
Appendix VIII – Fuel Oil Specifications	8-9
Appendix IX – Power Engine Factory Test Log	8-10

**DOCUMENT
CONTROL DATE**

JAN 21 1980

**DUKE POWER COMPANY
DESIGN ENGINEERING**

LIST OF ILLUSTRATIONS

Fig. No.	Title	Page
1-1	Cross Section, Typical Model RV Diesel Engine	1-3
2-1	Suggested Foundation Bolt Template	2-2
2-2	Crankshaft Alignment Record, Form D-1063	2-4
2-3	Flywheel Mounting	2-5
3-A-1	Diagram of Working Principle	3-A-1
3-B-1	Oil Pressure Regulating Valve	3-B-1
6-A-1	Engine Rotation and Cylinder Designation	6-A-1
6-B-1	Cylinder Head Lifting Fixture	6-B-1
6-B-2	Valve Spring Removal Tool	6-B-2
6-B-3	Removing Valve Keepers	6-B-2
6-B-4	Tightening Sequence For Cylinder Head Stud Nuts	6-B-3
6-C-1	Pistons and Connecting Rods	6-C-1
6-C-2	Bearing Replacement Tool Arrangement	6-C-1
6-C-3	Tools Installed For Removing Piston and Link Rod	6-C-2
6-C-4	Lifting Piston and Link Rod From Cylinder Liner	6-C-3
6-C-5	Tools Installed For Piston and Master Rod Removal	6-C-3
6-C-6	Lifting Master Rod and Piston From Cylinder Liner	6-C-4
6-C-7	Piston Assembly	6-C-5
6-C-8	Piston and Rod Installation	6-C-9
6-C-9	Liner Sealing Rings	6-C-10
6-D-1	Main Bearing Cap	6-D-1
6-D-2	Crankshaft Thrust Rings	6-D-1
6-D-3	Pre-Strusser Assembly	6-D-2
6-F-1	Sectional View of Typical Nozzle and Holder Assembly	6-F-2
6-F-2	Pump Plunger and Barrel Arrangement	6-F-3
6-F-3	Effective Stroke	6-F-3
6-F-4	Flywheel Timing Marks	6-F-6
6-F-5	Pump Base To Tapnet Adjustment	6-F-6
6-G-1	Overspeed Trip Governor	6-G-1
6-G-2	Governor Drive Coupling	6-G-3
6-I-1	Starting Air Valve	6-I-2
6-J-1	Water Pump Assembly	6-J-3
6-J-2	Water Pump to Crankcase Adapter	6-J-4
6-J-3	Gear Carrier Assembly	6-J-4
6-K-1	Lubricating Oil Pump and Gear Carrier Assembly	6-K-1
6-K-2	Lubricating Oil Pump Assembly	6-K-2
6-K-3	Gear Carrier Assembly	6-K-4
6-L-1	Manometer With Vacuum Pump	6-L-1
6-L-2	Reading Manometer	6-L-1



Record Of Changes

CHANGE NUMBER	DATE OF CHANGE	VOLUME			DATE CHANGE ENTERED	ENTERED BY
		I	II	III		

Instruction Manual

SECTION 1 INTRODUCTION

PURPOSE.

The purpose of this instruction manual is to assist the owner and operating personnel in the operation, maintenance, adjustment and repair of the Transamerica Delaval Inc., Engine and Compressor Division equipment described on the data sheet in the front of the manual. The instructions given herein cover generally the operation and maintenance of this equipment. Should any questions arise which is not answered specifically by these instructions, they should be referred to Transamerica Delaval for further detailed information and technical assistance.

SCOPE OF MANUAL.

This manual cannot possibly cover every situation connected with the operation, adjustment, inspection, test, overhaul and maintenance of the equipment furnished. Every effort is made to prepare the text of the manual so that engineering and design data is transformed into the most easily understood wording. Transamerica Delaval, in furnishing this equipment, must presume that the operating and maintenance personnel assigned thereto have sufficient technical knowledge to apply sound safety and operational practices which may not be otherwise covered herein. In applications where Transamerica Delaval furnished equipment is to be integrated with a process or other machinery, these instructions should be thoroughly reviewed to determine the proper integration of the equipment into the overall plant operational procedures.

NOTES, CAUTIONS AND WARNINGS.

Notes, cautions and warnings, as used in this manual, are intended to convey the following meanings.

- a. NOTES – Operating procedures, conditions, etc., which it is essential to emphasize or highlight because of their importance to the proper operation of the machinery.
- b. CAUTIONS – Operating procedures, practices, etc., which, if not strictly observed, could result in damage to, or destruction of equipment.
- c. WARNINGS – Operating procedures, practices, etc., which could result in personal injury or possible loss of life if not correctly followed.

CUSTOMER ASSISTANCE.

Transamerica Delaval Engine and Compressor Division maintains a staff of factory trained service personnel who are available at nominal rates to assist or advise in the installation, overhaul and repair of 'Enterprise' machinery. It is recommended that one of these service men be requested when extensive repairs are being made on the equipment. If assistance is required, write or wire Transamerica Delaval, Engine and Compressor Division, Customer Service Department, furnishing complete information including serial numbers.

Instruction Manual

PARTS MANUAL.

The *Parts Manual*, designated Volume II, contains engine specifications, group parts lists, assembly parts lists and assembly drawings which are applicable to the unit. Instructions are provided to assist in the ordering of spare and replacement parts. The assembly drawings are intended to assist in the identification of parts, however, it is recommended that the part numbers appearing on these drawings not be used when ordering parts. Rather, use the part numbers shown on the appropriate group parts list.

ASSOCIATED PUBLICATIONS MANUAL.

The *Associated Publications Manual*, designated Volume III, is an alphabetical assembly of manufacturer's bulletins, forms, instructions, etc. which are applicable to the components which are furnished with the engine, but which are not of Transamerica Delaval Engine and Compressor Division manufacture. The contents are indexed, both alphabetically by manufacturer, and numerically by Transamerica Delaval Engine and Compressor Division part number.

GENERAL ENGINE DESCRIPTION.

The Model RV diesel engine is a four-stroke-cycle, turbocharged, aftercooled, V-type engine. The angle of the Vee is 45 degrees. Trunk-type pistons, removable wet-type cylinder liners, pressure lubrication and mechanical fuel injection are features of the engine. Individual fuel injection pumps are provided for each cylinder and, as they are of standard design, are interchangeable. The fuel lines are of equal length and are relatively short, reducing line surge to a minimum. Fuel pumps, nozzles and orifice size and angle are all carefully matched to the engine and the fuel to be used to give a maximum thermal efficiency. Engine rotation and cylinder bank designation are determined while facing the engine at the flywheel. Number one cylinders are always the pair farthest from the flywheel end.

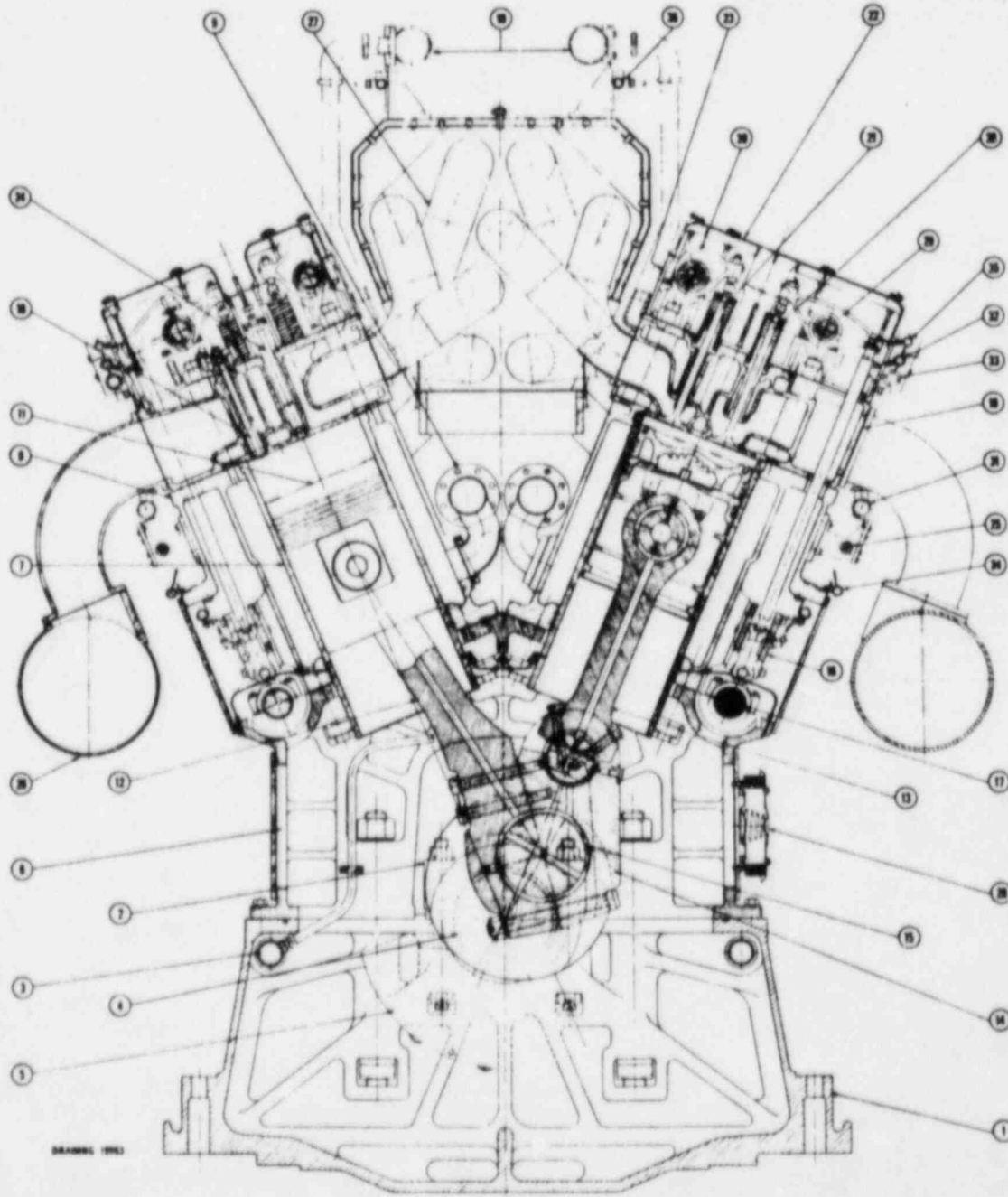

Item	Description	Group Parts List
1	Engine Base	305
2	Main Bearing Cap	305
3	Lubricating Oil Header	307
4	Crankshaft & Bearings	310
5	Crankshaft Counterweight	310
6	Crankcase Assembly	311
7	Cylinder Liner	315
8	Engine Block	315
9	Jacket Water Header (In)	315
10	Jacket Water Header (Out)	317
11	Piston	340
12	Master Rod	340

Item	Description	Group Parts List
13	Link Rod	340
14	Connecting Rod Box	340
15	Connecting Rod Bearings	340
16	Tappets	345
17	Camshaft & Bearings	350
18	Air Starting Valve	355
19	Cylinder Head	360
20	Intake Valve	360
21	Exhaust Valve	360
22	Cylinder Head Cover	362
23	Cylinder Head Sub Cover	362
24	Fuel Injection Nozzle	365

Item	Description	Group Parts List
25	Fuel Pump Linkage	371
26	Intake Manifold	375
27	Exhaust Manifold	380
28	Crankcase Relief Valve	386
29	Rocker Arm, Intake	390
30	Rocker Arm, Exhaust	390
31	Starting Air Manifold	441
32	Fuel Oil Header	450
33	Fuel Oil Header	450
34	Fuel Oil Drain	450
35	Rocker Arm Oil Header	465
36	Pyrometer Conduit	630

Figure 1-1. Cross Section, Typical Model RV Diesel Engine

Instruction Manual

SECTION 2 INSTALLATION

GENERAL.

As the installation requirements for an engine may vary from site to site, the instructions contained in this section of the manual are representative of a typical installation and not necessarily the exact procedure for a specific site. Certified installation and foundation drawings are furnished to each customer which detail the dimensions and installation requirements for that particular unit.

FOUNDATION DRAWING.

The foundation drawing will be accurately dimensioned and must be carefully observed. Carelessness in locating foundation bolts, pipes, conduits and drains will cause difficulty during installation and alignment of the unit. It is essential that the foundation be constructed to the highest standards of accuracy.

INSTALLATION DRAWING.

The installation drawing details the measurements for machinery location, distances required for normal maintenance tasks and the overhead clearances necessary for piston removal. In addition, the drawing will indicate the location and size of connection points for pipes and the electrical requirements for alarm and control mechanisms.

SYSTEM SCHEMATIC DRAWINGS.

Electrical and flow diagrams are furnished for the various systems. Flow diagrams describe graphically the recommended system for interconnecting the various items of equipment in that particular circuit, as well as the minimum pipe sizes.

HANDLING AND SHIPMENT.

Care must be exercised to avoid damage during the handling of the engine and associated equipment during shipment and installation. The unit should be lifted only from the lift pads on the side of the engine base (where provided) as indicated on the installation drawing. When securing the engine during shipment or other movement, make sure no binding stresses are imposed on the engine base or crankshaft.

FOUNDATION.

Make a foundation bolt template, using the certified foundation drawing to determine the location of the equipment mounting bolts. See figure 2-1 for a suggested method of building the template. Exercise care in locating bolt centers. Place and support the template from the foundation forms. Anchor securely to prevent movement of the template. Thread foundation bolt into lower nut in pipe sleeve being careful not to damage cap at bottom of nut. Insert foundation bolts and sleeves in holes provided in the template then tighten the upper nuts. Sleeves must be securely held in correct position to prevent any movement when pouring concrete. A suggested method is to use reinforcing rods welded to each sleeve or on top of each anchor plate in both rows of bolts, running the length of the engine, and adding "X" bracing between the two rows of bolts. Another suggestion is to tie the bolt assemblies to other reinforcing rods already in the foundation. *Recheck template position, alignment and elevation before pouring concrete.* It is recommended that a DELAVAL Engine and Compressor Division service representative be present to check bolt layout. The foundation is to be poured monolithic and must be suitably reinforced with reinforcing steel. Let concrete set for 10 days before installing equipment, and 30 days before running equipment.

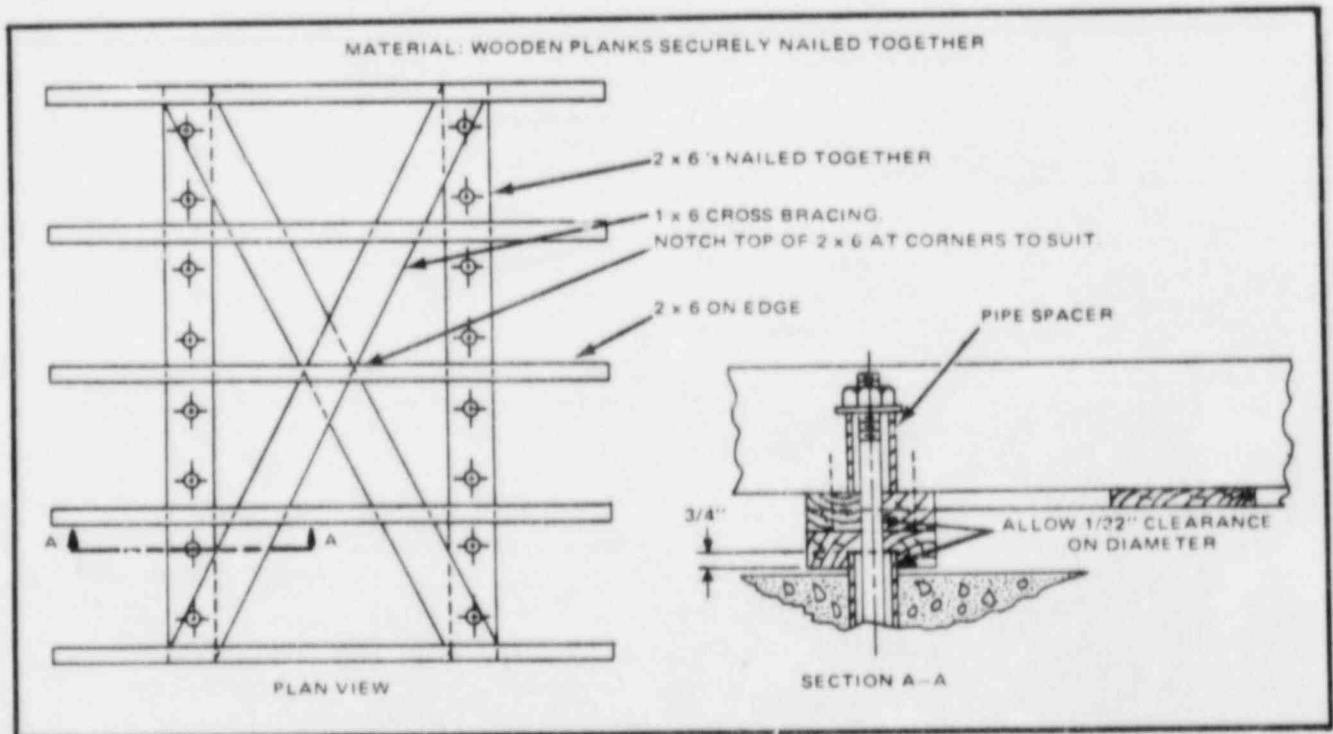

Figure 2-1. Suggested Foundation Bolt Template

FOUNDATION BOLT ASSEMBLIES.

The foundation bolts are so designed that the anchor studs can be removed from the anchors after the foundation has been poured. This permits the engine to be placed over the foundation without any interference or danger of damage to the studs. Once the engine is in place, the studs are installed and screwed into the anchor assemblies.

INSTRUCTION MANUAL

DELAVAL ENGINE AND
COMPRESSOR DIVISION
550 - 85th AVENUE
OAKLAND, CALIFORNIA 94621



PREPARATION FOR INSTALLATION.

Before landing the unit on the foundation, the surfaces of the foundation must be roughened wherever grout is to be applied. Chip and clean as necessary to remove all laitance and foreign matter so that the clean, dry, sharp aggregate required for a good bond to epoxy grout is exposed. The machined surfaces of the sole plates and chocks must be thoroughly cleaned and the leveling screws waxed to prevent their sticking to the grout. The machined bottom faces of the engine base must also be cleaned thoroughly. Remove engine foundation bolts. Place steel plates at jacking screw locations, level plates and grout in place.

PLACING ENGINE OVER FOUNDATION.

Position engine over foundation and insert four toe jacks, one at each corner of the engine, inboard of the shipping skids. If engine is rolled into position, the ends of the jacking screw shields and foundation bolt shields must be protected to avoid damaging shield ends with the rollers. Do not place jacks in the center of the engine as this could cause damage to the engine base. Insure that the combined capacity of the jacks is at least fifty percent greater than the total weight of the engine. See Installation Drawing for weights.

- a. Remove shipping skids, thoroughly clean mounting rails and then lower engine to grade. Be sure the foundation bolt holes in the engine base are correctly aligned with the foundation bolt sleeves in the foundation for easy installation of the foundation bolts.
- b. Clean sole plates and chocks with a degreasing type solvent. It is recommended that after the sole plates are washed, they be primed with a primer recommended by a grout manufacturer. Lubricate the threads of the jacking screws with a mixture of powdered graphite and engine lubricating oil. The lower end of the jacking screws should be coated with wax to prevent the epoxy grout material from binding to the screws.
- c. Place sole plates and chocks in position under the engine as shown in the foundation drawing. Install sole plate retainers on the front and rear sole plates, making sure the sole plates are forced tightly against the shoulder at the inner edge of the engine mounting rails.
- d. Lubricate lower threads of the foundation bolts with standard graphite and oil mixture, install bolts in sleeves and screw firmly into the threads at the bottom of the sleeve. Lubricate threads at the upper end of foundation bolts with oil and graphite powder then place washers and nuts on bolts.
- e. Level and align the engine. Refer to Section 6, Part D of this manual for the method of taking crankshaft web deflection measurements. Record web deflection measurements on Form D-1063. Insure that all sole plate jacking screws are so adjusted as to distribute the weight evenly on all sole plates. When leveling and alignment is satisfactory, snug down the foundation bolt nuts to prevent movement of the engine during installation of the driven equipment and grouting.

INSTRUCTION MANUAL

DELAVAL ENGINE AND
COMPRESSOR DIVISION
550 - 85th AVENUE
OAKLAND, CALIFORNIA 94621



CRANKSHAFT WEB DEFLECTION AND THRUST CLEARANCE RECORD

CUSTOMER _____ ENGINE MODEL _____ SERIAL NO. _____

Use this form to record crankshaft deflection and thrust clearance information. Thrust clearance should be measured by the dial indicator method. Deflection and thrust clearance should be checked and recorded immediately after grouting or chocking the unit, the day before unit start up, after 7 days (168 hours) of continuous operation, and each 6 months thereafter. Deflection and thrust clearance checks made after the unit is in service should be made while the engine is hot, i.e., within 4 hours after the unit has been shut down. Record the temperature of the oil in the engine lube oil sump tank or engine base.

When an engine in which the connecting shaft is solidly coupled to the flywheel is grouted on a concrete foundation, the desired deflection at crank position No. 3 is zero to plus (+) 1 mil (one thousandth) in all cranks except the crank adjacent to the flywheel which should be minus (-) 1/2 mil. This deflection allows for thermal distortion of the concrete foundation.

When an engine is mounted on a steel foundation, i.e., marine installations, appropriate compensations for thermal distortions of the foundation will be based on the locations and temperatures of fuel and lubricating oil tanks adjacent to the engine foundation.

If the deflection in any crank in an engine in service exceeds 3 mils, corrective action must be taken. Also, if the total deflection value in any two adjacent cranks exceeds 3 mils, corrective action must be taken. Example, a +2 mils in any crank with a -2 mils in the next adjacent crank adds up to a total of 4 mils deflection between these adjacent cranks. The exception to the above will be engines that have a flexible coupling between the flywheel and the connecting shaft. These engines may have in excess of 3 mils deflection at position No. 3 in the crank adjacent to the flywheel. In engines with solidly coupled connecting shafting excessive deflection at positions No. 2, 3, or 4 in the crank adjacent to the external shafting usually indicates misalignment between the connecting shafting and the engine crankshaft.

Set the deflection gauge at zero at position No. 1 and turn the crankshaft in the direction of normal rotation.

Position No. 1 for placing the deflection gauge is as follows:

ALL INLINE ENGINES	15° AFTER BOTTOM CENTER
HV, HVA & GVB ENGINES	38° AFTER VERTICAL BOTTOM CENTER
RV ENGINES	52° AFTER VERTICAL BOTTOM CENTER

Record oil sump temperature and thrust clearance and sign the form.

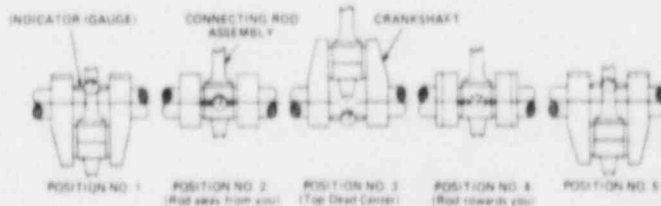

DATE	SUMP TANK TEMP	THRUST CLEAR	SIGNATURE

Record readings in mils, i.e., 1- $\frac{1}{4}$ rather than 0.00125 inches.

POSITION	CYLINDER NUMBER STARTING AT GEARCASE END										DATE	
	1	2	3	4	5	6	7	8	9	10		

Form D-1063 (R 2) 1/75

Figure 2-2. Crankshaft Alignment Record, Form D-1063.

INSTRUCTION MANUAL

DELAVAL ENGINE AND
COMPRESSOR DIVISION
550 - 85th AVENUE
OAKLAND, CALIFORNIA 94621

DELAVAL
A Transamerica Company

MOUNTING FLYWHEEL AND CONNECTING SHAFT.

Carefully clean and de-burr the bores and mating surfaces of the flywheel, the crankshaft flange and the connecting flange. Dirt or burrs will cause misalignment between the crankshaft and the connecting shaft.

a. Apply a thin coat of anti-seize lubricant such as "Molykote" or "Lubriplate" to the mating surfaces of the flywheel and the flange, then mount the flywheel on the engine crankshaft flange. Make sure no dirt is allowed between the mating surfaces while the flywheel is being mounted. Install three retaining plates (see figure 2-3) and draw the flywheel up on the flange until it is seated.

b. Bring the connecting shaft into position, lubricate the mating surfaces with anti-seize lubricant, align the half-inch locating hole in the connecting shaft flange with the locating hole in the flywheel and move the connecting shaft into engagement with the flywheel. Keep dirt from entering the mating area. Use two long one or one and one-quarter inch diameter temporary bolts with washers and nuts to draw the connecting shaft to the flywheel until it is seated. Check with feeler gauges between face of connecting shaft flange and flywheel to be sure the flange is fully seated and square with the flywheel.

c. Special tapered aligning dowels and a flywheel bolt reamer are available from the DELAVAL Engine and Compressor Division Service Department for use in aligning and fitting the flywheel bolts. Lubricate the two aligning dowels with a thin coat of anti-seize lubricant then tap them into two opposite flywheel bolt holes, aligning the bolt holes with those of the shaft flanges. *Do not drive dowels up hard.* Ream two flywheel bolt holes with the special reamer and measure diameter of reamed hole to the nearest 0.0005 inch, and compare diameter of reamed hole with diameter of bolt. Reamed holes should be approximately 0.0005 inch larger than the bolts to allow for an easy tap fit. *Do not drive the bolts in with a sledge, hydraulic ram or jack.* Coat bolts with an anti-seize lubricant and fit into reamed holes. Lubricate threads with powdered graphite and engine oil, assemble nuts on bolts and draw up tight. Remove two temporary bolts and aligning dowels and fit remaining bolts. Torque all bolts to the torque specified in Appendix IV.

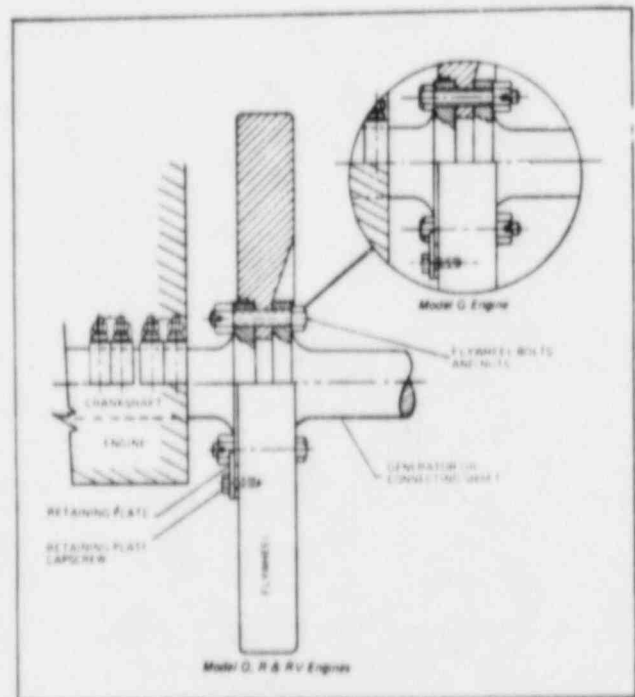

Figure 2-3. Flywheel Mounting

GROUTING.

Check alignment of crankshaft, then align driven equipment. Tighten foundation bolts on driven equipment moderately with jacking screws in place, then recheck entire alignment including crankshaft. Record crankshaft deflections on Form D-1063, *Crankshaft Alignment Record*. A DELAVAL Engine and Compressor Division service representative must be present to supervise alignment procedures.

a. Pour and vibrate the grout under the engine and driven equipment. It is recommended that a representative of the grout supplier be present at the installation to be sure that grout is prepared and placed in accordance with specifications. Do not fill bolt shield holes with grout.

b. After grout has cured, back off the sole plate jacking screws one turn each and torque the foundation bolts to the specified value. Snug all bolts in a criss-cross pattern, then apply a light torque to each, using the same criss-cross pattern. Continue applying torque in increments and in the same pattern until the final torque value is reached.

INSTRUCTION MANUAL

DELAVAL ENGINE AND
COMPRESSOR DIVISION
550 - 85th AVENUE
OAKLAND, CALIFORNIA 94621



PIPING SYSTEMS.

DELAVAL Engine and Compressor Division furnishes suitable piping diagrams to the purchaser or his design agent, recommending minimum pipe sizes for all service lines. In addition, the following should be observed in the fabrication and installation of piping not furnished with the unit, but procured from other sources.

- a. Piping must never cause deflection in the mounting of reciprocating or rotating auxiliary equipment, nor should heavy auxiliary equipment ever be supported by service piping.
- b. Whenever there is a possibility of deflection, flexibility must be designed into the piping.
- c. Chill rings should not be used in welded pipe joints as they tend to retain scale, welding slag and beads which can come loose as the pipe becomes hot during operation.

TREATMENT OF PIPING.

It is strongly recommended by DELAVAL Engine and Compressor Division that all lubricating oil and fuel gas system piping be pickled by a company specializing in this kind of work. Such a company will have the necessary equipment and possess the technical knowledge to completely clean and prepare the pipe for service. Piping which is furnished by DELAVAL Engine and Compressor Division with the unit will have been pickled at the time of fabrication. All piping procured from other sources should be pickled and prepared as follows:

- a. Accessible welds inside carbon steel pipes and fittings must be visibly inspected and the welding beads ground off. All fabricated steel pipes, valves and fittings must be blown clean with steam or air to remove loose scale, sand and welding beads, and be cleaned by the following procedure before the pickling process.

- (1) Wirebrush the entire surface, including the interior with boiler tube brushes or a commercial pipe cleaning apparatus, then blast thoroughly with air to remove loose particles.

- (2) Depending on the degree of contamination, submerge parts for 15 minutes or longer in a solution containing seven to ten ounces of anhydrous trisodium phosphate or sodium hydroxide and one ounce of detergent, Military Specification MIL-D-16791 to one gallon of water at 200° F (93.3° C) to insure complete removal of paint and grease.

- (3) Rinse parts in warm, fresh water at 120° F (48.9° C) to prepare them for the acid treatment.

- (4) Pickle fabricated carbon steel pipes and fittings by submerging them for 30 to 45 minutes in an acid bath containing one part of sulphuric acid, 66° Baume to 15 parts fresh water, supplemented with an inhibitor. The acid bath must be maintained at a temperature between 160° F (71.1° C) and 186° F (82.2° C). While the parts are submerged, agitate the bath. At the end of the pickling procedure, rinse parts in warm, fresh water. After the rinse the parts must be momentarily submerged in a cooling solution containing four ounces of sodium carbonate per gallon of water, then rinsed in cold fresh water and dried by air blast.

- b. Immediately following pickling and rinsing, coat both the inside and the outside of the fabricated steel pipes and fittings with a rust and corrosion preventive compound and seal the ends to prevent entry of dirt. The compound must be soluble in the lubricating oil that will be used, and compatible with it so as not to contaminate the oil. Ordinary lubricating oil will not prevent rust in the pipes. Mechanical cleaning will not completely clean the pipes, therefore, this method is not acceptable. Apply the compound by spraying or flooding the pipes—swabbing with rags or mops will leave lint.

Note

The above procedure is a minimum requirement to produce acceptable clean piping. Substitute methods may produce pipes and fittings of equal or better cleanliness.

Instruction Manual

JACKET WATER SYSTEM.

The jacket water system is individual for each engine. The recommended water treatment is sodium dichromate and boiler compound. Refer to Section 6 of this manual for the method of treatment. The jacket water system consists of an engine driven jacket water pump to circulate the coolant, a thermostatic valve to regulate the temperature of the water by diverting the necessary part of the flow through a jacket water cooler, and a standpipe to maintain a constant head on the pump, and to allow for expansion and bleeding of entrained air. A heater and a "keep-warm" pump are provided to take water from the standpipe, heat it and circulate it through the engine to maintain it in a warmed condition while in standby status. Refer to the jacket water piping schematic drawing in the "Drawings" section of this manual for the relative location of system components, pipe sizes and the direction of flow.

Instruction Manual

COOLING WATER SYSTEM.

There is no separate cooling water system provided by Delaval for the engine. The cooling medium for the jacket water cooler is supplied from other plant sources.

INSTRUCTION MANUAL

DELAVAL ENGINE AND
COMPRESSOR DIVISION
550 - 85th AVENUE
OAKLAND, CALIFORNIA 94621



FUEL OIL SYSTEM.

The fuel system provides the means for storing fuel in the day tank, removal from the day tank and delivery to the fuel injection pumps at the cylinders. The fuel oil system piping schematic drawing in the "Drawings" section of this manual show the pipe sizes, connections, direction of flow and relative location of all major components. Fuel injection equipment on the engine is hand lapped to extremely close tolerances, therefore, fuel cleanliness is of the utmost importance. The fuel system must be kept clean as possible during installation and assembly, and should be cleaned internally and blown clean before initial start up. All piping must be properly supported to minimize pipe vibration and flange loading. Flexible connections are not recommended at customer connections because of the potential failure hazard during operation. All piping must be mechanically cleaned after welding and preserved to prevent rust. The day tank should be mounted high enough to provide adequate suction at the engine-driven fuel oil booster pump. Drains should be provided at all low points and vents at all high points.

Instruction Manual

LUBRICATING OIL SYSTEM.

The lubricating oil system is of the dry sump type which has a sump tank for holding the oil supply. Oil is circulated through the system by an engine-driven pump. Refer to the lubricating oil piping schematic drawing in the "Drawings" section of this manual for the specific details of the system, relative location of major components, direction of flow, and notes relative to installation of the system.

FLOW PRINCIPLE.

Pump suction draws the lubricating oil from the sump tank and discharges it to the lubricating oil cooler. Flow from the cooler is through a lubricating oil filter and pressure strainer to the engine main headers. A branch line from the strainer takes oil to the turbochargers. Return is by gravity flow from the engine base to the sump tank. Separate lines direct return flow from the turbochargers from the sump tank. A relief valve, set at 70 psi, provides protection to the system, and pressure regulating valves regulate the system pressure. Refer to Section 3, Part B of this manual for a description of the pressure regulating valve.

KEEP WARM CIRCUIT.

A "keep warm" circuit is provided to maintain the lubricating oil charge, and thereby the engine, in a warmed and lubricated condition when in the standby status. Heaters at the sump tank warm the oil which is then pumped by the keep-warm pump to the keep-warm filter and strainer and then to the main engine lubricating oil header. To prevent flooding of the turbochargers, there is no supply to the turbochargers in this circuit.

INSTRUCTION MANUAL

DELAVAL ENGINE AND
COMPRESSOR DIVISION
560 - 56th AVENUE
OAKLAND, CALIFORNIA 94621



PLACING LUBRICATING OIL SYSTEM IN SERVICE.

Before the engine is first started, the assembled lubricating oil piping system must be thoroughly flushed with oil. Disconnect the pipe at the pressure strainer inlet and arrange a temporary bypass from this pipe to the sump tank. The bypass will permit oil circulation through the pipes without filling the internal lubricating oil system of the engine. Several thicknesses of cloth sack should be secured to the outlet of the bypass to catch debris as it is flushed out. The sump tank and engine base must be thoroughly cleaned before being filled. An auxiliary lubricating oil pump, or any other continuous duty pump of sufficient capacity, can be used to pump oil during flushing operations. Flushing should continue for at least eight hours if care was exercised during fabrication of the system. As much as 24 hours of flushing may be required for a dirty system. When oil is circulating through the system, the pipes should be thoroughly pounded several times with a heavy hammer to loosen dirt and debris. Hot flushing oil will clean better than cold oil. Piping around the oil cooler requires special attention to insure that the pipes and oil cooler are properly flushed. Precautions must be taken to insure the complete removal of testing fluids, water or other liquids before attempting to flush the cooler.

Note

Engines may be received with the strainer mounted on the engine and connected to the engine lubricating oil header. If it is certain that the connections between the strainer and the engine oil header have not been disconnected since the engine left the factory, the following paragraph may be omitted.

Disconnect jumper tubes between the engine lubricating oil header and the main bearings, and between main headers and auxiliary headers. Secure a fine screen such as a nylon stocking over each main header fitting to catch debris that may be washed through as the system is flushed. Cover main bearing fittings and open ends of auxiliary header feeders to prevent the entry of dirt. Engine oil should be pump through the open system for at least four hours to be sure that any foreign material remaining in the headers is removed. Reassemble internal tubes and brackets as required.

INSTRUCTION MANUAL

DELAVAL ENGINE AND
COMPRESSOR DIVISION
550 - 55th AVENUE
OAKLAND, CALIFORNIA 94621



INTAKE SYSTEM.

Each engine has an independent intake system, the combustion air being piped from outside the engine room through a remotely installed air filter. An inline silencer is fitted in the pipe just ahead of the turbocharger air inlet. The air filter protects the working parts of the engine from the entry of dust. Filters should be cleaned at regular intervals to maintain adequate protection against abrasion and wear.

INSTRUCTION MANUAL

DELAVAL ENGINE AND
COMPRESSOR DIVISION
560 - 85th AVENUE
OAKLAND, CALIFORNIA 94621



EXHAUST SYSTEM.

Each engine is provided with an individual, independent exhaust system. The water jacketed, multi-pipe passage manifold discharges directly into the engine mounted turbocharger(s), and the gas then discharges from the turbocharger(s) through exhaust piping and a silencer to atmosphere. As few bends as possible should be used when laying out exhaust piping. Necessary bends should be of long radius. If three to six bends are used, the entire pipe should be increased to the next nominal size. If more than six bends are necessary, pipe size should be increased two nominal sizes. The length of exhaust piping is not critical, however, if an unusually long pipe is used, the pipe size should be increased to reduce back pressure. A length of flexible metal tubing should be installed in the exhaust line as near the engine as possible to allow for movement, heat expansion, and for isolation of vibration. The exhaust line should be lagged to minimize heat radiation in the engine room. A separate support should be provided so the weight of the exhaust silencer and line is not borne by the engine.

Instruction Manual

STARTING AIR SYSTEM.

The required redundancy of the starting air system is accomplished by utilizing two separate systems. Each consists of a motor-driven air compressor, an air dryer, an aftercooler and a storage tank. Each storage supply is then piped to solenoid valves, two for each system, which block air flow until a starting signal is applied. Check valves downstream of the solenoid valves prevent back flow from one system to the other. When a start signal is applied, the solenoid valves open, admitting starting air to the interconnected headers on the engine. The two starting air distributors then send timed pilot signals to the starting air valves in the cylinder heads in the correct sequence and, as each starting air valve opens, starting air is admitted to the combustion chamber of that cylinder, forcing the piston downward and rotating the crankshaft. This system permits the engine to be cranked even though one supply system fails to operate, or if three of the four solenoid valves fail to function. Reference should be made to the starting air piping schematic drawing in the "Drawings" section of this manual for complete details of the system.

Instruction Manual

SECTION 3

OPERATING PRINCIPLES

PART A – GENERAL

WORKING PRINCIPLE.

ENTERPRISE engines operate on the four stroke cycle principle. The complete cycle for each cylinder consists of the intake, compression, power (or expansion) and exhaust strokes, and requires two complete revolutions of the crankshaft.

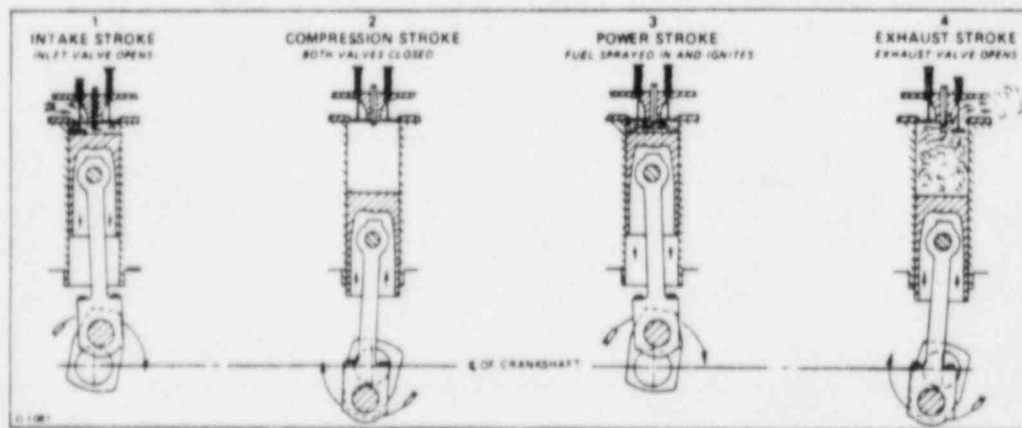

Figure 3-A-1. Diagram of Working Principle

INTAKE STROKE.

During the downward movement of the piston on the intake stroke, the intake valve is open and combustion air enters the cylinder. The exhaust valve remains open during the early part of the stroke to scavenge the cylinder of any unburned gases from the previous power stroke. Combustion air enters the cylinder from the turbocharger under pressure.

COMPRESSION STROKE.

Shortly after the piston passes bottom center and starts upward, the intake valve closes and the air is compressed, raising the temperature of the air to well above the ignition temperature of the diesel fuel. Just before the piston reaches top center, diesel fuel is injected into the combustion chamber by a nozzle which atomizes the fuel and sprays it in a pattern that will achieve optimum combustion efficiency. The heat of compression ignites the fuel.

POWER STROKE.

The burning fuel-air mixture expands and forces the piston downward. This downward thrust transmits power through the connecting rod to the crankshaft, causing it to rotate. Towards the end of the power stroke the exhaust valve opens and exhaust gases start to leave the cylinder.

EXHAUST STROKE.

As the piston moves upward, past bottom center, exhaust gases are forced out of the cylinder through the open exhaust valves. During the last half of the exhaust stroke the intake valve opens to admit combustion air into the cylinder for scavenging purposes.

Instruction Manual

PART B – LUBRICATING OIL SYSTEM

GENERAL.

An engine-driven pump draws oil from the sump through a strainer, and discharges it through the lubricating oil cooler directly to the filter. Filtered oil is then passed through a strainer to the engine lubricating oil header. Oil return to the sump tank is by gravity flow. An integral safety valve on the pump prevents excess discharge pressure, and a pressure regulating valve controls the pressure in the engine lubricating oil header. Refer to the lubricating oil system schematic drawing for the relative location of components and for the direction of flow.

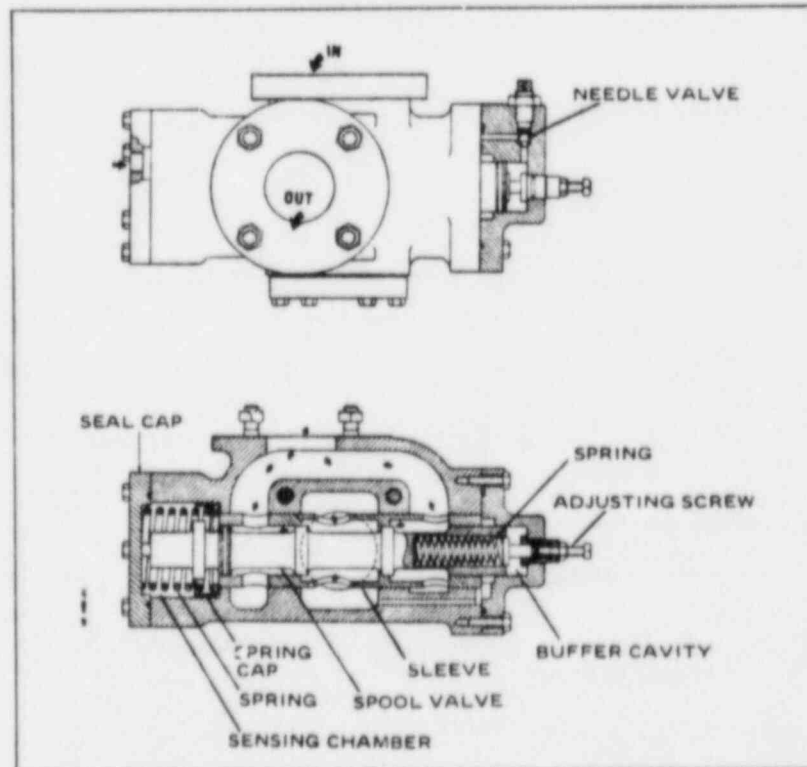

Figure 3-B-1. Oil Pressure Regulating Valve

PRESSURE REGULATING VALVE.

Lubricating oil header pressure in the engine is regulated by a pressure regulating valve, mounted on the pump discharge piping so that the pump discharge is directed to this valve before reaching any other system components. Set at 50 psig, it senses header pressure and regulates the bypass volume to maintain the set header pressure. Besides regulating header pressure, the valve protects the system from excessive pressure during starts with cold oil, or when flow in the system is restricted between the pressure regulating valve and the header pressure sensing point. The functioning of the valve is as follows.

a. The "IN" port of the valve is connected to the pump discharge line and the "OUT" port is connected to a bypass line leading back to the engine base. A sensing tube, connecting the valve seal cap to a point on the main engine oil header, applies header pressure to the valve pressure sensing chamber.

b. The pressure in the sensing chamber acts against the end of a spool valve, compressing a spring at the adjusting screw end of the assembly. If the sensed pressure rises above the set point, the lands of the spool valve will clear the lands on a sleeve. Oil then flows from the inlet section to the outlet-section of the regulating valve and back to the engine base to bypass a part of the pump discharge to reduce the pressure in the header.

INSTRUCTION MANUAL

DELAVAL ENGINE AND
COMPRESSOR DIVISION
550 - 85th AVENUE
OAKLAND, CALIFORNIA 94621



PART B - LUBRICATING OIL SYSTEM (Continued)

c. A drilled passage connects the inlet section of the valve to the annular space around the spool valve at the adjusting screw end. This allows pump discharge pressure to act against the end of the sleeve and oppose the spring force at the other end. When an excessive pressure differential exists between the pump discharge and the header pressures, such as when starting with cold oil, or because of an obstruction in the system between the regulating valve and the header pressure sensing point, the sleeve is forced towards the sensing chamber end, compressing the spring. This will uncover the lands of the spool valve and the excess oil will bypass through the spool valve and the excess oil will bypass through the outlet side of the valve back to the engine base.

d. The oil in the annular space around the spool valve, at the adjusting screw end, will leak past the sealing grooves of the spool valve and into a cavity in the cap. This cavity functions as a buffer chamber. To stop valve oscillation, an adjustable needle valve controls oil spillage from the buffer cavity to the outlet-section of the valve.

e. The oil header pressure is set by increasing or decreasing the spring force acting against the header pressure in the valve sensing chamber. Turning the adjusting screw in will increase header pressure, and backing it out will decrease pressure.

f. Normal lubricating oil pressure is 50 psi, measured between the engine lubricating oil strainer and the engine oil header which is also the pickup point for all gauges and other instrumentation that show or indicate engine lubricating oil pressure. Lubricating oil pressure shutdown devices may take their sensing point at the opposite end of the engine in which case the shutdown set pressure will take into account the normal change in pressure between the supply end of the engine and the shutdown sensor under all conditions of engine speed and lubricating oil temperature.

FILTERS AND STRAINERS.

The full flow filter continuously filters all of the lubricating oil from the pump before it passes to the oil strainer. The length of time that the lubricating oil and the filter elements may remain in service can best be determined by carefully watching the result of oil analysis and the pressure drop across the oil filter. Change periods will vary with the operating conditions to which each individual engine is subjected. During the first two or three days of engine operation after initial installation, or after a major overhaul, the basket-type strainers at the pump suction and at the oil header inlet should be checked and cleaned as necessary to remove any debris and foreign matter that may be present. If at any time the oil pressure gauge shows a low reading, the following should be done to the degree necessary to correct the situation.

- a. Check the oil level in the sump tank, or engine base.
- b. Inspect strainer, filter and lubricating oil cooler. A leak in the cooler may be detected by a sudden increase in oil consumption, and by the presence of oil in the cooling water system. Leakage may occur in the packing between the tubes and the tube sheet, or may be due to tube erosion, depending on the construction of that particular cooler.
- c. Inspect all external and internal piping for tightness and freedom from obstructions.
- d. Dismantle and inspect pump. Refer to manufacturer's instructions on the *Associated Publications Manual*.

Instruction Manual

PART C – CONTROL SYSTEM

GENERAL.

The following is a description of the local engine control system and its operation. The system will start, stop, protect and monitor the integrity of the diesel/generator in the various modes of operation under guidelines specified by the various regulatory and standards committees.

REFERENCES.

The *Associated Publications Manual* contains manufacturer's literature covering the various components of the system. Of special significance are the Delta Switchboard Company's publications, which describe the Local Generator Control Panel. Also significant are the ARO Corporation's publications which give a clear, concise explanation of the functions of the various pneumatic logic elements as well as a parts breakdown and repair procedures. When ordering spare parts for the system, refer to the *Parts Manual* for the correct part numbers.

DRAWINGS.

The drawings provided with these instructions include system schematics, interconnection drawings, and layouts and connections pertaining to the pneumatic logic board assembly, showing the location and orientation of the components of the board, the circuit diagram and checkout procedures. Refer to the control panel group parts list Q2-500 for 75017 in the *Parts Manual* for a listing of the drawings applicable to the system.

OPERATING MODES.

There are two base modes incorporated into the system, the OPERATIONAL mode and the MAINTENANCE or LOCKOUT mode. In the OPERATIONAL mode, the unit will accept a manually injected start signal from either the remote or local control location, if certain permissives have been satisfied. In the OPERATIONAL mode, the unit will also accept an emergency "START DIESEL SIGNAL" (SDS) generated from the owner's equipment in response to a station emergency. The MAINTENANCE or LOCKOUT mode allows routine maintenance or repair. The unit will not accept a start signal while in the MAINTENANCE mode.

CONTROL OPTIONS – REMOTE AND LOCAL.

All control operations, such as starting, stopping, operating and loading of the diesel/generator are normally carried out from the owner's Remote Control Room. Signals generated from the Remote Control location are interfaced with the Local Generator Control Panel, allowing the remote operator to control all voltage, speed/load and synchronization operations. These signals are also interfaced with the electrical and pneumatic circuitry at the Local Engine Control Panel, allowing the remote operator to start, stop and monitor the vital system conditions of the unit and its auxiliaries. Provisions are also included in the system for switching to Local control of diesel/generator operations. If Local control is selected, starting, stopping and monitoring operations are carried out at the Local Engine Control Panel, while voltage control, speed/load adjustment, synchronization and breaker closure operations are carried out from the Local Generator Control Panel. In addition, a breakglass station at the Local Generator Control Panel provides the means of locking out all remote control in the event of a remote circuitry failure or a station emergency when only local control is desired.

a. While in the OPERATIONAL mode the unit will accept a manually injected start signal from the control location selected by the remote operator. If the unit's entire protective system is permissive, it will start, come up to governed speed and build voltage automatically, and controls at the selected location are then used to perform loading operations. While running in this mode the unit's entire protective system is active, and will cause a shutdown in the event of a malfunction. If such a shutdown occurs, or if a deliberate stop signal is applied from either control location, the generator circuit breaker will automatically trip to disconnect the unit from load.

b. If an emergency "START DIESEL SIGNAL" (SDS) is generated from the owner's equipment while the unit is in OPERATIONAL mode, the unit will start if overspeed and generator/switchgear differential trips only are permissive, if d-c power is available, and if at least 150 psi starting air is present in the receivers. Note that the unit will accept

Instruction Manual

PART C – CONTROL SYSTEM (Continued)

such an emergency start signal even if remote control has been disabled by activation of the Lockout Relay at the Local Generator Control Panel. In such a case, sequencing and load control operations would be performed locally. In the emergency start condition, the unit will come up to speed and voltage as required and a load permissive signal will be generated for use in breaker closure and loading. Under this condition, the unit will shut down on overspeed and generator/switchgear differential, and, 60 seconds after starting, low low lubricating oil pressure. No other protective device is functional while the unit is operating in response to an SDS signal.

c. If the unit is undergoing its periodic "Exercise Test" at the moment an emergency SDS signal is received, and running at a speed greater than 200 rpm, the control system will cause the unit to return to a preset voltage and speed setpoint, and will disarm all protection except overspeed, low low lubricating oil pressure and generator/switchgear differential. If the unit is running at a speed of less than 200 rpm, tripping on a fault other than overspeed, generator/switchgear differential or low low lubricating oil pressure, or coasting to a stop at the moment an SDS signal is received, the control system will cause starting air to be admitted to the starting air headers on the engine, in addition to disarming the protective system and returning the unit to its preset voltage and speed setpoints.

d. Every time the engine is shut off, or given an SDS signal, the setpoints of the voltage regulator and governor are returned to their preset values for fifteen seconds. Thereafter, the preset signal is released to allow the operator at either the Local Control Panel or the Remote Control Panel, whichever has been selected, to control both voltage and speed. Note that the governor is automatically placed in isochronous operation when an SDS signal is received.

e. If the emergency is corrected, and the maintained SDS signal is terminated, the control system will automatically reinstate full shutdown protection. Once this is done, however, it will require the receipt of another SDS signal from the owner's equipment to disarm the shutdown system again. This feature prevents an operator from running the diesel manually without shutdown protection. The keyed local manual start switch is used to allow only authorized personnel to initiate a local start sequence.

f. Mode selection is accomplished so as to afford maximum protection for the plant and also for maintenance personnel. Only the local operator can select the system's mode, using the mode selector controls on the Local Engine Control Panel, and local MAINTENANCE selection must be accompanied by a remote permissive signal. If the unit is in the OPERATIONAL mode, the local operator must place the mode selector switch in the MAINTENANCE mode position and depress the MAINTENANCE mode select pushbutton. Simultaneously, the remote operator must send a permissive signal, in order to energize the MAINTENANCE mode solenoid switch. The unit will not accept a start signal while it is in the MAINTENANCE mode. The barring device may be engaged in this mode to turn the engine over manually, or, if the barring device is disengaged and locked out, the unit may be turned over on starting air without starting, by depressing the Engine Roll pushbutton at the Local Panel. An annunciator light will illuminate at the local panel whenever MAINTENANCE mode is selected. If a return to OPERATIONAL mode is desired, the barring device must be disengaged and locked out, and the mode selector switch must be manually reset.

PANEL ELECTRICAL CONTROL (See Drawing 52218).

The Local Engine Control Panel electrical circuitry is shown in schematic form on sheets 1 of 4 through 4 of 4 on the referenced drawing.

a. Starting circuitry is shown on the left side of sheet 1. Note that there are two redundant circuits, each having a separate d-c power source. These circuits are physically spaced as far apart as possible on the panel. Solenoid valves SOL-1L, SOL-2R, SOL-1R and SOL-2L are located on the engine, and when energized admit starting air to the starting air headers on the engine. They are controlled by contacts of relays R3, R4, R6 and R7. Relays R3 and R6 are the emergency start relays, and R4 and R7 are for normal starting.

b. The 6C and 7C MS contacts shown are from the mode selector switch, and they will be in their normally closed position if the unit is in the OPERATIONAL mode, arming the start circuitry. Contacts of the Remote/Local

Instruction Manual

PART C – CONTROL SYSTEM (Continued)

selector switch, located at the owner's Remote Panel, and contacts of the Lockout Relay, located at a break-glass station at the Local Generator Control Panel, are also used as permissives in starting. If the Remote/Local selector switch is in the Remote position, the REM contacts in the Local Manual Start circuitry will open, disarming the circuit. If Local position is selected, the REM contacts will be in their normally closed position, and the start circuitry will be active in the local location. In the event of a remote electrical failure, or if a station emergency occurs and local control only is desired, operation of the Lockout Relay at the Local Generator Control Panel will open the LR contacts in the Remote Manual Start Circuit, and will automatically close the REM contacts in the Local Manual Start Circuitry. In such a case, all remote control is disarmed, and the unit may be operated from the local panels only. Refer to Transamerica Delaval Interconnection Drawing 52437 and Delta Switchboard Company's Drawing D35700 for further details on the Lockout Relay and the Remote/Local selector switch.

c. The redundant "START DIESEL SIGNAL" (SDS) maintained contacts are from the owner's equipment. When these contacts close, relays R9 and R10 are energized, provided the unit is in OPERATIONAL mode, and if pressure switches PS-7 and PS-8 are closed, indicating that at least 150 psi starting air is left in the receivers. These pressure switches are present so that, if for some reason the unit does not fire (valve closed in the fuel supply line, for instance), there will be enough starting air left in the receivers for several manual starts. Contacts of R9 and R10 are used to lock out the Shutdown Activating Solenoid, SOL-3, and energize the Shutdown De-activating Solenoids, SOL-6 and SOL-7, causing the shutdown system to disarm except for overspeed, generator/switchgear differential and low low lubricating oil pressure. In addition, contacts of R9 and R10 will energize relays R3 and R6, provided that tach transmitter contacts SS1-K1 and SS1-K2 have not transferred (i.e., the unit is not running at 200 rpm or higher). Contacts of R3 and R6 are used to energize the starting air solenoids, to energize time delay relays TD1 and TD2, to energize the R1 relays, to place the governor in isochronous operation, and to energize the pre-position circuit for the voltage regulator and the governor setpoints.

d. Note that SS1 failure will not prevent an emergency start. If SS-1 fails to transfer, or even if the device is faulty and fails to function in any way, SS-1 remains closed and the unit will start. If it fails to open at 200 rpm, combustion will close the air start valves, and no damage is done. Field flash is accomplished by the transfer of SS-1, which energizes relays R13 and R14. Contacts of these relays arm the exciter field flash circuit, and when voltage builds to desired levels, field flash is terminated by voltage relay contacts integral to the exciter. Note that, as in the start circuit, SS-1 failure will not prevent field flash, due to the presence of contacts of time delay relays TD1 and TD2. These contacts are in parallel with SS1, and will flash the exciter field after three seconds through R13 and R14.

e. At a manual start either of the switch contacts shown (local or remote, whichever location has been selected for control) are closed momentarily, which energizes relays R4 and R7. Contacts of these relays are used to energize the starting air solenoids, time delay relays TD1 and TD2, and the Shutdown Activating Solenoid, SOL-3. Note that SOL-3 transmits a signal to the pneumatic control circuitry, and the Shutdown Activating Sequence begins. This sequence lasts for approximately 60 seconds, after which time the unit will be running with full shutdown protection. Field flash is accomplished as in the emergency start circuit, by SS1 transfer, or by contacts of TD1 and TD2.

f. The four Run relays (R1, R1A, R1B and R1C) are latched in by contacts of R3 and R6 at an emergency start, or by contacts of TD1 and TD2 at a manual start, provided pressure switch PS-9 is closed, indicating that the unit is not tripped. The R1 relays are used to propagate the Run signal throughout the electrical circuitry. The R2 relay shown is responsive to the latching of R1 or R1A, but there is a 60 second time delay (TD3) before R2 latches. Contacts of R2 are used to disarm various alarm functions which are normally in a fault state when the unit is stopped, starting or stopping.

g. Tachometer transmitter contacts SS2-K3 and SS2-K4 transfer at 430 rpm, energizing relay R25. Contacts of this relay are used to generate the "Up To Speed" permissive for use in sequencing operations. Contacts of the Undervoltage relays are used to energize relays R11A and R11B, indicating that the unit is "Ready To Load". Contacts of these relays are provided for remote sequencer used as needed.

Instruction Manual

PART C – CONTROL SYSTEM (Continued)

h. The "Fail To Start" timers, TD4 and TD5, are energized by contacts of R1 and R1A at a start signal. If neither the tach transmitter nor the Undervoltage relay contacts open within 15 seconds, contacts of the time delay relays energize relays AUX R1 and AUX R2, producing a "Unit Failure To Start" indication. In addition, contacts of the time delay relays are used to reset the R1 relays and R2 if such a failure occurs.

REFERENCE TABLES (See Drawing 52218).

The following reference tables list various electrical components and their functions. Devices covered by these tables include solenoid valves, time delay relays and relays. Line numbers, corresponding to the line numbers on the schematic drawing, are included for each device. For relays, the line number of the relay coil is given, and also the line numbers for the individual contacts. See Table 3-C-3.

LOCAL ENGINE CONTROL PANEL (See Drawing 52213).

The Local Engine Control Panel houses those control components which are not engine or remotely mounted, or mounted, on the generator control panel. Access to the interior of the panel is through hinged doors in the back and sides. A 60 point annunciator is mounted on the upper portion of the face of the panel, and pushbuttons are provided which allow the operator to test, silence, acknowledge and reset alarms. Beneath the annunciator, at eye level, are ten pressure gauges which monitor lubricating oil, turbocharger oil, fuel oil, jacket water, combustion air, starting air and control air system pressures. A manometer is also provided for monitoring crankcase pressure. There are two level gauges used, one to indicate fuel oil day tank level and one to indicate lubricating oil sump tank level. Status lamps, separate from the annunciator, are provided to indicate a-c and d-c circuits available, and shutdowns active. An engine hourmeter is provided which is responsive to relay R1. A tachometer is also included, reading the speed in rpm directly from the speed transmitter. A remote output is available from this transmitter by removing the burden resistor and connecting on the 4-20 MA terminals. Essential controls, located in the lower portion of the panel, are separated from the non-essential controls by a metal barrier. These controls include starting, stopping and mode selection controls, as well as switches for pumps, heaters and compressors. Delaval engines are arranged so that the engine-driven fuel oil pump is driven from the free end of the overspeed drive assembly. For nuclear service, a d-c fuel oil booster pump is used as a standby pump, and will be activated automatically if a low fuel oil pressure condition arises. However, if the overspeed drive fails the operator would have no indication that there is no longer overspeed protection. An annunciator is provided which senses the loss of engine fuel pump pressure and, therefore, alerts the operator to possible loss of overspeed protection.

AUTOMATIC SAFETY SHUTDOWN SYSTEM (See Drawing 52216).

The shutdown system is a network of vent-on-fault pneumatic devices which are arranged in the various systems on the engine. The venting of such a device is sensed by the pneumatic logic circuitry, and this circuitry then produces a 60 psi pressure signal which operates a cylinder on the engine to shut off fuel delivery. This shutdown signal is automatically vented after the unit has rolled to a stop, retracting the cylinder and readying the unit for a restart. In the emergency condition, a signal is generated which blocks the shutdown signal upon receipt of a malfunction indication. Note that the sensor network is always pressurized; it is merely the shutdown signal which is inhibited in the emergency condition. This allows sensors to be electrically monitored under any condition. Upon application of starting air, several things occur directly from the air start header. The governor oil pressure is pneumatically boosted, and the Stop/Run valve on the engine is pressure driven to the Run position. Note that only the overspeed trip, generator differential protection and the low low lubricating oil pressure trip remain active in the emergency condition. Shutdowns are divided into two functional groups. The Group I sensors are those which must be "GO" before a start may be accomplished, and the Group II shutdowns are those which would normally be in a shutdown (venting) condition until the engine is running, jacket water pressure, for instance. Group II shutdowns are locked out during engine starts for a fixed period of time. The shutdown logic board, 1A-6147, functions to provide the necessary shutdown signals to the engine; when operating in response to an emergency start signal, it prevents the engine from shutting down while still providing panel indications of an existing shutdown condition. Assuming that 60 psi control air is present at all points marked , the shutdown logic board functions as follows.

Instruction Manual

DOCUMENT
CONTROL DATE

OCT 30 1980

DUKE POWER COMPANY
DESIGN ENGINEERING

PART C - CONTROL SYSTEM (Continued)

a. If MAINTENANCE mode is selected, solenoid valve SOL-5 becomes energized, admitting a 60 psi control air signal to Port 5 of the shutdown logic board. This signal is applied to port "A" of element NOT-6, inhibiting the output of that element. Note that an output from NOT-6 is necessary for the pressurization of the Group I shutdown network. Since the Group I shutdowns must be "GO" before a start can be accomplished, selection of MAINTENANCE mode effectively prevents the unit from accepting a start signal. Output from SOL-5 also actuates pressure switch PS-10, which illuminates an annunciator at the control panel to alert the operator that the unit is in MAINTENANCE mode. The SOL-5 signal is also sent through a shuttle valve (21) to line E-89, where it passes through two shuttle valves (15, Dwg. 52215) and extends the shutdown cylinder (6, Dwg. 52215), which moves the fuel racks to the NO FUEL position, cutting off fuel delivery to the engine. This signal also activates the "Unit Tripped" pressure switches on line E-90, pressure switches PS-41 and PS-9, resetting the pre-position and run relays. In addition, output from SOL-5 pressurizes valve P₁, venting the barring device interlock and allowing manual operation of that device.

b. If OPERATIONAL mode is selected, solenoid valve SOL-5 becomes de-energized, causing a loss of control air pressure at Port 5 of the shutdown logic board. There is a consequent loss of pressure at port "A" of NOT-6, which allows control air [Z] from Port 4 to pass through element NOT-6. Note that control air [Z] also pressurizes the "B" ports of elements MEM-15, AND-11 and AND-7, arming the shutdown line. Output from NOT-6 pressurizes the "B" ports of elements MEM-13 and AND-17, and also passes through a metering orifice (10) to pressurize port "A" of NOT-18, port "B" of AND-14 and Port 10. The Port 10 output arms the Group I shutdowns, and the shutdown system will now permit a start. Note that selection of OPERATIONAL mode also actuates the barring device lockout, as well as venting the shutdown cylinder on line E-89, allowing fuel rack movement. Loss of pressure at pressure switch PS-10 will cause the MAINTENANCE mode annunciator light to extinguish.

c. A MANUAL START, initiated from either the local or remote location, whichever is in control, will cause solenoid valve SOL-3 to become energized, admitting a 60 psi control air signal to Port 12 of the shutdown logic board. This signal is transmitted through OR-4 to the "C" port of S/R-22, which converts the momentary signal to a constant output from the "C" port of MEM-13. Note that this output will remain after the momentary signal to S/R-22 is lost. The MEM-13 output pressurizes port "A" of AND-17 and, due to the presence of control air at the "B" port of that element, there is an output at port "C" of AND-17. This output signal is directed to port "B" of element NOT-18, but since there is pressure at port "A" of NOT-18, the element does not have an output at this time. AND-17 output is also sent to the "B" port of T/N-9, causing an output from port "C" of that element. This signal is conducted to Port 9 of the board, and the Port 9 output acts to lock out the vibraswitch trips on line E-24. The Port 9 signal is also directed through a shuttle valve to actuate valve P₃. The output from element T/N-9 is also metered through an orifice (1) to port "A" of OR-5, which transmits a signal to Port 2, and through a check valve (2) to the "A" ports of elements AND-23 and AND-19. The Port 2 output feeds the Group II sensors, and is directed through valve P₂ to the low low lubricating oil pressure trip line and valve P₃. Note that the Group II sensors and the low low lubricating oil trip sensor will be in a venting condition until the unit achieves operating pressures, and will not be able to effect a trip at this time.

d. Group II lockout timing is a function of AND-17 output metered through a parallel orifice/check (21) and an accumulator at Port 1. It takes 60-90 seconds for the metered signal to fill the accumulator, and this delay is known as Group II lockout timing. Note that the output from T/N-9 is metered through an orifice (1) and OR-5 throughout this delay period. As the engine builds to proper operating pressure, the sensors in the Group II lines shift to the blocking position, and the metered signal begins to fill the lines. By the time Group II lockout timing is completed, the Group II shutdown lines should be completely pressurized. When the Port 1 accumulator is filled, a signal at port "A" of element T/N-9 terminates the output of that element, and Port 9 pressure is lost, venting the vibraswitch lockout line and reinstating vibration protection. Note that loss of Port 9 pressure would also vent valve P₃, but by this time the metered Port 2 signal which passes through valve P₂ should fully pressurize the line and maintain pressure at valve P₃. Note also that although the metered T/N-9 signal to Port 2 is lost, the Port 1 accumulator output is applied to port "A" of AND-14 and port "B" of OR-5 to maintain Port 2 pressure. Significantly, this causes the Group II shutdown lines to be fed through the same orifice (10) which feeds the Group I shutdowns. At this time the unit should be running at governed speed, with all operating temperatures and pressures normal, and with full shutdown protection.

Instruction Manual

PART C – CONTROL SYSTEM (Continued)

e. If a SHUTDOWN condition should develop which would cause one of the shutdown sensors to vent, there would be a loss of pressure at either Port 2, in the case of a Group II shutdown, or at Port 10, in the case of a Group I shutdown. Since both ports are fed through orifice (10), a shutdown signal received through either port would vent the line downstream of the orifice, causing a loss of pressure at port "A" of element NOT-18. Due to the action of a metering orifice (10), pressure is maintained at port "B" of NOT-18, and since the inhibitory port "A" signal at that element has been lost, control air passes through NOT-18 to port "B" of NOT-24. The signal passes through NOT-24 and NOT-20 and is transmitted through OR-16 to the "C" port of S/R-12, causing an output at port "C" of MEM-15. Since control air is present at port "B" of AND-11, MEM-15 output transmits through AND-11 and pressurizes Port 8. Port 8 output is conducted through a shuttle valve to line E-89, where it extends the shutdown cylinder, cutting off fuel delivery and shutting the unit down.

f. Note that AND-11 output is also passed through an orifice/check (3) and two accumulators (19) at Port 6, causing a delay of approximately 120 seconds. When this delay is completed, and shutdown has been accomplished, a signal is passed through AND-7, which is transmitted to the reset port of S/R-22, causing a loss of pressure at port "B" of NOT-18, which terminates the shutdown signal. AND-7 output also passes through OR-8 to the reset port of S/R-12, which vents Port 8, retracting the shutdown cylinder and readying the unit for a restart.

g. A shutdown due to engine overspeed is accomplished in a different manner. Note that there are two overspeed trip valves (11, Drawing 52215) which provide "two out of two" logic in the event of an overspeed condition. The arrangement of the valves is such that the tripping of only one overspeed device will not result in a shutdown. The combined action of both valves is necessary to effect such a shutdown. The circuitry functions as follows. Under normal operating conditions, when an overspeed trip signal is not present, the overspeed trip valves will be in the blocking position as shown. Control air at 60 psi present in line E-53 is metered through two orifices (12, Drawing 52215) to the overspeed trip valves, and since they are in the blocking position, the control air signal pilots two three-way valves (13, Drawing 52215). The valves shift to block the flow of control air to the overspeed trip line, E-20. If an overspeed condition develops, the overspeed trip valves dump the control air pilot pressure from the three-way valves. Control air then passes through the valves to line E-20. Note that both valves must be in the unpiloted position to complete the shutdown path. Pressure in line E-20 activates pressure switch PS-11 (Drawing 52216), transmitting the overspeed trip signal to the electrical system. Line E-20 pressure is also directed to the Overspeed Air Shutoff Cylinder (8, Drawing 52215), which extends to close the butterfly valve in the intake air manifold, thereby cutting off the supply of combustion air. In addition, line E-20 pressure passes through the Stop/Run valve (14, Drawing 52215) and a shuttle valve (15, Drawing 52215) to extend the Shutdown Cylinder (6, Drawing 52215) and pressurize line E-90. The shutdown cylinder moves the fuel racks to the NO FUEL position, cutting off the supply of fuel to the engine. Pressure in line E-90 activates the "Unit Tripped" pressure switches at the panel. Note that the engine is shut down due to both fuel and air starvation at an overspeed trip.

h. A normal stop signal, applied from the remote location or from the local panel, or a generator differential signal from the switchgear, energizes solenoid valve SOL-4, admitting 60 psi control air to Port 11 of the shutdown logic board. This signal is transmitted through OR-16 to the "C" port of S/R-12 which causes an output from port "C" of MEM-15. This output is transmitted through AND-11 to Port 8 which pressurizes line E-89 and extends the shutdown cylinder, readying the unit for a restart. Note that the stop circuit is still functional even when the unit is running in response to an emergency start signal.

i. Upon receipt of an emergency start signal, solenoid valve SOL-6 and SOL-7 will become energized, transmitting a signal through a shuttle valve to Port 7 of the Shutdown Logic Board. This signal also activates pressure switch PS-35, and pilots valve P₂, which then shifts to allow passage of a signal metered through a 0.028 inch orifice (30). This signal will cause pressure to build up in the low low lubricating oil trip line, and will also be applied through a shuttle valve to the pilot of valve P₃. The signal from the shutdown de-activating solenoids also passes through a 0.004 inch orifice/check (31) to pressurize Port 3 of the shutdown logic board, and also to build pressure in the line leading to valve P₃. Control air at Port 7 of the shutdown logic board pressurizes the "B" ports of elements AND-19 and AND-23, and pressure at Port 3 causes the "A" ports of the same elements to become pressurized. The outputs from AND-19

Instruction Manual

PART C – CONTROL SYSTEM (Continued)

and AND-23 act to pressurize the "A" ports of elements NOT-24 and NOT-20, inhibiting the passage of control air through these elements which is necessary to effect a shutdown. Note that the two NOT elements form a redundant series, affording protection in the event of a malfunction of one or the other. Note that Port 7 input is also transmitted through OR-4 to pressurize the Group I and Group II sensors and to provide Group II lockout timing, as outlined in sections (c) and (d) above. The Group I and Group II shutdown sensors remain active in the emergency situation, and continue to monitor the condition of the unit and display fault indications on the control panel annunciator. However, since the shutdown line is blocked, these sensor signals, with the exception of overspeed, low low lubricating oil pressure and generator differential, will not be able to effect a unit shutdown while the unit is operating in response to an emergency start.

j. As mentioned in the previous section, the following fault indications will effect a shutdown while the unit is operating in response to an emergency start signal: overspeed, generator differential and low low lubricating oil pressure. Refer to section (g) above for coverage of the overspeed trip. Generator differential protection is derived from the owner's equipment and the switchgear, which will generate a signal activating solenoid valve SOL-4, which effects a shutdown as outlined in section (h) above. A shutdown due to low low lubricating oil pressure will be effected any time lubricating oil drops below a preset value, after Group II lockout timing has been completed. The low low lubricating oil trip is locked out during a unit start, and remains locked out for a timed period. Note that the output from Port 9 of the shutdown logic board, which locks out vibration trips during the start sequence, also pressurizes the pilot of valve P₃. When Group II lockout timing is completed, the metered signal from the shutdown de-activating solenoids which passes through valve P₂ should maintain pressure at valve P₃. If a low low lubricating oil pressure condition arises after Group II lockout timing has ended, a shutdown will be accomplished as follows.

Three pressure actuated valves (10, Drawing 52215) mounted on the engine will vent line E-10LL through three 0.024 inch orifices (22, Drawing 52215). Note that, since line E-10LL is fed by a 0.028 inch orifice, the venting of only one 0.024 inch orifice would not produce a net loss of pressure at valve P₃. When at least "two out of three" sensors vent, there is a net pressure loss at valve P₃, and pressure is lost at Port 3 of the shutdown logic board. There is a consequent loss of pressure at the "A" ports of elements AND-23 and AND-19, which causes a loss of the inhibiting signals at the "A" ports of NOT-24 and NOT-20. Since the blocking action of the NOT elements is thereby terminated, a shutdown signal is free to pass through the normal shutdown path. Note that the venting of Port 3 provides this shutdown signal, as the Group II shutdown line fed by orifice (10) vents through Port 3, and the inhibiting signal at port "A" of NOT-18 is lost. NOT-18 then has an output, which is directed through NOT-24 and NOT-20, and through the shutdown line to Port 8 and line E-39, where the shutdown cylinder is extended and the unit is shut down.

Instruction Manual

PART C – CONTROL SYSTEM (Continued)

SOLENOID	LINE NO.	FUNCTION	OPERATED BY
SOL-1L	3	Starting Air Admission	R3, R4, R6, R7
SOL-2R	5	Starting Air Admission	R3, R4, R6, R7
SOL-1R	27	Starting Air Admission	R3, R4, R6, R7
SOL-2L	29	Starting Air Admission	R3, R4, R6, R7
SOL-3	56	Shutdowns Activated	R4, R7
SOL-4	60	Stop Engine	Remote & Local Stop Pushbuttons, Generator Fault 86 Relay
SOL-5	66	MAINTENANCE Lockout	Mode Selector Switch (MS), PS-12
SOL-6	17	Shutdowns De-activated	R9, R10
SOL-7	43	Shutdowns De-activated	R9, R10

Table 3-C-1. Solenoid Valves

RELAY	LINE	CONTACT	TIME	LINE	FUNCTION (WHEN ENERGIZED)
TD1	6	TC1-1 N.O.	3 sec.	12	Provides power to R13 after timing out
		TD1-2 N.O.	3 sec.	88	Provides latching power to R1 relays after timing out
TD2	30	TD2-1 N.O.	3 sec.	36	Provides power to R14 after timing out
		TD2-2 N.O.	3 sec.	90	Provides latching power to R1 relays after timing out
TD3	98	TD3-1 N.O.	60 sec.	92	Provides power to R2 after timing out
TD4	79	TD4-1 N.O.	15 sec.	83	Resets R1 relays and R2 if unit fails to start
		TD4-2 N.C.	15 sec.	86	Releases latch signal to R1 relays if unit fails to start
		TC1-3 N.O.	15 sec.	93	Provides power to AUX R1 at unit failure to start
TD5	80	TD5-1 N.O.	15 sec.	83	Resets R1 relays & R2 if unit fails to start
		TD5-2 N.C.	15 sec.	88	Releases latch signal to R1 relays if unit fails to start
		TD5-3 N.O.	15 sec.	94	Provides power to AUX R2 at unit failure to start

Table 3-C-2. Time Delay Relays

Instruction Manual

PART C – CONTROL SYSTEM (Continued)

RELAY	LINE	CONTACT	LINE	FUNCTION (WHEN ENERGIZED)	
R1	83	R1-1	N.O.	79	Provides power to TD-4 and TD-5
		R1-2	N.O.	96	Provides power to TD-3
		R1-3	N.C.	118	Customer Contact – Circuit breaker circuit
		R1-4	N.O.	94	Provides power to AUX R3
		R1-5	N.O.	140	Provides power to engine start timer
		R1-6	N.O.	126	Customer contact – Starting
R1A	86	R1A-1	N.O.	80	Provides power to TD-4 and TD-5
		R1A-2	N.O.	98	Provides power to TD-3
		R1A-3	N.C.	119	Customer contact – Circuit breaker circuit
		R1A-4	N.O.	94	Provides power to AUX R3
		R1A-5	N.C.	123	Customer contacts – exciter shut down circuit
		R1A-6	N.O.	124	Customer contacts – exciter shut down reset
AUX R1	93	AUX R1-4	N.O.	139	Customer Contact – "Unit Failure To Start"
		AUX R1-5	N.O.	139	Customer Contact – "Unit Failure To Start"
R1B	88	R1B-1	N.O.	127	Customer contact
		R1B-2	N.C.	13	De-energizes R4 after a start
		R1B-3	N.O.	95	Provides power to AUX R3
		R1B-4	N.O.	169	Arms DC Fuel Oil Booster Pump in AUTO
		R1B-5	N.C.	188	Terminates AUTO operation of Jacket Water Circulating Pump and Heater at Start
		R1B-6	N.C.	199	Terminates AUTO operation of Lubricating Oil Circulating Pump and Heater at Start
R1C	90	R1C-1	N.O.	37	De-energizes R7 after start
		R1C-2	N.O.	128	Customer Contacts
		R1C-3	N.O.	129	
		R1C-4	N.O.	130	
		R1C-5	N.O.	135	Provides power to AUX R3
		R1C-6	N.O.	96	
R2	92	R2-1	N.O.	170	Arms DC Fuel Oil Booster Pump
		R2-2	N.O.	126	Customer Contacts
		R2-3	N.C.	128	
		R2-4	N.C.	129	
		R2-5	N.C.	130	Provides power to AUX-R4
		R2-6	N.O.	95	
AUX R2	94	AUX R2-1	N.O.	404	Provides power to "Unit Failure To Start" Annunciator
		AUX R2-2	N.O.	139	"Unit Failure To Start" Customer Contact
		AUX R2-3	N.O.	139	"Unit Failure To Start" Customer Contact
R3	9	R3-1	N.O.	3	Provides power to SOL-1L and SOL-2R at SDS
		R3-2	N.O.	28	Provides power to SOL-1R and SOL-2L at SDS
		R3-3	N.O.	84	Latches R1 relays at SDS
		R3-4	N.O.	136	Provides power to UPR circuit customer contact
		R3-5	N.C.	140	Provides power to UPR circuit customer contact

DOCUMENT CONTROL DATE
OCT 30 1980
DUKE POWER COMPANY
DESIGN ENGINEERING

Table 3-C-3. Relays

Instruction Manual

RELAY	LINE	CONTACT	LINE	FUNCTION (WHEN ENERGIZED)	
AUX R3	95	AUX R3-1	N.O.	112	Start Signal Chart Recorder input Customer Contacts Customer Contacts Arms High Temperature Lubricating Oil OUT and Low Pressure Turbocharger Oil Annunciators Energizes hourmeter at start Customer contact
		AUX R3-2	N.O.	139	
		AUX R3-3	N.O.	139	
		AUX R3-4	N.O.	282	
		AUX R3-5	N.O.	164	
		AUX R3-6	N.O.	120	
R4	13	R4-1	N.O.	5	Provides power to SOL-1L and SOL-2R at Manual Start Provides power to SOL-1R and SOL-2L at Manual Start Latches R4 at Manual Start Provides power to SOL-3 Customer Contact
		R4-2	N.O.	30	
		R4-3	N.O.	16	
		R4-4	N.O.	55	
		R4-5	N.O.	140	
AUX R4	96	AUX R4-2	N.O.	139	Customer Contacts Customer Contacts
		AUX R4-3	N.O.	140	
R5	20	R5-1	N.O.	53	Provides power to DC Power Indicating light Provides power to R12
		R5-2	N.O.	57	
R6	33	R6-1	N.O.	27	Provides power to SOL-1R and SOL-2L at SDS Provides power to SOL-1L and SOL-2R at SDS Latches R1 relays at SDS Provides power to Governor and Voltage Regulator Pre-position circuits Customer Contact
		R6-2	N.O.	4	
		R6-3	N.O.	86	
		R6-4	N.O.	134	
		R6-5	N.O.	140	
R7	37	R7-1	N.O.	29	Provides power to SOL-1R and SOL-2L at Manual Start Provides power to SOL-1L and SOL-2R at Manual Start Latches R7 at Manual Start Provides power to SOL-3 Customer Contact
		R7-2	N.O.	6	
		R7-3	N.O.	42	
		R7-4	N.O.	56	
		R7-5	N.O.	140	
R8	46	R8-1	N.O.	53	Provides power to DC Power indicator light Provides power to R12
		R8-2	N.O.	58	
R9	8	R9-1	N.O.	17	Provides power to SOL-6 at SDS Provides power to SOL-7 at SDS Provides power to R3 and R13 at SDS Provides power to R3 at SDS Disarms Manual Start Circuit at SDS Disarms SOL-3 at SDS
		R9-2	N.O.	44	
		R9-3	N.O.	9	
		R9-4	N.O.	9	
		R9-5	N.C.	11	
		R9-6	N.C.	56	
R10	32	R10-1	N.O.	43	Provides power to SOL-7 at SDS Provides power to SOL-6 at SDS Provides power to R6 and R14 at SDS Provides power to R6 at SDS Disarms Manual Start Circuit at SDS Disarms SOL-3 at SDS
		R10-2	N.O.	18	
		R10-3	N.O.	33	
		R10-4	N.O.	33	
		R10-5	N.C.	35	
		R10-6	N.C.	56	
R11A	102	R11A-1	N.C.	140	Permissive for R26 "Ready To Load" customer contacts
		R11A-2	N.O.	134	
		R11A-3	N.O.	135	
		R11A-4	N.C.	136	
		R11A-5	N.C.	137	
		R11A-6	N.C.	138	

DOCUMENT CONTROL DATE
OCT 30 1980
DUKE POWER COMPANY
DESIGN ENGINEERING

Table 3-C-3. Relays

Instruction Manual

PART C – CONTROL SYSTEM (Continued)

RELAY	LINE	CONTACT	LINE	FUNCTION (WHEN ENERGIZED)	
R11B	103	R11B-1	N.O.	126	"Ready To Load" customer contacts
		R11B-2	N.O.	127	
		R11B-3	N.O.	128	
		R11B-4	N.C.	129	
		R11B-5	N.C.	130	
		R11B-6	N.C.	131	
R12	58	R12-2	N.O.	133	Control Power – Customer Contacts
		R12-3	N.O.	134	
		R12-4	N.O.	135	
		R12-5	N.C.	136	
		R12-6	N.C.	137	
		R12-7	N.C.	138	
		R13	11	R13-1	
R13-2	N.O.			137	
R14	35	R14-1	N.O.	121	Field Flash – Customer contacts
		R14-2	N.O.	138	
R16	156	R16-L	N.C.	274	Arms Low Temperature Lube Oil IN Annunciator
		R16-H	N.O.	278	Arms High Temperature Lube Oil IN Annunciator
R17	156	R17-L	N.C.	276	Arms Low Temperature Lube Oil OUT Annunciator
		R17-H	N.O.	280	Arms High Temperature Lube Oil OUT Annunciator
R18	156	R18-L	N.C.	360	Arms Low Temperature Jacket Water IN Annunciator
		R18-H	N.O.	364	Arms High Temperature Jacket Water IN Annunciator
R19	156	R19	N.O.	358	Arms High Temperature Aftercooler Water IN Annunciator
R21	156	R21-L	N.C.	362	Arms Low Temperature Jacket Water OUT Annunciator
		R21-H	N.O.	366	Arms High Temperature Jacket Water OUT Annunciator
R25	77	R25-1	N.C.	140	Permissive for R26
		R25-2	N.C.	124	Disarms Exciter Shutdown Reset signal
		R25-3	N.O.	124	Sequencer Interlock
		R25-4	N.C.	125	Sequencer Interlock
		R25-5	N.O.	123	430 rpm – Customer Contact
		R25-6	N.O.	124	430 rpm – Customer Contact
		R25-7	N.O.	125	430 rpm – Customer Contact
R26	107	R26-1	N.O.	108	Latches R26
		R26-2	N.C.	140	Stops engine starts timer

Table 3-C-3. Relays



**SECTION 4
ENGINE OPERATION**

GENERAL.

If the engine is being started for the first time, remove any preservative materials that may have been applied to the control and exterior surfaces of the engine. Rust preventive which has been sprayed inside the engine will mix with the lubricating oil without causing contamination. To reduce the amount of preservative absorbed by the oil charge, however, it may be desirable to wash and clean the interior surfaces of the engine before circulating oil for the first time. Do not attempt to wash connecting rods, crankshaft or pistons as this may deposit dirt between the bearing surfaces. The following inspections and checks are recommended prior to starting the engine for the first time, or after a long shutdown or major overhaul.

- a. Check bolts, nuts and capscrews, both inside and outside the engine to insure that all locking wires, clips and cotter pins are in place and secure.
- b. Inspect all piping systems. Trace out each system to insure that all connections are secure and that all valves and other control devices are properly positioned for engine operation.
- c. Check lubricating oil strainers and filters for cleanliness and proper assembly.
- d. Check that lubricating oil and cooling water systems are clean and filled to the proper level.
- e. Check starting air system for cleanliness and absence of moisture.
- f. Check all control linkages for proper adjustment and freedom of movement.
- g. Check crankshaft alignment (see Section 2).
- h. Open indicator cocks on cylinders and bar engine over four revolutions to make sure cylinders are clean, and that engine is ready to run.

CAUTION

- Any resistance to free turning must be investigated and corrected before engine is started.
- i. With the indicator cocks open, fuel controls off, crank engine several revolutions.
 - j. Close indicator cocks. If all conditions for starting are satisfied, the engine may be started, using the procedures contained in subsequent paragraphs.

Instruction Manual

PRE-START PROCEDURE.

The following procedure should be carried out before starting the engine under routine conditions.

- a. Energize Control Panel. Note status lamps for a-c and d-c circuits illuminated.
- b. Depress TEST pushbutton momentarily to verify alarm functions. Alarm horn should sound and flashing annunciators should operate. Depress SILENCE pushbutton. Note alarm horn silenced. Depress ACKNOWLEDGE pushbutton. Note steady annunciator lights. Depress RESET pushbutton. Note annunciator lights extinguished.
- c. Check Starting Air Pressure at panel gauge. If pressure low, turn Air Compressor switch to ON position. Monitor pressure rise and shut off compressor when desired pressure is reached.
- d. Open any manual shut off valves in the starting air lines.
- e. Check levels of Fuel Oil Day Tank and Lube Oil Sump Tank.
- f. If Pre-lube desired, place switch in RUN or AUTO position. Note pump ON indicator light illuminated. Pre-lube for five minutes maximum to prevent flooding of turbochargers. If RUN position selected, pump must be turned off manually. If AUTO position selected, pump operation terminated automatically at start.
- g. When starting a cool engine after a shutdown it is very important that the following procedure be carried out prior to attempting a start.
 - (1) Open indicator cocks on all cylinder heads.
 - (2) Place the Mode Selector Switch at Local Control Panel in the MAINTENANCE position.
 - (3) Depress MAINTENANCE Mode Select pushbutton at Local Control Panel.
 - (4) Inject Remote Control Room MAINTENANCE mode permissive.
 - (5) Note annunciator indicating system's mode.
 - (6) Depress Engine Roll pushbutton at Local Engine Control Panel. Allow engine to crank for at least two revolutions, then release pushbutton.
 - (7) Inspect all indicator cocks. If liquid has been ejected from any of the cocks, the source must be found and the defect corrected before proceeding.
 - (8) Close indicator cocks.
 - (9) Place Mode Selector Switch in OPERATIONAL mode position.
- h. Insure that all manual reset shutdown devices, such as the overspeed trips, have been reset.

REMOTE MANUAL START.

The following procedure should be used to start the engine manually from the Remote Panel.

- a. Place the REMOTE/LOCAL selector device at the Remote Control Room panel in the REMOTE position. All local control of the engine and generator then will be locked out.
- b. Depress the Remote Manual Start pushbutton momentarily in the Remote location.

Instruction Manual

c. The unit will automatically crank, start, come up to governed speed and generate voltage as required. Remote Governor and Voltage Regulator RAISE/LOWER switches may be used to adjust speed/frequency and voltage as necessary.

d. Note "Shutdowns Activated" indicator light illuminated.

e. "Up to Speed" and "Ready To Load" permissive signals will be generated automatically for use with remote synchronizing and loading controls.

LOCAL MANUAL START.

Perform the following operations to start the unit from the Local Engine Control Panel.

a. Place the REMOTE/LOCAL selector device at the Remote Control Room Panel in the LOCAL position.

b. Place the OFF/START switch at the Local Engine Control Panel in the START position momentarily.

c. The unit will automatically crank, start, come up to governed speed and generate voltage as required. Governor and Voltage Regulator RAISE/LOWER switches at the Local Generator Control Panel may be used to adjust speed/frequency and voltage as necessary.

d. Note "Shutdowns Activated" indicator light illuminated.

e. "Up To Speed" and "Ready To Load" signals will be generated automatically for use of the synchronizing and loading controls at the Local Generator Control Panel.

START DIESEL SIGNAL.

If an emergency "Start Diesel Signal" is generated by the owner's equipment, the unit will automatically crank, start and come up to speed and voltage as required. "Up To Speed" and "Ready To Load" permissives will be generated for use with the remote sequencing equipment. The setpoints of the voltage regulator and governor will be placed at a pre-set value for fifteen seconds. Thereafter, the pre-set signal will be released, allowing the operator to control speed/load and voltage. The governor will automatically be placed in isochronous operation. The shutdown system will be disarmed except for overspeed, generator differential and low low lubricating oil pressure. Note that the SDS start circuitry remains active if the unit is in LOCAL control, or if the Lockout Relay has been energized at the Local Generator Control Panel, but in such a case loading operations would be performed at the local panel.

REMOTE CONTROL ROOM EMERGENCY.

If the Remote circuitry malfunctions, or in the event of a station emergency when local control only is desired, perform the following.

a. Actuate Lockout Relay at break-glass station at Local Generator Control Panel.

b. Place the OFF/START switch at the Local Engine Control Panel in the START position momentarily.

c. The unit will automatically crank, start and come up to speed and voltage as required. Governor and Voltage Regulator RAISE/LOWER switches at the Local Generator Control Panel may be used to adjust speed/load and voltage setpoints as required.

d. Note "Shutdowns Activated" indicator light at Local Engine Control Panel illuminated.

e. "Up To Speed" and "Ready To Load" permissive signals will be generated for use of the synchronizing and loading controls at the Local Generator Control Panel.

Instruction Manual

NORMAL STOP.

Reduce load and allow engine to cool. When temperatures have fallen to the desired levels, actuate the stop control at either the local or remote location.

EMERGENCY STOP.

Perform one of the following actions to stop the engine in an emergency situation.

- a. Depress the Stop pushbutton in either control location.
- b. Place the Stop/Run valve at the engine in the STOP position.
- c. Turn the governor load limit knob on the governor to zero.
- d. Manually trip the overspeed trips.
- e. If none of the above procedures work, the engine may be stopped by pushing a fuel pump lever towards the engine block. This will rotate the fuel shaft and cut off fuel delivery. Hold the lever until the engine stops.

STARTING, STOPPING AND OPERATING PRECAUTIONS.

As soon as the engine is running, all gauges should be checked for proper operating pressures and temperatures as shown in Appendix II. If conditions are not normal, shut down engine and determine cause before restarting.

WARNING

Use only compressed air for starting. Substitution of compressed gasses, especially oxygen, may result in a violent explosion.

INSTRUCTION MANUAL

DELAVAL ENGINE AND
COMPRESSOR DIVISION
550 - 85th AVENUE
OAKLAND, CALIFORNIA 94621



SECTION 5 MAINTENANCE

GENERAL.

Units employed as a source of on-site emergency power at nuclear power stations will experience relatively few operating hours during the span of their normal service life, yet the requirement that the unit be able to start, come up to rated speed and assume a load quickly in response to an emergency start signal from the owner's equipment dictates that there must be a maintenance program in use which is designed to ensure the necessary high level of reliability of the engine, generator and associated equipment to accomplish this.

MAINTENANCE CONCEPT.

The precise number of hours a standby diesel-generator unit will be operated in any given time period cannot be known in advance. Under ideal conditions the complete engine-generator installation will be operated only in periodic testing situations, although certain systems such as the lubricating oil and jacket water "keep warm" circuits will be operating all the time when the unit is in standby operation. Operating hours, then, cannot alone be the determining factor. Calendar time is also significant for some systems. As there are few operating hours, many maintenance actions are based on operating hours and/or reactor refueling shutdown, whichever comes first. To formulate an effective schedule, certain assumptions must be made.

- a. The diesel-generator will undergo periodic exercise tests, the frequency of which will be determined by regulations issued by the U.S. Nuclear Regulatory Commission and other cognizant authority. The frequency of testing is assumed to be no less than once every thirty-one days.
- b. The periodic exercise test will involve starting the unit, bringing it to rated speed, applying some load, running under load for a period of time, shedding the load and shutting down. It is assumed that the test will be of a minimum duration of two hours.
- c. The plant will be shut down on a periodic basis for refueling of the reactor.
- d. The maintenance actions will be performed by personnel who are trained and qualified to do this sort of work.

RECORD KEEPING.

The keeping of records can greatly assist in the evaluation of engine performance and keeping operating personnel informed of the current running condition of the engine. Comparison of present and past log sheets and charts may reveal gradual changes in temperatures, pressures, noise and overall performance, all indicators of the engine's condition which can be of assistance in planning future overhaul and repair schedules. The majority of engine problems are preceded by signs and indications. Performance trends are not easily detectable, however, unless data is recorded in a manner that makes these trends apparent. Charts and curves can perform this function. Essential to any technique which depends upon the recording of observations is the careful and accurate charting of data. Because of the few operating hours experienced by an engine in nuclear standby service, data should be plotted at frequent intervals during those periods of operation to obtain sufficient data to readily reveal operating trends. The following paragraphs illustrate some of the information that can be obtained from charts and curves.

INSTRUCTION MANUAL

DELAVAL ENGINE AND
COMPRESSOR DIVISION
550 - 85th AVENUE
OAKLAND, CALIFORNIA 94621

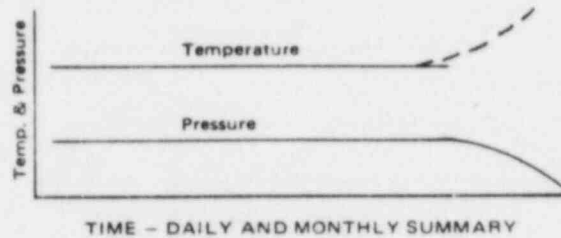

a. If lubricating oil pressure starts to fall off but the temperature remains constant, it would indicate that the bearings are starting to wear to excessive clearances, that the lubricating oil pump is wearing excessively, or that the relief valve is not functioning properly. It could also indicate excessive fuel dilution. If lubricating oil pressure starts to fall off and the lubricating oil temperature rises, it might indicate that the heat exchanger equipment is plugging up.

WARNING

A sudden increase in lubricating oil temperature with an increase in the amount of vapor from the crankcase ventilation discharge may indicate some overheated internal part of the engine. A sudden increase in lubricating oil temperatures requires an immediate reduction or removal of the load if this is possible. The cause of the temperature increase must be determined and corrected.

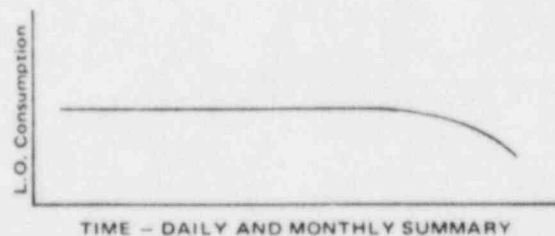

b. If lubricating oil consumption starts to increase it could mean that the piston oil control rings are starting to foul, or have worn excessively. If this is the case, oil is being burned and should show up in the exhaust as a light blue or grey smoke. It could also mean that the intake or exhaust valve guides have worn excessively. A third possibility is a leak in the lubricating oil cooler. This can be checked by looking for evidence of oil in the cooling water.

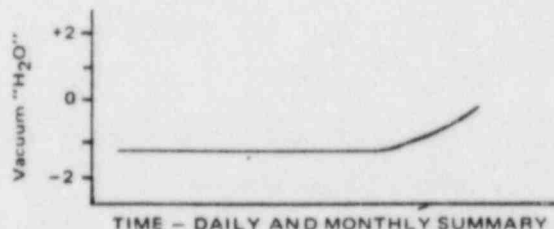

c. If crankcase vacuum starts to go towards a positive pressure it may indicate that the compression rings on the pistons have worn excessively. This may be checked by taking a set of compression cards.

INSTRUCTION MANUAL

DELAVAL ENGINE AND
COMPRESSOR DIVISION
550 - 85th AVENUE
OAKLAND, CALIFORNIA 94621

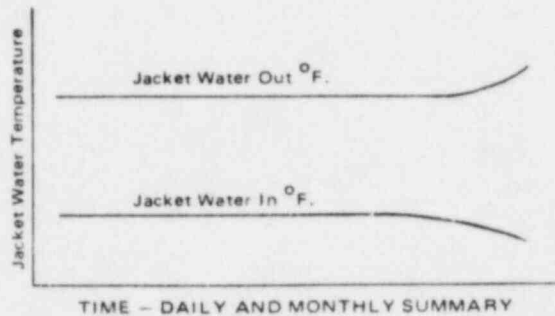

d. If jacket water temperature starts to rise it could mean that the jacket water cooler is starting to foul. However, it must be remembered that the AMOT temperature valve starts to open five degrees farenheit before the set point. This means that the controlled outlet temperature may vary 15° F, depending upon ambient weather conditions. If inlet temperature starts to drop, indicating a greater temperature differential across the engine, it could mean one or more of the following.

- (1) Poor combustion.
- (2) Leaky head gasket(s).
- (3) Scuffed piston(s).
- (4) Faulty venting of jacket water system.
- (5) Faulty water pump.

MAINTENANCE SCHEDULES.

The following maintenance schedules are recommended. Inspection intervals are optimum, however, operating experience must be used to determine the ultimate suitability of the schedule. Where experience indicate more frequent inspection is desirable, the inspection interval should be shortened. Unless otherwise stated, the following inspection intervals are used.

- a. DAILY - Operations which are to be performed on a daily basis, independent of engine operating hours.
- b. WEEKLY - Operations which are to be performed weekly, regardless of engine operating hours.
- c. MONTHLY/EXERCISE TEST - Operations which should be performed each time the unit undergoes its periodic exercise test, but in no case less frequently than once a month.
- d. ANNUAL/EACH PLANT SHUTDOWN - Inspections that should be performed on an annual basis, or at plant shutdown for reactor refueling. The interval may be adjusted to meet plant shutdown schedules.
- e. BI-ANNUAL/ALTERNATE PLANT SHUTDOWNS - To be performed at alternate reactor refueling shutdowns, or bi-annually.
- f. FIVE YEARS - To be performed at the nearest plant shutdown period to a five year interval.

INSTRUCTION MANUAL

DELAVAL ENGINE AND
COMPRESSOR DIVISION
550 - 85th AVENUE
OAKLAND, CALIFORNIA 94621



ITEM	NUCLEAR EMERGENCY STANDBY ENGINE MAINTENANCE SCHEDULE	FREQUENCY CODES					
		A	B	C	D	E	F
	COMPONENT GROUP: DIESEL ENGINE						
	MAINTENANCE ACTION						
	Observe and record lubricating oil and jacket water temperatures. (Only if unit operating in standby mode with keep-warm pumps on)	XX					
	Drain all low point water collectors, "Y" strainers and air receiver tanks in starting air system.	XX					
	Check engine and auxiliary equipment for oil, water and fuel oil leaks.	XX					
	Check level of lubricating oil in sump tank, governor and pedestal bearing.	XX					
	Check fuel pump racks for freedom of movement through full limit of travel. Do not disconnect from governor.	XX					
	Check operation of air strangulation valve and actuating cylinder.		XX				
	Turn on electrical fuel oil booster pump for a short time and circulate fuel through system. Check strainers for clean fuel.		XX				
	Clean and inspect "Y" strainers in starting air system. Note: if fouling of strainers is such that more frequent inspection is indicated, shorten inspection interval.			XX			
	Check lubricating oil filter pressure differential.			XX			
	Inspect and clean air filter in starting air distributor. If conditions warrant, inspect more frequently.			XX			
	Drain water and/or sludge from lubricating oil full flow filter.			XX			
	If differential pressure indicates, check strainer screens in fuel oil and lubricating oil pressure strainer.			XX			
	Check lubricating oil for fuel dilution with a viscosimeter.			XX			
	Send lubricating oil sample to laboratory for analysis.			XX			
	Drain lubricating oil system. Clean sump and strainers, refill with new oil.				XX		
	Check pH factor of jacket water. Correct as necessary as recommended by chemical supplier. Recommended pH is 8.25 - 9.75.			XX			

INSTRUCTION MANUAL

DELAVAL ENGINE AND
COMPRESSOR DIVISION
550 - 85th AVENUE
OAKLAND, CALIFORNIA 94621



ITEM	NUCLEAR EMERGENCY STANDBY ENGINE MAINTENANCE SCHEDULE	FREQUENCY CODES					
		A	B	C	D	E	F
	COMPONENT GROUP: DIESEL ENGINE (Continued)						
	MAINTENANCE ACTION						
	Remove alternate left side doors and examine inside of engine for any abnormal conditions.				XX		
	Check hydraulic valve lifters for operation and proper adjustment.				XX		
	Remove fuel injector nozzles, clean, reset and reinstall.				XX		
	Check connecting rods and link rod bearing clearances using the "Bump" method.				XX		
	Check and record crankshaft deflections.				XX		
	Visually inspect foundation for breaks in bond between sole plates and grout.				XX		
	Check foundation bolts for correct torque. Retorque as necessary then recheck crankshaft deflections.				XX		
	Check lubricating oil jets at gears for plugged or broken lines.				XX		
	Remove cam covers and cylinder head covers. Inspect cams, tappets, rollers, rocker arms, push rods, springs and valve guides.				XX		
	Drain governor oil, clean, flush, refill with new oil. If necessary, replace governor drive coupling.				XX		
	Remove turbocharger(s). Disassemble and clean.					XX	
	Check cold compression pressures, maximum firing pressures and take an indicator card. If indicated, remove cylinder heads, grind valves. Check valves and liners.				XX		
	Inspect gears for general condition. Check backlash and replace worn gears exceeding maximum clearance.					XX	
	Remove fuel injection pumps. Disassemble, clean, repair and adjust as necessary.					XX	
	Remove end plates from heat exchangers and intercoolers. Examine and clean as necessary.				XX		
	Check main bearings.					XX	
	Inspect intake air filter oil distribution plate. Change oil in filter.				XX		

INSTRUCTION MANUAL

DELAVAL ENGINE AND
COMPRESSOR DIVISION
560 - 85th AVENUE
OAKLAND, CALIFORNIA 94621



PRESERVING ENGINE FOR SHIPMENT OR STORAGE.

The following instructions are for preserving an operable engine for shipment, storage or inactivating for an indefinite period of time.

- a. **COOLING SYSTEM AND WATER PUMPS** - Before shutting an engine down, add a water soluble liquid such as Texaco Soluble Oil "C", to the water system and circulate for about 15 minutes, then drain. Disconnect the water line from its source and seal with a blind flange to prevent water seepage into the system. Remove engine water header and make sure all water has been removed from around the liners. Drain all water lines and when sure the system is dry, reconnect all lines and engine header to form an airtight system.
- b. **FUEL SYSTEM** - To preserve the fuel system, disconnect the fuel line ahead of the engine fuel transfer pump and allow engine to burn about five gallons of Tectyl No. 502-C before shutting down. Cap the fuel line to the engine. Drain all fuel tanks and spray insides with Tectyl No. 502-C. Drain all other fuel lines.
- c. **LUBRICATING OIL SYSTEM** - Using an auxiliary lubricating oil pump, circulate a mixture of 50% lubricating oil and 50% Tectyl No. 502-C, then drain. If the turbocharger has a separate lubricating air system, circulate a 50-50 mixture of lubricating oil and Tectyl No. 502-C, then drain.
- d. **CRANKCASE, CAM GALLERY, CYLINDER HEADS AND FUEL INJECTION PUMPS** - Remove camshaft covers and spray cams, tappets, etc. with 100% Tectyl No. 502-C and replace cam covers. Remove crankcase doors and spray 100% Tectyl No. 502-C all over the inside of the crankcase then replace covers. Remove cylinder head covers and spray 100% Tectyl No. 502-C on rocker arms, etc. Remove fuel injection pumps and spray 100% Tectyl No. 502-C down on the tappet parts and up on the fuel pump cup (plunger follower) then reassemble. For all non-painted parts, such as the fuel rack shaft on the outside of the engine, Tectyl No. 502-C can be sprayed on if protection is required for only a short time, that is two or three months. Be sure the exposed parts are cleaned and dried before spraying. This makes a good seal for such parts as heim joints. Fuel pump racks require a little grease on the edge of the pump body to prevent the compound from entering the pump body and sticking the pump racks.
- e. **GOVERNOR** - The engine governor lubricating oil should be drained and refilled with new oil.
- f. **OPENING** - Air intake and exhaust openings to the engine should be sealed with gaskets and blind flanges of the metal type. All other such openings to the engine should also be sealed with gaskets and blind flanges.
- g. **SHIPPING AND STORAGE** - In addition to the above instructions, the engine must be stored in a building out of the weather elements. While in shipment the engine must be protected by a tarpaulin or boxed when shipped overseas.

SPECIFICATION FOR PROTECTIVE MATERIALS

MATERIAL	MANUFACTURE
Tectyl No. 502-C	Valvoline Oil Company Freedom, Pennsylvania
Soluble Oil "C" - Use 3 to 5% mixture in the cooling water	Texaco, Inc.

INSTRUCTION MANUAL

DELAVAL ENGINE AND
COMPRESSOR DIVISION
550 - 85th AVENUE
OAKLAND, CALIFORNIA 94621



PRESERVATION EQUIPMENT.

In the foregoing instructions it is recognized that many times it is necessary to apply protective materials under difficult field conditions. A common paint brush may be used for applying preservative to accessible parts, and a hand operated pump sprayer with a pointed discharge nozzle of the type commonly used to spray insecticides may be used for inaccessible points. If desired, a small oil pump may be rigged with a motor drive to make a convenient mechanical pressure spray unit. Shop compressor air lines usually carry too much moisture to be safe for this purpose, and should not be used.

TORQUE WRENCH TIGHTENING PROCEDURES AND VALUES.

Torque figures given in this manual are based on the use of a thread lubricant composed of equal parts by volume of engine lubricating oil and Dixon Number 2 powdered medium flake graphite, or equal. They do not apply to dry threads, or to threads lubricated with "Super Lubricants". Dry thread torque readings can be as much as 50 percent in error.

PROCEDURE.

- a. Lubricate threads with oil and graphite mixture and tighten nuts hand tight.
- b. Tighten all nuts by snugging the first nut, then moving to the one farthest removed and continuing in a crisscross pattern until all nuts are snug.
- c. Unless otherwise specified, apply 20 percent of the required torque to each nut in the same sequence as described above, then repeat procedure for 50, 60, 80, and 100 percent of the prescribed torque value.
- d. Active nuts which are locked with cotter pins must be brought to the specified torque value before attempting to align the cotter holes. If the cotter pin hole in the bolt is halfway between the slots in the nut, or beyond, the nut should be tightened to make alignment. If the cotter pin hole in the bolt is short of the halfway point the nut may be backed off to the nearest point where it will align.

TORQUE VALUES.

See Appendix IV for torque wrench values to be used when torquing the various engine parts.

PRE-STRESSED STUDS.

Cylinder head studs and main bearing cap studs on Model RV engines are pre-stressed when installed rather than torqued with a wrench because of their size, location and high torque requirements. This is accomplished by stretching the studs with a hydraulic tool, then tightening the stud nuts. When the tool is removed a pre-determined stress remains in the stud. For this type application pre-stressing offers certain advantages.

- a. Less physical effort is required.
- b. It is easier to accomplish in confined areas.

SECTION 6**DISASSEMBLY, INSPECTION AND REPAIR****PART A - GENERAL****ROTATION AND CYLINDER DESIGNATION.**

Crankshaft rotation and cylinder bank designations are determined while viewing the engine from the flywheel end. Number one cylinder on each bank is that nearest the gearcase, or auxiliary end, on the opposite end of the engine from the flywheel (see figure 6-A-1). Engines are designated as either right hand or left hand according to the side of the engine on which the controls are mounted.

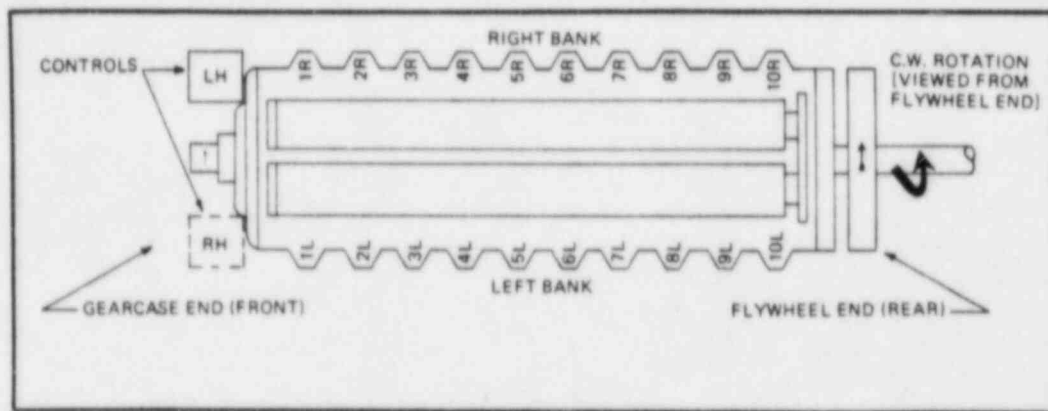

Figure 6-A-1. Engine Rotation and Cylinder Designation

ASSEMBLY OF PARTS.

Before starting any disassembly of the engine, observe that many parts are match-marked and identified by part or assembly number. Engine parts which have been in service should be returned to the same position in the same engine from which they were removed. This applies principally to cylinder liners, pistons, connecting rods and bearing caps. New parts should be marked in the same way as the parts which they replaced. Safety clips, cotter pins and safety wire, where specified, must be re-installed correctly to insure that the parts remain secure in use.

USE OF ASSEMBLY DRAWINGS.

Reference may be made to the assembly drawings in the *Parts Manual* to assist in the disassembly and assembly of various engine components.

Note

Do not use the part numbers on these drawings for ordering replacement parts. The *Parts Manual* should always be used for this purpose.

INSTRUCTION MANUAL

DELAVAL ENGINE AND
COMPRESSOR DIVISION
550 - 85th AVENUE
OAKLAND, CALIFORNIA 94621



PART A -- GENERAL (Continued)

SPECIAL TOOLS.

Refer to the 590 Group Parts List in the *Parts Manual* for a listing of the special maintenance tools and equipment furnished with the engine.

CLEANLINESS.

Care must be exercised to keep dirt, grit or other debris from entering any of the lubricating oil or cooling water system as well as from the bearing surfaces of pistons, shafts, etc.

TORQUING.

Make reference to Section 5 for the correct method of torquing nuts and bolts, and to Appendix IV for the specified torque values.

Instruction Manual

PART B – CYLINDER HEADS AND VALVES

CYLINDER HEAD REMOVAL.

Each cylinder head may be removed from the block independently of the other cylinder heads. The cylinder head has two intake and two exhaust valves, together with their associated springs, wedges, retainers, etc. Valve springs may be replaced with the cylinder head installed on the engine provided the piston is at top dead center to prevent the valves from falling into the cylinder. To remove a cylinder head from the engine, proceed as follows.

- a. Drain jacket water from engine.
- b. Remove cylinder head cover.
- c. Remove air jumpers.
- d. Disconnect exhaust and intake air manifolds.
- e. Disconnect fuel injection lines and nozzle drain fittings.
- f. Remove rocker assemblies and push rods. Remove hydraulic valve lifters if engine is so equipped.
- g. Remove fuel injection nozzles and holder assemblies.
- h. Remove cylinder head sub-cover.
- i. Attach lifting fixture to the fuel injection studs as shown in Figure 6-B-1. Attach an overhead hoist to the lifting ring of the fixture.
- j. Remove cylinder head stud nuts and washers.



Figure 6-B-1. Cylinder Head Lifting Fixture

- k. Lift head from block. If head sticks it may be necessary to take a strain on the hoist and break the head loose by striking the sides with a babbitt or lead hammer.

INSPECTION.

Clean inside of combustion chamber. Bar engine over until piston is at bottom dead center and clean and inspect upper portion of cylinder bore. Clean gasket surfaces of engine block and cylinder head. Remove intake and exhaust valves. Reface and reseat as necessary, following the procedures outlined in subsequent paragraphs.

INSTRUCTION MANUAL

DELAVAL ENGINE AND
COMPRESSOR DIVISION
550 - 85th AVENUE
OAKLAND, CALIFORNIA 94621



PART B - CYLINDER HEADS AND VALVES (Continued)

VALVES.

Intake and exhaust valves are constructed of alloy steel, however, the steel alloy specifications differ. Valves may be identified by the marking "IN" for intake valves and "EX" for exhaust valves, stamped on the valve stem.

VALVE SPRING REPLACEMENT (Cylinder Head Not Removed).

Valve springs may be replaced without removing the cylinder head from the block. Remove rocker arms assemblies then bar engine over until piston of cylinder being worked on is at top dead center. Attach valve spring removal tool to the two fuel injector studs as shown in Figure 6-B-2. Make sure the nuts are rundown far enough on the studs to hold securely. Tighten nut on cross arm, making sure the cross arm is not bearing on the top of the wedges. Tighten nut until valve springs are compressed. Lift the valve by its stem and remove the two keepers from each valve. Back off on compression nut on tool, then remove tool from cylinder head. Springs may be lifted off valve stems. Spring installation is the reverse of removal.

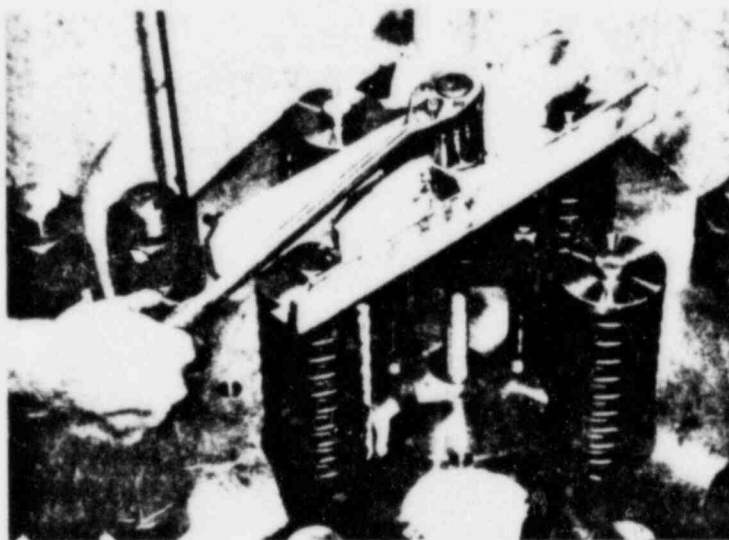

Figure 6-B-2. Valve Spring Removal Tool

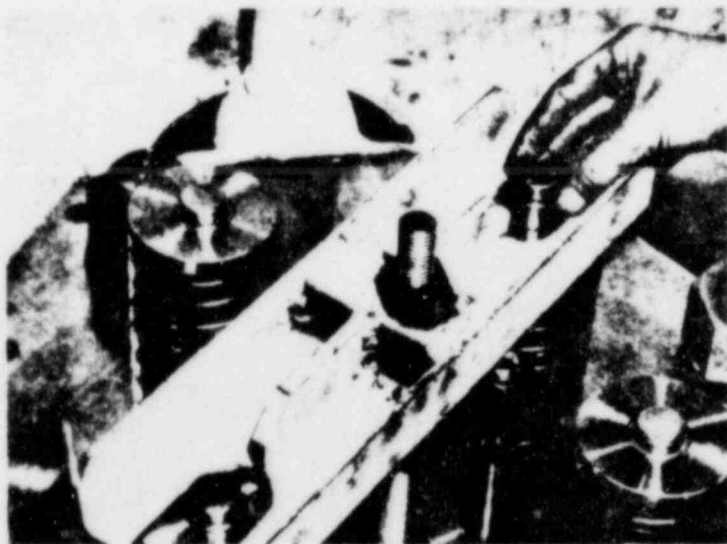

Figure 6-B-3. Removing Valve Keepers.

VALVE REMOVAL FROM CYLINDER HEAD.

With cylinder head removed from engine, install valve spring removal tool as shown above, and remove valve springs. Remove valves from combustion side of cylinder head.

PART B - CYLINDER HEADS AND VALVES (Continued)

VALVE INSPECTION AND RECONDITIONING.

The seating surface of valves, particularly exhaust valves, may have the appearance of pitting due to small carbon particles which may have been trapped on the seats and impressed on the metal. This condition has no effect on operation unless there is an indication of blowby, in which case the valves should be resealed. Valves may be re-faced on a standard valve re-facing machine, or on an ordinary lathe. The seating should be exactly 45 degrees. If done on a lathe with a cutting tool, be sure to use very fine feed and a sharp tool for the final cut. If a grinding wheel is used, the wheel should be dressed for exact trueness before the final grinding cut is taken. Remove just enough material to eliminate pits and to make the seat run exactly true with the stem. If the valve guide is worn, a new guide should be installed before re-facing valve seats. Re-seat head with a valve grinder. If a grinder is not available, use a 45 degree hand reamer. Face just enough for trueness and removal of pits. Limit width of valve seat to $19/32 \pm 1/64$ inch (1.51 ± 0.04 cm) with a 45 degree tool. If the engine is equipped with valve rotators, the rotators must be replaced whenever the valves are serviced. Before removing intake valve guides from the cylinder head, match-mark both the cylinder head and the guide to insure proper alignment when guides are reinstalled in the heads. Remove, clean and inspect valve guides as necessary. It is not practical to measure exhaust valve-in-guide clearances directly. Therefore, wear is determined by measuring the diameter of the exhaust valve guide bore at two points, one at a point one-half inch from the top of the bore and the other two inches from the bottom of the bore. Refer to Appendix III for the proper bore diameters.

CYLINDER HEAD INSTALLATION.

Use new seals when the cylinder head is installed on the engine block. Make sure all areas are clean and free of dirt or other foreign matter.

- a. Attach lifting fixture to cylinder head and hoist head in place over cylinder head studs.
- b. Carefully lower head into place, taking care not to damage stud threads or seals.
- c. Lubricate cylinder head studs and nut threads with a 50-50 mixture of graphite and lubricating oil. Assemble washers and nuts on studs and run down on the threads.
- d. Tighten nuts in increments, and in a criss-cross pattern, following the sequence shown in figure 6-B-4. Torque to the specified torque value. This procedure will pull the head down evenly.



Figure 6-B-4. Tightening Sequence For
Cylinder Head Stud Nuts.

PART C -- PISTONS AND RODS

GENERAL.

Pistons and their attached rods may be removed from the engine by lifting them straight out of the cylinder liners. To prepare the engine for piston removal, remove the cylinder heads and the engine side doors adjacent to the pistons and rods to be pulled. If, however, it is only desired to remove or inspect the connecting rod bearings, the cylinder heads need not be removed. Follow the procedure in the next paragraph.

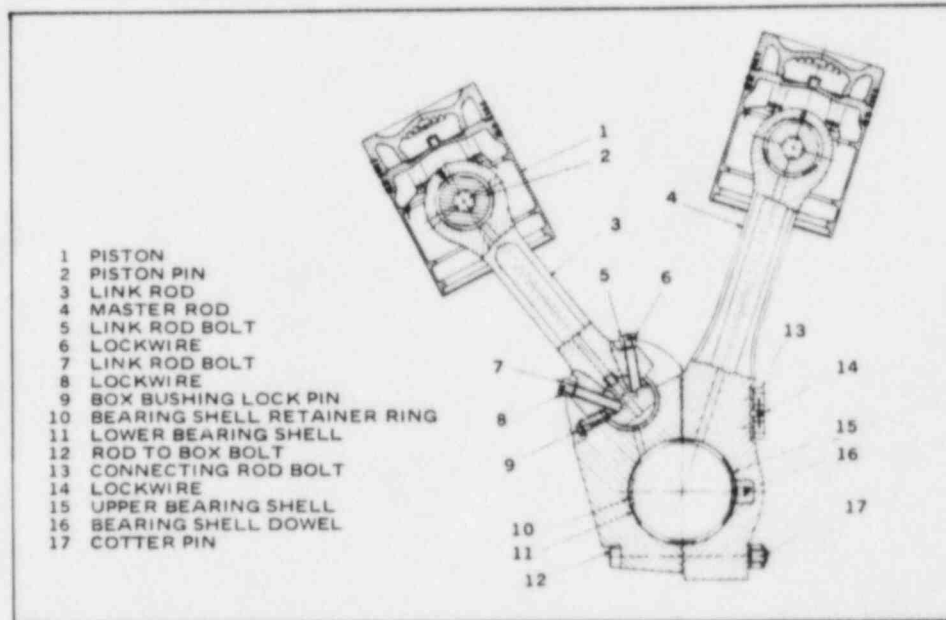

Figure 6-C-1. Pistons and Connecting Rods

CONNECTING ROD BEARING SHELL REPLACEMENT.

With engine side door covers adjacent to the bearing to be replaced removed, proceed as follows.

- a. Loosen all connecting rod bolts slightly, but do not remove.
- b. Block crankshaft to prevent further movement.
- c. Install connecting rod saddle and plate on master rod side of engine. Adjust jacking screw to hold master rod in place against crankpin.
- d. Attach chain puller bracket to side of crankcase, then attach chain puller.
- e. Attach chains to each end of link pin with capscrews. Attach chain puller to chain and take up slack as necessary to hold the link rod firmly against the crankpin.
- f. Place a piston holder spacer ring in the lower end of each cylinder liner, then install two jacking assemblies in each cylinder liner and bolt in place to retain the spacer rings.
- g. Adjust locking ring assembly jacking screws until spacer ring is snug against skirt of piston, holding it in place in the liner.

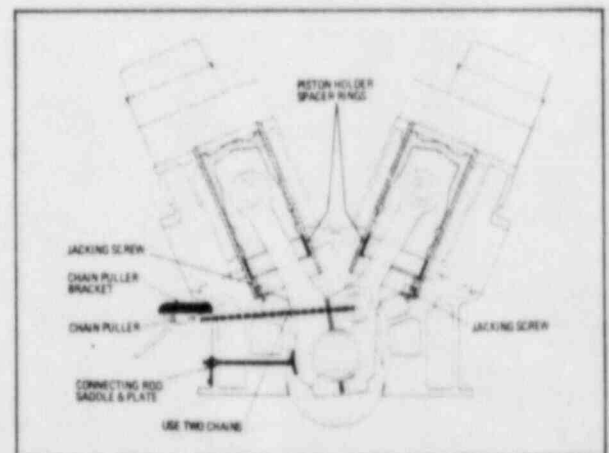

Figure 6-C-2. Bearing Replacement Tool Arrangement

Instruction Manual

PART C – PISTONS AND RODS (Continued)

- h. Remove six bolts which attach link rod box to master rod. Slack off chain puller to allow link rod box to swing clear of bearing shell. Adjust locking ring assembly jacking screw as necessary to prevent binding.
- i. Back off on connecting rod saddle jacking screw until master rod is clear of crankpin.
- j. Support lower bearing shell by hand and remove locking clips, then remove both bearing shells.
- k. Inspect, clean and replace bearing shells before working on any other bearings. Only one set at a time should be removed.
- l. Install bearing shells and lock in place with clips.
- m. Use connecting rod saddle jacking screw to position master rod firmly against bearing shell. Locking ring assembly and jacking screws may be used to adjust vertical position of rod. It may be necessary to rotate the bearing shells slightly to help with dowel engagement.
- n. Tighten chain puller and guide link rod box into engagement with the crankpin and the serrated joint of the master rod.
- o. Install connecting rod bolts and torque to the value specified in Appendix IV.
- p. Remove all tools and blocking from engine.

LINK ROD AND PISTON REMOVAL.

With the cylinder heads removed and the engine side doors removed, bar engine over until master rod piston is at top dead center, then block crankshaft to prevent further movement. Refer to figure 6-C-3 for installation of the special tools that are required for piston and rod removal.

- a. Attach piston pulling tool to the crown of the link rod piston.
- b. Place a piece of one-half inch plywood vertically on inner side of outer cylinder head studs to prevent piston from coming into contact with studs.
- c. Suspend a one-ton capacity chainfall from plant crank hook and attach hook to side lifting hole of pulling tool.
- d. Attach chain puller bracket and chain puller to master rod side of crankcase.
- e. Install connecting rod saddle and plate to master rod side of crankcase. Adjust to hold rod snug against crankshaft.
- f. Attach a chain to each end of link pin with capscrews and connect other ends to chain puller and take up all slack in chain.

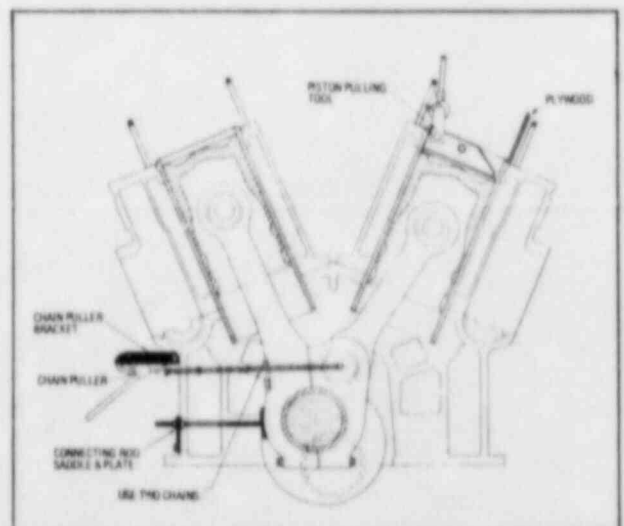

Figure 6-C-3. Tools Installed For Removing Piston and Link Rod.

Instruction Manual

PART C – PISTONS AND RODS (Continued)

- g. Remove six bolts (see figure 6-C-1) which hold link rod box to master rod then slack off on chain puller, allowing link rod box to swing clear of crankpin.
- h. Use chain puller as necessary to position connecting rod while clearing box from crankshaft. Adjust until link rod is in line with the axis of the cylinder liner.
- i. Coat walls of cylinder liner with clean lubricating oil then place a piece of 3/32-inch compressed asbestos gasket material between link rod box and liner wall to prevent box from scoring liner wall. Coat side of gasket material which contacts liner wall with clean lubricating oil.
- j. Carefully hoist piston and rod out of liner with 1 ton chainfall taking care not to allow piston to bind in liner (see figure 6-C-4).
- k. When bottom end of connecting rod box is clear of liner, move piston and rod clear of engine and lower to floor or a suitable stand.

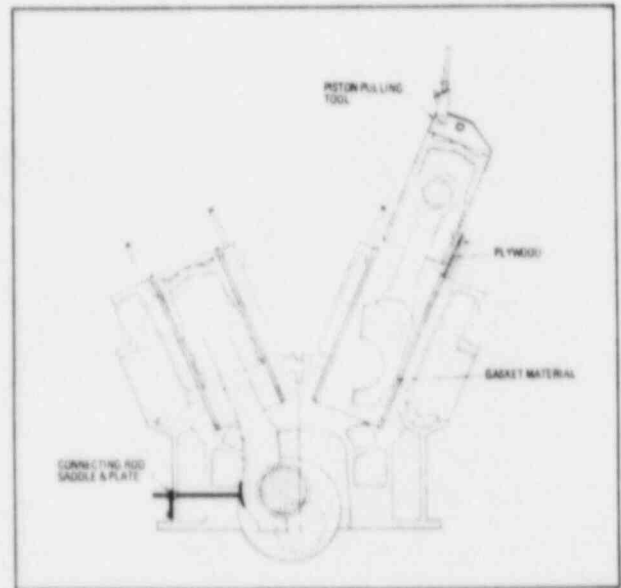

Figure 6-C-4. Lifting Piston and Link Rod From Cylinder Liner.

PISTON AND MASTER ROD REMOVAL.

Attach special tools as shown in figure 6-C-5 and take up slack with chain puller to hold master rod in place against the crankshaft.

- a. Loosen connecting rod saddle assembly then slack off on chain puller until master rod swings clear of crankshaft and is in line with the cylinder liner bore. It may be necessary to adjust the position of the piston and rod with the chainfall.
- b. Rotate crankshaft approximately 30° past top center, away from master rod to permit rod to clear crankshaft journal.
- c. Pull piston and rod in the same manner as piston and link rod were pulled (see figure 6-C-6).

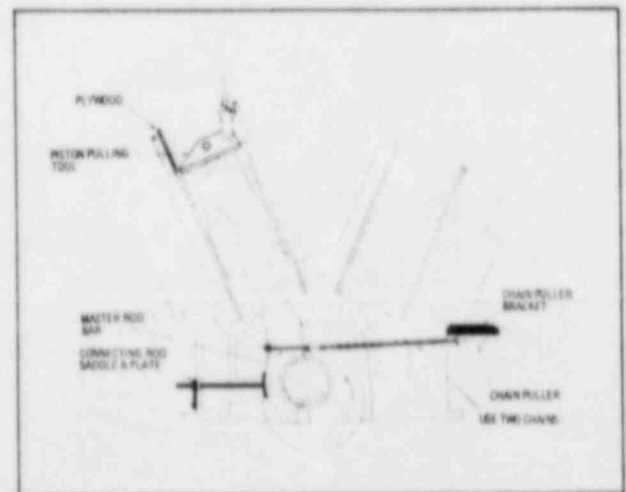

Figure 6-C-5. Tools Installed For Piston and Master Rod Removal.

Instruction Manual

PART C – PISTONS AND RODS (Continued)

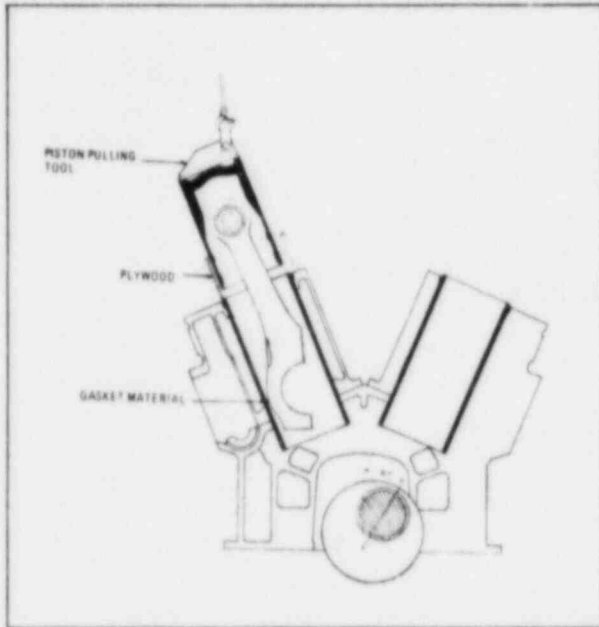

Figure 6-C-6. *Lifting Master Rod and Piston From Cylinder Liner.*

REMOVAL OF A SEIZED STUD.

When it is evident that a bolt has seized in the connecting rod box, do not attempt to force it. The following procedure is recommended for the removal of a seized connecting rod bolt.

- a. Position the crankshaft to place the connecting rod at its closest point to the engine side door and block the crankshaft to prevent movement.
- b. Leave at least one good bolt in position to hold the master rod and connecting rod box together while the seized bolt is being removed.
- c. Form a shield of asbestos gasket material around the master rod to catch molten metal and slag and prevent it from falling into the engine base.
- d. Cut off the head of the seized bolt with an oxy-acetylene cutting torch. Exercise great care not to damage the master rod with the cutting flame.
- e. Clean out the slag and burned metal and remove the gasket shield.
- f. Install a master rod retaining bar and plate assembly to hold the master rod firmly against the connecting rod bearing and crank journal.
- g. Install the tools and fixtures necessary to remove the link rod and piston.
- h. Remove the remaining bolts and carefully disengage the link rod and connecting rod box from the master rod. Carefully guide the headless bolt stud through its hole in the master rod. Allow the link rod and box to rest against the lower edge of the cylinder liner.
- i. Place a shallow pan of water beneath the stub of the seized bolt to catch the molten metal and slag when the stub is cut off, then cut the stub off approximately one inch from the surface of the connecting rod box.
- j. Clean the debris from the area then remove the link rod and piston assembly from the engine in the normal manner. Remove the connecting rod box from the link rod.
- k. Set the connecting rod box up on a good radial drill and drill out the remainder of the seized bolt. Exercise care to drill the bolt on dead center to prevent damage to the threads in the tapped hole in the connecting rod box.
- l. Try a new bolt in the hole to be sure the threads are good, and that the bolt will run free in the tapped hole.
- m. Reassemble the link rod and connecting rod box and place the piston and connecting rod assembly in the engine in the normal manner. Use new locking devices when assembling the link rod to the link pin.

INSTRUCTION MANUAL

DELAVAL ENGINE AND
COMPRESSOR DIVISION
550 - 85th AVENUE
OAKLAND, CALIFORNIA 94621



PART C - PISTONS AND RODS (Continued)

DISASSEMBLY.

With piston and rod suspended from a hoist and with the weight of the assembly resting lightly on the piston crown, remove piston pin retainer rings from grooves on ends of piston pin then slide piston pin out of piston. Lift rod assembly clear of piston.

INSPECTION.

Carefully inspect piston, rod, pin and bushings for wear and/or damage.

- a. inspect connecting rod bearing shells for evidence of scratches, nicks, burrs, excessive heat and wear. Clearance tables should be consulted for the required bearing shell wall thickness.

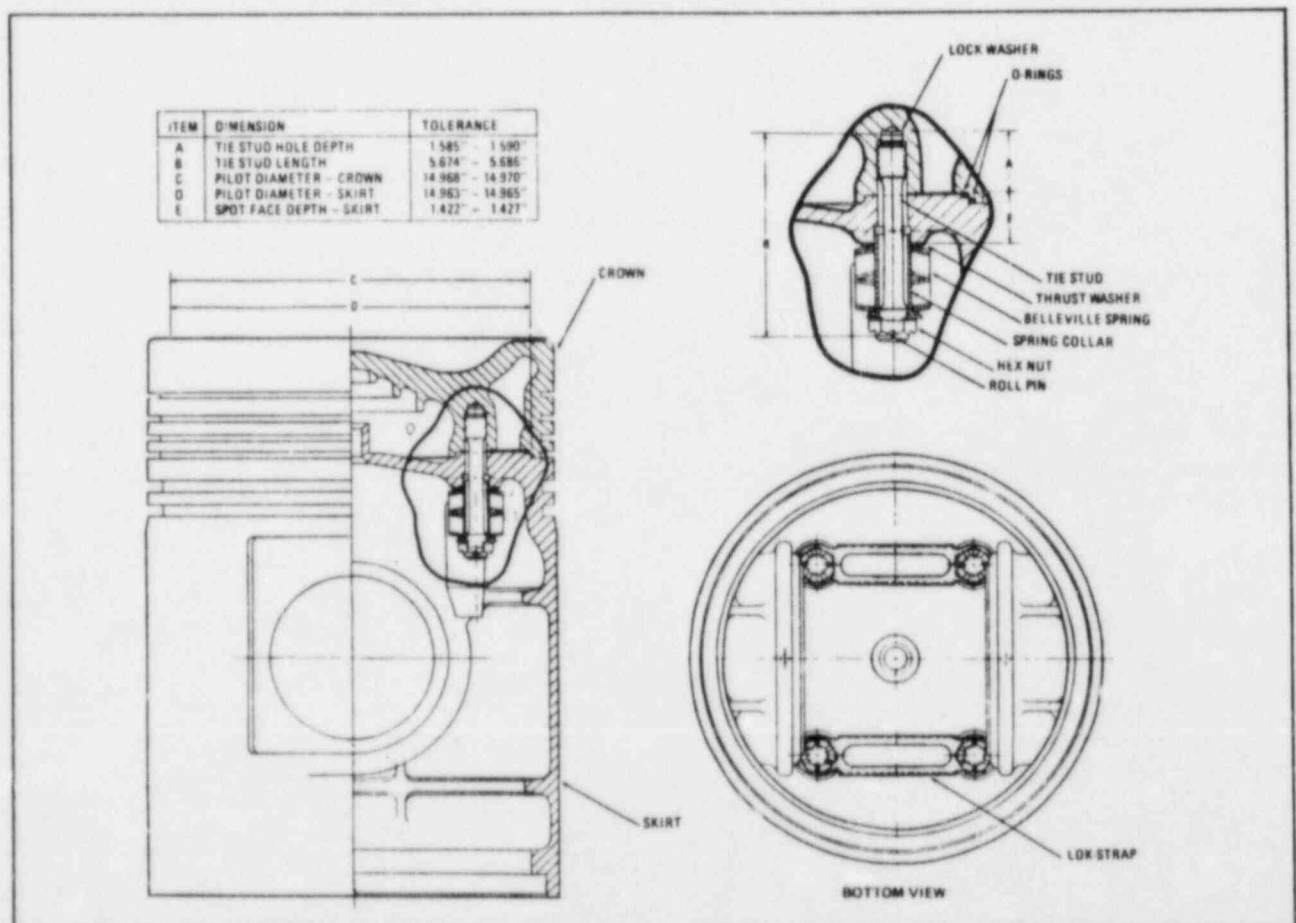

Figure 6-C-7. Piston Assembly

- c. Reassemble pistons as follows.

- (1) Measure depth of crown stud holes. Measure from raised inner ring towards the center of the crown, not from the 0.007" deep relieved area. Must be within tolerances (A, Fig. 6-C-7).

Instruction Manual

PART C – PISTONS AND RODS (Continued)

- (2) Install a heavy spring lock washer in each of the four tie stud holes. Use Enterprise Part No. GA-002-091 washer (0.388" I.D., 0.691" O.D., 0.115" thick). Do not substitute.
- (3) Measure length of tie stud from lock washer end to centerline of roll pin hole (B, Fig. 6-C-7). Acceptable tie studs must be within tolerances.
- (4) Lubricate threads of tie studs (end opposite roll pin hole) with a 50-50 mixture of graphite and engine oil, and thread studs into holes in crown. Torque to 250 ft-lb.
- (5) Take a micrometer measurement of crown and skirt pilots (C, D, Fig. 6-C-7). Must be within tolerances to ensure ease of assembly without damage to O-rings.
- (6) Measure skirt spot face depth (E, Fig. 6-C-7). Should be within stated tolerances.
- (7) Install O-rings on skirt. Do not twist rings during installation. Use no adhesive, grease or solvent on rings. Mineral oil may be used to ease entry of O-rings into crown.
- (8) Assemble crown to skirt. Observe that there is a dowel pin in the crown which must enter the dowel hole in the skirt. Check O-rings for proper positioning.
- (9) Clean each Belleville spring and the spring collars by dipping them in solvent then thoroughly drying. Dip all springs and collars into a 50-50 mixture of graphite and engine oil, making sure washer faces are completely wetted.
- (10) Install thrust washer on each tie stud, then install exactly 13 Belleville springs on each stud, concave side towards skirt. Install 13 more Belleville springs on studs, concave side towards crown.
- (11) Install spring collars on each tie stud, then install two lok-straps as shown in Figure 6-C-7.
- (12) Apply Locktite to threads of studs, and assemble hex nuts to studs and tighten finger tight. Do not lubricate threads.
- (13) Align each washer stack with fingers so outer edge of washer stack is even. Torque each nut to 95 ft-lb, then back off three-quarter turn.
- (14) Retorque each nut to 85 ft-lb and check alignment of tie stud roll pin holes with nut slots. Increase torque as necessary to align roll pin holes with closest nut slot. Do not exceed 100 ft-lb.
- (15) Check for proper assembly. Roll pin hole in stud should be even with, or a maximum of 1/32" above base of nut slot. If within this tolerance, clean roll pin hole and install roll pin, using loktite. If not within tolerance, check assembly of parts for proper size and correct number of springs each way.
- (16) Bend lok-strap tabs up securely against side of nuts.

PISTON RING REPLACEMENT.

If piston rings require replacement, remove and install as follows.

- a. Starting with top ring, spread and slide piston rings up and off piston. Four brass strips, measuring approximately 1/32" x 1/2" x 8" may be inserted under rings to protect piston during removal and installation of rings.

PART C - PISTONS AND RODS (Continued)

b. Replace piston rings in reverse order of removal. Intermediate compression rings are marked "UP" on the upper sides. Top compression rings may be installed with either side up. The oil cutter rings must be installed with the cutting edge down.

c. Rotate the rings in the grooves so gaps are staggered around circumference of piston.

PISTON RING GAP AND SIDE CLEARANCES.

Piston ring gap may be measured by inserting piston ring into cylinder liner and sliding it down squarely, measuring the gap at various levels in the liner. The gap clearance should be determined at the smallest diameter, usually near the bottom of the liner. Piston ring wear is usually indicated by excessive ring gap clearance. Refer to "Appendix III" in Section 8 for correct gap clearance. If the recommended gap clearance is exceeded by 1/16-inch or more, the bore of the liner should be measured with an inside micrometer. If the bore at any point is worn more than shown in "Appendix III" the liner should be replaced. Liner wear is usually limited to the last few inches of ring travel near the top.

PISTON PIN BUSHING REPLACEMENT.

Use the following method to replace the piston pin bushing in the connecting rod.

a. If an arbor press is available, press the bushing from the rod, otherwise, carefully split the bushing with a hacksaw and drive it out of the rod. Remove all burrs and clean the connecting rod.

b. Place the new bushing in a suitable container such as a bucket or a deep pan.

c. Fill the container with liquid nitrogen. Nitrogen level should be approximately one inch from the top of the bushing to allow for handling.

d. Lay connecting rod on its side on a suitable support. Both ends of the piston pin bushing bore should be accessible.

WARNING

Wear suitable gloves when handling bushing to avoid injury to the hands. Gloves should be of a type approved for protection against extreme low temperatures.

e. When the nitrogen stops boiling, remove the bushing from the container and insert in the bore, taking care to align the oil holes with the oil passages in the connecting rod. Insure that the bushing protrudes the same distance on both ends. The operation must be done quickly before the bushing expands due to heat pickup.

LINK PIN BUSHING REPLACEMENT.

If the link bushing requires replacement, proceed as follows.

a. Remove the bushing lock pin, split the bushing with a hacksaw to relieve stress, then drive bushing out of connecting rod box.

b. Clean the connecting rod box, removing all burrs and rough surfaces.

c. Place new bushing in a suitable container such as a bucket or a deep pan.

PART C - PISTONS AND RODS (Continued)

d. Fill container with liquid nitrogen. Nitrogen level should be approximately one inch from the top of the bushing to allow for handling.

e. Lay the connecting rod box on its side on a suitable support. Three pieces of 1-1/2 inch rough stock, laid parallel on a piece of metal plate, will provide adequate support for the box and act as a stop for the bushing so that it will be flush with the side of the box when it is inserted.

WARNING

Wear suitable gloves when handling bushing to avoid injury to the hands. Gloves should be of a type approved for protection against extreme low temperatures.

f. When the nitrogen stops boiling, remove the bushing from the container.

g. Insert the bushing in the connecting rod box, taking care to line up the bushing cutouts with the internal surface contour of the box. Insure that both ends of the bushing are aligned with the side of the box. This must be done quickly before the bushing expands due to heat pickup.

PISTON AND ROD ASSEMBLY.

Assemble pistons, rods and connecting rod box as follows. Make sure pistons and rods are reassembled in the same relative position as they occupied before disassembly.

a. Insert link rod pin in connecting rod box bore and position link rod on link pin.

b. Apply a lubricant consisting of a 50-50 mixture of powdered graphite and lubricating oil to the threads of the link-rod-to-pin bolts. Torque bolts to specified torque and secure with lockwire.

c. Place piston upside down, resting on its crown. Lift connecting rod with rod turning plate then lower end of connecting rod into piston, aligning piston pin hole in rod with that of piston.

d. Insert piston pin through piston and rod. Clean piston groove and the outside end of the piston pin retainer rings and insert retainer rings into piston grooves at either end of piston pin. Apply "Loctite" to ends of retainer rings to prevent rings from rotating in the grooves.

PART C - PISTONS AND RODS (Continued)

PISTON AND MASTER ROD INSTALLATION.

Install a piston pulling tool on piston crown then suspend piston and rod from an overhead hoist then proceed as follows.

- a. Lubricate walls of cylinder liner with clean lubricating oil.
- b. Install piston ring fixture on top of cylinder liner.
- c. Place a piece of one-half inch plywood vertically on inner side of outer cylinder head studs.
- d. Position crankshaft with crankpin approximately 30° past top center, away from master rod side.
- e. Position piston and rod over cylinder liner.
- f. Lubricate one side of a piece of 3/32-inch asbestos gasket material with clean lubricating oil. Wrap around lower end of connecting rod with oiled side towards liner wall.

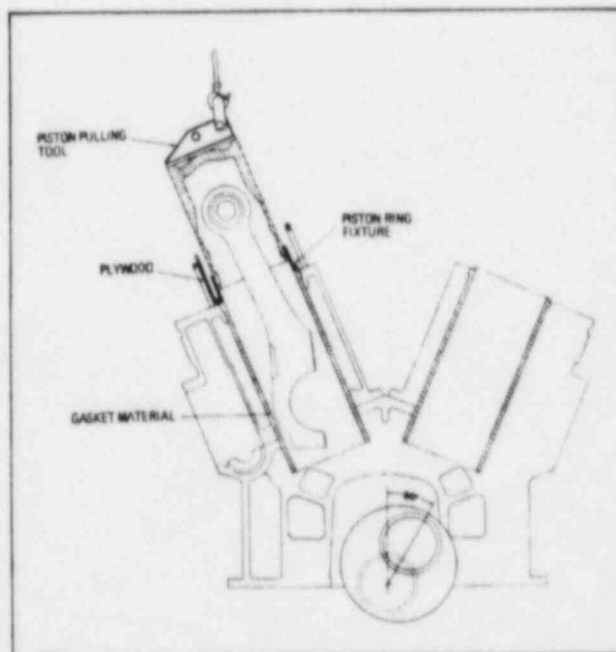

Figure 6-C-8. Piston and Rod Installation

- g. Lower rod into cylinder (see figure 6-C-8). Hold piston rings in place as they enter the piston ring fixture. Insure ring gaps are staggered around circumference of piston.
- h. Continue to lower piston until connecting rod bore is opposite crankpin. Remove gasket material.
- i. Attach chain puller bracket, chain puller, chains and master rod bar then rotate crankshaft towards rod. By adjusting rod and crankshaft positions, bring master rod into engagement with crankpin. Make sure dowel seats in dowel hole - rotation of bearing shell may be necessary.
- j. Install connecting rod saddle and plate on master rod side (see figure 6-C-5) and set to hold master rod tight against crankpin.

WARNING

Do not rotate crankshaft until link rod has been assembled and bolted to master rod. Block crankshaft to prevent movement.

PART C - PISTONS AND RODS (Continued)

PISTON AND LINK ROD INSTALLATION.

Use same procedure used for master rod and piston installation to install link rod, connecting rod box and piston in engine, then use the following procedure to attach connecting rod box to master rod.

- Attach chain puller bracket to master rod side of crankcase and attach chains in same way as was done for removal (see figure 6-C-3) and draw connecting rod box into engagement with crankpin and master rod. Make sure serrated joints are properly engaged.
- Apply graphite and lubricating oil mixture to threads of connecting rod bolts and washers and install bolts and washers and tighten bolts to the specified torque. Secure bolt heads with lockwire (see figure 6-C-1).
- Install connecting rod-to-box bolts in lower holes and assemble washers and nuts that are lubricated with oil and graphite lubricant. Torque nuts as specified and insert cotter pins.
- Remove all installation tools, brackets, fixtures and other installation equipment.

CYLINDER LINERS.

The water contact type cylinder liners fit into the cylinder block. Three sealing rings are recessed in grooves at the lower end of the liner, preventing water from entering the crankcase. The silicone seal goes into the lower sealing ring groove.

LINER REMOVAL.

Remove the cylinder head, piston and connecting rod, then disconnect lubricating lines from lower end of liner. Install liner pulling tool, Part No. 00-590-01-OV to the bottom of liner and attach a chain hoist to the lifting pad on the tool. Pull liner straight out of the block. It may be necessary to use blocking and a hydraulic jack to break the liner free of the cylinder block.

LINER INSTALLATION.

Installation of the liner is the reverse of removal. To prevent damage to the seals, they should be installed in the grooves after the liner has been lowered approximately two-thirds of the way into the cylinder block. Use new sealing rings and coat them with a liquid dishwashing soap, or a tire installing lubricant before installing. The bottom seal is silicone and should be handled carefully to prevent tearing or nicking. It is essential that liners be replaced in their original positions in the block and that the scribe marks on top of the liner be aligned with the mark on the block.

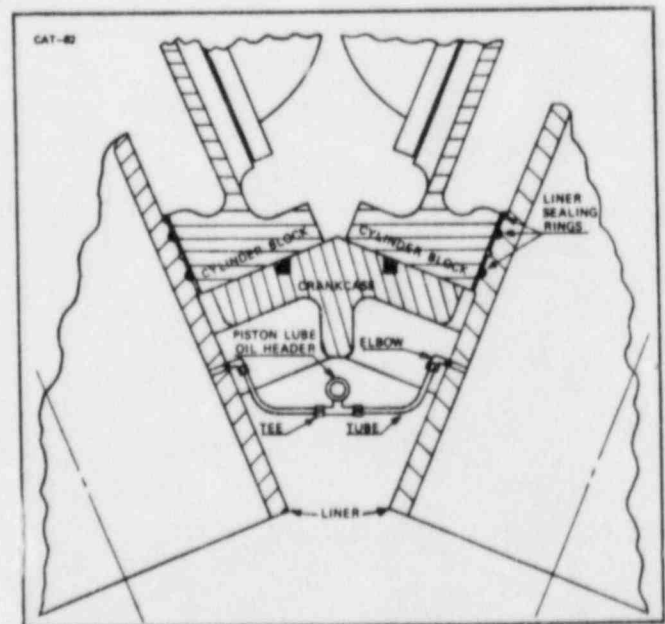

Figure 6-C-9. Liner Sealing Rings

PART D – CRANKSHAFT AND BEARINGS

MAIN BEARINGS.

Main bearings are made of aluminum alloy, the upper and lower bearings being interchangeable. The upper shell is held in place on the bearing cap by two lock rings and socket head capscrews. Main bearings are front, intermediate and rear, the number of intermediate bearings being determined by the number of cylinders. Bearing caps are secured to the engine base by studs (see figure 6-D-1). Oil passages through the bearing cap provide for bearing shell lubrication. To prevent axial movement of the crankshaft, thrust rings are attached to the rear bearing caps, each secured with button head capscrews (see figure 6-D-2).

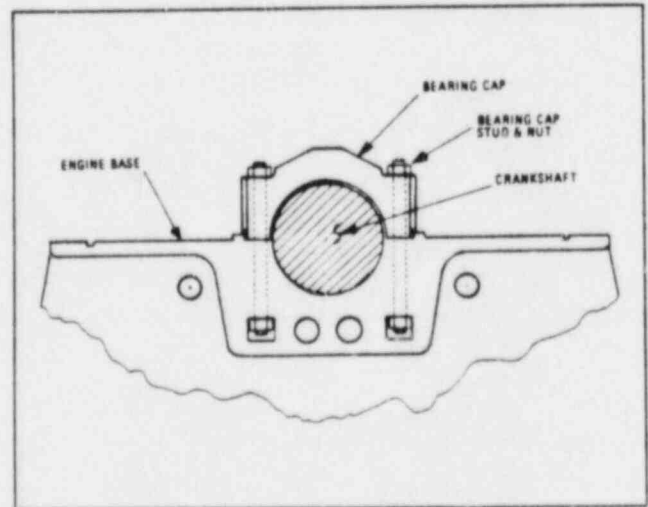

Figure 6-D-1. Main Bearing Cap

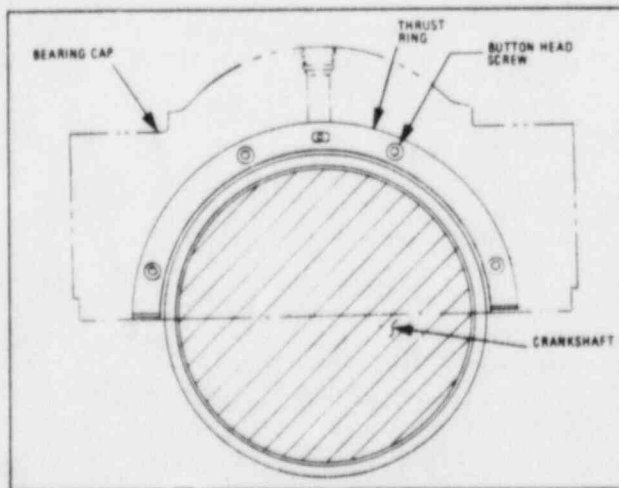

Figure 6-D-2. Crankshaft Thrust Rings

BEARING CAP REMOVAL.

Main bearing caps are pre-stressed by means of a special tool, normally furnished with the engine. The tool consists of a pre-stresser assembly (Part No. 1A-1801), and adapter (Part No. 00-590-01-0K) and a spacer (Part No. 00-590-01-0J).

- a. Remove lubricating oil fittings, temperature sensing devices and locking plates from stud nuts.
- b. Attach adapters to pre-stresser assemblies and place a spacer over each of two diagonally opposite stud nuts.
- c. Use jacking screws on micrometer bar to force piston flange against top of cylinder, then back off jacking screws one-quarter inch.
- d. Assemble a pre-stresser to each of the two main bearing cap studs, running them down on the stud threads until pre-stressers are snug against adapters.
- e. Attach hydraulic hose between two pre-stressers, and between one pre-stresser and a suitable hydraulic pumping unit. Bleed air from system by opening pipe plug on second pre-stresser then operating pumping unit to supply a small pressure. When all air bubbles disappear, tighten pipe plug.

PART D – CRANKSHAFT AND BEARINGS (Continued)

f. Slowly apply hydraulic pressure to pre-stresser assemblies until bearing cap studs have stretched sufficiently to permit stud nut to be loosened. Approximately 10,500 psi pressure will be required. Use a brass drift pin through the spacer side opening to loosen nut. Do not turn nut up tight against lower face of adapter as it will bind when hydraulic pressure is released. *Do not exceed maximum allowable pressure of 11,500 psi.*

g. Relieve hydraulic pressure on pre-stressers, remove pre-stressers, spacers and adapters from stud. Remove stud nuts.

h. Repeat procedure on remaining studs, following a criss-cross pattern. Remove all stud nuts and lift bearing cap from crankshaft.

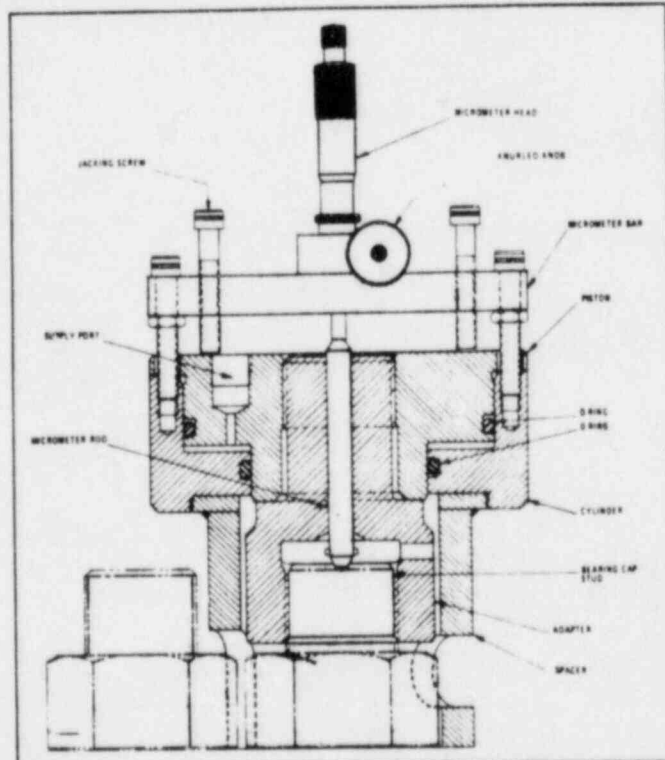

Figure 6-D-3. Pre-Stresser Assembly

BEARING SHELL REPLACEMENT.

If it is necessary to remove the main bearings, remove the two socket head capscrews and lock rings that hold the upper bearing shell to the main bearing cap and carefully remove the shell from the cap. Install a bearing shell removal tool (Part No. 00-590-01-AE) in the crankshaft journal oil hole then slowly rotate the crankshaft until the tool is bearing against the bearing shell. Slowly continue to rotate the crankshaft and roll the bearing shell out of the journal. To remove the thrust rings from the rear bearing caps, remove the button head screws and pull the thrust rings. Reverse the procedure to install thrust rings and bearing shells.

BEARING CAP INSTALLATION.

Install bearing cap in position in the reverse order of removal. Take care not to damage the bearing shells. The bearing cap studs are tightened as follows.

a. Install pins to lock lower stud nuts to studs, then place wedges between lower nuts and the base cavity bottom and side walls. Check that height of stud end is 11-3/16 inch above cap mounting surface to permit proper engagement with the pre-stresser assembly.

b. Lubricate threads with 50-50 mixture of oil and graphite and tighten upper stud nuts hand tight. Place spacers (Part No. 00-590-01-OK) to the pre-stresser assemblies. Use jacking screws to force piston flange tight against top of cylinder. Back off jacking screws 1/4 inch.

c. Install pre-stresser assemblies on two diagonally opposite studs and assemble the micrometer bar on the units.

PART D – CRANKSHAFT AND BEARINGS (Continued)

- d. Insert micrometer head into the hole in the micrometer bar, making sure that it is fully seated. Tighten knurled knob to hold micrometer head in place.
- e. Attach hoses to pre-stressers and apply pressure to bleed air.
- f. Run micrometer spindle against the micrometer pin until the pin is snug against the end of the bearing cap stud. Observe and record the micrometer reading.
- g. Loosen knurled knob and remove micrometer head from the micrometer bar. Insure that jacking screws on pre-stressers and backed off one-quarter inch for each stud.

CAUTION

Failure to back off on micrometer spindle will result in damage to the micrometer.

- h. Apply 10,500 psi pressure to pre-stressers and hold while using brass drift pin through spacer opening to tighten nut snugly (about 50 ft-lb). Relieve pressure.

Note

This operation is necessary to insure proper seating of parts and to minimize the effect of dirt or high spots on future readings.

- i. Apply 10,500 psi pressure and hold. Tighten nuts to a snug fit with drift pin (about 50 ft-lb).

WARNING

Do not exceed maximum allowable pressure of 11,500 psi.

- j. Relieve hydraulic pressure and install micrometer head in the micrometer bar. Run spindle snug against micrometer pin and record reading. Subtract the first reading from this reading. This is the amount the stud has stretched. Stud should stretch 0.056"-0.051". Repeat operation if stretch is not within specified range.
- k. Remove pre-stresser assemblies and repeat operation on next pair of diagonally opposite studs.

INSTRUCTION MANUAL

DELAVAL ENGINE AND
COMPRESSOR DIVISION
560 - 85th AVENUE
OAKLAND, CALIFORNIA 94621



PART D - CRANKSHAFT AND BEARINGS (Continued)

CRANKSHAFT ALIGNMENT AND THRUST CLEARANCE.

It must be emphasized that excessive crankshaft deflection can lead to an ultimate catastrophic failure of the crankshaft. This is costly in both time and money. It is recommended that crankshaft alignment and thrust clearance be measured immediately after grouting or chocking of the unit, the day before initial start up, after the first seven days of continuous operation, and at six month intervals thereafter. Refer to Delaval Engine and Compressor Division Form D-1063 (see figure 2-2) for an outline of these procedures. Note that space is provided for recording both deflection and thrust clearance readings. Copies of this form may be obtained from Delaval.

CHECKING THRUST CLEARANCE.

Experience has shown that the feeler gauge method of measuring thrust clearance does not always produce satisfactory results. The dial indicator method is recommended to produce the desired accuracy of readings. A Starrett No. 196, or similar, type dial indicator with magnetic base and extension rod long enough to allow the indicator to be mounted between the engine and flywheel with the spindle bearing on the flywheel. Check thrust clearances as follows:

- a. Start auxiliary (B&A) lubricating oil pump. Bar engine over at least one-half revolution to establish an oil film between the main bearings and their journals. This should permit easy movement of the crankshaft.
- b. Mount dial indicator on rear of engine frame, between frame and flywheel. Spindle of indicator must bear on flywheel to measure horizontal movement of the crankshaft.
- c. The crankshaft may be moved forward and aft in the horizontal plane with a pry bar such as a heavy, spade-type, tempered steel digging bar, approximately six feet long. Make sure bar is clean enough for use inside the engine. Insert bar between rear crank web and nearest frame member inside crankcase. Do not insert bar deeply enough to damage either the main bearing shell or the crankshaft journal.
- d. Pry crankshaft forward, towards the gearcase end as far as it will go. If the crankshaft is all the way forward, it should be impossible to insert a 0.0015 inch feeler gauge between the crankshaft rear thrust collar and the rear thrust ring. Zero the dial indicator, allowing for at least 0.050 inch movement towards the minus direction.

Note

If crankshaft cannot be moved to the limit of its possible travel by use of the pry bar alone, it may be necessary to bar the engine over with the barring device while at the same time exerting a horizontal force on the crankshaft with the bar to move it.

- e. Reposition pry bar to move crankshaft to the rear, towards the flywheel end. Pry crankshaft to the rear as far as it will go as indicated by the inability to insert a 0.0015 inch feeler gauge between the forward crankshaft thrust collar and the forward thrust ring.

- f. Observe dial indicator. The number of thousandths (minus) indicated on the dial is the crankshaft thrust clearance. Record reading in the appropriate space on Form D-1063, and compare with previous thrust clearance readings.

Note

If there is any doubt as to the accuracy of the reading, repeat procedure.

INSTRUCTION MANUAL

DELAVAL ENGINE AND
COMPRESSOR DIVISION
550 - 85th AVENUE
OAKLAND, CALIFORNIA 94621



PART D - CRANKSHAFT AND BEARINGS (Continued)

CRANKSHAFT WEB DEFLECTION.

The importance of crankshaft web deflection measurements is such that the care and attention to detail required to obtain and record these measurements cannot be overemphasized. Placement of the dial indicator is vital if accurate readings are to be obtained. Form D-1063 (see figure 2-2) illustrates the five positions of the crankshaft at which web deflections are to be measured, and the starting position of the crankshaft for each crank web. Care must be exercised to insure that the dial indicator is positioned in the center of the web, exactly opposite the center of the crankpin, and one-fourth inch from the edge of the crankweb. Take deflections as follows:

- a. Remove engine side doors to gain access to the crankcase.
- b. Bar engine over in direction of normal rotation with barring device until number one crank is 52 degrees after vertical bottom center.
- c. Insert dial indicator between web for number one crank. Double check that crankshaft is properly positioned. If not in correct position, it is possible that the connecting rod will knock the dial indicator out of the web as the engine is barred over to the next position. Insure the two bearing points of the indicator are in a line exactly parallel to the centerline of the crankshaft. If indicator is not parallel, erroneous readings will be obtained. Zero the indicator.
- d. With the dial indicator in place and not disturbed, bar the engine over, stopping at each position (2,3,4 & 5) as indicated on form D-1063. Record reading at each position in mils (plus or minus) in the appropriate space for each position.
- e. Repeat entire procedure for each crankshaft web and record readings on Form D-1063.
- f. Compare all readings with each other and with previous measurements. Evaluate results, based on the standards set forth in the following paragraph, and determine need for corrective action.

DEFLECTION STANDARDS.

If the deflection in any crank of an engine in service exceeds 3 mils (0.003 inch/0.0762 mm), corrective action is indicated. If the deflection in any web exceeds 6 mils (0.006 inch/0.1524 mm), the engine should be taken out of service until the fault is corrected. Corrective action is also necessary if the total deflection in any pair of adjacent cranks exceeds 3 mils. For example, if the deflection in one crank is plus two mils, and the deflection in an adjacent crank is minus two mils, the total deflection is four mils, and corrective action is indicated.

CORRECTIVE ACTION.

The nature of the corrective action needed to deal with excessive crankshaft deflections will vary, depending upon the specific cause of the defect. The cause may be worn main bearings, improper foundation bolt torque, the foundation itself, or the grouting, misalignment of the engine and/or driven equipment, or a combination of elements. For instance, excessive deflection at positions two, three or four in the crank web adjacent to the external shafting on engines having a solidly coupled connecting shaft usually indicates misalignment between the connecting shafting and the engine crankshaft. In some cases replacement of main bearings may correct the problem, and often the problem is correctable by realignment of the engine. If one portion of the engine base is found to be lower than other parts, it may be necessary to jack the base with jacking screws and shim the low area. It must be emphasized that engine alignment is a complex, trial and error procedure which should be undertaken only by experienced and qualified personnel who are capable of correctly interpreting the web deflection pattern, and of taking the appropriate measures to correct defects. It is recommended that the Delaval Engine and Compressor Division Customer Service Department be consulted prior to undertaking any corrective measures involving a suspected or confirmed crankcase alignment problem.

Instruction Manual

PART E – CAMS, CAMSHAFTS AND BEARINGS

GENERAL.

The induction hardened steel cams are shrink fit on the precision ground camshaft, using hydraulic expansion of the cam bore to position them on the camshaft. Camshaft bearings are aluminum alloy and are pressure lubricated. Cams, camshafts and associated operating gear should be checked periodically for wear and/or damage.

CAMSHAFT BEARING REPLACEMENT.

Should it be necessary to inspect and replace camshaft bearings, do the following.

- a. Remove covers over camshaft.
- b. Disconnect lubricating oil line from bearing cap.
- c. Remove bearing cap, lock rings and upper bearing shell, then roll lower bearing shell out of its saddle.
- d. Inspect bearings for evidence of damage or wear. Refer to Appendix III for permissible wear limits.
- e. Installation is the reverse of removal.

CAM REPLACEMENT.

Cams are positioned on the camshaft at the factory by hydraulically expanding the cam bore and sliding the cam into position on the shaft. If it ever becomes necessary to remove and replace cams in the field, the following procedure is recommended.

- a. Cams are located on the camshaft by scribe marks on the cams and the camshaft, placed there during manufacture. Circumferential marks locate the cams longitudinally on the camshaft, and longitudinal marks locate the cams circumferentially. Cams have a radial scribe mark on the side of the cam which passes through the center of the hole in the side of the cam.
- b. Make a sketch of the camshaft assembly, indicating the location of the cams and the distance between each. Make sure the camshaft and all cams are scribed.
- c. Clean the camshaft and place on Vee blocks on top of a clean workbench. Make sure all burrs, dents and other irregularities are reduced to the common diameter of the camshaft. Irregularities will prevent removal of the cams.
- d. Obtain a hydraulic pump unit, such as a "Porto-Power", complete with a hose and fittings, and a pressure gauge capable to reading up to 20,000 psig.
- e. Remove camshaft gear from camshaft, then connect hydraulic unit to the first thrust ring. Raise pressure to approximately 2000 psig and slide thrust collary off camshaft. Repeat procedure to remove other thrust ring.
- f. Connect hydraulic unit to first cam nearest the tapered end of camshaft. Apply approximately 16,000 psig pressure (or pressure that will allow the cam to slide on the camshaft) and move the cam towards the drive end of the shaft.

PART E - CAMS, CAMSHAFTS AND BEARINGS (Continued)

WARNING

The camshaft has a taper near the drive end which serves as a starting ramp when installing the cams. As the cams reach the taper there is a strong tendency for them to shoot off the shaft with considerable velocity. Arrange a stop plate at the end of the shaft to keep the cams from shooting off the camshaft.

- g. Remove all cams in order.
- h. Wash and dry the camshaft and the replacement cams. Check that scribe marks are clean, sharp and clearly visible. Lay cams out on a clean surface in the correct sequence and orientation for installation. Refer to the sketch and make sure the cams are facing in the proper direction.
- i. Choose the cam which will be farthest from the drive end of the camshaft and slide it up on the starting ramp as far as it will go.
- j. Attach the hydraulic unit to the cam and start raising the pressure. A vigorous effort will be required to move the cam up the starting ramp to the straight part of the shaft. Approximately 16,000 psig pressure will be required.
- k. Move the cam to its correct location on the shaft. Align the edge of the cam bore with the circumferential scribe mark and align the radial (longitudinal) scribe mark on the shaft with the mark on the cam. Release the hydraulic pressure when the cam is correctly aligned.
- l. Install and position the remaining cams in order, then replace the thrust rings.

Instruction Manual

PART E – CAMS, CAMSHAFTS AND BEARINGS (Continued)

TIMING GEARS.

Timing gears are enclosed in the gearcase, and are lubricated by jets of oil. Gearcase covers should be removed periodically, and the gears inspected for wear and for backlash. Refer to Appendix III for backlash clearances. If the prescribed backlash clearance is exceeded by 0.006 inch, or if damage is discovered, perform the following disassembly steps to the degree necessary to accomplish the required inspection and repair. Accessories are doweled at assembly. If it is necessary to remove a dowel to reposition an accessory, drill and ream another dowel hole of the proper size in the accessory mounting flange and in the gearcase.

a. Remove the governor, overspeed trip, pumps and other accessories which would interfere with gearcase removal. As the pumps are removed, cover the shaft, drive gears and openings in the pump housing to exclude dirt and to prevent damage. Cover the open ends of connecting pipes and tubing.

b. Remove gearcase from engine. The gearcase is heavy and difficult to handle, therefore, rigging must be done very carefully to insure that it is under control at all times.

(1) Rig chainfalls and slings for handling gearcase.

(2) Remove bolts and capscrews, then lift gearcase from engine. Do not let it drop or swing. Set aside, secured in such a manner that it cannot fall.

c. Remove the governor drive assembly, and the overspeed trip and fuel booster pump drive assembly.

d. Insure that the crankshaft, camshaft and idler gears are match-marked for proper positioning at reassembly. If a new gear is to be installed, check both cylinder banks to insure that the number one fuel injection pumps are correctly timed. Fuel injection pump timing marks will serve as a reference point when reinstalling the gears.

e. Remove idler gear and bracket assemblies.

(1) Rig a small chainfall and wire rope sling to lift the idler gear and bracket assembly from the engine.

(2) Straighten locking clips. Remove top bracket retaining capscrew and replace with a long capscrew to serve as a guide and safety device while removing the gear and bracket assembly.

(3) Remove remaining capscrews and take a strain on the chainfall.

(4) Carefully pry bracket assembly free of the aligning dowels at the top and bottom of the bracket.

(5) Slide gear teeth clear of other gears, taking care not to damage any teeth.

(6) Remove long guide capscrew, and move bracket assembly clear of engine.

f. Remove camshaft gear assemblies.

(1) Remove cotter pins from camshaft gear hub retaining nut. A gear puller may be needed to start the gear hub off the shaft. The gear assembly will usually jump when it breaks free of the taper. If the initial movement is too great the ram effect may cause displacement of camshaft collars or upset thrust clearance. To prevent this, loosen hub retaining nut only far enough to limit this initial movement to 1/16 inch.

Instruction Manual

PART E – CAMS, CAMSHAFTS AND BEARINGS (Continued)

(2) If the gear assembly will not come loose with a gear puller, use an oxy-acetylene torch and quickly apply heat to expand the hub. Protect the front camshaft bearing from the torch flame. *Do not overheat.*

(3) Remove camshaft gear hub retaining nut and slide gear off shaft.

g. Remove camshaft gear.

(1) Protect the front main bearing with a wet asbestos heat dam.

(2) Make two 3/4-inch diameter handling rods, 24 inches long with 3/4-10 threads at one end, and screw rods into the two tapped holes in the gear.

(3) Use two "Rosebud" type heating torches to quickly heat the gear until it can be slipped off the crankshaft with the handling rods. Be sure the exposed end of the crankshaft is clean and free of burrs.

INSPECTION.

Inspect gears for broken teeth, or other damage. If gears are damaged, inspect camshaft with dial indicator to determine if shaft is bent.

a. Clean camshaft tapers and check fit of drive keys in hubs.

b. Clean gear seat area of crankshaft.

c. If it is necessary to remove the idler gear from the bracket, cut the safety wire and remove the four bolts that hold the idler gear stub shaft in the bracket. Remove the stub shaft then carefully slide the gear out of the bracket. When reassembling the idler gear in the bracket take care not to damage the bushings or the gear teeth.

ASSEMBLY.

a. Install camshaft gear.

(1) Lubricate camshaft taper with white lead and lubricating oil. If a new gear hub is being installed, fit a new key in the key slot.

(2) If a new gear and hub are being installed, position the slotted holes in the hub over the drilled holes in the gear. Install camshaft gear to hub bolts, washers and nuts. Tighten to hold gear and hub together.

(3) Using a chainfall and sling, lift gear assembly into position and slide onto camshaft taper. Assemble washer and nut, tighten, and install cotter pin.

b. Install crankshaft gear.

(1) Heat camshaft gear to 350^o F in hot oil. *Do not overheat.*

(2) Screw two handling rods into tapped holes in gear. Lift gear out of the oil with rods, and with one smooth, continuous motion, position heated gear against the shoulder. This must be done quickly before the gear cools. Allow gear to cool, then proceed.

Instruction Manual

PART E – CAMS, CAMSHAFTS AND BEARINGS (Continued)

- (3) Set the flywheel to the left bank fuel injection point (see Engine Data Sheet in front of manual).
 - (4) Set the left bank camshaft so that number one fuel injection pump timing marks are matched.
- c. Install idler gear and bracket assembly.
- (1) Camshaft, idler and crankshaft bears are match-marked at the factory. If the original gears are being replaced, install and align gears with these marks. If a new gear is being installed, the following procedures must be used to insure correct camshaft timing and engine firing order.
 - (2) Lift the gear and bracket assembly into position with a chainfall and suitable sling. Align with match-marks (if present) and mesh teeth. The camshaft bear may be moved part of a tooth to allow gears to mesh.
 - (3) Install a long capscrew through the top bracket mounting hole to serve as a guide. Seat bracket on engine block and install all capscrews.
 - (4) Rotate flywheel in the direction of normal engine rotation to the right bank fuel injection point. (See Engine Data Sheet in front of manual or engine nameplate).
 - (5) Set right bank camshaft with number one fuel injection pump timing marks matched.
 - (6) Lift right idler gear and bracket assembly into place and install capscrews. The camshaft gear may be moved part of a tooth to allow the three gears to mesh.
- d. Adjust backlash clearance between gears.
- (1) Make four brass shims, 0.010 inch thick by one-half inch wide and one inch long. Install shims between crankshaft gear and idler gears, and between idler gears and camshaft gears.
 - (2) Loosen capscrews holding idler gear bracket to engine block, and lift idler gear assemblies until shims are held tight between gear teeth. This will establish the required backlash between each gear. Tighten idler gear retaining capscrews on each idler assembly.
 - (3) Rotate the flywheel and check backlash clearance in at least four places around each gear. Refer to the Table of Clearances. If backlash is within tolerances, tighten all idler assembly retaining capscrew to torque values shown in Appendix IV. Remove shims.
 - (4) Drill and ream two holes in each idler bracket, install No. 108-2 dowels in holes, and stake in place.

CAMSHAFT TIMING.

The camshafts of four-valve head model engines must be timed to the engine crankshaft by the fuel injection pump tappet lift method only. These camshafts are equipped with hydraulically expanded keyless cams and cannot be timed by the cam key method. Failure to observe the proper camshaft timing sequence can result in an altered firing order and an incorrectly operating engine.

- a. Remove number one fuel injection pump on master rod bank.
- b. Bar the flywheel over until the tappet roller for number one fuel injection pump, master rod bank, is on the base circle of its cam.

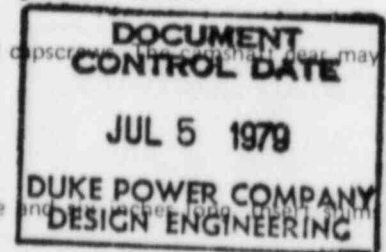

PART E — CAMS, CAMSHAFTS AND BEARINGS (Continued)

c. Set up a one-inch travel dial indicator on the pump base for number one fuel injection pump with the spindle of the indicator bearing on top of the tappet pin for number one fuel tappet, master rod bank, and zero the indicator.

d. Bar the flywheel in the direction of normal rotation until the tappet roller for number one fuel injection pump starts up the lifting ramp of its cam.

e. Continue barring the flywheel until the degree mark for fuel injection for number one master rod bank is directly in line with the flywheel pointer. This degree mark is shown on the Engine Data Sheet in front of the manual, and on the engine nameplate.

f. Observe the dial indicator to determine the lift of the fuel tappet at this point. Lift should be 0.197 inch. If lift is other than 0.197 inch, camshaft timing must be corrected.

(1) Loosen two fitted bolts that fasten camshaft ring gear to gear hub.

(2) Loosen remaining four bolts and rotate camshaft gear within ring gear to raise or lower the tappet as necessary.

(3) If there is not enough travel in the slotted holes in the gear hub to allow the required correction, it will be necessary to lift the gear end of the camshaft until the cam gear teeth disengage from the idler gear teeth, and slip the mesh one or more teeth as judged necessary. Re-engage the teeth of the cam gear and idler.

(4) Observe dial indicator to find tappet lift after correction. Make final correction by rotating the camshaft gear hub within ring gear.

(5) When correct tappet lift is obtained, lock up the four bolts in the slotted holes and drill and ream for two fitted bolts. New holes for fitted bolts should be moved approximately one inch from the original holes.

(6) Torque six bolts that fasten ring gear to hub to a torque value of 70 ft.-lb. plus or minus 10% as required to align cotter pin holes. Tighten and lock camshaft bearing cap bolts if they were loosened to gear tooth mesh.

g. Replace number one fuel injection pump, master rod bank.

h. Bar flywheel to place fuel injection timing point for number one, master rod bank directly in line with the flywheel pointer.

i. Remove number one, link rod bank fuel injection pump. Set up dial indicator in same manner as was done for master rod bank.

j. Bar the flywheel in the direction of normal rotation approximately 315 degrees to position the degree mark for fuel injection for number one, link rod bank cylinder directly in line with the flywheel pointer. Refer to Engine Data Sheet or engine nameplate for the correct degree mark. This will place the timing and firing order of the master rod bank and the link rod bank in the correct relationship.

k. Time the number one, link rod bank fuel injection pump in the same manner as used to time the master rod bank pump.

l. When both banks are timed, recheck fuel injection pump timing and cylinder head valve lash for both banks.

DOCUMENT
CONTROL DATE

JUL 5 1979

DUKE POWER COMPANY
DESIGN ENGINEERING

Instruction Manual

PART F – FUEL SYSTEM

FUEL INJECTION EQUIPMENT.

Each cylinder is fitted with an individual fuel injection pump and nozzle. The fuel supply to the pumps is from a common header, and a separate high pressure line connects each pump to its respective nozzle. As was stated in Section 2, fuel injection equipment is built to extremely close tolerances and, therefore, requires a great deal of care when being worked on to avoid damage to the parts. Only trained fuel injection equipment mechanics should be allowed to perform this work.

FUEL INJECTION NOZZLES.

Because nozzles and tips are subjected to extremes in pressure and temperature, they normally are the first source of engine trouble. A nozzle in good condition must pop open at the proper pressure without dribble, then close completely almost immediately. When subjected to a steady pressure at the opening pressure, it should "chatter", that is, open and close rapidly. The spray form should be a uniform, finely atomized mist pattern, never a solid stream. If the fuel nozzle is suspected of malfunctioning, remove from engine and test as follows.

- a. Disconnect high pressure line and drain connections.
- b. Remove nuts from injector studs and remove nozzle retainer.
- c. Lift or pry the nozzle holder assembly from the cylinder head.
- d. Close opening in cylinder head to prevent dirt or other foreign matter from entering the combustion chamber.
- e. Test the nozzle holder and tip assembly on a suitable nozzle tester, checking for the following.
 - (1) Apply pressure and check nozzle valve for popping action. The valve should chatter if it is seating properly.
 - (2) Raise pressure slowly to determine pressure at which valve opens. The valve should open at 3000 psi (211 kg-cm²) pressure. The opening pressure is adjusted by means of shims in the valve assembly, requiring disassembly of the unit. See figure 6-F-1 and "Nozzle Adjustment" instructions.
 - (3) Dry off spray tip and raise pressure to within 100 psi of the opening pressure and observe tip for dribbling of fuel.
 - (4) Check to see if any spray tip holes are plugged.
 - (5) Place a clean piece of paper under nozzle tip and check spray pattern for uniform density and a symmetrical pattern.
 - (6) Nozzles that fail to perform satisfactorily should be repaired or replaced. Refer to manufacturer's instructions in the *Associated Publications Manual* for overhaul instructions.

WARNING

The penetrating power of atomized fuel under high pressure is sufficient to puncture the skin and serious injury can result. To avoid this danger, the hands must be kept away from a spraying nozzle.

Instruction Manual

PART F – FUEL SYSTEM (Continued)

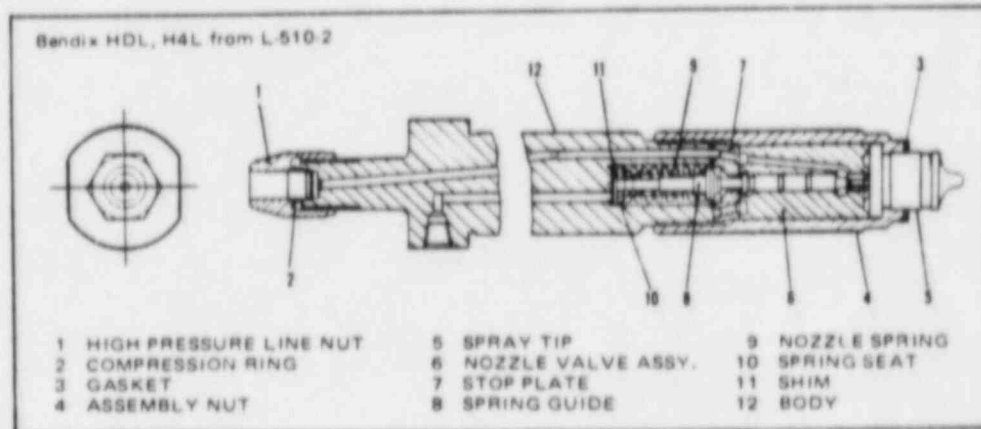

Figure 6-F-1. Sectional View of Typical Nozzle and Holder Assembly

NOZZLE ADJUSTMENT (See Figure 6-F-1).

Nozzle opening pressure is adjusted by means of shims (11), located between the body (12) and the spring seat (10). If the opening pressure does not conform to 3000 psi (211 kg-cm²), adjust as follows.

- a. Install nozzle and holder assembly on a pop tester then rapidly actuate pop tester handle four to six times to allow needle to seat properly. Pump the pressure up to the point where the pressure gauge needle falls away quickly. This point is the nozzle opening pressure.
- b. If pressure is not correct, do the following.
 - (1) Disassemble the holder.
 - (2) Add shims if opening pressure is too low, or remove shims if opening pressure is too high.
 - (3) Reassemble and check opening pressure. If fuel leaks around the assembly nut, it indicates poor lapped fits. Re-examine the parts.
 - (4) Always use a new gasket (3) when installing nozzle and holder assembly on engine.

FUEL INJECTION PUMPS.

The fuel injection pumps are of the constant stroke, variable output type. Equally important with clean, properly adjusted fuel nozzles are clean, properly adjusted and timed fuel injection pumps. Refer to the manufacturer's instructions in the *Associated Publications Manual* for complete details of the fuel injection pump installed on this engine.

Instruction Manual

PART F – FUEL SYSTEM (Continued)

DESCRIPTION OF OPERATION.

The following is a general discussion of the operation of the fuel injection pumps.

a. The pumps are of the constant stroke design, but the effective stroke, or that portion of the plunger movement in which fuel is actually delivered, is governed by a fuel metering helix in the plunger (see figure 6-F-2). On some pumps there is a second helix to retard the point of delivery at low fuel settings.

b. To pump fuel at high pressure it is necessary to bring it into a pressure chamber through an inlet, close the inlet and apply pressure for injection, terminate injection pressure and re-open the inlet to admit more fuel. The fuel injection cycle is accomplished by the location of inlet and spill ports in the barrel.

It is further accomplished by the metering helix and a passage in the plunger that extends from the end of the plunger to the metering helix on the side of the plunger. This passage allows fuel in the pressure chamber to spill into the inlet chamber when the helix uncovers the spill port.

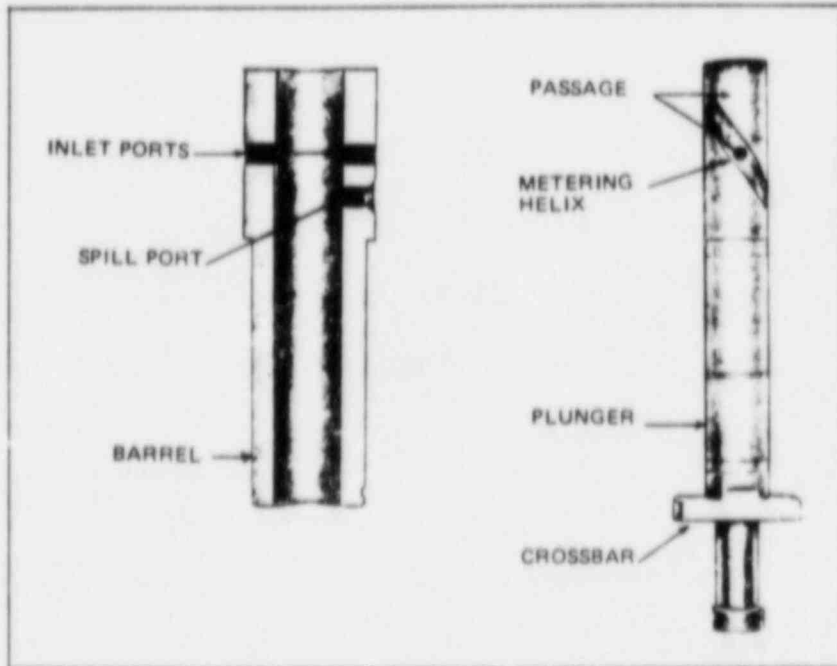

Figure 6-F-2. Pump Plunger and Barrel Arrangement

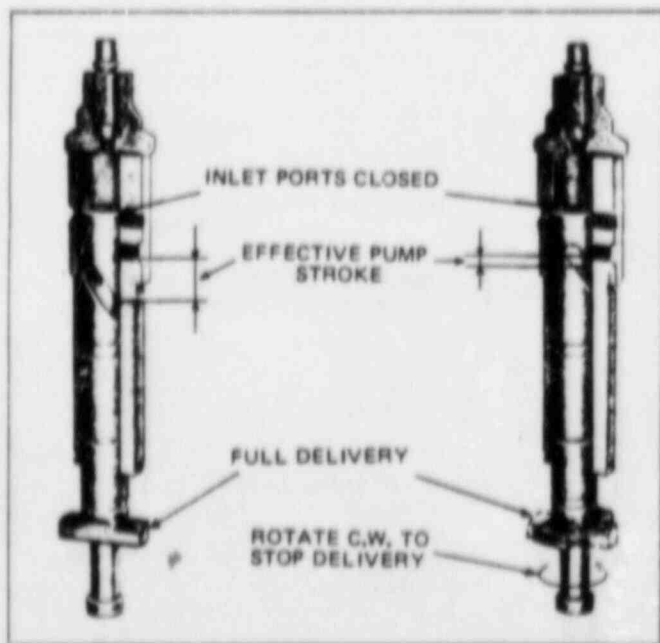

Figure 6-F-3. Effective Stroke

c. When the plunger is at its lowest point, fuel enters the barrel through the inlet port. As the plunger rises, it closes off the inlet port, pressure starts to rise and the delivery valve opens. Fuel injection continues until the upper edge of the metering helix reaches the lower edge of the spill port. Pressure is then released through the passage in the plunger to the spill port and delivery stops. The delivery valve closes. The effective stroke is the distance between the upper edge of the helix and the lower edge of the spill port at the moment the inlet port closes. The rotation of the plunger and its helix, then, determines the duration of fuel injection.

Instruction Manual

PART F – FUEL SYSTEM (Continued)

MALFUNCTIONING PUMP.

Should a fuel pump be suspected of malfunctioning, the following checks should be made before removing the pump from the engine for inspection and repair, unless it is known for certain that the pump is defective.

- a. Check to insure that fuel oil is being delivered to the pump. With the fuel oil system pressurized, loosen air bleed screw on pump. Fuel should flow freely with complete absence of air bubbles.
- b. If air is present in fuel oil, loosen nuts on high pressure line connection at nozzle holder end and bar engine over until all bubbles disappear.
- c. If fuel oil flow is sluggish at the pump, it is a good indication that the fuel filters are clogged. Check and clean filter.
- d. If fuel oil does not flow, check fuel level in tank and for closed valves in lines.
- e. Having made certain of fuel oil flow, operate engine and if pump still does not function properly, remove and replace with spare pump.

PUMP REMOVAL.

Fuel injection pumps are removed from the engine as follows.

- a. Disconnect high pressure line fitting and remove high pressure line from pump.
- b. Disconnect supply and return lines from fuel pump.
- c. Disconnect fuel control rack from linkage.
- d. Remove hold down nuts and lift pump off mounting studs.

PUMP DISASSEMBLY.

The manufacturer's instructions contained in the *Associated Publications Manual* provide detailed instructions for the overhaul and repair of fuel injection equipment, and should be consulted when any work is being done on fuel injection pumps. Pumps may be disassembled as follows.

- a. Secure pump in the inverted position in a soft jawed vise. Depress the plunger follower and insert a 1/8 inch diameter pin in the hole in the pump flange.
- b. Remove lock ring by prying it out with a screwdriver. Again depress follower and remove 1/8 inch pin.
- c. Remove plunger follower. Take lower spring seat from plunger, then carefully remove plunger from barrel. Carefully submerge plunger in spindle oil.
- d. Remove plunger spring, then pull control sleeve using a specially fabricated puller, or a pair of pliers whose jaws are wrapped with masking tape. The upper spring plate will come out with the control sleeve.

Instruction Manual

PART F – FUEL SYSTEM (Continued)

- e. Remove pump from vise and re-secure in an upright position.
- f. Remove delivery valve flange and delivery valve holder. Remove and discard preformed packing.
- g. Remove delivery valve stop and spring, then, using a delivery valve puller, carefully remove delivery valve.
- h. Remove barrel locating screw then slide barrel from housing.
- i. Remove control rack locating screw and control rack. Do not remove timing indicator or shims unless pump is to be re-calibrated.

PUMP ASSEMBLY.

Assemble the pump as follows, observing the manufacturer's instructions in the *Associated Publications Manual*.

- a. Secure pump housing in a vise in an upright position.
- b. Position control rack in housing with teeth facing center of pump. Install lockwasher and control rack locating screw, making sure the screw enters the rack locating groove.
- c. Insert barrel in pump housing. Locating groove must be aligned with locating screw hole. Install lockwasher and locating screw.
- d. Invert pump and install control sleeve so that tooth directly under timing mark meshes between two teeth indicated by timing dot on control rack.
- e. Install upper spring plate and plunger spring then carefully start plunger into barrel. It should settle in of its own weight. Turn plunger so marked end of crossbar will go into control sleeve slot that has a mark adjacent to it.
- f. Position lower spring plate on end of plunger. Fit plunger follower into housing. Compress and insert pin in housing flange. Install lock ring and remove pin.
- g. Install delivery valve assembly in pump housing. Lubricate and install preformed packing and install delivery valve spring and delivery valve stop. Assemble flange in housing.
- h. Install pressure screw and new copper gasket. Install bleed screw and new gasket.
- i. After pump is completely assembled, hold it horizontally with the control rack vertical. The rack should settle to its lower extreme by its own weight.
- j. If pump will not be immediately installed, fill inlet and outlet with clean, anti-corrosive lubricating oil and close openings with caps.

PART F - FUEL SYSTEM (Continued)

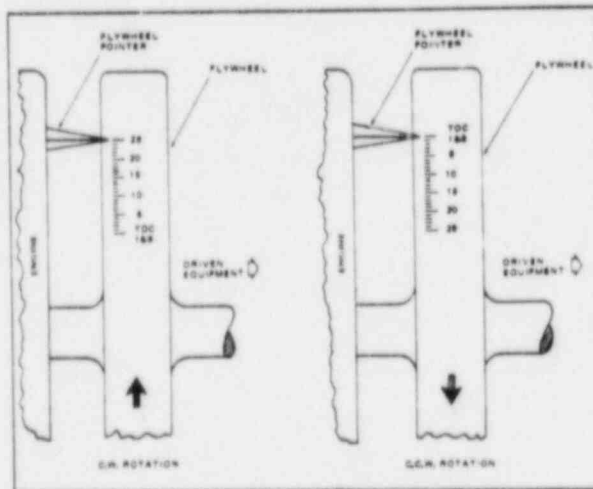

Figure 6-F-4. Flywheel Timing Marks

PUMP INSTALLATION AND TIMING.

Refer to the Engine Data Sheet in the front of the manual, and to page 6-A-1 for determination of engine rotation, bank designation (V-type engines) and cylinder numbering. The flywheel is marked to locate top dead center (TDC) of each cylinder, and is laid out in one degree increments for the twenty-five crankshaft degrees preceding TDC (see figure 6-F-4). For instance, on a six cylinder inline engine, there will be marks "TDC 1&6", "TDC 2&5" and "TDC 3&4", each preceded by degree marks. On eight cylinder inline engines the markings will be for cylinder pairs 1&8, 2&7, 3&6 and 4&5. Markings on the flywheel for V-type engines follow the same pattern, except that the banks are also designated. Refer to the Engine Data Sheet in the front of the manual for the fuel injection point. Install and time fuel pumps as follows.

- Before mounting pump on engine, and with the fuel tappet roller on the base circle of the fuel cam (see figure 6-F-5), measure distance from the fuel pump mounting surface on the base assembly to the tappet with a depth micrometer. Add or remove shims from the top of the base assembly to obtain a measurement of approximately 0.197 inch.
- Place pump on base assembly and install nuts on studs. Torque nuts as specified in Appendix IV.
- Bar engine over in the direction of normal rotation until the flywheel pointer is aligned with the fuel injection point (degrees BTDC specified on Engine Data Sheet) for the cylinder served by the fuel pump being installed.
- Observe plunger follower timing mark in pump timing window. If the plunger follower timing mark does not line up with the index mark on the timing window, remove pump and add or remove shims between the pump and the pump base assembly as necessary so that the marks will line up. Re-install the pump and bar engine through one complete injection cycle to insure that marks do align at the fuel injection point.

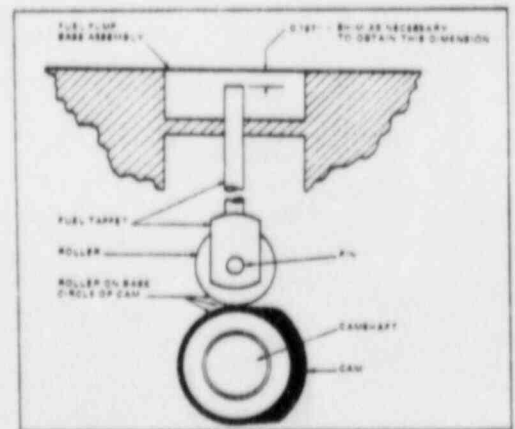

Figure 6-F-5. Pump Base To Tappet Adjustment.



CAUTION

The timing mark on the plunger follower must never go beyond the upper or lower edge of the timing window. If it does, the pump may be severely damaged.

Instruction Manual

PART G – ENGINE CONTROLS

OVERSPEED TRIP (See Figure 6-G-1).

A Woodward Model SG overspeed trip governor is mounted on the gearcase end of the engine. At a pre-set engine speed (15% above rated speed) it will initiate positive engine shutdown by tripping a dump valve which vents the automatic safety shutdown system. Operation of the overspeed trip governor is as follows.

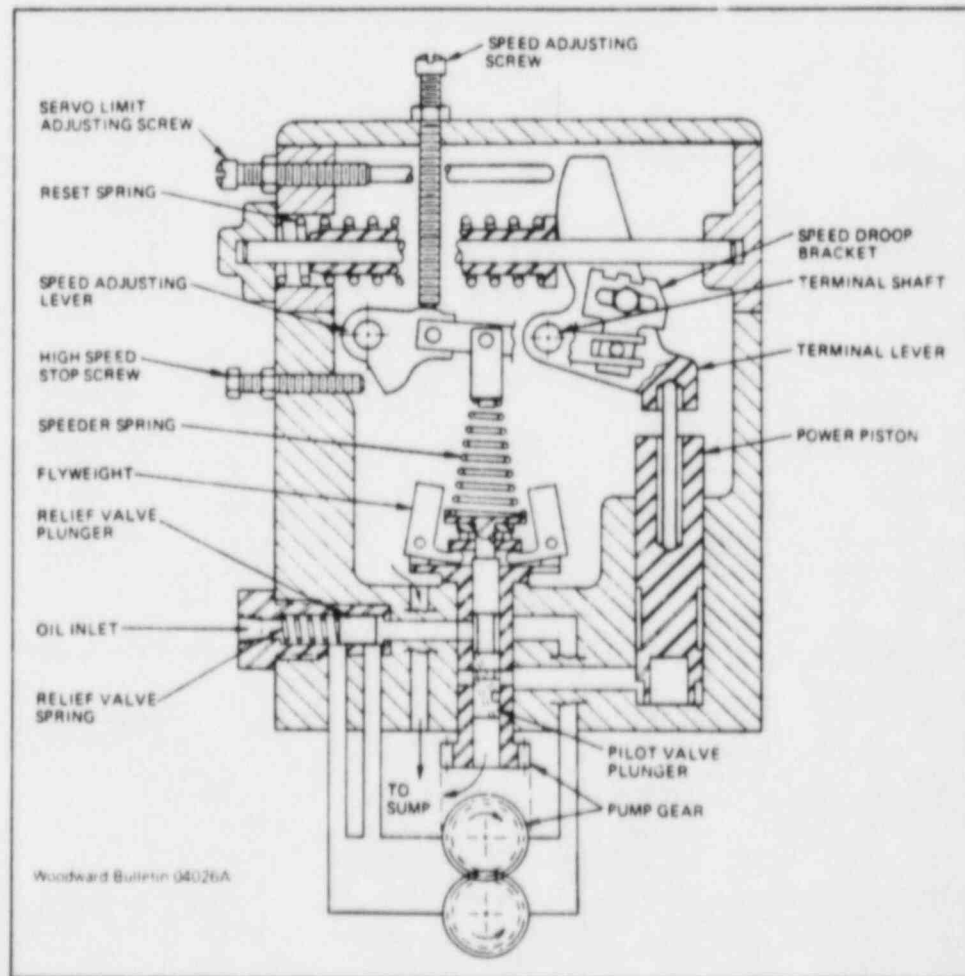

Figure 6-G-1. Overspeed Trip Governor

a. Oil enters the overspeed trip at the oil inlet, drops down into the cavity on the suction side of the pump gears, then around to the pressure side of the pump. If the supply of pressure oil is greater than required, the pump builds up pressure until the relief valve plunger is pushed to the left against the force of the relief valve spring. This uncovers the bypass hole in the relief valve sleeve and oil is recirculated through the pump. If the overspeed trip requires more oil than is being recirculated, pressure will be reduced and the spring will move the relief valve to the right, blocking the recirculating passage to maintain operating pressure. Additional oil, as needed, will enter the pump through the inlet port.

Instruction Manual

PART G – ENGINE CONTROLS (Continued)

b. The pilot valve plunger controls the movement of the power piston by directing oil to or from the area beneath the power piston. The power piston in turn controls the position of the terminal lever, and, therefore, the position of the terminal shaft. Two opposing forces act upon the pilot valve plunger - the speeder spring force tends to push the plunger down and the centrifugal force developed by the rotating flyweights tends to lift the plunger.

c. When the engine is operating below the trip set point the speeder spring force holds the pilot valve plunger down and connects the oil under the power piston to drain. The reset spring, pushing the reset rod against the terminal lever, holds the power piston down.

d. If engine speed rises above tripping speed the centrifugal force of the flyweights overcomes the speeder spring force and lifts the pilot valve plunger. As the plunger rises, pressure oil flows to the underside of the power piston, forcing the piston up. As the terminal lever is rotated by the upward movement of the power piston, the pin in the speed droop bracket raises the right end of the floating lever. This decreases the downward force of the speeder spring and the flyweights move to their extreme out position. The power piston then moves to the top of its stroke, as allowed by the terminal lever, which rotates the terminal shaft. The external lever on the terminal shaft then actuates the trip valve.

e. When engine speed drops back below the reset speed the speeder spring pushes the pilot valve plunger down and the area under the power piston is again connected to the sump. The reset spring rotates the terminal lever and pushes the power piston down. Oil is then recirculated through the pump as before.

OVERSPEED TRIP ADJUSTMENT.

The speed at which the unit trips is determined by the position of the speed adjusting screw. Turning the screw into the cover raises the tripping speed, and turning it out lowers tripping speed. The overspeed set point is adjusted at the factory, and under normal conditions should not be changed in the field. If it becomes necessary to reset the trip point, follow these steps.

- a. Back out servo limit adjusting screw so that it does not limit travel in the power piston.
- b. Make tentative speed droop bracket setting at approximately one-half its travel from minimum to maximum droop.
- c. Make preliminary tripping speed adjustment with speed adjusting screw.
- d. Readjust speed droop bracket to obtain approximately ten percent excess range, then readjust tripping speed. The speed adjusting lever can be locked in place by tightening the high speed stop screw against the speed adjusting lever.
- e. Reset overspeed trip at a speed slightly below the desired reset speed. The servo limit adjusting screw affects only the reset speed. Turn in to raise the reset speed to the desired value.

PART G - ENGINE CONTROLS (Continued)

GOVERNOR DRIVE ELEMENT REPLACEMENT.

Because of its operating environment, the Buna N flexible drive element (part no. AK-007-001) in the governor drive coupling should be changed annually. The element is a wrap around design (see Figure 6-G-2), joined by a split insert which permits easy removal and installation.

- a. Remove fasteners all around on both hubs.
- b. Pull end of element at split insert and remove element.
- c. Install new element. Use Locktite on fastener threads.
- d. If coupling was in proper alignment before replacement of the drive element, no additional alignment is necessary.
- e. If alignment is considered necessary, it may be accomplished with only a straight edge.

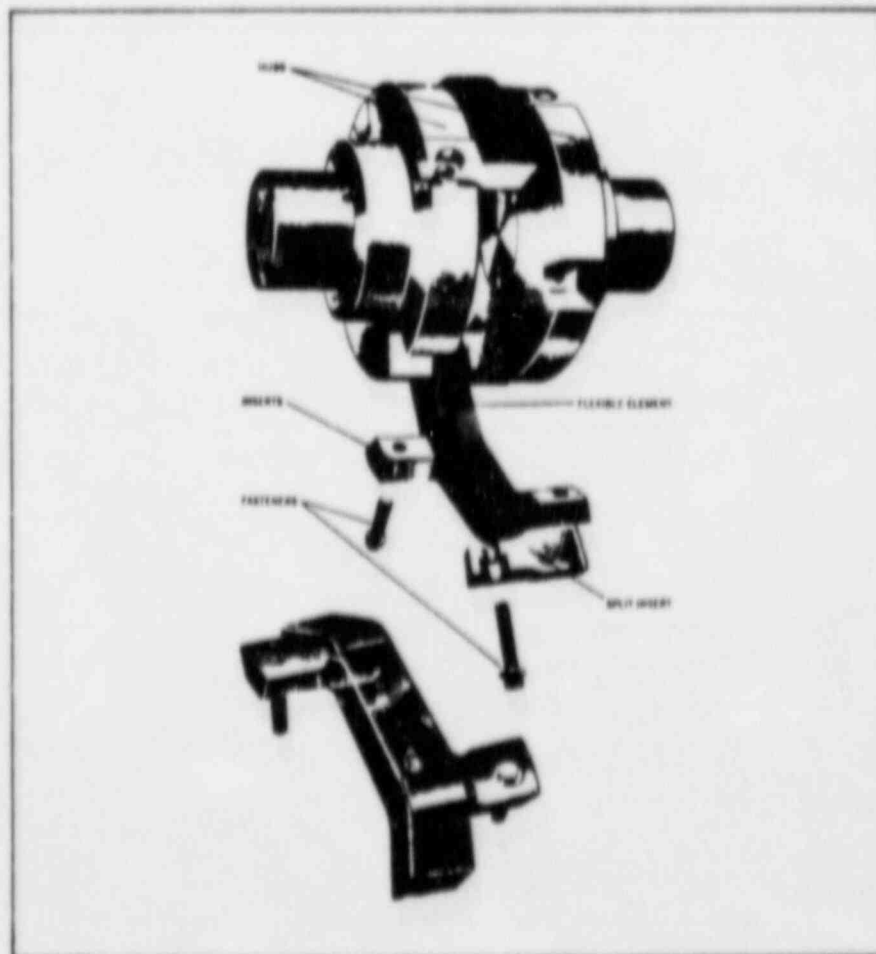

Figure 6-G-2. Governor Drive Coupling

INSTRUCTION MANUAL

DELAVAL ENGINE AND
COMPRESSOR DIVISION
560 - 85th AVENUE
OAKLAND, CALIFORNIA 94621



PART G - ENGINE CONTROLS (Continued)

LOGIC BOARD TROUBLE SHOOTING.

Trouble shooting of the logic boards should be approached in a logical manner, eliminating the obvious first. The following steps will assist in the finding of faults in the system.

- a. Check that there is proper supply pressure in the system, as specified on the applicable system drawings.
- b. Check that all operator controls are in the correct positions for the selected mode of operation.
- c. Check the board for the proper output signals. Since the system is designed to provide a predictable series of output signals, the first place to start trouble shooting is to determine if the output signals that should be present are present, and which ones should not be present when the problem occurs. Check out procedures for individual logic boards are shown on the drawing for that board. Also, check to see if the signals come on and off sharply without gradual increases or decreases in pressure unless this is called for in the check out procedures. If the increase or decrease is slow, check for leaks, pinched tubes, etc. If the proper signals are present, then the malfunction may be in one of the power devices.
- d. Check for proper input signals to the logic board. Once the determination has been made that the output signals from the board are not on and off at the proper time, check the input signals to the board to make sure they are correct. Once again, return to the control schematic drawings and determine which input signals are to be on and which are supposed to be off when the problem occurs. Of equal importance is the order in which they go on and off.
- e. Once the output signal conditions have been checked and found to be incorrect, and after the input signals have been checked and found to be correct, then and only then is the circuit board to be considered for trouble shooting. Make sure the problem is in the circuit board before proceeding.

CHECKING LOGIC ELEMENTS.

If a logic board is not performing properly, the logic elements should be checked for proper installation on the board before removing them. Then, if the functioning of an element is suspect, it may be removed and replaced. Testing and the repair of the elements should be in accordance with the manufacturer's instructions in the *Associated Publications Manual*.

- a. Refer to the layout diagram on the appropriate assembly drawing and check element location on the circuit board to make certain that all elements are in their proper locations.
- b. Check for proper rotation of each element. Elements can be rotated 180°, providing two different positions that it can assume on the board. The rotation is selected at the time the circuit is designed and must agree with the circuit pattern layout. Each element has an "a" or a "b" located on its top cover and these letters are to be oriented as shown on the assembly drawing. Any element that is mislocated or rotated should be changed and the circuit rechecked.

INSTRUCTION MANUAL

DELAVAL ENGINE AND
COMPRESSOR DIVISION
550 - 95th AVENUE
OAKLAND, CALIFORNIA 94621



PART H - ENGINE BALANCING

GENERAL.

The load on a diesel engine should be evenly divided between all cylinders. If it is not, one or more of the cylinders will be forced to carry more than their share of the load while other cylinders loaf with a resulting loss in operating economy and the possibility of experiencing one or more of the following conditions.

- a. Scored pistons and liners.
- b. Excessive vibration.
- c. Excessive piston, valve, bearing and crankshaft wear.
- d. Excessive fuel consumption.
- e. Excessive lubricating oil usage.

CYLINDER BALANCE.

The balance between power cylinders on Enterprise diesel engines is obtained by having all the fuel injection pumps read the same millimeter of rack position when the governor is in a position equivalent to full load. In order to accomplish this it is essential that all fuel pumps be calibrated in accordance with the fuel pump manufacturer's specifications. The fuel pump rack levers are adjusted during factory test and the lever clamps are then doweled to the fuel rack shaft.

CAUTION

This setting should not be changed in the field, nor should shimming ever be used between the fuel rack lever clamp and the fuel rack lever to change fuel rack settings for individual cylinders. Also, the female rod end which connects the fuel rack lever to the fuel rack should not be adjusted. When a variation in cylinder exhaust temperatures indicates an overloaded or an underloaded cylinder, this condition should not be remedied by changing the individual fuel rack settings. Rather, the real cause of the malfunction should be determined and corrected.

FUEL INJECTION EQUIPMENT.

Clean fuel is essential to the operation of a diesel engine. Injection equipment is manufactured with close working tolerances and, therefore, dirt or other impurities in the fuel can cause pumps or spray nozzles to malfunction. Small depressions in injector valve seats, some so small they are not visible to the naked eye, may be caused by small particles of dirt and will affect spray patterns in the combustion chamber. Pumps and valves must be checked and cleaned periodically. The frequency of cleaning can best be determined from experience, however, care must be taken not to wait too long before cleaning. Fuel pumps should deliver exact amounts of fuel according to the millimeter settings of their fuel pump racks. If they do not, obviously the balance of the cylinders will be affected and the problem must be corrected. It is recommended that whenever a fuel pump is disassembled for any reason, it be recalibrated in accordance with the manufacturer's specifications.

ENGINE OUT OF TUNE.

Spray nozzles are usually suspect if an engine is out of tune or smoking. There are other factors which may also contribute to these conditions. All of them should be considered when evaluating engine performance.

INSTRUCTION MANUAL

DELAVAL ENGINE AND
COMPRESSOR DIVISION
550 - 85th AVENUE
OAKLAND, CALIFORNIA 94621



PART H - ENGINE BALANCING (Continued)

- a. Ignition timing.
- b. Short or long burning lag in some fuels.
- c. Cetane rating of the fuel.
- d. Low compression pressure due to leaking valves.
- e. Worn piston rings and/or liners.
- f. A change in fuel oil.
- g. Defective fuel injection pump(s).
- h. Valve or linkage maladjustment.

PREVENTIVE MAINTENANCE.

All available operating information should be used as diagnostic tools for determining the condition of an engine and in planning preventive maintenance actions to maintain the engine in peak operating condition. Among the conditions to be considered, peak firing pressures and cylinder exhaust temperatures are very valuable indicators of the condition of a cylinder. The pyrometer and thermocouples provide individual cylinder exhaust temperature information. There are a number of commercial instruments available to take peak firing pressures and cold compression pressures, and the manufacturer of the model selected can provide detailed instructions for its use. The engine log is also an excellent tool for use in recording engine performance and making diagnostic evaluations for preventive maintenance purposes. Readings should be taken and recorded hourly and be supplemented with written observations of all pertinent factors.

TROUBLE SHOOTING.

When trouble shooting the engine, all available information should be used to determine the cause of a malfunction. The trouble shooting tables in Section 7 can be of assistance, as well as the preventive maintenance curves and the engine logs.

INSTRUCTION MANUAL

DELAVAL ENGINE AND
COMPRESSOR DIVISION
550 - 85th AVENUE
OAKLAND, CALIFORNIA 94621



PART I - STARTING AIR SYSTEM

GENERAL.

The engine is started by the timed admission of high pressure starting air to the power cylinders during the equivalent of the power stroke of the respective cylinders. The air is admitted at approximately top center of the power stroke, and admission continues until approximately the opening of the exhaust valves. The pressure is then relieved, thereby causing rotation of the engine comparable to the normal power stroke. As the engine accelerates on starting air, the heat of compression of the combustion air plus that of the starting air develops a sufficiently high temperature to ignite the injected fuel within a few revolutions. The engine then initiates normal combustion and begins to accelerate under its own power without further aid of starting air.

AIR SUPPLY.

The starting air supply is produced and stored in the starting air module at 250 psig (17.57 kg/cm²). The storage tanks are provided with relief valves set at 275 psig (19.53 kg/cm²).

OPERATION.

The on-engine portion of the starting air system consists of a remotely controlled, pilot operated diaphragm valve in the air supply line, two camshaft driven starting air distributors, one for each cylinder bank, an air filter for each distributor, and a pilot operated air starting valve (figure 6-1-1) in each cylinder head. When the starting air admission valve in the supply line is opened, 250 psig (17.57 kg/cm²) starting air is admitted into the starting air manifold and, therefore, to the starting air valves in the cylinder heads as well as to the starting air distributors. Individual spool valves in the distributors (one for each cylinder of the bank serviced) are engaged by air pressure and follow the profile of the starting cam attached to the end of the camshaft. The cam profile is such that at least one spool valve is always in position to emit a pilot signal to its respective starting valve in the cylinder, allowing starting air to enter the combustion chamber of that cylinder, rotating the engine. As the engine rotates, the starting air cam will cause the spool valves to emit timed and sequenced pilot air signals to the starting air valves. The starting process will continue until the signal to the starting air admission valve is terminated. The starting air distributors emit a timed pilot air signal that starts five degrees before top dead center and ends at 115 degrees after top dead center on the power stroke.

Instruction Manual

PART I – STARTING AIR SYSTEM (Continued)

STARTING AIR VALVE REMOVAL.

Disconnect pilot air line(s) from valve cap and remove 12 point flanged capscrews holding valve to cylinder head. Pull valve assembly from cylinder head.

VALVE DISASSEMBLY (See Figure 6-1-1).

The starting air valve may be disassembled for inspection and/or repair as follows.

- a. Lift valve cap from housing and remove piston.
- b. Remove roll pin securing hex nut then, using a pin spanner or other suitable device in the two holes in the valve head to hold the valve in position, remove hex nut from threaded end of valve stem.
- c. Slide valve out through bottom of valve housing. Slide spacers and guides off valve stem.
- d. Remove spring, retaining washer and spring washer from housing.
- e. Remove O-rings and valve-to-head gasket.
- f. Inspect all surfaces of valve, guides, rings and piston. Replace defective parts.

VALVE ASSEMBLY (See Figure 6-1-1).

Assembly of the valve is the reverse of disassembly.

- a. Assemble lower guide with rings in place, long spacer and upper guide to valve stem.
- b. Slide valve into housing from bottom, taking care not to damage rings on lower guide.
- c. Slide short spacer down over top of valve stem, ensuring it seats in the upper valve guide.
- d. Slide retaining washer down over short spacer, ensuring it seats on the shoulder of the housing bore. Slide down the spacer and install spring washer.
- e. Assemble hex nut to the valve stem and tighten. Install roll pin then install piston and valve cap.

VALVE INSTALLATION.

Assemble O-rings and valve-to-head gasket to the valve assembly. Insert valve assembly into valve hole in cylinder head. Lubricate threads of capscrew(s) with a 50-50 mixture of lubricating oil and powdered graphite and thread capscrew(s) into cylinder head. Torque capscrews to 150 ft-lbs. Connect pilot air line(s).

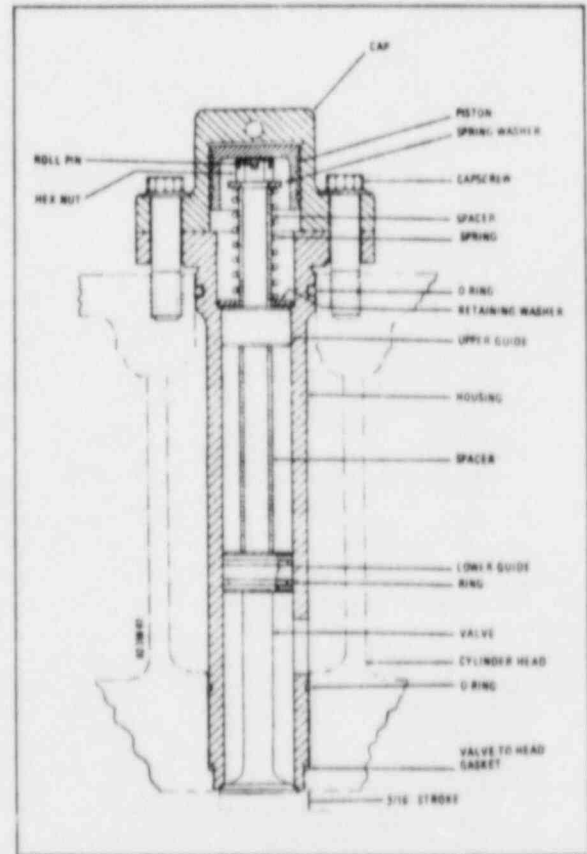

Figure 6-1-1. Starting Air Valve

Instruction Manual

PART I – STARTING AIR SYSTEM (Continued)

TIMING THE STARTING AIR DISTRIBUTOR.

The starting air distributors are timed at the factory when they are installed. If it should become necessary to re-time them, the following procedure may be used.

- a. Bar engine over in direction of normal rotation until number one cylinder of bank being timed is five degrees before top dead center (BTDC) on the end of the compression stroke.
- b. Remove hex head capscrews that secure distributor cover to housing. Remove cover and gasket to gain access to interior of distributor.
- c. Disconnect tubing and elbow at number one cylinder port on distributor. Remove cap, spring and spool from number one position. Re-install spool.
- d. Loosen capscrews in elongated holes in distributor housing sufficiently to permit slight rotation of housing assembly.
- e. Direct a beam of bright light into spool valve opening at top of distributor housing to observe position of spool valve for number one cylinder. When valve is open light should be visible through tubing port. While holding spool tight against cam, rotate housing until light is just visible through tubing port. This is the correct timing point. Without moving distributor housing, tighten capscrews in elongated holes to secure distributor housing to engine.
- f. Re-check timing by rotating crankshaft in direction of normal rotation until light just becomes visible in tubing port. The flywheel pointer should indicate that crankshaft is five degrees BTDC with number one cylinder on end of its compression stroke. If it is not, repeat timing procedure.
- g. Remove spool from number one position in distributor housing, install spring, spool and cap. Connect elbow and tubing to port on housing. Install gasket, cover and hex head bolts.
- h. If timing of the other cylinder bank is necessary, insure that number one cylinder of that bank is on the end of its compression stroke. An error in selecting the correct position will result in a failure of that bank to crank when a starting air signal is applied to the engine.

AIR FILTER INSPECTION.

The air filter in the supply line to the distributor should be inspected and cleaned at regular intervals. The frequency of inspection and cleaning should be determined by operating conditions and experience.

STRAINERS.

Low point water collectors, "Y" strainers and air receiver tanks must be drained daily whether engine/generator is run or not. Inspect and clean "Y" strainers weekly. If the fouling of the strainers is such that more frequent inspection is warranted, shorten the inspection interval.

STARTING AIR DISTRIBUTOR.

Refer to Drawing 00-420-08 in the *Parts Manual* for details of the construction of the starting air distributors. In addition to the information contained on the drawing, the following information is provided as per customer's request.

Spring (Part No. F-115-067)

Outside Diameter	0.720 in.
Free length	1-1/2 in.
Installed length	1-5/16 in.
Minimum working length	11/16 in.

Spool Valve (Part No. 00-442-07-AE)

Length	3-11/16 in.
Diameter	0.4970/0.4965 in.

Distributor Shaft (Part No. 00-442-08-AA)

Length	5-7/8 in.
Diameter	3.500 in.

**DOCUMENT
CONTROL**
JAN 21 1980
**DUKE POWER COMPANY
DESIGN ENGINEERING**

INSTRUCTION MANUAL

DELAVAL ENGINE AND
COMPRESSOR DIVISION
560 - 85th AVENUE
OAKLAND, CALIFORNIA 94621



PART J - COOLING WATER SYSTEMS.

GENERAL.

All enterprise engines are cooled by a closed loop system in which a fixed supply of treated water is continuously circulated by the jacket water pump with practically no loss in quality. The water supply for the jacket water system should be completely treated for both scale and corrosion, and raw untreated water must never be introduced into the system. The degree and type of treatment depends on the source of the water. Distilled water and rain water are usually considered as being completely soft and non-corrosive, but they generally require treatment for dissolved corrosive gases such as oxygen which may accelerate rusting. Plain distilled water is not recommended unless it is properly treated. Rain water may also require treatment for fungus picked up in the air or from contamination from air pollutants. Delaval Engine and Compressor Division does not specify any particular form of water treatment, or the frequency of water analysis. Rather, it is recommended that a water treatment specialist be consulted. The degree and frequency of treatment, then, will be based on the water being used. It must be remembered, however, that additives to the cooling water supply should not alter the heat transfer characteristics to which the system was designed. The specific heat of the jacket water system should be kept as close to $1.0 \frac{\text{Btu}}{\text{lb} \cdot \text{F}}$ as possible. The following discussions of water treatment are suggestions only. The actual means used to treat jacket water should be determined by the owner.

OPERATION.

All cooling surfaces must be kept free of scale or other deposits as any such accumulation will degrade the cooling capability of the system and, therefore, cooling water temperatures will not accurately indicate the extent of cooling. Any coating on the cooling surfaces will act as an insulating material and will prevent transfer of heat. If for any reason there is a disruption of the circulation of cooling water flow, the engine should be shut down as soon as practicable to prevent a build up of temperatures and possible serious damage to the engine. To avoid thermal shock, which could cause damage to the engine, do not admit cold water to the cooling system until the temperature of the cooling surfaces in the engine have dropped to approximately that of the inlet water. The use of ethylene glycol antifreeze in the cooling water will materially affect the cooling capacity of radiators and other cooling devices. A 50% ethylene glycol mixture will reduce radiator cooling capacity approximately 12%. Therefore, unless the cooling system was originally designed for this coolant mixture, the Delaval Engine and Compressor Division Customer Service Department should be consulted prior to using such a coolant.

TREATMENT OF JACKET WATER.

The pH value of the jacket water should be maintained within a range of 8.25 and 9.75. The minimum pH value is necessary to prevent acid attack on the metallic surfaces, and the 9.75 maximum value will prevent corrosion due to high alkaline content in the water. A suggested water treatment material for jacket water systems is sodium dichromate and a commercial boiler compound, however, it is recommended that a commercial water treatment company be consulted to insure that local conditions are taken fully into account. Sodium dichromate is an inexpensive source of alkaline chromate (CrO_4) which has been found to form a protective film on metallic surfaces that prevents attack by the corrosive elements found in the jacket water. Sodium dichromate is an acid compound which must have an alkaline compound such as boiler compound added to convert the dichromate to an effective alkaline chromate form. The alkaline chromate concentration must be maintained between 700 and 1700 parts per million (ppm). Less than 700 ppm can result in accelerated corrosion while more than 1700 ppm serves no useful purpose and is a waste of material. The chloride content must not be allowed to exceed 100 ppm as the effectiveness of alkaline chromate decreases as the chloride content increases. When initiating alkaline chromate water treatment for the first time, or after the system has been refilled, the water should be tested daily for alkaline chromate concentration and for pH value. When the treatment becomes stable, the test interval can be extended to weekly tests. After each addition of chemicals, the water should be circulated through the system, then tested to insure that the required limits are met.

INSTRUCTION MANUAL

DELAVAL ENGINE AND
COMPRESSOR DIVISION
550 - 85th AVENUE
OAKLAND, CALIFORNIA 94621



PART J - COOLING WATER SYSTEMS (Continued)

WATER SOFTENERS.

Depending on the location of the installation and the source of the cooling water supply, it may be advisable to utilize some means of softening the water. This can best be accomplished by consulting a commercial water treatment company for technical assistance so that the specific needs may be determined and the proper treatment method instituted.

CLEANING THE JACKET WATER SYSTEM.

The following methods may be used to clean rust and scale from the jacket water system. Most water treatment companies have their own proprietary solutions and method for cleaning engine jacket water systems which are equally as effective. The following acid cleaning method *can not be used* for systems which have components containing aluminum.

a. Rust can be removed from the jacket water system by filling the system with a solution of 75 pounds of ammonium citrate in enough fresh water to make 100 gallons of solution. Make enough solution to fill the jacket water system then operate the engine for two hours. The jacket water system must then be flushed with fresh water and neutralized.

b. Scale can be removed from the system by using a scale solvent solution composed of 7 gallons of 20° Baume muratic (hydrochloric) acid, one-half gallon of liquid inhibitor and 92½ gallons of fresh water at 160°F. Make enough solution to fill the system. Circulate the acid solution through the system for one or two hours, depending on the extent of the scale deposit. The temperature of the acid solution must be maintained at 160°F during circulation. After circulating the acid solution, drain the jacket water system and then fill with clean fresh water and flush it thoroughly. After flushing, neutralize the system with a solution composed of 20 pounds of soda ash (sodium carbonate) and enough fresh water at 160°F to make 100 gallons of neutralizing solution. Fill the jacket water system with the neutralizing solution and circulate it through the system for one-half hour. Maintain the temperature of the during circulation.

ENVIRONMENTAL RESTRICTIONS.

Alkaline chromate water treatment compounds, such as sodium dichromate, may be considered environmentally objectionable in some locations, or may be prohibited. In these instances, nitrite compounds such as sodium nitrite (NaNO_2) are suggested as adequate substitutes. When using sodium nitrite, the concentration must be 500 ppm with a pH of 7.5 to 8.5 to achieve effective corrosion control. Nitrite compounds for treating engine jacket water systems are available from most commercial chemical supply houses, and instructions for their use are available from the chemical supplier.

PART J – COOLING WATER SYSTEM.

WATER PUMP (See Figure 6-J-1).

The engine driven water pump is of the centrifugal type in which a rotating impeller (22) imparts a rotating motion to the fluid, and discharges it into the circulating system. The pump is mounted on the engine gearcase cover by means of an adapter (7 and Fig. 6-J-2). The pump is driven through a gear carrier assembly (Fig. 6-J-3). An external spline (4) engages the internal splines on the gear carrier coupling (see Fig. 6-J-3). The pump is very reliable, and should require little maintenance. Certain parts are subject to wear, however, and may require replacement sometime during the life of the pump. These items include the mechanical seal (28), the volute wear ring (21), the back plate wear ring (15), the shaft bushings (Fig. 6-J-2), the thrust ring (6), the thrust collar (10), and the oil seal (9). The need for replacement must be determined by periodic inspection of the pump, and by symptomatic evidence obtained from these routine inspections, and from performance figures obtained from operating logs. Table 6-J-1 outlines the common symptoms, their causes and the appropriate repair procedures.

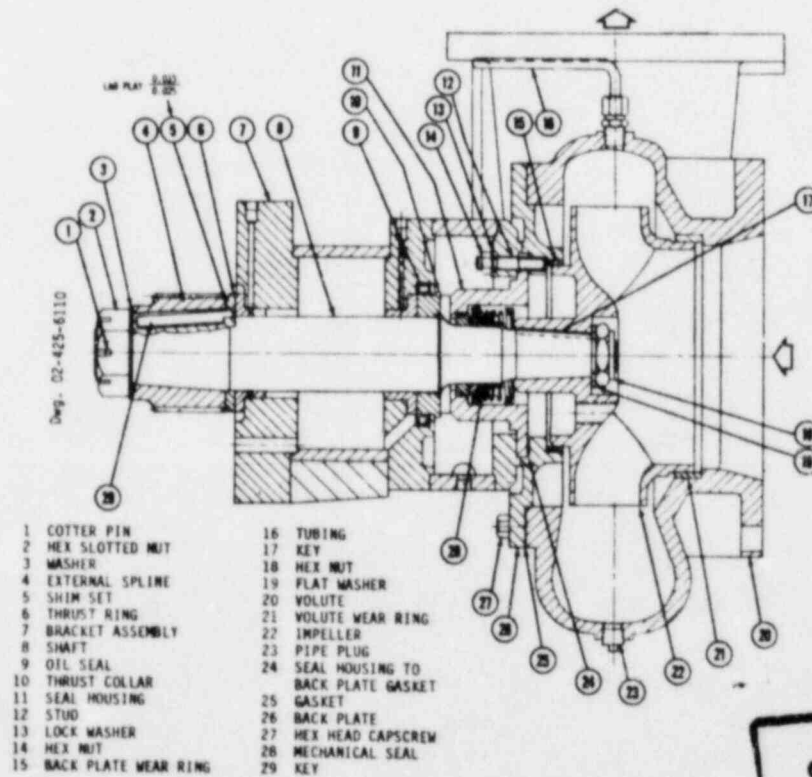

Figure 6-J-1. Water Pump Assembly

**DOCUMENT
CONTROL DATE**

JAN 21 1980
**DUKE POWER COMPANY
DESIGN ENGINEERING**

PART J – COOLING WATER SYSTEM (Continued)

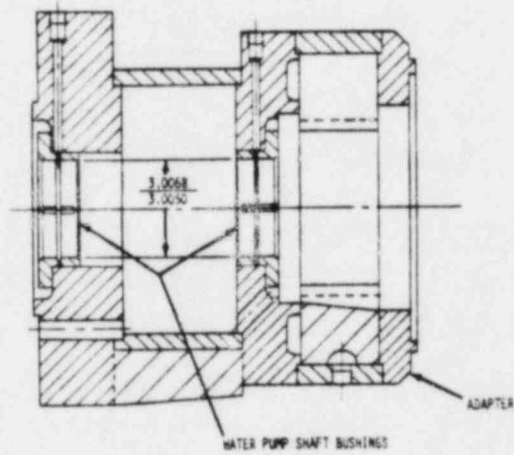

Figure 6-J-2. Water Pump to Crankcase Adapter

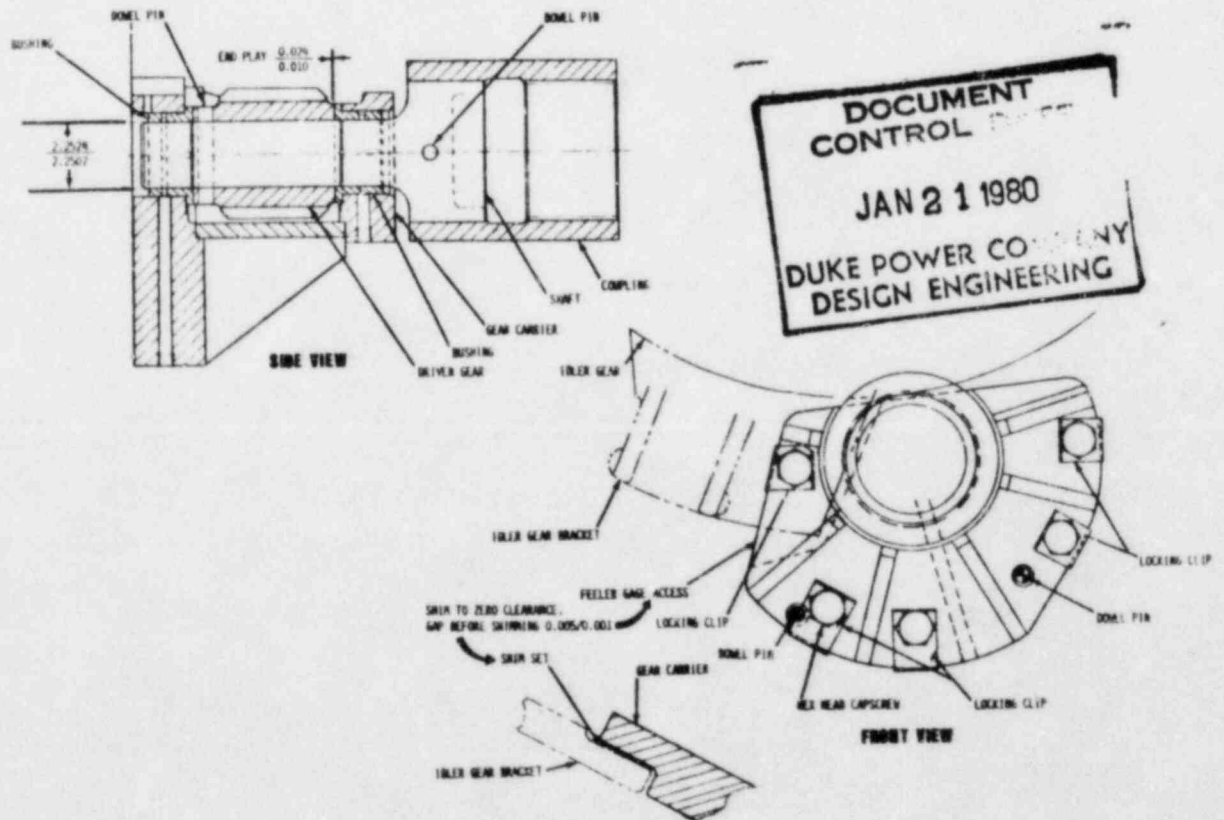
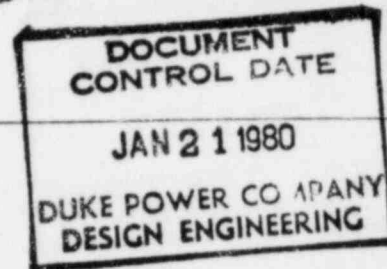

Figure 6-J-3. Gear Carrier Assembly

Instruction Manual



6-J-5

PART J – COOLING WATER SYSTEMS (Continued)

PUMP REPAIR PROCEDURES.

Repair procedures to the engine driven water pump(s) may be placed in two general categories. In the first group are those repair procedures which require only partial disassembly of the pump while still mounted on the engine. These include replacement of the mechanical seal, and the wear rings. In the second group are those which require removal of the pump and adapter from the engine. This includes thrust ring, shaft bushings and oil seal replacement.

Symptom	Possible Cause	Repair Action	Procedure
Loss of pump head	Worn wear rings	Replace wear rings	A
Water leakage around pump shaft at thrust collar	Worn mechanical seal	Replace seal	A
Noisy operation	Worn bushings	Replace bushings	B
Gear rattle/excessive end play	Worn thrust ring or thrust collar	Replace thrust ring and/or thrust collar	B
Oil leakage around pump shaft at thrust collar	Worn oil seal	Replace oil seal	B

Table 6-J-1. Water Pump Trouble Shooting

PARTIAL DISASSEMBLY OF PUMP – PROCEDURE "A".

Mechanical seal failure will be evidenced by water leakage around the pump shaft at the thrust collar. Excessive wear or failure of the wear rings will result in loss of pump head. Although there may be other causes for this malfunction, wear rings must be considered as a possible cause. Proceed as follows to disassemble the pump to the degree necessary to perform the intended work.

- a. Disconnect inlet and outlet piping from pump.
- b. Disconnect tubing (16) from volute (21).
- c. Remove eight hex head capscrews (17) that secure volute (20) to back plate (26). Slide volute off over impeller (22).
- d. Inspect volute wear ring (21). If significant deterioration is in evidence, remove old wear ring, clean inner shoulder of volute and install new wear rings.
- e. Block pump shaft rotation, using a block of wood or similar means to stop impeller rotation. Remove hex nut (18) and flat washer (19) from end of shaft (8), and slide impeller (22) off shaft and remove key (17).
- f. Inspect back plate wear ring (15). Remove and replace if condition indicates this is necessary.
- g. Remove eight hex head nuts (14) and lockwashers (13) and remove back plate (26). Slide mechanical seal (28) and seal housing (11) forward off pump shaft.
- h. Install new mechanical seal (28) into seal housing (11). Insure that seal mates firmly into seal housing. Slide seal housing and mechanical seal over pump shaft (8).
- i. Pump assembly is the reverse of disassembly. Install new gaskets (24, 25). When reinstalling impeller retainer nut (18) to pump shaft (8), lubricate threads with a 50-50 mixture of graphite powder and lubricating oil and torque nut to 80 ft-lbs.

PART J – COOLING WATER SYSTEM (Continued)

MAJOR OVERHAUL OF PUMP – PROCEDURE "B" (See Figure 6-J-1).

The water pump is extremely reliable and a major overhaul is not anticipated during the service life of the pump. However, it is possible that the pump, being a mechanical device, could experience a malfunction which would require complete disassembly of the pump. Noisy pump operation, for instance, could be caused by worn shaft bearings or thrust rings. Failure of the oil seal would result in oil leakage visible around the pump shaft at the thrust collar. Complete pump failure due to a broken shaft, or similar breakdown would be evidenced by a rapid rise in water temperature. If any of these conditions occur, an overhaul of the pump is indicated. Disassembly of the pump should be only to the degree necessary to perform the degree of overhaul intended or indicated by pump condition.

- a. Remove suction and discharge piping as well as any other interfering piping or accessories.
- b. Position a sling on the pump, attach to a chainfall or overhead hoist, and take up slack.
- c. Remove eight capscrews securing bracket assembly to crankcase cover, and pull pump straight away from engine, sliding pump shaft external spline (4) clear of gear carrier coupling (Fig. 6-J-3).
- d. Disassemble pump from bracket assembly as shown in the preceding Procedure "A", sub-paragraphs b. through g.
- e. Remove bracket assembly (7) from pump by removing cotter pin (1), hex slotted nut (2), washer (3), external spline (4), thrust ring (6), shim set (5) and key (29) from pump shaft (8). Slide bracket assembly off shaft.
- f. Inspect thrust ring (6) for signs of wear. Replace if necessary upon reassembly.
- g. Remove thrust collar (10) from bracket assembly (8). Inspect for signs of wear, and replace if necessary.
- h. Remove shaft bushings from bracket assembly (see Fig. 6-J-2). Inspect both shaft faces and thrust faces of bushings for signs of wear. Install new bushings if necessary.
- i. Replace oil seal (9). Note that seal tends to mate with other parts, and tends to fail if adjacent parts are disturbed. Use engine oil to lubricate oil seal for ease of installation. Insure that seal seats firmly.
- j. Inspect pump shaft (8) thoroughly for signs of scoring or damage. Carefully smooth and deburr shaft surfaces before reassembly of pump.
- k. Reassembly of the pump is the reverse of disassembly. At assembly, the following should be noted. After installation of impeller (22) to pump shaft (8), lubricate threads of hex nut (18) with a 50-50 mixture of powdered graphite and lubricating oil, and torque nut to 80 ft-lbs. After assembly of bracket assembly (7) to the pump, install thrust ring (6) and shim set (5) and adjust shims to provide end play of 0.015 to 0.025 in. After shimming, insert key (29), external spline (4), washer (3) and slotted hex nut (2). Note that hex nut is to be cleaned and lubricated with a 50-50 mixture of powdered graphite and lubricating oil then torqued to 120 ft-lbs. Increase torque until slot of nut allows cotter pin (1) to be installed. Check end play between spline and thrust ring and reshim if necessary. Check that key is properly seated to achieve good drive tang engagement of spline (4) to pump shaft (8), avoiding excessive protrusion of key through thrust ring.



INSTRUCTION MANUAL

DELAVAL ENGINE AND
COMPRESSOR DIVISION
550 - 85th AVENUE
OAKLAND, CALIFORNIA 94621



PART K - LUBRICATING OIL SYSTEM

FILTERS AND STRAINERS.

The full flow filter continuously filters all of the lubricating oil from the pump before it passes to the oil strainer. The length of time that the lubricating oil and the filter elements may remain in service can best be determined by carefully watching the result of oil analysis and the pressure drop across the oil filter. Change period will vary with the operating conditions to which each individual engine is subjected. During the first two or three days of engine operation after initial installation, or after a major overhaul, the strainer at the pump suction and the strainer at the oil header inlet should be checked and cleaned as necessary to remove any debris and other foreign matter that may be present. If at any time the oil pressure gauge shows a low reading, the following should be done to the degree necessary to correct the situation.

- a. Check the oil level in the sump tank.
- b. Inspect strainer, filter and lubricating oil cooler. A leak in the cooler may be detected by a sudden increase in oil consumption, and by the presence of oil in the cooling water system. Leakage may occur in the packing between the tubes and the tube sheet, or may be due to tube erosion, depending on the construction of the cooler.
- c. Inspect all external and internal piping for tightness and freedom from obstructions.
- d. Dismantle and inspect pump.

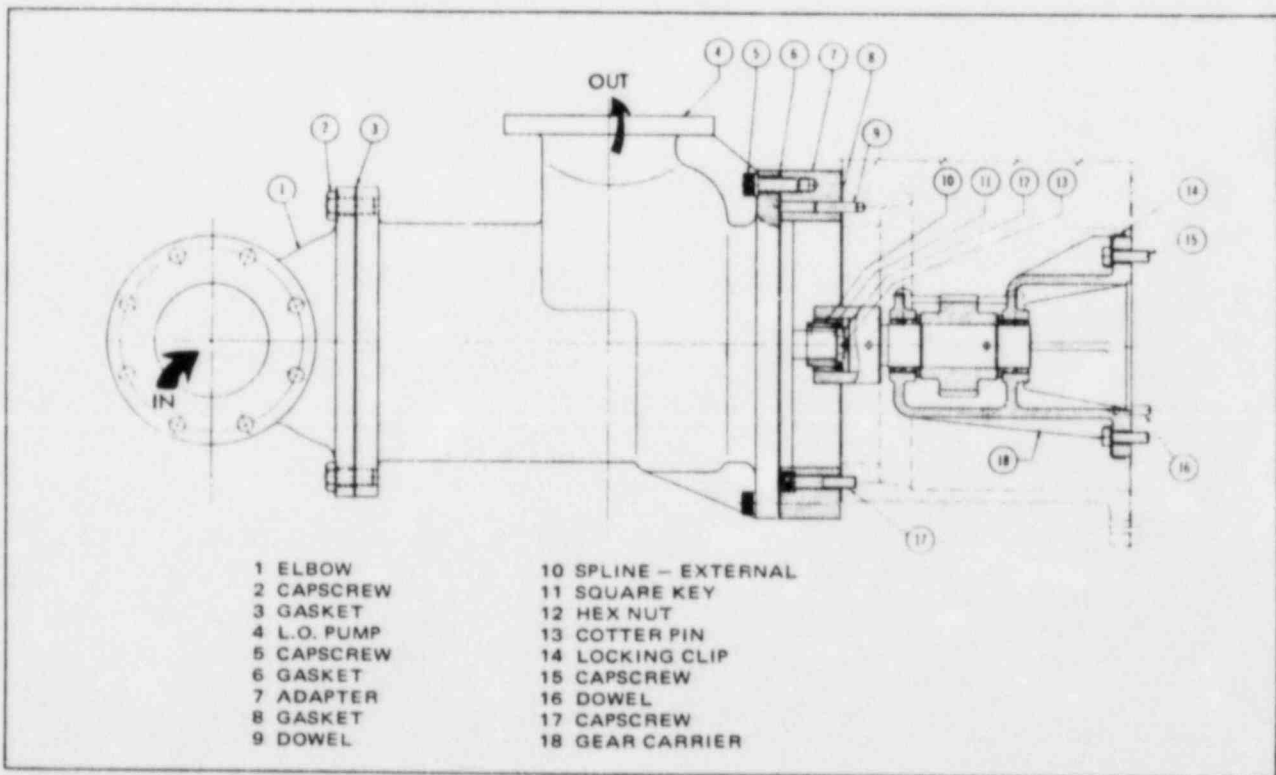

Figure 6-K-1. Lubricating Oil Pump and Gear Carrier Assembly

PART K - LUBRICATING OIL SYSTEM (Continued)

LUBRICATING OIL PUMP.

A Delaval IMO, constant displacement, rotary screw type lubricating oil pump is used. Lubricating oil in the pump is propelled axially in a constant, uniform flow through the action of but three moving parts - a power rotor and two idler rotors. The smooth intermeshing of these rotors propels the lubricating oil in a steady flow without any churning, pocketing or pulsation. There are no timing gears, cams, valves, sliding vanes or reciprocating parts to wear or become noisy. The pump is mounted on the front of the gearcase, and is coupled to a carrier assembly by a splined coupling. The carrier assembly is mounted on the front of the engine base, and is driven by the crankshaft speedup gear. Once the pump has been placed in service it should continue to operate satisfactorily with little attention other than an occasional inspection. Noisy pump operation is usually indicative of excessive suction lift, air in the system, misalignment or, in the case of an oil pump, excessive wear.

REMOVING PUMP (See Figure 6-K-1).

To remove the pump from the engine, do the following.

- a. Remove the inlet and discharge piping as well as any other interfering piping or accessories.
- b. Position a sling on the pump and attach to a chainfall and take up the slack.
- c. Remove the capscrews that secure the pump to the adapter and pull the pump directly away from the engine until it is clear.

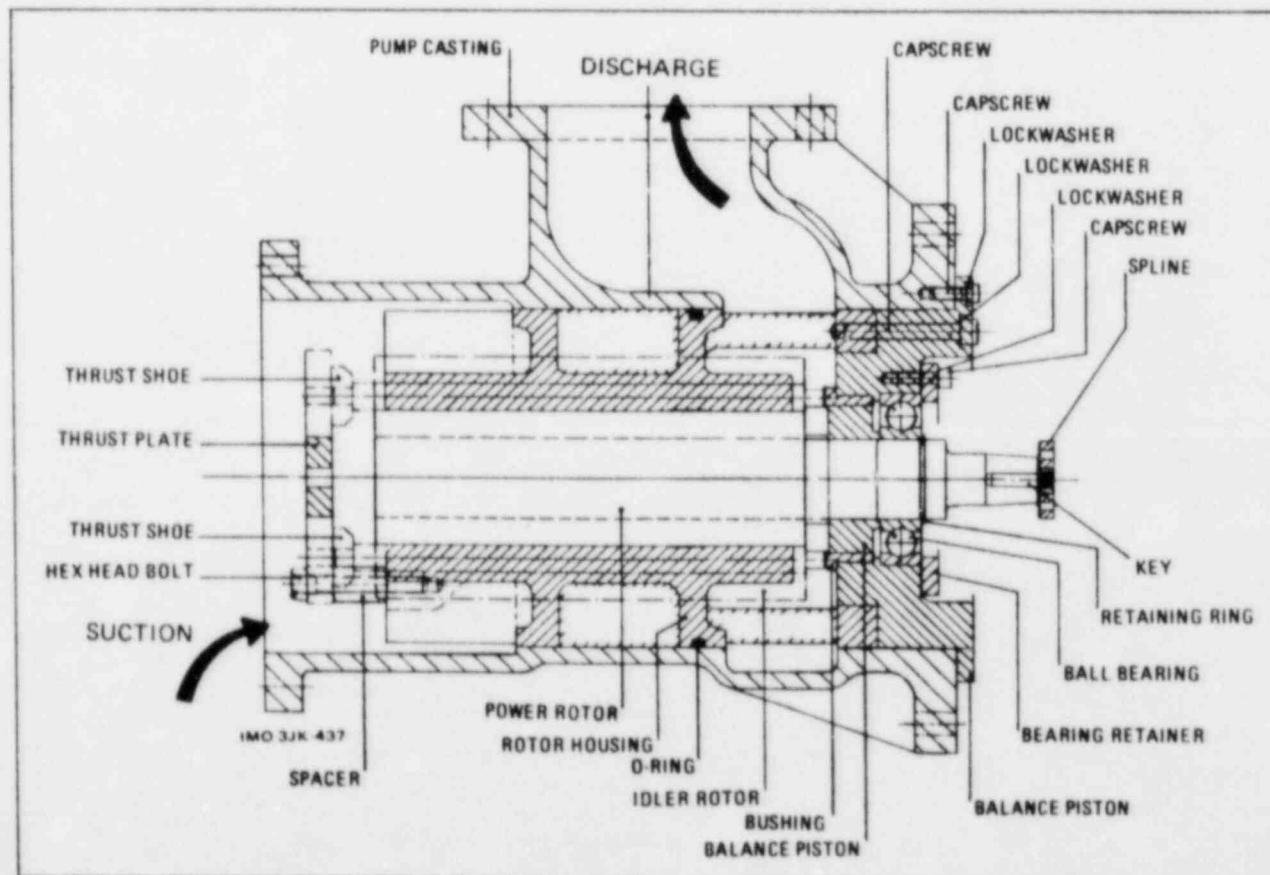

Figure 6-K-2. Lubricating Oil Pump Assembly

INSTRUCTION MANUAL

DELAVAL ENGINE AND
COMPRESSOR DIVISION
550 - 95th AVENUE
OAKLAND, CALIFORNIA 94621



PART K - LUBRICATING OIL SYSTEM (Continued)

PUMP DISASSEMBLY (See Figure 6-K-2).

If it is necessary to disassemble the pump, exercise care to keep the parts clean so that no dirt, grit or other foreign matter will be present when the pump is assembled. Disassemble as follows.

- a. Set pump on suction end and remove capscrews and lockwashers holding balance piston housing in pump casing. Remove two capscrews with lockwashers from opposing positions, 180 degrees apart and insert $\frac{1}{2}$ - 13 eyebolts into vacated holes. Lift internal assembly out of pump case and set assembly on its side. *Do not* set it down on thrust plate. Remove eyebolts.
- b. Remove bolts, lockwashers, spacers and thrust plate from suction end of rotor housing. Note location of each spacer with respect to the rotor housing. Support and remove each spacer as each bolt is removed. Set parts aside in order of removal.
- c. Grasp thrust shoe on end of each idler rotor and unscrew idler rotors from rotor housing. Do not remove thrust shoe from idler rotor.
- d. Remove capscrew with lockwashers and bearing retainer. Grasp coupling end of power rotor shaft and pull power rotor out of rotor housing. Avoid hitting bushing with end of power rotor as it is removed. Inspect power rotor and ball bearing.
- e. If it is necessary to replace the ball bearing, proceed as follows. Remove retaining ring. Obtain wheel or gear puller and small piece of soft metal. Place soft metal over end of power rotor shaft and use puller to remove the ball bearing from balance piston. Discard bearing.
- f. Remove retaining capscrews with lockwasher and separate balance piston housing from rotor housing. Do not disassemble bushing from balance piston housing unless it requires replacement. This completes disassembly necessary for maintenance purposes.

PUMP REASSEMBLY (See Figure 6-K-2).

- a. If ball bearing was removed, pressure a new bearing into position on the balance piston. Replace retaining ring. If a new bushing is required, coat outside diameter of new bushing with *Locktite Retaining Compound* and insert bushing into balance piston housing.
- b. Set rotor housing on suction end and install new O-ring. Place balance piston housing on discharge end of rotor housing and fasten down with four capscrews and lockwashers, leaving two holes, 180 degrees apart, vacant.
- c. Lay rotor housing on its side and insert power rotor into housing from discharge end. Fasten bearing retainer to balance piston housing with capscrews and lockwashers.
- d. Insert idler rotors into rotor housing from suction end. Reassemble thrust plate to rotor housing with bolts and washers, making sure that each spacer is assembled to the housing in its original location. Note: *The four spacers have been machined to close tolerances to assure accurate spacing between thrust plate and rotor housing. A minimum torque of 800 in.-lb applied to each bolt should assure proper spacing between thrust plate and rotor housing. Improper spacing will result in accelerated wear of internals.*
- e. Insert two $\frac{1}{2}$ " x 13 eyebolts into vacated holes in balance piston housing and lift internal assembly into position over pump case. Insert assembly into pump case, being careful not to damage O-ring during process. Fasten internal assembly to pump case with capscrews and lockwashers.

PART K - LUBRICATING OIL SYSTEM (Continued)

f. This completes pump reassembly. Before mounting to gearcase, make sure that pump turns freely. Do not force piping into place as the strain on the casing may cause excessive pump wear.

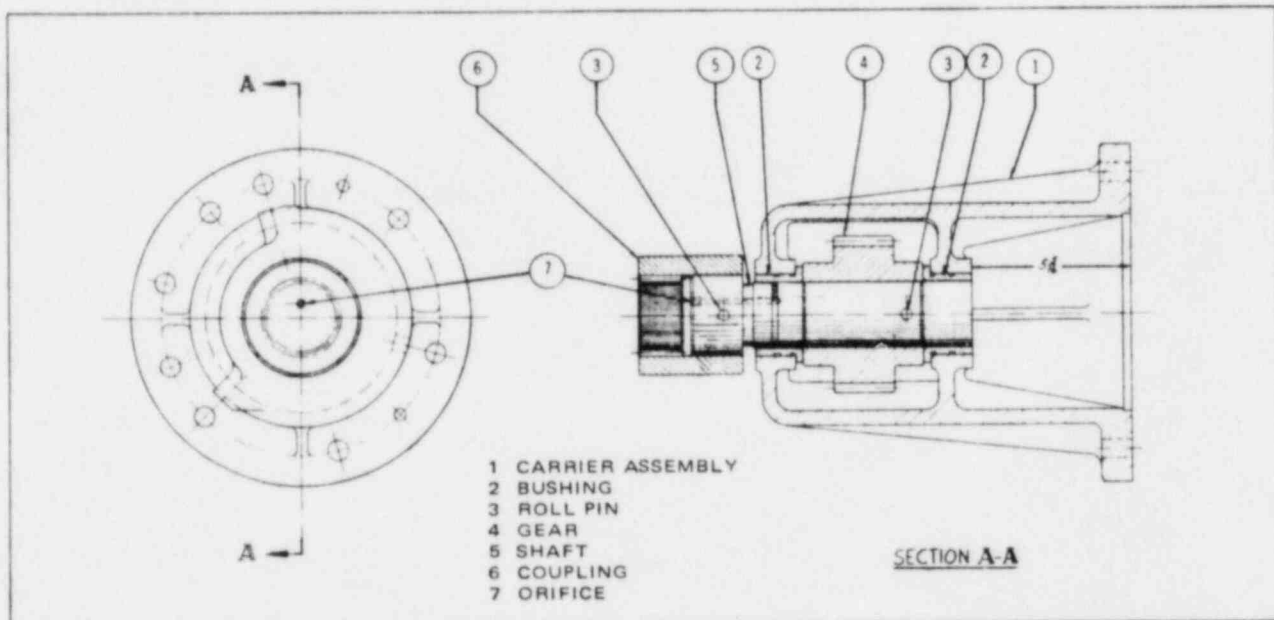

Figure 6-K-3. Gear Carrier Assembly

OIL PUMP GEAR CARRIER ASSEMBLY (See Figure 6-K-3).

The pump gear carrier assembly consists of a shaft supported by two bronze bushings, pressed into the carrier assembly with their flanges to the inside. The pump end of the shaft has an internally splined coupling, attached to the shaft by a roll pin, which accepts the external spline adapter secured to the end of the pump power rotor shaft. The drive gear is mounted on the shaft between the two bushings and engages the speedup gear. The carrier assembly is secured to the engine block by cap screws and locking clips, and is located by two dowels.

DISASSEMBLY AND ASSEMBLY OF GEAR CARRIER ASSEMBLY (See Figure 6-K-3).

To remove the pump gear carrier assembly, the pump must be removed as outlined above, then the gearcase removed.

- Remove lubricating oil lines from carrier assembly.
- Bend back locking clips and remove cap screws. Remove carrier assembly.
- To remove gear, shaft and bushings from carrier assembly, remove gear-to-shaft roll pin then press shaft out of gear. With shaft and gear removed, press bushing out of drive bracket.
- Assembly is the reverse of disassembly. Use new locking clips.

Instruction Manual

PART L – MISCELLANEOUS

MANOMETER.

The U-type manometer is a primary standard for the measurement of pressure. No other device offers a higher degree of accuracy of result. The vertical distance between the two levels of fluid in the U-tube is a measurement of the difference in pressure between the two sides of the manometer. The difference may be expressed in linear units of the indicating fluid, such as inches of water or inches of mercury. Because the pressure being measured acts directly on the indicating liquid in the tube rather than through any mechanical devices, the column will respond directly and immediately to the slightest change in applied pressure. For example, if water is the indicating medium, a pressure change of one ounce per square inch will change the indicating levels approximately one inch. As standard scales are graduated in tenths of an inch, very accurate readings are possible.

MEASURING VACUUM.

Vacuum and pressure, in the sense used here, are the same thing, vacuum being merely the degree to which the pressure has been brought below atmospheric pressure. Vacuum is normally read in inches of mercury. If a vacuum pump were to be connected to one leg of a U-type manometer while the other leg remained open to atmosphere (see figure 6-L-1), the pressure on the pump side would be reduced as the pump works. Atmospheric pressure, then being the greater pressure, will force the column of mercury down on the open side and consequently, the column of the leg will rise. The resultant difference in the height of the column is the measure of vacuum in inches of mercury created by the pump.

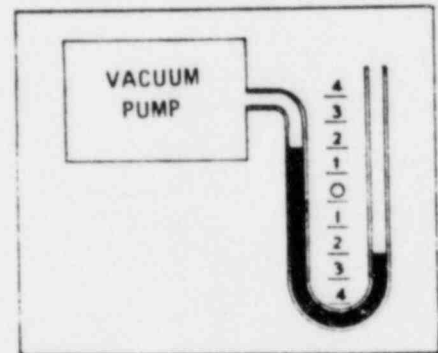

Figure 6-L-1. Manometer with Vacuum Pump

OPERATION AND MAINTENANCE.

With both legs of the manometer open to atmosphere as shown in figure 6-L-2, indicating fluid is placed in the tube until the level is at the center, or zero graduation of the scale. If the level of the two columns is less than zero, fluid should be added. If the reading is more than zero, fluid should be removed. Minor adjustments may be made by moving the scale to obtain an exact zero reading. Application of pressure to the right leg will force the fluid column down in the right leg and up in the left. The instrument is then read by noting the deflection from zero in both legs, then adding the two. In the case of the manometer illustrated on the right side of figure 6-L-2, the difference is the sum of two inches below zero and two inches above, or four inches.

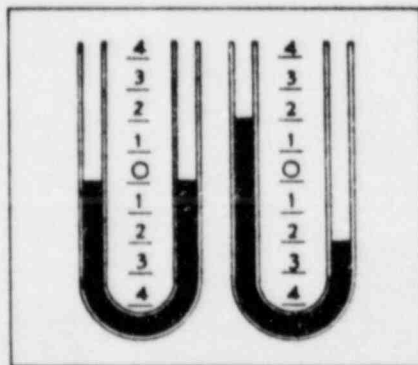

Figure 6-L-2. Reading Manometer

Instruction Manual

PART L – MISCELLANEOUS (Continued)

CRANKCASE VENTILATION.

The crankcase is ventilated by natural flow of vapors through a ventilating pipe to atmosphere outside the engine room. A drip leg should be provided to collect any oil that may accumulate in the vent pipe. The vent piping should be inspected periodically, and cleaned as necessary to remove any accumulation of oil and dirt that may possibly restrict the flow through the piping. The frequency of inspection will depend on operating conditions and hours of running.

SECTION 7 TROUBLE SHOOTING

GENERAL.

Effective maintenance trouble shooting requires a sound knowledge of the engine in both a theoretical and a practical sense. The mechanic must analyze the cause and effect of different conditions and, where the cause is not readily apparent, he must employ a fine sense of logic based upon the use of all the tools available to determine that cause. Section 5 of this manual illustrates some trouble shooting data that can be obtained from the charts and curves which are recommended. In addition, this section contains a listing of possible troubles that may be encountered, their possible causes, and the action that would appear to be appropriate.

RECORDS.

All possible malfunctions and their probable causes cannot be foreseen and recorded in advance. Each engine will develop and display characteristics which may not be common to all engines of the same model or type. Also, the same operator or mechanic will not always perform the trouble shooting and repair work. It is, therefore, suggested that the owner establish a detailed repair and trouble shooting record system. Each malfunction should be recorded in a readily usable form, listing the indications and findings for each malfunction encountered together with the repair action required. This record will be of assistance in determining the cause of any future malfunctions, and will be a valuable training aid for all operators and mechanics.

INSTRUCTION MANUAL

DELAVAL ENGINE AND
COMPRESSOR DIVISION
550 - 85th AVENUE
OAKLAND, CALIFORNIA 94621



TROUBLE	POSSIBLE CAUSE	ACTION
1. Engine fails to turn over when air start valve turned on.	<ul style="list-style-type: none"> a. Air line valves closed. b. Air pressure too low. c. Air start valve leaking or stuck. d. Air distributor out of time. e. Control system electrical power turned OFF. 	<p>Check air line valves. Check pressure. Check for clogged air strainer. Release cylinder pressure by opening indicator cocks. Remove air start valve and examine. Adjust timing. Turn switch ON.</p>
2. Engine turns on starting air but will not start.	<ul style="list-style-type: none"> a. Fuel line valve closed. b. Fuel low in day tank. c. Air in fuel system. d. Fuel lines clogged. e. Dirty or plugged fuel oil filter(s). f. Water in fuel oil. g. Fuel control linkage sticking. h. Fuel oil relief valve stuck open. i. Fuel rack shutoff cylinder not actuated. j. Overspeed shutoff cylinder not actuated. k. Stuck valve. l. Air intake blocked. m. Valves riding open. n. Valve seats worn. o. Leaking cylinder head gasket. p. Piston rings stuck. 	<p>Open all fuel valves. Fill tank. Vent system by opening fuel pump bleeder screws. Clean lines. Clean filter(s). Drain and refill system with clean fuel oil. Free and lubricate. Free valve. Check engine control system. Check overspeed trip and valve. Check control system. Free, clean and lubricate. Check overspeed shutdown butterfly valve. Check intake air filter and lines. Adjust valve clearance or, if equipped with hydraulic lifters, check lifter adjustment. Reseat valves. Replace with new gasket(s). Replace rings as required, using oversized rings if necessary. Replace liners if scored or worn.</p>
3. Running engine slows or stops.	<ul style="list-style-type: none"> a. Safety shutdown system tripped. b. Low fuel level in day tank. c. Water in fuel oil system. d. Fuel filters plugged or dirty. e. Engine overloaded. f. Restriction in exhaust line. g. Intake air supply restricted. h. Seized piston. 	<p>Check control panel annunciator for cause. Fill tank. Drain and fill with new oil. Clean filters. Reduce load. Clear obstruction. Check and clear obstruction. Check intake air filter, overspeed air butterfly valve. Actual piston seizure makes a high pitched, squeaking noise. STOP ENGINE IMMEDIATELY. Check pistons, liners and cooling system.</p>
4. Engine fires irregularly when running.	<ul style="list-style-type: none"> a. Low fuel oil day tank level. b. Air in fuel oil system. c. Water in fuel oil system. d. Fuel lines clogged. e. Plugged or dirty fuel oil filter(s). f. Fuel injection nozzle stuck, clogged, damaged or dirty. g. Injection tube connections leaking. h. Fuel nozzle bleeder valve open. i. Fuel injection pump dirty, worn or damaged. j. Fuel injection pumps out of time. k. Fuel injection pumps out of balance with other pumps. l. Lack of compression. 	<p>Fill tank. Vent system by opening fuel pump header screws. Drain and fill with new fuel oil. Clean lines. Clean filters. Replace with spare and examine. Clean joints and tighten. Close valve. Replace with spare and examine. Adjust timing (see engine data sheet). Check millimeter setting of all pumps with setting at full load shown on engine data sheet. Check individual cylinder exhaust temperatures. See paragraph 2 above.</p>
5. Engine has black exhaust while running.	<ul style="list-style-type: none"> a. Fuel nozzle stuck, clogged, damaged or worn. b. Fuel injection pump(s) out of time. c. Fuel injection pump out of balance. d. Air intake blocked. e. Engine overloaded. 	<p>Replace with spare and examine. Adjust timing. See 4.k. above. See 2.l. above. Check load. Reduce as necessary.</p>

Instruction Manual

TROUBLE	POSSIBLE CAUSE	ACTION
6. Engine has blue smoky exhaust.	<ul style="list-style-type: none"> a. Piston rings stuck. b. Worn piston rings or liners. c. Burning lubricating oil. d. Crack or hole in piston. 	<p>Free, clean ring grooves and oil drain holes. Replace rings as required. If necessary, use oversized rings. Replace liners if scored or worn.</p> <p>Check piston rings, ring grooves and liners. Replace piston.</p>
7. Engine knocks while running.	<ul style="list-style-type: none"> a. Fuel nozzle stuck, clogged, damaged or worn. b. Fuel injection pump out of time. c. Poor fuel oil quality. d. Defective fuel tappet. e. Piston loose in liner. f. Loose piston pin or pin bushing. g. Connecting rod bearing defective. h. Defective main bearings. 	<p>Replace with spare and examine.</p> <p>Adjust timing.</p> <p>Check specifications of fuel being used against standards.</p> <p>Check, replace worn parts.</p> <p>Shut off fuel to suspected cylinder. If knock decreases, check piston and ring clearances. Replace worn parts.</p> <p>Place piston at bottom dead center. With pry bar, check piston for loose fit. Replace pin or bushing as necessary.</p> <p>Check clearances.</p> <p>Check clearances.</p>
8. Low lubricating oil pressure.	<ul style="list-style-type: none"> a. Low oil level in sump tank. b. Lubricating oil suction clogged. c. Loose lubricating oil piping. d. Loaded filter elements. e. Sticking relief valve. f. Defective lubricating oil pump. g. Pressure regulating valve set too low. h. Loose or worn bearings. 	<p>Add oil.</p> <p>Check strainer and clean.</p> <p>Check and retighten as necessary.</p> <p>Clean or replace elements.</p> <p>Free and clean valve.</p> <p>Inspect pump. Repair or replace.</p> <p>Adjust valve.</p> <p>Check bearing clearances.</p>
9. High lubricating oil pressure.	<ul style="list-style-type: none"> a. Relief valve stuck. b. Dirty lubricating oil cooler or full flow filter. c. Pressure regulating valve set too high. 	<p>Free and clean.</p> <p>Clean.</p> <p>Adjust to correct pressure.</p>
10. High jacket water inlet temperature.	<ul style="list-style-type: none"> a. Jacket water pressure too low. b. Air in water system. c. Pump suction or discharge clogged. d. Pump airbound. e. Water passage clogged with scale. f. Inadequate heat exchanger coolant. g. Dirty heat exchanger. h. Engine overloaded. i. Loose piping. j. Inadequate raw water supply. 	<p>Check and tighten connections.</p> <p>Check water pump -- bleed air.</p> <p>Check and clean.</p> <p>Open vents on pump, or on top of suction.</p> <p>Clean with recognized solvent.</p> <p>Inspect and clean as necessary.</p> <p>Inspect and clean.</p> <p>Reduce load.</p> <p>Check and tighten.</p> <p>Check.</p>
11. Excessive vibration.	<ul style="list-style-type: none"> a. Cylinder misfiring. b. Stuck valve. c. Mechanical problems. 	<p>Check fuel injector nozzles, fuel pump, cylinder fuel cut off.</p> <p>Free, re-face, reseat or replace.</p> <p>Investigate all systems and auxiliaries, particularly moving or rotating parts.</p>
12. Excessive exhaust temperatures, all cylinders.	<ul style="list-style-type: none"> a. Engine overloaded. b. Low manifold air pressure. c. Piston sticking. d. Bearing failure. e. Dirty intake air filter. 	<p>Reduce load.</p> <p>Increase manifold pressure.</p> <p>Remove, clean, check clearances.</p> <p>Inspect and check clearances.</p> <p>Clean.</p>
13. Unequal exhaust temperatures (wide spread with engine loaded)	<ul style="list-style-type: none"> a. Valve leakage. b. Fuel injection pump out of adjustment. 	<p>Check valves, grind and reseat.</p> <p>Adjust.</p>
14. Rising exhaust temperature in one cylinder.	<ul style="list-style-type: none"> a. Burned exhaust valve. b. Bad fuel injection nozzle. c. Faulty pyrometer. 	<p>Replace valve.</p> <p>Check and replace if necessary.</p> <p>Check thermocouples and pyrometer.</p>
15. High pre-turbine exhaust temperature.	<ul style="list-style-type: none"> a. Engine overloaded. b. Low manifold air pressure. c. Sticking piston. d. Bearing failure. e. Dirty intake air filter. 	<p>Reduce load.</p> <p>Increase pressure.</p> <p>Remove, clean, check clearances.</p> <p>Inspect and check clearances.</p> <p>Clean.</p>

INSTRUCTION MANUAL

DELAVAL ENGINE AND
COMPRESSOR DIVISION
550 - 85th AVENUE
OAKLAND, CALIFORNIA 94621



TROUBLE	POSSIBLE CAUSE	ACTION
16. Low exhaust temperature in one cylinder.	a. Bad fuel pump. b. Bad fuel pump nozzle. c. Faulty pyrometer.	Check and replace if indicated. Check and replace if indicated. Check thermocouples and pyrometer.
17. Erratic speed variations (hunting)	a. Injection pump improperly timed. b. Injection nozzle tip clogged. c. Injection nozzle improperly adjusted. d. Injection pump plunger stuck. e. Low oil level in governor. f. Low fuel oil pressure. g. Governor or linkage sticking. h. Governor adjustment.	Retime pump. Clean nozzle. Adjust. Free plunger. Fill governor with clean oil. Increase pressure. Lubricate linkage with engine oil. Refer to governor manufacturer's bulletins. Refer to manufacturer's bulletins.
18. Constant engine speed fluctuation.	a. Governor. b. Sticking control linkage. c. Speed signal control air pressure.	Refer to manufacturer's bulletins. Clean and lubricate with engine oil. Check system and supply.
19. Excessive venting and/or vapors from vent holes in each end of starting air header.	a. Leaking starting air valves.	Check valves. Repair or replace.
20. Low jacket water pressure.	a. Defective water pump. b. Water pump airbound.	Check and repair. Bleed air.
21. Low raw water pressure.	a. Defective water pump. b. Air in system. c. Dirty strainer.	Check and repair. Bleed air. Clean.
22. Low compression pressure.	a. Worn piston rings. b. Burned valves. c. Valve tappets improperly adjusted.	Replace. Replace. Adjust valve clearance, or if equipped with hydraulic valve lifters, adjust lifters.
23. Low fuel oil pressure.	a. Dirty filters or strainers. b. Relief valve stuck open. c. Defective booster pump. d. Air leak in suction line.	Check and clean. Free and check. Check and repair or replace. Repair.
24. Excessive lubricating oil consumption.	a. Worn piston rings or liners. b. Leak in sump or piping. c. Laquering of liners.	Check clearances. Replace if clearance is excessive. Repair. Hone.
25. Loss of crankcase vacuum.	a. Faulty manometer indications. b. Defective blower motor. c. Defective pressure sensing switch. d. Loose electrical connection. e. Air leak around cylinder head covers. f. Air leak at fuel line entrance to head sub covers. g. Air leak past valve guides. h. Piston blowing by. i. Plugged vent line. j. Fuming lubricating oil.	Check tubing for leaks or obstructions. Repair or replace. Replace. Repair. Check gasket condition and tightness of cover. Check grommet and fuel line gaskets. Check clearances. Check for stuck piston rings. Check for excessive piston ring wear. Check and clean line. Check for hot spots in crankcase.

WARNING

This heavy vapor may be very explosive and the engine should be stopped immediately. Allow to rest for 15 minutes to allow fumes and vapors to dissipate before removing any engine covers.

INSTRUCTION MANUAL

DELAVAL ENGINE AND
COMPRESSOR DIVISION
550 - 85th AVENUE
OAKLAND, CALIFORNIA 94621



TROUBLE	POSSIBLE CAUSE	ACTION
26. No fuel pump delivery, or insufficient delivery.	<ul style="list-style-type: none"> a. Fuel tank empty, or valve in line closed. b. Fuel inlet pipe clogged or filter element dirty. c. Air lock in pump. d. Pump plunger remains suspended in barrel. e. Broken plunger spring. f. Delivery valve not seating properly. g. Delivery valve spring broken. h. Leakage back to suction chamber from surfaces between top of barrel and delivery valve seat. i. Worn or defective plunger or barrel. j. Dirt causing pump plunger to jam. k. Control rack(s) coated with dirt. l. Supply connection leaks. m. Leakage past spring guide caused by worn plunger, or improper seal of barrel in main body. n. High pressure connection leaks. 	<p>Refill tank with fuel oil. Check if transfer pump delivers fuel to tank. Open all valves in fuel lines. Clean pipe. Clean filter element.</p> <p>Vent pump and nozzle. Thoroughly clean all parts, particularly plunger and barrel. If either are damaged, replace both with spares. Replace with spare. Clean delivery valve and seat. If either are damaged, replace with spare. Replace. Clean faces. Remove burrs and scratches from delivery valve seat and barrel.</p> <p>Replace with spare. Dismantle pump and clean. Clean and lubricate. Install new gasket or replace connection if damaged. Replace defective parts with spares.</p> <p>Install high pressure tube only on the cylinder for which it was factory fitted. Replace line if cone is damaged.</p>
27. Injection nozzle valve sticking.	<ul style="list-style-type: none"> a. Dirt in nozzle. b. Poor lubricating quality of fuel oil. c. Nozzle body and valve corroded, or eroded due to acid, water or dirt in fuel oil. d. Joint between nozzle holder and nozzle not tight. e. Nozzle valve worn and loose in nozzle body. f. Nozzle valve stuck in closed position or nozzle orifices closed. g. Carbon deposits on nozzle. 	<p>Remove and clean nozzle. *Analyze fuel oil sample. Change if tests indicate. Check fuel and filters. Replace nozzle body and valve with spares.</p> <p>Clean faces. Remove burrs and scratches from nozzle body and holder. Replace nozzle body and valve with spares. Check fuel and filters. Remove and clean nozzle.</p> <p>Clean nozzle.</p> <p>*Check fuel being used for conformance to approved specifications. Introduce additive in fuel if recommended.</p>
28. High peak firing pressure.	<ul style="list-style-type: none"> a. Overload condition. b. Early injection. c. Malfunctioning nozzle. 	<p>Reduce load.</p>
29. Low peak firing pressure.	<ul style="list-style-type: none"> a. Late ignition. 	

Instruction Manual

SECTION 8

APPENDICES

The purpose of this section of the manual is to provide a single location for specific data which, if located within the body of the manual, would be more difficult to locate. As a general rule, specific values have been omitted from the text and, where appropriate, reference is made to the applicable appendix. The following appendices are contained in this section.

Appendix I	Torsional Stress and Critical Speeds
Appendix II	Operating Temperatures and Pressures
Appendix III	Table of Clearances
Appendix IV	Torque Values
Appendix V	Timing Diagram
Appendix VI	Lubricating Oil Recommendations
Appendix VII	Alarms and Safety Shutdowns
Appendix VIII	Fuel Oil Recommendations
Appendix IX	Power Engine Factory Test Logs

APPENDIX I

TORSIONAL STRESS AND CRITICAL SPEEDS

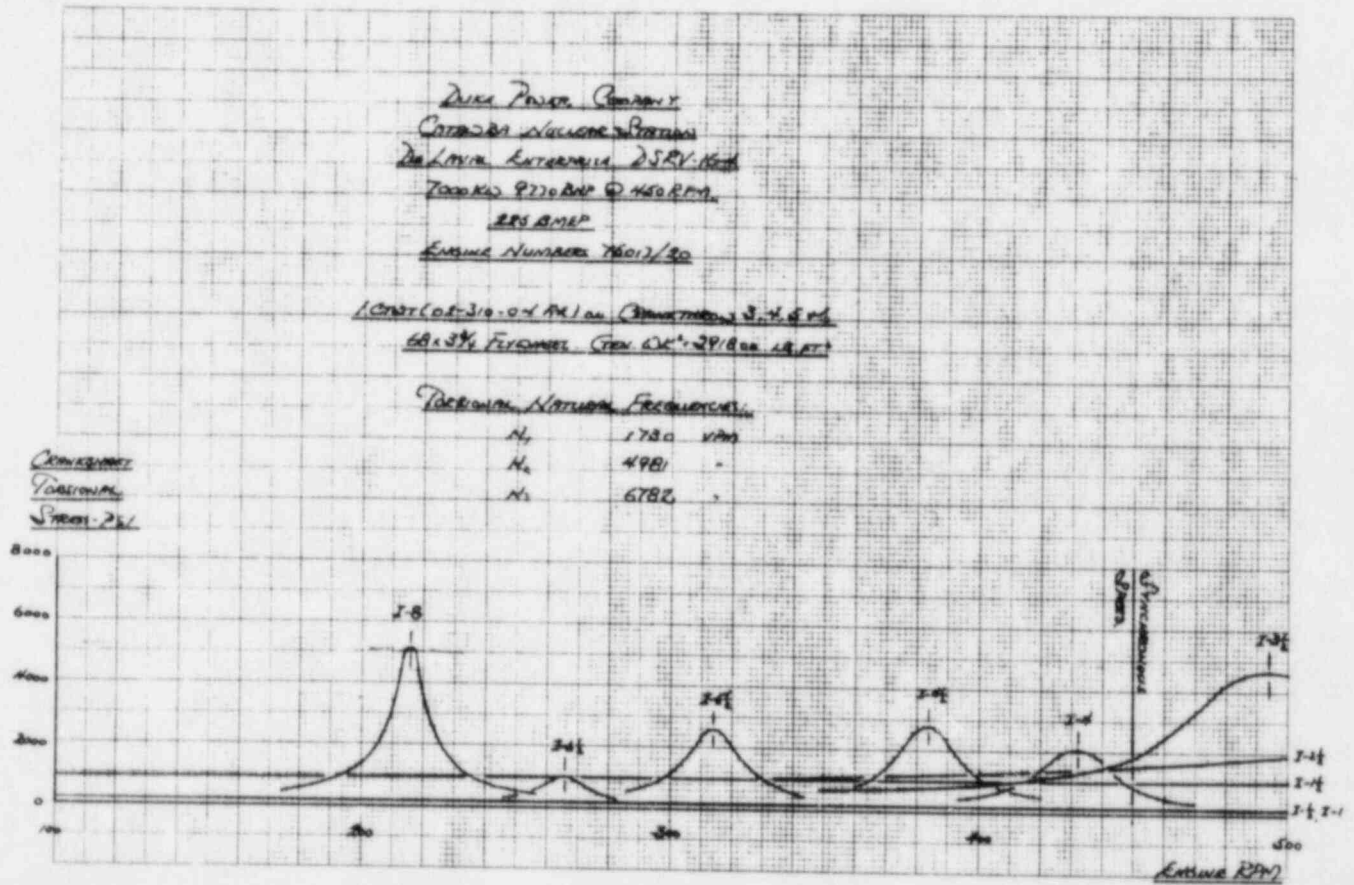

APPENDIX II

OPERATING PRESSURES AND TEMPERATURES

PRESSURES

The following pressures should be present for starting:

Starting Air Supply	250 psi	17.6 kg/sq cm
Starting Air Header	250 psi	17.6 kg/sq cm

While running at rated speed, the operating pressures should be as follows:

	psi	in.-hg	kg/sq-cm
Lubricating Oil*	45 - 55	91.6 - 112.0	3.16 - 3.87
Lubricating Oil at Turbocharger Inlet	25 - 35	50.9 - 71.26	1.76 - 2.46
Jacket Water	10 - 30	20.4 - 61.1	0.70 - 2.11
Fuel Oil	20 - 30	40.7 - 61.1	1.40 - 2.11

TEMPERATURES

While running under rated load, the outlet temperatures should be as follows:

Lubricating Oil out of Engine*	170 ^o F - 180 ^o F (76.6 ^o C - 82.2 ^o C)
Jacket Water out of Engine	170 ^o F - 180 ^o F (76.6 ^o C - 82.2 ^o C)

EXHAUST TEMPERATURE

The exhaust temperatures shown on the title page are the average for all cylinders during factory test under **local ambient conditions**. Temperatures in the field, therefore, may exceed this average temperature.

Pressures and temperatures listed are established as a guide to proper operation. They should be held within plus or minus 10 percent. Sudden changes in reading require immediate investigation and correction.

*With SAE 40 lubricating oil in engine.

APPENDIX III
TABLE OF CLEARANCES
MODEL RV ENGINE

Position		Clearance When New				Replace When Over		Notes
		Minimum		Maximum		Inches	Centimeters	
		Inches	Centimeters	Inches	Centimeters			
Exhaust Valve Guide Bore Dia.	Upper	0.997	2.532	0.998	2.534	1.010	2.565	(7)
	Lower	1.002	2.545	1.003	2.548	1.020	2.591	(8)
Air valve piston in cap		0.0055	0.014	0.0075	0.019	0.0085	0.022	(1)
Rocker arm bushing on shaft		0.002	0.005	0.0035	0.009	0.010	0.025	(1)
Tappet in guide		0.002	0.005	0.004	0.010	0.015	0.038	(1)
Tappet roller on pin		0.0015	0.004	0.0030	0.008	0.005	0.013	(1)
Conrod link pin to bushing		0.0039	0.010	0.0085	0.022	0.012	0.031	(1)
Idler gear bushing on shaft		0.003	0.008	0.005	0.013	0.010	0.025	(2)
Idler gear bushing to bracket thrust face		0.005	0.013	0.009	0.023	0.012	0.031	(2)
Piston pin in piston		Push fit at 70° F (21.1° C)				0.002	0.005	(1) or (2)
Piston pin in bushing		0.0095	0.024	0.0105	0.027	0.020	0.051	(1) or (2)

BEARING SHELLS*

Main bearing to crankshaft	0.012	0.031	0.0164	0.042	0.614	1.559	(1)(4)(5)
Rear main thrust bearing	0.022	0.056	0.030	0.076	0.611	1.552	(2)
Conrod bearing to crankshaft	0.011	0.028	0.0154	0.039	0.616	1.565	(3) (6)
Camshaft bearing to camshaft	0.0035	0.009	0.0065	0.017	0.193	0.490	(1)(4)(5)

SKIRT CLEARANCE IN LINER

Top (land tapered)	0.120- 0.074	0.305- 0.188	0.126- 0.077	0.320- 0.196	-----	-----	(1) or (2)
Bottom (skirt)	0.018	0.046	0.021	0.053			(1) or (2)
Liner bore	-----	-----	-----	-----	17.060	43.332	(1)

PISTON RING GAP CLEARANCES

Top compression ring	0.075	0.191	0.090	0.229	0.200	0.508	(2)
Compression ring - Groove No. 2	0.075	0.191	0.090	0.229	0.200	0.508	(2)
Compression ring - Grooves 3 & 4	0.050	0.127	0.065	0.170	0.200	0.508	(2)
Oil control ring - Grooves 5 & 6	0.035	0.089	0.060	0.152	0.200	0.508	(2)

PISTON RING SIDE CLEARANCE IN GROOVE

Top compression ring	0.007	0.018	0.011	0.028	0.020	0.051	(2)
Compression ring - Groove No. 2	0.005	0.013	0.009	0.023	0.020	0.051	(2)
Compression ring - Grooves 3 & 4	0.005	0.013	0.009	0.023	0.020	0.051	(2)
Oil control ring - Grooves 5 & 6	0.003	0.008	0.007	0.018	0.020	0.051	(2)

- Notes:
- (1) Use micrometer and snap gauges.
 - (2) Use feeler gauge.
 - (3) Use dial indicator (bump test).
 - (4) Use plasta-gauge.
 - (5) Measure at bottom of lower shell.
 - (6) Measure at top of upper shell.
 - (7) Diameter of bore, measured 1/8 inch from top of guide.
 - (8) Diameter of bore, measured 3 inches from bottom of guide.



*Bearing replacement figures are based upon wall thickness, measured as indicated by note.

APPENDIX III-1

GEAR SET AND BACKLASH CLEARANCES
MODEL RV ENGINE

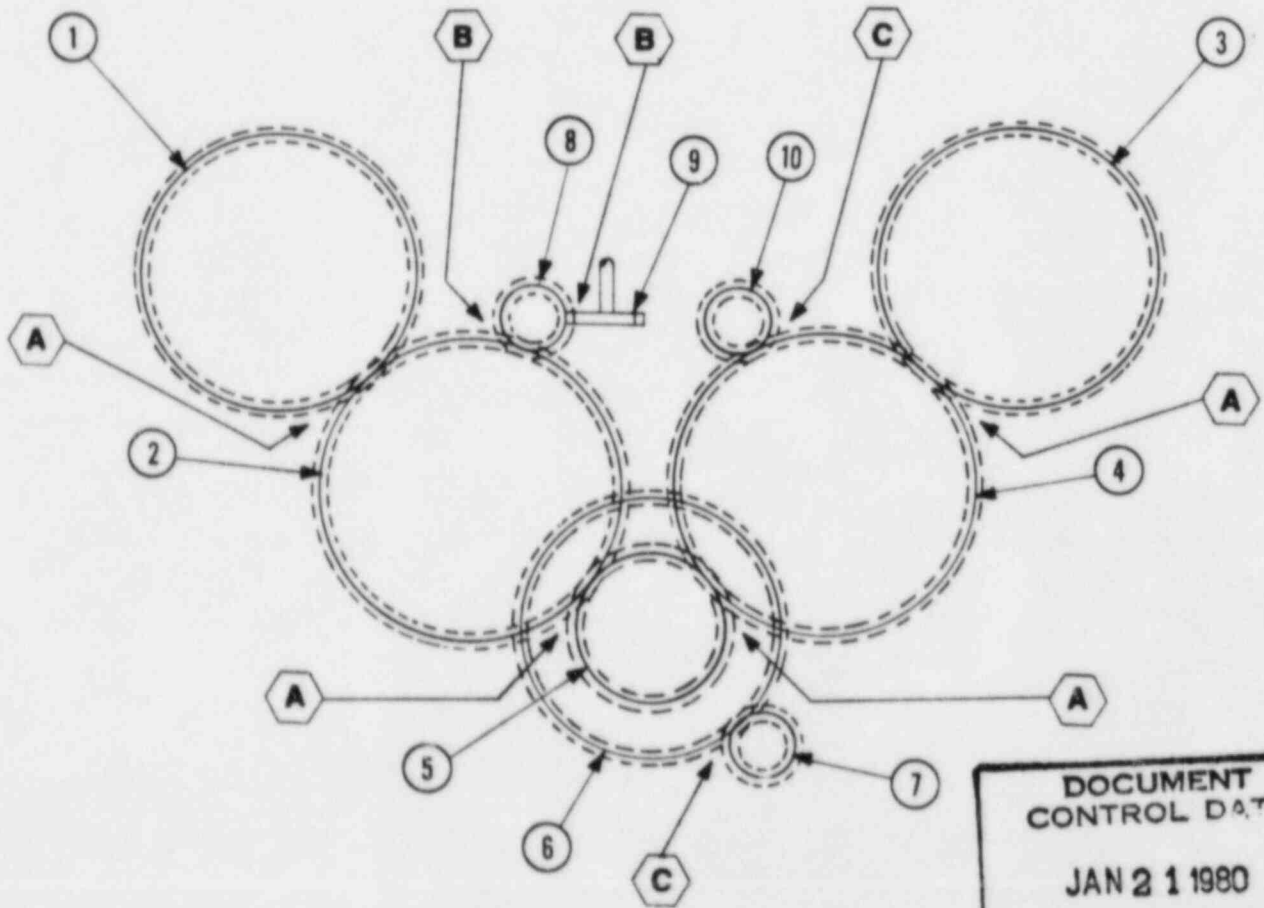

DOCUMENT CONTROL DATE
JAN 21 1980
DUKE POWER COMPANY
DESIGN ENGINEERING

ITEM	DESCRIPTION	GPL
1	CAMSHAFT GEAR, LEFT HAND	350
2	IDLER GEAR, LEFT HAND	355
3	CAMSHAFT GEAR, RIGHT HAND	350
4	IDLER GEAR, RIGHT HAND	355
5	CRANKSHAFT GEAR	310
6	LUBRICATING OIL PUMP DRIVE GEAR	355
7	LUBRICATING OIL PUMP DRIVEN GEAR	420
8	GOVERNOR & TACHOMETER DRIVE GEAR	411
9	GOVERNOR DRIVE AND DRIVEN GEAR	411
10	FUEL OIL PUMP & OVERSPEED TRIP DRIVE GEAR	410

POS	BACKLASH	
	INCHES	CENTIMETERS
A	0.008 - 0.010	0.020 - 0.025
B	0.004 - 0.006	0.010 - 0.015
C	0.005 - 0.008	0.013 - 0.025

FUEL OIL BOOST PUMP/L.O. PUMP DRIVE GEAR

APPENDIX III-2 VALVE SPRINGS

Part Number 03-360-02-OM

Direction of coils	Right hand
Active coils	10
Total coils	12
Load Rate	163.5 lbs/in.
Load at maximum working length	281/310 lbs.
Load at minimum working length	475/525 lbs.
Free length	9.060 in.
Maximum working length	7.250 in.
Minimum working length	6.000 in.
Solid length (ref.)	4.872 in.
Inside diameter	2-15/32 in.
Outside diameter	3.9/32 in.
Wire diameter	0.409/0.403 in.

**DOCUMENT
CONTROL DATE**
JAN 21 1980
**DUKE POWER COMPANY
DESIGN ENGINEERING**

APPENDIX IV

**TORQUE VALUES
Model RV Engine**

The torque values listed below are based upon the use of the lubricant specified on page 5-7 under "Torque Wrench Tightening Procedures". All values are given both in foot pounds and in kilograms per meter. Where applicable, bolt sizes are shown in parenthesis.

Item	Torque	
	ft-lb	kg-m
NUT, Foundation Bolt (heat treated steel*)	3800	525.6
NUT, Main Bearing Cap Stud (1½")**	3000	415
NUT, Base to Crankcase Thru-Bolt	7000	968
CAPSCREW, Crankcase to Base (1")	285	39.4
NUT, Cylinder Block to Crankcase Thru-Bolt (2½")	4500	622
" " " " " " " (2")	3000	425
NUT, Connecting Rod Bolt (1½")	1200	166
" " " " (1-7/8")	1800	248.9
BOLT, Link Connecting Rod to Link Pin (1¼")	735	101.5
" " " " " " " (1-1/8")	1050	145.2
NUT, Cylinder Head Stud (2-8NC)**	3300	456.4
NUT, Spark Plug Tube Retainer	Minimum 60 Maximum 65	8.29 8.98
NUT, Fuel Injection Nozzle Retainer	Minimum 75 Maximum 80	10.37 11
NUT, Fuel Pump Stud	80	11
CAPSCREW, Fuel Pump Base (Allen)	120	16.6
NUT, Camshaft Bearing Cap Stud	200	27.6
CAPSCREW, Idler Gear Mount Bracket	120	16.6
NUT, Flywheel Bolt	4500	622.3
NUT, Crankshaft Counter Weight (13" Crankpin)	2450	338.7
CAPSCREW, Rocker Shaft	365	50.5
CAPSCREW, Sub-Cover to Cylinder Head	120	16.6
Camshaft Gear Retainer Nut	1800	248.9

*Heat treated bolts are identified by the figure "4" stamped on end of bolt.

**Not applicable if pre-stressing method is used.

INSTRUCTION MANUAL

DELAVAL ENGINE AND
COMPRESSOR DIVISION
550 - 85th AVENUE
OAKLAND, CALIFORNIA 94621



GENERAL TORQUE VALUES

The torque values given on the preceding page are for specific applications and are to be used. The following torque values are for general application where no specific values are given.

Bolt Size & No. Threads	Torque	
	(ft-lb)	(Kg-m)
3/8-16	12	1.66
3/8-24	15	2.08
1/2-13	30	4.15
1/2-20	35	4.74
5/8-11	60	8.29
5/8-18	70	9.68
3/4-10	100	13.83
3/4-16	115	15.90
7/8-9	160	22.13
7/8-14	180	24.89
1-8	245	33.78
1-14	290	40.11
1-1/8-7	335	46.33
1-1/8-8	355	48.00
1-1/8-12	395	54.53
1-1/4-7	480	66.38
1-1/4-8	500	69.15
1-1/4-12	550	76.07
1-3/8-6	620	85.75
1-3/8-8	680	94.04
1-3/8-12	745	103.03
1-1/2-6	735	101.65
1-1/2-8	800	110.64
1-1/2-12	865	119.63

INSTRUCTION MANUAL

DELAVAL ENGINE AND
COMPRESSOR DIVISION
550 - 85th AVENUE
OAKLAND, CALIFORNIA 94621



APPENDIX V TIMING DIAGRAM

MODEL R/RV	TYPE STATIONARY - MECHANICAL LIFTERS	FUEL DIESEL
INTAKE CAM 02-350-06-AK	EXHAUST CAM 02-350-06-AJ	ROTATION CLOCKWISE

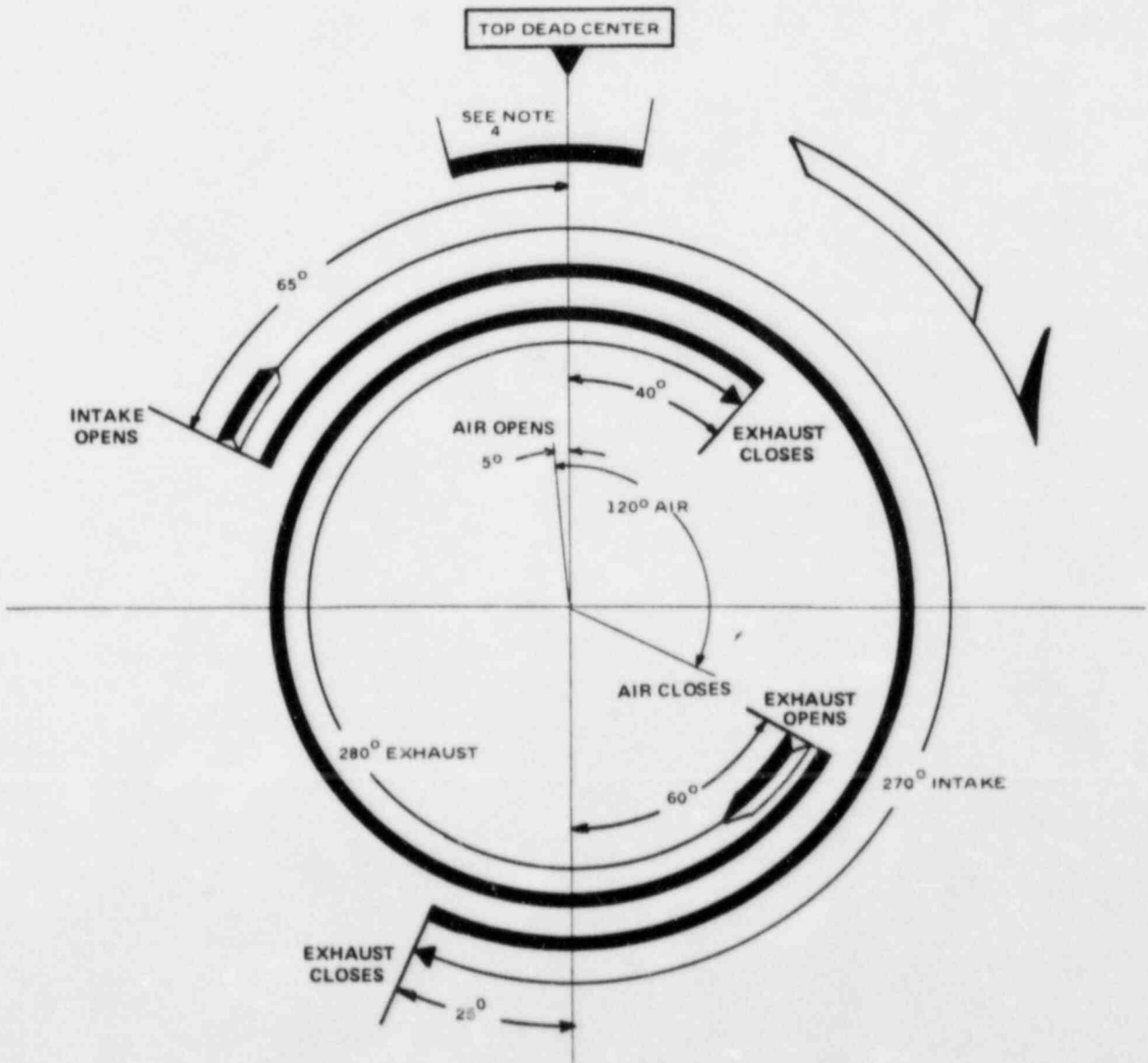

- NOTES:
1. Diagram is in crankshaft degrees.
 2. See Engine Data Sheet in front of manual, or engine nameplate for firing order.
 3. See engine nameplate for cylinder and bank designation.
 4. See Engine Data Sheet for diesel fuel injection point.

Power Engines - Diesel, Clockwise Rotation

INSTRUCTION MANUAL

DELAVAL ENGINE AND
COMPRESSOR DIVISION
550 - 85th AVENUE
OAKLAND, CALIFORNIA 94621



APPENDIX VI

LUBRICATING OIL RECOMMENDATIONS

The DELAVAL Engine and Compressor Division does not recommend lubricants by brand name. The final measure of the quality of an oil is its performance in service. The lubricant supplier must work with the fuel oil supplier to insure the use of the proper lubricant. *The consistent quality and performance of a suitable heavy duty oil must, therefore, be the responsibility of the company making the lubricant.*

CAUTION

It must be the concern of the operator to consult with the oil supplier concerning the proper selection of a lubricant which will perform compatibly with the type of fuel to be used in order to insure the most satisfactory performance and life with overall economical operation. In the case of unresolved questions, the DELAVAL Engine and Compressor Division should be consulted.

To determine the condemning limits for oil in service, have the oil supplier take representative samples at regular intervals for oil analysis. His recommendations, then, for either further service or for condemnation will be based on qualitative factors. The following applies to new oil only.

RECOMMENDED LUBRICATING OIL CHARACTERISTICS

SAE GRADE 40 OIL

	<u>Maximum</u>	<u>Minimum</u>
Viscosity Index (ASTM D567)	-	70
Gravity, A.P.I. at 60°F (25.6°C) (ASTM D287)	30	20
Flash Point °C (ASTM D92)	-	425 (218° C)
Pour Point °F (ASTM D97)	-	10 (5.6° C)
		below coldest oil starting temperature

OIL RECOMMENDATIONS

DIESEL ENGINES (Using fuel oil with less than 1.05% sulfur):

Engines rated 205 bmeq and below — API/SAE Classification "CC" or better.

Engines rated 206 bmeq and above — API/SAE Classification "CD" or better.

Instruction Manual

APPENDIX VII

ALARMS AND SAFETY SHUTDOWNS

During normal operation of the diesel engine/generator set, it is protected by an automatic safety shutdown system which senses certain operating conditions. When a sensed condition reaches a pre-determined setpoint, the system initiates an automatic shutdown sequence. There are other conditions which are monitored, and which will alarm if they reach their alarm setpoint, but which will not shut the engine down. If the unit is operating in response to an emergency start signal from the owner's equipment, only those shutdowns identified by an asterisk (*) on the following list will cause a shutdown. All other shutdowns will alarm while operating in an emergency condition, but will not initiate a shutdown sequence. The following conditions are monitored by the system's protective network.

FUNCTION	ALARM [Setting]	SHUTDOWN [Setting]
<u>TEMPERATURES</u>		
Lubricating oil inlet (low).....	140°F falling	---
Lubricating oil outlet (low)	140°F falling	---
Lubricating oil inlet (high)	175°F rising	---
Lubricating oil outlet (high)	190°F rising	200°F rising
Engine main bearings	---	228°F rising
Aftercooler water in (high)	155°F rising	---
Jacket water in (low)	140°F rising	---
Jacket water out (low)	140°F falling	---
Jacket water in (high)	175°F rising	---
Jacket water out (high)	190°F rising	200°F rising
Stator winding	###	
Exhaust temperature (high/low)	###	
<u>PRESSURES</u>		
Lubricating oil filter ΔP	20 psi rising	---
Lubricating oil strainer ΔP	20 psi rising	---
Lubricating oil pressure	40 psi falling	30 psi falling
Turbocharger lubricating oil, right front ...	20 psi falling	15 psi falling
Turbocharger lubricating oil, left front	20 psi falling	15 psi falling
Fuel oil filter ΔP	20 psi rising	---
Fuel oil TP strainer No. 1 ΔP	20 psi rising	---
Fuel oil TP strainer No. 2 ΔP	20 psi rising	---
Fuel pump strainer ΔP	20 psi rising	---
DC pump strainer ΔP	20 psi rising	---
Fuel oil	15 psi falling	---
Jacket water (inlet)	12 psi falling	
Crankcase	---	5 in.-H ₂ O †
Starting air	160 psi falling	---
Control air	80 psi falling	---
<u>SPEED</u>		
Engine overspeed (15% above rated speed)	---	517.5 rpm inc.*

Instruction Manual

APPENDIX VII ALARMS AND SAFETY SHUTDOWNS (Continued)

FUNCTION	ALARM [Setting]	SHUTDOWN [Setting]
<u>MISCELLANEOUS</u>		
Lubricating oil tank level	Low	---
Fuel oil drip tank level	High	---
Fuel pump/overspeed drive failure	Existing	---
Main fuel tank level	High or Low	---
Main fuel oil tank spec warning	Existing	---
Fuel day tank level	High or Low	---
Jacket water level	Low	---
Generator fault	---	Existing *
Ground fault	Existing	---
Overcurrent	Existing	---
Engine vibration	---	Excessive
Panel intrusion	Existing	---
Auxiliary equipment not in AUTO	Existing	---
Return to Operational mode	Selected	---
Barring device engaged	Existing	---
Building ventilation malfunction	Existing	---
DG room sump level	High	---
DG room sump level	High/High	---
Unit failure to start	Existing	---

APPENDIX VIII**FUEL OIL SPECIFICATIONS**

	<u>Maximum</u>	<u>Minimum</u>
Viscosity, S.S.U. at 100 ^o F	45	32
*Gravity, Deg. A.P.I.	38	26
Sulphur, %	1.05	—
Sulphur, Corrosion Test (Copper Strip, 3 hrs. at 212 ^o F)	Pass	Pass
Conradson Carbon, %	0.20	—
Ash, %	0.10	—
Water & Sediment, %	0.50	—
Flash Point, ^o F (P.M.C.C.)		150 or legal
Pour Point, at least 10 ^o F below coldest fuel oil temperature		
DISTILLATION, ^o F		
90% Point	675	
IGNITION QUALITY		
Cetane Number		40

*Heat Value — determine from A.P.I. gravity limits shown to determine total or net Btu/lb or gallon.

The above specification covers fuel oils classed as Grade F.S. No. 2.

Fuels heavier than the above can be burned in Enterprise engines provided proper treating and pre-heating facilities are available. In the event it is desirable to use such fuels, DELAVAL Engine and Compressor Division should be consulted for advice as to the arrangements that need to be made. An analysis of the particular fuel to be used must be provided.

For lubricating oil recommendations, refer to Section 2, Page 5.

INSTRUCTION
MANUAL FOR
ENTERPRISE
ENGINES

DELAVAL ENGINE AND
COMPRESSOR DIVISION
550-85TH AVENUE
OAKLAND, CALIF 94621

DELAVAL

APPENDIX IX

POWER ENGINE FACTORY TEST LOGS

Copies of the Power Engine Factory Test Logs are provided in this appendix to assist operating personnel in becoming familiar with the operating characteristics of the engine. The data included is that recorded during actual factory test of the engine.

DELAWARE ENGINE AND COMPRESSOR DIVISION OAKLAND, CALIFORNIA										POWER ENGINE FACTORY TEST LOG										LOG 1 A																			
CUSTOMER DUKE POWER										MODEL DSRY-16-4										TEST STAND R3		SER NO 2761		ENGINE NO 75017		FULL LOAD RATING 7758		HP @ 450 RPM 225 WHP											
SYNCHRONIZER LOAD DATA										A.C. GENERATOR LOAD DATA										FUEL PUMP RACK POSITION (MM)																			
DATE										TIME										11		12		13		14		15											
3-28 2346 2346										50 960 57892 9966 119										245 215		245 245		245 245		245 245		245 245											
3-1 0100 0200										75 450 85771 7299 1915										28 28		28 28		28 28		28 28		28 28											
3-1 0200 0300										90 450 113087 9758 225										37 37		37 37		37 37		37 37		37 37											
3-1 1830 1930										100 450 13807 9758 225										37 37		37 37		37 37		37 37		37 37											
3-1 1700 1800										25 460 2353 2515 58										205 205		205 205		205 205		205 205		205 205											
3-1 1855 1955										110 450 14520 9754 2027										43 43		43 43		43 43		43 43		43 43											
TURBINE INLET (TOP & BOTTOM)										TURBINE EXHAUST										EXHAUST ELONG																			
1 57 61										173 172										186 187										66 66									
2 99 104										325 323										341 340										67 63									
3 165 170										474 474										486 485										67 66									
4 161 171										473 473										481 481										71 69									
5 29 29										85 86										82 80										69 69									
6 89 106										536 538										593 588										69 69									
FUEL OIL DATA										DISSEL OIL										FUEL GAS DATA										SAFETY									
1 380 34 83										1830 1170 2427 135										353																			
2 350 33.2 70										1830 1530 2221 2572										344																			
3 325 33.2 70										1830 1560 1622 3462										357																			
4 375 33.7 77										18325 1530 1609 3468										358																			
5 455 33.7 77										18320 520 1681 1005										403																			
6 365 33.7 77										18320 1300 1205 3883										344																			
INJECTION (ON-TIME) (MIN)										22" LB										21" LB										AIR FLOW NOZZLE COEFFICIENT									
FUEL OIL SPEC. GRAV. @ 60°F										0.8136										0.8136										1.2283									
LUBE OIL SPEC. GRAV. @ 60°F										0.8136										0.8136										0.8136									
LUBE OIL VISC. @ 100°F										40 WT.										40 WT.										40 WT.									
OPERATOR										VITAL / G.W. MEIER										DATE										2-28-77									
ENGINEER										G. LEYBAUM										LOG NO.										A									
WITNESS										G. LEYBAUM										SER NO.										2761									

DELAWARE ENGINE AND COMPRESSOR DIVISION OAKLAND, CALIFORNIA										POWER ENGINE FACTORY TEST LOG										LOG 1 B									
CUSTOMER DUKE POWER										MODEL DSRY-16-4 TYPE SERVICE GEN										SER NO 2761		ENGINE NO 75017		DIRECTION OF ROTATION (AS VIEWED FROM FLYWHEEL END) CW					
TURBINE INLET (TOP & BOTTOM)										TURBINE EXHAUST										EXHAUST ELONG									
1 720 717										804 783 773 800 840 783 803 715										738 839 718 817 838 817 814 823									
2 788 777										878 882 892 904 942 862 864 864										855 930 804 923 894 895 910 901									
3 831 825										961 989 963 999 985 963 969 922										943 1028 960 953 969 985 963 968									
4 840 839										958 1028 974 971 971 985 969 887										992 1049 967 1008 997 977 964 961									
5 604 613										645 683 676 688 704 683 656 687										696 698 674 717 704 659 701 671									
6 856 863										981 1058 1048 1030 1042 1034 1042 1023										1032 1085 1045 1058 1050 1020 1046 1010									
ENGINE OIL PRESS. (PSI)										TURBOCHARGER OIL PRESS. (PSI)										AFTERCOOLER WATER PRESS. (PSI)									
1 215 162 165										169 167										117 115									
2 225 162 167										172 169										123 119									
3 225 163 169										175 172										115 117									
4 165 162 168										171 171										128 131									
5 205 161 163										166 164										112 113									
6 205 162 169										175 171										127 122									
LUBRICATING OIL PRESSURE (PSI)										LUBRICATING OIL TEMPERATURE (°F)										TURBOCHARGER OIL TEMPERATURE (°F)									
1 58.5 56.0										27.5 30.5										157 171									
2 58 55										27.5 28.5										158 174									
3 58 55										26.5 27.5										160 178									
4 57.5 55										26.5 28										158 174									
5 58.5 56										30 31										158 167									
6 58 55.5										27 28										157 177									
LEAKAGE PRESS. (PSI)										TURBOCHARGER MAKE & MODEL										OPERATOR									
1 0										8L B0994 8L B0994										VITAL / G.W. MEIER									
2 0																				DATE									
3 0																				2-28-77									
4 0																				LOG NO.									
5 0																				A									
6 0																				SER NO.									
7 0																				2761									

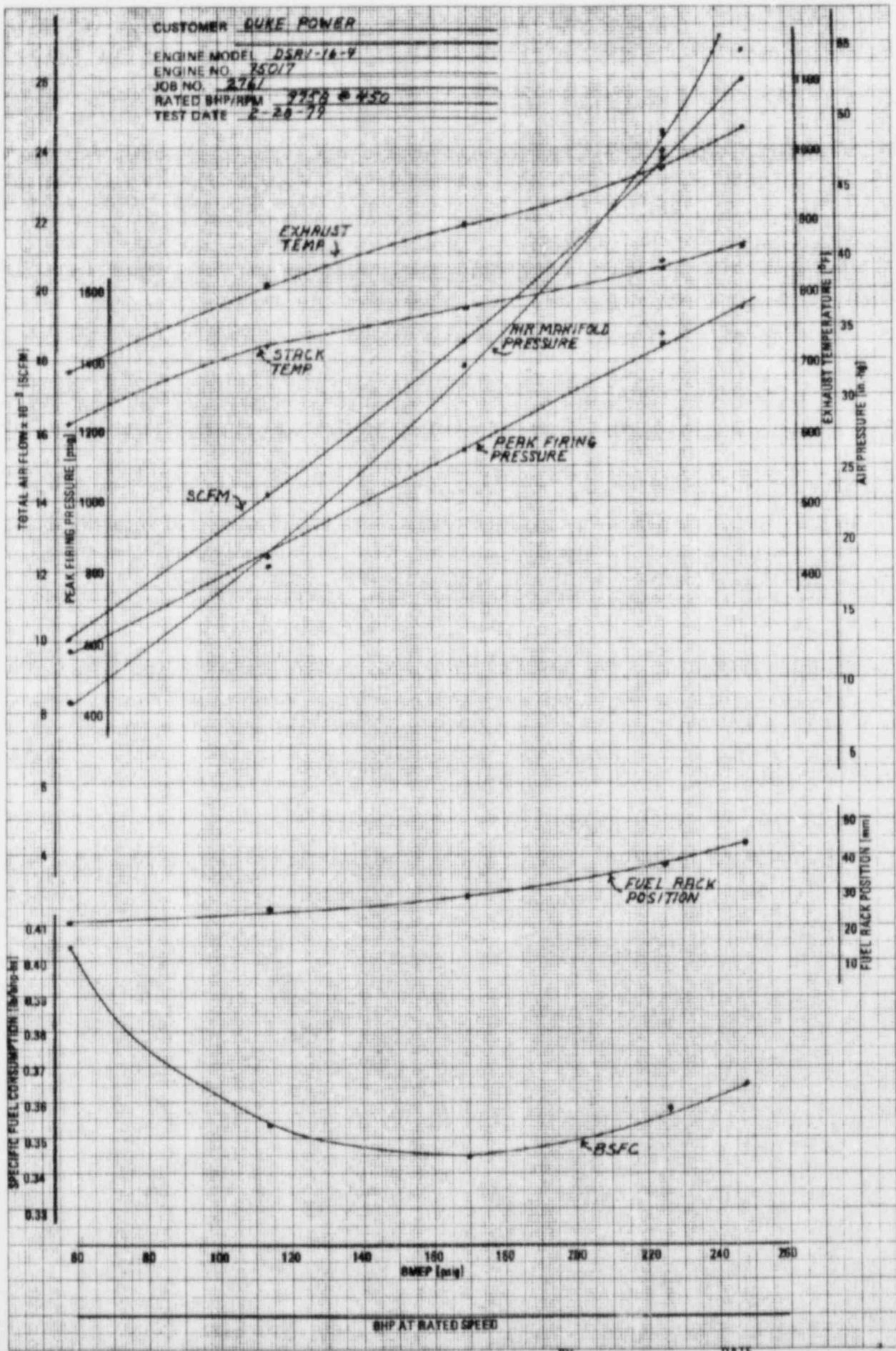

Instruction Manual

DRAWINGS





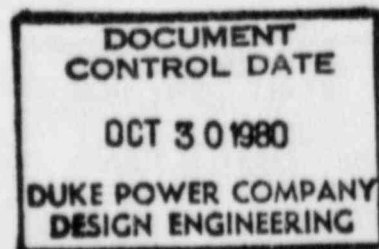







































The following drawings are provided for use in the installation and operation of the unit. These include installation, foundation (where applicable) and system piping schematic drawings. Control system drawings are also included. Assembly drawings may be found in the *Parts Manual, Volume II*.

<u>Dwg. No.</u>	<u>Rev.</u>	<u>Title</u>
Form CAT-123	R-1	Piping Symbols (same as Form D-4313)
Form CAT-129	-	Valve Symbols (same as Form D-4703)
Form D-4968	-	Symbols - Pneumatic Logic Elements
Form D-4969	-	Symbols - Pneumatic Control Devices
Form D-4973	-	Symbols - Electric Schematic
Form CAT-138	-	Piping Connections
Form CAT-139	-	Conversion Factors and Other Useful Information
Form D-4848	-	Procedure Notes For Mounting Enterprise Engines on Concrete Foundations
Form D-4597	-	Engine Lubricating Oil Piping Procedure
R-3909	R	Installation Drawing
R-3910	E	Foundation Drawing
02-550-03	C	Engine Mounting
100232	D	Suggested Concrete Foundation Details & Engine Erection & Installation Notes
09-805-75017	B	Exhaust, Intake & Crankcase Piping Schematic
09-820-75017	E	Lube Oil Piping Schematic
09-825-75017	E	Fuel Oil Piping Schematic
09-835-75017	B	Starting Air Piping Schematic
100546	F	Jacket Water Piping Schematic
52213	J	Panel Installation
52215	G	Engine Pneumatic Schematic
52216	J	Panel Pneumatic Schematic
52217	-	Engine & Auxiliary and Electrical Diagram & Schematic
52218	Q	Panel Electrical Schematic
09-688-75017	G	Engine Electrical Diagram & Schematic
09-691-75017	A	Off-Engine Electrical
52437	K	Interconnect Diagram
61-560-6147	A	Pneumatic Logic Shutdown Board



Instruction Manual

PIPING SYMBOLS

 MANOMETER	 PRESSURE REDUCER	 LEVEL GAUGE
 PRESSURE SWITCH	 GATE VALVE	 PLUGGED
 DIAL THERMOMETER	 GLOBE VALVE	 STRAINER
 TEMPERATURE SWITCH	 PLUG VALVE	 DIRECTION OF FLOW
 SIGHT FLOW GAUGE	 BUTTERFLY VALVE (Tight Sealing Type)	 WELD REDUCER
 ENGINE SHUT DOWN PRESSURE SWITCH	 CHECK VALVE	 SCREWED CAP AND NIPPLE
 PYROMETER	 STOP COCK	 UNION
 PRESSURE SHUT DOWN ELEMENT	 SAFETY OR RELIEF VALVE	 WELD CAP
 TEMPERATURE CONNECTION — Requires 1/4" half coupling for all dial thermometers and separable socket thermometer wells and 1/2" half couplings for temperature switches, etc. (Field locate as directed by owner.)	 PRESSURE CONNECTION — Requires 1/2" coupling, nipple, stop cock, 1/2" x 1/4" bushing and 1/4" plug. (Field locate as directed by owner.)	 LEVEL SWITCH
 STRAINER "Y"	 SOLENOID VALVE	<div style="border: 2px solid black; padding: 10px; text-align: center;"> <p>DOCUMENT CONTROL DATE</p> <p>OCT 30 1980</p> <p>DUKE POWER COMPANY DESIGN ENGINEERING</p> </div>
 TEMPERATURE SHUT DOWN ELEMENT	 DRESSER COUPLING	
 ELECTRIC WIRING	 EXPANSION JOINT	
 CAPILLARY TUBING	 ORIFICE	
 BLIND FLANGE	 ALARM CIRCUIT	
 THERMOMETER	 PRESSURE GAUGE	
 TEMPERATURE GAUGE	 METER	
 FLOAT VALVE	 FLOAT SWITCH	
 DIAPHRAGM CONTROL VALVE	 THERMOSTATIC TEMP. CONTROL VALVE	

This form same as
Form D 4313

Instruction Manual

VALVE SYMBOLS

TWO POSITION VALVE (W/O ACTUATOR)		ACTUATORS	
	Basic two position		Spring return
	Two way, two position		Manual push actuator
	Three way, two position		Manual pull actuator
	Four way, two position		Detented manual actuator
	Five way, two position		Pressure actuator
THREE POSITION VALVE (W/O ACTUATOR)			Solenoid actuator
	Basic three position		Vibration actuator
	Three way, closed center, three position		Flow actuator
	Three way, open center, three position		Liquid level actuator
	Four way, closed center, three position		Temperature actuator
	Four way, open center, three position		
	Five way, open center, three position		
	Five way, closed center, three position		

1. Actuators (there may be one or two) are shown attached to either end of valve symbol.
2. Valve symbols are always shown in non-actuated, i.e., "Normal, relaxed" condition.
3. The tube or pipe connections to the valve are considered to be immovable, while the internal passage blocks are mentally shifted between the external connections to visualize valve action.

EXAMPLES:

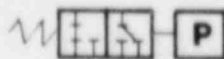

Three-way valve, two position, pressure actuated, spring return

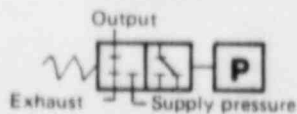

Valve connected normally closed (supply shut off when no pilot pressure exists). Note output is connected to exhaust.

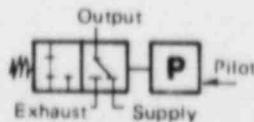

Valve shown with pilot pressure applied (actuated). Supply is now connected to output, and exhaust is blocked. Note that connections have not moved, and valve body is shifted to the left, causing the right passage block to come beneath the connections. Also note, this view will not show up on drawings.

DOCUMENT
CONTROL DATE

OCT 30 1980

DUKE POWER COMPANY
DESIGN ENGINEERING

Symbols - Pneumatic Logic Elements

Symbol	Device	Symbol	Device
	AND Pressure flows from port B to port C when there is pressure at A and B. If either A or B is depressurized, C will vent through internal exhaust port. With 60 psi supply at B, element snap acting at 40 psi rising and 20 psi falling (typical).		ACCUMULATOR A fixed volume chamber used for timing purposes. Commonly used in conjunction with an orifice, the accumulator is filled by a metered pressure to delay or dampen circuit functions.
	OR Pressure flows from port A to port C, or from port B to port C when there is pressure at A or B. Without pressure at either A or B, pressure vents back from C to B or A.		MEMORY Pressure flows from B to C if A is pressurized. By pressurizing, then blocking A, B to C flow is maintained because some port C pressure bleeds back to port A to overcome pressure leakage, if any. If port A vents completely, port C vents through internal exhaust port.
	NOT Pressure flows from port B to port C except when there is pressure at port A. With pressure at A, C vents through internal exhaust port. Element snap acting at 40 psi rising and 20 psi falling (typical).		SET/RESET - MEMORY Common configuration of Set/Reset and Memory elements combined to convert momentary input signals to maintained outputs. Pressure input at port C of S/R causes pressure flow to port B of S/R, which flows to port A of MEM element. With pressure at port A of MEM element, pressure flows from port B of MEM to port C of MEM. When pressure removed from port C of S/R element, pressure remains trapped between port B of S/R and port A of MEM. Pressure flow from port B of MEM to port C of MEM continues, despite loss of S/R input signal. With no pressure at port C of S/R element, pressure applied at port A of S/R element causes pressure between port B of S/R and port A of MEM to exhaust through port C of S/R. With no pressure at port A of MEM, no pressure flow from port B to port C of MEM.
	NOT With Plugged Exhaust Performs NOT function as above, but exhaust port is blocked. Pressure flows from B to C except when there is pressure at A. With pressure at A, pressure flow from B to C stops, but C does not vent. Pressure retained downstream of C.		
	TIMER Provides timing with slow pressure rise, from 0.08 to 7.5 seconds adjustable. With supply pressure at A, slow rising pressure at C, reaching full pressure when delay completed. Without pressure at A, C vents through internal exhaust port.		
	DELAY With pressure at B only, no pressure flow from B to C. When pressure applied to A, flow permitted from B to C after time delay. Output delay adjustable from 0.08 to 7.5 seconds. Ports A and B sometimes connected to common source for time delay output functions.		CHECK VALVE Permits one way pressure flow from port B to common output ports A and C. Prevents pressure backflow from common ports A and C to B.
	TIMER/NOT With pressure at port B only, pressure flows from port B to port C. When pressure is applied to port A, pressure flow from port B to port C is terminated after delay. Output termination time adjustable from 0.08 to 7.5 seconds. Ports A and B sometimes connected to common source for single shot pulse output.		ORIFICE Provides a restriction between two parts of a circuit. With pressure applied to common ports A and C, pressure is metered through orifice to port B. Orifice size is indicated on drawing.
	DIFFERENTIATOR With pressure at input port B, there is a single shot output pulse from port C. Pulse output duration is 80 msec.		PARALLEL ORIFICE/CHECK Combines functions of orifice and check valve in parallel. With pressure applied at common input ports A and C, pressure is metered through orifice portion of the element to port B. When pressure is vented upstream of common inputs A and C, pressure at port B exhausts quickly through check valve portion of the element. Orifice size indicated on drawing.
	SET/RESET Pressure flow from port C to port B will set element. Pressure output at port B remains trapped when input at port C is removed. Pressure applied at port A causes pressure at port B to exhaust through port C. Pressure at port C overrides pressure at port A if both pressures present at the same time.		SERIES ORIFICE/CHECK Combines function of orifice and check valve in series. With pressure applied at port B, pressure passed through check valve and is metered through orifice to common output ports A and C. The check valve portion of the element prevents pressure flow from ports A and C to port B. Orifice size indicated on drawing.

Symbols - Pneumatic Control Devices

Symbol	Device	Symbol	Device
	Tubing connections: Connected		Pneumatic Flag Indicator
	Not connected		Pneumatic Indicator, Spring Return Type
	Pressure Switch		Pneumatic Indicator, Spring Return Type, With Position Lock
	Differential Pressure Switch		Pressure Regulator with Pressure Gauge
	Manually Operated Two way Valve - normally open unless otherwise indicated		Filter
	Manually Operated Three way valve		Filter-Regulator with Pressure Gauge
	Shuttle Valve		Single Acting Pneumatic Cylinder - Spring Extended, Pressure Retracts Piston
	Pressure Relief Valve		Single Acting Pneumatic Cylinder - Spring Retracted, Pressure Extends Piston
	Pilot Operated Two way Valve - normally closed unless otherwise indicated		Pressure Gauge
	Manometer, "U" type		Differential Pressure Gauge
	Bulkhead Termination		Duplex Pressure Gauge
	Capped Test Tee	<div style="border: 2px solid black; padding: 10px; width: fit-content; margin: auto;"> <p style="text-align: center; margin: 0;">DOCUMENT CONTROL DATE</p> <p style="text-align: center; margin: 0;">OCT 30 1980</p> <p style="text-align: center; margin: 0;">DUKE POWER COMPANY DESIGN ENGINEERING</p> </div>	

Symbols - Electrical Schematic

Symbol	Device	Symbol	Device	Symbol	Device
SWITCHES -- General		SELECTORS			
	Disconnect (2 pole)		Normally Closed Manual		Time Delay Relay Coil - Slow Operating Type - On energization, contacts change state after delay and reset immediately on de-energization. (5 sec. shown)
	Circuit Breaker (2 pole)		Normally Open Manual		
	Normally Open Limit		Normally Open Held Closed		
	Normally Closed Limit		Normally Closed Held Open		Time Delay Relay Coil - Slow Release Type - on energization, contacts change state immediately and reset after delay on de-energization
	Held Closed Limit		Three Position Spring Return to Center		
	Held Open Limit		Three Position Maintained Position (shown in Hand position)		Slow Operating Normally Open Energized Contact
	Normally Open Liquid Level				
	Normally Closed Liquid Level	PUSHBUTTONS			Slow Operating Normally Closed Energized Contact
	Normally Open Pressure		Normally Open		
	Normally Closed Pressure		Normally Closed		Slow Release Normally Open Energized Contact
	Normally Closed Differential Pressure		Normally Closed, Held Open		
	Normally Open Differential Pressure		Multiple Contacts, Mechanically Connected		Slow Release Normally Closed Energized Contact
	Normally Closed Differential Pressure	CONDUCTORS			
	Dual Contact Differential Pressure		Not Connected	OTHER COILS	
	Normally Open Temperature		Connected		Solenoid
	Normally Closed Temperature	RELAYS			Overload, Thermal
	Normally Open Thermostatic - Adjustable		Relay Coil - numbers to right of ladder indicate contact locations - normally closed contacts are underlined		
	Normally Closed Thermostatic - Adjustable		Normally Open contact	<p>DOCUMENT CONTROL DATE</p> <p>OCT 30 1980</p> <p>DUKE POWER COMPANY DESIGN ENGINEERING</p>	
	Normally Open Flow		Normally Closed contact		
	Normally Closed Flow		Latch/Reset Relay Coil - numbers indicate contact locations, normally closed contacts underlined.		

Instruction Manual

Piping Connections

All engine and related auxiliary equipment connections are identified by a standard series of numbers applicable to all series of engines. These numbers are used on all equipment and installation drawings for the identification of external connections.

ITEM WATER CONNECTIONS

- 100 - Fresh Water Pump Suction
- 101 - Fresh Water Pump Discharge
- 102 - Salt Water Pump Suction - Marine
Raw Water Pump Suction - Stationary
- 103 - Salt Water Pump Discharge - Marine
Raw Water Pump Discharge - Stationary
- 110 - Jacket Water Vent
- 112 - Emergency Circulating Water - Inlet
- 116 - Fresh Water Inlet to Engine Manifold
- 117 - Jacket Water Manifold Outlet
- 119 - Thrust Bearing Water Outlet
- 120 - Bilge Pump Suction
- 121 - Bilge Pump Discharge
- 126 - Sea Water Discharge
- 130 - Surge Tank Connection from Tank
- 131 - Fill Line - Water System
- 133 - Circulating Water Outlet - Supercharger
- 137 - Cooling Water Vent - Supercharger
- 138 - Alt. Cooling Water Vent - Supercharger
- 154 - Bilge Pump Priming Connection
- 158 - Thrust Bearing Water Inlet
- 159 - Water Inlet - Lube Oil Cooler
- 160 - Thermostatic Valve - Inlet
- 161 - Jacket Water Outlet to Cooler
- 163 - Emergency Circulating Water Outlet
- 164 - Emergency Sea Water Inlet
- 165 - Jacket Sea Water Inlet
- 166 - Jacket Sea Water Outlet
- 170 - Jacket Water Outlet By-Pass
- 171 - Water By-Pass Inlet
- 179 - Water Inlet Compressor
- 180 - Water Outlet Compressor
- 184 - Raw Water Inlet - Turbo Water Cooler
- 185 - Raw Water Outlet - Turbo Water Cooler
- 187 - Water Outlet - Lube Oil Cooler
- 188 - Water Inlet - Intercooler
- 189 - Water Outlet - Intercooler
- 192 - Raw Water Inlet
- 194 - Water Inlet Turbocharger
- 206 - Cooling Water to Compressor L.O. Cooler
- 207 - Cooling Water from Compressor L.O. Cooler
- 228 - Jacket Water Drain & Fill Conn.
- 230 - Intercooler Pump Suction
- 231 - J.W. Standpipe Overflow to Aux. Surge Tank
- 232 - Return to J.W. Standpipe from Aux. Surge Tank
- 243 - Cylinder Block Drain
- 250 - Cooling Water to Radiator
- 251 - Cooling Water from Radiator
- 252 - Sea Water to Cooler
- 253 - Sea Water from Cooler
- 270 - Drain, Compressor Water Supply Pipe

ITEM WATER CONNECTIONS (Cont'd)

- 271 - J.W. Skid Inlet
- 272 - J.W. Skid Outlet
- 273 - Raw Water Pump Outlet
- 274 - Raw Water - L.O. Cooler Inlet
- 275 - Raw Water - L.O. Cooler Outlet
- 276 - Raw Water - J.W. Cooler Inlet
- 277 - Raw Water - J.W. Cooler Outlet
- 278 - Raw Water - Discharge
- 298 - Governor - L.O. Cooler Water Inlet
- 299 - Governor - L.O. Cooler Water Outlet
- 301 - J.W. Drain
- 304 - Steam Condensate Outlet

ITEM POWER GAS CONNECTIONS

- 216 - Pre-Lube Pump Motor Inlet
- 217 - Pre-Lube Pump Motor Outlet
- 222 - Pre-Lube Pump Motor Inlet (Compressor)
- 223 - Pre-Lube Pump Motor Outlet (Compressor)

ITEM HYDRAULIC CONNECTIONS

- 201 - Hydraulic Connections
- 202 - Hydraulic Pump Discharge
- 233 - Expansion Tank Gas Supply
- 234 - Expansion Tank Relief Valve Outlet
- 235 - Bleed Line Return to Expansion Tank
- 237 - Hydraulic Pump Discharge (Compressor)
- 240 - Hydraulic Pump Relief Valve Discharge

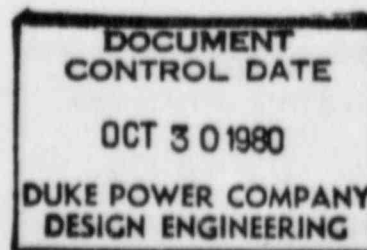

Instruction Manual



Conversion Factors and Other Useful Information

AREAS OF CIRCLES

(Diameters in Inches, Areas in Square Inches)

Diameters	Area	Diameters	Area	Diameter	Area	Diameters	Area	Diameters	Area
1/16	.00307	3		10		22		1/2	1046.349
1/8	.01227	5/8	10.3206	1/4	82.5161	1/2	397.609	3/4	1060.732
3/16	.02761	11/16	10.6783	3/8	84.5409	3/4	406.494	37	1075.213
1/4	.04909	3/4	11.0447	1/2	86.5903	23	415.477	1/4	1089.792
5/16	.07670	13/16	11.4158	5/8	88.6643	1/4	424.558	1/2	1104.469
1/8	.1104	7/8	11.7933	3/4	90.7628	1/2	433.737	3/4	1119.244
7/16	.1503	15/16	12.1767	7/8	92.8858	3/4	443.015	38	1134.118
1/2	.1964	4	12.5664	11	95.0334	24	452.389	1/4	1149.089
9/16	.2485	1/8	13.3641	1/8	97.2065	1/4	461.864	1/2	1164.159
5/8	.3068	1/4	14.1863	1/4	99.4022	1/2	471.436	3/4	1179.327
11/16	.3712	1/8	15.0330	3/8	101.6234	3/4	481.107	39	1194.593
3/4	.4418	1/2	15.9043	1/2	103.8691	25	490.875	1/4	1209.95
13/16	.5185	5/8	16.8002	5/8	106.1394	1/4	500.742	1/2	1225.42
7/8	.6013	3/4	17.7206	3/4	108.4343	1/2	510.706	3/4	1240.98
15/16	.6903	7/8	18.6655	7/8	110.7537	3/4	520.769	40	1256.64
1	.7854	5	19.6349	12	113.098	26	530.929	1/4	1272.39
1/16	.8866	1/8	20.6289	1/4	117.859	1/4	541.189	1/2	1288.25
1/8	.9940	1/4	21.6476	1/2	122.719	1/2	551.547	3/4	1304.20
3/16	1.1075	3/8	22.6907	3/4	127.677	3/4	562.003	41	1320.25
1/4	1.2272	1/2	23.7583	13	132.733	27	572.557	1/4	1336.40
5/16	1.3530	5/8	24.8505	1/4	137.887	1/4	583.209	1/2	1352.65
1/8	1.4849	3/4	25.9673	1/2	143.139	1/2	593.959	3/4	1369.00
7/16	1.6230	7/8	27.1086	3/4	148.489	3/4	604.807	42	1385.45
1/2	1.7671	6	28.2744	14	153.938	28	615.754	1/4	1401.99
9/16	1.9175	1/8	29.4648	1/4	159.485	1/4	626.789	1/2	1418.63
5/8	2.0739	1/4	30.6797	1/2	165.122	1/2	637.941	3/4	1435.37
11/16	2.2365	3/8	31.9191	3/4	170.874	3/4	649.182	43	1452.20
3/4	2.4053	1/2	33.1831	15	176.715	29	660.521	1/4	1469.14
13/16	2.5802	5/8	34.4717	1/4	182.655	1/4	671.959	1/2	1486.17
7/8	2.7612	3/4	35.7848	1/2	188.692	1/2	683.494	3/4	1503.30
15/16	2.9483	7/8	37.1224	3/4	194.828	3/4	695.128	44	1520.53
2	3.1416	7	38.4846	16	201.062	30	706.858	1/4	1537.86
1/16	3.3410	1/8	39.8713	1/4	207.395	1/4	718.689	1/2	1555.29
1/8	3.5466	1/4	41.2826	1/2	213.825	1/2	730.618	3/4	1572.81
3/16	3.7583	3/8	42.7184	3/4	220.354	3/4	742.645	45	1590.43
1/4	3.9761	1/2	44.1787	17	226.981	31	754.769	1/4	1608.16
5/16	4.2000	5/8	45.6636	1/4	233.706	1/4	766.992	1/2	1625.97
1/8	4.4301	3/4	47.1731	1/2	240.529	1/2	779.313	3/4	1643.89
7/16	4.6664	7/8	48.7071	3/4	247.447	3/4	791.732	46	1661.91
1/2	4.9087	8	50.2656	18	254.469	32	804.247	1/4	1680.02
9/16	5.1572	1/8	51.8487	1/4	261.587	1/4	816.865	1/2	1698.23
5/8	5.4119	1/4	53.4563	1/2	268.803	1/2	829.579	3/4	1716.54
11/16	5.6727	3/8	55.0884	3/4	276.117	3/4	842.391	47	1734.95
3/4	5.9396	1/2	56.7451	19	283.529	33	855.301	1/4	1753.45
13/16	6.2126	5/8	58.4264	1/4	291.040	1/4	868.309	1/2	1772.06
7/8	6.4918	3/4	60.1322	1/2	298.648	1/2	881.415	3/4	1790.76
15/16	6.7771	7/8	61.8625	3/4	306.355	3/4	894.618	48	1809.56
3	7.0686	9	63.6174	20	314.159	34	907.922	1/4	1828.46
1/16	7.3662	1/8	65.3968	1/4	322.063	1/4	921.323	1/2	1847.46
1/8	7.6699	1/4	67.2008	1/2	330.064	1/2	934.822	3/4	1866.55
3/16	7.9798	3/8	69.0293	3/4	338.164	3/4	948.418	49	1885.75
1/4	8.2958	1/2	70.8823	21	346.361	35	962.115	1/4	1905.04
5/16	8.6179	5/8	72.7599	1/4	354.657	1/4	975.909	1/2	1924.43
3/8	8.9462	3/4	74.6621	1/2	363.051	1/2	989.789	3/4	1943.91
7/16	9.2806	7/8	76.5888	3/4	371.543	3/4	1003.788	50	1963.49
1/2	9.6211	10	78.5398	22	380.134	36	1017.878	1/4	1983.18
9/16	9.9678	1/8	80.5158	1/4	388.822	1/4	1032.065	1/2	2002.97
								3/4	2022.85

Instruction Manual

ALTITUDE AND ATMOSPHERIC PRESSURES

Altitude Above Sea Level			Temperature**		Barometer*		Atmospheric Pressure	
Feet*	Miles	Meters*	°F	°C	Inches Hg. Abs.	mm Hg. Abs.	PSIA	Kg/sq cm Abs.
-5000		-1526	77	25	35.58	903.7	17.48	1.229
-4500		-1373	75	24	35.00	889.0	17.19	1.209
-4000		-1220	73	23	34.42	874.3	16.90	1.188
-3500		-1068	71	22	33.84	859.5	16.62	1.169
-3000		-915	70	21	33.27	845.1	16.34	1.149
-2500		-763	68	20	32.70	830.6	16.06	1.129
-2000		-610	66	19	32.14	816.4	15.78	1.109
-1500		-458	64	18	31.58	802.1	15.51	1.091
-1000		-306	63	17	31.02	787.9	15.23	1.071
-500		-153	61	16	30.47	773.9	14.96	1.052
0		0	59	15	29.92	760.0	14.696	1.0333
500		153	57	14	29.38	746.3	14.43	1.015
1000		305	55	13	28.86	733.0	14.16	.956
1500		458	54	12	28.33	719.6	13.91	.978
2000		610	52	11	27.82	706.6	13.66	.960
2500		763	50	10	27.32	693.9	13.41	.943
3000		915	48	9	26.82	681.2	13.17	.926
3500		1068	47	8	26.33	668.8	12.93	.909
4000		1220	45	7	25.84	656.3	12.69	.892
4500		1373	43	6	25.37	644.4	12.46	.876
5000	0.95	1526	41	5	24.90	632.5	12.23	.860
6000	1.1	1831	38	3	23.99	609.3	11.78	.828
7000	1.3	2136	34	1	23.10	586.7	11.34	.797
8000	1.5	2441	31	-1	22.23	564.6	10.91	.767
9000	1.7	2746	27	-3	21.39	543.3	10.50	.738
10,000	1.9	3050	23	-5	20.58	522.7	10.10	.710
15,000	2.8	4577	6	-14	16.89	429.0	8.29	.583
20,000	3.8	6102	-12	-24	13.76	349.5	6.76	.475
25,000	4.7	7628	-30	-34	11.12	282.4	5.46	.384
30,000	5.7	9153	-48	-44	8.903	226.1	4.37	.307
35,000	6.6	10,679	-66		7.060	179.3	3.47	.244
40,000	7.6	12,204	-70	-57	5.558	141.2	2.73	.192
45,000	8.5	13,730	-70	-57	4.375	111.1	2.15	.151
50,000	9.5	15,255	-70	-57	3.444	87.5	1.69	.119
55,000	10.4	16,781	-70	-57	2.712	68.9	1.33	.0935
60,000	11.4	18,306	-70	-57	2.135	54.2	1.05	.0738
70,000	13.3	21,357	-67	-55	1.325	33.7	.651	.0458
80,000	15.2	24,408	-62	-52	18.273 ¹	21.0	.406	.0285
90,000	17.1	27,459	-57	-59	5.200 ¹	13.2	.255	.0179
100,000	18.9	30,510	-51	-46	3.290 ¹	8.36	.162	.0114
120,000	22.8	36,612	-26	-48	1.358 ¹	3.45		
140,000	26.6	42,714	4	-16	5.947 ²	1.51		
160,000	30.4	48,816	28	-2	2.746 ²	16.97 ¹		
180,000	34.2	54,918	19	-7	1.284 ²	3.26 ⁻¹		
200,000	37.9	61,020	-3	-19	5.846 ⁻³	1.48 ¹		
220,000	41.7	67,122	-44	-42	2.523 ⁻³	6.41 ⁻²		
240,000	45.5	73,224	-86	-66	9.955 ⁻⁴	2.53 ⁻²		
260,000	49.3	79,326	-129	-90	3.513 ⁻⁴	8.92 ⁻³		
280,000	53.1	85,428	-135	-93	1.143 ⁻⁴	3.67 ⁻³		
300,000	56.9	91,530	-127	-88	3.737 ⁻⁵	9.49 ⁻⁴		
400,000	75.9	122,040			6.3 ⁻⁷	1.60 ⁻⁵		
500,000	94.8	152,550			1.4 ⁻⁷	3.56 ⁻⁶		
600,000	114	183,060			5.9 ⁻⁸	1.50 ⁻⁶		
800,000	152	244,080			1.6 ⁻⁸	4.06 ⁻⁷		
1,000,000	189	305,100			5.1 ⁻⁹	1.30 ⁻⁷		
1,200,000	228	366,120			2.0 ⁻⁹	5.08 ⁻⁸		
1,400,000	266	427,140			8.2 ⁻¹⁰	2.08 ⁻⁸		
1,600,000	304	488,160			3.8 ⁻¹⁰	9.65 ⁻⁹		
1,800,000	342	549,180			1.8 ⁻¹⁰	4.57 ⁻⁹		
2,000,000	379	610,200			9.2 ⁻¹¹	2.34 ⁻⁹		

DOCUMENT CONTROL DATE
OCT 30 1980
DUKE POWER COMPAN DESIGN ENGINEERING

Data from NASA Standard Atmosphere (1962).

*Temperature and barometer are approximate for negative altitudes.

**Temperatures are average existing at 40° latitude and are rounded to even numbers.

†Negative exponent shows number of spaces the decimal point must be moved to the left.

Instruction Manual

DOCUMENT CONTROL DATE

OCT 30 1980

**DUKE POWER COMPANY
DESIGN ENGINEERING**

CONVERSION FACTORS

Multiply	By	To Obtain	Multiply	By	To Obtain	Multiply	By	To Obtain
Atmospheres	76.0	Cms. of mercury	Cubic yards /min	0.45	Cubic feet /sec	Grams	980.7	Dynes
Atmospheres	29.92	Inches of mercury	Cubic yards /min	3.367	Gallons /sec	Grams	15.43	Grains
Atmospheres	33.90	Feet of water	Cubic yards /min	12.74	Liters /sec	Grams	10 ⁻³	Kilograms
Atmospheres	1.0333	Kgs. /sq. cm				Grams	10 ³	Milligrams
Atmospheres	14.70	Lbs. /sq. inch	Decigrams	0.1	Grams	Grams	0.03527	Ounces
Atmospheres	1.058	Tons /sq. ft	Deciliters	0.1	Liters	Grams	0.03215	Ounces (Troy)
Barrels—Oil	42	Gallons—Oil	Decimeters	0.1	Meters	Grams	2.205x10 ⁻³	Pounds
British Thermal Units	0.2520	Kilogram-calories	Degrees (angle)	60	Minutes	Grams/cm	5.600x10 ⁻³	Pounds /inch
British Thermal Units	777.5	Foot-lbs	Degrees (angle)	0.01745	Radians	Grams/cu. cm	62.43	Pounds cubic foot
British Thermal Units	3.927x10 ⁻⁴	Horse-power-hrs	Degrees (angle)	3600	Seconds	Grams/cu. cm	0.03613	Pounds cubic inch
British Thermal Units	107.5	Kilogram meters	Degrees /sec	0.01745	Radians /sec	Grams liter	58.417	Grains /gal
British Thermal Units	2.928x10 ⁻⁴	Kilowatt-hrs	Degrees /sec	0.1667	Revolutions /min	Grams /liter	8.345	Pounds 1000 gals
B.T.U. /min	12.96	Foot-lbs /sec	Degrees /sec	0.002778	Revolutions /sec	Grams /liter	0.062427	Pounds cubic foot
B.T.U. /min	0.02356	Horse-power	Decagrams	10	Grams	Grams /liter	1000	Parts /million
B.T.U. /min	0.01757	Kilowatts	Dekaliters	10	Liters	Hectograms	100	Grams
B.T.U. /min	17.57	Watts	Decimeters	10	Meters	Hectoliters	100	Liters
Centares (Centiares)	1	Square meters	Drams	27.34375	Grains	Hectometers	100	Meters
Centigrams	0.01	Grams	Drams	0.0625	Ounces	Hectowatts	100	Watts
Centiliters	0.01	Liters	Drams	1.771845	Grams	Horse-power	42.44	B.T. Units /min
Centimeters	0.3937	Inches	Fathoms	6	Feet	Horse-power	33.000	Foot-lbs. /min
Centimeters	0.01	Meters	Feet	30.48	Centimeters	Horse-power	550	Foot-lbs. /sec
Centimeters	10	Millimeters	Feet	12	Inches	Horse-power	1.014	Horse-pwr. (Metric)
Centimtrs of Mercury	0.01316	Atmospheres	Feet	0.3048	Meters	Horse-power	10.70	Kg. calories /min
Centimtrs of mercury	0.4461	Feet of water	Feet	1.3	Yards	Horse-power	0.7457	Kilowatts
Centimtrs of mercury	136.0	Kgs. /sq. meter	Feet of water	0.07950	Atmospheres	Horse-power (boiler)	33.479	B.T.U. /hr
Centimtrs of mercury	27.85	Lbs. /sq. ft	Feet of water	0.8826	Inches of mercury	Horse-power (boiler)	9.803	Kilowatts
Centimtrs of mercury	0.1934	Lbs. /sq. inch	Feet of water	0.03048	Kgs. /sq. cm	Horse-power-hours	2547	British Thermal Units
Centimeters second	1.969	Feet /min	Feet of water	62.43	Lbs. /sq. ft	Horse-power-hours	1.98x10 ⁶	Foot-lbs
Centimeters second	0.03281	Feet /sec	Feet of water	0.4335	Lbs. /sq. inch	Horse-power-hours	641.7	Kilogram calories
Centimeters second	0.036	Kilometers /hr	Feet /min	0.5080	Centimeters /sec	Horse-power-hours	2.73x10 ³	Kilogram meters
Centimeters second	0.6	Meters /min	Feet /min	0.01667	Feet /sec	Horse-power-hours	0.7457	Kilowatt-hours
Centimeters second	0.02737	Miles /hr	Feet /min	0.01829	Kilometers /hr	Inches	2.540	Centimeters
Centimeters second	3.728x10 ⁻³	Miles /min	Feet /min	0.3048	Meters /min	Inches of mercury	0.03342	Atmospheres
Cms. sec. /sec	0.03281	Feet /sec. /sec	Feet /min	0.01136	Miles /hr	Inches of mercury	1.133	Feet of water
Cubic centimeters	3.531x10 ⁻¹	Cubic feet	Feet /min	0.3048	Meters /sec	Inches of mercury	0.03453	Kgs. /sq. cm
Cubic centimeters	6.102x10 ⁻³	Cubic inches	Foot-pounds	1.286x10 ⁻³	British Thermal Units	Inches of mercury	70.73	Lbs. /sq. ft
Cubic centimeters	10 ⁻³	Cubic meters	Foot-pounds	5.050x10 ⁻³	Horse-power-hrs	Inches of mercury	0.4912	Lbs. /sq. inch
Cubic centimeters	1.308x10 ⁻⁴	Cubic yards	Foot-pounds	3.741x10 ⁻⁴	Kilogram-calories	Inches of water	0.002458	Atmospheres
Cubic centimeters	2.642x10 ⁻⁴	Gallons	Foot-pounds	0.1383	Kilogram-meters	Inches of water	0.07355	Inches of mercury
Cubic centimeters	10 ⁻¹	Liters	Foot-pounds	3.766x10 ⁻³	Kilowatt-hrs	Inches of water	0.002540	Kgs. /sq. cm
Cubic centimeters	2.113x10 ⁻¹	Pints (liq.)	Foot-pounds /min	1.286x10 ⁻²	B.T. Units /min	Inches of water	0.5781	Ounces /sq. inch
Cubic centimeters	1.057x10 ⁻¹	Quarts (liq.)	Foot-pounds /min	0.01667	Foot-pounds /sec	Inches of water	5.202	Lbs. /sq. foot
Cubic feet	2.832x10 ⁴	Cubic cms	Foot-pounds /min	3.030x10 ⁻¹	Horse-power	Inches of water	0.03613	Lbs. /sq. inch
Cubic feet	1728	Cubic inches	Foot-pounds /min	3.741x10 ⁻¹	Kg. calories /min	Kilograms	980.665	Dynes
Cubic feet	0.02832	Cubic meters	Foot-pounds /min	2.260x10 ⁻¹	Kilowatts	Kilograms	2.205	Lbs
Cubic feet	0.03704	Cubic yards	Foot-pounds /sec	7.717x10 ⁻¹	B.T. Units /min	Kilograms	1.102x10 ⁻³	Tons (short)
Cubic feet	7.48052	Gallons	Foot-pounds /sec	1.818x10 ⁻¹	Horse-power	Kilograms	10 ³	Grams
Cubic feet	28.32	Liters	Foot-pounds /sec	1.945x10 ⁻¹	Kg. calories /min	Kgs. meter	0.6720	Lbs. foot
Cubic feet	59.84	Pints (liq.)	Foot-pounds /sec	1.356x10 ⁻¹	Kilowatts	Kgs. sq. cm	0.9678	Atmospheres
Cubic feet	29.92	Quarts (liq.)	Gallons	3785	Cubic centimeters	Kgs. sq. cm	32.81	Feet of water
Cubic feet /minute	472.0	Cubic cms. /sec	Gallons	0.1337	Cubic feet	Kgs. sq. cm	28.96	Inches of mercury
Cubic feet /minute	0.1247	Gallons /sec	Gallons	231	Cubic inches	Kgs. sq. cm	2048	Lbs. /sq. foot
Cubic feet /minute	0.4720	Liters /sec	Gallons	3.785x10 ⁻¹	Cubic meters	Kgs. sq. cm	14.22	Lbs. /sq. inch
Cubic feet /minute	62.43	Lbs. of water /min	Gallons	4.95x10 ⁻¹	Cubic yards	Kgs. sq. millimeter	10 ⁶	Kgs. sq. meter
Cubic feet second	0.646317	Million gals. /day	Gallons	3.785	Liters	Kiloliters	10 ³	Liters
Cubic feet second	448.831	Gallons /min	Gallons	8	Pints (liq.)	Kilometers	10 ³	Centimeters
Cubic inches	16.39	Cubic centimeters	Gallons	4	Quarts (liq.)	Kilometers	3281	Feet
Cubic inches	5.787x10 ⁻⁴	Cubic feet	Gallons	0.83267	Imperial gallons	Kilometers	10 ³	Meters
Cubic inches	1.639x10 ⁻¹	Cubic meters	Gallons	8.3453	Pounds of water	Kilometers	0.6214	Miles
Cubic inches	2.143x10 ⁻¹	Cubic yards	Gallons	2.228x10 ⁻³	Cubic feet /sec	Kilometers	1094	Yards
Cubic inches	4.329x10 ⁻³	Gallons	Gallons /min	0.06308	Liters /sec	Kilometers /hr.	27.78	Centimeters /sec
Cubic inches	1.639x10 ⁻¹	Liters	Gallons /min	8.0208	Cu. ft. /hr	Kilometers /hr.	54.68	Feet /min
Cubic inches	0.03463	Pints (liq.)	Gallons /min	6.0086	Tons water /24 hrs.	Kilometers /hr.	0.9113	Feet /sec
Cubic inches	0.01732	Quarts (liq.)	Grains (Troy)	1	Grains (Troy)	Kilometers /hr.	0.5396	Knots
Cubic meters	10 ⁶	Cubic centimeters	Grains (Troy)	0.06480	Grains	Kilometers /hr.	16.67	Meters /min
Cubic meters	35.31	Cubic feet	Grains (Troy)	0.04167	Pennyweights (Troy)	Kilometers /hr.	0.6214	Miles /hr
Cubic meters	61.023	Cubic inches	Grains (Troy)	2.0833x10 ⁻³	Ounces (Troy)	Kms. hr. sec.	27.78	Cms. sec. /sec
Cubic meters	1.308	Cubic yards	Grains (Troy)	0.04167	Ounces (Troy)	Kms. hr. sec.	0.9113	ft. /sec. /sec
Cubic meters	264.2	Gallons	Grains (Troy)	2.0833x10 ⁻³	Ounces (Troy)	Kms. /hr. sec.	0.2778	Meters /sec. /sec
Cubic meters	10 ³	Liters	Grains U.S. gal.	17.118	Parts /million			
Cubic meters	21.13	Pints (liq.)	Grains U.S. gal.	142.86	Lbs. /million gal.			
Cubic meters	1057	Quarts (liq.)	Grains /imp. gal.	14.286	Parts /million			

Instruction Manual

CONVERSION FACTORS (Cont'd)

Multiply	By	To Obtain	Multiply	By	To Obtain	Multiply	By	To Obtain
Kilowatts	56.92	B.T. Units/min.	Milligrams	10 ⁻³	Grams	Pounds cubic inch	27.68	Grams/cubic cm.
Kilowatts	4.425x10 ⁶	Foot-lbs./min.	Milliliters	10 ⁻³	Liters	Pounds cubic inch	2.768x10 ⁻⁴	Kgs./cubic meter
Kilowatts	737.6	Foot-lbs./sec.	Millimeters	0.1	Centimeters	Pounds/cubic inch	1728	Lbs./cubic foot
Kilowatts	1.341	Horse-power	Millimeters	0.03937	Inches	Pounds/foot	1.488	Kgs./meter
Kilowatts	14.34	Kg.-calories/min.	Milligrams/liter	1	Parts/million	Pounds/inch	178.6	Grams/cm
Kilowatts	10 ³	Watts	Million gals./day	1.54723	Cubic ft./sec.	Pounds/sq. foot	0.01602	Feet of water
Kilowatt-hours	3.415	British Thermal Units	Miner's inches	1.5	Cubic ft./min.	Pounds/sq. foot	4.883x10 ⁻⁴	Kgs./sq. cm.
Kilowatt-hours	2.655x10 ⁶	Foot-lbs.	Minutes (angie)	2.909x10 ⁻⁴	Radians	Pounds/sq. foot	6.945x10 ⁻³	Pounds/sq. inch
Kilowatt-hours	1.341	Horse-power-hrs.	Ounces	16	Drams	Pounds/sq. inch	0.06804	Atmospheres
Kilowatt-hours	860.5	Kilogram-calories	Ounces	137.5	Grains	Pounds/sq. inch	2.307	Feet of water
Kilowatt-hours	3.671x10 ⁶	Kilogram-meters	Ounces	0.0625	Pounds	Pounds/sq. inch	2.036	Inches of mercury
Liters	10 ³	Cubic centimeters	Ounces	28.349527	Grams	Pounds/sq. inch	0.07031	Kgs./sq. cm.
Liters	0.03531	Cubic feet	Ounces	0.9115	Ounces (troy)	Quarts (dry)	67.20	Cubic inches
Liters	61.02	Cubic inches	Ounces	2.790x10 ⁻¹	Tons (long)	Quarts (liq.)	57.75	Cubic inches
Liters	10 ⁻³	Cubic meters	Ounces	2.835x10 ⁻¹	Tons (metric)	Quintal, Argentine	101.28	Pounds
Liters	1.308x10 ⁻³	Cubic yards	Ounces, troy	480	Grains	Quintal, Brazil	129.54	Pounds
Liters	0.2642	Gallons	Ounces, troy	20	Pennyweights (troy)	Quintal, Castile, Peru	101.43	Pounds
Liters	2.113	Pints (liq.)	Ounces, troy	0.08333	Pounds (troy)	Quintal, Chile	101.41	Pounds
Liters	1.057	Quarts (liq.)	Ounces, troy	31.103481	Grams	Quintal, Mexico	101.47	Pounds
Liters/min.	5.886x10 ⁻⁶	Cubic ft./sec.	Ounces, troy	1.09714	Ounces (avoir.)	Quintal, Metric	220.46	Pounds
Liters/min	4.403x10 ⁻³	Gals./sec.	Ounces, dry	480	Grains	Sq. ft. gal./min.	8.0208	Overflow rate (ft./hr.)
Lumber Width (in.) x Thickness (in.)	Length (ft.)	Board Feet	Ounces, dry	20	Pennyweights (troy)	Temp. °C: + 273	1	Abs. temp. (°C)
	12		Ounces, dry	0.08333	Pounds (troy)	Temp. °C: - 17.78	1	Abs. temp. (°F)
			Ounces, dry	31.103481	Grams	Temp. °F: + 460	1	Abs. temp. (°F)
			Ounces, dry	1.09714	Ounces (avoir.)	Temp. °F: - 32	5/9	Temp. (°C)
Meters	100	Centimeters	Ounces (fluid)	1.805	Cubic inches	Tons (long)	1016	Kilograms
Meters	3.281	Feet	Ounces (fluid)	0.02957	Liters	Tons (long)	2240	Pounds
Meters	39.37	Inches	Ounces/sq. inch	0.0625	Lbs./sq. inch	Tons (long)	1.12000	Tons (short)
Meters	10 ⁻³	Kilometers	Parts/million	0.0584	Grains/U.S. gal.	Tons (metric)	10 ³	Kilograms
Meters	10 ³	Millimeters	Parts/million	0.07016	Grains/Imp. gal.	Tons (metric)	2205	Pounds
Meters	1.094	Yards	Parts/million	8.345	Lbs./million gal.	Tons (short)	2000	Pounds
Meters/min.	1.667	Centimeters/sec.	Pennyweights (troy)	24	Grains	Tons (short)	32000	Ounces
Meters/min.	3.281	Feet/min.	Pennyweights (troy)	1.55517	Grams	Tons (short)	907.18486	Kilograms
Meters/min.	0.09468	Feet/sec.	Pennyweights (troy)	0.05	Ounces (troy)	Tons (short)	2430.56	Pounds (troy)
Meters/min.	0.06	Kilometers/hr.	Pennyweights (troy)	4.1667x10 ⁻¹	Pounds (troy)	Tons (short)	0.89287	Tons (long)
Meters/min.	0.03728	Miles/hr.	Pounds	16	Ounces	Tons (short)	29166.66	Ounces (troy)
Meters/sec.	196.8	Feet/min.	Pounds	756	Drams	Tons (short)	0.90718	Tons (metric)
Meters/sec.	3.281	Feet/sec.	Pounds	7000	Grains	Tons of water 24 hrs.	83.333	Pounds water/hour
Meters/sec.	3.6	Kilometers/hr.	Pounds	0.0005	Tons (short)	Tons of water 24 hrs.	0.16643	Gallons/min.
Meters/sec.	0.06	Kilometers/min.	Pounds	453.5924	Grams	Tons of water 24 hrs.	1.3349	Cu. ft./hr.
Meters/sec.	2.237	Miles/hr.	Pounds	1.21528	Pounds (troy)	Watts	0.05692	B.T. Units/min.
Meters/sec.	0.03728	Miles/min.	Pounds	14.5833	Ounces (troy)	Watts	44.26	Foot-pounds/min.
Microns	10 ⁻⁶	Meters	Pounds (troy)	5760	Grains	Watts	0.7376	Foot-pounds/sec.
Miles	1.609x10 ³	Centimeters	Pounds (troy)	240	Pennyweights (troy)	Watts	1.341x10 ⁻³	Horse-power
Miles	5280	Feet	Pounds (troy)	12	Ounces (troy)	Watts	0.01434	Kg.-calories/min.
Miles	1.609	Kilometers	Pounds (troy)	373.24177	Grams	Watts	10 ⁻³	Kilowatts
Miles	1760	Yards	Pounds (troy)	0.822857	Pounds (avoir.)	Watt-hours	3.415	British Thermal Units
Miles/hr.	44.70	Centimeters/sec.	Pounds (troy)	13.1657	Ounces (avoir.)	Watt-hours	2655	Foot-pounds
Miles/hr.	88	Feet/min.	Pounds (troy)	3.6735x10 ⁻⁴	Tons (long)	Watt-hours	1.341x10 ⁻³	Horse-power hours
Miles/hr.	1.467	Feet/sec.	Pounds (troy)	4.1143x10 ⁻⁴	Tons (short)	Watt-hours	0.8605	Kilogram-calories
Miles/hr.	1.609	Kilometers/hr.	Pounds (troy)	3.7324x10 ⁻⁴	Tons (metric)	Watt-hours	367.1	Kilogram-meters
Miles/hr.	0.8684	Knots	Pounds of water	0.01602	Cubic feet	Watt-hours	10 ⁻³	Kilowatt-hours
Miles/hr.	26.82	Meters/min.	Pounds of water	27.68	Cubic inches			
Miles/min.	2682	Centimeters/sec.	Pounds of water	0.1198	Gallons			
Miles/min.	88	Feet/sec.	Pounds of water/min.	2.670x10 ⁻⁴	Cubic ft./sec.			
Miles/min.	1.609	Kilometers/min.	Pounds cubic foot	0.01602	Grams/cubic cm.			
Miles/min.	60	Miles/hr.	Pounds cubic foot	16.02	Kgs./cubic meter			
Milliers	10 ³	Kilograms	Pounds cubic foot	5.787x10 ⁻⁴	Lbs./cubic inch			

DOCUMENT CONTROL DATE

OCT 30 1980

DUKE POWER COMPANY DESIGN ENGINEERING

PROCEDURE NOTES FOR MOUNTING ENTERPRISE ENGINES ON CONCRETE FOUNDATIONS

CONNECTIONS
DOCUMENT
CONTROL DATE
OCT 30 1980
DUKE POWER COMPANY
DESIGN ENGINEERING

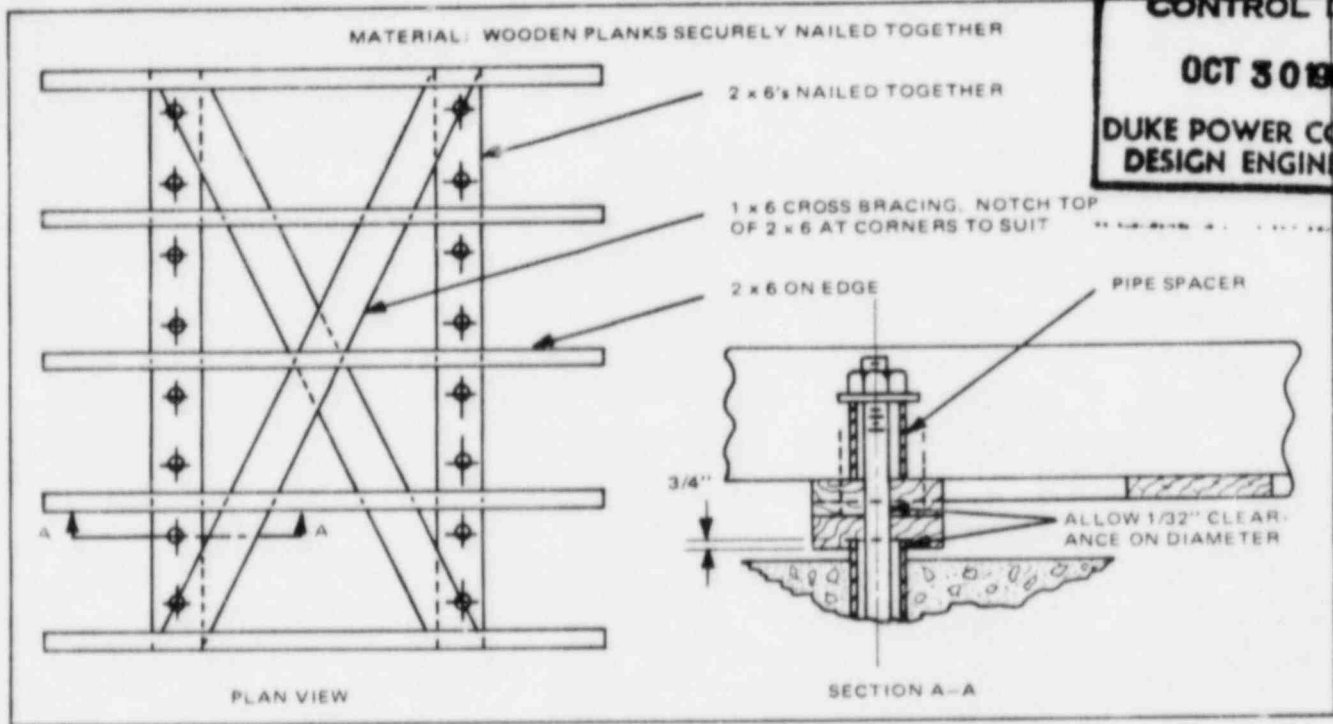

SUGGESTED FOUNDATION BOLT TEMPLATE

OBSERVE THE FOLLOWING SEQUENCE OF OPERATION:

1. Construct a foundation bolt template, using certified foundation drawing to determine positioning of foundation bolt holes. See sketch for a suggested template design. Exercise great care in locating bolt centers.
2. Position and support template from foundation forms, securely anchoring it to prevent movement.
3. Thread foundation bolt into lower nut in shield assembly, being careful not to damage cap at bottom of nut. Insert foundation bolts and shields in holes provided in template, then tighten upper nut. Shields must be securely held in correct position to prevent any movement during pouring of concrete. A suggested method is to use reinforcing rods, welded to each sleeve, or on top of each anchor plate in both rows of bolts running the length of the engine, and then adding "X" bracing between the two rows of bolts. Another method is to tie the bolt assemblies to other reinforcing rods already in the foundation.
4. Recheck template positioning, alignment and elevation before pouring concrete. It is recommended that a Transamerica Delaval Engine and Compressor Division Service Representative be present to check bolt layout.
5. Foundation is to be poured monolithic and must suitably reinforced with reinforcing steel. Let concrete set for 10 days before installing equipment and 30 days before running equipment.
6. Top surface of foundation must be roughened wherever

grout is to be applied to remove laitance, oil stains, etc., and to provide a rough, dry surface for good bonding of epoxy grout to foundation.

7. Remove engine foundation bolts from shields and set aside where they will not be damaged. Place jacking screw plates in position at each jacking screw location. Plates should either be imbedded in foundation before concrete sets, or grouted in place.
8. Bring engine into position over foundation. If engine is rolled into position, ends of foundation bolt shields must be protected to prevent damage.
9. Insert toe jacks at four corners of engine, just inboard of shipping skids to support engine while skids are being removed. **CAUTION: To avoid damage to base casting, do not locate jacks at center of engine.** Remove shipping skids, clean engine mounting rails and lower engine to grade. Be sure foundation bolt holes in engine base are correctly aligned with foundation bolt sleeves in foundation for easy installation of foundation bolts.
10. Clean sole plates and chocks with a degreasing type solvent. After cleaning, it is recommended that sole plates be primed with a primer recommended by grout manufacturer. Lubricate threads of jacking screws with a mixture of powdered graphite and engine lubricating oil. Lower end of jacking screws should be coated with wax to prevent epoxy grout material from binding to screws.
11. Place sole plates and chocks in position under engine as shown on foundation drawing. Install sole plate retainers on front and rear sole plates, making sure sole plates are forced tightly against shoulder at inner edge of engine

73029-30

mounting rails (The front and rear sole plates at each side of the engine are designed to make contact with the mounting rail shoulder and are intended to restrain side movement of the engine.)

12. Lubricate threads at lower end of foundation bolts with standard mixture of engine oil and powdered graphite, then replace bolts in sleeves and screw firmly into threads at bottom of sleeve. Lubricate upper threads with oil and graphite mixture then place washers and nuts on bolts.
13. Level and align engine, following crankshaft alignment instructions on Transamerica Delaval Engine and Compressor Division Form D-1063 (Revised 1/75). Record deflection readings on form. Insure that all sole plate jacking screws are so adjusted as to distribute the weight evenly on all sole plates. When leveling and alignment is satisfactory, snug down foundation bolts to prevent movement of engine during generator installation and grouting.
14. Attach sole plates to generator and outboard pedestal bearing, using approximately 1/8 inch of shimming material between each sole plate and generator or pedestal. To provide insulation protection against circulating currents, 1/16 inch of the shimming between the sole plates and the pedestal bearing must be insulation material.
15. An Engine and Compressor Division Service Representative *must be present to supervise the alignment of the engine.* See Instruction Manual, Section 2.
16. If not already installed, attach flywheel to crankshaft. Carefully clean and de-burr all mating surfaces of flywheel, crankshaft coupling flange and driven equipment coupling flange, including bolt holes. Lubricate crankshaft flange and flywheel counter bore with a light coat of anti-seize lubricant such as "Molykote" or "Lubriplate" and mount flywheel on crankshaft flange. Insure one-half inch locating holes are aligned. Make sure no dirt or other foreign matter is present between mating surfaces. Attach three retainer plates to flywheel and draw flywheel up on crankshaft flange until seated.
17. Bring generator and pedestal into position and attach generator shaft to flywheel. Lubricate bore in flywheel and connecting shaft flange with a light coat of anti-seize lubricant. Align half inch locating hole in flange with hole in flywheel and bring connecting shaft into engagement with flywheel. Be sure no dirt is allowed to get between mating surfaces. Insert two long 1 or 1 1/4 inch diameter bolts through two opposite flywheel bolt holes and draw connecting shaft flange until flange is seated. Check with feeler gauges between face of connecting shaft flange and flywheel to be sure flange is fully seated and square with flywheel. Lubricate two special aligning dowels with a thin coat of anti-seize lubricant (dowels and special flywheel bolt reamers are available from the Engine and

Compressor Division Service Department), and tap them into two opposite flywheel bolt holes. *Do not drive dowels up hard.* Ream two flywheel bolt holes with the special reamer and measure diameter of reamed hole to the nearest 0.0005 inch. Compare diameter of reamed hole with diameter of bolt. Reamed holes should be approximately 0.0005 inch larger than the bolts to allow for an easy tap fit. Flywheel bolts *must not* be driven with a sledge, jack or "Porto-Power". Fit bolts into two reamed holes, screw nuts on bolts and draw up tight. Use anti-seize lubricant on bolts and powdered graphite and engine oil on threads. Remove two temporary bolts and aligning dowels, ream holes and fit remaining bolts. Torque all bolts to the specified torque.

18. Check crankshaft alignment, then align outboard pedestal bearing. Line stator up with rotor and moderately tighten stator and pedestal foundation bolts with jacking screws in place. Check entire alignment, including crankshaft alignment. Record crankshaft deflections on Form D-1063.
19. Pour and vibrate grout under engine, generator and pedestal bearing. Carter Waters No. 604 or Ceilote No. 648 grout may be used. It is recommended that a representative of the grout supplier be present at the installation to be sure the grout is prepared and place in accordance with manufacturer's specifications. Do not fill bolt shields with grout. If a ramming strap is used, its movement should be slow so as not to entrain excess air in the grout.
20. After grout has cured, back off sole plate jacking screws one turn each and torque foundation bolts to recommended torque value. Snug all bolts in a criss-cross pattern, then apply a light torque to each, using the same criss-cross pattern. Continue applying torque in increments and in the same pattern until final torque value is reached. Foundation bolts should be torqued to the following values:

Engine Model	Torque (ft-lb)
G	650
HV, HVA, HA	480
Q, R	1400
RV	3800

21. If foundation bolts are re-tightened at a later date, the nuts must be removed and re-lubricated in order to get accurate torque values. Dry thread torque readings can be as much as 50 percent in error.
22. Recheck entire alignment of equipment and check crankshaft deflections (record readings on Form D-1063). Remove or add shims to pedestal bearing and generator as necessary. Dowel generator and pedestal bearing to sole plates when alignment is necessary.
23. Crankshaft alignment should be rechecked after engine start up when engine and concrete foundation are at their normal operating temperature. Section on Form D-1063.

Transamerica Delaval Inc.
 Engine and Compressor Division
 Oakland, California
 Form D-4848 (Back)

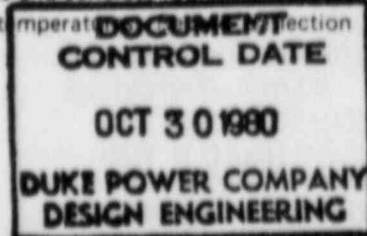

**1. PRECAUTIONS TO BE OBSERVED DURING CONSTRUCTION OF THE LUBRICATING OIL SYSTEM,
AND BEFORE STARTING ENGINE**

- 1.1. Chill rings should not be used in welded pipe joints because of their tendency to retain scale, welding slag and beads which can come loose as the pipe becomes hot during operation of the engine.
- 1.2. *All* lubricating oil system piping *must* be pickled after fabrication to remove varnish, mill scale, welding debris, dirt and grease. The pickled surfaces of the pipe must be coated with a rust preventive compound immediately after pickling to protect them from rust. The compound must be soluble in the lubricating oil that will be used in the engine, and compatible with it so as not to contaminate the oil. Apply the compound by spraying or flooding the pipes – swabbing with rags or mops will leave lint. Ordinary lubricating oil will not prevent rust in the pipes.
- 1.3. Mechanical cleaning will not completely clean the pipes, therefore, this method is not acceptable.
- 1.4. Before the engine is started, the assembled lubricating oil piping system must be thoroughly flushed with oil. Disconnect the pipe at the pressure strainer inlet, (item 168 on installation drawing) and arrange a temporary bypass line from this pipe to the sump tank, or engine base as appropriate. The bypass will permit oil circulation through the piping system without filling the internal lubricating oil system of the engine. Several thicknesses of cloth sack should be secured to the outlet end of the bypass line to catch debris as it is flushed out of the system.
- 1.5. The piping around the lubricating oil cooler requires special attention to insure that the pipes and the cooler are properly flushed. Precautions must be taken to insure the complete removal of testing fluids, water, or other liquids before attempting to flush the cooler.
- 1.6. The oil sump tank and engine base must be carefully cleaned before being filled with oil.
- 1.7. The auxiliary lubricating oil pump, or any continuous duty pump of sufficient capacity, can be used to pump oil during flushing operations. If care was exercised during fabrication of the piping system it should be flushed for at least eight hours. As much as 24 hours of flushing may be required for a dirty system. While the oil is circulating through the system the pipes must be thoroughly pounded several times with a heavy hammer to loosen dirt and debris. Hot flushing oil is recommended as it does a better job of cleaning.
- 1.8. After flushing is completed, reconnect the piping system for normal operation. Examine all strainers, and filters for cleanliness and for proper assembly.
- 1.9. Disconnect the jumper tubes between the engine lubricating oil header and the main bearings, and between the main headers and the auxiliary headers. Secure a nylon stocking over each main header fitting to catch debris that may pass through the system as it is flushed. Cover the main bearing fittings and the open ends of the auxiliary header feeders to prevent entry of dirt. *Engine oil* should be pumped through the open system for at least four hours to be sure of removing any foreign material that may have entered the headers during construction.
- 1.10. Reassemble the internal tubes and brackets as required.
- 1.11. The pressure strainer at the engine oil inlet will catch any debris that may remain in the piping system. It may require several cleanings during the first few hours of engine operation.

DOCUMENT
CONTROL DATE

OCT 30 1980

DUKE POWER COMPANY
DESIGN ENGINEERING

- 1.12. The utmost caution must be observed in the fabrication and preparation of the lubricating oil system for service. Foreign material of any kind can do a great deal of damage to the crankshaft, bearings, pistons, and cylinder liners.
- 1.13. NOTE. There may be instances where an engine is shipped with the pressure strainer mounted on the engine and connected to the engine lubricating oil header. If it is certain that the pipe connection between the pressure strainer and the engine lubricating oil header has not been disconnected since the engine left the factory, steps 9 and 10 above may be omitted.

2. PIPE PICKLING

- 2.1. Accessible welds inside carbon steel pipes and fittings shall be visibly inspected and welding beads shall be ground off. All fabricated carbon steel pipes, valves, and fittings shall be blown clean with steam or air to remove loose scale, sand, and welding beads and shall be cleaned by the following procedure prior to pickling.
- 2.2. The entire surface, including the interior, shall be wire brushed, using boiler tube brushes or commercial pipe cleaning apparatus; it shall then be blasted thoroughly with air to remove loose particles.
- 2.3. The parts shall be submerged for 15 minutes or longer, depending upon the degrees of contamination, in a solution containing 7 to 10 ounces of anhydrous trisodium phosphate or sodium hydroxide and one ounce of detergent, Mil. Spec. MIL-D-16791, to one gallon of water at 200°F, to insure complete removal of paint and grease.
- 2.4. Parts shall then be rinsed in warm fresh water at 120°F, to prepare them for acid treatment.
- 2.5. Fabricated carbon steel pipe and fittings shall be pickled by submerging them for 30 to 45 minutes in an acid bath contained one part of sulphuric acid, 66 deg. Baume, to 15 parts of fresh water and supplemented by an inhibitor. The acid bath shall be maintained at temperatures between 160 and 180 degrees F. While the parts are submerged, the bath shall be agitated. At the end of the pickling procedure the parts shall be rinsed in warm fresh water. After the rinse, the parts shall then be momentarily submerged in a boiling solution containing 4 ounces of sodium carbonate per gallon of water, and then rinsed in cold fresh water and dried by air blast.
- 2.6. Immediately following pickling and rinsing procedures, fabricated steel pipe and fittings shall be coated inside and outside with rust and corrosion preventive compound, and the ends sealed to prevent the entry of dirt.
- 2.7. The foregoing is minimum requirement to produce an acceptable cleaning of lubricating oil piping systems. Substitute methods must produce pipe and fittings of equal or better cleanliness.
- 2.8. The practice of fastening the sections of pipe together to form a system through which pickling acid is pumped should be discouraged. The difficulty of producing an acceptable job with this method is great.
- 2.9. Transamerica Delaval -- Enterprise recommends strongly that lubricating oil system piping should be pickled by a company which is equipped to do this kind of work. Such a company will have tanks and vats and the technical knowledge to completely clean and prepare the pipe for service.
- 2.10. It will be necessary to completely fabricate and finish weld all pipe prior to pickling. Remove all valves and non-ferrous fittings.
- 2.11. Make sure that the rust and corrosion preventive compound will mix with engine lubricating oil without causing contamination.
- 2.12. Make sure that cleanliness is maintained when the sections of pipe are reassembled to form the system.

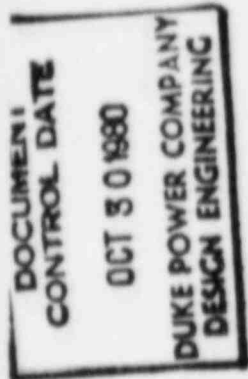

DOCUMENT CONTROL DATE
 OCT 3 0 1980
 DUKE POWER COMPANY
 DESIGN ENGINEERING

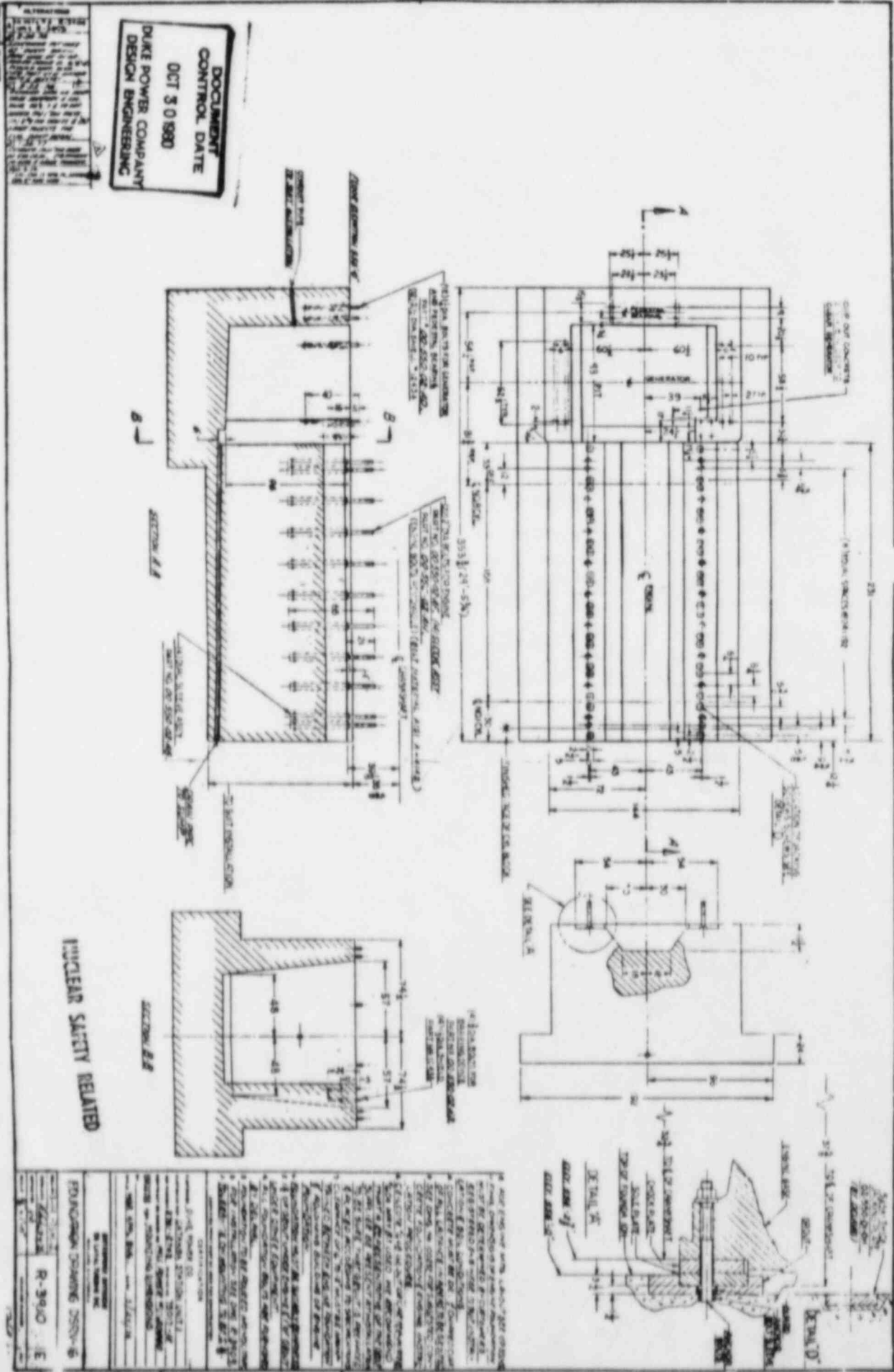

NUCLEAR SAFETY RELATED

EDUCATION TRAINING DIVISION	R-3400	E
DUKE POWER COMPANY		
DESIGN ENGINEERING		
CONTROL DATE		
OCT 3 0 1980		
DOCUMENT CONTROL DATE		

NUCLEAR SAFETY RELATED

(J.W. TEMPERATURE)

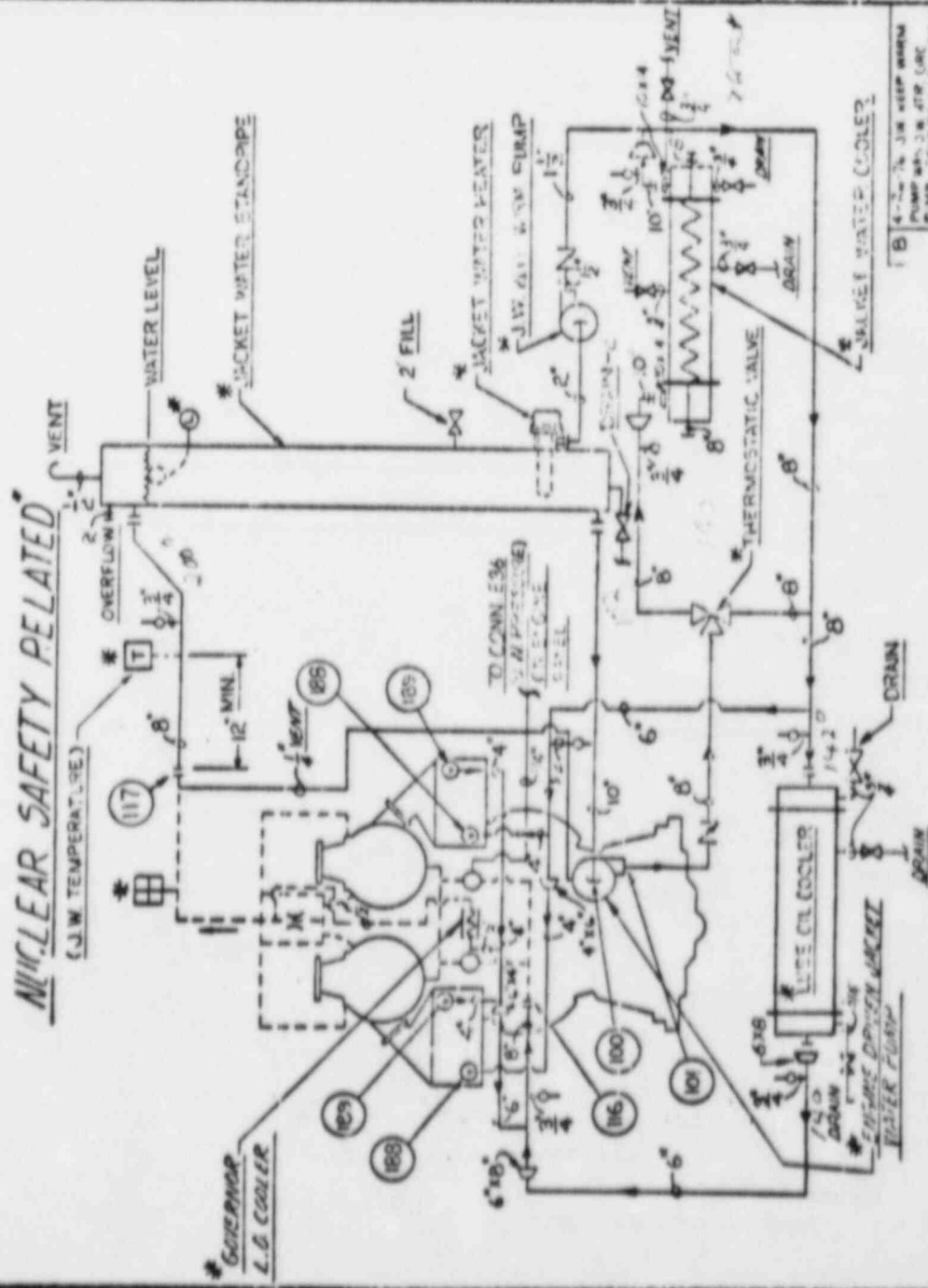

REV	DATE	DESCRIPTION
A	10-2-55	ADDED REVISIONS - PAYS
B	10-2-55	ADDED REVISIONS - PAYS
C	10-2-55	ADDED REVISIONS - PAYS
D	10-2-55	ADDED REVISIONS - PAYS
E	10-2-55	ADDED REVISIONS - PAYS

REV	DATE	DESCRIPTION
A	10-2-55	ADDED REVISIONS - PAYS
B	10-2-55	ADDED REVISIONS - PAYS
C	10-2-55	ADDED REVISIONS - PAYS
D	10-2-55	ADDED REVISIONS - PAYS
E	10-2-55	ADDED REVISIONS - PAYS

1. ALL ITEMS SHOWN ARE SUPPLIED BY DELAVAL.
2. ALL ITEMS SHOWN ARE SUPPLIED BY DELAVAL.
3. ALL ITEMS SHOWN ARE SUPPLIED BY DELAVAL.
4. ALL ITEMS SHOWN ARE SUPPLIED BY DELAVAL.
5. ALL ITEMS SHOWN ARE SUPPLIED BY DELAVAL.
6. ALL ITEMS SHOWN ARE SUPPLIED BY DELAVAL.
7. ALL ITEMS SHOWN ARE SUPPLIED BY DELAVAL.
8. ALL ITEMS SHOWN ARE SUPPLIED BY DELAVAL.
9. ALL ITEMS SHOWN ARE SUPPLIED BY DELAVAL.
10. ALL ITEMS SHOWN ARE SUPPLIED BY DELAVAL.
11. ALL ITEMS SHOWN ARE SUPPLIED BY DELAVAL.
12. ALL ITEMS SHOWN ARE SUPPLIED BY DELAVAL.

PROJECT ENG. *W. H. ...*

CUSTOMER: DUNE POWER - CATAMEN UNIT NO. 1

CUSTOMER REF: CN - 150100-2

DESIGN: (150101-5, 150101-6, 150101-7, 150101-8, 150101-9, 150101-10, 150101-11, 150101-12, 150101-13, 150101-14, 150101-15, 150101-16, 150101-17, 150101-18, 150101-19, 150101-20, 150101-21, 150101-22, 150101-23, 150101-24, 150101-25, 150101-26, 150101-27, 150101-28, 150101-29, 150101-30, 150101-31, 150101-32, 150101-33, 150101-34, 150101-35, 150101-36, 150101-37, 150101-38, 150101-39, 150101-40, 150101-41, 150101-42, 150101-43, 150101-44, 150101-45, 150101-46, 150101-47, 150101-48, 150101-49, 150101-50, 150101-51, 150101-52, 150101-53, 150101-54, 150101-55, 150101-56, 150101-57, 150101-58, 150101-59, 150101-60)

DELAVAL TOWER NO. 1
DELAVAL TOWER NO. 2
DELAVAL TOWER NO. 3
DELAVAL TOWER NO. 4
DELAVAL TOWER NO. 5

DELAVAL

JACKET WATER
PIPING SCHEMATIC

DESIGN NO. 4-5-15

CHECKED: C.F.

APPROVED: L.A.B.

SCALE: 1/2" = 1'-0"

100546E

1. ALL DIMENSIONS TO FACE UNLESS OTHERWISE SPECIFIED.
2. ALL DIMENSIONS TO CENTER UNLESS OTHERWISE SPECIFIED.
3. ALL DIMENSIONS TO CENTER UNLESS OTHERWISE SPECIFIED.
4. ALL DIMENSIONS TO CENTER UNLESS OTHERWISE SPECIFIED.
5. ALL DIMENSIONS TO CENTER UNLESS OTHERWISE SPECIFIED.
6. ALL DIMENSIONS TO CENTER UNLESS OTHERWISE SPECIFIED.
7. ALL DIMENSIONS TO CENTER UNLESS OTHERWISE SPECIFIED.
8. ALL DIMENSIONS TO CENTER UNLESS OTHERWISE SPECIFIED.
9. ALL DIMENSIONS TO CENTER UNLESS OTHERWISE SPECIFIED.
10. ALL DIMENSIONS TO CENTER UNLESS OTHERWISE SPECIFIED.
11. ALL DIMENSIONS TO CENTER UNLESS OTHERWISE SPECIFIED.
12. ALL DIMENSIONS TO CENTER UNLESS OTHERWISE SPECIFIED.
13. ALL DIMENSIONS TO CENTER UNLESS OTHERWISE SPECIFIED.
14. ALL DIMENSIONS TO CENTER UNLESS OTHERWISE SPECIFIED.
15. ALL DIMENSIONS TO CENTER UNLESS OTHERWISE SPECIFIED.
16. ALL DIMENSIONS TO CENTER UNLESS OTHERWISE SPECIFIED.
17. ALL DIMENSIONS TO CENTER UNLESS OTHERWISE SPECIFIED.
18. ALL DIMENSIONS TO CENTER UNLESS OTHERWISE SPECIFIED.
19. ALL DIMENSIONS TO CENTER UNLESS OTHERWISE SPECIFIED.
20. ALL DIMENSIONS TO CENTER UNLESS OTHERWISE SPECIFIED.
21. ALL DIMENSIONS TO CENTER UNLESS OTHERWISE SPECIFIED.
22. ALL DIMENSIONS TO CENTER UNLESS OTHERWISE SPECIFIED.
23. ALL DIMENSIONS TO CENTER UNLESS OTHERWISE SPECIFIED.
24. ALL DIMENSIONS TO CENTER UNLESS OTHERWISE SPECIFIED.
25. ALL DIMENSIONS TO CENTER UNLESS OTHERWISE SPECIFIED.
26. ALL DIMENSIONS TO CENTER UNLESS OTHERWISE SPECIFIED.
27. ALL DIMENSIONS TO CENTER UNLESS OTHERWISE SPECIFIED.
28. ALL DIMENSIONS TO CENTER UNLESS OTHERWISE SPECIFIED.
29. ALL DIMENSIONS TO CENTER UNLESS OTHERWISE SPECIFIED.
30. ALL DIMENSIONS TO CENTER UNLESS OTHERWISE SPECIFIED.
31. ALL DIMENSIONS TO CENTER UNLESS OTHERWISE SPECIFIED.
32. ALL DIMENSIONS TO CENTER UNLESS OTHERWISE SPECIFIED.
33. ALL DIMENSIONS TO CENTER UNLESS OTHERWISE SPECIFIED.
34. ALL DIMENSIONS TO CENTER UNLESS OTHERWISE SPECIFIED.
35. ALL DIMENSIONS TO CENTER UNLESS OTHERWISE SPECIFIED.
36. ALL DIMENSIONS TO CENTER UNLESS OTHERWISE SPECIFIED.
37. ALL DIMENSIONS TO CENTER UNLESS OTHERWISE SPECIFIED.
38. ALL DIMENSIONS TO CENTER UNLESS OTHERWISE SPECIFIED.
39. ALL DIMENSIONS TO CENTER UNLESS OTHERWISE SPECIFIED.
40. ALL DIMENSIONS TO CENTER UNLESS OTHERWISE SPECIFIED.
41. ALL DIMENSIONS TO CENTER UNLESS OTHERWISE SPECIFIED.
42. ALL DIMENSIONS TO CENTER UNLESS OTHERWISE SPECIFIED.
43. ALL DIMENSIONS TO CENTER UNLESS OTHERWISE SPECIFIED.
44. ALL DIMENSIONS TO CENTER UNLESS OTHERWISE SPECIFIED.
45. ALL DIMENSIONS TO CENTER UNLESS OTHERWISE SPECIFIED.
46. ALL DIMENSIONS TO CENTER UNLESS OTHERWISE SPECIFIED.
47. ALL DIMENSIONS TO CENTER UNLESS OTHERWISE SPECIFIED.
48. ALL DIMENSIONS TO CENTER UNLESS OTHERWISE SPECIFIED.
49. ALL DIMENSIONS TO CENTER UNLESS OTHERWISE SPECIFIED.
50. ALL DIMENSIONS TO CENTER UNLESS OTHERWISE SPECIFIED.

DOCUMENT CONTROL DATE
DIC 3 0 1980
DUKE POWER COMPANY
DESIGN ENGINEERING

CERTIFICATION	
PROJECT NUMBER	DUKE POWER - CATAMBA 112
DESIGNER	MILL POWER SUPPLY P.O. C-20640
DATE	12-07-80
DELUCA	
EXHAUST INTAKE & CRANKCASE PIPING SCHEMATIC	
SCALE	AS SHOWN
PROJECT NO.	09-805-75017 B
DATE	12-07-80
BY	ESG
CHECKED BY	None

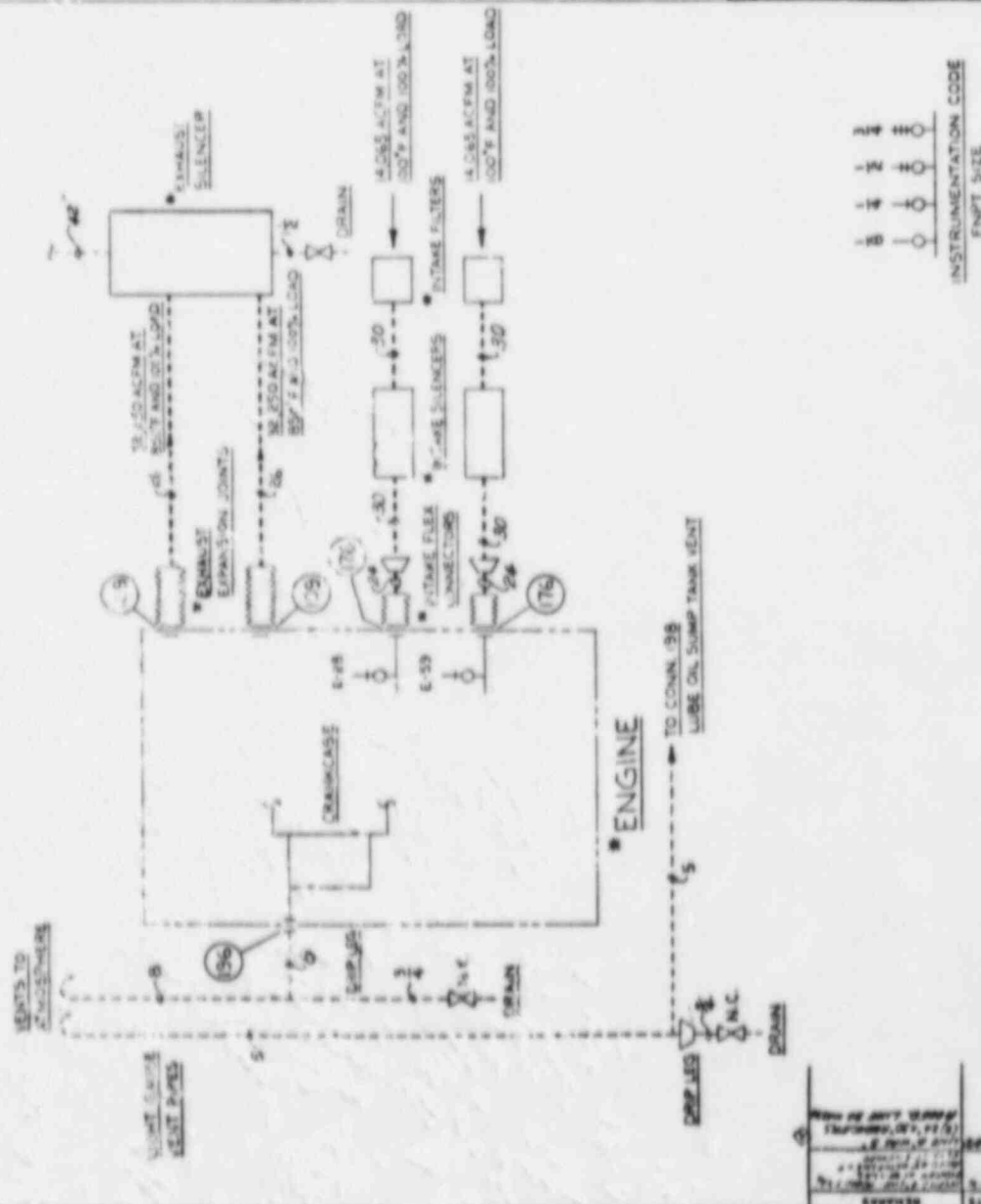

REVISIONS	DATE	BY	CHKD

1. ALL ITEMS MARKED "M" ARE ATTACHED TO AND SUPPLIED BY DELAVALL.
2. 1000 - 1000 SERIES NUMBERS CORRESPONDING TO NUMBERS IN PIPING CONNECTIONS BY CUSTOMER.
3. SOLID LINES: CODE OF 1000 - 1000 SERIES NUMBERS CONNECTIONS REPRESENT PIPING & FITTINGS SUPPLIED BY DELAVALL.
4. FOR PIPING SYMBOLS SEE DRAWING D-4313.
5. FLEXIBLE COUPLINGS ARE NOT RECOMMENDED AT CUSTOMER CONNECTIONS BECAUSE OF POTENTIAL FAILURE HAZARD DURING OPERATION.
6. ALL PIPING TO BE PROPERLY SUPPORTED TO MINIMIZE PIPE VIBRATION & FLANGE LOADING.
7. CUSTOMER TO SUPPLY AND INSTALL ALL PIPING EXCEPT BOTTLED LINES (1-1).
8. ALL PIPING TO BE MECHANICALLY CLEANED AFTER WELDING AND PRIOR TO ASSEMBLING.
9. PIPE SIZES SHOWN ARE MINIMUM FOR MOST INSTALLATIONS, BUT MAY VARY IF LENGTH OF PIPING, NUMBER OF FITTINGS & VALVES RESULT IN EXCESSIVE PRESSURE DROP.
10. VALVES MUST NOT BE OPENED. TANK TO BE WELL BELOW DRIP HEADERS.
11. TANK TO BE AT ELEVATION TO PROVIDE FLOODED SUCTION AT BOTH FEED PUMPS.
12. PROVIDE SUCH VENTS AND DRAINS AS DEEMED NECESSARY BY DELAVALL ENGINEERING.
- 13.
14. ALL ITEMS MARKED IN ARE AS PER SECTION B CLASS 1 FOR COMPLETE CONTROL AND INSTRUMENTATION SEE ENGINE CONTROL DRAWINGS.
15. UNLABELED INSTRUMENTATION CONNECTIONS ARE PLUGGED FOR USE AS REQUIRED.

CERTIFIED THAT THIS MUST BE USED FOR CONSTRUCTION

CERTIFICATION

PROJECT NUMBER: 54000000

CUSTOMER: DUKE POWER - DARTMOUTH 142

ENGINEER: 75017-20

DELAVALL
ENGINE AND COMPRESSOR DIVISION
OAKLAND, CALIFORNIA 94612

FUEL OIL
PIPING SCHEMATIC

CHECKED: CP

APPROVED: 6/5

DATE: 09-02-75

09-02-75017

DELAVALL

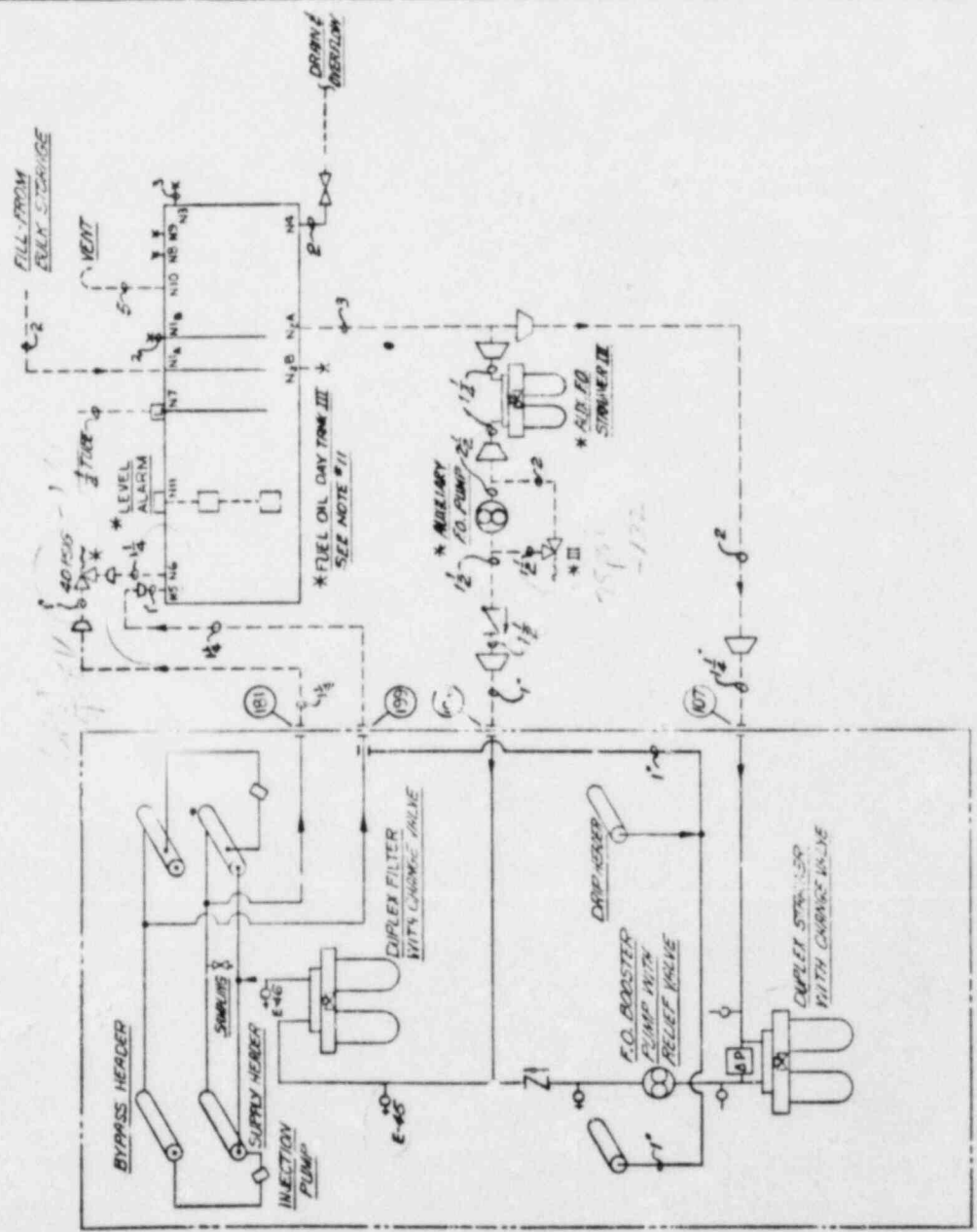

ENGINE *

LINE NO.	DESCRIPTION	SIZE	TYPE
1
2
3
4
5
6
7
8
9
10
11
12
13
14
15
16
17
18
19
20
21
22
23
24
25
26
27
28
29
30
31
32
33
34
35
36
37
38
39
40
41
42
43
44
45
46
47
48
49
50

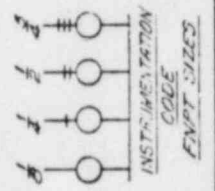

1. ALL ITEMS MARKED BY ABBREVIATION (V) ARE SUPPLIED BY DELAVAL.
2. ITEM - 1000 SERIES NUMBERS CORRESPOND TO NUMBERED PIPE CONNECTIONS BY CUSTOMER. - 1000 SERIES NUMBERS CORRESPOND TO DELAVAL CONNECTIONS BY CUSTOMER.
3. ALL FITTINGS AND CONNECTIONS SHALL BE TO THE NATIONAL ASSOCIATION OF PIPE AND FITTINGS SUPPLIED BY DELAVAL EXCEPT AS NOTED.
4. FOR PIPING SYMBOLS SEE DRAWING 0-4313.
5. FLEXIBLE COUPLERS ARE NOT RECOMMENDED AT CUSTOMER CONNECTIONS BECAUSE OF POTENTIAL FAILURE DURING SHUTDOWN.
6. ALL PIPING TO BE PROPERLY SUPPORTED TO MAINTAIN PIPE VIBRATION & FLANGE LOADS.
7. CUSTOMER TO SUPPLY AND INSTALL ALL PIPING BETWEEN IN DASHED LINE (---).
8. ALL PIPING TO BE CLEANED INTERNALLY & BLOWN CLEAR PRIOR TO START UP.
9. CUSTOMER TO PROVIDE A 1/2" DIA. 10' LONG CLEAN LINE FROM CUSTOMER TO BE RUN AT A LOWER LEVEL THAN THE DELAVAL CONNECTION NO. 1000. INSTALL WASTE LINE COLLECTORS AND DRAINS IN PIPING AT LOW POINTS NEAR WELDS.
10. CUSTOMER TO PROVIDE A 1/2" DIA. 10' LONG CLEAN LINE FROM CUSTOMER TO BE RUN AT A LOWER LEVEL THAN THE DELAVAL CONNECTION NO. 1000. INSTALL WASTE LINE COLLECTORS AND DRAINS IN PIPING AT LOW POINTS NEAR WELDS.
11. CUSTOMER PIPE SIZES ARE MINIMUM FOR MOST INSTALLATIONS BUT MAY VARY IN LENGTH OF PIPING. NUMBER OF FITTINGS & VALVES RESULT IN EXCESSIVE PRESSURE LOSS. CUSTOMER TO PROVIDE 200 PSI MINIMUM PRESSURE AT DELAVAL CONNECTIONS.
12. STRAINERS MUST BE INSTALLED IN A HORIZONTAL RUN OF PIPING.
13. INSTALLATION CONTRACTOR TO SUPPLY ALL OFF ENGINE PIPING, PIPING FITTINGS, EQUIPMENT & VALVES NOT SUPPLIED WITH ENGINE. INSTALL ALL OFF ENGINE EQUIPMENT SUPPLIED BY DELAVAL.
14. INSTRUMENT AND CONTROL SCHEMATIC FOR SIZE & LOCATION. INSTRUMENT AND CONTROL TUBING TO BE STEEL.
15. ALL PRESSURE INTO CONNECTION NO. 1000 MUST NOT EXCEED 200 PSI.
16. ALL ENGINE PIPING TO BE SCHEDULE 40 AND PIPE FITTINGS TO BE 316L SS UNLESS OTHERWISE SPECIFIED.

**DOCUMENT
CONTROL DATE**
OCT 30 1980
**DUKE POWER COMPANY
DESIGN ENGINEERING**

CERTIFIED PRINT SHALL BE USED FOR CONNECTIONS	
CERTIFICATION	
PROJECT NUMBER	100-14
CUSTOMER	DUKE POWER
CONTRACT NO.	CATAWBA UNITS I, II, R
ENGINEER	TSOIT-EO
DELAVAL TURBINE INC. ENGINE AND COMPRESSOR DIVISION DELAVAL CALIFORNIA DIVISION	
DELAVAL	
STARTING AIR PIPING SCHEMATIC	
DRAWN R.L.S.-9-78	09-83575017
CHECKED C.P.	8
APPROVED EIC	
SCALE	NONE
SHEET NUMBER	142

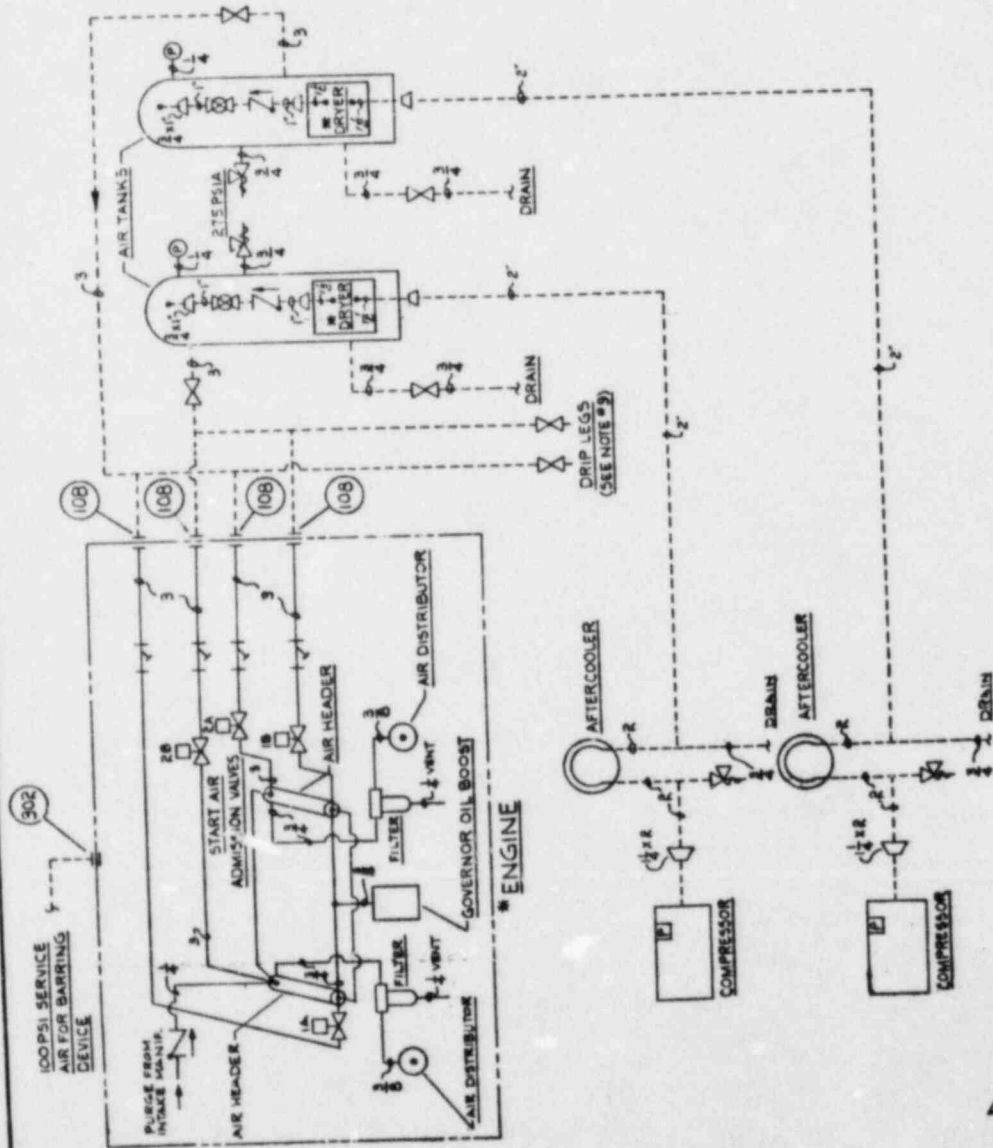

NO.	DATE	REMARKS
1	10/30/80	ISSUED FOR CONSTRUCTION
2		
3		

ITEM	DESCRIPTION	QTY	P.L. NO.
1	PRESSURE SWITCH	1	591 F 577 066
2	LEVEL SWITCH DRIP TRNK	1	521 F 528-028
3	LEVEL SWITCH	1	591 F 528-027
4	THERMO-COUPLE ASSY - LIQUID	2	591 F 540-050
5	LEVEL SWITCH HI/LO	1	591 F 528 124

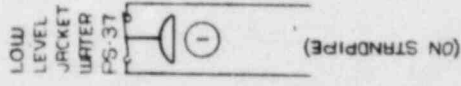

NOTE 2

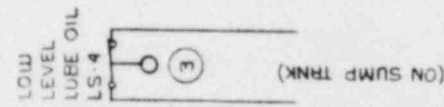
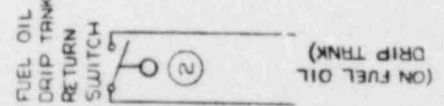

NOTE 3

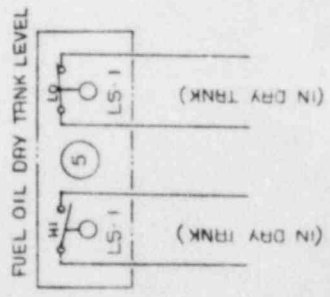
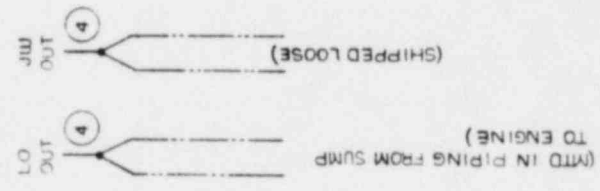
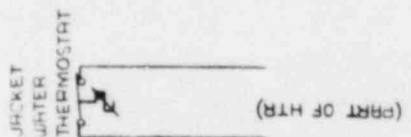
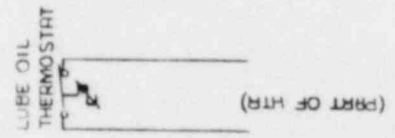

3 SET TO ACTIVATE 34" BELOW TOP OF TRNK
2 PS 37C TO BE LOCATED 35" BELOW C OF JACKET WATER INLET FLANGE ON STRANDPIPE.
1. SEE DWG NO. 52218 FOR WIRE IDENTIFICATION NUMBERS

CHK. DATE	REMARKS
12/26/77	FROM R.F. CHS. DWG. NO. 10000 ITEM 5

MILL POWER SUPPLY CO

DIESEL GENERATORS / R # 18
CATALINA NUCLEAR STATION
UNIT NO. 1

MATERIAL AND HARDNESS	APP. / DES. / BY / DATE	SCALE
	W. E. JOHNSON / 1/11/77	

DELAVAL

OFF-ENGINE ELECTRICAL

REV	DATE
A	09-691-75017

DELAVAL TURBINE CO
DE LAVAL HOUSE AND
OFFICE
OAKLAND, CALIF. 94612

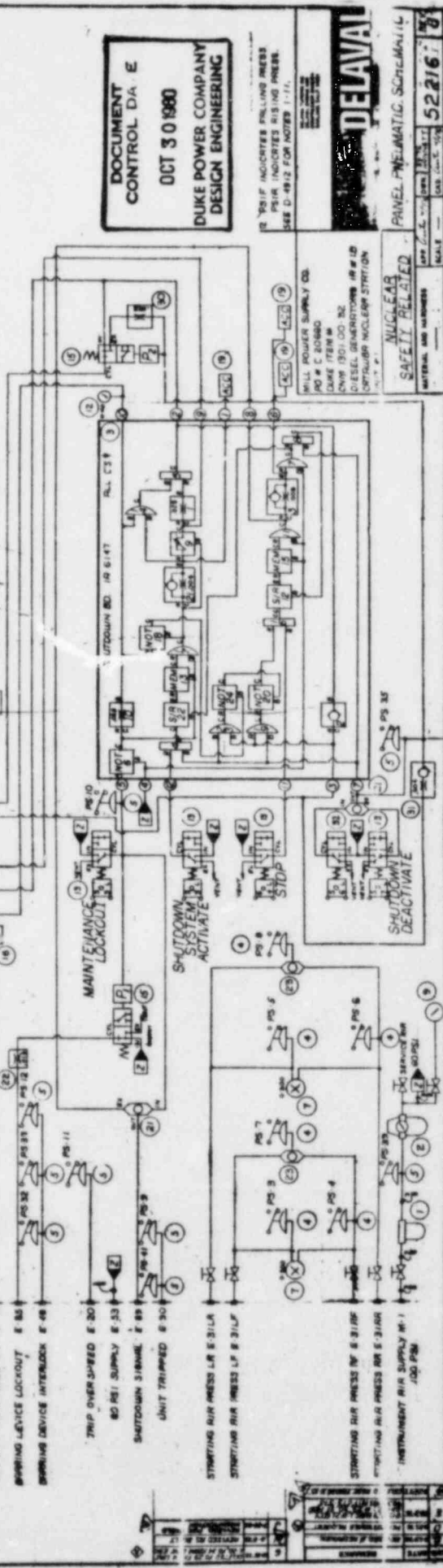
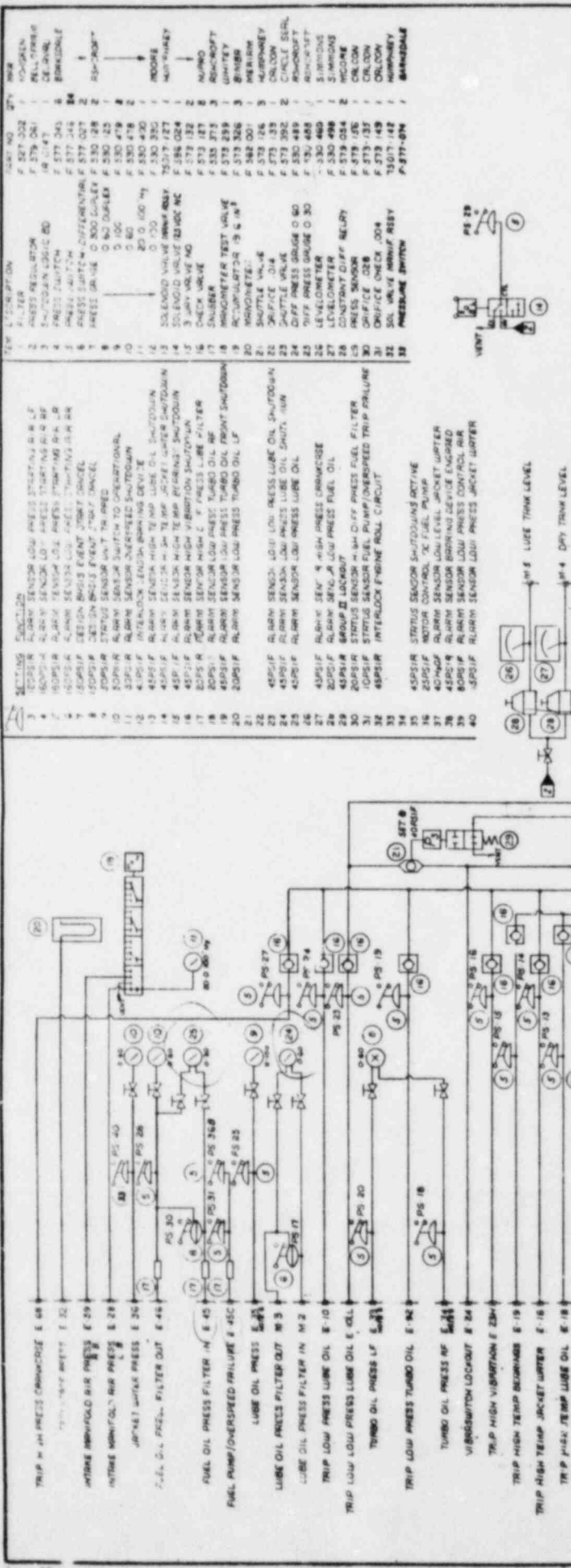

ITEM NO.	DESCRIPTION	QTY	UNIT
1	VALVE	1	PS-202
2	VALVE	1	PS-201
3	VALVE	1	PS-200
4	VALVE	1	PS-199
5	VALVE	1	PS-198
6	VALVE	1	PS-197
7	VALVE	1	PS-196
8	VALVE	1	PS-195
9	VALVE	1	PS-194
10	VALVE	1	PS-193
11	VALVE	1	PS-192
12	VALVE	1	PS-191
13	VALVE	1	PS-190
14	VALVE	1	PS-189
15	VALVE	1	PS-188
16	VALVE	1	PS-187
17	VALVE	1	PS-186
18	VALVE	1	PS-185
19	VALVE	1	PS-184
20	VALVE	1	PS-183
21	VALVE	1	PS-182
22	VALVE	1	PS-181
23	VALVE	1	PS-180
24	VALVE	1	PS-179
25	VALVE	1	PS-178
26	VALVE	1	PS-177
27	VALVE	1	PS-176
28	VALVE	1	PS-175
29	VALVE	1	PS-174
30	VALVE	1	PS-173
31	VALVE	1	PS-172
32	VALVE	1	PS-171
33	VALVE	1	PS-170
34	VALVE	1	PS-169
35	VALVE	1	PS-168
36	VALVE	1	PS-167
37	VALVE	1	PS-166
38	VALVE	1	PS-165
39	VALVE	1	PS-164
40	VALVE	1	PS-163
41	VALVE	1	PS-162
42	VALVE	1	PS-161
43	VALVE	1	PS-160
44	VALVE	1	PS-159
45	VALVE	1	PS-158
46	VALVE	1	PS-157
47	VALVE	1	PS-156
48	VALVE	1	PS-155
49	VALVE	1	PS-154
50	VALVE	1	PS-153
51	VALVE	1	PS-152
52	VALVE	1	PS-151
53	VALVE	1	PS-150
54	VALVE	1	PS-149
55	VALVE	1	PS-148
56	VALVE	1	PS-147
57	VALVE	1	PS-146
58	VALVE	1	PS-145
59	VALVE	1	PS-144
60	VALVE	1	PS-143
61	VALVE	1	PS-142
62	VALVE	1	PS-141
63	VALVE	1	PS-140
64	VALVE	1	PS-139
65	VALVE	1	PS-138
66	VALVE	1	PS-137
67	VALVE	1	PS-136
68	VALVE	1	PS-135
69	VALVE	1	PS-134
70	VALVE	1	PS-133
71	VALVE	1	PS-132
72	VALVE	1	PS-131
73	VALVE	1	PS-130
74	VALVE	1	PS-129
75	VALVE	1	PS-128
76	VALVE	1	PS-127
77	VALVE	1	PS-126
78	VALVE	1	PS-125
79	VALVE	1	PS-124
80	VALVE	1	PS-123
81	VALVE	1	PS-122
82	VALVE	1	PS-121
83	VALVE	1	PS-120
84	VALVE	1	PS-119
85	VALVE	1	PS-118
86	VALVE	1	PS-117
87	VALVE	1	PS-116
88	VALVE	1	PS-115
89	VALVE	1	PS-114
90	VALVE	1	PS-113
91	VALVE	1	PS-112
92	VALVE	1	PS-111
93	VALVE	1	PS-110
94	VALVE	1	PS-109
95	VALVE	1	PS-108
96	VALVE	1	PS-107
97	VALVE	1	PS-106
98	VALVE	1	PS-105
99	VALVE	1	PS-104
100	VALVE	1	PS-103
101	VALVE	1	PS-102
102	VALVE	1	PS-101
103	VALVE	1	PS-100
104	VALVE	1	PS-99
105	VALVE	1	PS-98
106	VALVE	1	PS-97
107	VALVE	1	PS-96
108	VALVE	1	PS-95
109	VALVE	1	PS-94
110	VALVE	1	PS-93
111	VALVE	1	PS-92
112	VALVE	1	PS-91
113	VALVE	1	PS-90
114	VALVE	1	PS-89
115	VALVE	1	PS-88
116	VALVE	1	PS-87
117	VALVE	1	PS-86
118	VALVE	1	PS-85
119	VALVE	1	PS-84
120	VALVE	1	PS-83
121	VALVE	1	PS-82
122	VALVE	1	PS-81
123	VALVE	1	PS-80
124	VALVE	1	PS-79
125	VALVE	1	PS-78
126	VALVE	1	PS-77
127	VALVE	1	PS-76
128	VALVE	1	PS-75
129	VALVE	1	PS-74
130	VALVE	1	PS-73
131	VALVE	1	PS-72
132	VALVE	1	PS-71
133	VALVE	1	PS-70
134	VALVE	1	PS-69
135	VALVE	1	PS-68
136	VALVE	1	PS-67
137	VALVE	1	PS-66
138	VALVE	1	PS-65
139	VALVE	1	PS-64
140	VALVE	1	PS-63
141	VALVE	1	PS-62
142	VALVE	1	PS-61
143	VALVE	1	PS-60
144	VALVE	1	PS-59
145	VALVE	1	PS-58
146	VALVE	1	PS-57
147	VALVE	1	PS-56
148	VALVE	1	PS-55
149	VALVE	1	PS-54
150	VALVE	1	PS-53
151	VALVE	1	PS-52
152	VALVE	1	PS-51
153	VALVE	1	PS-50
154	VALVE	1	PS-49
155	VALVE	1	PS-48
156	VALVE	1	PS-47
157	VALVE	1	PS-46
158	VALVE	1	PS-45
159	VALVE	1	PS-44
160	VALVE	1	PS-43
161	VALVE	1	PS-42
162	VALVE	1	PS-41
163	VALVE	1	PS-40
164	VALVE	1	PS-39
165	VALVE	1	PS-38
166	VALVE	1	PS-37
167	VALVE	1	PS-36
168	VALVE	1	PS-35
169	VALVE	1	PS-34
170	VALVE	1	PS-33
171	VALVE	1	PS-32
172	VALVE	1	PS-31
173	VALVE	1	PS-30
174	VALVE	1	PS-29
175	VALVE	1	PS-28
176	VALVE	1	PS-27
177	VALVE	1	PS-26
178	VALVE	1	PS-25
179	VALVE	1	PS-24
180	VALVE	1	PS-23
181	VALVE	1	PS-22
182	VALVE	1	PS-21
183	VALVE	1	PS-20
184	VALVE	1	PS-19
185	VALVE	1	PS-18
186	VALVE	1	PS-17
187	VALVE	1	PS-16
188	VALVE	1	PS-15
189	VALVE	1	PS-14
190	VALVE	1	PS-13
191	VALVE	1	PS-12
192	VALVE	1	PS-11
193	VALVE	1	PS-10
194	VALVE	1	PS-9
195	VALVE	1	PS-8
196	VALVE	1	PS-7
197	VALVE	1	PS-6
198	VALVE	1	PS-5
199	VALVE	1	PS-4
200	VALVE	1	PS-3
201	VALVE	1	PS-2
202	VALVE	1	PS-1

DOCUMENT CONTROL DA E
 OCT 30 1980
 DUKE POWER COMPANY
 DESIGN ENGINEERING

IF 251F INDICATES PULLING PRESSURE
 PRESS INDICATES RISING PRESSURE.
 SEE D-4912 FOR NOTES 1-11.

DELAVAL
 PANEL PNEUMATIC SCHEMATIC
 SAFETY RELATED

52216
 8

ITEM NO.	DESCRIPTION	QTY	UNIT	REMARKS
1	3/8" BOLT	100	EA	
2	1/2" BOLT	50	EA	
3	3/4" BOLT	20	EA	
4	1" BOLT	10	EA	
5	1/2" NUT	100	EA	
6	3/4" NUT	50	EA	
7	1" NUT	20	EA	
8	1/2" WASHER	100	EA	
9	3/4" WASHER	50	EA	
10	1" WASHER	20	EA	
11	1/2" LOCKWASHER	100	EA	
12	3/4" LOCKWASHER	50	EA	
13	1" LOCKWASHER	20	EA	
14	1/2" CONDUIT	100	FT	
15	3/4" CONDUIT	50	FT	
16	1" CONDUIT	20	FT	
17	1/2" RIGID CONDUIT	100	FT	
18	3/4" RIGID CONDUIT	50	FT	
19	1" RIGID CONDUIT	20	FT	
20	1/2" FLEXIBLE CONDUIT	100	FT	
21	3/4" FLEXIBLE CONDUIT	50	FT	
22	1" FLEXIBLE CONDUIT	20	FT	
23	1/2" THERMOPLASTIC SHEATH	100	FT	
24	3/4" THERMOPLASTIC SHEATH	50	FT	
25	1" THERMOPLASTIC SHEATH	20	FT	
26	1/2" THERMOPLASTIC SHEATH	100	FT	
27	3/4" THERMOPLASTIC SHEATH	50	FT	
28	1" THERMOPLASTIC SHEATH	20	FT	
29	1/2" THERMOPLASTIC SHEATH	100	FT	
30	3/4" THERMOPLASTIC SHEATH	50	FT	
31	1" THERMOPLASTIC SHEATH	20	FT	
32	1/2" THERMOPLASTIC SHEATH	100	FT	
33	3/4" THERMOPLASTIC SHEATH	50	FT	
34	1" THERMOPLASTIC SHEATH	20	FT	
35	1/2" THERMOPLASTIC SHEATH	100	FT	
36	3/4" THERMOPLASTIC SHEATH	50	FT	
37	1" THERMOPLASTIC SHEATH	20	FT	
38	1/2" THERMOPLASTIC SHEATH	100	FT	
39	3/4" THERMOPLASTIC SHEATH	50	FT	
40	1" THERMOPLASTIC SHEATH	20	FT	
41	1/2" THERMOPLASTIC SHEATH	100	FT	
42	3/4" THERMOPLASTIC SHEATH	50	FT	
43	1" THERMOPLASTIC SHEATH	20	FT	
44	1/2" THERMOPLASTIC SHEATH	100	FT	
45	3/4" THERMOPLASTIC SHEATH	50	FT	
46	1" THERMOPLASTIC SHEATH	20	FT	
47	1/2" THERMOPLASTIC SHEATH	100	FT	
48	3/4" THERMOPLASTIC SHEATH	50	FT	
49	1" THERMOPLASTIC SHEATH	20	FT	
50	1/2" THERMOPLASTIC SHEATH	100	FT	
51	3/4" THERMOPLASTIC SHEATH	50	FT	
52	1" THERMOPLASTIC SHEATH	20	FT	
53	1/2" THERMOPLASTIC SHEATH	100	FT	
54	3/4" THERMOPLASTIC SHEATH	50	FT	
55	1" THERMOPLASTIC SHEATH	20	FT	

DOCUMENT CONTROL DATE
OCT 30 1980
DUKE POWER COMPANY
DESIGN ENGINEERING

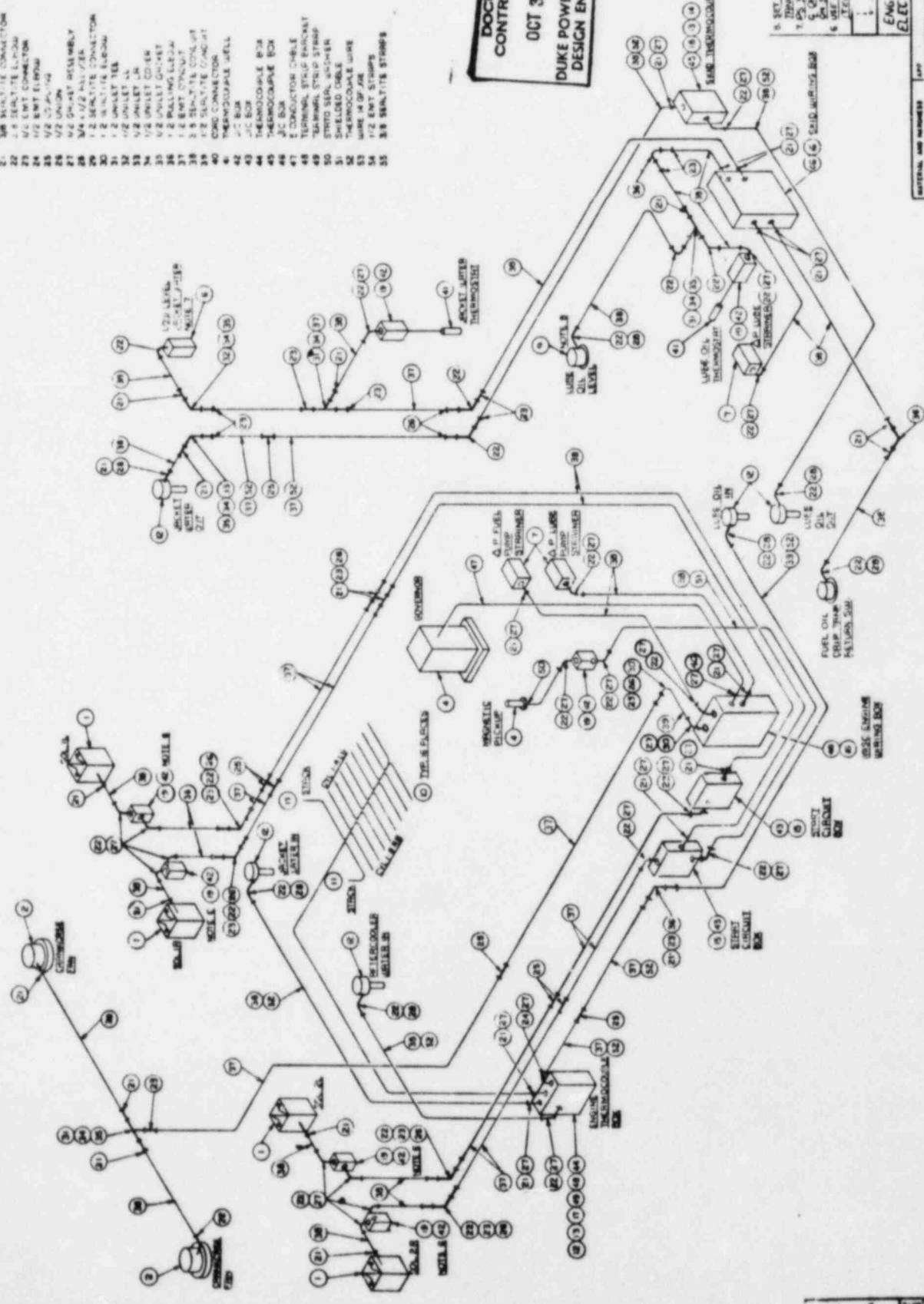

1. SEE TO INCLUDE 24 RELAY/CONTROL OF TRIP
2. TO BE LOCATED IN RELAY TRIP
3. TO BE LOCATED WITH LUBRICATION SYSTEM
4. TO BE LOCATED WITH LUBRICATION SYSTEM
5. TO BE LOCATED WITH LUBRICATION SYSTEM
6. SEE TO INCLUDE SEE TO INCLUDE
7. SEE TO INCLUDE SEE TO INCLUDE
8. SEE TO INCLUDE SEE TO INCLUDE
9. SEE TO INCLUDE SEE TO INCLUDE
10. SEE TO INCLUDE SEE TO INCLUDE
11. SEE TO INCLUDE SEE TO INCLUDE
12. SEE TO INCLUDE SEE TO INCLUDE
13. SEE TO INCLUDE SEE TO INCLUDE
14. SEE TO INCLUDE SEE TO INCLUDE
15. SEE TO INCLUDE SEE TO INCLUDE
16. SEE TO INCLUDE SEE TO INCLUDE
17. SEE TO INCLUDE SEE TO INCLUDE
18. SEE TO INCLUDE SEE TO INCLUDE
19. SEE TO INCLUDE SEE TO INCLUDE
20. SEE TO INCLUDE SEE TO INCLUDE
21. SEE TO INCLUDE SEE TO INCLUDE
22. SEE TO INCLUDE SEE TO INCLUDE
23. SEE TO INCLUDE SEE TO INCLUDE
24. SEE TO INCLUDE SEE TO INCLUDE
25. SEE TO INCLUDE SEE TO INCLUDE
26. SEE TO INCLUDE SEE TO INCLUDE
27. SEE TO INCLUDE SEE TO INCLUDE
28. SEE TO INCLUDE SEE TO INCLUDE
29. SEE TO INCLUDE SEE TO INCLUDE
30. SEE TO INCLUDE SEE TO INCLUDE
31. SEE TO INCLUDE SEE TO INCLUDE
32. SEE TO INCLUDE SEE TO INCLUDE
33. SEE TO INCLUDE SEE TO INCLUDE
34. SEE TO INCLUDE SEE TO INCLUDE
35. SEE TO INCLUDE SEE TO INCLUDE
36. SEE TO INCLUDE SEE TO INCLUDE
37. SEE TO INCLUDE SEE TO INCLUDE
38. SEE TO INCLUDE SEE TO INCLUDE
39. SEE TO INCLUDE SEE TO INCLUDE
40. SEE TO INCLUDE SEE TO INCLUDE
41. SEE TO INCLUDE SEE TO INCLUDE
42. SEE TO INCLUDE SEE TO INCLUDE
43. SEE TO INCLUDE SEE TO INCLUDE
44. SEE TO INCLUDE SEE TO INCLUDE
45. SEE TO INCLUDE SEE TO INCLUDE
46. SEE TO INCLUDE SEE TO INCLUDE
47. SEE TO INCLUDE SEE TO INCLUDE
48. SEE TO INCLUDE SEE TO INCLUDE
49. SEE TO INCLUDE SEE TO INCLUDE
50. SEE TO INCLUDE SEE TO INCLUDE
51. SEE TO INCLUDE SEE TO INCLUDE
52. SEE TO INCLUDE SEE TO INCLUDE
53. SEE TO INCLUDE SEE TO INCLUDE
54. SEE TO INCLUDE SEE TO INCLUDE
55. SEE TO INCLUDE SEE TO INCLUDE

ENGINE AUXILIARY SYSTEM
ELECTRICAL DIAGRAM SCHEMATIC
52217

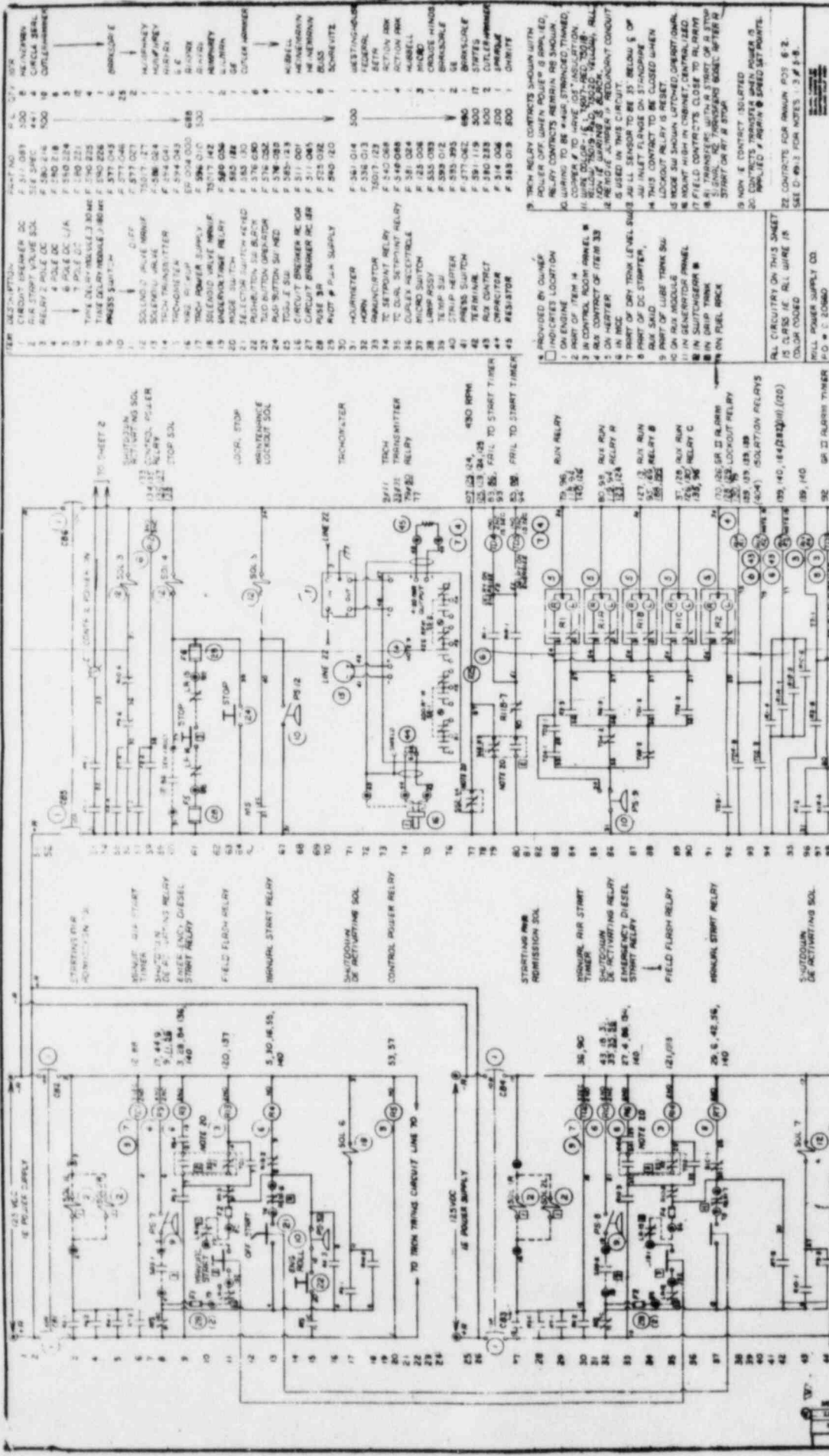

ITEM	DESCRIPTION	MARKING	QTY	UNIT
1	CIRCUIT BREAKER DC	F 311 081	100	RELAY
2	RELAY 2 POLE DC	F 580 214	500	RELAY
3	RELAY 2 POLE DC	F 580 214	500	RELAY
4	RELAY 2 POLE DC	F 580 214	500	RELAY
5	RELAY 2 POLE DC	F 580 214	500	RELAY
6	RELAY 2 POLE DC	F 580 214	500	RELAY
7	RELAY 2 POLE DC	F 580 214	500	RELAY
8	RELAY 2 POLE DC	F 580 214	500	RELAY
9	RELAY 2 POLE DC	F 580 214	500	RELAY
10	RELAY 2 POLE DC	F 580 214	500	RELAY
11	RELAY 2 POLE DC	F 580 214	500	RELAY
12	RELAY 2 POLE DC	F 580 214	500	RELAY
13	RELAY 2 POLE DC	F 580 214	500	RELAY
14	RELAY 2 POLE DC	F 580 214	500	RELAY
15	RELAY 2 POLE DC	F 580 214	500	RELAY
16	RELAY 2 POLE DC	F 580 214	500	RELAY
17	RELAY 2 POLE DC	F 580 214	500	RELAY
18	RELAY 2 POLE DC	F 580 214	500	RELAY
19	RELAY 2 POLE DC	F 580 214	500	RELAY
20	RELAY 2 POLE DC	F 580 214	500	RELAY
21	RELAY 2 POLE DC	F 580 214	500	RELAY
22	RELAY 2 POLE DC	F 580 214	500	RELAY
23	RELAY 2 POLE DC	F 580 214	500	RELAY
24	RELAY 2 POLE DC	F 580 214	500	RELAY
25	RELAY 2 POLE DC	F 580 214	500	RELAY
26	RELAY 2 POLE DC	F 580 214	500	RELAY
27	RELAY 2 POLE DC	F 580 214	500	RELAY
28	RELAY 2 POLE DC	F 580 214	500	RELAY
29	RELAY 2 POLE DC	F 580 214	500	RELAY
30	RELAY 2 POLE DC	F 580 214	500	RELAY
31	RELAY 2 POLE DC	F 580 214	500	RELAY
32	RELAY 2 POLE DC	F 580 214	500	RELAY
33	RELAY 2 POLE DC	F 580 214	500	RELAY
34	RELAY 2 POLE DC	F 580 214	500	RELAY
35	RELAY 2 POLE DC	F 580 214	500	RELAY
36	RELAY 2 POLE DC	F 580 214	500	RELAY
37	RELAY 2 POLE DC	F 580 214	500	RELAY
38	RELAY 2 POLE DC	F 580 214	500	RELAY
39	RELAY 2 POLE DC	F 580 214	500	RELAY
40	RELAY 2 POLE DC	F 580 214	500	RELAY
41	RELAY 2 POLE DC	F 580 214	500	RELAY
42	RELAY 2 POLE DC	F 580 214	500	RELAY
43	RELAY 2 POLE DC	F 580 214	500	RELAY
44	RELAY 2 POLE DC	F 580 214	500	RELAY
45	RELAY 2 POLE DC	F 580 214	500	RELAY

DELAVAL
 PANEL ELECTRICAL SCHEMATIC
 SCALE: 1" = 100'
 DATE: 10/30/60
 DRAWN BY: J. S. BROWN
 CHECKED BY: J. S. BROWN
 APPROVED BY: J. S. BROWN

SAFETY RELATED
 NUCLEAR
 ALL CIRCUITRY ON THIS SHEET IS CLASSIFIED AS SAFETY RELATED. SEE D-49-3 FOR NOTES 1, 3 & 5-8.

PROVIDED BY OWNER
 INDICATED LOCATION
 ON ENGINE
 IN CONTROL ROOM PANEL #
 PART OF ITEM #
 RELAY CONTRACT OF ITEM 33
 ON MOTOR
 PART OF DRY TONK LEVEL SW
 ALL SENSORS TO BE 3" BELOW TOP OF
 ALL INLET FLANGE ON STORAGE
 LOCKOUT RELAY IS RESET
 15 MOTOR SW SHOWN UNLATCHED, OPERATIONAL
 16 MOUNT HIGH IN CABINET, CENTRALIZED
 17 FIELD CONTACTS CLOSE TO ALARM
 18 TRANSFER WITH A START OF A STOP
 START ON RT # STOP
 19 NON E CONTACT ASSUMED
 20 CONTACTS TRANSFER FROM POWER IS
 UNLATCHED # AGAIN # SPEED SET POINTS
 22 CONTACTS FOR ALARM POS 6 2.
 SEE D-49-3 FOR NOTES 1, 3 & 5-8.

ALL CIRCUITRY ON THIS SHEET IS CLASSIFIED AS SAFETY RELATED. SEE D-49-3 FOR NOTES 1, 3 & 5-8.

ALL CIRCUITRY ON THIS SHEET IS CLASSIFIED AS SAFETY RELATED. SEE D-49-3 FOR NOTES 1, 3 & 5-8.

ALL CIRCUITRY ON THIS SHEET IS CLASSIFIED AS SAFETY RELATED. SEE D-49-3 FOR NOTES 1, 3 & 5-8.

ALL CIRCUITRY ON THIS SHEET IS CLASSIFIED AS SAFETY RELATED. SEE D-49-3 FOR NOTES 1, 3 & 5-8.

ALL CIRCUITRY ON THIS SHEET IS CLASSIFIED AS SAFETY RELATED. SEE D-49-3 FOR NOTES 1, 3 & 5-8.

ALL CIRCUITRY ON THIS SHEET IS CLASSIFIED AS SAFETY RELATED. SEE D-49-3 FOR NOTES 1, 3 & 5-8.

ALL CIRCUITRY ON THIS SHEET IS CLASSIFIED AS SAFETY RELATED. SEE D-49-3 FOR NOTES 1, 3 & 5-8.

ALL CIRCUITRY ON THIS SHEET IS CLASSIFIED AS SAFETY RELATED. SEE D-49-3 FOR NOTES 1, 3 & 5-8.

DOCUMENT CONTROL DATE
 OCT 30 1960
 DUKE POWER COMPANY
 DESIGN ENGINEERING

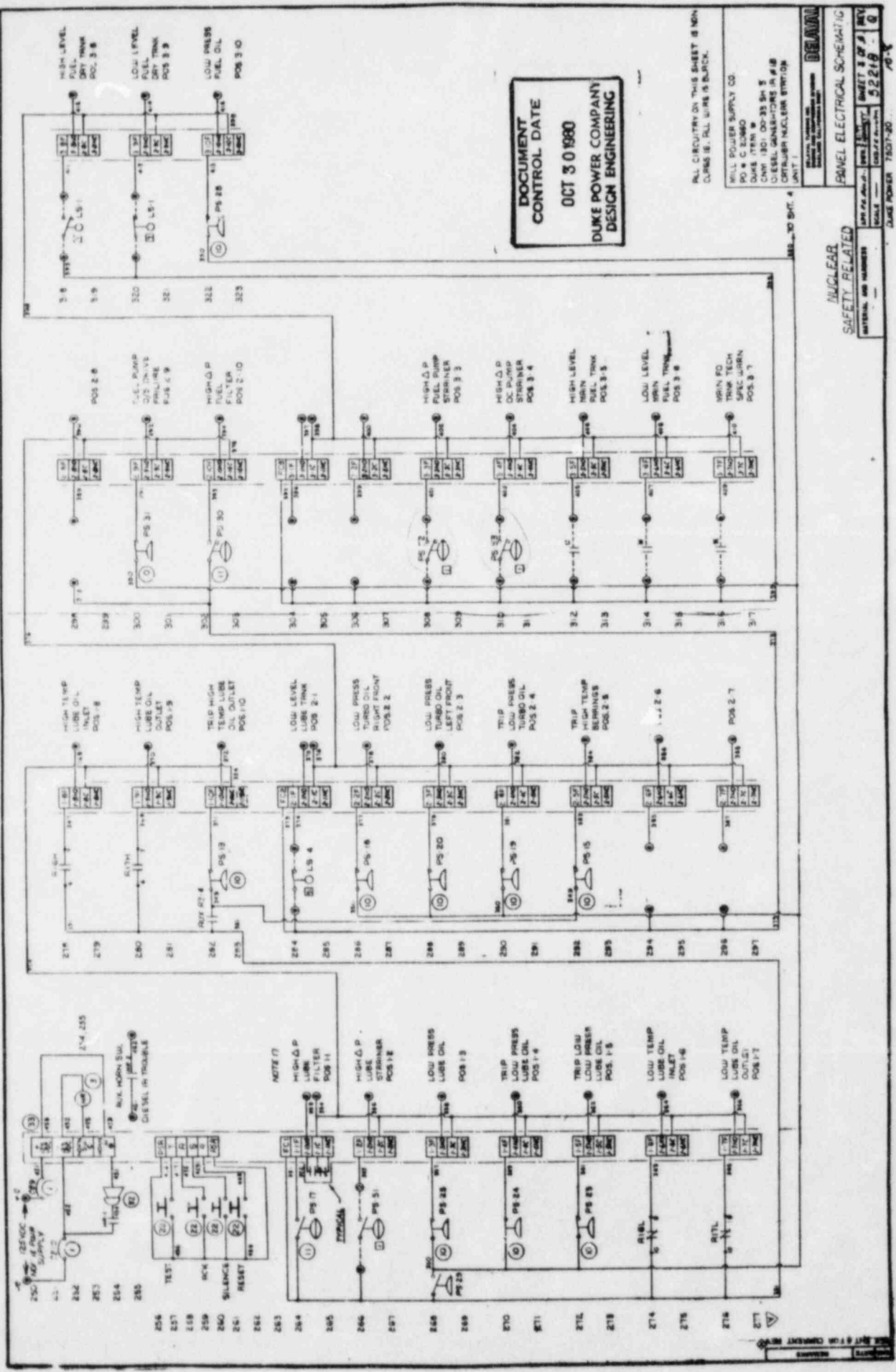

DOCUMENT
CONTROL DATE
OCT 30 1980
DUKE POWER COMPANY
DESIGN ENGINEERING

ALL CIRCUITS ON THIS SHEET IS NON CURS E. ALL WIRE IS BLACK.

WILL POWER SUPPLY CO.
PO 4 C 2080
CAMP 1301 DD-33 SH 3
LEVEL GENERATORS IN #18
OPTIMIZER NUCLEAR STATION

DETAILED

PANEL ELECTRICAL SCHEMATIC

REV. 1
REV. 2
REV. 3
REV. 4
REV. 5
REV. 6
REV. 7
REV. 8
REV. 9
REV. 10
REV. 11
REV. 12
REV. 13
REV. 14
REV. 15
REV. 16
REV. 17
REV. 18
REV. 19
REV. 20
REV. 21
REV. 22
REV. 23
REV. 24
REV. 25
REV. 26
REV. 27
REV. 28
REV. 29
REV. 30
REV. 31
REV. 32
REV. 33
REV. 34
REV. 35
REV. 36
REV. 37
REV. 38
REV. 39
REV. 40
REV. 41
REV. 42
REV. 43
REV. 44
REV. 45
REV. 46
REV. 47
REV. 48
REV. 49
REV. 50
REV. 51
REV. 52
REV. 53
REV. 54
REV. 55
REV. 56
REV. 57
REV. 58
REV. 59
REV. 60
REV. 61
REV. 62
REV. 63
REV. 64
REV. 65
REV. 66
REV. 67
REV. 68
REV. 69
REV. 70
REV. 71
REV. 72
REV. 73
REV. 74
REV. 75
REV. 76
REV. 77
REV. 78
REV. 79
REV. 80
REV. 81
REV. 82
REV. 83
REV. 84
REV. 85
REV. 86
REV. 87
REV. 88
REV. 89
REV. 90
REV. 91
REV. 92
REV. 93
REV. 94
REV. 95
REV. 96
REV. 97
REV. 98
REV. 99
REV. 100

NUCLEAR
SAFETY RELATED

INTERNAL AND NUMBER

DUKE POWER 7507-20
PAGE 1

DOCUMENT CONTROL DATE
OCT 30 1980
DUKE POWER COMPANY
DESIGN ENGINEERING

ALL CIRCUITRY ON THIS SHEET IS NON-NUCLEAR
E. ALL WIRE IS BLACK.

WELL POWER SUPPLY CO.
PO BOX 100
DUKE ITEM #
CMM 130.00-83 SNA
DIESEL GENERATORS IN # 18
CRYSTHER NUCLEAR STATION
UNIT 1

DATE: 10/30/80
DRAWN BY: [blank]
CHECKED BY: [blank]
APPROVED BY: [blank]

NUCLEAR
SAFETY RELATED

CUSTOMER FIELD CHANGE

PROJECT: [blank]
SHEET 4 OF 4 SHEETS
52218
DATE: 10/30/80

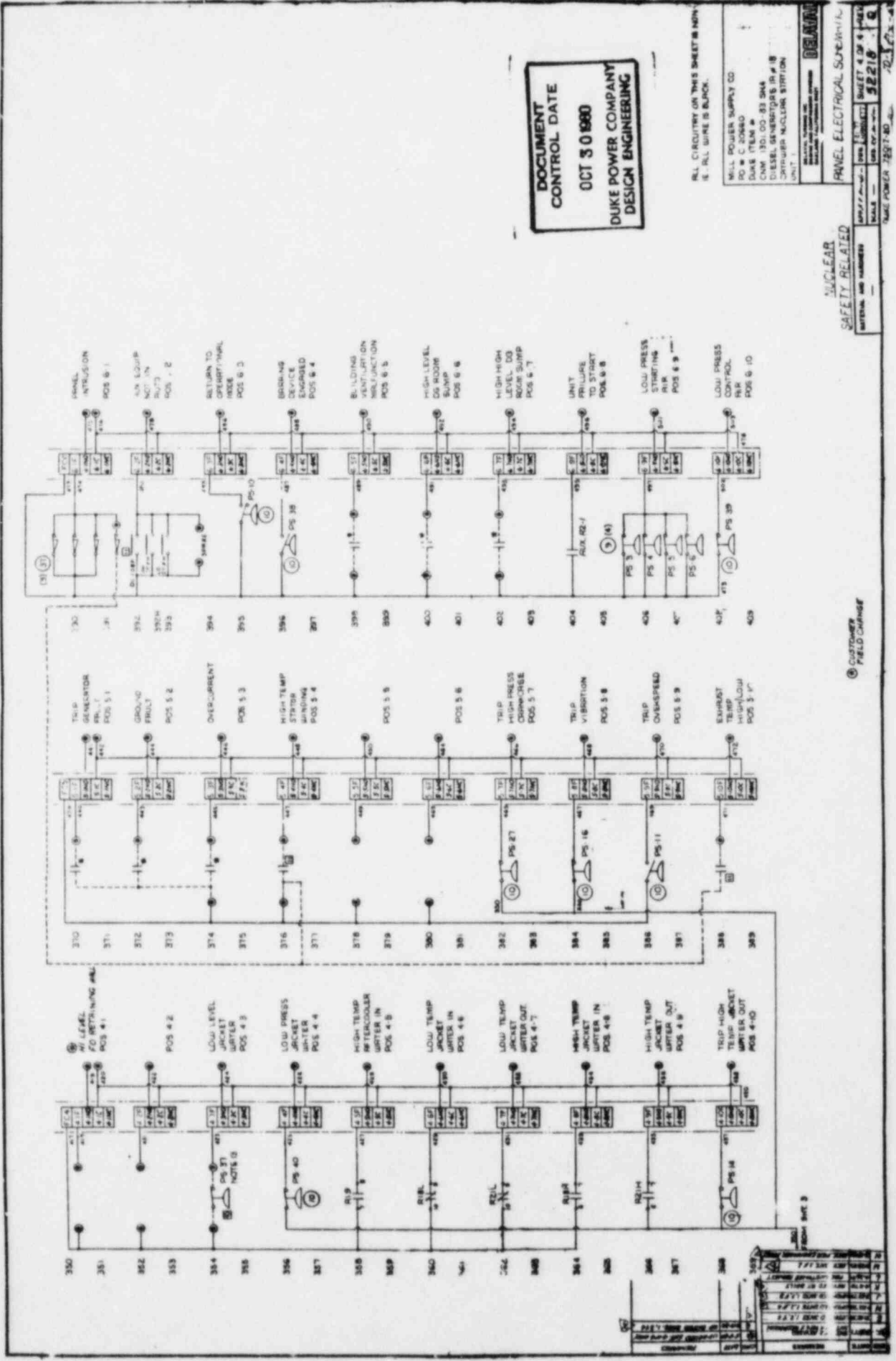

NO.	DESCRIPTION	QTY	UNIT	REMARKS
1	RELAY	1	EA	
2	RELAY	1	EA	
3	RELAY	1	EA	
4	RELAY	1	EA	
5	RELAY	1	EA	
6	RELAY	1	EA	
7	RELAY	1	EA	
8	RELAY	1	EA	
9	RELAY	1	EA	
10	RELAY	1	EA	
11	RELAY	1	EA	
12	RELAY	1	EA	
13	RELAY	1	EA	
14	RELAY	1	EA	
15	RELAY	1	EA	
16	RELAY	1	EA	
17	RELAY	1	EA	
18	RELAY	1	EA	
19	RELAY	1	EA	
20	RELAY	1	EA	
21	RELAY	1	EA	
22	RELAY	1	EA	
23	RELAY	1	EA	
24	RELAY	1	EA	
25	RELAY	1	EA	
26	RELAY	1	EA	
27	RELAY	1	EA	
28	RELAY	1	EA	
29	RELAY	1	EA	
30	RELAY	1	EA	
31	RELAY	1	EA	
32	RELAY	1	EA	
33	RELAY	1	EA	
34	RELAY	1	EA	
35	RELAY	1	EA	
36	RELAY	1	EA	
37	RELAY	1	EA	
38	RELAY	1	EA	
39	RELAY	1	EA	
40	RELAY	1	EA	
41	RELAY	1	EA	
42	RELAY	1	EA	
43	RELAY	1	EA	
44	RELAY	1	EA	
45	RELAY	1	EA	
46	RELAY	1	EA	
47	RELAY	1	EA	
48	RELAY	1	EA	
49	RELAY	1	EA	
50	RELAY	1	EA	
51	RELAY	1	EA	
52	RELAY	1	EA	
53	RELAY	1	EA	
54	RELAY	1	EA	
55	RELAY	1	EA	
56	RELAY	1	EA	
57	RELAY	1	EA	
58	RELAY	1	EA	
59	RELAY	1	EA	
60	RELAY	1	EA	
61	RELAY	1	EA	
62	RELAY	1	EA	
63	RELAY	1	EA	
64	RELAY	1	EA	
65	RELAY	1	EA	
66	RELAY	1	EA	
67	RELAY	1	EA	
68	RELAY	1	EA	
69	RELAY	1	EA	
70	RELAY	1	EA	
71	RELAY	1	EA	
72	RELAY	1	EA	
73	RELAY	1	EA	
74	RELAY	1	EA	
75	RELAY	1	EA	
76	RELAY	1	EA	
77	RELAY	1	EA	
78	RELAY	1	EA	
79	RELAY	1	EA	
80	RELAY	1	EA	
81	RELAY	1	EA	
82	RELAY	1	EA	
83	RELAY	1	EA	
84	RELAY	1	EA	
85	RELAY	1	EA	
86	RELAY	1	EA	
87	RELAY	1	EA	
88	RELAY	1	EA	
89	RELAY	1	EA	
90	RELAY	1	EA	
91	RELAY	1	EA	
92	RELAY	1	EA	
93	RELAY	1	EA	
94	RELAY	1	EA	
95	RELAY	1	EA	
96	RELAY	1	EA	
97	RELAY	1	EA	
98	RELAY	1	EA	
99	RELAY	1	EA	
100	RELAY	1	EA	

MATERIAL LIST

ITEM	QTY	DESCRIPTION	PART NO
1	1	CONNECTION - O PORT	47140-01-07
2	24	O RING	F 512 288
3	1	CHELVY MODULE GASKET	F 512 288
4	1	CHELVY MODULE GASKET	48 912 D
5	1	CIRCUIT MODULE GASKET	F 512 288
6	1	CIRCUIT BASE PLATE	F 512 288
7	1	CIRCUIT COVER PLATE	F 512 288
8	1	WASHER NO. 6.32 X 1/2	512 288
9	1	NUT - HEX LOCK NO. 6.32 X 1/2	512 288
10	1	SCREW ALLEN HEAD NO. 6.32 X 1/2	512 288
11	1	O-RING LOGIC ELEMENT	F 512 288
12	1	AND LOGIC ELEMENT	F 512 288
13	1	OR LOGIC ELEMENT	F 512 288
14	1	NOT LOGIC ELEMENT	F 512 288
15	1	MEMORY LOGIC ELEMENT	F 512 288
16	1	SET-RESET LOGIC ELEMENT	F 512 288
17	1	CHECK VALVE	F 512 288
18	1	CHECK VALVE	F 512 288
19	1	PARALLEL BRIDGE CHECK VALVE	F 512 288
20	1	TIMER NOT DIFFERENTIATION	F 512 288

*ITEM 10 TO BE USED TO MOUNT BRIDGE VALVE TO LOGIC BOARD

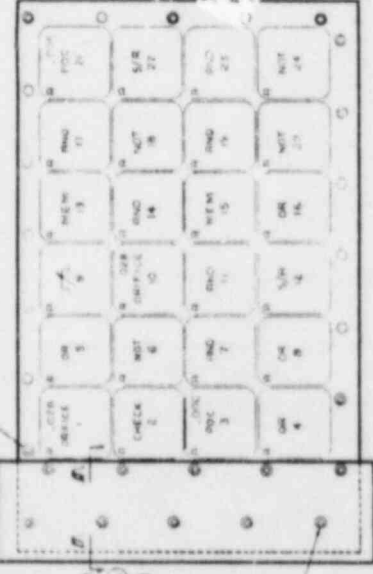
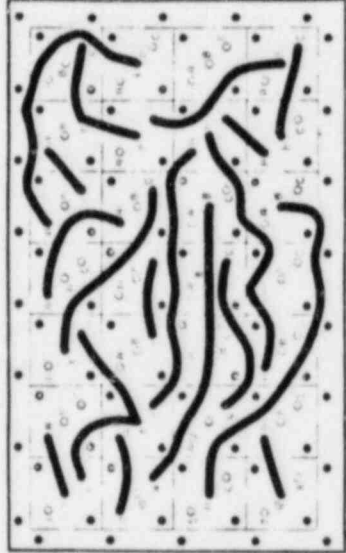
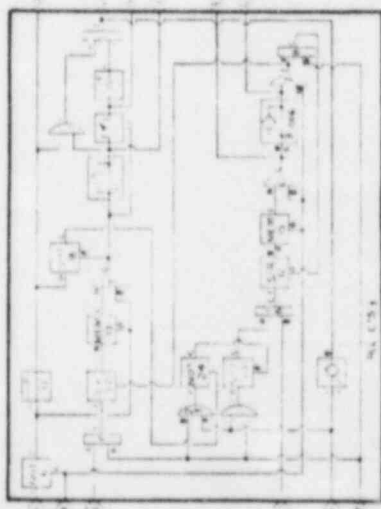

6 OUTPUT A, 500MS - 100% OF CHANNELS
CIRCUIT MODULE GASKETS
1 CLEAR GASKET VALVES AND VALVE OUTS BY 1/8"

FUNCTION TO PROVIDE NECESSARY SHUTDOWN SIGNALS TO ENGINE

- TEST PROCEDURE**
1. ATTACH TEST POINT ACCUMULATOR TO PORT 1.
 2. VERIFY THAT SUPPLY PRESSURE IS 100 PSI.
 3. VERIFY THAT OTHER BLOCK VALVE VALUES ARE CONNECTED TO ALL OTHER PORTS. ALL VALVES ARE IN THE LOCK POSITION.
 4. PRESSURIZE PORT A & MAINTAIN THROUGH REMAINDER OF TEST.
 5. NOTE OUTPUT AT PORT 10.
 6. TEMPORARILY ATTACH A GAUGE TO THE 'C' PORT OF AND 14 PRESSURIZE PORT 12. NOTE OUTPUT AT PORTS 2 & 8. ADJUST AND 14 GAGES HIGH. REMOVE GAUGE. VENT PORT 12.
 7. PRESSURIZE PORT 12. NOTE OUTPUTS AT PORTS 2 & 8. WAIT 10 SEC. NOTE LOSS OF OUTPUT AT PORT 2.
 8. PRESSURIZE PORT 11. NOTE OUTPUT AT PORT 8. REMOVE PRESSURE AT PORT 11. WAIT 120 SEC. NOTE LOSS OF OUTPUT AT PORT 8.
 9. VENT PORT 10. NOTE LOSS OF OUTPUT AT PORT 8. BLOCK PORT 10.
 10. VENT PORT 2. NOTE LOSS OF OUTPUT AT PORT 8.
 11. VENT PORT 3. NOTE LOSS OF OUTPUT AT PORT 8.
 12. VENT PORT 4. NOTE LOSS OF OUTPUT AT PORT 8.
 13. REMOVE PRESSURE AT PORT 12. PRESSURIZE PORT 7.
 14. REMOVE PRESSURE AT PORT 12. NOTE OUTPUTS AT PORTS 2 & 8.
 15. VENT PORT 13. NOTE NO CHANGE. BLOCK PORT 13. VENT PORT 2.
 16. VENT PORT 13. NOTE NO CHANGE. BLOCK PORT 13. VENT PORT 2.
 17. VENT PORT 13. NOTE NO CHANGE. BLOCK PORT 13. VENT PORT 2.
 18. VENT PORT 13. NOTE NO CHANGE. BLOCK PORT 13. VENT PORT 2.
 19. VENT PORT 13. NOTE NO CHANGE. BLOCK PORT 13. VENT PORT 2.
 20. VENT PORT 13. NOTE NO CHANGE. BLOCK PORT 13. VENT PORT 2.
 21. VENT PORT 13. NOTE NO CHANGE. BLOCK PORT 13. VENT PORT 2.
 22. VENT PORT 13. NOTE NO CHANGE. BLOCK PORT 13. VENT PORT 2.
 23. PRESSURIZE PORT 11. NOTE OUTPUT AT PORT 8.

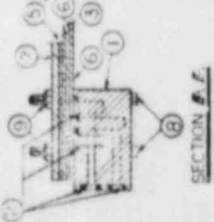

NOTE POINT INDICATOR INDICATION LOGIC ELEMENTS TO INDICATE SHOWN LOGIC FUNCTIONALITY

DELAVAL

SHUTDOWN
PNEUMATIC LOGIC BOARD ASSY

ITEM NO. 47140-01-07 REV. A
PART NO. 47140-01-07
QTY. 1
DATE 01-560-6147

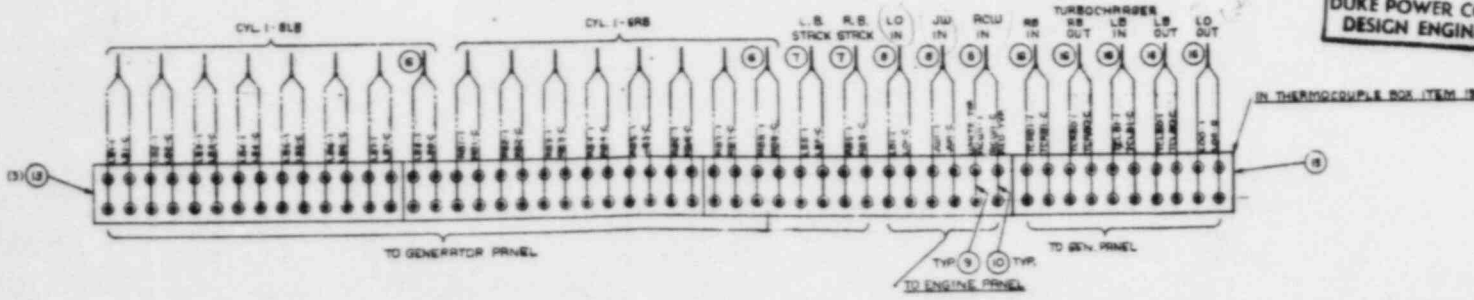
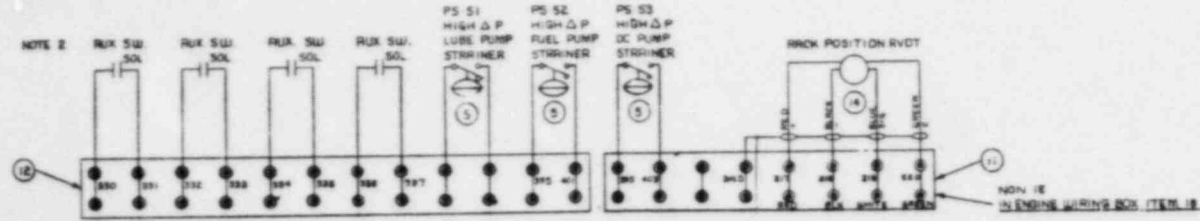
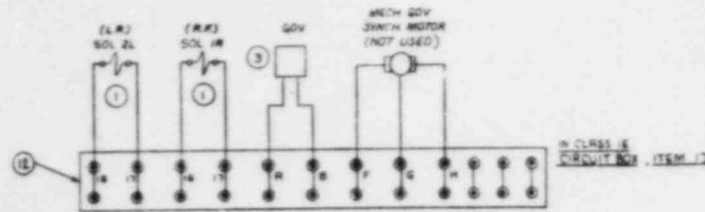
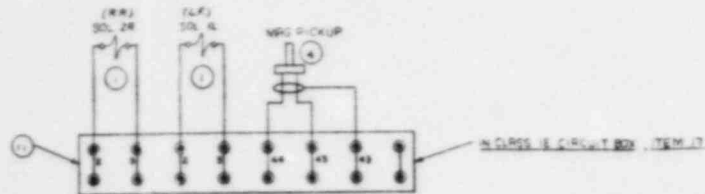

ITEM NO.	DESCRIPTION	QTY	UNIT	REV.
1	STARTING AIR SOLENOID	4	44	REL SPEC
2	Governor	1	415	REL SPEC
3	MAGNETIC PICKUP	1	498	EP-008-000
4	DIFFERENTIAL PRESSURE SWITCH	3	497	F 011-001
5	THERMOCOUPLE ASSY - CYLINDER	4	630	SEL SPEC
6	STACK	2	699	SEL SPEC
7	LIQUID LUG - CONSTANTAN	26	689	F 540-050
8	LUG - IRON	26	688	F 591-090
9	TERMINAL STRIP - 8 CIRCUIT	2	688	F 591-118
10	TERMINAL STRIP - 14	2	688	F 591-119
11	RVDT	1	500	F 540-180
12	TERMINAL STRIP - 10 CIRCUIT	1	688	F 591-013
13	THERMOCOUPLE ASSEMBLY	5	1	F 540-080
14	JIC BOX	1	1	F 510-114
15	JIC BOX	1	1	F 510-015
16	JIC BOX	2	1	F 510-015
17	TERM. STRIP BRACKET	2	1	F 510-142
18	TERM. STRIP STRAP	6	1	F 510-147

DOCUMENT CONTROL DATE
OCT 30 1980
DUKE POWER COMPANY DESIGN ENGINEERING

1	REVISED	DATE	BY
2	REVISED	DATE	BY
3	REVISED	DATE	BY
4	REVISED	DATE	BY
5	REVISED	DATE	BY
6	REVISED	DATE	BY
7	REVISED	DATE	BY
8	REVISED	DATE	BY
9	REVISED	DATE	BY
10	REVISED	DATE	BY

THIS SHEET CONTAINS
IS A NON-IE CIRCUITRY.
AS NOTED.

2 AUXILIARY SWITCHES ARE NON-IE
& MUST BE WIRED SEPARATELY FROM
START AIR SOLENOID.
1. IDENTIFY BOTH ENDS OF WIRES.

RELAY, THERMOCOUPLE, AND
MAGNETIC PICKUP SHOWN
ARE CALIFORNIA MADE

DELTA

NUCLEAR SAFETY RELATED

ENGINE ELECTRICAL DIAGRAM SCHEMATIC

MATERIAL AND HARDWARE

SCALE: 1" = 1'-0"

DATE POWER

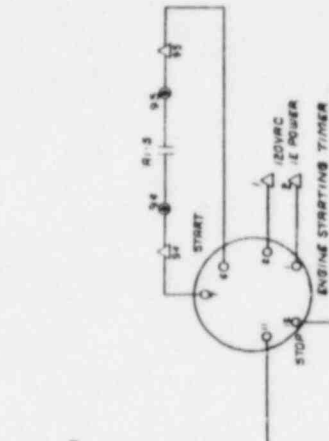
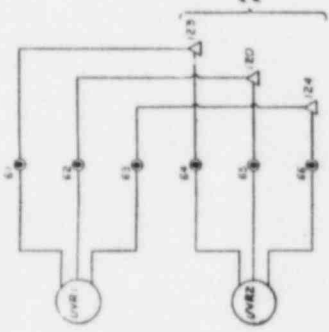
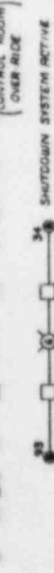
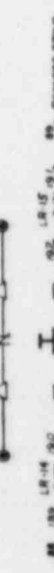
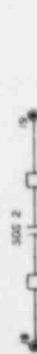

DOCUMENT
CONTROL DATE
OCT 30 1980
DUKE POWER COMPANY
DESIGN ENGINEERING

- ⊗ ENGINE OR RELATED EQUIP
- ENGINE CONTROL PANEL
- △ INHERIT OR CONTROL PANEL
- ELECTRIC PRODUCTS
- CONTROL ROOM
- ⊠ CUSTOMER SUPPLIED EQUIP

NUCLEAR
SAFETY
RELATED

NO.	DESCRIPTION	DATE	BY
1	ISSUED FOR REVIEW	10/20/80	...
2
3
4
5
6
7
8
9
10

INTERCONNECT DIAGRAM
SCALE: 1" = 100'

DUKE POWER TASK

DOCUMENT
CONTROL DATE
OCT 30 1980
DUKE POWER COMPANY
DESIGN ENGINEERING

INTERCONNECT DIAGRAM
SCALE 1:1
REV. 1
REV. 2
REV. 3
REV. 4
REV. 5
REV. 6
REV. 7
REV. 8
REV. 9
REV. 10
REV. 11
REV. 12
REV. 13
REV. 14
REV. 15
REV. 16
REV. 17
REV. 18
REV. 19
REV. 20
REV. 21
REV. 22
REV. 23
REV. 24
REV. 25
REV. 26
REV. 27
REV. 28
REV. 29
REV. 30
REV. 31
REV. 32
REV. 33
REV. 34
REV. 35
REV. 36
REV. 37
REV. 38
REV. 39
REV. 40
REV. 41
REV. 42
REV. 43
REV. 44
REV. 45
REV. 46
REV. 47
REV. 48
REV. 49
REV. 50
REV. 51
REV. 52
REV. 53
REV. 54
REV. 55
REV. 56
REV. 57
REV. 58
REV. 59
REV. 60
REV. 61
REV. 62
REV. 63
REV. 64
REV. 65
REV. 66
REV. 67
REV. 68
REV. 69
REV. 70
REV. 71
REV. 72
REV. 73
REV. 74
REV. 75
REV. 76
REV. 77
REV. 78
REV. 79
REV. 80
REV. 81
REV. 82
REV. 83
REV. 84
REV. 85
REV. 86
REV. 87
REV. 88
REV. 89
REV. 90
REV. 91
REV. 92
REV. 93
REV. 94
REV. 95
REV. 96
REV. 97
REV. 98
REV. 99
REV. 100

NUCLEAR
SAFETY
RELATED

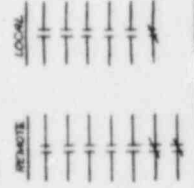
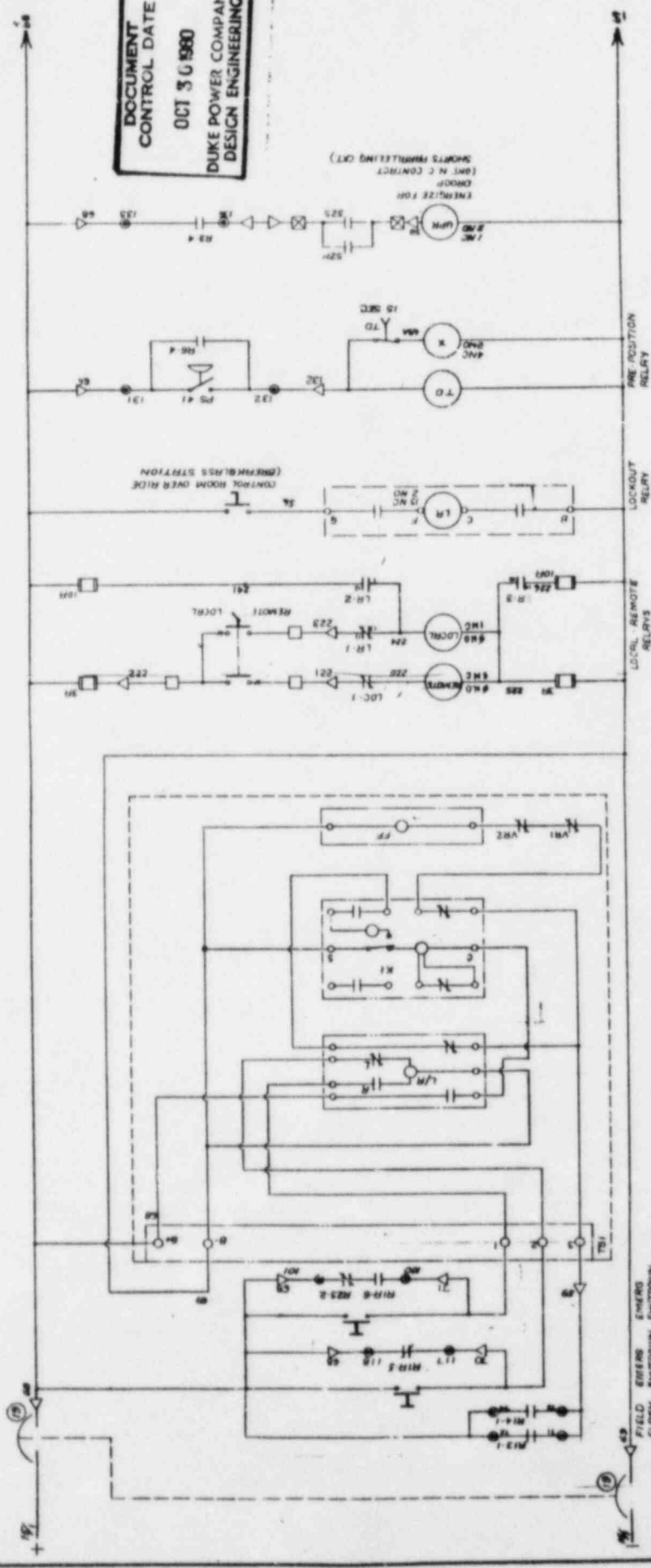

EXCITER CONTROL CIRCUIT
L/R AND N RELAYS SHOWN
IN RESET POSITION

NO.	DESCRIPTION	DATE
1	ISSUED FOR CONSTRUCTION	10/30/80
2	REVISION	
3	REVISION	
4	REVISION	
5	REVISION	
6	REVISION	
7	REVISION	
8	REVISION	
9	REVISION	
10	REVISION	

ENTRANCE FOR
SHORTS PROTECTING C.T.
(SEE N.C. CONTRACT
BOOK)

CONTROL ROOM OVER RIDE
(OVERHAUL STATION)

PRE POSITION RELAY

LOCKOUT RELAY

LOCAL REMOTE RELAYS

EXCITER CONTROL CIRCUIT
FIELD
EMERG
FLUSH
SHUTDOWN
RESET



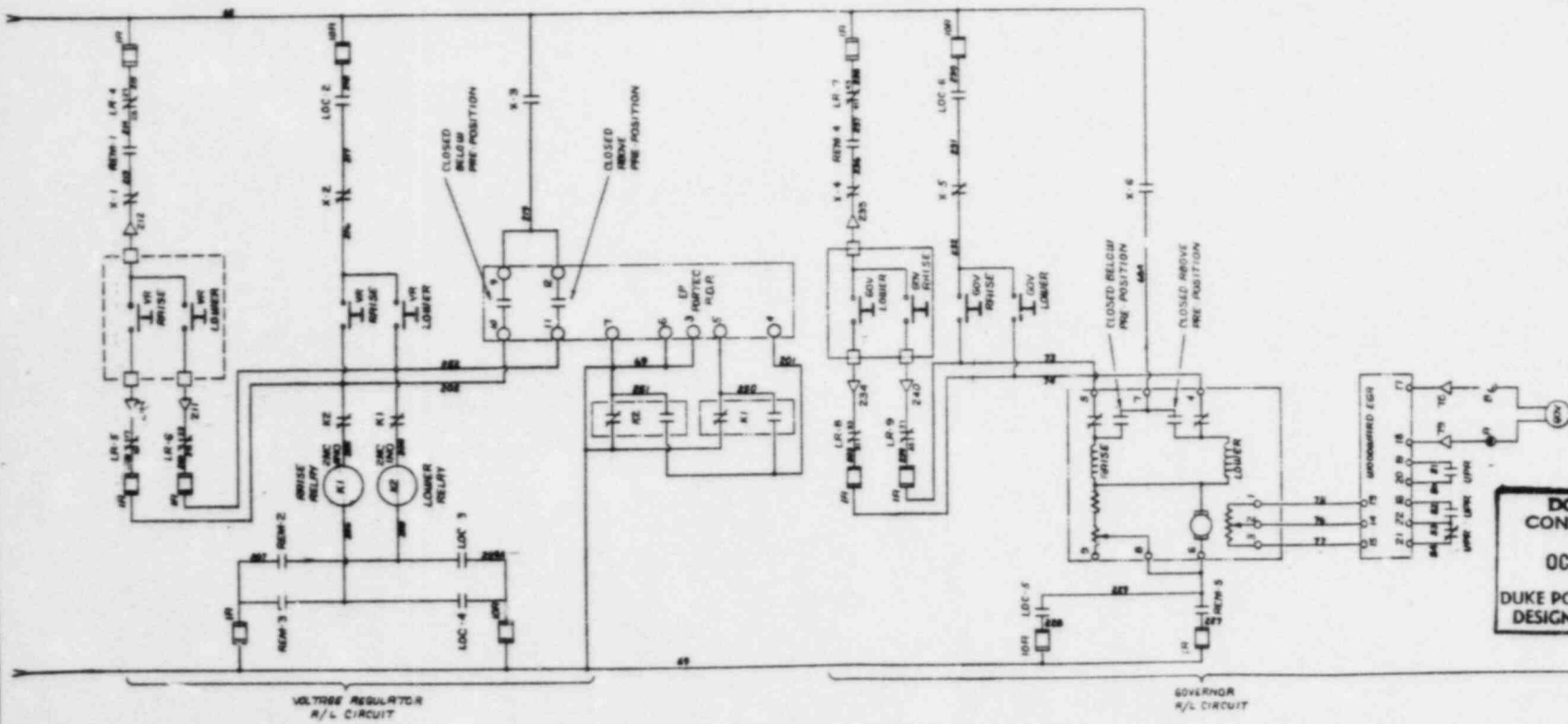

DOCUMENT
CONTROL DATE
OCT 30 1980
DUKE POWER COMPANY
DESIGN ENGINEERING

NUCLEAR
SAFETY
RELATED

DELTA

INTERCONNECT DIAGRAM

MATERIAL AND HARDWARE	APP. DATE	APP. BY	REV. DATE	REV. BY
			5/24/80	K
SCALE	CAB. (SEE L.C.)		52437	

10-7

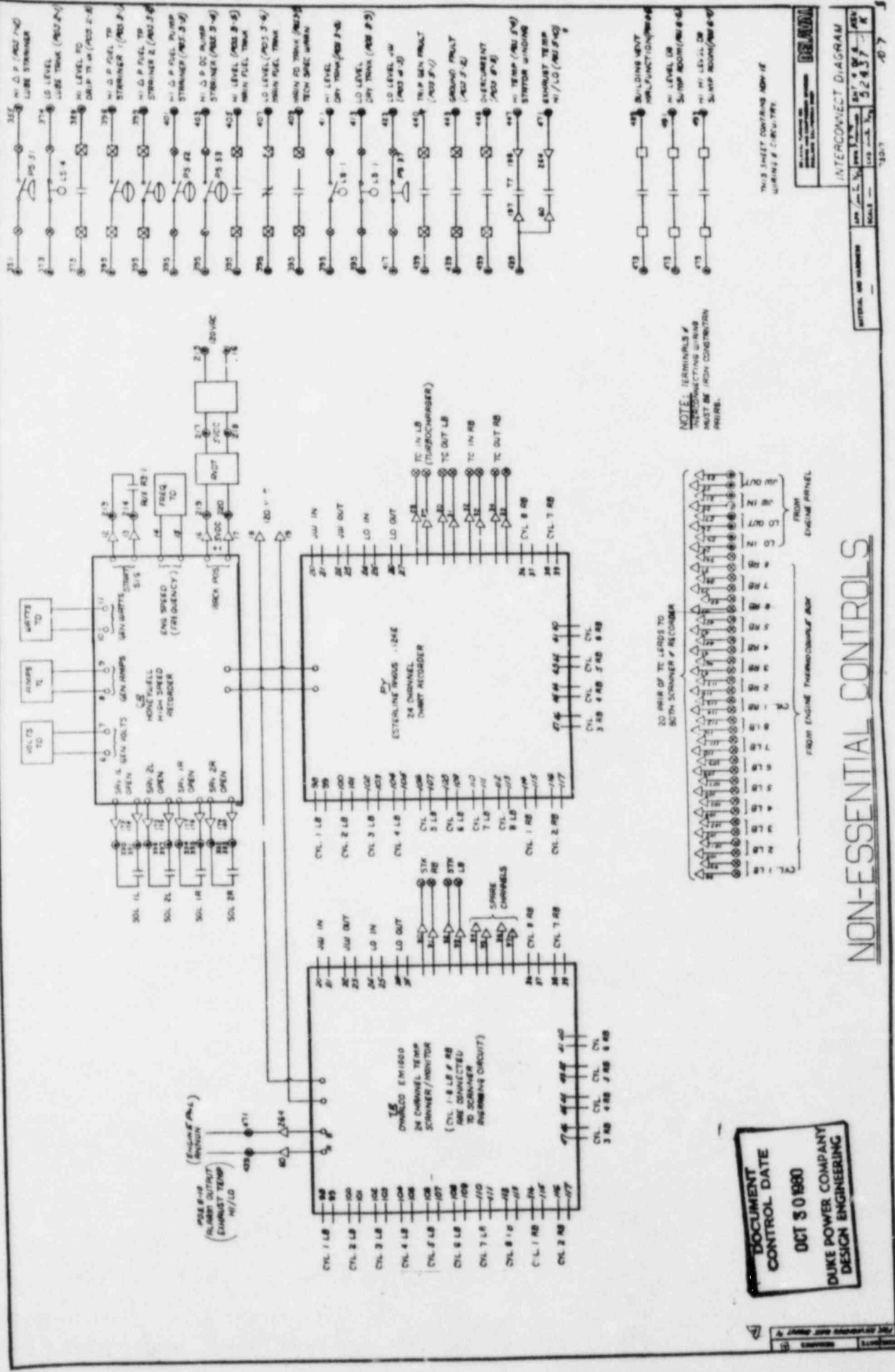

NON-ESSENTIAL CONTROLS

DOCUMENT CONTROL DATE
OCT 30 1980
DUKE POWER COMPANY
DESIGN ENGINEERING

DATE	BY	CHKD	APP'D
10/30/80	J. S. ...	J. S. ...	J. S. ...

THIS SHEET CONTAINS NON-ESSENTIAL CONTROLS
 WORKING P. CONTINUED

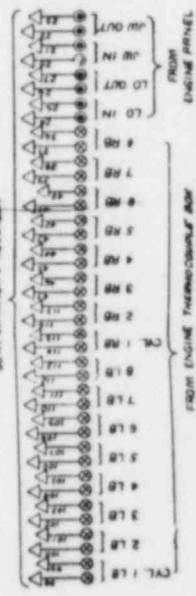

NOTE: TERMINALS / CHANNELS / FUNCTIONS MUST BE AS SHOWN IN THIS DRAWING.

TO PAIR OF TC LEADS TO BOTH SCANNER / RECORDER



LONG ISLAND LIGHTING COMPANY

SHOREHAM NUCLEAR POWER STATION

P. O. BOX 618, NORTH COUNTRY ROAD • WADING RIVER, N.Y. 11792

Direct Dial Number

April 27, 1984

TDI-20

H. R. Denton, Director
Office of Nuclear Reactor Regulation
U. S. Nuclear Regulatory Commission
Washington, D. C. 20555

50-413/414

Dear Mr. Denton:

Your letter of February 28, 1984 requested certain information relating to the TDI Diesels from the TDI Owners' Group, the majority of which have been responded to. The last request outstanding from this letter is for a copy of the Engine Instruction Manual for each of the TDI Owners' Group Diesel Engines.

Accordingly, enclosed please find one copy each of the TDI Engine Instruction Manual for all TDI Owners' Group Diesel Engines with the exception of River Bend (Gulf States Utilities). We are attempting to obtain the Instruction Manual for this plant and will forward it to NRC on receipt. This manual is presently under revision and the copy which will be forwarded to NRC will not incorporate all changes.

As indicated on the cover of the Shoreham Instruction Manual, that document is also being revised and does not incorporate all changes. Please note that these engine manuals are continually revised to incorporate TDI recommended changes as well as utility modifications.

Very truly yours,

W. J. Museler
Technical Program Director
TDI Diesel Generator Owners' Group

enclosure

RA/vf

cc: C. Berlinger
R. Caruso
W. Laity (Battelle Pacific
Northwest Lab.)

*13031
11*

~~445020029~~