

FOREIGN TRAVEL REPORT

ENVIRONMENTAL RESTORATION & WASTE MANAGEMENT
TECHNOLOGY EXCHANGE DISCUSSIONS
IN JAPAN

NOVEMBER 3 - 14, 1990

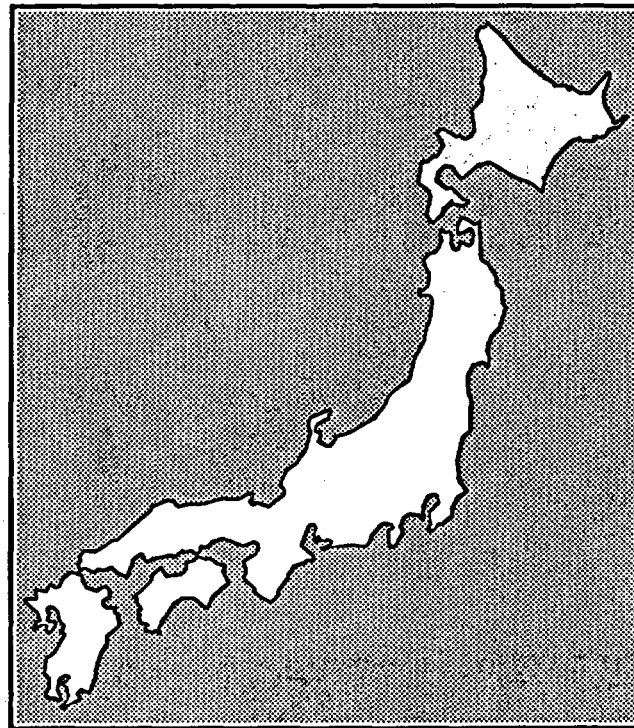

CONTRIBUTORS: LEO P. DUFFY,
DONALD H. ALEXANDER,
ELLEN LIVINGSTON-BEHAN,
SATYENDRA (JOHN) MATHUR,
DONALD T. OAKLEY,
W. MELINDA DOWNING,
WILLIAM C. SCHUTTE

A12

CONTENTS

<i>TRIP REPORT SUMMARY</i>	<i>PAGE</i>
<i>Travelers Names</i>	<i>1</i>
<i>Itinerary</i>	<i>2</i>
<i>Trip Cost</i>	<i>2</i>
<i>Abstract</i>	<i>2</i>
<i>Purpose of Trip</i>	<i>3</i>
<i>Objective I: Identify specific technologies of mutual interest</i>	
<i>Objective II: Determine if an annex to the current DOE-PNC Agreement is required</i>	
<i>Objective III: Identify technical areas or specific technologies that should be incorporated in "DOE-EM/PNC Record of Meeting"</i>	
<i>Objective IV: Initiate mechanism for collaboration with other Japanese organizations</i>	
 <i>DETAILED TRIP REPORT</i>	
<i>Introduction</i>	<i>6</i>
<i>General Observations</i>	<i>6</i>
 <i>MONDAY, NOVEMBER 5, 1990</i>	
<i>Abstract of Activities for November 5</i>	<i>7</i>
<i>Meeting at U.S. Embassy</i>	<i>9</i>
<i>Meeting with US/DOE Japan Staff, Tokyo</i>	<i>9</i>
<i>Meeting with Science and Technology Agency, Tokyo</i>	<i>10</i>
<i>Meeting with Japan Atomic Energy Research Institute, Tokyo</i>	<i>12</i>
<i>Meeting with Power and Nuclear Fuel Development Corporation, Tokyo</i>	<i>15</i>

TUESDAY, NOVEMBER 6

	PAGE
<i>Abstract of Activities for November 6</i>	17
<i>Meeting with National Research Institute for Pollution and Resources, Tsukuba Science City</i>	17
◦ <i>New Water Treatment System</i>	
◦ <i>CFC Decomposition by Thermal Plasma Reactor</i>	
◦ <i>Remote Sensing Techniques for Air Pollution Analysis</i>	
◦ <i>Measurement of Pollutants in Groundwater</i>	
<i>Meeting with JGC Corporation, Oarai</i>	23
◦ <i>Cold Test Facility, Radioisotope Buildings and Pilot Plant Test Building</i>	
◦ <i>High Temperature Demonstration Plant</i>	
◦ <i>Robotics</i>	
◦ <i>Soil Stabilization</i>	
◦ <i>Uranium-Selective Chelate Resin Process</i>	
◦ <i>Advanced Cement Solidification Process</i>	
◦ <i>Automated Waste Container Management System</i>	
◦ <i>Incinerators</i>	

WEDNESDAY, NOVEMBER 7

<i>Abstract of Activities for November 7</i>	27
<i>Meeting with Power Reactor and Nuclear Fuel Development Corporation, Tokai Works</i>	27
◦ <i>Uranium Enrichment</i>	
◦ <i>Reprocessing Technology</i>	
◦ <i>Plutonium Fuel Production</i>	
◦ <i>Waste Management</i>	
◦ <i>HLLW and TRU</i>	
◦ <i>Vitrification</i>	
◦ <i>LL Liquid Waste Treatment</i>	
◦ <i>Waste Treatment Facilities (PWTF and LWTF)</i>	
◦ <i>Pu Monitoring in Surface Waters</i>	
<i>Meeting with Power Reactor and Nuclear Fuel Development Corporation, Oarai Engineering Center</i>	32
◦ <i>Waste Dismantling Facility</i>	
◦ <i>Decontamination and Decommissioning</i>	

THURSDAY, NOVEMBER 8

	PAGE
<i>Abstract of Activities for November 8</i>	34
<i>Meeting with Japan Atomic Energy Research Institute, Tokai-Mura</i>	34
◦ <i>Decommissioning of JPDR</i>	
◦ <i>Concrete Disposal</i>	
◦ <i>Dismantling</i>	
◦ <i>Studies of Activated Metals</i>	

FRIDAY, NOVEMBER 9

<i>Abstract of Activities for November 9</i>	37
<i>Meeting with JAERI Takasaki Radiation Chemistry Research Establishment</i>	38
◦ <i>Industrial Applications</i>	
◦ <i>Environmental Applications</i>	
◦ <i>Nuclear/Space Applications</i>	
◦ <i>Scientific Exchange</i>	
<i>Meeting with PNC, Tokyo</i>	40
◦ <i>Record of Meeting</i>	

SATURDAY, NOVEMBER 10

<i>Abstract of Activities for November 10</i>	44
<i>Meeting at Kyoto University</i>	44
◦ <i>Site Characterization and Remediation</i>	
◦ <i>Neptunium Chemistry</i>	

MONDAY, NOVEMBER 12

<i>Ascension Day</i>	45
----------------------	-----------

TUESDAY, NOVEMBER 13

	PAGE
<i>Abstract of Activities for November 13</i>	46
<i>Meeting with PNC, Chubu Works</i>	46
◦ <i>Engineered Barrier Experiment</i>	
◦ <i>Nuclide Migration Tests</i>	
◦ <i>Excavation Response Tests</i>	
◦ <i>Exploratory Shaft Construction</i>	

WEDNESDAY, NOVEMBER 14

<i>Abstract of Activities for November 14</i>	49
<i>Meeting with MITI/AIST, Osaka</i>	49
<i>Glass and Ceramic Materials Department</i>	52
◦ <i>Glass and Ceramic Development, Optical Glasses</i>	
◦ <i>Nuclear Waste Form Glass</i>	
◦ <i>Ion Conducting Glass for Sensors</i>	
◦ <i>Porous Glass for Biochemical Catalysis and Bioreaction</i>	
◦ <i>New Water Treatment System</i>	
<i>Material Chemistry Department</i>	53
◦ <i>Chemical and Biosensor Technology</i>	
◦ <i>Catalysts for Gas Detection</i>	
◦ <i>Inorganic Shell Microcapsules</i>	
◦ <i>Glass Composite Membranes</i>	
<i>Meeting with Kobe Steel</i>	54
◦ <i>Waste Management, Incineration, Ash Melting and Crud-Slurry Solidification</i>	

LIST OF ATTACHMENTS

Leo P. Duffy's Presentation

Technologies discussed at NRIPR, Tsukuba Science City and Bibliography

Technologies discussed at JGC Corporation, Oarai and Bibliography

Technologies discussed at PNC, Takai and Bibliography

Technologies discussed at PNC, Oarai and Bibliography

Technologies discussed at JAERI, Takai and Bibliography

Technologies discussed at JAERI, Takasaki and Bibliography

Technologies discussed at PNC, Chubu Works and Bibliography

*Technologies discussed at Government Industrial Research Institute, Osaka
and Bibliography*

Technologies discussed with Kobe Steel and Bibliography

TRIP REPORT SUMMARY

1. TRAVELER'S NAMES:

Leo P. Duffy
Director
Office of Environmental Restoration
and Waste Management
U.S. Department of Energy

Donald H. Alexander
Program Manager
International Technology Exchange
U.S. Department of Energy

Ellen A. Livingston-Behan
Environmental Regulatory Specialist
Office of Environmental Restoration
and Waste Management
U.S. Department of Energy

Satyendra P. (John) Mathur
Program Manager
TRU Waste and WIPP R&D Programs, U.S.
U.S. Department of Energy

Donald T. Oakley
Senior Advisor to the Department of Energy's Office of
Environmental Restoration and Waste Management
Los Alamos National Laboratory

W. Melinda Downing
Program Review Coordinator
Office of Environmental Restoration and
Waste Management
U.S. Department of Energy

William C. Schutte
Group Manager
Technical Integration
Idaho National Engineering Laboratory

2. ITINERARY:

November 3 -Travel to Minneapolis

November 4 -Leave USA for Tokyo, Japan

November 5 -Tokyo, DOE Tokyo Staff, Atomic Energy Bureau/Science and Technology Agency, Embassy, JAERI and JGC Corporation.

November 6 -Mito, National Research Institute for Pollution and

November 7- Mito, Power Reactor and Nuclear Fuel Development Corporation, Tokai Works and Oarai Works.

November 8 -Mito, Japan Atomic Energy Research Institute

November 9 -Takasaki, Takasaki Radiation Chemistry Research Establishment Tokyo, Power Reactor and Nuclear Fuel Development Corporation

November 10-Kyoto, Kyoto University

November 13-Tajimi, Power Reactor and Nuclear Fuel Development Corporation, Chubu Works.

November 14-Osaka, Ministry of International Trade and Industry/Agency for Industrial Science and Technology.

November 15-Depart Osaka, Japan for U.S.

3. TRIP COST: Estimated cost per traveler of \$4,378.00

4. ABSTRACT: The Department of Energy Office of Environmental Restoration and Waste Management (DOE/EM) participated in a series of fact finding meetings and facility tours in Japan. Meetings with Power Reactor and Nuclear Fuel Development Corporation (PNC) were conducted in accordance with the bilateral agreement between the United States Department of Energy and Power Reactor and Nuclear Fuel Development Corporation (PNC) In the opening session with Japan's Science and Technology Agency the EM delegation, led by Mr. Leo P. Duffy, jointly underscored the continuing U.S. commitment that the technologies to be discussed would be limited to peaceful uses in the areas of environmental restoration and waste management. The delegation visited government, quasi-government and private organizations during the November 3-14, 1990, fact finding mission including the Science and Technology Agency (Tokyo), the Ministry of Trade and Industry (Tokyo, Mito, Osaka), the Power reactor and Nuclear Fuel Development Corporation (Tokyo, Tokai, Oarai, Chubu), the Japan Atomic Energy Research Institute (Tokai, Tokyo), Kyoto University, JGC Corporation (Oarai), and Kobe Steel. The delegation concludes that expanded collaboration in several technical areas described in this report appear to be of potential mutual benefit. Several areas of potential technical collaboration appear to have considerable merit in addition to successful on-going interactions related to vitrification, decommissioning, and TRU. This report provides meeting summaries and selected information on a wide range of technologies by organization.

5. PURPOSE OF TRIP: This trip was one in a series of fact-finding visits to Japan on environmental restoration and waste management. The following four pre-trip objectives were successfully met.

OBJECTIVE I: IDENTIFY SPECIFIC TECHNOLOGIES OF MUTUAL INTEREST

The facility and site visits were designed to encourage useful dialogue for identifying:

- 1) transferrable technologies,
- 2) technologies under development, and
- 3) areas for cooperative technology development.

The delegation identified key technologies that have potential for the highest payoff for use in EM site characterization and restoration efforts. The delegation was provided with a substantial amount of technical information through presentations and published materials with broad applicability to the EM mission. A number of technology breakthroughs with potential for significant impact for EM site characterization and environmental restoration were presented to the delegation.

OBJECTIVE II: DETERMINE IF AN ANNEX TO THE CURRENT DOE-PNC AGREEMENT IS REQUIRED

The current agreement appears to broadly cover DOE-EM/PNC exchanges. However, the agreement may need to be modified if new initiatives are pursued with PNC. The agreement will be revisited after joint workshops are conducted in early 1991 to determine if joint technical collaboration with organizations other than PNC will be pursued. Collaboration and possible agreements with JAERI, MITI and Kyoto University needs to be pursued since they are developing technologies or conducting research in areas relevant to DOE-EM.

OBJECTIVE III: IDENTIFY TECHNICAL AREAS OR SPECIFIC TECHNOLOGIES THAT SHOULD BE INCORPORATED IN "DOE-EM/PNC RECORD OF MEETING"

DOE and PNC agreed that several workshops would be arranged over the coming months to focus on areas of joint technical interest in preparation for the Bilateral Coordination Meeting in the spring of 1991. DOE appointed Dr. Donald Alexander as the DOE-EM coordinator. PNC appointed Mr. Takao Yagi as PNC-EM coordinator.

The workshops will provide reports recommending areas of technical collaboration to the DOE-EM/PNC Coordinating Committee in the Spring of 1991. The U.S. delegation identified several technical areas for continued collaboration in the November 9th meeting with PNC including decontamination and decommissioning, vitrification and TRU handling, treatment and disposal.

Areas of particular interest to the delegation which will be considered for future collaboration with PNC include:

1. the use of the plasma-arc saw for dismantling reactor vessels and related contaminated structures;
2. smelting of slightly contaminated ferrous metals for recycling;
3. methods for removal of contaminated concrete;
4. methods for reusing slightly contaminated concrete;
5. methods of waste reduction and minimization;
6. partitioning and transmutation;
7. robotics;

Areas of particular interest to the delegation which will be considered for future collaboration with MITI, JAERI and Kyoto University include:

1. methods for the removal of uranium from seawater;
2. applications of fiber-optics and lasers for in situ analysis of groundwater;
3. methods for the removal of organics such as trichloroethylene;
4. simulation modeling of groundwater contaminant migration;
5. research on actinide chemistry;
6. methods of underground characterization;
7. inorganic microencapsulated adsorbents;
8. optical microsensors for gases; and,

9. gold-metal oxide catalysts for sensor applications.

OBJECTIVE IV: INITIATE MECHANISM FOR COLLABORATION WITH OTHER JAPANESE ORGANIZATIONS

Based on the findings of the delegation, as outlined in Objective III, mechanisms for collaborating with MITI, JAERI, and Kyoto University should be pursued. A bilateral agreement between the USNRC and JAERI for exchanges in waste management currently exists and could serve as a model for DOE/EM-JAERI and DOE/EM-MITI. Amending the existing USNRC/JAERI agreement does not appear to be a viable option. Agreements with MITI and JAERI would be initiated by developing a broad scope of work, seeking State Department concurrence and then arranging meetings with MITI and JAERI representatives in Washington to discuss the U.S. proposal. Upon general agreement between parties to collaborate, formal agreements would be written, approval and signing of which would be coordinated through the DOE Office of International Affairs, IE-12.

Collaboration with Japanese Universities should be pursued through the Ministry of Education, Science and Culture or through laboratory to laboratory agreements.

One option being explored is to expand the existing DOE/JAERI Agreement on Decommissioning Nuclear Facilities (term 7-2-87 to 7-2-92) to include environmental restoration and waste management activities.

DETAILED TRIP REPORT

INTRODUCTION:

As the next step in the development of a cooperative initiative between the U.S. and Japan for technology development in the area of environmental restoration and waste management, Leo P. Duffy led a U.S. delegation to Japan on November 3-14, 1990.

The trip was closely coordinated with and supported by the Power Reactor and Nuclear Fuel Development Corporation (PNC). The PNC is a Japanese quasi-governmental agency responsible for developing fuel cycle technologies (including technologies related to reactor design, uranium mining and enrichment, spent fuel reprocessing, and radioactive waste disposal).

The Department of Energy (DOE) currently has an agreement (finalized in 1986) with the PNC for the cooperative development of technology and techniques for radioactive waste management. Objectives of the delegations trip to Japan focused on (1) identifying with the PNC specific technologies either in existence or under development that are applicable to EM efforts and that should be considered for exchange; (2) determining whether an annex to the existing DOE-PNC Agreement is required to support technology exchange and cooperative development efforts; and (3) identifying (in cooperation with PNC) appropriate future initiatives with other Japanese organizations having technologies that appear applicable to DOE's clean-up and waste-management activities.

Meetings and on site visits during the trip focused on specific Japanese research and development (R&D) initiatives of particular interest to the Office of Environmental Restoration and Waste Management (EM), including robotics, plasma-arc saw, recycling of slightly contaminated metals and concrete, methods of waste reduction and minimization, partitioning and transmutation, fiber optics, filtration, sensors, research on actinide chemistry, inorganic micro-encapsulated adsorbents, gold-metal oxide catalysts, trichloroethylene extraction and uranium extraction from groundwater.

GENERAL OBSERVATIONS:

The delegations general impressions of the activities and facilities reviewed during the trip are as follows:

- o technology development initiatives were generally at the same level of development for similar DOE initiatives;
- o as is the case in many U.S. research facilities, many Japanese research facilities are greatly under-utilized. Collaboration will reduce underutilization for both countries and eliminate costs of erecting new redundant facilities;

- o the facilities were clean and well managed;
- o As is the case in the U.S., the number of scientists that have specialized in Environmental Restoration and Waste Management research is insufficient to support future government needs for technology development. Collaboration will help reduce the manpower shortage for both nations.
- o The Japanese are developing foreign-scientist enclaves at major research centers to attract foreign post doctoral candidates. This approach is being discussed with Frank Parker, National Academy of Sciences, for possible implementation in U.S. Universities and at U.S. National Laboratories.
- o Collaborative efforts with PNC in decommissioning, TRU, waste reduction and minimization, and vitrification continue to be mutually beneficial.
- o New initiatives with MITI, JAERI, and MESC should be pursued.
- o U.S. mixed waste management capabilities should be shared with responsible Japanese organizations.

MONDAY, November 5

Abstract of Activities for November 5, 1990:

The first day of the trip was devoted to meetings with the directors of Japan's Science and Technology Agency (STA), the Japan Atomic Energy Research Institute (JAERI), and the Power Reactor and Nuclear Fuel Development Corporation (PNC).

The organizations have the following responsibilities:

- o The STA formulates policies for nuclear research and development, and establishes and enforces technical and safety standards applicable to nuclear material management and disposal.
- o The JAERI is a quasi-governmental research organization responsible for implementing national nuclear energy programs.
- o The PNC is a quasi-governmental research organization responsible for developing fuel cycle technologies (including technologies related to reactor design, uranium mining and enrichment, spent fuel reprocessing, and radioactive waste disposal). The Department of Energy (DOE) currently has an agreement (finalized in 1986) with

the PNC for the cooperation of technology development for radioactive waste management.

Principal spokesmen for each organization during meetings with the U.S. delegation were Mr. Hiroto Ishida, Deputy Director-General for the STA's Atomic Energy Bureau; Mr. Toyojira Fuketa, Vice President of JAERI; and Mr. Takao Ishiwatari, President of PNC.

During the meetings with these and other representatives of each organization, Mr. Duffy discussed the following topics:

- o Actions being taken by the DOE under the "Ten Point Plan" established by Secretary of Energy James Watkins to improve the DOE's performance and accountability in protecting the environment and public health and safety.
- o The development and implementation of DOE's program for environmental restoration, waste management, and related research and development initiatives under the "Environmental Restoration and Waste Management Five-Year Plan."
- o Objectives of the U.S. delegation's trip to Japan, with emphasis on:
 - 1) identifying with the PNC specific technologies either in existence or under development that are applicable to efforts of the Office of Environmental Restoration and Waste Management and that should be considered for exchange (specific Japanese research and development initiatives of preliminary interest to the Office of Environmental Restoration and Waste Management were noted to include robotics, fiber optics, partitioning and transmutation, filtration and sensors);
 - 2) determining whether an annex to the existing DOE-PNC Agreement is required to support technology exchange and cooperative development efforts; and
 - 3) identifying (in cooperation with the PNC) appropriate future initiatives with other Japanese organizations having technologies that appear applicable to DOE's cleanup and waste-management activities.

The spokesmen for each organization expressed interest in working to identify areas of cooperative effort. However, they emphasized the need (under existing laws and treaties) to limit such cooperation to activities that are not directly related to U.S. nuclear defense activities.

Later that day, the STA responded to press inquiries on the DOE-EM visit. The STA reviewed the mission of the U.S. fact finding team, reviewed technologies of particular interest to the DOE, noted its intent to cooperate positively in the DOE's fact-finding mission and the identification of cooperative technology initiatives, described the potential

development of a government-to-government agreement by 1992, and emphasized the need to focus any such initiatives on the peaceful uses of nuclear energy.

Meeting at U.S. Embassy, Tokyo

Address:

**EMBASSY OF THE UNITED STATES OF AMERICA
1-10-5 AKASAKA
MINATO-KU TOKYO 107
FROM THE U.S.A.
APO SAN FRANCISCO, CA 96503
PHONE: (03) 224-5066**

**(ADDRESS FOR MAIL FROM U.S.)
U.S. DEPARTMENT OF ENERGY
U.S. EMBASSY - TOKYO
APO SAN FRANCISCO, CA 96503**

Participants:

**William T. Breer
Minister**

**Richard S. Kanter
Assistant Commercial Attache**

Detailed Meeting Notes:

The Minister and his staff provided the delegation with an overview of local protocols, information on the Ascension of the Emperor, and background information on the role of the U.S. Embassy in international technology exchanges.

Meeting with US/DOE Japan Staff, Tokyo

Address:

**UNITED STATES DEPARTMENT OF ENERGY
AMERICAN EMBASSY
10-5 AKASAKA 1-CHOME
MINATO-KU, TOKYO 107
PHONE (03) 224-5475**

Participants:

**Milton Eaton
Senior DOE Representative**

**Toshiaki Okubo
Senior Energy Affairs Specialist**

**Mayumi Kainuma
Energy Affairs Specialist**

Detailed Meeting Notes:

The DOE Representative and Staff are responsible for all in country coordination of DOE related activities. The staff can provide on-site secretarial and other support services. The logistics for the delegation including the arrangement of lodging, travel accommodations and coordination of the itinerary and coordinating agenda topics with Japanese organizations prior to the trip were all arranged by the DOE Embassy Staff. The delegation highly recommends that all future EM exchanges with Japan be coordinated with the Senior DOE Representative.

Meeting with Science and Technology Agency, Tokyo

Address:

**SCIENCE AND TECHNOLOGY AGENCY
ATOMIC ENERGY BUREAU
2-2-1 KASUMIGASEKI
CHIYODA-KU, TOKYO
PHONE (03) 581-5271**

Role of STA in Nuclear Energy Development:

- The AEB formulates policies for nuclear energy R&D and supervises activities at JAERI, PNC, the National Institute of Radiological Sciences, and the Institute of Physical and Chemical Research (RIKEN). AEB also provides administrative support to the Atomic Energy Commission (AEC).
- The Nuclear Safety Bureau (NSB) determines technological standards and enforces safety regulations concerning new types of nuclear reactors, research reactors, nuclear fuel processing and reprocessing facilities, radioactive waste and transportation of nuclear fuel substances. NSB also provides administrative support to the Nuclear Safety Commission (NSC).

STA is also conducting the OMEGA Project, exchanging information of advanced waste treatment technology. The project involves two technological fields - partitioning and transmutation of TRU elements. A meeting of the OMEGA Project was convened in Tokyo during the first week of this visit.

Participants:

Hiroto Ishida
Deputy Director-General
Atomic Energy Bureau

Yukio Sato
Director, Power Reactor Development Division
Atomic Energy Bureau

Tomoyuki Murakami
Research and International Affairs Division
Atomic Energy Bureau

Yukihide Hayashi
Director, Research & International Affairs Division
Atomic Energy Bureau

Shizuo Hoshiba
Director, Nuclear Fuel Cycle Back-End Office

Agenda:

***Meeting with Mr. Ishida, Deputy-Director General, Atomic Energy Bureau.**

Detailed Meeting Notes:

Mr. Ishida chaired the meeting with STA. The DOE delegation provided STA with a copy of the presentation by Mr. Duffy entitled "The Program of the United States Department of Energy on Environmental Restoration and Waste Management" (See References). Mr. Duffy underscored the Department's commitment to involve all affected parties in the restoration of contaminated sites. He noted by way of example that Indian Nations, with lands affected by environmental contamination resulting from DOE activities, are participants in the restoration process.

Environmental restoration is being undertaken by many technologically advanced nations. However, the resource requirements are staggering and the demands on scientific and engineering personnel will increase substantially. Therefore, the U.S. delegation suggested that the joint international sharing of technologies should be pursued to reduce the overall resource requirements and accelerate clean-up.

Mr. Duffy assured STA that EM's role is limited to environmental restoration and waste management. Once a facility is turned over to EM, EM has the responsibility for the management of site clean-up. Mr. Duffy also stated that Secretary Watkins created the EM organization as an entity with clear separation from military activities.

STA responded very positively to continued technology exchanges with DOE-EM. STA underscored that joint activities must be restricted to peaceful uses and that the waste generated by military activities which are recovered with jointly developed technologies must not be used for military activities again.

****Mr. Duffy underscored the U.S. commitment to peaceful uses. He stated that many of the environmental problems being dealt with by EM were derived from non-nuclear wastes such as solvents, PCBs, and heavy metals.**

Meeting with Japan Atomic Energy Research Institute, Tokyo

Address:

**JAPAN ATOMIC ENERGY RESEARCH INSTITUTE
FUKOKU SEIMEI BLDG.
2-2-2 UCHISAIWAI-CHO
CHIYODA-KU, TOKYO 100, JAPAN
PHONE 03-592-2101**

Role of JAERI:

JAERI is a quasi-governmental research organization which implements national long-term programs in nuclear energy, including joint projects and international cooperative efforts.

Research Activities:

- **R&D of nuclear energy, nuclear safety, high temperature gas-cooled reactors, nuclear fusion, radiation applications, nuclear powered ships, basic research, decommissioning of nuclear reactors;**
- **Design, construction and operation of reactors;**
- **Education and training of researchers and engineers in the field of nuclear energy; and**
- **Dissemination of information obtained through R&D activities.**

Participants:

**Kazuo Sato
Executive Director**

**T. Tsujino
Deputy Director
Office of Planning**

**Masashi Iizumi
Director, Office of Planning**

**Keisuke Kaieda
Senior Staff, Office of Int'l Affairs**

**Hideki Omichi
Senior Staff, Office of Planning**

Bibliography of Literature Received:

"Development of Technologies on Decommissioning of Nuclear Fuel Cycle Technologies", Japan Atomic Energy Research Institute. 5 pages.

"JPDR Decommissioning Program", written by T. Hoshi from the 9th TAG Meeting on October 8-12, 1990 at the Japan Atomic Energy Institute. 10 pages.

"New JRR-3, Compiled by the Research Reactor Operation at the Tokai Research Establishment", Japan Atomic Energy Research Institute. 6 pages.

"Progress Report on Safety Research of High-Level Waste Management for the Period April 1988 to March 1989", Edited by Haruto Nakamura and Susumu Muraoka, Department of Environmental Safety Research, Tokai Research Establishment, Japan Atomic Energy Research Institute, 2 pages.

"Reactor Decommissioning Technology Development and Actual Dismantling of JPDR," compiled by the Tokai Research Establishment, Japan Atomic Energy Research Institute. 9 pages.

"Safety Studies on Glass Waste Form", written by S. Muraoka at Japan Atomic Energy Research Institute. 10 pages.

"Summary of WASTE-F Facility", from Japan Atomic Energy Research Institute. 10 pages.

"Volatilization of Cesium from Nuclear Waste in a Canister", Hiroshi Kamizono, Shizuo Kikkawa, Shingo Tashiro and Haruto Nakamura. at Japan Atomic Energy Research Institute. Department of Environmental Safety Research, 6 pages.

Agenda:

***Meeting with Executive Vice President and Directors of JAERI.**

Detailed Meeting Notes:

The DOE delegation provided JAERI with a copy of the presentation by Mr. Duffy entitled "The Program of the United States Department of Energy on Environmental Restoration and Waste Management" (See References). Mr. Duffy stated that there are an enormous number of sites in the United States that need to be restored. He emphasized the delegation's interest in any technologies which may expedite the clean-up of these sites including sensors, fiber-optics, remote measuring techniques for groundwater, robotics, biotechnology, filter technology and waste forms.

Mr. Kazuo Sato stated that the JAERI representatives were favorably impressed with Mr. Duffy's presentation and looked forward to future collaboration with DOE-EM with the caveat that all technology exchanged be used exclusively for peaceful uses. He stated that JAERI would be very interested in reviewing any DOE-EM proposals for collaboration.

Meeting with Power Reactor & Nuclear Fuel Development Corporation, Tokyo

Address:

**POWER REACTOR & NUCLEAR FUEL DEVELOPMENT CORPORATION
9-13, 1-CHOME, AKASAKA
MINATO-KU, TOKYO, 107 JAPAN**

Role of PNC:

Plays a central role in developing fuel cycle technologies, and fast breeder reactors. PNC has developed technologies for prospecting for uranium deposits, refinement and conversion, centrifugal uranium enrichment, spent fuel reprocessing and radioactive waste disposal and is preparing to cooperate with industry for demonstration and utilization of these technologies.

PNC operates the following facilities:

Tokai Works, Oarai Engineering Center, Fugen Nuclear Power Station (ATR prototype reactor), Monju Construction Office (FBR prototype reactor), Tsuruga Office, Chubu Works, and Ningyo Toge Works.

PNC has a plan to establish "Storage Engineering Center" in Horonobe, Hokkaido, to store vitrified HLW and to study technology for geological disposal in deep underground formations.

Participants:

**Takao Ishiwatari
President**

**Yoshikazu Hashimoto
Executive Director**

**Masao Yamamoto
Deputy Senior Director**

**Saburo Kikuchi
Secretary to the President**

**Kiyoshi Kikuchi
Ing. Geologue, Department des Ressources Nucleaires**

**Tadashi Mano
General Manager, Conditioning Research Program
Radioactive Waste Management Project**

Takashi Yoshikawa
Manager, Int'l Cooperation Office, Int'l Division

Reiko Nunome
Int'l Cooperation Office, Int'l Division

Akira Wadamoto
Engineer, Conditioning Research Prog.
Radioactive Waste Management Project

Bibliography of Literature Received:

"FBR Development in PNC for Commercialization", PNC, 8 pages.

"Technical Draft for Comments RD&D Program on Low-Level TRU Bearing Waste Management Technologies", PNC, 43 pages.

Agenda:

***Meeting with PNC President.**

Detailed Meeting Notes:

Dr. Takao Ishiwatari welcomed the delegation and stated that PNC was pleased with the long standing exchange program with the Department of Energy. He stated that future technology exchanges should be preceded by a statement of clear objectives, should be open to interested parties; and he underscored the need to limit collaboration to areas of peaceful uses of nuclear technology.

Mr. Duffy stated that the U.S. delegation appreciated the sensitivities. He stated that DOE-EM has nothing to do with weapons technologies. The technologies being developed by DOE-EM will have applications for the clean-up of contamination from industry, agriculture, as well as nuclear activities.

The two delegations agreed to meet on Friday November 9, 1990, to discuss the tours by the U.S. delegation and to prepare the Record of Meeting.

TUESDAY, November 6

Abstract of Activities for November 6, 1990:

A tour of STA's National Research Institute for Pollution (MITI, Tsukuba Science City) focused on the review of research on a water treatment system to promote biological treatment of hazardous chemicals; decomposition of CFC's through use of a thermal plasma reaction; measurements of organic pollutants in groundwater through fiber optics and the use of laser enhanced ionization methods for detecting trace amounts of inorganic pollutants; and remote sensing techniques using satellites for air pollution analysis. The laboratory appeared to be greatly under-utilized.

The delegation then traveled to Mito and visited the JGC Corporation's Oarai Center, where the following technology developments were reviewed: uranium removal from waste liquids; advanced cement solidification of hazardous wastes; on-site stabilization processes using fixing agents and cement or bentonite; automated waste-container inspection system; and incineration technologies for hazardous and radioactive waste.

Meeting with National Research Institute for Pollution & Resources (NRIPR):

Address:

**NATIONAL RESEARCH INSTITUTE FOR POLLUTION & RESOURCES
ONOGAWA 16-3
TSUKUBA SCIENCE CITY
IBARAKI 305, JAPAN**

Role of NRIPR:

NRIPR is 1 of 16 research institutes of the Ministry of International Trade and Industry (MITI); 9 are located within Ibaraki Prefecture and 7 are located elsewhere. The NRIPR has 9 departments conducting research in 4 overall areas: Resources, Industrial Safety, Energy, and Environmental Protection. The R&D budget for FY 1990 was 1,899 Million Yens (Approximately \$32.1 Million.) The total staff consists of 319 people, out of which 243 are technical officials.

The departments and the research activities are described on P.5 of the NRIPR brochure. (See Attachments) Major R&D activities of the NRIPR are:

- **Energy:** Development of new fuels as alternatives to oil, including oil shale and geothermal resources development.
- **Coal:** Gasification and liquefaction, and clean energy production.
- **Fuel:** Production of high quality natural gas, gas generation from biomass in sludges, and extraction of useful material from sea.

- **Combustion:** Project on control of oxides of Sulfur and Nitrogen emissions, development of a system for high combustion efficiency, and heat pipes for clean energy.
- **Resources:** Materials processing, mining and geotechnology development.
- **Materials:** Extraction of rare earths, development of fine silicone particles, and de-ashing and desulfurization of coal.
- **Mining:** Recovery of manganese and cobalt from sea bottom, and research on geothermal technology
- **Industrial Safety:** Safety in coal mines and other industries (prevention of fires and explosions)
- **Environmental Protection:** environmental assessments, atmospheric environmental protection, and water pollution control. Examples of environmental assessments are: impacts of housing projects, land reclamation, discharges of pollutants to land and sea, including remote sensing of pollutants in land and sea. Examples of atmospheric R&D are: Decrease/eliminate atmospheric discharges of pollutants from industries, measurement and control of exhausts from automobiles, and prediction of pollutant movements. Examples of water pollution control are: control of pollutants from agriculture and industries, and wastewater treatment (biophysical and biological).

Participants:

Akira Takata
Director

Osayuki Yokoyama
Deputy Director

Akira Miyazaki
Chief of Water Analysis Laboratory
Water Pollution Control Department

Seiji Matsumoto
Research Planning Office

Yasumasa Yamashita
Director, International Cooperation Office

Masanao Hirai
Director, Water Pollution Control Department

Shoichi Taguchi
Interspheric Environments Lab.

Bibliography of Literature Received from NRIPR:

"Summary of National Research Institute for Pollution and Resources", NRIPR, 44 pages.

Agenda:

***Tour National Research Institute for Pollution and Resources (NRIPR)**

***Attended Presentations at NRIPR on following topics:**

- 1) **New Water Treatment System "Aqua Renaissance '90":**
 - Nitrogen Removal by an Activated Sludge Process with Cross-Flow Filtration
 - Evaluation Technique for Organic Membrane Materials
- 2) **Treatment of Industrial Types of Waste Containing Halogenated Organic Compounds**
- 3) **Prediction of Groundwater Pollution**
 - Measurement of Pollutants
 - Measurements of Pollutants in Groundwater
- 4) **Treatment and recovery of Biological Refractory Chemicals in Wastewater with Supercritical Fluid.**
- 5) **Biological Treatment of Hazardous Chemicals**
- 6) **Remote Sensing Technologies**
- 7) **Mechanisms of Environmental Pollution**
- 8) **Biomass Energy**
- 9) **Waste Forms (Research on Solidification and Storage Techniques of High-Level Nuclear Wastes)**
- 10) **Research on High Performance Chemical Sensors**
- 11) **Anti-Pollution Technology**
 - Research on Automation Techniques for Monitoring Pollution in Lakes

- Research on High-Performance Materials for Treatment of Hazardous Waste
- Research on Optical Micro-Sensors for Gases

Detailed Meeting Notes:

Following the formal presentations, the DOE delegation went through a tour of the R&D facilities. The following is a brief description of the projects.

NEW WATER TREATMENT SYSTEM "Aqua Renaissance '90"

By: Dr. Y. Urushigawa, Chief, Ecological Chemistry and Microbiology Laboratory, Water Pollution Control Department.

The goals of the project are: energy recovery, and increasing treatment efficiency to allow reuse of treated waste water. This project was initiated in 1985, as 6-year project, for meeting energy and water needs of Japan. The project is co-sponsored by 4 government organizations and about 20 industrial companies. The total budget of the project is about 12 Billion Yen (about \$1 Billion 1990 dollars). The project elements are: selection of microorganisms for activated waste treatment; development of efficient filter membrane which is resistant to deterioration by sewage and microorganisms; bioreactor for denitrification, and R&D for on production of oil from sewage sludge; development of a membrane module for efficient separation of microorganisms and organic material; R&D on high efficiency bioreactor for methane production; development of monitoring system; and design and pilot plant operation by the end of 1990.

The DOE group saw the pilot plant which consists of a 20 cubic meter reactor for treating 7 different types of simulated wastes. The filter membrane had microorganisms which survived on the nutrients in the sewage. The pilot plant has an H₂S control system, but did not have any need for CO₂ controls. The pilot plant consists of a vertical tank into which wastewater is fed from the bottom. Fermentation of the solids occurs in the tank and methane gas is collected from the top of the tank. Supernatant liquid is pumped off from the top of the tank; the liquid goes through membrane filtration and settling. The effluent from this system is ready for reuse.

CFC Decomposition By Thermal Plasma Reactor:

By: Dr. T. Wakabayashi, Senior Researcher, Organic Chemicals Laboratory, Fuel Department

Management of organic chemical, CFC in particular, is a part of a Global Environmental Program. The major effort of this program is to reduce environment emissions that cause acid rain and global warming. CFCs are attributed to ozone layer depletion and the greenhouse effects.

The sources of CFC in Japan are: Production of CFCs which are used as solvents, propellants, refrigerants, and in semiconductor industries. The types of solutions are being worked: Development of degradable CFC, restrict emissions of CFC to the atmosphere, where possible reuse it, and "break up" CFC. CFCs used in the semiconductor industries cannot be reused because of the impurities in it.

The tour focused on thermal degradation of CFC. The NRIPR has built a pilot plant Thermal Plasma Reactor to treat 30 liters per hour of CFC. The reactor is heated by induction heating, developing maximum temperature of 10,000° C and up to 7,000° C in the reaction zone. Briefly, the process is: CFC is evaporated and mixed with water vapor. The mixture is thermally treated in the plasma reactor in the presence of Argon gas. Off-gases, consisting of HCl, HF, and water vapor, are treated in beds of KOH and CaO. Problems with the current system are: deposition of Carbon in the nozzles and efficiency of 70%. R&D is in progress to solve the carbon deposition problem and to improve the efficiency. Estimated cost of the process is 500 Yens (about \$4) per kg of CFC treated.

Remote Sensing Techniques for Air Pollution Analysis

By: Dr. S. Taguchi, Senior Researcher, Interspheric Environments Laboratory, Environmental Assessment Department

NRIPR is currently working on the Interspherometric Monitoring for Greenhouse Gases (IMG) project to remotely measure concentrations of gases in the atmosphere, that are associated with greenhouse effect. The gases under consideration are: water vapor, CO₂, oxygen, and chlorinated hydrocarbons. This project is sponsored by MITI, with participation of many other organizations, such as STA. Sensors will be attached to a satellite ADEOS, which will be in synchronous orbit; the satellite is scheduled to be launched in February, 1996. Sensors are being developed by TOSHIBA. Gas concentrations will be measured as a function of the difference between transmitted and reflected lights.

Measurement of Pollutants in Groundwater

By: Dr. A. Miyazaki, Chief, Water Analysis Laboratory, Water Pollution Control Department

The NRIPR is developing remote sensors for characterization of contaminated groundwater. Rapid analytical methods will be used to monitor groundwater quality. The R&D consists of two parts: development of remote optical fibers for measuring organic chemical contaminants; and development of a laser ionization method for determining concentrations of inorganic pollutants. Sensors have been developed for measuring TCE in ppb range and chloroform in 200ppm range.

During the lunch with NRIPR, Dr. Akira Takata, Director-General, said that Mr. Yasumasa Yamashita, Director, International Office will be the contact point.

Leo Duffy gave his presentation on EM's programs. Some of the points he discussed are briefly stated below:

- In the U.S., public hearings are held on power plant applications.
- In the environmental clean-up and restoration of ecology programs, DOE has problems with heavy metals, contamination of groundwater from buried wastes.
- We do not want to pass the problems to future generations.
- We are looking for cheaper and efficient extraction technologies to remove the contaminants.
- Dr. Donald Alexander is developing a 3-D model for contaminant transport in groundwater.
- We need to get more analytical capabilities to measure environmental releases in low concentrations. These measurements are to be made for demonstrating regulatory compliance and are expensive.
- The technologies DOE develops would be passed to industry. DOE would like to transfer some of these cleanup technologies to Eastern Europe.
- DOE has problems with chlorinated compounds. Dr. Donald Oakley said that groundwater contamination by TCE is at all DOE sites. The pump and treat method is not suitable. DOE is drilling horizontal wells and is vaporizing the volatile organic contaminants. Some U.S. sites are using stripping columns packed with activated carbon; this method is very expensive, including the cost of treating carbon. The first treatment system, utilizing horizontal drilling and vapor extraction, is being done at Savannah River Site. This system was able to reduce concentrations to below detectable limits (less than 2000ppb) in 90 days. We are looking into screening systems (biological or otherwise) also.
- We have looked into the use of ultra-violet light and catalysts (Hydrogen peroxide) to break down hazardous chemicals, but the system is not very efficient and is costly.
- The cheapest solution is in situ microorganisms with the appropriate nutrients.
- Briefly described RDDTE Plan.

Q. Mr. Duffy asked a question regarding materials extraction technology development, the response was that no research on materials extraction was being carried out because Oak Ridge has 500,000# of mercury in soil.

Q. Mr. Duffy asked if there were any problems with heavy metals in sewage.

A. Except Tokyo, there are no problems.

Meeting with JGC Corporation:

Address:

**JGC CORPORATION
ENGINEERS & CONSTRUCTORS
OARAI RESEARCH & DEVELOPMENT CENTER
NUCLEAR & ADVANCED TECHNOLOGY DIVISION
2205, NARITACHO OARAIMACHI, HIGASHIIBARAKI-GUN
IBARAKI PREFECTURE, 311-13 JAPAN
PHONE: 03-279-5441**

Participants:

**Takao Nakajima
Executive Vice President
General Manager**

**Hiroshi Kuribayashi
Director, Senior Deputy General Manager**

**Yasuhiro Moriya
Manager, Oarai Research & Development Center**

**Norimitsu Koshiba
Section Manager, Sales, No. 1 Sales Department**

**Hiroshi Yamashita
Manager, U.S. Marketing Dept.
U.S. Project Operations**

**Mamoru Shibuya
Oarai Research & Development Center**

**Takuro Yagi
Manager, No. 1 Team
Technology Development Department**

**Stephen D. Goetsch
Market Development Coordinator
No. 1 Team, Technology Development Dept.**

Bibliography of Literature Received:

"Advanced Waste Management Technologies", JGC Corporation, 100 pages.

Agenda:

- 1) Overview of Technologies to be Discussed.**
 - RASEP/Uranium Chelate Resin**
 - Soil Stabilization**
 - Drum Inspection**
 - Advanced Cement Solidification**
 - Others, Included**
 - ³H Separation by Column and Laser**
 - Incineration**
 - Induction Melting**
 - Wet Oxidization**
 - Radioactive Gas Monitoring Research**
- 2) View Drum Inspection System in Operation.**
- 3) View Induction Melting System.**
- 4) View ³H Separation Column.**
- 5) Transit to Cold Pilot Plant Building.**
- 6) View Wet Oxidization Pilot Plant.**
- 7) View High Temperature Incinerator.**
- 8) Pass Through Cold Building Pointing Out Other Pilot Plant Installations.**

Detailed Meeting Notes:

Dr. Kuribayashi opened the meeting and made the following remarks:

- JGC is modifying or developing technologies for treatment of mixed waste, with specific emphasis on mixed waste monitoring.**
- JGC has developed some technologies that could be applied to US through US companies.**
- During the visit of the US delegation, there will be some discussion of the technologies and a visit of the plant.**

Mr. Moriya briefly described the facilities included on the tour:

Cold Test Facility, Radioisotope Test Buildings & Pilot Plant Test Building:

Initial waste management R&D, using non-radioactive material, is conducted in the Cold Test facility. This facility is equipped with chemical and physical analytical capabilities, as well as electron microscope, plasma emission spectrochemical analyzers, etc.

The radioisotope test facility is used for radioactive waste treatment R&D, as well as for use of radioisotopes for liquid wastes generated at the Center, and demonstration of compliance with environmental regulations. The Center is not permitted to discharge any liquid wastes containing radioisotopes (allowable radioactivity is less than 10^{-7} mC/liter. JGC reuses all waste water.

High Temperature Demonstration Plant:

High Temperature Demonstration Plant. This plant directly converts mixtures of combustible and non-combustible radioactive wastes, including sludges, into stable granular form. This system could be used for mixed waste processing also. Waste material is shredded and fed into a cyclone furnace sludge incinerator/melter. High temperature, between 1400°C and 1500°C , is obtained by induction heating. The bottom ash and slag is removed in a molten state and cooled to form granular material. Off-gases are cooled and passed through ceramic and HEPA filters, and then discharged to the atmosphere.

Robotics:

Robot that moves on the floors as well as climbs over obstacles on walls was viewed and discussed.

Steve Goetsch made the following comments:

Soil Stabilization:

JGC submitted a proposal to INEL (August 1990) in response to PRDA for On-Site Stabilization Process (OSSP). The concept of the process is to stabilize by chemical and physical methods soils contaminated with heavy metals, mercury, uranium and TRU isotopes. The process uses a proprietary fixing agent (non-silicate compound + cementitious agent) to render the contaminants insoluble. The insoluble reaction products will be adsorbed into the soil. The advantages of this process are: low leach rates, and minor volume increases. This process has application to Oak Ridge and Rocky Flats Plant.

Uranium-Selective Chelate Resin Process:

This process utilizes a uranium selective chelate resin (UR-3100) for removing uranium from liquid wastes. This resin is highly selective for uranium, and the ion can be easily eluted

from the resin by using NaHCO_3 to give a concentrated solution of uranium. UR-3100 has been tested with a solution containing zinc, copper, and iron. The resin did not absorb zinc or copper, and absorbed very small quantities of iron. Solutions containing uranium up to 71.1 ppm could be processed through this system. JGC proposed this system for Weldon Springs (did not receive any response; HydroPure got the contract); and has proposed the system for the Portsmouth Plant. Jerry Westerbeck from Fernald will be going to Japan to look at this system.

Advanced Cement Solidification Process:

The process consists of pretreatment and mixing with cement. This process has been used for immobilization of spent resins, boric acid wastes and incinerator fly ash and bottom ash. In the case of spent resins and boric acid waste, an additional step is introduced in the system - solid liquid separation or waste concentration. For Incinerator wastes, pretreatment consists of treatment with $\text{Ca}(\text{OH})_2$ and NaOH , while for spent resins, cement and water are used. In case of boric acid wastes, pretreatment is provided by using calcium borate. The leachability of the immobilized waste form is very low. Tests with wastes containing cadmium or mercury showed that bentonite, instead of cement works better as an immobilization agent. This system has potential application to the mercury problems at Oak Ridge.

Automated Waste Container Management System:

The system consists of the following steps: Visual inspection unit - top, sides and bottom of waste drums are inspected by three ITV cameras; Surface Contamination and Dose Rate Measurement Unit - Smear samples are taken from four locations of the drums to determine surface contamination density. At the same time surface dose rates are measured by sensors built into the smear sampling unit; Radioactivity/Weight Measurement Unit - Nondestructive determination of radioactivity concentrations of each radionuclide in the drum are made by spiral scanning Ge semi-conductor sensor, a plastic scintillator (radioactivity concentration is determined from total dose - plastic scintillator, g scaling factors, and nuclides), and weights are determined by a simple machine; and Labeling Unit - Identification labels with a serial number and surface dose rates are automatically printed on the drums. TRU radioassay and free liquid detection systems are available, but have not been incorporated in the system. JGC submitted a proposal in response to INEL PRDA. This system could be potentially used for analysis gas in head space of drums to be disposed of at WIPP.

Incinerators:

Different types of incinerators at JGC were very briefly described: rotary kiln for hazardous waste, radwaste, irradiated carcasses, and medical waste.

WEDNESDAY, November 7

Abstract of Activities for November 7, 1990:

A visit to the PNC's Tokai Works focused on R&D activities related to the (1) glass vitrification of high-level waste; (2) processing of transuranic waste through a process of incineration, and acid digestion, with the production of metal ingots, ceramics and liquid residues that are discharged into the sea; and (3) treatment of solid and liquid low-level waste through incineration, compaction and filtration processes. Presentations were also provided on environmental monitoring programs at the Tokai Works, and, upon request, the facility's building that houses a high-level waste tank was toured.

Meeting with Power Reactor and Nuclear Fuel Development Corporation, Tokai Works:

Address:

**TOKAI WORKS, PNC
MURAMATSU, TOKAI-MURA
319-11 IBARAKI-KEN, JAPAN**

Role of PNC:

Plays a central role in developing fuel cycle technologies and fast breeder reactor and ATR. PNC has developed technologies for prospecting for uranium deposits, refinement and conversion, centrifugal uranium enrichment, spent fuel reprocessing and radioactive waste disposal and is preparing to cooperate with industry for demonstration and utilization of these technologies.

Participants:

**Tanehiko Yamanouchi
Director**

**Y. Kishimoto
Director
Technology Development, Coordination Division**

**Yoshiro Asakura
Director
Waste Plants Operation Division**

Takao Tsuboya
Director
Waste Technology Development Division

Ken-Ichi Matsumoto
Deputy Director

Shin-Ichiro Torata
Assistant Senior Engineer
Waste Tech. Devel. Division

Hiroyuki Umeki
Manager, Geological Isolation Technology Section
Waste Technology Development Division

Bibliography of Literature Received:

Budget Information from PNC, Tokai. PNC, Tokai, 1 page.

"Nuclear Fuel Cycle, Tokai Reprocessing Plant", PNC- Tokai Works, 15 pages.

"Present Status of R&D Activities on HLLW and TRU Conditioning in Tokai Works", PNC Tokai Works, 26 pages.

"Some Aspects of Natural Analogue Studies for Assessment of Long Term Durability of Engineered Barrier Materials, CEC 4th Natural Analogue Working Group Meeting", Prepared by Y. Yusa, G. Kamei and T. Arai, PNC, 19 pages.

"Tokai Vitrification Facility", PNC, Tokai Works, 3 pages.

"Pu-Contaminated Waste Treatment Facility", PNC, Tokai Works. 3 pages.

Agenda:

- 1) Attended Presentations at PNC Tokai Works on following topics:**
- Present status of R&D Activities on HLLW and TRU Waste Conditioning in Tokai Works. (T. Tsuboya/PNC)**
 - Present Status of Waste Treatment Facilities in Tokai Works (Y. Asakura/PNC)**
 - Present Status of other activities on Nuclear Fuel cycle in Tokai Works (Y. Kishimoto/PNC)**

- 2) Tour of Tokai Vitrification Facility (TVF).
- 3) Tour of Engineering Demonstration Facility III (EDF-III).
- 4) Tour of Engineering Testing Facility (ETF).
- 5) Tour of Chemical Processing Facility (CPF).
- 6) Tour of Plutonium Contaminated Waste Treatment Facility (PWTF) and Plutonium Contaminated Waste Storage Facility (PWSF).

Detailed Meeting Notes:

Director Tanehiko Yamanouchi gave a general introduction and overview of Tokai operations.

Mr. Duffy thanked the Tokai Directors for inviting the DOE-EM delegation to the Tokai plant.

T. Tsuboya presented information describing the status of the R&D activities on HLLW and TRU waste. Information relating to the Organization of PNC including staff and budget is given on page 2 and 3 of the booklet for the Power Reactor and Nuclear Fuel Development Corporation, PNC. The 1989 PNC budget is $2,3 \times 10^{11}$ yen or 1.8×10^9 dollars with a 1989 staff of 2800. Activities discussed were uranium enrichment, reprocessing, plutonium fuel, and waste management.

Uranium Enrichment:

Uranium Enrichment method consisted of gas centrifuge enrichment where UF_6 gas containing U-234 and U-238 is centrifuged. The gas centrifuge has shown to be more efficient. Presently the Japan Nuclear Fuel Industries is constructing a plant that will have a capacity of 1,500 tons SWU per year. For more information see page 9 of the PNC booklet.

Reprocessing Technology:

Reprocessing technology to recover uranium and plutonium from spent fuel are being investigated at its Tokai Reprocessing Plant. This plant opened in 1977 and has reprocessed 392 tons of spent fuel, this includes 5.2 tons of MOX fuel from ATR Fugen. Note they had initial problems with the acid recovery evaporator and dissolvers. The short-term goal is to operate the plant on a 90-ton per year basis to recover plutonium for FBR Monju, which is scheduled to reach criticality in 1992. The flow diagram of the LWR Spent Fuel Reprocessing is given on page 11.

Plutonium Fuel Production:

The production of plutonium fuel for new reactors such as the ATR and FBR is produced by combining the plutonium with uranium to form a mixed oxide (MOX) fuel. The MOX fuel is produced by mixing the nitrates of plutonium and uranium and converting to the oxide by using microwave-heating to decompose the mixed uranium and plutonium nitrate to a mixed uranium and plutonium oxide. This system is automated and went into operation at the Tokai Plutonium Conversion Development Facility with a daily co-conversion capacity of 10kg MOX. PNC has fabricated more than 100 tons of MOX fuel and more than 40,000 fuel rods have been successfully irradiated as of March 1989. At the Tokai Plutonium Fuel Production Facility they have the capacity of 5 tons of MOX fuel per year and another line is now under construction that will supply 40 tons of MOX fuel per year. Flow diagram of the process is on page 13.

Waste Management:

Waste Management activities are described on page 14 of the PNC booklet. Briefly, they consist of research and development in vitrification using the liquid-fed ceramic melter; processing of TRU waste by incineration, melting the ash with microwave, and melt metal waste by electro slag remelting; and conducting extensive research and development related to long-term management of high-level radioactive waste.

HLLW and TRU:

T. Tsuboya indicated that he gave an extensive presentation to Larry Harmon and thus gave a brief presentation of the R&D activities on HLLW and TRU. Title of the presentation is Present Status of R&D activities on HLLW and TRU Waste conditioning in Tokai Works. Material presented was: R&D in the areas of Vitrification by LFCM and HLLW; Nuclide separation from low level liquid waste and decomposition and nuclide separation from spent solvent for TRU waste; Demonstration phases of Pu-Contaminated Waste Treatment Facility, Bituminization Demonstration Facility and Solvent Waste Treatment Facility.

Vitrification:

In the area of Vitrification a flow diagram was included in the presentation; it is important to note that this process includes glass fiber addition. The delegation noted during the tour of the vitrification facility that the facility was nearly identical in design to the Savannah River Defense Waste Processing Facility (DWPF) but approximately 20-30% larger. The Tokai vitrification facility is 1 to 2 years behind the DWPF plant. Interior stainless steel walls were not finished in the same manner as the DWPF plant.

LL Liquid Waste Treatment:

In the area of Low Level Liquid Waste Treatment silver nitrate and sodium sulfite are added to the low level liquid waste. The silver precipitates the iodide ions present, the silver iodide is removed via ultra filtration. Sodium hydroxide and ferric nitrate are then added to the supernatant and plutonium, uranium and the fission products are precipitated and removed via ultra filtration. Ion exchange is used to remove the cesium and strontium ions. Sodium is removed by evaporation and the liquid is released to the sea. The Spent Solvent Oxidative Decomposition Process consists of oxidizing the solvent with hydrogen peroxide in the presence of a copper (II) oxide catalyst producing carbon dioxide, water, and calcium hydrogenphosphate. Lanthanum (III) is then added to precipitate the plutonium phosphate.

Waste Treatment Facilities (PWTF and LWTF):

Y. Asakura, presented "Present Status of Waste Treatment Facilities in Tokai Works". This presentation basically covered the Pu-Contaminated Waste Treatment Facility (PWTF) and the Low Level Waste Treatment Facility (LWTF). The PWTF uses conventional incineration for metals, HEPA filters and cellulose. The ash is melted and converted to ceramics and the metals are melted and converted to an ingot. The PVC chloroprene is shredded, followed by cyclone incineration or acid digestion; the ash is melted and converted to ceramics. A flow diagram is included in the presentation. In the WTF for solids the combustibles are incinerated by open incineration, the Cl containing materials are incinerated by closed incineration, HCL is collected, the ash is melted and converted to ceramics. The non-combustibles are cut, decontaminated and melted into ingots or pressure compacted. The low level liquid waste undergoes ultrafiltration, absorption, and is solidified. The flow diagram for these processes is also included in Asakura's presentation.

Pu Monitoring in Surface Waters:

Y. Kishimoto reviewed the Present Status of Other Activities on Nuclear Fuel Cycle in Tokai Works. He identified the sampling and monitoring points off site, the sampling points for surface water and sediment, and the analysis and measurement methods they are using. Included in his presentation was the concentration of Pu-239 and 240 in sea sediments off shore of Tokai-mura.

The Plant Tour from 10:00 to 12:00 consisted of the Tokai Vitrification Facility, the Engineering Demonstration Facility-III, the Engineering Test Facility and the Chemical Processing Facility. From 1:30 to 2:30 pm the delegation was given a plant tour of the PWTF (Pu-contaminated Waste Treatment Facility) by Y. Asakura.

Meeting with PNC, Oarai Engineering Center:

Address:

**POWER REACTOR & NUCLEAR FUEL DEVELOPMENT CORPORATION
OARAI ENGINEERING CENTER
4002, NARITA
OARAI, IBARAKI, JAPAN
PHONE: (0292)67-4141**

Role of PNC:

Plays a central role in developing fuel cycle technologies and fast breeder reactor and ATR. PNC has developed technologies for prospecting for uranium deposits, refinement and conversion, centrifugal uranium enrichment, spent fuel reprocessing and radioactive waste disposal and is preparing to cooperate with industry for demonstration and utilization of these technologies.

Basically, the mission of OARAI is to conduct research and development of key technologies associated with FBR and ATR power plants. This includes design studies for framing plant systems with safety and economic competitiveness, research and development on base technologies and innovative technologies, research and development using experiences obtained through construction and operation of Joyo, Monju, and Fugen, and research and development on fuel recycling (this includes research in the area of transmutation.)

Participants:

**Mitsuru Kamei
Deputy Director
Technology Development Division**

**Kyoichiro Suzuki
Deputy Director
Oarai Engineering Center**

**Hidehiko Miyao
General Manager
Waste Management Section**

**Hiroki Kanemaru
Manager, Administration Div.
PNC Oarai Engineering Center**

Masao Shiotsuki
Senior Research Engr., Waste Mgmt. Sec.
Oarai Engineering Center

Shigeyoshi Kawamura
Waste Management Section
Oarai Engineering Center

Masahiko Itoh
Research & Devel. Coordination Section
Technology Development Division

Bibliography of Literature Received:

"Development of a Heat Resistant and Angle Beam Type Electro-Magnetic Acoustic Transducer", Compiled by K. Ara, H. Rindo, K. Nakamoto, T. Doi, K. Morimoto, and T. Sakamoto, Oarai Engineering Center, PNC, 5 pages.

"Development of Decommissioning Technologies for Nuclear Fuel Cycle Facility in Waste Dismantling Facility", Oarai Engineering Center, PNC, 18 pages.

"Research and Development in Oarai Engineering Center", Oarai Engineering Center, PNC, 16 pages.

Agenda:

- 1) Arrive Oarai Engineering Center
- 2) Tour Waste Dismantling Facility (WDF).

Detailed Meeting Notes:

Waste Dismantling Facility:

H. Miyao at OARAI presented the activities of the Waste Dismantling Facility. The efforts in decontamination included dry ice blasting (ice-blasting), electro-polishing, and redox processes. In the area of dismantling they were using plasma cutting, robotics, and laser cutting. In the area of monitoring they were using radiation image display through remote measurement.

Decontamination and Decommissioning:

S. Kawamura, discussed the technologies that were needed to decontaminate and decommission a facility. These needed technologies are in the areas of monitoring, radiation control, decontamination, dismantling, remote handling, waste treatment, and system engineering.

For the tour of the facility they distributed ear phones to the DOE contingency. This was extremely helpful for the people standing at the back of the group. Technologies viewed on the tour consisted of ice-blasting, electropolishing, the alpha facility, laser cutting, monitoring, Hot Isostatic Pressure (HIP), robotics, fiber optics, and electromagnetic acoustic sensors.

THURSDAY, November 8

Abstract of Activities for November 8, 1990:

A tour of JAERI Tokai Research Institute facilities included review of safety evaluations of long-term storage and disposal of high-level wastes (with research focusing on confinement ability and durability of materials), reactor decommissioning and actual dismantling activities, the use of robotics, and heat/radiation resistant fiberscopes.

Meeting with JAERI, Tokai-Mura

Address:

**JAPAN ATOMIC ENERGY RESEARCH INSTITUTE
TOKAI RESEARCH ESTABLISHMENT
TOKAI-MURA, IBARAKI-KEN
JAPAN
PHONE: 0292-82-5410**

Role of JAERI:

JAERI is a semi-governmental research organization which implements national long-term programs in nuclear energy, including joint projects and international cooperative efforts.

Research Activities:

- R&D of nuclear energy, nuclear safety, high temperature gas-cooled reactors, nuclear fusion, radiation applications, nuclear powered ships, basic research, decommissioning of nuclear reactors;
- Design construction and operation of reactors;
- Education and training of researchers and engineers in the field of nuclear energy; and
- Dissemination of information obtained through R&D activities.

Participants:

Kakuzo Tomii
Director
Department of JPDR

Satoshi Yanagihara
Senior Engineer
Decommissioning Tech. Lab.

Tsutao Hoshi
General Manager
Reactor Decommissioning Op. Div.

Eiji Shirai
Deputy Director, Department of Research
Reactor Operation

Yoshiki Wadachi
Deputy Director
Department of Env. Safety Research

Susumu Muraoka
Head, Engineered Barrier Materials Laboratory

Bibliography of Literature Received:

"Development of Technologies on Decommissioning of Nuclear Fuel Cycle Technologies," Japan Atomic Energy Research Institute. 5 pages.

"JPDR Decommissioning Program", written by T. Hoshi from the 9th TAG Meeting on October 8-12, 1990 at the Japan Atomic Energy Institute. 10 pages.

"New JRR-3, Compiled by the Research Reactor Operation at the Tokai Research Establishment", Japan Atomic Energy Research Institute. 6 pages.

"Progress Report on Safety Research of High-Level Waste Management for the Period April 1988 to March 1989", Edited by Haruto Nakamura and Susumu Muraoka, Department of Environmental Safety Research, Tokai Research Establishment, Japan Atomic Energy Research Institute, 74 pages.

"Reactor Decommissioning Technology Development and Actual Dismantling of JPDR," compiled by the Tokai Research Establishment, Japan Atomic Energy Research Institute. 9 pages.

"Safety Studies on Glass Waste Form", written by S. Muraoka at Japan Atomic Energy Research Institute. 10 pages.

"Summary of WASTEF Facility", from Japan Atomic Energy Research Institute. 10 pages.

"Volatilization of Cesium from Nuclear Waste in a Canister", Hiroshi Kamizono, Shizuo Kikkawa, Shingo Tashiro and Haruto Nakamura. at Japan Atomic Energy Research Institute. Department of Environmental Safety Research, 6 pages.

Agenda:

- 1) Visit JAERI Tokai Research Facility.
- 2) Tour of JRR-3 (Japan Research Reactor No. 3).
- 3) Tour of Japan Power Demonstration Reactor-BWR TYPE (JPDR).
-R&D for decommissioning technology.
- 4) Tour of Waste Safety Testing Facility (WASTEF).
-Glass solidification technology for high-level radioactive wastes management.

Detailed Meeting Notes:

Decommissioning of JPDR:

The delegation was given a short overview of the JPDR decommissioning program which is continuing through Jim Fiore and Bill Murphie (EM40). Mr. Hoshi is responsible for

decommissioning of the JPDR. The program started in 1981. The first phase completed in 1986 involved technology development for cutting and disassembly and waste management. Phase II involving actual decommissioning started in 1986. Equipment surrounding the reactor vessel was removed by 1989. Reactor internals were removed by 1989 and the pressure vessel was projected for removal in 1990. Removal of the biological shield concrete is projected by 1992 and site restoration should be completed in 1993. Mr. Duffy asked where the materials were being stored. All materials are being stored on site at Tokai.

Concrete Disposal:

Two thousand tons of concrete are proposed to be stored in shallow land burial sites. The Japanese are exploring ways to reuse minimally contaminated concrete.

Dismantling:

All dismantling of the biological shield is remote. Dose levels for workers in the U.S. and Japan is 5Rem in special cases. Plasma arc cutting is conducted underwater to prevent release of fumes. Shaped explosives are used to minimize air contamination. A central vacuum system is used to remove dust from cutting and blasting operations. The arc cutter system has been adopted from the U.S. The U.S. typically uses a vacuum system at the cutter head in addition to the central vacuum system with appropriate in line filters.

Studies of Activated Metals:

Studies of steel are being conducted to determine the extent of corrosion and to evaluate "cracking" and embrittlement, particularly in weldment materials.

FRIDAY, November 9

Abstract of Activities for November 9, 1990:

The delegation visited the JAERI Radiation Chemistry Research Establishment in Takasaki where presentations focused on research initiatives related to the practical application of nuclear energy (e.g., irradiation of food products to prevent spoilage). Of particular interest were studies on uranium extraction from seawater. The development of a new accelerator lab will depend heavily on the ability to attract foreign scientists committed to live with their families at the site in a foreign-scientist community development.

The delegation then traveled to Tokyo for a final meeting with PNC. A record of meeting was signed, and the delegation agreed that Dr. Donald H. Alexander would be assigned the lead for working with the Japanese to formalize cooperative R&D initiatives. The PNC close-out discussion focused on R&D initiatives of particular interest to the U.S. including:

- Application of Japanese decontamination and decommissioning techniques.
- Waste vitrification.
- Fiber-optics.
- Extension of studies of uranium extraction from seawater to contaminated groundwater.
- Robotics.
- Development of a "profile system" for tracking developments in international waste-management R&D initiatives.
- Exchange of scientists and students.

Meeting with JAERI Takasaki Radiation Chemistry Research Establishment:

Address:

**TAKASAKI RADIATION CHEMISTRY RESEARCH ESTABLISHMENT
JAPAN ATOMIC ENERGY RESEARCH INSTITUTE
1233 WATANUKI-MACHI, TAKASAKI
GUNMA, 370-12, JAPAN
PHONE: 0273-46-1211**

Role of JAERI:

JAERI is a quasi-governmental research organization which implements national long-term programs in nuclear energy, including joint projects and international cooperative efforts.

Research Activities:

- R&D of nuclear energy, nuclear safety, high temperature gas-cooled reactors, nuclear fusion, radiation applications, nuclear powered ships, basic research, decommissioning of nuclear reactors;
- Design construction and operation of reactors;
- Education and training of researchers and engineers in the field of nuclear energy; and
- Dissemination of information obtained through R&D activities.

Participants:

**Sueo Machi
Director General**

**Waichiro Kawakami
Deputy Director
Department of Development**

Shoichi Sato
Director, Department of Research

Isao Ishigaki
General Manager
Radiation Processing Devel. Laboratory
Department of Development

Bibliography of Literature Received:

"Amidoxime-Group-Containing Adsorbents for Metal Ions Synthesized by Radiation-Induced Grafting", Written by J. Okamoto, T. Sugo, A. Katakai and H. Omichi. JAERI, Takasaki Radiation Chemistry Research Establishment, 11 pages.

"A New Type of Amidoxime-Group-Containing Adsorbent for the Recovery of Uranium from Seawater", Written by H. Omichi, A. Katakai, T. Sugo and J. Okamoto. JAERI, Takasaki Radiation Chemistry Research Establishment. 6 pages.

Agenda:

- 1) Tour Takasaki Radiation Chemistry Research Establishment.

Detailed Meeting Notes:

Activities at RCRE are centered upon the use of Co-60 and electron beam irradiation facilities; principal activities are the 1) synthesis and modification of polymers for industrial and medical applications, 2) environmental protection, and 3) development of materials for nuclear/space applications.

Industrial Applications:

The most interesting recent development is the irradiation of a chelating membrane (5 micron thickness), which has been used to absorb uranium from sea water (2 gr U/Kg in 20 days). Uranium is desorbed from the membranes at ~pH 2. Dr. Alexander suggested that the use of polyethylene beads may be more efficient for certain applications. He noted that polyethylene beads have been used as tracers and have been pumped through groundwater systems. We discussed the potential use of micron-sized U-adsorbent beads to remediate uranium-and heavy element-contaminated ground water through vertical/horizontal wells. Adsorbant micro-spheres are being developed at MITI, Osaka. Other industrial applications included the development of new slow-release drugs, vulcanization of latex (which leads to less incineration residue and SO² emissions), and curing of various coating materials.

Environmental Applications:

RCRE has developed technologies for the treatment of flue gases, municipal wastewater and sewage sludge. The latter two applications, although effective, have also met resistance in Japan. RCRE is evaluating electron beam irradiation of flue gases (SO² and NO^x) in the presence of ammonia. The resulting ammonium nitrate/sulfate solids can then be removed by an electrostatic precipitator.

Nuclear/Space Applications:

Irradiation of materials that are used for nuclear and space applications is performed at RCRE. This includes wire, cable, and insulating materials.

Scientific Exchange:

EM programs should consider scientific exchange with JAERI-Takasaki. STA offers scholarships for studies at these facilities. Irradiation of chelating membranes for adsorption of actinides, such as uranium or adsorption of organics such as trichloroethylene could be critical to meeting EM objectives.

Meeting with PNC, Tokyo

Address:

**POWER REACTOR & NUCLEAR FUEL DEVELOPMENT CORPORATION (PNC)
9-13, 1-CHOME, AKASAKA
MINATO-KU, TOKYO, 107 JAPAN**

Participants:

**Takao Ishiwatari
President**

**Yoshikazu Hashimoto
Executive Director**

**Masao Yamamoto
Deputy Senior Director**

**Saburo Kikuchi
Secretary to the President**

**Kiyoshi Kikuchi
Ing. Geologue, Department des Ressources Nucleaires**

Tadashi Mano
General Manager
Conditioning Research Program
Radioactive Waste Management Project

Takashi Yoshikawa
Manager, International Cooperation Office
International Division

Reiko Nunome
International Cooperation Office
International Division

Akira Wadamoto
Engineer, Conditioning Research Program
Radioactive Waste Management Project

Bibliography of Literature Received:

"FBR Development in PNC for Commercialization", PNC, 8 pages.

"Technical Draft for Comments RD&D Program on Low-Level TRU Bearing Waste Management Technologies", PNC, 43 pages.

Agenda:

***Meeting with PNC President.**

Detailed Meeting Notes:

DOE and PNC agreed that several workshops would be arranged over the coming months to focus on areas of joint technical interest in preparation for the Bilateral Coordination Meeting in the spring of 1991. DOE appointed Dr. Donald Alexander as the DOE-EM coordinator. PNC appointed Mr. Takao Yagi as PNC-EM coordinator.

The workshops will provide reports recommending areas of technical collaboration to the DOE-EM/PNC Coordinating Committee in the Spring of 1991. The U.S. delegation identified several technical areas for continued collaboration in the November 9th meeting with PNC including decontamination and decommissioning, vitrification and TRU handling, treatment and disposal.

Areas of particular interest to the delegation which will be considered for future collaboration with PNC include:

1. the use of the plasma-arc saw for dismantling reactor vessels and related contaminated structures;
2. smelting of slightly contaminated ferrous metals for recycling;
3. methods for removal of contaminated concrete;
4. methods for reusing slightly contaminated concrete;
5. methods of waste reduction and minimization;
6. partitioning and transmutation;
7. robotics;

Areas of particular interest to the delegation which will be considered for future collaboration with MITI, JAERI and Kyoto University include:

1. methods for the removal of uranium from seawater;
2. applications of fiber-optics and lasers for in situ analysis of groundwater;
3. methods for the removal of organics such as trichloroethylene;
4. simulation modeling of groundwater contaminant migration;
5. research on actinide chemistry;
6. methods of underground characterization;
7. inorganic microencapsulated adsorbents;
8. optical microsensors for gases; and,
9. gold-metal oxide catalysts for sensor applications.

RECORD OF MEETING
BETWEEN
THE UNITED STATES DEPARTMENT OF ENERGY
AND
THE POWER REACTOR AND NUCLEAR FUEL DEVELOPMENT CORPORATION
OF JAPAN
IN THE RADIOACTIVE WASTE MANAGEMENT
NOVEMBER 9, 1990
TOKYO

In accordance with the terms of the Agreement between the United States (U.S.) Department of Energy (DOE) and the Power Reactor and Nuclear Fuel Development Corporation of Japan (PNC) in the Area of Radioactive Waste Management, representatives of the two organizations met in Tokyo on November 9, 1990.

A technical delegation led by Mr. Leo Duffy, Director, Office of Environmental Restoration and Waste Management (EM), Department of Energy (DOE), met with officers and staff of the Power Reactor and Nuclear Fuel Development Corporation of Japan (PNC), to discuss potential areas of possible technology exchange during 1991. The wrap-up meeting was convened after participants completed tours of PNC sites and facilities.

Mr. Ishiwatari, President, PNC welcomed Mr. Duffy and the U.S. delegation provided a brief overview of the status of PNC waste management activities. He encouraged continued technology exchanges.

Mr. Duffy thanked PNC for their hospitality and efforts in making the arrangements to visit PNC sites and facilities. He provided a brief overview of the status of the DOE-EM program and underscored his continued desire to pursue exchanges of technology.

DOE and PNC agreed that several workshops would be arranged over the coming months to focus on areas of joint technical interest in preparation for the Bilateral Coordination Meeting in the spring of 1991. DOE appointed Dr. Donald Alexander as the DOE-EM coordinator. PNC appointed Mr. Takao Yagi as PNC-EM coordinator.

Dr. Alexander and Mr. Yagi will meet in Washington, D.C. in December 1990, to define workshops in common areas of interest.

9 Nov 1990

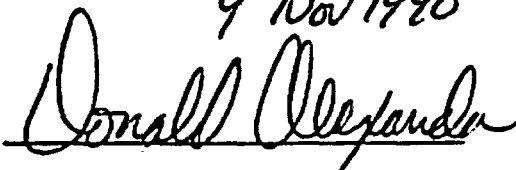

Dr. Donald Alexander, DOE

9, Nov. 1990



Mr. Kiyoshi KIKUCHI, PNC

SATURDAY, November 10

Abstract of Activities for November 10, 1990:

A meeting was held with Professor Higashi of the Kyoto University, where the delegation discussed actions taken by the DOE under the "Ten-Point Plan" and the development and implementation of the DOE's program for environmental restoration, waste management and related R&D under the "Five-Year Plan". Professor Higashi expressed great interest in the status of the U.S. high level waste repository program and in the concept of a student exchange. The University Staff expressed interest in pursuing opportunities for joint R&D projects related to neptunium chemistry.

Meeting at Kyoto University:

Address:

**KYOTO UNIVERSITY
DEPARTMENT OF NUCLEAR ENGINEERING
YOSHIDA, SAKYO-KU
KYOTO 606, JAPAN
TEL 075-753-5831**

Participants:

**Kunio Higashi
Professor**

**Hirotake Moriyama
Associate Professor**

**Kazukuni Shimoura
Associate Professor**

**Tetsuji Yamaguchi
Faculty of Engineering**

**M. I. Pratopo
Faculty of Engineering**

**Ichizou Kokaji
Chief of Reprocessing Section**

Agenda:

- 1) Meeting with Professor Higashi, Kyoto University.
- 2) Discussed following topics:
 - Yucca Mountain Project Overview
 - High Level Repository Siting
 - Treatment of Slightly Contaminated Soils

Detailed Meeting Notes:

Site Characterization and Remediation

Professor Higashi introduced faculty members and students. Mr. Duffy gave an overall presentation on the EM program and emphasized technology needs. Mr. Duffy invited Dr. Alexander to give a brief overview of performance assessment and site characterization activities at Yucca Mountain. Following the Yucca Mountain presentation, the participants discussed the three issues raised by Dr. Higashi:

- 1) A brief explanation on the present status of Yucca Mountain Project (Conceptual Design of the repository, and related matters).
- 2) Permanent disposal of HLW.
- 3) Treatment of soils which are slightly contaminated with metal oxides.

Neptunium Chemistry:

Dr. Alexander opened discussion on the Kyoto University research in neptunium chemistry. Several new compounds which raise the solubility limit of neptunium in groundwater were mentioned. This information could have a significant impact on transport calculations for neptunium in groundwaters. Copies of recent publications are being acquired.

MONDAY, November 12, 1990
Ascension Day

TUESDAY, November 13, 1990

Abstract of Activities for November 13, 1990:

The delegation visited the PNC Chubu Works where presentations were provided on R&D activities conducted at the Tono Uranium Mine to support the development of geologic disposal technologies. Activities reviewed included the performance of engineered barriers and corrosion testing; geochemical investigations of groundwater; and the development and validation of migration models of radionuclides. PNC representatives noted strong public opposition to the development of a geologic repository in the area.

Meeting with PNC, Chubu Works:

Address:

**CHUBU WORKS
POWER REACTOR AND NUCLEAR FUEL
DEVELOPMENT CORPORATION
OFFICE 959-31, SONODO, JYORINJI
TOKISHI, GIFUKEN, JAPAN
PHONE: 0572-54-1271**

Role of PNC, Chubu Works:

PNC Chubu Works is developing technical capability to characterize sites for the permanent disposal of CHLW.

Participants:

**Yozo Sugitsue
Director**

**Toshio Tomishige
Deputy Director**

**Toshihiro Seo
Geologist, Waste Isolation Research Section**

Kozo Sugihara
Research Engineer
Waste Isolation Research Section

Shougo Fujita
Manager, General Affairs Section

Bibliography of Literature Received:

"Field Tour Guide for Tono Mine Gallery (Tsukiyoshi Deposit)," PNC Chubu Works, 28 pages.

**"Natural Analogue Study of Tono Sandstone Type Uranium Deposit in Japan,"
Written by C. Sato, Y. Ochiai and S. Takeda. Waste Management and Raw
Materials Division, PNC-Chubu Works, 11 pages.**

**"Natural Analogue Study of Tono Sandstone Type Uranium Deposit in Japan,"
Written by T. Seo, Y. Ochiai, S. Takeda and N. Nakatsuka. PNC-Chubu
6 pages.**

Agenda:

- 1) Tour PNC Chubu Works.**
- 2) Tono Mine Gallery**
Stop 1- Engineered Barrier Materials Field Tests.
Stop 2,3- Hydrogeochemistry of Groundwater.
**Stop 4- Geochemistry of Natural U-Th Series Nuclides Uranium
Mineralization.**
Stop 5- Mine-by Experiments of Excavation Responses.
Stop 6- Shaft Excavation Effect Project Site.
- 3) General Discussions re: Chubu Works Activities.**

Detailed Meeting Notes:

The delegation was welcomed by Chubu Works Director Yozo Sugitsue and Deputy Director Toshio Tomishige. We were told that Tono is a well known area for ceramics. The PNC office at Tono (Chubu Works) was established about 25 years ago with the discovery of uranium. The deposits represent approximately 2/3 of the known Japanese reserves.

Exploration has since shifted overseas and has proven to be more economic, especially in Canada, Australia, Africa and China. Since 1986 Chubu Works has been devoted to R&D.

Chubu Works has 5 sections: 1) administrative; 2) overseas exploration; 3) geologic research; 4) Uranium deposit evaluation; and 5) physics and chemistry technology.

The ore at Tono is 135 meters deep with 7500 meters of developed underground galleries. The stratigraphy consists of sandstone, mudstone, and conglomerates over a granite basement. The ore is covered by marine mudstones and clays.

PNC is conducting a variety of site characterization studies at Tono:

- o natural analogue studies;
- o isotopic disequilibria;
- o excavation response/disturbance studies;
- o corrosion tests (glass and stainless steel)
- o development of a hydrogeologic model; and
- o fault studies.

The fault at Tono is a reverse fault with a displacement of approximately 30 meters and with an age of about 10 million years.

PNC has been conducting regional hydrogeologic studies at Shomasama where they maintain an extensive core library with several 1000 meters of core.

Other important HLW site characterization studies are ongoing in Horonobe tuff.

Engineered Barrier Experiment:

Two stations in the underground facility are devoted to engineered barrier experiments. The first involves the long term evaluation of bentonite backfill in a weathered granite block. The principal approach is similar to the U.S. approach of vertical emplacement of the waste packages in the floors of the drifts. However, since the Japanese site is expected to be saturated, bentonite blocks would be emplaced around the container. The objective of the first station is to examine the durability and behavior of the barriers under field conditions and develop methods for monitoring and performance evaluation. The second station is designed to examine a range of barrier materials including glass, copper, bentonite, stainless steel and bentonite blocks. Experiments include waste glass leaching (heating test), overpack

materials corrosion test (heating test), and monitoring the migration of groundwater contaminants.

Nuclide Migration Tests:

The nuclide migration test is designed to examine uranium migration (and uranium series nuclides) along the Tsukiyoshi fault which has displaced the ore body by 30 meters. Geologic, mineralogic, geochemical, migration and retardation studies are being pursued. Groundwater chemistry tests indicate mixing of surface and deep waters through tritium studies. Uranium phases include andersonite $(\text{Na}_2\text{Ca}(\text{UO}_2)(\text{CO}_3)_3 \cdot 10\text{H}_2\text{O})$ and zippeite $(\text{K}_4(\text{UO}_2)_6(\text{SO}_4)_3(\text{OH})_{10} \cdot \text{H}_2\text{O})$.

Excavation Response Tests:

Several drifts have been set aside for excavation response testing. Extensive cross hole testing and radial in-wall monitors are used to monitor excavation response. Measurements to date indicate minimal response.

Exploratory Shaft Construction:

An exploratory shaft is being excavated to the testing horizon. A radial set of instrumented boreholes are being used to monitor groundwater drawn down. Performance evaluations, similar to those at the Canadian URL and planned at Yucca Mountain are underway.

WEDNESDAY, November 14

Abstract of Activities for November 14, 1990:

The delegation visited the Government Industrial Research Institute in Osaka. The visit included a review of research on solidification and storage techniques (the research focused on glass vitrification and appeared to have been discontinued); water treatment systems for industrial waste using membrane materials and microorganisms; and pollution detection technologies using high-performance chemical sensors and optical microsensors for gases.

Meeting with MITI/AIST:

Address:

**MITI/AIST
GOVERNMENT INDUSTRIAL RESEARCH INSTITUTE, OSAKA
MIDORIGAOKA 1, IKEDA, OSAKA
PHONE: (0727) 51-8351**

Participants:

T. Komiyama
Director General

Takako Takahashi

Masatake Haruta
Head of Catalysis Section

Teruo Kodama
Director, Research Planning Office

Makoto Kinoshita
Glass and Ceramic Materials Department

Steven N. Crichton
Visiting U.S. Scientist, Glass Science Section
Glass and Ceramic Materials Department

Kunishige Higashi
Senior Researcher

Tetsuhiko Kobayashi
Research Chemist

Yoshiko Nakahara
Director, Material Chemistry Department

Bibliography of Literature Received:

"AIST Summary", AIST, 35 pages.

"Aqua Renaissance '90 Project", National Research and Development Program, MITI, 6 pages.

"Budget, Staff and Scale Information", MITI, 7 pages.

"Fine Structure of Nobel Gold Catalysts Prepared by Coprecipitation", Written by M. Haruta, H. Kageyama, N. Kamijo, T. Kobayashi, and F. Delannay. GIRI-Osaka, 10 pages.

- "40th ISE Meeting -Extended Abstracts", Volume 1, International Society of Electrochemistry, 3 pages.**
- "Glass and Ceramics for the Future", Glass and Ceramic Material Department, GIRI-Osaka. 27 pages.**
- "Gold Catalysts Prepared by Coprecipitation for Low-Temperature Oxidation of Hydrogen and of Carbon Monoxide", Written by M. Haruta, N. Yamada, T. Kobayashi, and S. Iijima. GIRI-Osaka, 9 pages.**
- "Gold Supporting Tin Oxide for Selective Co-Sensing", Written by T. Kobayashi, M. Haruta and H. Sano. GIRI-Osaka, 4 pages.**
- "Methodology for Making R&D Programs of Chemical Sensors", Written by M. Haruta, K. Hiroy, H. Tanigawa, H. Takenaka, S. Yoshikawa and H. Sano. GIRI-Osaka, 28 pages.**
- "New Technology Japan", Vol. 17, No. 2, May 1989, 2 pages.**
- "Outline of Researches", Government Industrial Research Institute, AIST, MITI, 9 pages.**
- "Preparation and Catalytic Properties of Gold Finely Dispersed on Beryllium Oxide", Written by M. Haruta, K. Saika, T. Kobayashi, S. Tsubota and Y. Nakahara. GIRI-Osaka, 4 pages.**
- "Preparation of Highly Dispersed Gold on Titanium and Magnesium Oxide", Written by S. Tsubota, M. Haruta, T. Kobayashi, A. Ueda, Y. Nakahara. GIRI-Osaka, 9 pages.**
- "Proceedings- 9th International Congress on Catalysis", M. Haruta, T. Kobayashi and F. Delannay, GIRI-Osaka, 6 pages.**
- "Proceedings of the 3rd International Meeting on Chemical Sensors", Cosponsored by the Edison Sensor Technology Center, Resource for Biomedical Sensor Technology, Electronics Design Center and Case Western Reserve University. 5 pages.**
- "Research on HLW Management in GIRI-Osaka", GIRI-Osaka, 2 pages.**
- "Selective Co Sensor Using Ti-DOPED Fe_2O_3 with Coprecipitated Ultrafine Particles of Gold". Written by T. Kobayashi, M. Haruta, H. Sano and M. Nakane. GIRI-Osaka, 11 pages.**

Agenda:

- 1) Visit AIST/MITI's Government Industrial Research Institute in Osaka.
- 2) Dr. T. Komiyama outlined the research activities of the institute.
- 3) Dr. M. Kinoshita discussed solidification and storage techniques of high-level nuclear wastes. He also presented the first part of a presentation on the New Water Treatment System (Aqua-Renaissance '90 project).
- 4) Dr. Y. Nakahara gave the second portion of the new water treatment system (Aqua-Renaissance '90 project) detailing micro-organisms. Dr. Nakahara also discussed anti-pollution technology.
- 5) Dr. Masatake Haruta made presentations on the development of new catalysis for sensor technology and micro-encapsulated spheres for the adsorption of contaminants.

Detailed Meeting Notes:

The MITI Government Industrial Institute in Osaka was established in 1918. The Institute is well known for its work on batteries, metal alloys for storage of hydrogen, and development and adaptation of new compounds for optical applications. They have manufactured some large optical lenses (the delegation saw some display) and are conducting optical fiber research.

Perhaps one of the most promising efforts for collaboration with EM involves the efforts of the Glass and Ceramic Materials Department and Materials Chemistry Department to develop a wide range of sensors, adsorbants, and HLW glass waste forms.

GLASS AND CERAMIC MATERIALS DEPARTMENT

Glass and Ceramic Materials Development, Optical Glasses

The institute is developing glasses with high refractive index and low dispersion such as LaK and LaF utilized for lenses in the camera industry. They have succeeded in casting high quality discs 2m in diameter for telescopes with low thermal expansion.

Nuclear Waste Form Glass

Glass is being evaluated as a waste form for high level wastes. Chemical and physical properties, including ionic diffusion, electrical conductivity of the melt, thermal conductivity, volatilization, crystallization and phase separation of waste form glasses have been evaluated for over a decade. They have established glass compositions and melting technology necessary for solidification of waste glass. Basic research continues on phase separation,

nucleation and crystallization, volatilization, diffusion, electrical conductivity, and mixed alkali effect. They have also compared synthetic glass leachability with natural glasses.

Ion Conducting Glass for Sensors

The Institute has been investigating Lithium-ion-conducting glasses for sensor applications. Li enhances conductivity at $0.3 \text{ Li}_2\text{O} \cdot 0.3 \text{ B}_2\text{O}_3 \cdot 0.4 \text{ Li}_2\text{SO}_4$.

Porous Glass for Biochemical Catalysis and Bioreaction

Porous glasses have been successfully developed for biochemical catalysis as carriers of enzymes. Enzymes thus immobilized by adsorption on the porous glasses maintain high activity for a long period and may be used repeatedly.

The EM application may be the delivery of porous enzyme bearing glass beads (inorganic microcapsules) to the underground bioreactor zone. (Alexander)

New Water Treatment System (Aqua-Renaissance '90 Project)

The Institute is developing a series of membranes for water purification. The project is coordinated with MITI-Mito. For details see materials from Tuesday November 6, 1990.

MATERIAL CHEMISTRY DEPARTMENT

Chemical and Bio Sensor Technology

The Institute sponsors state-of-the-art research in sensor technology as the references attest. Emphasis is placed on the development of catalysts with an emphasis on gold plated metal oxides. The Institute is developing sensors for chemical detection in gas and liquids and enzyme immuno sensors. They have worked on multiple layer sensors. They are also working jointly with Belgium to develop sensors to detect gases such as CO.

Catalysts for Gas Detection

Preparation of well defined metal compound catalysts is attempted by using homodisperse fine particles as a building block and by applying modern thin film techniques. Catalysts are characterized using EXAFS, XPS, and IR. The work is focused on the catalytic behavior of ultrafine gold particle and their interaction with the support oxides. These materials have widespread application as catalysts for low temperature oxidation of CO and as sensors for flammable gases. This technology is applicable to Hanford tank characterization.

Inorganic Shell Microcapsules

The Institute is developing inorganic porous spheres and inorganic-shell microcapsules for adsorption of contaminants. The chemical and physical properties governing adsorption can

be selectively controlled by preparation conditions. These microcapsules could have wide application for restoration activities.

Glass Composite Membranes

Containment of microbes in the reactor and reuse of the filtered water by separating microbes and pollutants from waste water is being researched. Glass and glass-ceramic membranes are being evaluated. A range of membranes are being selected for each reactor type.

Meeting with Kobe Steel:

Address:

**KOBE STEEL, LTD.
TEKKO BLDG.
8.2, MARUNOUCHI 1-CHOME
CHIYODA-KU, TOKYO, 100 JAPAN
PHONE: TOKYO (03) 218-6733**

Participants:

**Yoshimasa Yamamoto
Chief Manager, Sales & Marketing
Nuclear Engineering and Equipment Department**

Detailed Meeting Notes:

Waste Management, Incineration, Ash Melting, and Crud-Slurry Solidification

Kobe Steel provides technological support to PNC. Although we did not have a formal meeting scheduled, we met with Mr. Yamamoto who provided the delegation with information on their capabilities. They are involved in the management of alpha contaminated wastes, incineration and ash melting for plutonium-contaminated combustible wastes, and crud-slurry solidification systems. They have a U.S. Patent (4330698 My 18, 1982) on their Microwave Melter.

LEO P. DUFFY'S PRESENTATION

THE PROGRAM OF THE UNITED STATES DEPARTMENT OF ENERGY
ON ENVIRONMENTAL RESTORATION AND WASTE MANAGEMENT

LEO P. DUFFY
DIRECTOR, OFFICE OF ENVIRONMENTAL RESTORATION AND WASTE MANAGEMENT
U.S. DEPARTMENT OF ENERGY

VISIT TO JAPAN
NOVEMBER 1990

THE PROGRAM OF THE UNITED STATES DEPARTMENT OF ENERGY
ON ENVIRONMENTAL RESTORATION AND WASTE MANAGEMENT

INTRODUCTION

The Department of Energy (DOE) sponsors energy research and development in the United States and is ultimately responsible for the disposal of nuclear and hazardous waste from its operations as well as commercial spent reactor fuel. The DOE's role has evolved over the last forty years from one of almost total control over nuclear-related activities to a more limited one with additional regulatory oversight, primarily by the Nuclear Regulatory Commission (NRC) and the Environmental Protection Agency (EPA). The original Atomic Energy Commission (AEC) was divided in 1974 into a regulatory function performed by the NRC and a research and operations function provided by the Energy Research and Development Administration (ERDA), which was later changed by the Congress into the DOE. The DOE collaborates with the EPA on matters dealing with the environmental restoration of DOE sites and the disposal of nuclear and hazardous waste.

In fulfilling its mission, the DOE is responsible for a wide complex of facilities in which radioactive and other hazardous materials are used. These facilities have produced wastes that have led to varying degrees of physical plant and environmental contamination. The DOE facilities (at Hanford, Washington; Idaho Falls, Idaho; Savannah River, South Carolina; and Oak Ridge, Tennessee; and others) have produced a variety of radioactive wastes. In addition to radioactive wastes, the DOE facilities produce hazardous chemical wastes such as heavy metals, organic solvents, and acids. These wastes and mixed wastes, containing both radioactive and hazardous chemical constituents, have only recently received much attention in the United States and have added a new element to the DOE waste management program. Although waste generation has been reduced in recent years and waste handling techniques have been improved, the need remains for continuing safe waste management practices, and for correcting inadequate past practices.

Commercial uranium mining and milling operations, along with processing of radioactive materials in the early years of nuclear development, have left some sites and facilities contaminated. Reactors at the Savannah River, Hanford, and Idaho sites have produced high-level radioactive wastes that are stored locally in underground tanks. Operation of DOE facilities has resulted in the creation of burial grounds, storage facilities, underground tanks and pipes, surface impoundments, treatment facilities, and accumulation areas that have the potential for releasing radionuclides and hazardous chemicals into the environment. The primary contaminants at major DOE sites are summarized in Table 1.

The United States has, since the inception of its nuclear program, managed the bulk of its wastes in a manner considered safe and consistent with the standards and understanding of environmental protection needs at the time. These standards have become more stringent and the old practices were, in some cases, found to be inadequate. Some unsatisfactory disposal practices have occurred in the use of injection wells, drainage trenches, and shallow-land burial sites. Most wastes since these early days are still stored or disposed of safely, but improvements, such as high-level waste vitrification plants now under construction, can add to long-term safety. The high-level wastes resulting from DOE programs, along with a small amount of high-level wastes produced in the reprocessing of commercial spent fuel at West Valley, New York, are safely isolated for the short term. Active programs are under way for vitrifying and disposing of the high-level portion of the wastes which are stored at the Savannah River, Hanford, Idaho, and West Valley sites, and for disposing of the low-level portion of the wastes as a cement-based waste form in engineered vaults.

The environmental restoration work now under way typically involves low levels of contaminants in relatively large volumes of soil, water, or structures. Characterization of the environmental problems created by the early practices used for disposing of the low-level liquid and solid radioactive, transuranic, and hazardous wastes is just beginning. A true measure of contamination has yet to be established and the ongoing characterization of site contamination will continue for some time.

TABLE 1. Primary contaminants at major DOE sites.

<u>SITE</u>	<u>RADIOACTIVE</u>	<u>NON-RADIOACTIVE</u>
FERNALD	Uranium contamination of surface soil and groundwater	Adjacent stream contains PCBs, organic solvents and heavy metals
HANFORD	580,000 m ³ of soil contaminated with U, Pu and fission products 66 tanks of HLW have leaked to surrounding soil Groundwater contaminated with Tc-99, Cs-137, tritium and uranium	Areas contaminated with acids, chemicals and organic solvents
IDAHO	Soil contaminated with Pu	Groundwater contaminated with organic solvents and chromium
LIVERMORE	On-site groundwater and soil contamination with tritium and Ra-226	On-site groundwater and soil contaminated with organic solvents, PCBs and heavy metals
OAK RIDGE	On-site and off-site soils contaminated with U, Tc-99, Np-237 and fission products Off-site public waters contaminated with fission products Groundwater contaminated with Tc-99	Widespread mercury contamination Soils and groundwater contaminated with metals, PCBs and organic solvents
ROCKY FLATS	Groundwater and soil contaminated with U and Pu	Groundwater and soil contaminated with organic solvents, nitrates and heavy metals
SAVANNAH RIVER	Groundwater and soil contaminated with U, Pu, tritium and fission products	Groundwater and soil contaminated with organic solvents, nitrates and metals

The United States Government is committed to effective waste management and correcting past inadequacies at its facilities. In concert with the growing public demands for reducing environmental pollution and correcting environmental problems, the DOE has embarked on a major effort to restore its contaminated sites to satisfactory conditions and to improve the management of wastes currently being generated. DOE's three goals are to reduce risk to human health and the environment, to responsibly manage and minimize the overall cost of the necessary restoration activities, and to complete this cleanup work within 30 years.

DOE'S ORGANIZATION FOR ENVIRONMENTAL RESTORATION AND WASTE MANAGEMENT

To implement this effort, the DOE has established a new Office of Environmental Restoration and Waste Management to consolidate the Department's activities in this area. The new Office, outlined in Figure 2, integrates management, budgets, and technologies for the DOE-wide waste management and cleanup program. It contains three programmatic offices and two support offices.

The Office of Waste Operations has program responsibilities for waste management at all DOE sites. Waste management includes the treatment, storage, and disposal of several types of waste: high-level radioactive wastes; transuranic wastes, including the Waste Isolation Pilot Plant (WIPP); low-level radioactive wastes; chemically hazardous wastes; mixed wastes; and sanitary solid wastes. Waste minimization efforts are managed within this Office, as are corrective activities at waste management facilities.

**FIGURE 2. Office of Environmental Restoration and
Waste Management organization chart.**

The Office of Environmental Restoration has program responsibilities for cleanup of inactive hazardous and radioactive waste sites at all DOE facilities and some non-DOE sites for which DOE has responsibility (e.g., uranium mill tailings sites). Included are remedial actions and decontamination and decommissioning (D&D) along with two ongoing programs, the Uranium Mill Tailings Remedial Action Program (UMTRAP) and the Formerly Utilized Sites Remedial Action Program (FUSRAP). Remedial actions are concerned with all aspects of the assessment and cleanup of inactive but potential release sites. D&D is primarily concerned with the safe caretaking of surplus nuclear facilities until either they are decontaminated for reuse or are completely removed. Excluded from DOE responsibility are sites under the authority of the electric power marketing administrations, the Office of Naval Reactors, and the Office of Fossil Energy.

The Office of Technology Development has program responsibilities for providing new and more effective technologies to meet DOE's goal of regulatory compliance and cleanup. Activities included are research and development of new technologies; demonstration, testing, and evaluation of technologies developed elsewhere; transportation; and educational programs to provide trained staff to maintain the momentum of technology development.

The Office of Planning and Resource Management supports the program offices in budget preparation and accounting and has the responsibility for coordinating the annual update of the DOE Environmental Restoration and Waste Management Plan. The Office of Environmental Quality Assurance and Quality Control performs independent internal oversight to ensure compliance with environmental and safety laws and regulations and to enhance the technical validity and cost effectiveness of programs and projects.

The regulatory oversight of hazardous and radioactive waste management is shared by several organizations. Establishment of overall standards for environmental protection is performed by the EPA, which reports directly to the U.S. President. The EPA's area of responsibility covers non-nuclear as well as nuclear areas. The NRC regulates commercial nuclear activities, long-

term storage and disposal of spent fuel and high-level waste, and (together with the Department of Transportation) transportation of radioactive materials and wastes.

SCOPE OF THE ENVIRONMENTAL RESTORATION AND WASTE MANAGEMENT PROGRAM

The activities of the DOE in the areas of environmental restoration and waste management have been divided into four technical areas for management purposes: (1) Corrective Activities, (2) Environmental Restoration, (3) Waste Operations, and (4) Technology Development. Categories (1) and (3), being similar in nature, are both managed by the DOE Office of Waste Operations.

CORRECTIVE ACTIVITIES

Corrective Activities are those activities necessary to bring active and standby DOE facilities into compliance with local, state, and federal regulations. Because corrective activities must be completed in a timely and effective manner to protect the public health and safety and the environment, these activities will generally be accomplished by the application of existing technologies rather than new technologies that would require significant time for development. Examples of corrective activities are the installation of modern equipment to monitor air and liquid waste streams and replacement of obsolete waste handling and storage equipment.

ENVIRONMENTAL RESTORATION

Past operations connected with DOE nuclear programs have resulted in contamination of a large number of sites and facilities with quantities of radioactive, hazardous, and mixed wastes. Environmental restoration is concerned with assessment and cleanup of such sites and facilities to meet prescribed standards derived from federal and state laws. A listing of typical environmental restoration activities is presented in Table 2.

TABLE 2. Typical environmental restoration activities.

Uranium Mill Tailings Remedial Action Program (UMTRAP)
Formerly Utilized Sites Remedial Action Program (FUSRAP)
Remediate contaminated surface waters
Remediate contaminated underground waters
Remediate contaminated soils
Remediate improper burial grounds
D&D contaminated inactive facilities

Note: Contaminants may include:

- Organics (polychlorinated biphenyls (PCBs), trichloroethylene (TCE), volatile organic compounds (VOCs), pesticides, petroleum products)
- Heavy metals (mercury, barium, beryllium, lead, etc.)
- Radionuclides (including plutonium, thorium, and uranium)
- Chemicals (nitrates, asbestos, acids)

The DOE has two major restoration programs underway. Since 1974, the FUSRAP has been working to restore 30 inactive federal facilities contaminated with radioactive and/or hazardous materials. Nine sites have been completed. The UMTRAP activity has been underway since 1978. The program was established by a federal law to remediate uranium mill tailings resulting from uranium production conducted between the early 1950s and the early 1970s. The program is stabilizing 24 sites. Stabilization has been completed at 5 of these sites.

Contaminated soil cleanup represents a major problem. The soil columns at several of the sites are contaminated with radioactive and hazardous substances resulting from the use of ponds and drainage fields for disposal of

process effluents. Characterization and cleanup of these sites is difficult because of the low concentrations of the contaminants, their variability, and the large volumes of soil involved. The Hanford site, for example, covers an area of 1,450 square kilometers. The near-surface disposal sites on the Hanford Reservation contain 1.1 million cubic meters of solid waste which were buried before segregation of alpha-contaminated waste was required. There are also 32,000 cubic meters of soil contaminated with transuranic radionuclides.

Soils are often excavated and disposed of in secure landfills or processed at the surface to separate the contaminants. A technique (in situ vitrification) to convert soils in place to a vitreous and crystalline mass using electrical current is being developed. The resulting mass significantly lowers the solubility of inorganic contaminants. Such a treatment will also destroy organic hazardous chemicals. Other prospective treatments for organic contaminants include vacuum extraction, chemical oxidation, temporary removal and soil treatment, and bioremediation.

Groundwater contamination arises from leaking tanks, buried waste, and from lagoons previously used for the disposal of liquid wastes. For example, at the Portsmouth uranium enrichment facility, the groundwater has been found to be contaminated with trichloroethylene and polychlorinated biphenyls. If the level of contamination is high and the available technical means are not adequate, interdiction wells can be used to temporarily retard migration. New interdiction techniques under consideration are soil freezing, vitrified barriers underneath the contamination zone, and various forms of grouting and chemical injections to retard migration. It must be recognized, however, that in the case of complex aquifers contaminated with dense, non-aqueous phase liquids, current restoration technologies are probably inadequate.

Decontamination and decommissioning (D&D) of obsolete facilities produces significant amounts of additional radioactive and hazardous waste. D&D needs to rely on techniques to minimize the generation of waste by means of better characterization and selective decontamination using materials that can be recycled. Certain metals such as stainless steel, aluminum, nickel, and lead might be recycled and used for containment and shielding materials in future

construction. The use of robotic manipulators can improve safety by reducing the radiation dose to workers.

WASTE OPERATIONS

Waste Operations include the treatment, storage, and disposal of wastes generated as a result of ongoing operations at active facilities. This includes the programs to build vitrification facilities for high-level wastes at the Savannah River, Hanford, Idaho, and West Valley sites, and the WIPP repository for transuranic wastes. One of the major waste operations objectives is to effectively manage its processes and facilities in a safe and environmentally responsible manner. Current efforts in this area also include such tasks as establishing management controls over nonradioactive wastes, including segregation of waste types and minimizing waste produced in DOE facilities.

Mixed wastes, which contain both hazardous chemicals and radioactive materials, can be reduced by minimizing the use of hazardous materials and identifying non-hazardous substitutes. The mixed wastes that already exist can be treated to separate or destroy the hazardous components. A number of physical and chemical processes are available to treat the waste: electrochemical recovery of metals, leaching, washing, chromatographic separation, evaporation and distillation, and smelting. Reactive metals can be deactivated by controlled chemical reactions, and organic compounds can be destroyed by heat provided by sources such as plasma arc furnaces, glass melters, and even solar energy.

High-level radioactive waste treatment, although well-advanced, can be tailored to address specific problems. Chemical compositions can be adjusted to reduce the volume and the associated disposal cost. Stored calcined high-level waste can be processed into a ceramic or glass to provide more stable forms for geologic disposal.

TECHNOLOGY DEVELOPMENT

Many waste management methods used in the past are no longer adequate. DOE is striving to transcend current environmental restoration and waste management practices and tools, replacing them with more effective and efficient techniques. Where needed capability is not presently available, the Office of Technology Development will seek to develop it. This can occur through applied research and development by its laboratories, through adaptation of technology from other fields, or through development in concert with industry, academic institutions, and the international scientific community. Current environmental restoration must be performed effectively the first time and preclude the need for additional restoration in the future. Waste management must prepare and treat residual materials to produce a minimum volume of physically and chemically stable waste forms. Facility operations must minimize waste generation by eliminating or recycling hazardous materials.

To achieve these improvements, the attention of the scientific and engineering communities is required. The long-term protection of human health and the environment must be assured, and public confidence and respect for the technical community are at stake. The aims of the environmental restoration and waste management programs are to ensure that unacceptable risk of exposure to contamination is eliminated and that there is no lasting adverse impact on the environment resulting from radioactive and hazardous wastes.

ENVIRONMENTAL RESTORATION AND WASTE MANAGEMENT PLAN

The 1992-96 update of the DOE Environmental Restoration and Waste Management Five Year plan has been completed. The plan describes the current state of technology and identifies improvements needed to fulfill DOE's three goals of reducing risk to human health and the environment, decreasing the overall cost of its restoration activities, and completing its cleanup work within 30 years. The technology development part of the plan provides for:

- o development of new technologies and techniques for waste minimization;
- o development of technologies for improved waste treatment and storage;
- o site characterization for environmental restoration using in-situ monitoring, modeling to predict and prevent migration of contaminants, and improved methods for assessing environmental and human health risks;
- o development of large promising, but underdeveloped, new technologies such as robotics, biotechnology, and remote sensing to add new capability and reduce the cost and/or risks of remediation;
- o establishment of an outreach program through schools and universities for educating students in science and waste management; and
- o international technology exchanges to reduce or eliminate duplication of efforts and to assist the international waste management community in solving similar types of problems.

The technology development plan will continue to evolve over time because the field of waste management is dynamic. Technology development will focus on near-term research, development, and application, and it will not constitute basic research. DOE intends to support development of innovative concepts

that are mature enough to begin demonstration within the present 5-year planning horizon. Emphasis will be placed on creativity and the program will have a strong international component.

INTEGRATED DEMONSTRATIONS AND PROGRAMS

Integrated demonstrations and programs will be used as a means to rapidly develop, demonstrate, and transfer needed technology to the environmental restoration and waste operations efforts. The integrated demonstration is the cost-effective mechanism that evaluates the performance of related technologies as part of a complete system in correcting waste management and environmental problems from "cradle-to-grave". An integrated program is similar, but is focused to solve a specific aspect of a problem.

The integrated demonstration involves three major facets: 1) the various steps to solving the problem (e.g., planning, site characterization, waste treatment, waste disposal, site monitoring), 2) development and application of innovative technology solutions, and 3) evaluations relative to performance goals and/or applicable regulatory requirements. Selecting and moving promising technologies from research and development through final evaluation is a continuous process. The transition of technologies into more advanced phases of development requires the establishment of technical and regulatory criteria for ascertaining if and when a developmental project should be advanced. Because development costs increase dramatically as a project progresses to more advanced phases, funds will not be available to support full development of all concepts. Therefore, for technical, regulatory, and cost-related reasons, the number of projects moving forward will be selectively decreased by a filtering process. Technology development will be conducted with programmatic integration at all stages.

The DOE sites themselves are important resources for technology development and will be used for the demonstration and evaluation of new technologies. The three main areas of focus and planned integrated demonstrations in these areas are:

1) groundwater and soils cleanup

- cleanup of organics in saturated soils and groundwater
- cleanup of organics in unsaturated soils and groundwater
- cleanup of plutonium/uranium from contaminated soils

2) waste retrieval and waste processing

- remediation of underground storage tanks
- remediation of buried wastes
- decontamination and decommissioning

3) waste minimization

- uranium manufacturing waste minimization
- non-nuclear waste minimization

WASTE MINIMIZATION

Throughout the DOE environmental restoration and waste management programs, waste minimization will be a key objective. Waste minimization includes volume reduction technology, such as supercompaction, and concentration. However, true waste minimization is the avoidance of the generation of radioactive, hazardous, and mixed wastes before treatment, storage, or disposal. Waste minimization can be attained by various measures, including administrative action, material substitution, recycling, and process changes. Development and demonstration of new processes to avoid the generation of wastes containing radioactive and hazardous constituents will be conducted. Equipment used in waste processing will be designed to clean with nonhazardous substances and/or to yield a nonhazardous product.

While waste minimization will significantly reduce the amount of waste that must be managed, waste generation cannot be altogether eliminated. Generated wastes must be managed more effectively than what was done in the past, which will require new and better ways to treat, store, and dispose of wastes. The

Technology Development Program will seek to develop and demonstrate technologies to provide permanent solutions for generated wastes.

CONCLUSION

In the past, the highest-quality technological efforts have been directed toward other missions than waste management. The Technology Development Program will serve as a catalyst for applying today's technology to unresolved cleanup and waste management problems in ways never before considered, as well as the means for development and demonstration of new and innovative environmental protection technologies. DOE will be providing hundreds of millions of dollars to develop technical expertise through a series of new partnerships between DOE's national laboratories, industry, and universities. Integrated demonstrations will use experts from all sources in a systems approach, including collaboration with other agencies and countries. International technology exchange will be a major activity to help provide a global approach to solving waste management problems.

**The Program of
the United States Department of Energy
on Environmental Restoration and
Waste Management**

Leo P. Duffy

**Director, Office of Environmental Restoration and
Waste Management
U.S. Department of Energy**

**Visit to Japan
November 1990**

Presentation Outline

- **DOE Waste Management Legacy**
- **DOE ER & WM Organization**
- **ER & WM Program Scope**
- **Technology Development Program**

DOE Waste Management Legacy

- **Some past practices are below present standards**
- **Many facilities and sites are contaminated**
- **Environmental restoration needed**
 - **Uranium mill tailings**
 - **Contaminated soils**
 - **Surface and groundwater contamination**
 - **Decommission inactive facilities**
- **Hazardous chemical and mixed wastes included**

DOE ER & WM Goals

- **Reduce risk to human health and environment**
- **Decrease cost of restoration**
- **Complete cleanup in 30 years**

DOE's Organization for Environmental Restoration and Waste Management

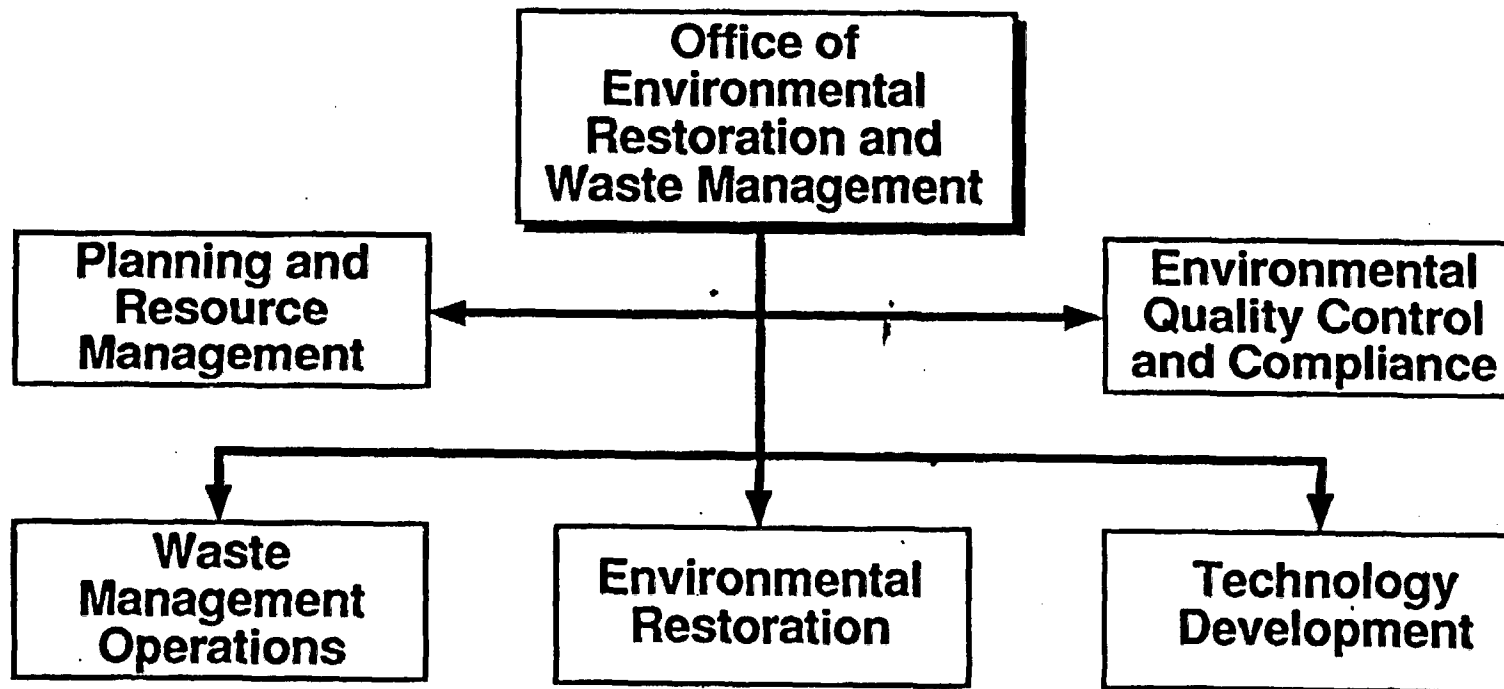

ER & WM Program Scope

- **Corrective activities**
- **Environmental restoration**
- **Waste operations**
- **Technology development**

Technology Development Program

- **Goal is to develop new technologies that are:**
 - **safer, faster, cheaper; better**
 - **while achieving and maintaining compliance**

Objective of the Research, Development, Demonstration, Testing, and Evaluation Program

Rapidly develop, demonstrate, and transfer needed technology to Environmental Restoration and Waste Management Operations for:

- A. Groundwater and soils cleanup**
- B. Waste retrieval and waste processing**
- C. Waste minimization and waste avoidance**

Environmental Restoration Technologies

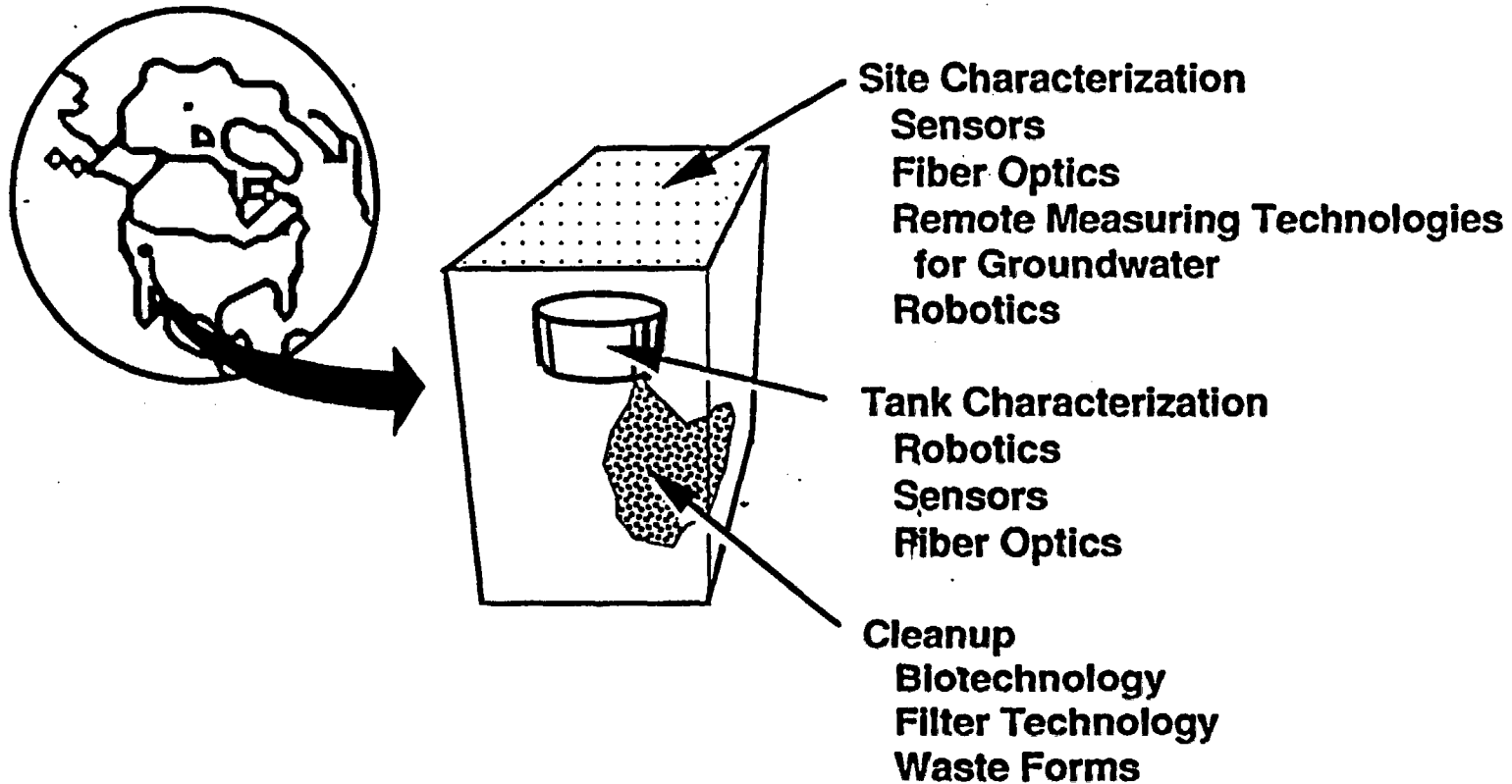

The Research, Development, Demonstration, Testing, and Evaluation Process

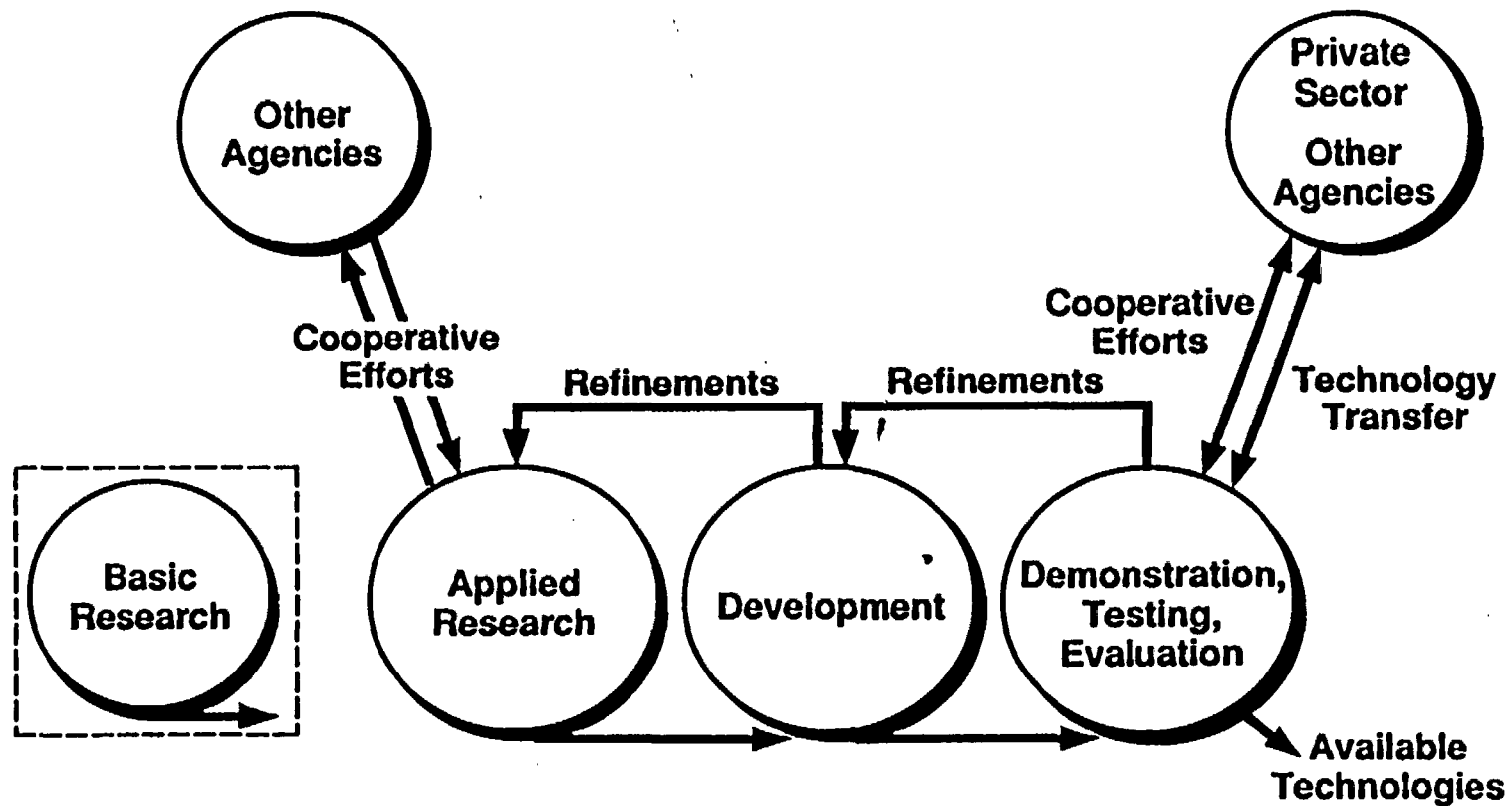

Integrated Demonstration

- **Cost-effective mechanism to evaluate the performance of related technologies as part of a complete system**
- **Components include:**
 - **All steps to solving the problem (planning, site characterization, waste treatment, waste disposal, site monitoring, etc.)**
 - **Development and application of innovative technology solutions**
 - **Evaluations relative to regulatory requirements**

The Three Dimensions of the Integrated Demo

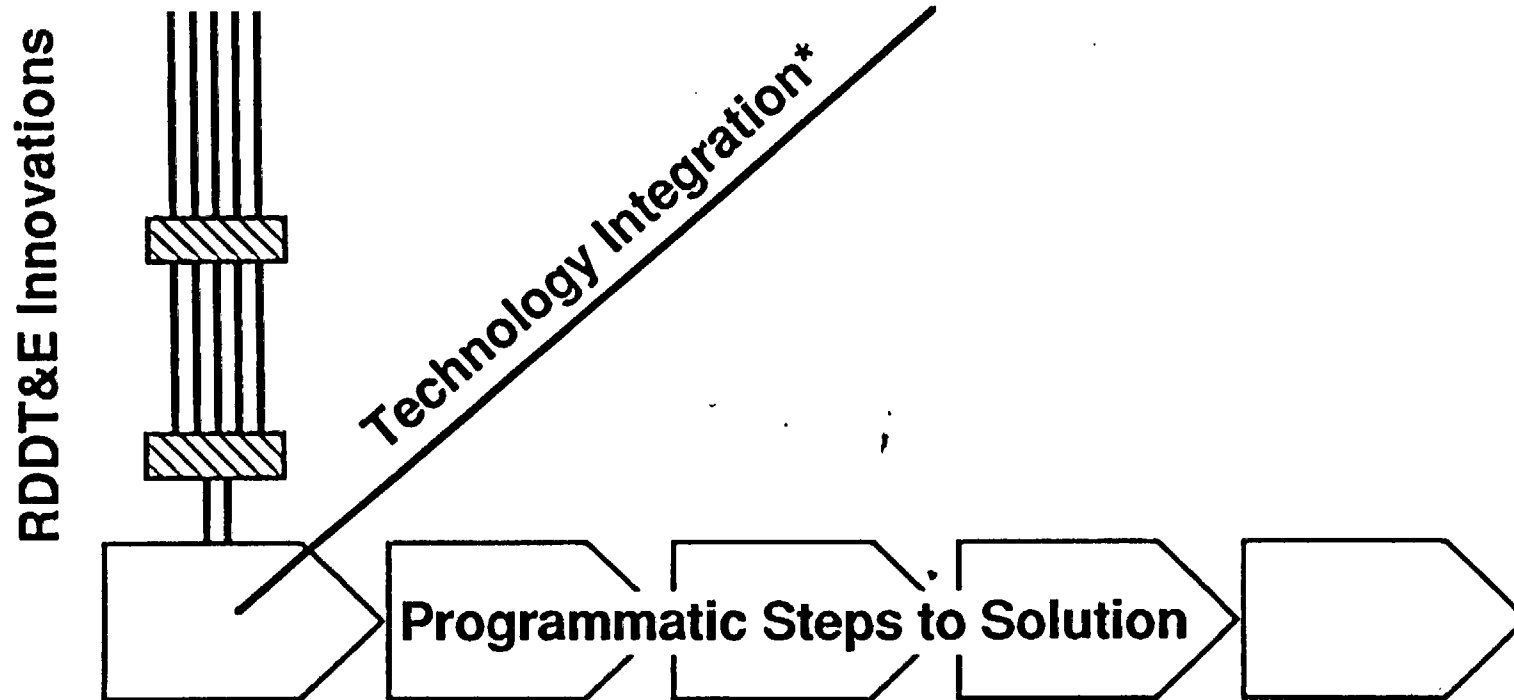

***Including regulatory linkage**

Components of ER Integrated Demonstrations

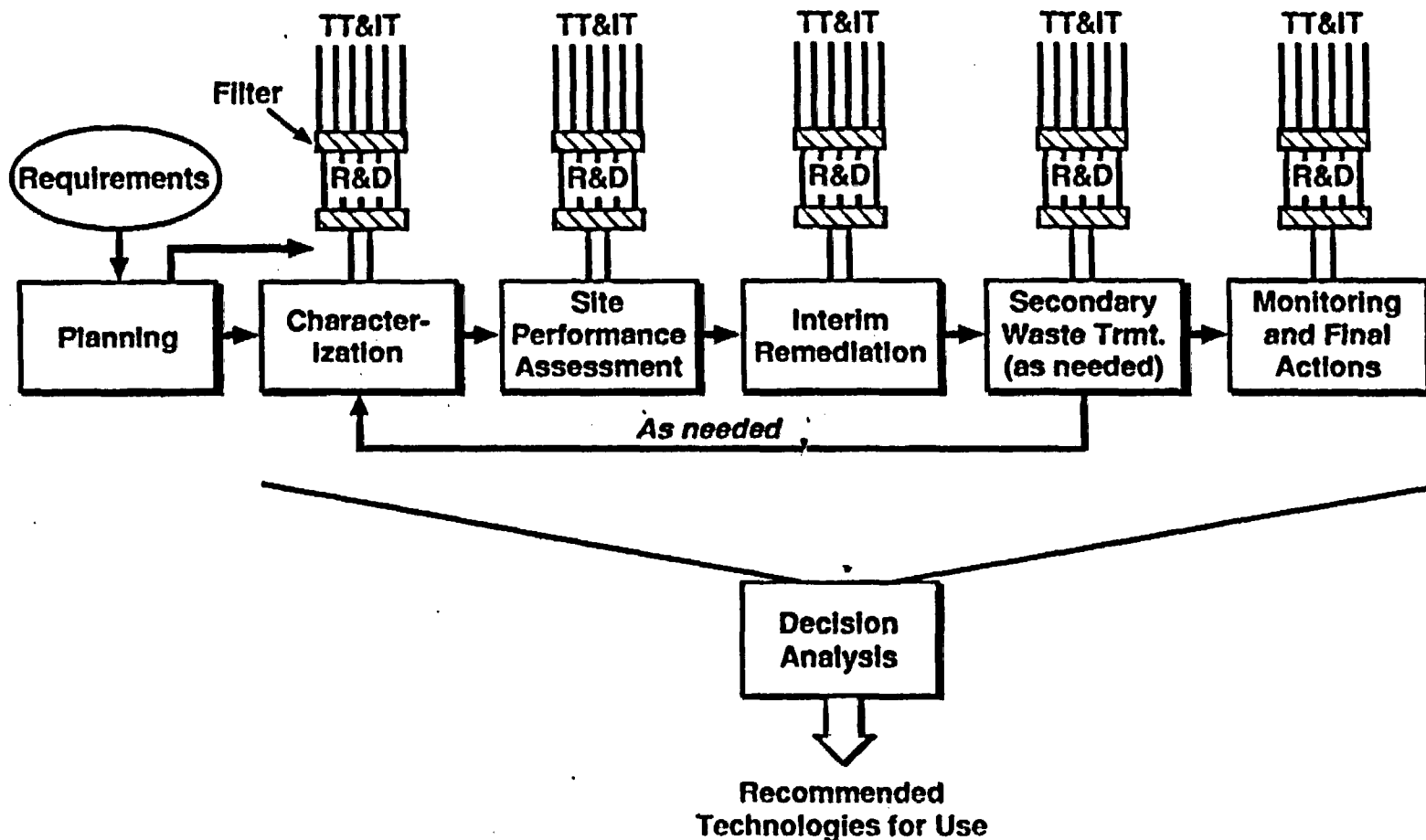

Components of WO Integrated Demonstrations*

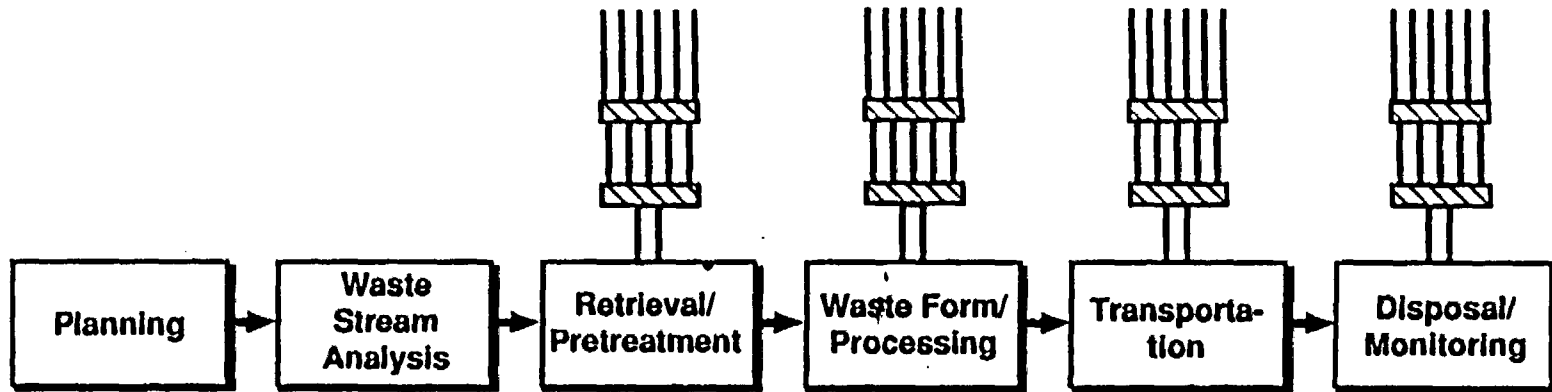

***Like ER, WO integrated demonstrations will have inputs on requirements, include assessment of multiple options, and make recommendations**

WO Integrated Demonstrations

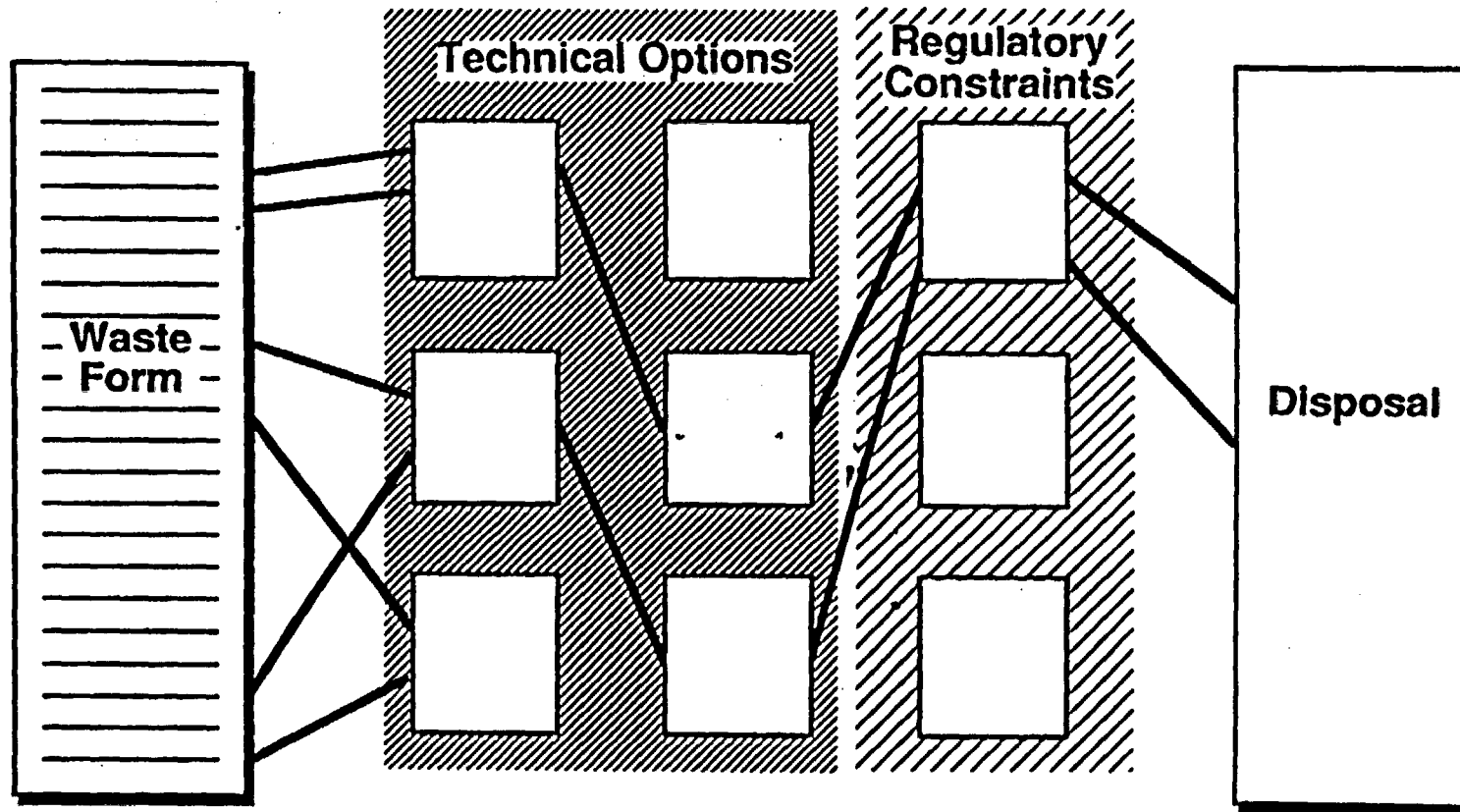

Planned Integrated Demonstrations

- **Groundwater and soils cleanup**
 - Cleanup of organics in saturated soils and groundwater
 - Cleanup of organics in unsaturated soils and groundwater
 - Cleanup of plutonium/uranium contaminated soils
- **Waste retrieval and processing**
 - Remediation of underground storage tanks
 - Remediation of buried wastes
 - Decontamination and decommissioning
- **Waste minimization**
 - Radioactive waste minimization
 - Non-radioactive waste minimization

Waste Minimization

- **Avoidance of waste generation**
 - **Administrative actions**
 - **Material substitutions**
 - **Recycling**
 - **Process changes**
- **Volume reduction**
 - **Supercompaction**
 - **Waste concentration**
 - **Waste processing**

DOE Will Utilize Expertise from All Sources to Solve ER & WM Problems

- **National laboratories**
- **Industry**
- **Universities**
- **International cooperation**

International Technology Exchange

- **Provides global approach to waste management**
- **Transfers innovative technologies**
- **Reduces cost and remediation time**
- **ITE mechanisms include:**
 - **Joint projects**
 - **Exchange of staff**
 - **Exchange of students**
 - **Workshops**
 - **Exchange of documents**

Summary

- **DOE is committed to 30-year goal to clean up sites**
- **DOE established Environmental Restoration and Waste Management Organization**
- **Technologies that are safer, faster, better, and cheaper will be developed**
- **DOE will utilize expertise from all sources**
 - **International technology exchange will be a major activity**

TECHNOLOGIES DISCUSSED AT JAPAN ATOMIC ENERGY RESEARCH INSTITUTE (JAERI)

- High Level Radioactive Waste
- Mineralogical Research
- Leaching and Volatilization of Radionuclides from Glass Waste
- Spectroscopic Method
- Fixation
- Long-Term Reaction Path Modelling
- Plutonium
- Adsorption of Neptunium
- Irradiation of Materials
- Cold Neutron Source
- Reactor Decommissioning Technology Development
- Dismantling
- Decommissioning
- Safety Studies on Glass Waste Form
- Waste Safety Testing Facility
- Volatilization of Cesium from Nuclear Waste Glass in a Canister

BIBLIOGRAPHY OF LITERATURE RECEIVED:

"Development of Technologies on Decommissioning of Nuclear Fuel Cycle Technologies," Japan Atomic Energy Research Institute. 5 pages.

"JPDR Decommissioning Program", written by T. Hoshi from the 9th TAG Meeting on October 8-12, 1990 at the Japan Atomic Energy Institute. 10 pages.

"New JRR-3, Compiled by the Research Reactor Operation at the Tokai Research Establishment", Japan Atomic Energy Research Institute. 6 pages.

"Progress Report on Safety Research of High-Level Waste Management for the Period April 1988 to March 1989", Edited by Haruto Nakamura and Susumu Muraoka, Department of Environmental safety Research, Tokai Research Establishment, Japan Atomic Energy Research Institute, 74 pages.

"Reactor Decommissioning Technology Development and Actual Dismantling of JPDR," compiled by the Tokai Research Establishment, Japan Atomic Energy Research Institute. 9 pages.

"Safety Studies on Glass Waste Form", written by S. Muraoka at Japan Atomic Energy Research Institute. 10 pages.

✓
"Summary of WASTEF Facility", from Japan Atomic Energy Research Institute.
10 pages.

✓
"Volatilization of Cesium from Nuclear Waste in a Canister", Hiroshi Kamizono,
Shizuo Kikkawa, Shingo Tashiro and Haruto Nakamura. at Japan Atomic
Energy Research Institute. Department of Environmental Safety Research, 6 pages.

cc

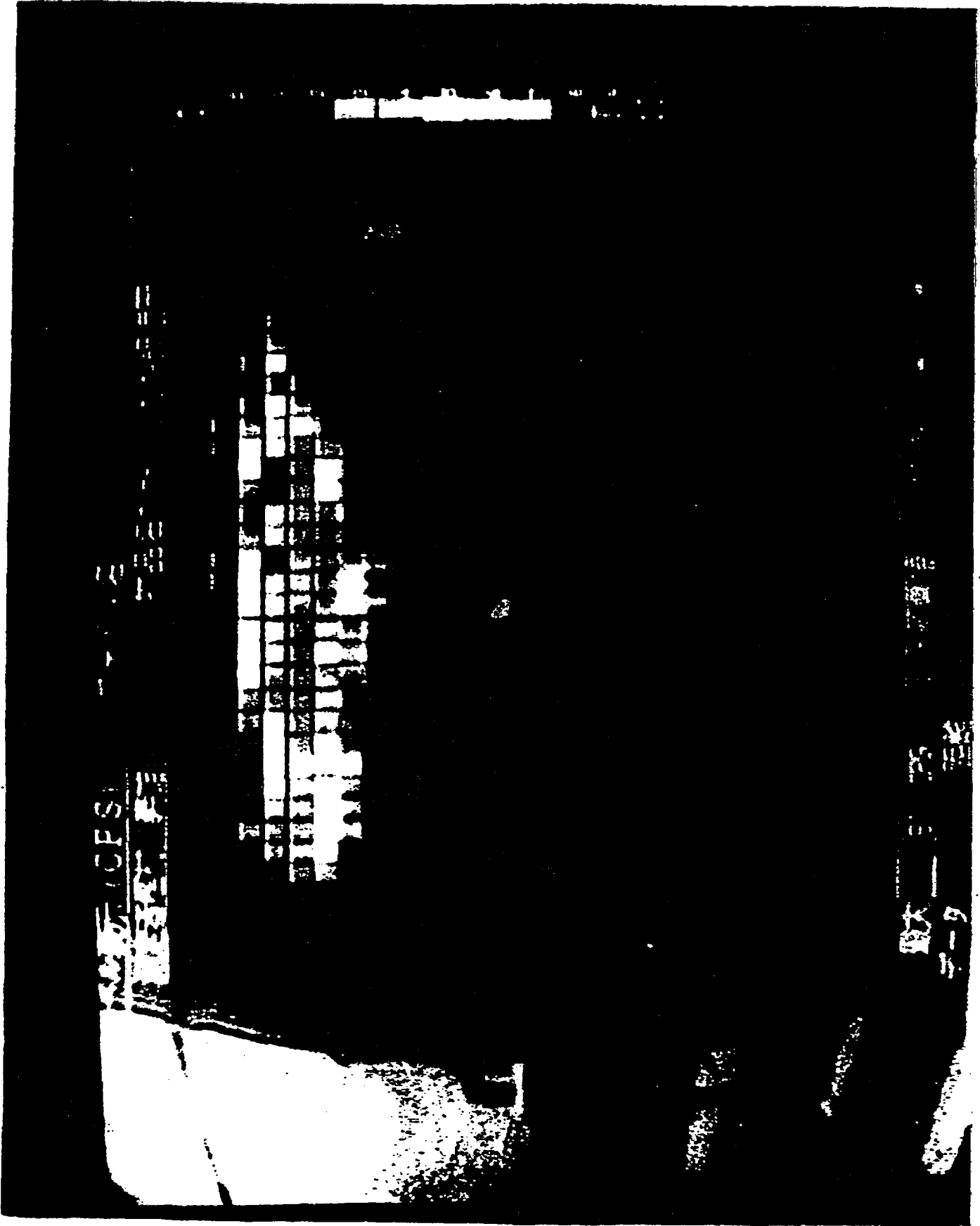

WDF PROCESS FLOW

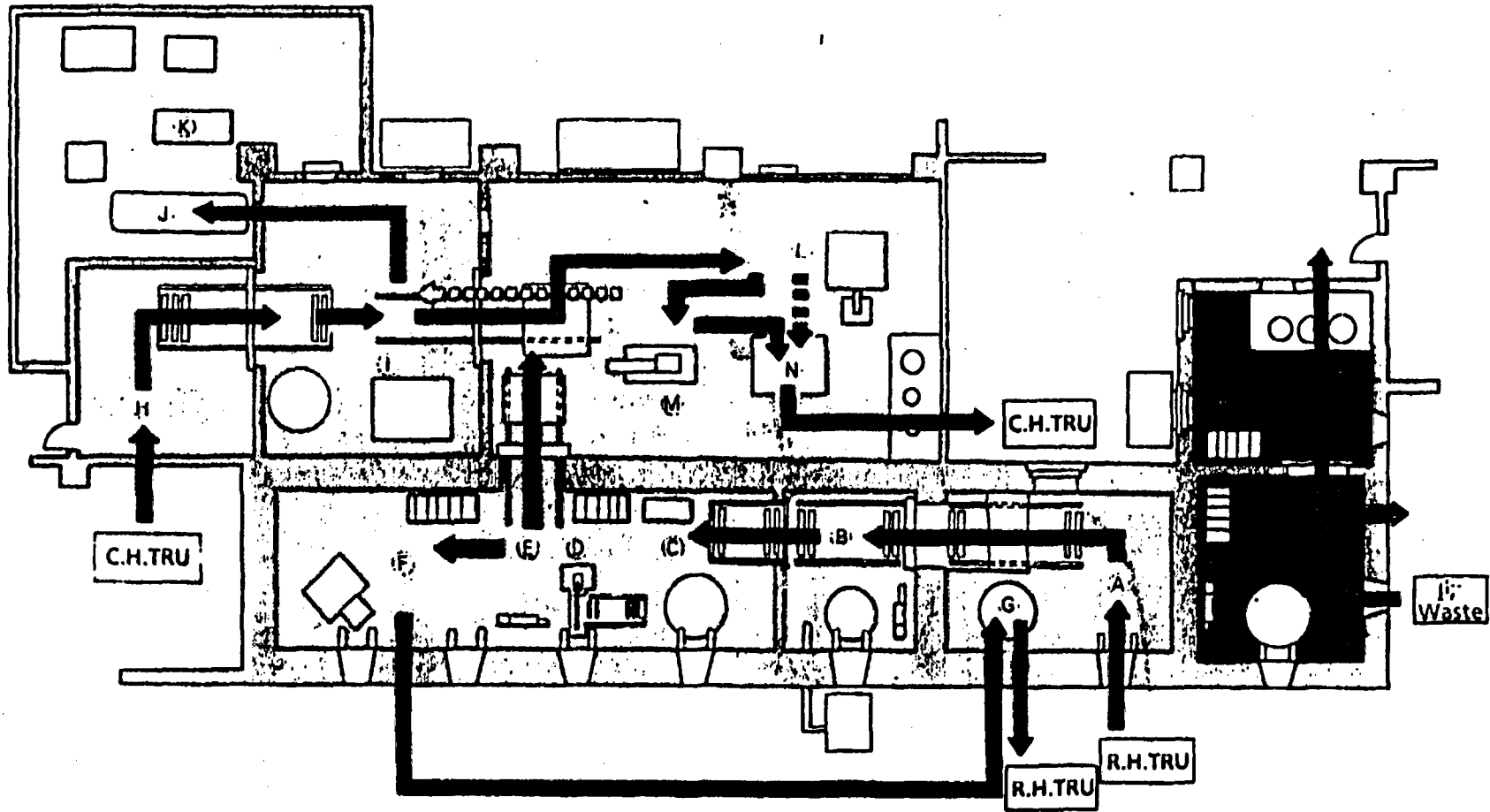

- | | |
|------------------------------------|--|
| A : Receiving | H : Reseiving |
| B : Decontamination (Ice Blasting) | I : Decontaimation (Electro-Polishing) |
| C : Plasma Cutting | J : Evaluation Glove Box |
| D : Hacksaw Cutting | K : Experiment hood |
| E : Classification | L : Plasma Cutting Robot |
| F : Compression | M : Press Cutting |
| G : Packaging | N : Packaging |

R&D of DECOMMISSIONING TECHNIQUES

DECONTAMINATION

- High Decontamination Factor (DF)
- Reduction of Arising Secondary Wastes
- Applicable to Complicated Form
- Cost Effectiveness



ICE-BLASTING

ELECTRO-POLISHING

REDOX PROCESS

DISMANTLING

- Applicable to Miscellaneous Items
- Remote Handling Superior to Contact Handling in Economics and Safety

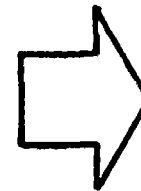

PLASMA CUTTING

ROBOTICS

LASER CUTTING

MEASUREMENT

- Remote Measurement
- High Reliability
- High Efficiency



RADIATION

IMAGE

DISPLAY

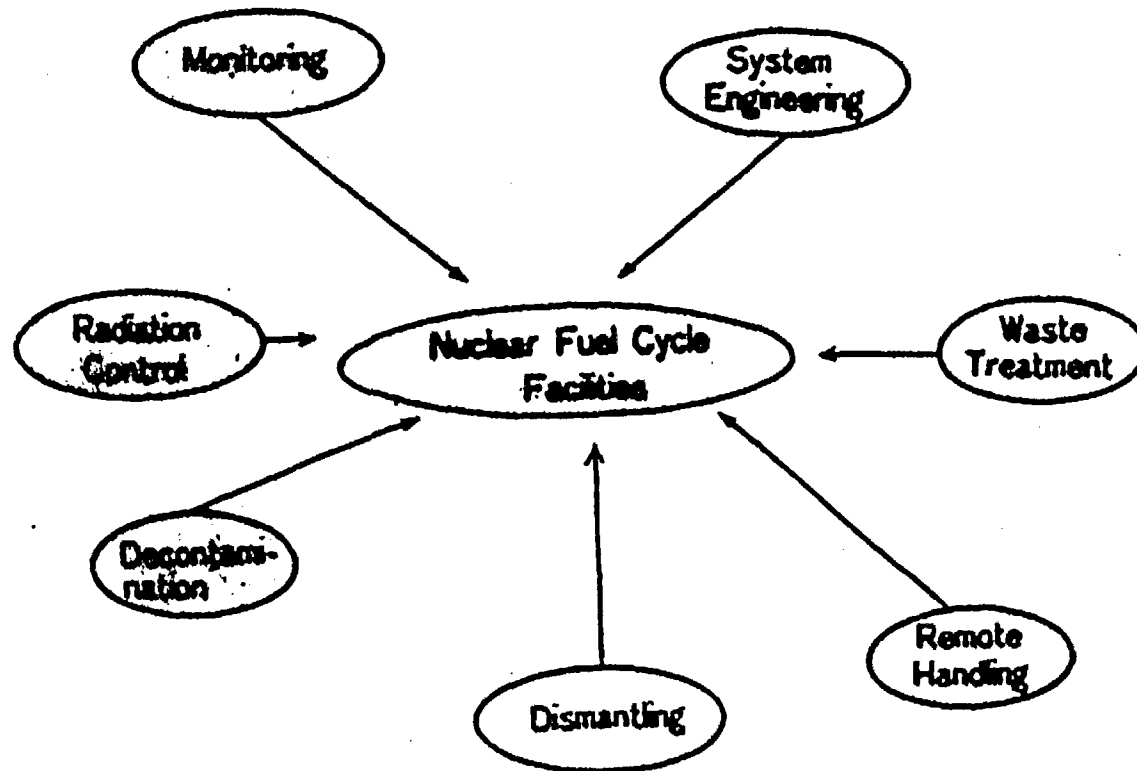

Development of Technologies on Decommissioning of Nuclear Fuel Cycle Facilities

HIP METHOD

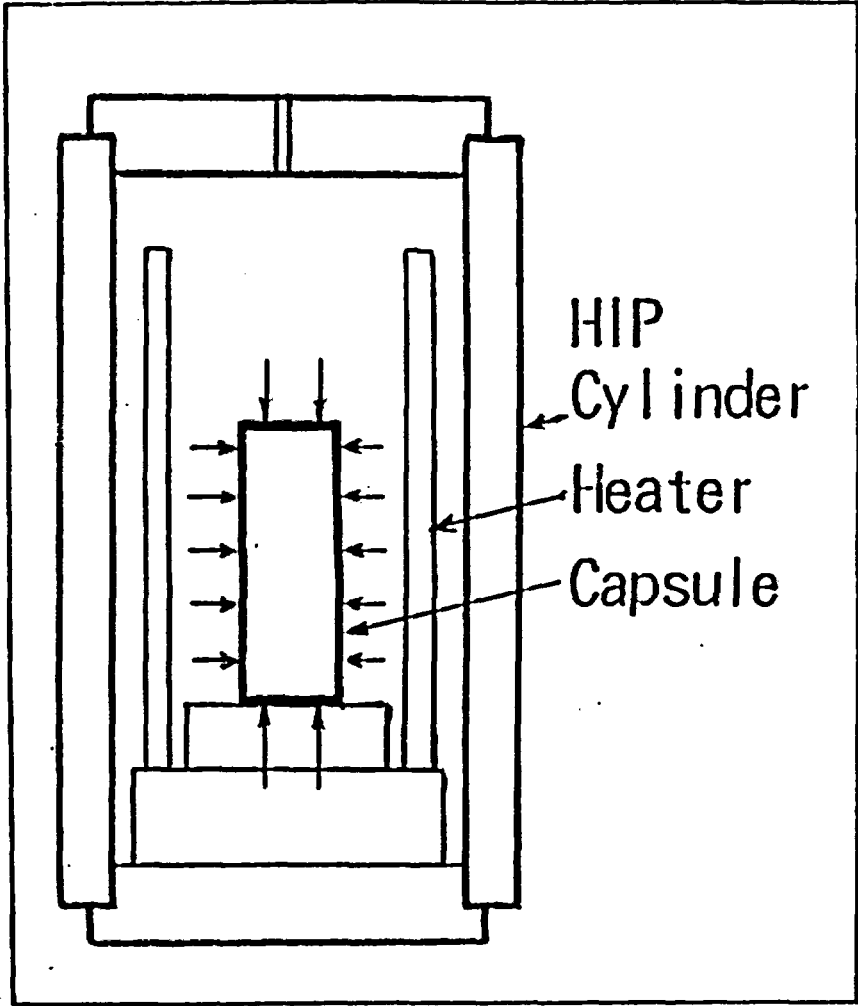

HIP equipment

• HIP treatment	: Temperature	: 1000 °C
	Pressure	: 10 ~ 100 MPa
	Time	: 1 ~ 3 Hrs

1st Isostatic Processing with Ar₂

1) Dismantling of the RPV

Actual cutting of the RPV was started in the end of April and was completed successfully in the beginning of October, 1990. The underwater arc-saw cutting technique was applied to cut the body portion of the RPV where it was highly activated. The lower spherical portion was cut by the conventional technique, a gas cutting technique. Chronologies on the removal operations of the RPV are as follows;

- Oct. 1989 - Apr. 1990 : Installation of the water tank, water treatment system, and arc-saw system
- Apr. - Jul. 1990 : RPV cutting by arc-saw cutting system
- Jul. - Sep. 1990 : Removal of arc-saw cutting system
- Sep. - Oct. 1990 : RPV cutting by gas cutting method.

Arc-saw cutting system and cutting plan of the RPV are shown in Figs 1 and 2, respectively.

Cutting Characteristics of Arc-saw System

The body portion of the RPV was segmented into 65 pieces less than 900 X 900 mm in size underwater. Cut pieces were, then, hanged up onto the service floor in the reactor containment building and were put into the containers. Shielded containers were used for the pieces around the reactor core region (Sections of 4 to 8 shown in Fig.2), but the pieces of the upper portions (Sections of 1 to 3) were put into the standard 1 m³ containers.

Cutting speeds were 0.2 - 0.5 mm/sec at the flange portion of which thickness was 250 mm and 1 - 5 mm/sec at the body of about 80 mm in thickness. These results are within the results obtained both in the developing tests and in the mock-up tests as shown in Fig. 3 : However, a difficulty was experienced at the beginning of this work, i.e., frequently over current trip in the system. This over current trip was observed in the vertical cutting operation of the flange portion, especially, at the first cutting. This was due to inappropriate setting of an arc current and a cutting speed as well as the most thick portion of the RPV. It took about 3 days to cut one vertical line of 700 mm at the beginning, but it decreased soon to 5 - 8 lines (4,000 - 7,000 mm) per day. Planned and actual schedule is shown in Table 1 and scenes of operations are shown in Photos 1 - 4.

Working Days and Manpower

Total number of days required to cutting by the arc-saw was 50 days and it is considerably less than the planned ones (60 days). It was concluded that this was due to increasing the skill of workers by progressing the cutting operations. On the other hand, about 8 months were required for such preparatory works as installations of cutting system, water tank and water treatment system as well as removals of these systems.

Manpower expenditures were of 1,700 man-days for arc-saw cutting and of about 6,200 man-days for the preparatory works.

Radiation Exposure

Total radiation exposure of workers in the work was about 9 man-rem. Radiation exposure for cutting with the remote operated arc-saw cutting system was only 0.2 man-rem, but the rest was come from the preparatory works as shown in Table 2. This larger radiation exposure during the preparatory works was resulted from the installation of the water tank since the workers were obliged to access to the RPV during this work, where the radiation dose rate was of 20 - 80 mR/hr (Maximum dose rate at the surface of the RPV was about 7 R/hr at the core center level).

Radioactive Contamination

Insignificant contamination in the air was observed . A little contamination (3×10^{-5} μ Ci/cc) was measured in water, but it is easily reduced by the water treatment system with filters. Almost all of dross generated by cutting was also removed by the dross collecting pan which was installed in the lower portion of the RPV without difficulty.

Cutting of the Lower Spherical Portion of the RPV

The lower spherical portion of the RPV was hang up onto the service floor and was cut by using a conventional gas cutting technique. Radiation dose rate was about 10 mR/hr at the surface of the RPV.

2) Removal of Components in Turbine Building

















Dismantling work of the components in the turbine building has been started in April, 1990. Components of the condensate and feed water system, the auxiliary system, the sea water circulation system, etc., were removed. Turbine and generator will be removed in coming quarter.

3) Future Plan

Installation of the diamond and coring concrete cutting system will be started in October and cutting of the biological shield concrete at the highly activated portion using this system will be carried out during December, 1990 and January, 1991. Water jet cutting will be followed from March to July, 1991.

Removal of the components in the turbine building has been continued until next year. Removal of components in the waste treatment building, the fuel storage building, etc., will be initiated from April, 1990.

Table 1 Arc-saw Cutting Schedule of the RPV

Section	April	May		June		July		
	26	10	20	10	20	4	10	19
1	 							
2			 					
3				 				
4				 				
5					 			
6						 		
7							 	
8						 		



 Planned schedule
 Actual schedule

Table 2 Man-power and Radiation Exposure
in Cutting the RPV by Arc-saw

Item	Man-days	Man-rem
Preparatory Works		
Installation of arc-saw	2,470	0.24
Installation of water tank	1,710	8.39
Installation of water treatment system	460	0.17
Removal of systems	1,600	0.36
----- Sus-total	----- 6,240	----- 9.16
Cutting operation	1,700	0.21

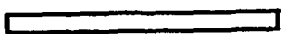
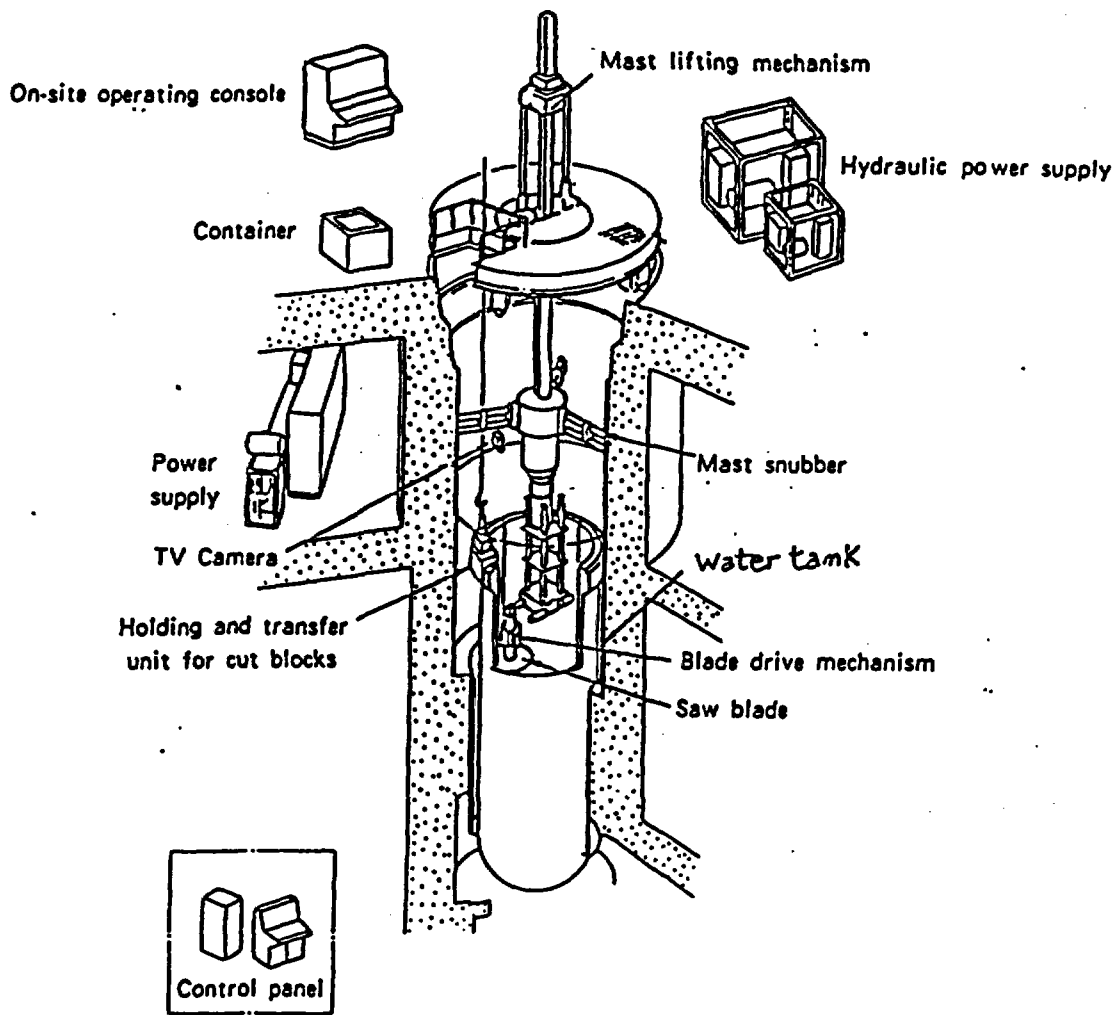

Fig. 1 Basic concept of arc saw cutting system

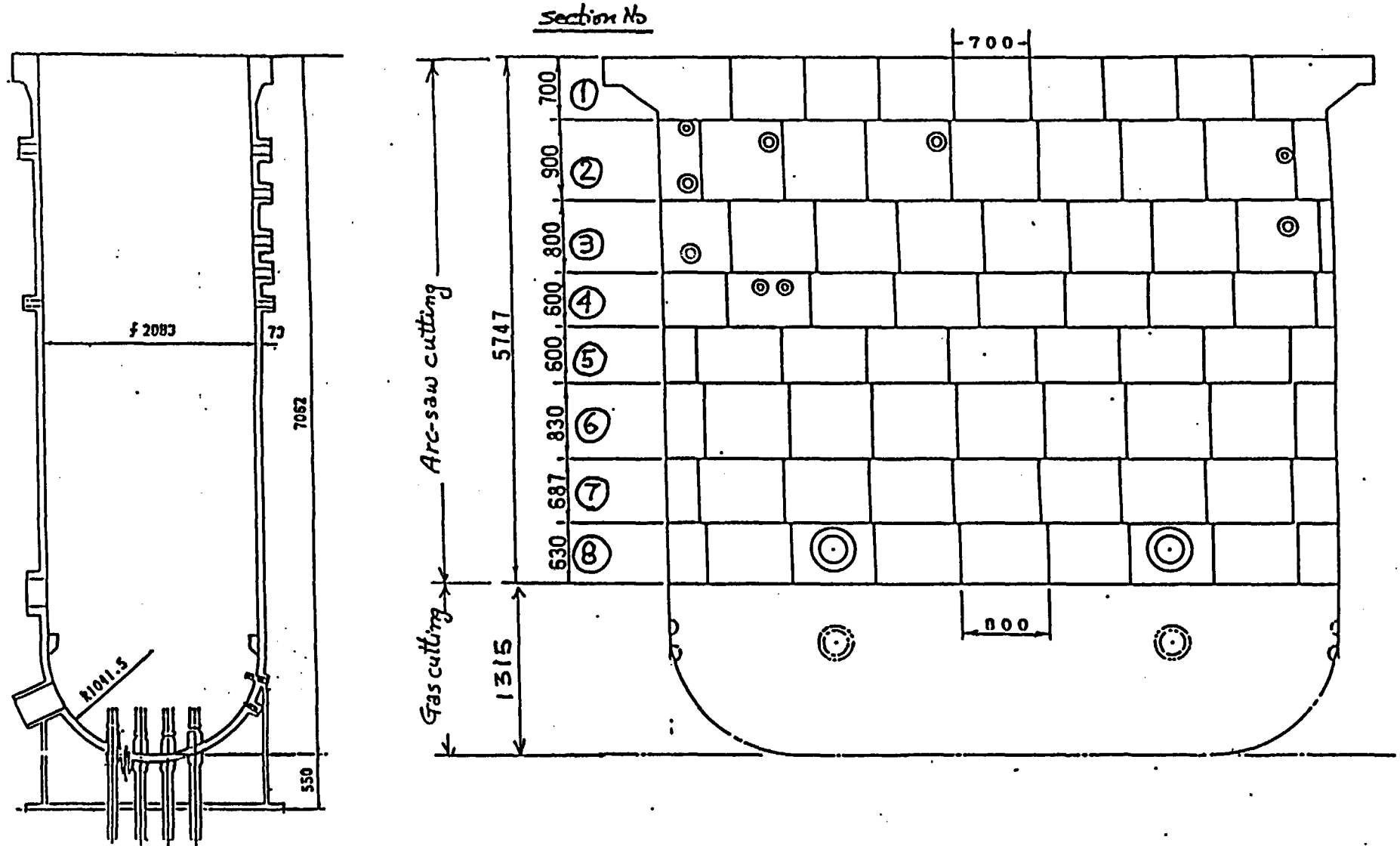

Fig. 2

Cutting Plan of The RPV by Arc-saw System

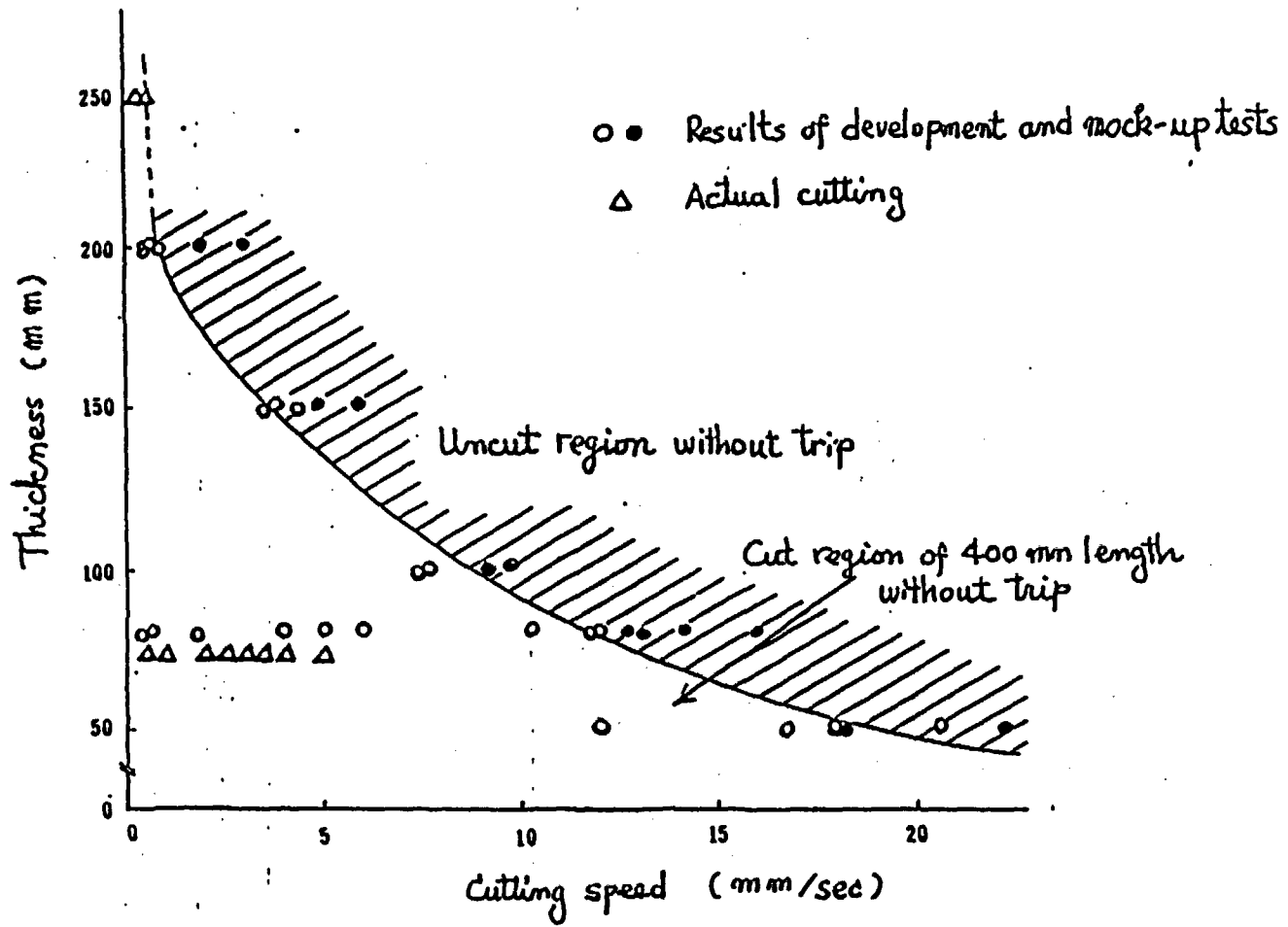

Fig. 3 Cutting Characteristics of Arc-saw System.

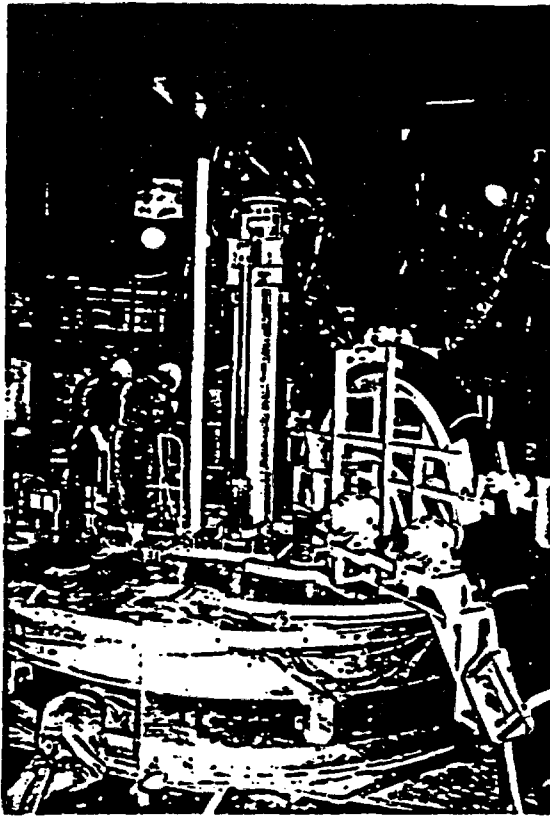
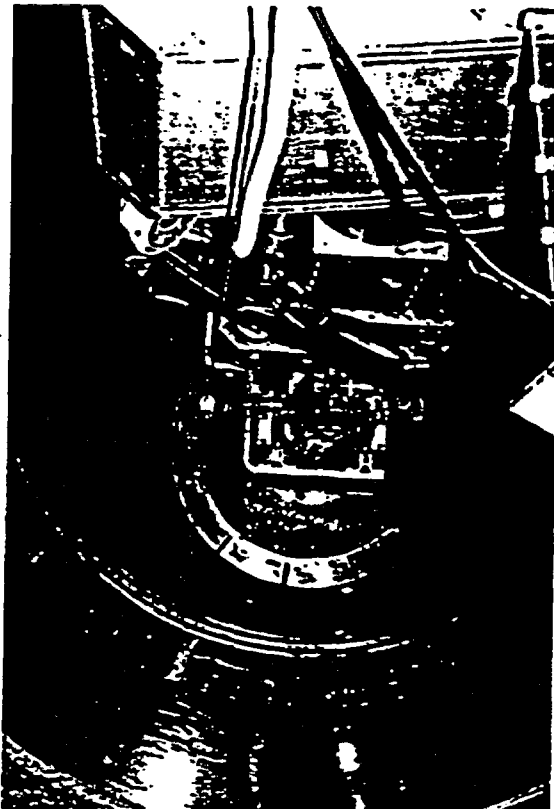

Photo -1 Arc saw cutting system installed above RPV



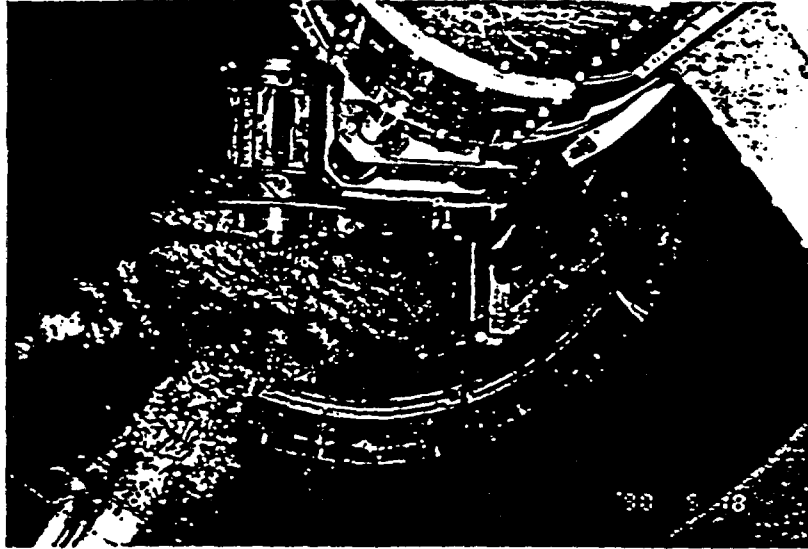

Photo 3 Cutting work for the RPV body

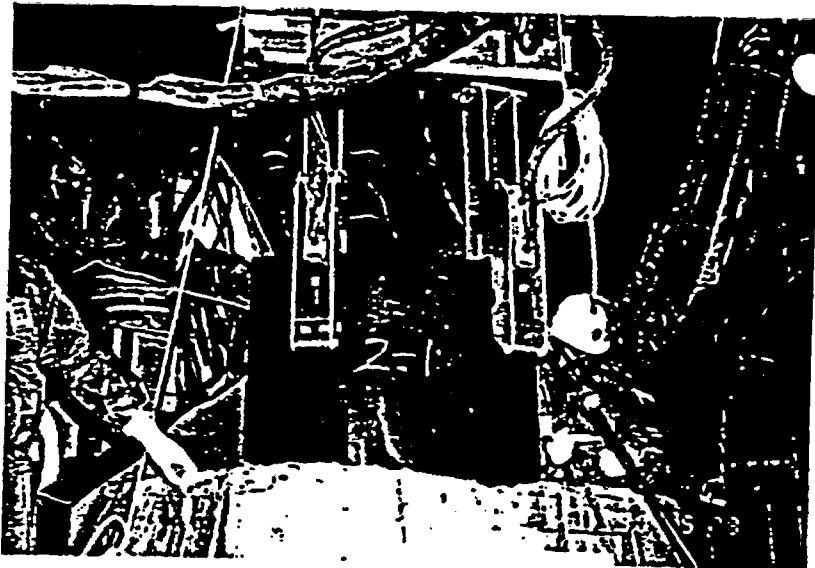

Photo 4 Cut piece of RPV being put into container

JPDR DECOMMISSIONING PROGRAM

Japan Atomic Energy Research Institute

NATIONAL STRATEGY ON DECOMMISSIONING OF POWER REACTORS IN JAPAN

- Dismantling to reuse the site
- Development of dismantling techniques to assure safety and reduce costs



Improvement of current technologies
and development of new technologies

(In JAERI,
development of technologies and demonstration)

PURPOSE OF JPDR DECOMMISSIONING PROGRAM

1. To obtain actual experience on dismantling of nuclear power plant
2. To develop and demonstrate dismantling techniques
3. To obtain data concerning;
 - 1) radiation (exposure of workers, airborne activities, radiation level, etc.)
 - 2) waste (measurement and segregation, decontamination, etc.)
 - 3) system engineering (number of workers, working time, cost, etc.)

STANDARD DISMANTLING SEQUENCE OF COMMERCIAL POWER REACTORS IN JAPAN

(planned for 1,000 MWe plant by MITI)

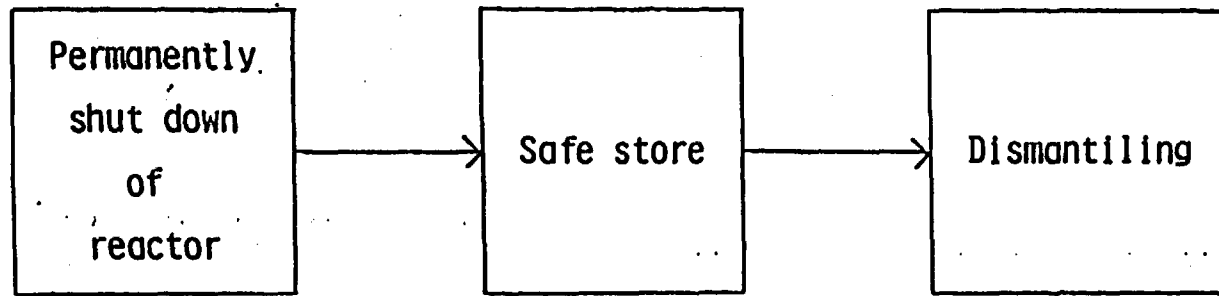

after 30-40 years
operation

5-10 years
to reduce
activities

3

CHARACTERISTICS OF UPDR

Reactor	BWR
Power	90 Mwt (Initial 45 Mwt) 12.5 Mwe
RPV	8 mH x 2mID x 67 mmt
Biological Shield Concrete	1.5 ~ 3 mt
	Reinforcing Bar (29 mmOD, 150 ~ 200 mmPitch
Operation	1963, 10
Final Shutdown	1976, 3

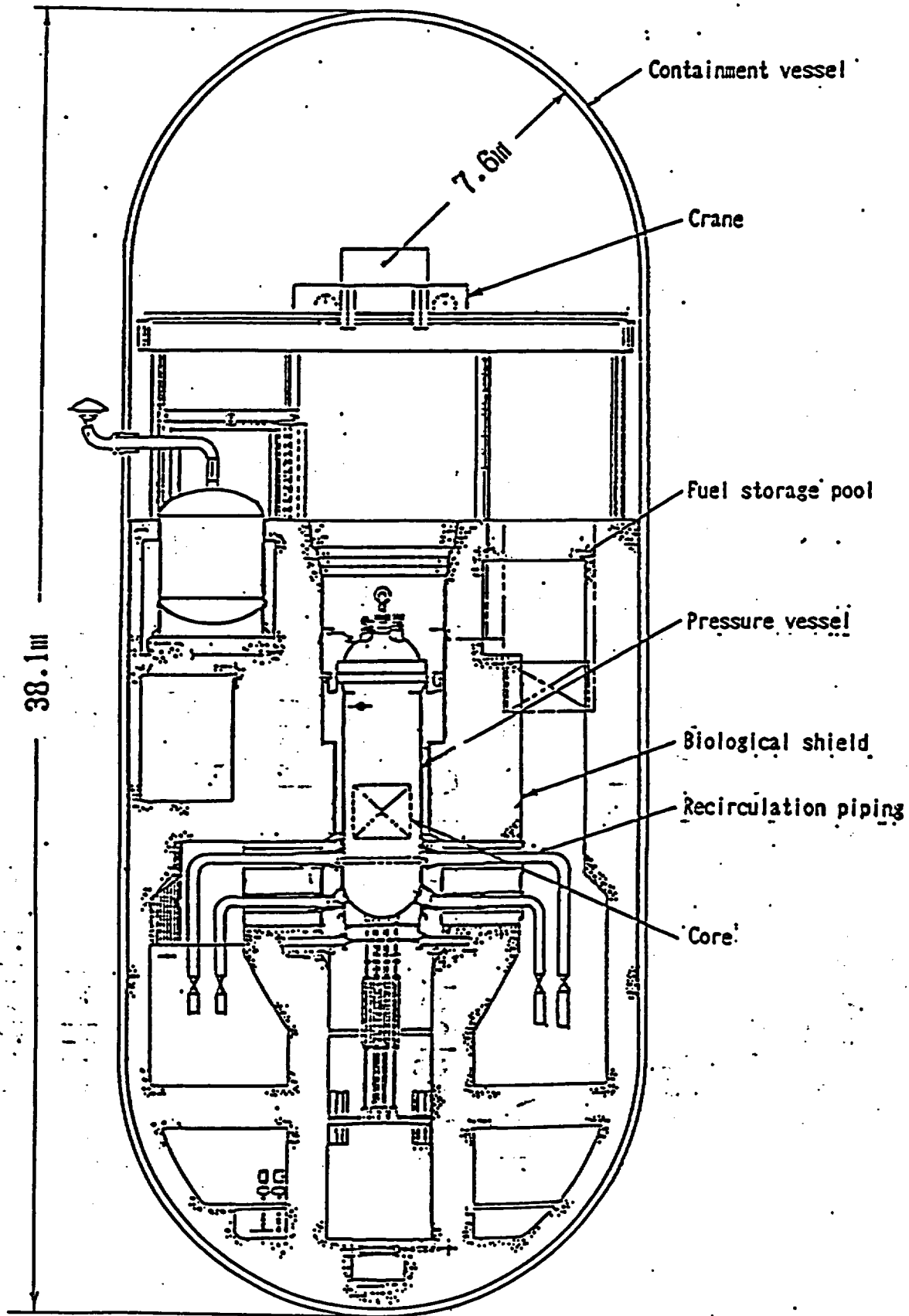

CROSS-SECTION OF REACTOR CONTAINMENT BUILDING

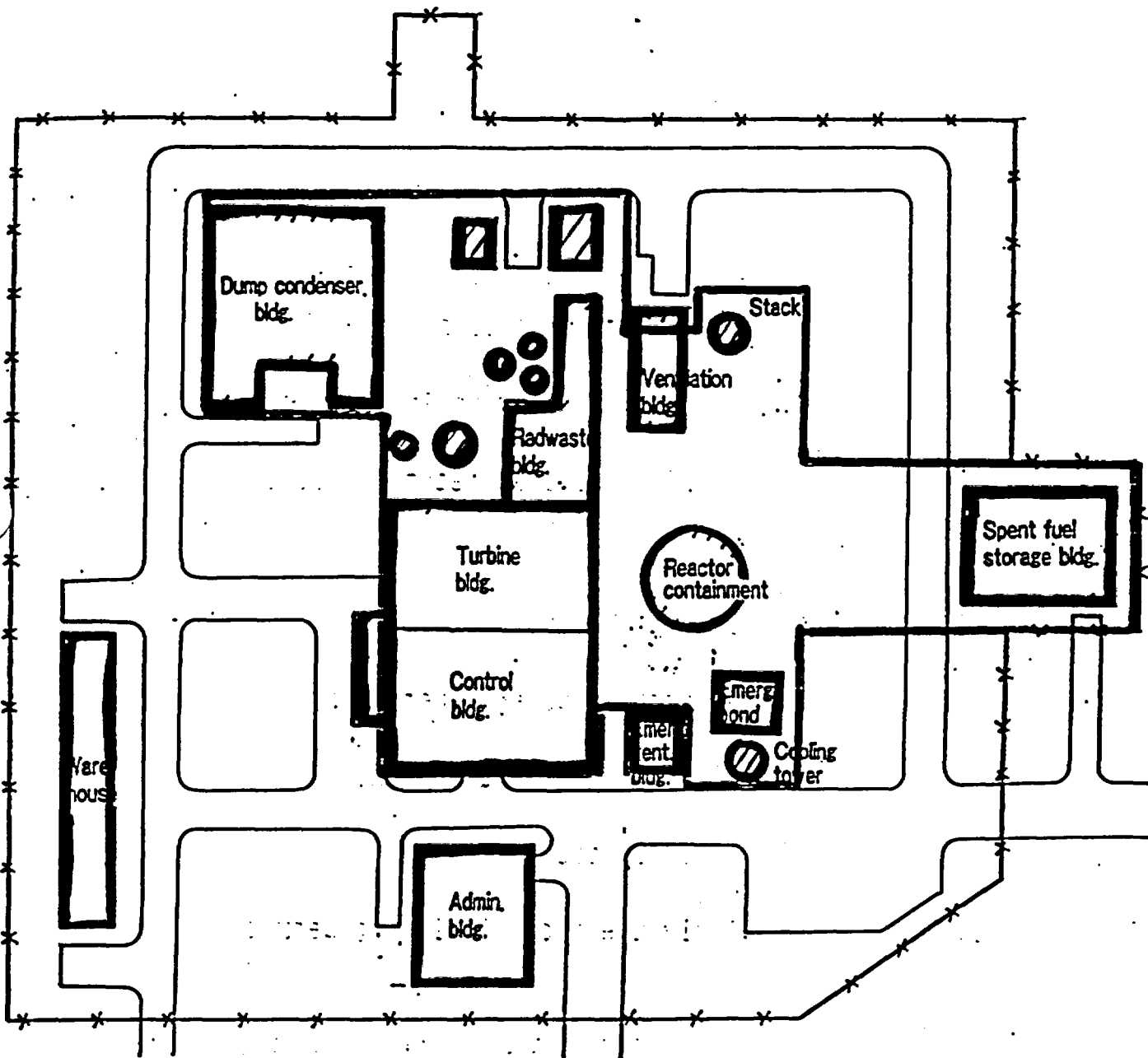

 Buildings to be dismantled

 Radiation Control Area

OPERATIONAL HISTORIES OF JPDR

↑ JPDR I ↓	1963.8 <div style="border: 1px solid black; padding: 2px; display: inline-block;">1963.10</div>	Critical Electrical power generation (45 MWt operation in natural convection of coolant)
↓ ↑ JPDR II ↓	<u>1969.9</u> <div style="border: 1px solid black; padding: 2px; display: inline-block;">1969.10 ~ 1971.12</div>	Shutdown reactor to increase power Modifications of reactor core and plant to 90 MWt
	1972.2 <div style="border: 1px solid black; padding: 2px; display: inline-block;">1972.5</div>	Critical in new core Electrical power generation (power increase to approx. 60 MWt)
	<u>1976.3</u>	Final shutdown
	1982.12	Apply the decommissioning permit
	1986.7	Apply the revised decommissioning report
	1988.12	Start physical dismantlement

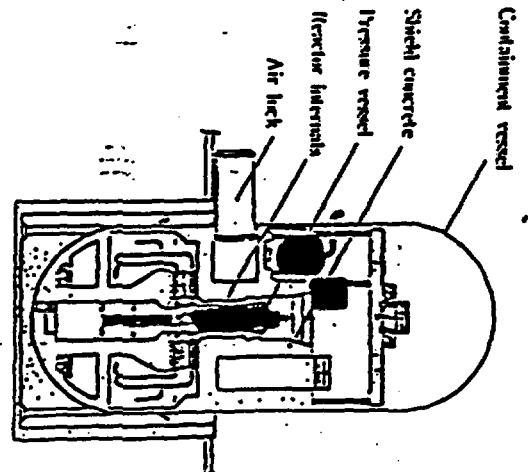

Preparation & Core internals

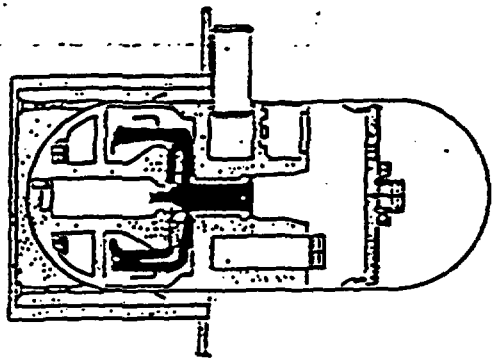

RPV

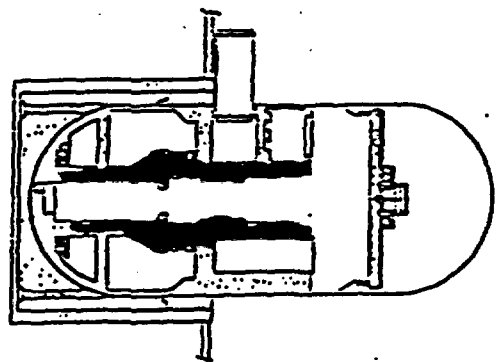

Bio-shield concrete

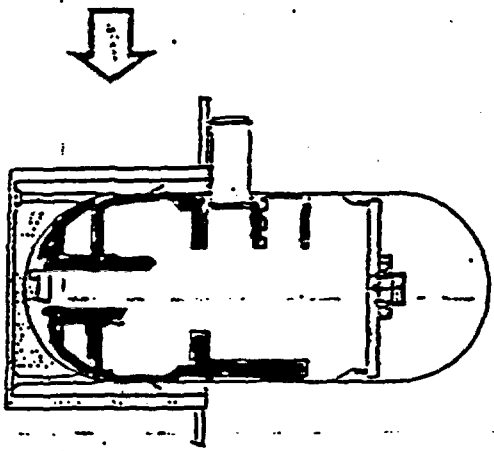

Decontamination

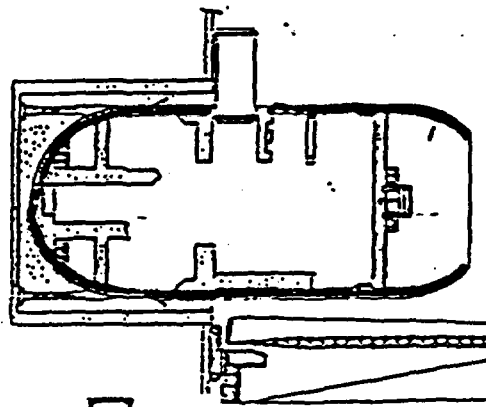

Containment

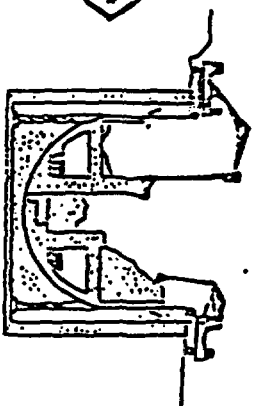

Dismantlement procedure of reactor, its surroundings and containment.

JPDR DECOMMISSIONING SCHEDULE

	86	87	88	89	90	91	92	93
Preparation	████████████████████							
RPV Internals			████████████████████					
RPV				████████████████████				
Blo. Shield Concrete					████████████████████			
Containment							████████████████████	
Other Buildings						████████████████████		
Landscaping								████████

1981~1986 : R&D

6

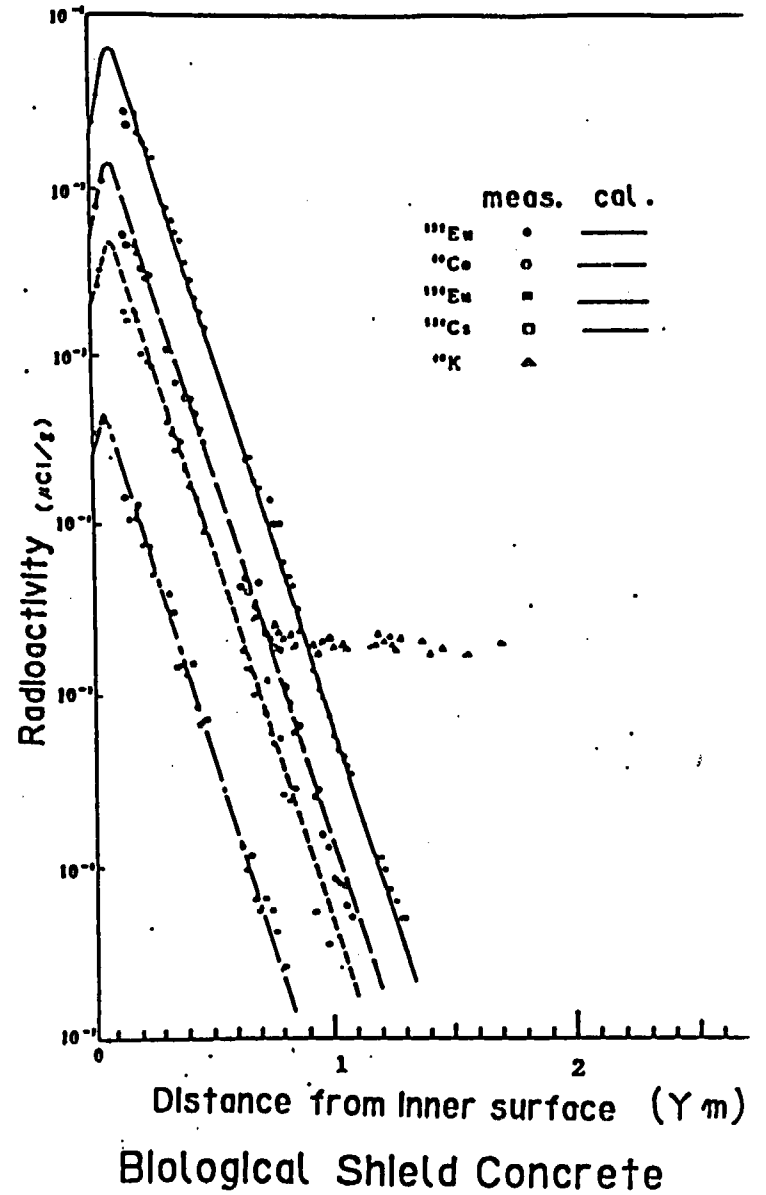
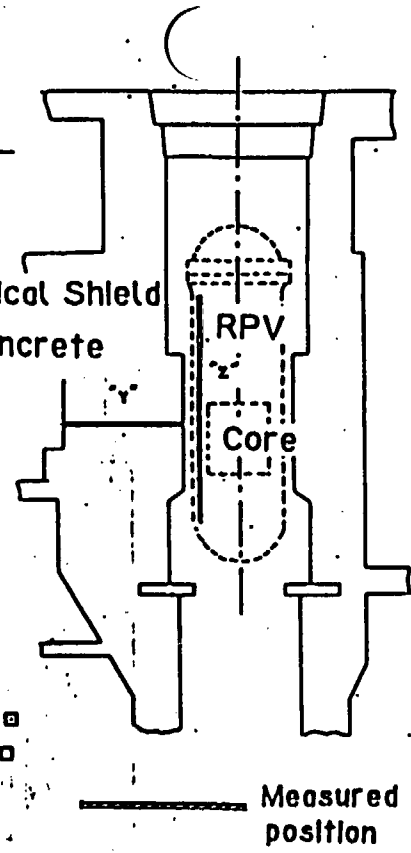
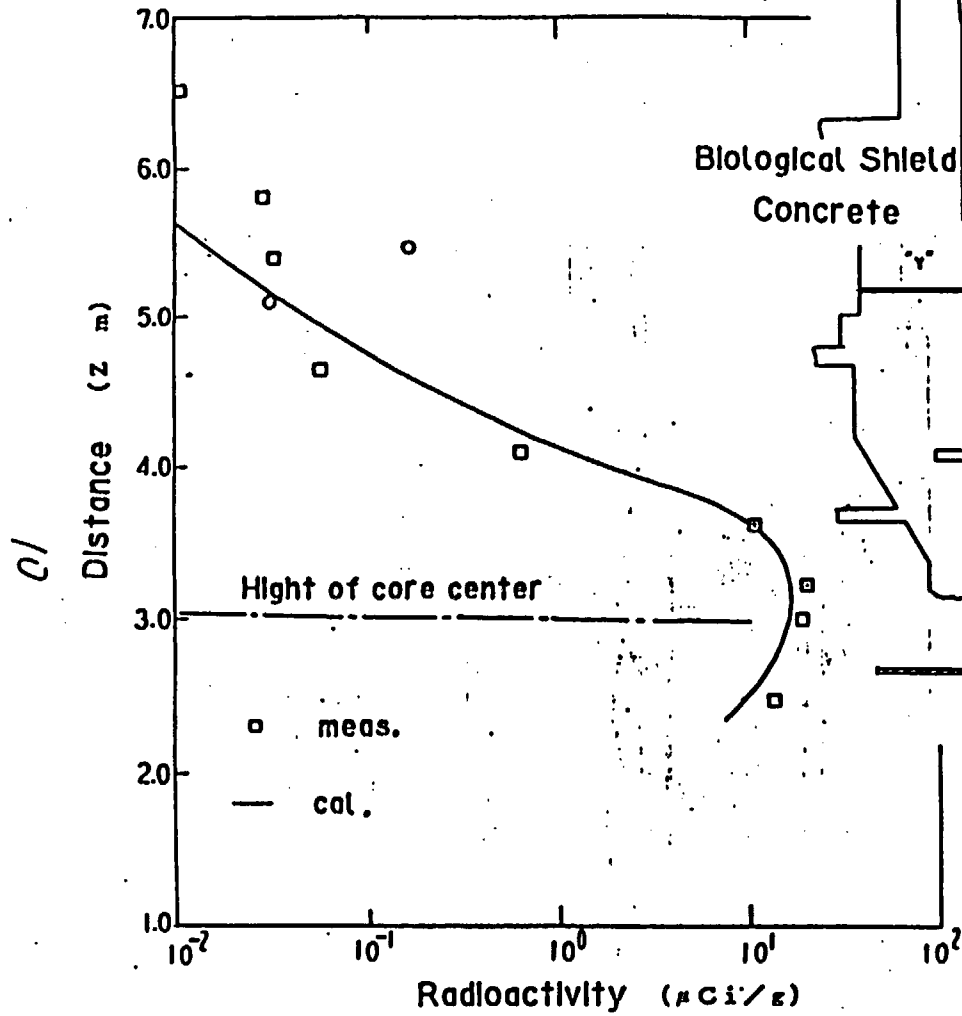

RPV

Radioactivity In RPV and Biological Shield Concrete

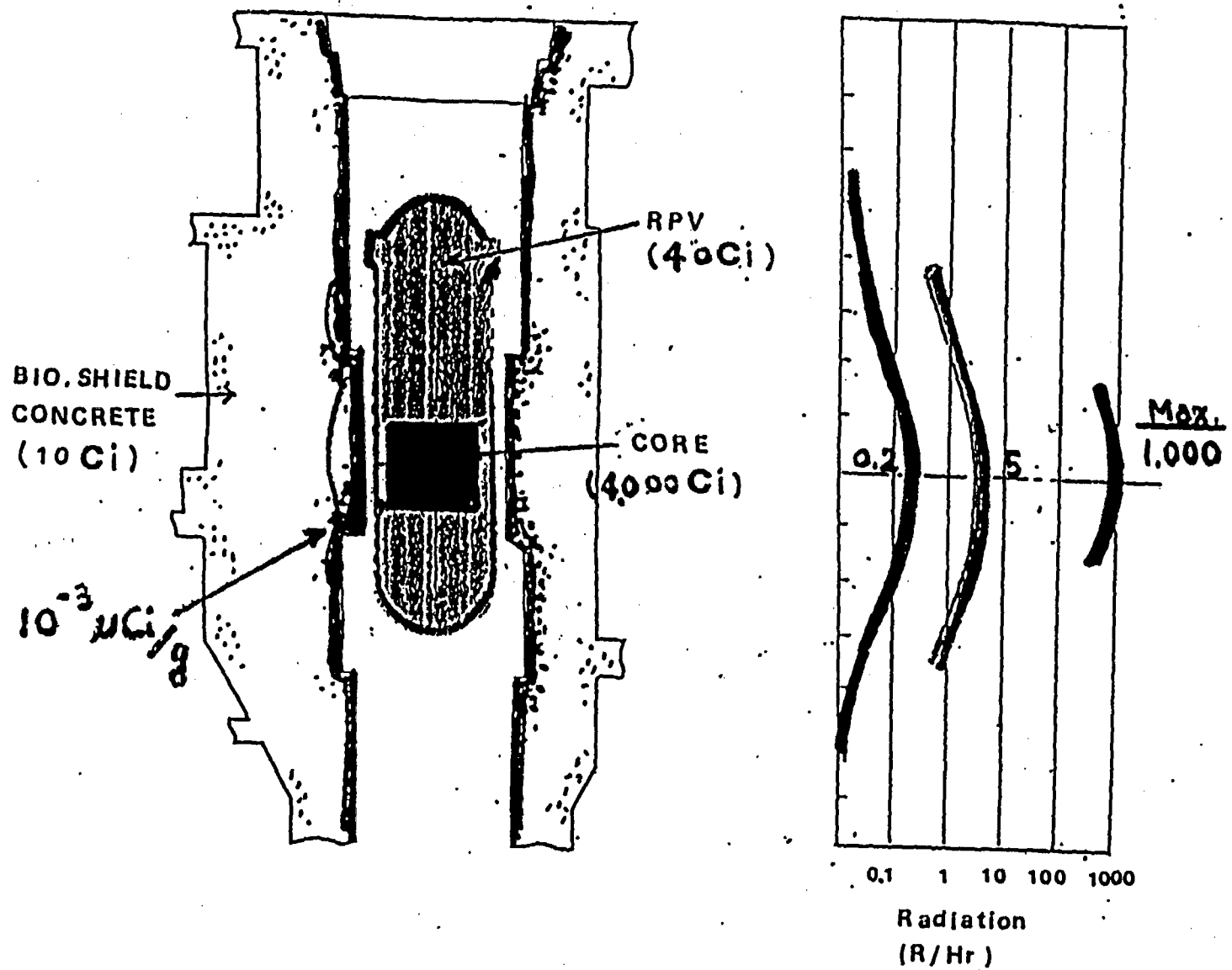

RADIATION DOSERATE IN JPDR FACILITY

DISMANTLING TECHNIQUES

Object	Technique	Example of performance
Pressure vessel	Arc-saw	Carbon steel 250mm (in water) 200mm (in air)
Reactor internals	Plasma arc	Stainless steel 130mm (in water)
Piping connected to pressure vessel	Rotary disk knife	Stainless steel 12in, Sch 80
	Shaped explosive	Carbon steel 26in, Sch 80
Biological shield	Diamond sawing and coring	Cutting efficiency $2.5\text{m}^2/\text{hr}$
	Abrasive-Water jet	Depth of cut 450~600mm
	Controlled blasting	Blasting efficiency $10\text{hr}/\text{m}^3$

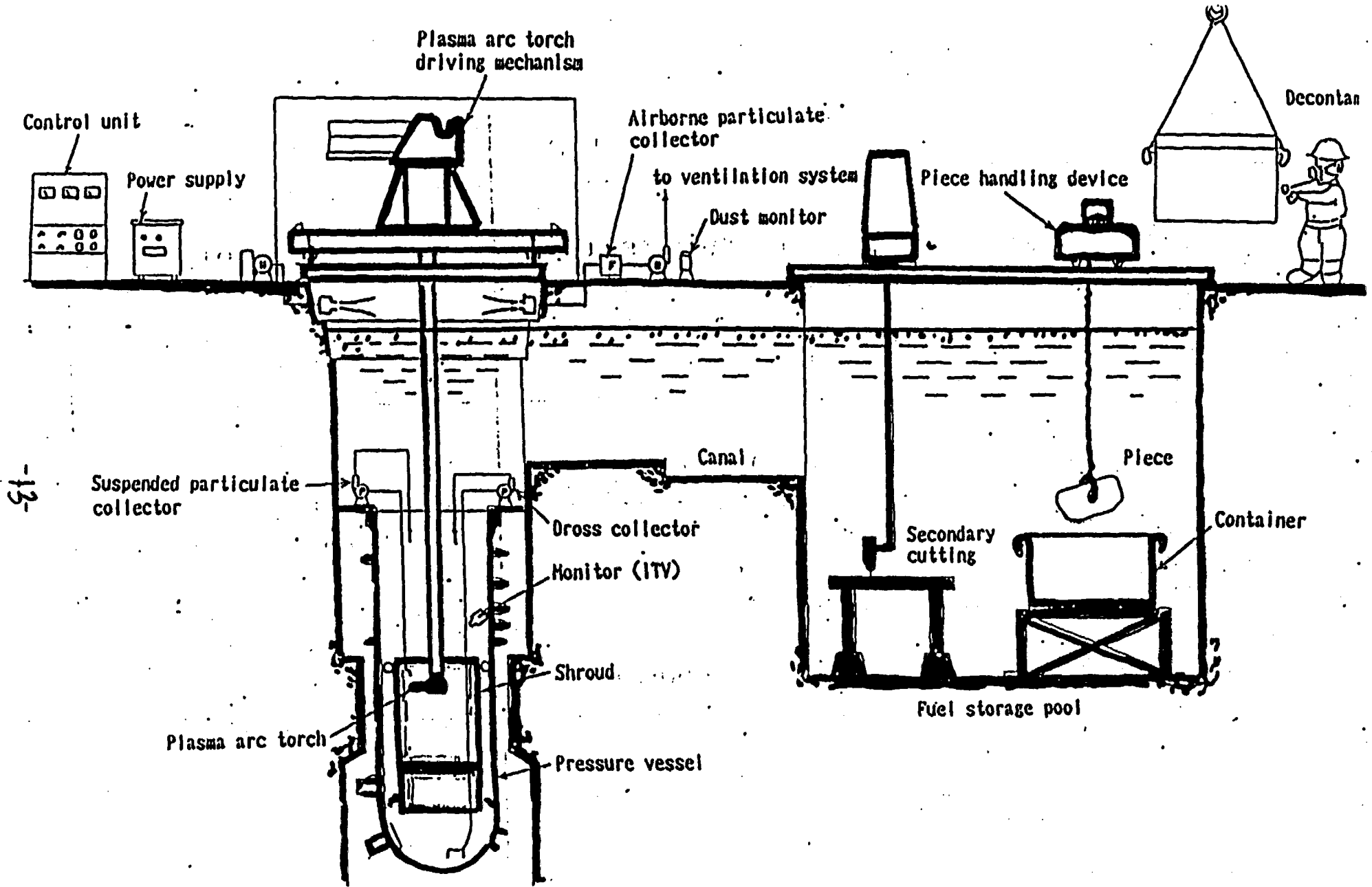

Fig. 4 PLASMA ARC CUTTING SYSTEM APPLIED TO REACTOR INTERNALS

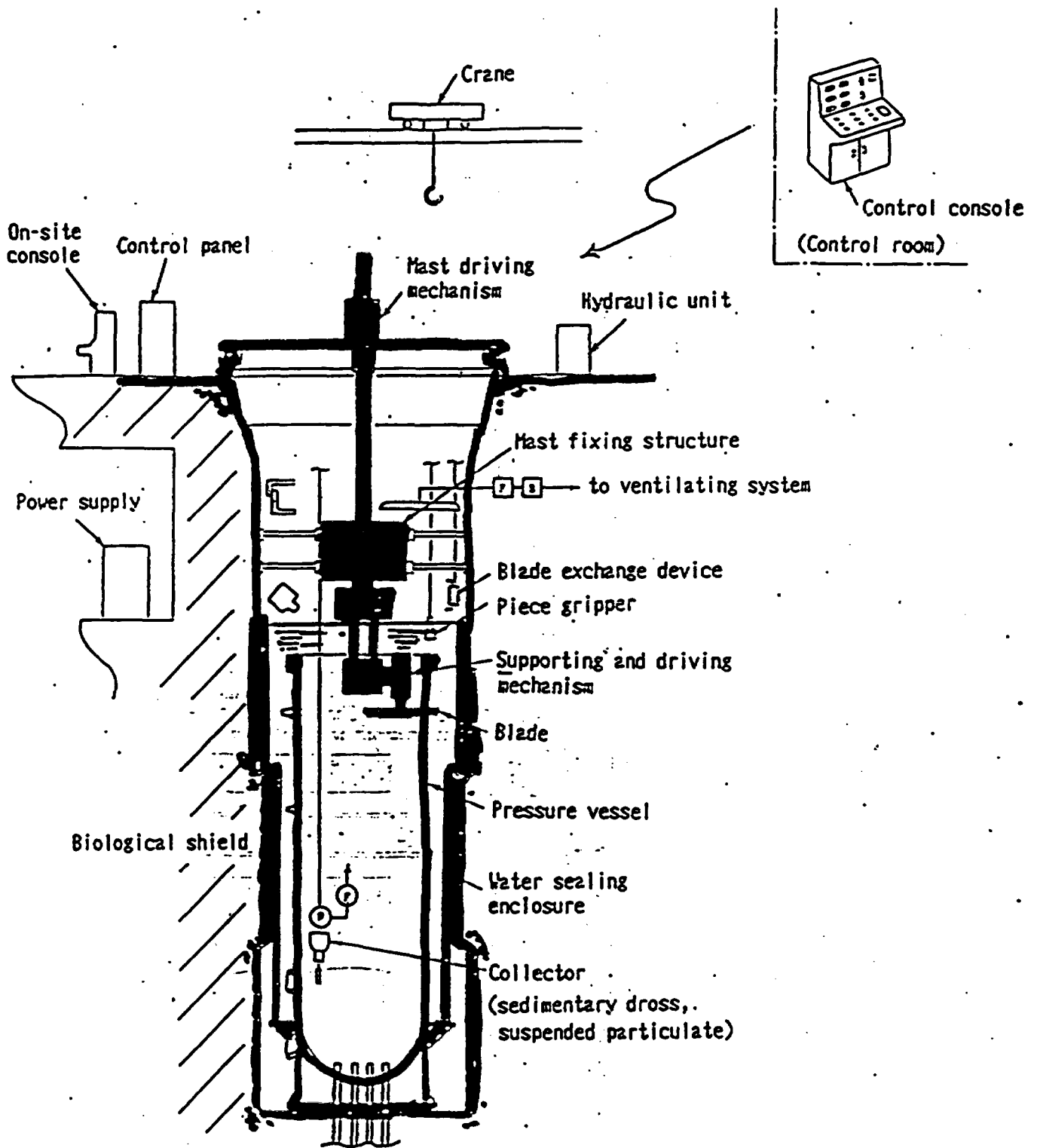

Fig. 5 ARC-SAW CUTTING SYSTEM APPLIED TO PRESSURE VESSEL

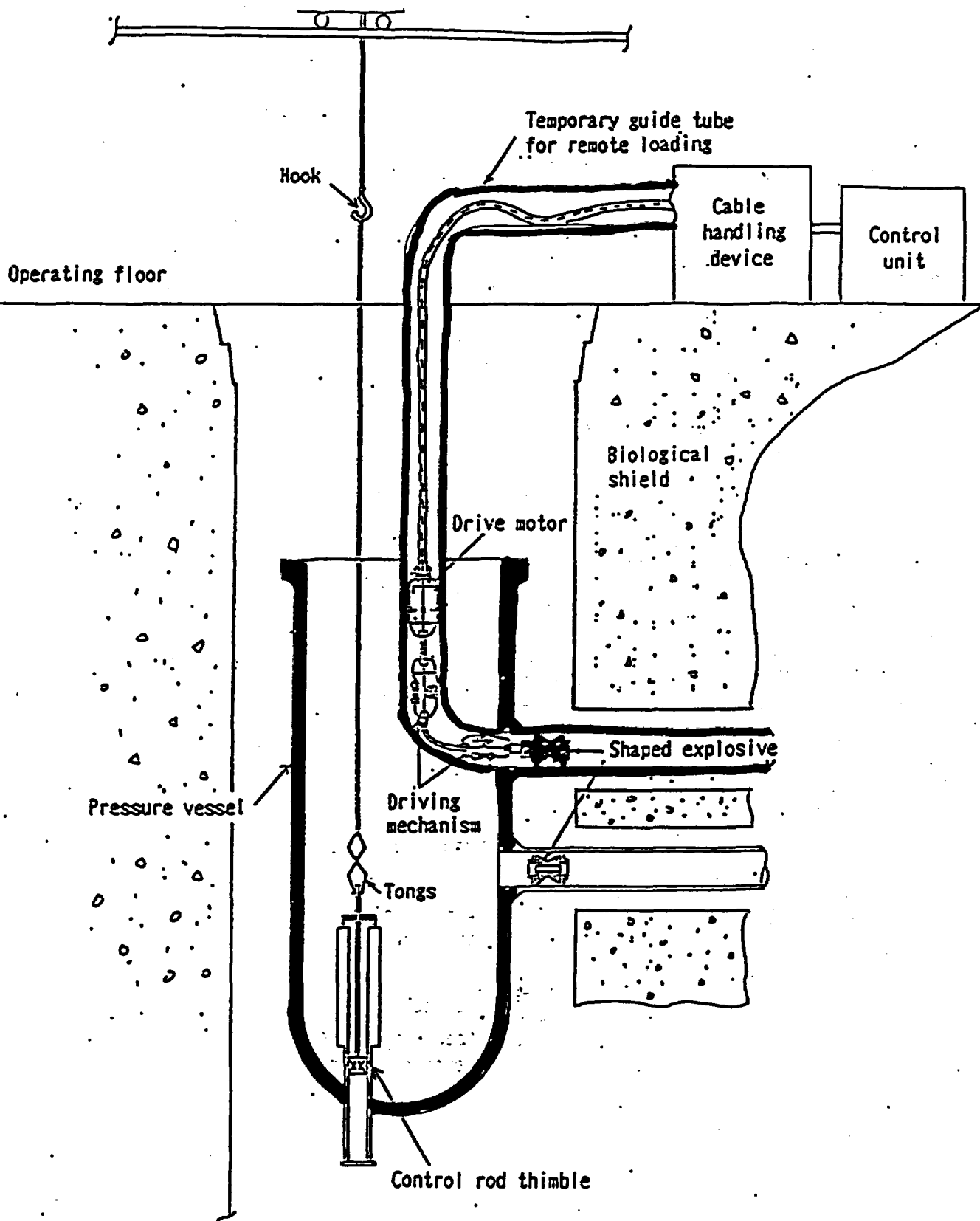
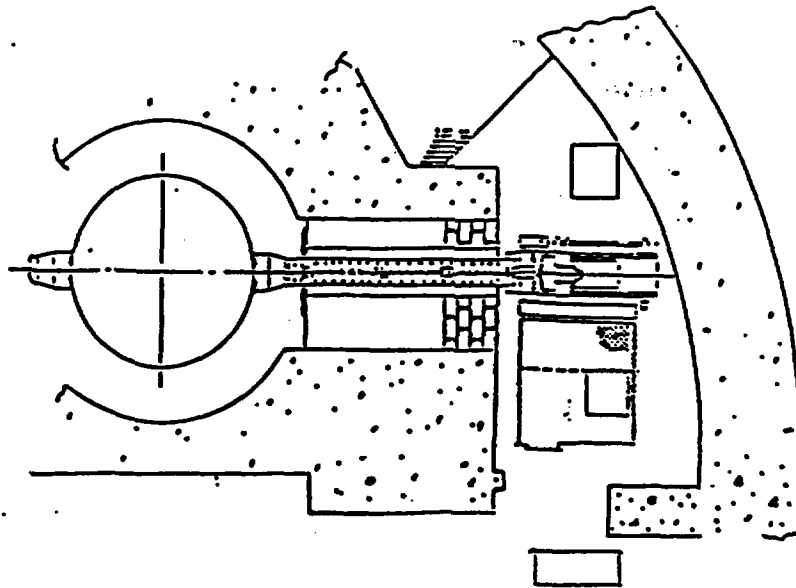
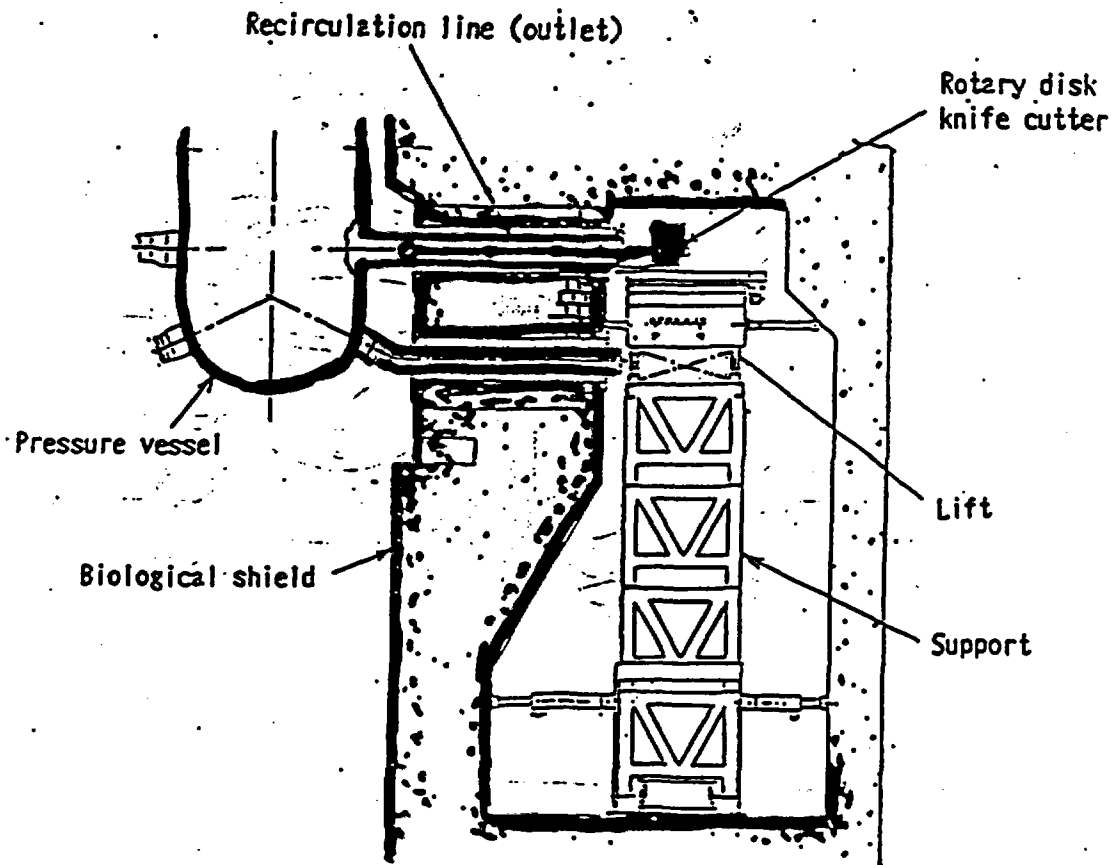

Fig. 6 SHAPED EXPLOSIVE CUTTING SYSTEM



Top view



Side view

Fig. 7 ROTARY DISK KNIFE CUTTING SYSTEM

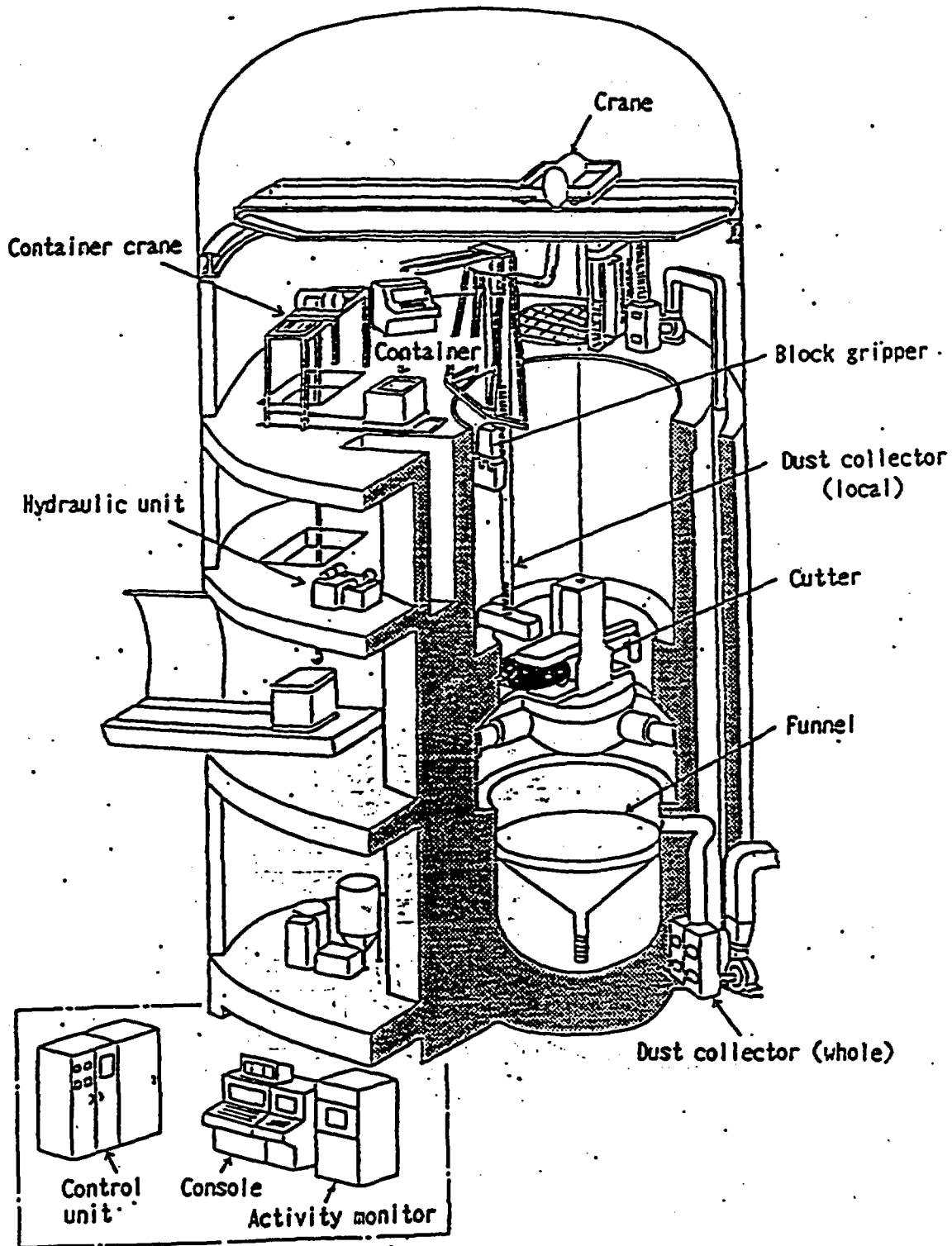

Fig. 8 DIAMOND SAWING AND CORING CUTTING SYSTEM.

Table I SPECIFICATION AND PERFORMANCE OF ABRASIVE-WATER JET CUTTING SYSTEM

Specification	Water pressure	196 MPa
	Water flow rate	50 l/min
	Abrasive feed rate	3-7 kg/min
	Nozzle traverse rate	0-120 cm/min
Performance	Cutting time*	60 min
	Concrete dust generation*	33 kg

* Cutting time and concrete dust generation per one block cut off
 Block size: 40 cm (depth) x 40 cm (height) x 100 cm (length)

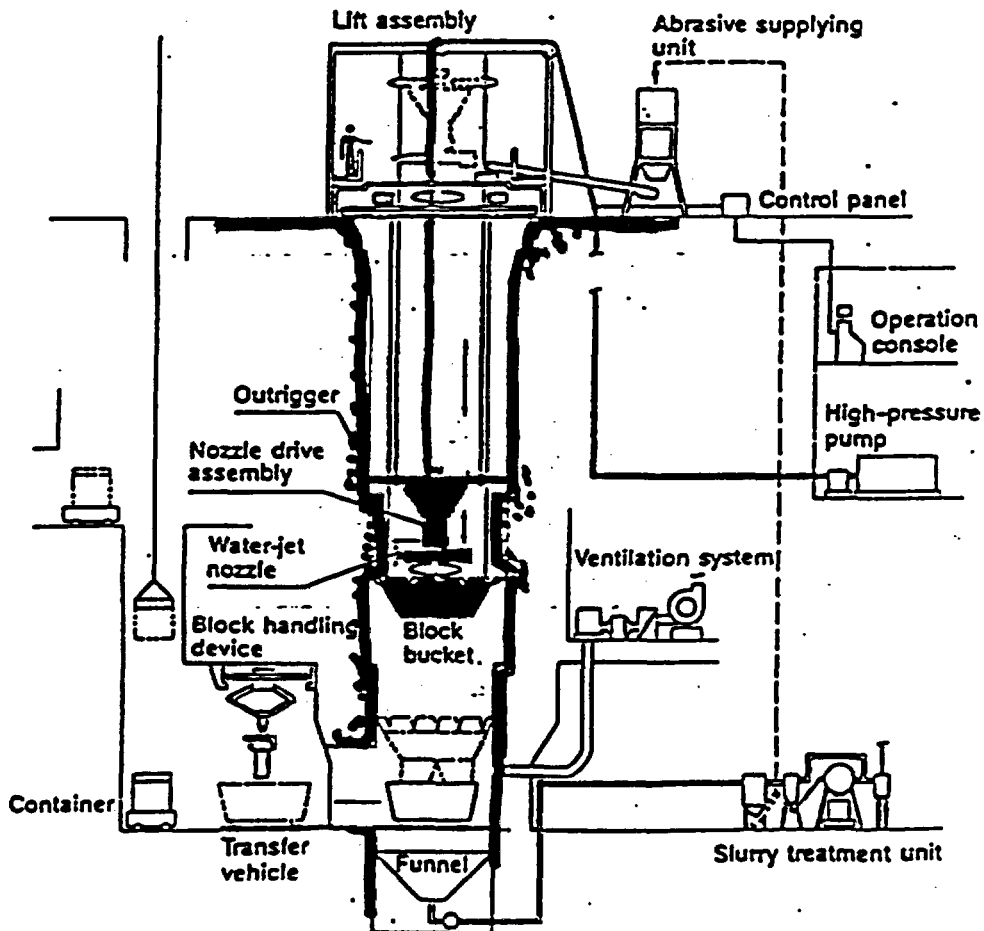
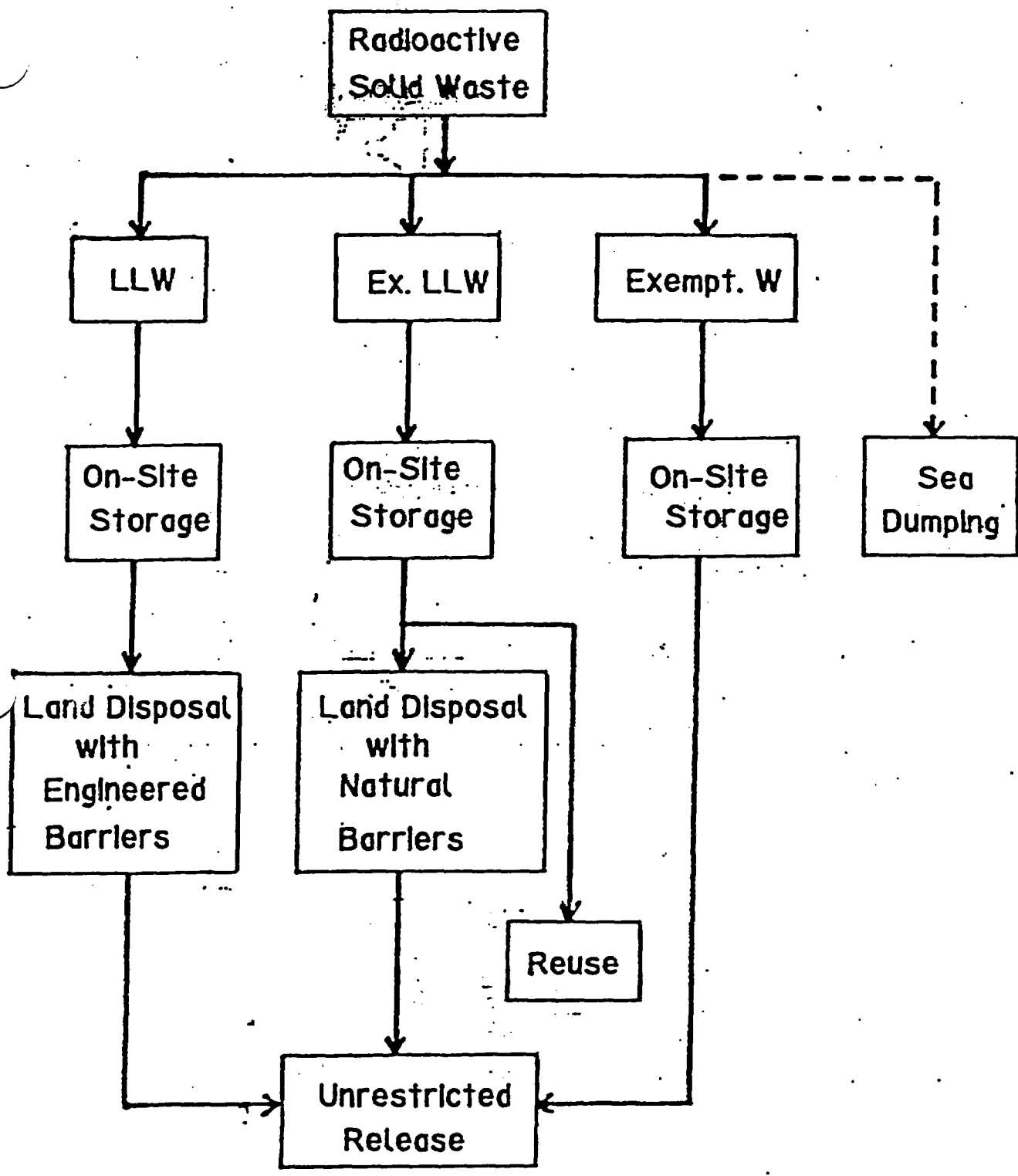

Fig. 6 ABRASIVE-WATER JET CUTTING SYSTEM

**Kinds and Activity of Radioactive Waste
generated from the JPDR Decommissioning**

Kinds of Radioactive Waste		Activity (Ci)	Weight (Ton)
Activated Components	Core Internals Control rods, Core shroud, etc.	4,050	20
	Pressure Vessel	40	110
	Biological Shield Concrete	10	1,350
Contaminated Components	Components	4.2	1,640
	Concrete	0.2	830
	Resin, etc.	0.5	130
Total		4,100	4,100



Management System of
Radioactive Solid Waste
in Japan 20

RADIATION EXPOSURE FOR WORKERS

<u>Dismantling Item</u>	<u>Man-Days</u>	<u>Man-rem</u>
Equipments	8,700	14
RPV Internals	9,200	17
RPV	4,100	26
Blo. Shield Concrete	4,500	8
Containment	9,000	11
<u>Sub Total</u>	<u>35,500</u>	<u>66</u>
Other Buildings	37,500	34
<u>Total</u>	<u>73,000</u>	<u>100</u>

Worker Exposure
(man·day/month)

Manpower (man·day/month)

Manpower and Worker Exposure

(b) Worker Exposure

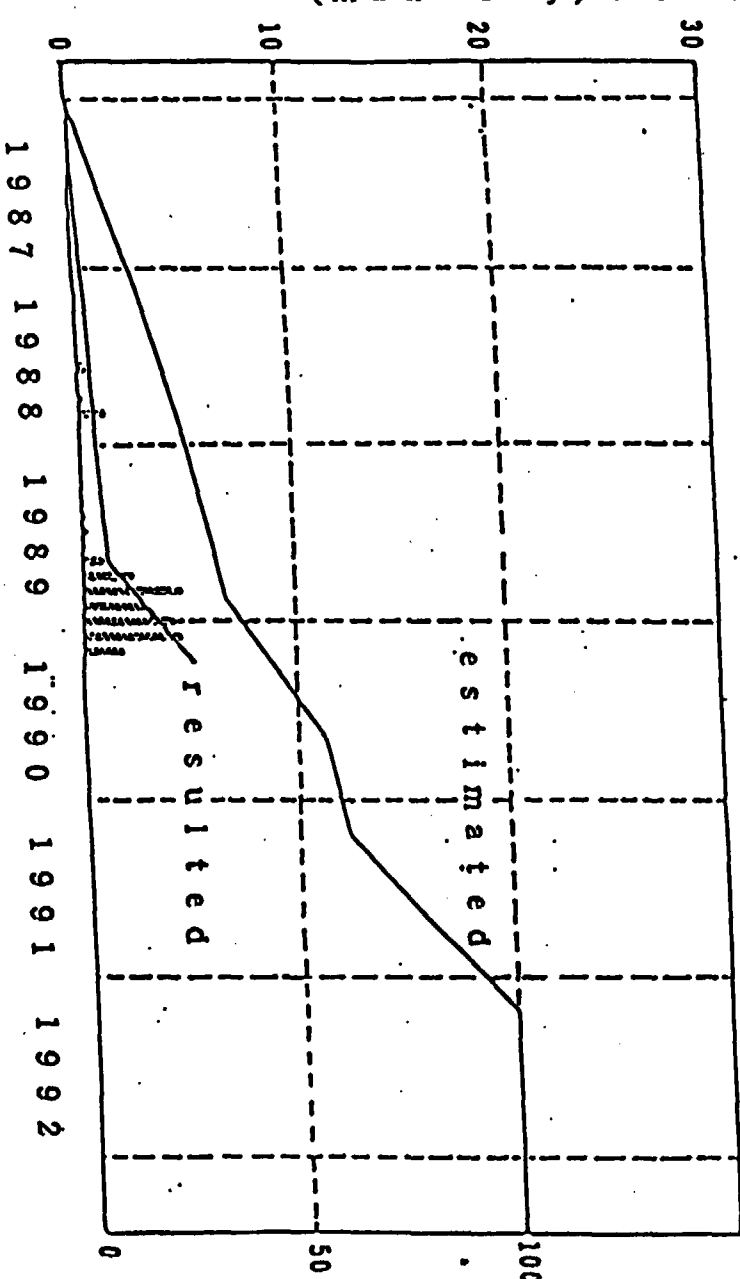

(a) Manpower

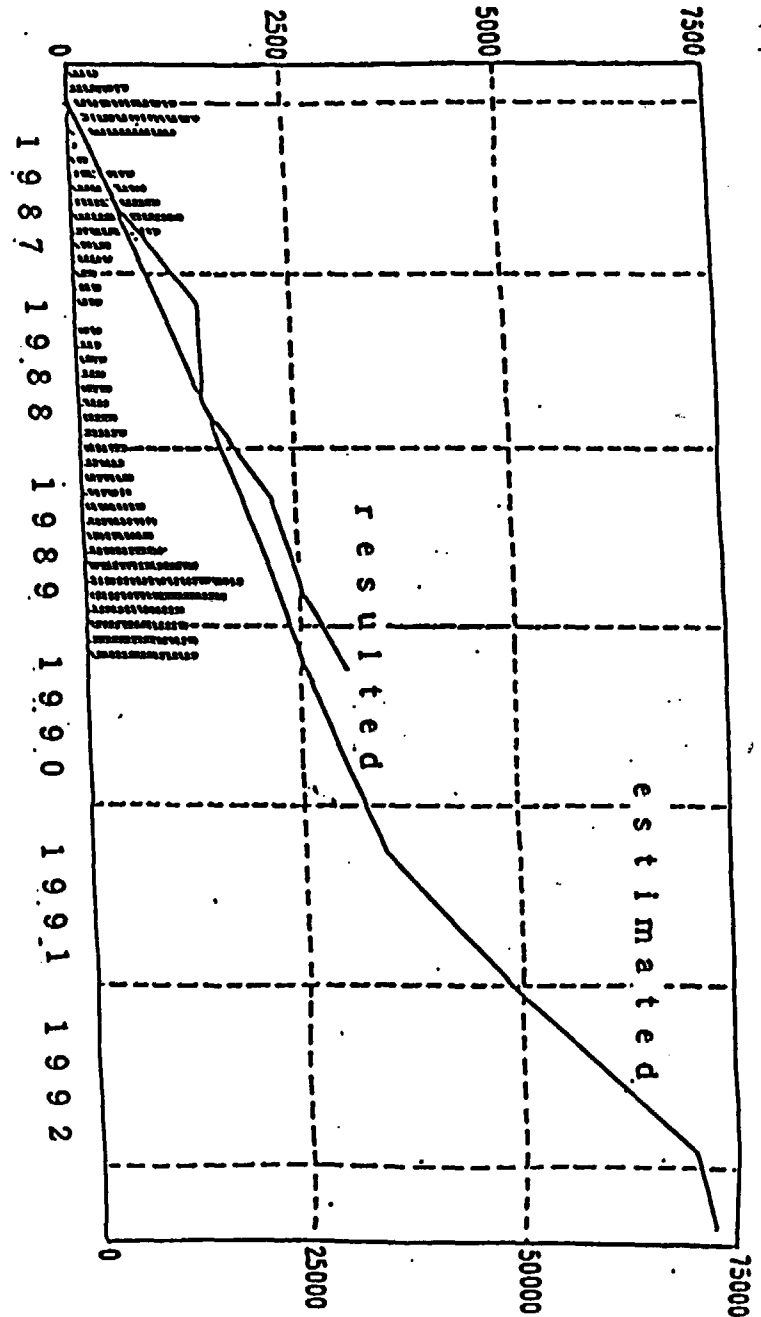

Comulative Worker Exposure
(man·rem)

Comulative Manpower
(man·da)

New JRR-3

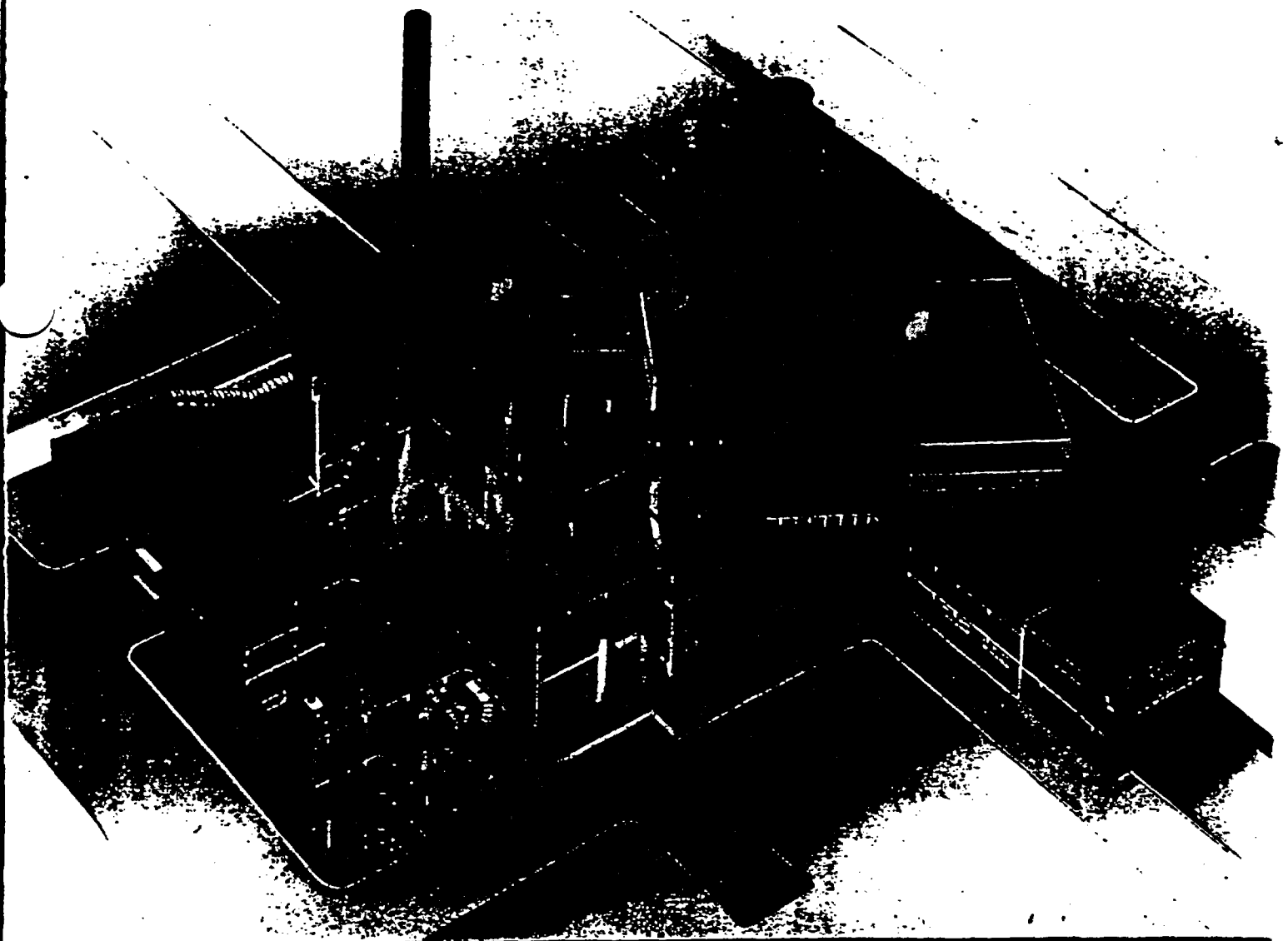

Department of Research Reactor Operation
Tokai Research Establishment

High quality irradiation conditions and high neutron flux conditions have been required in recent years for neutron irradiation and neutron beam experiments in the research reactors. To fulfil these requirements, it was decided that the Japan Research Reactor No.3(JRR-3) should be reconstructed to be upgraded, and the project of new JRR-3 is now progressing. The JRR-3 was constructed in 1962, originally for general studies of nuclear reactors, irradiation of materials, production of radioisotopes, and research and development of nuclear reactors.

The new JRR-3 is equipped with various kinds of experimental facilities for irradiation and beam experiments including a cold neutron source so that the new reactor may be utilized as a multi-purpose research reactor which is at the highest level in the world, with the maximum thermal neutron flux of about 2×10^{14} n/cm²·s, one order higher than that of the old reactor. The safety for the new JRR-3 is fully preserved with highly reliable control systems and cooling systems (including a facility to prevent the core from being unflooded).

The work of the construction for the new JRR-3 started in August, 1985 and Initial criticality of the new reactor was achieved in March, 1990.

Isometric View of Reactor Pool

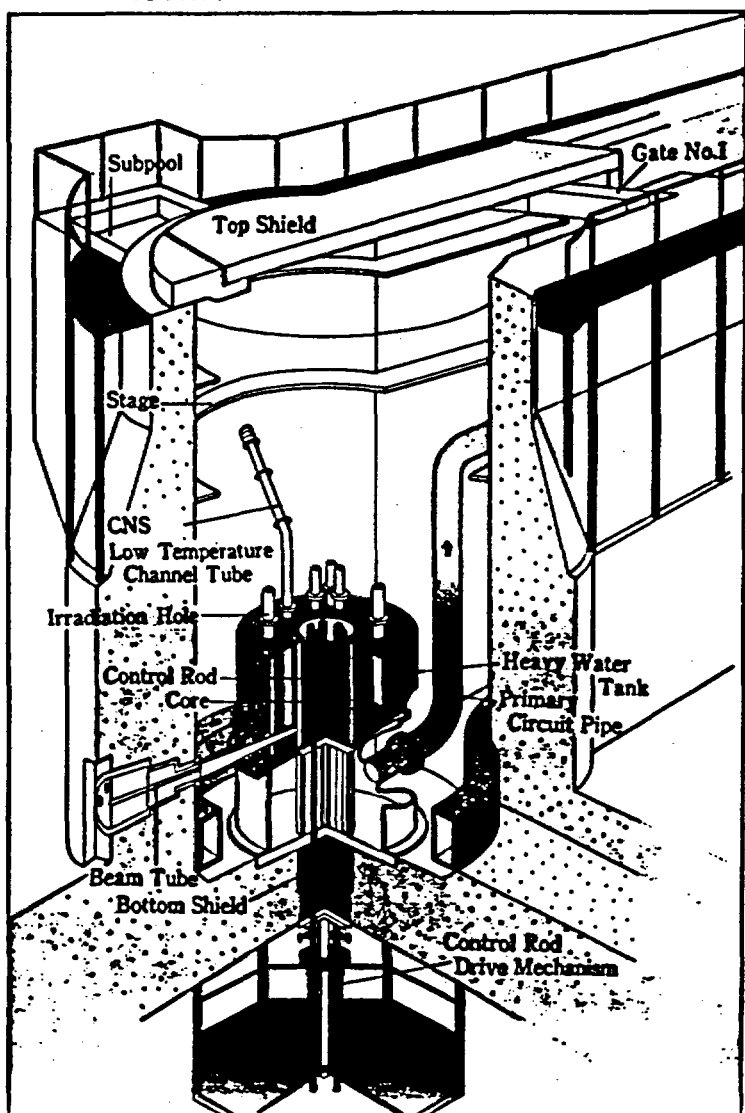

Major Specifications of the New JRR-3

Reactor Type	Low Enriched Uranium, Light Water Cooled and Moderated, Swimming Pool Type.
Rated Power	20 MW
Size of Core	Approx. 60cm dia. and 75cm high (with Beryllium Reflector).
Fuel	UAlx-Al Dispersed, MTR Plate Type 20% Enriched Fuel 26 Standard Fuel Elements and 6 Follower Fuel Elements.
Control Rod	6 Control Rods, Box Type Absorber, followed with Follower Fuel Element.
Reactor Pool	Swimming Pool Type 4.5m dia. 8.5m deep
Experimental Facilities	9 Horizontal Beam Tubes, 17 Vertical Irradiation Holes, and

Experimental beam facilities

3 Beam Hall up to 60 m from Reactor

Nine beam tubes and five neutron guide tubes are installed in order to lead out neutrons for beam experiments.

Good quality thermal neutrons can be obtained for the experiments in the new JRR-3 with these beam tubes arranged tangentially to the core because the γ rays and fast neutrons not preferable to the experiment are much reduced in such a tangentially arranged beam tubes.

The neutron guide tubes lead out neutrons in the distance so that a sufficient number of beam experimental apparatus can be provided to many experimenters and users.

Cold neutron source (CNS)

Cold neutron has very low energy with a wave length of the same order as the molecular structure of substance. So, it is able to research the structure of macro-molecule such as a high polymer with the cold neutron.

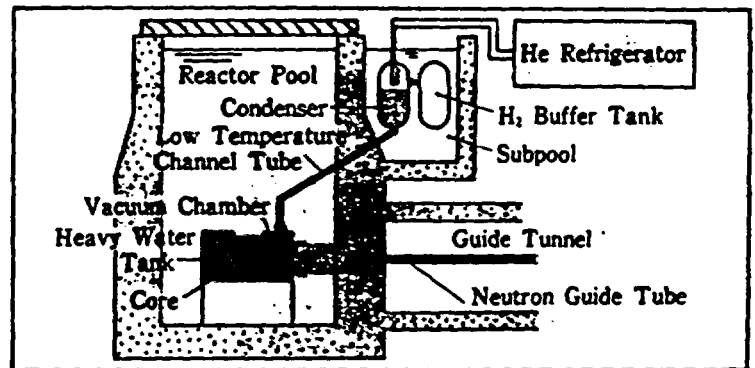

Schematic Diagram

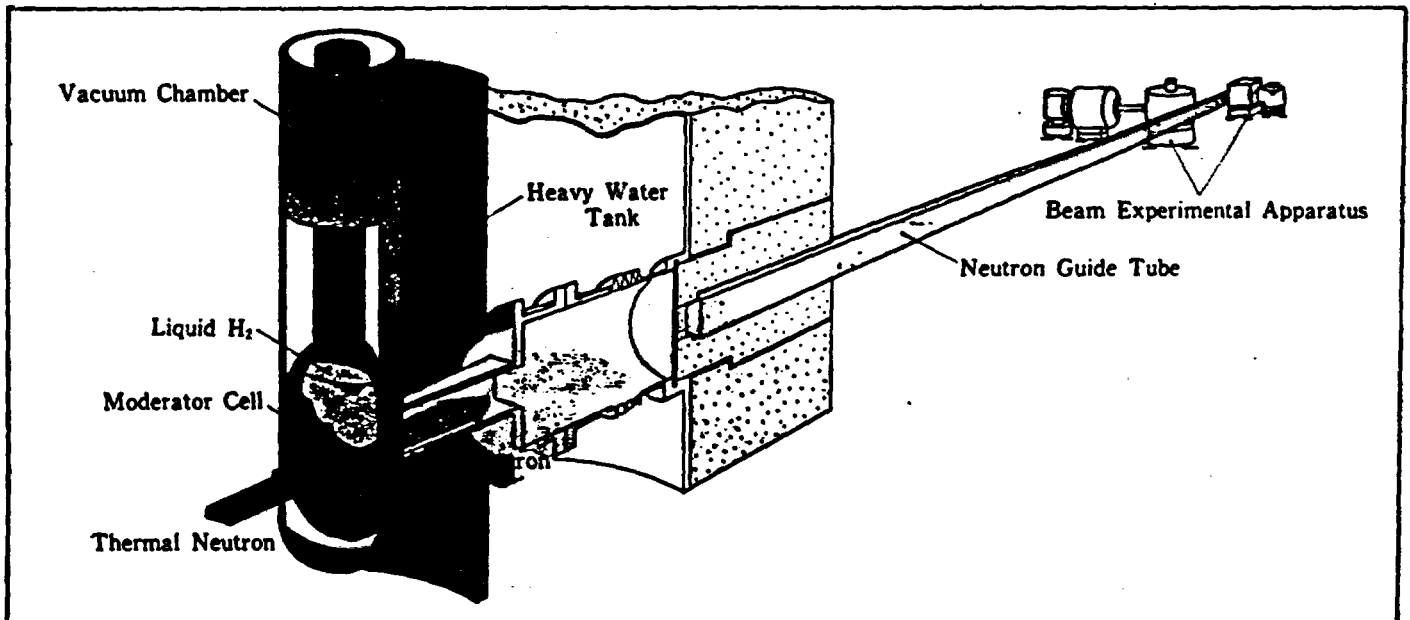

CNS and Neutron Guide Tube

CNS converts thermal neutron into cold neutron with liquid H₂ at 20K. The cold neutron beam is led to the beam experimental apparatus in the beam hall through neutron guide tubes.

COOLING SYSTEMS

Cooling circuit systems are composed of a primary circuit, a secondary circuit and a heavy water circuit. Core heat is finally removed into atmosphere through the cooling tower.

The primary circuit has two independent siphon break valves to prevent the core from being unflooded.

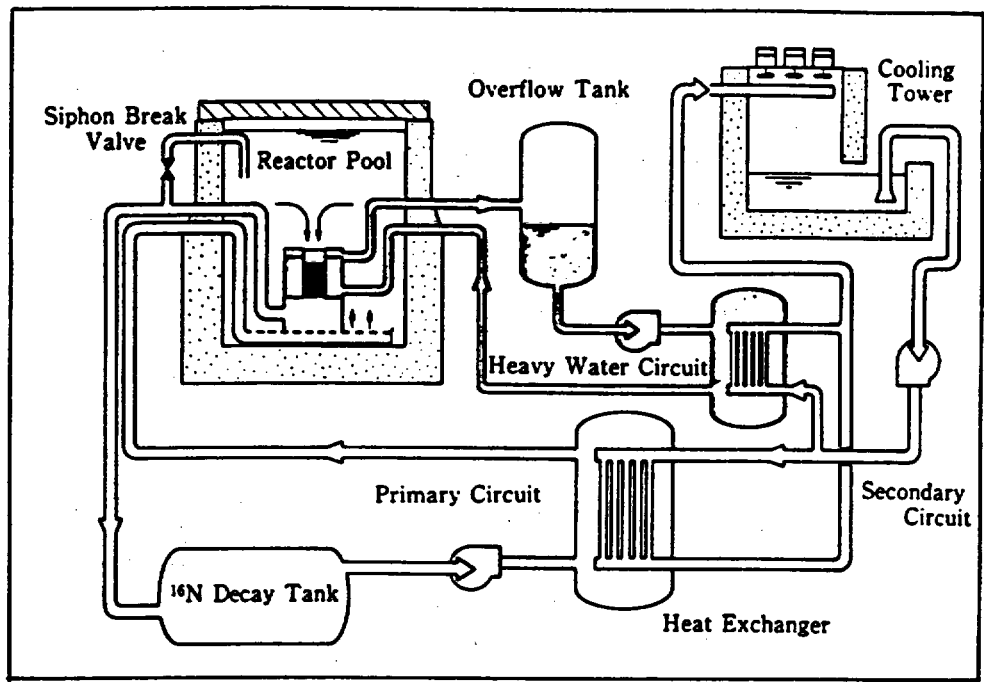

Flow Diagram of Cooling Systems

Standard Fuel Element

FUEL

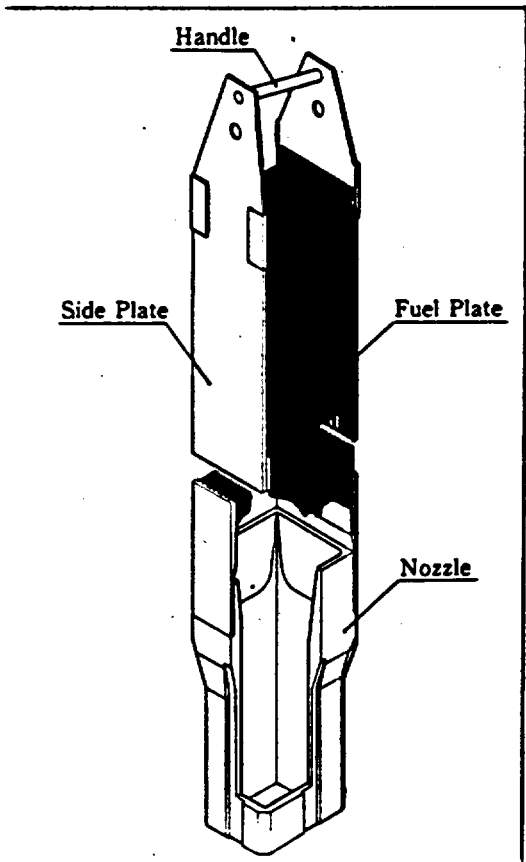

Plate-type Aluminium-Uranium alloy fuels which have higher power density, more coolability and higher performance than Oxide-Uranium fuels of light water reactors, are used in the new JRR-3 as in other research reactors. The new JRR-3 adopts two kinds of fuels, standard fuel element and follower fuel element following the control rod.

Summary of Fuel Specification

Item	Standard Fuel Element	Follower Fuel Element
Size of Fuel	76×76×1150mm	64×64×880mm
U-235 Enrichment	20%	20%
U-235 Contents	300g	190g
Size of Fuel Plate	1.52'×71'×770 ^l mm	1.52'×60'×770 ^l mm
Fuel Plate Number	20/Element	16/Element
Fuel Meat Material	Dispersed UAlx-Al	
Cladding Material	Aluminium Alloy	

UTILITY SERVICES

For irradiation, vertical irradiation holes are arranged both in the core and in the heavy water tank.

For beam experiment, horizontal beam tubes are arranged in the heavy water tank.

Irradiation utilization facilities

For the purposes of reactor fuels and materials exposure tests, radioisotope production and activation analysis, these facilities are used to irradiate by neutron the samples inserted into the vertical irradiation holes.

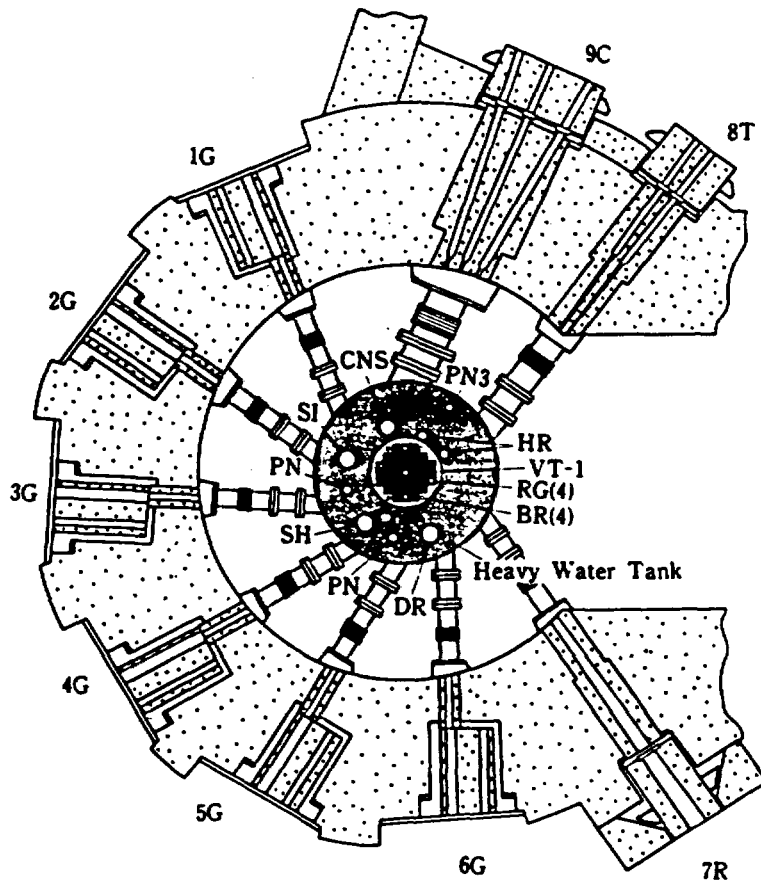

(Vertical Irradiation Holes:
HR, PN, PN3, SI, DR, RG, VT-1, BR, SH)
Horizontal Beam Tubes:
1G~6G, 7R, 8T, 9C)

Arrangement of Experimental Holes

Summary

Name	No	Application	Feature
Hydraulic rabbit irradiation facility (HR)	2	General irradiation Radioisotope production	The rabbit is conveyed and cooled by water. This facility is used to irradiate the relatively heavy and high heat generating samples.
Pneumatic rabbit irradiation facility (PN)	2	General irradiation Radioisotope production	The rabbit is conveyed and cooled by N ₂ gas. This facility is used to irradiate the light and low heat generating samples.
Activation analysis irradiation facility (PN3)	1	Activation analysis of the short life radio nuclides	The radiation measurement is started immediately after the irradiation. This facility is used to analyze the short life radio nuclides.
Uniform irradiation facility (SI)	1	Material irradiation Silicon irradiation	The sample is rotated and moved up and down during the irradiation. This facility is used to irradiate the sample uniformly.
Rotating irradiation facility (DR)	1	Large material irradiation	The sample is rotated during the irradiation. This facility is used to irradiate the sample uniformly in the radial direction.
Capsule irradiation facility	10	Exposure test	This facility is used to irradiate for long period or control the sample temperature in response to the

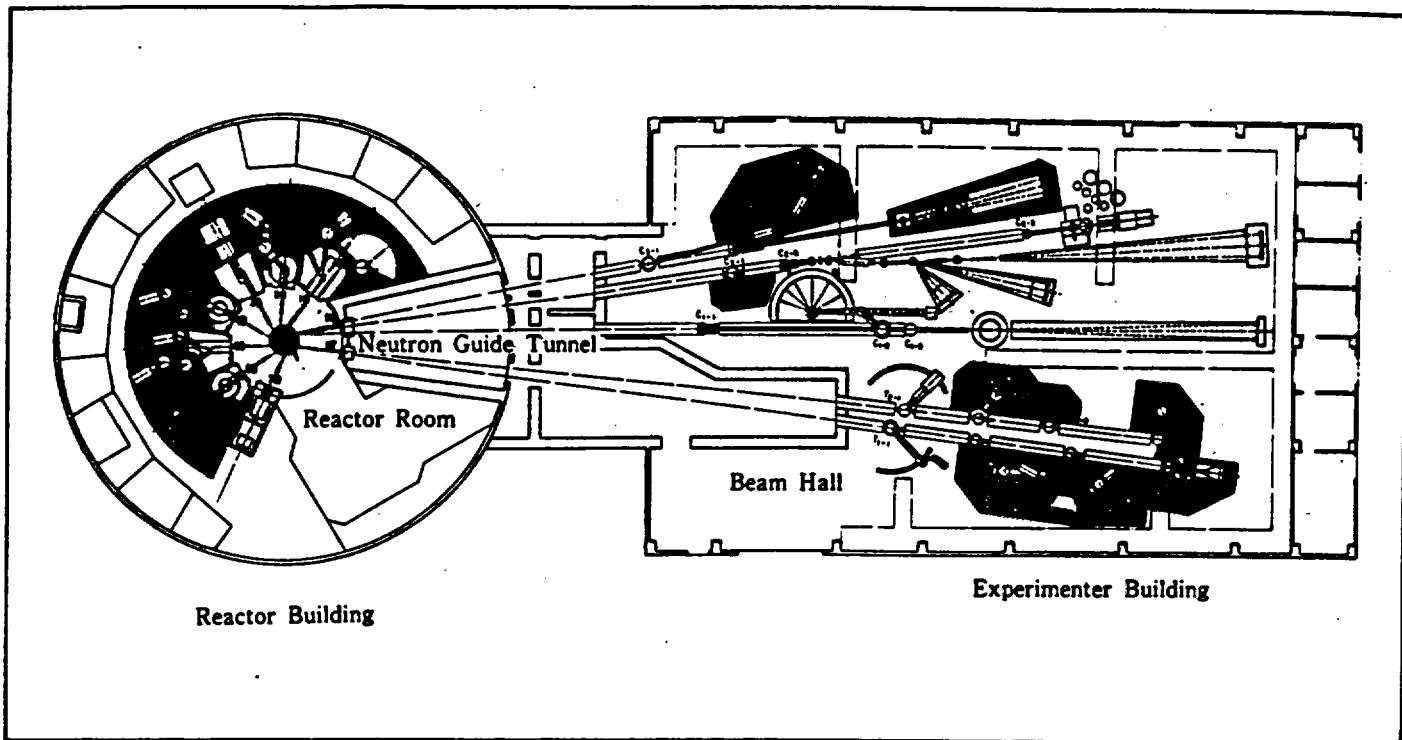

Beam Experimental Facilities

History of JRR-3

Year	Major Events	Year	Major Events
1959	Beginning of JRR-3 construction	'76	Integrated power 300,000 MWH achieved The twentieth anniversary since the reactor critical Close of common use Finish of safety review for new JRR-3 Beginning of the construction work for new JRR-3 ↑ Construction ↓ Completion of new JRR-3
'60		'77	
'61	Reactor completion	'78	
'62	Reactor critical	'79	
'63		'80	
'64	Rated power 10,000 KW achieved	'81	
'65	Beginning of RI production	'82	
'66	Beginning of common use	'83	
'67	Beginning of homemade fuel use	'84	
'68		'85	
'69	Medical irradiation for a brain tumor	'86	
'70		'87	
'71	Sample irradiation of nuclear fuel in LHTL	'88	
'72	Beginning of shift to UO ₂ fuel core	'89	
'73		'90	
'74	Integrated power 200,000 MWH achieved		
'75	Completion of shift to UO ₂ fuel core		

JAERI-M 89-192

Progress Report on Safety Research of High-Level Waste
Management for the Period April 1988 to March 1989

(Eds.) Haruto NAKAMURA and Susumu MURAOKA

Department of Environmental Safety Research
Tokai Research Establishment
Japan Atomic Energy Research Institute
Tokai-mura, Naka-gun, Ibaraki-ken

(Received October 23, 1989)

Researches on high-level waste management at the High Level Waste Management Laboratory and the Waste Safety Testing Facility Operation Division of the Japan Atomic Energy Research Institute in the fiscal year of 1988 are reviewed.

The topics are following studies on the long-term chemical behaviors of long-lived nuclides in geosphere.

- 1) Mineralogical researches on the alteration layer of glass exposed to water were carried out by laboratory experiments and investigation of natural glass. Leaching experiments of Pu and Np were also conducted.
- 2) The spectroscopic methods are applied to study the long-term reaction path modeling of radionuclide fixation using natural materials.

Keywords: High-level Radioactive Waste, Glass, Mineralogical Research, Leaching, Plutonium, Neptunium, Spectroscopic Method, Long-term Reaction Path, Fixation

Contents

Introduction	1
1. Studies on waste forms	2
1.1 Studies on leaching and volatilization of radionuclides from glass waste form	3
(1) Continuous-flow leach tests of simulated high-level waste glass in synthetic basalt groundwater	3
(2) Formation and evolution of alteration layers of borosilicate and basaltic glasses I: Initial stage	6
(3) Growth rate of alteration layer and elemental mass losses during leaching of borosilicate waste glass	9
1.2 Leaching of Pu and Np	12
(1) Temperature effect on Pu leach rate of the nuclear waste glass	12
(2) Release of Np from Np-doped borosilicate waste glass	20
1.3 Volatilization of radionuclides from actual high-level waste	28
(1) Volatilization of ^{137}Cs and ^{106}Ru from borosilicate glass containing actual high-level waste	28
(2) Elemental analysis of the supernatant of actual high-level radioactive liquid waste	31
1.4 Change in density of curium-doped Synroc due to self- irradiation	33
2. Safety evaluation for geological disposal	40
2.1 Studies on migration of radionuclides	41
(1) An experimental study on nuclide migration in simulated single fractures in granite	41
(2) Porosities and diffusion coefficients of iodine anion in rock	45
(3) Adsorption of neptunium on naturally occurring iron- containing minerals in aqueous solutions	48
2.2 Long-term reaction path modelling of radionuclide fixation in geosphere by spectroscopic methods	51
2.3 Safety assessment methods for geological disposal	66
(1) Scenario and data base	66
(2) Rough estimation of ^{237}Np concentrations	66
3. Hot operation at WASTE-F	71

Reactor Decommissioning Technology Development and Actual Dismantling of JPDR

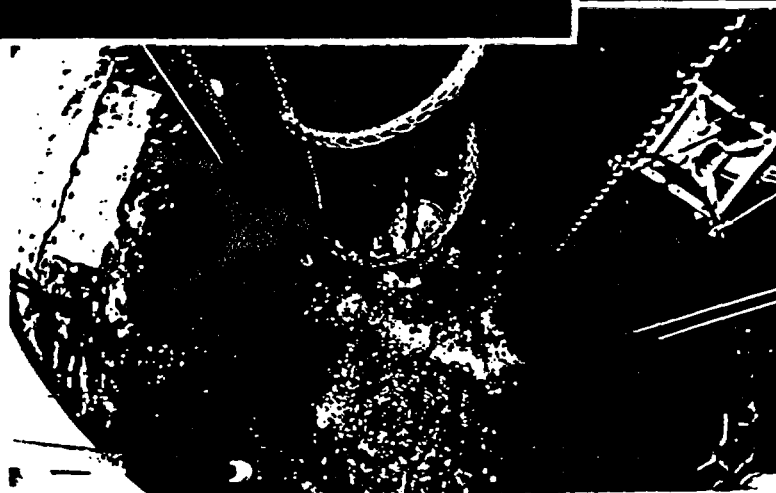
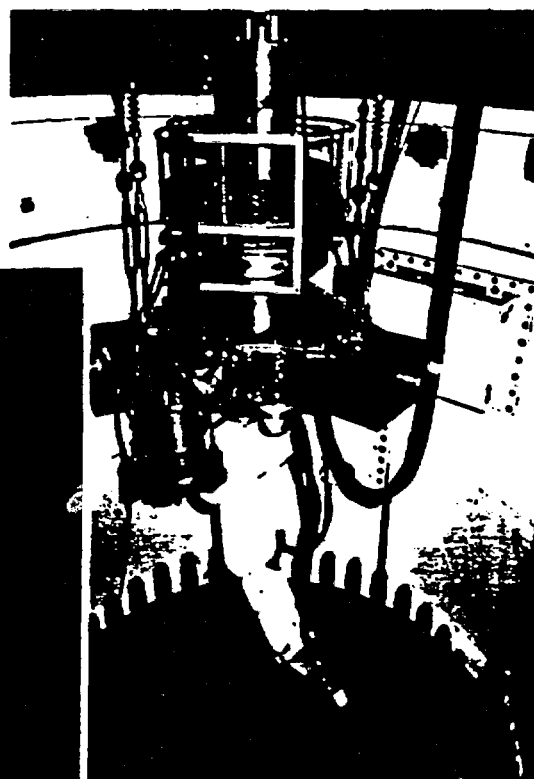

Tokai Research Establishment
Japan Atomic Energy Research Institute

Preparing for Reactor Decommissioning

Necessity of Reactor Decommissioning Technology Development

The useful lifetime of a nuclear power plant is estimated to be 30 to 40 years. Worldwide, a few plants have reached this age. The number of plants reaching this age will increase substantially in this decade. As a result, the technology for nuclear power plant decommissioning must be developed and made available in the near future.

The Elk River Reactor in the United States is an unusual example of a power plant which was completely dismantled after its duty life ended. However, there have been only a few reactors decommissioned worldwide. Reactor decommissioning technology

therefore is not well established. It must be advanced through the development of necessary techniques and these techniques must be applied to actual dismantling.

The Japan Atomic Energy Research Institute, JAERI, has been developing techniques needed for dismantling the Japan Power Demonstration Reactor, JPDR. This is being done under a contract with the Science and Technology Agency, STA. This work, begun in 1981, has progressed to the actual dismantling of the JPDR using the techniques developed.

Schedule of Reactor Decommissioning Technology Development and Actual Dismantling of JPDR

The JPDR decommissioning program consists of two major phases. The purpose of Phase 1 was to develop techniques necessary for dismantling JPDR. It was essentially completed in 1986. The purpose of Phase 2 is to dismantle the JPDR. This is

now underway using the techniques developed in Phase 1. The major objectives of this dismantling program are to develop and demonstrate dismantling techniques and to accumulate power reactor decommissioning experience.

▼ Schedule

Phase	Fiscal Year	1981	1982	1983	1984	1985
Development of Reactor Dismantling Techniques (Phase 1)						
Actual Dismantling of JPDR (Phase 2)						



Reactor Decommissioning Alternatives

Decommissioning a power reactor can be accomplished by any of the three following methods. Dismantlement is considered to be the most suitable decommissioning option in Japan because it effectively uses scarce land.

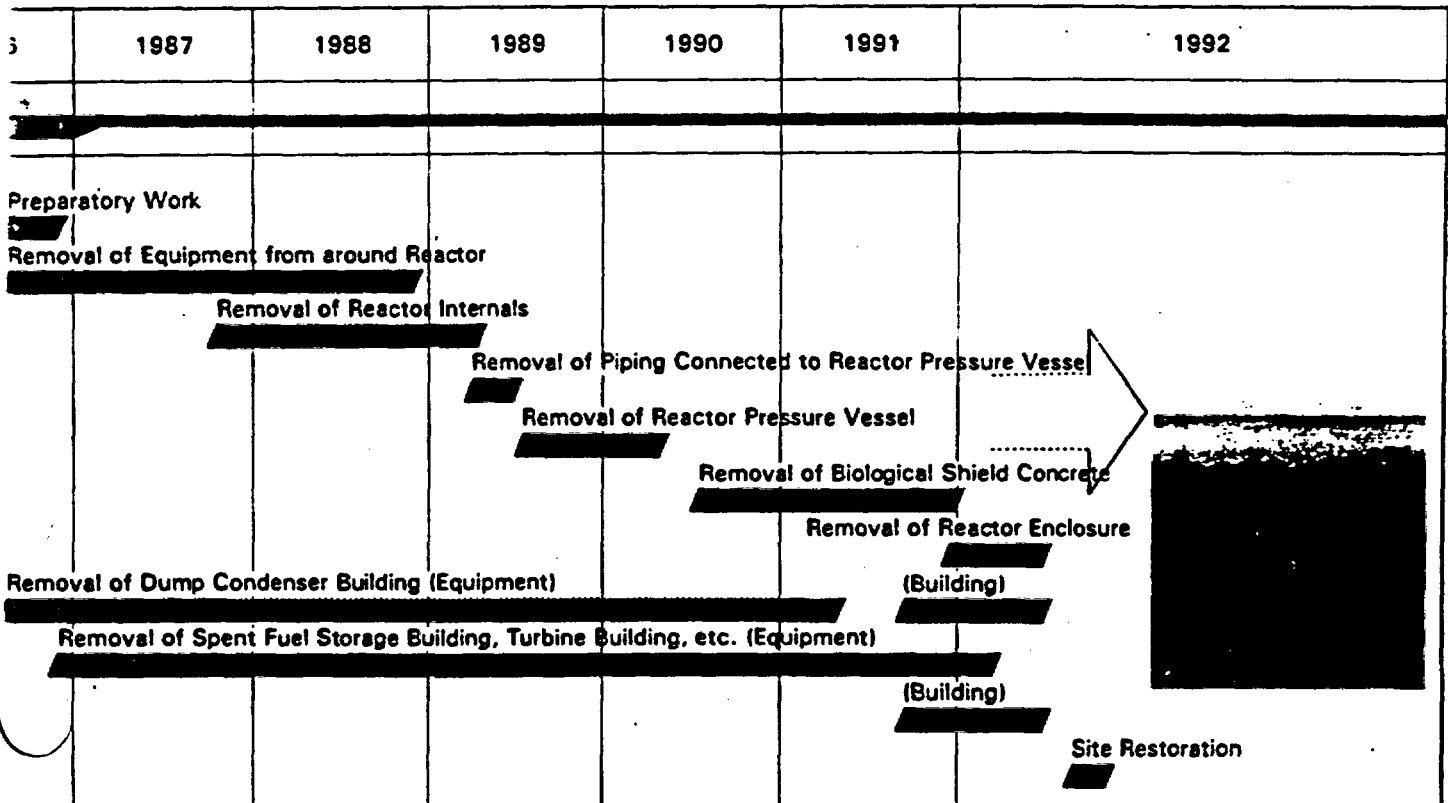
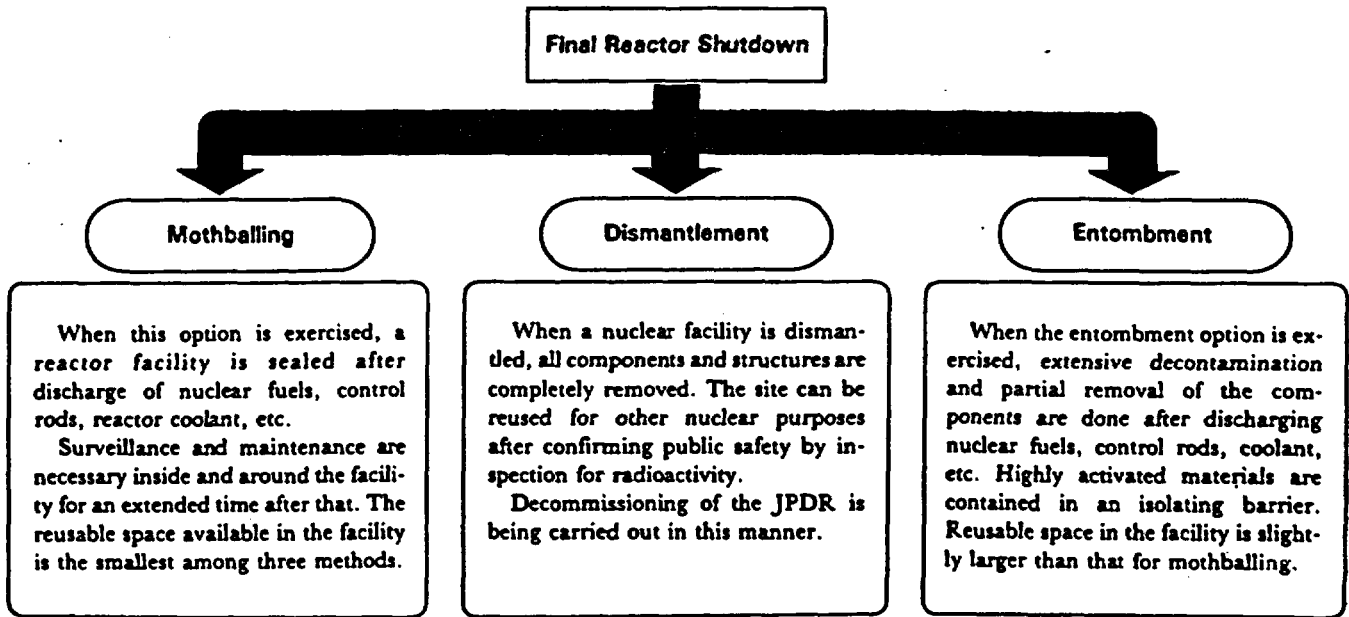

Systems Engineering for Reactor Decommissioning

To accomplish reactor decommissioning safely and economically, it is necessary to analyze the work involved and to select the most favorable modes and procedures. The following decommissioning management data must be evaluated, worker exposure, the amount and type of radioactive waste produced, the cost of labor, equipment and materials, etc.

A computer code system has been developed for evaluating these data efficiently. Evaluation results using this code system have already been used in management of JPDR decommissioning work.

Noninvasive Measurements of Radioactivity Inside Pipe

To cut pipes safely and efficiently, beforehand it is important to evaluate quantitatively their radioactive inventory, the constituent radionuclides and their distribution, inside the pipes. As a result, an in situ noninvasive measurement system for radioactivity inside pipe has been developed.

Radioactive Inventory Estimation

A good estimate of the radioactive inventory in a reactor facility at the end of its life is essential and fundamental to prepare a decommissioning plan. For this reason, methods to identify radionuclides and measure their distributions have been extensively evaluated throughout the JPDR facility. These measurements and calculations were used to prepare a rational dismantling plan for the JPDR.

Dismantling Techniques and Systems

Dismantling techniques and systems appropriate for each component and structure have been developed to efficiently and safely dismantle steel structures and concrete structures which are activated or contaminated or both. The following dismantling systems have been used in the JPDR dismantling.

For Steel Structures

- Plasma Arc Cutting System
- Arc Saw Cutting System
- Rotary Disk Knife Cutting System
- Shaped Explosive Cutting System

For Concrete Structures

- Diamond Sawing and Cutting System
- Abrasive Water Jet Cutting System
- Controlled Blasting

Development of Reactor Decommissioning Technology

Many varieties of techniques are needed for dismantling a reactor because of the radioactivity within and around a reactor and its systems. Research and development of the following techniques has been systematically performed by researchers and engineers in JAERI.

Decommissioning Waste Treatment, Storage and Disposal

The following techniques have been developed for the treatment, storage and disposal of the very large volume of wastes produced when dismantling a reactor facility.

- Containers for Wastes
- Volume Reduction and Separation of Wastes
- Cement Solidification of Crushed Concrete Wastes
- Immobilization of Surface Contamination on Dismantled Components

Decommissioning for Reactor Decommissioning

The following decommissioning techniques for reactor decommissioning have been developed to minimize radiation exposure to workers and to reduce the quantity of radioactive wastes produced.

- Decommissioning of the System before Dismantling
- Decommissioning of Dismantled Components
- Concrete Surface Decommissioning

Radiation Control

Various devices and techniques have been developed to establish radiation control technology for reduction of radiation exposure to workers and improvement of work efficiency in reactor dismantling.

- Contamination Inspection Monitor
- Remote High Dose-Rate Measuring Instrument
- Respirable Dust Monitor
- Extremely Low-Level Waste γ -Scanner
- Waste Package Contamination and Dose-Rate Monitor
- Environmental Impact Assessment for Radioactivity Released

Remote Operation Techniques

Remote operation techniques are vital for dismantling work in a high level radiation environment to reduce radiation exposure to workers. The following research and development activities have been conducted to accomplish this.

- Research of Remote Control Technology
- Testing of Radiation-Resistant Sensors for Remotely Operated Systems
- Fabrication and Testing of a Robotic Manipulator System

Techniques Needed for Reactor Dismantling

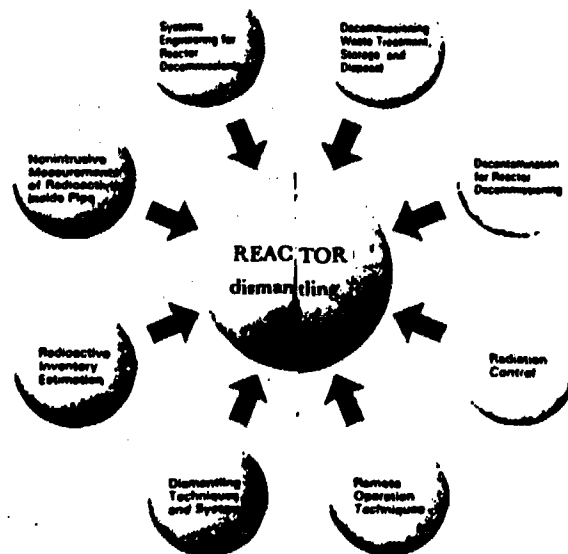

Actual Dismantling of JPDR

The actual dismantling of the JPDR is being carried out on a seven-year plan which began in 1986. It uses techniques developed in JAERI. The major objectives of the dismantling program are to develop and demonstrate the applicability and effectiveness of these techniques, to contribute to dismantling technology, and to establish safety standards for power reactor dismantling work. Except for the office building and the storehouse, the entire JPDR facility is scheduled to be dismantled. Following restoration, the site will be landscaped.

Major items of the dismantling procedure and dismantling techniques to be applied are illustrated as follows.

Underwater Plasma Arc Cutting

Plasma Arc Cutting with Robotic Manipulator

Diamond Sawing and Coring



Water Jet Cutting

Controlled Blasting

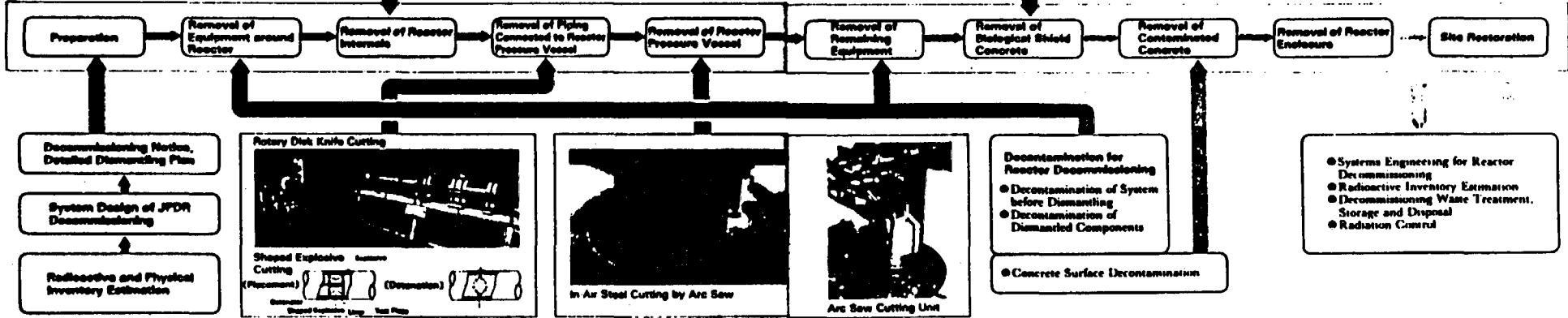

Process for Reactor Dismantling

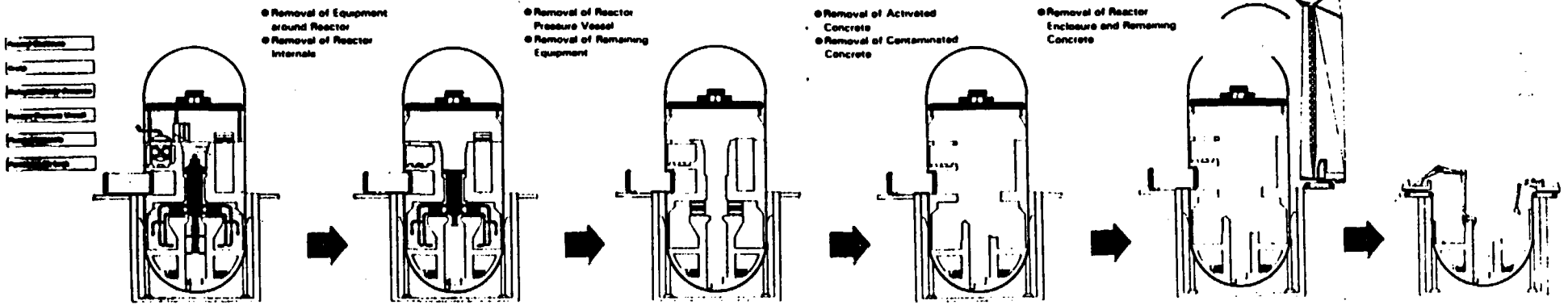

Systems Engineering for Reactor Decommissioning

Reactor decommissioning management data (such as cost, manpower and worker exposure) are influenced by specific aspects of the reactor to be dismantled, the types of dismantling techniques to be employed, etc. Systems engineering applied to reactor decommissioning will estimate management data using computer codes and will analyze the dismantling work systematically to plan decommissioning work which is both safe and economical.

Development of a code system for management of JPDR decommissioning, COSMARD, is complete. The COSMARD was used to prepare the JPDR Decommissioning Plan. Verification of the capability of this system is underway using the JPDR dismantling data. An advanced code, COSMARD-1, for use with a large power reactor, is being developed by using the knowledge gained and the various data collected during the dismantling of JPDR.

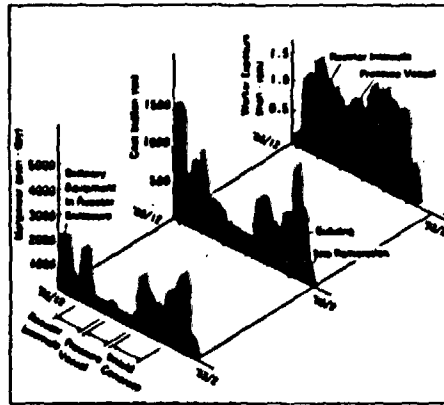

COSMARD Estimates of Some Management Data for JPDR Decommissioning

Nonintrusive Measurement of Radioactivity inside Pipe

A remotely operated in situ nonintrusive measuring system was developed for determining the constituents radionuclides and their concentrations inside pipes of the reactor primary coolant system. Internal pipe contamination was investigated before dismantling to prepare appropriate dismantling procedures and to prevent unex-

pected contamination accidents.

This system was used for contamination measurements of the JPDR forced circulation pipes. The results proved that this remotely controlled system can measure internal pipe radioactivity with the accuracy required.

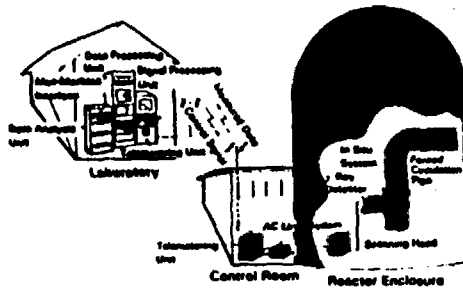

Configuration of In Situ Measuring System for JPDR Forced Circulation Pipe

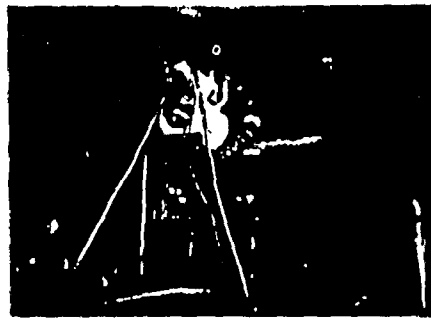

In Situ Measuring System on a Horizontal Pipe

Radioactive Inventory Estimation

Techniques for efficiently estimating the radioactive inventory (activation and contamination) in a reactor facility with the required accuracy were developed. Various data necessary for planning and performing reactor decommissioning have been obtained using these techniques.

A code system was developed for calculating the distribution of radioactivity of activated and contaminated components and structures such as the reactor internals, the pressure vessel, the biological shield concrete and the piping. The capability of this code system to estimate radioactivity from activation was verified with measurements of samples taken from the components and structures of the JPDR. The contamination of components and structures such as the piping and building concrete was also measured to evaluate the ability of the code to estimate the concentration and distribution of contamination.

These data have been used for planning safe and efficient dismantling and decommissioning activities and for managing the waste produced by the dismantling.

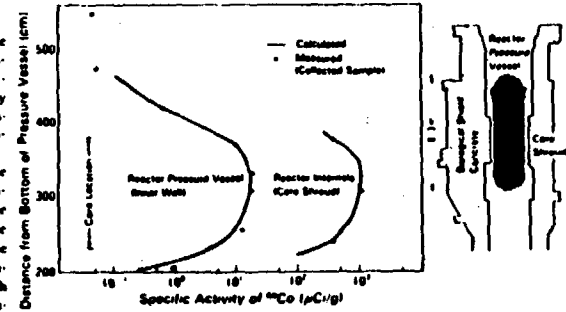

Distribution of Radioactivity in Reactor Pressure Vessel and Reactor Internals

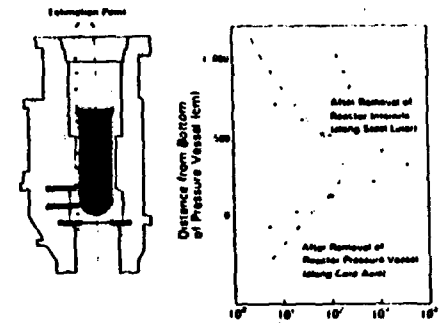

Calculated Distribution of Dose Rates along Core Axis and Steel Liner

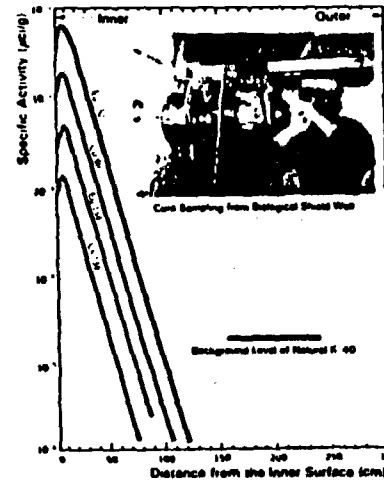

Distribution of Radioactivity in JPDR Concrete Biological Shield (at the height of core center)

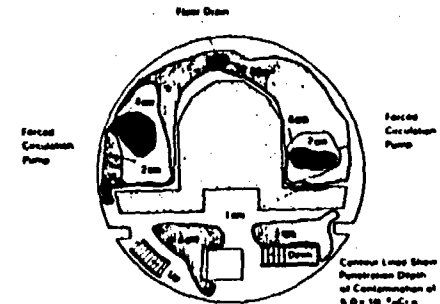

Distribution of Radioactive Contamination on B2F of JPDR Reactor Enclosure

Removal of Reactor Internals Using Plasma Arc Cutting System

Reactor internals in a reactor pressure vessel are usually stainless steel and among the most activated components to be dismantled. In addition, there is very limited working space for tools used to dismantle the internals. A plasma arc cutting system was therefore developed for this purpose.

Plasma arc cutting produces intense local heat, generated by the electric arc which flows through the gas between the plasma torch electrode and the metal being cut. The metal is cut when the heat melts the metal and the molten metal is driven away.

The reactor internals are cut into large pieces in the reactor

pressure vessel using the primary plasma arc cutting device. These pieces are transferred underwater to the spent fuel storage pool where they are cut into smaller pieces suitable for packing in containers. Cutting in the pool is done with the secondary plasma arc cutting device.

Two types of plasma arc cutting systems have been used in dismantling the reactor internals. They are the robotic manipulator type and the mast type, so named because of the differences in supporting and positioning the plasma torch, as shown below.

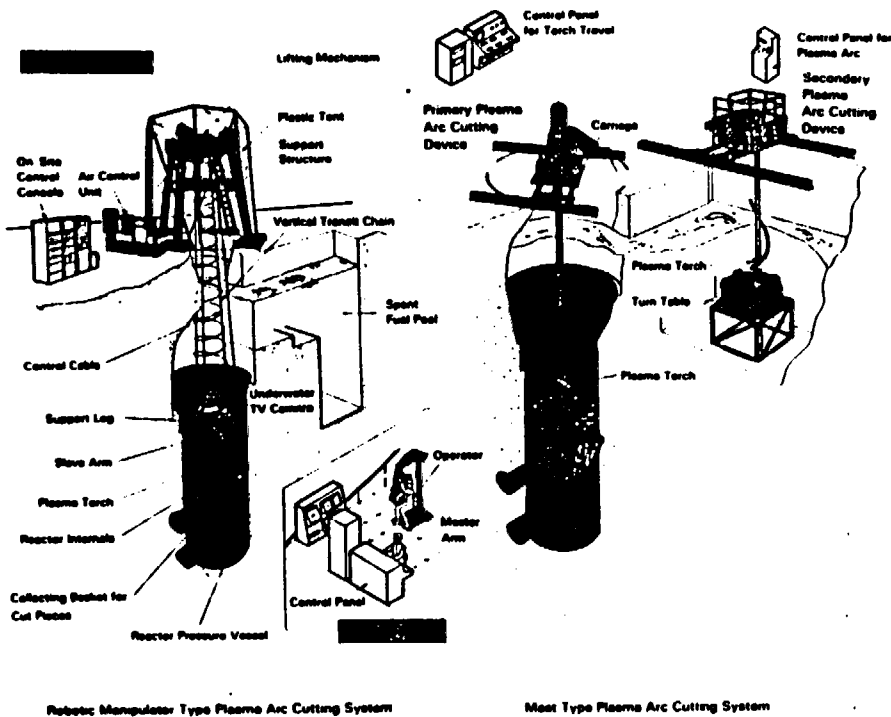

Removal of Piping Connected to Reactor Pressure Vessel Using Shaped Explosive and Rotary Disk Knife Cutting Techniques

Piping connected to a reactor pressure vessel through the biological shield concrete must be cut from the interior of the pipe. The pipe exterior has little access because of the very limited space between the reactor pressure vessel and the biological shield concrete. Shaped explosive and rotary disk knife cutting systems were therefore developed for these pipes. Small pipes (76.2mm (3in) O.D) or less) are cut with shaped explosives and the other larger pipes are cut with the rotary disk knife.

The rotary disk knife, forced against the inner surface of a pipe by hydraulic pressure, cuts the pipe by making it deform plastically and does so without producing cutting chips. The shaped cylindrical explosive has a copper lined V groove on the circumferential surface. It cuts the pipe as a result of the impact of high velocity molten copper produced by detonation of the explosive.

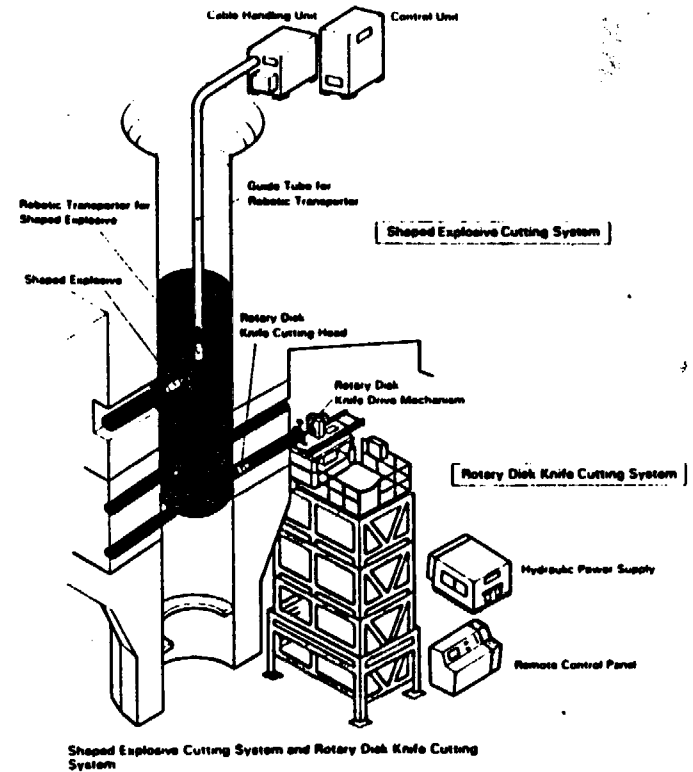

Removal of Reactor Pressure Vessel Using Arc Saw Cutting System

A reactor pressure vessel is a thick walled carbon steel vessel with a stainless steel liner. Thus, a technique capable of cutting the thick carbon steel wall and both metals is required. An arc saw cutting system was developed for this task. With this system, an electric arc is established between a rotating blade and the metal to be cut. The intense heat produced by the electric arc melts the metal being cut and the molten metal is removed by the rotating blade.

The development of this system concentrated mainly on improving cutting performance.

A reactor pressure vessel is cut underwater using the arc saw cutting system. Cutting is done in a water-filled cylinder constructed in the space between the bulkheads of shield concrete and the pressure vessel. Cut blocks have side dimensions of about 7 ft x 6 ft x 6 ft. The blocks are transferred in the air to storage containers.

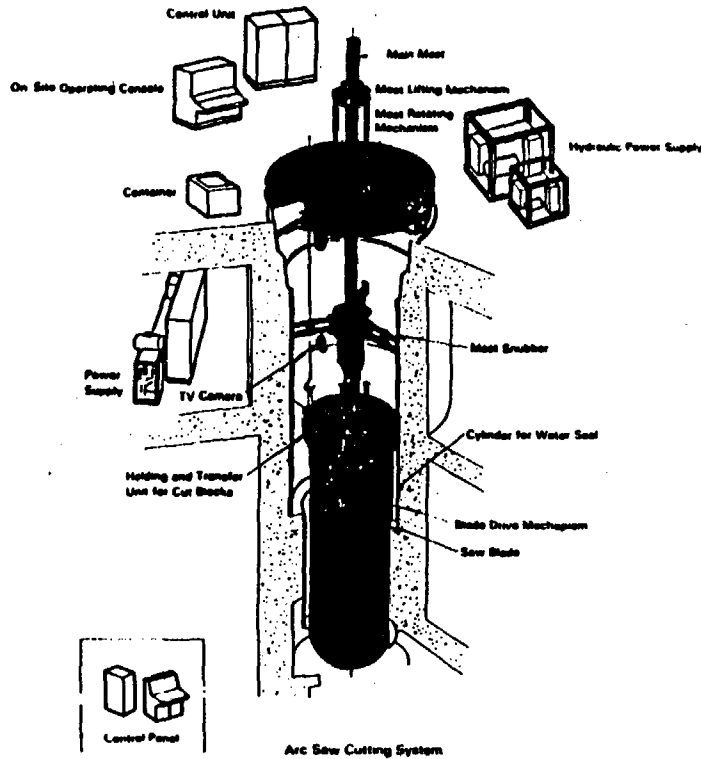

Removal of Biological Shield Concrete Using Diamond Sawing and Coring, and Water Jet Cutting Techniques, and Controlled Blasting

The biological shield for a power reactor is a massive concrete structure with many large reinforcing rods embedded in it. Moreover, the concrete and steel closest to the reactor core is highly activated. This highly activated portion is cut into blocks using a diamond sawing and coring system and an abrasive water jet cutting system.

With the diamond sawing and coring system, the concrete is cut by remote control with a disk-shaped saw blade and a cylindrical core bit, both tipped with diamond abrasives.

The abrasive water jet cutting system functions by forcing high pressure water (2,000 kg/cm²) containing abrasives from a small nozzle at the concrete being cut.

Concrete which has been only slightly activated is demolished by controlled blasting.

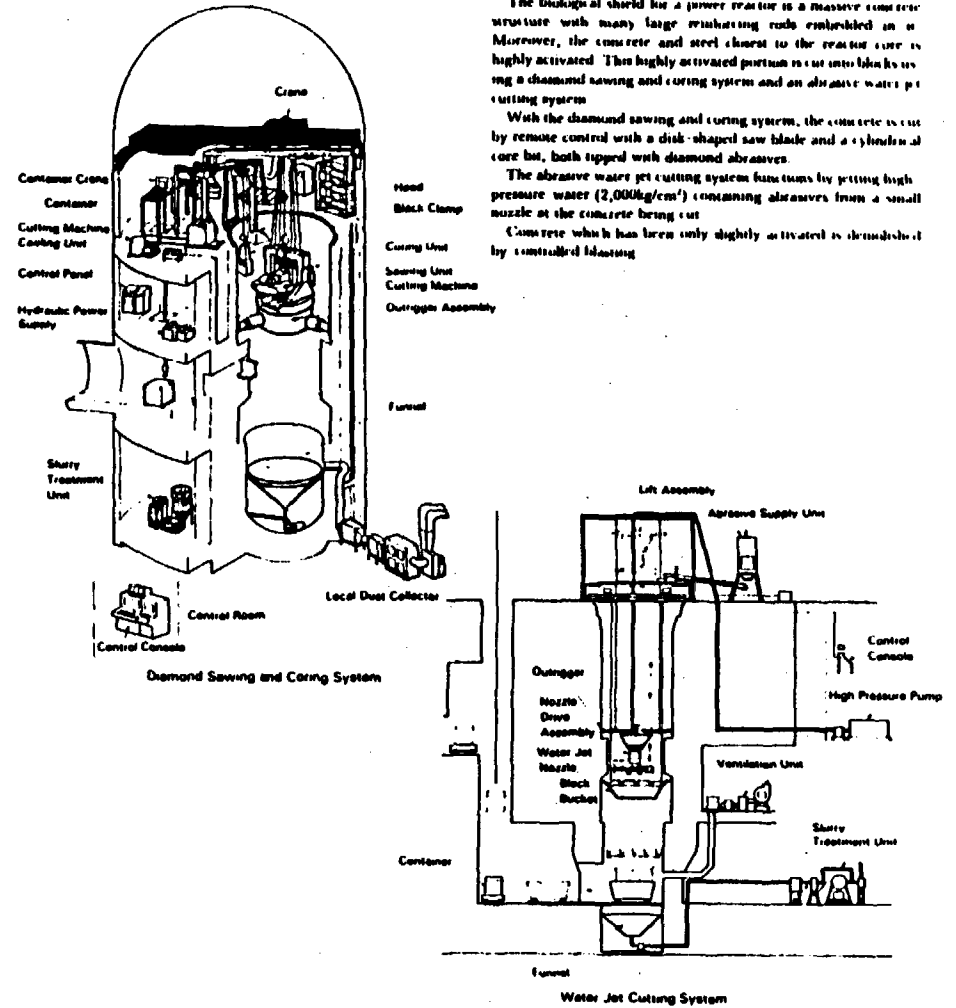

Decommissioning Waste Treatment, Storage and Disposal

A management system developed in JAERI for JPDR decommissioning wastes is being used. Several shielded containers and drums have been designed and fabricated. These are used to package wastes having various sizes and with various activity levels.

Technology was already developed for volume reduction of dismantled metal wastes by cutting and high compaction, cement solidification of concrete wastes, and immobilization of surface contamination. These techniques are being used in the dismantling of JPDR and are also available for dismantling commercial power reactors.

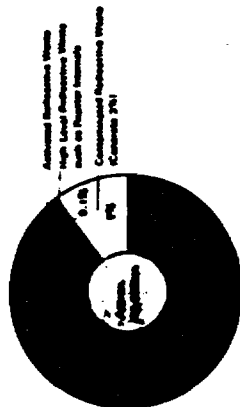

Estimated Percentages of Solid Waste Weight Arising from JPDR Decommissioning

Decommissioning is very important in dismantling reactor facilities. Properly applied, decommissioning will reduce the radiation exposure to workers and the volume of radioactive wastes. It will also permit the reuse of some materials which would otherwise become waste.

System Decommissioning before Dismantling

Decommissioning of the components and pipes in the primary coolant system before dismantling will reduce the radiation exposure to workers.

Before dismantling the JPDR primary coolant system pipes, decommissioning was for the effectiveness of improved and newly developed decommissioning techniques were conducted. These pipes had a relatively high level of contamination. In these tests, high decommissioning efficiencies were obtained for both a flowing abrasive decommissioning method and a Sulfuric acid-Cerium (II) decommissioning method. Both methods were developed in JAERI.

The flowing abrasive method uses the crushing power of flowing abrasive particles. The Sulfuric acid-Cerium (II) method is a redox decommissioning method which uses the superior oxidizing action of cerium. The decommissioning efficiency was also improved

An experimental system for investigating volume reduction techniques by sorting dismantled metal wastes is to be fabricated and tested.

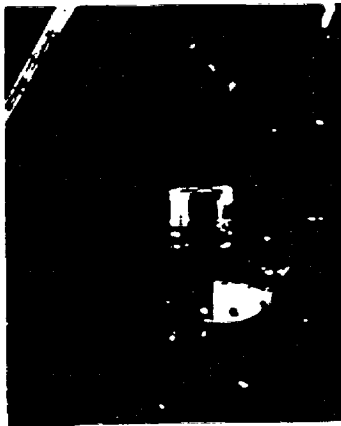

Underwater Storage Work for Pieces of Reactor Intermediate in Shielded Container

Decommissioning for Reactor Decommissioning

For the modified concentration decommissioning method, three decommissioning methods provided a considerable reduction in the contamination level of the primary coolant system and thus, radiation exposure to workers.

Decommissioning of Dismantled Components

Dismantled steel structures such as components and pipes can be moved and they are not so treated. This will reduce the quantity of radioactive wastes requiring disposal.

Three decommissioning methods, acid leaching, chemical immersion and electroplating, have been used to remove contamination thoroughly from dismantled steel components.

Concrete Surface Decommissioning

Contaminated surface layers of the concrete structures of a reactor facility being dismantling must be removed before demolition of the building. A new remote decommissioning was developed to remove contaminated surfaces of concrete. Microwave energy from the decommissioning is absorbed within the first few centimeters of the concrete surface. This energy heats the water hydrating contained in the concrete and produces high pressure steam. The concrete surface is then removed (blown away) through a spalling process caused by the high pressure steam.

Radiation Control

The environmental impact of an air radioactivity was assessed because of the shallow land burial of extremely low-level radioactive wastes at the JPDR site.

The various measuring instruments and monitors for radiation control listed below were developed to reduce radiation exposure to workers and to assess the efficiency of the dismantling work.

- Remote High Dose-Rate Measuring Instrument
- Respirable Dust Monitor
- Contamination Inspection Monitor
- Extremely Low-Level Water J-Sampler
- Waste Package Contamination and Dose Rate Monitor

Remote Operation Techniques

Studies of basic techniques for an advanced robotic system for reactor dismantling have been completed. A robotic manipulator system for the dismantling of JPDR was fabricated based on the results of the studies and mock-up tests were conducted on it. During the period of January through March of 1989, this system was used to cut the reactor internals and much useful data were obtained on operational performance, working efficiency, etc.



Control Room for Remote Operation of Underwater Plasma Arc Cutting System

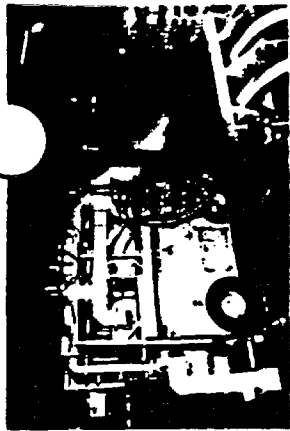

Remote Controlled Carrier for Microwave Decommissioning

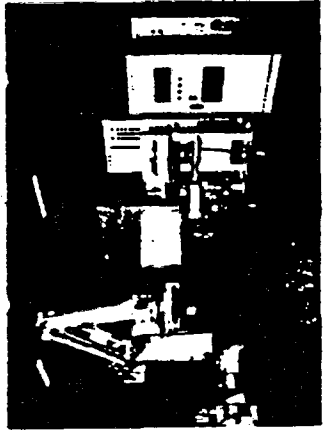

Automatic Surface Contamination and Dose Rate Monitor for Specific Waste Packages

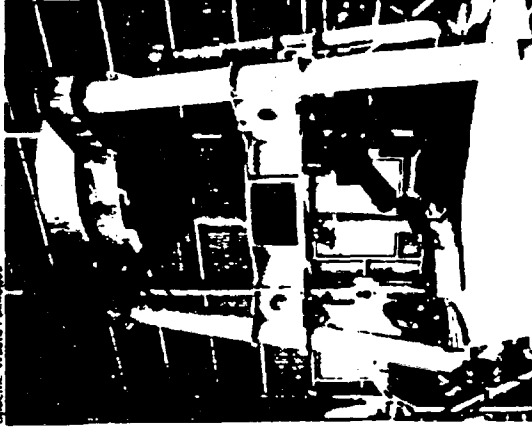

Robotic Manipulator for Dismantling Reactor Internals

Preparing for Decommissioning of Commercial Power Reactors in the Near Future

Decommissioning of nuclear reactors has become a matter of worldwide concern. Research and development of decommissioning technology is actively being pursued in many countries.

In 1985, the "Cooperative Programme for the Exchange of Scientific and Technical Information Concerning Nuclear Installation Decommissioning Projects" was initiated by OECD/NEA to contribute to the improvement of the decommissioning technology

through the systematic exchange of related techniques and experience. Fifteen organisations in ten countries, including Japan, have joined the cooperative programme and the exchange of information has proceeded vigorously. JAERI has played an important role since the start of the programme and the results of decommissioning technology development in JAERI have been highly esteemed by many countries.

Bilateral Cooperation in Decommissioning

In this cooperative programme, much closer bilateral and multinational information exchanges are feasible under special arrangements. JAERI now has bilateral arrangements with the United Kingdom, Canada and France, and is proceeding with exchanges of the information, technology and experience regarding

decommissioning. JAERI is also cooperating with the United States in a wide and significant exchange of technical information related to decommissioning.

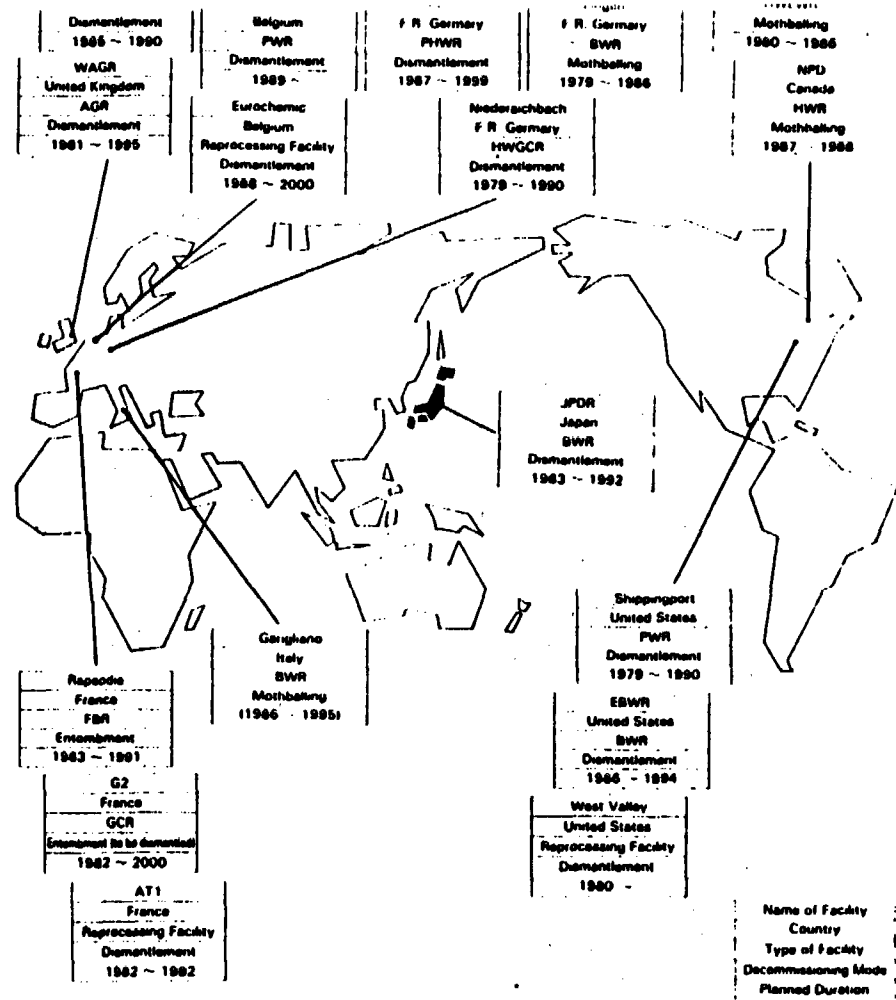
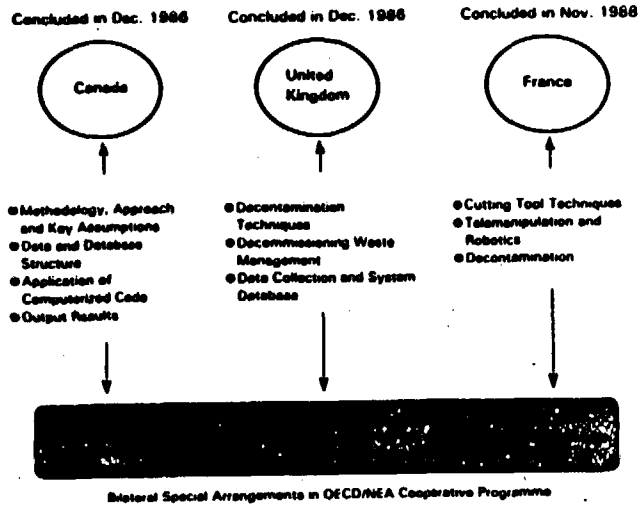

Decommissioning Projects Participating in the OECD/NEA Cooperative Programme for the Exchange of Scientific and Technical Information Concerning Nuclear Installations (As of March 1990)

'90.11.8

Safety Studies on Glass Waste Form

S. Muraoka

In order to achieve the safe disposal of radioactive waste, it is necessary to promote the development of waste management technology as well as the safety assessment study. In JAERI, safety studies for contribution to establishment national safety criteria and safety assessment are being conducted as well as basic research to support development of waste management technology which is adaptable to environmental conditions in Japan.

Characterization of radioactive waste has been carried out for some items to evaluate the safety, according to process of transportation, storage and disposal.

In this document, some of our recent activities are described briefly of the JAERI's studies on the glass waste form for high level waste disposal.

(1) Volatilization of ^{137}Cs and ^{106}Ru from Borosilicate Glass Containing Actual High Level Waste [1]

As the safety evaluation test in relation to operation of storage facility, the volatilization of Cs and Ru from borosilicate glass containing actual HLW was examined in an almost closed canister.

The HLW glass used for the present study was borosilicate glass. The reagents for the glass additives and the simulated HLW which should be converted into 1300g of oxide glass were mixed simultaneously and placed in a vitrification apparatus with about one liter of a denitrated actual HLW solution. About 50g of various oxides were assumed to come from the actual HLW solution. This mixture was calcined at about 750°C , melted at 1200°C , for 2 hours in the vitrification apparatus. Half the molten glass was poured into an 8.1cm-i.d., 24.4cm-high stainless steel canister, kept at 600°C for 2 hours, and then cooled to room temperature at a cooling rate of less than $40^{\circ}\text{C}/\text{h}$. The furnace temperature was raised in steps from 25°C to 1000°C (Fig.1). The temperature rise by the decay heat of the HLW was so small in the present study that it did not affect the temperature control of the glass. During the course of heating, part of the air in the upper space of the canister was collected in an evacuated sampling bottle with a volume of about 7 cm^3 .

Radioactivity from volatile elements trapped by both the sampling bottle and the sampling needle was measured by an intrinsic Ge solid state detector. Figure 2 shows the temperature dependence of volatility of ^{137}Cs and ^{106}Ru at a fixed time of 24 hours when both nuclides are at apparent saturation concentrations. The solid line in the figure represents the data obtained in our previous work [2] in which the activation energy of about 140 kJ/mol was obtained on simulated HLW glass

containing about 1.6×10^{10} Bq of ^{134}Cs . The present data shows fairly good agreement with previous one.

The volatility of ^{106}Ru measured at 600°C and 800°C is about one fifth that of ^{137}Cs . Since Gray [3] has pointed out that the activation energy for various elements are almost the same as each other, the air contamination of ^{106}Ru at a usual storage temperature of 400°C is also expected to be one fifth that of ^{137}Cs ; thus, the normalized concentration of ^{106}Ru would be about 5×10^{-10} at 400°C . This extrapolated value may be conservative, since 400°C is below the softening point of the present glass and diffusion may not be a significant mechanism at this temperature. It should be also mentioned that the volatility of ^{106}Ru at 1000°C could not be measured; it was under the detection limit of $5 \times 10^{-2} \text{Bq/cm}^3$. This is probably an example that the backward step plays an important role; the stainless steel canister is markedly oxidized at around 1000°C and reacted with ^{106}Ru in the air inside the canister. It is also probable that RuO_4 is not stable at high temperatures, and this is one of the causes that ^{106}Ru disappeared at around 1000°C .

(2) Release of Neptunium from a ^{237}Np doped Borosilicate Waste Glass [4]

The MCC 1 static leach tests were performed for a ^{237}Np doped borosilicate waste glass at 90°C with deionized water and silicate water leachants to speculate the release mechanism of Np from waste glasses. The composition of the Np doped glass is shown in Table 1. Teflon vessels were used as leach containers and SA/V ratio was 0.1cm^{-1} .

Deionized water and silicate water were used as leachants. At the desired leach durations, the Np concentrations in the leachates were measured by gamma counting with a high purity germanium detector.

The amounts of Np released from the glass are plotted as a function of time as shown in Fig. 3 in terms of the normalized elemental mass loss $(\text{NL})_{\text{Np}}$. Although the release behaviors as a function of time are appreciably different between the deionized water and silicate water, the $(\text{NL})_{\text{Np}}$ values of about 5g/m^2 are similar for the two leachates after 91 day leaching. The release behavior of Np in this study are compared with those of other elements (Fig. 4). A linear relation between $\log(\text{NL})$ and $\log(\text{time})$ is observed for Na, B and Cs within the studied leaching duration. As time proceeds, NL's for Np and Sr approach to constant values.

According to our previous study, Na, B and Cs were found in the leachates but not found in the surface layer; they are released from the bulk glass by decomposition of the glass and diffuse through the surface layer without being trapped. Sr was detected both in the surface layer and in the leachates. Probably Np, representing a similar time dependent release behavior to that for Sr, is also present in the surface layers.

It is reasonable to assume that Np concentrations in leachates are controlled by the solubilities of Np solid phases formed in the surface layer. This assumption leads to that the solid phases formed in the surface layers must be primarily

identified in order to predict Np concentrations in glass leachates. Since none of present analytical techniques is applicable to wet surfaces, the Np species in the surface layers can not be identified directly. Then, an attempt was made to speculate it based on the predicted species in the bulk glass and that in leachates.

In bulk glasses either the tetravalent or the pentavalent species possibly exists. Np species in aqueous solutions can be estimated by pH and Eh of the solutions. However, such redox parameters have not been studied for solutions contained in surface layers. Instead, we use pH and Eh values of the leachates. The measured pH and Eh of the leachates in the present experiments are plotted in Fig. 5. These values change with time, but they are similar for different leach durations except 3 days. Referring available pH-Eh diagrams, the tetravalent and the pentavalent species are possibly present in comparable amounts in the present leachates, and the trivalent and the hexavalent species are probably absent. Since the tetravalent and/or pentavalent species are expected to exist in both the bulk glasses and leachates, the valence of Np in the surface layer is also likely to be tetravalent and/or pentavalent.

Considering the above estimation on the valence and OH^- as a predominant complexing anion present in the leachates, we take $\text{NpO}_2 \cdot \text{H}_2\text{O}(\text{am})$ and $\text{NpO}_2\text{OH}(\text{am})$ as Np solid phases in the surface layer, and assume the following three types of solubility equilibrium; (1) $\text{Np}_2\text{OH}(\text{am}) = \text{NpO}_2 + \text{NpO}_2\text{OH}(\text{aq})$ and $\text{NpO}_2\text{CO}_3^-$
(2) $\text{NpO}_2 \cdot \text{H}_2\text{O}(\text{am}) = \text{NpO}_2 + \text{H}_2\text{O}$
(3) $\text{NpO}_2 \cdot \text{H}_2\text{O}(\text{am}) = \text{Np}(\text{OH})_4(\text{aq})$

Apparent steady state concentrations of Np from MCC-1 leach tests are plotted in Fig. 6. Solubilities of $\text{NpO}_2\text{OH}(\text{am})$ and $\text{NpO}_2 \cdot \text{H}_2\text{O}(\text{am})$ calculated from equilibrium constants at 25°C are also shown in the same figure by dotted and hatched regions, respectively. These regions include the predicted solubilities for different ionic strengths of aqueous solutions. As seen in this figure, Np concentrations in the leachates are apparently limited by the solubilities of $\text{NpO}_2 \cdot \text{H}_2\text{O}(\text{am})$; the above mentioned equilibria (2) and (3) are expected. Np concentrations obtained from the leachates are distinguishably lower than the solubilities of $\text{NpO}_2\text{OH}(\text{am})$. If Np in the surface layers had been $\text{NpO}_2\text{OH}(\text{am})$, the Np concentrations in the leachates should have been higher, approaching to the $\text{NpO}_2\text{OH}(\text{am})$ solubilities. These facts imply that Np exists as the tetravalent solid phase $\text{NpO}_2 \cdot \text{H}_2\text{O}(\text{am})$ rather than the pentavalent solid phase $\text{NpO}_2\text{OH}(\text{am})$ in the surface layers of leached waste glasses.

(3) Leaching Behavior of Simulated High Level Waste Glass in Groundwater [5], [6]

The purpose of the work is to examine the leaching behavior of simulated high level waste glass in actual groundwater in Japan. In-situ burial tests were carried out by immersing the sample in groundwater coming through schalstein type rock in southwestern Japan. The results were compared with the ones of laboratory test obtained using synthesized groundwater and deionized water.

Figure 7 shows the scanning electron microphotographs of the surface before and after leaching. In the case of actual groundwater (Fig. 7(b)) and synthesized groundwater (Fig. 7(c)), many grooves occur on the specimen along with the surrounding flat surface, indicating that some parts of simulated high level waste glass dissolve more easily than others. On the other hand, in the case of deionized water (Fig. 7(d)), such grooves are not clearly observed, which means that leaching is progressing more uniformly than in the case of groundwater.

We assume that the leaching behavior of the simulated high level waste glass is divided into two categories; one is leaching from the flat surface and the other is that from the grooves. The extent of leaching from the flat surface can be measured by SEM-EDX. Here we define the C/C_0 values as the ratio of the concentration of Na on the flat surface of a leached specimen (C) to the initial concentration of Na before leaching (C_0).

We pave the way for estimating the order of normalized elemental mass loss of Na (NL_{Na}) of the glass leached in groundwater by measuring the C/C_0 value and measuring the size and the number of grooves without leachates examinations. For instance, in the case of the specimen leached in actual groundwater for one year and seven months, the C/C_0 value is about 0.86 which corresponds to NL_{Na} of 6.5×10^{-5} g/cm² for the flat surface. On the other hand, by measuring the size and the number of the grooves, we obtain NL_{Na} of 3.9×10^{-4} g/cm² which corresponds to the amount of Na leached from the grooves. The sum of 6.5×10^{-5} g/cm² for the flat surface and 3.9×10^{-4} g/cm² for the grooves is 4.6×10^{-4} g/cm², resulting in a leach rate of about 8×10^{-7} g/cm² day.

(4) Accelerated Alpha Radiation Stability Test [7]

An accelerated alpha radiation stability test started in connection with characterization of returnable waste forms from overseas reprocessing facilities, and the test equivalent to 10,000 years aging of actual waste forms has been finished.

Curium-244 and plutonium-238 were added to a simulated waste substituting transuranium elements and 90% of rare earths (²⁴⁴Cm: 43.3 GBq/g-glass, ²³⁸Pu: 4.4 GBq/g-glass). The waste was molten with borosilicate glass in three platinum crucibles of 14 mm in diameter. Twenty four specimens were prepared by cutting the crucibles into pieces 5 mm thick, and each specimen was stored in a helium leak protective capsule.

Four or five specimens were taken out from the storage pits for each time equivalent test including zero time tests. The tests were performed with a mass spectrometer, a differential scanning calorimeter (DSC), Soxhlet type leaching apparatus and a microscope for measurement of helium remained in the matrix, stored energy in the matrix, leachability and fine-structure alteration, respectively.

It was found by measuring the amount of helium released from the specimens that 97-99% of helium remained in the matrix at the room temperature. The total amount of helium generated in the specimen was obtained from the amount of helium released from the specimen kept at 600°C for 15 min and that at room temperature,

because at 600°C the helium was completely depleted from the glass specimen.

The test results are shown in Fig.8. Density of the specimens decreased slightly with the increase of time and the decrement of 1.1% was observed at 10,000 years equivalent. Regarding leachability based on the total weight losses, some fluctuating results were obtained in the initial stages of the test but subsequently the curve is flat to the 10,000 years equivalent. Microscopic observation also did not show any change in the microstructure. Those results seem to suggest that alpha radiation has no significant influence on the performance of glass forms to confine high level wastes.

References

- [1] Kamizono, H., Kikkawa, S., Togashi, Y. and Tashiro, S., "Volatilization of ¹³⁷Cs and ¹⁰⁶Ru from borosilicate glass containing actual high-level waste," J. Am. Ceram. Soc., 72, 1438 (1989)
- [2] Kamizono, H., Kikkawa, S., Tashiro, S. and Nakamura, H., "Volatilization of cesium from nuclear waste glass in a canister," Nucl. Technol., 72, 84-88 (1986)
- [3] Gray, W.J., "Volatility of some potential high-level radioactive waste forms," Radioact. Waste Manage., 1, 147-149 (1980)
- [4] Nakayama, S. and Banba, T., "Release of neptunium from a neptunium-doped borosilicate waste glass," J. Nucl. Sci. Technol. (in press)
- [5] Kamizono, H., "Leaching behavior of simulated high-level waste glass in groundwater," J. Nucl. Mater., 127, 242-246 (1985)
- [6] Kamizono, H. and Nakamura, H., "Simulated high-level nuclear waste glass leached in one type of Japanese groundwater," J. Nucl. Mater., 152, 339-342 (1988)
- [7] Tashiro, S., Banba, T., Mitamura, H., Kamizono, H., Kikkawa, S., Matsumoto, S., Muraoka, S. and Nakamura H., "Safety examination of HLW solidified products at WASTE," Proceedings of The 1989 Joint International Waste Manage. Conf., Kyoto, Japan (1989)

Table 1 Composition of ^{237}Np -doped JAERI glass.

Component	Content (wt %)	Component	Content (wt %)
Additive		Waste	
SiO_2	45.15	TeO_2	0.23
B_2O_3	13.90	Cs_2O	0.97
Al_2O_3	4.89	BaO	0.62
CaO	4.01	La_2O_3	0.48
Na_2O	9.79 *	CeO_2	0.95
ZnO	2.47	Pr_6O_{11}	0.46
Li_2O	2.00	Nd_2O_3	1.55
Waste		Sm_2O_3	0.31
Rb_2O	0.12	Eu_2O_3	0.06
SrO	0.34	Gd_2O_3	0.03
Y_2O_3	0.19	SeO_2	0.02
ZrO_2	2.64	RuO_2	0.80
MoO_3	1.73	Fe_2O_3	2.90
MnO_2	0.26	NiO	0.40
Ag_2O	0.03	Cr_2O_3	0.50
CdO	0.03	P_2O_5	0.30
SnO_2	0.02	Ru	0.12
Sb_2O_3	0.004	Rh	0.15
		Pd	0.43
		$^{237}\text{NpO}_2$	1.15

* : Component contains both additive and waste.

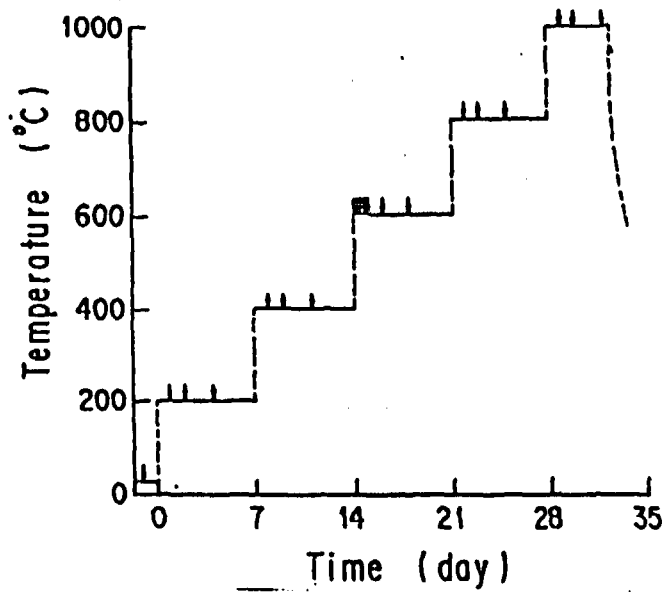

Fig. 1 Schematic heating conditions
Arrows show the sampling positions.

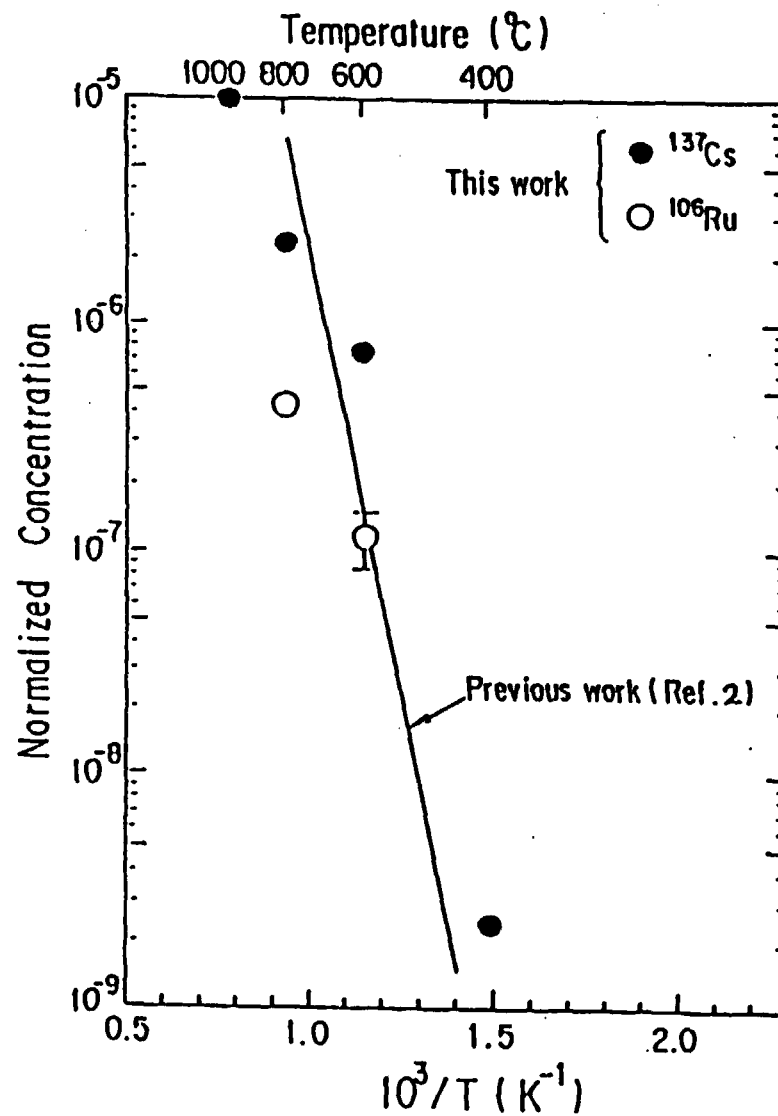

Fig. 2 Temperature-dependence of the volatility of ^{137}Cs and ^{106}Ru .

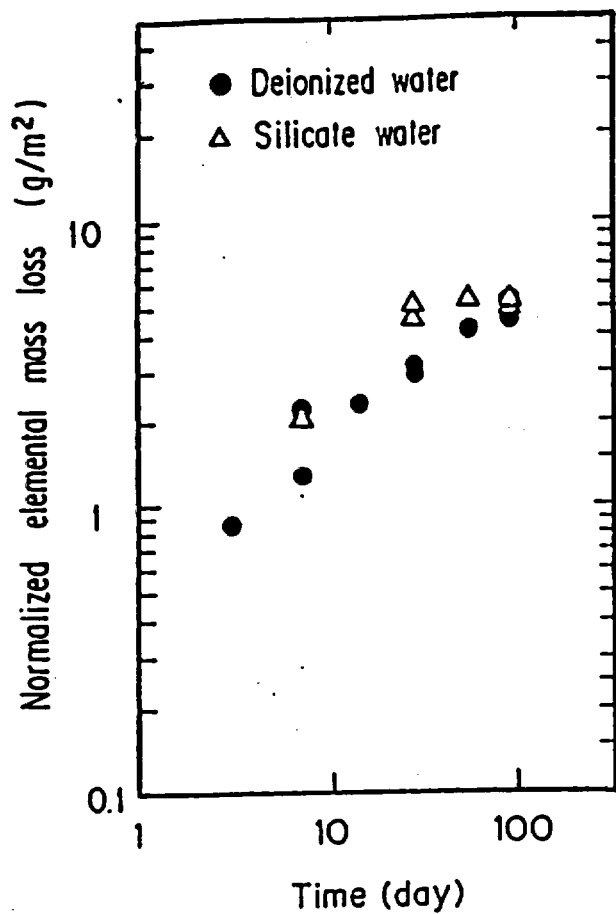

Fig. 3 The normalized elemental mass losses as a function of time for Np released from the ^{237}Np -doped borosilicate waste glass in the MCC-1 static leach tests at 90°C .

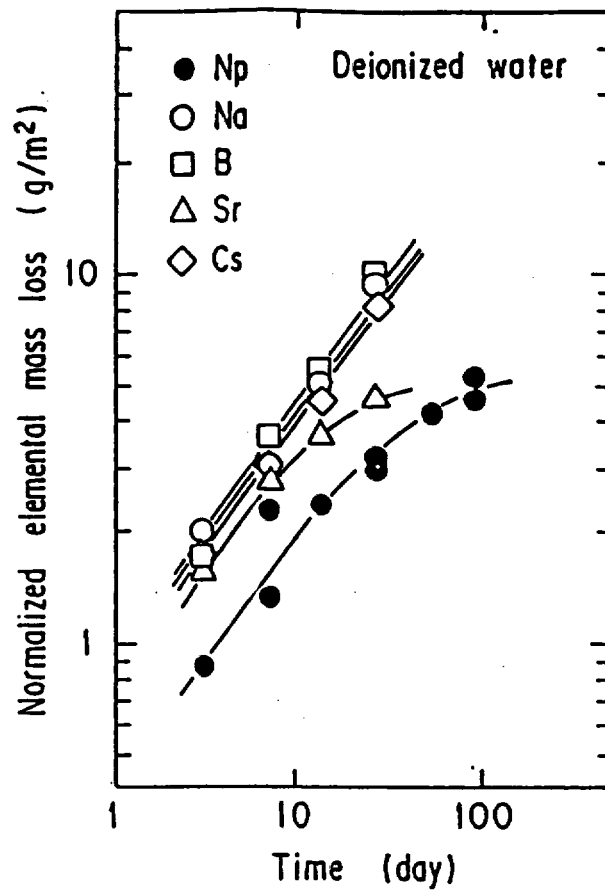

Fig. 4 The normalized elemental mass losses as a function of time for Na, B, Sr, Cs and Np released from JAERI glasses in the MCC-1 static leach tests. Data on neptunium in Fig. 3 for deionized water were replotted. Data on Na, B, Sr and Cs were cited from Ref.[12].

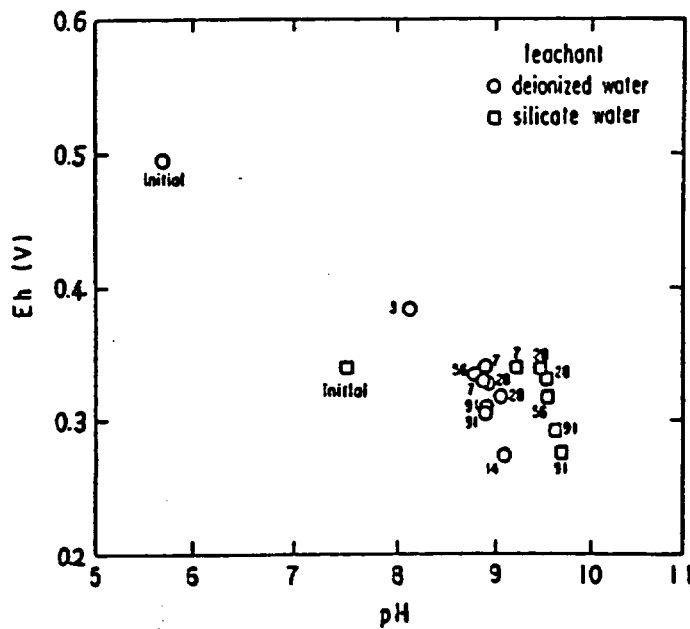

Fig. 5 Measured pH and Eh values of the glass leachates. Numbers next to the points denote the leach durations. The "initial"s denote the values for leachants.

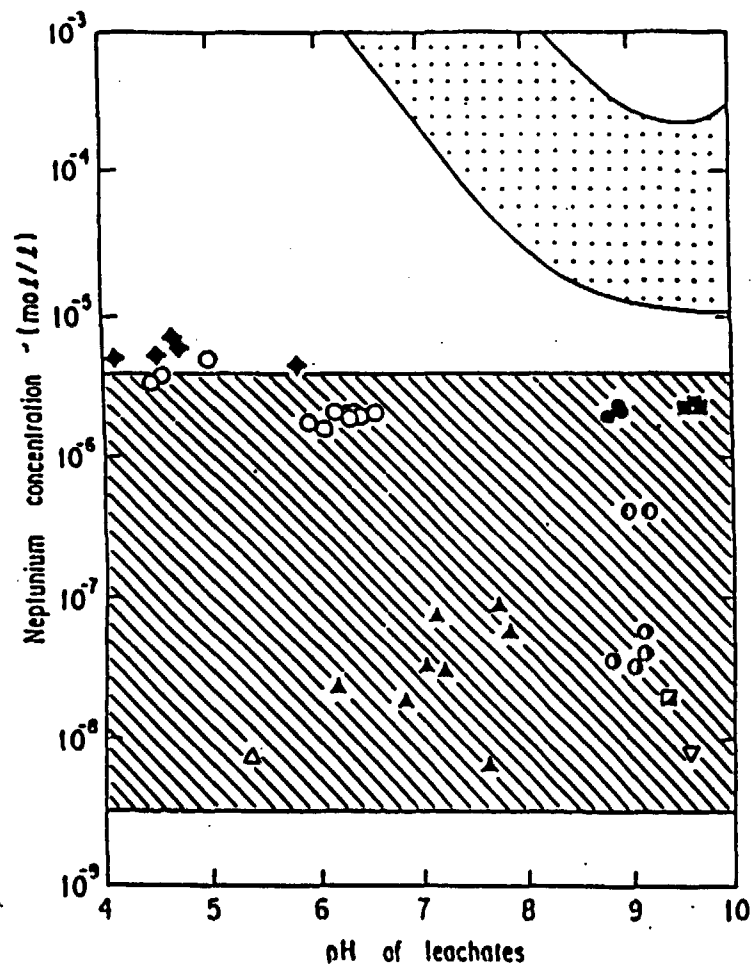

Fig. 6. Neptunium concentrations in glass leachates obtained from the MCC-1-type static leach tests for durations of 56 days or longer, and expected solubilities of $\text{NpO}_2 \cdot x\text{H}_2\text{O}(\text{am})$ and $\text{NpO}_2\text{OH}(\text{am})$ based on thermodynamic data.

Neptunium dissolution from glasses

symbol	leachant	leach duration (day)	Ref.
○	0.0015M CaCl_2	288-302	(1)
○	0.001M quaternary		
○	tuffaceous formation groundwater	90-183	(2)
○	tuffaceous formation groundwater	56-91	(3)
□	deionized water	56	(4)
▽	synthetic basalt groundwater	56	(4)
△	synthetic Permian Basin brine	56	(4)
▲	synthetic Permian Basin brine	56-371	(5)
●	deionized water	56-91	This study
■	silicate water	56-91	This study

References

- (1) Rai, D., et al., Nucl. Technol., 50, 69, 1982.
- (2) Bazar, F., et al., MRS Symp. Proc. Vol. 84, 447, 1987.
- (3) Bates, J.K., et al., J. Mater. Res., 3, 576, 1988.
- (4) Apted, M.J., et al., Nucl. Technol., 73, 165, 1986.
- (5) McGrath, B.P., Ibid., 75, 168, 1986.
- (6) Haya, L., Inorg. Chem., 22, 2093, 1983.
- (7) Lierse, Ch., et al., Radiochim. Acta, 38, 27, 1985.
- (8) Kraus, K.A., Nelson, F., AECD-1864, 1948.
- (9) Sevastyanova, E.P., Khaliturn, G.V., Soviet Radioch (Engl. Transl.) 18, 730, 1976.
- (10) Nakayama, S., et al., Radiochim. Acta, 44/45, 179, 1988.
- (11) Bidoglio, G., et al., Ibid., 38, 21, 1985.
- (12) Moriyama, H., et al., In Symposium on Transuran Elements Today and Tomorrow, Karlsruhe, October, 1
- (13) Rai, D., et al., Radiochim. Acta, 42, 35, 1987.
- (14) Allard, B., et al., Inorg. Chim. Acta, 94, 205, 1984.

Solubilities of neptunium solid phases

Symbol	Chemical Reaction	Ref.
□ (dotted)	$\text{NpO}_2\text{OH}(\text{am}) \rightleftharpoons \text{NpO}_2^+, \text{NpO}_2\text{OH}(\text{aq}), \text{NpO}_2\text{CO}_3^-$	(6)-(11)
◆	$\text{NpO}_2 \cdot x\text{H}_2\text{O}(\text{am}) \rightleftharpoons \text{NpO}_2^+$	(12)
▨ (hatched)	$\text{NpO}_2 \cdot x\text{H}_2\text{O}(\text{am}) \rightleftharpoons \text{Np}(\text{OH})_4(\text{aq})$	(12)-(14)

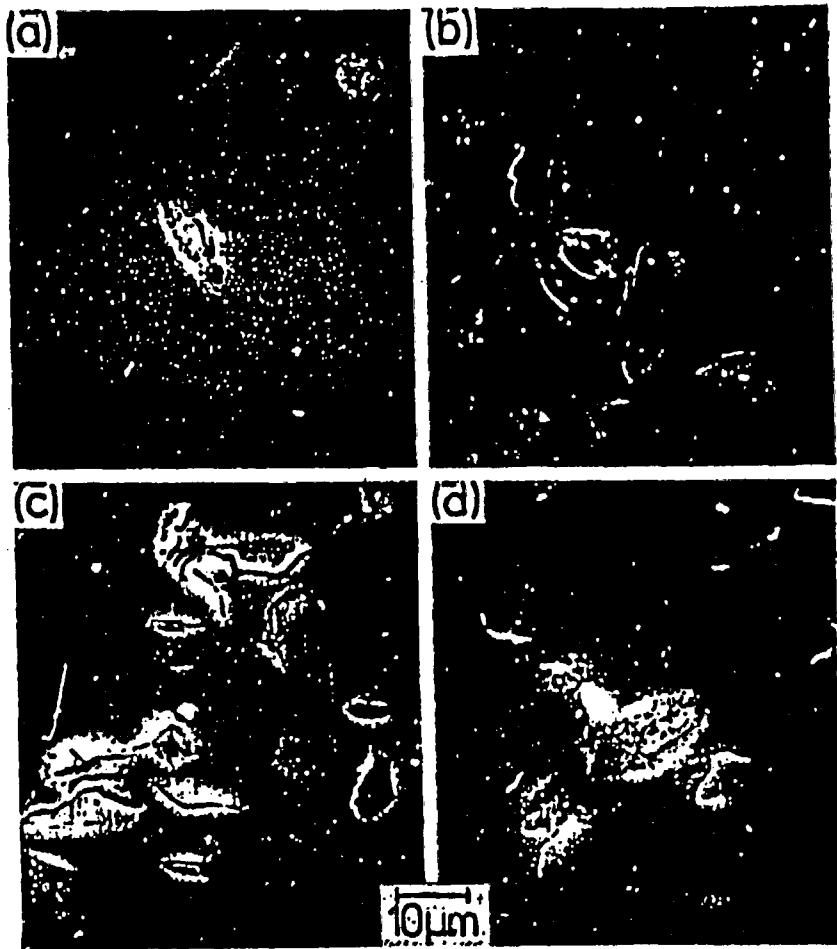

Fig. 7 Scanning electron microphotographs of the surface of the unleached specimen (a) and the surface of the specimens leached in actual groundwater (b), in synthesized groundwater (c) and in deionized water (d) for 1 year.

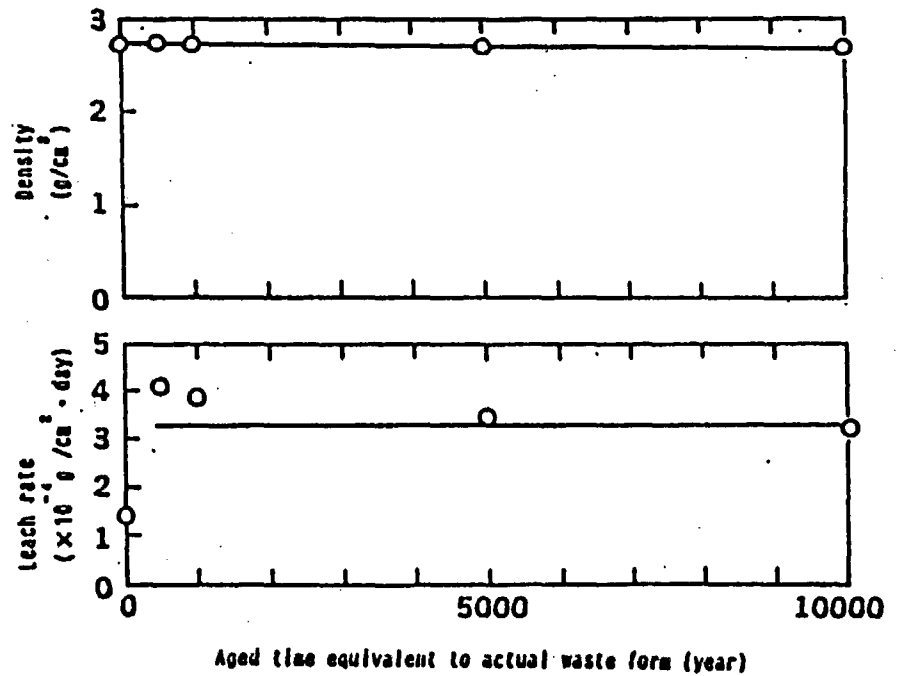

Fig. 8 Results of accelerated alpha radiation stability test for the waste glass.

VOLATILIZATION OF CESIUM FROM NUCLEAR WASTE GLASS IN A CANISTER

HIROSHI KAMIZONO, SHIZUO KIKKAWA, SHINGO TASHIRO, and HARUTO NAKAMURA *Japan Atomic Energy Research Institute*
Department of Environmental Safety Research
Tokai-mura, Ibaraki-ken, 319-11 Japan

Received February 21, 1985

Accepted for Publication July 23, 1985

Volatilization of ^{134}Cs from simulated high-level waste glass in a canister during several reheatings up to a maximum of 1000°C was examined. The results showed that the temperature dependence of the amount of ^{134}Cs suspended in the air inside the canister could be divided into two categories. As the temperature was increased above 500°C , the amount of ^{134}Cs suspended in the air inside the canister also increased. On the other hand, for temperatures $<500^{\circ}\text{C}$, the amount of ^{134}Cs suspended in the air inside the canister had an almost constant value after several reheatings up to a maximum of 1000°C . In this case, the air contamination by cesium-bearing material inside the canister is considered to be significant even at waste storage temperatures $<500^{\circ}\text{C}$.

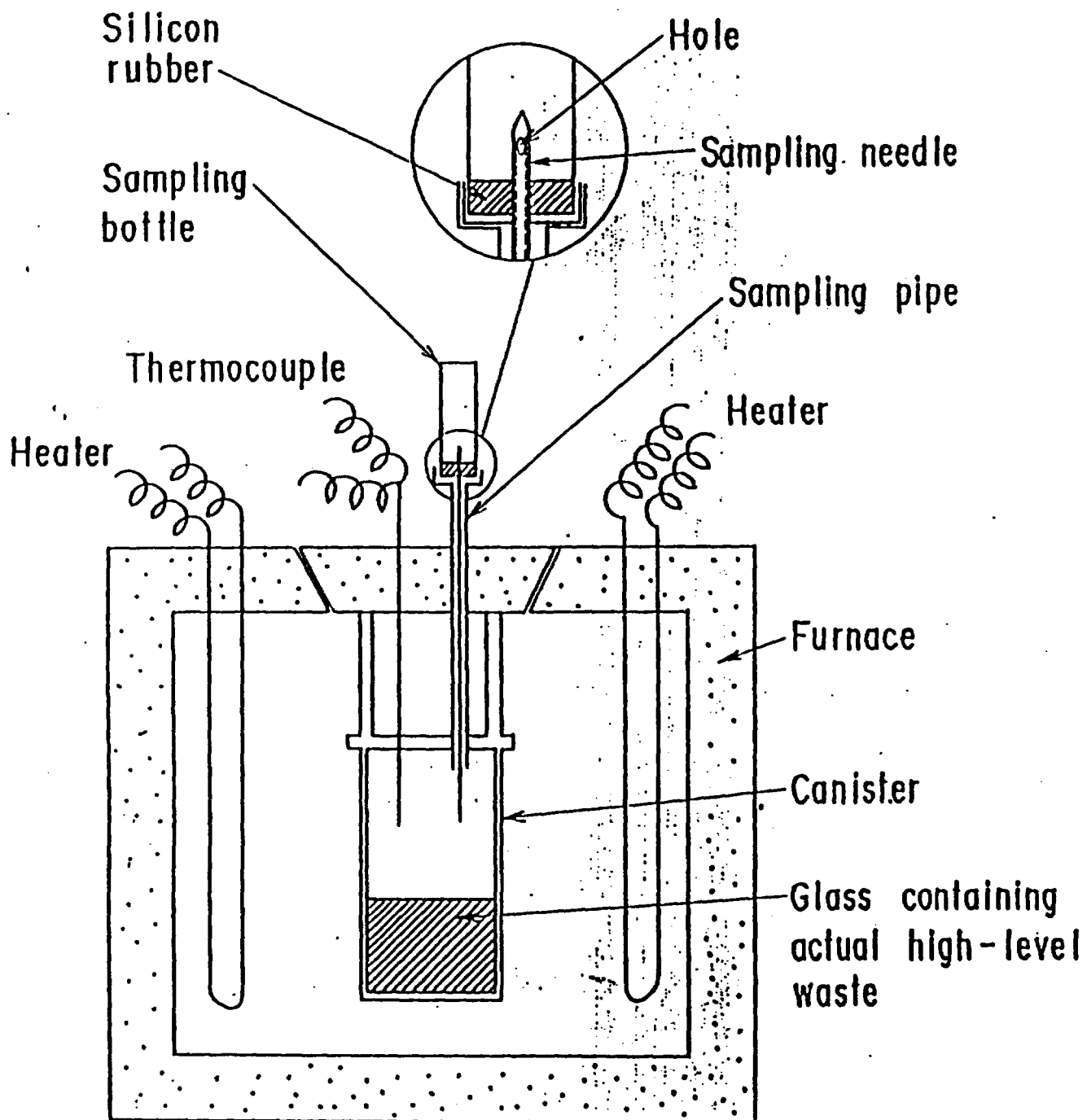

Fig. 1

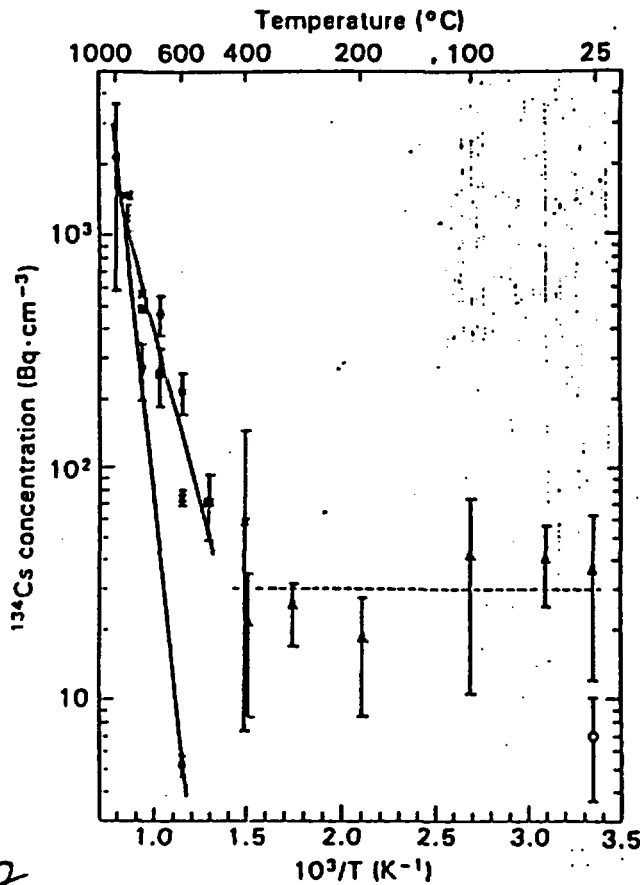
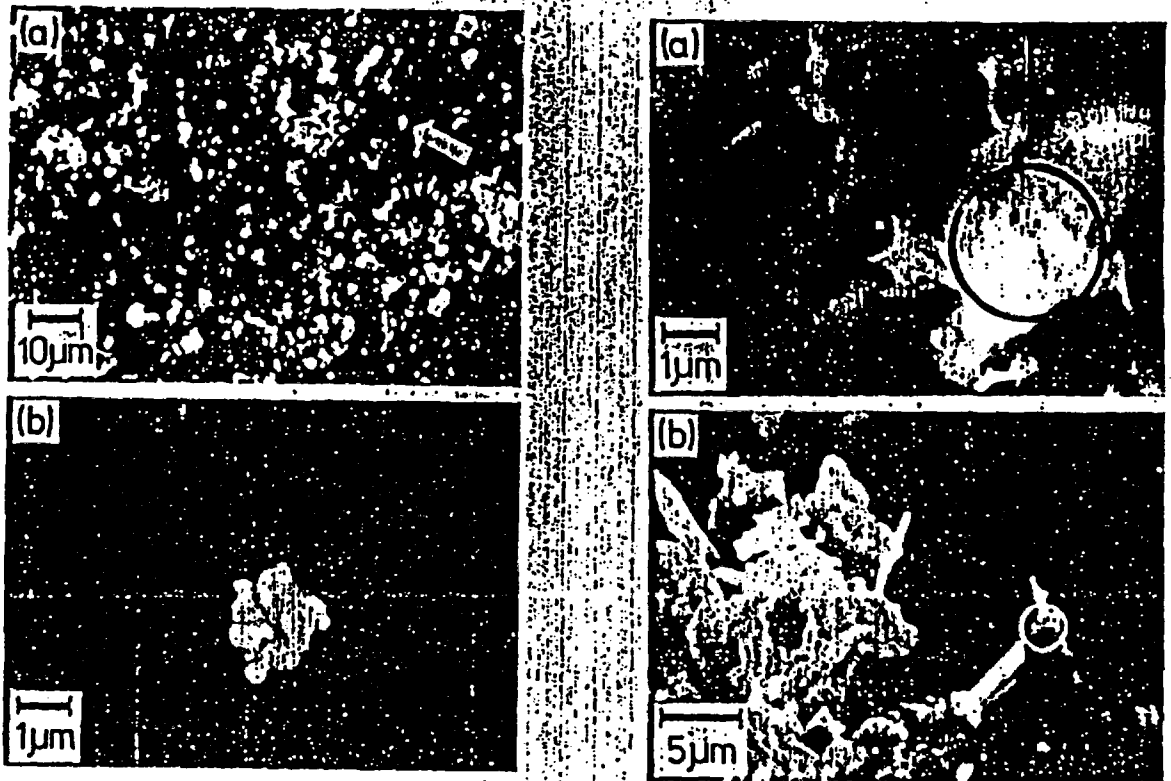

Fig. 2

Temperature dependency of the ^{134}Cs concentration that represents the amount of ^{134}Cs suspended in the air inside the canister ($A_{134\text{Cs}}$) at a fixed time of 1 day. The data were collected during the first cycle of reheating up to 1000°C (\diamond), the second cycle up to 900°C (\equiv), the third cycle up to 900°C (\times), the fourth cycle up to 700°C (\circ), and the fifth cycle up to 400°C (\triangle), which correspond to Fig. 2. The error bars show the standard deviation of each plot. Note: Thus far, we have not yet examined the exact cesium speciation. We speculate, however, that cesium may exist as a vapor phase for temperatures of more than 500°C and fine particles containing cesium play an important role in air contamination for temperatures of $<500^{\circ}\text{C}$. Therefore, it is not appropriate to plot in partial pressures of single chemical species in the present paper. Instead, we prefer to plot $\ln A_{134\text{Cs}}$, which does not need the cesium speciation.



Scanning electron microphotographs of the fine particles trapped by the air sampler.

Scanning electron microphotographs of the cesium-bearing materials trapped by the air sampler. Compositional analyses were carried out by WDX within the circles.

Fig. 3

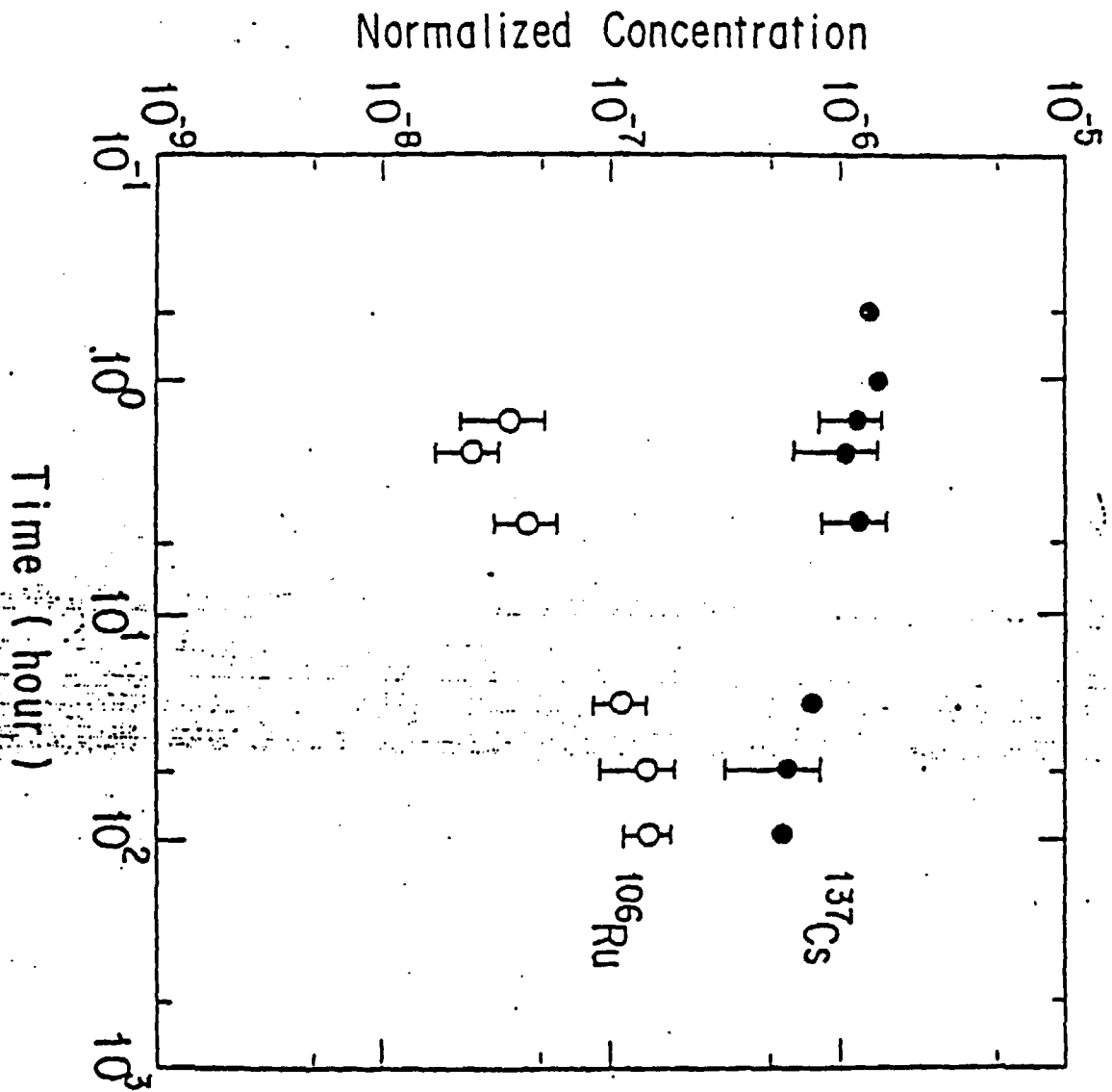

at 600°C

Fig. 4

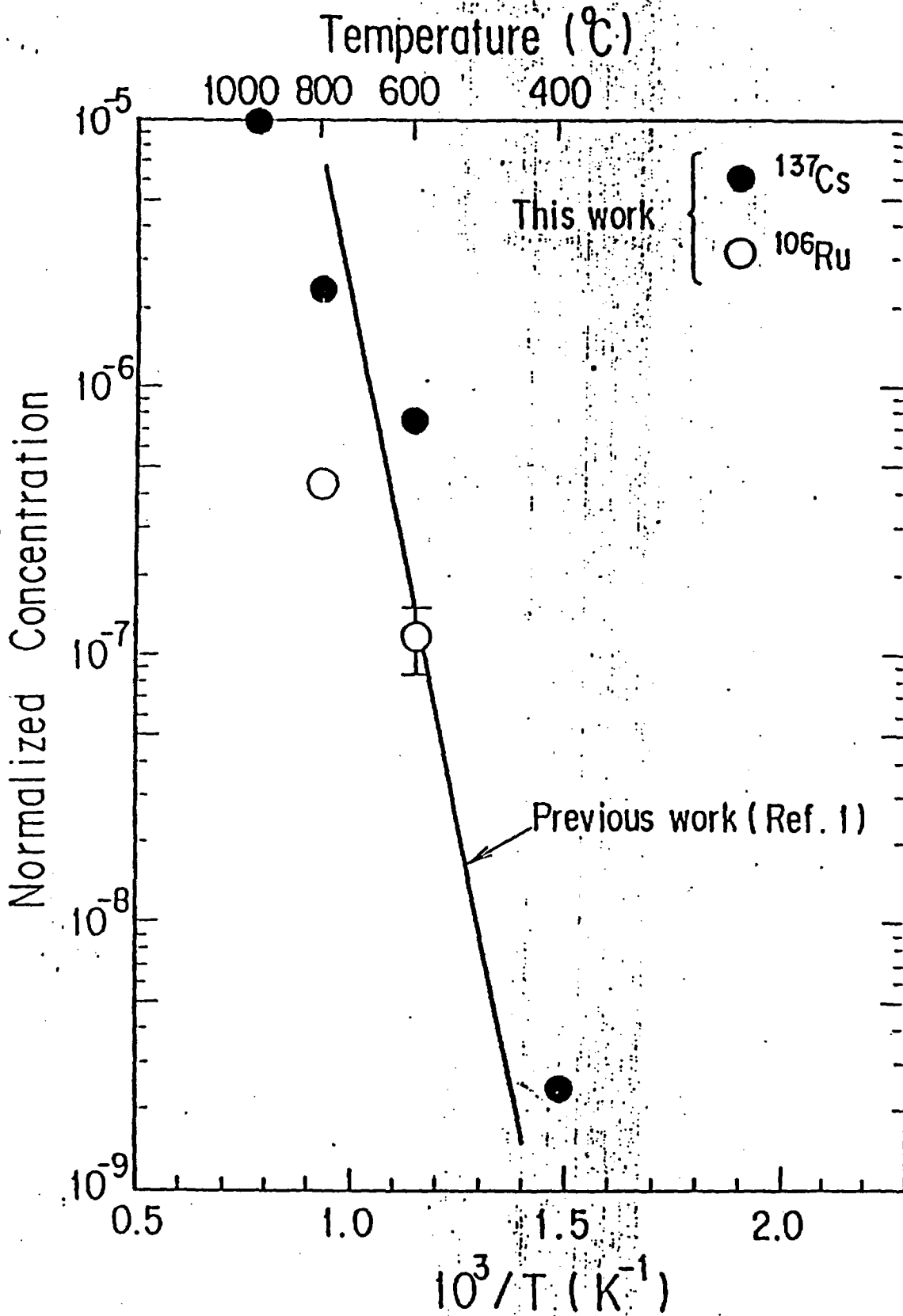

Fig. 5

WASTE

Japan Atomic Energy Research Institute

1. WASTE F

The Waste Safety Testing Facility (WASTE F) constructed at the Tokai Research Establishment, Japan Atomic Energy Research Institute (JAERI), has been operated since November 1982 to research safety evaluation of the long-term storage and disposal of high-level radioactive wastes (HLW).

The present research includes tests on characteristics, confinement ability and durability of materials applied to artificial barriers and natural barriers against the waste release under storage and disposal conditions.

The tests will continue to the research with actual wastes after accumulating the data obtained with radioactive synthetic wastes.

The research has been performed in accordance with the national waste management program and the results will contribute to establish a safety system for HLW management in Japan.

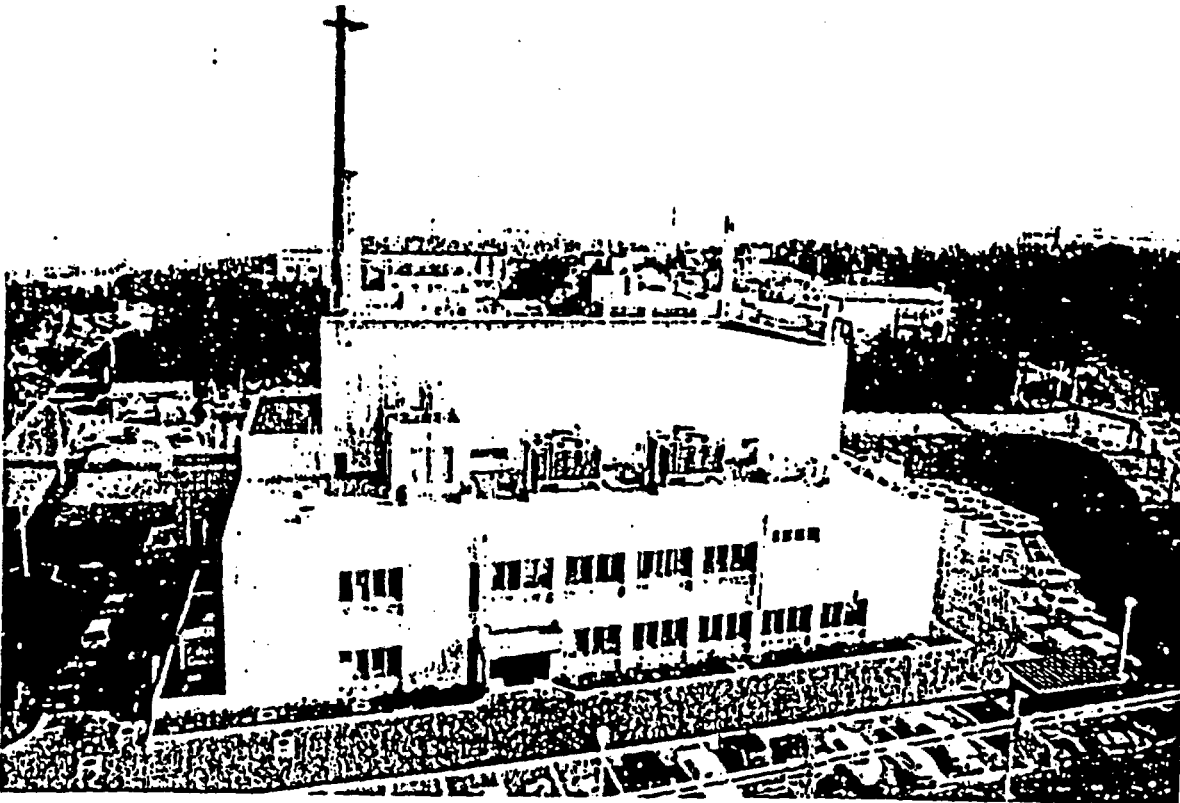

2. Layout of WASTE

Five concrete shielded cells (3 beta-gamma cells (No.1-3) and 2 alpha-gamma cells (No.4&5)) and a lead shielded cell are maintained and operated in the first floor.

Liquid waste tanks, ventilation and exhaust system, emergency power supply system and utilities services are installed in the basement floor.

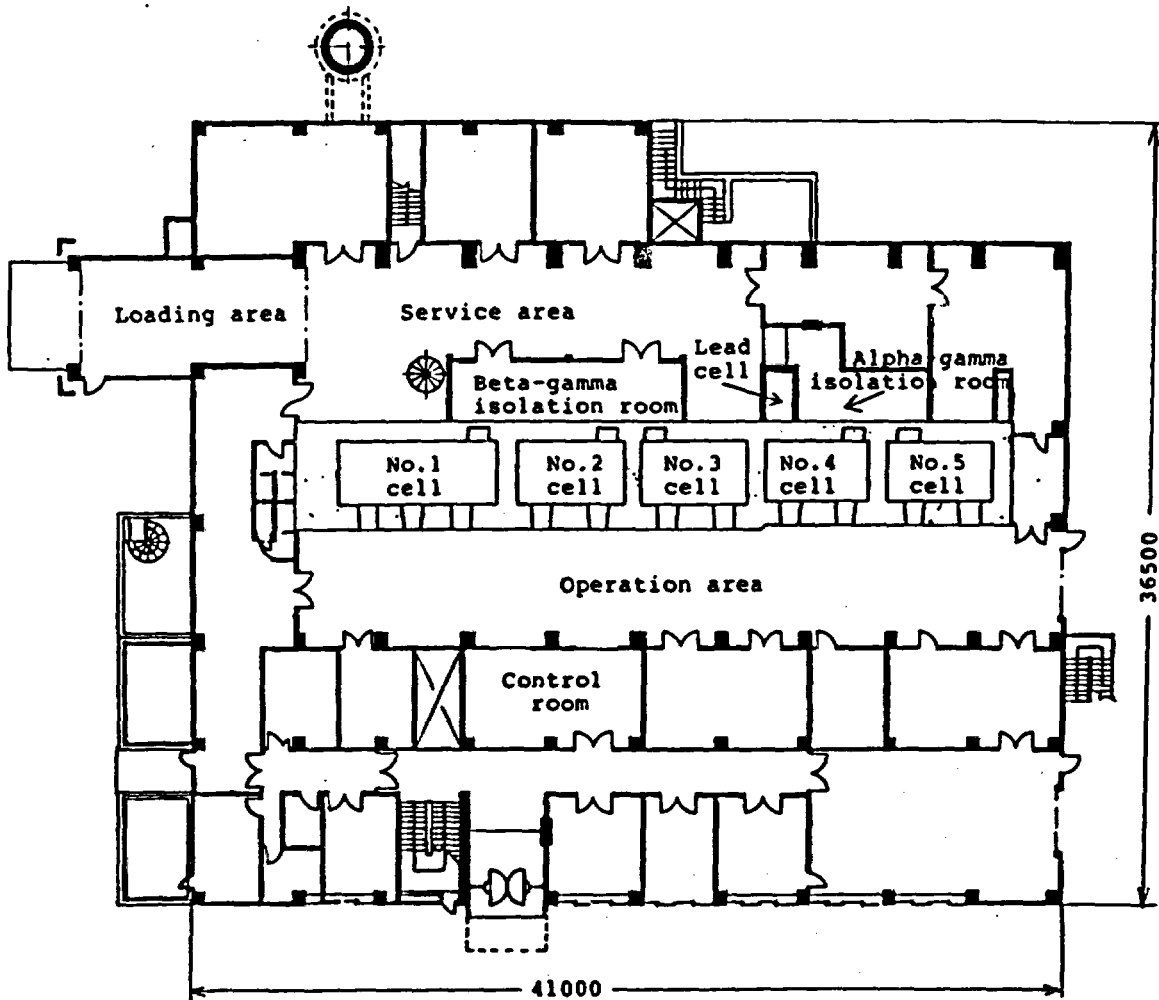

Layout of WASTE in the first floor

3. Specification of Hot Cells

Cell		Inside dimension WxDxH (m)	Shielded wall thickness (m)	Maximum activity (Ci) (HLLW & typical nuclides)			Pu (gr)
				HLLW	Cs-137	Sr-90	
Beta-gamma	No.1	7.5x3.0x4.5	1.05 [*]	5x10 ⁴ (1x10 ⁶ in storage)	1x10 ⁴	1x10 ⁴	-
	No.2	5.0x3.0x5.0	1.05 [*]	5x10 ⁴	1x10 ⁴	1x10 ⁴	-
	No.3	5.0x3.0x4.5	1.05 [*]	5x10 ⁴	1x10 ⁴	1x10 ⁴	-
Alpha-gamma	No.4	5.0x3.0x4.2	1.05 [*]	1x10 ⁴	2x10 ³	2x10 ³	12
	No.5	5.0x2.75x4.2	1.1 ^{**}	5x10 ²	5x10 ²	5x10 ¹	12
	Lead	2.5x1.4x2.0	0.15	2x10 ¹	2x10 ¹	1x10 ¹	1

* Magnetite concrete ** Ordinary concrete

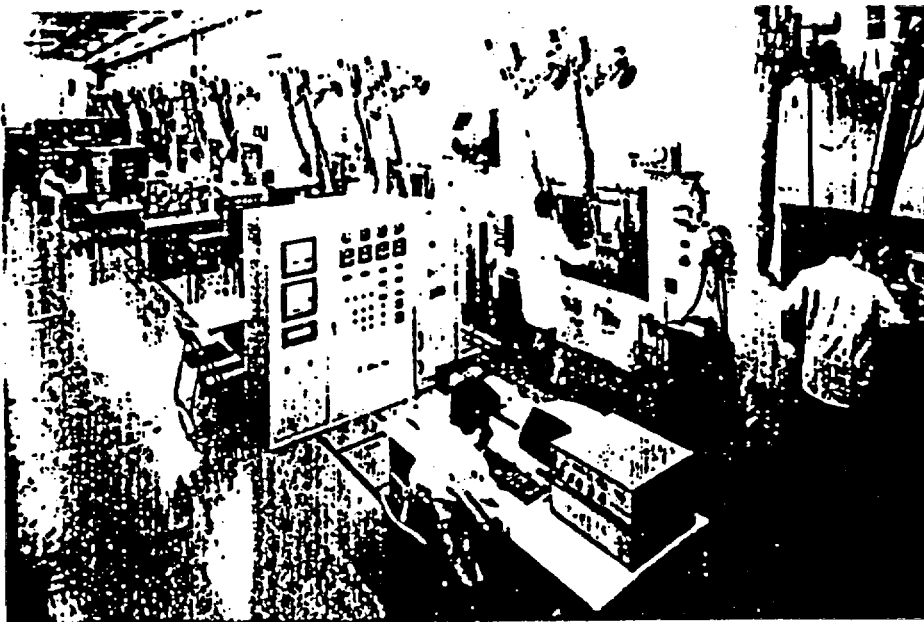

Interior of the
operation area

4. Tests in WASTEF

Flow chart of tests in WASTEF

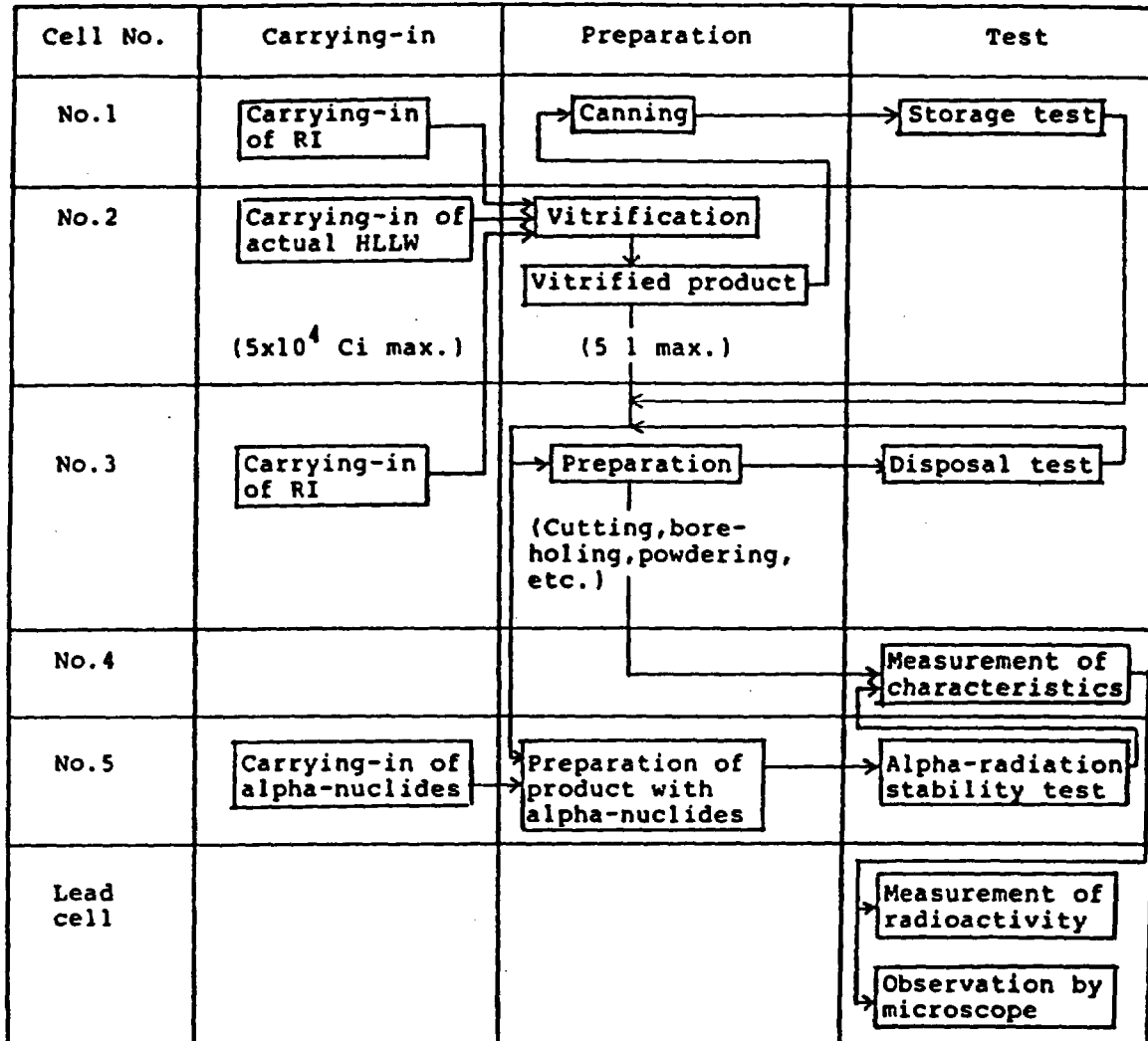

Test item and its Purpose in WASTE F

Test item	Purpose	Measurement items
Storage	Safety evaluation on long-term storage of vitrified package	<ul style="list-style-type: none"> •Temperature distribution •Volatility at high temperature •Cooling efficiency •Corrosion rate of packaging
Disposal	Safety evaluation on geological disposal	<ul style="list-style-type: none"> •Immobility of nuclides in rocks •Compatibility of glass and engineered barriers
Characterization	Accumulation of basic data on glass forms	<ul style="list-style-type: none"> •Density •Heat generation •Thermal conductivity •Leachability •Activity distribution
Alpha-radiation stability	Long-term durability evaluation of glass forms	<ul style="list-style-type: none"> •Stored energy •Number of helium •Change of structure
Vitrification	Safety evaluation on vitrification facility	<ul style="list-style-type: none"> •Integrity of applied materials •Performance of off-gas system •Material balance of process

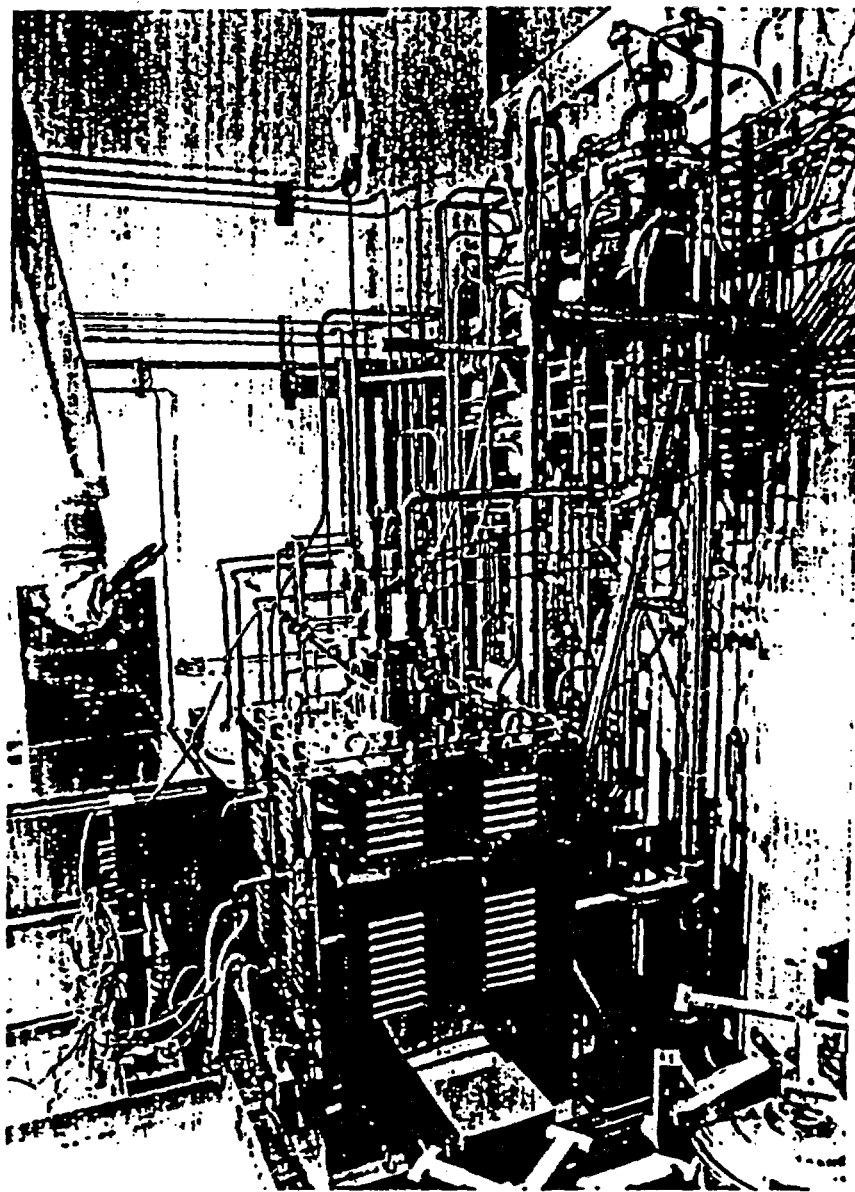

Vitrification apparatus in No.2 cell

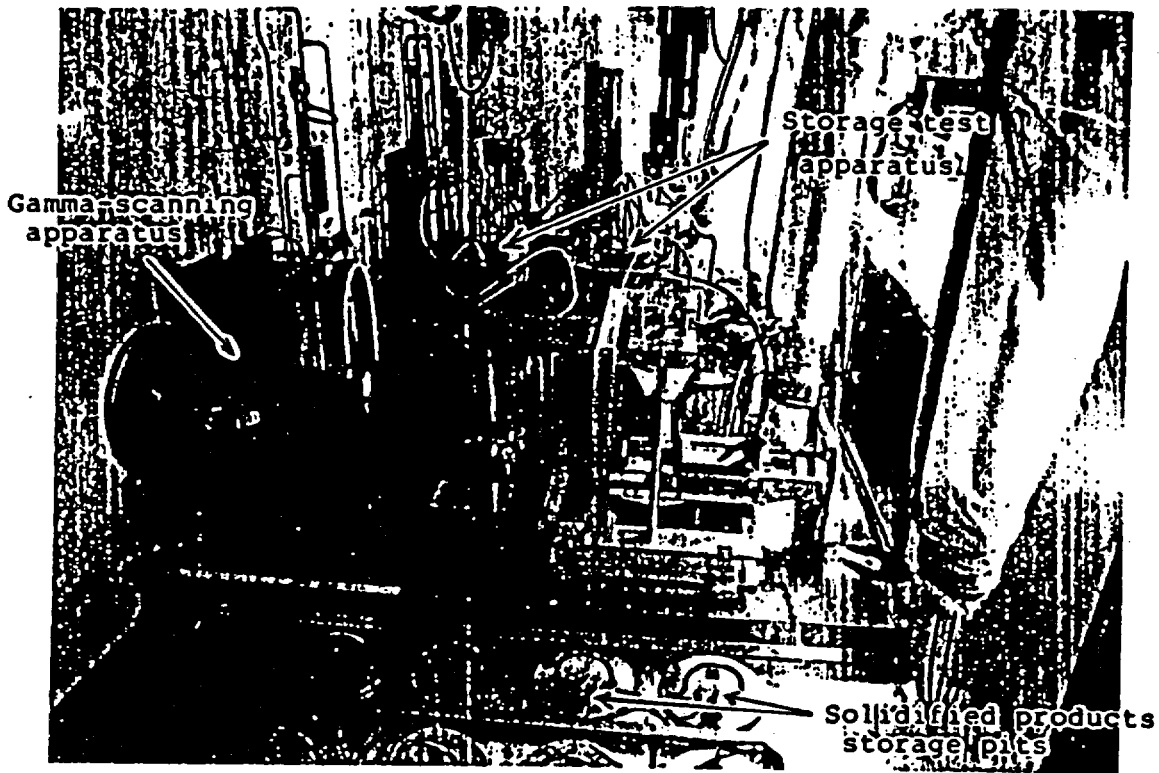

Gamma-scanning and storage test apparatus in No.1 cell

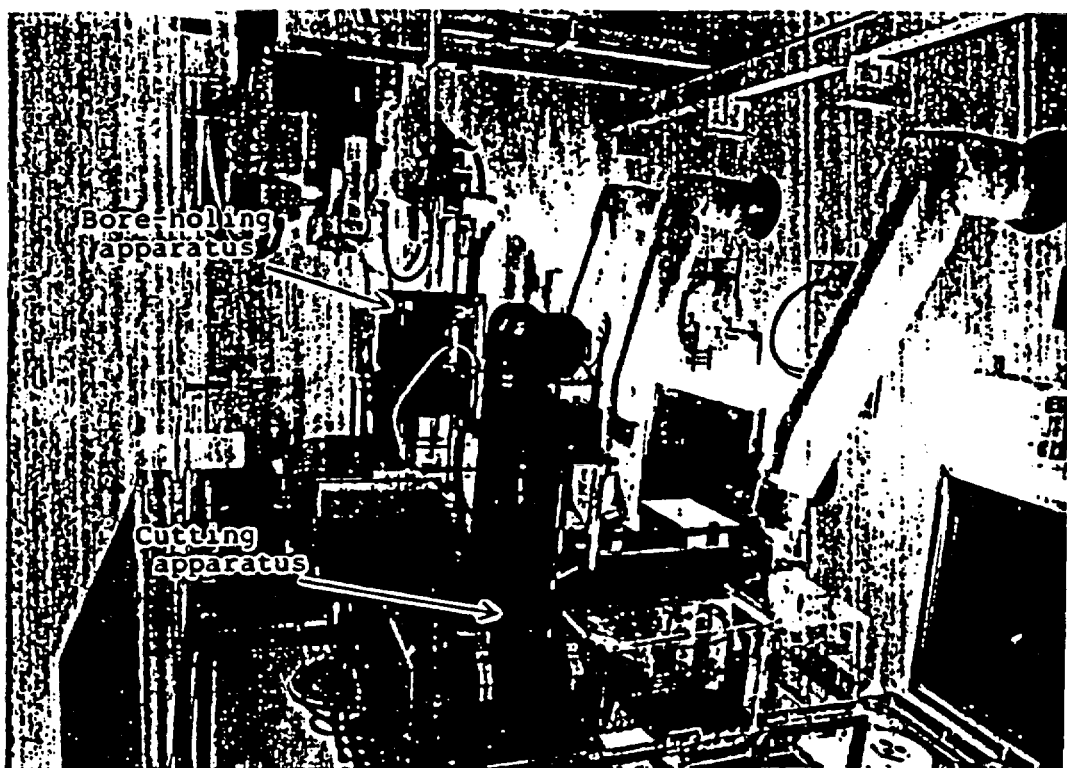

Test specimens preparation apparatus in No.3 cell

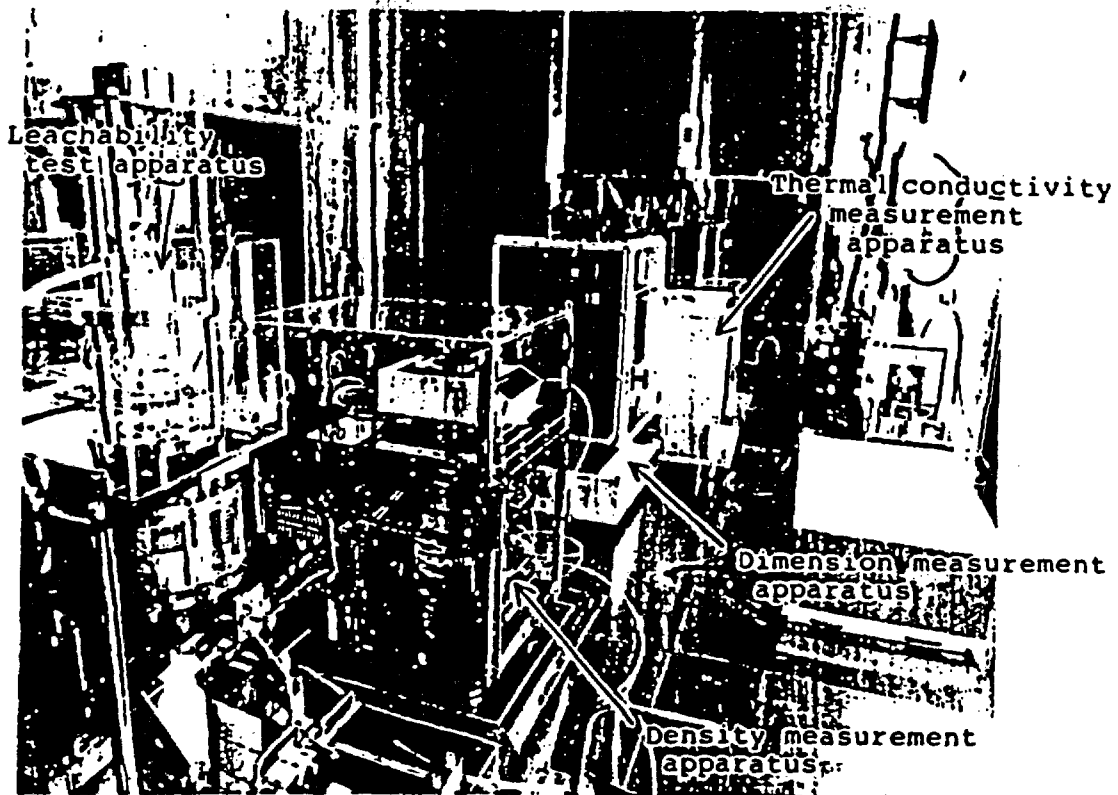

Characterization test apparatus in No.4 cell

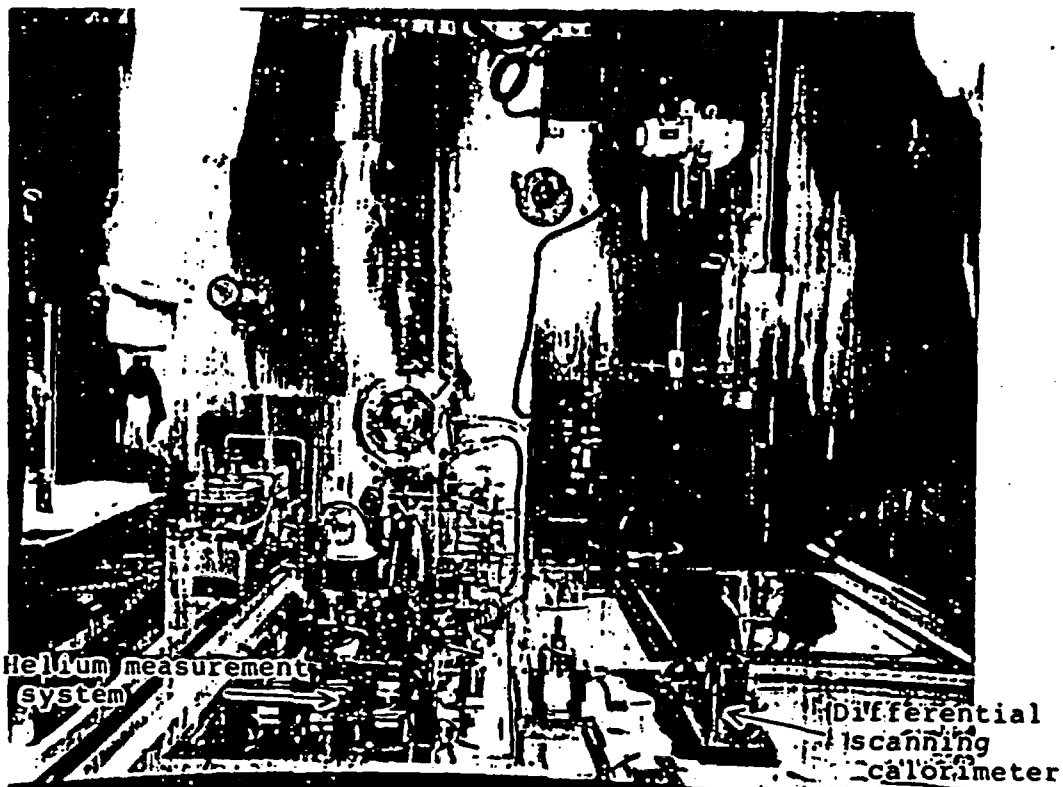

Alpha-radiation stability test apparatus in No.5 cell

5. WASTE F Operation Schedule

Item	Fiscal year						
	1981	1982	1983	1984	1985	1986	1987
Construction	⇒						
Test run	⇒	⇒					
Simulated waste tests on vitrification, storage, disposal, alpha-radiation stability and characteristics using Cs-137, Sr-90 etc.			⇒	⇒	⇒	⇒	
Actual waste tests on vitrification, storage and disposal						⇒	⇒

Organization Chart of Environmental Safety Research at JAERI

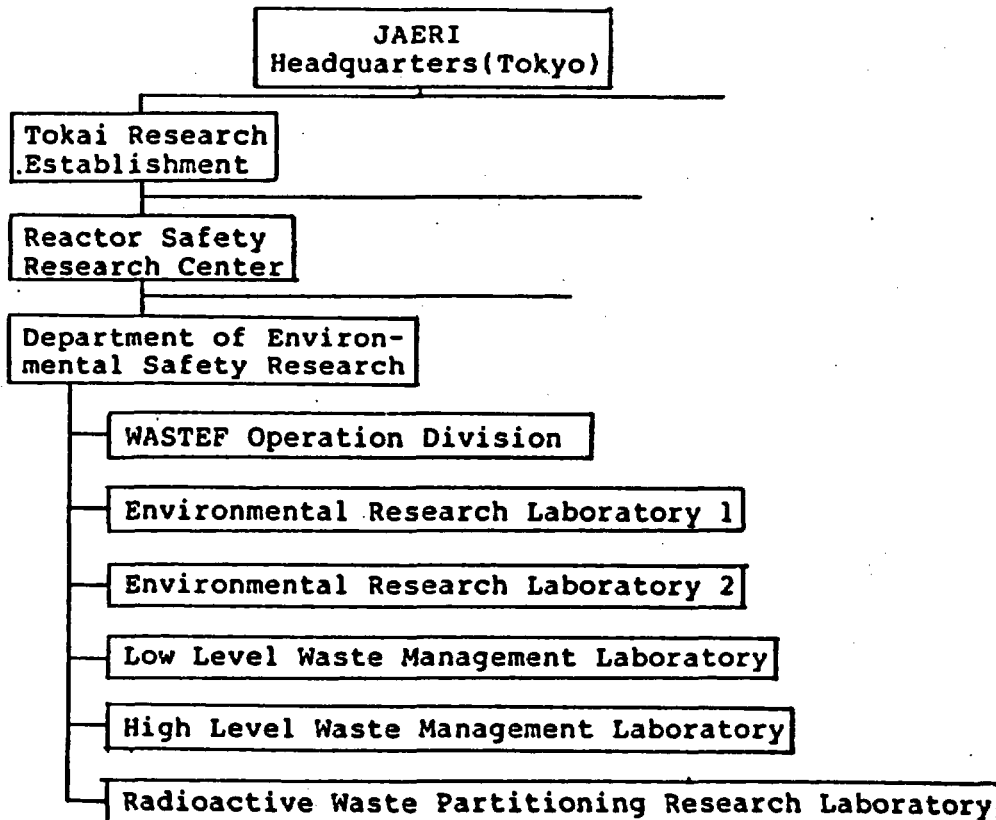

**TECHNOLOGIES DISCUSSED AT THE NATIONAL RESEARCH INSTITUTE FOR
POLLUTION AND RESOURCES (NRIPR)**

- Environmental Assessment Activities
- Water Pollution Control Activities
- Remote Sensing Techniques for Marine Pollution Analysis
- Study of CO₂ Behavior in the Environment
- Treatment of Individual Types of Waste Containing Halogenated Organic Compounds
- Measurement of Pollutants in Groundwater
- Bio Treatment of Hazardous Chemicals in Waste Water

BIBLIOGRAPHY OF LITERATURE RECEIVED FROM NRIPR

"Summary of National Research Institute for Pollution and Resources", NRIPR, 44 pages.

通商産業省工業技術院

公害資源研究所

NATIONAL RESEARCH INSTITUTE FOR POLLUTION AND RESOURCES



沿革

History

公害資源研究所は、石炭・石油等の化石燃料の合理的利用及び燃焼技術に関する研究を行ってきた「燃料研究所（大正9年設立）」と地下資源の開発・選鉱・製錬及び鉱山保安技術に関する研究を行ってきた「鉱業技術試験所（昭和24年鉱業研究所等3所の統合により設立）」が昭和27年に合併した資源技術試験所を前身としています。さらに昭和45年に公害部門を拡充強化し、公害資源研究所として組織を改め、昭和63年には産業構造の転換に対応して組織改革を行い現在に至っています。

現在、当所の組織は企画室、総務部、9研究部（石炭部、燃料資源部、燃焼技術部、材料資源部、資源開発部、産業保安部、立地環境部、大気環境保全部、水環境保全部）のほか、技術相談所、北海道石炭鉱山技術試験センター及び九州石炭鉱山技術試験センターからなっています。

National Research Institute for Pollution and Resources (NRIPR) was established in 1952 as the Resources Research Institute by the merger of two institutes: the Fuel Research Institute and Mining and Safety Research Institute. The former had carried out studies on the utilization of fossil fuels and their combustion technology, and the latter, the exploitation and utilization of underground resources and mining safety.

Resources Research Institute was reorganized into NRIPR in 1970 so as to meet the social demands at the time and expanded its research field to include industrial pollution control.

NRIPR was further reorganized in 1988 to accelerate its research activities on future industry and the global environment. The present NRIPR is composed of nine Research Departments, Administration Department, Research Planning Office, Technology Advice Office and two Coal Mine Safety Research Centers in Hokkaido and Kyushu.

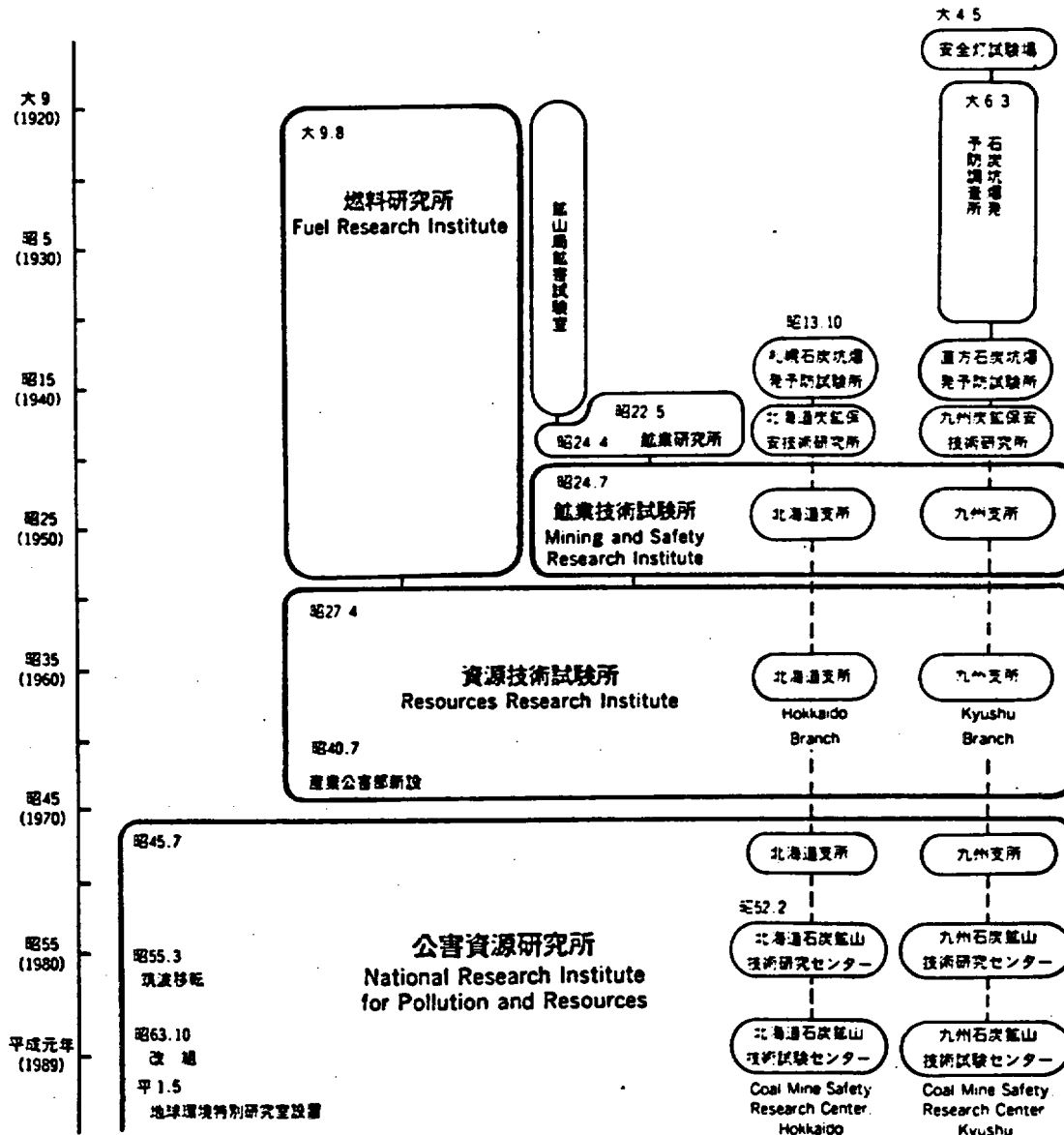

二〇九
所長 工学博士 高 多 明

Director-General Akira Takata, Dr. Eng.



地球上のすべての産業活動にとって、資源とエネルギーの確保はその基盤であり、豊かな人間生活はその上に支えられています。この美しい惑星、地球の環境の中で、資源とエネルギーをいかに確保し、また有効に利用するかは、公害資源研究所に与えられた責務であります。

科学技術における研究開発の急速な進歩には目を見張るものがあり、それに伴う産業の発展は人類に大きな恩恵をもたらしてきました。しかし、無限とも思われた天然資源やエネルギー、自然環境にも地球規模での制約が認識されてきたいま、研究開発の面でもその調和を図るべきであります。

そのためには、高度の技術と同時に広い学際的知識が必要とされます。当所は、研究開発に日夜努める工業技術院の一研究所として、資源・エネルギーの開発から利用までの一貫した研究、さらにそれに伴う安全と環境を確保する研究に、今後とも積極的に取り組んで参ります。

For all the industrial activities in the world, natural resources and energy are of essential importance, and a more affluent human life greatly depends on a sufficient supply of these resources. National Research Institute for Pollution and Resources (NRIPR) is responsible for the development of technology on how to secure the natural resources and energy, and how to utilize them effectively while preserving our environment of the beautiful planet, the earth.

Research and development in the field of science and technology have advanced at an amazing speed, and the developments of these progressive industries have brought about a great deal of benefit to mankind. During the development of technology it has been also recognized that the natural resources and energy are not infinite, and that the environment can be destroyed even to a global scale by industrial pollution. Therefore, future research and development should be carried out to harmonize human activities with the surrounding environment. Highly advanced technology and wide-ranging knowledge based on various fields of science are necessary for achievement of this desired harmony.

Agency of Industrial Science and Technology (AIST) dedicates itself to the welfare of people through the development of technology. NRIPR, as one of the members belonging to AIST, makes supreme efforts in carrying out studies on the safety of various industrial processes, on environmental protection of a global scale and on the exploitation and effective utilization of the natural resources and energy.

Role of the Institute

National Research Institute for Pollution and Resources is concerned with a wide range of research fields related to exploitation, processing and utilization of mineral resources and energy, mine and industrial safety and environmental protection. The Institute is affiliated with the Agency of Industrial Science and Technology under the Ministry of International Trade and Industry.

A great effort is being focussed on the following research subjects in each field at the Institute.

1. Mineral Resources Development and Utilization

- Exploitation and development of marine mineral resources at offshore or at deep seabeds, such as manganese nodules, hydrothermal deposits and cobalt-rich manganese clusts.
- Advanced construction technology for underground space utilization.
- Production of new materials, such as functional silicone materials and ultrafine powder.
- Processing and refining technology for low quality ore and unexploited resources, especially rare metals.

2. Energy Development and Utilization

- Comprehensive utilization technology of oil-alternative fuel resources such as coal, natural gas, oil sand, oil shale

and biomass, including organic materials technology.

- Advanced combustion technology utilizing various low grade fuels and energy-saving technology.
- Geothermal energy exploitation and heat extraction technology.

3. Environmental Protection

- Comprehensive industrial pollution control technology for emission abatement, pollutants measurement and environmental assessment.
- Pollution control and measurement technology of new chemical substances.
- Advanced assessment technology for regional scales.
- Global scale environmental studies on climatic change, acidic rain formation and transformation of chemicals in the troposphere.

4. Mine and Industrial Safety

- Coal mine safety technology, such as gas and coal-dust explosions, mine fires and gas outbursts in support of the domestic coal mining industry.
- Safety assessment for utilization of underground space.
- Safe demolition of old facilities using explosives.

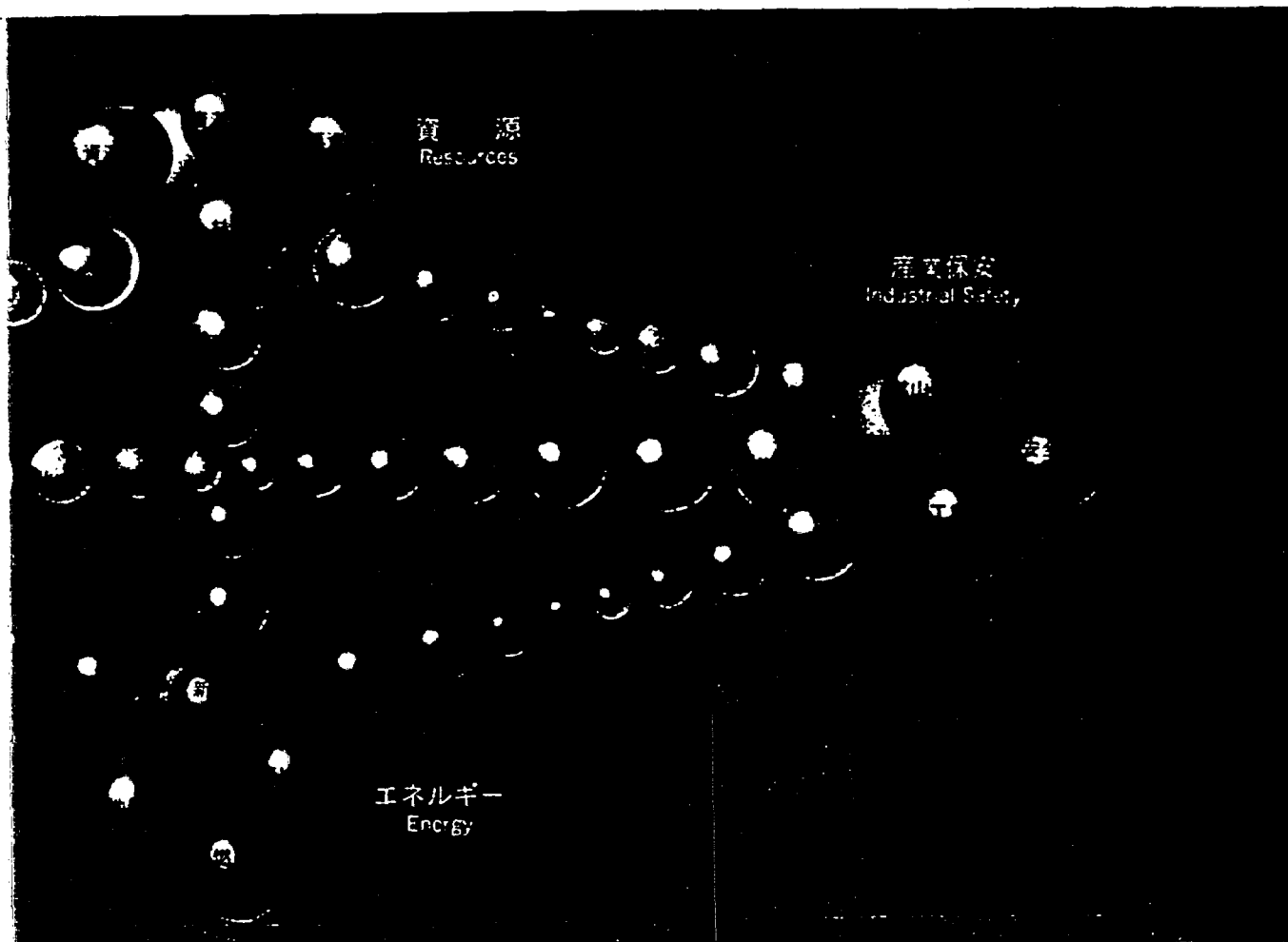

資源

Resources

大部分の資源を海外に依存する我が国にとって、鉱産物資源の長期安定供給の確保とその多様化・低質化に対応する有効利用技術の確立は、我が国経済社会の発展と国民生活の向上にとって不可欠の要件です。

そのためには、海底鉱物資源など新しい資源の開発や低品位・未利用資源の開発・利用、さらにはその高付加価値化が強く望まれています。また産業の新たな展開を図るため、水資源（工業用水源）の確保並びに地下空間利用技術の開発も急務とされています。

当所では、マンガン団塊など海底鉱物資源の開発・利用、花崗岩・蛇紋岩など国内資源の有効利用、レアメタルなどの精製素材化、炭素資源からの化学原料・新素材などの製造、及びバイオテクノロジーと膜分離を組合わせた水処理・再生システムの研究並びに地下空間開発のための各種要素技術の研究を推進し、これらの社会的な要請に応じています。

For Japan, as poorly endowed with mineral resources as it is, the sufficient supply of resources and the development of advanced technologies for utilization are of particular importance to support its vital economic activities and to provide for a more amiable life.

The Institute has conducted R & D on the techniques for mining and processing of deep-sea mineral resources (manganese nodules, cobalt-rich crusts, polymetallic sulfides...), the advanced utilization of granite and serpentinite for industrial materials, the purification and preparation of rare metals into high-grade materials, the production of carbon materials from organic carbon resources, the reclamation of water resources with high-density bioreactor and organic membrane filter, and the underground space development and utilization.

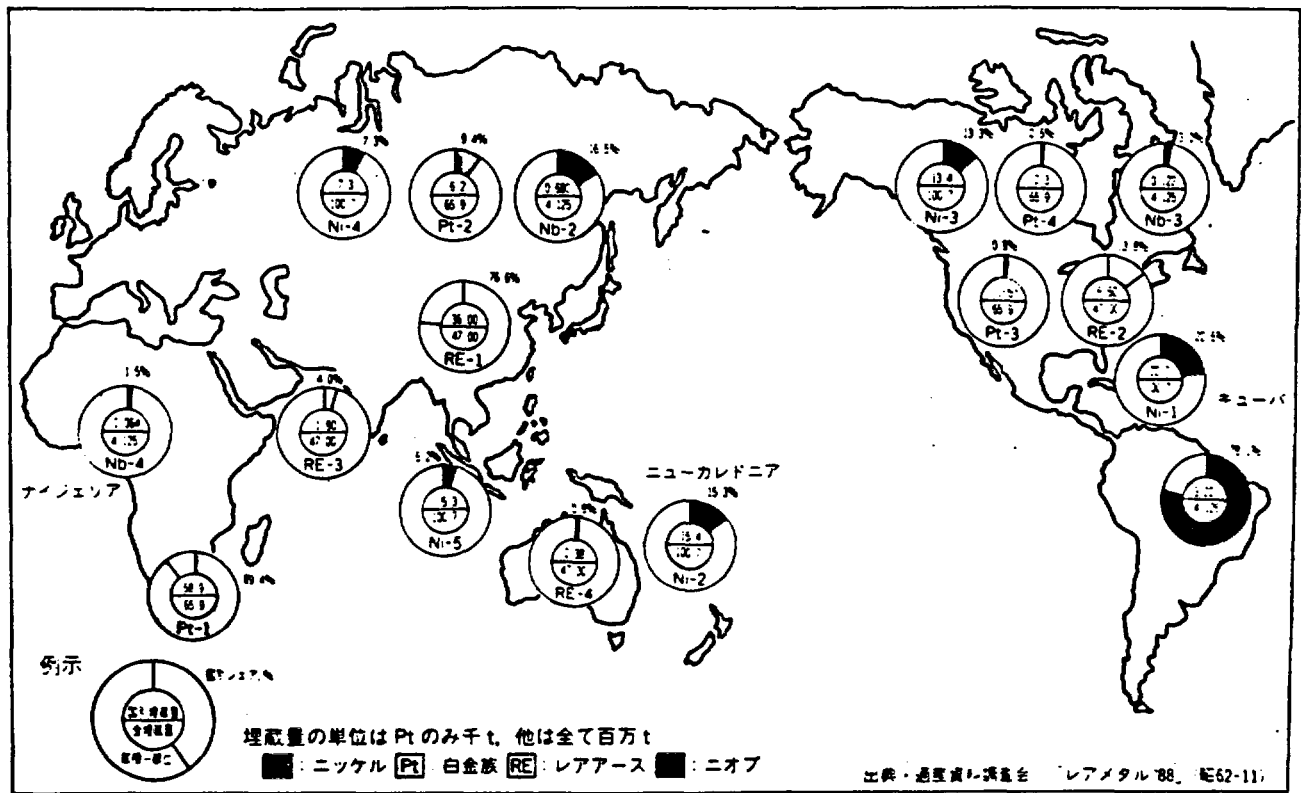

代表的なレアメタルの主要埋蔵国とそのシェア
 Main Countries with Rare Metal Resources and these Shares

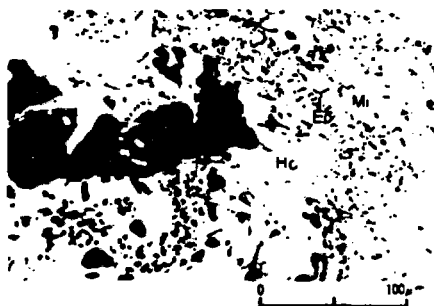

中国湖北省襄陽産レアメタル鉱石
 偏光顕微鏡: 透過・オープンニコルを使用
 (R: 金紅石, Ho: 角閃石, Ep: 緑れん石,
 Ca: 雲母)

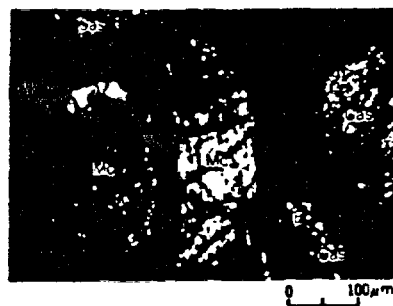

オーストラリア産重砂鉱石
 偏光顕微鏡: 反射・クロスニコルを使用
 (Mo: モナズ石, E: ユークセナイト,
 Ca: 錳石)



南鳥島海域より採取したコバルトリッチ
 クラスト
 (Mn: 12.0, Fe: 29.4, Ni: 0.82, Co: 1.08,
 Cu: 0.09 wt%DB)

深海底鉱物資源の開発

Development of Deep-Sea Mineral Resources

海洋は資源の宝庫といわれていますが、海底にもさまざまな鉱物資源が眠っています。経済的に有望なものとして、太平洋の深海底に砂利を敷きつめたように分布しているマンガン団塊、海底が拡大している箇所に湧き出したように分布している海底熱水性鉱床、海山の頂上や斜面を覆うように分布しているコバルトリッチクラスト鉱床などが発見されています。

マンガン団塊については、世界の各国で採鉱技術の開発が進められており、我が国においても工業技術院の大型プロジェクトとして研究開発が進められています。当所では、このプロジェクトの基礎的な研究や、熱水性鉱床、コバルトリッチクラスト鉱床の開発のための基礎的な研究を進めています。

Several mineral deposits deep at the bottom of ocean floors. Manganese nodules on the pelagic sea floor, polymetallic sulfide (PMS) around oceanic spreading centers, and cobalt rich manganese crusts of seamounts have been identified as potential economic resources.

Some groups around the world have been developing mining technology for manganese nodules. In Japan, AIST is promoting it as a national R & D program. The NRIPR is conducting fundamental research on nodules under this program and fundamental studies for PMS and Co-rich manganese crusts as well.

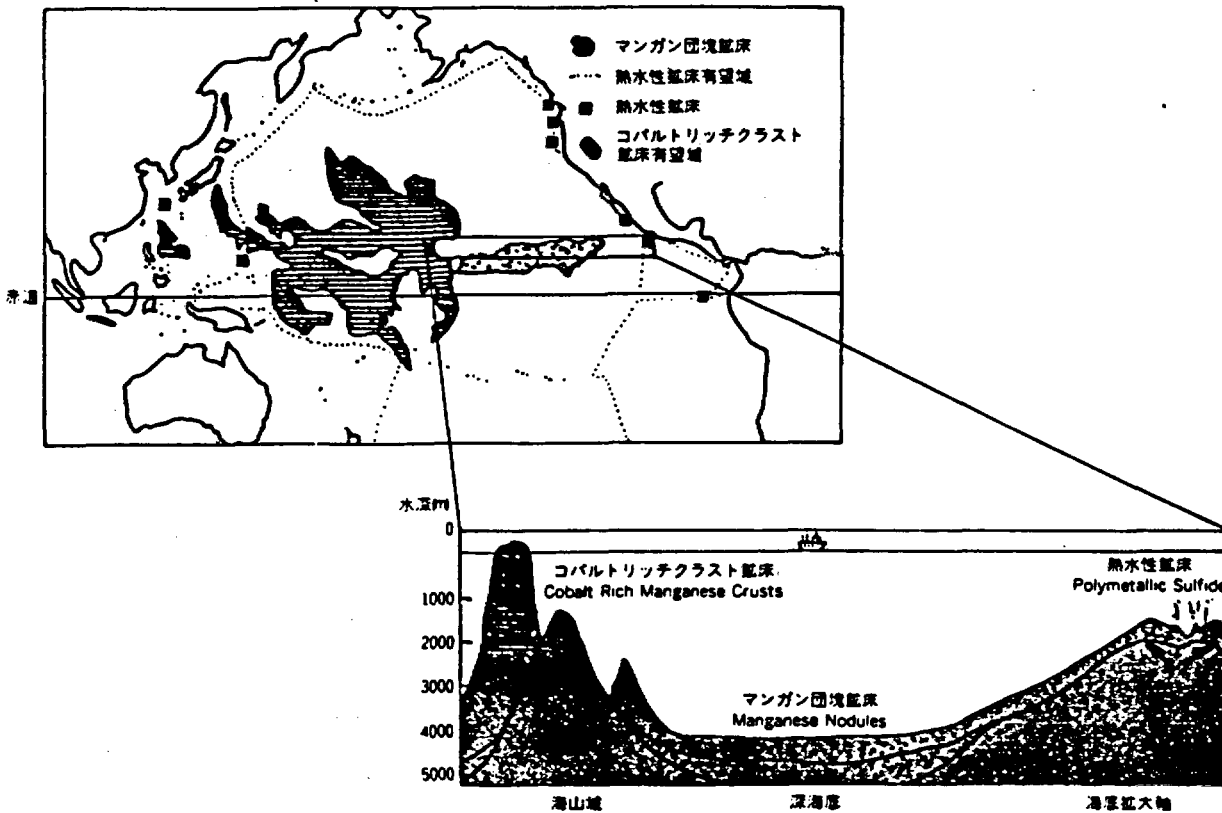

海底鉱物資源の分布模式図 Distribution of Deep-Sea Mineral Deposits

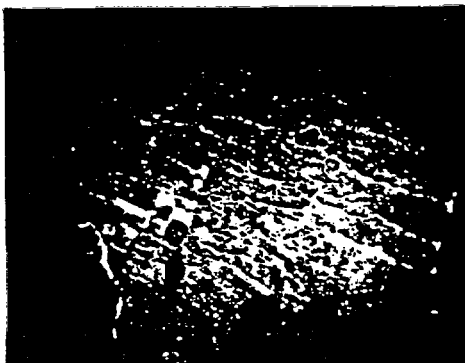

コバルトリッチクラスト海底写真

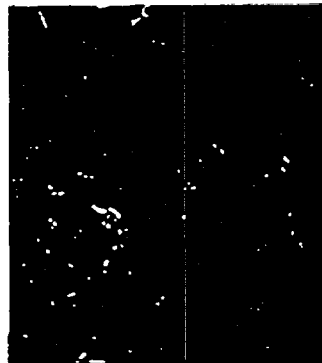

マンガン団塊ボックスコア試料

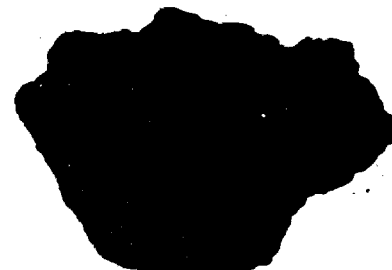

熱水性鉱床試料

マンガン団塊の開発技術

マンガン団塊採鉱実験システムは下図に示したように、海底でマンガン団塊を採掘する集鉱システム、海底から輸送する揚鉱システム、海中機器ハンドリングシステム、採鉱実験船などから構成されています。当所では、このうち集鉱システム及び揚鉱システムに関する基礎的な研究を進めています。また、マンガン団塊の開発が海洋環境に及ぼす影響についても研究を進めています。

Manganese Nodule Mining Technology

The test mining system of manganese nodules consists of collecting, lifting and machinery handling systems, and a mining ship. The NRIPR is conducting fundamental research on the collecting and lifting systems. An environmental impact study is also being carried out.

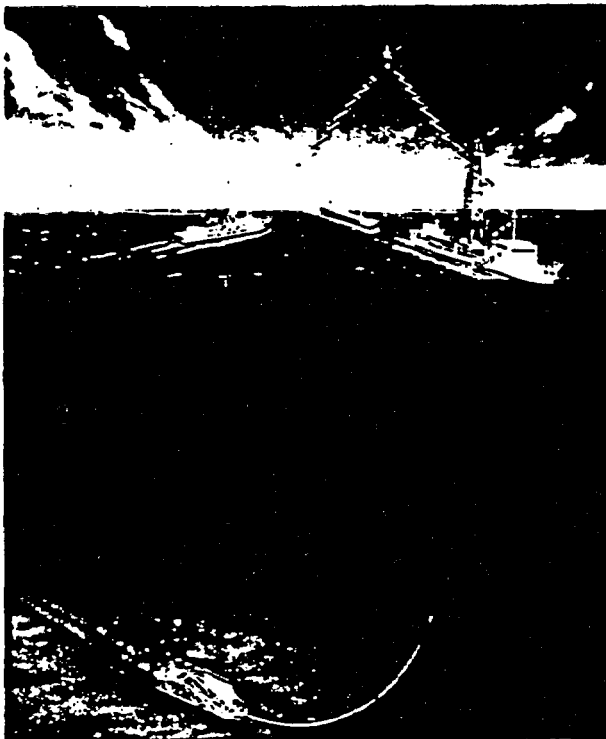

マンガン団塊採鉱システム
Manganese Nodule Mining System

海底塊状鉱床の開発

マンガン団塊に次ぐ、第2、第3の深海底鉱物資源として注目されている海底熱水性鉱床やコバルトリッチクラスト鉱床を開発するためには、その賦存特性や物理的、工学的特性を把握する必要があります。本研究では、海底の微小地形を工学的に評価する方法の開発や、対象物の比重や弾性波伝播速度などの物理的特性及び圧縮強さや被掘削性などの工学的特性の把握を行っています。

Research on PMS and Co-Rich Manganese Crusts

An accurate assessment of the topographical characteristics and engineering properties of PMS and Co-rich manganese crusts are required for their development. An evaluation method of micro topography is being developed. Physical and engineer-

採掘性の研究 Research on Collecting System

深海底の軟弱な堆積層の表面に分布している団塊を安全に、効率良く採掘する集鉱装置を開発するためには、深海底堆積層のさまざまな性質を知り、集鉱装置との相互作用を把握する必要があります。本研究では、実海域から採取した堆積層の強さ、支持力などの測定、模型実験による集鉱装置の挙動の観測、集鉱装置の採掘機構の検討などを実施しています。



集鉱機模型曳航実験 Towing Test of Model Collector

揚鉱特性の研究 Research on Lifting System

マンガン団塊を海底から海面まで輸送する方法としては、揚鉱管内に発生させた水流による水力揚鉱方式がとられます。その方式として、ポンプリフト方式とエアリフト方式が提案されています。これらの技術を確立するためには管内での固体粒子の流れの状態を把握する必要があります。本研究では、固液二相流、気液固三相流について、動揺管路での実験や濃度変動実験などにより輸送特性の解明を行っています。

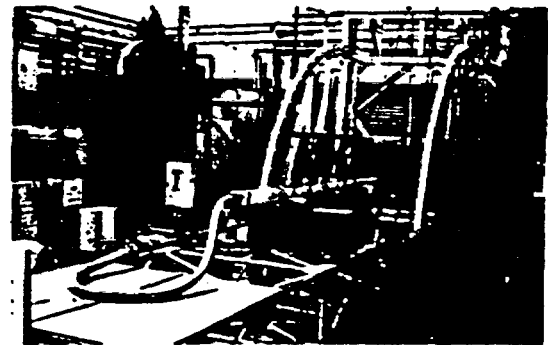

動揺傾斜管路揚鉱実験
Ore Lifting Test Using Inclined and Swaying Pipe



コバルトリッチクラスト一面せん断試験

岩盤開発と利用技術

Underground Space Development and Utilization

鉱物資源の開発

高い地圧を受けている地層あるいは軟弱な地層中に賦存する鉱物資源を開発するためには、従来とは異なる技術を開発することが必要です。当所ではこの技術開発に関する研究を現場実験、模型実験および数値解析などによって進めています。

また、南極などの極地における鉱物資源開発技術に関する研究も行っています。

Mineral Resources Development

It is necessary to establish a special method for development of mineral resources in highly stressed strata, or very soft strata. At our Institute, studies on this problem have been carried out with in situ and laboratory model tests as well as numerical analyses.

Also, a study on a method for development of mineral resources in polar regions is now being research.

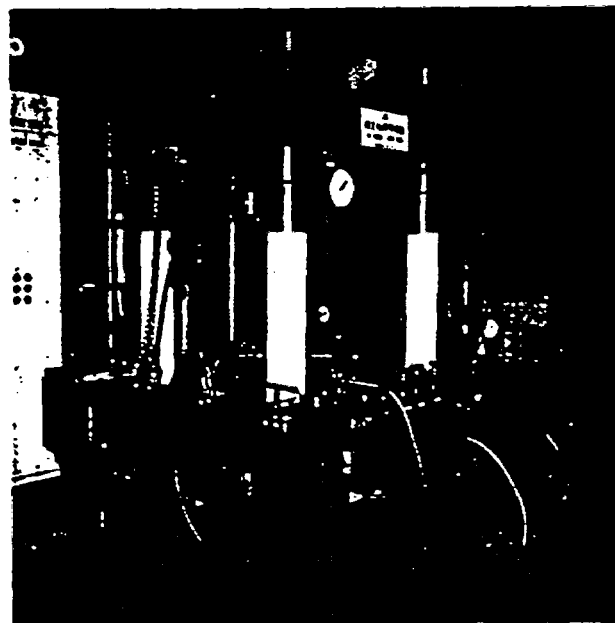

立方体試体に三方向から独立して載荷する真三軸圧縮試験装置
True Triaxial Compressive Testing Apparatus

地下の利用

近年、地下発電所、石油地下備蓄基地の建設など、大規模な地下の利用が見られるようになりました。しかし、快適な生活環境を得るためには、今後、特に都市部の地下をもっと有効に利用するべきであり、当所でも、岩盤特性の調査方法、地下空間の掘削及び維持方法などに関する研究開発を実施しています。

Underground Space Utilization

Recently, some construction of underground power plants and oil storage plants are taking place. However, only a few underground space utilization projects have been undertaken in Japan.

For a better human life, underground space in urban areas has to be more effectively utilized.

The Institute is conducting research on a method for determining properties of underground, design of opening, and support system of opening.

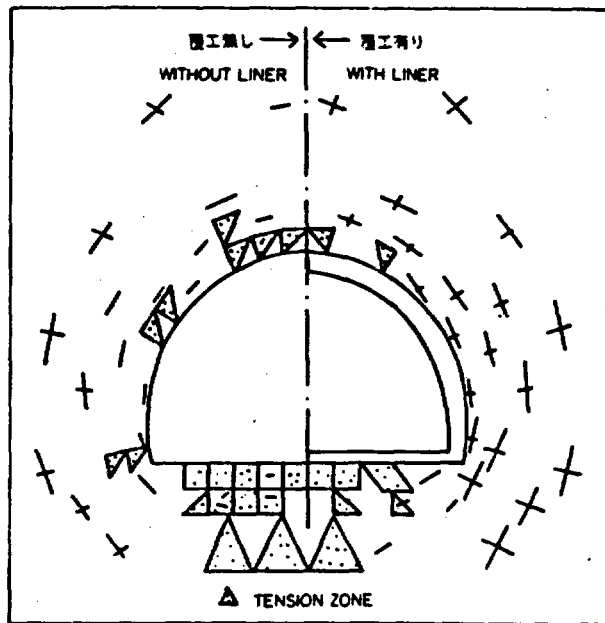

地下周辺における応力解析結果
Stress Distribution around an Underground Opening

水噴流利用技術

「水滴石を穿つ」という諺に示されるように、また、河川の侵食作用にみられるように、水の流れは時として大きな破壊力を示します。これらの例は、長い時間を要する水の破壊作用ですが、水の速度を通常より速めると、この作用を著しく急速に、一瞬のうちに生じさせることができます。

小さな孔から噴射させて人為的に高速化した水の流れ（水噴流、あるいはウォータージェットと呼びます）の破壊力を道具として利用しようとする技術が各方面で期待されています。当所では、この技術を鉱山での採掘作業や土木工事に利

Water Jet Cutting Technology

The erosive capabilities of water are well known. This erosive action can be concentrated and accelerated by creating localized coherent jets of high-velocity water. For over 20 years, water jetting has been used as a cutting and cleaning tool for industrial purposes.

The NRIPR is doing fundamental research on water jet cutting technology, particularly in abrasive jets, oscillating jets and air-coated jets, to apply it to hydraulic mining and civil engineering.

鉱物資源の高度有効利用

Processing of Mineral Resources

花崗岩の資源化技術

Utilization of Granite for Industrial Materials

花崗岩を構成する石英・長石・雲母という鉱物は、次のような重要な用途を持っています。石英はガラス材料として大量に利用されるほか、高純度のはハイテク用のシリコン原料に、長石はガラス・セラミック原料として、雲母は電気絶縁材料のほか、各種樹脂・ゴム等の充填材としても使われています。

Quartz, feldspar and mica, which are also the main component minerals of granite, have the following important uses. Quartz is consumed in large quantities for making glass. Extra pure quartz is used for high-tech products such as semiconductors and solar cells. Feldspar is indispensable for glass and ceramic industries. Mica is mixed with various plastics and rubbers to reinforce them in addition to being used as electric insulators. This study aims to recover those minerals from granite and process them for various industrial uses.

本研究では我が国に豊富に産する花崗岩から石英、長石、雲母をそれぞれ分離して取りだし、様々な用途に向けて工業原料化することを試んでいます。また雲母の中には、リチウムやガリウム等の重要な元素もわずかながら含まれているため、これらの元素の抽出についても検討を行っています。

The extraction of rare elements such as lithium and gallium from mica is also investigated.

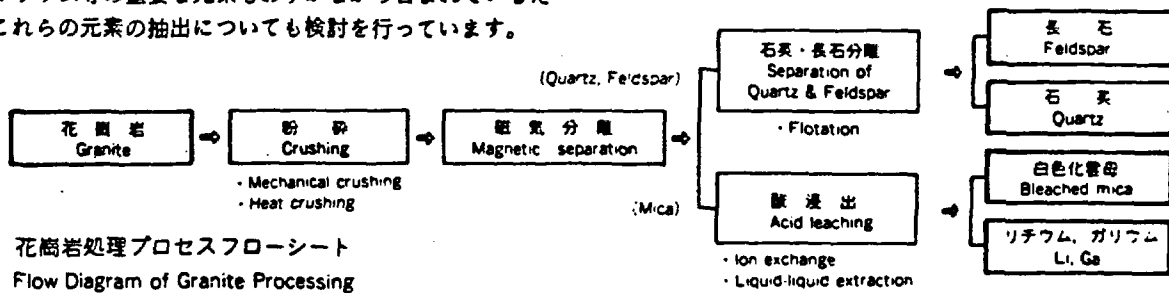

蛇紋岩の高付加価値化処理

To evaluate the potential of this amorphous silica for industrial uses, some siliceous materials such as high silica zeolites, calcium silicate hydrates and silicon carbide are being synthesized using the amorphous silica as a source of silica.

国内に大量に賦存する蛇紋岩を鉱酸処理することにより、比表面 5~500m²/g の繊維束状及び小粒集合体形状のアモルファスシリカの生成方法を開発した。このシリカはこれまでにない素材適性を有しており、これを出発物質としてゼオライト、炭化珪素、水和珪酸カルシウム等数種のハイテク用珪素系材料に合成するための研究を行っています。

また蛇紋岩の種類と酸処理条件に対応した生成物の形態制御とその用途開発及びマグネシウム分の回収法を検討しています。

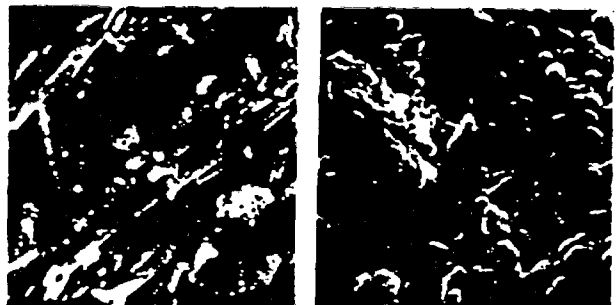

アモルファスシリカの微細組織
SEM Photographs of Amorphous Silica with Different Textures

Advanced Utilization of Serpentinite

Amorphous silica with high purity and high surface area has been prepared from serpentinite by acid dissolution. The micro textures of the product are dependent on the original ores and acid treatment conditions.

中国レアメタルの分離精製技術

Separation and Refining of Rare Metal Ores from China

当所は、東北工業技術試験所と協力して、中国有色金属工業総公司広州有色金属研究院との間で、国際産業技術研究事業に基づく「中国レアメタルの分離精製に関する共同研究」を実施しています。

Our Institute, Government Industrial Research Institute, Tohoku and Guanzhou Research Institute of Nonferrous Metals have conducted this joint research under a five-year program (FY 1988-1992).

具体的には、広西栗木地区のニオブ、タンタル鉱石及び湖北襄陽地区のルチル等難処理レアメタル鉱石について、レアメタル元素の迅速定量技術、高度な鉱物相互分離技術ならびに高純度精製技術を開発しています。

Main research activities

- (1) Mineralogical study and chemical analysis
- (2) Studies on various separation methods, gravity/magnetic/electrostatic separation and flotation for rare metal ores

鉱物資源の高付加価値・材料化

Processing of Mineral Resources

レアメタルの精製素材化技術

エレクトロニクスなど先端技術産業にはレアメタルが不可欠となっています。これを含有する鉱石は低品位化が進み、分離回収に多量のエネルギーを消費すると同時に、高純度化への要求がますます高くなるため、精製工程は一段と複雑となっています。このため低含有率資源からの有価金属の分離回収と精製技術の開発を図るとともに、高純度化により金属の潜在特性が発現され、付加価値の高い新機能材料への利用が図られるような高純度素材化技術の開発の必要があります。新素材としてのレアメタルおよびレアメタル酸化物の微粉体は、単に微細であるばかりでなく、高純度であること、粒度分布が狭いこと、均質性があり、凝集性を示さないこと等が要求され、単なる物理的な処理では対応が困難であり、精製段階で均質なものを作る必要があります。本研究では、複雑な工程を排し、しかも経済的にも有利な手段として、有機試薬とレアメタルの化学反応性を利用し、選択的分離と結合性の把握を図ることにより高純度化と機能性の発現を密接に関連させながらレアメタルの精製素材化技術の開発に取り組んでいます。

Purification and Preparation of Rare Metals into High Grade Materials

Rare metals are indispensable to high-tech industry and the need of rare metal materials of higher quality is increasing more and more. Therefore, the innovation of purification and preparation process becomes very important. The important features of rare metals powders into high grade materials are high purity, uniform particle size, homogeneity and high dispersibility in addition to having small particle size. The controlled preparation process through organo-metallic compound formation may realize those effectively instead of conventional physical methods. At this institute, the interaction characteristics and selectivity in chemical reaction between the organic reagents and the rare metals are utilized for high purification and powder synthesis, and the above-mentioned highly controlled powders are prepared due to the merits of process simplification with a great reduction in costs.

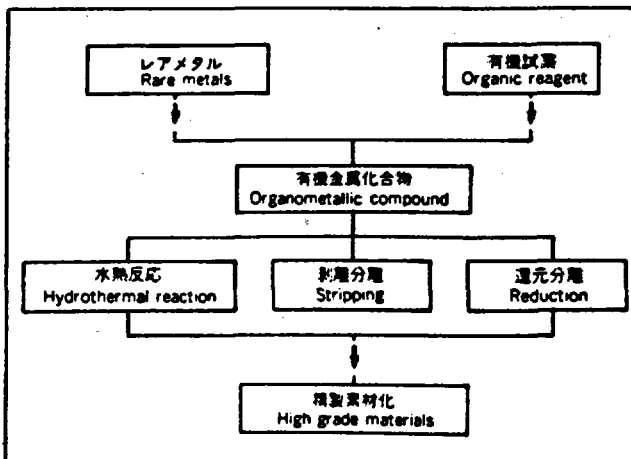

レアメタルの精製素材化フローシート

Fig. 2. Diagram of Refining Process of Rare Metals

超微粉碎技術

本研究では、サブミクロン粒子を効率よく製造する新しい超微粉碎機の開発を目的として、傾斜軸ボールミルと円板粉碎機について研究を進めています。傾斜軸ボールミルは、円筒状粉碎室の中心軸を回転軸に対して傾斜させたもので、ボール及び砕料には回転運動と粉碎室円筒の軸方向の往復運動とが同時に作用するため通常のボールミルよりも粉碎能力が高くなります。一方、円板粉碎機（写真参照）は、円筒状粉碎室に数枚の中央を穿った円板と、それらの穴を貫く一本のロッドを粉碎媒体として用い、機体を回転した時に発生する摩擦現象を利用して砕料を粉碎するものです。

各円板は各々独立して動くため、砕料に対するバランスが良く、接触点が増し、粉碎効率が向上するものと期待されています。超微粉碎の操作条件として、ボールミルやロッドミル等に比較して、回転速度が極めて大きいのが特徴であります。また、粉碎室の内張り、粉碎媒体はすべてアルミナ製セラミックスで加工されているため、不純物の混入がなく、クリーンな粉碎産物が得られます。

Ultrafine Grinding Process

At the Institute, a new ultrafine grinding machine to produce submicron material with higher efficiency than other mills is under development. One example is called multi-disc mill consisting of a cylindrical vessel charged with several center-perforated discs and a rod as the grinding bodies. The breakage of material is carried out mainly by the abrasive stresses caused through the rotation of the vessel. In this mill, each disc behaves independently, then the mill contents are distributed almost homogeneously and the number of contact points not only between grinding bodies but also between grinding bodies and the wall of the vessel increases so that desirable grinding efficiency is brought about. The operating condition of this mill for ultra fine grinding is characterized by an extremely higher rotating speed compared with the ball or rod mill case.

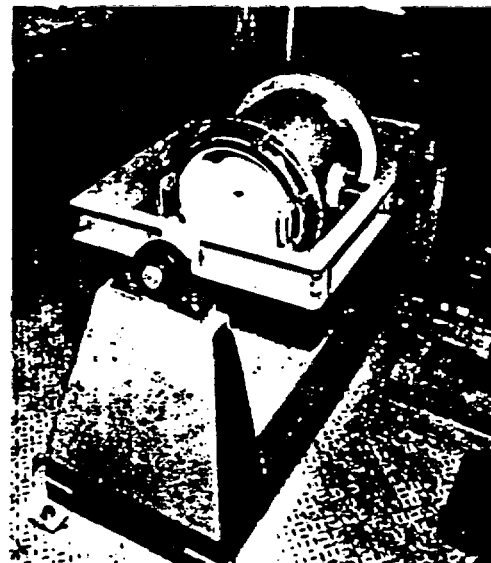

超微粉碎機 Multi-Disc Mill

金属超微粒子の合成と機能化

RF プラズマや DC プラズマの超高温を利用して磁性のある金属・合金超微粒子 (0.1 μ m 以下) を合成し、それを直ちに有機被膜でくるんだのち酵素や薬剤を付けることによって一粒一粒が機能を持ったコロイド分散系を作ることができます。当所ではこのように超微粒子が分散した状態で特異な機能が発現する材料 (ゼロ次元機能性材料) の創製のための研究を進めています。現在はより強い磁石になりうるレアアース系の合金・化合物超微粒子の合成技術とその超微粒子の表面機能化および分散技術についての研究を始めています。

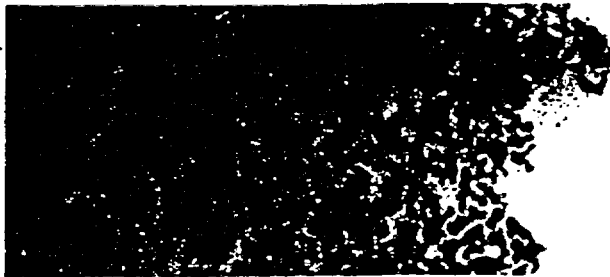

ニッケル超微粒子の透過型電子顕微鏡写真
TEM Image of Ni-UFPs

50nm

Preparation of Functional Colloids of Ultrafine Powder

Ultrafine powder technology offers a limitless potential in the near future. Fundamental studies on the preparation of functional colloids are being carried out at this institute, in which magnetic ultrafine particles (UFPs, less than 0.1 μ m) are produced using ultrahigh temperature plasma reactors and their surfaces are coated with functional organic materials. Currently, highly magnetized superparamagnetic colloids of rare-earth metals or compounds are one of the target.

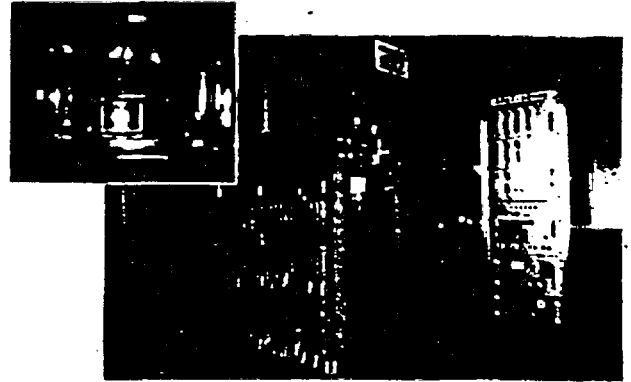

RF プラズマ装置 RF Plasma Reactor (for UFPs Processing)

炭素系資源の原料化・素材化

炭素系資源に含まれている付加価値の高い化合物、あるいは炭素系資源を燃料化した際の副生成物を分離し、原材料化することは炭素系資源の経済的かつ総合的利用を図る上から重要な研究課題です。

すなわち石炭、石油、オイルシェール、バイオマス等種々の燃料資源について、それらのエネルギー源としての利用技術開発と併行して、高付加価値化、すなわち原材料化のための技術開発研究を行っています。

Advanced Utilization of Carbonaceous Resources

Studies on the separation, functionalization and carbonization of useful components or by-products from fuel-derived carbonaceous resources are important both now and particularly in the future for the economical and total utilization of carbonaceous resources.

For the same reasons, studies should be carried out on hydrocarbon resources, petroleum, oil shale and biomass.

炭素系新材料

炭素材料の多様な構造、物性は有機物から反応してはじめに生成した固体 (炭素前駆体) の構造によって大きく支配されます。当所では今後発展が期待できる気相及び固相炭素化に重点をおいて研究しています。気相炭素化では熱プラズマ及び低温プラズマ法などによってダイヤモンド、硬質炭素などを析出させています。

また、固相炭素化としては化学的手法によって特長ある高分子を合成し、それを炭素化して機能性炭素材料を得る研究を進めています。さらに、複合材料、多孔質炭素の製造について基礎的研究を行っています。

being made to modify the surface of substrates and produce high grade or hybrid carbon materials. Specific polymers synthesized by electrochemical polymerization are carbonized during the solid phase process to prepare high performance carbon materials.

Carbon Materials

An understanding of the structure of carbon precursors is very important for obtaining characteristic materials in view of the relation to the mechanical, electric and chemical properties of the end products. The study is primarily being directed to structural modifications of the precursors through gas-phase and solid-phase processes which have a great potential to be developed. In the gas-phase process of carbon deposition from chemical species activated by plasma CVD etc. an attempt is

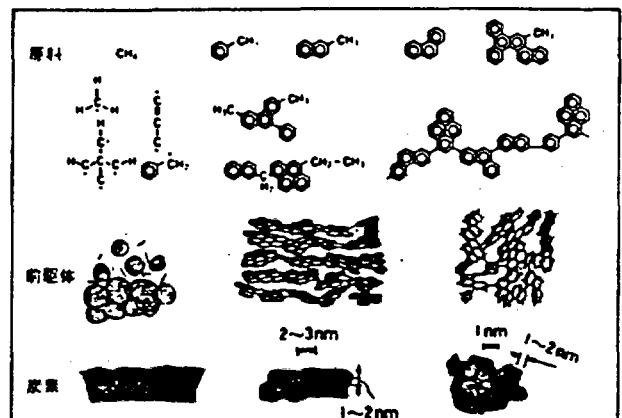

炭素の生成 Formation of Carbon

炭素前駆体が最終的にできる炭素材料の性質を支配する
Structural modifications of precursors to produce

燃料資源の有機原材料化

石炭、石油、オイルシール、バイオマス等種々の燃料資源をエネルギー源としてだけでなく、有機原材料の製造のために利用することは、これらの資源の総合的かつ経済的利用を図る上から重要です。そのためには、右図の示すように、炭素系燃料資源から有用成分を取り出すための分離プロセス、分離して得られた成分を化学原材料または化学製品に変換するための反応プロセスが必要です。現在、これらに関して効率の高い新規技術を開発するために様々な研究を行っています。

Production of Chemicals from Fuel Resources

Fuel resources such as coal, petroleum, oil shale, biomass and so on can be utilized for the production of organic chemicals as well as for energy production. The production of useful chemicals from fuel resources is very important for the total and economical utilization of those resources. Separation processes for obtaining useful components or their mixtures from fuel resources and chemical reaction processes for converting the components separated into chemical feedstocks or products are necessary for the production of chemicals from fuel resources, as shown in the diagram. At our research institute, various studies aimed at the development of efficient technologies and processes both for separation and chemical reaction are being carried out.

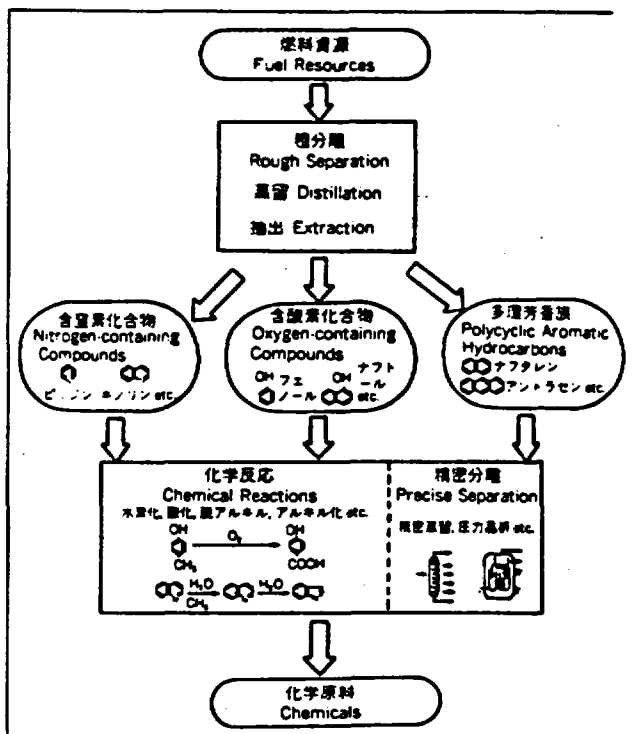

燃料資源の有機原材料化の工程
Flow Diagram of Production of Organic Chemicals from Fuel Resources

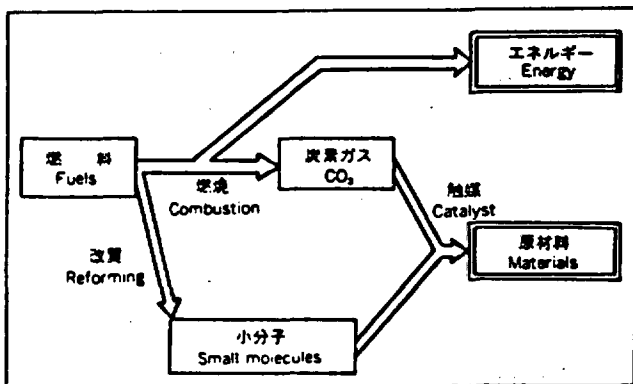

燃料から原料、エネルギー同時生産システムの概念図
A Concept of CO₂ Free Utilization of Fuels

炭酸ガスの原材料化

燃料からエネルギーを取り出した後の形態である炭酸ガスを利用して有用な化合物を合成できれば、有機資源の節約と炭酸ガス公害の軽減に役立ちます。当所では、遷移金属錯体等の触媒を用いて炭酸ガスとオレフィン、アセチレン、アルコール、アミン等の小分子を反応させ、プラスチックや医薬薬原料となる基礎化成品の製造方法を研究しています。

Utilization of CO₂ as a Chemical Carbon Source

Fixations of CO₂ into organic materials are studied with transition-metal complexes as the catalyst, which may serve to some extent for reducing the amount of CO₂ released into the atmosphere.

レーザー化学反応

レーザー光は、単一の波長と、そろった位相を持つ光線で、かつ強力なパワーを持っています。本研究ではレーザー光の特徴を利用して、化学反応の制御、物質の超高純度化あるいは、クラスターの生成など、燃料資源を付加価値の大きい物質へ転換する新技術の開発を目指しています。

Laser Chemistry

There have been many examples in which new technology came into being from a new scientific discovery and innovated an industry. Is just the case, laser light is coherent and monochromatic, and gives very high photon density. We are working on projects to apply laser light with its special features to fuels to produce ultrapure compounds or fine clusters as new materials.



レーザー照射装置
Laser Irradiation System for Selective Photochemical Reaction and Molecular Formation

水総合再生利用システム

New Water Treatment System "Aqua Renaissance '90"

現在、我が国では、中長期的な水需給の逼迫化、上水、工業用水の水源水質の悪化などが社会問題になりつつあります。

通商産業省では、これらの問題に対処するため、近年、発展の著しいバイオテクノロジーと膜分離技術を組み合わせたシステムにより、都市下水や産業廃水を、その中に含まれる有機汚濁物をメタンガスに転化、回収しながら、工業用水などに再利用できるように処理する技術の研究開発（アクアルネサンス'90）を昭和60年度より6年計画で実施しています。

本計画には、工業技術院の試験研究機関並びに協会と民間企業で構成されている技術研究組合が参加しており、当所では次に示す研究を担当しています。

As a means of solving the problems concerning the larger demand for water in future and the pollution of the source of water supply for the city and industrial water, a six-year plan entitled New Water Treatment System (Aqua Renaissance '90) was set up by MITI and research on this project was started as of 1985. The new system consists of a bioreactor having a high concentration of microorganisms and a membrane as the separator of microorganisms from the bioreactor.

What is attractive about the new system is that it will be able to recover marsh gas from the organic material contained in the sewerage and industrial wastewater and will be able to reuse the treated water as industrial water.

窒素除去の効率化

本研究では活性汚泥法の固液分離過程に膜分離装置を組み込むことによって、従来に比べはるかに高い微生物濃度を維持すると同時に、汚泥滞留時間を長くして窒素除去に係わる微生物（硝化菌、脱窒菌等）をリアクター内に保持し、窒素除去を効率化することを目指しています。本リアクターで硝化を行わせるとき、従来系を上回る窒素負荷で運転できることが示されました。同時に、曝気槽内で脱窒が進行することも認められました。本リアクターは一槽式でBODと窒素が除去できる経済的な装置として期待されています。

Nitrogen Removal by an Activated Sludge Process with Cross-Flow Filtration.

The capability of ammonium oxidation of an activated sludge process with cross-flow filtration while retaining a higher concentration of activated sludge, and operating with very long sludge retention time is investigated. By this process, higher nitrogenous and organic loadings were attained, and some amount of oxidized nitrogen were denitrified. Thus, organic carbon removal, nitrification, and also denitrification may possibly all occur at the same time when using this process with a single reactor.

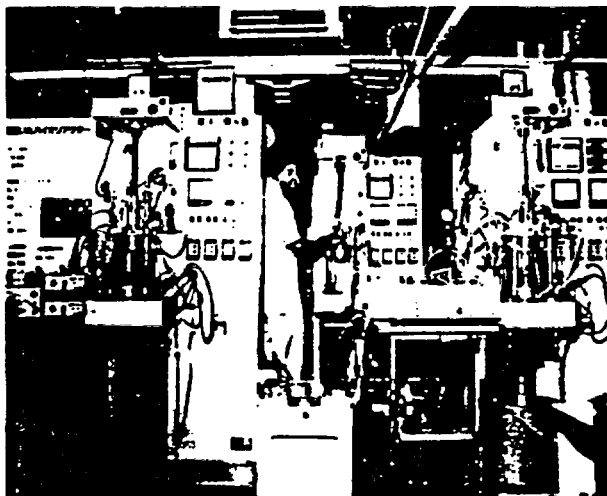

膜分離リアクター

有機膜素材の評価技術

本研究では有機または無機性の膜を用いて微生物、有機物等を分離し、リアクター内の微生物の保持、透過水の再生利用を可能とすることを目標に、汚濁物質負荷に強く、微生物により劣化せず、長期使用が可能な透過膜を選定しようとするものです。当所では既存及び新規に開発される有機膜の検討・評価を行っています。

Evaluation Technique for Organic Membrane Materials

To develop a means by which the microbes within the bioreactor can be maintained and the wastewater recycled for reuse, we have been conducting research related to high performance organic type membranes which exhibit excellent contaminant load capabilities, are resistant to microbial deterioration, and which can be used over long period of time due to their favorable durability characteristics.

Permeability test has been carried out on already existing organic membrane materials using wastewater containing anaerobic microorganisms.

Those materials, exhibiting superior performance, have been selected and the optimal operating conditions have been investigated.



膜評価試験装置

我が国はエネルギーの資源の約6割を海外の石油に依存していますが、石油資源は世界的に偏在しており、また埋蔵量も少なく、長期的な安定供給は保証されていません。そこで我が国では環境問題にも配慮しつつ、将来のエネルギー問題に対応できるような石油代替エネルギーの開発技術やエネルギーの有効利用技術を確立しておく必要があります。

当所では、資源が豊富にあり安定して輸入可能な海外産石炭のクリーンな利用技術としてその液化及びガス化技術、スラリー化技術、天然ガスやバイオマスからの液体燃料製造技術、劣質・重質油等の軽質化技術などの研究のほか、石油の燃焼技術の改良による低公害化と熱エネルギーの有効利用による省エネルギー化の研究を行っています。さらに国内エネルギー資源である地熱エネルギーに着目して高温の地下岩盤からの地熱エネルギーの回収技術、地熱坑井の効率的掘削技術等の研究を行い、エネルギー資源の多様化と有効利用を図っています。

About 60% of Japanese primary energy consists of petroleum which is all imported. Petroleum resources are irregularly distributed in the world and cannot cover the world's enormous demand for oil consumption in the future. So, it is necessary to establish technologies both to use various energy resources and to use them very effectively considering the global environmental protection to maintain a high standard of living.

The Institute has conducted various studies on energy technologies such as coal liquefaction and gasification for clean use of coal which has large reserve of resources in the world, liquefaction of Natural Gas and biomass resources and upgrading of heavy oil. Also, new technologies for low emission combustion of coal and thermal energy savings are being developed. For utilization of geothermal energy, effective extraction of geothermal energy and drilling technology for geothermal wells are under study at present.

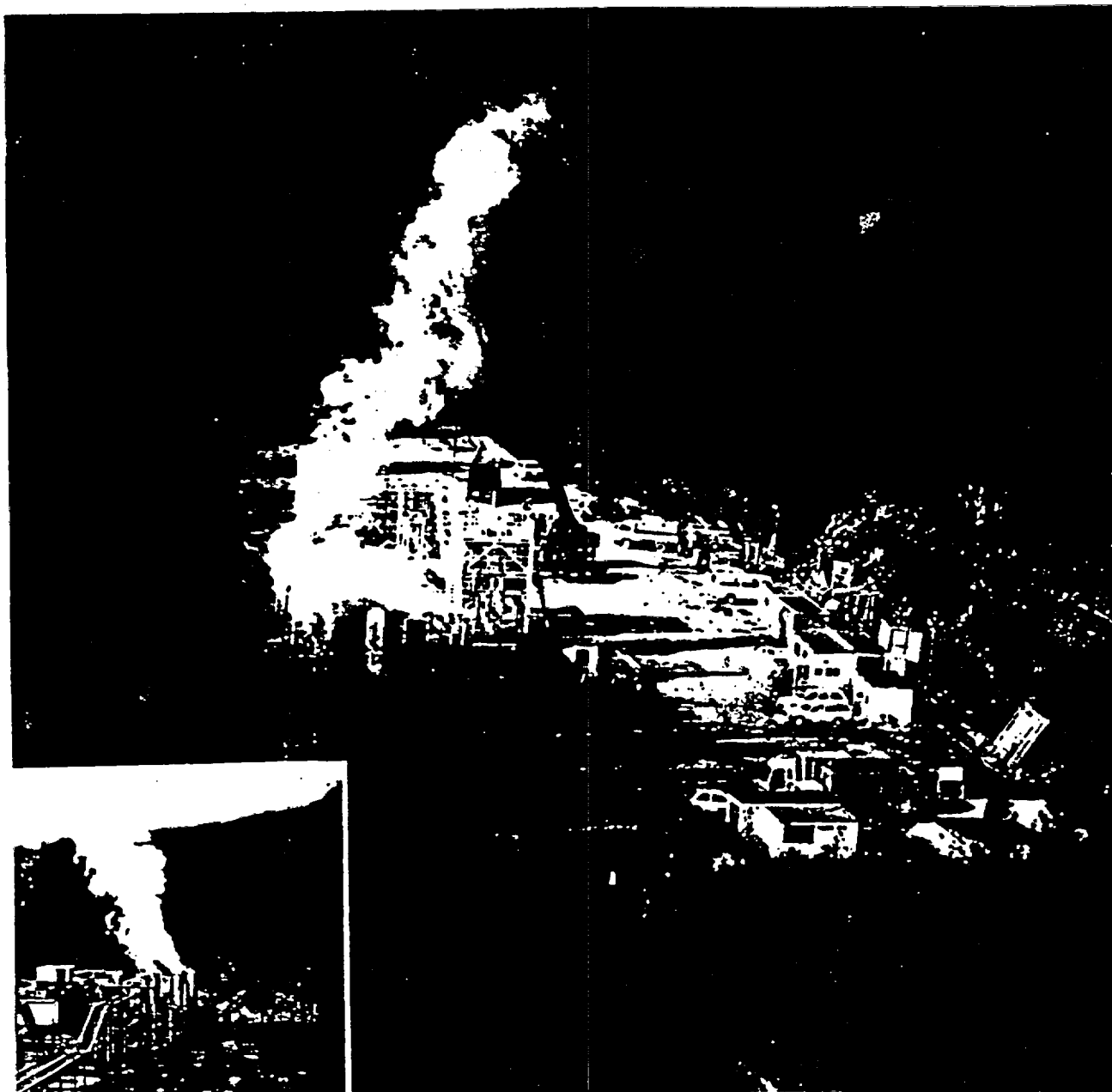

（左）石炭の液化装置の運転状況（右）形造時新温泉）

我が国はエネルギーの資源の約6割を海外の石油に依存していますが、石油資源は世界的に偏在しており、また埋蔵量も少なく、長期的な安定供給は保証されていません。そこで我が国では環境問題にも配慮しつつ、将来のエネルギー問題に対応できるような石油代替エネルギーの開発技術やエネルギーの有効利用技術を確立しておく必要があります。

当所では、資源が豊富にあり安定して輸入可能な海外産石炭のクリーンな利用技術としてその液化及びガス化技術、スラリー化技術、天然ガスやバイオマスからの液体燃料製造技術、劣質・重質油等の軽質化技術などの研究のほか、石油の燃焼技術の改良による低公害化と熱エネルギーの有効利用による省エネルギー化の研究を行っています。さらに国内エネルギー資源である地熱エネルギーに着目して高温の地下岩盤からの地熱エネルギーの回収技術、地熱坑井の効率的掘削技術等の研究を行い、エネルギー資源の多様化と有効利用を図っています。

About 60% of Japanese primary energy consists of petroleum which is all imported. Petroleum resources are irregularly distributed in the world and cannot cover the world's enormous demand for oil consumption in the future. So, it is necessary to establish technologies both to use various energy resources and to use them very effectively considering the global environmental protection to maintain a high standard of living.

The Institute has conducted various studies on energy technologies such as coal liquefaction and gasification for clean use of coal which has large reserve of resources in the world, liquefaction of Natural Gas and biomass resources and upgrading of heavy oil. Also, new technologies for low emission combustion of coal and thermal energy savings are being developed. For utilization of geothermal energy, effective extraction of geothermal energy and drilling technology for geothermal wells are under study at present.

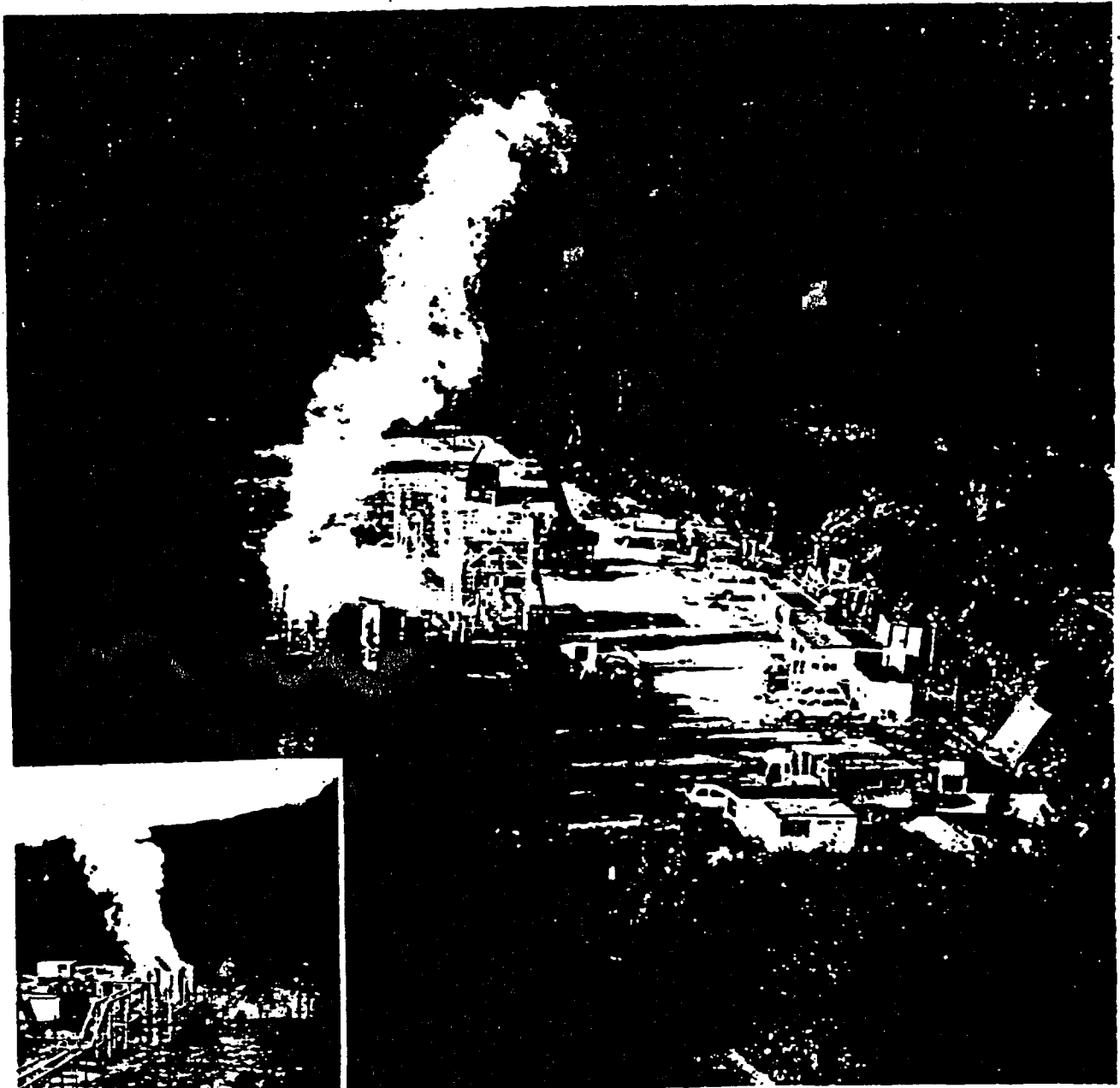

循環試験中の高温岩体実験場(山形県肘折温泉)

Overlooking the Hijiori Hot Dry Rock Test Site in Yamagata

石炭の液化

石炭を液化し、原油あるいは石油製品の代替として使用可能なクリーンな燃料油を製造するプロセスとして、サンシャイン計画では褐炭液化技術と瀝青炭液化技術についての技術開発が進められています。そのなかには解決すべき、多くの要素技術があります。

当所では主として基礎的な部門を担当し、瀝青炭から褐炭までの各種石炭について、石炭の物性から始まり、液化反応、粗液化油の水素化改質、改質油の安定性や内燃機関燃料としての評価及び液化副生成物の有効利用等の幅広い研究を相互に連携を保ちつつ総合的に進めています。これらの結果から、石炭の液化反応条件と液化生成物の量と質との関係の一般則を見いだすとともに、生成物の改質処理によって、用途に応じた性状の製品を製造するための基礎資料を得ています。

The Sunshine Project has developed Brown Coal Liquefaction and Bituminous Coal Liquefaction.

The method, which has been carried out at this Institute, is one of the coal liquefaction processes conducted by solvent extraction and is essentially a two-stage process. The purpose of this research is to provide fundamental data for the selection of optimum reaction conditions for the liquefaction of various coals and the upgrading of coal liquid. Product Utilization is also being investigated.

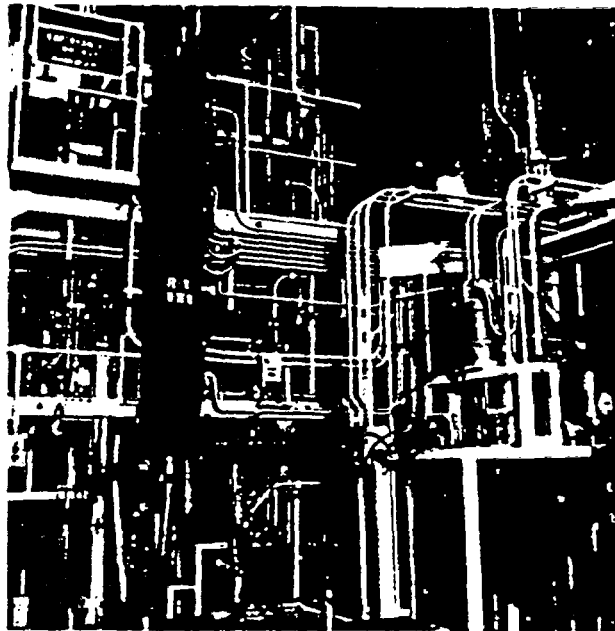

石炭液化装置
Coal Liquefaction Test Plant

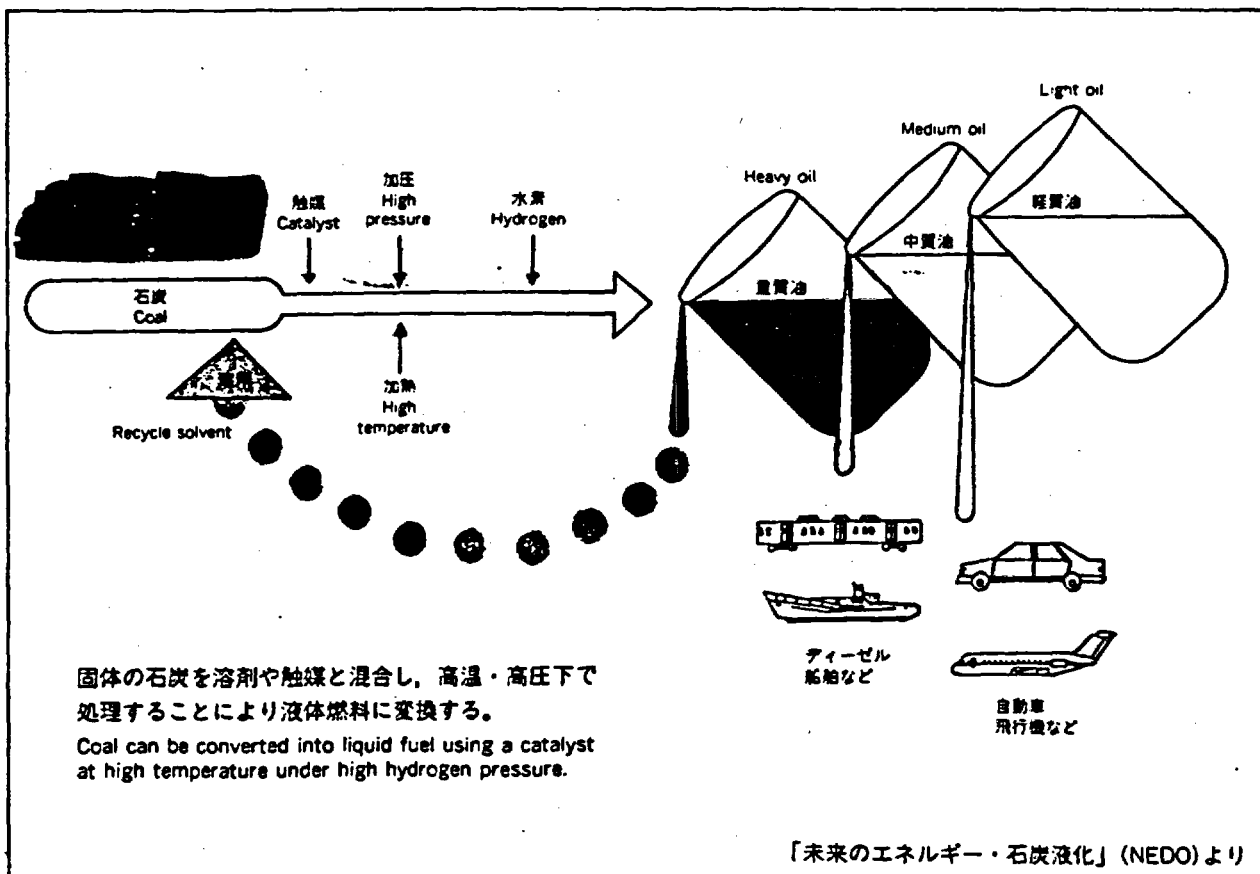

石炭の液化反応

石炭の液化反応ではまず、石炭を粉砕し、溶剤や触媒と混合してペーストとしたのち、高温、高圧水素下で反応させる、いわゆる一次液化反応で液状生成物を出来るだけ高収率で得ることが必要です。生成物の収率や物性は石炭の種類と反応条件によって大きく左右されますが、当所では各々の石炭に適合した溶剤や反応条件の選定をオートクレーブあるいは小型連続装置を用いた実験によって行い、更に液化残渣についても適切な利用方法を検討しています。

一次液化反応の条件は次の様な範囲です。

反応温度	380~480°C
反応圧力	100~300 kg/cm ²
溶剤/石炭(重量比)	2~5
触媒	鉄系

Liquefaction Reaction of Coal

In coal liquefaction, coal is first ground and mixed with a solvent and catalyst to make a feed paste. It is important to obtain a high yield of liquid product in the first-stage liquefaction at high temperature under high hydrogen pressure. The yields and properties of the products greatly depend on the reaction conditions and coal ranks and thus selection of optimum conditions and suitable solvents for coal have been studied, at our institute, using autoclave and continuous bench scale plants. The utilization of liquefaction residues is also under investigation.

液化油の改質と評価

一次液化から得られる粗液化油は、窒素、酸素等のヘテロ化合物を多量に含むと同時に、空気や光によって容易に着色します。二次水素化処理は、粗液化油をクリーンかつ良質な燃料にするための有効な方法です。

当所では、液化油の水素化処理方法、最適反応条件を検討するとともに、灯油、軽油等の製品評価、貯蔵安定性、着色防止技術、石油と混合使用する場合の問題点等について検討しています。

Upgrading and Evaluation of Coal Liquid

Raw coal liquid contains lots of hetero-atoms (such as nitrogen), and is readily colored by air and light.

To produce a good quality coal liquid, operating conditions for hydrotreating, evaluation of product oils, storage stability, color stability and various other problems have been studied.

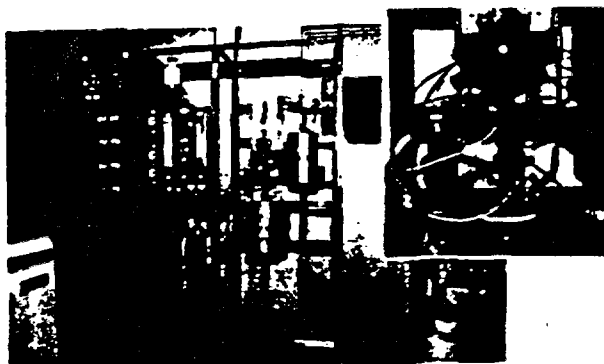

液化油軽質化触媒試験装置 (MAT)

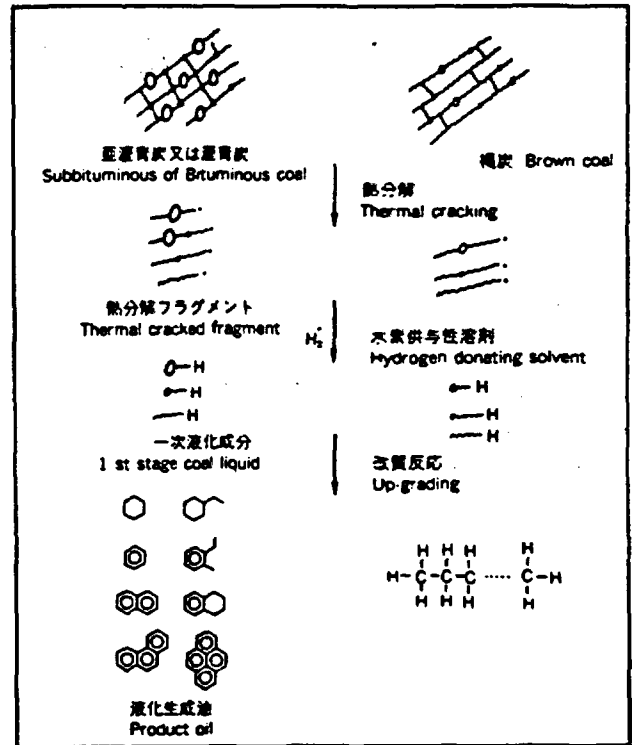

石炭液化反応

Liquefaction Reaction of Coal

液化油からの有効成分の分離

粗液化油の中には、化学製品の原料として利用できる化合物が多種含まれています。これらを分離し、有効に利用することは、液化油を安価に製造するためにも重要なことです。

当所では NEDO とも協力してその分離法について研究を進めています。

Separation of Valuable Components from Coal Liquid

Coal liquid includes a lot of valuable components, which are useful for chemical feedstocks. It is very important to separate them coal liqued for reducing the price of the production of fuel from coal.

We are studying their separation methods in cooperation with the New Energy Development Organization (NEDO).

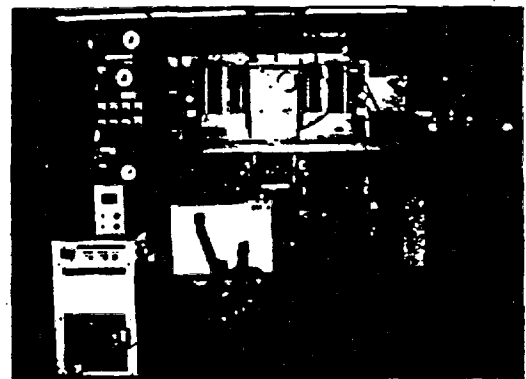

圧力晶析法による石炭液化油中の有効成分の分離
High Pressure Crystallization of Valuable Components from Coal Liquid

石

石炭をCO、H₂、CH₄等にガス化する技術は、100年以上も利用されてきました。今日でも、クリーンなエネルギーへの転換技術として、サンシャイン計画において官民合同による開発が進められています。このプロジェクトでは、石炭を1600°C以上の高温によりO₂でガス化する技術を目指しています。

高温でガス化するため、(1)どんな種類の石炭でも使える、(2)H₂、CO以外のガスが生成しにくい、(3)小さな炉で大量の石炭を処理できる、(4)石炭中の灰分はガラス状の固体になるので、自然環境に与える影響を最少にできる、などの特徴を持ったプロセスです。

当所では、効率よく石炭をガス化するための条件を詳しく調べたり、効率よく生成ガスから硫黄化合物を除去する方法を基礎的に解明しながら、このプロジェクトを支援しています。この中で、石炭の持っているエネルギーをガスのエネルギーに最も効率よく転換するためのガス化条件を、理論と実験の両面から明らかにして来ました。また、これまで運転されたガス化プラントの成績を世界中から集め、これを総合的に

解析するためのデータベースも作成しています。脱硫技術としてはガス化と同時に硫黄化合物を除去する炉内脱硫技術や、ガス化炉から出たガスを冷さずに脱硫する高温乾式脱硫剤の開発を進めています。

Although the gasification of coal has been carried out for more than a century ago, the development of an advanced gasification process in which the problems of efficiency, reliability and environment have been solved, is still being anticipated. The R & D activities associated with coal gasification are being studied by government and private enterprises in cooperation with each other as a part of the Sunshine Project.

At this Institute, a fundamental study for coal gasification at a high temperature has been carried out. One of the objects of this investigation was the accumulation of basic data to improve the gasification efficiency of coal. Fundamental studies are in progress on gasification phenomena and the influence of molten slag on gasification reaction above the melting temperature of the ash using a bench-scale moving gasifier, plasmometer, and other apparatus.

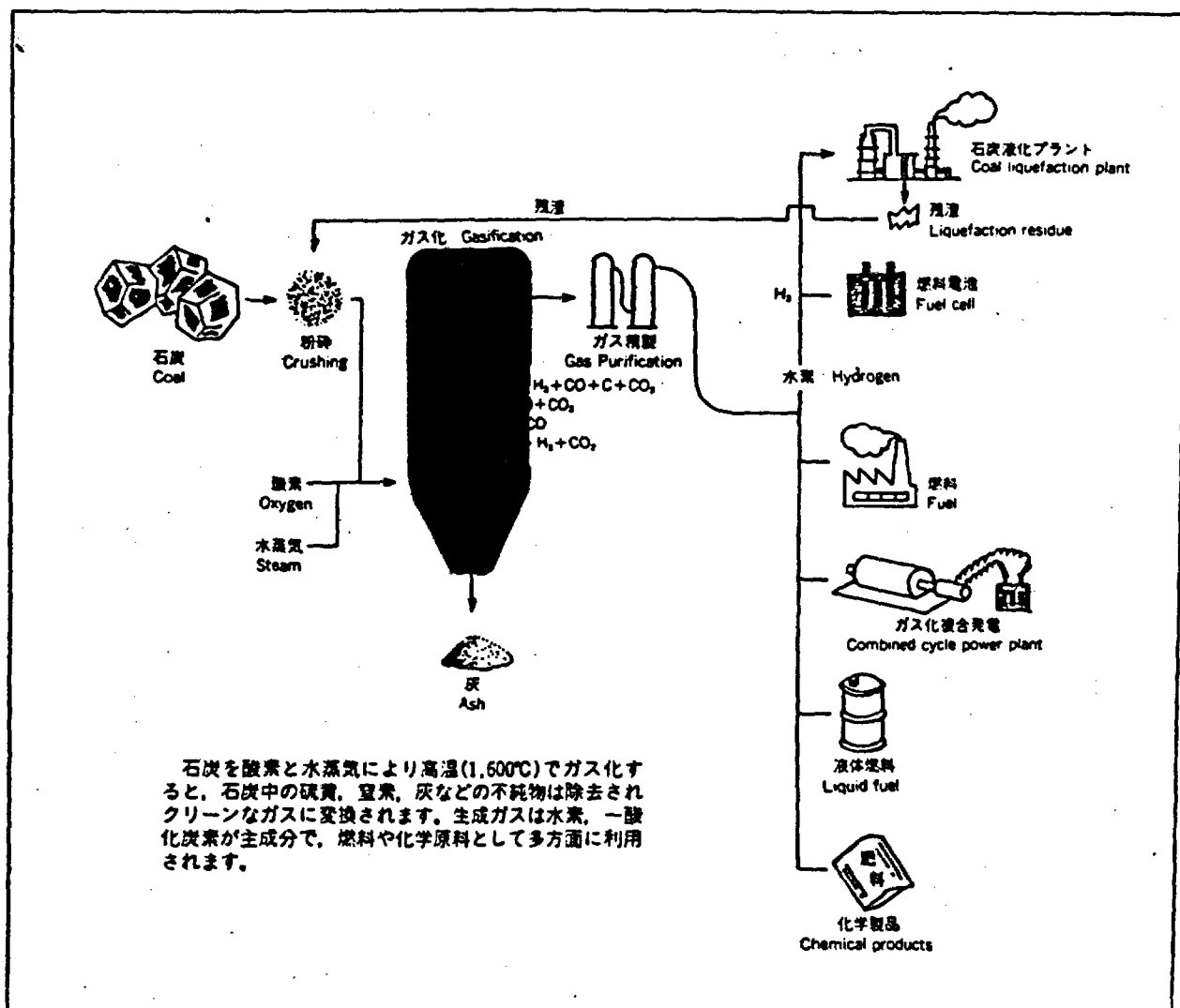

バイオマスから液体燃料の製造

バイオマスは非化石系エネルギー資源の中で、再生産可能（リニューアブル）かつ唯一の炭素系の資源です。本研究の目的は、木質系バイオマスである木材や樹皮、あるいは都市廃棄物の下水汚泥、アルコール製造工程から排出される有機汚泥から液体燃料を製造することにあります。

このために、これらの原料を高温、高圧下で処理することにより液化反応を進行させます。現在、下水汚泥の油化実験に関してはベンチスケールの装置により、連続運転を行っています。

Production of Liquefied Fuels from Biomass

Biomass resources are unique because they are renewable and carbonaceous among non-fossil energy sources. The purpose of this study is to produce liquid fuels resembling heavy fuel oil by thermochemical conversion.

In this process, woody material is mixed with an aqueous solution of alkali salt and treated at high temperature and under high pressure to achieve liquefaction. At the present time research is being done for sewage sludge liquefaction using a pilot plant.



液化反応の原料(木材チップ)
Feedstocks for Liquefaction (Wood Chips)

この液化方法は、(1)水素や一酸化炭素などの還元性ガスが不要である、(2)反応が水相で進行するため、原料の脱水、乾燥工程が不要である、(3)木材などのバイオマスは重油に比べて、硫黄、塩素、重金属などの環境汚染物質が少ないためにクリーンな燃料が得られるなどの利点があります。一連の実験結果によれば、適切に反応条件を選択することにより、7,000~8,000 kcal/kgの発熱量を有する液体燃料を約50%の収率で得ることができます。

This process has the following advantages: (1) No hydrogen or carbon monoxide is needed; (2) No drying or dewatering of starting material is needed since liquefaction proceeds in an aqueous phase; and (3) Clean fuel is obtained since woody material hardly contains any pollutants such as sulfur, chlorine and heavy metals. According to a series of experiments, liqued

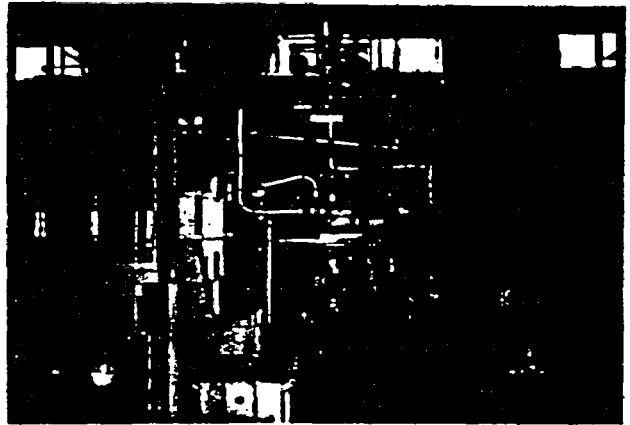

バイオマス液化装置
Biomass Liquefaction Test Plant

我が国では、未利用の木質系バイオマスが年間で約3,000万 m^3 程度が廃棄処分されています。また、下水処理場からは年間5,000万 m^3 もの下水汚泥が排出され、同様に各製造工場からも膨大な量の有機性汚泥が不可避免的に排出され、これらの処理、処分が大きな社会問題になりつつあります。これらは高含水状態で排出されることが多く、水の存在下で反応を進行させる本方法に適した原料であるといえます。当所で開発した液化法は、コストをかけて処理、処分しなければならない廃棄物から逆にエネルギーを取り出すことができ、その成果が大いに期待されています。

In Japan, roughly 30 million cubic meters of waste wood and 50 million cubic meters of sewage sludge are being generated annually. However, the difficulty of finding the available space for disposition and other environmental reasons are making the matter of waste disposal a serious social problem.

Since this type of liquefaction is carried out in the presence of water, it can be applied to many kinds of organic material containing water. For example, sewage sludge, pulping sludge, and peat are desirable potential candidates.



我が国は原油のほとんどすべてを海外に依存していますが、近年、輸入原油の質は次第に悪くなり、原油中に含まれる軽質油（ガソリン、灯油、軽油など）の割合が少なくなる傾向にあります。一方、これら中間三品の需要増、C重油の需要減にみられるように、国内石油製品の需要動向は軽質化の傾向にあります。このギャップを埋めるために重質油から軽質油を製造する技術を早急に開発する必要があります。

本研究で開発を進めている高分散触媒は、重質油とよく接触するので少量でも重質油を効率よく分解して軽質油を製造することができます。また、重質油中に含まれるバナジウム、ニッケル、アスファルテン等の触媒被毒物質に対しても強い抵抗力を持つなど、既存の触媒にない長所を有しています。

Almost all crude oils consumed in Japan, are imported from foreign countries. Recently, the yield of light fractions in crude oils imported is going down. On the other hand, the demand for light oils (such as kerosene and diesel fuel) is increasing.

To compensate for the lack of light oils, it is necessary to produce light oils from heavy oils.

A homogeneous catalyst is useful for the hydrocracking of heavy oils which contain a great deal of vanadium, nickel and asphaltenes. Homogeneous catalysts have very high efficiency for contact between a catalyst and heavy oil molecules. Even a small amount of a homogeneous catalyst is capable of reducing asphaltenes in heavy oils.



生成油と触媒
Product Oil and Homogeneous Catalysts

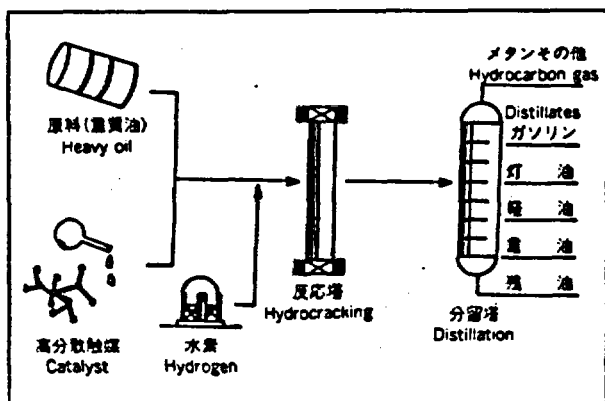

天然ガスは、石油に比べて比較的広く賦存していますが、取扱いが不便な気体燃料であるため、これまで世界の生産量の20%が現地で焼却されています。我が国では、 -160°C に冷却された液化天然ガス(LNG)として海外から輸入され、火力発電や都市ガスに利用されています。天然ガスを化学反応によって液体燃料に変換する技術は、常温での輸送を可能にし、自動車用・民生用液体燃料や化学工業用原料にまで利活用の幅を拡大でき、さらに硫黄分や窒素分のほとんどを含まれない良質燃料を供給できると期待され、我が国のエネルギー源の多様化に貢献することができます。

本研究では、天然ガスを炭化水素や燃料アルコールに化学変換するプロセスの開発を目的として、触媒、反応形式及び生成液体燃料評価を中心とした研究を行っています。

Although natural gas reserves in the world are next to those of oil, so far about 20% of the world production has been burned off at production sites because of difficulty in storing or handling gaseous fuels. Liquefied Natural Gas (LNG), cooled at -160°C , is imported to Japan for limited uses such as electric power fuel and town gas.

The chemical conversion of natural gas to liquid fuels is desirable: (1) to expand its utilization to automotive fuels, heating fuels, and chemical feedstocks; (2) to easily transport the fuels at ambient temperature; and (3) to supply clean fuels containing no sulfur or nitrogen compounds. Aiming at chemical conversion of natural gas into hydrocarbons and alcohols, research has been carried out on: (1) catalysts for the conversion; (2) reaction processes; and (3) evaluation of product fuels.

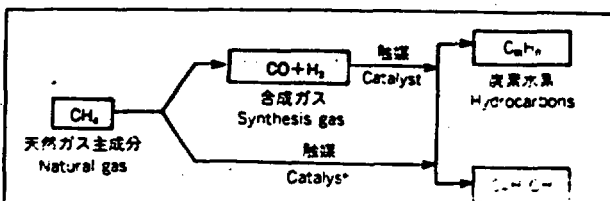
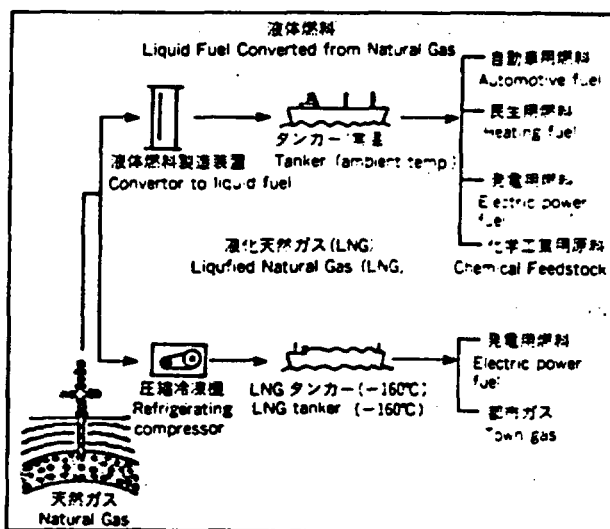

石炭の高効率低公害燃焼

埋蔵量の多い石炭の利用を拡大することは、エネルギー政策上不可欠のことですが、固体で灰分多く、また燃焼すると NO_x 、 SO_x を多く排出する等石炭には多くの問題があります。この対策としてガス化・液化も一つの方法ですが直接燃焼の改善も有力な手段です。

循環流動層燃焼は最も新しい燃焼法の一つで、各種石炭をはじめ多様な固体燃料の低 NO_x 、低 SO_x での燃焼が可能です。現在、ベンチスケールのプラントで、燃焼過程の基礎研究を行っています。

高温湿式燃焼法は石炭を高温で燃焼し、炉内で熔融した灰を遠心力の作用でガスから分離する燃焼方法で、テストプラントによる研究が進行中です。

従来の微粉炭燃焼についても、炭種による燃焼性、 NO_x 生成特性の違いを調べています。このように総合的に石炭の燃焼法の研究を進めています。

High Efficiency Low Emission Coal Combustion

Coal utilization must be expanded for stable primary energy supply. However, coal has many problems, such as handling and pollutant emissions. Gasification and liquefaction are the countermeasures for them, and direct combustion is more efficient in energy utilization. Circulating fluidized-bed combustion is one of the newest combustion methods. It can burn many kinds of coal and various solid fuels with low pollutant emissions. Basic research on combustion procedures is carried on by using bench-scale equipment. High temperature slagging combustion method is also under development by using a testing equipment. Conventional pulverized coal combustion method is being studied to know combustibility and NO_x emission characteristics of various coals.

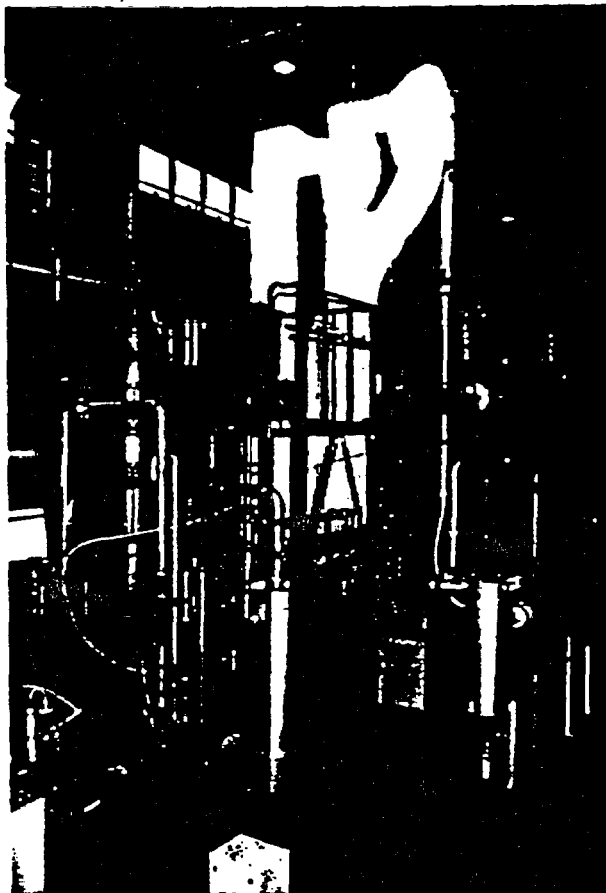

循環流動層燃焼試験装置
Circulating Fluidized Bed Combustion Equipment

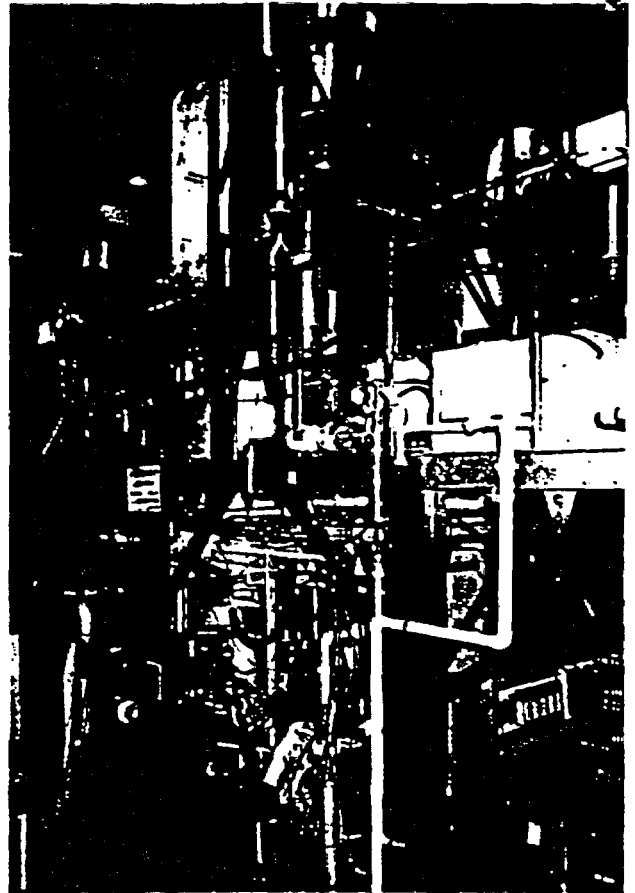

高温湿式燃焼試験装置
High Temperature Slagging Combustion Equipment

高効率な燃焼制御技術

産業用エネルギーの大部分は燃料の燃焼によって産み出されていますが、地球規模環境問題に対処するためには高効率な燃焼を達成し省エネルギー化を図ることが重要な課題です。そのため、CARSなどレーザー応用計測、衝撃波管、レーザードップラー流速計などにより複雑な燃焼過程を解明し、様々な運転条件のもとで燃焼状態を最適に制御する技術を開発しています。

Advanced Combustion Technology

In this research program, basic research on reaction kinetics and flame structure is conducted to develop optimum combustion control techniques for stabilizing global climate.

CARS (Coherent Anti Stokes Raman Spectroscopy) method facilities, laser pyrolysis/laser fluorescence equipment, and shock tubes are used for reaction kinetics research in high temperature. Furthermore, the laser doppler anemometer is used for flame structure analysis.

This basic research is also being conducted to develop combustion simulation modeling.

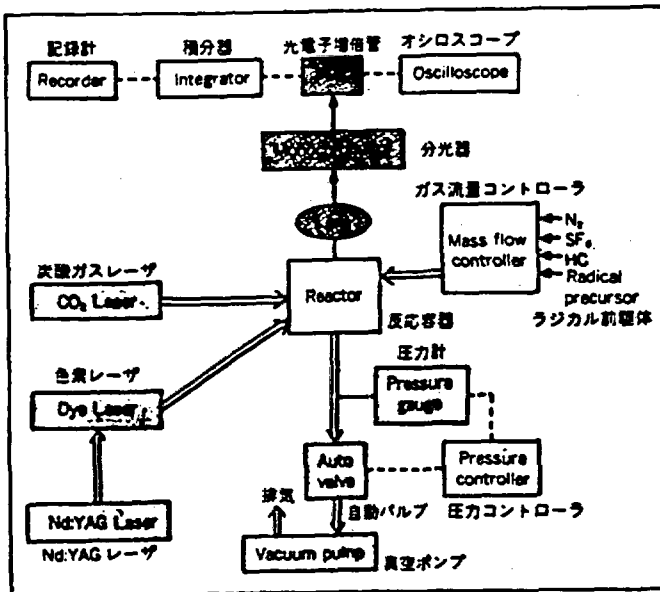

レーザー加熱/レーザー誘起蛍光実験装置
Laser Pyrolysis / Laser Fluorescence Equipment



高温ヒートパイプ

本研究は高温ヒートパイプ(蒸気温度範囲350~1200°C)における最大熱輸送能力等と材料適合性を調べることを目的として行っています。作動流体には、4種類の熔融金属(水銀、カリウム、ナトリウム、リチウム)を、容器材料としてステンレス、インコネル等を用いています。下の写真は蒸気温度800°Cで作動中のナトリウムヒートパイプ凝縮部を示しています。

High Temperature Heat Pipes

This study consists of analyzing the maximum heat transport capability etc., for the high temperature heat pipes which is available for vapor temperature range from 350 to 1200°C and testing the container material compatibility. In the heat pipes, mercury, potassium, sodium, and lithium are used as working fluid, and stainless steel tubing, inconel steel tubing, etc., are used as the container materials. The following photograph shows the condenser section part of the sodium heat pipe at the vapor temperature of 800°C.



ナトリウムヒートパイプ Sodium Heat Pipe

電気較正式熱量計

現代産業において、特に熱を加熱・動力用として利用する分野においては、エネルギー源となる物質を燃焼させたときにどれだけの熱が発生するかが重要な尺度となります。そこで、その尺度の基準となる標準物質の燃焼熱量を電気的なエネルギーを用いて精度良く値付ける方法を研究しています。

Electrically Calibrated Calorimeter

From the industrial point of view, in the field where the heat is utilized for heating or producing power in particular, how much heat the material for an energy source generates in burning is an important measure. So the method of determining the quantity of combustion heat of some standard samples precisely with electrical energy is under investigation.

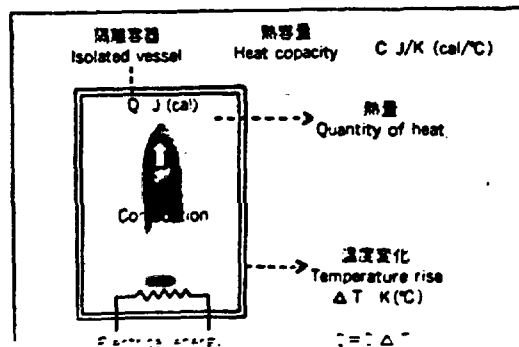

高温岩体の開発・利用技術

天然の熱水系を有していない高温の岩盤を高温岩体といいます。高温岩体から熱エネルギーを抽出する方法として2本の坑井を地下深部の高温岩体中に掘削し、これらの坑井間をフラクチャ（人工貯留層）で連結した後、1本の坑井へ冷たい水を注入して人工貯留層で暖め、もう1本の坑井から熱水あるいは蒸気として回収する方法が考えられています。

高温岩体を効率的に開発するには、地下の深部かつ高温の岩盤に十分な熱交換面積を有する人工貯留層をつくらなければなりません。一般に、水圧破砕法によって人工的にき裂を造成し、これを人工貯留層として利用しますが、き裂の規模や方向は、岩盤に加わる地圧、既存のき裂等の天然条件と坑井に注入する流体の性質、流量、圧力などの作業条件に依存します。そのため、室内において、き裂を含む岩石ブロックに地圧に相当する封圧を加え、水圧破砕によってき裂を発生・成長させて、き裂の発生条件や成長方向を明らかにしています。このときの破壊音(AE)を計測し、AEの発生個所と流体の通路との関係も検討しています。

さらに、山形県折衝の高温岩体実験場で得られた定方位コア（方位が明らかなコア）を用いて、天然き裂の方向や傾度、岩盤の物性を調べるのと同時に、DSCA（差歪曲線解析）法等により地圧を求めています。また、人工貯留層から抽出できるエネルギー量を予測するため、人工貯留層の規模を知る必要があります。そのため、現場においてヨウ化カリウムなどを用いたトレーサー試験を実施するとともに、コンピュータシミュレーションによる貯留層評価を行っています。



水圧破砕実験装置と花崗岩中に発生した水圧破砕によるき裂(左上)
Apparatus for Hydraulic Fracturing Experiment and
Hydraulically Initiated Fractures in Granite Rock

Development and Utilization of Hot Dry Rock

The heat extraction concept from hot dry rock geothermal system requires drilling two wells into hot crystalline rock, connecting them at a depth through large hydraulic fractures, and then circulating pressurized water through this closed connected system to recover heat from the rock. The volume and orientation of hydraulic fractures depend on both natural condition such as earth stress and natural joints in rocks and experimental condition such as flow rate and water pressure. The water pressure required to initiate fracture and the orientation of fracture are investigated using rock blocks containing an existing joint in a laboratory. During these tests, acoustic emission (AE) is measured to map the fractures.

At Hijiori hot dry rock test site, we are investigating the fracture orientation and physical properties of rock using oriented cores. The earth stress is estimated by differential strain curve analysis (DSCA) method. Computer simulation and tracer tests are being conducted to evaluate a hot dry rock reservoir.



地圧測定のためのDSCA試験装置と試験試料
Apparatus for DSCA Stress Determination Method
and a Specimen

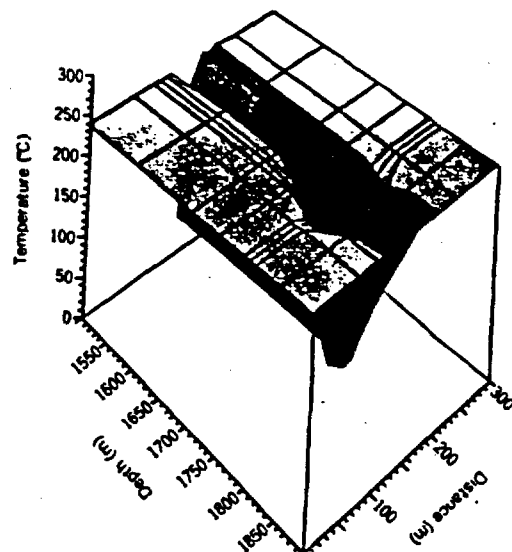

高温岩体貯留層評価のシミュレーション結果
A Result of Simulation for HDR Reservoir Evaluation

掘削技術及び掘削工具の評価と開発

地熱エネルギーを利用するには地中に存在する熱水や蒸気を地上に導くために、数千mの坑井を掘削しなければなりません。地熱井掘削は基本的には石油井掘削技術が利用されていますが、石油井と比較し、岩盤が高温であると同時に硬質であるため、これに適するように掘削方式や掘削工具(ビット)を改良する必要があります。このため地熱井の掘削能率向上を目的として、掘削方式の検討、ビットの性能評価及びビットの研究開発を行っています。

写真は掘削方式やビットの性能を基礎的に検討するための掘削実験装置と実験用のビット類です。開発した新型ビットの刃先には人工の多結晶集積ダイヤモンド (Polycrystalline Diamond Compact) を用いています。

Drilling Technology for Geothermal Wells

In order to drill geothermal wells economically and efficiently, improvements in the drilling techniques have been conducted. Aerated mud drilling methods have been introduced to improve the drilling efficiency of rock.

New bits with polycrystalline diamond compact cutters are also being developed for the drilling of hot and hard formations. The photos below are of a drilling test facility and drill bits for the tests.

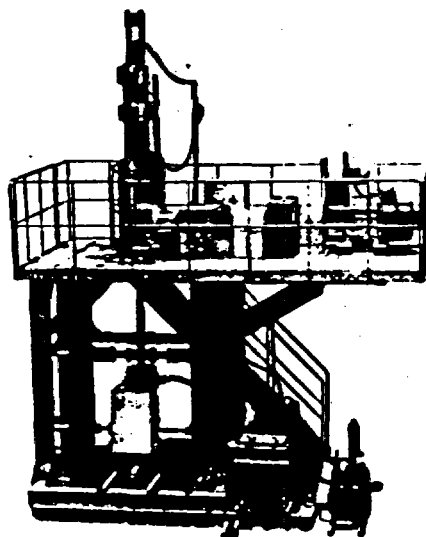

掘削実験装置 Drilling Test Facility

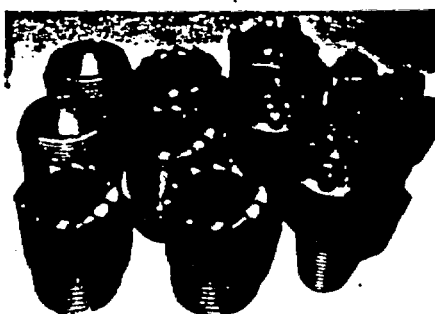

マグマ近傍からの熱抽出

低生産性の地熱貯留層やマグマ近傍の超高温地層、さらにはマグマそのものを開発できれば、我が国の地熱資源をさらに活用することができます。高温地層中に掘削された坑井を同軸熱交換器に仕立てあげて地熱エネルギーを採取する坑井内同軸熱交換方式は、上記の地熱資源の開発に最も適した方法と考えられています。これまでの検討により、断熱性能が優れた内管を用いることにより熱交換器の性能が大幅に向上することが明らかになりました。そこで、高性能の耐熱断熱内管の開発を行っています。また、この方式の熱出力には地層の熱伝導率や地層中の対流が大きく影響します。このため、岩石の高温・含水状態における熱伝導率の測定や対流が熱出力に及ぼす影響の検討を行っています。

Downhole Coaxial Heat Exchanger System

The geothermal resources such as hot wet rocks which contains insufficient amounts of steam or hot water for power generation, very high temperature formations adjacent to magma bodies and magma itself are considered difficult to develop by ordinary heat extraction techniques. In order to realize the development of those geothermal resources, research on the new heat extraction system, the downhole coaxial heat exchanger system, has been carried out.

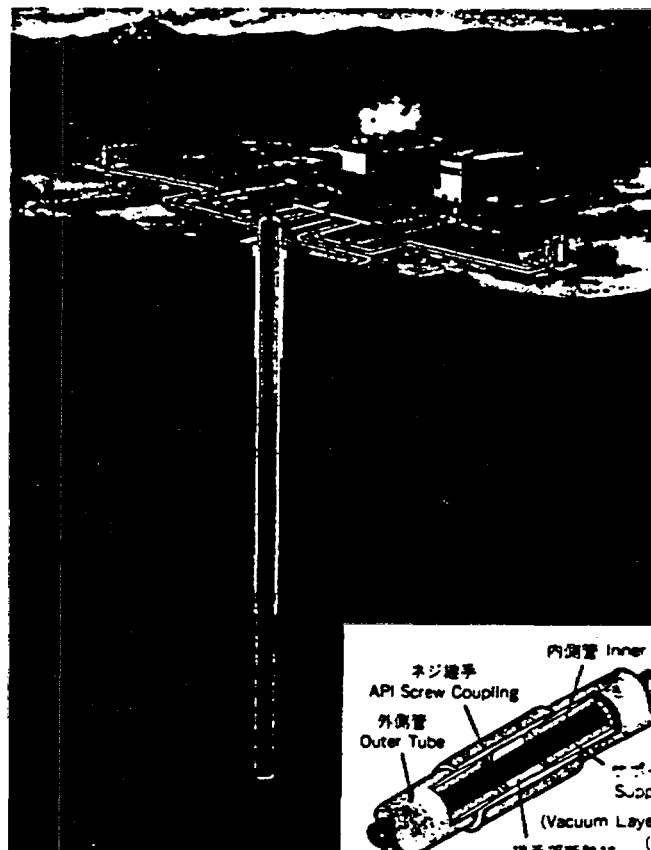

坑井内同軸熱交換方式概念図

試作した断熱内管の様子

我が国の環境問題は昭和40年代前半には深刻な状況を示していました。こうした状況に対処するため当所においては工業技術院における公害防止研究のセンターとして精力的に研究を進めてきました。その結果、我が国は今日では公害対策先進国とまで言われるようになりました。しかし、公害問題の危機的状況を脱したとはいえ、閉鎖系内海や湖における富栄養化現象ともなう水質汚濁や自動車排出ガス等による大気汚染はまだ未解決の問題として残されています。さらに最近ではCO₂等による気候温暖化、フロンガスによるオゾン層破壊など地球規模環境問題が重要となっています。これらの問題に対処するため当所においては発生源対策、計測技術、汚染メカニズム、環境アセスメント等の各分野において研究を進めています。

Air and water pollution problems were serious in the late 1960's in Japan. The National Research Institute for Pollution and Resources, operating under the Agency of Industrial Science and Technology, has conducted research and development on industrial pollution control technology.

As a result, air and water conditions in Japan have been greatly improved over the last 10 years. However, there are still many pollution problems to be solved, and recently global environmental problems such as climate changes due to green house gases such as CO₂, ozone holes caused by chlorofluorocarbons have become world problems. To solve these problems, the institute is carrying out research on the measurement and control of pollutants, their behavior and environmental assessment technology.

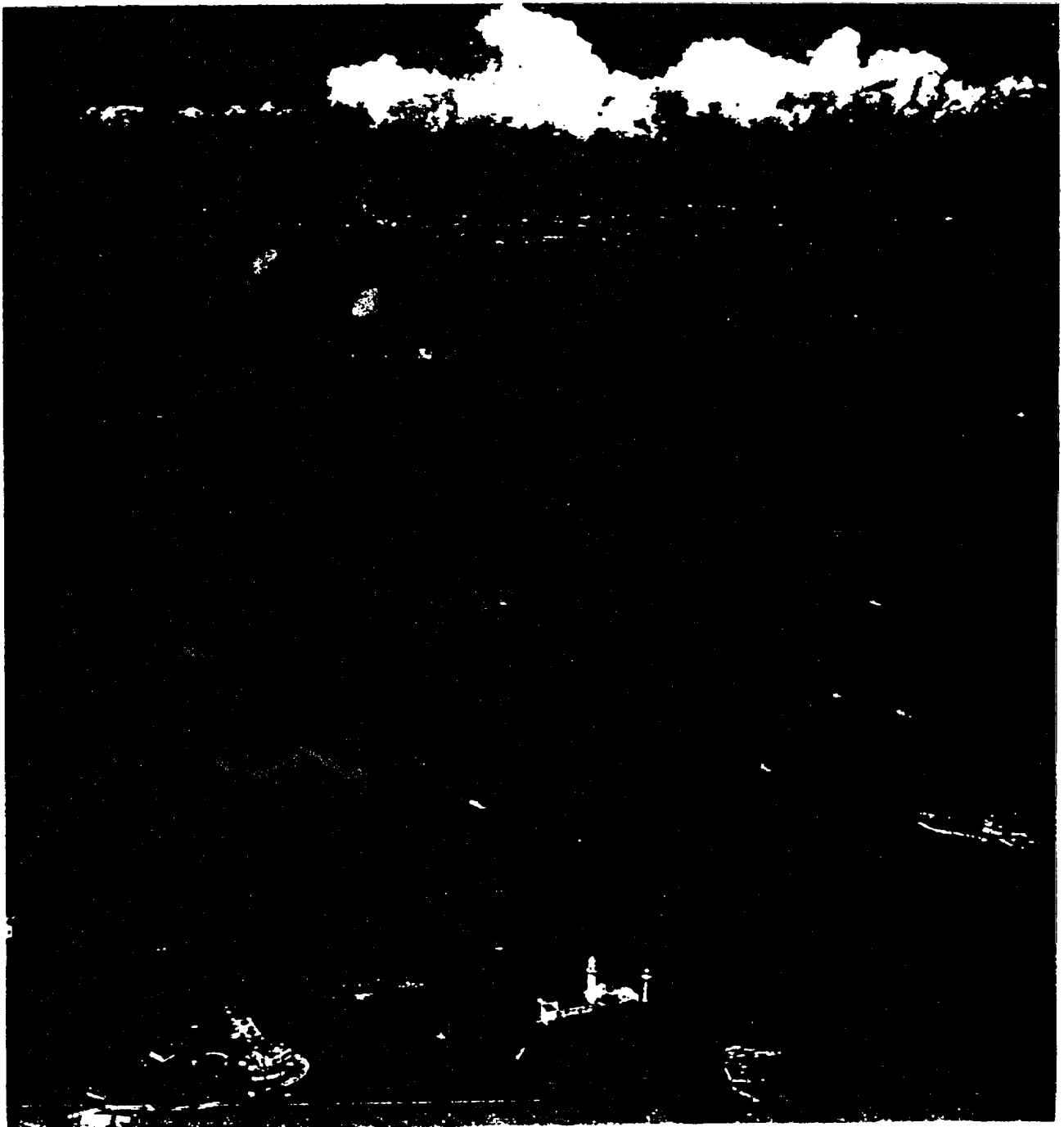

地球環境問題

Global Scale Environment Problems

地球規模環境予測技術

最近、環境が地球規模の問題にされています。例えば地球温暖化であり、オゾン層の破壊、酸性雨、砂漠化、熱帯林の減少、海洋汚染などです。従来の大気汚染等の環境問題は発生源周辺の現象でしたが、産業活動の進展、新規化学物質の登場、過去の排出の累積により影響範囲が地球規模にまで拡大したと云えます。これらに共通しているのは原因と結果の間に時間的にも空間的にも距離があることです。

特に地球温暖化は人類共通の問題として解決がせまられています。二酸化炭素は太陽光線には透明ですが、地表面からの赤外線放射を吸収する温室効果を持っています。大気中の二酸化炭素の増大は、太陽エネルギーの収支に影響し、対流圏での気温の上昇を、ひいては気候の変化をもたらします。

このような地球規模での環境問題を科学的に解決するためには、まず対象現象の正確な計測技術の確立が必要です。地球規模での環境のモニタリングには人工衛星や航空機を利用した測定器と観測方法の開発が進められています。

この大気中の二酸化炭素濃度の増大は人間活動による化石燃料や木質系燃料の大量使用に起因しています。大気中の二酸化炭素濃度の増加量は、化石燃料の使用量から推定した二酸化炭素の排出量の約半分で、残りがいずこへか吸収されています。その機構は未解決で今後の研究課題です。解明への手掛かりとして、二酸化炭素の地球規模での収支・循環に関する研究を行っています。これには、発生源での処理、燃焼方法の改善や省エネルギー技術による燃料使用量の減少、二酸化炭素の低排出燃料や新エネルギーの開発と転換等の発生源対策の有効性の評価も含めて考慮する必要があります。温室効果を持つ気体は二酸化炭素のほかに、フロン、メタン、亜酸化窒素等があり、これらの寄与も無視できません。フロン類は二酸化炭素と異なる赤外線領域に吸収帯があるため、フロン濃度の増大は温室効果に影響が大きくなります。

これらを含めて全体的に考える必要があります。発生状況や大気中における挙動を研究しています。

Studies of Global Environmental Pollution

The most update research subjects are global-scale environmental problems. Those are climate changes, the depletion of stratospheric ozone layer, acid rain, deforestation, desertification and ocean pollution. The warming-up of the surface temperature is an urgent and commonplace problem for humans. The probable cause is the increase of CO₂ gas in the atmosphere. This is assumed to be due to human activities in their consumption of coal, petroleum and biomass. CFCs are responsible for the ozone layer depletion and the greenhouse effect.

To investigate the global environmental subjects, this group is developing simulation models for materials and energy distribution on a global scale. The basic concepts are circulation (advection and diffusion), chemical reaction and balance of materials and energy including the different spheres. Monitoring systems using satellite and airplane are developing further the groundlevel measurements.

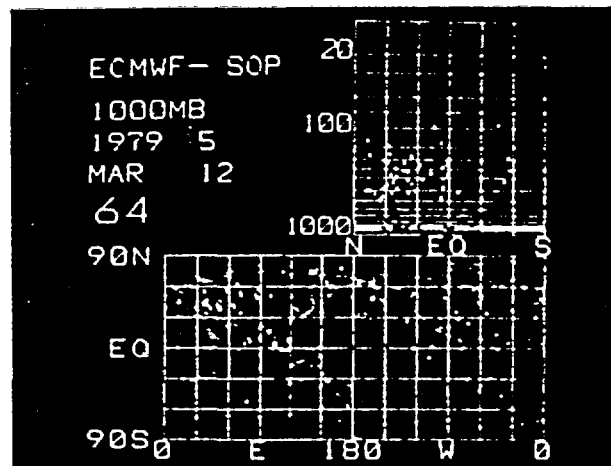

日本から放出した粒子の拡散
Particles Released from Japan

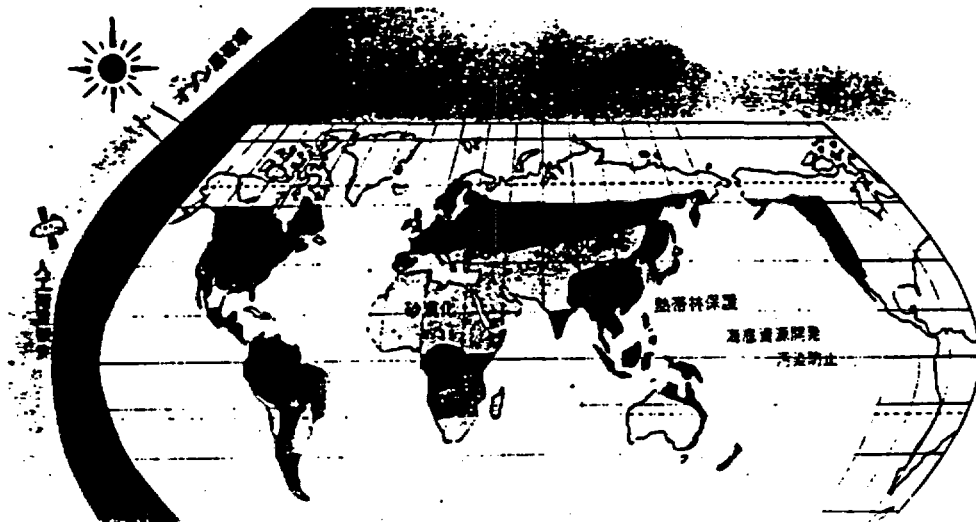

環境汚染のリモートセンシング

人工衛星や航空機などを利用したリモートセンシングにより、環境汚染を広域に、しかも同時に把握することができます。

現在ではこの手法によって海表面の水温分布やクロロフィルの分布がある程度観測できるようになっています。しかしながら、リモートセンシングを海洋現象の解明に用いるにはセンサーと海面の間の大気の状態、海表面の波や生物活動がデータに大きく影響を及ぼします。そのため、ランドサット(TM-5)で得られるようなデータと海洋現象を対比させ、統計的かつ画像解析的に現象を解明しています。また、大気中の現象としては、森林火災の煙や、火山の噴煙などの拡散状態を人工衛星データから解析することができます。今後は、リモートセンシング手法を海洋と大気の両方に適用し、地球規模の環境汚染の測定法として研究していきます。

Remote Sensing Techniques for Marine Pollution Analysis

Remote sensing data like multi-band spectra of radiation are quite useful for environmental assessment of marine and atmospheric environmental studies.

Measurements of seawater temperature and chlorophyll in coastal area have been already developed. For utilization of remote sensing to marine environmental problems, we have to study the relationship between physical factors and biological activities in the sea through statistical and image analyzing techniques.

It is also quite effective for atmospheric environmental problems, like diffusion of forest fire smoke, volcanic eruption, etc. We will continue the study of remote sensing data analysis for further utilization of it to environmental studies.

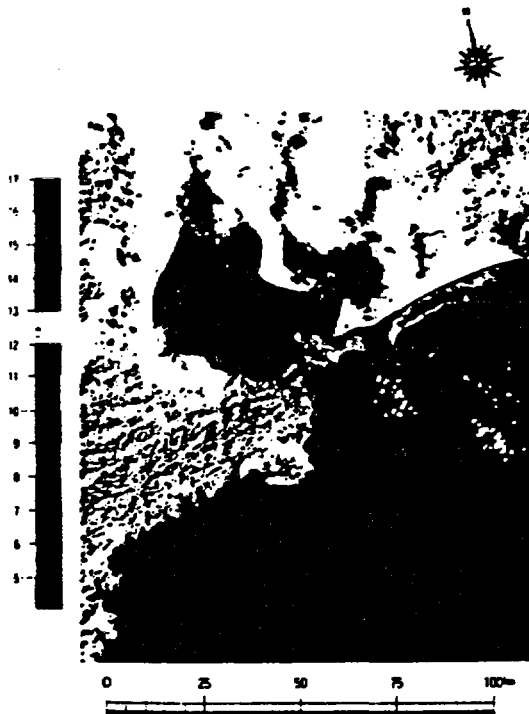

ランドサットからの海表面水温分布画像(伊勢湾)
Water Temperature Distribution of Surface in
Coastal Area by Remote Sensing (Landsat)

二酸化炭素濃度・フロンスの 野外立体観測による挙動の解明

二酸化炭素、フロンなどは地表面から放出される赤外線を吸収して対流圏大気を加熱する作用、すなわち温室効果を持っています。二酸化炭素、フロンなどの現状の増大傾向が続くと、今後50年間に1~2°Cの気温上昇があると予測されています。しかし、二酸化炭素濃度の将来推移については、産業革命前の濃度の二倍になる時期を2,040年代とする予測から、将来にわたって二倍に達しないとの予測まであり、未確定です。このような将来濃度予測が確定しない原因として二酸化炭素の循環過程が解明されていないこと、将来のエネルギー使用見込みに幅があることなどがあげられます。

本研究では、二酸化炭素の大気、海洋、植物圏各貯蔵庫間の交換過程を飛行機、地上野外観測により解明します。観測は緯度、発生源状況の異なる北海道から沖縄に至る海上、針葉樹林、亜熱帯樹林などで四季にわたり行い、二酸化炭素循環過程の季節・緯度変化について検討していきます。

Study of CO₂ Behavior in the Environment by the Field Observations

Trace gases such as CO₂ and CFC (Chlorofluorocarbons) absorb the infrared radiation from the earth surface and have possibility of changing the climate.

If the tendency of CO₂ and CFC concentration continues to increase, the air temperature at the surface will be increase by 1-2°C in the following 50 years.

The assessment of the CO₂ concentration in future is still not clear due to the uncertain behavior of CO₂ in the environment and the uncertainty of the fossil-fuel consumption in future.

Field observations using airplanes and towers are being carried out over land and sea inside and around Japan. The behaviors of CO₂ and CFC under the various surface conditions and latitudes are being investigated as a result of these observations.



観測用飛行機(セスナ402型)と気象測器
Airplane Equipped with Airborne Meteorological Sensors

汚染機構解明

人間の活動に伴い二酸化硫黄や窒素酸化物のような無機ガス、ガソリン等の炭化水素や種々の有機化学物質、金属化合物やススを含む粒子状物質など多様な汚染物質が様々な発生源から環境中へ放出されています。これらは大気、水及び土壌に分配され、光、水、微生物等の作用をうけてその形を変え、人体・動植物さらに自然環境・気候などに大きな影響を与えることが懸念されています。

Mechanisms of Environmental Pollution

Various kinds of primary pollutants, emitted into the environment from many sources, find their way into the atmosphere, waters and soil and are transformed/decomposed by complex chemical reactions. The products and primary pollutants both have serious adverse effects in the environment.

酸性雨生成機構解明及び監視技術

酸性雨の原因は二酸化硫黄と窒素酸化物が硫酸と硝酸になるためと考えられています。この大気中での酸化過程には気相反応、雲霧雨滴などの水滴中反応あるいは固体粒子状物質上での反応があり、酸素、オゾン、過酸化水素など様々な物質が関与します。酸性雨が何故、どのように起こるかを明らかにするために、これら反応の様子や反応に係わる種々の物質を分析・測定する方法、装置開発の研究をしています。

Mechanisms of Acid Precipitation and Development of Monitoring Technology

Acidification of environment is considered to arise from sulfuric and nitric acids formed from SO_2 and NO_x in the atmosphere. Many kinds of oxidants (oxygen, ozone, hydrogen peroxide) and chemical species (ammonia, metal ions, aldehydes) are concerned with the atmospheric oxidation reactions taking place in the gas phase, in the liquid phase (clouds, fogs and rain) and in the solid phase (particles). In order to know why and how the acidification of environment occurs, the rate and mechanisms of atmospheric chemistry and development of the instruments and methods measuring the various kinds of chemical species are being investigated.

化学物質の対流圏での変換・分解

フロンなど安定な化学物質は対流圏では分解されにくく、温室効果をもつとともに、成層圏では強い紫外線で光分解して成層圏オゾン層の破壊に関与すると考えられています。対流圏に存在する種々の固体粒子状物質（エアロゾル、土壌など）はフロン、フロン代替物質等を変換・分解する新たな化学反応の場となる可能性があり、反応速度や機構を明らかにする研究をしています。

Transformation and/or Decomposition of Chemicals in the Troposphere

Stable chemicals such as freons and their alternatives which cannot be decomposed by tropospheric gas-phase photochemical reactions are considered to have a reaction to the greenhouse effect and the destruction of the ozone layer. They may possibly be decomposed by the photocatalytic action of the solids in the troposphere. The rate and mechanisms of this transformation and decomposition are under investigation.



酸性雨の被害
Forest Damage Due to Acid Precipitation

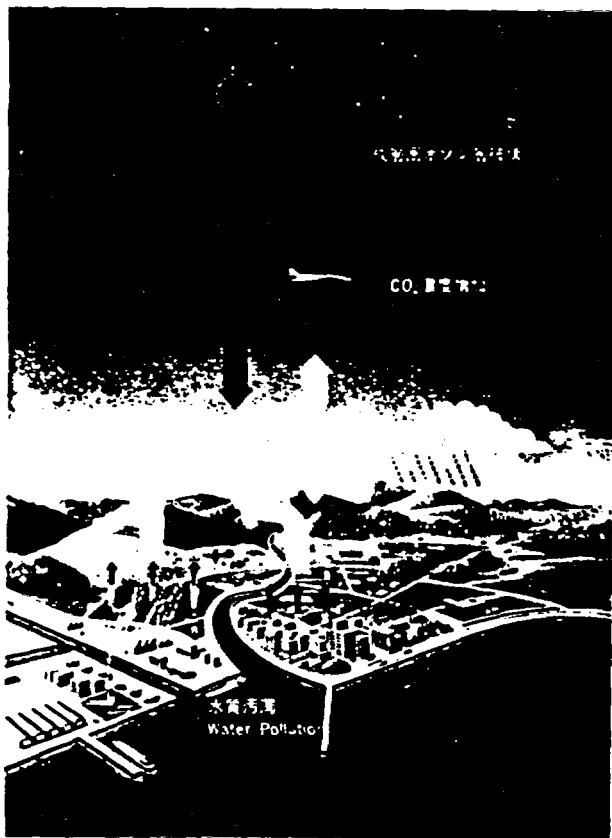

環境中へ放出される汚染物質(SO_2 , NO_x , 粉じん, 化学物質, その他)とそれらによりひきおこされる様々な環境汚染問題
Environmental Pollution Problems Resulting from Various Kinds of Primary Pollutants (SO_2 , NO_x , Particles, Chemicals and Others) and Secondary Ones Formed by Complex Chemical Reactions

有機ハロゲンの大気放出抑制技術

フロンガス、トリクロロエチレン等の揮発性有機ハロゲン化合物は、オゾン層破壊、発ガン性などが懸念され、広域的、地球規模の大気汚染問題を引き起こしています。このため、有機ハロゲン化合物を大気へ放出させないための防止技術の開発が望まれています。

発生源において気体状有機ハロゲンを多孔性固体に吸着して回収する技術は、その再使用が可能となるため有望な防止技術と考えられています。本研究では、新規吸着剤の開発、吸着有機ハロゲンの高効率な回収方法、並びに両者を組合せた新吸着システムの開発を研究しています。

また、上記の吸着法では抑制できない低濃度な廃ガスや廃棄物中の有機ハロゲンについては、新たな技術を開発する必要があります。このため、低濃度、難分解性等多くの問題点を克服すべく、各種高エネルギー並びに触媒による分解法を研究しています。本研究では分解法の確立とともに、分解したハロゲンの固定化、並びに微量副生物の分析にも注意を払っています。

Emission Control of Halocarbons

Chlorofluorocarbons and trichloroethylene have brought about serious problems of air pollution. Effective technologies for emission control of the halocarbons are greatly needed.

Recycling of the halocarbons by adsorption is suitable for the emission from many industries. Research efforts are being made on novel absorption materials, efficient desorption from adsorbed phase, and optimal systems for the adsorption-desorption cycle.

Moreover, decomposition of the halocarbons in dilute exhaust gases and wastes is also developed by means of high-level energies and catalysis. In addition to the decomposition methods, emphasis is placed on fixation of decomposed halogen and analysis of trace by-products.

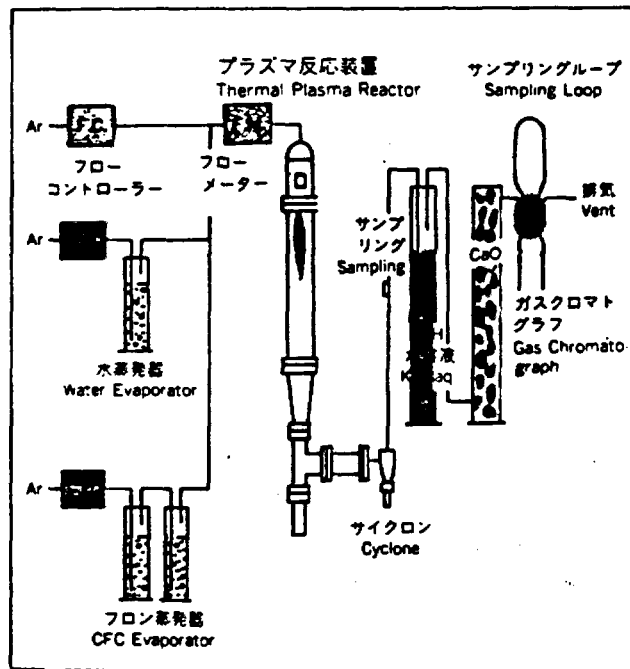

有機ハロゲン系産業廃棄物の焼却処理

有機ハロゲン化合物は、部品洗浄用や溶剤として多量に使用されていますが、これらは自然界では分解されにくく、放出されると環境に悪影響を与えるものが多いため、使用後の廃棄物を適切に処理する必要があります。焼却処理を行なう場合は、ダイオキシンのようにさらに有害な物質ができないように注意する必要があります。

これらの廃棄物を安全に焼却するために、処理条件が悪いとどのような化合物が生成する可能性があるか、また、有害物質を生成させないためには、どのような条件で燃焼させるべきかについて、実験排気の処理装置を完備し、安全性の配慮された施設で研究を行っています。

Treatment of Industrial Types of Waste Containing Halogenated Organic Compounds

Recently, the amount of hazardous waste containing halogenated organic compounds is increasing. These type of waste should be decomposed properly to avoid environmental pollution. Incineration is the most feasible treatment for their disposal. However, it is important to clarify the conditions of safe treatment because there is the possibility of forming more toxic compounds during the incineration of some halogenated compounds. In this investigation, the possible products and mechanisms of the thermal reactions of halogenated compounds are going to be studied to predict the optimum conditions for their combustion. Bench-scale combustion experiments will also be performed to investigate the practical aspects.

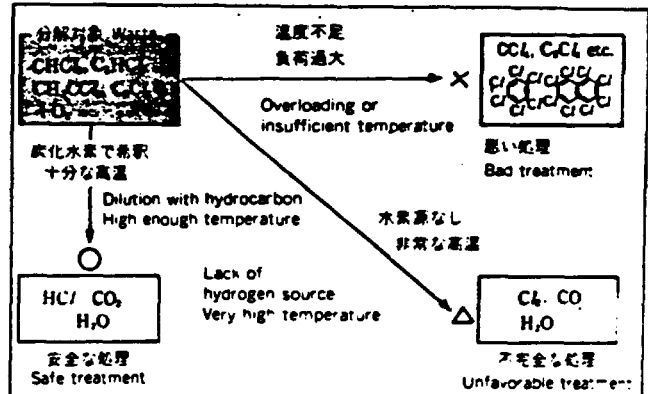

有機塩素化合物の熱分解反応例
Thermal Decomposition Behavior of Chlorinated Organic Compounds

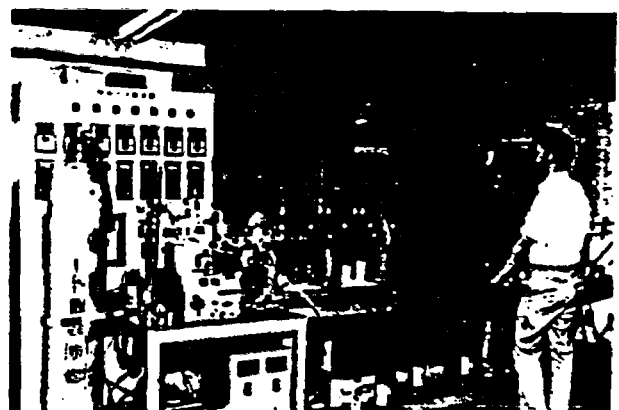

産業立地環境予測

Environmental Assessment

大気汚染予測

大気中に浮遊している粉じんは、一次粒子と呼ばれている。始めから粒子として大気中に放出されるもの他に、大気中で気体から粒子に変化した二次粒子と呼ばれるものがあります。これらの粒子の拡散や、二次粒子がどのように生成され、消滅して行くかを調べるために、飛行機やヘリコプターにパーティクルカウンター、NO_x計などを搭載し粒子状物質の濃度、粒径分布、NO_x濃度を測定し、同時に風速、湿度、気温など気象の立体分布を測定します。また、地上付近でも数十kmの広い範囲の中に測定点を配置し、濃度や気象の時間的な変化などを調べます。これらの測定結果を用いて粒子状物質の拡散シミュレーションモデルを開発しています。

また、先端技術関連の産業から排出される環境汚染物質の拡散予測手法についても研究していますが、工場が内陸の盆地や谷間など複雑な地形の場所に立地している場合、気流が複雑なためにSF₆などの無害なガスをトレーサーとした拡散実験や、地形模型を用いた風洞実験などを行っています。

Simulation Model of Diffusion for the Particulates

Particulates flowing through the air are composed of primary particles released from sources as particle phase and secondary particles changed from gas phase to particle. Diffusion of these particulates including the formation and removal process is investigated by particle counter, NO_x analyzer and other equipment on an airplane or helicopter, with the measurement of wind, temperature and humidity. Near the ground surface, beyond several tens kilometers in horizontal, the concentrations of contaminants and weather are observed. The data are utilized to develop simulation model of diffusion for the particulates.

Diffusion experiments with SF₆ as a tracer and wind tunnel experiments over complex terrain are being made to clarify the effects of configuration on the diffusion, since some factories concerning advanced technological industry are located within very complex terrains.

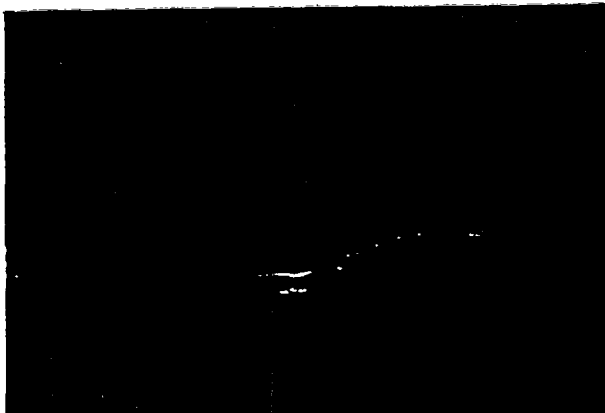

山を越す気流についての風洞実験

大気拡散場構造

汚染物質の移流と拡散は主に地上から2000m程度までの大気境界層中で行なわれます。そのため海陸風や都市のヒートアイランドなども汚染物質の拡散に大きく影響します。このような大気拡散場の構造を調べるために、飛行機や低層ゾンデなどを利用して乱流や温度分布などを広範囲で測定しています。また、夜間形成される接地逆転層中で汚染濃度が極めて高くなることもあるため、接地逆転層の構造についても小塔を利用した乱流測定などにより流れの場について解明を進めています。これらの結果を用いて、計算モデルによりコンピュータで大気の流れを再現する試みを行っています。

Mechanisms of Atmospheric Diffusion Process

Pollutants released near the ground surface are mainly advected and diffused in an atmospheric boundary layer lower than 2000m or so. Under this circumstance, sea/land breeze circulation and heat island near urban areas affect the diffusion of the pollutants. Measurements of turbulence and temperature with an airplane and low altitude sonde are carried out to investigate the mechanisms of airflow in the boundary layer. Concentrations of pollutants often become very high at night in the inversion layer near the ground surface. Turbulence in the inversion layer is also measured by equipment on short masts. Using these results, computer simulation of airflow can be carried out.

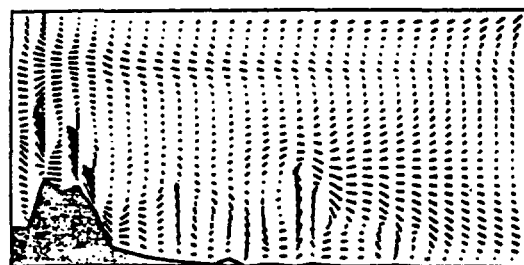
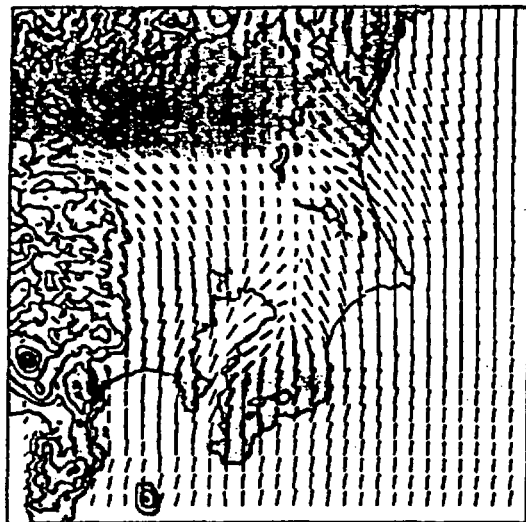

計算モデルにより得られた夏季の関東地方の流線
Wind Flow over the Kanto Plains in Summer Estimated

海洋汚染予測技術

大都市近くの内湾地帯の水質汚染は工業地帯からの排水、都市排水、近郊の農地から河川を經由して海に流れ込む農業・畜産の排水等の複合した形態で起こっています。これらの沿岸地帯は海上の交通の重要な場所として、産業活動の拡大に伴う埋め立ての場所として、また一方では市民の釣り、ボードセーリングなどのレジャーなど多方面に利用されています。近年、ウォーターフロント計画の遂行にともない水辺の重要性が叫ばれています。また、新しい埋め立てや工場の立地に伴って生じる地形の変化や排水の質・量の変化は水質や海底の汚染に大きく影響を及ぼします。

これらの影響を予想するために数値シミュレーションを用いて水質や底質の将来予測を行い、埋め立て地形や工場の立地の適正化を図ります。

Prediction Methods for Marine Environmental Pollution

In general, the water pollution in coastal areas is caused by mixed wastewater from industries, agriculture, stockbreeding and sewerage. We easily recognize sea phenomena with physical factors such as tidal currents and wind waves, chemical factors such as water quality and salinity, and biological factors such as the abundant growth of phytoplankton and marine organisms. Nowadays, we found to realize the problems of water pollution in open ocean caused in oil spill, heavy metals and chemical organic compounds. These problems are closely related to the economical and industrial activities of mankind, so we must protect the marine ecosystem and more adequately manage the social behavior of activities of humans in future. Our laboratory is investigating predictive methods for pollution effects on natural coastal waters. For instance, an attempt is being made to develop an ecological and hydraulical numerical simulation model by a computer. For this purpose, we are developing instruments for field surveys and studying a methodology for field observation to obtain accurate data from the sea.

沿岸環境保全技術

沿岸の水質、底質、生物の環境は海水の流動、波浪、潮位あるいは流入してくる種々の排水(工場、都市、農業、船舶など)や河川の水の量・質によって大きく影響を受けます。沿岸にはその海域特有の沢山の種類の生物(海藻、魚介類、鳥類)が生命を営んでいます。これらと季節、年月を問わず人間生活とバランスよく生活をしなければなりません。近年の産業構造の変化にともなって分解されにくい物質、蓄積性のある物質(農業、ハイテク産業物質)などの海への流入が問題となっています。

本研究では、海に生息する生物(プランクトン、ベントス、バクテリア)と水質、底質との関係の解明に重点を置いています。これらの測定結果を利用して海的环境保全を図らねばなりません。そのために生態系のシミュレーションの開発とその精度の向上を図っています。

Development of Marine Environmental Management Techniques

Coastal marine environment such as water quality, properties of sediment and life of organisms is affected by physical factors as tidal current, wave motion, meteorological conditions and chemical factors as discharge of waste water. We must develop an observation instrument and systems for maintaining a clean coastal environment to protect many organisms.

We are studying the relationship between environmental phenomena and marine organisms which enfocussed on bacteria, plankton and benthic organism for ecological study in coastal areas. Moreover, we have developed a numerical model for eutrophication and using it to simulate the environmental changes in the coastal waters

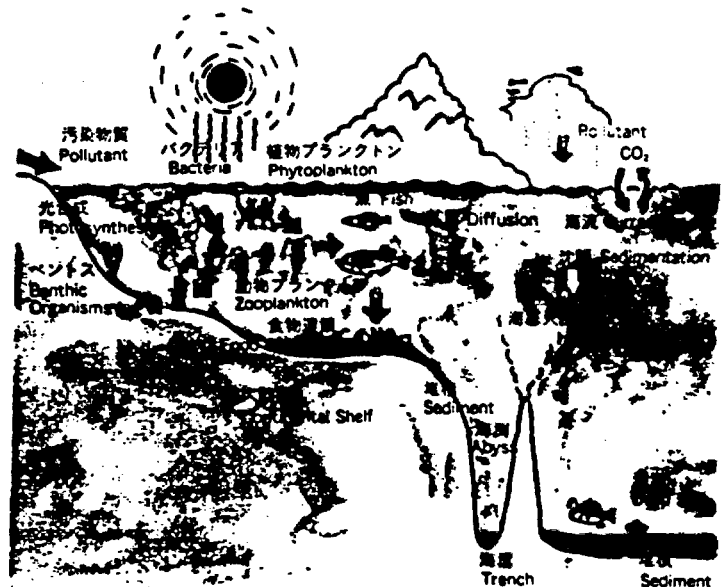
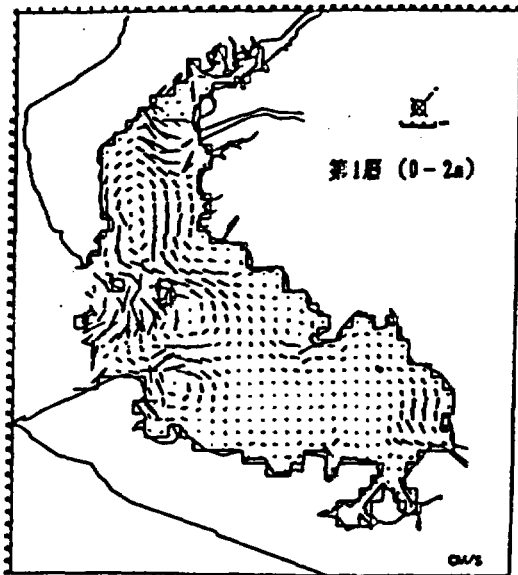

環境汚染と海洋生態系

Marine Ecosystem Related to the Water Pollution

地下水汚染の予測技術

地下水は、貴重な水資源として、量的にも質的にも管理及び監視を行わなければなりません。しかし、最近になって、有害な化学物質による地下水汚染が広範囲に生じていることが判明しつつあります。その対策としてはまず、地下水がどのように汚染されていくかの予測の方法を確立する必要があります。

右上の図は、典型的な地下水汚染を示した例です。地表面に汚染源があるとすると、降雨によって地層中(不飽和層)を浸透し地下水表面に達します。その後、地下水のある層(帯水層あるいは飽和層)を地下水の流れによって移動し広がって行きます。これらのプロセスを解明することによって、地下水汚染の予測手法が確立されます。

種々の汚染物質は、地層中で減衰したり変質したりします。この研究では、変化する物質としてトリクロロエチレン等を選び、その移動や広がり機構の解明に努めています。

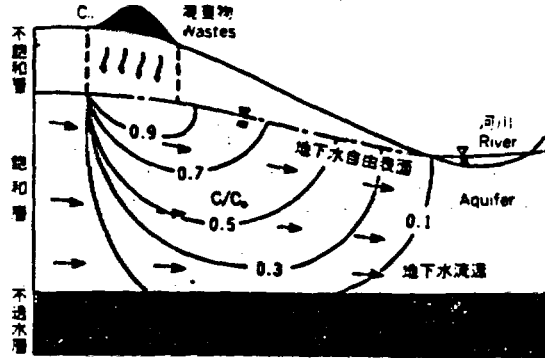

地下水汚染モデル
Groundwater Pollution Model

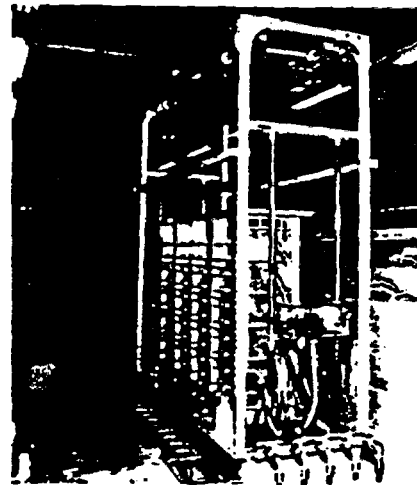

地下水流模擬装置
Groundwater Flow Simulator

Prediction of Groundwater Pollution

We must manage and monitor the quality and quantity of groundwater as precious water resources. However, in recent years, it has been found that groundwater pollution by many dangerous chemical substances is becoming a wide occurrence. For appropriate treatment, it is necessary to develop a prediction method of groundwater pollution processes.

The illustration above shows a typical pattern of groundwater pollution. Contaminants on the ground surface infiltrate through the soil (unsaturated layer) to the groundwater surface and migrate to the groundwater (aquifer or saturated layer). A prediction method of groundwater pollution is being developed on the basis of the observation of these processes. Various substances decay and change in the soil. This project examines substances decay and change in the soil and examines trichloroethylene *et al.* as non-conservative tracers and follows those migrations.

計測・分析

環境保全、公害防止施策を推進するためには大気汚染物質あるいは水質汚濁物質を高精度で、しかも迅速に測定する計測技術が重要です。これにより、汚染の原因及び影響が解明されると同時に、種々の防止対策はもちろん、法的な対応も可能となります。発生源対策、環境監視、予測あるいは計測の標準化などの多様な目的に対応し得る高度な計測技術の開発を先導的に行っています。あわせて、今後のエネルギーの多様化、産業界の動向をも見極めながら、新しい環境汚染物質を予測し、これらに対処する計測技術についても研究を進めています。

The development of accurate and rapid analytical methods for air and water pollutants is essential to preserve a clean environment, and make possible the identification of the sources of pollution and estimation of their effects on the environment. Furthermore, the establishment of various pollution control and regulation systems owes much to the development of these measuring methods.

This Institute conducts studies to develop new analytical methods useful to control, monitor and simulate pollution. In addition, analytical methods for new pollutants which may emerge from change in future energy sources and industrial

Measurement of Pollutants



発生源ダストの新しい測定法

昭和47年に環境基準が設定されてから、大気中の浮遊粒子状物質 (SPM) の基準達成率は、全国的にみて極めて低いレベルで推移しており、現在も大気汚染行政上の大きな問題となっています。この対策として、SPM の発生源寄与率解明の研究は重要となっています。現在の公的測定法によって得られる発生源データを基に展開されるソースモデルでは、ばい煙が大気中に放出されたのち生成する粒子に関する情報が十分でなく、SPM の現状を正確に把握することが困難になっています。

本研究は、現状の発生源ダストの測定方法を見直し、排ガスが大気中に放出されて凝縮あるいは酸化過程をへて、大気中で二次的に生成するダストの評価をも含め、SPM との相関を考慮した新しい測定方法の確立を目指しています。

New Measuring Method of Source Dust

Since an environmental quality standard for suspended particulate matter (SPM) was enacted in 1972, the compliance rate with the standard has remained at low level in Japan, and it is a very serious administrative problem to improve the compliance rate. The identification of emission source is important for this purpose, but it is difficult to determine the origin of SPM because the data about particle, which is produced from exhaust gas after it is emitted from stack to the air, is insufficient in the source model based on current official measuring method.

At our Institute, research is being carried out to develop a new evaluation and measuring method for source dust in consideration of the relation with SPM by improving the current official method. The new method can take the contribution of secondary particle into consideration, which is produced through condensation and oxidation from exhaust gas in the air.

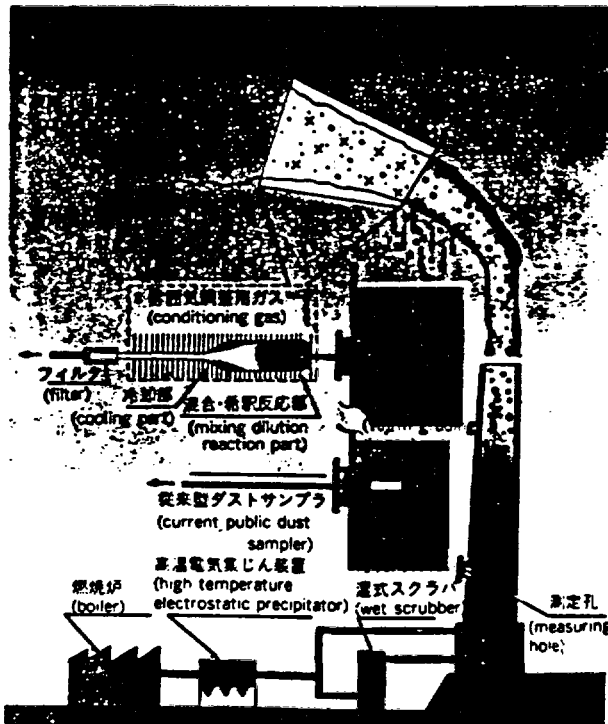

地下水汚染物質の計測

地下水は貴重な水資源として工業用水、生活Fされていますが、最近になって有機塩素系化合物による広範な汚染が判明しています。地下水は一度汚染されるとその回復が非常に困難なので未然防止が重要です。したがって、地下水の水質監視や、事業所、埋め立て処分場における水質管理を十分に行なう必要があります。このため地下水汚染物質を迅速に測定する技術が不可欠です。

本研究では、地下水汚染計測技術の高度化を目的として、光ファイバーやレーザー等の先端技術を応用した汚染物質の遠隔計測法や高感度分析法の検討を行っています。すなわち、有機汚染物質についてはレーザー蛍光法、光ファイバー化学センサー法、無機汚染物質についてはレーザー励起イオン化法を適用し、汚染物質の地下への漏出を早期に検出し、また、地下水質を的確に把握することが可能な計測技術の開発について研究を進めています。

Measurements of Pollutants in Groundwater

Groundwater is regarded as one of the precious water resources. However, in recent years it has been found that groundwater is widely polluted by toxic organo chloro compounds, etc. Since groundwater is difficult to clean if it is once polluted, prevention of the pollution is of extreme importance. Rapid analytical methods for pollutants, therefore, are essential to sufficiently monitor the quality of groundwater. The object of this investigation is to establish rapid and remote measuring methods for pollutants in groundwater. This investigation consists of two parts: 1) the development of remote optical fiber fluorimetry for the determination of organic pollutants; and 2) the development of laser enhanced ionization methods for the determination of trace inorganic pollutants.

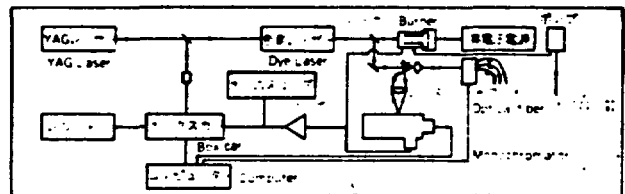

レーザーを用いる地下水汚染物質の検知システムの構成
Block Diagram of Measuring System for Groundwater Contaminants



発生源対策

環境を守るためには、公害はその発生源において防止することが大切です。我が国においては大気汚染防止、水質汚濁防止について厳しい対策がとられてきた結果、公害が減少し、大気、水ともきれいになった事は明らかです。しかし近年汚染の発生源、発生形態には変化がみられ、都市周辺や幹線道路における交通公害や湖沼などの閉鎖水域での水の汚染、新素材や電子技術関連産業からの新しい化学物質による汚染など、複雑、多様化に対するきめこまやかな対策が必要となってきました。

当所ではこれらの問題に対応するため、大気汚染の発生源対策として、燃焼に係わる低公害燃料、低公害燃焼、排気ガス浄化、並びに化学物質の分離・分解について、水質汚染防止としては活性スラッジにより廃水を処理する生物処理法、分解、分離、吸着などの適用を図る物理化学処理法について幅広く研究開発を行っています。

In order to protect our environment from pollution, it is important to control pollutant emission sources. In Japan, we have taken stringent measures against air and water pollution. As a result, environmental pollution is decreasing year by year and the air and water are returning to their former clean state. These days, however, emission sources and the character of pollutants have changed in various ways. We need a further detailed investigation on complex pollution systems, such as

Pollution Control

traffic air pollution around big cities and along main roads, water pollution in semi-closed water areas such as lakes and marshes, and pollution caused by new types of chemical compounds from new material and electronic industries.

To cope with these problems, we are conducting research to develop better techniques that will ensure high quality fuel, low emission combustion systems, exhaust gas purification techniques and separation, decomposition of chemical compounds for air pollution reduction, biological treatment systems of wastewater using activated sludge and physical chemical treatment systems applying various decomposition, separation and adsorption techniques for water pollution reduction.

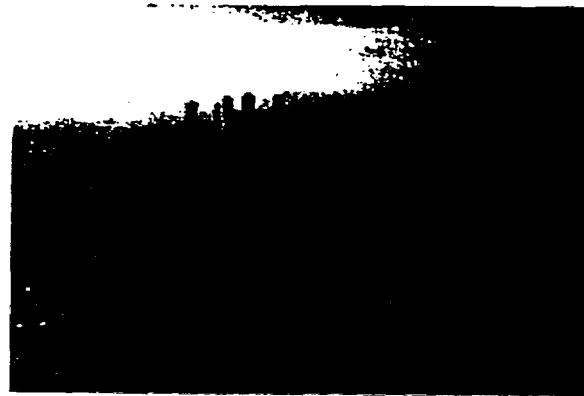

流体化燃料用クリーンコールの製造

石炭を利用する際の最大のネックは硫黄及び灰分等の環境汚染を起こしやすい不純物を多量に含有し、また固体であるために取扱いに手間がかかることです。従って、石炭を利用する前にあらかじめ不純物を除去し、クリーンで利用しやすい石炭・油スラリー (Coal Oil Mixture: COM)、石炭・水スラリー (Coal Water Mixture: CWM) 等の流体燃料用の石炭を製造する脱硫・脱灰技術が重要となります。石炭から灰分・硫黄分等の不純物質を除去するコールクリーニング法に関しては多くの技術開発が各国で進められています。

当所では、石炭粒子と不純物質粒子の表面性質の差を利用して両者を分離するカラム浮遊選炭法及び薬剤を用いて処理する化学的クリーニング法の研究を行っています。カラム浮遊ではカラム中の石炭スラリーに微細気泡を導入し、気泡に付着した石炭粒子 (疎水性粒子) をカラム頂部から回収し、不純物質 (親水性粒子) を底部から排出して両者を分離します。化学的クリーニング法は不純物を水に可溶性物質に変えて除去します。

Ultra Clean Coal Processing
for Fluidized Fuel (CWM, COM)

Using coal as a substitute for oil poses serious air pollutant problems due to ash and sulfur emitted when coal is burned. Therefore, it is important to develop techniques to remove these substances from coal prior to combustion.

Coal cleaning processes offer economical means for reducing the sulfur and ash content to environmentally acceptable

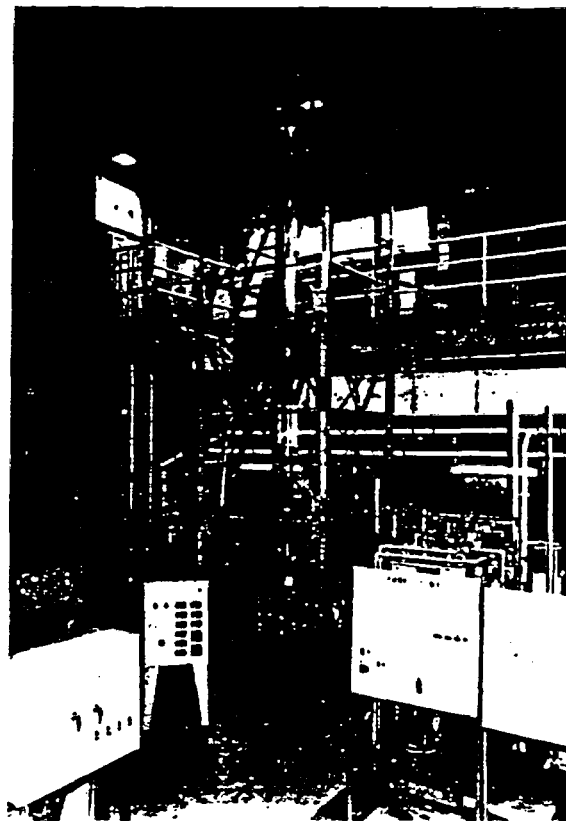

高燃料比炭の燃焼技術

石油危機を契機として、ボイラーや工業炉などにおいては、石油代替燃料としての石炭の利用拡大が積極的に推進されています。この石炭利用拡大のほとんどは海外からの輸入の増加でまかなわれる予定です。そして、この海外炭の中でも高燃料比炭が増加する傾向にあります。

高燃料比炭は燃焼性が悪く、NO_x排出濃度が高いという欠点があります。そこで微粉炭ガス化燃焼や循環流動層燃焼のように、低公害で高効率な燃焼技術の開発を行っています。

Combustion Control Techniques for Low Volatile Coal

Coal has been utilized positively in commercial steam boilers and furnaces as one of the main alternative energy sources since the 1970 oil crisis. Therefore, it is forecasted that the demand for imported coal will increase in Japan. Especially, the percentage of low volatile coal among the imported coal is on the increase.

Low volatile coal has poor combustibility and high NO_x emission level in comparison with high volatile coal. Therefore, combustion techniques for low volatile coal, such as a pulverized coal combustion with a gasification process or a circulating fluidized bed combustion have been studied to control the emission of pollutants and obtain high combustion efficiency.



微粉炭燃焼炉 Pulverized Coal Combustion Furnace

NO_x低減化のための触媒燃焼技術

燃焼反応を触媒表面で低温で行わせる触媒燃焼は、火炎燃焼に比べ本質的に低NO_x、低公害の特性を持っており、これを小型燃焼器用に応用できれば、大都市域での群小発生源からのNO_x排出を大幅に減らすことができます。そこで、燃焼触媒の評価や触媒中での燃焼反応等の基礎研究と触媒燃焼装置の高性能化のためのシステム研究を行っています。

Catalytic Combustion Techniques for the Small Scale Stationary Sources

Since the low combustion temperature on a catalytically active surface, the use of catalytic combustion has shown significant advantages in the control of emissions. The purpose

ディーゼル自動車排出物質対策

現在、環境中の二酸化窒素及び浮遊粒子状物質の環境基準の達成状況には改善の傾向が認められません。そのため、これらの主要排出源であるディーゼル自動車に対する排出規制の強化が望まれています。しかしながら、ディーゼル機関の燃焼特性として窒素酸化物に対する低減対策は粒子状物質の排出を増加させる一方、粒子状物質に対する低減対策は窒素酸化物の排出を増加させるという二律背反の傾向があるため、新しい観点からのアプローチが必要とされています。

当所では、ディーゼル機関から排出される窒素酸化物の低減のため、酸化雰囲気下で一酸化窒素を低減できる触媒の開発、粒子状物質低減のためのフィルタートラップ等による黒煙低減技術、窒素酸化物と黒煙を同時に低減するためのディーゼル燃料の改良に取り組んでいます。

Development of the Control Techniques for Diesel Exhaust Emissions

There is no indication that compliance rate with environmental quality standard for NO_x and suspended particulate matter (SPM) has been improved. It is, therefore, desired to strengthen the emission standard for diesel-powered vehicles which are one of the primary emission sources of NO_x and SPM. For the contrary tendency between NO_x and particulate emission that the control techniques for NO_x increases particulate emission and vice versa, it is necessary to develop other approaches for the control techniques rather than engine modifications.

At our Institute, the control techniques for diesel exhaust emissions are under study, especially in the survey of the catalyst for NO reduction, development of trap systems for particulate reduction and improvement of diesel fuels for simultaneous reduction of NO_x and particulates.

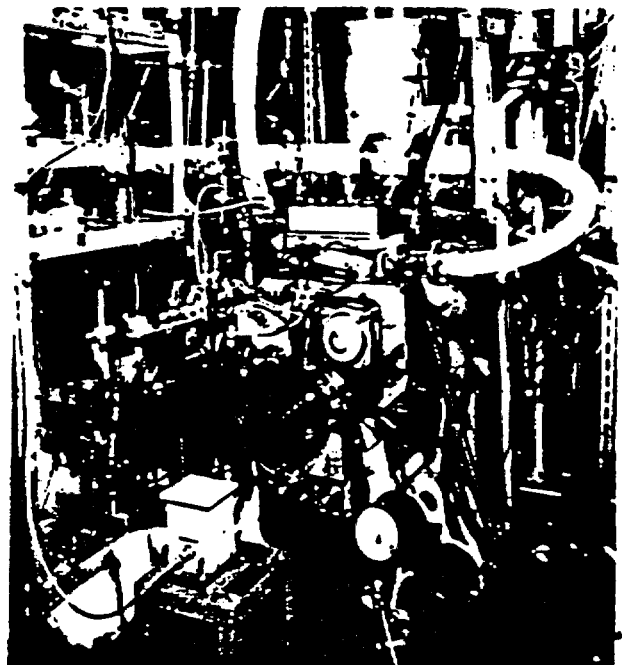

排出物質特性を評価するための試験装置

超臨界流体による排水中の難分解性化学物質の処理・回収

化学物質の多様化、使用量の増大に伴い、環境中への化学物質の拡散、蓄積が深刻な問題になっています。本研究は排水中の微生物により分解しにくい化学物質を、超臨界流体を利用して効率よく処理する技術の開発を目的としています。臨界点以上の状態にある物質は、わずかな圧変化で化学物質の溶解度が急変する等、特徴ある性質を持っています。これを超臨界流体と呼び、流体の持つこのような性質を利用して排水中の化学物質を分離、回収することが可能です。排水中の化学物質の濃度が低い場合は、吸着剤等で排水を処理し、使用済みの吸着剤を超臨界流体で再生する方法を、排水中の化学物質の濃度が高い場合には、排水と超臨界流体を向流接触させて処理する方法を研究しています。

また、これらの方法を実行するときに必要な、超臨界状態での相平衡データの収集も行っています。

Treatment and Recovery of Biological Refractory Chemicals in Wastewater with Supercritical Fluid

According to the production of various chemical substances, the dispersion and accumulation in environment of these chemicals have become a serious problem. The purpose of this research is to develop supercritical fluid technology for removing chemical pollutants that are not amenable to biological treatment from wastewater.

A substance that has been brought beyond a critical point, has the great solubility change with relatively small changes in operating conditions. This substance is referred to supercritical fluid (SCF). SCF can be used to separate and recover pollutants from wastewater by two processes. One is SCF regeneration of adsorbents that have become saturated with pollutants, allowing the adsorbents to be recycled. This method is advantageous in the concentration of dilute pollutants. The other is direct counter current contact of SCF with wastewater for recovery of pollutants. This one-step process is applicable when the concentration of a pollutant is relatively high. The data on phase equilibrium for many SCFs is also collected. This data offers the key to useful applications of SCF technology.

微生物による化学物質含有廃水処理

廃水による水質汚染防止は、従来、BOD（生物学的酸素要求量）やCOD（化学的酸素要求量）といった包括的な基準に基づいて行われてきました。生物処理を中心とした多くの廃水処理法が開発され、現在では、これらの基準はほぼ満足されています。しかし、近年、これらの基準で捉えることが困難な、有害化学物質による環境の汚染が問題となってきたことから、個々の化学物質についての廃水基準が定められることになりました。本研究では微生物の化学物質に対する馴化能力を利用して廃水中の有害化学物質を処理する方法を開発することを目指しています。

そのため、有害化学物質に対する微生物の馴化方法、分離活性の高い微生物の検索、分解の動力学、分解微生物の生理、処理装置内での分解微生物の制御法等の研究を行っています。

Biological Treatment of Hazardous Chemicals in Wastewater

The regulatory emphasis in the Water Pollution Control Law in Japan shifted from regulation based on conventional pollutants, such as BOD or COD, to regulations based on specific hazardous chemicals and conventional pollutants. Hence, the need for innovative wastewater treatment technology to manage hazardous chemicals in wastewater has been strengthened. In this work, biological treatment process for hazardous chemicals in wastewater has been investigated based on the adaptability of microbes to the chemicals. Hence, acclimatization of activated sludge to specific chemicals, isolation of microbes degrading the chemicals, kinetics of degradation, physiology of the microbes, and the behaviour of the microbes in activated sludge process, are under study.

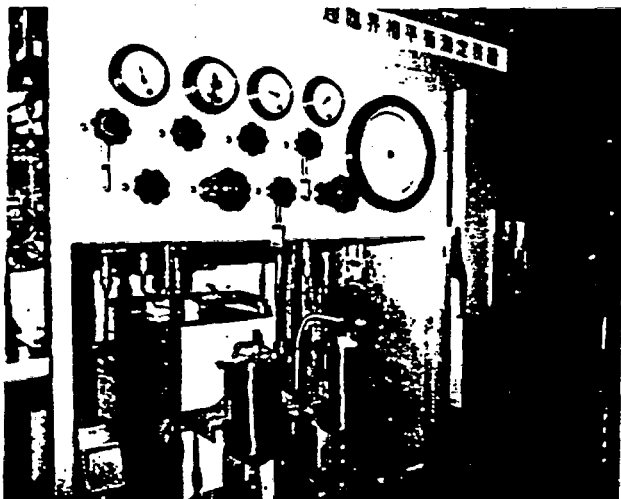

超臨界相平衡測定装置
Apparatus for Phase Equilibrium Measurement

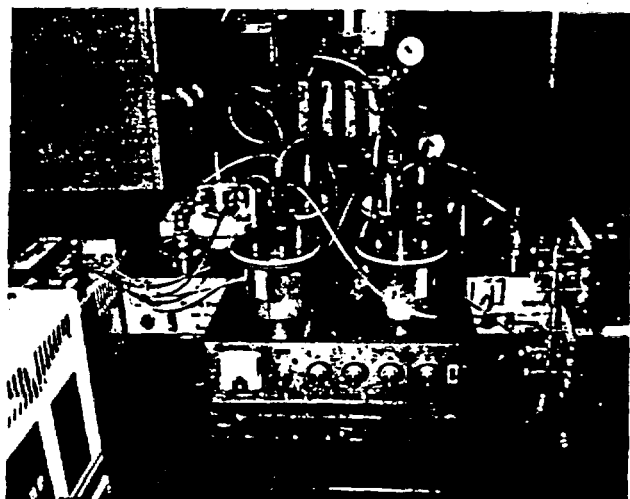

有害物質処理試験装置
Apparatus for the Treatment of Hazardous Chemicals

世界に産する資源の膨大な量を輸入かつ消費している我が国にとって、資源・エネルギーの開発、利用及び貯蔵等ともなう安全確保は重要な課題です。さらに、産業活動を円滑にし、快適で安全な社会をつくるために強力に保安研究を推進する必要があります。

当所においては火災・爆発災害や、破壊の発生機構の解明、それら災害の予知・予測、防災システムの開発等を基盤とし、鉱山保安はもとより大深度地下空間の安全・防災技術、制御発破による構築物破壊技術の高度化、放射性廃棄物処分空洞の安定性評価等の研究課題に取り組んでいます。

As a major importing country of natural resources extracted from all over the world, it is a very important subject to achieve safety during development of resources and energy and also their utilization.

For the purpose of safety achievement in mines, industrial sites, underground openings for industrial use and others, basic studies on the occurrence mechanism solution of fire, explosion fracture and on the development of foreseeing or estimating technique and prevention techniques of industrial disasters are carrying out in the Institute. The new demolition technique of old facilities by blasting and the technique for the stability estimation of underground openings for disposal of radioactive waste are also the subjects being carried out.

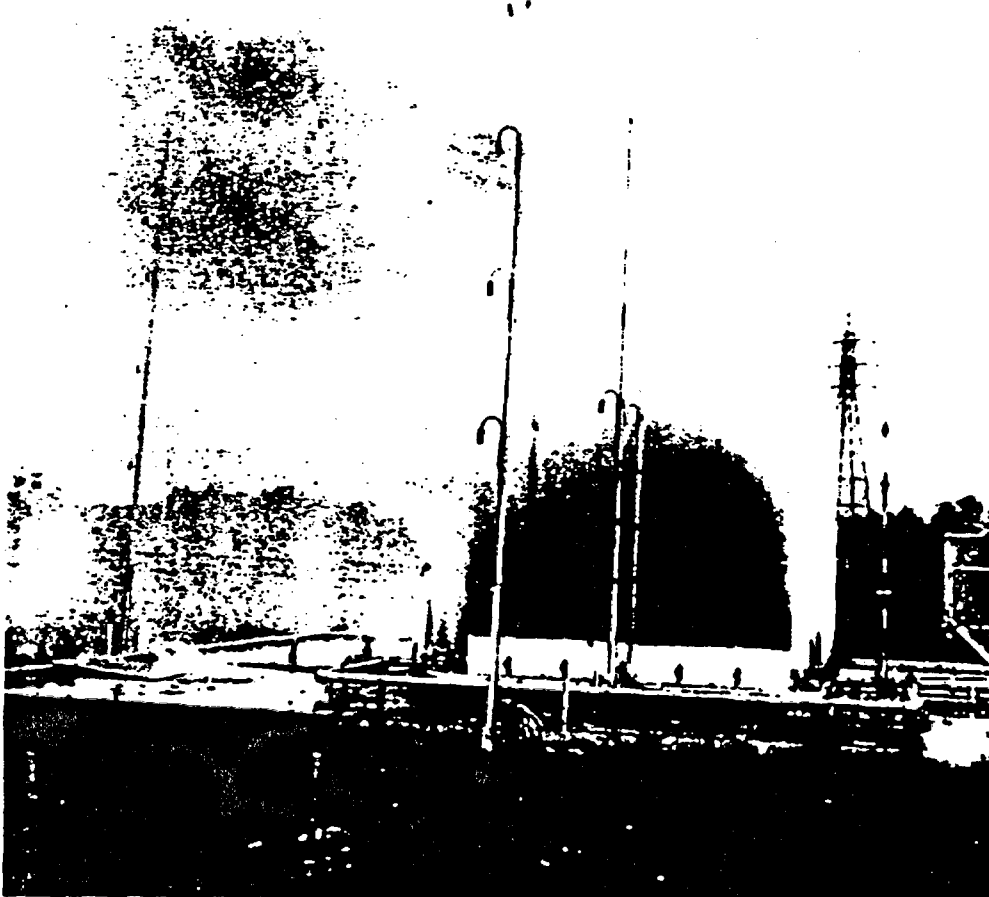

自動水幕による危険性ガスの急速拡散
Rapid Diffusion by Automatic Water Spray



PC-メンブレン式液化ガスタンク

産業火災対策

資源・エネルギーを取り扱う各種産業は、常に可燃物や工業用資材などによる火災の危険性にさらされています。このような産業火災を防止し、安全な作業環境を維持するため、可燃物の火災危険性評価、難燃性試験の標準化、燃焼生成ガスの発生機構などに関して検討を進めています。

また、大深度地下空間や鉱山などの閉鎖系空間における火災性状の解明や退避システムの開発についても取り組んでいます。さらに、実規模の実験施設を使用し、水噴霧や防火構造による火災拡大防止技術や各種消火技術に関して研究を進めています。

Industrial Fire Safety

Industries handling of many kinds of resources and energy always brings about the risk of fire related to mineral products and industrial materials. Studies to prevent industrial fires and maintain a safe working environment are being conducted. Main research subjects are the flammability of combustible materials, the standardization of flame resistance tests and characteristics of combustion products.

Studies on fire spread characteristics and the escape system at an emergency in great depth underground spaces and coal mines are also in progress. Further, full-scale experiments on fire spread prevention techniques such as water spray or fireproof method and fire fighting techniques have been carried out by using large-scale test galleries.

消火技術

地下空間、鉱山及び大規模建築物などの閉鎖系空間では、火災が発生すると煙や有害ガスが充満し、初期消火を困難なものにします。また、空間内の熱的フィードバックにより火勢が激しくなったり、フラッシュオーバー現象によって被害を大きくするなどの特徴があります。

このような火災を遠隔的に制御し、短時間での消火を図るために、高膨張泡沫や不活性ガスを火災区域に注入する技術を開発しています。また、液体窒素の急速気化法や液体窒素と泡沫の複合消火法などの新しい消火技術についても検討を進めています。

退避システム

地下環境は地上に比べ閉鎖性の点で特異性があります。その閉ざされた環境から、緊急時の最適退避システムを確立するため、救命器、緊急通信、救急設備に関する研究を行うほか、災害時の人間の行動様式の解明に取り組んでいます。

石炭鉱山を主な対象とし、事故救命器の性能向上、性能試験方法及び緊急時の坑内情報の収集、指令伝達手法について、また、坑内避難所の安全性の向上についての研究を進めています。さらに熱・光・音の地下環境要素の下での人間の行動を探り、退避・誘導技術への人間工学的な取り組みを行っています。

Fire Prevention and Extinction

Direct fire-fighting in confined spaces such as at a great depth in underground spaces, underground mines and large-scale facilities must be much more difficult compared with on ground surface because of the concentration of combustion products, the effect of thermal feedback and explosions caused by the flash-over phenomena.

In order to suppress fires underground directly and then to establish the extinction at short notice, researches have been conducting development of extinguishing techniques using high expansion foam and inert gas. Experimental studies are in progress on new extinguishing techniques such as a rapid evaporation system of liquid nitrogen and a combined system of inert gas generator and foam generator.

Emergency Refuge System

Studies to devise an optimum refuge system in an emergency in underground space or mines are being carried out. The main research subjects are improvement and test methods for self rescues, information-processing techniques and suitable wireless instruction methods for underground communication systems and safety enhancement and structure intensification methods for refuge stations underground. Behavior of the people in an emergency situation underground is also studied to develop optimum refuge system.



試験炭鉱での火災実験

Fire Experiment in the 400m Full Scale Test Gallery

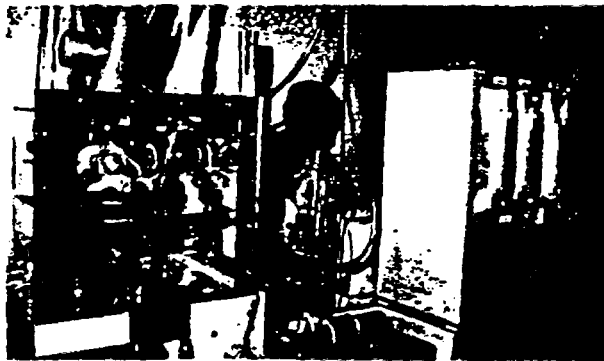

人工肺による救命器の性能向上

Improvement of Emergency Rescuers by an Artificial Lung

爆発対策と火薬類の利用技術

Explosion Prevention and Utilization of Explosive Energy

爆発事故につながる物質は、化学工場で使用される水素・エチレン・液化石油ガス、家庭で使用される天然ガス・LPガスなど数多くあります。また、薬・食品など粉体を取り扱う工場における粉体爆発や、炭鉱における炭塵爆発による事故等があります。これら事故を減少させるため、爆発現象の機構解明をはじめ、着火源対策、爆発伝播防止技術などの研究を行っています。さらに、新火薬類も市場に出回っており、より一層の安全性対策も望まれてるものと共に、都市発破・制御発破等、より高度に火薬類の利用技術に対する研究にも着手しています。

There are many kinds of materials like hydrogen, ethylene, liquefied petroleum gas used in chemical plants and natural gas, propane used in homes, which give rise to accidents. Also another explosion hazard in process industries which are handling foods, chemicals, plastics, metals is dust explosions. This type of an explosion is very common in coal mines.

In order to decrease these types of accidents, clarification of the mechanism of such explosions, ignition sources and controlling propagation of explosion is under study.

Recent explosives are fairly well safe, and number of accidents due to explosives is on the decrease. However, new safety inspection technology for new explosives developed in future, new construction blasting in the city and controlled blasting for new frontier of geo-space is also being studied.

爆発対策

可燃性液体・ガス・粉体といった物質は多くの産業活動の場で扱われており、それらの爆発災害の危険性はあらゆるところに潜んでいます。

この爆発の抑制対策として、爆発現象（圧力、火炎等）の詳細についての研究、水袋をはじめ爆発抑制剤の効果と設置方法等についての研究を行っています。また、爆発災害の未然防止の観点から、漏洩ガスの流動拡散の解析、着火限界・静電気着火の究明、機器の防爆技術等についても検討を重ねています。

Explosion Prevention

Concerning inflammable gases or dust explosions, the way to lessen explosions and to prevent explosions are being researched. For lessening the occurrence of explosions, gas explosion phenomena, such as blast wave development and flame propagation, are under study. The effect of the explosion restraint materials is also one of the Institute's research subject. Main subjects about the explosion prevention are the diffusion methods for released gas, ignitionability of flammable gas, static electricity and techniques for the design of explosion proof equipment.



吹上式粉じん爆発実験装置における爆発

Dust Explosion Experiment on Crammer

制御発破技術

発破は他の掘削技術に比較すると安価で効率もよいと考えられます。特に地下空間掘削では空間周辺の破壊したくない部分を破壊しない発破方法の開発が望まれております。そこで、AVL法のように従来の火薬をうまく使用し岩盤に適した制御発破工法を研究しています。都市におけるビル・道路などの寿命は限界にきており、その解体のための制御発破技術の研究が要請されています。都市における発破は、効率は良いが騒音・振動が大きいため我が国ではあまり利用されていません。騒音・振動の制御技術を開発し、積極的に都市でも発破を使えるよう検討を行っています。

Controlled Blasting

Blasting is far superior in that the cost of blasting is lower and more efficient than other forms of excavating technology. New controlled blasting which can control the breakage area is desired for excavating the new geo-space. So, new controlled blasting like the AVL (Alternate Velocity Loading Blasting) method and construction blasting method which can control the vibration and the noise is being studied.



爆薬の落槌感度試験

Drop Hammer Test of Explosives

地下環境制御・防災技術

Underground Environment Control and System Safety

地下空間の利用は狭い我が国にとって重要な課題です。地下には恒温性・断熱性・遮光性・気密性など多くの利点があります。鉱山で培われてきた保安技術のポテンシャルを発展させ、次のような地下空間利用に関連する研究を推進しています。

地下の岩盤や構造物を電磁波や超音波を利用して可視化する研究と地下岩盤内の力学特性と安全性評価の研究は地下空間の利用過程における空洞維持の技術指針に役立てられます。材料の特殊条件下での腐食の研究はより信頼性のある機器の開発に、センサー開発利用と通気の研究は閉鎖空間内の環境の清浄化及び維持に、災害と人間のかかわりに関する研究はヒューマンエラーの防止や安全システムの構築にそれぞれ役立つことを目指して研究しています。

Land should be more effectively utilized in Japan due to lack of it. In underground openings, there are many advantages such as temperature stability, insulation of heat, light, air and others. For highly advanced utilization of underground openings several subjects are being carried out which are as follows: the visualization technique of underground rock body by using waves, rock mechanics and the stability assessment technique for the purpose long-term utilization of underground openings, the corrosion properties of materials under a special environment for the purpose of developing reliable instruments, sensor development and ventilation research for better underground environment and the mechanism of human error occurrence to establish a underground safety system.

地下構造物安全性評価

現在、地下空間利用の例として石油や液化石油ガスの備蓄、ワイン・穀物の備蓄、排水処理施設などがありますが、さらにさまざまな生産活動、娯楽・スポーツ施設あるいは産業廃棄物処分など、利用の可能性を拡大するには地下空間特有の問題が残されています。安全に関するそれら問題の解決を図るため、現在、電磁波などの波動を利用した岩盤の事前評価技術、緩み領域の低減、地下構造物の劣化・異常予知などの安全性評価の研究が進められています。さらに、地下空洞へ及ぼす地下水の影響、地下水位の低下による地表沈下、地下水汚染の研究など地下環境保全技術について研究しています。

センサーと安全監視システム

産業施設の大型化や高度化にともないその保安監視や安全維持のためにより高度化されたシステムが求められます。また施設の利用目的次第では、温度、湿度、風速、各種ガス濃度など環境内の多くの項目について監視を継続する必要があります。さらに、監視警報システムは誤動作の無い信頼性の置けるものでなければなりません。これらの目的達成のために、高精度で長期に安定性のあるセンサーの開発、それらを組み込んだ監視システムの構築及び運用ソフトウェアの開発などを含めた総合的な保安研究を推進しています。

Safety Assessment for Underground Structures

As examples of the utilization of geo-space in the rock, there are the oil storage tanks, LPG storage tanks in the rock already. In order widely to use the geo-space in the rock, the rock assessment by using geo-tomography, the effect of underground water on the structure of rock, the relaxation range around the cavity, the mechanism of the deterioration of underground structures, prediction of the deterioration or something unusual, refreshment of underground rooms is now under study.

Development of Sensors and a Monitoring System

A more highly advanced safety monitoring system is being requested to allow for enlarged and modernized industrial facilities. Also depending on the purpose of the facility, continuous monitoring may be required in such environmental criteria as temperature, humidity, wind speed and the concentration of gases. Furthermore, the monitoring and alarm system should be reliable from the point of view of error action. To achieve the purpose above, research on the development of long-term stable sensors and the system software for monitoring are being promoted.

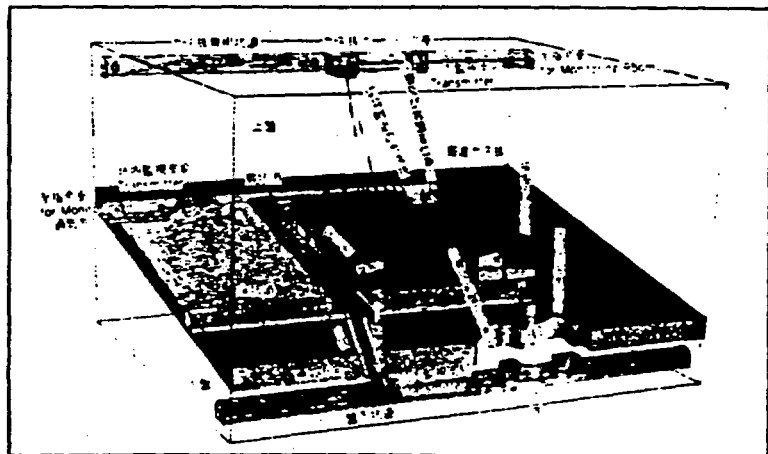
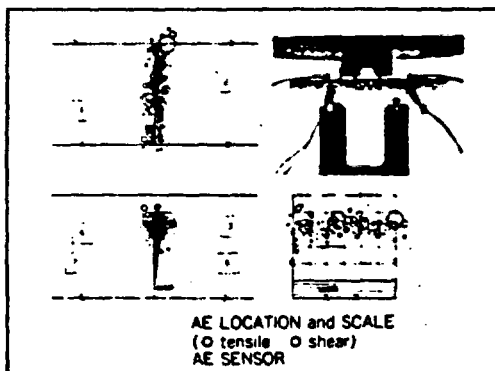

AEによる異常診断技術

炭鋼集中自動監視システムの開発

Development of Centralized Monitoring and Processing

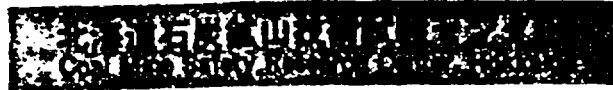

当センターは、鉱山保安を主とする課題に取り組んでいます。特別研究については、産業保安部及び九州石炭鉱山試験センターと共同研究の形で実施しています。この中では、北海道という乾燥気候に伴う静電気の課題が取り上げられ、主として静電気火花によるガス着火防止対策に取り組んでいます。

1. 坑内用移動機構の開発：切羽のような上・下盤等、二面拘束平面での自走ロボットの開発で、面の傾斜及び粗さを問わないという利点を持つ移動機構の要素技術の開発
2. 新型監視センターの開発：超音波利用センターでは、静電気発生頻度及び発生箇所推定システムの開発、光ファイバーセンサーの開発では、光干渉型検出機構を用いた本質安全な各種センサーの開発
3. 本質安全防爆の高度化：九州センターとタイアップして容量回路の高電圧限界値の開発

The Coal Mine Safety Research Center (Hokkaido) has focussed its research efforts on developing safety technology for coal mines. Major research activities are being carried out as a special project in cooperation with the Industrial Safety Dept. and the Coal Mine Safety Research Center (Kyushu).

The project involves a study on the electrostatic charge in the dry weather of Hokkaido to prevent gas explosions caused by electrostatic discharges. Typical research work at the Center include:

1. Locomotive Mechanism for Underground Development
2. Advanced Monitoring Sensor Development
3. Extension of the Intrinsic Safety Concept

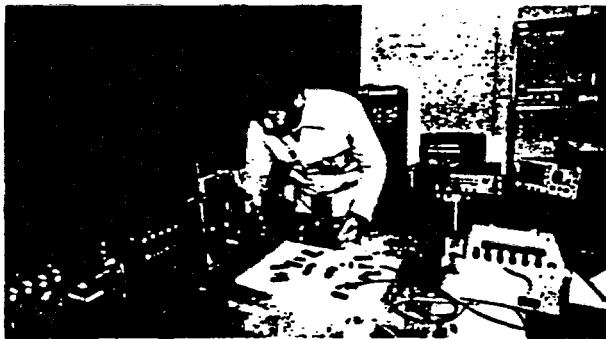

干渉型光ファイバーセンサーの基礎実験
Experiment of Optical Fiber Sensor

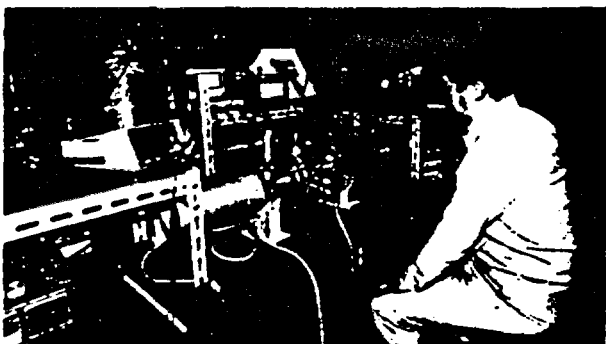

流動メタンガスにおける静電気火花着火



当センターは、国及び産炭地の強い要請に対応して、大正4年5月の直方に設立され、石炭鉱山の災害防止技術開発の研究を推進し、約75年の歴史と多くの研究成果を蓄積して炭鉱現場の保安向上に寄与してきました。特に国立研究機関で唯一の試験炭鉱を有し、この坑道内で大型実験装置を使用する実規模に近い大型研究を行い、今日まで幾多の成果をあげてきました。近時、九州産炭地においても、自然条件の悪化や操業条件が厳しくなってきたことから、遠隔通信、情報伝達技術や緊急退避所の高度化、ガスの流動拡散の把握あるいは坑内火災消火技術等、当センターにおける研究成果を拡大発展させて、炭鉱現場への適用を図るために努力しています。更に、長い歴史と伝統のもとに豊富な炭鉱保安技術研究の蓄積を活用し、中国との国際産業技術研究事業や産業保安技術、公害防止技術等の分野にも研究開発の推進を行っています。試験炭鉱の主な大型設備としては、ガス、炭じん爆発や坑内火災の実験に使用出来る400mと230m試験坑道や実際の炭鉱と同様な構造の黒川坑のほか火薬類の試験坑道などがあります。黒川坑内では火薬類の試験や坑内通信の試験、坑内退避所の高度化の試験などが実施されています。

The Coal Mine Safety Research Center (Kyushu) was established by the Japanese Government and Civilian Organization in May 1915. For over 70 years, the Center has provided technology and technical services to the coal mining industry for coal mine safety. The experimental coal mine of the Center, which is a unique facility in Japan, has been used for full-scale tests and useful results have been obtained.

Over the past decades, the working environment of coal mines in the Kyushu coal-mining area has been getting worse. The Centers research focuses on developing advanced technology for coal mines, such as underground communication systems, data transfer techniques in mines, monitoring the fire-damp movement and fire-extinguishing method for coal mines. The Center also encourages technology transfer to apply these technologies to the mining industry

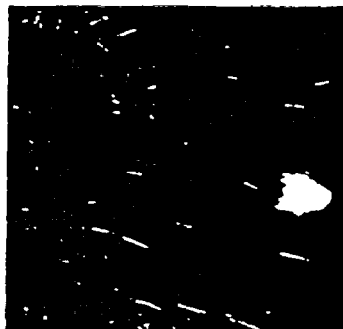

臼砲発射の爆炎写真
Explosion Flame of Explosive in Motar

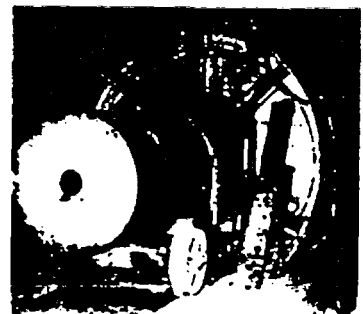

爆薬検定坑道
Test Gallery of Explosives

国際研究協力

科学技術立国の日本において国立の研究所として国際研究協力の重要性はとみに高まって来ています。先進国をはじめ発展途上国からも、フロンティア問題に代表されるような地球規模環境問題や、資源エネルギー関連研究、保安関連研究等の協力要請が年々急増しています。

当所ではこれらの要請にこたえるべく多様な国際研究協力の充実を図っています。研究交流事業の内容は次の通りです。

1. 先進国との研究交流協力

多国間協力、二国間協力、サミット協力、国際特定共同研究事業など、例えば OECD との環境問題研究協力、天然資源の開発利用に関する日米会議、日米環境保護協力協定にかかる研究協力、国際エネルギー機関における多国間研究協力などを行っています。

2. 発展途上国との研究協力、技術協力

国際産業技術研究事業 (ITIT 事業) として、「中国レアメタルの分離精製技術に関する研究」、「熱帯地域における大気汚染アセスメント手法に関する研究」を行っています。

3. 国連、国際協力事業団 (JICA) 等からの関連技術協力

国際連合からの技術協力要請 (特に研修)、JICA からの要請として「産業公害防止コース」、「鉱山保安コース」の2つの集団研修をはじめ、数多くの個別研修、専門家派遣依頼等にこたえています。

4. その他の国際交流

長期、中期の在外研究、海外の大学、研究機関からの招へい、国際研究集会 (国際会議) への出席、海外からの見学者の対応などを行っています。今後もあらゆる科学技術の面で増加する国際化の波に応じて行きます。

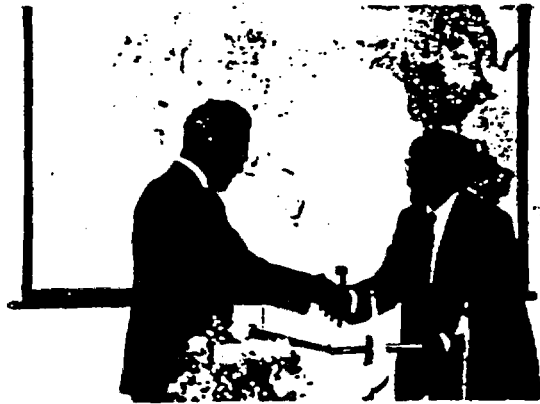

ITIT 調印式 (インド)
The Signing Ceremony of ITIT Program with India



JICA 集団研修
JICA Group Training Course

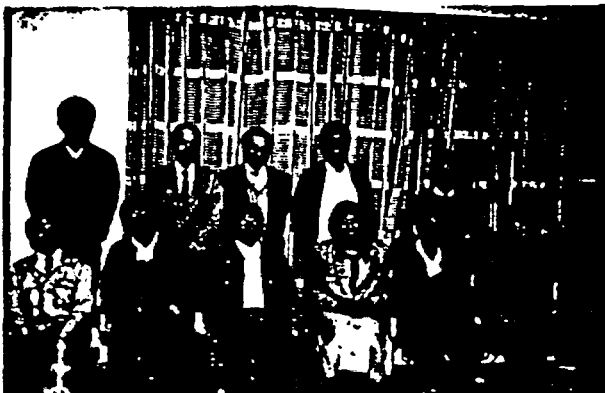

JICA 集団研修



広州有色金属研究院メンバーとの討議

International Cooperation of Science and Technology

Science and Technology have greatly contributed to our health and welfare, but they also have brought about some problems of a global scale regarding natural resources, energy and the environment. Future science and technology should not be indifferent to such problems, and their research and development should be carried out so as to harmonize industrial activities with the global environment. International cooperation is indispensable to cope with such problems.

On the other hand, as recent science and technology have become and complicated, it is difficult for a country to make their further progress only by itself. International cooperation is necessary from this point of view.

The International Research Cooperation Office was set up to promote research cooperation with foreign countries through the offer of the latest information about countries overseas and their research activities.

The following programs are in progress at the National Research Institute for Pollution and Resources:

1. Joint research with the organizations of advanced countries.
2. Institute for the Transfer of Industrial Technology (ITIT) projects.
3. Cooperation with JICA (Japan International Cooperation Agency) in its projects by dispatching specialists and accepting foreign trainees.
4. The interchange of research personnel and guidance for foreign visitors.

技術情報サービス Technical Information Services

当所では下記の技術情報サービスの他に、科学技術週間、又は環境週間に研究施設の一般公開を行っています。

The following Technical Information Services are carried out at this Institute.

研究講演会 Technical Symposium

当所の研究成果の広報、普及を目的とし、研究分野を絞ってテーマを設定し、年2回開催しています。

(担当 業務課)

共同研究 Joint Research

新技術開発のための研究は、基礎研究から企業化への一貫性のある均衡のとれた展開が必要です。その一環として、民間企業等と技術・知識を交換し、研究及び費用を分担して共同で研究を実施しています。

(担当 業務課)

官民連帯共同研究 Government and Private Joint Research

我が国が今後技術立国として飛躍するためには、先端的・基盤的分野における基礎研究を充実させる必要があります。そのため、産業基盤確立に必要な基盤的研究で、民間企業において共同研究についてのニーズの高いもののうち、公共性の高いと認められる研究テーマを工業技術院で選定、予算化し、各研究所で実施しています。

(担当 業務課)

受託研究 Sponsored Research

当所の研究成果の普及、実用化の観点から、現行の研究内容で直接企業に有効な資料を提供し得る場合に、民間企業からの委託を受けて実施しています。

(担当 業務課)

技術相談 Technical Advice

当所の研究業務に関連のある事項について、電話、面談あるいは文書による相談に応じています。

(担当 技術相談所)

技術指導 Technology Transfer

当所の研究業務に関連のある分析・測定・試験・製造法などの各種技術についての実験指導を依頼に応じて行っています。

(担当 技術相談所)

見学 Laboratory Visit

当所の設備、機器などを見学される場合はあらかじめ問い合わせの上、文書でお申し込み下さい。

(担当 技術相談所)

検定・その他 Certification and Others

鉱山坑内用品検定規則に基づく鉱山用機械器具、火薬等の検定及び計量法に基づく熱量計の検定を行っています。そのほか一般から依頼された試験、分析、鑑定等を行っています。これには試験、分析及び設備の使用規則による手数料が定められています。

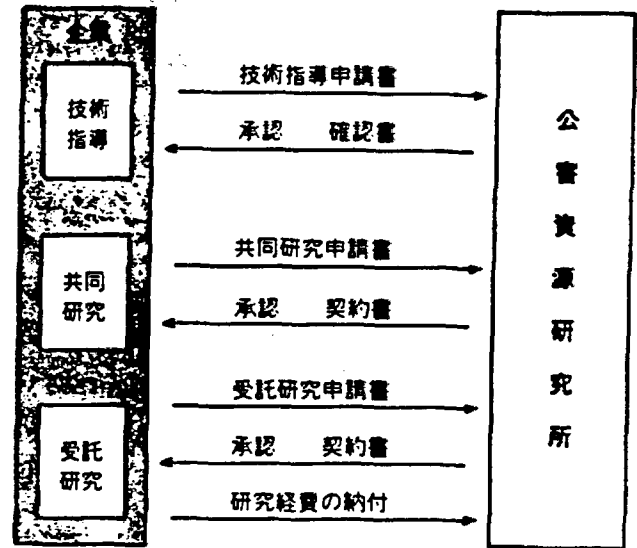

工業所有権 Patent Licensing

当所の研究を通じてなされた発明及び考案に関する権利は国に帰属します。これらの通常実施権は財団法人産業技術振興協会を通じて許諾されることになります。

Patents and Utility Models for inventions on studies at the Institute belong to the Government.

Licenses of these patents are granted through the Japan Industrial Technology Association.

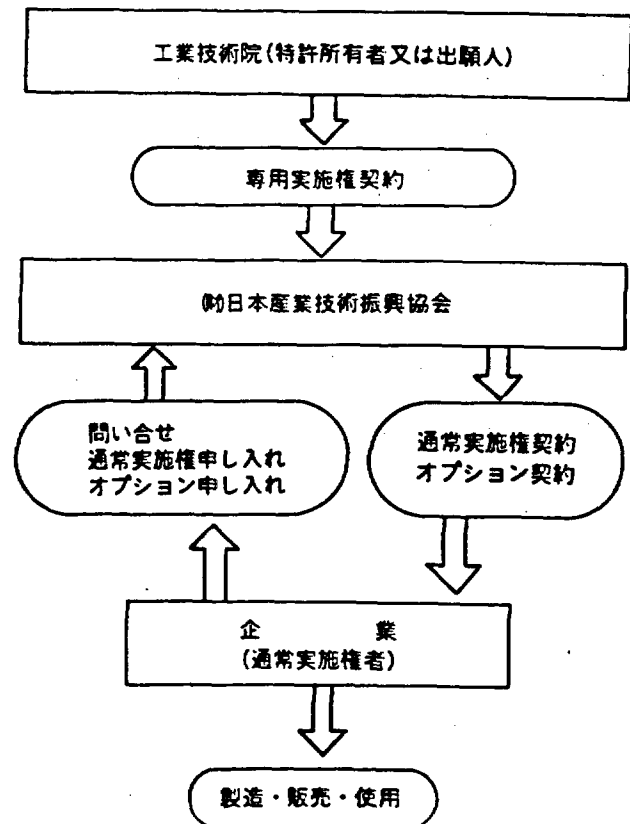

刊行物紹介 Publications

当所の業務内容や、研究成果、調査報告は、下記の当所による出版物のほか、一般学術誌にも掲載されています。

公害資源研究所報告 (不定期) Report of NRIPR (Irregular)

研究成果のうち、集大成された研究論文について発行しています。

公害資源研究所集報 (季刊) Bulletin of NRIPR (Quarterly)

研究成果及び調査結果の報文、並びに一般学術誌に掲載された論文の要旨を収録掲載しています。

公害資源研ニュース (月刊) News of NRIPR (Monthly)

業務の目的、内容、成果等の広報及び関連技術ニュース等の紹介を行っています。

資源 (月刊) (旧「採鉱と保安」を1989年1月に改題) SHIGEN (Monthly)

資源・エネルギー分野の研究報文、調査結果等を掲載しています。

公害 (隔月刊) Pollution Control (Bi-monthly)

環境保全分野の研究報文、調査結果等を掲載しています。

公害資源研究所年報 (年刊) Annual Report of NRIPR (Annual)

組織、予算、研究内容等の単年度における業務報告を掲載しています。

鉱山坑内用品検定公報 (隔月刊) Bulletin of Inspection of Underground Articles Used in Mines (Bi-monthly)

鉱山坑内用品の検定結果の報告を掲載しています。

○当所刊行物の入手等については、業務課広報係までお問い合わせ下さい。

情報管理 Management of Technical Information

最近の科学技術の発展は著しく、情報量も膨大で、昭和62年に世界中で発表された論文数は約80万編にもなり、研究上必要な論文・資料の効率的な収集・整理は重要な課題です。

情報管理室は、これらの文献・特許を収集・整理し、データベース化するとともに、必要に応じデータを提供することを目的としています。

具体的には、(1)オンライン情報検索の強化、(2)購入・寄贈図書・雑誌の案内、(3)工業技術院内各研究所図書・資料室蔵書目録のデータベース化などを進めています。

At Technical Information Office, literature and patents are collected, databased, and provided when requested. The following services are provided:

1. Reinforcement of on-line literature search
2. Listing of new books and journals
3. Databasing of book catalogues in AIST

図書 Library

本所では石炭・石油関係の古い貴重な図書・雑誌を多数保有し、また産業保安、廃水処理及び大気汚染関係の資料、特に生化学と大気・海洋の拡散関係の充実を図っています。赤外線、NMR、X線などのデータカードを所有しています。

九州石炭鉱山技術試験センターでは炭鉱の変遷史関係の貴重な図書のほか、廃水処理、騒音、振動関係を所有しています。

北海道石炭鉱山技術試験センターでは炭鉱保安のうちでもガス関係のものを多く所有しています。

The Library of the Central Laboratory contains about 30,000 volumes. The main collections are books related to coal, petroleum, industrial safety, wastewater treatment and air pollution.

The Library of Coal Mine Safety Research Center, Kyushu has about 4,000 volumes. The main collections are books related to wastewater treatment, prevention of noise and vibration in addition to those on coal mine history.

The Library of Coal Mine Safety Research Center, Hokkaido has about 3,000 volumes, most related to mine safety and the safe use of gas in particular.

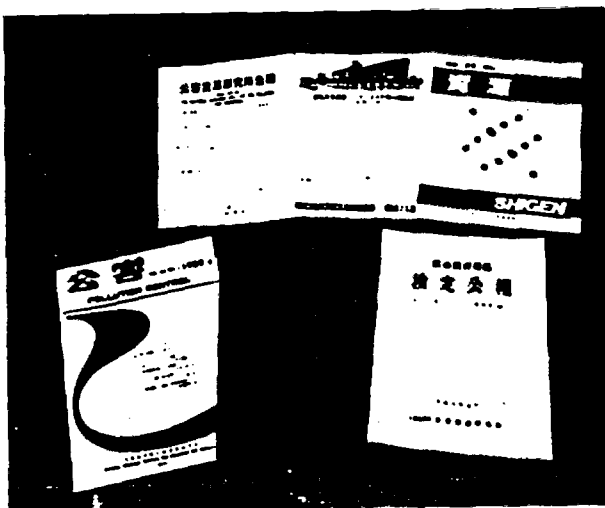

本所

〒305 茨城県つくば市小野川16番の3
 Tel(0298)54-3000(代表)
 FAX(0298)54-3038, 3049
 Telex 3652570 AIST J

National Research Institute for Pollution
 and Resources
 16-3 Onogawa, Tsukuba-shi, Ibaraki,
 305 Japan

企画室 (0298)54-3026,3027
 技術相談所 (0298)54-3036
 国際研究協力室 (0298)54-3060
 庶務課 (0298)54-3022
 業務課 (0298)54-3024,3025
 情報管理室 (0298)54-3163,3050

Research Planning Office
 Technology Advice Office
 International Cooperation Office
 General Affairs Division
 Research Service Division
 Technical Information Office

北海道石炭鉱山技術試験センター

〒003 北海道札幌市白石区平和通3丁目北1番25号
 Tel(011)861-2191(代) FAX(011)864-3469

Coal Mine Safety Research Center, Hokkaido
 Kita 1-25, Heiwadori 3, Shiroishi, Sapporo,
 003 Japan.

九州石炭鉱山技術試験センター

〒822 福岡県直方市領野1541
 Tel(09492)6-5511(代) FAX(09492)6-5518

Coal Mine Safety Research Center, Kyushu
 1541 Tonno, Nogata, Fukuoka, 822 Japan.

同産井分室(試験炭鉱)

〒820-05 福岡県嘉穂郡碓井町西郷1142
 Tel(0948)62-2057(代) FAX(0948)62-5280

Experimental Coal Mine, Usui
 1142 Saigo, Usui, Kaho, Fukuoka,
 820-05 Japan.

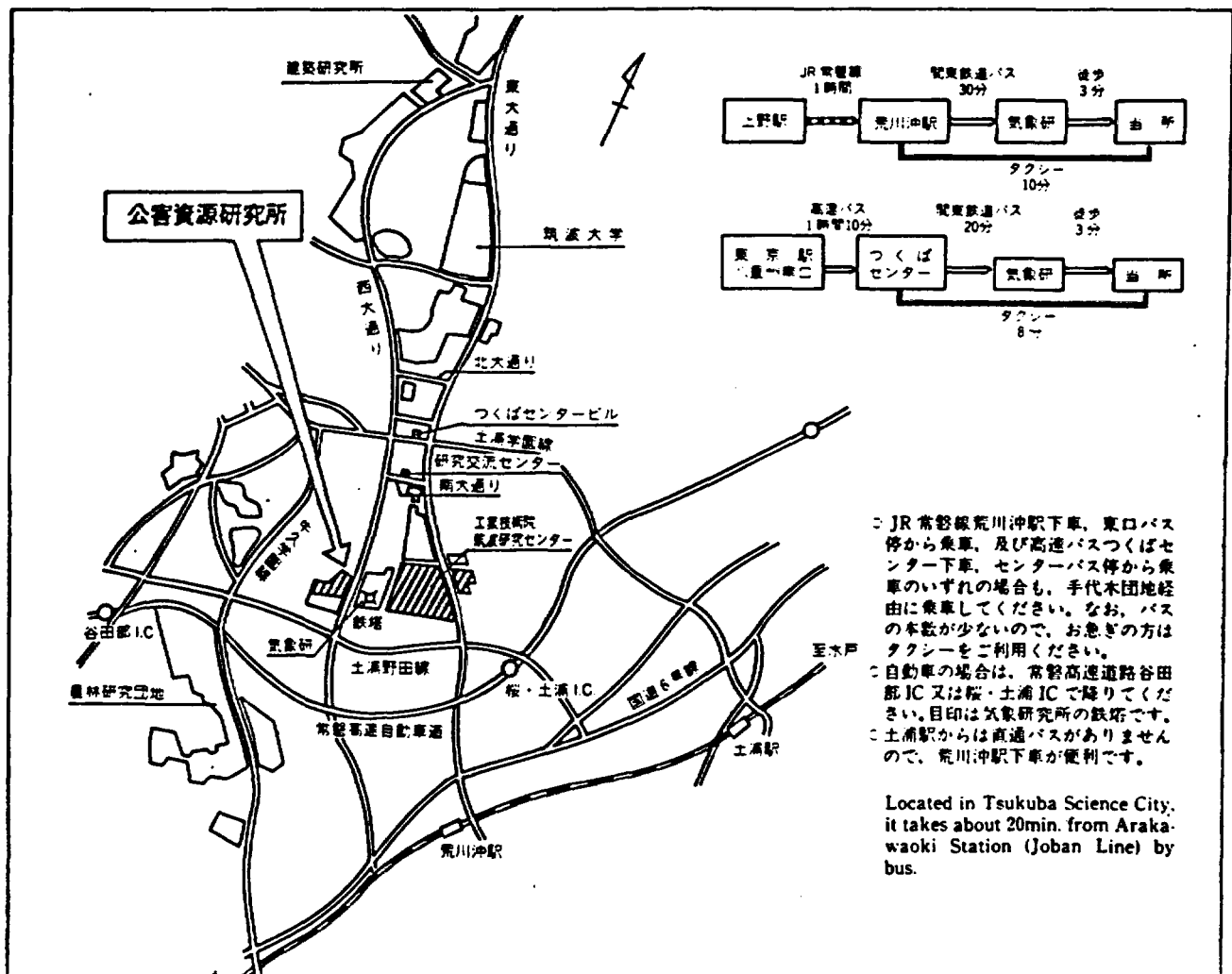

- JR 常磐線荒川沖駅下車、東口バス停から乗車、及び高速バスつくばセンター下車、センターバス停から乗車のいずれの場合も、手代本団地経由に乗車してください。なお、バスの本数が少ないので、お急ぎの方はタクシーをご利用ください。
- 自動車の場合は、常磐高速道路谷田部IC又は桜・土浦ICで降りてください。目印は気象研究所の鉄塔です。
- 土浦駅からは直通バスがありませんので、荒川沖駅下車が便利です。

Located in Tsukuba Science City, it takes about 20min. from Arakawa-oka Station (Joban Line) by bus.

TECHNOLOGIES DISCUSSED AT JGC CORPORATION

- Radioactive Waste Management Technologies

- 1. Treatment of High Conductivity Liquid Waste**
- 2. Treatment of Liquid Waste Containing Ammonia**
- 3. Microwave Dryer for Spent Resins**
- 4. New Vacuum Conveying System for Radioactive Liquid Waste**

- Incinerator Technologies

- 1. SIAS**
- 2. Gasification Furnace Incinerator**
- 3. Hazardous Waste Incinerator**
- 4. Energy- Recovery of Liquid Injection**
- 5. Radioisotope Carcass Incinerator**
- 6. Radwaste Incinerator**
- 7. Medical Waste Incinerator**
- 8. High Temperature Waste Incinerator**
- 9. CyForMelt**
- 10. Induction Heating Melting System**

- Tritium Separation/Concentration**
- Wet Oxidization**
- Reprocessing Facility Real-Time Gas Monitoring System**
- Mixed Waste and Reprocessing Management Technologies**

- 1. Advanced Cement Solidification**
- 2. Induction Heating Melting System**
- 3. Incineration of Spent TBP Contaminated U and Pu**
- 4. Liquid Waste Treatment**

- Hazardous Waste Management Technologies

- 1. Recovery of Solvent from Off-Gas by Activated Carbon Fiber Filter**
- 2. In-situ Stabilization of Cd and Pb Contaminated Soil**
- 3. Hazardous Waste Incinerator**
- 4. PCB and VCM Waste Incinerator**
- 5. Energy Recovering Type Liquid Injection Incinerator**
- 6. Gasification Furnace Type Incinerator**
- 7. Treatment of Heavy Metal and Organisms Contained in Liquid Waste**
- 8. Regeneration of Spent Activated Carbon**

BIBLIOGRAPHY OF LITERATURE RECEIVED FROM JGC CORPORATION

"Advanced Waste Management Technologies", JGC Corporation, 100 pages.

**ADVANCED WASTE MANAGEMENT
TECHNOLOGIES**

NOVEMBER, 1990

 **JGC CORPORATION**



WASTE MANAGEMENT TECHNOLOGIES

- Treatment of High Conductivity Liquid Waste by Special Resins & Electrodeposition
- Treatment of Liquid Waste Containing Ammonia
- Microwave Dryer for Spent Resins
- New Vacuum Conveying System for Radioactive Liquid Waste

- Separation of Oil from Liquid Waste (CM/SPI)
- Desulfurization (Moresana)
- Denitrification (Paranox)
- Odor Removal (Catalytic Oxidation)
- Sewage Sludge Melting (CyFurkeit)
- Sewage Sludge Centrifuge
- Sewage Waste Dehydration
- Sewage Sludge Composting

- Recovery
- Stabilization
- Incineration
- Liquid Waste Treatment

- Recovery of Tritium for Nuclear Fusion
- Non-Precoated and Backwashable Type Filter (High Efficiency Filter, NPMF)
- Forced Circulation Evaporator
- Treatment of Oil Contaminated Liquid Waste (SPI)
- Dry Cleaning System
- Laundry Drain Recycling System (Marimo Filter, Reverse Osmosis)
- Recycling Process of Regeneration Waste (Electro-dialysis)

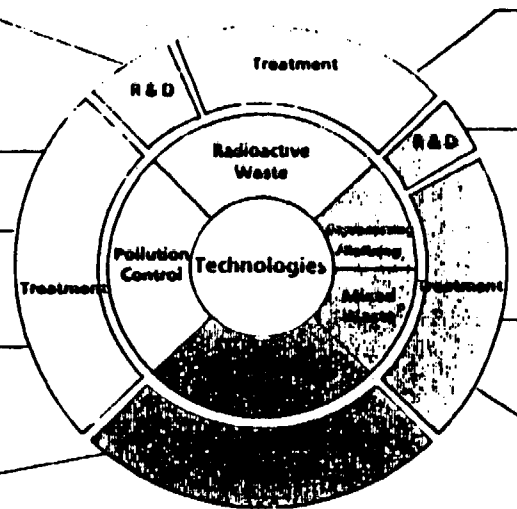

- Stabilization
- Incineration
- Liquid Waste Treatment

Liquid Waste Treatment

Volume Reduction & Solidification

Decontamination

Robotics

Package & Shipping

- Cyclone Type Incinerator (for contaminated Carcass)
- Wet Oxidation for Spent Resins
- Bituminization of Radioactive Liquid Waste (Drum Mixer, Extruder, Lumm)
- Plastic Solidification Process
- Advanced Cement Solidification Process
- DAW Treatment Technologies
 - High Temperature Incinerator
 - RW Incinerator
 - Screw Compactor
 - Shredder Compactor
- Chemical and Mechanical Decontamination
 - High Pressure Water Jet Cleaning
 - Chemical Decontamination Technology
- Inspection Robot
 - In-line Mobile Inspection Equipment
 - On-wall Inspection Robot
- Automatic Vehicle (Drum Handling)
- Waste Package Shipping Inspection
 - Surface Contamination/Dose Rate Measuring Apparatus
 - Radioactivity Counting Unit
 - Labeling Unit

Reprocessing

Uranium Refining

- Reprocessing
- Uranium Refining

JGC CORPORATION
 14-1 Bessho 1-chome, Minami-ku
 Yokohama, 232 Japan
 TEL 011-45-721-7256
 FAX 011-45-721-7353
 Contact Person : Stephen D. Goetsch
 Kenzo Suda

URANIUM - SELECTIVE CHELATE RESIN

- Reasonable Cost - Good Performance
- Six years of Operating Experience at Ningyo Touge Uranium Processing Facility
- Proposed for Use at Weldon Spring
(Competing technology not yet demonstrated)
- Proposed for Limited Use at Portsmouth Gaseous Diffusion Plant
- Under Consideration at Private Uranium - Contaminated Sites
- Could Substantially Reduce the Cost of Removing Uranium from Waste Liquids

JGC'S ACHIEVEMENTS IN THE NUCLEAR FIELD IN U.S.A.

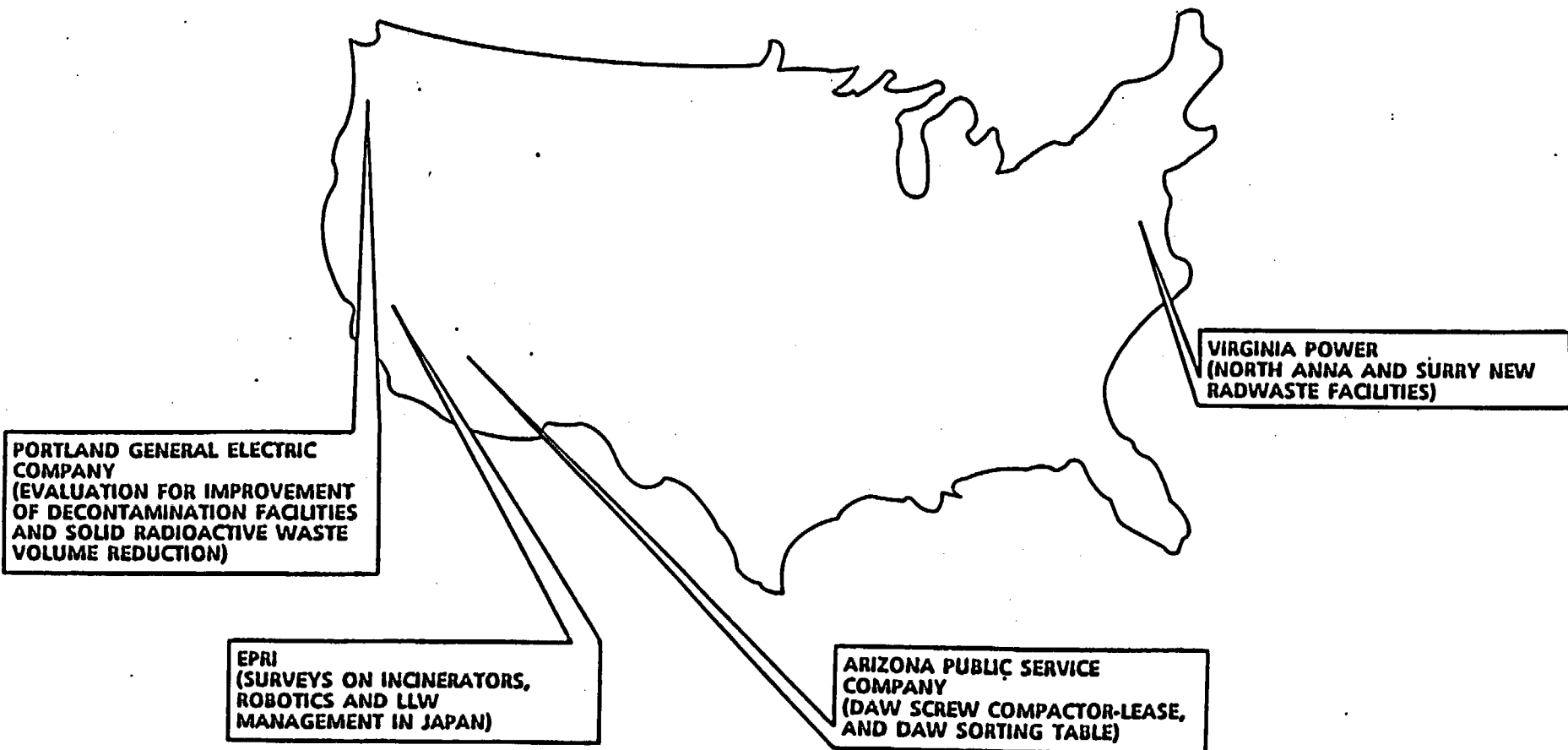

ON - SITE STABILIZATION PROCESS (OSSP)

- **Utilizes a Promising Stabilization Compound**
- **Proposed in Response to INEL's PRDA**
- **TCLP Test Results Indicate Good Results**
- **Test on Uranium-Containing Soils Required**
- **Structure of Stabilization Agent can be varied to improve
Stabilization Characteristics of Particular Contaminates**

JGC ADVANCED CEMENT SOLIDIFICATION

Waste to be treated	Conventional cement method	JGC technology	Remarks
Incinerator ash	No pretreatment	Pretreated by the $\text{Ca}(\text{OH})_2$ and NaOH	A retarded cement hydrating reaction problem are solved.
Spent resin	No pretreatment	Pretreated by the cement and water	Swelling phenomenon of the immersion test are protected.
Boric acid waste	No pretreatment	Hydrate calcium metaborate are generated by pretreatment	Volume reduction and stable products are provided

Leach Test Results – Treated by fixing agent and bentonite –

	Fixing agent (I) and bentonite			Fixing agent (II) and bentonite		
Method	EP - Toxicity			TCLP		
	Sample (mg / l)	Criteria (mg / l)		Sample (mg / l)	Criteria (mg / l)	
Cd	0.63	1.0	○	0.04	0.066	○
Cr	<0.01	5.0	○	0.11	0.084~5.2	○
Hg	0.20	0.2	○	— ¹⁾	0.025	— ¹⁾
Pb	<0.01	5.0	○	0.33	0.18~0.51	○

1) Analysis is now in progress

Leach Test Results - Treated by fixing agent (I) and Cement -

Method	EP - Toxicity			TCLP		
	Sample (mg / l)	Criteria (mg / l)		Sample (mg / l)	Criteria (mg / l)	
Cd	4.86	1.0	X	0.10	0.066	X
Cr	0.68	5.0	○	0.11	0.084~5.2	○
Hg	0.20	0.2	○	— ¹⁾	0.025	—
Pb	0.71	5.0	○	0.36	0.18~0.51	○

1) Analysis is now in progress

JGC INCINERATION TECHNOLOGIES

800 - 900 °C

- **SIAS (Formerly Labopherix)**
 - Submerged - flue Incineration and Stabilization
 - Treats organic and inorganic liquid wastes simultaneously
 - Laboratory use (6 operating units)
- **Gasification Furnace Incinerator**
 - Pyrolizer
 - Municipal industrial wastes (Used tires, refusefuel pellets)
 - Industrial facility (Many operating units)
- **Hazardous Waste Incinerator**
 - Rotary kiln type
 - Industrial wastes or sludges
 - Waste management facility (8 operating units)
- **Energy - Recovering Liquid Injection Incinerator**
 - Liquid injection type
 - High concentration COD liquid waste
 - Industrial facility (1 operating unit)

AUTOMATED WASTE CONTAINER MANAGEMENT SYSTEM

- **Current system can include up to 11 types of fully automated inspection operations non-destructively**
- **Complete computerized record of Inspection**
- **Modularity allows flexible design options**
- **Compressive strength & voidage inspection units currently on location at customer sites**
- **TRU radioassay technology available, but not yet incorporated. Subject of JGC proposal in response to INEL's PRDA**
- **Free liquid detection technology similiary not yet incorporated. Also part of response to INEL's PRDA**
- **Would likely reduce DOE cost & manpower requirements for dispositioning "Grouted" drums at Oak Ridge**

JGC INCINERATION TECHNOLOGIES (Con't)

Greater than 1400 °C

- **High Temperature Incinerator**
 - Thin - film melting furnace
 - Combustible & Incombustible Wastes
 - Nuclear Power Facilities (2 operating units)

- **CyFurMelt**
 - Cyclone furnace sludge incinerator / melter
 - Municipal Sewage Sludge
 - Municipal Sewage Facility (2 operating units)

- **Induction Heating Melting System**
 - Uses Electric Induction to melt ash
 - Treats (vitrifies) ash
 - Nuclear Facility Use (Under development)

JGC INCINERATION TECHNOLOGIES (CONT.)

- **Radioisotope (RI) Carcass Incinerator**
 - Cyclone Type
 - Carcasses, Spent Solvents
 - Medical Industry (70 operating units, Most are not for RI Waste)

- **Radwaste Incinerator**
 - Hearth Furnace, Wanson, SGN Type
 - Combustible Radwaste (α , β , γ contamination)
 - Nuclear Facility (3 operating units)

- **Medical Waste Incinerator**
 - Hearth Furnace
 - Medical, Infections Waste
 - Hospital (1 operating unit)

OTHER TECHNOLOGIES

- **Tritium Separation / Concentration**
 - Counter flow catalytic column
 - Laser - stripping
- **Wet Oxidation**
 - Well - Tested
 - May soon be available at SEG's facility in Oak Ridge
 - Treats resins, filteraids, and chelate agents
 - Low temperature & pressure system
- **Reprocessing Facility Real - Time Gas Monitoring System**
 - Will detect ^{14}C , I, & ^3H in stack gases

Membrane

HIGH TEMPERATURE INCINERATOR

- **Efficient**
 - High Temperature Combustion Assures Complete Destruction
 - Accepts a Wide Range of Combustible and Incombustible Radioactive Waste
 - Accepts Wastes Containing Up to 20% Water
- **Safe**
 - Low Flue Gas Content/Simple Filtration System
 - Very Stable Vitrified Product
- **Cost - Effective**
 - Simple Operation
 - Stable, Easily Solidifiable Product
 - Compact Facility
- **Experience**
 - Demonstration Plant
 - Operating Plant
 - Second Operating Plant now under Construction

JGC

PART 1

INTRODUCTION
TO
JGC CORPORATION

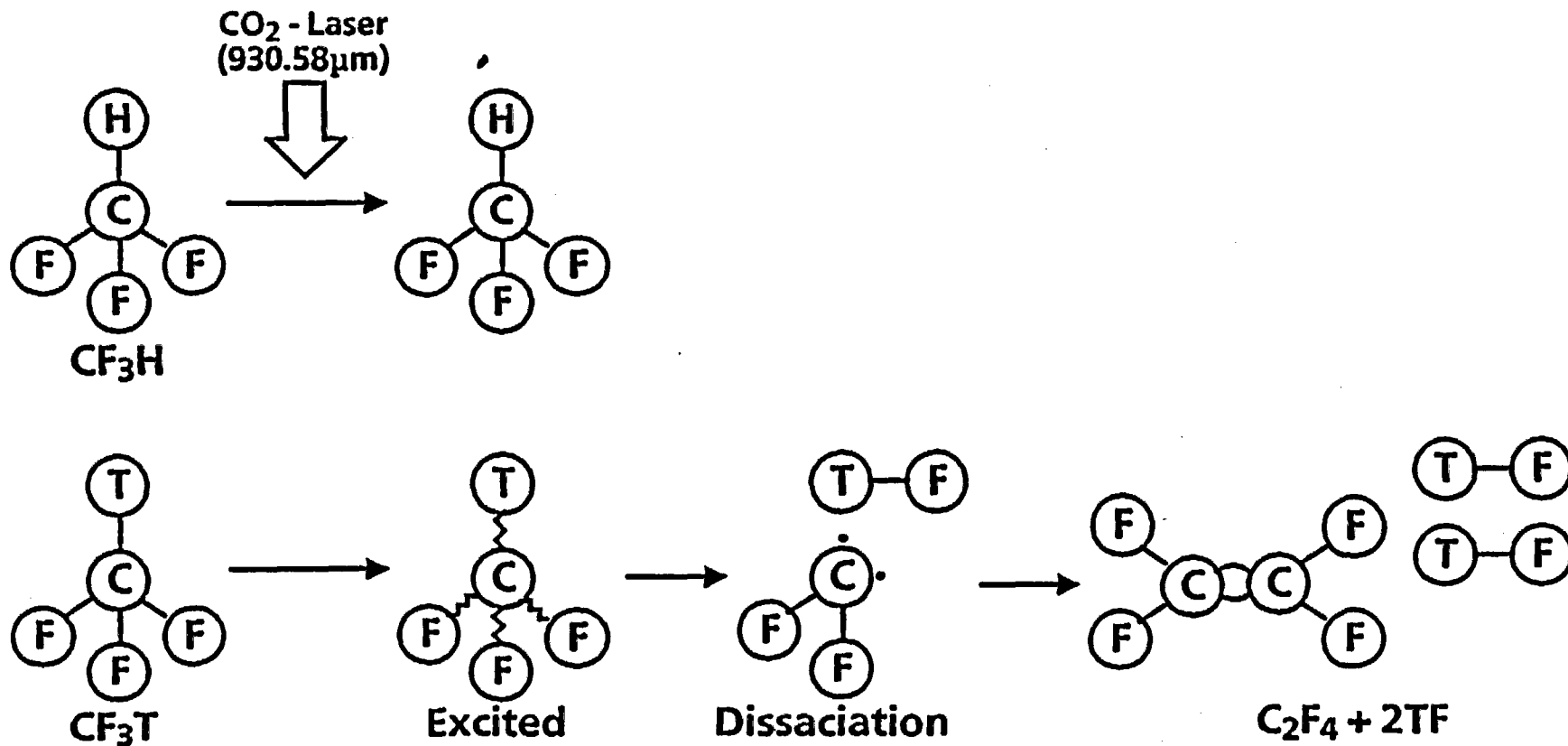

Reaction Mechanism of Laser Tritium Separation

JGC'S BACKGROUND

- Established : October 25, 1928

- Employees : 2,800
 (including)
 18 in the U.S.A
 120 in other foreign countries

- Contracts completed : \$ 1,180 Million (fiscal year 1989)

- Contracts awarded : \$ 3,800 Million (fiscal year 1989)

Memo ;

JGC'S ACTIVITIES AND FIELDS (1)

Fields of Activity

- › Nuclear plant services
 - › Radioactive waste management
 - › Spent fuel reprocessing plant
 - › Electric power generation plants
 - › Environmental conservation facilities
 - › Robotics
 - › Petroleum refineries
 - › Natural gas processing plants
 - › Natural gas liquefaction plants
 - › Town gas manufacturing plants
 - › Petrochemical plants
 - › Gas chemical plants
 - Coal chemical plants
 - Inorganic chemical plants
 - Pipelines
 - Airport facilities
 - Port and offshore facilities
 - Desalination plants
 - Municipal sewage treatment facilities
 - Synthetic rubber resin fiber plants
 - Food processing plants
 - Pharmaceutical plants
 - Medical facilities
 - Oil terminals
 - Development and application of new technologies
-

Memo ;



JGC'S ACTIVITIES AND FIELDS (2)

Services Offered

- Feasibility studies
- Project management
- Planning
- Basic design
- Detailed design
- Procurement
- QA / QC
- Transportation
- Construction
- Test and start up
- Training
- Maintenance and post - installation services
- Financing arrangements
- Process license arrangements
- Research and development

Memo ;

WORLDWIDE OFFICE NETWORK

(Excluding the U.S.A.)

JGC

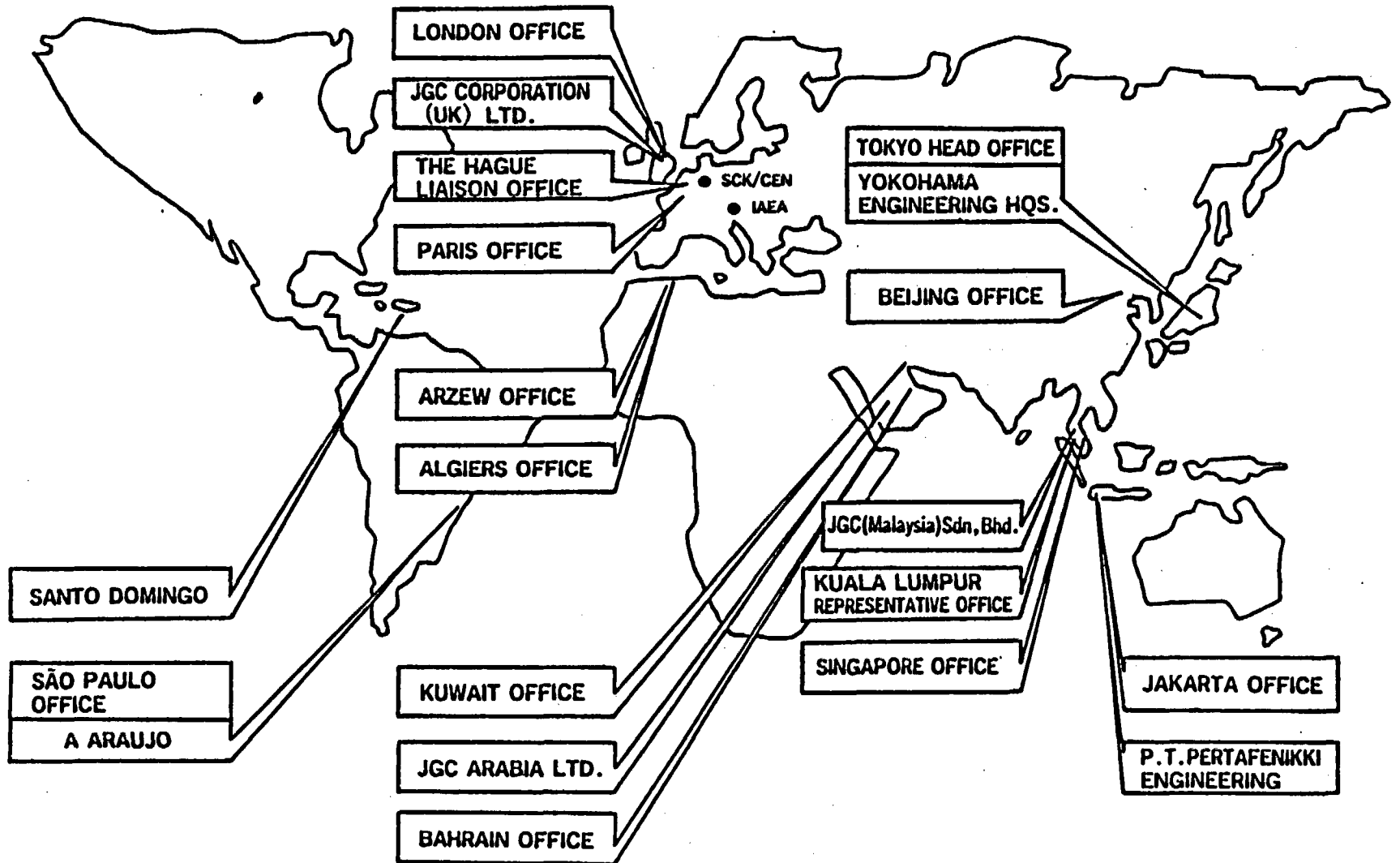

OFFICE NETWORK IN U.S.A

1-6

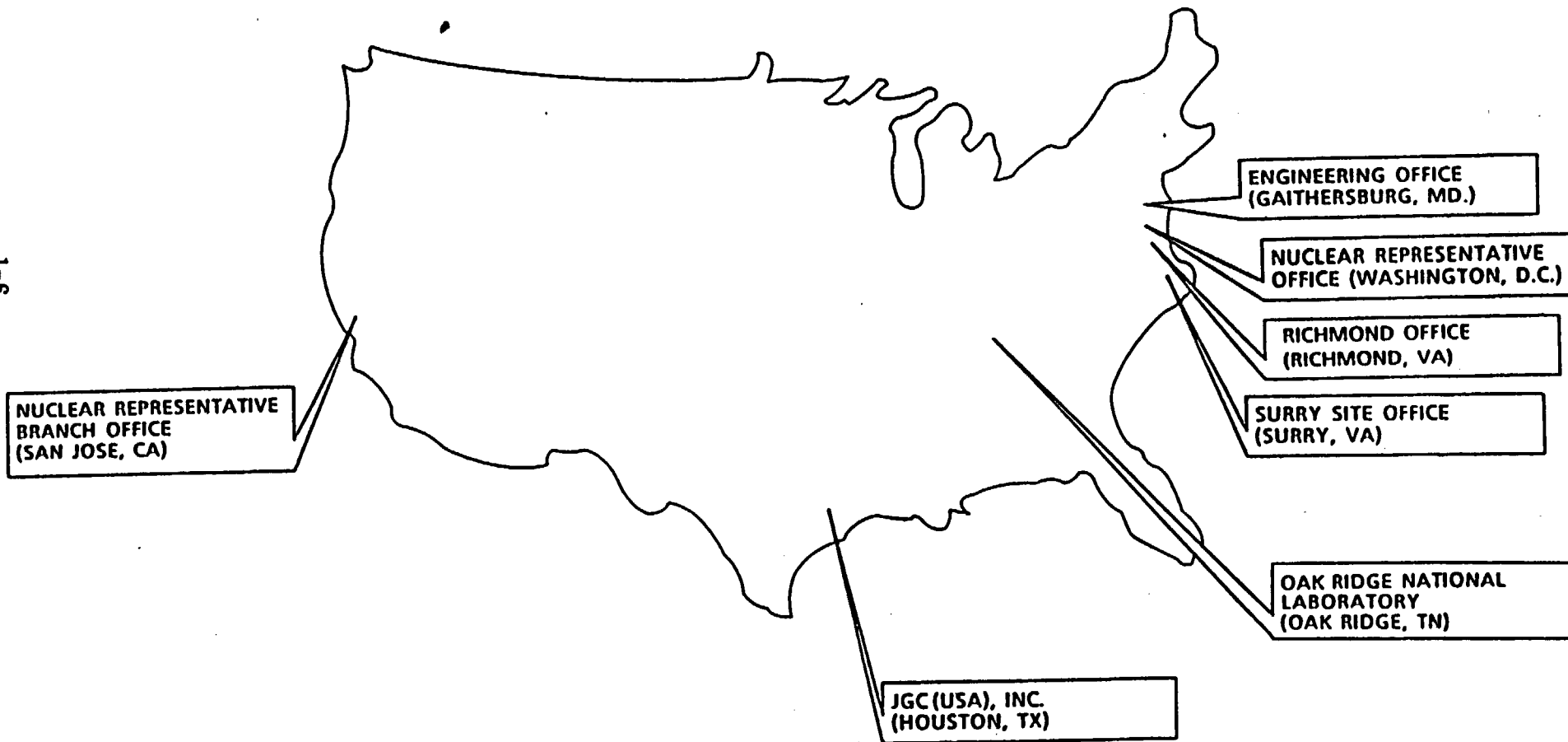

JGC'S ACTIVITIES IN THE NUCLEAR AND ADVANCED TECHNOLOGY FIELDS

- Nuclear Project Division established in 1965
- Project achievements – More than 200 projects completed
 - Japan's first spent nuclear fuel reprocessing plant at Tokai
 - R/W treatment facilities
- R & D achievements – More than 120 individual programs
- Nuclear Research Center opened in Oarai in 1984

Memo ;

JGC'S LEADING ROLE IN THE WASTE MANAGEMENT AREA

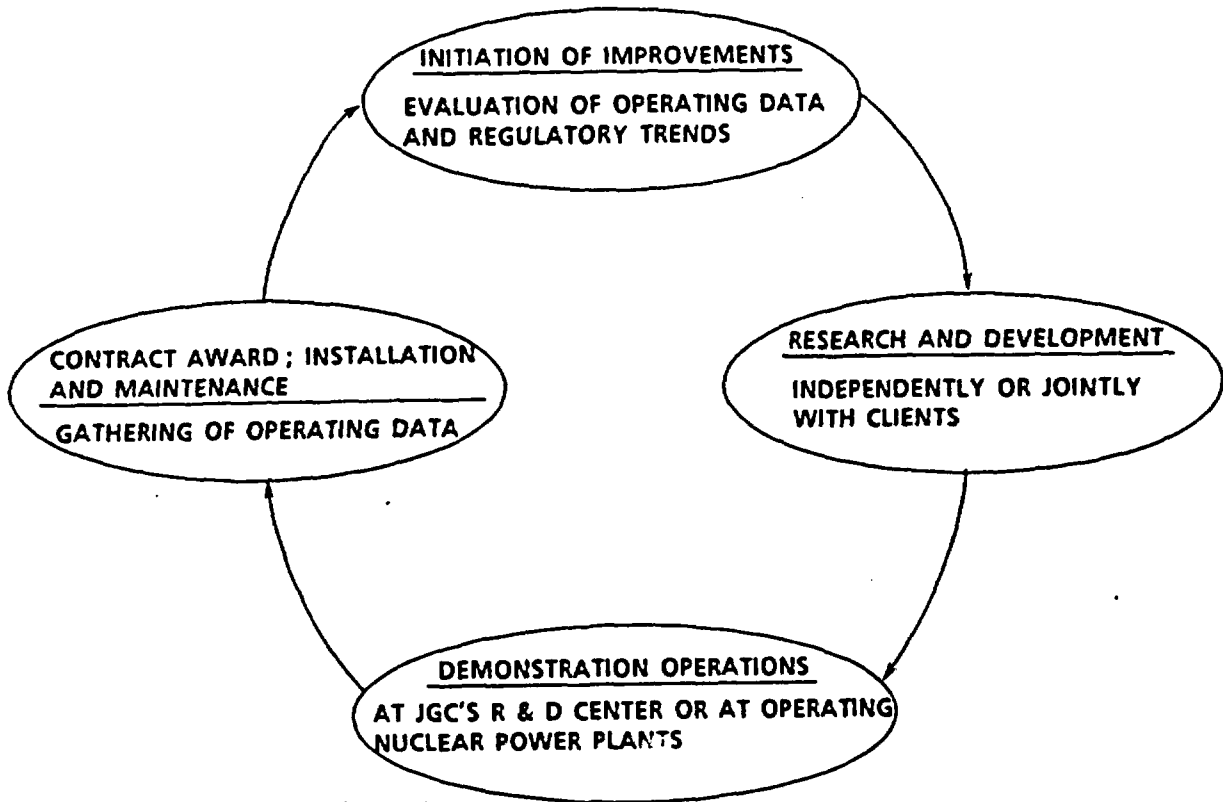

Memo ;

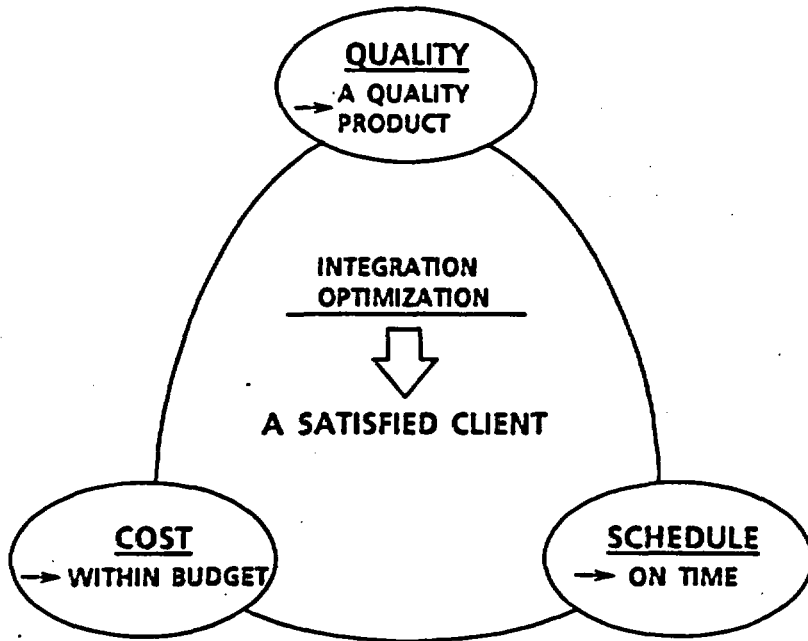

Memo ;

JGC'S ACHIEVEMENTS IN THE NUCLEAR FIELD IN JAPAN

- BWR Plants
- ▲ PWR Plants
- Other Nuclear Facilities

- Advanced Cement Solidification System
- ▲ Bituminization System
- Plastic Solidification System
- Nuclepore Membrane Filter
- HE Filter
- Dry-Wet Cleaning System
- Concentrator
- Incinerator
- Compactor

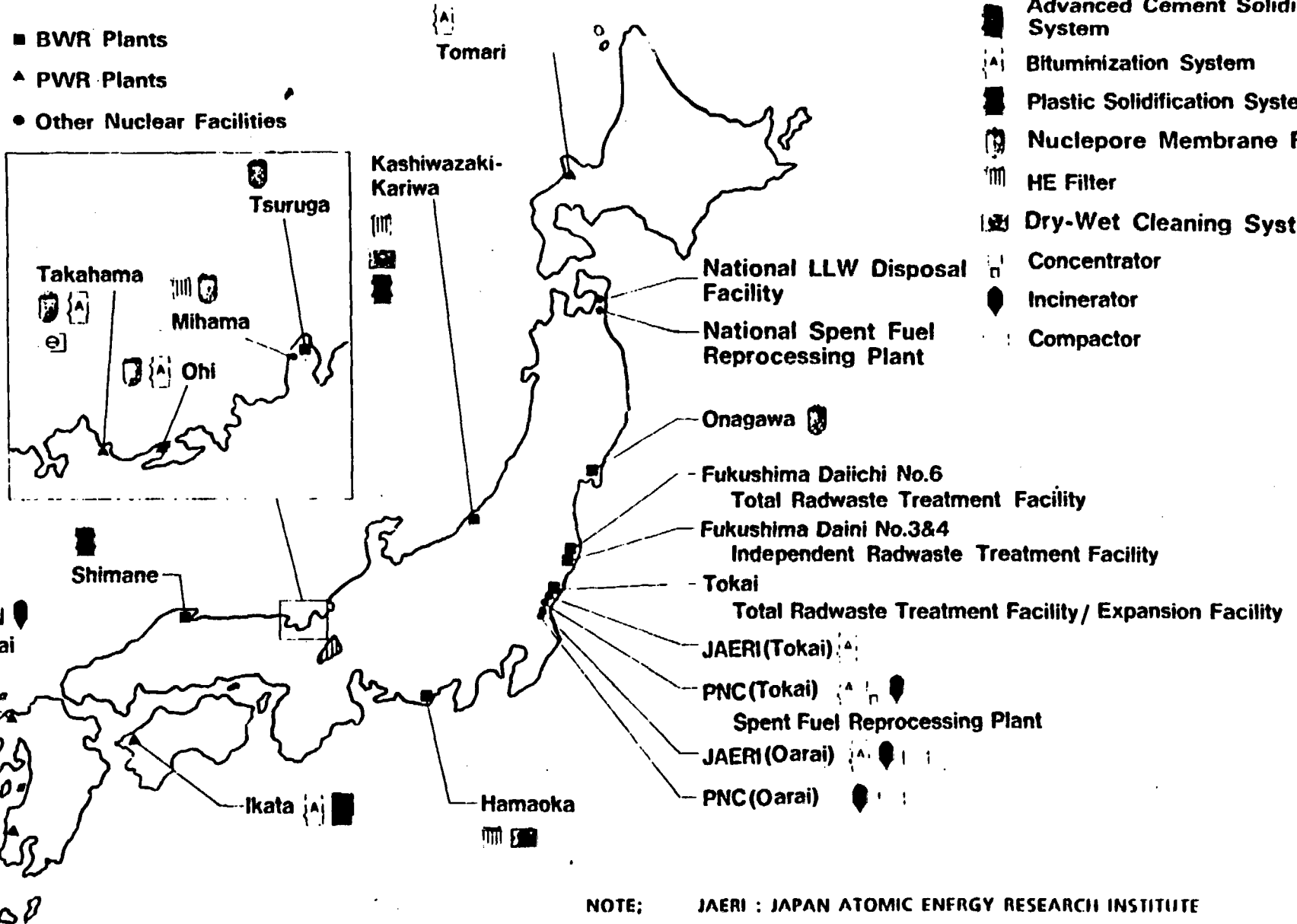

NOTE: JAERI : JAPAN ATOMIC ENERGY RESEARCH INSTITUTE
 PNC : POWER REACTOR AND NUCLEAR FUEL DEVELOPMENT CORP.

JGC'S ACHIEVEMENTS IN THE NUCLEAR FIELD IN U.S.A.

I-11



**PORTLAND GENERAL ELECTRIC COMPANY
(EVALUATION FOR IMPROVEMENT OF DECONTAMINATION FACILITIES AND SOLID RADIOACTIVE WASTE VOLUME REDUCTION)**

**VIRGINIA POWER
(NORTH ANNA AND SURRY NEW RADWASTE FACILITIES)**

**EPRI
(SURVEYS ON INCINERATORS, ROBOTICS AND LLW MANAGEMENT IN JAPAN)**

**ARIZONA PUBLIC SERVICE COMPANY
(DAW SCREW COMPACTOR-LEASE, AND DAW SORTING TABLE)**

MAJOR ACHIEVEMENTS IN THE NUCLEAR FIELD (1)

JAPAN'S FIRST SPENT NUCLEAR FUEL REPROCESSING PLANT AT TOKAI

- Main Reprocessing Plant
- R/W Treatment Facilities
- Hot Functional Test Operation of Reprocessing Plant
- Plutonium Storage Unit
- High Active Liquid Waste Storage Facility
- Replacement of Acid Recovery Evaporator
- New Reprocessing Dissolver
- Storage Facility for Bituminized Products

Memo ;



MAJOR ACHIEVEMENTS IN THE NUCLEAR FIELD (2)

INDEPENDENT R / W TREATMENT FACILITIES

- Fukushima Daiichi No.6 Total R / W Treatment Facilities for Tokyo Electric Power Co. (TEPCO)
- Tokai No.2 Total R / W Treatment Facilities for the Japan Atomic Power Co. (JAPC)
- Fukushima Daini No.3 & 4 Independent R / W Treatment Facility for TEPCO
- Tokai No.2 Expansion of Total R / W Treatment Facility for JAPC
- Large - sized Incombustible Solid Waste Treatment Facility for Government Sector
- North Anna / Surry New R / W Facilities for Virginia Power and Electric Company (VEPCO)

memo ;

MAJOR ACHIEVEMENTS IN THE NUCLEAR FIELD (3)

	COMPLETION	CONSTRUCTION
PACKAGED SYSTEMS		
(1) Bitumen solidification	13	
(2) Plastic solidification	2	1
(3) Cement solidification	2	
(4) Advanced cement solidification		2
(5) Incineration	4	2
(6) Filtration	16	
(7) Compaction	7	
(8) Laundry (dry and wet systems)	11	3
(9) Wet oxidation of resins	1	
(10) Robotics	2	1

Memo ;



JGC'S ROLE IN MAJOR NUCLEAR PROJECTS

	FUKUSHIMA DAINI UNITS 3 & 4 R/W	TOKAI - 2 R/W EXPANSION	TOKAI REPROCESSING PLANT	NORTH ANNA/ SURRY R/W
1. BASIC DESIGN	JGC	JGC	SGN	JGC
2. DETAILED DESIGN	JGC	JGC	JGC / SGN	JGC
3. BUILDING DESIGN	JGC		JGC	JGC
4. BUILDING CONSTRUCTION	JGC (SUPERVISION)	JGC (SUPERVISION)	JGC	JGC
5. PROCUREMENT	JGC	JGC	JGC / SGN	JGC
6. INSTALLATION	JGC	JGC	JGC	JGC
7. TEST AND STARTUP	JGC	JGC	JGC / SGN	JGC

Memo ;

JGC

PART 2

**OVERVIEW OF
JGC WASTE MANAGEMENT
TECHNOLOGIES**

INTRODUCTION

- **JGC Can Provide Total Engineering/Construction & Test Operation Services in the Environmental Conservation Field & Various Other Fields Based on its 60 Years of Experience**

RELEVANT JGC TECHNOLOGIES

- **Radioactive Waste Management**
- **Mixed Wastes & Reprocessing Management**
- **Hazardous Waste Management**
- **Pollution Control**

List of Radioactive Waste Management Technologies

- Treatment of High Conductivity Liquid Waste by Special Resins & Electrodeposition

- Treatment of Liquid Waste Containing Ammonia

- Microwave Dryer for Spent Resins

- New Vacuum Conveying System for Radioactive Liquid Waste

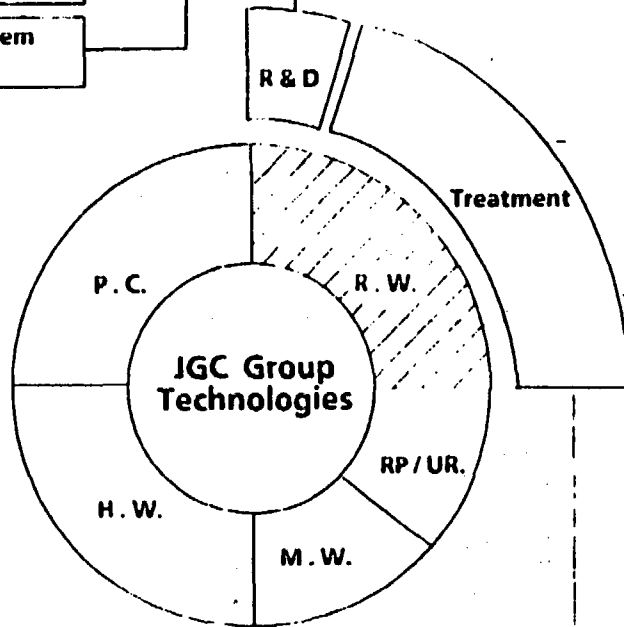

- R.W. : Radioactive Waste
- RP/UR. : Reprocessing / Uranium Refining
- M.W. : Mixed Waste
- H.W. : Hazardous Waste
- P. C. : Pollution Control

Packaging, Shipping

Automatic Vehicle (Drum Handling)

Waste Package Shipping Inspection
 Surface Contamination Dose Rate
 Measuring Apparatus
 Radioactivity Counting Unit
 Labelling Unit

Liquid Waste Treatment

- Recovery of Tritium for Nuclear Fusion
- Non Precoated and Backwashable Type Filter (High Efficiency Filter, NPMF)
- Forced Circulation Evaporator
- Treatment of Oil Contaminated Liquid Waste (SPI)
- Dry Cleaning System
- Laundry Drain Recycling System (Marimo Filter, R/O)
- Recycling Process of Regeneration Waste (Electro dialysis)

Volume Reduction & Solidification

- Wet Oxidation for Spent Resins
- Bituminization of Radioactive Liquid Waste (Drum Mixer Extruder, LUV/A)
- Plastic Solidification Process
- Advanced Cement Solidification Process
- DAW Treatment Technologies
 - High Temperature Incinerator
 - RW Incinerator
 - Sirex Compactor
 - Shredder Compactor

Decontamination

- Chemical and Mechanical Decontamination
 - High Pressure Water Jet Cleaning
 - Chemical Decontamination Technology

Robotics

- Inspection Robot
- In-line Mobile Inspection Equipment
- On-wall Inspection Robot

List of Mixed Waste & Reprocessing Management Technologies

- R.W. : Radioactive Waste
- RP/UR. : Reprocessing/Uranium Refining
- M.W. : Mixed Waste
- H.W. : Hazardous Waste
- P.C. : Pollution Control
- TBP : Tributylphosphate

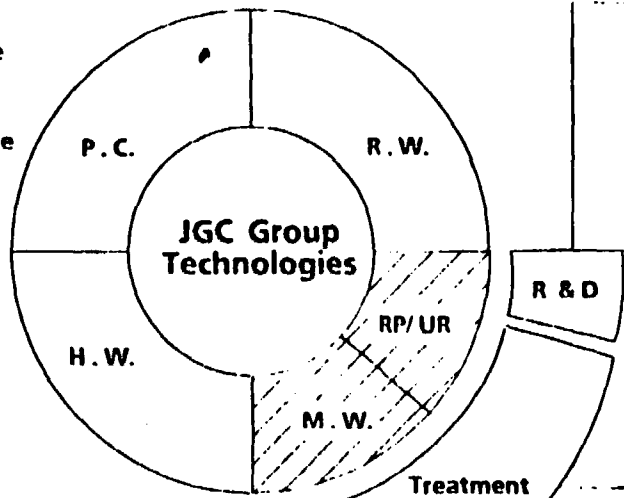

Reprocessing

Uranium Refining

- Removal of Iodine from Contaminated Liquid Waste (Reverse Osmosis)
- Extraction of U and Pu by 30 vol% TBP in HNO₃ Medium and Subsequent Back Extraction by Mixer-settlers
- Removal of U and Pu from Organic Wastes by Carbonate Washing using Mixer-settlers
- Acid Recovery of HNO₃ from Raffinate of Extraction Process, by Atmospheric and Reduced Pressure Evaporator and Distillator
- Co-precipitation of TBP U and Pu from Liquid Wastes
- Incineration of Spent Organic Wastes Containing U and Pu
- Adsorption of U by Ion-exchange Resins
- Extraction of U by Solvent (Amine)
- Recovery of Fine UF₆ Slurry Membrane Filter
- Co-precipitation of U by CaF₂ Flocculation from H₂SO₄ - HCl - HF Waste
- Removal of U from Spent Organic Wastes by Carbonate Washing
- Recovery of Sulfuric Acid from Waste Acid Containing HCl and HF

- Treatment of Incinerator Ash Containing Metals
 - Advanced Cement Solidification
 - Induction Heating Melter System
- Incineration of Spent TBP Containing U and Pu
- Decomposition of Chelating Agents Used in Decontamination and Decommissioning Processes (Wet Oxidation/UV - H₂O₂ Oxidation)
- Removal of Cr⁶⁺ and Other Salts with UF / RO / ED Systems
- Processing of Liquid Waste Contaminated with Uranium, Heavy Metals and Other Potentially Toxic substances
- Removal of U & Pu from Liquid Waste Generated in the Fuel Processing Cycle

- Stabilization
- Incineration
- Liquid Waste Treatment

2-5

List of Hazardous Waste Management Technologies

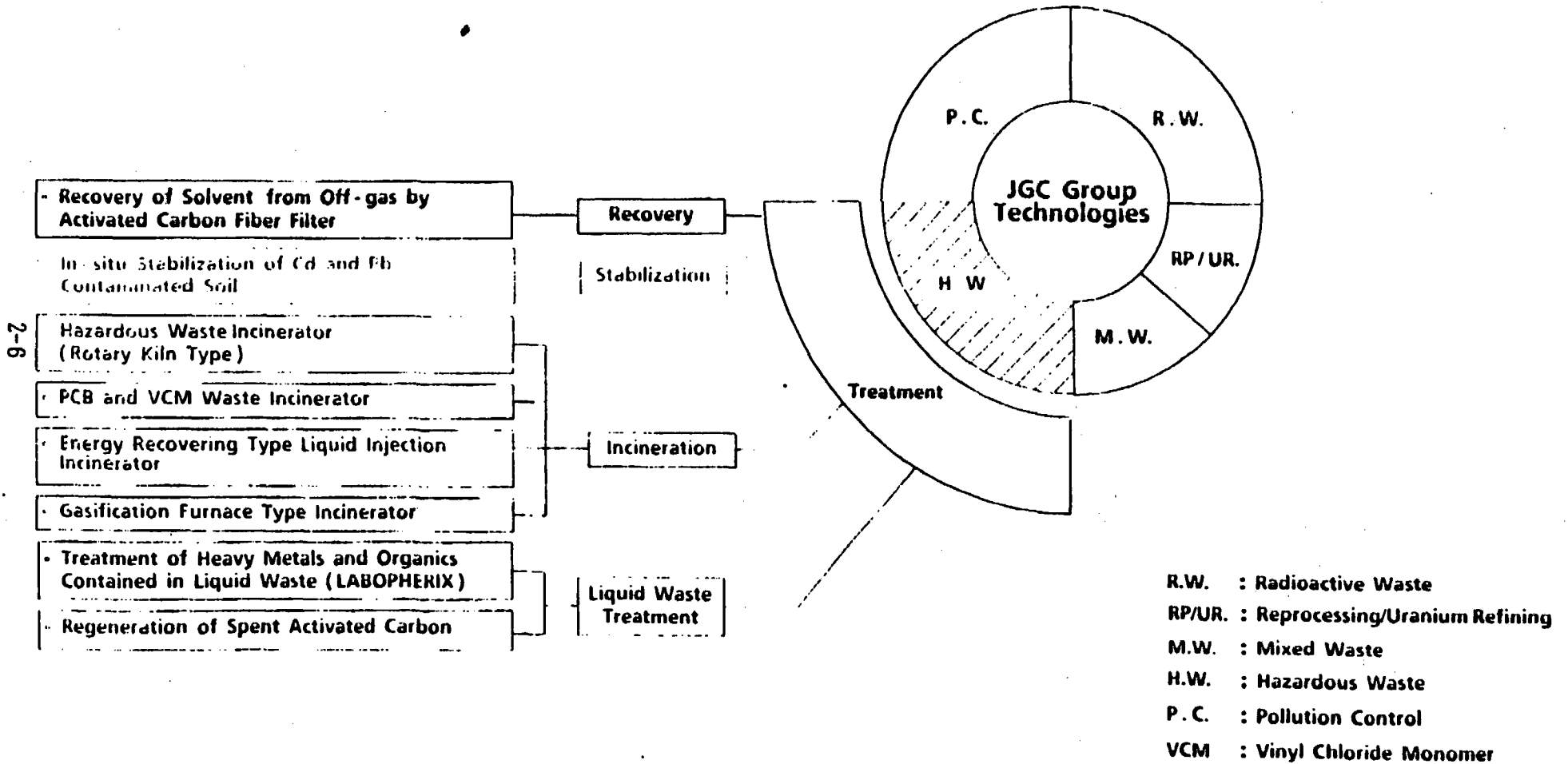

List of Pollution Control Technologies

- Separation of Oil from Liquid Waste (CPI/SPI)
- Desulfurization (Moretana)
- Denitrification (Paranox)
- Odor Removal (Catalytic Oxidation)
- Vertical Swirl Sludge Melter System
- Sewage Sludge Centrifuge
- Sewage Waste Dehydration
- Sewage Sludge Composting

- Liquid Waste Treatment
- Off-gas Treatment
- Sewage Treatment

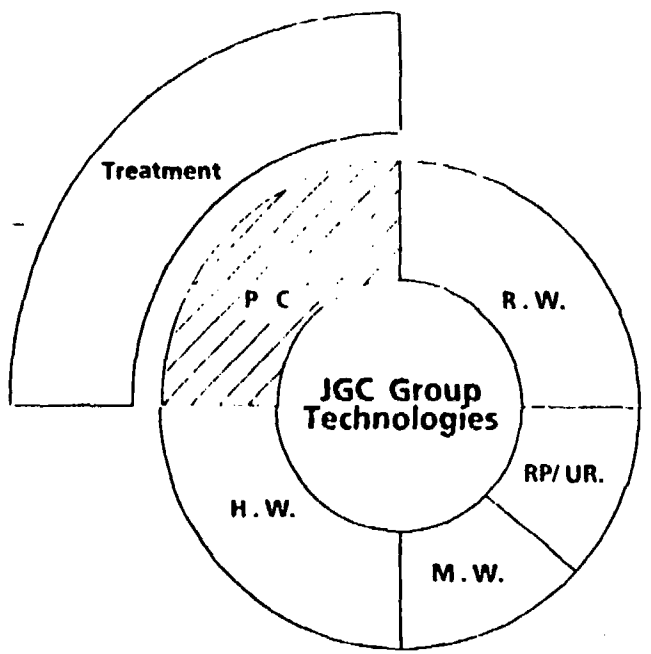

- R.W. : Radioactive Waste
- RP/UR. : Reprocessing/Uranium Refining
- M.W. : Mixed Waste
- H.W. : Hazardous Waste
- P.C. : Pollution Control

PART 4

MIXED / HAZARDOUS
WASTE MANAGEMENT
TECHNOLOGIES

TABLE OF CONTENTS

<u>No.</u>	<u>Title</u>
1.	Automated Waste Container Management System
2.	RASEP / Uranium - Selective Resin
3.	On - Site Stabilization Process (OSSP)
4.	Advanced Cement Solidification
5.	Wet Oxidation
6.	High Temperature Incineration
7.	Other Technologies



JGC's Automated Waste Container Management System (AWCMS) *Proposed in response to INEL's PRDA*

The JGC Automated Waste Container Management System (AWCMS) builds on JGC's drum inspection system already tested and currently being commercially installed in Japan to inspect, classify and label drums of solidified power reactor waste. The current system conducts a series of automated checks to determine compliance to packaging requirements, including the presence of surface contamination, and then scans the package for gamma radiation to perform a fully automated radioassay of the contents. The system then classifies the waste according to Japanese requirements and applies appropriate color-coded labels. Finally, the system records the results of all the inspections, and a video image of the drum on a micro floppy disk. The research and development work proposed in response to the PRDA at INEL would extend the technology to include checks for internal free liquids and perform a radioassay for alpha-emitting isotopes, as well as to determine which technologies would be economically appropriate to include in a system to process the tens of thousands of DOE waste drums awaiting inspection, classification, and disposition.

The demonstration facility at the JGC Nuclear Research Center in Oarai includes four stations, one each for:

- o Recording a video image of all surfaces of the package
- o Performing a surface contamination smear test
- o Performing a gamma radioassay of the drum
- o Classifying and labeling the inspected drum

The entire process is automated and computerized to reduce error, limit operator exposure, and to minimize manpower requirements.

In addition to the systems in the demonstration facility, JGC has developed and implemented additional systems to non-destructively check the compressive strength of the waste form, and to check for voids in the drum. These systems are being incorporated into systems being implemented in Japan, and prototypes demonstrating their operation have been built. These prototypes are currently on location at customer sites to verify their performance on actual waste drums scheduled for future shipping.

The technology to perform non-destructive radioassays of alpha-emitting waste containers is still emerging. While basic research to perform this kind of inspection has been completed, it has not yet been adapted to an automated system, nor has it been used for large inspection campaigns like those required by DOE. Non-destructive/non-invasive methods for detecting free liquids within the drums also have not yet been automated, and some basic research remains to determine which combination of technologies might most reliably detect significant free liquids.

However, the ability to reliably and efficiently inspect the undocumented, often poorly stabilized containers of TRU and suspected TRU in the DOE inventory could provide significant cost savings in the final disposition of these wastes. In addition, successful implementation of the AWCMS would provide a very high level of confidence in the actual condition and classification of these wastes.

of Radioassay in Decontamination System

PRACTICABLE ASSAY SYSTEM FOR RADIONUCLIDE QUANTIFICATION OF DISPOSAL PACKAGES

T. Yagi, T. Kato, N. Hashimoto, H. Kuribayashi, Y. Moriya
JGC Corporation

ABSTRACT

The requirements for land disposal of LLW from nuclear power plants and facilities have necessitated a more complete and accurate analysis of the radionuclide contents of waste packages.

JGC has developed a new direct assay technique based on gamma-ray spectroscopy and total gamma-ray counting, combined with a scaling factor methodology for difficult-to-measure nuclides.

The system consists of an HpGe detector, a plastic scintillator, a microcomputer and a waste package handling system such as a turntable.

The radioactivity concentrations of Co-60 and Cs-137, which are key nuclides for difficult-to-measure nuclides, are calculated from the activity ratio of Co-60 to Cs-137 measured by using an HpGe detector and total radioactivity is measured by using a plastic scintillator.

The concentrations of difficult-to-measure nuclides in a waste package are calculated by combining the radioactivity concentrations of Co-60 and Cs-137 with the waste package data and scaling factors.

The system is simple and enables a complete analysis of all nuclides specified prior to shipment and disposal of waste packages, and also ensures that not only homogeneous solidified waste but also nonhomogeneous DAW (dry active waste) can be measured within a short time.

INTRODUCTION

In land disposal of radioactive solid waste generated at nuclear power plants, it is necessary to assay radionuclides contained in waste packages for the safe operation of the disposal site.

Important nuclides from the standpoint of land disposal are Co-60 and Cs-137.

In addition, difficult-to-measure nuclides such as C-14, Ni-63, Sr-90, etc. are also listed (see Table I).

In shipping waste packages from nuclear power plants to the disposal site, confirmation of the contents of these nuclides is also required in compliance with disposal package technical package requirements.

Considering such background needs, JGC has been developing the most suitable radionuclide assay technique for nuclear power plants since 1983 and has developed a new radionuclide assay system which combines the scaling factor method and the gamma scanning and gross gamma counting method.

This radionuclide assay system is essentially simple in nature. It is capable of counting the radioactivity of not only homogeneous solidified waste but also nonhomogeneous waste within a short time, and due consideration has been given to the suitability of the confirmation techniques applied in waste package shipment.

The principle, composition, performance, etc. of the radionuclide assay system based on the gross gamma method are explained below.

SYSTEM CONCEPT

In order to assay the radioactivity content specific to nuclides in shipping waste packages from nuclear power stations, a radionuclide assay system suitable for this purpose must be developed with consideration given to the following matters.

- Capable of assaying α and β nuclides which are important in land disposal.
- Applicable to waste which is varied in type, size, and weight.
- Capable of covering the measurement of extensive radioactivity concentrations (most DAW is distributed in the extremely low level region).
- Simple system and short measuring time.

To solve these problems, JGC has developed a new radionuclide assay system based on the following approaches.

- Evaluation of the correlation between difficult-to-measure nuclides and key nuclides and data verification.
- Simple nondestructive direct measurement of key nuclides.

TABLE I

Activity Concentration Limits of LLW Burial in Japan

(γ Ci/g)

C - 14	1×10^0
Co - 60	3×10^2
Ni - 63	3×10^1
Sr - 90	2×10^0
Cs - 137	3×10^1
TRU	3×10^{-2}

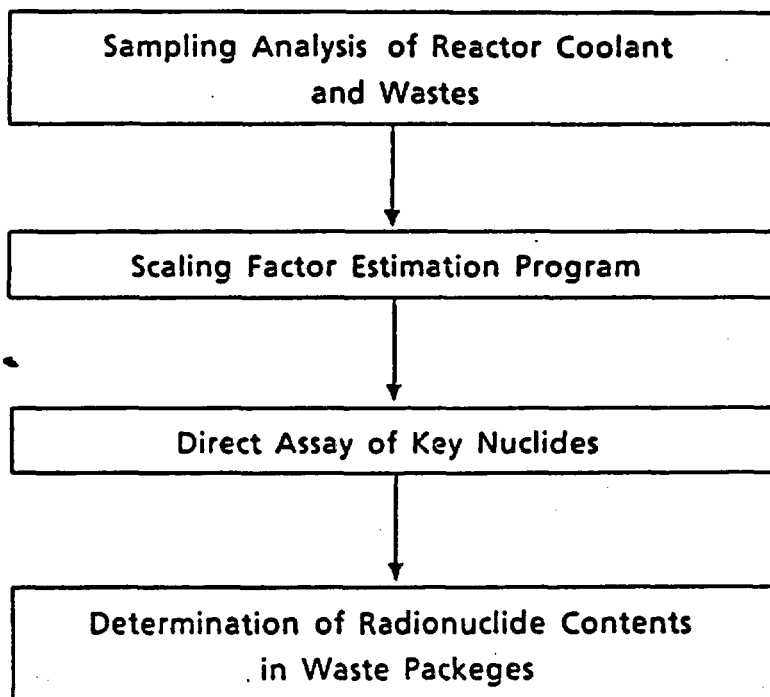

Fig. 1. Concept of Assaying Radionuclides in Waste Package.

Yagi RADIONUCLIDE QUANTIFICATION OF DISPOSAL PACKAGES

As shown by Fig. 1, the former approach has been attained basically by establishing a scenario for nuclide behavior in nuclear reactor systems and determining the correlation between key nuclides and difficult-to-measure nuclides (C-14, Ni-63, Sr-90, TRU nuclides, etc.).

The latter approach is based on the method in which the radioactivity of key nuclides is assayed by selecting Co-60 as a key nuclide for CP nuclides (and C-14, TRU nuclides) and Cs-137 as a key nuclide for FP nuclides from among the nuclides important from the standpoint of land disposal, then measuring the ratio between Co-60 and Cs-137 and the total gamma radiation. (Co-60 is used as an empirical key nuclide for C-14 and Cs-137 for TRU nuclides.)

This system is intended to be used for the nondestructive inspection of waste packages before shipment. Therefore, in settling its target performance, due consideration must be given to the trend of applicable laws and regulations, and the actual conditions of the waste.

Trial calculation results have been obtained which indicate that if the radioactivity concentrations of Co-60 and Cs-137 can be measured to 10^{-4} $\mu\text{Ci/g}$ or so, there is no effect on the disposal capacity which is important in safety evaluation, when the trend of applicable laws and regulations up to the present is considered.

From the conditions of actual waste at nuclear power plants, it is found that especially the radioactivity concentration of DAW is distributed in a wide range centering around the low concentration region. Therefore, measures to cover every type of waste package are required and the range of the relative concentration ratio between Cs-137 and Co-60 must be considered.

Considering these requirements, the target performance of our system is as follows.

Measuring range	: $10^{-5} - 10^{-1}$ $\mu\text{Ci/g}$
Measuring Cs-137/Co-60 ratio	: 1/100
Measuring time	: 5 minutes

BASIC PRINCIPLES

As shown by Fig. 2, in this nuclide assay system, the concentrations of radionuclides contained in waste packages are estimated by measuring the radioactivities of Cs-137 as a key nuclide for FP nuclides and Co-60 as a key nuclide for CP nuclides and considering scaling factors, half-lives, etc.

The gamma-ray counts from any point inside a drum of waste can be expressed by the following equation on condition that no consideration is given to the background gamma-ray.

$$\sum_{i=1}^n Ni(E) = \epsilon(E) \sum_{i=1}^n Si(x,y,z,E) \cdot \frac{\Omega_i(x,y,z)}{4\pi} \cdot \exp(-bi(x,y,z,E)) \quad (1)$$

Where, $Ni(E)$: Detector count of the radiation from the radiation sources Si

$\epsilon(E)$: Detection efficiency for each energy

$Si(x,y,z,E)$: Intensity of the radiation source inside the drum

$\Omega_i(x,y,z)$: Detector solid angle as seen from the radiation source Si

$bi(x,y,z,E)$: Attenuation distance from radiation source Si to the detector

Eq. (1) indicates that the gamma-ray counts at the detection point depends on the geometrical efficiency at any point inside the package and the attenuation distance between the radiation source and the detector.

In this system, the geometrical efficiency at any point inside the drum is made constant by measuring the gamma-ray flux radiated from the whole circumferential surface of the drum and correction for attenuation is made based on the mean density of the waste (weight/volume).

Thus, Eq. (1) is expressed as follows.

$$\sum_{i=1}^n Si(x,y,z,E) = \frac{\sum_{i=1}^n Ni(E)}{\epsilon(E) \cdot \frac{\bar{\Omega}_i}{4\pi} \cdot \exp(-\bar{b}_i(E))} \quad (2)$$

As the measured value $Ni(E)$ is a function of energy, it is necessary to identify the nuclides to be measured.

Assuming that the nuclides to be measured are Co-60 and Cs-137:

$$\sum Si^{60\text{Co}} = \frac{\sum_{i=1}^n Ni(^{60}\text{Co})}{\epsilon(^{60}\text{Co}) \cdot \frac{\bar{\Omega}_i}{4\pi} \cdot \exp(-\bar{b}_i(^{60}\text{Co}))} \quad (3)$$

$$\sum Si^{137\text{Cs}} = \frac{\sum_{i=1}^n Ni(^{137}\text{Cs})}{\epsilon(^{137}\text{Cs}) \cdot \frac{\bar{\Omega}_i}{4\pi} \cdot \exp(-\bar{b}_i(^{137}\text{Cs}))}$$

As the plastic scintillator is incapable of spectroscopic analysis, it is impossible to distinguish Co-60 and Cs-137 from each other. Therefore, the Cs-137/Co-60 ratio must be measured using another detector. This system uses a Ge semiconductor detector for this purpose.

In this system, in order to make the geometrical efficiency constant, the mean geometrical efficiency is raised

Yagi RADIONUCLIDE QUANTIFICATION OF DISPOSAL PACKAGES

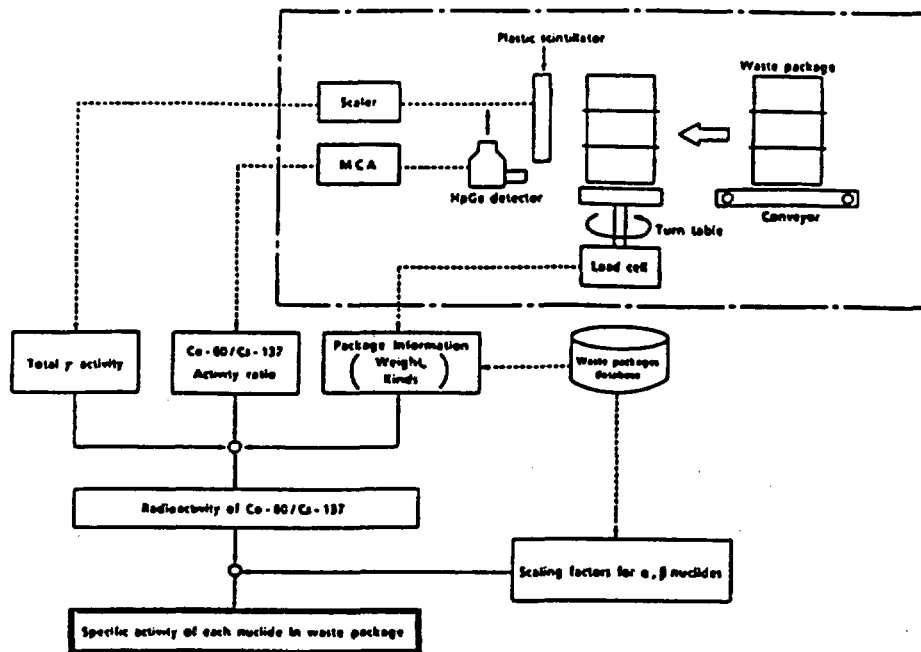

Fig. 2. Schematic Diagram of Nuclide Assay System

to 0.5 - 0.6 by rotating the drum and disposing the plastic scintillator so as to cover the overall height of the drum.

APPLICATION TO WASTE PACKAGES

As described above, the radiation incident on the scintillator from the sources contained in the waste package is expressed by Eq. (1) and varies in accordance with the location of the sources and the effects of the attenuation depending on the waste type.

In order to ensure accurate measurements, it is therefore necessary to make corrections after grasping the condition of the content of the package or to devise a measurement method which is not easily affected by the condition of the content.

In the case of homogeneous solidified waste, the density of the content and the distribution of radioactivity are uniform. Therefore, once the solidifying agent used and the target nuclides are determined, the variables used in the equations can be made constant and accurate measurements can be ensured.

In the case of DAW packages, however, the kind of waste, packing condition, contamination pattern, etc. are varied and the measured values are affected by these conditions.

The effects of these conditions are observed as the attenuation of radioactivity in waste packages. For instance, the measured values become large when nuclides exist near

the drum surface and become small when they exist in the center of the drum.

Such difference in the measured values becomes larger as the density of the content of the drum becomes larger.

In this system, the amount of radioactivity is counted as the gross gamma radiation dose whose energy region is not specified.

Radiation is attenuated due to the scattering of radiation by the contents of packages, but in this system, such scattered rays are also counted together.

It is known that the degree of scattering tends to increase as the density of the content becomes higher and as the transmission distance in materials becomes longer.

Therefore, even if materials having a large attenuation effect unevenly exist in the drum, the influence of such materials can be averaged by measuring the gross gamma radiation dose from various directions but not from a particular direction.

As described above, this system is aimed at correcting measurements for the effects of the uneven distribution of density and radionuclides in waste packages and also improving the measuring time and the detection limits by providing several detectors.

Yagi RADIONUCLIDE QUANTIFICATION OF DISPOSAL PACKAGES

BASIC SYSTEM SPECIFICATIONS

The basic system specifications are shown in Table II and each item is detailed below. A photograph of the prototype assay system is shown in Fig. 3.

1. Waste packages to be measured

The standard system is calibrated to measure the radioactivity of 200-liter drum waste packages. The system is also applicable to waste packages of other drum sizes by being calibrated. Concerning the kinds of waste to be measured, the system is also applicable to homogeneous solidified waste and DAW.

2. Nuclides to be measured

In principle, the nuclides to be measured are Co-60 and Cs-137, which are the key nuclides in the scaling factor method. However, an optional device permits the measurement of the key nuclide concentration even if waste packages specific to sites contain interfering nuclides such as Mn-54.

The concentrations of difficult-to-measure nuclides such as Ni-63, Sr-90, etc. are calculated based on the data base, using the scaling factor method.

3. Measurable activity

The system is capable of measuring the radioactivity up to approximately 0.1 $\mu\text{Ci}/\text{drum}$ as gamma-ray radioactivity (for Co-60 when the bulk density of waste packages is 0.5).

4. Measuring time

The standard measuring time is 3 minutes but selection can be left to the operator's selection.

Data processing requires about 2 minutes.

5. Detectors

A high-purity Ge semiconductor detector is used to measure the Cs-137/Co-60 ratio, and a plastic scintillator is used to measure the gross gamma radiation dose.

6. Operation control

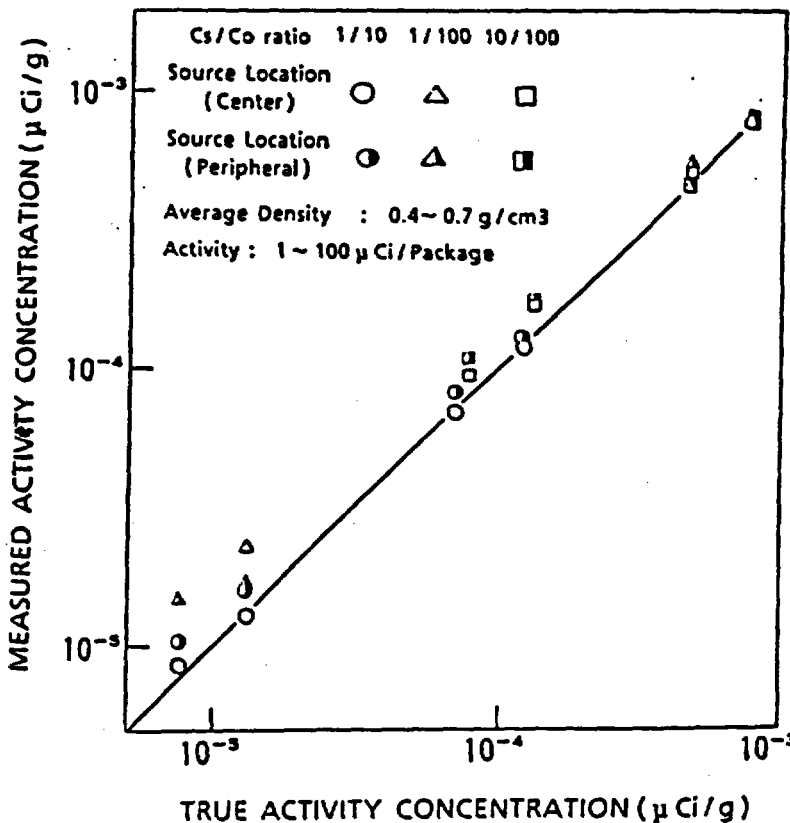

Fig. 4. Measurement Results of Pattern Test.

The operation of the system is automatically controlled by a computer. All waste package information can be inputted by interfacing with the computer using the keyboard. (The system can be connected to a superior computer system.) As-measured data, i.e., MCA spectrum data and scaler counts are stored in a floppy disk to permit easy retrieval of past measured data and easy erasure of unnecessary data.

SYSTEM PERFORMANCE

The performance of this system was evaluated stepwise firstly by a pattern test, then a full-scale simulated waste package test, and finally an actual waste package test. Especially in applying this system to DAW packages, such an approach is important because it is impossible to specify the geometrical configuration and the distribution of density and radioactivity in such a package.

An example of the results of each test is described below.

1. Pattern test

In this test, measurements were conducted by preparing a simulated waste package whose inside was divided into several segments so that the density of waste in each segment could be changed, and placing a standard radiation source in the specified position inside the package.

An example of the measurement results is shown in Fig. 4.

2. Full-scale simulated waste package test

In this test, more realistic measurements were conducted, using full-scale simulated waste packages similar to actual ones in the aspects of configuration and material, which were obtained by extending a model package. A single scaled radiation source was used in this test.

3. Actual waste package test

In this test, a reference simulated waste package was used for calibration purposes, and then performance tests were carried out by using actual waste packages (cement packages and DAW packages).

The tests on the cement packages were conducted to ascertain the calibration constant, and it was

confirmed that errors in the key nuclides measurements were within 5%.

The results of the measurements of the key nuclides were compared with the activity of difficult-to-measure nuclides, which was estimated by the scaling factor method and also with that of the core sample which was analyzed by a manual method.

The tests on DAW were implemented to check for errors due to changes in the filling pattern of radwaste, and it was established that the deviation factor was within $\pm 5\%$ at 1σ when the bulk density was 0.5 g/cm^3 .

CONCLUSION

This system is very simple in mechanism and capable of assaying all radionuclides which are important from the standpoint of land disposal. In addition, it is widely applicable to not only homogeneous solidified waste packages but also nonhomogeneous DAW packages. Therefore, this system can be said to be most suited for nondestructive inspection required in shipping waste packages from nuclear power plants to disposal sites. In future studies, more extensive simulation tests and site verification tests will be continued further and the scaling factor estimation program will be improved.

FULL-SCALE TESTING OF WASTE PACKAGE INSPECTION SYSTEM

T. Yagi, H. Kuribayashi, Y. Moriya, H. Fujisawa,
N. Takebayashi
JGC Corporation, Japan

ABSTRACT

In land disposal of low-level radioactive waste (LLW) in Japan, it is legally required that the waste packages to be disposed of be inspected for conformance to applicable technical regulations prior to shipment from each existing power station.

JGC has constructed a fully automatic waste package inspection system for the purpose of obtaining the required design data and proving the performance of the system.

This system consists of three inspection units (for visual inspection, surface contamination/dose rate measurement and radioactivity/weight measurement), a labelling unit, a centralized control unit and a drum handling unit.

The outstanding features of the system are as follows: The equipment and components are modularized and designed to be of the most compact size and the quality control functions are performed by an advanced centralized control system.

As a result of the full-scale testing, it has been confirmed that this system satisfies all the performance requirements for the inspection of disposal packages.

The treatment capacity, operability and data control functions of this system were also checked and confirmed in the full-scale testing of the system.

The results of the performance tests show that JGC can establish the most rational and economical waste package inspection system applicable to any nuclear power station.

INTRODUCTION

At present, approximately 440,000 drums filled with LLW are stored at nuclear power stations in Japan: of them, some drums contain solidified waste having "barrierability" and some contain untreated miscellaneous solid wastes.

In accordance with the Nuclear Installation Regulation Law revised in 1986, and the Waste Burial Regulation and related notifications established in 1988, various items of work concerning the transportation to and the burial disposal of wastes at the Radioactive Waste Storage Center which will be constructed in Rokkasho Village, Aomori Prefecture, are being conducted by national and private organizations for the commencement of the operation of the Center in 1991.

Waste package shipping inspection facilities are being planned at each nuclear power station in Japan for shipping several thousand to dozen thousand waste packages per year.

Waste package shipping inspection facilities are being planned at each nuclear power station in Japan for shipping several thousand to dozen thousand waste packages per year.

This report will discuss the concept of LLW shipping inspection and introduce one example of the structuring of a nondestructive inspection system.

BASIC CONCEPT OF INSPECTION OF WASTE PACKAGES

If the plan for burial disposal is put into practice, the waste stored at each nuclear power station will be transported to the storage center where it will be buried in a concrete pit and controlled therein for several hundred years. (See Fig. 1.)

Thus, the entirely different circumstances of the waste packages, including other barriers such as the concrete pits and earth strata, will enable their long-term safe disposal.

Accordingly the shipping inspection, the preparation of base data is required to ensure the control of the safety of packages as minimum units.

Therefore, in the case of the inspection of waste packages at the power station, it is important to not only inspect the external appearance of packages but also the quality of their contents and the history after the generation of the waste. Furthermore, it is essential to evaluate and confirm the results accurately and rationally.

It is necessary to ensure the quality of waste packages by obtaining evaluation data for the technical criteria based on a combination of information from (See Table I.):

(1) Waste and process control program

Operation control and quality control data, such as the waste content code, operation records of the waste treatment facilities and the certifications of solidification materials and containers.

(2) Nondestructive inspection

Data obtained by conducting nondestructive inspections of waste packages (surface contamination density, radioactivity concentration, etc.).

(3) Sampling program

Sampling analysis data such as radioactivity concentration data for each type of nuclide and product property evaluation test data (compressive strength, leachability, etc.).

WASTE PACKAGE INSPECTION DEMONSTRATION PLANT

The commercial-scale demonstration plant constructed at JGC's Nuclear Research Center is an example of waste package inspection facilities based on the above basic concept of waste package inspection. (See Fig. 2.)

This demonstration plant is designed to conduct five types of inspection (visual inspection, surface contamination density measurement, dose rate measurement, radioactivity measurement and weight measurement).

It is a fully automatic module system whose inspection equipment, labelling unit, handling unit and centralized control system have been developed and designed to be rational and practical.

The major components of the system are as outlined below.

Yazı **WASTE PACKAGE INSPECTION SYSTEM**

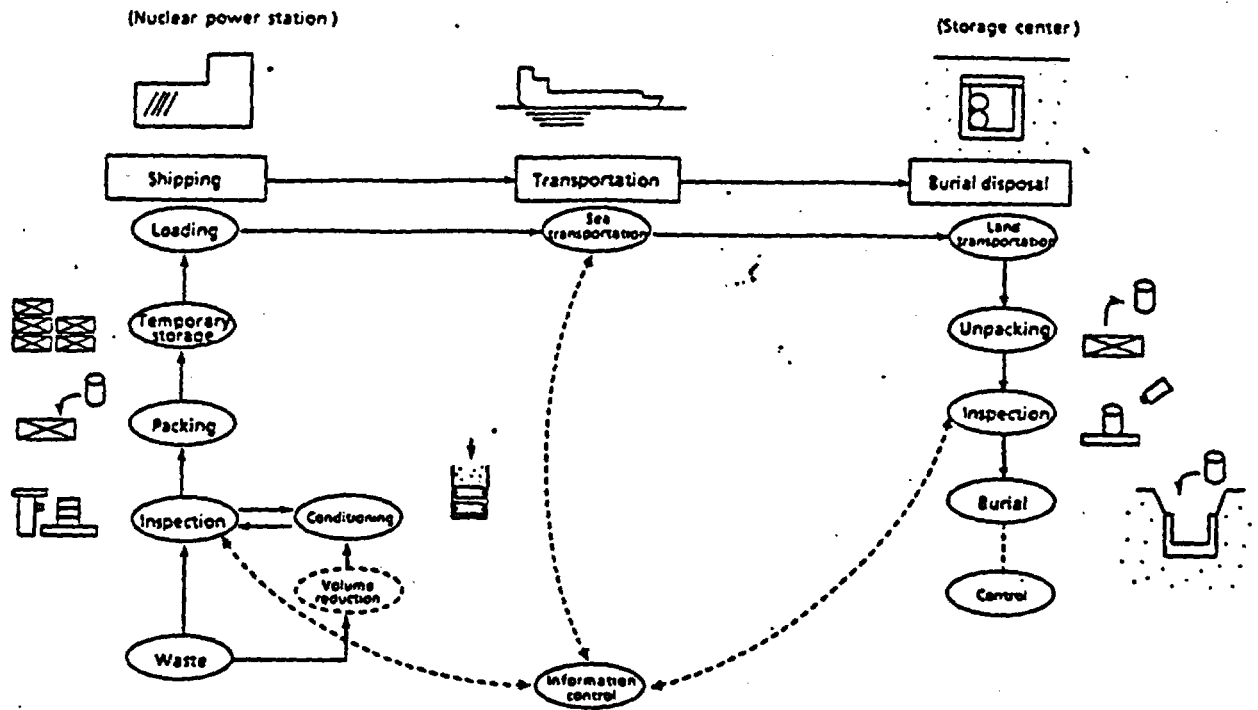

Fig. 1. Concept of LLW Disposal System.

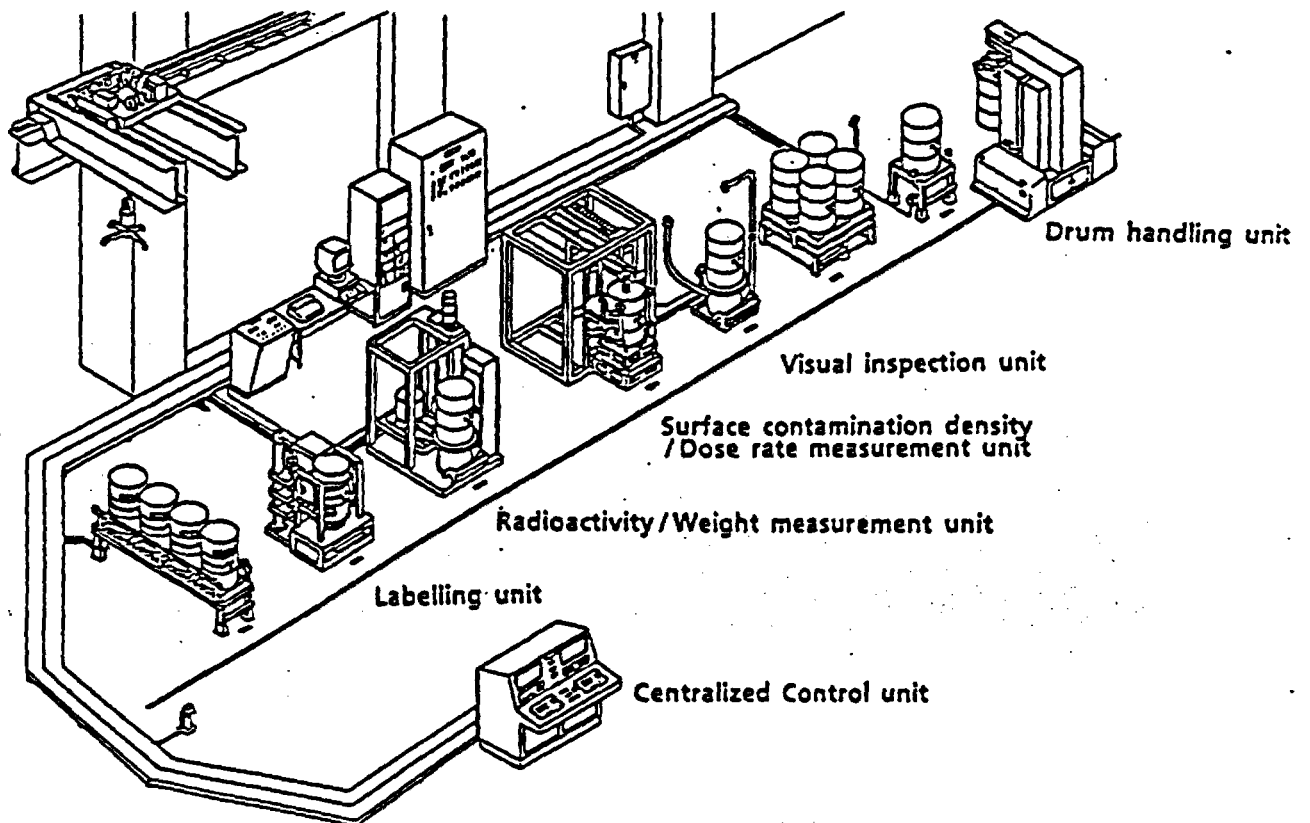

Fig. 2. Waste Package Inspection Demonstration Plant.

Visual Inspection Unit

The surfaces of the waste package are all visually checked by using three ITV cameras; one for the top surface, a second for the side surface and a third for the bottom surface.

The image of the waste package is displayed on the monitor screen of the central control unit and recorded on a video floppy disk. (See Fig. 3.)

Surface Contamination/Dose Rate Measurement Unit

The surface contamination density and the surface dose rate of the waste package are automatically measured.

Smear samples (smear pads with which the surfaces of the waste package are wiped) are taken from four locations, the top surface, upper side surface, lower side surface and bottom surface, and each sample is checked to determine the surface contamination density.

At the same time, the surface dose rate is measured by the sensor built into the smear sampling portion.

This unit is designed to carry out all of these operations (sampling, measurement, calculation and smear pad replacement) automatically.

Radioactivity/Weight Measurement Unit

This unit determines the radioactivity concentration of the waste package nondestructively for each type of nuclide contained therein.

The unit consists of a spiral scanning Ge semi-conductor sensor, a plastic scintillator, calculation software and a

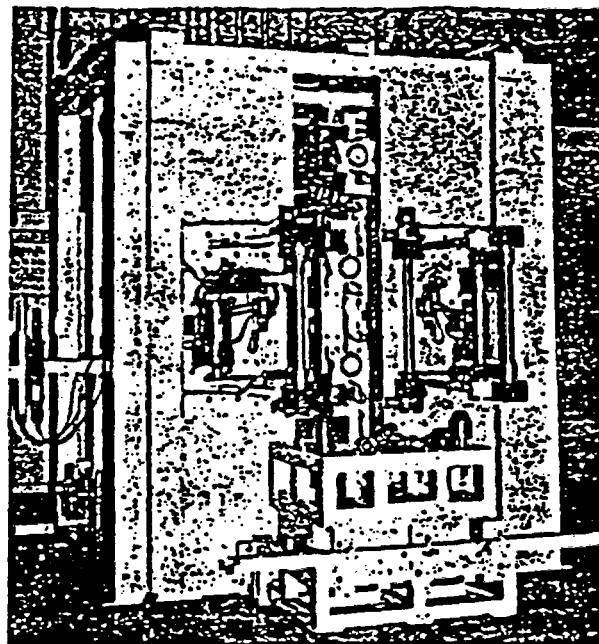

Fig. 4. Surface Contamination/Dose Rate Measurement Unit.

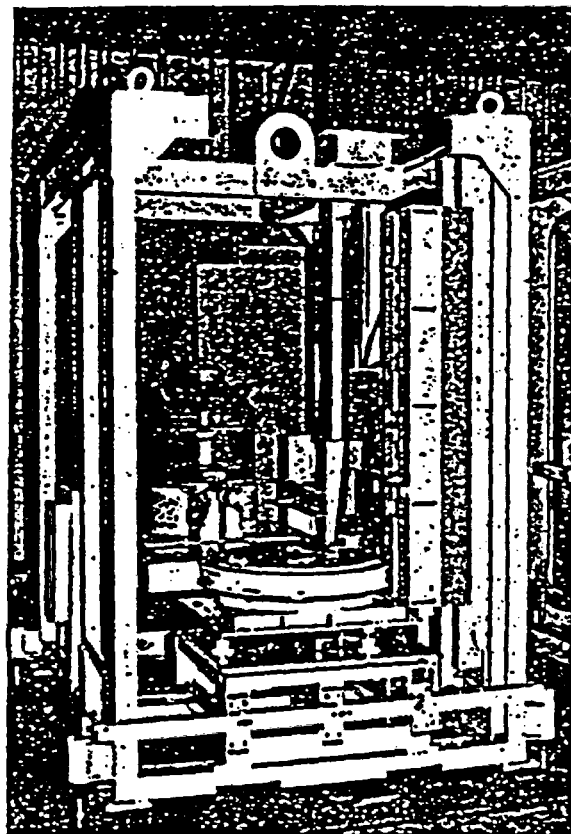

Fig. 5. Radioactivity/Weight Measurement Unit.



Fig. 3. Visual Inspection.

TABLE I
Qualification of Waste Package for Disposal

Regulation	Qualification Method		
	NDI	PCP	SP
1. Solidification Binder		●	
2. Waste Container	○ (UT)	●	
3. Compressive Strength (Cement)	○ (Ultrasonic Speed)	●	○
4. Hardness (Plastic)	○ (Durometer)	●	○
5. Mixing Ratio (Bitumen, Plastic)		●	○
6. Homogeneous Mixing		●	○
7. Void	○ (Ultrasonic Speed)	●	
8. Activity Concentration	● (γ Scanning)	●	● (α, β Nuclide Analysis)
9. Surface Contamination Density	● (Smear Method)		
10. Chemicals		●	
11. Stackability		●	
12. Package Damage	● (ITV) ○ (UT/Thermography)		
13. Weight	●		
14. Surface Dose Rate	●		
15. Labelling	●		

(Property Test)

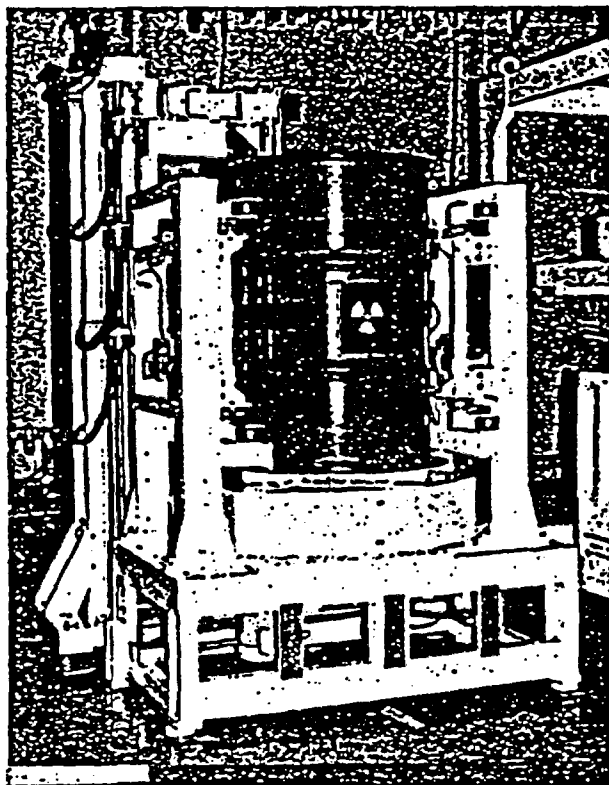

Fig. 6. Labelling Unit.

turntable with a load cell. (See Fig. 5.)

The radioactivity concentration is determined for each type of nuclide from the total dose (plastic scintillator), γ scaling factors for difficult-to-measure nuclides and γ nuclides, which is available from the data base.

Labelling Unit

This unit labels the waste package with a color band to classify surface dose rates. It also affixes stickers indicating identification numbers for shipping and disposal management after the completion of the abovementioned five types of inspection. (See Fig. 6.)

Color bands (white, orange and red) are automatically selected based on the surface dose rate measurement results and attached to the waste package. The identification numbers are automatically marked on the yellow base labels by heat transfer printing.

This labelling is conducted automatically by recognition of the radiation warning symbol marked on the waste package, using an optical sensor.

Centralized Control Unit

This unit automatically controls each inspection unit and the drum handling unit.

Data on each waste package are received into this system and inspection data from each inspection unit are processed. Daily reports, inspection reports and shipping management data are then prepared.

TEST RESULTS

Performance tests of each inspection unit were conducted and the capacity, workability and measurement accuracy of each unit were evaluated. As a result, it has been ascertained that each unit is capable of achieving the

Yagi WASTE PACKAGE INSPECTION SYSTEM

performance required for the waste package inspection. (See Table II.)

The capacity, operability and data processing functions the entire system were checked by conducting the overall operation of the system.

It has been confirmed that the system can inspect one waste package every 10 minutes. The system can be used at almost all power stations even if the inspection modules are not expanded.

It has also been confirmed that the data processing functions of the system are satisfactory for the confirmation of the data on the waste packages to be disposed of.

FUTURE DEVELOPMENT

Regarding "package damage" and the "compressive strength" of cement solidified waste shown as disposal inspection items in Table I, since there is a possibility that further precise qualification may be required in the future, JGC is proceeding with the development of the following automatic nondestructive inspection units:

Drum Integrity Inspection Unit

This unit is designed to heat the package uniformly by high frequency inductive heating and to check the package for corrosion and damage, sensing the infrared rays from

the package by thermography and inspecting by an ultrasonic thickness gauge. (See Fig. 7.)

Compressive Strength Measurement Unit

This unit utilizes the correlation between the compressive strength of the solidified waste and the velocity of the ultrasonic wave propagation through the waste.

The pulsar and receiver probes are attached to the side surface of the waste package and ultrasonic waves are emitted. (See Fig. 8.)

The compressive strength of the waste in the package is determined from the ultrasonic wave propagation velocity.

CONCLUSION

JGC's waste package inspection system is an overall waste package quality control system for the land disposal of LLW.

By using this system, it is possible to provide the data required to ensure the safety of land disposal of waste packages by means of data management from the nuclear plant to the land disposal facility.

From this standpoint, we have shown one concept of waste package inspection and taken up JGC's demonstration plant as an example.

TABLE II
Results of Performance Test

<u>Module</u>	<u>System</u>	<u>Required time</u>	<u>Performance</u>
1. Visual inspection unit	Remote ITV	3 min	3 mm defects detectable
2. Surface contamination density / Dose rate measurement unit	Automatic smear method / Automatic whole surface scanning	8 min	Smear efficiency : 90% Measurement limit : $1 \times 10^{-4} \mu\text{Ci}/\text{cm}^2$ Measurement range : 0.1 - 2000 mR/h
3. Radioactivity / Weight measurement unit	Spiral scanning / Load cell	5 min	Measurement nuclides : γ nuclides Measurement limit : $1 \times 10^{-5} \mu\text{Ci}/\text{g}$ (Co-60) Fluctuation factor : $\pm 20\%$
4. Labelling unit	Automatic lettering and labelling	4 min	Labelling accuracy : $\pm 15 \text{ mm}$

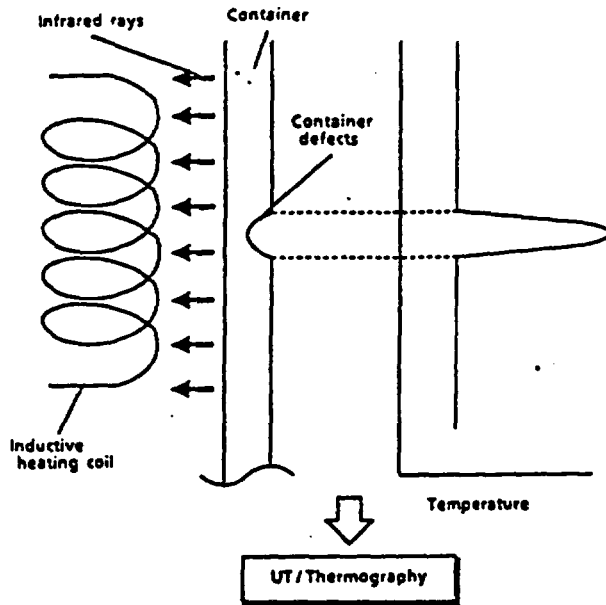

Fig. 7. Principle of Drum Integrity Inspection.

In Japan, at present, various committees and working groups are proceeding with the studies and reviews of the inspection of waste packages for land disposal, and, accordingly, opinions are not uniform.

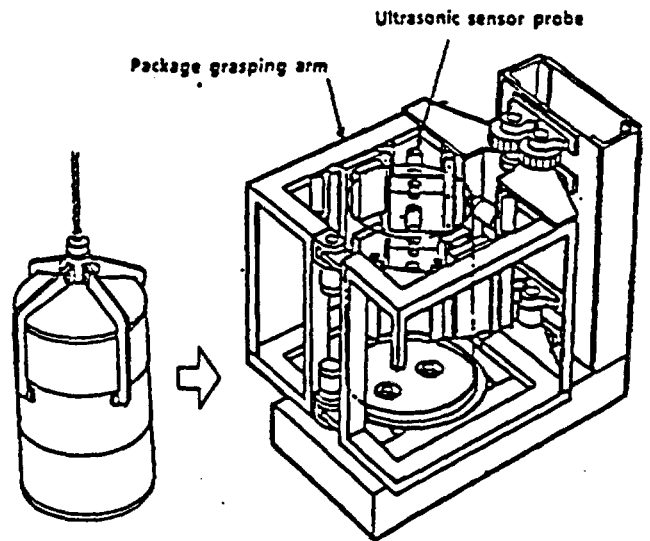

Fig. 8. Compressive Strength Measurement Unit.

Under these circumstances and in view of future LLW disposal regulatory changes, JGC intends to establish a further improved, rational, overall waste package inspection system.

**NONDESTRUCTIVE COMPRESSIVE STRENGTH INSPECTION SYSTEM
FOR
CEMENT-SOLIDIFIED WASTE PACKAGES**

O. Nagiwa, Y. Itoh, K. Sugai
Tokyo Electric Power Company, Tokyo, Japan

T. Ujihara, I. Oda, Y. Yoshida
Tokyo Electric Power Environmental Engineering Co., Inc.
Tokyo, Japan

T. Yagi, N. Takebayashi, M. Kado
JCC Corporation, Tokyo, Japan

INTRODUCTION

In land disposal of low-level radioactive waste (LLW) in Japan, it is legally required that waste packages to be disposed of be verified for conformance to applicable technical regulations prior to shipment from each existing power station to the Radioactive Waste Storage Center. Concerning the physical properties of cement-solidified waste packages, technical regulations require verification that the compressive strength of the waste packages exceeds 15 kg/cm^2 . Although the conformity to this requirement may be verified indirectly by reviewing such documents as solidification records, the ultrasonic pulse velocity method is considered to be effective when nondestructive inspection is required. Thus, a nondestructive compressive strength inspection system was developed considering the actual conditions of the cement-solidified waste packages.

PRINCIPAL DEVELOPMENT ITEMS

In developing this system, the following points were given special consideration.

A. Transmission of ultrasonic waves into the cement-solidified product

In order to measure the pulse velocity in a cement package, it is necessary to transmit ultrasonic waves into the solidified product through the steel drum. A slight contraction of the cement may occur during solidification leaving a small gap between the drum wall and the cement-solidified product. To solve this problem, the receiving and transmitting transducers were closely pressed against the drum wall and an appropriate ultrasonic wave frequency was selected so that ultrasonic waves propagated in the solidified product.

In securing the transducers on the drum wall, the contact pressure was set in the range of $10 - 30 \text{ kg/cm}^2$ and the transducer ends were tapered so as to lower the hydraulic pressure. (See Figure 1.)

In addition, in order to select an appropriate transmission frequency, tests were conducted using three transmitting transducers of 24, 34, and 100 kHz. A frequency of 34 kHz was selected as the transmission frequency.

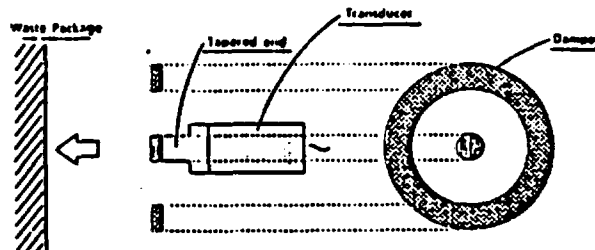

Fig. 1 Surface wave attenuation mechanism

B. Surface waves and direct waves

As the pulse velocity is measured from the outside of the package, two kinds of waves are received by the receiving transducer: waves propagating in the solidified product (direct waves) and waves propagating on the surface of the steel drum (surface waves).

The transit time of the direct waves is approximately $150 - 180 \mu \text{ sec}$ and that of the surface waves is about $165 - 170 \mu \text{ sec}$. Therefore, if the direct waves are slower than the surface waves, the surface waves or the composite waves consisting of the surface and direct waves will be measured at the wave receiving point. For this reason, it is necessary to reduce the influence of the surface waves. To solve this problem, a close contact mechanism was provided around the transducers as shown in Figure 1 so that the surface waves could be attenuated in the contact zone by bringing the cement-solidified product into close contact with the steel drum wall. The contact pressure was set in the range of $10 - 30 \text{ kg/cm}^2$ which was equivalent to the contact pressure of the transducers.

OUTLINE OF INSPECTION SYSTEM

A full-scale inspection system was constructed in consideration of the above. The main components of the system are as follows. (See Figure 2.)

A. Ultrasonic probe unit

This unit measures the velocity of ultrasonic waves propagating inside a cement-solidified product and consists

of transmitting transducers, receiving transducers, a transducer contact device and a surface wave attenuation mechanism.

B. Hydraulic unit

This unit supplies the hydraulic pressure necessary to press the ultrasonic probe unit against the drum wall and detach it therefrom. This unit consists of an oil tank, a drive motor, a solenoid valve, and a remote-controlled hydraulic pressure control valve.

C. Lifting and transporting

This unit sets the waste package in position and vertically moves the ultrasonic probe unit. It consists of a transporter, guide rails, and a drive unit.

D. Data processing unit

This unit performs wave pattern recording, pulse velocity calculation, measurement accuracy judgment, and compressive strength estimation on the basis of output from the ultrasonic probes.

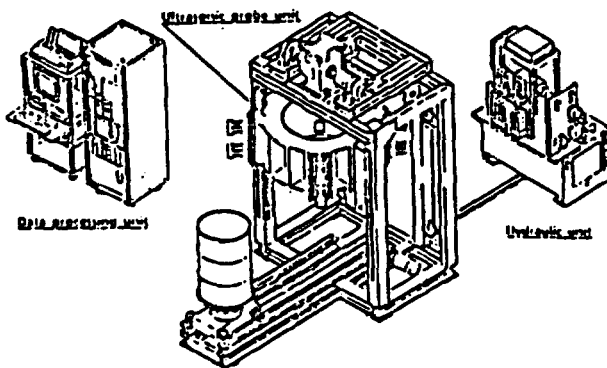
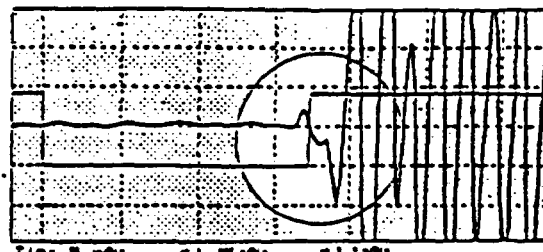

Fig. 2 Full-scale inspection system

TEST RESULTS

A. Confirmation of the effect of the surface wave attenuation mechanism

Figure 3 shows an example of wave patterns obtained when a surface wave attenuation mechanism was applied and an example of when not applied. When the mechanism was not used, the transit time measured was approximately 170 μ sec as a result of the influence of the surface waves reaching the receiving transducer in 160 - 170 μ sec. When the mechanism was used, however, the attenuation of the surface waves eliminated their influence and made it possible to measure the transit time of the direct waves (approximately 180 μ sec). Through this test, it was confirmed that the surface wave attenuation mechanism was effective in attenuating the surface waves.



(1) Wave pattern without damper

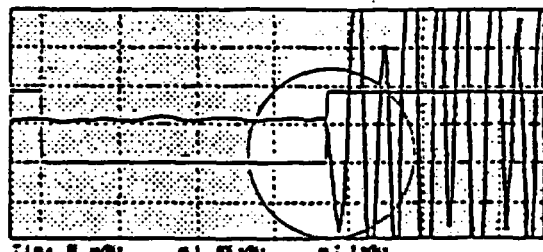

(2) Wave pattern with damper

Fig. 3 Effect of surface wave attenuation mechanism

B. Confirmation of the correlation between pulse velocity and compressive strength

Pulse velocity was measured from the outside of the drums of simulated solidified waste packages whose solidification conditions are shown in Table 1, and compressive strength data were obtained from small test specimen samples from each product of the same lot during drum charging. Figure 4 shows the relationship between the pulse velocity and the compressive strength measured in such a manner.

As a result, it was confirmed that there is a correlation between the pulse velocity and the compressive strength and that this inspection system enabled the pulse velocity in cement-solidified products to be automatically measured in a wide range of compressive strengths.

C. Not test

Using this inspection system, measurement investigation was carried out on about 270 cement waste packages stored at TEPCO's Fukushima Daiichi Nuclear Power Station. Of these waste packages, about 60 packages were subjected to core sampling. Destructive inspection tests were conducted to measure their compressive strength.

Pulse velocity measured from the outside of the packages and that of core samples

Figure 5 shows a comparison between the pulse velocity measured from the outside of the packages and that of core samples. As seen from this figure, a correlation of approximately 1 to 1 (standard deviation 80 m/sec) is obtained in a range of 3,200-3,800 (m/sec).

Table 1 Solidification conditions of simulated cement products

Product No	Solidification Conditions		
	Cement	Filler	Water/Cement Ratio
1	Slag cement 100%	No	0.45
2	1	1	0.50
3	1	1	0.60
4	Slag cement 50%	CaCO ₃ 40%	1.35
5	Slag cement 20%	CaCO ₃ 80%	2.70
6	Slag cement 10%	CaCO ₃ 90%	5.40

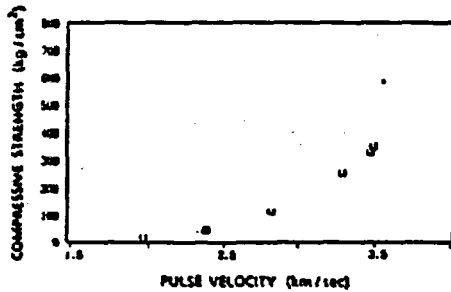

Fig. 4 Relationship between pulse velocity and compressive strength

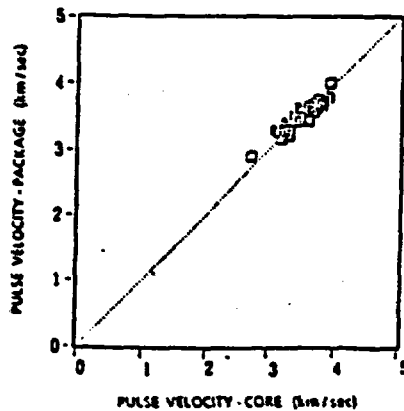

Fig. 5 Comparison between pulse velocity measured from the outside of the package and that of core samples.

From this fact, it was confirmed that the pulse velocity in cement waste packages could be measured nondestructively from the outside of the drums using this compressive strength inspection system.

Correlation between pulse velocity and compressive strength

Figure 6 shows the correlation between the pulse velocity measured by this inspection system and the compressive strength obtained from core samples. The following equation was obtained as a regression line of the plots.

$$C_c = 204.9 \times V_p - 268.4$$

where

C_c = Compressive strength (Kg/cm^2)

V_p = Ultrasonic pulse velocity (Km/sec)

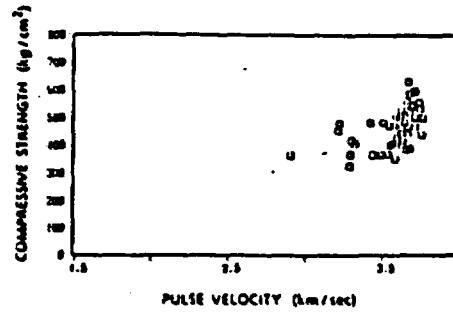

Fig. 6 Pulse velocity vs Compressive strength

Estimation of compressive strength

The compressive strengths of 270 actual waste packages were estimated using the above equation and its frequency distribution was shown in Figure 7. The mean compressive strength and standard deviation were 445 kg/cm^2 and 58 kg/cm^2 , respectively.

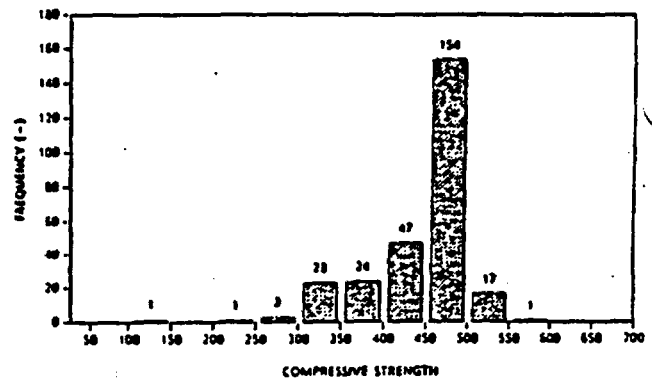

Fig. 7 Frequency distribution

CONCLUSION

To establish a highly reliable nondestructive compressive strength inspection system, this paper reported the design and the fabrication of a full-scale demonstration unit, results of the basic tests and the actual tests, and the practical applicability of this system.

Regulations and standards relating to nondestructive testing such as ASTM, BS, and DIN, show a problem of accuracy of nondestructive inspection techniques as a means of estimating the compressive strength of concrete. However, as described above, satisfactory accuracy was obtained in the case of cement-solidified waste packages generated at nuclear power plants where very stringent quality control was achieved.

In the future, a more reliable nondestructive compressive strength inspection system will be established through the study of the correlation between the pulse velocity and the compressive strength on the basis of the data obtained from the measurements using actual cement-solidified products.

JGC's Uranium-selective Chelate Resin

To be used in the RASEP processing equipment to remove uranium contamination from liquids

JGC has proposed the use of a proven uranium selective chelate resin for removing uranium contamination from liquid wastes containing other contaminating materials, thereby allowing the wastes to be classified as hazardous rather than mixed wastes. This resin, developed in Japan, is currently being used in the treatment of liquid wastes at the Ningyo Touge uranium processing facility in south central Japan. This successful experience was the basis for its proposed use (in collaboration with Dominion Energy) at Weldon Spring; and it is currently being considered for use at non-DOE uranium contaminated sites. The resin cost is reasonable, and excellent performance has been attained in practice. The resin is highly selective for uranium, and the ion is easily eluted from the resin if required, to obtain a concentrated solution of uranium. The resin has actually been used (for demonstration purposes) to process ordinary seawater to obtain a ten gram sample of yellowcake.

This resin, called UR-3100, has been tested with a solution containing zinc, copper, and iron. It was found that the resin will adsorb virtually no zinc or copper, and only very little iron. Well over 150 column volumes of 71.1 ppm uranium solution could be processed before initial breakthrough of uranium. After initial breakthrough, the effluent uranium concentration increases only very slowly, indicating that significant adsorption capability remains for the processing of well over 200 column volumes at this concentration.

It was found that using NaHCO_3 , the uranium could be eluted almost quantitatively, and that the concentration of zinc, copper, and iron in the eluate were lower than 0.1mg/liter. In other words, the eluate of this resin contained substantially no metal ions other than uranium and sodium.

JGC believes that this resin could substantially reduce the cost of remediation at Weldon Spring, and at other sites both within the DOE complex and at privately owned sites. It is our understanding that demonstration tests of the conventional ion exchange system selected at Weldon Spring have not yet begun. However, the process system proposed by JGC through Dominion Energy Inc. may not require further development testing, as it has been in operation for over six years. JGC considered the use of conventional ion-exchange methods and activated alumina treatment process, and concluded that the UR-3100 resin would provide the most cost effective, reliable treatment to meet the requirements of the RFP. The introduction to that proposal, outlining the appropriateness of the chelate resin technology to this application, has been included in this compendium. We believe that there is a continuing need for this technology at several other DOE locations.

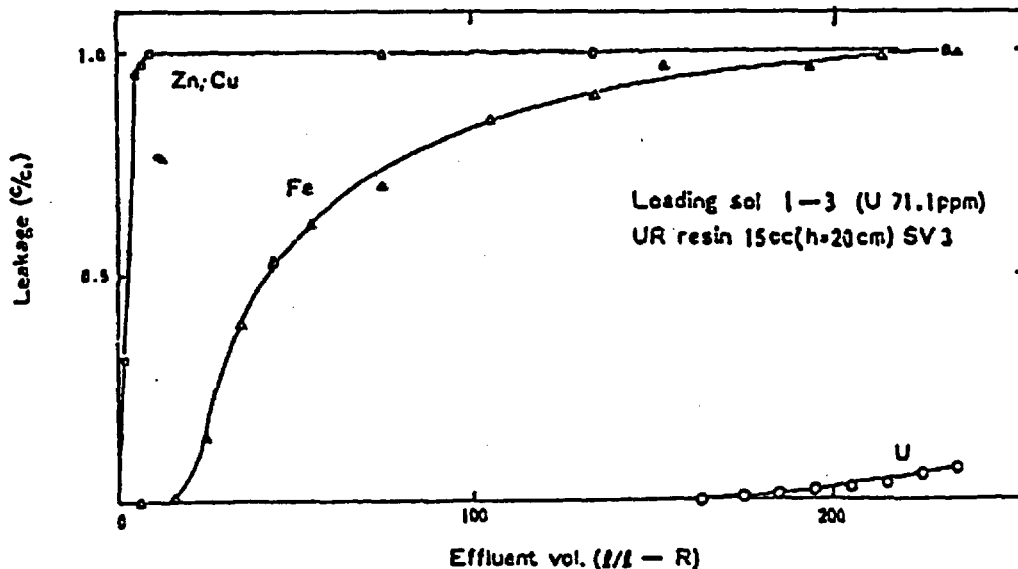

Breakthrough curves of metal ions

1. INTRODUCTION

This Proposal is offered in response to the Request For Proposal No. RFP-3589-WP 140 issued by Contractor, MK-Ferguson Company, Inc. (hereinafter referred to as MK-Ferguson).

Dominion Energy, Inc. (DEI) is a subsidiary of Dominion Resources, Inc., located in Richmond, Virginia. Dominion Resources, Inc. is the holding company for Virginia Power, the major utility company serving the state of Virginia. It is the intention of DEI to commercialize various technologies and services as a result of its in depth technical and operating experience related to nuclear power plant and fossil power plant waste treatment. Furthermore, a major strategy of DEI is to enter into partnerships with other companies which possess the technology which compliments the operating experience of DEI.

DEI has selected JGC Corporation (JGC), Tokyo, Japan as a lower-tier Subcontractor for the design of the water treatment facility based on JGC's significant experience in the design of facilities for treating radioactive wastes and hazardous materials.

With respect to the treatment of uranium that currently exists in the Veldon Spring quarry, it is DEI's technical position based on extensive testing and operating experience that conventional water treatment techniques will not, because of known inefficiencies, be successful in removing uranium from the quarry water in accordance with the requirements of the technical specifications of the RFP. Therefore, the use of conventional techniques will be highly inefficient and will not meet the environmental objectives of MK-Ferguson with respect to the discharge of the effluent to an uncontrolled environment. In this proposal, DEI recommends the use of a chelating resin that has been demonstrated to be effective in the removal of uranium impurities from waste water in Japan.

The following specific technical information is provided to support these statements:

1. Use of conventional ion exchange methods — Based on testing and operating experience in Japan, the use of ion exchange resin in this application will be highly inefficient. The ion exchange resin used in this system should be a non-regeneration system. The reasons are as follows. In the case of a regeneration system of ion exchange resin, the regeneration solution (Na_2SO_4 solution) should be treated by an additional solidification process. For the SO_4^{2-} ion, it is appropriate to add Ca^{2+} in order to cause CaSO_4 precipitation. However, in that case, the quantity of $\text{Ca}(\text{OH})_2$ to be added will increase and Na^+ which is not removed by precipitation will accumulate. Therefore, the regeneration interval will be significantly decreased.

For the volume of water and the concentration of uranium contained in the quarry, it is estimated, in the case of a non-regeneration system, that it will require approximately 20,000 ft³ of ion exchange resin to treat the waste stream. Operating with such a large quantity of resin will be very inefficient and will result in significant maintenance and operating expenditures in order to operate the treatment system.

The following discussion provides the technical basis for the above statements. In a conventional system, the ion exchange resin will adsorb all ions present in solution. In addition to the uranium contamination, the quarry also contains relatively large concentrations of calcium, manganese and sodium. Since the ion exchange resin will not have a preference for uranium versus other contaminated material, conventional non-regenerative resins will quickly saturate and a very large quantity of resin would be required.

On the other hand, a regenerative ion exchange system will not be feasible since the large quantity of regenerated effluent as well as the resin chemicals will accumulate in the equalization basin. This situation would seriously interfere with the discharge of effluent to an uncontrolled environment.

A chelating resin will selectively remove uranium ions from the waste stream and therefore require significantly less resin and will be easily regenerated. DEI estimates that the volume of chelating resin will be 1/240th the volume of the ion exchange resin that would be required. Table 1 demonstrates the efficiency of uranium separation under various conditions.

2. Uranium removal using activated alumina -- DEI predicts that the activated alumina will not provide the reduction in concentration required by the RFP technical specifications. Based on extensive laboratory testing, it is known that a removal efficiency of approximately ninety percent for uranium using activated alumina adsorption.

Based on an influent concentration of 1750pci/l stated in table 11300-1 of the specification, it is predicted that an effluent concentration of 30pci/l would not be achieved.

Furthermore, for the use of a non-regenerative system, the volume of activated alumina that would be required is very large. According to the information from the manufacturer, it is estimated that approximately 6500 cubic feet would be required. On the other hand, in a regenerative system, the frequency of regeneration will be once per eighty hours and a large amount of chemical could be required. Hence, the chelate resin has distinct advantages over activated alumina.

3. Uranium removal using coprecipitation and chelate resin -- Based on JGC's testing and operating experience, DEI/JGC propose to use a system that is based on the use of coprecipitation and chelating resins. The details of this system are described in section 7 of this proposal. In addition to having conducted significant R&D to substantiate the design described in this proposal, JGC has experience in the operation of the Waste Treatment plant at Ningyo Touge, Japan. This facility which is operated by the Power Reactor and Nuclear Fuel Development Corporation routinely processes waste water contaminated with uranium. The nominal flow rate of this plant is 23 gpm. Figure 1 provides a summary of the demonstrated removal efficiencies for uranium. Please note that although some samples exceed 30pci/l, the average value of the effluent would meet the 30pci/l limit.

The Ningyo Touge plant was commissioned in January 1984 and the water treatment plant has operated in a consistently reliable manner over the last five years. The commercial purpose of the plant is to provide water treatment for liquid waste generated from the refining of uranium ore into UF_6 . Therefore, the operation of this plant has provided JGC with extensive operating history and operations experience with respect to uranium removal. This type of operating experience does not exist in the U.S. Therefore, JGC has a unique base of experience that has been factored into the design described in this proposal. As a result of the experience gained at this Japanese plant, DEI can state, with a high degree of confidence, that the other competitors who are bidding on this RFP do not have this extensive experience base.

In summary, DEI has developed sufficient test and operating data to demonstrate that the chelating resins and coprecipitation techniques described in this proposal will provide an effective means of removing uranium from the Veldon Spring quarry in accordance with the effluent discharge limits specified in this RFP.

JGC has extensive experience in integrating the various technologies required to treat the Veldon Spring quarry waste water into an integrated turnkey system that operates in a highly reliable manner.

Additionally, DEI has selected NUS Corporation located in Gaithersburg, Maryland, to be responsible, as a lower-tier Subcontractor, for the detail design work to ensure compliance with the laws, regulations and standards in the U.S.A. and also for the engineering coordination between the U.S. fabricators from whom all of the equipment and materials will be ordered, except the new chelating resin which is only manufactured in Japan.

DEI has selected Corrigan Company as the local construction contractor for site work. Figure 1.1 provides a summary of the work scope of the companies in this team. Figure 1.2 provides a summary of proposed equipment suppliers.

Concerning the remainder of this Proposal, Chapter 2 provides the administrative text of this Proposal in accordance with MK-Ferguson's format, and Chapter 3 provides clarifications and modifications to the commercial conditions proposed in the RFP.

The submittals required in the Technical Instructions to Proposers in the "Request for Proposal" are provided in Chapters 4 through 7.

Chapters 8 through 11 provide the Proposer's technical description of its processes.

Chapter 12 indicates the extent of items which will be imported and which will be limited to one consumable essential for the above-mentioned innovative processing.

Table 1

Adsorption parameters of UR-3100 for M^{n+} at 25°C

$$Q = KC^{1/n} \quad Q = \text{mg M/l-Res.}$$

$$C = \text{mg M/l-Sol.}$$

HCl M ⁿ⁺	1.0 N		0.1 N	
	K	1/n	K	1/n
U ⁶⁺	2800	0.53	8400	0.39
Fe ³⁺	380	0.60	700	0.59
Cu ²⁺	< 1	—	220	0.56
V ⁵⁺	< 1	—	780	0.63
Zn ²⁺	< 1	—	< 1	—
Ni ²⁺	< 1	—	< 1	—
Mn ²⁺	< 1	—	< 1	—

Definition of terms:

M - applicable metal, for example Fe, U, etc.

Q - amount (mg) of adsorbed metal per liter of resin

C - amount of influent metal per liter of solution

K - constant

URANIUM CONCENTRATION

[mg/l]

Report of Japan Mining Institute/102, 1178 ('86-4) 253 [11]
Waste Treatment at Ningyo Touge of Power Reactor and
Nuclear Fuel Development Corporation (Japanese Government Sector)

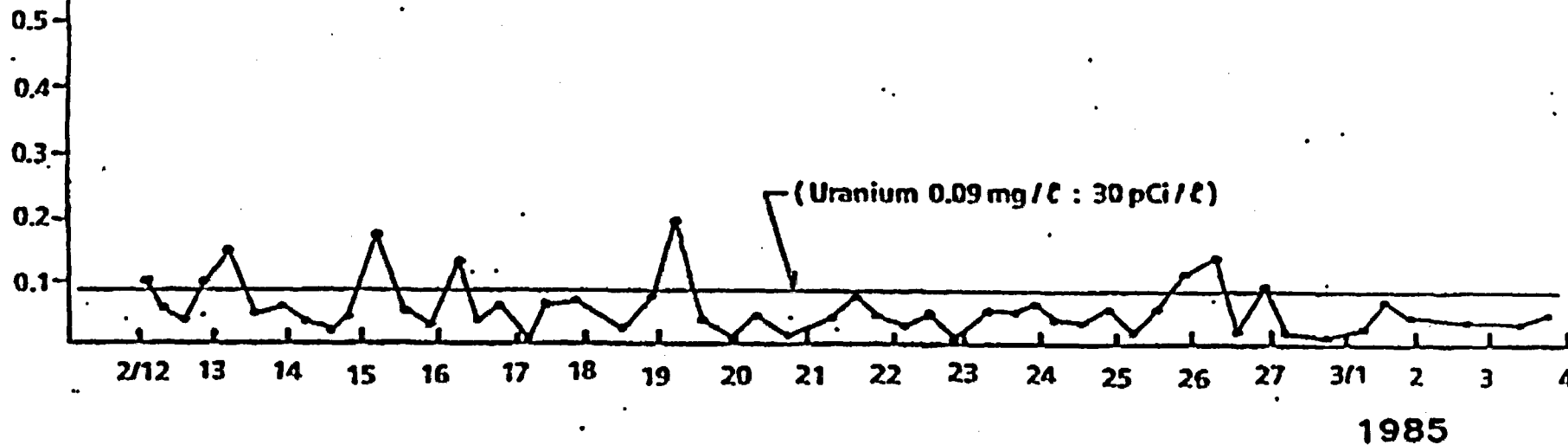

OPERATION DATE

Figure. 1.1 Demonstrated Removal Efficiencies

RADIONUCLIDE SEPARATION PROCESS (RASEP)

H. Kuribayashi, Y. Koshiba, K. Suzuki, M. Shibuya
JGC Corporation, Japan

ABSTRACT

Liquid radwaste generated from nuclear power plants or other nuclear facilities consists of a small amount of radioactive nuclides and a large amount of non-radioactive matter. By separating radioactive and non-radioactive matter, original liquid radwaste can be further reduced in volume and a large portion of it can be released as non-radioactive waste. In addition, by fixing the separated radionuclides according to their nature, it will be possible to effectively and efficiently meet the waste disposal requirements. With this approach, JGC developed a radionuclide separation process called RASEP in which radionuclides are selectively separated from liquid waste and fixed in an inorganic adsorbent. As a result, maximum reduction of waste via a simple and economical method, plus safe discharge of the treated (decontamination) liquid waste to the environment can be achieved.

INTRODUCTION

Liquid radwaste generated at nuclear power plants and other nuclear facilities usually contains insoluble CP nuclides, soluble CP/FP nuclides and non-radioactive substances. The CP and FP are contained in the waste with a considerable amount of non-radioactive substances, which occupy substantial volumes in waste packages produced by conventional immobilization processes.

By separating and fixing only the trace amounts of radioactive nuclides from the large amount of non-radioactive substances present in liquid radwaste, the quantity of final waste packages can be greatly reduced since the resulting decontaminated effluent may be discharged to the environment. By using inorganic material and metal as long term and radioactivity-fixing media, JGC developed a process which solely and selectively separates radioactive nuclides from liquid radwaste. This process fixes separated nuclides in the form of stable packages for safe, long-term storage and disposal.

In cooperation with Tokyo Electric Power Inc., and other five Japanese utility companies, JGC has established this radionuclide separation (RASEP) process which mainly consists of filtration, adsorption and electro-deposition.

RASEP PROCESS

Figure 1 shows these major steps.

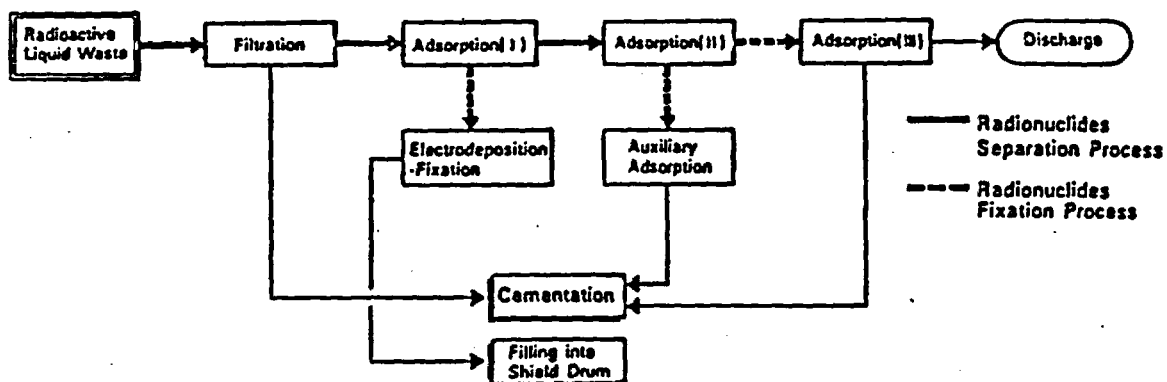

Fig. 1. Major Steps of RASEP System.

BASIC PROCESS FLOW

Figure 2 shows the basic process flow. Principal specifications of the filter materials and adsorbents are summarized in Table I.

Moreover, Sr nuclides adsorbed in the chelating resin during adsorption step III are eluted by hydrochloric acid for re-adsorption onto inorganic adsorbents which are suitable for disposal.

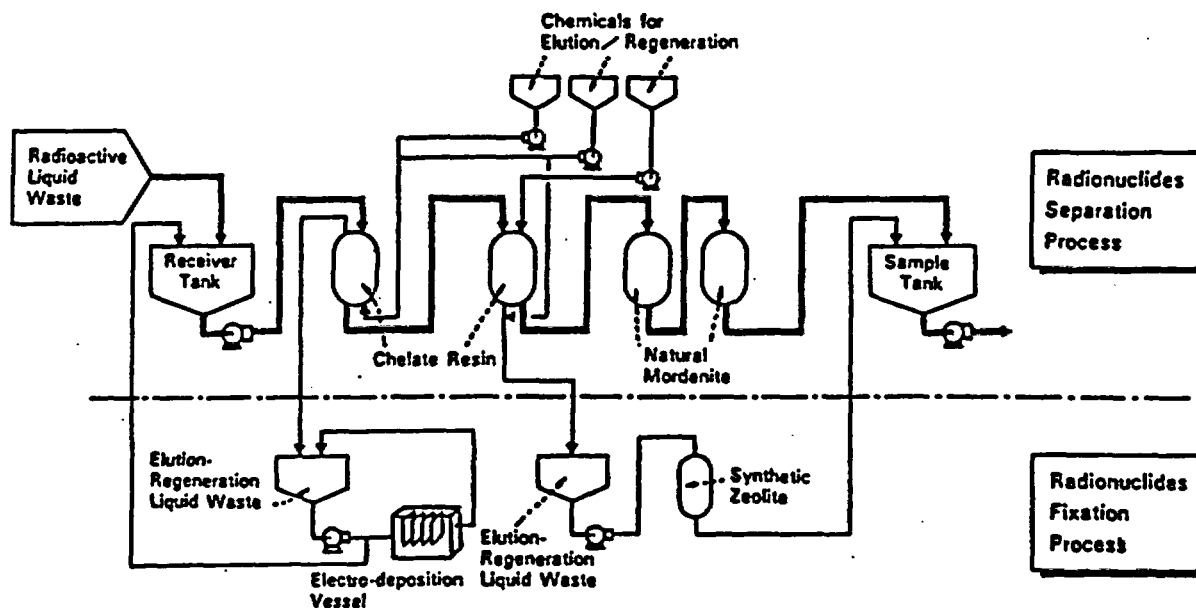

Fig. 2. Basic Flow Diagram of RASEP System.

TABLE I

Principal Specifications of the Filter Materials and Adsorbents.

Unit Operation	Material
Filtration	Hollow fiber filter
Adsorption I	Chelate resin (Unicellex UR-10)
Adsorption II	ditto
Adsorption III	Natural mordenite
Auxiliary adsorption	Synthetic zeolite (A-4)

Major steps for the treatment of liquid waste and filtration, and three adsorption steps from (I) to (III).

Liquid radwaste is fed to the RASEP process by a pump under slight pressure. Radioactivity level of the treated liquid radwaste is below the detectable limit of conventional monitoring method. The adsorbed radioactive nuclides in the chelating resin at the adsorption step I are eluted by sulfuric acid, then electro-deposited under certain electrochemical conditions and the nuclides are finally fixed on the metal cathode.

RADIOACTIVE NUCLIDE SEPARATION PERFORMANCE TEST

1. Simulated liquid radwaste solutions: Radwaste solutions simulating the high conductivity liquid waste generated at a BWR power plant were used to test the RASEP process performance.
2. Filtration step: A High Efficiency (HE) filter, capable of removing particles larger than 0.04 microns, thoroughly separated suspended solids consisting mainly of Fe, and most Co-60, Mn-54, Zn-65.
3. Adsorption step I: Chelating resin, Unicellex UR-10, was adopted in the test. All soluble CP nuclides present in a simulated solution were removed to the extent that the radioactivity level of the treated solution was below the detectable limits. The bed volume defined as a ratio of volume of treated liquid waste to resin volume, was found to be extremely large. Figures 3 and 4 show adsorption curves and the bed volume of the resin respectively.

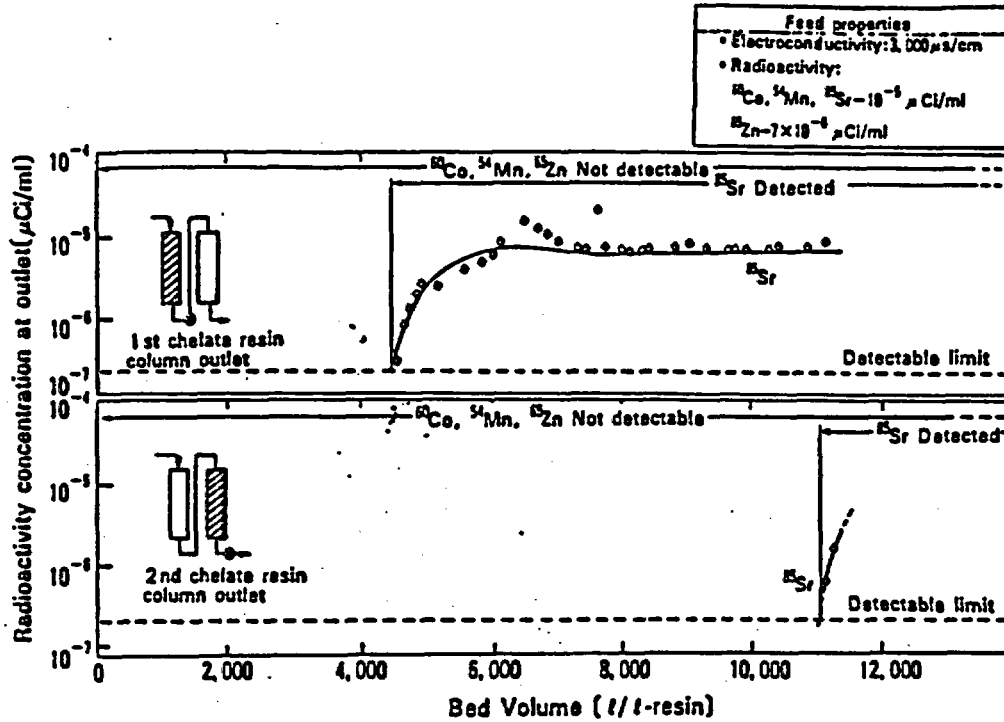

Fig. 3. Radionuclide Adsorption Performance of UR-10 Chelating Resin.

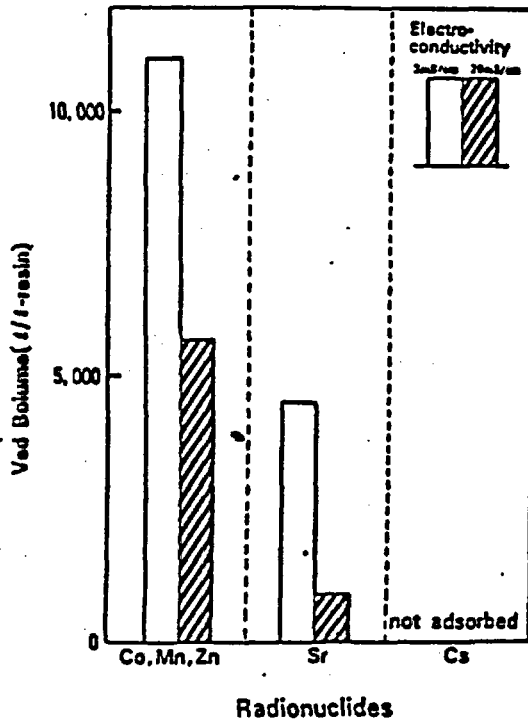

Fig. 4. Bed Volume of UR-10 Chelating Resin for Radionuclides.

4. Adsorption step II: As shown in Fig. 3, Sr nuclides passing through adsorption step I were efficiently removed by this additional UR-10 column.

5. Adsorption step III: Natural mordenite selected from various inorganic adsorbents was used to selectively remove Cs nuclide from the waste. Radioactivity level of the treated effluent was below the detectable limit.

Adsorption steps II and III are auxiliary steps when soluble FP nuclides coexist in the liquid radwaste.

6. Electrodeposition step: The eluted solution was obtained by treating spent UR-10 by sulfuric acid. Co-60 and Mn-54 as major CP nuclides were tested in the presence of a small amount of Ni ion with the application of DC voltage. The Ni deposition on a metal cathode was observed with simultaneous incorporation of these nuclides.

Figure 5 shows the removal ratio of CP nuclides vs time under Ni deposition conditions. Figure 5 indicates that more than 90% of the CP nuclides was removed and the metal cathode could be repeatedly used.

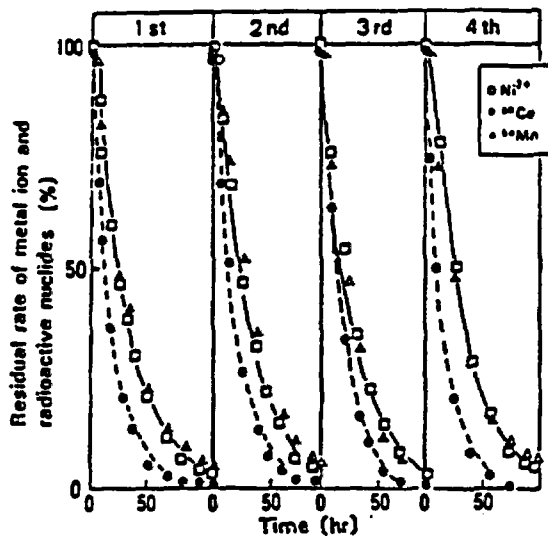

Fig. 5. Metallic Ion and Radionuclide Removal Characteristics by Electro-deposition Unit.

7. Auxiliary adsorption step: For the purpose of concentrating Sr nuclide from original liquid waste, chelating resin is superior to zeolite because of higher bed volume even for high conductivity liquid waste. However, zeolite is a more stable long term matrix material for fixing Sr nuclides.

VOLUME REDUCTION

High conductivity liquid waste is conventionally concentrated by evaporation, then solidified using cement, asphalt or plastic.

In the RASEP, however, liquid radwaste can be treated to obtain almost non-radioactive liquid effluent which renders the solidification of such liquid unnecessary as a rule. As a result, a very high volume reduction is achieved. Figure 6 compares volume reductions achievable with the RASEP process and with conventional processes at BWR plants.

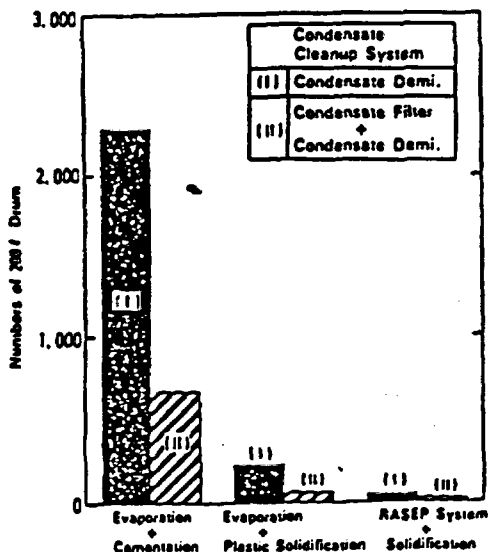

Fig. 6. Comparison of Amounts of Waste Packages between Three Systems.

COST-EFFECTIVENESS OF THE RASEP SYSTEM

The RASEP consumes minimal energy since it can be operated at normal temperatures and pressures. Cost can also be reduced since its simple construction eliminates the need for any special, expensive components or equipment.

Compared with an evaporation concentration system (without a solidification process), the RASEP facility and utility costs are below one-sixth of those of the evaporation system, as shown in Fig. 7. Since a costly solidification unit is usually installed for conventional evaporation systems, the RASEP process can be expected to be far more economically advantageous than conventional processes.

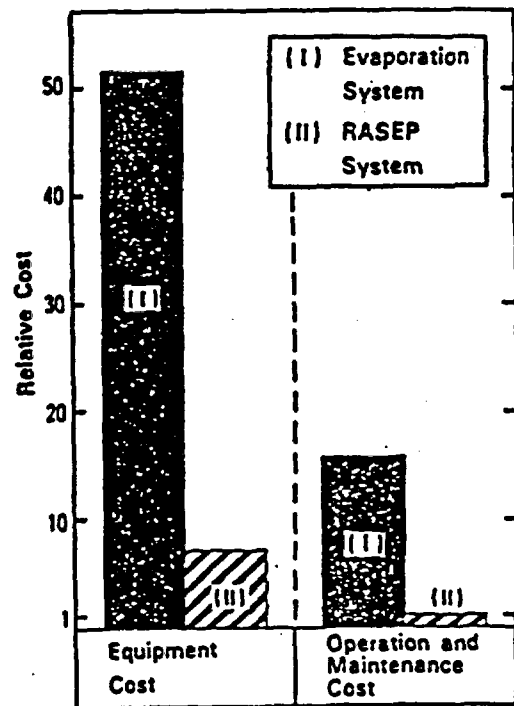

Fig. 7. Cost-Benefit Comparison between the RASEP and Evaporation Systems.

ACKNOWLEDGEMENTS

This study was partly sponsored by Tokyo Electric Power Co., Inc., Tohoku Electric Power Co., Inc., Chubu Electric Power Co., Inc., Hokuriku Electric Power Co., Inc., Chugoku Electric Power Co., Inc., and Japan Atomic Power Co., Inc.

JGC's Wet Oxidation Process

1. General

The Wet Oxidation Process is applicable for volume reduction of organic radioactive solid and liquid waste. It is especially effective for the treatment of liquid waste containing organic chelating agents which may be generated from the decontamination of nuclear facilities. Through an oxidation reaction with hydrogen peroxide, chelate compounds are decomposed into CO₂ and H₂O. BWR cellulosic filter aids can also be treated using this process.

JGC's Wet Oxidation Process consists of the following:

- (1) Waste feed
- (2) Chemical feed
- (3) Reaction and distillate condensation
- (4) Distillate neutralization

The auxilliary equipment for the Wet Oxidation system includes an Ultraviolet oxidation system to complete the decomposition of chelate agents, and a solidification system to solidify the sludge produced by the system.

2. Process Conditions

2.1 Plant Capacity

The design basis of the existing Wet Oxidation Process (at JGC's Oarai Research and Development Center) is as follows:

- o NTA concentration 3 %
- o EDA concentration 0.7 %
- o Feed rate of liquid waste:
 - Initial charge 1.4 m³
 - Continuous feed (8hrs.) 0.7 m³/hr
 - Total
 - 1.4 m³+ (0.7m³/hr)(8hrs.) = 7 m³/batch
 - (7 m³/batch)(2 batches/day) = 14 m³/day = 3,700 gals/day

2.2 Operation Schedule

The duration of one batch operation for the treatment of liquid waste is 12 hours. The operation schedule is as follows:

- (1) Initial charge of liquid waste 45mins.
- (2) Adjustment of pH in the reactor 45 mins.
- (3) Feed of catalyst into the reactor 15 mins.
- (4) Heating up the reactor (begin with (2))
- (5) Continuous reaction in the reactor 8 hrs.
- (6) Residual liquid reaction and concentration 1 hr.
- (7) Neutralization of reactor bottom sludge 45 mins.
- (8) Discharge of reactor bottom sludge 30 mins.

2.3 Chemicals

- (1) A 50% H_2O_2 solution is used as an oxidizing agent during the reaction.
- (2) A 98% H_2SO_4 solution is used to maintain an acidic pH-value.
- (3) A mixture of 10% $FeSO_4$ solution and 10% $CuSO_4$ solution is used as a catalyst.
- (4) A silicone-emulsion type anti-foaming agent is used under the additive condition of 1,000 - 5,000ppm aqueous solution.
- (5) 25% NaOH solution is used to neutralized reactor bottom sludge after the residual liquid reaction and concentration.

3. Description of Each Process Unit

3.1 Waste Feed

Decontamination liquid waste is directly charge into the reactor from the receiving tank by a pump.

3.2 Chemical Feed

The chemical feed unit consists of the following storage tanks and pumps:

- o One storage tank for the 50% H_2O_2 solution and one pump.
- o One storage tank for the 98% H_2SO_4 solution and one pump.
- o One storage tank for the 10% $FeSO_4$ and 10% $CuSO_4$ solutions and one pump.
- o One silicone-emulsion type anti-foaming agent tank and one pump.
- o One storage tank for the 25% NaOH solution and two pumps.

3.3 Reactor

The reactor unit consists of one reactor, one demister and one condenser.

(1) Initial charge

The effective reactor volume is $111.4m^3$. After the initial charge of liquid waste into the reactor from the receiving tank, the pH-value shall be adjusted to between 3 and 4 by adding sulphuric acid.

A 10% $FeSO_4$ and 10% $CuSO_4$ mixture solution is fed to the reactor, where the concentrations of $FeSO_4$ and $CuSO_4$ are 0.01mol/liter.

(2) Heating up the reactor

A steam heating coil and an agitator are installed inside the reactor. Chemically adjusted liquid waste is steam heated up to $95^\circ C$.

(3) Continuous reaction in the reactor

The oxidation reaction proceeds under an evaporative condition by the continuous feeding of liquid waste and 50% H_2O_2 oxidizing agent solution accompanied by steam heating.

The silicone-emulsion type anti-foaming agent is constantly added.

Vapor and produced gas, mainly consisting of CO_2 , are evacuated into the condenser through the demister. The vapor is condensed and introduced into the distillate tank.

(4) Residual liquid reaction and concentration

After the continuous waste feed is stopped, heating is required in order for the residual liquid reaction to proceed with the supply of H_2SO_4 and H_2O_2 .

(5) Neutralization of reactor bottom sludge

The residual liquid in the reactor consists mainly of SO_4^{-2} and suspended solids. Before discharge, a 25% NaOH neutralizing solution is added.

(6) Discharge of reactor bottom sludge

The reactor residue liquids and solids are discharged and transferred to the sludge dewatering unit.

3.4 Distillate neutralization

The distillate neutralization unit consists of one tank and one agitator. Before discharge of the distillate, the pH value is monitored by the pH sensor and the distillate is neutralized by adding 25% NaOH solution.

4. Control System

4.1 Process Parameters

During operation of the Wet Oxidation Process, the following parameters shall be controlled in order to ensure the correct reaction conditions:

(1) Initial Conditions

CuSO ₄ (catalyst) :	0.01 mol/liter of reaction liquid
FeSO ₄ (catalyst) :	0.01 mol/liter of reaction liquid

(2) Liquid Waste :

Constant feed

(3) Chemicals

50% H ₂ O ₂ :	Constant feed
Anti-foaming agent :	Constant feed
98% H ₂ SO ₄ :	Constant feed

(4) Reaction Conditions

Operating temperature :	Boiling point (approximately 100°C)
Operating pressure :	Atmospheric
Operating pH range :	3-4

4.2 Process Control

The Wet Oxidation Process is controlled remotely and automatically from the control panel. The main indicators and recorders are mounted on the control panel to provide information on the operation status. During the reaction, liquid waste and chemicals are fed at a constant flow rate. Heated steam is supplied at a controlled flow rate based on the evaporation flow rate and the reactor temperature.

(1) Feed Rate of the Liquid Waste

The liquid waste feed rate to the reactor must be kept constant in order to maintain the vaporizing capacity. The flow rate is controlled by presetting the pump discharge rate.

(2) Feed Rate of Chemicals

The 50% H_2O_2 oxidizing solution and silicone-emulsion type anti-foaming agent are fed at a preset flow rate to maintain a normal reaction.

The concentrations of $CuSO_4$ and $FeSO_4$ catalysts in the reactor are 0.01 mol/liter of liquid waste in order to maintain a normal reaction. Prior to the start of the reaction, the liquid level in the reactor is checked and an estimate made of the volume of catalyst required. The flow rate of the pump is then set.

A 98% sulphuric acid solution is intermittently fed at a fixed flow rate so as to keep the pH value in the reactor between 3 and 4.

(3) Liquid Level and Temperature

In order to prevent excessive concentration of liquid, overflow and foaming in the reactor, the level of liquid is maintained at a constant level.

Additionally, the temperature in the reactor must be kept at boiling point to maintain good reaction conditions. In order to maintain the reaction temperature, heating steam consumption is controlled. If the liquid level falls below the "Low Level" set point, subcooled distillate reflux from condenser is added until the liquid level regains the "Normal Level".

(4) Interlocks and Alarms

For the maintenance of safe operating conditions, interlocks and alarms are installed in the Wet Oxidation Process.

o Liquid level in the reactor

When the liquid level in the reactor rises to the "High" set point, feed of liquid waste and chemicals is stopped automatically and an alarm sounds.

o Foaming level in the reactor

When the foaming level in the reactor rises to the set point "High", the feed of liquid waste and chemicals are stopped automatically and an alarm sounds.

o Pressure in the reactor

When the pressure difference between the inside and the outside of the reactor rises to the set point "High", an alarm sounds.

o pH value in the reactor

When the pH value in the reactor decreases below 2, an alarm sounds.

(5) CO_2 Concentration Sampling System

The reaction operation is stopped by the time controller. When the decomposition is almost completed, the CO_2 concentration in the off-gas decreases rapidly. Therefore, CO_2 sampling is required.

(6) Radiation Monitoring System

To discharge the distillate, a radiation monitoring system is required.

METHOD OF TREATING RADIOACTIVE WASTE WATER CONTAINING EDTA
AND OTHER ORGANIC ACIDS

Yasuhiro Moriya, Norimitu Kurumada,
Fukuzo Todo and Hiroshi Kuribayashi

JGC Corporation
2205, Naritacho Oharaimachi, Higashiibaraki-gun
Ibaraki Pref. 311-13 Japan
(0292)66-3311

I. INTRODUCTION

In the decontamination of radioactive waste from nuclear installations, there is a considerable discharge of radioactive waste water containing decontaminating agents. Decontaminating agents often contain disodium ethylenediamine tetraacetic acid (EDTA), formic acid, citric acid and other organic acids. The radioactive waste water is concentrated by evaporation to reduce its volume, and the resulting residue is solidified by the use of a solidifier such as cement. However, when EDTA and other organic acids are present in the residue, the properties of the solidified product are unfavorably affected, particularly the mechanical strength and the leachability of nuclides thereof. Therefore, it is essential to remove EDTA and other organic acids from the radioactive waste water prior to the evaporation-concentration processing. Here we report a method, the wet oxidation method, of decomposing EDTA and other organic acids present in the radioactive waste water.

II. PRINCIPLE

Wet oxidation is a method of oxidizing organic compounds by the use of hydrogen peroxide as an oxidizing agent in the presence of catalyst under atmospheric pressure. This method has been developed to decompose solid organic compounds such as ion-exchange resins or filter sludges suspended in aqueous solutions¹. Here we apply this method to decompose water-soluble organic acids present in radioactive decontaminating agents².

III. REACTION CONDITIONS

The decomposition reaction depends on the concentration of organic compounds, the reaction temperature, the concentration of catalyst, the pH of the reaction mixture and the supply rate of hydrogen peroxide.

A. Types and Concentrations of Organic Compounds

1-15% EDTA, which is a decomposition-resistant material, was mainly tested, and 1% formic acid, 1% citric acid and 1% oxalic acid were also tested as reference materials.

B. Reaction Temperature

The reaction temperature was changed in the range of 80 to 100°C to study the effect of temperature on the decomposition of organic acids.

C. Types and Concentrations of Catalysts

Fe and Cu are effective catalysts for the present decomposition reaction of organic acids. We added 0.01 to 0.02 mol/liter of Fe, Cu or a mixture of the two as the catalyst.

D. pH of the Reaction Mixture

The catalyst becomes inactive when the pH of the reaction mixture is alkaline. By adding various amounts of sulfuric acid and changing the pH of the reaction mixture, we investigated the effect of the pH of the reaction mixture on the rate of decomposition of organic acids.

E. Supply Rate of Hydrogen Peroxide

When the supply rate of 35wt% hydrogen peroxide is too high, the oxidizing efficiency of the hydrogen peroxide falls. On the otherhand, when the supply rate of hydrogen peroxide is too low, the rate of decomposition of organic acids becomes impracticably slow. We studied the effect of the hydrogen peroxide supply rate on the rate of decomposition of organic acids where the longest reaction time was set at 5 hours.

IV. PROCESS DESCRIPTION

A schematic flow sheet, of the wet oxidation process is shown in Fig. 1. The operation is performed as follows.

A. Initial Feeding

The radioactive waste water is supplied from the storage tank to the reactor. FeSO₄ and/or CuSO₄ is added to the reactor as a catalyst. Sulfuric acid is added to the

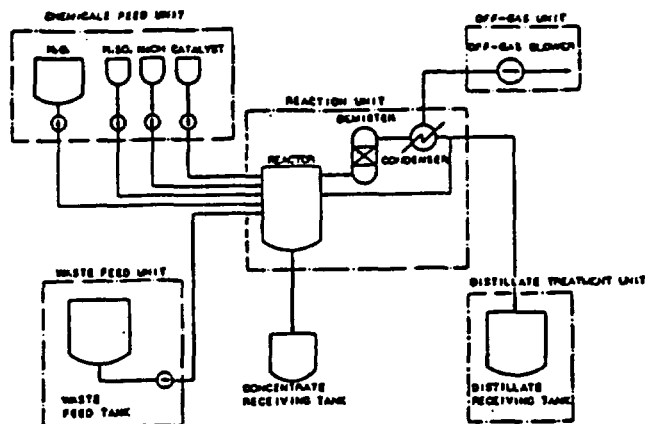

Fig. 1 Schematic flow sheet

reactor, if necessary, to make the pH of the reaction mixture acidic.

B. Heating

The reaction mixture is heated to 80 to 100°C by the use of an electric heater or a steam-coil heater.

C. Reaction

After heating the reaction mixture, the oxidation reaction proceeds by continuously supplying 35% H₂O₂. When the reaction mixture is boiled, the vapour is condensed by a condenser. The condensate is transferred to the distillate treatment unit, and the produced gas to the off-gas unit.

D. Neutralization

When the reaction mixture is acidic at the end of reaction, 25% NaOH is added to neutralize the reaction mixture.

E. Evaporation Concentration

After neutralizing the reaction mixture, it is concentrated by evaporation to make the concentration of Na₂SO₄ 25%. The concentrate is drained to the concentrate receiving tank and then transferred to the solidification system.

V. RESULTS

Tests were performed by the use of beaker-scale test system with a glass-made reactor having an effective volume of 1 liter, and also by the use of a pilot-plant test system with a titanium-made reactor having an effective volume of 150 liters. Firstly using the beaker-scale test system, optimal reaction conditions for decomposing EDTA and other organic acids were determined to study the decomposability of various organic acids. Then using the pilot-plant test system, the decomposition of EDTA was studied, as a typical organic acid.

Table 1 Reaction conditions

	1	2	3	4	5	6
Organic material concentration (wt%)	1, 3, 15	3	3	3	3	1
Reaction temperature (°C)	100	80-100	100	100	100	90-100
Catalyst concentration(mol/l)	Pb 0.01 Cu 0.01	Pb 0.01 Cu 0.01	Pb 0.01-0.02 Cu 0.01-0.02	Pb 0.01 Cu 0.02	Pb 0.01 Cu 0.01	Pb 0.01 Cu 0.01
Reaction time (hr)	5	5	5	5	5	5
Amount of H ₂ O ₂ added (g)	10-50	15	15	0-15	15	15
H ₂ O ₂ feed rate (g/hr)	30-270	70-90	70-90	70	30-140	30-60

A. Beaker-Scale Test

1. Decomposition of EDTA. Using a beaker-scale test system, we studied the effect of the EDTA concentration, the reaction temperature, the type and concentration of the catalyst, the pH of the reaction mixture and the supply rate of hydrogen peroxide on the decomposition degree of EDTA.

a. Effect of the EDTA concentration. One liter of test waste water, containing 1, 3 and 15 wt% of EDTA, was treated under the reaction conditions shown in column 1 of Table 1. The relations between the decomposition degree of EDTA and the consumption of 35% H₂O₂ were investigated. Here the decomposition degree is defined as:

$$\text{Decomposition degree(\%)} = \left[\frac{\text{initial TOC} - \text{TOC after reaction}}{\text{initial TOC}} \right] \times 100$$

where TOC represents the total amount of organic carbon. At 90% decomposition of EDTA, the amount of H₂O₂ consumed was about 4.6g per 1g of EDTA decomposed, which did not depend on the concentration of EDTA. The decomposition of EDTA reached 99% at the completion of reaction when EDTA concentration was 1% and 3%, but it leveled off at 94% when the EDTA concentration was 15%. The latter results is due to the raising of the pH of the reaction mixture in the later phase of the reaction, as will be described later.

b. Effect of the reaction temperature. One liter of 3% EDTA aqueous solution was treated under the reaction conditions shown in column 2 of Table 1. At 90% decomposition of EDTA, the consumption of H₂O₂ per 1g of EDTA decomposed was 4.6g at

100°C, and 6.7g at 80°C. At lower reaction temperatures, the consumption of H₂O₂ increased substantially, i.e. the oxidizing efficiency of H₂O₂ is low. Therefore, it is recommended to treat EDTA at as high a temperature as possible.

c. Effect of the catalyst concentration. One liter of 3% EDTA aqueous solution was treated under the reaction conditions shown in column 3 of Table 1. The decomposition of EDTA was compared in the presence of FeSO_4 , CuSO_4 or a mixture of the two as a catalyst. We found that the mixture of FeSO_4 and CuSO_4 , each concentration being 0.01 mol/liter, is the most effective catalyst.

d. Effect of the pH of reaction mixture. One liter of 3% EDTA aqueous solution was treated under the reaction conditions shown in column 4 of Table 1. When H_2SO_4 was not added, the decomposition degree of EDTA was 75% at best. However, it reached 99% when H_2SO_4 was added. In the decomposition of EDTA sodium ions are dissociated, which increases the pH of the reaction mixture if H_2SO_4 is not added. As the catalyst precipitates and becomes inactive in the range of alkaline pH, the decomposition degree of EDTA levels off unless H_2SO_4 is added. Therefore, it is recommended to keep the pH value of the reaction mixture acidic by adding H_2SO_4 .

e. Supply rate of H_2O_2 . One liter of 3% EDTA aqueous solution was treated under the reaction conditions shown in column 5 of Table 1. In the range of 0.90 to 4.8g of H_2O_2 per 1g of EDTA per hour for the supply rate of 35% H_2O_2 , the consumption of H_2O_2 did not depend on its rate of supply. Therefore, one can select any H_2O_2 supply rate mentioned above as long as the reaction rate is within a practicable range.

2. Other organic acids. Other than EDTA, we selected 1% formic acid, 1% citric acid, and 1% oxalic acid and treated them under the reaction conditions shown in column 6 of Table 1. The decomposition degree of all these organic acids reached 97 to 100% within one hour. The consumption of 35% H_2O_2 was less than 2.5 to 3.6g per 1g of organic acid decomposed. In the case of volatile formic acid, the decomposition reaction was performed at 90°C. The decomposition degree of formic acid was the same at 90°C and at 100°C. Therefore, it is recommended to treat volatile organic acids at lower temperatures in order to reduce loss by evaporation.

B. Pilot-Plant Test

A volume of 150 liters of 3% EDTA solution was treated by a pilot-plant test system based on the reaction conditions indicated in Fig. 2.

The relations between the decomposition degree of EDTA and the consumption of H_2O_2 were studied and the results are shown in Fig. 2. At 90% decomposition of EDTA, the consumption of H_2O_2 was 4.3kg per 1kg of EDTA decomposed,

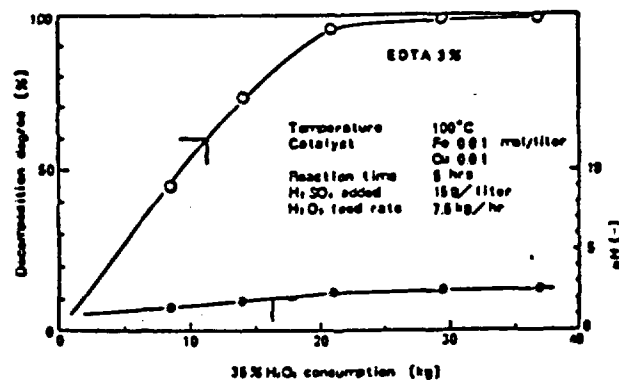

Fig. 2. Pilot test results for EDTA

which was comparable to consumption of 4.6kg of H_2O_2 per 1kg of EDTA decomposed observed in the case of the beaker-scale test. Therefore, we consider that EDTA is similarly decomposed in the pilot-plant system as in the beaker-scale system.

VI. CONCLUSION

Almost perfect decomposition of the organic acids is achieved by the wet oxidation method when the reaction temperature increases up to the boiling point. In order to avoid decay of the catalyst, a small amount of sulfuric acid must be added to the reaction mixture before starting the reaction so as to maintain the pH value of the reaction mixture within the allowable low range. More than 90% decomposition of EDTA was achieved when the reaction was performed at the boiling point and at a low pH value. A quantity of 5 to 10kg of 35% H_2O_2 was consumed per 1kg of EDTA decomposed in order to achieve at a 90 to 99% decomposition degree of EDTA.

VII. REFERENCES

1. H. Kuribayashi et al., "Volume Reduction by Oxidation," Waste Management '84, 2, 105 (1984).
2. M. Toshikuni et al., "Method of Treating Radioactive Waste Water Resulting from Decontamination," United States Patents 4,693,833, September 1987.

IMPROVEMENT OF THE HIGH TEMPERATURE SLAGGING INCINERATION SYSTEM

H. Kuribayashi, N. Kurumada, S. Shibata and K. Kugal
JGC Corporation
Yokohama, Japan

ABSTRACT

The objective of the paper is to describe the High Temperature Slagging Incinerator (HTSI) application study to reduce the volume of low level dry active waste (DAW) generated at nuclear power stations in Japan. The system, originally developed by SCK/CEN in Belgium, is being practically applied for the treatment of radioactive waste in Europe. JGC has been conducting the R&D work with a view to improving overall performance of the system and enhancing its safety and reliability. The performance tests of a pilot plant with a design capacity of 100 kg/hr revealed a number of positive attributes. It also ensures stable products which can be readily solidified when necessary for disposal.

INTRODUCTION

The High Temperature Slagging Incineration (HTSI) system characteristically volume-reduces combustible and non-combustible dry active waste (DAW) at the same time. The system was developed at the Belgian Nuclear Research Center (SCK/CEN) where the system shown in Fig. 1 is presently operating. To introduce HTSI as a main subsystem into the DAW treatment system, JGC has advanced improvement of the SCK/CEN system and related technology development through cooperation with Belgonucleaire, with the following goal:

1. Improvement of the pretreatment subsystem to enlarge composition range of waste to be treated, and enhance system component durability.
2. Scaling up of the incinerator.
3. Improvement of the off-gas cleaning subsystem to raise the DF value, relieve the corrosive environment and raise heat recovery.
4. Development of a solidification process which ensures easy solidification of incineration residue.

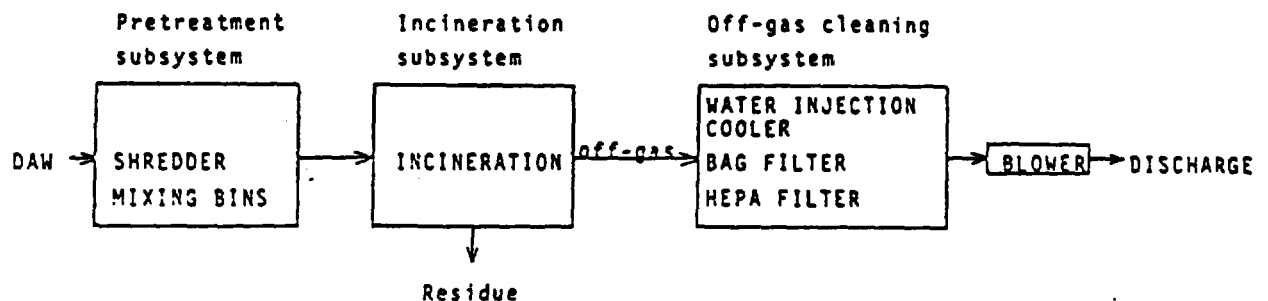

Fig.1. HTSI system at SCK/CEN

In order to achieve these goals, JGC constructed a 100 kg/hr pilot plant at the JGC Nuclear Research Center in Oharai in July 1985 by making principal improvements of the pilot plant in Belgium. Operation records after those improvement are described below.

BACKGROUND OF IMPROVEMENTS

The following DAW is generated at nuclear power stations mainly through periodical inspection and facility improvement:

1. Hard materials such as concrete, thermal insulation material, wood blocks, etc.
2. Soft materials such as waste cloth, plastic sheets, etc.
3. Comparatively easily shreddable small metals such as wire, thin iron plates, small diameter pipes, etc.
4. Unshreddable large metals such as large diameter thick pipes, valves, etc.

To ensure stable incinerator operation, DAW should be shredded into 5 cm or smaller size pieces, while the waste listed in Item 4 above should be excluded for treatment by the HTSI system. The DAW (hard and soft) listed in Items 1 to 3 differ in properties from each other; when they are treated by a shear shredder only, the abrasion of shredder edges lowers the throughput of the pretreatment subsystem.

In order to solve this problem, the pretreatment subsystem was modified as shown in Fig. 3, so that the subsystem could perform its anticipated function; shredding waste into small pieces for prolonged period of time.

The modified pretreatment subsystem characteristically treats hard and soft materials by a crusher and shredder, respectively.

After waste sorting, acceptable hard and soft DAW is directly fed to the crusher and shredder, respectively, through Line 2. When perfect waste sorting is not expected, mixed DAW is fed to a sorting unit through Line 1. Hard DAW is then crushed into small pieces by the crusher and separated from the mixed DAW by a trommel screen before remaining soft DAW is fed to the shredder. As a result, abrasion of the shredder edges is avoided and durability of the shredder is improved. In order to allow the HTSI system to function satisfactorily, hard DAW must be completely crushed into small pieces by the crusher. Thus, a rotary hammer type machine was selected for the crusher.

In the SCK/CEN off-gas cleaning subsystem, off-gas is released after being cooled by a water injection cooler (WIC) and then treated by a bag and HEPA filter. The following were considered in modifying the off-gas cleaning subsystem:

5. Replacement of the bag filter with another high efficiency filter system aiming at a prolonged life of HEPA filter elements.
6. Elimination the WIC since some measures must be taken to prevent dew condensation due to high water content when the WIC is used.
7. High temperature off-gas treatment to prevent condensation of HCl and SO₃.

Fig. 4 shows a modified off-gas cleaning subsystem in which these improvements were incorporated:

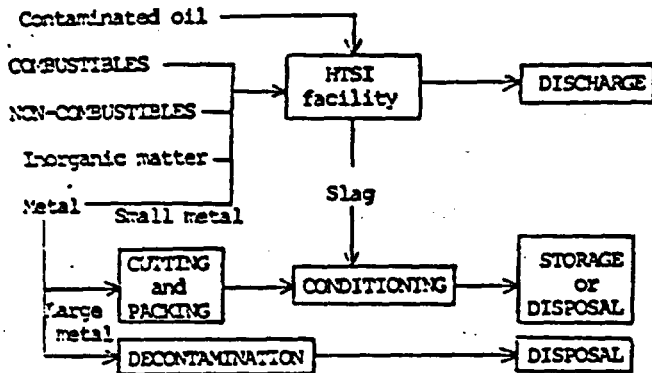

Fig.2. Plan for DAW treatment.

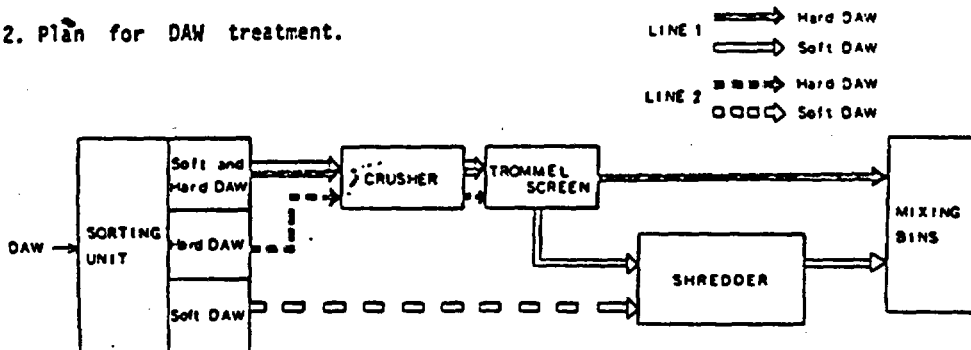

Fig. 3. Modified pretreatment subsystem.

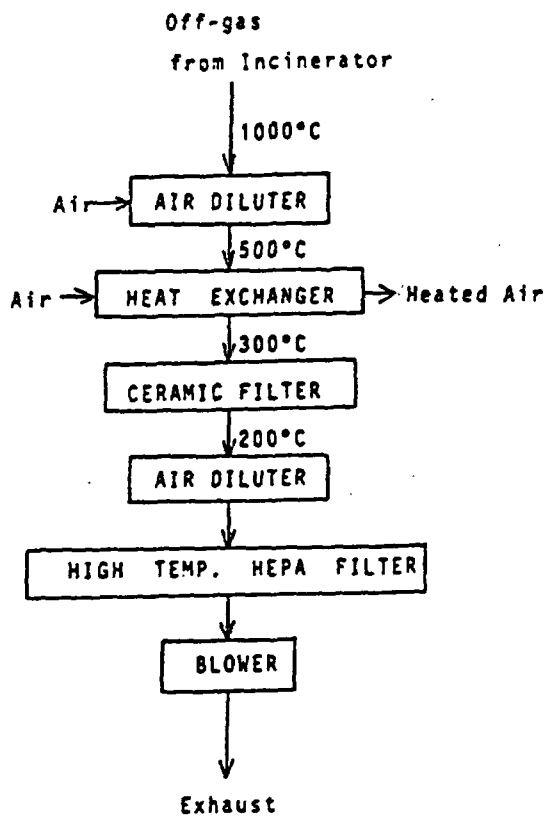

Fig.4. Off-gas cleaning system

The HEPA filter load is reduced by adopting a high-efficiency ceramic filter, and the entire system can be operated at high temperature by adopting a high temperature HEPA filter. Water content in the off-gas is reduced by adopting a heat exchanger and fuel saving is ensured by using heated air for combustion air.

PILOT PLANT DESCRIPTION

The main process flow diagram of the HTSI is shown in Fig. 5. The simulated non-radioactive waste consists mainly of wood, paper cloth, sheet, rubber, small metals, concrete and thermal insulation material. The waste is crushed or shredded, then fed to a mixing bin. The mixed waste is then fed to the incinerator at a normal feeding rate of 100 kg/hr, with intermittent operation of a conveyor at 20 minutes per hour. The incinerator residue, falling from FLK in the form of droplets into a water bath, is cooled in water, dried by heated air, then packed into 200 liter drums.

The incinerator off-gas is cooled to about 500°C in a shell-and-tube countercurrent air heat exchanger and further cooled to 300°C by an air diluter, then filtered by the ceramic filter. To prevent the off-gas from leaking, the entire facility is kept below atmospheric pressure by an off-gas blower.

Pretreatment unit

The crusher is a heavy duty industrial machine equipped with a vertical rotating shaft with hammers capable of crushing hard materials into 1 to 3 cm pieces, having a crushing rate of 2 ton/hr for average composition waste.

The shredder consists of a single low-speed rotating shaft equipped with disk-shaped blades, stationary edges fixed on the outer wall, and a 5 cm perforated screen below them. Its shredding rate is 5 ton/hr.

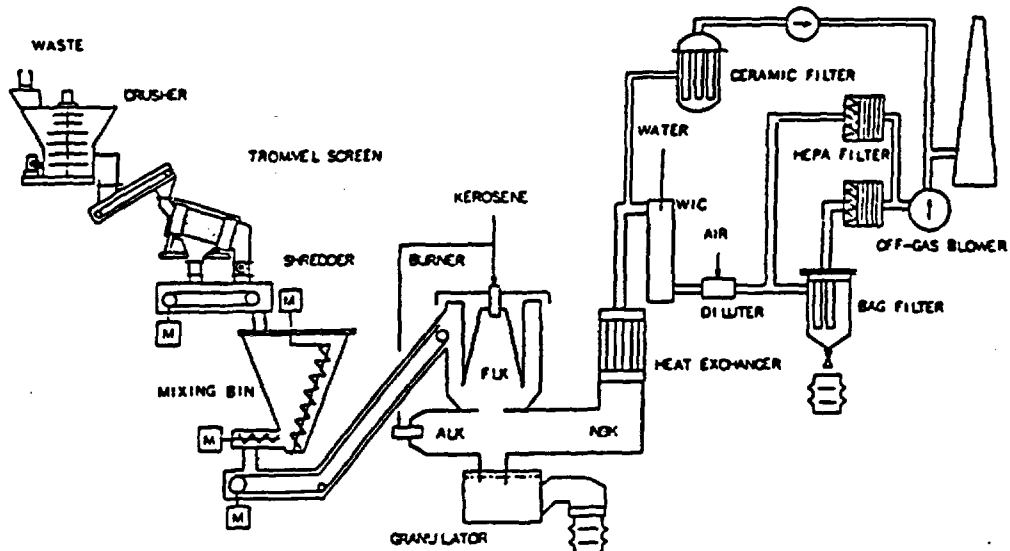

Fig. 5. Flow scheme of the HTSI Pilot Plant

Off-gas cleaning system

To avoid corrosion problems, the heat exchanger tube sheet and tube inlet portions are coated by ceramics. To confirm filtering performance and durability, two types of ceramic filters are equipped just for performance evaluation purposes. The ceramic filters are cleaned on-line by blowing compressed pulse jet air on each element.

OPERATING EXPERIENCE

Cumulative operating time has reached approximately 2,000 hrs, and about 40 start-up and shut down procedure have been experienced. Soundness of all refractory has been verified, though small cracking caused by thermal cycling has been observed. In the highest temperature range, the refractory inside the main combustion chamber has shown no evidence of significant surface attack by adhered molten slag.

In the performance test, non-combustibles such as iron, concrete, thermal insulation material, HEPA filter elements, etc., and combustibles such as paper, wood, plastic sheets, ion exchange resin, etc., were treated in the pilot plant. Although waste composition effected incinerating and shredding performances and volume reduction, the residual carbon was kept at approximately zero. Continuous and constant composition feeding ensured very small fluctuation of the residue properties as shown in Fig. 6.

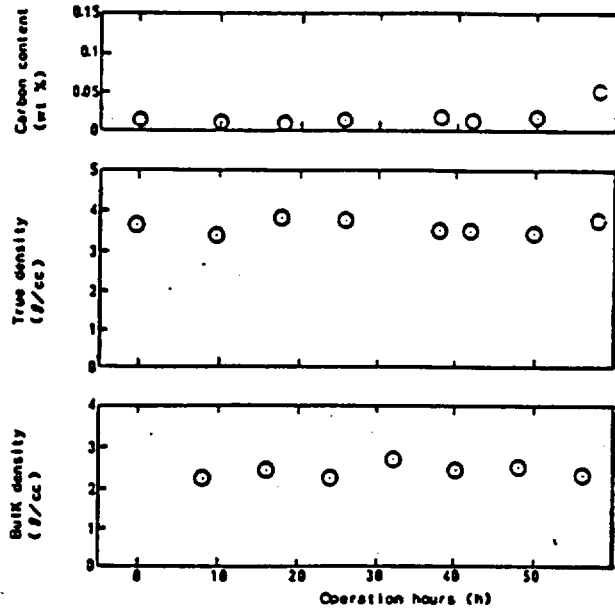

Fig. 6. Incinerator residue properties in a campaign.

Run No	Waste Composition (wt %)		Operation time (h / 1Run)	Treated Waste (ton / 1Run)	Capacity (kg/h)
	Unburnable	Burnable			
H-06	50	50	35	2.8	90
H-09-10	30	70	60 ~ 90	5 ~ 8	90 ~ 100
H-12-18	40	60	60 ~ 100	6 ~ 9	90 ~ 100
H-19-20	60	40	80 ~ 90	8 ~ 9	100
H-21-32	70	30	80 ~ 90	8 ~ 9	120
H-33-36	80	20	30 ~ 50	3 ~ 5	120
H-38-39	70	30	30 ~ 65	5 ~ 8	120
H-40-41	60	40	50	5	110

Table 1. Typical operating results

The HTSI system achieves high volume reduction since combustibles are almost completely burned, and the residue bulk density is high. DF value of each component was then measured, using $\text{Co}(\text{NO}_3)_2$ and Cs_2SO_4 as chemical tracers; results are shown in Table 1. DF measurement indicated a DF of over 10^4 for the ceramic filter, and above 10^5 for the entire system including the incinerator.

In commercial plants, additional HEPA filters may be installed to the system for safety purposes so that radioactivity released to the environment can be reduced to near zero.

Run No.	(H-30)		(H-22,23,24)	
	Co	Cs	Co	Cs
Incinerator	167	1.5	229	2.8
Ceramic filter	$>1.74 \times 10^4$	1.1×10^5	$>1.74 \times 10^4$	1.1×10^5
Total	$>2.9 \times 10^6$	1.7×10^5	$>4.0 \times 10^6$	3.1×10^5

* Calculated from the detection limit.

Table 2. DF Value of each component

Element	Duration (day)	Leaching rate* (g/cm ² ·day)
Weight	3	1.6×10^{-7}
Fe	3	8.4×10^{-8}
Na , K	3	1.5×10^{-6}
Co	20	8.4×10^{-9}
Cs	28	** 8.9×10^{-8}

**Calculated from the detection limit

Non-combustibles / combustibles = 70/30 (wt/wt)

* Measured by the MCC-55 method

Table 3. Leaching rate of the residue

INCINERATION RESIDUE SOLIDIFICATION

In the main combustion chamber (FLK), the residue becomes molten slag at a high temperature of 1,500°C. For easy handling, the molten slag is granulated by quenching in water. The average granule size was approximately 3 mm, apparent specific gravity approximately 3, and leaching rate based on the Soxhlet test below 10^{-6} g/cm² day as shown in Table 2. Although the residue can be easily solidified with conventional cement by out-drum mixing, this method generates secondary waste liquid from washing the mixer. The in-drum post packing method was found to be suitable for eliminating secondary waste. In this method, the residue is poured into a 200 liter drum, half filled with cement grout, which sits on the vibrating table.

CONCLUSION

The incinerator was scaled up actually attaining the design treatment capacity, and the HTSI system having wide range of throughput can be designed.

Operating of the HTSI system has substantiated that it is capable of the treatment of DAW having an extensive waste composition, and ensures stable products and a high VRF without any concerns to environment with high off-gas DF.

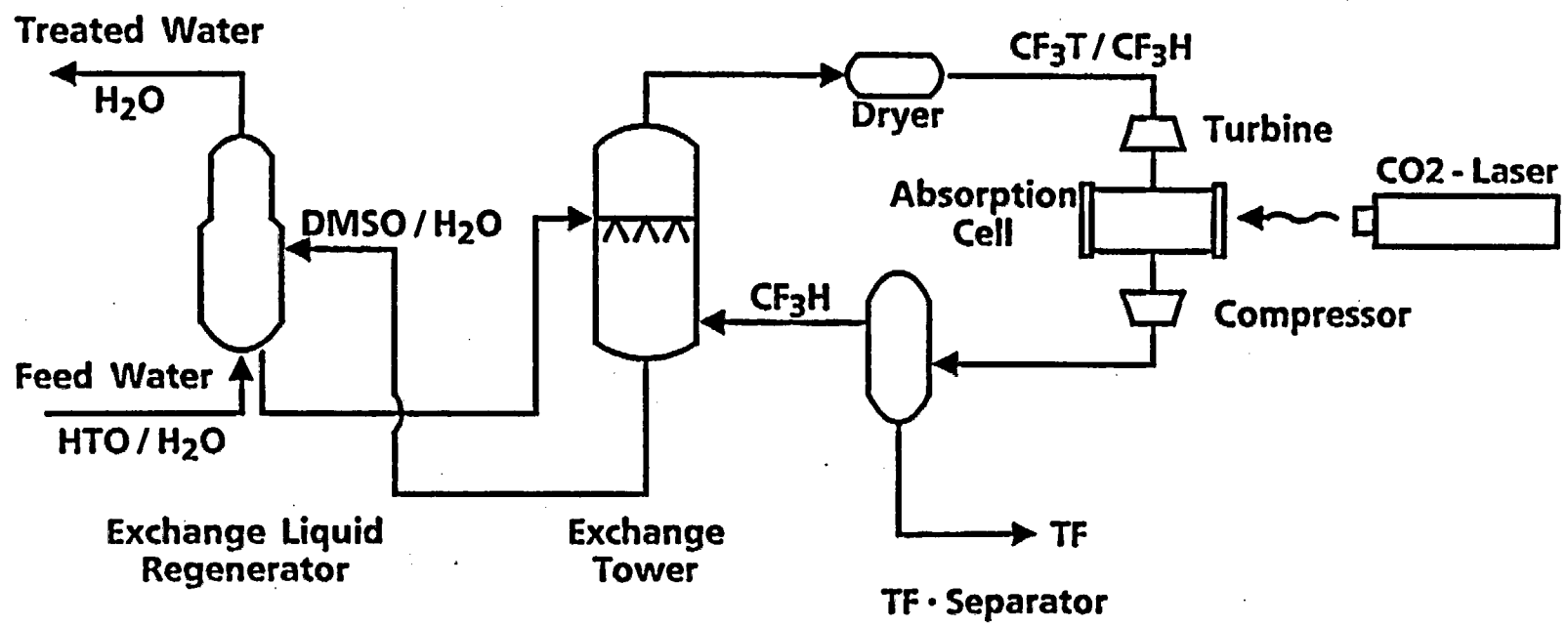

Outline of Laser Tritium Separation Process

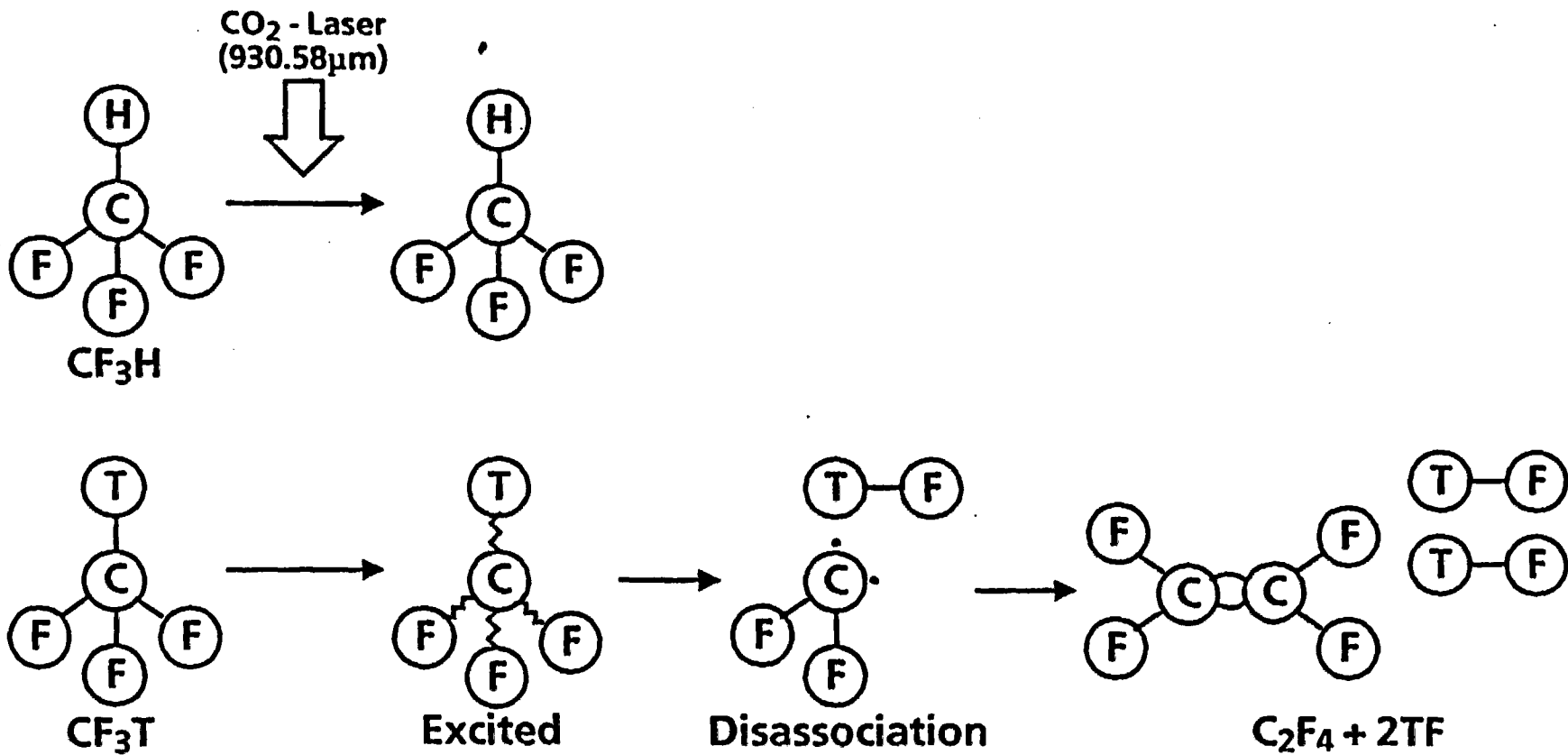

Reaction Mechanism of Laser Tritium Separation

JGC

- o After treatment, soils exhibit very low leach rates for mercury and heavy metals, as well as for other contaminants.
- o Uranium and TRU contamination can be effectively stabilized.
- o Excessive volume increases are eliminated.

In addition, the system can easily be adapted to a mobile system, providing economical treatment at diverse locations without excessive set-up costs.

Successful Implementation of the concept will:

- o Allow more effective stabilization and leach resistance for heavy metals.
- o Provide the first effective method of on-site stabilization of low levels of mercury contamination.
- o Reduce the cost of remediating sites contaminated with mercury.
- o Allow the stabilization of soils contaminated with a combination of hazardous metals, uranium, and TRU.
- o Allow efficient remediation of smaller contaminated sites.
- o Reduce volume of low concentration TRU required to be sent to WIPP
- o Provide a method for stabilization of soils containing heavy metals and TRU fixed to chelate agents such as EDTA and DTPA.

JGC is optimistic that this process could substantially improve the effectiveness and cost of remediation of these DOE sites. In addition, it is likely that many EPA-designated Superfund sites could benefit from the successful implementation of the concept.

Soil

Excavate

Crushing

Mixing

Mixing

Backfill

Chemical Reagent Solution

Bentonite or Portland Cement

Leach Test Results - Treated by fixing agent (I) and Cement -

Method	EP - Toxicity			TCLP		
	Sample (mg / l)	Criteria (mg / l)		Sample (mg / l)	Criteria (mg / l)	
Cd	4.86	1.0	X	0.10	0.066	X
Cr	0.68	5.0	○	0.11	0.084~5.2	○
Hg	0.20	0.2	○	— ¹⁾	0.025	—
Pb	0.71	5.0	○	0.36	0.18~0.51	○

1) Analysis is now in progress

Leach Test Results – Treated by fixing agent and bentonite –

	Fixing agent (I) and bentonite			Fixing agent (II) and bentonite		
Method	EP - Toxicity			TCLP		
	Sample (mg / l)	Criteria (mg / l)		Sample (mg / l)	Criteria (mg / l)	
Cd	0.63	1.0	○	0.04	0.066	○
Cr	<0.01	5.0	○	0.11	0.084~5.2	○
Hg	0.20	0.2	○	— ¹⁾	0.025	— ¹⁾
Pb	<0.01	5.0	○	0.33	0.18~0.51	○

1) Analysis is now in progress

Comparison between the Conventional Cement System and JGC's AC - Process

Waste to be treated	Conventional cement method	JGC technology	Remarks
Incinerator ash	No pretreatment	Pretreated by the $\text{Ca}(\text{OH})_2$ and NaOH	A retarded cement hydrating reaction problem are solved.
Spent resin	No pretreatment	Pretreated by the cement and water	Swelling phenomenon of the immersion test are protected.
Boric acid waste	No pretreatment	Hydrate calcium metaborate are generated by pretreatment	Volume reduction and stable products are provided

Table 1 Typical Product Properties

No.	Test Item	Regulatory Position (NRC)		JGC's Data					
		Standard	Estimation value	Boric acid waste	Spent resins	Laboratory drain	Laundry drain	Incinerator ash	
1	Free liquid	ANS 55.1	No more than 0,5 vol%	0	0	0	0	0	
2	Compressive strength	ASTM C 39	More than 60 Psi	3,150	3,070	8,380	7,250	3,600	
3	Gamma irradiation	ASTM C 39	More than 60 Psi	2,800	2,550	6,760	7,190	3,400	
4	Leach test	ANS 16.1	More than LI 6 (90 dyas)	Co	12.1	13.0	14.6	11.1	14.1
				Cs	8.4	7.9	8.5	7.9	8.2
5	Immersion	ASTM C 39	More than 60 Psi	3,090	2,650	8,620	7,790	3,700	
6	Thermal degradation	ASTM B 553	More than 60 Psi	2,810	1,970	8,670	4,830	3,100	
7	Homo-geneity	ASTM C 39	More than 60 Psi	2,950	2,140	6,510	4,390	3,900	
8	Bio-degradation	ASTM G 21	More than 60 Psi	3,740	2,060	7,140	5,970	3,700	
		ASTM G 22		3,510	2,940	6,370	8,280	4,600	

WASTE MANAGEMENT '85

Waste Isolation in the U.S.
Technical Programs and Public Education

Volume 2

WASTE POLICIES AND PROGRAMS,
LOW-LEVEL WASTE

Proceedings of the
Symposium on Waste Management
at Tucson, Arizona
March 24-28, 1985

ON Boric Acid
Pre-treatment

ADVANCED CEMENT SOLIDIFICATION PROCESS

Teruo Iji, Hideo Kodama
Kyushu Electric Power Co., Inc.
1-82, Watanabe-Dori, 2-Chome, Chuo-ku,
Fukuoka, 810 Japan.

René Pierlas, Claude Jaouen
Société Générale pour les Techniques Nouvelles (SGN)
78184, Saint Quentin Yvelines Cedex,
France.

Hiroshi Kuribayashi, Norimitsu Kurumada
JGC CORPORATION
2205, Naritacho, Oharai-machi, Higashi-
Ibaraki-gun, Ibaraki Pref., 311-13 Japan.

ABSTRACT

The Advanced Cement Solidification Process, which features improved volume reductivity and properties of solidified wastes, has been developed to establish a better radioactive waste management system. Cement has been widely used as an inorganic solidification agent for the treatment of radioactive wastes generated at nuclear facilities. With current technology, borate waste solutions generated at PWR plant are neutralized with caustic soda and solidified directly with cement. This causes an increase in the volume of waste. Moreover, since borates retard the hydration of cement, the properties of solidified waste are not always such that meet the final disposal requirements. In order to eliminate these defects and to improve conventional cement solidification processes, SGN and JGC have conducted co-operative research, especially basic research on the pretreatment of borate. As a result of numerous experiments, a new process has been developed, by which solidified products with high volume reductivity and excellent physical properties can be produced. On the other hand, research and development work on a pilot plant have been carried out in co-operation with Kyushu Electric Power Co., Inc., including small scale hot tests of actual wastes at its Genkai Nuclear Power Station. A commercial-scale cold pilot plant was constructed and several proving tests have been conducted successfully.

INTRODUCTION

An increase in the amount of radioactive wastes generated at nuclear power plants along with an increase in their construction and operation, has created significant problems of radioactive waste management. Under such circumstances, the development of practical treatment processes for such wastes is an urgent task facing the world's nuclear power industry.

In order to store and transport medium- and low-level radioactive wastes generated at nuclear power plants easily and economically, it is essential not only to reduce their volume to the maximum extent but also to transform them into a solidified product so that it is suitable for final disposal and will maintain its chemical and physical soundness over a very long period of time.

For this purpose, the Advanced Cement Solidification Process with high volume reducibility has been developed. Cement has been most commonly used as an inorganic solidification agent for radioactive wastes at nuclear facilities, since it has many advantages as follows:

- It is standard, low cost embedding material.
- It is compatible with wet waste.
- Its hardened product is stable, and has high density and high mechanical resistance.

However, it has been generally observed that the volume of solidified products produced by conventional

cement solidification processes becomes larger than the original volume of radioactive wastes. Moreover, the high quality solidified products are not always produced in cases where borate wastes generated at PWR plant are treated by such processes, because borates present in the wastes retard the hydration of cement and impede the progression of the hardening of cement paste.

In order to eliminate these defects of most of the conventional cement solidification processes, mainly related to borate wastes, SGN had been developing a new volume reduction and cement solidification system, in which a borate waste solution is pretreated and then overconcentrated. Independently of SGN, JGC was conducting basic research on the pretreatment of borates and on the hydration of cement.

In 1982, SGN and JGC agreed to begin co-operative work on the research and development of a volume-reducing cement solidification process, based on their past experience. After a series of basic experiments, particularly on the pretreatment of borates, SGN and JGC developed the Advanced Cement Solidification Process, by which the volume of wastes can be highly reduced and solidified products with good physical properties can be produced.

Small scale hot tests of actual wastes based on this process, with the co-operation of Kyushu Electric Power Co. Inc., were carried out at its Genkai Nuclear Power Station. In this hot test, the results of basic research were reconfirmed and the practicability of the process was proved. Based on preliminary performance test data on selected equipment, commercial-scale

pilot plants were designed and constructed in both JGC and SGN laboratories, the former sponsored by Kyushu Electric Power Co., Inc., to carry out various demonstration tests on the operability, durability and optimal operating conditions of all equipment and systems. These tests have almost been completed, with the result showing that the process can be put into commercial service.

An outline of this process, mainly relating to treatment of borate waste, is described in this paper.

PROBLEMS WITH MOST OF THE CONVENTIONAL CEMENT SOLIDIFICATION PROCESSES

In most of the conventional cement solidification processes, the concentrated borate waste solutions generated at PWR plants are directly solidified with cement. This causes two main problems. These are:

- Borates ions present in the waste solution retard the hydration reaction of cement. This makes it difficult to obtain sufficiently hardened products with good physical properties.
- The volume of hardened products is larger than the original volume of wastes.

The first problem may be solved by the following mechanical or chemical means:

- Mechanical means
When cement particles come in contact with a solution containing soluble borates, calcium borates is formed on their surfaces. It remarkably retards the hydration reaction of cement clinker mineral, such as calcium silicate, and also consequently setting time of cement. In order to make the hydration proceed, the calcium borate must be removed from the surfaces of the cement particles. This can be achieved, for example, by using a high-shear mixer.
- Chemical means
Borates present in the waste solution can be transformed into almost hardly soluble borates. This eliminates the formation of calcium borates on the surfaces which retard the hydration and setting of cement.

In order to solve the second problem whereby the volume of solidified products must be further reduced, some means that would enable further concentrating of such solutions had to be developed.

SGN and JGC decided to solve these two problems by chemical methods and carried out extensive basic research on various pretreatment methods for borate waste solutions. SGN and JGC finally succeeded in overcoming the problems by developing an effective pretreatment method, by which insoluble borates are formed from such solutions.

BASIC RESEARCH

Basic Research on Pretreatment

An objective of the pretreatment is to transform soluble borates present in the waste solution into hardly soluble borates so that their retarding action on the hydration of cement can be eliminated.

Some alkali earth metal salts of boric acid such as calcium borate are known to be very insoluble in water. For examples, calcium borates exist in nature as born containing minerals. It is anticipated to be

stable in the hardened cement matrix which also consists of calcium compounds. Therefore, in the basic research, SGN and JGC's efforts were directed toward finding methods by which insoluble calcium borates could be formed when a calcium compound is added to the borate waste solution.

In cases where the pH of concentrated borates waste solutions was on the acidic side, the rate at which calcium borates were formed was extremely slow, whatever calcium compounds were added.

When an alkaline calcium compound was added to an acidic waste solution, the reaction rate was extremely slow, so it seemed that no reaction was taking place. The alkaline calcium compound is solid. When its particles came in contact with a boric acid solution, a thin film of insoluble calcium borates was formed on their surfaces, and it prevented the particles from being dissolved in the solution and stopped their reaction.

In order to further advance the reaction, two methods were considered.

- To enlarge the lattice structure of the thin film of the insoluble salt so as to allow calcium ions to easily pass through the film.
- To promote the dissolution of the calcium compound under specific conditions.

It is well known that in cases where cement is mixed directly with a borate solution, the mixture does not harden neither develop strength even after curing for one month, but the addition of sodium hydroxide to the solution to transform boric acid into sodium tetraborate or sodium metaborate causes the mixture develop strength. This fact was effective in solving the problem.

Sodium hydroxide was added to a borate solution, and the solution was then mixed with a calcium compound. The mixture was continuously stirred. As the reaction advanced, a thixotropic paste was produced. The higher the concentration of boric acid, the more viscous it became. And it sometimes stiffened and remained in a nearly pasty condition only when the stirring was continued. When the stirring was stopped, it became a gel and was difficult to handle. By this pretreatment method, it was possible to obtain low soluble calcium borates but it was difficult to concentrate the solution.

In order to improve reaction conditions in the pretreatment step, such as reaction temperature, stirring conditions (stirrer type, blade shape, revolution speed), dosage of chemicals, method of dosage, etc., further detailed studies were conducted.

It was found that pretreatment under adequate stirring conditions prevented the formation of the pasty substance and produced precipitates of insoluble calciumborate. The precipitates are crystals having good sedimentation tendency and can exist stably in a cement matrix.

Basic Research on Mixing Ratio

The solid/water/cement mixing ratio to prepare a cement paste is determined according to the procedures shown in Fig. 1. The cement paste must have a sufficient consistency at which it can be poured into a container. The consistency or workability can be measured as flow values defined in JIS R 5201 or ASTM C124-71.

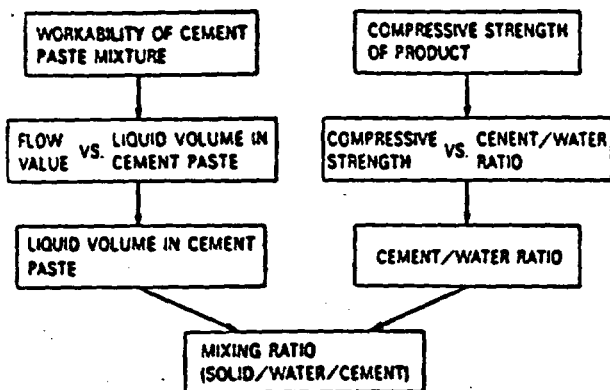

Fig. 1. Procedure of Design of Mixing Ratio.

Experiments showed that the consistency or workability of cement paste increased proportionally as the volume fraction of liquid in a mixture increased. The volume of liquid in a mixture can be determined if the target flow value is set.

Meanwhile, the strength of solidified products depends upon cement/water ratio in a mixture. The cement/water ratio can be determined if the target strength of solidified product is set. Since liquid volume determines the quantity of water, the mixing ratio can be determined if the consistency of a mixture and the strength of solidified products are set.

Experiments on consistency and strength showed that a mixing ratio of 50/30/20 (solid/cement/water) by weight was adequate in cases where the target flow value was set at 200 mm or larger, while the target one month compressive strength of solidified product was set at 20 MPa or larger.

HOT TEST

A series of small-scale hot tests of this process were carried out at the Genka Nuclear Power Station of Kyushu Electric Power Co., Inc. The experimental results are summarized below.

- Calcium borate precipitates were successfully obtained in a pretreatment step.
- Pretreated waste solutions were concentrated. The concentrates were solidified with cement. Sufficiently hardened products were produced.
- In cases where the concentration of boric acid in the waste solutions was 12 wt %, the volume of solidified product became approximately 1/4 of that of their original waste solution.
- Solidified products showed good water resistance.

The hot tests confirmed the results of the basic research and proved that the process is effective in solidifying actual borate waste solutions.

BASIC PROCESS FLOW

The basic flow of the Advanced Cement Solidification Process is shown in Fig. 2. This process consists of the following three main steps.

Pretreatment Step

The pretreatment step, the key to the successful operation of the process, is indispensable for ensuring

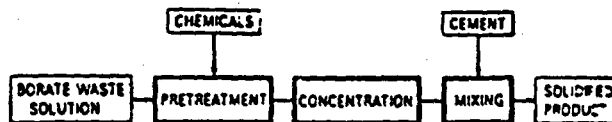

Fig. 2. Basic Flow Diagram of Advanced Cement Solidification Process.

the hardening of cement to produce sufficiently solidified products, with good physical properties in a reproducible way.

In the pretreatment step, calcium borate is formed and precipitated. The precipitates are stable crystals and have good sedimentation properties.

Since dissolved borate, detrimental to the hydration of cement, can be converted into insoluble calcium borate precipitates, it has become possible to obtain sufficiently hardened products with good physical properties, which are suitable for waste storage, transportation and final disposal.

Concentration Step (Volume Reduction Step)

In this step, a borate waste solution is concentrated to such an extent that only a minimum quantity of water necessary for mixing with cement is left. This operation has become feasible by removing dissolved borate in the form of insoluble calcium borate showing good sedimentation.

From the viewpoint of reducing the volume of a borate waste solution, the most common method that enables the greatest volume reduction is to evaporate such solution to complete dryness. In the process, the borate waste solution is not evaporated to dryness but is concentrated to an optimum volume, because cement must be mixed with water so as to harden it.

The concentration step avoids technically difficult dry powder handling operations.

Mixing Step

An out-drum mixing method is employed in the mixing step. In order to produce solidified products having high strength and highly reduced volume, it is important to prepare a cement paste of good consistency with a minimum quantity of water. It is also important to increase the packing efficiency of such paste in a container. For these reasons, it is preferable to adopt the out-drum method, which can provide high mixing and filling.

Different kinds of cement can be used depending on requirements of the final product qualities. The results presented hereinafter are based on the ordinary portland cement (corresponding to ASTM Type I).

Advantages

The advantages of the Advanced Cement Solidification Process are:

- Based on 12 wt % of boric acid, the volume of solidified products produced by the process is 1/7 - 1/8 of that produced by conventional cement solidification processes.
- Solidified products having good physical properties are produced.

- The process is safe. The process does not need any flammable material. Moreover, it is a wet process, air-borne contamination due to radioactive nuclides resulting from a dry process can be avoided.
- All materials to be used in the process are readily available and inexpensive.

PILOT PLANT TEST FOR COMMERCIALIZATION

Examples of Typical System

As shown in Fig. 2, the process basically consists of three steps: pretreatment of borate waste solution, concentration of slurry, and cement mixing. With regard to the concentration methods and operating modes, several systems are feasible. Examples of a typical system are shown in Fig. 3.

System-1 is a continuous process and consists of three steps: pretreatment, overconcentration and mixing. The slurry, obtained in the pretreatment step, is evaporated and concentrated in the step of overconcentration. The concentrated slurry is cooled and mixed with cement. This system is of advantage in cases where there are frequent discharges of borate waste solution. Since the slurry is concentrated by evaporation, the concentrating vessel is equipped with a specially designed scraping mechanism so as to keep the heat transfer surface exposed at all times to the slurry. The mixer is also equipped with a similar mechanism. SGN has designed and built a pilot plant based on this system and has been conducting experiments.

System-2 is a batch wise process and consists of four steps. The concentration step in the basic process, which is shown in Fig. 2, is divided into two steps: solid-liquid separation and concentration of separated liquid. This system is advantageous in cases where discharges of borate waste solutions are less frequent. Calcium borate precipitates obtained in the pretreatment step have good sedimentation properties and easy to separate. This separated solid portion is sent to the mixer and the separated supernatant is concentrated by evaporation. Since borate precipitates

can be almost removed in the separation step, a conventional type concentrator can be used.

With the co-operation of Kyushu Electric Power Co., Inc., JGC has built a commercial-scale pilot plant based on this system and has been carrying out various tests to put this System-2 process into commercial service.

System-3 is also a batch wise process, using pretreatment, concentration and cement mixing—depending on the basic data. These three steps can be operated in one or two stages. The system is based on the concentration under reduced pressure condition of the slurry, during and/or after the pretreatment step. The concentrated slurry is then mixed together with the binder. The concreted product is poured into a drum in the last step. This system has been developed with a view of reducing the number of equipment and making the entire system design compact. SGN intends to design a compact mobile unit based on this system, the corresponding tests are going on.

Pilot Plant Based on System-2

The effectiveness of system-2 process has been proven in pilot plant, which is outlined below.

Pretreatment:

A reaction vessel, equipped with a specially designed stirrer, was used. The stirrer served to effectively mix the borate waste solution with an added calcium compound. Crystalline precipitates of insoluble calcium borate were formed.

Solid-Liquid Separation:

A conventional type separator was used to separate the slurry into the supernatant and solid portions. The separated solids were sent to the mixer. The separated supernatant was first stored in a tank and then fed to an evaporator.

Concentration:

A small conventional type evaporator was used to concentrate the supernatant. Concentrated liquid was sent to the mixer and used as mixing water. Therefore, the supernatant was concentrated to the minimum

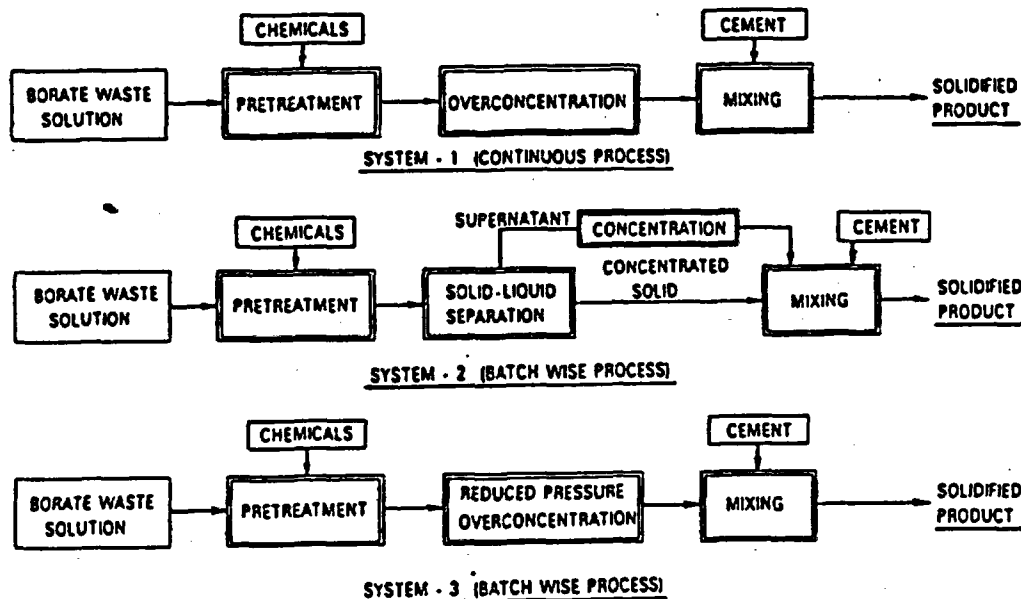

Fig. 3. Typical Flow Diagrams of Advanced Cement Solidification Process.

possible volume by which the separated solids could be mixed with cement.

Mixing:

The pilot mixer used has blades which rotate at high speeds. Weighed quantities of the separated solids and the further concentrated liquid were pre-mixed. The pre-mixture was well mixed with a weighed quantity of cement for a few minutes so as to obtain a workable cement paste. The paste was poured into a container. After curing the mixture at room temperature, a sufficiently and uniformly hardened product was obtained. After the mixing operation was completed, the mixer was easily washed.

A series of pilot plant tests on the performance, operation and durability of the equipment used in each step proved that the System-2 process successfully met all pre-set targets. Also, a large volume of engineering data including the operability and optimal operating conditions of the whole system was obtained. All experimental results showed that it would be feasible to put this process into commercial service. A conceptual design of an actual plant was carried out, using the experimental results. It was known from the conceptual design that a sufficiently economical and compact system could be constructed.

PHYSICAL PROPERTIES OF SOLIDIFIED PRODUCT

Several typical physical properties of solidified product obtained by this system-2 process are shown below.

Strength Development and Specific Gravity

The strength development of a solidified product obtained is plotted in Fig. 4. After it was cured for about one month, it showed a strength of more than 20 MPa. Even one year later, measurements showed that its strength was steadily increasing.

An electron microscopic observation of a cross-section of the solidified product proved that the calcium borate formed in the pretreatment step was also stable in cement matrix for a long period of time.

The specific gravity of the solidified product is about 1.8.

Water Resistance

The solidified product does not lose its strength, as shown in Fig. 5, even if it is immersed in water for a long period of time. Its volumetric change was equal to or less than 1% in one year, with result that there was no appreciable change in its shape. It has good water resistance.

Leachability

The leaching rate of two typical nuclides, Co^{60} and Cs^{137} , measured by using a specimen, 45 mm in diameter and 44 mm in height, was as follows.

Co^{60} : 10^{-6} cm³/cm². day or less

Cs^{137} : 10^{-6} cm³/cm². day or less

The leaching rate of Cs^{137} can be further improved, if necessary, by adding zeolite or using blended cement.

Uniformity

A 200-liter (55-gallon) solidified product was

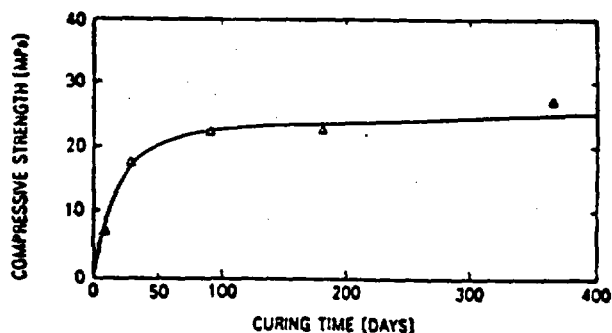

Fig. 4. Strength Development of Solidified Product Cured in Moist Air.

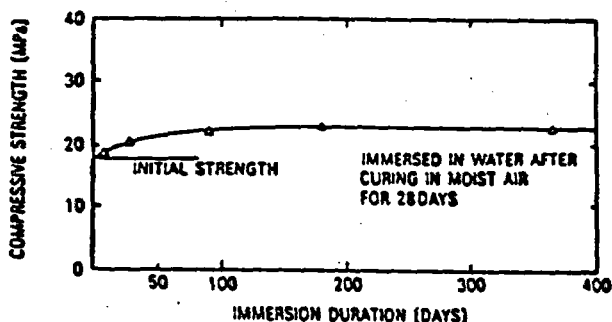

Fig. 5. An Example of Water Resistance of Solidified Product (Strength Development).

produced. Samples were taken from the core to measure the specific gravity and strength. The measurements showed that the specific gravity and strength of the solidified product were uniform throughout product.

VOLUME REDUCIBILITY

The volume reducibility obtained by the Advanced Cement Solidification Process is shown in Fig. 6. When treating 1 m³ of concentrated waste solution containing 12% boric acid, conventional cement solidification processes produce about 2 m³ of solidified product, with the result that the original volume is increased. On the other hand, this process produces 0.25 m³ of solidified product, resulting in the volume being 1/4 of the original volume. When compared with most of the conventional process, the volume of the solidified product obtained by this process is about 1/8. Thus, this process attains an extremely large volume reducibility.

Accordingly, this process is very effective in many respects, i.e., reductions in storage space, transportation costs, etc., when treating radioactive waste containing borates.

CONCLUSION

A method by which radioactive wastes containing borate generated at PWR power plants can be chemically treated in such a manner that insoluble borates can be formed has been established, and based on the method, the Advanced Cement Solidification Process has been developed.

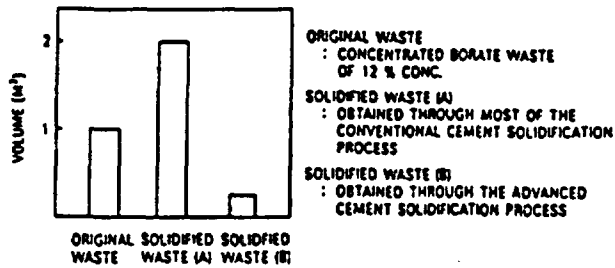

Fig. 6. Comparison of Volume Reduction.

- The volume of solidified products produced by the process is about 1/8 of that obtained by conventional cement solidification processes.
- The process produces solidified products having good physical properties. Such products are suitable for storage, transportation and disposal.

- Cement, used as a solidifying agent, is inexpensive.
- Radioactive wastes are processed in liquid or slurry form, so no airborne radioactive powders are produced. Thus, the process can be safely operated.
- The system is highly reliable and consists of practical equipment. Proving tests were successfully carried out on a commercial scale pilot plant.
- The pretreatment step of the process was proved to be practicable by numerous pilot plant tests and also by hot tests.

ADVANCED CEMENT-SOLIDIFICATION PROCESS FOR SPENT ION-EXCHANGE RESINS

K. Sauda, F. Todo, T. Nakashima, T. Kagawa, H. Kuribayashi
JGC Corporation
Yokohama, Japan 232

ABSTRACT

JGC has developed an advanced cement-solidification process (AC-Process) for the treatment and stabilization of radioactive spent ion-exchange resins generated at nuclear power plants. The AC-Process can produce excellent products in comparison with other existing cement solidification processes. In addition, this process requires a lower operating cost than that of the HIC system.

In general, cement-solidification products derived from spent ion-exchange resins tend to swell in water. Such swelling is caused by the expansion of resins in water due to the absorption of water and by the adsorption of soluble contents in the cement matrix. In order to solve this problem, JGC has developed a new pretreatment technique for obtaining cement-solidified products which will meet the requirements for final disposal. Extensive tests were conducted to determine pretreatment conditions. The properties of obtained products were evaluated to verify that they met the requirements for final disposal. The results of the tests and evaluation are reported below.

INTRODUCTION

JGC has carried out research and development work on cement solidification technologies for radioactive wastes for a long time. Such wastes as PWR evaporator concentrates, incineration ashes, etc., were difficult to cement-solidify using existing technologies. To stabilize such wastes, JGC has already established a new technology for obtaining highly volume-reduced solidified products excellent in water resistivity and other properties by using a JGC-developed unique pretreatment method (USP 4800042).

Also for ion-exchange resins, JGC has succeeded in solving problems associated with existing cement-solidification processes by pretreating ion-exchange resins before mixing them with cement.

The advanced cement-solidification technology for spent ion-exchange resins, developed by JGC, is described below with respect to the pretreatment method, process control program, Technical Position tests for cementitious waste forms.

PRETREATMENT OF SPENT ION-EXCHANGE RESINS

A problem associated with existing well-known cement-solidification processes for spent ion-exchange resins is that the matrix of the cement-solidified products obtained is disrupted when immersed in water for a long time. Cement-solidified products derived from spent bead resins particularly exhibit such a phenomenon. For this reason, the pretreatment of spent ion-exchange resins has been actively discussed at the Workshop on Cement Stabilization of LLRW held by the U.S. Nuclear Regulatory Commission (1).

This report describes the concept of the spent ion-exchange resin pretreatment method developed by JGC in comparison with other pretreatment methods. The mech-

anism of the matrix disruption of cement-solidified spent ion-exchange resin products in water has not yet been clarified. However, such a disruption is said to be caused by the adsorption of soluble cement components by resins during the curing and by the swelling and contraction of resins due to the reactions between cement-water and resin-water.

Various methods have been proposed to prevent such a disruption of the matrix and they can be classified roughly as follows:

- 1) Adsorption of such ions as Na, Ca, etc., by cation exchange resins (2).
- 2) Improvement of cement binders (3).
- 3) Coating of resins with polyester or similar materials (4).
- 4) Pretreatment to raise the water content (1).

Concerning method 1, the following problem exists: When spent ion-exchange resins are pretreated by NaOH, the adsorbed Na ions are replaced after a long period of time by Ca ions contained in cement. As a result, the matrix of the cement-solidified product is disrupted. The pretreatment of spent ion-exchange resins by lime (CaO) cannot prevent an increase in the anion exchange resin volume, though it is very effective in preventing an increase in the cation exchange resin volume.

According to our test results, it is revealed that when a cement-solidified product derived only from anion exchange resins is subjected to a water immersion test, the volume of the product gradually increases and finally disruption of the matrix and cracking occurs. Figure 1 shows the immersion test results.

On the other hand, the following problems are associated with methods 2 and 3: As methods for improving cement binders, examples exist of using slag cement, alumina cement, polymer gypsum cement, or sulfur cement. However, these methods do not differ from the use of

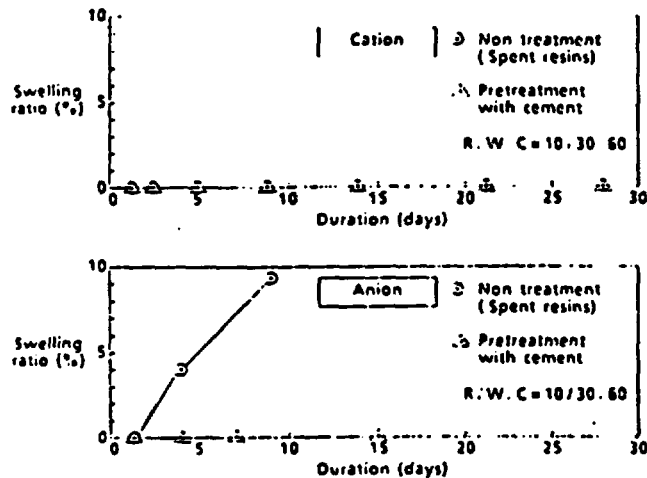

Fig. 1. Swelling of Solidified Spent Resin Products During Immersion Tests.

ordinary Portland cement. In method 3, spent ion-exchange resins are coated with an organic high-viscosity liquid such as polyester which requires a special chemical or heating for hardening to occur. This complicates the solidification process. Therefore, this method is undesirable although is effective.

Alternatively, as listed as method 4, spent ion-exchange resins can be cement-solidified under water-containing conditions. However, this method is not very effective because spent resins become dry during the curing.

As described above, the spent ion-exchange resin pretreatment methods reported up to the present time have both advantages and disadvantages. The development of a new cement solidification technology has therefore been desired. Considering such circumstances, JGC conceived the following pretreatment.

After the addition of a certain amount of cement and water, dewatered spent ion-exchange resins are agitated at a high speed in a highly alkaline cement slurry. Cement hydration of the spent resins after mixing with cement can thereby be prevented.

On the basis of this concept, JGC studied the spent ion-exchange resin pretreatment conditions, especially the amount of cement to be added, pretreatment time, and agitator revolutions. As a result of the study, it was revealed that satisfactory pretreatment effects could be achieved by high-speed agitation at 350 rpm using a high shearing mixer, cement addition of 20 wt% on a dry resin basis, agitation for

shown in Fig. 1, application of the cement pretreatment could also prevent matrix disruption of cement-solidified anion resin products.

TECHNICAL POSITION TESTS ON SOLIDIFIED PRODUCTS

Technical Position tests were conducted to verify that cement-solidified products obtained by applying this new pretreatment method met the technical requirements of 10 CFR 61, Technical Position (1983). The tests were comprised of a compressive strength test, radiation stability test, biodegradation test, leachability test, immersion test, thermal cycling test, free liquid test, and a full-scale test.

Preparation of test products

Non-radioactive spent ion-exchange resins were used to prepare solidified products for laboratory and full-scale tests. For leachability tests, the radionuclides, Co and Cs, were added to resins. For field tests, spent ion-exchange resins actually generated at a PWR plant in Japan were used.

Spent bead and powdered resins were both used as ion-exchange resins and the standard mixing ratio of cation to anion exchange resins was 1:1.

Test procedure

Compressive strength tests were conducted in accordance with ASTM C 39. Test specimens were cured in water-saturated air for 30, 60, and 90 days.

For radiation stability tests, specimens were irradiated with gamma rays of 10^8 rads at the Japan Atomic Energy Research Institute. Biodegradation tests were conducted in accordance with ASTM G21 and ASTM G22.

Leachability tests and immersion tests were conducted in accordance with ANSI 16.1. Test specimens cured in water-saturated air for 30 days were used for all the tests.

Thermal degradation tests were conducted in accordance with ASTM B553 and free liquid tests were conducted using full-size (55-gal drum) solidified products prepared by a demonstration pilot plant (Fig. 2) at JGC Oarai Research and Development Center.

Full-scale tests were conducted using specimens taken from a 55-gallon drum size solidified product prepared by the pilot plant, using a core boring machine.

Physical properties of products

The physical properties of cement-solidified products obtained are shown in Table I. All the data satisfied the criteria required by the Technical Position on Waste Form. From the test data, it is concluded that the cement-solidified

products obtained by this process meet the requirements for Class B and Class C waste forms.

System Description

JGC's advanced cement-solidification process, for the effective pretreatment of spent ion-exchange resins, is shown in Fig. 3. Spent ion-exchange resins are received in a spent resin receiving tank, then sent to a dehydrator or centrifugal separator for dehydration purposes. The supernatant is returned to a spent resin storage tank and the dewatered resins are received in a mixer, where the resins are mixed with the specified amount of cement and water. After the specified amount of cement is added, the pretreated resins are sufficiently mixed, then filled into drums.

Control parameters

The following parameters are controlled to obtain satisfactory cement-solidified products. The amount of cement to be added for pretreatment is more than 20 wt% on a dry resin basis. Resins are mixed for more than 10 minutes at an agitation speed of 350 rpm and cured for more than 3 hours. In addition, when the pretreated resin is mixed in the mixer, the weights are controlled so as to enable the follow-

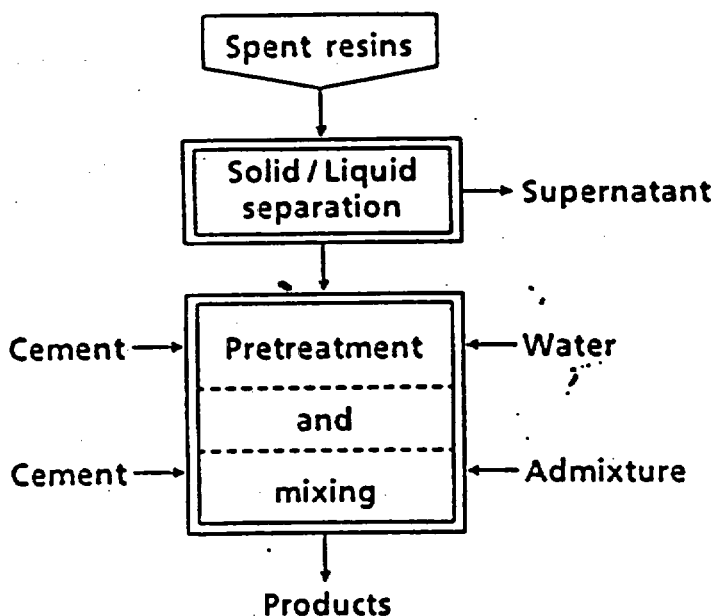

Fig. 3. Basic Flow Diagram of AC - Process.

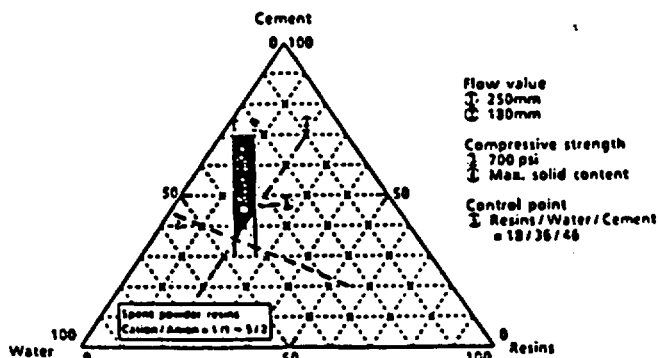

Fig. 4. Relation Between Mixing Ratios (R/W/C) and Bounding Limits.

ing mixing ratios:

Resin/Water/Cement = 18/36/46

Resin : Dry resin (lb)

Water : Water contained in resin + Free water (lb)

Cement: Portland cement (lb)

When the amount of water increases beyond the No. 1 line in Fig. 4, bleeding occurs, and when the amount of water decreases below the No. 2 line, the dischargeability from the mixer is lowered. An increase in the amount of resin lowers the compressive strength of cement-solidified products and causes disruption of the matrix in immersion tests. The No. 3 line indicates the condition under which cement-solidified products cured in water-saturated air for 30 days show a compressive strength of 700 psi. When the amount of resin is increased above the No. 4 line, cracks develop on the surface of cement-solidified products in 90-day immersion tests.

ECONOMICAL EVALUATION

This advanced cement solidification process eliminates the need for using expensive HIC liners because spent ion-exchange resins are stabilized by cement. A large reduc-

tion of direct expenses such as container cost, disposal cost, etc., can therefore be achieved.

CONCLUSION

In the advanced cement solidification process developed by JGC, solidified products obtained are excellent in physical properties because spent ion-exchange resins are sufficiently pretreated before being cement-solidified. Therefore, the products can satisfactorily meet the waste form criteria required by 10 CFR 61 and Technical Position. In addition, direct expenses can be largely reduced because there the use of expensive HIC liners is not required.

REFERENCES

1. U.S. NRC, "Workshop on Cement Stabilization of Low-Level Radioactive Waste," NUREG/CP-0103, NISTIR 89-4178.
2. T. TSUTSUI and K. NISHIMAKI, "Evaluation Method for Cement-Solidified Products of Radioac-

tive Waste," Vol. 9, P87 94, Health Physics, (1974).

3. Brookhaven National Laboratory "Waste Form Development Program Annual Report," BNL 51614, (1982).
4. Brookhaven National Laboratory, "Waste Form Development Program Annual Report," BNL 51756, (1983).

INCINERATION CONFERENCE 1990

MAY 14TH - 18TH
HAWALEI HOTEL
SAN DIEGO, CALIFORNIA USA

Includes AC Solidification
Process Technology For
Incinerator Ash

Technology of Stabilization for Incinerator Ash Wastes

K. Yokoyama, K. Suzuki, F. Todo and Y. Moriya
JGC CORPORATION, (Tokyo, Japan)

ABSTRACT

This report concerns the stabilization of incinerator ashes; advanced cement solidification and high frequency induction melting.

(1) AC Solidification

Most important points in this process are pretreatment of ashes by $\text{Ca}(\text{OH})_2$ addition and use of high shearing mixer to give efficient homogeneity. The products contain 35wt% ashes, and have high compressive strength ($200\text{kg}/\text{cm}^2$) and low leachability.

(2) HFIM

Ashes are melted at $1,200 - 1,600^\circ\text{C}$ by the induced heating using a 25KHz high frequency, in a melter made of carbon material. The vitrified products have good chemical-physical properties. Furthermore, the process is capable of treating concrete, heat-insulator materials and other noncombustible DAW.

INTRODUCTION

The stabilization of incinerator ash wastes is classified into two main processes; one is embedding in a binder matrix⁽¹⁾⁽²⁾, and the other is melting into hard blocks⁽³⁾. Cement-, bitumen, plastic-solidification belong to the former process. These are easily operated by simple equipment, though both volume and weight of solidified products are increased. The latter is the melting treatment by method such as Joule-heat, high frequency induction, microwave and so on. These processes have higher volume reduction but involve considerably more complicated systems.

The application of these techniques to actual wastes should be reasonably selected with consideration given to several parameters; waste-volume, -weight, -form, contamination levels of radioactive or/and hazardous wastes, required capacity and foreign materials in ashes.

In this paper, advanced cement (AC) solidification and high frequency induction melting (HFIM), developed by JGC, for radioactive ash wastes are reported.

ADVANCED CEMENT SOLIDIFICATION

I. Concept of AC solidification

AC solidification process for incinerator ashes consisted of two main procedures; pretreatment and homogeneously mixing by high shearing mixer. Figure 1 shows the basic flow diagram. Pretreatment is required to effectively prevent a cement-hydration reaction due to Zn, Pb metal compounds. Also, this can avoid the deterioration of product-block strength due to H_2 gas generation reacting with Al metal. The above mentioned metal compounds are generally contained in incinerator ashes. The process proceeds with the direct addition of $\text{Ca}(\text{OH})_2$ and NaOH into ash-wastes in the presence of appropriate amount of water.

II. Properties of cement product

To obtain the fairly homogeneous mixture of cement the pretreated ash waste, a high shearing mixer, as shown in Figure 2, has been used at the mixing condition of 35wt% ash-waste content and weight ratio of water to cement=1:1. The pretreatment requires about one day.

The physical-chemical properties of products are summarized in Table 1. The density and compressive strength are range from 1.7 - 1.9 and 200 - 400 kg/cm², respectively. The incinerator ashes are effectively embedded in cement matrix by AC process.

Leaching index(LI) values, defined by ANS16.1 are obtained for radioactive Co and Cs, based on the leaching tests results over 90day. These LI values satisfy the requirement that LI>6.

III. Features of the process system

- The pretreatment of additive Ca(OH)₂ to incinerator ashes is sufficiently effective to obtain stabilized cement products.
- This process system has very simple equipment and a easy to operate, although the weight and volume of wastes finally increase.
- The homogeneous mixture of cement and ash waste (35wt% content) is given by high shearing mixer.

HIGH FREQUENCY INDUCTION MELTING

I. Concept of HFIM

Figure 3 illustrates main system-components in the HFIM test pilot. The noncombustible wastes, which are shredded or crushed, if necessary, are fed to the melting pot made of carbon material. The outside of this pot is surrounded with high frequency induction coils. The wastes are directly melted in the pot without any additives, and blown down into the canister to storage vitrified products. The off-gas is cleaned through the combination system of cyclone, electrostatic precipitator and HEPA filter. The main wastes to be treated are the following;

The main wastes to be treated are the following;

- Incinerator ash
- Heat-insulation material (containing asbestos)
- HEPA filter material
- Concrete debris

The melting temperature of these waste are ranges from 1200 to 1600°C, so that the wastes can be melted by HFIM method in either respective or mixed forms.

II Feature of pilot plant

The main features of the pilot plant to be used in experiments are shown below;

capacity	:	15 kg/h (based on incinerator ash)
melting pot	:	5 liter
electric power	:	42 KWH
cooling water	:	3m ³ /h
off-gas	:	12 - 13 Nm ³
canister	:	50 liter

Figure 4 to Figure 6 correspond to the photographs of induction heating melter main part, canister/holder, and off-gas treatment, respectively. The melted wastes are blown from the bottom of the carbon material pot, by controlling the carbon rod stopper setting in the pot. A sample of vitrified product is shown in Figure 7.

III. Characteristics of the process

(1) Melting pot material

In this experiment, tests were conducted on the applicability of carbon and silicon-ceramic materials to a melting pot in the HFIM process. As a results, the ceramic had severe damage due to the complicate reaction with a little amount of iron metal in melted wastes. On the other hand, although carbon material has easily reacted with oxygen and decreased the weight in high temperatures, the long operation time, 60 - 100 hours could be done under the nitrogen atmosphere. Then, carbon material was selected. The effective procedure will be expected by complete deoxygen-pretreatment of wastes and shielding the inside of whole processes by nitrogen.

(2) Off-gas treatment

In order to confirm the performance of off-gas treatment system, the wastes doped radioactive materials, ^{60}Co , ^{134}Cs were melted in the melter. Table 2 shows results of DF in the off-gas system. More than 10^4 is obtained as the total DF values.

(3) Physical-chemical properties of vitrified products

Table 3 indicates the volume reduction factors of noncombustible wastes treated by the pilot plant. High Volume reduction was achieved. Table 4 summarizes the density, compressive strength etc., of the vitrified products. The leachability of Fe and Na tested by the MCC-5S method (100°C, 7days) ranges from 10^{-3} to 10^{-6} g/cm² day, being almost same as that of general vitrified glass melted products.

IV. Features of the process system

- Various noncombustible wastes can be treated simultaneously
- Final products are vitrified form with excellent physical-chemical properties.
- High volume reduction can be obtained, for example, 5 - 9 for incinerator ashes.
- The melter is heated from outside using high frequency induction coils.
- The inventory volume of melted wastes in melter is small, thus allowing the maintenance of the melter to be readily carried out.

CONCLUSION

As a result of the experiments, it was confirmed that both processes of AC solidification and HFIM can be applied to treating incinerator ash wastes. The AC solidification process is suitable for treating large amounts of ash waste which is less contaminated by radioactive and/or hazardous materials. The HFIM process can be applied to treating small amounts of ash waste which is highly contaminated, in order to obtain stable vitrified products.

REFERENCES

- (1) D. L. Charlesworth et al., The International Conference on Incinerator of Hazardous radioactive & Mixed Wastes, May 3 - 6, 1988, pB*-2
- (2) N. Kurumada et al., Waste Management 85, Vol. 2, 1985, p211
- (3) K. Kato et al., J. At. Energy Soc. Japan, Vol. 31, No. 9, p1053 (1989)

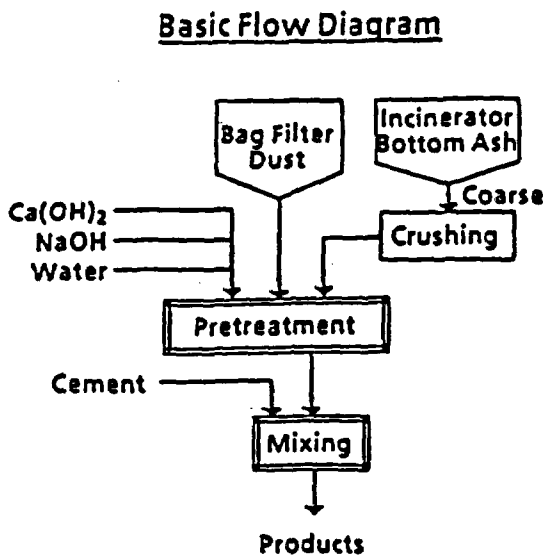

Figure 1. Basic Flow Diagram of AC Solidification for Ashes



Figure 2 High Shearing Mixer

Table 1 Characteristic of Cement Products for Ash Wastes

Waste	Content	Density	Compressive Strength	Leaching Index value
Incinerator bottom ash	35 wt%	1.8	420 kg/cm ²	60Co 14
Filtered ash	35 wt%	1.6	620 kg/cm ²	134Cs 8

Compressive Strength ; at the curing time = 30 days
 Leaching Index ; the required LI value > 6, at 90 days, in ANS 16.1

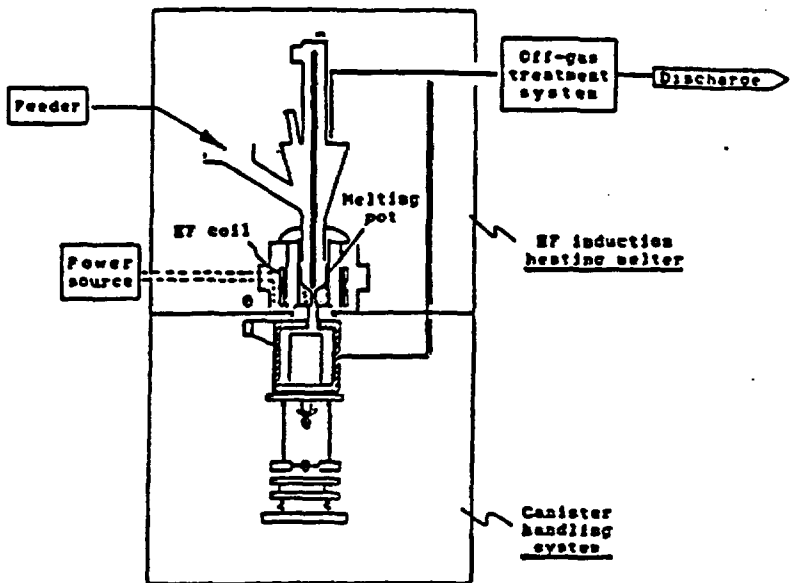

Figure 3 Basic Flow of Pilot Plant of HFIM

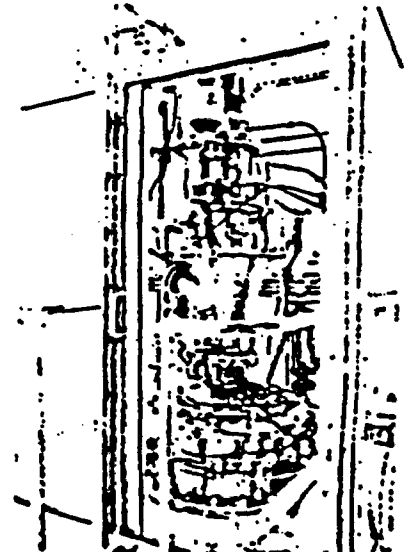

Figure 4 HF Induction Heating Melter

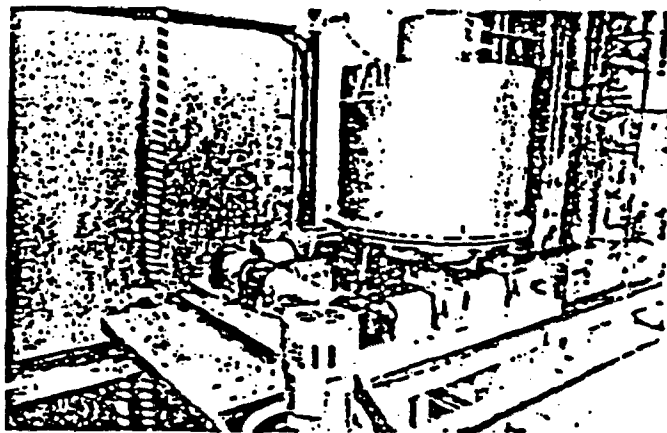

Figure 5 Canister Holder

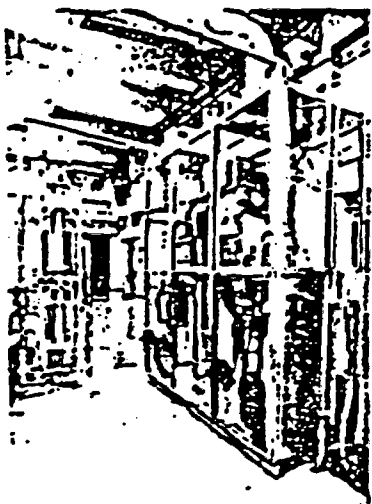

Figure 6 Off-gas Treatment System

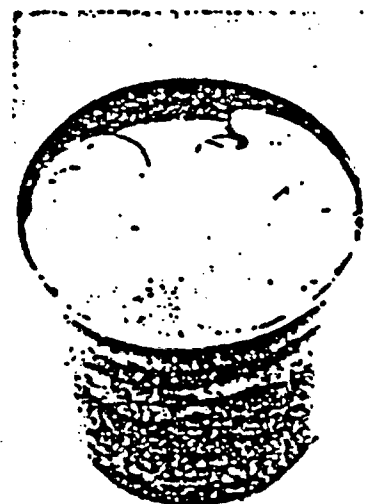

Figure 7 Vitrified Product Block

Table 2 DF in Off-gas Treatment

Nuclide	Cyclone	Electric Precipitator
⁶⁰ Co	8 × 10 ²	10
¹³⁴ Cs	2 × 10 ²	6 × 10 ²

Table 3 Volume Reductivity of Wastes

Waste	VR Factor
Ash	5 ~ 9
Heat-insulator	9 ~ 53
HEPA - filter	13 ~ 54
Concrete debris	1 ~ 3

Table 4 Characteristic of Vitrified Wastes

Waste ^a	Density	Compressive Strength	Weight Loss	Leaching Ratio [*]	
				Fe	Na
Ash	2.7	>4000 kg/cm ²	0.02 ~ 2wt%	10 ⁻⁴ ~10 ⁻⁵	10 ⁻² ~10 ⁻⁵
Ash/Heat-insulator (50/50)	2.6	>2000	0.2 ~ 2wt%	10 ⁻⁴ ~10 ⁻⁵	10 ⁻³ ~10 ⁻⁴
Ash/HEPA-Filter (50/50)	2.5	>10 ⁴	0.2 ~ 2wt%	10 ⁻³ ~10 ⁻⁶	10 ⁻³ ~10 ⁻⁴

^ag/cm²·day
MCC-5S (100-C, 7 days)

JGC

PART 5

**DESIGN AND CONSTRUCTION
OF VIRGINIA POWER
LOW LEVEL RADWASTE
FACILITIES PROJECT**

OUTLINE OF NRF BUILDING

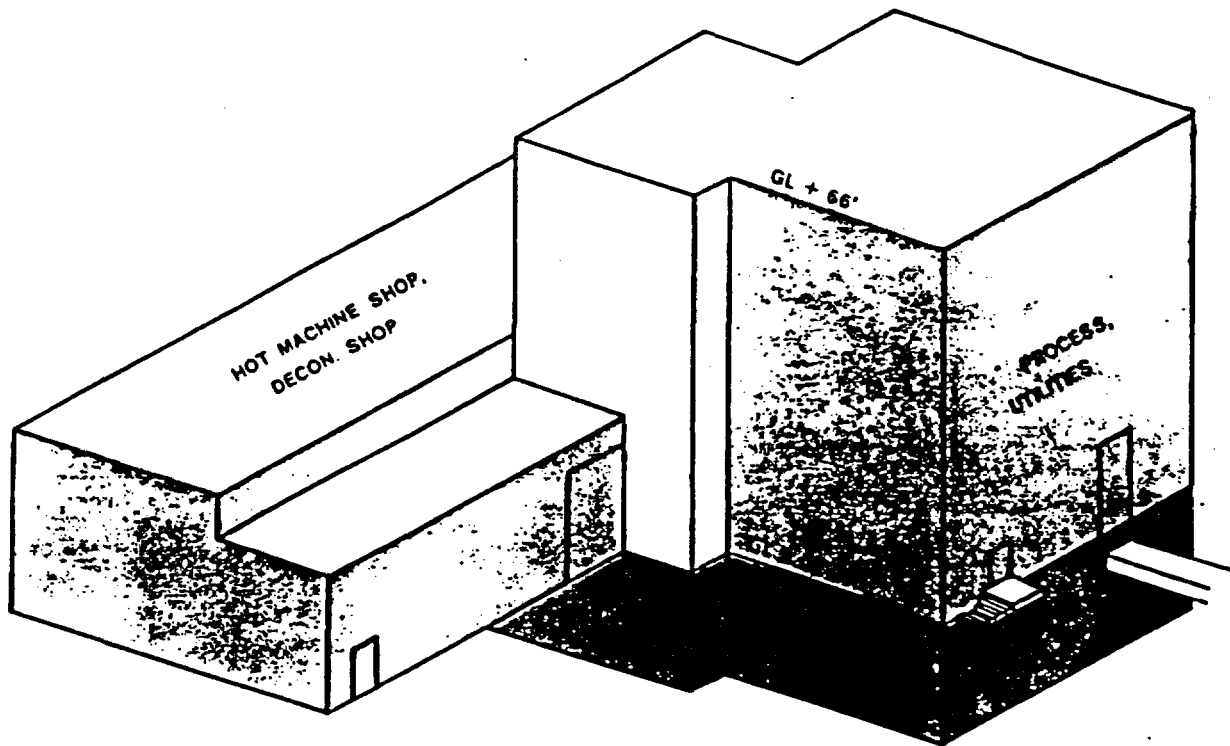

Memo ;

NRF MAJOR GOALS AND OBJECTIVES

1. On - site storage requirements to be one (1) year.
2. Radioactive effluent discharges not to exceed 0.1 Ci / year / site, and chemical discharges less than 50% of NPDES limits.
3. Waste shipped off - site not to exceed 16,000 CF / year / site.
4. No inadvertent radioactive gaseous release.

Memo ;

BLOCK FLOW FOR SURRY'S NEW RW FACILITY

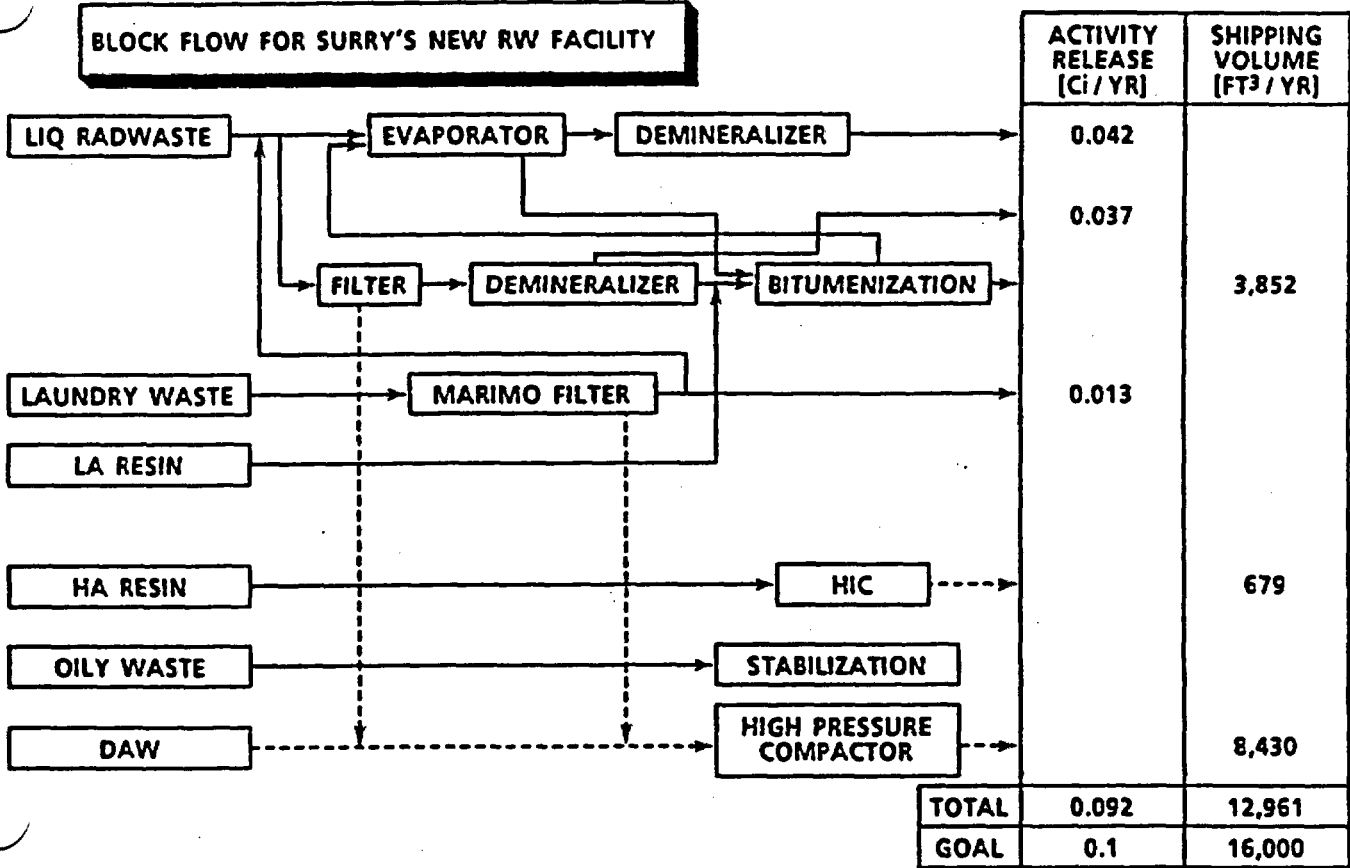

Memo ;

PROJECT FEATURES — SCOPE OF WORK

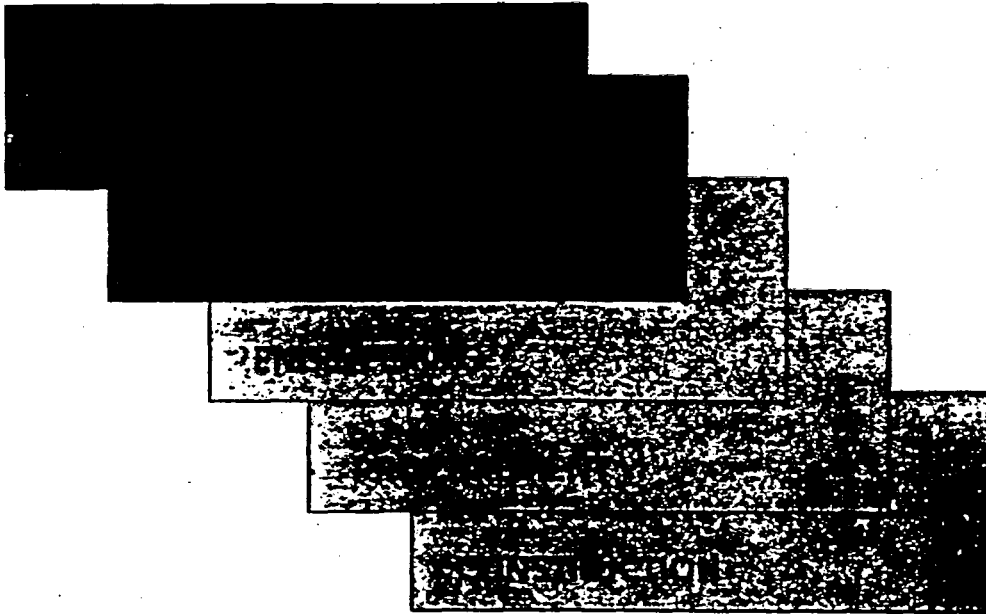

Memo ;

PROJECT CONFIGURATION — SUBCONTRACTING

E	P	C
JGC	JGC	JGC
US ENGINEER ING SUBCONT RACTOR	US VENDORS	

Memo ;

PLASTIC MODEL

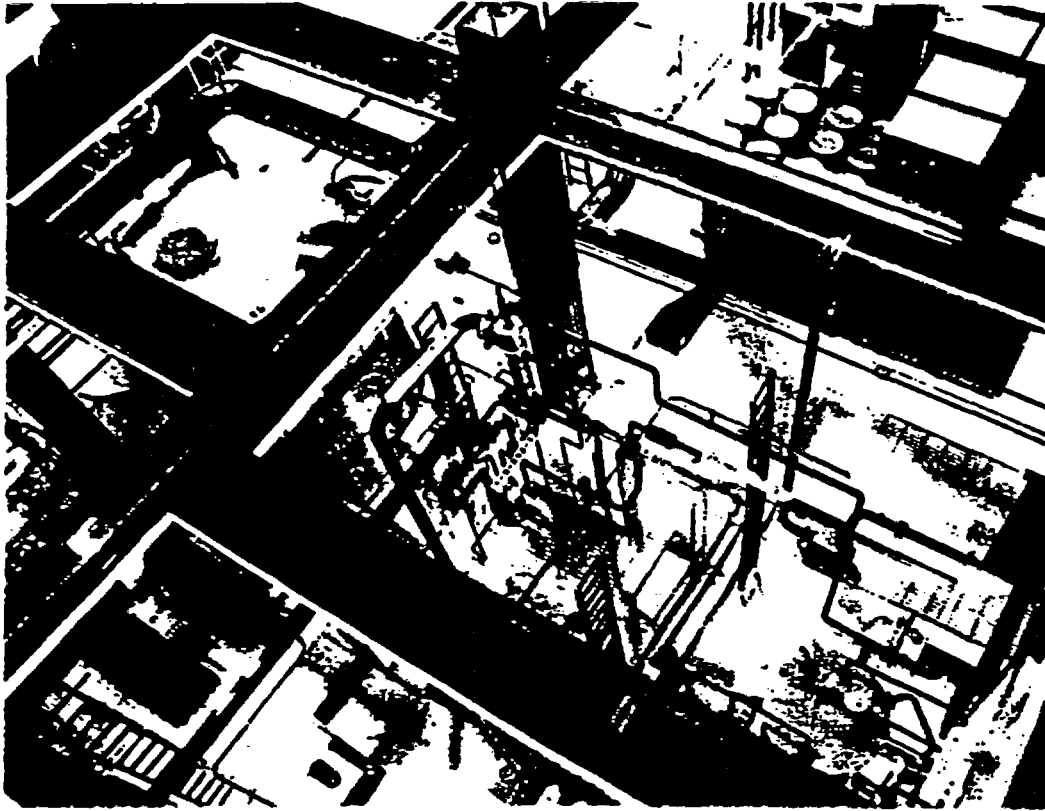

Memo ;

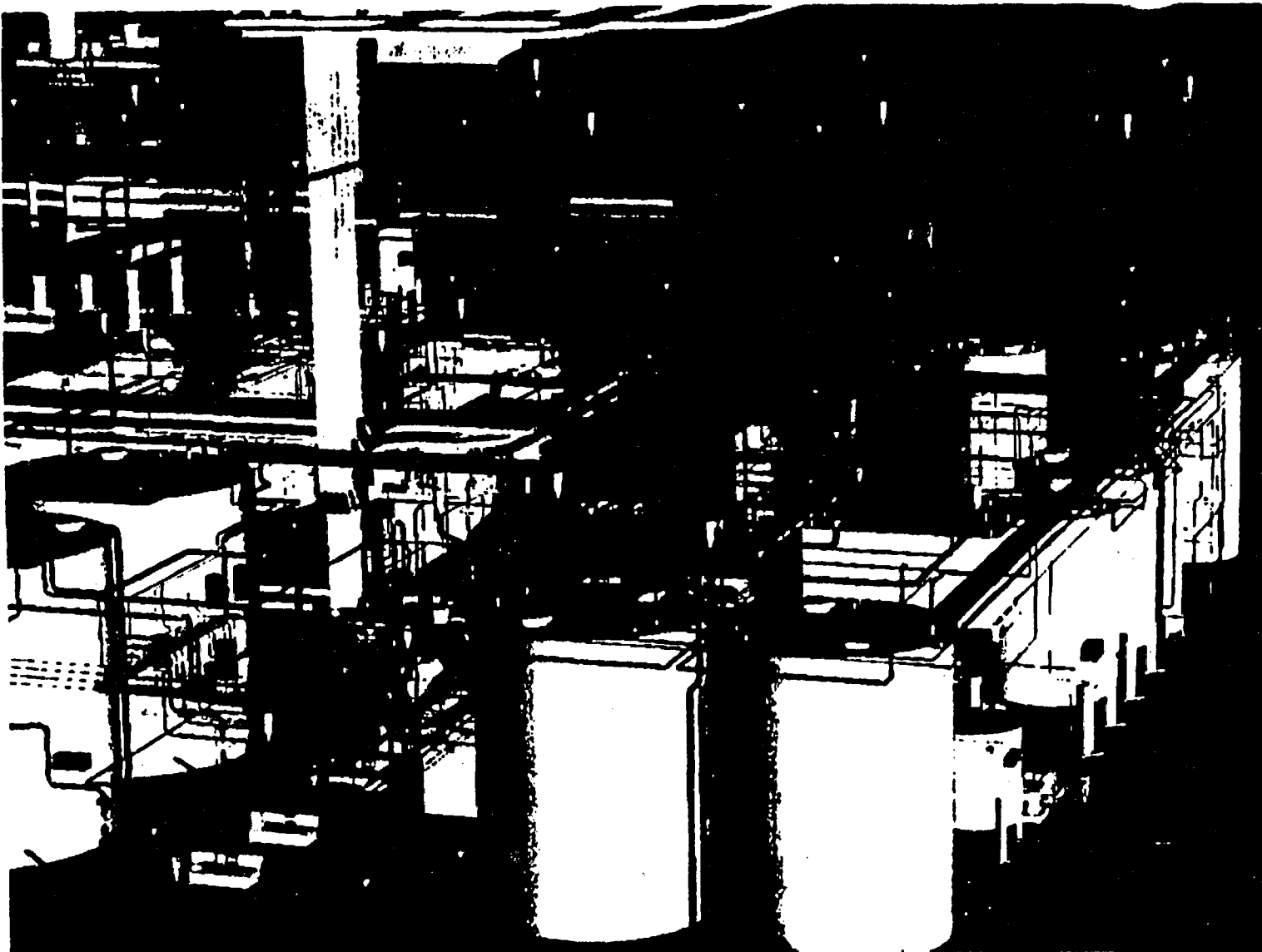

3 - D CAD MODEL

PROJECT ORGANIZATION AND OFFICE LOCATIONS

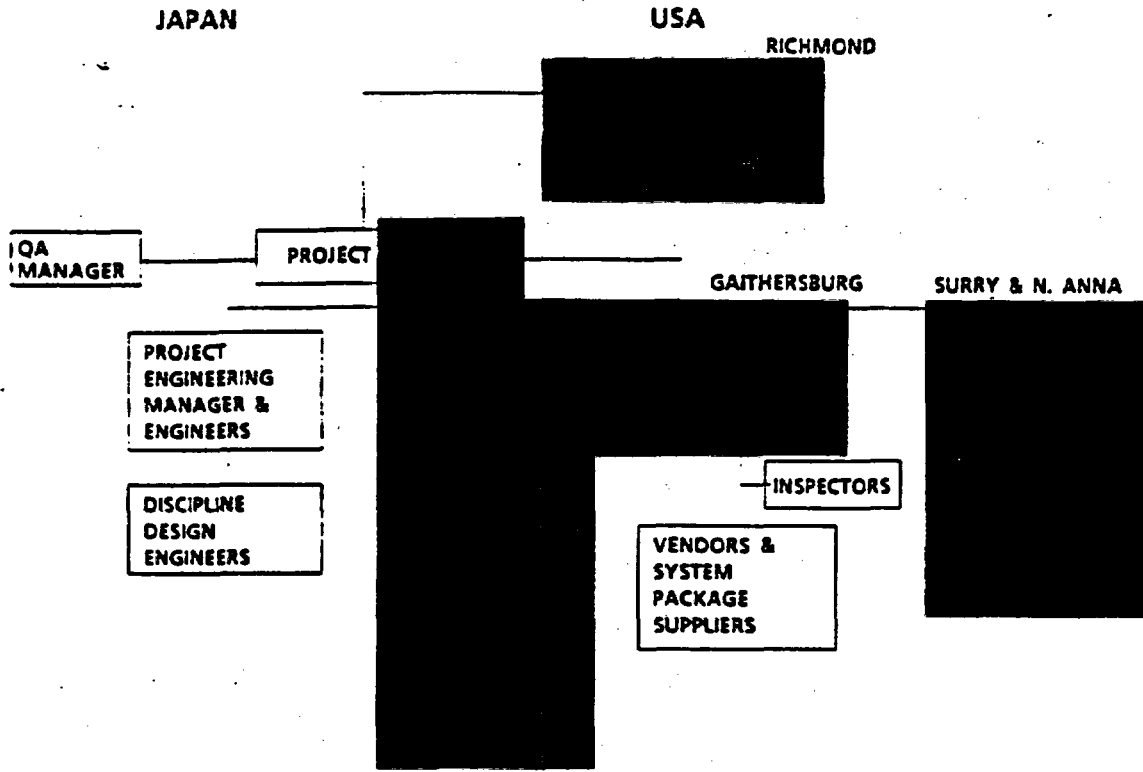

Memo ;

OWNER INVOLVEMENT

E	<ul style="list-style-type: none">- PERIODIC MEETING- DOCUMENT REVIEW- MODEL CHECK
P	<ul style="list-style-type: none">- VENDOR SELECTION- SHOP INSPECTION
C	<ul style="list-style-type: none">- FIELD INSPECTION- AUDIT, MONITORING- PERFORMANCE TEST- TRAINING

Memo ;

QUALITY ASSURANCE

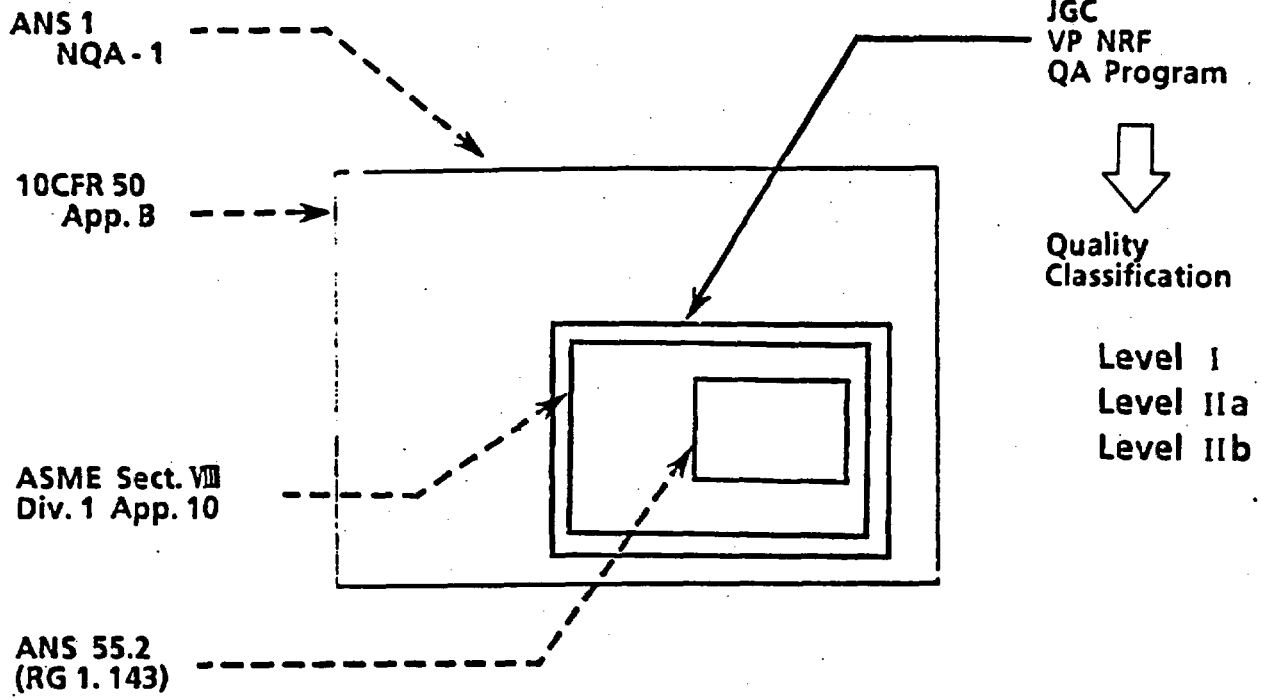

Memo ;

SURRY CONSTRUCTION SITE

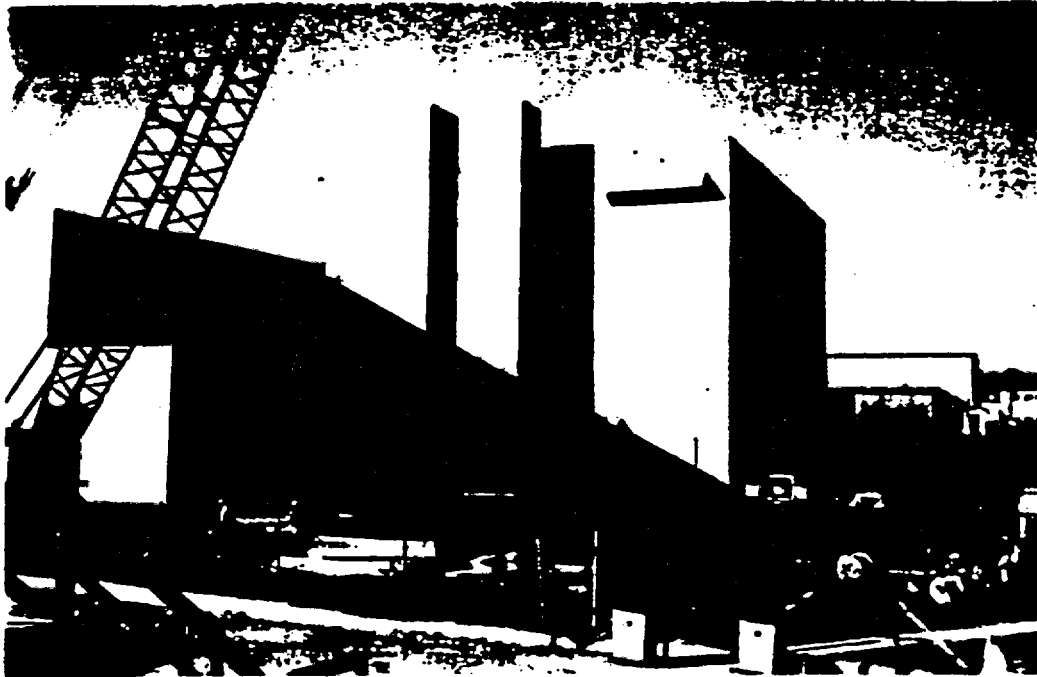

Memo ;

TECHNOLOGIES DISCUSSED AT PNC, TOKAI WORKS

- Vitrification of HLLW
- Nuclear Fuel Cycle and Reprocessing
 - Receiving and Storage of Spent Fuel
 - Mechanical Treatment
 - Dissolution, Clarification and Adjustment
 - Separation
 - U-Purification, - Concentration, and Denigration
 - Pu-Purification, and - Concentration
 - Analysis and Operational Testing Laboratory
 - Treatment of Waste
- Microwave Melter
- ESR Furnace
- Assessment of Long Term Durability of Engineered Barrier Materials

BIBLIOGRAPHY OF LITERATURE RECEIVED FROM PNC, TOKAI WORKS

Budget Information from PNC, Tokai. PNC, Tokai, 1 page.

"Nuclear Fuel Cycle, Tokai Reprocessing Plant", PNC- Tokai Works, 15 pages.

"Some Aspects of Natural Analogue Studies for Assessment of Long Term Durability of Engineered Barrier Materials, CEC 4th Natural Analogue Working Group Meeting", Prepared by Y. Yusa, G. Kamei and T. Arai, PNC, 19 pages.

"Tokai Vitrification Facility", PNC, Tokai Works, 3 pages.

"Pu-Contaminated Waste Treatment Facility", PNC, Tokai Works. 3 pages.

予 算 (単位: 百万円) Budget (Unit: Million Yen)

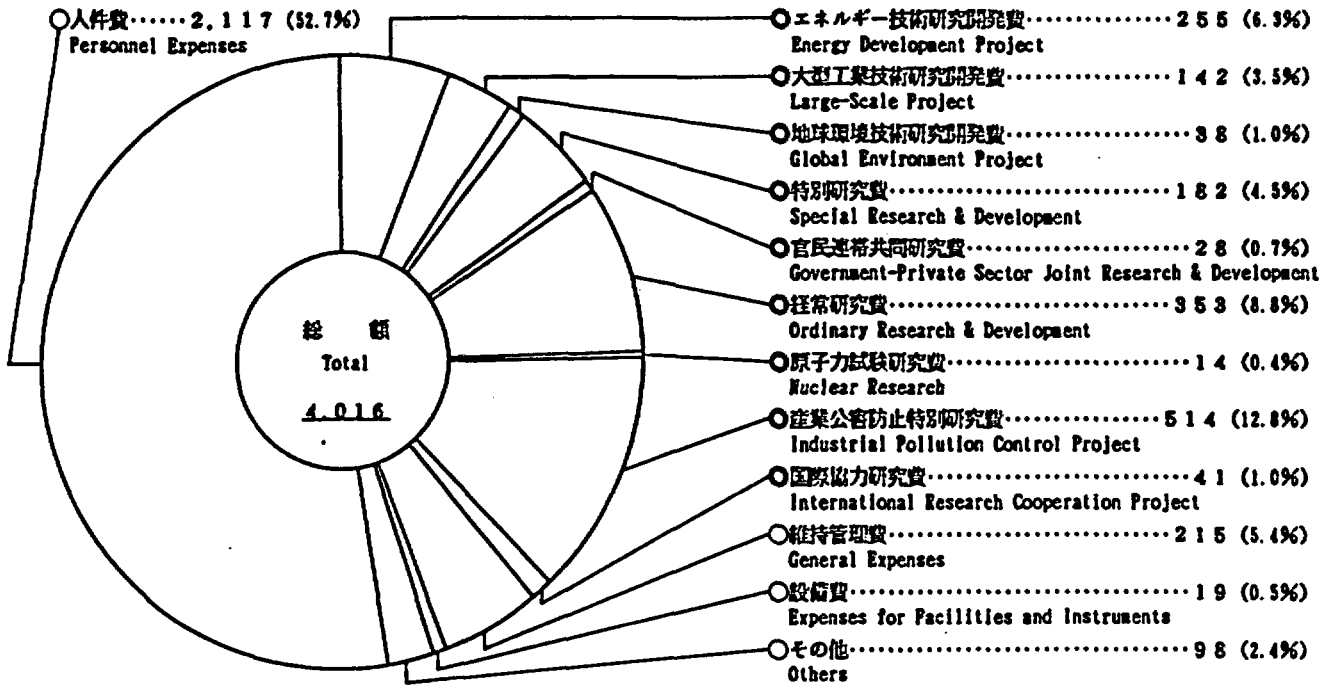

研究分野別予算 (単位: 百万円) Budget Research Field (Unit: Million Yen)

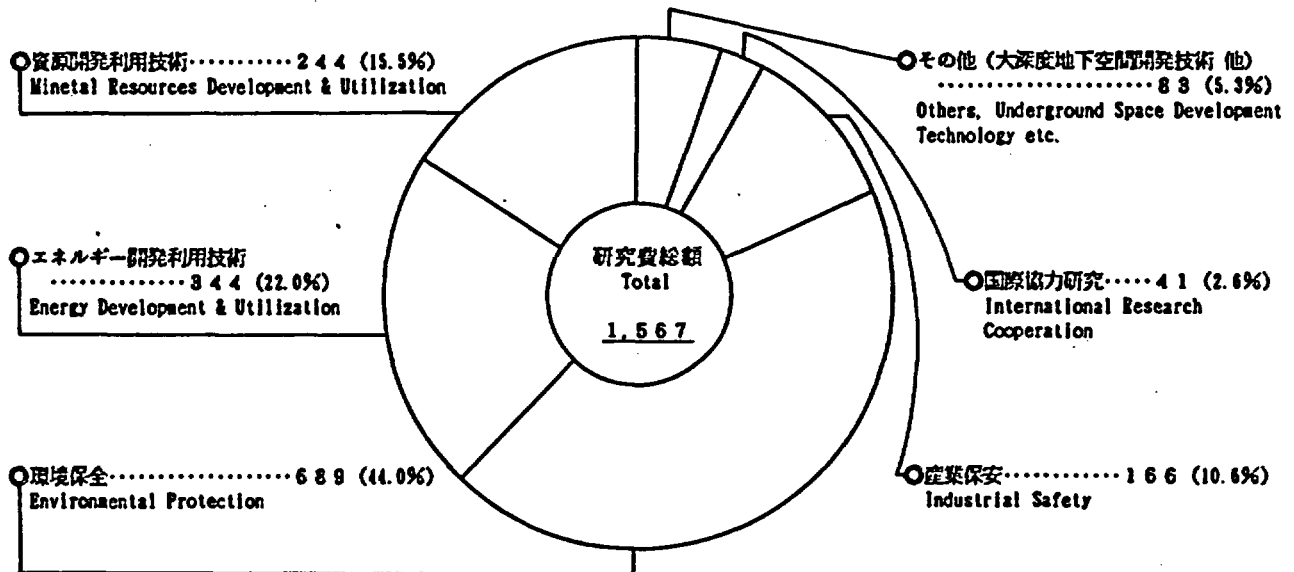

職員 Staff 219

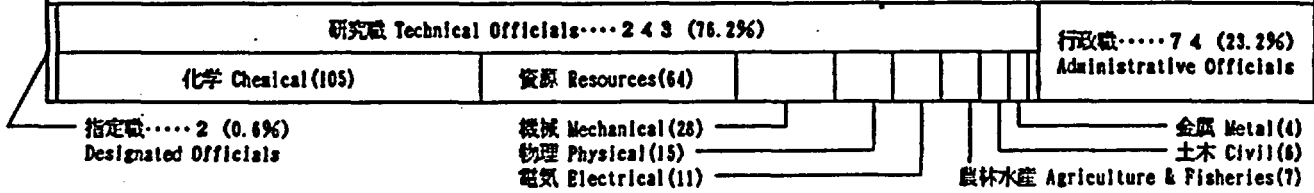

規模 Scale	本所 National Research Institute for Pollution and Resources	北海道石炭鉱山技術 試験センター Coal Mine Safety Research Center, Hokkaido	九州石炭鉱山技術 試験センター Coal Mine Safety Research Center, Kyushu	硯井分室 (試験炭鉱) Experimental Coal Mine, Usui
敷地面積 Site Area	262,497 m ²	9,943 m ²	20,769 m ²	80,268 m ²
建物の延面積 Total Floor Area	48,077 m ²	3,765 m ²	3,400 m ²	2,148 m ²

TOKAI REPROCESSING PLANT



Reprocessing Plant in Japan

Since Japan has scarce energy resources and depends for most of its energy on other countries, it's a very important problem how to secure energy resources. Our desire is to substitute nuclear energy for oil energy. To achieve this, an independent nuclear fuel cycle must be established so that the valuable fuel can be used effectively. The reprocessing plant for spent fuel is the most important component of the nuclear fuel cycle, since the nuclear fuel can not be used without it.

The reprocessing plant built by FNC at Tokai Mura is the first step in the establishment of an independent nuclear fuel cycle.

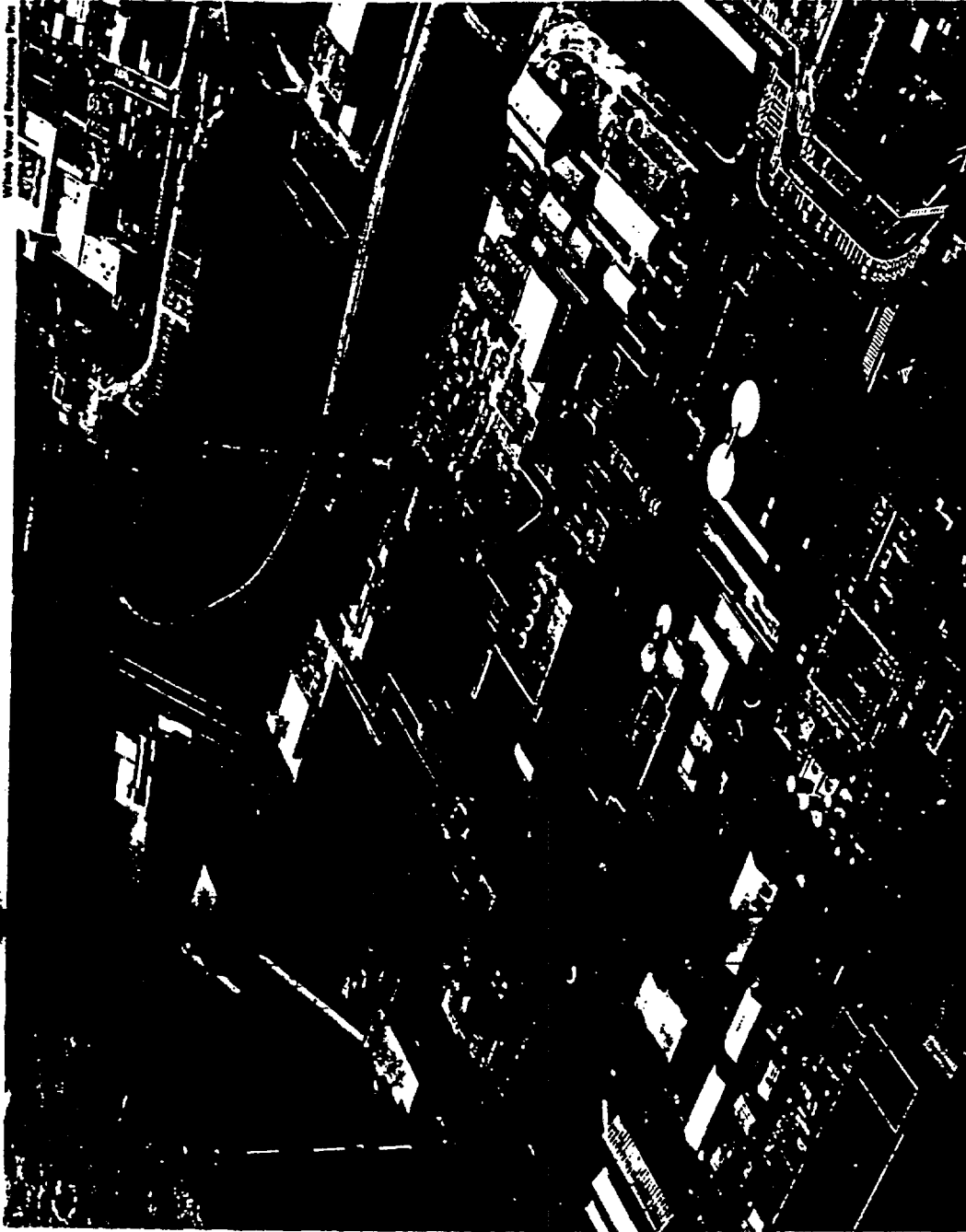

Reprocessing Plants in the World

Nation	Plant	Capacity and Status
U.S.A.	Idaho	for research reactor fuel
	Hanford	several tons/day, military purpose
	Savannah River	"
	West Valley Baraboo	300t/y, for LWR fuel; ceased operation 1,500t/y, for LWR; abandoned
U.K.	Dunfermline	for research reactor fuel
	Windscale	1,500t/y, for natural uranium fuel 400t/y, for LWR fuel; ceased operation
France	Marcoule	900~1,200t/y, military purpose
	La Hague	800t/y, for natural uranium fuel 400t/y, for LWR fuel
India	Trambay	30t/y for natural U, military purpose
	Tarapur	0.5t/day for LWR, HWR fuel
Belgium	Mol	100t/y for LWR-research reactor fuel; awaiting permission to restart
FRG	Karlsruhe	35t/y
Japan	Total	0.7t/day

Nuclear Fuel Cycle and Reprocessing

• Nuclear Fuel Cycle

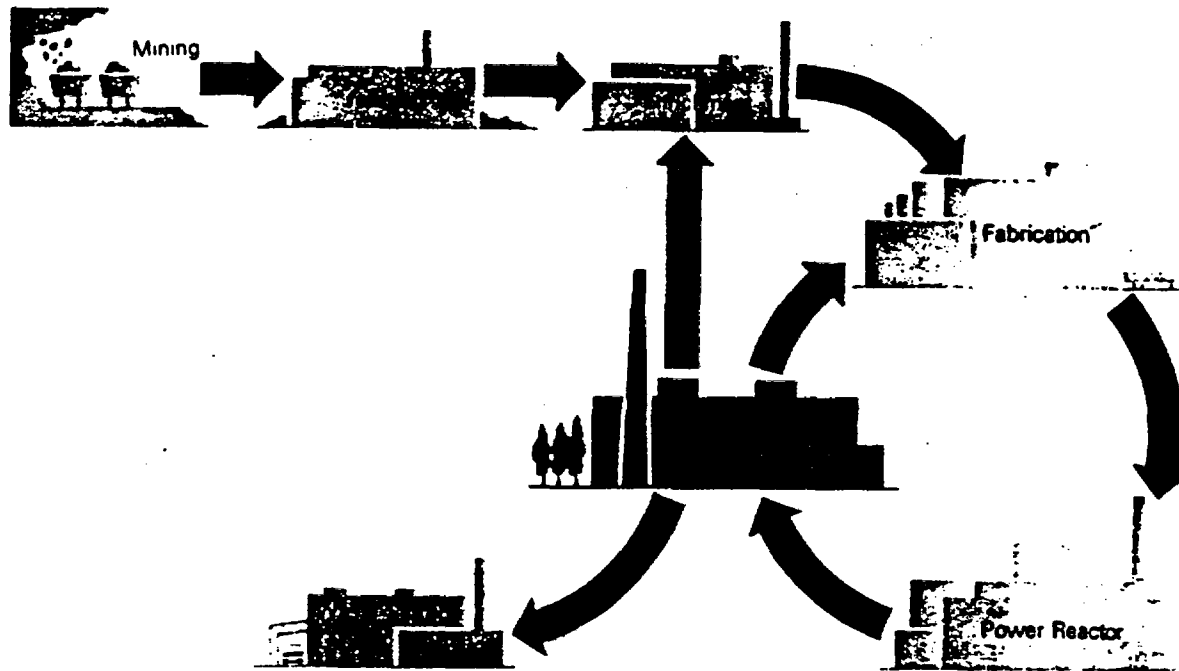

• Development of the nuclear fuel cycle and PNC

PNC is developing most parts of the nuclear fuel cycle, from prospecting for uranium to reprocessing of spent fuel, as well as development of new reactors such as FBR and ATR. Reprocessing plant construction began in June, 1971, and after finishing blank test, chemical test, and hot test, operations began in January, 1981.

This plant can reprocess 0.7 ton-uranium of fuel per day and has a key role to promote the future reprocessing industry in Japan.

• Establishment of the nuclear fuel cycle

In the operation of a reactor, uranium-235 content decreases and fission product (FP) content increases as the fuel burns. At the same time nonfissionable uranium-238 is converted to plutonium by neutron absorption. After about three years of fuel irradiation in the reactor the fissionable uranium-235 content is reduced and the FP content increased so that the reactor can not maintain criticality, and it is necessary to refuel the reactor.

A one million kWe LWR plant consumes about 30 tons of fuel per year on the average. Spent fuel contains about 1% uranium-235 (new fuel contains about 3%), about 95% uranium-238 (new fuel, 97%), about 1% plutonium, and 2~3% FP.

The reprocessing plant function is to recover the plutonium produced and the uranium remaining from the spent fuel and to separate and treat the FP as waste. Therefore, the nuclear fuel is not disposed of after only one use but is used many times as nuclear fuel because of the reprocessing.

The recycle of nuclear fuel in this way is called the nuclear fuel cycle and the reprocessing plant is the key to the nuclear fuel cycle.

3 View of Main Plant

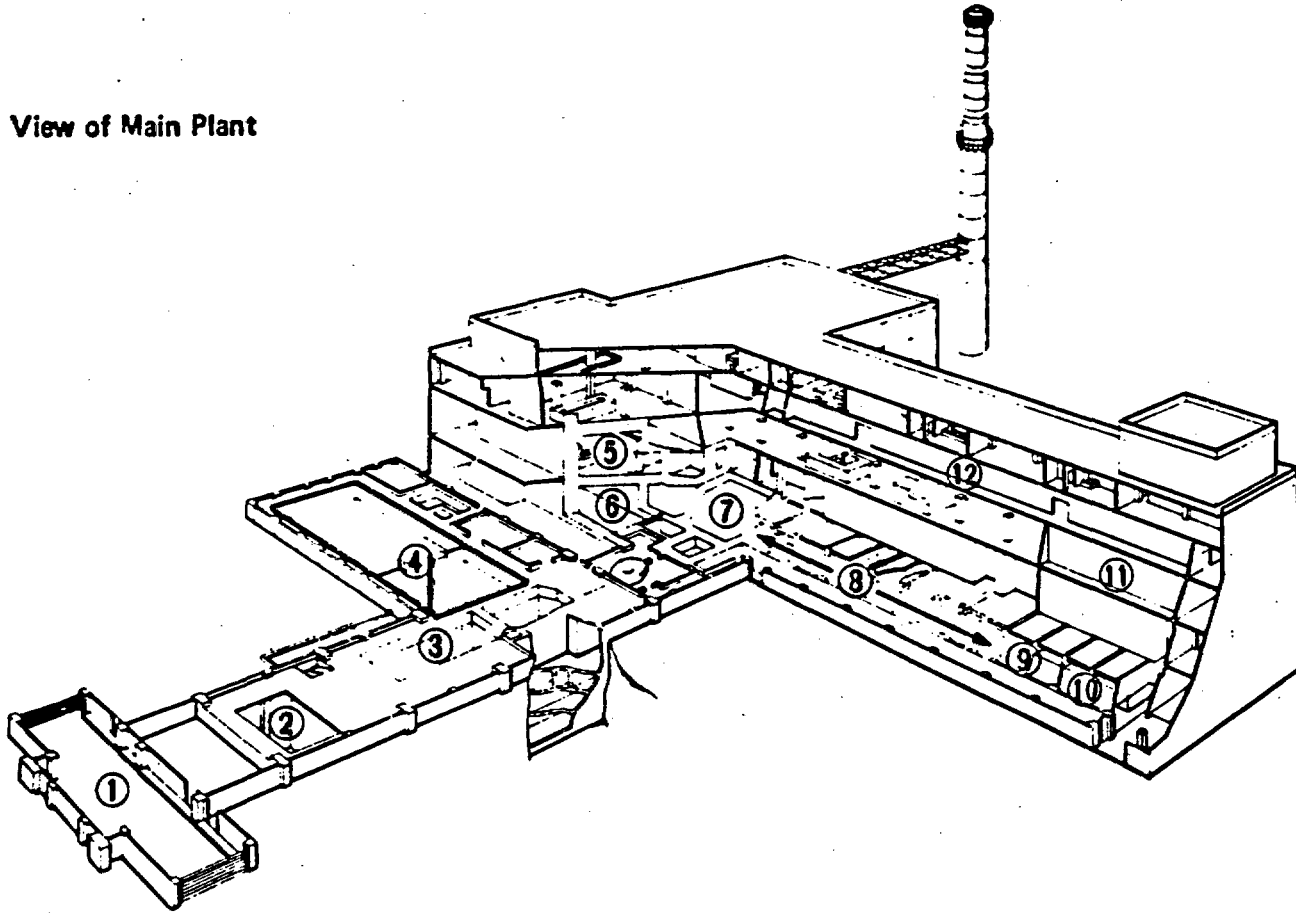

12 View of main plant

Plant capacity : About 0.7 Metric ton of uranium per day
 Input fuel to be processed : Enriched uranium fuel
 Cladding material : Zircaloy or stainless steel
 Burn-up : About 28,000 MWD/t (Average)
 Specific power : About 35 MW/t (Average)
 Cooling time : 180 days (Minimum)
 Enrichment : 4% (Maximum)
 Name of process : Purex process with chop and leach
 Product
 Uranium trioxide (UO_3)
 Plutonium nitrate [$Pu(NO_3)_4$]

- 1 Truck airlock
- 2 Cask decontamination room
- 3 Fuel unloading pool
- 4 Fuel Storage pool
- 5 Mechanical treatment cell
- 6 Dissolver loading cell
- 7 Feed adjustment cell
- 8 Separation cells
- 9 U-purification cell
- 10 Pu-purification cell
- 11 Utility room
- 12 Control room

Process of Reprocessing

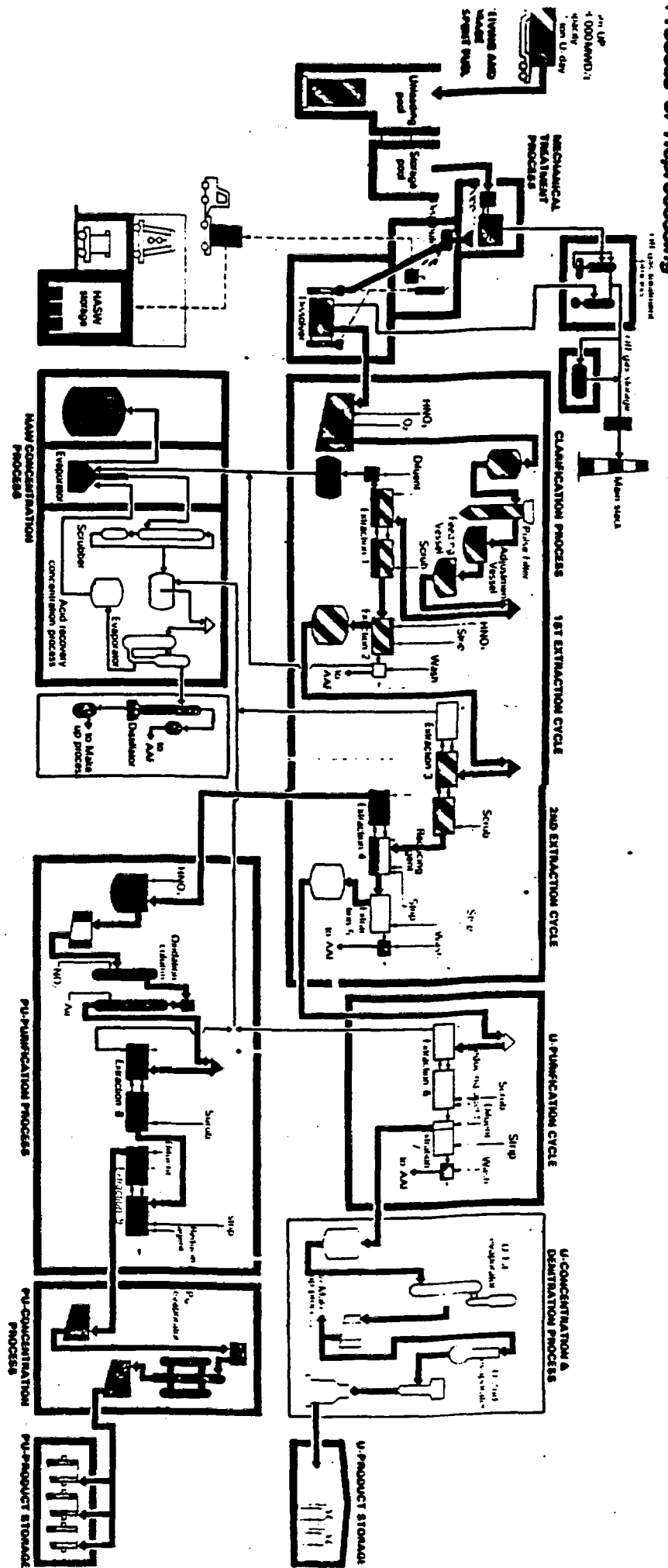

○ Order of the Reprocessing Process
 Spent fuel transported from a reactor site to a reprocessing plant, undergoes a series of operations. The spent fuel is first cut into small pieces, which are then dissolved in a solvent. The spent fuel is then transported to a reprocessing plant. The spent fuel is first cut into small pieces, which are then dissolved in a solvent. The spent fuel is then transported to a reprocessing plant. The spent fuel is first cut into small pieces, which are then dissolved in a solvent. The spent fuel is then transported to a reprocessing plant.



General view of reprocessing plant

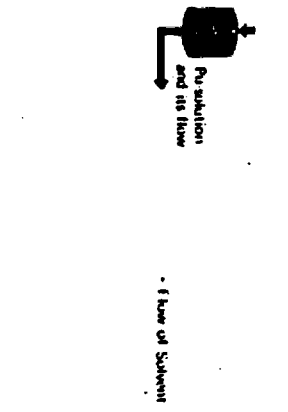
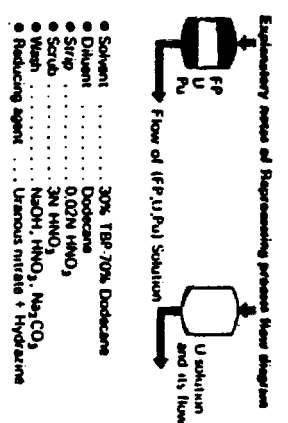

- Solvent 30% TBP 70% Dodecane
- Diluent Dodecane
- Strip 0.02N HNO₃
- Scrub 3N HNO₃
- Wash NaOH, HNO₃, Na₂CO₃
- Reducing agent Uranous nitrate + Hydrazine

rocessing process

Receiving and Storage of Spent Fuel

The cask containing spent fuel is received at the truck airlock. Then the cask is moved into the cask decontamination room, the water in the cask is exchanged, and so on. Then, the cask is moved into the unloading pool and the spent fuel is removed. The spent fuel assemblies are placed into fuel baskets, sent to a storage pool, and cooled there.

The cooled-storage purpose is to await the decay of relatively short-lifetime fission products in the spent fuel assemblies, which decreases the activity and decay rate. After the fuel is cooled over a certain period of time, the assemblies are removed from the fuel basket one at a time, and sent to a mechanical treatment cell.

The storage pool of this plant can store about 100 tons of spent fuel.

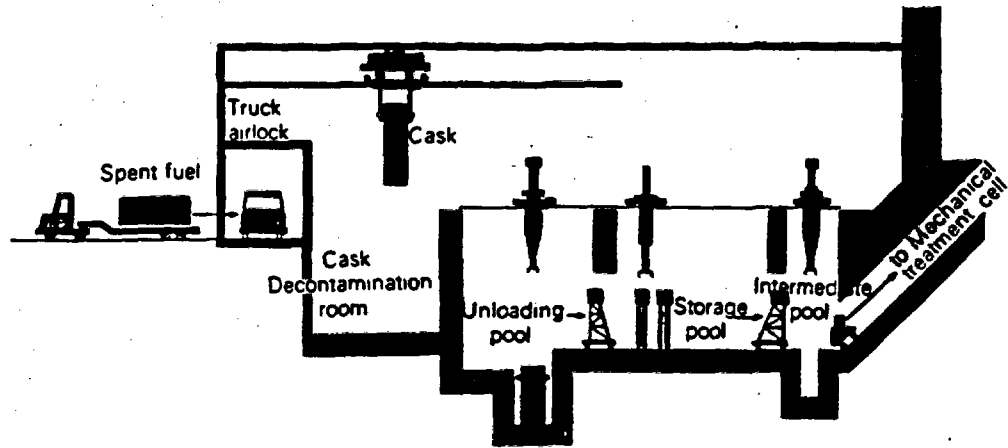

View of cask receiving

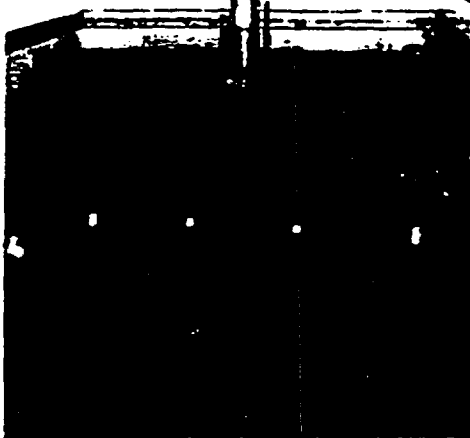
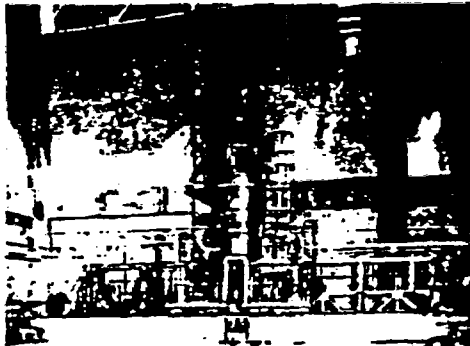

Storage pool



Unloading pool



Intermediate pool

Reprocessing process

Mechanical Treatment

The spent fuel assemblies sent to the mechanical treatment cell from the storage pool have the end parts of the fuel assemblies removed, and then the remainder is chopped into pieces about 5cm (3 inches) long. These fuel pieces are sent to a dissolver in the dissolver cell. Solid wastes, such as the end parts of the fuel assemblies which have been off first, and the hulls (fuel element clad) which don't dissolve in the dissolver, are put into a waste container and stored in a high active solid waste storage facility.

The mechanical treatment cell is surrounded by a concrete wall about 150cm thick. Viewing windows and manipulators are set up for remote operation of the chopping work. A decontamination cell and airlock cell are also set up for and maintenance of the machinery.



Operation of manipulator at mechanical treatment cell

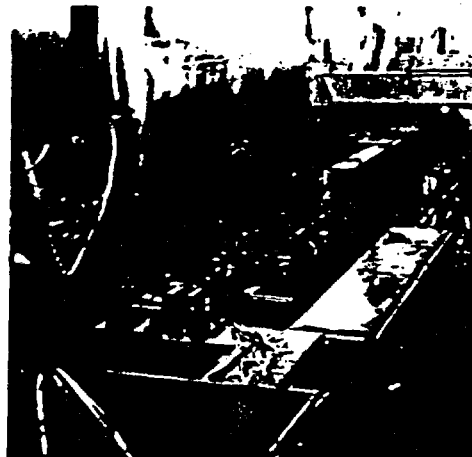

Chopping machine



Hulls

rocessing process

Dissolution, Clarification and Adjustment

ent fuel elements chopped by the
hanical process are transferred to the
olver in the dissolver cell. Of the
ded fuel pieces, only oxide fuel is
olved in nitric acid and the cladding
e of stainless steel or zircaloy re-
is undissolved.

the dissolution, oxygen is introduced
ne dissolver, which oxidizes the nitro-
oxides, which originates in the dis-
tion.

er dissolution, dissolved solution is
ferred to the buffer vessel, diluted
adjusted with nitric acid. Undissolved
rials such as solid particles are re-
ed by a pulse filter and the acidity
e solution is adjusted in the adjust-
vessel of the feed adjustment cell.

n this vessel, after accounting for the
onium and uranium, this solution is
ferred to the 1st extraction bank in
1st separation cycle. Undissolved
s" are rinsed, removed with a per-
ed basket, put into a waste container
sent to the high active solid waste
ge facility. Off gas originating in the
lution is sent to the off gas treatment
ess.



Distributor in dissolver loading cell

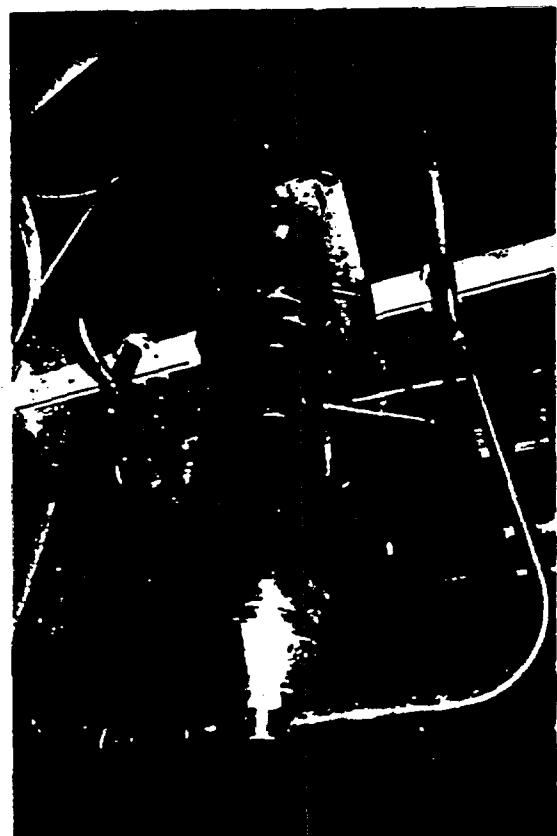

Dissolver

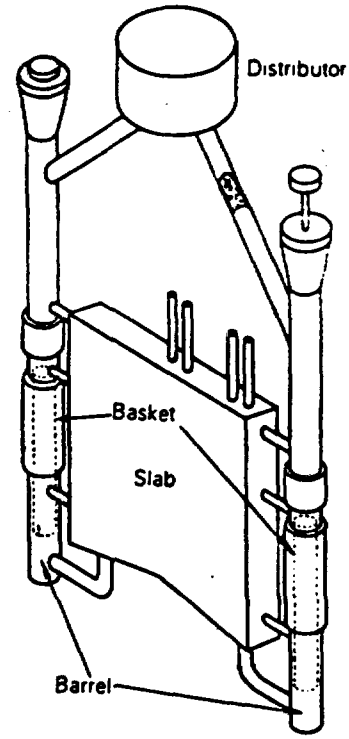

Reprocessing process

Separation

Dissolved solution contains U, Pu and FP. The purpose of the separation process is to separate U, Pu and FP from each other in the solution. This process can be roughly classified as the 1st separation cycle (co-decontamination), and the 2nd separation cycle (partition). The 1st separation cycle is the process to separate fission products from dissolved solution and the 2nd cycle is to separate Pu from U.

(1) 1st separation cycle (co-decontamination)

This process has the function to extract U, Pu in the solution into solvent and to separate them from FP. U and Pu extracted into solvent at mixer-settler extraction 1, are turned again into the aqueous phase by stripping the solution at mixer-settler extraction 2 and they are transferred to the 2nd cycle. On the other side, FP remaining in the aqueous phase at mixer-settler extraction 1 are washed at the diluent washer and transferred to the high active waste evaporator via the buffer vessel.

(2) 2nd separation cycle (partition)

At the extraction 2 of the 1st separation cycle, U and Pu are stripped into the aqueous phase and this aqueous phase is introduced to the extraction 3. And there, U and Pu are extracted into the organic phase to separate them from FP

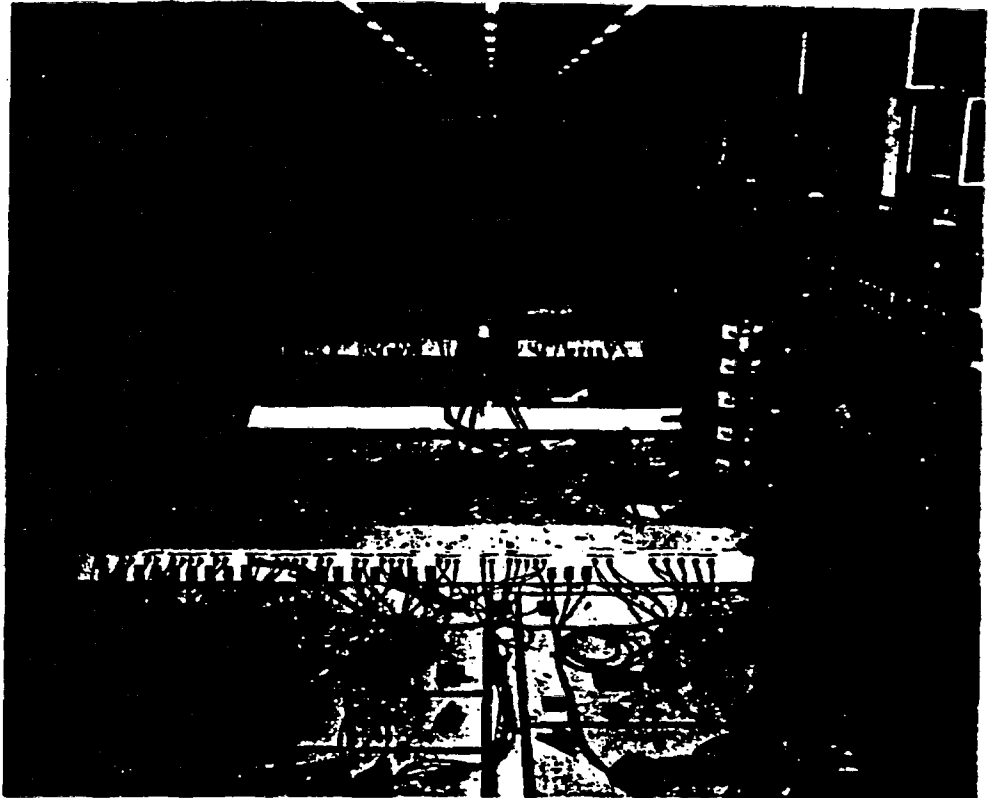

Extraction maintenance area

remaining in the aqueous phase by the same process as the extraction 1. Of U, Pu in the organic phase, Pu is reduced and stripped by the mixture of uranous nitrate and hydrazine at the extraction 4, and resulting in separation of uranium in the organic phase from Pu in the aqueous phase. After this, the aqueous phase

containing Pu is transferred to the Pu purification process. The organic phase containing U is transferred to the extraction 5 and there U is stripped into the aqueous phase and transferred to the U purification process.

reprocessing process

purification, -concentration and Denitration

The solution containing U that is stripped into the aqueous phase at the extraction 5 of the 2nd separation cycle, is transferred to the extraction 6 of the U purification cycle. There, U is separated in the trace of FP by the solvent as in extraction 1 and they are purified. Separated U is transferred to the extraction 7, stripped again into the aqueous phase by dilute acid and then transferred to the U concentration-denitration process.

The U-containing solution (uranyl nitrate) is transferred to the U concentration-denitration process. The concentrate, keeping a constant concentration, is removed from the evaporator and after cooling it is transferred to the dilute vessel via the concentrate receiver. At this vessel, inspection is done and if within specification it is transferred to the feed vessel.

The concentrate transferred to this feed vessel is re-concentrated at the 2nd evaporator, transferred to the denitrator via a buffer vessel and there it is decomposed into UO_3 powder.

UO_3 powder is continuously removed from the bottom of the denitrator, packed into the container as final product and transferred to UO_3 storage.



U-purification cell



Uranium nitrate and uranium trioxide

Principle of Solvent Extraction Method and Mixer-settler

In the reprocessing plant, the main technique covering U and Pu from spent fuel is the solvent extraction method.

This method has the function of extracting all elements from the nitric acid solution. It involves dissolving spent fuels, conversion of organic solvent or stripping elements from the organic phase into the aqueous phase and separation of U and Pu from FP.

For example, at the 1st separation cycle that has the function of separating U, Pu from FP, U and Pu are extracted into the organic phase because the higher acidity makes it them easy to dissolve in the organic phase. Under this condition, FP remain in the aqueous phase because of their low solubility.

Thus, U and Pu are separated from U and Pu. And U, Pu and the organic phase are able to be stripped

into the aqueous phase because the lower acidity makes it easier to dissolve in the aqueous phase than in the organic phase.

Furthermore, tetravalent Pu in the organic phase is reduced to trivalent Pu by a reduction reagent. Trivalent Pu is so insoluble in the organic phase and is stripped into the aqueous phase. So Pu is separated from U remaining in the organic phase. Thus, repeating the extraction, stripping and Pu stripping make it possible to separate U, Pu and FP from each other.

● The mixer-settler consists of the mixing part and the settling part.

mixing part : contacting the organic solvent with acid solution

settling part : dividing the aqueous phase

For example, at the extraction 1, the extraction operation proceeds as in the figure.

Real mixer-settlers differ in size from each other, but a model is shown in the photo.

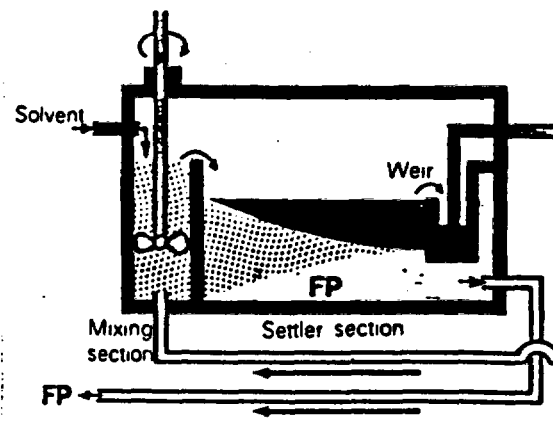

Reprocessing process

Pu-purification and -concentration

Pu solution that is stripped at the extraction 4 of the 2nd separation cycle is transferred to the extraction 8 of the Pu purification cycle and there Pu is separated from a small amount of FP by solvent extraction and purified.

The aqueous solution containing a small amount of FP is transferred to the medium level liquid waste treatment process as waste. The organic phase containing Pu that is separated at the extraction 8, is stripped to the aqueous phase by the mixture of uranous nitrate and hydrazine at the extraction 9 and they are transferred to the evaporator in the Pu concentration cell.

The concentrate, plutonium nitrate, is transferred to the storage tank as a final product.



Plutonium nitrate

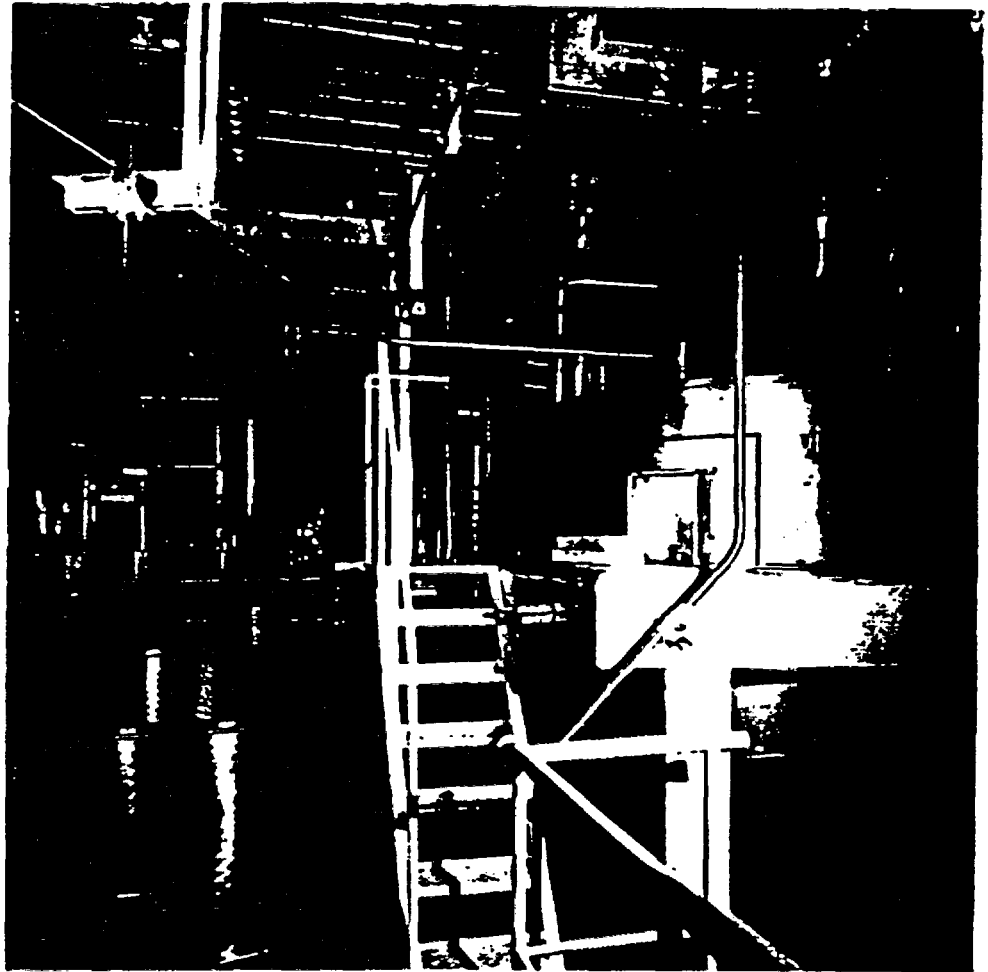

Pu-purification cell

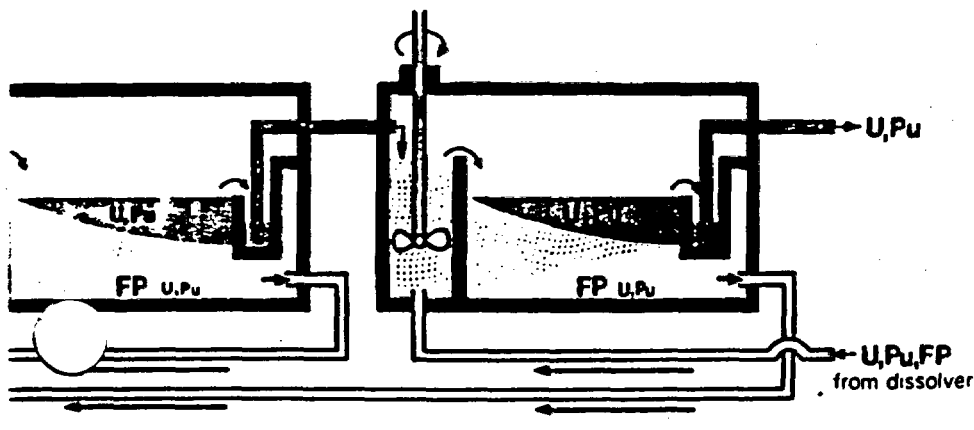

Model of mixer settler

analytical laboratory and OTL are central building which is the largest building next to the main plant. The role of the analytical laboratory is to provide the necessary information on the process and the material balance concerning uranium and plutonium. Samples are taken by means of sampling vehicles transferred through the pneumatic transfer system inside the plant. These areas are at different activity levels, so there are analysis cells for high and medium activity samples and glove boxes for low activity samples, all with modern equipment.

The OTL is a miniature of the main plant, on a smaller scale, of the chemical treatment, including the fission product concentration, uranium denitration, plutonium denitration and acid recovery.

The role of the OTL is to reproduce the operation, review the problems and provide positive proof of operation before starting the process.

Elements of irradiated fuel are transferred from the plant to the laboratory in a lead cask "Cendrillon".



Atomic absorption spectrometer

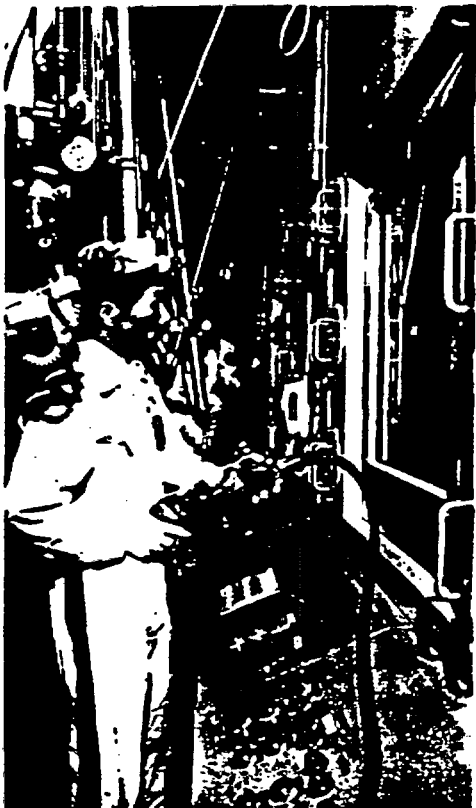

Operational area of OTL

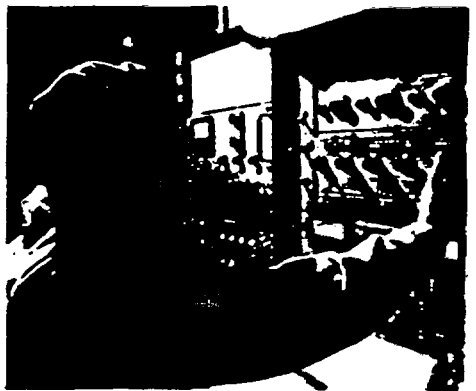

Surface ionization mass spectrometer

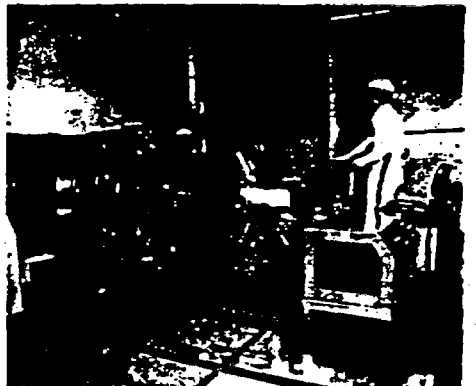

Transfer of spent fuel to OTL

Reprocessing process
Treatment of Waste

In the plant, nuclear material such as uranium and plutonium is recovered, but also, radioactive waste must be treated safely. Airborne radioactivity from mechanical treatment and dissolution processes are washed and filtered several times. Radioactive liquid wastes are reduced in volume by evaporation and stored in a stainless steel vessel. Condensate removed from the evaporator is closely monitored for radioactivity and the concentration of radioactivity is confirmed to be within acceptable limits before release to the sea.

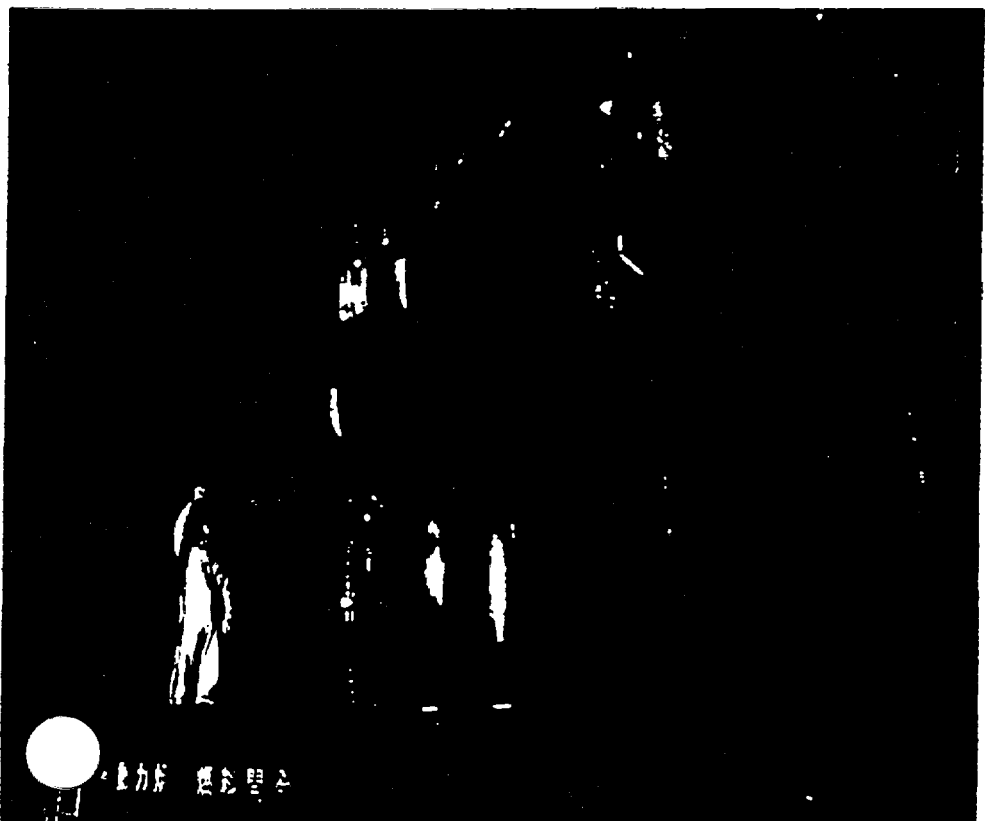

View of HASW(Hufts) shipping to HASWS

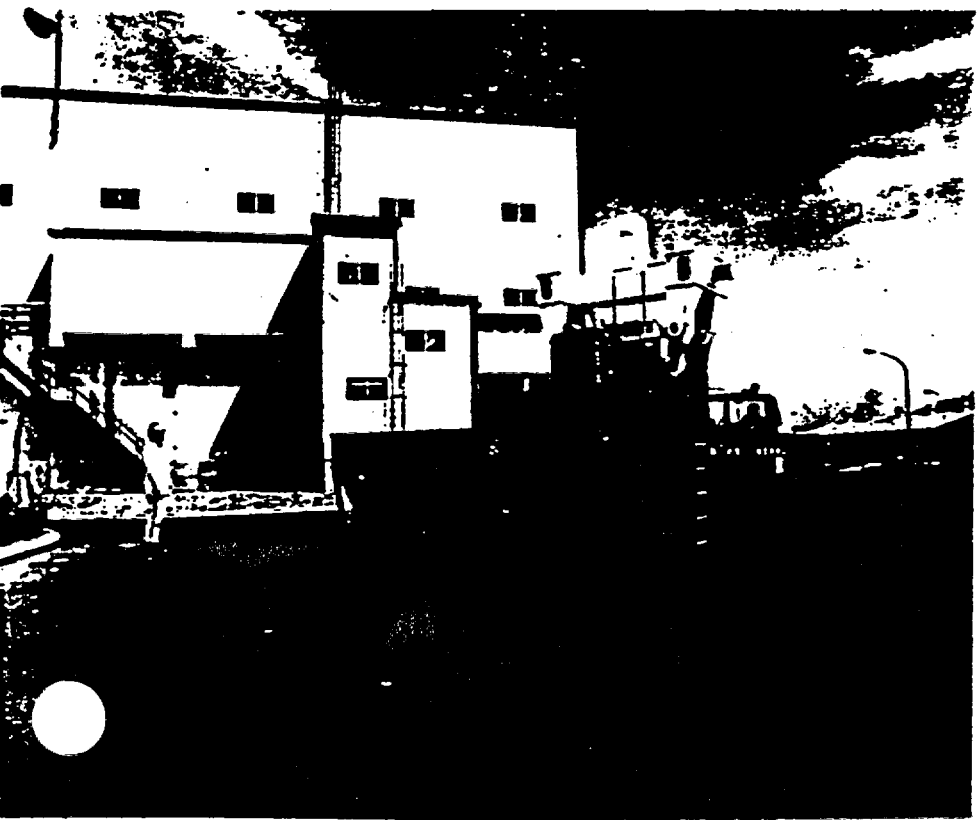

Hufts shipping and HASWS

Gaseous waste

Most of the radioactive gaseous waste is from the dissolution process and mechanical treatment process, with a small amount from various cell and ventilation systems. These gaseous wastes are assayed and filtered several times according to their activity level and released to the atmosphere after regular activity monitoring.

Liquid waste

High active level liquid waste (HALW) is mainly the aqueous raffinate from the 1st reprocessing cycle, which contains nearly all the nonvolatile fission products. HALW is reduced in volume by evaporation and stored in underground tanks.

Medium active level liquid waste (MALW) is the raffinate from the 2nd reprocessing cycle, uranium purification and plutonium purification cycle. The nitric acid solution recovered from the absorber of the uranium denitration process and HALW concentration process.

MALW is treated by the acid recovery process. The distillate is reused in the process as recovered nitric acid and the concentrate in the evaporator bottom is transferred to the HALW evaporator.

Low active level liquid waste (LALW) from other processes and facilities is transferred to the auxiliary active facility (AAF) and stored temporarily according to activity level. The comparative high active liquid waste such as the raffinate from the solvent regeneration cycle is reduced in volume by evaporation and its concentrate is transferred to the buffer tanks and the other concentrate is stored in vessels.

Low active liquid waste such as laundry water is treated by flocculation, and the treated water is transferred to buffer tanks and the sludge is stored in vessels.

To reduce the sea-discharge activities, additionally two evaporator stations for LALW (E and Z facility) were constructed after start of hot operation. For the untreated TBP, the de-oiling station (C facility) was installed before sea-discharge monitoring vessels.

The water is carefully monitored and refined, and the concentration of radioactivity is determined to be within acceptable limits before release to the sea.

Solid waste

High active level solid waste (HASW) consists of the end plugs of spent fuel assemblies sheared in the mechanical treatment process and insoluble hulls from the dissolving process. HASW is contained in stainless steel drums and stored in HASW storage.

Low active level solid waste is sorted as combustible waste or non-compressible waste, which is either incinerated, compacted or placed in drums.

These treated wastes are stored in the HASW storage area.



Control room of AAF

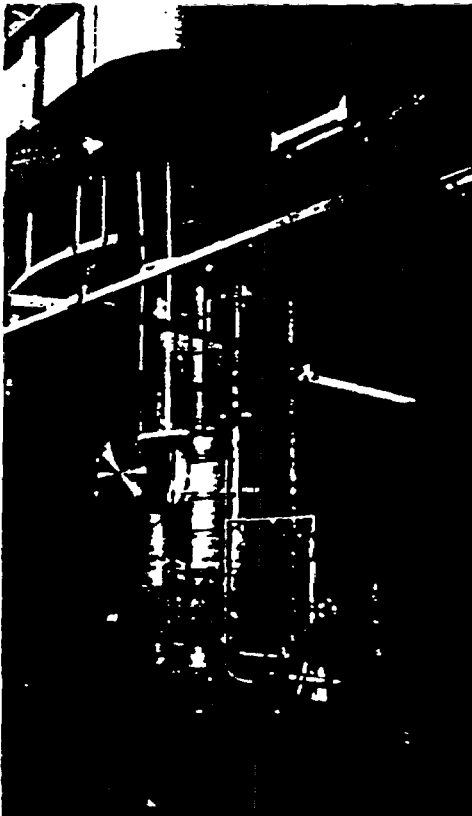

Treatment of LALW

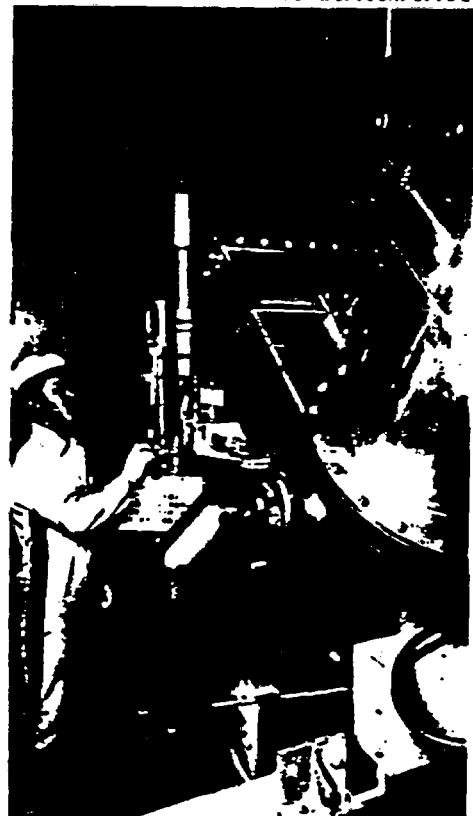

Treatment of LASW

Safety Design and Safety Administration

The reprocessing plant must be designed and administered considering first the safety of the facility, process design and influence on the circumstances.

(1) Confinement

The main parts of plant have triple confinement barriers where the primary confinement barrier is the building, the secondary is the interior wall and the third is the reaction vessel. If leakage of a vessel containing radioactive material occurs, the plant is designed to restrict radioactive release to the environment.

(2) Aseismic design

Aseismic design is based on the basic conditions that the buildings, structures, equipment and piping have sufficient strength to assure safety of the employees and public of the nearby area during and after earthquakes.

(3) Criticality control

The following basic control parameters are considered.

- equipment geometry limitation
- fissionable material mass limitation
- concentration limitation

The nuclear safety of the system is maintained by exercising control over one or more of the above parameters and using neutron poison supplementally.

(4) Maintenance

The mechanical cell equipments treating the high active material are maintained remotely and are able to be remotely decontaminated prior to repair. The equipment in the chemical process is all to be repaired by direct maintenance after decontamination. The key cells and equipment such as HALW concentration process are installed in parallel.

In addition to the above safety design, the health physics of employees is controlled by a PNC system. PNC establishes the monitoring station, ground monitoring posts, sea and coast monitoring, monitoring cars and one monitoring boat.

Environmental Monitoring System at Tokai

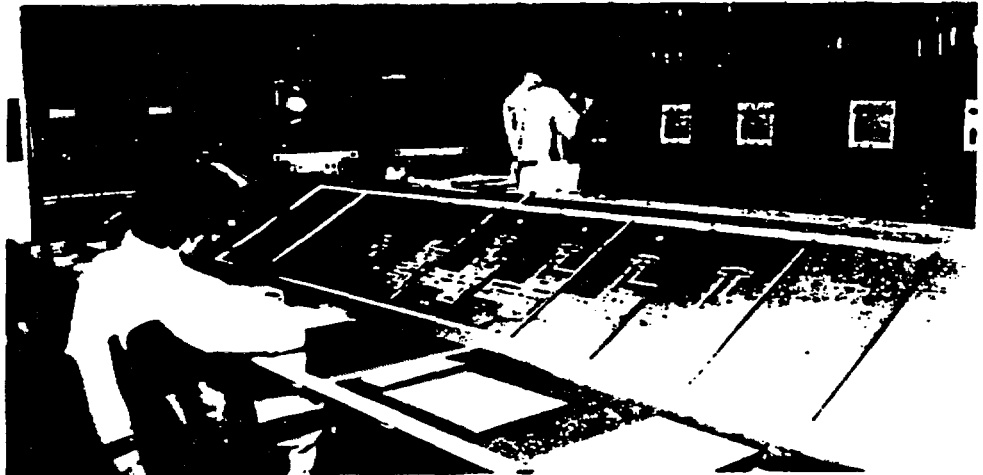
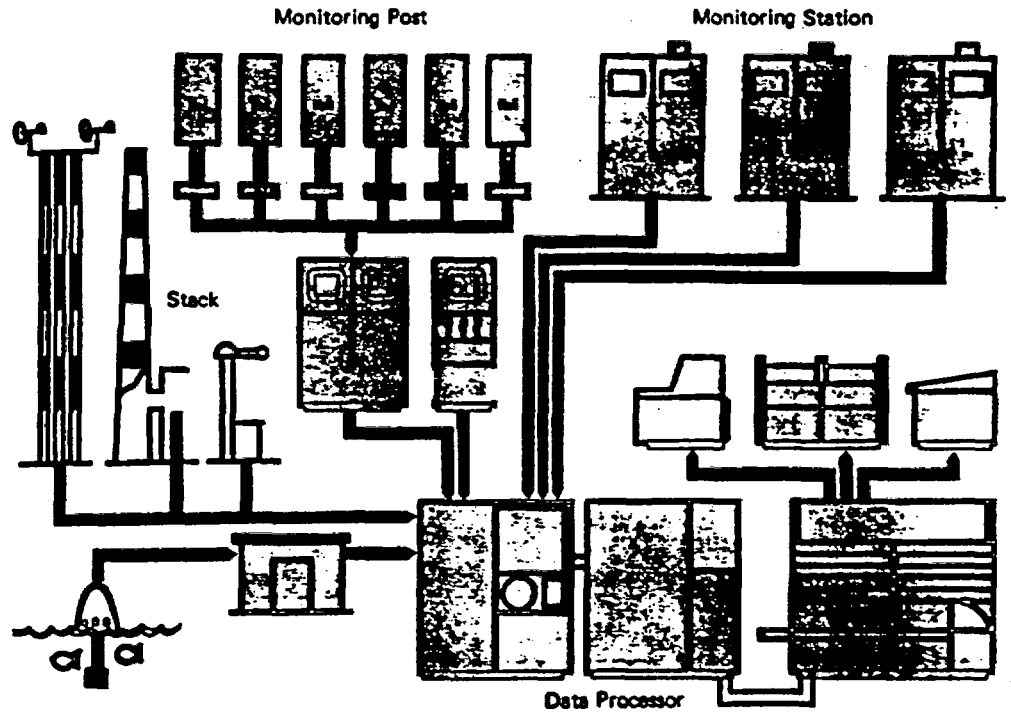

Safety administration room



Monitoring boat "Seikai"

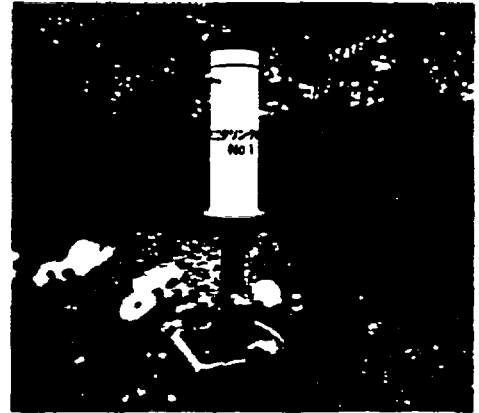

Monitoring post

Present Status of R & D Activities on HLLW and TRU Waste Conditioning in Tokai Works

November 1990

POWER REACTOR AND NUCLEAR FUEL
DEVELOPMENT CORPORATION(PNC)



PNC

Major RD and D Activities on HLLW and TRU Waste Conditioning in Tokai Works.

R & D phase

- HLLW : Vitrification by LFCM Process
- TRU Wastes: Nuclide Separation from Low Level Liquid Waste
Decomposition and Nuclide Separation from Spent Solvent

Demonstration phase

- PWTF : Pu - Contaminated Waste Treatment Facility
- AspF : Bituminization Demonstration Facility
- STF : Solvent Waste Treatment Facility

HLLW Conditioning Technology

Vitrification Technology Development

Process Development

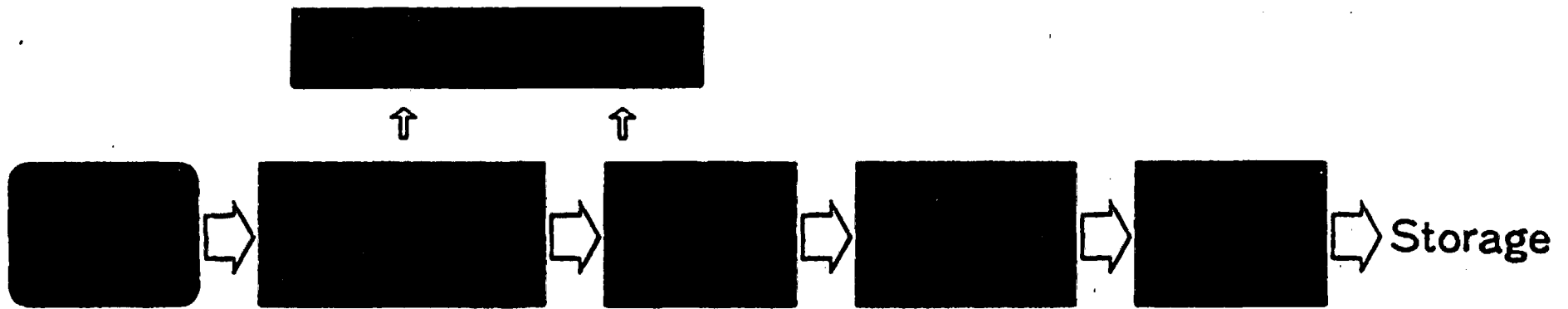

■ Cold Test (ETF, MTF, EDF-III)

■ Hot Labo. Test (CPF)

Development of Vitrification Process and Related Technology in PNC

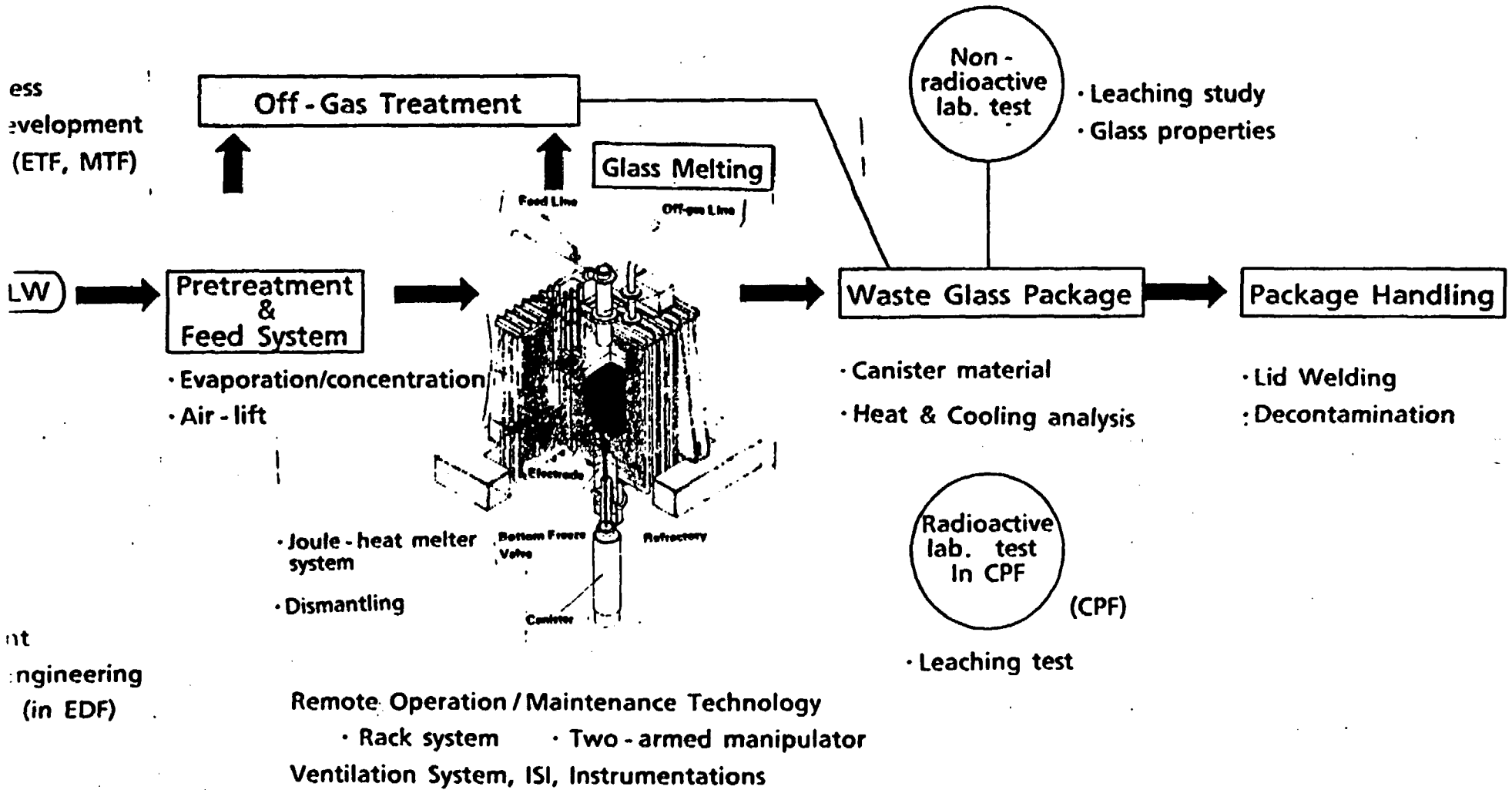

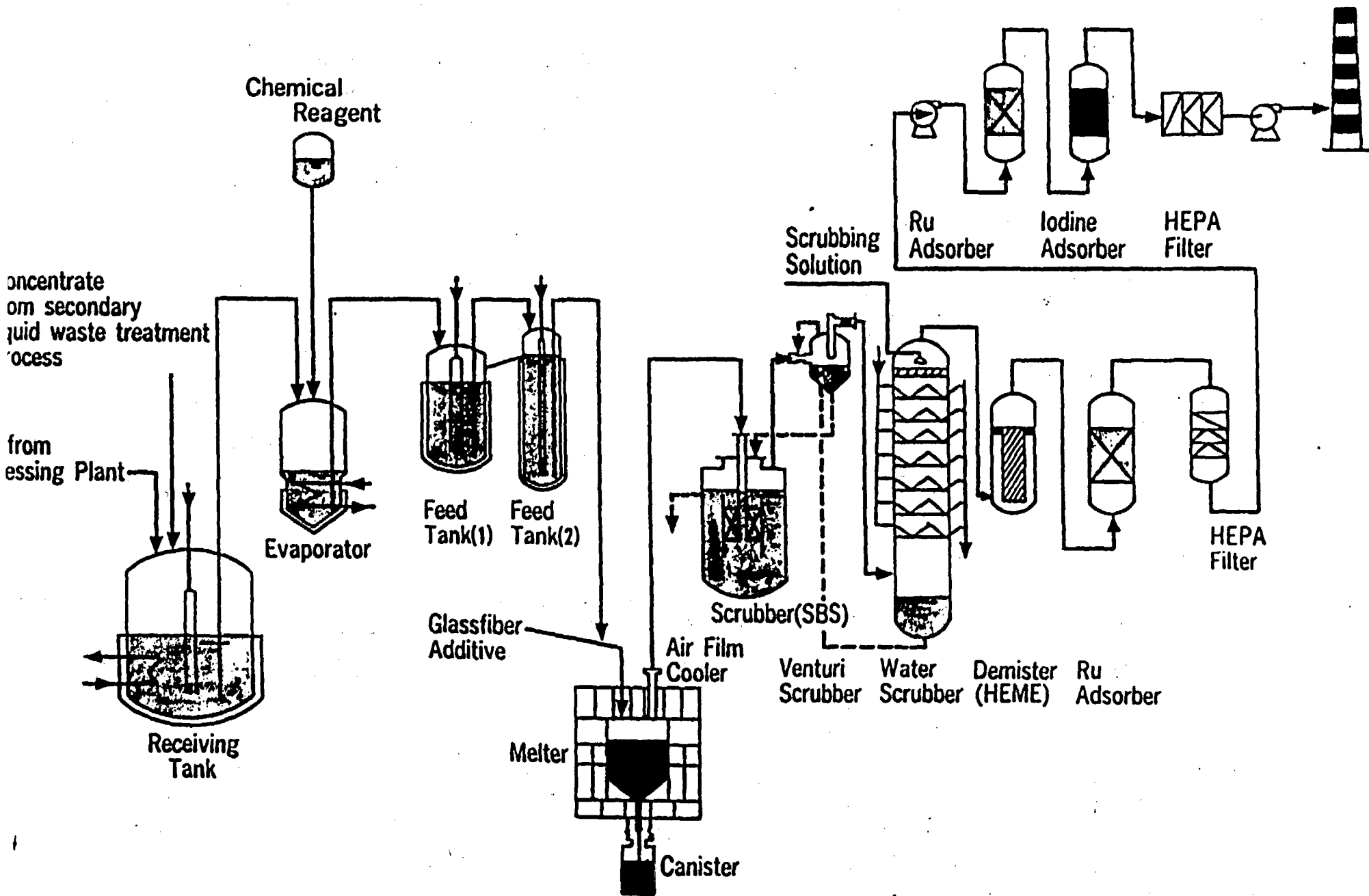

Vitrification Process Flow

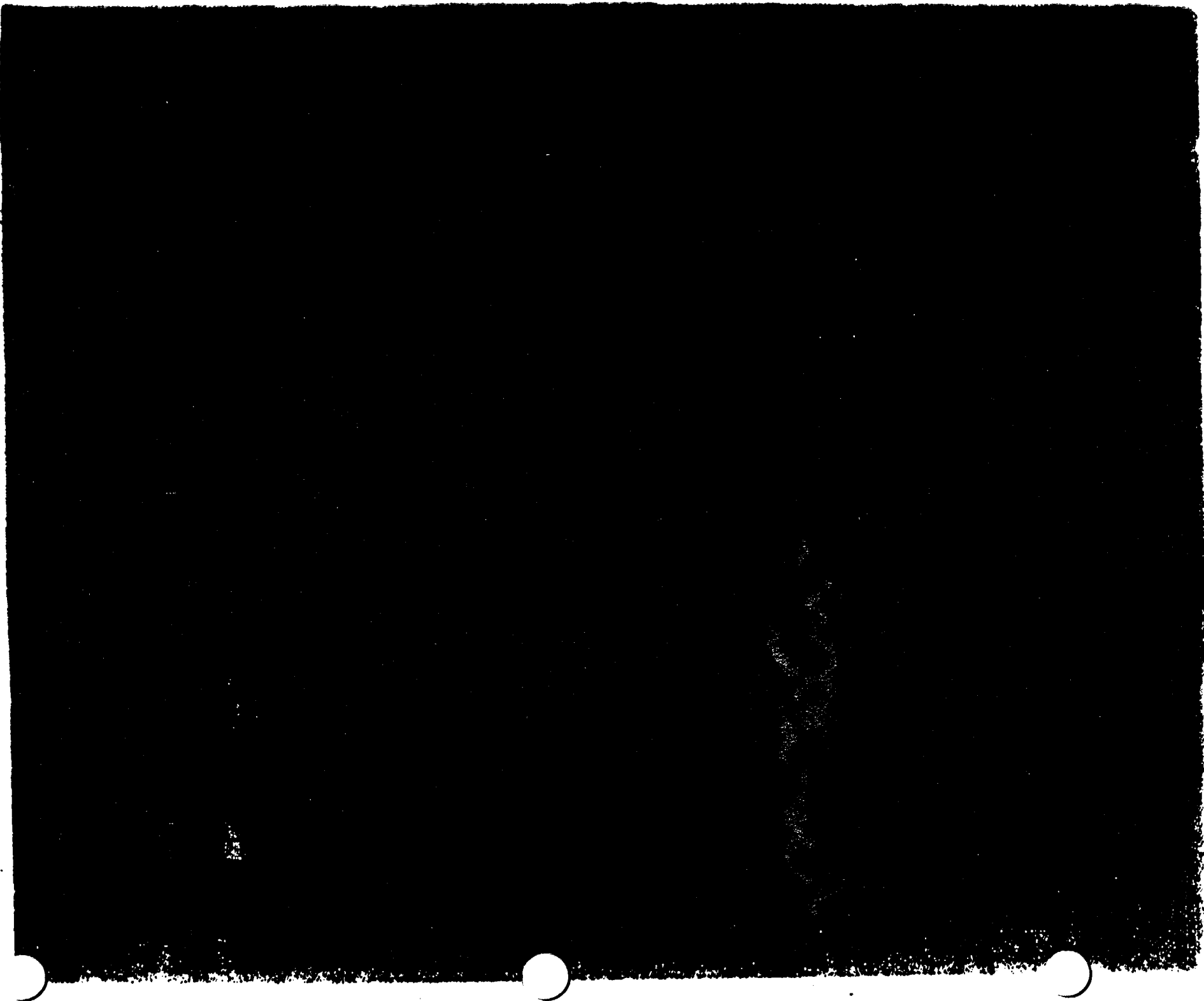

CONFIDENTIAL

TRU Waste Conditioning Technology

Low Level Liquid Waste Treatment Process

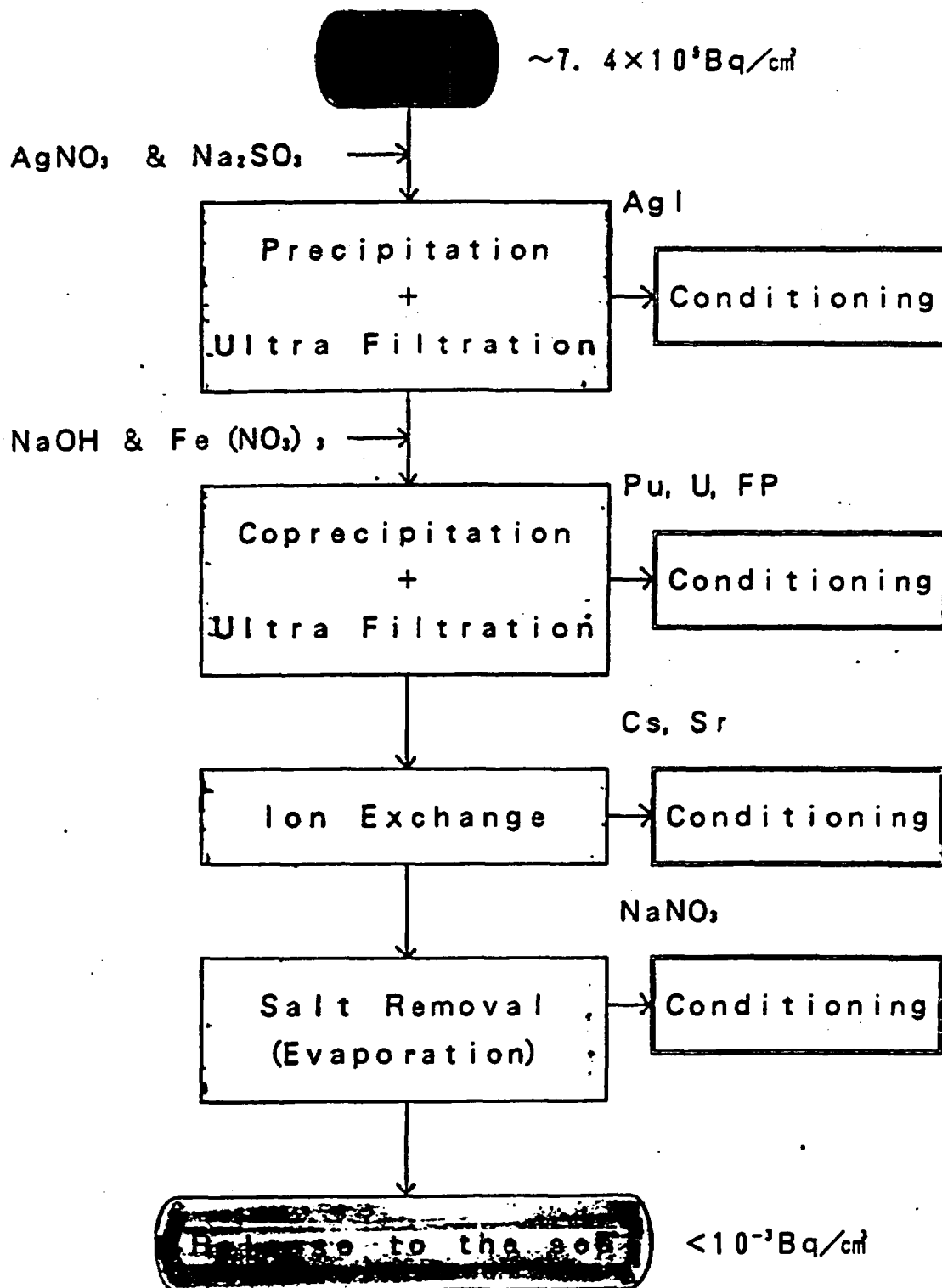

Spent Solvent Oxidative Decomposition Process

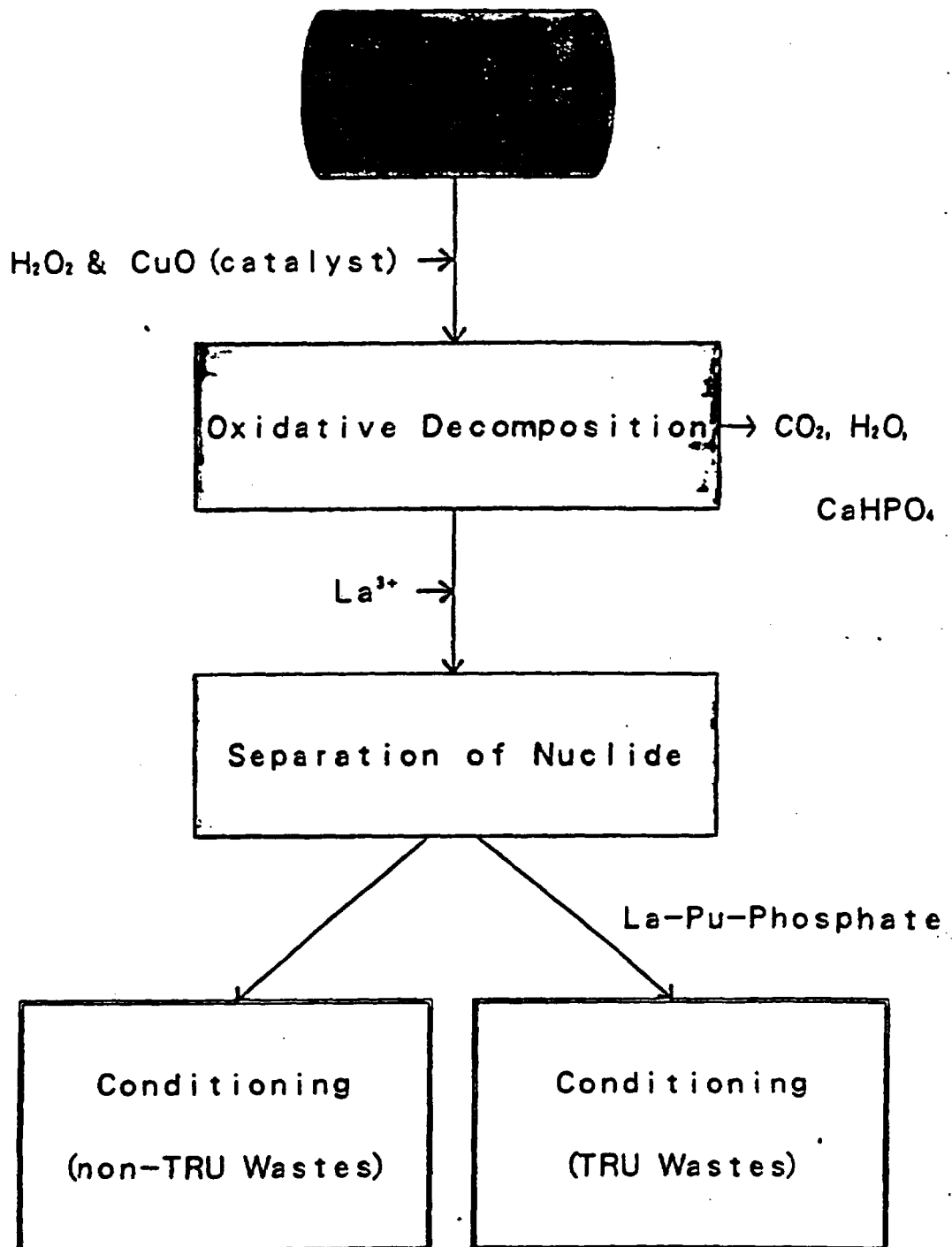

Present Status of Waste Treatment Facilities in Tokai Works

November 1990

POWER REACTOR AND NUCLEAR FUEL
DEVELOPMENT CORPORATION(PNC)



PNC

Major TRU Waste Treatment Facility in Tokai Works

Demonstration phase

PWTF : Pu - Contaminated Waste Treatment Facility

AspF : Bituminization Demonstration Facility

STF : Solvent Waste Treatment Facility

Design phase

LWTF : Low Level Radioactive Waste Treatment Facility

HWTF : Hull Waste Treatment Facility

Pu-Contaminated Waste Treatment Facility (PWTF)

Objectives

- 1. Demonstration of the volume reduction and conditioning processes developed by PNC**
- 2. Characterization of the conditioned waste**



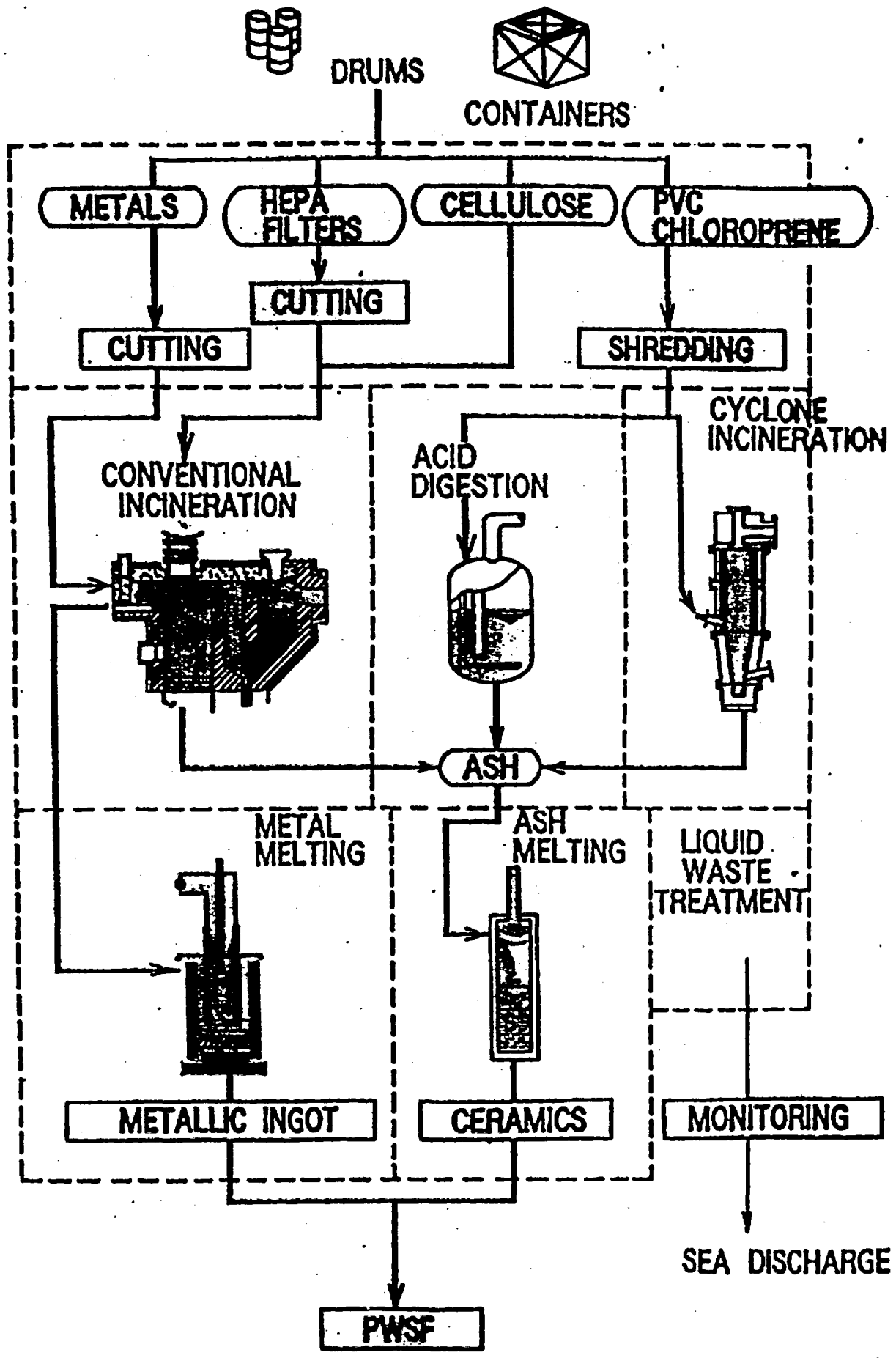

Weight Reduction Ratio of the Wastes (PWTF)

Sep. 1990

40,000	4,840	270 *
3,400	58	8
12	83	34

* simulated waste

Low Level Radioactive Waste Treatment Facility (LWTF)

Objective

- (1) Volume reduction and conditioning of low level solid wastes from Tokai Reprocessing Plant
- (2) Demonstration of the nuclide separation processes
- (3) Characterization of the conditioned wastes

[SOLID WASTE]

[LIQUID WASTE]

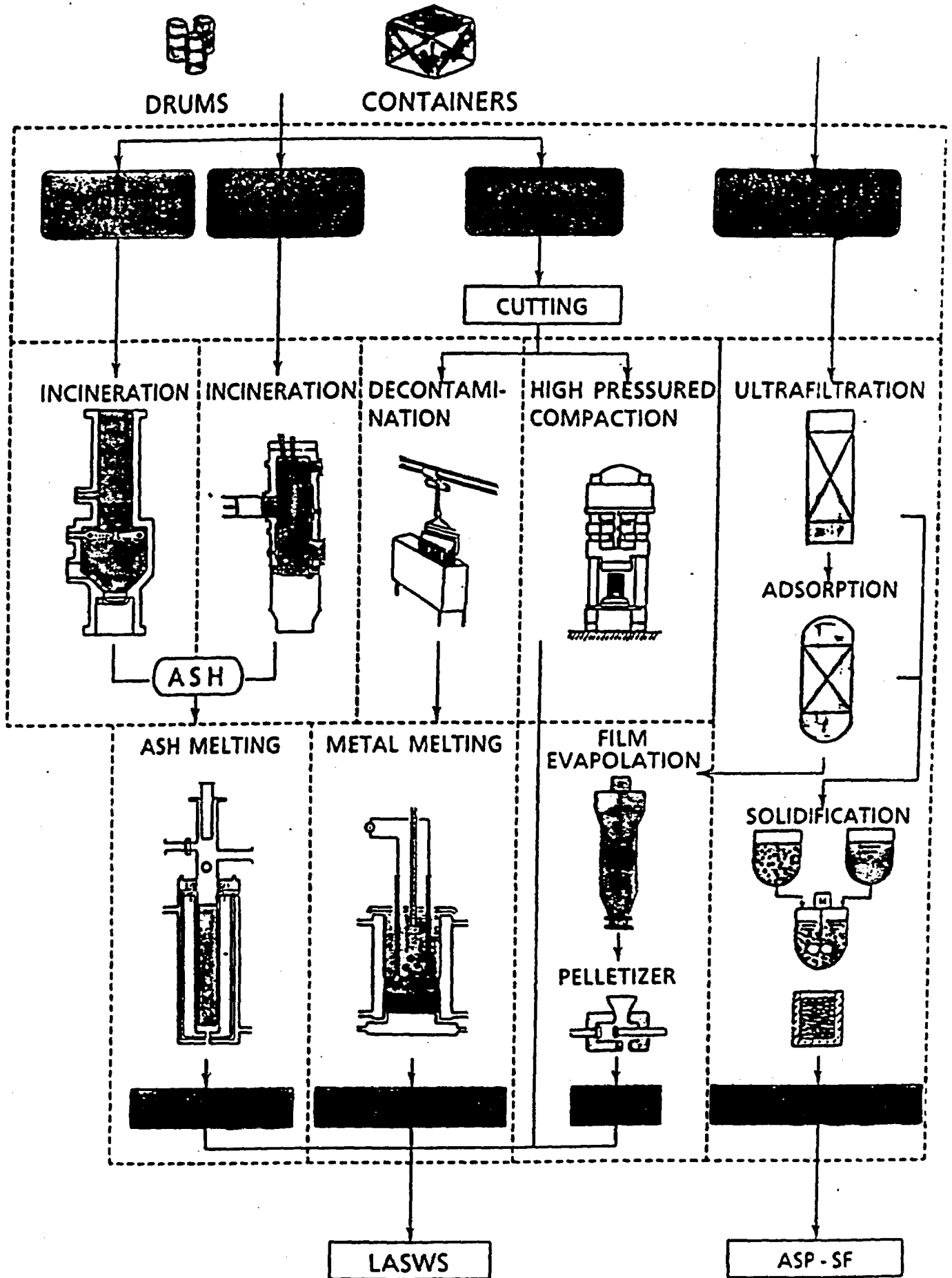

WASTE PROCESSING IN LWTE

Reduction Ratio of Waste (design)

	Combustible Incineration	Cl Contained Materials Incineration	Nuclide Separation
Waste [kg/year]	30,600	19,800	912,000
Product (Ash, sludge) [kg/year]	2,780	2,480	45,600
Weight reduction ratio	11	8	20

	High Pressured Compaction	Metal Melting
Waste [m ³ /year]	342	116
Product [m ³ /year]	69	17
Volume reduction ratio	5	7

Present Status of Other Activities on Nuclear Fuel Cycle in Tokai Works

November 1990

POWER REACTOR AND NUCLEAR FUEL
DEVELOPMENT CORPORATION(PNC)



PNC

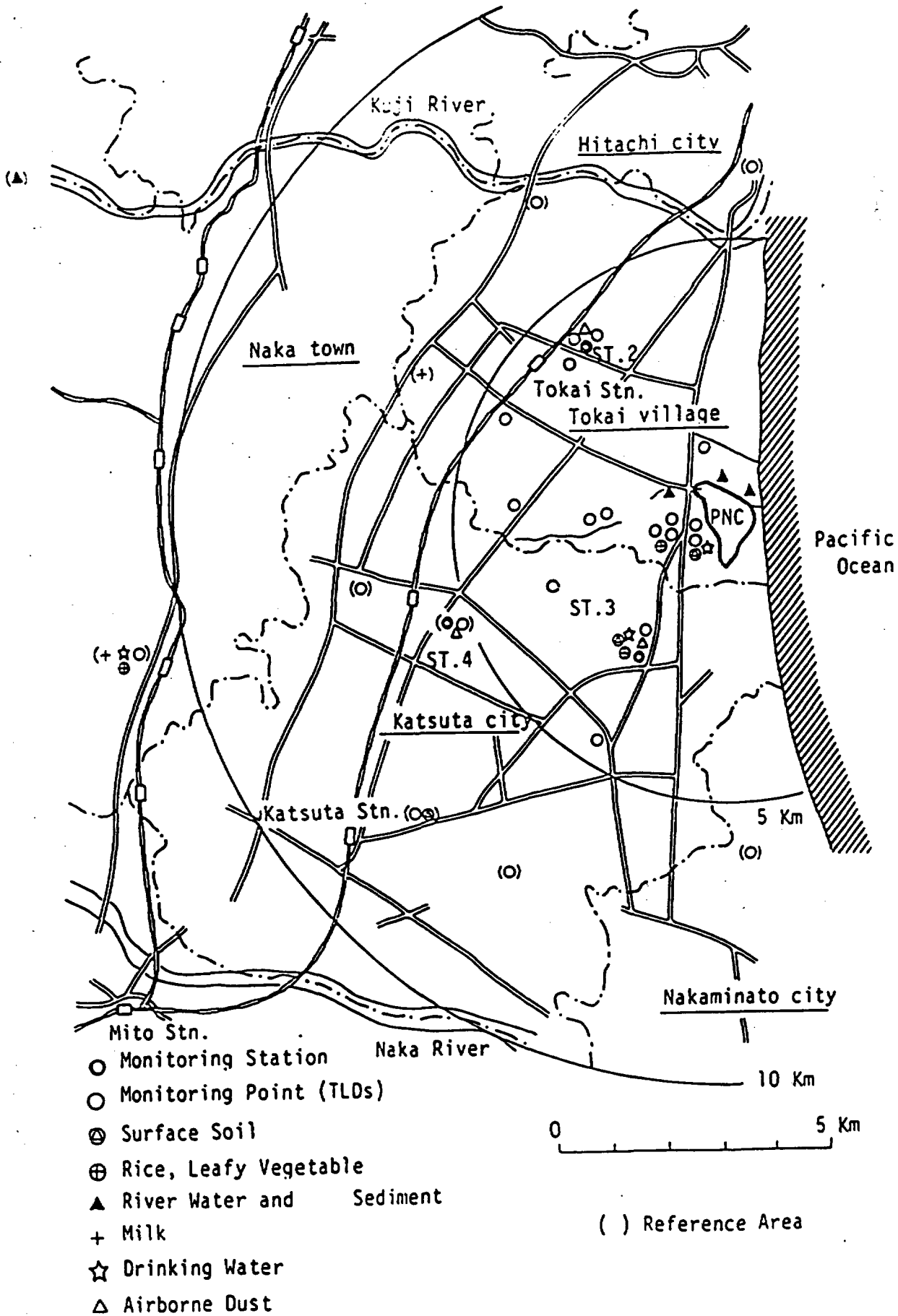

Fig. Sampling and Monitoring Points (Off-Site)

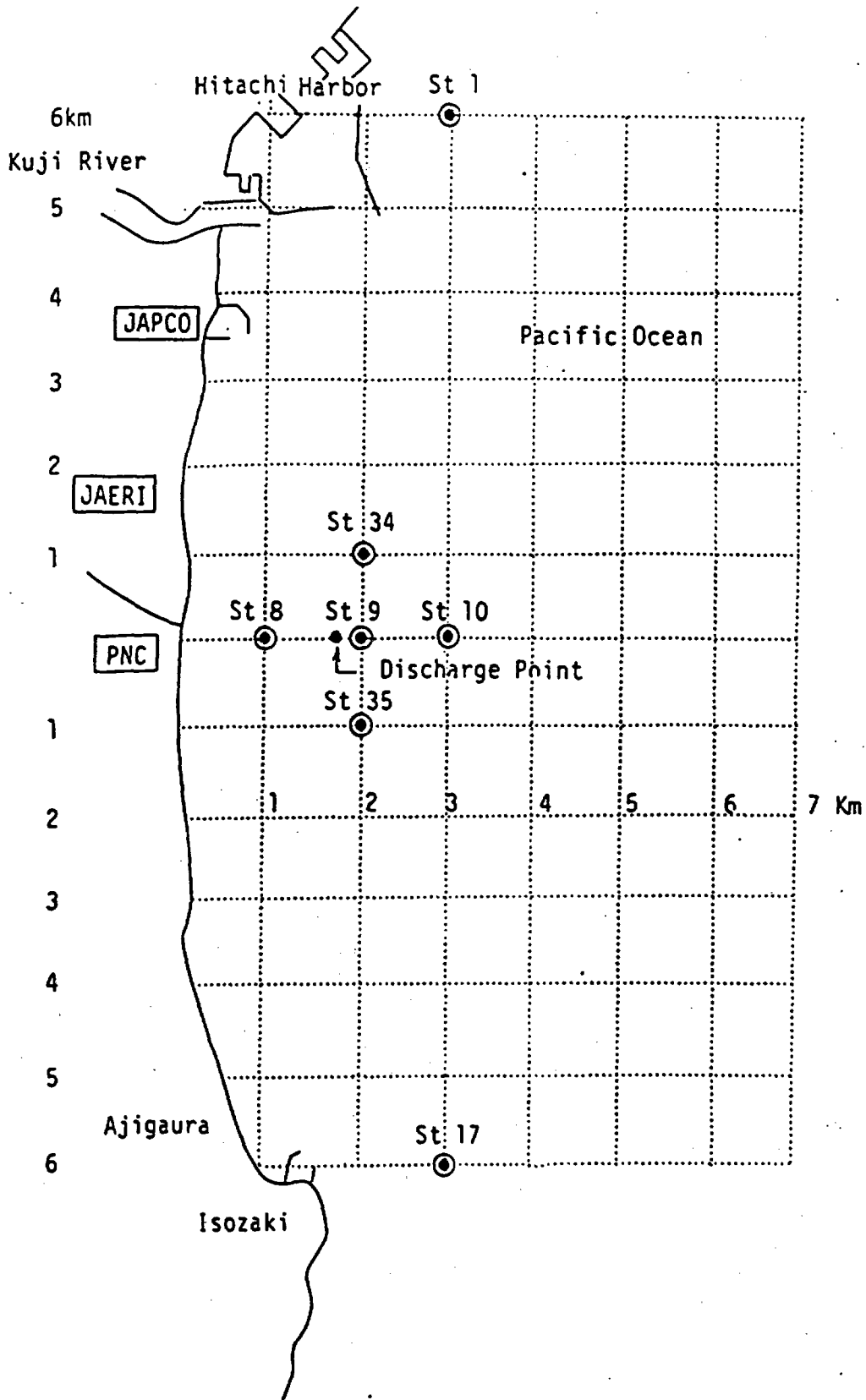

Fig. Sampling Points for Surface Water and Sediment

Table-1. Analysis and Measurement Methods and the Detection Limits of Radionuclides in the Terrestrial Environmental Monitoring Program at PNC Tokai Works.

Sample	Nuclide	Analysis and Measurement Method	Detection Limit
Airborne Particulates	Gross Alpha	Direct alpha counting of filter paper	0.02 mBq/m ³
	Gross Beta	Direct beta counting of filter paper	0.7 mBq/m ³
	Sr-90	Radiochemical analysis and beta counting	0.004 mBq/m ³
	Cs-137	Gamma spectrometry	0.007 mBq/m ³
	Pu-239,240	Radiochemical analysis and alpha spectrometry	0.0001 mBq/m ³
Airborne Iodine	I-131	Gamma spectrometry	0.2 mBq/m ³
Airborne Rare Gas	Kr-85	Continuous measurement of air	7 kBq/m ³
Rain Water	H-3	Liquid scintillation spectrometry	2 Bq/l
Fallout	Gross Beta	Beta counting	4 Bq/m ²
Drinking Water	Gross Beta	Evaporation and beta counting	0.04 Bq/l
	H-3	Liquid scintillation spectrometry	2 Bq/l
Leafy Vegetables	I-131	Gamma spectrometry of chopped samples	0.2 Bq/kg fresh
	Sr-90	Radiochemical analysis and beta counting	0.04 Bq/kg fresh
	Cs-137	Gamma spectrometry of chopped samples	0.08 Bq/kg fresh
	Pu-239,240	Radiochemical analysis and alpha spectrometry	0.00008 Bq/kg fresh
Polished Rice	Sr-90	Radiochemical analysis and beta counting	0.04 Bq/kg fresh
Surface Soil	Sr-90	Radiochemical analysis and beta counting	0.08 Bq/kg dry
	Cs-137	Gamma spectrometry of dried samples	0.8 Bq/kg dry
	Pu-239,240	Radiochemical analysis and alpha spectrometry	0.04 Bq/kg dry

Table-1. Analysis and Measurement Methods and the Detection Limits of Radionuclides in the Terrestrial Environmental Monitoring Program at PNC Tokai Works.

Sample	Nuclide	Analysis and Measurement Method	Detection Limit
Airborne Particulates	Gross Alpha	Direct alpha counting of filter paper	0.02 mBq/m ³
	Gross Beta	Direct beta counting of filter paper	0.7 mBq/m ³
	Sr-90	Radiochemical analysis and beta counting	0.004 mBq/m ³
	Cs-137	Gamma spectrometry	0.007 mBq/m ³
	Pu-239,240	Radiochemical analysis and alpha spectrometry	0.0001 mBq/m ³
Airborne Iodine	I-131	Gamma spectrometry	0.2 mBq/m ³
Airborne Rare Gas	Kr-85	Continuous measurement of air	7 kBq/m ³
Rain Water	H-3	Liquid scintillation spectrometry	2 Bq/l
Fallout	Gross Beta	Beta counting	4 Bq/m ²
Drinking Water	Gross Beta	Evaporation and beta counting	0.04 Bq/l
	H-3	Liquid scintillation spectrometry	2 Bq/l
Leafy Vegetables	I-131	Gamma spectrometry of chopped samples	0.2 Bq/kg fresh
	Sr-90	Radiochemical analysis and beta counting	0.04 Bq/kg fresh
	Cs-137	Gamma spectrometry of chopped samples	0.08 Bq/kg fresh
	Pu-239,240	Radiochemical analysis and alpha spectrometry	0.00008 Bq/kg fresh
Polished Rice	Sr-90	Radiochemical analysis and beta counting	0.04 Bq/kg fresh
Surface Soil	Sr-90	Radiochemical analysis and beta counting	0.08 Bq/kg dry
	Cs-137	Gamma spectrometry of dried samples	0.8 Bq/kg dry
	Pu-239,240	Radiochemical analysis and alpha spectrometry	0.04 Bq/kg dry

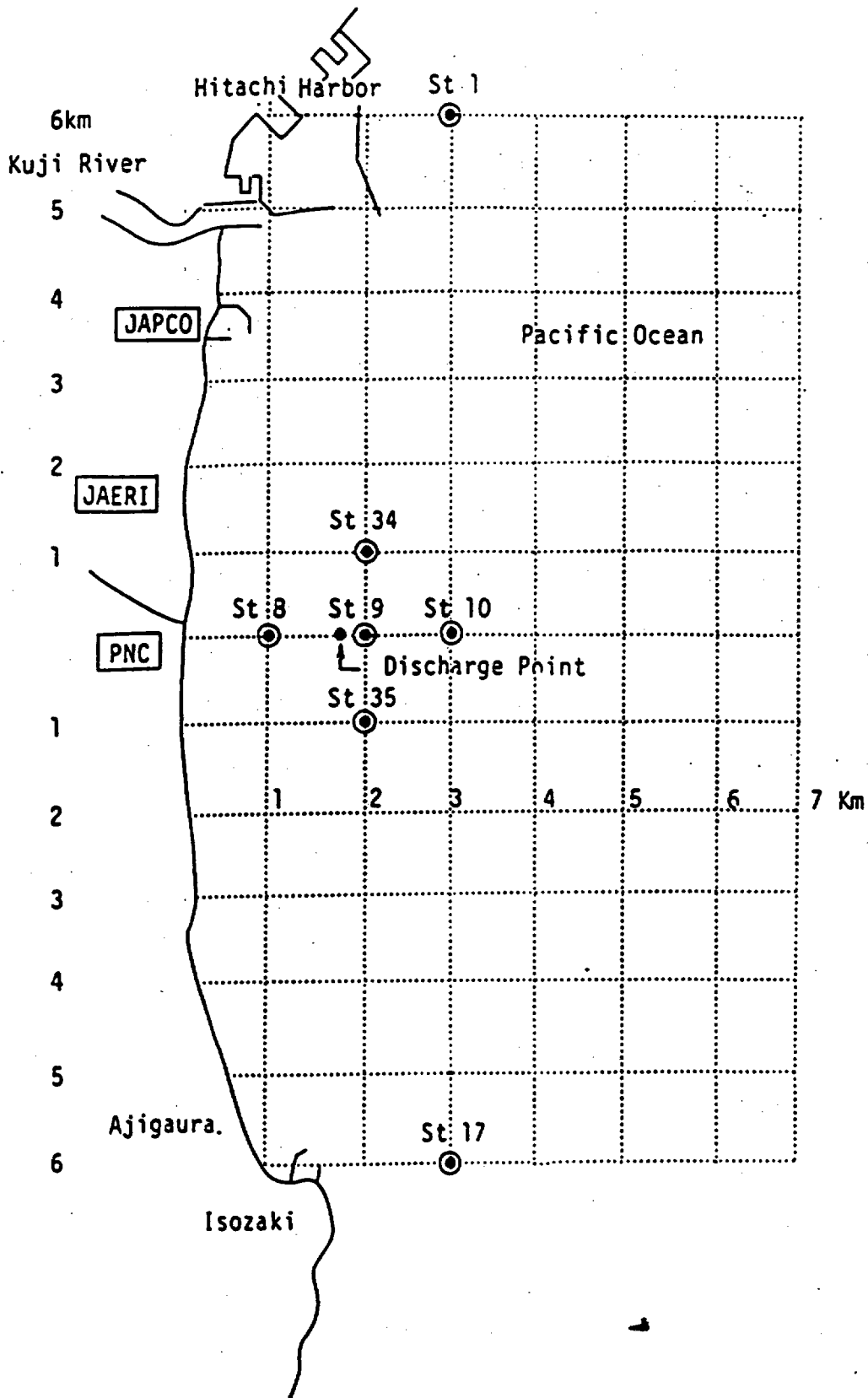

Fig. Sampling Points for Surface Water and Sediment

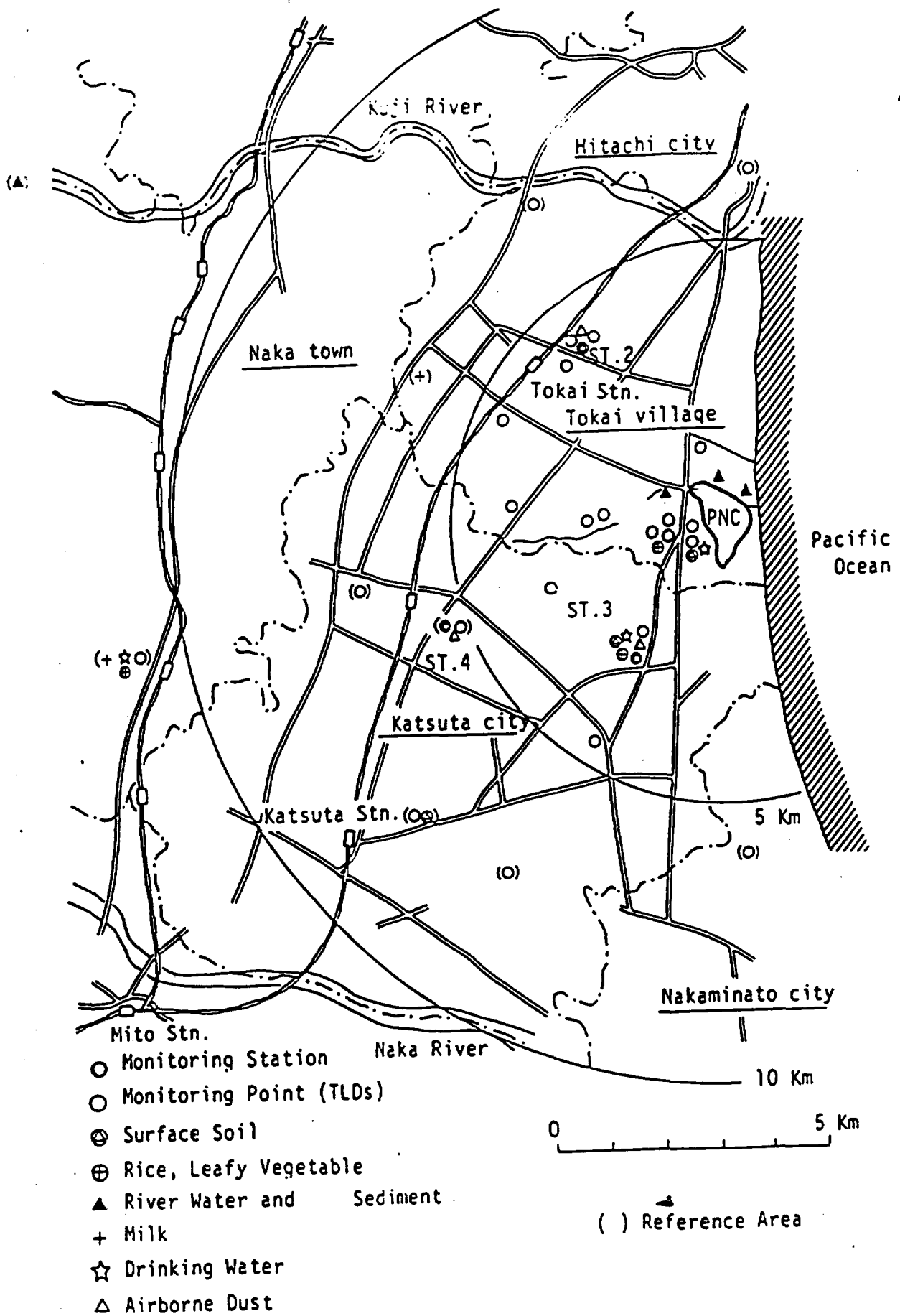
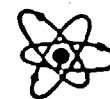

Fig. Sampling and Monitoring Points (Off-Site)

Present Status of Other Activities on Nuclear Fuel Cycle in Tokai Works

November 1990

POWER REACTOR AND NUCLEAR FUEL
DEVELOPMENT CORPORATION(PNC)



PNC

Reduction Ratio of Waste (design)

	Combustible Incineration	Cl Contained Materials Incineration	Nuclide Separation
Waste [kg/year]	30,600	19,800	912,000
Product (Ash, sludge) [kg/yr]	2,780	2,480	45,600
Reduction ratio	11	8	20

	High Pressured Compaction	Metal Melting
Waste [m ³ /year]	342	116
Product [m ³ /year]	69	17
Volume reduction ratio	5	7

[SOLID WASTE]

[LIQUID WASTE]

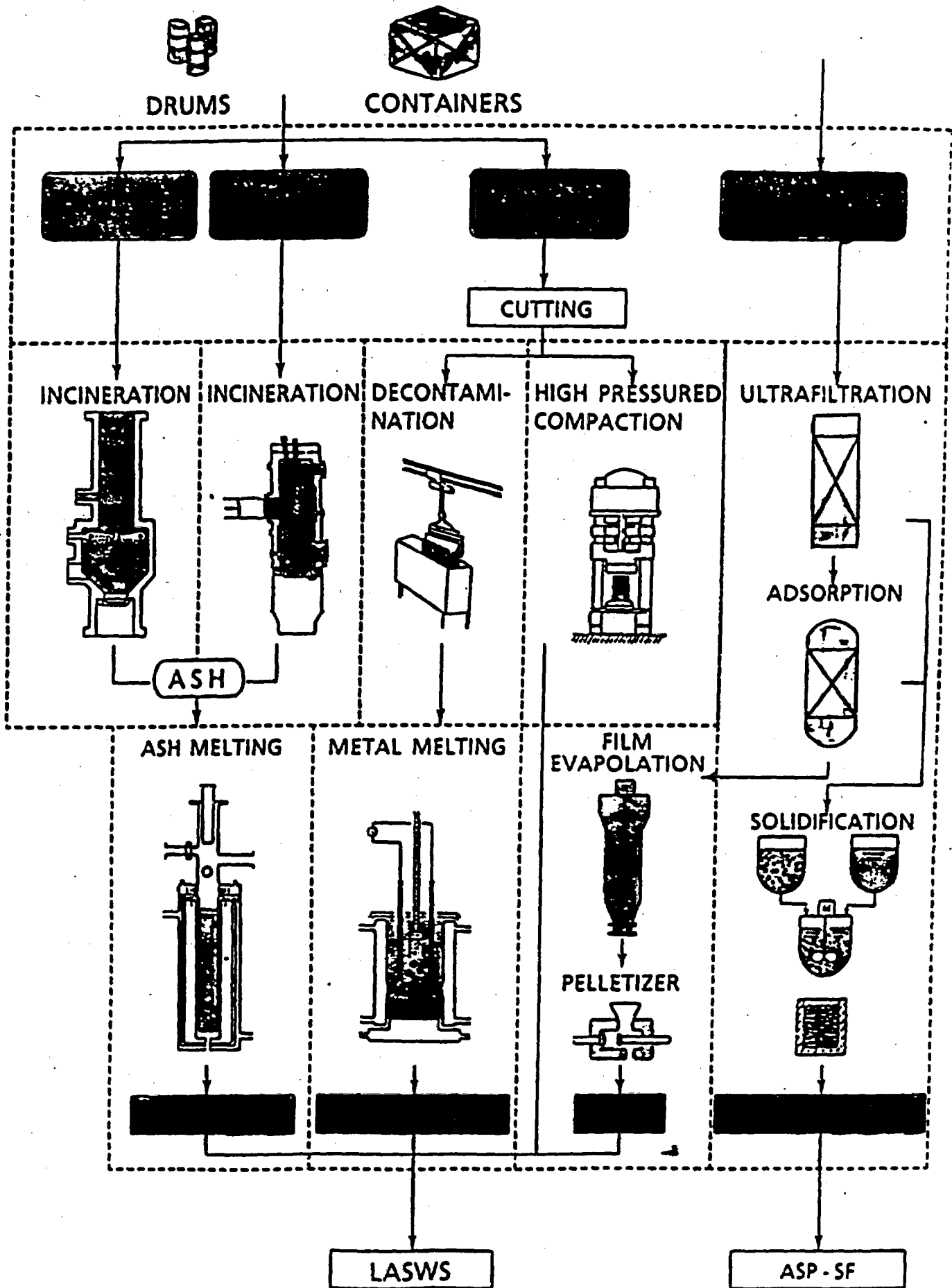

Low Level Radioactive Waste Treatment Facility (LWTF)

Objective

- (1) Volume reduction and conditioning of low level solid wastes from Tokai Reprocessing Plant
- ↳ (2) Demonstration of the nuclide separation processes
- (3) Characterization of the conditioned wastes

Weight Reduction Ratio of the Wastes (PWTF)

Sep. 1990

40,000	4,849	270 *
3,400	53	8
12	83	34

* simulated waste

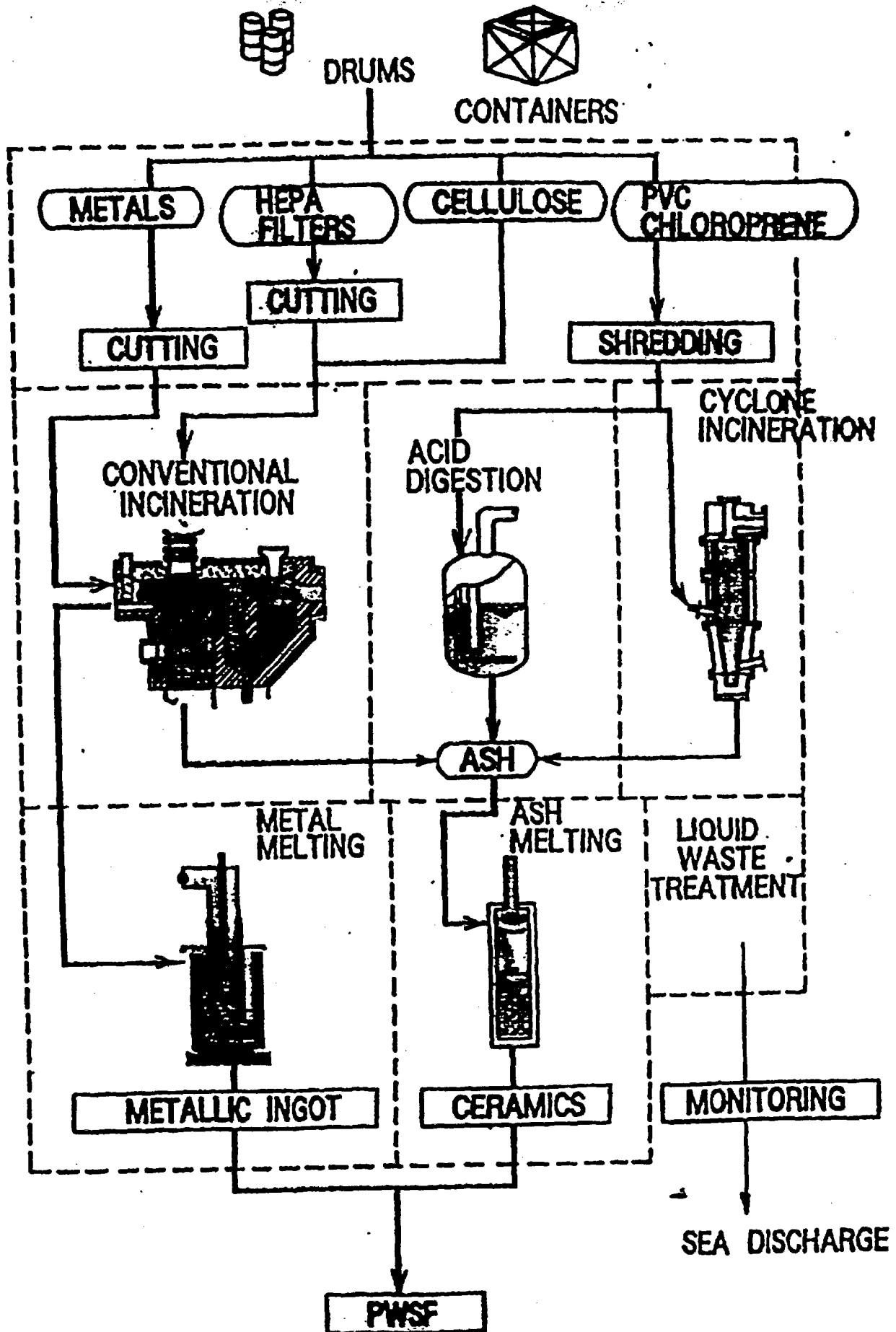

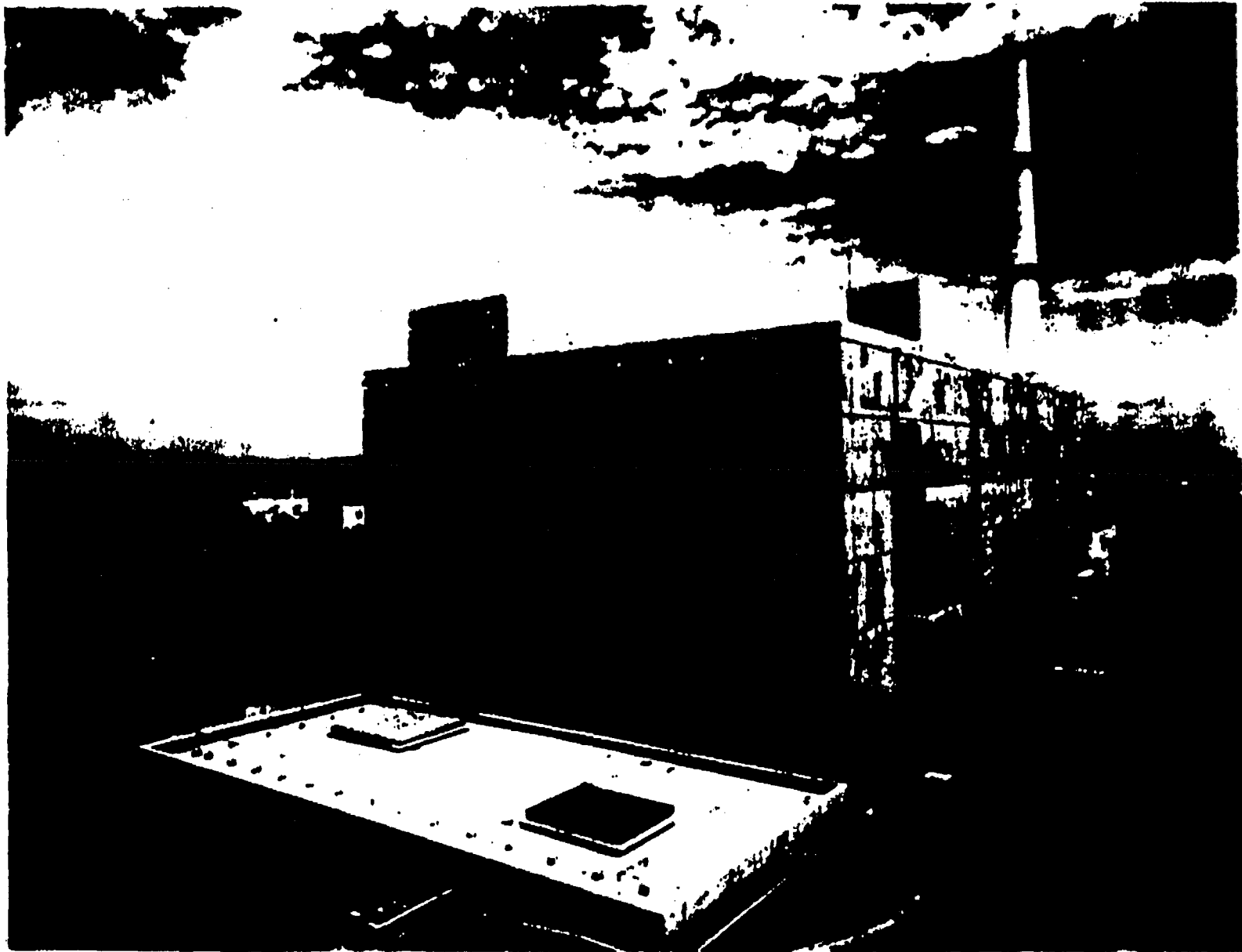

²³⁹u-Contaminated Waste Treatment Facility (PWTF)

Objectives

1. Demonstration of the volume reduction and conditioning processes developed by PNC
2. Characterization of the conditioned waste

Major TRU Waste Treatment Facility in Tokai Works

Demonstration phase

PWTF : Pu - Contaminated Waste Treatment Facility

AspF : Bituminization Demonstration Facility

STF : Solvent Waste Treatment Facility

Design phase

LWTF : Low Level Radioactive Waste Treatment Facility

HWTF : Hull Waste Treatment Facility

Present Status of Waste Treatment Facilities in Tokai Works

November 1990

POWER REACTOR AND NUCLEAR FUEL
DEVELOPMENT CORPORATION(PNC)



PNC

Spent Solvent Oxidative Decomposition Process

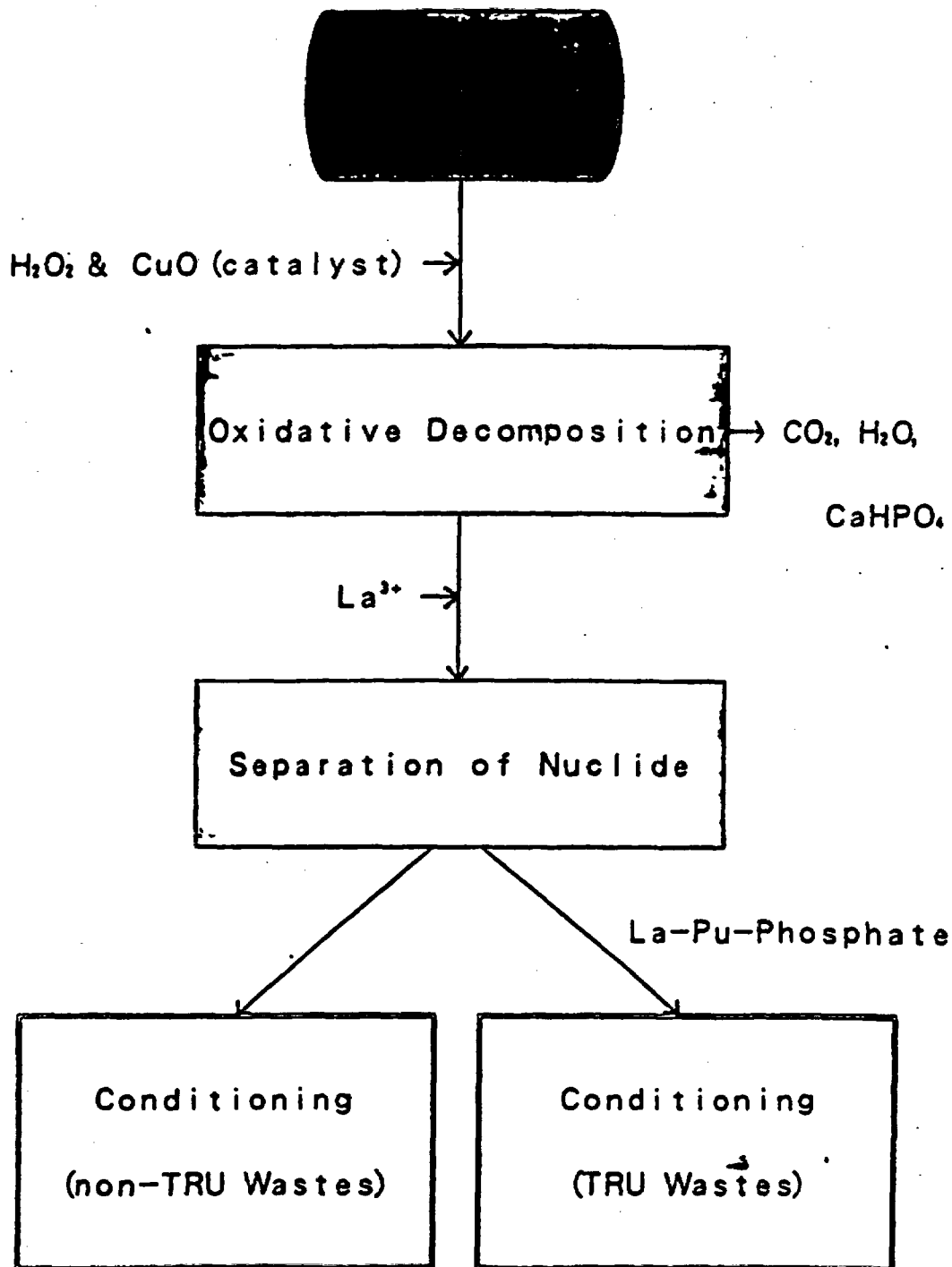

Low Level Liquid Waste Treatment Process

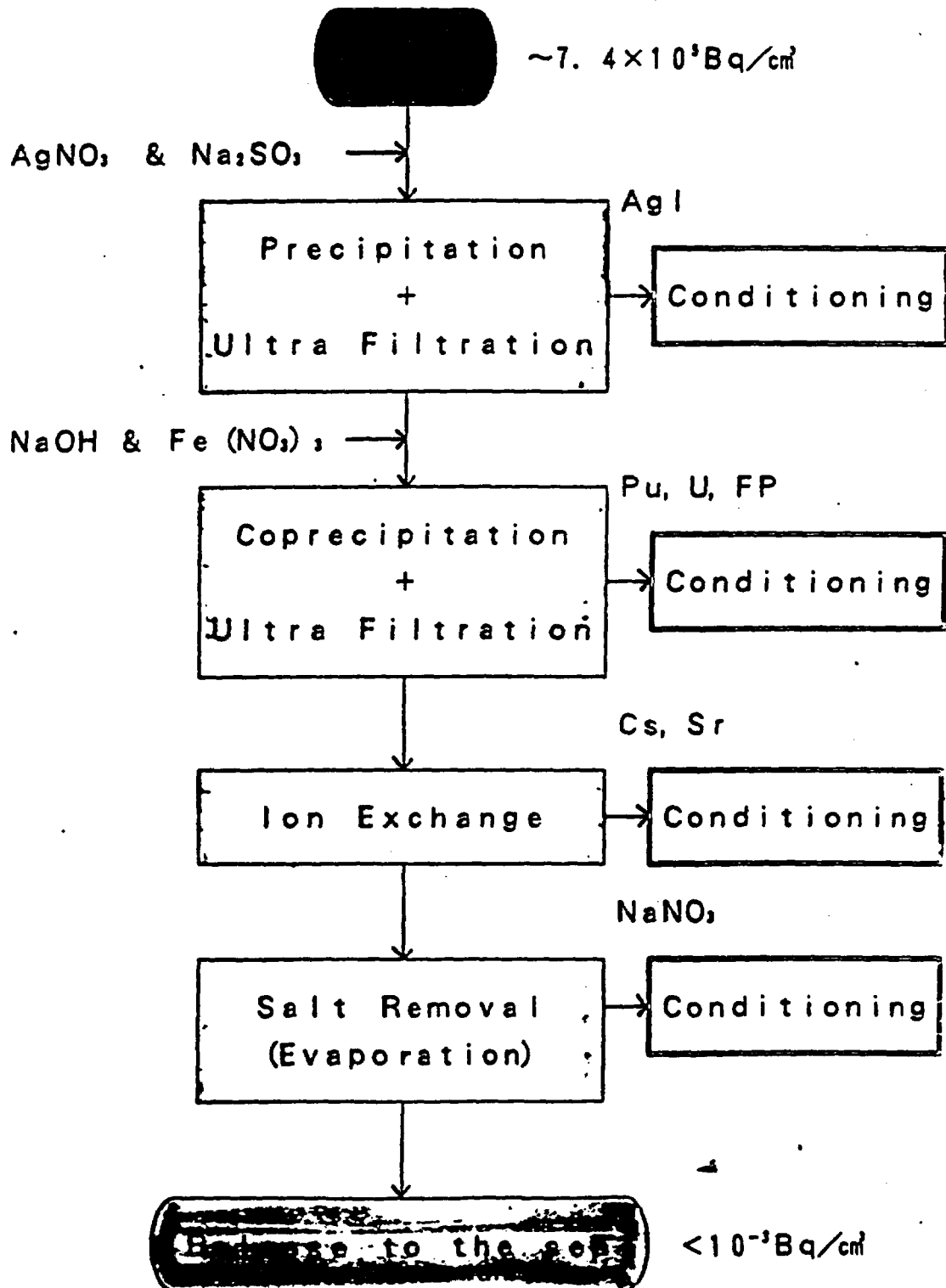

TRU Waste Conditioning Technology

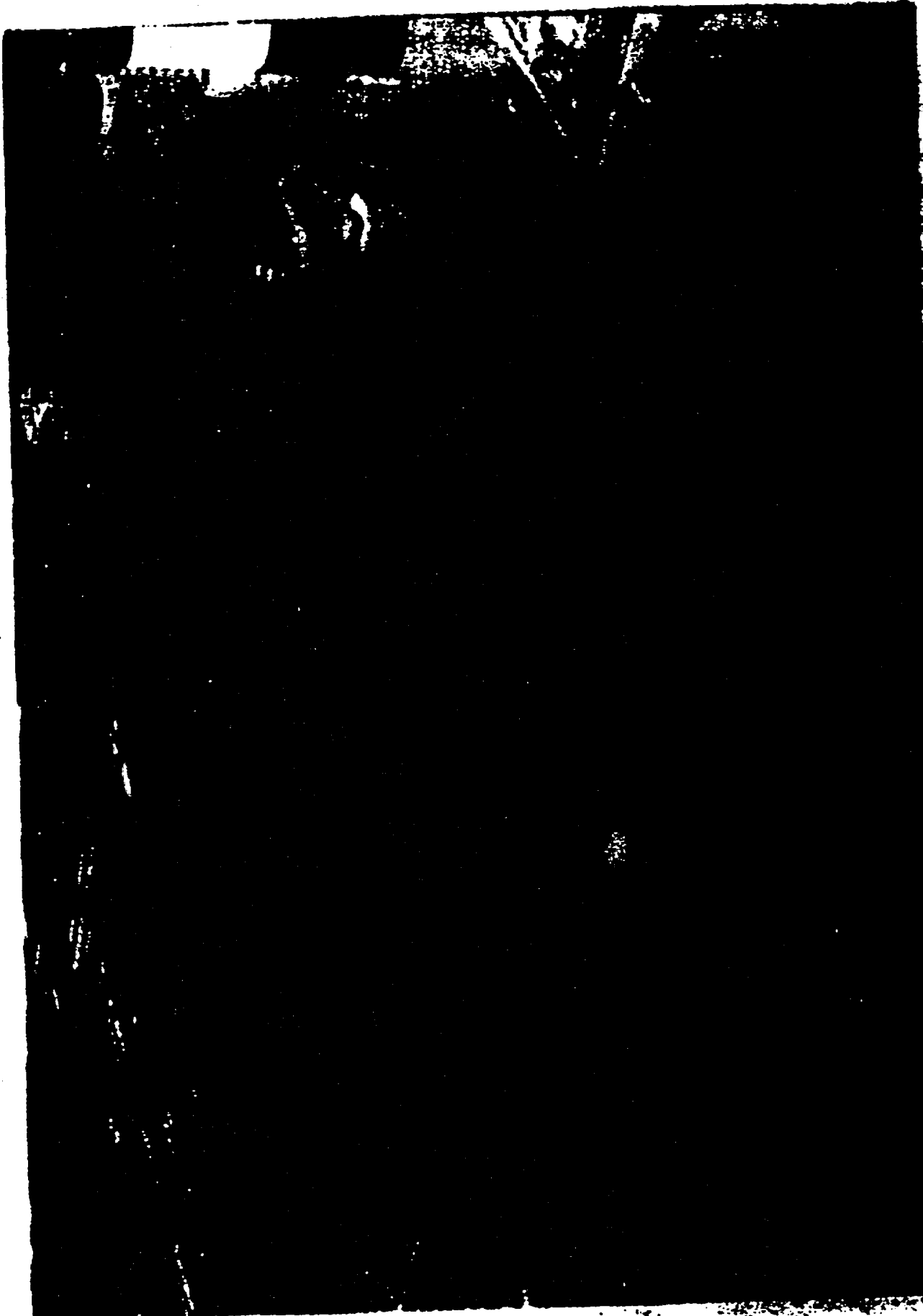

Construction of the

C

C

C

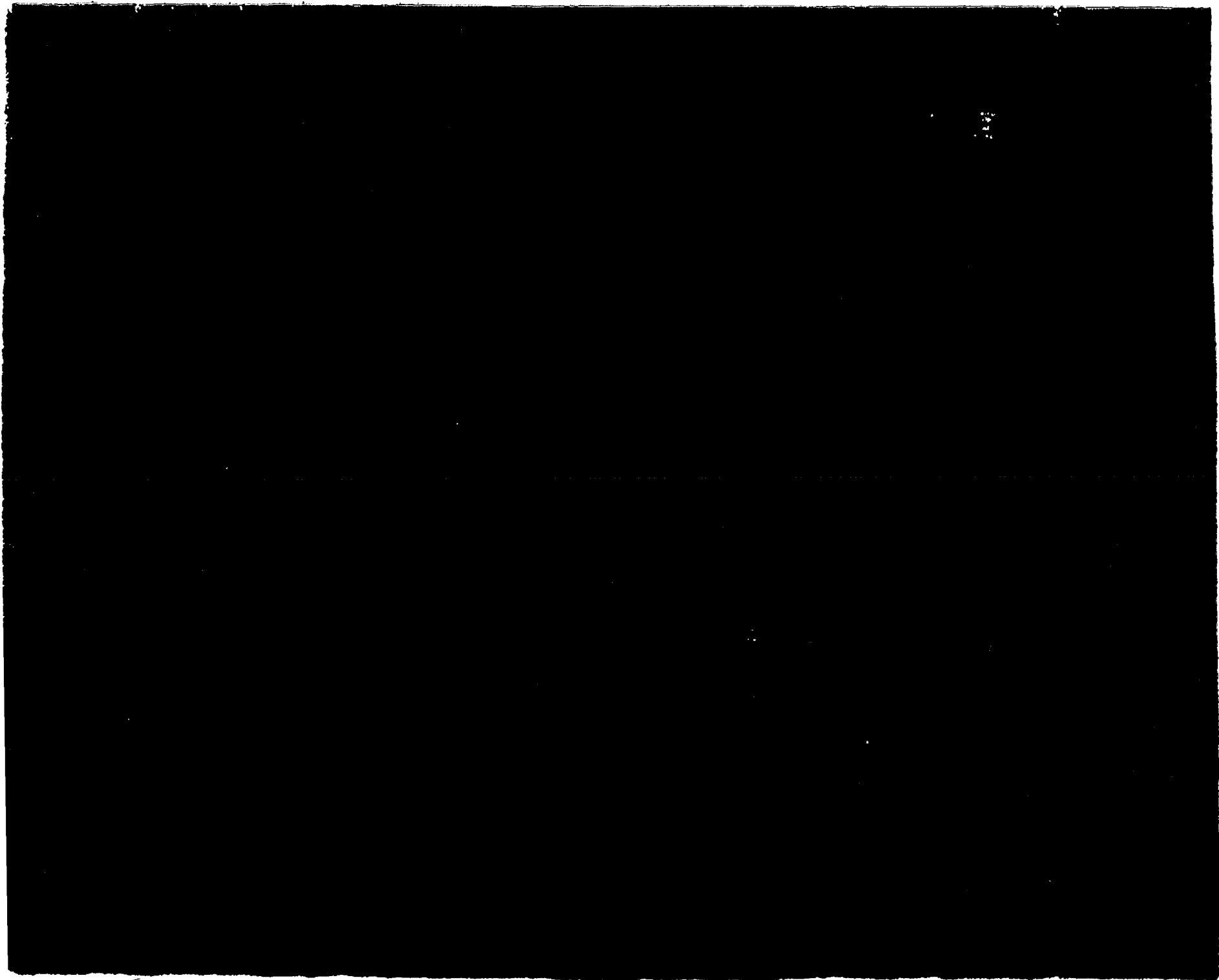

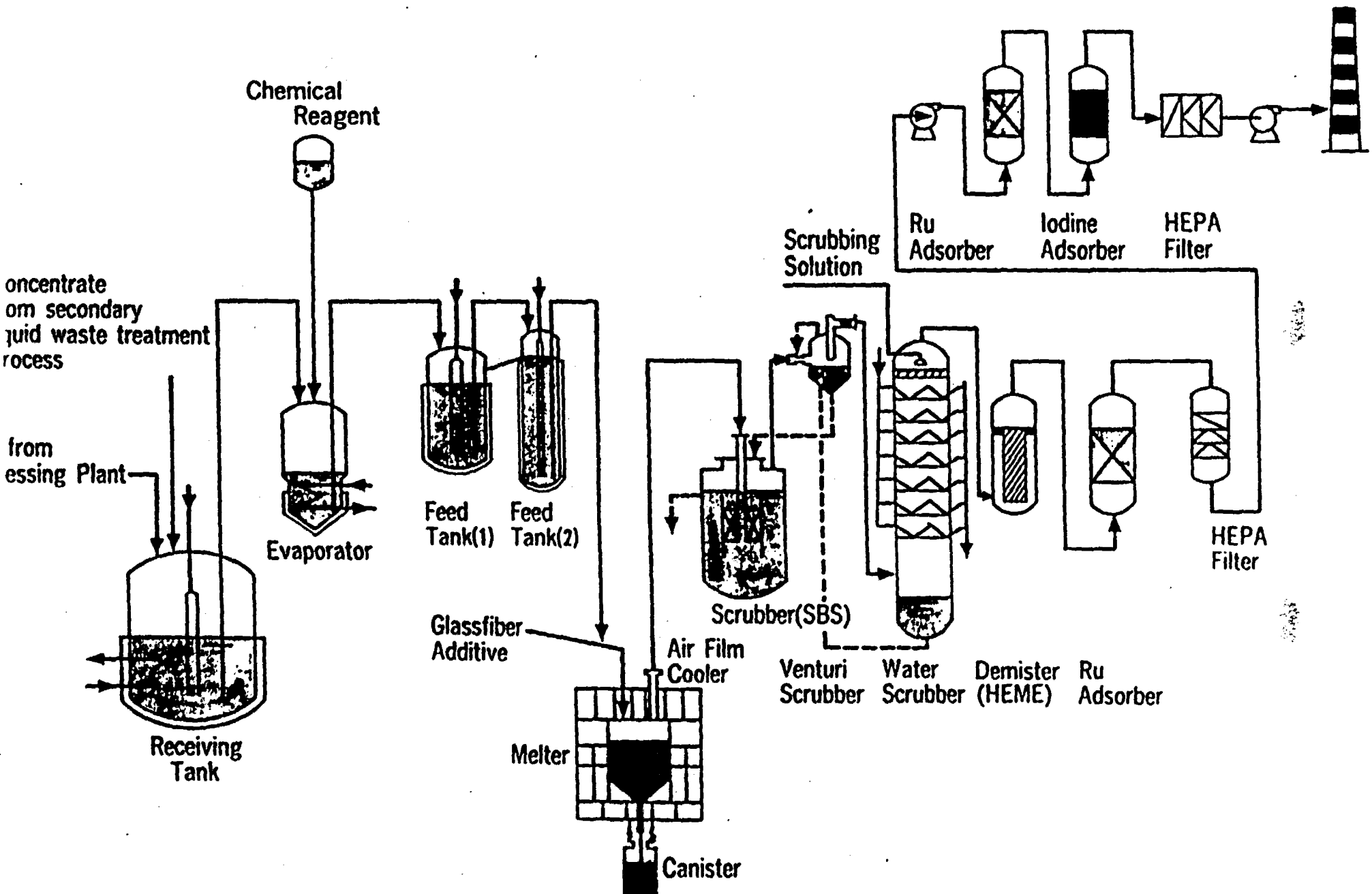

Vitrification Process Flow

Development of Vitrification Process and Related Technology in PNC

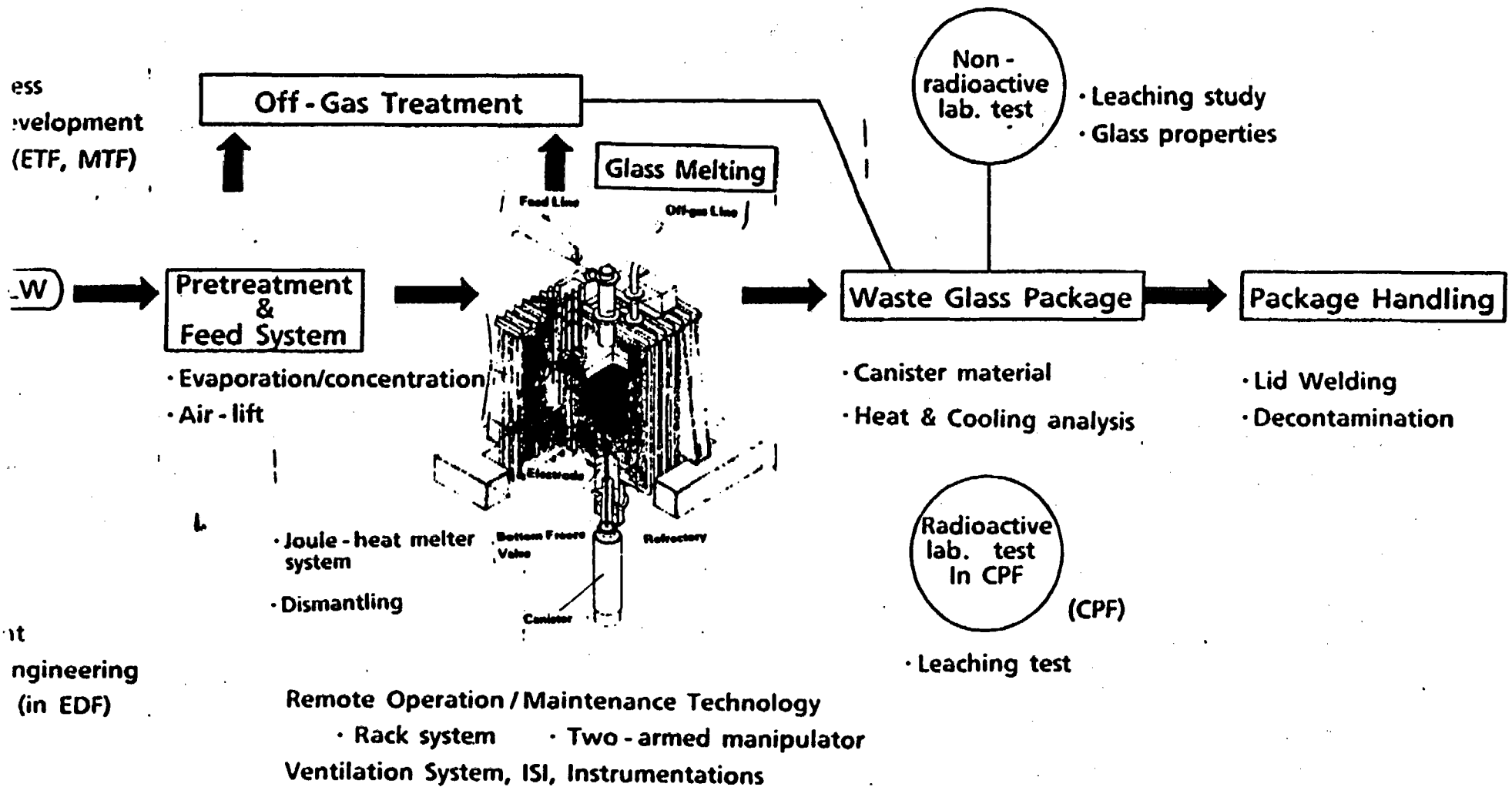

Process development (ETF, MTF)

W

Remote Operation/Maintenance Technology (in EDF)

Vitrification Technology Development

Process Development

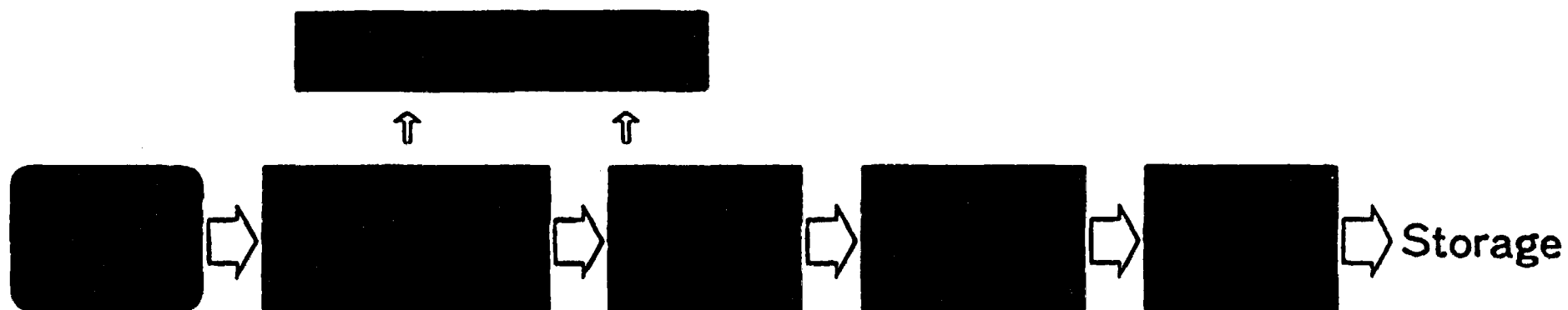

■ Cold Test (ETF, MTF, EDF-III)

■ Hot Labo. Test (CPF)

HLLW Conditioning Technology

Major RD and D Activities on HLLW and TRU Waste Conditioning in Tokai Works.

R & D phase

- HLLW : Vitrification by LFCM Process
- TRU Wastes: Nuclide Separation from Low Level Liquid Waste
Decomposition and Nuclide Separation from Spent Solvent

Demonstration phase

- PWTF : Pu - Contaminated Waste Treatment Facility
- AspF : Bituminization Demonstration Facility
- STF : Solvent Waste Treatment Facility

Present Status of R & D Activities on HLLW and TRU Waste Conditioning in Tokai Works

November 1990

POWER REACTOR AND NUCLEAR FUEL
DEVELOPMENT CORPORATION(PNC)



PNC

CEC 4th Natural Analogue working Group Meeting

Pitlochry, Scotland, 17-22 June 1990

(C E C E U R R E P O R T)

SOME ASPECTS OF NATURAL ANALOGUE STUDIES FOR ASSESSMENT
OF LONG-TERM DURABILITY OF ENGINEERED BARRIER MATERIALS

— RECENT ACTIVITIES AT PNC, JAPAN —

(YUSA, Y., KAMEI, G. and ARAI, T.)

5. Framework of our analogue studies: Our natural analogue programme has three components: 1) investigation of alteration phenomena, 2) examination of environmental conditions, 3) support experiments. The support experiments are an essential part of our study in order to enhance the wider applicability of the natural analogue.

1. INTRODUCTION

1.1 COMPONENTS OF ENGINEERED BARRIERS

The Components, candidate materials, and functions of various types of engineered barriers are as follows:

Components	Candidate materials	Function expected
• Vitrified waste	• Borosilicate glass	• Restricts release*
• Overpack	• Carbon steel or Cast iron	• Retards water penetration * • Provides favourable chemistry *
• Buffer materials	• Bentonite	• Restricts water penetration * • Delays commencement of release* • Restricts radionuclides release *
• Backfill materials	• Concrete (Cement)	• Minimizes water access to package † • Alters groundwater chemistry † • Retards solute transport †

(* :NAGRA [1985], † :Chapman et al [1987])

As a part of the study on engineered barrier materials and systems for geological disposal of radioactive waste in Japan, analogue studies for the assessment of long-term durability of engineered barrier materials are conducted at PNC Tokai Works. This paper describes the state-of-the-art on the studies, specifying their main purposes and framework, and demonstrating our emphasis on natural materials. The results obtained to date will be summarized. Some parts of studies on natural glass and bentonite were already presented at the MRS Symposium (Arai et al., 1988; and Kamei et al., 1989), although revised and expanded data are shown here.

1.2 DEFINITION OF "NATURAL ANALOGUE"

One of the most critical aspects in the evaluation of the durability of candidate materials for engineered barriers is the extrapolation of the results of short-term experiments over a long time scale. Natural analogues currently provide the only means by which such extrapolated long-term behaviour can be confirmed.

SOME ASPECTS OF NATURAL ANALOGUE STUDIES FOR ASSESSMENT
OF LONG-TERM DURABILITY OF ENGINEERED BARRIER MATERIALS
— RECENT ACTIVITIES AT PNC TOKAI, JAPAN —

YUSA, Y., KAMEI, G. and ARAI, T.
Geological Isolation Technology Section, Tokai Works
Power Reactor and Nuclear Fuel Development Corporation
319-11 Tokai Ibaraki JAPAN

SUMMARY

This paper contains an overview of analogue studies for the assessment of long-term durability of engineered barrier materials at PNC Tokai.

Materials of young age and with simple history are the most suitable for study as: 1) properties of the materials tend to deteriorate over longer historical time intervals; and 2) detailed quantitative data on time intervals and environmental conditions are more likely to be available. The following materials and their alteration phenomena were selected: 1) weathering alteration of basaltic glass (as vitrified waste form), 2) corrosion of iron in soil (as overpack), 3) illitization of smectite associated with contact metamorphism (as buffer material), 4) alteration of cement (as buffer or backfill material).

1. Weathering alteration of basaltic glass: Basaltic glasses, from the Fuji and the Izu-Ohshima pyroclastic fall deposits were studied. The observations were made: 1) Climatological conditions have not varied significantly during the last three thousand years. Therefore, values for temperature, amount, and chemistry of ground water are quantified. 2) The cases studied could be regarded as leaching experiments in groundwater, using mass balances in water-glass interaction. 3) Although the groundwater is of Ca(Mg)-HCO₃ type in the Fuji area and of Na-Cl type in the Izu-Ohshima, similar alteration ratios (2 ~ 3 μm/1000yr) were obtained.

2. Corrosion of iron in soil: Industrial materials, such as gas/water service pipes of carbon steel or cast iron embedded in soil for 20 ~ 110 years, were selected for an analogue study of corrosion of iron in bentonite. The maximum corrosion rates obtained so far fall in the range of 0.04 ~ 0.09 mm/yr.

3. Illitization of smectite associated with contact metamorphism: In the Murakami bentonite deposit in central Japan, lateral variation of smectite to smectite/illite mixed-layer minerals are found in the aureole of the rhyolite intrusion body. Conversion of smectite to the mixed-layer mineral composed of 40% illite was found to have occurred in a period of 2.4 Ma over a temperature range of above 240 (±50) °C to 105 °C.

4. Alteration of cement: Concrete components of fabrications, such as estuary walls, with a known age were studied. Chemical alteration of the cement were detected to a depth of few centimeters by EPMA, SEM, TEM and XRD.

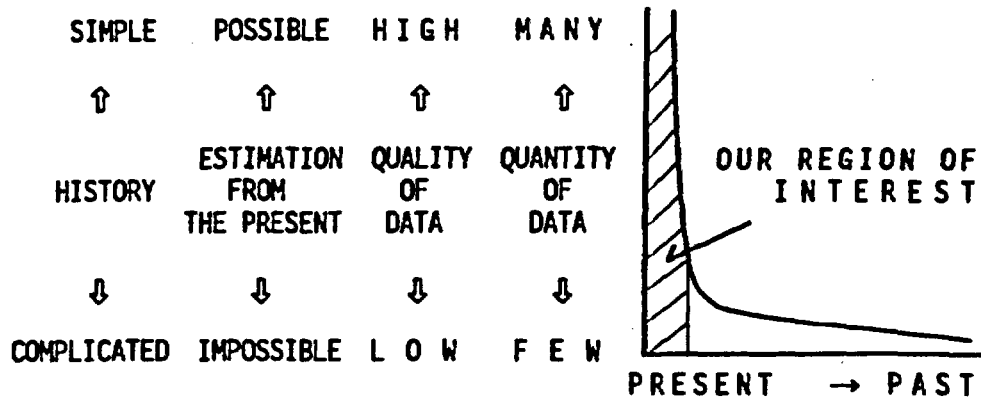

Fig. 1 Properties of historical materials

1.4 SELECTION OF SUBJECTS FOR THE STUDIES

Cases of younger age and simple process, therefore, are regarded as more suitable subjects for the studies, as quantitative data on time and environmental conditions are probably available. Many previous analogue studies consisted of descriptions of the results of natural experiments without incorporating data on well-defined environmental conditions.

We selected subjects for the analogue studies according to the following criteria:

1) analogy of materials with candidates, 2) analogy of environmental conditions with simulated repository conditions, 3) simplicity and availability on environmental conditions, and 4) availability of chronological data. Table 2 shows the subjects of our analogue studies on engineered barrier materials.

Table 2 The subjects of our analogue studies on engineered barrier materials

Engineered Barriers	Candidate Material	Assumed phenomena in Repository Conditions	Analogue Phenomena in Analogous Conditions
1. Waste Form	Boro-silicate Glass	Leaching of Waste Borosilicate Glass with Groundwater	Weathering Alteration of Basaltic Glass with Goundwater
2. Overpack	Carbon Steel	Corrosion of carbon steel in Bentonite	Corrosion of Iron in Soil
3. Buffer Materials	Compacted Bentonite	Illitization of Smectite in Bentonite	Illitization with Contact Metamorphism
4. Backfill Materials	Concrete (Cement)	Alteration of cement with Groundwater	Alteration of Cement with Groundwater

The term "natural analogue" can be defined as "natural phenomena which resemble those assumed in geological disposal scenarios". The selection of an appropriate natural analogue is the key issue which will determine whether the natural analogue study will be successful.

1.3 PROPERTIES OF NATURAL ANALOGUE

First, consideration is given to the properties of the natural analogues. In order to extrapolate the results of short-term experiments to the long-term, it is desirable that the natural phenomena can be individually and quantitatively described in terms of three constituents: 1) starting materials, 2) environmental conditions (including time scale), and 3) results. These are the three normal constituents of all "experiments".

However, there are some intrinsic difficulties in regarding such phenomena as experiments. Most naturally occurring materials, from which an relevant analogue must be selected, have complicated histories resulting the overprint of different processes, as shown in Table 1.

Table 1 Comparison between laboratory experiments and natural phenomena

	Laboratory Experiments	Natural Phenomena
(1) Materials	Candidates	Analogue
① Number	Many	Solitary, few
(2) Environmental (Experimental) Condition	Simple, Uniform Constant, Controlled Common Small Scale	Complicated Variable Individual Large Scale
(3) Period	Short-term	Long-term
(4) Results	Independent variables Discrimination among conditions is possible	Overprinting of factors Restoration is difficult

Secondly, geological and historical records are often incomplete, and errors in the determination of time scale and environmental conditions are not small. Although such disadvantages differ case to case and sample to sample, as materials age, their histories generally become more complicated; the factors with which alteration phenomena were related become overlapped, and quality and quantity of available data decreases. Thus, estimation from present observations becomes virtually impossible with very old samples (Figure 1).

Table 3 Chemical compositions of glasses.

Sample	Oxide (wt%)								Total
	SiO ₂	TiO ₂	Al ₂ O ₃	Fe ₂ O ₃ *	MgO	CaO	Na ₂ O	K ₂ O	
Fuji									
HS	52.9	2.3	12.1	16.5	3.9	8.5	1.8	1.2	99.2
ZS	50.7	1.6	15.0	13.8	4.9	8.8	2.9	0.9	98.6
Izu-Ohshima									
N1	53.7	1.4	13.0	15.6	3.4	8.8	2.3	0.5	96.9
N4	53.0	1.4	13.1	15.3	4.4	8.4	3.9	0.5	98.6

*: Total Fe as Fe₂O₃

Alteration layer

The alteration layer is optically isotropic and X-ray amorphous. The surface form of the alteration layer of the HS is grainy and that of ZS, N1, and N4 is flaky.

Despite the difference in morphology, the chemical composition of the alteration layer of the Houei Scoria is similar to that of the Zunazawa Scoria. The morphology of the alteration layers of both scoria is strikingly similar to that observed on the surface of experimentally altered borosilicate glasses (Hirose, unpublished data). Alteration layer thicknesses are summarized in Table 5. The elemental concentrations in the alteration layer are characterized by greater depletion of Mg, Ca, Na, and K, as compared to Si, Al, Fe, and Ti.

Table 4. Chemistry of pore water, spring water and rainwater.

Sample	Chemical composition (mg/l)									pH	Eh (mV)
	Na	K	Ca	Mg	Fe	HCO ₃	SO ₄	Cl	SiO ₂		
Fuji											
HS P.W.	4.4	1.7	5.3	1.3	—	24	6.5	4.1	34	—	—
ZS P.W.	8.4	3.3	4.6	1.3	5.0	35	6.4	4.3	218	—	—
S.W.	5.0	1.4	8.9	6.9	2.9	67	4.4	2.6	41	7.0	178
Izu-Ohshima											
N1 P.W.	78	2.9	27	12	3.2	7.6	27	176	52	(6.0)	—
N4 P.W.	86	3.7	40	15	4.0	6.1	26	222	48	(6.0)	—
Rain water*	1.1	0.3	0.4	1.0	0.2	—	1.5	1.1	0.8	—	—

P.W. = Pore Water; S.W. = Spring water, * after Sugawara (1968)

Water chemistry

2. Weathering alteration of basaltic glass

2.1 SCOPE OF STUDIES

Many analogue studies of the alteration of natural glasses indicate that the alteration rates at low temperatures of natural glasses vary from $0.001 \mu\text{m}/1000 \text{ yr}$ to $30 \mu\text{m}/1000 \text{ yr}$ (Hekinian et al. 1975; Bryan et al. 1977; Allen 1982; Lutze et al. 1985 & 1987; Grambow et al. 1986; Ewing et al. 1987; Jercinovic et al. 1988). This variation is interpreted as the result of variations in environmental conditions. However, few detailed studies on environmental conditions have been reported.

Described below are the effects of alteration by weathering of basaltic glasses with well established environmental conditions and ages. The alteration is a long-term leach test carried out by nature with rainwater as the leachant and groundwater as the leachate. The young-aged (280 ~ 2800 years) samples were selected to investigate environmental conditions during alteration based on present meteorological data.

Samples

Volcanic glasses constituting scoria of pyroclastic fall deposits were studied. Scoria samples were collected at the foot of the Fuji and Izu-Oshima volcanoes, on both of which the stratigraphy and chronology of pyroclastic fall deposits have been studied in detail.

The samples collected were Houei Scoria (HS, 280 years ago) and Zunazawa Scoria (ZS, 2800 years) from the Fuji, and N1 (880 years) and N4 Scoria (1240 years) from the Izu-Oshima volcano.

All of the scoria samples contained pore water, and spring water was found about 2.5 m below the Zunazawa Scoria bed.

Methods

Glass compositions were determined by Electron Probe Microanalyser (EPMA). Alteration layers were studied by optical microscope, EPMA and Scanning Electron Microprobe (SEM). The thickness of alteration layers was measured from SEM photos of the sections oriented nearly perpendicular to the layers.

In the field, the pH and Eh of the spring water were measured by portable meters. The spring water was filtrated through a $0.45 \mu\text{m}$ filter and the filtrate was analyzed by absorption spectrophotometry, flame spectrometry and atomic absorption spectrometry.

2.2 RESULTS

The chemical compositions of the glasses are shown in Table 3. These are within the range of basalts.

The relation between alteration layer thickness and age is shown in Figure 2. The two kinds of alteration rates, the forward rate of alteration ($3 \sim 20 \mu\text{m}/1000 \text{ yr}$, under silica-unsaturated conditions) and the final rate of alteration ($0.1 \mu\text{m}/1000\text{yr}$, under silica-saturated conditions) by Grambow et al. (1985), are also shown in Figure 2. The alteration rates estimated in this study are near or below the forward rate of alteration.

Mass Balance Between Alteration Layer and Spring Water

Spring water can be regarded as the leachate. In order to discuss the leaching behaviour of glass, it is necessary to clarify the relation between the elemental concentration in the leachate and the elemental loss from the alteration layer. Elemental concentrations in groundwater have previously examined (Arai et al., 1989) and the results indicate that the calculated composition of groundwater is in fair agreement with the composition of spring water (Figure 3). The discrepancies in the concentrations of Fe and SiO_2 can be explained by the precipitation of iron hydroxides and silica gel respectively among scoria grains.

Table 5 Summary on alteration behaviour of volcanic glasses and their environmental conditions

(1) MATERIALS STUDIED	F U J I			IZU - OHSHIMA	
	HP	HS	ZS	N1	N4
(2) GLASS COMPOSITION [$\text{SiO}_2\text{wt}\%$]	64	53	51	54	53
(3) ENVIRONMENTAL CONDITIONS					
① TEMPERATURE ($^{\circ}\text{C}$)	14			15	
② WATER CHEMISTRY	Ca(Mg) - HCO_3 , type			Na - Cl type	
③ WATER SUPPLY RATE ($\text{g}/\text{cm}^2/\text{yr}$)	0.20			0.21	
(4) PERIOD (yr)	280	280	2800	880	1240
(5) RESULTS					
① ALTERATION RATE ($\mu\text{m}/1000\text{yr}$)	<0.2	1.6	3.1	1.7	1.8
[Alteration Layer Thickness: μm]	<0.05	0.44	8.8	1.5	2.2
② ALTERATION PRODUCTS					
• Amorphous Materials	N.D.	○	○	○	○
• Goethite	N.D.	○	○	○	○
• Smectite	N.D.	×	○	○	○

N.D. : Not Determined, ○ : Present, × : Absent

2.4 CONCLUSION

The chemistry of the pore and spring water is listed in Table 4, together with the average of rainwater in Japan (Sugawara, 1968). The elemental concentrations in ZS pore water are higher than those in HS pore water. This implies that elemental concentration in groundwater increases with depth.

2.3 DISCUSSION

Environmental Conditions

Analyses of paleo-sea level variations (Sugimura, 1977) and paleo-climatological data (Yamamoto, 1980; and Maejima, 1984), indicate that the climatic conditions in Japan have not varied significantly for the last 2800 years. Therefore, the temperature and the water supply rate are estimated from meteorological data such as mean annual temperature, annual rainfall, and evapotranspiration. The samples were situated in the unsaturated zone; accordingly, percolating meteoric water is the only source of pore water. The pore water flows downward in the deposits and dissolves the components of scoria. This natural phenomenon can be regarded as a leach test being constantly renewed fresh rainwater.

Alteration Rate

In natural alteration systems, it is generally difficult to know the exposure age of a sample, that is, the time that the glass has actually been in contact with water (Jercinovic et al., 1988). The exposure ages of the samples in this study are equivalent to the samples ages as their surfaces were always in wet conditions and were always in contact with renewed pore water.

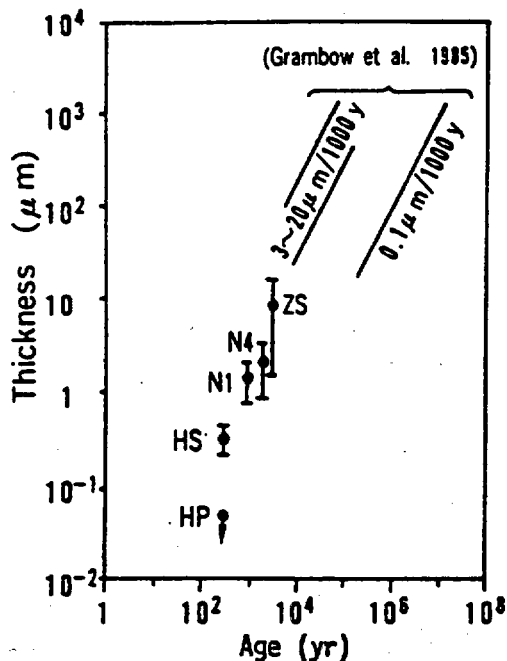

Fig. 2 The relation between age of samples and thickness of alteration layer

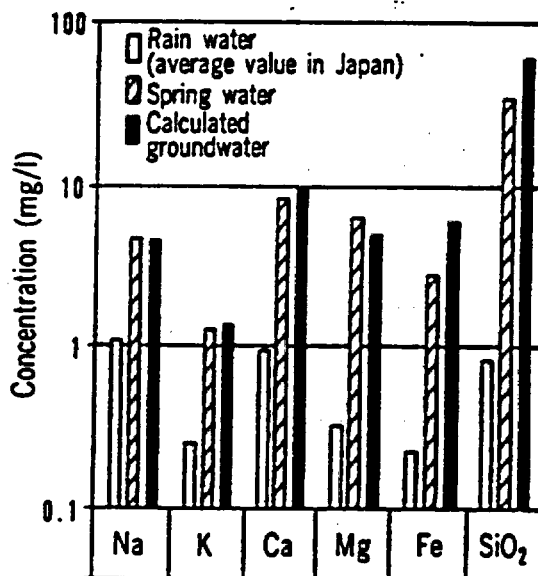

Fig. 3 The comparison between elemental concentrations of spring water and calculated groundwater

were identified with X-ray diffraction (XRD). The results obtained to date are shown in Figure 5 and Table 6.

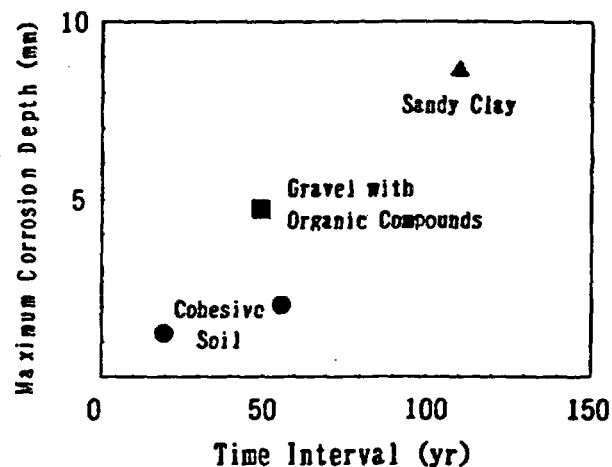

Fig. 5 Maximum corrosion depth as a function of time intervals

In conclusion, the maximum corrosion rates of cast iron and carbon steel embedded in soils were estimated in the range of 0.04~0.09 mm/yr. Corrosion of industrial materials in soil is a useful analogue and further studies are planned.

Table 6 Corrosion behaviour of iron in soil

(1) MATERIALS STUDIED				
① Site	Yokohama	Nagasaki	Tokyo	Tokyo
② Sample	Gas S.P.	Water S.P.	Water S.P.	Water S.P.
③ Material	Cast Iron	Carbon Steel	Cast Iron	Cast Iron
(2) ENVIRONMENTAL CONDITIONS				
	Sandy Clay	Gravel with Org. Comp.	Cohesive Soil	Cohesive Soil
(3) PERIOD (yr)				
	110	50	56	20
(4) RESULTS				
① CORROSION RATE (mm/yr)				
Uniform Corrosion	0.03	0.01	N.D.	N.D.
Pitting Corrosion	0.08	0.09	0.04	0.06
② CORROSION PRODUCTS				
	FeCO ₃	Not identified	FeCO ₃ , α-FeO(OH)	FeCO ₃ , α-FeO(OH)

S.P. = Service Pipe; Org. Comp. = Organic Compounds

1) It was possible to determine the alteration behaviour of volcanic glasses from three experimental constituents: 1) starting materials, 2) environmental conditions and time scale, and 3) results (Table 5).

2) Calculation of the mass balance between the elements depleted from the glasses and the chemical composition of groundwater permitted us to regard the cases studied as experiments in the leaching of glasses by groundwater.

3) The natural alteration products of the volcanic glasses were very similar to those of laboratory experiments with simulated waste glasses.

4) Although the ground water is Ca(Mg)-HCO₃ type in the Fuji area, and of Na-Cl type in the Izu-Oshima area, similar alteration rates (2 ~ 3 μm/1000 yr) were obtained.

3. CORROSION OF IRON IN SOIL

Industrial materials such as water service pipes, were studied for the following reasons: 1) iron or steel is one of the candidate materials for waste package, 2) soil environment is probably similar to the bentonite fill environment, 3) samplavailability, and 4) chronology and environmental data are fairly assessable in ccomparison to those of archeological artifacts. One of the purposes of this analogue study is to validate whether the results of corrosion rates and models derived from the results of laboratory experiments can be extrapolated to a few tens of years (Figure 4).

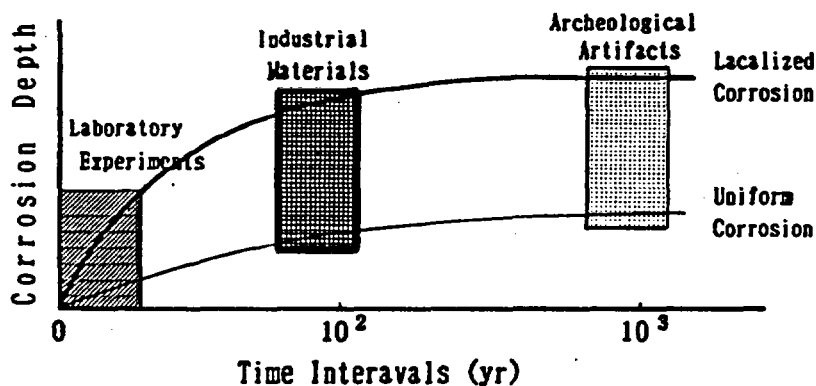

Fig. 4 The relation between the subjects for studies on corrosion of iron and their time interval

The samples studied were gas or water service pipes, composed of cast iron or carbon steel. The soil or clay adjacent to the pipe was examined in order to avoid the influence of the macro-cell effect. The corrosivities of the soil environment at each site were estimated as not being very severe from the viewpoint of both electrochemical and chemical characteristics of the soil. Corrosion rates were derived from the measurements of the thickness of the pipe, and chemical composition of the material were determined. The corrosion products

4. ILLITIZATION WITH CONTACT METAMORPHISM

4.1 SCOPE OF STUDIES

The research on illitization of smectite in the natural environment affords indispensable information on the long-term durability of bentonite.

Geological processes associated with smectite-illite conversion can be classified as follows:

- 1) Diagenesis, 2) Regional metamorphism, 3) Contact(or thermal) metamorphism,
- 4) Hydrothermal alteration

Among these, contact metamorphism has been selected as being a suitable analogue because of the prevailing temperature and the water/rock ratio. Furthermore, a study of contact metamorphism has potentiality to give clear-cut data on the reaction term and the thermal conditions of illitization of smectite, provided that: 1) the bentonite bed is distributed, and 2) simple history and simple geology can be recognized.

One such case of contact metamorphism is the Murakami bentonite deposit in central Japan, where a homogeneous bentonite bed and rhyolitic intrusive rock are present. Geological, petrological and geochronological studies have already been presented at the MRS symposium in Boston, 1989 (Kamei et al. 1990), so only a brief description of this deposit is given below:

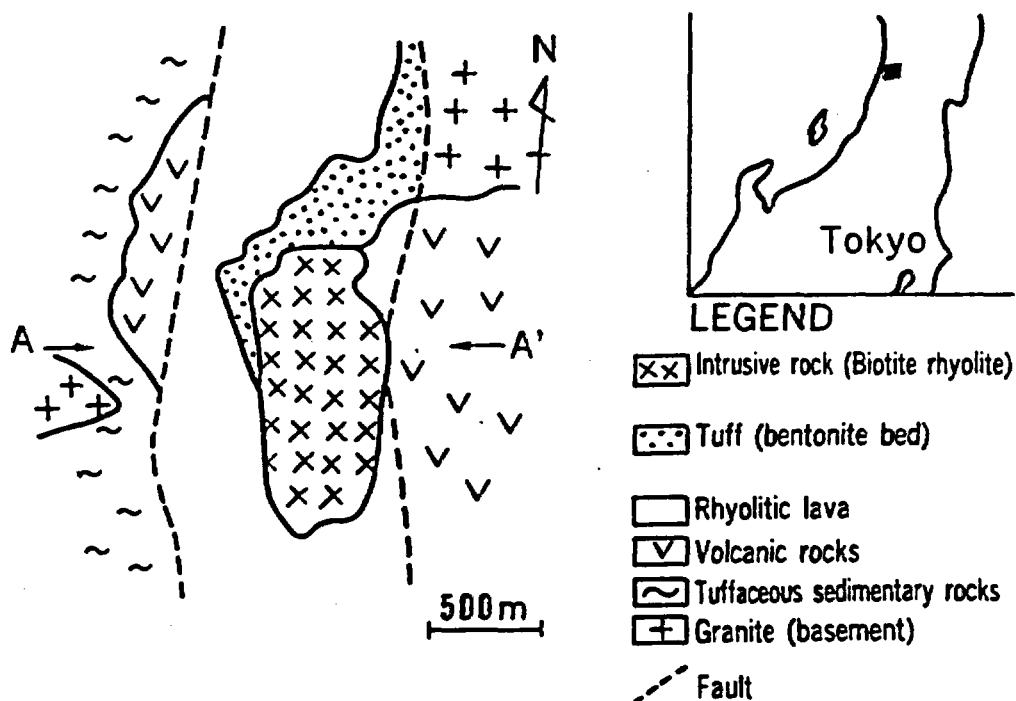

Fig. 6 Geological map of the Murakami deposit

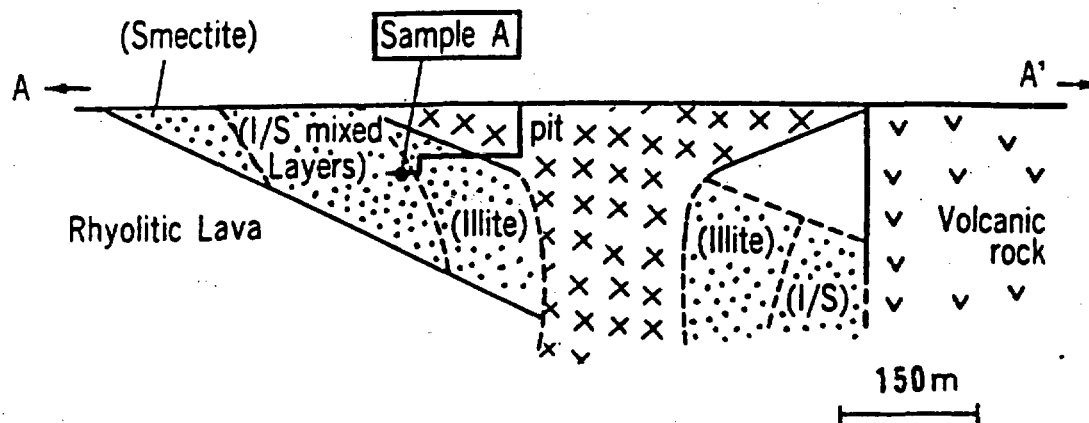

Fig. 7 An idealized geological section of the Murakami deposit

Geology

A geological map and an idealized section of the Murakami deposit area are shown in Figure 6 and 7, respectively. Rhyolitic lava and tuff are distributed in a graven with a width of approximately one kilometer. The reported age of deposition of this unit ranges from 18 to 14 Ma (Muramatsu, 1988). The tuff is regarded as being deposited in a marine environment, and was converted into bentonite probably due to diagenetic reaction. Subsequent intrusions of biotite rhyolite are found in the bentonite bed. The contact between the intrusive rock and the tuff dips about 30° near the surface of the ground, and the intrusive rock body is assumed to form a funnel with a diameter of less than 200 meters (Figure 7).

Samples

Sample A was collected from a point 30 meters distant from the contact between the intrusive body and the bentonite bed. X-ray diffraction showed that sample A contained illite-smectite mixed layers with an illite ratio of about 40 %.

4.2 RESULTS

Thermal History

The cooling rate of the intrusive rock was determined from combining radiometric mineral ages and each closure temperature. The cooling rate of sample A was estimated by the "TRUMP" thermal analysis code. The results are shown in Figure 8.

The cooling rates of the intrusive rock and of sample A were 70 °C/Ma, and 60 °C/Ma, respectively. (Figure 8 and the values for cooling rates are newly revised, therefore those reported in the MRS Proceedings (Kamei et al. 1990), should be ignored.)

The Illitization Period

In the Murakami deposit area, a minimum temperature of illitization is regarded as

Table 7 Summary of a study on illitization of smectite associated contact metamorphism— A case study at the Murakami deposit

(1) Material	Smectite in marine sediment
(2) Environment ① Water chemistry ② Temperature	Modified seawater > 240 °C ~ 105 °C
(3) Period	2.4 Ma
(4) Result	I/S mixed layers mineral (Illite; approximate 40%)
(5) Activation energy	Approximate 27 kcal/mol

4.3 CONCLUSION

Once again returning to the three-part concept of starting materials, environmental and chronological conditions, and results, it was possible to describe the illitization of smectite associated with contact metamorphism in terms of 1) material studied, 2) environment, 3) period, and 4) results (Table 7).

A more precise estimation of activation energy is possible through an estimation of the overall thermal history during contact metamorphism, using a thermal analysis code. This work is in progress.

5. ALTERATION OF CEMENT

Concrete components such as tunnels or estuary walls with known ages were studied.

Environmental conditions such as temperature, surrounding materials, water content, and water chemistry were either measured or estimated. The alteration of cement materials has been analyzed by EPMA, SEM, TEM (Transmission Electron Microscopy), and XRD. Results obtained to date are shown in Table 8.

The following alteration features of cement materials was able to be traced:

- (1) Decrease in pH of pore water,
- (2) Decrease of CaO/SiO₂ ratio of C-S-H gel,
- (3) Partial dissolution of C-S-H gel,
- (4) Formation of CaCO₃,
- (5) Permeation of Cl, resulting in formation of Friedel's salt.
- (6) Dissolution of Calcium hydroxide,
- (7) Dissolution of Calcium which cause dissolution of CaCO₃,

Such alteration phenomena were detected within a range of a few centimeters. Further studies are necessary to permit any definite conclusions.

105°C, because this was the temperature estimate made by Oda et al. (1985) for the appearance of illite-smectite mixed layers in Japanese oil fields, of which the Murakami deposit forms a part. In the vicinity where sample A was collected, the temperature at 6.4 Ma was presumed to be $240 \pm 50^\circ\text{C}$. Therefore, a period of about 2.4 Ma was required to cool these rocks from 240 to 105°C.

In short, smectite was converted into illite-smectite mixed layers, in which the illite ratio is approximately 40 %, in the period of more than 2.4 Ma.

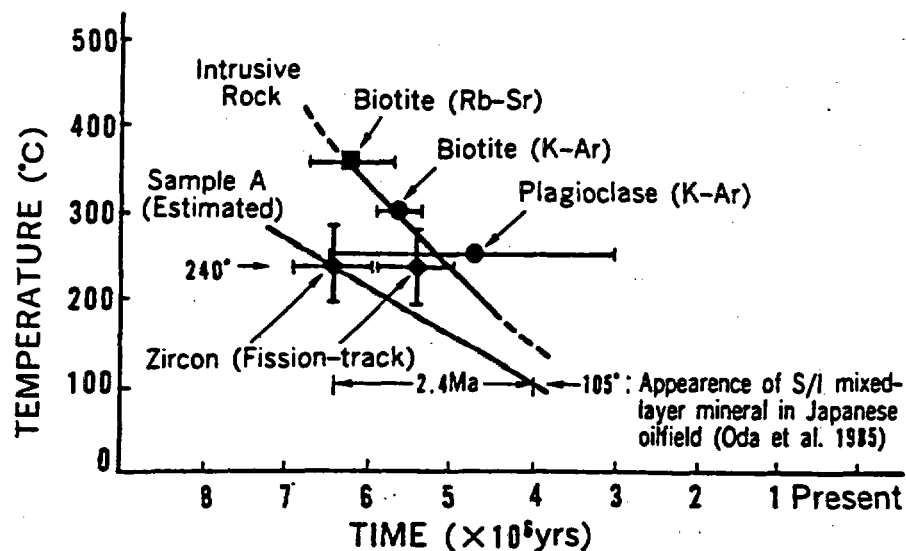

Fig. 8 Thermal history of intrusive body and sample A

Water Chemistry

The chemical composition of the rocks distributed in the Murakami area is mostly rhyolitic, and the tuff, now converted into bentonite bed, is of marine origin. The geological evidence leads to the idea that the chemistry of the water related to illitization was very similar to that of seawater after it was modified by interaction with rocks of rhyolitic composition.

The hydrogen isotopic composition (D/H) of water, in the form of hydroxyl groups, in the illite and the smectite-illite mixed layers, were measured, and from this an assessment of the water involved in illitization was made. The results supported the idea noted above.

Provisional Calculation of Activation Energy

The activation energy for illitization at the Murakami deposit was provisionally calculated on the basis of the estimated thermal history. The calculation procedure was already described in Kamei et al. (1990). Using the revised cooling rate of $.60^\circ\text{C}/\text{Ma}$ and a period of 2.4 Ma, the activation energy is approximately 27 kcal/mol. This value is close to that obtained by Roberson & Lahann (1981) of approximately 30 kcal/mol. The water used for their experiments contained 400 ppm K^+ and 9400 ppm Na^+ , the chemistry of seawater. A similar water chemistry can be inferred at Murakami.

6. SUMMARY AND FUTURE PROSPECTS

Table 9 summarizes the present state of PNC analogue studies on engineered barrier materials, and Figure 9 shows the framework of our analogue studies.

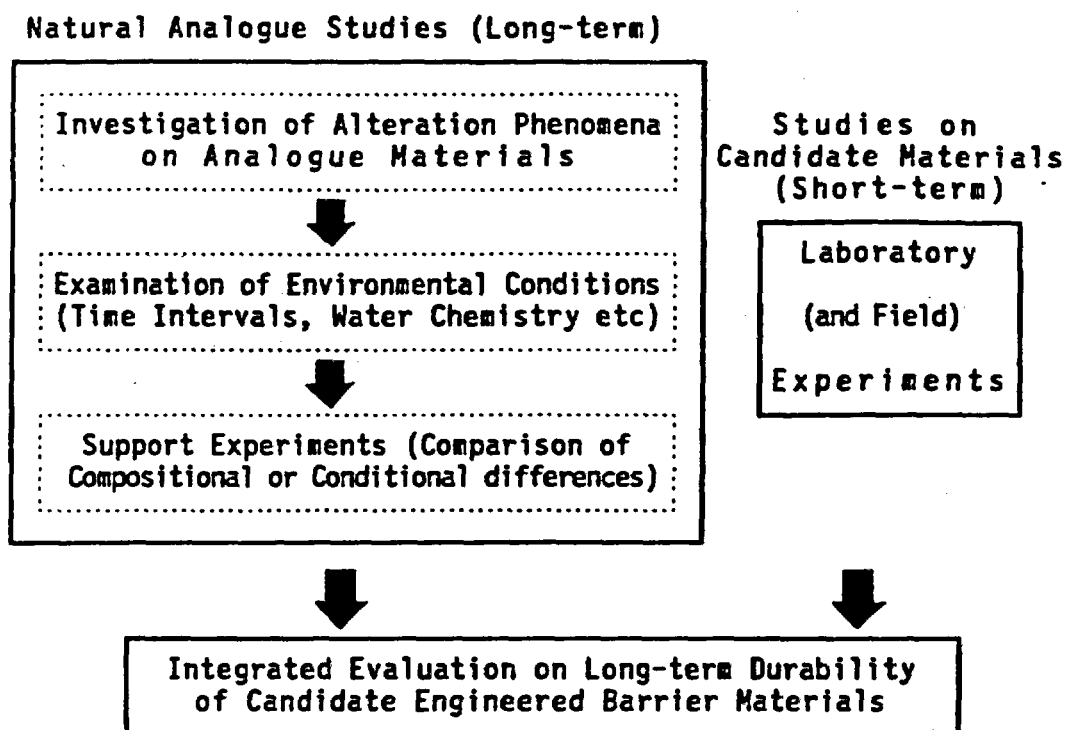

Fig. 9 Framework of analogue studies on engineered barrier materials

Our natural analogue studies have three components:

- 1) investigation of alteration phenomena of analogue materials,
- 2) examination of environmental conditions (time intervals, water chemistry etc),
- 3) support experiments

The validity of the analogue study is determined by the selection of alteration phenomena of analogue materials out of various natural phenomena acting on historical materials from the point of view of best analogical fit.

An examination of environmental conditions occupies an inevitable part of the study. Time intervals, prevailing temperature, and water chemistry related to the alteration are key items.

Table 8. Alteration behaviour of cement fabrics

(1) MATERIALS STUDIED ① SITE ② SAMPLE MATERIALS	Kanagawa-Manazuru Concrete of Railway Tunnel Wall	Yokohama-katabira Concrete of Estuary Wall
(2) ENVIRONMENT ① Temperature ② Surrounding Materials ③ Water Content ④ Water Chemistry	13 °C Lapilli tuff 40 % Ca - NO ₃ (HCO ₃)	15 °C Soil 33 % Na - Cl
(3) PERIOD (yr)	6 7	6 1
(4) RESULTS OF ALTERATION	Ca depletion < few mm	Cl permeation >10 cm CaCO ₃ formation >8 cm CaCO ₃ dissolution >5 cm

Table 9 The present state of PNC analogue studies on engineered barrier materials

Barrier Components (Candidate Materials)	Materials and Mode of Occurrence	Period (yr)	Estimation of Period	Estimation of Environmental Conditions
Waste Form (Borosilicate glass)	Scoria (Pyroclastic Fall Deposit)	10 ² ~10 ⁴	Tephro-chronology	From Recent Climatological Conditions
Buffer (Compacted Bentonite)	Contact Metamorphosed (Natural) Bentonite	10 ⁶ ~10 ⁷	Radiometric Age Determination	Closure Temperature of Radiometric Ages Geological and Geochemical Data
Overpack (Carbon Steel)	Industrial Materials (Pipe)	10 ¹ ~10 ²	Documents	From Present Embedded Conditions
Backfill (Concrete)	Industrial Materials (Components of Fabrics)	10 ¹ ~10 ²	Documents	From Present Embedded Conditions

3. Chapman, N.A., and McKinley, I.G. (1987) The Geological Disposal of Nuclear Waste, John Wiley & Sons,
4. Ewing, R.C., and Jercinovic, M.J., (1987) Mat. Res. Soc. Proc., 84, 67-83.
5. Bryan, W., and Moore, J.G. (1977) Geol. Soc. Amer. Bull., 88, 556-570.
6. Grambow, B., Jercinovic, M.J., Ewing, R.C. and Byers, C.D. (1986) Mat. Res. Soc. Proc., 9, 263-272.
7. Hekinian, H., and Hoffert, M., (1975) Marine Geology, 19, 91-109.
8. Jercinovic M.J. and Ewing, R.C. (1988) JSS Project Technical Report, 88-01, 21.
9. Kamei, G., Arai, T., Yusa, Y., Sasaki, N., and Sakuramoto Y., (1990) Mat. Res. Soc. Symp. Proc., 176, 657-663.
10. Lutze, W. Malow, G., Ewing, R.C., Jercinovic, M.J. and Keil, K., (1985) Nature, 314, 252-255.
11. Lutze, W., Grambow, B., Ewing, R.C. and Jercinovic, M.J. (1987) Natural Analogues in Radioactive Waste Disposal, 142-152.
12. Maejima, I., (1984) Jour. of Geol., 93, 413-419 (in Japanese).
13. Muramatsu, T., (1988) Regional Geology of Japan IV. CHUBU-1, p.62.
14. NAGRA (1985) Project Report NGB 85-09.
15. Oda, Y., Suzuki, S., and Ohyama, Y., (1985) Jour. Petrol. Mineral. Econ. Geol. 80, 526-536 (in Japanese).
16. Roberson, H.E. and Lahann, R.W., (1981) Clays and Clay Minerals, 29, 1-29.
17. Sugawara, K., (1967) Tkyu Kagaku (Geochemistry) 2, 501 (in Japanese).
18. Sugimura, S., (1977) Kagaku (Science) 47, 749-755 (in Japanese).
19. Yamamoto, T., (1980) Tenki (Weather), 27, 76-85 (in Japanese).

Support experiments are indispensable to the study in order to enhance the wider applicability of the natural analogue. Comparison of differences in composition or condition is the key issue for laboratory support experiments. Such experiments for the comparison of compositional differences between basaltic glasses and candidate waste glass have already started, and the results to date indicate that there is no significant recognizable difference in the leaching rates.

From a combination of the natural analogue studies outlined above and laboratory experiments on the candidate materials, an integrated evaluation of the long-term durability of candidate engineered barrier materials can be conducted.

ACKNOWLEDGMENTS

We are sincerely grateful to Prof. H. Machida, Dr. K. Hakamada, Dr. K. Marumo and Mr. M. Sato for their useful suggestions for obtaining samples, to Prof. K. Suzuki for provision of standard samples for analysis by EPMA, to Mr. Y. Sakuramoto for valuable discussions, to Mr. T. Teshima and Mr. J. Yamagata for their preparation of Tables and Figures, to Prof. Y. Kuroda and Mr. Y. Suzuki for hydrogen isotope determinations, to Mr. H. Takano for field survey, and Dr. M. Apted and Dr. G. Davidson for their helpful editing.

The organizations which collaborated with PNC on its analogue programme on engineered barriers were:

- 1) Department of Glass Industry, Ohsaka Industry Laboratory, in the laboratory leaching experiments of both borosilicate and basaltic glasses;
- 2) Dr. K. Tamada, Corrosion Protection Laboratory, NKK Corporation, in charge of corrosion studies on carbon steel pipe in soil environments;
- 3) Laboratory of Clay Mineralogy, Jyoetsu University of Education, especially Professor T. Watanabe as technical and scientific advisor concerning the illitization study;
- 4) A cooperative group of companies consisting of Kajima Corporation, Shimizu Construction Co. Ltd, Taisei Corporation, and Ohbayashi Corporation, in the sampling of concrete materials and in acquisition of data on environmental conditions;
- 5) Laboratory of Cement Mineralogy, Nagoya Institute of Technology, especially Professor K. Suzuki as technical advisor concerning hydration of cement materials;

to all of these organizations and people we are much indebted.

REFERENCES

1. Allen, C.C. (1982) Mat. Res. Soc. Proc., 5, 37-44.
2. Arai, T., Yusa, Y., Sasaki, N., Tsunoda, N., and Takano, H., (1989) Mat. Res. Soc. Symp. Proc., 127, 73-80.

Tokai Vitrification Facility (TVF)

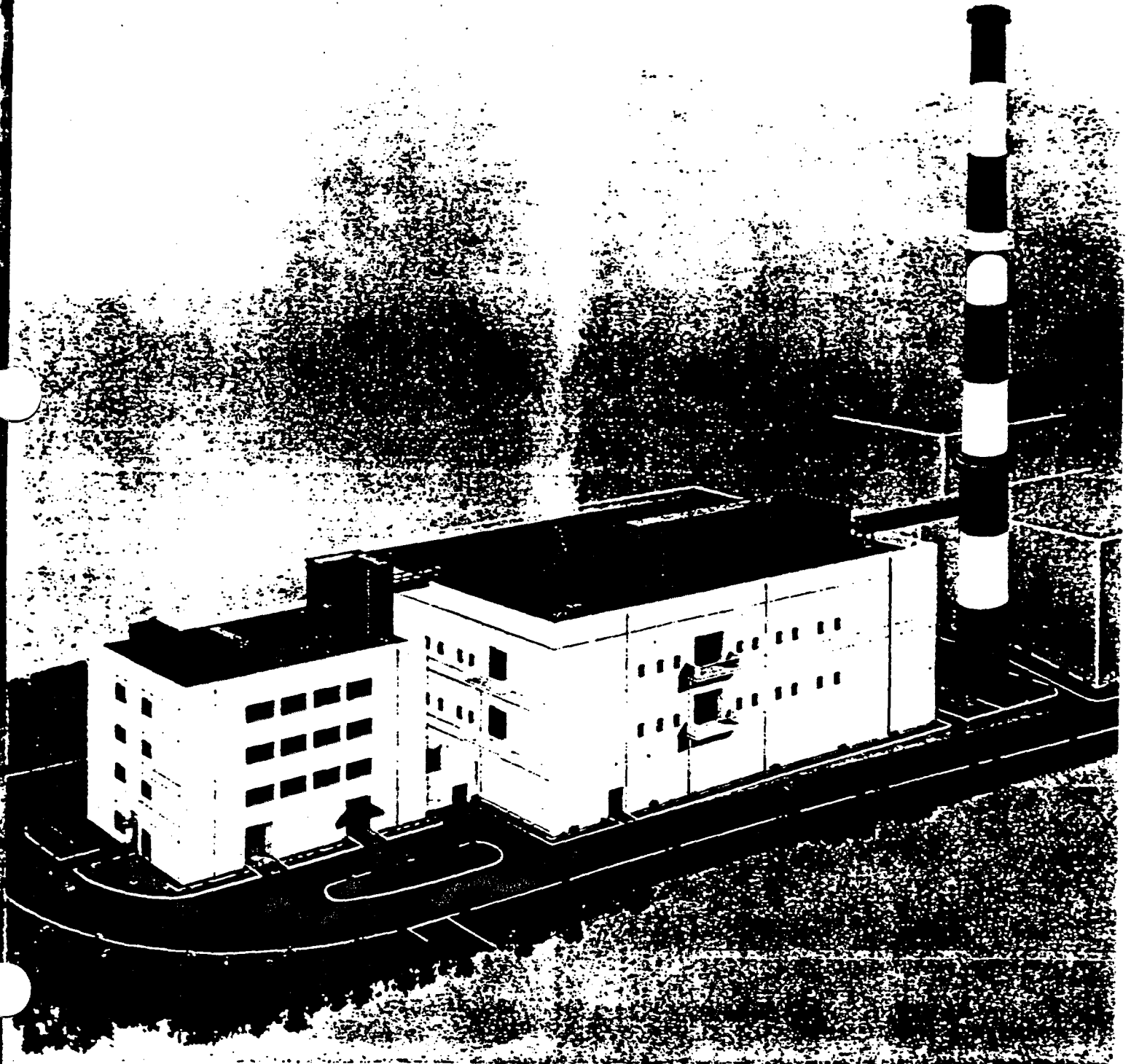

Power Reactor and Nuclear Fuel Development Corporation

Tokai Works

Tokai vitrification Facility Basic Flow Sheet and Key Components

Outline

The mission of the TVF is to immobilize the high level radioactive liquid waste (HLLW) stored in the Tokai Reprocessing Plant into the stable glass form.

Main Process

Received HLLW is continuously fed into the glass melter with glass additive to be melted after conditioning of it. The molten glass is discharged into the canister periodically, and filled canister is stored in the storage cell after the lid welding, decontamination, and inspections. The off-gases from the melter, and vessels are treated by cleaning equipment.

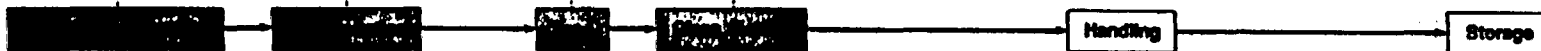
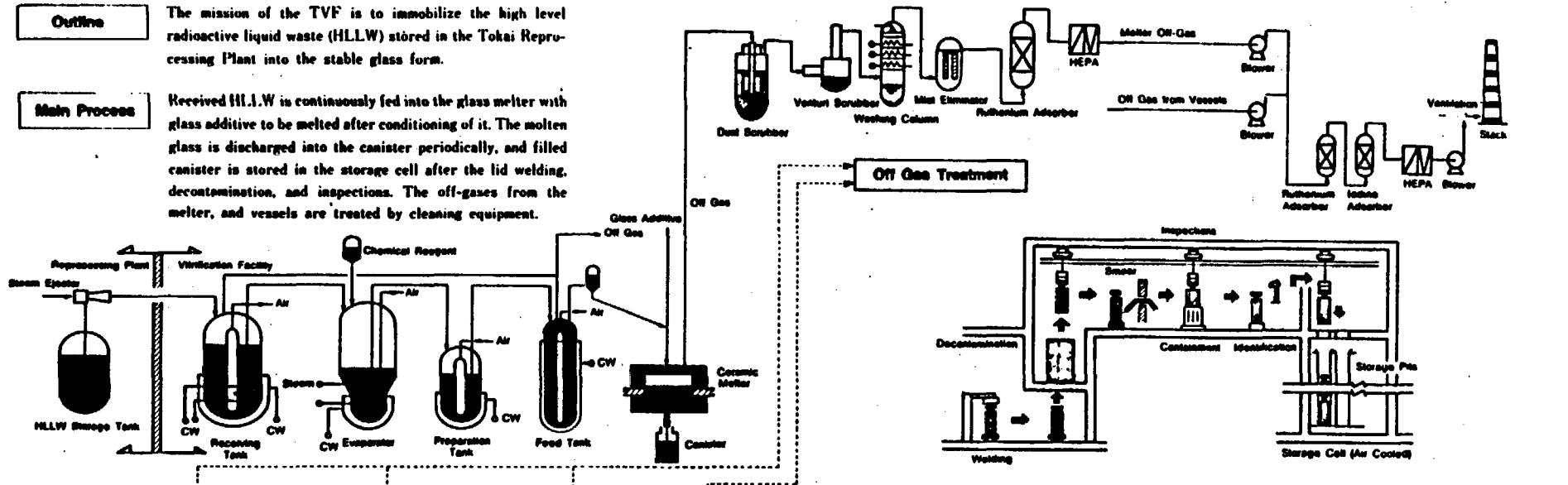

Characteristics of HLLW (after cooling for 5.5yrs)

Generation of HLLW	0.5m ³ /MTU
Specific Activity	1.5x10 ¹⁰ Bq/MTU
Specific Heat	1.4kW/MTU
	HNO ₃
	NaNO ₂
Fission Products	
Major Components	(Cs, Sr, Ru) (Zr, Nd, Co, etc)
	Actinides (U, Np, Pu, Am, Cm)
	Others

Glass Melting

Temperature	1100~1200°C (MAX 1250°C)
Design	Liquid-Fed Jute-heated Ceramic Melter
Capacity	0.36m ³ /Day
Feed Materials	HLLW & Glass Additive (Fiberglass Cartridge)

Composition & Density of Waste Glass Product

Glass Additive	(%) (wt%)
SiO ₂	43~47
B ₂ O ₃	14
Li ₂ O	3
CaO	3
ZnO	3
Al ₂ O ₃	2.5~5
BaO	0~3.5
Waste	(%)
F.P. residues	10
H ₂ O	10
Others	5
Density of Product	2.7~2.9g/cm ³

Vitrified Product

Content	Sorosicate Glass
Weight	300kg
Volume	110ℓ
Canister Shape	Cylinder
Dimension	430mmφ/1040mmH

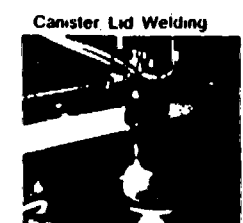
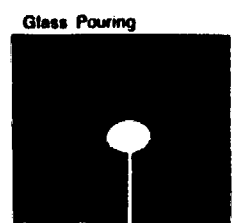
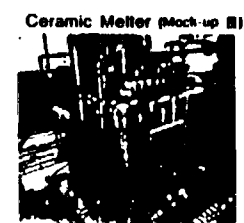
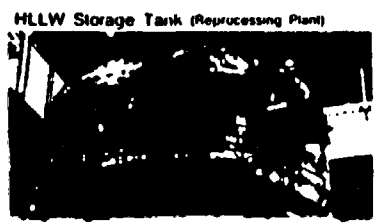
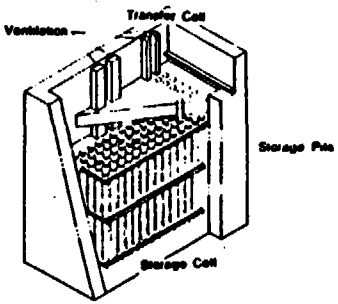

Structure of Melter

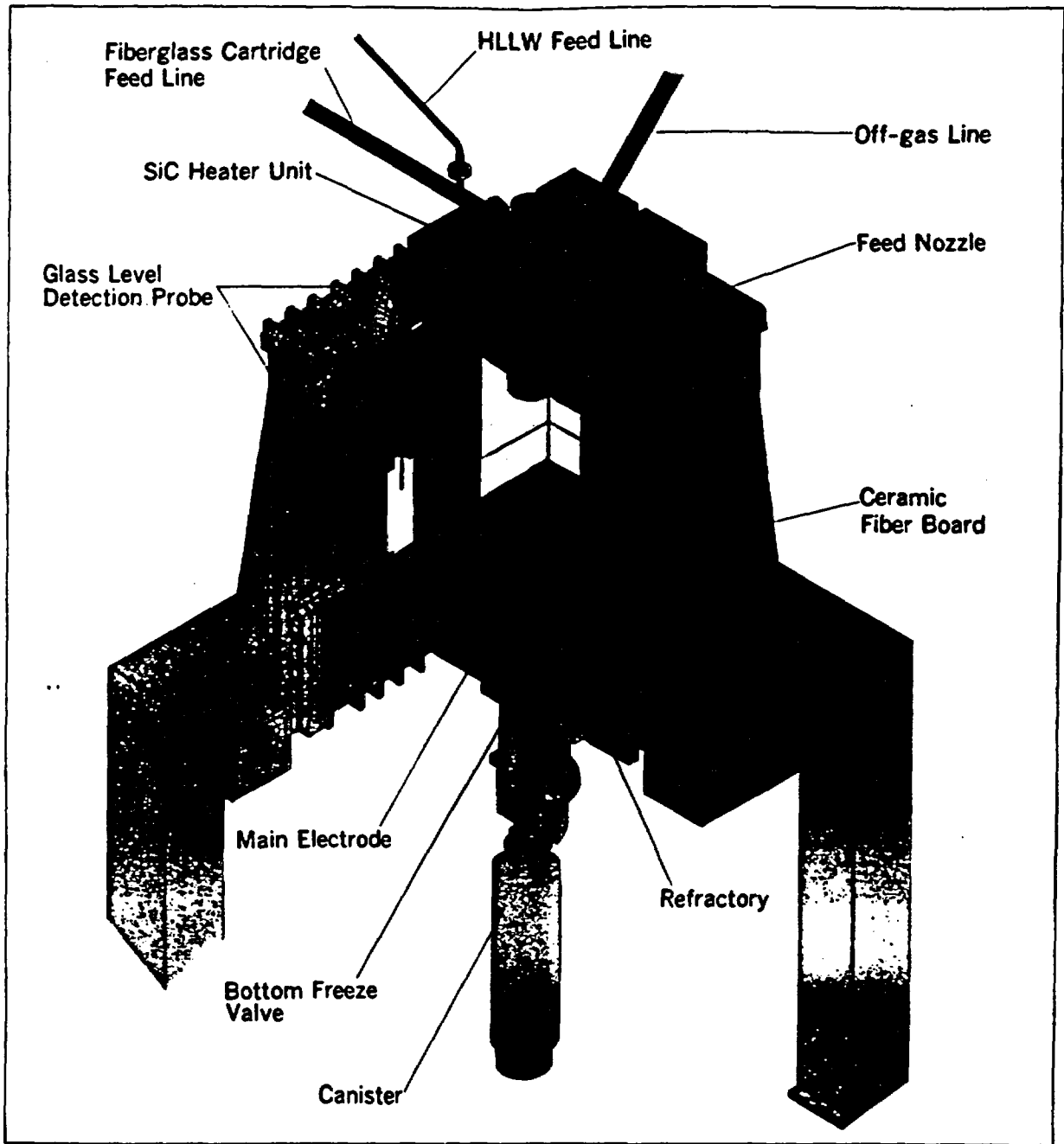

Pu-contaminated Waste Treatment Facility (PWTF)

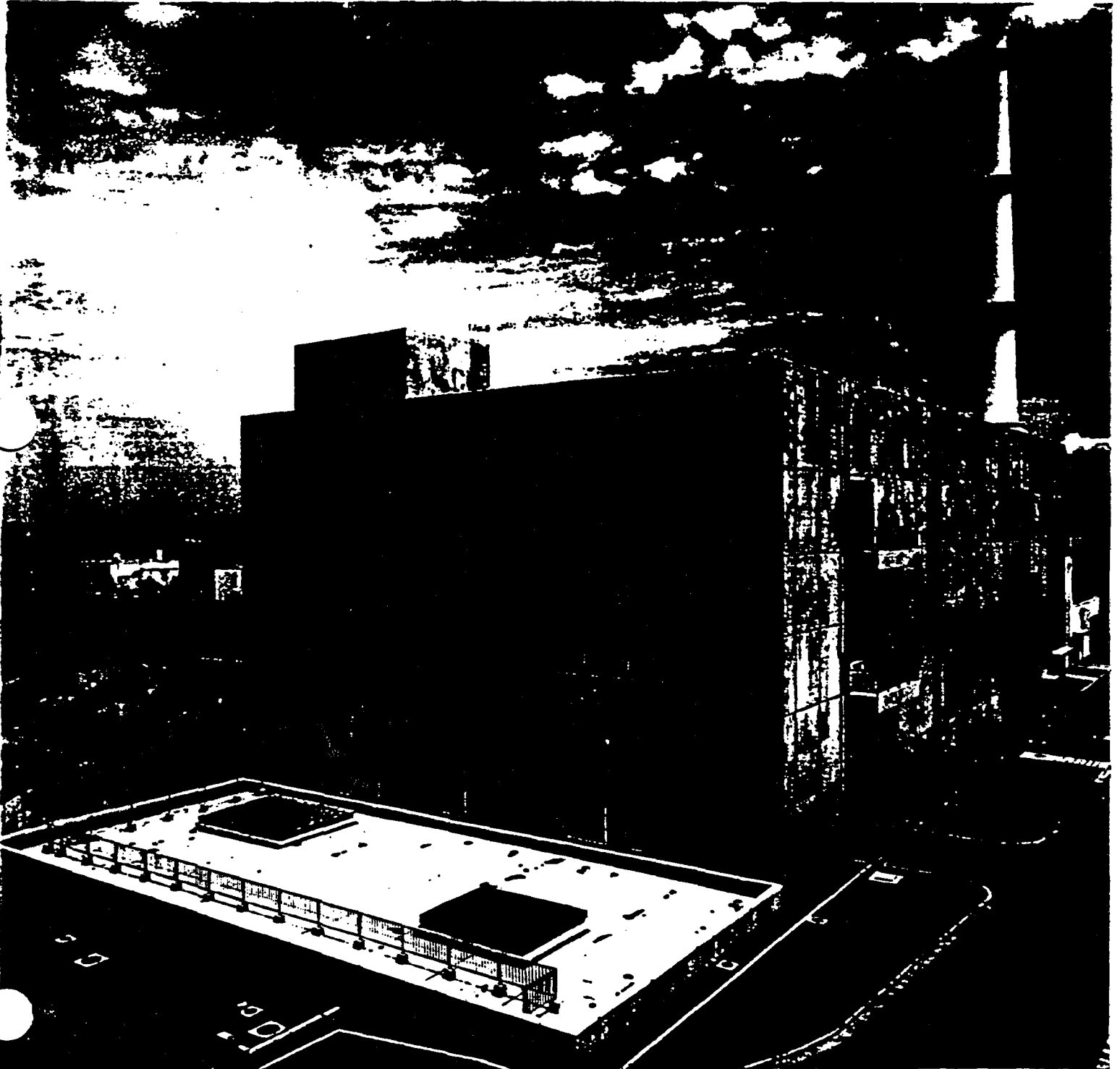

Power Reactor and Nuclear Fuel Development Corporation

Tokai Works

Flow Diag. of Waste Processing at the PWTf

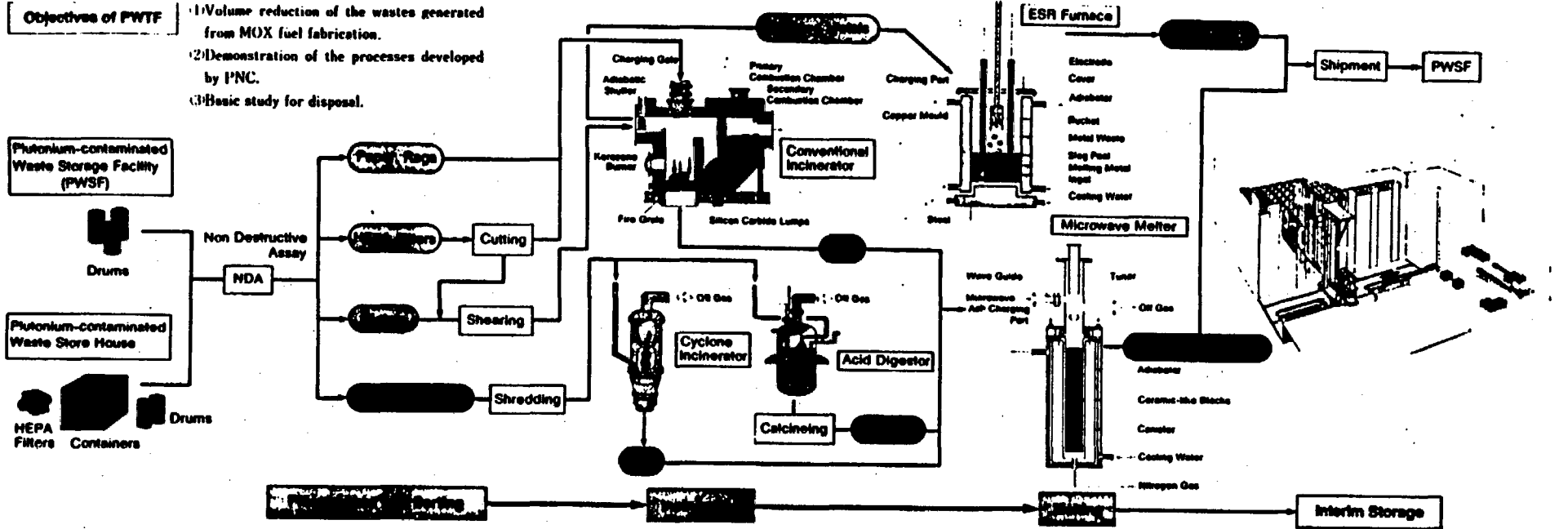

Constitutions of Plutonium-contaminated Waste

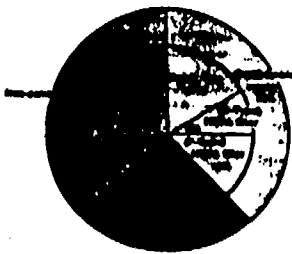

Operating Data on Incineration Process

Operating condition	Waste composition	Temp (°C)	Throughput (kg/day)
Type of incinerator			
Conventional	Combustible (2kg/bag) HEPA filter piece (<30cm) Metal piece (<5X5cm)	Primary ~800 Secondary ~900	200
Cyclone	Shredded waste	~800	30
Acid digester	Shredded waste	~250	30

Operating Data on Metal Melting Process

Melting method	Electroslag melting
Type	Water cooling copper mould
Material of melter	Copper
Volume of melter	~50 t
Wastes	SUS, SS
Throughput	100kg/Batch
Feeding rate	1.2kg/1.2min
Melting temp.	~1900°C

Operating Data on Microwave Melting Process

Melting method	Microwave heating
Type	Cavity type
Frequency	2450MHz
Microwave output	10kW
Throughput	30kg/day
Feeding method	Continuously or Batch
Melting temp.	~1400°C

Specification of Waste Form

Ceramic-like block	Metal ingot
Content	
Weight	~25kg
Volume	~10 t
Density	2~3g/cm ³
Container	
Material	SUS 304 St
Dimension	φ129mm X 770mmH
Weight	~20kg
	Weight: ~100kg
	Volume: 300mm X 270mm X 180mmH
	Density: ~7.8g/cm ³

Air lock system for this waste handling



Cyclone for incinerator



Acid Digester

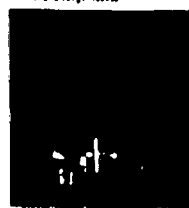

ESR Furnace

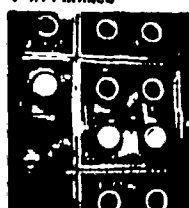

Microwave Melter

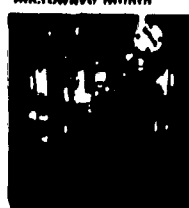

Non-Destructive Assay (NDA)

- Passive γ-ray technique
- Active neutron technique

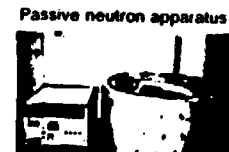

Storage form of the ceramic-like blocks

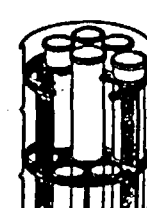

Storage form of the metal ingot





Cross-section view of melted ash



Polarizing Microscope view of sectional ceramic-like block

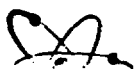

Key Technical Issues for Commercialization of FBR Power Plants

Key Technical Issues	Target of Development
Long-life high performance fuels	• Reliable fuel with its burn-up above 200,000Mwd/t
High performance core for large-scale FBRs	• Optimization of a high performance core for 1,500MWe plant
Plant service at high temperature	• Structural material resisting higher temperature (over 550°C)
Optimization of heat transport and fuel handling systems	• Optimization of systems' layout to reduce the size of reactor building • Development of compact and reliable components
Optimization of reactor containment design	• Realistic estimation of a rise in pressure at severe accident
Seismic isolation	• Licensable evaluation model and standards of seismic isolation design
Elimination of secondary heat transport system.	• Establishment of safety logic and corresponding protection system • Development of reliable double-walled tube type steam generator
Reliable decay heat removal system	• Passive decay heat removal system of natural convection
Autonomous plant operation	• Fully automatic plant operation using the artificial intelligence (AI) technology
Optimization of safety logics	• Safety design and evaluation with an adequate margin



Artist's View of a Commercialized FBR

- 1 Reactor vessel
- 2 Core
- 3 Shield plug
- 4 Control rod drive mechanism
- 5 Refueling machine
- 6 In-cell crane
- 7 Spent fuel storage rack
- 8 Reactor coolant pump
- 9 Reactor coolant pipe
- 10 Steam generator
- 11 Air cooler
- 12 Dump tank
- 13 Water/steam pipe
- 14 Operation floor
- 15 HVAC system
- 16 Seal bellows
- 17 Advanced shut down mechanism
- 18 Heat exchanger for residual heat removal
- 19 Ceramics liner
- 20 Seismic isolation device
- 21 Cold trap

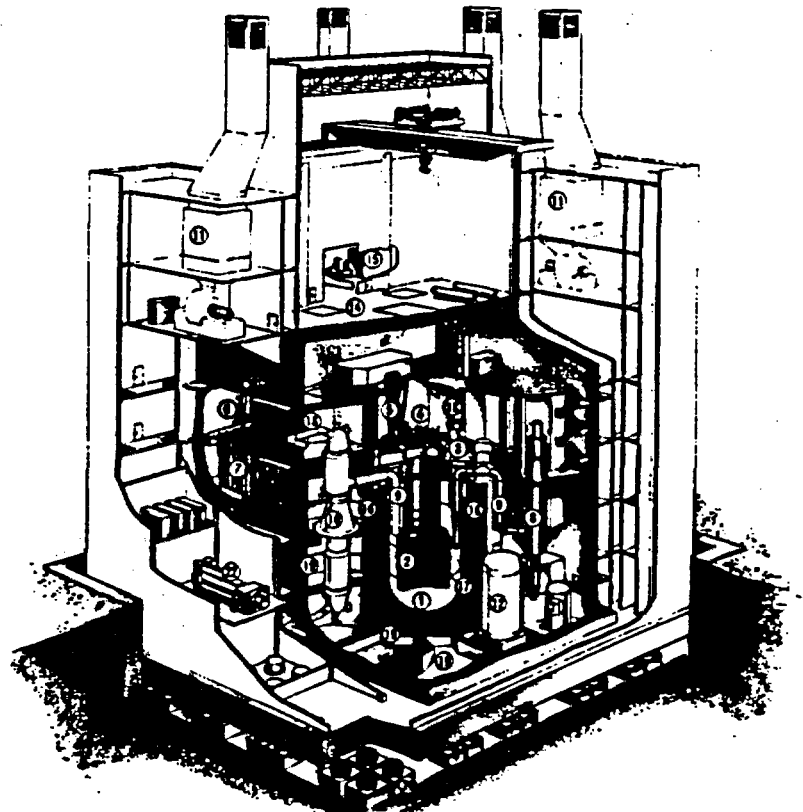

Developing Plutonium Utilization Technologies is a Key Role of PNC



In order to realize the full potential of nuclear power, it is essential to utilize plutonium and establish the nuclear fuel cycle. To utilize plutonium as an energy resource, Japan is pursuing a strategy of shifting

from light water reactors (LWRs) to fast breeder reactors (FBRs). PNC is carrying out extensive R&D programs in various elements of the fuel cycle.



**Power Reactor and Nuclear Fuel
Development Corporation**

Head Office

Sankaido Bldg.,
1-9-13, Akasaka, Minato-ku, Tokyo, Japan 107
Tel: 03 586-3311
Telecopy: 03 505-5125 (International Division)
Tlx: J 27654 PNRD

Overseas Offices

PNC Paris Office

4-8, Rue Sainte-Anne, 75001 Paris, France
Tel: 1-4260-3101 Telecopy: 1-4260-2413 Tlx: 42-240750

PNC Washington Office

2600 Virginia Avenue, N.W., #715, Washington, D.C., 20037 U.S.A.
Tel: 202-338-3770 Telecopy: 202-333-1097 Tlx: 23-089-2777

PNC Beijing Office

Beijing Fortune Building, Rm. 602, 5 San Huan Bei-lu, Chao Yang District,
Beijing 100004 China
Tel: 1-501-0564 Telecopy: 1-501-0566 Tlx: 85-210195

PNC Exploration (Canada) Co., Ltd.

650 West Georgia Street, #2401, Vancouver, B.C., V6B4N8 Canada
Tel: 604-681-8151 Telecopy: 604-682-3452 Tlx: 21-4507862

PNC Exploration (Australia) Pty. Ltd.

16th Floor, Royal Exchange Building, 56 Pitt Street, Sydney, N.S.W. 2000 Australia
Tel: 2-241-1594 Telecopy: 2-251-1584 Tlx: 71-25912

TECHNOLOGIES DISCUSSED AT PNC-OARAI

- **Decommissioning Technology for Nuclear Fuel Cycle Facility in WDF**
- **Separation and Removal**
 - **Decontamination with Melting**
 - **Electropolishing I**
 - **Electropolishing II**
 - **Ice Blasting Decontamination**
 - **REDOX**
- **Radiation Control**
- **System Engineering**
- **Waste Treatment**
- **Remote Handling**
- **Dismantling- Plasma Arc Cutting**
- **Monitoring- Radiation Image Display**
- **R&D of Fast Breeder Reactors (FBR)**
- **R&D of Advanced Thermal Reactors (ATR)**
- **R&D on Fuel Recycling**
- **Development of a Heat resistant and Angle Beam Type Electro-Magnetic Acoustic Transducer**
- **R&D on Plutonium Fuel**
- **Low Level TRU Bearing Waste Management Technologies**
 - **Incineration**
 - **Acid Digestion**
 - **U-Contaminated Waste Incineration**
 - **TRU- Contaminated Waste Incineration**
 - **Cyclone Incineration**
 - **Waste Incineration**
 - **Decomposition**
 - **Dismantling**
 - **Plasma Arc Cutting**
 - **Laser Arc Cutting**
 - **Immobilization**
 - **Microwave Melting**
 - **Electro-Slag Remelting**
 - **Hip Solidification**
 - **Dehydration and Solidification with Microwave**
 - **Hypothermal Solidification**
 - **Cementation**
 - **Plastic Solidification**
 - **Bituminization**
 - **Krypton Immobilization**

BIBLIOGRAPHY OF LITERATURE RECEIVED FROM PNC-OARAI

- "Development of a Heat Resistant and Angle Beam Type Electro-Magnetic Acoustic Transducer", Compiled by K. Ara, H. Rindo, K. Nakamoto, T. Doi, K. Morimoto, and T. Sakamoto, Oarai Engineering Center, PNC, 5 pages.**
- "Development of Decommissioning Technologies for Nuclear Fuel Cycle Facility in Waste Dismantling Facility", Oarai Engineering Center, PNC, 18 pages.**
- "FBR Development in PNC for Commercialization", PNC, 8 pages.**
- "Research and Development in Oarai Engineering Center", Oarai Engineering Center, PNC, 16 pages.**
- "Technical Draft for Comments RD&D Program on Low-Level TRU Bearing Waste Management Technologies", PNC, 43 pages.**

**DEVELOPMENT OF A HEAT RESISTANT AND ANGLE BEAM TYPE
ELECTRO-MAGNETIC ACOUSTIC TRANSDUCER**

K. ARA, H. RINDO, K. NAKAMOTO

(O-ari Engineering Center,
Power Reactor and Nuclear Fuel Development Corporation)

JAPAN

T. DOI

(Advanced Technology Reseach Center,
Mitsubishi Heavy Industries Ltd.)

JAPAN

K. MORIMOTO

(Takasago Technical Institute,
Mitsubishi Heavy Industries Ltd.)

JAPAN

T. SAKAMOTO

(Kobe shipyard & Machinery Works,
Mitsubishi Heavy Industries Ltd.)

JAPAN

ABSTRACT

The in-service inspection (ISI) system of fast breeder reactor (FBR) is required to be miniaturized and rationalized, because of the severe environmental conditions around the reactor vessel of an FBR during ISI. A new ultrasonic testing methods using an electro-magnetic acoustic transducer (EMAT) has been developed to apply for the ISI of the FBR reactor vessel in a practical manner. The new method can generate directly ultrasonic waves in the materials without the couplant such as oil and water, through the interaction of a magnetic field and eddy currents. The high performance EMAT has been developed. So the inspection system with the EMAT will be able to get compact, because it needs no couplant supplying and collecting equipment.

The developed "EMAT" can be available up to 240°C and detect 20% slit in depth artificial flaw in austenitic stainless steel which wall thickness of 50mm under 240°C in laboratory. Transmission cable of forty meters was applied for the EMAT to consider the actual interval between an inspection point and the signal processing equipment.

For presentation in IAEA Specialist's Meeting on "Experience and Further improvement of In-Service Inspection Methods and Programmes of NPPs with Particular Emphasis on On-Line Techniques"

1. INTRODUCTION

The ISI will be done in the narrow space between the reactor vessel and the guard vessel of a FBR under the condition of high temperature and high radiation field as shown in Table 1. The probe is required to be compact for remote inspection and to have the excellent property under high temperature without

cooling. If conventional UT probes are used in this case, the ISI equipment might be large because it needs the additional couplant equipment. The inspection system applied EMAT satisfies all of the above requirements. The EMAT is a couplant free sensor and has potential of high temperature use, as described in the next section.

The basic design conditions for the EMAT are shown in Table 2.

Table 1: Environmental Conditions

Temperature (°C)	: approx.200
Radiation dose rate (R/hr)	: max.1000
Access space (mm)	: 300
Signal transmission length (m)	: max. 40

Table 2: Basic Design Conditions requirements

Subject	: Heat affected zone of weld (austenitic stainless steel)
Detectability	: 50% slit in depth at wall thickness of 50mm (In laboratory, 20% slit)
Operating temperature and operating time	: 200°C, 100 hr

2. PRINCIPLE AND STRUCTURE OF EMAT

A principle of the EMAT is shown in Figure 1. The EMAT consists of a set of magnets array and coil, and the high frequency current in the coil generate eddy current in the surface layer of the materials. Lorentz force \vec{F} is generated by the interaction between the magnetic field and the eddy current. And Lorentz force \vec{F} is defined by the following equation,

$$\vec{F} = \vec{J} \times \vec{B}$$

where \vec{J} is eddy current and \vec{B} is magnetic flux density. The direction of Lorentz force depends on the frequency of eddy current, and vibration of a material results in generation of ultrasonic waves. The thickness (t) of one magnet piece is given by the following equation.

$$t = \frac{C}{2f \sin \theta} \quad (1)$$

where C is sound velocity
 f is frequency
 θ is refraction angle

The ultrasonic wave generation and detection mechanism of shear horizontal (SH) wave angle beam EMAT are shown in Figure 1. In the opposite way, in detection, ultrasonic waves near the surface of the test sample besides the coil and electronic oscillations are produced. By the interaction between external magnetic field and vibration force, electrons flow in the direction of the force generated and produced alternative current in the surface of the materials. The current induces a voltage in the detection coil on the test piece.

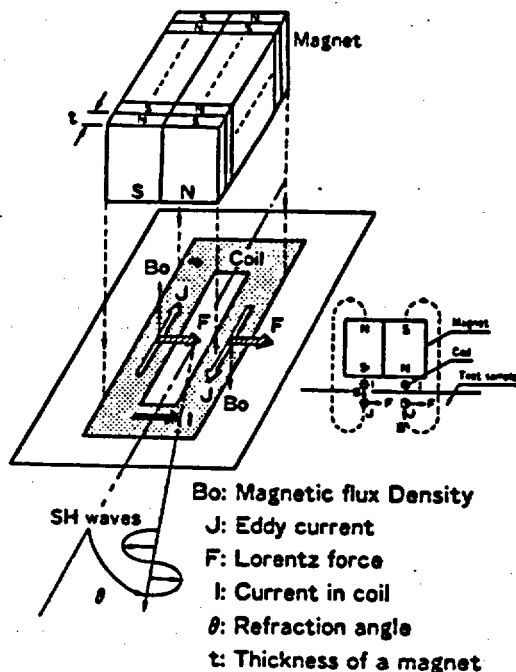

Figure 1: -Schematic diagram of ultrasonic generation by SH wave angle beam EMAT

3. DEVELOPMENT OF EMAT AND EVALUATION

(1) INVESTIGATION OF SPECIFICATIONS OF EMAT AND SELECTION OF OPTIMUM CONDITION

The specifications of EMAT were investigated under the actual environment conditions and basic design requirements for the EMAT are shown in Table 3.

Table 3: Specification of EMAT

Ultrasonic wave mode	: SH wave
Refraction angle (deg)	: 60
Frequency (kHz)	: 700 (at 240 °C)
Operating Temperature (°C)	: 200 (max. 240)
Transmission cable length (m)	: 40

ULTRASONIC WAVE MODE: In the case of the inspection for the heat affected zone (HAZ) of welded part in austenitic stainless steel, ultrasonic wave mode is one of the most important factor on designing of the probe, because that acoustical anisotropic materials exist in HAZ. SH wave was selected by the results of wave mode characteristics test. SH wave keeps its sound velocity in HAZ. And the loss of wave mode transformation is lower than that of shear vertical (SV) wave, because SH wave has no transformation at reflection on the boundary of a flaw.

REFRACTION ANGLE: The EMAT is required to detect primarily a defect in the inner surface of the stainless wall. Because of the wide heat affected zone of welded part, the angle beam function is necessary for a probe, especially applied for heavy wall thickness such as reactor vessel. The refraction angle of 60 degree was selected for the EMAT by experiment.

FREQUENCY: Generally, the signal level obtained from an EMAT is very low. Especially, a flaw detection ability of an EMAT in applying for inspection of non-magnetic materials is inferior to that in applying for magnetic materials. The reactor vessel of FBR 'MONJU' was applied for non-magnetic stainless steel. Therefore, the optimum frequency was investigated. As a result, it was confirmed that the EMAT had the highest signal level at the frequency of 700kHz.

HIGH TEMPERATURE APPLICATION: The EMAT for high temperature use of 200 °C has been developed. High performance heat resistant parts and components were developed shown in Table 4. The sheet type coil is coated poly-imide film. The magnet assembly is an array of thin Sm-Co magnet pieces. In this case, the thickness of a magnet (t) is 2.4mm.

Figure 2 is the overview of the EMAT and Figure 3 shows the inner structure of the EMAT applied for experiment. This EMAT is the angle beam EMAT for high temperature use.

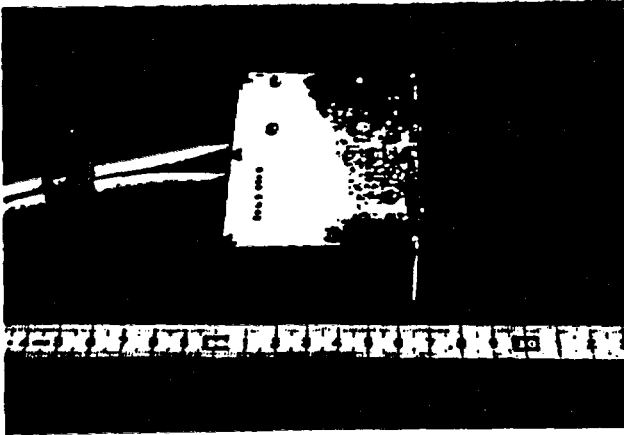

Figure 2: -Prototype EMAT

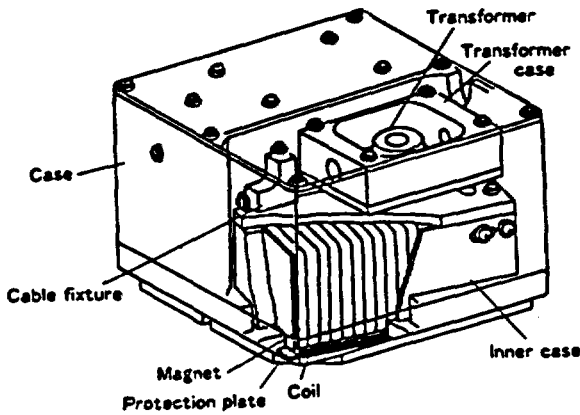
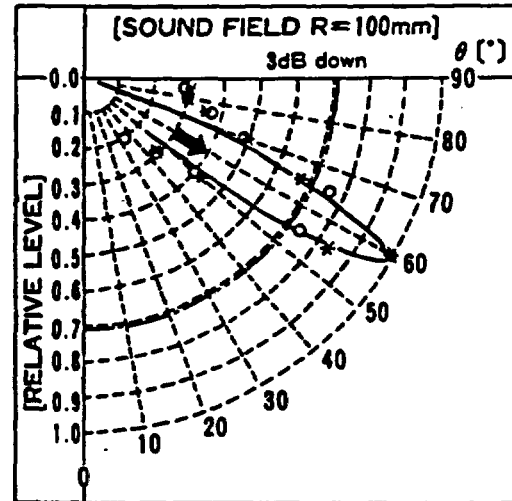

Figure 3: -Schematic diagram of structure of prototype EMAT

Table 4: Materials of Elements of EMAT

ELEMENTS	MATERIALS
Coil	Poly-imide sheet coil
Magnet	Sm-Co(Curie point;820°C)
Cable	Teflon insulator

ANGLE INCIDENT OF SH-WAVE EMAT: The sound field of the EMAT was measured and confirmed its angle incident function. Figure 4 shows the sound field at the distance of 100mm from the center of the EMAT. The points marked "x" show the measured sound intensity of transmitter and "o" show that of receiver. And the line shows its simulation result. Close agreement between measured and simulation value was obtained, and the center angle of the sound field was 60 degree.



x Transmitter
o Receiver
— Simulation

Figure 4: -Sound fields of EMAT

(2) DETECTION OF FLAW

The flaw detection ability of the developed EMAT was confirmed by experiment. As shown in Figure 5, the EMAT was placed on the outer surface of the test specimen, which has the artificial slit type flaw at the inner surface. The test specimen is made of the austenitic stainless steel as same as the reactor vessel of FBR.

One of the typical results of flaw indication pattern is shown in Figure 6. A slit type flaw, 35mm in length and 20% of wall thickness in depth, in the heat affected zone could be clearly detected with the signal to noise ratio (S/N) of over 2.0, under the both conditions of room and high(240°C) temperature. Sensitivity obtained was kept continuously for 100 hours at the temperature of 240°C.

(3) SIGNAL TRANSMISSION PERFORMANCE

The EMAT applying for FBR reactor vessel is required to have excellent property of the signal transmission from itself to signal processing equipment at intervals of 40m. The output signal strength from the EMAT is very low, furthermore it

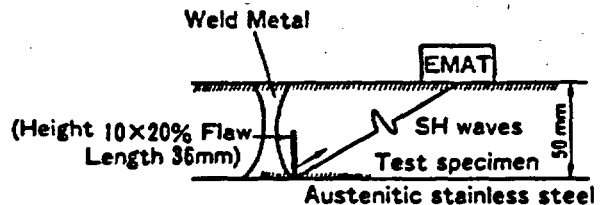

Figure 5: -Test configuration for detecting the flaw

(Time $20\mu\text{s}/\text{div}$, Amp, $50\text{mV}/\text{div}$)

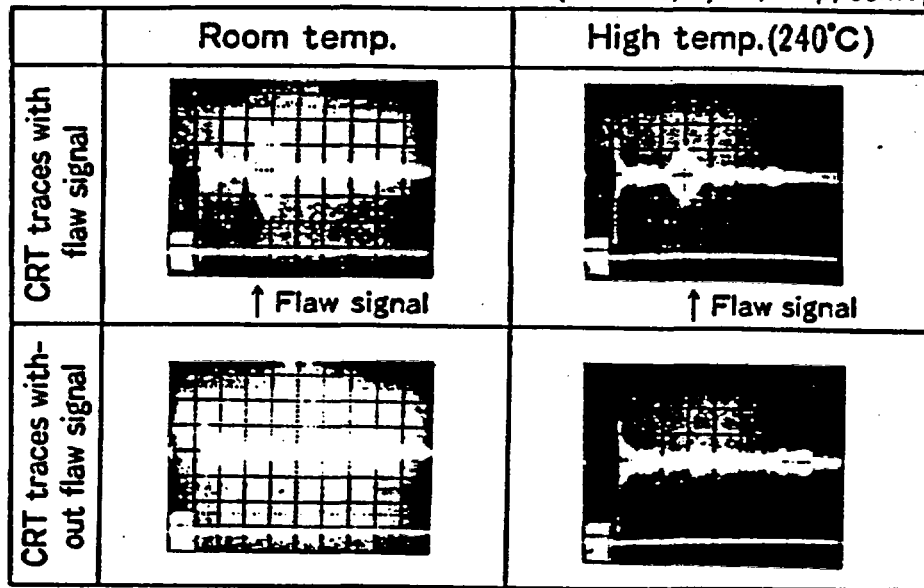

Figure 8: -CRT traces for detecting the slit type flaw in laboratory

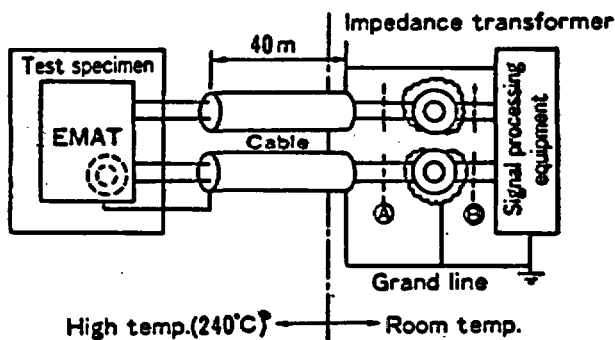

Figure 7: -Test configuration for signal transmission

attenuate through the long transmission cable. Therefore, signal impedance matching between the EMAT and the signal processing equipment is needed. Test configuration for signal transmission is shown in Figure 7. The attenuation ratio in transmission line under high temperature of 240°C was higher than that in room temperature as shown in Figure 8.

(4) EVALUATION

HIGH TEMPERATURE OPERATION: Minimum Requirement of operating temperature is 200°C for 100 hours. It was confirmed by the experiment that the EMAT could be operated up to 240°C for 100 hours over. The element

with the low heat resistance are coil and cable, especially electrical insulator. The maximum operating temperature of the EMAT depends on that of the electrical insulation materials. It is necessary to improve these materials for realizing higher temperature use.

DESIGN PARAMETERS: The specifications of the EMAT for FBR reactor vessel were decided through some experiments. It was confirmed that design value agreed with measured value well. Design parameters depend on the conditions of an inspected material. For example, in the case of applying for the thin wall inspection such as piping, refraction angle and frequency of ultrasound should be selected optimum value.

DETECTABILITY: The requirements of flaw detection ability is 20 % slit in depth in austenitic stainless steel under high temperature of 240°C . The results of the research satisfied with the target. We could get the result that the flaw signal level in high temperature of 240°C was about 3dB lower than that in room temperature.

APPLICATION: In remote operation, the flaw signal level is attenuated through the long transmission cable. But impedance matching is effective, it could transmit the flaw signal without a amplifier.

(Time 20 μ s/div, Amp, 50mV/div)

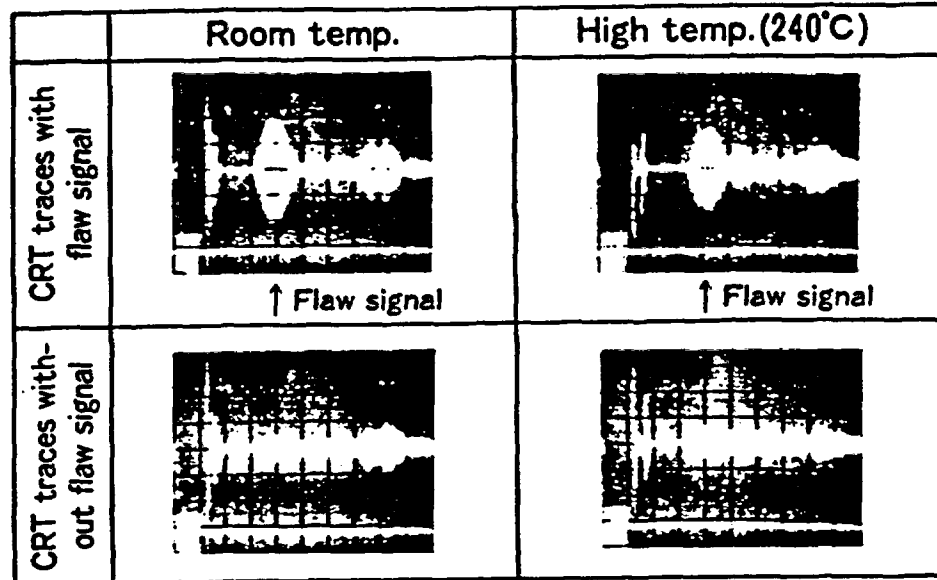

Figure 8: -CRT traces for transmitting signal at intervals of 40m in laboratory

4. CONCLUSION

SH wave, angle beam EMAT with high temperature use was developed which is applicable to the reactor vessel inspection of FBR. It was confirmed in laboratory that the EMAT could be operated up to 240°C for over 100 hours, the flaw detection ability was 20% slit in depth artificial flaw in austenitic stainless steel wall thickness of 50mm, and forty meters of signal transmission cable could be applied.

REFERENCE

- [1] Nakamura, T. and H. Rindo, K. Ara, T. Kanimura, S. Tsuzuki, K. Morimoto, E. Nagaoka, N. Ikeda, "Conceptual Design of ISI System for 'MONJU'",

Mitsubishi Heavy Industries, Ltd. Technical Rev. 24,2,100-106(1987)

- [2] Doi, T. and K. Morimoto, T. Sakamoto, K. Ara, H. Rindo, K. Nakamoto, "Development of High Temperature EMAT", Proc. Autumn Convention AES Japan, (1986) (in Japanese)
- [3] Doi, T. and K. Morimoto, T. Sakamoto, K. Ara, H. Rindo, K. Nakamoto, "DEVELOPMENT OF HIGH TEMPERATURE EMAT" ASM 9th International Conference on NDE in Nuclear Industry, (1988)
- [4] K. Ara, N. Oyama, "Overview of Examination and Inspection Technology in FBR", Vol. 28, No. 12 pp1133-1134 (1986) AES (in Japanese)

Development of Decommissioning Technologies for Nuclear
Fuel Cycle Facility

July, 1989

OARAI ENGINEERING CENTER
POWER REACTOR AND NUCLEAR FUEL DEVELOPMENT CORPORATION

CONTENTS

1. INTRODUCTION	1
2. OUTLINE OF WDF	2
3. R&D STRATEGY OF D/D TECHNOLOGIES	7
4. DEVELOPMENT OF DECONTAMINATION TECHNIQUES.....	7
4-1 Ice Blast Decontamination	8
4-2 Electropolishing Decontamination	9
4-3 REDOX Decontamination	10
5. DEVELOPMENT OF DISMANTLING TECHNIQUES.....	11
5-1 Plasma Cutting Robot	11
6. DEVELOPMENT OF MONITORING TECHNIQUES.....	13
6-1 Radiation Image Display (RID)	13
7. CONCLUSION	16
8. REFERENCES	16

DEVELOPMENT OF DECOMMISSIONING TECHNOLOGIES FOR NUCLEAR FUEL CYCLE FACILITY
IN WASTE DISMANTLING FACILITY

MASAO SHIOTSUKI, SATOSHI IKEDA, and HIDEHIKO MIYAO
Power Reactor and Nuclear Fuel Development Corporation (PNC)

1. INTRODUCTION

Nuclear facilities such as power reactors, reprocessing plants and fuel fabrication plants are generally said to have a limited life of up to 30 or 40 years. When they are superannuated, these facilities have to be dismantled and removed safely, and wastes from such dismantling must be treated under appropriate control. These operations are comprehensively termed as "decommissioning".

Power Reactor and Nuclear Fuel Development Corporation (PNC) has so far dedicated itself to the technical development of fast breeder reactors, reprocessing techniques and MOX fabrication techniques. Programs are based on national policy of plutonium fuel recycle. PNC is now developing fuel cycle facility decommissioning techniques.

At the Waste Dismantling Facility (WDF) located in O-arai Engineering Center (OEC), PNC is eager to validate its technical development efforts aimed at the treatment of surface-contaminated large size wastes from post irradiated FBR fuel and material examination (PIE) facilities.



Photo.1 View of Waste Dismantling Facility (WDF)

2. OUTLINE OF WDF

The plan and the waste stream of WDF are shown in Fig.1 and 2. The WDF is a ferroconcrete building with three stories and one basement. The building area is 1,700 m² and the total floor area is about 5,400 m².

The wastes are classified into three categories such as high radiation level α wastes (surface radiation level: ≥ 50 mrem/h), low radiation level α wastes (surface radiation level: < 50 mrem/h), and β, γ wastes. The high radiation level α wastes are received through the overhead hatch of the α waste loading cell.

The wastes are then sent to the decontamination cell via an air lock chamber and unpacked by means of master slave manipulators. After measurement of the dose rate and surface contamination, the wastes are subjected to surface decontamination by an ice blasting process. Thereafter, they are transferred to the dismantling cell and are cut into pieces with a plasma cutter and a hacksaw (Photo.2 and 3). Compressible wastes are further subjected to a compressing process (Photo.4) and then are packed in metallic containers.

The low radiation level α wastes are brought into the acceptance hall and then are transferred by a cart to the decontamination hall, where the wastes are unpacked and dose rate and surface contamination are measured directly by the workers wearing airline suits. Then the wastes are decontaminated by an electropolishing process. Thereafter, the wastes are dismantled with the plasma cutter into small pieces and packed into containers. The hall is constantly monitored from the 2nd floor control room during these operations.

The β, γ wastes are introduced directly into the β, γ dismantling cell from the overhead hatch of the cell and cut into small pieces by remote cutting techniques. The high radiation level wastes are packed into metallic containers and stored into casks for transportation. The low radiation level wastes are sent to the β, γ loading cell, and after sorting and classifying, they are packed into drums. The process flow sheet is shown in Fig.3.



Photo.2 Plasma cutting



Photo.3 Hacksaw cutting



Photo. 4 Compressing Machine

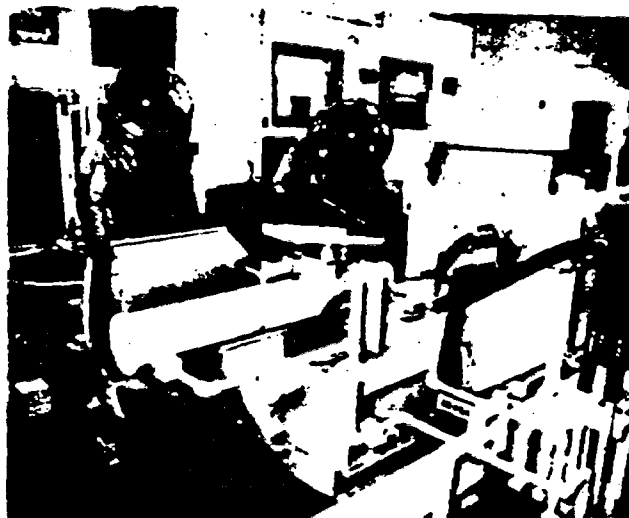

Photo. 5 Operator wearing Frog-man suit

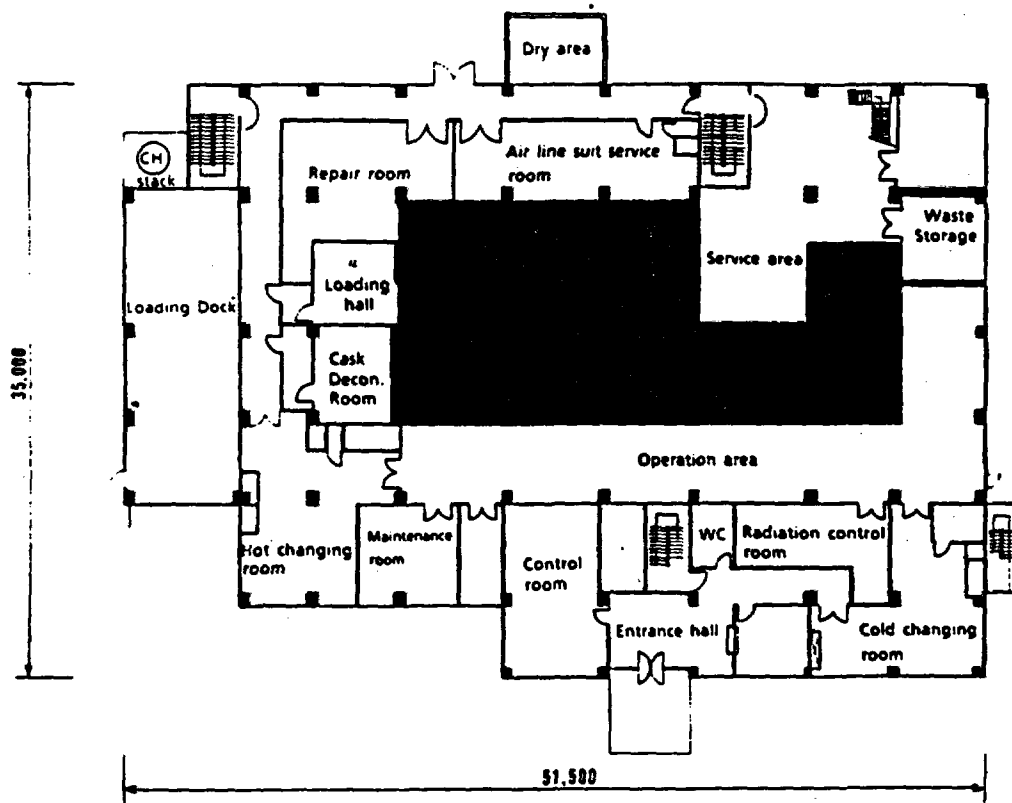

Fig. 1 WDF Plan

Table.1 Specification of Cells

		a Dismantling Cell	a Decontamination Cell	a Loading Cell	B 7 Dismantling Cell	B 7 Loading Cell
Dimension (m) L x W x H		13.4 x 4.0 x 6.1	3.5 x 4.0 x 6.1	6.3 x 4.0 x 6.1	4.8 x 4.2 x 6.6	4.6 x 4.6 x 6.6
Shielding (mm)	Front	1000 : Heavy Concrete			750 : Concrete	550 : Concrete
	Roof	1050 : Concrete			500 : Concrete	
	Floor	1150 : Concrete			650 : Concrete	
Lining	Wall/ Roof	SUS 304		Epoxy Resin	Epoxy Resin	Epoxy Resin
	Floor			SUS 304	SUS 304	
Air tightness		< 0.1 vol% /Hr			Negative Pressure	

Table.2 Specification of equipment

EQUIPMENT	SPECIFICATION
(PROCESS) 1) Plasma Cutting	<ul style="list-style-type: none"> • Gas : Ar, N₂ • Current : Max. 250 A • Capacity : SUS 70 mm
2) Hacksaw Cutting	<ul style="list-style-type: none"> • Capacity : SUS 200 mm
3) Compression	<ul style="list-style-type: none"> • Type : Uniaxial Press • Object : 259φ x 320 mm • Capacity : 70 Ton
4) Press Cutter	<ul style="list-style-type: none"> • Object : 200 x 1000 x 8 mm • Capacity : 400 Ton
(HANDLING) 1) Roller Conveyor	<ul style="list-style-type: none"> • Type : Motor Drive with Chain • Capacity : Max. 2.0 Ton
2) Transfer Car	<ul style="list-style-type: none"> • Type : Self-Drive with Motor Self-Drive with Linear Motor • Capacity : Max. 2.0 Ton
(AIR LINE SUITS)	<ul style="list-style-type: none"> • Type : Fixed, Free • Number : 2(Decon.), 3(Dismantl.) 2(Beta-Gamma) • Temp : 12 ~ 35 °C • Humidity : 20 ~ 80 %
(REMOTE HANDLING) 1) Master-Slave Manipulator	<ul style="list-style-type: none"> • Type : Gas-Tight Rugged-Duty • Handling : Max. 23 Kg Load : Max. 45.3 Kg • Number : 5 Pairs 3 Pairs
2) Power Manipulator	<ul style="list-style-type: none"> • Handling : 67.5 Kg (All Position) Load • Shoulder : 450 kg Hook Load • Number : 3
3) In-Cell Crane	<ul style="list-style-type: none"> • Capacity : Max. 2.0 Ton

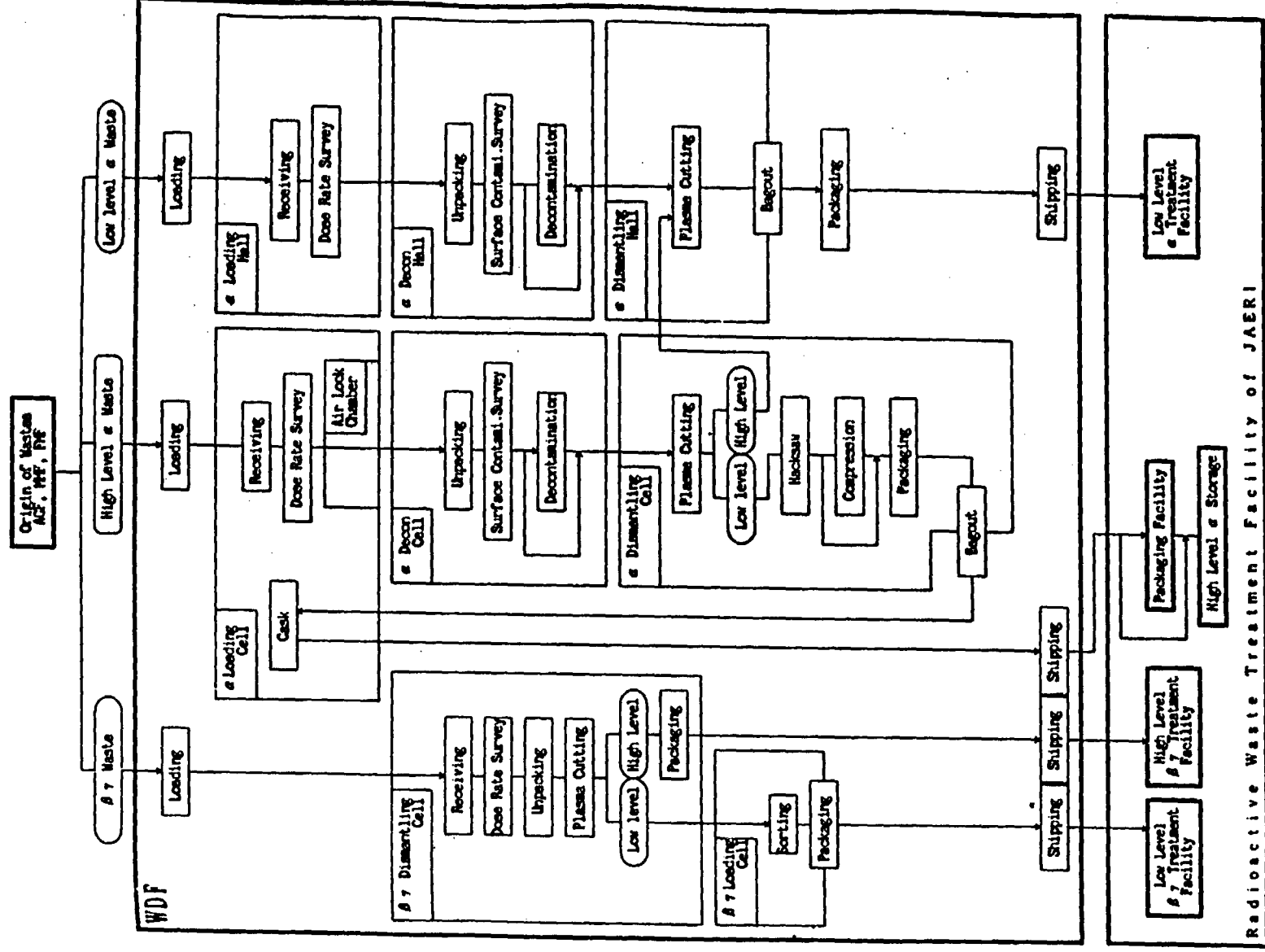

Fig. 2 Waste Stream in WDF

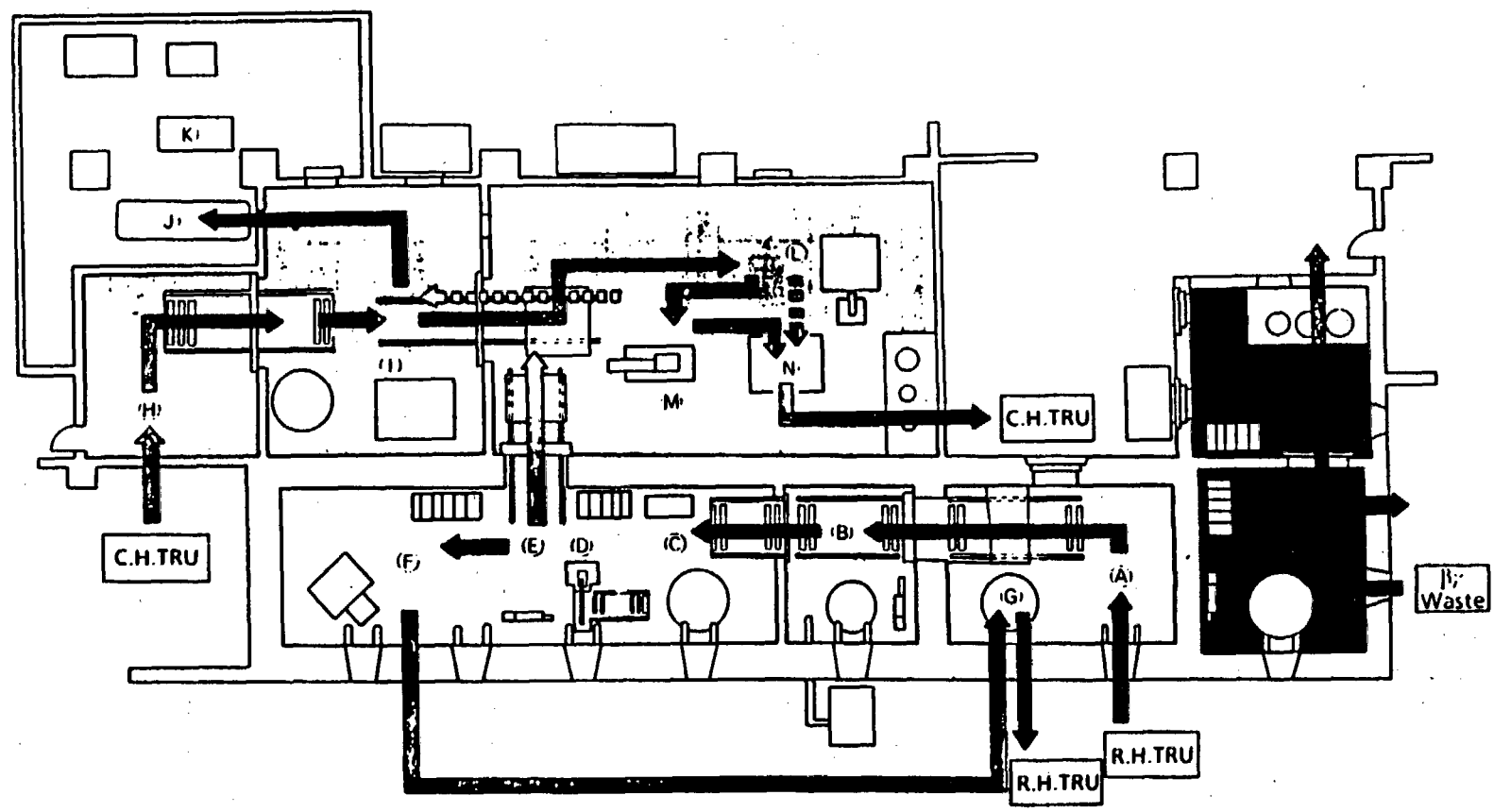

Fig.3 WDF Process Flow

3. R & D STRATEGY OF D/D TECHNOLOGIES

Technology needed for areas on nuclear fuel cycle decommissioning operations have been identified and prioritized using the results of past power reactor decommissioning studies for each major decommissioning activity. (Fig.4)

In comparison with reactors, the decommissioning of nuclear fuel cycle facilities has distinctive features that objects to be removed are contaminated with TRU nuclides and their contamination conditions, structure, configuration and materials vary.

These factors have been considered in developing decommissioning techniques for PNC's nuclear fuel cycle facilities. Safe and effective decommissioning of nuclear fuel cycle facilities with minimum generation of secondary wastes and cost would be achievable with an integration of the techniques discussed below.

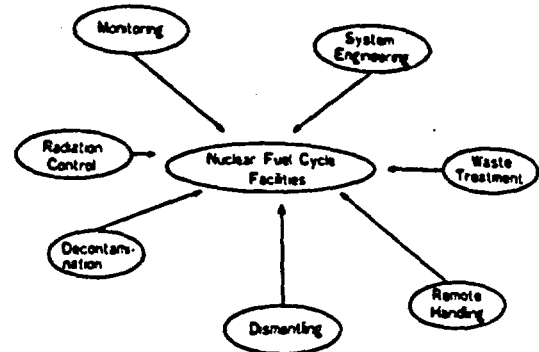

Fig.4 Development of Technologies on D/D of Nuclear Fuel Cycle Facilities

4. DEVELOPMENT OF DECONTAMINATION TECHNIQUES

Decontamination techniques are classified into two groups, namely, "Primary decontamination techniques" and "Complete decontamination techniques".(See Fig. 5.)

The former envisages the removal of loose contaminants to reduce the exposure dose rate involved in handling nuclides and to prevent spread of contamination. The latter aims at the absolute reduction of radioactivity down to background level.

The WDF is now developing an "Ice blast decontamination process" as a means of primary decontamination as well as an "Electropolishing process" and a "REDOX process" as a means of complete decontamination.

CATEGORY	MECHANISM	REMOVAL SIZE	TECHNIQUE
Primary Decon.	① Exfoliation of Contaminants	Particle	→ Spray → Ice-blasting
	② Solution of Nuclides	Molecule	→ Chemical Decon
Complete Decon.	③ Surface Removal	Atom	→ Electro-Polishing
	④ Refining		→ REDOX → Electro-Slag-remelting

Fig.5 Decontamination Techniques and Mechanism

4-1 Ice Blast Decontamination

Ice blast decontamination is a surface decontamination process using ice and dry ice mixed particles made by pelletizer, which are blasted onto an object to be decontaminated using a carrier medium such as compressed air.

This process features the utilization of blast impact energy and low temperature to remove nuclides, coatings and oils for improved decontamination efficiency in comparison with that of a spray process with far less secondary waste generation.

The impact energy produced by a blaster in the WDF (with compressed air rated at 6kg/cf) come up to hundreds of kg/cf.

Fig.6 is a conceptual illustration of ice blast system. The system consists of a pelletizer and a blaster. Only a maintenance-free flexible pressure hose and a blasting nozzle are installed in the cell.

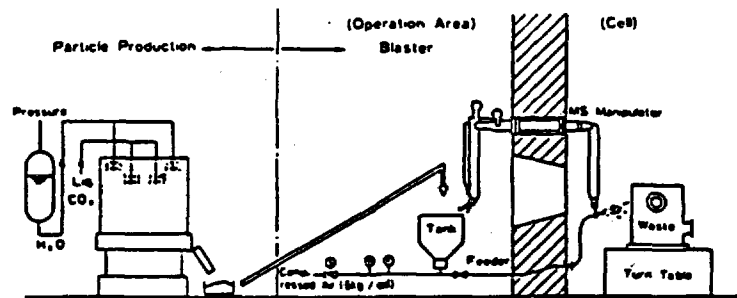

Fig. 6 Ice Blasting Decontamination System

The pelletizer is capable of producing blast particles at a rate of about 200kg/h. (Photo.6) The particles are made by converting liquefied carbon dioxide into a fine powder through adiabatic expansion and then compacting these into column shaped particles of 4mm diameter and 5mm length. The pelletizer is provided with a water supply system, which can mix up to approximately 20% water (ice) into blast particles. The objective of mixing water into blast particles is to increase the hardness of blast particles and to facilitate transfer of nuclides to the liquid waste stream during decontamination.

The evaluation of test results obtained so far has verified the validity of this decontamination process. In comparison with pressurized water processes, this method holds down the secondary waste generation to the order of one tenth and achieves higher decontamination levels.

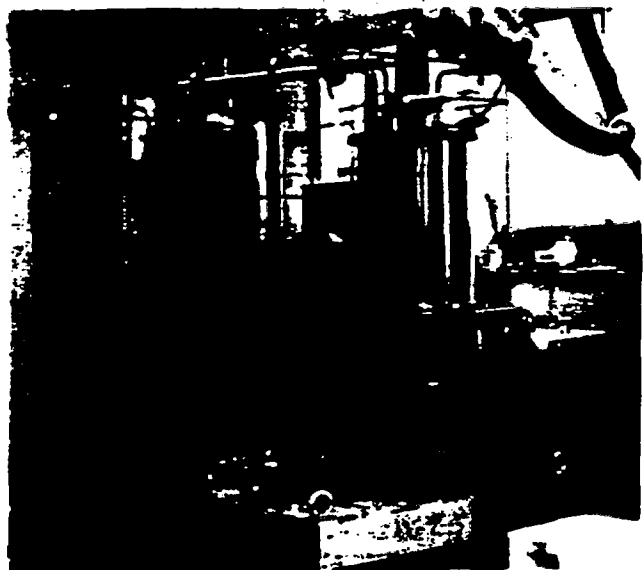

Photo. 6 The Pelletizer

Hence, this process will be given increased impetus for development as an effective primary decontamination process that promises wider applicability and further improved decontamination efficiency.

4-2 Electropolishing Decontamination

This is the application of electropolishing, a common industrial technique for surface processing of metals, to nuclear decontamination.

In this process, as the surface of contaminated metal dissolves, nuclides will move into the electrolyte. Theoretically, a decontamination efficiency as high as 8G level can be expected.

The WDF started developing this process in 1982 and selected a 5% sulfuric acid solution as the electrolyte in consideration of its electrolytic properties such as polishing efficiency and uniform dissolubility as well as after treatment of spent electrolyte. WDF sets up a demonstration decontamination system (Photo.7) in a Decontamination Hall.

The basic concept of electropolishing system is illustrated in Fig.7.

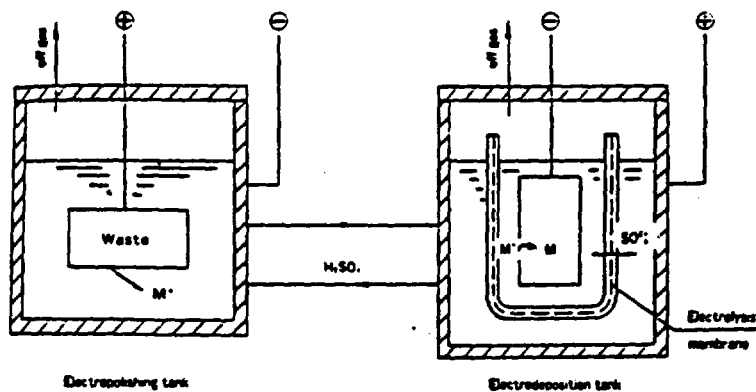

Fig.7 Schematic Diagram of Electropolishing



Photo.7 Electropolishing Decon. system

Decontamination will take place with the application of positive charge to metallic wastes in a conductive electrolyte because the charge will displace the metal surface into the electrolyte as cation. Also, successive electropolishing operations will lead to an increased metal ion concentration in the electrolyte, decreasing the polishing efficiency down to 1/3 to 1/4 of the initial value when the concentration rises to 30 g metal ion/liter or more. Finally the spent electrolyte itself becomes waste. In order to recover such a spent electrolyte for reuse, an electrodeposition technique which is reverse to electrolysis is used to recover metal ions from the spent electrolyte. A critical element of this technique is pH control, which can be achieved by providing an electrolytic diaphragm between the regenerative cathode and anode which selectively allows the permeation of the sulfuric acid ion (SO_4^{2-}).

From the decontamination of wastes derived from irradiated FBR fuels, WDF has

confirmed the high efficiency of this decontamination process (Fig.8). The WDF's comparative evaluation of this process versus ultrasonic cleaning has verified excellent efficiency of this process (Fig.9) as demonstrated by the distribution of contamination and the SEM observation of polished metal surface. The sulfuric-acid electrolytic decontamination which can remove effectively the contamination embedded in the grain boundaries of metals, is particularly effective.

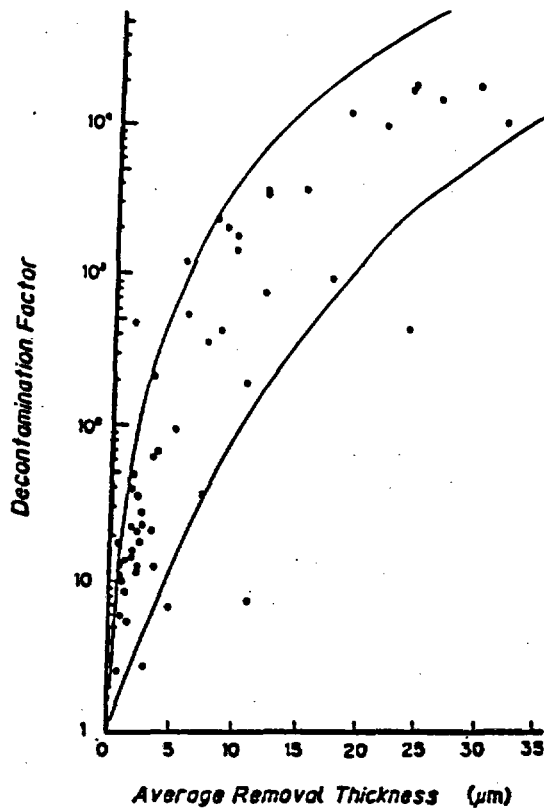

Fig. 8 Relationship A.R.T. and DF

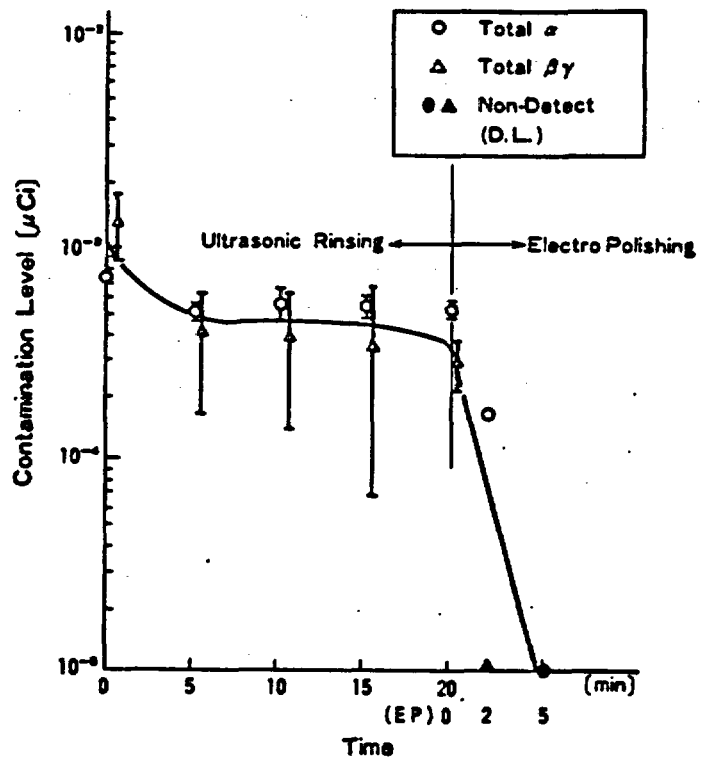

Fig. 9 Decontamination Effect by Ultrasonic Rinsing and Electropolishing

4-3 REDOX Decontamination

This is an electro-chemical decontamination process, where the dissolution of metals and contaminated wastes is accelerated by the addition of quadrivalent cerium ion (Ce(IV)) to nitric acid to form a strong oxidizing agent. Reduced cerium ion (Ce (III)) is oxidized into quadrivalent cerium ion by electrolysis to regenerate the oxidant. Its principle is shown in Fig.10.

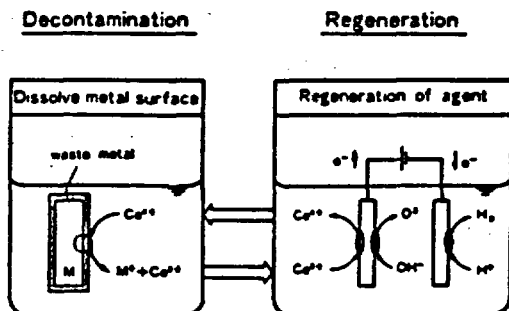

Fig.10 Principles of REDOX Decontamination

Unlike electropolishing decontamination, this process has its electrolytic and decontamination steps clearly separated. Since its decontamination is based on the electro-chemical reaction between solution and metallic surface, it resulted in a high DF and uniform dissolubility.

The WDF has been operated as a cold decontamination experiment system (with a 100-liter decontamination bath) since 1985 and has verified the validity of its highly uniform dissolubility in polishing tests on plates and valves with different surface roughnesses.

This process, however, is not free from problems due to the strong acidity of quadrivalent cerium ion. Such problems include the selection and evaluation of the equipment component materials and the treatment of spent decontamination solutions. These will be solved through subsequent studies plus hot tests to be conducted on actual wastes.

5. DEVELOPMENT OF DISMANTLING TECHNIQUES

Facilities, machines and equipment used in the nuclear fuel cycle are diverse in construction, configuration and material. Thus, it is essential to evaluate the applicability, safety and efficiency of dismantling techniques under development.

In its efforts to develop dismantling operations, the WDF places greater emphasis on plasma cutting technique which has wide applicability to many components. In the WDF, large-size wastes generated in OEC have been cut by a plasma arc or a hacksaw, and operation of the plasma torch with a master slave manipulator and preliminary plasma cutting robot have been demonstrated. In the same way, various methods, peripheral techniques and remote control techniques for dismantling are being developed.

5-1 Plasma Cutting Robot

In order to dismantle large-size equipment and machines of complex configuration installed in high-radiation and high-contamination areas, it is essential to use remote control techniques for automatic, efficient and safe dismantling and removal operations.

In 1984 a plasma cutting robot (Photo.8) was installed in WDF, as a modified version of industrial robots, as a link in the development of remote control technology to verify its usefulness in the dismantling of wastes from operating plants. This robot was based on a teaching playback method, in which a cutting path on an object is preliminarily taught to the robot and cutting is made to the given cutting path. If the object to be cut has a complex configuration, its teaching procedure takes much time. To solve this problem, some notable improvements have been made, i.e. the addition of a voltage arc sensor which will feedback voltage fluctuations to the robot during cutting for automatic operation. In addition a non-contact type laser distance sensor, a joy stick and a master arm (Photo.9 and 10) have been added.



Photo.8 Plasma Cutting Robot

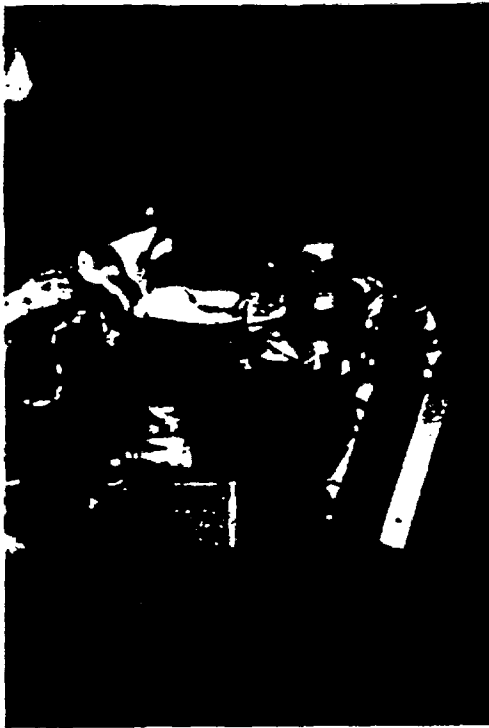

Photo.9 Laser Distance Sensor



Photo.10 Controller

Based on the dismantling method, algorithm and many other design factors obtained from the WDF robot, a small-size portable robot for decommissioning use is now being developed. Its design concept is shown in Fig.11.

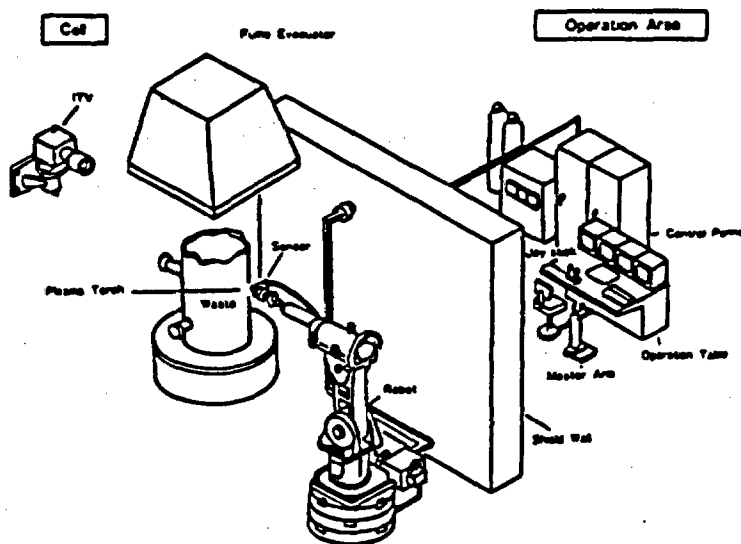

Fig.11 Concept of D/D Plasma Robot

6. DEVELOPMENT OF MONITORING TECHNIQUES

Efficient and safe decommissioning operation addresses importance to monitoring techniques by which to determine the quantity and distribution pattern of contaminated nuclides.

PNC is developing a radiation image display (RID) which could be replaceable the conventional smear method and direct survey method and provide a reliable and quick means of evaluating the distribution of nuclide contamination by remote control.

6-1 Radiation Image Display (RID)

To improve measurement and evaluation efficiency for decommissioning, to decrease radiation exposure during the work and also to improve the reliability of measurement data, PNC has been developing a radiation image display capable of remote and automatic measurement and image display of the distribution of radioactive substances.

Its operating principle is to run a collimated γ ray detector and distance meter to scan across a contaminated object to be measured and obtain radiation information and distance information, from which a computer will create a picture of the distribution of radioactive substances (evaluation picture) composed of 1,500 to 9,000 plots divided into ten color levels and then will display the picture on a TV monitor as a synthetic image.

The measurement principle is illustrated in Fig. 12. Photo.11 shows the prototype equipment No. 1 manufactured in 1986.

Table.3 Specification of RID No.1

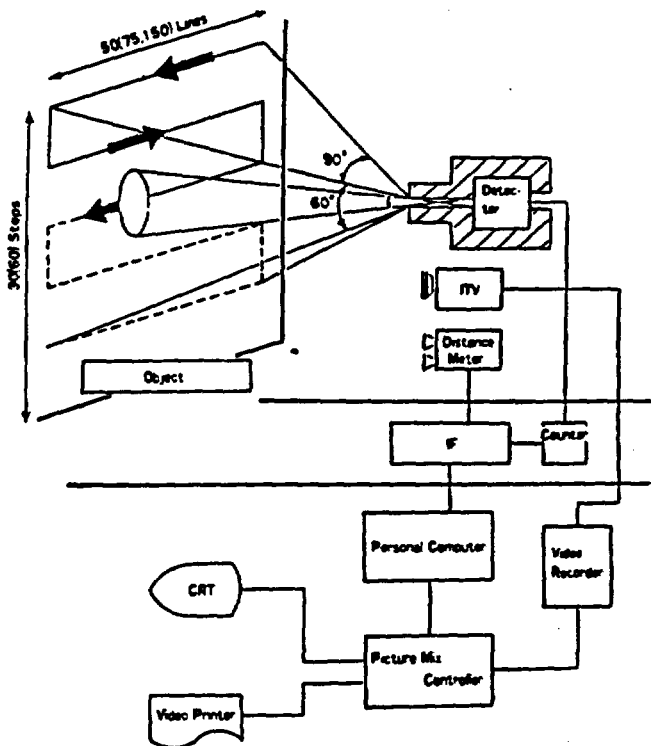

ITEM	RID (I)
γ Detector	CsI(Tl)-PD $\phi 28 \times 50(\text{mm})$
Shielding Material	Tungsten
Shielding Thickness	50mm
Shielding Power (γ Energy: 1MeV)	1/100
Detector Weight	-50kg
Detector Dimension	300(W) \times 350(D) \times 900(H)
Cable Numbers	5
Measurement Time	10, 15, 30, 60 min
Calculation Time	3min

Fig.12 Composition of Radiation Image Display

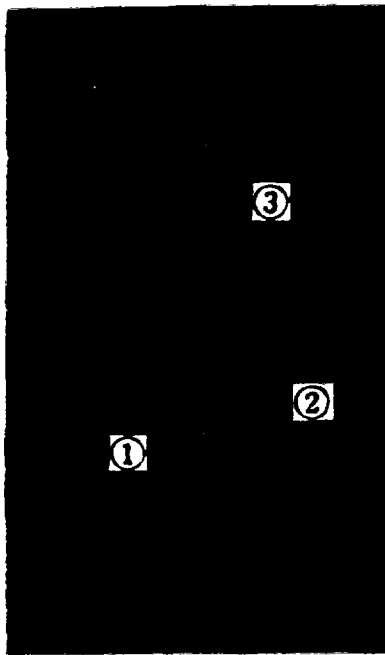

Detecting section

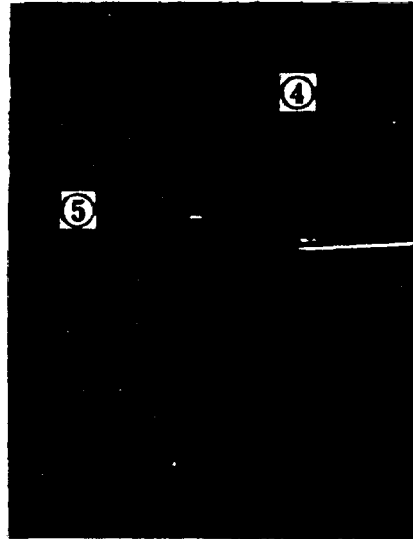

Data processing section

- ① Collimator. ② TV camera. ③ Upper box .
- ④ Personal computer. ⑤ Image display equipment

Photo.11 Radiation Image Display Unit

Photo.12 shows the results of measurements on a liquid waste tank. The TV monitor shows the entire measurement range. The evaluation picture gives a counting value at each plot in ten color levels (red-yellow-green-blue-non color)with the largest counting value of the plots in the picture placed as the upper limit. The synthetic image of both the screen and the picture provides information about radioactive substances deposited on the bottom of liquid waste tank.



Photo.12 Example of Liquid Waste Tank Measurement

The applicability of this equipment was evaluated in a test made on wastes and a liquid waste tank. The results obtained from the test are shown below:

(1) Measurement of wastes

The measurement results of a 200-liter drum containing processed wastes are shown in Photo.13.

The evaluation of the result clearly indicates the location of radioactive substances existing in spots.

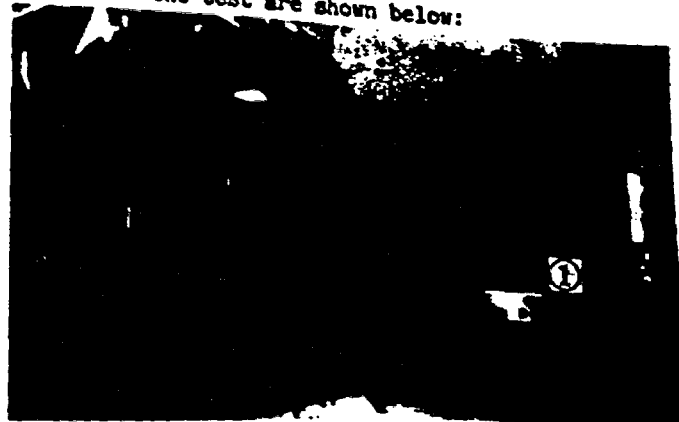

① Sealed position of radioactive substances

Photo.13 Result of 200-liter Drum Measurement

(2) Measurement of a liquid waste tank before and after decontamination

A tank containing liquid waste from the cleaning of FBR fuel assemblies was decontaminated with high-pressure water. This decontamination process was evaluated by this equipment. Images obtained before and after decontamination are shown respectively in Photo.14. The measurement was done over 30 minutes and from a distance of 3.5 meters.

It is noted that the high-pressure water decontamination carried highly contaminated deposits, which is observed at the top of tank before the decontamination, to the bottom of tank.



Before decontamination

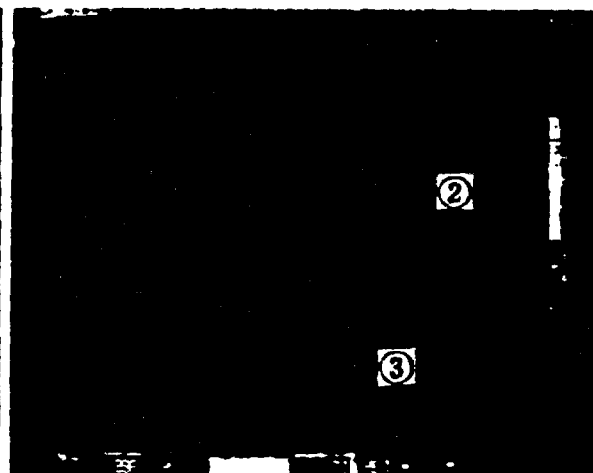

After decontamination

The display of high-level contamination ① shifted to the display of low-level contamination. ② and ③.

Photo.14 Evaluation of Liquid Waste Tank before and after Decontamination

7. CONCLUSION

We will continue the development of decontamination and dismantling technologies undertaken by WDF to establish techniques that can validate the safety and economy of various nuclear fuel cycle facilities.

8. REFERENCES

E. INADA, et al: "Development of Electropolishing Decontamination Technique for Surface Contaminated TRU Wastes" (text in Japanese), Annual Meeting of the Atomic Energy Society of Japan, 1986.

T. MANO, et al: "Development of Ice Blasting Decontamination Technique for Surface Contaminated TRU Wastes" (text in Japanese), Fall Meeting of the Atomic Energy Society of Japan, 1987.

H. MIYAO, et al: "Development of Radiation Image Display", Annual Meeting of the Atomic Energy Society of Japan, 1988.

M. SHIOTSUKI, et al "Decommissioning of Nuclear Fuel Facilities Technological Experiences and R&D", SPECTRUM'88, 1988.

FBR Development
in PNC
for
Commercialization





Construction of "Monju", A Prototype Fast Breeder Reactor

The construction of Monju is now 85% completed at the end of June 1990. All the components is scheduled to be installed by April 1991. The target date for initial criticality is October 1992.

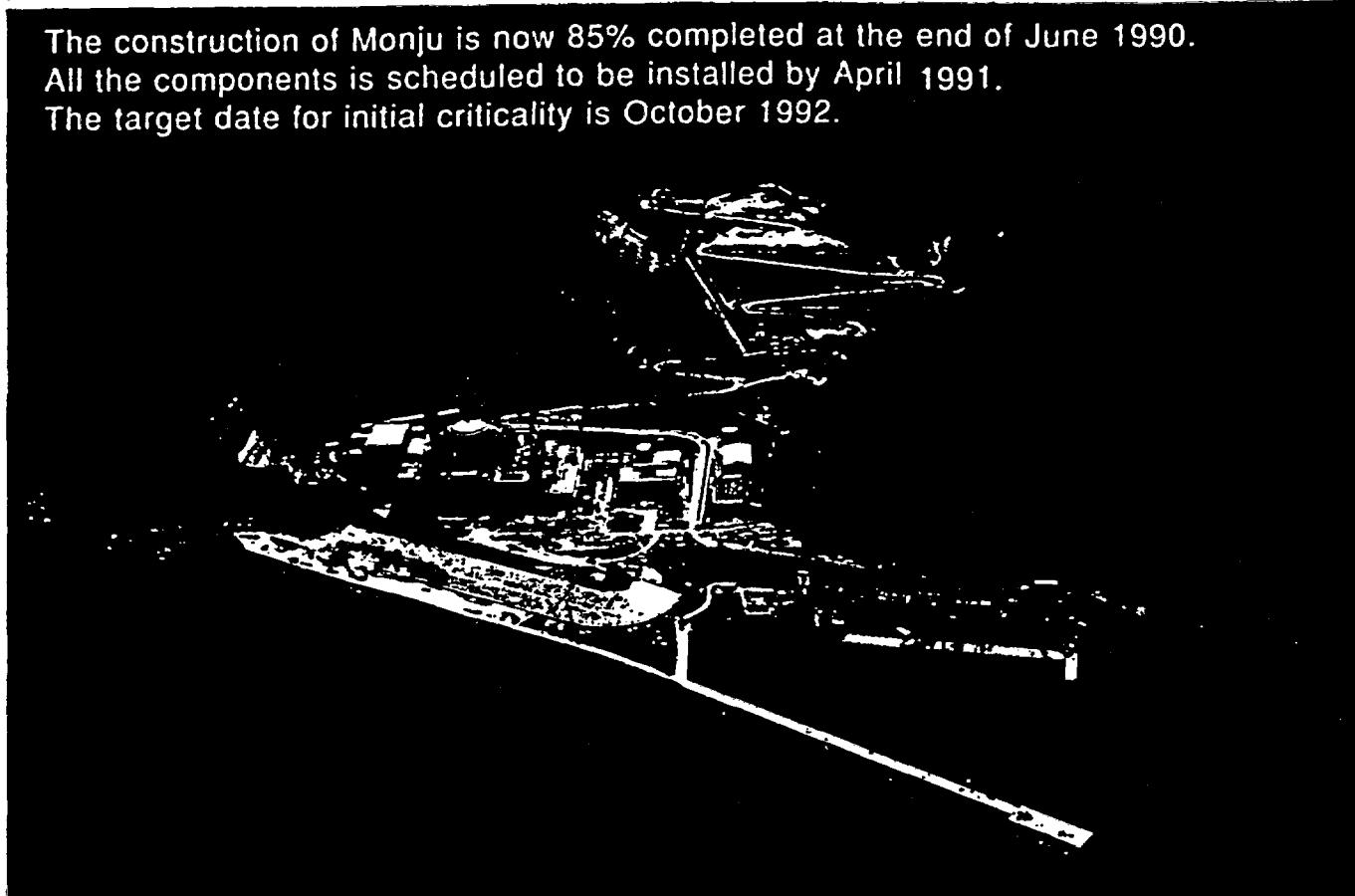

Aerial view of Monju, May 1990

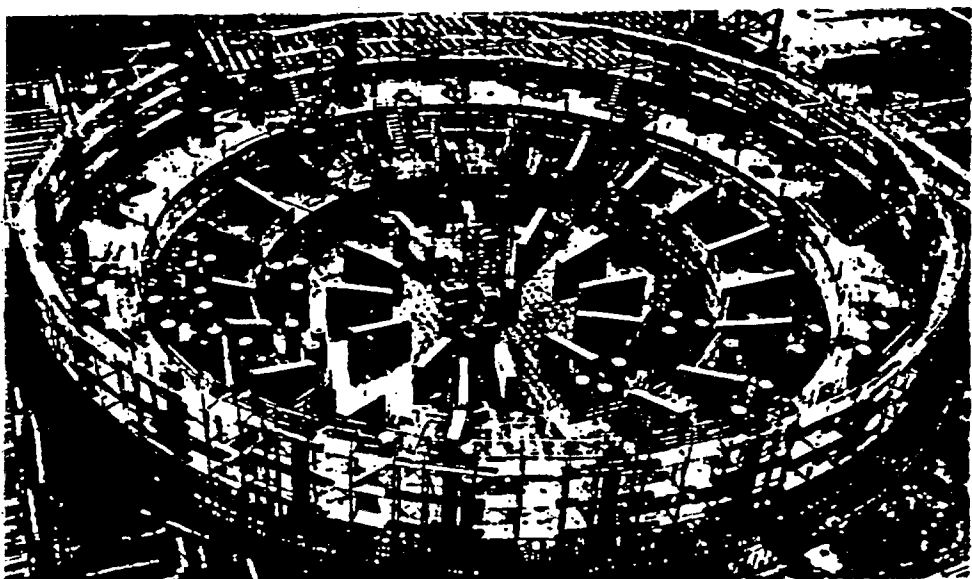

Excavation completed in May 1986



Reactor containment vessel completed in April 1987

CONSTRUCTION SCHEDULE OF MONJU

FISCAL YEAR	'84	'85	'86	'87	'88	'89	'90	'91	'92	'93
KEY MILESTONE		EXCAVATION START OCT '85	BASEMAT CONCRETE START FEB '86		REACTOR VESSEL SET OCT '88				INITIAL CRITICALITY OCT '92	

Research and Development on Plutonium Fuel

PNC's Tokai Works is mainly developing and manufacturing plutonium fuel, developing reprocessing technology, treatment and disposal of high level radioactive waste and uranium enrichment.

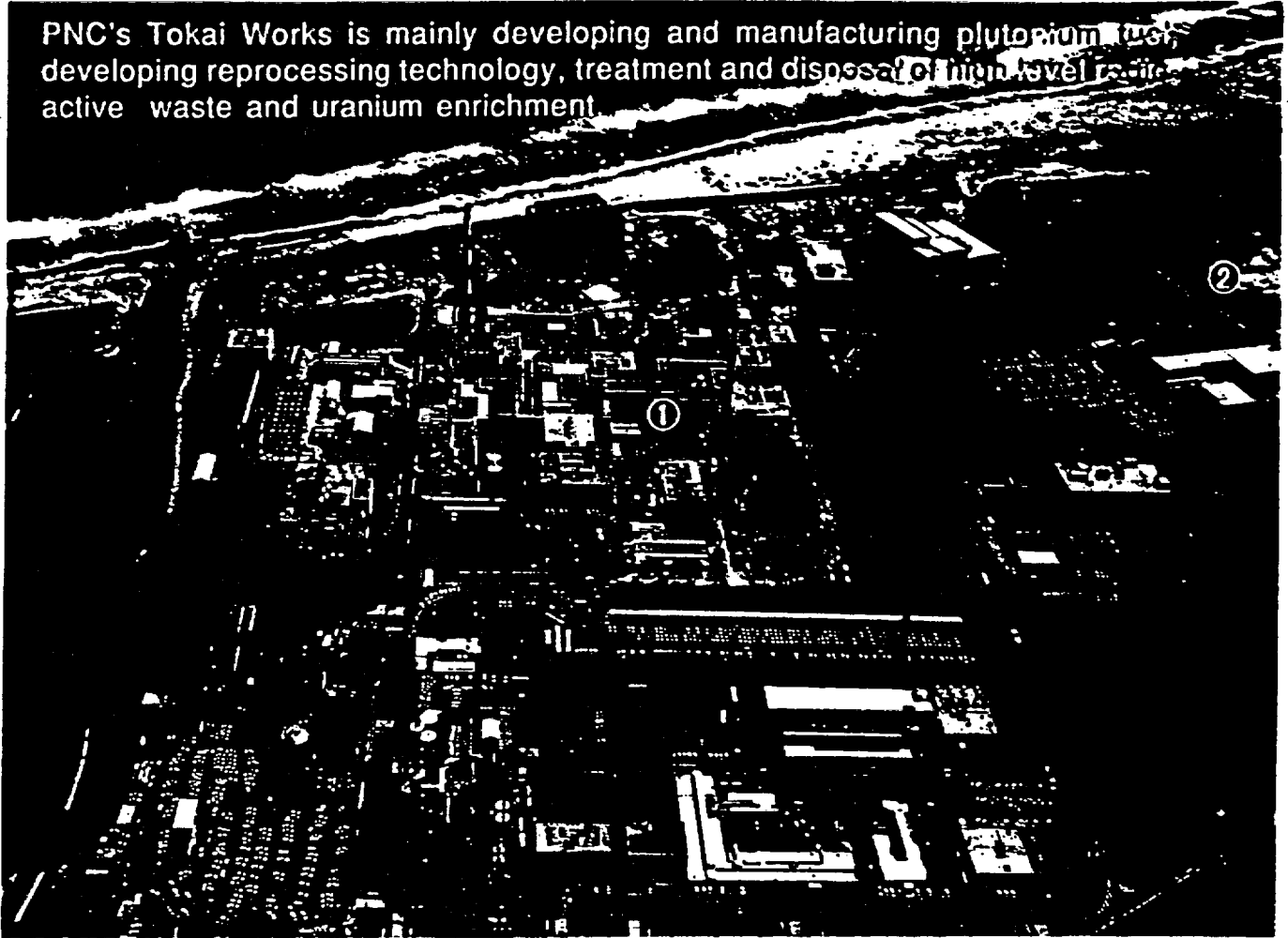

Aerial view of Tokai Works

① The Tokai Reprocessing Plant

② Plutonium Fuel Facilities at Tokai

An essential element of fuel for new reactors such as the ATR and FBR is plutonium - a byproduct of nuclear reactor operation that can be recovered from spent fuel. The plutonium is combined with uranium to form mixed oxide (MOX) fuel.

Since MOX fuel consists of both uranium and plutonium, an effective non-proliferation measure is to mix the two and convert them to oxide immediately after extracting the plutonium.

PNC developed its own process, called the "microwave-heating direct denitration process," to carry out this co-conversion. It has been used since 1979 at the Tokai Plutonium Fuel Fabrication Facility (PFFF). The Tokai Plutonium Conversion Development Facility, with a daily co-conversion capacity of 10kg MOX, went into operation in 1983, using plutonium nitrate and uranium nitrate from the reprocessing plant to produce MOX powder for ATR Fugen, FBR Joyo, and FBR Monju.

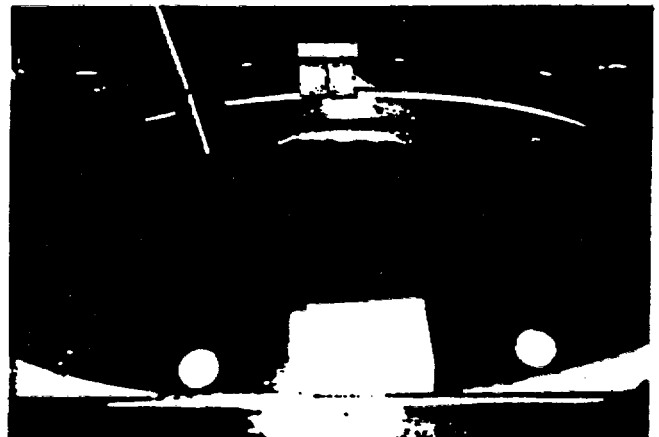

Uranium-plutonium mixed oxide (MOX) powder

"Monju" is a 280MWe Reactor Cooled by Liquid Sodium in Three Loops

Cutaway view of FBR Monju

- 1 Core
- 2 Reactor vessel
- 3 Control rod drive mechanism
- 4 Fuel handling machine
- 5 Shielding plug
- 6 Guard vessel
- 7 Intermediate heat exchanger
- 8 Primary main pump
- 9 Primary heat transport system piping
- 10 Secondary heat transport system piping
- 11 Containment vessel
- 12 Ex-vessel transfer machine
- 13 Secondary main pump
- 14 Evaporator
- 15 Superheater
- 16 Auxiliary coolant system/Air cooler
- 17 Sodium-water reaction product tank
- 18 Ex-vessel storage tank
- 19 Steam, feedwater system piping

- 20 Steam turbine
- 21 Condenser
- 22 Generator
- 23 Transformer
- 24 Polar crane
- 25 Vent stack

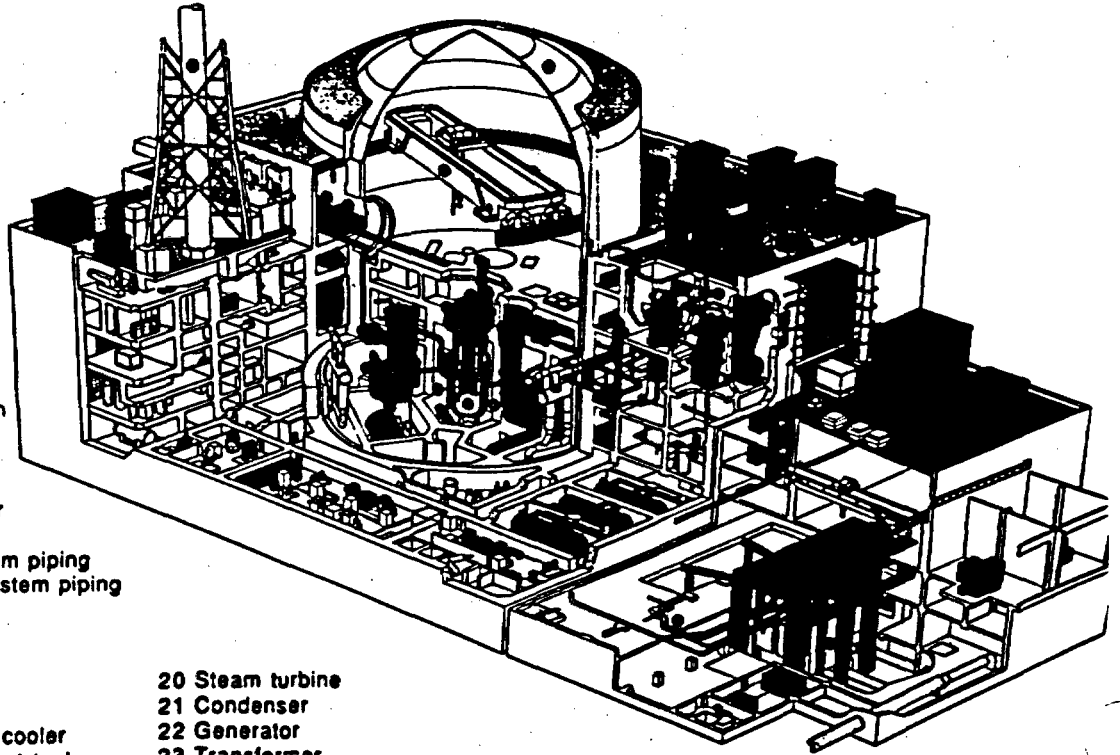

Reactor vessel installed in October 1988

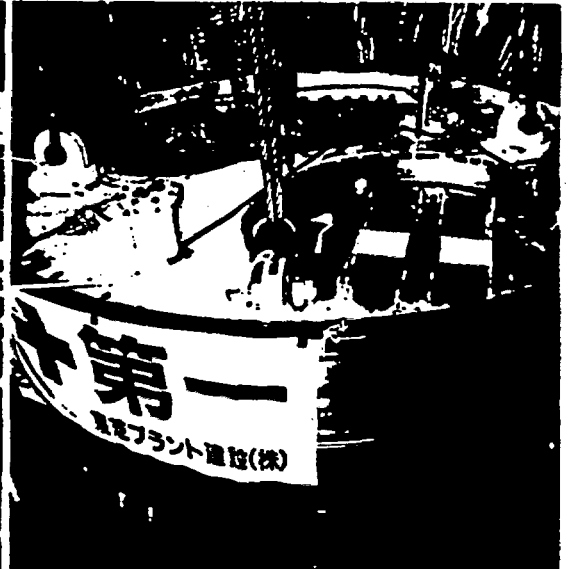

Installation of shielding plug started in May 1990

MONJU Plant Parameters

Reactor type	Mixed oxide fuel, sodium cooled, fast neutron breeder reactor, loop type	Secondary sodium temperature (IHX outlet/inlet)	505/325°C
Thermal power	714MW	Type of steam generator	Helical coil, once-through unit type
Electrical power	280MW	Steam temperature (Turbine inlet)	483°C
Fuel material	PuO ₂ -UO ₂	Steam pressure (Turbine inlet)	127 kg/cm ² g
Discharged fuel average burnup rate	80000MWd/t	Refueling system	Single rotating plug with fixed-arm fuel handling machine
Breeding ratio	1.2	Refueling interval	6 months
Number of loops	3		



R&D for Advanced Power Reactors

PNC's O-arai Engineering Center is carrying out the R&Ds for FBRs and HWRs.

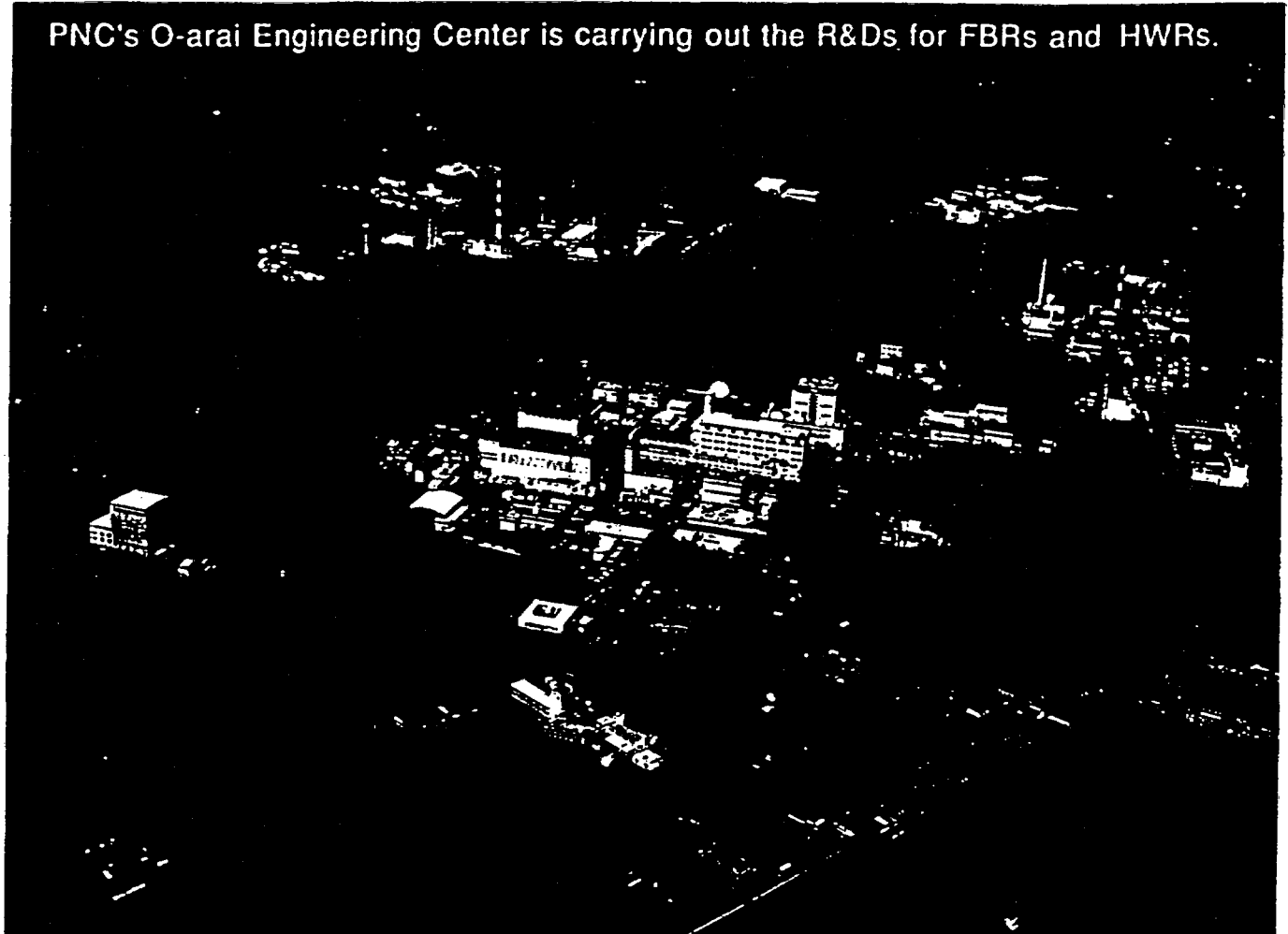

Aerial view of O-arai Engineering Center

Although conventional light water reactors will continue to provide the majority of Japan's nuclear-generated electricity into the next century, the government has designated the development of fast breeder reactors as a top priority. PNC is working toward this goal with the development of the Joyo and Monju FBRs.

Because they utilize uranium resources so efficiently, FBRs represent the ideal nuclear power source for Japan's future. The FBR, which can be fueled by plutonium recovered from spent fuel, is often called the "ultimate reactor." It not only generates electricity, but actually creates more fuel than it consumes by converting U-238 in the fuel to Pu-239. After the year 2030, the FBR is expected to take over as Japan's chief source of nuclear energy.

PNC's role is to carry out R&D to develop commercial-scale FBRs that are competitive with LWRs in terms of safety and economy.

This work involves many new technologies, such as the use of uranium-plutonium mixed oxide (MOX) fuels and the use of efficient yet chemically active liquid sodium coolant.



Development of computer analysis code for major structures as a reactor vessel and related components

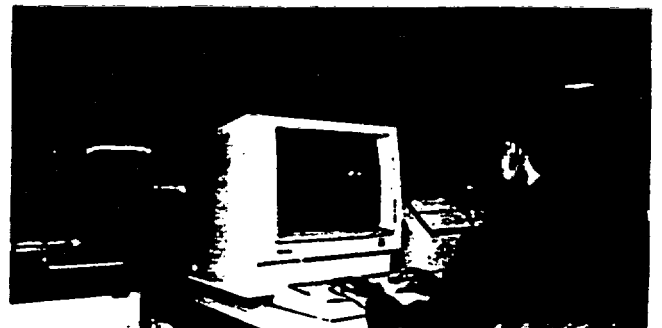

MOX Fuel Production at PNC

(March 1990)

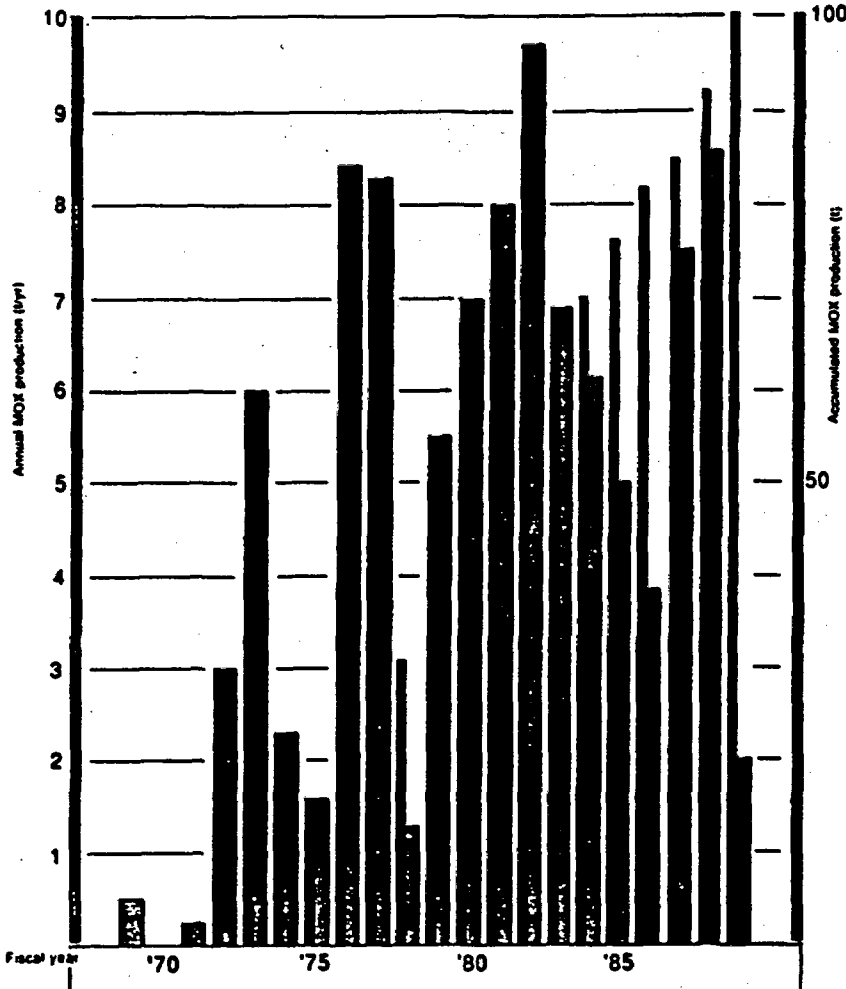

Our work in this area began with basic research on plutonium handling, MOX fuel properties, and fuel fabrication at the Tokai Plutonium Fuel Development Facility (PFDF). Technology developed here was confirmed on a larger scale at PFFF, which began producing fuel in 1972 and has supplied fuel for experimental FBR Joyo and prototype ATR Fugen. Initial core fuel assemblies were completed for Joyo in 1975 and for Fugen in 1978.

The next step is the demonstration of mass production technology in the Tokai Plutonium Fuel Production Facility (PFPF), which will supply large quantities of fuel to FBRs Monju and Joyo and to the demonstration ATR. The FBR fuel production line at PFPF started operation in 1988 with a capacity of 5 tons of MOX fuel per year. Another line now under construction will supply 40 tons of MOX fuel per year for the demonstration ATR and other plants. It is scheduled to start operation in 1993.

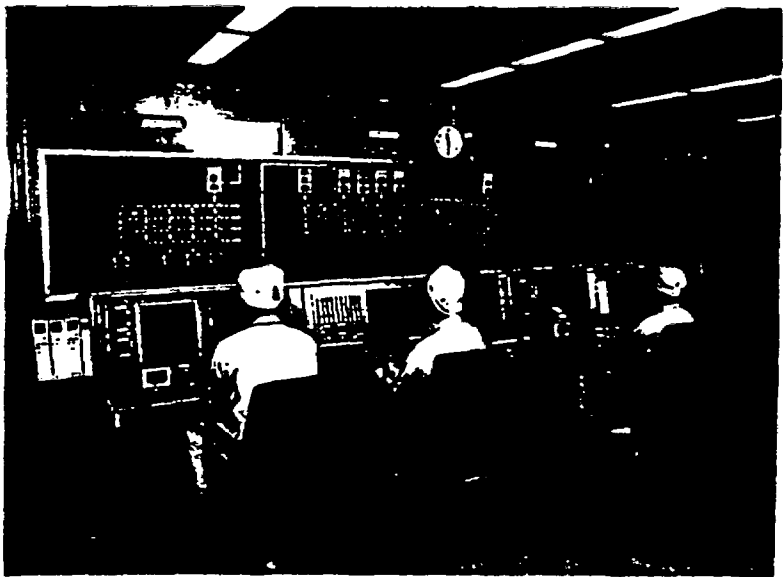

Automation system for pellet

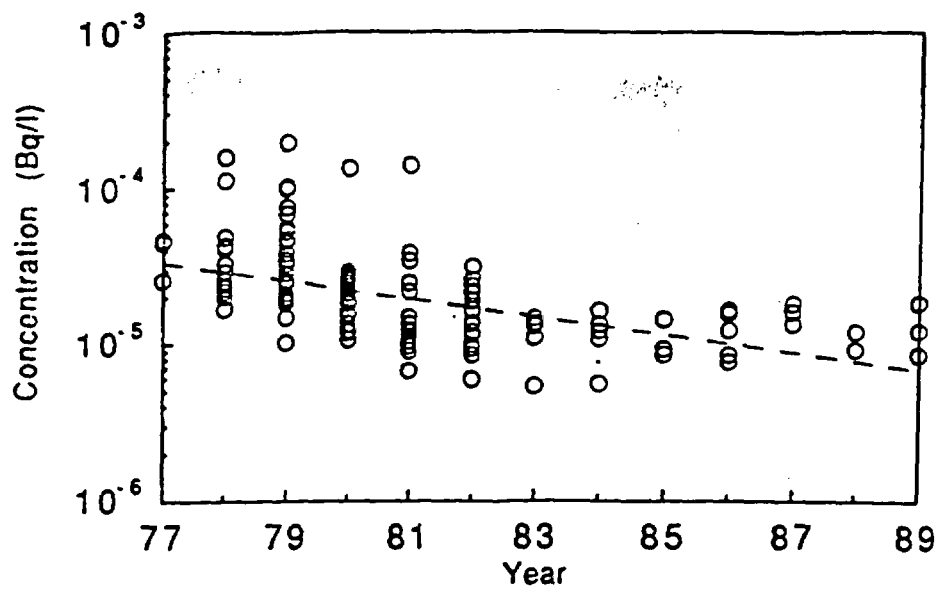

Fig. Concentration of $^{239,240}\text{Pu}$ in Sea Water off-shore Tokai-mura.

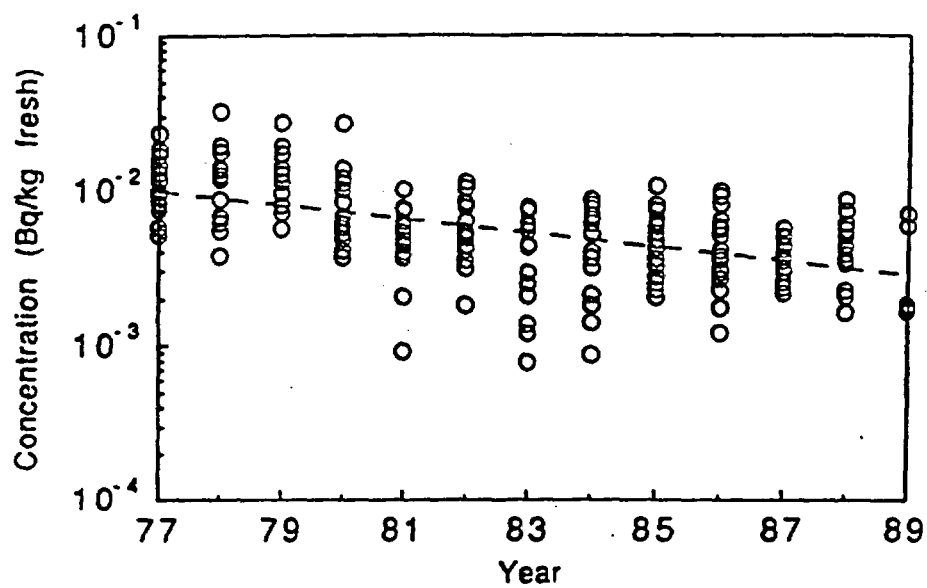
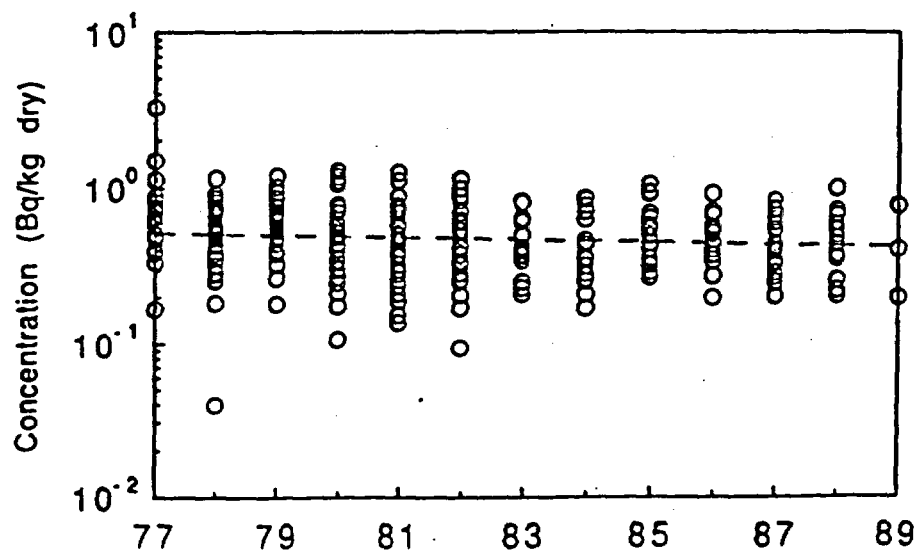

Fig. Concentration of $^{239,240}\text{Pu}$ in Seaweed off-shore Tokai-mura.



Comparison of Dose Equivalents
from Natural Radionuclides and
Radionuclides Discharged from
Tokai Reprocessing Plant

The height of poles means the amount
of radiation exposure to an individual
in a year.

*The radiation exposure from radionuclides
discharged from the reprocessing plant is
less than one-hundredth of the exposure
from natural radionuclides including
radon and thoron and these daughters.*

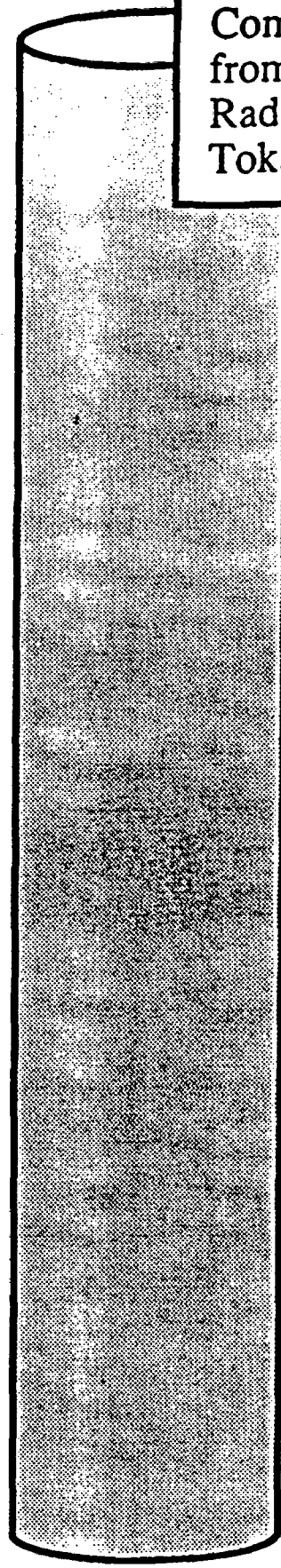
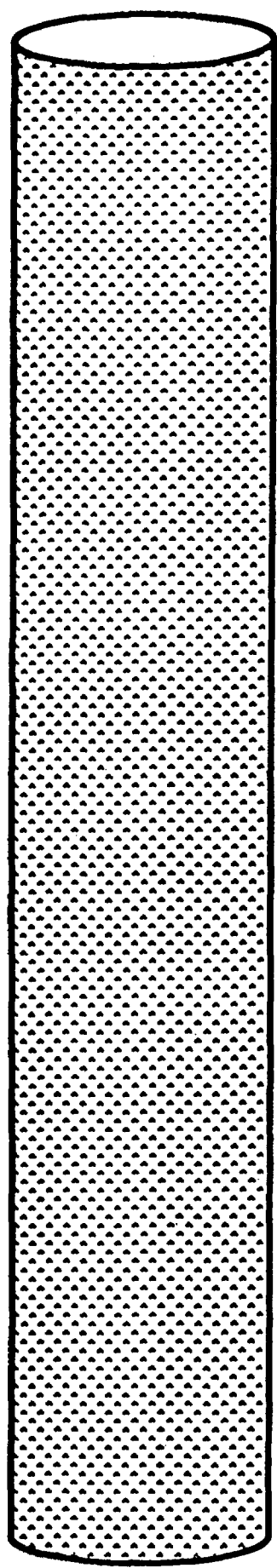

Inhalation of Radon

Natural Radionuclides
except for Radon and

Radionuclides Discharged
from Reprocessing Plant

RESEARCH AND DEVELOPMENT
IN OARAI ENGINEERING CENTER

November 7

OARAI ENGINEERING CENTER,
POWER REACTOR AND NUCLEAR FUEL DEVELOPMENT
CORPORATION

RESEARCH AND DEVELOPMENT IN OARAI ENGINEERING CENTER

1. Mission of Oarai Engineering Center ... P. 1
2. Outline of Oarai Engineering Center ... P. 2
3. Research and Development on Fast Breeder Reactors(FBRs) P. 6
4. Research and Development on Advanced Thermal Reactors(ATRs) P. 9
5. Research and Development on Fuel Recycling P.10
6. 'Frontier' Research P.11
7. Facilities for Research and Development in Oarai Engineering Center P.13

1 Mission of Oarai Engineering Center

◎ Research and Development of Key Technologies Associated with FBR & ATR Power Plants (Plant Systems, Fuels and Core, Sodium Technologies, Components, Safety, etc.).

(1) Design Studies for Framing Plant Systems with Safety and Economic Competitiveness

(2) Research and Development on Base Technologies and Innovative Technologies

(3) Research and Development Using Experiences Obtained through Construction and Operation of Joyo and Monju, and Fugen.

◎ Research and Development on Fuel Recycling
Research and Development on Decommissioning, Nuclear Criticality, etc. of Fuel Recycling Facilities

2 Outline of Oarai Engineering Center

(1) Schema of Oarai Engineering Center (Location of Facilities)

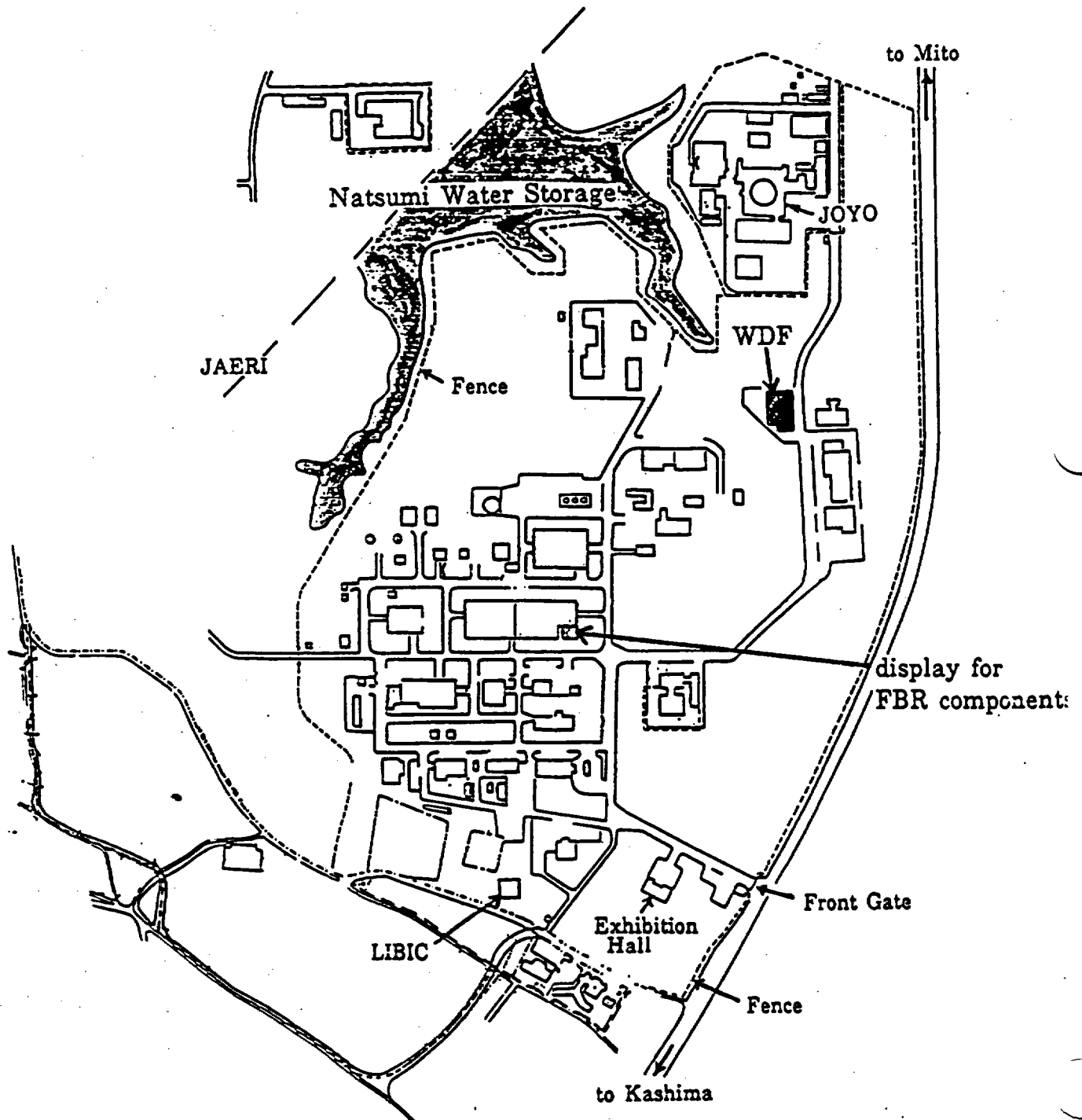

Site Area : 679,663 m²
No. of Main Buildings : ~50

(2) Organization of Oarai Engineering Center

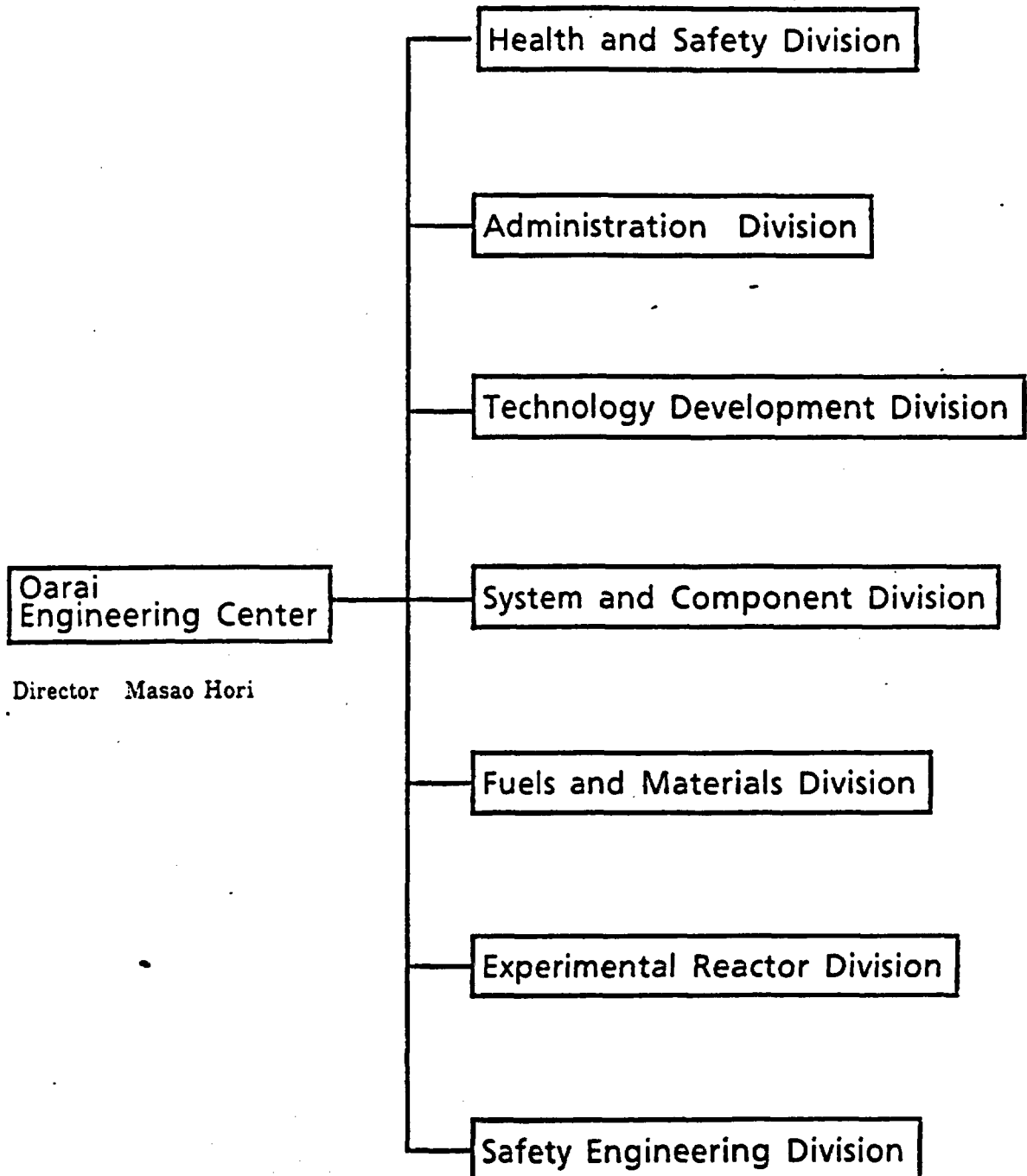

(3) Chronology of Oarai Engineering Center

- Oct.1967 Foundation of Power Reactor and Nuclear Fuel Development Corporation
- Dec.1969 Initial Nuclear Criticality in the Deuterium Criticality Assembly (DCA)
- Mar.1970 Establishment of Oarai Engineering Center
- May.1970 Start of the Fast Experimental Reactor "Joyo" Construction
- July 1974 Start of 50MW Steam Generator Test Facility Operation
- Apr.1977 Initial Nuclear Criticality of "Joyo"
- Nov.1982 First Nuclear Criticality of "Joyo" Irradiation Core(MK-II Core)
- Sep.1984 Completion of the Fuel Cycle 'Loop' Using "Joyo"

- Feb.1987 Agreement between "Joyo" and "Phenix" on Exchange Irradiation of Fuel Assembly
- Mar.1989 Contract of Technical Cooperation Agreement between PNC and JAPC for Research and Development of the Demonstration Fast Breeder Reactor.
- DEC.1989 Achievement of 40,000 accumulating hours' Operation for "Joyo"

3. Research and Development of FBRs

(1) Extensive Preparations for the Prototype FBR "Monju" Operation on Items As Follows

- Planning of Start-up Test Program
- Research and Development for Operation, Maintenance and Repairing
- Training for "Monju" Operators

(2) Cooperation for the Demonstration FBR

Cooperation Based on Technical Agreement between PNC and JAPC

- ① Application of Operation Experience on "Joyo"
- ② Application of R&D Results Obtained in Oarai Engineering Center
- ③ Conduct of R&D Associated with the Demonstration FBR by Utilizing Technical Capabilities of Oarai Engineering Center

(3) Research and Development for Commercial Type FBRs

① Framing of Concepts for Commercial Type FBR Plants

○ Conceptual Design Studies for These FBR Plants

② Research and Development of Key Technologies

i) Development of High Performance Fuel

ii) Development of Large Reactor Core with High Performance

iii) Development for Higher Temperature Service of Plant System

iv) Rationalization of Component, Piping and These Layout

v) Development of Rationalized Reactor Containment System

vi) Development of Seismic Isolation Structures

- vii) Development of Plant System without Intermediate Heat Transport System
 - viii) Development of Decay Heat Removal System with High Reliability
 - ix) Reduction of Radiation Exposure during Maintenance
 - x) Establishment of Rational Safety Logic
- ③ Utilization of "Joyo"
- i) Modification to a highly Efficient Irradiation Facility
 - ii) Development of Advanced Technology and Concepts

4 Research and Development of Advanced Thermal Reactors(ATRs)

- (1) Cooperation to the Demonstration ATR
(Oma Nuclear Power Station in Aomori Pref.)
 - Conduct of Tests to Ensure Designing of the Demonstration ATR under Contract with Electric Power Development Corporation

- (2) Research and Development of Base Technologies
 - Conduct of High Performance Fuel Development, and of Safety Research Associated with Severe Accidents

5 Research and Development on Fuel Recycling

(1) Research and Development on Fuel Recycling

- ① Conduct of Development concerning De-commissioning Technologies Common to Fuel Recycling Facilities
- ② Conduct of Research Concerning TRU Transmutation Treatment Technologies by Utilizing FBR
 - Planning of Transmutation Demonstration Tests in the Fast Experimental Reactor "Joyo"
- ③ Conduct of Research for Waste Disposal Technology

(2) Research on Nuclear Criticality Safety

- Conduct of Research Concerning Nuclear Criticality Safety Necessary for FBR Recycling Facilities by Using DCA

6. 'Frontier' Research

Conduct of the Following 'Frontier' Research Subjects for Innovation and Improvement of Advanced Power Reactors

(1) Research for Nuclear Reactor Materials

- New Materials Resistant to High Temperature
- New Materials Resistant to Neutron Irradiation

(2) Research on Artificial Intelligence Technologies for Nuclear Reactor Plants

- Conduct of Research and Development for Nuclear Reactor Plants with Artificial Intelligence Systems
- Demonstration Tests of Artificial Intelligence Systems in Joyo.

(3) Diversification of Plutonium Utilization

- Conduct of Research on FBRs Using Advanced Fuels, Small- and Medium-Sized FBRs, Inherent Safe FBRs, etc.

7. Facilities for Research and Development in
Oarai Engineering Center

Present Facilities under Operation ;

- (1) Reactor Facilities (Joyo and DCA)
- (2) Test Facilities for Post-Irradiation
Examination
- (3) Test Facilities for Developments of
Components and Structures
- (4) Test Facilities for Safety Research
- (5) Test Facilities for Fuel Recycling
- (6) Administration Facilities for Health
and Safety

◎ Total No. of Facilities : 34

New and Modified Facilities under Planning ;

- (1) Expansion of the Fuel Monitoring Facility for MONJU and Other Large LMFBR Fuel Assemblies
- (2) Modification of Joyo for Improvement of Irradiation Capabilities and Demonstration of Innovative Technologies (Joyo MK-III Program).
- (3) Modification of DCA for Research of Nuclear Criticality Safety
- (4) Construction of a Information Center for Advanced Utilization of Computers
- (5) A Safety Test Reactor "SERAPH"^{*} for FBR (Under Investigation)

* Safety Engineering Reactor for Accident
Phenomenology

Technical Draft for Comments
R D & D Program
on
Low-Level T R U Bearing Waste
Management Technologies

March 1, 1990

Power Reactor and Nuclear Fuel Development Corporation
(PNC)

Translated into English and Prepared
by
Radioactive Waste Management Project, PNC
in
February 1990
for
the U.S. Department of Energy

Technical Draft for Comments
R D & D Program
on
Low-Level T R U Bearing Waste
Management Technologies

March 1, 1990

Radioactive Waste Management Project
Power Reactor and Nuclear Fuel Development Corporation

CONTENTS

1. Incineration	1
(1) Acid Digestion	1
(2) U-contaminated Waste Incineration	1
(3) TRU-contaminated Waste Incineration	1
(4) Cyclone Incinerator	3
(5) β γ Waste Incinerator	3
2. Decomposition	5
(1) Immobilization of Spent Solvent into Inorganic Stable Form	5
3. Separation and Removal	7
(1) Pu Recovery from Incinerated Ash	7
(2) CP Separation/Removal Technology	7
(3) Separation of Long-lived Nuclides from Low-level Liquid Concentrate ...	7
(4) Nuclide Separation from Spent Solvent	9
(5) Nuclide Separation from Low-level Liquid Waste	9
(6) Iodine Removal from Spent Solvent	9
4. Decontamination	11
(1) Decontamination with Melting	11
(2) Electropolishing I	11
(3) Electropolishing II	13
(4) Redox	13
(5) Ice Blasting	15

5. Dismantling	17
(1) Plasma-arc Cutting	17
(2) Laser Cutting	17
6. Immobilization (Stabilization)	19
(1) Micro-wave Melting	19
(2) Electro-slag Remelting	19
(3) HIP Solidification	21
(4) Dehydrating and Solidification with Micro-Wave	21
(5) Solidification of Separated Nuclide Residue	21
(6) Hydrothermal Solidification	23
(7) Cementation	23
(8) Krypton Immobilization	23
(9) Plastic Solidification	23
(10) Flame Retardation of Bitumen	25
(11) Bituminization	25
7. Solidified Waste Characterization	27
(1) Evaluation of Synthetic Minerals produced at PWTF	27
(2) Evaluation of Metal Ingots produced at PWTF	27
(3) Compressive Strength Measuring Test of Plastic-solidified Waste	27
(4) Evaluation of Bitumen	29
(5) Surface Contamination Measurement Test	29
(6) Verification Test of Solidified Waste Homogeneity	29
8. Source Term	31
(1) NDA	31
(2) Scanner for Solidified Waste	31

9. Facility Management	33
(1) PWF Operation Supporting System	33
(2) Automation and Remotization of α Hall	33
(3) Hull Retrieval Technology	33
(4) Radiation Image Display (RID)	35
10. Miscellaneous	37
(1) Treatment of Alcoholate Liquid Waste	37
(2) Purification of Recovered Xenon	37
(3) De Minimis Level Measurement Technique	37
(4) Entrusted Research of	
"Hot Treatment Test of Concentrated Liquid Waste"	37

1. Incineration

Incineration technology is to oxidize combustibles such as paper, clothe, etc. and Cl-contained wastes such as PVC by heating or other means, in order to reduce the waste volume and to transform into inorganic materials.

(1) Acid Digestion (Tokai)

Cold engineering test has been conducted at Pu-contaminated Waste Treatment Facility (PWTF) for volume reduction of Cl-contained wastes generated at MOX fabrication facilities etc., and for recovering Pu with acid digestion process characterized by low-temperature treatment. These test results will be reflected to future TRU waste treatment facilities.

(2) U-contaminated Waste Incineration (Waste Plants Operation Division at Tokai)

Vertical fixed-grid fueled incinerator is under hot operation, which object is to reduce the volume of combustible U-contaminated wastes generated at U handling facilities. The operational experiences and know-how will be utilized to the design, construction and operation of U-contaminated Waste Treatment Facility (UWTF).

(3) TRU-contaminated Waste Incinerator (Waste Plants Operation Division at Tokai)

Moving-grid incinerator is under demonstration operation at PWTF, which object is to reduce the volume of TRU Wastes generated at TRU handling facilities. The results will be reflected to the design, construction, etc. of the Low-level Waste Treatment Facility (LWTF).

Item	Fy	1989	1990	1991	1992	1993	1994	1995	1996	1997	1998
	PNTF										
CI-contained-waste Acid Digestion Equipment		Cold Eng. Test		Facility Transfer							
Pu Recovering with Acid Digestion					Cold Test	Pu behavior in Solid-liquid system					
U-contaminated Wastes Incinerator		Study on Facility Concept	Basic Design	Detailed Design	Incinerator operation					Operation	
UNTF				Licensing			Construction	Cold Test			
TRU Wastes Incinerator						Demonstration Test					
LNTF, etc.		Conceptual Design	Detailed Design				Construction		Cold Test	Operation	

(4) Cyclone Incinerator (Tokai)

Self-burning cyclone incineration technology which is characterized by using good-corrosion-resistant electro-melted Alumina for refractories, and non-moving parts, is under demonstration test at PWTf, in order to establish the technology of the volume reduction with incineration for Cl-contained wastes generated from MOX fuel fabrication facilities, etc.

(5) β γ Waste Incinerator (Tokai)

Moving-grid incinerator is under construction to reduce the volume of β γ wastes from Tokai Reprocessing Plant.

Item \ Fy	1989	1990	1991	1992	1993	1994	1995	1996	1997	1998
Cyclone Incinerator (PWTF)			Technology Demonstration			C/R				
LWTF, etc.			Establishing Double-Line System							
β 7 waste Incinerator	Construction		Cold Test			Operation				

2. Decomposition

Decomposition is to transform organic materials into stable inorganic form except oxide by heating, etc.

(1) Immobilization of Spent Solvent into Inorganic Stable Form (Tokai)

RI tracer tests of the advanced technology characterized by incorporation of synthetic mica or hydrated lime and pyrolysis are being carried out to inorganize spent solvent.

Item \ Fy	1989	1990	1991	1992	1993	1994	1995	1996	1997	1998
Immobilization of Spent Solvent into Inorganic Stable Form		RI Test <div style="text-align: center;">○</div>	Evaluation							

3. Separation and Removal

Radioactive nuclides in liquid waste shall be separated and removed by chemical methods such as filtration, precipitation, etc., in order to change the liquid waste into non-radioactive or lower-level waste.

(1) Pu Recovery from Incinerated Ash (Tokai)

In order to reduce the volume of Cl-contained waste from MOX fuel fabrication facilities, etc. and to recover Pu, etc., adhered on the waste, tests of acid digestion characterized by low temperature treatment are currently being carried out at PWTF. The test results will be reflected to future TRU waste treatment facility.

(2) CP Separation/Removal Technology (O-arai)

Radioactive corrosion product (CP) separation/removal process with hollow film and reverse osmosis is under design at "Joyo" Waste Treatment Facility. The objective of the process is removal of CP contained in liquid waste from fuel washing. The results will be reflected to commercial FBR project.

(3) Separation of Long-lived Nuclides from Low-level Liquid Concentrate (Tokai)

In order to dispose of bituminized wastes from Tokai Reprocessing Plant in shallow land burial, long-lived nuclides contained in waste concentrate are planned to be separated and removed as pretreatment of Bituminization by ferrite treatment, precipitation, ion-exchange, etc. The results of cold tests obtained are currently evaluated, and the achievements will be fed to Bituminization Facility (AspF) for practical use.

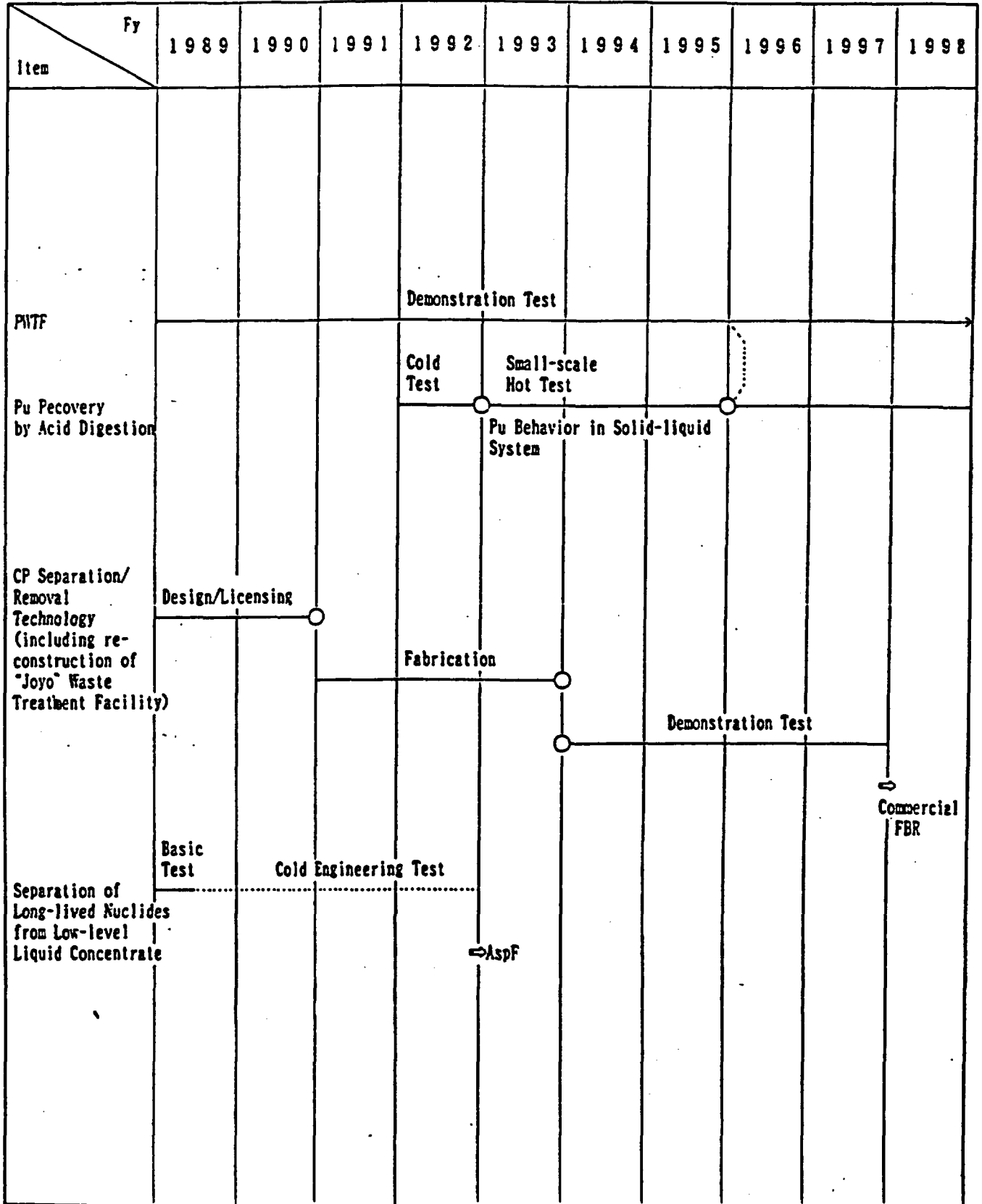

1989 1990 1991 1992 1993 1994 1995 1996 1997 1998

(4) Nuclide Separation from Spent Solvent (Tokai)

This technology is to reduce the radioactive concentration in the liquid waste below the regulatory level of sea discharge, by separation and removing the radionuclides in phosphoric-acid liquid waste with coprecipitation-ultrafiltration, etc., after inorganization of spent solvent into phosphoric-acid waste using hydro peroxide. The results will be reflected to the design of LWTF.

(5) Nuclide Separation from Low-level Liquid Waste (Tokai)

The objective of the technology is the volume reduction of low-level concentrated liquid waste, etc., generated in Tokai Reprocessing Plant. The technology will enable to reduce the concentration of the radioactive nuclides in liquid waste below the regulatory level of sea discharge, by adsorption, coprecipitation-ultrafiltration and ion-exchange. Cold basic test using simulated waste is currently implemented, and the results will be reflected to the design of LWTF.

(6) Iodine Removal from Spent Solvent (Tokai)

In order to reduce iodine concentration discharged to the environment, hot test of removal(adsorption, etc.) of iodine contained in spent solvent, TBP and dodecane is currently being conducted. The results will be reflected to Solvent Waste Treatment Demonstaration Facility (STF) for practical use.

Item \ Fy	1989	1990	1991	1992	1993	1994	1995	1996	1997	1998
Nuclide Separation of Spent Solvent	Basic Test	Engineering Test		C/R ▽						
					↳ LNTF					
Nuclide Separation of Low-level Liquid Waste	Cold Basic Test	Hot Basic Test	Engineering Test	C/R ▽						
					↳ LNTF					
Iodine Removal from Spent Solvent		Evaluation Test		Design/Reconstruction of STF						
							Development Test			

4. Decontamination

Decontamination technology enables to remove radioactive nuclides adhered on solid wastes by chemical or mechanical methods. The objective is to change the radioactive solid wastes into non-radioactive or lower-level wastes.

(1) Melt Decontamination (Tokai)

Melt decontamination can achieve the volume reduction and decontamination of metal wastes, simultaneously. The electro-slag melting is currently under cold and hot testing at PWTF for volume reduction and stabilization of TRU-contained metal wastes. The test results will be reflected to the future TRU waste treatment facility projects such as LWTF, Hull Waste Treatment Facility (HWTF), etc.

(2) Electropolishing I (Tokai)

Electropolishing will be utilized to decontaminate the surface of metal wastes for volume reduction of TRU contaminated metal wastes generated at reprocessing plants and MOX fuel fabrication facilities. Hot test is currently being carried out using active metal wastes, and the results will be reflected to the practical use for TRU waste volume reduction hereafter.

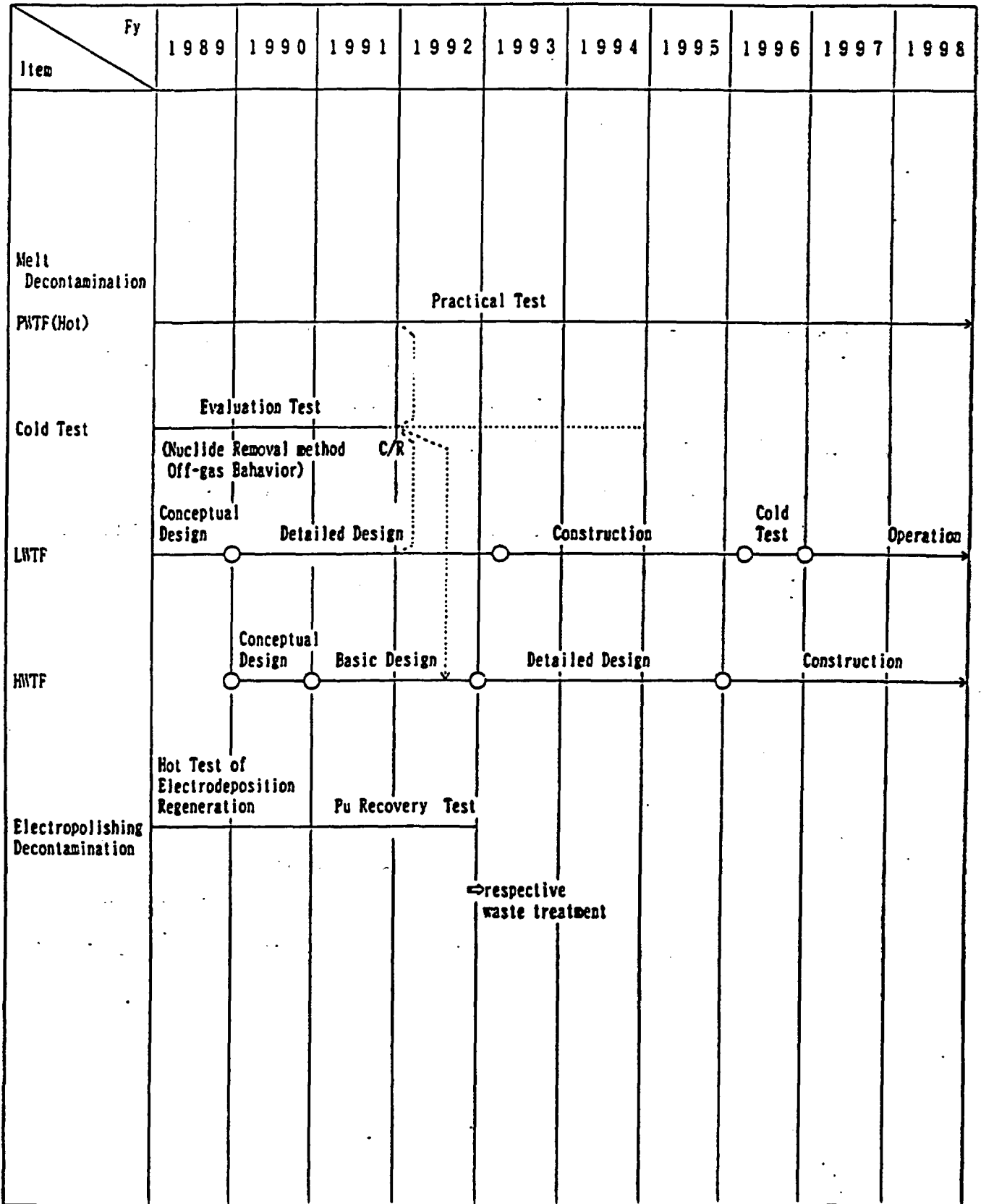

(3) Electropolishing II (O-arai)

Electropolishing is removing the surface layer of metal wastes electrochemically as the wastes for anion in electrolyte. Cold plant-scale test and hot basic test of electropolishing is currently being implemented so as to develop the reuse technology of depleted electrolyte and the electrodeposition technology separating eluted metal ion from acid, as increasing the concentration of eluted metal ion in electrolyte. The aim of the tests is to make life of electrolyte longer.

(4) Redox (O-arai)

Redox decontamination is expected to be advantageous technology for miscellaneous waste decontamination, because of its applicability for complex shaped metal wastes and high decontamination effect. Utilizing Ce(IV) in nitric acid as strong oxidizing agent, it is currently under development through cold engineering tests, etc.

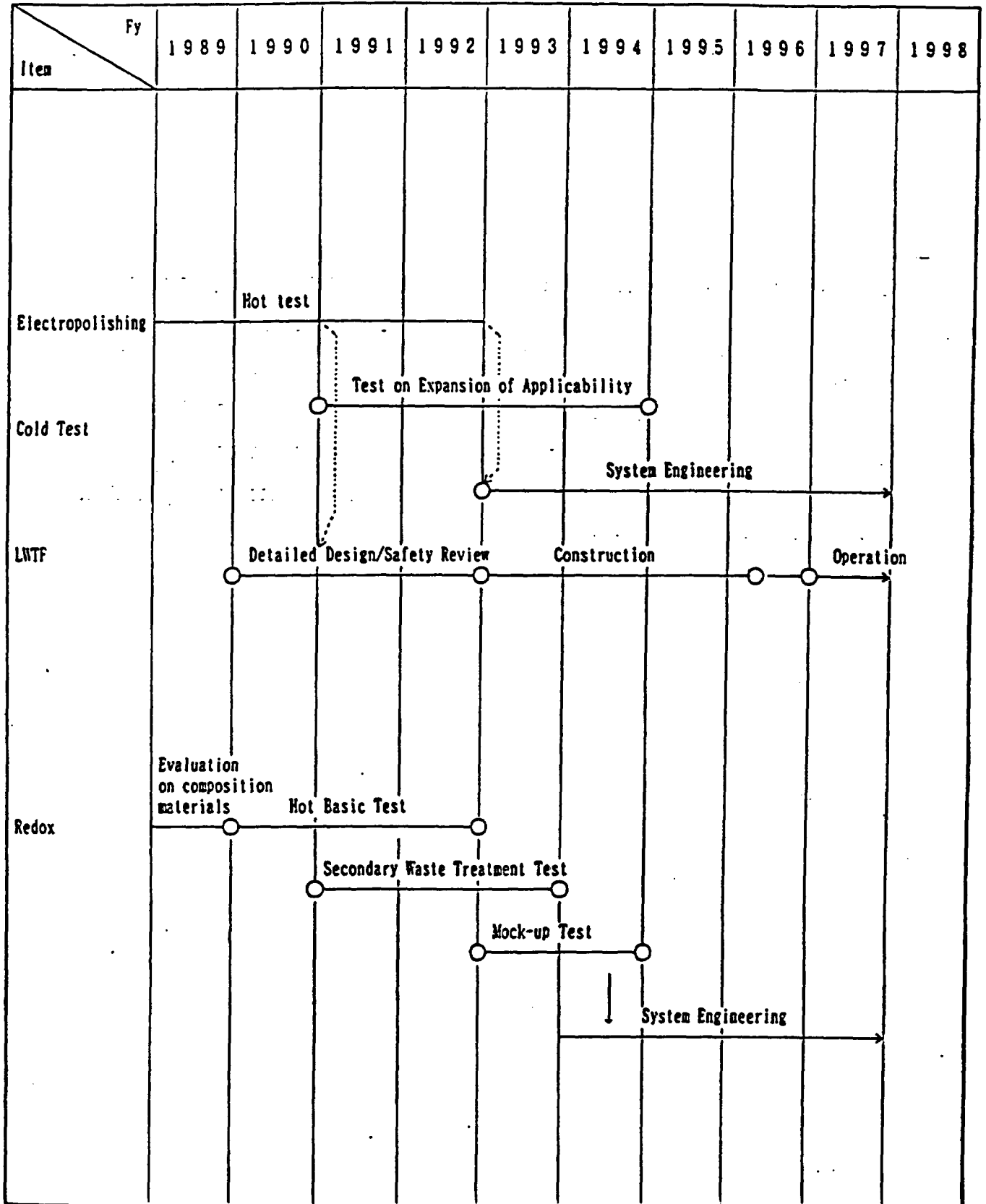

1
2
3
4
5
6
7
8
9
10
11
12
13
14
15
16
17
18
19
20
21
22
23
24
25
26
27
28
29
30
31
32
33
34
35
36
37
38
39
40
41
42
43
44
45
46
47
48
49
50
51
52
53
54
55
56
57
58
59
60
61
62
63
64
65
66
67
68
69
70
71
72
73
74
75
76
77
78
79
80
81
82
83
84
85
86
87
88
89
90
91
92
93
94
95
96
97
98
99
100

(5) Ice Blasting (O-arai)

Ice Blasting has been developed as the decontamination technology in which water and dry ice are sprayed on to waste surface using air as the transfer media. It is regarded as good primary decontamination technology because of generating small quantity of secondary waste, and hot test has been conducted using actual waste, at the Waste Dismantling Facility (WDF) since Fy1984. Ice blasting will be applied more extensively for decontamination use of in-situ equipment surface and concrete, etc. aiming establishment of decommissioning purpose, hereafter.

Item \ Fy	1989	1990	1991	1992	1993	1994	1995	1996	1997	1998
Ice Blasting										
Expansion of application										
Nuclide Recovery										

The diagram is a Gantt chart with a grid representing years from 1989 to 1998. It tracks four project items:

- Ice Blasting:** A solid horizontal line with an arrowhead at the end, spanning from the start of 1990 to the end of 1997.
- Expansion of application:** A solid horizontal line with circular markers at the start of 1989, the start of 1990, and the start of 1991. A dashed vertical line with an upward arrowhead connects the 1991 marker to the top of the 'Ice Blasting' line.
- Nuclide Recovery:** A solid horizontal line with circular markers at the start of 1989, the start of 1990, and the start of 1991. A dashed vertical line with an upward arrowhead connects the 1991 marker to the top of the 'Expansion of application' line.
- Decommissioning System Engineering:** A solid horizontal line with a circular marker at the start of 1992 and an arrowhead at the end, spanning from the start of 1992 to the end of 1997. A dashed vertical line with a downward arrowhead connects the top of the 'Ice Blasting' line to the 1992 marker.

5. Dismantling

Dismantling is the cutting or sectioning technology for large solid wastes by the use of thermal and or mechanical techniques, in order to facilitate the handling of solid wastes.

(1) Plasma-arc Cutting (O-arai)

Plasma-arc cutting method, and related recovering methods of aerosol and dross, etc. are under development as remotely dismantling technology for large TRU-contaminated solid waste to obtain good efficiency of work, excellent dismantling capability and extended applicability.

In particular, automatic arc-cutting robot has been designed and fabricated for dismantling in-cell equipments. The achievements will be reflected to R&Ds of TRU waste treatment and decommissioning technologies.

(2) Laser Cutting (O-arai)

Laser cutting technology, which is suitable for remote operation, because of generating less amount of aerosol or dross and being applicable to broad materials for cutting, is under development as the advanced, promising dismantling technology for large equipments, etc.

Especially, the basic research has been implemented on the cutting performance of CO₂-laser, power transmission characteristics, etc, and application for the decommissioning of fuel cycle facilities is planned, increasing laser power step-by-step, hereafter.

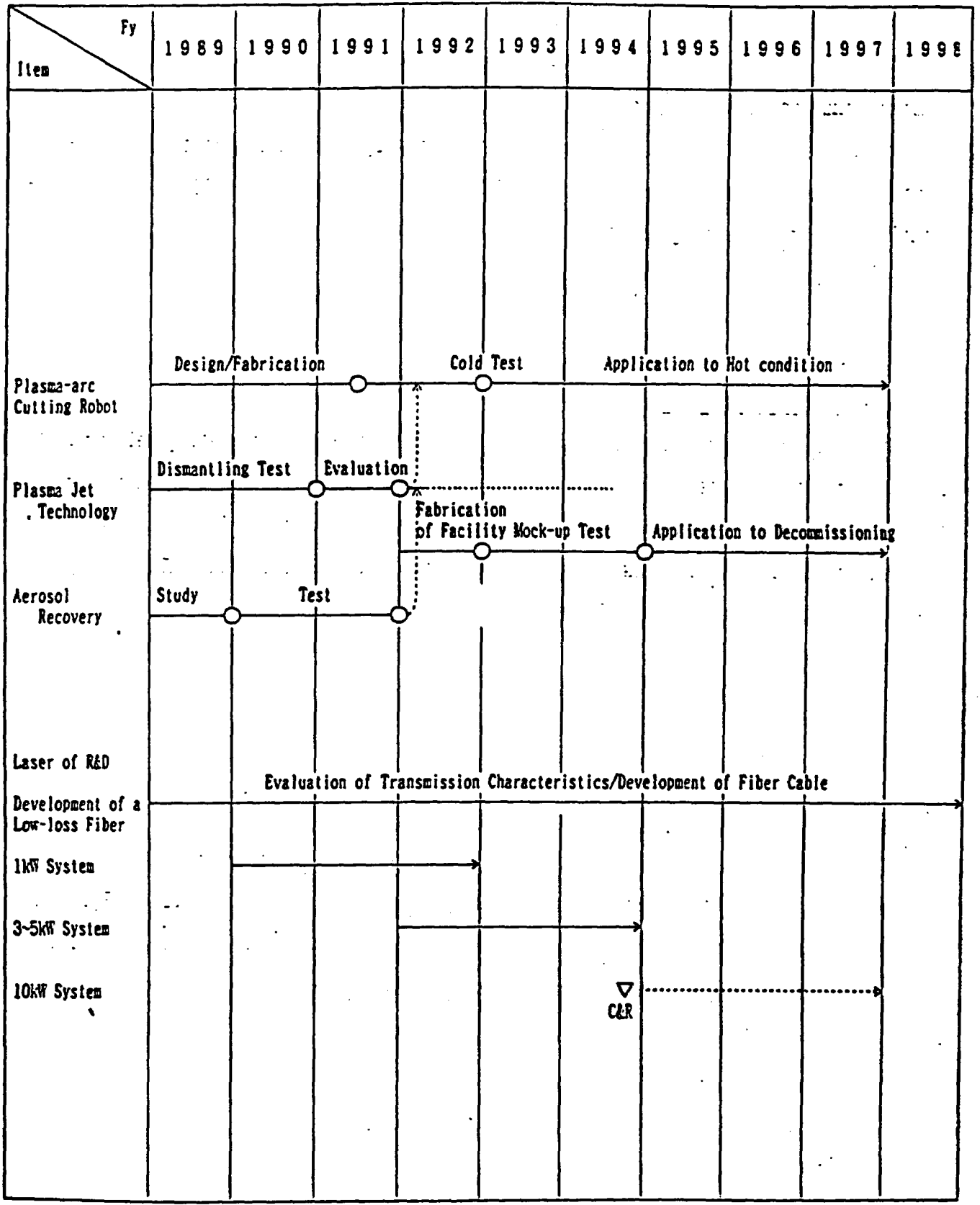

1989 1990 1991 1992 1993 1994 1995 1996 1997 1998

6. Immobilization (Stabilization)

Immobilization is waste stabilization technology by which solid waste including incineration ash and cut scrap, liquid waste and gaseous waste are solidified by wastes mixing with matrix, melting and so on.

(1) Micro-wave Melting (Tokai)

Micro-wave melting technology is characterized by homogenized heating(melting). Cold and hot demonstration tests of the technology have been currently implemented in order to stabilize and to reduce the volume of incineration ash or residue arisen from incineration and/or acid degestion. The test results will be reflected to the future TRU waste treatment facilities such as LWTF for practical use.

(2) Electro-slag Remelting (Tokai)

Electro-slagging technology is characterized by achieving volume reduction and decontamination simultaneously. Hot demonstration tests are now implemented at PWF for volume reduction and stabilization of TRU-contaminated metals. The results will be utilized for the future TRU waste treatment facilities such as LWTF and HWTF for practical use.

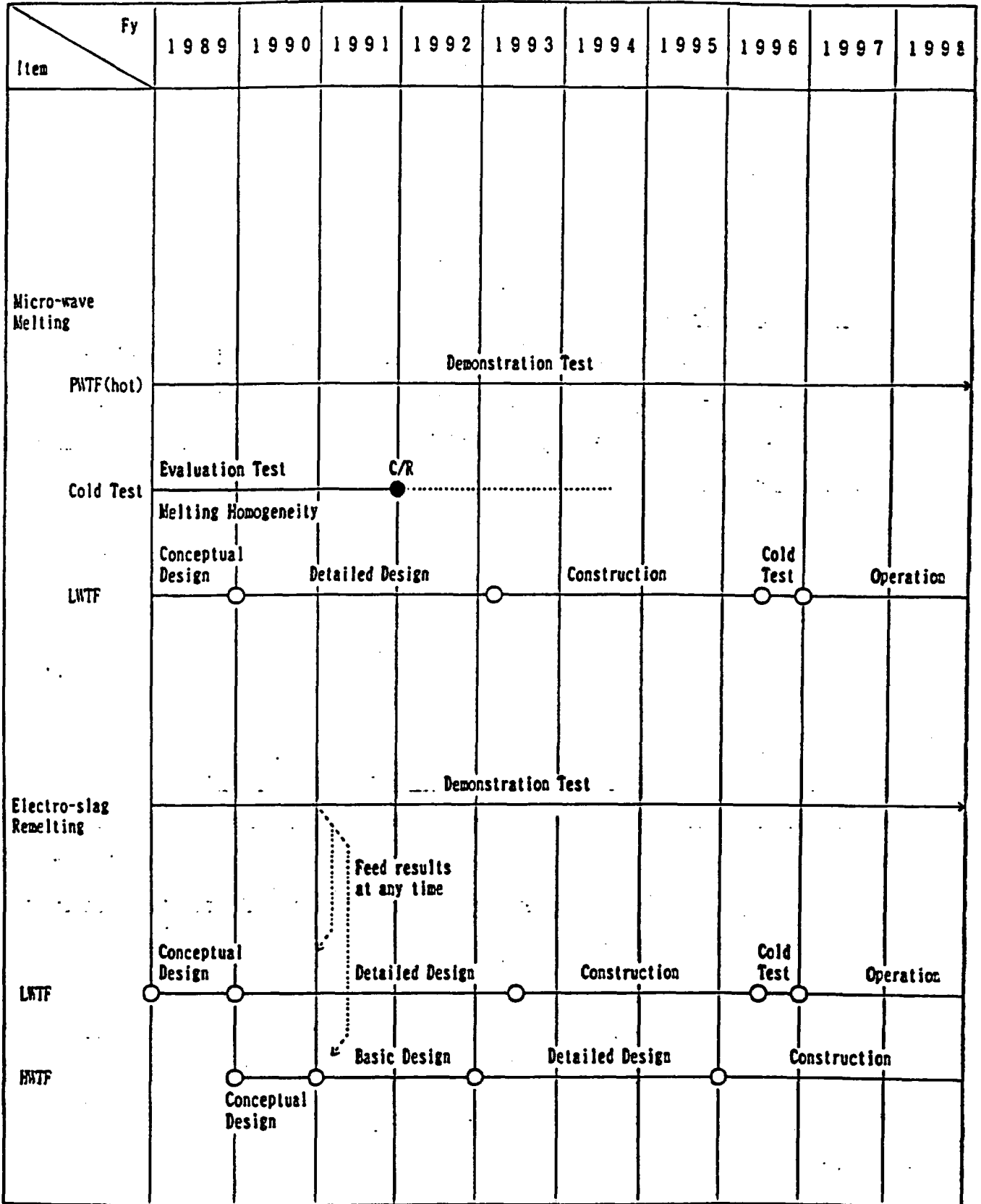

(3) HIP Solidification (O-arai)

Cold test of solidification by Hot Isostatic Press (HIP) method is under progress. The HIP technology is planned to be applied for volume reduction and stabilization of hulls and other metal wastes arising at Tokai Reprocessing Plant, and the achievements obtained from the development activities will be utilized for the facility design of HWTF.

(4) Dehydrating and Solidification with Micro-wave (Stabilization) (O-arai)

Dehydrating and solidification technology which converts the fuel washing liquid waste of "Joyo"(high-alkali property including corrosion products), into glass-like block safely with simple facility, is under development. The results will be utilized to reconstruct the existent waste treatment facility.

(5) Solidification of Separated Nuclide Residue (Tokai)

In order to stabilize the separated nuclide residue removed from low-level liqued waste and spent solvent, an advanced solidification process is to be developed. In the present, solidification technologies is under investigation, and the results will be reflected to the design of LWTF.

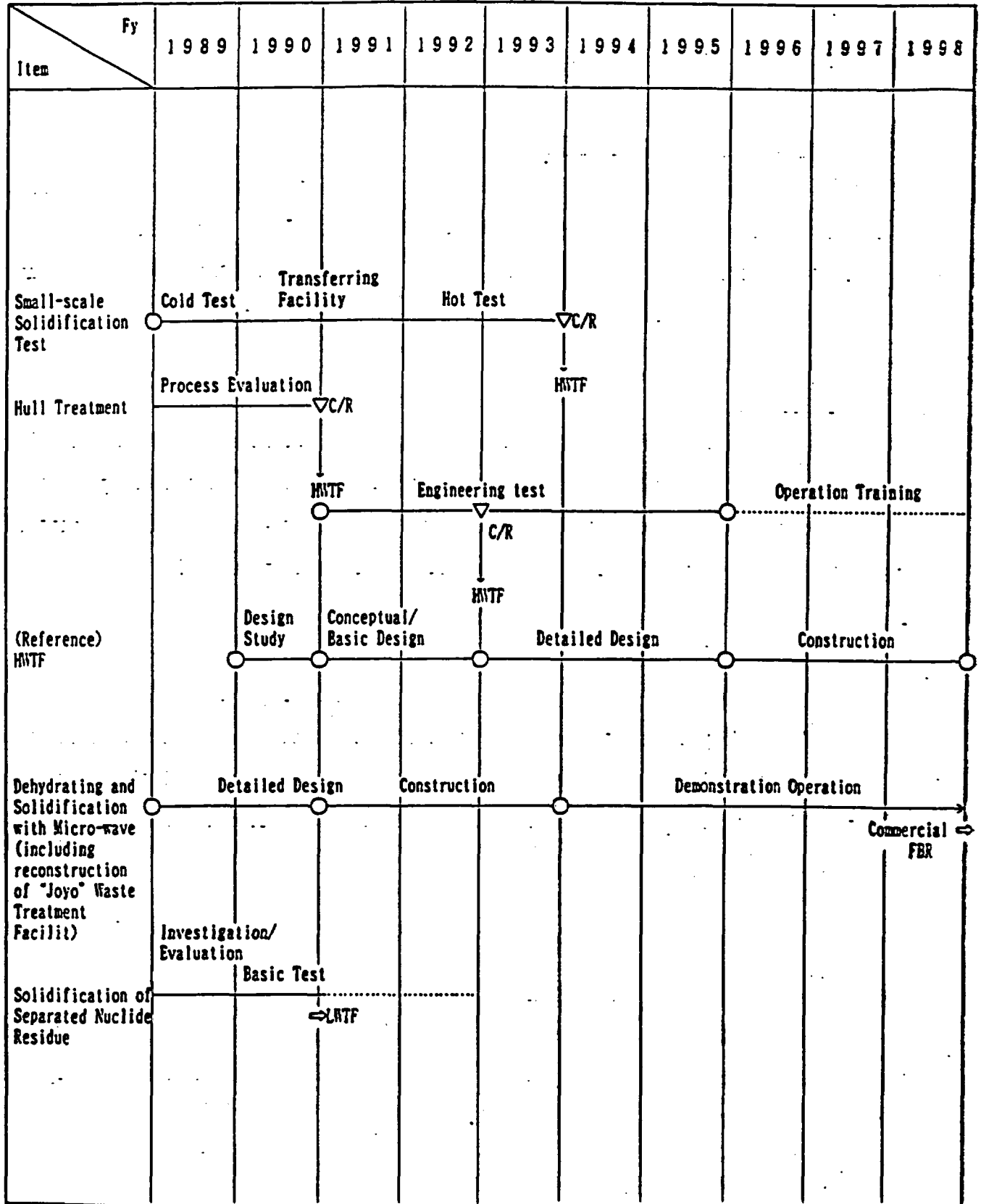

(6) Hydrothermal Solidification (Tokai)

In order to solidify uncombustible residues, including incineration ash, spent silica-gel, waste sand and spent iodine filter elements arising from Tokai Reprocessing Plant, solidification process applied hydrothermal reaction (Temp:100°C, Press:300 kg/cm²) is under cold basic testing. The results will be reflected to the design of LWTF.

(7) Cementation (Tokai)

In order to solidify uncombustible residues, including incineration ash, spent silica-gel, waste sand and spent iodine filter elements arising from Tokai Reprocessing Plant, Cementation using cement-glass, low-hydrated cement, silica cement and portland cement is under basic testing. The results will be reflected to the design of LWTF.

(8) Krypton Immobilization (Tokai)

In order to immobilize gaseous Krypton recovered from off-gas flow of Tokai Reprocessing Plant, Krypton is planned to be ionized and immobilized in metal. Cold basic tests are currently being implemented and the verification of process principle has been completed. The results will be utilized in Krypton Recovery Development Facility (KRF) for practical use.

(9) Plastic Solidification of Spent Solvent (Tokai)

In Solvent Waste Treatment Development Facility (STF), separation of TBP from spent solvent from Tokai Reprocessing Plant and its plastic solidification is under development operation to demonstrate the stable operation of STF.

Item	Fy	1989	1990	1991	1992	1993	1994	1995	1996	1997	1998
Hydrothermal Solidification		Cold Basic Test									
				↔LNTF							
Cementation		Cold Basic Test									
				↔LNTF							
Krypton Immobilization		Basic Test	Design	Licensing	Fabrication						
							↔KRF				
Plastic Solidification of Spent Solvent		Development Operation									

3
 1
 2
 3
 4
 5
 6
 7
 8
 9
 10
 11
 12
 13
 14
 15
 16
 17
 18
 19
 20
 21
 22
 23
 24
 25
 26
 27
 28
 29
 30
 31
 32
 33
 34
 35
 36
 37
 38
 39
 40
 41
 42
 43
 44
 45
 46
 47
 48
 49
 50
 51
 52
 53
 54
 55
 56
 57
 58
 59
 60
 61
 62
 63
 64
 65
 66
 67
 68
 69
 70
 71
 72
 73
 74
 75
 76
 77
 78
 79
 80
 81
 82
 83
 84
 85
 86
 87
 88
 89
 90
 91
 92
 93
 94
 95
 96
 97
 98
 99
 100

00 Flame Retardation of Bitumen (Tokai)

The technology of flame retardation of bitumen by adding reagent before bituminization, is being tested (cold, laboratory-scale). The results will be utilized for the operation improvement of Bituminization Facility (AspF).

00 Bituminization (Tokai)

In order to demonstrate the bituminization process for liquid waste arising from Tokai Reprocessing Plant and the storage of bituminized wastes, developmental operation has been continued at AspF.

Item \ Fy	1989	1990	1991	1992	1993	1994	1995	1996	1997	1998
Flame Retardation of Bitumen		Experimental Research (V) ▽ C/R				⇒AspF				
Bituminization				Operation for Development						

7. Solidified Waste Characterization

In order to establish the database for quality assurance of conditioning process and disposal, mechanical and chemical characteristics of solidified wastes are planned to be evaluated.

(1) Evaluation of Synthetic Minerals Produced at PWF (Tokai)

Solidified waste characterization such as leachability, etc., is conducted for performance assessment at PWF using actual wastes to establish the safe and rational storage and disposal of molten waste of incineration ash, etc. In addition, nuclide leach mechanism will be evaluated by observation and measurement of nuclide stability, taking account of disposal conditions. The results will be used to determine the conditions of solidification process, and to establish waste characterization database.

(2) Evaluation of Metal Ingots produced at PWF (Tokai)

In order to establish the proper management of metal ingots produced from electro-slag remelting at PWF, material properties including ingot compositions and distribution of nuclide concentration are being measured in cold and hot experiments. The obtained data will be used to determine the melting conditions of metal wastes and to develop the standards for reutilization of metal wastes.

(3) Compressive Strength Measuring Test of Plastic-Solidified Waste (Tokai)

Non-destructive compressive strength measuring tests are planned to control the spent solvent treatment process at STF, and the obtained data will be reflected to the operation of STF.

Item	Fy	1989	1990	1991	1992	1993	1994	1995	1996	1997	1998
Evaluation of Solidified Waste Soundness (PNTF)					Performance Assessment of Active Solidified Wastes						
					Leachability, Mineral Compositions						
Cold Test					Leaching Test						
					Leaching Mechanism						
Evaluation of Metal Ingots (PNTF)					Fundamental Properties of Solidified Waste (Density, Nuclide Stability)						
					Evaluation of Properties of Active Solidified Wastes						
Cold Test					Compositions Distribution of Nuclide Concentration						
					Evaluation of Properties of Metal Ingots						
Compressive Strength Measuring Test of Plastic-Solidified Waste					Melting Properties (Slag Behavior, Nuclide Decontaminability)						
			Prototypical Test								
				⇒STF							

(4) Evaluation of Bitumen (Tokai)

Hot evaluation test of bituminized waste and plastic-solidified waste is being implemented to verify the soundness during the long-term storage at 2nd Bituminized Waste Storage and disposal. The results will be reflected to the plans of storage facilities and repositories

(5) Surface Contamination Measurement Test (Tokai)

Surface contamination measurement tests except smear method are planned to be implemented at 2nd Bituminized Waste Storage for contamination control of bituminized waste. The results will be utilized for practical use in AspF, and Shipping Facility, if necessary.

(6) Verification Test of Solidified Waste Homogeneity (Tokai)

Verification test of solidified waste homogeneity by non-destructive measurement is planned for quality control of bitumen waste at 2nd Bituminized Waste Storage. The results will be utilized for practical use in AspF, and Shipping Facility, if necessary.

Item \ Fy	1989	1990	1991	1992	1993	1994	1995	1996	1997	1998
Evaluation Test of Bitumen	Cold Test			Evaluation Test			▽			
Surface Contamination Measurement Test		Prototype Test	Modification/ Verification Test		Design Construction	(⇒Shipping Facility)	⇒AspF			
Verification Test of Solidified Waste Homogeneity		Prototype Test	Modification/ Verification Test		Design Construction	(⇒Shipping Facility)	⇒AspF			

8. Source Term

Source term has to be established for obtaining the basic data for performance assessment of waste disposal.

(1) NDA (Tokai)

Non-destructive assay method incorporating γ activity measurement and neutron measurement is under development at PWTF in order to determine proper classification standard for TRU waste management. The obtained results will be utilized for evaluation of nuclide inventory and for establishing classification standard value in TRU waste treatment processes.

(2) Scanner for Solidified Waste (O-arai)

Solidified waste scanner which enables automatic measuring evaluation is currently being investigated at Waste Management Section at O-arai. The objective of the study is quantitative and qualitative evaluation of total radioactivity and nuclides of glass-like solidified waste which incorporates radioactive corrosion products (CP). The results will be reflected to modification of "Joyo" Waste Treatment Facility.

3
 4
 5
 6
 7
 8
 9
 10
 11
 12
 13
 14
 15
 16
 17
 18
 19
 20
 21
 22
 23
 24
 25
 26
 27
 28
 29
 30
 31
 32
 33
 34
 35
 36
 37
 38
 39
 40
 41
 42
 43
 44
 45
 46
 47
 48
 49
 50
 51
 52
 53
 54
 55
 56
 57
 58
 59
 60
 61
 62
 63
 64
 65
 66
 67
 68
 69
 70
 71
 72
 73
 74
 75
 76
 77
 78
 79
 80
 81
 82
 83
 84
 85
 86
 87
 88
 89
 90
 91
 92
 93
 94
 95
 96
 97
 98
 99
 100

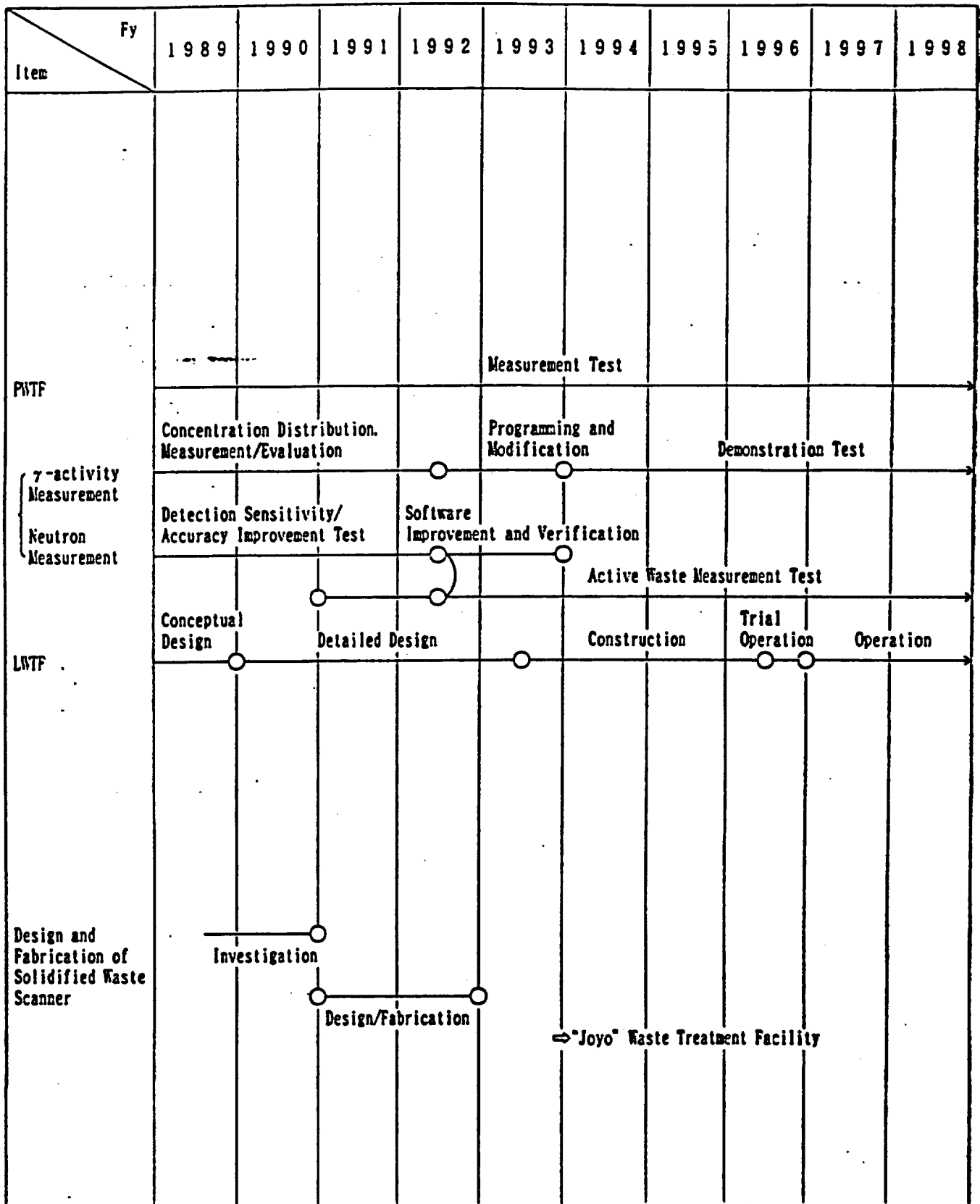

9. Facility Management

R&Ds for appropriate operation of waste handling facilities, are summarized.

(1) PWF Operation Supporting System (Tokai)

Operating supporting system on the basis of knowledge database is currently being developed at PWF. The objectives of the system are the improvement of the safety and reliability, and are the establishment of long-term stable operation of Pu-contaminated waste treatment process by integrating data related to design, operation and maintenance. It is expected that the facilities can be operated and maintained without skilled engineers by the support system. The results will be applied to the future waste treatment facilities such as LWTF and HWTF.

(2) Automation and Remotization of α Hall (O-arai)

By automation and remotization of the facilities in α -Decontamination Hall and α -Dismantling Hall of Waste Dismantling Facility(WDF), flogman work, man-hour and waste treatment cost have to be reduced as well as improving safety.

In FY1988, the system optimization was studied. In FY1989, the basic design has been carried out to take shape of the whole system. The obtained results from this will be reflected to the future decommissioning projects of nuclear facilities.

(3) Hull Retrieval Technology (O-arai)

In order to retrieve the Hull cans piled in water pool of High Active Solid Waste Storage (HASWS) located in Tokai, the remote system comprised of underwater robot and large manipulators is currently under conceptual design. The results will be utilized for Hull treatment in the future Hull Waste Treatment Facility (HWTF).

(4) Radiation Image Display (RID) (O-arai)

Radiation Image Display (RID) which visualizes the distribution, quantity etc. of radioactive substances is currently being developed, as a part of development of radiation measurement technologies which aim efficient and economical operation of decontamination and dismantling (D&D), measuring contaminants and dose prior to determining D&D method.

Item	Fy	1989	1990	1991	1992	1993	1994	1995	1996	1997	1998
RID											

Applicability Evaluation/
Improvement



Demonstration Test/Commercialization



10. Miscellaneous

(1) Treatment of Alcoholate Liquid Waste (O-arai)

Advanced treatment technologies such as the catalytic oxidation method or the membrane treatment method is under investigation in order to treat the alcoholate liquid waste generated at "Joyo" Waste Treatment Facility during washing of fuel gripper. The information obtained will be reflected for practical use at "Joyo" Waste Treatment Facility.

(2) Purification of Recoverd Xenon (Tokai)

Xenon contained in off-gas of Tokai Reprocessing Plant is planned to be separated and purified by adsorption for reutilization. The basic test is currently being carried out and the results will be reflected to KRF for practical use.

(3) De minimis Level Measurement Technique (Tokai)

Since the de minimis level is required to be decided to establish disposal system of TRU waste which is arisen from MOX fabrication facilities, reprocessing plants and decommissioning, related measurement techniques have to be developed. In the present, the measurement techniques are under investigation evaluation. The results will be reflected to planning of the future waste management system.

(4) Entrusted Research of "Hot Treatment Test of Concentrated Liquid Waste" (Tokai)

Hot test of dry pulverization of concentrated liquid waste from reprocessing plant is under authorization procedure at AspF.

The test results will be used at Low-level Concentrated Waste Treatment Facility of Shimokita Reprocessing Plant.

Item \ Fy	1989	1990	1991	1992	1993	1994	1995	1996	1997	1998
Treatment of Alcoholate Liquid Waste		Investigation		Cold Test		Design	Fabrication			
Xenon Purification	Basic Test	Design	Licensing	Fabrication						
De minimis Level Measurement Technique	Investigation/Evaluation						Study of Measurement Technologies			
Entrusted Research of "Hot Treatment Test of Concentrated Waste"	Before Design Approval	Design & Installation	Test and evaluation/Removal							
							⇒ "Joyo" Waste Treatment Facility			
							⇒ KRF			

TECHNOLOGIES DISCUSSED AT JAERI- Takasaki Radiation Chemistry Research Establishment

- Amidoxime Group Containing Adsorbents for Metal Ions Synthesized by Radiation-Induced Grafting
- New Type of Amidoxime Group Containing Adsorbent for the Recovery of Uranium from Seawater

BIBLIOGRAPHY OF LITERATURE RECEIVED FROM TAKASAKI RADIATION CHEMISTRY RESEARCH ESTABLISHMENT

- "Amidoxime-Group-Containing Adsorbents for Metal Ions Synthesized by Radiation-Induced Grafting", Written by J. Okamoto, T. Sugo, A. Katakai and H. Omichi. JAERI, Takasaki Radiation Chemistry Research Establishment, 11 pages.
- "A New Type of Amidoxime-Group-Containing Adsorbent for the Recovery of Uranium from Seawater", Written by H. Omichi, A. Katakai, T. Sugo and J. Okamoto. JAERI, Takasaki Radiation Chemistry Research Establishment. 16 pages.

Amidoxime-Group-Containing Adsorbents for Metal Ions Synthesized by Radiation-Induced Grafting

J. OKAMOTO, T. SUGO, A. KATAKAI, and H. OMICHI, *Japan Atomic Energy Research Institute, Takasaki Radiation Chemistry Research Establishment, Takasaki, Gunma 370-12, Japan*

Synopsis

Amidoxime-group-containing fibrous adsorbents for metal ions were synthesized by radiation-induced grafting of acrylonitrile followed by amidoximation of cyano groups with hydroxylamine. The degree of amidoximation and the distribution of amidoxime groups in the fiber were followed by means of electron probe X-ray microanalysis. The efficiency of adsorbing metal ions was increased by alkaline treatment of the adsorbent at high temperature for a short period before use. The order of adsorption for various bivalent metal ions was $Hg > Cu > Ni > Co > Cd$. From the distribution pattern of metal ions in the fibrous adsorbent, the adsorption was found to be controlled by the diffusion of the solution containing metal ions inside the adsorbent. It was found that confining amidoxime groups superficially and making short chain length of grafts were effective to obtain a high degree of adsorption.

INTRODUCTION

A variety of adsorbents for recovering metal ions dissolved in water or seawater has been reported.¹⁻⁴ Especially, adsorbents containing amidoxime groups which make chelate complexes with uranyl ions are noted for the recovery of uranium from seawater.⁵⁻¹²

These amidoxime-group-containing adsorbents are synthesized through the reaction of acrylic resins and hydroxylamine. The amidoximation, however, often causes a dimensional instability of the resin when used in aqueous solution because of large swelling in water.¹³ When the acrylic resin is made from a copolymer of acrylonitrile and a crosslinking monomer such as divinylbenzene to reduce the swelling, on the other hand, the ability to adsorb metal ions decreases tremendously.¹⁴ One of the causes is the decrease in the free movement of amidoxime groups due to the crosslinking among polymer chains. Therefore, both the stability to swelling and the free movement of the functional groups are essential to the adsorbent which is used in water.

The radiation-induced grafting is known as a method for introducing functional groups in a variety of polymers and inorganic substances.¹⁵ As polymer chains containing functional groups are chemically bonded with trunk polymers only at their chain end, a free movement of the polymer chains is maintained by this method. When a hydrophobic polymer is used as a trunk polymer, the part swollen in water can be restricted only to graft chains. Therefore, the two essential conditions mentioned above are satisfied by this synthesizing method. In addition, the distribution of the introduced functional groups is easily controlled by selecting reaction

conditions such as irradiation dose, dose rate, temperature, and reaction time. However, the studies of synthesizing adsorbents for metal ions by radiation-induced grafting have been little reported.

In the present study, fibrous adsorbents containing amidoxime groups were synthesized by the radiation-induced grafting of acrylonitrile onto fibers and adsorption of heavy metal ions such as copper ions were attempted.

EXPERIMENTAL

Fibers used for synthesizing adsorbents are listed in Table I. The fiber (ca. 40 μm in diameter, and 15mm long) rinsed with acetone and dried in a vacuum oven for 16 h was packed in a polyethylene bag under nitrogen atmosphere and was irradiated with an electron accelerator (Dynamitron, Model IEA 3000-25-2, Radiation Dynamics) operating at beam energy of 1.5 MeV and a current of 1 mA at room temperature. In order to reduce the heat accumulation on the sample along with the irradiation, the polyethylene bag was conveyed back and forth under the window of the accelerator at a rate 2.3 m/min. The dose rate was 1 Mrad/pass.

The irradiated fiber was installed in a glass ampoule and was evacuated for 5 min followed by the introduction of purified acrylonitrile under a nitrogen atmosphere. The graft polymerization was carried out at 25°C. When acrylonitrile was grafted in vapor phase, the fiber was separated from liquid acrylonitrile with a perforated plate. After the grafting, homopolymer and unreacted monomer were extracted with *N,N*-dimethyl formamide. The grafting yield was obtained from the weight increase based on the initial weight.

The amidoxime group-containing fiber (AO fiber) was obtained by heating grafted fiber with 3% hydroxylamine solution (methanol/water = 1/1) at pH 7 then rinsed with methanol and dried at 40°C under a reduced pressure. The amount of amidoxime groups was measured by elemental analysis.

The distribution of amidoxime groups combined with metals in the cross section of AO fiber was measured by means of a JEOL electron probe X-ray microanalyzer (EPMA), Model JXA 733.

About 0.5 g of AO fiber was immersed in 1 L of metal ion (0.1-0.2 mM)-containing Clark-Lubs buffer solution in the pH 2-7 region at 30°C for the prescribed periods. Then the fiber was rinsed with water and was dried in a vacuum oven. A concentrated sulfuric acid was added to a platinum

TABLE I
Fibers Used for Synthesizing Adsorbents

No.	Materials	Producers
1	Tetrafluoroethylene-ethylene copolymer [poly(TFE-E)]	Asahi Glass
2	Polypropylene (PP)	Ube Industries
3	Polyamide	Teijin
4	Polyethylene (PE)	Mitsui Petrochem.
5	Polyester	Teijin
6	Carbon fiber	Toray

crucible containing the fiber and was evaporated to dryness. This procedure was repeated three times. Sodium carbonate was added to the ash of fiber, which was calcined at 550°C and melted. Then 1*N* hydrochloric acid was added to dissolve the melt. The amount of metal in the hydrochloric acid solution was measured by means of a Jarrell-Ash atomic absorption spectrophotometer, Model AA-845.

RESULTS AND DISCUSSION

Grafting

Grafting of acrylonitrile was attempted onto the preirradiated fibrous raw materials as shown in Table I. Figure 1 shows the grafting yield at different reaction time. A relatively high grafting yield was obtained with poly(TFE-E), PP, and polyamide. Especially, the grafting yield with poly(TFE-E) reached ca. 60% in 24 h. The grafting yield with PE, polyester, and carbon fiber, on the other hand, was less than 5%, which is probably due to the low radical concentration in these irradiated polymers. From the results in Fig. 1, the following study was carried out mainly with poly(TFE-E). Moreover, it has a high heat stability and a sufficient resistance to chemical reagents such as base and acid solution due to C—F bonds in polymer structure.

Figure 2(a) shows the effect of diameter of poly(TFE-E) fiber on the grafting yield. The smaller the diameter, the higher the grafting yield. The rate of grafting obtained from Figure 2(a) was found to have a simple relationship with specific surface area of the fiber which was calculated from the fiber diameter as shown in Figure 2(b). These results are due to the fact that grafting is controlled by the diffusion of monomer into the fiber.¹⁴

As shown in Figure 3, both the grafting rate R , and the final grafting yield G , increase with the increase in the irradiation dose D . If the polymer radical is produced in proportion to the n th power of D , that is, $[R \cdot]$

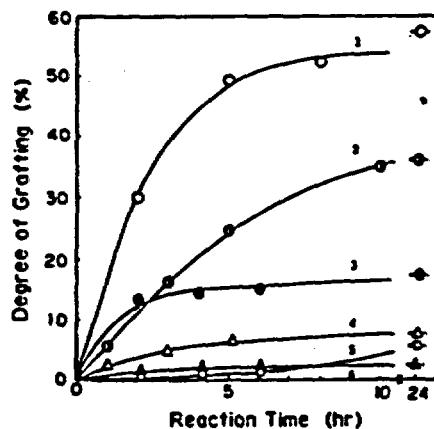

Fig. 1. Grafting yield of acrylonitrile onto preirradiated fibrous materials. The numbers are the same as shown in Table I.

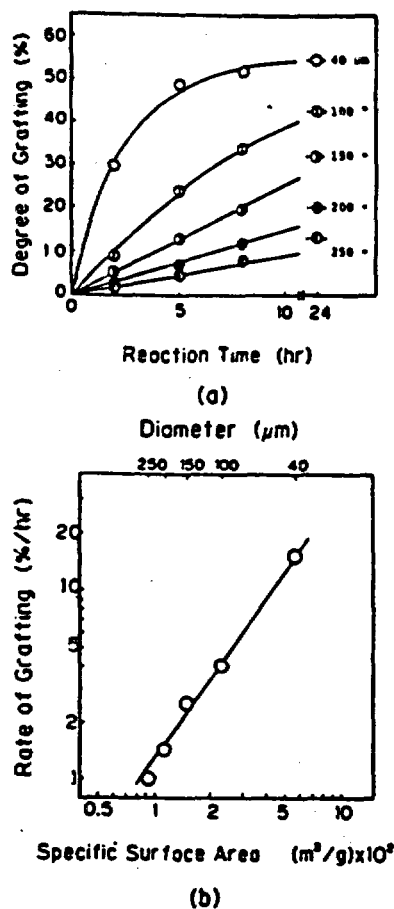

Fig. 2. Effect of diameter of poly(TFE-E) fiber on (a) grafting yield and (b) rate of grafting. (a): (○) 40 μm ; (□) 100 μm ; (△) 150 μm ; (●) 200 μm ; (◼) 250 μm .

$= k_p D^n$, where $[R \cdot]$ is the radical concentration and k_i is the rate constant for initiation, respectively, R_p is expressed as

$$R_p = k_p [R \cdot] [M] = k_i k_p D^n [M] \quad (1)$$

where k_p is the rate constant for the propagation and $[M]$ is the monomer concentration in the reaction site, respectively. The final grafting yield G_f at $t = t_f$ is obtained by integrating eq. (1) from $t = 0$ to $t = t_f$:

$$G_f = \int_0^{t_f} R_p dt = k_i k_p D^n [M] t_f \quad (2)$$

Equations (1) and (2) show that both R_p and G_f are proportional to D^n . From the results in Figure 3, n is estimated as ca. 0.5. The result that R_p is proportional to $D^{0.5}$ agrees with the previous work in which styrene was grafted onto the preirradiated TFE Teflon.¹⁷

From the dependency of grafting rate on the reaction temperature the apparent activation energy was estimated as ca. 13 kcal/mol, which is

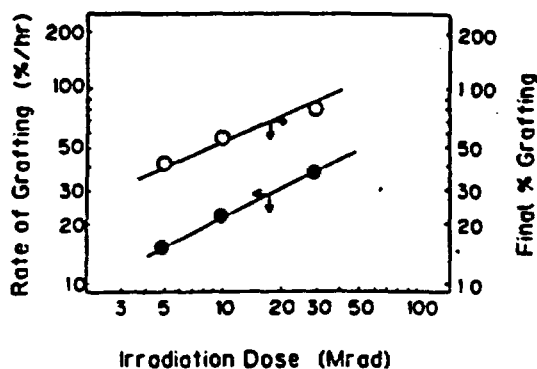

Fig. 3. Effect of irradiation dose on rate of grafting (●) and final grafting yield (○).

comparable to the previously reported values for a variety of radiation-induced grafting.¹⁸

Amidoximation

As shown in the experimental section, AO fiber was obtained by converting cyano groups of graft chains to amidoxime groups. Figure 4 shows the effect of temperature on the amidoximation of the grafted fiber with average degree of grafting: 54–58%. At 40°C the conversion after 10 h was still less than 5%. The temperature was raised until it reached the boiling point of hydroxylamine solution (ca. 80°C). The conversion reached more than 60% after 6 h. The activation energy for amidoximation was estimated as 12 kcal/mol from the Arrhenius plots of the conversion as shown in Figure 4.

The distribution of the amidoxime groups in the cross section of AO fiber was measured by means of EPMA. Figure 5 shows the distribution of amidoxime groups when the period of amidoximation was changed from 1 to 6 h at 80°C. It is clear that the amidoximation gradually proceeds from the surface to the center of the fiber and that it takes more than 6 h to obtain a homogeneous distribution.

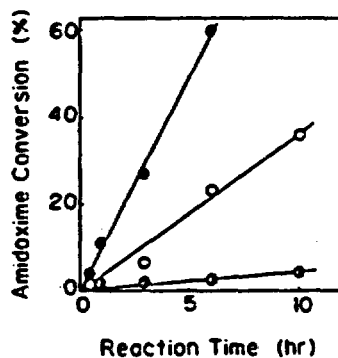

Fig. 4. Effect of temperature on amidoximation of the grafted poly(TFE-E) fiber (grafting yield = 54–58%): (○) 40°C; (◻) 60°C; (●) 80°C.

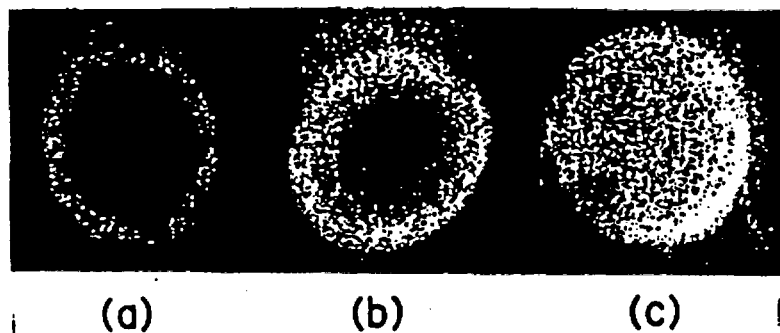

Fig. 5. Distribution of amidoxime groups in the cross section of AO fiber measured by means of EPMA; reaction time (h): (a) 1; (b) 3; (c) 6.

Figure 6 shows the temperature effect on the width of distribution of amidoxime groups in AO fiber obtained from EPMA measurement. When the temperature is high and the reaction time of amidoximation is long, the distribution becomes widespread. The almost linear relationship of the width with reaction time indicates that amidoximation in the center of the fiber proceeds at a similar rate as on the surface region. The activation energy for spreading amidoxime groups in the fiber was estimated as ca. 10 kcal/mol. This value is in fair agreement with the above-mentioned activation energy for converting cyano groups to amidoxime groups.

Such thermodynamic similarity between the conversion of amidoximation and the spread of distribution of amidoxime groups inside the fiber is more clearly indicated when these values are plotted against each other as shown in Figure 7. Clearly, the conversion increases in proportion to the increase in the width under all the present experimental conditions. Therefore, it is reasonable to say that the amidoximation occurs homogeneously at least within 20 μm from the surface of the fiber. Probably, cyano groups of graft chains exist homogeneously in the fiber and as soon as the hydroxylamine solution reaches the cyano groups the amidoximation occurs. In other words, the reaction is controlled by the diffusion of hydroxylamine solution in the fiber.

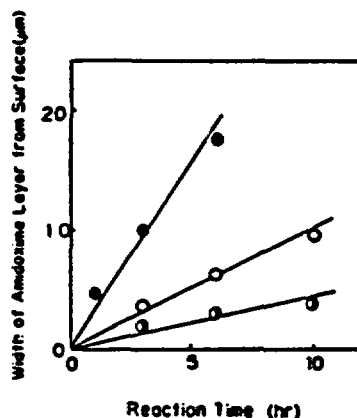

Fig. 6. Effect of temperature on the width of distribution of amidoxime groups in AO fiber. The symbols are the same as shown in Figure 4.

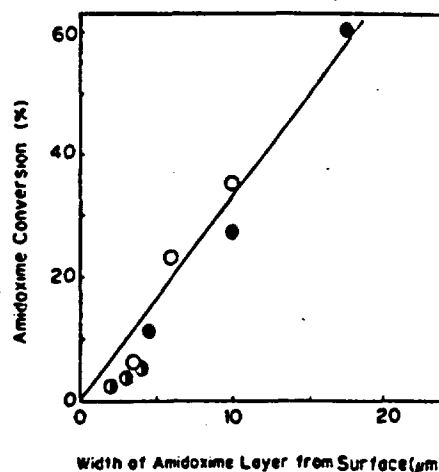

Fig. 7. Relationship between the conversion of amidoximation and the spread of distribution of amidoxime groups. The symbols are the same as shown in Figure 4.

Adsorption of Metal Ions

The dried AO fiber did not adsorb metal ions at room temperature. One of the causes is the insufficient swelling of the fiber in metal ion-containing solution. The hydrophilicity of poly(TFE-E) fiber itself is virtually negligible and amidoxime groups are not so hydrophilic.¹⁰

Heating of AO fiber in alkaline solution was found to increase the swelling of AO fiber in aqueous solution. For example, the contact of AO fiber with 0.5*N* potassium hydroxide solution at 20°C for 8 h elicited 30% augmentation in the water uptake.

The increase in hydrophilicity of the fiber is expected to increase the adsorption of metal ions. Figure 8 shows the effect of temperature of alkaline treatment on adsorption efficiency expressed as the percentage of amidoxime groups used for complexation with copper ions. It is clear that raising the temperature increases the efficiency. Although the efficiency abruptly

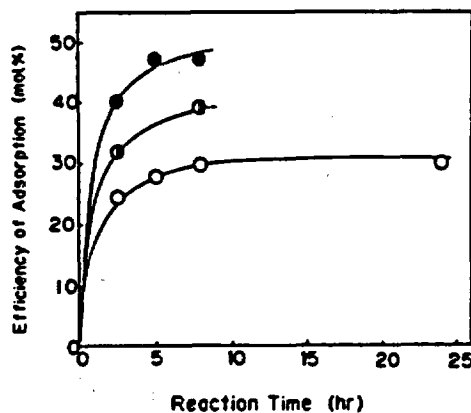

Fig. 8. Effect of temperature of alkaline treatment of AO fiber on adsorption efficiency for copper ion: (O) 20°C; (◐) 50°C; (●) 70°C.

increased when the fiber was treated with alkaline solution for a short period, the elongation of treatment period was not so effective to increase the efficiency. As shown in Figure 8, the efficiency levels off when the period is more than 8 h. In addition, the long contact of AO fiber with alkaline solution at high temperature should be avoided to reduce an undesirable decomposition of amidoxime groups.¹⁰ It was found that the treatment at 80°C for 10 min was the optimum condition to keep a high adsorption capacity with less decomposition of amidoxime groups introduced into poly(TFE-E).

When a sufficient period of adsorption was maintained, the adsorption of copper ion increased in proportion to the amount of amidoxime groups in the alkaline treated AO fiber as shown in Figure 9. From the slope, the number of amidoxime groups necessary for fixing one copper ion by complexation was estimated as, on the average, 3.3. As amidoximes are supposed to be bidentate, two amidoximes may be used for chelate formation with a copper ion which makes a square planar chelate. Therefore, the number 3.3 indicates that more than one extra amidoxime which does not directly participate in the chelate formation exists. Probably, the graft chains containing amidoximes have a loop structure, which makes it impossible that some of the amidoximes which exist in the middle of the loop take part in the chelate formation.

Figure 10 shows the effect of acidity of metal ion-containing solution on the adsorption of Hg^{2+} , Cu^{2+} , and Cd^{2+} . About 0.1 mmol of Hg^{2+} was adsorbed per 1 gAO fiber at pH 2, while no adsorption of Cu^{2+} and Cd^{2+} was observed at this acidity. Cd^{2+} was not adsorbed until pH was beyond 4.

The amount of adsorbed metal ions increased with the increase in pH value. A steep increase was observed in the case of Hg^{2+} and Cu^{2+} when pH was more than 5. However, when pH was beyond 6 a precipitation of Cu was observed. The order of adsorbing various bivalent metal ions was



which agrees with Irving-Williams order.¹⁹

Figure 11 shows the distribution of copper ions complexed with amidoxime groups at various contact periods. It is apparent that the migration of

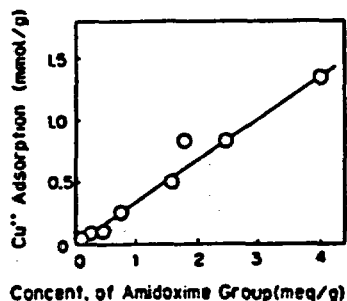

Fig. 9. Relationship between the amount of amidoxime groups in AO fiber and the amount of adsorbed copper ions.

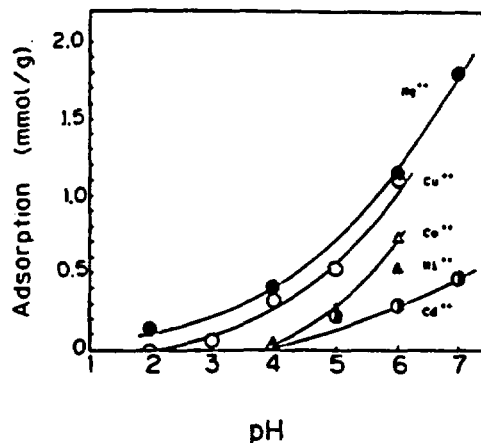

Fig. 10. Effect of acidity of metal ion-containing solution on the adsorption of various bivalent metal ions.

copper ion through the amidoxime group layer is slow. It took about 1 day to obtain an almost homogeneous distribution of copper ions in AO fiber. The rapid increase in the population of copper ions on the surface region, on the other hand, suggests that confining amidoxime groups superficially on the adsorbent fiber is effective to obtain a high adsorption ability. This assumption was confirmed by the result shown in Figure 12 where the distribution of amidoxime groups in AO fiber and the adsorption amount

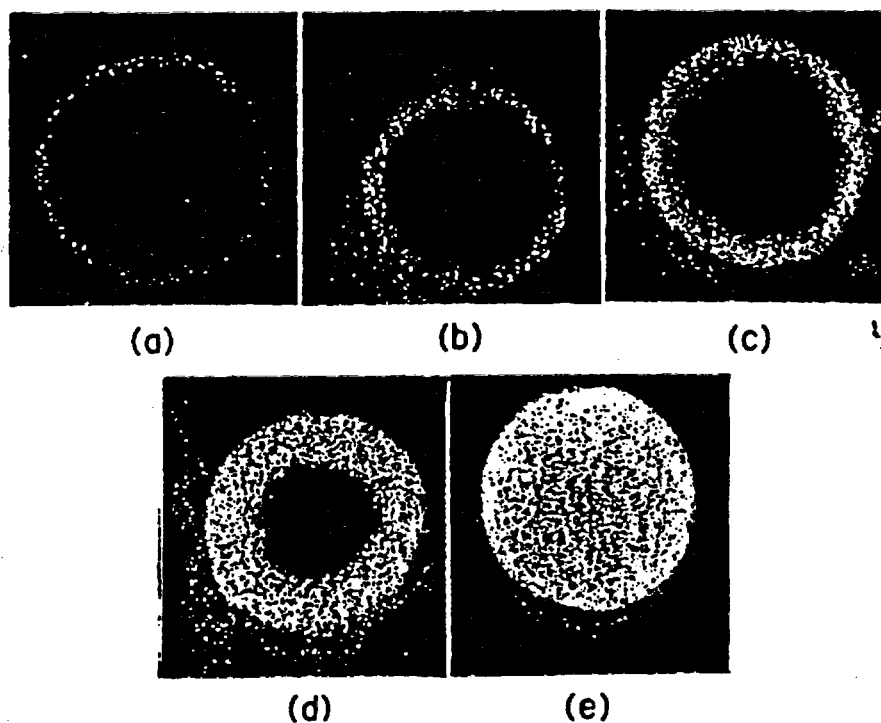
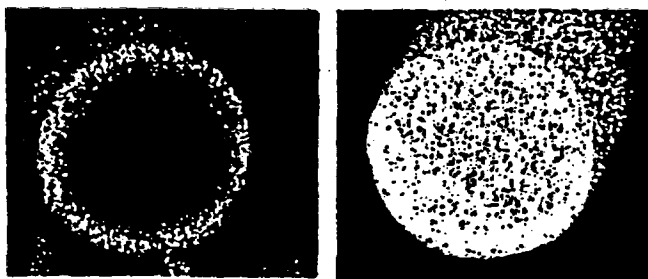
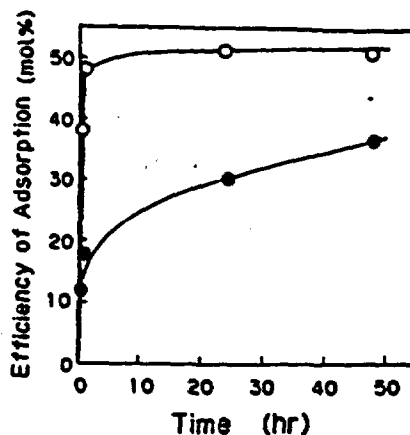

Fig. 11. Distribution of copper ions complexed with amidoxime groups at various contact periods: (a) 1 min; (b) 5 min; (c) 10 min; (d) 20 min; (e) 24 h.



Surface Grafting

Homogeneous Grafting

Fig. 12. Distribution of amidoxime groups and adsorption amount of copper ions with the adsorbents made by (O) surface grafting and by (●) homogeneous grafting.

of copper ions were compared between two types of adsorbents—one made by surface grafting with acrylonitrile vapor and the other by homogeneous grafting using liquid acrylonitrile. It is clear that amidoxime groups in the surface layer (within 10 μm from the surface) provide about twice as much adsorption of copper ions as the homogeneously distributed amidoximes do.

Another possibility of obtaining high adsorption ability is shown in Figure 13, where AO fibers with similar grafting yield and therefore an almost constant amidoxime amount obtained at different irradiation doses were

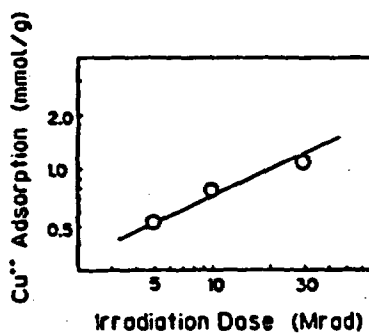

Fig. 13. Effect of irradiation dose for grafting acrylonitrile on adsorption of copper ions.

used. By increasing the irradiation dose, the number of trunk polymer radicals which can initiate graft polymerization increases. As the grafting yield is the product of the number of initiation radicals and the length of the graft chains, the result that these AO fibers have similar grafting yield indicates that the graft chain lengths are different according to the difference in the number of initiation radicals. It is clear that the AO fiber of shorter chain length (or irradiated with higher dose) provides a higher adsorption capacity for copper ions. Probably, the shorter chains have more flexibility of the movement of amidoxime groups for the complex formation with copper ions.

AO fiber has high stability to various kinds of treatment. For example, when dry AO fiber was treated with 2.5% potassium hydroxide solution at 80°C for 10 min, the diameter increased only 4%, which proves that AO fiber swells little in alkaline solution. No further increase in diameter was observed when the alkaline treated AO fiber was contacted with water at 30°C for 24 h, while a considerable amount of water uptake (ca. 30%) was observed as mentioned above.

Thus, this new adsorbent produced by radiation-induced grafting proves very effective for the use in water because of high adsorption ability for heavy metal ions and sufficient stability under various conditions.

References

1. A. D. Kelmers, *Separation Sci. Technol.*, **16**, 1019 (1981).
2. H. J. Schenk, L. Astheimer, E. G. Witte, and K. Schwochau, *Separation Sci. Technol.*, **17**, 1293 (1982).
3. T. Miyake, K. Takeda, and A. Ikeda, *Hyomen (Japanese)*, **20**, 21 (1982).
4. H.-J. Fischer and K. H. Lieser, *Angew. Makromol. Chem.*, **112**, 1 (1983).
5. T. Miyamatsu, N. Oguchi, Y. Kanchiku, and T. Aoyagi, *J. Soc. Fiber Sci. Technol. Jpn.*, **38**, T-537, T-546 (1982); **39**, T-25, T-62 (1983).
6. I. Tabushi, Y. Kobuke, and T. Nishiya, *Nature*, **280**, 665 (1979).
7. D. Heitkamp and K. Wagener, *Ind. Eng. Chem., Process. Des. Dev.*, **21**, 781 (1982).
8. Z. Sulcek and V. Sixta, *Coll. Czech. Chem. Commun.*, **40**, 2295 (1975).
9. H. Egawa and H. Harada, *J. Chem. Soc. Jpn.*, **1979**, 958; **1980**, 1767, 1773.
10. S. Katoh, K. Sugasaka, K. Sakane, N. Takai, H. Takahashi, Y. Umezawa, and K. Itagaki, *J. Chem. Soc. Jpn.*, **1982**, 1449, 1455.
11. K. Sugasaka, S. Katoh, N. Takai, H. Takahashi, and Y. Umezawa, *Separation Sci. Technol.*, **16**, 971 (1981).
12. L. Astheimer, H. J. Schenk, E. G. Witte, and K. Schwochau, *Separation Sci. Technol.*, **18**, 307 (1983).
13. K. Sakane, T. Hirotsu, N. Takagi, S. Katoh, K. Sugasaka, Y. Umezawa, N. Takai, and H. Takahashi, *Bull. Soc. Sea Water Sci. Jpn.*, **36**, 101 (1982).
14. S. Katoh, K. Sugasaka, T. Hirotsu, N. Takai, T. Itagaki, and H. Ouchi, *Proc. IMRUP-Tokyo*, **1983** p. 138.
15. A. Chapiro, *Radiation Chemistry of Polymeric Systems*, High Polymer Ser. Vol. 15, Interscience, New York, 1962.
16. I. Sakurada, T. Okada, and N. Hatakeyama, *Bonded Mater.*, **1**, 11 (1962).
17. X. Zhi-li, W. Gen-hua, W. Han-ing, C. Gyn, and N. Min hua, *Radiat. Phys. Chem.*, **22**, 939 (1983).
18. S. N. Bhattacharyya and D. Maldas, *J. Polym. Sci., Polym. Chem. Ed.*, **21**, 3291 (1983).
19. H. Irving and R. J. P. Williams, *Nature*, **162**, 746 (1948).

Received September 18, 1984

Accepted November 27, 1984

A New Type of Amidoxime-Group-Containing Adsorbent for the Recovery of Uranium from Seawater

H. OMICHI, A. KATAKAI, T. SUGO, and J. OKAMOTO

TAKASAKI RADIATION CHEMISTRY RESEARCH ESTABLISHMENT
JAPAN ATOMIC ENERGY RESEARCH INSTITUTE
TAKASAKI, GUNMA 370-12, JAPAN

Abstract

A new type of adsorbent containing amidoxime groups for the recovery of uranium from seawater was synthesized by the radiation-induced graft polymerization of acrylonitrile onto polymeric fiber followed by amidoximation with hydroxylamine. When amidoxime groups were introduced superficially on the fiber, the amount of uranium adsorbed by the amidoxime groups was higher than that with the amidoxime groups introduced homogeneously in the fiber. The introduction of the poly(acrylic acid) chain and the increase in temperature and flow rate in the adsorption process were effective in increasing the amount of adsorbed uranium. Although alkali metals and alkaline earth metals were found in the adsorbent, the concentration factors for these metals were less than $1/10^3$ of that for uranium. The present adsorbent had a high stability to various treatments such as contact with alkali and seawater.

INTRODUCTION

Separation of uranium from seawater has been studied with various kinds of inorganic (1-5) and organic adsorbents (6-15). Among them, amidoxime-group-containing polymeric adsorbents are noted because of the high loading of uranium and the rapid adsorption rate. Recently, a fibrous adsorbent containing amidoxime groups synthesized through the amidoximation of a commercially available acrylic synthetic fiber with hydroxylamine has been used. It has been reported that the fibrous adsorbent has much higher adsorption ability for uranium when compared with a corresponding bead-type adsorbent (16).

The fibrous adsorbent, however, has poor mechanical stability when it is contacted with alkali. This is supposed to be due to the hydrolysis of residual cyano groups in the polymer chain, which brings about the swelling of the whole fiber and a decrease in mechanical strength. Therefore, in order to synthesize a more stable fibrous adsorbent, a controlled amount of amidoxime groups should be introduced in the prescribed part of the fibrous material without changing the original mechanical strength. Radiation-induced grafting is a convenient method for such a purpose.

When a polymeric substrate is irradiated with ^{60}Co γ -rays or electron beam, about 10^{19} radicals are produced in 1 gram of polymer. The graft polymerization of a monomer is initiated by using these radicals when the monomer is introduced to the irradiated substrate. The number and the length of graft chains are easily controlled by irradiation and polymerization conditions. For example, the number of graft chains has roughly a linear relationship with the irradiation dose. The chain length is affected by the reaction time, the temperature, the presence of chain transfer agents in a monomer solution, etc.

When acrylonitrile is grafted onto fiber followed by amidoximation, a fibrous adsorbent is obtained. This adsorbent has the prescribed number and the length of amidoxime-group-containing graft chains which are connected with the trunk polymer fiber only at their chain ends. It is said that about one graft chain is connected with one trunk polymer on the average (17). In other words, the chemical modification of a trunk polymer by grafting is restricted to a very tiny region of the trunk polymer. Therefore, the chemical structures which were previously possessed by the trunk polymer are well maintained even after grafting.

It is another advantage of the radiation-induced grafting method that the graft chains can be introduced to any part of the substrate—for example, only in the surface region, the inner part, or in the entire substrate. According to the distribution of graft chains containing functional groups, the ability to adsorb metals is expected to differ.

In the present paper, several types of fibrous adsorbents containing amidoxime groups were synthesized by changing the grafting condition of acrylonitrile onto tetrafluoroethylene-ethylene copolymer fiber and were applied to the recovery of uranium from seawater.

EXPERIMENTAL

Fibrous adsorbents containing amidoxime groups (AOF) were prepared by the routes shown in Scheme 1.

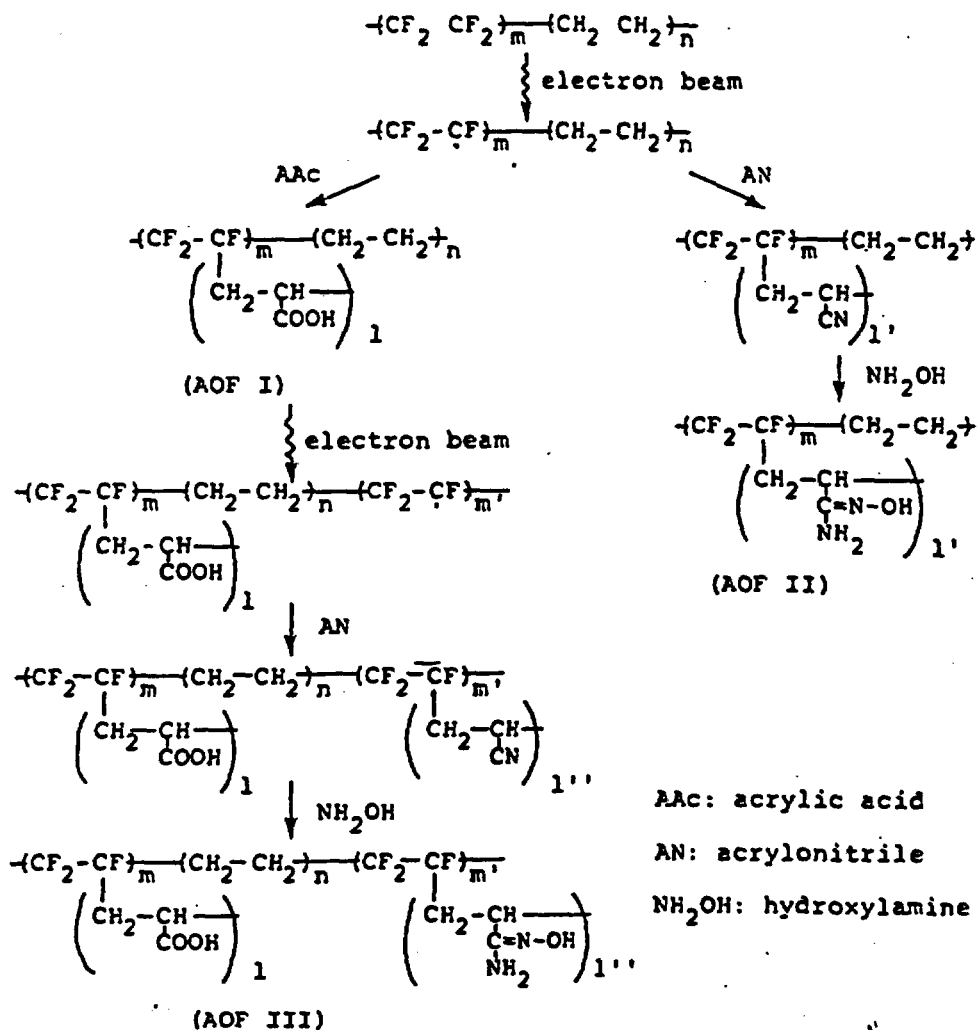

AAC: acrylic acid

AN: acrylonitrile

NH₂OH: hydroxylamine

SCHEME 1. Synthesis of AOF by radiation-induced grafting.

Tetrafluoroethylene-ethylene copolymer fiber (40 μm ϕ , 15 mm length) was irradiated with a Radiation Dynamics electron accelerator, Dynamitron, model IEA 3000-25-2, under nitrogen atmosphere at room temperature. The irradiation dose was estimated as 10 Mrd (100 kGy). The irradiated fiber was introduced in a glass ampule containing purified monomer under nitrogen atmosphere. The graft polymerization was carried

out at 25°C. After grafting, the homopolymer as well as the unreacted monomer were extracted with solvents: *N,N*-dimethylformamide for acrylonitrile homopolymers and water for acrylic acid homopolymers. When both acrylic acid and acrylonitrile were introduced to the fiber, acrylic acid was grafted as the first step, then the grafted fiber was irradiated again followed by the introduction of acrylonitrile as the second step of grafting (18). The cyano groups in the grafted fiber were converted to amidoxime groups through the reaction with hydroxylamine (3% methanol/water 1:1 solution) at pH = 7. The conversion was determined by elemental analysis. The details were reported in a previous paper (19).

The distribution of amidoxime groups in the cross section of the amidoximated fiber was measured by means of a JEOL electron probe x-ray microanalyzer, model JXA 733.

The adsorption of uranium from seawater with AOF was carried out by the following four processes:

1. Batch process: AOF was mixed with seawater in a vessel under vigorous agitation at $25 \pm 1^\circ\text{C}$ for the prescribed period.
2. Semibatch process I: The seawater in the batch vessel was intermittently exchanged for fresh seawater.
3. Semibatch process II: Seawater was supplied continuously to the stirred vessel.
4. Fixed-bed process: AOF was packed in a column (10 mm ϕ , 10 cm length) and seawater was continuously supplied.

The desorption of uranium adsorbed in 0.1 g of AOF was accomplished by contacting the fiber with 25 mL of sulfuric acid for 1 h at room temperature. The amount of uranium complexed with arsenazo III was measured optically (20) at 665 nm by means of a Shimadzu spectrophotometer, model UV-100-02. Metals other than uranium were determined by means of a Jarrell-Ash atomic absorption and flame emission spectrophotometer, model AA-8200.

RESULTS AND DISCUSSION

Preparation of Adsorbents

As mentioned above, one of the advantages of the grafting method for synthesizing adsorbents is that any amount of functional groups can be introduced to the trunk polymer fiber by selecting proper irradiation and

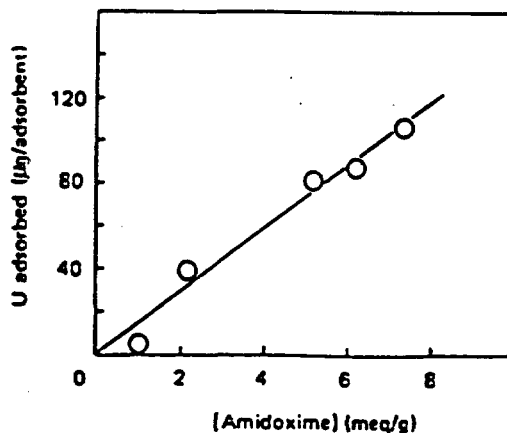

FIG. 1. Effect of concentration of amidoxime groups in AOF on the adsorption of uranium from seawater: AOF 0.1 g, seawater 10 L, in the semibatch process I at 25°C.

grafting conditions. Several kinds of fibrous adsorbents containing amidoxime groups up to 6.5 meq/g were synthesized by changing the reaction time. Figure 1 shows the results when these AOF were used for uranium adsorption from seawater in semibatch process I. As 2 L of seawater was exchanged with fresh seawater for 5 d, the total amount of supplied seawater was 10 L. The amount of adsorbed uranium increased in proportion to the increase in the concentration of amidoxime groups in AOF. Such relationships have been observed in various amidoxime-group-containing bead-type adsorbents (9).

Although the results in Fig. 1 show that the adsorption of uranium is facilitated by increasing the amount of amidoxime groups in the fiber, it should be pointed out that the amidoxime groups used for adsorption of uranium from seawater is only a small portion of the total amidoxime groups introduced in AOF. The molar ratio of the adsorbed uranium to amidoxime groups is of the order of 10^{-4} . Even if four amidoxime groups are necessary to make a chelate complex with one uranyl ion (21), the number of the amidoxime groups used is estimated as $\sim 1/2500$ of the total amidoxime groups. In other words, the present adsorbents shown in Fig. 1 can, in theory, adsorb 0.5–1.5 mmol uranium per 1 g adsorbent. This value is reasonable when compared with the previous work by Schwochau et al. (21).

Two types of AOF, AOF-L and AOF-V, each containing ~ 5 meq of amidoxime groups per 1 g of fiber, were synthesized by liquid-phase grafting and vapor-phase grafting of AN, respectively. As shown in Fig. 2, the distribution of amidoxime groups in the cross section of AOF-L

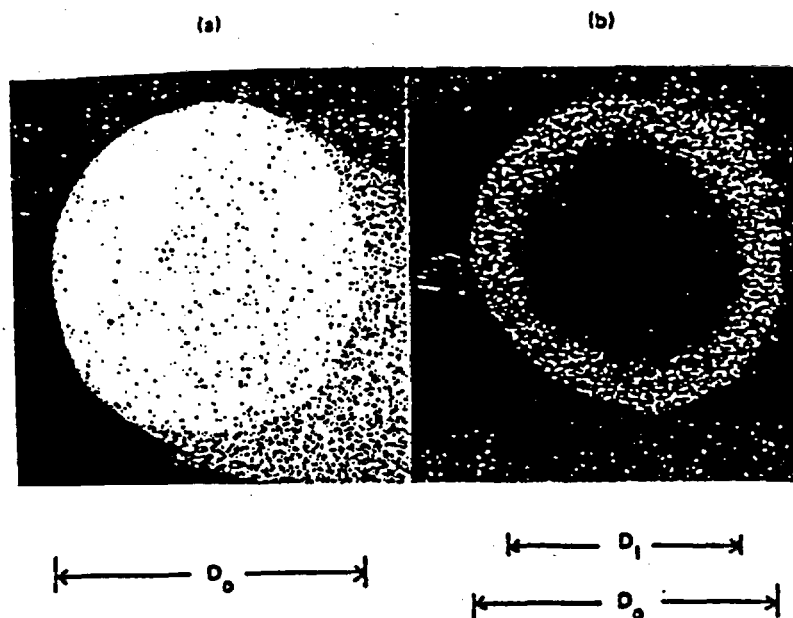

FIG. 2. Distribution patterns of amidoxime groups in the cross section of (a) AOF-V and (b) AOF-L. D_o and D_i are the outer and inner diameters, respectively.

observed by means of EPMA is homogeneous. On the other hand, in AOF-V the distribution is heterogeneous—mostly restricted to the layer within 10 μm from the surface. Because uranium in seawater is adsorbed in the thin surface layer of the adsorbent (21), only the amidoxime groups existing in the surface layer are supposed to be effective for adsorbing uranium.

The concentration of amidoxime groups in the thin surface layer of AOF-L was compared with that of AOF-V. The ratio between the two amounts is given as

$$\frac{F_1}{F_2} \frac{S_o - S_i}{S_o} / \frac{F_1}{F_2} = (F_1/F_2) \left(\frac{D_o^2 - D_i^2}{D_o^2} \right) \quad (1)$$

where F_1 and F_2 are the concentrations of amidoxime groups for AOF-L (5.1 meq/g) and AOF-V (5.0 meq/g), respectively, and D_o and D_i are the outer and inner diameters of cross section, respectively, as shown in Fig. 2. S_o and S_i are the corresponding areas. By introducing $D_o = 80 \mu\text{m}$, $D_i = 60 \mu\text{m}$, $F_1 = 5.1 \text{ meq/g}$, and $F_2 = 5.0 \text{ meq/g}$, the ratio was obtained as 0.45. This result indicates that the concentration of amidoxime groups in a unit surface layer of AOF-V is twice as large as that of AOF-L. According

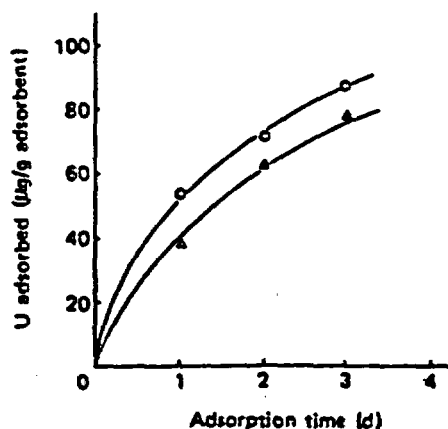

FIG. 3. Adsorption of uranium from seawater with (O) AOF-V and (Δ) AOF-L in the semibatch process I.

to the results in Fig. 1, therefore, the adsorption of uranium with AOF-V is expected to be twice as much as that with AOF-L. However, Fig. 3 shows that the adsorption of uranium with AOF-V is slightly higher than that with AOF-L. This is a rather unexpected result because we observed that the adsorption of copper ions from a buffer solution at pH = 6 with AOF-V was about twice as much as that with AOF-L (22). In the case of adsorbing uranium from seawater, the functional groups existing on the surface layer are occupied by various kinds of metal ions other than uranium and are quickly covered with organic substances such as seaweeds. Therefore, there are fewer residual functional groups which work for adsorbing uranium compared with those functional groups existing inside an adsorbent like AOF-L. In the latter case, the surface layer may work as a filter for these obstacle substances. The result in Fig. 3 indicates that an adsorbent which is effective in a pure solution is not always effective in seawater. Therefore, the following experiments were carried out with the homogeneous adsorbent AOF-L.

Figure 4(a) shows the amount of uranium adsorbed from 2 L of seawater with 0.1 of three types of adsorbents, AOF-I, II, and III, which were made by liquid-phase grafting. The compositions of the adsorbents are shown in Table I. AOF-I, containing only carboxyl groups, did not adsorb uranium at all. Referring to the report that poly(acrylic acid) can make a chelate complex with uranyl ions under acidic condition (23), the present result may be partly due to the insufficient pH value of seawater for chelate formation between carboxyl groups and uranyl ions. At pH = 8,

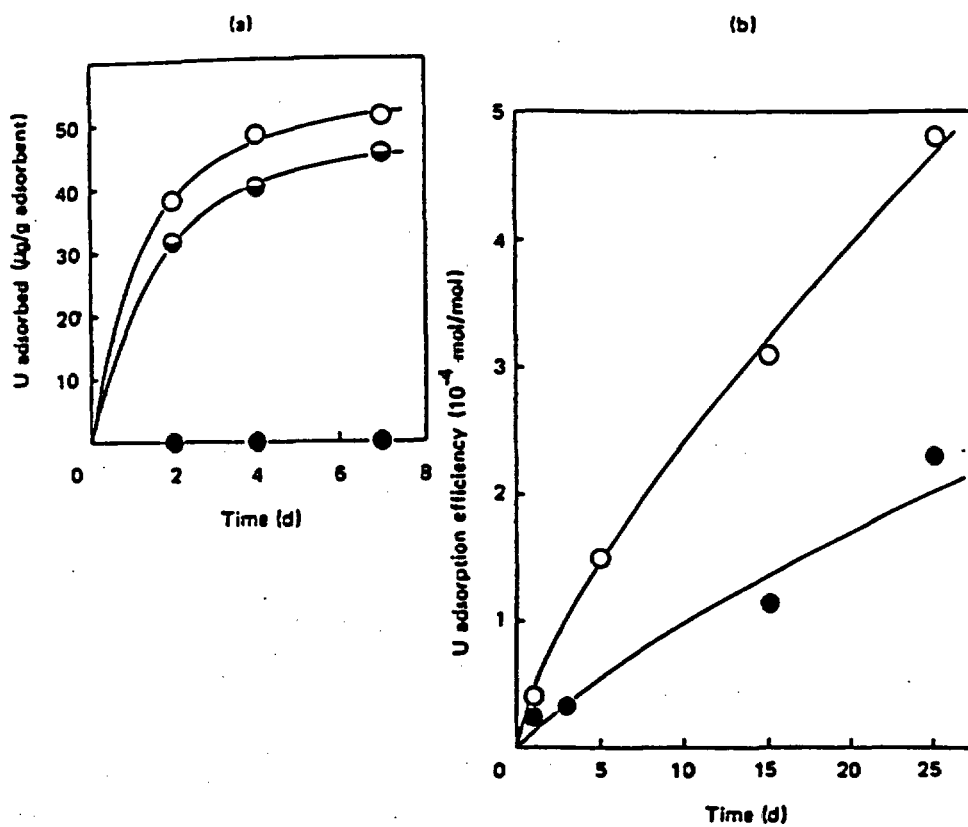

FIG. 4. Amounts of uranium adsorbed in (a) the batch process with (●) AOF-I, (○) AOF-II, and (○) AOF-III, and in (b) the semibatch process I with (●) AOF-II and (○) AOF-III.

TABLE I
Composition of Adsorbents AOF

Adsorbent	Concentration of functional groups (mmol/g)	
	Carboxyl	Amidoxime
AOF-I	5.2	0
AOF-II	0	5.1
AOF-III	1.9	3.4

poly(acrylic acid) dissociates into carboxylate anion, which may be undesirable for chelate formation.

When AOF-II and III are compared, AOF-III adsorbed more uranium in spite of the fact that the amount of amidoxime groups in AOF-III is less than in AOF-II. Therefore, the higher adsorption with AOF-III is supposed to be due to carboxyl groups. The effect of carboxyl groups on uranium adsorption was more clearly indicated when the molar ratio of adsorbed uranium to amidoxime groups was plotted against the adsorption period as shown in Fig. 4(b). AOF-III adsorbed twice as much uranium as did AOF-II. The effect of carboxyl groups on uranium adsorption with AOF is explained as follows: As already pointed out (14), uranyl tricarbonate, which is the major form of uranyl ion in seawater at $\text{pH} = 8$, is converted to bicarbonate when the pH value is lowered. Therefore, it is probable that poly(acrylic acid) graft chains locally decrease the pH of seawater sorbed in the adsorbent, which promotes the conversion from tricarbonate to bicarbonate. This conversion may be accompanied by a new chelate formation with uranyl bicarbonate and an amidoxime group in the vacant site. In other words, the presence of carboxyl groups is thought to have a synergistic effect on chelate formation between amidoxime groups and uranyl ions.

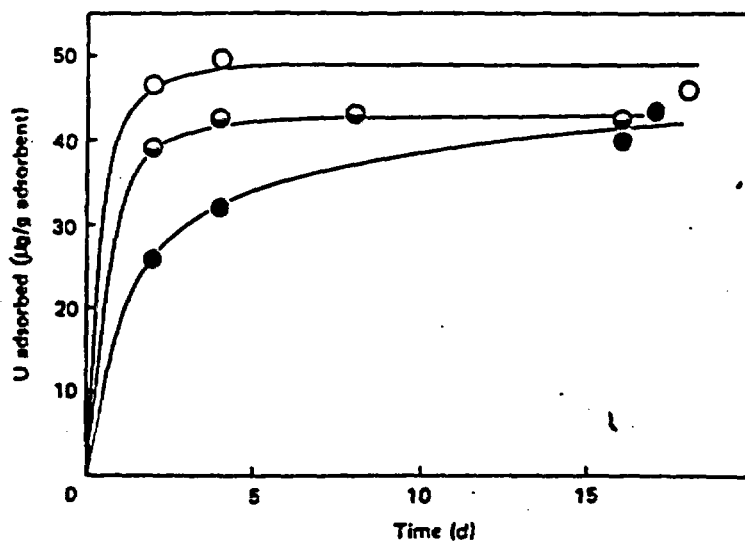

FIG. 5. Effect of temperature of seawater on adsorption of uranium with AOF in the batch process: (●) 15°C, (⊙) 25°C, and (○) 35°C.

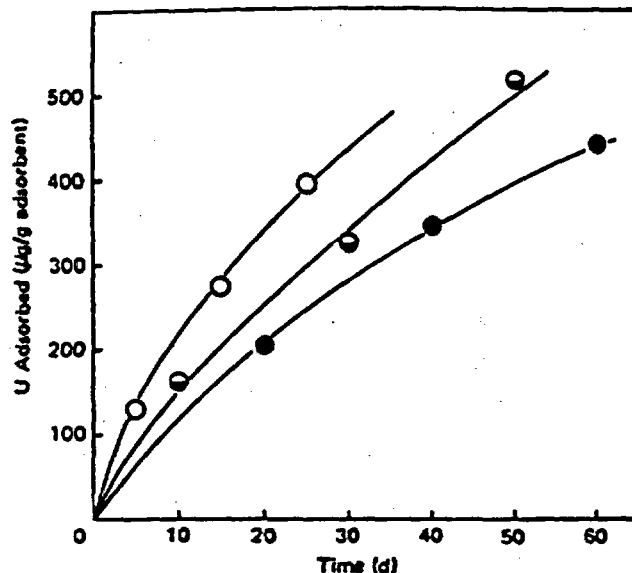

FIG. 6. Effect of exchange rate of 2 L of seawater on adsorption of uranium with AOF-III in the semibatch process I: (●) every 1 d, (◐) 2 d, and (○) 4 d.

Adsorption Method

The adsorption of uranium from seawater with AOF was carried out at 15 to 35°C. Although the equilibrium amount of adsorbed uranium did not change, the initial rate of adsorption was increased by increasing the temperature as shown in Fig. 5. From Arrhenius plots, the activation energy for adsorption was estimated as ~8.8 kcal/mol.

The results in Fig. 5 indicate that a higher temperature is preferable for the recovery of uranium from seawater with AOF. Especially when the adsorption-desorption cycle is carried out at short intervals, such a large initial rate is desirable.

As shown in Fig. 4(a), the amount of adsorbed uranium levels off after 7 day's adsorption in the batch process. About 0.1 g of AOF-III recovered more than 80% of the uranium contained in 2 L of seawater. The saturation of adsorption is, therefore, supposed to be due to the depletion of uranium in seawater contained in the batch vessel. In order to clarify this assumption, seawater was exchanged with fresh seawater every 1, 2, and 4 days in semibatch process I. Figure 6 shows the amount of adsorbed

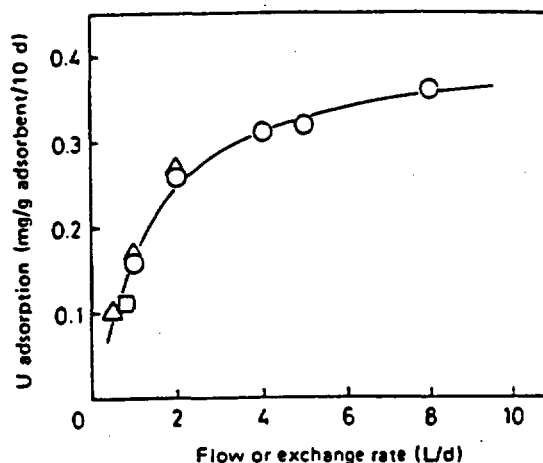

FIG. 7. Effect of flow rate and exchange rate of seawater on adsorption of uranium with AOF-III in (O) semibatch process I, (Δ) semibatch process II, and (\square) fixed-bed process.

uranium thus obtained. When the results in Fig. 6 are compared with those in Fig. 4(a), it is clear that uranium adsorption is facilitated by exchanging seawater. The adsorbed uranium was at most 50% of the total uranium in seawater, even if the exchange rate was small. This result indicates that the depletion of uranium was fairly avoided by this exchange procedure.

Uranium adsorption did not increase in proportion to the exchange rate of seawater. Doubling the exchange rate brought about only a 20 to 30% increase in uranium adsorption. This adsorption behavior was observed when the flow rate was increased in semibatch process II and the fixed-bed process. As shown in Fig. 7, the increase in uranium adsorption levels off when the flow rate of seawater in semibatch process II and the fixed-bed process increases. It is interesting that the amount of adsorbed uranium obtained in semibatch process I is virtually the same as in semibatch process II and the fixed-bed process. This is probably due to the slow feed of seawater. For example, 10 L/d of flow, adopted in the present experiment, corresponds to only 8.8 cm/min of line velocity, which means that at least 2 s is necessary for one drop (~ 0.2 mL) of seawater to get out of the column. Therefore, it is supposed that the flow rate in the continuous processes is slow enough to assure a sufficient contact of AOF with seawater as observed in the batch process with vigorous agitation.

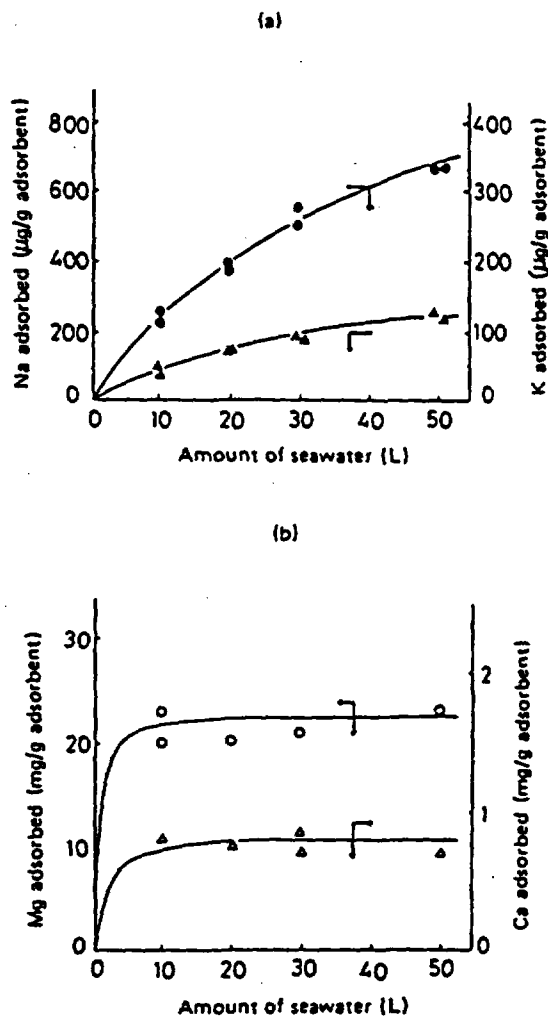

FIG. 8. Amounts of (a) alkali metals ((●) Na and (Δ) K) and (b) alkaline earth metals ((○) Mg and (Δ) Ca) adsorbed in AOF-III at different periods.

Characteristics of AOF

It has been reported that alkaline earth metals disturb the recovery of uranium from seawater (24). The smaller uptake of these metals is desirable as adsorbents for uranium. Although alkali metal ions and alkaline earth metal ions were reported to have small affinity for amidoxime groups (10),

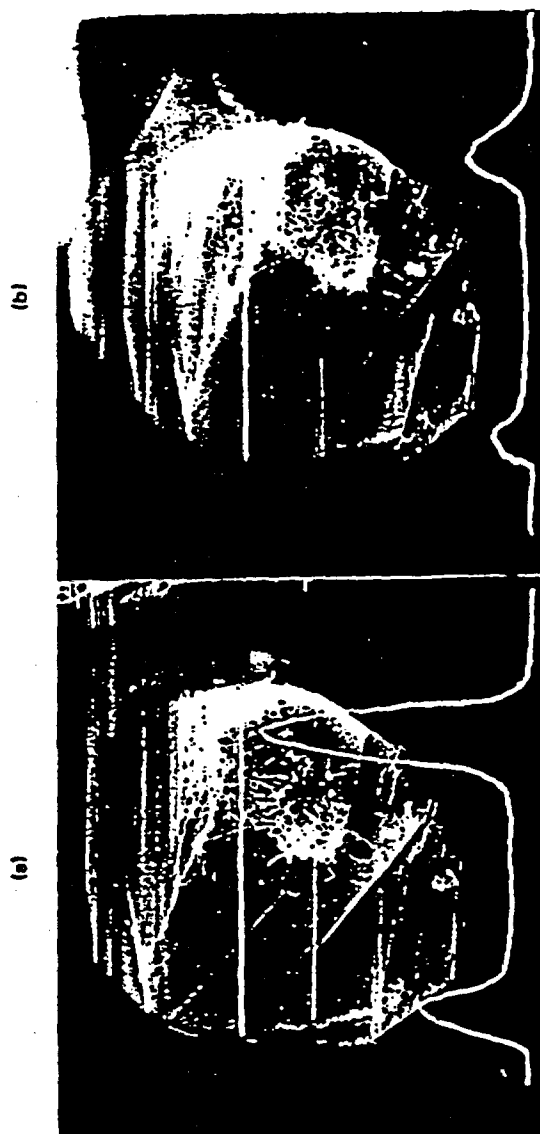

Fig. 9. Distribution of (a) Mg and (b) Ca in the cross section of AOF-III when contacted with seawater for 25 d.

TABLE 2
Natural Abundance of Various Metal Ions in Seawater, and Concentration Factors (CF)
Based on Adsorption with AOF

Metal ion	Abundance in seawater (g/L)	CF
U	3×10^{-6}	1.3×10^4
Zn	5×10^{-6}	7.0×10^5
Ni	7×10^{-6}	2.0×10^3
Ca	0.41	29
Mg	1.3	6.3
Na	10.8	0.34
K	0.39	0.13

a considerable amount of these metals was found in AOF after contact with seawater. Figure 8 shows the amounts of (a) alkali metals and (b) alkaline earth metals in AOF-III at different adsorption periods in the fixed-bed process. The amount of such alkali metals as sodium and potassium gradually increases with an increase in the adsorption period (amount of seawater). The amount of alkaline earth metals, on the other hand, levels off quite soon, as shown in Fig. 8(b). From the distribution pattern of Mg and Ca in AOF as shown in Fig. 9, it is clear that these alkaline earths locate only in the surface region of the adsorbent even if AOF are contacted with seawater for a long period.

The equilibrium adsorption of Mg was ~ 2 mg, which is at least 10 times that of uranium. However, this large amount is due to the large content of Mg in seawater. Table 2 shows the natural abundances of various metal ions in seawater, and the concentration factors (CF) indicated are the ratios of the concentration in the adsorbent to that in seawater. It is clear that CF for uranium and some transition metals is over 10^4 . On the other hand, CF for alkalis and alkaline earths is less than 10^2 . These results indicate that amidoxime groups in AOF have a high selectivity for heavy metal ions.

The adsorbent AOF made by the radiation-induced grafting method has some characteristic polymer structures when compared with the corresponding adsorbents made from commercially available acrylic synthetic fiber. First, the graft chains which contain amidoxime groups are connected with the trunk polymer fiber only at the chain ends. Therefore, the mechanical properties of the trunk polymer itself is mostly unchanged, even after grafting. Second, swelling occurs only in the amorphous region of the trunk polymer because grafting is restricted to this region (17). This heterogeneous swelling behavior brings about a small dimensional change of the adsorbent when it is contacted with various solutions such as alkali,

TABLE 3
Change in Diameter of AOF by Contact with Various Liquids

Liquid	Diameter (μm)
Original AOF	66
Alkali ^a	70
Seawater ^b	72

^a2.5% KOH solution, 10 min at 80°C.

^b24 h at 30°C.

acid, and seawater. As shown in Table 3, the increase in diameter of AOF by contact with these liquids is less than 10% on the whole. This dimensional stability is very important when the adsorbent is used repeatedly through the cycle: pretreatment with alkali—contact with seawater—acid desorption. A preliminary study showed that the decrease in adsorption of uranium and the dimensional change of AOF are both negligible up to cycle³five. Further details will be presented in future publications.

REFERENCES

1. Y. Ozawa, T. Murata, H. Yamashita, and F. Nakajima, *J. Nucl. Sci. Technol.*, **17**, 204, 634 (1980).
2. H. Yamashita, Y. Ozawa, F. Nakajima, and T. Murata, *Bull. Chem. Soc. Jpn.*, **53**, 1, 1331, 3050 (1980).
3. H. Yamashita, Y. Ozawa, F. Nakajima, and T. Murata, *Sep. Sci. Technol.*, **16**, 676 (1981).
4. Yu. P. Novikov and V. M. Komarevsky, *Radiochem. Radioanal. Lett.*, **48**, 45 (1981).
5. N. Jaffrezic and M. H. Andrade, *J. Radioanal. Chem.*, **55**, 307 (1980).
6. N. Jaffrezic, M. H. Andrade, and D. H. Trang, *J. Chromatogr.*, **201**, 187 (1980).
7. I. Tabushi, Y. Kobuke, and T. Nishiya, *Nature*, **280**, 665 (1979).
8. I. Tabushi, Y. Kobuke, K. Ando, M. Kishimoto, and E. Ohara, *J. Am. Chem. Soc.*, **102**, 5947 (1980).
9. K. Sugasaka, S. Katoh, N. Takai, H. Takahashi, and Y. Umezawa, *Sep. Sci. Technol.*, **16**, 971 (1981).
10. M. B. Colicla, S. Siggia, and R. M. Barnes, *Anal. Chem.*, **52**, 967 (1980).
11. S. Fried, A. M. Friedeman, and J. C. Sullivan, *Environ. Sci. Technol.*, **15**, 834 (1981).
12. J. Borzekowski, M. J. Driscoll, and F. R. Best, *Trans. Am. Nucl. Soc.*, p. 44 (1983).
13. H. J. Schenk, L. Astheimer, E. G. Witte, and K. Schwochau, *Sep. Sci. Technol.*, **17**, 1293 (1982).
14. L. Astheimer, H. J. Schenk, E. G. Witte, and K. Schwochau, *Ibid.*, **18**, 307 (1983).
15. D. Heitkamp and K. Wagener, *Ind. Eng. Chem., Process Des. Dev.*, **21**, 781 (1982).
16. S. Katoh, K. Sugasaka, K. Sakane, N. Takai, H. Takahashi, Y. Umezawa, and K. Itagaki, *J. Chem. Soc. Jpn.*, pp. 1449, 1455 (1982).
17. H. Omichi and K. Araki, *J. Polym. Sci., Polym. Chem. Ed.*, **14**, 2773 (1976).

18. H. Omichi and J. Okamoto, *Ibid.*, 20, 521 (1982).
19. J. Okamoto, T. Sugo, A. Katakai, and H. Omichi, *J. Appl. Polym. Sci.*, To Be Published.
20. H. Ohnishi and Y. Toyota, *Bunseki Kagaku*, 14, 1141 (1965) (in Japanese).
21. K. Schwochau, L. Astheimer, J. K. Schenk, and E. G. Witte, *Proceedings of the International Meeting for the Recovery of Uranium from Seawater*, Tokyo, 1983, p. 178.
22. T. Sugo, A. Katakai, H. Omichi, and J. Okamoto, Unpublished Data.
23. H. Nishide, N. Oki, and E. Tsuchida, *Eur. Polym. J.*, 18, 799 (1982).
24. K. Sugasaka and A. Katoh, *Bull. Soc. Seawater Sci. Jpn.*, 35, 317 (1982).

Received by editor September 24, 1984

TECHNOLOGIES DISCUSSED AT PNC-CHUBU WORKS

- National Analogue Study on TONO Sandstone- Type Uranium Deposit in Japan

BIBLIOGRAPHY OF LITERATURE RECEIVED FROM PNC-CHUBU WORKS

"Field Tour Guide for Tono Mine Gallery (Tsukiyoshi Deposit)," PNC Chubu Works, 28 pages.

**"Natural Analogue Study of Tono Sandstone Type Uranium Deposit in Japan,"
Written by C. Sato, Y. Ochiai and S. Takeda. Waste Management and Raw
Materials Division, PNC-Chubu Works, 11 pages.**

**"Natural Analogue Study of Tono Sandstone Type Uranium Deposit in Japan,"
Written by T. Seo, Y. Ochiai, S. Takeda and N. Nakatsuka. PNC-Chubu
6 pages.**

November 13, 1990

Field Tour Guide
for
Tono Mine Gallery(Tsukiyoshi Deposit)

Chubu Works
Power Reactor and Nuclear Fuel
Development Corporation(PNC)
JAPAN

Field Tour

Meeting Room :

- Brief Overview of R&D Activities of PNC at Chubu Works
- Introduction of Field Tour

Tono mine gallery ; (see next three pages)

- STOP 1 Engineered Barrier Materials Field Tests
- STOP 2,3 Hydrogeochemistry of groundwater
- STOP 4 Geochemistry of Natural U-Th Series Nuclides
 Uranium Mineralization
- STOP 5 Mine-by Experiments on Excavation Responses
- STOP 6 Shaft Excavation Effect Project Site

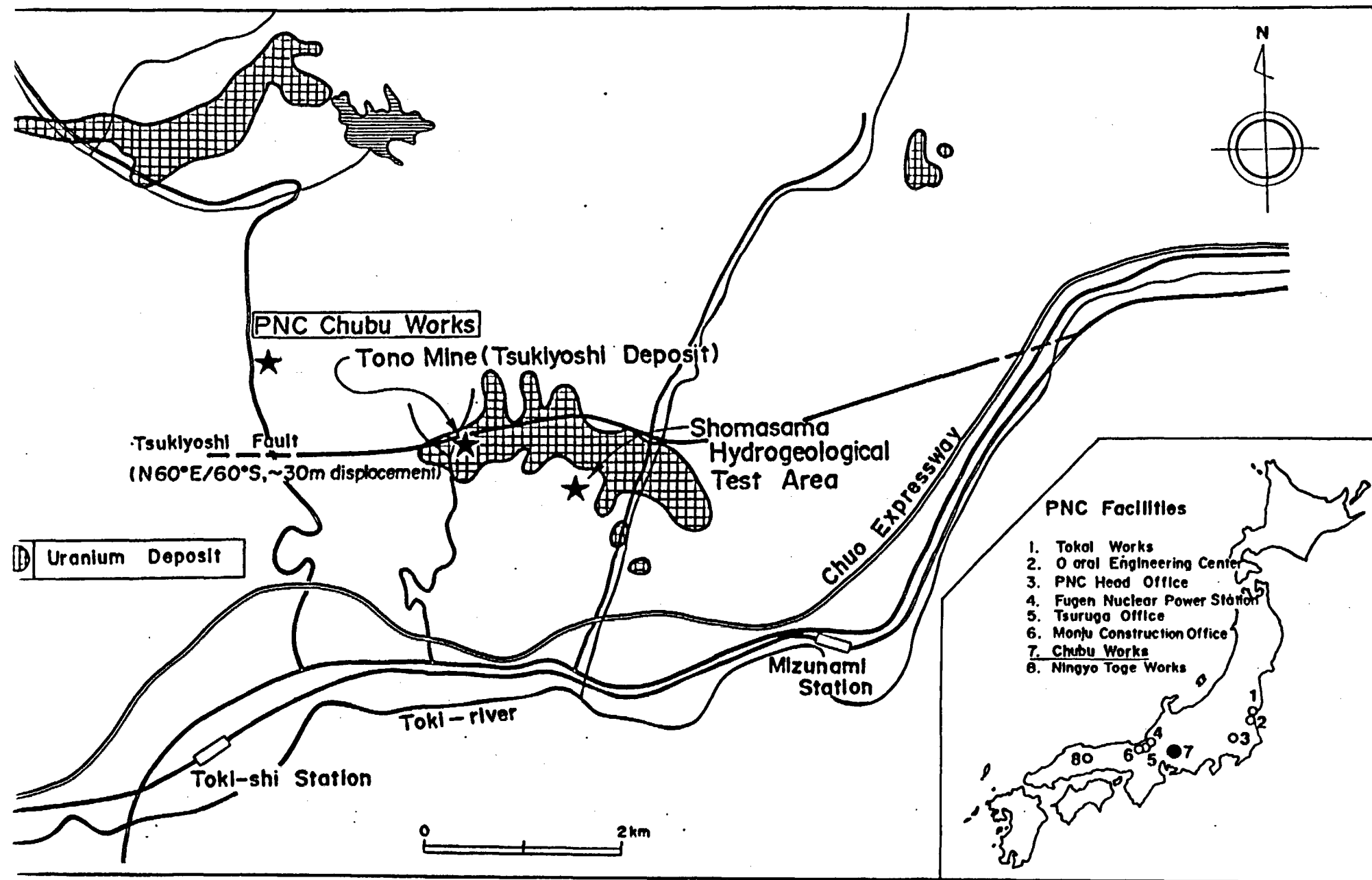

Location Map of Test Area in Tono Mine and Adjacent Area

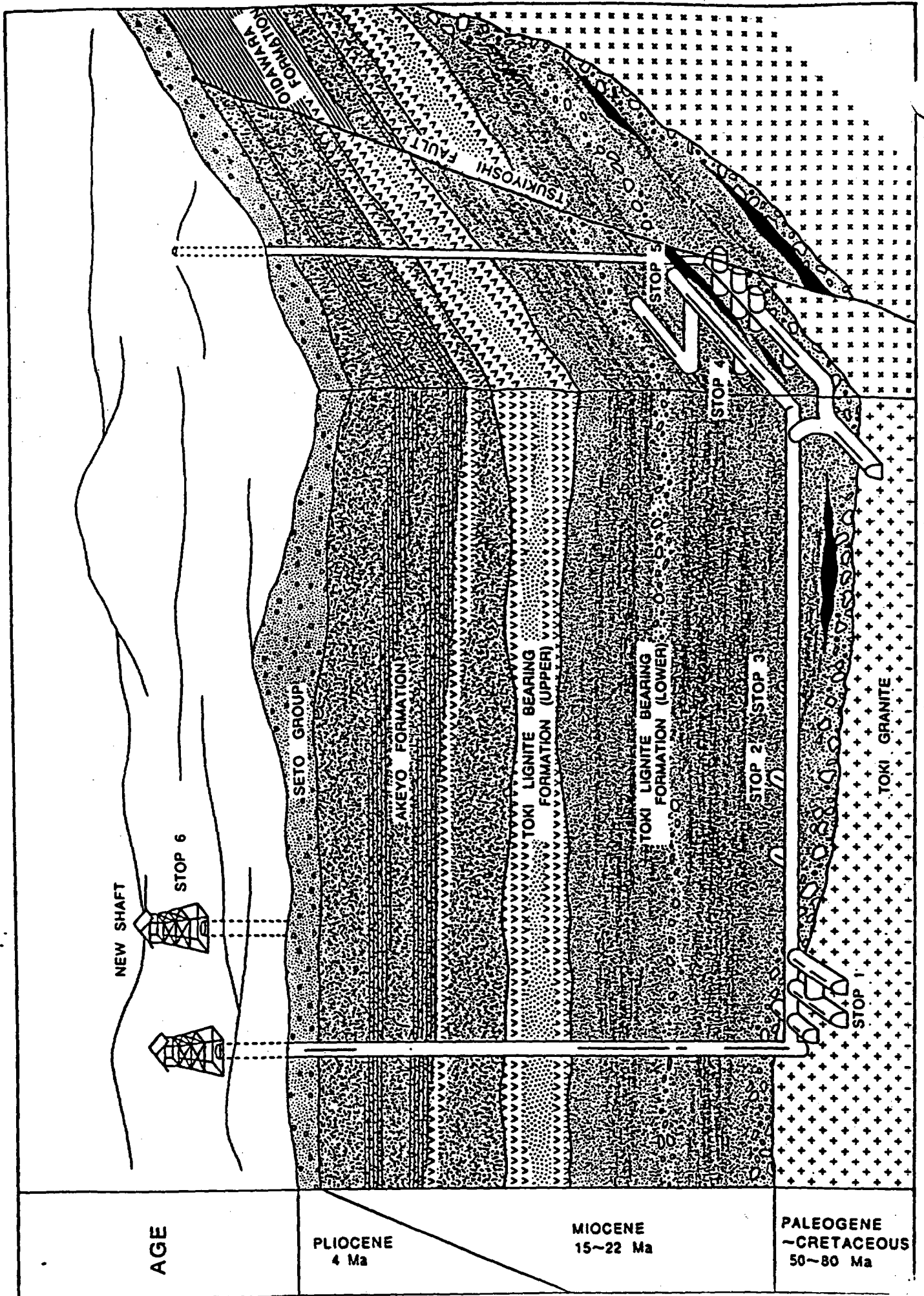

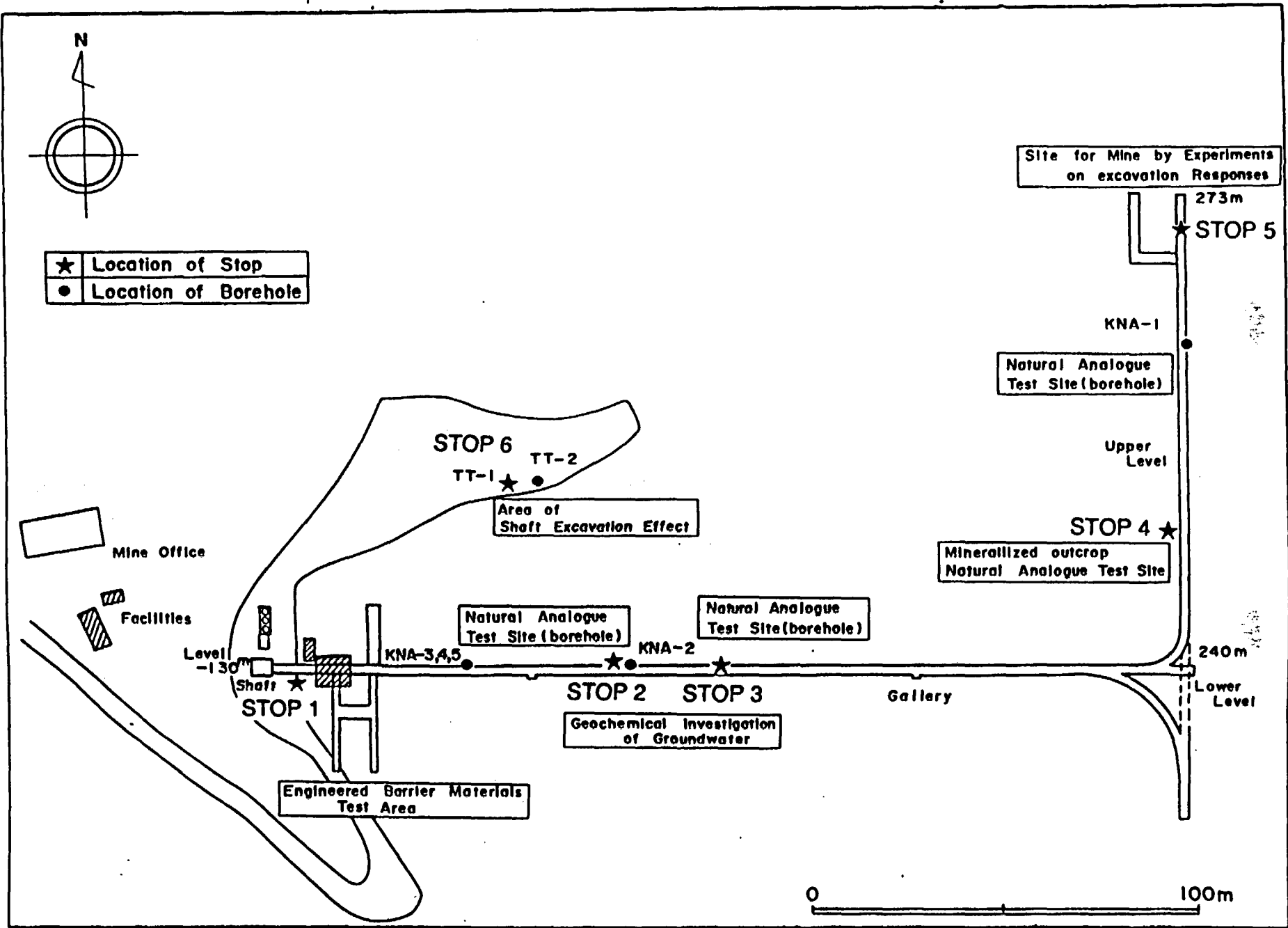

Location Map of Test Sites and Facilities in Tono (Tsukiyoshi Deposit) Mine.

STOP 1 ; Engineered Barrier Materials Field Tests

Objectives

- (1) Evaluation of chemical durability of waste glass under field conditions.
- (2) Evaluation corrosion behavior of overpack materials under field conditions.
- (3) Establishment of experimental methods of field tests for engineered barrier materials.

Test items

- (1) Hydrological characterization of field test site:
 - Sampling and analysis of groundwater composition.
 - Periodic monitoring of groundwater;
pH, Eh, DO, conductivity and temperature measurement.
 - Groundwater flow measurement.
- (2) Engineered barrier materials corrosion tests under field conditions:
 - Leaching test of simulated waste glass;
(Glass=P0798, Temperature=19°C, 90°C)
 - Corrosion tests of candidate overpack materials;
(Specimen: mild steel, cast steel, copper, titanium alloy (ASTM G-12Ti), hastelloy C, Temperature:19°C)
 - Evaluation of specimens:
Corrosion rate (weight loss), analysis of alteration layer and corrosion products (SEM, XRD)

Result

- (1) Hydrological characterization of field test site:
 - Tono groundwater chemistry (See Table 1);
Na-HCO₃ Type
 - Hydraulic conductivity at Tono test site:
 $10^{-6} \sim 10^{-5}$ cm/sec
- (2) Corrosion behavior of engineered barrier materials under field conditions:
 - Waste glass (P0798) leach rate as a function of temperature (See Fig.2);
The activation energy (65KJ) of waste glass alteration calculated from field leaching tests was quite similar as that obtained from a soxhlet test in laboratory.
 - Overpack materials weight loss as a function of time (See Fig.2);
Weight loss of test specimens (mild steel, cast steel and pure copper) in field tests at Tono test site were smaller than those in laboratory tests using Tono groundwater.
Very low corrosion rate at the field tests was obtained for Titanium, its alloy and nickel alloy.

Table 1 Data of Tono groundwater chemistry

	1st Test Site	2nd Test Site
Temp (°C)	19	19
pH	8.9 ~ 9.1	8 ~ 9
Eh (mV)	242 ~ 296	160 ~ 260
Cond. (μS/cm)	244 ~ 260	200 ~ 300
DO (ppm)	< 1	< 1
Na ⁺	46.8 (mg/L)	65.0 (mg/L)
K ⁺	0.32	3.0
Ca ²⁺	2.04	11.0
Mg ²⁺	0.04	ND
Fe ²⁺	0.024	< 0.3
Al ³⁺	1.2	0.6
Cl ⁻	1.0 (mg/L)	1.5 (mg/L)
SO ₄ ²⁻	0.7	1.2
F ⁻	8.7	5.4
PO ₄ ³⁻	0.07	ND
HCO ₃ ⁻	90	140
CO ₃ ²⁻	11	< 3
Si	6.5 (mg/L)	6.5 (mg/L)
B	0.3	0.3
T-Fe	< 0.12	< 0.3

ND : Not Detected

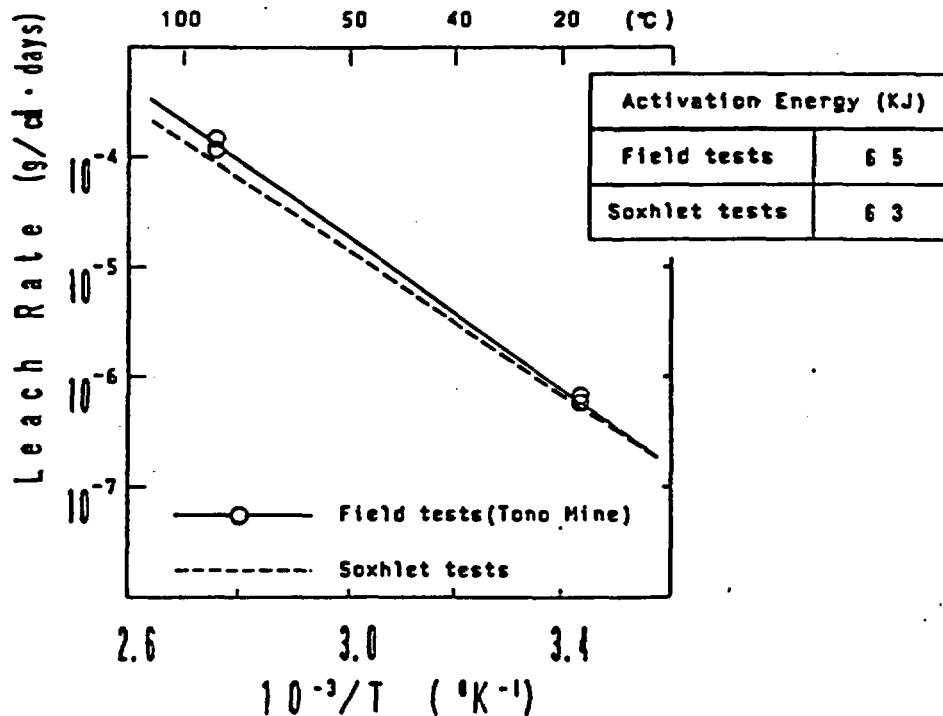

Figure 1 Waste glass (P0798) leach rate as a function of temperature

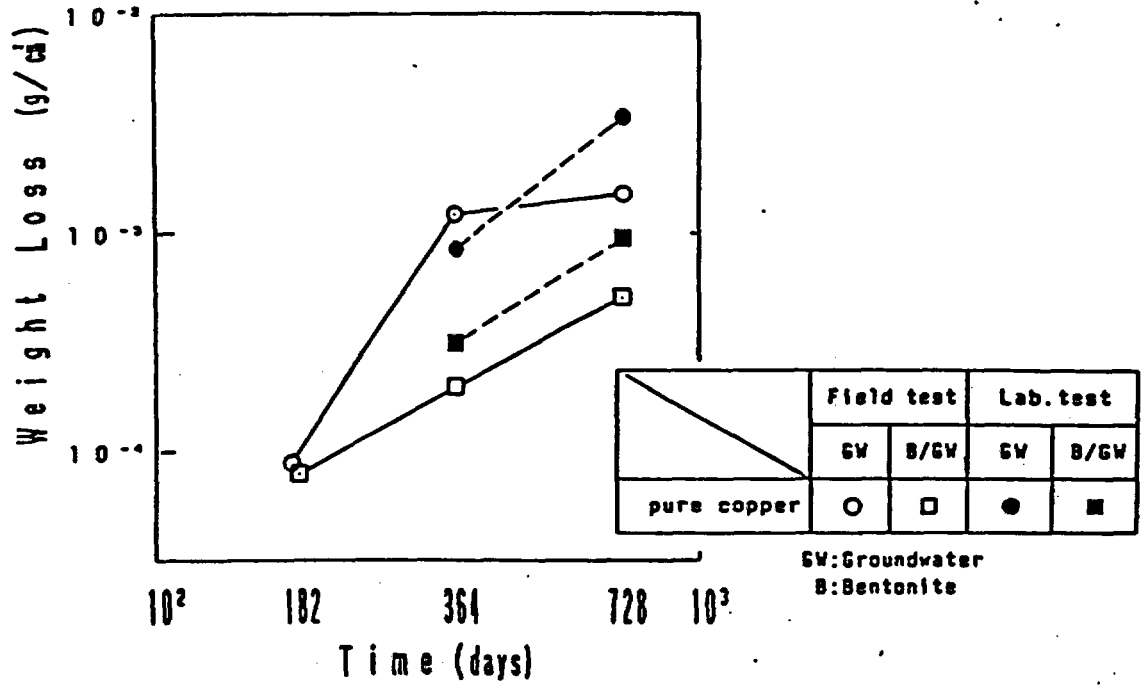
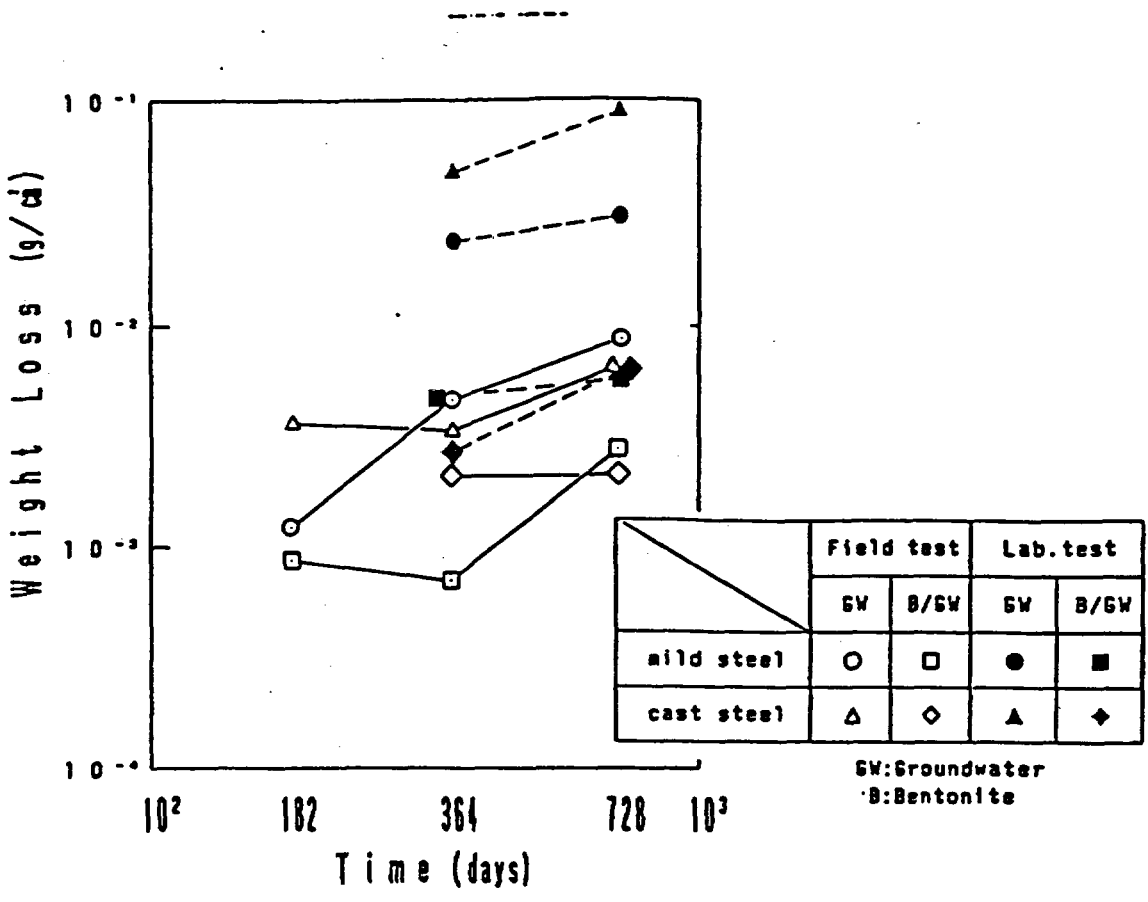

Figure 2 Overpack materials weight loss as a function of time

STOP 2; General Programme and Work Scope on Natural Analogue Studies

Objectives

- (1) Contribution to validation of migration models in natural barrier for long-term safety assessment.
 - To understand geochemical basis related to migration and fixation of U-series nuclides for long-term prediction models.
- (2) Contribution to the site investigation process.
 - To develop the methodology and equipments for the characterization of suitable geological environment for isolation of radioactive wastes.
- (3) Contribution to establishment of public acceptance.
 - To support the feasibility of geological isolation of radioactive wastes in Japanese geological environment.

Work Scope

The following studies are in progress to investigate fixation-migration of U-series nuclides, and its relevant geological and geochemical environment.

- (1) Migration and retardation studies uranium of series nuclides.
 - Uranium series disequilibria in ore zone and around the Tsukiyosi Fault.
 - In-situ distribution coefficients
 - Matrix diffusion into granite boulders in ore zone.
 - Transportation to biosphere.
- (2) Geochemical study of groundwater.
 - Geochemical parameters.
 - Characterization of natural colloids.
 - Geochemical modelling of groundwater.
- (3) Hydrogeological study at Tono area.
 - Hydrogeological parameters.
 - Modelling of groundwater flow system.
- (4) Geological and geochronological study.
 - Occurrence of uranium deposits.
 - Geological history of Tono area.
 - Mineralogy of host rock.
- (5) Migration modelling.
 - Data base of above studies.
 - Validation of models

Remarks

- (1) General and economic geology have been studied i.e. stratigraphy, geological structure, geological history, ore distribution, ore grade ore characteristic, mineralogy of host rock, etc.
- (2) There is no evidence of migration of uranium series nuclides such as ^{238}U , ^{234}U and ^{230}Th for a period of at least 1 million years.
- (3) ^{226}Ra has been migrated over a distance of several meters for recent thousand years.
- (4) The chemical and isotopic composition is characterized in correspondence with the stratigraphy.
- (5) The tritium concentration in groundwater show that shallow groundwater is directly recharged by rainfall and discharge very quickly and the deep groundwater is stagnant.

Natural Analogue Program in Tono Uranium Deposits

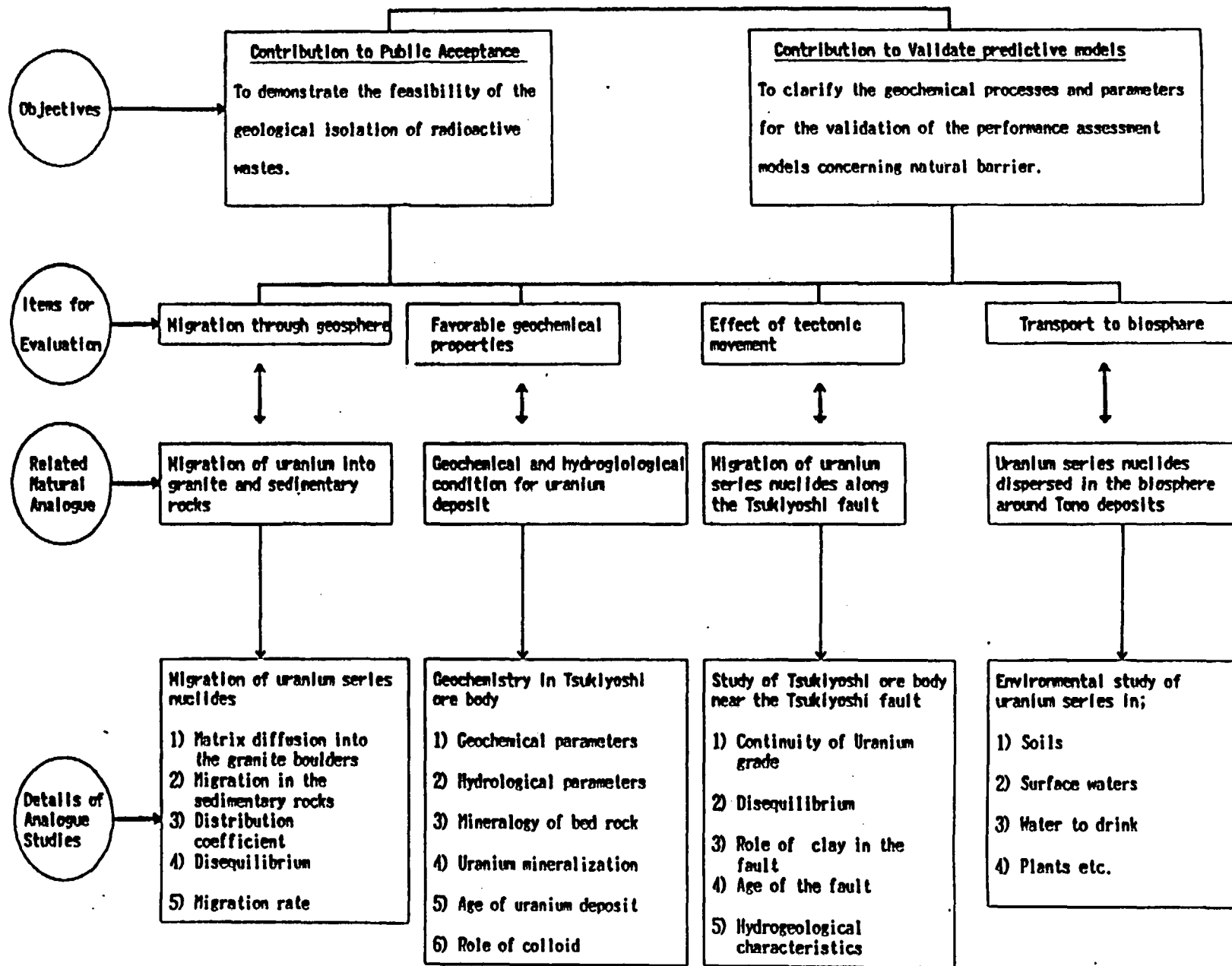

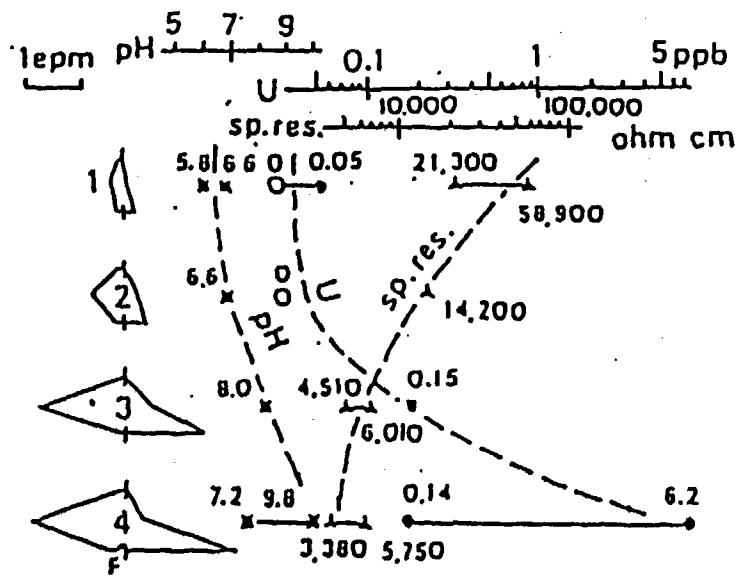
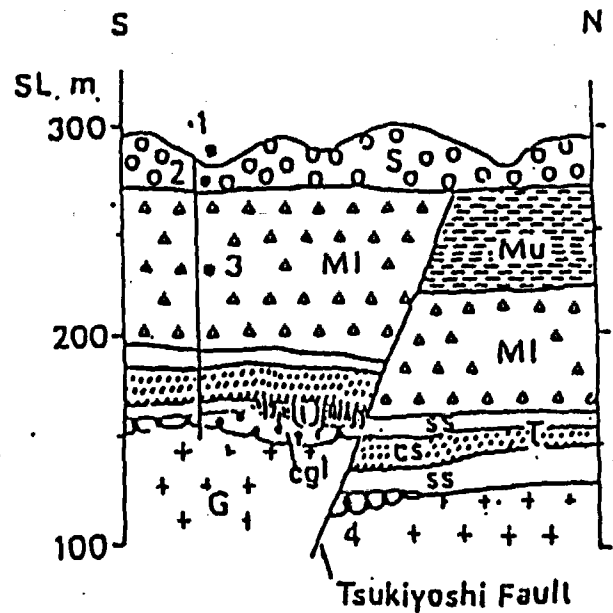

- samplest 1: surface water
 (hexadiagram -- from Kyuroku-bora)
 2: groundwater, Seto G. (sublevel A conduit)
 3: do., Mizunami G. (sublevel C conduit)
 4: do., Toki G. (main level No. 11 bora hole)
 coll. in Dec. 1976

abbr.: S: Seto Group M: Mizunami G. (u: upper l: lower) T: Toki G. (cgl: conglomerate
 ss: sandstone and shale cs: calcally sandstone) C: Granite U: uranium deposit

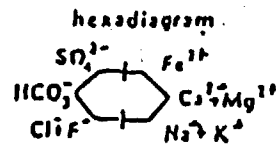
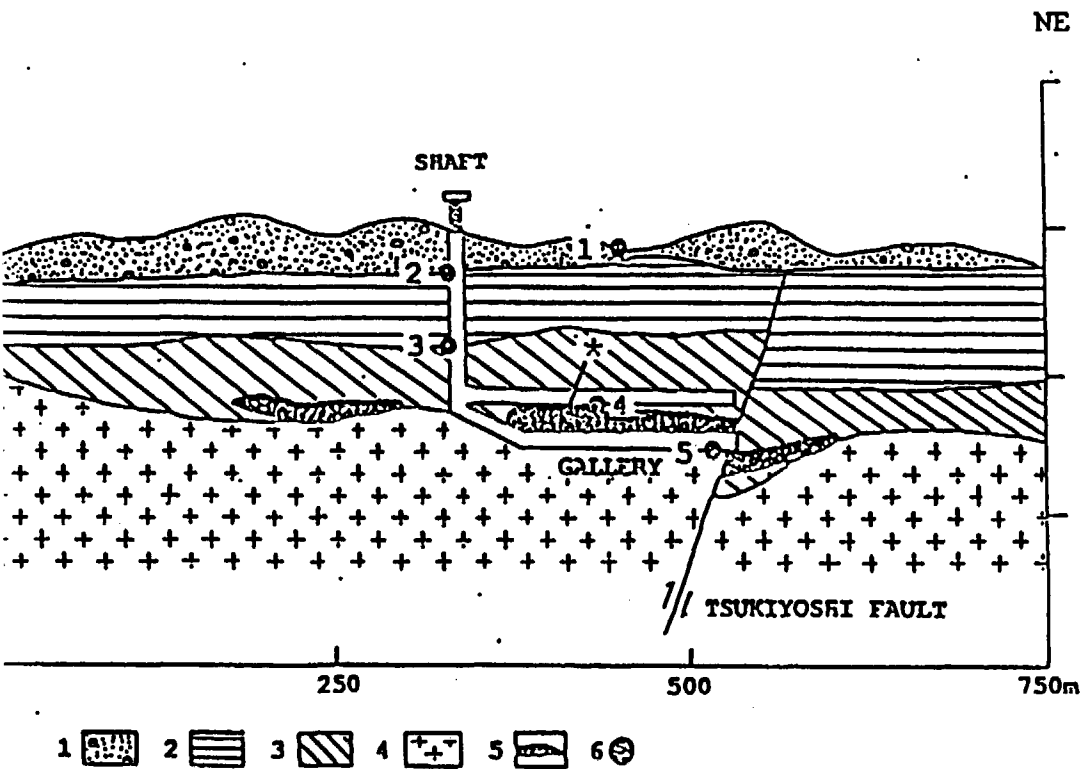

Fig. Chemistry of groundwater around Tsukiyosi deposit.



Geological cross-section of Tsukiyoshi deposit.

(1) Seto Group, (2) Mizunami Group, (3) Toki Group, (4) basement granite, (5) ores, (6) sampling point of waters.

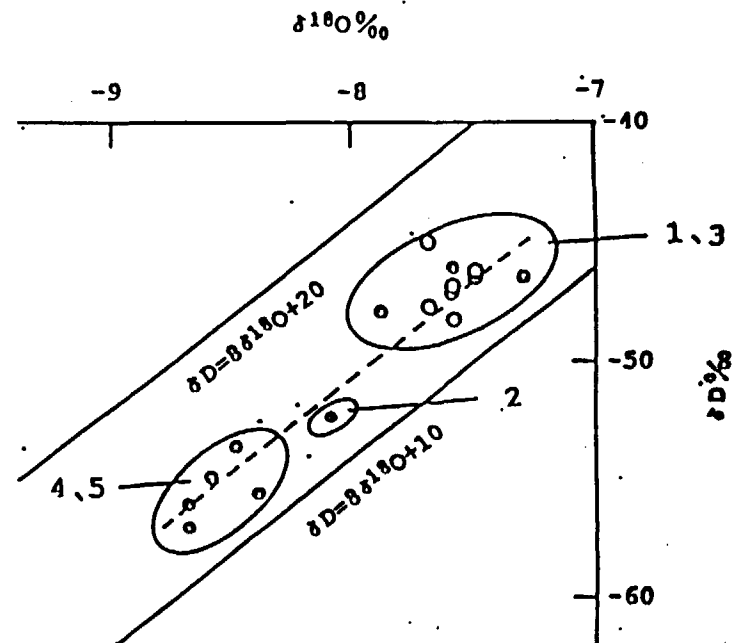

Fig. δD vs $\delta^{18}\text{O}$ of surface water and groundwater.

O: surface waters and \square : ground waters.
The number represents the sampling point given in left figure..

STOP 4; Geochemistry of Natural U-Th series Nuclides
(Disequilibrium of Uranium series Nuclides)

Objectives

- (1) To estimate the time scale and spacial scale of migration of U-series nuclides in sedimentary ore zone and fault zone.
- (2) To identify the minerals on which U-series nuclides are fixed.
- (3) To understand the geochemical mechanism related to migration and fixation of U-series nuclides for long-term prediction model.

Works

The measurement of U-series disequilibrium and analysis of associated minerals are in progress concerning the following samples.

- (1) Three dimensional grid samples in fresh ore zone of gallery.
- (2) Two dimensional grid samples in fault zone of gallery.
- (3) Drilled core samples in ore body along the direction of groundwater flow.
- (4) Drilled core samples in the vicinity of fault zone.

Results

- (1) Uranium has not been migrated over distances of 1 m for at least recent 1 million years.
- (2) ^{226}Ra has been leached over distances of 1 m for recent thousands years.
- (3) Radioactive disequilibrium is observed within a few meters along fault zone.
- (4) Uranium is associated with various materials such as zeolite, clay titanium compound and organic carbon.

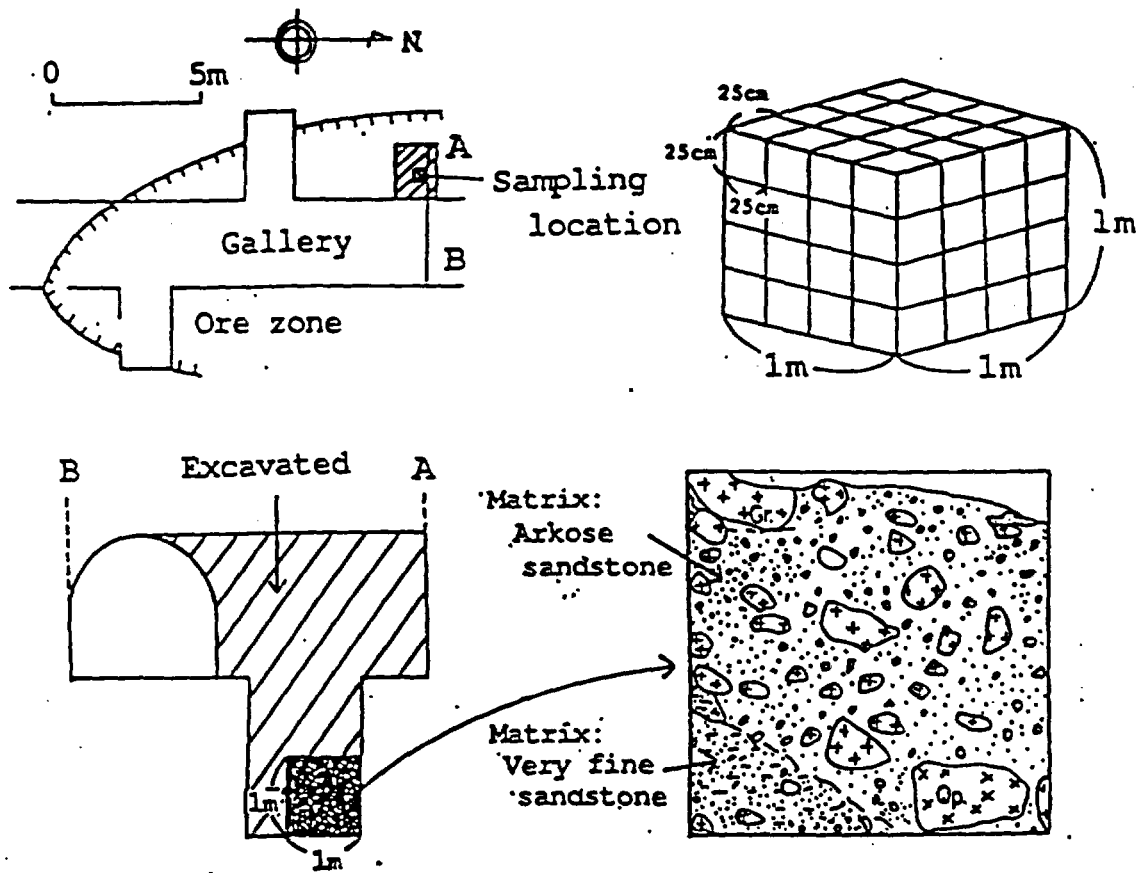

Sampling site for grid survey in the gallery.

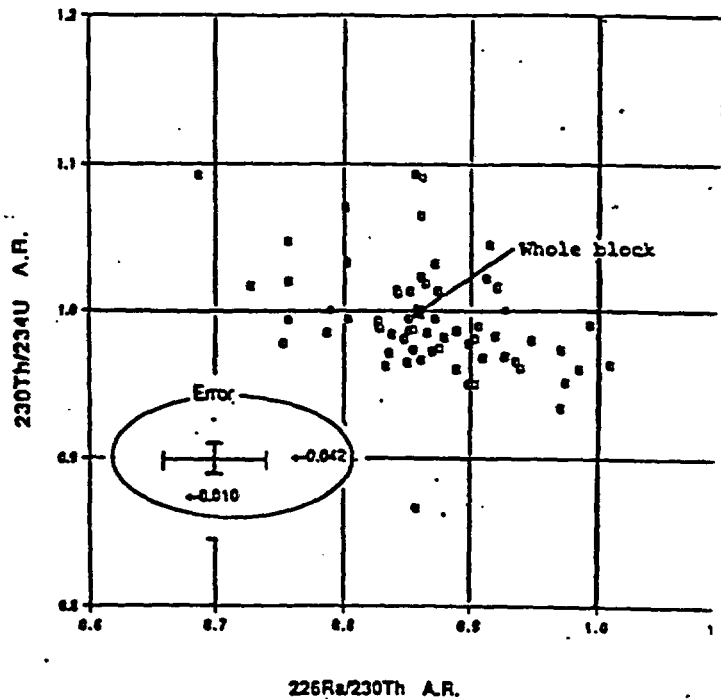
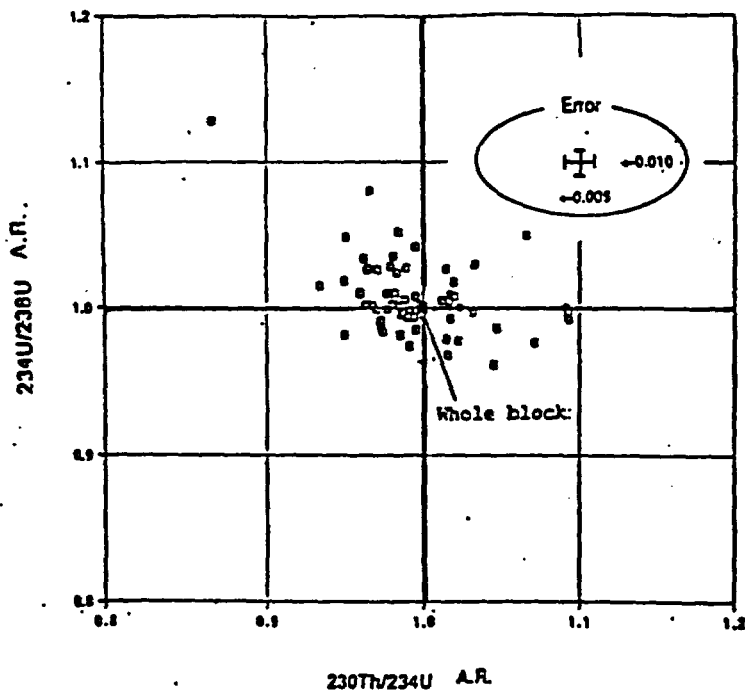

Disequilibrium of ^{238}U - ^{234}U - ^{230}Th - ^{226}Ra .
 □: 25cm x 25cm x 25cm blocks. ■: Whole block (1m x 1m x 1m).

STOP 5 ; Mine-by Experiments on Excavation Responses

Objectives

- (1) Preliminary study on the monitoring system of excavation responses.
- (2) Test and evaluation of the instruments and methods which are currently available for the measurements of rock mass behavior.
- (3) Acquisition of the geomechanical and hydraulic data on excavation responses for the preparation of the further experiments in the actual deep underground research laboratory.

Works

- (1) Pilot boring for the initial investigations.
- (2) Laboratory tests on the boring cores.
- (3) Geological mapping.
- (4) Measurements of the porewater pressures.
- (5) Permeability measurements.
- (6) Measurements of the rock mass displacements.
- (7) Measurements of the axial stress of rockbolts.
- (8) Borehole loading tests.
- (9) Seismic tomography.
- (10) In-situ stress measurements
- (11) Groundwater level monitoring.
- (12) Comparison of the actual rock mass displacements with the predicted ones by the F.E.M. model.

Results

- (1) Rock mass displacement was almost terminated when the excavation face proceeded about 2 times of the drift diameter from the measuring point.
- (2) In-situ stress was not isotropic.
- (3) Permeability measurement was impossible at the zone of 0.5-1.0m from the drift face after the drift excavation.
- (4) Seismic survey suggested the low velocity zone of 0.8m thickness around the drift.
- (5) F.E.M. simulation result was consistent with the actual measurements assuming the excavation influenced zone of 1.0m thickness around the drift.

Mine-by Experiment Site

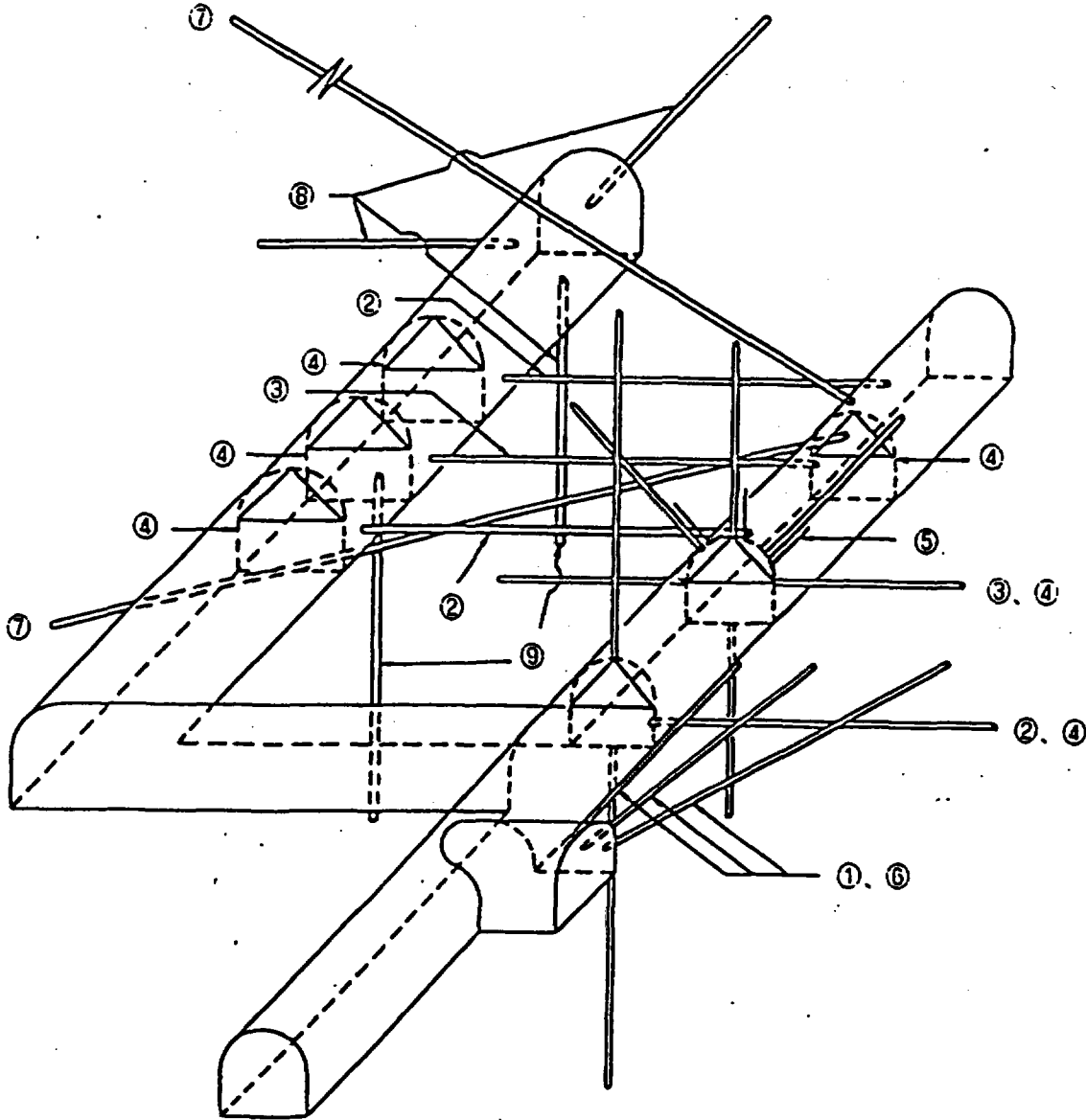

- ① Pourwater Pressure
- ② Permeability
- ③ Rock Mass Displacement (Extensometer)
- ④ Rock Mass Displacement (Convergence)
- ⑤ Axial Stress of Rockbolt
- ⑥ Borehole loading Test
- ⑦ Seismic Tomography
- ⑧ In-situ Stress (Hydro-fracturing method)
- ⑨ In-situ Stress (Over-coring Method)

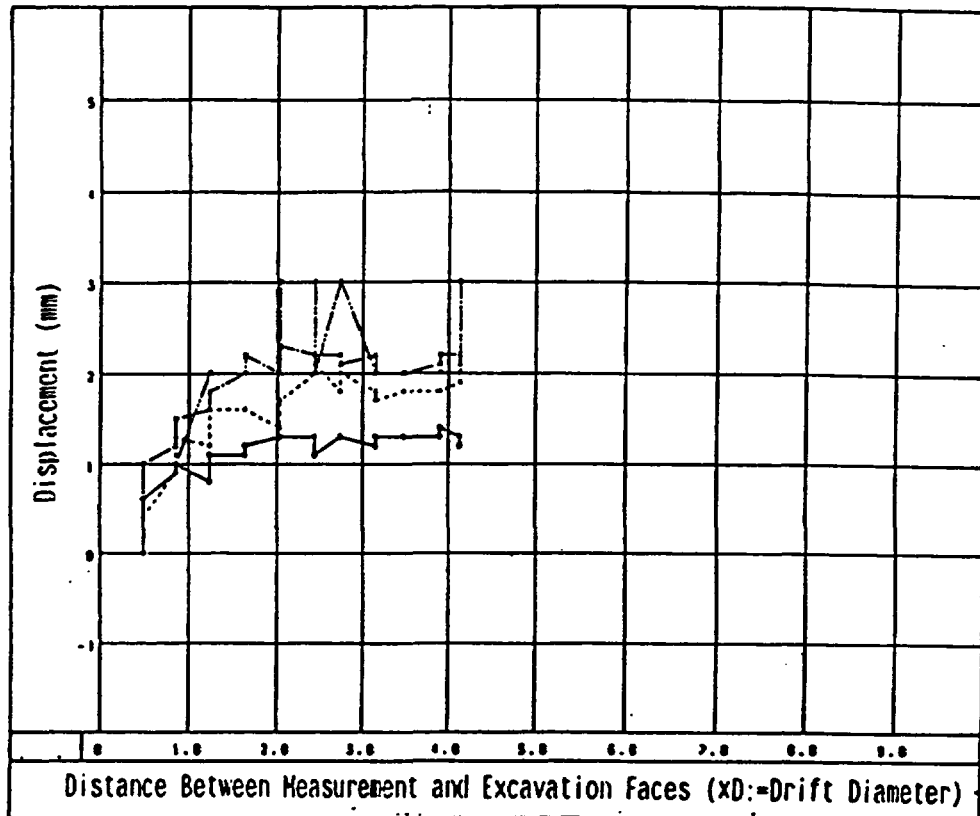

Rock Mass Displacement (by Convergence Measurement)

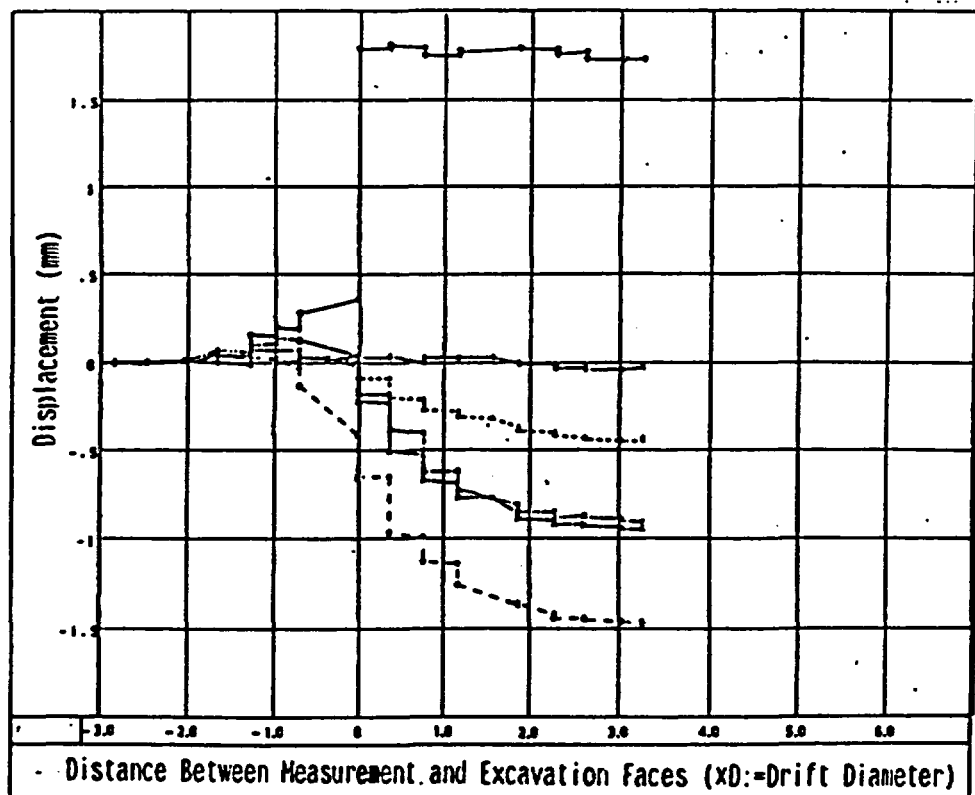

Rock Mass Displacement (by Extensometer)

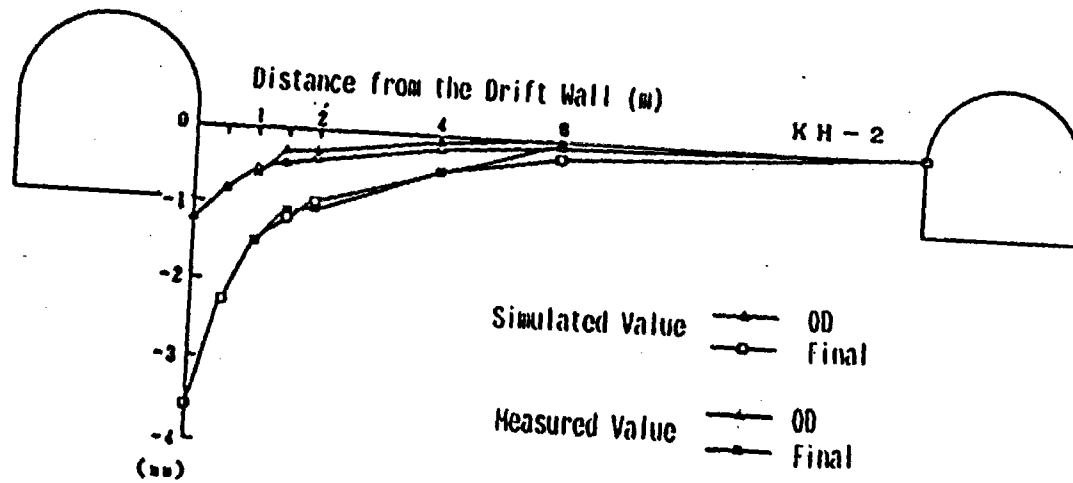

Comparison of Simulated and Measured Values
of Rock Mass Displacement

STOP 6: Shaft Excavation Project

Objectives

- (1) Evaluate the mechanical and hydrological characteristics of rock mass which is influenced by the shaft excavation.
- (2) Evaluate the change of hydrological condition around the shaft.
- (3) Develop the repository design and the performance assessment of geological isolation for nuclide transport.

Works

- (1) Measurement of the mechanical and hydrological changes of zone influenced by the shaft excavation.
- (2) Numerical model development of the groundwater flow around the shaft.
- (3) Natural analogue study.

Remarks

- (1) Following items are prepared as the pre-excavation monitoring :
 - ① Tensiometers and piezometers for the monitoring of the subsurface water flow are installed.
 - ② Boreholes of up to 200m depth are drilled and geophysical loggings. BTV-monitoring and permeability measurement are performed.
 - ③ MP systems are installed and the multiple piezometric pressure measurements are being performed in the boreholes.
- (2) Shaft excavation was started in January 1990 and its present depth is 96m. During this period, some property measurements of disturbed zone has been done in the shaft.

BOREHOLE & HYDROLOGICAL MONITORING SYSTEM

Legend

Geological Logging
Subsurface Monitoring
MP System
Parshall Flume
Clinometer

0 (m) 50

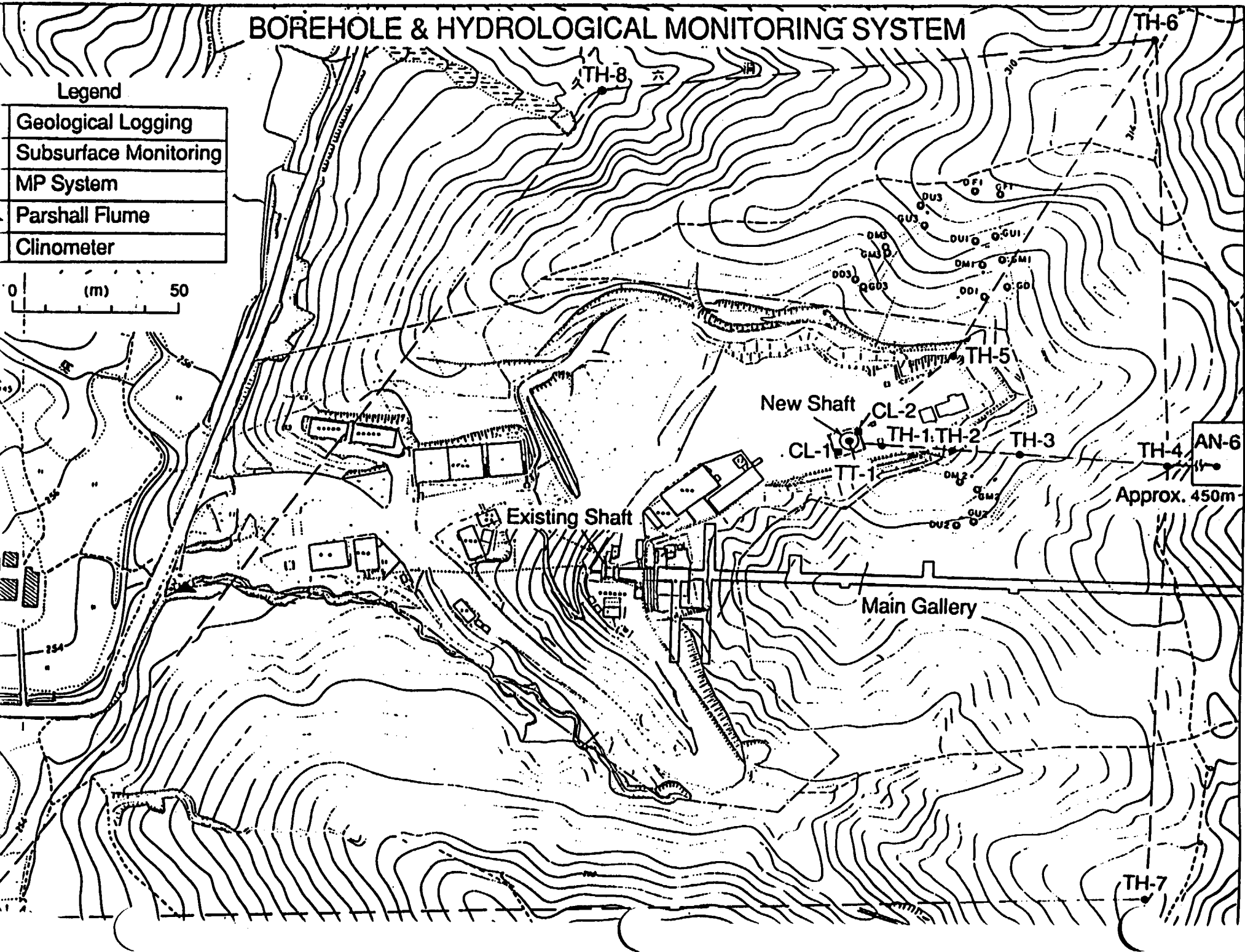

SCHEMATIC FIGURE OF PROPERTY MEASUREMENT OF DISTURBED ZONE (1)

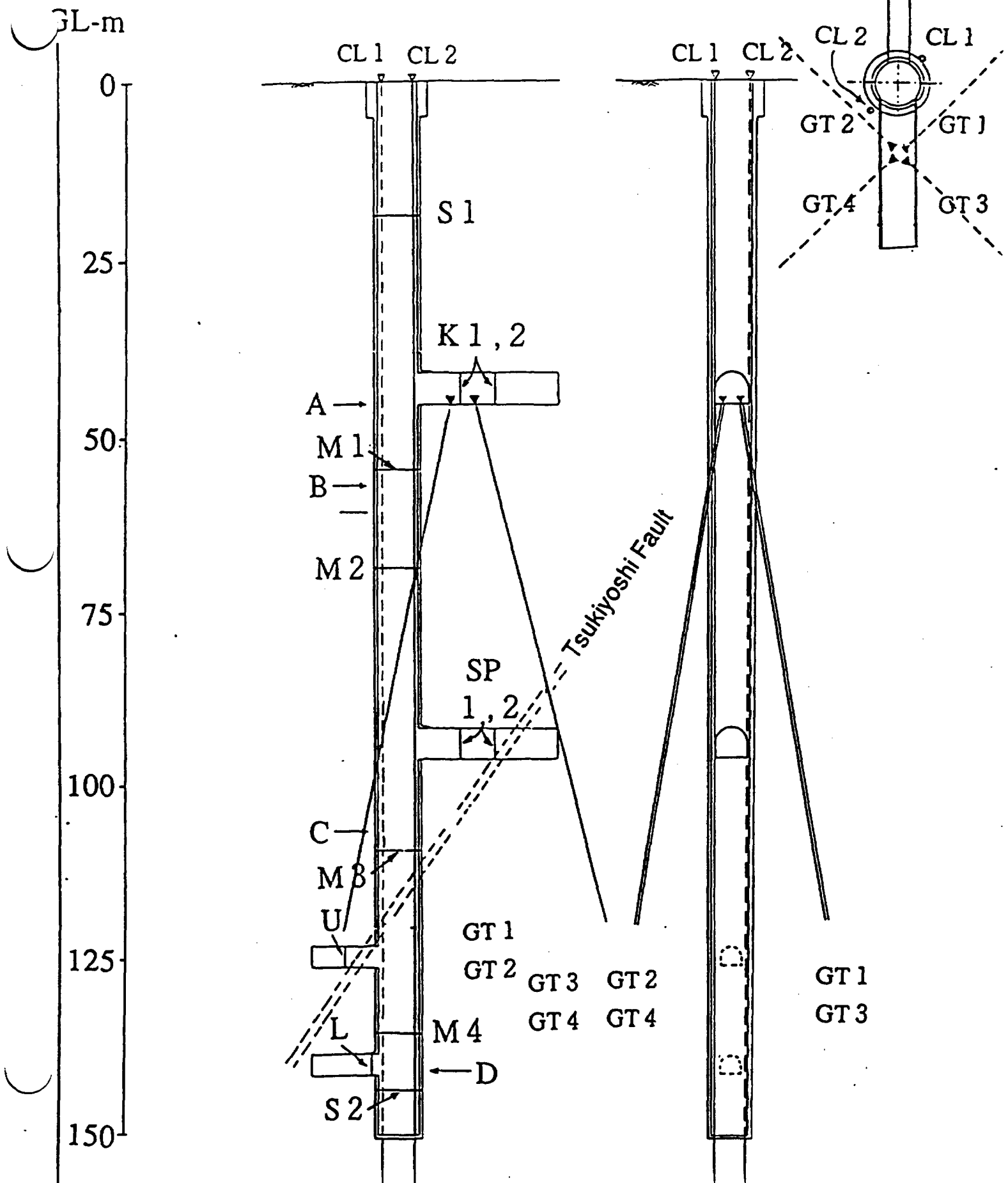

SCHEMATIC FIGURE OF PROPERTY MEASUREMENT OF DISTURBED ZONE (2)

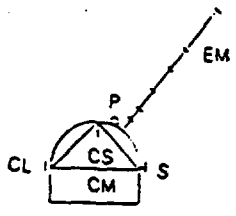

Legend
 CS: Crown Settlement Measurement
 CM: Convergence Measurement
 EM: Extensometer
 CL: Concrete Stress Measurement
 S : Steel Set Stress Measurement
 P : Radial Stress Measurement

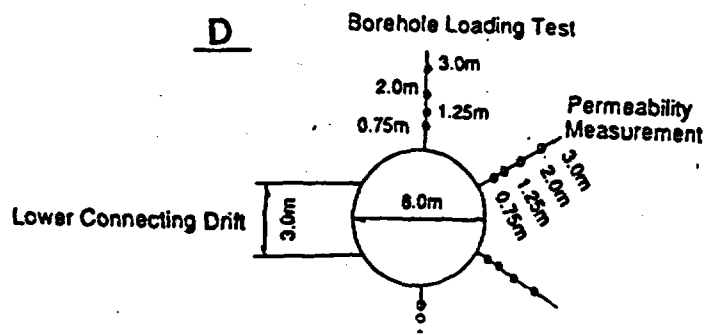
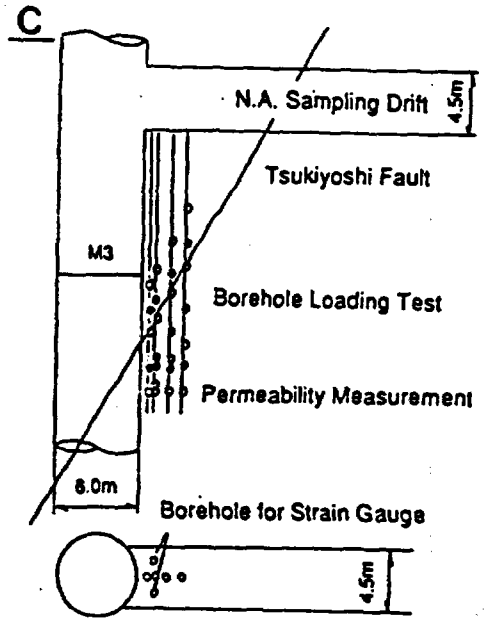
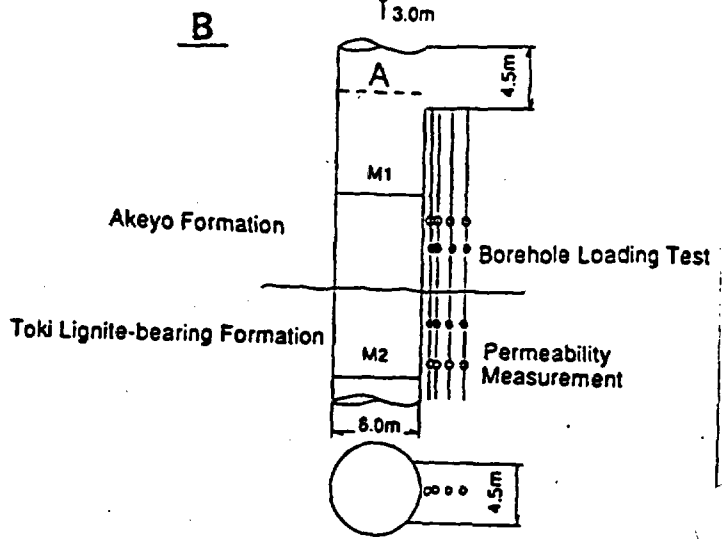
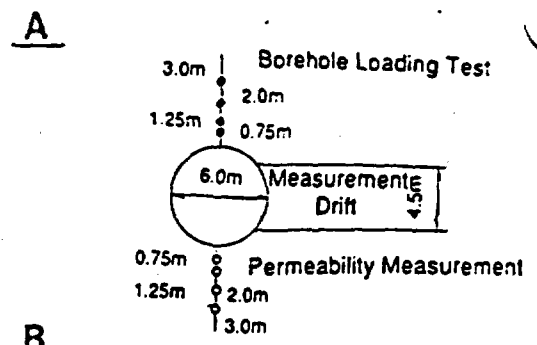
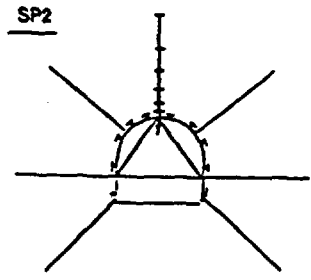
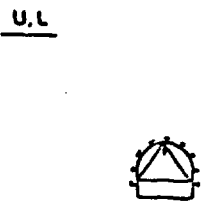
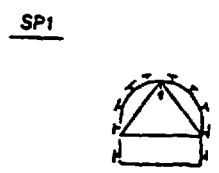
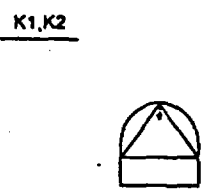
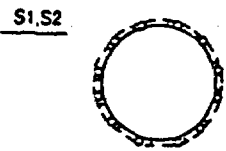
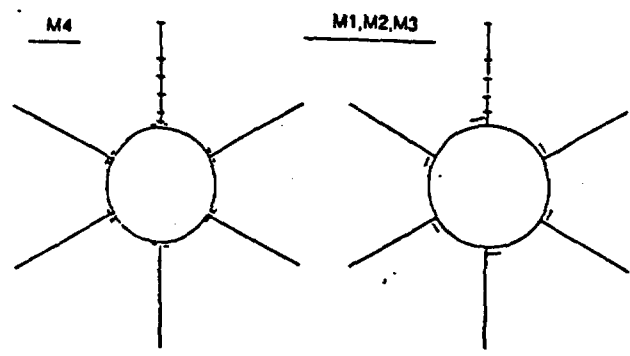

Hydrogeological Investigation for Regional Groundwater Flow

Objectives

- (1) Development of methodology and equipment for analyzing the groundwater flow relevant to mechanism of radionuclide migration.
 - To develop method of hydrological, hydrogeological and hydrogeochemical investigation.
 - To develop equipments obtaining data relevant to hydrological, hydrogeological and hydrogeochemical characters.
- (2) Development and validation of groundwater flow models for long-term safety assessment.
 - To understand hydraulic and hydrogeological characters related to the 3D-migration model in the regional area (12km×15km×depth 1,000m) including Tsukiyoshi Uranium deposits.
 - To develop regional three-dimensional hydrological models.
 - To validate regional three-dimensional hydrological models by hydraulic data obtained on hill-slope (surface and subsurface) hydrology and in borehole and drift.
- (3) Contribution to establishment of public acceptance.
 - To support the feasibility of hydrogeological isolation of radioactive waste in the Japanese rainy environment.

Works

The following studies are in progress to investigate hill-slope hydrology, hydrogeological characters. And it is also to develop the hydraulic equipment and to establish the model.

- (1) Investigation of hill-slope hydrology.
 - Lineament analysis by LANDSAT.
 - Vegetational and morphological analysis by aerial photograph.
 - Geological and topographic interpretation by mapping.
 - Zebra map and drainage interpretation by topographic map.

- Investigation of surface hydraulic characterization of evapotranspiration, river flow and precipitation.
- Measurement of specific discharge and electric conductivity.

(2) Hydrogeological characters.

2-1 Core logging

- Investigation of fracture characterization(fracture pattern, filling materials, RQD etc.)
- Measurement of physical properties(effective porosity, density and hydraulic conductivity etc.)

2-2 borehole hydraulic investigation

- Measurement of hydraulic parameters(hydraulic conductivity, pore pressure and groundwater flow velocity by tracer test).
- Geophysical logs(sonic log, neutron log, BHTV and RADER etc.).
- Measurement of groundwater physico-chemical parameters(Eh, pH, electric conductivity and groundwater composition etc.) and groundwater sampling.

2-3 Hydraulic investigation in drift

- Geological analysis of fracture system.
- Measurement of hydraulic parameters(hydraulic conductivity, pore pressure and groundwater discharge etc.).
- Evaporation analysis on tunnel wall.
- Geochemical analysis of groundwater composition and filling materials in fracture.

(3) Development and validation of 3D regional hydrogeological models.
(TAGSAC CORD developed by Dr. WATANABE, SAITAMA UNIVERSITY)

- Data base of above studies.
- Validation of regional three-dimensional hydrogeological model from hydraulic data obtaining on hill-slope hydrology, and in borehole and drift.
- PNC Tracer Test System.

(4) Development of hydraulic equipments.

- PNC Aquifer Test System.
- PNC Low Pressure Lugeon Test System.
- Hydraulic Testing Machine(Laboratory Permeability Test).
- PNC BAT Groundwater Sampling System.
- PNC Tracer Test System.
- PNC Geochemical Logging System.

Results

- (1) Based on core observation, most of the fractures are classified as four types as follows. ①Planer type, ②Irregular type, ③Curved type, ④Stepped type(Fig.1).
- (2) In-Situ hydraulic conductivity in the granite is approximately $10^{-4} \sim 10^{-5}$ cm/s at fracture-predominant parts, $10^{-7} \sim 10^{-8}$ cm/s at fracture-predominant parts in case of occurrence of filling-minerals in fracture, and $10^{-8} \sim 10^{-9}$ cm/s at fracture-poor parts measured by PNC Aquifer Test Method(Fig.2).
- (3) In-situ hydraulic conductivity at fracture-predominant parts in the granite tends to decrease with depth as areas in some other countries (Fig.3).
- (4) Hydrogeological models has been developed for groundwater flow in the sedimentary rock and the granite, considering the recharge of water from the overlying high permeability Seto Group, the geochemical analysis of the surface-water and the groundwater, the geological survey, and the in-situ hydraulic test(Fig.4).

Natural Analogue Study of Tono Sandstone Type Uranium Deposit in Japan

C. Sato, Y. Ochiai and S. Takeda
Waste Management and Raw Material Division
Power Reactor and Nuclear Fuel Development Corporation (FNC)

Summary

Sandstone type uranium deposit, located in Tono area, central part of Japan, has been recognized as a potentially useful analogue of geological isolation of radioactive wastes in Japan. The uranium deposit occurs as the stratiform which is less than 150 m in depth and below the water table. The studied area is not far from inhabitant. Preliminary study has been undertaken on migration of natural uranium series nuclides and on hydrogeochemistry in Tsukiyoshi ore body. The radioactive disequilibrium study of drill core shows that the equilibrium has been almost kept within the ore body. The hydrogeochemical study has revealed that there are three types of groundwater classified in correspondence with the stratigraphy and high-alkaline, fluoride-rich groundwater is confined into paleoweathered basement granite and permeable beds in the ore horizon. The aim of this study is to reveal the geological, geochemical and hydrological conditions which is favorable to keep uranium series nuclides undisturbed for a certain period of time, and to prove the feasibility of underground disposal of radioactive wastes in Japan where geological environment is complicated and unstable.

1. Introduction

Japanese island arch is a part of the circum-Pacific mobile belt and not considered to have geological stability as the area such as Precambrian shield. However, geological isolation of high level radioactive waste has been recognized to be basically feasible in Japan by means of a combination of engineered and natural barriers. Occurrence of uranium deposit as natural analogue is thought to support the verification of geological isolation system.

Uranium deposits including small bodies in Japan, most of which are sandstone-type hosted in Tertiary system overlying crataccous granites, have been reviewed from the point of natural analogue. As a result, Tono deposit was chosen as the most favorable one for the following reasons, (1) it is the only unmined deposit with minable ore grade, (2) it has a size which is roughly equivalent to that of the repository, (3) it is possible to investigate the influence of fault and groundwater on nuclide migration and (4) many information is already available (1),(2),(3),(4),(5).

A boundary between oxidized and reduced zone which is common in roll

front type deposit is not observed in this deposit. A reducing environment may have been dominant during and after the deposition. It is particularly important in natural analogue study to investigate the geological, geochemical and hydrological conditions which is favorable to keep uranium series nuclides undisturbed. Product of this study also make a contribution to site characterization as well as to validation of model for performance assessment.

Preliminary study was carried out on mainly nuclides distribution and hydrogeochemistry in Tsukiyoshi ore body of Tono deposit in order to discuss the availability of natural analogue study in this deposit.

2. Geological Outline

Tono area is located in 350 km southwest of Tokyo. In this area, sedimentary rocks of Miocene age overlies unconformably cretaceous granites (Fig. 1). The remarkable structural feature of uranium occurrence is paleochannel control on the plane of unconformity. The most favorable zone in the channel for uranium mineralization is in the lower part of tertiary fluvial sediment of Toki Group which is composed of arkosic sandstone, tuffaceous sandstone, carbonaceous mudstone and conglomerate. The depth of uranium occurrence is less than 150 m (Fig. 2, 3).

The deposit is classified into sandstone type. Most of uranium is characteristically accompanied with zeolite, clay minerals, carbonaceous matter et al (2). Very small amount of uraninite and coffinite are observed.

Tono uranium deposit consists of four ore bodies namely Tsukiyoshi, Misano, Utosaka and Jorinji. Tsukiyoshi ore body is roughly 3400 m by 500 m in size with thickness of 1 to 3 m. There is a reverse fault named Tsukiyoshi Fault, N-W, 60-70°S, with a throw of 35 m, which cuts the ore body. Shaft and gallery for exploration have been constructed in the middle part of the ore body. Present natural analogue study is undertaken within Tsukiyoshi ore body.

3. Distribution of Natural Uranium Nuclides

The preliminary studies was made for ore samples which were taken from the gallery and drill core within the ore body.

3.1 Sample and Location

(i) Samples in the gallery

The samples were collected in the exploration gallery, and their locations are shown in Fig. 3, 4. The redistribution of radionuclides after construction of the gallery is assumed for samples (No. 1-10) taken from the surface of the gallery. Sample No. 11, in the outside of the ore body, is a radioactive anomaly accompanied with a fragment of carbonized wood.

(ii) Drill core samples

Drill core samples were taken from the uranium mineralized zone and its neighbours at upstream and midstream in channel structures of the ore body. The locations of the drill holes, SM-2 and AI-12, are shown in Fig. 3.

3.2 Mineralogy

The mineralogy of samples in the gallery are shown in Table-1. The samples within ore zone mainly consist of quartz, plagioclase, kaolinite, montmorillonite, calcite and heulandite. Low amount of iron oxides as limonite are also present. In a few samples (No. 5, 6, 7), secondary uranium minerals as andersonite and zippeite are observed which may have mineralized due to oxidation after construction of the gallery. Sample No. 11 contains a

large quantity of sulfate minerals as jarosite and gypsum in addition to montmorillonite, kaolinite and carbonized wood. Autoradiography and radioluminography show uranium does not exist in carbonized wood but in clay minerals in this particular sample.

Except for small amount of pyrite, the mineral composition of the drill core samples is similar to that of the gallery samples No.1-4.

3.3 Natural Uranium Series Disequilibrium

(i) Samples from the gallery

Assay of U-238, U-234 and Th-230 were carried out by alpha spectrometry. Ra-226 and Pb-210 were nondestructively analysed by high pure germanium detector. In the gamma-ray measurement, sample was kept in sealed container for three weeks and U-238 was calculated from the 63 keV gamma ray of the short lived daughter Th-234.

The results of assay are presented in Table-I together with the uranium contents. The relative activities of U-238, U-234 and Th-230 are plotted in ternary diagram Fig.5 (6). According to their radioactive disequilibrium states, the following geochemical processes which cause redistributions of uranium series nuclides can be inferred.

No.1: U-238, U-234 and Th-230 are almost in radioactive equilibrium. This means that the age is older than at least a million years. On the other hand radium is slightly leached out by reduced groundwater fairly recently. No.2,4,10,11: Uranium, preferentially U-234, and radium is partially leached out probably by oxidized groundwater. While long lived daughter Th-230 which is almost immobile is present in excess state.

No.3,5,6,7,8,9: Accumulation of uranium occurred fairly recently by secondary inflow of uranium, in which excess of U-234 was contained by alpha recoil process.

(ii) Drill core samples

The U-234/U-238 and Th-230/U-234 activity ratios are shown in Fig.6. together with uranium content and geologic column. There are no significant fractionations between these nuclides in the two drill cores from upstream and midstream of the channel structure of Tsukiyoshi ore body. However, the results of SN-2 cores suggest partial uranium leaching had occurred just above unconformity.

3.4 Selective Phase Separation

Sequential extraction techniques were applied to identify the phases of uranium series nuclides in ore. The following five fractions were separated as identifiable phases: exchangeable, bond to carbonates, bond to iron oxides, bond to organic matter and residual (7). Leaching procedures and reagents are summarized in Table-II, and the results obtained on samples from the gallery are shown in Fig.7. A large portion of uranium is associated with carbonates and iron oxides, even though total of iron and carbonate is less than 6 percent in weight for all of the samples.

Complementary measurements as alpha spectrum and X-ray diffraction are not yet performed on the individual leachates and on the residuals following each extraction.

4. Hydrogeochemistry

Uranium in Tono deposit could be originated from the basement granites and transported by circulated groundwater through permeable host rock. The uranium deposit is assumed to be enriched by repetitions of leaching- and fixing cycle between host rock and groundwater (3). The present ore horizon lies below water table and mostly in aquiclude.

The general stratigraphy of Tono area is composed of Toki Group, Mizunami G., and Sato G. in ascending order. Groundwater samples were collected from each geological group for chemical analysis (Table-III, Fig.3.).

There is a significant increase in pH, bicarbonate, sodium and fluorine in correspondence with the stratigraphical depth. The groundwater in Toki Group where uranium is deposited is classified chemically as Na-HCO₃ type. The high level of these ions seems to be caused by long term interaction between water and the minerals in host rock (4). The results of tritium analysis suggest that the groundwater is stagnate for more than 30 years. However, the groundwater in Toki Group doesn't contain higher level of uranium in contrast to higher bicarbonate content. The uranium concentration is almost as same as that of surface water.

These results suggest that the groundwater in ore horizon is stagnate for a long time and the hydrogeochemical environment is reducing.

5. Conclusions and Future Studies

The results of preliminary study are summarized as follows:

- (1) A quite minor disequilibrium of uranium series nuclides is observed in the ore body.
- (2) A large portion of uranium exist in the three fractions of carbonate, iron oxides and exchangeables.
- (3) Three types of groundwater is identified in correspondence with the stratigraphy of Tono area.
- (4) The groundwater of ore zone is characterized by high content of bicarbonate, sodium and fluorine ion against the low content of uranium and tritium ion.

These results suggest that this natural analogue study is available to reveal the favorable environment for the repository and to demonstrate the feasibility of the geological isolation as well as to understand the nuclides migration by groundwater.

Therefore, the future studies should include the following subjects to contribute the assessment of radioactive waste repository sites:

- (1) Detailed study on nuclides distribution within and around the ore body.
- (2) Detailed geological and mineralogical study with a emphasis on uranium occurrence.
- (3) Investigation on colloid formation and transport.
- (4) Further study on hydrogeology and hydrogeochemistry including development of in-situ measurement techniques.
- (5) Validation of developed model for nuclide migration.

The authors wish to thank Prof. Dr. T. Kakanishi of Kanazawa University and Dr. T. Murano and Dr. M. Yamakawa of Power Reactor and Nuclear Fuel Development Corporation for valuable suggestion.

References

- (1) Sakanoue, M. et al, *Geochem. Jour.* 2, (1968) 71-86
- (2) Katayama, M., Hirano, S. and Hirano, S., *IAEA-SM-183/11*, (1974) 437-452
- (3) Doi, K., Hirano, S. and Sakamaki, Y., *Econ. Geol.* 70, (4), (1975) 628-646
- (4) Sakamaki, Y., *IAEA-TECDOC-328*, (1985) 135-154
- (5) Yanagisawa, M., *Sci. Papers Coll. Faculty of Science, Kanazawa Univ.* (1983)
- (6) Kosholt, J.M., *Uranium Series Disequilibrium Applications to Environmental Problems*, Clarendon Press, Oxford, (1982) 167-180
- (7) Tissier, A. et al, *Anal. Chem.* 51, (7), (1979) 844-850

Table-I. Activity ratios, uranium concentrations and minerals in the samples from the gallery

Sample NO	$\frac{^{230}\text{U}}{^{235}\text{U}}$	$\frac{^{230}\text{Th}}{^{235}\text{U}}$	$\frac{^{232}\text{Th}}{^{235}\text{U}}$	$\frac{^{210}\text{Pb}}{^{230}\text{Th}}$	U ₂ O ₅ %	Main Minerals (*)
1	1.01	1.01	0.95	1.09	0.175	Qz, Pl, Kao, Cal
2	0.84	1.87	0.90	1.02	0.100	Qz, Pl, Kao, Zoo
3	1.04	0.94	0.85	0.95	0.031	Qz, Pl, Mont, Cal
4	0.84	1.94	1.05	0.92	0.121	Qz, Pl, Mont
5	1.01	0.80	1.07	1.00	0.166	Qz, Pl, Kao, Zoo, Cal
6	1.19	0.75	1.01	1.11	0.091	Qz, Pl, Zoo, Kao
7	1.11	0.84	1.02	1.05	0.063	Qz, Pl, Zoo
8	1.00	0.75	1.29	1.08	0.097	Qz, Pl, Cal
9	1.01	0.72	1.22	1.03	0.060	Qz, Pl, Mont, Kao
10	0.84	1.12	0.87	1.03	0.067	Qz, Pl, Mont, Kao, Zoo, Cal
11	0.96	4.94	0.86	1.05	0.200	Mont, Kao, FeI, Jar, Gyp

(*) Qz : Quartz, Pl : Plagioclase, Kao : Kaolinite, Mont:Montmorillonite
 Cal : Calcite, Zoo : Zeolite (Heulandite), FeI : Feldspar
 Jar : Jarosite, Gyp : Gypsum

Table-II. Sequential extraction procedures for selective phase separation

Fraction	Extractant	Condition
1. Exchangeable	1N NaOAc 10ml (PH 8.7)	Room Temperature Occasional Agitation 24H
2. Bond to Carbonates	1N NaOAc:HOAc 10ml (PH 5.0)	Room Temperature Occasional Agitation 24H
3. Bond to Fe Oxides	0.04N NH ₂ OH · HCl +25%HOAc 0 ml	80°C, 6H Occasional Agitation
4. Bond to Organic Matter	(1) 30% H ₂ O ₂ , 3ml +0.02% HNO ₃ , 3ml (2) 30% H ₂ O ₂ , 3ml (3) 3.2% NH ₄ OAc:20%NH ₃ , 3ml	(1) 85°C, 6H Occasional Agitation (2) 85°C, 2H Occasional Agitation (3) Room Temperature Occasional Agitation
5. Bond to Silicates	(1) HF 10ml:HC10 ₄ , 3ml (2) 6N HCl	(1) Digestion (2) Dissolution

Initial Weight of Sample : 1g

Table-III. Hydrogeochemical composition of waters around Teuklyeakhi ore body

Samples (a) Depth (m)	pH	HCO ₃ ⁻ (ppm)	Cl ⁻ (ppm)	SO ₄ ⁻² (ppm)	F ⁻ (ppm)	Na ⁺ (ppm)	K ⁺ (ppm)	Ca ⁺⁺ (ppm)	Mg ⁺⁺ (ppm)	Total				Fe (ppm)	Mn (ppm)	Zn (ppm)	No. of Samples
										Fe (ppm)	Mn (ppm)	Zn (ppm)	(pct/l)				
Surface water	6.5	10	3	7	0.2	1	1	5	1	0.3	0.1	35					3
GYRPT-1a cells leach	6.0	20	4	10	0.1	2	2	3	1	0.1	0.2	35					1
GYRPT-1a Mittelman c.	7.2	60	5	10	0.1	18	4	20	0.5	<0.1	<0.1	-					2
GYRPT-1a Total c.	8.6	90	1	1	3	35	0.3	5	0.1	0.1	0.1	<3					5

(a) See FIG.3

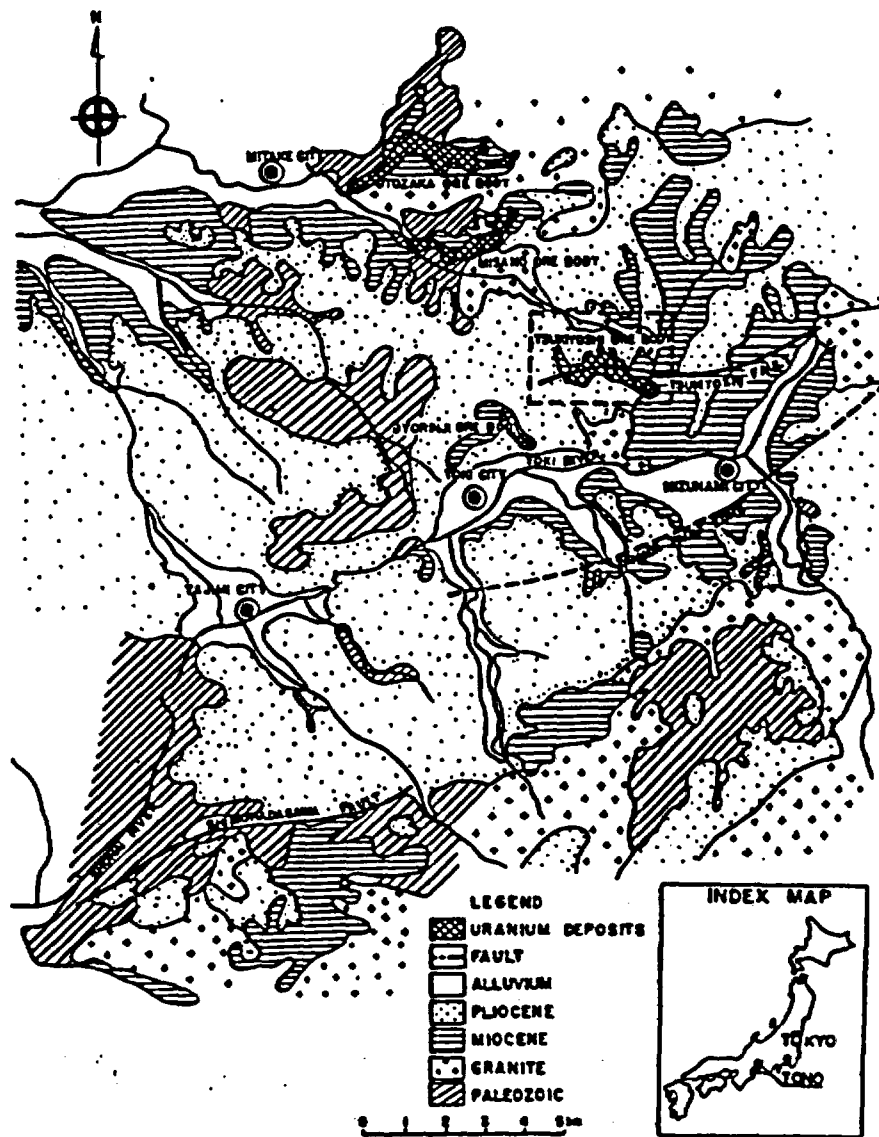

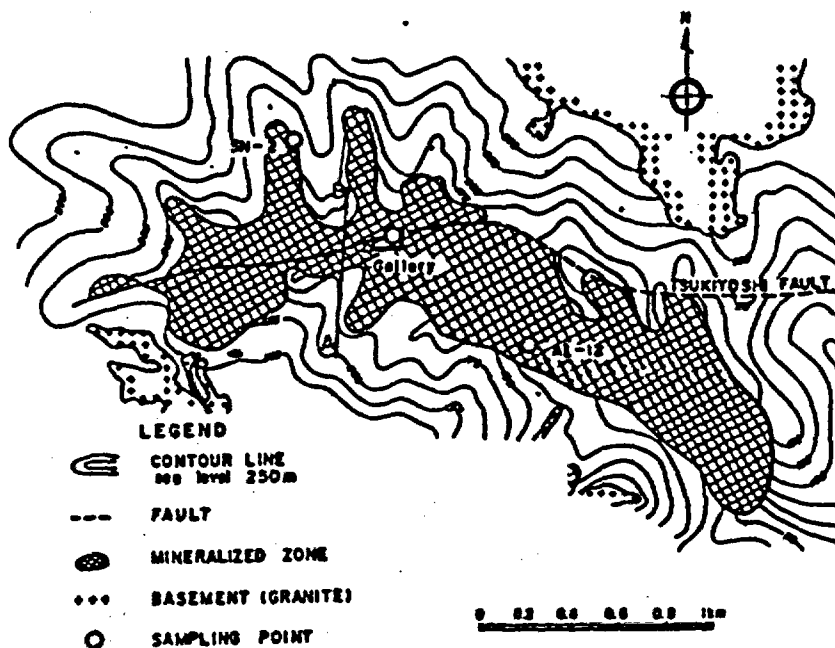

Fig. 2. Underground contour map of the plane of unconformity above the basement of Tsukiyoshi area and sampling locations in Tsukiyoshi ore body.

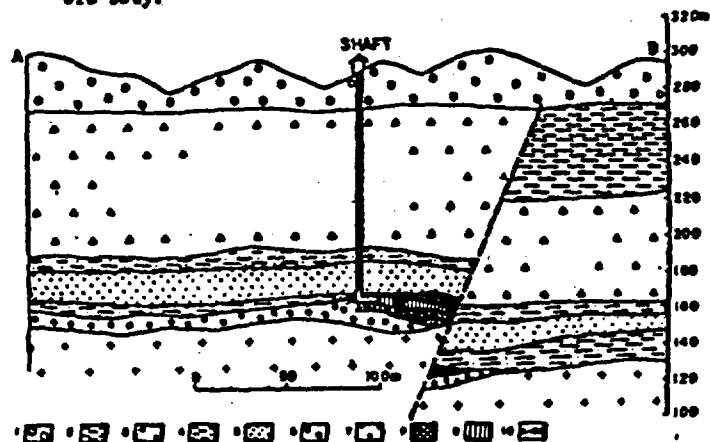

Fig. 3. Geological cross-section of Tsukiyoshi ore body.
 (1) Sato Group, (2) upper members of Misunami Group, (3) lower members of Misunami G., (4) sandstones and shales in Toki Group, (5) carbonaceous in Toki G., (6) conglomerates in Toki G., (7) basement granite, (8) low-grade ores, (9) high-grade ores.

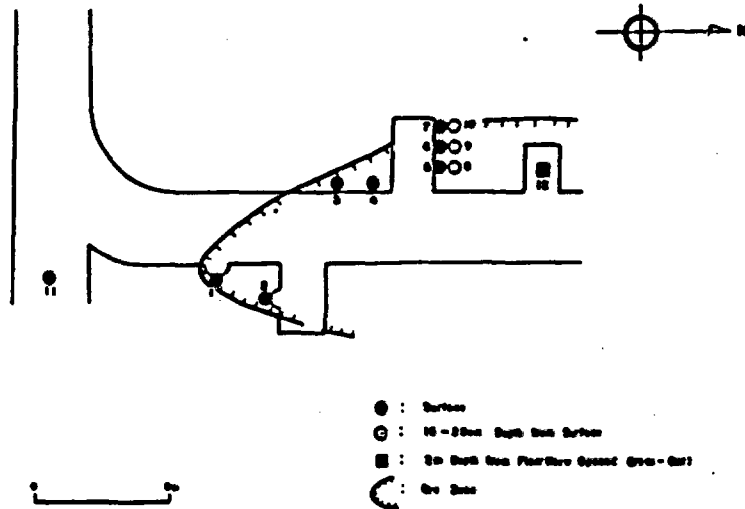

Fig. 4. Locations of the samples collected from gallery of Tsukiyoshi ore body.

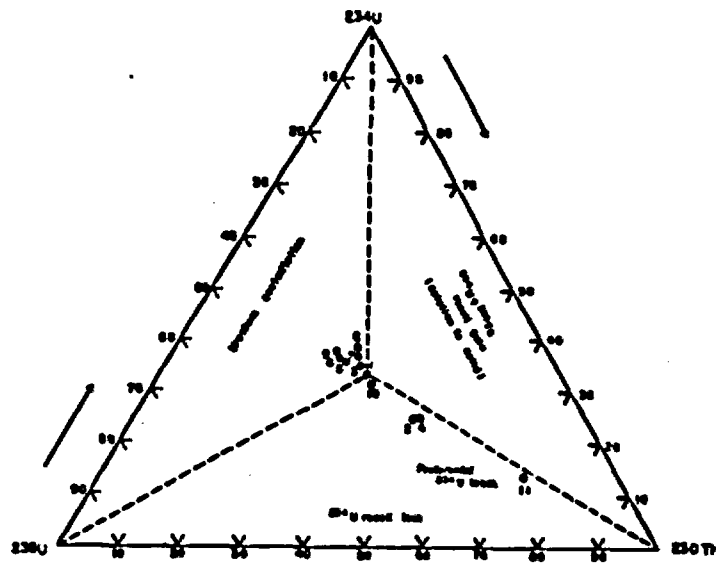

Fig. 5. Ternary diagram of relative activities of U-238, U-234 and Th-230 for the samples from the gallery.

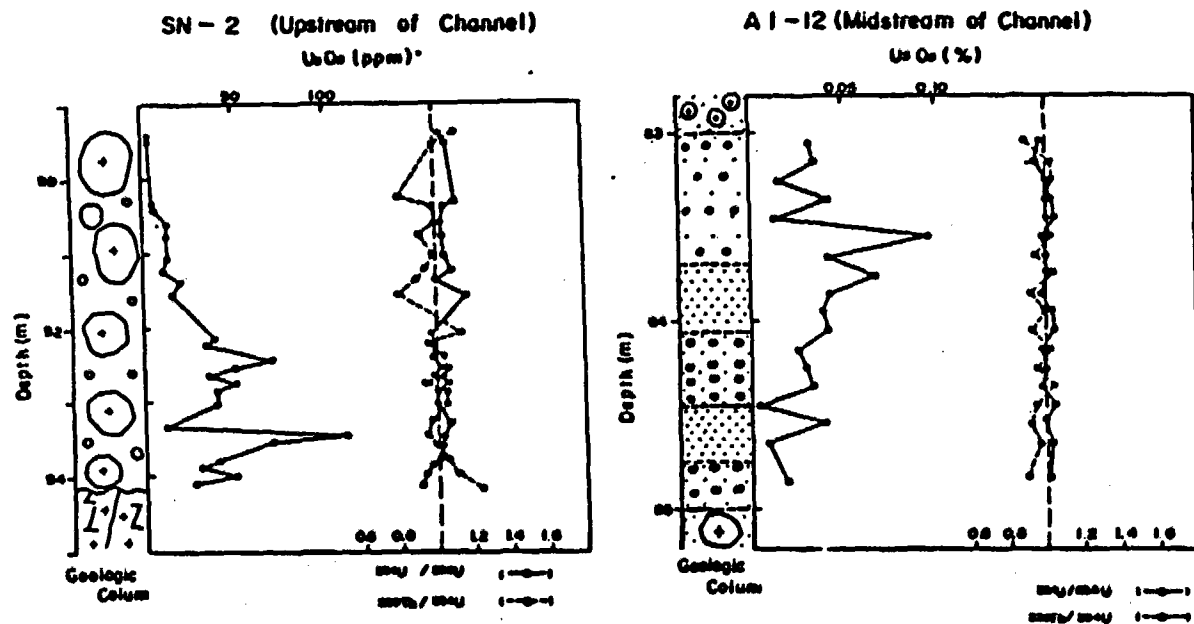

Fig. 6. Variation with depth of activity ratios and uranium concentrations for drill core samples from the upstream and midstream of Tsukiyoshi ore body.

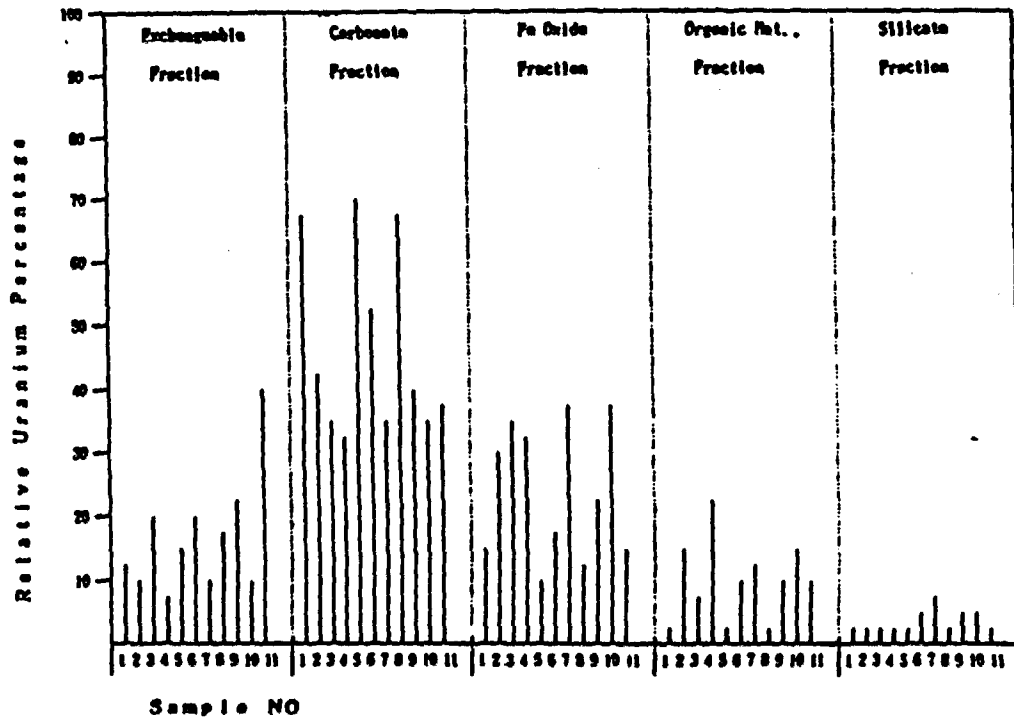

Fig. 7. Relative percentage of uranium in selectively extracted phase for samples in the gallery.

NATURAL ANALOGUE STUDY ON TONO SANDSTONE-TYPE URANIUM DEPOSIT IN JAPAN

T. Seo, Y. Ochiai, S. Takeda, and N. Nakatsuka
Power Reactor and Nuclear Fuel Development Corporation
Toki City, Japan

ABSTRACT

The Tertiary Tono sandstone-type uranium deposit is recognized as a potentially useful analogue for the geological isolation of radioactive wastes in Japan. The study of this natural analogue is being carried out to acquire information about the geochemical processes that relate to the containment and migration of uranium series nuclides over geologic time. There is no significant migration for uranium for the samples investigated as the result of radioactive disequilibrium study. The hydrogeochemical study suggests that the groundwater in the ore horizons is very stagnant and reducing.

INTRODUCTION

Research and development of geological disposal for high-level radioactive waste have been conducted in accordance with a program announced by the Atomic Energy Commission (1987) in Japan. To implement geological disposal, it is essential to take account of the geological features. Japan is located in the Pacific rim unstable mobile belt, and its hydrogeology is characterized by a large amounts of rainfall. However, geological disposal has been considered feasible in Japan by means of a multibarrier system of engineered and natural barriers. In order to validate predictive models for safety assessment of a geological disposal system, the natural analogue study provides invaluable information and understanding for similar processes occurring over geological time and large spatial scales in a natural system.

The main purpose of this study is to clarify the

geological, geochemical and hydrogeological conditions that have been contained uranium successfully over geologic time, and to verify the fundamental process of safe isolation of radioactive wastes in a Japanese geological environment.

Since 1986, PNC Chubu works has conducted a natural analogue study on the Tono uranium deposit. The main site of this study is limited within the Tsukiyoshi ore body, which is the largest ore body in the Tono uranium deposit. It is remarkable that the ore body is apparently cut by a fault that is available to investigate and to evaluate the effect of faulting on uranium series nuclides migration.

The main areas of the natural analogue study in the Tono uranium deposit are as follows:

- (1) Investigation on occurrence of uranium series nuclides in a geological environment.
- (2) Investigation on migration of uranium series nuclides along a fault.
- (3) Investigation of hydrogeochemistry and hydrogeology of groundwater.
- (4) Evaluation of the role of colloids in the migration-retardation process.

DISCUSSION

Geology

The Tono area, the largest uranium deposit, is located in central Japan, approximately 350 km southwest of Tokyo (Fig.1). Since the deposit was discovered in 1964, more than 560 holes of 50 m grids have been drilled. The 130 m-deep shaft and galleries for the exploration tests have already been constructed in the middle of the ore body.

The area is underlain by Tertiary sediments on the

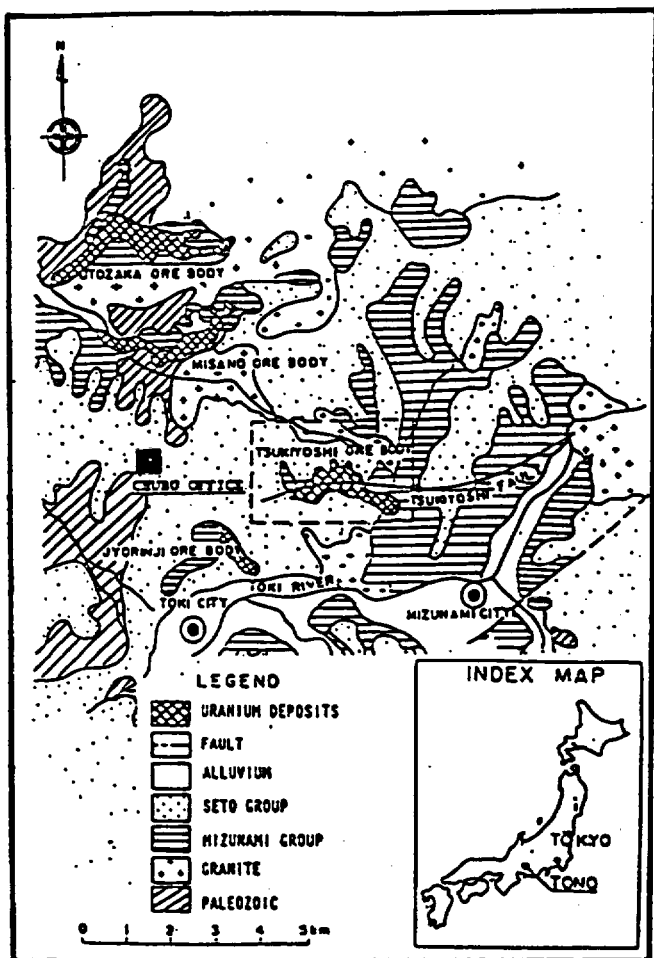

Fig. 1 Schematic geologic map around the Tono area and the location of the Tono uranium deposit.

basement rocks, which are composed mostly of granitic rocks ranging in age from the late Cretaceous to the early Paleogene period. Tertiary sediments are composed of the Mizunami Group and the Seto Group. The detailed regional geology is given Itoigawa (1974), and study of the uranium deposits are given in Katayama et al. (1974).

The Mizunami Group sedimentation occurred in a basin, which developed in the first stage of the Miocene transgression. The sequence is formed of lacustrine sediment which is overlain by marine sediment and divided into three formations. The lower unit has been correlated with the Toki lignite-bearing Formation, which is unconformably overlain by the Akeyo Formation and the Oidawara Formation. The general dipping of formation within the basin is from 0° to 10°.

The Toki lignite-bearing Formation consists of arkosic sandstone and mudstone with tuffaceous materials, interbedded with granule to pebble conglomerate. The sediments often contain carbonaceous and coal materials. The basal part is conglomeratic and consists of angular to subangular granite and quartz porphyry gravel. The basal

conglomerate and several distinct parts of the upper beds are the principal uranium-bearing units.

The Akeyo Formation consists of fine to medium grained sandstone and mudstone containing many marine fossils. The Oidawara Formation, composed of siltstone and mudstone, is deposited in the deeper marine than that of the Akeyo Formation. The Mizunami Group is unconformably overlain by clay, sand and gravel beds of the Seto Group in Pliocene age (Fig.2).

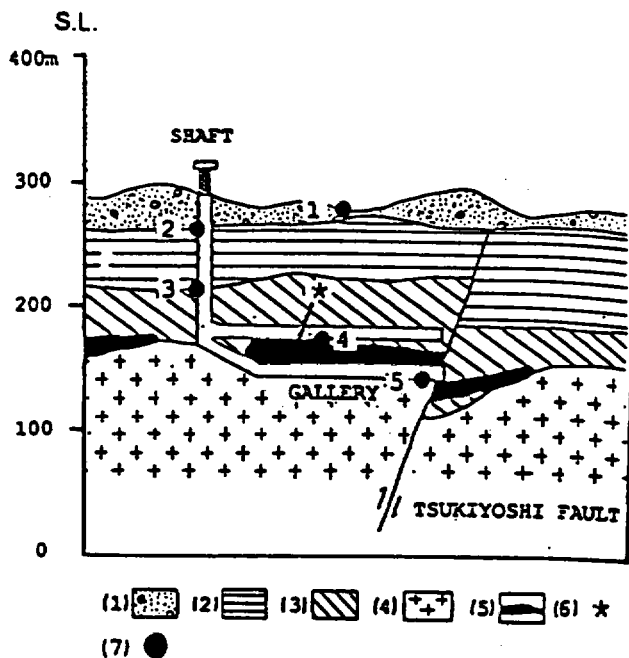

Fig. 2 Schematic cross-section of the Tsukiyoshi ore body and sampling points of rock and water. (1) Seto Group, (2) Akeyo & Oidawara Formation (3) Toki Formation, (4) basement granite, (5) ore body, (6) sampling site for grid survey, (7) sampling points of water.

Uranium Mineralization

The Tono uranium deposit consists of several ore bodies, the largest of which is the Tsukiyoshi ore body as shown in Figure 1. The Tsukiyoshi ore body is the Tono uranium deposit in a practical sense because other ore body occur as satellites.

The Tono uranium deposit contains 4000 tons of contained U_3O_8 at an average grade of 0.06% U_3O_8 . It is about 3400 meters in length and 500 meters in average width, with a thickness of 1 to 3 meters. The ore body is 100 meters to 150 meters in deep.

The uranium deposit is located in the basal part of the Miocene sediment and its distribution is typically controlled by paleochannel structures of the plane of unconformity on the basement. The uranium mineralization occurs as layers and is highly concentrated in the middle part.

The uranium mineralization is classified into two

types by the difference of host rocks: the conglomerate type and the lignite-bearing tuffaceous sandstone type. In the case of the former, uranium is adsorbed either in clay minerals such as montmorillonite or in calcite within the matrix of fine to coarse sandstone and siltstone. In high-grade ores, the uranium is characteristically associated with zeolite, which belongs to the heulandite-clinoptilolite group. In the case of the latter, uranium is adsorbed in carbonaceous material which is rich in coal materials. A very small amount of primary uranium minerals such as uraninite and coffinite are associated with pyrite and carbonaceous materials. According to fission track data, this sequence indicates an approximate age of 5-20 million years for the sedimentation. The age of mineralization is estimated to be about 10 million years. It is inferred that the Tono deposit is the epigenetic deposit.

In the Tono area, a reverse fault called the Tsukiyoshi Fault, runs along the central part of the channel and cuts the ore body. The fault strikes E-W and dips 65° to 70° S, with a replacement of 35 m. The Tsukiyoshi fault occurred before the deposition of the Seto Group.

Migration of Uranium Series Nuclides

Sato et al (1987) discussed that there is no significant fractionation among ^{238}U , ^{234}U and ^{230}Th for the two drill core samples in upstream and midstream of the channel structure of the Tono uranium deposit.

As shown in Fig.2 and Fig.3, a grid survey was carried out. The large block specimen of 1m^3 was sampled by dividing it into blocks $25\text{cm} \times 25\text{cm} \times 25\text{cm}$ in the fresh ore zone. The total of 64 samples were analysed individually to investigate the migration of uranium series nuclides.

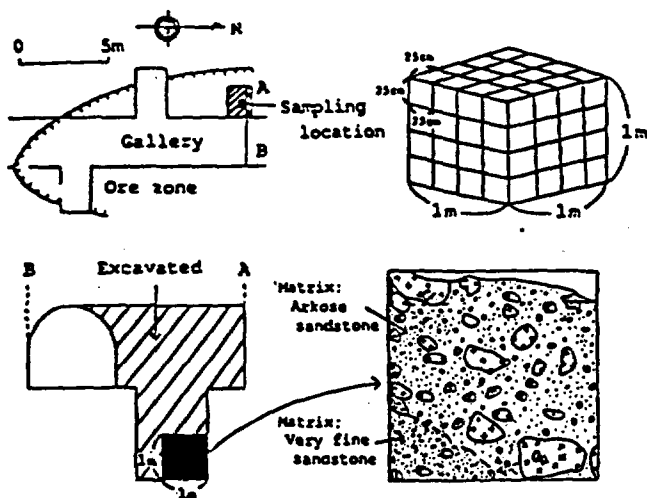

Fig. 3 Sampling site of ore for grid survey in the gallery.

The uranium contents of these samples ranges from 0.01 % to 0.049 % U_3O_8 in every block. The thorium contents are less than 10 ppm. The data of $^{238}\text{U}/^{234}\text{U}$ vs. $^{230}\text{Th}/^{234}\text{U}$ activity ratio are plotted in Fig.4, and the data of activity ratio of the whole-rock (1m^3) is also plotted for comparison. Although a slight deposition and leaching of uranium have occurred in some samples, the total activity of these nuclides is completely in equilibrium in the whole rock. It appears

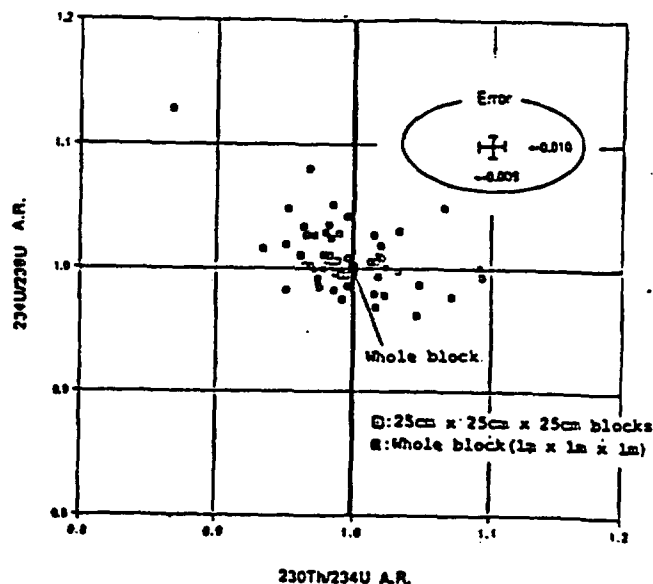

Fig. 4 Disequilibrium diagram of ^{238}U - ^{234}U - ^{230}Th for the samples in the grid survey.

that these uranium series nuclides have not migrated more than 1m in the last one million years.

In the same way, as shown in the disequilibrium diagram of ^{234}U - ^{230}Th - ^{226}Ra (Fig.5), the depletion of ^{226}Ra is observed in the most of samples and there is no enrichment of ^{226}Ra . The total activity ratio of $^{226}\text{Ra}/^{230}\text{Th}$ in the whole block is 0.86. From this result, it might be inferred that the radium has been leached recently by reducing groundwater over a distance of several meters.

The mineralogical and chemical composition for these 64 blocks were also investigated to reveal the mineralogical and the geochemical condition where uranium is preserved for long time. The mineral assemblages of samples have large amounts of quartz, k-feldspar, plagioclase and small amounts of heulandite, kaoline minerals, smectite and others. Uranium minerals are not observed in any separated fractions. Although there is no evidence of correlation between uranium and these minerals, chemical analysis show that uranium is correlated to iron, titanium and cation exchangeable capacity. Therefore, it is suggested that uranium is concentrated in clay, iron and/or titanium minerals.

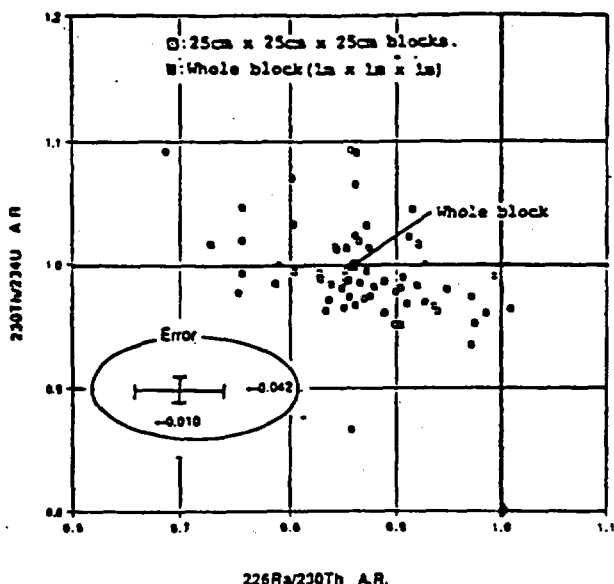

Fig. 5 Disequilibrium diagram of ^{234}U - ^{230}Th - ^{226}Ra for the samples in the grid survey.

This sampling method seems to be effective for investigating three-dimensional radionuclide migration.

Hydrogeochemistry and Groundwater System

The isotopic and chemical characteristics of groundwater and surface water in the area of the Tono uranium deposit were investigated. The results are summarized in Table 1. In correspondence with the stratigraphy, there are significant differences in the hydrogeochemical compositions.

Groundwater in the aquifers of the Toki lignite-bearing Formation, where uranium is deposited, were sampled from boreholes in the gallery. Some of the boreholes are intersected across the Tsukiyoshi Fault. These groundwater samples have similar characteristics, that is, lower values in δH , δD

Table 1. Chemical and isotopic composition of waters around the Tsukiyoshi ore body.

Sample No	pH	Na (ppm)	Fe (ppm)	U (ppb)	HCO_3 (ppm)	F (ppm)	Eh (mv)	δH (‰)	δD (‰)	$\delta^{18}\text{O}$ (‰)
1	6.5	<1	0.3	0.1	10	0.2	-	35	-46	-7.6
2	6.2	2	0.1	0.1	20	0.1	-	35	-46	-7.5
3	7.2	10	<0.1	0.1	60	0.1	-	-	-52	-8.1
4	6.6	35	<0.1	0.1-1	90	3	-300	<3	-55	-8.3
5	6.8	36	<0.1	0.1-1	60	4	-	<3	-55	-8.6

and $\delta^{18}\text{O}$ and higher values in pH, bicarbonate, sodium, and fluoride.

As shown in Fig. 6, δD and $\delta^{18}\text{O}$ values of groundwater and surface water samples, which are important parameters of a groundwater recharging systems, fall on the line of $\delta\text{D} = 8\delta^{18}\text{O} + 13$. This relation is in the range of the meteoric origin in the southern part of Chubu district of Japan. The δD and $\delta^{18}\text{O}$ values of the groundwaters in the Toki lignite-bearing Formation are lower than those for surface water and groundwater in the Seto Group over scale of 10 and 1 per mil respectively. Consequently, although the origin of these natural waters is rainfall, the source of groundwater in the Toki lignite-bearing Formation is clearly different from the present rainfall, which is represented by surface waters and groundwaters in the Seto Group.

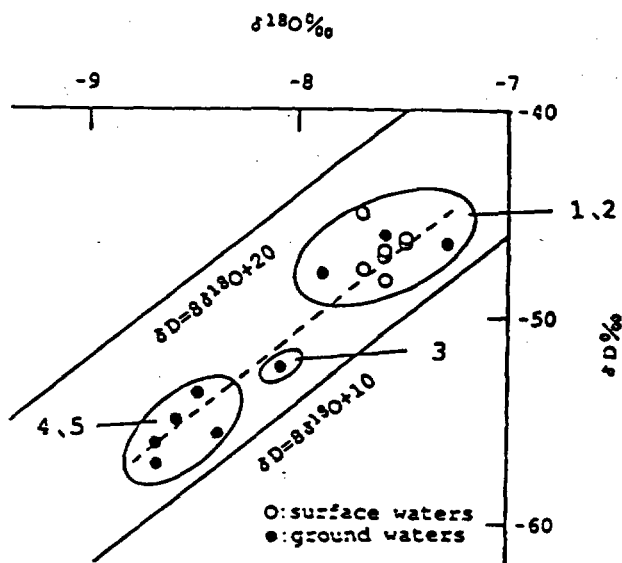

Fig. 6 δD vs. $\delta^{18}\text{O}$ of surface and ground waters around the Tsukiyoshi ore bore body. The number represents the sampling point given in Fig. 2.

The groundwater in the Seto Group is directly recharged by rainfall and discharged within a very short residence time through the loose sand gravel beds. The groundwater in the aquifer of the Mizunami Group, except for the Toki lignite-bearing Formation, which is overlain by the Seto Group, is more stagnant and has characteristics intermediate between those of the Seto Group and the Toki lignite-bearing Formation.

On the other hand, the groundwater in the Toki lignite-bearing Formation is stagnant for a long time in the deepest aquifer, and very little recharge of vertical flow occurs along the Tsukiyoshi Fault. The groundwater is reducing due to the presence of

Table 2. Hydrological parameters measured in a drill hole.

Depth (m)	Rock Type	Pore Pressure		Permeability		Velocity and Direction	
		JFT (m)	Rugeon (m)	JFT (cm/sec)	Rugeon (cm/sec)	Velocity (cm/sec)	Direction
6.2-8.5	siltstone (O.F.)	-7.1	-	>10 ⁻⁷	-	>10 ⁻⁶	N.D.
9.0-14.0	siltstone (O.F.)	-	-7.4	-	5 x 10 ⁻⁷	-	-
33.5-38.5	conglomerate (A.F.)	-31.1	-31.3	1.3 x 10 ⁻⁵	3 x 10 ⁻⁶	2.5 x 10 ⁻⁵	S → N
38.5-39.5	sandstone (A.F.)	-28.7	-	>10 ⁻⁷	-	-	-
40.5-45.5	conglomerate (A.F.)	-30.9	-28.0	>10 ⁻⁷	>10 ⁻⁷	>10 ⁻⁶	N.D.
48.5-53.0	sandstone (A.F.)	-28.5	-28.4	9 x 10 ⁻⁶	5 x 10 ⁻⁷	>10 ⁻⁶	N.D.
57.0-62.0	sandstone (A.F.)	-27.3	-27.2	>10 ⁻⁷	4 x 10 ⁻⁶	>10 ⁻⁶	N.D.
69.6-74.6	sandstone (T.F.)	-26.9	-27.3	5.2 x 10 ⁻⁵	7.1 x 10 ⁻⁶	>10 ⁻⁶	N.D.
80.0-85.0	sandstone (T.F.)	-	-29.9	>10 ⁻⁷	5 x 10 ⁻⁶	>10 ⁻⁶	N.D.

O.F. : Oidawara Formation A.F. : Akeyo Formation T.F. : Toki Formation, N.D. : Not Detectable

organic materials in the Toki lignite-bearing Formation.

A hydrogeological investigation on the regional groundwater movement is also in progress. Understanding the dynamics of groundwater is important in evaluating the effects of Japan's heavy rainfall on the migration of the uranium series. It is emphasized that investigation of hill-slope hydrology is necessary as well as the hydraulic characteristics of deep groundwater to establish a regional hydrogeological model of this area; core logging, geophysical logging and hydraulic testing have been under way.

The result of a hydrogeological also indicates that the shallow groundwater in the Seto Group is directly recharged by rainfall and that the groundwater in the Mizunami Group is stagnant for a long time in the deepest aquifer.

The hydrological parameters such as pore pressure, flow direction and velocity measured in the borehole are in Table 2. There are various values of permeability which depend on rock type. Almost all groundwater velocity values are lower than 10⁻⁶ cm/sec.

The investigation of colloids and other components such as microorganisms in groundwater is important to evaluate the effect on radionuclide migration. The physical and geochemical composition and characteristics of natural colloids are also investigated.

CONCLUSION

- (1) General geology and geology have been studied i.e. stratigraphy, geological structure, general geological history, ore distribution,

ore grade, ore characteristic, mineralogy of host rock, etc.

- (2) There is no evidence of migration of uranium series nuclides among ²³⁸U, ²³⁴U, and ²³⁰Th. On the other hand, ²²⁶Ra is inferred to have been leached recently by reducing groundwater more than several meters.
- (3) The chemical and isotopic data of groundwater show that the shallow groundwater in Seto Group is directly recharged by rainfall and discharge very quickly and the deep groundwater in the Mizunami Group is stagnant.

FUTURE WORK

- (1) Investigation on migration of uranium series nuclides in order to understand the geochemical migration processes.
- (2) Investigation on distribution of uranium series nuclides along the fault to evaluate effects of faulting on uranium series nuclides migration.
- (3) Investigation of hydrogeology and hydrogeochemistry to understand the three-dimensional water transport pathways and how they affect nuclide migration.
- (4) Interpretation of geological events by age determination in order to estimate time scale and paleo-environment.
- (5) Investigation of the role of colloids and microorganisms in nuclide migration. These studies are under way through cooperation with national research institutes, universities and private consultants.

REFERENCES

Atomic Energy Commission, 1987, Long-Term Program for Development and Utilization of Nuclear Energy, Atomic Energy Commission, Japan, p.1-87.

Itoigawa, J. , 1974, Geology and Paleontology of Mizunami City, Bulletins of the Mizunami Fossil Museum, No. 1, p. 3-42, p. 353-386.

Katayama, N., Kubo, K. and Hirono, S., 1974, Genesis of Uranium Deposits of Tono Mine, Japan, Symposium of the Formation of Uranium Ore Deposits, Athens, May, 1974, Proc, IAEA-SM-183/11, p.437-452.

Sato, C., Ochiai, Y. and Takeda, S., 1987, Natural Analogue Study of Tono Sandstone-Type Uranium Deposit in Japan, Natural Analogue in Radioactive Waste Disposal, CEC, p.462-472.

TECHNOLOGIES DISCUSSED AT GOVERNMENT INDUSTRIAL RESEARCH INSTITUTE-OSAKA

- Natural Analogues for Leaching Behavior of Nuclear Waste Glass Forms
- Vitrification
- Improvement of Melter Elements
- Characterization of Solidified Products
- Alternative Solidification Processes
 1. Alcoholated Gelatin of HLW and Melting by Microwave Furnace
 2. Pressure Sintering Process
 3. Normal Sintering of HLW Powders
- Anti-Pollution Technologies
 1. Inorganic Microencapsulated Adsorbents
- Research on Optical Micro-Sensors for Gases
- Gold Catalysts Prepared by Coprecipitation for Low Temperature Oxidation of Hydrogen and of Carbon Monoxide
- X-ray Photoelectron Spectroscopy
- Transmission Electron Microscopy
- Gold Immobilization
- Chemical Sensors (Overall, Humidity, Ion, Bio, Gas)
- Selective Co-Sensing
- Inorganic Microcapsule
- Glass and Ceramics

BIBLIOGRAPHY OF LITERATURE RECEIVED AT GOVERNMENT INDUSTRIAL RESEARCH INSTITUTE-OSAKA

- "A Selective Co Sensor Using Ti-DOPED Fe_2O_3 with Coprecipitated Ultrafine Particles of Gold". Written by T. Kobayashi, M. Haruta, H. Sano and M. Nakane. GIRI-Osaka, 11 pages.
- "Fine Structure of Novel Gold Catalysts Prepared by Coprecipitation", Written by M. Haruta, H. Kageyama, N. Kamijo, T. Kobayashi, and F. Delannay. GIRI-Osaka, 10 pages.
- "40th ISE Meeting -Extended Abstracts, Volume 1", International Society of Electrochemistry, 3 pages.
- "Glass and Ceramics for the Future", Glass and Ceramic Material Department, GIRI-Osaka. 27 pages.
- "Gold Catalysts Prepared by Coprecipitation for Low-Temperature Oxidation of Hydrogen and of Carbon Monoxide", Written by M. Haruta, N. Yamada, T. Kobayashi, and S. Iijima. GIRI-Osaka, 9 pages.

- "Gold Supporting Tin Oxide for Selective Co-Sensing",** Written by T. Kobayashi, M. Haruta and H. Sano. GIRI-Osaka, 4 pages.
- "Methodology for Making R&D Programs of Chemical Sensors",** Written by M. Haruta, K. Hiroy, H. Tanigawa, H. Takenaka, S. Yoshikawa and H. Sano. GIRI-Osaka, 28 pages.
- "New Technology Japan",** Vol. 17, No. 2, May 1989, 2 pages.
- "Outline of Researches",** Government Industrial Research Institute, AIST, MITI, 9 pages.
- "Preparation and Catalytic Properties of Gold Finely Dispersed on Beryllium Oxide",** Written by M. Haruta, K. Saika, T. Kobayashi, S. Tsubota and Y. Nakahara. GIRI-Osaka, 4 pages.
- "Preparation of Highly Dispersed Gold on Titanium and Magnesium Oxide",** Written by S. Tsubota, M. Haruta, T. Kobayashi, A. Ueda, Y. Nakahara. GIRI-Osaka, 9 pages.
- "Proceedings- 9th International Congress on Catalysis",** M. Haruta, T. Kobayashi and F. Delannay, GIRI-Osaka, 6 pages.
- "Proceedings of the 3rd International Meeting on Chemical Sensors",** Cosponsored by the Edison Sensor Technology Center, Resource for Biomedical Sensor Technology, Electronics Design Center and Case Western Reserve University. 5 pages.
- "Research on HLW Management in GIRI-Osaka",** GIRI-Osaka, 2 pages.

A SELECTIVE CO SENSOR USING Ti-DOPED α -Fe₂O₃ WITH COPRECIPITATED ULTRAFINE PARTICLES OF GOLD*

TETSUHIKO KOBAYASHI, MASATAKE HARUTA, HIROSHI SANO and
MASANORI NAKANE

Government Industrial Research Institute of Osaka, Midorigaoka 1, Ikeda 563 (Japan)

(Received January 15, 1987; in revised form June 30, 1987; accepted October 15, 1987)

Abstract

Titanium-doped α -Fe₂O₃ with ultrafine deposits of Au was prepared by the coprecipitation method. A thick-film sensor fabricated from the above semiconductor had high sensitivity and excellent selectivity to CO against ethanol and H₂ in the temperature range 30 °C to 100 °C. This unique sensing property was found to originate from a high catalytic activity of the material, which could catalyse CO oxidation even at a temperature as low as -70 °C. High-resolution electron microscopic observation has revealed that gold ultrafine particles with a mean diameter of 36 Å are homogeneously dispersed and that they are not merely supported on but strongly held by the host oxide α -Fe₂O₃-Ti⁴⁺. The sensing mechanism and the origin of the high selectivity to CO are discussed.

1. Introduction

There are growing needs for selective detection of CO in both domestic and industrial sectors of society, because it is toxic even at a concentration as low as 100 ppm. Selective CO gas sensors are indispensable for the detection of incomplete combustion, the prevention of poisoning in mines, and the detection of early stages of a fire.

Gas sensors based on a conductivity change of n-type semiconductive oxides, such as ZnO [1] and SnO₂ [2], have been widely used in gas-leak alarms. Several oxidation catalysts have been used as sensitizing additives to the above semiconductive oxides in order to control the sensitivity and the selectivity to reducing gases [3, 4]. In the case of CO detection, the addition of Pt [5], Pd [6 - 8], CuO [7, 9], or Pd, MgO and ThO₂ [10] can increase the sensitivity. However, since these sensitizers also tend to increase the sensitivity to ethanol and/or H₂ [11 - 13], it has been difficult to obtain sufficiently high selectivity for CO.

*Paper presented at the 2nd International Meeting on Chemical Sensors, Bordeaux, France, July 7 - 10, 1986.

We have recently reported that a novel catalyst composed of $\alpha\text{-Fe}_2\text{O}_3$ and ultrafine particles of gold (UFP-Au) with an optimum atomic ratio of Au:Fe = 5:95 can catalyse the oxidation of CO even at a temperature as low as -70°C [14]. This catalyst exhibits remarkably enhanced activity in comparison with those of Au powder and $\alpha\text{-Fe}_2\text{O}_3$; when these single compounds were used, the CO oxidation needed much higher temperatures, 200°C for $\alpha\text{-Fe}_2\text{O}_3$ and 300°C for Au powder. Furthermore, the UFP-Au/ $\alpha\text{-Fe}_2\text{O}_3$ catalyst is so stable that it does not lose its high catalytic activity during continuous oxidation of CO for one week in a moistened atmosphere at room temperature.

It is reasonable to expect that the high catalytic activity of the UFP-Au/ $\alpha\text{-Fe}_2\text{O}_3$ catalyst may lead to a high sensitivity to and high selectivity of CO at low temperatures, if suitable modification of the catalyst can be made. The present study has been undertaken in an attempt to make n-type semiconductors from UFP-Au/ $\alpha\text{-Fe}_2\text{O}_3$ and to utilize them as a CO gas sensor.

2. Experimental

2.1. Preparation of semiconductive materials

Haematites ($\alpha\text{-Fe}_2\text{O}_3$) doped with tetravalent metal ions were prepared by coprecipitation from a mixed aqueous solution of $\text{Fe}(\text{NO}_3)_3$ and each of SiCl_4 , $\text{Ti}(\text{OH})_3(\text{OOH})$, SnCl_4 and ZrOCl_2 with an aqueous solution of Na_2CO_3 . The precipitates were washed with distilled water then vacuum dried and calcined in air at 400°C for 3 h. Titanium-doped $\alpha\text{-Fe}_2\text{O}_3$ with ultrafine gold particles (UFP-Au/ $\alpha\text{-Fe}_2\text{O}_3\text{-Ti}^{4+}$) was prepared by a similar coprecipitation method using a mixed solution of HAuCl_4 , $\text{Fe}(\text{NO}_3)_3$, and $\text{Ti}(\text{OH})_3(\text{OOH})$. For comparison, the following four kinds of materials were also prepared; (1) Photodepo-Au/ $\alpha\text{-Fe}_2\text{O}_3\text{-Ti}^{4+}$ was obtained by the photodeposition method [15] from a mixed aqueous solution of HAuCl_4 , ethanol and a dispersion of $\alpha\text{-Fe}_2\text{O}_3\text{-Ti}^{4+}$ powder under the illumination by a mercury arc lamp (100 W) for 10 h. (2) Au-sol/ $\alpha\text{-Fe}_2\text{O}_3\text{-Ti}^{4+}$ was prepared by coprecipitation from a mixed solution of $\text{Fe}(\text{NO}_3)_3$ and $\text{Ti}(\text{OH})_3(\text{OOH})$ with a Na_2CO_3 solution containing Au-sol. The gold sol was previously prepared by the reduction of HAuCl_4 with formaldehyde [16]. (3) Impreg-Au/ $\alpha\text{-Fe}_2\text{O}_3\text{-Ti}^{4+}$ was obtained by impregnation of a HAuCl_4 solution into $\alpha\text{-Fe}_2\text{O}_3\text{-Ti}^{4+}$ particles. (4) Au/ SnO_2 was prepared by coprecipitation from a mixed solution of HAuCl_4 and SnCl_4 . These materials were calcined at 400°C for 3 h and were further calcined at 600°C for 1 h.

2.2. Characterization

X-ray diffraction (XRD) analysis was made by using the Rad-B system (Rigaku Denki Co. Ltd.). The mean particle diameter of $\alpha\text{-Fe}_2\text{O}_3$ and Au was estimated from half-widths of the (104) peak of $\alpha\text{-Fe}_2\text{O}_3$ at $2\theta = 33.15^\circ$ and the (111) peak of Au at $2\theta = 38.18^\circ$ using Scherrer's equation [17].

To observe the fine structure of the material, a high resolution transmission electron microscope (TEM) (H-800, Hitachi Co. Ltd.) operated at 200 kV was used.

2.3. Fabrication of thick-film sensors and gas sensitivity measurements

An aqueous paste of the gas-sensing material calcined at 400 °C was deposited on an alumina plate on which a pair of comb-like Au electrodes was previously printed. Both the width of the Au electrodes and that of the gap between the electrodes are 0.2 mm, and the total length of the electrodes is 77 mm. The amount of gas-sensing material used for one sensor device was about 10 mg per cm² of the alumina plate. The thick film was finally heat treated at 600 °C for 1 h in air before measurements. The sensor device thus obtained was set on a temperature-controlled hot plate in a test chamber (7000 cm³) that was filled with clean air humidified to 65% r.h. The change in resistance of the device was measured when a reducing gas, such as CO, ethanol or H₂ was introduced by a gas syringe into the test chamber. The sensitivity is expressed by the ratio of the resistance measured in air alone, *R*-air, to that measured in the presence of reducing gases, *R*-gas.

2.4. Catalytic activity measurements

Catalytic activities of the materials for CO oxidation and H₂ oxidation were measured by using a small fixed-bed reactor with 0.2 g of the materials, which had passed through 70 and 120 mesh sieves. A standard gas consisting of 1.0 vol.% CO or H₂ balanced with dry air to 1.0 atm was passed through the catalyst bed at a flow rate of 66 ml min⁻¹. Conversion efficiencies from CO to CO₂ or from H₂ to H₂O were determined by the gas chromatographic analysis (G-1880, Yanagimoto Co.) of the effluent from the reactor. The catalytic activities were expressed by the specific temperatures, denoted as *T*_{1/2}, at which 50% conversion efficiency was attained, and therefore lower *T*_{1/2} implies higher catalytic activity for the oxidation.

3. Results

3.1. Doping of metal ions into α -Fe₂O₃

The resistance of a thick-film device fabricated from UFP-Au/ α -Fe₂O₃ catalyst (Au:Fe = 5:95 in atomic ratio) was over 10 M Ω at 250 °C in air. This resistance value is so high that a precise measurement of the resistance change caused by reducing gases is difficult without sufficient amplification. Therefore, several tetravalent metal cations like Si⁴⁺, Ti⁴⁺, Sn⁴⁺ and Zr⁴⁺ were used to dope α -Fe₂O₃ by a coprecipitation method in order to increase its n-type semiconductivity. The resistances of the thick-film devices prepared from the doped α -Fe₂O₃ were measured at 250 °C in air and the results are shown in Fig. 1 as a function of the radius of the dopant ions. Titanium ion, Ti⁴⁺, which has a nearly identical ionic radius to that of Fe³⁺, was found to decrease the resistance of α -Fe₂O₃ most effectively. Figure 2 shows that

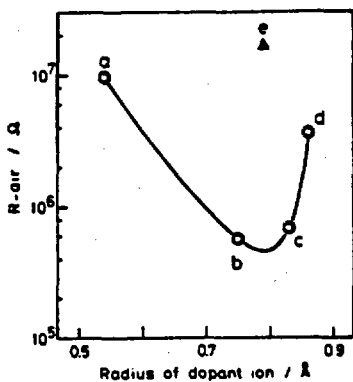

Fig. 1. The conductivity change of $\alpha\text{-Fe}_2\text{O}_3$ on doping with tetravalent metal cations. The resistance was measured at 250 °C in air in the thick-film device. (a) Si^{4+} ; (b) Ti^{4+} ; (c) Sn^{4+} ; (d) Zr^{4+} ; (e) dopant free (Fe^{3+}). $M^{4+}:\text{Fe}^{3+} = 1:99$ in atomic ratio.

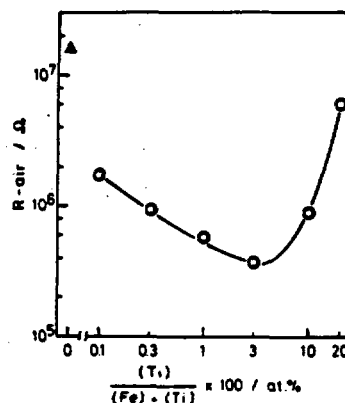

Fig. 2. Dependence of the conductivity of $\alpha\text{-Fe}_2\text{O}_3$ at 250 °C on Ti^{4+} concentration.

the resistance of $\alpha\text{-Fe}_2\text{O}_3$ could be minimized at a composition of $\text{Ti}:\text{Fe} = 3:97$ in atomic ratio. Based on the above results, $\text{Au}/\alpha\text{-Fe}_2\text{O}_3\text{-Ti}^{4+}$ ($\text{Au}:\text{Fe} = 5:95$, $\text{Ti}:\text{Fe} = 3:97$ in atomic ratio) has been chosen as the most promising gas-sensing semiconductor to be examined.

3.2. Sensing performance of Au/Ti-doped $\alpha\text{-Fe}_2\text{O}_3$

Figure 3 shows the sensitivities to CO, EtOH and H_2 of the thick-film sensors fabricated from Au-loaded and -unloaded $\alpha\text{-Fe}_2\text{O}_3\text{-Ti}^{4+}$ as a function of sensor operating temperature. Gold-loaded $\alpha\text{-Fe}_2\text{O}_3\text{-Ti}^{4+}$ exhibits a significantly high sensitivity to CO at temperatures below 100 °C, while having maximum sensitivities to EtOH and H_2 at around 150 °C and 250 °C, respectively. From the comparison with the results obtained for Au-unloaded $\alpha\text{-Fe}_2\text{O}_3\text{-Ti}^{4+}$, it is clear that the presence of Au leads to a shift of the temperatures for the maximum sensitivities towards lower temperatures, and that this shift and the enhancement of the sensitivities are most remarkable for CO detection.

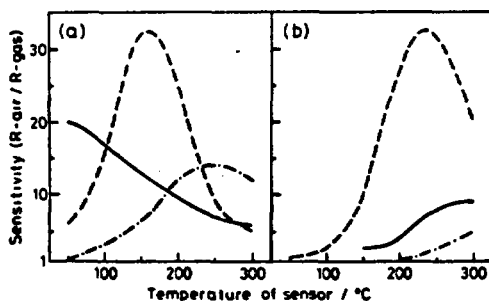

Fig. 3. Dependence of the sensitivities of thick-film sensors fabricated from UFP-Au/ $\alpha\text{-Fe}_2\text{O}_3\text{-Ti}^{4+}$ (a), and $\alpha\text{-Fe}_2\text{O}_3\text{-Ti}^{4+}$ without UFP-Au (b) on operating temperatures. —, 300 ppm CO; ---, 50 ppm EtOH; - · - · -, 300 ppm H_2 .

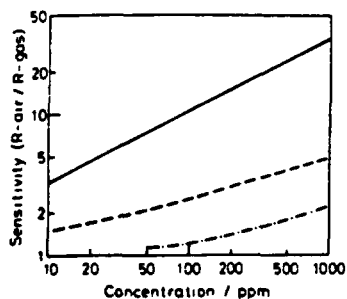

Fig. 4. The sensitivities of UFP-Au/ α -Fe₂O₃-Ti⁴⁺ sensor operated at 40 °C as a function of gas concentration. —, CO; ---, EtOH; - · - · -, H₂.

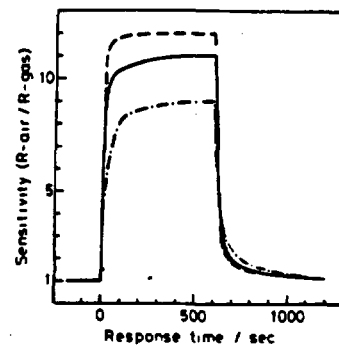

Fig. 5. The response time of UFP-Au/ α -Fe₂O₃-Ti⁴⁺ sensor to 100 ppm CO. ---, 50 °C; —, 40 °C; - · - · -, 30 °C.

At temperatures below 50 °C, an excellent high selectivity to CO against EtOH and H₂ was obtained. Figure 4 shows the dependence of the sensitivities on the concentrations of these gases at 40 °C. The sensitivity obtained for 20 ppm of CO corresponds to those for 1000 ppm of EtOH and for a much higher concentration of H₂. Figure 5 shows that the sensitivity reached 90% of the final steady-state signal after 40 s for 100 ppm of CO at 40 °C. This response at such a low temperature as 40 °C can be considered to be sufficiently rapid.

3.3. Effect of the particle size of gold and of the kind of host metal oxides on sensing properties.

Figure 6 shows the sensitivities to CO and H₂ of α -Fe₂O₃-Ti⁴⁺ with Au deposits of different particle size. The sensitivity as well as the selectivity to CO is markedly enhanced by a decrease in the Au particle size. In addition, CO sensing properties are dependent on the kind of host metal oxide on which the Au particles are supported. The sensitivity of Au/SnO₂ to CO at 50 °C, also shown in Fig. 6, is lower than that of photodepo-Au/ α -Fe₂O₃-Ti⁴⁺, although the particle size of Au on SnO₂ is smaller than that of Au photo-deposited on α -Fe₂O₃-Ti⁴⁺.

Figure 7 shows the catalytic activity of the semiconductors for CO oxidation and for H₂ oxidation. The same tendency as observed in the gas sensitivities can also be seen in the catalytic properties of the materials for the oxidation of CO and H₂.

3.4. Characterization of UFP-Au/ α -Fe₂O₃-Ti⁴⁺

Figure 8 shows an X-ray diffraction pattern of UFP-Au/ α -Fe₂O₃-Ti⁴⁺. Several sharp peaks due to α -Fe₂O₃ and appreciably broadened peaks due to metallic Au can be seen. From these peaks, the mean particle diameters of α -Fe₂O₃ and Au were estimated to be 170 Å and 30 Å, respectively. As TiO₂ could not be detected by X-ray diffraction, Ti⁴⁺ seems to be dissolved in the lattice of α -Fe₂O₃ to form a solid solution [18]. Since the particle size of

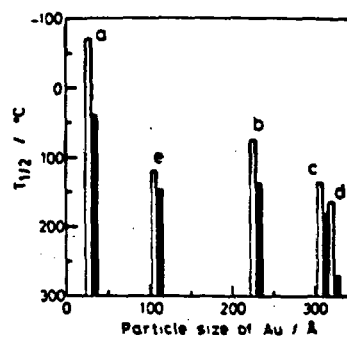
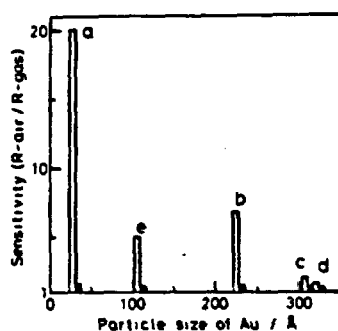

Fig. 6. Variation of the gas sensitivity at 50 °C with the particle size of Au. (a) UFP-Au/ α -Fe₂O₃-Ti⁴⁺; (b) Photodepo-Au/ α -Fe₂O₃-Ti⁴⁺; (c) Au-sol/ α -Fe₂O₃-Ti⁴⁺; (d) Impreg-Au/ α -Fe₂O₃-Ti⁴⁺; (e) Au/SnO₂. Au content in atomic ratio. (a) - (c), Au:Fe = 5:95; (d), Au:Fe = 1:99; (e), Au:Sn = 5:95. (□); 300 ppm CO, (■); 300 ppm H₂.

Fig. 7. Variation of the catalytic activity for the oxidation of CO (□) and H₂ (■) with the particle size of Au. (a) UFP-Au/ α -Fe₂O₃-Ti⁴⁺; (b) Photodepo-Au/ α -Fe₂O₃-Ti⁴⁺; (c) Au-sol/ α -Fe₂O₃-Ti⁴⁺; (d) Impreg-Au/ α -Fe₂O₃-Ti⁴⁺; (e) Au/SnO₂. Au content in atomic ratio: (a) - (c), Au:Fe = 5:95; (d), Au:Fe = 1:99; (e), Au:Sn = 5:95.

α -Fe₂O₃, i.e., 230 Å, in Au/ α -Fe₂O₃ was larger than that in Au/ α -Fe₂O₃-Ti⁴⁺, the doping of Ti⁴⁺ might lead to the formation of smaller particles in the coprecipitates.

Figure 9 shows the fine structure observed by TEM of Au/ α -Fe₂O₃-Ti⁴⁺ calcined at 400 °C. Since both the XRD pattern and the catalytic activity of the material calcined at 600 °C were nearly identical with those for the material calcined at 400 °C, the fine structure of the material calcined at 600 °C might be almost the same. Gold ultrafine particles are homogeneously dis-

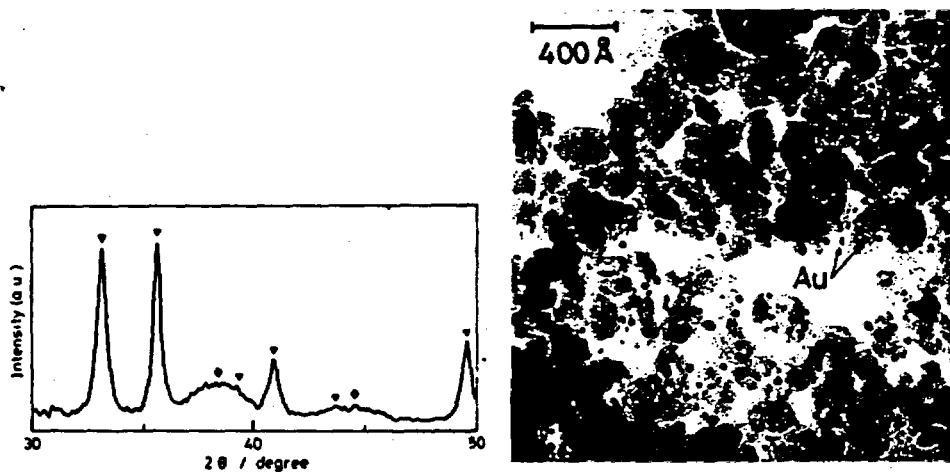

Fig. 8. X-ray diffraction pattern of UFP-Au/ α -Fe₂O₃-Ti⁴⁺. (▽) α -Fe₂O₃; (◆) Au.

Fig. 9. TEM photograph of UFP-Au/ α -Fe₂O₃-Ti⁴⁺.

persed on the surface of $\alpha\text{-Fe}_2\text{O}_3$ particles of about 200 Å in diameter. The diameter of 2663 particles of Au in the enlarged TEM photographs was measured by using a slide caliper and their distribution is plotted in Fig. 10. The mean particle diameter of Au and the standard deviation were calculated to be 36 Å and 13 Å, respectively. The particle diameters of $\alpha\text{-Fe}_2\text{O}_3$ and of Au determined from TEM coincided well with those estimated by XRD and indicate the validity of the XRD method.

Figure 11 shows that, typically, at the junction between Au particles and $\alpha\text{-Fe}_2\text{O}_3$, the basal planes of hemispherical Au particles are in contact with the surface of $\alpha\text{-Fe}_2\text{O}_3$ particles. From the interplanar spacing of the crystallites, it can be seen that the (111) plane of a Au crystallite is grown on a $\alpha\text{-Fe}_2\text{O}_3$ (110) plane. Such a crystal orientation is often but not always observed at Au/ $\alpha\text{-Fe}_2\text{O}_3$ junctions. Furthermore, ultrafine Au particles are stable on $\alpha\text{-Fe}_2\text{O}_3\text{-Ti}^{4+}$ and did not coagulate under the electron beam radiation in a TEM, while ultrafine Au particles vacuum-deposited on SiO_2 change their crystal structure in less than 0.1 s and occasionally move on the SiO_2 surface to coagulate with each other [19].

Neither the strongly bound interface nor the crystal orientation could be observed by TEM for impreg-Au/ $\alpha\text{-Fe}_2\text{O}_3\text{-Ti}^{4+}$, where spherical particles of Au were grown to a size larger than 200 Å in diameter and were present as a simple mixture with $\alpha\text{-Fe}_2\text{O}_3\text{-Ti}^{4+}$ particles.

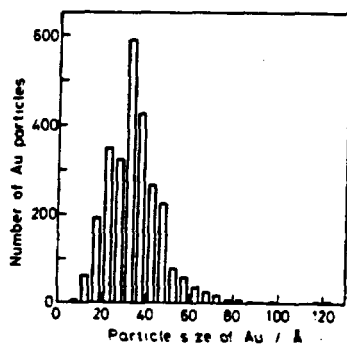

Fig. 10. Size distribution of UFP-Au on $\alpha\text{-Fe}_2\text{O}_3\text{-Ti}^{4+}$. Total number of measured Au particles: 2663. Mean particle size: 36 Å. Standard deviation: 13 Å.

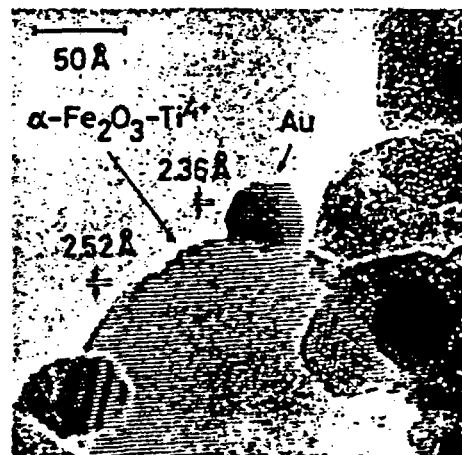

Fig. 11. The fine structure of the interface between Au and $\alpha\text{-Fe}_2\text{O}_3$. Note that the interplanar spacings of Au(111) and $\alpha\text{-Fe}_2\text{O}_3$ (110) are 2.355 Å and 2.519 Å, respectively.

4. Discussion

4.1. Sensing mechanism

It has been shown that the gas-sensing semiconductor, UFP-Au/ $\alpha\text{-Fe}_2\text{O}_3\text{-Ti}^{4+}$, can selectively detect CO with a high sensitivity at temperatures

below 100 °C (Figs. 3 and 4). Some Pd-added SnO₂ sensors [6, 8] have also been reported to detect CO at temperatures below 100 °C. Gold-loaded α -Fe₂O₃-Ti⁴⁺ has a sensitivity and selectivity comparable to those of the Pd/SnO₂ sensor of best performance reported so far [20]. However, there is a marked difference in the response time between the two materials. The response time with UFP-Au/ α -Fe₂O₃-Ti⁴⁺ is less than 1 min (Fig. 5), while it is over 10 min with Pd/SnO₂ [6].

Another big difference is the catalytic activity for CO oxidation; *i.e.*, over UFP-Au/ α -Fe₂O₃-Ti⁴⁺, CO oxidation takes place even at -70 °C (Fig. 7), while it commences only at around 100 °C on Pd/SnO₂ catalysts [21]. Hence, at the temperatures for which both of the materials have high CO sensitivity, CO oxidation takes place vigorously on UFP-Au/ α -Fe₂O₃-Ti⁴⁺ but not on Pd/SnO₂. This difference strongly suggests that there should be a substantial difference in the CO sensing mechanism between these two materials.

The activation mechanisms of the gas-sensing semiconductors sensitized by Pd, Pt and Ag have been classified into two types [22]. In the first mechanism, the reducing gases are adsorbed and activated on the sensitizers, and then the activated gases react with the oxygen adsorbed anionically on the semiconductor surfaces. The resultant removal of the surface oxygen causes an increase in the conductivity of the n-type semiconductors. In this case, a high sensitivity is expected to appear as a reflection of a high catalytic activity for the oxidation of reducing gases at the same temperature range.

The second mechanism is an electronic one in which the sensitizers create such surface states as to directly exchange electrons with the semiconductors. The reducing gases are adsorbed on the sensitizers and then donate electrons to the semiconductors via the surface states originated from the sensitizers, which also results in an increase in the conductivity of the n-type semiconductors. In this case, catalytic activity for the oxidation is not necessarily needed for sensing reducing gases.

From the relation between the sensitivity and the catalytic activity at temperatures below 100 °C, the first mechanism would be valid for UFP-Au/ α -Fe₂O₃-Ti⁴⁺, and the second for Pd/SnO₂. In the latter case, it is likely that CO molecules will be adsorbed too strongly on the Pd surfaces [23] to react with the surface oxygen on SnO₂ at such low temperatures. This may be responsible for the very slow response time of Pd/SnO₂.

4.2. Origin of high CO sensitivity

Carbon monoxide oxidation takes place at temperatures above 200 °C on α -Fe₂O₃ [14], where the rate-determining step is the adsorption of CO onto the α -Fe₂O₃ surface [24]. Such a catalytic nature of α -Fe₂O₃ is reflected in the CO-sensing property of α -Fe₂O₃-Ti⁴⁺ without UFP-Au (Fig. 3). If UFP-Au provides sites for the activation of CO and then facilitates its transfer to the α -Fe₂O₃ surface, the fast CO oxidation at low temperatures and hence the high sensitivity to CO of UFP-Au/ α -Fe₂O₃-Ti⁴⁺ will be explainable.

Since the surface of pure gold is known to be essentially inactive to most chemicals, including CO [25], it can be suggested that the surface property of Au is significantly changed in UFP-Au held on the $\alpha\text{-Fe}_2\text{O}_3$ surface.

The first experimental evidence is the size effect of Au particles shown in Figs. 6 and 7. The UFP-Au particles on $\alpha\text{-Fe}_2\text{O}_3\text{-Ti}^{4+}$ are so small that a large part of the constituent Au atoms is exposed to the surface. The number of constituent Au atoms in an Au sphere with a diameter of 36 Å is calculated to be about 10^3 , and about 40% of the Au atoms exist on the outermost surface of the particle. The catalytic properties of such ultrafine metal particles are expected to differ significantly from those of bulk metals [26], due to an increase in the surface dangling bonds [27] and/or a change in the electronic structure due to quantum size effects [28] with a decrease in the particle size. In fact, it has been reported that atomic Au can react with both CO and O_2 even at 10 K and that the resultant $\text{Au}(\text{CO})_2\text{O}_2$ complex decomposes to produce CO_2 at 40 K [29].

Secondly, it can be pointed out that 'metal-support interaction' [30] may govern the chemical properties of UFP-Au. Electron microscopic observation showed that UFP-Au particles were not spherical but hemispherical and were strongly held on the host oxide of $\alpha\text{-Fe}_2\text{O}_3\text{-Ti}^{4+}$. The activity to CO at low temperatures was appreciably dependent on the kinds of host metal oxides; on SnO_2 , instead of $\alpha\text{-Fe}_2\text{O}_3$, UFP-Au catalysts did not exhibit high catalytic activity (Fig. 7). Bond *et al.* [31] have proposed that ultrafine Au particles supported on Al_2O_3 or SiO_2 become electron deficient by donating electrons to the supports and the catalytic properties of the electron-deficient Au particles then resemble somewhat those of Pt, which is the element to the left of Au in the Periodic Table.

It is well known that CO is adsorbed strongly on Pt in contrast to the weak adsorption on 'inherent' Au and that CO adsorbed on the Pt surface is too stabilized to be oxidized by O_2 at temperatures below 150 °C [23]. The adsorption energy of CO on Pt is 110 - 140 kJ/mole [23], while that on 'inherent' Au is about 40 kJ/mole [32]. If UFP-Au becomes electron deficient by donating electrons to the host oxide of $\alpha\text{-Fe}_2\text{O}_3\text{-Ti}^{4+}$ and then has intermediate CO adsorption between that of Pt and 'inherent' Au, UFP-Au can provide suitable sites for the CO adsorption, which would facilitate reaction with O_2 adsorbed on the $\alpha\text{-Fe}_2\text{O}_3$ surface.

Acknowledgement

We are greatly indebted to Dr. S. Iijima of Research Development Corporation of Japan for his helpful discussions.

References

- 1 T. Seiyama, A. Kato, K. Fujiishi and M. Nagatani, A new detector for gaseous components using semiconductive thin films, *Anal. Chem.*, 34 (1962) 1502 - 1503.

- 2 N. Taguchi, Method for making a gas-sensing element, *Jpn. Patent, S45-38200* (1970).
- 3 P. J. Shaver, Activated tungsten oxides gas detectors, *Appl. Phys. Lett.*, **11** (1967) 255 - 257.
- 4 T. Seiyama, H. Futada, F. Eera and N. Yamazoe, Gas detection by activated semiconductor sensor, *Denki Kagaku*, **40** (1972) 244 - 249.
- 5 Y. Okayama, H. Fukaya, K. Kojima, Y. Terasawa and T. Handa, Characteristics of CO gas sensor of Pt and Sb dispersed SnO₂ ceramics, *Proc. Int. Meet. Chemical Sensors, Fukuoka, Japan, September 1983*, pp. 29 - 34.
- 6 M. Nagase and H. Futata, A town gas alarm with a pair of semiconductor gas sensors, *Proc. Int. Meet. Chemical Sensors, Fukuoka, Japan, September 1983*, pp. 67 - 72.
- 7 R. Lambrich, W. Hagen and J. Lagois, Metal oxide films as selective gas sensors, *Proc. Int. Meet. Chemical Sensors, Fukuoka, Japan, September 1983*, pp. 73 - 74.
- 8 N. Murakami, Y. Matsuura, K. Takahata and K. Ihokura, Effect of Pd additive on a SnO₂ gas sensor for CO detection in combustion gas, *Proc. 2nd Int. Meet. Chemical Sensors, Bordeaux, France, July 1986*, pp. 268 - 269.
- 9 G. Heiland, Homogeneous semiconducting gas sensors, *Sensors and Actuators*, **2** (1982) 343 - 361.
- 10 M. Nitta and M. Haradome, Thick film CO sensors, *IEEE Trans. Electron Devices*, **ED-26** (1979) 247 - 249.
- 11 N. Yamazoe, Semiconductor gas sensors, *Denki Kagaku*, **50** (1982) 29 - 37.
- 12 K. Murakami, S. Yasunaga, S. Sunahara and K. Ihokura, Sensing and sintering temperature of SnO₂ gas sensor, *Proc. Int. Meet. Chemical Sensors, Fukuoka, Japan, September 1983*, pp. 18 - 23.
- 13 N. Saito and S. Kobayashi, Adsorption and electrical properties of surfaces, *J. Metal Finish. Soc. Jpn.*, **31** (1980) 176 - 184.
- 14 M. Haruta, T. Kobayashi, H. Sano and N. Yamada, Novel gold catalysts for the oxidation of carbon monoxide at a temperature far below 0 °C, *Chem. Lett.*, (1987) 405 - 408.
- 15 E. Borgarello, R. Harris and N. Serpone, Photochemical deposition and photorecovery of gold using semiconductor dispersions, *Nouv. J. Chim.*, **9** (1985) 743 - 747.
- 16 N. Uyeda, M. Nishio and E. Suito, Nucleus interaction and fine structures of colloidal gold particles, *J. Colloid Interface Sci.*, **43** (1973) 264 - 276.
- 17 J. H. Lemaire, P. G. Menon and F. Delannay, in F. Delannay (ed.), *Characterization of Heterogeneous Catalysts*, Marcel Dekker, New York, 1984, pp. 299 - 365.
- 18 G. Shirane, S. J. Pickart, R. Nathans and Y. Ishikawa, Neutron-diffraction study of antiferromagnetic FeTiO₃ and its solid solutions with α -Fe₂O₃, *J. Phys. Chem. Solids*, **10** (1959) 35 - 43.
- 19 S. Iijima and T. Ichihashi, Structural instability of ultrafine particles of metals, *Phys. Rev. Lett.*, **56** (1986) 616 - 619.
- 20 N. Murakami, Selective CO detection with SnO₂ gas sensor operated by the periodical temperature cycle, *Proc. 5th Symp. Chemical Sensors (in Fall Meet. Electrochem. Soc. Jpn.)*, Tokyo, Japan, September 1986, pp. 53 - 54.
- 21 G. C. Bond, L. R. Malloy and M. J. Fuller, Oxidation of carbon monoxide over palladium-tin (IV) oxide catalysis: an example of spillover catalysis, *J. Chem. Soc. Chem. Commun.*, (1975) 796 - 797.
- 22 N. Yamazoe, Y. Kurokawa and T. Seiyama, Effects of additives on semiconductor gas sensors, *Sensors and Actuators*, **4** (1983) 283 - 289.
- 23 R. P. H. Gasser, *An Introduction to Chemisorption and Catalysis by Metals*, Clarendon Press, Oxford, 1985, Ch. 9, pp. 206 - 252.
- 24 K. H. Kim, H. S. Han and J. S. Choi, Kinetics and mechanisms of the oxidation of carbon monoxide on α -Fe₂O₃, *J. Phys. Chem.*, **83** (1979) 1286 - 1289.
- 25 R. J. Puddephatt, *The Chemistry of Gold*, Elsevier, Amsterdam, 1978, Ch. 1, pp. 1 - 29.
- 26 G. C. Bond, The origin of particle size effects in heterogeneous catalysis, *Surface Sci.*, **156** (1985) 966 - 981.

- 27 R. Van Hardeveld and F. Hartog, The statistics of surface atoms and surface sites on metal crystals, *Surface Sci.*, 15 (1969) 189 - 230.
- 28 R. Kubo, Electronic properties of metallic fine particles. I, *J. Phys. Soc. Jpn.*, 17 (1962) 976 - 986.
- 29 H. Huber, D. McIntosh and G. A. Ozin, A metal atom model for the oxidation of carbon monoxide to carbon dioxide. The gold atom-carbon monoxide-dioxygen reaction and the gold atom-carbon dioxide reaction, *Inorg. Chem.*, 16 (1977) 975 - 979.
- 30 G. C. Bond, in B. Imelik, C. Naccache, G. Coudurier, H. Praliaud, P. Meriaudeau, P. Gallezot, G. A. Martin and J. C. Vedrine (eds.), *Metal-Support and Metal-Additive Effects in Catalysis*, Elsevier, Amsterdam, 1982, pp. 1 - 10.
- 31 G. C. Bond and P. A. Sermon, Gold catalysts for olefin hydrogenation. Transmutation of catalytic properties, *Gold Bull.*, 6 (1973) 102 - 105.
- 32 R. R. Ford, in D. D. Eley, H. Pines and P. B. Weisz (eds.), *Advances in Catalysis*, Vol. 21, Academic Press, New York, 1970, pp. 51 - 150.

Biographies

Tetsuhiko Kobayashi received B. E. and Doctor of Engineering degrees from Osaka University, in 1978 and 1983, respectively. From 1983 to 1984 he remained at Osaka University as a postdoctoral fellow of the Japan Society for the Promotion of Science to continue his work on electrochemistry. Since joining GIRIO in 1984, his research has focused on the development of new gas sensors.

Masatake Haruta received a B. E. from Nagoya Institute of Technology in 1970 and a Doctor of Engineering from Kyoto University in 1976. Since joining GIRIO in 1976, he has worked on the preparation of combustion catalysts and gas-sensing oxide materials.

Hiroshi Sano received a B. Sc. from Niigata University in 1955 and a Doctor of Engineering from Kyoto University in 1976. He has been the director of the Material Chemistry Department in GIRIO since 1986, and his current fields of interest are catalysts and their application to new energy technology and pollution control.

Masanori Nakane received a B. E. from Kumamoto Institute of Technology in 1948 and a Doctor of Engineering from Osaka University in 1971. He was the director of the Material Chemistry Department in GIRIO until 1986. His major activities are concerned with the development of new materials.

FINE STRUCTURE OF NOVEL GOLD CATALYSTS PREPARED BY COPRECIPITATION

M. HARUTA¹, H. KAGEYAMA¹, N. KAMIJO¹, T. KOBAYASHI¹, and F. DELANNAY²

¹Government Industrial Research Institute of Osaka, Midorigaoka 1, Ikeda, 563 (Japan)

²Université Catholique de Louvain, Department of Material Science and Processes, Place Sainte Barbe 2, B-1348 Louvain-la-Neuve(Belgium)

ABSTRACT

Highly dispersed gold catalysts have been prepared by calcining the coprecipitates obtained from an aqueous solution of HAuCl_4 and the nitrate of Fe, Co, Ni, or Be. They are active for the oxidation of CO even at such a low temperature as -70°C and become more active in the presence of moisture. The gold particles are hemispherical in shape and are nearly homodispersed with a mean diameter smaller than 10nm. Most of them are strongly attached at their flat planes to the metal oxide support exhibiting a specific crystal orientation. The chemical shifts in XPS showed that the ultrafine gold particles were electron deficient. The results of EXAFS studies suggested the possibility of the existence of gold atoms coordinated with iron atoms.

INTRODUCTION

Gold has attracted little attention as a catalyst because of its inert character and the difficulties in preparing highly dispersed small particles. Schwank noticed unusual activities and selectivities of monometallic gold catalysts in his review¹). However, gold catalysts have been considered in many cases not to be competitive with other noble metal catalysts in terms of activity. This remains to be true even in the small supported gold particles²).

An interesting discovery made recently is that gold supported on borosilicate catalyzes the oxidation of many organic compounds by nitrogen dioxides^{3,4}). The reactions are efficient and highly selective and are being applied to the detection of butylated hydroxytoluene(BHT). On the other hand, we have also found recently that coprecipitation enables us to prepare highly dispersed gold catalysts and that the combination with the oxides of group VIII 3d transition metals⁵⁻⁷) and alkaline earth metals⁸) makes gold so active that it can catalyze the oxidation of CO, even at -70°C . The above gold catalysts are now under way for the application to the removal of CO from air, the oxidation of CO in sealed CO₂ laser, and selective CO gas sensors⁹).

The present paper deals with the characterization of the novel gold catalysts, specifically Au/ α -Fe₂O₃ and Au/BeO, through XPS, EXAFS, and TEM. The

mechanism is also discussed of the oxidation of CO on these gold catalysts in moistened air at a room temperature.

EXPERIMENTAL

The gold catalysts were prepared by coprecipitation with sodium carbonate from an aqueous solution of HAuCl_4 and the nitrates of various metals. The coprecipitates were washed, vacuum dried, and calcined in air at temperatures from 80°C to 500°C . Catalytic activity measurements were carried out in a small fixed bed reactor, with 0.20g of catalysts that had passed through 70 and 120 mesh sieves. A standard gas consisting of 1.0 vol% H_2 or CO balanced with air to 1 atm. was passed through the catalyst bed at a flow rate of 66 ml/min.

The structures of the gold catalysts were observed using a Hitachi H-9000 electron microscope operated at 300 kV. X-ray photoelectron spectroscopic analyses were made using a Shimadzu ESCA 750 under a vacuum below 5×10^{-6} torr. The binding energies were calculated by reference to that of C1s carbon contamination peak assumed at 285.0 eV. Measurements of EXAFS and XANES were carried out at the beam line 10B of the 2.5 GeV storage ring of Photon Factory in the National Laboratory for High Energy Physics (KEK, Tsukuba). Data analysis was made following the method of Maeda et al.¹⁰.

RESULTS

Catalytic properties of gold catalysts prepared by coprecipitation

Table 1 shows the catalytic activities of the gold catalysts with different metal oxide supports for the oxidation of H_2 and CO. The activity is expressed in terms of the temperature corresponding to 50% conversion ($T_{1/2}$). The particle sizes of gold were calculated from peak half-widths of XRD and in some cases from TEM photographs.

There are two groups of metal oxide supports that can generate remarkably high catalytic activities for the oxidation of CO at -70°C . They are the oxides of group VIII 3d transition metals like Fe, Co, and Ni and the oxides of alkaline earth metals like Be and Mg. In contrast to the catalytic nature of pure gold that the oxidation of H_2 occurs at lower temperatures than that of CO, the above gold catalysts can catalyze the oxidation of CO at much lower temperatures. On the contrary to the metal oxide supports alone which are seriously deactivated by moisture, the coprecipitated gold catalysts become more active in the presence of moisture. In the experiments carried out at 30°C using the large grain of $\text{Au}/\alpha\text{-Fe}_2\text{O}_3$ (7-9 meshes) calcined at 400°C under a space velocity of $4 \times 10^4 \text{ h}^{-1}$, the oxidation efficiency of CO was raised to 100% from 95% by the addition of water in a range from 0.6 to 4.0 vol%. These characteristic properties may permit us to distinguish the coprecipitated gold catalysts from the conventional ones which are prepared by impregnation on MgO .

Al_2O_3 , and SiO_2 1,2).

The oxides of transition metals other than Fe, Co, and Ni, namely Sc_2O_3 , La_2O_3 , TiO_2 , ZrO_2 , Cr_2O_3 , etc., appeared to be far less effective as a support because they did not give rise to active catalysts even when gold particles smaller than 5 nm had been prepared. Semiconductive oxides like CuO , ZnO , In_2O_3 , SnO_2 were relatively good supports to exhibit high catalytic activities for the oxidation of CO. All the above metal oxide supports changed the catalytic nature of gold and made it more active for CO oxidation than for H_2 oxidation, however, as far as Al_2O_3 and SiO_2 supports were concerned, gold retained its original nature.

The above results strongly support the indication by Schwank¹¹⁾ that the

TABLE 1
Catalytic activities of gold catalysts prepared by coprecipitation for the oxidation of H_2 and CO, and mean diameters of gold particles.

Oxides	Au content (atom%)	Calc. Temp. (°C)	$T_{1/2}[\text{H}_2]$ (°C)	$T_{1/2}[\text{CO}]$ (°C)	Diameter of Au (nm)
$\text{BeO}^a)$	5	200	<0	<-70	4f)
$\text{MgO}^a, b)$	2	200	67	<-70	<2f)
$\text{CaO}^a, b)$	10	200	—	5	—
Sc_2O_3	5	600	94	60	—
$\text{La}_2\text{O}_3^a)$	5	200	205	92	very small
TiO_2	5	400	108	63	5
ZrO_2	5	400	141	111	very small
Cr_2O_3	5	400	212	155	>30
MnO_2	10	400	152	—	—
Fe_2O_3	5	400	27	<-70	4, 1f)
Co_3O_4	5	400	56	<-70	6 f)
NiO	10	400	67	<-70	8 f)
CuO	5	400	154	24	—
ZnO	5	400	60	>-70 ^{d)}	5
CdO	5	200	—	206	21
Al_2O_3	5	300	66	84	5
In_2O_3	5	400	68	>1 ^{e)}	5
$\text{SiO}_2^c)$	5	300	184	204	20
SnO_2	5	400	54	0	3
Au	100	120	103	295	c. a. 20
Fe_2O_3	0	400	314	190	
Co_3O_4	0	400	139	81	
NiO	0	200	168	147	

a) hydrous oxides, b) deposition-reduction, c) deposition-precipitation
d) 20% conversion at -70°C , e) 20% conversion at 1°C , f) by TEM

type of support might play crucial role in determining the catalytic activity of gold in reactions of oxygen-bearing molecules. Especially, in the cases of gold catalysts prepared by coprecipitation the metal-support interactions could strikingly change the nature of gold due to the small sizes of particles. Among a variety of supported gold catalysts, Au/ α -Fe₂O₃ and Au/BeO, that were the most active, have been chosen as samples for the further investigation.

Effect of calcination temperature on catalytic activity

Figure 1 shows the dependence of the conversion in H₂ oxidation at 30°C and CO oxidation at -70°C on the calcination temperature for the Au-Fe coprecipitate. Figure 2 shows the dependence of T_{1/2} values for the oxidation of H₂ and CO on the calcination temperature for the Au-Be coprecipitate. The contents of Au in these catalysts were 5 atom%, which had been proved to be the optimum content.

In the Au-Fe coprecipitate, a maximum catalytic activity was obtained by calcination at 200°C for H₂ oxidation, but for CO oxidation it was obtained by calcination at 300°C, X-ray diffraction confirmed the sample calcined at 200°C as poorly crystalline hematite(α -Fe₂O₃) with no other apparent crystalline compounds. In the samples calcined at 300°C only hematite became more crystallized. At 400°C, broad diffraction peaks due to metallic gold appeared.

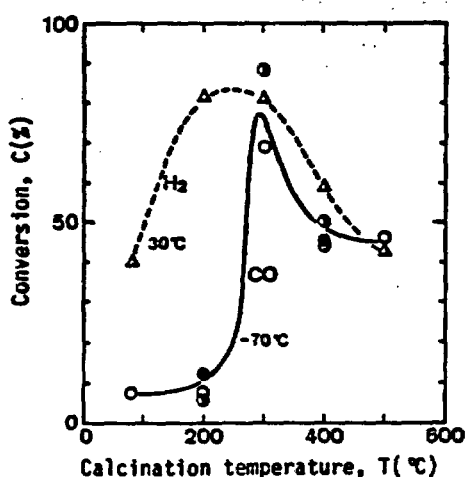

Fig. 1. Effect of calcination temperature on the catalytic activities of Au-Fe coprecipitate for the oxidation of H₂ and CO. Δ , H₂ at 30°C; \circ, \circ, \circ , CO at -70°C.

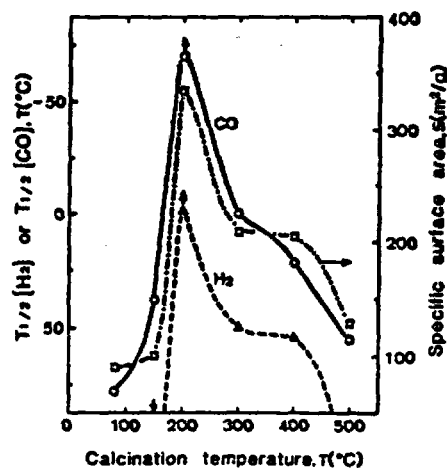

Fig. 2. Effect of calcination temperature on the catalytic activities of Au-Be coprecipitate for the oxidation of H₂ and CO and on specific surface area. Δ , H₂; \circ , CO; \square , specific surface area. The arrows denote that T_{1/2} values are lower than indicated.

On the other hand, calcination of the Au-Be coprecipitate at 200°C gave a maximum catalytic activity for both H₂ and CO oxidation. The XRD patterns showed that the sample calcined at 200°C contained very fine gold crystallites with no other apparent crystalline phase. Thermogravimetric and differential thermal analyses showed that the support was still in the phase of amorphous beryllium hydroxide at 200°C.

X-ray photoelectron spectroscopy

In order to investigate the change of the coprecipitates during calcination, XPS measurements were carried out for the samples calcined at different temperatures. Figures 3 (a) and (b) show the variation of the binding energies (BE) of Au4f_{7/2} and Au4d_{5/2} peak maxima with calcination temperature for Au/ α -Fe₂O₃ and Au/BeO, respectively. The error bars correspond to the reproducibility of the BE measurements. The dashed lines in the figures indicate the BE values that were measured for pure gold powder.

The distinct shifts toward higher BE observed for the samples dried at 80°C are about 1 eV for Au4f_{7/2} and about 2 eV for Au4d_{5/2}. Since shoulders were observed in the Au4f_{7/2} and 4f_{5/2} peaks at around 86 and 90 eV, respectively, which were very close to the BEs of auric oxide (Au₂O₃), such oxidic species of

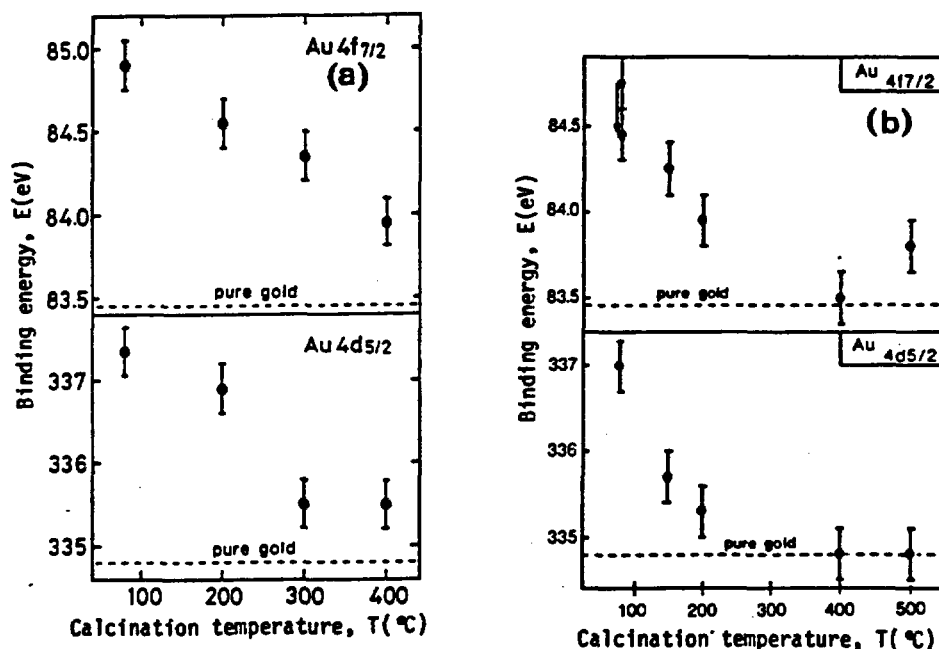

Fig. 3. Variation of BE of the maxima of Au4f_{7/2} and 4d_{5/2} lines as a function of calcination temperature for gold coprecipitates. (a), Au-Fe(1-19) coprecipitate; (b), Au-Be(1-19) coprecipitate.

gold should be at least partly responsible for the large chemical shifts of the samples calcined at low temperatures. For the Au-Be coprecipitate dried at 80°C, a gradual shift of the position of the Au4f peaks toward lower BE values was observed during analysis. This is the reason why two BE values for Au4f_{7/2} are given in Fig. 3(b). This suggests that the coprecipitates dried at 80°C were less stable in Au-Be system than in Au-Fe system. The change of chemical shift with calcination temperature occurs in a narrower temperature range (80°C ≤ T ≤ 200°C) for Au-Be system than for Au-Fe system (80°C ≤ T ≤ 400°C).

Both the Au-Fe coprecipitate calcined at 300-400°C and the Au-Be coprecipitate calcined at 200°C, that were the most active, exhibited the chemical shifts of about 0.5 eV toward higher BE values in Au 4f_{7/2} and 4d_{5/2} peak maxima. This indicates that such an amplitude of chemical shift is closely correlated with the catalytic properties of ultrafine gold particles.

EXAFS Analysis of the Au-Fe coprecipitate

Figures 4 and 5 show Fourier transforms of k³-weighted EXAFS oscillation of Au L₃-edge of the Au-Fe and Au-Be coprecipitates calcined at different temperatures, respectively. In Fig. 4 the data for Au₂O₃ and Au foil measured at 300 K are also included for reference. The Au-Fe coprecipitate calcined at 200°C still contains oxidic species of gold as a main compound of Au. The decomposition of oxidic species into metallic gold occurred at 300°C and was completed at 400°C. On the other hand, in the Au-Be coprecipitate calcined at 200°C the oxidic gold was already completely decomposed.

The coordination numbers, N, of a Au atom in the Au-Fe coprecipitate, which were obtained by curve fitting analysis of Au-Au peaks in the radial distribution function (RDF), are 4-8 for the sample calcined at 300°C, 7-10 for 400°C, 9-12 for 500°C. Since the ultrafine gold particles supported on α-Fe₂O₃ are hemispherical in shape as observed in TEM (Fig. 7), the coordination number was calculated as a function of particle diameter. From the curve, the diameter of gold particles in the sample calcined at 300°C is estimated to be smaller than 2nm and that in the sample calcined at 400°C is 1.5-3 nm.

The mean particle diameter determined directly by measuring the size of more than 2,000 particles in TEM photographs was 4.1nm for the sample calcined at 400°C. The discrepancy seems to suggest a possibility that gold atoms are coordinated with other light atoms. In order to examine this possibility, the "difference" technique was applied for the Au L₃ EXAFS signal of the sample calcined at 300°C to separate the signals of minor components¹²). As shown in Fig. 6, two peaks, one of which could be ascribed to Au-O coordination, were observed in the Fourier transform of the residual signal obtained by subtracting the Au-Au pair and noise signals from the measured signal. By

subtracting the Au-O pair signal from the residual signal and by Fourier transforming, the final RDF could be obtained. The curve fitting of the obtained peak on the assumption that it came from Au-Fe coordination output its distance of 2.48 Å. This value is very close to 2.51 Å, which is the sum of metal bond radii of Au and Fe. Therefore, it is likely that there exist Au-Fe bonds, most possibly at the interface between gold crystallites and hematite particles.

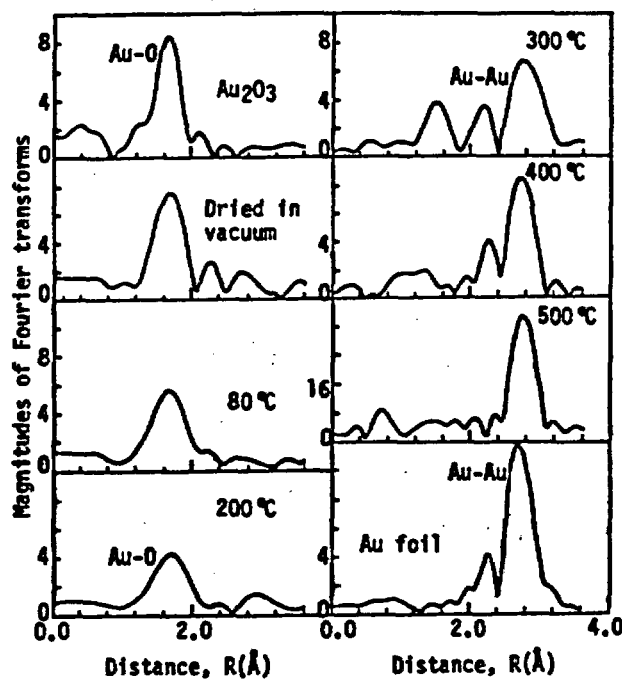

Fig. 4. Fourier transforms of k^3 -weighted EXAFS oscillation about Au L_3 -edge measured at 60 K for Au-Fe coprecipitate calcined at various temperatures.

Transmission electron microscopy

Figure 7 clearly shows the specific crystal orientation of gold crystallites; the Au(111) plane with a lattice spacing of 2.36 Å is in junction with the hematite(110) plane having a lattice spacing of 2.52 Å. This kind of epitaxy-like junction was very often observed not only in Au/ α -Fe₂O₃ but also in Au/Co₃O₄ and Au/NiO^{6,7}). The reduction and oxidation treatment of Au/ α -Fe₂O₃ to transform the host oxide (α -Fe₂O₃ \rightarrow Fe₃O₄ \rightarrow γ -Fe₂O₃) did not cause any tiny change of the sizes of gold particles. These facts support that there should be a strong bonding between Au and Fe at the interface.

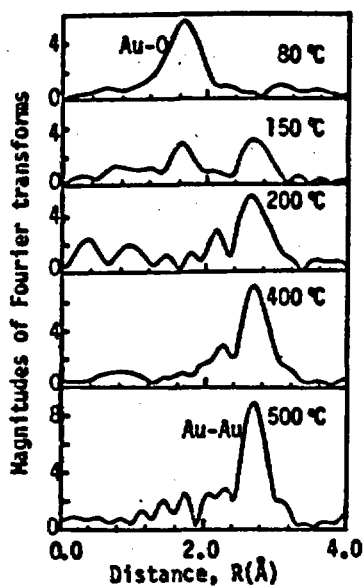

Fig. 5. Fourier transforms of k^3 -weighted EXAFS oscillation about Au L₃-edge measured at 300 K for Au-Be coprecipitate calcined at various temperatures.

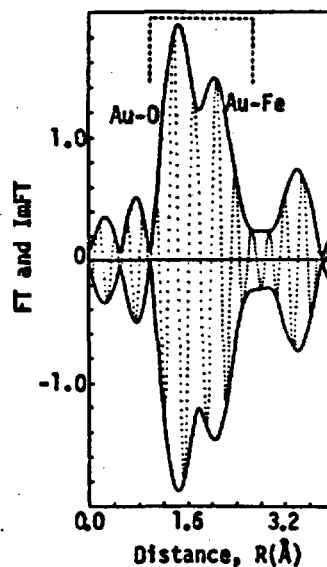

Fig. 6. The first difference Fourier transform of the Au L₃ difference signal obtained by subtracting the Au-Au pair signal from the measured signal.

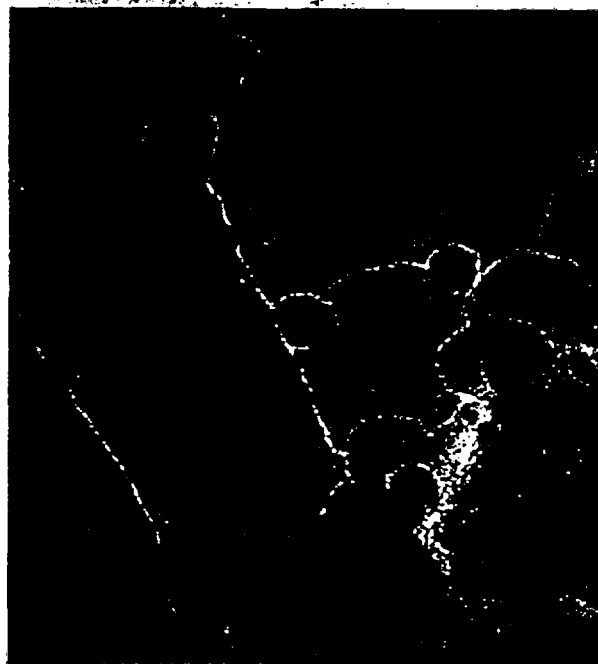

Fig. 7. TEM photograph of Tl doped Au-Fe (1-19) coprecipitate calcined at 400 °C.

DISCUSSION

In order to make highly dispersed gold catalysts, well mixed, most preferably homogeneously mixed coprecipitates, should be prepared. It is assumed that such precursors could not be prepared by coprecipitation of Au with Cr and Cd, and by deposition-precipitation of auric hydroxide on SiO_2 sols, because the sizes of gold particles in the calcined samples were larger than 20 nm.

The stability of oxidic gold species including auric oxide in the well mixed coprecipitates depends on the kinds of counter metals. The oxidic species of gold in the Au-Be coprecipitate were stabilized only little and were completely decomposed into metallic gold at 200°C even though no appreciable thermal change occurred in the matrix of beryllium hydroxide. On the other hand, in the Au-Fe coprecipitate the oxidic species of gold were much more stabilized and were not completely decomposed up to 400°C. The above difference can be explained by the affinities of oxidic gold species for metal hydroxide matrices. In the case of the Au-Fe coprecipitate, gold might be strongly embedded into the matrix of hydrous ferric oxide. During calcination, simultaneously with the crystallization of hematite, the oxidic gold species incorporated were decomposed into very tiny gold crystallites to come outside to the surface of hematite particles searching for favorable planes to the strong fixation. The epitaxy-like joining of gold crystallites with hematite particles could prevent gold crystallites from further coagulation.

It should be noted from the comparison between Au/ $\alpha\text{-Fe}_2\text{O}_3$ and Au/BeO that strikingly high catalytic activities for the oxidation of CO were generated only when metallic gold was present while the oxidation of H_2 did not necessarily need the metallic gold. This might be due to the difference in the reaction mechanism. The oxidation of H_2 may take place between gaseous hydrogen and weakly adsorbed oxygen²⁾, whereas the oxidation of CO can be assumed to occur between adsorbed CO and adsorbed oxygen. It is plausible that not oxidic but metallic gold surface is necessary for the adsorption of CO.

The results shown in Table 1 lead us to consider that the catalytic activities of monometallic gold catalysts for H_2 oxidation are largely dependent on the size of gold particles, namely the exposed surface area of metallic gold, and almost independent of the kinds of metal oxide supports. In contrast to this, the markedly high activities for the oxidation of CO were obtained only when the sizes of gold particles smaller than 10 nm were supported on the selected groups of metal oxides. The effective oxides of the first group are $\alpha\text{-Fe}_2\text{O}_3$, Co_3O_4 , and NiO, which can adsorb oxygen to a certain extent and are themselves active for the oxidation of CO. The oxides of the second group are the hydroxides of Be and Mg, where only little of oxygen but a large amount of water is adsorbed on the surface. Taking into consideration of

the enhancing effect of water in Au/ α -Fe₂O₃ as well as the surface properties of hydroxides of Be and Mg, it could be concluded that adsorbed water as well as adsorbed oxygen on the surface of support oxides is involved in the oxidation of CO.

The XPS studies showed that in the active gold catalysts ultrafine gold particles were electron deficient. Hence, they become electronically similar to the metal to the left in the Periodic Table, namely Pt¹³, on which CO molecules are strongly chemisorbed. Therefore, the nature of ultrafine gold particles immobilized on the selected metal oxides might possibly be altered so that the sufficient chemisorption of CO occurs at low temperatures although bulk gold surface does not chemisorb CO¹.

Based on the above considerations, the following mechanism can be speculated for the oxidation of CO in moistened air at a room temperature. Owing to the transmutation of catalytic properties of ultrafine gold particles immobilized on α -Fe₂O₃, carbon monoxide and oxygen can be chemisorbed on the surface of gold. The adsorbed CO molecules react with H₂O molecules and OH groups on the surface of metal oxides to form formic acid or formate ions. The adsorbed oxygen then reacts with the formate intermediates to produce carbon dioxide.

Without ultrafine gold particles, metal oxide catalysts like α -Fe₂O₃, Co₃O₄ are seriously deactivated by moisture because water prevents CO molecules from adsorption on the metal sites. Even with hydrous BeO and MgO where little oxygen species are adsorbed, high activities were obtained. This fact may indicate that oxygen is activated on the gold surface and is spilled over to the metal oxide surface.

REFERENCES

- 1 J. Schwank, Gold Bull., 16 (1983) 103-110.
- 2 G. Zhang, Ph. D. Dissertation, Stanford University, 1985. UMI 8608245.
- 3 S. A. Nyarady and R. E. Sievers, J. Amer. Chem. Soc., 107 (1985) 3726-3727.
- 4 Chem. Engng. News, June 24, 1985, pp. 42-43.
- 5 M. Haruta, T. Kobayashi, H. Sano and N. Yamada, Chem. Lett. (1987) 405-408.
- 6 M. Haruta, Hyomenkagaku (Surface Science), 8 (1987) 407-414.
- 7 M. Haruta, T. Kobayashi, S. Iijima and F. Delannay, Proc. 9th Intern. Congr. Catal., Calgary, June 26-July 1, 1988, pp. 1206-1213.
- 8 M. Haruta, K. Saika, T. Kobayashi, S. Tsubota and Y. Nakahara, Chem. Express, 3 (1988) 159-162.
- 9 T. Kobayashi, M. Haruta, H. Sano and M. Nakane, Sensors and Actuators, 13 (1988) 339-349.
- 10 H. Maeda, H. Terauchi, K. Tanabe, N. Kamijo, M. Hida and H. Kawamura, Jpn. J. Appl. Phys., 21 (1982) 1342-1346.
- 11 J. Schwank, S. Galvano and G. Parravano, J. Catal., 63 (1980) 415-423.
- 12 B. K. Teo, EXAFS: Basic Principles and Data Analysis, Inorganic Chemistry Concepts, Vol. 9, Springer Verlag, 1986, pp. 139-142.
- 13 G. C. Bond and P. A. Sermon, Gold Bull., 6 (1973) 102-105.

INTERNATIONAL SOCIETY OF ELECTROCHEMISTRY

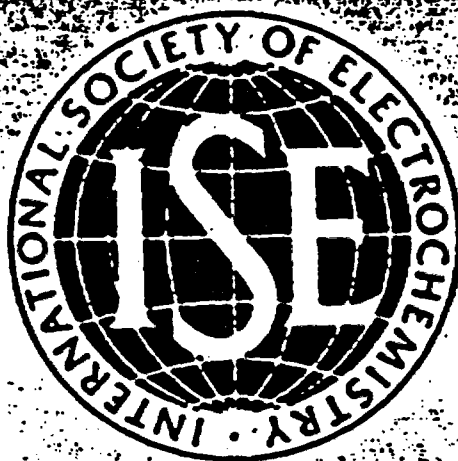

40th ISE MEETING

EXTENDED ABSTRACTS

VOLUME I

KYOTO, JAPAN

SEPTEMBER 17-22, 1989

19-08-03-G

SELECTIVE CO SENSING WITH SEMICONDUCTIVE METAL OXIDES SUPPORTING ULTRAFINE GOLD PARTICLES

T. Kobayashi, M. Haruta, and H. Sano
Government Industrial Research Institute of Osaka,
Midorigaoka 1, Ikeda 563, Japan

There has been strong need for the selective and highly sensitive detection of CO, since CO is toxic even at a concentration of 100 ppm. The detection of CO with conventional Pd- or Pt-sensitized SnO₂ semiconductor sensors is appreciably interfered by the presence of H₂. We have recently developed several supported gold catalysts which are extremely active for CO oxidation [1-3]. One of the advantageous features of these gold catalysts is that the oxidation of CO is accelerated with water and proceeds preferentially with respect to the oxidation of H₂. This property has led us to the investigation of the selective detection of CO with semiconductive Fe₂O₃ or SnO₂ supporting ultrafine gold particles (UFP-Au) [4,5].

Semiconducting materials, UFP-Au/Fe₂O₃ doped with Ti⁴⁺ (Au:Fe:Ti=5:97:3 in atomic ratio) and UFP-Au/SnO₂ doped with Na⁺ and Sb⁵⁺ (Au:Sn:Na:Sb=1:99:5:1), were prepared by coprecipitation [4,5] from an aqueous solution of metal nitrate or chloride and chloroauric acid with an alkaline solution (Na₂CO₃ or NH₃). The coprecipitates were washed with distilled water, vacuum-dried, and then calcined at 400°C. The thick

film gas sensor devices were fabricated [4] from the above semiconducting powder, and they were finally sintered at 550 - 650°C. Gas sensitivity is expressed by the ratio of the electrical resistance of a device measured in fresh air with a relative humidity of 65 % to that measured in the presence of CO or H₂, R-air/R-gas.

Figure 1 shows the sensitivities of the UFP-Au/Fe₂O₃·Ti⁴⁺ sensor operated at 75°C as a function of the concentration of CO and H₂. The sensitivity to 30 ppm of CO is still higher than that to 1000 ppm of H₂. Furthermore, the sensitivity to 10 ppm of CO is hardly affected by the co-presence of 100 ppm of H₂. The sensitivity of this sensor tended to decline gradually in a continuous

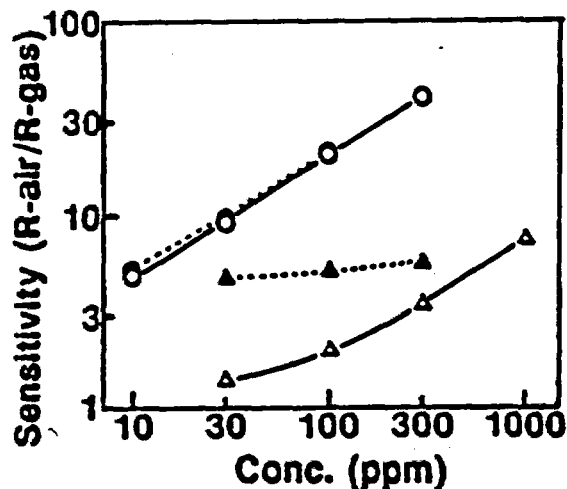

Fig. 1 The sensitivities of UFP-Au/Fe₂O₃·Ti⁴⁺ sensor operated at 70°C as a function of gas concentration.

(○); CO, (●); CO with 100 ppm H₂,
(△); H₂, (▲); H₂ with 10 ppm CO.

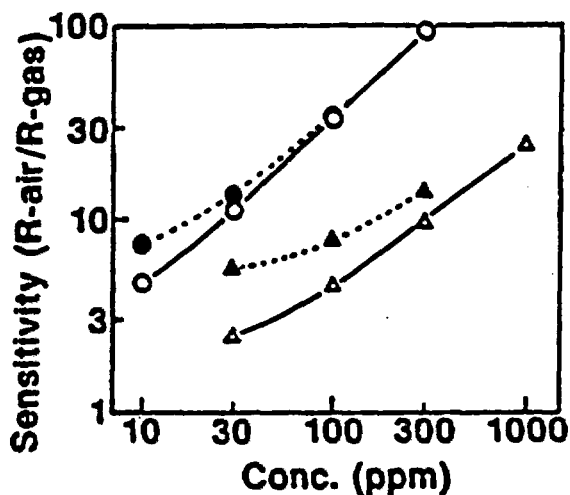

Fig. 2 The sensitivities of UFP-Au/SnO₂·Na⁺·Sb⁵⁺ sensor operated at 200°C as a function of gas concentration.

(○);CO, (●);CO with 100 ppm H₂,
(△);H₂, (▲);H₂ with 10 ppm CO.

operation for several hours, the reason of which might be the accumulation of water molecules adsorbed onto the sensor surface. Such a decline is a temporary one and the original sensitivity can be restored by heat-flashing at temperatures above 200°C.

Figure 2 shows a similar relationship to that observed in Fig. 1, for the UFP-Au/SnO₂·Na⁺·Sb⁵⁺ sensor operated at 200°C. While the selectivity for CO is a little inferior to that in the UFP-Au/Fe₂O₃·Ti⁴⁺ sensor, the sensitivity to CO is still appreciably larger than the one to H₂ and it is hardly affected by the presence of H₂. The UFP-Au/SnO₂·Na⁺·Sb⁵⁺ sensor can be free from the accumulation of contaminants like ammonia and water molecules adsorbed on the surface,

owing to its high operation temperature as 200°C, and is advantageous over the UFP-Au/Fe₂O₃·Ti⁴⁺ sensor in that it does not need the heat-flashing in the continuous operation.

Through the investigation of catalytic properties and microstructures, the following conclusions have been obtained concerning the ruling factors which determine CO sensitivity;

- (1) The gas sensing properties of semiconducting metal oxides are closely related with their catalytic activities for oxidation reactions.
- (2) Smaller particle size of Au supported on the semiconductors gives higher sensitivity and higher selectivity towards CO.
- (3) Surface basicity of the oxides might play an important role in both CO sensing and CO oxidation, especially under the condition of humid atmosphere.

References

- [1] M. Haruta, T. Kobayashi, H. Sano, N. Yamada; Chem. Lett., 405 (1987).
- [2] M. Haruta, H. Kageyama, N. Kamijo, T. Kobayashi, F. Delannay; "Successful Design of Catalysts", Elsevier, (1988), p. 33.
- [3] M. Haruta, N. Yamada, T. Kobayashi, S. Iijima; J. Catal., 115, 301 (1989).
- [4] T. Kobayashi, M. Haruta, H. Sano, M. Nakane; Sensors and Actuators, 13, 339 (1988).
- [5] T. Kobayashi, M. Haruta, H. Sano; Chem. Express, 4, (1989), in press.

35 Fellowships through STA

GLASS AND CERAMICS FOR THE FUTURE



(Growth of Superconducting Whisker, Bi-System, x1100)

GLASS AND CERAMIC MATERIAL DEPARTMENT
GOVERNMENT INDUSTRIAL RESEARCH
INSTITUTE, OSAKA

BRIEF HISTORY AND BACKGROUND

Government Industrial Research Institute, Osaka, (GIRIO) was founded in 1918 as a national research laboratory to develop and promote the chemical industry in the western area of Japan. It now belongs to the Ministry of International Trade and Industry. Glass and Ceramic Material department is one of five research departments. There is also a general administrative department within GIRIO.

Since the foundation we have pursued a wide range of studies on glass. Much of the work has borne fruits and has found application within the Japanese glass industry. For example, great advances in the camera industry have been made using the result of our research on optical glass. The department began ceramic research after the second world war.

Through comprehensive studies on the effects of constituents on the optical properties of glass, we succeeded in developing glasses with high refractive index and low dispersion, such as LaK and LaF. The Japanese camera industry has benefited greatly from this development. Our interest in optical glass led us to produce a large telescope mirror disc with a low thermal expansion coefficient. We succeeded in casting high quality discs 2m in diameter. A bobbin for a precise electrical inductance coil has made from glass with an extremely low expansion coefficient.

Borosilicate glass is well known for its durability. In the course of research on this glass system, we have developed the technique of preparing porous glass with high silica content by phase separation and subsequent leaching. Comprehensive developmental research is continuing on porous glasses.

Glass has the capacity to incorporate many elements. For this reason, it may be used for the disposal of high level radioactive waste from nuclear processes. We have conducted research and development in this field for more than a decade and have established the glass compositions and melting technology necessary for solidification of nuclear waste. The chemical and technical properties of the solidified wastes were investigated.

We have performed excellent basic researches on, for example, phase separation; nucleation and crystallization; volatilization; diffusion; electrical conductivity; mixed alkali effect. As will be explained after, We are now exploring so-called new glasses.

New ceramic materials have great potential and are currently finding

Industrial applications. We developed cutting tools made of alumina which show excellent performance compared with carbide tools. In the course of our research on MHD materials, we have succeeded in developing a new type of heating element, made of lanthanum chromite, which is commercially produced by a private company.

We have taken part in an R/D project on high efficiency gas turbines and are currently participating in fine ceramic project (one of the JISEDAl projects). In these projects, our attention has been mainly focused on composite ceramics, composed of a non-oxide ceramic matrix reinforced with ceramic fibers or whiskers to improve the reliability.

Ceramic joining is an important industrial problem. We have developed many joining methods, most of which could easily applied to large scale production.

Our research interests also include functional ceramics. We have worked on gas sensor materials and conductive perovskite-type oxides. We are currently working on superconducting oxides which are synthesized by melting process. So far the results look very promising.

ION-CONDUCTING GLASSES

Lithium-ion-conducting glasses

Lithium ion conductors are used as solid electrolytes in batteries, ECD devices, sensors, etc. Glassy solid electrolytes have certain merits compared with crystalline electrolytes. These are as follows:

- higher ionic conductivity,
- wide composition region,
- isotropy, no grain boundaries,
- lower electronic conductivity.

Figure 1 shows the ionic conductivity of the $\text{Li}_2\text{O}-\text{B}_2\text{O}_3-\text{Li}_2\text{SO}_4$ system at room temperature. In this system, the conductivity exhibits a maximum at $0.3\text{Li}_2\text{O}\cdot 0.3\text{B}_2\text{O}_3\cdot 0.4\text{Li}_2\text{SO}_4$, and decreases with increasing Li content. This result shows that the introduction of lithium salt enhances the conductivity, and that there is an optimum structure and Li content for high ionic conductivity.

Preparation of glassy thin films

Thin films formed by PVD or CVD show low resistance and are therefore suitable for device applications. We are investigating sulfide glassy thin films which are expected to have high ionic conductivity of the order of 10^{-3}Scm^{-1} at room temperature. Glass samples in the system $\text{Li}_2\text{S}-\text{GeS}_2$ are prepared by sputtering. Li_2S -containing films are very hygroscopic, hence they must not come into contact with oxygen or moisture. Therefore we handle both sputtering target and films in an argon-filled glove box. The film composition is analyzed by ESCA and the sample is isolated from air when placing it into the apparatus.

Mechanism of ionic conduction

Ionic conductivity is dominated by the concentration and mobility of the mobile ion. At low concentrations, the conductivity increases as the ionic concentration increases. However, at high concentrations, the conductivity becomes saturated. In order to obtain high conductivity, therefore, not only optimum ionic concentration but also the composition and structure which give high mobility are needed. Therefore we are currently investigating the structures and properties of ion-conducting glass by means of Raman spectroscopy; IMA; radio-isotope tracer methods; dielectric measurements; and pulse NMR. We are examining the relationship between these

properties and the ionic conductivity.

Raman spectroscopy is used to estimate the structural units of glass. In lithium borate glasses, we found an unknown structural unit by Raman spectroscopy as shown in Fig.2. Since lithium has no radio-isotope, the self-diffusion coefficient is measured by IMA using the isotope exchange method and by pulse NMR. The value is used to calculate the Haven ratio. We are also examining the "mixed alkali effect" which may be related to the mechanism of ionic conduction.

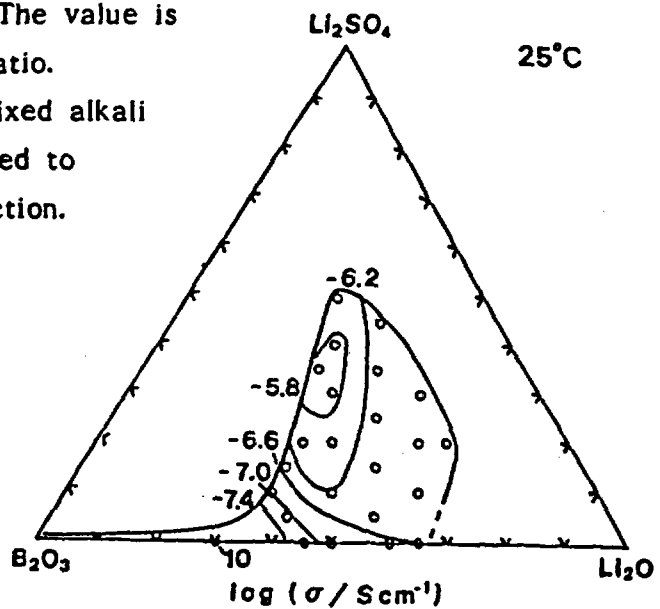

Fig.1. Ionic conductivity in the system $\text{Li}_2\text{O}-\text{B}_2\text{O}_3-\text{Li}_2\text{SO}_4$ at room temperature.

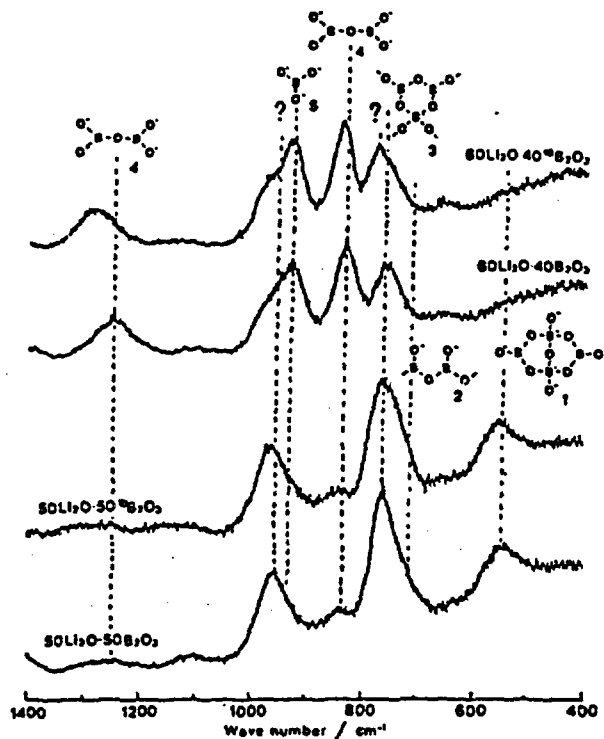

Fig.2. Raman spectra for lithium borate glasses.

HIGH LEVEL RADIOACTIVE WASTE GLASS

High-level liquid radioactive wastes generated from the reprocessing of spent nuclear fuel must be converted to a durable solid form in order to immobilize the radio-nuclides before they can be permanently stored. As part of a government directive we have for the past two decades been carrying out a research program on the fundamental problems of the vitrification of spent nuclear fuel. The work is also in cooperation with PNC (the Power Reactor and Nuclear Fuel Development Corporation). The following topics have been studied by our group:

- 1) We have searched for the optimum glass composition for nuclear waste containment. Phase separations such as crystallization and 'yellow phase' separation must be avoided in the glass formation. Screening of the glasses was done by a Soxhlet leach test.
- 2) Other solidification processes have been investigated. These include hot pressing and batch preparation of glass by the sol-gel method. The wet gels were first dried and then melted by microwave heating.
- 3) We have performed corrosion tests on refractory and electrode materials and have developed new corrosion resistant materials for use in ceramic melters. PNC have applied our results to the vitrification of nuclear waste program.

Atomic transport and surface analysis in waste glass

In order to assess the long term stability of the glass, we have investigated the material transport properties such as ionic diffusion, electrical conductivity of the melt, thermal conductivity, volatilization, crystallization, phase separation and corrosion in aqueous solutions.

An understanding of ionic diffusion in glasses is essential to elucidate the leaching mechanism. The self-diffusion coefficients of alkali ions and protons have been measured using radio isotope tracer techniques. The self-diffusion coefficients decrease in the order $\text{Na}^+ > \text{proton} > \text{Cs}^+$. Protons play a key role in the corrosion of nuclear waste glass.

Corroded surface layers caused by water attack have been analyzed by ESCA and FTIR, which provide information about deposits in the layers and their dissolution in water. Figure 1 shows the ESCA depth profile of each element in a hydrated surface layer of nuclear waste glass which has been corroded by a Soxhlet leaching treatment. Alkali metals, alkaline earth elements, silicon and aluminum are depleted in the surface layer, whilst

the concentrations of rare earth elements, zirconium and iron are increased. The behavior is governed by thermodynamics, whether an element leaches out or deposits depends on the solubility product of its hydrate.

Comparison of the leachability of nuclear waste glasses with natural glasses

This project, 'Research on natural analogues for leaching behavior of nuclear waste glass forms', seeks to compare the long-term stability of nuclear waste glasses with that of natural glasses which have undergone weathering. However, the corrosion rate may be different owing to differences in composition. Basaltic glasses found in nature have a similar composition to nuclear waste glasses, although they contain no borate and comparatively few alkali oxide ions. We have therefore compared properties such as the Soxhlet leaching ability and the diffusion coefficients of Na^+ and protons. Figure 2 shows an example of a Soxhlet leaching test. The corrosion rate increased when alumina was substituted by borate.

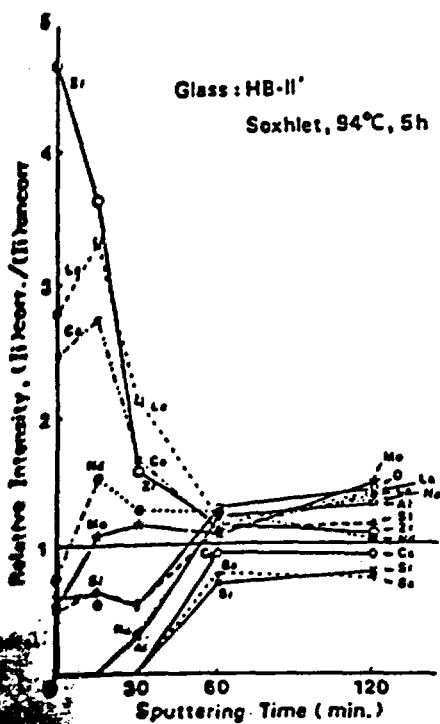

Fig. 1. Depth profile of leached elements measured by ESCA.

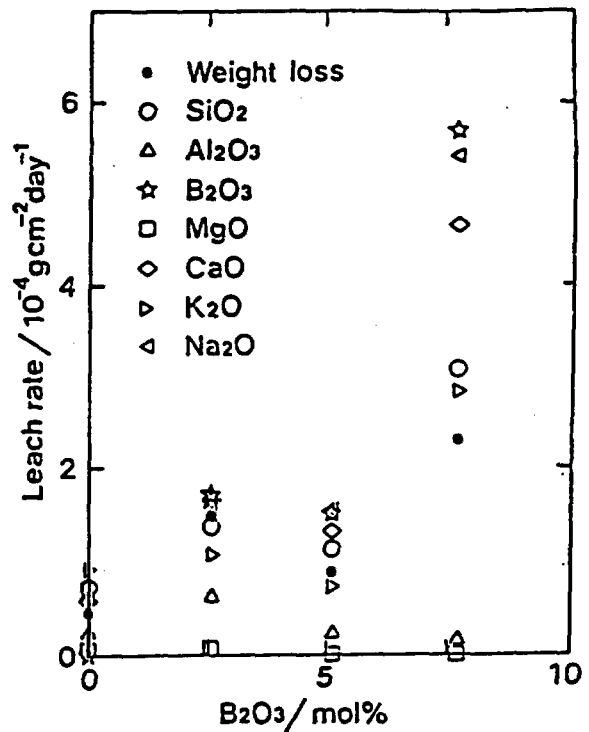

Fig. 2. The change of weight loss and leach rate in Basalt-type glasses containing B_2O_3 . The composition is as follows; $52.3\text{mol}\% \text{SiO}_2 \cdot (10.3-x)\text{Al}_2\text{O}_3 \cdot x\text{B}_2\text{O}_3 \cdot 21.5\text{MgO} \cdot 11.7\text{CaO} \cdot 0.8\text{K}_2\text{O} \cdot 3.3\text{Na}_2\text{O}$.

POROUS GLASSES

Porous glasses, the products of leaching of heat-treated alkali borosilicate glasses in a certain composition range, have been known for more than forty years. The numerous studies on the structure and properties of the porous glasses have made a great contribution to our knowledge of chemically inhomogeneous glasses. The fundamental studies on the porous glasses having finished, we are currently examining the possible application in various branches of science and engineering.

Preparation

Borosilicate glasses of appropriate compositions can be separated by heat treatment into two phases. One phase is rich in silica, the other is rich in alkali borate. The alkali borate-rich phase is leached out by an acidic solution leaving behind a porous glass consisting of the silica-rich phase. Figures 1 and 2 show the preparation process and an SEM photograph of the porous glass, respectively. In order to obtain high-quality porous glass, we must have an initial glass satisfying the following requirements: (1) both silica-rich and alkali borate-rich phases must be interconnected; (2) the silica-rich phase must contain as much silica as possible; (3) the alkali borate-rich phase must be readily soluble in an acidic solution, and last but not least; (4) the stress developing during leaching at the interface between bulk glass and leached layer must not exceed a level determined by the mechanical strength of the glasses.

Applications

We are currently researching the following applications of the porous glass:

- ✓ 1. Porous glasses have been successfully for biochemical catalysis as carriers of enzymes. Enzymes thus immobilized by absorption on the porous glasses maintain a high activity for a long period and may be used repeatedly.
2. Microporous glasses may be used as semipermeable membranes for separating liquid mixtures by reverse osmosis. The salt rejection rate is over 90 % using 0.5 wt% NaCl solution[1].
3. Alkali resistant glasses are useful as separating media or membranes and filling materials of gel permeation chromatography. These glasses may also be applicable for the phase separation method in a manufacture. We

have succeeded in making highly alkali resistant porous glasses which consist of a silica-rich phase with a certain amount of ZrO_2 [2].

4. Porous glasses may be used as membranes for separating gas mixture. The permeation rate increases dramatically with increasing the pore volume. We have produced a high speed membrane with a permeation rate 500 times higher than that of ordinary porous glasses[3].

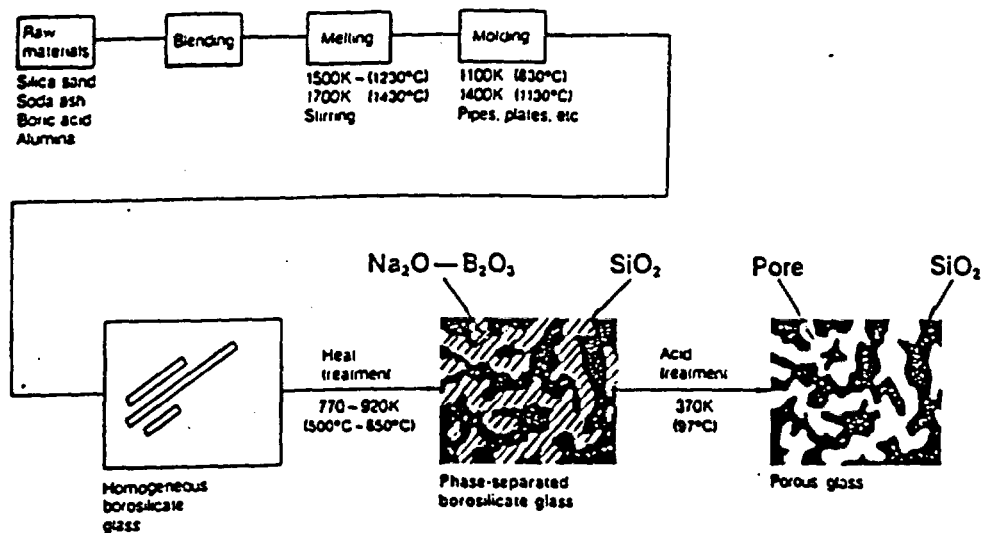

Manufacturing process for porous glass

Fig. 1 Preparation process of the porous glasses.

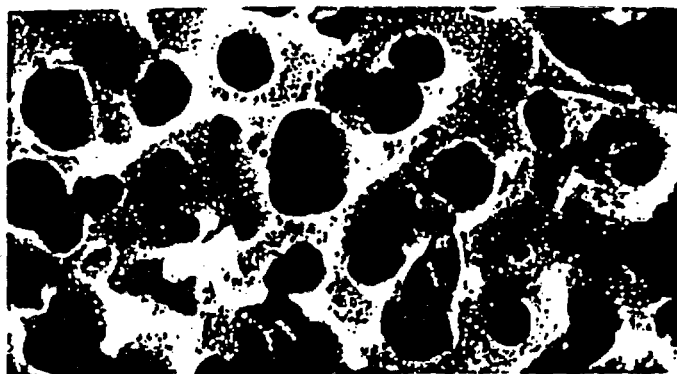

Fig. 2 SEM photograph of the porous glass ($\times 20000$).

References

- [1] T.Yazawa, H.Tanaka, K.Eguchi and T.Yamaguro, J.Chem.Soc.Jpn., Chem. & Industrial Chem., 866 (1985).
- [2] US Patent No.4778777.
- [3] T.Yazawa, H.Tanaka and K.Eguchi, J.Chem.Soc.Jpn., Chem. & Industrial Chem., 201 (1986).

HALIDE GLASSES

Our halide glass team is currently working on glasses based on chlorides, bromides and iodides, but not fluorides. The present research project of non-fluoride halide glasses started in 1986 following a two-year preliminary study.

Much attention on ZrF_4 -based glasses in glass science and technology in the past decade has stimulated research activities on the non-fluoride halide glasses. This is because the use of halides other than fluorides theoretically enable us to obtain glasses with ultralow optical loss, which is superior to fluoride glasses. Another more important possibility is the application as a glass fiber transmitting CO_2 laser energy. However, several problems arise which must be overcome before halide glasses can be successfully used e.g. they are highly hygroscopic and have low thermal stability. Every new glass forming system is being explored in order to solve these problems.

The final goal of our research is to establish the technology of glass preparation, purification, and fabrication for the halide glasses. We are also interested in the structure and fundamental properties of halide glasses as they are intermediate between oxide glasses with more covalent bonds and fluoride glasses with more ionic bonds.

The hygroscopic nature of halide glasses prevents them from being prepared by the usual method of melting in air. They are therefore prepared in a glove box containing dry N_2 . Figure 1 shows the glass forming region of the $ZnBr_2$ - $BaBr_2$ - KBr ternary system[1]. Glasses with glass transition temperatures higher than $90^\circ C$ have been obtained in this system. The infrared transmission of several different types of glass is shown in Fig. 2. This indicates that the $ZnBr_2$ -based glass is transparent over a wider band of wavelengths than the other glass systems.

The crystallization behavior of the $ZnBr_2$ -based glasses has been examined by DSC. We are carrying out structural analyses of ZnX_2 -based and CdX_2 -based glasses using vibrational spectroscopy[2] and XAFS.

The practical application of halide glasses in the near future seems to be difficult. However, we believe that these materials will eventually play an important role in the region of far-infrared optics.

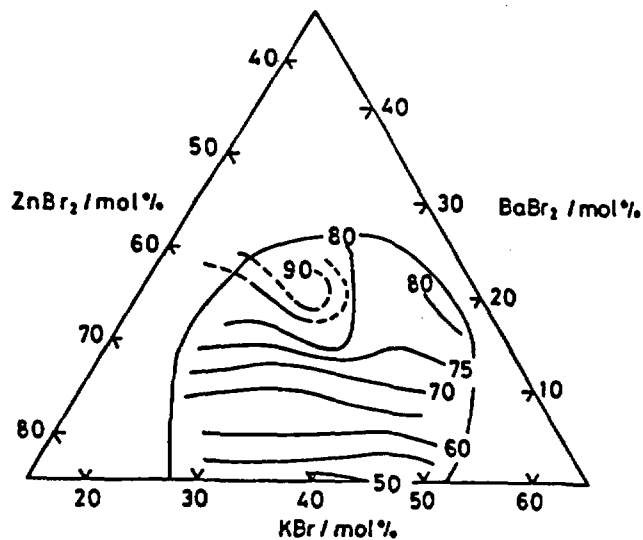

Fig. 1 The glass forming region in the system $\text{ZnBr}_2\text{-BaBr}_2\text{-KBr}$. Isothermal curves of the glass transition point are also depicted.

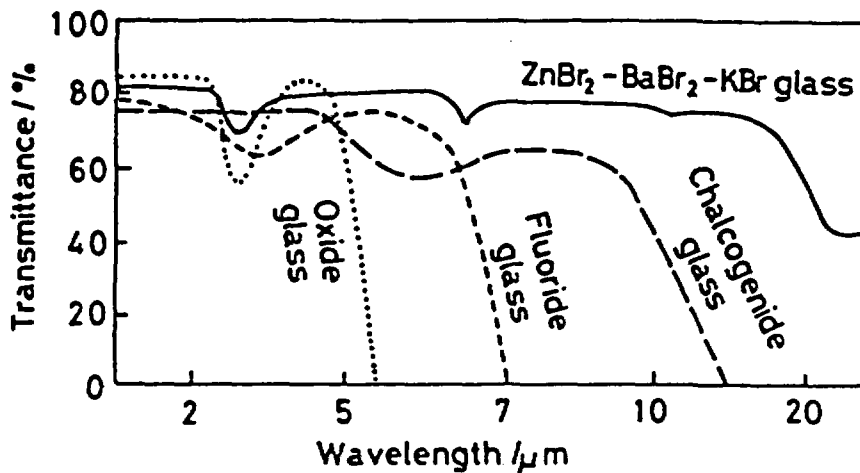

Fig. 2 Infrared transmission spectra of the ZnBr_2 -based glass compared with other types of glass.

References

- [1] K. Kadono, A. Yasuyoshi, T. Tarumi, H. Tanaka, M. Nogami and H. Nakamichi, *Mat.Res.Bull.*, **23**, 785 (1989).
- [2] K. Kadono, H. Nakamichi, H. Tanaka, *Mat.Sci.Forum.*, **32&33**, 433 (1988).

GLASS SCIENCE UNDER MICROGRAVITY CONDITION

New and pure glassy materials are required for highly functional elements in opto-electronics technology. It is, however, difficult to prepare such glasses on the earth, since glass cannot be produced without a crucible, which contaminates the glass. Nucleation of crystals also occurs at the container wall and the container material restricts the upper limit of the glass melting temperature. These difficulties can be solved if the melting process is carried out without the crucible. In outer space only very weak force is needed to control the movements of objects experiencing microgravity. Glasses may therefore be produced by the containerless melting process. The objective of this study is to develop the technology of glass production under microgravity and to prepare new glasses with superior transmittance in the non-visible region, particularly in the infrared region.

Development of Containerless Melting Process

The first stage of the research was to develop a suitable furnace for containerless melting. In cooperation with NASDA (National Space Development Agency of Japan) and Ishikawajima-Harima Heavy Industry(Fig.1) we developed an image furnace equipped with acoustic levitation apparatus which floats and holds the specimen at the center of the furnace under microgravity. Glass melting tests have been conducted using this furnace at gravitational forces of 1/10-1/100 G for 20-22 seconds produced by the ballistic flight of an aircraft. We succeeded in containing the material in the center of the furnace. On melting the floating materials a sphere of molten glass was obtained(Fig.2)[1,2].

Properties of Glasses Prepared under Microgravity Conditions

In 1991, we shall conduct a glass melting experiment in the NASA space shuttle. We plan to prepare glasses in the system $\text{CaO-Ga}_2\text{O}_3\text{-GeO}_2$, which have good near-infrared transmittance[3,4]. The glass-forming region, crystallization rate and glass transition temperature have all been investigated at a force of 1G, in order to select the most suitable glass composition and operating conditions of the furnace[4]. Having developed the furnace and its operating conditions we then went on to examine the problems of hot working of glass production under microgravity.

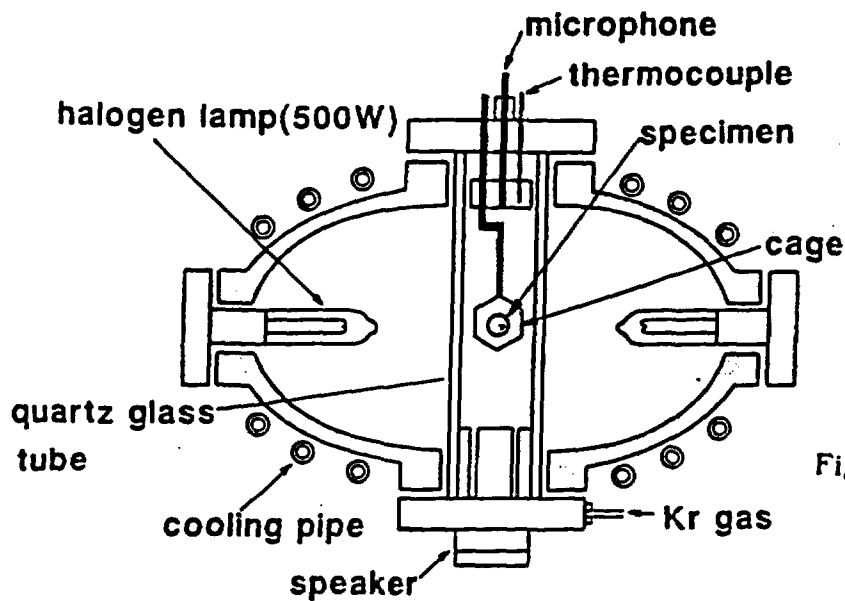

Figure 1. Schematic representation of the acoustic levitation furnace.

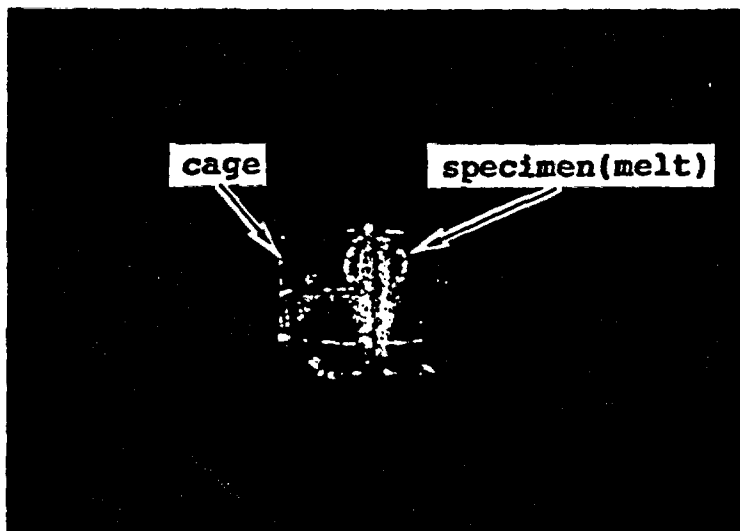
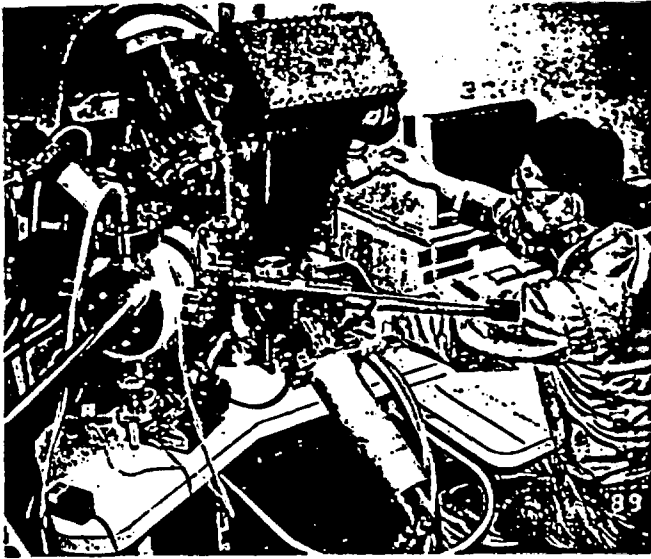

Figure 2. Photograph of specimen floating in the furnace by acoustic power under microgravity.

References

- [1] J.Hayakawa et al., Proceedings of the 6th European Symposium on Material Sciences under Microgravity Conditions, Bordeaux, Dec. 1986, p.263.
- [2] J.Hayakawa et al., Nippon-Koku-Uchu-Gakkai-Shi, 34, 554 (1986).
- [3] J.Hayakawa et al., Proceedings of the 25th Symposium on Glass of the Ceramics Society of Japan, Kyoto, Nov. 1984, p.44.
- [4] M.Makihara et al., Yogyo-Kyokai-Shi, 93, 774 (1985).



XPS and UPS measurement

Measurement of elect
conductivity of ionic-
conductive glass

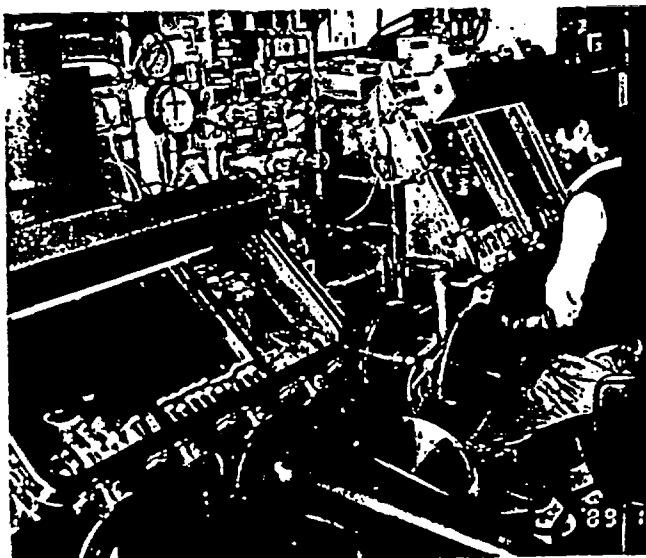
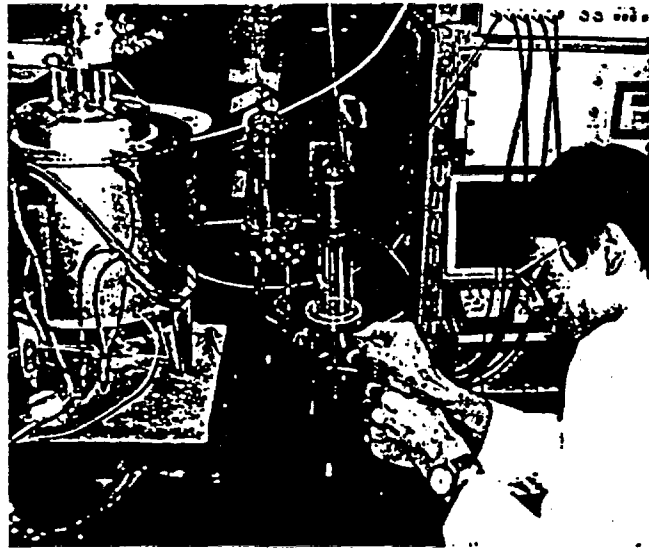

Preparation of halide glass
in dry atmosphere

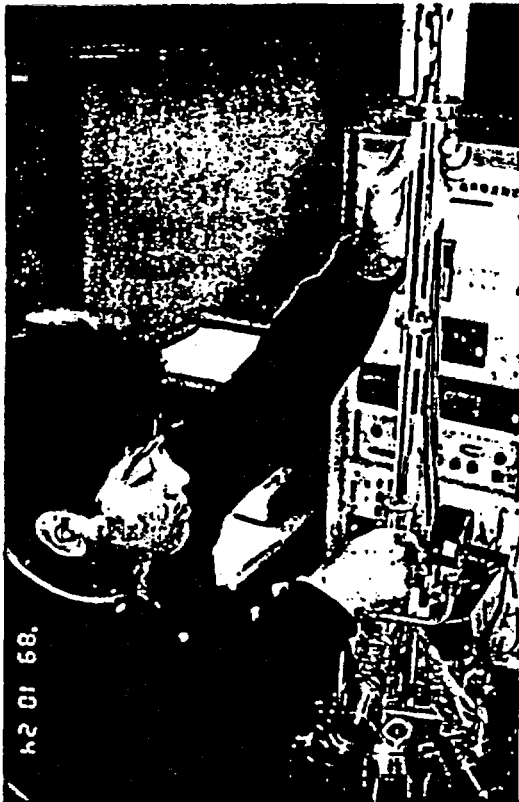

Probe for superconductive properties

h2 01 68.

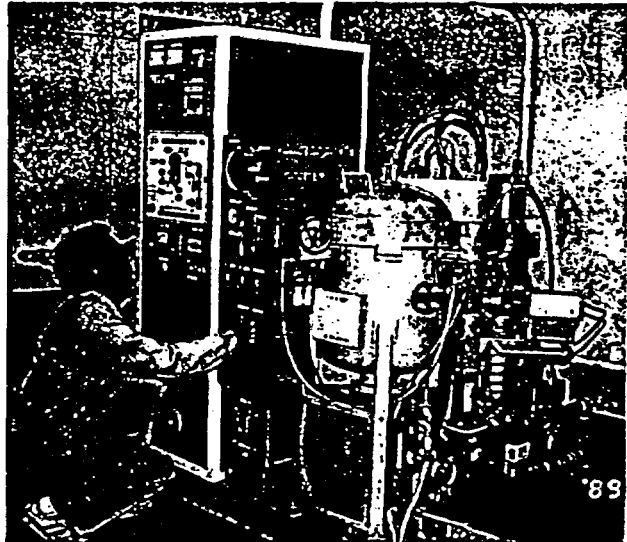

Hot-pressing of ceramics in inert or vacuum atmosphere

'89

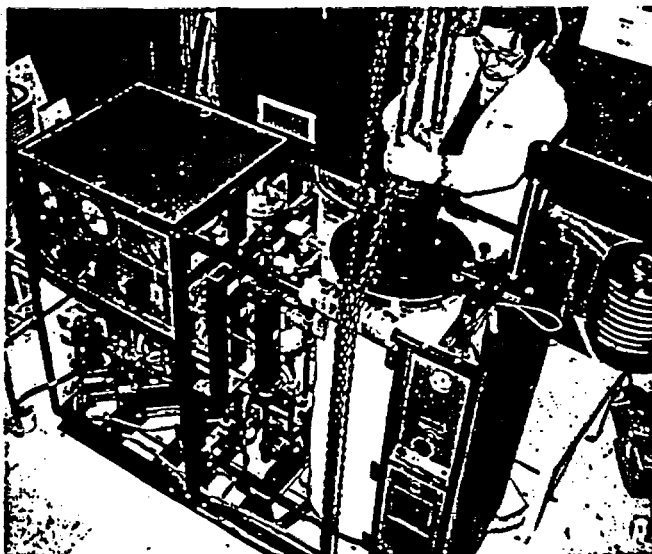

HIP apparatus

GLASSES FOR NON-LINEAR OPTICAL DEVICES

Materials which have non-linear optical properties have attracted much attention in the fields of information processing and optical communications. Switching devices, optical bistable devices, amplifiers and modulators all makes use of non-linear optical effects. Glass dispersed with semiconductors is one candidate material, since various optical properties of semiconductors are more easily controlled in a glass matrix. In this department, we are developing the basic technology for producing glasses dispersed with a semiconductor which have well controlled characteristics. Control of the composition and of the dispersion conditions is important as are the particle size and shape of the dispersed semiconductor. New processes for producing glasses with a dispersed semiconductor are also being investigated.

ACCURATE DETERMINATION OF REFRACTIVE INDEX OF SILICA GLASSES

Refractive index (n) and its temperature coefficient (dn/dT) have been determined accurately for various silica glasses. In the ultra-violet (UV) region, photo-lithography is of great importance for fabrication of semiconductor LSI circuits. Silica glass is an ideal material for transmitting UV light since it does not degrade on irradiation. It is commonly used as a lens material in UV light projectors. Lenses to be used at 248nm require n to be known to an accuracy of $\pm 1 \times 10^{-5}$ or better. The temperature coefficient of n is about $1 \times 10^{-5}/^{\circ}\text{C}$ for most silica glasses at room temperature so the ambient temperature of the lens must be controlled to within 1°C . The value of n is found to depend on the fabrication method and thermal history of the glass. We are currently studying the way in which n is related to specific gravity, which directly reflects the thermal history of the glass and is easier to measure than the refractive index.

LOW DISPERSION UV TRANSMITTING FLUORIDE GLASSES

Glass which can transmit UV light with low dispersion is required for making achromatic projector lenses for use in UV lithography. Fluoride glasses transmit UV light well and are readily formed into the requisite lens shape without surface cleavage which occurs in many optical crystals.

We are currently studying fluoride glasses which have a wide band gap. Our interests include the melting technology, the transmittance, refractive index, dispersion and coloration of the glasses under UV lights.

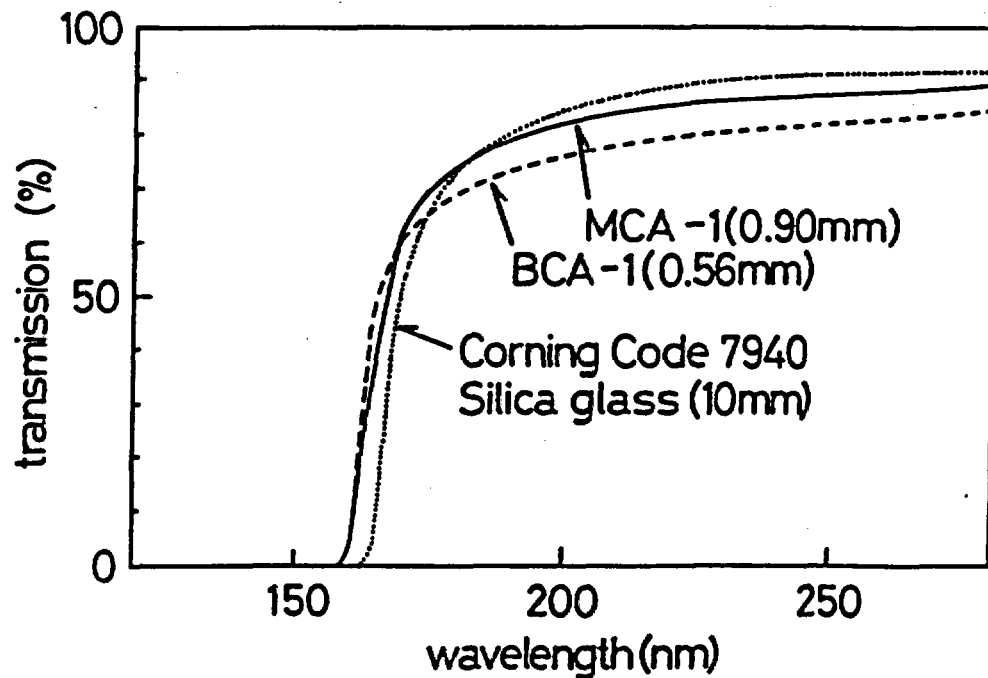

Figure 1 UV-transmittance of fluoride glasses. Transmittance of silica glass is also shown for comparison.

References

- [1] J.Hayakawa et al., Proceedings of the 29th meeting of Glass Forum (1988).
- [2] N.Kitamura et al., Proceedings of 36th annual meeting of the Applied Physics Society of Japan (1989).

CERAMIC COMPOSITE

Brittleness is the weakest point of ceramics when they are used as structural components for example in a diesel engine or a gas turbine. One of the ways to overcome this problems is "toughening" of the ceramic through reinforcement with fibers or particles. In such CMC (Ceramic Matrix Composite), fibers or particles improve toughness by dissipating or absorbing fracture energy at the top of crack front. Research on CMC's with various combinations of matrix and fibers/particles is one of the main themes of ceramic research in our department. Current efforts in this area are as follows:

Whisker reinforced composite

As whiskers of SiC or Si₃N₄ have very high strength and refractivity, they are suitable for use as the reinforcing fiber in CMC's. CMC's with various matrices such as Si₃N₄, SiC, and Al₂O₃ are being investigated.

The SiC(whisker)/Si₃N₄ composite[1], which was first successfully fabricated in our department, exhibits an strength increase at temperatures over 1100°C. This is attributed to the fact that the whisker which prevent grains from sliding at high temperatures. Both fracture toughness and wear-resistivity are also enhanced[2]. Whisker incorporation has a remarkable effect on the electric resistivity, which decreased markedly from that of Si₃N₄ which is an insulator to about 10 ohm cm or less. Such a low resistivity means the composite can be subjected to electric discharging machining (see Fig.1).

One of current topics of interest is to tailor the texture of whisker-reinforced CMC's. SiC or Si₃N₄ whisker are mixed with organosilicon polymer, which forms a matrix of SiC or Si₃N₄ upon pyrolysis. The interface between the whisker and matrix is also being investigated.

Other research is aimed at clarifying the fundamental phenomena in the composite forming process, in order to develop highly reliable ceramics for gas turbine components. The effects of fibers or sintering aids on toughness and on densification behavior of CMC are being studied.

Long fiber-reinforced composite

CMC's reinforced with a continuous fiber such as SiC fiber or carbon fiber attracts much attention as they have extraordinary toughness similar to that of bamboo or other wooden material. Such composites are expect-

ed to be the next generation material of choice for structural application eg. in the aerospace industry. We are currently looking at ways of improving fabrication of the composite without damaging the fiber in the process.

Particle reinforced composite

Ceramics have medical applications as they can be used to make artificial bone or tooth. The texture of apatite is similar to that of human bone, but it suffers from low strength. The strength and toughness may be improved by dispersing ZrO_2 particles in it.

Several combinations of different matrices and particles are currently being studied. ZrC particle / B_4C matrix composite exhibits improved strength and toughness. A roller bearing made of Si_3N_4 dispersed with TiC particles had a longer lifetime than one made from Si_3N_4 alone.

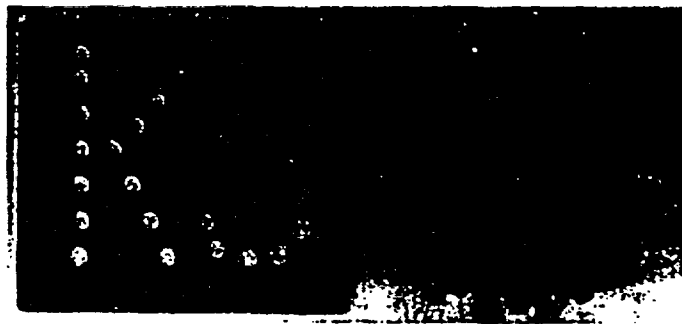

Fig.1 SiC (whisker)/ Si_3N_4 composite pieces machined by means of electric discharging. — ; 1 cm

- [1] R.Hayami, K.Ueno, I.Kondo, N.Tamari and Y.Toibana, Tailoring Multiphase and Composite Ceramics, ed. by R.Tressler, G.L.Messing, C.G.Pantano and R.E.Newnham, pp. 663-674, Plenum Pub. Co., 1986.
- [2] H.Ishigaki, R.Nagata, M.Iwasa, N.Tamari and I.Kondo, Tran. ASME. J. Tribology, **110**, 434-438 (1988).

TRIBOLOGY OF CERAMICS

Measurement of tribological properties

The efficiency and life time of gas turbines are expected to be greatly improved by using fine-ceramic materials instead of metals, since fine ceramics have superior mechanical strength, chemical durability and wear resistance at elevated temperatures.

A knowledge of the tribological properties of ceramics is indispensable for predicting the friction and wear of mechanical parts. The ball-on-disk method is the most reliable way to measure friction and specific wear rate accurately (see Fig.1). Fundamental measurements are continuing in order to assess the reliability and reproducibility of this method. The next stage of our work is to measure the frictional resistance of ceramics to abrasive particles in the combustion gas running through gas turbine on frictional resistance of ceramics. The effect of solid lubricants on wear will also be investigated.

Development of ceramic bearings

The most interesting practical application of the superior tribological properties of ceramics is the ceramic bearing. It has many advantages over ordinary metal bearing, eg. it can be used at temperatures over 800°C in air without water cooling and oil lubrication. The chemical durability of a ceramic bearing enables it to be used in corrosive environment such as in a chemical reactor, where the presence of strong acid or alkalis means that a metal bearing will be rapidly damaged. Ceramics do not rust and can be used for long continuous period, so a ceramic bearing saves maintenance costs.

We are currently studying the performance of ceramic bearings made of Si_3N_4 , which is widely regarded as an excellent material for this application because of its well-balanced properties such as strength, hardness and toughness. We have investigated the relationship between fatigue characteristics and the material properties. We found that fracture toughness predominantly determines the lifetime of the bearing. High hardness resulted in microfracture at the contact point between the ball and the ring under compressive loads.

An application of ceramic composites to bearing material is also tried. TIC particle-reinforced Si_3N_4 composite, which has an improved toughness, exhibited longer life as a ball bearing material.

Development of ceramics containing solid lubricating agent

When ceramic bearings are used at higher temperatures, the ball holder (retainer) should withstand oxidation. An ability to lubricate is also desirable because ordinary oil is not stable at higher temperatures such as 500 or 600°C.

A new type of ceramic composite, containing graphite microcrystals in the sintered body, has been fabricated in our department (Fig.2)[1]. Composites with carbides such as SiC, TiC or B₄C as the matrix component shows a superior tribological properties when dispersed with graphite particles. A sliding bearing test showed that the graphite was effective in lowering the friction coefficient and specific wear rate and was therefore acting as a lubricating agent.

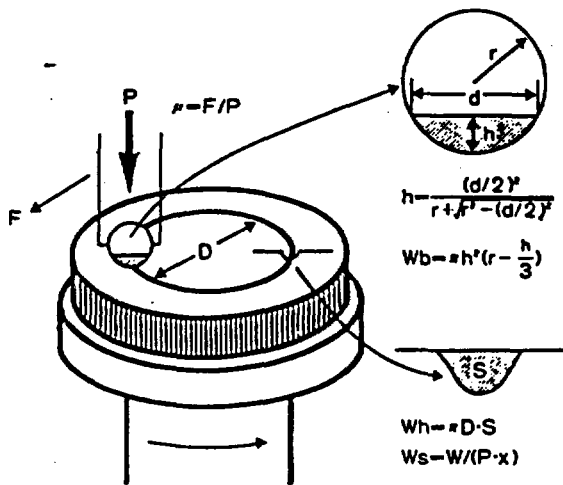

Fig.1 Friction and wear measurement by ball-on-disk method.

P: applied load, x: sliding distance, F: friction force,
 μ : coefficient of friction, r: radius of ball, d: diameter
of wear track, h: wear depth, D: diameter of sliding circle,
S: cross sectional area of sliding circle. W: wear volume.
W_s: specific wear rate



Fig.2 Microstructure of Graphite/TiC composite.

— ; 5 μm

[1] K.Ueno, S.Sodeoka, M.Yano, J.Cer.Soc.Jpn.Inter.Ed., 97, 497-501 (1989).

SUPERCONDUCTING CERAMICS

A Superconducting cuprate (La-Ba-Cu-O) was first reported by Bednorz and Muller in 1986, and a number of studies on this material have been undertaken all over the world. Our institute started to investigate the superconducting ceramics at the Glass and Ceramic Material department in 1987.

The effects of sulfur addition

The effects of sulfur addition on the superconductivity of Y-Ba-Cu-O system were studied[1]. We examined whether the substitution of oxygen with sulfur took place or not, and expected to improve the superconductivity by adding sulfur to the Y-Ba-Cu-O system. Sulfur-containing compounds with nominal compositions $YBa_2Cu_3O_{x-y}S_y$ were prepared by the solid state reaction method using CuS or Cu_2S instead of CuO. By this method, sulfur atoms were not incorporated into the crystal lattice of the 1:2:3 phase and made it multiphase. Although T_c (critical temperature) was lowered with increasing sulfur content, J_c (critical current density) for $y=0.03$ was about twice as high as that for $y=0.00$, this is due to the increasing the bulk density by adding sulfur.

Superconducting glass ceramics

The new type superconducting oxide, Bi-Sr-Ca-Cu-O system, was found by Maeda et. al. in 1988. The characteristic nature upon processing is that the Bi-Sr-Ca-Cu-O compounds form a glassy state when it is rapidly quenched from a molten state. We have been researching into the crystallization of superconducting phases from a glassy melt-quenched solid. We found that the addition of Ga or Ge to the Bi-Sr-Ca-Cu-O system was effective for manufacturing when the glass was formed. The wide glass forming region is obtained by adding Ga or Ge. We made fibers and ribbons (10cm length) by the melt-quench method using a single roller with Ga or Ge additives. After heating at $820^\circ C$, the ribbons showed T_c (end) at 77-80K. We determined the composition region where the superconductivity was maintained in spite of the improvement in manufacturing.

Superconducting whiskers

The superconducting whiskers of Bi(Pb)-Sr-Ca-Cu-O were prepared by heating a glassy melt-quenched plate in a stream of oxygen gas (Fig.1).

The dimensions of the whiskers are $2\text{-}10\mu\text{m} \times 10\text{-}300\mu\text{m} \times \sim 15\text{mm}$. The whiskers have the 2212 structure (low- T_c phase) and show a zero-resistance state at 70K. Each whisker exhibits the structure where several platelike single crystals are stacked. The orientation of the longest c axis is perpendicular to the platelike crystal plane and the ab plane is parallel to the crystal plane. The whiskers are able to be bent to a radius of curvature (R) of 0.4mm without a decrease in the T_c value. The highest J_c is $67000\text{A}/\text{cm}^2$ (63K, zero magnetic field) in a nonbending state. It surpasses $35000\text{A}/\text{cm}^2$ even in a bending state of $R \geq 1\text{mm}$ and finally decreases down to $3200\text{A}/\text{cm}^2$ for $R=0.4\text{mm}$ (Fig.2). Our further subjects for study related to the whiskers are the elucidation of the growth mechanism, preparation of high- T_c whiskers, lengthening the whiskers and evaluation of the mechanical properties[2,3].



Fig.1 The whiskers of Bi(Pb)-Sr-Ca-Cu-O grown by heating a glassy melt-quenched plate in a stream of oxygen

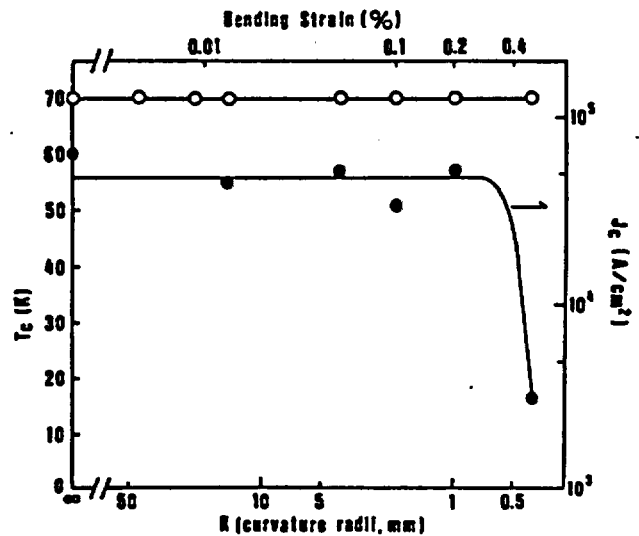

Fig.2 The T_c and J_c (63K, zero magnetic field) of the whiskers as a function of the radius of curvature.

References

- [1] I.Matsubara, H.Tanigawa, T.Ogura and S.Kose, Jpn.J.Appl.Phys., 27, 1080 (1988).
- [2] I.Matsubara, H.Kageyama, H.Tanigawa, T.Ogura, H.Yamashita and T.Kawai, Jpn.J.Appl.Phys., 28, 1121 (1989).
- [3] I.Matsubara, H.Tanigawa, T.Ogura, H.Yamashita, M.Kinoshita and T.Kawai, Jpn.J.Appl.Phys., 28, 1358 (1989).

CERAMIC COATING

Ceramic coating by the plasma spraying technique is being studied. METCO 9MB Low-Pressure-Plasma-Spraying (LPPS) system and TAFA 90HV Atmospheric-Plasma-Spraying (APS) system are used in this section. Plasma spraying is one of the coating processes in which molten raw material powders are accelerated and shot onto the substrate in the plasma flame. In principle, anything that can be melted is applicable as the sprayed material. Any material may be coated when it is adequately cooled.

Ceramic-ceramic composite coating and non-oxide ceramic coating are studied as part of the ordinary research and development "A study on the ceramic coating by low pressure plasma spraying". Coatings made of non-oxide ceramics, such as SiC , Si_3N_4 , etc., are expected to resist wear at high temperature. However, non-oxide ceramic coatings can not be made by plasma spraying in air because of thermal decomposition. These coatings are achieved when the appropriate spraying aid is added and the spraying is carried out in a closed chamber with the a controlled atmosphere.

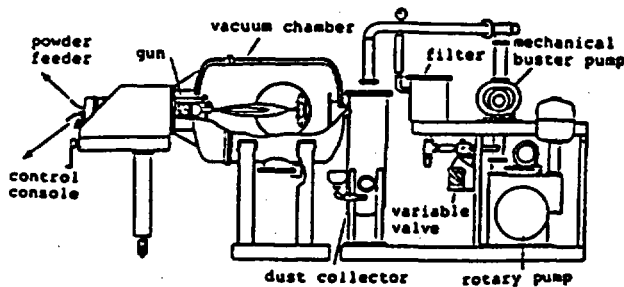

Fig.1 Low-Pressure-Plasma-Spraying system.

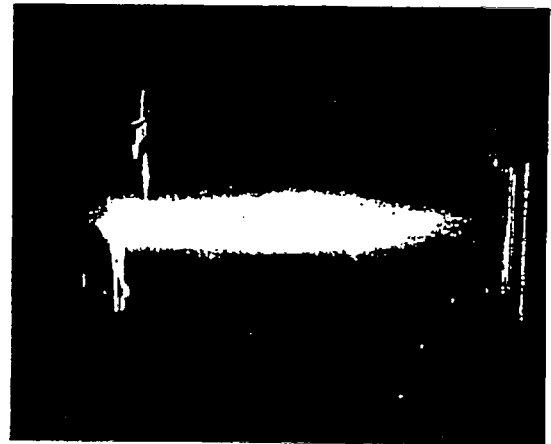

Fig.2 Plasma flame at 300 torr, 40kW.

FLUORINE RESISTIVE ENAMELS

This research aims at development of fluorine resistive coatings on metals to be used in the fluorine chemical and semiconductor industries.

In these fields, corrosion of tanks and pipes by fluoride gasses or fluoric acids causes severe safety problems. Traditional enamels composed of oxides are easily attacked by these fluorides leading to failure in a closed system.

Fluoride enamels, on the other hand, composed of metal fluorides such as MgF_2 , CaF_2 , SrF_2 , BaF_2 , NiF_2 , YF_3 , etc. are highly resistive to these atmospheres, even at moderately high temperatures. They are therefore promising materials for use in this field. We are surveying glass compositions which are durable to these gasses and acids, and are highly adhesive to metals without fracture at elevated temperatures under bending stress.

THEORETICAL STUDY OF CERAMIC INTERFACES

Various properties of ceramics depend on grain boundaries, mechanical and electrical properties and sintering ability. The joining between ceramics and metals is an essential technique in order to realize the practical use of ceramics. It is essential to understand the fundamental properties of grain boundaries and interfaces in ceramics and of metal/ceramic interfaces from a macroscopic viewpoints. We are investigating theoretically the atomic structure and properties of grain boundaries in covalent ceramics such as SiC and of metal/ceramic interfaces such as alumina/transition metal interfaces. In these systems, it is necessary to calculate the electronic structure of the interface. With powerful modern computers, interfacial electronic structures, stable atomic configurations and interfacial energies can be calculated using the electronic theory of solids. The effects of impurities and the dependence on the kinds of ceramics and metals are also being examined. By comparing the calculated results with observations and experiments, such as HREM images and photoelectron spectroscopy, it is possible to understand the fundamental properties of grain boundaries and interfaces from a microscopic viewpoint.

References

- [1] M.Koyama et al., J.Phys. C 21, 3205 (1988).
- [2] M.Koyama et al., J.Phys. C 21, 695 (1988).
- [3] M.Koyama et al., Trans. ISIJ 28, 836 (1988).
- [4] M.Koyama et al., Phys.Status Solidi b 152, 533 (1989).
- [5] M.Koyama et al., to be published in J.Phys.:Condens.Matter (1988).

ORGANIZATION AND OTHER ACTIVITY

This department consists of 5 sections. Three of them deal with glass research and two with ceramics. The total research staff number 33. We have now more than 20 research projects both large and small. Some of them are inter-sectional and inter-departmental. We participate in national R&D projects, most of which are in cooperation with other national laboratories and private companies.

Organization and main research fields

Director: Dr. M. Kinoshita

Glass technology section: Mr. J. Hayakawa

Glass melting under microgravity, optical properties of glasses.

Glass science section: Dr. H. Wakabayashi

Ion conducting glasses, technology of waste management.

Advanced glass section: Dr. H. Tanaka

Halide glasses, porous glass, non-linear photonic materials.

Engineering ceramics section: Mr. S. Kose

Composite ceramics, ceramic coating, tribology, ceramic interfaces.

Functional ceramics section: Dr. H. Yamashita

Superconducting oxides, fluorine resistive materials.

Other Activities

Most of the researchers in this department are members of the Ceramic Society of Japan. We also have close contact with other societies such as those of optical glass, applied physics, power metallurgy, and fine ceramics. Ours is the only national laboratory dealing widely with glass. We have therefore run a glass technology course for foreign researchers for many years.

There are several invitation schemes applicable to foreign researchers, whose numbers in our institute have been increasing in recent years.

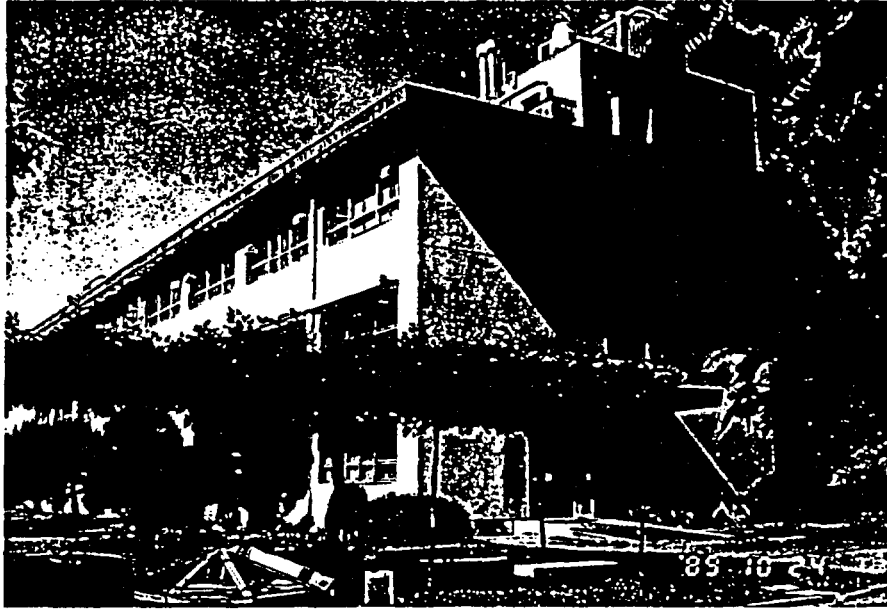

The main building of the glass and ceramic material department



The annex of the department

**GLASS AND CERAMIC MATERIAL DEPARTMENT
GOVERNMENT INDUSTRIAL
RESEARCH INSTITUTE, OSAKA**

**8-31 MIDORIGAOKA-1, IKEDA,
OSAKA 563**

**PHONE: (0727) 51-8351
TELEFAX: (0727) 51-2156**

Gold Catalysts Prepared by Coprecipitation for Low-Temperature Oxidation of Hydrogen and of Carbon Monoxide

M. HARUTA,* N. YAMADA,† T. KOBAYASHI,* AND S. IJIMA‡¹

*Government Industrial Research Institute of Osaka, Midorigaoka 1, Ikeda 563, Japan; †Kishida Chemicals Company, Ltd., Joshoji-machi, Kadoma 571, Japan; and ‡Research Development Corporation of Japan, Science Building, 5-2 Nagata-cho 2-chome, Tokyo 100, Japan

Received October 7, 1987; revised June 6, 1988

Novel gold catalysts were prepared by coprecipitation from an aqueous solution of HAuCl_4 and the nitrates of various transition metals. Calcination of the coprecipitates in air at 400°C produced ultrafine gold particles smaller than 10 nm which were uniformly dispersed on the transition metal oxides. Among them, $\text{Au}/\alpha\text{-Fe}_2\text{O}_3$, $\text{Au}/\text{Co}_3\text{O}_4$, and Au/NiO were highly active for H_2 and CO oxidation, showing markedly enhanced catalytic activities due to the combined effect of gold and the transition metal oxides. For the oxidation of CO they were active even at a temperature as low as -70°C . © 1989 Academic Press, Inc.

INTRODUCTION

During the course of an investigation into new oxide catalysts useful for the low-temperature catalytic combustion of hydrogen (1-4), it became evident that the catalytic activities of transition metal oxides for hydrogen oxidation had a volcano-like relation with the heat of formation of oxides per gram-atom of oxygen (5). The volcano relation indicates that the formation of metal-oxygen ($M\text{-O}$) bonds is rate determining for the oxides of Ag and Au, which are located on the left side, while the breaking of $M\text{-O}$ bonds is the slow step for the other metal oxides located on the right side. Therefore, an attempt was made to develop composite oxides of Ag with the 3d transition metals, for which an enhancement in both catalytic activity and thermal stability was expected.

Our earlier paper (5) reported that an appreciable enhancement in catalytic activity was, in fact, achieved in some composite oxides of silver with 3d transition metals which were prepared by coprecipitation. Specifically, a mixed oxide composed of

Co, Mn, and Ag (20 : 4 : 1 in atom ratio) was both thermally stable and highly active for the oxidation of H_2 and CO . The successful results obtained for these composite oxides of silver led us to expect that a significant enhancement in catalytic activity might also be exhibited by composites of gold and the other metal oxides. The present investigation into gold-based oxide catalysts was undertaken to test this hypothesis.

Previous work on gold catalysts has been reviewed by several authors (6-10). All the gold catalysts investigated so far are gold supported on inactive ceramic oxides, such as SiO_2 (11-17), Al_2O_3 (14-16, 18), MgO (15-17, 19), and TiO_2 (20), or unsupported gold filaments (21), powder (22, 23), sponges (24), filings (25), and gauze (26).

The chemical reactivity of gold catalysts has been studied for the oxidation by oxygen or nitrogen oxides of CO (11, 22, 24, 26) and H_2 (12, 15, 17, 21-23), selective oxidation of organic compounds by nitrogen dioxide (13), hydrogenation of alkenes (7), and so on. However, the conventional gold catalysts prepared by impregnation have been reported to be usually far less active than platinum-group metal catalysts, although they are superior in selectivity for only a few reactions such as the oxidation

¹ Present address: NEC Corp., Miyazaki 4, Miyamae, Kawasaki 213, Japan.

of 1-pentanol to 1-pentanaldehyde by NO_2 (13) and the hydrogenation of 1-pentene to *n*-pentane (7). The present paper deals with a new type of gold catalyst prepared by coprecipitation instead of impregnation. In a previous short communication (27), we reported that combination with the oxides of Group VIII 3d transition metals makes gold so active that it catalyzes the oxidation of CO, even at -70°C .

EXPERIMENTAL

The gold catalysts were prepared by coprecipitation. An aqueous solution of chloroauric acid and a transition metal nitrate was poured into an aqueous solution of sodium carbonate under stirring. The precipitate was washed, vacuum dried, and calcined in air at 400°C for 4 h. Gold powder and the simple oxides of Fe, Co, and Ni were also prepared in this manner. Conventional gold catalysts were prepared by immersing support oxides in an aqueous solution of HAuCl_4 with a small excess volume. After drying, the impregnated samples were reduced with hydrogen at 200 or 300°C . They were then washed in hot water several times and dried in air at 200°C . The support oxides used were $\alpha\text{-Fe}_2\text{O}_3$ calcined at 400°C (SA = $42\text{ m}^2/\text{g}$) and $\gamma\text{-Al}_2\text{O}_3$ (anhydrous extra pure, Merck, SA = $97\text{ m}^2/\text{g}$). Another type of gold catalyst was prepared by the reduction of HAuCl_4 with diammonium citrate in an aqueous dispersion of colloidal SiO_2 (STO, Nissan Chemicals Ind., Ltd.). This catalyst was finally calcined in air at 300°C after washing and drying.

All the starting materials used were reagent grade (Kishida Chemicals Co., Ltd.). Elemental analysis of chloroauric acid tetrahydrate ($\text{HAuCl}_4 \cdot 4\text{H}_2\text{O}$) was conducted by means of atomic emission spectroscopy using an inductively coupled argon plasma source (Hitachi, Ltd., ICP Emission Analysis System 306) to determine the impurity levels of Pd, Pt, and Ir, because trace amounts of these Pt-group metals may sometimes account for part or almost all the

catalytic activity of the gold sample under study (10). The impurity levels were approximately 11, 2, and 7 ppm, for Pd, Pt, and Ir, respectively.

Catalytic activity measurements were carried out in a small fixed-bed reactor, with 0.20 g of catalyst that had passed through 70- and 120-mesh sieves. After the pretreatment of catalysts in a dried air stream at 200°C for 30 min, a standard gas consisting of 1.0 vol% H_2 or CO balanced with air to 1 atm was passed through the catalyst bed at a flow rate of 66 ml/min. This reaction gas was dried by passing through columns of silica gel and P_2O_5 granules. In the experiments at temperatures below 0°C , the reaction gas was further passed through a silica gel column cooled to -77°C to prevent the accumulation of moisture in the catalyst bed. In order to investigate the influence of moisture on the catalytic activity, the reaction gas was passed into a constant moisture device (28) which contained saturated NH_4Cl aqueous solution. The relative humidity of the reaction gas was kept constant at 76%, as confirmed by humidity measurements using a Humidector (Shinyei Co., Ltd.).

Activated carbon and molecular sieve 13X were used as column packing agents to analyze CO_2 and CO, respectively, in the effluent gas by a gas chromatograph. The conversion efficiencies, determined from the changes in concentrations of CO_2 and CO, were in good agreement with each other under all the conditions tested.

The activity of a given catalyst is usually expressed in terms of the temperature corresponding to 50% conversion ($T_{1/2}$), which can be obtained from the conversion vs temperature curves. A lower temperature for $T_{1/2}$ indicates correspondingly greater catalytic activity.

Specific surface areas were determined by the single-point method using a Quantasorb surface area analyzer. A mixture of 30 vol% N_2 in He gas was used, with N_2 as adsorbate at a temperature of -195.8°C . The reproducibility of the data was within

±5%. X-ray diffraction experiments were performed after each thermal treatment in a Rigaku X-ray powder diffractometer with Ni-filtered CuK α radiation. Crystallite sizes of Au were calculated from peak half-widths by using the Scherrer equation with corrections for instrumental line broadening.

The fine structure of the gold catalysts was observed using an Akashi EM-002A electron microscope operated at 120 kV. X-ray photoelectron spectroscopic analyses were made using a Shimadzu ESCA 750 under vacuum below 5×10^{-6} Torr. The surface composition was determined by using a sensitivity factor for each element (29). The bulk composition was determined by X-ray fluorescence analysis.

RESULTS

Oxidation of Hydrogen

A variety of mixtures of metallic gold with single and binary oxides was prepared to seek appreciable enhancement in the catalytic oxidation of H₂. The results are summarized in Table 1. Among the 3d transition metal oxides investigated, the oxides of cobalt, iron, and nickel, the Group VIII metal oxides, were found to exhibit appreciably enhanced catalytic activity in the presence of gold.

Figure 1 shows the catalytic activities ex-

TABLE I
Catalytic Activities for H₂ Oxidation and Specific Surface Areas of Various Metal Oxides and Gold Catalysts

Catalysts	Au (at.%)	T _{1/2} (°C)	Surface area (m ² /g)
Au/MnO ₂	10	152	69
Au/MnO ₂	50	134	115
Au/ α -Fe ₂ O ₃	10	73	73
Au/Co ₃ O ₄	10	66	69
Au/NiO	10	73	116
Au/CuO	10	143	20
MnO ₂	0	244	32
α -Fe ₂ O ₃	0	225	43
Co ₃ O ₄	0	128	47
NiO	0	221	55
CuO	0	>300	6
Ag ₂ O	0	89 ~ 103	—
PdO	0	1	—
PtO ₂	0	38	—
Au ₂ O ₃	100	131	1

pressed by T_{1/2} and specific surface areas as a function of gold content. Maximum activities were obtained at 5 at.% of gold for the Fe-Au and Co-Au systems and at 10 at.% for Ni-Au. As the T_{1/2} values for gold powder and the host metal oxides individually were above 130°C, it was clear that their combination resulted in noticeably enhanced catalytic activities.

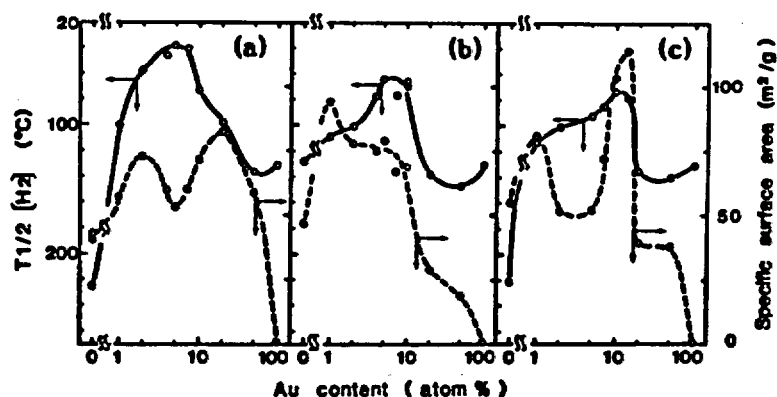

FIG. 1. Dependence of T_{1/2}[H₂] and specific surface area on gold content in the coprecipitates calcined at 400°C. (a) Au/ α -Fe₂O₃; (b) Au/Co₃O₄; (c) Au/NiO.

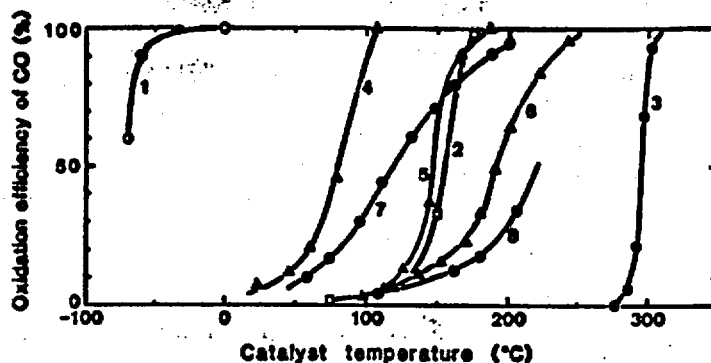

FIG. 2. Oxidation efficiencies of CO over various catalysts as a function of temperature. 1, Au/ α -Fe₂O₃ (Au/Fe = 1/19, coprecipitation, 400°C); 2, 0.5 wt% Pd/ γ -Al₂O₃ (impregnation, 300°C); 3, Au fine powder; 4, Co₃O₄ (carbonate, 400°C); 5, NiO (hydrate, 200°C); 6, α -Fe₂O₃ (hydrate, 400°C); 7, 5 wt% Au/ α -Fe₂O₃ (impregnation, 200°C); 8, 5 wt% Au/ γ -Al₂O₃ (impregnation, 200°C).

The changes of specific surface area with composition appeared to be bimodal for all three systems. The maximum catalytic activity was obtained at the minimum in specific surface area in the Fe-Au system, while it was observed at the second peak in the Co-Au and Ni-Au systems.

Oxidation of CO

The coprecipitated gold catalysts were much more active for the oxidation of CO than for the oxidation of H₂. The three typical gold catalysts, hereinafter denoted Au/ α -Fe₂O₃ (Au/Fe = 1/19), Au/Co₃O₄ (Au/Co = 1/19), and Au/NiO (Au/Ni = 1/9) (see characterization), were able to oxidize CO even at -70°C (27). They were also able to oxidize the CO completely at 30°C even under a relative humidity of 76%. While a Hopcalite catalyst (mixed oxides mainly composed of Mn and Cu) commercially used for CO safety gas masks had lost its activity after 20 min, the Au/ α -Fe₂O₃ and Au/Co₃O₄ catalysts maintained their activity for at least 7 days.

Comparison of Catalytic Activity for CO Oxidation with That for H₂ Oxidation

It is useful to compare the new gold catalysts with the support metal oxides, gold powder, impregnated gold catalysts, and a

supported Pd catalyst, for the oxidation of CO and H₂. Figures 2 and 3 show such a comparison. The impregnated gold catalysts, Au/ γ -Al₂O₃ and Au/ α -Fe₂O₃, were active only at temperatures above 100°C, although they were calcined at 200°C, which was lower by 200°C than the calcination temperature for the coprecipitated catalysts. The support oxides, namely Co₃O₄, NiO, and α -Fe₂O₃, and gold powder are active only at temperatures in the range 60 to 300°C under the same experimental conditions. These comparisons clarify that it is only the gold catalysts prepared by coprecipitation that exhibit marked enhancement in catalytic activity.

Figure 4 shows $T_{1/2}$ values for CO oxidation and H₂ oxidation as a function of mean diameter of Au crystallites determined from TEM and/or XRD. The coprecipitated gold catalysts exhibited the highest activities when they were calcined at 300–400°C, while the impregnated and reduction-deposited catalysts exhibited lower catalytic activities with an increase in calcination or reduction temperature. For example, the gold catalyst supported on α -Fe₂O₃ by impregnation (No. 5 in Fig. 4) had higher catalytic activity, although much lower than those of coprecipitated catalysts, when calcined at 70°C than at 200 and 300°C.

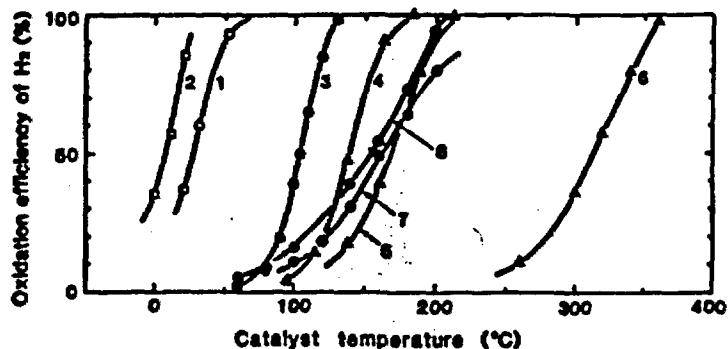

FIG. 3. Oxidation efficiencies of H₂ over various catalysts as a function of temperature. 1, Au/ α -Fe₂O₃ (Au/Fe = 1/19, coprecipitation, 400°C); 2, 0.5 wt% Pd/ γ -Al₂O₃ (impregnation, 300°C); 3, Au fine powder; 4, Co₃O₄ (carbonate, 400°C); 5, NiO (hydrate, 200°C); 6, α -Fe₂O₃ (hydrate, 400°C); 7, 5 wt% Au/ α -Fe₂O₃ (impregnation, 200°C); 8, 5 wt% Au/ γ -Al₂O₃ (impregnation, 200°C).

A general trend is that catalytic activity increases with the decreasing diameter of Au crystallites in the oxidation of both CO and H₂. However, small crystallites of Au do not necessarily lead to catalytic activity at such an extremely low temperature as -70°C. In the Au/Al₂O₃ catalysts prepared by coprecipitation, the $T_{1/2}$ value for CO oxidation is much higher than those for Au/ α -Fe₂O₃, Au/Co₃O₄, and Au/NiO even though the crystallite size of Au is similar in all cases. On the other hand, the $T_{1/2}$ value for H₂ oxidation is comparable for all four catalysts. Accordingly, the oxidation of CO at low temperatures seems to require both the control of Au crystallite size and the selection of appropriate support oxides.

Characterization

The X-ray diffraction patterns showed that the coprecipitates calcined at 400°C in air were composed of metallic crystallites of Au and the oxides, namely α -Fe₂O₃, Co₃O₄, and NiO. The crystallite sizes of Au were estimated to be 3.6 nm for Au/ α -Fe₂O₃ from the peak half-width of Au(111) at $2\theta = 38.2^\circ$, ca. 6.0 nm for Au/Co₃O₄ from Au(200) at $2\theta = 44.4^\circ$, and ca. 8.0 nm for Au/NiO from Au(220) at $2\theta = 64.6^\circ$. The crystallite sizes of Au in the impregnated catalysts were estimated to be 16, 20, and

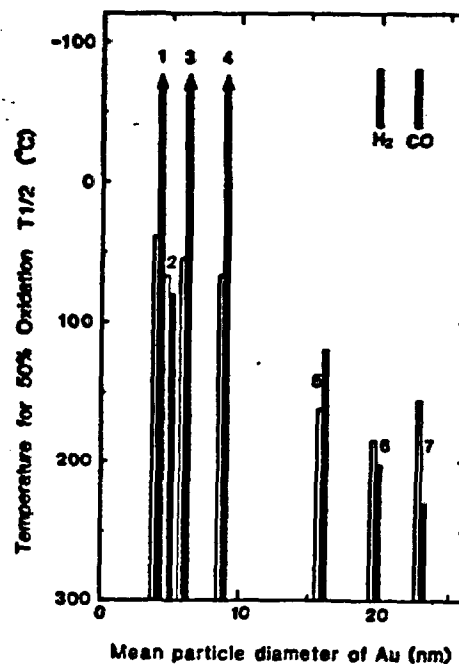

FIG. 4. Catalytic activities for H₂ and CO oxidation as a function of mean particle diameter of Au. 1-4, coprecipitates calcined at 400°C; 1, Au/ α -Fe₂O₃ (Au/Fe = 1/19); 2, Au/Al₂O₃ (Au/Al = 1/19); 3, Au/Co₃O₄ (Au/Co = 1/19); 4, Au/NiO (Au/Ni = 1/9); 5, Au/ α -Fe₂O₃ (5 wt%, impregnation, reduction at 200°C); 6, Au/SiO₂ (17 wt%, reduction, calcination at 300°C); 7, Au/ γ -Al₂O₃ (5 wt%, impregnation, reduction at 200°C).

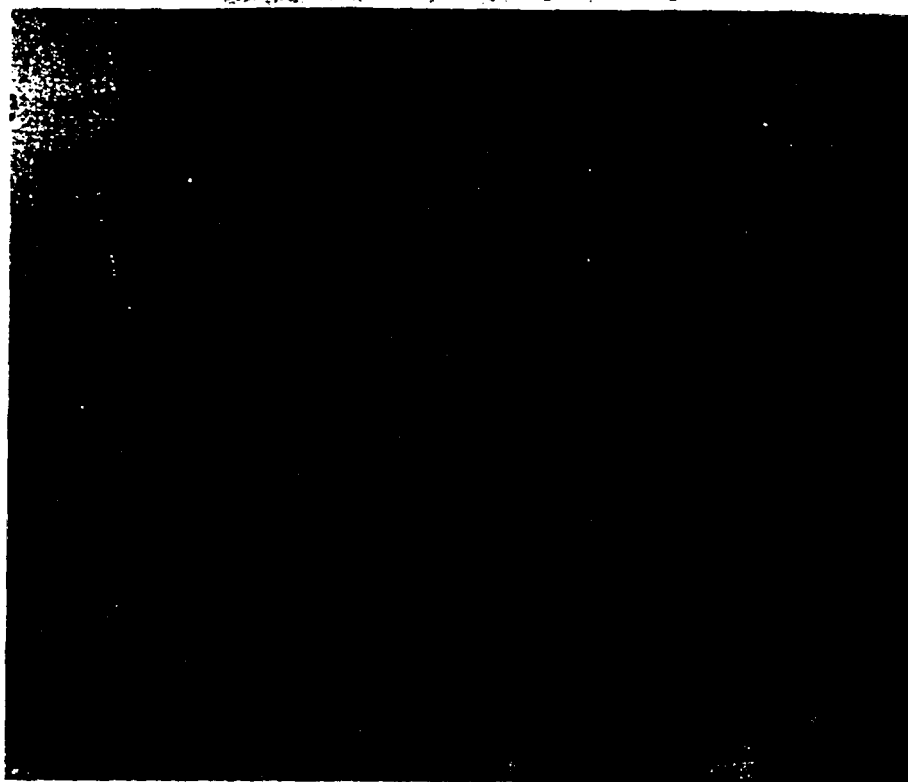

FIG. 5. TEM of Au/ α -Fe₂O₃ (Au/Fe = 1/19) prepared by coprecipitation and calcination at 400°C.

23 nm for α -Fe₂O₃, SiO₂, and γ -Al₂O₃-supported catalysts, respectively.

Figure 5 shows a high-resolution TEM photograph of Au/ α -Fe₂O₃ (Au/Fe = 1/19). Gold particles are uniformly dispersed on the hematite particles of size around 20–50 nm. The histogram in Fig. 6 shows that gold particles exist with a rather sharp size distribution. The mean diameter of 2131 particles of Au is 4.1 nm with a standard deviation of 1.4 nm (34%). This diameter agreed well with the value estimated from XRD data.

In the XPS spectra of coprecipitated Au/ α -Fe₂O₃ (Au/Fe = 1/19), the binding energy of Au 4f_{7/2} was 83.9 eV, a little larger but very close to that of metallic gold evaporated onto α -Fe₂O₃ and appreciably different from that of Au₂O₃, 86.3 eV. No detectable differences in the Fe 2p_{3/2} and O 1s

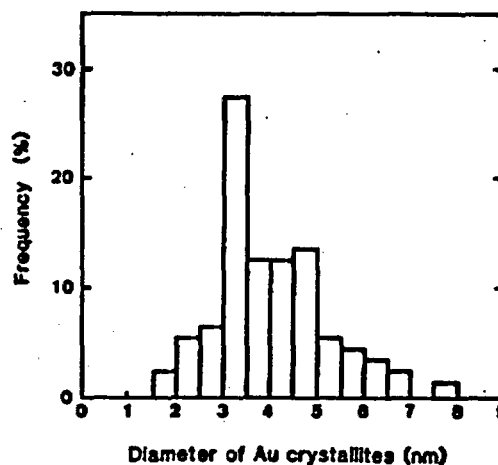

FIG. 6. Histogram of gold crystallites in Au/ α -Fe₂O₃ (Au/Fe = 1/19) prepared by coprecipitation and calcination at 400°C.

TABLE 2
Composition of Au/ α -Fe₂O₃ Catalysts
Prepared by Coprecipitation

Oxides	Fe	Au
Prepared (at.%)	95	5
Elem. anal. (at.%)	94.6	5.4
XPS (at.%)	93.4	6.6
XRD	Au particles and α -Fe ₂ O ₃	

spectra between Au/ α -Fe₂O₃ (Au/Fe = 1/19) and α -Fe₂O₃ were observed.

Table 2 summarizes the results of analyses for the surface composition calculated from the peak area of Au 4f_{3/2} and Fe 2p_{3/2} in XPS and the bulk composition obtained from X-ray fluorescence measurements. The compositions of the starting solution, surface layer, and bulk were nearly identical. This result shows that gold particles are deposited mainly on the surface of hematite particles with little, if any, being incorporated into the bulk of the hematite.

DISCUSSION

It has been demonstrated in the present study that gold becomes a very active catalyst for the oxidation of CO when small gold particles are prepared in the presence of 3d transition metal oxides. In the impregnation and reduction methods, which were used for the preparation of almost all the conventional gold catalysts, gold was obtained only as large particles, usually above 10 nm in diameter. This is because gold has a very low melting temperature, low sublimation energy, and very low Tamman temperature (10). These properties, in addition to the intrinsically poor reactivity of gold metal, make gold markedly different from Pt-group metals in catalytic behavior.

An attempt has recently been made by Zhang (10) to prepare small gold particles supported on MgO and Y-zeolite by incipient wetness impregnation of chloroauric acid and by ion exchange with gold diethylenediamine trichloride, respectively. Although gold particles smaller than 2 nm

were obtained by calcining at temperatures below 200°C, the reported catalytic activity for H₂ oxidation was not appreciably high. It could be assumed that chloride ions remained in the MgO carrier because the catalysts were not washed by hot water after reduction. In fact, the catalytic activity of Au/Al₂O₃ prepared in our laboratory by impregnation was appreciably improved by washing with hot water. In the coprecipitated gold catalysts, the coprecipitates were thoroughly washed before calcination and therefore were considered to be almost free from chloride ions. It could also be expected that Pt-group metal impurities contained in HAuCl₄ might be mostly excluded during the coprecipitation of gold and 3d transition metals because of the extremely low concentrations of those impurities in the starting solution. The small gold particles held inside the supercages of zeolite Y containing Na⁺ grew at temperatures above 100°C, indicating that they were not thermally stable when used as an oxidation catalyst.

From a comparison with Zhang's work, it is evident that coprecipitation is an effective method to prepare small gold particles with good thermal stability and possibly to avoid contamination from chloride ions and Pt group metals which are usually contained in the starting materials. During calcination, gold components were decomposed to form metallic gold crystallites which move out from the inner part of the coprecipitate particles toward the surface. This process might cause the gold particles to be strongly held by the support oxides thereby preventing their coagulation.

The parabolic changes in catalytic activity for H₂ oxidation shown in Fig. 1 may be closely related to the dispersion and exposed surface area of Au metal. The total surface area of exposed Au metal increases with an initial increase in Au content and may then decline with a further increase in Au content due to the coagulation of Au particles. This compensating effect of Au content gives rise to the maximum in the

exposed surface area of Au and, accordingly, to the maximum catalytic activities at 5–10 at.% of Au. It seems to be a coincidence that a catalyst supporting smaller gold particles requires a smaller content of Au to reach the maximum catalytic activities: Au/ α -Fe₂O₃ (4.1 nm, 5–7 at.%) < Au/Co₃O₄ (ca. 6 nm, 5–10 at.%) < Au/NiO (ca. 8 nm, 10–14 at.%).

The bimodal change of the specific surface area appears to be complex in comparison with the simple parabolic change observed for the composite oxides of Ag with Co and Mn (5). The initial increase in the specific surface area up to 2 at.% of Au might be due to the incorporation of gold into the precipitates of Fe, Co, and Ni, as in the case of Ag–Co and Ag–Mn oxides. Since the ionic radius of Au³⁺ is 1.37 Å, larger than 0.65–0.78 Å for divalent or trivalent ions of Fe, Co, and Ni, gold may retard the crystal growth of the coprecipitates leading to a larger specific surface area than that of the pure oxides of Fe, Co, and Ni.

In a sodium carbonate solution of pH around 8.5, gold tetrachloride anions were progressively transformed, before coprecipitation, to gold hydroxide anions thereby releasing free chloride ions. This reaction is not as fast as the precipitation of hydroxides of Fe, Co, and Ni. With an increase in Au content, the amount of chloride ions released appreciably increases during coprecipitation to change the precipitation conditions. Au at 5 at.% causes release of chloride ions of more than one-tenth the concentration of nitrate ions. The coexistence of the chloride ions in a concentration comparable to that of nitrate ions might possibly result in a change in the size of primary solid coprecipitates and their coagulation phenomena. The above phenomena can be considered to be closely related to the occurrence of the bimodal change in specific surface area.

The final decline toward the small surface area of gold powder for a gold content above 20 at.% could be ascribed to the sintering of gold and the decreased proportion

of metal oxides. In fact, the catalyst with 20 at.% Au had the same appearance as that of metallic gold powder. It should be noted that the maximum catalytic activity was obtained at the minimum in specific surface area for Au/ α -Fe₂O₃, but at the second peak or plateau in Au/NiO or Au/Co₃O₄.

It is noteworthy that the catalytic activity of Au/Al₂O₃ was comparable to those of Au/ α -Fe₂O₃, Au/Co₃O₄, and Au/NiO for H₂ oxidation but remarkably inferior for CO oxidation. As shown in Fig. 4, the catalytic activity for H₂ oxidation seems to be solely dependent on the particle diameter, namely the exposed surface area of gold metal. On the other hand, the support oxides may also play an important role in the oxidation of CO. Even though gold was supported in the form of small particles of 5 nm in diameter, the catalytic activity is not as high with inactive Al₂O₃ as that obtained for Au/ α -Fe₂O₃, Au/Co₃O₄, and Au/NiO. These results indicate that either a kind of metal-support interaction occurs or oxidation may proceed through a bifunctional mechanism in which both gold particles and support oxides activate different steps of the CO oxidation.

Hydrogen is considered not to chemisorb on the gold surface while CO chemisorbs weakly on the gold surface (10). Therefore, it is probable that the contribution of support oxides may differ in H₂ oxidation from that in CO oxidation. The interaction of gold crystallites with the support oxides, α -Fe₂O₃, Co₃O₄, and NiO, which are all semiconductors, might alter the surface properties of gold crystallites so as to favor CO adsorption. According to simple calculations, outer surface atoms compose about 40% of the total atom content for hemispherical gold particles of diameter 4.0 nm. This suggests that the electronic states of the outer surface gold atoms can be readily modified by the interaction with the support oxides.

ACKNOWLEDGMENTS

The authors thank Mr. T. Takeuchi for carrying out the preparation experiments and Mr. M. Yanagida for

the elemental analyses by atomic emission spectroscopy. Thanks are also due to Dr. A. R. West, University of Aberdeen, for his valuable comments and critical reading of the manuscript.

REFERENCES

1. Haruta, M., and Sano, H., *Int. J. Hydrogen Energy* **6**, 601 (1981).
2. Haruta, M., Suoma, Y., and Sano, H., *Int. J. Hydrogen Energy* **7**, 729 (1982).
3. Haruta, M., and Sano, H., *Int. J. Hydrogen Energy* **7**, 737 (1982).
4. Haruta, M., and Sano, H., *Int. J. Hydrogen Energy* **7**, 801 (1982).
5. Haruta, M., and Sano, H., in "Preparation of Catalysts III" (G. Poncelet, P. Grange, and P. A. Jacobs, Eds.), p. 225. Elsevier, Amsterdam, 1983.
6. Bond, G. C., *Gold Bull.* **5**, 11 (1972).
7. Bond, G. C., and Sermon, P. A., *Gold Bull.* **6**, 102 (1973).
8. Wachs, I. E., *Gold Bull.* **16**, 98 (1983).
9. Schwank, J., *Gold Bull.* **16**, 103 (1983).
10. Zhang, G., Ph.D. thesis, Stanford University, UM 8608245, 1985.
11. Yates, D. J., *J. Colloid Interface Sci.* **29**, 194 (1969).
12. Lam, Y. L., and Boudart, M., *J. Catal.* **50**, 530 (1977).
13. Nyarady, S. A., and Sievers, R. E., *J. Amer. Chem. Soc.* **107**, 3726 (1985).
14. Sermon, P. A., Bond, G. C., and Wells, P. B., *J. Chem. Soc. Faraday Trans. 1* **74**, 385 (1978).
15. Galvagno, S., and Parravano, G., *J. Catal.* **55**, 178 (1978).
16. Fukushima, T., Galvagno, S., and Parravano, G., *J. Catal.* **57**, 177 (1979).
17. Lea, J. Y., and Schwank, J., *J. Catal.* **102**, 207 (1986).
18. Buchanan, D. A., and Webb, G., *J. Chem. Soc. Faraday Trans. 1* **70**, 134 (1974).
19. Schwank, J., Parravano, G., and Gruber, H. L., *J. Catal.* **61**, 19 (1980).
20. Shastri, A. G., Datye, A. K., and Schwank, J., *J. Catal.* **87**, 265 (1984).
21. Chapman, D. L., Ramsbottom, J. E., and Trotman, C. G., *Proc. Soc. London A* **107**, 29 (1925).
22. Benton, A. F., and Elgin, J. C., *J. Amer. Chem. Soc.* **49**, 2426 (1927).
23. Chambers, R. P., and Boudart, M., *J. Catal.* **5**, 517 (1966).
24. Cant, N. W., and Fredrickson, P. W., *J. Catal.* **37**, 531 (1975).
25. Bollinger, M. J., Sievers, R. E., Fahey, D. W., and Fehsenfeld, F. C., *Anal. Chem.* **55**, 1980 (1983).
26. Hodges, C. N., and Roselaar, L. C., *J. Appl. Chem. Biotechnol.* **25**, 609 (1975).
27. Hartua, M., Kobayashi, T., Sano, H., and Yamada, N., *Chem. Lett.*, 405 (1987).
28. Nakamura, O., Ogino, I., and Kodama, T., *Rev. Sci. Instrum.* **50**, 1313 (1979).
29. Wagner, C. D., Davis, L. E., Zeller, M. V., Taylor, J. A., Raymond, R. H., and Gale, L. H., *Surf. Interface Anal.* **3**, 211 (1981).

GOLD-SUPPORTING TIN OXIDE FOR SELECTIVE CO SENSING

Tetsuhiko KOBAYASHI,* Masatake HARUTA, and Hiroshi SANDO

Government Industrial Research Institute of Osaka,
1-8-31 Midorigaoka, Ikeda, Osaka 563

The sensitivity and selectivity of semiconducting SnO_2 towards CO at 150 - 250°C was appreciably enhanced by supporting highly dispersed gold and by doping with Mg^{2+} ions. The addition of Mg^{2+} prevented the Au/ SnO_2 solid from sintering and maintained it catalytically active for CO oxidation, even in a moist atmosphere.

In a recent paper we reported that Ti^{4+} -doped Fe_2O_3 supporting ultrafine gold particles with a diameter of about 4nm (hereafter denoted as UFP-Au) exhibits excellent CO selectivity against H_2 and ethanol at an operating temperature below 100°C [1]. This sensing property originates from the high catalytic activity of UFP-Au/ Fe_2O_3 for CO oxidation at low temperatures [2]. The gas sensors operating below 100°C, however, seem to have the disadvantage that they usually need periodic heat-flashing in long-time operation to avoid the accumulation of water and contaminants on the surface [3]. A commercial semiconductor CO sensor, which is fabricated from Pd-supporting SnO_2 , also uses periodic heat-flashing to remove CO molecules which are adsorbed at around 90°C [4].

In order to obtain a CO sensor operated at a constant temperature without the need for heat-flashing, a new gas-sensing semiconductor must be developed that exhibits sufficient CO sensitivity and selectivity at temperatures above 150°C. Since CO oxidation over UFP-Au/ SnO_2 needs a temperature at least 100 degrees higher than UFP-Au/ Fe_2O_3 [5], a relatively high sensing temperature of CO would be required for the former material. Therefore, we have made an attempt to prepare new CO selective semiconductors composed of SnO_2 and Au.

Semiconducting SnO_2 incorporating Au, Mg^{2+} , and Sb^{5+}

(Sn:Au:Mg:Sb = 100:1:5:1, in atomic ratio) was prepared by coprecipitation from a mixed aqueous solution of SnCl_4 , HAuCl_4 , and SbCl_5 with an aqueous solution of NH_3 . Since the electrical conductivity of SnO_2 markedly decreased with the addition of Mg^{2+} , the doping of Sb^{5+} , which scarcely affected the gas selectivity of the semiconductor, was necessary to maintain the resistance of a SnO_2 thick film at a level of 300 $\text{K}\Omega$ at 200°C. The precipitate was washed with distilled water, vacuum dried, and then impregnated with an aqueous solution of $\text{Mg}(\text{NO}_3)_2$. This precursor was vacuum dried again and calcined in air at 400°C for 3h. For comparison, Au/SnO_2 (Au:Sn = 1:100, in atomic ratio) and SnO_2 were also prepared in a similar manner to that described above.

Thick-film gas sensor devices were fabricated from the above semiconductors using final calcination temperature of 600°C for stabilization [1]. Gas sensitivity is expressed by $R\text{-air}/R\text{-gas}$, this being the ratio of the electrical resistance of the device measured in air with a relative humidity of 65% to that measured in

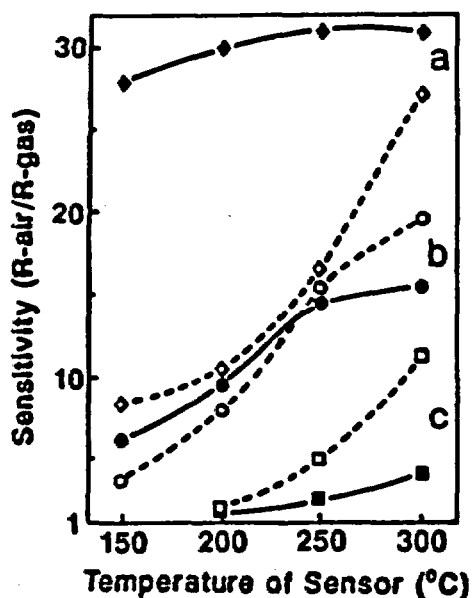

Fig. 1 The sensitivities of SnO_2 sensors as a function of device temperature.

a; $\text{Au}/\text{SnO}_2/\text{Mg}^{2+}/\text{Sb}^{5+}$, b; Au/SnO_2 , c; SnO_2 .

—◆—●—■—; 300ppm CO,
- -◆- -○- -□- -; 300ppm H_2 .

the presence of 300ppm CO or 300ppm H_2 . The catalytic activities of these materials for CO and H_2 oxidation were measured by using a small fixed bed reactor [2].

Figure 1 (a) shows the sensitivities to CO and H_2 of the $\text{Au}/\text{SnO}_2/\text{Mg}^{2+}/\text{Sb}^{5+}$ sensor as a function of operating temperature. A high sensitivity with a fairly good selectivity to CO against H_2 was obtained at temperatures between 150°C and 250°C.

Figure 1 (b) and (c) show gas sensitivities for Au/SnO_2 and SnO_2 . The addition of Au into SnO_2 improved the sensitivity for CO more appreciably than for H_2 , but such a high selectivity to CO as observed in Fig. 1 (a) could not be obtained without the addition of Mg^{2+} . Since the

addition of Mg^{2+} into SnO_2 without Au did not improve the original sensitivities of SnO_2 , selective CO detection obtained with $Au/SnO_2/Mg^{2+}/Sb^{5+}$ might be due to a synergism between the Au particles and Mg^{2+} .

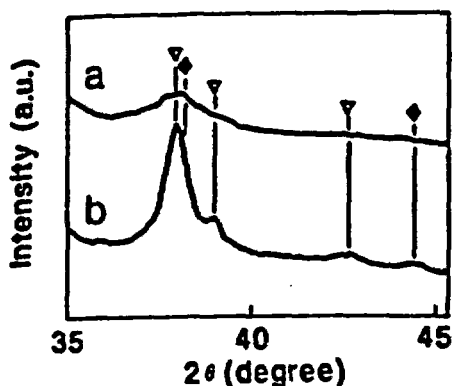

Fig. 2 The XRD patterns of sensor materials.
a: $Au/SnO_2/Mg^{2+}/Sb^{5+}$ (color; black),
b: Au/SnO_2 (color; deep purple).
 ∇ ; SnO_2 , \blacklozenge ; Au.

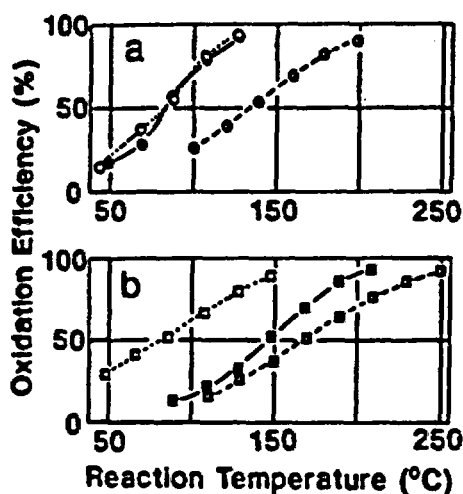

Fig. 3 The efficiency of CO and H_2 oxidation over sensor materials as a function of temperature:
a: $Au/SnO_2/Mg^{2+}/Sb^{5+}$, b: Au/SnO_2 .
---○---□---; 1% CO + air (dried by P_2O_5 column),
---●---■---; 1% CO + air (saturated with H_2O at $0^\circ C$),
---◇---; 1% H_2 + air.
Space velocity; $20000h^{-1} ml g^{-1}$.

Figure 2 shows the XRD patterns of $Au/SnO_2/Mg^{2+}/Sb^{5+}$ and Au/SnO_2 . The XRD peaks of $Au/SnO_2/Mg^{2+}/Sb^{5+}$, which are broader than those of Au/SnO_2 , clearly indicate that Mg^{2+} suppresses the sintering of Au/SnO_2 to give smaller gold particles. The Mg^{2+} doped sample show no appreciable XRD peaks due to metallic Au even after heat-treatment at $600^\circ C$. The black color of this material may indicate the presence of highly dispersed Au particles, which are smaller than those in Au/SnO_2 .

Direct information concerning the difference in the sensitivities of Au/SnO_2 with and without Mg^{2+} was obtained by measuring the catalytic activities of the materials for CO oxidation. Figure 3 shows that CO oxidation takes place in preference to H_2 oxidation over the above two materials in the dried reaction gas. In the humidified reaction gas, water vapor does not affect the catalytic activities of Mg^{2+} doped Au/SnO_2 but inhibits CO oxidation over Au/SnO_2 without Mg^{2+} decreasing the preference to CO oxidation.

The difference in the size of Au particles may account for the difference in the sensing

properties of the Au/SnO₂/Mg²⁺/Sb⁵⁺ and the Au/SnO₂ sensor. It has been found in the case of UFP-Au/Fe₂O₃-Ti⁴⁺ that the sensitivity as well as the selectivity towards CO increases with smaller Au particles [1]. The measurements of gas sensitivities were conducted under humid conditions, despite this Au/SnO₂/Mg²⁺/Sb⁵⁺ remains selective to CO due to the fact that it is unaffected by water in the catalytic oxidation of CO. Recently, UFP-Au supported on hydrous oxides of alkaline earth metals have been found to catalyze CO oxidation even at -70°C [5,6]. An increase in the basicity of SnO₂ by doping with Mg²⁺ might play an important role in the water-resistant oxidation of CO.

References

1. T. Kobayashi, M. Haruta, H. Sano, and M. Nakane, *Sensors and Actuators*, **13**, 339 (1988).
2. M. Haruta, T. Kobayashi, H. Sano, and N. Yamada, *Chem. Lett.*, 405 (1987).
3. M. Nagase and H. Futata, *Proc. Int. Meet. Chem. Sens.*, Fukuoka (1983), p.65.
4. T. Amamoto and N. Murakami, *Sensor Gijutsu (Sensor Technology)*, **7(13)**, 45 (1987).
5. M. Haruta, H. Kageyama, N. Kamijo, T. Kobayashi, and F. Delannay, in T. Inui (ed.), "Successful Design of Catalysts", Elsevier, Amsterdam, 1988, pp. 33-42.
6. M. Haruta, K. Saika, T. Kobayashi, S. Tsubota, and Y. Nakahara, *Chem. Express*, **3**, 159 (1988).

COを選択的に検知する金担持酸化スズ

小林哲彦、* 春田正毅、佐野 寛

工業技術院 大阪工業技術試験所

〒563 池田市緑ヶ丘1-8-31

150~200°Cの中温領域における SnO₂ガスセンサのCOに対する検知感度および選択性は、高分散した金粒子およびMg²⁺イオンの添加により著しく増感された。Mg²⁺の添加により Au/SnO₂の焼結が抑制され、湿分を含む雰囲気中でもCO酸化の触媒活性が維持された。

METHODOLOGY FOR MAKING R&D PROGRAMS OF CHEMICAL SENSORS

Masatake HARUTA, Kazuo HIIRO, Hideo TANIGAWA, Hiroyasu TAKENAKA,
Susumu YOSHIKAWA, and Hiroshi SANO

Government Industrial Research Institute of Osaka
Midorigaoka 1, Ikeda 563, Japan

ABSTRACT

The R&D programs of chemical sensors should particularly be focused on the practical needs. Sensing materials and signal transducers should be exploited efficiently and should be combined synergetically by taking into consideration of the sensitivities, selectivities, and stabilities required. The methodology for program making is presented by showing the examples of Government Industrial Research Institute of Osaka. The practical needs, technological bottle necks, prospects of development, and fields of application were disclosed through the survey by distributing questionnaires to the people engaged in chemical sensors. The results of needs analyses together with seeds exploration substantially helped the establishment of the needs-orientated and motivation-enforced R&D programs. The activities and achievements of research carried out in the framework of the programs at GIRIO are also described.

1. INTRODUCTION

Chemical sensors are a sort of artificial eyes to recognize chemical species. They measure the presence or concentration of gases, ions in solutions, and organic compounds. They are widely used in microwave ovens, gas safety alarms, air-fuel ratio control systems for automobiles, monitoring of water pollution, medical drug delivery devices for diabetes, process control of fermentation and so forth. They are really becoming indispensable for many industries and for our daily lives as well.

There are various kinds of chemical sensors; multifarious sensors are existing and will be needed even for a single chemical compound depending on the conditions of operation, sensing materials, transducers, and detecting principles. Especially, sensing materials used are diverse from organic metal complexes, conductive polymers,

biological materials, metals, and metal oxides. This situation makes it difficult for users to choose suitable chemical sensors without a vast amount of knowledge and for engineers and makers to find the efficient approach to the development of a sensor specifically desired.

From the above points of view, it is very important to establish the methodology for making R&D programs of chemical sensors. The R&D programs of Government Industrial Research Institute of Osaka(GIRIO) were made based on the results of questionnaire survey of social needs to chemical sensors and on the results of literature and patent survey of the past ten years. Several distinguished results were obtained in the framework of the R&D programs. These activities at GIRIO for the past five years are presented to show one of the examples of the methodology for program making and its validity.

2. THE STRUCTURES AND PERFORMANCES OF CHEMICAL SENSORS

Chemical sensors can be classified into four groups; humidity, gas, ion, and bio-sensors. Structurally, they are divided into two types[1] as shown in Fig. 1. The first type is called "unstructured sensors", where sensing of chemical species and transducing the resulting physico-chemical changes to an electrical signal is performed in a single phase. Humidity and gas sensors using sintered ceramics are typical examples of this type. The adsorption and reaction of water or flammable gases on the surface results in a change of the electrical conductivity of the sintered body ceramics, thus leading to an increase in electrical current under a constant applied voltage.

The second type is "structured sensors", because the part of receptor for chemical species and the part of transducer are clearly separated into two phases. Conventional ion selective electrodes are a typical example of this type. They are combined with reference electrodes to measure the potential difference between the two electrodes. Almost all biosensors are also included in this category. For example, glucose oxidase recognizes glucose and then catalyzes the reaction to produce H_2O_2 , the concentration of which is transduced with an oxygen electrode to an electrical signal.

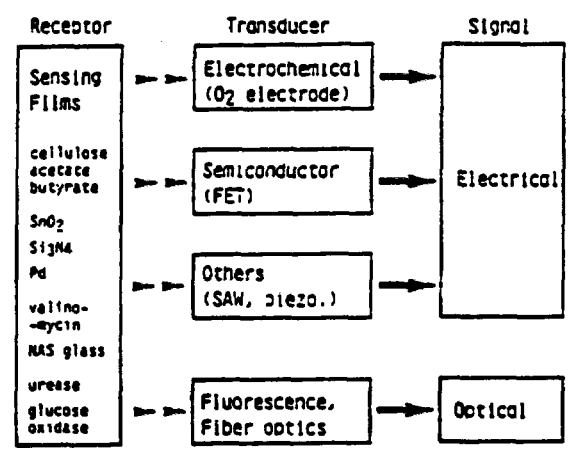
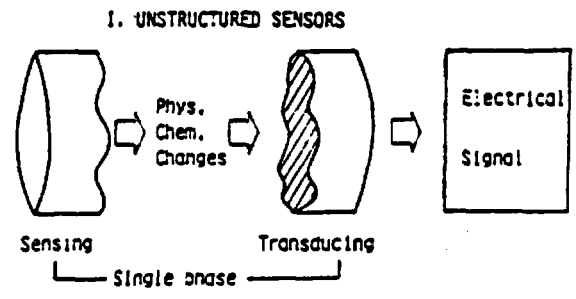

Fig. 1. Structure of chemical sensors.

Many advanced sensors have been developed in the structured type by using FET(Field Effect Transistor)[2], SAW(Surface Acoustic Wave) devices[3,4], piezoelectric crystals[5,6,7], fluorescence[8,9], and fiber optics[10] as a transducer. One of the advantageous features of this type is that it allows us to choose and prepare sensing materials without taking into consideration of their transducing properties. The typical examples of sensing membranes are cellulose acetate butyrate[11] for humidity, Pd[12] and SnO₂[13] for gases, Si₃N₄[14], NAS glass[15], valinomycin[16] for ions, and urease and glucose oxidase[17] for bio-related compounds.

The R&D work of chemical sensors consists of exploiting sensing materials and transducing devices, fabricating them into sensing

devices, and testing sensor performances. There are three "S"s in the performances of chemical sensors. The first is sensitivity which includes range of detectable concentration, resolution with respect to a certain concentration change, and response time, namely, three "r"s. The second S is selectivity. The interference by other coexisting species is one of the serious problems of the present chemical sensors. It should be examined beforehand which kinds of species coexist in the atmosphere where the target sensors are used. The third S is stability which includes reproducibility of signal output during the repetition of measurements and durability in the long term use.

3. SURVEY AND ANALYSES OF NEEDS TO CHEMICAL SENSORS

In order to establish a self-consistent and effective strategy for the R&D programs of chemical sensors, a comprehensive survey of social needs was made by GIRIO in 1983[18]. Questionnaire sheets were sent to 341 people who were engaged in chemical sensors at industries(256), universities(65), national and public research laboratories(14), and technical consultants(6). Forty eight per cent of them sent us back their answers, from which the needs to chemical sensors were analyzed as described below.

3.1 Overall Chemical Sensors

Figure 2 shows the number of answers to the question "Please choose three chemical sensors which you think will grow remarkably in the future.". The area of each circle is proportional to the number of answers. In the category of gas sensors, oxygen sensors gained the largest number. It seemed to be reasonable because oxygen sensors were being commercially used for the control of air-fuel ratio in automobiles. The second is CO sensors. This is probably because there were no reliable CO sensors to monitor whether combustion of fuel in household appliances is safely taking place. The third is H₂O, namely, humidity sensors. This might be due to the very humid climate in Japan. Humidity sensors are in a wide-spread use for air conditioners, video tape recorders, automatic cooking oven ranges and

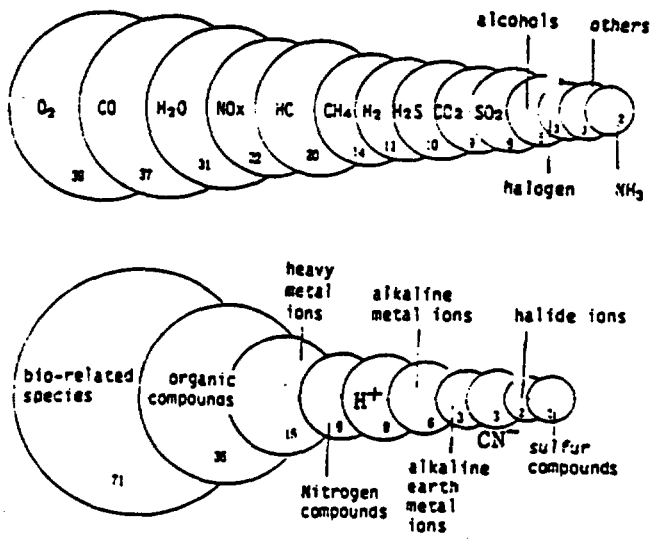

Fig. 2. Sensors to be expected to grow. Figures in the circles show the number of answers.

so forth. It should also be noted that nitrogen oxide sensors obtained more points than hydrocarbon fuel sensors which had been commercially used for gas leak alarms.

In the category of ion and bio-sensors, the expectation to sensors for bio-related compounds is far the largest. Sensors for organic compounds gained answers as many as oxygen or CO gas sensors did. The broad definition of biosensors includes not only the sensors with biological materials such as enzyme, immuno-assay, micro organisms for sensing but also other types of sensors which simply measure bio-related species such as Li⁺ concerned with psychology and K⁺ in body fluid. These fields of biosensors are expected to make the greatest progress in the future. As for ion sensors, heavy metal ions and nitrogen compounds such as NO₃⁻ are ranked at the top and at the second, respectively.

The opinions concerning chemical sensors described freely by answerers are schematically summarized in Fig. 3. The area corresponds to the number of opinions. In the category of gas sensors, PH₃ and AsH₃, doping gases used in semiconductor industries, CO, and humidity are attracting large concerns of answerers. Relatively great demands are seen to the high temperature use of gas sensors and to some extent

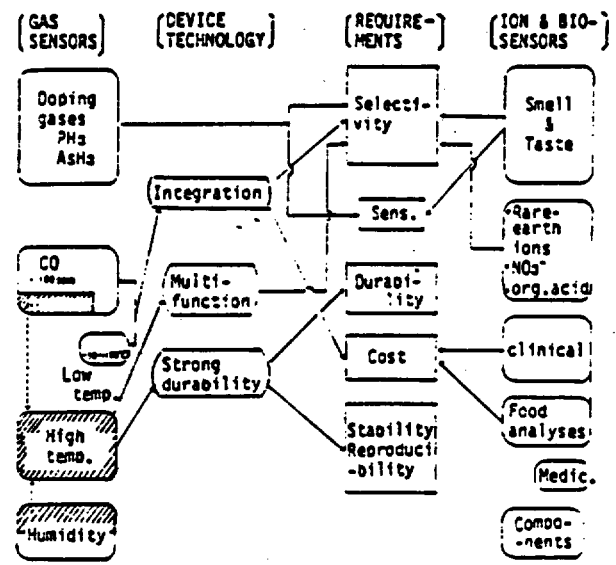

Fig. 3. Schematic summary of the opinions written freely by correspondents.

to the low temperature use. In the category of ion and biosensors, smell and taste sensors are pointed out as a future target of research. Ion sensors for rare earth metal ions, NO₃⁻, organic acids are also a big concern. Among the requirements for the performances of chemical sensors, selectivity and stability are of the greatest.

It is important for making R&D programs to grasp properly the technological problems. Figure 4 shows that the most serious problems are degradation, reproducibility, stability of signal output, and contamination by oil and dust. These all concerns the stability of sensors in a wider sense of meanings.

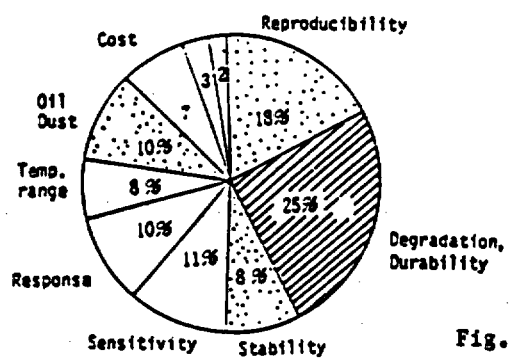

Fig. 4. Problems of chemical sensors.

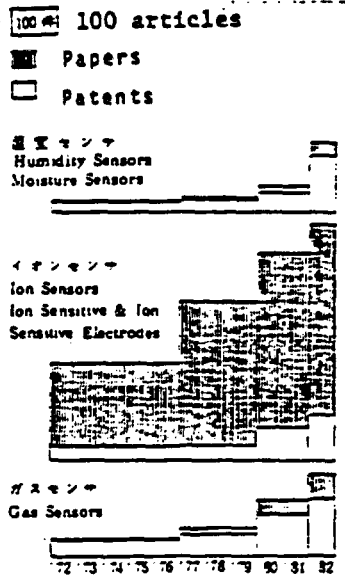

Fig. 5. Annual growth in the number of papers and patents concerning chemical sensors.

A literature and patent survey was done for the past ten years to know the state of the art of chemical sensors mostly from the point of seeds. Figure 5 shows that there is a big contrast in the number of scientific papers and patents between ion sensors and the other chemical sensors. In the field of ion sensors, scientific papers are much more than patents, probably because R&D work is mainly done in university laboratories, especially as the subjects of analytical chemistry. On the other hand, in the fields of humidity and gas sensors the number of patents largely exceeds that of scientific

papers indicating that R&D work has been carried out mainly in industries.

3.2 Humidity Sensors

As shown in Fig. 6, few people think that the present humidity sensors have no serious problems and that their cost are too high. The biggest problems are reproducibility and precision, secondly, stability of signal output, thirdly, durability and life and then the range and conditions of measurements. The former three constraints are more or less concerned with the stability properties of sensors in a short and long term use. Therefore, an improvement in stability is considered to be the most important task of R&D on humidity sensors. Figure 7 shows the fields of application of humidity sensors. They are expected to be the most frequently used for air conditioning in residences and offices, probably because the humid hot summer and dry cold winter in Japan. The second largest field of application is drying processes, where high temperature performance and durability is particularly required for humidity sensors.

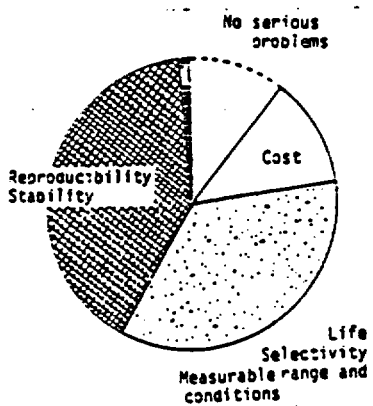

Fig. 6. Problems of humidity sensors.

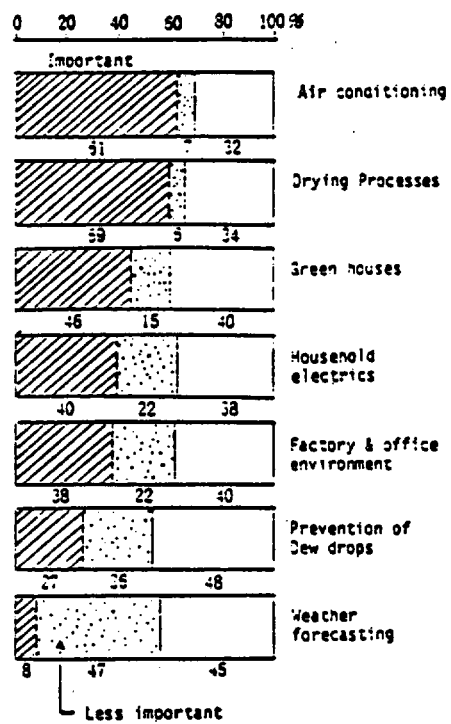

Fig. 7. Fields of application of humidity sensors.

3.3 Gas Sensors

Figure 8 shows several problems of gas sensors with their respective percent fractions in the number of answers.

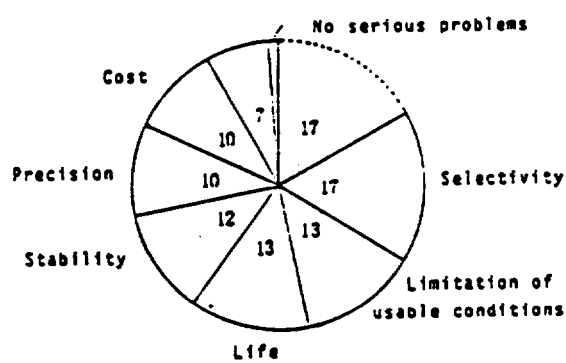

Fig. 8. Problems of gas sensors.

Selectivity occupies the largest fraction. Then, limitation to the applicable conditions, life, and stability occupy almost equal fractions to each other.

Table I shows more detailed data how differently producers, sellers, users, and researchers recognized the problems of each gas sensor. Concerning CO gas sensors, although producers and sellers do not think there are any serious problems, users and researchers complain of selectivity, stability, and applicable conditions. As for fuel gas sensors which had been already commercialized in Japan, selectivity and stability are considered similarly by the four groups to be very serious problems. Therefore, it may be suggested that the types of CO gas sensors under consideration are different between the group of producers and sellers and the group of users and researchers; the former is actually dealing with electrochemical sensors and the latter is developing oxide semiconductor or other types of compact sensors.

In the case of oxygen sensors, durability is the largest constraint and the second largest ones are convenience and conditions for use. There also observed a big discrepancy in answers between the group of producers and sellers and the group of users and researchers. This may again suggest that users and researchers were seeking for stabilized-zirconia based oxygen sensors or other ones of the new type which were different from conventional electrochemical sensors. Concerning hydrogen sulfide and sulfur dioxide gas sensors, for which electrochemical cells have long been used, no serious problems are pointed out for the present.

Table I. Constraints of producers, sellers, users, and researchers on the respective gas sensors.

Sensors \ Problems	CO				Fuel gases				O ₂				H ₂ S · SO ₂				T
	P	S	U	R	P	S	U	R	P	S	U	R	P	S	U	R	
Usability	-	+	-	-	-	-	-	-	+	+	-	-	+	-	+	-	39
Cost	-	+	+	-	-	-	-	-	+	-	-	-	+	-	-	-	59
Durability	-	-	-	-	-	-	-	-	-	-	-	-	-	-	-	-	72
Selectivity	-	-	-	-	-	-	-	-	+	-	-	-	+	-	-	-	33
Conditions	-	+	-	-	+	+	-	-	+	-	+	-	+	-	-	-	73
Stability	+	+	+	-	-	-	-	-	+	-	+	+	+	+	-	-	68
Precision	-	+	-	-	-	+	-	-	-	+	+	+	-	-	-	-	59
TOTAL	10	15	29	37	24	43	56	39	16	21	34	40	11	15	21	12	590

PROBLEMS - : no + : a little ++ : serious
 +++ : very serious * : Total

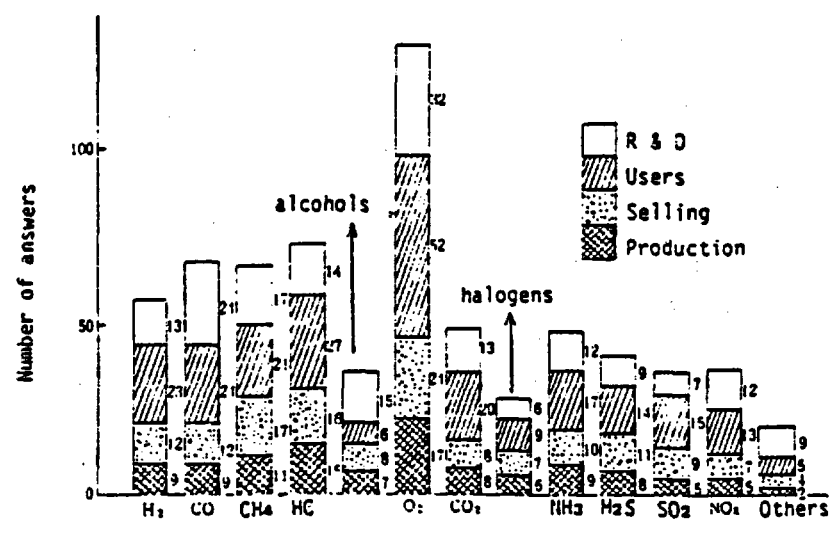

Fig. 9. The number of people engaged in gas sensors.

Figure 9 shows the number of answerers who were engaged in respective gas sensors at the time of questionnaire survey. The number was by far the largest for those who were engaged in O₂ sensors. Sensors for H₂, CO, CH₄, and hydrocarbons had almost the same number of people engaged, however, the fraction of R&D was relatively large in the case of CO gas sensors.

The comparison of the present situation shown in Fig. 9 with the future situation estimated from the number of answers to the question "In the future which gas sensors do you wish to develop, use, sell, or produce?" can tell us the growth potentials of respective gas sensors. The ratios of the numbers of the future involvement to those of present one, namely, "future indices", are shown in Table II. The production and selling of CO sensors will appreciably grow. Nitrogen oxide sensors are exceptional that they will grow appreciably in every sector. Users will increase in the sensors for alcohols, NO_x, halogens, and SO₂. Research & development activities will be strengthened in the sensors for SO_x, halogens, H₂S, NO_x, and H₂. Strong interest in MOSFET sensors might be responsible for the large index of H₂.

Among the fields of application of gas sensors, prevention of gas explosion and of accidental death by oxygen shortage is considered to

be the most important(Fig. 10). Industrial applications to process control in chemical factories and energy savings are regarded as the second most important.

Table II. Future indices for various gas sensors.

Present	Future				
	P	S	U	R	
H ₂	100	122	108	91	146
CO	100	200	142	108	104
CH ₄	100	73	118	67	82
HC	100	67	69	78	114
alcohols	100	157	98	217	80
O ₂	100	106	75	63	116
CO ₂	100	125	113	70	100
halogens	100	50	43	122	167
NH ₃	100	56	50	82	67
H ₂ S	100	50	36	114	144
SO ₂	100	80	44	120	200
NO _x	100	160	117	162	142

P, Production; S, Selling;
U, Users; R, R&D.

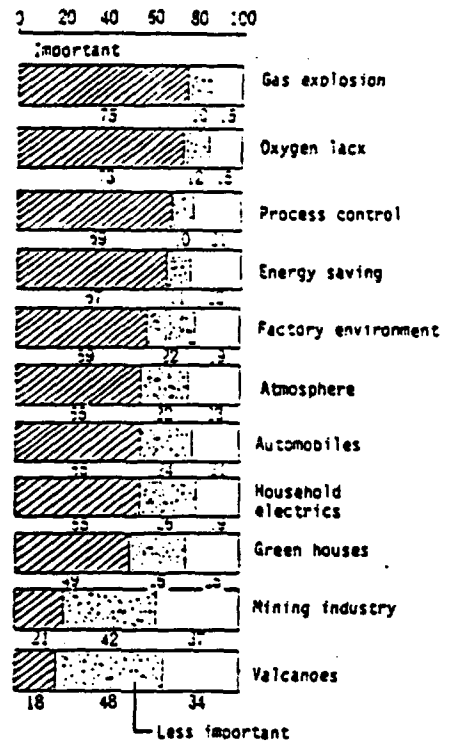
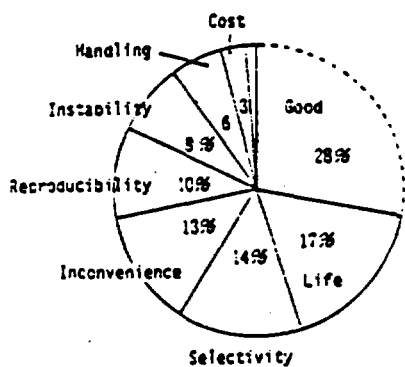

Fig. 10. Fields of application of gas sensors.

3.4 Ion Sensors

The general problems of ion sensors that were pointed out by correspondents are first life, secondly selectivity, and thirdly inconvenience in using sensors(Fig. 11(a)). What appear to be characteristics of ion sensors are that relatively large fraction of people feel no problems and that many people regard them as inconvenient to use. The former is due to the long history of commercial use of ion selective electrodes, as typically represented by pH electrodes. The latter is due to the fact that they need a reference electrode to measure potential difference.



(a) overall ion sensors (307 answers)

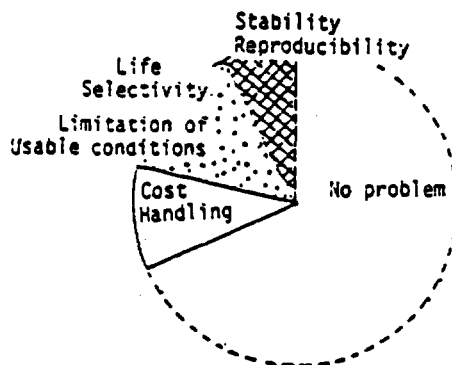

(b) proton sensors (29 answers)

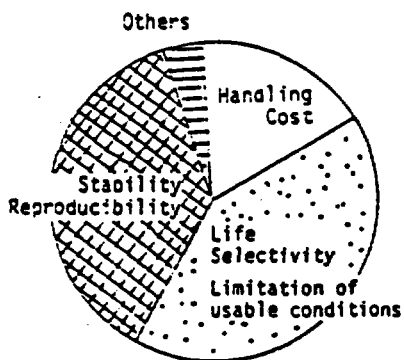

(c) bio-related compounds (29 answers)

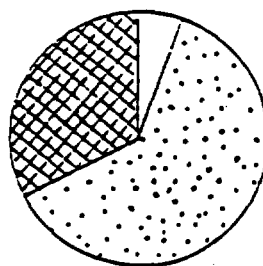

(d) organic compounds (18 answers)

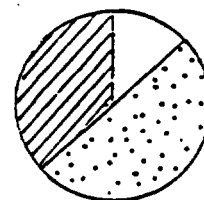

(e) heavy metal ions (8 answers)

Fig. 11. Problems of ion sensors.

The problems of several respective ion sensors are also shown in Fig.11. Concerning proton ion sensors, more than 70% of correspondents answered "there is no problem". In the following three ion sensors which were expected to grow markedly in the future, no one answered "no problem". The heavy metal ion sensors need more improvements in fundamental properties such as life, selectivity, and applicable conditions than in stability of operation, reproducibility, and precision of measurements. Similarly, for organic compounds, life, selectivity, and applicable conditions are the major constraints. In the case of bio-related compounds, the problems concerning stability and reproducibility are as serious as the problems of life, selectivi-

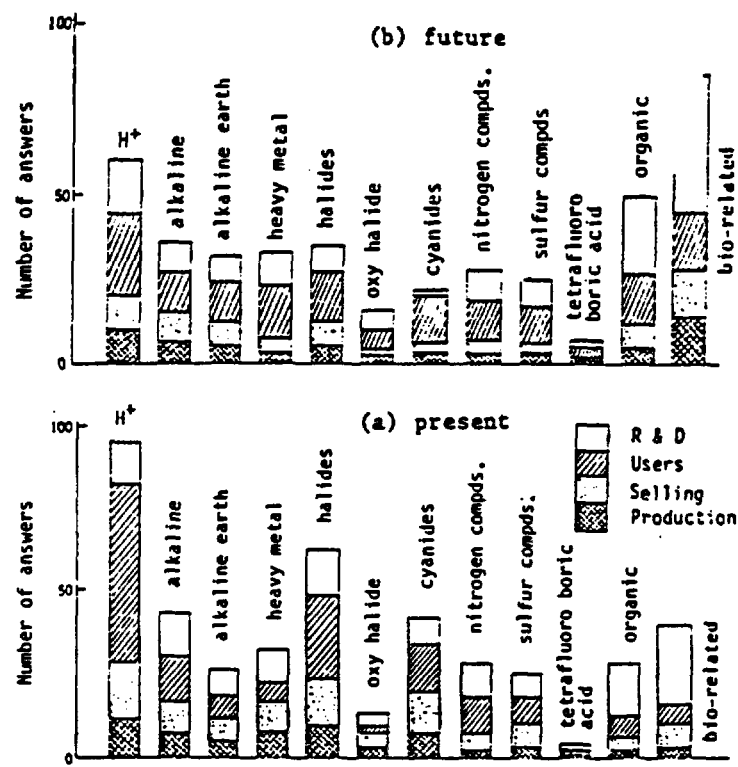

Fig. 12. The number of people engaged in ion sensors.

ty, and applicable conditions. This might be because living biological materials like enzyme, microorganism are used as sensing materials.

Figure 12(a) shows the number of answerers who are concerned with respective ion sensors. Those who are concerned with proton occupy the largest number, halide ions the second, and alkaline and cyanide ions the third and then bio-related compounds. It should be noted that the fractions of R&D on organic compounds and on bio-related compounds are very large while that of users is more than half in proton sensors.

When the future involvement shown in Fig. 12(b) are compared with the present one, a marked increase is observed in organic and bio-related compounds whereas an appreciable decrease is observed in proton. It is worthy of noting that the fractions of R&D are relatively large in both present and future involvement in heavy metal ions and nitrogen compounds.

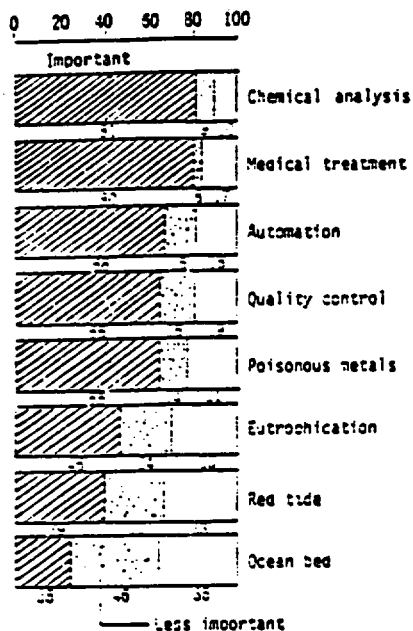

Fig. 13. Fields of application of ion sensors.

As can be seen from Fig. 13, ion sensors are expected to be very useful for the automatic chemical analyses and speedy and simple clinical analyses in medical treatment. The second largest fields of application are automation, quality control in factories, and monitoring of pollution by poisonous heavy metal ions.

3-5 Biosensors

Table III shows one of the typical data obtained from an intensive investigation of biosensors which was made by Osaka Science & Technology Center in 1986[19]. Glucose and Na⁺ and K⁺ ions are most frequently measured in clinical analyses. Ions such as Cl⁻ and H⁺, as well as O₂ and CO₂ gases, are also very often measured.

There are four types of chemical sensors which use biological materials for molecular recognition, that is, enzymes, microbes, immunity, and the others like organera. Figure 14 shows the number of Japanese patents concerning biosensors published in the period of 1980-1984. Enzyme sensors occupy by far the largest portion. More than 90 species can be detected by using different types of enzyme sensors, eleven of which are already commercially available. In this sense, among biosensors enzyme-based ones are the most popular and successful.

Table III. Frequency of measurements with biosensors in clinical analyses.

Measured species	Frequency of measurements			Total
	Everyday	Often	Sometime	
Glucose	13	3	2	18
Lactic acid	2	1	5	8
Uric acid	3	1	1	5
Urea	3	2	1	6
Creatinine	2	2	0	4
Amylase	2	0	0	2
Na ⁺	14	3	2	19
K ⁺	15	3	2	20
Ca ²⁺	5	1	4	10
Mg ²⁺	1	0	2	3
Cl ⁻	12	2	2	16
NH ⁴⁺	1	1	4	6
O ₂	10	5	3	18
CO ₂	10	4	4	18
pH	10	8	3	21

(32 answerers)

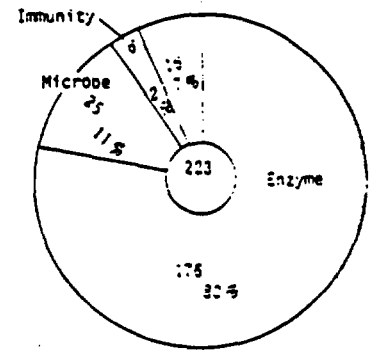

Fig. 14. The number of Japanese patents concerning biosensors.

4. R&D PROGRAMS OF CHEMICAL SENSORS IN GIRIO

Based on the results of needs and seeds analyses, a few targets were set up for humidity, gas, ion, and bio-sensors. The first target for humidity sensors, the operating temperature above 200°C, is mainly for the application to combustion exhaust gases. The second target for linearity of signal output is for the simple signal processing in monitoring process gases and air conditioning. As for gas sensors, selectivity to CO is not only one of the largest practical requests but also the most rewarding fundamental research subject. Low temperature operation is also attempted for the future combination with silicon devices. In ion sensors, extension of measurable ions to heavy metal ions and organic acids and miniaturization through ISFET are two main targets. Lastly for biosensors, proteins in blood and K⁺, Na⁺, Ca²⁺, Cl⁻ ions in body fluid are targeted together with multi-enzyme electrodes.

4.1 Humidity Sensors

A glassy material composed of $V_2O_5-TeO_2-Li_2O + Ag_2O-K_2O[20]$ was exploited for a humidity sensor which could be operated at above $200^\circ C$. The main component $V_2O_5-TeO_2$ is one of electrically conductive glasses, to which Li_2O was added to provide moisture sensitivity. The addition of Ag_2O was to reduce the electrical resistivity. The role of K_2O was to enhance the sensitivity to trace amount of moisture. The above compounds are mixed and ground well. To the fine powder urea was added and then it was pressed and calcined at $300-350^\circ C$. The addition of urea made the sintered elements macro-porous to facilitate the diffusion of water molecules into the inside of the elements.

The material without K_2O can be used as a dew point sensor for VTR heads and the rear windows of automobiles. Figure 15 shows that the electrical resistance decreases only slightly until it sharply drops at a relative humidity around 90%. This sharp drop can be operated as an on-off switch which works at around a dew point.

On the other hand, if K_2O is added, the material turns to be sensitive to the whole range of humidity as shown in Fig. 16. The resistance change of two order of magnitude can be obtained for a

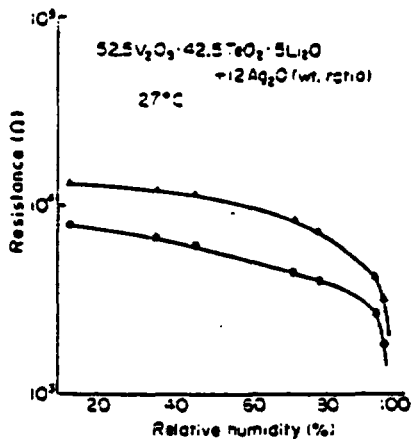

Fig. 15. Response curves of glassy sintered elements for dew point sensors.

▲ : comb-like electrodes.
● : embedded electrodes.

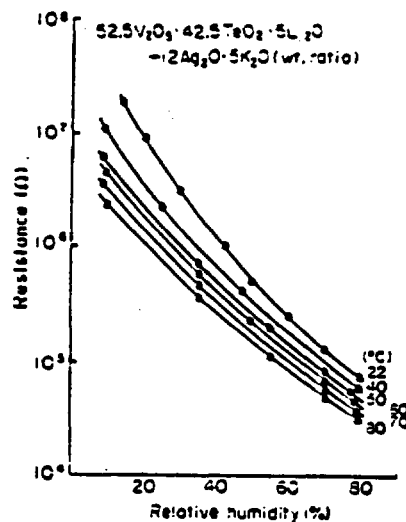

Fig. 16. Response curves of glassy sintered elements for the whole range humidity sensors.

relative humidity variation from 10 to 70 %. The response was also sufficiently rapid that the steady-state signal values toward increased humidity could be reached within 30 seconds and toward decreasing humidity within 60 seconds. It was also confirmed that this sintered glassy material could respond to a small change of moisture from 16 ppm to 31 ppm at least up to 230°C. Another type of humidity sensitive material mainly composed of P_2O_5 and potassium titanate whisker was also developed[21].

In the second line of approach to the development of humidity sensors with linear response, the techniques of solid polymer electrolyte(SPE) water electrolysis[22] have been applied. Figure 17 shows the structure of SPE amperometric humidity sensor. Noble metals of 2-4mg/cm² are chemically deposited on both sides[23]. When a potential over 3V is applied between the two electrodes, the observed

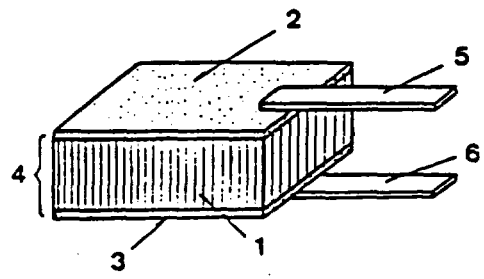

Fig. 17. Structure of SPE amperometric humidity sensor
 1: Solid polymer electrolyte, 2,3: Electrode,
 4: SPE-electrode composite, 5,6: Lead.

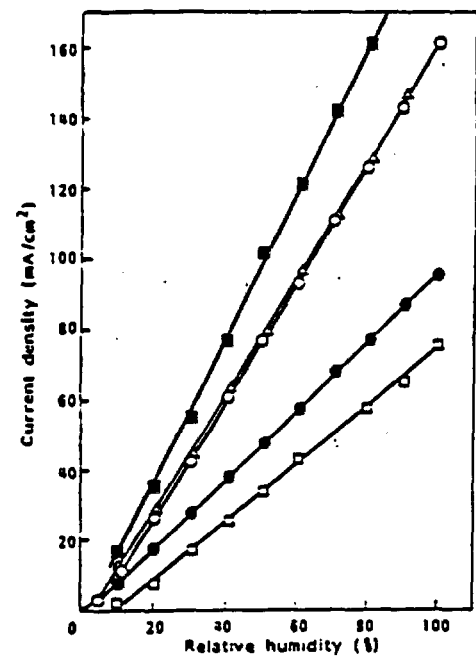

Fig. 18. Response curves of SPE amperometric humidity sensors at 30°C and 3.5V.

Δ: Pt/Nafion120/Rh (0.1cm²), ○: Rh/Nafion117/Rh (0.1cm²), ●: Rh/Nafion117/Rh (0.25cm²), □: Pt/Nafion125/Ir (0.25cm²), ■: Ir/Nafion125/Pt (0.1cm²).

current is proportional to the amount of water decomposed, which is again in proportion to the concentration of water in a gas stream. This amperometric sensors exhibited perfectly linear responses in the whole range of relative humidity as shown in Fig. 18. As monometallic electrode catalysts Rh, Ir, and Pt were found to be preferable owing to their corrosion resistivity.

4.2 Gas Sensors

There are two types of CO sensors commercially available. Semiconductive SnO_2 catalyzed by Pd needs periodical heat flashing to sweep out CO adsorbed at a low temperature[24]. Electrochemical CO sensors are not compact and are troublesome in maintenance[25]. Therefore, new sensing materials were exploited for the development of highly selective CO gas sensors which could hopefully be operated at low temperatures for the future combination with silicon devices.

The material newly developed was a novel gold catalyst which exhibited an extremely high activity for the oxidation of CO at low temperatures[26-30]. Figure 19 shows TEM photographs of the gold catalyst prepared by calcination of Au-Fe coprecipitate in air at 400°C . The gold loading is about 13wt%, which corresponds to an atomic ratio of $\text{Au/Fe} = 1/19$. Very fine gold particles are homogeneously dispersed with a mean diameter of 4.1nm and a standard deviation of 36%. These gold particles are not spherical but hemispherical in shape and are contacted at their flat planes with $\alpha\text{-Fe}_2\text{O}_3$ (hematite) exhibiting a specific crystal orientation of Au (111) plane toward the (110) plane of hematite. This epitaxial-like growth of gold particles makes them very stable against heating and reduction-oxidation treatments.

The catalytic properties of the $\text{Au}/\alpha\text{-Fe}_2\text{O}_3$ are very unique compared with those of single oxides and gold powder itself (Fig. 20). Over gold powder, CO oxidation takes place at much higher temperature than hydrogen oxidation. The same nature can be seen for Pd supported on Al_2O_3 . On the other hand, on almost all the metal oxides, the oxidation of CO occurs at lower temperatures as typically shown by $\alpha\text{-Fe}_2\text{O}_3$. The coprecipitated gold catalyst is so active that it can catalyze the oxidation of CO even at -70°C and has similar nature to

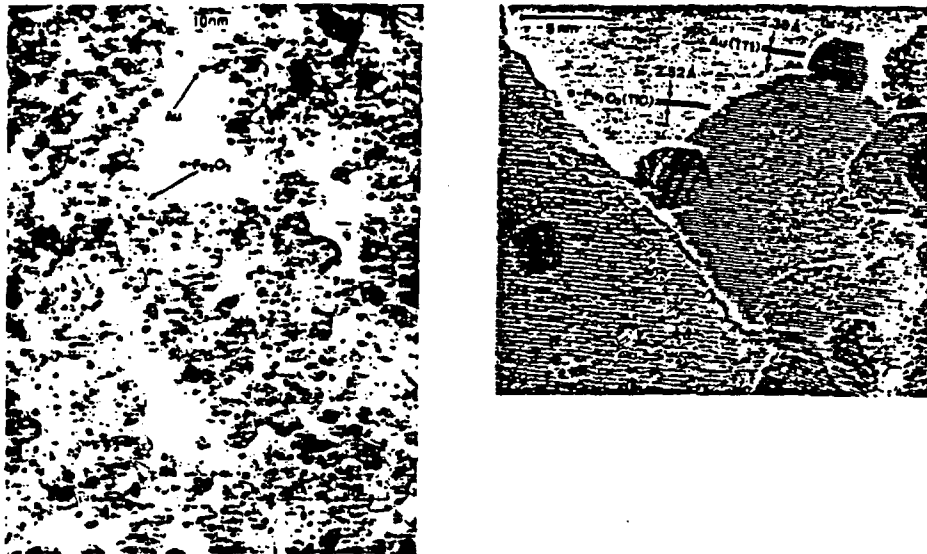

Fig. 19. TEM photographs of Au/ α -Fe₂O₃ catalyst calcined at 400°C.

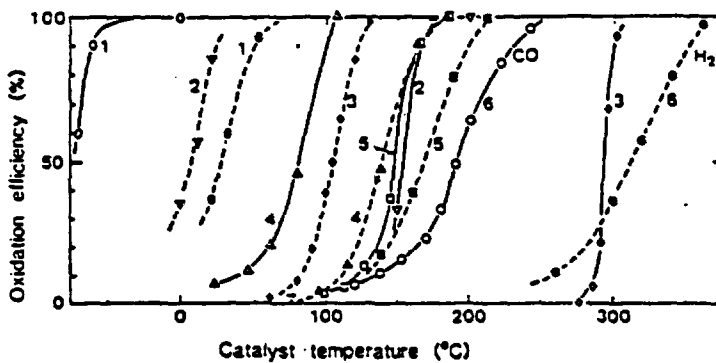

Fig. 20. Catalytic oxidation of H₂ and CO over various metals and metal oxides.

- : H₂ oxidation — : CO oxidation
- 1: Au/ α -Fe₂O₃(Au/Fe=1/19, coprecipitation, 400°C)
- 2: 0.5 wt% Pd/Al₂O₃ (impregnation, 300°C)
- 3: Au fine powder
- 4: Co₃O₄ (carbonate, 400°C)
- 5: NiO (hydrate, 400°C)
- 6: α -Fe₂O₃ (hydrate, 400°C).

Reaction conditions: catalysts 42-70 meshes, H₂ or CO 1 vol% in air, space velocity=2×10⁴ h⁻¹ ml/g

those of transition metal oxides. In addition, the catalytic activity for the oxidation of CO is not depressed but is enhanced by moisture.

In order to make hematite really n-type semiconducting to reduce electrical resistance, Ti^{4+} ion was doped at a concentration of 3 atom% ($Ti/Ti+Fe$)[31]. The thick film sensor devices were prepared by painting the paste of semiconducting materials calcined at $400^{\circ}C$ on an alumina substrate with comb-shaped gold electrodes and then by calcining in air at $600^{\circ}C$. The electrical resistivity (R) was measured in a synthesized air moistened at a relative humidity of 65%.

Figure 21 shows the sensitivities expressed by the ratios of R_{air} to R_{gas} to CO, H_2 , and EtOH as a function of device temperature. Without gold, Ti^{4+} doped hematite exhibited only small sensitivities to CO and H_2 even at temperatures above $150^{\circ}C$. Only EtOH was detected with high sensitivity, which was one of the common features of metal oxide semiconductor gas sensors. With finely dispersed gold, temperatures at maximum sensitivities shift by about $100^{\circ}C$ toward lower temperatures for H_2 and EtOH. For CO, much larger shift was observed and an appreciably high sensitivity over 30 could be obtained at a device temperature below $50^{\circ}C$.

The logarithmic plots of both sensitivities and concentrations yield straight lines. Figure 22 shows that at $40^{\circ}C$ 20 ppm CO can be detected with the same sensitivity as that to 1000ppm EtOH and with much larger sensitivity than that to 1000 ppm H_2 . Furthermore, the slope for CO is larger than the other two showing higher resolution for CO.

In the next step, an attempt was made to develop an optical gas sensor with a structure schematically represented in Fig. 23[32]. The fiber optic temperature sensor under a thin film oxidation catalyst detects a temperature increase due to the oxidation of CO over the catalyst surface. Since highly dispersed gold catalyst will possibly have high absorbability of infrared light and be readily warmed as a commercial infrared light sensor using evaporated gold thin film does, the surface of the gold catalyst can be kept clean from moisture and other adsorptive gases.

Optical chemical sensors are advantageous over the conventional electricity-based sensors in that they are free from the interference by electromagnetic noise and the danger of inducing gas explosion and

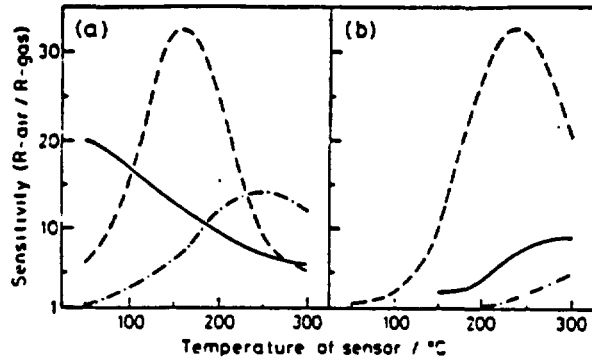

Fig. 21. Sensitivities of thick film semiconductors as a function of operating temperature. (a) Au/ α -Fe₂O₃(Ti⁴⁺), (b) α -Fe₂O₃(Ti⁴⁺)
 —, 300 ppm CO; ---, 50 ppm EtOH; - · - · -, 300 ppm H₂.

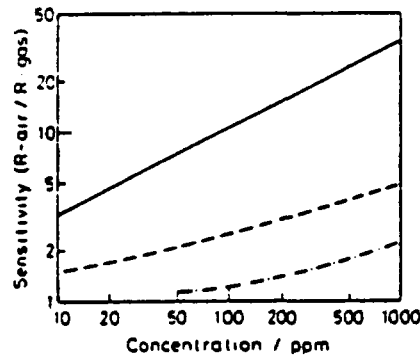

Fig. 22. Sensitivities of thick film Au/ α -Fe₂O₃(Ti⁴⁺) sensor at 40°C as a function of gas concentration.
 —, CO; ---, EtOH; - · - · -, H₂.

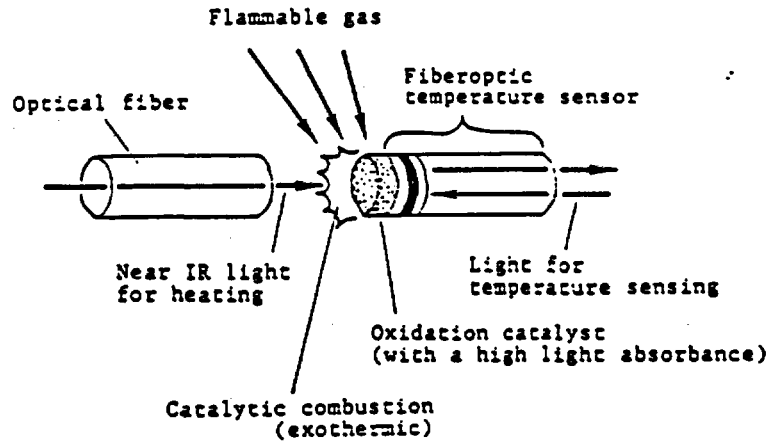

Fig. 23. Structure of optical gas sensor with thin catalytic film.

that they are capable of the control at remote location and of the direct linkage with an optical information system.

A film of 0.5 μ m thick composed of α -Fe₂O₃ with highly dispersed Au was prepared by simultaneous sputtering. The pillar-structured thin film obtained was still less active than the thick film prepared from the paste of coprecipitated powder, however, it was sufficiently active at temperatures around 150°C. The preparation of thin film gold catalysts in connection with their optical properties is under study.

4.3 Ion Sensors

The first line of approach to the development of new ion sensors was the utilization of a natural lacquer, Urushi as a matrix material of ion sensitive membranes. Urushi is an oriental natural lacquer used extensively for Japanese lacquer-wares[33] and has excellent durability and mechanical strength. Many ion-selective electrodes for iodide[34], perchlorate[35], nitrate[36] and thiocyanate[37] ions have already been developed using Urushi at GIRIO. The second line of approach was the application of FET to the fabrication of miniaturized ion sensors.

Selenocyanate ion selective electrodes were prepared from tri-n-octylmethylammonium selenocyanate ion-exchanger and Urushi[38]. Figure 24 shows that linear potential-concentration curves with a slope of 60mV per decade were obtained within the concentration range of 10⁻¹-10⁻⁵mol/l selenocyanate for the membranes composed of ion-exchanger at 45-50wt%. The static response time was less than 30 seconds. The electrode exhibited constant potential within the pH range 2-10 and good selectivity except for a few cases. Figure 25 shows selectivity coefficients, K_{ij} in the Nernstian equation $E = E^{\circ} + [(2.303RT)/zF] \log(a_i + K_{ij}a_j)$.

As the first step for the miniaturization, a coated wire electrode was linked to the gate lead-wire of a conventional field effect transistor[39]. This coated lead-wire ion sensitive FET(CLISFET) was prepared by using even weight of selenocyanate ion-exchanger and Urushi. A linear response was obtained in the range of 10⁻² to 10⁻⁵mol/l selenocyanate.

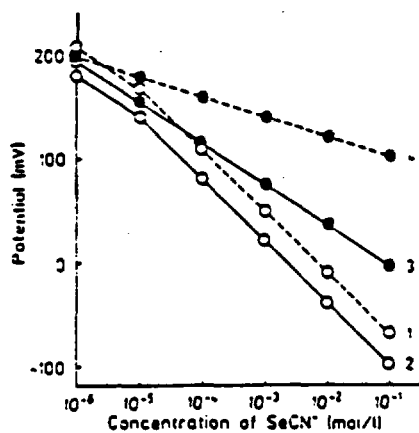

Fig. 24. Potential-concentration curves of selenocyanate-selective electrodes: wt% of ion-exchanger: (1) 30; (2) 45; (3) 40; (4) 35

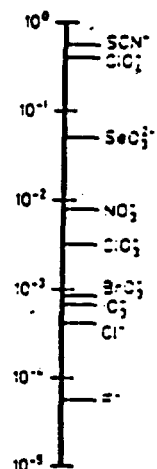

Fig. 25. Selectivity coefficients.

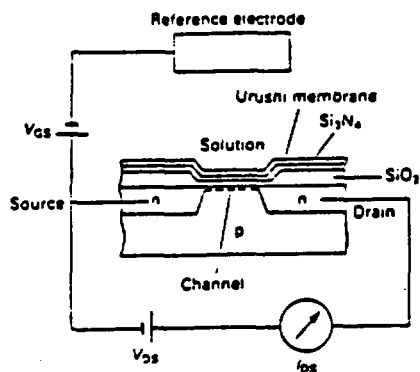

Fig. 26. Measuring circuit of Urushi ISFET.

A selenocyanate ion sensitive FET (ISFET) was fabricated by coating a mixture of selenocyanate ion-exchanger(45%) and Urushi(55%) directly on the gate of a FET device with a size of 0.5mm x 6.5mm[40]. The FET device was water resistive owing to Si₃N₄ coating. Figure 26 shows the measuring circuit of Urushi ISFET. A linear response was also obtained in the range of 10⁻¹-10⁻⁵ mol/l. The selectivity coefficients

and other characteristics of the above two FET sensors were almost the same as those of the ion selective electrode.

A chemically modified CLISFET for silver ion was prepared using silver-7,7,8,8-tetracyanoquinodimethane anion radical(Ag-TCNQ⁻) film formed by dipping the wire in the TCNQ dry acetonitrile solution[41]. A CLISFET for copper(II)ion was also developed by using Cu-TCNQ⁻ film[42]. These sensors showed linear responses to the concentration of their respective ions in the range of 10⁻¹ to 10⁻⁵ mol/l with Nernstian slopes.

New ISFET sensors using silica on sapphire(SOS) wafer are under development for the detection of copper(II) ion and gluconic acid.

4.4 Biosensors

As a typical ion sensor useful for clinical monitoring a K^+ CLISFET was fabricated by using valinomycin as an ion-sensing material

and Urushi as a membrane matrix[43]. Figure 27 shows a linear response in the range of 1 to 10^{-5} mol/l of potassium ion. Sodium ion interferes slightly. However, rubidium ion terribly interferes by yielding a drain-source current as large as potassium ion does at the same concentration, which is also a constraint on commercial potassium ion selective electrodes.

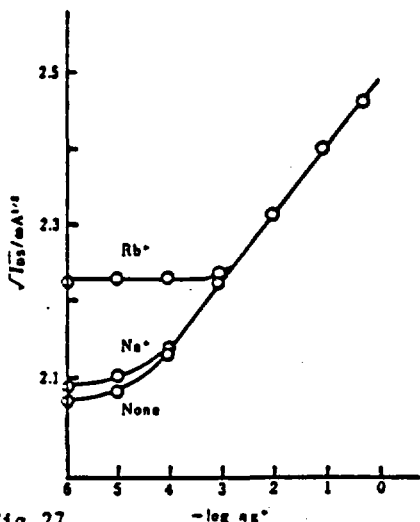

Fig.27. Response of CLISFET with 10^{-3} mol dm^{-3} interfering ion. $V_{DS}=0V$, $V_{GS}=3V$

Among the biosensors using biological materials for sensing, enzyme-based ones are the most successfully developed and becoming popular. More than 90 analytes can be detected with

various enzyme electrodes, eleven of which were commercially available until 1985. Multi-data processing has become very important for the measurement of multi-component systems. An auto-calibration system with a multiplexer was developed for detecting simultaneously more than two components in an attempt to apply to freshness and taste sensors in the future[44].

Compared with the enzyme-based biosensors, immunosensors still have the problem how to transduce efficiently the antigen-antibody binding into a processable signal, because antibodies merely attach to their analytes.

An attempt was made at GIRIO to develop a direct amperometric immunosensor[45]. In body fluid, the antigen-antibody bindings are transduced into the enzymatic reactions of complements, which consist of the cascading enzymatic systems of serin proteases and some regulator proteins. Terminal reaction of this cascade is the

formation of membrane attack complex, which is a channel of 11 nm in diameter, in the cell membranes or artificial lipid bilayers. Lipid membranes containing some hapten ligand, which were complete insulators, were formed in the filter and attached to the end of electrode. The membranes become conductive in proportion to the degree of the immunological reactions induced by the addition of anti-serum sample. The conductivity change is measured by an usual amplification apparatus.

This detecting system, an unlabeled method named by us "Complement-mediated Amperometric Immunosensor(CAIS)", is highly sensitive up to sub-nanomolar concentration, easy-handled, and free from background noise caused by non-specific protein adsorption. This is applicable to the detection of both immuno-assay and complement assay.

5. CONCLUSION

Research on chemical sensors at GIRIO has been initiated as a practical subject of surface science and at the same time as one of the attempts to explore new functional surface materials. The social needs to chemical sensors were gathered through the questionnaire survey. The analyses of the answers led to the establishment of self-consistent and efficient strategy for the R&D of humidity, gas, ion, and bio-sensors. Through the exploitation of new sensing materials and the application of material technology already accumulated in different lines of research, several new chemical sensors were successfully developed.

The above experiences concerning the methodology for making R&D programs of chemical sensors led us to the following conclusions.

- 1) Needs-orientated programs are particularly important for the R&D of chemical sensors. It has been often the case that necessity is the mother of invention of chemical sensors.
- 2) Needs to chemical sensors should be properly translated into the required properties represented by the three Ss, namely, sensitivities, selectivities, and stabilities.
- 3) Seeds of chemical sensors, namely, sensing materials and transducing devices should be synergetically combined so as to

fulfill the requirements to chemical sensors.

- 4) Liaison between universities, national laboratories, and industries will be the key for the efficient program making and successful accomplishment. Scientists in university laboratories and engineers in industries are expected to be good sensors to needs and seeds, respectively. Those who work for national laboratories like GIRIO will have to be good transducers for seeds to needs, and vice versa.

Acknowledgment. We thank Dr. Nakane, former director of material chemistry department, GIRIO for his guidance and support throughout the research. We also thank Mr. S. Wakida and Dr. T. Kobayashi for their significant contribution to the R&D work on ion sensors and gas sensors, respectively.

REFERENCES

1. Clifford P. K., Proc. 1st Intern. Meet. Chem. Sensors, Fukuoka, 1983, pp. 135-146.
2. Janata J., Proc. 2nd Intern. Meet. Chem. Sensors, Bordeaux, 1986, pp. 25-31.
3. Vetelino J. F., Lade R., Falconer R. S., *ibid*, pp.688-691.
4. Jarvis N. L., Lint J., Snow A. W., and Wohltjen H., "Fundamentals and Applications of Chemical Sensors" ACS Sym. Series 309, Schuetzle D. and Hammerle R. eds., Washington DC, 1986, pp.309-319.
5. Ross J. F. and Roberts G. G., Proc 2nd Intern. Meet. Chem. Sensors, Bordeaux, 1986, pp.704-707.
6. Beitnes H. and Schroder K., *Anal. Chim. Acta* 158, 57-65(1984).
7. Guilbault G. G., Proc. 1st Intern. Meet. Chem. Sensors, Fukuoka, 1983, pp. 637-643.
8. Carpenter M. K., Van Ryswyk H., and Ellis A. B., *Langmuir* 1, 605-607(1985).
9. *Chem. Engng. News*, April 27, 1987, p. 48.
10. Narayanaswamy R. and Sevilla III F., *J. Phys. E: Sci. Instrum.* 21, 10-17(1988).
11. Hijikikawa M., Proc. 2nd. Intern. Meet. Chem. Sensors, Bordeaux, 1986, pp. 101-108.
12. Lundström I., Armgarth M., Spetz A., and Winqvist F., *ibid*,

31. Kobayashi T., Haruta M., Sano H., and Nakane M., *Sensors and Actuators* 13, 339-349(1988).
32. Kobayashi T. and Haruta M., *Koatsu Gasu(J. High Pressure Gas Safety Inst. of Jpn.)* 24, 684-686(1987).
33. "Encyclopaedia Chimica", Vol.1, Kyoritsu Pub. Co., Tokyo, p.807 (1960).
34. Hiiro K., Tanaka T., and Kawahara A., *Bunseki Kagaku* 25, 653-654 (1976).
35. Hiiro K., Kawahara A., and Tanaka T., *Anal. Chim. Acta* 110, 321-324(1979).
36. Hiiro K., Kawahara A., and Tanaka T., *Bull. Chem. Soc. Jpn.* 46, 1447-1452(1980).
37. Hiiro K., Kawahara A., and Tanaka T., *Bunseki Kagaku* 31, E33-E39 (1982).
38. Hiiro K., Wakida S., Tanaka T., Kawahara A., and Yamane M., *Fresenius Z. Anal. Chem.* 326, 362-364(1987).
39. Wakida S., Tanaka T., Kawahara A., and Hiiro K., *Bull. GIRIO* 37, 36-39(1986).
40. Wakida S., Tanaka T., Kawahara A., Yamane M., and Hiiro K., *Analyst* 111, 795-797(1986).
41. Wakida S. and Ujihira Y., *Anal. Sci.* 2, 231-233(1986).
42. Wakida S. and Ujihira Y., *Jpn. J. Appl. Phys.* 27, 68-70(1988).
43. Wakida S., Tanaka T., Kawahara A., and Hiiro K., *Bunseki Kagaku* 33, 556-560(1984).
44. Ishikawa T., *Jpn. Pat.(claimed)* 62-002674(1987).
45. Yoshikawa S., Fukumura H., and Hayashi K., *Proc. 56th Annual Meet. Chem. Soc. Jpn., I*, p559(1988).

pp.387-390.

13. Dobos K., Krey D., and Zimmer. G., Proc. 1st Intern. Meet. Chem. Sensors, Fukuoka, 1983, pp. 464-467.
14. Lefevre C., Lacombe P., Bayre JI., and Chauvet F., Proc. 2nd Intern. Meet. Chem. Sensors, Bordeaux, 1986, pp. 427-430.
15. Shoji S., Esashi M., Matsuo T., Denki Tsushin Gakkai Ronbunshi (Bull. Electro-communication Society of Jpn.) 1, J68-C, 475(1985).
16. Sohn B., Lee D., and Lee J., Proc. 2nd Intern. Meet. Chem. Sensors, Bordeaux, 1986, pp. 411-414.
17. Kuriyama T., Nakamoto S., Kawana Y., and Kimura J., *ibid*, pp. 568-571.
18. "A Report of the Survey of Chemical Sensors"(Japanese), Ikeda, 1983, Government Industrial Research Institute of Osaka.
19. "A Report of the Survey of Development and Application of Biosensors", Osaka, 1986, Osaka Science and Technology Center.
20. Tanigawa H., Sano H., and Matsumoto Y., Bull. GIRIO 38, 148-154 (1987).
21. Tanigawa H., Nakane M., and Onishi S., Bull. GIRIO 37, 17-23 (1986).
22. Takenaka H., Torikai E., Kawami Y., Wakabayashi N., and Sakai T., Denki Kagaku(J. Electrochem. Soc. Jpn.) 53, 261-265(1985).
23. Takenaka H., Torikai E., and Kawami Y., Sensor Technology (Japanese) 4(5), 56-59(1984).
24. Murakami N., Proc. 5th Meet. Chem. Sensors Jpn., Tokyo, 1986, pp.53-54.
25. Yoneyama H. and Tamura H., Sensor Technology(Japanese) 2(13), 81-90(1982).
26. Haruta M., Kobayashi T., Sano H., and Yamada N., Chem. Lett., 405-408(1987).
27. Haruta M., Hyoumen Kagaku(Surface Science) 8, 407-414(1987).
28. Haruta M., Yamada N., Kobayashi T., and Iijima S., J. Catal., in press.
29. Haruta M., Kobayashi T., Iijima S., and Delannay F., Proc. 9th Intern. Cong. Catal., Calgary, 1988, pp. 1206-1213.
30. Haruta M., Kageyama H., Kamiyo N., Kobayashi T., and Delannay F., "Studies in Surface Science and Catalysis : Successful Design of Catalysts", Inui T. eds., Elsevier, Amsterdam, in press.

NEW TECHNOLOGY JAPAN

Vol.17 No.2 May, 1989

INNOVATIVE PRODUCTION NOW

Automotive Lighting Manufacturing Plant

TOPICS

*Shimane Prefecture's Exchange Groups between Different Trades
Development of Deep-Sea Submersible Shinkai 6500*

HIGH-TECH INFORMATION

*System for Efficient Treatment of Emulsifying Oil Wastewater
Technology for Coating Ceramic Materials on Metals
Water-Alcohol Separation with Hollow Fiber Membrane Module
Fabrication of Power Transistor in IC Form
Paulownia Saplings Cultured by Biotechnological Method*

NATIONAL R&D PROJECTS

*New Water Treatment System "Aqua-Renaissance '90 Project"
— From MITI's Large-Scale Project —*

FLASH

*Special-Purpose Calculator for Dietetic Treatment
Automatic Finger Sphygmomanometer*

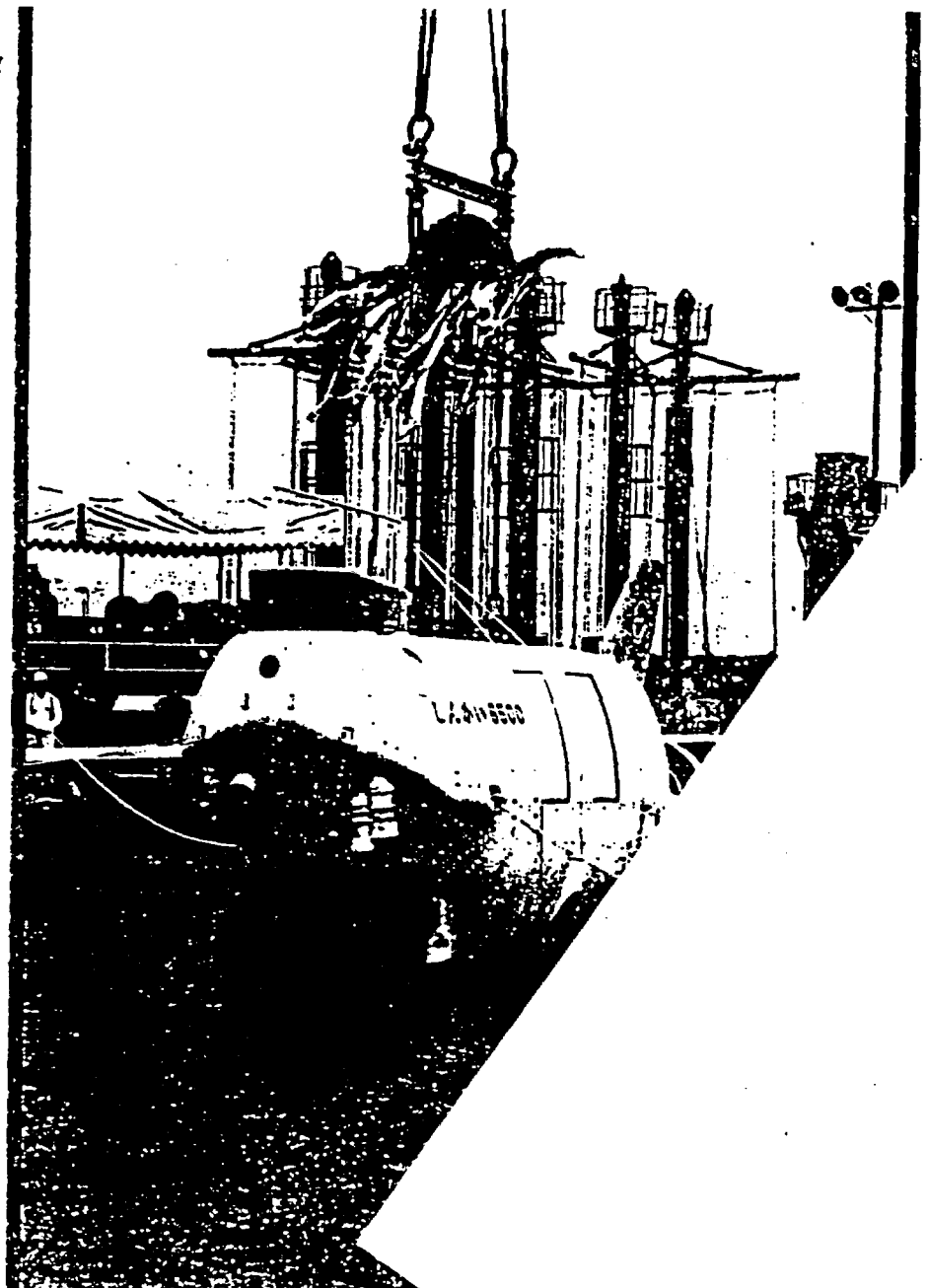

LETRO

NEW TECHNOLOGY & PRODUCTS

contact with coolant, losing their cooling effect, however. Hitachi Metals has conducted intensive research to develop a high rust-resistant stainless steel for molds. If lowering of the cooling effect due to rust can be prevented, plastic products will continue to harden promptly as they do while the molds are new and no rust is generated.

This enhances productivity, and plastic molding manufacturers will have less downtime for descaling.

• *Hitachi Metals, Ltd.*
Public Relations President's Office
1-2, Marunouchi 2-chome, Chiyoda-ku,
Tokyo
Tel: 03-284-4552 Telex: HITAMET J
24494

Since the capsule wall is porous, the encapsulated substance is released gradually, so the capsule can be used for purposes other than those for conventional microcapsules. Research is in progress by the private sector to use the microcapsule for controlled-release pharmaceuticals, such as powder deodorant and organic phosphorous medicines over a period of time, as a filler for functional sheets and films, and as a base material for cosmetics.

• *Government Industrial Research Institute, Osaka, the Agency of Industrial Science and Technology*
8-31, Midorigaoka 1-chome, Ikeda City, Osaka
Tel: 0727-51-8351

89-5-002-381

Inorganic Microcapsule

The Government Industrial Research Institute, Osaka, has developed an inorganic microcapsule manufactured by the interface reaction process and it is being produced commercially by Suzuki Yushi Industrial Co., Ltd.

This microcapsule consists of a powder and has a diameter of from several to several dozen micrometers. Uses of conventional microcapsules are limited because their wall material is an organic substance having little resistance to heat, water, and solvents. In the manufacturing process, they are mutually agglomerated or adhere to production machinery which significantly reduces production yield.

The wall material of the new microcapsule is inorganic, such as calcium carbonate or iron oxide, so it has excellent resistance to water, heat, and chemicals. Being harmless, it eliminates the toxicity problem of conventional chemicals for forming capsule walls. As a result, it can be used as a base material for manufacturing cosmetics and pharmaceuticals.

In the interface reaction process, an emulsion of oil and an aqueous solution is used when precipitating the powder particles and for forming hollow spherical particles. Dispersing the substance to be encapsulated in the aqueous solution for a while causes it to be encapsulated in the microcapsules.

89-5-002-382

Garments Made of New Endothermic, Heat-Storage Fiber

Unitika, Ltd. and Descente, Ltd. have jointly developed a new endothermic, heat-storage fiber, called Solar α , and using this fiber, Unitika has begun producing a new line of garments including winter work clothing and healthcare apparel for senile persons. Solar α was used for producing skiwear for use in the Calgary Olympic Games. These sold very well, so the company has trebled production of sportswear: autumn and winter apparel, including winter work clothing; and healthcare apparel for senile persons.

Solar α is a double-layer solar fiber consisting of a core and a sheath, with zirconium carbide incorporated in the core layer. Zirconium carbide absorbs visible light rays and reflects infrared rays, so shortwave energy of less than $2 \mu\text{m}$, which comprises 95% of sunlight, is efficiently absorbed for conversion into heat and storage in the fiber. Since the fiber reflects longwave heat equivalent to infrared rays of over $2 \mu\text{m}$, it increases heat retention by preventing the infrared rays (roughly $10 \mu\text{m}$) generated by the human body from being dissipated outside.

Initially, the companies tried coating zirconium carbide on the fiber, but the substance's tremendous hardness prevented spinning of the treated fiber. Subsequent research led to the devel-



Solar α Skiwear

opment of a core-sheath fiber whose endothermic and heat storage effects were fully proved at the Calgary Olympic Games, leading to brisk sales of skiwear.

Based on these results, Unitika began mass production of various autumn and winter apparel and *kotatsu* (foot warmer) coverlets.

• *Unitika, Ltd.*
Public Relations Section
4-4, Nihonbashi Muromachi 3-chome,
Chuo-ku, Tokyo
Tel: 03-246-7536 Telex: J23503

89-5-002-383

New High-Performance Polystyrene

Asahi Chemical Industry Co., Ltd. has developed two new types of high-performance polystyrene (PS) having superlative strength and luster.

One of these, general-purpose polystyrene (GPPS), has a high molecular weight and can be formed into large objects. The other, high-impact polystyrene (HIPS), is mixed with rubber and has a remarkable luster and superlative impact strength. Both are characterized by performances comparable to those of conventional high-performance resins such as acrylonitrile styrene (AS) and acrylonitrile butadiene styrene (ABS). The com-

通商産業省 工業技術院

大阪工業技術試験所

GOVERNMENT INDUSTRIAL RESEARCH INSTITUTE, OSAKA
 AGENCY OF INDUSTRIAL SCIENCE AND TECHNOLOGY
 MINISTRY OF INTERNATIONAL TRADE AND INDUSTRY

研究概要

当所は新材料の開発とこれに関連する計測技術の確立を目標に研究を行っている。研究は各研究者の創意により、基礎的な問題を取扱う経常研究とこれを基盤として組立てられる特別研究に大別される。更に国民経済上重要かつ緊急に必要とされ昭和41年度から発足した大型工業技術研究開発(大型プロジェクト)、エネルギーの長期的な安定供給を図るために昭和49年度から発足した新エネルギー技術研究開発(サンシャイン計画)、昭和53年度から発足した省エネルギー技術研究開発(ムーンライト計画)、また昭和56年度に発足した次世代産業基盤技術研究開発制度、昭和63年度から医療福祉機器技術研究開発、平成元年度から重要地域技術研究開発、更に平成2年度から地球環境技術研究開発に参加して種々の技術の研究開発を行っている。

Outline of Researches

Research and Development on New Materials and Measurement Technology

Ordinary Research and Development

Special Research and Development

National R & D Program

Research and Development on New Energy Technology,

Research and Development on Energy Conservation Technology

Research and Development Project of Basic Technologies for Future Industries

National R & D Programs for Medical and Welfare Apparatus

Specific Regional Technology Development System

Global Environment Project

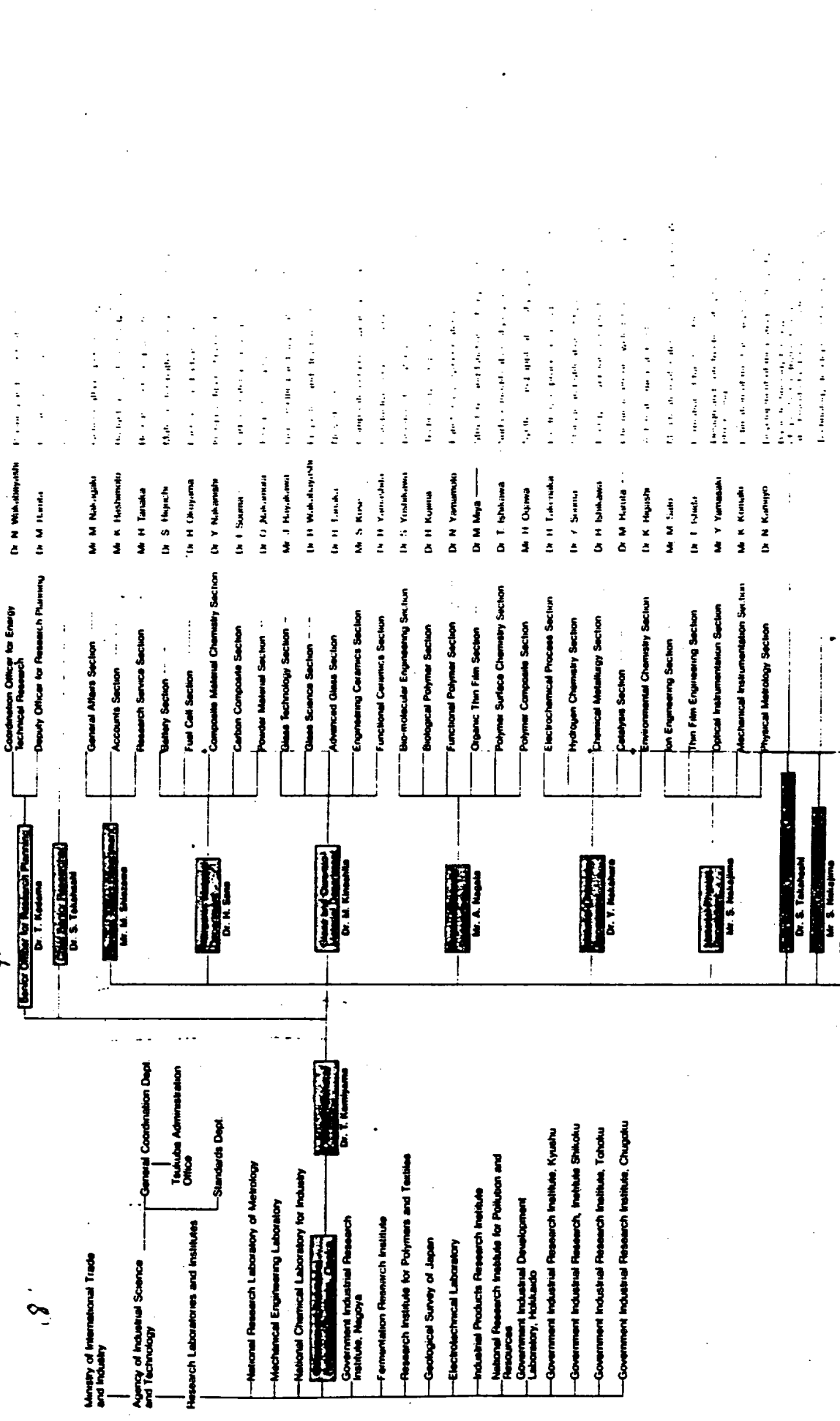

予算・人員 Budget/Personnel

■平成2年度予算額 (単位：百万円)

Budget for Fiscal Year 1990

内 訳 Item	金額 Account
試験研究費 Research expenses	1,029
人件費 Personnel expenses	1,541
合 計 Total	2,570

■職 員

Personnel

定員 Permanent staff	219名
研究職* Research officials*	168名
行政職 Administrative officials	51名

*指定職を含む including Director-General

■試験研究費内訳

Research Expenses

平成2年度試験研究費内訳

Breakdown of Research Expenses in 1990

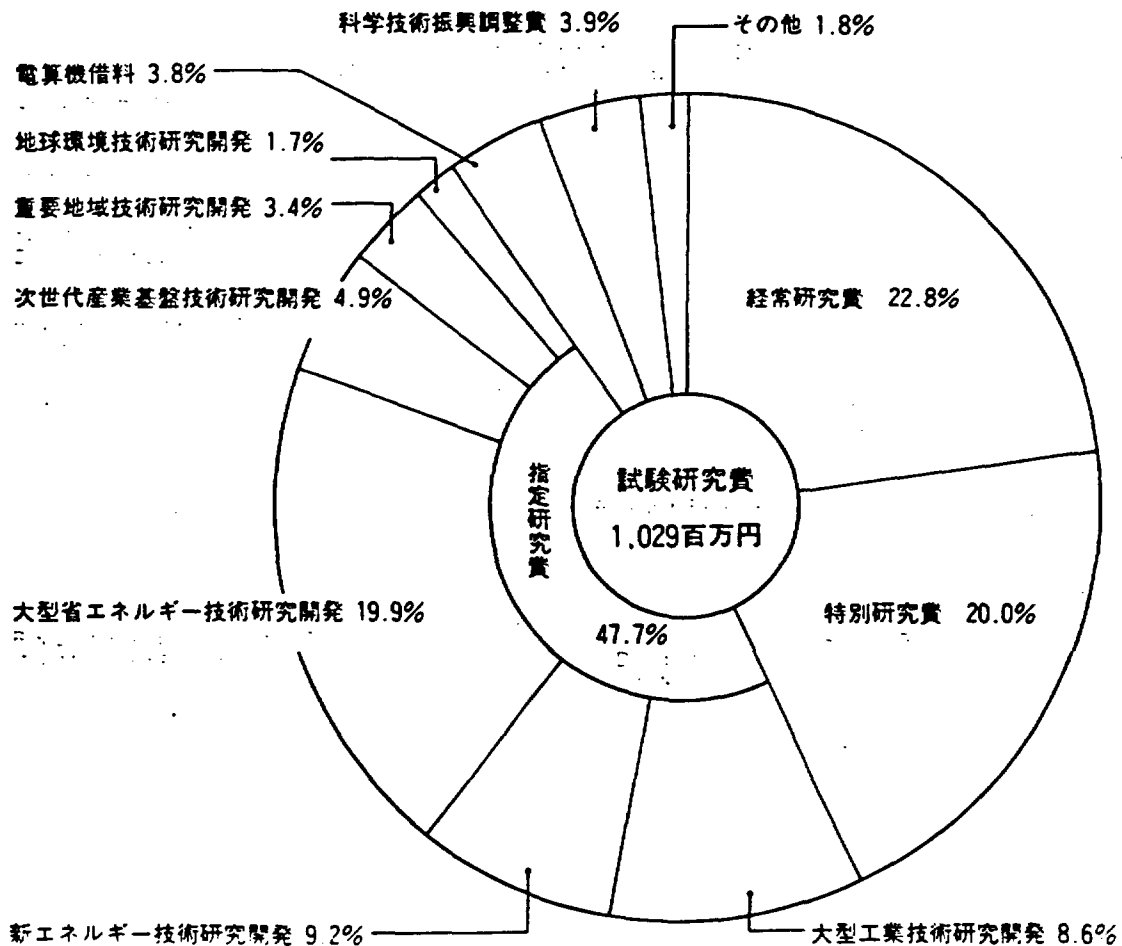

平成2年度研究課題

List of Research Project in FY 1990

特別研究

■計測・標準技術

高性能複合材料の強度評価技術に関する研究

1. 機械的特性値評価法の研究
2. 加速寿命試験法の研究

■新材料技術

ウイスキー複合セラミックスの構造制御に関する研究

1. ウイスキー複合セラミックスの作製
2. 複合セラミックスの微構造と靱性

屈折率変化型記録材料に関する研究

1. 単一波長光応型材料の研究
2. 二波長光応型材料の研究

複合化機能性セラミックスの界面伝導特性制御に関する研究

1. 微細構造制御の研究
2. 導電機構の研究

ハロゲン化物ガラスの光学特性制御に関する研究

1. 光学特性の研究
2. 成形性研究

センシング能をもつ分子複合系に関する研究

1. 分子認識型バイオセンサーの創製技術の研究

イオン伝導性ガラス薄膜の調製技術に関する研究

1. イオン伝導性ガラス薄膜の調製技術の研究
2. ガラス薄膜の特性評価技術の研究

高性能透明セラミック薄膜製造技術に関する研究

1. 精密制御薄膜製造技術の開発

黒鉛複層層間化合物の合成に関する研究

1. 合成法の研究
2. 機能開発の研究

■反応・分離技術

微粒子・薄膜を利用した触媒設計技術に関する研究

1. 微粒子設計の研究
2. 薄膜技術による固体表面の構造及び機能設計の研究
3. 触媒表面のキャラクタリゼーション

■産業基盤確立技術

X線光学素子の高度化に関する研究

■原子力平和利用技術

ガラス固化体の浸出挙動に関するナチュラル・アナログ研究

1. ガラス固化体の化学的安定性研究
2. 天然ガラス等の実験室環境における浸食の研究

■公害防止技術

有害排出物処理材の開発に関する研究

1. 無機質マイクロカプセル化吸着材の開発

難分解性有害有機化学物質の触媒酸化分解に関する研究

1. 固体触媒湿式酸化用触媒の開発

■国際特定共同研究事業

オプティカルマイクロガスセンサに関する研究

■官民連携共同研究

炭素及び炭素系ハイブリッド複合材料の物理特性の評価・向上技術に関する研究

SPECIAL RESEARCH

Measurement and Standardization Technology

Research on evaluation and standardization of mechanical properties of composite materials

1. Evaluation technology of mechanical strength
2. Evaluation technology of accelerated durability test

New Material Technology

Research on structure controls of composite ceramics containing whiskers

1. Preparation of composite ceramics containing whiskers
2. Microstructure and mechanical properties of composite ceramics

Research on photochemically refractive-index recording materials

1. Single-photon sensitive materials
2. Two-photon sensitive materials

Control of interfacial conduction in ceramic composites

1. Microstructure control
2. Conduction mechanism

Research on optical property refinement of halide glasses

1. Optical properties of glasses
2. Forming properties of glasses

Research on molecular complexes with sensing ability

1. Molecular-recognition type biosensor

Research on preparation technology of ion-conducting glass thin films

1. Preparation of ion-conducting glass thin films
2. Characterization of glass thin films

Research on preparation of optoelectronic transparent ceramic film

1. Preparation and evaluation of film
2. Evaluation and application of film

Studies on synthesis and reaction of intercalation compounds

1. Studies of synthesis methods
2. Studies of intercalation

Reaction and Separation Technology

Research on chemical catalysts based on transition metal complexes

Research on catalytic oxidation of refractory organic substances

Technology for Establishment of Industrial Foundation

Design and fabrication of silica components for X-ray

Technology for Peaceful Use of Atomic Energy

Research on natural analogues for leaching behavior of nuclear waste glass forms

1. Chemical stability of glass forms
2. Burial site simulation in laboratory environments

Anti-pollution Technology

Research on non-pollutative materials for treatment of hazardous waste

1. Design and synthesis of activated adsorbents

Research on catalytic oxidation of refractory organic substances

1. Development of solid catalyst for wet oxidation

Specific International Joint Research Projects

Research on optical sensors for gases

Joint Government-Private Sector Research

Study on evaluation and improvement of carbon materials and their application to catalysis

経常研究

重点研究

- 炭素繊維の改質による強化用耐熱繊維の研究
- 真空プラズマ溶射によるセラミック成膜技術の研究
- 着衣模擬装置による快適性衣服の測定法の標準化
- 生分解性高分子材料の基礎的研究
- 高分子系複合材料の界面特性の研究
- 固体高分子電解質を用いたオゾン生成法における電極材料の研究
- プラスチックの特性値の基準値決定方法の研究
- 目波による非破壊試験法の研究

一般研究

- 二次電池の総合的性能評価法の調査研究
- 二次電池用電極材料の基礎的研究
- 新型固体電解質型燃料電池の材料の研究
- 複合化炭素材料の研究
- 高輝度蛍光体の合成の研究
- 連続繊維強化複合セラミックスの研究
- 導電性セラミックスの基礎的研究
- 耐フッ素材料の研究
- セラミック材料界面の基礎的研究
- ガラスの精密成形・加工技術の研究
- 光機能性ガラスの研究
- 光材料の屈折率温度係数の研究
- ペプチドを利用した分子工学の調査研究
- 有機高イオン伝導材料の研究
- アルコキシシラン加水分解シリカの有機修飾と複合効果の研究
- 有機強磁性材料の研究
- 浸透気化分離膜の研究
- 超伝導薄膜の製造技術の研究
- 地球環境保全のための水処理技術の研究
- 固体材料における酸素吸放出特性の研究
- イオンビーム技術による機能性表面設計の研究
- 光情報処理技術を用いたロボット・ビジョン技術の研究
- 光学的機能をもつ多層薄膜の作製技術の研究
- 非球面の高屈折率利用技術の研究

次世代産業基盤技術研究開発

- 石炭ガス化用セラミックタービンの要素評価等開発
 - 製品特性評価（耐摩耗性）
 - 製造プロセス技術（靱性強化技術）
- 高電流・高磁界超電導材料評価
 - 製造プロセス技術
- 非線形光子材料の研究開発
 - 発現機構の解明及び評価技術開発

ORDINARY RESEARCH

Important Normal Research

- Studies on thermostable reinforcement from carbon fiber
- A study on the ceramic coating by low pressure plasma spraying
- Development of measurement of garment comfort with a wearability measurement system
- Study on the synthesis procedure of the polymer matrix compounds
- A study on the interface materials in composite materials using polymer electrolytes
- Determination of standard values of properties of plastics
- Non-destructive testing by acoustic wave

Normal Research

- Research on comprehensive evaluation of secondary batteries
- Fundamental research on electrode materials for secondary batteries
- Investigation into materials for advanced solid electrolyte fuel cells
- Study on composited carbon materials
- Study on synthesis of high efficient phosphors
- A study on continuous fiber reinforced ceramic matrix composite
- Electric conductive ceramics
- Fluorine resistant materials
- Theoretical study of interlayers in ceramic materials
- Study of high precision glass fabrication
- Study of the new functional optical glass
- Temperature coefficient of refractive index of optical materials
- Molecular design using peptides
- Research on organic material of high ionic conductivity
- The study on organic modification and filler effect of silica made from alkoxysilane
- Research on organic ferromagnetic compounds
- Research on membrane for pervaporation
- Study on fabrication technology of superconductive film
- Study on water treatment technology using photocatalyst
- Studies on oxygen adsorption and desorption of solid materials
- Design of functional surface of solid by plasma technology
- Development of system for robot vision
- Studies on generation of optical structure materials
- Study on the accurate measurement of optical properties of lens

R & D PROJECT OF BASIC TECHNOLOGIES FOR FUTURE INDUSTRIES

Ceramic Turbine for Coal Gasification

- Material selection and design concept
- Preparation of test technology for material

Superconductive Materials for High Current Density and High Magnetic Field

- New structure and less ion material

R & D of Nonlinear Photonics Materials

- Study on the Mechanism of Nonlinear Photonic Effects and Development of their Evaluation Technology

新エネルギー技術研究開発 (サンシャイン計画)

水素エネルギー技術研究開発

- 水素の製造技術の研究
 - 高温水蒸気電解法の研究
 - 固体高分子電解質水電解法の研究
- 水素の輸送・貯蔵技術の研究
 - 金属水素化物による水素貯蔵技術の研究
- 水素利用技術の研究
 - 水素吸蔵合金を用いるエネルギー変換技術の研究
 - 水素吸蔵合金電池の解析・評価

省エネルギー技術研究開発 (ムーンライト計画)

新型電池電力貯蔵システム

- 新型電池の研究開発
 - 新型電池の適用性拡大のための研究
 - 新型電池の性能評価

燃料電池の研究開発

- 熔融炭酸塩型燃料電池の研究開発
 - 新規構成材料の研究
 - 材料試験評価

先導的・基盤的省エネルギー技術

- 高リチウムイオン導電性固体電解質の研究
- 銅触媒等を用いた省エネルギー的有機合成の研究

大型工業技術研究開発 (大型プロジェクト)

水総合再生利用システムの研究開発 (アクアルネッサンス'90計画)

■微生物の研究開発

1. 固定化微生物の高活性化

■膜素材の研究開発

1. ガラス複合膜の研究開発
2. 無機膜素材の評価技術

超先端加工システムの研究開発

■イオンビームプロセス技術

発電施設用部材高度加工装置の要素技術評価等開発

■部材の表面微細特性評価

高機能化学製品等製造法(海洋生物活用)の研究開発(海洋バイオ)

■海洋生物活用基盤技術

- 細胞菌類の育理・改良技術(宿主・ベクター系の開発)

■有用生体機能の探索・解明等に係る技術

- 微生物の有用天然有機化合物変換機能の探索・解明

超音速輸送機用推進システムの研究開発

■トータルシステムの研究開発

- 熱障壁コーティング技術の研究

R & D ON NEW ENERGY TECHNOLOGY (THE SUNSHINE PROJECT)

Hydrogen Energy

Hydrogen Production Technology

- Research on high temperature water vapor electrolysis
- Research on solid polymer electrolyte water electrolysis

Transportation and Storage of Hydrogen

- Hydrogen storage by metal hydride

Utilization of Hydrogen

- Energy conversion using hydrogen storage alloys
- Evaluation and testing of metal hydride batteries

R & D ON ENERGY CONSERVATION TECHNOLOGY (THE MOONLIGHT PROJECT)

Advanced Battery Electric Power Storage System

New Types of Batteries

- Research on battery performance evaluation methods
- Performance evaluation of advanced batteries

Fuel Cell Power Generation Technology

Molten Carbonate Fuel Cells

- Research on new component materials
- Evaluation and testing methods for components

Leading and Basic Technology for Energy Conservation

- Research on High Lithium Ion Conductive Solid Electrolytes
- Research on Energy Saving Organic Synthesis Using Copper Catalyst

NATIONAL R & D PROGRAM (LARGE-SCALE PROJECT)

New Water Treatment System (Aqua-renaissance '90 project)

Micro-organisms

Membrane Materials

- Research on membrane materials
- Evaluation technology for ultra-fine membranes

Advanced Material Processing and Machining System

Ion Beam Processing Technology

Evaluation of Essential Technology in Advanced Material

Processing System for Power Plants

Characterization of Micro-areared Surface Layer

Fine Chemicals from Marine Organism

Fundamental Technology for Utilization of Marine Organisms

- Techniques for selective breeding and genetic improvement of microalgae. A new bio-reactor system for industrial uses

Basic Technology for Research and Utilization of Useful Biological Functions

- Research on conversion functions of marine microorganisms to useful organic substances

Super/Hyper Sonic Transport Propulsion System

Thermal barrier coating technology

医療福祉機器技術研究開発

■動脈内レーザー手術装置

1. レーザー光による動脈硬化除去の研究開発

NATIONAL R & D PROGRAMS FOR MEDICAL AND WELFARE APPARATUS

Laser Device for Arteriosurgery

1. Study on removal of arterial protoid stenosis by laser light

地球環境技術研究開発

■人工光合成等による二酸化炭素の固定化技術の研究

■新エネルギー利用による二酸化炭素のリサイクル資源化技術の研究

GLOBAL ENVIRONMENT PROJECT

Study on the CO₂ Fixation by Artificial Photo-synthesis.

Study on the CO₂ conversion to resources by new energy.

重要地域技術研究開発

■素材加工における高度表面処理技術の研究開発

1. 被覆形成における機能付与技術
2. 被覆形成のための素材加工技術

SPECIFIC REGION TECHNOLOGY DEVELOPMENT SYSTEM

Technology Development for Advanced Surface Modification in Material Processing.

1. Film formation for improvement in surface function
2. Surface processing for qualified-film formation

データベースマネジメントシステム等の開発

■省エネルギー材料開発支援システムの研究開発

DATA BASE MANAGEMENT SYSTEMS

Information Supporting System for Material Development in Energy Conservation Technologies.

先導的一般地域技術

■高靱性複合材料に関する研究開発

LEADING TECHNOLOGY DEVELOPMENT FOR ORDINARY LOCAL AREAS

Research and Development of Highly Tough Plastic Composites

科学技術振興調整費重点基礎研究

■耐プラズマ材料の合成と評価

■モデル電極界面のキャラクタリゼーションと機能発現に関する研究

■強化用繊維のミクロ構造と強度発現機構の基礎的研究

■分子複合系における光電子放出過程の研究

■圧搾効果を利用した触媒及び化学センサ用新規材料の開発に関する研究

SPECIAL COORDINATION FUNDS FOR PROMOTING SCIENCE AND TECHNOLOGY ENCOURAGEMENT OF BASIC RESEARCH AT NATIONAL RESEARCH INSTITUTE

■Synthesis and Evaluation of Plasma-Resistive Materials
■Study on Characterization and Mechanism of Catalytic Activity of Molecular Sieves

■Basic study on micro-structure and strength of reinforcing fibers
■Photoelectron process in molecular complexes

■Study on the creation of catalysts and chemical sensors related to the above

技術・情報サービス

Technology and Information Services

●技術指導・相談

当所では技術交流推進センターを設け、各種要望に答えるために技術相談あるいは技術指導を行っている。

●受託研究

研究成果の普及、実用化のために、現行の研究内容を若干延長するとか、現行設備そのままか若干の手直しをすることで直接有効な資料を提供しうる場合に限り、民間企業からの委託を受けて、受託研究を実施している。「工業技術院受託研究規程」(昭和40年9月1日改正)

●共同研究

新技術開発における研究活動の効率的な運用を図るために、共同研究者が十分な技術的能力及び経理的基礎を有することを要件として「工業技術院共同研究規程」(平成元年7月1日改正)に基づき民間企業等と共同研究を実施している。

●見学

当所の設備や機器などを見学される場合はあらかじめ問い合わせの上、文書でお申し込み下さい。

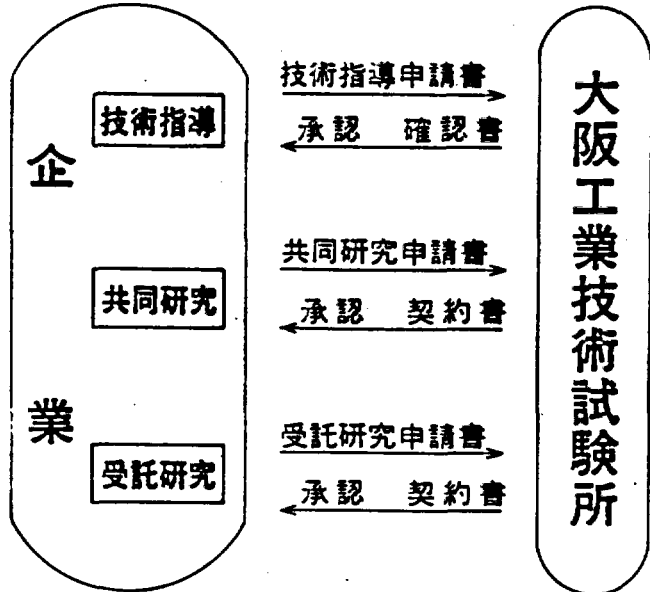

刊行物・図書

Publications and Library

●主な刊行物

大阪工業技術試験所報告

Report of the Osaka Institute of Technology

大阪工業技術試験所季報

Quarterly Report of the Osaka Institute of Technology

大工試ニュース

Osaka Institute of Technology News

大阪工業技術試験所年報

Annual Report of the Osaka Institute of Technology

大阪工業技術試験所要覧

Activities of the Osaka Institute of Technology

●図書

当所の図書室には国内外の専門図書、文献、雑誌などを収集している。当図書室所蔵の図書は、所員の紹介で閲覧することができる。なお、外国雑誌、国内雑誌の各々について、工業技術院試験研究機関図書連絡会議編「1988年版、外国雑誌総合目録」、「1988年版、国内雑誌総合目録」を参照下さい。

所蔵書籍数

平成2年3月

	図書(冊) Books	雑誌(冊) Journals	計 Total
国内 Domestic	7,940	14,200	22,140
外国 Overseas	9,860	28,100	37,960
計 Total	17,800	42,300	60,100

案内

大阪工業技術試験所

〒563 大阪府池田市緑丘1-8-31

TEL 0727-51-8351 (代表)

FAX 0727-51-2156 (総務部)

Government Industrial Research Institute, Osaka

Midorigaoka 1-8-31, Ikeda, Osaka.

563 Japan

案内図 Guide Map

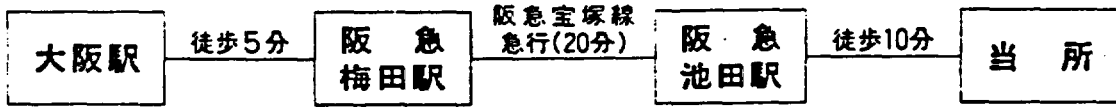
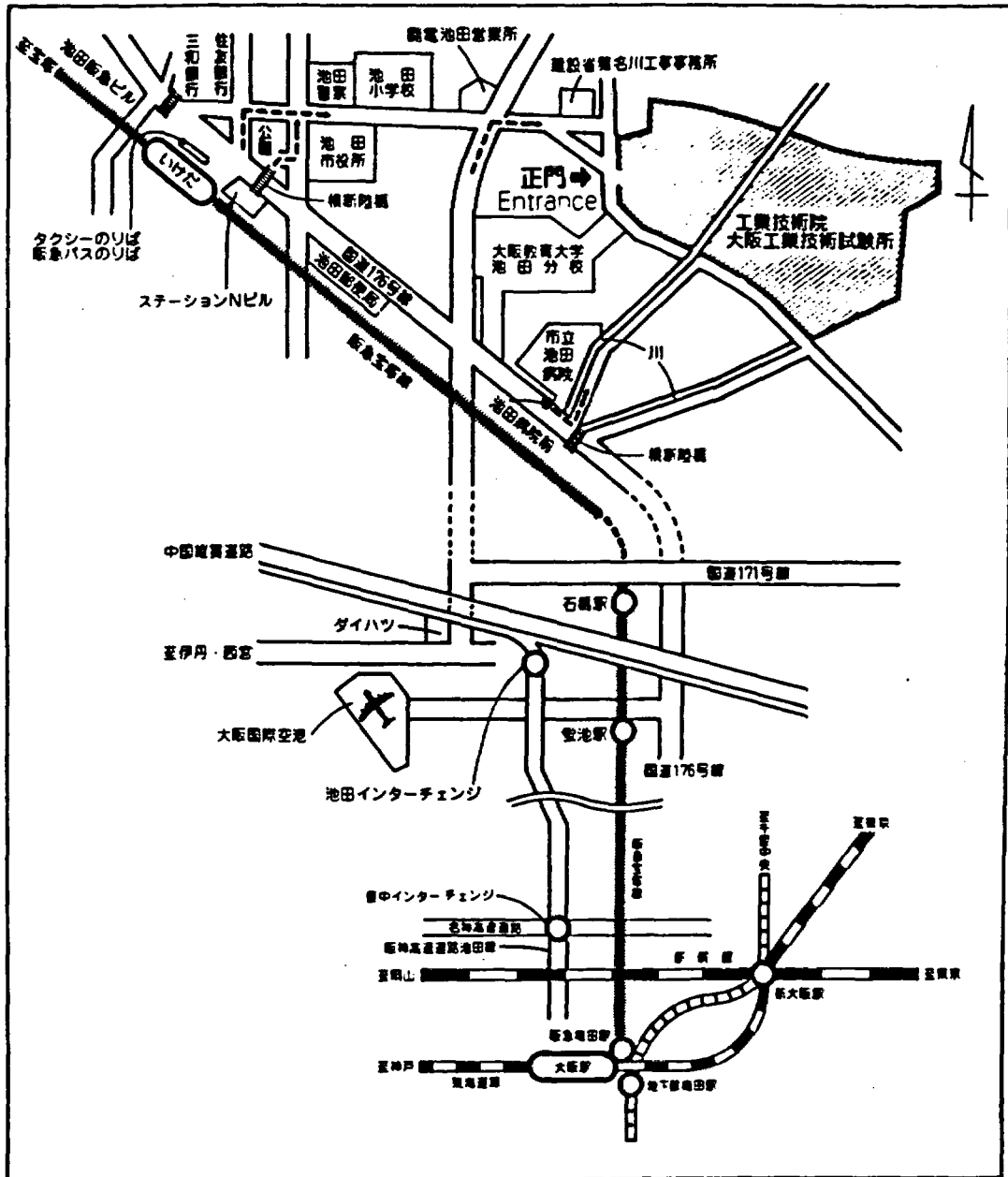

注) 電車を利用の方は 阪急宝塚線池田駅下車 (タクシーのりばは駅正面にあります。徒歩で10分)
 車で来られる方は 国道176号線の池田病院手前交差点(横断陸橋下)を左へ、または池田インターチェンジを
 出て北行、大阪教育大学横の交差点を右へ。

PREPARATION AND CATALYTIC PROPERTIES OF GOLD FINELY DISPERSED ON
BERYLLIUM OXIDEMasatake HARUTA,* Kenji SAIKA,† Tetsuhiko KOBAYASHI,
Susumu TSUBOTA, and Yoshiko NAKAHARAGovernment Industrial Research Institute of Osaka,
Midorigaoka 1-8-31, Ikeda 563
† Osaka Institute of Technology
Oniya 5-16-1, Asahi-ku, Osaka 535

Ultrafine gold particles supported on beryllium oxide have been prepared by calcination in air of the coprecipitates obtained from an aqueous solution of HAuCl_4 and $\text{Be}(\text{NO}_3)_2$. The coprecipitate with an atomic ratio of $\text{Au/Be}=1/19$ calcined at 200°C was the most active and could catalyze the oxidation of H_2 at 0°C and CO at -70°C .

Experimental data presented in the previous papers[1,2,3] have demonstrated that coprecipitation, instead of impregnation, enabled us to prepare gold finely dispersed on metal oxides and that the oxide of Fe, Co, or Ni as a support could yield very active catalysts for the oxidation of carbon monoxide at low temperatures. During the course of an investigation undertaken to see if other metal oxides could also be used as a support suitable for markedly enhancing the catalytic activity of gold, we have recently found that some alkaline earth metal oxides act as an effective support. The present investigation deals with the preparation of gold finely dispersed on beryllium oxide and its catalytic activities for the oxidation of hydrogen and carbon monoxide.

The new gold catalysts were prepared by coprecipitation with sodium carbonate from an aqueous solution of HAuCl_4 and $\text{Be}(\text{NO}_3)_2$. The coprecipitates were washed, vacuum-dried, and calcined in air at different temperatures for 3 - 18h. Catalytic activity measurements were carried out in a small fixed bed reactor, with 0.10g of catalysts that had passed through 70 and 120 mesh sieves. A standard gas consisting of 1.0 vol% H_2 or CO balanced with air to 1 atm. was passed through the catalyst bed at a flow rate of 33 ml/min. The reaction gas was dried by passing through a silica gel column cooled to -77°C to prevent the accumulation of moisture in the catalyst layer. The analytical techniques were

similar to those described elsewhere[1,3].

Figure 1 shows oxidation efficiencies for H_2 at $30^\circ C$ and CO at $-70^\circ C$ as a

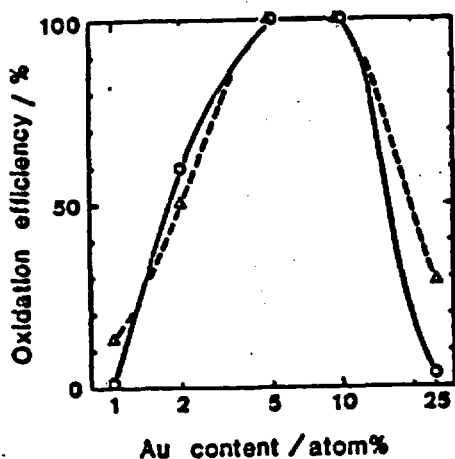

Fig.1. Catalytic activities for the oxidation of H_2 and CO as a function of Au content.
 Δ , H_2 at $30^\circ C$; O , CO at $-70^\circ C$.

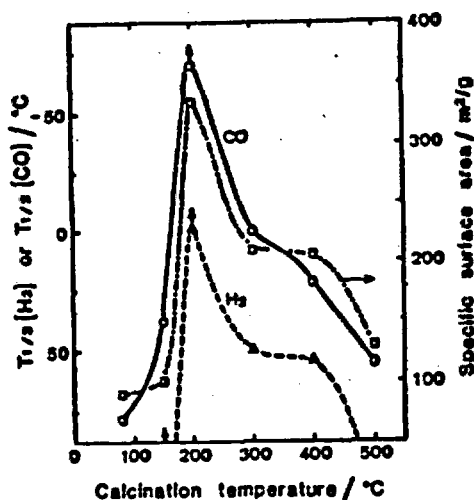

Fig.2. Effect of calcination temperature on the catalytic activities for the oxidation of H_2 and CO and on specific surface area. $T_{1/2}$ expresses the temperature where 50% conversion is attained.
 Δ , H_2 at $30^\circ C$; O , CO at $-70^\circ C$;
 \square , specific surface area.
 The arrows denote that $T_{1/2}$ values are lower than indicated.

function of Au content in the Au-Be coprecipitates calcined at $200^\circ C$. The oxidation of CO over the Au-Be catalysts can take place at much lower temperatures than the oxidation of H_2 . This feature presents a striking contrast to the catalytic behavior of the conventional SiO_2 or Al_2O_3 supported Au catalysts, where H_2 can be oxidized at lower temperatures than CO . Maximum catalytic activities were obtained in the range of 5-10 atom% (Au/Be=1/19-1/9) for both H_2 and CO oxidation. This range of Au content coincided with the optimum Au contents for Au/ Fe_2O_3 , Au/ Co_3O_4 , and Au/ NiO .

Figure 2 shows the effect of calcination temperature on the catalytic activities of the Au-Be(1/19) coprecipitate. Maximum catalytic activities were obtained for both H_2 and CO oxidation when the coprecipitate was calcined at $200^\circ C$, where a maximum value was also attained for specific surface area. This may indicate that the larger surface area was preferable in obtaining higher catalytic activities in Au-Be system. On the other hand, higher calcination temperatures ranging from $300^\circ C$ to $400^\circ C$ were required for the Au-Fe coprecipitate to generate markedly enhanced catalytic activity for CO oxidation[1,3]. This is probably because strong interaction at the interface between Au and Fe_2O_3 which might be created by calcination at

relatively higher temperatures was more important than the large surface area of Fe_2O_3 . The activity of the Au-Be(1/19) catalyst was so stable even at $-70^\circ C$ that 100% efficiency of CO oxidation was maintained in a continuous run for 42 h, while the efficiency declined to about 50% in a few hours over Au/ Fe_2O_3 [1].

In the X-ray diffraction patterns shown in Fig. 3, a broad plateau assigned to metallic Au was first observed in a sample calcined at $150^\circ C$. The peak became more apparent at $200^\circ C$ and from the peak half-width the mean particle diameter of gold was estimated to be 4.3 nm. Since DTA data indicated that the formation of anhydrous BeO starts at $280^\circ C$, the most active catalysts were considered to be composed of ultrafine Au particles and hydrous BeO. The particle diameter of Au increased only slightly with an increase in calcination temperature; it was 4.9 and 5.1 nm for the samples calcined at 400 and $500^\circ C$, respectively. Therefore, it is likely that not anhydrous but hydrous BeO played an important role in enhancing the catalytic activity.

Figure 4 shows the binding energies for the maxima of Au $4f_{7/2}$ and $4d_{5/2}$ XPS peaks for the Au-Be coprecipitate. The binding energies for the sample calcined at $200^\circ C$ are larger by 0.5eV than those for Au bulk metal, whereas the sample calcined at 400 and $500^\circ C$ exhibited no such chemical shifts. Since the Au-Fe coprecipitate calcined at $300-400^\circ C$, which exhibited catalytic activities close to that of Au-Be calcined at $200^\circ C$, showed chemical shifts of almost the same degree, it appears that the electron deficiency that gives the chemical shift of about +0.5 eV leads to the most suitable surface state for the low temperature oxidation of CO. Accordingly, on ultrafine Au particles supported on hydrous BeO the adsorption of CO might turn to occur moderately, neither too weakly as on pure gold surface nor too strongly as on platinum surface[4].

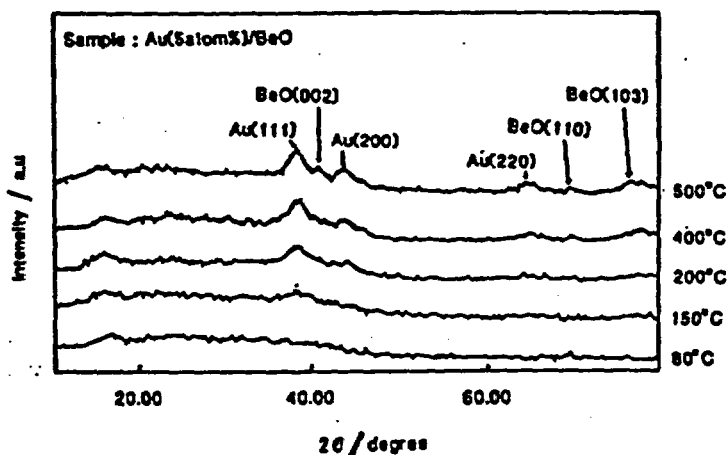

Fig.3. X-ray diffraction patterns for the Au-Be coprecipitates calcined at different temperatures.

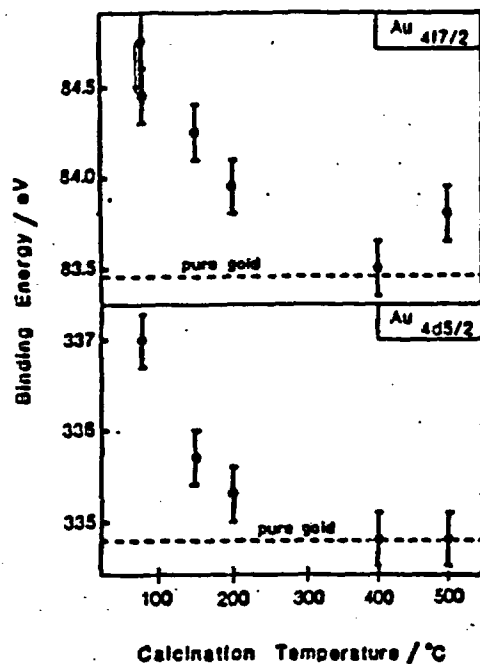

Fig. 4. Variation of the binding energies for the maxima of Au 4f_{7/2} and 4d_{5/2} XPS peaks with calcination temperature.

The reason why only Au/hydrous BeO could maintain high catalytic activity for CO oxidation at -70°C is not clear at present. It might be, at least partly, due to the difference that carbonate species are hardly formed and unstable on the surface of BeO while they are readily formed and relatively stable on the surface of the oxides of Fe, Co, and Ni.

The authors thank Professor S. Minami of Osaka Institute of Technology for his continued encouragement throughout the work.

References

- 1) M. Haruta, T. Kobayashi, H. Sano, and N. Yamada, *Chem. Lett.*, **1987**, 405.
- 2) M. Haruta, *Hyomenkagaku (Surface Science)*, **9**, 407 (1987).
- 3) M. Haruta, N. Yamada, T. Kobayashi, and S. Iijima, *J. Catal.* in submission.
- 4) T. Matsushima, *Hyomen (Surface)*, **23**, 259 (1985).

金を高分散担持した酸化ベリリウムの調製と触媒特性

春田正毅,^{*} 西家隆司,[†] 小林哲彦, 坪田 年, 中原佳子

大阪工業技術試験所 〒563 池田市緑ヶ丘 1-8-31

+大阪工業大学 〒535 大阪市旭区大宮 5-16-1

塩化金酸と硝酸ベリリウムの混合水溶液から得られた共沈物を空气中で焼成することにより、金を超微粒子状にして酸化ベリリウム上に分散担持した。200℃で焼成したAu/Be=1/19の組成をもつ共沈物が最も触媒活性が高く、 H_2 及びCOをそれぞれ0℃、 -70°C でも酸化できる。

PREPARATION OF HIGHLY DISPERSED GOLD ON TITANIUM AND MAGNESIUM OXIDE

Susumu TSUBOTA, Masatake HARUTA, Tetsuhiko KOBAYASHI, Atsushi UEDA, and Yoshiko NAKAHARA
Government Industrial Research Institute of Osaka
Midorigaoka 1, IKEDA 563, Japan

ABSTRACT

Gold could be highly dispersed on titanium oxide and magnesium oxide in their aqueous dispersion containing Mg citrate. The mean diameters of gold particles are smaller than 5nm. These gold catalysts are active for the oxidation of CO even at a temperature below 0°C. On magnesia support, Mg citrate acts not as a reducing agent but as a sticking agent which blocks the coagulation of gold particles. On titania support dispersed in neutral solution Mg²⁺ ions instead of citrate ions are mainly adsorbed. It is likely that Mg²⁺ ion suppresses the transformation of amorphous titania to anatase during calcination and prevent gold particles from coagulation caused by earthquake effect.

INTRODUCTION

Gold has been regarded as catalytically far less active than platinum-group metals. This is because of its chemically inert character and of low dispersion in supported catalysts. We have recently reported that through coprecipitation gold particles smaller than 10 nm can be highly dispersed on Co₃O₄, α-Fe₂O₃, NiO¹⁻³, and Be(OH)₂⁴). These gold catalysts are active in the oxidation of CO at a temperature as low as -70°C. However, coprecipitation is valid only for a selected group of metal oxides as mentioned above, because the precipitation rates of support metal hydroxide and gold hydroxides and their affinity might determine in the dispersion of gold.

This paper deals with the methods for supporting gold in a highly dispersed state on pre-formed TiO₂ and MgO powder, on which ultrafine gold particles have been difficult to be supported by the conventional methods.

EXPERIMENTAL

Preparation of gold catalysts

The following materials were used for catalyst supports; magnesia (Ube Industries, Ltd.; crystalline small particles

prepared by vapor method; BET=140m²/g), titania-A (Idemitsu Kōsan Co.; amorphous dried at 120°C; BET=110m²/g), and titania-B (JRC-TIO4; anatase; BET=40m²/g). Each of these supports was dispersed in an aqueous solution of H₂AuCl₄. The pH of titania dispersion was adjusted to 7.0 with Na₂CO₃, while the pH for magnesia dispersion, which was not intentionally adjusted, was naturally settled at around 9.6. The aqueous dispersions were stirred for 2 hrs after the addition of a variety of reagents (citrate of Mg, Na, or NH₄, or HCHO; 2.5mol/Au for magnesia, and 6.0mol/Au for titania). These precursors were washed with distilled water and then filtered. The cake was vacuum dried and calcined in air for 5 hrs at 400°C and 250°C for TiO₂ and MgO, respectively. The gold content of these catalysts thus obtained were 1atom% (Au/Ti) in Au/titania and 2atom% (Au/Mg) in Au/magnesia.

Catalytic Activity measurements

The activities of the gold catalysts were measured in the oxidation of CO or H₂. Experiments were carried out in a small fixed bed reactor with 0.10g of catalysts that had passed through 70 and 120 mesh sieves. A standard gas of 1.0 vol.% H₂ or CO balanced with air to 1 atm was passed through the catalyst bed at a flow rate of 33ml/min. The conversion of CO and H₂ was determined through gas chromatographic analyses (G-2800, Yanagimoto Co. Ltd.) of effluent from the reactor.

Characterization of Catalysts

The structures of the gold catalysts were observed using a Hitachi H-9000 electron microscope operated at 300 kV. X-ray diffraction (XRD) analysis was made by using a Rad-B system (Rigaku Denki Co.Ltd.). Infrared spectra were taken with a Nicolet 20-SXC spectrometer. For the IR analysis, each sample was mixed with KBr (2wt.% for magnesia; 10 wt.% for titania), and pressed into a thin wafer. Differential thermal analysis (DTA) was made by using a SSC-5200 thermal analyzer (Seiko Denshi Kogyo Co.Ltd.). X-ray photoelectron spectroscopy (XPS) was measured with a SSX-100 spectrometer (Surface Science Laboratories, Inc.).

RESULTS

Gold supported on magnesia

Table 1 shows the catalytic activities of Au/magnesia prepared with different additives. It was found that catalytic

activities were enhanced by the addition of Mg citrate. When Mg citrate was added into the suspension before the addition of HAuCl_4 , the activity enhancement could not be observed. The use of Na citrate or HCHO caused lower catalytic activity. The pH of the suspension during the preparation, usually 9.6, was increased to 11 when Na citrate was added. The addition of HCHO to the suspension produced a purple color, which indicated the reduction of Au^{3+} to colloidal gold.

Figure 1 shows the XRD patterns of Au/magnesia catalysts, where the presence of $\text{Mg}(\text{OH})_2$, not MgO , are evidenced. The starting material, MgO , changed to $\text{Mg}(\text{OH})_2$ by hydration in the aqueous suspension. From the width of the XRD peak of $\text{Au}(200)$, the particle size of gold is calculated as about 14nm for Au/MgO prepared without additives, and this value is in good agreement with 10 nm determined by TEM observations. On the other hand, in the catalyst prepared with the addition of Mg citrate, gold particles smaller than 3 nm are observed by TEM. Although such a very small particles of gold did not show the diffraction peak in XRD, the presence of metallic gold were confirmed by the binding energy of 84.2 eV for the XPS peak of $\text{Au}4f_{5/2}$. The catalyst prepared with the addition of HCHO contained only large gold particles (more than 20nm, by TEM observation).

Figure 2 shows the IR spectra of the precursor of Au/magnesia before calcination. Without Mg citrate, the IR absorption of surface H_2O and MgCO_3 are observed at 1638cm^{-1} and 1449cm^{-1} , respectively. In the case of the precursor prepared with Mg citrate, other absorptions are detected at 1595cm^{-1} , 1423cm^{-1} , 1263cm^{-1} , 1083cm^{-1} , and 1061cm^{-1} . These absorption peaks coincide with those obtained for pure Mg citrate powder.

TABLE 1

Catalytic activity of Au/magnesia prepared with various additives.

Additives	Catalytic activity	
	CO conv., %	$T_{1/2}[\text{H}_2], ^\circ\text{C}$
none	10	>200
Mg ct.	100	67
Na ct.	5	>200
HCHO	0	>200

CO conv.: CO conversion at -70°C
 $T_{1/2}$: temperature for 50% conversion
 ct.: citrate

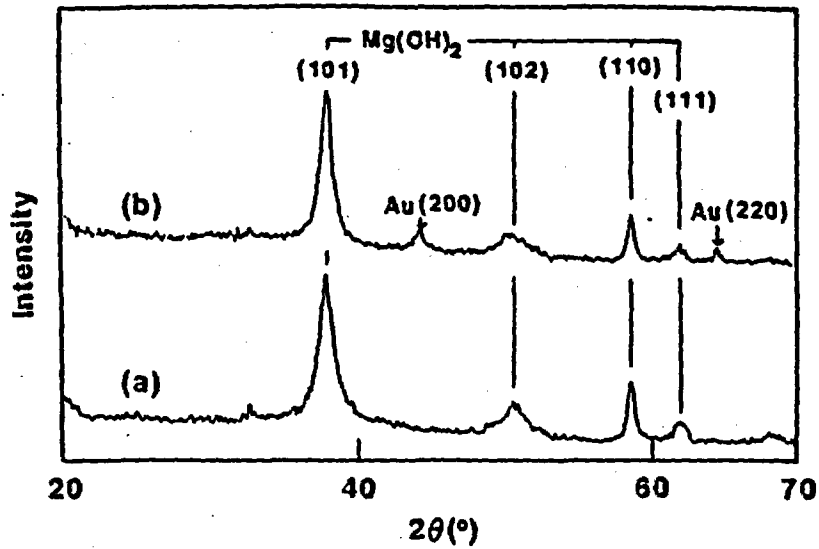

Fig. 1. XRD patterns of Au/magnesia.
 (a) prepared with Mg citrate; (b) prepared without Mg citrate.

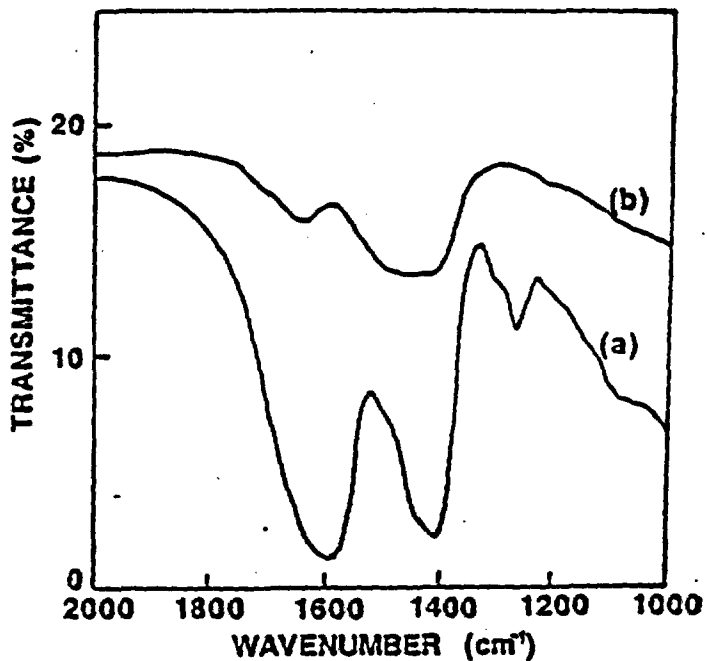

Fig. 2. IR spectra of Au/magnesia before calcination.
 (a) prepared with Mg citrate; (b) prepared without Mg citrate.
 (resolution 4cm⁻¹; accumulation 100times)

gold supported on titania

In Table 2, the effect of the addition of Mg citrate on the catalytic activity is compared on the two different types of TiO₂ supports. While the catalytic activity of Au/titania-A (amorphous) is enhanced by use of Mg citrate, Au/titania-B (anatase) shows a high catalytic activity regardless of the addition of Mg citrate.

Figure 3 shows TEM photographs of Au/titania catalysts. When Mg citrate is added in the dispersion, the gold particles are highly dispersed on titania-A (the average particle size of gold is about 4nm), and gold particles become larger without Mg citrate. In the case of titania-B, however, the small gold particles are highly dispersed even when Mg citrate was not used.

The IR absorption spectra of the precursor of Au/titania prepared with Mg citrate were shown in Fig. 4. The adsorption peak at 1400cm⁻¹ on titania-A might correspond to the adsorbed citrate species. Compared with the case of Au/Mg(OH)₂, however, the amount of citrate species is much less on the titania support.

TABLE 2

Catalytic activity of Au/titania prepared with and without Mg citrate, (Comparison of two different titania supports).

Titania Support	Catalytic activity			
	Addition of Mg citrate		none	
	T _{1/2} [CO], °C	T _{1/2} [H ₂], °C	T _{1/2} [CO], °C	T _{1/2} [H ₂], °C
Titania-A(amorphous)	<0	25	35	139
Titania-B(anatase)	<0	35	<0	34

T_{1/2}: temperature for 50% conversion

TABLE 3

Catalytic activity of Au/titania-A prepared with additives.

Additives	Catalytic activity	
	T _{1/2} [CO], °C	T _{1/2} [H ₂], °C
none	35	139
HCHO	83	165
Na ct.	23	93
NH ₄ ct.	5	85
Mg ct.	<0	25
Mg(NO ₃) ₂	<0	35

ct.:citrate

T_{1/2}: temperature for 50% conversion

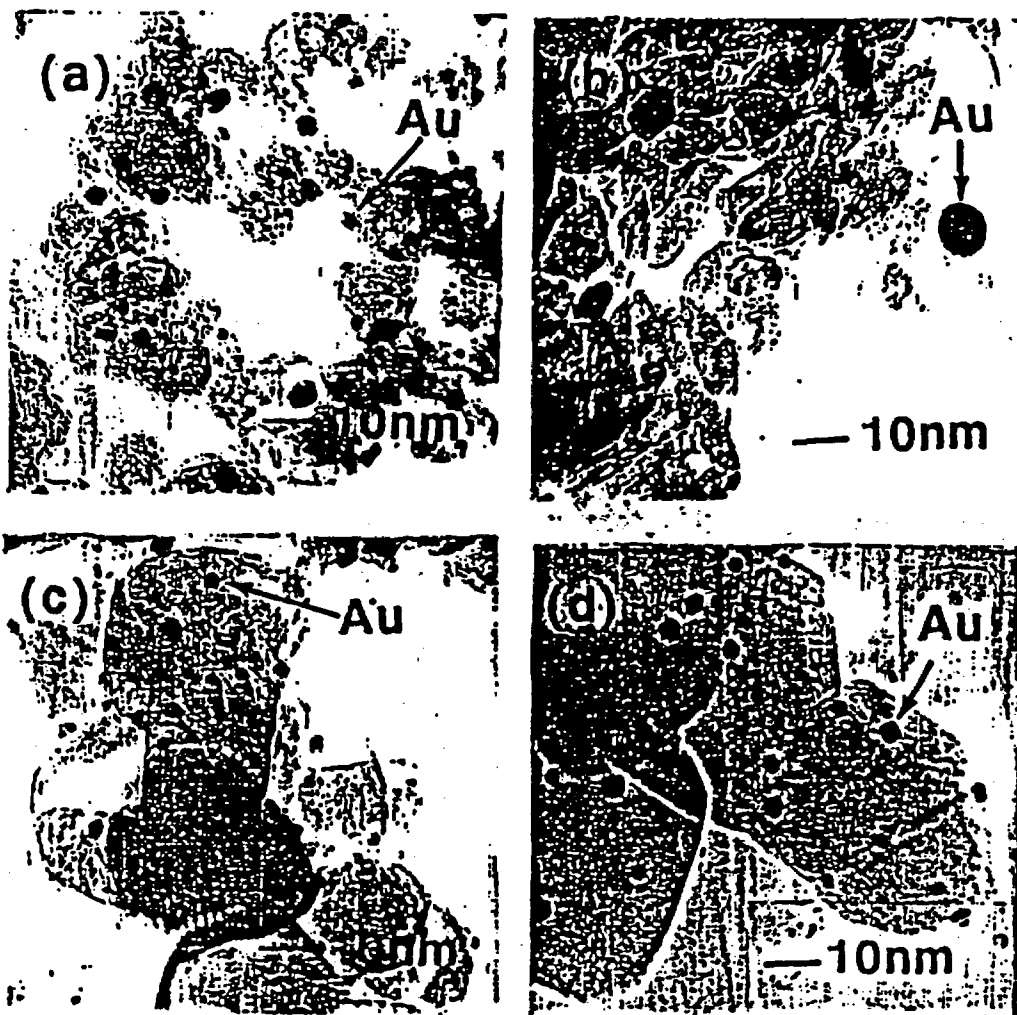

Please
arrange
Fig 3-
← as these.

Fig. 3. TEM photograph of Au/titania prepared with or without Mg citrate.
 (a)with Mg citrate; (b)without Mg citrate, on titania-A (amorphous):
 (c)with Mg citrate; (d)without Mg citrate, on titania-B (anatase).

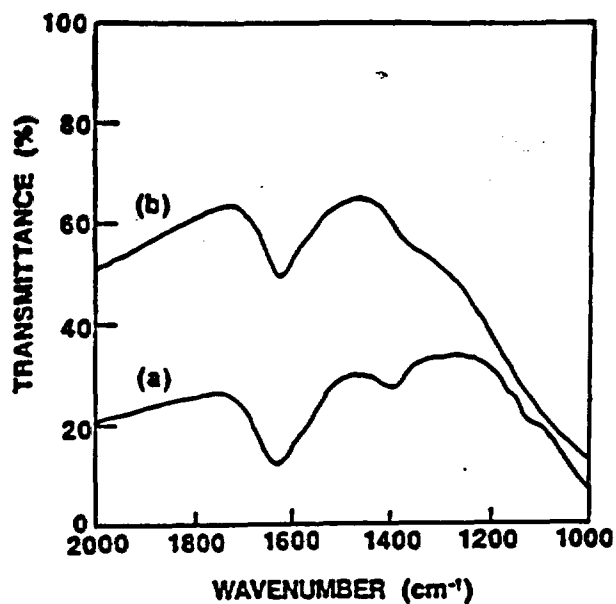

Fig. 4. IR spectra of Au/titania prepared with Mg citrate before calcination. (a) on titania-A; (b) on titania-B. (resolution 4cm^{-1} ; accumulation 100 times)

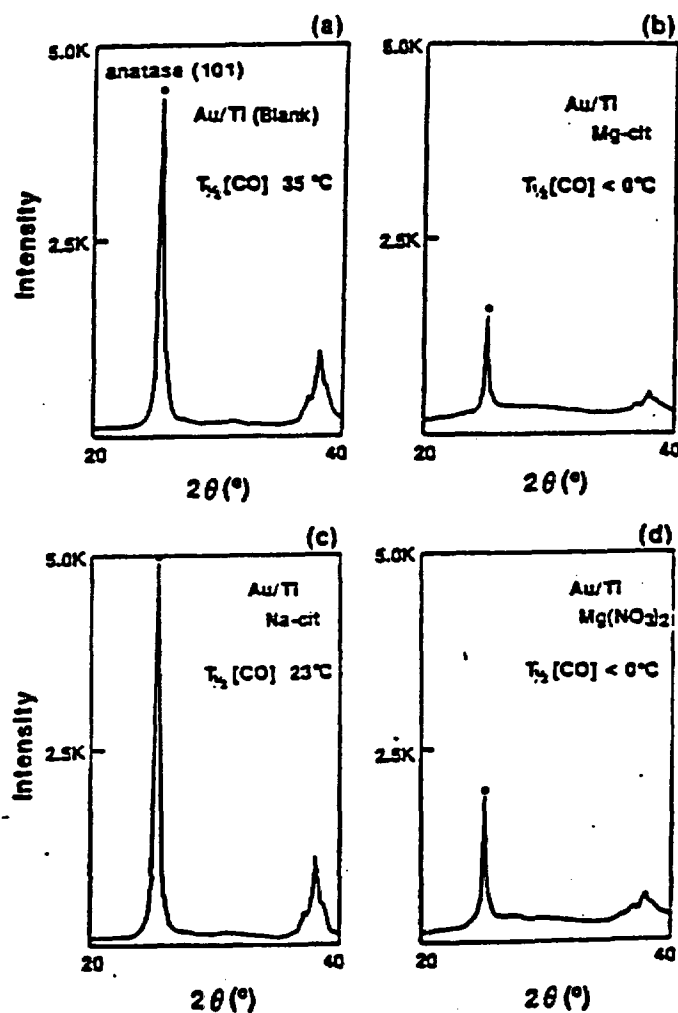

Fig. 5. XRD patterns of Au/titania-A prepared with various additives. (a) without any reagent (blank); (b) with Mg citrate; (c) with Na citrate, (d) with $\text{Mg}(\text{NO}_3)_2$.

Table 3 shows the catalytic activities of Au/titania-A prepared with a variety of additives. The appreciable enhancement of the catalytic activity is observed not only through the addition of Mg citrate but also through $Mg(NO_3)_2$ addition. Other citrates bring about a slight increase in activity. Similarly to the case of the magnesia support, HCHO causes the reduction of Au^{3+} in the suspension of titania-A giving a poor catalytic activity.

Figure 5 shows the XRD patterns of four kinds of Au/titania. The amorphous titania-A is transformed into anatase by calcination, and Mg^{2+} seems to suppress this crystallization. The catalytic activity tends to become low with an increase in crystallinity of the support.

Figure 6 shows DTA curves for the precursors of Au/titania-A before calcination. There is an exothermic peak at around $460^\circ C$ in each signal. These peaks corresponds to the transformation from amorphous titania to anatase. It is clear that the addition of Mg^{2+} shifts the temperature for the crystallization toward higher temperature.

DISCUSSION

It has been demonstrated that Mg citrate plays an important role in the preparation of highly dispersed gold catalysts with $Mg(OH)_2$ and TiO_2 as supports.

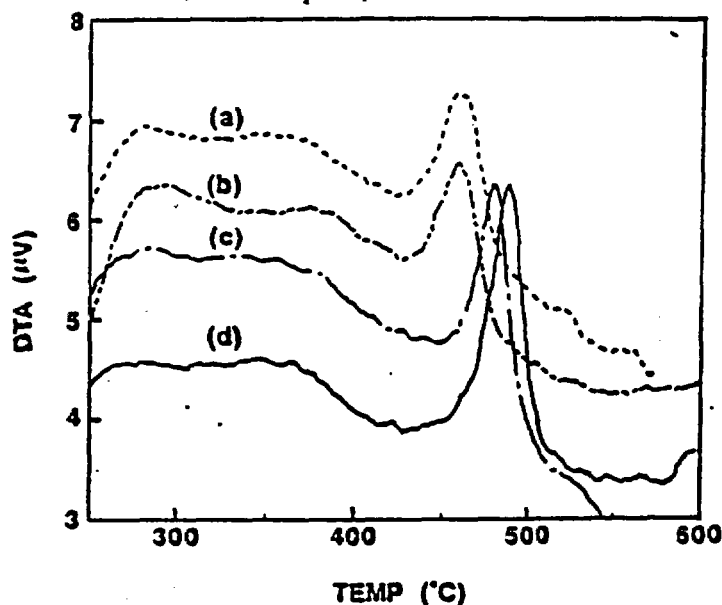

Fig. 6. DTA curves for Au/titania-A before calcination. (a) without any reagent (blank); (b) with Na citrate; (c) with $Mg(NO_3)_2$; (d) with Mg citrate. (heating rate : $5^\circ C/min$ in air).

However, it has appeared that the role of Mg citrate is different between TiO_2 and $\text{Mg}(\text{OH})_2$.

Gold supported on magnesia

The pH of the suspension of magnesia is 9.6 during the preparation. At such a pH region, AuCl_4^- should be sufficiently hydrolyzed into $\text{Au}(\text{OH})_3$ judging from the stability of gold species in aqueous solutions⁵). Then the hydroxide of Au might be deposited on the surface of $\text{Mg}(\text{OH})_2$ before the additives are introduced into the suspension. Since the point of zero charge (PZC) of $\text{Mg}(\text{OH})_2$ appears at pH = 12⁶), the positively charged surface is suitable for the adsorption of anions such as citrate ion, as observed in the IR spectrum.

The reduction of Au^{3+} by HCHO in the suspension made the Au particles large and lowered the catalytic activity (Tables 1 and 3), and therefore, the reducing power of citrate ion seems not to be related to the high activity. The adsorbed citrate ion is considered to act as a sticking reagent which can block the coagulation of gold species in the suspension and/or during calcination. A speculated behavior of citrate ion is illustrated in Fig. 7.

The pH of the suspension containing Na citrate was 11 and close to the PZC of $\text{Mg}(\text{OH})_2$. Since the effective adsorption of citrate ion is not expected at such a pH region, the enhancement of the catalytic activity might not be observed in $\text{Au}/\text{Mg}(\text{OH})_2$ prepared with Na citrate.

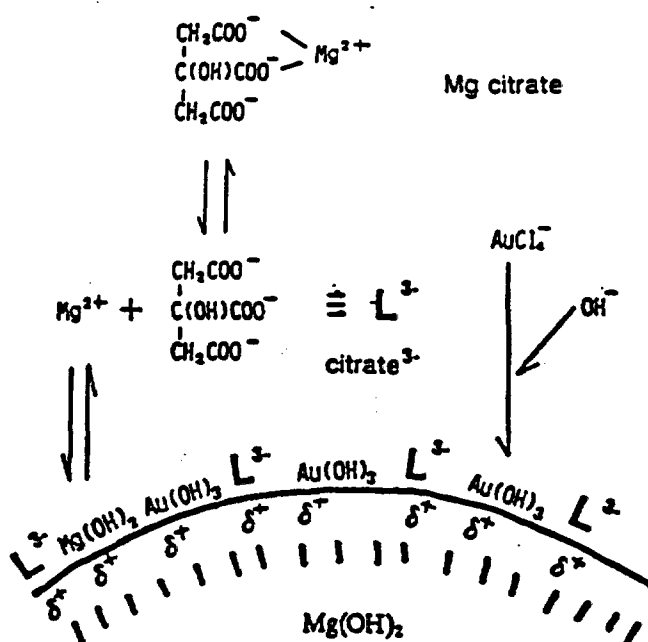

Fig. 7. Speculated behavior of Mg citrate in aqueous dispersion.

Gold supported on titania

Since the pH of the suspension of titania is adjusted to 7.0, Au species to be deposited on the support might be $\text{Au}(\text{OH})_3$ as in the case of $\text{Au}/\text{Mg}(\text{OH})_2$. However, since the surface of titania in the suspension was proved to be negatively charged, as was reasonable from the PZC of TiO_2 at $\text{pH} = 4 - 6$, cations such as Mg^{2+} should be more easily adsorbed on titania than citrate anion.

Figures 4 and 5 show that the addition of Mg citrate or $\text{Mg}(\text{NO}_3)_2$ enhances the catalytic activity of Au/titania-A and suppress the crystal growth of anatase. On the other hand, when anatase support, titania-B, was used as a starting support, there was observed no appreciable effect of Mg citrate addition. The liability of the surface of the carrier will accelerate the coagulation of supported species due to the so called "earthquake effect". The presence of Mg^{2+} prevents amorphous titania-A from crystallization and therefore from the "earthquake effect". On the other hand, since anatase support has already crystallized structure, there is no appreciable effect of Mg citrate addition on the dispersion of gold.

A small amount of citrate species are detectable on titania-A in Fig. 6. The citrates other than Mg salt might have also a certain effect on an increase in catalytic activity of Au/titania-A. It is probable that citrate ions in Au/titania-A play similar role to that in $\text{Au}/\text{Mg}(\text{OH})_2$.

Acknowledgment

We would like to thank Mr. M. Genet (UCL, Belgium) for the analyses of X-ray photoelectron spectroscopy.

REFERENCES

- 1) M. Haruta, N. Yamada, T. Kobayashi, and S. Iijima, *J. Catal.*, 115, 301-309 (1989).
- 2) M. Haruta, H. Kageyama, N. Kamijo, T. Kobayashi, and F. Delannay, *Stud. Surf. Sci. Catal.* 44, 33-42 (1988).
- 3) M. Haruta, T. Kobayashi, S. Iijima, and F. Dellannay, *Proc. 9th Intern. Congr. Catal.*, 3, 1206-1213 (1988).
- 4) M. Haruta, K. Saika, T. Kobayashi, S. Tsubota, and Y. Nakahara, *Chem. Express*, 3, 159-162 (1988).
- 5) R. J. Puddephatt, *The Chemistry of Gold*, Elsevier, Amsterdam, 1978, p.91.
- 6) G. A. Parks, *Chem. Rev.* 65, 177-198 (1965).

9th ICC

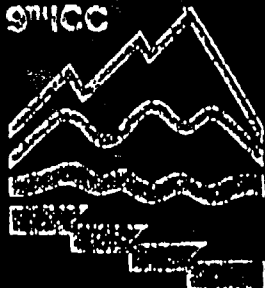

CALGARY 1988

Catalysis:
Theory to Practice

PROCEEDINGS
9th International
CONGRESS ON CATALYSIS

Volume 3 CHARACTERIZATION
AND METAL CATALYSTS

ULTRAFINE GOLD PARTICLES IMMOBILIZED WITH OXIDES OF Fe, Co, or Ni
FOR THE CATALYTIC OXIDATION OF CARBON MONOXIDE AT -70°C

M. HARUTA*, T. KOBAYASHI*, S. IJIMA**, and F. DELANNAY***

* Government Industrial Research Institute of Osaka
Midorigaoka 1, Ikeda, 563 Japan

** Research Development Corporation of Japan,
c/o Department of Physics, Yagoto-urayama, Tenpaku,
Nagoya 468, Japan.

*** Department of Material Science,
Université Catholique de Louvain,
Place Sainte Barbe, B-1348, LLN, Belgium

ABSTRACT

Gold particles smaller than 10 nm in diameter, immobilized with α - Fe_2O_3 , Co_3O_4 , or NiO , were prepared by coprecipitation from an aqueous solution of HAuCl_4 and the nitrate of Fe, Co, or Ni and by calcination of the coprecipitates in air at 300 – 400°C . The ultrafine gold particles were hemispherical in shape and strongly held by the host oxides. In most cases, hemispherical gold crystallites were deposited directing their flat (111) planes toward α - Fe_2O_3 (110), Co_3O_4 (111), and NiO (111) planes. X-ray photoelectron spectra showed that the gold particles with a mean diameter of 4.1 nm immobilized on α - Fe_2O_3 were more electron deficient than evaporated gold particles of the same size. The ultrafine gold particles immobilized with 3d transition metal oxides were active for the oxidation of CO even at such a low temperature as -70°C .

INTRODUCTION

It has generally been understood that gold is catalytically far less active in most of the reactions than platinum metal catalysts. Since gold particles were supported with a size larger than 10 nm and mostly ranging from 50 to 100 nm in the conventional gold catalysts^{1,2}, the difficulty to obtain highly dispersed gold particles might be another additional reason for the poor catalytic activities of gold catalysts. Although an attempt has recently been made to prepare highly dispersed gold catalysts by impregnation, they are thermally unstable at temperatures above 200°C and are poorly active for the oxidation of H_2 and CO_3 .

On the other hand, our previous letter has reported that gold catalysts prepared by coprecipitation with group VIII 3d transition metal oxides exhibit extremely high activities for the oxidation of CO even at -70°C ⁴. The present paper will deal with the characterization of the coprecipitated gold catalysts by TEM and XPS and will discuss the origin of the catalytic activities.

EXPERIMENTAL

carbonate from an aqueous solution of HAuCl_4 and the nitrate of various transition metals. The coprecipitates were washed, vacuum dried, and calcined in air at temperatures from 80°C to 500°C . Catalytic activity measurements were carried out in a small fixed-bed reactor, with 0.20g of catalysts that had passed through 70 and 120 mesh sieves. A standard gas consisting of 1.0 vol% of CO or H_2 balanced with air to 1 atm. was passed through the catalyst bed at a flow rate of 66 ml/min.

The fine structures of the gold catalysts were observed using an Akashi EM-002A electron microscope operated at 120 kV and a Hitachi H-9000 electron microscope operated at 300 kV. X-ray photoelectron spectroscopic analyses were made using a Shimadzu ESCA 750 under vacuum below 5×10^{-6} torr.

RESULTS

Gold immobilized with $\alpha\text{-Fe}_2\text{O}_3$

Figure 1 shows the dependence of the oxidation efficiencies of H_2 and CO on calcination temperature of Au-Fe coprecipitate containing 5 atom% Au. As is clearly understood from the reaction temperature, the gold catalysts prepared by coprecipitation are highly active for the oxidation of both H_2 and CO. In addition, they are much more active in the oxidation of CO than in the oxidation of H_2 . This is one of the characteristic features of coprecipitated gold catalysts because the gold powder and the conventional gold catalysts supported on inert metal oxides such as MgO , Al_2O_3 , SiO_2 are less active in the oxidation of CO than in the oxidation of H_2 . There was also observed a pronounced contrast between H_2 oxidation and CO oxidation in the effect of calcination temperature on the catalytic activity. While calcination at 200°C gave a maximum catalytic activity for H_2 oxidation, it did not create the catalytic activity for CO oxidation. The catalytic activity for the oxidation of CO appreciably increased only when the coprecipitate was calcined at temperatures above 300°C .

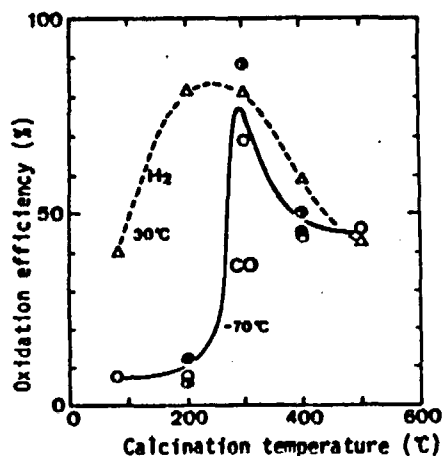

Fig. 1. Efficiencies for CO and H_2 oxidation as a function of calcination temperature of Au-Fe(1/19) coprecipitate.

high BE side. As the BEs for Au_{203} were 86.4eV and 90.1eV for Au 4f7/2 and

coprecipitate calcined at temperatures below 200°C . No significant difference of the BE value or of the shape of Fe 2p3/2 and FeL3VV lines were recorded for samples calcined at 200°C and 300°C , and for pure Fe_2O_3 calcined at 400°C .

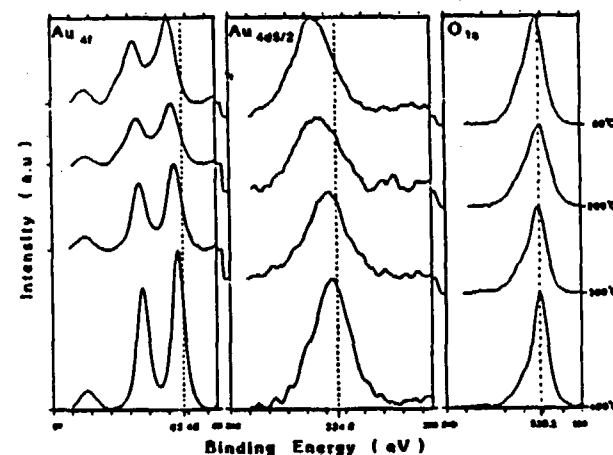

Fig. 2. Change of XPS spectra of Au-Fe(1/19) coprecipitate with calcination temperature.

The presence of metallic gold could be detected by XRD as a broad peak of Au(111) at $2\theta=38.2^\circ$ only for samples calcined at 400°C . It was also only for samples calcined at 400°C that sharp and intensified diffraction peaks corresponding to $\alpha\text{-Fe}_2\text{O}_3$ were observed. However, the diffraction pattern for the samples calcined at 300°C showed the onset of crystallization toward $\alpha\text{-Fe}_2\text{O}_3$. The above results obtained by XPS and XRD indicate that coprecipitates calcined at temperatures above 300°C consist of metallic gold particles and $\alpha\text{-Fe}_2\text{O}_3$, while coprecipitates calcined at lower temperatures consist of metallic and oxidized gold, and amorphous precursor of $\alpha\text{-Fe}_2\text{O}_3$.

Figures 3 and 4 shows TEM photographs for Au-Fe coprecipitate (Au/Fe=1/19) calcined at 400°C . Very small gold particles are homogeneously dispersed on the surface of $\alpha\text{-Fe}_2\text{O}_3$ particles. The mean diameter of the gold particles measured for 2131 particles was 4.1nm with a standard deviation of 1.4. The TEM observation both in the bright and dark fields indicated that the gold particles were not twinned or poly-crystals but single crystals. The enlarged view of the interface between ultra-fine gold particles and hematite shows that the gold particles are not spherical but hemispherical in shape and are strongly bound at their flat planes with the host oxide. It was most commonly observed that the crystal of gold particles grew with a specific crystal direction: Au(111) plane with a lattice spacing of 2.36\AA was in junction with $\alpha\text{-Fe}_2\text{O}_3(110)$ plane having a lattice spacing of 2.52\AA . The difference of the lattice spacings was within 7%.

The strength of interaction operating between ultrafine gold particles and hematite appeared to be very high because the reduction and oxidation treatment of Au/ $\alpha\text{-Fe}_2\text{O}_3$ to transform the host oxide ($\alpha\text{-Fe}_2\text{O}_3 \rightarrow \text{Fe}_3\text{O}_4 \rightarrow \gamma\text{-Fe}_2\text{O}_3$) did not cause any tiny change of the mean particle diameter of



Fig. 3. Fine structure of Au-Fe(1/19) coprecipitate calcined at 400°C.

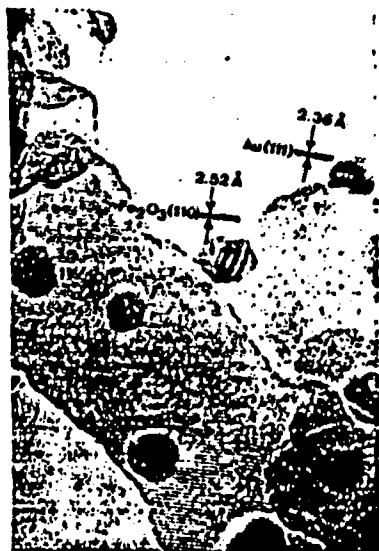

Fig. 4. Ultrafine gold particles immobilized with α -Fe₂O₃.

Au immobilized with Co₃O₄

Figures 5 and 6 show TEM photographs for Au-Co coprecipitate (Au/Co=1/19) calcined at 400°C. Ultrafine gold particles of 6-7 nm in diameter were dispersed on Co₃O₄ crystallites of about 15 nm in diameter. Comparison with Au/ α -Fe₂O₃ suggests that the size of gold particles is larger while the size of host oxide is smaller. This might be because Au-Co coprecipitate was obtained as small primary particles and during calcination the gold crystallites had difficulty in finding suitable crystal planes of Co₃O₄ to be strongly bound, thus being more or less exposed to coagulation. In Au/Co₃O₄, typically one gold particle is attached to one Co₃O₄ particle facing Au(111) plane to Co₃O₄(111). The lattice spacing of Co₃O₄(111) is 4.67 Å, about double of that for Au(111) with only 1.1% deviation.

Gold immobilized with NiO

Figure 7 shows a TEM photograph of Au-Ni coprecipitate (Au/Ni=1/9) calcined at 400°C. Since nickel oxide particles were very small with a diameter of around 10 nm and were comparable in size with gold particles, this catalyst looked like a mixture of gold and NiO particles. However, the interface between the two particles also showed that gold particles had grown facing Au(111) plane to NiO(111). The lattice spacing of NiO(111) is 2.41 Å, slightly larger than the lattice spacing of Au(111) by 2.1%. As this epitaxial-like growth of gold on NiO has to find the specific crystal plane for stabilization during calcination, host oxide with smaller size might cause larger probability for the coagulation of gold.

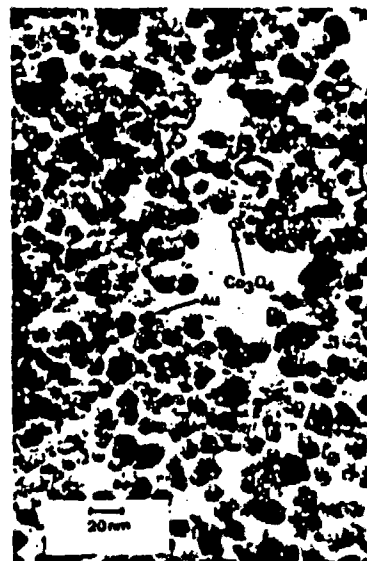

Fig. 5. Fine structure of Au-Co(1/19) coprecipitate calcined at 400 °C.

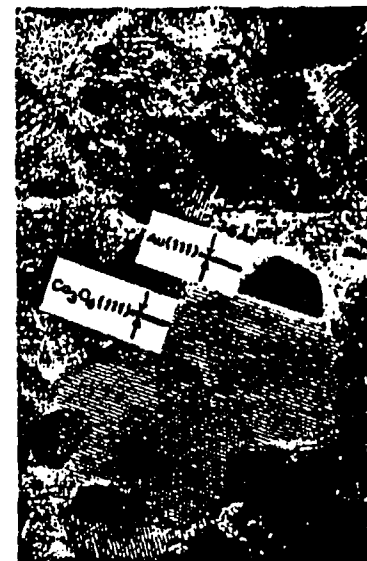

Fig. 6. Ultra-fine gold particles immobilized with Co₃O₄.

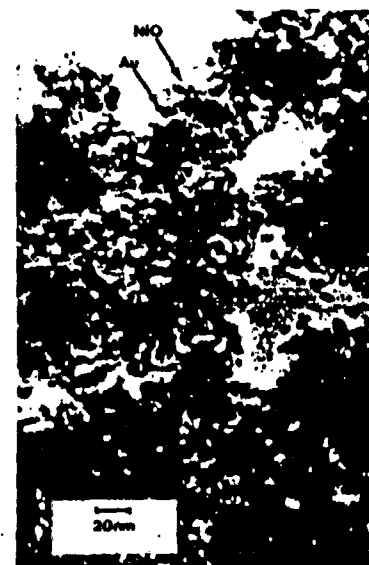

Fig. 7. Fine structure of Au-Ni(1/9) coprecipitate calcined at 400 °C.

REFERENCES

- 1) Bond, G. C. and Sermon, P. A., *Gold Bull.* 6, 102(1973).
- 2) Galvano, S. and Parravano, G., *J. Catal.* 55, 178(1978).
- 3) Zang, G., Ph. D. Thesis, Stanford University, UM 8608245 (1985).
- 4) Haruta, M., Kobayashi, T., Sano, H., and Yamada N., *Chem. Lett.* 1987, 405(1987).
- 5) Haruta, M., Delannay, F., Iijima, S., and Kobayashi, T., *Shokubai (Catalysis)* 29, 162(1987).
- 6) Oberli, L., Monat, R., Matieu, H. J., Landolt, D., and Butter, J., *Surf. Sci.* 106, 301(1981).
- 7) Raub, E. and Walter, P., *Z. Metallkunde* 41, 234(1979).
- 8) Wagner, C. D., Riggs, W. M., Davis, L. E., Moulder, J. F., and Muilenberg, G. E., "Handbook of X-ray Photoelectron Spectroscopy", Perkin-Elmer Co., Eden Prairie, U. S. A., (1979).

Comparison of catalytic activities between various gold catalysts in the oxidation of CO and H₂

Figure 8 shows catalytic activities for the oxidation of CO and H₂ as a function of mean particle diameter of gold. The catalytic activities are expressed by the temperature for 50% conversion and the crystallite sizes of gold were determined by TEM and/or peak-half widths of XRD. The mean diameter of gold exceeded 15 nm in gold catalysts prepared by impregnation and reduction. On the other hand, the mean particle diameter of gold in the coprecipitated catalysts was smaller than 10 nm even though they were calcined at a temperature (400°C) comparably higher than the final heat-treatment temperatures (200°C or 300°C) for impregnated and reduced catalysts.

A general trend is that catalytic activity increases with decreasing diameter of Au crystallites in the oxidation of both CO and H₂. However, small crystallites of Au do not necessarily lead to catalytic activity at -70°C. In the Au/Al₂O₃ catalysts prepared by coprecipitation, the T_{1/2} value for CO oxidation is much higher than those for Au/ α -Fe₂O₃, Au/Co₃O₄, and Au/NiO even though the crystallite size of Au is similar in all cases. On the other hand, the T_{1/2} value for H₂ oxidation is comparable for all four catalysts. Accordingly, the oxidation of CO at low temperatures seems to require both the control of Au crystallite size and the selection of appropriate support oxides.

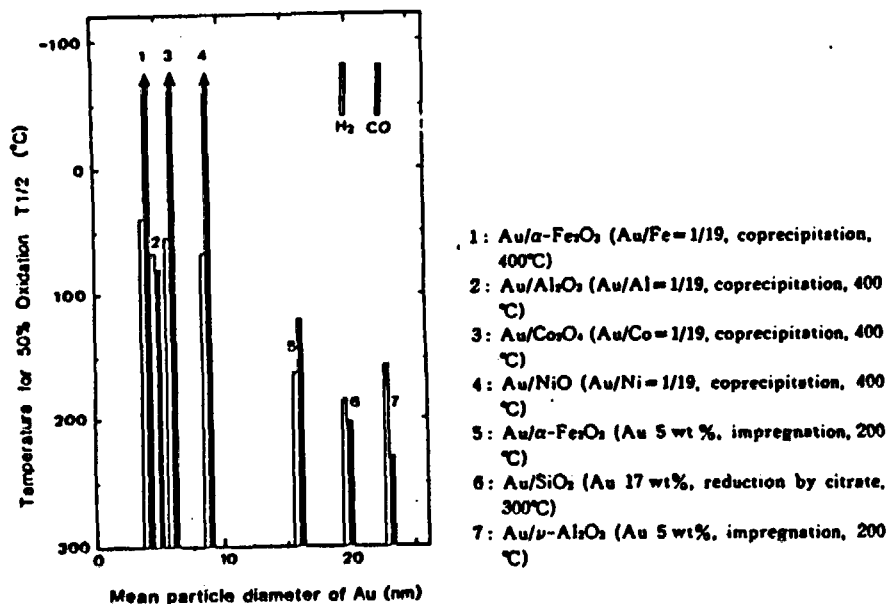

Fig. 8. Catalytic activities for CO and H₂ oxidation as a function of mean particle diameter of gold.

DISCUSSION

The characteristic features of gold catalysts immobilized through coprecipitation with α -Fe₂O₃, Co₃O₄, NiO can be summarized as follows.

- 1) Gold particles are hemispherical in shape and stabilized with host oxides through epitaxial-like crystal growth.
- 2) The mean diameter of gold decreases with an increase in the size of host oxides, namely Au(4.1nm)/ α -Fe₂O₃<Au(6-7nm)/Co₃O₄<Au(7-8nm)/NiO and much smaller than the conventional gold catalysts prepared by impregnation or reduction.
- 3) The ultrafine gold particles immobilized with α -Fe₂O₃, Co₃O₄ and NiO exhibit appreciably large chemical shift toward higher binding energies in XPS than the simple, separated ultrafine gold particles.
- 4) Catalytic activity for the oxidation of CO at a temperature as low as -70°C was remarkably enhanced only when ultrafine gold particles were combined with α -Fe₂O₃, Co₃O₄, and NiO.

The above features strongly suggest that there should be a kind of metal-support interaction between ultra-fine gold particles and group VIII 3d transition metal oxides. In comparison with the data reported by Oberli⁶⁾ that the chemical shift for Au particles of 2-6 nm in diameter is only 0.2eV, the chemical shift, 0.5eV, observed for the gold particles of the same size which are immobilized with α -Fe₂O₃ is appreciably large. This result provides a strong evidence for the metal-support interaction, however, it is not clear at the present stage whether the interaction is physical or chemical nature.

If the interaction is physical electron transfer to the host oxides from hemispherical-spherical gold particles, their junction with flat interface might be advantageous for the enhancement of electron transfer. Usually, the electron transfer causes little effect on the metal side of the junction because conduction electrons are abundant. However, it is possible when gold particles are very small that the change created on the particles by such an effect becomes sufficient to affect the values of the binding energy of the core electrons. According to this model, the progressive shift of the BE of gold 4f_{7/2}+5/2 and 4d_{5/2} with decreasing calcination temperature would be due to the decreasing average size of Au particles.

It is also probable that Au and Fe can form intermetallic compound, or, at least, that Fe has some solubility in Au. It is reported that iron is soluble in Au upto about 10 atom% at 300°C-400°C⁷⁾. The formation of such compounds or solid solution should affect the BE of Au lines. For example, literature⁸⁾ indicates that the BE of Au 4f_{7/2} is higher by about 1 eV for AlAu₂ in comparison with Au metal. It may be thought that the preparation method induces such a type of alloying of Fe into Au during calcining the coprecipitate. Such an alloy formation may require relatively high temperature as 300°C. The abrupt increase in the catalytic activity of Au/ α -Fe₂O₃ for CO oxidation at a calcination temperature of 300°C might probably be ascribed to the formation of intermetallic compounds. As the junction interface between gold particles and hematite was flat and was not broken by the reduction-oxidation treatment, it could be considered that at least at the interface gold and iron forms intermetallic compounds.

PROCEEDINGS OF THE

**THIRD INTERNATIONAL MEETING ON
CHEMICAL SENSORS**

**September 24-26, 1990
Cleveland, Ohio, USA**

Cosponsored by:
The Edison Sensor Technology Center
Resource for Biomedical Sensor Technology
Electronics Design Center
Case Western Reserve University

OPTICAL DETECTION OF CO IN AIR THROUGH CATALYTIC CHROMISM OF METAL-OXIDE THIN FILMS

Tetsuhiko KOBAYASHI, Masatake HARUTA and Hiroshi SANO,
Material Chemistry Department,
Government Industrial Research Institute of Osaka,
Midorigaoka 1, Ikeda, Osaka 563, Japan

Bernard DELMON
Groupe de Physico-Chimie Minérale et de Catalyse,
Université Catholique de Louvain,
Place Croix du Sud 1, B-1348 Louvain-la-Neuve, Belgium

Abstract

Transparent thin films of transition-metal oxides (Cr, Mn, Fe, Co, Ni, or Cu-oxide) were prepared by pyrolysis of organic metal salts on glass substrates. At 250°C - 350°C, the thin films of Mn_3O_4 , Co_3O_4 and NiO showed detectable decreases of optical absorption in visible region due to the presence of CO in air, which can be regarded as catalytic chromism. Since the optical response of these oxides toward CO reversibly occurred with the change in the concentration of CO (0.5 - 10 vol.% in air), the catalytic chromism is applicable to the optical detection of CO.

Introduction

The optical detection of gases has been attracting a growing interest owing to the following advantages; (i) less danger against ignition of explosion, (ii) resistance to electro-magnetic noise, and (iii) operation through optical fibers without electricity. We have recently reported that combustible gases can be optically detected by a combination of an optical thermometer and the oxidation catalyst through exothermic catalytic oxidation of the gases¹.

In the present study, the absorption spectra of transition-metal oxides have been investigated in order to develop a novel optical gas sensor which can directly output the optical signal responsive to the presence of gases. The thin oxide films were adopted as a specimen because of the high transmission efficiency of light. The high ratio of "surface" to "bulk" of the thin films enable us to expect a large optical response induced by the interaction of gases with the surface.

Experimental

Transparent thin films of Cr_2O_3 , Mn_3O_4 , Fe_2O_3 , Co_3O_4 , NiO, and CuO were prepared by pyrolysis of naphthenates or 2-methylhexanoates of corresponding transition metals². The butanol solution or the toluene solution of the organic salts of metals (2.5 - 6 wt.% of metal) was deposited on the one side of glass substrate (18 x 18 x 0.1 mm) by use of a spin-coater at a rotating rate of 5000 rpm. After dried in the ambient atmosphere and temperature for 1 h, the organic salts deposited on the glass surface were pyrolyzed in air

for 2 h at appropriate temperatures where the pyrolysis of the organic salts could be readily completed. The temperatures confirmed by TG and DTA beforehand were 500°C for Cu-oxide and 400°C for other oxides. Thickness of the films were in a range of 300 - 700 nm, determined by SEM observation.

Absorption spectra of the oxide films were analyzed with a transmitted visible light by use of a spectrometer which has a multi-channel photodetector and a halogen lamp (150W) as a light source. In order to control the atmosphere and the temperature of the films during the optical measurements, the thin film specimen was set in a quartz cell (200 ml) with an electric heating coil and a pair of parallel flat windows for the transmission of the light. The atmospheric gases were passed through the cell at a flow-rate of 100 ml·min⁻¹.

Table 1 Change in the absorbance (Δ Abs) of the thin oxide films induced by 1 vol.% CO in air.

Oxide	Absorbance in air		Δ Abs by CO	
	at 250°C	at 350°C	at 250°C	at 350°C
Cr ₂ O ₃	...	0.039	...	nd
Mn ₃ O ₄	0.107	0.108	-3.7 %	-4.6 %
Fe ₂ O ₃	...	0.129	...	nd
Co ₃ O ₄	0.170	0.174	-2.9 %	-1.7 %
NiO	0.042	0.054	-2.3 %	-21.1 %
CuO	...	0.248	...	nd

Wavelength = 700nm, nd < 0.1 %

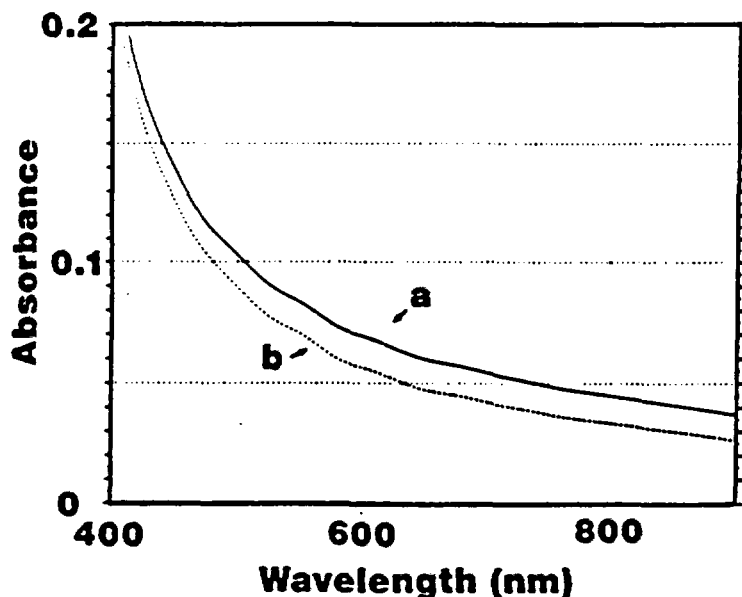

Fig. 1 Visible-light absorption spectra of a NiO thin film at 350°C.

a; in air, b; in 1 vol.% CO + air.

Catalytic activity of the oxide films for the oxidation of CO was measured calorimetrically by a DSC equipment in a stream of air containing 1 vol.% CO.

Results and discussion

Effects of CO on optical absorption of the thin oxide films were measured at 250°C and 350°C, and the results at the wavelength of 700 nm were summarized in Table 1. It was found that the thin films of Mn₃O₄, Co₃O₄, and NiO showed detectable decreases in the absorbance when 1 vol.% of CO was introduced to air in the quartz cell. The optical response to CO was most remarkable on the NiO film at 350°C.

The absorption spectra of the NiO film in the visible region at 350°C are shown in Fig. 1. The decrease in the absorbance by CO

was not specific to a certain wavelength but was observed in the whole visible region.

Figure 2 shows the time-response of the optical change of the NiO film to CO. Since 99.9% of the atmosphere in the cell is replaceable within 14 min after the flowing gas was changed, the optical change of the film seems to follow rapidly the change in the composition of the atmosphere.

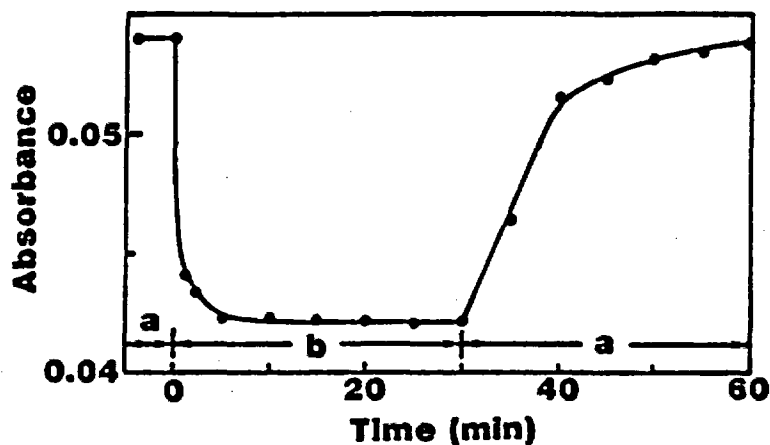

Fig. 2 Time-response of the change in the absorbance of a NiO thin film at 350°C. a: in air, b; in 1 vol.% CO + air. Wavelength = 700 nm.

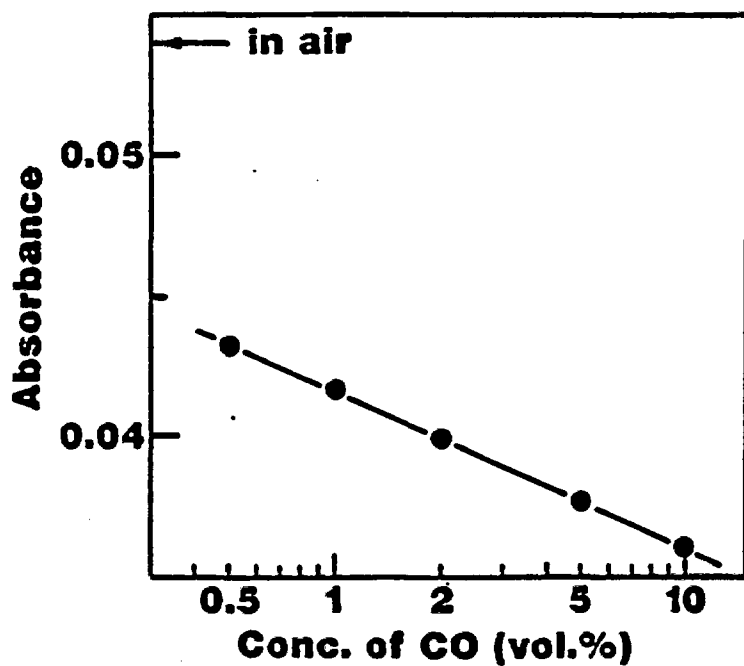

Fig. 3 Decrease in the absorbance of a NiO thin film with the concentration of CO at 350°C. Wavelength = 700 nm.

Figure 3 shows the dependency of the absorbance on the concentration of CO. The decrease in the absorbance is proportional to the logarithm of CO concentration in the range of 0.5 to 10 vol.%. It should be noticed that the absorbance change is observed due to a small amount of CO even in the co-presence of a large excess of oxygen, and therefore, a simple reduction of the oxide film by CO can not be regarded as an origin of the phenomenon.

Similar results shown in Figs. 1 - 3 were also obtained in the cases of Co_3O_4 film³ at 250° C and Mn_3O_4 film at 350° C.

Catalytic oxidation of CO over a NiO film could be calorimetrically detected at temperatures above 250° C and the rate at 350° C was evaluated as ca. $8 \times 10^{-9} \text{ mol} \cdot \text{s}^{-1} \cdot \text{cm}^{-2}$. This strongly suggests that the change in the absorbance of the NiO film is caused by one or a combination of the elementary steps in the catalytic CO oxidation (Catalytic Chromism); adsorption of CO, elimination of adsorbed oxygen species, or formation of carbonates.

The decrease in the absorbance of the film was also observed when the atmosphere was changed from air to N_2 at 350° C. According to the reported results⁴ on the TPD of oxygen over NiO, O_2^- species seem to be adsorbed and desorbed depending upon the concentration of O_2 at around 300° C. Since NiO shows p-type semiconductivity⁵, the adsorption of O_2^- produces the positive holes, p^+ , in the valence band. Catalytic CO oxidation reduces the concentration of adsorbed O_2^- and hence that of p^+ .

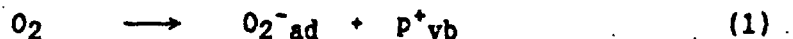

If it is assumed that the electron-excitation in the valence band from the filled states toward p^+ causes optical absorption of wide wavelength, the decrease in the absorbance is explainable as the decrease in the concentration of p^+ due to the catalytic oxidation of CO.

The reversibility with a fast response and the concentration-dependency observed in Figs. 2 and 3 have proved that the catalytic chromism is applicable to an optical detection of CO contained in air.

References

- 1 T. Kobayashi, M. Haruta, S. Tsubota, H. Sano and B. Delmon, *Sensors and Actuators*, **B1**, 222 (1990).
- 2 S. Mizuta, T. Kunagai, W. Kondo and H. Yokota, Technical Report of JITA, No.162, Jpn. Ind. Techn. Assoc. (1986) p.82.
- 3 T. Kobayashi, M. Haruta and H. Sano, Proc. 9th Chem. Sens. Sympo. Jpn., 149 (1989).
- 4 M. Iwamoto, Y. Yoda, M. Egashira and T. Seiyama, *J. Phys. Chem.*, **80**, 1989 (1976).
- 5 F. S. Stone, *Adv. Catal.*, **13**, 1 (1962).

**RESEARCH ON HLW MANAGEMENT IN
GOVERNMENT INDUSTRIAL RESEARCH INSTITUTE - OSAKA**

Our laboratory has been contributing to the development of solidification processes of high-level nuclear waste, HLW, from the fundamental aspects. The studies are carried out at cold and laboratory scale, in co-operation with the Power Reactor and Nuclear Fuel Development Corporation, PNC. Testing methods for the characterization of solidified products are concerned with.

Present Subjects

1. Natural analogues for leaching behavior of nuclear waste glass forms
 - Chemical stability of glass forms
 - Corrosion of natural glass in laboratory environments
 - Evaluation technique for long term stability in waste glasses (in co-operation with PNC)

Finished Subject

1. Vitrification process

- (1) Phase separation of molybdates from melt
 - Solubility of MoO_3 in glass melt
 - Change of physical properties of borosilicate glass by MoO_3 -phase separation
- (2) Volatilization
 - Volatilization of HLW containing borosilicate glass at elevated temperature
 - Effect of water vapor on the rate of volatilization from B_2O_3 -containing glass
 - Volatilization mechanism of cesium from molten borosilicate glass
- (3) Corrosion of materials for glass melting furnace
 - Corrosion of heat-resisting alloys by melts contained HLW at high temperatures
 - Corrosion test of various refractories for glass melting furnace
 - Corrosion mechanism of INCONEL electrode by glass melts
- (4) Measurement of physical properties of HLW-containing borosilicate glasses at elevated temperatures
 - Viscosity
 - Electrical conductivity

2. Improvement of melter elements

- (1) Development of long-life refractory materials for ceramic melter
 - Synthesis of ZnCr_2O_4 spinel by sintering and the corrosion test
- (2) Development of long-life electrode materials for ceramic melter
 - Synthesis of Cr-metal and ZnCr_2O_4 spinel composites by hot-pressing and the corrosion test

3. Characterization of solidified products

- (1) Thermal conductivity
 - Measurement of thermal conductivity of borosilicate glasses by laser-flash method
 - Thermal conductivity of mixed alkali glasses
 - Thermal conductivity of glass-copper composites
 - Calculation of thermal conductivity in glass-copper system by sphere packing models

(2) Leachability

- Chemical durability of HLW containing borosilicate glasses
- Effect of surface roughness of glass on the leachability
- Effect of pH of leachants on the leachability
- Leach models of alkali from HLW containing borosilicate glasses

(3) Crystallization

- Effects of crystallization on thermal properties and chemical durability of HLW containing glasses

(4) Characterization of glassy solid form

- Depth-profiling of leached glass surface by ESCA
- Characterization of the simulated waste glass produced in France (COGEMA); Collaboration work with CRIEPI, Density, thermal expansion coefficient, transition temperature, thermal conductivity, elastic constants, leachability.

4. Alternative solidification processes

(1) Alcoholated gelation of HLW and melting by micro-wave furnace

- Preparation of alcoholated gel from HLW
- Drying, calcination and melting of alcoholated gel by micro-wave irradiation

(2) Pressure sintering process

- Pressure sintering of simulated HLW with glass powders
- Pressure sintering of copper-glass composites
- Development of continuous pressure sintering process with HLW-containing glass and copper metal powders

(3) Normal sintering of HLW powders

- Normal sintering of HLW powders with porous high-silica glass powders

5. Other

- (1) Possibility of application of solid form containing HLW as heat generator**

TECHNOLOGIES DISCUSSED WITH MITI:

- **Rapid Measurement Technique of Pollutants in Groundwater**
- **Treatment of Wastewater Chemicals by Super Critical Fluid**
- **Enhancement of Microbial Activity in Membrane Bioreactor**
- **Evaluation of Organic Membrane Materials for Bioreactor**
- **Microhabitat of Microbes Degrading Hazardous Compounds in Activated Sludge Floc**
- **Decomposition of Organic Compounds by Oxidation Methods**
- **Oxidation of Organic Compounds with Biomimetic Catalysts**
- **Trace Metal Species in Inland Sea Bottom Water**
- **Interferometer Type Sensors Using Optical Fibers**
- **New Waste Water Treatment System Using High-Concentrated Bioreactor and Separation membrane, for Water Reuse and Energy Recovery**
- **Remote Fiber Sensing of Some Organic Contaminants in Water by Laser Spectrometry**

BIBLIOGRAPHY OF LITERATURE RECEIVED FROM MITI

"Aqua Renaissance '90 Project", National Research and Development Program, MITI, 6 pages.

"Budget, Staff and Scale Information", MITI, 7 pages.

National Research and Development Program

AQUA RENAISSANCE '90 PROJECT

**R&D on new wastewater treatment system,
using high-concentrated bioreactor
and separation membrane,
for water reuse and energy recovery**

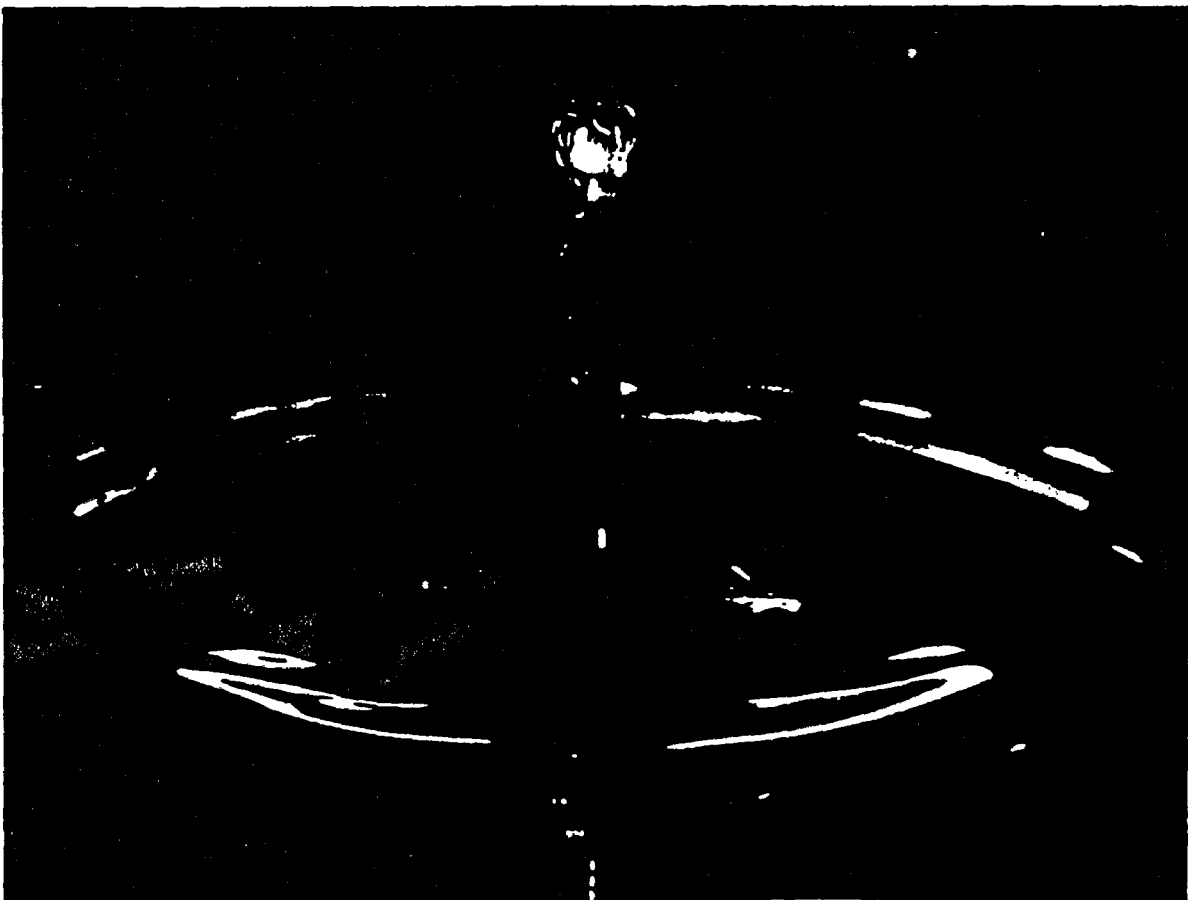



Aqua Renaissance '90 Project

To cope with short supply of water in the near future and water pollution, industrial wastewater, sewage, and other aqueous effluents must be processed to get new water resource. But the prevailing water treatment process require large treatment facility sites or large land as sludge-disposal dumps and much energy consumption.

Japan depends heavily on imported petroleum for its energy supply and its energy supply structure is fragile compared with other advanced countries. For this reason, it is necessary to establish novel ways of ob-

taining new, inexpensive energy in order to make the nation less dependent on petroleum.

The Ministry of International Trade and Industry (MITI) has been conducting research and development on new wastewater treatment systems permitting water reuse and energy recovery under the name of "the Aqua Renaissance '90 Project" This undertaking is part of the National Research and Development Program "large-scale project". The total budget of the project is about 12 billion yen during six years (1985 - 1990).

Development on biotechnology and separation-membrane technology in the new water treatment system.

The principal research and development items are the following:

1. R & D on Microorganism (Selection and activation of valuable microorganisms)
2. R & D on Membrane (R & D on efficient membrane for separation which is resistant to the deteriorating effects of sewage and microorganisms)
3. R & D on Final Treatment Reactor (R & D on bioreactor for denitrification, and R & D on production of oil from the sludge)
4. R & D on Membrane Module (R & D on compact membrane module which can effectively separate the microorganisms and organic materials)
5. R & D on Bioreactor (R & D on high-efficiency bioreactor for methane production)
6. R & D on Control System (R & D on optimum control and sensor system consist of instrumentation for monitoring flow rates, methane fermentation, etc.)
7. R & D on New Watertreatment System (Completion of new system for water reproduction and energy recovery)

Research & Development Schedule

Fiscal year	1985	1986	1987	1988	1989	1990
R&D on microorganisms						
R&D on membrane						
R&D on final treatment reactor		Basic research	Fundamental experiments			
R&D on membrane module		Basic research	Fundamental experiments			
R&D on bioreactor		Basic research	Fundamental experiments			
R&D on control system		Basic research	Fundamental experiments			
R&D new watertreatment system	Overall planning	Study on related technology	Schematic design	Detail design and construction	Pilot plant operation	
(1) R&D on total system technology						
(2) Support studies						

Intermediate evaluation

Final evaluation

Epoch-making water treatment and methane production technology.

Advantage of the new wastewater treatment

- 1) compact facility
- 2) large reduction in the amount of sludge generated
- 3) little energy consumption
- 4) easy to control and maintain

Comparison between prevailing water treatments and the Aqua Renaissance '90 Project

Prevailing water treatment

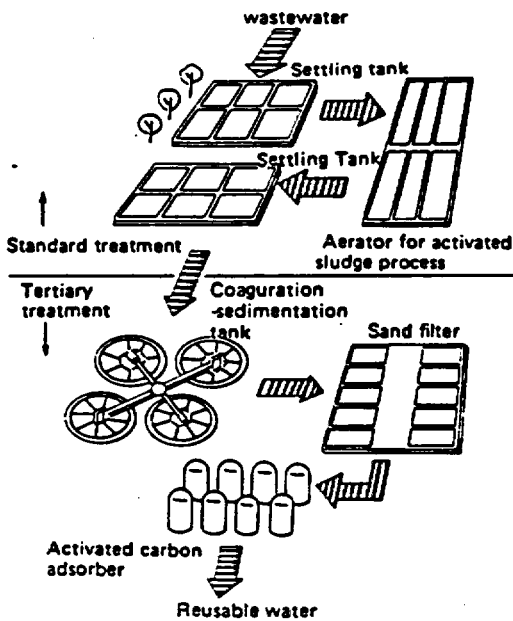

Aqua Renaissance '90 Project

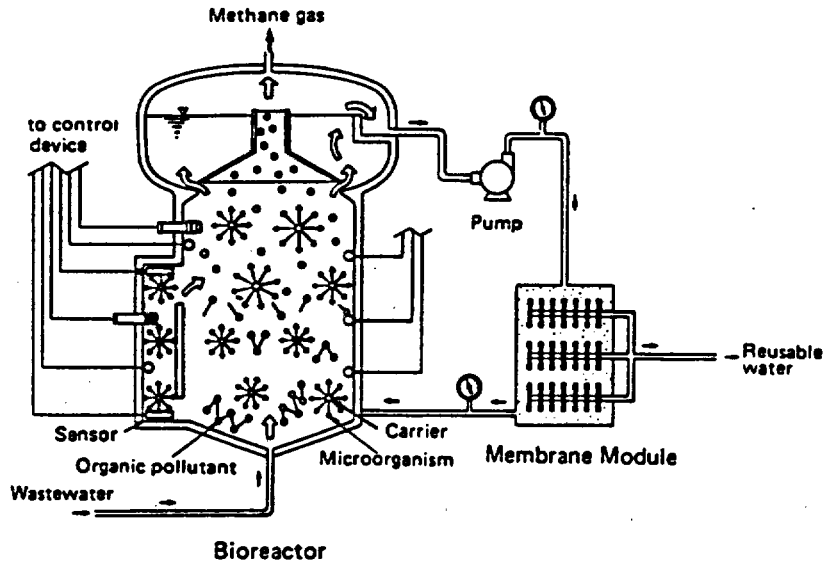

The Aqua Renaissance '90 Project will realize the followings

Quality of treated Water (BOD)*	Aqua Renaissance 2 ppm	5 ppm	Prevailing water treatment
Energy Consumption	1/20-1/3		
Installation Site	1/20-1/3		
Excess Sludge	1/40-1/3		
Cost of Water Treatment	1/20-1/3		
Cost of Methane Production	1/20-1/3		

● Extensive Spin-off of Aqua Renaissance '90 Project

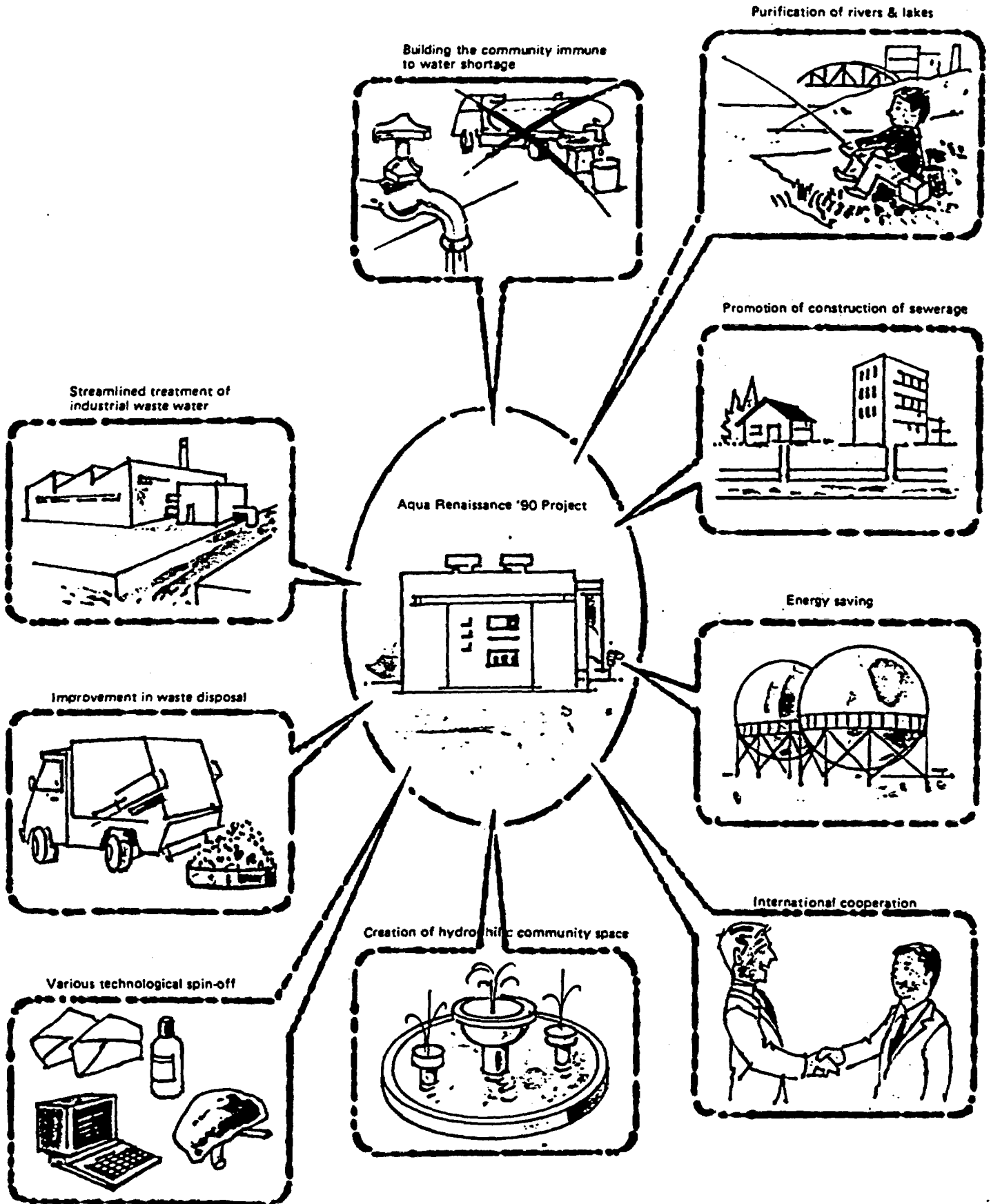

Members of Association

Ishikawajima Harima Heavy Industries Co., Ltd.
Ebara Corporation
Japan Organo Co., Ltd.
Kawasaki Heavy Industries, Ltd.
Kubota, Ltd.
Kurita Water Industries Ltd.
Kobe Steel, Ltd.
Sanki Engineering Co., Ltd.
Shimizu Construction Co., Ltd.
Water Re-use Promotion Center
Chiyoda Chemical Engineering &
Construction Co., Ltd.
DIC-Degremont Co., Ltd.
Toshiba Corporation
Toto Ltd.
Nishihara Environmental Sanitation Research Corporation
Nitto Electric Industrial Co., Ltd.
NGK Insulators, Ltd.
Nippon Petroleum Refining Co., Ltd.
The Japanese Association of Industrial Fermentation
Hitachi Plant Engineering & Construction Co., Ltd.
Mitsubishi Electric Corporation
Mitsubishi Rayon Engineering Co., Ltd.

Organization chart of the associaton

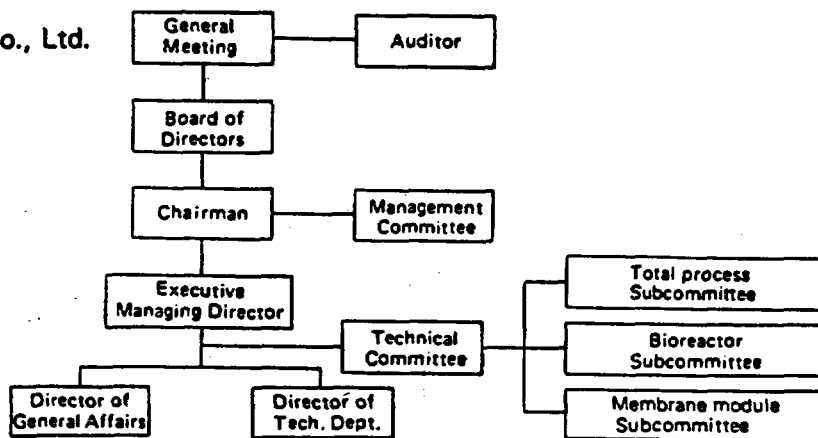

Aqua Renaissance Research Association

Aqua Renaissance Research Association

Address: Toranomon Takagi Bldg. 2F
7-2, Nishi-Shimbashi 1-Chome
Minato-Ku, Tokyo 105
JAPAN
Tel: (03) 503-2131 Fax: (03) 503-2139

公害資源研究所 平成元年度 予算, 人員及び規模 Budget, Staff and Scale, FY1989

予算 (単位百万円) Budget (Unit: Million Yen)

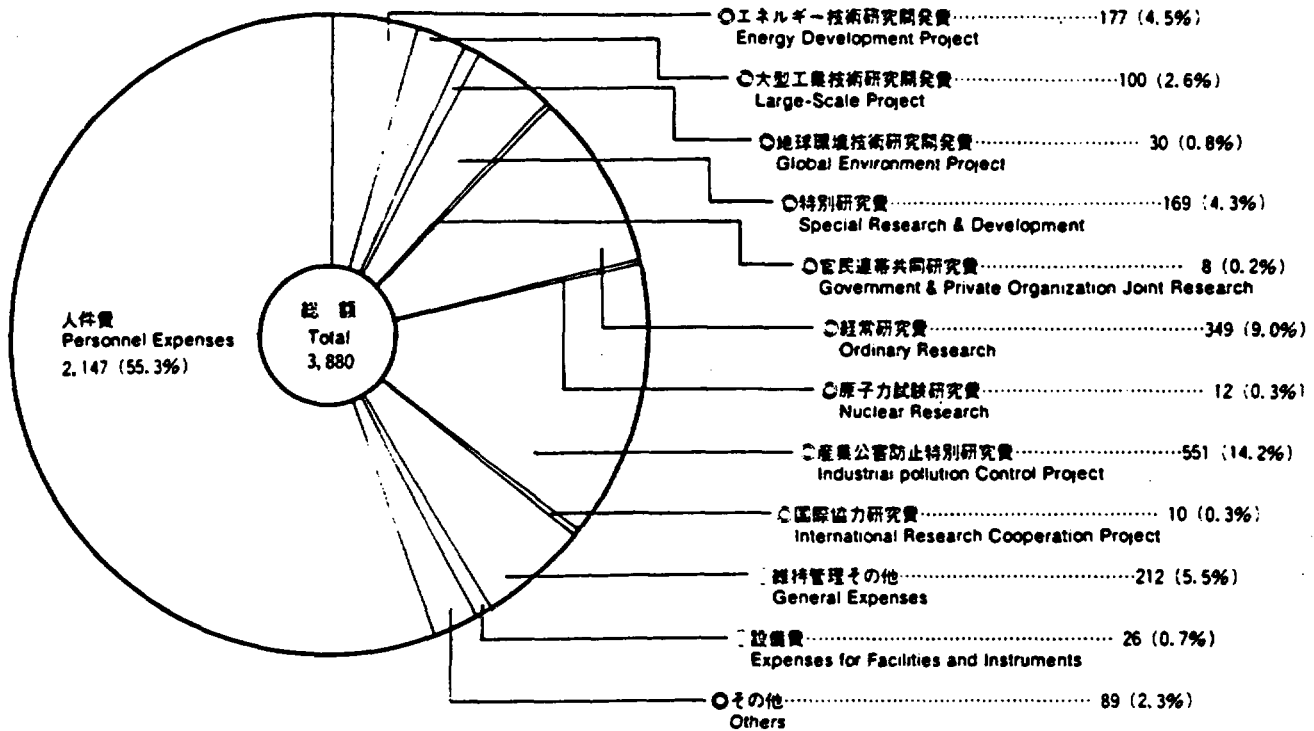

研究分野別予算 (単位百万円) Budget Research Field

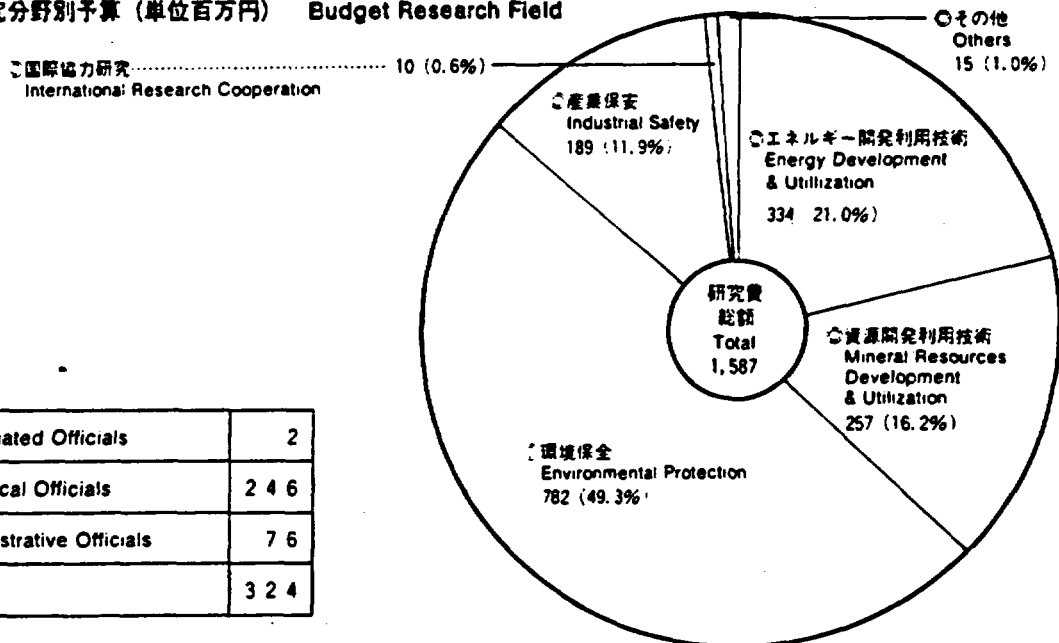

人員 Staff

指定職 (Designated Officials)	2
研究職 (Technical Officials)	246
行政職 (Administrative Officials)	76
合計 (Total)	324

規模 Scale

	本所 National Research Institute for Pollution and Resources	北海道石炭鉱山技術 試験センター Coal Mine Safety Research Center, Hokkaido	九州石炭鉱山技術 (試験炭鉱) Coal Mine Safety Research Center, Kyushu	稚井分室 試験センター Experimental Coal Mine, Usui
敷地面積 Area	262,497 m ²	10,197 m ²	20,769 m ²	80,268 m ²
建物の延面積 Building	54,826 m ²	3,765 m ²	3,400 m ²	2,113 m ²

組織及び業務 Organization and Activities

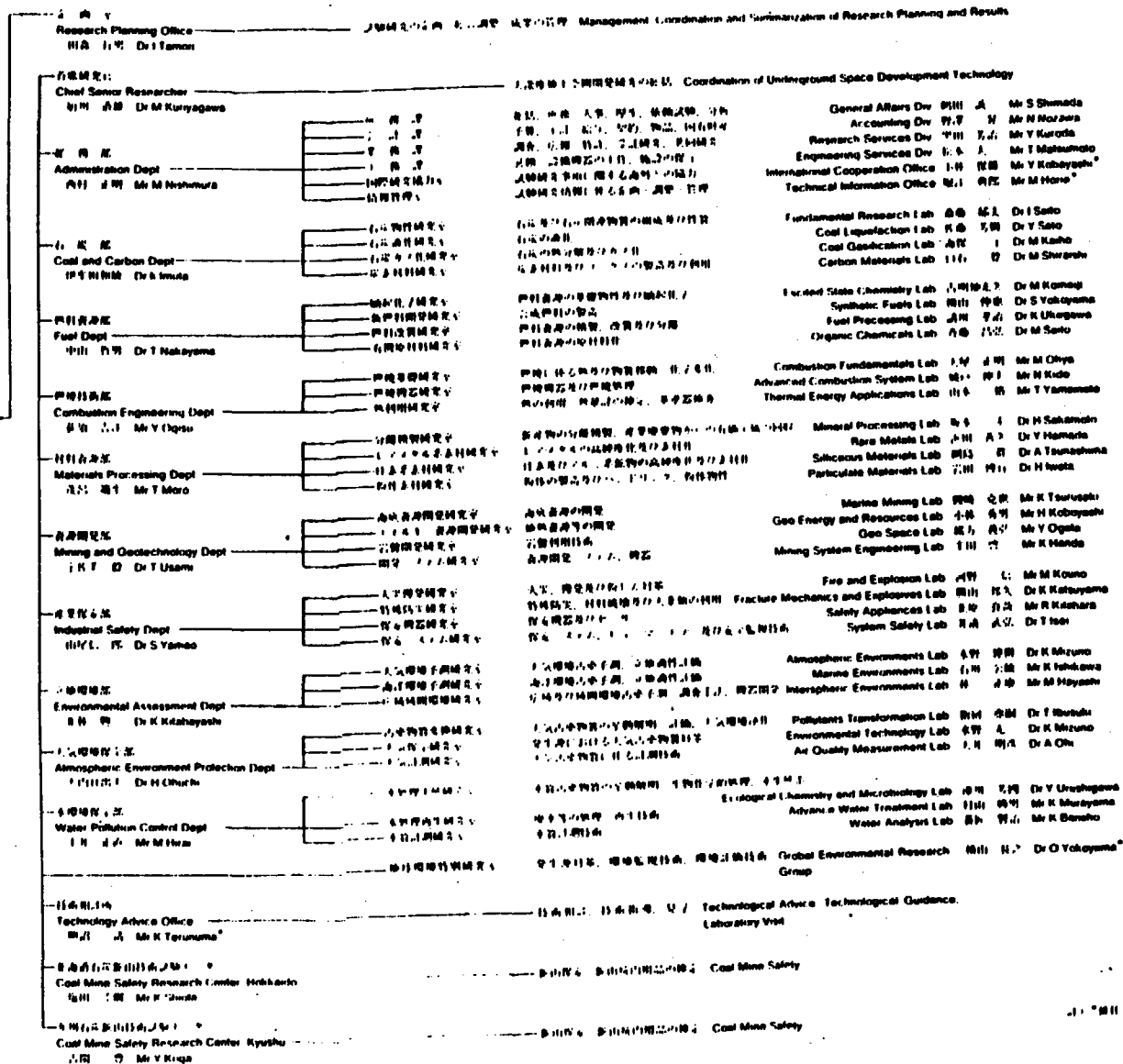
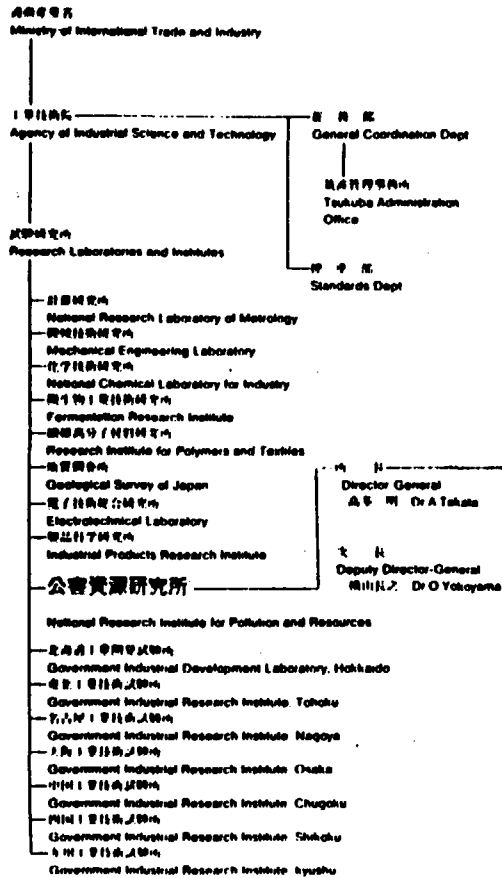

平成元年度研究課題

List of Research Project in FY1989

特別研究

Special Research & Development

安全・保安技術

- 鉱山保安技術に関する研究(火災対策と退避システム)
- 液化石油ガス保安対策技術に関する研究
- 不連続性岩盤の安全性評価に関する研究

Mine and Industrial Safety

- Mine Safety Technology (Fire prevention and emergency escape system)
- Safety technology on the Liquefied Petroleum Gas
- Safety in Discontinuous Rocks

資源・エネルギー技術

- 天然ガスからの液体燃料の製造に関する研究
- 珪素鉱物からの高付加価値シリコン系素材の製造に関する研究
- 湿式法によるレアメタルの濃縮精製技術に関する研究
- 花崗岩の資源化技術に関する研究
- 高温ヒートパイプに関する研究

Resources and Energy Technology

- Production of Liquid Fuel from Natural Gas
- Production of Silicon Materials from Low-grade SiO₂ Ores by Chlorination
- Refining of Rare Metals
- Utilization of Granite for Industrial Use
- High Temperature Heat Pipes

新材料技術

- 気相熱分解法による炭素系材料の製造に関する研究
- レアアース系ゼロ次元複合機能性材料の創製に関する研究

New Materials

- Formation of Carbon Materials by CVD
- Formation of Functional Suspension Colloids of Ultrafine Powder Containing Rare-Earth Compounds

産業基盤確立技術

- 超微粉砕技術に関する研究
- レーザーによる炭素複合クラスターの創製に関する研究

Basic Technology for Future Industry

- Ultra-fine Grinding Process
- Production of carbon Clusters and Carbon Metal Complexes Using Laser

鉱山保安技術研究

- 坑内火災消火技術に関する研究
- 静電気着火防止技術に関する研究

Coal Mine Safety

- Mine Fire Extinguish Techniques
- Countermeasures against Electrostatic Charges

官民連帯共同研究

- 地下空間におけるAE・地圧・岩盤特性の精密評価技術に関する研究

Government & Private Organization Joint Research

- Precise Measurement of AE, Earth Pressure and Deformation of Rockmass around the Cavern

原子力平和利用技術

- 放射性廃棄物処分空洞の岩盤力学特性に関する研究

Nuclear Research

- Rock Mechanics about Storage Caverns for Radioactive Wastes

公害防止技術

- 不活性化学物質の不均一系光反応による変換・分解に関する研究
- 物理化学的方法による窒素・リンの高度処理技術に関する研究
- 工場騒音の複数伝搬モデルに関する研究
- 活性汚泥の生態学的制御による有害化学物質の高効率処理手法に関する研究
- 工業都市域における浮遊粒子状物質の大気環境濃度予測手法に関する研究
- 化学工場周辺の海域における難処理性合成有機化合物の挙動に関する研究
- 地下水汚染防止に係る水中汚濁成分の迅速分析技術に関する研究
- 海外炭の利用拡大に対応する大気汚染防止技術に関する研究
- ディーゼル重量車NO_x低減対策に関する研究
- 酸性物質生成に係る環境中反応性化学種の高感度簡易測定に関する研究
- 臨海工場地先の停滞海域における黄酸素水塊構造の解明に関する研究

Pollution Control

- Transformation and Decomposition of Less Active Chemical Substances in the Troposphere
- Physical Chemical Wastewater Treatment for Nitrogen and Phosphorus Removal
- Complex Propagation Model for Factory Noise
- Ecological Control of Activated Sludge Process for Hazardous Compounds
- Simulation Models of Suspended Particulate Concentration from Industrial Emission
- Behavior of Synthetic Organic Compounds in Coastal Environment
- Rapid Measurement Technique of Pollutants in Groundwater
- Preparation Technology of Ultra Clean and Combustion Control Technique for Low Volatile Coal
- Reduction of NO_x emitted from Heavy-Duty Diesel-Powered Vehicles
- Measurements of Various Reactive Species Related to Environmental Acidification by Developing Sensitive Analytical Methods
- Anoxic Water Mass Formed in the Stagnant Waters of Inland Sea

- エタノール発酵残渣の油化処理技術に関する研究
- 浅海環境の長期的変遷過程の解明による最適立地の予測技術に関する研究
- 沿岸海域における浮遊生物組成変化の予測と自動計測技術に関する研究
- 有害有機化合物混合系産業廃棄物の処理技術に関する研究
- 先端技術産業に係る環境汚染物質の拡散予測とモニタリング手法の開発に関する研究
- 揮発性有機ハロゲン化合物の大気放出制御技術に関する研究
- 大気中粒子との相関を考慮した発生源ダストの評価と測定方法に関する研究
- 超臨界流体による排水中の化学物質の処理技術に関する研究
- 群小発生源からのNO_x低減化のための触媒燃焼技術に関する研究
- フロン代替物質の対流圏内における分解過程に関する研究

- Liquid Fuel Production from Ethanol Fermentation Stillage by Thermochemical Conversion
- Long Range Prediction Model for the Change of Shallow Water Environment for Optimum Industrial Development
- Structure of Lower Trophic Ecosystem in an Eutrophicated Bay-Automated Measurement and Prediction of Plankton Organismus Succession
- Treatment of Industrial Wastes Containing Mixed Hazardous Organic Compounds
- Diffusion Processes and Monitoring Method of Pollutants Related to High Technology Industries
- Emission Control of Volatile Organic Halides by Adsorption
- Evaluation and Measuring Method for Source Dust in Consideration with SPM
- Treatment of Wastewater Chemicals by Super Critical Fluid
- Catalytic Combustion Technique for Reduction of NO_x from Small Scale Stationary Sources
- Removal Processes of Alternatives to the Legislated Chlorofluorocarbons in the Troposphere

地球環境

- 産業活動起源の温暖化関連物質の挙動解明に関する研究

Global Environment

- Environmental Behavior of Green House Gases of Industrial Origin

国際産業技術研究事業

- 中国レアメタルの分離精製技術に関する研究
- 熱帯地域における大気汚染アセスメント手法に関する研究

International Research Cooperation

- Separation and Refining of Chinese Rare Metal Ores
- Air Pollution Assessment in a Tropical Area, India

公害防止事前調査

Assessment Technology for Industries

- 大気汚染シミュレーションモデル開発
- 水質汚染予測手法開発

- Assessment Models of Air Pollution
- Assessment Models of Water Pollution in Coastal Area

指定研究

Designated Research & Development

——大型工業技術研究開発 (大型プロジェクト)——

——Large-Scale Project——

マンガン団塊採鉱システムの研究開発

- マンガン団塊の採掘性に関する研究
- マンガン団塊の揚鉱特性に関する研究
- マンガン団塊の採鉱に伴う環境保全に関する研究

Manganese Nodule Mining System

- Manganese Nodule Collecting Technology
- Hydraulic Lifting Technology of Deep Sea Manganese Nodules
- Marine Environmental Assessment Studies for Ocean Mining of Manganese Nodules

水結合再生利用システムの研究開発

- 微生物の高活性化技術/膜で分離された微生物の高活性化
- 有機膜の研究開発/有機膜素材の評価技術

New Water Treatment System

- Enhancement of Microbial Activity in Membrane Bioreactor
- Evaluation of Organic Membrane Materials for Bioreactor

大深度地下空間開発技術に関する研究

- 高精度地下構造評価技術
- 大深度地下空間構築技術
- 大深度地下空間環境制御・防災技術

Underground Space Development Technology

- Geological Survey and Evaluation Technology
- Dome Construction Technology
- Environment Conditioning and Hazard Preventing Technology

——新エネルギー技術研究開発 (サンシャイン計画)——

——New Energy Development Project——

石炭エネルギー

- 石炭ガス化の高効率化に関する研究

Coal Energy

- Improvement of Gasification Efficiency of Coal
- Coal Gasification Upgrading and Utilization of By-product Pro-

地熱エネルギー

- 高温岩体の破砕熱抽出技術に関する研究
- 地熱井掘削技術等に関する研究
- 高温岩体熱抽出システムの解析評価

新エネルギー技術の基礎的研究開発

- 木質系バイオマスから液体燃料の製造に関する研究

——省エネルギー技術研究開発（ムーンライト計画）——

先進的基礎的省エネルギー技術

- 燃焼技術の高度化に関する研究

——地球環境技術研究開発——

- 産業起源の二酸化炭素放出低減技術分析モデルの構築
- 二酸化炭素還元反応の研究

Geothermal Energy

- Fracturing and heat Extraction Technology of Hot Dry Rock
- Geothermal Well Drilling Technology
- Data Analysis and Evaluation on the Heat Extraction System of Hot Dry Rock

Basic Study on New Energy Development

- Liquid Fuel Production from Woody Biomass by Thermochemical Conversion

——Energy Saving Project——

Leading and Basic Technology for Energy Conservation

- Advanced Combustion Technology

——Global Environment Project——

- System Studies for Reduction of Industrial Carbon Dioxide Emission
- Research for Reduction of Carbon Dioxide

科学技術庁重点基礎研究

Accelerated Basic Research

- 二酸化炭素の再資源化技術の基礎的研究
- 地下環境制御技術の基礎的研究
- 光機能特性を有する含窒素化合物の基礎的研究
- 基盤的研究分野における知識ベース構築手法の基礎的研究

- Preparation of Chemicals from Carbon Dioxide
- Control Technology of the Underground Space
- Synthesis of Nitrogen Compounds with Photoinduced Functions
- Knowledge Base Systems in the Fields of Pollution and Resources

経常研究

Ordinary Research

石炭部

- 石炭組織成分の分光学的手法による構造研究
- 石炭の液化反応機構の研究
- 炭素-鉱物系多孔質への微生物固定化の研究
- 熱プラズマ法によるダイヤモンド合成の基礎研究
- 高分子炭化物の吸着分離能向上の研究
- 芳香族系ポリマーからの新炭素体の合成

Coal and Carbon Department

- Structural Study on Petrographic Components of Coal by Spectroscopic Methods
- Reaction Mechanism of Coal Liquefaction
- Porous Materials from Coal for Microbes
- Synthesis of Diamond using a Plasma Jet
- Improvements of Adsorptive Ability of Carbonized Products
- Novel Carbon Materials from Aromatic Polymers

燃料資源部

- レーザー特異反応の基礎研究
- 光動起ピロール錯体の特性及び利用の研究
- 有機スラッシュ油化の基礎的研究
- 炭化水素の膜分離技術の研究
- 重質分解油から縮合多環芳香族分離技術の研究
- 金属化合物を含有するカーボンブラックの研究
- シェール油の高度利用のための基礎的研究
- ナフタレン類及びナフトール類の酸化反応の研究

Fuel Department

- Fundamental Interactions between Hydrocarbon Molecules and Laser Photons
- Characterization and Utilization of Aromatic Hydrocarbons-Pyrroles Exciplex
- Thermochemical Treatment of Organic Sludges
- Membrane Separation for Hydrocarbons
- Separation for Aromatic Hydrocarbons from Heavy Cracked Oils
- Carbonblack Intercalated with Metal Compounds
- Distinctive Utilization Method of Shale Oil
- Oxidation of Naphthalenes and Naphthols

燃焼技術部

- CARSによる反応場のダイアグノスティクスの研究
- 高酸素燃焼技術の基礎研究
- 燃焼における混相流の流体力学的特性の研究
- 火花放電における炭化反応の研究

Combustion Engineering Department

- Combustion Diagnostics by CARS
- Combustion Technology by Oxygen Rich Air
- Structure of Particle-Laden Turbulent Jet
- Diamond-Like-Carbon Formation during Combustion

- アルコール燃焼の研究
- 熱量測定技術の研究
- 臨界域の輸送現象の研究
- 高負荷ボイラーの研究

材料資源部

- 酸化鉱の選択凝集の基礎的研究
- 希土類元素の分析法の研究
- 石炭微量成分の選別分離の研究
- レアメタル鉱物の選鉱法の高効率化の研究
- 高純度セラミックス原料粉末の生成の研究
- コバルトクラストの精錬技術の研究
- モリブデンの高純度化技術の研究
- 非水溶液を利用するレアメタルの精製微粉体化の研究
- レアメタル系複合素材のための超微粒子の合成及び機能化の研究
- 高付加価値珪酸質素材の低温合成の研究
- 超微粒子合成における熱プラズマの特性の基礎的研究
- 非水溶液を用いた微粉砕技術の高効率化の研究
- 粉粒体充填特性の基礎的研究
- 微粉スラリーの特性と利用の研究

資源開発部

- 海底塊状鉱床の開発技術の基礎研究
- 原位置地圧計測法の研究
- 重圧帯における岩盤評価の研究
- 南極大陸鉱物資源開発の調査研究
- セラミックスビットによる岩石掘削の研究
- 超高压水噴流高度利用の基礎的研究

産業保安部

- 閉鎖系空間における火災・爆発性状の研究
- 高濃度領域粉じん人の均一分散技術の研究
- 地下構築物のセーフティアセメントの研究
- 含水爆薬の動加圧下の爆ごう特性の研究
- ガスセンサーの基礎的研究
- 不均質物体内の流動物性値分布のリモートプロービング技術の研究
- 高压ガス設備の隙間腐食等の研究
- 坑内通気量計測値評価法の研究
- ヒューマンエラー発生機構とその分析手法の研究

立地環境部

- 雲物理過程を含む汚染質の上空拡散の研究
- 青潮湧昇モデルの基礎的研究
- 組み換え体の水系環境内での挙動に関する基礎的研究
- 遺伝情報による海洋微生物群集の機能の評価手法の研究
- リモートセンシングによる太陽光散乱粒子の広域水平拡散現象の研究
- 沿岸海域の環境調査手法の基礎的研究

大気環境保全部

- 低濃度窒素酸化物の除去機能材料開発の研究

- Combustion of Alcohols
- Precise Combustion Calorimetry and Electrical Calibration for Bomb Calorimeter
- Transport Properties near Critical Region
- Study of Direct-Contact Type Boiler

Materials Processing Department

- Selective Flocculation of Oxide Ores
- Determination of Rare Earth Minerals
- Separation and Concentration of Valuable Trace Elements in Coal by Advanced Coal Cleaning Processes
- Advanced Separation for Rare Metal Minerals
- Preparation of Ceramic Powder
- Metallurgy of Cobalt-rich Ferromanganese Crusts
- Refining of Molybdenum
- Refining of Rare Metals with Non-aqueous Solutions
- Preparation of Highly Controlled Ultra-fine Particles for Rare Metal Composites
- Ceramic Processing for Siliceous Materials
- Diagnostics and Modeling of Thermal Plasmas in Connection with Ultra-fine Particles Formation
- Improvement of Fine Grinding Using Non-aqueous Solutions
- Packing Characteristics of Powders
- Characterization and Utilization of Fine Particulate Slurry

Mining and Geotechnology Department

- Massive Mineral Deposits on the Ocean Floor
- Measurements of In-situ Earth Stress
- Rockmass Behaviors under Heavy Earth Pressure
- Research for the Development of Antarctic Mineral Resources
- Rock Drilling by Ceramic Bit
- Fundamental Studies on the Application of Ultra High Pressure Water Jet

Industrial Safety Department

- Characteristics of Confined Fires and Explosions
- Homogeneous Dust Dispersion Technique at Higher Dust Cloud Concentration
- Safety Assessment of Underground Construction
- Detonability of Water-gel Explosives under Dynamic Pressure
- Development of Gas Sensors
- Remoto-proving of Wave Properties through Heterogeneous Bodies
- Crevice Corrosion of the High Pressure Facilities
- Measuring System of Mine Airflow
- Outbreak Mechanism and Analysis Technique of Human Errors

Environmental Assessments Department

- Upward Diffusion Process Accompanying with Cloud Formation
- Fundamental Model of "Aoshio" Water Upwelling
- Ecological Modelling of Engineered Bacteria in Natural Coastal Environment
- Ecological Characterization of Marine Microbial Communities Based on Genetic Information
- Horizontal Diffusion Detected by Remote Sensing Techniques
- New Approach Methods of Coastal Environmental Study

Atmospheric Environment Protection Department

- New Materials Removing Low Concentration Nitrogen Oxides from Air

- 環境中粒子状物質の反応活性発現機構の研究
- フロン、トリクレン等の脱ハロゲン化反応の研究
- 宇宙資源開発利用に係る要素技術の調査研究
- ホスト・ゲスト相互作用の応用による有害化学物質の捕捉の研究
- 作業用ディーゼル機関から排出される黒煙低減の研究
- 超微粒子の捕集性能評価の研究
- 粒子状物質への土壌成分寄与についての研究
- 有機汚染物質の多成分データ解析方法の研究

水環境保全部

- 化学分類手法による混合微生物集団解析法の基礎的研究
- 活性汚泥の微細構造と浄化活性の研究
- 磁気凝集法の研究
- 各種酸化法の組合せによる有機物の分解の研究
- 生体関連触媒による有機化合物の酸化の研究
- 複合化分析技術による水中微量汚濁成分の分析法の研究
- 沿岸域底層水中の全金の挙動の解明

北海道石炭鉱山技術試験センター

- 坑内作業用移動機構の基礎的研究
- 本質安全化超音波監視センサーの基礎的研究
- 光ファイバー干渉型センサーの基礎的研究
- 連続容量回路の本質安全防爆化の基礎的研究

九州石炭鉱山技術試験センター

- ガス流動拡散の研究
- プロパン-空気混合気の点火限界の研究
- 爆薬検定試験法の小型化に関する研究

- Development Mechanisms of Catalytic Action of Particulate Matters in the Environment
- Catalytic Dehalogenation of Halocarbons
- Exploitation of Extraterrestrial Resources
- Capture of Hazardous Chemicals Applying Host-Guest Interaction
- Reduction of Smoke Emitted from Diesel-Powered Vehicles in Working Environment
- Estimation of Collection Efficiency for Ultra-fine Particles
- Estimation of Soil Source Contribution to Metal Components in Suspended Particulate Matters
- Multi-component Data Analysis for Organic Vapor Pollutants

Water Pollution Control Department

- Characterization of Microbial Community Structures by the Cellular Materials
- Microhabitat of Microbes Degrading Hazardous Compounds in Activated Sludge Floc
- Magnetic Coagulation in Effluent and Water Treatment
- Decomposition of Organic Compounds by Oxidation Methods
- Oxidation of Organic Compounds with Biomimetic Catalysts
- Trace Pollutants in Water by Hybrid Analytical Method
- Trace Metal Species in Inland Sea Bottom Water

Coal Mine Safety Research Center, Hokkaido

- Locomotive Mechanism for Underground Development
- Intrinsic Safe Ultrasonic Sensor for Integrated Monitoring System
- Interferometer Type Sensors using Optical Fibers
- Intrinsic Safety for Continuation Circuits with Capacity

Coal Mine Safety Research Center, Kyushu

- Fluidity and Diffusion of Methane Gas
- Ignition Limits of Propane-Air Mixture
- Miniaturization of Testing Methods for Permissible Explosives

TECHNOLOGIES DISCUSSED WITH AIST:

- Superconductivity
- High Performance Ceramics
- Synthetic Membranes for New Separation Technology
- Synthetic Metals
- High Performance Plastics
- High Performance Materials for Severe Environments
- Photoactive Materials
- Non-linear Photonics Materials
- Biotechnology (Utilization of Recombinant DNA)
- Molecular Assemblies for Functional Protein Systems
- New Electron Devices (Superlattices Devices)
- Three Dimensional ICs
- Bio-Electronic Devices
- New Models for Software Architecture
- Manganese Module Mining System
- New Water Treatment System
- Interoperable Database System
- Advanced Materials Processing & Machining System
- Fine Chemicals from Marine Organisms
- Super/Hyper-Sonic Transport & Propulsion System
- Underground Space Development Technology
- Advanced Chemical Processing Technology
- Human Sensory Measurement Application Technology
- High Performance and Low Cost Solar-Photovoltaic Conversion Technology
- Solar-Thermal Applications Systems for Industrial Processes
- Coal Liquidification Technology
- Coal-Based Hydrogen Production Technology
- Integrated Coal Gasification Combined Cycle Power Generation Technology
- Geothermal Energy
- Technologies on Hydrogen Production, Storage, Transportation, Use and Safety
- New Energy technologies (Wind, Ocean, Bio)
- High-efficiency Membrane Complex Methane Production Unit
- Advanced Battery Electric Power Storage System
- Fuel Cell Power Concentration Technology
- Super Heat Pump
- Superconducting Technology for Electric Power Apparatuses
- Ceramic Gas Turbine Project
- Synthetic Technology of Artificial Clay for HP Ceramics
- Re-utilization System Technology of Composite Materials

BIBLIOGRAPHY OF LITERATURE RECEIVED FROM AIST

"AIST Summary", AIST, 35 pages.

LABORATORIES AND INSTITUTES

Technology is a repository of great hope in today's world. At the research laboratories of AIST, work is carried on in developing the leading and basic technologies that will form the groundwork for future technological innovations.

New R&D projects aim at finding solutions to energy shortages, the depletion of the world's natural resources, environmental pollution and other pressing problems.

R&D

Research carried out at AIST laboratories and institutes includes the following characteristics.

- Research and development of leading technologies to form a base for future technological innovation.
- As national institutes, AIST facilities conduct research needed for the propagation of technical standards required for government administration, the establishment, maintenance and supply of standards, and the creation of sophisticated experimental methods.
- Research addressing Social needs in earthquake prediction and environmental protection.
- Government support makes possible fundamental and comprehensive experimental research which would be beyond the resources of the private sector.

Research projects are classified into two broad categories: ordinary fundamental research, and special research. Research institutes under AIST have over 600 ordinary research themes and more than 150 special ones. These are further classified into 17 fields, such as electronics, earthquake prediction and biotechnology.

Besides these, the designated research is executed. This project research is aimed at industrialization, and includes the national R&D large-scale project. R&D project on basic technology for future industries, R&D on new energy technology called the "Sunshine Project" and R&D on energy conservation technology called the "Moonlight Project". AIST institutes are taking charges of fundamental fields represented by the above-mentioned project.

THE TSUKUBA RESEARCH CENTER

In fiscal year 1979, nine research laboratories under AIST moved to Tsukuba Academic City to form the Research Center of the Agency of Industrial Science and Technology. Having previously been scattered over the Tokyo metropolitan area, consolidation of these nine institutions - National Research Laboratory of Metrology, Mechanical Engineering Laboratory, National Chemical Laboratory for Industry (formerly the Industrial Laboratory of Tokyo), Fermentation Research Institute, Research Institute for Polymers and Textiles, Geological Survey of Japan, Electrotechnical Laboratory, Industrial Products Research Institute, and National Research Institute for Pollution and Resources, helped the Center forge closer relations among AIST institutions and supported the efficient development of advanced research activities.

1. Project for Expanding Infrastructure for Research and Information

To support research and development and permit more effective use of research and technological information and more advanced computerization and processing, AIST is developing system for promoting laboratory automation, constructing and expanding data bases on research and technology, and expanding networks, aided by the Research Information Processing System (RIPS), installed for joint use by AIST institutions at the time of their move to Tsukuba.

2. Project for Promoting Research Cooperation

AIST is taking a variety of steps to promote interaction between AIST institutes in Tsukuba, while stepping up private/public international technical exchanges and more effective use of research and technical information. This includes holding comprehensive symposiums and other forums at Tsukuba, accepting researchers from foreign countries and receiving technical trainees from local public entities and other organizations. These arrangements are aimed at strengthening research projects and encouraging studies in Japan.

3. Activities of RIPS (Research Information Processing System)

At the end of fiscal 1987 a large-scale, general-purpose computer system (FACOM M-780/20) and a super computer system (CRAY supercomputer XMP/216 and its IBM front-end processor 3090/18E) were installed as the third stage to meet increasing demands for high-speed calculations and large-scale memory capability. Furthermore, software for structural analysis, image processing, models of simulation and scientific calculations were installed in this system. In addition to the present one, a high-speed channel (EATHERNET) enhanced the network among the laboratories. Now, RIPS is aimed at supporting the advanced, efficient research activities demanded by the AIST laboratories.

INTRODUCTION TO INDIVIDUAL LABORATORIES AND INSTITUTES

The National Research Laboratory of Metrology (NRLM) is the national representative institute for standards of length, time, mass, temperature and related quantities in Japan, and takes the lead in unifying units of various physical and engineering quantities and improving standards for science and technology. The research works cover broad fields for the development and the improvement of standards. The NRLM is responsible for establishing of working standards and calibration of measuring instruments in compliance with the Measurement Law. The technical consultancies are also being carried out. Another important responsibility is to promote international cooperation for metrological unification, in pursuance with the Metric Convention. The NRLM keeps close contact with the International Bureau of Weights and Measures, the International Bureau of Legal Metrology and the research institutes for standards in many countries. The major research projects of the institute are as follows:

- 1. Standards and Metrology (1) Basic standards of length, time, temperature and mass (2) Industrial standards of density, force, pressure, flow rate, vibration, shock acceleration, surface roughness, microparticles and viscosity.
- 2. Applied Precision Metrology (1) Precision measurement of laser frequency (2) Precision nonlinear spectroscopy (3) Precision

long distance measurement (4) Nanometrology (5) High temperature thermophysical properties (6) Thermal and mechanical properties of solids (7) Thermophysical properties of fluids (8) Precision dimensional metrology (9) Measurement system and evaluation (10) Reliability of measurement apparatus (11) Measurement for high temperature superconductivity.



New Cesium Time and Frequency Standard Adopts the "Optical Pumping Technique"

National Research Laboratory of Metrology 1-4, Umezono 1-chome, Tsukuba-shi, Ibaraki, 305	Tsukuba Gakuen 0298 (54) 4118 Senior Officer for Research Planning	Total personnel Total budget	218 2,243 (million yen)
--	---	---------------------------------	----------------------------

The Mechanical Engineering Laboratory (MEL) was established in 1937 with the objective of promoting advancement of the Japan's machine industry. Today, still maintaining its traditional role, MEL has changed and expanded its role for the development of new engineering technologies through association of mechanical engineering with other technical fields, development of traditional technologies in mechanical engineering towards their limits, and intellectualization of machines and systems. The major R&D fields are shown below:

- 1. Basic Researches in Mechanical Engineering (1) Optics, Instrumentation and control. (2) Micro machines. (3) Tribology. (4) Control of noise and vibration.
- 2. Materials and Manufacturing Engineering (1) Synthesis and evaluation of novel materials for machines. (2) Advanced metal forming and high-precision machining/grinding. (3) Energy processing and binding. (4) Intelligent manufacturing system.
- 3. Energy Saving and New Energies (1) Wind power conversion system. (2) Advanced combustion engines. (3) High-performance heat transfer/exchange. (4) Environment control.
- 4. Robotics and Intellectualization (1) Locomotion and manipulation. (2) Motion control. (3) Computer-aided analysis and design for manufacturing.
- 5. Bioengineering (1) Engineering for medical diagnosis. (2) Biocompatible materials. (3) Elucidation of biological functions.

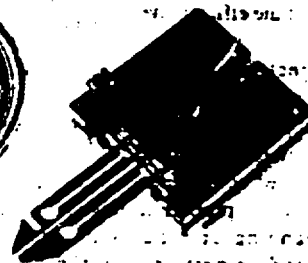

Micro Gripper Prototype-I for Miniature Operation

Mechanical Engineering Laboratory 1-2, Namiki, Tsukuba-shi, Ibaraki, 305	Tel. 81-298-54-2521 (Research Planning Office)	Fax. 81-298-54-2513	Total personnel Total budget	276 3,320 (million yen)
---	---	---------------------	---------------------------------	----------------------------

DIFFUSION OF TECHNOLOGICAL ACCOMPLISHMENTS

The Agency of Industrial Science and Technology registers as industrial properties both at home and abroad the technological developments of its 16 research laboratories and several projects under outside contract, and works to ensure their effective utilization and diffusion.

Patents and other industrial properties (collectively referred to as "patents") within the jurisdiction of AIST can be licensed to both domestic and foreign companies under certain conditions. They are (1) a license fee is paid, (2) the licensee is capable of using the patents and (3) the licenses is non-exclusive.

Since October, 1985, NEDO conducts management and propagation of accomplishment of development contacted to NEDO.

Industrial properties under AIST's Jurisdiction (registered or pending as of March 31, 1990)

	Domestic	Foreign
Laboratories	7,702	1,700
Commissioned research and development	6,236	423
Total	15,938	2,123

Note: Total number of patents, utility models, designs, and trademarks for "Domestic" and total number of cases for "Foreign"

1. Patents under AIST's Jurisdiction and Their Licensing

The present status of patents under the jurisdiction of AIST as of March 31, 1990 is shown in the table below. The Agency is in charge of about 15,900 patents in Japan and about 2,100 abroad. Of the total, 762 patents are licensed to private and semiprivate enterprises. The revenue from licensed patents totaled ¥330 million in fiscal 1989.

2. System of Disseminating Technological Accomplishments

Permission to use patents under the jurisdiction of AIST, with exception of some patents, is granted to abroad segment of Japanese and foreign businesses by the Japan Industrial Technology Association (JITA).

JITA is a nonprofit foundation intended primarily to diffuse the technological achievements of AIST. The Association offers (1) mediation by specialized consultant engineer, (2) conclusion and mediation of state-owned patents for conclusion of license agreement and agreement management, and (3) briefings and publishings of information on state-owned patents likely to be exercised in the near future, in order to ensure effective dissemination of state-owned patents.

In a tie-up arrangement with the Research Development Corporation of Japan, JITA calls on it to promote application of unused state-owned patents while presenting mutual characteristics.

INDUSTRIAL TECHNOLOGY COUNCIL

1. Overview

The Industrial Technology Council was established on July 25, 1973, as an affiliated institution of the Ministry of International Trade and Industry. ITC officials investigate and deliberate on important matters related to scientific technology in the mining and manufacturing industries in response to inquiries from the Minister of International Trade and Industry.

Conditions affecting Japanese technological development have changed in recent years. The time has come for Japan to develop original technologies in a way that can give full play to national ingenuity and creativity. Moreover, Japan is pinning high hopes on technological development as a means of enhancing the quality of national life, upgrading the domestic industrial structure and contributing to international society.

Under this situation, ITC is working on a broad range of issues related to technological development from a standpoint of MITI as a whole.

2. Activities (Recommendations and Reports Since FY 1982)

- Industrial technology development policies (Report of the Planning Subcommittee, Coordinate Committee, November 27, 1984)

- Future system of the Second Round

(Report of the Planning Subcommittee, Future Technology Development Committee, June 24, 1988)

- Industrial Science and Technology Policies for 1990s

(Report of the Technology Innovation Subcommittee for 1990s, Coordination Committee, May 11, 1990)

- New Evolution of the Sunshine Project

(Interim Report of the New Energy Technology Development Committee, June 15, 1990)

Organization Chart of the Industrial Technology Council (as of August 30, 1990)

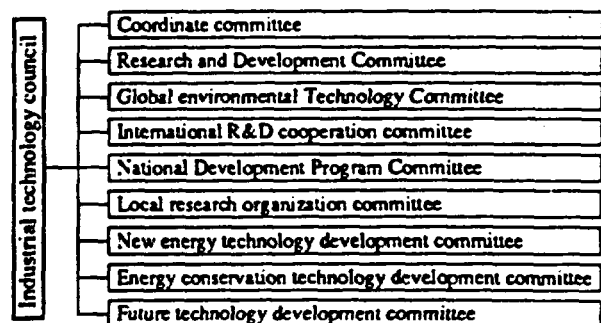

RECENT TRENDS INVOLVING AIST

The situation surrounding the science and technology is changing substantially. For example, the so-called approaching/resonance phenomenon of the science and technology is going on and the necessity of harmony between the science/technology and nature/society is increasing. Japan is now expected to contribute positively to the international society in terms of science and technology. In this background, it is essential to promote techno-globalism from the global point view as well as to proceed with R & D with balance established between the science and technology. In particular, the global environmental problems are common subjects of human being, and their solution requires technological break-through. The "Vision for 1990s" recently publicized by the Industrial Structure Council and Japan Industrial Technology Association as well as the Recommendation No.17 of the Science and Technology Conference stress this concept.

In the field of standardization administration, active discussions are under way concerning the future industrial technology, such as proposition made on the basic concept of long-term plan for the future JIS policy.

Vision for 1990s

The Technological Policy for 1990s Subcommittee was erected under the Coordination Committee of the Industrial Technology Council in the course of review on "Trade and Industry Policies for 1990s" of MITI. The industrial technology policies in 1990s were studied in its joint meeting with the Industrial Technology Policy Subcommittee of the 1990s Policy Committee of the Industrial Structure Conference, and the report publicized in May 16, 1990.

The science and technology is one of development infrastructures of a country and the world and at the same time a powerful means to solve subjects common to all human beings. In this recognition, the importance or expectation on the science and technology is growing rapidly. In this situation, Japan is requested to make international contribution worthy of its power in the field of science and technology. On the other hand, the present state of science and technology of Japan indicates relative lagging in the field of fundamental researches and heavy shortage of talents for research and development. Moreover, this report sets forth following four vital columns of industrial technology policies for 1990 in view of changes in tides surrounding of the science and technology, such as progress of approach and resonance phenomenon between science and technology, harmony between science/technology and nature/society, or necessity of achieving the comfortable and affluent national living. These columns are promotion of techno-globalism from a global point of view, promotion of R & D with balance established between science and technology, promotion of R & D to realize the comfortable and affluent national life, and improvement and expansion of infrastructures for development of the science and technology.

Recommendation and report of the Science and Technology Conference

(1) Report for Inquiry No.7

"R and D basic plan on environmental protection technology"

Concerning global environmental protection technology, the guideline of science and technology policies determined by the cabinet in March, 1986 set forth planning of the research and development basic plan as a priority field of promotion. With an aim placed on deepening of comprehensive understanding on the earth and full exploitation of the result to contribute to prosperity of humankind, with due consideration on international contribution, the prime minister made inquiry on the R & D basic plan of global science and technology in March, 1989 to the 42nd Science and Technology Conference. In response, the discussions were made in the global environmental protection technology committee and its subcommittees and the report made in June, 1990.

(2) No.18 inquiry, "Comprehensive basic policies for future"

In compliance with the guideline for science and technology policies determined in the cabinet in March, 1986, the science and technology promotion policies have been pushed forward toward creation of more affluent society and national life while centering around the creative and affluent science and technology. However, the environment surrounding the science and technology has undergone substantial change. In order for Japan to play the role as a member of the international society and to make effort for enhancement of the national life and continuous prosperity, the prime minister made inquiry on planning of comprehensive science and technology policies for coming 10 years with insight into the coming new century.

INDUSTRIAL STANDARDIZATION

1. Outline

Promoting industrial standardization is one of AIST's most important tasks. By law, deliberations on JIS (Japanese Industrial Standards) are the responsibility of an AIST subsidiary organization, JISC (the Japanese Industrial Standards Committee).

Industrial standardization has contributed to the building of Japan's industrial infrastructure and helped rationalize production in its industries. JIS operates through deliberations by some 9,000 experts from industry and academia, as well as consumers. As all JIS are voluntary standards, it is essential that they reflect the opinions of all concerned.

2. JIS and JIS Marking System

Like many other countries, the purpose of JIS is to promote (i) improved quality and rationalized production, (ii) smooth and fair trade, and (iii) rational consumption through appropriate and rational "standards." Some 8,400 JIS are established at the end of FY 1990.

The JIS marking system is used to encourage standardization (see figures below). Under the JIS Marking System, following government inspection regarding quality control and other factors, authorized manufacturers are permitted to attach the JIS mark to products which belong to categories designated by the relevant Minister(s) as worthy of the mark, thus helping users and consumers to judge the quality and performance of the product. So far, some 1,100 items bear the JIS mark, and some 16,300 permits, including about 150 approvals for overseas factories, have been granted.

There are two possible ways of obtaining JIS marking approval for foreign factories: procedures A and B, as explained in the note below.

Fig. A



Fig. A: The mark to be affixed by the manufacturer of the designated commodities provided in Article 19, of the Industrial Standardization Law, to the designated commodities, their packages, containers or invoices when the manufacturer has obtained permission or approval.

Fig. B



Fig. B: The mark to be affixed by the manufacturer using the designated processing techniques provided in Article 25, of the Industrial Standardization Law, to the processed commodities, their packages, containers or invoices when the manufacturer has obtained permission or approval.

3. International Standardization

(1) Participation in ISO and IEC

A large number of international standards have been established by the International Organization for Standardization (ISO) and the International Electrotechnical Commission (IEC). Both organizations are involved in a wide range of activities. There were about 7,400 ISO standards and about 2,100 IEC standards at the end of 1989. The Japanese Industrial Standards Committee (JISC) is a member of ISO and IEC and has participated actively in ISO's work since 1952 and in IEC's since 1953. Whenever possible, JISC has taken on important duties in the secretariats of the organizations' technical committees and

sub-committees and has been active in promoting international cooperation and exchanges of technology information.

At the 13th General Assembly of ISO was held in Tokyo in 1985, Mr. Isamu Yamashita, vice-president of Keidoren, was elected the 14th ISO president. The first Japanese president of ISO, he served until 1988.

(2) Technical Cooperation with Developing Countries

The Standards Department carries out technical cooperation in the field of Industrial standardization and Quality Control. These cooperation are designed to help developing countries progress in industrial standardization and Quality Control in collaboration with the Japan International Cooperation Agency (JICA) and the Japanese Standards Association (JSA).

Three group training courses are conducted each year: a 3-month course on implementation of TQC and standardization activity, a 2-month course on certification and inspection system and a 1-month course on a senior seminar on industrial standardization and quality control. Participants in these courses are Governmental officials in charge of standardization in government agencies or national standard bodies in developing countries.

Aside from holding training courses, the Standards Department sends experts and survey teams on Industrial Standardization and quality control to developing countries upon official request. And in order to transfer technology from Japan to a developing countries by means of training engineers and the governmental officials in charge of standardization and quality control in developing countries, center for standardization is scheduled to be built, where Japanese experts will work for technical cooperation. The center will be a base to establish and promote standardization in the country. In 1989, five year cooperation plan started the Industrial Standardization and Certification Test Center Thailand.

(Note) JIS Marking System for Foreign Products

A foreign factory seeking JIS marking approval may proceed

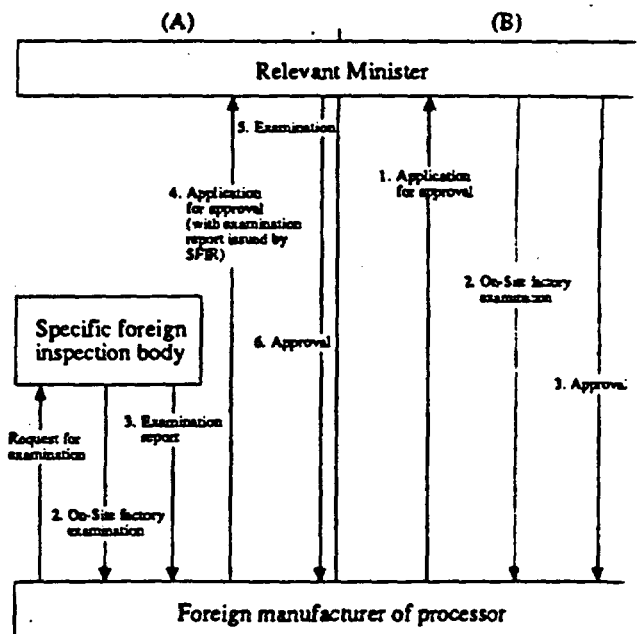

according to scheme A or B.

TECHNOLOGY RESEARCH AND INFORMATION

1. Technological Surveys

In order for Japan to make sound economic progress and contribute to global welfare, it must deal successfully with a wide variety of issues, including trade friction, resources and energy supply, and employment. The creative and independent development of technology in a comprehensive and efficient manner will be indispensable to achieve these goals. In the planning and preparation of a reasonable and effective industrial technology policy, there is a need to come to grips with research and development both at home and abroad and to analyze industry and its problems while checking these findings against actual research and development in Japan.

To this end, AIST surveys trends in research and development, technology trade, and patents in Japan and overseas; the technology policies and development status of other countries, and more comprehensively, the important and urgent questions involved in the pursuit of creative and independent technological development.

Domestic surveys

AIST conducts surveys in Japan to understand trends in technological development, research and development activities of enterprises, problems surrounding technology, and technological policies.

[Themes for 1989]

- Survey on technology transfer
- Survey on reorganization and location trends of research agency of enterprises in Japan
- Survey on the present state of industrial technology level of NIEs in Asia and the research and development strategy of our enterprises for NIEs of Asia

Overseas surveys

The office conducts collection and analyses of various overseas technological publications, reports, and literature as well as surveys and analyses of technological development and technological policies in advanced countries such as the USA and Europe in cooperation if JETRO and other organization while utilizing the fund for scientific technological promotion adjustment.

[Themes for 1989, related to the fund for scientific technological promotion adjustment]

Survey on the method of advanced scientific technological promotion adjustment fund

The Committee for Science and Technology Policy (CSTP) of the OECD conducts various programmes including the exchange of experiences and information on science and technology policies of member countries in order to promote the international cooperation in the field of science and technology. AIST makes positive contribution to the activities of CSTP, participating in various conferences.

In May, 1988, OECD started the 3-year programme named TEP (Technology/Economy Programme) for the purpose of analyzing the inter-relationship between science, technology, economy and society and also developing useful indices for the governments of member countries to plan, execute, and evaluate the technology-related policy.

In this regard, the Government of Japan hosted an international conference for TEP in Tokyo in March, 1990.

2. Propagation Activities

To enhance awareness of mining and manufacturing technologies and the industrial technology policies of AIST, the Agency publicizes its policies and the technological achievements made at its 16 research laboratories in its bulletin "ISAT (Industrial Science and Technology)". In addition, AIST issues "An Introduction to AIST", distributed domestically and overseas in both Japanese and English, in which on-going projects are described. AIST also publishes details of its work in the "AIST Annual Report". Newspapers, television, and radio are also used to report on the progress of AIST projects under way.

Name of Research Project	Japanese Research Institute	Counterpart Research in Developed Country	Counterpart Institute in Developing Country	Duration (Fiscal year)
1. Research on exploration techniques for rare mineral resources (Rare mineral resources)	Geological Survey of Japan	United States Geological Survey, USA	Bureau of Mines and Geo-Sciences, Philippines	1987-1991
2. Chemical assessment in Nile River (Chemical assessment)	National Research Institute for Pollution and Resources	United States Environmental Protection Agency, USA	Mansoura University, Egypt	1990-1992

5) Joint Researches for Global Environmental Technology

Name of Research Project	AIST Research Institute	Counterpart Research Institute	Country	Duration (Fiscal year)
1. Studies on afforestation with functional soil improving materials (Functional soil)	National Chemical Laboratory for Industry Government Industrial Development Laboratory, Hokkaido	Central Arid Zone Research Institute Industrial Technology Development Institute	India Philippines	1990-1993
2. Prevention of expanded pollution in the tropical zone with the metal mining development (Pollution with metal mining)	National Research Institute for Pollution and Resources	National Department of Mineral Production	Brazil	1990-1992

(2) Promotion Program of Research and Development Cooperation

Name of Research Project	Japanese Research Institute	Counterpart Research Institute	Country	Duration (Fiscal year)
Research and Development Project of Machine Translation System with Japan's Neighboring Countries	Electrotechnical Laboratory Center of the International cooperation for Computer-relation	China Software Technique Corporation	China	1987-1992
		National Electronics and Computer Technology Center	Thailand	
		Language Research Division	Malaysia	
		Agency for the Assessment and Application of Technology	Indonesia	
International Research Cooperation on Recovery of Valuable Resources in Brine	Governmental Industrial Research Institute, Shikoku	Comision de Fomento Minero	Mexico	1989-1994
		The Institute of Saline, Academia Sinica	China	

(3) Bilateral and Multilateral Cooperation

AIST Promotes bilateral cooperation with China, Korea, etc. through science and technology agreements and multilateral cooperation with ASEAN countries.

3. NEDO International Research Exchange Center

NEDO has established the International Research Exchange Center in 1989 to conduct the following four programs:

- (1) International joint research program
- (2) International research exchange program to invite foreign researchers in the long-term and help them do research and live in Japan smoothly.
- (3) On the Research Training Program to re-educate researchers in and out of Japan.
- (4) International Joint Research Grant Program to contribute the advancement of international exchange.

THE JAPAN KEY TECHNOLOGY CENTER

The Japan Key Technology Center, established in response to a proposal by the private sector, conducts activities directed at the overall improvement of the environment for private research and development in fundamental technologies.

- (a) Capital Investment
The Center provides capital investment for researches carried out by companies established for joint research purposes. ('90FY ¥21.7 billion)
- (b) Loan Service
The Center provides conditional interest-free loans to aid in reducing R&D related risks and costs. ('90FY ¥6.3 billion)
- (c) Mediation in Arranging Joint Research
Mediation is performed for private companies wishing to conduct joint research with national research institutions.

(d) Execution of Consigned Research

The Center brings together experts from government, industry, and academia to conduct research consigned to The Center by private companies.

- (e) Japan Trust International Research Cooperation Service
The Center has established a charitable trust called the Japan Trust Fund. The operating profits from this fund will be used to invite foreign researchers in key technologies to Japan.
- (f) Research Information Service
The Center collects and sorts a wide variety of important research literature which is kept on file at national research institutes and other organizations.
- (g) Surveys Service
The Center conducts various kinds of surveys to aid private-sector research in key technologies.

PROMOTION OF TECHNOLOGICAL DEVELOPMENT IN THE PRIVATE SECTOR

To encourage R&D by the private sector, tax incentives are offered for technological development as well as financing for the development of industrial technology (through the Japan Development Bank) and conditional loans for R&D projects, and that operates a research association is operated for promoting mining and industrial technology.

Tax Incentives for Technological Development

(1) The following tax incentives have been instituted (effective until March 31, 1993) for facilitating research and development in fundamental technologies. These cover a 15 percent maximum deductible for corporate or income taxes or 10 percent in (a) below.

(a) Tax method for Deducting Additional Research Expenses
These are deductible from corporate or income taxes, and are equal to 20 percent of the excess of current qualified R&D expenditures over the highest amount of the previous R&D expenditure.

(b) Tax Incentives for Promoting R&D in Fundamental Technologies

Also deductible from corporate or income taxes is seven percent of the cost of acquiring facilities for conducting R&D in fundamental technologies. Categories of facilities are stipulated in the Ministry of Finance Notifications - No.47 dated March 30, 1985, No.60 dated March 31, 1986, No.126 dated September 29, 1987, No.52 dated March 31, 1988, No.58 dated March 31, 1989, and No.56 dated March 31, 1990.

(c) Tax Incentives for Promoting R&D by small and medium enterprises

Six percent of the cost of R&D by small and medium enterprises during the business year, applied selectively with (a) above are deductible from corporate or income taxes.

(2) Tax Incentives for Mining and Industrial Technological Research Associations

A. Special depreciation allowances are given to members of research associations for acquiring fixed assets used in experimental research in promoting mining and industrial technology.

B. Condense recording, of down to one yen, of charges imposed by cooperatives for the acquisition of fixed assets required for the study of mining and industrial technology.

C. Tax reductions are given on fixed assets used for research.

(3) Special depreciation allowances are permitted for assets used in subject research.

(4) Donations to Research Corporations, by special permissions, may be calculated as losses.

2. Promotion of International Joint Research

In order to develop future industrial technology and improve both domestic and international cooperation on researches and studies, grant is given to international joint research teams in material fields. This program is administered by the New Energy and Industrial technology development Organization.

3. Conditional Loans for R&D Projects

Other conditional loans are available for R&D development of energy-saving technology and alternative energy technologies for petroleum and new power generation techniques.

4. Financing for the Promotion of Industrial technological Development (Development of new technology) (Japan Development Bank)

Funds are provided at attractive interest rates for the commercialization of important industrial technologies and the construction of special structures for advanced basic research which will make a significant contribution to the advancement of industrial technology and play a key role in upgrading the industrial structure.

5. Research Association System for the Development of Mining and Industrial Technology

This system, taking into account the efficiency and importance of joint research by enterprises, gives legal status to cooperative research organizations producing technology related to industry and mining. It was started in May, 1961 and 53 associations are currently active.

Outline of Finance System for the Promotion of Industry and Technology; Budget for FY1990

		Development of new technology	
	Improvement of research facilities	Development for commercialization	Commercialization of new technology
Construction costs eligible for financing	Cost entailed in acquiring special buildings and structures for basic and applied research	<ul style="list-style-type: none"> • Construction of demonstration plants • Trial manufacture of machinery and equipment 	<ul style="list-style-type: none"> • Production line construction • Development of heavy machinery
Ratio of financing	Approximately 50% of construction costs of works eligible for financing		
Financing period	15 years or less (in principle)		
Redeemable period	Two to three years (in principle)		
Budget for FY1990	750,000 (million yen)		

(4) Multilateral Cooperation

1) International Energy Agency (IEA) Energy R&D Projects

MITI participants in cooperative research and information exchange under the Committee of Research and Development of IEA.

1990. 9

Working Parties	MITI's Joining Implementing Agreements	Start of MITI's Participation
End Use Technology	<ul style="list-style-type: none"> Advanced Heat Pump Alcohol and Alcohol Blends as Motor Fuels Energy Conservation in Combustion Advanced Fuel Cells CADDET June, 1990 Assessing the impact of High-temperature Superconductivity June, 1990 	April, 1979 February, 1986 April, 1984 (April, 1990)
Renewable Energy	<ul style="list-style-type: none"> Bioenergy Wind Energy Conversion Systems Solar Heating and Cooling Systems Production of Hydrogen from water 	May, 1987 April, 1978 October, 1977 October, 1977
Fossil Energy	<ul style="list-style-type: none"> Coal Technology Information Service Coal/Oil Mixtures Enhanced Oil Recovery Atmospheric Fluidized bed combustion 	March, 1977 March, 1981 May, 1979 February, 1980
Fusion Power	<ul style="list-style-type: none"> Reversed Field Pinches 	(May, 1990)
Other	<ul style="list-style-type: none"> Energy Technology System Analysis Energy Technology Data Exchange 	September, 1981 January, 1987

2) International Cooperation Projects proposed by the Working Group on Technology, Growth and Employment (Summit).
 These projects will be carried out on an independent basis, separated from the Summit framework.

Projects promoted by AIST	Participants (Observers)
Photovoltaic Solar Energy	Italy, France, Germany, UK, EC, (US)
Advanced Robotics	France, US, UK, Germany, Canada, Italy, (EC)
VAMAS (Versailles Project on Advanced Materials and Standards)	UK, US, Canada, EC, France, Germany, Italy

3) Organization of Economic Cooperation and Development
 AIST takes part in the Committee of Science and Technology Policy of OECD. In 1990, Technology/

Economy Program (TEP) Symposium will be held in Tokyo under the auspice of CSTP.

2. Cooperation with Developing Countries

(1) Institute of Transfer of Industrial Technology (ITIT project)

1) Joint Research for New Technology

Fiscal year: April 1 - March 31

Name of Research Project	AIST Research Institute	Counterpart Research Institute	Country	Duration (Fiscal year)
1. Research on sensing technology for cutting process information (Sensing for cutting process information)	Mechanical Engineering Laboratory	Korea Institute of Machinery and Metals	Korea	1987-1991
2. Research on geology and mineral resources of the collision zone in Pakistan (Geology of the collision zone)	Geological survey of Japan	Geological Survey of Pakistan	Pakistan	1987-1990
3. Research for industrialization of thermomechanical pulping of oil palm by-products (Thermomechanical pulping of oil palm)	Government Industrial Research Institute, Shikoku	Palm Oil Research Institute of Malaysia	Malaysia	1987-1990
4. Measurement of three dimensional object and nondestructive testing (Measurement of three dimensional object)	Mechanical Engineering Laboratory	Research and Development Center for Calibration, Instrumentation and Metrology	Indonesia	1988-1990
5. Hydrogenation of palm oil components (Hydrogenation of palm oil)	National Chemical Laboratory for Industry	Palm Oil Research Institute of Malaysia	Malaysia	1988-1990
6. Enhancement of reference sections of sedimentary basing (Sedimentary basing)	Geological Survey of Japan	Mines and Geosciences Bureau	Philippines	1988-1991
7. Separation and refining of rare metal ores from China (Rare metal ores from China)	National Research Institute for pollution and Resources Government Industrial Research Institute, Tohoku	Guangzhou Research Institute of Non-ferrous Metals	China	1988-1992

Name of Research Project	AIST Research Institute	Counterpart Research Institute	Country	Duration (Fiscal year)
Research on the new coal combustion technology by fluidized bed (Coal combustion technology)	Government Industrial Development Laboratory, Hokkaido	Institute of Coal Chemistry, Academia Sinica	China	1988-1990
Study on the effective utilization of neglected hydrocarbons (Utilization of neglected hydrocarbons)	National Chemical Laboratory for Industry	Korea Advanced Institute of Science and Technology	Korea	1989-1991
Air pollution assessment at tropic area, (Air pollution assessment)	National Research Institute for Pollution and Resources	Indian Institute of Technology	India	1989-1991
1. Research on utilization of natural zeolite (Utilization of natural zeolite)	Government Industrial Research Institute, Tohoku	Mineral Technology Development Center	Indonesia	1989-1992
2. Development of Al/Li Alloy Composites (Al/Li alloy composites)	Mechanical Engineering Laboratories	Nayang Technological Institute	Singapore	1990-1993
3. Research on rare-metal resources in weathering crusts of granitoid. (Weathering crusts of granitoid)	Geological Survey of Japan	Department of Mineral Resources	Thailand	1990-1992
4. Study on countermeasures for the ignition source of gas and coal dust explosions in coal mine (Ignition source in coal mine)	National Research Institute for Pollution and Resources	Central Coal Mining Research Institute	China	1990-1993
5. Effective activation treatment of lignite and peat materials (Lignite and peat materials)	Government Industrial Development Laboratory, Hokkaido	Thailand Institute of Scientific and Technological Research	Thailand	1990-1992
16. Study on utilization of sepiolitic Mg bearing clay from Turkey. (Sepiolitic Mg bearing clay)	Government Industrial Research Institute, Nagoya	Mineral Research and Exploration Institute of Turkey	Turkey	1990-1992
17. Study on evaluation and utilization of Brazilian Quartz (Brazilian Quartz)	Government Industrial Research Institute, Nagoya	State University of Campinas	Brazil	1990-1992

2) Joint Research for transfer of Technology

Name of Research Project	AIST Research Institute	Counterpart Research Institute	Country	Duration (Fiscal year)
1. Research on evaluation for standard of large force (Standard of large force)	National Research Laboratory of Metrology	National Institute of Metrology	China	1987-1990
2. Research on reliability of volume measuring instruments in the tropics (Volume measuring instruments)	National Research Laboratory of Metrology	Directorate of Metrology National Institute of Science and Technology	Indonesia Philippines	1988-1990
3. Evaluation for material selection and corrosion prevention of materials in the tropical environments (Materials selection and corrosion prevention)	Government Industrial Research Institute, Chugoku	Research and Development Center for Metallurgy	Indonesia	1990-1992
4. Development of durable concrete based on the utilization of indigenous resources (Durable concrete)	Government Industrial Research Institute, Kyusu	Institute of Human Settlements	Indonesia	1990-1992

3) General Research

Name of Research Project	AIST Research Institute	Duration (FY)
1. Research on plasticization of tropical and subtropical plant materials (Plasticization of plant materials)	Industrial Products Research Institute	1987-1990

INTERNATIONAL COOPERATION IN RESEARCH AND DEVELOPMENT

International research and development cooperation advances Japan's own R&D while contributing to the formation of harmonious economic ties with other nations.

AIST is therefore an active research partner with developed and developing countries alike.

AIST conducts joint research programs in the area of advanced technology with developed countries and invites foreign researchers. Besides, under the Institutes of Transfer of Industrial Technology (IIT), AIST conducts joint research and exchange of researchers with developing countries.

Further, NEDO help foreign researchers work and live in Japan smoothly.

1. Cooperation with Developed Countries

(1) Invitation of foreign researchers

1) AIST has established on program in FY1988 to provide foreign researchers with an opportunity to conduct research for a certain period of time with researchers at the institutes of the Agency of Industrial Science and Technology (AIST) in order to advance scientific and technological knowledge in their respective fields and to promote creative research and development in the open environment of the institutes.

(2) Joint Research Project

1) Specific International Joint Research Projects

(Research conducted jointly by AIST research institutes and research institutions in developed countries)

Name of Project	Japanese Research Institute	Counterpart Research Institute	Country	Duration (Fiscal year)
Research on optical microgassensors	Government Industrial Research Institute, Osaka	University Catholic Luban	Belgium	1987-1990
Research on precision evaluation of new superconductors and development of precision measurement devices	Electrotechnical Laboratory	National Institute of Standard	USA	1988-1992
Research on the synthesis of fluorine-containing heterocyclic compounds and evaluation of their biological activities	Government Industrial Research Institute, Nagoya	National Institute of Health	USA	1989-1992
Research on generation and utilization of high energy density plasma	National Chemical Laboratory for Industry	Technische Universität München	Germany	1990-1993
Research on the thermobiology, emphasizing on water structure in living cells	Fermentation Research Institute	National Institute for Medical Research	United Kingdom	1990-1992
Research on mechanisms for release of methane into the atmosphere	Fermentation Research Institute Geological Survey of Japan	Ohio State University Tübingen Universität United State Geological Survey	USA Germany	1990-1993
Research on Acid rain Mechanism by the advanced observation and modeling	National Research Institute for Pollution and Resources Government Industrial Research Institute, Nagoya	National Center for Atmospheric Research Iowa State University	USA	1990-1993

2) Research Grants to International Joint Research Team

In order to develop the future industrial technology and to contribute to the improvement of both domestic and international cooperation on researches and studies, the system is to promote international joint research team carrying out original research related material fields. This program is administered by the New Energy and Industrial Technology Development Organization.

(3) Bilateral Cooperation

AIST cooperates with developed countries such as United States, West Germany, France, Italy, United Kingdom, through science and technology cooperation agreements, industrial cooperation talks and so on concerning joint research, exchange of researchers, and information.

a. Qualifications

Generally, a researcher under the age of 35, holding a doctorate in science or engineering.

b. Number and period of invited researchers

Approximately 13 persons for a period of one year

c. Host institutes

Sixteen research institutes belonging to AIST

d. Compensation

Round trip airfare, living expense, housing allowance, family allowance and relocation allowance

e. Japanese language course

A Japanese language course is given as a general rule at the beginning of the researcher's stay.

Besides Foreign Researchers can be invited to AIST laboratories by

3) AIST accepts researchers in EC countries through Japan-EC Industrial Cooperation Center

4) Foreign Researchers are invited by a charitable trust called the Japan Trust Fund which is administered by the Japan Key Technology Center.

5) AIST has made a memorandum of understanding with National Science Foundation to accept up to thirty US researchers a year to AIST laboratories.

Country	Frame Work	Year of Initiation	Field of Cooperation (Mutually Selected Areas)
USA	US-Japan Conference on Natural Resources (U.J.N.R.)	1964	Fire Research and Safety, Marine Mining, Marine Instrumentation and Communications, Marine Geology, Others
	Agreement between the Government of Japan and the Government of the United States of America on Cooperation in Research and Development in Energy and Related Fields	1979	Fusion, Coal Energy, Solar Energy, High-energy Physics, Other energy and energy-related research and development areas, as may be mutually selected.
	Agreement between the Government of Japan and the Government of the United States of America on Cooperation in the field of Environmental Protection	1975	Stationary Source Pollution Control Technology, Management of Bottom Sediment Containing Toxic Substances, Air Pollution-related Meteorology, Others
	Agreement between the Government of Japan and the Government of the United States of America on Cooperation in research and Development in Science and Technology	1988	Life sciences, including biotechnology; Information science and technology; Manufacturing technology; Automation and process control; Global geoscience and environment; Joint database development; and Advanced materials, including superconductors.
United Kingdom	MITI-DTI Talks.	1988	Superconductivity, Marine Technology Biotechnology, Others.
France	Agreement between the Government of Japan and the Government of the French Republic on Cooperation in the field of Science and Technology	1974	Marine Science and Technology, Biological and Medical science and Technology, New Energy Technology, Energy Conservation, Others
West Germany	Agreement between the Government of Japan and the Government of Federal Republic of Germany on Cooperation in the Field of Science and Technology	1974	Marine Science and Technology, Biological and Medical Science and Technology, Environmental Protection Technology, New Energy Resources, Transport Technology, New Materials, Data processing, Information and Documentation, Mechanical Engineering, Others
Australia	Agreement between the Government of Japan and the Government of Australia on Cooperation in Research and Development in Science and Technology	1980	Experimental Petrology, Lower Atmosphere Physics, Fluidized Bed combustion Technology, Vision Technology for Robots, Others
	Cooperation between Japan and Australia in Energy Research and Development and Related Areas	1978	Coal Technology, Solar Energy Utilization, Energy Conservation, Others
Canada	Agreement between the Government of Japan and the Government of Canada on Cooperation in Science and technology	1986	Environment Technology, Energy Technology, Space and Communications, Computers and Robotics, Others
Sweden	Japan (AIST) — Sweden (STU) Research and Development Cooperation	1981	Medical and Welfare Technology, Biotechnology, Materials (Polymer and Composite, Ceramics, Lignan), Others
Italy	Agreement between the Government of Japan and the Government of Italy on cooperation in Science and Technology	1988	New materials, Biotechnology, Volcanology and Seismology, Physics Environment, Artificial Intelligence Energy

Name of project	Budget for 1990	Outline of project
Study on carbon dioxide fixation technology by artificial photosynthesis etc.	165	R&D to transform carbon dioxide (which is the major cause of greenhouse effect) into other useful materials by using energies (solar rays, etc.) currently not used.
Study on carbon dioxide fixation by algae		R&D on the counteraction ability of the nature against increase in carbon dioxide and countermeasures using such counteraction through quantitative definition of photosynthesis of algae by conditions and study on its mechanism. Technical development to enable easier and more correct measurement of the concentration of carbon dioxide in seawater with less sample
Study on coral reefs as sinks of atmospheric carbon dioxide		R&D on fixation of carbon dioxide to calcium carbonate by clarifying the past concentration level of carbon dioxide and lime stone generation state, and actual state of present coral reef and factors affecting growth of coral
Analysis and evaluation of technologies for reducing anthropogenic carbon dioxide emissions		R&D to establish an engineering model to analyze and evaluate of technologies for reducing anthropogenic carbon dioxide emissions and to clarify the effectiveness of reducing technology and composition of an energy system with less emissions
Study on recovery technology of carbon dioxide		R&D on effective separation and concentration of carbon dioxide
Development of biodegradable plastics		R&D on materials compatible with environment, such as plastics degradable in nature

International joint researches on global environmental technology for 1990

Classification	Name of project	Counterpart	Period	Outline of project
Specific international joint research projects (global environment)	Research on mechanisms for release of methane into the atmosphere	USA, West Germany	90-93	Biological and geometrical researches to clarify the release mechanism of methane gas (whose green house effect is about 20 to 40 times larger than carbon dioxide) into atmosphere.
	Research on Acid rain Mechanism by the advanced observation and modeling	USA	90-93	Precision analysis of the acid rain components and creation of a simulation model based on in-situ observation of generation, long-distance transport, and transformation process of acid rain components.
Joint researches for global environmental technology	Studies on afforestation with functional soil improving materials (Functional soil)	India, Philippine	90-93	Development of functional soil recovering agent with water and fertilizer retaining capacity and soil-organisms compatibility in order to recover soils suffering degradation due to expansion of desert, excessive pasturing.
	Prevention of expanded pollution in the tropical zone with the metal mining development (Pollution with metal mining)	Brazil	90-92	Development of wide-area pollution survey technology and prevention technology for mining production of tropical forests which is presumed to affect animals and plants over a wide-area.

CONSOLIDATING RESEARCH AND DEVELOPMENT SYSTEMS RELATING TO INDUSTRIAL TECHNOLOGY

Outline of Policy

If Japan, now holding a key position in the world economy, is to play a role worthy of its position toward well-balanced development of the world economy while achieving further development toward the 21st century, it is essential for Japan to promote positively the creative technical development and to contribute to the world community through technical development. What is required for this purpose is to improve and expand large-scale research and development infrastructures, to put into full swing the research and development in basic and advanced fields, and to establish a system for consolidated augmentation of international research cooperation.

Under the "Law for Consolidating Research and Development System Relating to Industrial Technology" enacted in May, 1988, the New Energy Development Organization (NEDO) was expanded in October to the New Energy and Industrial Technology Consolidated Development Organization. This organization is given responsibility for undertaking industrial technology.

1. Research and Development Program

(1) Description

In addition to conventional R&D Program on Basic

Development Program (Large-scale Program), and Research and Development Program on Medical and Welfare Equipment Technology, NEDO has started newly the Research and Development Program on Earth Environment-Industrial Technology. NEDO will undertake comprehensive and mobile R&D for these programs while carrying them out in closer cooperation with government, and academic sector and private industry as well as foreign institutes. In 1991, NEDO will attempt efficient and steady execution of programs continued from the previous year. At the same time, NEDO will set upon new six themes, including a new software structuring model for the Future Industrial Program, advanced function creation machining technology and application technology of human senses to measurement for the Large-scale Program, and the condition monitoring system for the aged, digital hearing aid, and continuous blood sugar measurement system for the Medical and Welfare Program.

In the field of earth environment, NEDO will undertake general planning and research, technical development for carbon dioxide fixation and effective utilization, development of materials with less environmental load, and technical development for production process well matched to the environment.

(2) Budget

General accounts of ¥5.7 billion will be earmarked as fund for NEDO, while special accounts of ¥13.7 billion as grant to NEDO.

2. Research Facility Development Program

(1) Description

Large and high-level research facilities, which are indispensable for promotion of creative R&D in the advanced field, will be improved and expanded, and opened wide for domestic and foreign researchers.

Improvement and operation of these facilities are performed by the third sector erected for each facility. The third sector will finance one half of the initial investment by the capital and another half by the loan. Two-thirds of the capital will be provided by NEDO while remaining one-third by private and local government agencies. On the other hand, 70% of the loan can be obtained interest-free from Japan Development Bank and Hokkaido and Tohoku Development Corporation, and Industrial Infrastructure Improvement Fund will provide guarantee of obligation for the commercial bank loan.

In cases where it is particularly difficult to establish basic research facilities due to the high level of research and development required, NEDO will also undertake to develop the needed equipment and support systems.

(2) Outline of projects

1) Ion Engineering Center

(Location: Kansai Culture and Science City, Hirakata, Osaka)

A facility to study the technology of applying ion beam to industries will be founded for general utilization. Incorporated in November, 1988 and partially opened in July, 1990

2) Research Center for the Industrial Utilization of Marine Organisms

(Location: Kamaishi, Iwate; Shimizu, Shizuoka)

A facility to study the technology of utilizing marine organisms in mining and industries for general service. Incorporated in January, 1989 and opened in April, 1990

3) Japan Microgravity Center

(Location: Kami Sunagawa Town, Hokkaido)

A vertical drop facility which enables various non-gravity tests for about 10 seconds using existing vertical pits of old mines will be improved and expanded for general service. Incorporated in March, 1989 and opened at the end of 1990 Fy

4) Applied Laser Engineering Center

(Location: Nagaoka, Niigata)

A facility to study the technology of applying laser to industries will be erected for general service. Incorporated in March, 1990

5) Advanced Material Research Center

(Location: Ube, Yamaguchi; Tajimi, Gifu)

A facility to study and evaluate material physical properties and functions in super-high temperature environment will be improved and expanded for general service. Incorporated in March, 1990

(3) Budget

Industrial investment account capital of ¥2.2 billion will be earmarked as a component of investment of NEDO to the third sector and general accounts of ¥200 million as a fund necessary for improvement of facilities by NEDO itself.

3. International research program

(1) Background

Today, not only overseas demand on research and technical cooperations is increasing quantitatively, but also the content of demands is growing more and more diversified. It is difficult to meet these demands by NEDO alone. On the other hand, foreign researchers accepted by NEDO is increasing steadily in number and expected to increase further in future. Notwithstanding this situation, a system of providing lodgings and various benefits to researchers accepted is not yet completed, and it is urgently requested to improve and expand the comprehensive acceptance system. Moreover, domestic and foreign enterprises are showing an attitude to augment further fostering and retraining of researchers to cope smoothly with worldwide structural adjustment of industries.

In view of above present state, NEDO will execute following four programs under integrated control.

(2) Outline of programs

1) International research cooperation

Joint research with foreign research institutes will be made on subjects requested from foreign countries under cooperation of the private sector while making the best of talents and knowhow of National Laboratories.

In 1990, two themes started in 1989 will be put into full gear and simultaneously the new "Research and Development concerning Improvement of Low-temperature Starting Performance of Methanol-fueled Automobiles" will be started jointly with the USA.

2) International research fellowship

In addition to invitation of foreign researchers (mainly young researchers) for the long period, various benefits, such as training of Japanese, consulting on daily life, leasing and facilitating of lodgings, etc. will be offered to accepted foreign researchers to enable them to spend comfortable research life in Japan. R&D information necessary to expedite international research exchange will be supplied to foreign countries.

3) Researcher training

The researcher program including lectures and on-the-research-training will be executed in an attempt to foster and mutual exchange of researchers of domestic and foreign enterprises.

4) International joint research support program

The grant will be provided to cover expenses incurred by the research activity to international joint research teams, including foreign researchers, which engage in R&D in the basic field (physical properties, etc.) expected to become fruitful seeds of industrial technologies toward the 21st century.

New four programs will be added to continuous 12 programs for 1990.

(3) Budget

1) International research cooperation

Special accounts of ¥197 million will be earmarked as grant to NEDO and ODA of ¥59 million as fund entrusted to NEDO.

2) International research fellowship

General accounts of ¥54 million will be earmarked as grant to NEDO and general accounts of ¥161 million as fund entrusted to NEDO.

3) International joint research support program

General accounts of ¥516 million will be earmarked as financial resources of grant.

MEASURES FOR REGIONAL TECHNOLOGY DEVELOPMENT

1. Specific Regional Technology Development System (Regional Large-Scale Projects; see table below)
This system was inaugurated in 1982 to promote regional technological development, and executes 7 projects in 7 areas in 1990.
2. System of Advanced General Regional Technology Development
This system promotes joint research for development to introduce advanced technology into local areas.
3. Regional Technical Cooperation Promotion Projects Major projects under this heading include:

- (1) Expansion of AIST's "Research Information Processing System (RIPS)" network to include regional research institutes, with the aim of closing "research information gaps" between different localities;
- (2) Preparation of a high technology application manual containing research information and know-how on advanced industrial technology, gathered by regional research institutes of AIST;
- (3) Promotion of joint research and cooperation with local societies, as well as dispatch of researchers for technical instruction, seminars for technical learning for local researchers, and technical symposiums.

(Unit: million yen)

Project Name	Period (FY)	Total Expenditure	Budget for FY1990	Outline of Project	R&D Results
Intelligent snow removing technology for cold regions (Hokkaido region)	1987 - 1991	500	30	Development of an advanced snow remover equipped with newest sensing and automatic control systems to promote safety, increase efficiency and decrease operating loads.	Experiments on the obstacle detector using ultrasonic, microwave and laser was carried out. The snow shooter controller using image analyzer and automatic snow remover was designed. Field test of snow fall sensors was continued.
Visual recognition and identification for flexible manufacturing systems (Chugoku region)	1987 - 1990	400	28	Development of a system to promote the efficient production of mechanical and electrical components in small lots of way many varieties through visual recognition of the components' position, shape, and surface properties, and a database consisting of the knowledge of skilled workers.	The apparatus detecting surface defects on mechanical and electrical parts has been developed together with a classifying technique. The image recognition system has been also developed, which can identify complicated objects correctly using the knowledge database.
Synthetic technology of artificial clay for high performance ceramics (Chubu region)	1988 - 1992	600	40	Development of economical synthetic technology of highly pure and plastic kaolinitic clay for plasticizer and raw material of high performance ceramics.	The effects of the addition of several anions and cations on the hydrothermal synthesis was studied. Usefulness of seed crystals was clarified and has been applied to the 1kg batch scale synthesis. The relations between synthetic conditions and plasticity of produced kaolinite were studied in detail. These results indicated the necessity of break down of coagulated particles.
R&D on re-utilization system technology of composite materials (Shikoku region)	1988 - 1992	350	28	For manufacturing valuable products from large FRP wastes, i.e., fishery boats and bath tubs; this project is aimed at developing automatic cutting and crushing apparatuses for wastes and constructing new re-utilization system from the crushed and separated composite.	For development of efficient automatic cutting machine, automatic supplying equipment was made on trial. In composite of the recycled FRP powder with plaster, products had higher bending strength than of cement concrete. In thermal decomposition of FRP waste under steam, phthalic acid and styrene were easily recovered. The reinforced glass fiber were investigated to endow porosity.
Advanced utilization of lime and lime-based compounds for materials development (Kyushu region)	1988 - 1992	500	33	Development of technology for advanced utilization of lime and lime-based compounds such as calcium carbonate, calcium silicate hydrates, apatites etc. for pigment and filler for paper, substitute for asbestos, filter medium, adsorbent, fixed bed for bioreactor, etc.	Plate type particles of basic calcium carbonate with high dispersibility were synthesized in the larger scale, and stoichiometric hydroxylapatite with high purity were obtained. Synthesizing conditions for tricalcium silicate hydrate (TSH) of longer crystals than 100µm were clarified.
Advanced surface modification in material processing (Kinki region)	1989 - 1993	600	35	Development of technology on advanced surface modification for materials such as metals, plastics and ceramics for mechanical, electrical, magnetical, and optical surface functions.	Improvement of adhesion strength between thin films and the substrates of various kind by ion beam irradiation was carried out. The energies of ions were selected in the following ranges; 0.5-2keV, 10-40keV and some MeV.
Advanced Internal Inspection Technology for Composite Substances (Tohoku region)	1990 - 1994	500	11	Development of the internal inspection system by using ultrasonic imaging, X-ray imaging and image analysis to certify the reliability of an internal structure and of a bonded interface in the composite substances such as ceramic-metal bond, micro-electronic device and carbonfiber reinforced plastic.	(Project launched in FY 1990)

THE HUMAN FRONTIER SCIENCE PROGRAM

Since the Industrial Revolution, technology has long been recognized as a method of conquering, managing, and controlling nature. Technological developments have helped us to move into scientific domains of higher temperature, higher pressure, higher speed, and greater magnitude. As a result, our knowledge base, as well as the range of human activities, has greatly expanded. In the meantime, a variety of serious problems have emerged which include increases in resource and energy consumption and the heavier load imposed on the environment as well as more intense man-machine conflicts. In order to ensure more humanity and greater prosperity in the 21st century, it is necessary to create a new system of scientific technology which will foster harmonious relationships with society and nature.

Based on these observations, it is believed that basic research on the precise mechanisms of organisms has the potential to become a driving force in developing various research areas and could become a treasure chest of scientific and technological seeds as it is expected to exploit the frontier of scientific technology for the 21st century.

Living organisms possess superior functional characteristics which have become extremely sophisticated and precise over a billion years of biological evolution. In contrast, only several hundred years have passed since the Industrial Revolution.

Today's most advanced scientific technology is no match for the superior mechanisms of living organisms. If these superior biological functions were to be clearly elucidated and properly utilized, it would help develop a new system of scientific technology characterized by "anti-pollution" and "energy saving", thus bringing humans an unlimited number of benefits.

1. Human Frontier Science Program

The Human Frontier Science Program is an international joint project in which basic research to elucidate superior functions of living organisms will be conducted in an attempt to utilize its results for the benefit of all human beings.

Voices which call for Japan to contribute more in the field of basic research are growing stronger. In response in the international area to this, the Japanese government proposed the Program at the Venice Summit in 1987 in an effort to exploit the scientific frontier of the 21st century. After the proposal was adopted at the Venice Summit, an international feasibility study was conducted by scientists in 1987 and the successful results were reported at the Toronto Summit in June, 1988.

The organization for the implementation of the HFSP was established in Strasbourg, France in October, 1989, starting the undertakings of research grants to international joint research teams, fellowships for travel and accommodation charges for research outside the country, and holding and sponsoring of workshops for information exchange and discussions. The first awardees have been designated in March, 1990.

2. Research and Development Program for the Elucidation of Biological Functions.

While promoting the Human Frontier Science Program, the Research and Development Program for the Elucidation of Biological Functions was newly established in 1988 and research is currently in progress at research facilities of the Agency of Industrial Science and Technology in an attempt to elucidate biological functions under investigation.

RESEARCH AND DEVELOPMENT OF TECHNOLOGIES RELATED TO GLOBAL ENVIRONMENT

Global environmental problems such as global warming (greenhouse effect) by carbon dioxide, depletion of the ozone layer may exert substantial effects on the industrial society and human life. The solution of such problems is urgently demanded as a subject to be overcome commonly by human beings. In this respect, the designated research frame in the global environment field was created in 1989 to start promotion of advanced R&D in an attempt to promote researches on fixation of carbon dioxide by artificial photosynthesis etc., while exploiting technical knowhow and resources of laboratories and institutes of the Agency of Industrial Science and Technology.

In 1990, the international joint researches on global environment technologies by the AIST and foreign research institutes were started. The R&D program of global environment industrial technology was added to research and development activities of NEDO to proceed with improvement and expansion of the integrated R&D organization participated by the industry, government, and college.

R&D projects of global environment industrial technologies for 1990

Name of project
(1) Development of environmentally benign production processes
1) R&D on advanced bioreactor system
(2) Development of environmentally benign substances
1) Development of CFC substitutes without global warming or ozone layer depleting characteristics
2) Development of biodegradable plastics
(3) Development of full carbon cycle technology
1) R&D on fixation and reutilization of carbon dioxide by photosynthetic microorganisms and algae
2) R&D on fixation and reutilization of carbon dioxide by catalytic hydrogenation
3) Study of carbon cycle mechanism in the ocean

R&D ON ENERGY CONSERVATION TECHNOLOGY

—THE MOONLIGHT PROJECT—

Launched in 1978, the Moonlight Project is a comprehensive program of R&D for energy conservation under which work is

carried out cooperatively by national laboratories, industries and universities.

(Unit: million yen)

Project Name	Period (FY)	Budget for FY1990	Outline of Project	R&D Results
Advanced Battery Electric Power Storage System	1980 - 1991	2,273 [26 2,247]	Development of an electric energy-storage system including high-efficiency, large scale advanced batteries. The system is expected to have a load leveling function, allowing electric energy to be stored during off-peak hours and discharged during peak hours.	Developed 4 type Advanced Batteries with capacity of 60kW, and with efficiencies of 77%. Developed 1000kW class power storage, system using improved lead-acid batteries, and with efficiency of 70%.
Fuel Cell Power Generation Technology	1981 - 1995	3,180 [36 3,144]	Development of design concepts for systems adaptable to both dispersed and centralized power stations, using fuel cell power generating devices whose potential efficiency can reach as much as 40 to 60%. Natural gas, methanol and coal-derived gas are used as fuels.	(Phosphoric acid fuel cell) Developed two 1000kW plants and two on-site 200kW systems which were installed in Tokashiki Island and Osaka. (Molten carbonate fuel cell) Developed 1kW, 10kW and 25kW class cell stacks. (Solid oxide fuel cell) Developed 500W class cell stacks. (Alkaline fuel cell) Developed 1kW class cell stacks and tested more than 2000 hours continuously.
Super Heat Pump Energy Accumulation	1984 - 1992	1,784 [37 1,746]	Development of several new systems, each of which consists of a high-performance electric driven heat pump system and a chemical heat storage system. These are expected to be used for air conditioning for large buildings, for district heating and cooling, or as process heat sources. The systems are to be operated so as to store energy at night and to discharge the stored energy in the daytime in order to contribute to a leveling of electric power demand.	Applied for 81 patents as a result of studies on working fluids, materials, elemental apparatuses, systematization, etc. Developed bench plant.
Superconducting Technology for Electric Power Apparatuses	1988 - 1995	2,610 [82 2,527]	Development of a more efficient and stable electric power system using superconducting power apparatuses, among which generators are the closest target. The system will assist in overcoming problems such as power loss and lack of suitable sites for transmission lines which occur as power stations become bigger and more remotely situated.	Developed high stability and high current density type 10KA class NbTi conductors for field windings. Designed 70MW class model machine. Designed compressor unit of refrigeration system.
Ceramic Gas Turbine Project	1988 - 1996	1,132 [65 1,067]	Development of ceramic gas turbines applicable to co-generation and electric power generation systems. These turbines, which use non-petroleum, fuels such as natural gas and methanol, offer thermal efficiency which may be increased to 42% by raising the turbine inlet temperature to 1350°C	(Project launched in FY 1988)
Other		644 [291 353]	Leading and Basic Technology for Energy Conservation; International Cooperation in R&D; Technology Assessment on Energy Conservation; Conditional Loans for Energy Conservation Promotion; Promotion of Energy Conservation through Standardization, etc.	

NOTE: Upper columns in parentheses represent general accounts and lower ones special accounts. Those not in parentheses represent general accounts only

Completed R&D Projects on Energy Conservation Technology (Unit: billion yen)

1. Waste Heat Utilization Technology System (1976-1981, 4)
2. Magneto-Hydro Dynamic (MHD) Power Generation Technology (1966-1983, 11.4)
3. Advanced Gas Turbine (1978-1987, 26)
4. Sirling Engine for Wide Use (1982-1987, 8)

R&D ON MEDICAL AND WELFARE EQUIPMENT AND RESEARCH ON EVER-IMPROVING TECHNOLOGY

Japan is putting much effort into raising the standard of its medical and welfare services, and there is an urgent need for more advanced equipment in this field. Often however, the development of technology for medical and welfare apparatus is hampered by large risks. Since 1976 fiscal year, AIST has addressed this problem by carrying out R&D aimed at the rapid development and marketing of reasonably priced, high-performance apparatus in this "high-risk" category. Research work is conducted at AIST's national research laboratories or on a consignment basis at the Technology Research Association of Medical and Welfare Apparatus (administered jointly by MITI and the Ministry of Health and Welfare).

By the end of fiscal 1989, R&D had been completed on twelve types of equipment for medical care and thirteen for Nursing "handicap" eleven these are already in use.

Development of non-invasive continuous blood glucose monitoring system, digital hearing-aids and health monitoring system for the elderly started this year by the New Energy and Industrial Technology Development Organization.

Development of four types of equipment for medical care and three for nursing "handicap" continued into 1990 (fiscal year) from the previous year.

(Unit: million yen)

Project Name	Period (FY)	Budget for FY1990	Outline of Project
I. Medical equipment technology			
1. Automatic HLA typing system	1987-1990	40	Device to automatically classify leukocyte forms in treatment of leukemia
2. Laser angioplasty system	1988-1991	221	Device to remove thrombus into arteria with laser beam
3. Three dimensional imaging system for medical diagnosis	1988-1991	114	System providing three-dimensional imaging for medical diagnosis
4. Laser osteotomy system	1989-1992	74	System to perform osteotomy accurately with excimer laser beam
5. Non-Invasive Continuous blood glucose Monitoring system	1990-1993	8	System to measure the value of blood glucose non-invasively and continuously with bio-sensor
II. Nursing "Handicap" equipment technology			
1. Anti-decubitus mechanical mattress	1987-1990	24	A bed to provide prolonged prevention of decubitus ulcers for those who are the bed ridden and are unable to turn
2. Evacuation care system	1989-1993	68	System to crush and remove the solidified feces standing in the rectum with supersonic vibration
3. Three-dimensional tactile display terminal for visually handicapped	1989-1992	54	System to form tactile solid body out of pin display of high density for visually handicapped
4. Digital hearing-aids	1990-1994	8	Hearing-aids to be able to adjust correspondent to each hearing characteristic and to change the sound speed
III. Support Equipment for participation of the elderly in society			
1. Health monitoring system for the elderly	1990-1992	57	System to be able to participate and detect early in case of emergency of the elderly

Completed R&D on Medical and Welfare Equipment (Unit: million yen)

1. Medical equipment technology

- (1) Multichannel automated biochemical analyzer (1976-1978, 251)
- (2) Automated differential blood cell analyzer (1976-1978, 269)
- (3) Artificial heart for clinical use (1976-1979, 480)
- (4) Portable artificial kidney (1976-1980, 617)
- (5) Laser scalpel (1978-1981, 533)
- (6) Positron computer technology (1979-1982, 470)
- (7) Liver function support device (1979-1984, 653)
- (8) Diagnosis and therapy support system for neural disorders (1981-1986, 600)
- (9) Blood treatment system for immuno-related diseases (1983-1987, 362)
- (10) Photochemical reaction system for diagnosis and therapy of cancer (1984-1987, 306)
- (11) Immunological cancer diagnosis system (1985-1988, 306)
- (12) Hyperthermia system for cancer therapy (1986-1989, 388)

2. Welfare equipment technology

- (1) Modular-type motorized wheelchair (1976-1978, 226)
- (2) Braille duplicating system (1976-1978, 143)
- (3) Gait pattern analyzer for the handicapped (1976-1978, 161)
- (4) Multifunctional bed for the severely handicapped (1976-1978, 101)
- (5) Middle ear implant (1978-1982, 429)
- (6) Guidance device for the blind (1979-1983, 366)
- (7) Vocal and speech training device (1979-1983, 346)
- (8) Power driver artificial wheel leg (1980-1985, 427)
- (9) Chair capable of 3-dimensional movement (1981-1985, 297)
- (10) Book reader for the blind (1982-1988, 585)
- (11) Transfer supporting system for the handicapped (1983-1988, 522)
- (12) Automated body temperature adjuster (1984-1988, 272)
- (13) System for processing prosthetic sockets (1986-1989, 209)

THE NATIONAL RESEARCH AND DEVELOPMENT PROGRAM

—THE LARGE-SCALE PROJECT—

Under the National Research and Development Program (popularly known as the Large-Scale Project), AIST conducts R&D projects on technologies which are of particular importance and urgent need to the nation. Government funds are given by contract to participating private enterprises, which work closely with national laboratories and academic organizations.

A total of 27 projects have been undertaken since 1966. Sixteen of these have already been completed, with various technical

results, including large-scale integrated circuits, high performance electric car battery technology and the practical use of desalination equipment. The results of such efforts are all available to the public, and have attracted worldwide attention. In 1990, AIST will continue to work on eight R&D projects currently in progress, and will also start two new projects: "Advanced Chemical Processing Technology" and "Human Sensory Measurement Application Technology".

(Unit: million yen)

Project Name	Period (FY)	Budget for FY1990	Outline of Project	R&D Results
Manganese Module Mining System	1981-1994	978	R&D on an efficient and reliable hydraulic mining system in which manganese modules are collected by a towed vehicle for commercial-scale mining to help ensure a stable supply of non-ferrous mineral resources.	The midterm assessment on detailed design and experiment development of fundamental components. Manufacturing of underwater pump, underwater cable, air compressor and collector.
Automated Sewing System	1982-1990	894	R&D on an automated industrial sewing system, involving processes such as preparation, making-up and finishing, to cope with rapid changes in the domestic apparel market.	Fundamental technologies essential to the automated sewing system were developed, and experimental machines were manufactured and operated. Software and hardware of the demonstration system were designed.
Advanced Robot Technology	1983-1990	[2,483 217 2,266]	R&D on advanced robot technology for systems to support people working under difficult or dangerous conditions.	Basic key technologies such as locomotion, manipulation, and sensor technologies have been developed for three types of robots - for nuclear power plants, for undersea, and for oil plant fire for oil refineries. Using these technologies, robots for feasibility study were designed.
New Water Treatment System	1985-1990	[1,539 250 1,289]	R&D on a new wastewater treatment system using a high-concentration bioreactor and separation membrane, for water reuse and energy recovery (e.g. methane gas from anaerobic bioprocess).	Bench-scale experiments made it possible to design a bioreactor-process for high-rate methane fermentation and a membrane-module with a persistent flux.
Interoperable Database System	1985-1991	[1,708 453 1,255]	R&D on technology for interoperable information systems with such features as distributed databases and multi media technology, to form an infrastructure for the "information-oriented society".	Some of the Implementation Specifications required for the Infrastructure to assure the interoperability among networked heterogeneous computers have been developed in conformity with OSI.
Advanced Material Processing and Machining System	1986-1993	[2,935 169 2,766]	R&D on advanced surface processing using excimer laser beam and/or ion beam, and on ultraprecision mechanical processing, for advanced industries such as energy, precision machining and electronics.	Elementary techniques for the high power, high repetition ratio, long life excimer laser and the ultra fine ion beam and the deep ion injection were developed.
Fine Chemicals from Marine Organisms	1988-1996	[1,186 396 790]	R&D on biotechnological production of fine chemicals such as pigments, dyestuffs, moisturizing materials, and coating materials for underwater structures.	Preliminary investigations on useful materials from marine organisms and on utilization technology of biofunction.
Super/Hyper-Sonic Transport Propulsion System	1989-1996	[1,621 191 1,430]	R&D on a combined-cycle engine which will combine the "ramjet" and "high performance turbojet", and provide high reliability and efficiency at both the subsonic and the hyper-sonic level.	Conceptual study for combined cycle engine and its components for SST/HST
Underground Space Development Technology	1989-1995	[564 193 371]	R&D on underground space development technology are as follows: (1) geological survey and evaluation technology (2) dome construction technology (3) environment conditioning and hazard prevention technology (4) pilot dome construction.	Preliminary investigations on key technologies such as geo-tomography, constructing machines and fire hazard prevention.
Advanced Chemical Processing Technology	1990-	29	R&D on advanced chemical processing technology for producing new functional materials such as functionally gradient materials, pure metals, polymers with fine alignment of molecules.	(Project launched in FY1990)
Human Sensory Measurement Application Technology	1990-	50	R&D on technologies for measurements of psychological and physiological effects, method of quantitative analysis and evaluation of complicated human sensation, and sensory evaluation simulator.	(Project launched in FY1990)

NOTE: Upper columns in parentheses represent general accounts and lower ones special accounts. Those not in parentheses represent general accounts only.

Completed National Research and Development Projects (Unit: million yen)

1. Super High Performance Electronic Computer (1966-1981, 10,100)
2. Desulfurization process (1966-1971, 2,700)
3. New Method of Producing Olefin (1967-1972, 1,200)
4. Remote-controlled Undersea Oil Drilling Rig (1970-1975, 4,500)
5. Sea-water Desalination and By-product Recovery (1969-1976, 6,700)
6. Electric Car (1971-1976, 5,700)
7. Comprehensive Automobile Control Technology (1973-1978, 7,300)
8. Pattern Information Processing System (1971-1980, 21,900)
9. Direct Steelmaking Process using High-temperature Reducing Gas (1973-1980, 13,700)
10. Olefin Production from Heavy Oil (1975-1981, 13,800)
11. Jet Aircraft Engines (1971-1981, 19,700)
12. Resource Recovery Technology (1973-1982, 12,600)
13. Flexible Manufacturing System Complex using Laser (1977-1984, 13,500)
14. Subsea Oil Production System (1978-1984, 18,200)
15. Optical Measurement and Control System (1979-1985, 15,700)
16. C₁ Chemical Technology (1980-1986, 10,500)
17. Observation System for Earth Resources Satellite-1 (1984-1988, 10,900)
18. High-Speed Computing System for Scientific and Technological Uses (1981-1989, 17,500)

R&D ON NEW ENERGY TECHNOLOGY RESEARCH

—THE SUNSHINE PROJECT—

The Sunshine Project was started in July 1974 to secure a stable energy supply for Japan which has a vulnerable energy structure. High priorities are given to the development of the following five projects.

- (1) Solar Energy
- (2) Geothermal Energy
- (3) Coal Energy
- (4) Hydrogen Energy
- (5) Comprehensive Research

The Agency promoting the Sunshine Project is also active in international cooperation through IEA and other international organizations.

(Unit: million yen)

Project Name	Budget for FY1990	Outline of Project	R&D Results
1. Solar Energy	7,324 [190 7,134]	<ol style="list-style-type: none"> (1) Research and development of high-performance and low-cost solar-photovoltaic-conversion technology which we hope will be widely used by early 21st century. (2) Development of the application of solar-thermal-application systems for industrial processes which require sophisticated thermal controls. 	<ul style="list-style-type: none"> • The price of solar cell has been reduced from 20,000-30,000 yen/Wpeak to 720 yen/Wpeak. • The cost of solar-photovoltaic-conversion system has been reduced from 2,000 yen /kWh to 200 yen/kWh. • Technology of fixed-temperature-stock-room system (-5°C) driven by solar-thermal energy has been achieved.
2. Geothermal Energy	5,378 [133 5,245]	<ol style="list-style-type: none"> (1) Nation-wide geothermal exploration survey assessing geothermal potential in Japan. (2) Research to confirm the effectiveness of exploration techniques for deep geothermal resources. (3) Development of binary cycle generation plant and hot dry rock generation system. 	<ul style="list-style-type: none"> • Completion of geothermal potential map in Japan. • Geothermal potential assessment and development of optimum exploration methods for high potential areas. • Development of high-precision magneto-telluric method. • Design and test operation studies of Downhole Pump for binary cycle power generation. • Production of geothermal reservoirs by fracturing techniques developed for hot dry rock power generation system.
3. Coal Energy	24,901 [266 24,635]	<ol style="list-style-type: none"> (1) Coal Liquefaction Technology Development of original liquefaction processes for both bituminous and brown coal. (2) Coal-based Hydrogen Production Technology Development of mass-production technology for low-cost clean hydrogen energy. (3) Integrated Coal Gasification Combined Cycle Power Generation Technology (IGCC; Sponsored by ANRE) Development of the technology of IGCC which is more efficient and have less environmental impact than conventional coal-fired power generation. 	<ol style="list-style-type: none"> (1) • Design of 150 t/d pilot plant for liquefaction of bituminous coal. • Operation of 50 t/d pilot plant for liquefaction of brown coal. (2) Construction of 20 t/d pilot plant for coal-based hydrogen production. (3) Construction of 200 t/d IGCC pilot plant with entrained bed reactor.
4. Hydrogen Energy	108	<p>Development of technologies on hydrogen production, storage and transportation, use and safety</p> <p>Development of technologies on producing highly efficiently, and on transportation and storage using metal hydrides</p> <p>Development of hydrogen batteries and hydrogen-fueled engines</p>	The pilot plant of alkaline-water electrolyzer with a 20N m ³ /h capacity was successfully operated for a long period at the highest efficiency in the world.
5. Comprehensive Research	1,784 [145 1,639]	<ol style="list-style-type: none"> (1) Basic studies of other new energy technologies, such as wind energy, ocean energy, bio energy, but excluding four areas (solar, geothermal, coal and hydrogen) are proceeding. (2) Development of a high-efficiency membrane complex methane production unit. 	The pilot plant of 100kW-class wind turbine generator system was successfully operated for a long period.
6. International Cooperation	61	<ol style="list-style-type: none"> (1) International cooperation through IEA. (2) Bilateral cooperation with Australia, etc. 	

NOTE: Upper columns in parentheses represent general accounts and lower ones special accounts. Those not in parentheses represent general accounts only.

FY1990 BUDGET AND PERSONNEL IN AIST

1. Budget

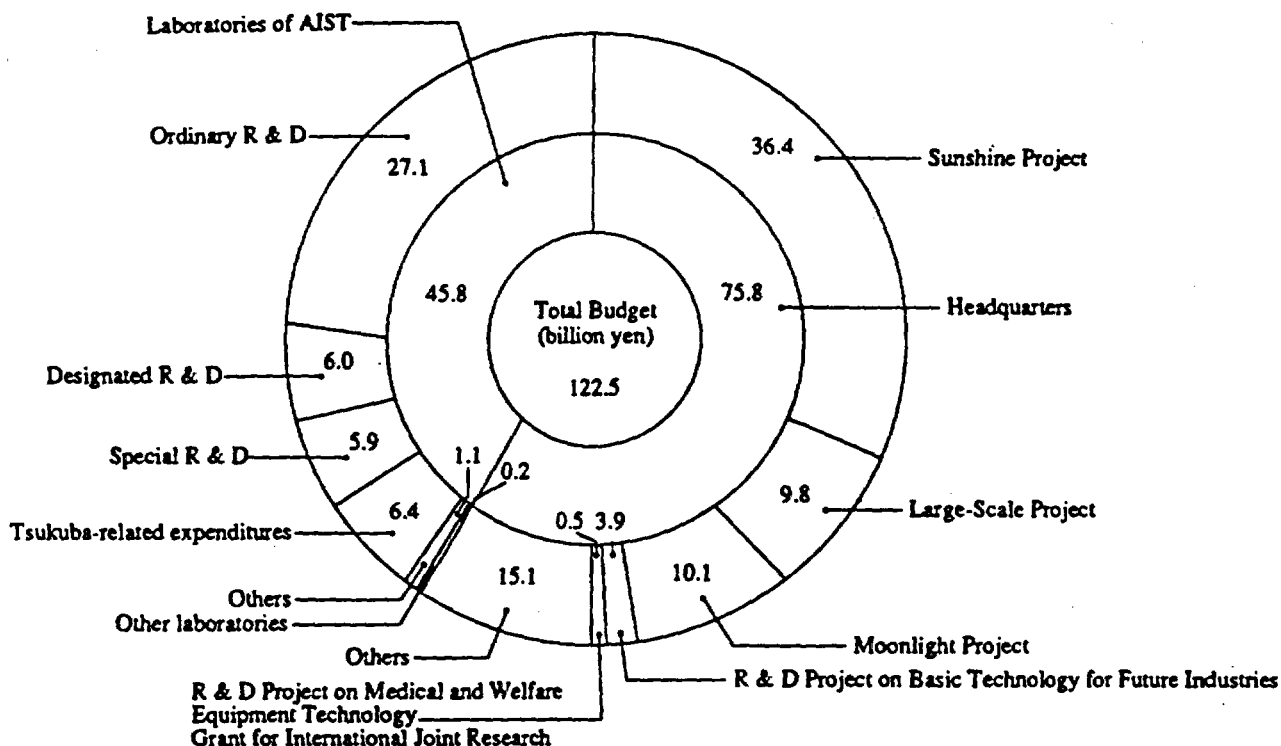

- Note: Ordinary R&D : Personnel expenditures and ordinary research expenditures of AIST laboratories.
 Designated R&D : Research expenditures incurred by research laboratories through work connected with the Large-Scale Project, the Sunshine and Moonlight Projects, the R&D Project on Medical and Welfare Equipment Technology, the R&D Project on Basic Technologies for future Industries, and the Regional Large-Scale Project.
 Special R&D : Expenditures incurred through Special Research, Expansion of Laboratory Facilities, Operation of Geological Research Vessel, Nuclear Research, R&D Promotion for Small Industries, Research Related to Prevention of Environmental Pollution.
 Tsukuba-related expenditure : Expenditures in operating joint facilities at Tsukuba.
 Budget for individual projects : The total budget for the large-Scale Project, Sunshine and Moonlight Projects and R&D Project on Basic Technology for Future Industries, minus the budget for Designated R&D. (Designated R&D is also omitted from the Total Budget for AIST.)

2. Budget and Personnel for Government Laboratories

	Budget (million yen)	Personnel	Researchers	Administrators
Agency of Industrial Science and Technology (Headquarters)	75,799	315	1	314
National Research Laboratory of Metrology	2,186	218	128	90
Mechanical Engineering Laboratory	3,289	276	217	59
National Chemical Laboratory for Industry	3,936	350	276	74
Fermentation Research Institute	1,122	90	72	18
Research Institute for Polymers and Textiles	1,532	125	102	23
Geological Survey of Japan	4,574	353	237	116
Electrotechnical Laboratory	9,217	686	554	132
Industrial Products Research Institute	1,413	125	102	23
National Research Institute for Pollution and Resources	3,916	319	245	74
Government Industrial Development Laboratory, Hokkaido	1,224	96	73	23
Government Industrial Research Institute, Tohoku	559	53	39	14
Government Industrial Research Institute, Nagoya	2,560	241	186	55
Government Industrial Research Institute, Osaka	2,628	219	168	51
Government Industrial Research Institute, Chugoku	720	52	40	12
Government Industrial Research Institute, Shikoku	513	45	35	10
Government Industrial Research Institute, Kyushu	969	91	71	20
Common Expenditures	41,185	—	—	—
Other Laboratories	5,525	—	—	—
Total	112,509	3,654	2,546	1,108

RESEARCH AND DEVELOPMENT PROJECT ON BASIC TECHNOLOGIES FOR FUTURE INDUSTRIES

This project is aimed at the development of innovative basic technologies essential for establishing new industries.

The five fields covered are superconductivity, new materials, biotechnology, new electronics devices and software. The following fourteen special categories, all of which have theoretically

or experimentally shown potential for application in new industrial technologies, have been selected. Research and development in these categories are conducted until the materials involved are ready for practical application.

(Unit: million yen)

Project Name	Period (FY)	Budget for FY1990	Outline of Project	R&D Results
(1) Superconductivity 1) Superconducting Materials and Devices	1988-1997	2,347 [910 1,437]	Development of new superconducting materials, processing technologies for applying superconducting materials to electric power equipments, e.g. magnets and wires, and technologies for fabricating superconducting electronic devices.	Effective pinning centers were introduced in oxide superconductors. New method to directly observe magnetic flux distribution in oxide superconductors was developed. Y-type proximity effect superconductor device was developed.
(2) New Materials 1) High-Performance Ceramics	1981-1992	1,313 [9 1,304]	Development of high-strength ceramics at extremely high temperatures to be used as materials for gas turbine components.	Si ₃ N ₄ and SiC ceramics with high reliability which can stand high temperature (~1200°C) were developed as materials for gas turbine components.
2) Synthetic Membranes for New Separation Technology	1981-1990	192	Development of synthetic membranes for new separation technology, to separate and refine freely mixed gases or liquid mixtures by utilizing differences in physical properties.	Synthetic membranes which can efficiently separate ethanol/water mixed solutions, CO ₂ /N ₂ mixed gases, and optical isomers of amino acid were developed.
3) Synthetic Metals	1981-1990	162	Development of synthetic metals and polymeric materials with electroconductive properties of metals.	Layered synthetic graphites with the highest electroconductivity of 9x10 ³ S/cm was found. The first example of soluble conducting polymer was demonstrated by the introduction of a long alkyl chain on polythiophene rings.
4) High-Performance Plastics	1981-1990	126	Development of high-performance plastics and polymeric materials with mechanical properties of metal.	Polymers with high flexural moduli, and molding-techniques for obtaining high performance liquid-crystalline polymers and molecular composites have been developed.
5) High-Performance Materials for Severe Environments	1989-1996	1,001 [163 838]	Development of carbon/carbon composites, intermetallic compounds, and fiber reinforced intermetallic compounds which can be used to develop a space plane and SST/HST.	SiC fiber, modified by the electron beam method, was developed to stand high temperature (~1500°C).
6) Photoactive Materials	1985-1993	471 [76 396]	Development of photoactive materials, which characteristically exhibit a reversible change in the structure or arrangement of molecules in response to a light stimulus.	Photochromic LB films for multiplex recording and photochemical hole burning materials which work at liquid N ₂ temperature have been developed.
7) Non-linear Photonics Materials	1989-1998	540	Development of photonics materials which exhibit high nonlinear optical susceptibilities and short response times for application of optical information systems.	Conjugated polymers and CuCl dispersed glasses having the highest susceptibility reported so far have been developed.
(3) Biotechnology 1) Utilization of Recombinant DNA	1981-1990	152	Investigation into the use of recombinant DNA technology for the development of new microorganisms for practical use in industry.	Noble host-vector systems of yeasts were developed. Various enzymes and bioactive substances have been efficiently produced by the improvement of host-vector systems of industrial microorganisms.
2) Molecular Assemblies for Functional Protein System	1989-1998	321	Development of molecular assemblies of functional proteins for reactors with sophisticated functions such as production and conversion of complexed biomaterials coupled with selective transport and recognition.	Photosynthesis protein complexes were extracted from photosynthetic bacteria and absorbed to the surface membrane with orientation of the molecule. Phycobiliprotein was isolated from thermophilic cyanobacteria for the first time and evaluated.
(4) New Electron Devices 1) Superlattices Devices	1981-1990	185	Development of superlattices electron devices with extremely fine structure tailored to atomic scale for utilizing new electronic effects.	Multifunctional high speed devices which utilize resonant tunneling, high mobility, and ballisticity of electrons in superlattices were fabricated by molecular beam epitaxy (MBE) and metal organic chemical vapor deposition methods.
2) Three-Dimensional ICs	1981-1990	301	Development of ICs characterized by a three-dimensional arrangement of active elements made of semiconductor layers.	Prototype of 3D devices with optical detector, A/D logic and memory circuits were fabricated by SOI formation and through-hole wiring technologies.
3) Bio-electronic Devices	1986-1995	280	Development of bio-electronic devices for future computer elements by using biological information processing functions based on plasticity, molecular recognition and self organization in a cell level.	A new optical method for detecting neural activities in the brain was developed. A photo-electro device which had very high quantum efficiency was also developed by piling up organic membrane.
(5) software 1) New Models for Software Architecture	1990-1997	53	Development of innovative models for flexible software architecture so that software can function according to the surrounding situation.	(Project launched in FY1990)

NOTE: Upper columns in parentheses represent general accounts and lower ones special accounts. Those not in parentheses represent general accounts only.

Completed Research and Development Projects on Basic Technologies for Future Industries (Unit: million yen)

- Fortified ICs for Extreme Conditions (1981-1985, 1,315)
- Advanced Alloys with Controlled Crystalline (1981-1988, 3,903)
- Advanced composite Materials (1981-1988, 4,649)
- Bioreactor (1981-1988, 2,978)
- Large-Scale Cell Cultivation (1981-1989, 3,362)

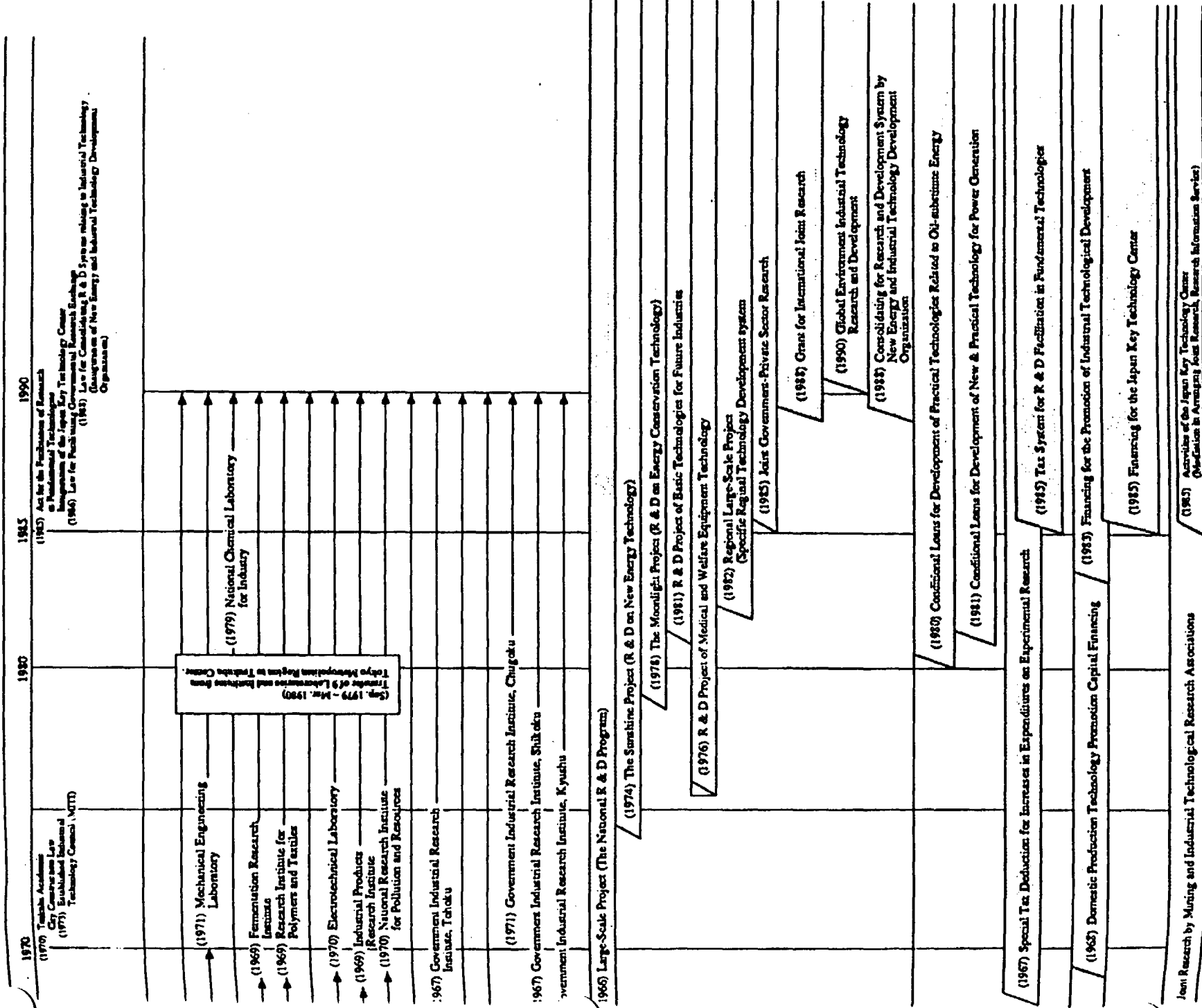

FY1990 APPROPRIATIONS RELATED TO INDUSTRIAL TECHNOLOGY IN MITI

(Unit: one hundred million yen)

Item	Fiscal 1989 Appropriations	Fiscal 1990 Appropriations	Increase over the Previous Year	Notes
Request for R&D-related appropriations	2,336	2,498	162	Growth rate against previous year 6.9%
General accounts	694	685	Δ9	Δ1.3%
Special accounts	1,360	1,531	171	12.6%
Industrial investment accounts	282	282	0	
Major Projects [Positive contribution to international society]				
• Promotion of Human Frontier Science Program (HFSP)	9	13	4	International HFSP Organization (Tentative name for the fund)
• Promotion of International R&D Center	6	10	3	To be located in NEDO.
• Development of global environment technology	1	2	1	Specific R&D at national experimental research laboratories
• R&D cooperation with developing countries	16	21	5	
• Support to international joint R&D	4	4	0	
[Further promotion of technological development projects] (AIST-related)				
• Preparation project of research foundation by Integrated of New Energy & Industrial Technology Development Organization	22	22	0	Participation from industrial investment accounts
• R&D expenses of national experimental research institutes (Special R&D, Government-private sector joint R&D, important area technology R&D, operation expenses of laboratories, etc.)	147	145	2	Including development of global environment technology
• R&D project on basic technologies for future industries	68 (21)	75 (40)	6 (19)	Applied technologies for new models for soft architecture
• Large-scale project	139 (92)	141 (102)	2 (10)	Advanced chemical processing, Human sensory measurement application
• Development of medical and welfare equipment	7	7	Δ0	Non-invasive continuous blood glucose monitoring system, digital hearing-aids, health monitoring system for the elderly.
• R&D on new energy technology	271 (259)	275 (265)	4 (6)	
• R&D on energy conservation technology	107 (101)	116 (110)	8 (9)	
(Aerospace-related)				
• International joint research on aircrafts (YXX, V2500)	42	39	Δ3	
• Unmanned space experiment system (Free flier)	45 (40)	53 (48)	8 (5)	
(Data processing-related)				
• R&D for 5th generation computer	65 (28)	70 (35)	5 (7)	
(Technological development relating to superconductivity)	44 (29)	52 (43)	8 (14)	Moonlight, etc.
[Others]				
• Promotion of development for new industrialized housings	1 (1)	10 (9)	9 (8)	Development of new industrialized housings to realize the needs of those living
• The Service of the Japan Key Technology Center	260 (260)	260 (260)	0 (0)	Participation of financing from industrial investment accounts
• Promotion of standardization	9	10	1	

Note: Figures in () belong to special accounts, which are part of the upper figures.

FY1990 Appropriations Related to Science and Technology in Japanese Government (Summary)

(Unit: million yen)

Agency/Ministry	Item		Special accounts	Growth rate against previous year (%)	Total	Growth rate against previous year (%)
	General accounts	Growth rate against previous year (%)				
Ministry of Education	204,580	4.0	689,721	4.9	894,301	4.7
Science and Technology agency	369,838	4.1	124,937	12.4	494,775	6.0
Ministry of International Trade and Industry	68,492	Δ1.3	181,340	10.4	249,832	6.9
Defense Agency	104,268	12.0	—	—	104,268	12.0
Ministry of Agriculture, Forestry and Fishery	66,707	3.2	3,300	Δ2.4	70,007	2.9
Ministry of Health and Welfare	40,150	7.0	11,092	2.3	51,242	5.9
Ministry of Posts and Telecommunications	4,657	4.7	26,543	0.5	31,199	1.1
Ministry of Transport	16,371	6.4	1,039	13.3	17,410	6.8
Environment Affairs	9,217	16.9	—	—	9,217	16.9
Ministry of Foreign Affairs	7,095	10.7	—	—	7,095	10.7
Others	12,006	5.3	4,250	Δ10	16,257	1.0
Total	903,381	4.7	1,016,222	6.6	1,919,603	5.7

ORGANIZATION OF AISI

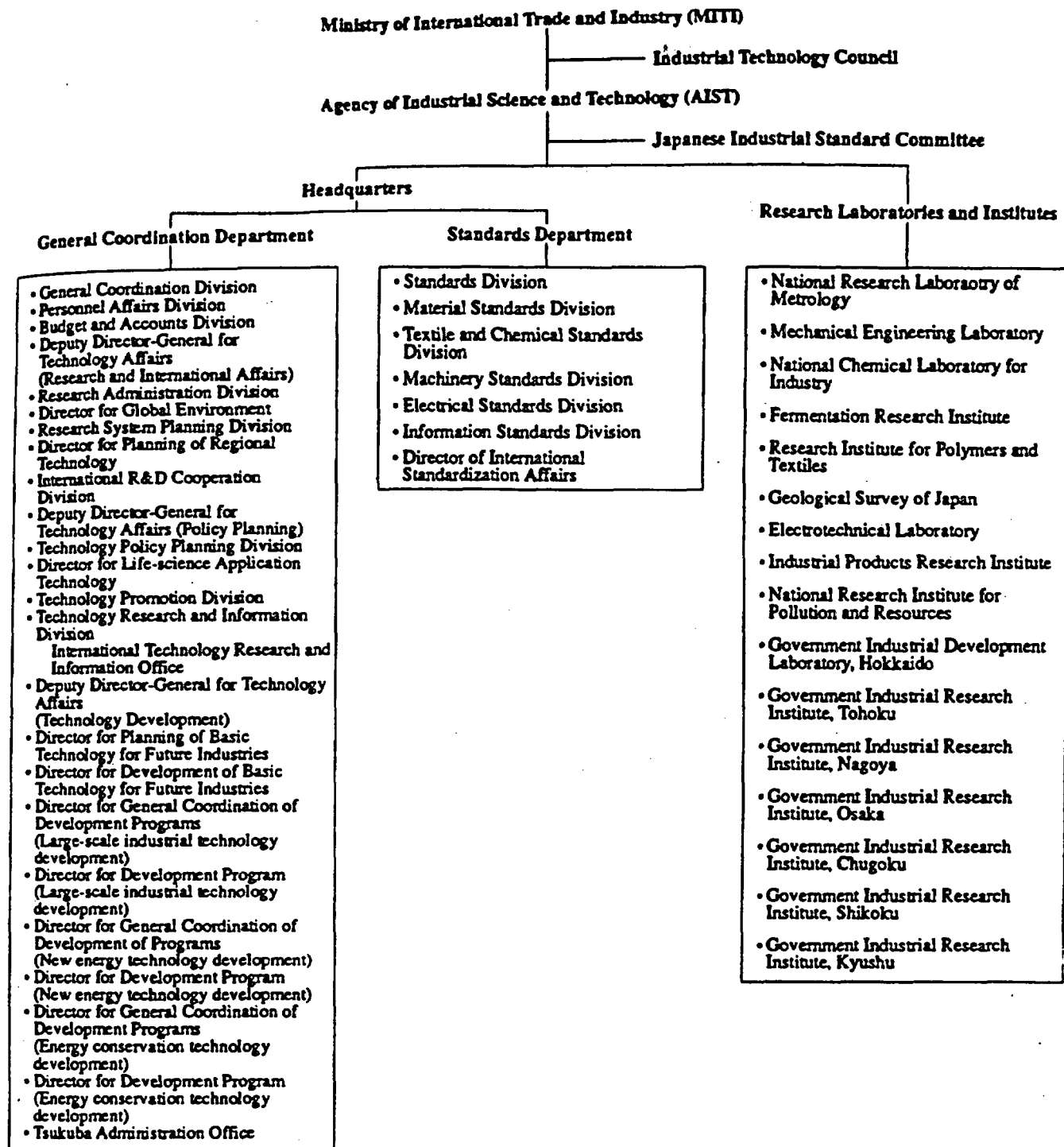

Contents

Organization of AIST	1
History	2
FY90 Budget and Personnel	4
Activities	
Basic Technologies for Future Industries	6
The large-Scale Project	7
The Sunshine Project	8
The Moonlight Project	9
Medical and Welfare Equipment Technology	10
Regional Technology Development	11
The Human Frontier Science Program	12
Earth Environment	12
Consolidating Research and Development Systems Relating to Industrial Technology	13

International Cooperation in Research and Development	15
The Japan Key Technology Center	19
Technological Development in the Private Sector	20
Industrial Standardization	21
Technology Research and Information	22
Diffusion of Technological Accomplishments	23
Industrial Technology Council	
Recent Trends Involving AIST	24
Laboratories and Institutes	
R&D, Tsukuba Research Center	25
Introduction to Individual Laboratories and Institutes	26

HISTORY OF AIST

1945	1950	1956
<p>Category</p>	<p>(1949) Substantial Agency of Industrial Trade and Standards (1949) Text and Sewing (1950) Textile Industrial Technology Council (1951) Weigh and Measure Law (1952) Established AIST (1952) Empirical Research Institute Promoted Law</p>	<p>(1956) Substantial Science and Technology Agency (1956) Textile Science and Technology Council (1961) Metallurgy and Technology Research Organization Law</p>
<p>Laboratories and Institutes built before 1945 (1909) Central Inspection Institute of Weights and Measures (1937) Government Mechanical Laboratory</p>	<p>(1952) Central Inspection of Metrology</p>	<p>(1961) National Research Laboratory of Metrology</p>
<p>(1900) Industrial Laboratory (1940) Chiba Alcohol Plant (1943) Fermentation Research Institute (1945) SRI Laboratory (1937) Textile Research Institute</p>		
<p>(1918) Industrial Laboratory of Tokyo</p>		
<p>(1942) Alcohol Research Institute (1943) Fermentation Research Institute</p>		
<p>(1945) SRI Laboratory (1937) Textile Research Institute</p>		
<p>(1911) Electric Laboratory (1928) Industrial Art Institute (1920) Fuel Research Institute</p>	<p>(1952) Industrial Arts Institute (1952) Resource Research Institute (1949) Mining and Safety Research Institute</p>	<p>(1960) Government Industrial Development Laboratory, Hokkaido</p>
<p>(1920) Industrial Laboratory of Osaka</p>	<p>(1952) Government Industrial Research Institute, Niigata (1952) Government Industrial Research Institute, Osaka</p>	<p>(1964) The Expenses Commission System for R & D of Mining and Industrial Technology</p>
<p>Promotion of R & D (Projects) through Government Private Sector Cooperation</p>		
<p>Promotion of Technological Development in the Private Sector</p>	<p>(1951) Financing of Expenses for New Technologies</p>	<p>(1961) Promotion of Technological Development in the Private Sector</p>

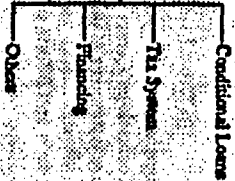

(1961) Promotion of Technological Development in the Private Sector

AIST

Agency of Industrial Science and Technology

1990

OVERVIEW OF THE AGENCY OF INDUSTRIAL SCIENCE AND TECHNOLOGY

R&D in advanced fields of electronics, new materials, biotechnology, and so forth is remarkable at the present time. In view of contributing to the international society through technical development while taking into account domestic and international changes surrounding science and technology, Japan will promote Techno-Globalism to stimulate scientific and technological creativity as well as distribution and transfer of the results of such activities. Domestically, Japan, which is now one of top ranking economic and technological powers in the world, will maintain and enhance the bases for building up an affluent economic society in the future. This will enable us to establish a long-and medium-term basis for the economic development of Japan. Also in contributing positively to the international society through R&D it is essential for Japan to play a role in promoting increased R&D in innovative areas which will benefit all humankind.

For 1991, the Agency of Industrial Science and Technology will promote R&D in such areas as new energy, energy conservation, and pollution control to tackle environmental problems while making efforts to expand and argument R&D activities of designated research organizations in developing global environmental technologies, promoting international joint studies on global environmental technologies, and establishing R&D organizations to study industrial technology related to the global environment. We also intend to develop overall industrial technology policies, in particular the following.

First of all, for this year, international research cooperation will promote the Human Frontier Science Programs designed to explain the superior functions of the living body and to search for possible applications. Specifically, we will make effects to further improve and expand international research exchange by:

- (1) R&D in specific areas through task sharing among the Agency of Industrial Science and Technology and research institutes of advanced countries,
- (2) assistance to R&D development by international joint study teams in explaining physical properties and functions,
- (3) invitation of foreign researchers to the research institutes of the Agency of Industrial Science and Technology, and
- (4) incorporation of the International Exchange Center established in NEDO in 1990 into the International Industrial Technology Research Exchange Center.

Secondly, regarding R&D in basic and advanced fields, the following projects will be further expanded:

Basic Technologies for Future Industry to promote advanced technology development (new materials, superconductivity), Large-Scale Project of Industrial Technologies vital in terms of the national economy (effective utilization of marine micro organisms), and R&D for of Medical and Welfare Equipment Technology to contribute to the welfare of society through technological development.

Continued promotion is also planned for the Sunshine Project aimed at developing clean new energies (solar and geothermal energies, etc.) and the Moon-light Project for generating energy conservation technology to achieve high energy efficiency in view of Japan's energy security.

Technological R&D for Vital Regions will be actively promoted to stimulate economic growth of regional areas.

In line with these R&D focusing on basic areas will continue in 16 research laboratories under the Agency of Industrial Science and Technology, while furthering mutual exchanges through joint research among industries, government, and universities.

Thirdly, in order to encourage R&D in the private sector, R&D founding will be provided by the Infrastructure Technology Promotion Center, utilizing various tax incentives (Added R&D Expenditure tax deductions and tax incentives for promoting infrastructure technology for R&D). The latter refers to improving the research infrastructure necessary for promoting high-level R&D.

Finally, regarding the industrial standardization system (JIS) which has supported our development in industries, we will advance international cooperation through making positive contributions to international standardization activities and standardization technical cooperation, promotion of standardization in advanced technology fields (information technology, new materials, and biotechnology).

We hope this pamphlet will help in understanding the policies of the Agency of Industrial Science and Technology.



Masaru Sugiura

Dr. Masaru Sugiura
Director-General,
Agency of Industrial
Science and Technology

The Government Industrial Research Institute, Aomori was established in 1967 as a research facility for developing mining and industrial technology for the Tohoku region. Initially, it conducted a major project on automatic processing for Kuroko ore which is abundant in the Tohoku district and its vicinity. Since then, it has made a number of research contributions ranging from utilization of regional resources to advanced technology areas, all stemming from the desire to develop industries in this region as well as share the responsibilities for national projects. In addition, since 1975, it has taken part in international joint research and development projects with various countries such as Thailand, Indonesia and China.

At the present time, Research is focused on the following three fields:

1. Researches on regional resources and energies
 - (1) Separation and refining technique for finechemicals from low utilized biomass (2) Technique for extracting lipids (3) Developing materials for geothermal power plants (4) Recovery of useful metals from geothermal hot water (5) Geothermal data analysis associated with well-stimulation by hydro-fracturing (6) Development of groundwater velocimetry.
2. Development and evaluation of new materials
 - (1) Development of nano-composites by intercalation (2) Development of mesoporous materials from synthetic silicate-bearing smectites (3) Functionally gradient material by a self-propagating high temperature synthesis process (4) Internal inspection system for composite substances (5) Mechanical properties of austempered ductile iron.

refining of rare metals produced in China (2) Research on utilization of natural zeolite in Indonesia.



High Temperature Electrochemical Measurement Apparatus

Government Industrial Research Institute, Tohoku
4-2-1, Nigateke, Miyagino-ku, Sendai-shi, Miyagi, 983

Sendai 022 (237) 5211

Total personnel 53
Total budget 575 (million yen)

The Government Industrial Research Institute, Nagoya (GIRIN) was established in 1952 as a national research center to contribute to R&D on advanced regional technology as well as national program. Research activities are conducted in six departments, namely, Mechanical Engineering, Metallurgical Engineering, Chemistry, Radiation Research, Ceramics Science, and Ceramics Technology. It has 241 staffs and 2.6 billion-yen budget in total in fiscal year 1990. One division in Ceramics Technology is located at Seto-city, which is well known for her largest production of pottery and porcelain wares in Japan, to contribute to her regional technology.

Since its establishment, GIRIN has played an important role for R&D on such industrial science and technology as liquid bulge forming, casting and foundry technologies, synthesis of organic fluorine compounds, radiation graft polymerization, solar energy utilization, functional and engineering ceramics, and pottery and porcelain production technologies.

GIRIN has recently focused her research activities more on inorganic material (ceramics) research aiming to Energy (including hard energy technologies for high temperature gas turbine, nuclear fission, and large power transportation, soft energy technologies such as passive solar device, and energy conservation technologies) and Space & Aircraft technologies. GIRIN is executing 42 research projects in conjunction with national R&D projects such as Basic Technologies for Future Industries (Engineering Ceramics, High Temperature Ceramic Super Conductor, Metal Based Composite Materials and Inter Metallic Compounds), Sunshine (Passive Solar Device, Photo Catalysis), Moonlight, Large Scale Project (Surface modification of ceramics by beam technology), Special Programs for Mines & Technologies (Bio Ceramics and other Functional

ceramics, Functional Organic Fluorine Compounds) and so forth. It is also conducting 50 basic research programs. Among those, new metals and casting technologies, environmental protection technologies, radiation physics and chemistry, biotechnologies and pottery and porcelain technologies are included.

GIRIN has also actively joining to the bilateral international cooperative research programs under AIST scheme in the field of fluorine bionics organic compound, acid rain project, and utilization of indigenous materials in developing countries as well as to multi national cooperative programs under IEA in the fields of ceramics and solar materials.

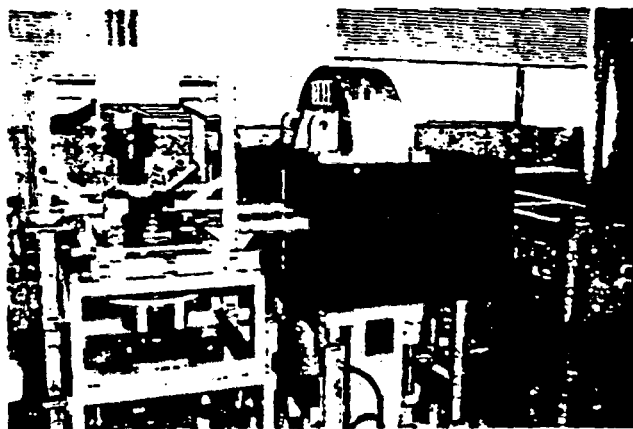

Ultra-High Pressure Cold Isostatic Press for Ceramics Forming

Government Industrial Research Institute, Nagoya
1-1, Hirate-cho, Kita-ku, Nagoya-shi, Aichi, 462

Nagoya 052 (911) 2111

Total personnel 241
Total budget 2,600 (million yen)

The Government Industrial Research Institute, Osaka was established in 1918. Since then it has produced a number of outstanding research achievements in the exploration and development of new materials including carbon fibers and electrically conductive transparent thin films. Our research institute consists of five research departments and is giving priority to the following research fields:

- 1) Energy-related Materials: materials for energy conversion such as for batteries, fuel cells, electrolysis processes, hydrogen energy, and high-temperature ceramics for gas turbines, etc..
- 2) Optical Materials: glasses and thin films for optics, nonlinear optical materials, optical chemical sensors, etc..
- 3) Functional Surface Materials: heterogeneous catalysts, biocompatible materials, atomic-scale designing of graphite intercalation compounds, new functions and theoretical analyses of the interconnection in composite materials, surface modification with ion implantation, etc..

In addition to the above fields of materials research, the following lines of approach are also being put forward:

- 1) Intensification of innovative, fundamental studies to create highly advanced functions of materials.
- 2) Initiation of unexplored approaches to materials through human sensation and feelings.
- 3) Fermentation of basic science concerning the creation and analyses of novel materials through atomic-scale techniques and computer calculation and graphics.

4) Promotion of R&D programs for global environment technology.

Through the above research activities, our institute encourages contacts and cooperation between industrial and university research on a regional, national, and international level.



Ion Implantation Machine

Government Industrial Research Institute, Osaka
8-31, Midorigaoka 1-chome, Ikeda-shi, Osaka, 563

Ikeda 0727 (51) 8351

Total personnel	219
Total budget	2,560 (million yen)

The Government Industrial Research Institute, Chugoku was established in 1971 to conduct pollution control studies in the Seto Inland Sea and engineering studies to develop new industrial technology in the Chugoku district. Since then, there have been many noteworthy achievements by the Institute results, including research on dissolution of pollutant out of the bottom sediment in the Seto Inland Sea, development of a fresh surface characterizing microscope using exo-electron, and materials evaluation in severe environments.

Two research department, the Marine Science and Technology Department and the Industrial System Department, are affiliated with the Institute. The first has four research divisions, and studies ocean engineering using the largest hydraulic model of the Seto Inland Sea in the world, shown in the picture, as well as physical, chemical and biological oceanographies. The second has three research divisions, and studies machining technology, the surface science of new materials and computer science in factory automation.

The institute also conducts marine biology studies under a major national R&D program, a materials study of hydrogen energy and ocean thermal energy conversion (OTEC) under national R&D projects focusing on new energy, computer image processing studies for developing specific regional technology, and international joint research with Indonesia in the area of corrosion.



Large-scale Hydraulic Model of the Seto Inland Sea

Government Industrial Research Institute, Chugoku
2-2, Hirosuchiro 2-chome, Kure-shi, Hiroshima, 737-01

Kure 0823 (72) 1111

Total personnel	52
Total budget	726 (million yen)

The Government Industrial Research Institute, Shikoku was established in 1967 as a R&D center for developing mining and industries in the Shikoku region, taking advantage of its mild climate and location near the sea and rich forest resources. Its R&D centers upon pulp and paper technology and in developing marine resources, it is primarily concerned with extraction and uses of minor elements dissolved in sea water, and underwater welding and cutting.

Balancing its regional and national interests, the institute has emphasized research in marine resources, functional resources and mechatronics. Furthermore, our institute is the leader in the Shikoku region for research and technologies.

The major research area of the Institute are as follows:

1. Marine resources

- (1) Manufacturing process of high-functional chemicals from sealife. (2) Developing excellent absorbents for uranium and lithium. (3) Developing functional sheets from acidic polysaccharides, the main constituents of seaweeds. (4) Manufacturing degradation-controlled sheet. (5) Development of magnesium pyroborate whisker.

2. Local technologies

- (1) R&D on re-utilization system technology of composite materials. (2) Control of a flexible long arm and development of a small active mass damper. (3) Swing and vibration control of a crane. (4) Sophisticated surface processing with laser beam and ion beam.

3. International R&D cooperation projects and fundamental research

- (1) Research on industrization of thermomechanical pulping of oil palm by-products. (2) International research cooperation on recovery of valuable brine resources. (3) Molecular mechanism of interactive recognition between cell surface and polysaccharides.

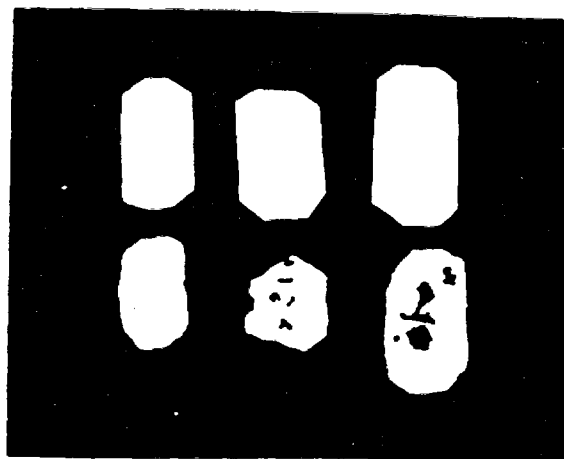

Bio-degradable Polymer Film

Government Industrial Research Institute, Shikoku
3-3, Hananomiya-cho 2-chome, Takamatsu-shi, Kagawa, 761

Takamatsu 0878 (67) 3511 Total personnel 45
Total budget 513 (million yen)

The Government Industrial Research Institute, Kyusyu was established in 1964 to contribute to developing mining and industries in Kyusyu.

The institute has conducted 17 special research and 35 general research projects in the following major fields:

- 1. Production and processing technologies for new materials; (1) Study of ductile ceramics at high temperatures, (2) Development of intelligent ceramic composite materials, (3) Research on fabrication and thermal characterization of heat resistant carbon ceramic composite materials, (4) Machining technology in ceramics and cutting tool application, (5) Development of ceramic cutting tools for steel, (6) Development of high-performance engineering carbons, (7) Development of advanced carbon/carbon composites with oxidation resistance, (8) Technology for improving properties of materials by the powder forming method, (9) Development of particle dispersed composite metals by high pressure solidification method, (10) Research on metallic materials using quantitative stereology, (11) Study of production of multifunctional microspheres, (12) Study of spectroscopic characterization of ceramics.

- 2. Advanced technology for utilizing natural resources; (1) R&D utilizing lime and lime-based compounds in advanced materials, (2) Processing and evaluation of inorganic polymer having layer structure, (3) Production of porous ceramic materials from rice husks, (4) Advanced utilization of volcanic glass, (5) Production and utilization of molecular sieves from coal, (6) Research on concentrating a trace amount of gallium, (7) Refining process of fine parts of weathered granite.

- 3. Energy and pollution control technologies; (1) Study of the behavior of coal and solvent mixtures in the initial stages of coal liquefaction, (2) Hot-gas corrosion of ceramics for gas turbine blades, (3) Development of new muffler adaptable with controlled resonators, (4) Research on the advanced biological treatment of organic waste water, (5) Liquefaction of coal and extraction of liquefied products under the condition of supercritical state.

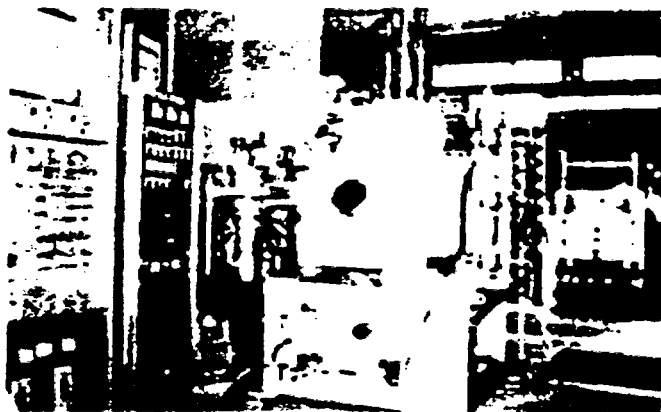

Friction and Wear Testing Apparatus

Government Industrial Research Institute, Kyusyu
Syuku-machi, Tosu-shi, Saga, 841

Tosu 0942 (82) 5161 Total personnel 91
Total budget 946 (million yen)

The National Chemical Laboratory for Industry (NCLI) was established in 1900 for promoting the chemical industry in Japan. The laboratory conducts numerous research projects in four areas: 1. development of new substances and highly functional materials; 2. bio and biomimetic chemistry; 3. conversion and conservation technologies for energy and resources; and 4. standardization and safety technologies. Many strategies aiming the first area are introduced in chemical reactions and processes, for examples, ultra-high temperature plasma, ultra-high pressure, laser beams, computer-aided molecular design systems. For the elucidation and application of biological functions, the laboratory has developed technologies for genetic engineering, cell membranes, artificial and super enzymes, and artificial photosynthesis. In effective utilization of energy and natural resources, extensive studies are being made on catalysis technology, coal liquefaction, heat storage using chemical reactions, fuel cells, superconductors, membrane technology, and biomass utilization. Regarding the final area, intensive studies are also made on standardization of chemicals, as well as a means of controlling environmental pollution, eliminating industrial hazards, and preventing explosions of gases and explosives. The main research projects of the laboratory are as follows:

- (1) Ultra-high temperature: generation, measurement and utilization
- (2) Solid state polymerization under ultra-high pressure
- (3) Laser regulated chemical reactions
- (4) Development of organo-silicon compounds
- (5) Research and development of superconducting materials and devices
- (6) Research on the analytical and evaluational technology for high-quality functional materials by

- beam technology
- (7) Advanced material processing and machining systems
- (8) Synthetic membranes for new separation technology
- (9) Research for morphogenesis and expression of genetic information
- (10) Development of proteins with new function
- (11) Liquefaction of coal
- (12) Super heat pump energy accumulation system
- (13) Reference materials for calibration of analytical instruments
- (14) Estimation and prevention of explosion hazards of special material gasses.



Application of Excimer Lasers to Chemical Syntheses

National Chemical Laboratory for Industry
1, Higashi 1-chome, Tsukuba-shi, Ibaraki, 305

Tsukuba Gakuen 0298 (54) 4431
Research Planning Office

Total personnel 349
Total budget 4,300 (million yen)

The Fermentation Research Institute (FRI) was established in 1940 with the objective of contributing to the development of industries involved with microorganisms. The Institute conducts a broad range of activities including the development of a variety of enzymes, techniques for biologically treating industrial waste water, and improved industrial processes related to microorganisms. Recent years have brought advances in such areas as recombinant DNA technology, bioreactors using immobilized enzymes and coenzymes, cell growth and gene expression control in cultured animal and plant cells, hydrogen producing microorganisms, the production of substances regulating cell function, the development of new enzymes and the utilization of thus far unused resources. As the authorized depository for patent microorganisms in Japan, the Institute also handles the deposition and distribution of domestic and foreign strains of microorganisms.

Major research performed at the Institute centers on the areas below.

Designated Research: Protein Molecular Assembly Technology, R&D on a New Water Treatment System, Fundamental Technology for Utilization of Marine Organisms, Basic Technology for Utilization of Useful Biological Function, Research on Energy Conversion by Photosynthetic Microorganisms, Algal Potential for Carbon Dioxide Fixation, Molecular and Cellular Biological Study of Morphogenesis in vitro, Regulation of Plant Gene Expression, Molecular Mechanisms for Regulatory Protein Functions, Research on Photosynthetic Molecular Assembly, Molecular Recognition and Response of Smooth Muscle Cells, Expression Regulation of an Intestine Contractor Peptide Gene, and Theoretical and Experimental Investigation on Ribozymes.

Special Research: New Transferring Enzymes and their Functions, Construction of Bioreactor, Biocatalyst for Oxidation in Micro aqueous System, Application of Recombinant DNA Technology to Hydrocarbon Utilizing Soil Pseudomonads, Development of Plant Genetic Engineering, Development of Substances Regulating Cell

Function, Regulatory Mechanisms of Cell Proliferation on Eukaryotic Microorganisms, Studies on the Thermobiology, Mechanisms for Release of Methane into the Atmosphere by Microorganisms, Treatment of Offensive Odors Using Microorganisms, Flocculant Produced by Microorganisms, and Studies on the Role of Calcium Ion in Signal Transduction in Animal Cells.

Special Coordination Funds for Promoting Science and Technology: Basic Study on Safety of Genetical Engineering Techniques in Open System, Structure-Function Relationship of RNA Molecules and Application of Synthetic Ribozymes, Development of Experimental System for the Analysis of the Response Mechanism of Plant Cells, and Studies on Angiogenic Factors.

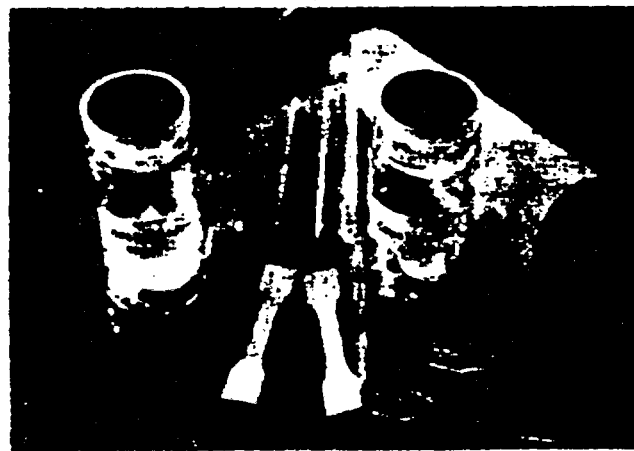

Various Kinds of Biodegradable Plastics

Fermentation Research Institute
1, Higashi 1-chome, Tsukuba-shi, Ibaraki, 305

Tsukuba Gakuen 0298 (54) 6023
Technical Service Office

Total personnel 89
Total budget 1,105 (million yen)

The Research Institute for Polymers and Textiles was originally established in 1918 as the SER Laboratory and in 1933 came the Textile Research Institute covering the entire area of textile technology. After the War, polymer science and technology is integrated into this research field, and the present name was opted in 1969. The present organization was founded in 1988 comprised of 4 research departments; Polymer Chemistry Dept., Chemical Engineering Dept., Material Physics Dept. and Material Design and Engineering Dept. In recent years, research activity has been focused on upgrading polymer materials, the synthesis of new functional polymers, bio-function utilizing technology and innovative technology for textile industries. And, future emphasis to be placed on the development of functional materials based on molecular-level science. Main research items are as follows:

- Synthesis and structuring of polymeric materials (1) Synthesis of ordered polymers (2) Organization of polymer surfaces (3) Synthesis of biologically functional polymers
- Functional Molecules (1) Photo-reactive polymers (2) Energy transforming polymers (3) Conductive polymers (4) Polymeric materials for specific separation
- Bio-functional materials (1) Structure analysis and molecular design of biopolymers (2) Biocompatible materials and pharmacologically active polymers (3) Biosensor and biodevice (4) Biomimetic materials
- Composite and high performance materials (1) Highly durable materials under extreme conditions (2) Light-weight strong polymeric materials (3) Polymer alloys

- 5. Innovative synthesis and processing technology (1) Experimentation for polymer design (2) Innovative processes with computerized Bioreactor
- 6. Measurements and analysis of materials (1) Characterization and evaluation of polymers (2) Nondestructive evaluation techniques for polymeric materials (3) Weathering of polymeric materials

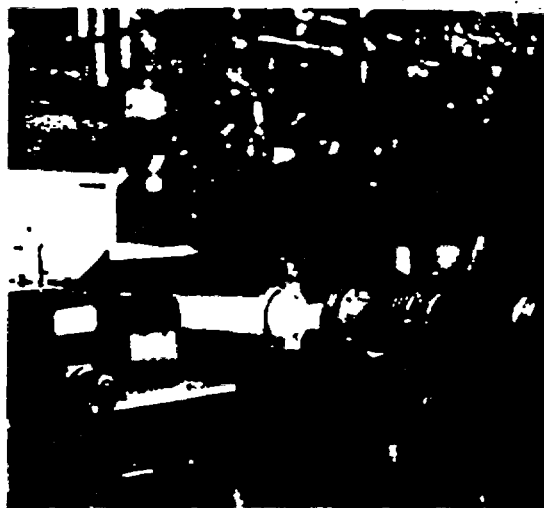

Plasma Reactor

Research Institute for Polymers and Textiles
1-4, Higashi 1-chome, Tsukuba-shi, Ibaraki, 305

Tsukuba Gakuen 0298 (54) 6229
Senior Officer for Research Planning

Total personnel	124
Total budget	1,607 (million yen)

Established in 1882, the Geological Survey of Japan is the national research institute in the country concerned with the systematic investigation of geology and mineral resources. It is responsible for geological sheet mapping and for research on geology and various kinds of resources (metallic and non-metallic minerals, fuel, geothermal energy and ground water) in the Japanese archipelago and adjoining offshore areas. Its work has contributed substantially to environmental conservation and to mitigating damage from geological hazards such as earthquakes, volcanic eruptions and landslides. The Survey also takes an active part in international efforts. Experts on geology and mineral resources are sent overseas and foreign trainees are admitted to training course in the Survey. In addition, the Survey provides technical guidance to other agencies, local governments and the general public. The results of its work are published in the form of various scales of geological maps and thematic maps, bulletins and special publications. Major research programs in each field are as follows:

- 4. Field of geological study for atomic energy utilization (1) Geological study of deep underground disposal of high-level radioactive waste (2) Geochronological study on fault activity, etc.
- 5. Field of international cooperation (1) Mechanism of methane discharge into atmosphere, etc.

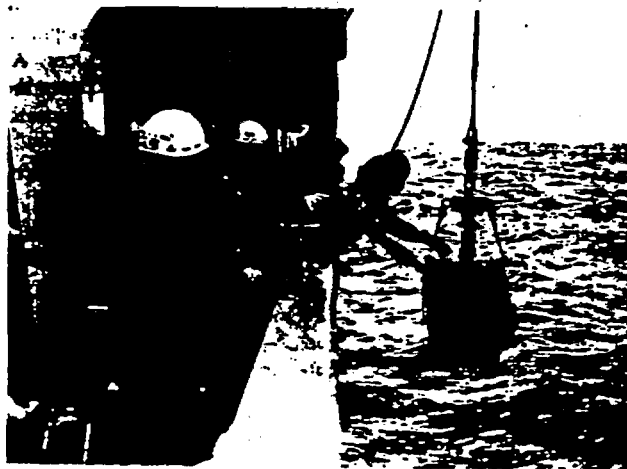

Taking Samples of Sea Bottom Sediment by the Geological Survey Vessel "Hakurei-Maru"

Geological Survey of Japan
1-3, Higashi 1-chome, Tsukuba-shi, Ibaraki, 305

Research Planning Office 0298 (54) 3572

Total personnel	349
Total budget	4,300 (million yen)

The Electrotechnical Laboratory (ETL) was founded in 1891 as a testing laboratory for electrical materials in the Ministry of Communications. After several major organizational changes since then, including the separation of what is now the Electrical Communication Laboratories, NTT, in 1943, the ETL now stands as the largest national research institute in Japan. For promoting future industrial science and technology, the ETL is responsible for conducting advanced research and development in electronics, standards and measurements, energy, and information and computer technologies. A list of ETL's notable achievements begins with the wireless telegraph, developed as early as 1896, and includes, just to name a few, Japan's first transistorized computer — the Mark IV (1959); the Kondo effect (1964), which later earned the London Award for Dr. Kondo, ETL Advisory Fellow; the first genuinely data-driven computer SIGMA-1 (1987); the discovery of a new type of oxide superconductor and the development of Josephson Computer ETL-JC1 (1989, see picture); and the record high-power excimer laser ASHURA (1989).

The ETL consists of 14 research divisions located in Tsukuba Science City and one research center in the Osaka area. Within 58 sections some 550 researchers, including approximately 250 Ph.D's are now actively working in the vast new frontiers of science and technology. The major research topics are: (1) Electronics fundamentals; physical studies on superconductivity, dynamics of elementary excitations, etc., development of new superconductors, opto-electronic materials, and amorphous semiconductors, VLSI technologies based on superlattice and three dimensional structures, advanced microfabrication technologies, supermolecular technology utilizing organic molecular assemblies, and biochemical and physiological studies on information processing in living organisms; (2) Standards and measurements; establishment and supply of national standards of electricity, photometry, acoustics, and ionizing

radiation and radioactivity, and microwave technology based on the uses of quantum effects; (3) Energy-related technologies including solar and other environmental energy sources, fuel cells, redox flow batteries, magnetically and inertially confined nuclear fusion, advanced laser technologies, and superconductor application technologies; (4) Information and computer technologies; cognitive science and its applications, artificial intelligence, pattern recognition, parallel processing computer architecture, software engineering, and intelligent robotics.

The ETL, keenly aware of the increasing importance of technical exchanges both with the private sector and academia, is also actively participating in a wide range of cooperative research efforts.

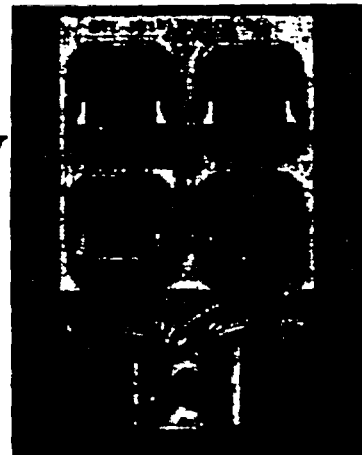

"Josephson Computer ETL-JC1"

Electrotechnical Laboratory
1-4, Umezono 1-chome, Tsukuba-shi, Ibaraki, 305

Tsukuba Gakuen 0298 (54) 5006
Research Planning Office

Total personnel 686
Total budget 9,280 (million yen)

The Industrial Products Research Institute (IPRI), established in 1928, specializes in the fields of improving the quality of life. Fundamental researches in this field are (1) biomimetic chemistry; (2) materials evaluation technology; (3) biometrics and sensor technology; (4) psychometrics and cognitive science. Those researches have been applied to development of materials and apparatuses for medical use, equipment related to human health and welfare, to design and evaluation of housing systems, and also to evaluation of consumer goods, by combining material and human engineering. Since we have various specialists in physics, chemistry, mechanical engineering, electrical engineering and electronics, information science, psychology, physiology, forestry, industrial design, and so on, IPRI is able to synthetically and systematically solve interdisciplinary problems, which might be difficult for an institute engaged in one specific field to solve. The current research topics are listed below.

1. Research related to materials and apparatuses for medical use, human health and welfare; (1) Biometric transduction of sensory information, (2) Cell compatible biomaterials, (3) Three dimensional display for the blind, (4) Non-invasive measurement of functional decreases in humans, and etc.
2. Research related to housing systems; (1) Fundamental system technology for emergency in living space, (2) Psychological and physiological measurement of the influence of low frequency noise on the body, and etc.
3. Research related to consumer goods; (1) Measurement of human fuzzy information processing, (2) Research on the ergonomic design of visual display terminals, (3) Modelling of thinking process in conceptual design of products, and etc.

4. Special research projects; (1) Fundamental research on organic liquid and gas separation by membranes, (2) Research and development of advanced composite materials, (3) Application of measuring human sense to product design, (4) Design of synthetic receptor molecules, and etc.

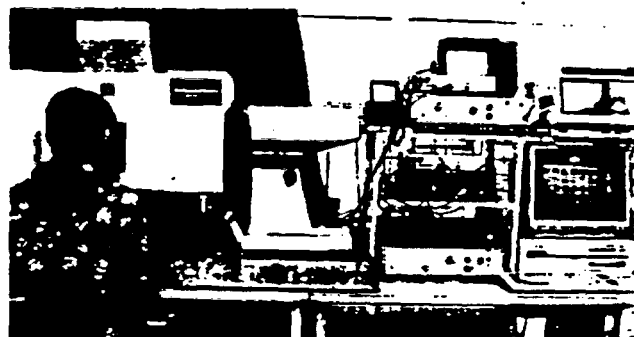

Three-dimensional Optometer

Industrial Products Research Institute
1-4, Higashi 1-chome, Tsukuba-shi, Ibaraki, 305

Tsukuba Gakuen 0298 (54) 6610
Research Planning Office

Total personnel 125
Total budget 1,441 (million yen)

The National Research Institute for Pollution and Resources, established in 1920, is concerned with a wide range of research related to exploitation, processing and utilization of mineral resources and natural energy resources, mining and industrial safety, environmental protection. Research on safety maintenance in mines is also conducted at the Institute's Coal Mine Safety Research Centers in Hokkaido and Kyushu (including the Usui experimental coal mine). At the Institute extensive research efforts focused on the following fields.

Mineral Resource Development and Utilization

- Exploitation and development of marine mineral resources off shore or in deep seabeds, such as manganese nodules, hydrothermal deposits and cobalt-rich manganese crusts.
- Advanced construction technology for underground space utilization.
- Production of new materials, such as functional silicon materials and ultrafine powder.
- Processing and refining technology for low quality ore and unexploited resources, especially rare metals.

Energy Development and Utilization

- Comprehensive utilization technology for oil-alternative fuel resources such as coal, natural gas, oil sand, oil shale and biomass, including organic material technology.
- Advanced combustion technology utilizing various low-grade fuels and energy-saving technology.
- Geothermal energy exploitation and heat extraction technology.

Environmental Protection

- Comprehensive industrial pollution control technology for emission abatement, pollutant measurement and environmental assessment.

- Pollution control and environmental technology for quality developed chemical industry.
 - Advanced assessment technology on regional scales.
 - Global environmental studies on climatic changes, acid rain formation and transformation of chemicals in the troposphere.
4. Mining and Industrial Safety
- Coal mine safety technology, such as gas and coal-dust explosions, mine fire and gas outbursts to support the domestic coal mining industry.
 - Safety assessment for utilization of underground space.
 - Demolition of old constructions using explosives and its safety assessment.

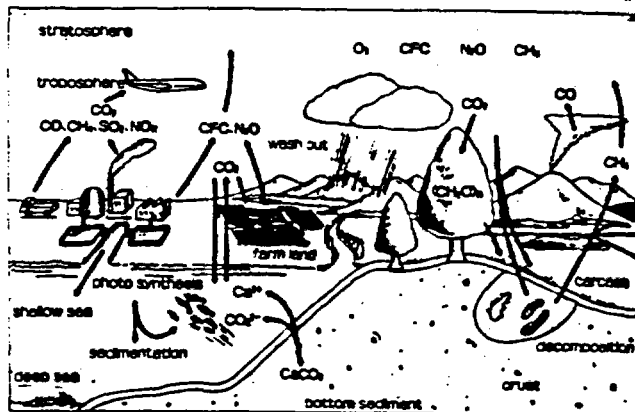

Environmental Pollution and the Circulation of Substances

National Research Institute for Pollution and Resources 6-3, Onogawa, Tsukuba-shi, Ibaraki, 305	Tsukuba Gakuen 0298 (54) 3026 Research Planning Office	Total Personnel 319 Total budget 4,016 (million yen)
--	---	---

The Government Industrial Development Laboratory, Hokkaido (GIDLH) was established in 1960 as an institute for developing industries and mining in Hokkaido. The GIDLH consists of three research departments. The Resources and Energy engineering Department is engaged in a wide range of basic and applied researchers in the field of energy and natural resources. The Applied Chemistry Department covers analytical chemistry, synthetic chemistry, and the chemistry field including life sciences. The Material Science and Technology Department is carrying out the R&D in new and functional materials, the research on evaluation techniques for these materials and advanced utilization of these materials for cold regions.

In recent years, the GIDLH has been working on the following R&D projects:

- Energy technology R&D; (1) Research in coal liquefaction, gasification and combustion, (2) Development of heat pump technology for cold regions.
- Environmental protection R&D; (1) Evaluation of new snow tire having low dust pollution, (2) Development of combustion catalyst for reducing NOx, (3) Development of technology processing wastes from advanced industry.
- New materials R&D; (1) Development of fine ceramics from silica in rice husks, (2) Development of inorganic fibers and non-crystal materials with a high functional ability, (3) Development of a new preparation method for ultrafine particles, (4) Evaluation of functional single crystal produced in high-pressure hybrid system.
- Biomass and biotechnology R&D; (1) Synthesis of optically active substances by enzymatic reactions, (2) Construction of unique strains of yeast with hydroxylation ability on

polyaromatic compounds by genetic engineering, (3) Advanced pyrolysis of biomass resources.

- 5. Regional technology R&D; (1) Intelligent snow removing technology for cold regions, (2) Research on medical diagnostic remote system.
- 6. International cooperation in the R&D with developing countries; (1) Research on new coal combustion technology by fluidized bed, (2) Research on afforestation with functional soil improving materials, (3) Effective activation treatment of lignite and peat materials.

Non-frost type heat exchanger



Government Industrial Development Laboratory, Hokkaido 2-17, Tsukisamu-Higashi, Toyohira-ku, Sapporo-shi, Hokkaido, 004	Sapporo 011 (851) 0151	Total personnel 96 Total Budget 1,228 (million yen)
--	------------------------	--

TECHNOLOGIES DISCUSSED WITH KOBE STEEL

- **KSL Technology of Microwave Melter**
- **Management of Alpha-Contaminated Wastes**
- **Incineration and Ash Melting for Plutonium-Contaminated Combustible Wastes**
- **Microwave Solidification Treatment of Incinerated Ash Contaminated by Radioactive Materials**
- **Crud Slurry Solidification System**
- **Copper Alloy for High-Cycle Plastic Molding**
- **Cryopump for Producing a Good Quality Vacuum**
- **Twin-Head Arc Welding Robot- GT-5000**

BIBLIOGRAPHY OF LITERATURE RECEIVED FROM KOBE STEEL

"KSL Technology of Microwave Melter", Kobe Steel, 49 pages.

K S L T E C H N O L O G Y
O F
M I C R O W A V E M E L T E R

Dec. 14. 1989

K O B E S T E E L . L T D .

Reprint from

**"MANAGEMENT OF
ALPHA-CONTAMINATED WASTES"**

**INTERNATIONAL ATOMIC ENERGY AGENCY
VIENNA, 1981**

DEVELOPMENT OF A NEW SOLIDIFICATION METHOD FOR WASTES CONTAMINATED BY PLUTONIUM OXIDES

Utilization of microwave power

F. KOMATSU, Y. SAWADA
Mechanical Engineering Research
Laboratory,
Kobe Steel Ltd, Kobe

K. OHTSUKA, J. OHUCHI
Power Reactor and Nuclear Fuel
Development Corporation,
Tokai,
Japan

Abstract

DEVELOPMENT OF A NEW SOLIDIFICATION METHOD FOR WASTES CONTAMINATED BY PLUTONIUM OXIDES: UTILIZATION OF MICROWAVE POWER.

Non-combustible wastes such as incineration ash contaminated by radioactive materials were immobilized with cement or bitumen, and were also vitrified with low melting glass powder. These methods are in practical use at present. For permanent storage or disposal these treatments are excellent because they offer stabilization. As a result much reagent or flux is used, but there is one disadvantage: the volume of solid material is increased. In 1978, at the Tokai Works of PNC, research and development work was started on the treatment facilities of non-combustible wastes containing plutonium oxides, such as incineration ash, residues of inorganic acid digestion, components of the HEPA filter and glass or ceramic pieces. A new treatment method using microwave power is being investigated in this project. These wastes are solidified directly in the cylindrical metal crucible of a microwave melter, and are then continuously converted to ceramic-like solid materials. As a result of this research, fundamental data such as the physico-chemical properties of these wastes and the physico-chemical and elution properties of solid materials were obtained. Furthermore, having produced an experimental microwave melter of 5 kW output at 2450 MHz, the melting conditions and engineering data for developing the practical equipment for an output of 100 kW at 915 MHz are now being investigated. In this paper, the treatment system for these wastes, the fundamental data of these wastes and solid materials, and the microwave melter are described.

INTRODUCTION

Heating by microwaves, as is represented by the microwave oven, has various advantages compared with other heating methods — facility of remote control, heating speed and low occurrence rate of deteriorated or damaged parts.

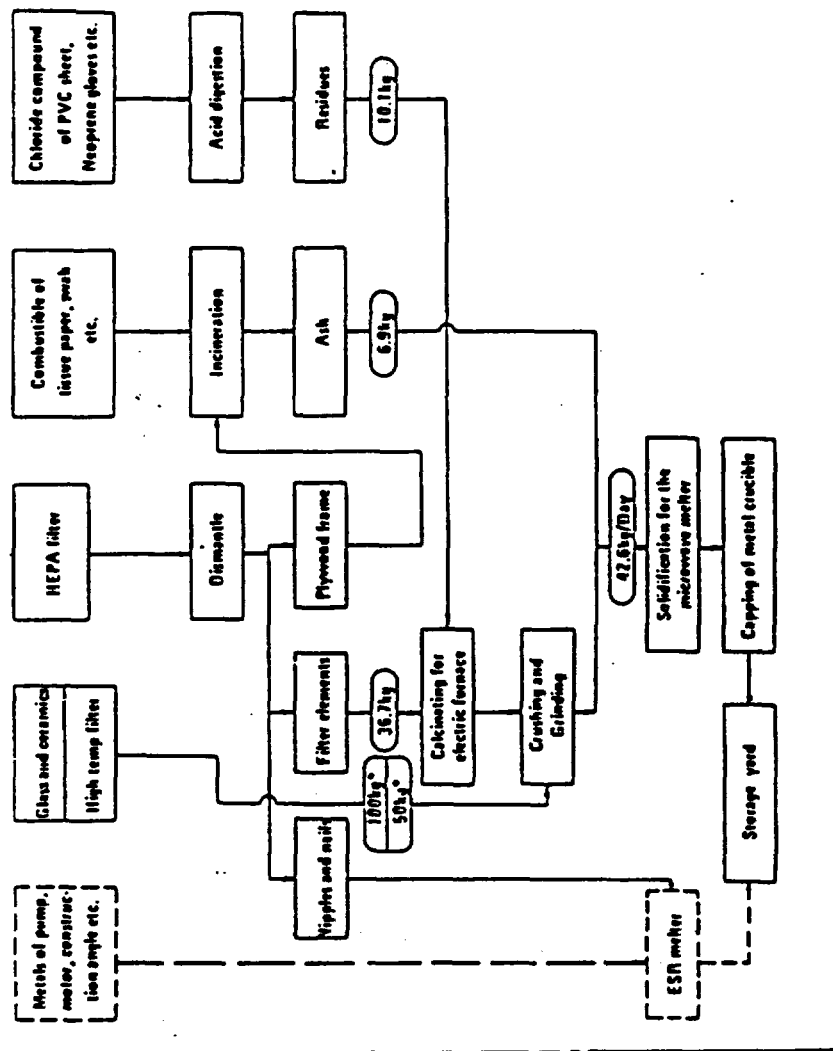

Main category of Plutonium contaminated wastes from the fuel facility.

2nd treatment for reduction.

Products for 2nd treatment
 [Products rate (kg/Day)]
 • (kg/Year)

Pre-treatment for the microwave melting

Final treatment for reduction and stabilization

FIG.1. Outline flow-sheet of microwave treatment for the plutonium-contaminated wastes.

The principle of microwave heating is the dielectric heating method intended to oscillate directly by electric waves the molecules which compose the substance. Hence, it could be one of the most excellent methods for melting non-combustible wastes composed of inorganic oxide substances such as Al_2O_3 , SiO_2 and CaO .

The Power Reactor and Nuclear Fuel Development Corporation (PNC) is currently investigating the solidification treatment method by microwaves for non-combustible wastes, other than metals, of the plutonium fuel facilities at Tokai Works. This PNC plan has set a timetable, with completion in 1985, of treatment facilities including the secondary treatment process for reduction.

1. PROPERTIES AND OUTPUT OF WASTES

At present plutonium-contaminated HEPA filters, neoprene gloves and combustible wastes are stored temporarily in the storage yard. When the treating facilities are completed they will be removed from the storage yard and treated.

The kinds of waste to be treated, the secondary treatment method for reduction and the output of secondary wastes, are shown in Fig. 1. The major waste outputs are HEPA filter elements, residues of acid digestion and incinerated ash, which occur at the rate of 1:0.28:0.19.

The physico-chemical properties of the wastes for solidification treatment are presented in Table I.

Samples possessing the same analytical values as given in this Table were also used in the microwave solidification experiment. Since the actual wastes containing plutonium cannot be used for the experiment, HfO_2 , whose physical properties with respect to density, vapour pressure and free energy of oxides are similar to those of PuO_2 , was added by 0.1 wt% in the solidification experiment, as the dummy substance for PuO_2 .

1.1. Incinerated ash

In the plan, combustible matter such as tissue paper, cardboard boxes, swabs, latex gloves and plywood frames of the HEPA filter, after dismantling, are burnt in the incinerator installed at the facility. The ash output is assumed to be about 7 kg/d.

The chemical composition of incinerated ash varies with the kind and quantity of the materials incinerated. The ash of the chemical composition presented in Table I is the result of incineration in an ordinary incinerator of tissue paper, 85%; cardboard boxes, 5%; latex gloves + gummed tape, 1.5%; and LPDE sheets, 1.5%.

TABLE I. COMPARISON OF CHEMICAL COMPOSITION, MINERAL PHASES AND BULK DENSITY OF WASTE MATERIALS

Waste material Items	HEPA filter elements		High temp filter	Acid digestion residues	Incinerated Ash	
	Glass fiber	Asbestos separator				
Chemical Composition (wt%)	SiO ₂	56.60	35.48	48.88	16.08	30.72
	Al ₂ O ₃	5.37	1.23	0.36	13.60	24.69
	Fe ₂ O ₃	0.13	4.69	45.18	2.71	5.53
	CaO	3.15	1.03	1.29	0.02	8.43
	MgO	< 0.005	35.89	5.62	0.22	5.36
	TiO ₂	0.045	0.032	0.057	0.55	1.23
	Na ₂ O	5.26	0.026	0.022	0.05	5.29
	K ₂ O	1.57	0.057	0.12	0.19	0.69
	Cr ₂ O ₃	1.57	0.11	< 0.005	0.10	0.03
	CuO	1.57	0.11	< 0.005	< 0.01	0.07
	ZnO	3.49	0.37	< 0.006	4.85	0.81
	PbO	3.49	0.37	< 0.005	1.49	0.05
	MnO	< 0.005	0.03	< 0.45	0.02	0.13
	NiO	< 0.005	0.16	< 0.005	—	< 0.01
	C	1.38	5.31	< 0.27	—	< 0.1
	P ₂ O ₅	1.38	5.31	< 0.005	0.026	0.19
	Cl	1.38	2.10	< 0.27	0.14	0.32
	SO ₂	—	—	< 0.005	49.68	2.85
	NO ₂	—	—	< 0.01	< 0.01	—
	B ₂ O ₃	—	—	—	—	0.48
F ⁻	—	—	—	—	1.11	
Ig loss ^a	4.34	22.11	< 0.1	—	10.44	
Mineral Phases	Amorphous	Crystalline	Granite, Rankinite	Al ₂ (SO ₄) ₃	α-Quartz Anatase Calcite Anorthite	
Bulk Density (g/cm ³)	0.11		0.062 - 0.071	0.4 - 0.53	0.293	

^a Ig = ignition

The samples used in this case were based on the data of the kinds of combustible at present used in the facilities and the results of investigations into the percentages of such materials.

It was found that the volume of combustible waste was reduced to about 1/100 of the original by incineration.

1.2. HEPA filter elements

HEPA filters used in the facilities consist of cases made of plywood frames and elements made of glass fiber filter and asbestos separators. HEPA filters are subjected to secondary treatment (dismantled) for reduction [1]. The output of waste elements is assumed to be about 37 kg/d.

In the analysis and experiment, new HEPA filters were used after dismantling.

1.3. Residues of acid digestion

Chloride compounds such as PVC and neoprene gloves are treated by the acid-digestion method. The residues are white powder or lumps. The residues presented in Table I were obtained when neoprene gloves were treated in the test equipment.

The bulk density ranges from 0.4 to 0.53, and these values are the highest owing to the effects of oxides of heavy metals such as ZnO and PbO. The output is estimated about 10 kg/d.

The chemical components are sulphate compounds such as aluminium sulphate anhydrate. Residues of acid digestion contain sulphate ions by about 50 wt%. At present, a digestion technique to reduce this content is being investigated.

1.4. High-temperature filters

This is a wool-type filter which is used as a dust trap in incinerators. The estimated output is as low as 50 kg/a. The bulk density is the lowest of all, about 0.062 to 0.071.

1.5. Glass and ceramic pieces

These pieces include experimental implements such as pyrex beakers, measuring flasks, porcelain dishes, etc. The output is as low as 100 kg/a.

2. EQUIPMENT OF MICROWAVE SOLIDIFICATION

When materials composed of inorganic oxide matter such as Al_2O_3 , SiO_2 , and CaO (which are generally called dielectrics) are placed in a high-frequency

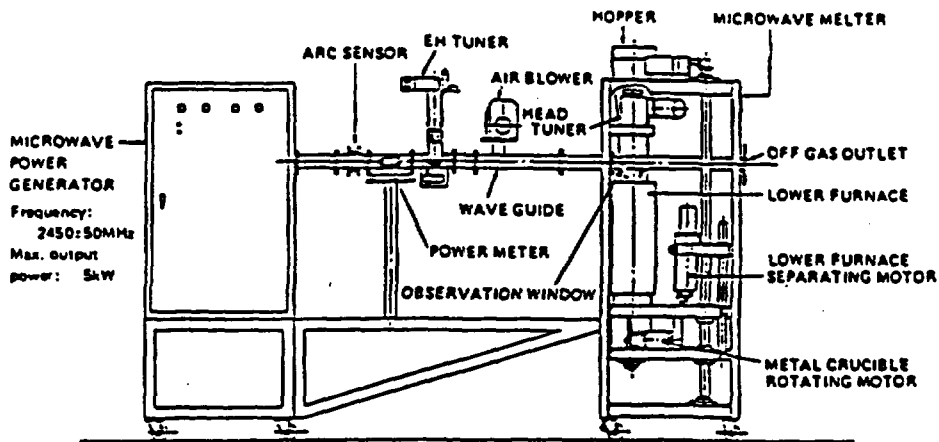

(A) Composition of microwave melter

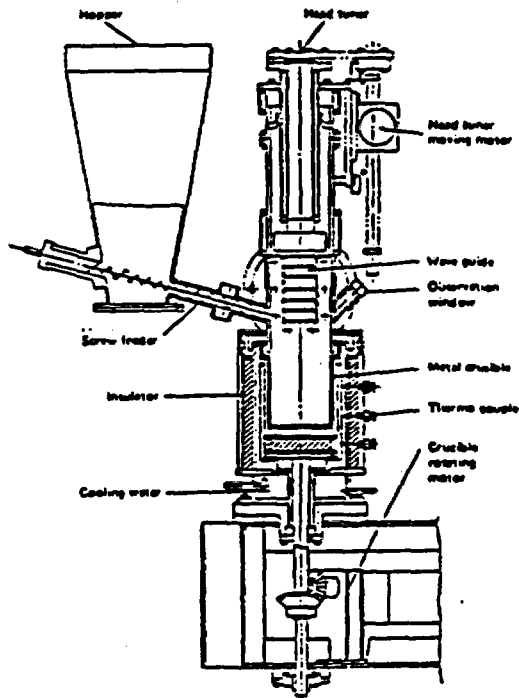

(B) Cross-section of microwave melter

FIG.2 Microwave solidification test unit.

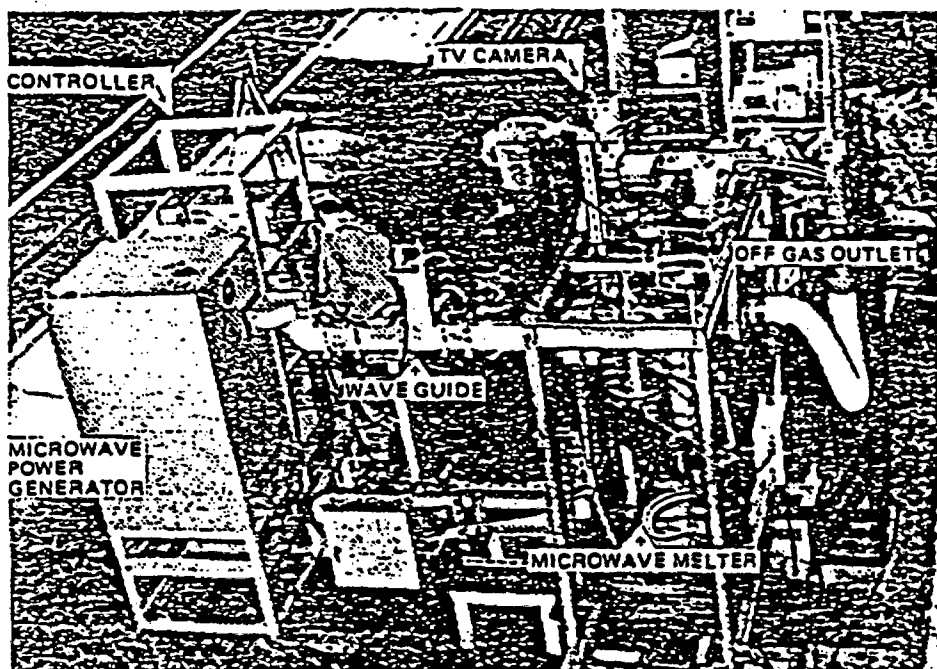

FIG.3. Photograph of the microwave solidification test unit.

electric field (microwave), the molecules, which are in an electrically neutral state, are turned into molecules with electric dipoles by the strong electric field.

Molecules violently change polarity owing to the frequencies and they generate frictional heat. As a result, the substance reaches the molten state.

By using microwave energy the solidifiable temperature is determined by the material of the crucible and its melting point. When a metal crucible manufactured from low carbon steel is used, the maximum applicable temperature is 1500°C. The microwave melter shown in Figs 2 and 3 was newly developed for the purpose of treating waste containing radioactive substances.

Microwaves from a microwave power generator are radiated into the microwave melter through a wave guide. The melter is the so-called cavity type, which can concentrate the microwave energy on to the sample by vertically adjusting the head tuner.

The sample is continuously fed into the metal crucible — which is also used as a canister — from the hopper by means of a screw feeder and is continuously solidified. During solidification the metal crucible is rotated at a speed of 2 to 5 rpm to radiate the microwaves uniformly.

TABLE II. COMPARISON OF CHEMICAL COMPOSITION, MELTING POINT, MINERAL PHASES AND DENSITY OF SOLID MATERIAL

Items	Single Melt Treatment			Mixed Melt Treatment				
	Incinerated Ash (I.A)	HEPA filter (H.F)	Acid digestion residue (A.D.R)	A.D.R + I.A (1.47:1)	H.F + I.A (5.26:1)	H.F + A.D.R (3.57:1)	H.F + A.D.R + I.A (1.0.28:0.19)	
Chemical Composition of Solid Material (wt%)	SiO ₂ (wt%)	42.45	45.22	32.82	32.72	45.64	43.88	42.96
	Al ₂ O ₃ ..	22.82	3.98	25.77	31.30	8.70	9.24	13.26
	Fe ₂ O ₃ ..	3.75	3.27	6.73	7.73	4.70	4.37	5.05
	CaO ..	9.78	1.90	0.28	5.20	2.60	0.48	1.50
	MgO ..	7.46	28.07	1.45	3.48	28.58	28.54	27.52
	TiO ₂ ..	4.16	0.07	0.18	1.11	0.30	0.38	0.42
	Na ₂ O ..	1.01	0.30	0.27	3.17	3.07	1.82	1.62
	K ₂ O ..	0.27	0.05	1.39	1.08	0.87	0.75	0.48
	Cr ₂ O ₃ ..	0.03	0.10	0.47	0.25	0.14	0.16	0.15
	CuO ..	0.11	<0.01	0.03	0.06	0.02	0.01	0.02
	ZnO ..	0.38	0.36	11.10	6.37	0.81	2.45	1.58
	PbO ..	0.08	<0.01	4.90	2.60	<0.01	0.88	0.24
	MnO ..	0.04	0.09	0.08	0.13	0.09	0.07	0.09
	P ₂ O ₅ ..	0.53	0.07	0.372	0.308	0.16	0.09	0.19
	SO ₂ ..	0.27	0.16	0.14	0.247	0.02	0.01	0.01
Cl ..	<0.1	<0.005	<0.01	<0.01	<0.01	<0.01	<0.01	
Melting point (°C)	1250	1450	1440	1310	1345	1325	1330	
Mineral phases	Anorthite Augite	Forsterite	Mercynite Gahnite	Anorthite Ringwoodite Gahnite	Forsterite	Forsterite	Forsterite	
Density	2.85	2.97	3.57	3.16	3.01	3.04	3.08	

The crucible is cooled with nitrogen gas on the outside in order to prevent oxidation and meltdown due to high temperatures. Once a crucible is filled with solidified matter it is replaced with a new one. Since the produced solidified matter is slowly cooled in the crucible it is converted to a crystalline structure with the most stable physico-chemical properties.

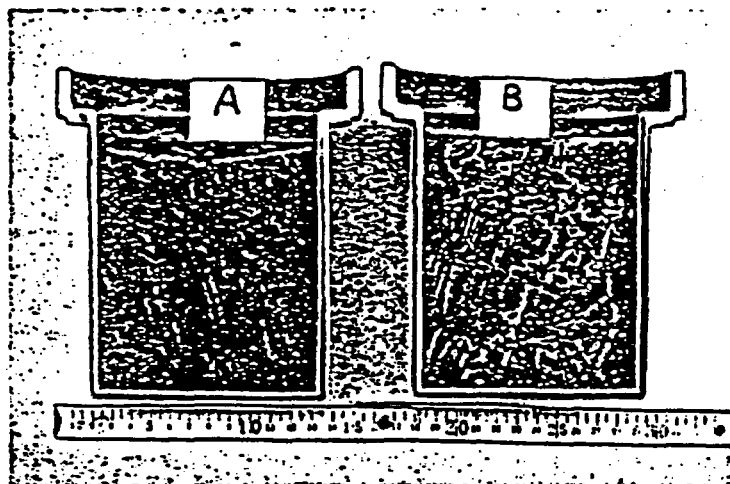

Mixed treatment sample: H.F. + A.D.R. + I.A (1:0.28:0.19) Melting point: 1330°C Weight of solid material: 2.6 kg	Single treatment sample: HEPA filter element Melting point: 1450°C Weight of solid material: 2.8 kg
---	--

FIG.4. Cross-section of solidified solid material in the metal crucible.

The off-gas released during solidifying is discharged from the exhaust pipe and is treated in a scrubber. The off-gas temperature is about 60 to 70°C, which is lower than that of other melters such as an electric furnace.

The equipment crucible in this paper measures 100 mm in diameter and is 130 mm high. In practical facilities, where the treating capacity will increase, the crucible size will be much larger, about 300 mm in diameter and 300 mm high.

One crucible can solidify about 50 kg material and it is planned to treat 15 to 20 kg/h at 60 kW microwave output power. As a result, the microwave power generator to be used should have a maximum output of 100 kW at 915 MHz.

3. PRETREATMENT FOR SOLIDIFICATION

Satisfactory solidification by microwaves largely depends on the pretreatment to increase the microwave absorption and insulation effects. For this purpose the sample should be in powder or granular form.

Residues of acid digestion and HEPA filter elements are heated for 15 minutes at 800°C in an electric furnace. As a result, SO₂ contained in residues of acid digestion is almost completely eliminated so that the fuming phenomenon by sulphate mist may be avoided. Also, HEPA filter elements become fragile and can be crushed very easily.

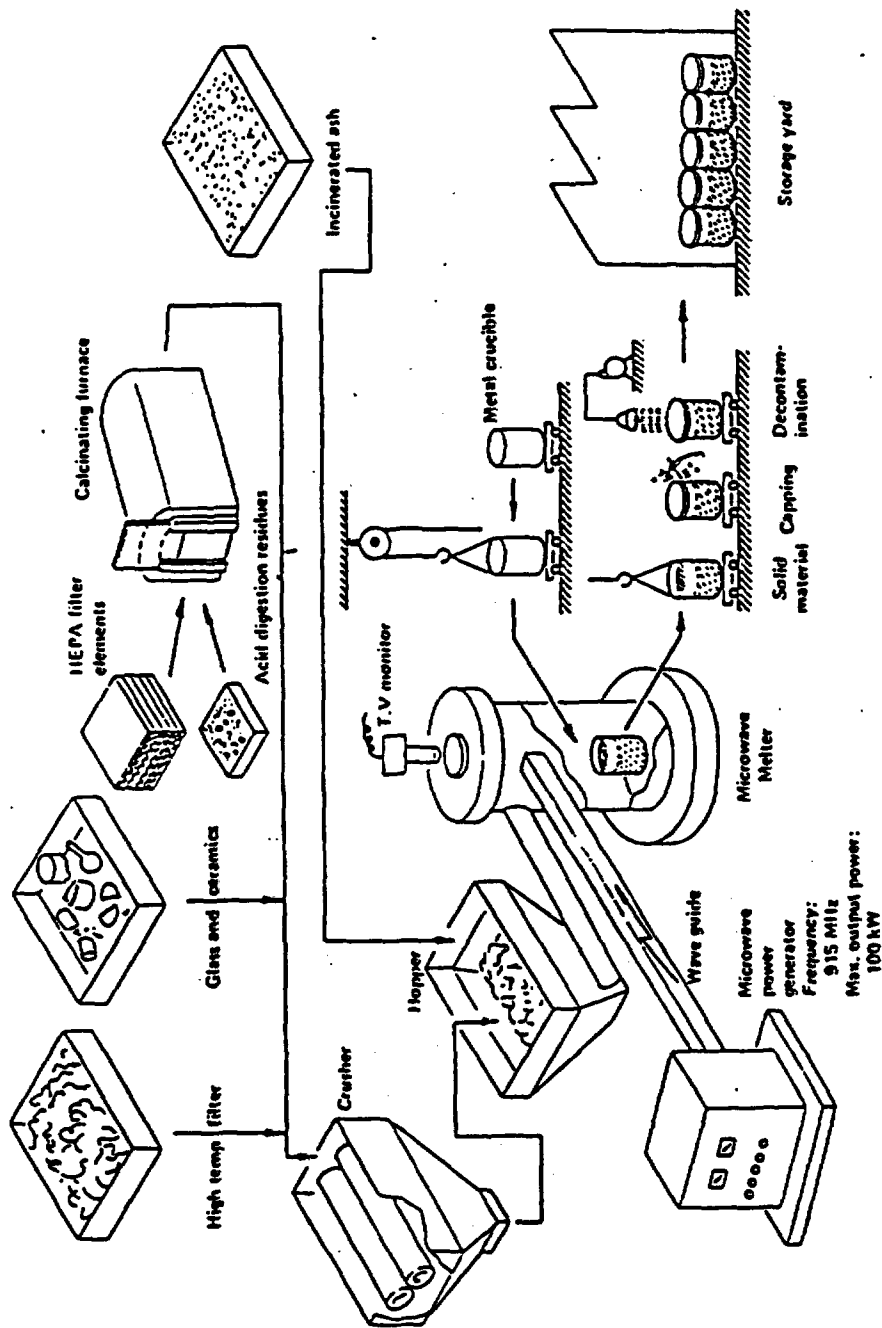

FIG. 5. Microwave treatment process.

TABLE III. COMPARISON OF ELUTION TEST ON SOLID MATERIALS AND WINDOW GLASS

Solid material	Solubility (wt%)	Element (mg/l)											
		T.Fe	Ca	Mg	Ti	Al	Si	Na	K	Pb	Zn	S	Hf
H.F	0.48	<0.05	1.0	0.9	3	<1	24	10.5	1.32	<0.1	<0.05	<1	<3.7 $\times 10^{-2}$
H.F+A.D.R+I.A (1 : 0.28 : 0.19)	0.28	<0.05	0.9	1.3	3	2	9	3.45	0.45	<0.1	<0.05	<1	<3.0 $\times 10^{-3}$
Window glass*	1.75	<0.05	10.3	1	-	0.5	65	187	10.1	-	-	-	-

*Chemical composition (wt%): SiO₂ 69.52, Al₂O₃ 1.04, Fe₂O₃ 0.61, MgO 0.31, Na₂O 14.15, K₂O 1.06, BaO 0.17, PbO <0.01, B₂O₃ 0.40

By this pretreatment the residues of acid digestion and the HEPA filter elements are reduced by about 50% and 17% respectively by weight.

High-temperature filters and glass and ceramic pieces are crushed for easy transport and melting.

4. RESULTS OF TREATMENT BY MICROWAVES

As shown in the flow-sheet in Fig.1, wastes occurring at highest rates were HEPA filter elements, residues of acid digestion and incinerated ash. Although these wastes are treated by daily operation, in actual treatment it is difficult to melt according to the determined mixing ratio and sequence.

Therefore, in this experiment single treatment and mixed treatment were individually assumed. The mixing ratio was based on the product rate of these wastes.

The physico-chemical properties of the solid material obtained by melting are presented in Table II. The sample, which was continuously solidified in a metal crucible by using microwaves, is shown in Fig.4. The amount of solid material melted in the crucible was 2.6 to 3 kg. For instance, the HEPA filter element with the highest melting point (1450°C) was solidified at the rate of 960 g/h by using a microwave energy of 4.7 kW (55-W/cm²). The components of the off-gas in this case were dust concentration, 500 to 600 mg/m³; SO₂, 600 to 1000 ppm; HCl, 1.5 to 2.0 ppm; NO_x, 70 ppm. Production of SO₂ gas might be caused by the decomposition of SO₃ in the residues of acid digestion and CaSO₄ in the incinerated ash.

TABLE IV. VOLUME REDUCTION RATE OF WASTE MATERIALS FOR MICROWAVE MELTING

Waste material	Volume reduction rate
Incinerated ash	1/10
HEPA filter elements	1/27
Residues of acid digestion	1/8

The results of an elution test on the sample shown in Fig.4 are presented in Table III. The elution properties of the solid material and window glass were compared under identical conditions. The 5-g sample, crushed to under 200-mesh size, was immersed in 200 ml boiling (100°C) distilled water for an hour.

After the test, the sample was filtrated by a 0.45- μ m membrane filter, and the solubility and soluble ions were analysed. The results showed that the solid material was more resistant to elution than the window glass.

5. CONCLUSION

In this paper, the microwave solidification technique for plutonium-contaminated non-combustible wastes, the treatment process, treating conditions, and properties of the obtained solidified matter are outlined.

The treatment process is illustrated in Fig.5. By applying the solidification treatment technique, as shown in Table IV, a reduction effect of, for instance, more than 1/10, is expected in the case of ash, and this method may be an excellent technique when compared with the cement or bitumen immobilized method.

REFERENCE

- [1] OHTSUKA, K., MIYO, H., OHUCHI, J., SHIGA, K., MUTO, T., "Developments in the treatment of solid alpha-bearing wastes at the PNC Plutonium fuel facilities", Treatment, Conditioning and Storage of Solid Alpha-Bearing Waste and Cladding Hulls (Proc. NEA/IAEA, Tech. Seminar Paris, 1977), OECD/NEA, Paris (1977).

DISCUSSION

C. SOMBRET: The experimental furnace which you described has a low output (5 kW). The corresponding throughput which you quoted is less than 1 kg per hour, which is understandable. Work on the processing of other types of waste in microwave furnaces has been carried out in France and also, I believe, in Harwell. Mr. Grover could, I'm sure, provide a few details on this point. In France, the studies were discontinued owing to the difficulty of finding a high-output industrial generator, which is essential in order to process any form of waste from an industrial installation. Do you know of any manufacturer in Japan or elsewhere in the world who could supply a suitable generator, let us say, with an output 100 kW?

F. KOMATSU: The magnetron tube of 100 kW output (915 MHz) is commercially available in Japan.

J.R. GROVER: Microwave heating is being studied in the United Kingdom for both the evaporation stage and melting stage of a possible vitrification process for high-level wastes to produce a borosilicate glass product.

C. BAUER: Mr. Komatsu, did you investigate the structure and composition of the phase or phases present in the crucible after the melting? And did you consider the possibility of accumulation of Pu in one of the phases?

F. KOMATSU: For the experiment we used HfO_2 , whose physical properties are similar to those of PuO_2 ; it was added up to 0.1 wt%. We investigated the structure and composition of the solidified matter using the electron probe microanalyser. The Hf element was found to be distributed uniformly over the matrix. We have performed no experiments with plutonium so far.

Printed by the IAEA in Austria

INCINERATION AND ASH MELTING FOR PLUTONIUM-CONTAMINATED COMBUSTIBLE WASTES

K.MIYATA*, J.OHUCHI, E.INADA and N.TSUNODA
Power Reactor and Nuclear Fuel Development Corporation (PNC)
Tokai-mura, Ibaraki, Japan 319-11

1. Introduction

Plutonium-contaminated solid wastes have been generated during MOX fuel fabrication in PNC. These wastes are classified into combustibles, non-combustibles and chlorine-containing organic materials such as PVC and chloroprene, and packed in 200ℓ drums or 1.7m³ cubic containers at the MOX fuel facilities.

These wastes have been treated for the volume reduction and conditioned in the Plutonium-contaminated Waste Treatment Facility (P WTF) since late 1987. The combustible wastes have been treated in the conventional incinerator. The incinerated ashes are melted without any additives to be a 20~30kg ceramics-like block in the stainless steel made canister by powering microwave. The products are packed in the 200ℓ drums and stored temporarily in the Plutonium-contaminated Waste Storage Facility (P W S F).

2. Process Description

2.1 Waste Feed

The combustible wastes are introduced into the glove box from drums after being assayed Pu-contents. The wastes of paper and rags are sealed in a paper bag by 2kg automatically and wood-framed HEPA filters are cut into several pieces using circular saw. These wastes are sent to the incinerator by the belt conveying system.

2.2 Incineration

The conventional incineration unit consists of feeder, incinerator, ash transfer unit and off-gas treatment unit and has the throughput of 50kg/h in one-shift operation. The incinerator is composed of primary and secondary combustion chamber, and covered with stainless steel casing to keep alpha-tightness and prevent the leakage of radionuclides. The pressure and temperature in the incinerator are regulated automatically by controlling the flow rates of exhaust gas and kerosene.

Paper bagged combustible wastes and cut pieces of HEPA filters are fed to the primary combustion chamber from the top of the incinerator through the airlock room with adiabatic shutter. These wastes are incinerated on the inconel made fire grades by two kerosene burners. The combustion off-gas with coarse dusts from primary combustion chamber is transferred to the secondary chamber and high-temperature filter (HTF) for post combustion and filtration. Secondary chamber is filled with silicon carbide lumps. HTF is mainly composed of many vertical cylindrical tubes that are coated with asbestos fiber.

Figure 1 and 2 show the artistic view of the conventional incineration unit and the cross section of the incinerator.

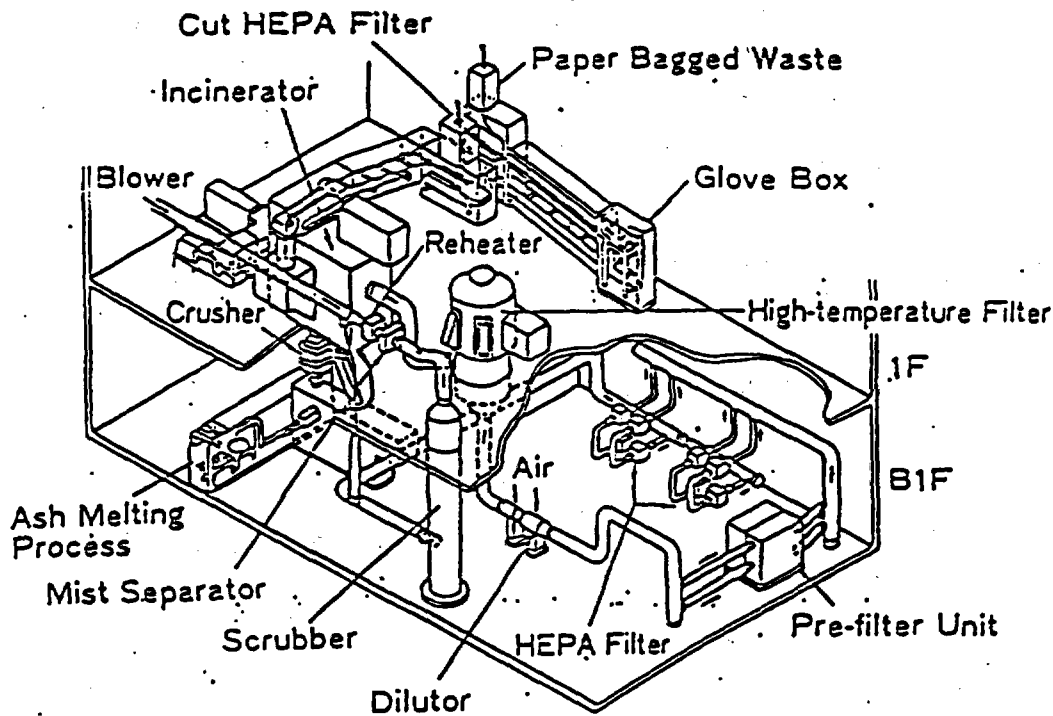

Fig. 1 Artistic View of the Conventional Incineration Unit

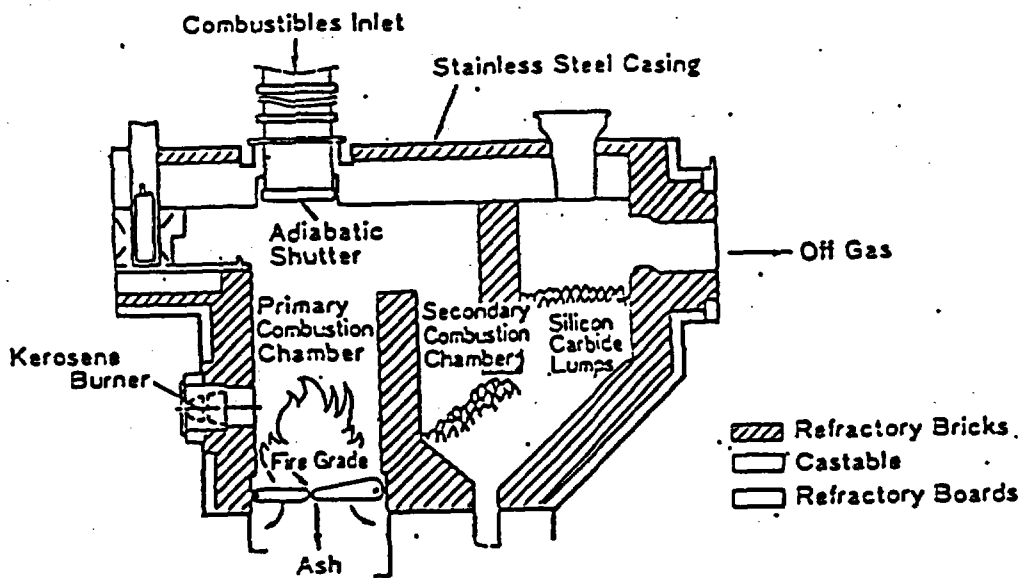

Fig. 2 Cross Section of the Incinerator

2.3 Off-gas Treatment

The off-gas treatment unit consists of dilutor, pre-filter, HEPA filter, scrubber, mist separator and blowers. The off-gas from high-temperature filter is mixed with air and cooled below 80°C by the dilutor. Radionuclides are removed from the off-gas by the HEPA filters, and environmental pollutants such as SO_x and NO_x gas are removed by the scrubber prior to discharge to the atmosphere.

2.4 Ash Handling

The ash handling unit consists of hopper, crusher, vibrating sieve, and belt conveyers. The ash is crushed and separated from nails after being removed from the bottom of the primary chamber. The ash is sent to the microwave melting process by flight conveyer.

2.5 Microwave Melting

The microwave melting unit consists of a microwave generator, wave guide and melter. The melter is equipped with tuner, power monitor, isolator, discharge detector and ITV monitor, installed in a glove box. Microwave from microwave generator is radiated to the ash in the cavity-type melter through a wave guide. Microwave energy is focused on the ash in the canister by adjusting the tuner vertically. The microwave generator has the output of 10kW with 2450MHz frequency. The melter has the throughput of 5kg/h.

The ash is melted in the canister (130mm^φ X 770mm^h) at 1200 - 1400°C, and converted into ceramics-like blocks, which are bagged out for packing in 200ℓ drum. The drum with eight ceramics-like blocks is stored in PWSF. The major mineral phases of the products are forsterite, anorthite and augite. The off-gas released during melting is sent to the off-gas treatment unit of the conventional incinerator.

Figure 3 and Table 1 show the microwave melting process flow and the operating data of incineration and melting, respectively.

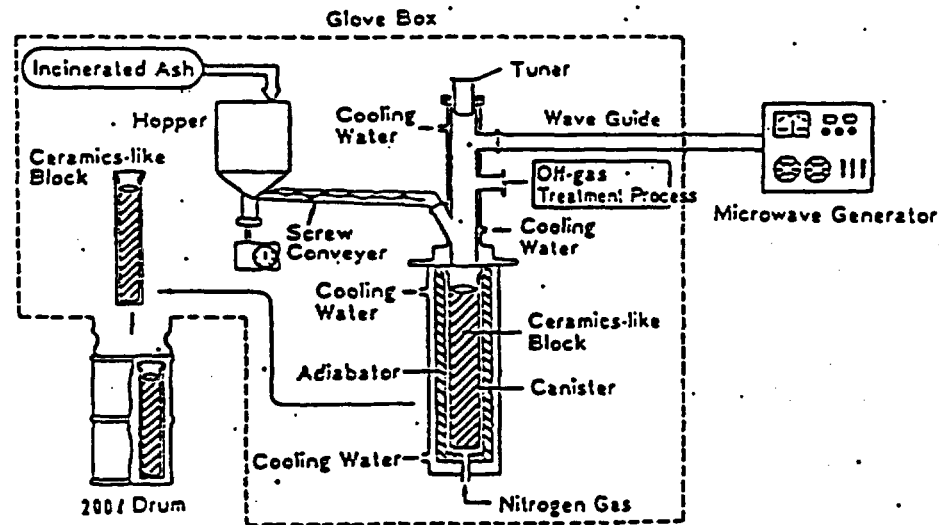

Fig. 3 Microwave Melting Process Flow

Table 1 Operating Data.

	Incineration	Melting
Feed Rate	2.0 kg/3 min. (Paper Bag). 5.0 kg/5 min. (Cut HEPA Filter)	4 kg/h
Temperature	Primary Chamber 800~900°C Secondary Chamber 900~1000°C HTF 500~600°C	1200~1400°C
Operating Pressure (mmH ₂ O)	-30~-40	-45~-55
Exhaust Gas (Nm ³ /h)	7000~9000	.5~6
Density (g/cm ³)	0.1~0.3	3

2.6 Cost

The construction cost of the P WTF is about one hundred million US dollars. The incineration unit and microwave melter share 14% and 4% in the construction cost of the P WTF respectively. These equipments need the glove boxes, alpha-tightness, radiation control system and licensing/inspection to treat the plutonium-contaminated wastes, which are not necessitated for non-radioactive wastes.

3. Operational Results

As shown in Table 2, approximately 12 tons of the combustible wastes such as paper, rags and HEPA filters have been incinerated for the first one-year-operation in P WTF, and approximately 0.9 tons of ashes have been generated. The weight reduction ratio is about 1/13. HEPA filter composed of glass fiber and asbestos are the major cause of small weight reduction ratio. The volume reduction ratio of combustible waste is about 1/130 by incineration and melting.

Figure 4 shows a temperature and pressure change during the incineration of paper, rags and HEPA filters. During the operation, the temperature of primary chamber and secondary chamber are maintained at 800 to 900°C and 900 to 1000°C, respectively, and the pressure at -40 mmH₂O.

Table 2 Weight and Volume Reduction Ratio of the Incineration and Melting

Items	Treatment Method	
	Incineration	Melting
Treated Waste Weight	12 ton	760 kg
Product	900 kg (Ash)	34 blocks (800 ℓ)
Weight Reduction Ratio	1/13	1
Volume Reduction Ratio	1/130	

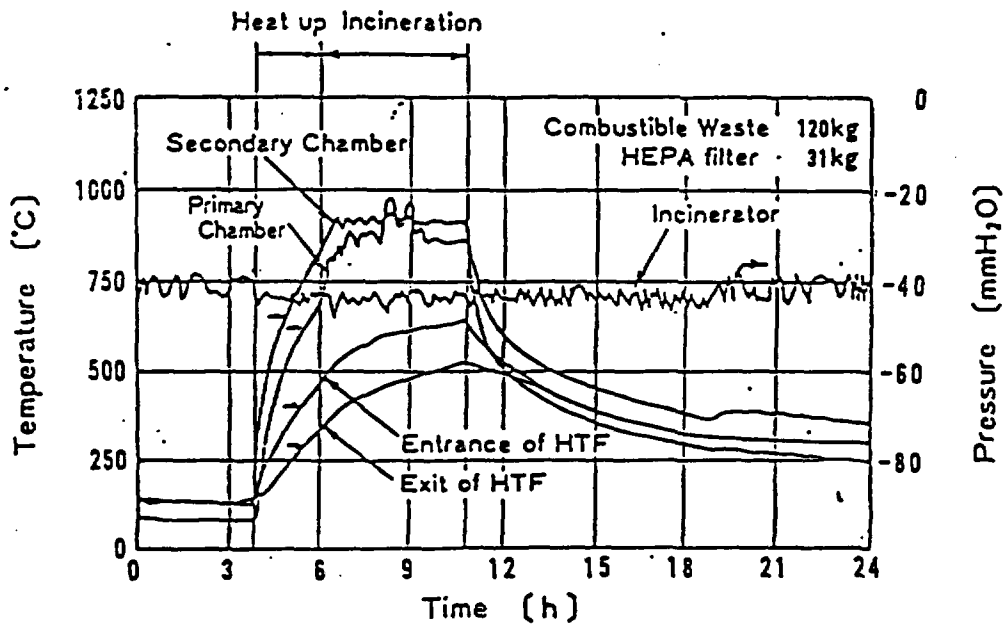

Fig. 4 Temperature and Pressure Change of the Incinerator

4. Conclusions

- (1) Incineration and microwave melting for plutonium-contaminated combustible waste has been demonstrated successfully for the volume reduction and immobilization.
- (2) The alpha-tightness of the conventional incinerator have been maintained during the incineration up to date.
- (3) The volume reduction ratio of 1/130 for the combustible wastes have been attained by the combined process of conventional incineration and microwave melting.
- (4) The incinerated ash have been conditioned stably without any additives by powering microwave.
- (5) Treatment for plutonium-contaminated waste from MOX facilities will be continued to reduce the stored waste volume and the characterization of the conditioned waste will be also progressed.

Reference

- (1) F.KOMATSU, Y.SAWADA, K.OHTSUKA, J.OHUCHI, "Development of a new solidification method for wastes contaminated by plutonium oxides", Radioactive waste management (IAEA in Seattle, 16-20 May 1983)
- (2) Y.OGATA, J.OHUCHI, E.INADA and N.TSUNODA, "Processing of Plutonium-contaminated waste at PWF" (IAEA in Stockholm, May 1988)

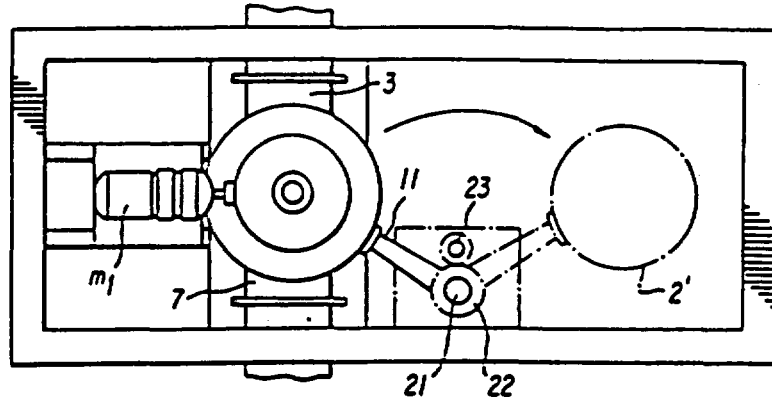

FIG. 1A

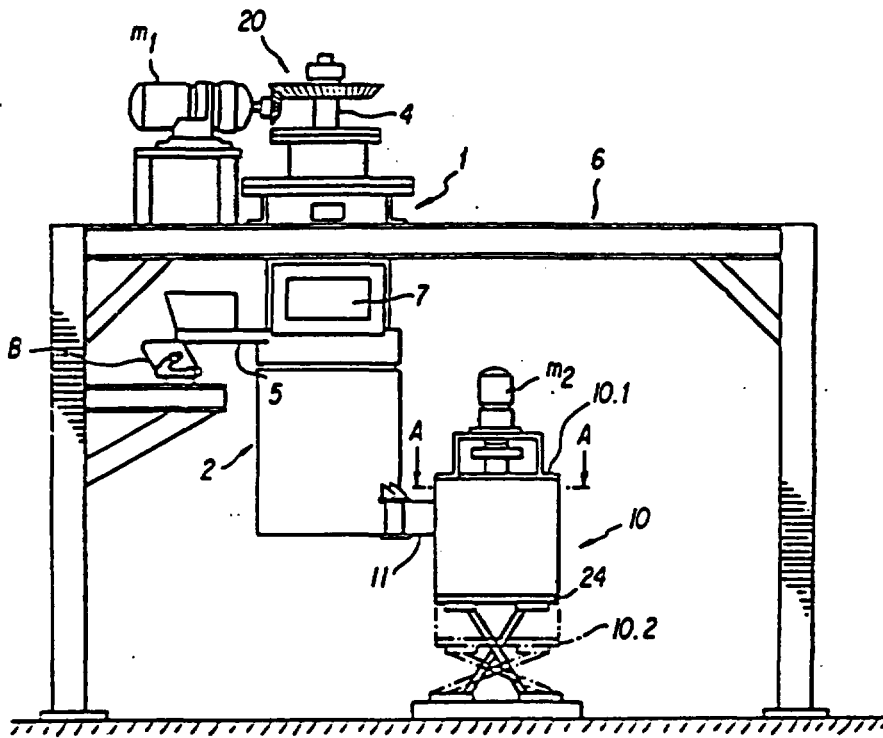

FIG. 1B

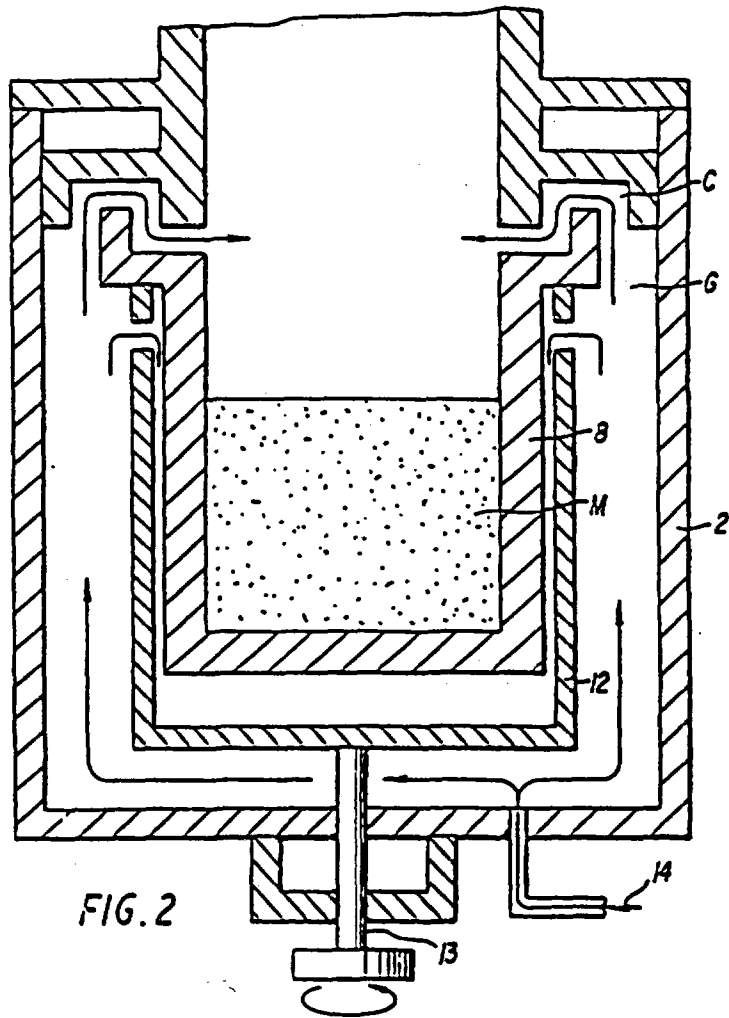

FIG. 2

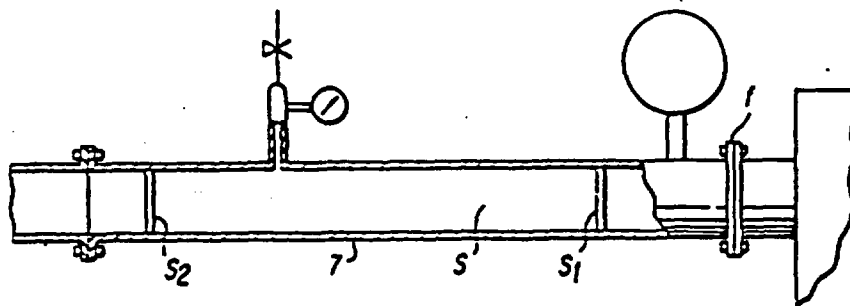
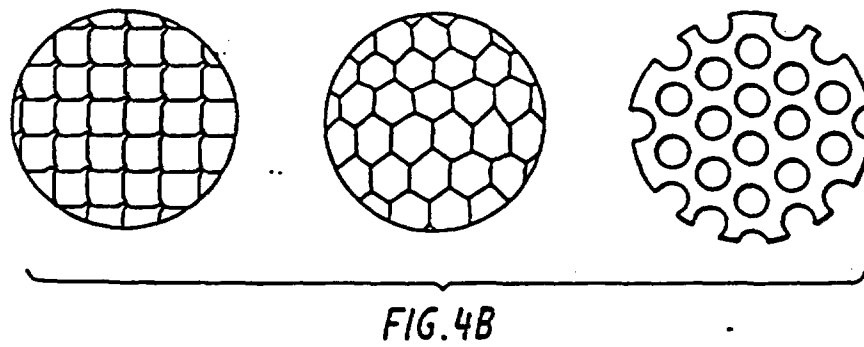
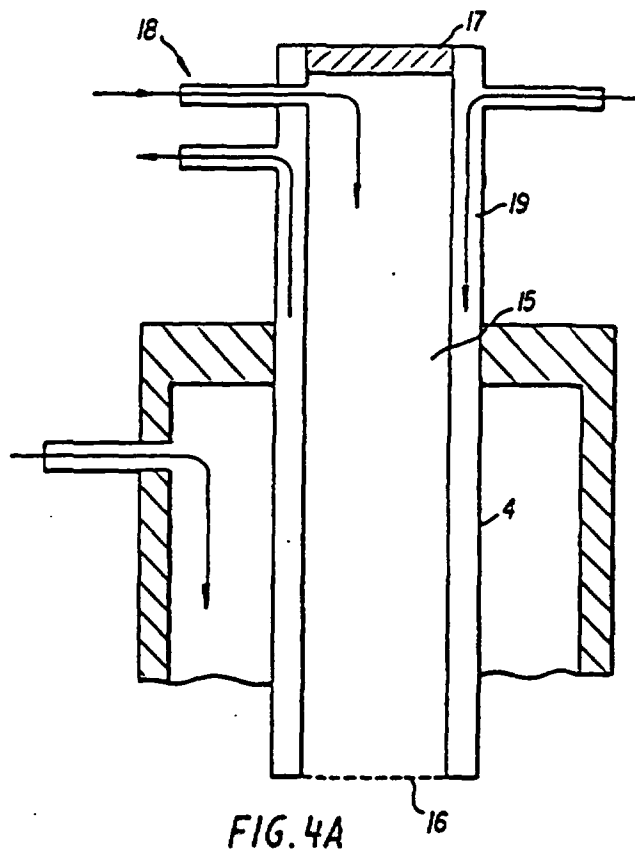

FIG. 3



19 BUNDESREPUBLIK
DEUTSCHLAND



DEUTSCHES
PATENTAMT

17 Patentschrift
11 DE 30 15 300 C 2

51 Int. Cl. 3:
H 05 B 6/80

21 Aktenzeichen: P 30 15 300.5-34
22 Anmeldetag: 21. 4. 80
30 Offenlegungstag: 30. 10. 80
35 Veröffentlichungstag: 5. 1. 83

Innerhalb von 3 Monaten nach Veröffentlichung der Erteilung kann Einspruch erhoben werden

32 Unionspriorität: 22 33 31
21.04.79 JP P54-49599

73 Patentinhaber:
Kobe Steel, Ltd., Kobe, Hyogo, JP

74 Vertreter:
Tiedtke, H., Dipl.-Ing.; Bühling, G., Dipl.-Chem.; Kinne, R.,
Dipl.-Ing.; Grupe, P., Dipl.-Ing.; Pellmann, H., Dipl.-Ing.,
Pat.-Anw., 8000 München

72 Erfinder:
Sawada, Yoshihisa; Komatsu, Fumiaki, Nishinomiya, JP;
Sanada, Kazuo, Kobe, JP; Sakaki, Yoriyisa, Akashi, JP

55 Entgegenhaltungen:
US 40 39 797
US 25 86 754

54 Mikrowellenofen

DE 30 15 300 C 2

30 15 300 C 2

Patentansprüche:

1. Mikrowellenofen zum Erwärmen eines Gutes, der aus einem das Gut aufnehmenden und abnehmbaren Unterteil und einem Oberteil besteht, das über einen Mikrowellenleiter mit einem Mikrowellenoszillator verbunden ist, dadurch gekennzeichnet, daß zum Verflüssigen eines schmelzbaren Gutes (M) im Unterteil (2) ein Schmelztiegel (8) vorgesehen ist, der über eine im Oberteil (1) vorgesehene Füllöffnung (5) beschickbar ist, wobei die Leistung des Mikrowellenofens (1, 2) über eine auf dem Oberteil (1) angeordnete Abstimmvorrichtung (4) steuerbar ist, die von einem hohlen, zylindrischen Metallkörper gebildet ist, der verschiebbar im Oberteil (1) geführt ist, und daß die Mikrowellenzuleitung (3) gegen im Ofenraum entstehende Gase abgedichtet ist.

2. Mikrowellenofen nach Anspruch 1, dadurch gekennzeichnet, daß der Schmelztiegel (8) in einem Behälter (12) aufgenommen ist, der drehbar innerhalb des Unterteils (2) montiert ist.

3. Mikrowellenofen nach Anspruch 1 oder 2, dadurch gekennzeichnet, daß das Unterteil (2) mit einem Inertgasanschluß (14) versehen ist, durch den in einen Spalt (G) zwischen der Innenwand des Unterteils (2) und der Außenwand des Behälters (12) ein Inertgas einleitbar ist, welches einen Druck besitzt, der über dem Innendruck des Mikrowellenofens liegt.

4. Mikrowellenofen nach Anspruch 2 oder 3, dadurch gekennzeichnet, daß der Behälter (12) eine Antriebswelle (13) trägt, die aus dem Unterteil (2) herausführt und über eine Antriebsvorrichtung angetrieben ist.

5. Mikrowellenofen nach Anspruch 1 bis 4, dadurch gekennzeichnet, daß die Mikrowellenzuleitung (3) ein Hohlleiter ist, in dem zueinander im Abstand stehend mehrere luftdichte Zwischenwände (S₁; S₂) eingesetzt sind und somit zwischen sich und der Innenwand des Hohlleiters (3) einen Innenraum begrenzen, dessen Druck höher gehalten ist als der Innendruck des Mikrowellenofens.

6. Mikrowellenofen nach Anspruch 1 bis 5, dadurch gekennzeichnet, daß der Hohlzylinder ein doppelwandiger Zylinder ist, dessen Zentralhohlraum (15) auf der dem Schmelztiegel (8) zugewandten Seite durch ein Neiz (16) aus leitfähigem Material und auf der anderen Seite durch ein Sichtfenster (17) abgeschlossen und mit einem Inertgas-Anschluß (18) versehen ist und dessen Wandungs-Hohlraum (19) einen Anschluß für eine Mantelkühlung besitzt.

Die Erfindung bezieht sich auf einen Mikrowellenofen gemäß dem Oberbegriff des Patentanspruchs 1.

Das Verfahren zum Erwärmen und Schmelzen verschiedener Materialien durch Einwirkung von Mikrowellenstrahlen hat im Vergleich zu anderen Anwärm- und Schmelzverfahren eine Reihe von Vorteilen, zu denen die Vergleichmäßigung des Erwärm- und Schmelzprozesses und die Möglichkeit der genaueren Steuerung der Geschwindigkeit des Schmelzvorgangs durch Einstellen der aufgebrachten Mikrowellenleistung gehören.

Das Prinzip der Mikrowellen-Erwärmung kann auf zahlreichen verschiedenen Gebieten und zu verschiedensten Zwecken angewendet werden. Beispielsweise kann das Volumen von Abfallschlämmen, die bei diversen industriellen Prozessen anfallen, durch Trocknen oder Schmelzen (mit nachfolgender Erstarrung) mit Hilfe von Mikrowellen verringert werden, um die weitere Behandlung zu erleichtern. Die Schmelz- und Erstarrungsbehandlung zur Volumenverringern durch Mikrowellenbestrahlung kann auch bei radioaktiven Abfällen angewendet werden, die in kerntechnischen Anlagen anfallen, gesammelt werden und während langer Zeit an abgeschirmten Orten gelagert werden, um Behälter und Raum für die Lagerung einzusparen und dadurch die Lagerkapazität zu erhöhen, wobei außerdem der Arbeitsaufwand zur Handhabung der Abfälle verringert wird.

Aus der US-PS 25 86 754 ist ein Mikrowellenofen gemäß dem Oberbegriff des Patentanspruchs 1 bekannt, bei dem die Energieübertragung vom Mikrowellenoszillator in den Mikrowellenofen durch eine Koaxialkabel-Einrichtung erfolgt, deren Aufbau auf eine vorbestimmte Mikrowellenlänge hin so optimiert ist, daß die Mikrowellen-Übertragungsverluste vom Mikrowellenoszillator zum Mikrowellenofen möglichst klein gehalten werden. Die Mikrowellenleistung bzw. die auf das zu schmelzende Gut zu übertragende Mikrowellenleistung ist bei diesem bekannten Mikrowellenofen allein über den Mikrowellenoszillator einflußbar.

Der Wirkungsgrad eines Mikrowellenofens hängt allerdings im wesentlichen davon ab, wie exakt die Mikrowellenfrequenz auf den Mikrowellen-Resonanzkörper abgestimmt ist. Wenn das zu erwärmende Gut während des Erwärmungsvorgangs sein Volumen ändert, wird der Mikrowellen-Resonanzkörper dadurch ebenfalls beeinflußt, so daß diese Abstimmung nicht mehr exakt vorliegt. Der aus der US-PS 25 86 754 bekannte Mikrowellenofen eignet sich deshalb nur für die wirtschaftliche Erwärmung eines Gutes, das im Verhältnis zur Ofenkonstruktion bzw. zum Erwärmungsbehälter oder Schmelzbehälter so klein ist, daß es den sich aus Mikrowellenofengehäuse, Mikrowellenleiter und zu erwärmendem Gut zusammensetzenden »Mikrowellen-Resonanzkörper« nur unwesentlich prägt. Das Resonanzverhalten des aus den oben angegebenen Komponenten bestehenden Mikrowellen-Resonanzsystems ist dabei weitestgehend unabhängig von dem zu erwärmenden Gut; mit einem Mikrowellenofen, wie er aus der US-PS 25 86 754 bekannt ist, und der ein derartiges Resonanzsystem besitzt, können somit nur Güter erwärmt werden, deren Größe und Form beim Erwärmungsvorgang gleich bleibt. Für die wirtschaftliche Aufschmelzung von anderen Gütern, wie sie im industriellen Anwendungsgebiet, beispielsweise in sich stetig ändernden Mengen anfallen, kann dieser bekannte Mikrowellenofen nicht mehr wirtschaftlich eingesetzt werden.

Der Erfindung liegt die Aufgabe zugrunde, einen Mikrowellenofen gemäß dem Oberbegriff des Patentanspruchs 1 zu schaffen, mit dem selbst größere Mengen eines im Rahmen eines industriellen Verfahrens anfallenden Gutes in einem Schmelztiegel wirtschaftlich aufgeschmolzen werden können.

Diese Aufgabe wird durch die im kennzeichnenden Teil des Patentanspruchs 1 angegebenen Merkmale gelöst.

Die sich beim Aufschmelzen und durch die kontinuierliche Zufuhr des zu schmelzenden Gutes stetig

verändernden Volumina des aufzuschmelzenden Gutes im Mikrowellenofen bestimmen wesentlich das Resonanzverhalten des oben beschriebenen Mikrowellen-Resonanzkörpersystems aus Mikrowellenleiter, Ofenwandung und Gut, so daß sich bei herkömmlicher Konstruktion der Wirkungsgrad des Mikrowellenofens mit dem momentanen Zustand des Gutes ändert. Durch die erfindungsgemäße Maßnahme, die Abstimmvorrichtung justierbar im Oberteil des Ofens zu führen, kann der Wirkungsgrad des Ofens den jeweiligen Betriebsbedingungen des Aufschmelzvorgangs optimal angepaßt werden. Diese zur Wirkungsgrad-Optimierung führende Abstimmung erfolgt zudem mit geringstem Aufwand, indem durch einfaches Verschieben des Abstimmkörpers die Resonanzfläche und damit die Resonanzfähigkeit bzw. die Resonanzbedingungen des Mikrowellenofen-Resonanzsystems exakt justiert und abgestimmt werden. Unter Loslösung von der herkömmlichen Lehre, die Mikrowellenfrequenz auf den Mikrowellen-Resonanzkörper im Hinblick auf eine wirtschaftliche Erwärmung starr abzustimmen, eröffnen die erfindungsgemäßen Maßnahmen erstmals die Möglichkeit, auch variable Volumina bzw. sperrige Güter wirtschaftlich zu erwärmen, deren Ausdehnung sich im Schmelzraum beim Erwärmen stark ändert. Dadurch kann auch kontinuierlich aufzuschmelzendes Gut zugeführt werden, ohne Wirkungsgradverluste in Kauf nehmen zu müssen.

Vorteilhafte Weiterbildungen hinsichtlich der zusätzlichen Anhebung des Wirkungsgrades des Mikrowellenofens sind Gegenstand der Unteransprüche.

Nachstehend werden anhand schematischer Zeichnungen mehrere Ausführungsbeispiele der Erfindung näher erläutert. Es zeigt

Fig. 1(I) eine Draufsicht auf einen Mikrowellenofen, der als Schmelzvorrichtung dient,

Fig. 1(II) eine Seitenansicht des Mikrowellenofens

Fig. 2 einen senkrechten Schnitt, der einen Schmelztiegel zeigt, der sich in einem Unterteil des Mikrowellenofens befindet,

Fig. 3 eine Schnittdarstellung der Mikrowellenzuleitung des Mikrowellenofens,

Fig. 4(I) eine Schnittdarstellung einer einstellbaren Abstimmvorrichtung des Mikrowellenofens, und

Fig. 4(II) Ansichten von Ausführungsbeispielen der im Mikrowellenofen benutzten Netze.

Im folgenden wird zunächst auf Fig. 1 eingegangen. Die darin dargestellte Mikrowellen-Schmelzvorrichtung umfaßt einen Mikrowellen-Schmelzofen, der aus einem Oberteil 1 und einem Unterteil 2 besteht. Um den Schmelzofen herum ist eine nicht dargestellte Kühleinrichtung angeordnet, die normalerweise aus Rohren besteht, durch die ein Kühlmittel umgewälzt wird. Das Oberteil bzw. die obere Ofenhälfte 1 ist mit einem Hohlleiter bzw. Wellenleiter 3 für Mikrowellen, einer einstellbaren Abstimmvorrichtung 4 und einer Zufuhrleitung 5 für Schmelzgut, d. h. für zu schmelzendes Material, versehen. Die obere Ofenhälfte 1 ist an einer Tragkonstruktion 6 unabhängig vom Unterteil bzw. von der unteren Ofenhälfte 2 befestigt und wird von dieser Tragkonstruktion abgestützt. Zum Antrieb des einstellbaren Tuners bzw. der Abstimmvorrichtung 4 dient ein Motor m_1 , der mit dem Tuner 4 über ein Kegelradgetriebe 20 verbunden ist, damit die Höhe der Abstimmvorrichtung 4 im Mikrowellenofen eingestellt werden kann. Die obere Ofenhälfte 1 ist ferner mit einer Abgasleitung 7 versehen, durch die Schwebstoffe, d. h. Staub und Rauch, die im Schmelzofen entstehen und die Wirksam-

keit der Mikrowellenbestrahlung senken, aus dem Schmelzofen abgeleitet werden. In der unteren Ofenhälfte 2 ist ein Schmelztiegel 8 (siehe Fig. 2) angeordnet. Die untere Ofenhälfte 2 wird von einer Trageinrichtung 10 getragen, die die untere Ofenhälfte 2 von der oberen Ofenhälfte 1 wegbewegen und zu dieser hinbewegen kann. Die Trageinrichtung 10 besteht aus einem Drehmechanismus 10.1 mit einem Motor m_2 und einem Hubmechanismus 10.2. Zum Drehmechanismus 10.1 gehört ein Tragarm 11, dessen eines Ende mit der unteren Ofenhälfte 2 verbunden ist. An seinem anderen Ende ist der Tragarm 11 mit einem Zahnrad 22 versehen, das auf einer Welle 21 befestigt ist, wie Fig. 1(I) erkennen läßt, in der die Trageinrichtung 10 im Schnitt gemäß A-A in Fig. 1(II) dargestellt ist. Das Zahnrad 22 kämmt mit einem Zahnrad 23, das zum Motor m_2 gehört und von diesem angetrieben wird, so daß der Tragarm 11 in einer horizontalen Ebene um die Achse der Welle 21 gedreht bzw. geschwenkt wird und dabei die untere Ofenhälfte 2 von der oberen Ofenhälfte 1 wegbewegen und in eine zurückgezogene Stellung bringen kann, in der die untere Ofenhälfte mit 2' bezeichnet ist. Der Drehmechanismus 10.1 wird von einem Hubtisch 24 des Hubmechanismus 10.2 getragen. Der Hubtisch 24 wird von einer hydraulischen oder anderen Antriebseinrichtung aufwärts- und abwärtsbewegt, um die untere Ofenhälfte 2 in senkrechter Richtung zur oberen Ofenhälfte 1 und von dieser wegzubewegen.

Während des Betriebs der vorstehend beschriebenen Schmelzvorrichtung in Gestalt eines Mikrowellenofens wird die untere Ofenhälfte 2, die den Schmelztiegel 8 trägt, mit der oberen Ofenhälfte verbunden, indem die Trageinrichtung 10 die untere Ofenhälfte in ihre Arbeitsstellung schwenkt und hebt, bevor der Mikrowellen-Schmelzofen mit dem Material bzw. Schmelzgut M gefüllt wird, das aus einer Aufgabevorrichtung B durch die Zufuhrleitung 5 zugeführt wird. Während des Schmelzens werden Schwebstoffe, d. h. Staub und Rauch, die im Schmelzofen während des Schmelzens auftreten und die Bestrahlung mit Mikrowellen behindern, durch die Abgasleitung 7 abgeleitet, während das Material M im Schmelztiegel 8 mit Mikrowellen bestrahlt wird, die von einem nicht dargestellten Mikrowellengenerator erzeugt werden und durch die Mikrowellenzuleitung 3 zum Schmelzofen geleitet werden.

Es versteht sich, daß die obere Ofenhälfte 1 und die untere Ofenhälfte 2 dicht miteinander verbunden sind, damit weder die in den Schmelzofen geleiteten Mikrowellen noch der Staub austreten können, der im Schmelzofen während des Schmelzens entsteht.

Damit der Erwärmungs- und Schmelzvorgang gleichmäßig und wirkungsvoll durchgeführt werden kann, ist es erforderlich, das eingefüllte Schmelzgut gleichmäßig mit den Mikrowellen zu bestrahlen. Es hat sich allerdings oftmals als schwierig erwiesen, eine gleichmäßige Mikrowellenbestrahlung durchzuführen, wenn das Schmelzgut in den Schmelzofen derart eingeführt werden mußte, daß sich an bestimmten Stellen des Schmelzofens eine größere Schmelzgutmenge ansammelte oder daß das Schmelzgut eine unebene Oberflächenkontur annahm, die eine unregelmäßige Wirkung der auftreffenden Mikrowellen verursachten, so daß unterschiedliche Bereiche des Schmelzgutes unterschiedlich stark erwärmt wurden. Dies könnte dadurch vermieden werden, daß am Mikrowellen-Schmelzofen mehrere Mikrowellen-Bestrahlungsquellen vorgesehen

werden; allerdings hätte das den Nachteil, daß die Schmelzvorrichtung groß und kompliziert würde. Bei der vorliegenden Mikrowellen-Schmelzvorrichtung wird dieses Problem durch eine drehbare Ofenkonstruktion, d. h. durch einen drehbaren Behälter gelöst, der den Schmelztiegel aufnimmt und im Unterteil des Ofens gelagert ist.

Wie in Fig. 2 erkennbar ist, ist der Schmelztiegel 8 an und in einem drehbaren Behälter 12 ausgehängt, der auf einer drehbaren Welle 13 im unteren Abschnitt der unteren Ofenhälfte 2 angebracht ist, so daß der drehbare Behälter 12 und der Schmelztiegel in einer horizontalen Ebene gedreht werden können. Die Welle 13 ist mit einem geeigneten, nicht dargestellten Drehantrieb verbunden, beispielsweise einem Antriebsmotor, der an der unteren Ofenhälfte 2 befestigt ist. Der im drehbaren Behälter 12 aufgehängte Schmelztiegel 8 wird somit während der Mikrowellenbestrahlung mit geeigneter Geschwindigkeit gedreht, so daß alle Bereiche des Materials *M* gleichmäßig mit Mikrowellen bestrahlt werden, d. h. gleichmäßig erwärmt und geschmolzen werden, unabhängig von ungleichmäßiger Verteilung des Materials *M* im Schmelzofen und unabhängig von gegebenenfalls unebenen Oberflächen des Schmelz-

gutes. Der drehbare Behälter 12 ist vorzugsweise lösbar an der unteren Ofenhälfte 2 angebracht, um die Wartung des Schmelzofens in dem Fall zu erleichtern, daß geschmolzenes Material aufgrund einer Undichtheit des Schmelztiegels 8 in den drehbaren Behälter 12 fließt.

Während der Schmelzbehandlung des Schmelzgutes dehnt sich der Schmelztiegel 8 in Längsrichtung thermisch aus. Durch diese thermische Ausdehnung des Schmelztiegels treten bei der Erfindung keine Schwierigkeiten auf, da der Schmelztiegel im bzw. am drehbaren Behälter 12 aufgehängt ist.

Während des Erwärmens und Schmelzens des Schmelzgutes ist es bisweilen notwendig, Reaktionen zwischen dem Schmelzgut und der Atmosphäre im Mikrowellen-Schmelzofen zu verhindern, um nach der Schmelzbehandlung erstarrtes Material mit bestimmten chemischen und physikalischen Eigenschaften zu erhalten. In diesem Fall kann der Schmelzofen mit Mitteln zum Einleiten eines Inertgases versehen sein, um auf diese Weise im Schmelzofen eine Inertgasatmosphäre zu erzeugen. Das Einleiten eines Inertgases hat die zusätzlichen Wirkungen, daß der durch Oxidation hervorgerufene Verschleiß des Schmelztiegels geringer bleibt und daß ein Kühleffekt erzielt wird, der Schäden am Schmelztiegel durch Überhitzen verhindert.

Bei der Ausführungsform gemäß Fig. 2 ist am Boden der unteren Ofenhälfte 2 ein Inertgasanschluß 14 vorgesehen, durch den ein Inertgas in einen Spalt *G* zwischen der Außenseite bzw. -wand des drehbaren Behälters 12 und der Innenseite der Wand der unteren Ofenhälfte geleitet wird. Der Druck der Inertgasatmosphäre im Spalt *G* wird auf einen Wert eingestellt, der etwas höher als der Druck der Atmosphäre im Schmelzofen ist, so daß das Inertgas im Spalt *G* in den Schmelzofen strömt und darin eine Inertgasatmosphäre erzeugt, wobei es gleichzeitig das Austreten von Rauch oder anderen Abgasen durch einen Spalt *C* verhindert.

Rauchgase, die in die Mikrowellenzuleitung 3 gelangen, werden mit Mikrowellen bestrahlt und verringern die nutzbare Mikrowellenenergie erheblich,

da sie zu Entladungen oder anderen Phänomenen führen. Um dies zu verhindern, ist in der Mikrowellenzuleitung 3 eine Zwischenwand *S*₁ bzw. *S*₂ vorgesehen, wobei Luft oder ein Inertgas in den Raum auf der dem Mikrowellen-Schmelzofen zugewandten Seite der Zwischenwand geleitet wird, damit Gasströme entstehen, die die Rauchgase und den Staub ständig in Richtung zum Schmelzofen spülen. Insbesondere bei einer Schmelzvorrichtung zur Behandlung radioaktiven Materials sind vorzugsweise zwei Zwischenwände *S*₁ und *S*₂ aus »Teflon« oder Quarzglas am inneren bzw. äußeren Ende der Mikrowellenzuleitung 3 angeordnet, wie dies in Fig. 3 gezeigt ist. Für den Fall, daß die Luftdichtheit durch Ermüdung der inneren Zwischenwand *S*₁ nachläßt, ist der Innenraum *S* zwischen den zwei Zwischenwänden *S*₁ und *S*₂ vorzugsweise mit einem Inertgas gefüllt, das einen Druck hat, der etwas höher als der Druck der Ofenatmosphäre ist, wodurch verhindert wird, daß Gas aus dem Schmelzofen in die Mikrowellenzuleitung 3 strömt.

Der bei der Mikrowellenofen-Schmelzvorrichtung verwendete und als Abstimmvorrichtung dienende Tuner 4 hat vorzugsweise die in Fig. 4(I) dargestellte Ausbildung; er weist einen Hohlkörper aus Metall mit einer Längsbohrung 15 auf. Der Tuner ist an seinem unteren Ende mit einem Gitter bzw. Netz 16 aus leitfähigem Material, das das Austreten von Mikrowellen unterbindet, sowie an seinem oberen Ende mit einem Sichtfenster 17 aus einem plattenförmigen, lichtdurchlässigen Material wie Quarzglas versehen, das eine Beobachtung des Inneren des Mikrowellen-Schmelzofens ermöglicht und das Austreten von Gasen und Staub, die im Schmelzofen entstehen, verhindert. Beispiele für die Ausbildung des Netzes 16 sind in Fig. 4(II) dargestellt.

Das Eindringen von Staub in die Längsbohrung 15 des Tuners bzw. der Abstimmvorrichtung 4 kann durch Einleiten eines Inertgases durch einen Inertgasanschluß 18 in die Längsbohrung verhindert werden. Das eingeleitete Inertgas hat einen Druck, der etwas höher als der Innendruck des Mikrowellen-Schmelzofens ist. Gegen Strahlungswärme kann der Tuner geschützt werden, indem durch einen Wandungshohlraum 19 auf seiner Außenseite Kühlwasser umgewälzt wird.

Der Schmelztiegel kann aus einem metallischen Material, beispielsweise rostfreiem Stahl, oder einem kohlenstoffhaltigen Material, beispielsweise Graphit, bestehen. Vorzugsweise wird allerdings ein Schmelztiegel aus Metall benutzt. Wenn das Schmelzgut einen hohen Schmelzpunkt hat, kann ein Schmelztiegel benutzt werden, dessen Innenseite mit einer Lage aus wärmeisolierendem Material mit hohem Schmelzpunkt wie beispielsweise Aluminiumoxidzement beschichtet ist.

Während des Schmelzens mittels der beschriebenen Mikrowellen-Schmelzvorrichtung kann das zu behandelnde Material kontinuierlich dem Schmelztiegel zugeführt werden, wobei dann die Erwärmungs- und Schmelzbehandlung durch Mikrowellenbestrahlung kontinuierlich erfolgt. Alternativ kann, nachdem eine Materialcharge geschmolzen worden ist und dadurch ihr Volumen verringert worden ist, immer wieder unbehandeltes Material in die Schmelze zugegeben werden, bis die Füllung des Schmelztiegels auf ein bestimmtes Maß angewachsen ist.

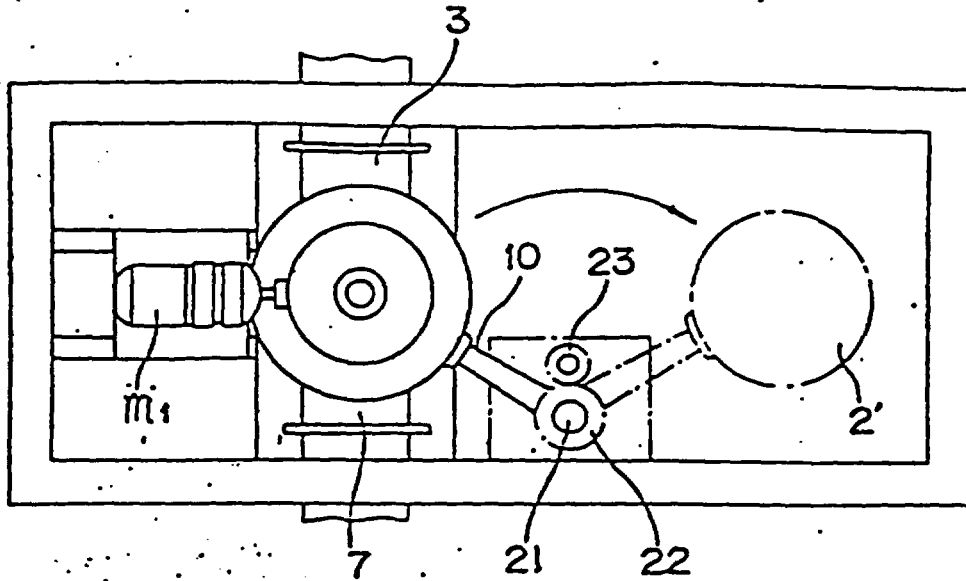

Fig. 1 (I)

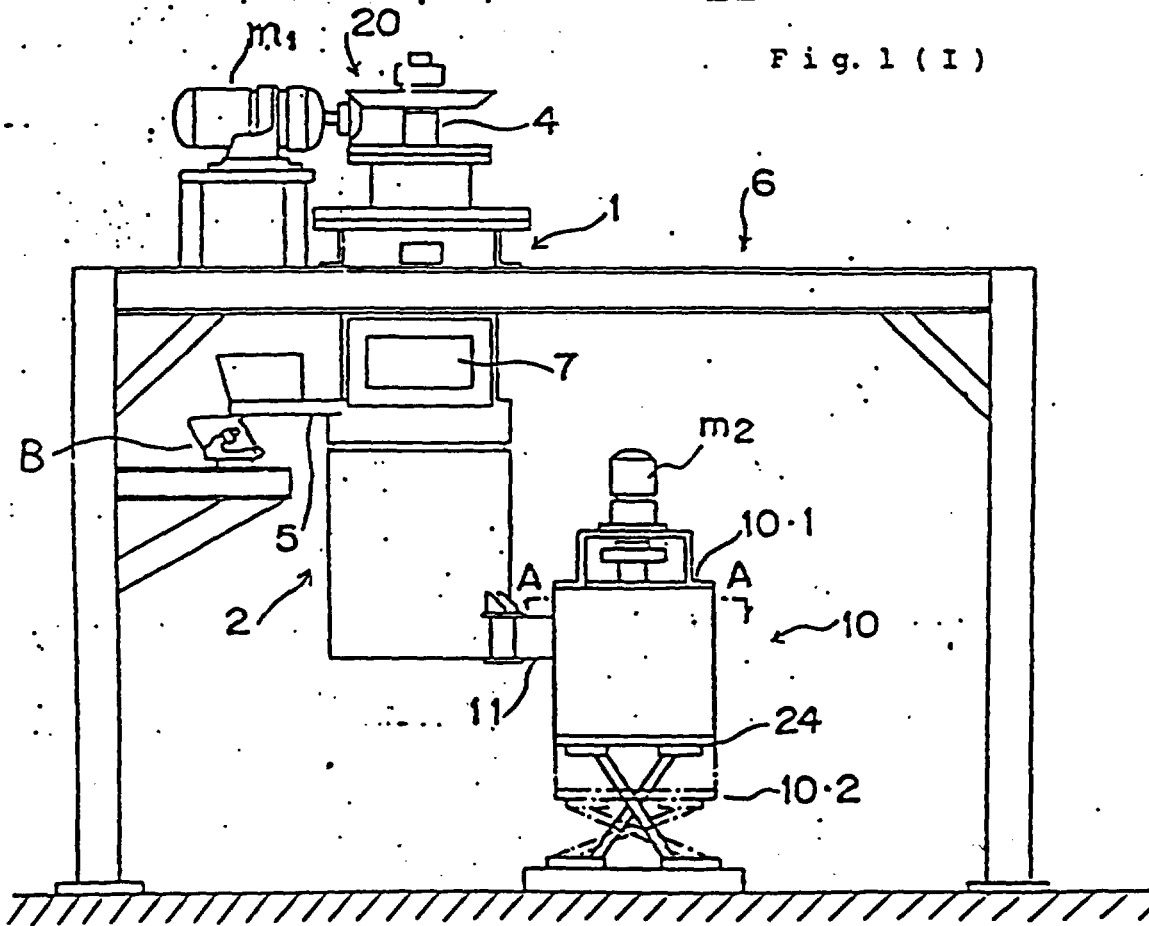

Fig. 1 (II)

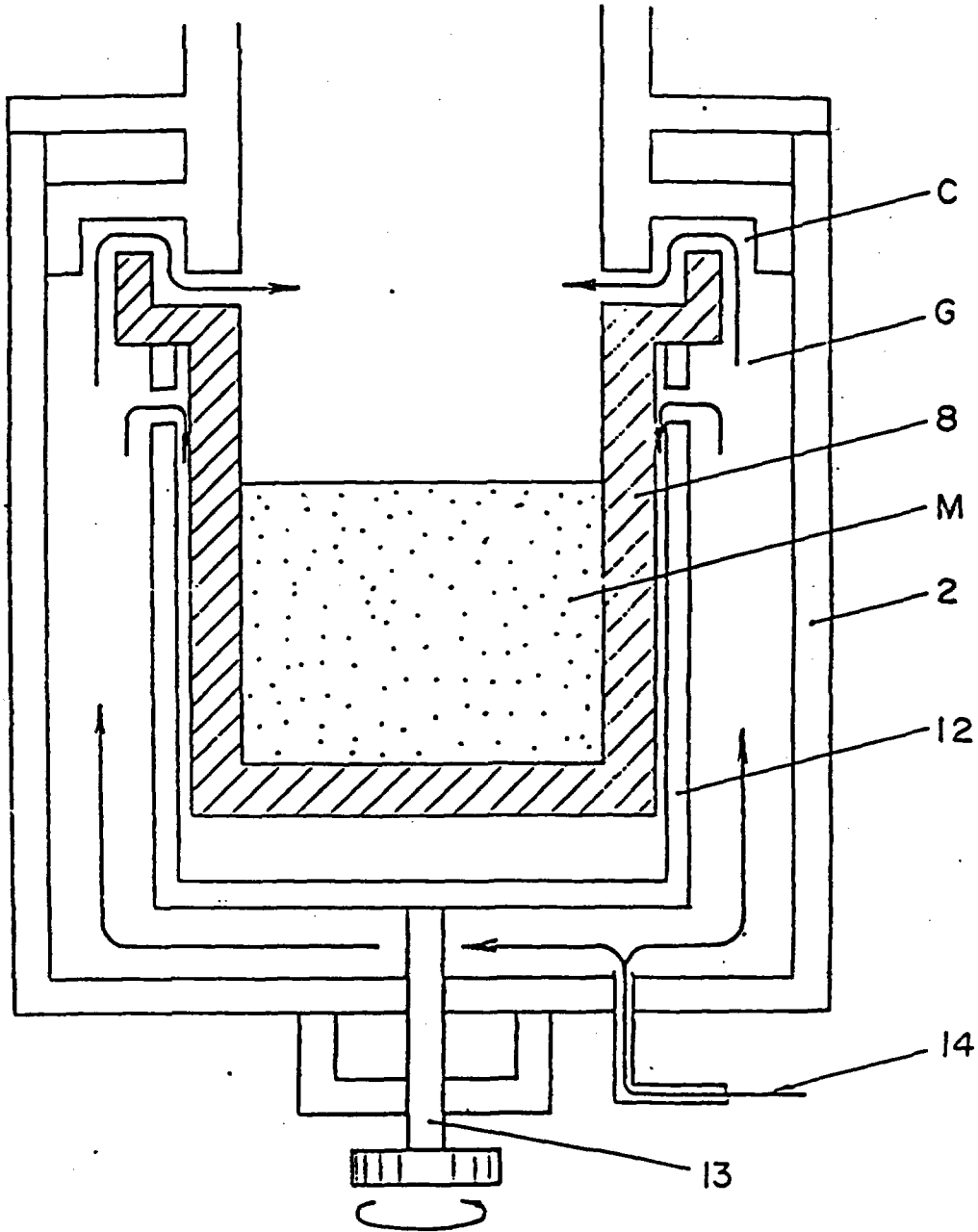

Fig. 2

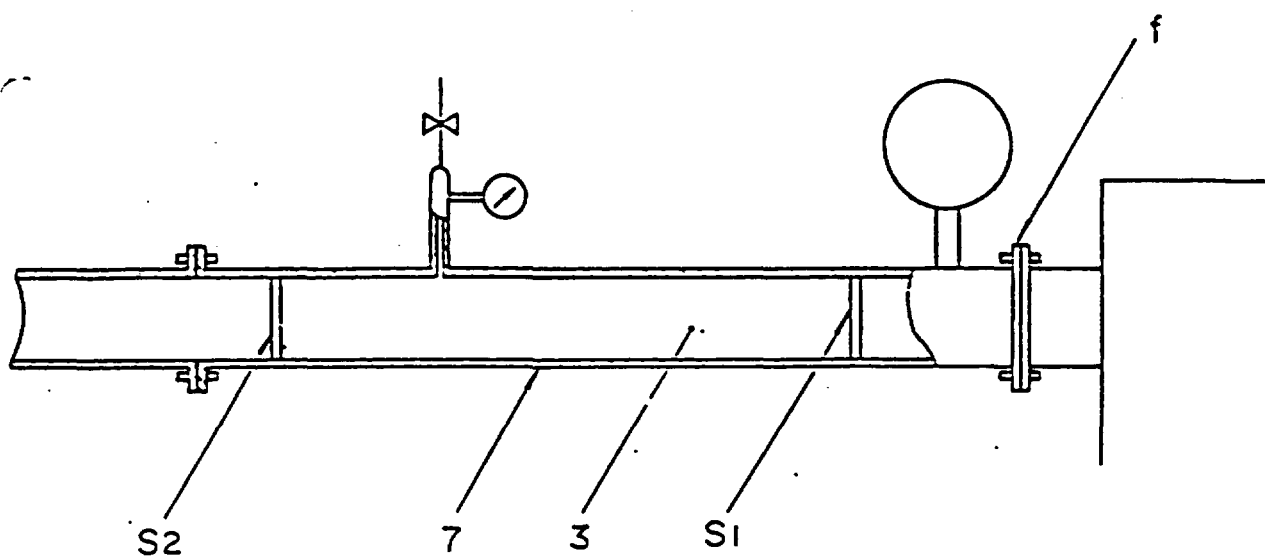

Fig. 3

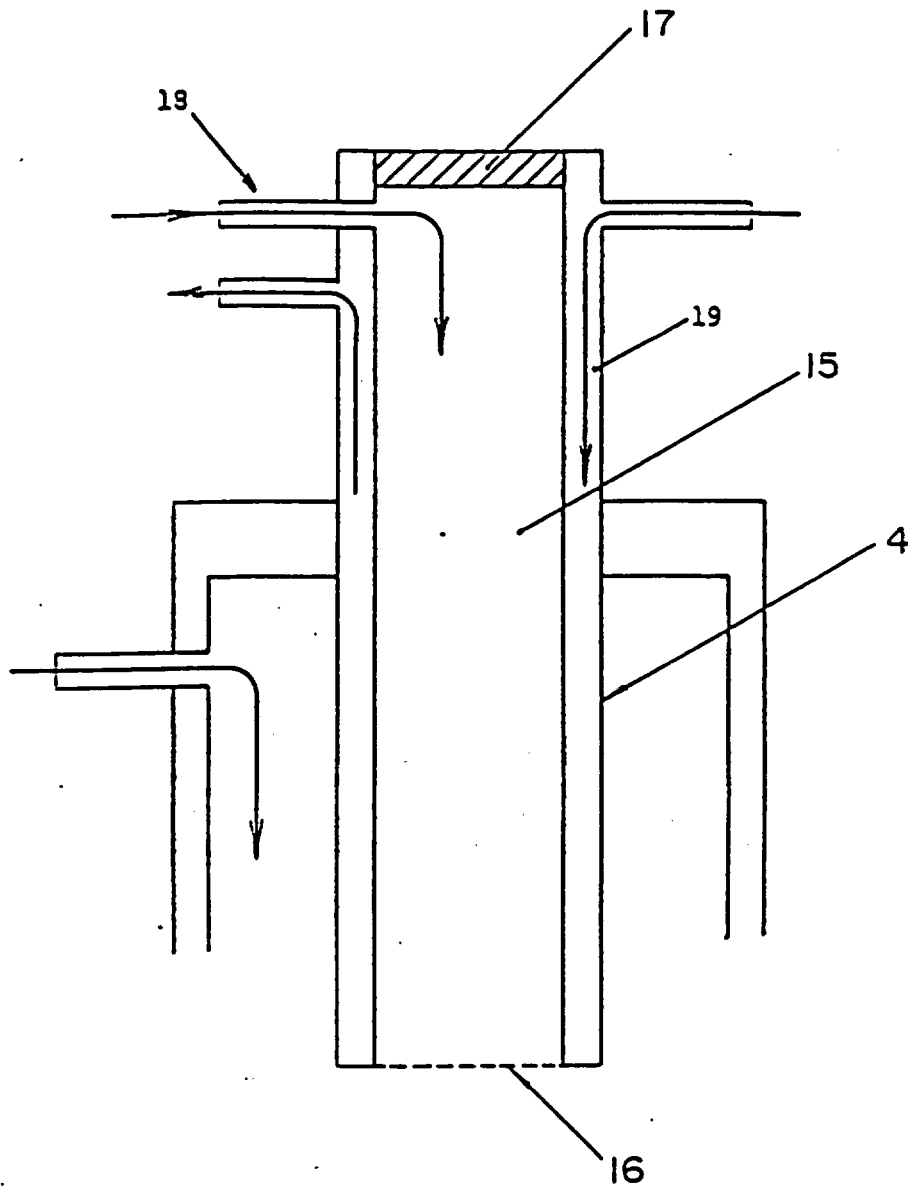

Fig. 4 (I)

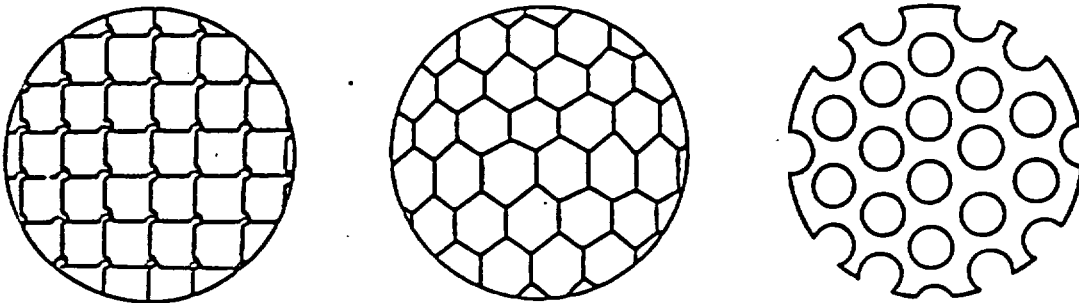

Fig. 4 (II)



(12) UK Patent (19) GB (11) 2.067 823 B

(54) Title of invention

System for treating radioactive waste

(51) INT CL³: G21F 9/00

(21) Application No
8041441

(22) Date of filing
29 Dec 1980

(30) Priority data

(31) 54/184308
55/060291

(32) 28 Dec 1979
6 May 1980

(33) Japan (JP)

(43) Application published
30 Jul 1981

(45) Patent published
11 May 1983

(52) Domestic classification
G6R 1A10

(56) Documents cited
GB 1510494

(58) Field of search
G6R

(73) Proprietor
Kobe Steel Limited,
3-18 1-chome, Wakinohama-
cho, Fukiai-ku, Kobe-City,
Japan

(72) Inventors
Atsushi Tagusagawa,
Yorihisa Sakaki,
Yoshihisa Saweda,
Fumiaki Komatsu,
Masaru Hayashi

(74) Agent
Elkington and Fife,
High Holborn House, 52/54
High Holborn, London
WC1V 6SH

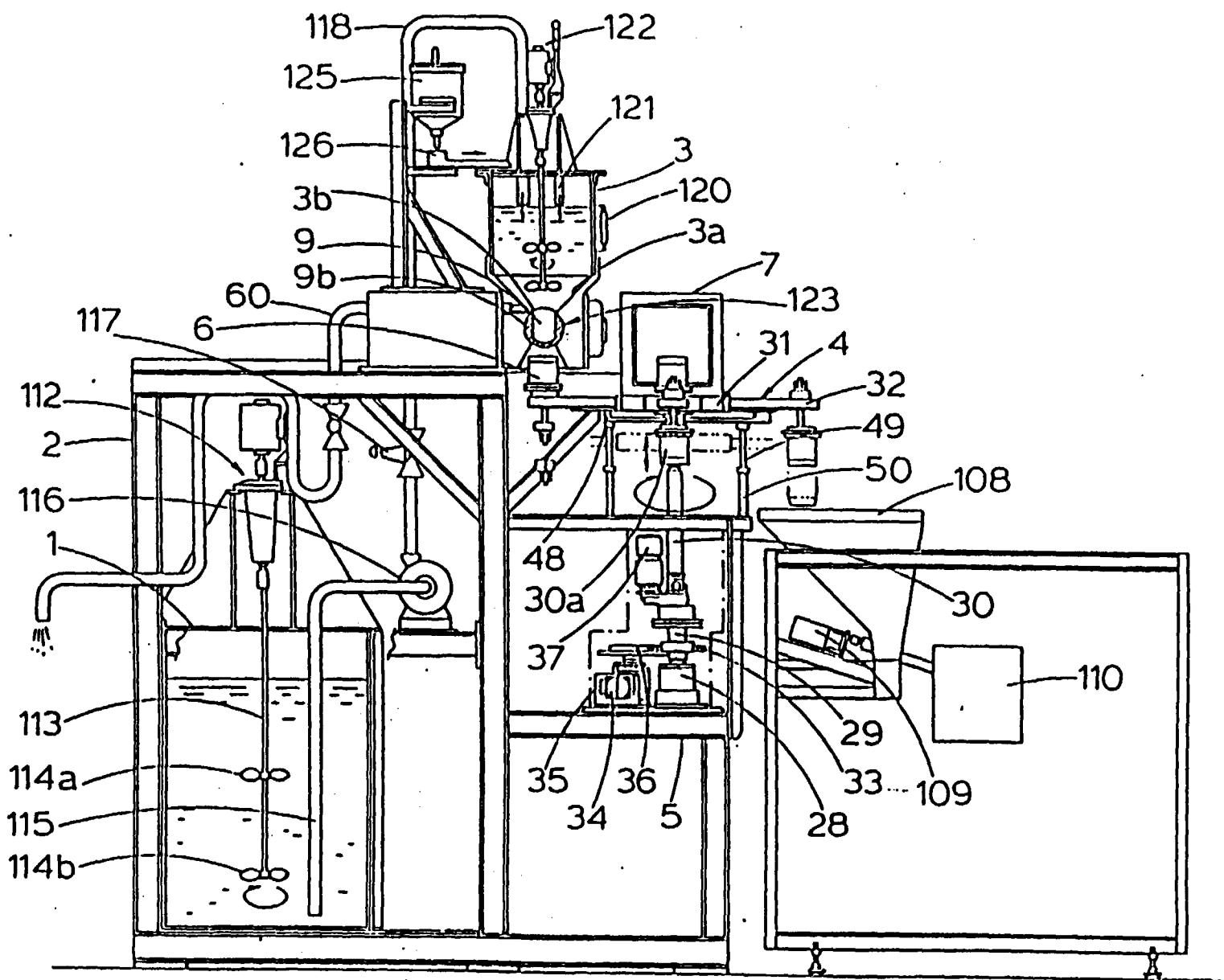

Fig.1

1/6

2067823

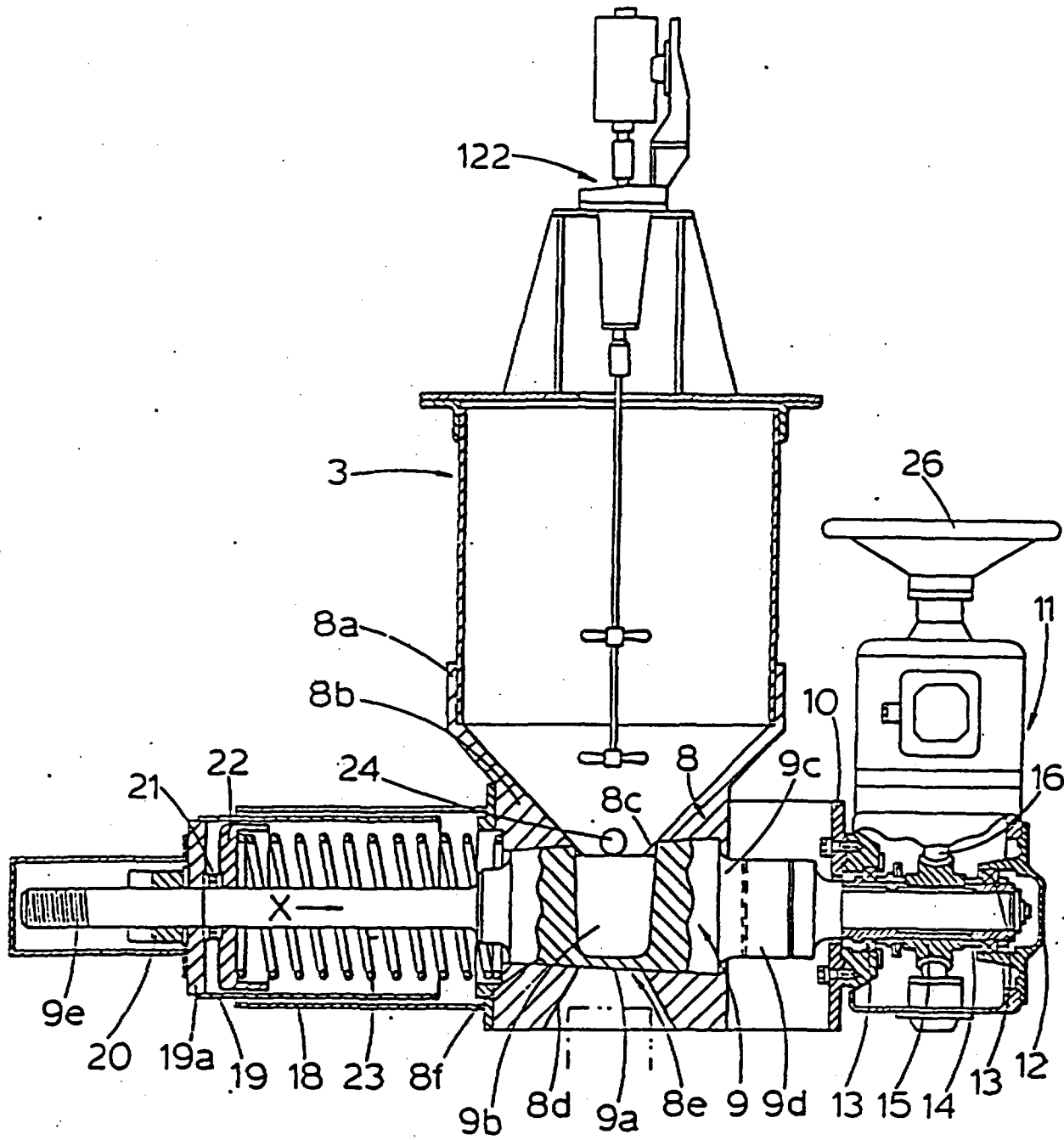

Fig. 2

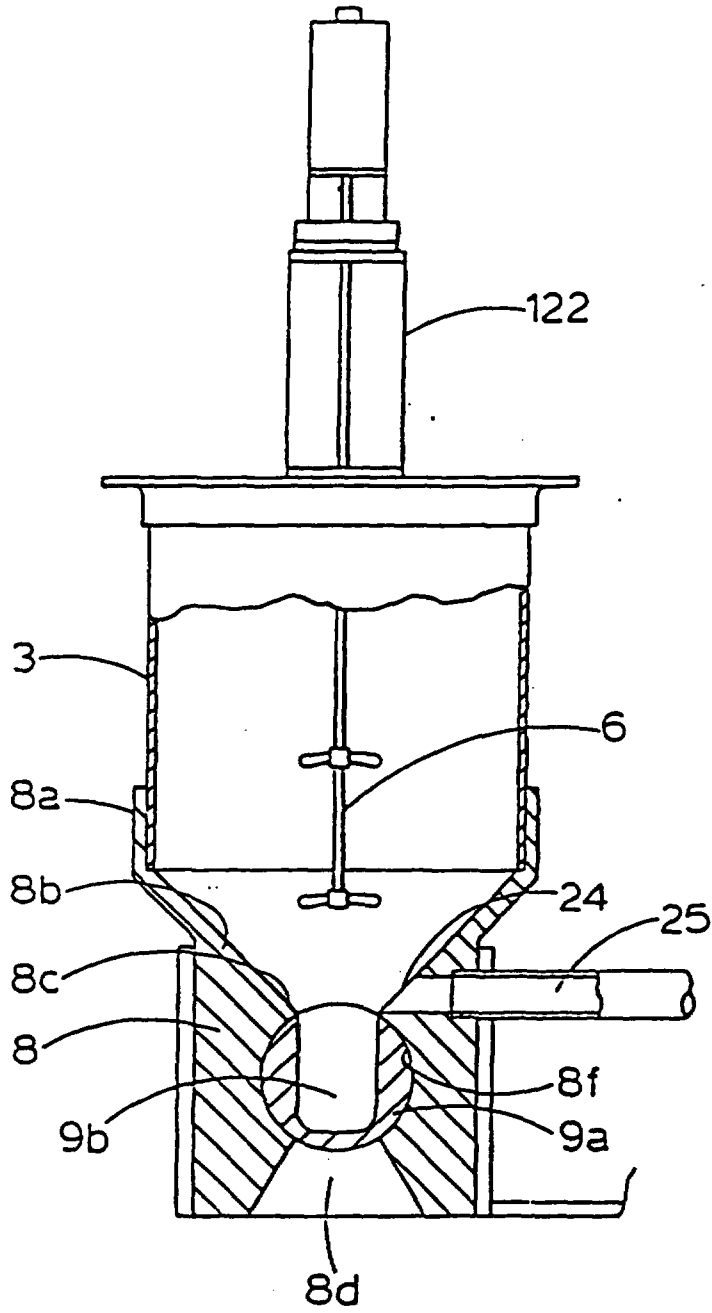

Fig. 3

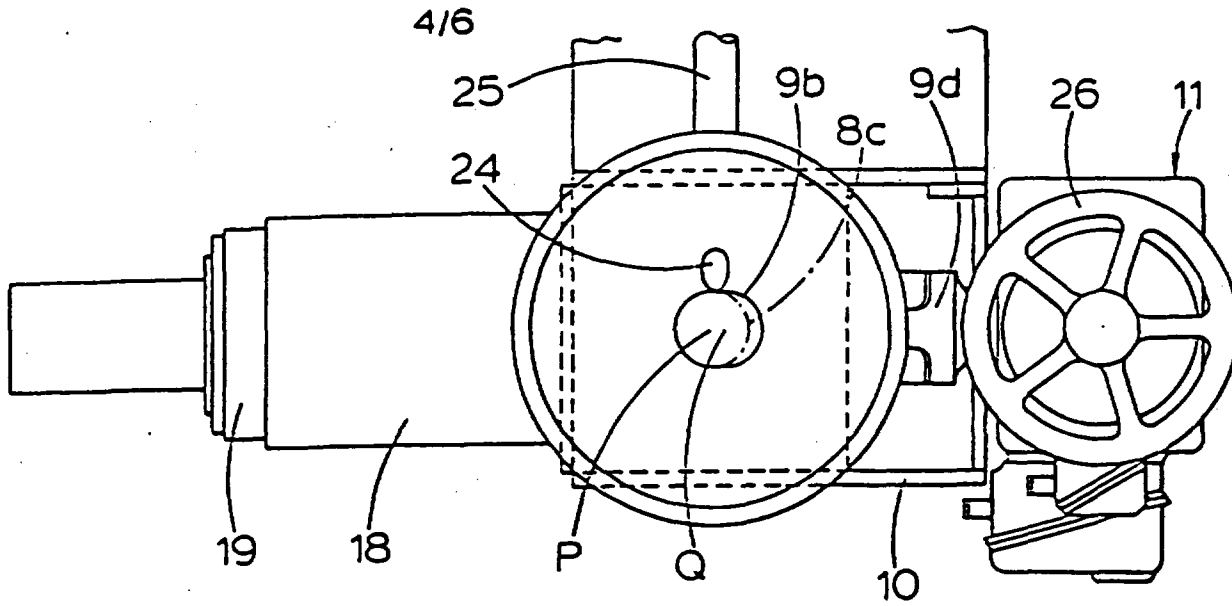

Fig. 4

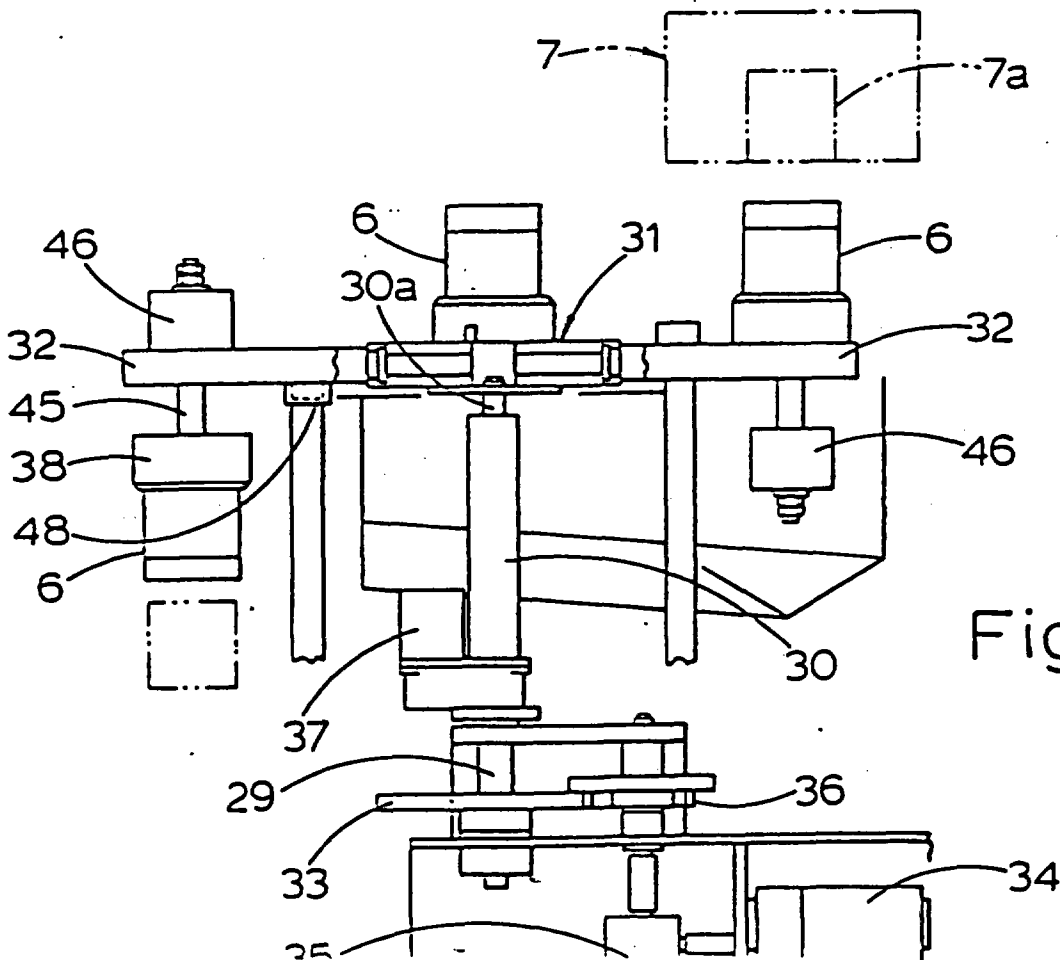
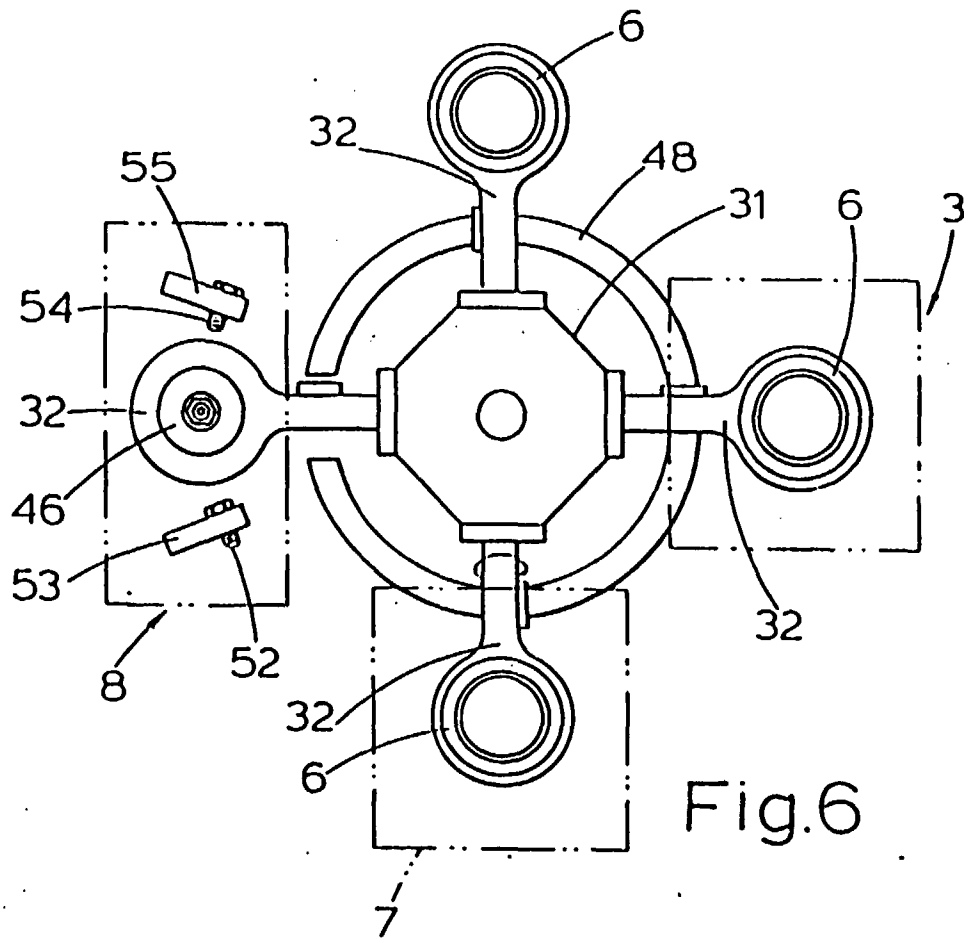
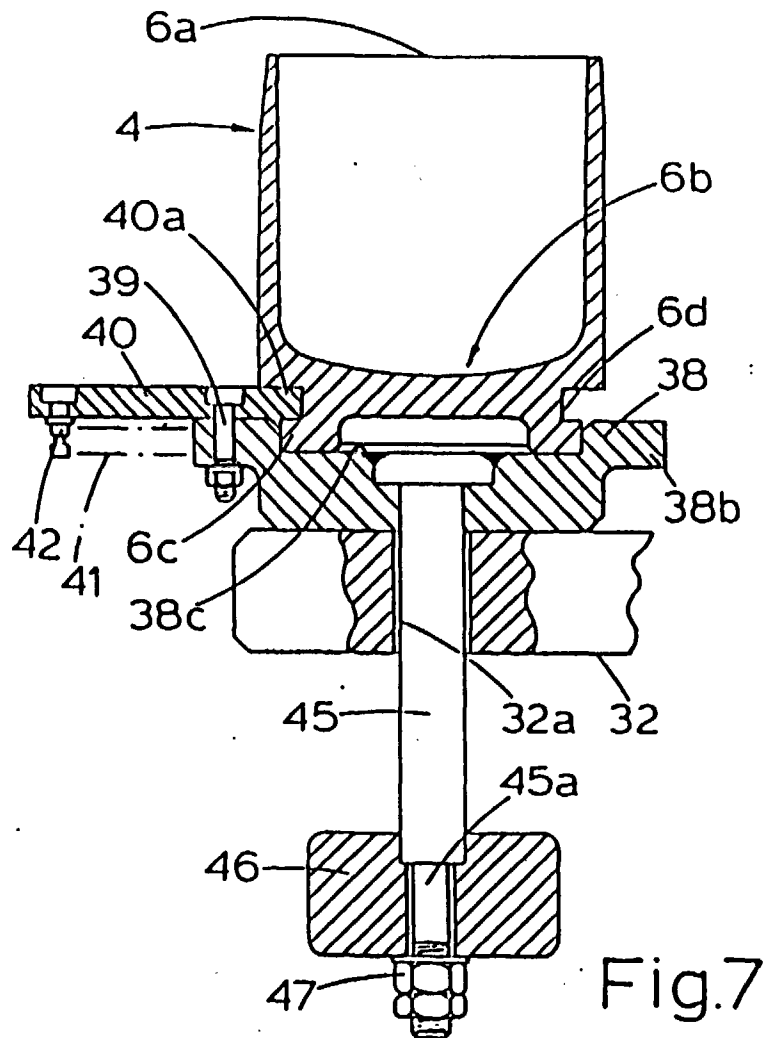

Fig. 5



5/6

2067823

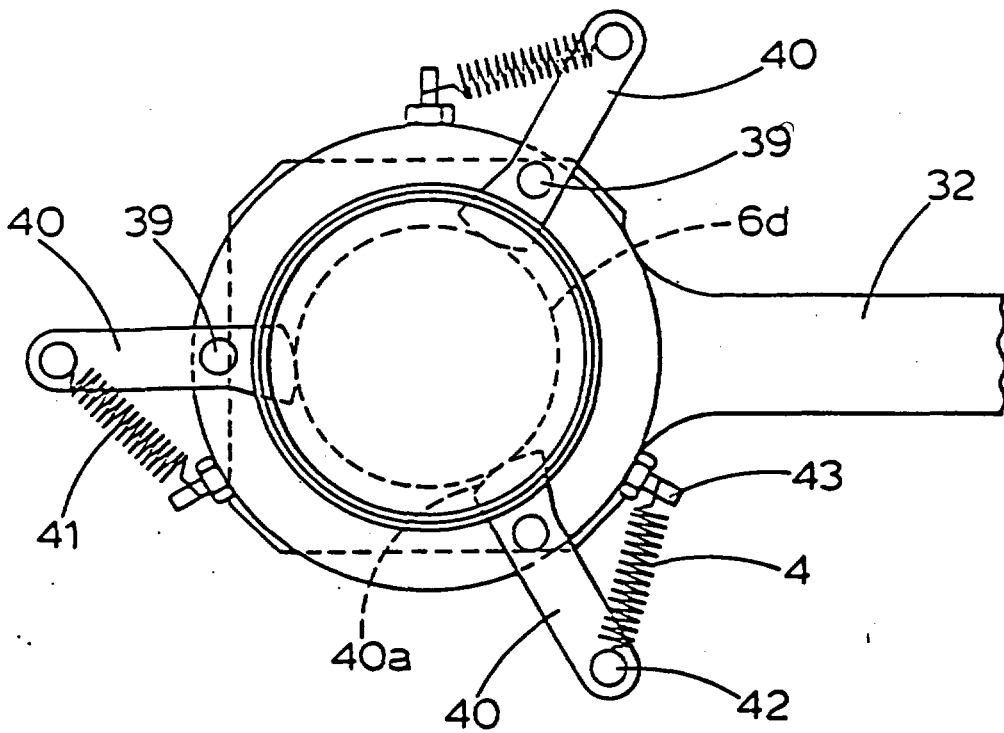

Fig. 8

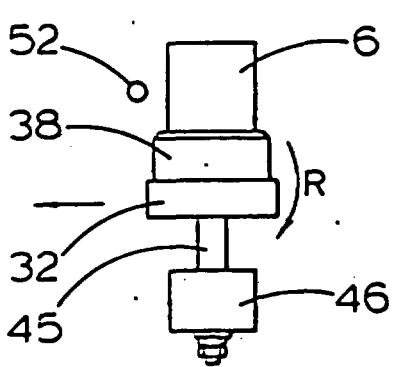

Fig. 9

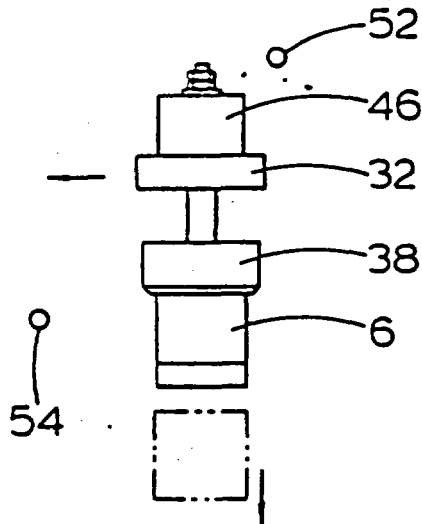

Fig. 10

SPECIFICATION

System for treating radioactive waste

Background of the Invention

This invention relates to comprehensive system for treating the radioactive waste which is discharged as a slurry in large quantities from an atomic plant and is subsequently thickened, dried and prepared for melting.

There have already been proposed a number of methods for treating radioactive waste in slurry form, which contains radioactive components such as the primary cooling water of an atomic pile. These proposals include that of Japanese Laid-Open Patent Specification No. 17572/78, in which it has been considered advantageous from the viewpoint of the economic disposal of radioactive waste to store the latter after sedimental collection, drying, melting and solidification of the radioactive component.

However, up to the present, apparatus for putting such proposals into practical operation has not yet been developed.

Summary of the Invention

Under these circumstances, the present invention has as its object the provision of a comprehensive system which can treat a slurry with radioactive components efficiently in one place by successively thickening and drying the radioactive waste into a form ready for charging to the hopper of a melter.

According to the present invention, there is provided an apparatus for the treatment of radioactive waste, comprising:

- a storage tank holding a slurry of the radioactive waste;
- a sedimentation tank for thickening the slurry of radioactive waste received from said storage tank;
- a drier for drying the thickened radioactive waste;
- a hopper for receiving the dried radioactive waste; and
- a rotary mechanism for transferring the radioactive waste to and from the sedimentation tank, drier and hopper, said mechanism having a number of containers for holding the radioactive waste, rotary arms for supporting said containers; a rotational drive mechanism for said rotary arms, and a lift mechanism for vertically lifting said containers up and down.

In one embodiment of the apparatus of the invention the sedimentation tank and drier are located successively above the rotational path of travel of said containers, and said hopper is located beneath said rotational path of travel in a position spaced from said drier by a predetermined angle about the axis of rotation of said rotary mechanism. The apparatus may also comprise means for inverting and upturning said containers, provided respectively before and after said hopper in the rotational path of travel of said containers.

In a particular embodiment of the invention, said sedimentation tank is provided with a rotary

vertical bore forming inlet and outlet openings on the upper and lower sides thereof in alignment with an opening at the bottom of said sedimentation tank and a tapered bore formed perpendicularly to, and across, said vertical bore, a rotary shaft having a tapered body portion fitted in said tapered bore and provided with a cavity in said tapered body portion in alignment with said inlet opening for collecting radioactive sediment, a spring urging one end of said rotary shaft in the tapered direction thereof, and a rotational drive mechanism connected to the other end of said rotary shaft for rotating the latter through a predetermined angle, the radioactive sediment collected in said cavity being dropped through said outlet opening upon rotation of said rotary shaft.

In one embodiment of the apparatus of the invention the lift mechanism is so designed as to lift said rotary arms up and down.

In another embodiment, said lift mechanism is installed beneath said drier or said rotary collector whereby said container is lifted up and down when said container comes beneath said drier or said rotary collector.

Brief Description of the Drawings

Reference is now made to the accompanying drawings in which:

Fig. 1 is a schematic illustration of one embodiment according to the present invention of apparatus for treating radioactive waste;

Fig. 2 is a schematic vertical section of a rotary collector;

Fig. 3 is a sectional view across a rotary collector shaft;

Fig. 4 is a plan view of the rotary collector;

Fig. 5 is a schematic view of a rotary transfer mechanism;

Fig. 6 is a plan view of the rotary transfer mechanism;

Fig. 7 is a schematic section of pot supporting structures;

Fig. 8 is a plan view of the pot supporting structures;

Fig. 9 is a view explanatory of the inversion of a pot; and

Fig. 10 is a view showing an inverted pot to be upturned into initial upright position.

Description of Preferred Embodiments

Referring to the accompanying drawings and first to Fig. 1, indicated at 1 is a tank which is provided in the lower half of a fixed frame 2 to hold a slurry of radioactive waste therein, and at 3 a vessel which is supported on top of the frame 2 for thickening the slurry and which is, in the particular example shown, a sedimentation tank. Provided beside the frame 2 is a side frame 5 of a smaller height supporting thereon a rotary mechanism which turns a number of pots 6 along a predetermined rotational path of travel. Designated at 7 is a dryer such as a microwave dryer for drying the condensate which is accommodated in the pot 6, and at 108 is a hopper which receives the dried material and

supplies it to a melter 110 of the next stage, if necessary, by means of a feeder 109.

In the upper portion of the slurry storage tank 1, there is provided a stirrer 112 with upper and lower stirring blades 114 and 114b which are mounted on a drive shaft 113. The slurry in the tank 1 is sucked by a slurry feed pump 116 through a suction pipe 115 and quantitatively fed to the sedimentation tank 3 through a pipe 118 with an electromagnetic valve 117.

The sedimentation tank 3 is provided with a level switch 120 which produces a signal when the slurry fed from the slurry feed pump 116 reaches a predetermined level, thereby stopping the operation of the pump 116 and closing the electromagnetic valve 117, to suspend the supply of the slurry to the tank 3. The sedimentation tank 3 is supplied with a high molecular weight flocking liquid through a nozzle 121, which is mixed with the slurry by a stirrer 122, which is mounted on top of the tank 3. The slurry contains in addition iron rust such as hematite, and magnetite, radioactive corrosion products of cobalt, manganese and the like. The suspended radioactive components are flocked by the high molecular weight flocking liquid and gradually fall to the bottom 3a of inverted conical shape and finally in to a rotary collector 123 which is located at the pointed end of the bottom portion 3a.

Indicated at 125 is a hopper which holds a fusible additive which is to be used in the succeeding melting and solidifying stage, the fusible additive in the hopper 125 being supplied to the sedimentation tank 3 in a predetermined quantity through a feeder 126. The fusible additive is dispersed into the slurry by the stirrer 122 and collected in the rotary collector 123 in the form of a mixture with the radioactive substance or substances.

The above-mentioned rotary collector 123 consists of a cylindrical rotary shaft 9 which is provided with a cavity 9b in alignment with the opening 3b at the bottom end of the sedimentation tank 3 to receive the condensate in the cavity 9b. The condensate received in the cavity 9b is dropped into a pot 6 as the cavity 9b is turned 180° about the axis of the shaft 9.

Fig. 2 shows a more particular example of the rotary collector 123, in which the collector 123 includes a metal housing of stainless steel having an annular portion 8a fixedly fitted on the outer periphery of the sedimentation tank 3 and, contiguously to the annular portion 8a, a collecting portion of inverted conical shape forming the bottom of the sedimentation tank 3. The housing 8 is provided with an opening 8d at the pointed bottom end of the collecting portion 8b in communication with a conical opening 8d in the bottom wall of the housing 8, through a vertical bore 8e formed in alignment with the vertical center line of the sedimentation tank 3.

A rotary shaft 9 is journaled in a horizontal bore 8f which is formed in the housing 8 of stainless steel or other metal across the vertical

intermediate portion thereof, a tapered body 9a which is fitted liquid-tight in the horizontal bore 8f to prevent leakage of the slurry. The tapered body portion 9a is centrally provided with a cup-shaped cavity 9b at a position substantially in vertical alignment with the opening 8c in the bottom wall of the housing 8, to receive and collect flocks which gravitate through the opening 8c.

One end 9c of the rotary shaft 9 is extended axially through a cup ring 9d and keyed to a rotational sleeve 14 which is rotatably journaled in bearings 13 within a housing 12 of a rotational drive mechanism 11 fixed on a support frame 10. The rotational sleeve 14 has a worm wheel 15 fixedly fitted thereon and rotatably driven by a worm shaft 16, which is connected to a motor 10, thereby rotatably driving the collector shaft 9.

The other end of the collector shaft 9 is extended through a cylindrical spring cover 19, which is rotatably and axially slidably fitted in the cylindrical hool 18 fixed on one side wall of the housing 8. An externally threaded end 9e of the shaft is engaged in an internally threaded screw member 20 which is supported on an end wall 19a of the cover 19. A compression coil spring 23 having a large spring constant is interposed between the side wall of the housing 8 and a spring seat 22, which is supported on the end wall 19a of the cover 19. A compression coil spring 23 having a large spring constant is interposed between the side wall of the housing 8 and a spring seat 22, which is supported on the end wall 19a through a bearing 21, coaxially and rotatably relative to the shaft 9, constantly urging the shaft 9 in the direction indicated by arrow X to maintain the intimate fitting contact between the tapered body 9a of the shaft 9 and the bore 8f. In this instance, it is desirable to have a fitting surface pressure of 1 kg/cm² or greater from the standpoint of secure sealing.

The cavity 9b in the tapered body 9a of the rotary shaft 9 is shaped in an oval form in section, as shown in Fig. 4, with the longer axis of the oval being disposed in the axial direction of the rotary shaft, 9 to give a large allowance to its axial alignment with the opening 8c at the bottom of the housing 8. In an initially assembled state, the center O of the cavity 9b is preferred to be located slightly closer to the divergent end of the bore 8f in consideration of the friction which would result from the rotation of the rotary shaft 9.

In Figs. 2 to 4, the reference numeral 24 denotes a passage which opens into the bottom portion 8b of inverted conical shape of the housing 8 and is connected to a discharge pipe 25, as shown in Fig. 3, to discharge a supernatant liquid from the tank 3. Designated at 26 in Figs. 2 and 4 is a handle for manual operation of the rotary shaft 9.

In operation, the sedimentation tank 3 receives a slurry to be treated, for example, a slurry containing radioactive suspended matter (hereinafter referred to as "clud slurry"), which is filtered out from primary cooling water of a pile or the like. The major components of the clud slurry

are iron oxides which are suspended in a concentration of 500—50,000 ppm.

When feeding the clud slurry to the sedimentation tank 3, the rotary collector shaft 9 is retained in the collecting position shown in Figs. 2 and 3. After feeding a predetermined quantity of the clud slurry to the tank 3, the stirrer is started to mix the clud slurry. For this purpose, the stirrer is preferred to be driven at a speed of 100—200 r.p.m. Next, a predetermined amount of flocking agent of high molecular weight is added to the slurry in a concentration of about 2—10 ppm, to flock the suspended substances.

After continuing the stirring at that speed for a predetermined time period, the stirring speed is dropped to allow small flocks to grow into larger ones, to facilitate the sedimentation of the flocks. Upon lapse of a predetermined time, the stirrer is stopped and the suspension is left to stand for a while for sedimentation of the flocks. The precipitated flocks go down the tank, guided by the bottom wall 8b of inverted conical shape, and finally settle in the cavity 9b in the tapered body portion 9a of the rotary collector shaft 9.

After sedimentation of a predetermined time period, the supernatant liquid is drawn out and collected by opening a valve (not shown) of the discharge pipe 25. Thereafter, the motor of the rotational drive mechanism 11 is actuated to rotate the rotary collecting shaft 9 by 180° through the worm shaft 16 and worm wheel 15, turning the cavity 9b upside down, to drop the sediment into a pot of the rotary transfer mechanism 4, which is located beneath the collector shaft 9.

As shown in Fig. 5, the rotary transfer mechanism 4 basically includes a center shaft 29 which is rotatably supported on the side frame 5 by a bearing 28 for rotation about a vertical axis, a hydraulic cylinder 30 which is coaxially fixed to the upper portion of the center shaft 29, and a rotary head 31, which is attached to the upper end of a plunger 30a of the hydraulic cylinder 30. The rotary head 31 supports thereon four rotary arms 32 which have their respective base ends supported in bearings for rotation about a horizontal axis, each rotary arm 32 supporting reversibly, at its outer or front end, a pot 6 for receiving the collected sediment.

A driven gear 33, which is fixedly mounted at an intermediate position on the center shaft 29, is meshed with a drive gear 36 which is driven from a motor 34 through a reducer 35, so that the center shaft 29 is rotated upon actuating the motor 34. If necessary, the hydraulic cylinder 30 is operated by a hydraulic control device 37 to lift or to lower the rotary head 31 through the plunger 30a.

Instead of a mechanism such as power cylinder, e.g. the hydraulic cylinder 30, the lifting and lowering means may be installed beneath the drier 7 or the rotary collector 123, respectively.

The pot 6 is lifted and lowered when, through the rotation, the pot 6 reaches positions where the pot 6 receives the collected sediment and where

the collected sediment in the pot 6 is subjected to drying treatment in the drier 7.

As shown in fig. 7, each pot 6 is in a tapered form with an inside diameter increasing towards the upper open end and a round bottom, so that its content is easily released when the pot is turned upside down. Contiguously beneath an annular groove 6d, the pot 6 is provided with a flanged bottom wall 6c to be fitted with a recess 38a of a seat plate 38, which is mounted on the rotary arm 32. The seat plate 38 is provided with a flanged portion 38b around its outer periphery, on which a locking lever 40 is hinged by a hinge pin 39, rockably in a horizontal plane. As shown in Fig. 8, a pawl portion 40a at the front end of the locking lever 40 is fitted into the annular groove 6d on the outer periphery of the pot 6. In this manner, the pot 6 and the seat plate 38 are integrally connected with each other by hinge pins, which are located at three positions on the outer periphery of the pot 6. As shown in Figs. 7 and 8, a spring 41 tensioned between a spring stop pin 42 fixed at the rear end of the locking lever 40 and a spring stop pin 43 fixed on the circumference of the seat plate 38, urges the locking lever 40 in the locking direction.

Fixedly secured to the center portion of the seat plate 38 of the pot 6 is the upper end of a reversing rod 45 which is extended vertically through a bore 32a in the front end-portion of the rotary arm 32, and provided with an externally threaded portion 45a at its lower end, in engagement with a weight 46 and a stop nut 47. The pot 6 is thus stably supported on the rotary arm 32 by the weight 46, and, when the pot is turned upside down, the contents of the pot are securely released by the falling impact of the weight 46.

In Figs. 1, 5 and 6, designated at 48 is a circular guide rail which guides the turning movements of the rotary arms 32 on the underside thereof, and which is liftable up and down and normally urged upward by guide rods 49 and guide cylinders 50.

As shown in Fig. 1, the sedimentation tank 3 and drier 7 are located above the locus of rotation of the pots 6 on the rotary arms 32, and in positions spaced from each other by 90° about the axis of rotation, as particularly shown in Fig. 6. In this instance, the lower opening of the rotary collector shaft 9 at the bottom of the sedimentation tank 3 is positioned so that it is brought into alignment with the center axis of a pot 6 which latter pot is turned into a receiving position, ensuring that the dropped sediment is securely received in the pot 6.

On the other hand, the hopper 108 is located beneath the locus of rotation of the pots 6 at a position 90° shifted from the drier 7, so that the dried material in the pot 6 is dropped into the hopper 108 when the pot 6 is turned upside down, as will be described hereinafter.

As shown in Fig. 6, in order to invert the pots 6, a pot-inverting mechanism is provided above the hopper 108, including a knock pin 52 which is supported on an arm 53 knocking upside down

the pots 6 which are successively turned towards the hopper 8. The inverted pot 6 is upturned again by an upturning knock pin 54, similar to the pot-upsetting knock pin 52, which is supported on an arm 55 at a position rotationally forward of the hopper 108.

Referring to Fig. 9 the pot-upsetting pin 52 hits the outer wall surface of the pot 6 when the latter is rotated by the rotary arm 32 to a point above the hopper 108, and, upon further rotation, the pot 6 is turned upside down together with the rotary arm 32, about the axis thereof, as indicated by the arrow R in Fig. 9. Upon inversion of the pot 6, the weight 46 is allowed to drop freely by a play of the rod 45 relative to the rotary arm 32 and hits against the arm, the impact transmitted to the pot 6 encouraging dumping of its contents.

The inverted pot 6 then abuts against a pot upturning pin 54 which, as shown in fig. 10 is located in a position beneath, and spaced by a certain angle from, the pot-inverting pin 52, causing the vacant pot 6 and arm 32 to turn clockwise to assume again their original upright position.

In the operation of the above-described treatment system, with stirring by the stirrer 112, a slurry in the slurry tank 1 is fed to the sedimentation tank 3 through conduits 115 and 118 by operation of the slurry feed pump 116. As soon as the slurry in the sedimentation tank 3 reaches a predetermined level, the level switch 120 is actuated to stop the slurry feed pump 116 so as to suspend the feed of the slurry. A predetermined amount of a high molecular weight flocking liquid is added to the slurry in the sedimentation tank 3 through the nozzle 121 and mixed therewith by actuating the stirrer 122. Simultaneously, a fusible additive stored in the hopper 125, which is quantitatively fed by the feeder 126, is also mixed into the slurry in the tank 3.

In this stirring and mixing stage, the radioactive substances in the slurry are flocked by the high molecular weight flocking liquid and, upon stopping the stirrer 122, allowed to fall by gravitation onto the bottom portion 3a of the tank, finally settling in the cavity 9b of the rotary collector 123. In this flocking and settling stage, the fusible additive is also collected together with the condensate in the form of a mixture with the radioactive substances.

At the time point when the sedimentation has proceeded to a sufficient degree, the supernatant liquid is drawn out of the tank 3 by opening the electromagnetic valve in the discharge pipe 60 which communicates with the bottom portion 3a of the tank 3, sending the liquid to a waste water treatment process.

After the extraction of the supernatant liquid, the rotary shaft 9 of the rotary collector 123 is rotated by 180° to drop the condensate in the cavity 9b into a pot 6, which has been lifted to a position close to the outlet opening 8e of the rotary collector 123 by the operation of the lift

During the above-described flocking and collecting operation, a condensate collected by the preceding flocking and collecting operation is dried in the drier 7 until the succeeding mass of condensate is received in a vacant pot 6, whereupon the cylinder 30 is lowered once and the motor 34 is actuated to rotate the rotary arm 32 through 90° to bring the received condensate to a position beneath the drier 7. The water vapour which is generated by heating is passed through an exhaust gas treatment device like a condenser.

As a result of the rotation of the arm 32, the pot 6 which holds the dried condensate is turned upside down above the hopper 8 by the pin 52 of the pot-inverting mechanism of Fig. 6, to release the dried condensate into the hopper 8 in the manner explained hereinbefore in connection with Fig. 9. At this time, the dried material which is deposited on the inner wall surface of the pot 6 is caused to fall off more forcibly by the impact of the dropping weight 46 than when resort is made to natural or spontaneous fall of the material.

After the 90° rotation, the rotary head 31 is lifted by the operation of the lift cylinder 30 to position a vacant pot 6 immediately beneath the rotary collector 123 of the sedimentation tank 3, while passing a pot 6 filled with a condensate to the dryer 7 from beneath for heating and drying the condensate.

During the above-described revolution of the rotary head 31, a pot 6 which passes over the hopper 108 in an inverted state is upturned into an upright position and is stopped in a stand-by position.

The dried condensate released into the hopper 8, which is a mixture of the radioactive substances and fusible additive, is fed into the melting furnace 110 by the feeder 9. The mixture which is melted in the furnace 110 is solidified and put in a storage container, which is then capped, sealed and cleaned of contaminants for storage over a long time period.

The condensate in the pots, which is heated and dried by a single dryer in the foregoing embodiment, may be adapted to be preheated and then fully heated by driers which are located in two separate positions in the rotational path of travel.

Further, although the fusible additive is admixed to the slurry in the sedimentation tank, it may be fed to, and mixed with, the condensate in the hopper 108 prior to charging to the melting furnace 110.

As appears from the foregoing description, the present invention employs a rotary mechanism which includes in its rotational path of travel a number of stages required for treating a slurry of radioactive substances, i.e., a stage of condensation of the slurry, a stage of heating and drying the condensate and a stage of transfer to a melting furnace, prior to the final melting and solidifying stages, thereby allowing treatment of radio-active waste continuously in one place.

According to the invention, the waste is

respective stages of treatment by the operation of a single rotary mechanism, so that it becomes possible to enhance the capacity of treatment and to reduce the floor space required for the treatment operation. In addition, the rotary mechanism with liftable pots simplifies the treatment operation and permits of remote control or complete automation of the treatment operation.

10 CLAIMS

1. Apparatus for the treatment of radioactive waste, comprising:

a storage tank holding a slurry of the radioactive waste;

15 a sedimentation tank for thickening the slurry of radioactive waste received from said storage tank;

a drier for drying the thickened radioactive waste;

20 a hopper for receiving the dried radioactive waste; and

a rotary mechanism for transferring the radioactive waste to and from the sedimentation tank, drier and hopper, said mechanism having a number of containers for holding the radioactive

25 waste, rotary arms for supporting said containers; a rotational drive mechanism for said rotary arms, and a lift mechanism for vertically lifting said containers up and down.

2. Apparatus as set forth in claim 1, wherein 30 said sedimentation tank and drier are located successively above the rotational path of travel of said containers, and said hopper is located beneath said rotational path of travel in a position spaced from said drier by a predetermined angle

35 about the axis of rotation of said rotation

mechanism.

3. Apparatus as set forth in claim 1 or 2, further comprising means for inverting and upturning said containers, provided respectively before and after 40 said hopper in the rotational path of travel of said containers.

4. Apparatus as set forth in claim 1, 2 or 3, wherein said sedimentation tank is provided with a rotary collector including a housing block having 45 a vertical bore forming inlet and outlet openings on the upper and lower side thereof in alignment with an opening at the bottom of said sedimentation tank and a tapered bore formed perpendicularly to, and across, said vertical bore, a rotary shaft having a tapered body portion fitted in 50 said tapered bore and provided with a cavity in said tapered body portion in alignment with said inlet opening for collecting radioactive sediment, a spring urging one end of said rotary shaft in the tapered direction thereof, and a rotational drive 55 mechanism connected to the other end of said rotary shaft for rotating the latter through a predetermined angle, the radioactive sediment collected in said cavity being dropped through said 60 outlet opening upon rotation of said rotary shaft.

5. Apparatus as set forth in claim 1, 2, 3 or 4, wherein said lift mechanism is so designed as to lift said rotary arms up and down.

6. Apparatus as set forth in claim 1, 2, 3 or 4, wherein said lift mechanism is installed beneath 65 said drier or said rotary collector whereby said container is lifted up and down when said container comes beneath said drier or said rotary collector.

70 7. Apparatus as set forth in claim 1 substantially as hereinbefore described with reference to the accompanying drawings.