

mecc alte

LET'S TALK ABOUT MECCALTE APP

mecc alte

UNIQUE COMPANY.
UNIQUE PEOPLE.

Scan Serial

Connect via Wi-Fi

Work offline

POWER FROM WITHIN





CONTENTS

Download the app	4
Connections	5
Introduction	7
1. Homepage	8
2. Dashboard	9
3. Menu	10
A. Settings	11
A.1 Base Setting	12
A.2 Advanced Setting	13
B. Archive	14
C. Alarms	15
E. Info	16
Notes	17

DOWNLOAD THE APP

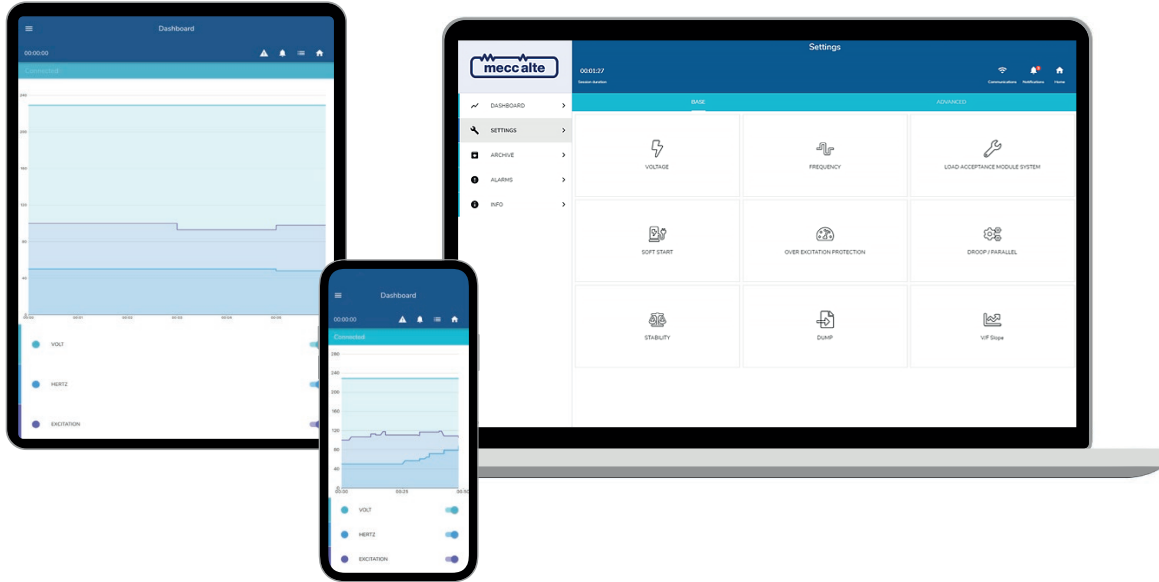

Getting Started: Downloading the App

Welcome to our guide, where we'll walk you through the process of downloading and setting up the app you'll need for your device. The first step is to download the app by scanning the QR codes below that corresponds to your specific device.

In the following pages, you will find detailed instructions and representations of the app, helping you get started quickly and effortlessly.

PC



Smartphone/Tablet



Smartphone/Tablet



CONNECTIONS **M2K** **M2K^S** **M3K** **M3K^S** **M3K^{SHD}**

1

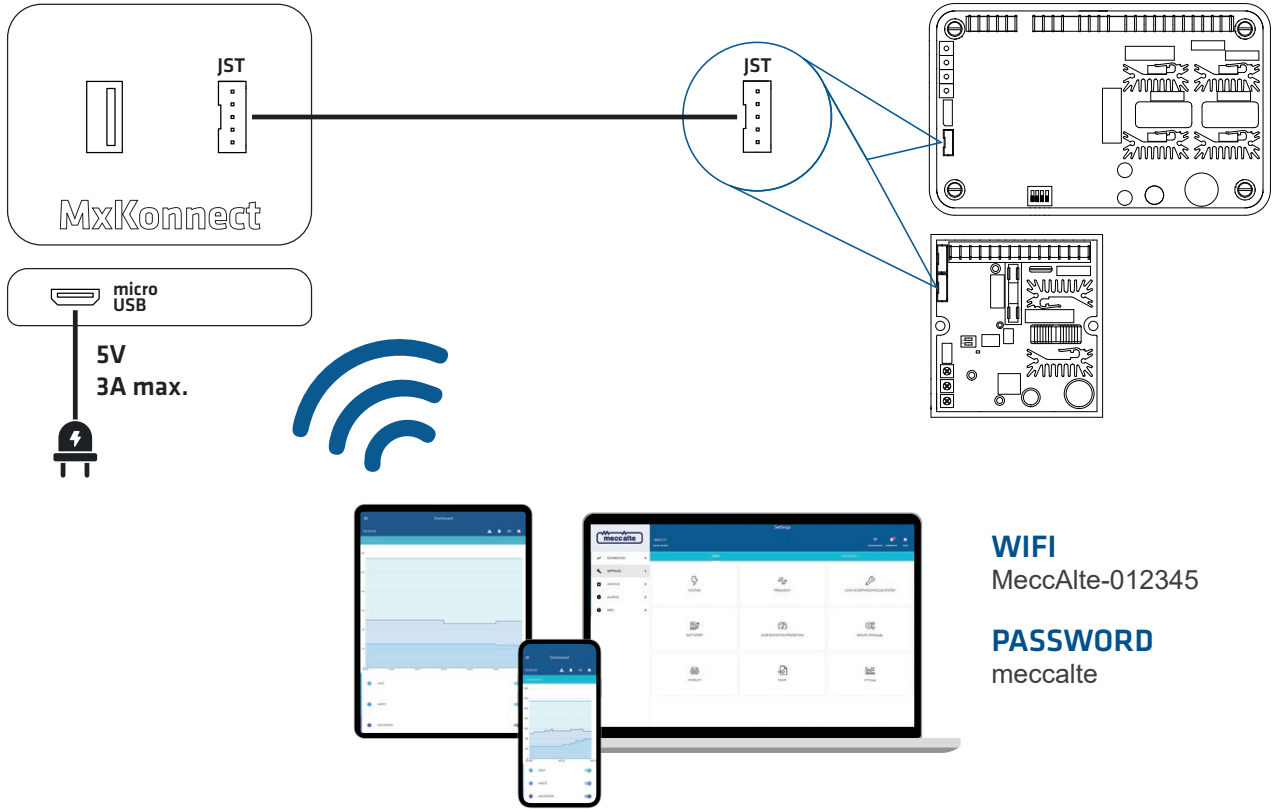

2

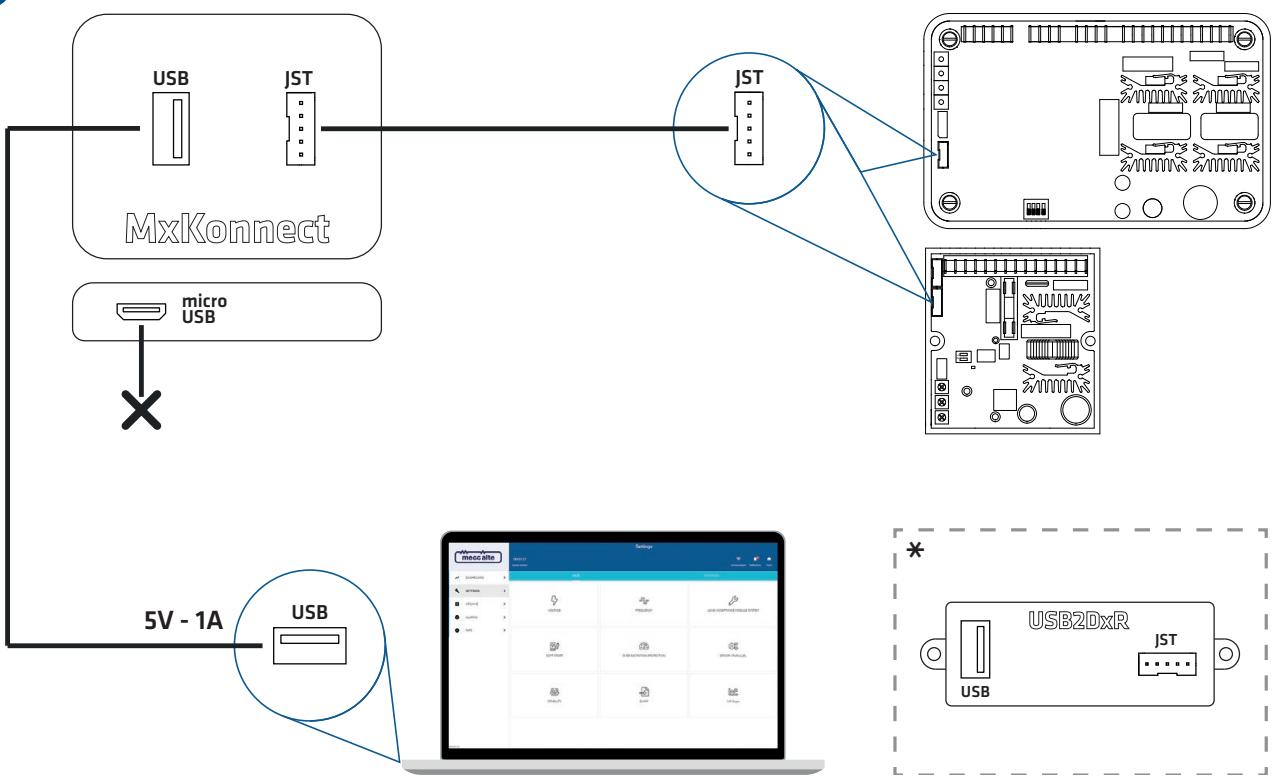

* The USB2DxR device can be used in the same way to directly connect a PC with USB to the MxK via the JST connector.

CONNECTIONS **M3K^{BHD}**

1

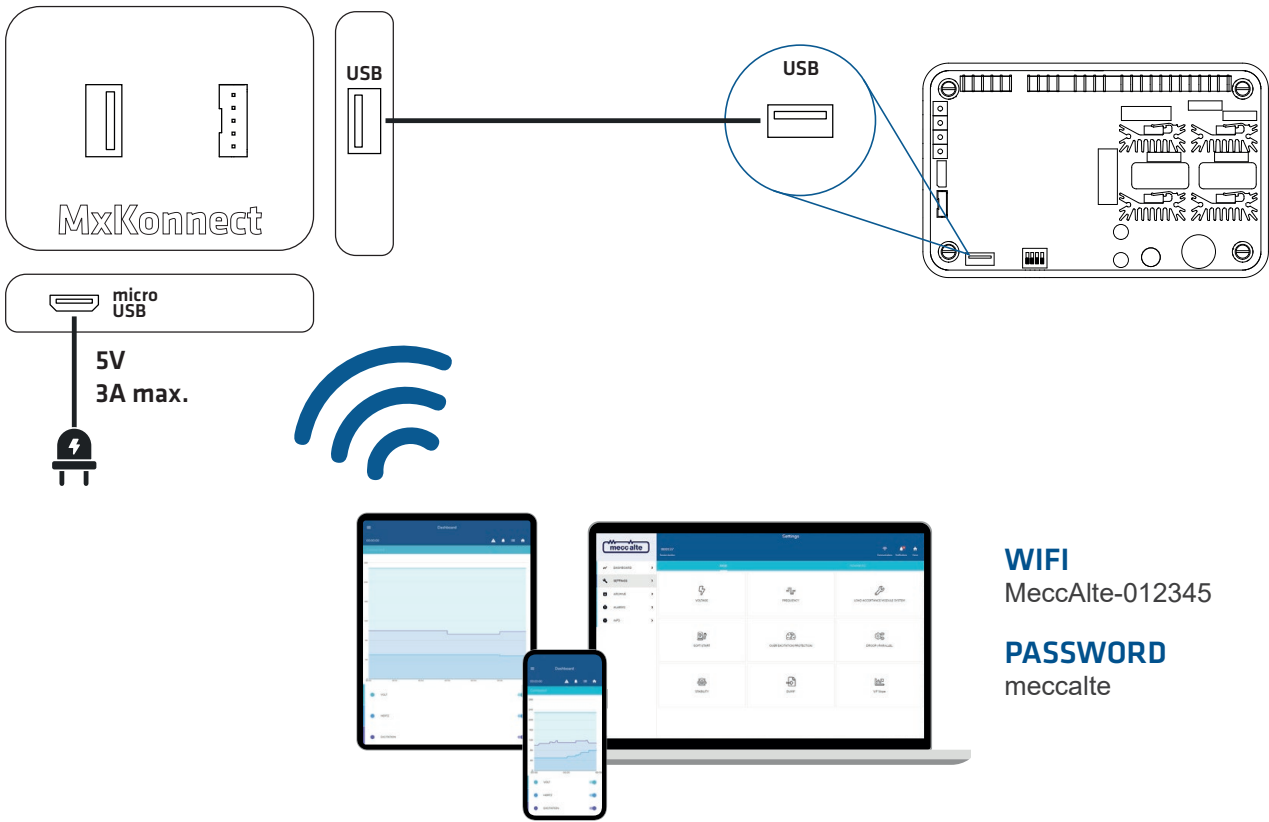

2

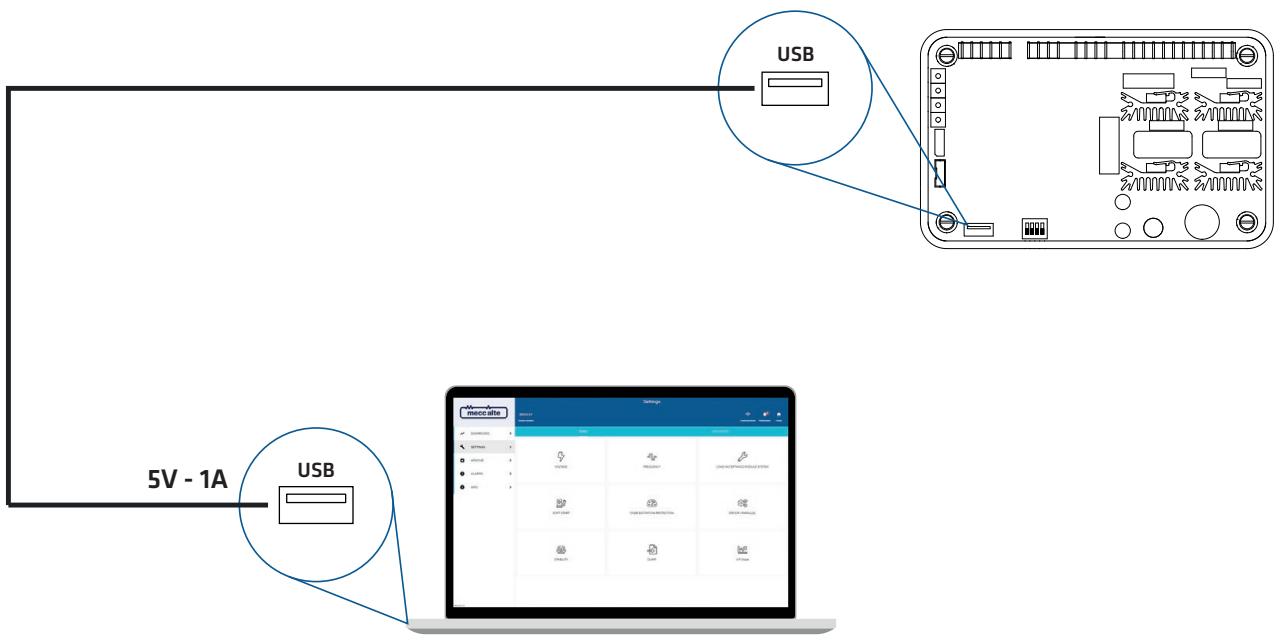

INTRODUCTION

B. DASHBOARD

This is the main control screen of your regulator. From here, you have real-time visual monitoring of the overall regulation status.

A. HOMEPAGE

Initial app startup screen. From here, you can either connect to the board or directly scan your alternator's barcode.

D. STATUS CONNECTION

The bar indicates whether you are successfully connected to the controller with your device, displaying 'Connected' if connected, or 'Disconnected' if not.

F. GRAPHIC

Here, the real-time graph of the just-established connection will be displayed, showing the trends of the three active characteristics: Voltage, Hertz, and Excitation.

C. MENU

This button opens the sidebar of the main app menu, allowing access to the Dashboard, regulator Settings, Archive of recorded logs, active Alarms and their logs and statistics, Parameters list with descriptions, and the Info page.

E. TIMER

This timer displays the duration of the connection session with the regulator, which will then be saved in the Archive.

G. SWITCHES

The three characteristics visible on the real-time graph can be toggled on or off for display.

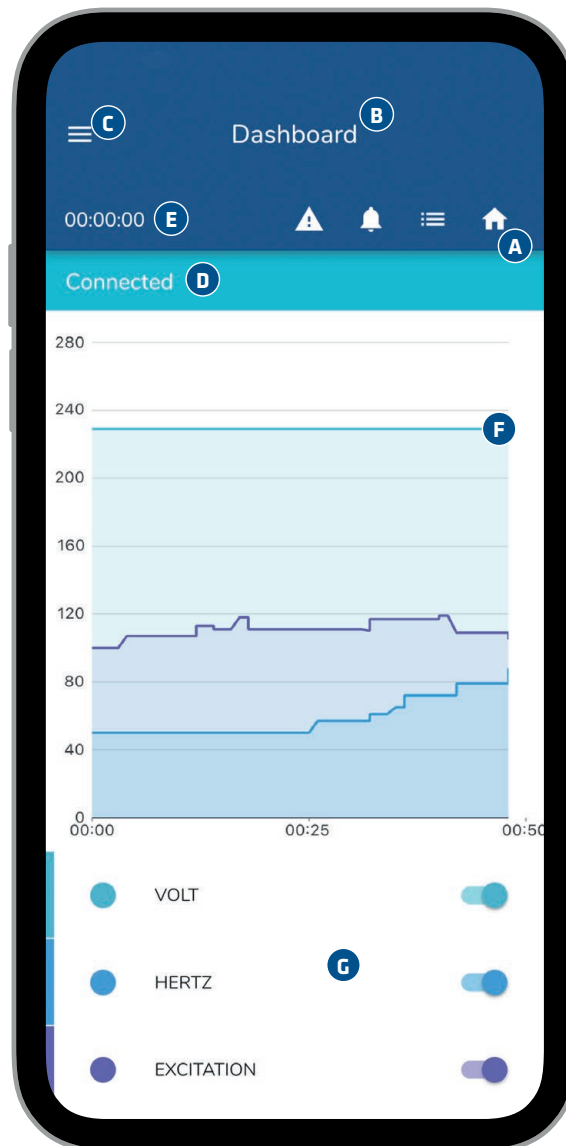

1. HOMEPAGE

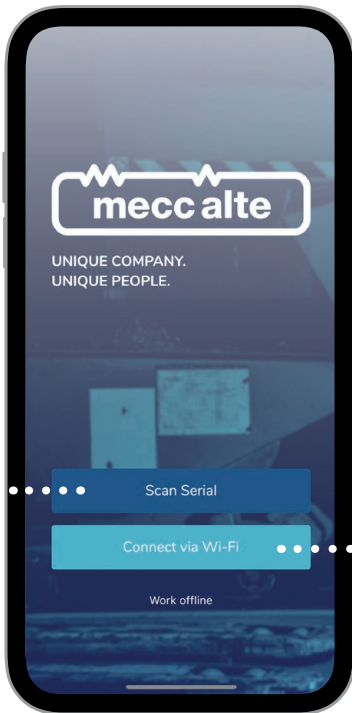

Here is the screen that will appear after opening the Mecc Alte app. There are two buttons: Scan Serial for scanning the alternator's S/N barcode, Connect via Wi-Fi to link with the MxK controller through the MxKconnect interface, and finally, Work offline to access the dashboard without a connection.

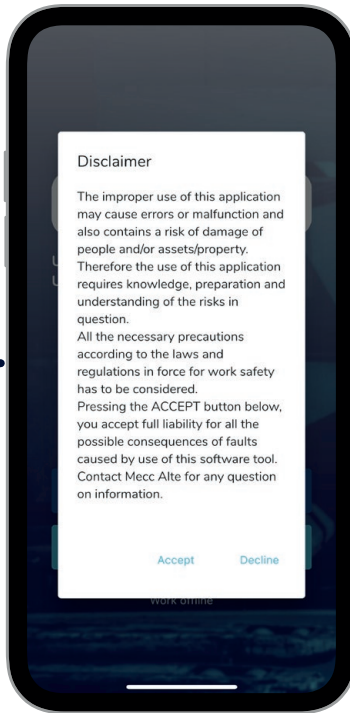

After carefully reading the disclaimer, click Proceed to continue.

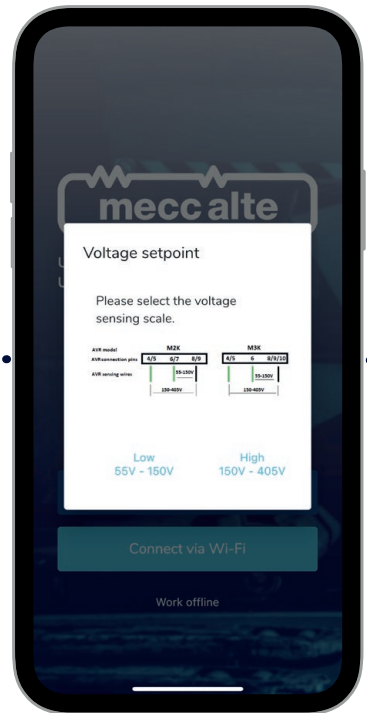

Select the appropriate sensing by checking the type of controller you have and the connection made to it.

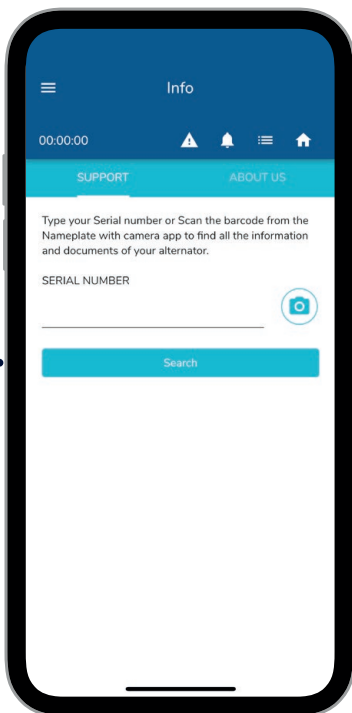

**GO TO
E. INFO
PAGE 16**

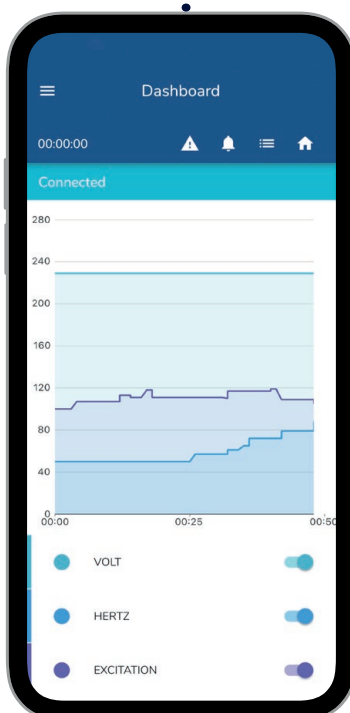

After a brief loading period, the control dashboard page will open.

**GO TO
2. DASHBOARD
PAGE 9**

2. DASHBOARD

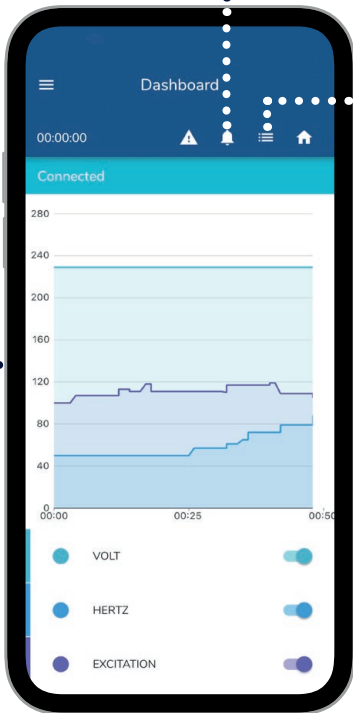

"In the Dashboard page, briefly introduced in the Introduction chapter, there are some very important sections that will be explained below.

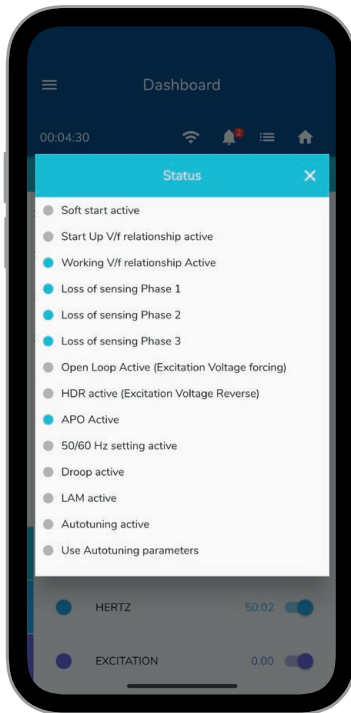

The 'Status' button immediately displays which settings and configurations are active on the controller, providing an overview.

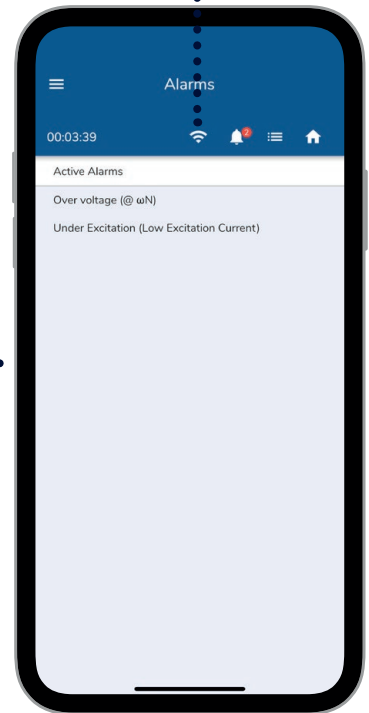

The 'Active Alarms' button shows in real-time if there are active alarms reported by the controller.

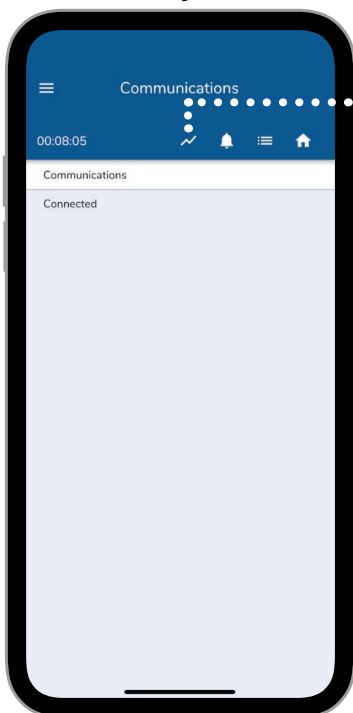

The 'Communications' button displays the status of the connection between the device and the controller.

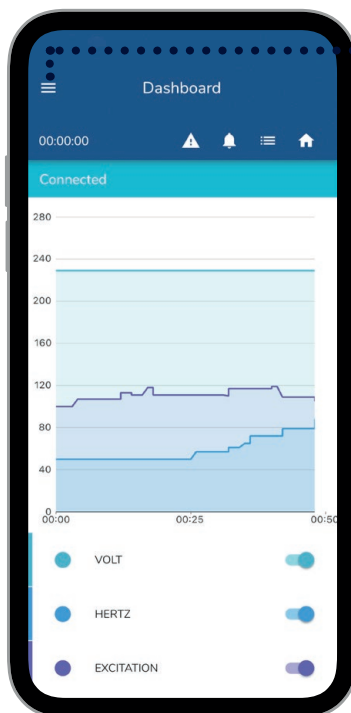

The 'Dashboard' button allows you to quickly return to the initial screen.

**GO TO
3. MENU
PAGE 10**

3. MENU

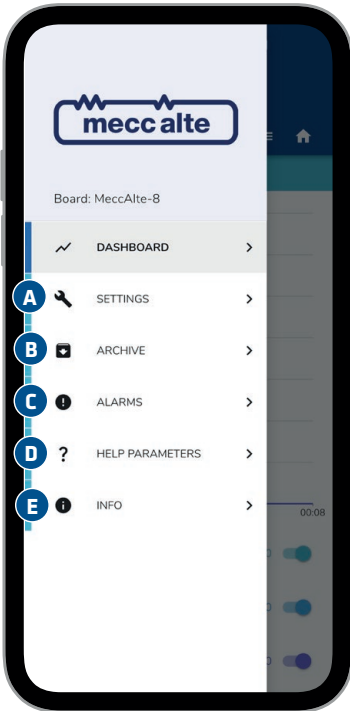

Opening the sidebar menu using the corresponding button will appear these menu items as shown in the image above.

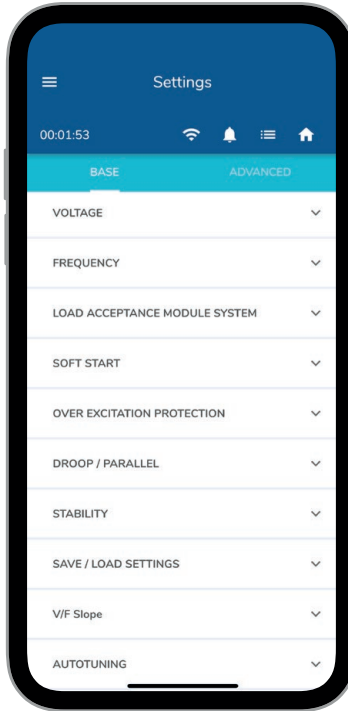

A. SETTINGS

The settings menu is a crucial part of the Mecc Alte app for controlling the regulation. The settings are divided into BASE and ADVANCED for experienced users.

GO TO PAGE 11

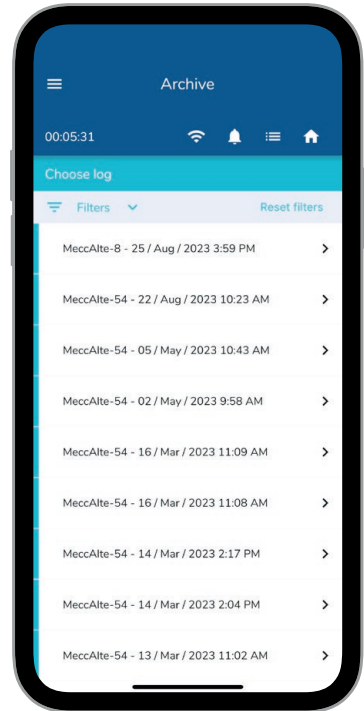

B. ARCHIVE

The Archive menu allows you to view the stored sessions of accesses and adjustments made, with the option to export them.

GO TO PAGE 14

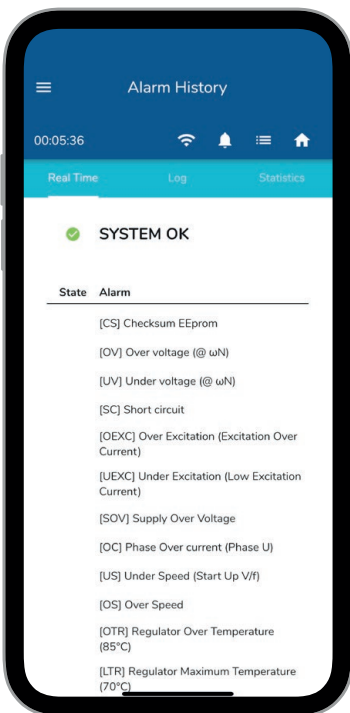

C. ALARMS

Here you can see in real-time if there are active alarms, download the log of various alarms triggered over time, and access statistics related to the different states of alarms activated over time.

GO TO PAGE 15

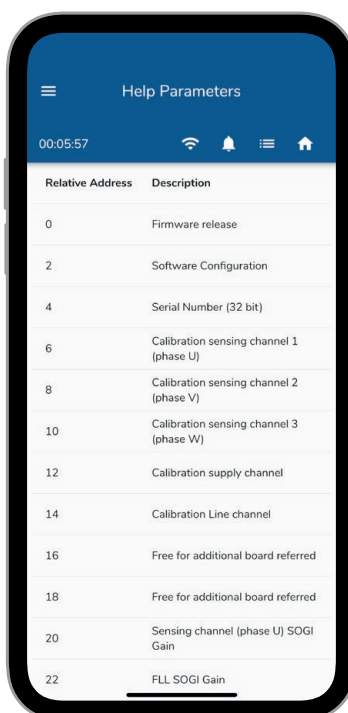

D. HELP PARAMETERS

Here, you can find a list of all the parameters of the MxK controllers along with their respective descriptions.

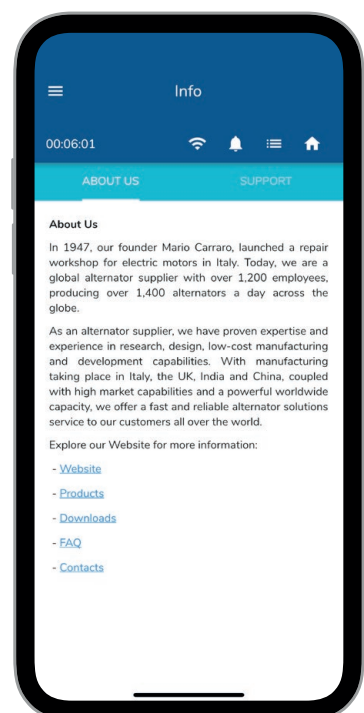

E. INFO

Here, you can find information about Mecc Alte, and in the Support section, you can search or scan an S/N to retrieve all the information about that alternator.

GO TO PAGE 16

A. SETTINGS

BASE

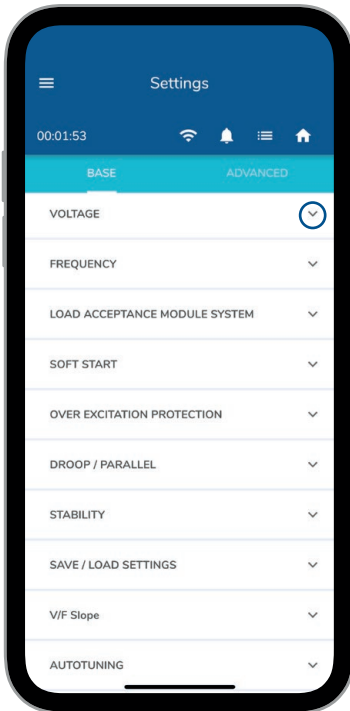

The settings page is divided into BASE and ADVANCED settings. In the BASE section, you will find the main settings with their corresponding adjustment buttons.

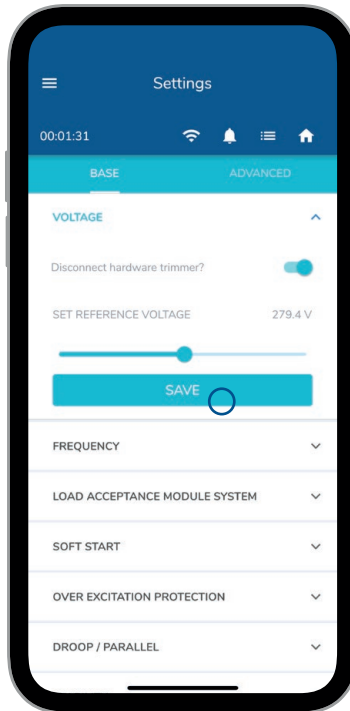

Once the panel is opened and the respective setting is correctly adjusted, press the 'SAVE' button to confirm the changes made.

SETTINGS BASE DETAIL

GO TO PAGE 12

ADVANCED

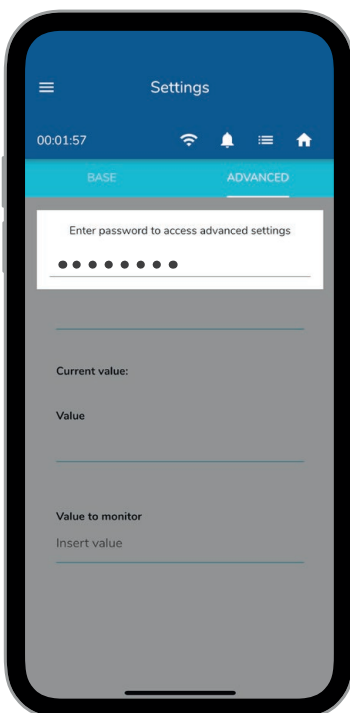

This distinction of settings allows more qualified personnel to intervene in a more detailed manner through the ADVANCED section

To access the advanced settings, a protective password needs to be entered:

Password: meccalte

ATTENTION!
The **ADVANCED** section is intended for **QUALIFIED** personnel **ONLY**. Under no circumstances will Mecc Alte be liable for any special, direct, indirect, consequential, or incidental damages or any other damages arising from or related to the use of this section of the app.

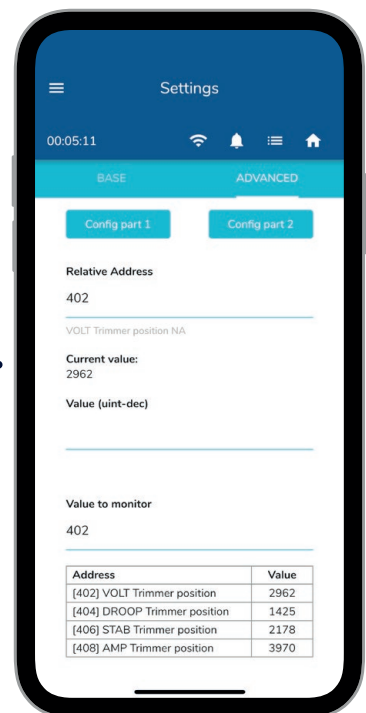

A.1 BASE SETTING

VOLTAGE

Voltage potentiometer adjustment. To disconnect the trimmer, click on the selector and adjust using the dedicated sliding bar.

[Refer to the MxK manual for proper configuration.](#)

STABILITY

STAB potentiometer adjustment for stability. To disconnect the trimmer, click on the selector and adjust using the dedicated sliding bar.

[Refer to the MxK manual for proper configuration.](#)

FREQUENCY

Frequency setting. To disable hardware-based frequency selection, click on the selector and choose the desired frequency.

[Refer to the MxK manual for proper configuration.](#)

LOAD ACCEPTANCE MODULE SYSTEM

Selector to enable or disable the Load Acceptance Module System.

[Refer to the MxK manual for proper configuration.](#)

SOFT START

Sliding bar to adjust the Soft Start.

[Refer to the MxK manual for proper configuration.](#)

OVER EXCITATION PROTECTION

AMP potentiometer adjustment. To disconnect the trimmer, click on the selector and adjust using the dedicated sliding bar.

[Refer to the MxK manual for proper configuration.](#)

DROOP / PARALLEL

DROOP potentiometer adjustment. To disconnect the trimmer, click on the selector and adjust using the dedicated sliding bar.

[Refer to the MxK manual for proper configuration.](#)

V/F SLOPE

This setting allows you to properly configure the voltage-frequency ramp using an interactive graph.

[Refer to the MxK manual for proper configuration.](#)

AUTOTUNING

The autotuning setting allows you to choose whether to use autotuning through the onboard dip switches or through the app, and whether to set it using the STAB for stability or use the preset autotuning.

[Refer to the MxK manual for proper configuration.](#)

SAVE / LOAD SETTINGS

The changes made in the controller settings can be exported to a file and can also be reloaded or loaded with new configurations. This allows you to save a backup of the correct settings or load configurations provided by Mecc Alte.

A.2 ADVANCED SETTING

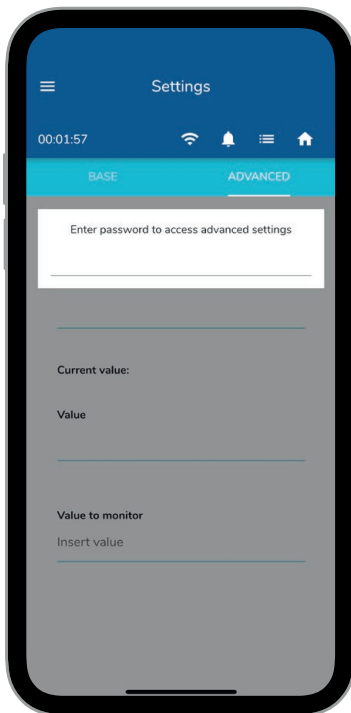

To access the advanced settings, a protective password needs to be entered:

Password: meccalte

ATTENTION!

The ADVANCED section is intended for QUALIFIED personnel ONLY. Under no circumstances will Mecc Alte be liable for any special, direct, indirect, consequential, or incidental damages or any other damages arising from or related to the use of this section of the app.

Under the field 'Value to monitor,' by entering a parameter address, the app will display the real-time value of that parameter and the following 3 parameters in numerical order.

Within the Advanced section of the settings, you can search for parameters to modify using their respective addresses. The result will provide the parameter's description and its current value. In the 'Value (unit-dec)' field, you can enter the new value that the searched parameter should have.

CONFIG PART 1

In this screen, the Configuration Word is shown with quick activation flags for various settings.

CONFIG PART 2

In this screen, the Configuration Word is shown with quick activation flags for various settings.

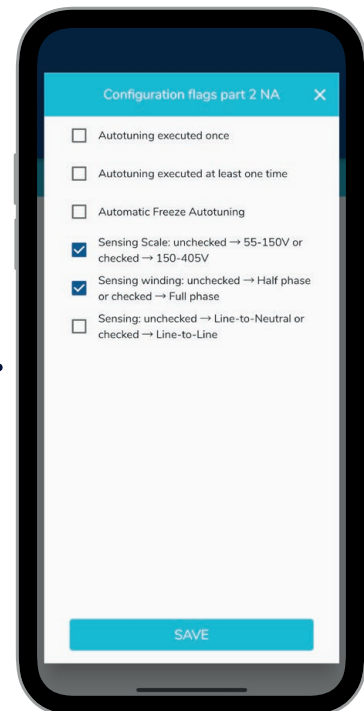
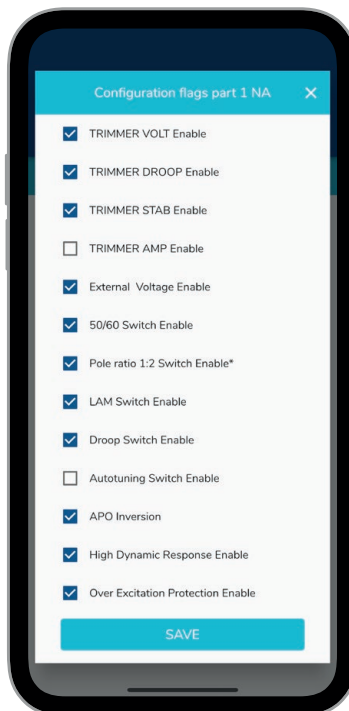
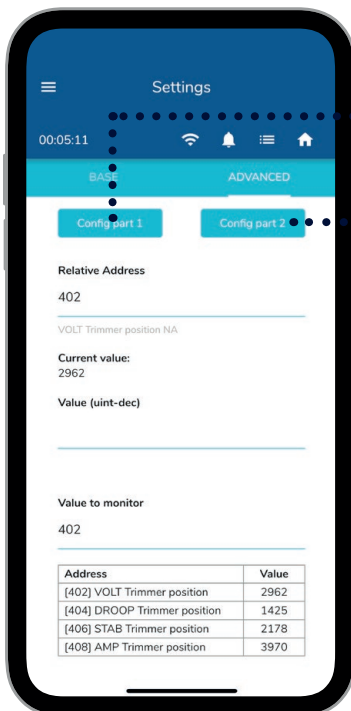

B. ARCHIVE

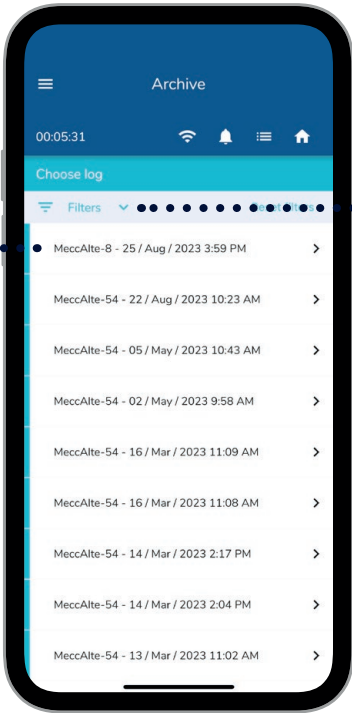

The Archive section of the app allows you to view all past sessions made with the control of the MxK regulator through the Mecc Alte app. Here, you can select the session of interest or apply filters to facilitate the search for a specific session.

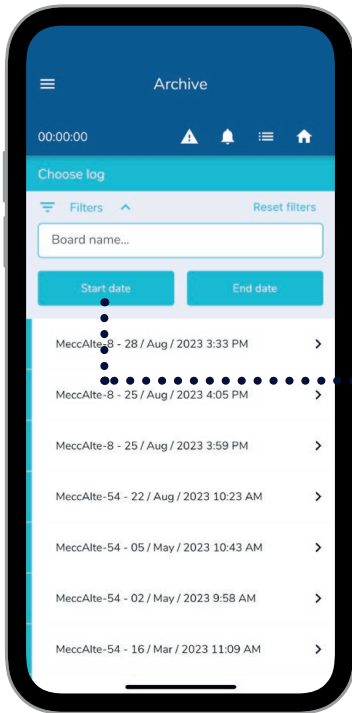

Clicking the 'Filters' button will open a window where you can enter the name and number of the regulator to facilitate the search.

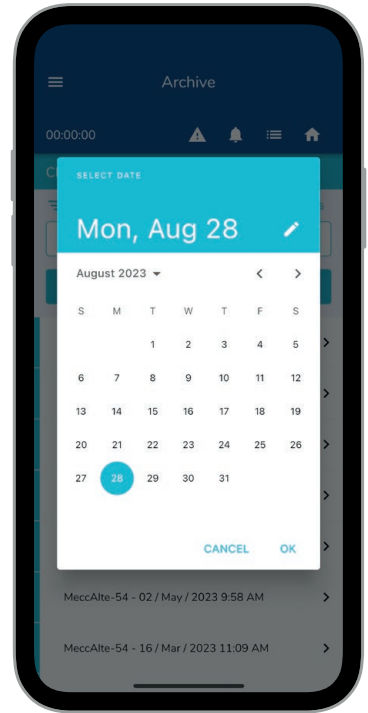

By clicking on 'Start Date' and 'End Date,' a convenient calendar will open for selecting a specific date range.

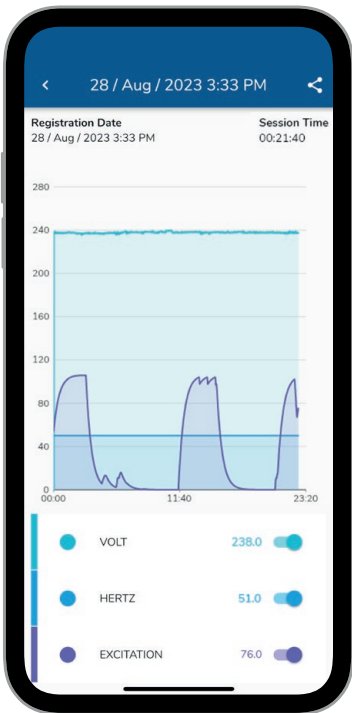

When clicking on the desired session, a panel very similar to the Dashboard screen will open, displaying the recording made with the three parameters: Volt, Hertz, and Excitation.

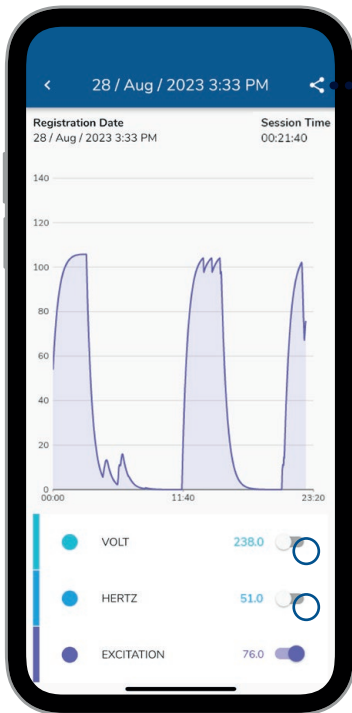

Since everything is saved within the section, the buttons for the three recorded units can be turned on or off at will.

By clicking the 'Share' button, a CSV file will be exported and it can be shared on any sharing platform and then opened on a PC for graphing and performing specific analysis of the recorded session.

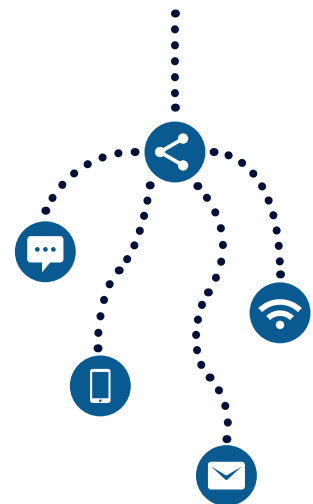

C. ALARMS

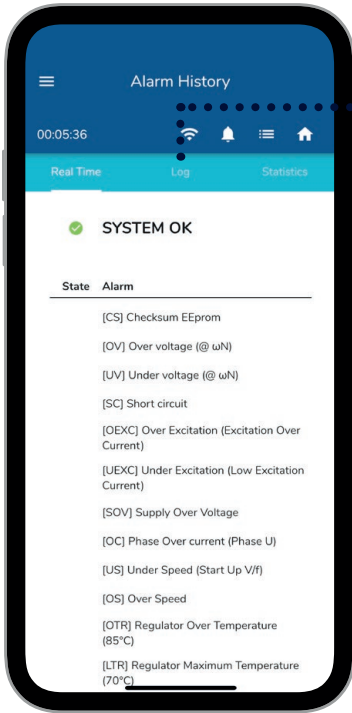

The Alarms section has 3 sub-menus. The first of these sub-menus displays the currently active alarms in real-time (which are also visible through the bell icon at the top of the app). From here, you can see which alarms are currently active.

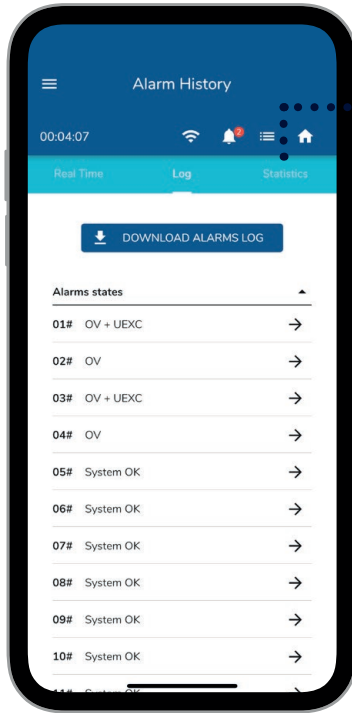

The Log section allows you to view all alarm states that have occurred over time. The 'Download Alarms Log' button allows you to download all these events in a format that can be shared, even with Mecc Alte.

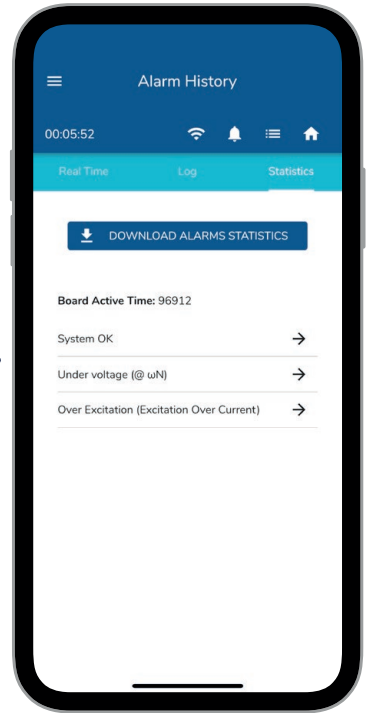

On the other hand, the Statistics section displays how many times and for how long a specific alarm has occurred on the specific regulator you are monitoring. The 'Download Alarms Statistics' button allows you to download all these events in a shareable format, which can also be shared with Mecc Alte.

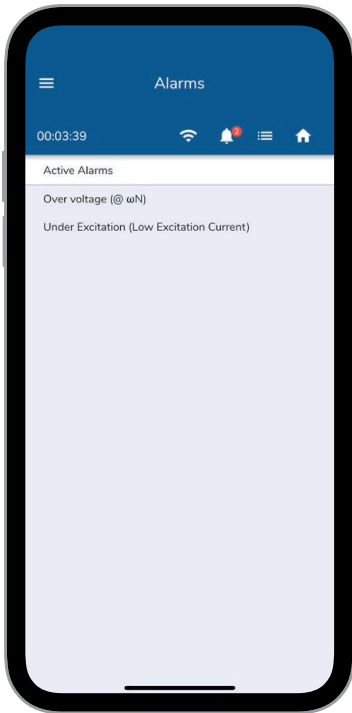

The Active Alarms screen can be accessed from any point in the app by clicking on the bell icon with a badge indicating how many alarms are active at that moment.

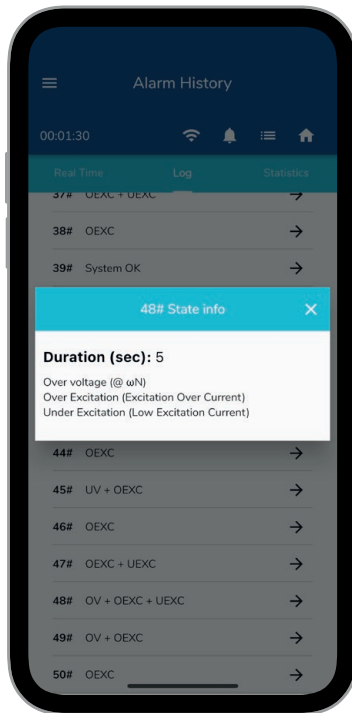

By clicking on a single event, you can see the event's duration and how many events occurred simultaneously (an example is visible above).

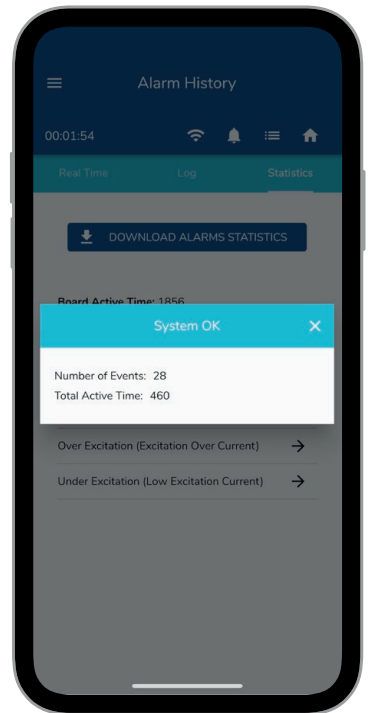

Clicking on the alarm allows you to see how many times it has occurred since the regulator was first powered on and its total duration (an example is visible above).

E. INFO

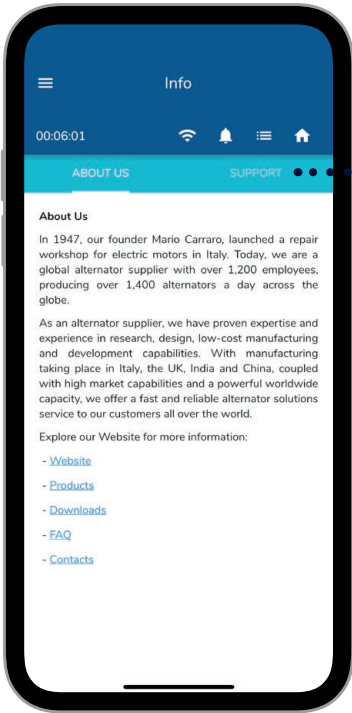

The Archive section of the app allows you to view all past sessions made with the control of the MxK regulator through the Mecc Alte app. Here, you can select the session of interest or apply filters to facilitate the search for a specific session.

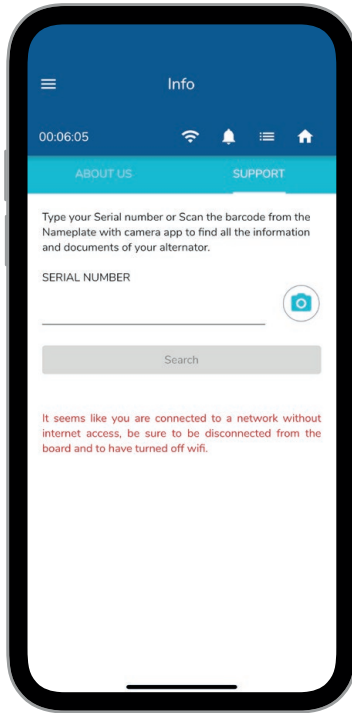

When you click on 'Support,' a page will open that allows you to view all the characteristics of that machine using the alternator's Serial Number. You can search by manually entering the Serial Number or by clicking on the camera symbol to open the barcode scanner on the machine's label.

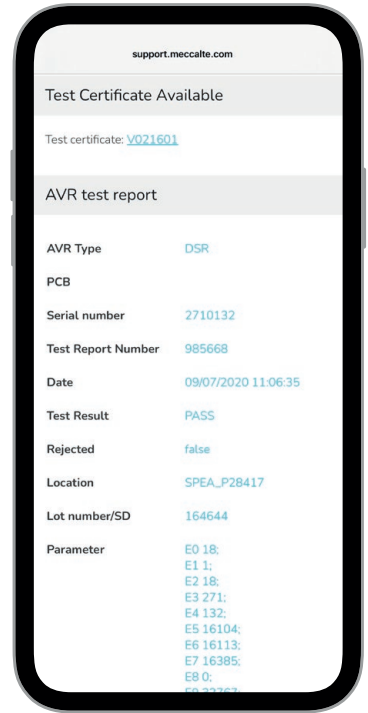

Once you have entered or scanned the serial number and press 'Search,' a web page will open, displaying all the characteristics.

Please note that an internet connection is required to use this service, which is not available when connected to the MxKconnect device.

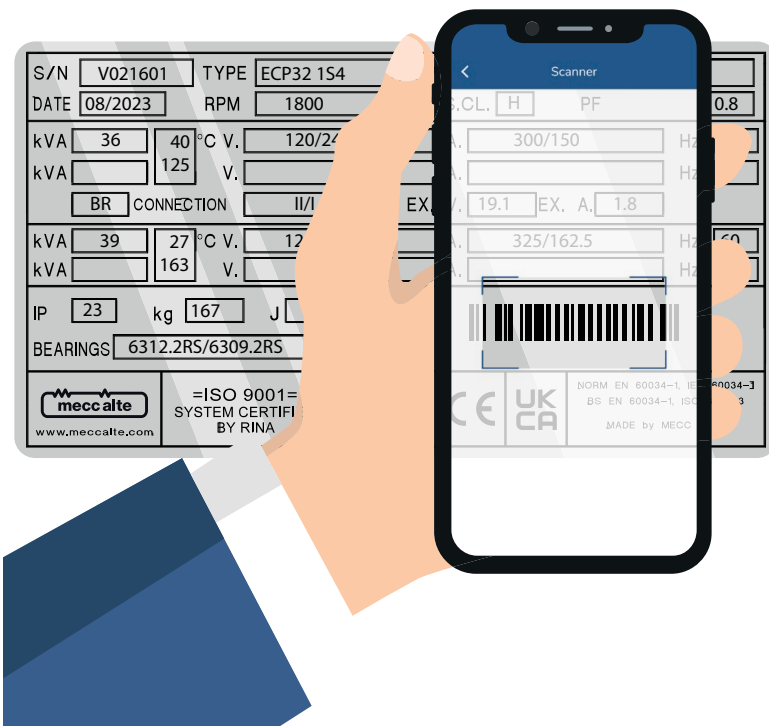

NOTES

All the screens presented in this guide for the Mecc Alte app depict the mobile device view. However, each screen displayed is exactly the same as what you will find in the PC app, only wider and in landscape mode. It can be considered the same for use on the PC app. Below are some mobile and PC comparison images.

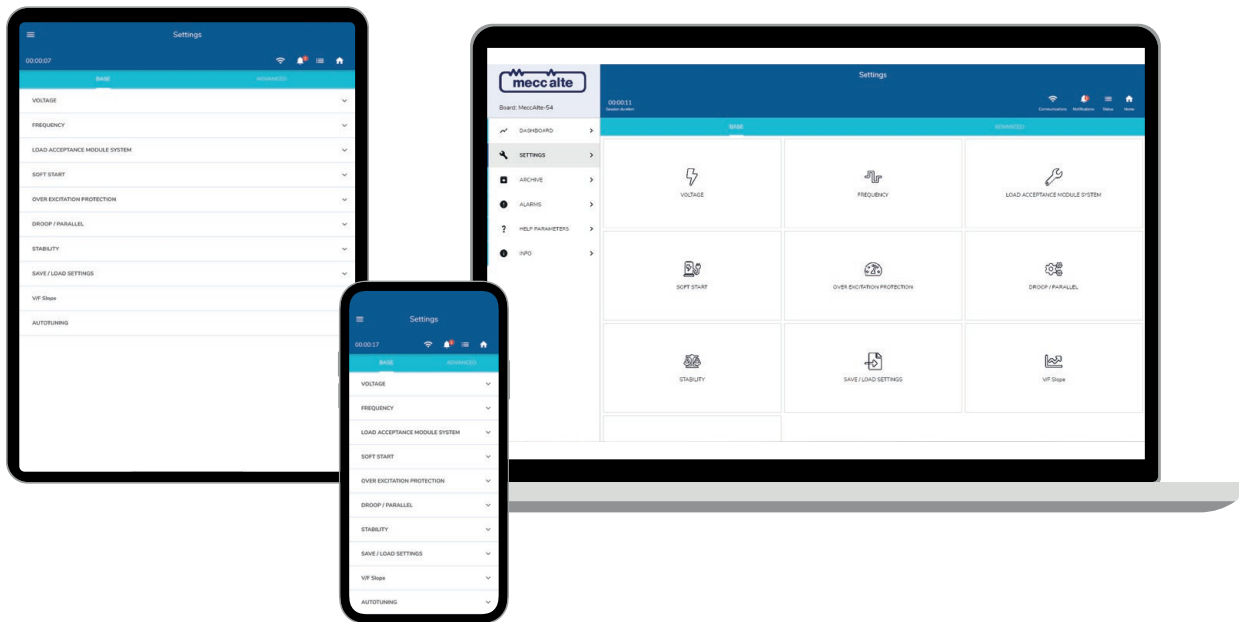
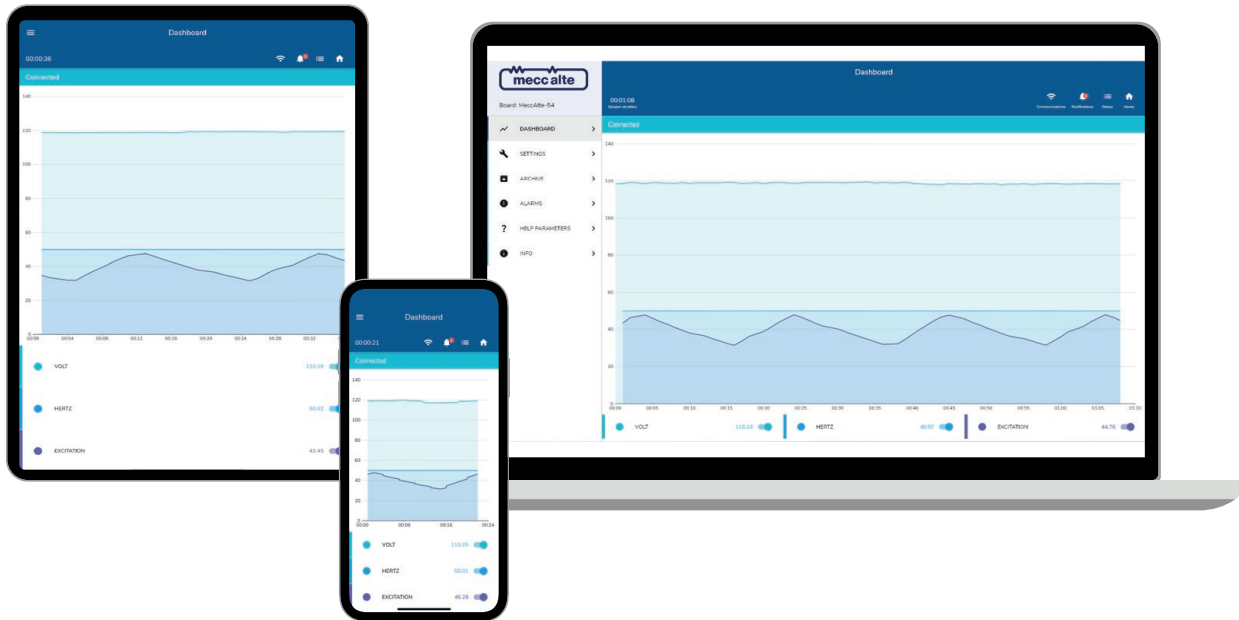

MECC ALTE SPA (HQ)

Via Roma
20 - 36051 Creazzo
Vicenza - ITALY

T: +39 0444 396111
F: +39 0444 396166
E: info@meccalte.it
aftersales@meccalte.it

MECC ALTE PORTABLE

Via A. Volta
137038 Soave
Verona - ITALY

T: +39 0456 173411
F: +39 0456 101880
E: info@meccalte.it
aftersales@meccalte.it

MECC ALTE POWER PRODUCTS

Via Melaro
2 - 36075 Montecchio
Maggiore (VI) - ITALY

T: +39 0444 1831295
F: +39 0444 1831306
E: info@meccalte.it
aftersales@meccalte.it

ZANARDI ALTERNATORI

Via Dei Laghi
48/B - 36077 Altavilla
Vicenza - ITALY

T: +39 0444 370799
F: +39 0444 370330
E: info@zanardialternatori.it

UNITED KINGDOM

Mecc Alte U.K. LTD
6 Lands' End Way
Oakham
Rutland LE15 6RF

T: +44 (0) 1572 771160
F: +44 (0) 1572 771161
E: info@meccalte.co.uk
aftersales@meccalte.co.uk

SPAIN

Mecc Alte España S.A.
C/ Río Taibilla, 2
Polig. Ind. Los Valeros
03178 Benijofar (Alicante)

T: +34 (0) 96 6702152
F: +34 (0) 96 6700103
E: info@meccalte.es
aftersales@meccalte.es

CHINA

Mecc Alte Alternator (Nantong) Ltd
755 Nantai East Rd
Jiangsu Nantong
HEDZ 226100 PRC

T: +86 (0) 513 82325758
F: +86 (0) 513 82325768
E: info@meccalte.cn
aftersales@meccalte.cn

INDIA

Mecc Alte India Pvt Ltd
Plot NO: 1, Talegaon
Dhamdhare S.O
Taluka: Shirur,
District: Pune - 412208
Maharashtra, India

T: +91 2137 673200
F: +91 2137 673299
E: info@meccalte.in
aftersales@meccalte.in

U.S.A. AND CANADA

Mecc Alte Inc.
1229 Adams Drive
McHenry, IL, 60051

T: +1 815 344 0530
F: +1 815 344 0535
E: info@meccalte.us
aftersales@meccalte.us

GERMANY

Mecc Alte Generatoren GmbH
Ensener Weg 21
D-51149 Köln

T: +49 (0) 2203 60541-0
F: +49 (0) 2203 60541-49
E: info@meccalte.de
aftersales@meccalte.de

AUSTRALIA

Mecc Alte Alternators PTY LTD
10 Duncan Road, PO Box 1046
Dry Creek, 5094, South
Australia

T: +61 (0) 8 8349 8422
F: +61 (0) 8 8349 8455
E: info@meccalte.com.au
aftersales@meccalte.com.au

FRANCE

Mecc Alte International S.A.
Z.E. la Gagnerie
16330 St. Amant de Boixe

T: +33 (0) 545 397562
F: +33 (0) 545 398820
E: info@meccalte.fr
aftersales@meccalte.fr

FAR EAST

Mecc Alte (F.E.) PTE LTD
10V Enterprise Road, Enterprise 10
Singapore 627679

T: +65 62 657122
F: +65 62 653991
E: info@meccalte.com.sg
aftersales@meccalte.com.sg



www.meccalte.com

Totally focused.
Totally independent.



MASPA: 10.2023 | V010