



Quality Products for Mechanical
& Fluid Power



ALM Series External Gear Motors

Groups 1, 2 & 3



 **MARZOCCHI**POMPE
HIGH PRESSURE GEAR PUMPS

jsi
TECHNIQUES
LIMITED

GEAR MOTORS



an excellence in engineering

www.jbj.co.uk/pumpsandmotors.html

Reduce noise levels by an average of 15 dBA.
 Including group 2, 3 and multiple pumps. The helical profile of the gears reduces pressure oscillations and vibrations produced by the pump and transmitted to the other components, reducing the noise of the hydraulic system. Axial forces induced by the helical teeth are optimally balanced in all operating conditions by the axial compensation system integrated in the pump cover. Specific compensation areas into flange and cover, insulated by special gaskets reinforced with anti-extrusion, allow for fully free axial and radial movement of the bushings, which is proportional to pump operating pressure. In this way, internal leakage is dramatically reduced, ensuring very good volumetric and mechanical pump performances, as well as proper lubrication of pump's moving parts.

Gear pump high pressure, teflon shaft seal can bear over-pressures of over 210 bar. A system of radial sealing at the shaft that can bear enormous internal over-pressures without resulting in damage. This radial sealing is particularly useful in single direction hydraulic motors when, in certain conditions of use, high over-pressures will be generated at the motor output. With bi-directional motors, the area adjacent to the seal ring of the drive-shaft is maintained at atmospheric pressure by the drainage circuit. In single-direction motors, this area is directly connected to the output so any over-pressure impacts directly on the seal ring, causing the lip to turn over or the ring to be expelled from its seat with a consequent leakage of fluid. The Teflon (P450) material adapts evenly to the texture of the machining on the shaft to guarantee a perfect seal.

Allow close coupling of hydraulic pumps directly to the flywheel / flywheel housing of diesel engines, electric and hydraulic motors.

www.jbj.co.uk/hydraulic-adaptors.html

The package consists of a bellhousing and flexible drive coupling that are fully machined to suit the pump and any driving interface; diesel or petrol engine, electric or hydraulic motor.

jbj's in-house design team and manufacturing facility provide tailored solutions for your applications at competitive prices with quick delivery.

A range of composite bell housings to accommodate electric motor flanges from 300 mm diameter to 800 mm diameter. See pages 40 to 44 of the Pump Drive Components technical specification catalogue.

A collection of different ways of connecting hydraulic pumps and motors to various driver devices.



quality products for mechanical & fluid power

01737 767493

info@jbj.co.uk

www.jbj.co.uk



jbj Techniques Limited is ISO certified, committed to international coordination & unification of industrial standards.

- registered in England No: 1185469 -

A range of products ATEX certified to directive 94/9/E requirements





The details contained within this catalogue are reproduced in accordance with the latest information at publication of this catalogue.

Errors and Omissions Excepted

Last update: 29/03/2023

	<i>Page</i>
Full range of gear pumps and motors	4 - 5
Basic design	6
ALM Series range	7
ALM Series installation and running information.	8 - 11
ALM1 Series ordering codes.	12
ALM1 Series dimensions & technical data table.	13
ALM1A Series dimensions & technical data table.	14
ALM1 Series flanges & shafts.	15
ALM1 Series ports	16
ALM1 Series performance curves.	17 - 19
ALM2 Series ordering codes.	20
ALM2 Series dimensions & technical data table.	21
ALM2A Series dimensions & technical data table.	22
ALM2BK1 Series dimensions & technical data table	23
ALM2BK2 Series dimensions & technical data table	24
ALM2BK4 Series dimensions & technical data table	25
ALM2BK7 Series dimensions & technical data table	26
ALM2 Series flanges & shafts.	27 - 28
ALM2 Series ports	29 - 30
ALM2 Series performance curves.	31 - 35
ALM3 Ordering codes.	36
ALM3 Series dimensions & technical data table.	37
ALM3A Series dimensions & technical data table.	38
ALM3 Series flanges & shafts.	39
ALM3 Series ports	40 - 41
ALM3 Series performance curves.	42 - 45
Accessories.	46
Basic construction of gear pump and motor range	47
Valves and mounting arrangements	48
#DriveLineHarmony	50 - 51

	Displacement	P1 Max. continuous pressure	P2 Max. intermittent pressure	P3 Maximum peak pressure	Maximum speed	Maximum drain line pressure
Group 0.25	from 0.19 to 0.64 cm ³ /rev.	190 bar	210 bar	230 bar	7000 rpm	-
0.25 RO	from 0.19 to 0.64 cm ³ /rev.	230 bar	250 bar	270 bar	7000 rpm	-
Group 0.50	from 0.50 to 1.50 cm ³ /rev.	190 bar	210 bar	230 bar	4000 to 7000 rpm	-
0.50 RO	from 0.50 to 1.25 cm ³ /rev.	230 bar	250 bar	270 bar	5000 to 7000 rpm	-
Group 1P	from 1.1 to 8 cm ³ /rev.	160 to 230 bar	190 to 250 bar	200 to 270 bar	2100 to 6000 rpm	-
Group ALP1	from 1.4 to 13.8 cm ³ /rev.	150 to 250 bar	165 to 270 bar	180 to 290 bar	1800 to 6000 rpm	-
Group ALP2	from 4.5 to 35.2 cm ³ /rev.	140 to 250 bar	155 to 270 bar	170 to 290 bar	2500 to 4000 rpm	-
Group ALP3	from 20 to 87 cm ³ /rev.	140 to 230 bar	155 to 250 bar	170 to 270 bar	2000 to 3500 rpm	-
Group ALP4	from 87 to 200 cm ³ /rev.	130 to 240 bar	140 to 260 bar	150 to 280 bar	2400 to 2800 rpm	-
Group GHP1	from 1.4 to 13.8 cm ³ /rev.	190 to 270 bar	195 to 290 bar	210 to 310 bar	1800 to 6000 rpm	-
Group GHP2	from 4.5 to 35.2 cm ³ /rev.	160 to 280 bar	175 to 295 bar	190 to 310 bar	2500 to 4000 rpm	-
Group GHP3	from 20 to 87 cm ³ /rev.	160 to 280 bar	175 to 295 bar	190 to 310 bar	2000 to 3500 rpm	-
Group ALP/GHP1 Modular	from 1.4 to 13.8 cm ³ /rev.	150 to 270 bar	165 to 290 bar	180 to 310 bar	1800 to 6000 rpm	-
Group ALP/GHP2 Modular	from 4.5 to 35.2 cm ³ /rev.	140 to 280 bar	155 to 295 bar	170 to 310 bar	2500 to 4000 rpm	-
Group ALP/GHP3 Modular	from 20 to 87 cm ³ /rev.	140 to 280 bar	155 to 295 bar	170 to 310 bar	2000 to 3500 rpm	-
Group ALP4 Modular	from 87 to 200 cm ³ /rev.	130 to 240 bar	140 to 260 bar	150 to 280 bar	2400 to 2800 rpm	-
	Displacement	P1 Max. continuous inlet pressure	PC Max. continuous outlet pressure	PP Max. peak inlet pressure	Maximum speed	Maximum drain line pressure
Group ALM1 Uni-directional	from 2.8 to 11 cm ³ /rev.	170 to 250 bar	160 to 240 bar	185 to 270 bar	2200 to 5000 rpm	-
Group ALM1 Bi-directional	from 2.8 to 11 cm ³ /rev.	170 to 250 bar	160 to 240 bar	185 to 270 bar	2200 to 5000 rpm	6 bar
Group ALM2 Uni-directional	from 4.5 to 28.2 cm ³ /rev.	170 to 250 bar	160 to 240 bar	185 to 270 bar	2500 to 4000 rpm	-
Group ALM2 Bi-directional	from 4.5 to 28.2 cm ³ /rev.	170 to 250 bar	160 to 240 bar	185 to 270 bar	2500 to 4000 rpm	6 bar
Group ALM3 Uni-directional	from 22 to 87 cm ³ /rev.	140 to 230 bar	130 to 220 bar	155 to 250 bar	2000 to 3500 rpm	-
Group ALM3 Bi-directional	from 22 to 87 cm ³ /rev.	140 to 230 bar	130 to 220 bar	155 to 250 bar	2000 to 3500 rpm	6 bar
Group GHM1 Uni-directional	from 2.8 to 11 cm ³ /rev.	200 to 270 bar	190 to 260 bar	215 to 290 bar	2200 to 5000 rpm	-
Group GHM1 Bi-directional	from 2.8 to 11 cm ³ /rev.	200 to 270 bar	190 to 260 bar	215 to 290 bar	2200 to 5000 rpm	6 bar
Group GHM2 Uni-directional	from 4.5 to 28.2 cm ³ /rev.	200 to 280 bar	190 to 270 bar	215 to 295 bar	2500 to 4000 rpm	-
Group GHM2 Bi-directional	from 4.5 to 28.2 cm ³ /rev.	200 to 280 bar	190 to 270 bar	215 to 295 bar	2500 to 4000 rpm	6 bar
Group GHM3 Uni-directional	from 22 to 87 cm ³ /rev.	160 to 280 bar	150 to 270 bar	175 to 295 bar	2000 to 3500 rpm	-
Group GHM3 Bi-directional	from 22 to 87 cm ³ /rev.	160 to 280 bar	150 to 270 bar	175 to 295 bar	2000 to 3500 rpm	6 bar
	First stage small displacement. High pressure.	Second stage large displacement. Low pressure.	Unloading valve.	Ports.	RPM range.	Flange and shafts.
Group HL	from 1.1 to 8.3 cm ³ /rev. P1 = up to 250 bar.	from 3.7 to 35.2 cm ³ /rev. (pressure set by unloading valve).	Standard setting from 30 to 50 bar, special settings on request	Common inlet. Common outlet. Side ports code FG, FA, D	1000 rpm to 3500 rpm	According to the HL pump type
	Displacement			Ports.	RPM range.	Flange and shafts.
Group ALPC/GHPC	from 1.4 to 35.2 cm ³ /rev. Max. pressure 270 bar.			Common inlet (option). Side ports code E; EP; FG; FC; FA; D (according to the pump type); Rear ports KA (only group 2)	1000 rpm to 4000 rpm	According to the HL pump type

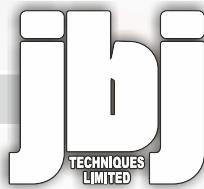

www.jbj.co.uk/gearpumps.html



0.25 - 0.5 Series Micro Gear Pumps

Extensive range and very high performance of these pumps integrated in to micro power packs make them ideal for many applications from aerospace to marine, medical to automotive.



1P Series Gear Pumps

High production rates, performance consistency and absolute reliability ensure this a benchmark product for the hydraulic power pack market.



ALP Series Gear Pumps

This product range includes pumps of displacements (up to 200cc/rev) in a full aluminium configuration, able to withstand medium to high pressures and using different versions of flanges (European, German and SAE), porting and shafts. Mono-directional as well as reversible.



GHP Series Gear Pumps

The GHP series offer identical configurations to the ALP series and guarantees extreme reliability in very high pressure applications. Ideal for mobile applications from agricultural to construction machines as the cast iron allows more flange, cover and port options.



ALP/GHP Series Multiple Modular Gear Pumps

Modularity and flexibility are the characteristics of these pumps. They allow the assembly of pump modules of the ALP and GHP (from 0.25 to 4) enabling solutions to a wide range of application requirements.



ALM Series Gear Motors

For medium to high pressure rates the ALM series is ideal for mobile and industrial sectors. Mono-directional and bi-directional with internal and external drain available.



GHM Series Gear Motors

The GHM series offer identical configurations to the ALM series but more robust thanks to the cast iron front flange and rear cover.



High/Low 2-Pass Gear Pumps

Ideal pump for applications which require a fast approach and/or return of the actuator at low loads and slow motion of the actuator at high loads. e.g. log splitters, compactors & presses. Volumetric and mechanical efficiencies as well as low noise levels are further benefits of this range.



ALPC/GHPC Series Short Multiple Gear Pumps

For reduced axial layout. Available with both flanges and covers in aluminium or cast iron.



ELIKA®
The low noise, low pulsation helical gear pump. Groups 2, 3, 4 and multiple pumps.



Reduces the noise level by up to 20 dBA.

jbj Techniques Limited, UK distributor for **MARZOCCHI POMPE**

quality products for mechanical & fluid power

01737 767493

info@jbj.co.uk

www.jbj.co.uk

jbj Techniques Limited is ISO certified, committed to international coordination & unification of industrial standards.

- registered in England No: 1185469 -

A range of products ATEX certified to directive 94/9/E requirements



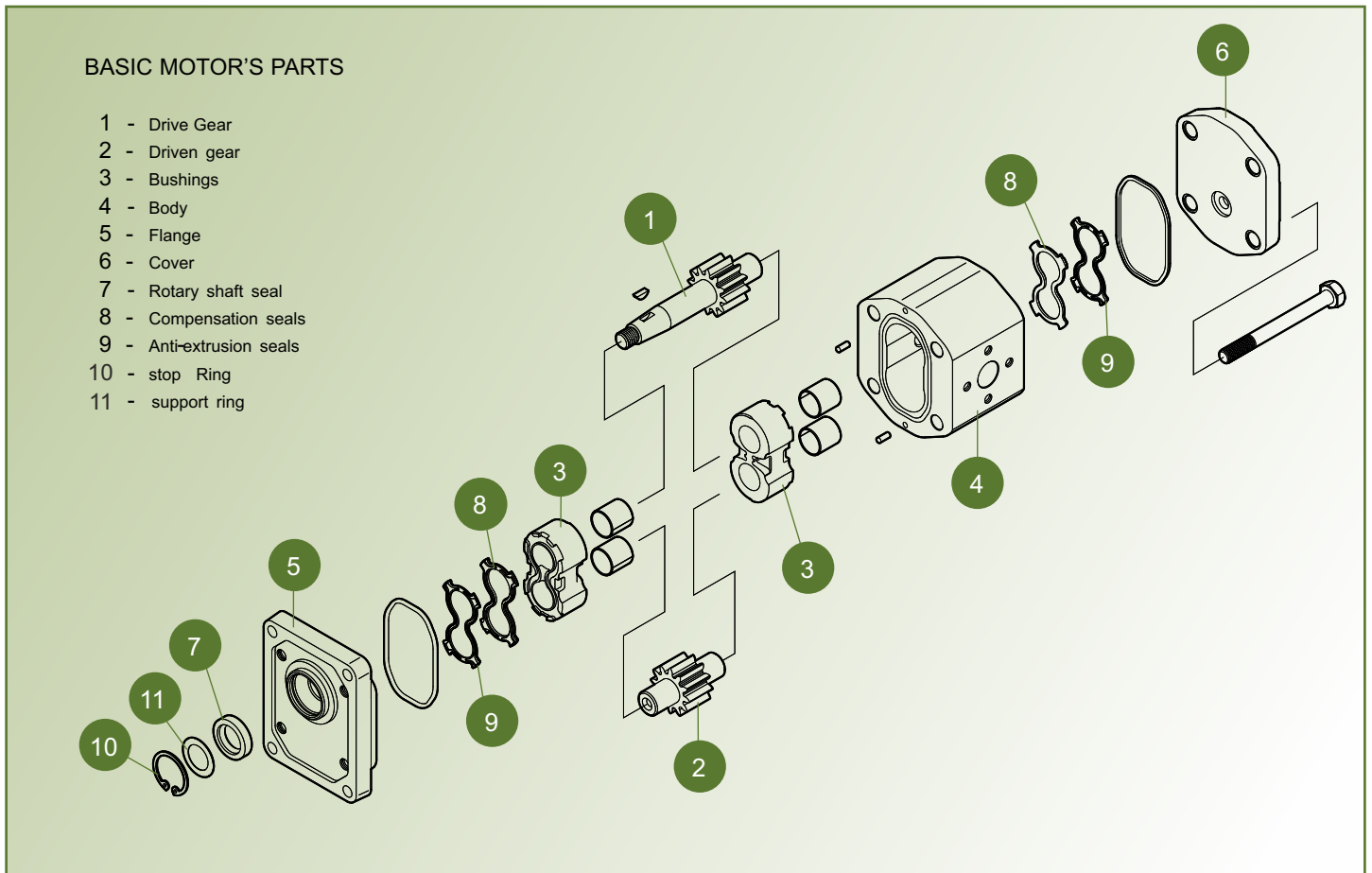

Gear motors convert hydraulic pressure and flow into torque and angular displacement, rotary mechanical power, applied to a load via the shaft. They feature versatility, strength and long useful life. Their simple construction compared to other types of motors (piston, orbital, etc) ensures limited purchase costs and servicing.

Thanks to these basic concepts, together with ever-improving product design and features, research-based on many years of experience, accuracy in material selection, production process followed in great detail and tests on mass-produced parts, jbj Techniques can provide Marzocchi gear motors with top quality standards that can work under heavy operating conditions and transmit high hydraulic power. Furthermore, these gear motors feature good hydraulic, mechanical and volumetric efficiency, low noise level and compact dimensions with low weight/power ratio.

Marzocchi Pompe has renewed its own range of products, now launched with the new name of GHM1, GHM2 and GHM3, suitable for the widest range of application, both in the industrial and the mobile sector.

Generally these gear motors usually consist of a gear pair supported by two aluminum bushings, a body, a securing flange and a cover. Shaft of the driving gear projecting beyond the flange mounts a seal ring coupled with a metallic ring to strengthen the solution; both rings are held in place by an elastic securing ring. The body is profiled by means of extrusion and it is made of a special aluminium alloy with high strength for minimized deformation even when subject to high pressure.

The flanges and covers are made out of cast iron, obtained through a process of continuous flow casting and with a final surface treatment of phosphating. Gears are made of special steel. Their manufacturing process includes case-hardening and quench hardening. Then gears are ground and fine finished so to have a high degree of surface finishing. Proper tooth profile design and geometric proportions ensure low pulsation levels and low noise levels during motor operation. Bushings are made of special low-friction and hi-resistant aluminium alloy and manufactured from die-casting that have excellent characteristics of high strength and anti-friction properties. Also equipped with anti-friction DU bearings with tight tolerance. Special and symmetric compensation zones onto bushings, insulated by special preformed seals with special anti-extrusion ring, allow fully free axial and radial movement to the bushings, which is proportional to motor operating pressure. In this way, internal leakage is dramatically reduced, thus ensuring very good pump performance (both in terms of mechanical and total efficiencies) and proper lubrication of pump moving parts.



Bi-directional motors.

Produced in three different groups with very good power/weight ratio and power/size ratio allowing a wide range of displacements within each group (between 2.8 and 87 cc/rev). The wide range of allowed speeds, the excellent functionality also on their use in series, with strong counter-pressures and limited drain, give to motors of the ALM series very good characteristics even starting under load. The drain is always external and it is through a thread port on the cover. A range of flanges, shafts, inlet and pressure ports are available.

Mono-directional motors.

These motors are without external drain and can be used with counter-pressures of maximum 6 bars; they can be used in both left (ALM...S) or right (ALM...D) configuration. The available displacements for the ALM1 group are between 1.4 to 13.8 cc/rev, for the group ALM2 between 4.5 to 35.2 cc/rev while for the group ALM3 between 20 and 87 cc/rev. For applications that require counterpressures higher than 6 bar please contact jbj Techniques technical office, email: info@bj.co.uk or telephone: +44(0)1737 767493.

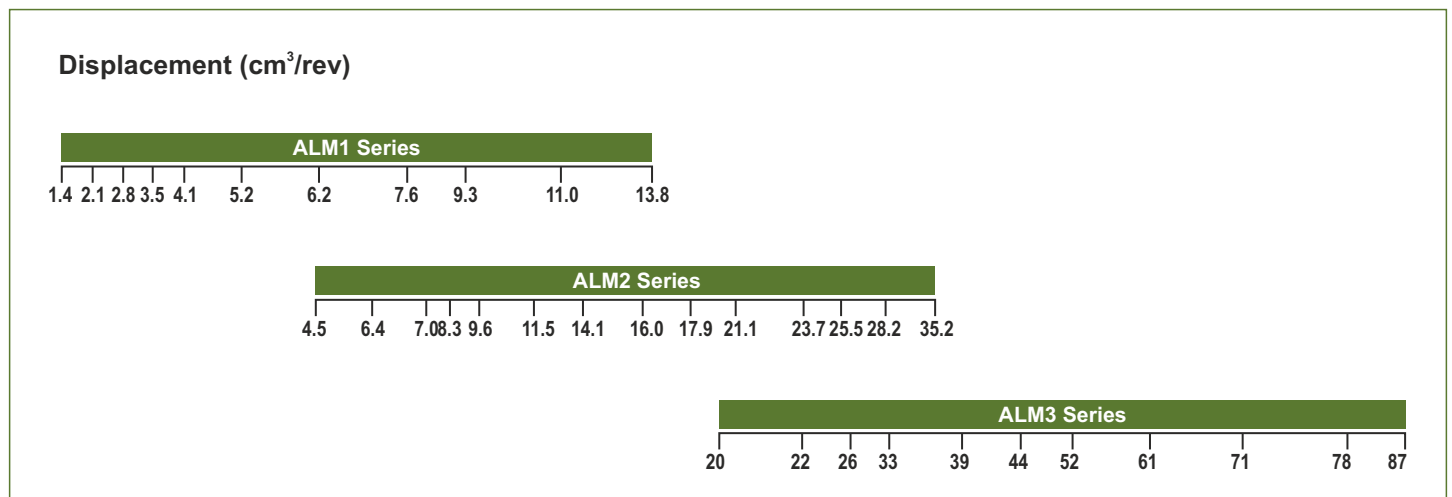

Special Versions

For special uses are also available:

"V" Version suitable for fluid at high temperatures.

Range between -10°C and +120°C. In the range between -10°C and +80°C maximum pressures as stated in the individual product tables are allowed; beside that figures in the 'PC' column of the tables should not be exceeded.

"VV" Version suitable for fluid at high temperatures.

Range between -10°C and +150°C with maximum pressure 20 bar

"ST" Version suitable for fluid at high or low temperature.

Range between -40°C and +120°C. In the range between -10 °C and +80°C maximum pressures as stated in the individual product table; below and beside that figures in the 'PC' column of the tables should not be exceeded.

"H" Version suitable for fluid at low temperature.

Range between -40°C and +80°C. In the range between -10 °C and +80°C maximum pressures as stated in the product table; below that figures in the 'PC' column of the tables should not be exceeded.

The above descriptions are to be specified in the SEAL field of the ordering code.



It is essential for correct running, top performance and longer life of the GHM series hydraulic gear motors to follow the installation and running information provided in this catalogue.

Some general considerations should be made regarding the hydraulic system, in which the motor is to be fitted. Special attention should be given to hydraulic system design and assembly, especially to intake, delivery, return and drain pipes and position of system parts (valves, filters, tanks, heat exchangers and accumulators).

Proper safety devices and reliable instruments to avoid fluid turbulence and prevent air, water or foreign bodies from entering into the system are of major importance. It is also very important to equip the hydraulic system with a proper filtering unit.

Installation Notes

Before starting the system on a continuous basis, we suggest to adopt some simple precautions.

In the case of a mono-directional motor check for the direction of rotation of the pump to be consistent with the inlet side.

Check for the proper alignment of motor shaft and that of the driven part. It is necessary that the connection does not induce axial or radial loads.

Protect drive shaft seal during motor painting. Check if contact area between seal ring and shaft is clean: dust could cause quicker wear and leakage.

Remove all dirt, particles and all foreign bodies from flanges connecting inlet and delivery ports.

Ensure that intake of the supply pump and return pipes ends are always below fluid level and as far from each other as possible.

Disconnect supply pump drain during startup to bleed air off the circuit.

At first startup, set pressure limiting valves at minimum value possible.

Do not allow the motor to run at speed lower than minimum allowed with pressure higher than the figures indicated in the 'PI' column of model specific data tables.

Do not start the system at low temperatures under load conditions or after long stops.

Start the system for a few minutes and turn on all components. Bleed air off the circuit to check its proper filling.

Check fluid level in the tank after loading all components.

Lastly, gradually increase pressure, continuously check fluid and moving parts temperatures. Check rotation speed until you reach set operating values that must be within the model specific limits indicated in this catalogue.

Cleaning And Filtering The System

It is widely known that most motors early failures are due to contaminated fluids. The extreme reduction of the tolerances required in the design of the motors and therefore their operation with minimum clearances, are heavily influenced by a fluid that is not perfectly clean. It is proved that particles circulating in the fluid act as abrasive agents, damaging the surfaces they touch and increasing the quantity of contaminant.

For this reason, ensure that system is perfectly clean during startup and keep it clean for its whole operating life.

Necessary interventions to check and limit contamination should be performed in a preventive and corrective way. Preventive actions include: proper cleaning of the system during assembly, deburring, eliminating the welding scum and fluid filtering before filling up.

Starting contamination level of system fluid should not exceed class 18/15 (ref. ISO 4406). Even fresh fluids might exceed this contamination level; therefore always pre-filter the fluid when filling up or topping up the system. Fit a proper tank; its capacity should be proportional to the volume displaced in one working minute.



Fluid contamination level check and correction during operation can be obtained through filters that retain the particles present in the fluid itself. Two parameters tell which filter is most suitable: absolute filtering power and b filtering ratio. Low absolute filtering power and high b filtering ratio for small particles help ensuring good filtration.

It is then very important to limit not only maximum dimensions, but also the number of smaller particles that pass through the filter. It goes without saying that with an operating pressure increase and according to the system sophistication degree, filtering should become more and more efficient.

The filtering system shall always ensure contamination levels not exceeding the values indicated below:

Pressure	<140 bar	140 to 210 bar	>210 bar
NAS 1638 Class	10	9	8
ISO 4406 Class	19/16	18/15	17/14
Ratio bx = 75	25-40 µm	12-15 µm	6 -12 µm

It is recommended to use a filtering system having absolute filtering capability of 5 µm or lower in the systems using sophisticated valve slaves.

Hydraulic Fluids

Use specific mineral oil based hydraulic fluids having good anti-wear, anti-foaming (rapid deaeration), antioxidant, anti-corrosion and lubricating properties. Fluids should also comply with DIN 51525 and VDMA 24317 standards and get through 11th stage of FZG test.

For the standard models, the temperature of the fluid should be between -10°C and +80°C.

Fluid kinematic viscosity ranges are the following:

allowed value (upon verification)	6 to 500 cSt
recommended value	10 to 100 cSt
value allowed at startup	<2000 cSt

If fluids other than the above mentioned ones are used, please always indicate type of used fluid and operating conditions so that jbj Techniques technical office can consider possible problems with compatibility or useful life of system parts.

Min. Rotation Speed

The versatility of the ALM series motors can be perceived from the wide range of rotation speeds they can be subject to: maximum values are indicated in product tables and change according to the model, while minimum values are as follows:

Group	ALM1							
Size	4	5	6	7	9	11	13	16
Min. Speed (rpm)	700							

Group	ALM2												
Size	6	9	10	12	13	16	20	22	25	30	34	37	40
Min. Speed (rpm)	800			700					500				

Group	ALM3										
Size	33	40	50	60	66	80	94	110	120	135	
Min. Speed (rpm)	600	500			400						



Pressure Definition

Product tables show three max. pressure levels (PC, PI and PP) to which each motor can be used.

P_c = max pressure continually as output counterpressure.

P_i = max inlet pressure continually.

P_p = max peak inlet pressure.

The value of the maximum continuous PI pressure can be reached only if the following ranges of rotation are not overcome.

Group	ALM1							
Size	4	5	6	7	9	11	13	16
Speed (rpm)	4000		3000		2500		2000	

Group	ALM2												
Size	6	9	10	12	13	16	20	22	25	30	34	37	40
Speed (rpm)	3500			3000			2600			2200			2000

Group	ALM3									
Size	33	40	50	60	66	80	94	110	120	135
Speed (rpm)	3000		2500			2000				

Please contact jbj Techniques technical department, email: info@jbj.co.uk or telephone: +44 (0)1737 767493 for system operating conditions other than indicated in the product tables.

Supply & Delivery Lines

Hydraulic system pipes should show no sudden changes of direction, sharp bends and sudden differences in cross-section. They should not be too long or out of proportion. Pipe cross-section should be sized so that fluid velocity does not exceed recommended values. It is advisable to carefully consider the possible diameter reduction of the inlet or outlet pipes fitted on flange fittings. Reference values are the following:

Input and delivery line	2 to 6 m/s
Drain line	0.5 to 1.6 m/s

Direction of Rotation

The motors of the GHM series can be supplied both in mono-directional version and bi-directional. The direction of rotation is defined in the following way: looking at the front of the motor with the driver shaft positioned upward and sticking toward the observer, it will be a mono-directional right "D". GHM...D motor therefore with right. "D" rotation, if its rotation will be clockwise and therefore the inlet port will be on the left while the outlet port will be on the right. Vice-versa it will be a mono-directional left GHM...S therefore with left "S" rotation maintaining of course the same view of observation.

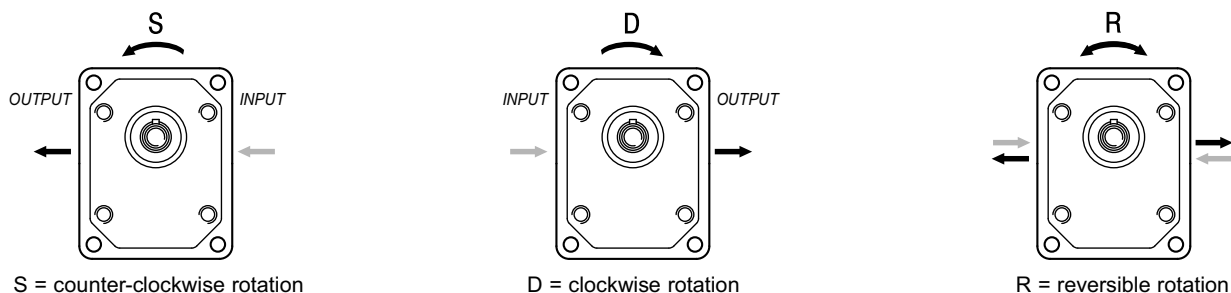

The bi-directional GHM series motors, "R" have both functional characteristics of the mono-directional motors with clockwise and counterclockwise rotation.



Drive

The link between the motor and the driven device must be via a mechanical power transmission coupling that will not transfer radial and/or axial thrust to the shaft of the motor otherwise wear of the internal components will quickly occur. jbj Techniques have a wide range of suitable couplings to suit a wide range of applications and we can advise on which coupling depending on the circumstances of the application.

In case of axial and/or radial loads on the motor's shaft T option is available for some GHM2 models and RA option is available for some GHM1 types.

For further details contact jbj Techniques technical office, email: info@jbj.co.uk or telephone: +44 (0)1737 767493

Frequently Used Formulas

Fluid velocity

Calculate the velocity (v) of a fluid in a pipe as follows:

$$v = Q / 6 \cdot A \text{ [m/s]}$$

Q = flow rate [litre/min]

A = inside area of pipe [cm²]

Absorbed flow rate

Calculate flow rate (Q) as follows:

$$Q = V \cdot n \cdot 10^{-3} / \text{hvol} \text{ [litre/min]}$$

V = displacement [cm³/rotation]

n = rotation speed [rotations per minute]

hvol = pump volumetric efficiency (take 0.95 as an indicative value for rotation speeds ranging between 1000 and 2000 rotations per minute)

Delivered torque

Calculate necessary torque (M) of a motor subject to pressure differential between input and output as follows:

$$M = (V \cdot D_p \cdot \text{hhm}) / 62,8 \text{ [Nm]}$$

V = displacement [cm³/rotation]

D_p = pressure differential [bar]

hhm = hydromechanical efficiency (take 0.80 as indicative value under cold conditions and 0.85 under working conditions).

Delivered power

Calculate hydraulic power (P), delivered by a motor subject to a pressure differential between input and output as follows:

$$P = (Q \cdot D_p \cdot \text{htot}) / 600 \text{ [kW]}$$

Q = flow rate [litre/min.]

D_p = pressure differential [bar]

htot = total pump efficiency (hhm • hvol)

Values for hvol and hhm (and consequently htot) depend on pressure differential between supply and delivery, rotation speed, fluid features (temperature and viscosity) and filtering degree.

Contact jbj Techniques technical office, email: info@jbj.co.uk or telephone: +44 (0)1737 767493 for further details on efficiency.

The proper values for flow rate, torque and supplied according to pressure differential, rotation speed and set test conditions, can be found on the **Performance Curve** pages.



Ordering Code

ALM1	Type	Rotation	Size	Shaft*	Ports*	Seals*	Options*	Drain**
	omit	D Clockwise	...			Seals omit (T range = -10°C + 80°C)		
	A	S Counter Clockwise	...			V		
		R Reversible	4			...		
			5			Options RA		
			6			...		
			7			Drain E0 = internal drain E1 = external drain G1/4 E2 = external drain 1/16-18 UNF***		
			9			...		
			11			(*) = to be specified if different from standard "motor type". (**) = only for R rotation. (***) = "E2" drain port is machined in compliance with threaded port with O-ring seal in truncated housing SAE J1926/1 (ISO 11926-1). Thread depth 12,7 mm.		
			13					
			16					
			...					

Motor Standard Types

omit = European flange + shaft T0 + ports E + standard seals.

A = flange A + shaft C1 + ports FA + standard seals.

Examples

ALM1-D-2 = clockwise rotation, 1.4 cc/rev, European flange, 1:8 tapered shaft, flanged ports E type, standard seals.

ALM1-D-2-FG-V = clockwise rotation, 1.4 cc/rev, European flange, 1:8 tapered shaft, threaded ports (FG), high temperature seals (V).

ALM1A-D-2-S1 = clockwise rotation, 1.4 cc/rev, SAE A-A2 bolt flange, splined shaft 9T (S1), threaded ports, standard seals.

ALM1-R-4-E1 = reversible motor, 2.8 cc/rev, European flange, 1:8 tapered shaft, flanged ports E type, standard seals, external drain (E1).

The product data sheets show our standard model types. The synoptic tables for flanges, shafts and ports show all the possible configurations. For further details about the availability of each configuration please contact jbj Techniques technical office, email: info@jbj.co.uk or telephone: +44 (0)1737 767493



Accessories supplied with the standard motor: woodruff key (code 522054), M10x1 exagonal nut (code 523015), washer (code 523004).

Standard ports: M6 threads depth 13 mm.

G1/4 drain port thread depth 12 mm.

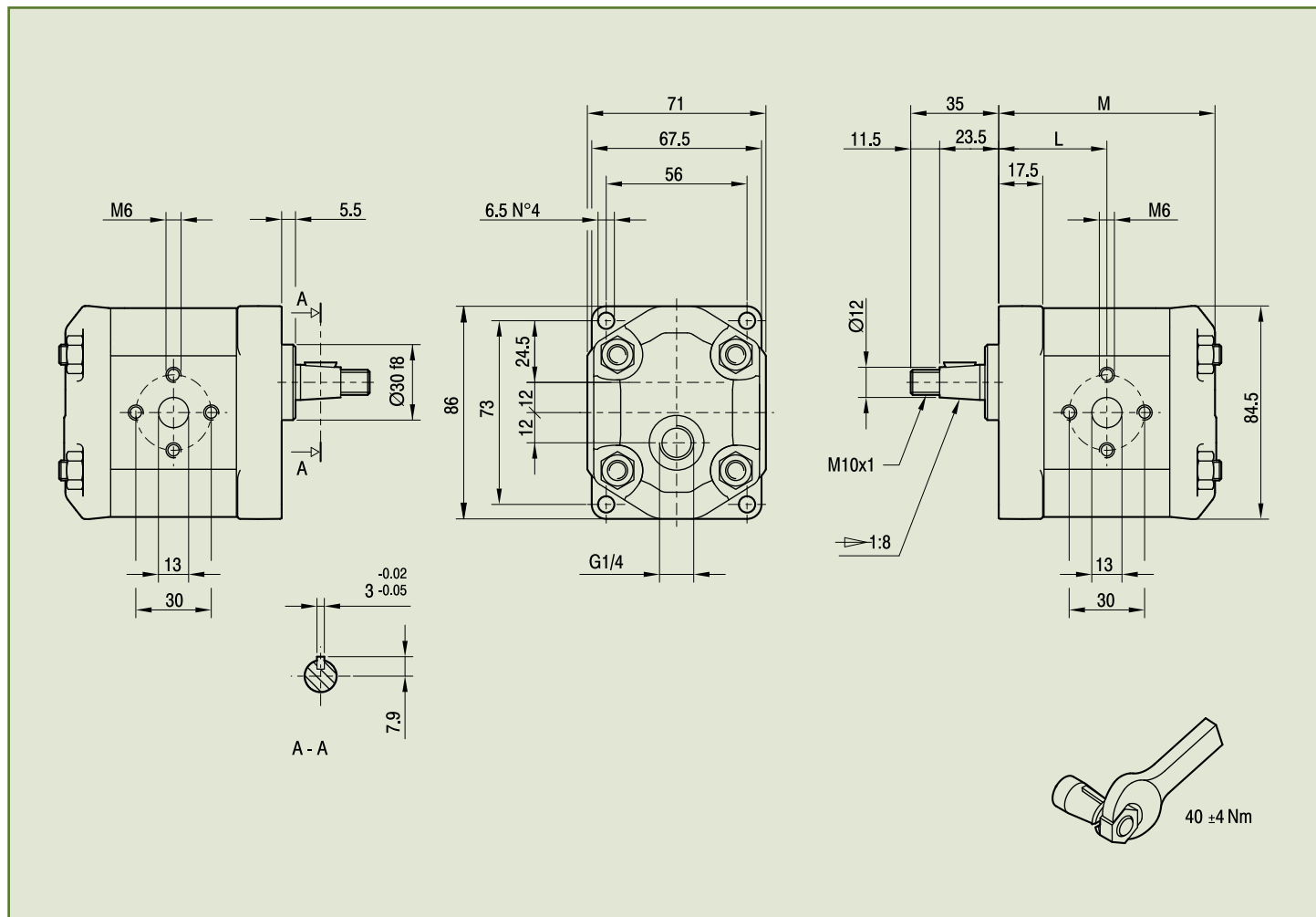

Type	Displacement cm ³ /rev	Flow at 1500 rev/min litres/mim	Maximum Pressure			Maximum Speed rpm	Dimensions	
			P _I bar	P _C bar	P _P bar		L mm	M mm
ALM1-R-4-E1	2,8	3,9	250	240	270	5000	42	84.5
ALM1-R-5-E1	3,5	4,9	250	240	270	5000	43	86.5
ALM1-R-6-E1	4,1	5,9	250	240	270	4000	44	88.5
ALM1-R-7-E1	5,2	7,4	230	220	245	4000	45,5	91.5
ALM1-R-9-E1	6,2	8,8	230	220	245	3800	47	94.5
ALM1-R-11-E1	7,6	10,8	200	190	215	3200	49	98.5
ALM1-R-13-E1	9,3	13,3	180	170	195	2600	51,5	103.5
ALM1-R-16-E1	11,0	15,7	170	160	185	2200	54	108.5



Accessories supplied with the standard motor: key (code 522070).

Mounting flange 50-2 (A-A) in compliance with SAE J744c.

“D” standard ports are machined in compliance with threaded port with O-ring seal in truncated housing SAE J1926/1 (ISO 11926-1).

G1/4 drain port thread depth 12 mm.

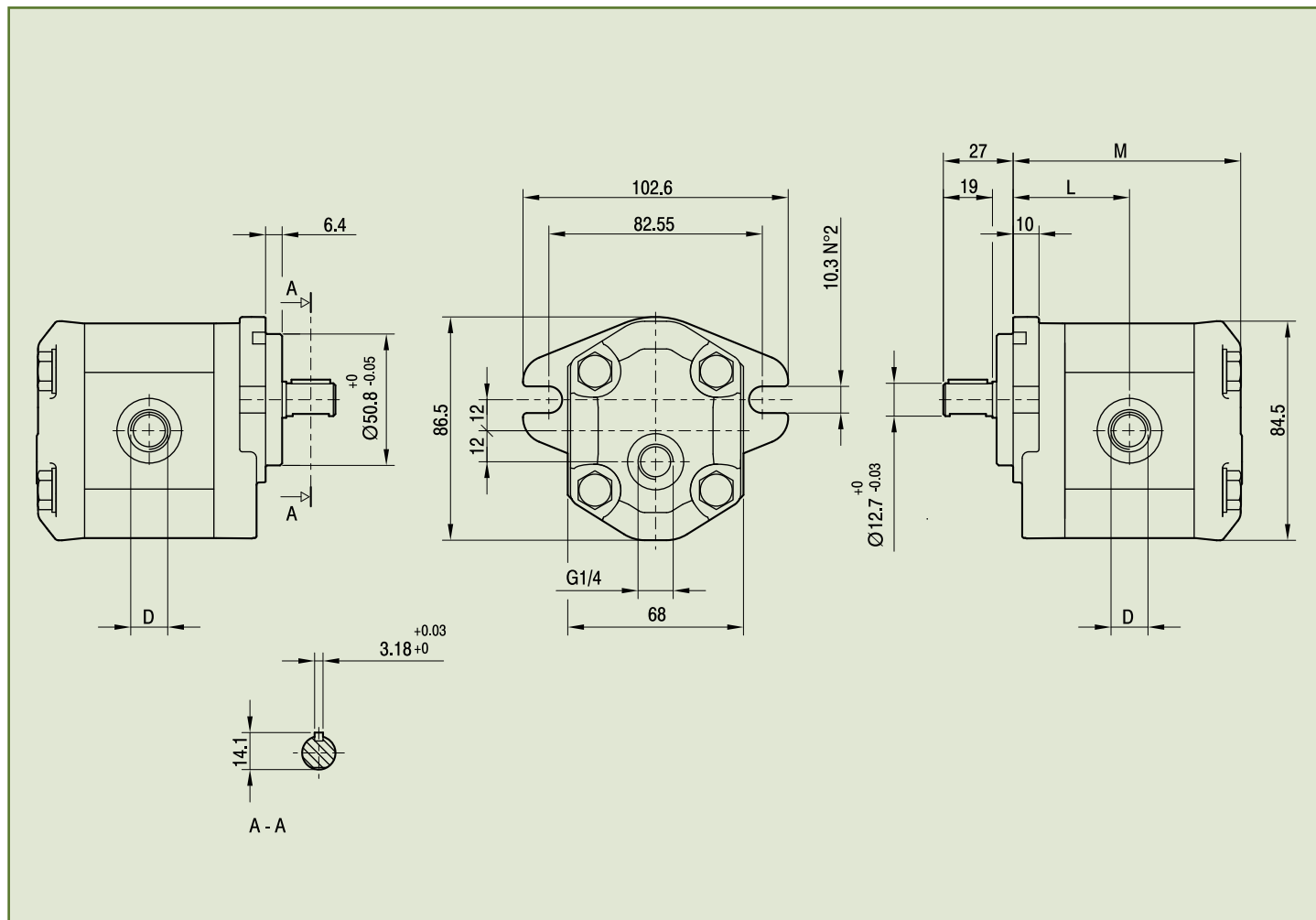

Type	Displacement cm ³ /rev	Flow at 1500 rev/min litres/mim	Maximum Pressure			Maximum Speed rpm	Dimensions		
			P _I bar	P _C bar	P _P bar		L mm	M mm	D mm
ALM1A-R-4-E1	2.8	3.9	250	240	290	5000	44	86.5	3/4-16 UNF
ALM1A-R-5-E1	3.5	4.9	250	240	290	5000	45	88.5	3/4-16 UNF
ALM1A-R-6-E1	4.1	5.9	250	240	290	4000	46	90.5	3/4-16 UNF
ALM1A-R-7-E1	5.2	7.4	230	220	275	3500	47.5	93.5	3/4-16 UNF
ALM1A-R-9-E1	6.2	8.8	230	220	275	3000	49	96.5	3/4-16 UNF
ALM1A-R-11-E1	7.6	10.8	200	190	215	3500	51	100.5	7/8-14 UNF
ALM1A-R-13-E1	9.3	13.3	180	170	225	3000	53.5	105.5	7/8-14 UNF
ALM1A-R-16-E1	11.0	15.7	170	160	215	2500	56	110.5	7/8-14 UNF



Flanges

Shafts

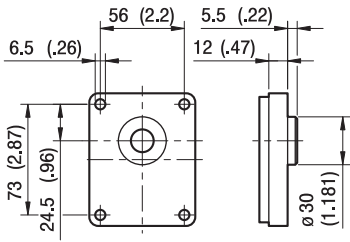

T0

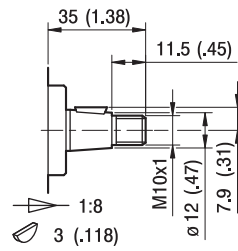

Max Torque 100 Nm

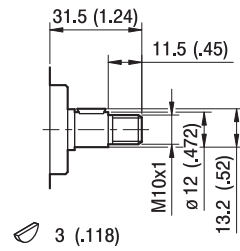

Max Torque 55 Nm

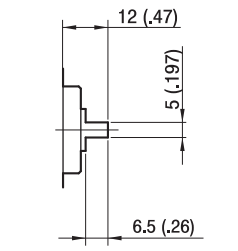

Max Torque 45 Nm

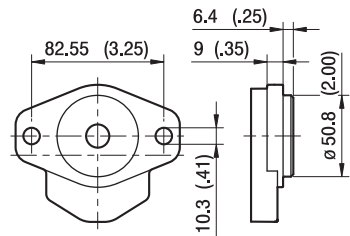

A

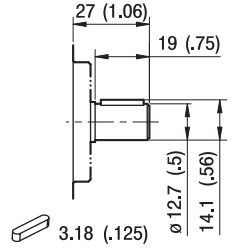

Max Torque 60 Nm

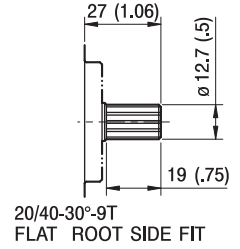

Max Torque 100 Nm

Allow close coupling of hydraulic pumps directly to the flywheel / flywheel housing of diesel engines, electric and hydraulic motors.

www.jbj.co.uk/hydraulic-adaptors.html

The package consists of a bellhousing and flexible drive coupling that are fully machined to suit the pump / motor and any driving interface; diesel or petrol engine, electric or hydraulic motor.

jbj's in-house design team and manufacturing facility provide tailored solutions for your applications at competitive prices with quick delivery.

A range of composite bell housings to accommodate electric motor flanges from 300 mm diameter to 800 mm diameter. See pages 40 to 44 of the Pump Drive Components technical specification catalogue.

A collection of different ways of connecting hydraulic pumps and motors to various driver devices.



Ports

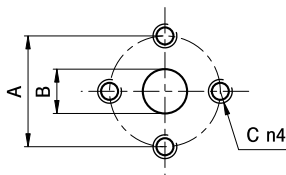

E

Type	Bi-directional Motor			Mono-directional motor		
	Output -Input			Input		
	A	B	C	A	B	C
ALM1...4 to ALM1...16	30	13	M6	30	13	M6

Tightening torques of the fittings screws are specified on page 52 (accessories section).

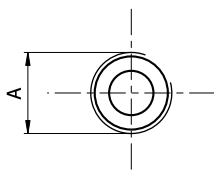

FG

Type	Bi-directional Motor	Mono-directional motor
	Output -Input	Input
	A	A
ALM1...4 to ALM1...5	G½	G¾
ALM1...6 to ALM1...16	G½	G½

Tightening torques for G½ fitting: 50 Nm. Tightening torques for G¾ fitting: 35 Nm. Please check with the fittings suppliers.

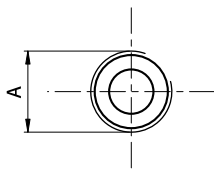

FC

Type	Bi-directional Motor	Mono-directional motor
	Output -Input	Input
	A	A
ALM1...4 to ALM1...16	Rc½	Rc½

Tightening torques for Rc½ fitting: 50 Nm. Please check with the fittings suppliers.

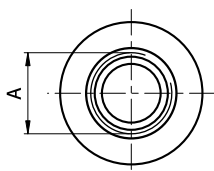

STANDARD SAE J1926/1

FA

Type	Bi-directional Motor	Mono-directional motor
	Output -Input	Input
	A	A
ALM1...4 to AM1...9	¾-16 UNF	¼-18 UNF
ALM1...11 to ALM1...16	7/8-14 UNF	¾-16 UNF

Tightening torques for 9/16-18 UNF fitting: 30 Nm. Tightening torques for 3/4-16 UNF fitting: 60 Nm. Tightening torques for 7/8-14 UNF fitting: 70 Nm. Please check with the fittings suppliers.

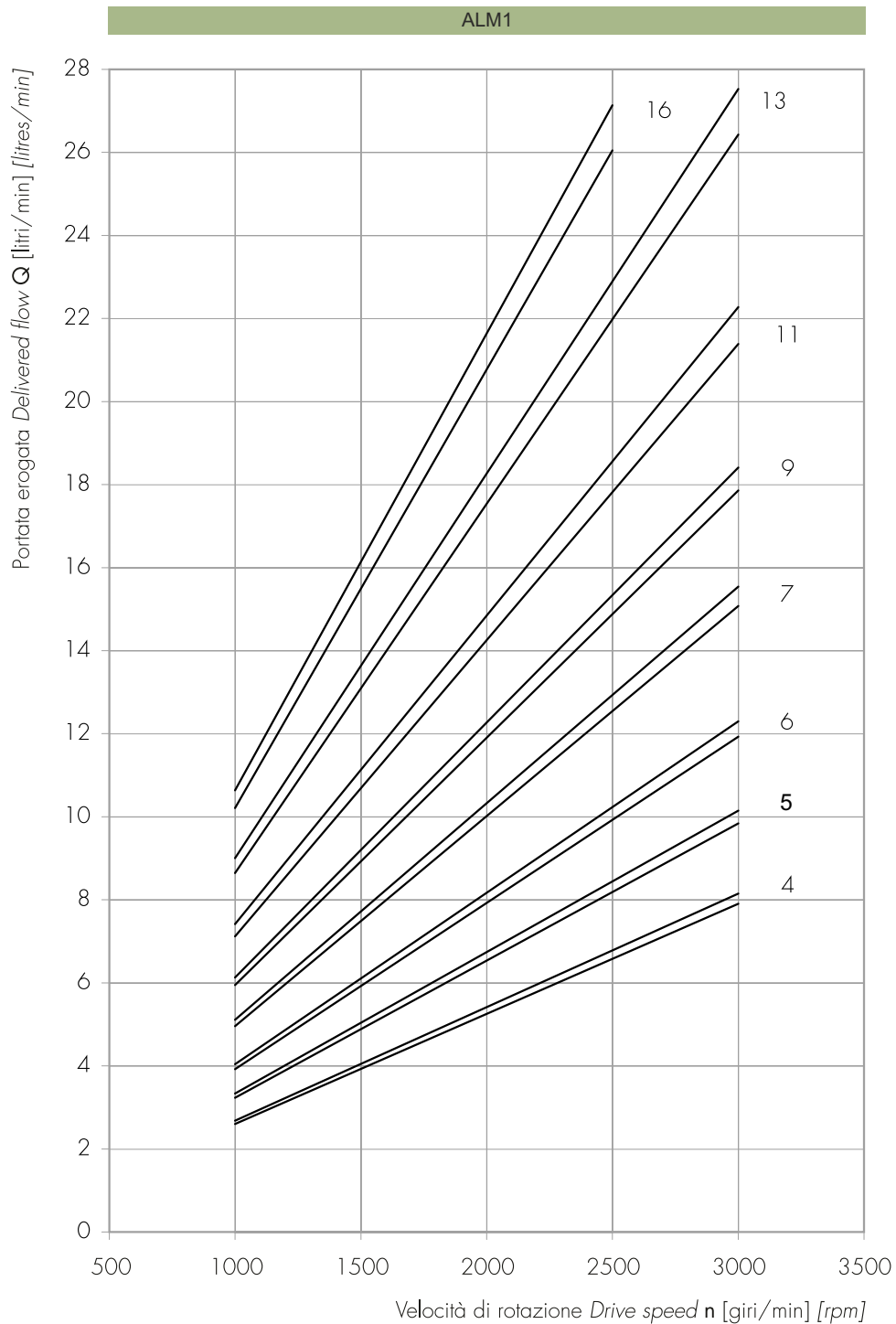

Each curve has been obtained at 50°C, using oil with viscosity 30 cSt at these pressure.

4 | 25-240 bar
5 |

9 | 25-220 bar

13 | 25-170 bar

6 | 25-230 bar
7 |

11 | 25-180 bar

16 | 25-150 bar



Delivered power P [kW]. Delivered torque M [Nm]. Drive speed n [giri/min] [rpm]

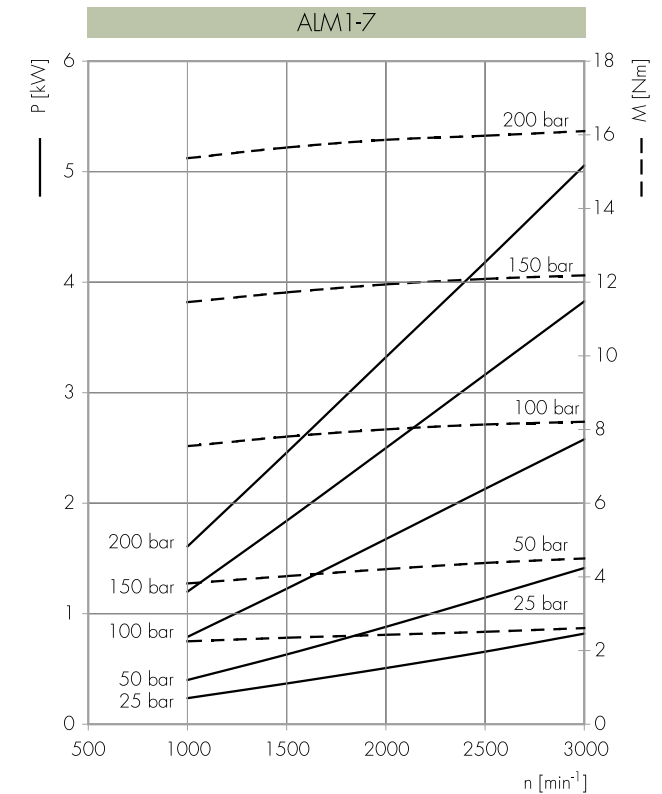
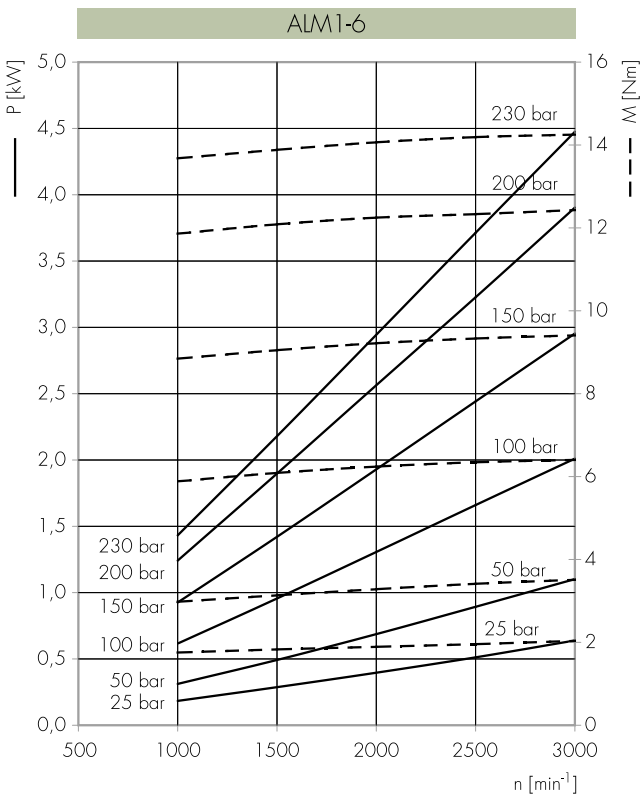
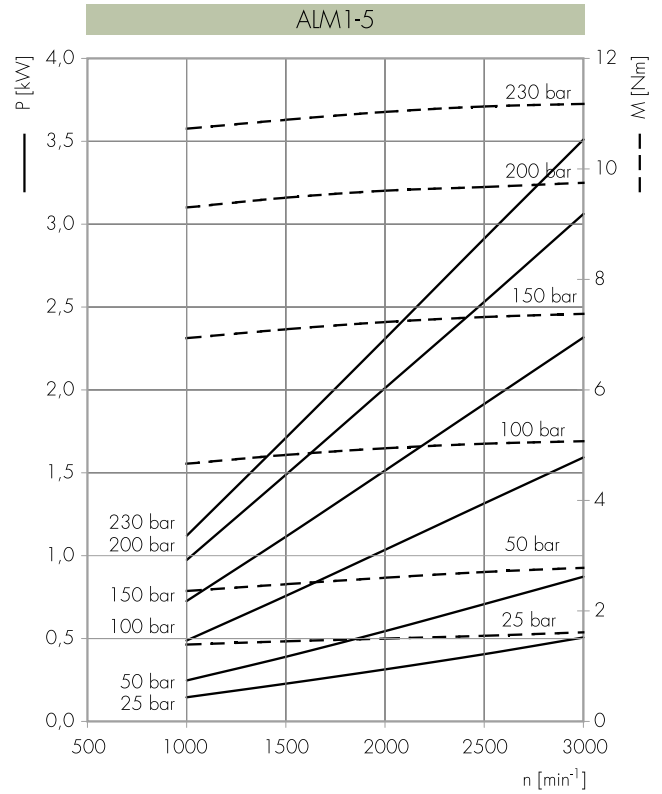
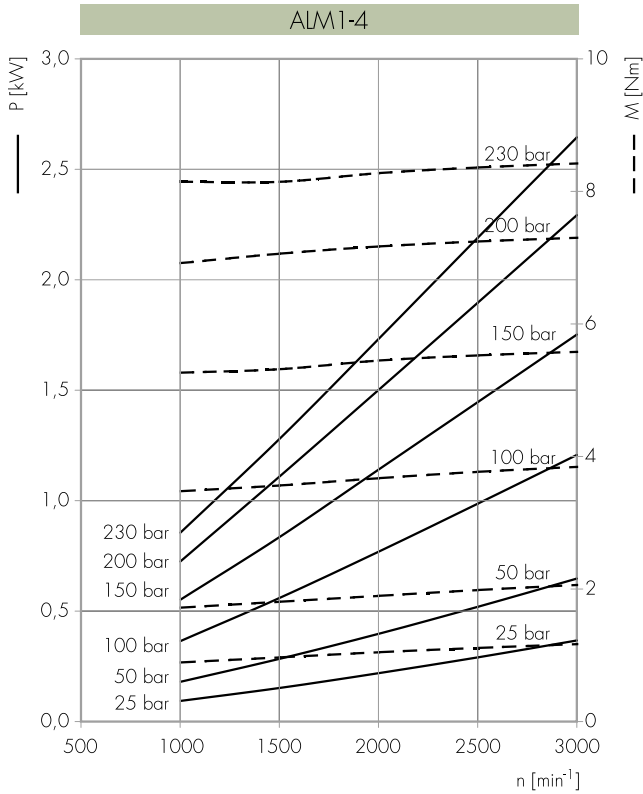



Delivered power P [kW]. Delivered torque M [Nm]. Drive speed n [giri/min] [rpm]

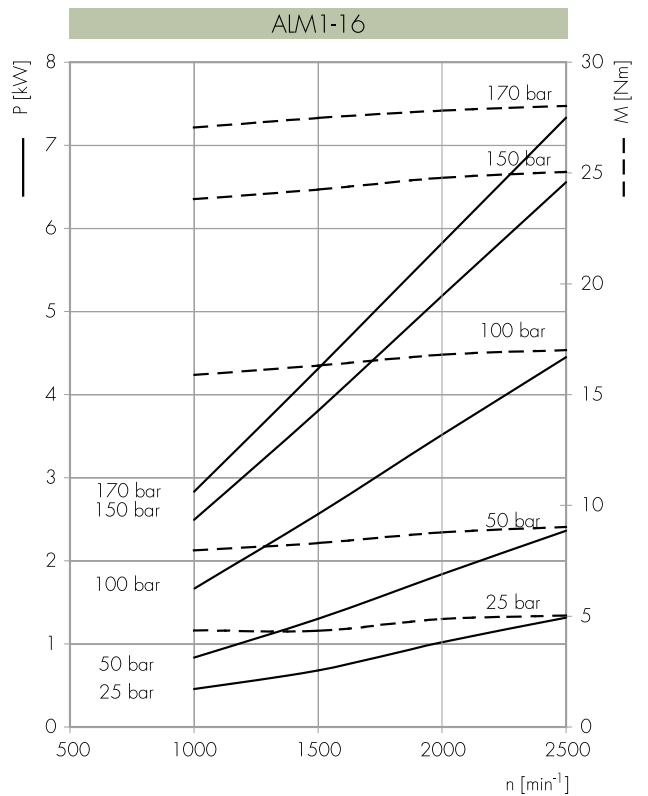
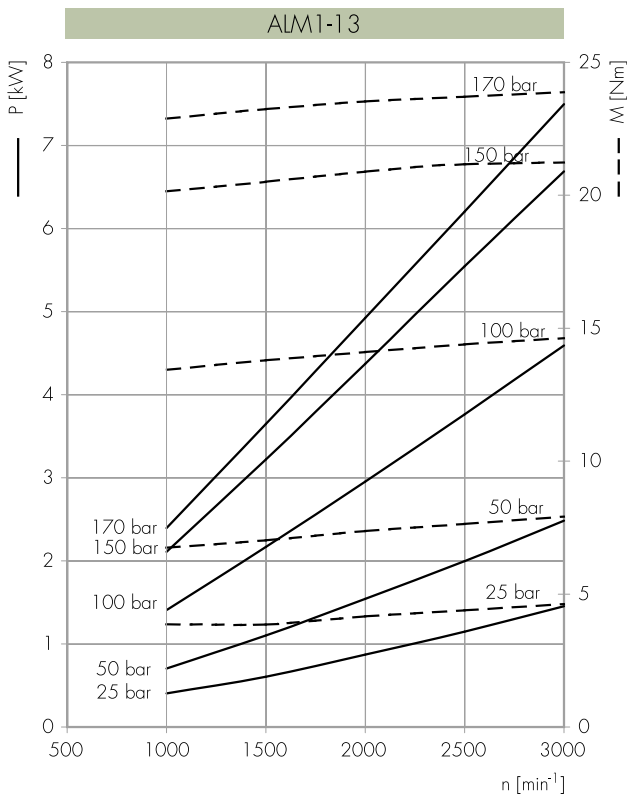
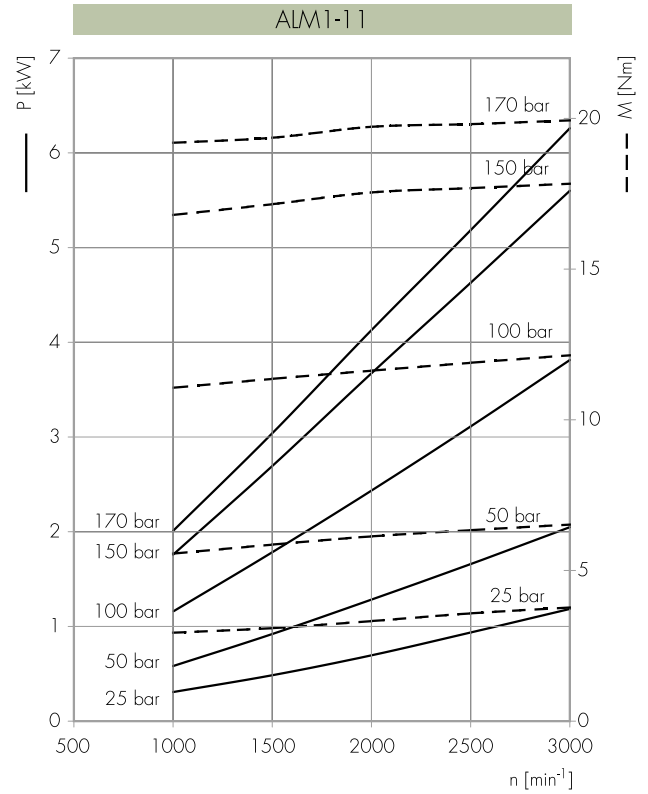
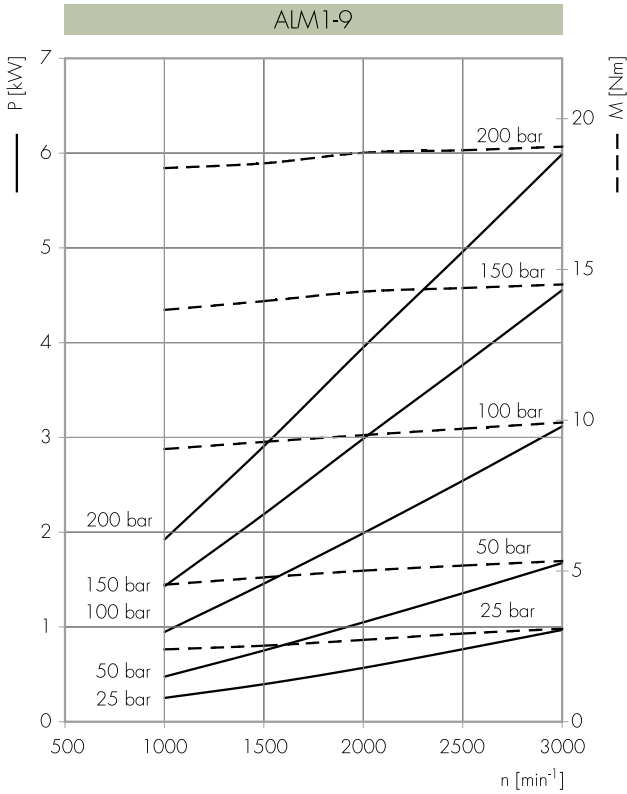



Ordering Code

ALM2	Type	Rotation	Size	Shaft*	Ports*	Seals*	Options*	Drain**
	omit	D Clockwise	6			Seals omit (T range = -10°C + 80°C)		
	A	S Counter Clockwise	9			V		
	BK1	R Reversible	10			...		
	BK2		12				Options	
	BK4		13				T	
	BK7		16				OR****	
			20				...	
			22					Drain
			25					E0 = internal drain
			30					E1 = external drain G1/4
			34					E2 = external drain 9/16-18 UNF***
			37					...
			40					
							

(*) = to be specified if different from standard "motor type".

(**) = only for R rotation.

(***) = Drain ports are machined in compliance with threaded port with O-ring seal in truncated housing SAE J1926/1 (ISO 11926-1).

(****) = only for A and BK1 motor types.

Motor Standard Types

omit = European flange + shaft T0 + ports E + standard seals.

A = flange A + shaft C1 + ports FA + standard seals.

BK1 = flange BK1 + shaft T1 + ports D + standard seals.

BK2 = flange BK2 + shaft T2 + ports D + standard seals.

BK4 = flange BK4 + shaft T2 + ports D + standard seals.

BK7 = flange BK7 + shaft G0 + ports D + standard seals.

Examples

ALM2-D-6 = Clockwise rotation, 4.5 cc/rev, European flange, 1:8 tapered shaft, flanged ports E type, standard seals.

ALM2A-D-6-KA = Clockwise rotation, 4.5 cc/rev, SAE A2 bolt flange, cylindrical shaft, standard seals, UNF threaded rear ports (KA).

ALM2BK2-D-6-E = Clockwise rotation, 4.5 cc/rev, German square flange, 1:5 tapered shaft, European flanged ports (E), standard seals.

ALM2-R-13-E1 = Reversible motor, 9.6 cc/rev, European flange, 1:8 tapered shaft, flanged ports E type, standard seals, external drain (E1).

ALM2A-R-6-OR-E2 = Reversible motor, 4.5 cc/rev, SAE A2 bolt flange, cylindrical shaft C1, threaded ports FA, standard seal, OR seal on pilot, external drain (E2).

The product data sheets show our standard model types. The synoptic tables for flanges, shafts and ports show all the possible configurations. For further details about the availability of each configuration please contact jbj Techniques technical office, email: info@jbj.co.uk or telephone: +44 (0)1737 767493



Accessories supplied with the standard motor: woodruff key (code 522057), M12x1.5 hexagonal nut (code 523016), washer (code 523005).
 Standard ports: M8 threads depth 17 mm.
 The tapered shaft is also available with 3,2 mm key ("T3").
 G1/4 drain port thread depth 12 mm.

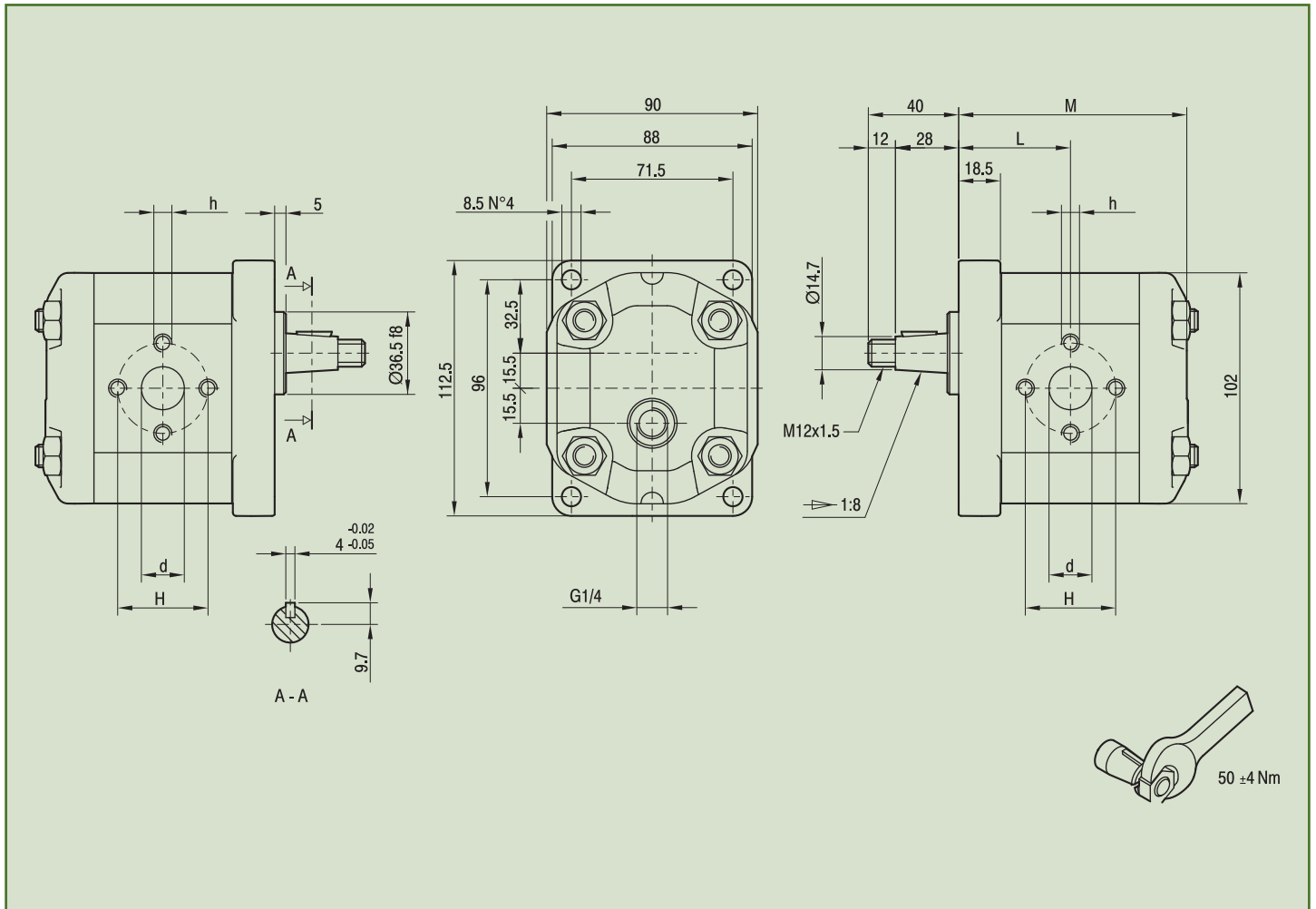

Type	Displacement cm ³ /rev	Flow at 1500 rev/min litres/min	Maximum Pressure			Maximum Speed rpm	Dimensions				
			P _I bar	P _C bar	P _P bar		L mm	M mm	d mm	h	H
ALM2-R-6-E1	4,5	6,4	250	240	270	4000	45,5	93.5	13	M6	30
ALM2-R-9-E1	6,4	9,1	250	240	270	4000	47	96.5	13	M6	30
ALM2-R-10-E1	7	10	250	240	270	4000	47,5	97.5	13	M8	40
ALM2-R-12-E1	8,3	11,8	250	240	270	3500	48,5	99.5	13	M8	40
ALM2-R-13-E1	9,6	13,7	250	240	270	3000	49,5	101.5	13	M8	40
ALM2-R-16-E1	11,5	16,4	230	220	250	4000	51	104.5	19	M8	40
ALM2-R-20-E1	14,1	20,1	230	220	250	4000	53	108.5	19	M8	40
ALM2-R-22-E1	16,0	22,8	210	200	225	4000	54,5	111.5	19	M8	40
ALM2-R-25-E1	17,9	25,5	210	200	225	3600	56	114.5	19	M8	40
ALM2-R-30-E1	21,1	30,1	180	170	195	3200	58,5	119.5	19	M8	40
ALM2-R-34-E1	23,7	33,7	180	170	195	3000	60,5	123.5	19	M8	40
ALM2-R-37-E1	25,5	36,4	170	160	185	2800	62	126.5	19	M8	40
ALM2-R-40-E1	28,2	40,1	170	160	185	2500	64	130.5	19	M8	40



Accessories supplied with the standard motor: key (code 522067). Mounting flange 82-2 (A) in compliance with SAE J744c.
 Standard ports are machined in compliance with threaded port with O-ring seal in truncated housing SAE J1926/1 (ISO 11926-1).
 1/4-28 UNF thread depth 16 mm.
 G1/4 drain port thread depth 12 mm.

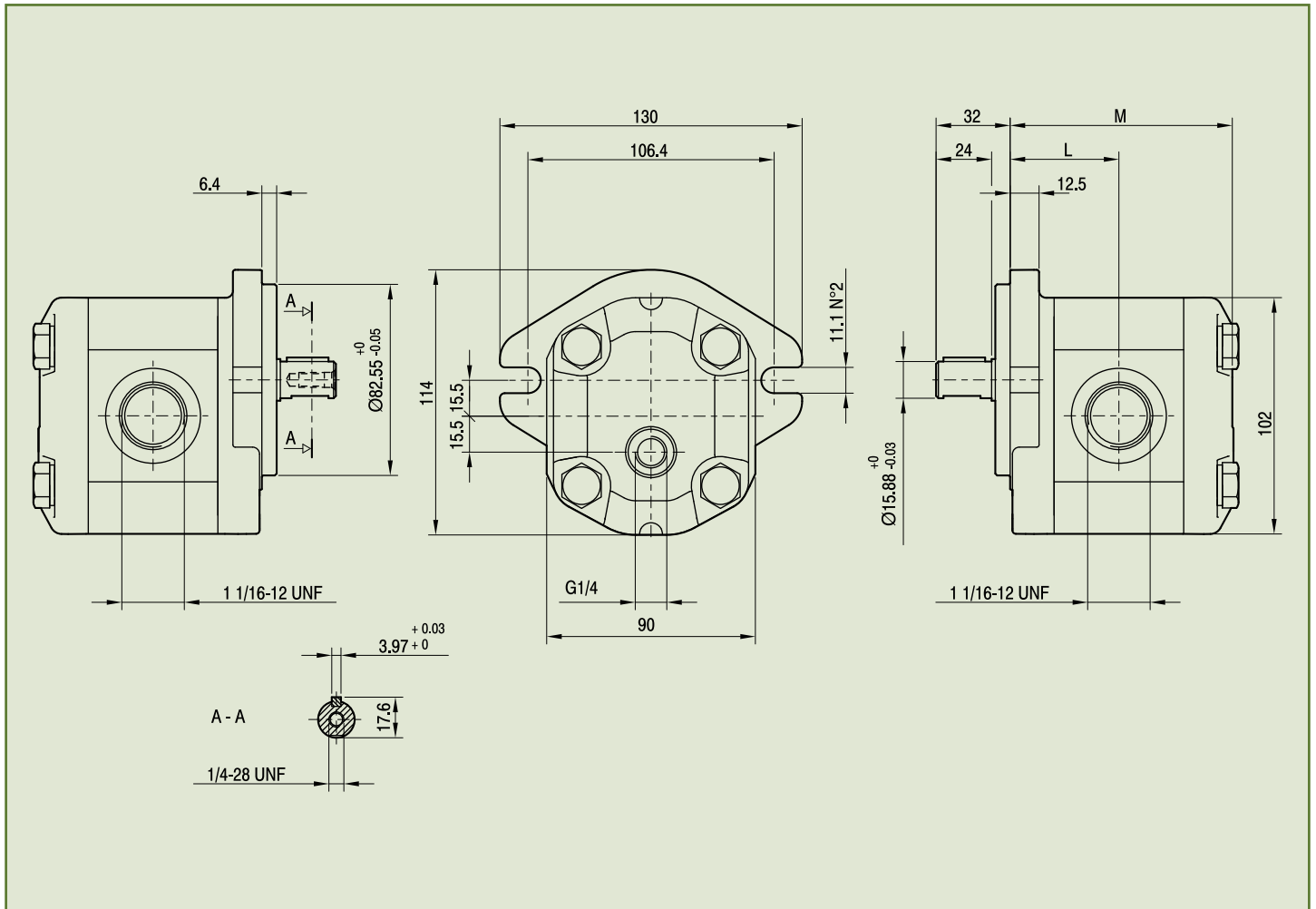

Type	Displacement cm ³ /rev	Flow at 1500 rev/min litres/mim	Maximum Pressure			Maximum Speed rpm	Dimensions	
			P _I bar	P _C bar	P _P bar		L mm	M mm
ALM2A-R-6-E1	4,5	6,4	250	240	270	4000	45,5	93.5
ALM2A-R-9-E1	6,4	9,1	250	240	270	4000	47	96.5
ALM2A-R-10-E1	7	10	250	240	270	4000	47,5	97.5
ALM2A-R-12-E1	8,3	11,8	250	240	270	4000	48,5	99.5
ALM2A-R-13-E1	9,6	13,7	250	240	270	4000	49,5	101.5
ALM2A-R-16-E1	11,5	16,4	230	220	250	4000	51	104.5
ALM2A-R-20-E1	14,1	20,1	230	220	250	3200	53	108.5
ALM2A-R-22-E1	16,0	22,8	210	200	225	2800	54,5	111.5
ALM2A-R-25-E1	17,9	25,5	210	200	225	2500	56	114.5
ALM2A-R-30-E1	21,1	30,1	180	170	195	2200	58,5	119.5
ALM2A-R-34-E1	23,7	33,7	180	170	195	2000	60,5	123.5
ALM2A-R-37-E1	25,5	36,4	170	160	185	1800	62	126.5
ALM2A-R-40-E1	28,2	40,1	170	160	185	1800	64	130.5



Accessories supplied with the standard motor: woodruff key (code 522055), M12x1.5 hexagonal nut (code 523016), washer (code 523005).
 Standard ports: M6 threads depth 13 mm.
 G1/4 drain port thread depth 12 mm.

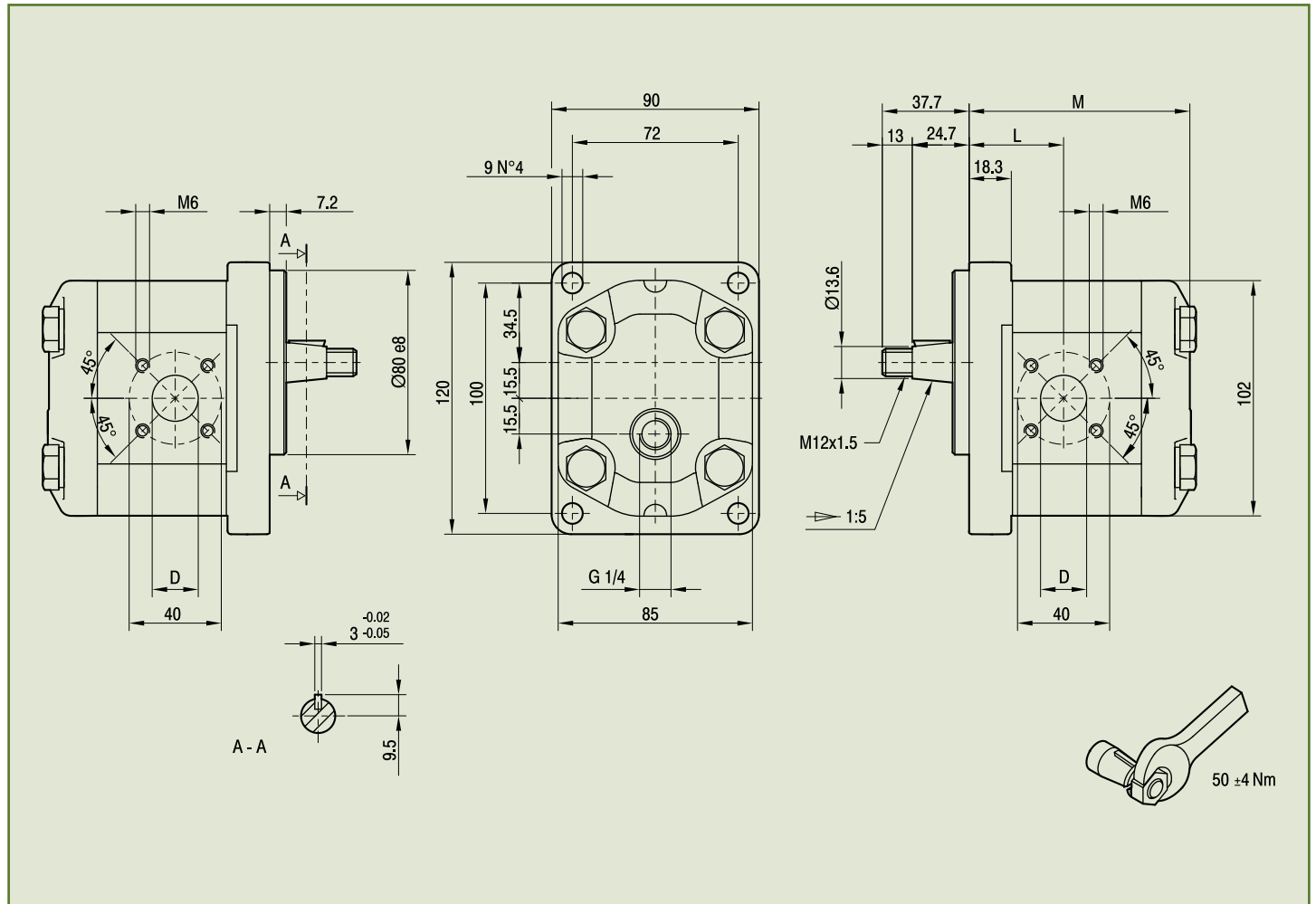

Type	Displacement cm ³ /rev	Flow at 1500 rev/min litres/min	Maximum Pressure			Maximum Speed rpm	Dimensions		
			P _i bar	P _c bar	P _p bar		L mm	M mm	D mm
ALM2BK1-R-6-E1	4,5	6,4	250	240	270	4000	39,8	93.5	15
ALM2BK1-R-9-E1	6,4	9,1	250	240	270	4000	41	96.5	15
ALM2BK1-R-10-E1	7	10	250	240	270	4000	47,3	97.5	15
ALM2BK1-R-12-E1	8,3	11,8	250	240	270	4000	48,3	99.5	15
ALM2BK1-R-13-E1	9,6	13,7	250	240	270	4000	43,1	101.5	20
ALM2BK1-R-16-E1	11,5	16,4	230	220	250	4000	47,5	104.5	20
ALM2BK1-R-20-E1	14,1	20,1	230	220	250	4000	47,5	108.5	20
ALM2BK1-R-22-E1	16,0	22,8	210	200	225	4000	47,5	111.5	20
ALM2BK1-R-25-E1	17,9	25,5	210	200	225	4000	55,8	114.5	20
ALM2BK1-R-30-E1	21,1	30,1	180	170	195	3400	47,5	119.5	20
ALM2BK1-R-34-E1	23,7	33,7	180	170	195	3000	55	123.5	20
ALM2BK1-R-37-E1	25,5	36,4	170	160	185	2600	61,8	126.5	20
ALM2BK1-R-40-E1	28,2	40,1	170	160	185	2600	63,8	130.5	20



Accessories supplied with the standard motor: woodruff key (code 522055), M12x1.5 hexagonal nut (code 523016), washer (code 523005).
 Standard ports: M6 threads depth 13 mm.
 To mount the motor: n.2 M10 screws with a torque wrench setting fixed at 46 ± 4 Nm.
 G1/4 drain port thread depth 12 mm.

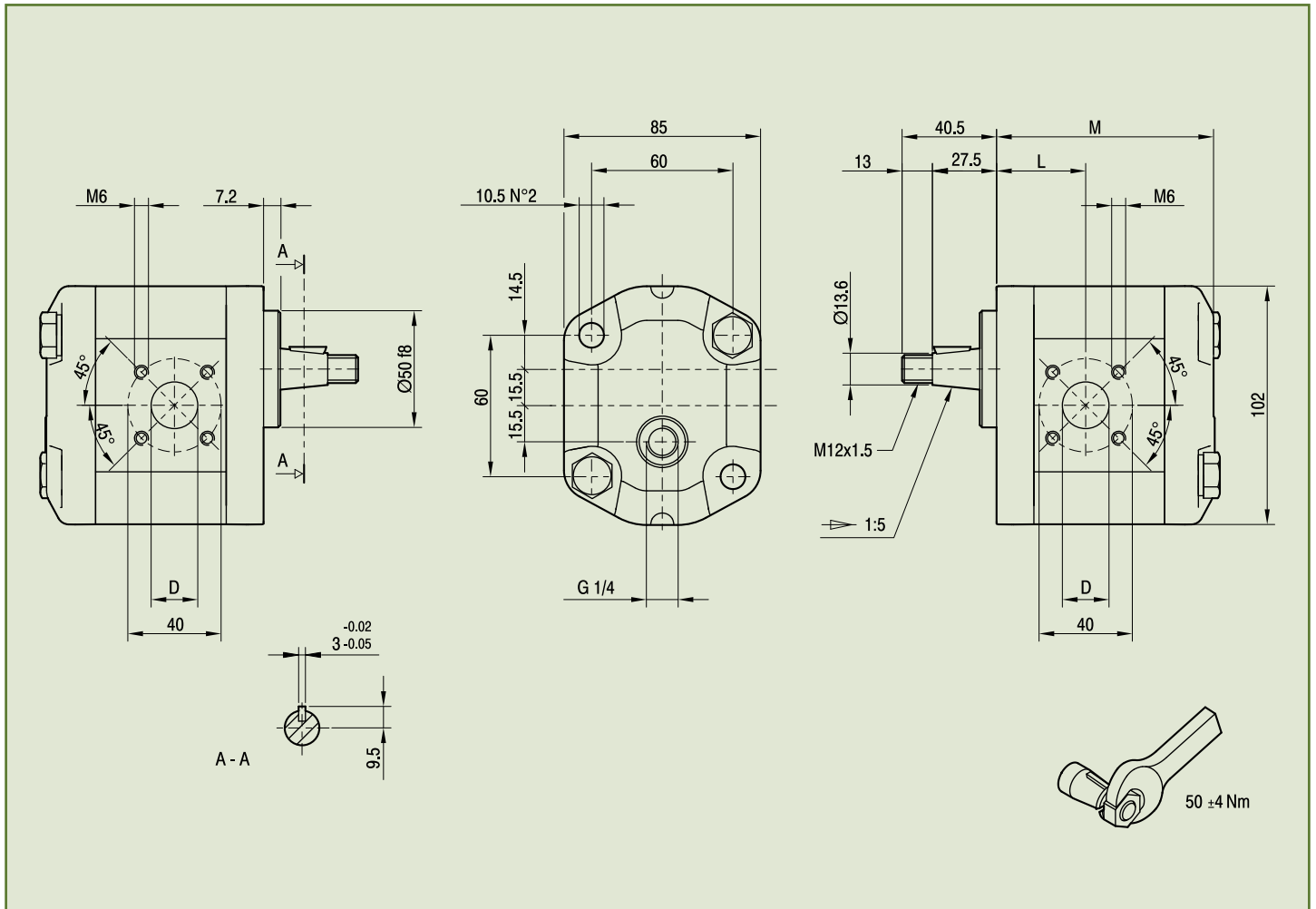

Type	Displacement cm ³ /rev	Flow at 1500 rev/min litres/min	Maximum Pressure			Maximum Speed rpm	Dimensions		
			P _i bar	P _c bar	P _p bar		L mm	M mm	D mm
ALM2BK2-R-6-E1	4,5	6,4	250	240	270	4000	37	90.5	15
ALM2BK2-R-9-E1	6,4	9,1	250	240	270	4000	38,2	93.5	15
ALM2BK2-R-10-E1	7	10	250	240	270	4000	44,5	94.5	15
ALM2BK2-R-12-E1	8,3	11,8	250	240	270	4000	45,5	96.5	15
ALM2BK2-R-13-E1	9,6	13,7	250	240	270	4000	40,3	98.5	20
ALM2BK2-R-16-E1	11,5	16,4	230	220	250	4000	44,7	101.5	20
ALM2BK2-R-20-E1	14,1	20,1	230	220	250	4000	44,7	105.5	20
ALM2BK2-R-22-E1	16,0	22,8	210	200	225	4000	44,7	108.5	20
ALM2BK2-R-25-E1	17,9	25,5	210	200	225	4000	53	111.5	20
ALM2BK2-R-30-E1	21,1	30,1	180	170	195	3400	44,7	116.5	20
ALM2BK2-R-34-E1	23,7	33,7	180	170	195	3000	52,2	120.5	20
ALM2BK2-R-37-E1	25,5	36,4	170	160	185	2600	59	123.5	20
ALM2BK2-R-40-E1	28,2	40,1	170	160	185	2600	61	127.5	20



Accessories supplied with the standard motor: woodruff key (code 522055), M12x1.5 hexagonal nut (code 523016), washer (code 523005).

Standard ports: M6 threads depth 13 mm.

To mount the motor: n.2 M10 screws with a torque wrench setting fixed at 46 ± 4 Nm.

G1/4 drain port thread depth 12 mm.

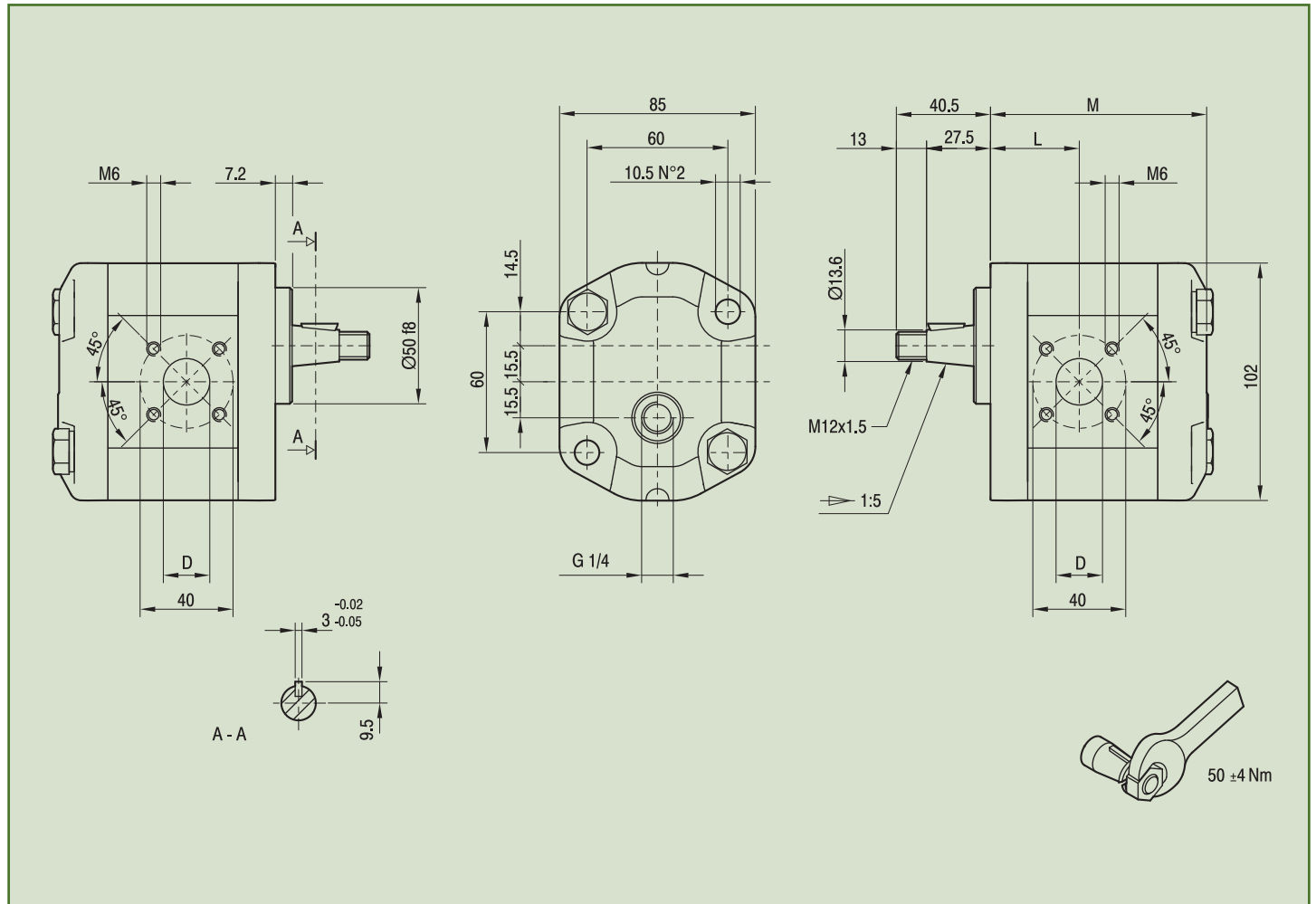

Type	Displacement cm ³ /rev	Flow at 1500 rev/min litres/min	Maximum Pressure			Maximum Speed rpm	Dimensions		
			P _I bar	P _C bar	P _P bar		L mm	M mm	D mm
ALM2BK4-R-6-E1	4,5	6,4	250	240	270	4000	37	90.5	15
ALM2BK4-R-9-E1	6,4	9,1	250	240	270	4000	38,2	93.5	15
ALM2BK4-R-10-E1	7	10	250	240	270	4000	44,5	94.5	15
ALM2BK4-R-12-E1	8,3	11,8	250	240	270	4000	45,5	99.5	15
ALM2BK4-R-13-E1	9,6	13,7	250	240	270	4000	40,3	98.5	20
ALM2BK4-R-16-E1	11,5	16,4	230	220	250	4000	44,7	101.5	20
ALM2BK4-R-20-E1	14,1	20,1	230	220	250	4000	44,7	105.5	20
ALM2BK4-R-22-E1	16,0	22,8	210	200	225	4000	44,7	108.5	20
ALM2BK4-R-25-E1	17,9	25,5	210	200	225	4000	53	111.5	20
ALM2BK4-R-30-E1	21,1	30,1	180	170	195	3400	44,7	116.5	20
ALM2BK4-R-34-E1	23,7	33,7	180	170	195	3000	52,2	120.5	20
ALM2BK4-R-37-E1	25,5	36,4	170	160	185	2600	59	123.5	20
ALM2BK4-R-40-E1	28,2	40,1	170	160	185	2600	61	127.5	20



Standard ports: M6 threads depth 13 mm.

To mount the motor: n.2 M10 screws with a torque wrench setting fixed at 46 ± 4 Nm.

G $\frac{1}{4}$ drain port thread depth 12 mm.

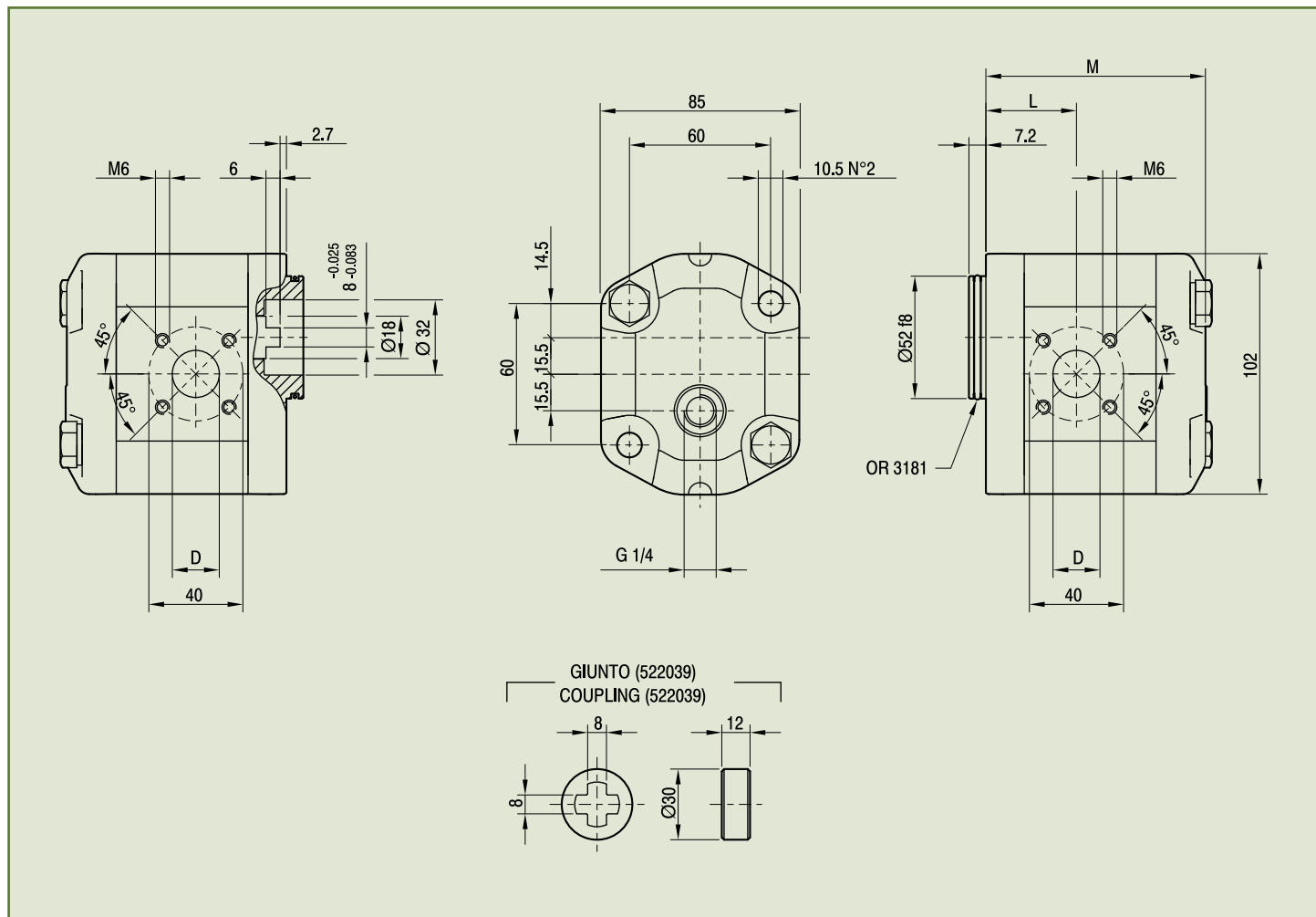

Type	Displacement cm ³ /rev	Flow at 1500 rev/min litres/mim	Maximum Pressure			Maximum Speed rpm	Dimensions		
			P _I bar	P _C bar	P _P bar		L mm	M mm	D mm
ALM2BK7-R-6-E1	4,5	6,4	250	240	270	4000	37,3	91	15
ALM2BK7-R-9-E1	6,4	9,1	250	240	270	4000	38,5	94	15
ALM2BK7-R-10-E1	7	10	250	240	270	4000	44,8	95	15
ALM2BK7-R-12-E1	8,3	11,8	250	240	270	4000	45,8	97	15
ALM2BK7-R-13-E1	9,6	13,7	250	240	270	4000	40,6	99	20
ALM2BK7-R-16-E1	11,5	16,4	230	220	250	4000	45	102	20
ALM2BK7-R-20-E1	14,1	20,1	230	220	250	4000	45	106	20
ALM2BK7-R-22-E1	16,0	22,8	210	200	225	4000	45	109	20
ALM2BK7-R-25-E1	17,9	25,5	210	200	225	4000	53,5	112	20
ALM2BK7-R-30-E1	21,1	30,1	180	170	195	3400	45	117	20
ALM2BK7-R-34-E1	23,7	33,7	180	170	195	3000	52,5	121	20
ALM2BK7-R-37-E1	25,5	36,4	170	160	185	2600	59,3	124	20
ALM2BK7-R-40-E1	28,2	40,1	170	160	185	2600	61,3	128	20



Flanges

Shafts

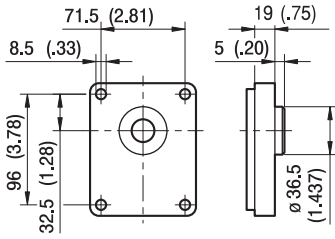

T0

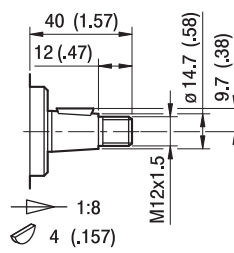

C0

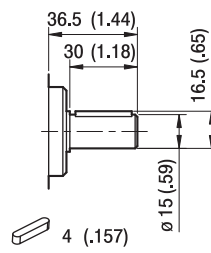

S0

DIN 5482
B17x14

Max Torque 140 Nm

Max Torque 200 Nm

Max Torque 135 Nm

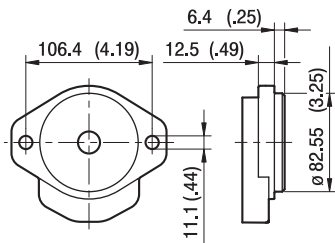

A

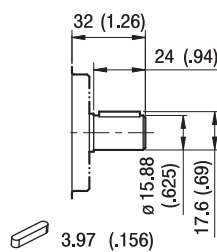

C1

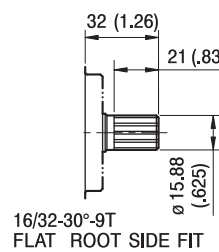

S1

Allow close coupling of hydraulic pumps / motors directly to the flywheel / flywheel housing of diesel engines, electric and hydraulic motors.

www.jbj.co.uk/hydraulic-adaptors.html

The package consists of a bellhousing and flexible drive coupling that are fully machined to suit the pump and any driving interface; diesel or petrol engine, electric or hydraulic motor.

jbj's in-house design team and manufacturing facility provide tailored solutions for your applications at competitive prices with quick delivery.

A range of composite bellhousings to accommodate electric motor flanges from 300 mm diameter to 800 mm diameter. See pages 40 to 44 of the Pump Drive Components technical specification catalogue.

A collection of different ways of connecting hydraulic pumps and motors to various driver devices.

Max Torque 140 Nm

Max Torque 185 Nm

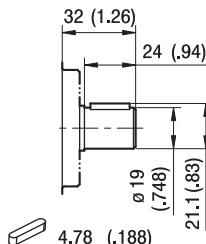

C2

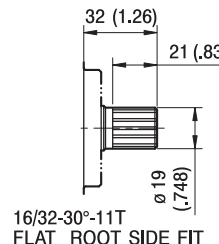

S2

Max Torque 160 Nm

Max Torque 200 Nm

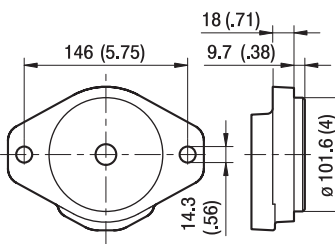

A3

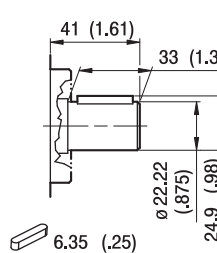

C3

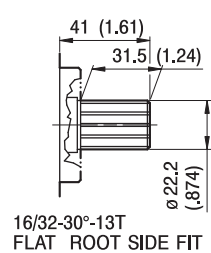

S3

Max Torque 140 Nm

Max Torque 140 Nm



Flanges

Shafts

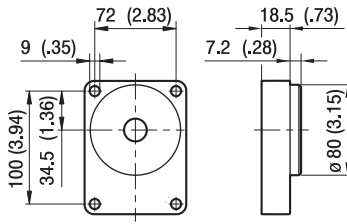

BK1

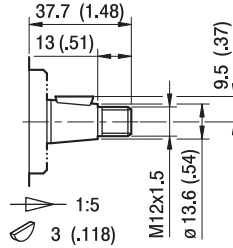

T1

Max Torque 180 Nm

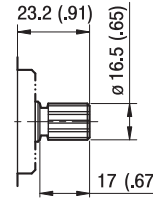

S3

DIN 5482
B17x14

Max Torque 140 Nm

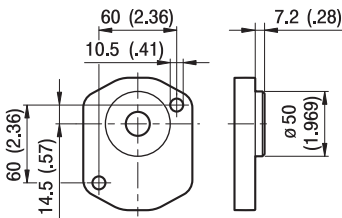

BK2

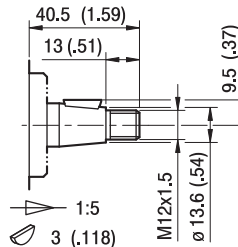

T2

Max Torque 180 Nm

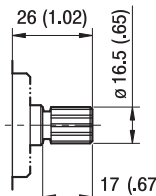

S4

DIN 5482
B17x14

Max Torque 140 Nm

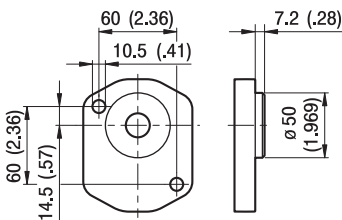

BK4

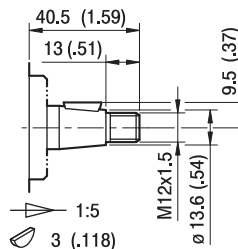

T2

Max Torque 180 Nm

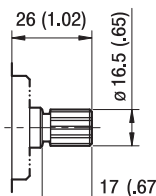

S4

DIN 5482
B17x14

Max Torque 140 Nm

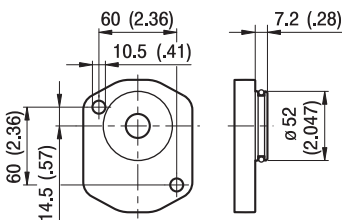

BK7

OR 3181

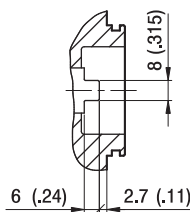

G0

Max Torque 100 Nm

Allow close coupling of hydraulic pumps / motors directly to the flywheel / flywheel housing of diesel engines, electric and hydraulic motors.

www.jbj.co.uk/hydraulic-adaptors.html

The package consists of a bellhousing and flexible drive coupling that are fully machined to suit the pump and any driving interface; diesel or petrol engine, electric or hydraulic motor.

jbj's in-house design team and manufacturing facility provide tailored solutions for your applications at competitive prices with quick delivery.

A range of composite bellhousings to accommodate electric motor flanges from 300 mm diameter to 800 mm diameter. See pages 40 to 44 of the Pump Drive Components technical specification catalogue.

A collection of different ways of connecting hydraulic pumps and motors to various driver devices.



Ports

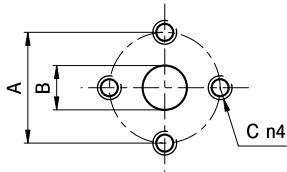

E

Type	Bi-directional Motor			Mono-directional motor		
	Output -Input			Input		
	A	B	C	A	B	C
ALM2...6 to ALM2...9	30	13	M6	30	13	M6
ALM2...10 to ALM2...13	40	13	M8	40	13	M8
ALM2...16 to ALM2...25	40	19	M8	40	13	M8
ALM2...30 to GALM2...40	40	19	M8	40	19	M8

Tightening torques of the fittings screws are specified on page 52 (accessories section).

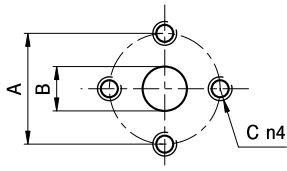

EP

Type	Bi-directional Motor			Mono-directional motor		
	Output -Input			Input		
	A	B	C	A	B	C
ALM2...6	40	13	M8	30	13	M6
ALM2...10 to ALM2...13	30	13	M6	30	13	M6
ALM2...16 to ALM2...40	40	19	M8	30	13	M6

Tightening torques of the fittings screws are specified on page 52 (accessories section).

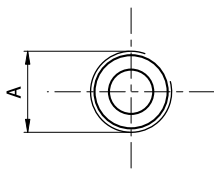

FG

Type	Bi-directional Motor		Mono-directional motor	
	Output -Input		Input	
	A		A	
ALM2...6 to ALM2...16	G½		G½	
ALM2...20 to ALM2...40	G¾		G½	

Tightening torques for G½ fitting: 50 Nm. Tightening torques for G¾ fitting: 60 Nm. Please check with the fittings suppliers.

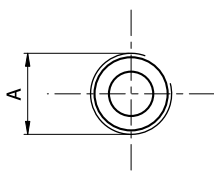

FC

Type	Bi-directional Motor		Mono-directional motor	
	Output -Input		Input	
	A		A	
ALM2...6 to ALM2...16	Rc½		Rc½	
ALM2...20 to ALM2...40	Rc¾		Rc½	

Tightening torques for Rc½ fitting: 50 Nm. Tightening torques for Rc¾ fitting: 60 Nm. Please check with the fittings suppliers.



Ports

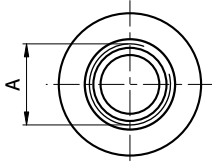

STANDARD SAE J1926/1

FA

Type	Bi-directional Motor	Mono-directional motor
	Output -Input	Input
	A	
ALM2...6 to ALM2...40	1 1/16-12 UNF	7/8-14 UNF

Tightening torques for 7/8-14 UNF fitting: 70 Nm. Tightening torques for 1 1/16-12 UNF fitting: 70 Nm. Please check with the fittings suppliers.

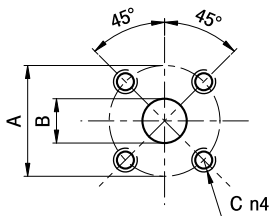

D

Type	Bi-directional Motor			Mono-directional motor		
	Output -Input			Input		
	A	B	C	A	B	C
ALM2...6 to ALM2...12	40	15	M6	35	15	M6
ALM2...13 to ALM2...40	40	20	M6	35	15	M6

Tightening torques of the fittings screws are specified on page 52 (accessories section).

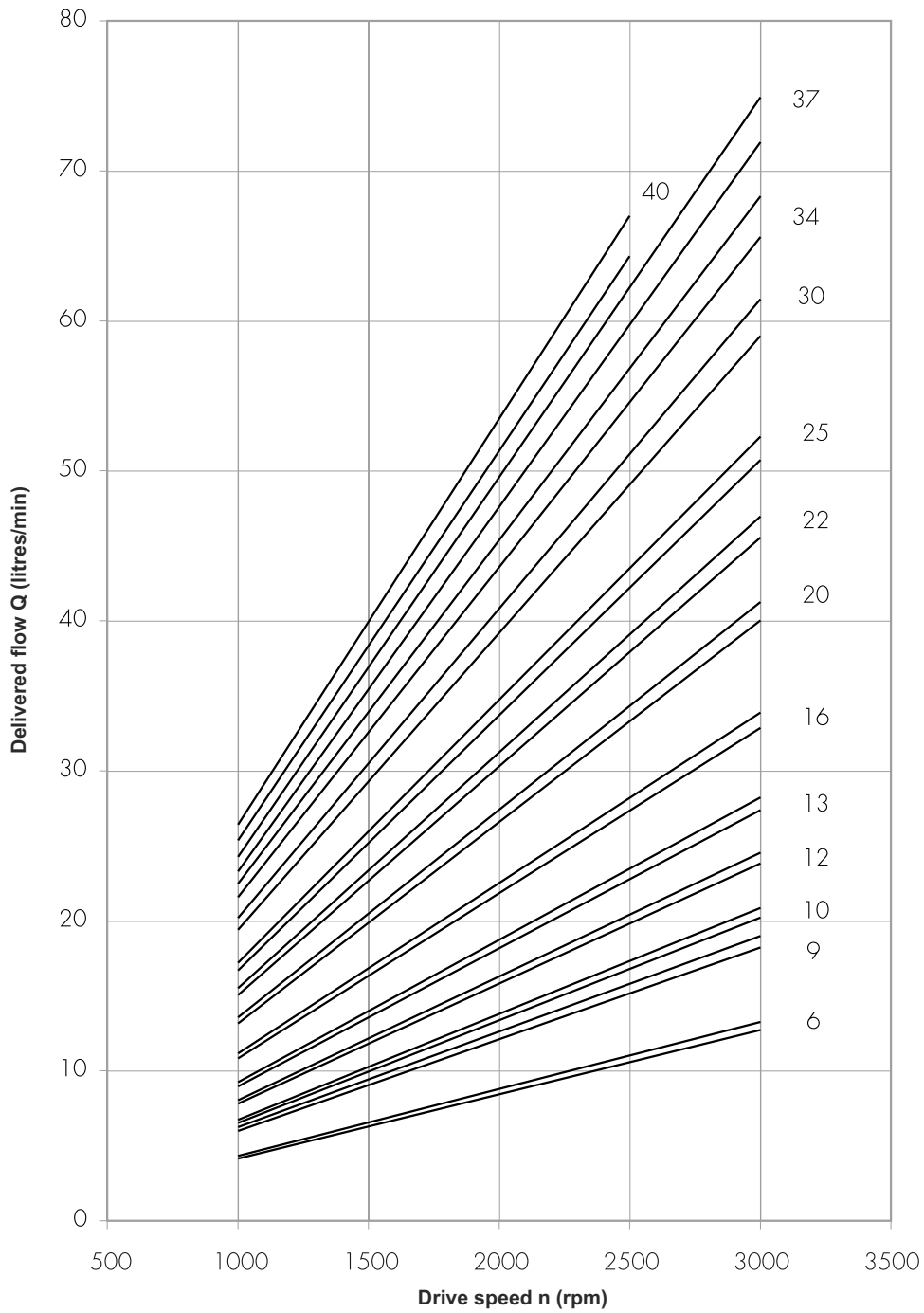

Each curve has been obtained at 50°C, using oil with viscosity 30 cSt at these pressure.

6 |
 9 |— 25-250 bar
 10 |
 12 |
 13 |— 25-240 bar
 16 |

20 |— 25-220 bar
 22 |
 25 |— 25-210 bar
 30 |— 25-190 bar

34 |— 25-170 bar
 37 |
 40 |— 25-160 bar



Delivered power P [kW]. Delivered torque M [Nm]. Drive speed n [giri/min] [rpm]

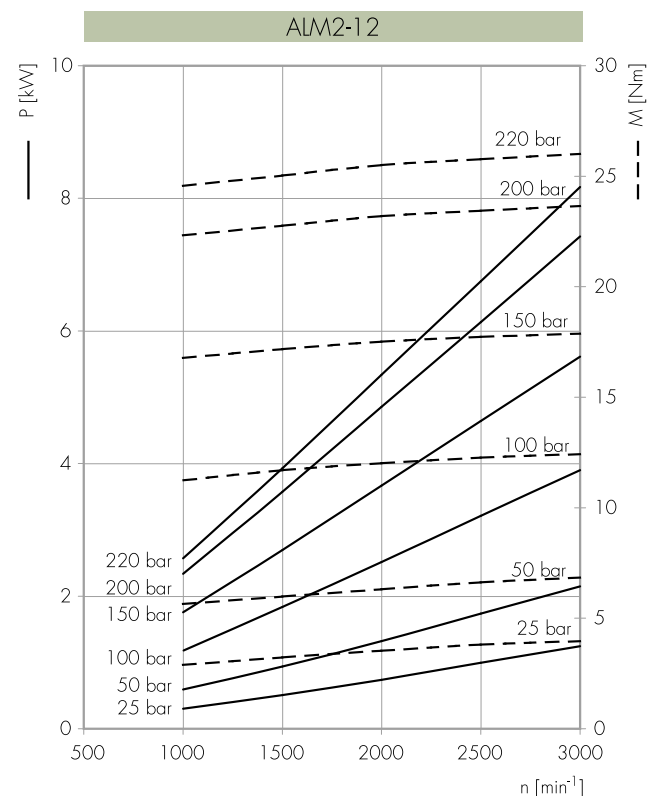
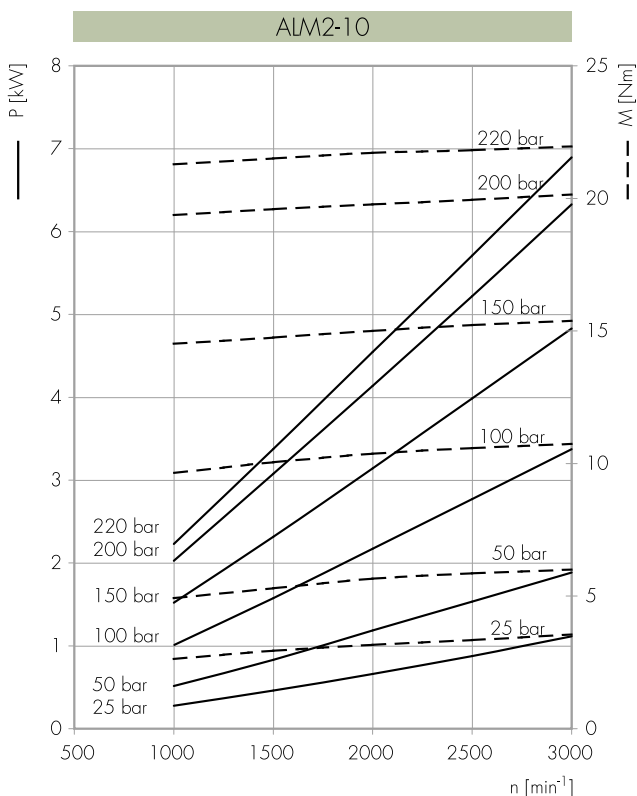
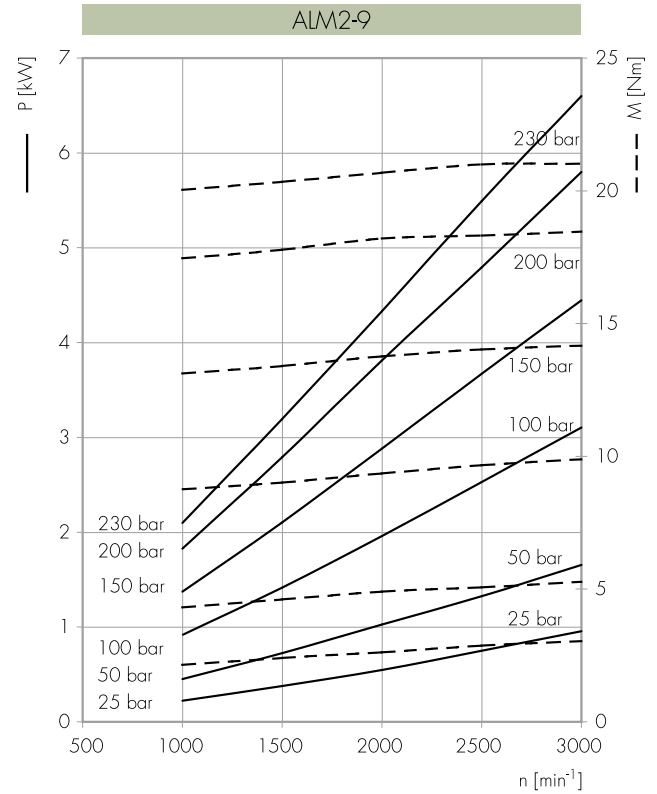
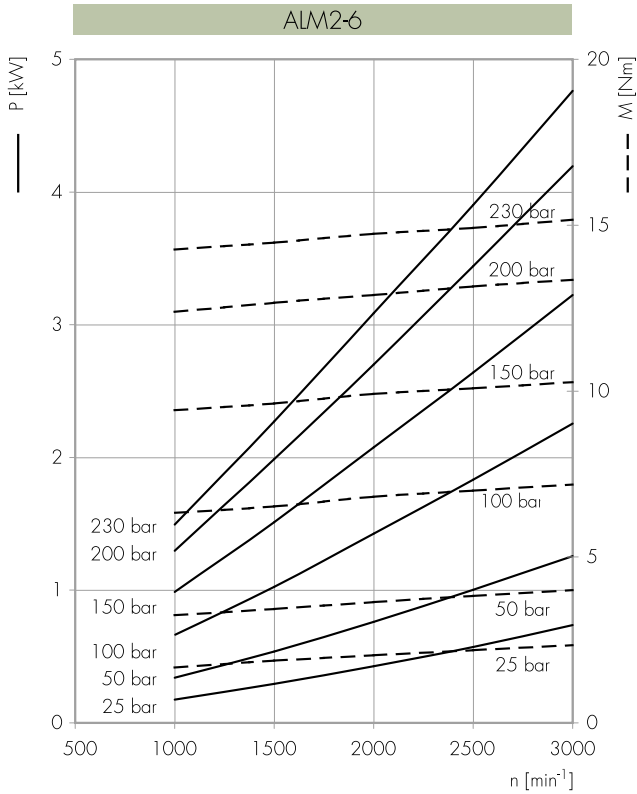



Delivered power P [kW]. Delivered torque M [Nm]. Drive speed n [giri/min] [rpm]

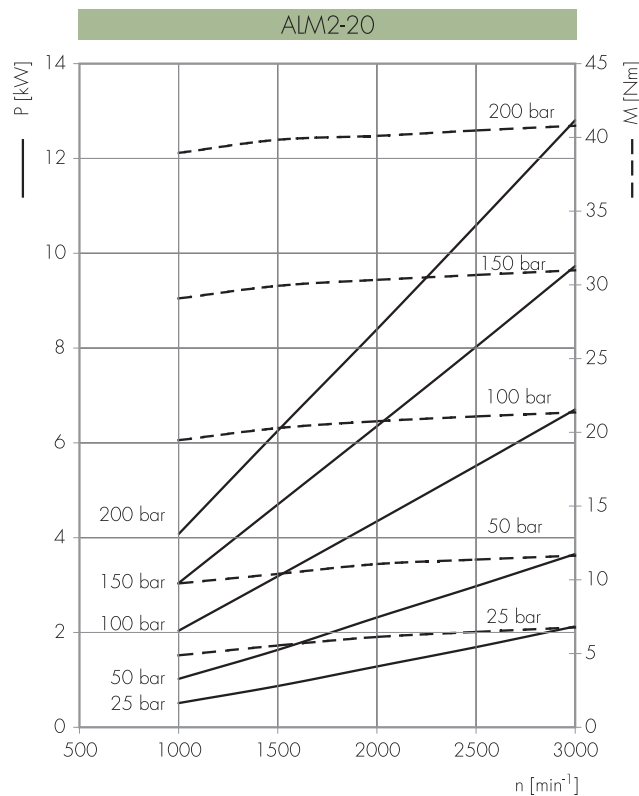
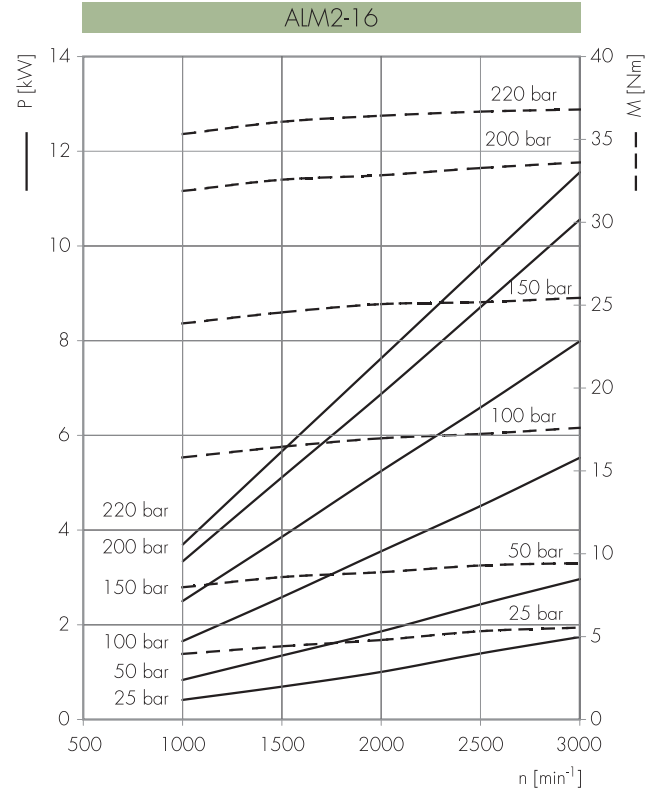
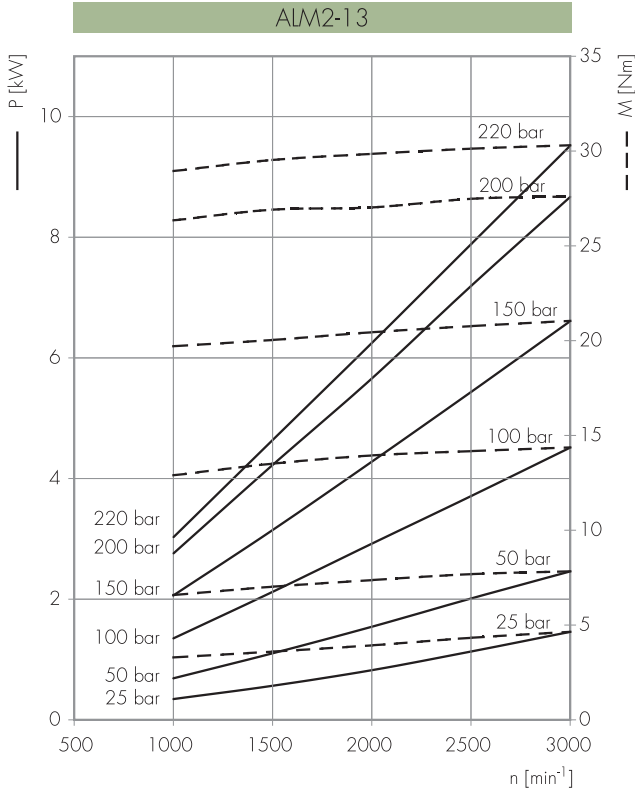



Delivered power P [kW]. Delivered torque M [Nm]. Drive speed n [giri/min] [rpm]

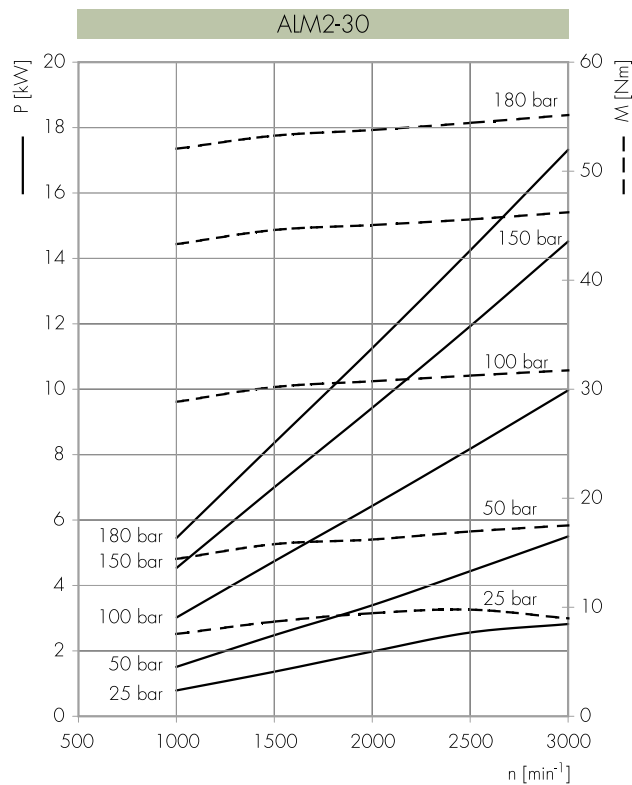
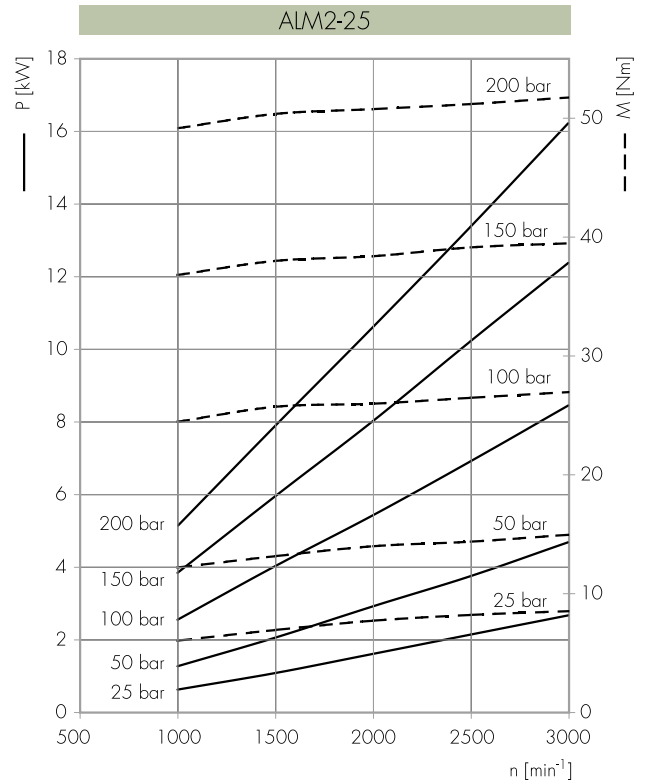
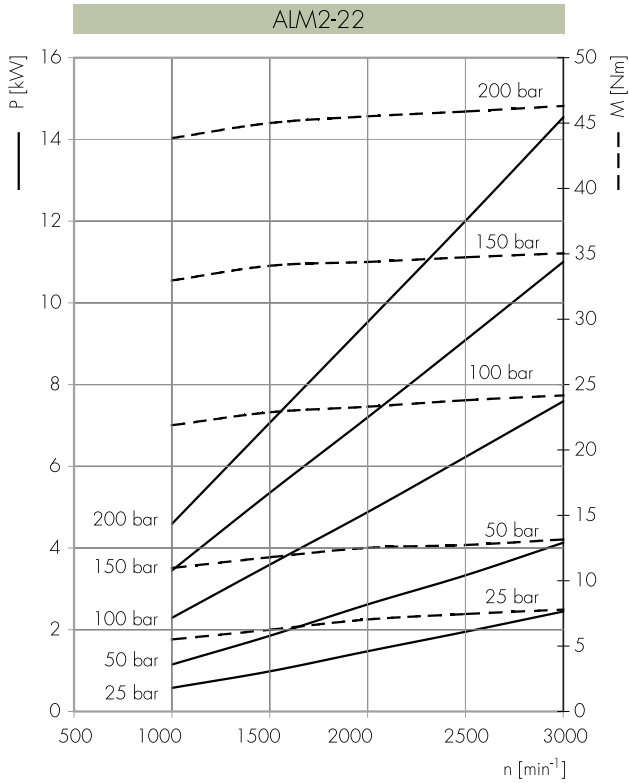



Delivered power P [kW]. Delivered torque M [Nm]. Drive speed n [giri/min] [rpm]

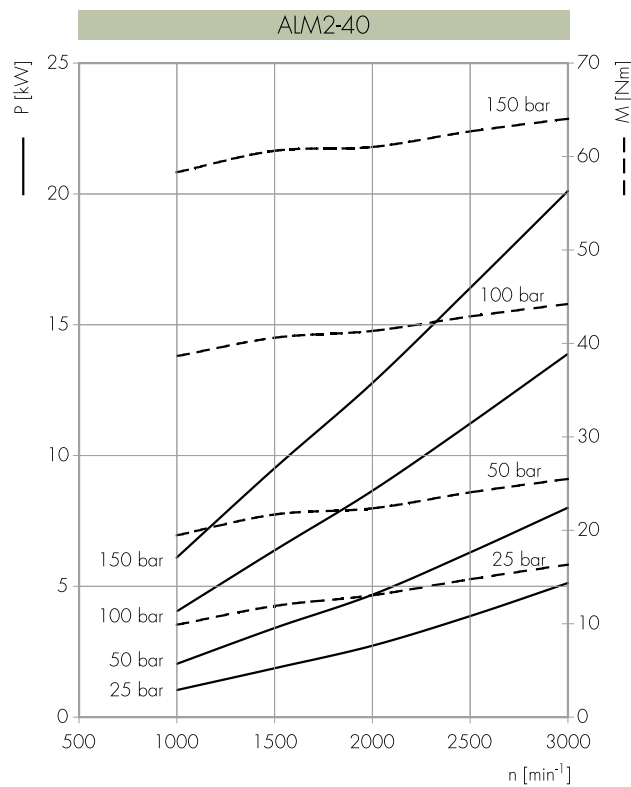
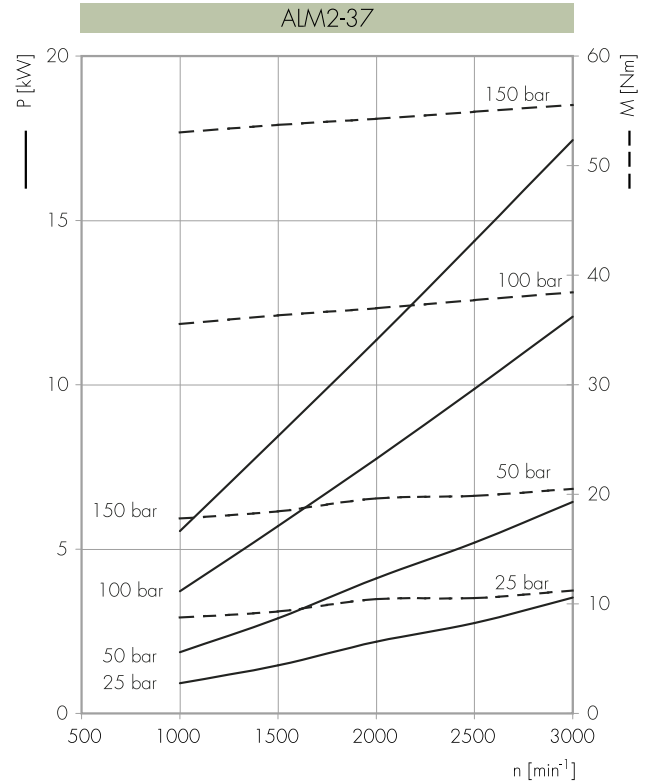
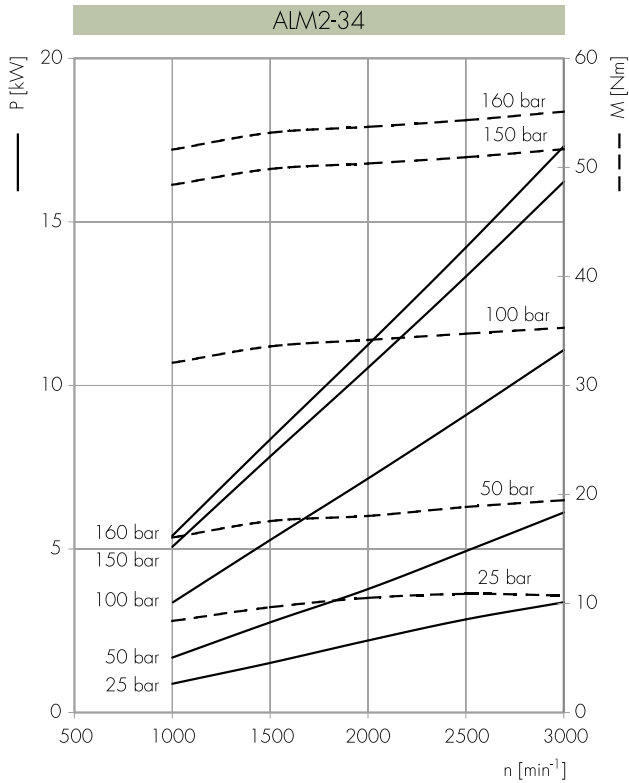



Ordering Code

GHM3	Type	Rotation	Size	Shaft*	Ports*	Seals*	Options*	Drain**
	omit	D Clockwise	...			Seals omit (T range = -10°C + 80°C) V ...		
	A	S Counter Clockwise	33					
		R Reversible	40			Options ...		
			50			Drain E0 = internal drain E1 = external drain G3/8 E2 = drain 3/4-16 UNF *** E3 = drain G1/4 E4 = drain 9/16-18 UNF ***		
			60					
			66					
			80					
			94					
			110					
			120					
			135					

(*) = to be specified if different from standard "motor type"

(**) = only for R rotation

(***) = Drain ports are machined in compliance with threaded port with O-ring seal in truncated housing SAE J1926/1 (ISO 11926-1).

Motor Standard Types

omit = European flange + shaft T0 + ports E + standard seals

A = flange A + shaft C1 + ports A + standard seals

Examples

ALM3-D-30 = clockwise rotation, 20 cc/rev, European flange, 1:8 tapered shaft, flanged ports E type, standard seals.

ALM3-D-30-C0 = clockwise rotation, 20 cc/rev, European flange, cylindrical shaft (C0), flanged ports E type, standard seals.

ALM3A-D-30-E = clockwise rotation, 20 cc/rev, SAE B 2 bolt flange, cylindrical shaft, European flanged ports (E), standard seals.

ALM3A-R-40-E1 = reversible motor, 26 cc/rev, SAE B 2 bolt flange, cylindrical shaft, European flanged ports A, standard seals, external drain (E1).

The product data sheets show our standard model types. The synoptic tables for flanges, shafts and ports show all the possible configurations. For further details about the availability of each configuration please contact jbj Techniques technical office, email: info@jbj.co.uk or telephone: +44 (0)1737 767493



Accessories supplied with the standard motor: woodruff key (code 522058), M14x1.5 exagonal nut (code 523017), washer (code 523006).

Standard ports: M10 threads depth 19 mm.

G3/8 drain port thread depth 15 mm.

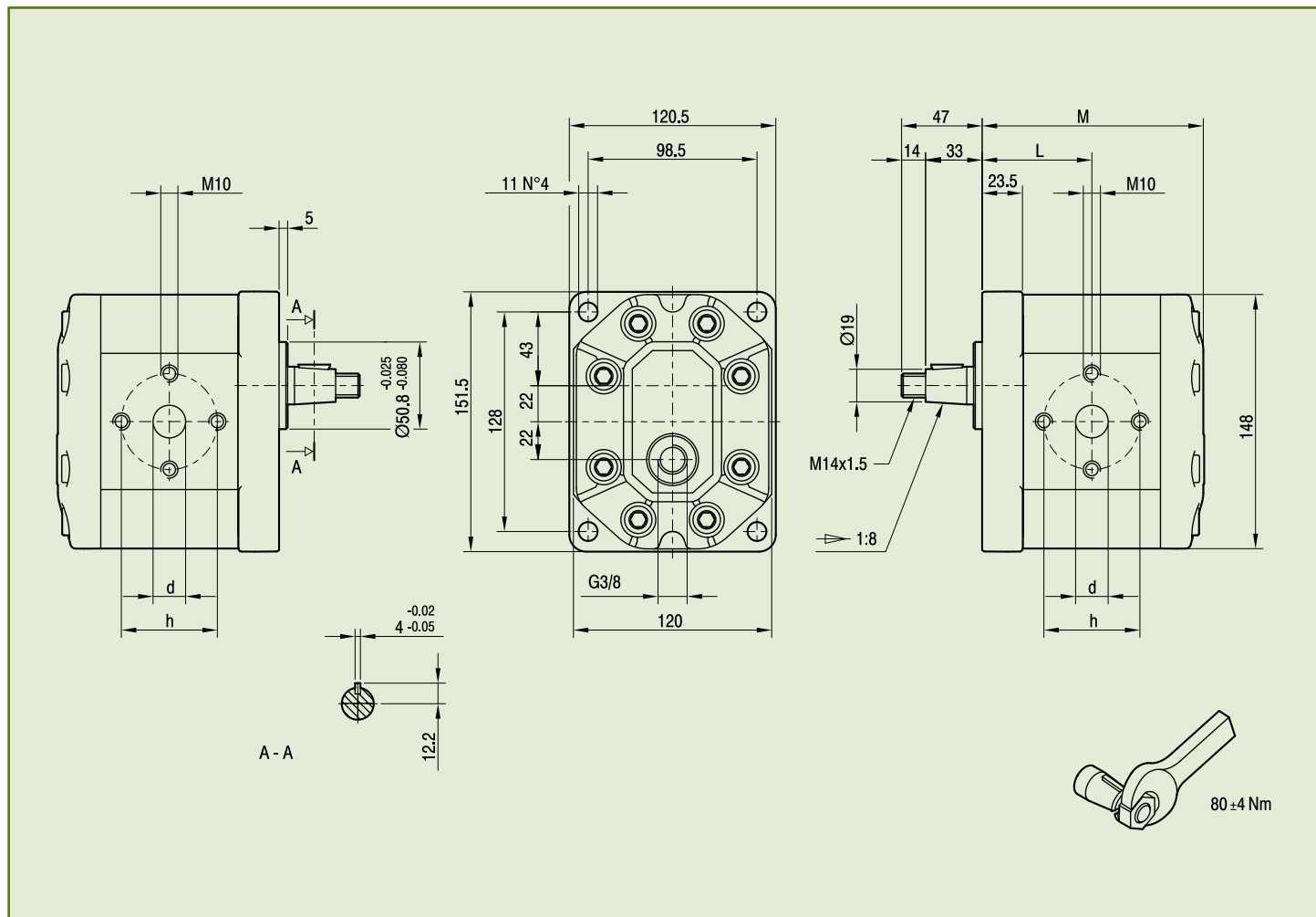

Type	Displacement cm ³ /rev	Flow at 1500 rev/min litres/mim	Maximum Pressure			Maximum Speed rpm	Dimensions			
			P _I bar	P _C bar	P _P bar		L mm	M mm	d mm	H mm
ALM3-R-33-E1	22	31	230	220	250	3500	64.5	130.5	27	56
ALM3-R-40-E1	26	37	230	220	250	3000	66	133.5	27	56
ALM3-R-50-E1	33	48	230	220	250	3000	68.5	138.5	27	56
ALM3-R-60-E1	39	56	220	210	240	3000	70.5	142.5	27	56
ALM3-R-66-E1	44	62	210	200	230	2800	72	145.5	27	51
ALM3-R-80-E1	52	74	200	190	215	2400	75	151.5	27	56
ALM3-R-94-E1	61	87	190	180	205	2600	78	157.5	33	62
ALM3-R-110-E1	71	101	170	160	185	2500	81.5	164.5	33	62
ALM3-R-120-E1	78	112	160	150	175	2300	84	169.5	33	62
ALM3-R-135-E1	87	124	140	130	155	2000	87	175.5	33	62



Accessories supplied with the standard motor: key (code 522068).

Mounting flange 101-2 (B) in compliance with SAE J744c. 1/4-28 UNF thread depth 20 mm.

Standard ports: 3/8-16 UNC threads depth 19 mm, 7/16-14 UNC threads depth 19 mm.

G3/8 drain port thread depth 15 mm.

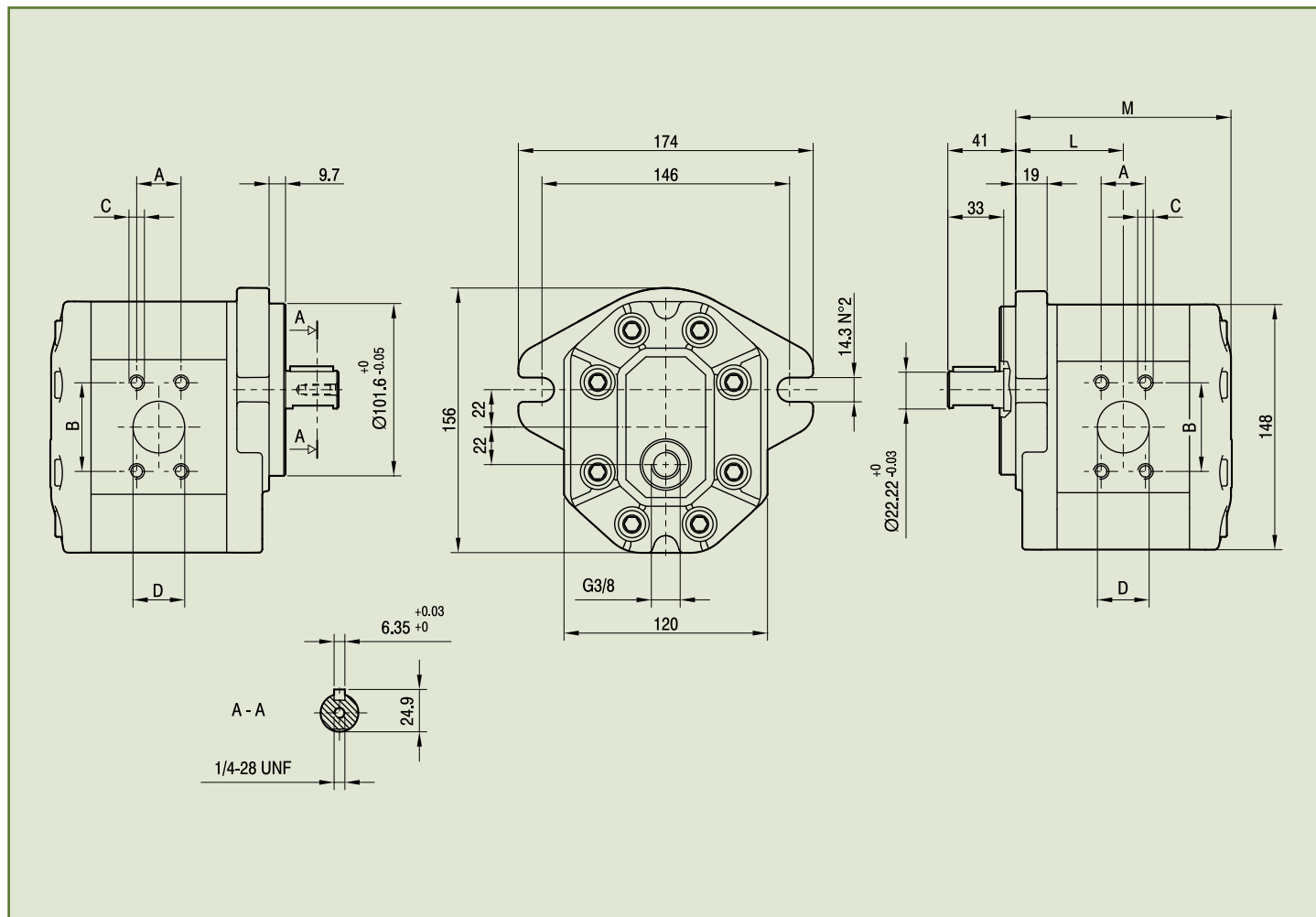

Type	Displacement cm ³ /rev	Flow at 1500 rev/min litres/min	Maximum Pressure			Maximum Speed rpm	Dimensions					
			P _I bar	P _C bar	P _P bar		L mm	M mm	A mm	B mm	C UNC	D mm
ALM3A-R-33-E1	22	31	230	220	250	3500	65.5	131.5	26.19	52.37	3/8	27
ALM3A-R-40-E1	26	37	230	220	250	3300	67	134.5	26.19	52.37	3/8	27
ALM3A-R-50-E1	33	48	230	220	250	3300	69.5	139.5	26.19	52.37	3/8	27
ALM3A-R-60-E1	39	56	220	210	240	3000	71.5	143.5	26.19	52.37	3/8	27
ALM3A-R-66-E1	44	62	210	200	230	2800	73	146.5	26.19	52.37	3/8	27
ALM3A-R-80-E1	52	74	200	190	215	2500	76	152.5	26.19	52.37	3/8	27
ALM3A-R-94-E1	61	87	190	180	205	2800	79	158.5	30.2	58.7	7/16	33
ALM3A-R-110-E1	71	101	170	160	185	2500	82.5	165.5	30.2	58.7	7/16	33
ALM3A-R-120-E1	78	112	160	150	175	2300	85	170.5	30.2	58.7	7/16	33
ALM3A-R-135-E1	87	124	140	130	155	2000	88	176.5	30.2	58.7	7/16	33



Flanges

Shafts

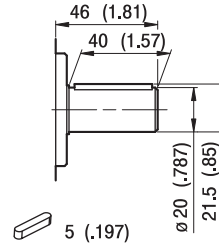
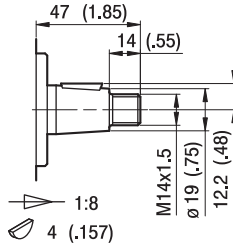
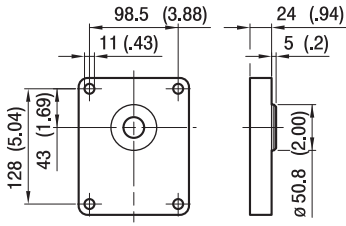

Max Torque: 300 Nm

Max Torque: 350 Nm

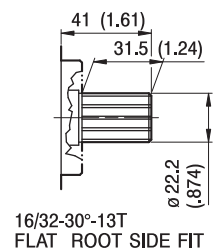
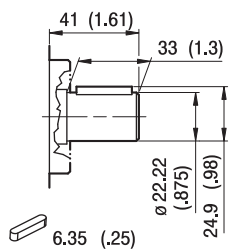
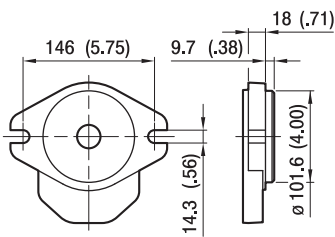

Max Torque: 450 Nm

Max Torque: 600 Nm

Allow close coupling of hydraulic pumps directly to the flywheel / flywheel housing of diesel engines, electric and hydraulic motors.

www.jbj.co.uk/hydraulic-adaptors.html

The package consists of a bellhousing and flexible drive coupling that are fully machined to suit the pump / motor and any driving interface; diesel or petrol engine, electric or hydraulic motor.

jbj's in-house design team and manufacturing facility provide tailored solutions for your applications at competitive prices with quick delivery.

A range of composite bell housings to accommodate electric motor flanges from 300 mm diameter to 800 mm diameter. See pages 40 to 44 of the Pump Drive Components technical specification catalogue.

A collection of different ways of connecting hydraulic pumps and motors to various driver devices.



Ports

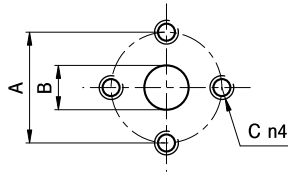

E

Type	Bi-directional Motor			Mono-directional motor		
	Output -Input			Input		
	A	B	C	A	B	C
ALM3...33 to ALM3...60	56	27	M10	56	19	M10
ALM3...66	51	27	M10	51	27	M10
ALM3...80	56	27	M10	56	27	M10
ALM3...94 to GHM3...135	62	33	M10	51	27	M10

Tightening torques of the fittings screws are specified on page 52 (accessories section).

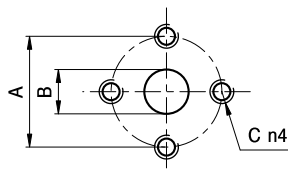

EP

Type	Bi-directional Motor			Mono-directional motor		
	Output -Input			Input		
	A	B	C	A	B	C
ALM3...33	40	19	M8	40	19	M8
ALM3...40 to ALM3...80	51	27	M10	40	19	M8

Tightening torques of the fittings screws are specified on page 52 (accessories section).

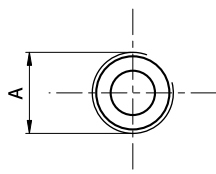

FG

Type	Bi-directional Motor		Mono-directional motor	
	Output -Input		Input	
	A		A	
ALM3...33	G $\frac{3}{4}$		G $\frac{3}{4}$	
ALM3...40 to ALM3...60	G1		G $\frac{3}{4}$	
ALM3...66 to ALM3...94	G1 $\frac{1}{4}$		G1	
ALM3...110 to ALM3...135	G1 $\frac{1}{2}$		G1 $\frac{1}{4}$	

Tightening torques for G $\frac{3}{4}$ fitting: 60 Nm. Tightening torques for G1 fitting: 70 Nm. Tightening torques for G1 $\frac{1}{4}$ fitting: 80 Nm.

Tightening torques for G1 $\frac{1}{2}$ fitting: 90 Nm. Please check with the fittings suppliers.

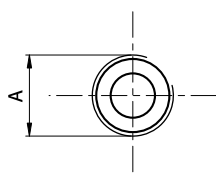

FC

Type	Bi-directional Motor		Mono-directional motor	
	Output -Input		Input	
	A		A	
ALM3...33	Rc $\frac{3}{4}$		Rc $\frac{3}{4}$	
ALM3...40 to ALM3...60	Rc1		Rc $\frac{3}{4}$	
ALM3...66 to ALM3...94	Rc1 $\frac{1}{4}$		Rc1	
ALM3...110 to ALM3...135	Rc1 $\frac{1}{2}$		Rc1 $\frac{1}{4}$	

Tightening torques for Rc $\frac{3}{4}$ fitting: 60 Nm. Tightening torques for Rc1 fitting: 70 Nm. Tightening torques for Rc1 $\frac{1}{4}$ fitting: 80 Nm.

Tightening torques for Rc1 $\frac{1}{2}$ fitting: 90 Nm. Please check with the fittings suppliers.



Ports

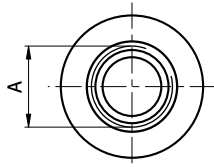

STANDARD SAE J1926/1

FA

Type	Bi-directional Motor	Mono-directional motor
	Output -Input	Input
	A	A
ALM3...33 to ALM3...50	1 1/16-12 UNF	1 1/16-12 UNF
ALM3...60 to ALM3...80	1 5/8-12 UNF	1 5/8-12 UNF
ALM3...94 to ALM3...135	1 7/8-12 UNF	1 7/8-12 UNF

Tightening torques for 1 1/16-12 UNF fitting: 70 Nm. Tightening torques for 1 5/16-12 UNF fitting: 80 Nm. Tightening torques for 1 5/8-12 UNF fitting: 80 Nm. Tightening torques for 1 7/8-12 UNF fitting: 80 Nm. Please check with the fittings suppliers.

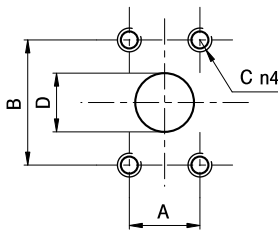

A

Type	Bi-directional Motor				Mono-directional motor			
	Output -Input				Input			
	A	B	C	D	A	B	C	D
ALM3...33 to ALM3...80	26.19	52.37	3/8-16 UNC	27	22.23	47.6	3/8-16 UN	19
ALM3...94 to ALM3...135	30.2	58.7	7/16-14 UNC	33	26.19	52.3	3/8-16 UNC	27

Tightening torques of the fittings screws are specified on page 52 (accessories section).

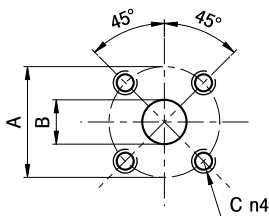

D

Type	Bi-directional Motor			Mono-directional motor		
	Output -Input			Input		
	A	B	C	A	B	C
ALM3...33 to ALM3...80	55	2	M8	55	1	M8

Tightening torques of the fittings screws are specified on page 52 (accessories section).

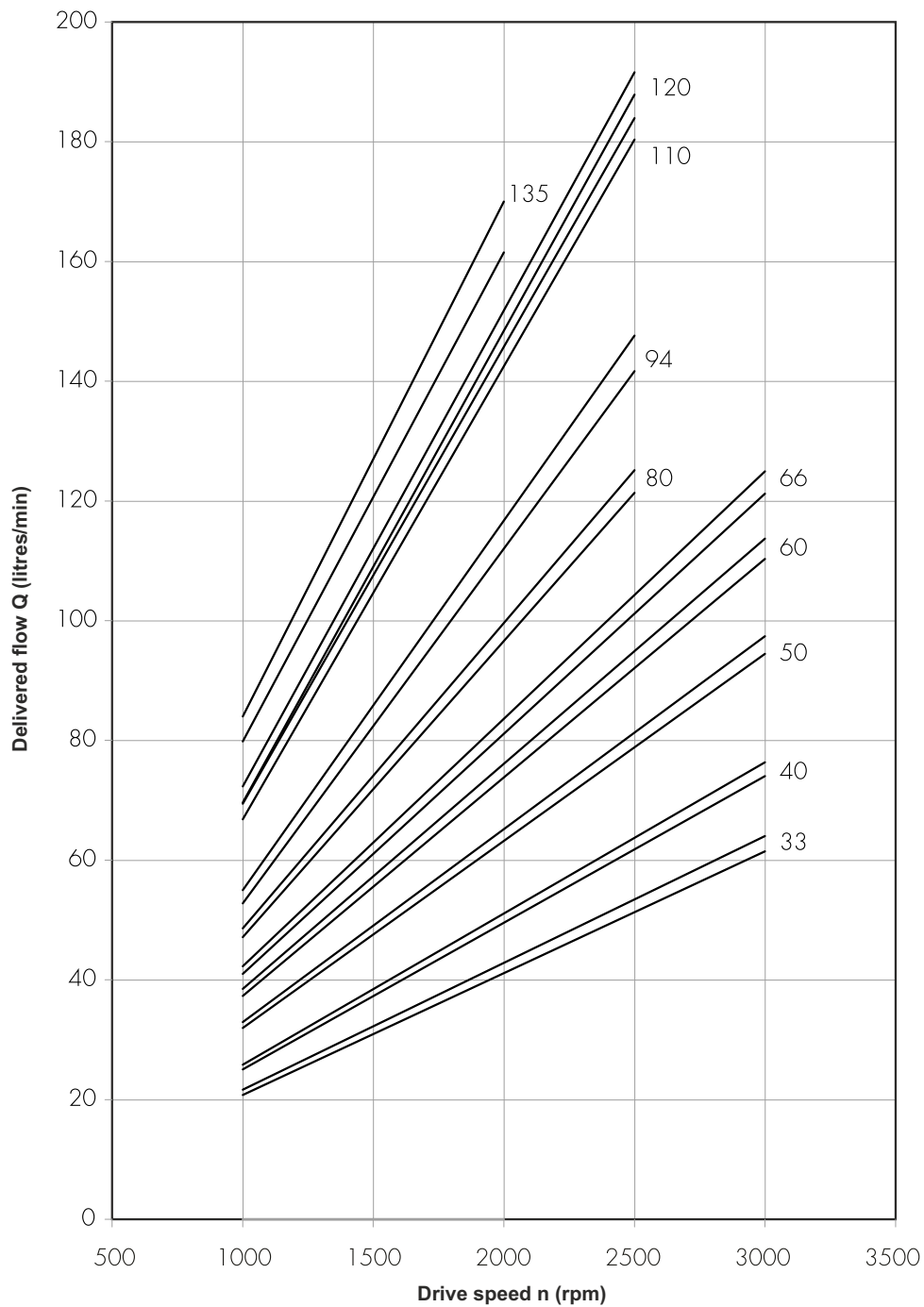

Each curve has been obtained at 50°C, using oil with viscosity 30 cSt at these pressure.

33 | 25-250 bar
40 |

80 | 25-220 bar

110 | 25-180 bar

50 |
60 | 25-240 bar
66 |

94 | 25-200 bar

120 | 25-170 bar

135 | 25-150 bar



Delivered power P [kW]. Delivered torque M [Nm]. Drive speed n [giri/min] [rpm]

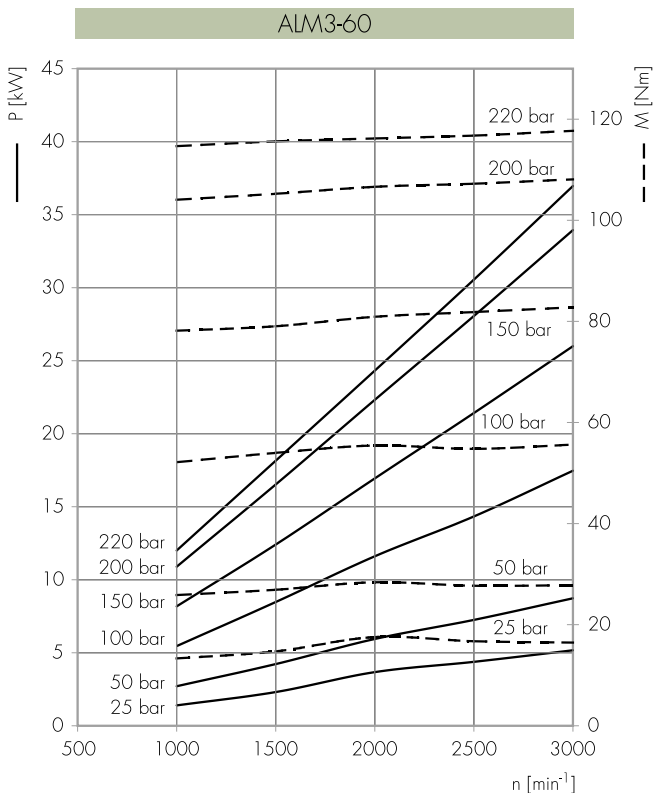
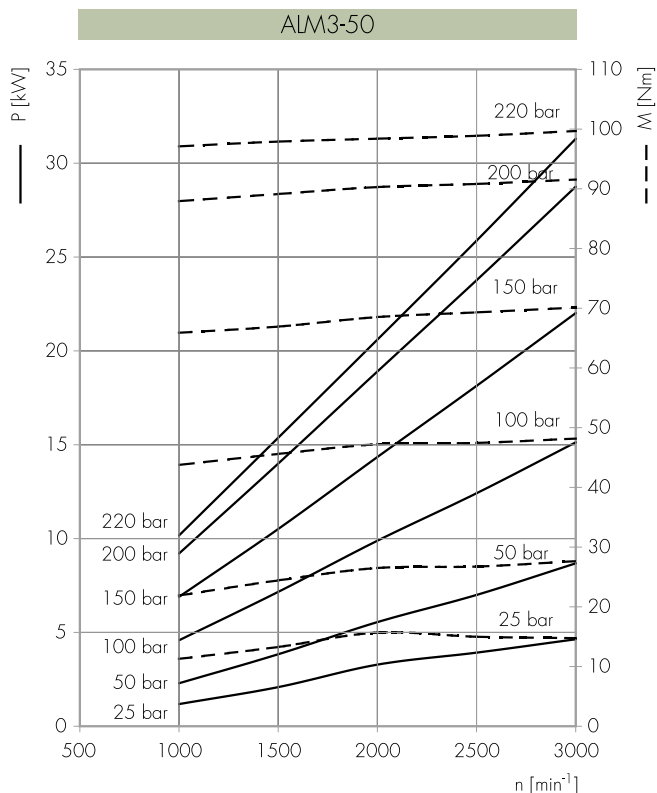
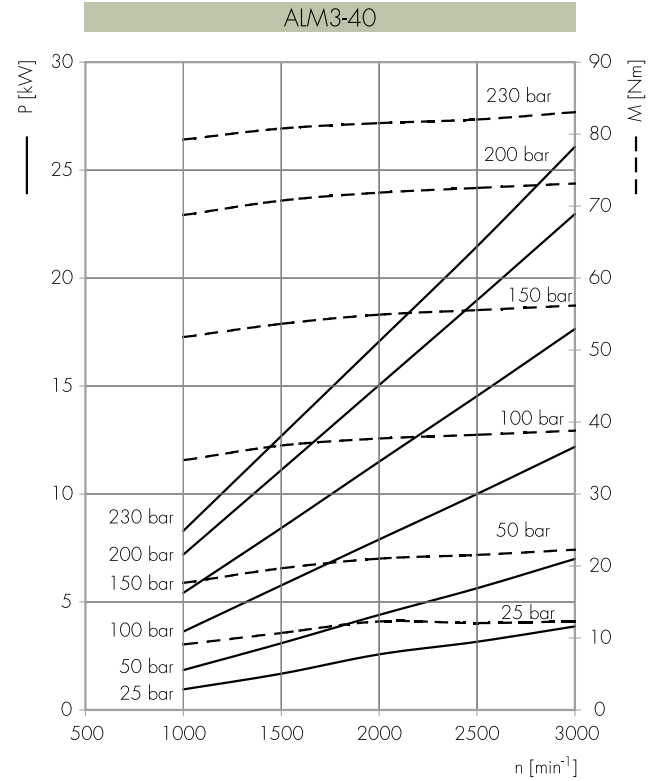
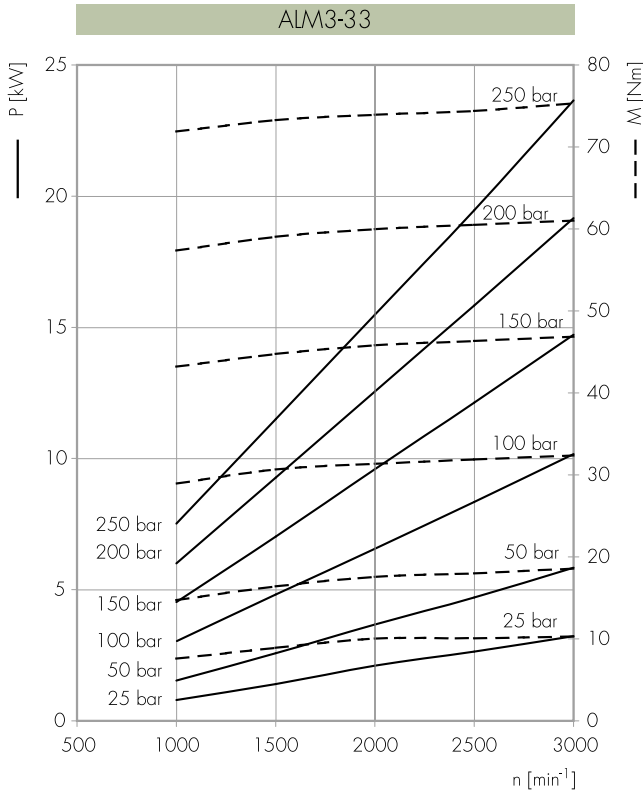



Delivered power P [kW]. Delivered torque M [Nm]. Drive speed n [giri/min] [rpm]

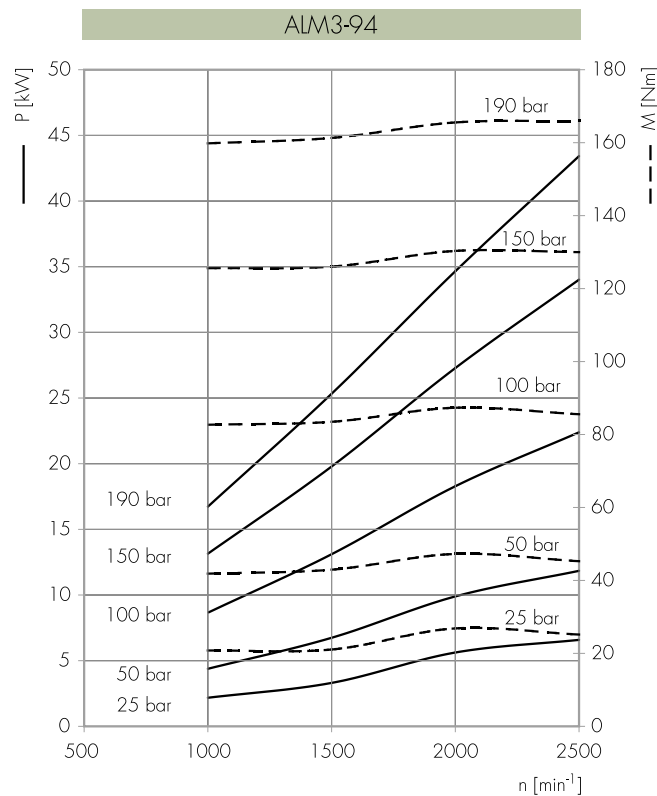
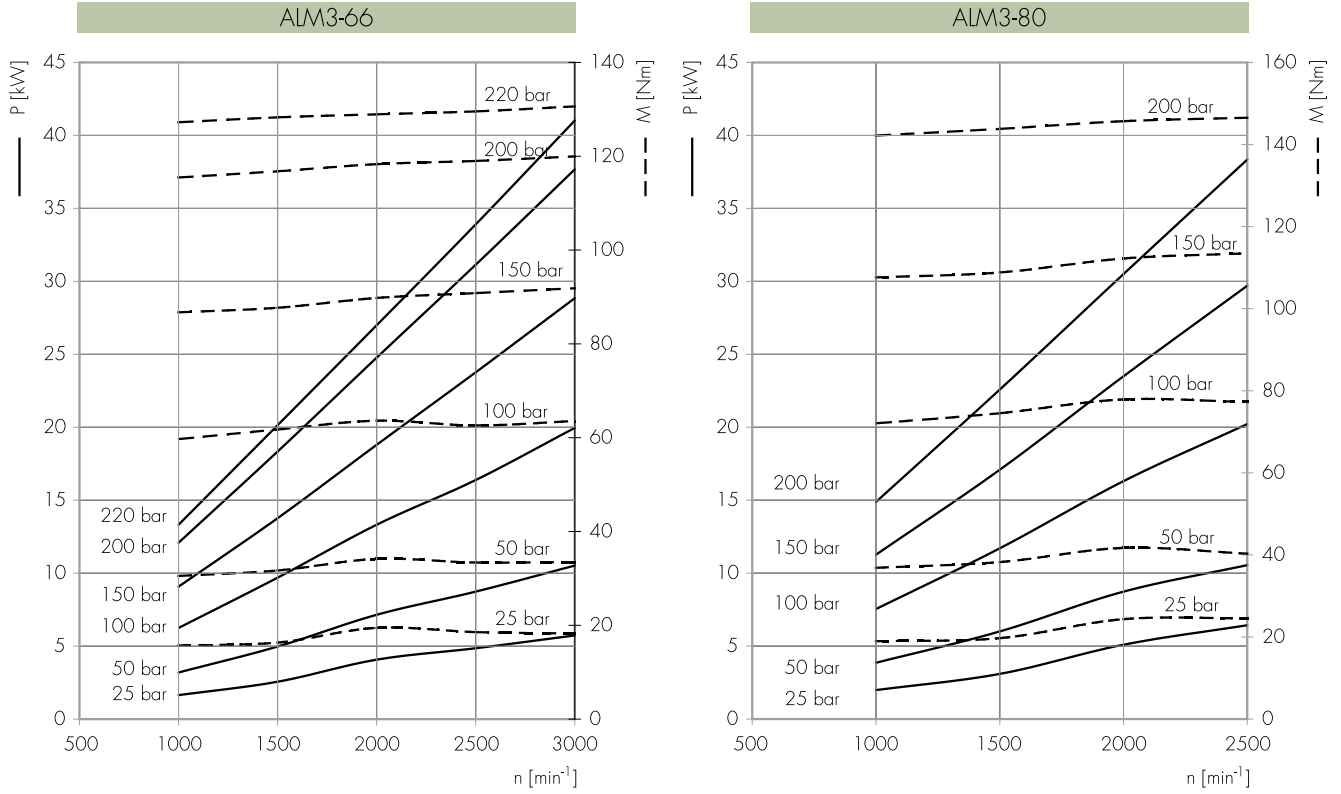



Delivered power P [kW]. Delivered torque M [Nm]. Drive speed n [giri/min] [rpm]

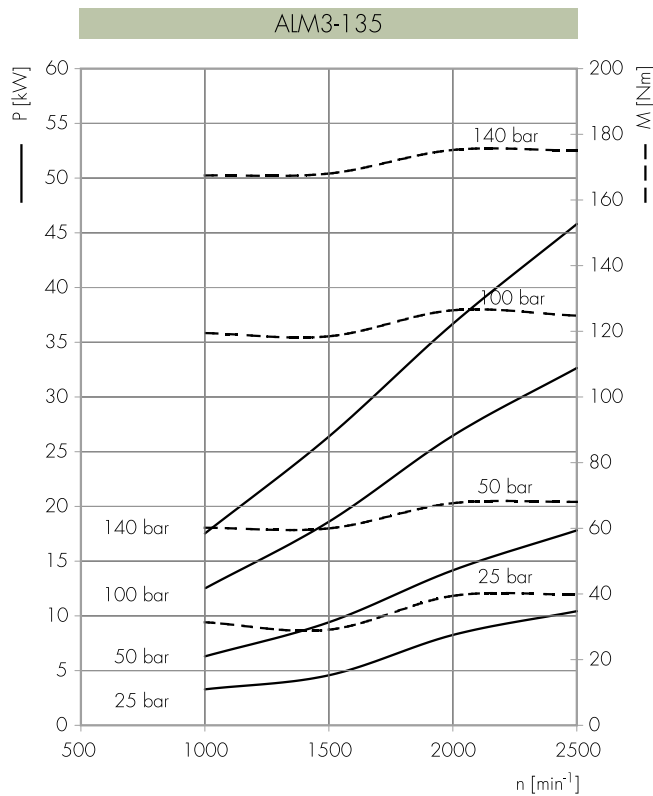
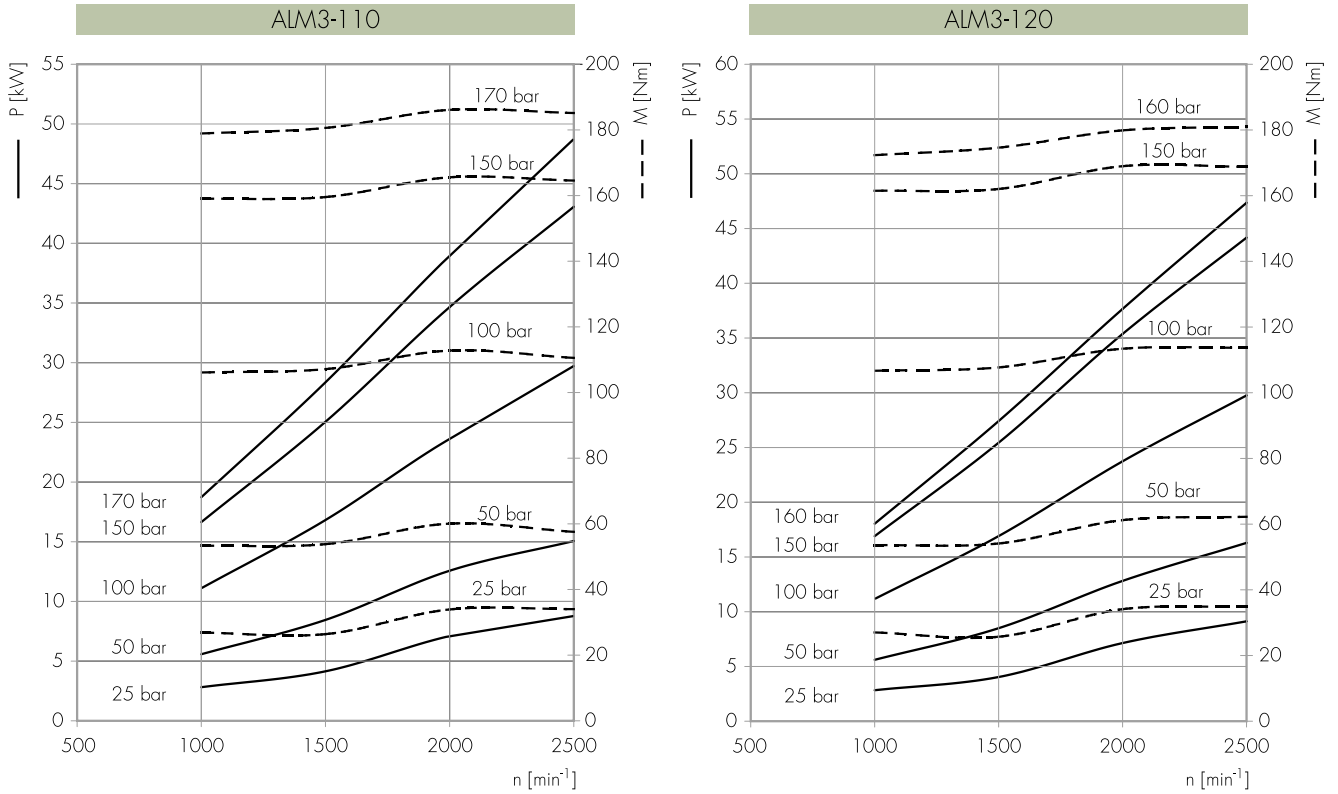



Fittings

Cast iron and steel fittings are available as follows, complete with assembly screws, washers and NBR seals (temperature range -30°C to +100°C). Screws tightening torque are showed in the following tables.

For further information concerning the dimensions of the available fittings, please refer to the GHP Series gear pumps catalogue.

Spare Gasket Kit

The standard model types are supplied with NBR seals. Allowed operating conditions are indicated in the technical information section.

In case of change of the motor's seals, please pay attention to not damage the parts; it is important to clean all the components in order to avoid contamination and to tighten the motor bolts correctly.

Group	Type	Rotation	Seals	Options	Code
ALM1	all	D/S	omit	omit	650241/R
			V		650242/R
			ST		650243/R
			H		650252/R
		R	omit		650225/R
			V		650253/R
			ST		650255/R
			H		650254/R
ALM2	all	D/S	omit	omit	650259/R
			V		650260/R
			ST		650261/R
			H		650262/R
		R	omit		650230/R
			V		650256/R
			ST		650258/R
			H		650257/R
ALM3	omit	D/S	omit	omit	650343/R
			V		650344/R
			ST		650346/R
			H		650345/R
		R	omit		650335/R
			V		650336/R
			ST		650338/R
			H		650337/R
	A	D/S	omit	omit	650347/R
			V		650348/R
			ST		650350/R
			H		650349/R
		R	omit		650339/R
			V		650340/R
			ST		650342/R
			H		650341/R

ad esclusione del modello GHM2BK7 / type GHM2BK7 excluded



Gear Pump/Motor Basic Design - simple construction, long and useful life.

External gear pumps are the most popular pumps used in modern hydraulic systems.

They feature versatility, strength and long life. Their simple construction ensures cost effective purchasing and service. Thanks to these basic concepts, coupled with ever improving product design and features, result in a quality product manufactured to the very highest standards. Due to the many years of research and experience, accurate material selection, rigid production process and rigorous testing on all aspects of the product range, enables Marzocchi gear pumps to operate under extreme working conditions and transmit high hydraulic power. In addition Marzocchi pumps are produced with good mechanical and hydraulic efficiency, low noise level and their compact dimensions give a low weight too power ratio.

A gear pump usually consists of a gear pair supported by two aluminium bushes for groups 0.25, 0.5 and 1P, or bushes with plain bearings coated with anti-friction material for groups 1, 2, 3 and 4, a body, a securing flange and a cover.

Shaft of the driving gear projecting beyond the flange mounts a twin-lip seal ring (the inner lip being a seal, the outer lip being a dust seal) for groups 0.25, 0.5 and 1P, or two opposed single-lip seal rings (the outer being a dust seal) for groups 1, 2, 3 and 4.

Pump body, flange and cover are made of special high-resistant aluminium alloys for minimized deformation even when subject to high pressure, be it continuous or intermittent or peak pressure. The body is profiled by means of extrusion, whereas flange and cover are obtained by means of die-casting (gravity die-casting for some models).

Gears are made of special steel. Their manufacturing process includes case-hardening and quench hardening. The gears are ground and fine finished so as to have a high degree of surface finishing. Proper tooth profile design and geometric proportions ensure low pulsation levels and low noise levels during pump operation. Bushes are made of special low-friction and high-resistant aluminium alloy and manufactured from die-casting. Special compensation zones onto flange and cover, insulated by special seals with anti-extrusion rings, allow fully free axial and radial movement to the bushes, which is proportional to pump operating pressure. In this way, internal leakage is dramatically reduced, thus ensuring very high pump performance (both in terms of flow and overall) and proper lubrication to the moving pump parts.

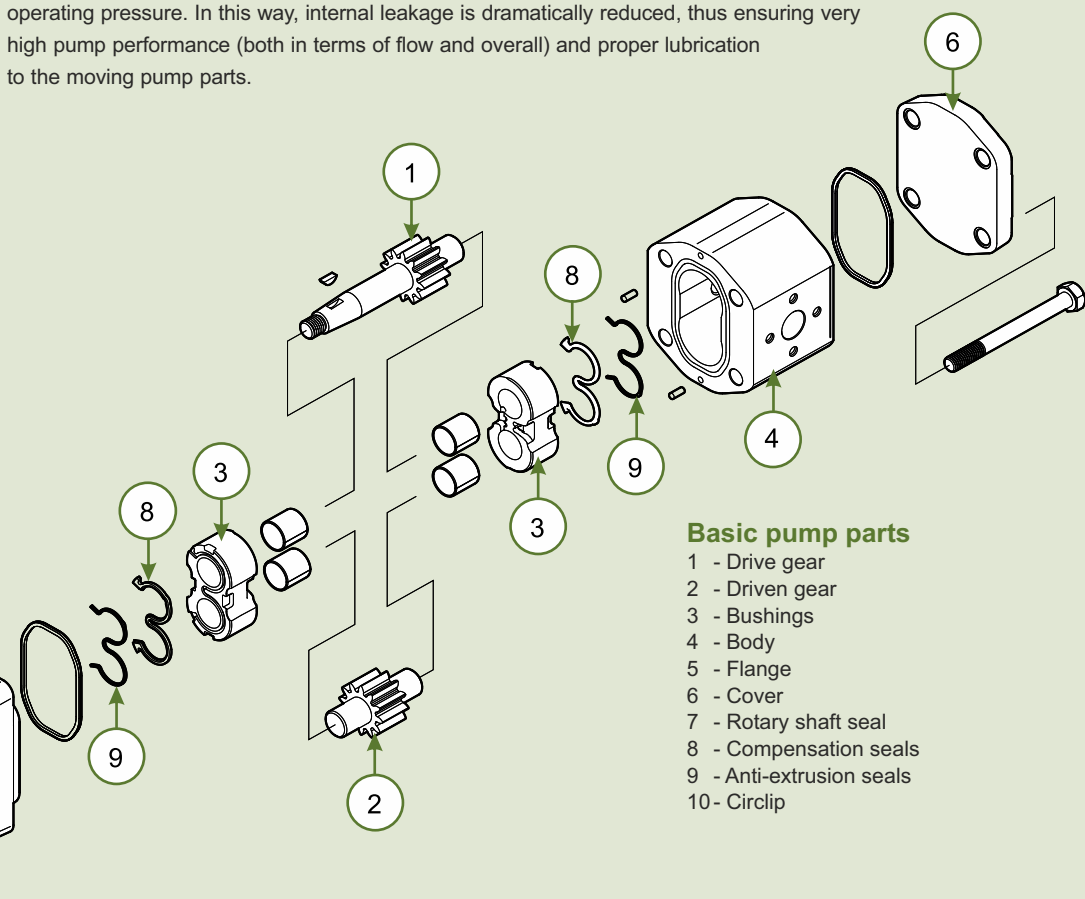

Basic pump parts

- 1 - Drive gear
- 2 - Driven gear
- 3 - Bushings
- 4 - Body
- 5 - Flange
- 6 - Cover
- 7 - Rotary shaft seal
- 8 - Compensation seals
- 9 - Anti-extrusion seals
- 10 - Circlip

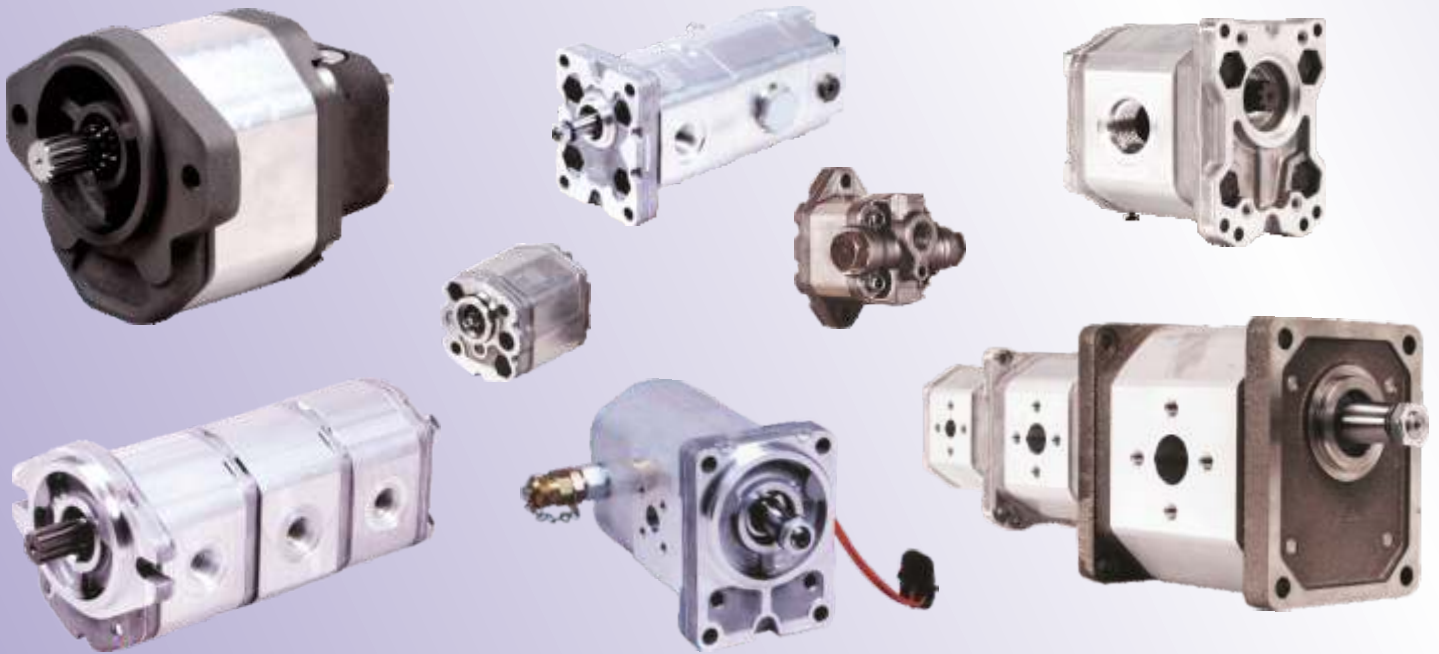

integrated valves and mounting arrangements

ALP/GHP VP-LS: Load sensing pump with priority valve.
 ALM VE: Motor with proportional relief valve.
 ALP VM: Pump with integrated relief valve.

ALM VN - VM: Motors with anti-cavitation valves and relief valve.
 ALP/GHP T: Pumps with support bearing for high side/radial loads.
 ALM/GHM T: Motors with support bearings for high side/radial loads.

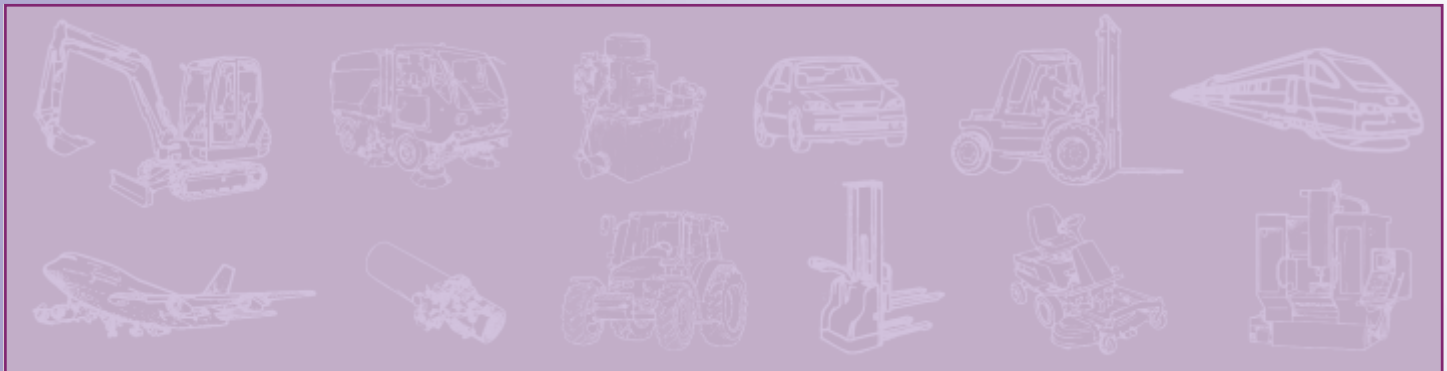

www.jbj.co.uk/Marzocchigearpumps.html

jbj Techniques Ltd provide a diverse range of mechanical drive & transmission solutions to industrial markets including design engineering, product supply and after sales service.

An experienced and dedicated team of technical sales engineers are on hand to work with customers and deliver results.

The markets where jbj operate are tough and time sensitive. In such circumstances customers need reliable solution partners, people who are conscious of deadlines, innovative in design and always willing to seek the best solution for the customers' needs.

On all counts, jbj Techniques Limited deliver. From specification, through technical advice, manufacture and support, together with our extensive product database, jbj Techniques provide a comprehensive and valued service to the power transmission and hydraulic industries.



an excellence in engineering

www.jbj.co.uk/FTP-gear-pumps.html

Ideal for low-pressure, low viscosity, lubrication applications such as fire-resistant fluids.

The FTP gear pump from Marzocchi is an ideal solution for low-pressure lubrication applications where low-viscosity fluids are required, such as fire-resistant fluids. Typical applications include large lubrication systems, lubrication of the guides of machine tools, and the lubrication and cooling of tools themselves.

Fire-resistant fluids are used whenever there is a possibility that a hydraulic fluid (also used for lubrication) may encounter a source of ignition, such as the surface of very hot equipment. Fire-resistant hydraulic fluids are specially formulated so they are more difficult to ignite and do not propagate a flame from an ignition source.

There are several types of fire-resistant fluids and they are generally classified as follows: oil and water emulsions, water-polymer solutions, and anhydrous synthetics. More specifically, the International Standards Organization (ISO) further classifies these fluids as follows: HFAE – oil-in-water emulsions, typically with more than 80% water content; HFAS – synthetic aqueous fluids, typically with more than 80% water content; HFB – water-in-oil emulsions, typically with more than 40% water content; HFC – water polymer solutions, typically with more than 35% water content (also known as glycol solutions, polyalkylene glycol solutions or water glycols); HFDR – synthetic anhydrous fluids composed of phosphate esters; and HFDU – synthetic anhydrous fluids other than phosphate esters. Examples include polyol esters and polyalkylene glycols.

The only fire-resistant fluids that are completely incompatible with gear pumps are the HFDR ones; for all the others, it is possible to obtain a configuration that makes them compatible. To avoid fast wear of the sliding contact parts, FTP pumps can be supplied, depending on the type of application with bronze or bronze/PTFE thrust plates.

These FTP helical gear pumps are available in versions with or without a relief valve built into the cover, and maximum working pressure is 50 bar. The gear pumps have very high specifications for rotation speed and viscosity range.

FTP pumps are available in clockwise rotation whilst a counter-clockwise rotation version is currently under development.



Marzocchi FTP pumps are based on ELIKA Gear Technology that reduces the noise level by an average of 15 dBA compared with a conventional external gear pump.

The helical gears ensure the continuity of motion despite the low number of teeth. FTP pumps are perfectly interchangeable with standard gear pumps. The low number of teeth reduces the fundamental frequencies of the pump noise, therefore lowering sound levels.

The shape of the Elika profile, patented by Marzocchi Pompe, eliminates the encapsulation phenomenon typical of standard gear pumps, remedying the source of the main cause of noise and vibrations.

By reducing the pressure-oscillations and vibrations produced by the pump and transmitted to the other components, the noise of the hydraulic system itself is reduced. Specific compensation areas in the flange and cover, insulated by special gaskets reinforced with anti-extrusion, allow for fully free axial and radial movement of the bushings.

www.jbj.co.uk/ftp-gear-pumps.html



an excellence in engineering

quality products for mechanical & fluid power

Getting the most out of your machinery often depends on close integration between all components. An organisation that manufactures and integrates all the diverse components of a drivetrain provides the experience to help you select the best component combination for your application. jbj Techniques' in-house design team and manufacturing facility provide tailored solutions for your applications at competitive prices with quick delivery.

The following examples are a simplistic view of how jbj Techniques assists customers.

Hydraulic Adaptors

Designed primarily to allow the close coupling of hydraulic pumps to a variety of prime movers, such as diesel / petrol engines, electric, air or hydraulic motors, they can also be used in the connection from prime mover to alternative driven parts i.e. gear boxes, generators, water or vacuum pumps etc. An additional range of engine front PTO adaptors, which provide additional connection between the engine pulley and the driven part are also available.

The kit comprises of a [bellhousing](#) and flexible drive [coupling](#) that are fully machined to suit the driving and driven components. These can be to suit either shaft to shaft, flange (flywheel) to shaft or even flange to flange connections.

Getting the most out of your equipment will demand close integration between all components. In specifying jbj Techniques as your preferred supplier, you will have selected a company with the experience to specify, manufacture and integrate all of the [diverse components](#) that will ensure the best component combination for your application.

jbj's in house design team and manufacturing facility provide tailored solutions for your applications at competitive pricing and on-time deliveries.

Pump shaft alignment is key to preventing unnecessary wear and [damage to the pump shaft seal](#) and bearing. Improper alignment may lead to premature pump failure.

Also to be considered are [unwanted torsional resonant frequencies](#) in the system which can quickly cause damage to components in the drivetrain and reduce system life and performance. Improper pump installation can lead to premature failure, increased maintenance costs and reduced production levels of final product.

jbj Techniques can advise on the correct installation of [hydraulic pumps](#) into Industrial / mobile / marine / machine tool / agricultural / offshore industries and can specify complete driveline systems from their [extensive range of components](#) which are available from stock or manufactured to order, albeit simple or complex, standard or bespoke.

Electric Motor – Hydraulic Pump Adaptors (safe area)

jbj Techniques Limited offer the most comprehensive range of [bellhousings](#) in Europe. Designed to connect electric motors with frame size IEC D56 - D400 (0.06kW – 750kW) and can be compatible with electric motor 'B5' or 'B14' flange configurations. Accompanying the metric frame units above is a complete range of mountings to suit Nema and imperial frame motors with 'C' face or 'D' flange fitments.

With fully machined [torsionally flexible couplings](#), or [torsionally rigid couplings](#) available, jbj ensure the most suitable combination is selected for the application in hand. As an example spider couplings are available in various materials including aluminium, grey cast iron, nodular iron, steel and stainless steels and can be finish machined with parallel, taper or splined bores to DIN, SAE, ANSI or ISO standards.

Bellhousings can be manufactured in aluminium or cast iron material as standard, however, units can be produced in a variety of exotic materials on request.

The aluminium product range is produced in either monoblock or composite formats giving great flexibility in design and allows for early delivery time, often with same or next day delivery possibilities.

For applications where low noise levels are a

requirement then a complete range of [anti-vibration and noise reduction components](#) add to the range.

Electric motor – Hydraulic Pump Adaptors (hazardous area)

Designed to meet the exacting safety standards of the offshore and chemical process industries, jbj Techniques produce [adaptor kits](#) certificated to Directive 2014/34/EU I12GD-IM2-TX -50 C < Service Temp < +105 C. Harmonised standards BS EN 1127:1, BS EN 13463:1, BS EN13463:5, BS EN 50303, BS EN 1834-1, BS EN 1834-3.

Generally manufactured in Cast or Nodular iron, bellhousings can be produced in steel, stainless steel or alternative exotic materials on customer request.

Couplings supplied for these applications are the jbj Techniques 'JXL' pin and bush range which provide an anti-static and flameproof drive which meet zone 1 area requirements, conforming to all of the above standards.

Also available are spider and gear couplings which are certified to zone 2 standards. ([Contact jbj Techniques](#) for details).

An important development of equipment for use within hazardous areas is the wet mount series of bellhousings. Commissioned to research and develop a product that would control the high temperature generated by a piston pump shaft seal when working within cycling applications. A little considered issue is the frictional heat generated at the shaft seal when the application requires the pump to cycle between different pressures causing the seal temperature to increase. This process will often take the seal temperature out and above the levels required by the relevant ATEX standards requirement. This specially designed assembly allows a pumped cooling flow to be passed over the seal face and through an auxiliary cooler, this in turn reduces the seal face temperature which can be maintained at an acceptable level. With a vast array of components to select from, jbj are well

placed to provide all required components to support the required cooling system.

Diesel Engine – Hydraulic Pump Adaptors

A complete range of bellhousing and couplings exist for the connection of a diesel engine flywheel to a specified driven component, be it an oil hydraulic pump, water pump, generator or similar device. With the bellhousing available in various materials to suit all application areas. With a standard range to connect Diesel engines with SAE dimensions from SAE '6' to SAE '0' jbj are well placed to satisfy the majority of customer requirements. Couplings to complete the assembly are available in either torsionally flexible or torsionally rigid design and can be supplied to suit SAE flywheel dimensions from SAE 6.5" to SAE 18".

For hydraulic pumps to be mounted to engines that do not conform to SAE dimensions, we offer a full range of assembly parts, some of which (but not all) are shown here » [for diesel engines](#)

All bellhousings within this range can be finished machined to accept any, piston, vane or gear pump interfaces requested by customer.

As with the electric motor range of product jbj offer complete solutions for ATEX environments, using our well proven 'JXL' coupling range which has standard design to connect to the engine flywheel.

Directive 2014/34/EU I12GD-IM2-TX -50°C ≤ Service Temp ≤ +105°C.

Harmonised Standards: BS EN 1127:1 BS EN 13463:1 BS EN 13463:5 BS EN 50303.

Petrol Engine – Hydraulic Pump Adaptors

Petrol engine adaptors have been developed for use with industrial petrol engines. Design exists to suit Honda, Briggs and Stratton, Kawasaki, Kubota, Hatz, Mag, Robin, Suzuki, Winsconsin, to name but a few, all adaptors can be finished to accept most hydraulic pumps. Adaptors to suit engine crankshaft drives and for vertical mounting are available on request.



Small Individual Components to Large Combinations

“ensuring a continuing high quality service in which customers can have complete confidence.”

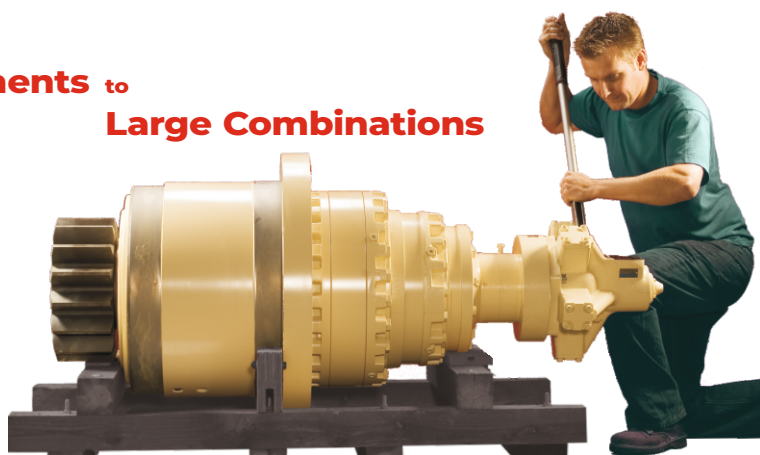

jbj Techniques is a specialist supplier of high-quality products for the mechanical power transmission and fluid power sectors. The company offers a high level of in-house expertise plus a huge selection of products to meet a very broad range of customer applications. From specification, through technical advice and manufacture to after-sales support, jbj Techniques provides a comprehensive and valued service to the power transmission and hydraulics industries. The company fields a UK-wide team of technical sales engineers to ensure that the business is close to its customers, and it enjoys excellent associations with European manufacturers, acting as sole UK distributor in many cases.

jbj's team is recognised for its expertise in the selection and configuration of hydraulic and mechanical transmission systems. Able to draw on an **extensive product range** that provides the building blocks for **bespoke systems both large and small**, the in-house design team offers a complete service, ranging from an assessment of customer requirements to full technical backup, including product specification, CAD based system design, system build and certification. Moreover customers can take advantage of **jbj's own machine-shop facilities and skilled engineers** to **guarantee quality and control costs**.

jbj Techniques provides one of the widest ranges of couplings available within the UK; mechanical power transmission couplings for a vast range of applications. Ranging from miniature couplings, all steel gear couplings, flexible spider couplings, shaft couplings, torque limiting couplings, disc and grid type couplings, ATEX compliant and shaft locking devices. Magnetic couplings for power transmission between hermetically sealed areas. However as extensive as the selection is, couplings make up a fraction of jbj's portfolio. As power transmission specialists the company stock and provide gearboxes, clutches, pumps, hydraulic motors, flow meters, fluid power accessories including: cooling & heat exchange products, reservoirs, pipe flanges, seals and level indicators, as well as a variety of bellhousings and engine adaptors, to name just a few of the product categories.

jbj Techniques Limited is proud of its relationship and reputation with customers and suppliers.

The core client base is stable and loyal, which is testament to the quality of service provided by the company. A similar relationship exists with suppliers, ensuring a continuing high quality service in which customers can have complete confidence.



Bellhousings



Torsionally Flexible Couplings



Torsionally Rigid Couplings



Torsional Couplings



Anti-static/Flameproof Couplings



Tyre Couplings



Torque Limiting Couplings



Permanent Magnetic Couplings



Hydraulic Adaptors



Engine Adaptor Kits



Dampers



from Small Individual Components to Large Combinations



“ ensuring a continuing high quality service in which customers can have complete confidence. ”



an excellence in engineering

comprehensive range of components www.jbj.co.uk



Gear Pumps/Motors



Screw Pumps



Axial & Radial Piston Motors



LSHT Motors/Geared Motors



Vane Pumps



Splitter Gearboxes



Pneumatic Motors & Starters



BD Clutches & Gearboxes



BDS Clutches



Planetary Gearboxes



Coolers



Oil Bath Clutches



Flow Dividers



Tanks/Accessories



Fluid Level Indicators



Flanges



Mini Power Packs



Pressure Intensifiers



quality products for mechanical & fluid power



01737 767493



info@jbj.co.uk



www.jbj.co.uk



jbj Techniques Limited is ISO certified, committed to international coordination & unification of industrial standards.

- registered in England No: 1185469 -

A range of products ATEX certified to directive 94/9/E requirements





jbj Techniques Limited
28 Trowers Way Holmethorpe Industrial Estate
Redhill Surrey RH1 2LW. UNITED KINGDOM

quality products for mechanical & fluid power

 01737 767493  info@jbj.co.uk  www.jbj.co.uk



MARZOCCHIPOMPE
HIGH PRESSURE GEAR PUMPS

UK distributor



jbj Techniques Limited is ISO certificated,
committed to international coordination &
unification of industrial standards.

registered in England No: 1185469

A range of products ATEX certificated
to directive 94/9/EC requirements

