

ALNOR® LOFLO BALOMETER® CAPTURE HOOD

OWNER'S MANUAL

P/N 116620001, REV 08
SEPTEMBER 2014



TABLE OF CONTENTS

Section 1	General Description	1
Section 2	Theory of Operation	1
Section 3	Safety	2
Section 4	Instrument Setup and Storage	2
Section 5	About the Instrument Display	4
Section 6	Getting Started	5
Section 7	Detailed Operation	5
Section 8	Troubleshooting	8
Section 9	Maintenance	9
Section 10	Service Information	10
Appendix A	Correction Factors for Standard Flow Rate to Actual Flow Rate	11
Appendix B	Model 6200 LoFlo Balometer® Capture Hood Field Setting Instruction for User Programmable Correction Factors	12

SECTION 1

General Description

The Alnor® LoFlo Balometer® Capture Hood is a compact instrument that measures very low air flow rates in HVAC systems. It measures from 10 to 500 cfm (17 to 850 m³/h, 4.7 to 236 l/s). The LoFlo Balometer® Capture Hood displays standard air volume rate when placed at supply or return diffusers, registers, or grilles located on the ceiling, wall, or floor.

The LoFlo Balometer® Capture Hood has a vent mechanism which reduces the restriction of air flow caused by the instrument. This unique venting system (patent pending) allows the instrument to remain compact while still measuring a wide range

of volume rates. The LoFlo Balometer® Capture Hood should be used with the vents closed at lower volume rates, but higher volume rates should be measured with the vents open to minimize any resistance effects. A 2-point measurement may be taken to compensate for the resistance effect of the instrument at higher volume rates.

The LoFlo Balometer® Capture Hood is battery powered and may be used with or without optional hoods. It weighs just over 6 pounds with the 2' x 2' hood, helping to reduce worker fatigue.

SECTION 2

Theory of Operation: Capture Hoods and Thermo-anemometry Sensing

As air exits a diffuser, it is captured in the hood or base and directed over a manifold. The manifold averages the velocity pressure and directs air over the sensors. The velocity and temperature of the air passing through the manifold are sensed, using a constant temperature thermo-anemometer principle. The voltage output from the sensor is then calibrated for the entire volume rate passing through the LoFlo Balometer® Capture Hood.

All capture hoods are susceptible to “odd” air flow patterns. “Odd” could refer to any air flow pattern different from the pattern where it was calibrated. Substantial negative effects can be observed when using a large hood on a small diffuser. For

example, using a 2' x 2' hood on a 10" x 10" diffuser. This creates large recirculation regions on the sides of the fabric hood and causes an “odd” air flow pattern as it passes over the manifold. It is recommended to match the hood closely to the size of the diffuser.

➔ **NOTE:** *Throughout this manual, the units cfm, m³/h and l/s are used for simplicity. Note, however, that the LoFlo Balometer® Capture Hood actually reads in standard cubic feet per minute (scfm), standard cubic meters per hour (std. m³/h), or standard liters per second (std. l/s).*

SECTION 3

Safety

When using the LoFlo Balometer® Capture Hood to check air flow at ceiling diffusers, make certain that you can safely raise and hold the unit while making measurements. Be especially careful when working on a ladder.

Observe all necessary precautions so that the unit does not become caught in moving machinery or touch any exposed electrical wiring.

The LoFlo Balometer® Capture Hood is not designed for gas mixtures other than air. Use with corrosive or other dangerous or explosive gas mixtures is not recommended and is at the user's risk.

	CAUTION
	WHILE USING THE LOFLO BALOMETER® INSTRUMENT TO TEST AIR FLOW IN DUCTS, YOU MAY COME INTO CONTACT WITH OR BE EXPOSED TO DUST, POLLEN, MOLD, FUNGUS, OR OTHER AIRBORNE CONTAMINANTS. IF YOU ARE OR MAY BE SENSITIVE TO DUST, POLLEN, MOLD, FUNGUS, OR OTHER AIRBORNE CONTAMINANTS, ALWAYS USE AN APPROPRIATE MASK OR RESPIRATOR WHILE EMPLOYING THE LOFLO BALOMETER® INSTRUMENT.

SECTION 4

Instrument Setup and Storage

Hood Setup

1. Locate the four (4) aluminum channels for the hood and position them into a square with the foam facing up. Slide the "U" opening on the channel end (Fig. 1) and corner bracket toward the brass eyelets until you feel it latch.
2. Continue with the other two channels until you have a square frame that is locked tightly in all four corners.
3. Locate the hood for the frame size you have assembled.
4. Position a corner seam of the hood onto the corner of the frame. Stretch the nylon hood to an adjacent corner until the hood corner meets the frame corner.
5. Push the elastic cord into the channel along the side of the frame.
6. Repeat steps 4 and 5 until the hood assembly is complete and ready to mount onto the base.
7. Place hood on a table or clean floor with the base inside the opening. Pull the hood over

the base. Rotate the hood assembly until the metal cups are above the spring-loaded pins.

8. Locate the hood support rods. Extend the hood so it is taut and insert one support rod onto the spring-loaded pin closest to you.
9. Push the support rod down and insert the top end of the rod into the metal cup on the hood frame. Fig 1.
10. Install the rod on the opposite side then install the last two rods.

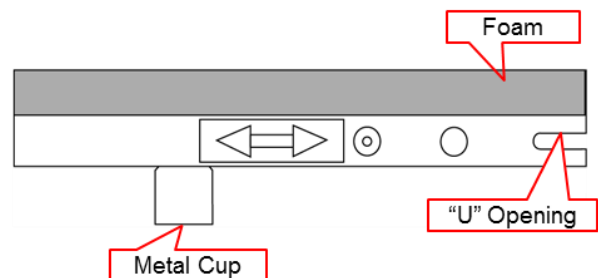

Figure 1
Hood Frame Channel

Instrument Storage

The hood and frame assemblies can be detached from the instrument base and placed inside their own carrying case without disassembly.

The LoFlo Balometer® Capture Hood should always be turned off before re-packing the instrument. If storing the LoFlo Balometer® Capture Hood for an extended period of time, remove the batteries to prevent damage due to leakage.

Battery Installation

To install the 4 C-size batteries that ship with the LoFlo Balometer® Capture Hood:

1. Make sure the LoFlo Balometer® Capture Hood switch is off.
2. Remove the battery cover located on top of the meter.
3. Slide the battery holder up until the snap connector is exposed.
4. Disconnect the battery holder from the LoFlo Balometer® Capture Hood.
5. Install the 4 C size batteries in the holder.
6. Reconnect the snap connector and slide the battery holder into the battery compartment.
7. Replace battery cover.

SECTION 5

About the Instrument Display

This display is an analog display, simulated with 26 LCD segments to give the user the response of a mechanical Balometer® Capture Hood. It also displays an exact digital number, using 3½ digit numeric section. The LCD has indicators for supply, return, manual range, vent modes, and low battery.

Figure 3 shows the front of the LoFlo Balometer® Capture Hood.

Index No.	Name
1	LCD
2	On/Off Switch
3	Supply/Return Button
4	Manual Range Button
5	Handle Button
6	Battery Holder
7	Vents
8	Vent Open/Close Slide

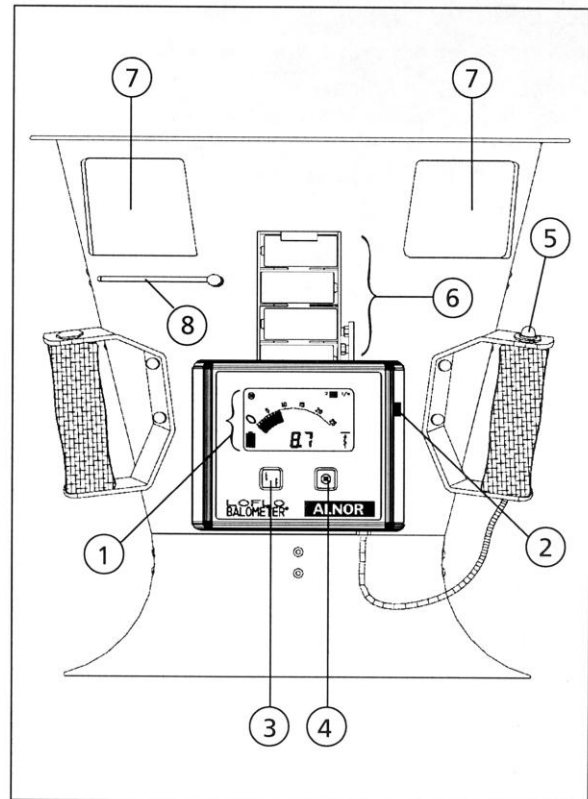

Figure 3
Front View of LoFlo Balometer® Capture Hood

Figure 4 shows the LCD.

Index No.	Name
1	Digital Readout
2	Simulated Analog Display
3	Manual Range Indicator
4	Supply/Return Indicator
5	2-Point Mode Indicator
6	Vent Indicator
7	Units Indicator
8	Low Battery Indicator

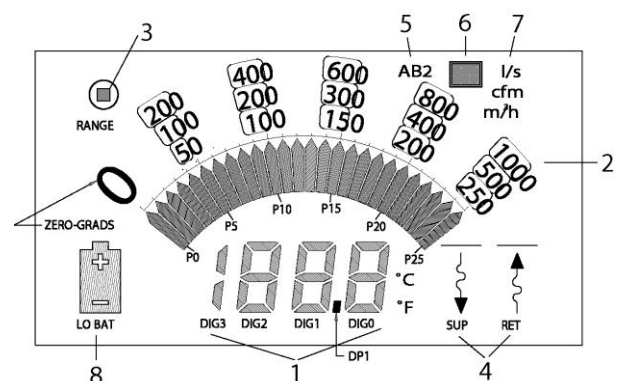

Figure 4
LoFlo Balometer® Capture Hood LCD

SECTION 6

Getting Started

- ➔ **NOTE:** *The instrument should be allowed to stabilize to room conditions in order to achieve specified accuracy.*
1. If you are using a hood with the unit, assemble the LoFlo Balometer® Capture Hood as described in Section 4, "[Instrument Setup and Storage](#)."
 2. Turn on the unit using the slide switch located on the right side of the meter.
 3. When turned on, the LoFlo Balometer® Capture Hood displays the vent closed indicator. Close the vent on the base by turning the top baffle counter clockwise.
 4. Select the proper mode for air flow direction, supply or return.
 5. Place the LoFlo Balometer® Capture Hood over the diffuser or grille to be measured.
 6. The auto range feature of the LoFlo Balometer® Capture Hood will choose the correct scale and display the volume rate in the digital readout section. A quick press on the handle switch will freeze the display.
 7. Another quick press will unfreeze the display.
 8. For volume rates above 150 cfm (255 m³/h, 71 l/s), it is recommended to use the vent open mode to minimize air flow resistance effects. See Section 7, "[Detailed Operation](#)."
- ➔ **NOTE:** *Make sure that there are no gaps between the LoFlo Balometer® Capture Hood and the surface around the diffuser or grille. Also, make sure that your body or other objects are not blocking or diverting the air flow where the air is exiting (supply) or entering (return). This will affect the reading.*
-

SECTION 7

Detailed Operation

Handle Button

In 1-point mode, the handle button will freeze the digital reading and flash the value when it is pressed for less than three seconds. When the handle button is pressed for more than three seconds, it switches the LoFlo Balometer® Capture Hood between vent closed mode and vent open mode.

In 2-point mode, the handle button cycles the instrument through the 2-point measurement process. See 2-point mode section for detail.

Auto/Manual Ranging Button



When turned on, the instrument is in auto-range mode. The user can switch to manual range mode by pressing the range button. The manual range indicator will show. By pressing the range button, the meter display switches to the next volume range. To return to auto-range mode, press and hold the range switch until the manual range indicator disappears.

Changing Measurement Units

To change measurement units:

1. Turn the instrument off.
2. Press and hold the supply/return button and switch the instrument on at the same time.
3. The display will flash one of the three available measurement units: cfm, m³/h, l/s.
4. Press and hold the supply/return button or the range button to scroll through the measurement units.
5. When the units you desire are displayed, switch the instrument off.
6. When you turn the instrument on again, your chosen units will be displayed.

Supply/Return Button

The LoFlo Balometer® Capture Hood is in supply mode when turned on. This is indicated on the display with the supply indicator . To take return air measurements, press the supply/return button on the front of the meter. Return air mode will be indicated on the display with the return indicator .



Significant errors may result if:

- Instrument is not in proper mode.
- Fabric hood is not used with vent open mode.

Vent Closed/Vent Open Modes

When the instrument is turned on, it is in the vent closed mode . When the vent closed indicator is on, the vents must be closed to take the measurement. Close the vents by loosening the thumbscrew and sliding the vent baffle to the fully closed position and locking the vent in place again.

The vent open mode is indicated with the vent open indicator on the LCD . Open the vents by loosening the thumb screw and sliding the vent baffle to the fully open position and locking it into place again. Then press and hold the handle switch for more than 3 seconds to switch the LoFlo Balometer® Capture Hood to the open vent mode.

The vent open mode was developed for higher volume rates on larger diffusers; the 2' x 2' or 650 mm x 650 mm hood should always be used with vent open mode.

1-Point Measurement Mode

The default mode of the LoFlo Balometer® Capture Hood is the 1-point measurement mode. If you are in 2-point measurement mode, simply turn the instrument off and turn back on.

The 1-point measurement mode is described in the [Getting Started](#) section earlier in this manual. This is the faster, simpler way to take measurements.

Use Vent Closed Mode for measurements between:

10 to 150 cfm (17 to 255 m³/h, 4.7 to 71 l/s).

➔ **NOTE:** *In Vent Closed Mode, volume rates below 8 cfm (13 m³/h, 3.6 l/s) are displayed as 0; volume rates above 517 cfm (879 m³/hr, 244 l/s) are displayed as Or.*

Use Vent Open Mode for measurements between:

150 to 500 cfm (255 to 850 m³/h, 71 to 236 l/s)

➔ **NOTE:** *In Vent Open Mode, volume rates below 150 cfm (255 m³/h, 71 l/s) are displayed as Ur; volume rates above 517 cfm (879 m³/h, 244 l/s) are displayed as Or.*

2-Point Measurement Mode—Supply Only

To activate the 2-point measurement mode, turn the instrument off. While pressing the handle button, turn the instrument back on. The 2-point mode indicator will show.

The 2-point measurement mode takes both vent open and vent closed measurements to calculate a resistance-compensated volume flow rate.

The process starts with the vents closed and the display showing the vent closed indicator.

1. Place the LoFlo Balometer® Capture Hood over the diffuser to be measured and press the handle switch once to take the vent closed measurement.
2. The instrument stores that reading.
3. The display will now show the open vent indicator and you should open the vents.

➔ **NOTE:** *Make certain you are using a fabric hood when in 2-point mode.*

4. Again place the LoFlo Balometer® Capture Hood over the diffuser to be measured and press the handle switch to take the vent open measurement.
5. The instrument calculates and displays the compensated reading.
6. The numeric display will flash; press the handle switch again and the instrument will display the vent closed indicator. Close the vents.
7. Return to Step 1 to take another resistance compensated reading.

➔ **NOTE:** *Return to 1-point measurement mode at any time by turning the power off and on.*

When “—” is displayed at the last step of the 2-point mode, the calculation for the resistance effect cannot be made. It can be caused by any of the conditions listed here.

Condition	Reason
The vent closed or vent open measurement is less than 150 cfm (70 l/s, 255 m ³ /h).	<ul style="list-style-type: none"> Calculations are not made at the low end since the effect is small and can generally be neglected. Use 1-point mode.
The vent closed or vent open measurement is greater than 500 cfm (235 l/s, 850 m ³ /h).	<ul style="list-style-type: none"> Calculations are not made beyond the calibrated range.
The vent open measurement minus the vent closed measurement is too small (< 0).	<ul style="list-style-type: none"> A mistake has occurred in the process. Repeat the two-point measurement. The resistance effect is small and was overwhelmed by natural fluctuations. Use single-point mode.
The vent open measurement minus the vent closed measurement is too large.	<ul style="list-style-type: none"> A mistake has occurred in the process. The vent may not have been open for the open vent measurement. Repeat the two-point measurement. The effect is beyond the range of the compensation equation. Perform a traverse of the system instead.

➔ **NOTE:** The display will also show “—” when the return mode is selected. The 2-point measurement mode is for supply only.

SECTION 8

Troubleshooting

Symptom	Possible Cause and Corrective Action
Meter does not turn on.	<ul style="list-style-type: none"> • Battery holder snap connector not connected. Connect battery holder to instrument. • Batteries may be discharged. Charge or replace them. • Switch failure, wiring failure, or circuit failure. Call TSI.
Meter reading lower than expected.	<ul style="list-style-type: none"> • Wrong vent mode chosen. Choose correct vent mode, open or closed. • Wrong air direction mode chosen. Choose correct direction, supply or return. • Back pressure effects could be significant. Use 2-point measurement mode. • Hood frame not sealing properly around diffuser or grill. Press hood evenly against diffuser. • Odd air flow pattern present. Perform traverse and use proportional balancing. • Hood torn. Replace, or repair tear with duct tape or other non-porous material. • Meter out of calibration. Call TSI. • Damage to manifold. Call TSI.
Meter reading higher than expected.	<ul style="list-style-type: none"> • Wrong vent mode chosen. Choose correct vent mode, open or closed. • Wrong air direction mode chosen. Choose correct direction, supply or return. • Odd air flow pattern present. Perform traverse and use proportional balancing. • Meter out of calibration. Call TSI.
Meter not at zero at zero flow.	<ul style="list-style-type: none"> • Instrument not at room temperature. Allow instrument to acclimate before turning on the power. • The LoFlo Balometer® Capture Hood is reading real room air currents. Place on floor with a piece of cardboard over the top to determine if it is measuring real air currents. • Meter out of calibration. Call TSI.
Meter displays Er.	<ul style="list-style-type: none"> • Self test failed. Call TSI.
Handle button not working.	<ul style="list-style-type: none"> • Call TSI.

SECTION 9

Maintenance

Hoods

Hoods may be cleaned in cool water with a mild detergent.

Sensing Manifold

The manifold should be checked visually before using to be certain that the sensing holes have not become clogged with dirt or dust particles. Do **not** immerse the manifold in water. It is recommended that cleaning be done with extreme care with the manifold in place. Do **not** use highly compressed air to clean the manifold tubes.

Calibration

It is recommended that your LoFlo Balometer[®] Capture Hood be returned to the factory once a year for a calibration check. When shipping the LoFlo Balometer[®] Capture Hood for factory calibration, pack it carefully, and follow the Instructions for Return in this manual.

Vent Operation

If the vent becomes difficult to operate, remove both thumbscrews from the vent mechanism and spray the contacting surfaces with silicone spray lubricant. Wipe off excess and reassemble vent mechanism.

Performance Check

If the calibration is to be checked, the best way is to use a reference flow standard more accurate than the LoFlo Balometer[®] Capture Hood. Flow standards that may be used for this purpose include orifice plates, venturis, nozzles, and laminar flow elements. These devices require accurate differential pressure, barometric pressure, and temperature reading instruments to measure either actual or standard volume rate.

If the LoFlo Balometer[®] Capture Hood is checked against a velocity instrument such as a pitot probe/manometer or thermo-anemometer, there may be errors. If a velocity standard is used, the average velocity must be obtained by taking a traverse.* The accuracy of the traverse is dependent on the flow uniformity, the number of readings taken, the accuracy of the velocity instrument, and operator expertise. This average velocity reading must then be multiplied by the area over which the traverse was taken.

Finally, air flow instrumentation is dependent on environmental conditions such as temperature, atmospheric pressure, humidity, and even turbulence. These conditions can have very different effects on various instrument types. Caution must be exercised when making comparisons.

**A traverse is a set of velocity readings taken in a prescribed pattern which will provide an overall velocity value when averaged together. Any of the Alnor velocity measuring instruments can be used for this purpose.*

LOFLO BALOMETER®

Specifications*

Range:	10–500 cfm (17–850 m ³ /h) (4.7–236 l/s)	Display:	3.5 digit, .44 in. (11 mm) high, digital display with 26 segment simulated analog display
Accuracy:	±(3% + 5 cfm) [±(3% + 8,5 m ³ /h, 2,4 l/s)]	Resolution	1 cfm from 10–500 cfm (Supply or 0.1 l/s from 4.7 to 9.9 Return) 1 l/s from 10 to 236 l/s
Height:	15.5 in., base only (394 mm) 22 in., with 16 x 16 hood (559 mm) 34.5 in., with 2 x 2 hood (876 mm)	Power Source:	4C 1.5V alkaline batteries (optional Nickel Cadmium)
Weight:	about 6 lbs (2.7 kg) with hood 4.6 lbs (2.1 kg) base only	Battery Life:	10 hrs. minimum with continuous use
Base Diameter Opening:	13.3 in. diameter (338 mm)		
Hood sizes:	16 x 16 in., 2 x 2 ft., or 26 x 26 in. (406 x 406 mm, 610 x 610 mm, or 650 x 650 mm)		

*Specifications subject to change without notice.