

# AdS/CFT and applications

Horatiu Nastase

IFT-UNESP

Preparatory Minicourse

Holography@25 School, ICTP-SAIFR

June 2023

## Plan:

- Lecture 1. Elements of General Relativity and AdS space
- Lecture 2. Elements of string theory and D-branes
- Lecture 3. Black holes in supergravity vs. D-branes
- Lecture 4. AdS/CFT and gauge/gravity duality in Euclidean and Lorentzian signatures
- Lecture 5. Holographic renormalization and holographic RG flow
- Lecture 6. Finite temperature and  $\mathcal{N} = 4$  SYM plasma
- Lecture 7. Solitons and probes in AdS/CFT
- Lecture 8. The pp wave correspondence and spin chains
- Lecture 9. Applications to condensed matter: AdS/CMT
- Lecture 10. Applications to QCD

# Lecture 1

## Elements of General Relativity and AdS space

- **Special relativity:** speed of light = const. in all inertial reference frames,  $c = 1 \Rightarrow$

$$ds^2 = -dt^2 + d\vec{x}^2 = \eta_{ij} dx^i dx^j$$

is invariant  $\rightarrow$  invariant distance. SR: Physics is Lorentz invariant, i.e. invariant under

$$x'^i = \Lambda^i_j x^j; \quad \Lambda^i_j \in SO(1, 3)$$

- **General relativity:** General spacetime: curved. Distance between points is

$$ds^2 = g_{ij}(x) dx^i dx^j$$

Here  $g_{ij}(x)$  = arbitrary functions: the metric.

- E.g. 2-sphere in 3d Euclidean space

$$\begin{aligned} ds^2 &= dx_1^2 + dx_2^2 + dx_3^2; \quad x_1^2 + x_2^2 + x_3^2 = R^2 \Rightarrow \\ ds^2 &= dx_1^2 \left(1 + \frac{x_1^2}{R^2 - x_1^2 - x_2^2}\right) + dx_2^2 \left(1 + \frac{x_2^2}{R^2 - x_1^2 - x_2^2}\right) + 2dx_1 dx_2 \frac{x_1 x_2}{R^2 - x_1^2 - x_2^2} \\ &\equiv g_{ij} dx^i dx^j (= d\theta^2 + \sin^2 \theta d\phi^2) \end{aligned}$$

- But for arbitrary symmetric metric  $g_{ij}(x)$ , we cannot embed in flat space:  $\exists \frac{d(d+1)}{2}$  functions  $g_{ij}(x)$  -  $d$  functions  $x'_i(x_j)$  and moreover: signature of embedding space is not fixed.

- E.g. 2d surfaces can be embedded in 3d with Euclidean OR Minkowski signature. So: general space is *intrinsically curved*.

- Curved space: triangle made by geodesics has angles  $\alpha + \beta + \gamma \neq \pi$ . E.G. sphere  $\alpha + \beta + \gamma > \pi$ : positive curvature  $R > 0$ .

- But  $\exists$  also spaces of negative curvature, for which  $\alpha + \beta + \gamma < \pi$ , e.g. Lobachevski space (or "Euclidean  $AdS_2$ "),

$$ds^2 = dx^2 + dy^2 - dz^2; \quad x^2 + y^2 - z^2 = -R^2$$

but  $\det g_{ij} > 0 \Rightarrow$  space has (intrinsic) Euclidean signature.

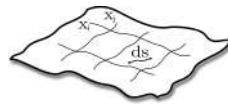

a)



b)

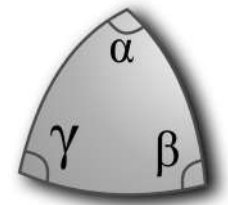

c)

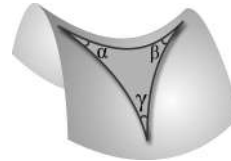

d)

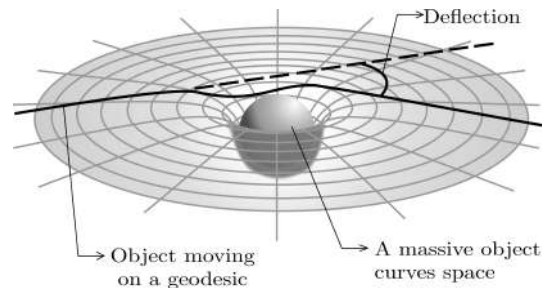

# Einstein's theory of general relativity:

- A1: Gravity is geometry: matter follows geodesic in curved space, and to us it appears as gravity.
- A2: Matter sources gravity: matter curves space  $\Rightarrow$  Princ.:
- 1. Physics is invariant under general coordinate transformations:

$$x'_i = x'_i(x_j) \Rightarrow ds^2 = g_{ij}(x) dx^i dx^j = g'_{ij}(x') dx'^i dx'^j$$

- 2. Equivalence principle: there is no difference between acceleration and gravity

$$m_i = m_g, \text{ where } \vec{F} = m_i \vec{a} (\text{Newton}) \quad \vec{F}_g = m_g \vec{g} (\text{gravity})$$

- Dynamics of gravity: Einstein's eqs.

- Before that: define kinematics.  $g_{\mu\nu}$  can be put locally to zero by coordinate transformations

$$g'_{\mu\nu}(x') = \frac{\partial x^\rho}{\partial x'^\mu} \frac{\partial x^\sigma}{\partial x'^\nu} g_{\rho\sigma}(x)$$

→ not a good measure of gravity. What else?

- Define tensors:  $A^\mu$  transforms like  $dx^\mu$ ,  $B_\mu$  transforms like  $\partial/\partial x^\mu$ , mixed transform as the product.
- Define: inverse metric  $g^{\mu\nu} = g_{\mu\nu}^{-1}$ , and then Christoffel symbol:

$$\Gamma^\mu{}_{\nu\rho} = \frac{1}{2} g^{\mu\sigma} (\partial_\rho g_{\nu\sigma} + \partial_\nu g_{\sigma\rho} - \partial_\sigma g_{\nu\rho}),$$

and Riemann tensor

$$R^\mu{}_{\nu\rho\sigma}(\Gamma) = \partial_\rho \Gamma^\mu{}_{\nu\sigma} - \partial_\sigma \Gamma^\mu{}_{\nu\rho} + \Gamma^\mu{}_{\lambda\rho} \Gamma^\lambda{}_{\nu\sigma} - \Gamma^\mu{}_{\lambda\sigma} \Gamma^\lambda{}_{\nu\rho}$$

- $\Gamma^\mu{}_{\nu\rho} \sim$  gauge field of gravity.  $R^\mu{}_{\nu\rho\sigma} \sim$  field strength. Indeed, analogous to field strength of  $SO(d-1, 1)$  gauge group,

$$F^A{}_{\mu\nu} = \partial_\mu A_\nu^A - \partial_\nu A_\mu^A + f^A{}_{BC} (A_\mu^B A_\nu^C - A_\nu^B A_\mu^C),$$



- Moreover, covariant derivative of tensor is

$$D_\mu T_\nu^\rho \equiv \partial_\mu T_\nu^\rho + \Gamma^\rho_{\sigma\mu} T_\nu^\sigma - \Gamma^\sigma_{\mu\nu} T_\sigma^\rho,$$

similar to  $D_\mu \phi^a = \partial_\mu \phi^a + (A^a_b)_\mu \phi^b$ ,  $A = (ab)$ . Note  $D_\rho g_{\mu\nu} = 0$ .

- Then  $R^\mu{}_{\nu\rho\sigma} \rightarrow$  tensor, as are  $R_{\mu\nu} = R^\lambda{}_{\mu\lambda\nu}$ ,  $R = R_{\mu\nu} g^{\mu\nu}$ .  $R$  is coordinate invariant  $\rightarrow$  true measure of curvature of space.
- The simplest choice for action for gravity is correct (compatible with experiment)

$$S_{gravity} = \frac{1}{16\pi G} \int d^d x \sqrt{-\det(g_{\mu\nu})} R$$

$\Rightarrow$  Einstein's equation

$$8\pi G \left[ \frac{\delta S_{gravity}}{\sqrt{-g} \delta g^{\mu\nu}} + \frac{\delta S_{matter}}{\sqrt{-g} \delta g^{\mu\nu}} \right] = 0 \Rightarrow R_{\mu\nu} - \frac{1}{2} g_{\mu\nu} R = 8\pi G T_{\mu\nu}$$

- Indeed,

$$\delta S_{gravity} = \frac{1}{16\pi G_N} \int d^d x \sqrt{-g} \delta g^{\mu\nu} \left[ R_{\mu\nu} - \frac{1}{2} g_{\mu\nu} R \right].$$

$$T_{\mu\nu} = -\frac{2}{\sqrt{-g}} \frac{\delta S_{matter}}{\delta g^{\mu\nu}}.$$

## Global structure: Penrose diagrams

- To understand topological & causal structure: Penrose diagrams.
- For light propagation,  $ds^2 = 0 \Rightarrow$  conformal factor is irrelevant.
- Make coordinate transformation that bring  $\infty$  to finite distance, drop conformal factors. E.g. 2d Minkowski,

$$ds^2 = -dt^2 + dx^2; \quad u_{\pm} = t \pm x \Rightarrow ds^2 = -du_+ du_-$$
$$u_{\pm} = \tan \tilde{u}_{\pm}, \quad \tilde{u}_{\pm} = \frac{\tau \pm \theta}{2} \Rightarrow$$
$$ds^2 = \left[ \frac{1}{4 \cos^2 \tilde{u}_+ \cos^2 \tilde{u}_-} \right] (-d\tau^2 + d\theta^2)$$

Here  $|\tilde{u}_{\pm}| \leq \pi/2 \Rightarrow |\tau \pm \theta| \leq \pi \Rightarrow$  diamond Penrose diagram

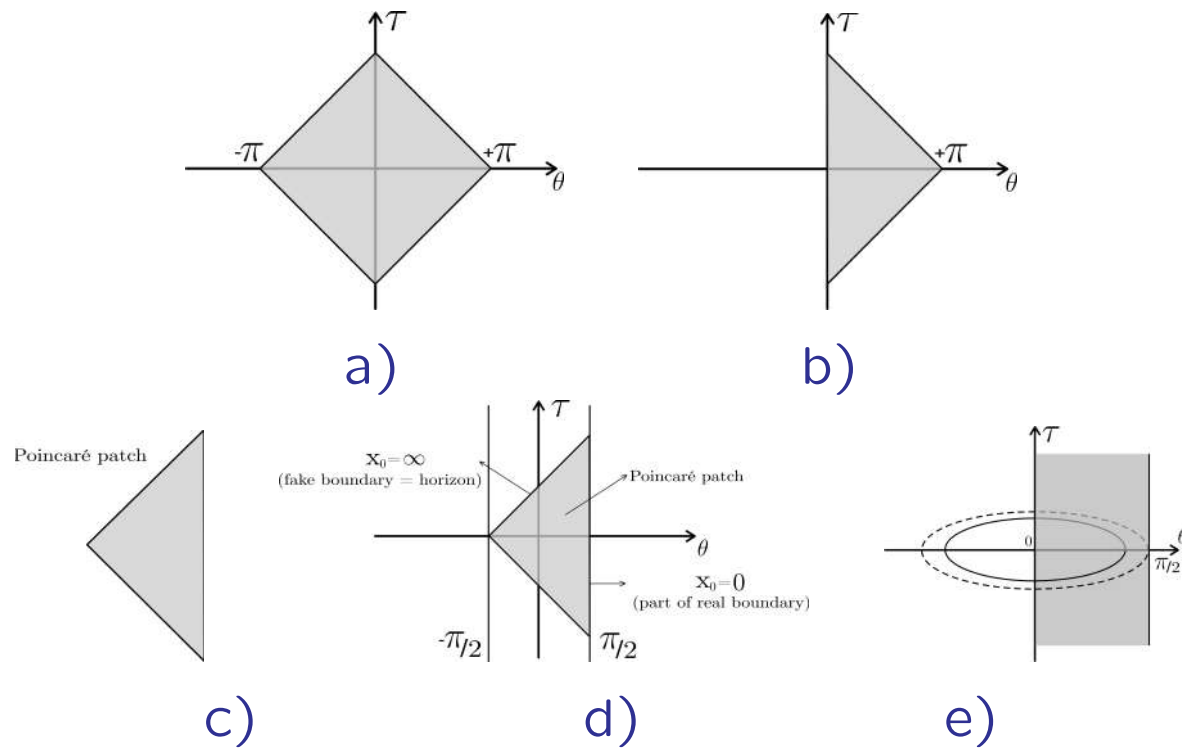

Penrose diagrams. a) Penrose diagram of 2 dimensional Minkowski space. b) Penrose diagram of 3 dimensional Minkowski space. c) Penrose diagram of the Poincaré patch of Anti-de Sitter space. d) Penrose diagram of global  $AdS_2$  (2 dimensional Anti-de Sitter), with the Poincaré patch emphasized;  $x_0 = 0$  is part of the boundary, but  $x_0 = \infty$  is a fake boundary (horizon). e) Penrose diagram of global  $AdS_d$  for  $d \geq 2$ . It is half the Penrose diagram of  $AdS_2$  rotated around the  $\theta = 0$  axis.

## Anti-de Sitter space

- We saw examples of 2d (curved) surfaces of Euclidean signature (usual):

- 2d sphere, embedded in 3d Euclidean space:

$$\begin{aligned} ds_3^2 &= dx_1^2 + dx_2^2 + dx_3^2; & x_1^2 + x_2^2 + x_3^2 &= R^2 \Rightarrow \\ ds_2^2 &= g_{ij} dx^i dx^j; & \det(g_{ij}) &> 0 \end{aligned}$$

is explicitly  $SO(3)$  invariant by construction, and  $\mathcal{R} > 0$ .

- 2d Lobachevski space, embedded in 3d Minkowski space:

$$\begin{aligned} ds_3^2 &= dx_1^2 + dx_2^2 - dx_3^2; & x_1^2 + x_2^2 - x_3^2 &= -R^2 \Rightarrow \\ ds_2^2 &= g_{ij} dx^i dx^j; & \det(g_{ij}) &> 0 \end{aligned}$$

- Is explicitly  $SO(2, 1)$  invariant by construction, and  $\mathcal{R} < 0$ .
- Generalize to Lorentzian signature.  $\mathcal{R} > 0$  case (generalization of the sphere) = de Sitter space.  $\mathcal{R} < 0$  case (generalization of Lobachevski) = Anti de Sitter. So, sometimes: sphere = "Euclidean de Sitter" and Lobachevski = "Euclidean Anti de Sitter"

- Thus,  $d$ -dimensional de Sitter space:

$$ds^2 = -dx_0^2 + \sum_{i=1}^{d-1} dx_i^2 + dx_{d+1}^2; \quad -x_0^2 + \sum_{i=1}^{d-1} x_i^2 + x_{d+1}^2 = R^2$$

is explicitly invariant under  $SO(d, 1)$  by construction and  $\mathcal{R} > 0$ .

- $d$ -dimensional Anti de Sitter space:

$$ds^2 = -dx_0^2 + \sum_{i=1}^{d-1} dx_i^2 - dx_{d+1}^2; \quad -x_0^2 + \sum_{i=1}^{d-1} x_i^2 - x_{d+1}^2 = -R^2$$

is explicitly invariant under  $SO(d-1, 2)$  by construction and  $\mathcal{R} < 0$ .

- **Metrics:** Poincare coordinates ( $t, x_i \in \mathbb{R}, x_0 \in \mathbb{R}_+$ )

$$ds^2 = \frac{R^2}{x_0^2} \left( -dt^2 + \sum_{i=1}^{d-2} dx_i^2 + dx_0^2 \right)$$

- Up to conformal factor, same as flat space  $\Rightarrow$  Penrose diagram is the same. For  $d > 2$  however, we use radial coordinate  $\rho > 0$  instead of spatial coordinate  $x \in \mathbb{R} \Rightarrow$  obtain half of diamond = triangle.

- We can make explicit also the exponential "warp factor"

$$ds^2 = e^{2y} \left( -dt^2 + \sum_{i=1}^{d-2} dx_i^2 \right) + dy^2 \quad (x_0 = e^{-y})$$

- Even though  $r, x_i, x_0$  are  $\infty$  in extent, space is not complete: Infinity at  $y = \infty$  is reached in finite time by a null ray:

$$ds^2 = 0 \Rightarrow dt^2 = e^{-2y} dy^2 \Rightarrow t = \int^{\infty} e^{-y} dy < \infty$$

- $\Rightarrow \exists$  other coordinates covering whole space: global coordinates:

$$\begin{aligned} \text{AdS :} \quad ds_d^2 &= R^2 (-\cosh^2 \rho d\tau^2 + d\rho^2 + \sinh^2 \rho d\vec{\Omega}_{d-2}^2) \\ \text{sphere :} \quad ds_d^2 &= R^2 (\cos^2 \rho dw^2 + d\rho^2 + \sin^2 \rho d\vec{\Omega}_{d-2}^2) \end{aligned}$$

- Coordinate transf.: global  $\leftrightarrow$  embedding:

$$X_0 = R \cosh \rho \cos \tau; \quad X_i = R \sinh \rho \Omega_i; \quad X_{d+1} = R \cosh \rho \sin \tau$$

- Finally, coordinate transf.  $\tan \theta = \sinh \rho \Rightarrow$

$$ds_d^2 = \frac{R^2}{\cos^2 \theta} (-d\tau^2 + d\theta^2 + \sin^2 \theta d\vec{\Omega}_{d-2}^2)$$

• Here  $0 \leq \theta \leq \pi/2$ ,  $\tau \in R \Rightarrow$  infinite cylinder. Poincare patch: figure of revolution obtained by rotating triangle around a side, situated along the axis of the cylinder:

- Boundary of cylinder still reached by light ray in finite time (and reflected back).
- AdS is somewhat like a finite box, with a boundary.
- $d$ -dimensional boundary of  $AdS_{d+1}$  space: In Poincare coordinates, at  $x_0 = \epsilon$  (and fixed) is Minkowski $_d$ ,

$$ds^2 = \frac{R^2}{\epsilon^2} \left[ -dt^2 + \sum_{i=1}^{d-1} dx_i^2 \right]$$

- In global coordinates, at  $\theta = \pi/2 - \epsilon$  is  $S^3 \times R$  cylinder

$$ds^2 = \frac{R^2}{\epsilon^2} [-d\tau^2 + d\vec{\Omega}_{d-2}^2]$$

- But the 2 are related, in the Euclideanized version, by a conformal transformation:

$$ds^2 = d\rho^2 = \rho^2 d\Omega_{d-1}^2 = e^{2\tau} [d\tau^2 + d\Omega_{d-1}^2]; \quad \rho = e^\tau$$

- So conformal symmetry of boundary = invariance symmetry of  $AdS_{d+1}$ .

- Perhaps physics in  $AdS_{d+1}$  space is **holographic**: Physics inside AdS = physics at its boundary.

- Reason why possible: Boundary of space is reached in finite time.



- Anti-de Sitter space is a maximally symmetric space: constant negative curvature  $\mathcal{R} < 0$ .

- Solution of Einstein's eq. with a cosmological constant,  $T_{\mu\nu} = \Lambda g_{\mu\nu}$  and  $\Lambda < 0$ , i.e.

$$R_{\mu\nu} - \frac{1}{2}g_{\mu\nu}R = 8\pi GT_{\mu\nu}$$

- Observation: Light takes an  $\infty$  time to reach the middle of AdS space,  $\rho = 0$  or  $x_0 = \infty$ :

$$ds^2 = 0 \Rightarrow t = \int_0^{\infty} \frac{dx_0}{x_0} \sim -\ln x_0|_{x_0 \sim 0} \rightarrow \infty$$

- $\Rightarrow$  In order for AdS to become truly like a box of finite size, we must cut out a tube in the middle.

## Vielbein-spin connection formulation of GR: 1st vs. 2nd order

- Any space is locally flat: tangent space: Lorentz invariance that is local (at any point).

- **Vielbein**  $e_{\mu}^a$ : "square root" of metric, making local Lorentz invariance manifest:

$$g_{\mu\nu}(x) = e_{\mu}^a(x)e_{\nu}^b(x)\eta_{ab}$$

$$\rightarrow e_{\mu}^a \rightarrow \Lambda^a_b e_{\mu}^b.$$

- Covariant derivative acting on tensors (bosons): with  $\Gamma^{\mu}_{\nu\rho}$

$$D_{\mu}T_{\nu}^{\rho} \equiv \partial_{\mu}T_{\nu}^{\rho} + \Gamma^{\rho}_{\mu\sigma}T_{\nu}^{\sigma} - \Gamma^{\sigma}_{\mu\nu}T_{\sigma}^{\rho}$$

- Covariant derivative acting on spinors (fermions): with **spin connection**  $\omega_{\mu}^{ab}$ , multiplying the generator of the Lorentz group in the spinor representation,  $\frac{1}{4}\Gamma_{ab}$ ,

$$D_{\mu}\Psi = \partial_{\mu}\Psi + \frac{1}{4}\omega_{\mu}^{ab}\Gamma^{ab}\Psi$$

- Second order formulation:  $\omega_\mu^{ab} = \omega_\mu^{ab}(e)$  satisfies "vielbein postulate", or "no torsion constraint" ( $T_{\mu\nu}^a = \text{torsion}$ ),

$$T_{[\mu\nu]}^a = D_{[\mu} e_{\nu]}^a = \partial_{[\mu} e_{\nu]}^a + \omega_{[\mu}^{ab} e_{\nu]}^b = 0$$

(if there are no fundamental fermions; if there are, there are extra terms). Equivalently,

$$D_\mu e_\nu^a \equiv \partial_\mu e_\nu^a + \omega_\mu^{ab} e_\nu^b - \Gamma^\rho_{\mu\nu} e_\rho^a = 0$$

- The solution is

$$\omega_\mu^{ab}(e) = \frac{1}{2} e^{a\nu} (\partial_\mu e_\nu^b - \partial_\nu e_\mu^b) - \frac{1}{2} e^{b\nu} (\partial_\mu e_\nu^a - \partial_\nu e_\mu^a) - \frac{1}{2} e^{a\rho} e^{b\sigma} (\partial_\rho e_{c\sigma} - \partial_\sigma e_{c\rho}) e_\mu^c.$$

- Define the field strength of  $\omega_\mu^{ab}$  ( $=SO(1, d-1)$  gauge field)

$$R_{\mu\nu}^{ab}(\omega) = \partial_\mu \omega_\nu^{ab} - \partial_\nu \omega_\mu^{ab} + \omega_\mu^{ab} \omega_\nu^{bc} - \omega_\nu^{ab} \omega_\mu^{bc}.$$

- Then we have

$$R_{\rho\sigma}^{ab}(\omega(e)) = e_{\mu}^a e^{-1,\nu b} R^{\mu}_{\nu\rho\sigma}(\Gamma(e)), \quad R = R_{\mu\nu}^{ab} e_a^{-1\mu} e_b^{-1\nu}$$

so that the Einstein-Hilbert action *in second order formulation* ( $\omega = \omega(e)$ ) is

$$S_{EH} = \frac{1}{16\pi G_N} \int d^d x (\det e) R_{\mu\nu}^{ab}(\omega(e)) e_a^{-1,\mu} e_b^{-1,\nu}.$$

- But then: first order formulation:  $\omega_{\mu}^{ab}$  = independent variable in the same action, rewritten as

$$\begin{aligned} S_{EH} &= \frac{1}{16\pi G_N} \frac{1}{4} \int d^4 x \epsilon^{\mu\nu\rho\sigma} \epsilon_{abcd} R_{\mu\nu}^{ab}(\omega) e_{\rho}^c e_{\sigma}^d \\ &= \frac{1}{16\pi G_N} \int \epsilon_{abcd} R^{ab}(\omega) \wedge e^c \wedge e^d \end{aligned}$$

- Then the  $\omega_{\mu}^{ab}$  equation of motion is

$$T_{[\mu\nu]}^a \equiv 2D_{[\mu} e_{\nu]}^a = 0$$

so solving it, we are back at the second order formulation.

# Black holes

- The Schwarzschild solution = most general solution of vacuum ( $T_{\mu\nu} = 0$ ) Einstein equation, with spherical symmetry:

$$ds^2 = - \left( 1 - \frac{2MG_N}{r} \right) dt^2 + \frac{dr^2}{1 - \frac{2MG_N}{r}} + R^2 d\Omega_2^2.$$

- In the Newtonian limit, with  $g_{\mu\nu} = \eta_{\mu\nu} + \kappa h_{\mu\nu}$ ,

$$\kappa_N h_{00} = \kappa_N h_{ii} = -2U_N = + \frac{2MG_N}{r},$$

so we are back to the Newtonian potential, satisfying

$$\Delta U_{\text{Newton}} = 4\pi G_N M \delta^3(x) \Rightarrow \Delta \kappa_N h_{00} = -8\pi G_N M \delta^3(x).$$

- Solution *apparently* singular at  $r = r_H = 2MG_N$ , so we cannot reach the source at  $r = 0$ ?
- If the solution is valid all the way to  $r_H$ , we have a (Schwarzschild) black hole.
- $r = r_H$  is the *event horizon*: light, at  $ds^2 = 0$ , gives

$$dt = \frac{dr}{1 - \frac{2MG_N}{r}}, \quad r \rightarrow r_H : dt \simeq 2MG_N \frac{dr}{r - 2MG_N} \Rightarrow t \simeq 2MG_N \ln(r - 2MG_N) \rightarrow \infty.$$

- But at the horizon,  $R \sim 1/r_H^2 = 1/(2MG_N)^2 = \text{finite!} \Rightarrow$  not singular. Need better coordinates: Kruskal.

- First, tortoise coordinates,

$$\frac{dr}{1 - \frac{2MG_N}{r}} = dr_* \Rightarrow r_* = r + 2MG_N \ln \left( \frac{r}{2MG_N} - 1 \right),$$

then Eddington-Finkelstein ones,

$$u = t - r_*; \quad v = t + r_*,$$

and finally Kruskal coordinates,

$$\bar{u} = -4MG_N e^{-\frac{u}{4MG_N}}; \quad \bar{v} = +4MG_N e^{\frac{v}{4MG_N}},$$

so that the metric is (region  $r \geq 2MG_N$  becomes  $-\infty < r_* < +\infty$ , thus  $-\infty < \bar{u} \leq 0, 0 \leq \bar{v} < +\infty$ )

$$ds^2 = -\frac{2MG_N}{r} e^{-\frac{r}{2MG_N}} d\bar{u}d\bar{v} + r^2 d\Omega_2^2,$$

- Then we have

$$-\frac{\bar{u}\bar{v}}{(4MG_N)^2} = e^{\frac{v-u}{4MG_N}} = e^{\frac{r^*}{2MG_N}} = e^{\frac{r}{2MG_N}} \left( \frac{r}{2MG_N} - 1 \right)$$

• so the  $r = 0$  singularity corresponds to  $\bar{u}\bar{v} = (4MG_N)^2$ , while  $r = 2MG_N$  is  $\bar{u} = 0$  or  $\bar{v} = 0$ . Define  $\bar{t}, \bar{r}$  as  $\bar{u} = \bar{t} - \bar{r}$ ,  $\bar{v} = \bar{t} + \bar{r}$  → Kruskal diagram.  $r = 0$  is then  $\bar{t}^2 - \bar{r}^2 = (4MG_N)^2$ .

- Penrose diagram: drop  $d\Omega_2^2$  and conformal factor in Kruskal metric. Then: subset of flat space, restricted by  $\bar{t}^2 - \bar{r}^2 = (4MG_N)^2$ . The usual transformation is

$$\bar{u} = 4MG_N \tan \tilde{u}_+; \quad \bar{v} = 4MG_N \tan \tilde{u}_-; \quad \tilde{u}_\pm = \frac{\tau \pm \theta}{2},$$

and the  $r = 0$  singularity is then

$$1 = \tan \frac{\tau + \theta}{2} \tan \frac{\tau - \theta}{2} = \frac{\sin^2(\tau/2) - \sin^2(\theta/2)}{1 - \sin^2(\tau/2) - \sin^2(\theta/2)},$$

leading to  $\sin^2(\tau/2) = 1/2$ , thus  $\tau = \pm\pi/2$  ( $\tau_{\max}$ , for  $\theta = 0$ , is  $\pi$ ).

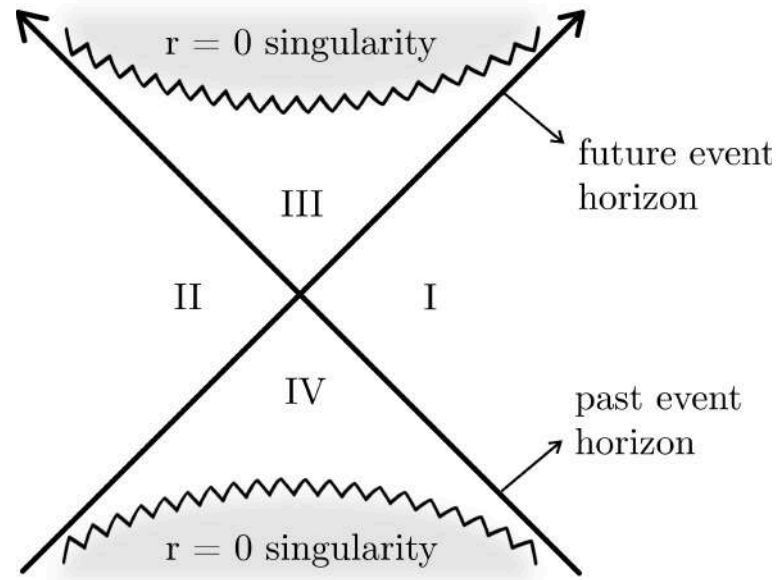

Kruskal diagram of the Schwarzschild black hole.



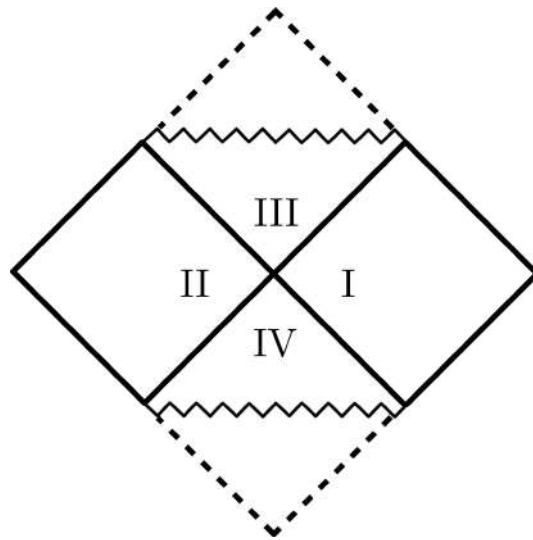

a)

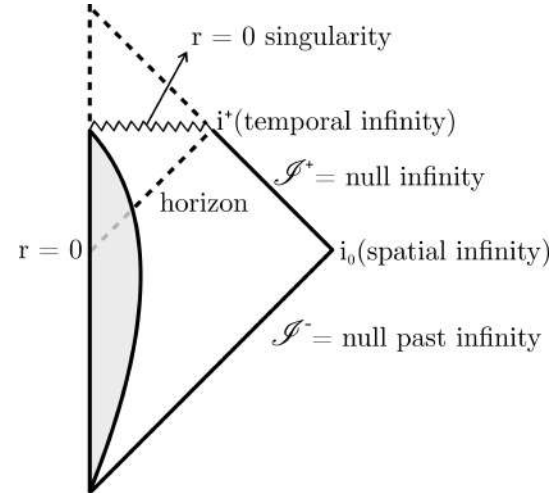

b)

a) Penrose diagram of the eternal Schwarzschild black hole (time independent solution). The dotted line gives the completion to the Penrose diagram of flat 2 dimensional (Minkowski) space. b) Penrose diagram of a physical black hole, obtained from a collapsing star (the curved line). The dotted line gives the completion to the Penrose diagram of flat  $d > 2$  dimensional (Minkowski) space.

## Lecture 2

# Elements of string theory and D-branes

## Worldline particle action: analogy

- Action on particle worldline = proper time: in terms of  $X^\mu(\tau)$ :

$$S = -m \int d\tau \sqrt{-\dot{X}^\mu \dot{X}^\nu \eta_{\mu\nu}}.$$

- In the nonrelativistic limit: OK:

$$S = -mc^2 \int dt \sqrt{1 - \frac{v^2}{c^2}} \simeq \int dt \left[ -mc^2 + \frac{mv^2}{2} \right].$$

- Action is reparametrization invariant,  $\tau' = \tau'(\tau)$ ,  $dx^\mu/d\tau = (dx^\mu/d\tau')d\tau'/d\tau$ ;  $X'^\mu(\tau'(\tau)) = X^\mu(\tau)$ .
- Equations of motion and boundary conditions from  $\delta S$ :

$$\delta S = +m \int d\tau \frac{d}{d\tau} \left[ -\frac{\eta_{\mu\nu} \dot{X}^\mu}{\sqrt{-\dot{X}^\rho \dot{X}^\rho}} \right] \delta X^\nu + \delta X^\mu m \frac{dX_\mu}{d\tau} \Big|_{\tau_i}^{\tau_f} \Rightarrow \frac{dp_\mu}{d\tau} = 0$$

- Couple to gravity: nontrivial:  $\eta_{\mu\nu} \rightarrow g_{\mu\nu}$ , geodesic equation.
- Couple to background charge: add worldline term =  $\int A_\mu j^\mu$ ,

$$\int d\tau A_\mu(X^\rho(\tau)) \left( q \frac{dX^\mu}{d\tau} \right) = \int d^4x A_\mu(X^\rho(\tau)) q \frac{dX^\mu}{d\tau} \delta^3(X^\rho(\tau)) \equiv \int d^4x A_\mu(X^\rho(\tau)) j^\mu(X^\rho(\tau)).$$

- First order action: introduce auxiliary field = independent worldline metric  $\gamma_{\tau\tau}$ , or einbein (vielbein)  $e(\tau) = \sqrt{-\gamma_{\tau\tau}(\tau)}$ . Write action for massive scalars  $X^\mu$  in 1d on worldline, coupled to gravity (GR). Use  $\sqrt{-\det \gamma} \times \gamma^{\tau\tau} = e^{-1}(\tau)$  and  $\sqrt{-\det \gamma} = e(\tau)$ .

$$S_p = \frac{1}{2} \int d\tau \left( e^{-1}(\tau) \frac{dX^\mu}{d\tau} \frac{dX^\nu}{d\tau} \eta_{\mu\nu} - em^2 \right),$$

- Write the equation of motion for  $e(\tau)$ , solve it, and replace it:

$$-\frac{1}{e^2} \dot{X}^2 - m^2 = 0 \Rightarrow e^2(\tau) = -\frac{\dot{X}^\mu \dot{X}_\mu}{m^2} \Rightarrow$$

$$S_p = \frac{1}{2} \int d\tau \left[ \frac{m}{\sqrt{-\dot{X}^2}} \dot{X}^2 - \frac{\sqrt{-\dot{X}^2}}{m} m^2 \right] = -m \int d\tau \sqrt{-\dot{X}^\mu \dot{X}_\mu} \equiv S_1.$$

- Take  $m \rightarrow 0$  limit, then fix a gauge for reparametrization invariance ( $e(\tau) \rightarrow e'(\tau')$ ),  $e(\tau) = 1$ :

$$S_{m=0, e=1} = \frac{1}{2} \int d\tau \frac{dX^\mu}{d\tau} \frac{dX^\nu}{d\tau} \eta_{\mu\nu}.$$

- Equation of motion ( $X^\mu(\tau)$ ) and constraint (for  $e(\tau) = 1$ : previous eq. for  $e(\tau)$ ):

$$\frac{d}{d\tau} \left( \frac{dX^\mu}{d\tau} \right) = 0, \quad -\frac{ds^2}{d\tau^2} = \frac{dX^\mu}{d\tau} \frac{dX^\nu}{d\tau} \eta_{\mu\nu} \equiv T = 0.$$

# Strings

- Nambu-Goto action for bosonic string = area of "worldsheet" spanned by string  $\times$  string tension. Generalization of particle action: area of worldsheet.  $X^\mu(\sigma, \tau)$  = coordinates in spacetime.  $\xi^a = (\sigma, \tau)$  = intrinsic coordinates on worldsheet.

$$S_{NG} = -\frac{1}{2\pi\alpha'} \int d\sigma d\tau \sqrt{\det(h_{ab})}$$

where  $h_{ab}$  = metric induced on worldsheet (pullback)

$$\begin{aligned} ds_{ind}^2 &= dx^\mu dx^\nu g_{\mu\nu}(X) = d\xi^\mu d\xi^\nu h_{ab}(\xi) \Rightarrow \\ h_{ab}(\sigma, \tau) &= \partial_a X^\mu \partial_b X^\nu g_{\mu\nu}(X) \end{aligned}$$

- Is worldsheet diffeomorphism (gen. coord., or reparametrization) invariant.

- First order form: again introduce auxiliary field = independent worldsheet metric.

- $\Rightarrow$  Polyakov action. In flat spacetime,

$$S_P[X, \gamma] = -\frac{1}{4\pi\alpha'} \int d\sigma d\tau \sqrt{-\gamma} \gamma^{ab} \partial_a X^\mu \partial_b X^\nu \eta_{\mu\nu}$$

- Symmetries:

- Spacetime Poincare invariance

- Worldsheet diffeomorphism invariance:  $X'^\mu(\sigma', \tau') = X^\mu(\sigma, \tau)$

- Worldsheet Weyl invariance:  $\gamma'_{ab} = e^{2\omega(\sigma, \tau)} \gamma_{ab}$

- Use them to fix conformal (unit) gauge:  $\gamma_{\alpha\beta} = \eta_{\alpha\beta}$ .

- Action becomes

$$S = -\frac{T}{2} \int d^2\sigma \eta^{\alpha\beta} \partial_\alpha X^\mu \partial_\beta X^\nu \eta_{\mu\nu}$$

→ action for free massless scalars in 2d: **conformally invariant** (conf. inv. = residual gauge invariance: dependence on  $\sigma + \tau$  only), with equations of motion

$$\square X^\mu = \left( \frac{\partial^2}{\partial \sigma^2} - \frac{\partial^2}{\partial \tau^2} \right) X^\mu = 0 \Rightarrow X^\mu(\sigma, \tau) = X_R^\mu(\sigma - \tau) + X_L^\mu(\sigma + \tau)$$

- Boundary term: gives string types:

$$-\frac{1}{2\pi\alpha'} \int d\tau \sqrt{-\gamma} \delta X^\mu \partial_\sigma X_\mu \Big|_{\sigma=0}^{\sigma=l} = 0 \Rightarrow$$

- Closed strings (periodic):  $X^\mu(\tau, l) = X^\mu(\tau, 0)$ ;  $\gamma_{ab}(\tau, l) = \gamma_{ab}(\tau, 0)$ .

- Neumann open strings (free endpoints,  $v = c$ ):  $\partial^\sigma X^\mu(\tau, 0) = \partial^\sigma X^\mu(\tau, l)$ .

- Dirichlet open strings (fixed endpoints):  $\delta X^\mu(\tau, 0) = \delta X^\mu(\tau, l) = 0$ .

- (Virasoro) Constraints: equations of motion of  $\gamma_{ab}$  (fixed to unit) =  $T_{ab}$

$$T_{ab} = -\frac{1}{4\pi} \frac{1}{\sqrt{-\gamma}} \frac{\delta S_P}{\delta \gamma^{ab}} \Big|_{\gamma_{ab}=\eta_{ab}} = \frac{1}{\alpha'} \left( \partial_a X^\mu \partial_b X_\mu - \frac{1}{2} \eta_{ab} \partial_c X^\mu \partial^c X_\mu \right) \Rightarrow$$

$$\alpha' T_{01} = \alpha' T_{10} = \dot{X} \cdot X', \quad \alpha' T_{00} = \alpha' T_{11} = \frac{1}{2} (\dot{X}^2 + X'^2).$$

- Closed strings: expand  $X_R^\mu(\tau - \sigma)$  and  $X_L^\mu(\tau + \sigma)$  in Fourier modes  $\alpha_n^\mu, \tilde{\alpha}_n^\mu$ ,

$$X^\mu(\sigma, \tau) = x^\mu + \alpha' p^\mu \tau + i \frac{\sqrt{2\alpha'}}{2} \sum_{n \neq 0} \frac{1}{n} \left[ \alpha_n^\mu e^{-in(\tau-\sigma)} + \tilde{\alpha}_n^\mu e^{-in(\tau+\sigma)} \right].$$

- Neumann open strings: identify  $\alpha_n^\mu = \tilde{\alpha}_n^\mu$ .
- Fourier modes  $L_m, \bar{L}_m$  of constraints  $T_{--}, T_{++}$  are  $L_m, \bar{L}_m$ , for closed strings

$$L_m = \frac{1}{2} \sum_{n=-\infty}^{+\infty} \alpha_{m-n}^\mu \alpha_n^\mu, \quad \bar{L}_m = \frac{1}{2} \sum_{n=-\infty}^{+\infty} \tilde{\alpha}_{m-n}^\mu \tilde{\alpha}_n^\mu.$$

and  $H = L_0 + \bar{L}_0 = 0$  (closed) or  $H = L_0$  (open) give (classically)

$$M_{\text{closed}}^2 \equiv -p_\mu p^\mu = \frac{2}{\alpha'} \sum_{n \geq 1} (\alpha_{-n}^\mu \alpha_n^\mu + \tilde{\alpha}_{-n}^\mu \tilde{\alpha}_n^\mu), \quad M_{\text{open}}^2 \equiv -p_\mu p^\mu = -\frac{\alpha_0^2}{2\alpha'} = \frac{1}{\alpha'} \sum_{n \geq 1} \alpha_{-n}^\mu \alpha_n^\mu$$



- What does the string action represent? Particle action: is first quantized: Need to also define vertices and propagators. String action: defines the propagator; vertex is unique!!

- **Quantization:**  $\alpha_{-n}^\mu, \tilde{\alpha}_{-n}^\mu$ : creation operators. More precisely,  $\alpha_m^\mu = \sqrt{m} a_m^\mu, \alpha_{-m}^\mu = \sqrt{m} a_m^{\dagger\mu}$  for  $m > 0$ .

- But  $\exists$  gauge inv.: easiest in light-cone gauge.  $X^\pm$  auxiliary,  $X^i$  physical. Then  $H = p^-$  and the open string mass spectrum is

$$M^2 \equiv 2p^+p^- - p^i p^i = \frac{1}{\alpha'}(N - a), \quad N = \sum_{n \geq 1} \alpha_{-n}^i \alpha_n^i = \sum_{n \geq 1} n a_n^{\dagger i} a_n^i,$$

where

$$a = - \sum_{i=1}^{D-2} \sum_{n \geq 1} \frac{n}{2} = - \frac{D-2}{2} \sum_{n \geq 1} n = \frac{D-2}{24} = 1 \Rightarrow D = 26.$$

- Bosonic closed string spectrum is similar, but with  $N$  and  $\bar{N}$ ,

$$\sim a_{n_1}^{i_1} \dots a_{n_k}^{i_k} \tilde{a}_{m_1}^{\tilde{i}_1} \dots \tilde{a}_{m_j}^{\tilde{i}_j} |0\rangle,$$

with the constraint  $P = L_0 - \bar{L}_0 = 0$ , so  $N = \bar{N}$ . Spectrum  $\rightarrow$  different fields  $\Rightarrow$  String theory = field theory of infinite number of different kinds of fields.

- Massless fields:  $A_{\mu\nu} = \alpha_{-1}^{\mu} \tilde{\alpha}_{-1}^{\nu} |0\rangle = \{A_{((\mu\nu))} = g_{\mu\nu}, A^{[\mu\nu]} = B^{\mu\nu}, \phi = A^{\mu\mu}\} \rightarrow$  spacetime fields.

- These massless fields create a spacetime background for the string

$$S = -\frac{1}{4\pi\alpha'} \int d^2\sigma [\sqrt{h} h^{\alpha\beta} \partial_{\alpha} X^{\mu} \partial_{\beta} X^{\nu} g_{\mu\nu}(X^{\rho}) + \epsilon^{\alpha\beta} \partial_{\alpha} X^{\mu} \partial_{\beta} X^{\nu} B_{\mu\nu}(X^{\rho}) - \alpha' \sqrt{h} \mathcal{R}^{(2)} \Phi(X^{\rho})]$$

- But bosonic string has tachyonic vacuum:  $M^2(|0\rangle) < 0$ . Need to get rid of it:

- **Superstring**: Supersymmetric string. In **Green-Schwarz formulation**, spacetime susy +  $\kappa$  symmetry. (Fix a gauge for  $\kappa$  symmetry  $\Rightarrow$  worldsheet susy). Introduce  $\theta^A =$  spacetime spinors and worldsheet scalars. Replace  $\partial_a X^{\mu}$  with spacetime susy invariant

$$\Pi_a^{\mu} = \partial_a X^{\mu} - i \bar{\theta}^A \Gamma^{\mu} \partial_a \theta^A$$

invariant under

$$\delta X^{\mu} = -\bar{\epsilon}^A \Gamma^{\mu} \partial_a \theta^A, \quad \delta \theta^A = \epsilon^A$$

$$S = -\frac{1}{4\pi\alpha'} \int d\tau d\sigma \sqrt{-\gamma} \gamma^{ab} \Pi_a^\mu \Pi_b^\nu g_{\mu\nu} + \int d\tau d\sigma \epsilon^{ab} \Pi_a^M \Pi_b^N B_{MN}$$

- flat space:

$$B \equiv \epsilon^{ab} \Pi_a^M \Pi_b^N B_{MN} = -idX^\mu \wedge (\bar{\theta}^1 \Gamma_\mu d\theta^2 - \bar{\theta}^2 \Gamma_\mu d\theta^1) + \bar{\theta}^1 \Gamma^\mu d\theta^1 \wedge \bar{\theta}^2 \Gamma_\mu d\theta^2$$

- Kappa symmetry,

$$\delta_\kappa \theta^A = -2\Gamma_\mu \Pi_a^\mu \kappa^{Aa}, \quad \delta_\kappa X^\mu = -\bar{\theta}^A \Gamma^\mu \delta\theta^A, \quad \dots$$

is fixed by the condition (together with lightcone gauge for bosons)

$$\Gamma^+ \theta^1 = \Gamma^+ \theta^2 = 0, \quad \Gamma^\pm = (\Gamma^0 \pm \Gamma^9)/\sqrt{2}$$

and  $\theta^{A\alpha}$  are regrouped as 2-comp. Majorana worldsheet spinors  $S^m$ ,  $m$  spinor of  $SO(8)$ ,

$$S_{lc} = -\frac{1}{4\pi\alpha'} \int d^2\sigma \left[ \partial_a X^i \partial^a X^i + 2\alpha' \bar{S}^m \gamma^a \partial_a S^m \right].$$

- Supersymmetry means tachyons (and other states) are out of the spectrum. Vacuum: massless states  $A^{\mu\nu} = \{g^{\mu\nu}, B^{\mu\nu}, \phi\} +$  others.
- Strings  $\rightarrow$  couple to  $B_{\mu\nu}$ .

- Gauge fixed Green-Schwarz action = gauge fixed action with manifest worldsheet susy:

- **Spinning string**: Neveu-Schwarz-Ramond (NSR) action, with  $\psi^\mu =$  worldsheet spinors, spacetime vectors:

$$S = -\frac{1}{4\pi\alpha'} \int d^2\sigma \left[ \partial_a X^\mu \partial^a X_\mu + \bar{\psi}^\mu \gamma^a \partial_a \psi_\mu \right],$$

with worldsheet susy:

$$\delta X^\mu = \bar{\epsilon} \psi^\mu, \quad \delta \psi^\mu = \gamma^a \partial_a X^\mu \epsilon$$

- Fermionic boundary term (for open string)

$$\psi_+ \delta \psi_+ - \psi_- \delta \psi_- \Big|_0^\pi,$$

means we can impose at 0  $\psi_+^\mu(0, \tau) = \psi_-^\mu(0, \tau)$ , but then at  $\pi$  we have 2 possibilities,

$$\psi_+(\pi, \tau) = \pm \psi_-(\pi, \tau),$$

giving the Ramond (+)  $\Rightarrow$  spacetime fermions, or Neveu-Schwarz (-)  $\Rightarrow$  spacetime bosons sectors. Closed strings: indep. for L or R  $\Rightarrow$  NS-NS and R-R (bosons) or NS-R and R-NS (fermions).

- Chirality of  $\theta^A$  in closed string GS theory ( $N = 2$ ): same  $\Rightarrow$  **type IIB string theory**; opposite  $\Rightarrow$  **type IIA string theory**. Open strings ( $N = 1$ ): single  $\theta$ ; can couple to  $SO(32)$  Yang-Mills fields (non-anomalous theory): **type I string theory**. Other  $N = 1$  theories: **heterotic** (left movers bosonic, right movers supersymmetric):  $SO(32)$  or  $E_8 \times E_8$ .

## Conformal invariance in 2 dimensions

- Conformal invariance: symmetry of QFT in flat space, under coordinate transformation that generalizes scale transf., of the type

$$x'^{\mu} = \alpha x^{\mu} \Rightarrow ds^2 = d\vec{x}'^2 = \alpha^2 d\vec{x}^2 \rightarrow$$

$$x_{\mu} \rightarrow x'_{\mu}(x) \text{ s.t. } ds^2 = dx'_{\mu} dx'_{\mu} = [\Omega(x)]^{-2} dx_{\mu} dx_{\mu}$$

- Obs: transf. on **flat space**. Transf. are a **subclass** of general coordinate transf. For strings in unit gauge,  $\sigma^+ \rightarrow \tilde{\sigma}^+ = f(\sigma^+)$ ,  $\sigma^- \rightarrow \tilde{\sigma}^- = g(\sigma^-)$  (residual gauge inv.).

- In Minkowski  $(d - 1, 1)$  spacetime, **for**  $d > 2$ , the conformal group is  $SO(d, 2)$ .

- **d=2**: special. Invariance group is not finite dimensional (like  $SO(d, 2)$ ), but infinite dimensional: Virasoro algebra

$$ds^2 = dzd\bar{z} \Rightarrow z' = f(z)$$

$$ds'^2 = dz'd\bar{z}' = \frac{\partial z'}{\partial z} \frac{\partial \bar{z}'}{\partial \bar{z}} dzd\bar{z} = \Omega^{-2}(z, \bar{z}) dzd\bar{z}$$

- So any **holomorphic** transformation is conformal. Generators  $\{L_m\}$  (qu. version of string constraint modes): Virasoro algebra:

$$[L_m, L_n] = (m - n)L_{m+n} + \frac{c}{12}(m^3 - m)\delta_{m,-n}$$

- GR tensors: covariant tensor  $T_{i_1 \dots i_n}$  transforms as

$$T_{i_1 \dots i_n}(z_1, z_2) = T'_{j_1 \dots j_n}(z'_1, z'_2) \frac{\partial z'^{j_1}}{\partial z^{i_1}} \dots \frac{\partial z'^{j_n}}{\partial z^{i_n}}$$

- Primary fields or tensor operators of CFT defined by analogy: " $T_{z \dots z \bar{z} \dots \bar{z}}$ " is a primary field of dimensions  $(h, \bar{h})$  (even if  $h, \bar{h} \notin \mathbb{Z}$ ) if

$$T_{z \dots z \bar{z} \dots \bar{z}} = T'_{z \dots z \bar{z} \dots \bar{z}} \left( \frac{dz'}{dz} \right)^h \left( \frac{d\bar{z}'}{d\bar{z}} \right)^{\bar{h}},$$

- Operator product expansion (OPE) (valid in any QFT, but there only asymptotically):

$$\mathcal{O}_i(x_i)\mathcal{O}_j(x_j) = \sum_k c^k_{ij}(x_i - x_j)\mathcal{O}_k(x_j).$$

and if operators  $\mathcal{O}_i$  have dimensions  $\Delta_i$ ,

$$\langle \mathcal{O}_i(x_i)\mathcal{O}_j(x_j)\dots \rangle = \sum_k \frac{c^k_{ij}}{|x_i - x_j|^{\Delta_i + \Delta_j - \Delta_k}} \left\langle \mathcal{O}_k\left(\frac{x_i + x_j}{2}\right)\dots \right\rangle,$$

whereas with the energy-momentum tensor  $T(z)$ ,

$$T(z)\mathcal{O}(0,0) = \dots + \frac{h}{z^2}\mathcal{O}(0,0) + \frac{1}{z}\partial\mathcal{O}(0,0) + \dots,$$

and for a primary field

$$T(z)\phi_i^{(h_i, \tilde{h}_i)} = \frac{h_i}{z^2}\phi_i^{(h_i, \tilde{h}_i)} + \frac{1}{z}\partial\phi_i^{(h_i, \tilde{h}_i)} + \text{nonsingular}.$$

- Example: free scalars (Polyakov string action in unit gauge)

$$S_E = \frac{1}{4\pi\alpha'} \int d^2\sigma [\partial_1 X^\mu \partial_1 X_\mu + \partial_2 X^\mu \partial_2 X_\mu] = \frac{1}{2\pi\alpha'} \int d^2z \partial X^\mu \bar{\partial} X_\mu.$$

- **T-duality of closed and open strings:** symmetry of string perturbation theory on compact spaces.
- For a string winding  $m$  times around  $X^{25}$ , bound. cond.

$$X^{25}(\tau, \sigma + 2\pi) = X^{25}(\tau, \sigma) + 2\pi\alpha'w.$$

- The classical solution is

$$X^{25}(\tau, \sigma) = X_L + X_R = x_0 + \alpha'p\tau + \alpha'w\sigma + i\sqrt{\frac{\alpha'}{2}} \sum_{n \neq 0} \frac{e^{-in\tau}}{n} (\alpha_n e^{in\sigma} + \tilde{\alpha}_n e^{-in\sigma}),$$

where  $p = n/R$  and  $w = mR/\alpha'$ . The constraint is now  $L_0 - \tilde{L}_0 = \alpha'pw + N^\perp - \tilde{N}^\perp$  and gives the spectrum

$$\begin{aligned} M_{\text{compact}}^2 &= p^2 + w^2 + \frac{2}{\alpha'}(N^\perp + \tilde{N}^\perp - 2) \\ &= \left(\frac{n}{R}\right)^2 + \left(\frac{mR}{\alpha'}\right)^2 + \frac{2}{\alpha'}(N^\perp + \tilde{N}^\perp - 2). \end{aligned}$$

- We observe the T-duality symmetry of the spectrum

$$M^2(R; n, m) = M^2(\tilde{R}; m, n).$$

extended to

$$x_0 \leftrightarrow q_0; \quad p \leftrightarrow w; \quad \alpha_n \leftrightarrow -\alpha_n; \quad \tilde{\alpha}_n \leftrightarrow \tilde{\alpha}_n,$$



- This T-duality exchanges then:

$$X^{25}(\tau, \sigma) X_L(\tau + \sigma) + X_R(\tau - \sigma) \leftrightarrow X'^{25}(\tau, \sigma) = X_L(\tau + \sigma) - X_R(\tau - \sigma)$$

- **T-duality of open strings:** Do the same exchange for the open string solution. Obtain

$$X'^{25}(\tau, \sigma) = X_L^{25}(\tau + \sigma) - X_R^{25}(\tau - \sigma) = q_0^{25} + \sqrt{2\alpha'} \alpha_0^{25} \sigma + \sqrt{2\alpha'} \sum_{n \neq 0} \frac{\alpha_n^{25}}{n} e^{-in\tau} \sin n\sigma ,$$

$$\alpha_0^{25} = \frac{1}{\sqrt{2\alpha'}} \frac{x_2^{25} - x_1^{25}}{\pi} .$$

- But then the boundary condition changes from Neumann to Dirichlet and vice versa,

$$\partial_\alpha X^{25} = \epsilon_{\alpha\beta} \partial_\beta X'^{25} .$$

- **Reminder:** Vary Polyakov action  $\Rightarrow$  equations of motion, and boundary term

$$\delta S_{P,bd.} = -\frac{1}{2\pi\alpha'} \int d\tau \sqrt{-\gamma} \delta X^\mu \partial^\sigma X_\mu \Big|_{\sigma=0}^{\sigma=\pi} \Rightarrow$$

- Neumann boundary condition:  $\partial^\sigma X_\mu = 0 \Big|_{\sigma=0,\pi} \Rightarrow$  endpoints of string move at the speed of light: usual.
- Dirichlet boundary condition:  $\delta X^\mu = 0 \Big|_{\sigma=0,\pi} \Rightarrow X^\mu = \text{constant}$  at  $\sigma = 0, \pi$ .  $\rightarrow$  endpoints fixed.
- We can have Neumann for  $p + 1$  coordinates and Dirichlet for  $D - p - 1 \Rightarrow$  "Dp-brane".
- Spacetime fields can excite coordinates  $X^\mu$  transverse to the Dp-brane (Dirichlet directions)  $\rightarrow$  fluctuations  $\Rightarrow$  this is Dp-brane is a dynamical object.

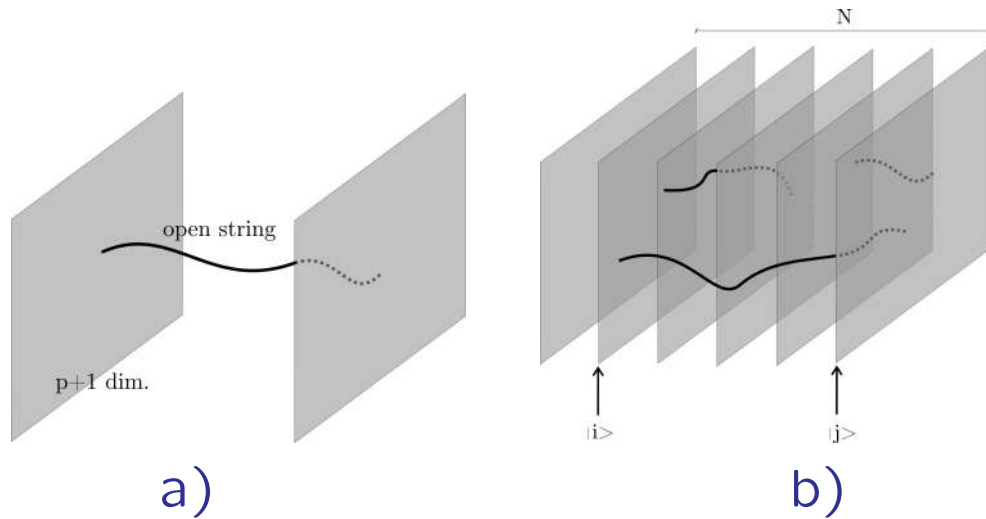

a) Open string between two D- $p$ -branes ( $p + 1$  dimensional "walls"). b) The endpoints of the open string are labelled by the D-brane they end on (out of  $N$  D-branes), here  $|i\rangle$  and  $|j\rangle$ .

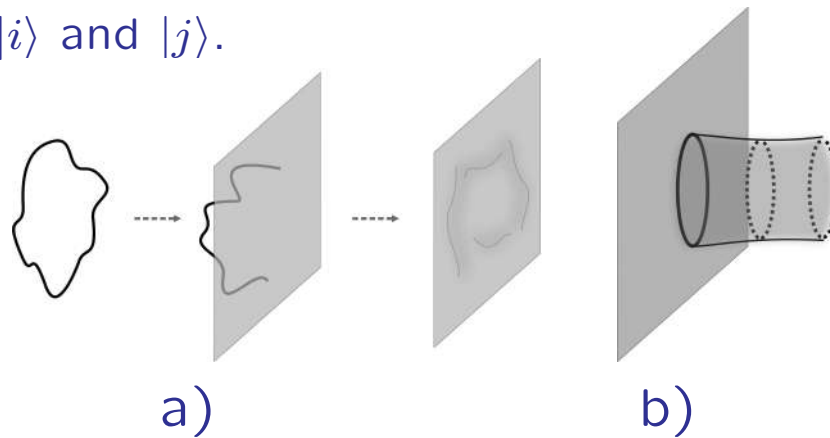

a) Closed string colliding with a D-brane, exciting an open string mode and making it vibrate b) String worldsheet corresponding to it, with a closed string tube coming from infinity and ending on the D-brane as an open string boundary. Allows us to calculate the D-brane action and couplings.

- Compute charges and tensions of Dp-branes and compare with supergravity p-brane solutions (Polchinski, 1995)  $\Rightarrow$  Dp-brane = extremal p-brane solution of supergravity.

- Open strings have "Chan-Patton factors" at endpoints  $\rightarrow$  indices  $\Rightarrow$  open string.  $\lambda_{ij}^a |i\rangle \otimes |j\rangle \Rightarrow$  massless open string state is  $A_{\mu}^a = \alpha_{-1}^{\mu} \lambda_{ij}^a |i\rangle \otimes |j\rangle =$  vector in  $U(N)$  gauge group for N D-branes.

- Action for a single D-brane is

$$S_p = T_p \int d^{p+1} \xi e^{-\phi} \sqrt{-\det(h_{ij} + \alpha' (F_{ij} + B_{ij}))} + \text{fermi} + \text{WZ}$$

- Static gauge:  $X^i = \xi^i, i = 0, \dots, p$  and  $g_{\mu\nu} = \eta_{\mu\nu} \Rightarrow$

$$\begin{aligned} h_{ij} &= \partial_i X^{\mu} \partial_j X^{\nu} g_{\mu\nu} = \eta_{ij} + \partial_i X^m \partial_j X_m \\ B_{ij} &= \partial_u X^{\mu} \partial_j X^{\nu} B_{\mu\nu} \end{aligned}$$

- WZ term:  $\int_{M_p} e^{\wedge F/2\pi} \wedge \sum_n A_n$ , e.g. a term on D5 in type IIB is

$$\frac{1}{2\pi} \int_{M_6} d^6 x \epsilon^{\mu_1 \dots \mu_6} A_{\mu_1} F_{\mu_2 \dots \mu_6}^+$$

- Then, for  $p = 3$  and a single brane

$$S_2 = \text{const.} + \int d^3x \left( -\frac{F_{ij}^2}{4} - \frac{1}{2} \partial_i X^m \partial^i X_m + \text{fermi} \right)$$

- In fact, the action: "  $\mathcal{N} = 4$  supersymmetric Yang-Mills" for  $N$  D3-branes.

- Fields:  $\{A_i^a, X^{a[IJ]}, \psi_\alpha^{aI}\}$ ,  $a \in SU(N)$ ,  $I \in SU(4)$ ,  $[IJ] \rightarrow$  anti-symmetric of  $SU(4)$ : **6** representation. ( $m = 1, \dots, 6$ : transverse to D3).

- Action

$$S_{\mathcal{N}=4SYM} = -2 \int d^4x \text{tr} \left[ -\frac{1}{4} F_{\mu\nu}^2 - \frac{1}{2} \bar{\Psi}_I \not{D} \Psi^I - \frac{1}{2} D_\mu X_{IJ} D^\mu X^{IJ} \right. \\ \left. + ig \bar{\Psi}^I [X_{IJ}, \Psi^J] - g^2 [X_{IJ}, X_{KL}] [X^{IJ}, X^{KL}] \right]$$

- **Observation:** Bosonic Nambu-Goto version → also volume spanned by worldvolume:

$$S_p = T_p \int d^{p+1}\xi \sqrt{-\det(h_{ab})}$$

$$h_{ab} = \partial_a \xi^\mu \partial_b \xi^\nu g_{\mu\nu}$$

- In fact, strings massless fields form **spacetime supergravity multiplet**.
- Supergravity has extremal p-branes solution ⇒ p-branes are string theory nonperturbative objects: D-branes.

- Super p-brane: generalization

$$S_p = T_p \int d^{p+1}\xi \left( -\frac{1}{2} \sqrt{-\gamma} \gamma^{ij} \Pi_i^A \Pi_j^B \eta_{MN} e^{\frac{a(p)\phi}{p+1}} \right. \\ \left. + \frac{p-1}{2} \sqrt{-\gamma} - \frac{1}{(p+1)!} \epsilon^{i_1 \dots i_{p+1}} \Pi_{i_1}^{A_1} \dots \Pi_{i_{p+1}}^{A_{p+1}} A_{A_1 \dots A_{p+1}} \right)$$

- Bosonic:  $\Pi_i^A \rightarrow \Pi_i^a = \partial_i X^\mu E_\mu^a$ .

## Lecture 3

# Black holes in supergravity vs. D-branes

## Supersymmetry

- Bose-fermi symmetry. e.g. 2d: 1 Majorana spinor  $\Psi$  + 1 real scalar  $\phi$ . **On-shell supersymmetry:** 1 bose degree of freedom, 1 fermi d.o.f.

$$S = -\frac{1}{2} \int d^2x [(\partial_\mu \phi)^2 + \bar{\Psi} \not{\partial} \Psi]$$

- Dimensions:  $[\phi] = 0, [\Psi] = 1/2$ . Fermi-bose  $\Rightarrow$  start as

$$\begin{aligned} \delta\phi &= \bar{\epsilon} \Psi \Rightarrow [\epsilon] = -1/2 \Rightarrow \\ \delta\Psi &= \not{\partial} \phi \epsilon \end{aligned}$$

- Action is on-shell invariant.
- **Off-shell supersymmetry:**  $\Psi$  has 2 d.o.f.  $\Rightarrow$  need to add 1 auxiliary field

$$\begin{aligned} S &= -\frac{1}{2} \int d^2x [(\partial_\mu \phi)^2 + \bar{\Psi} \not{\partial} \Psi - F^2] \\ \delta F &= \bar{\epsilon} \not{\partial} \Psi; \quad \delta\Psi = \not{\partial} \phi \epsilon + F\epsilon; \quad \delta\phi = \bar{\epsilon} \Psi \end{aligned}$$



- However, off-shell susy means that *the algebra of susy is satisfied off-shell (without the use of the eqs. of motion)*.
- The most general  $N$ -extended superalgebra in 4d, with central charges, is

$$\{Q_\alpha^i, Q_\beta^j\} = 2(C\gamma^\mu)_{\alpha\beta}P_\mu\delta^{ij} + C_{\alpha\beta}U^{ij} + (C\gamma_5)_{\alpha\beta}V^{ij},$$

and must be satisfied on all fields. In 2d, for the WZ model above,

$$\{Q_\alpha^i, Q_\beta^j\} = 2(C\gamma^\mu)_{\alpha\beta}P_\mu\delta^{ij} \Rightarrow [\delta_{\epsilon_1}, \delta_{\epsilon_2}] = 2\bar{\epsilon}_2\gamma^\mu\epsilon_1\partial_\mu.$$

- Representing the algebra with central charges and massive states using the Wigner method, we find

$$\begin{aligned} a_\alpha &= \frac{1}{\sqrt{2}}[Q_\alpha^1 + \epsilon_{\alpha\beta}\bar{Q}_{2\beta}] & a_\alpha^\dagger &= \frac{1}{\sqrt{2}}[\bar{Q}_{1\dot{\alpha}} + \epsilon_{\alpha\beta}Q_\beta^2] \\ b_\alpha &= \frac{1}{\sqrt{2}}[Q_\alpha^1 - \epsilon_{\alpha\beta}\bar{Q}_{2\beta}] & a_\alpha^\dagger &= \frac{1}{\sqrt{2}}[\bar{Q}_{1\dot{\alpha}} - \epsilon_{\alpha\beta}Q_\beta^2], \end{aligned}$$

so we obtain the algebra

$$\{a_\alpha, a_\beta^\dagger\} = 2(M - Z)\delta_{\alpha\beta}; \quad \{b_\alpha, b_\beta^\dagger\} = 2(M + Z)\delta_{\alpha\beta} \Rightarrow M \geq |Z|.$$

and the rest zero, giving the **BPS bound**.

- The interacting  $\mathcal{N} = 1$  chiral (WZ) model in 4d is

$$S = \int d^4x \left[ \phi^* \square \phi - i(\partial_\mu \bar{\psi})(\sigma^\mu)^T \psi - m \bar{\psi} \psi - 2\text{Re}[g\phi \bar{\psi} \psi] - |\lambda + m\phi + g\phi^2|^2 \right],$$

where the auxiliary field was solved as  $F^* = -(\lambda + m\phi + g\phi^2)$ .

- The  $\mathcal{N} = 1$  vector multiplet (vector+spinor) in 4d (off-shell) is

$$S_{\mathcal{N}=1 \text{ SYM}} = (-2) \int d^4x \text{Tr} \left[ -\frac{1}{4} F_{\mu\nu}^2 - \frac{1}{2} \bar{\lambda} \not{D} \lambda + \frac{D^2}{2} \right],$$

invariant under

$$\delta A_\mu^a = \bar{\epsilon} \gamma_\mu \lambda^a, \quad \delta \lambda^a = \left[ -\frac{1}{2} \gamma^{\mu\nu} F_{\mu\nu}^a + i \gamma_5 D^a \right] \epsilon, \quad \delta D^a = i \bar{\epsilon} \gamma_5 \not{D} \lambda^a.$$

- When we couple to WZ multiplets, we obtain the D-term (auxiliary field)  $D^a = \phi^\dagger{}^i (T^a)_{ij} \phi^j$ , and the scalar potential is

$$V = \sum_i |F_i|^2 + g^2 D^a D^a.$$

- $\mathcal{N} = 4$  SYM is obtained as  $\mathcal{N} = 1$  SYM in 10d reduced to 4d,

$$\begin{aligned} S_{10d, \mathcal{N}=1 \text{ SYM}} &= (-2) \int d^{10}x \text{Tr} \left[ -\frac{1}{4} F^{MN} F_{MN} - \frac{1}{2} \bar{\lambda} \Gamma^M D_M \lambda \right] \Rightarrow \\ S_{4d, \mathcal{N}=4 \text{ SYM}} &= (-2) \int d^4x \text{Tr} \left[ -\frac{1}{4} F_{\mu\nu}^2 - \frac{1}{2} \bar{\psi}_i \not{D} \psi^i - \frac{1}{2} D_\mu \phi_{ij} D^\mu \phi^{ij} \right. \\ &\quad \left. - g \bar{\psi}^i [\phi_{ij}, \psi^j] - \frac{g^2}{4} [\phi_{ij}, \phi_{kl}] [\phi^{ij}, \phi^{kl}] \right] \end{aligned}$$

# Supergravity

- Supergravity = supersymmetric theory of gravity, OR: theory of local supersymmetry.

- Local supersymmetry  $\Rightarrow \epsilon^\alpha(x) \Rightarrow \exists$  "gauge field of supersymmetry", " $A_\mu^\alpha(x)$ "  $\rightarrow$  gravitino  $\Psi_{\mu\alpha}(x)$ : supersymmetric partner of  $e_\mu^a(x)$ .

- $\mathcal{N} = 1$  supergravity in 4d:  $\{e_\mu^a, \Psi_{\mu\alpha}\}$ . Supersymmetry laws:

$$\delta e_\mu^a = \frac{\kappa_N}{2} \bar{\epsilon} \gamma^a \Psi_\mu$$

$$\delta \Psi_\mu = \frac{1}{\kappa_N} D_\mu \epsilon; \quad D_\mu \epsilon = \partial_\mu \epsilon + \frac{1}{4} \omega_\mu^{ab} \gamma_{ab} \epsilon$$

- Action:

$$S = S_{E-H}(\omega, e) + S_{RS}(\Psi_\mu)$$

$$= \frac{1}{16\pi G} \int d^d x (\det e) R_{\mu\nu}^{ab}(\omega) e_a^{-1\mu} e_b^{-1\nu} - \frac{1}{2} \int d^d x (\det e) \bar{\Psi}_\mu \gamma^{\mu\nu\rho} D_\nu \Psi_\rho$$

- Second order formalism:  $e_\mu^a, \psi_{\mu\alpha}$  indep.,  $\omega_\mu^{ab}$  dependent. However,  $\exists$  dynamical fermions, so  $\omega_\mu^{ab} = \omega_\mu^{ab}(e) + \psi\psi$  terms, obtained by varying action with respect to  $\omega_\mu^{ab}$  (as in first order formalism)  $\Rightarrow \omega_\mu^{ab}(e, \psi)$ .

- First order formalism:  $e_\mu^a, \psi_{\mu\alpha}, \omega_\mu^{ab}$  independent.

- 1.5 order formalism (best): Use 2nd order formalism, but in  $S(e, \psi, \omega(e, \psi))$ , we don't vary  $\omega(e, \psi)$ , since it is multiplied by  $\delta S / \delta \omega = 0$  (in second order formalism).

- In 4d, maximal susy (for multiplets of spins  $\leq 2$ ) is  $\mathcal{N} = 8$ . It has graviton  $e_\mu^a$ , 8 gravitini  $\psi_{\mu\alpha}^i$ , 28 vectors  $A_\mu^{IJ}$ , 56 fermions  $\chi_{ijk}^\alpha$  and 35 scalars forming a matrix  $\nu$  or, in terms of  $\mathcal{N} = 1$  multiplets, 1 supergravity, 7 gravitino, 21 vectors and 35 chiral (WZ) multiplets.

- It is the dimensional reduction of an  $\mathcal{N} = 1$  supergravity multiplet in 11 dimensions, with graviton  $e_\mu^a$ , gravitino  $\psi_{\mu\alpha}$  and 3-index antisymmetric tensor  $A_{\mu\nu\rho}$ .

- Higher ( $\mathcal{N} = 1$ ) supersymmetry in  $d > 4 \Rightarrow$  matter fields in the same multiplet: vectors  $A_\mu$ , fermions  $\Psi_\alpha$ , also p-form antisymmetric fields  $A_{\mu_1 \dots \mu_n}$

$$S = \int d^d x (\det e) F_{\mu_1, \dots, \mu_{n+1}}^2$$

$$F_{\mu_1 \dots \mu_{n+1}} = \partial_{[\mu_1} A_{\mu_2 \dots \mu_{n+1}]}$$

- Generalized Maxwell invariance

$$\delta A_{\mu_1 \dots \mu_n} = \partial_{[\mu_1} \Lambda_{\mu_2 \dots \mu_n]}$$

- **Black holes and p-branes:** Most general solution with spherical symmetry of Einstein's equations in vacuum ( $T_{\mu\nu} = 0$ ):  $R_{\mu\nu} - 1/2 g_{\mu\nu} R = 0$  is the Schwarzschild solution. In 4d,

$$ds^2 = - \left( 1 - \frac{2mG}{r} \right) dt^2 + \frac{dr^2}{1 - \frac{2mG}{r}} + R^2 d\Omega_2^2$$

- Is solution of a point particle of mass  $M$ , or of a spherical mass distribution of radius  $R$  at  $r > R$ . If it's valid down to  $r = r_H \equiv 2MG$ : **black hole**.  $r = r_H$ : event horizon.

- Can add charge  $Q$ . BPS bound  $|Q| \leq M$ . For  $|Q| = M$ : extremal black hole ( $r_+ = r_-$ ).

- Solution with charge: modify the Newtonian potential defining solution,

$$U_N(r) = -\frac{MG_N}{r} + \frac{Q^2 G_N}{4\pi\epsilon_0^2 4r^2},$$

where  $ds^2 = -(1 + 2U_N(r))dt^2 + dr^2/(1 + 2U_N(r)) + r^2 d\Omega_{D-2}^2$ .

- In  $D$  dimensions, the Schwarzschild solution is

$$ds^2 = -\left(1 - \frac{2C^{(D)}G_N^{(D)}M}{r^{D-3}}\right) dt^2 + \frac{dr^2}{1 - \frac{2C^{(D)}G_N^{(D)}M}{r^{D-3}}} + r^2 d\Omega_{D-2}^2.$$

- The Schwarzschild  $p$ -brane solution in  $D$  dimension is obtained by trivial extension of  $T^p$ ,

$$ds^2 = -\left(1 - \frac{2C^{(D-p)}G_N^{(D-p)}M}{r^{D-3-p}}\right) dt^2 + d\vec{x}_p^2 + \frac{dr^2}{1 - \frac{2C^{(D-p)}G_N^{(D-p)}M}{r^{D-3-p}}} + r^2 d\Omega_{D-2-p}^2.$$

- In 4d Einstein-Maxwell, the charged black hole is rewritten as

$$ds^2 = -\Delta dt^2 + \frac{dr^2}{\Delta} + r^2 d\Omega_2^2, \quad \Delta = \left(1 - \frac{r_+}{r}\right) \left(1 - \frac{r_-}{r}\right)$$

- For the extremal case,  $r_+ = r_-$ , and after  $r = M + \bar{r}$ , we obtain

$$ds^2 = -H(\bar{r})^{-2} dt^2 + H(\bar{r})^2 (d\bar{r}^2 + \bar{r}^2 d\Omega_2^2),$$

where  $H = 1 + M/\bar{r}$  is harmonic,

$$\Delta_{(3)} H = -4\pi M \delta^3(r).$$

- The AdS-Reissner-Nordstrom solution (charged BH in AdS) in 4d is

$$ds^2 = -\Delta dt^2 + \frac{dr^2}{\Delta} + r^2 d\Omega_2^2; \quad \Delta \equiv 1 - \frac{2MG_N}{r} + \frac{\tilde{Q}^2 G_N}{r^2} - \frac{8\pi G_N \Lambda r^2}{3}.$$

- In  $D$  dimensions, the extremal Reissner-Nordstrom (charged with respect to  $A_\mu$ ) black hole is rewritten by  $r^{D-3} = \bar{r}^{D-3} + r_H^{D-3}$  as

$$ds^2 = -f(\bar{r})^{-2} dt^2 + f(\bar{r})^{\frac{2}{D-3}} (d\bar{r}^2 + \bar{r}^2 d\Omega_{D-2}^2),$$

- in terms of the harmonic function

$$f(\bar{r}) = 1 + \left(\frac{r_H}{\bar{r}}\right)^{D-3}.$$

- In supergravity however, we can add charge  $Q_p$  associated with an  $A_{\mu_1 \dots \mu_{p+1}}$ , with source term in the action  $Q_p \int d^{p+1} \xi A_{01 \dots p+1} = \int d^D x j^{\mu_1 \dots \mu_{p+1}} A_{\mu_1 \dots \mu_{p+1}}$ , giving

$$A_{01 \dots p} = -\frac{C_p Q_p}{r^{D-p-3}}.$$

- The source term can be rewritten as (on the worldvolume)

$$-\frac{1}{(p+1)!} T_P \int d^{p+1} \xi \epsilon^{i_1 \dots i_{p+1}} \partial_{i_1} X^{M_1} \dots \partial_{i_{p+1}} X^{M_{p+1}} A_{M_1 \dots M_{p+1}},$$

but there is actually also a coupling to the dilaton and the metric, like for the string case.

- Extremal solutions  $M = |Q_p|$  play a fundamental role: extended in  $p+1$  dimensions:  $p$ -branes. Important nonperturbative objects.



- Extremal p-brane solutions of supergravity (with  $M = |Q_p|$ ), with action

$$S_D = \frac{1}{2k^2} \int d^D x \sqrt{-g} \left( R - \frac{1}{2} (\partial\phi)^2 - \frac{1}{2(d+1)!} e^{-a(d)\phi} F_{d+1}^2 \right)$$

(here  $\phi$  is a scalar = "dilaton"), are of type

$$\begin{aligned} ds_{Einstein}^2 &= e^{-\frac{\phi}{2}} ds_{string}^2; \quad H_p = 1 + \frac{\alpha_p Q_p}{|\vec{x}_\perp|^{7-p}} \\ ds_{string}^2 &= H_p^{-1/2} (-dt^2 + d\vec{x}_p^2) + H_p^{1/2} d\vec{x}_{9-p}^2 \\ e^{-4\phi} &= H_p^{\frac{p-3}{4}} \\ A_{01\dots p} &= -\frac{1}{2} (H_p^{-1} - 1) \end{aligned}$$

with source term  $\int A_{(p+1)} = \int d^d x j^{\mu_1 \dots \mu_{p+1}} A_{\mu_1 \dots \mu_{p+1}}$  added to  $S_D$ .

- Spans a p+1-dimensional "worldvolume".
- Play a special role when supergravity is embedded in string theory: are equal to D-branes.

## Conformal field theory in $d=4$

- For  $d \neq 2$ , infinitesimal transf. is

$$\begin{aligned}x'_\mu &= x_\mu + v_\mu(x) \Rightarrow \\v_\mu(x) &= a_\mu + \omega_{\mu\nu}x_\nu + \lambda x_\mu + b_\mu x^2 - 2x_{\mu\alpha}b \cdot x\end{aligned}$$

- Generators:  $(a_\mu, \omega_{\mu\nu}) \rightarrow (P_\mu, J_{\mu\nu})$ : Poincare ( $\Omega(x) = 1$ ).  $b_\mu \rightarrow K_\mu$ : special conformal transformation,  $\lambda \rightarrow D$ : dilatation.

- Form group:  $SO(d, 2)$  in Minkowski  $(d-1, 1)$ .

- Obs: All conformal transf. obtained from rotations, translations and inversions:

$$I : x'_\mu = \frac{x_\mu}{x^2} \Rightarrow \Omega(x) = x^2$$

- So we only need to check invariance under inversions for a Poincare invariant theory.

- Scaling dimension: eigenvalue  $-i\Delta$  of scaling operator  $D$

$$\phi(x) \rightarrow \phi'(x) = \lambda^\Delta \phi(\lambda x)$$

- From  $SO(d, 2)$  conformal algebra,

$$[D, P_\mu] = -iP_\mu \Rightarrow D(P_\mu\phi) = -i(\Delta + 1)(P_\mu\phi)$$

$$[D, K_\mu] = +iK_\mu \Rightarrow D(K_\mu\phi) = -i(\Delta - 1)(K_\mu\phi)$$

- Thus  $K_\mu \sim a$  (annihilation) and  $P_\mu \sim a^\dagger$  (creation). Generate representation of conformal group. Operator of lowest dimension in it = **primary operator**  $\phi_0$  ( $\sim |0\rangle$ ), s.t.  $K_\mu\phi_0 = 0$ .

- The orthogonal matrix representing inversion is

$$R_{\mu\nu}(x) \equiv I_{\mu\nu}(x) = \delta_{\mu\nu} - 2\frac{x^\mu x^\nu}{x^2},$$

and transforms under conformal transf. as

$$I_{\mu\nu}(x' - y') = R_{\mu\rho}R_{\nu\sigma}I_{\rho\sigma}(x - y); \quad (x' - y')^2 = \frac{(x - y)^2}{\Omega(x)\Omega(y)}.$$

- 2-point correlators for scalar operators  $\mathcal{O}_i$  and conserved currents  $J_\mu^a$  are

$$\begin{aligned} \langle \mathcal{O}_i(x)\mathcal{O}_j(y) \rangle &= \frac{C\delta_{ij}}{|x - y|^{2\Delta_i}} \\ \langle J_\mu^a(x)J_\nu^b(y) \rangle &= C\frac{\delta^{ab}I_{\mu\nu}(x - y)}{|x - y|^{2(d-1)}}, \end{aligned}$$

while 3-point correlators of scalar operators are

$$\langle \mathcal{O}_i(x)\mathcal{O}_j(y)\mathcal{O}_k(z) \rangle = \frac{C_{ijk}}{|x - y|^{\Delta_i + \Delta_j - \Delta_k}|y - z|^{\Delta_j + \Delta_k - \Delta_i}|z - x|^{\Delta_k + \Delta_i - \Delta_j}}.$$

- $d = 4 \rightarrow \mathcal{N} = 4$  Super Yang-Mills = representation of conformal group  $\{A_\mu^a, \Psi_\alpha^{aI}, X_{[IJ]}^a\}$ .

- In  $\mathcal{N} = 4$  SUM, beta function = 0  $\Rightarrow$  scale and conformal invariant. But  $\Delta = \Delta_0 + \mathcal{O}(g)$  in general. No *infinities*, but  $\exists$  finite renormalizations.

- So classically:  $[A_\mu^a] = 1, [\Psi_\alpha^{aI}] = 3/2, [X_{[IJ]}^a] = 1$ , but composite gauge invariant ops., e.g.  $\text{tr } F_{\mu\nu}^2$ , have  $\Delta(g)$ .

- $\mathcal{N} = 4$  susy invariance of SYM:

$$\delta A_\mu^a = \bar{\epsilon}_I \gamma_\mu \Psi^{aI}$$

$$\delta X_a^{[IJ]} = \frac{i}{2} \bar{\epsilon}^{[I} \psi^{J]a}$$

$$\delta \Psi^{aI} = -\frac{\gamma^{\mu\nu}}{2} F_{\mu\nu}^a \epsilon^I + 2i \gamma^\mu D_\mu X^{a,[IJ]} \epsilon_J - 2g f^a_{bc} (X^b X^c)^{[IJ]} \epsilon_J$$

## AdS/CFT in original formulation (Maldacena, 1997)

- String theory in  $AdS_5 \times S^5 = \mathcal{N} = 4$  SYM with  $SU(N)$  gauge group (low energy theory on  $N$  D3-branes), living at the boundary of  $AdS_5 \times S^5$ , involving a certain limit.

- Heuristical derivation:

- D-branes = extremal p-branes  $\Rightarrow$  curve space. Solution:

$$ds^2 = H^{-1/2}(r)d\vec{x}_{||}^2 + H^{1/2}(r)(dr^2 + r^2d\Omega_5^2)$$

$$F_5 = (1 + *)dt \wedge dx_1 \wedge dx_2 \wedge dx_3 \wedge (dH^{-1})$$

$$H(r) = 1 + \frac{R^4}{r^4}; \quad R = 4\pi g_s N \alpha'^2; \quad Q = g_s N$$

- Add a  $\delta M \rightarrow$  near extremal:  $M = Q + \delta M \Rightarrow$  horizon  $\Rightarrow$  emits Hawking radiation: 2 open strings on D3 collide and form a closed string that peels off and goes into the bulk.

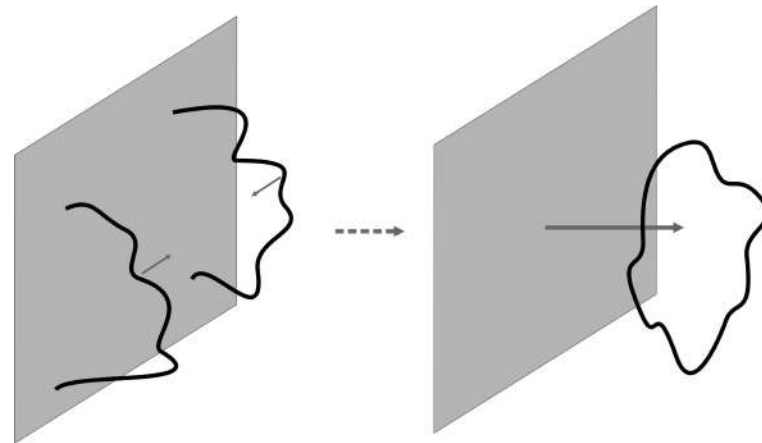

Two open strings living on a D-brane collide and form a closed string, that can then peel off and go away from the brane.

● **P.O.V. nr. 1** D3-branes = endpoints of strings. String theory gives:

-open strings on D3. Low energy ( $\alpha' \rightarrow 0$ )  $\Rightarrow \mathcal{N} = 4$  SYM

-closed strings in bulk (all spacetime): supergravity + massive modes of string. Low energy: supergravity only.

-interactions, giving e.g. Hawking radiation as above.

$$S = S_{bulk} + S_{brane} + S_{interactions}$$

● Low energy limit,  $\alpha' \rightarrow 0$ ,  $\Rightarrow S_{bulk} \rightarrow S_{supergravity}$ ,  $S_{brane} \rightarrow S_{\mathcal{N}=4SYM}$ ,  $S_{int} \propto \kappa_{Newton} \sim g_s \alpha'^2 \rightarrow 0$ . Moreover, since Newton  $\kappa_N \rightarrow 0$ ,  $\Rightarrow$  free gravity. Thus:

● free gravity in bulk

● 4d  $\mathcal{N} = 4$  SYM on D3's.

● Obs:  $\partial(AdS_5 \times S^5) = R^{3,1}$  or  $S^3 \times R$  (4 dimensional!):  $S^5$  shrinks to zero size at boundary.



- **P.O.V. nr. 2** D3-branes replaced by p-branes (supergravity solutions).

- Geometry has two asymptotic regions:  $r \rightarrow 0$ :  $AdS_5 \times S^5$  and  $r \rightarrow \infty$ : Minkowski<sub>10</sub>. Infinitely long throat:

- Energy at point  $r$  is

$$E_r \sim \frac{d}{d\tau} = \frac{1}{\sqrt{-g_{00}}} \frac{d}{dt} \sim \frac{1}{\sqrt{-g_{00}}} E_\infty \Rightarrow E_\infty = H^{-1/4} E_r \sim r E_r$$

- Then at  $r \rightarrow 0$ , for fixed  $E_r$  (energy of the throat)  $E_\infty \rightarrow 0 \Rightarrow$  low energy excitations.

- At  $r \rightarrow \infty$ , long distance  $\delta r \rightarrow \infty \Leftrightarrow E \rightarrow 0$ , effective gravity coupling  $GE^{D-2} \rightarrow 0 \Rightarrow$  free gravity  $\rightarrow$  in the bulk.

- Compare POV 1 with POV 2. Same free gravity in the bulk  $\Rightarrow$  Identify the others  $\Rightarrow$
- 4d  $\mathcal{N} = 4$  SYM with  $SU(N)$  on D3 = gravity at  $r \rightarrow 0$  in D-brane background, for  $\alpha' \rightarrow 0$ .
- Background for  $r \rightarrow 0$ , with  $r/R \equiv R/x_0$ .

$$ds^2 = R^2 \frac{-dt^2 + d\vec{x}_3^2 + dx_0^2}{x_0^2} + R^2 d\Omega_5^2 : AdS_5 \times S^5$$

## Lecture 4

AdS/CFT and gauge/gravity duality in  
Euclidean and Lorentzian signatures

- **Last time:** 4d  $\mathcal{N} = 4$  SYM with  $SU(N)$  on D3 = gravity at  $r \rightarrow 0$  in D-brane background, for  $\alpha' \rightarrow 0$ .

- Background for  $r \rightarrow 0$ , with  $r/R \equiv R/x_0$ .

$$ds^2 = R^2 \frac{-dt^2 + d\vec{x}_3^2 + dx_0^2}{x_0^2} + R^2 d\Omega_5^2 : AdS_5 \times S^5$$

- **Now:** Define limit further:  $r \rightarrow 0 \Rightarrow M \sim R^4/r^4 \propto \alpha'^2/r^4$ .

- $E_r \sqrt{\alpha'}$  fixed and  $E_\infty$  fixed  $\Rightarrow$

$$\frac{E_\infty}{E_r \sqrt{\alpha'}} = \frac{r}{\alpha'} \equiv U = \text{fixed (energy scale)}$$

- Then, metric is

$$ds^2 = \alpha' \left[ \frac{U^2}{\sqrt{4\pi g_s N}} (-dt^2 + d\vec{x}_3^2) + \sqrt{4\pi g_s N} \left( \frac{dU^2}{U^2} + d\Omega_5^2 \right) \right]$$

- And  $ds^2/\alpha'$  finite, but in order to have small string corrections we need also  $g_s \rightarrow 0$  (quantum string corrections) and

- $R_{AdS}^2 = \sqrt{4\pi g_s N}$  = fixed and large (small  $\alpha'$  corrections).

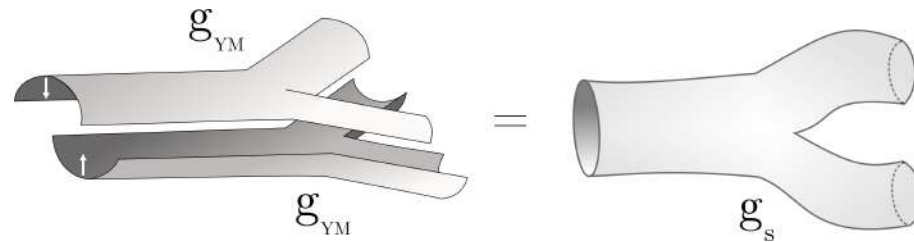

Two open string splitting interactions can be glued on the edges to give a closed string interaction ("pair of pants"), therefore  $g_{YM}^2 = g_s$ .

• Large  $N$  limit: 't Hooft: for gauge theories with only adjoints, we have an *effective, or 't Hooft coupling*  $\lambda = g_{YM}^2 N$ , besides  $1/N$ . The dependence of amplitudes is

$$A \sim (g^2 N)^L N^{1-2h},$$

where  $L =$  loop nr.,  $h =$  handle nr.,  $\chi = 2 - 2h - l$  ( $l =$  nr. of quark, external lines) is the Euler characteristic of a surface. Planar limit  $\equiv h = 0$

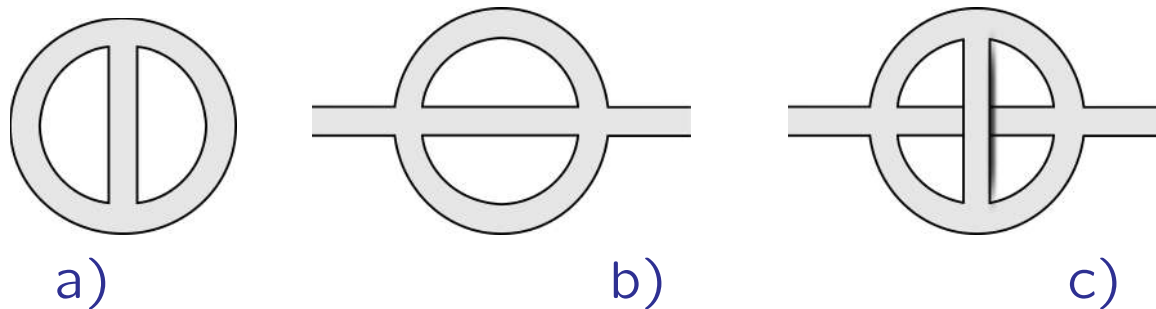

a) Planar 2-loop diagram with 2 3-point vertices b) Planar 2-loop diagram with 2 4-point vertices c) Nonplanar 3-loop diagram.

- (open string)<sup>2</sup>  $\sim$  closed string  $\Rightarrow g_s = g_{YM}^2$ .
- So, limit:  $g_{YM}^2 \rightarrow 0, N \rightarrow \infty$ , but 't Hooft coupling  $\lambda = g_{YM}^2 N$  large and fixed.
- Opposite of perturbation theory ( $\lambda \ll 1$ )  $\Rightarrow$  duality:  
 Perturbation theory in string theory  $\Rightarrow$  nonperturbative in SYM  
 and vice versa: Hard to test, but useful  $\rightarrow$  calculate nonperturbative effects.
- 3 possible versions of AdS/CFT:
  - Weakest: only at  $g_s \rightarrow 0$  and  $g_s N$  large  $\rightarrow$  string theory  $\simeq$  supergravity.  $\alpha'$  and  $g_s$  corrections might disagree.
  - Stronger: valid at any finite  $g_s N$ , but only at  $g_s \rightarrow 0, N \rightarrow \infty$ , i.e.  $\alpha'/R^2 = 1/\sqrt{g_s N}$  corrections agree, but not  $g_s$  corrections.
  - Strongest: believed to be correct: valid at any  $g_s$  and  $N$  (or  $g_s$  and  $\alpha'$ ).

- **Defining map:** (Witten, 1998)

- Gauge invariant operator  $\mathcal{O}$  of  $\mathcal{N} = 4$  SYM, with conformal dimension  $\Delta$  and representation  $I_n$  of  $SO(6) = SU(4) \leftrightarrow$  field in  $AdS_5$ , of mass  $m$  and representation  $I_n$  of  $SO(6) =$  symmetry of  $S^5$

- Reduce 10d fields on  $S^5$ :

$$\phi(x, y) = \sum_n \sum_{I_n} \phi_{(n)}^{I_n}(x) Y_{(n)}^{I_n}(y)$$

- Then  $\phi_{(n)}^{I_n} \leftrightarrow \mathcal{O}_{(n)}^{I_n}$ , with

$$\Delta = \frac{d}{2} + \sqrt{\frac{d^2}{4} + m^2 R^2}$$

- But  $\Delta$  doesn't receive quantum corrections ( $\Delta(\lambda \rightarrow \infty) = \Delta(\lambda = 0)$ ) only for chiral primary operators = primary operators preserving some susy:  $[Q_{comb}] \mathcal{O}_{ch.pr} = 0$

● **“Experimental” evidence:** towers of multiplets of operators in  $\mathcal{N} = 4$  SYM  $\leftrightarrow$  towers of KK fields on  $AdS_5 \times S^5$ .

● 6 families of chiral primary scalar representations:

$$Q^2 \mathcal{O}_n = \text{Tr}(\phi^{I_1} \dots \phi^{I_n}) \leftrightarrow \text{scalars with } m^2 R^2 = n(n-4), n \geq 2;$$

$$\mathcal{O}_n = \text{Tr}(\epsilon^{\alpha\beta} \lambda_{\alpha A} \lambda_{\beta B} \phi^{I_1} \dots \phi^{I_n}) \leftrightarrow m^2 R^2 = (n+3)(n-1), n \geq 0;$$

$$Q^2 \bar{Q}^2 \mathcal{O}_n = \text{Tr}(\epsilon^{\alpha\beta} \epsilon^{\bar{\alpha}\bar{\beta}} \lambda_{\alpha A_1} \lambda_{\beta A_2} \tilde{\lambda}_{\dot{\alpha}}^{B_1} \tilde{\lambda}_{\dot{\beta}}^{B_2} \phi^{I_1} \dots \phi^{I_n}) \leftrightarrow m^2 R^2 = (n+6)(n+2), n \geq 0;$$

$$Q^4 \mathcal{O}_n = \text{Tr}(F_{\mu\nu} F^{\mu\nu} \phi^{I_1} \dots \phi^{I_n}) \leftrightarrow m^2 R^2 = n(n+4), n \geq 0;$$

$$Q^4 \bar{Q}^2 \mathcal{O}_n = \text{Tr}(\epsilon^{\alpha\beta} \lambda_{\alpha A} \lambda_{\beta B} F_{\mu\nu}^2 \phi^{I_1} \dots \phi^{I_n}) \leftrightarrow m^2 R^2 = (n+3)(n+7), n \geq 0;$$

$$Q^4 \bar{Q}^4 \mathcal{O}_n = \text{Tr}(F_{\mu\nu}^4 \phi^{I_1} \dots \phi^{I_n}) \leftrightarrow m^2 R^2 = (n+4)(n+8), n \geq 0.$$



- **Global AdS/CFT**. Metric of global  $AdS_5 \times S^5$  and boundary: cylinder:

$$ds^2 = \frac{R^2}{\cos^2 \theta} (d\tau^2 + d\theta^2 + \sin^2 \theta d\Omega_3^2) + R^2 d\Omega_5^2 \rightarrow ds^2 = \frac{R^2}{\epsilon^2} (d\tau^2 + d\Omega_3^2).$$

- Metric in Poincaré coords, and boundary: plane:

$$ds^2 = R^2 \frac{d\vec{x}^2 + dx_0^2 + x_0^2 d\Omega_5^2}{x_0^2} \rightarrow ds^2 = \frac{R^2}{\epsilon^2} d\vec{x}^2.$$

- Boundary  $\mathbb{R}_t \times S^3$  (cylinder) and  $\mathbb{R}^4$  (plane) are related by conf. transf. (irrelevant for CFT):

$$ds^2 = d\vec{x}^2 = dx^2 + x^2 d\Omega_3^2 = x^2 ((d \ln x)^2 + d\Omega_3^2) = x^2 (d\tau^2 + d\Omega_3^2).$$

- CFT: operator-state correspondence. In 2d,  $z = e^{-w}$  maps cylinder (in  $w$ :  $w \sim w + 2\pi$ ) to plane (in  $z$ ) and incoming states (at  $w = -i\infty$ ) with operators on the plane.

- e.g. Closed string. Taylor exp. of operator on plane  $\Rightarrow$  state-operator map:

$$\alpha_{-m}^\mu = \sqrt{\frac{2}{\alpha'} (m-1)!} \frac{i}{\alpha'} \partial^m X^\mu(0) \Rightarrow \alpha_{-m}^\mu |0, 0\rangle \leftrightarrow \sqrt{\frac{2}{\alpha'} (m-1)!} \frac{i}{\alpha'} \partial^m X^\mu(0).$$

- Hamiltonian on  $\mathbb{R}_\tau$  (cylinder KK reduced on circle) is the same as the "dilatation operator" on plane, generator of  $\vec{r} \rightarrow \lambda\vec{r}$ , since ( $d\vec{r}^2 = dr^2 + r^2 d\theta^2$ )

$$H_{\mathbb{R}_\tau} = i\partial_\tau = ir\partial_r = D_{\mathbb{R}^2} .$$

- In 4d, similar. Only, conformal invariance requires  $\int R\phi^2$  term in action: on plane, =0; on cylinder: mass term  $-\int \phi^2/2$ .
- Scalars  $Z$  in  $\mathbb{R}^4$ : Taylor expansion for this op. are

$$z_{\alpha_1 \dots \alpha_m}^{(m)} \sim (\partial_{\alpha_1} \dots \partial_{\alpha_m}) Z ,$$

and correspond to KK states on cylinder, but const. term has energy  $E = 1$  due to mass term (is a harmonic oscillator).

- Again, QM Hamiltonian for KK states on  $\mathbb{R}_\tau$  (cylinder reduced on  $S^3$ ), same as dilatation operator on  $\mathbb{R}^4$ , for  $\vec{r} \rightarrow \lambda\vec{r}$ ,

$$H_{\mathbb{R}_\tau} = i\partial_\tau = ir\partial_r = D_{\text{plane}} .$$

## Witten construction

- Near boundary  $x_0 = 0$  in Poincaré coords.,  $\square\phi = 0$  has solutions  $\phi \rightarrow \phi_0$  and  $\phi \rightarrow x_0^d \phi_0$ , and  $(\square - m^2)\phi = 0$  (massive) has solutions  $\phi \rightarrow x_0^{d-\Delta} \phi_0$  and  $\phi \rightarrow x_0^\Delta \phi_0$  ( $\Delta = \text{dim. of dual op.}$ ).
- Then  $\phi_0 =$  source for dual operator  $\mathcal{O}$ .
- Observables for  $\mathcal{O} \leftrightarrow \phi$ : generating functional for  $\mathcal{O}$ :

$$Z_{\text{boundary}} = Z_{\mathcal{O},\text{CFT}}[\phi_0] = \int \mathcal{D}[\text{SYM fields}] e^{-S_{\mathcal{N}=4 \text{ SYM}} + \int d^4x \mathcal{O}(x) \phi_0(x)}$$

- Fundamental idea:  $Z_{\text{boundary}} = Z_{\text{bulk}} = Z_{\text{string}}[\phi_0]$ , where  $\phi_0 =$  boundary sources. But for  $\alpha' \rightarrow 0, g_s \rightarrow 0, R^4/\alpha'^2 \gg 1 \rightarrow \text{string} \simeq$  classical supergravity, and  $Z_{\text{string}}[\phi_0] = e^{-S_{\text{sugra}}[\phi[\phi_0]]}$ .

$$\Rightarrow Z_{\mathcal{O},\text{CFT}}[\phi_0] = e^{-S_{\text{sugra}}[\phi[\phi_0]]}$$

- But in CFT, correlators are obtained by derivation:

$$\begin{aligned} \langle \mathcal{O}(x_1) \dots \mathcal{O}(x_n) \rangle &= \frac{\delta^n}{\delta \phi_0(x_1) \dots \delta \phi_0(x_n)} Z_{\mathcal{O}}[\phi_0] \Big|_{\phi_0=0} \\ &= \frac{\delta^n}{\delta \phi_0(x_1) \dots \delta \phi_0(x_n)} e^{-S_{\text{sugra}}[\phi[\phi_0]]} \Big|_{\phi_0=0} \end{aligned}$$

- Define "bulk to boundary propagator"  $K_B$ , a propagator with the free leg on the boundary,

$$" \square_{\vec{x}, x_0} " K_B(\vec{x}, x_0; \vec{x}') = \delta^4(\vec{x} - \vec{x}') ,$$

such that the field in the bulk is written as a convolution of  $K_B$  with  $\phi_0$ ,

$$\phi(\vec{x}, x_0) = \int d^4 \vec{x}' K_B(\vec{x}, x_0; \vec{x}') \phi_0(\vec{x}') ,$$

and replaced in the sugra action allows us to calculate correlators.

• In our case,

$$K_{B,\Delta}(\vec{x}, x_0; \vec{x}') = C_d \left[ \frac{x_0}{x_0^2 + (\vec{x} - \vec{x}')^2} \right]^\Delta \cdot \xrightarrow{x_0 \rightarrow 0} x_0^{d-\Delta} \delta(\vec{x} - \vec{x}') , \quad x_0 \frac{\partial}{\partial x_0} K_B \Big|_{x_0 \rightarrow 0} \stackrel{\Delta=d}{=} \frac{dx_0^d}{|\vec{x} - \vec{x}'|^{2d}}$$

so • Example: **2 point function of scalars**

$$\langle \mathcal{O}(x_1) \mathcal{O}(x_2) \rangle = - \frac{\delta^2 S_{sugra}[\phi[\phi_0]]}{\delta \phi_0(x_1) \delta \phi_0(x_2)} \Big|_{\phi_0=0}$$

$$S_{sugra}[\phi] = \frac{1}{2} \int_{boundary} d^4 x \sqrt{h} (\phi \vec{n} \cdot \vec{\nabla} \phi) = \frac{Cd}{2} \int d^d \vec{x} \int d^d \vec{x}' \frac{\phi_0(\vec{x}) \phi_0(\vec{x}')}{|\vec{x} - \vec{x}'|^{2d}} \Rightarrow$$

$$\langle \mathcal{O}(x_1) \mathcal{O}(x_2) \rangle = - \frac{Cd/2}{|\vec{x} - \vec{x}'|^{2d}} . \quad \text{OK!}$$

- Another way to think about it, which can be generalized:

$$S_{sugra}[\phi[\phi_0]] = \int d^5x \sqrt{g} \int d^4\vec{x}' \int d^4\vec{y}' \partial_\mu K_B(\vec{x}, x_0; \vec{x}') \phi_0(\vec{x}') \\ \times \partial^\mu K_B(\vec{x}, x_0; \vec{y}') \phi_0(\vec{y}') + \mathcal{O}(\phi_0^3)$$

$$\Rightarrow \langle \mathcal{O}(\vec{y}) \mathcal{O}(\vec{z}) \rangle = \int d^5x \sqrt{g} \partial_{\mu\vec{x}, x_0} K_B(\vec{x}, x_0; \vec{x}') \partial_{\vec{x}, x_0}^\mu K_B(\vec{x}, x_0; \vec{y}')$$

- Generalize: Boundary Feynman diagrams (Witten) for  $\langle \mathcal{O}(x_1) \dots \mathcal{O}(x_n) \rangle$ , e.g.

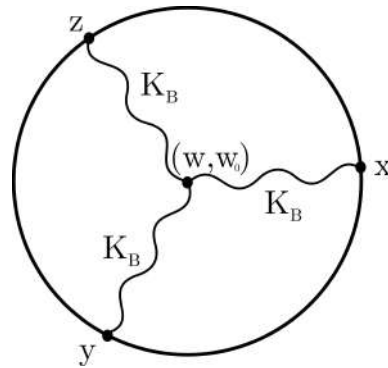

a)

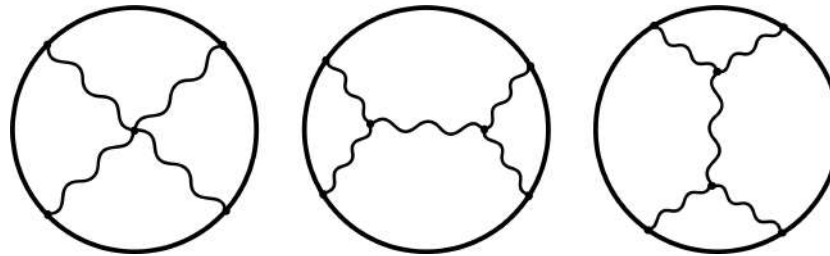

b)

- a) Tree level "Witten diagram" for the 3-point function in AdS space. b) Tree level Witten diagrams for the 4-point function in AdS space.

• Example: 3-point function R-current anomaly. In general, for 3-point functions, we obtain

$$\langle \mathcal{O}(x_1)\mathcal{O}(x_2)\mathcal{O}(x_3) \rangle = -\lambda \int \frac{d^d z dz_0}{z_0^{d+1}} K_{B,\Delta_1}(z_0, \vec{z}; \vec{x}_1) K_{B,\Delta_2}(z_0, \vec{z}; \vec{x}_2) K_{B,\Delta_3}(z_0, \vec{z}; \vec{x}_3).$$

• For the anomaly, we calculate

$$\langle J^{ia}(x_1) J^{jb}(x_2) J^{kc}(x_3) \rangle_{\text{CFT, d}_{\text{abc}} \text{ part}} = - \left. \frac{\delta^3 S_{\text{CS,sugra}}^{\text{3-pnt vertex}} [A_\mu^a [a_l^d]]}{\delta a_i^a(x_1) \delta a_j^b(x_2) \delta a_k^c(x_3)} \right|_{a=0},$$

using  $S_{\text{CS}}(A) = \frac{N^2}{18\pi^2} \text{Tr} \int_{B_5=\partial M_6} \epsilon^{\mu\nu\rho\sigma\tau} (A_\mu (\partial_\nu A_\rho) \partial_\sigma A_\tau + A^4 \text{ terms} + A^5 \text{ terms}),$

and find equality with the CFT result

$$\frac{\partial}{\partial z^k} \langle J_i^a(x) J_j^b(y) J_k^c(z) \rangle_{\text{CFT, d}_{\text{abc}}} = - \frac{(N^2 - 1) i d_{\text{abc}}}{48\pi^2} \epsilon^{ijkl} \frac{\partial}{\partial x_k} \frac{\partial}{\partial y_l} \delta(x - y) \delta(y - z),$$

coming from the one-loop triangle anomaly (which is one-loop exact!),

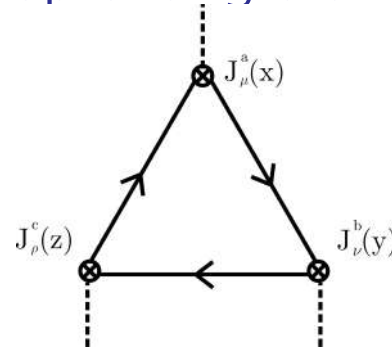

Triangle diagram contributing to the  $\langle J_i^a(x) J_j^b(y) J_k^c(z) \rangle$  correlator. Chiral fermions run in the loop.

- **(Euclidean)** Bulk to bulk propagator satisfies

$$(\square_x - m^2)G(x, y) = \frac{1}{\sqrt{g_y}} \delta^{d+1}(x - y) = -\delta^d(\vec{x} - \vec{y}) \delta(x_0 - y_0) \frac{y_0^{d+1}}{R^{d+1}},$$

and is found to be

$$G(x, y) = (x_0 y_0)^{d/2} \int \frac{d^d k}{(2\pi)^d} e^{i\vec{k} \cdot (\vec{x} - \vec{y})} I_\nu(kx_0^<) K_\nu(kx_0^>),$$

composed, as usual, of the two independent solutions to the homogenous eq.  $(\square - m^2)\Phi = 0$ ,

$$\Phi_{1, \vec{k}} \propto e^{i\vec{k} \cdot \vec{x}} x_0^{d/2} K_\nu(kx_0) \phi_0(\vec{k}), \quad \Phi_{2, \vec{k}} \propto e^{i\vec{k} \cdot \vec{x}} x_0^{d/2} I_\nu(kx_0) \phi_0(\vec{k}),$$

where  $\Phi_{1, \vec{k}}$  is regular everywhere (also in the center  $x_0 = +\infty$ ), and at the boundary ( $x_0 = 0$ ) is a combination of the non-normalizable mode  $x_0^{\Delta-}$  and the normalizable mode  $x_0^{\Delta+}$  (thus the non-normalizable mode is leading), while  $\Phi_{2, \vec{k}}$  is the normalizable mode  $x_0^{\Delta-}$  at the boundary, but blows up in the center (so is not a physical mode). Therefore

$$\begin{aligned} \Phi_{1,2} &\sim x_0^{\Delta_\pm}, \quad \Delta_\pm = \frac{d}{2} \pm \sqrt{\frac{d^2}{4} + m^2 R^2} \Rightarrow \\ \phi(\vec{x}, x_0) &= \int d^d y K_B(\vec{x}, x_0; \vec{y}) \phi_0(\vec{y}) \sim x_0^{d-\Delta} \phi_0(\vec{x}) = x_0^{\Delta-} \phi_0(\vec{x}). \end{aligned}$$

- **Poincaré, Lorentzian signature, modes:** Then  $k^2 = -m^2 < 0$  on-shell, so solutions

$$\Phi^\pm \propto e^{ik \cdot x} (x_0)^{d/2} J_{\pm\nu}(|k|x_0),$$

where  $\nu = \sqrt{d^2/4 + m^2 R^2}$ . Thus near boundary  $x_0 = 0$ ,

$$\Phi^- \sim (x_0)^{\Delta_-}, \quad \Phi^+ \sim (x_0)^{\Delta_+},$$

so  $\Phi^-$  is non-normalizable and  $\Phi^+$  is normalizable (like in Euclidean case), but now **both** are regular in the center! (unlike Euclidean case). Thus in the Lorentzian case we must understand  $\Phi^+$  (normalizable and regular).

- **Natural Lorentzian map:**  $\Phi^- \rightarrow$  sources,  $\Phi^+ \rightarrow$  states, in boundary CFT.

- Wick rotating partition function, Witten map is now ( $|s\rangle =$  state)

$$Z_{\text{sugra}}[\phi_0] = e^{iS_{\text{sugra}}[\phi(\phi_0)]} = Z_{\text{CFT}}[\phi_0] = \langle s | e^{i \int_{\partial M} \phi_0 \mathcal{O}} | s \rangle .$$



- But state  $|s\rangle$  mapped to normalizable mode  $\phi_n$ , so

$$\begin{aligned}\phi(x_0, \vec{x}) &= \phi_n(x_0, \vec{x}) + \int d^d y K_B(x_0, \vec{x}; \vec{y}) \phi_0(\vec{y}) \\ &= \phi_n(x_0, \vec{x}) + c \int d^d y \frac{x_0^d}{(x_0^2 + (\vec{x} - \vec{y})^2)^d} \phi_0(\vec{y}).\end{aligned}$$

- Substituting in sugra action, we get

$$\langle \tilde{\phi}_n | \mathcal{O}(\vec{x}) | \tilde{\phi}_n \rangle_{\phi_0} = \frac{\delta}{\delta \phi_0(\vec{x})} S_{\text{sugra}}[\phi(\phi_0)] = d \tilde{\phi}_n(\vec{x}) + cd \int d^d x' \frac{\phi_0(\vec{x}')}{|\vec{x} - \vec{x}'|^{2d}}.$$

- Then *non-normalizable modes are mapped to sources and normalizable modes to VEVs (or states)*,

$$\phi \sim \alpha_i(x_0)^{d-\Delta} + \beta_i(x_0)^\Delta,$$

implying

$$\begin{aligned}H &= H_{CFT} + \alpha_i \mathcal{O}_i, \\ \langle \beta_i | \mathcal{O} | \beta_i \rangle &= \beta_i + (\alpha_i \text{ piece}).\end{aligned}$$

- **Solutions and propagators in global Lorentzian space.** The metric is

$$ds^2 = \frac{R^2}{\cos^2 \rho} (-dt^2 + d\rho^2 + \sin^2 \rho d\Omega_{d-1}^2).$$

- Only one solution regular in the center of AdS,

$$\psi_1 = e^{-i\omega t} Y_{l,\{m\}}(\Omega) (\cos \rho)^{\Delta_+} (\sin \rho)^l {}_2F_1 \left( \frac{\Delta_+ + l + \omega}{2}, \frac{\Delta_+ + l - \omega}{2}; l + \frac{d}{2}; \sin^2 \rho \right).$$

- At boundary  $x_0 = \cos \rho = 0$ , two possible behaviours (solutions)

$$\begin{aligned} \Phi^+ &= e^{-i\omega t} Y_{l,\{m\}}(\Omega) (\cos \rho)^{\Delta_+} (\sin \rho)^l {}_2F_1 \left( \frac{\Delta_+ + l + \omega}{2}, \frac{\Delta_+ + l - \omega}{2}; \Delta_+ + 1 - \frac{d}{2}; \cos^2 \rho \right) \\ \Phi^- &= e^{-i\omega t} Y_{l,\{m\}}(\Omega) (\cos \rho)^{\Delta_-} (\sin \rho)^l {}_2F_1 \left( \frac{\Delta_- + l + \omega}{2}, \frac{\Delta_- + l - \omega}{2}; \Delta_- + 1 - \frac{d}{2}; \cos^2 \rho \right), \end{aligned}$$

where  $\Phi^+$  is normalizable,  $\Phi^-$  is non-normalizable, and in general  $\psi_1 \sim C^+ \Phi^+ + C^- \Phi^-$ . But if

$$\omega_{nl} = \pm(\Delta_+ + l + 2n),$$

$C^- = 0$ , so  $\psi_1$  is normalizable (and regular).

- So unlike in Poincaré coords., *the general solution is non-normalizable, but particular discrete frequencies, it is normalizable.*
- Non-normalizable modes: sources for CFT operators, but at special AdS frequencies, normalizable modes, corresponding to states of CFT on the cylinder, with energies  $\omega_{nl} = \Delta + 2n + l$ .
- We can compute global bulk to bulk propagator,

$$iG(x, y) = \frac{C_B}{(\cosh^2 \frac{s}{R})^{\frac{\Delta_+}{2}}} {}_2F_1 \left( \frac{\Delta_+}{2}, \frac{\Delta_+ + 1}{2}; \nu + 1; \frac{1}{\cosh^2 \frac{s}{R}} - i\epsilon \right),$$

and take limits to obtain the bulk to boundary, and boundary to boundary (thus, CFT) propagators,

$$K_B(b, x) = C_B \left[ \frac{\cos \rho'}{\cos(t - t') - \sin \rho' \Omega \cdot \Omega' + i\epsilon} \right]^{\Delta_+}$$

$$G_{\partial}(b, b') \propto \frac{1}{[(\cos(t - t') - \Omega \cdot \Omega')^2 + i\epsilon]^{\frac{\Delta_+}{2}}}.$$

• However, the Poincaré boundary to boundary propagator is different:  $x_{12}^2 = |x_1 - x_2|^2$  in global coordinates is different than the denominator of the above,

$$x_{12}^2 = \frac{2(\cos(t_1 - t_2) - \Omega \cdot \Omega')}{(\cos \tau_1 - \Omega_1^d)(\cos \tau_2 - \Omega_2^d)},$$

*so in each coordinate set we must define things from the start!*

## Gauge/gravity duality

- **Generalize:** other max. susy CFT cases:  $AdS_7 \times S^4$ ,  $AdS_4 \times S^7$   
→ "gravity dual"
- Conformal invariance  $\leftrightarrow$  AdS space. But we can obtain less susy by taking  $AdS \times X$ , e.g. by dividing by a finite group  $S^k/\Gamma$ .
- We can also break conformal invariance → modify AdS space.
- Theories with **mass gap**: AdS space like finite quantum mechanical box: must cut out a thin cylinder from the middle of the AdS cylinder.
- We have an UV-IR correspondence:  
 $E \sim U = r/\alpha' \Rightarrow$  IR in CFT =  $r \rightarrow 0$  (UV) in AdS. Cut out around  $r = r_{min}$ .
- Motion in  $U = r/\alpha' \rightarrow$  Renormalization group flow in QFT.

## Minimal ingredients to simulate QCD:

- A large  $N$  quantum gauge theory ( $N \rightarrow \infty$  for small  $g_s$  corrections)
- Boundary at infinity identified with flat space of QCD, but better: field theory at energy scale  $U$  corresponds to flat space at position  $r$  in the gravity dual.
- Thus  $d + 1$  dimensional gravity dual corresponds to  $d$ -dim. field theory plus its energy scale  $U$ .
- Since motion in  $U$  is RG flow, mass gap corresponds to minimum  $r$  of gravity dual.
- Gauge group appears in gravity dual only through  $N$ .

## Map field theory/gravity dual

- Global symmetries in  $\text{Mink}_d$  field th.  $\leftrightarrow$  gauge symmetries in  $d + 1$ -dim. gravity dual.  $\rightarrow$  global symmetries of compact space  $X_m$ .  $J_\mu^a$  couple to  $A_\mu^a$ .
- $P_\mu$  Noether current:  $T_{\mu\nu} \leftrightarrow$  (couples to)  $g_{\mu\nu}$ . So  $d$ -dim. transl. inv.  $\leftrightarrow$  diffeomorphism invariance in  $d + 1$  dimensions.
- Open/closed coupling:  $g_s = g_{YM}^2 / (4\pi)$ .
- Gauge invariant operators  $\leftrightarrow$  (sourced by) gravity dual fields in  $d + 1$  dimensions:
  - Supergravity fields in  $d + 1$  dim. (reduced on  $X_m$ )  $\leftrightarrow$  SYM operators (made of adjoints) ("glueballs").
  - For quarks (fundamentals of gauge group and of some global symmetry  $G$ ), introduce SYM fields for the group  $G$  in the gravity dual, coupling to  $G$ -charged, pion-like operators (made of quarks), so "SYM  $\leftrightarrow$  pion fields".

- Thus: supergravity modes  $\leftrightarrow$  glueballs, SYM fields  $\leftrightarrow$  mesons.
- Mass spectrum of tower of glueballs = mass spectrum for wave eq. of sugra mode in gravity dual. Similar for mesons.
- Baryons: more than two fields, e.g.  $B^{IJK} = \epsilon_{ijk} q^{Ii} q^{Jj} q^{Kk}$ . In field theory: solitonic.  $\rightarrow$  e.g. topological solitons in Skyrme model. In gravity dual: solitons: branes wrapped on cycles.
- Wave functions of states in field theory,  $e^{ik \cdot x}$ , correspond to gravity dual wave functions  $\Phi(x, U, X_m) = e^{ik \cdot x} \Psi(U, X_m)$ .

## General properties for gravity duals for QCD-like, or SQCD-like theories:

- At high energy: conformal (all mass scales irrelevant). Thus, for  $U \rightarrow \infty$ ,  $AdS_5 \times X_5$ , or maybe with subleading corrections to metric.
- At low energy, mass gap, so gravity dual must terminate at some  $U_{\min}$ , such that "warp factor"  $U^2$  in front of  $d\vec{x}^2$  remains finite.
- For fundamental quarks, open string modes on some brane must be introduced. Couple to meson-like operators. Alternative: free probe branes, probing physics at various energy scales.
- If QCD-like theory has global symm. (like flavor, or R, symm.), gravity dual, so  $X_m$ , must have this.



## Lecture 5

# Holographic renormalization and holographic RG flow

# Holographic renormalization

- There are infinities in the AdS (or gravity dual) calculation of the on-shell sugra action: must renormalize them.
  - In part., volume near bound. is  $\infty$ :  $\int dx_0 \sqrt{g} \propto \int dx_0 / (x_0)^{d+1} |_{z_0 \rightarrow 0} \rightarrow \infty$ .
  - Must add counterterms to on-shell sugra action:  $S_{\text{ren}} = S_{\text{on-shell, sugra}} + S_{\text{ct.}}$ , and take derivatives of  $S_{\text{ren}}$  with respect to boundary fields.
- We will obtain for the exact one-point functions for *nonzero source*

$$\begin{aligned}\langle \mathcal{O}(x) \rangle_{\phi_{(0)}} &= -\frac{1}{\sqrt{g(0)}} \frac{\delta S_{\text{ren}}}{\delta \phi_{(0)}(x)} \sim \phi_{(2\Delta-d)}(x) \\ \langle J_i(x) \rangle_{A_{(0)i}} &= -\frac{1}{\sqrt{g(0)}} \frac{\delta S_{\text{ren}}}{\delta A_{(0)i}(x)} \sim A_{(n)i}(x) \\ \langle T_{ij}(x) \rangle_{g_{(0)ij}} &= -\frac{1}{\sqrt{g(0)}} \frac{\delta S_{\text{ren}}}{\delta g_{(0)ij}} \sim g_{(d)ij}(x).\end{aligned}$$

- $\phi_{(2\Delta-d)}$  = coefficient in expansion near boundary of *the exact solution* (not determined by the near-boundary expansion of the equations of motion), and similar for  $A_{(n)i}$  and  $g_{(d)ij}$ .

- From the exact one-point function *with source*, so the exact solutions  $\phi_{(2\Delta-d)}$ ,  $A_{(n)i}$ ,  $g_{(d)ij}$ , we can calculate the n-point functions via derivatives,

$$\langle \mathcal{O}(x_1) \dots \mathcal{O}(x_n) \rangle \sim (-1)^{n-1} \frac{\delta^{n-1} \phi_{(2\Delta-d)}(x_1)}{\delta \phi_{(0)}(x_2) \dots \delta \phi_{(0)}(x_n)} \Big|_{\phi_{(0)}=0} .$$

- Also diff. and conformal Ward identities are obtained as

$$\nabla^i \langle T_{ij} \rangle_{g_{(0)ij}} = 0; \quad \langle T^i_i \rangle_{g_{(0)ij}} = \mathcal{A} .$$

- **Asymptotic expansion.** Define asymptotically AdS spacetimes by near boundary ( $z = 0$ ) expansion. Metric can be put into

$$ds^2 = \frac{1}{z^2} (dz^2 + g_{ij} dx^i dx^j) ,$$

- where  $g_{ij}(\vec{x}, z)$  solves Einstein's equation and admits Taylor expansion (is smooth),

$$g_{ij}(\vec{x}, z) = g_{(0)ij}(\vec{x}) + z g_{(1)ij}(\vec{x}) + z^2 g_{(2)ij} + \dots$$

- Einstein's equations fix all  $g_{(n)}(\vec{x})$  with  $n > 0$  in terms of  $g_{(0)}(\vec{x})$ . (in part., in pure gravity all odd powers vanish up to  $z^d$ ). If  $d$  is even, we can also have a logarithmic term at order  $z^d$ , so

$$g_{ij}(\vec{x}, z) = g_{(0)ij}(\vec{x}) + z^2 g_{(2)ij}(\vec{x}) + \dots + z^d (g_{(d)ij}(\vec{x}) + h_{(d)ij}(\vec{x}) \log z^2) + \dots$$

- Solutions for  $g_{(n)}$  in terms of  $g_{(0)}$  is *algebraic*. In the above,  $g_{(d)}$  is determined by  $g_{(0)}$ , but  $h_{(d)}$  equals the variation of the conformal anomaly with respect to the metric.

- A general field  $\Phi(\vec{x}, z)$  has the near boundary expansion

$$\Phi(\vec{x}, z) = z^m (\Phi_{(0)}(\vec{x}) + z^2 \Phi_{(2)}(\vec{x}) + \dots + z^{2n} (\Phi_{(2n)}(\vec{x}) + \log z^2 \tilde{\Phi}_{(2n)}(\vec{x})) + \dots$$

- The field equation for  $\Phi$  (second order in derivatives) has solutions near the boundary  $z^m$  and  $z^{m+2n}$ , and their coefficients,  $\Phi_{(0)}$  and  $\Phi_{(2n)}$ , correspond to the source for the dual operator, and to  $\langle \mathcal{O} \rangle$  (VEV), respectively (this is true for the exact one-point function).

- **Regularization and counterterms:** Regularize the boundary: at  $z = \epsilon$  instead of  $z = 0$ . Then regularized action is

$$S_{\text{reg}}[\Phi_{(0)}, \epsilon] = \int_{(z=\epsilon)} d^d x \sqrt{g_{(0)}} [\epsilon^{-2\nu} s_{(0)}[\Phi_{(0)}] + \epsilon^{-2\nu+2} s_{(2)}[\Phi_{(0)}] + \dots - \log \epsilon s_{(2\nu)}[\Phi_{(0)}] + \text{finite}].$$

- Leading divergent term:  $\sim \int dz/z^{d+1} \phi^2 \sim \epsilon^{d-\Delta}$ ; must be cancelled by counterterm. Minimal subtraction scheme:

$$S_{\text{ct}}[\Phi(\vec{x}, \epsilon); \epsilon] = -\text{div.terms in } S_{\text{reg}}[\Phi_{(0)}(\Phi(\vec{x}, \epsilon)); \epsilon].$$

- Then the *subtracted action*, varied in order to obtain correlation functions, is

$$S_{\text{sub}}[\Phi(\vec{x}, \epsilon); \epsilon] = S_{\text{reg}}[\Phi_{(0)}; \epsilon] + S_{\text{ct}}[\Phi(\vec{x}, \epsilon); \epsilon],$$

and has  $\epsilon$  finite (must be kept so; put  $\epsilon \rightarrow 0$  only at the end of the calculation). However, the renormalized on-shell action is its  $\epsilon \rightarrow 0$  limit,

$$S_{\text{ren}}[\Phi_{(0)}] = \lim_{\epsilon \rightarrow 0} S_{\text{sub}}[\Phi(\vec{x}, \epsilon); \epsilon].$$

- The one-point function, from which we can calculate the other correlation functions, is roughly

$$\langle \mathcal{O}(\vec{x}) \rangle_{\Phi_{(0)}} = \frac{1}{\sqrt{g_{(0)}}} \frac{\delta S_{\text{ren}}}{\delta \Phi_{(0)}(\vec{x})},$$

but really keep  $\epsilon$  finite and put it to zero at the end, so really,  $\Phi(\vec{x}, \epsilon) = \epsilon^m \Phi_{(0)} + \dots$  and  $\gamma_{ij} = g_{(0)ij}/\epsilon^2 + \dots$ . Then

$$\langle \mathcal{O}(\vec{x}) \rangle_{\Phi_{(0)}} = \lim_{\epsilon \rightarrow 0} \frac{1}{\epsilon^{d-m}} \frac{1}{\sqrt{\gamma}} \frac{\delta S_{\text{sub}}}{\delta \Phi(\vec{x}, \epsilon)}.$$

- The result is proportional to the linearly independent coefficient  $\Phi_{(2n)}(\vec{x})$ , but there could also be a local function of the source  $\Phi_{(0)}$  that leads to contact terms in the higher  $n$ -point functions, and is scheme dependent, so

$$\langle \mathcal{O}(\vec{x}) \rangle_{\Phi_{(0)}} \sim \Phi_{(2n)}(\vec{x}) + F(\Phi_{(0)}).$$

- RG transformations in field theory arise from bulk diffeomorphisms that induce Weyl transformations on the boundary, so

$$x^i = \mu x^{i'}; \quad z = \mu z'.$$

## Example: massive scalar in AdS

- Writing first  $\Phi(\vec{x}, z) = z^{d-\Delta}\phi(\vec{x}, z)$ ,  $\phi(\vec{x}, z)$  is finite at the boundary, and has a Taylor expansion in even powers of  $z$ ,

$$\phi(\vec{x}, z) = \phi_{(0)} + z^2\phi_{(2)} + z^4\phi_{(4)} + \dots$$

- Substituting in the KG eq. expanded in  $z$ , we find first  $m^2R^2 = \Delta(\Delta - d)$ , then

$$\phi_{(2)}(\vec{x}) = \frac{1}{2(2\Delta - d - 2)}\partial_i\partial_i\phi_{(0)}$$

$$\phi_{(4)}(\vec{x}) = \frac{1}{4(2\Delta - d - 4)}\partial_i\partial_i\phi_{(2)}, \dots, \phi_{(2n)} = \frac{1}{2n(2\Delta - d - 2n)}\partial_i\partial_i\phi_{(2n-2)},$$

and so on, and the series ends when  $2\Delta - d - 2n = 0$ , where we need to introduce a  $z^\delta \log z^2$  term in  $\Phi$ , so

$$\phi(\vec{x}, z) = \phi_{(0)} + z^2\phi_{(2)} + \dots + z^{2\Delta-d}(\phi_{(2\Delta-d)} + (\log z^2)\tilde{\phi}_{(2\Delta-d)}) + \dots$$

- From the equations of motion, expanded in  $z$  around the boundary, we find

$$\tilde{\phi}_{(2\Delta-d)} = -\frac{1}{2^{2\Delta-d}\Gamma(\Delta - \frac{d}{2})\Gamma(\Delta - \frac{d-2}{2})}(\partial_i\partial_i)^{\Delta-\frac{d}{2}}\phi_{(0)},$$

on the other hand  $\phi_{(2\Delta-d)}$  is not fixed by them.

•**Regularization and counterterms:** Regularized kinetic on-shell action for  $\Phi$  is

$$\begin{aligned}
S_{\text{reg.}} &= \frac{1}{2} \int_{z \geq \epsilon} d^{d+1}x \sqrt{g_{d+1}} (g^{\mu\nu} \partial_\mu \Phi \partial_\nu \Phi + m^2 \Phi^2) \\
&= \frac{1}{2} \int_{z \geq \epsilon} d^{d+1}x \sqrt{g_{d+1}} \Phi (-\square_{g_{d+1}} + m^2) \Phi - \frac{1}{2} \int_{z=\epsilon} d^d x \sqrt{g_{d+1}} g^{zz} \Phi \partial_z \Phi, \\
&= - \int_{z=\epsilon} d^d x \epsilon^{-2\Delta+d} \left( \frac{1}{2} (d - \Delta) \phi(\vec{x}, \epsilon)^2 + \frac{1}{2} \epsilon \phi(\vec{x}, \epsilon) \partial_\epsilon \phi(\vec{x}, \epsilon) \right),
\end{aligned}$$

where we integrated by parts, used the equations of motion, and expressed  $\Phi$  in terms of  $\phi$ . This is of the general form, with

$$\begin{aligned}
s_{(0)} &= -\frac{1}{2} (d - \Delta) \phi_{(0)}^2 \\
s_{(2)} &= -(d - \Delta + 1) \phi_{(0)} \phi_{(2)} = -\frac{d - \Delta + 1}{2(2\Delta - d - 2)} \phi_{(0)} \partial_i \partial_i \phi_{(0)}, \dots, \\
s_{(2\Delta-d)} &= d \phi_{(0)} \tilde{\phi}_{(2\Delta-d)} = -\frac{d}{2^{2\Delta-d} \Gamma\left(\Delta - \frac{d}{2}\right) \left(\Delta - \frac{d-2}{2}\right)} \phi_{(0)} (\partial_i \partial_i)^{\Delta - \frac{d}{2}} \phi_{(0)}
\end{aligned}$$



- For the counterterm action, cancel the divergences, but with  $\phi_{(2k)}$  re-expressed in terms of  $\Phi(\vec{x}, \epsilon)$ . Inverting  $\Phi(\vec{x}, \epsilon)$  to second order in  $\epsilon^2$ , we obtain

$$\begin{aligned}\phi_{(0)} &= \epsilon^{-(d-\Delta)} \left( \Phi(\vec{x}, \epsilon) - \frac{1}{2(2\Delta - d - 2)} \square_\gamma \Phi(\vec{x}, \epsilon) \right) \\ \phi_{(2)} &= \epsilon^{-(d-\Delta)-2} \frac{1}{2(2\Delta - d - 2)} \square_\gamma \Phi(\vec{x}, \epsilon),\end{aligned}$$

where  $\square_\gamma$  is the Laplacean of  $\gamma_{ij} = \delta_{ij}/\epsilon^2$  (induced metric at  $z = \epsilon$ ). Then the counterterm action is

$$S_{\text{ct.}} = \int_{\text{boundary}} d^d x \sqrt{\gamma} \left( \frac{d-\Delta}{2} \Phi^2 + \frac{1}{2(2\Delta - d - 2)} \Phi \square_\gamma \Phi \right) + \mathcal{O}(\square_\gamma^2),$$

- For  $\Delta = d/2 + k$ , the coefficient of  $\Phi \square_\gamma \Phi$  has a  $\log \epsilon$  (for  $k = 1, -\frac{1}{2} \log \epsilon$ ).

• Then for  $\Delta = d/2 + 1$ , we obtain

$$\begin{aligned}
\delta S_{\text{sub.}} &= -\frac{1}{2}\delta \int_{z=\epsilon} d^d x \sqrt{g} g^{zz} \Phi \partial_z \Phi + \delta \int_{z=\epsilon} d^d x \sqrt{\gamma} \left( \frac{d-\Delta}{2} \Phi^2 - \frac{1}{2} \log z \Phi \square_\gamma \Phi \right) + .. \\
&= \int_{z=\epsilon} d^d x \sqrt{\gamma} \delta \Phi \left( -\epsilon \partial_\epsilon \Phi + (d-\Delta) \Phi - \log \epsilon \square_\gamma \Phi \right) \Rightarrow \\
\frac{1}{\sqrt{\gamma}} \frac{\delta S_{\text{sub.}}}{\delta \Phi} &= -\epsilon \partial_\epsilon \Phi + (d-\Delta) \Phi - \log \epsilon \square_\gamma \Phi ,
\end{aligned}$$

so that

$$\begin{aligned}
\frac{1}{\sqrt{\gamma}} \frac{\delta S_{\text{sub.}}}{\delta \Phi} &= -\epsilon \partial_\epsilon \Phi + (d-\Delta) \Phi - \log \epsilon \square_\gamma \Phi \\
\langle \mathcal{O} \rangle_{\phi_{(0)}} &= \lim_{\epsilon \rightarrow 0} \left( \frac{1}{\epsilon^\Delta} \frac{1}{\sqrt{\gamma}} \frac{\delta S_{\text{sub.}}}{\delta \Phi} \right) = -2(\phi_{(2)} + \tilde{\phi}_{(2)}) ,
\end{aligned}$$

which is of the general form  $\langle \mathcal{O} \rangle_{\phi_{(0)}} \sim \phi_{(2\Delta-d)} + F(\phi_{(0)})$ , since for  $\Delta = d/2 + 1$ ,  $\phi_{(2\Delta-d)} = \phi_{(2)}$ , and  $\tilde{\phi}_{(2)} = \tilde{\phi}_{(2\Delta-d)} = F(\phi_{(0)})$ . For general  $\Delta$ , one finds (one can show)

$$\langle \mathcal{O} \rangle_{\phi_{(0)}} = -(2\Delta - d) \phi_{(2\Delta-d)} + F(\phi_{(0)}) .$$

- This proves that indeed,  $\phi_{(2\Delta-d)}$  (the coefficient of  $x^\Delta$ ) gives the (deformation of the) operator VEV, while we had that  $\phi_{(0)}$  (the coefficient of  $z^{d-\Delta}$ ) gave the operator deformation of the theory (source).
- To calculate the 2-point function from the 1-point function, we need  $\phi_{(2\Delta-d)}$  and  $F$  as a function of  $\phi_{(0)}$ , which only is true for the exact solution.
- For example, for  $d = 4$  and  $\Delta = d/2 + 1 = 3$ , the regular solution of the KG equation in momentum space (regular also at the center) is

$$\Phi = z^2 K_1(z) ,$$

expanded near the boundary  $z = 0$  as

$$\Phi(k, z) = \frac{1}{k} z \left[ 1 + k^2 z^2 \left( \frac{1}{4}(2\gamma - 1) - \frac{1}{2} \log 2 + \frac{1}{2} \log(kz) \right) \right] + \dots ,$$

so we have

$$\begin{aligned} \tilde{\phi}_{(2)}(k) &= \frac{k^2}{4} \phi_{(0)}(k) , \quad \phi_{(2)}(k) = \phi_{(0)}(k) k^2 \left[ \frac{1}{4}(2\gamma - 1) + \frac{1}{2} \log \frac{k}{2} \right] \Rightarrow \\ \langle \mathcal{O} \rangle_{\phi_{(0)}} &= -2(\phi_{(2)} + \tilde{\phi}_{(2)}) = -2\phi_{(0)}(k) \left[ k^2 \left( \frac{1}{4}(2\gamma - 1) - \frac{1}{2} \log 2 + \frac{1}{4} \right) + \frac{k^2}{4} \log k^2 \right] . \end{aligned}$$

• Then

$$\langle \mathcal{O}(k)\mathcal{O}(-k) \rangle = -\frac{\delta\phi_{(2)}(k)}{\delta\phi_{(0)}(-k)} = \frac{k^2}{2} \log k^2 + \text{contact terms},$$

which Fourier transforms to the  $x$  space into

$$\langle \mathcal{O}(x)\mathcal{O}(0) \rangle = \frac{4}{\pi^4} \mathcal{R} \frac{1}{x^6},$$

where  $\mathcal{R}1/x^6$  equals  $1/x^6$  away from  $x = 0$ . For  $\Delta = d/2 + k$ , one obtains

$$\langle \mathcal{O}(x)\mathcal{O}(0) \rangle = (2\Delta - d) \frac{\Gamma(\Delta)}{\pi^{d/2} \Gamma(\Delta - d/2)} \mathcal{R} \frac{1}{x^{2\Delta}}.$$

• Note that naive Witten prescription calculation differs by  $(2\Delta - d)/\Delta$ .

- RG transformations,  $\vec{x} = \vec{x}'\mu, z = z'\mu$ , onto scalar  $\Phi(\vec{x}, z)$ , imply

$$\begin{aligned}\phi'_{(2k)}(\vec{x}') &= \mu^{d-\Delta+2k} \phi_{(2k)}(\vec{x}'\mu), \quad 2k < 2\Delta - d \\ \tilde{\phi}'_{(2\Delta-d)}(\vec{x}') &= \mu^\Delta \tilde{\phi}_{(2\Delta-d)}(\vec{x}'\mu) \\ \phi'_{(2\Delta-d)}(\vec{x}') &= \mu^\Delta [\phi_{(2\Delta-d)}(\vec{x}'\mu) + \log \mu^2 \tilde{\phi}_{(2\Delta-d)}(\vec{x}'\mu)],\end{aligned}$$

leading to

$$\begin{aligned}\mu \frac{\partial}{\partial \mu} \phi_{(0)}(\vec{x}\mu) &= (\Delta - d) \phi_{(0)}(\vec{x}\mu), \\ \langle \mathcal{O}(\vec{x}') \rangle'_{\phi_{(0)}} &= \mu^\Delta \left( \langle \mathcal{O}(\vec{x}'\mu) \rangle_{\phi_{(0)}} - (2\Delta - d) \log \mu^2 \tilde{\phi}_{(2\Delta-d)}(\vec{x}'\mu) \right),\end{aligned}$$

consistent with  $\phi_{(0)}$  a source for an operator of dimension  $\Delta$ , and  $\tilde{\phi}_{(2\Delta-d)}$  giving the conformal anomaly.

- We already saw that  $\phi_{(2\Delta-d)}$  was a deformation of the VEV of the theory, and the above RG flow is also consistent with that.

## Holographic RG flow

- Motion in radial coordinate of the sugra solution, starting and ending at solutions with AdS symmetry  $\leftrightarrow$  RG flow between fixed points of the field theory.
- RG flow initiated by relevant deformation of CFT: must deform basis theory by some operator.
- **Example:**  $\mathcal{N} = 1$  susy deformation of  $\mathcal{N} = 4$  SYM. The superpotential of  $\mathcal{N} = 4$  SYM,

$$W = \text{Tr}(\Phi_3[\Phi_1, \Phi_2]) ,$$

is deformed by a supersymmetric mass deformation

$$\delta W = \frac{m}{2} \text{Tr}(\Phi_3^2) ,$$

- **Obs:** Superpotential is in *superspace*: Superfields  $\Phi(x, \theta)$ , where  $\theta$  is a fermionic (anticommuting) variable. For a 4d chiral superfield,

$$\Phi(x, \theta) = \Phi(y, \theta) = \phi(y) + \sqrt{2}\theta\psi(y) + \theta\theta F(y) , \quad y^\mu = x^\mu + i\theta\sigma^\mu\bar{\theta}$$

• In 4d,  $\exists$  2 anomaly coefficients characterizing fixed points, central charges  $c$  and  $a$ .  $g_{\mu\nu} \leftrightarrow T_{\mu\nu}$ ,  $A_\mu \leftrightarrow J_\mu$ . Consider  $J_\mu$  the R-current ( $SU(4) = SO(6)$  global symmetry, acting on the fermions).

• Then, anomaly in VEV of  $T^\mu{}_\mu$  (classically = 0 by conformal invariance) and VEV of  $\partial^\mu J_\mu$ ,

$$\begin{aligned}\langle T^\mu{}_\mu \rangle_{g_{\mu\nu}, A_\mu} &= \frac{c}{16\pi^2} C_{\mu\nu\rho\sigma}^2 - \frac{a}{16\pi^2} \tilde{R}_{\mu\nu\rho\sigma} \tilde{R}^{\mu\nu\rho\sigma} + \frac{c}{6\pi^2} F_{\mu\nu}^2 \\ \langle \partial_\mu \sqrt{g} J^\mu \rangle_{g_{\mu\nu}, A_\mu} &= -\frac{a-c}{24\pi^2} R_{\mu\nu\rho\sigma} \tilde{R}^{\mu\nu\rho\sigma} + \frac{5a-3c}{9\pi^2} F_{\mu\nu} \tilde{F}^{\mu\nu}.\end{aligned}$$

where  $\tilde{F}^{\mu\nu} = \frac{1}{2} \epsilon^{\mu\nu\rho\sigma} F_{\rho\sigma}$ ,  $\tilde{R}^{\mu\nu\rho\sigma} = \frac{1}{2} \epsilon^{\mu\nu\lambda\tau} R_{\lambda\tau\rho\sigma}$ , and  $C_{\mu\nu\rho\sigma}$  is the (conformal invariant) Weyl tensor,

$$C_{\mu\nu\rho\sigma} = R_{\mu\nu\rho\sigma} - \frac{2}{d-2} (g_{\mu[\rho} R_{\sigma]\nu} - g_{\nu[\rho} R_{\sigma]\mu}) + \frac{2}{(d-1)(d-2)} R g_{\mu[\rho} g_{\sigma]\nu}.$$

In 4d we have the topological density  $E_4$  and the conformally invariant  $I_4$ ,

$$\begin{aligned}\tilde{R}_{\mu\nu\rho\sigma} \tilde{R}^{\mu\nu\rho\sigma} &= R_{\mu\nu\rho\sigma} R^{\mu\nu\rho\sigma} - 4R_{\mu\nu} R^{\mu\nu} + R^2 = E_4 \\ C_{\mu\nu\rho\sigma} C^{\mu\nu\rho\sigma} &= R_{\mu\nu\rho\sigma} R^{\mu\nu\rho\sigma} - 2R_{\mu\nu} R^{\mu\nu} + \frac{R^2}{3} = I_4\end{aligned}$$

• Central charge  $c$  counts perturbative massless degrees of freedom in CFT, up to normalization. Here, normalization chosen such that  $c = \frac{1}{4}(N_c^2 - 1)$  for  $\mathcal{N} = 4$  SYM.

• Anomaly contributions in  $\langle \partial^\mu J_\mu \rangle$ :  $a - c$  from  $\partial^\mu J_\mu - T_{\mu\nu} - T_{\mu\nu}$  triangle, prop. to  $\sum_\chi R(\chi)$ , and  $5a - 3c$  from  $\partial^\mu J_\mu - J_\mu - J_\mu$ , prop. to  $\sum_\chi R(\chi)^3$ :

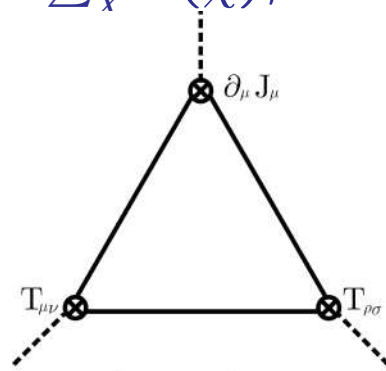

diagram for a-c

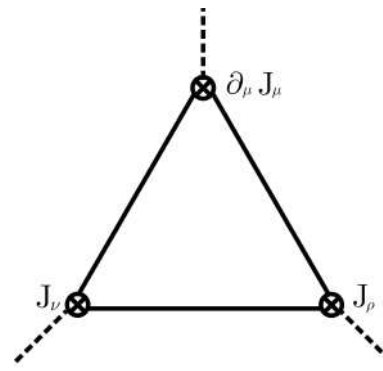

diagram for 5a-3c

a) Anomalous diagram contributing to  $a - c$  b) Anomalous diagram contributing to  $5a - 3c$ .

• For  $\mathcal{N} = 1$  RG flow on  $\mathcal{N} = 4$  SYM, UV:  $\sum_\chi R(\chi) = 0, \sum_\chi R(\chi)^3$ , IR:  $\sum_\chi R(\chi) = 0, \sum_\chi R(\chi)^3 = \frac{3}{4}(N_c^2 - 1)$ , so

$$a_{UV} - c_{UV} = 0; \quad 5a_{UV} - 3c_{UV} \propto \frac{8}{9}(N_c^2 - 1),$$

$$a_{IR} - c_{IR} = 0; \quad 5a_{IR} - 3c_{IR} \propto \frac{3}{4}(N_c^2 - 1) \Rightarrow$$

$$\frac{a_{IR}}{a_{UV}} = \frac{c_{IR}}{c_{UV}} = \frac{27}{32}.$$



- **c-theorem**: (2d:Zamolodchikov) For an RG flow between 2 fixed points,  $\exists$  *monotonically decreasing* function along RG flow, with value  $c_{UV}$  in the UV and  $c_{IR}$  in the IR, called c-function. In 2d,  $\dot{c}$  appears in the trace anomaly (in conformal invariance),

$$\langle T^\mu{}_\mu \rangle = -\frac{c}{12}R.$$

- In 4d, similar statement (Komargodski and Schwimmer, after conjecture by Cardy): *a*-theorem: for the *a* charge. Will be proven *constructively* via AdS/CFT.

- Cardy's statement applies *in general dimension* (thus including the *c*-theorem and the *a*-theorem) to the coefficient of  $E_d = \tilde{R}_{\mu\nu\rho\sigma}\tilde{R}^{\mu\nu\rho\sigma}$ , in

$$\langle T^\mu{}_\mu \rangle = -2(-)^{d/2}AE_d + \dots$$

- Central charges in  $\mathcal{N} = 4$  SYM: from holographic Weyl anomaly.

• **Holographic Weyl anomaly and central charge:** The variation of the on-shell sugra action under a Weyl transformation  $\delta g_{(0)} = 2\sigma g_{(0)}$ ;  $\delta\epsilon = 2\delta\sigma\epsilon$  gives the one-point function of  $T^\mu{}_\mu$  ( $\langle T_{\mu\nu} \rangle = \lim_{\epsilon \rightarrow 0} \frac{1}{\epsilon^{\Delta_T}} \frac{1}{\sqrt{-\gamma}} \frac{\delta S_{\text{sub}}}{\delta g^{\mu\nu}}$ , for  $\Delta_T = d$ ). But

$$S_{\text{reg}} = (16\pi G_N^{(d+1)})^{-1} \int d^d x \sqrt{g_{(0)}} [\dots + (-\log \epsilon) s_{(d)}] + S_{\text{finite}},$$

and the finite part is cancelled by the counterterm, so we obtain

$$\delta S_{\text{finite}} = - \int d^d x \sqrt{g_{(0)}} \delta\sigma \mathcal{A} \quad \dots \Rightarrow \mathcal{A} = \frac{1}{16\pi G_N^{(d+1)}} (-2s_{(d)}).$$

• A holographic calculation leads to  $a = c$ , so

$$\mathcal{A} = -\frac{a}{16\pi^2} (E_4 + I_4),$$

and ( $G_{N,5} = G_N^{(10)}/R^5\Omega_5$ , and  $\Omega_5 = \pi^3$ )

$$a = c = \frac{\pi^2 R^3}{l_{P,5}^3} = \frac{\pi R^3}{8G_N^{(5)}}.$$

- **Holographic RG flow and  $c$ -function: kink ansatz.** Holographic RG flow ansatz must be kink-type:

$$ds^2 = e^{2A(r)}(-dt^2 + d\vec{x}_{d-1}^2) + dr^2 = e^{2A(r)}\eta_{\mu\nu}dx^\mu dx^\nu + dr^2 ,$$

and  $\phi_i = \phi_i(r)$ . AdS:  $A(r) = r/R, \phi_i = 0$ . Thus, at endpoints:  $A_1(r) \simeq r/R_1(UV), A_2(r) \simeq r/R_2(IR), \phi_i \simeq 0$ , with  $R_2 < R_1$ .

- Consider perfect fluid  $T_{\mu\nu} = \text{diag}(\rho, p_1, \dots, p_{d-1})$ , satisfying weakest energy condition (satisfied by all QFTs),  $\rho + p_i \geq 0$ , then Einstein equations for the above ansatz, with

$$R_{\mu\nu} = e^{2A(r)}[A'' + d(A')^2]\eta_{\mu\nu}; \quad R_{rr} = -d[A'' + (A')^2] ,$$

one finds the condition  $A'' \leq 0$ . This means that we have the monotonically non-increasing function

$$C(r) = a(r) = \frac{a_0}{(A')^{d-1}}.$$

- With the proper normalization, we find the  $c$ -function (or  $a$ -function) in  $d$  dimensions, which gives  $c$  and  $a$  at the endpoints (fixed points),

$$C(r) = a(r) = \frac{\pi^{d/2}}{\Gamma(d/2)(l_P^{(d+1)} A'(r))^{d-1}}.$$

- Note this also gives the value of the holographic central charge in  $d$  dimensions!
- **Supersymmetric flow** For the  $\mathcal{N} = 1$  mass def. of  $\mathcal{N} = 4$  SYM, in  $\mathcal{N} = 8$  sugra: interpolate between the  $\mathcal{N} = 8$  susy  $AdS_5$  and another  $\mathcal{N} = 2$   $AdS_5$  (1/4 susy). Thus susy kink  $\Rightarrow \delta_{\text{SUSY}}\psi = 0$ .
- Supergravity scalar potential  $V$  in terms of superpotential  $W$  is

$$V = \frac{9}{8} \sum_j \left| \frac{\partial W}{\partial \phi_j} \right|^2 - 3l_P^2 |W|^2.$$

- Then from gravitino variation  $\delta\psi_\mu^a = 0$  and spin 1/2 variation  $\delta\chi^{abc} = 0$ , we find

$$A' = -l_P^2 W; \quad \frac{d\phi_i}{dr} = \frac{3}{2} l_P^2 \frac{\partial W}{\partial \phi_i},$$

- so the  $c$ -function or  $a$ -function in this case is

$$C(r) = a(r) = \frac{\pi^2}{(l_P^{(5)})^9 W^3},$$

- For the flow of interest, we indeed find  $a(0)/a(\infty) = 27/32!$
- Extension and application: radial time evolution (holographic cosmology)**. Consider the Domain Wall/Cosmology correspondence = double Wick rotation redefining radial  $r$  as time  $t$ , with background taken together as (note:  $z$  is not the previous one!! )

$$ds^2 = \eta dz^2 + a^2(z) d\vec{x}^2, \quad \Phi = \varphi(z)$$

where  $\eta = \pm 1$ , solutions to the action ( $\kappa^2 = 8\pi G_N$ )

$$S = \frac{\eta}{2\kappa^2} \int d^4x \sqrt{|g|} \left[ -R + (\partial\Phi)^2 + 2\kappa^2 V(\Phi) \right]$$

- Cosmologies are solutions to the equations

$$\frac{\dot{a}}{a} = -\frac{1}{2}W, \quad \dot{\varphi} = W_{,\varphi}, \quad 2\eta\kappa^2 V = (W_{,\varphi})^2 - \frac{3}{2}W^2,$$

where  $W$  is a "fake superpotential" ( $V(W)$  the same as in susy).

- Asympt. AdS:  $a(z) \sim e^z$ ,  $\varphi \sim 0$  at  $z \rightarrow \infty$ . Formalism includes also sympt. power law (non-conformal AdS/CFT),  $a(z) \sim (z/z_0)^n$ ,  $\varphi \sim \sqrt{2n} \log(z/z_0)$ ,  $z_0 = n - 1$ . These domain walls become cosmologies for  $\eta = -1$ .

- Asympt. AdS in Fefferman-Graham coords. vs. ADM parametrization:

$$ds^2 = \frac{1}{z^2} \left[ dz^2 + (g_{(0)ij} + \dots + z^d g_{(d)ij} + \dots) \right]$$

$$ds^2 = g_{\mu\nu} dx^\mu dx^\nu = \hat{\gamma}_{ij} d\hat{x}^i d\hat{x}^j + 2N^i d\hat{x}^i dr + (N^2 + N_i N^i) dr^2$$

match in the gauge  $N = 1, N_i = 0$ , for  $z = e^{-r}$ , so  $\hat{\gamma}_{ij} = g_{ij} = \frac{1}{z^2} (g_{(0)ij}(\vec{x}) + \dots) = e^{-2r} (g_{(0)ij}(\vec{x}) + \dots)$ .

- The usual canonical momenta in ADM formalism (with action  $-\frac{1}{2\kappa^2} \int d^{d+1}x \sqrt{\hat{\gamma}} N (\hat{R} + \hat{K} - \hat{K}_{\mu\nu} \hat{K}^{\mu\nu} - 2\kappa^2 \mathcal{L}_m)$ ),

$$\pi^{\mu\nu} \equiv \frac{\delta L}{\delta \dot{\gamma}_{\mu\nu}} = -\frac{1}{2\kappa^2} (\hat{K} \hat{\gamma}^{\mu\nu} - \hat{K}^{\mu\nu}), \quad \pi^I \equiv \frac{\delta L}{\delta \dot{\Phi}_I}$$

become equal to the momenta obtained from the variation of the on-shell action with respect to the boundary variables,

$$\pi^{\mu\nu}(r_1, \vec{x}) = \frac{\delta S_{\text{on-shell}}}{\delta \hat{\gamma}_{\mu\nu}(r_1, \vec{x})}, \quad \pi^I(r_1, \vec{x}) = \frac{\delta S_{\text{on-shell}}}{\delta \Phi_I}, \quad r_1 \rightarrow \infty.$$

- But since

$$\langle T_{ij}(\vec{x}) \rangle = \frac{1}{\sqrt{g_{(0)}(\vec{x})}} \frac{\delta S_{\text{on-shell}}(g_{(0)}, \dots)}{\delta g_{(0)}^{ij}(\vec{x})}, \quad \langle \mathcal{O}_I \rangle = \frac{\delta S_{\text{on-shell}}}{\delta \Phi^I},$$

we obtain

$$\begin{aligned} \langle T_{ij}(\vec{x}) \rangle &= \left( -\frac{2}{\sqrt{g}} \pi_{ij} \right)_{(d)} = -\frac{1}{8\pi G_N} (\hat{K}_{ij} - \hat{K} \hat{\gamma}_{ij})_{(d)} \simeq -\frac{d}{16\pi G_N} g_{(d)ij}(\vec{x}) \\ \langle \mathcal{O}(\vec{x}) \rangle &= \frac{1}{\sqrt{\hat{\gamma}}} \pi_{(\Delta_I)}^I, \end{aligned}$$

where the subscript means keep the part with the corresponding engineering dimension (or dilatation eigenvalue),  $d$  for  $T$  or  $\Delta$  for  $\mathcal{O}$ ; or the given term in the near boundary expansion in  $z$  (terms of less dimension are divergent, and are removed by renormalization). ( $\delta_r \simeq \delta_D$ , and  $\delta_D \pi_{(n)ij} = -n \pi_{(n)ij}$ ).

- Then, according to the general theory, 2-point function from 1-point function with nonzero source,

$$\langle T_{ij}(x) T_{kl}(y) \rangle = \frac{1}{\sqrt{g_{(0)ij}}} \frac{\delta}{\delta g_{(0)kl}(y)} \langle T_{ij}(x) \rangle = \frac{1}{\sqrt{g_{(0)ij}}} \frac{\delta}{\delta g_{(0)kl}(y)} \left( -\frac{2}{\sqrt{g}} \pi_{ij}(x) \right)_{(d)}.$$

- The r.h.s. can be calculated in gravity, and is related to the 2-point functions of gauge invariant fluctuation modes  $\gamma_{ij}$  and  $\zeta$ , linear combinations of the  $h_{ij}$  and  $\phi$  fluctuation modes of the cosmology.

## Lecture 6

Finite temperature and  $\mathcal{N} = 4$  SYM plasma



- **Finite temperature in field theory:** QM transition amplitude

$$\langle q', t' | q, t \rangle = \langle q' | e^{-i\hat{H}(t'-t)} | q \rangle = \sum_n \psi_n(q') \psi_n^*(q) e^{-iE_n(t'-t)},$$

with  $t \rightarrow -it_E, t' - t \rightarrow -i\beta, iS \rightarrow -S_E$ , gives

$$\langle q', \beta | q, 0 \rangle = \sum_n \psi_n(q') \psi_n^*(q) e^{-\beta E_n}.$$

- In the case  $q' = q$  and integrating over  $q$ , we get

$$\int dq \langle q, \beta | q, 0 \rangle = \int dq \sum_n |\psi_n(q)|^2 e^{-\beta E_n} = \text{Tr}\{e^{-\beta\hat{H}}\} = Z[\beta].$$

- But the transition amplitude is a path integral,

$$\langle q', t' | q, t \rangle = \int \mathcal{D}q(t) e^{iS[q(t)]},$$

so Wick rotating it to periodic euclidean time, we obtain

$$Z_E[\beta] = \int_{\phi(\vec{x}, t_E + \beta) = \phi(\vec{x}, t_E)} \mathcal{D}\phi e^{-S_E[\phi]} = \text{Tr}(e^{-\beta\hat{H}})$$

- Euclidean (Wick-rotated) Schwarzschild black hole

$$ds^2 = + \left( 1 - \frac{2MG_N}{r} \right) d\tau^2 + \frac{dr^2}{1 - \frac{2MG_N}{r}} + r^2 d\Omega_2^2$$

- Does not make sense for  $r < 2MG_N$  (unlike Minkowski signature) since signature of space changes! But near  $r = 2MG_N$ ,  $r - 2MG_N = \tilde{r} = \rho^2 \Rightarrow$

$$ds^2 \simeq 8MG_N \left[ d\rho^2 + \frac{\rho^2 d\tau^2}{(4MG_N)^2} \right] + (2MG_N)^2 d\Omega_2^2$$

- This is of the type of a cone,  $ds^2 = d\rho^2 + \rho^2 d\theta^2$  in general, and only if  $\theta \sim \theta + 2\pi$  is a plane.

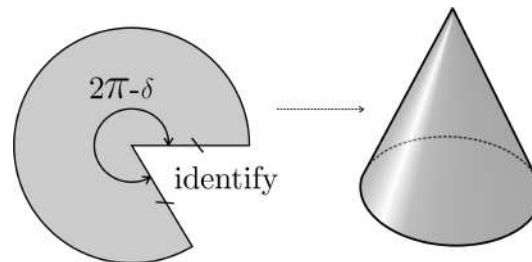

A flat cone is obtained by cutting out an angle from flat space, so that  $\theta \in [0, 2\pi - \Delta]$  and identifying the cut.

- To avoid conical singularity at  $r - 2MG_N = \rho^2 = 0$ , we need  $\tau/(4MG_N)$  to have period  $2\pi$ , so  $\exists$  temperature

$$T_{BH} = \frac{1}{\beta_\tau} = \frac{1}{8\pi MG_N}$$

- But Schwarzschild black hole is thermodynamically unstable, since the specific heat

$$C = \frac{\partial M}{\partial T} = -\frac{1}{8\pi T^2 G_N} < 0$$

- So we can't interpret the black hole as putting the QFT at finite temperature. In AdS space however, this can be done, as we will see.

● **Spin structure in black hole background.** At  $r \rightarrow \infty$ , the Euclidean BH solution is

$$ds^2 \simeq d\tau^2 + d\vec{x}^2,$$

where  $\tau \sim \tau + 8\pi MG_N$ , so  $\mathbb{R}^3 \times S^1_\tau$ : KK vacuum.

● Expand in Fourier modes. But fermions can acquire a phase  $e^{i\alpha}$  around a circle, here  $S^1_\tau$  at infinity,

$$\psi \rightarrow e^{i\alpha} \psi,$$

known as *spin structures*.  $\alpha = 0, \pi$  always OK, others depending on  $\mathcal{L}$ .

● At horizon  $r = 2MG_N$ , metric is  $\simeq \mathbb{R}^2 \times S^2$ , where  $\Omega_2$  is the sphere at  $\infty$ . But  $\mathbb{R}^2 \times S^2$  is simply connected, i.e.,  $\nexists$  nontrivial cycles: any loop can be smoothly shrunk to 0. Thus no non-trivial fermion phases possible around any loop, so  $\exists$  unique spin structure!

● But what is it at infinity?  $\tau \rightarrow \tau + \beta$  at infinity is  $\theta \rightarrow \theta + 2\pi$  near horizon, i.e., rotation in 2d plane, under which a fermion gets a minus sign. Thus unique spin structure is antiperiodic around circle at infinity.

- **KK masses and susy breaking:** If fermions are antiperiodic at infinity, they must depend on the Euclidean time  $\theta$ ,  $\psi = \psi(\theta)$ . Then at infinity

$$\not\partial\psi = 0 \Rightarrow \not\partial^2\psi = \square_{4d}\psi = 0.$$

- But under dimensional reduction  $\square_{4d} = \square_{3d} + \partial^2/\partial\theta^2$ , so

$$0 = \square_{4d}\psi = \left( \square_{3d} + \frac{\partial^2}{\partial\theta^2} \right) \psi = (\square_{3d} - m^2)\psi ,$$

so fermions become massive in the presence of the black hole (from the p.o.v. of the reduced 3d theory).

- Bosons can be periodic at infinity in  $\theta \sim \theta + 2\pi$ , so, e.g. for a scalar under KK reduction

$$0 = \square_{4d}\phi = \left( \square_{3d} + \frac{\partial^2}{\partial\theta^2} \right) \phi = \square_{3d}\phi ,$$

so they remain massless.

- But for susy we need  $m_{\text{scalar}} = m_{\text{fermion}}$ , so susy is broken by the black hole.

- In fact, one can prove that finite temperature always breaks susy in QFT (regardless of the existence of AdS/CFT). So **we have a way of breaking the unrealistic  $\mathcal{N} = 4$  susy by finite  $T$ !**

# The AdS black hole and Witten's finite temperature prescription

Witten, 1998

- Witten: to put AdS/CFT at finite  $T$ , put a black hole in  $AdS_5$ . Black hole in *global*  $AdS_{n+1}$ :

$$ds^2 = - \left( \frac{r^2}{R^2} + 1 - \frac{w_n M}{r^{n-2}} \right) dt^2 + \frac{dr^2}{\frac{r^2}{R^2} + 1 - \frac{w_n M}{r^{n-2}}} + r^2 d\Omega_{n-1}^2 .$$

- At  $M = 0$ , we obtain  $AdS_5$  in global coord. ( $w_n = \frac{8\pi G_N^{(n+1)}}{(n-2)\Omega_{n-1}}$ .)
- Follow Schw. case, first: (outer) horizon  $r_+$  is largest sol. of

$$\frac{r^2}{R^2} + 1 - \frac{w_n M}{r^{n-2}} = 0.$$

- Euclidean sol. near outer horizon ( $\delta r = r - r_+$ ) is

$$ds^2 \simeq \left( \frac{2r_+}{R^2} + \frac{(n-2)w_n M}{r_+^{n-1}} \right) \delta r dt^2 + \frac{(d\delta r)^2}{\delta r \left( \frac{2r_+}{R^2} + \frac{(n-2)w_n M}{r_+^{n-1}} \right)} + r_+^2 d\Omega_2^2.$$

- Metric is free of conical singularities if the period in  $t$  is

$$\beta = \frac{4\pi}{\frac{2r_+}{R^2} + \frac{(n-2)w_n M}{r_+^{n-1}}} = \frac{4\pi}{\frac{nr_+}{R^2} + \frac{(n-2)}{r_+}} .$$

Then the temperature of the  $AdS_5$  black hole is

$$T = \frac{nr_+^2 + (n-2)R^2}{4\pi R^2 r_+}$$

• From  $T = T(r_+)$  and  $r_+ = r_+(M)$ , we get  $T = T(M)$ . From  $d/dM$  on the horizon eq., we find

$$\frac{dr_+}{dM} \left[ \frac{nr_+^{n-1}}{R^2} + (n-2)r_+^{n-3} \right] = w_n ,$$

so  $dr_+/dM > 0$ . Therefore the min. of  $T(M)$  is when  $dT/dr_+ = 0$ , giving

$$r_+ = R\sqrt{\frac{n-2}{n}} \Rightarrow T_{\min} = \frac{nr_+}{2\pi R} = \frac{\sqrt{n(n-2)}}{2\pi R}.$$

- Low  $M$  branch ( $M < M(T_{\min})$ ) has  $C = \partial M/\partial T < 0$ , so is thermodynamically unstable (is a small enough perturbation of the flat space: Schwarzschild; black hole small w.r.t.  $AdS$  radius)
- High  $M$  branch ( $M > M(T_{\min})$ ) has  $C = \partial M/\partial T > 0$ , so thermodynamically stable.

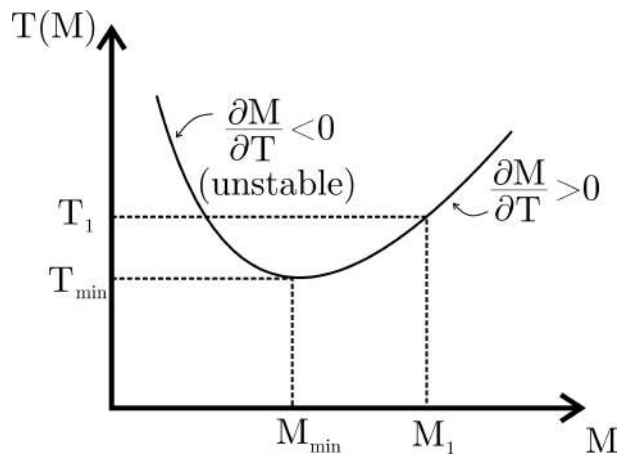

$T(M)$  for the AdS black hole. The lower  $M$  branch is unstable, having  $\partial M/\partial T < 0$ . The higher  $M$  branch has  $\partial M/\partial T > 0$ , and above  $T_1$  it is stable.

• Need to check also that free energy,  $F_{\text{BH}} < F_{\text{AdS}}$ . Free energy is def. by  $Z = e^{-F}$ , but in gravitational theory

$$Z_{\text{grav}} = e^{-S},$$

where  $S$ =Euclidean gravity action. Then

$$S(\text{Euclidean action}) = \frac{F}{T},$$

so the comparison we need to do (and can prove) is

$$F_{\text{BH}} - F_{\text{AdS}} = T(S_{\text{BH}} - S_{\text{AdS}}) \Rightarrow T > T_1 \equiv \frac{n-1}{2\pi R} > T_{\text{min}}.$$



- One more problem: Metric at  $r \rightarrow \infty$  is

$$ds^2 \simeq \left(\frac{r}{R}dt\right)^2 + \left(\frac{R}{r}dr\right)^2 + r^2 d\Omega_{n-1}^2,$$

and, while the transverse  $S^{n-1}$  has radius  $r \rightarrow \infty$ , only the *relative* distances matter in CFT at infinity, so  $r$  scales out, and boundary is  $S^{n-1} \times S^1$ , instead of  $\mathbb{R}^{n-1} \times S^1$  (flat space with periodic Euclidean time). Then we must have

$$\frac{r}{R} \frac{1}{T} = R \cdot T \rightarrow \infty \Rightarrow T \rightarrow \infty \Rightarrow M \rightarrow \infty,$$

and we need to rescale coords. to get finite results. We find  $M \propto r^n$  and  $r^2 dt^2$  must be finite, so

$$r = \left(\frac{w_n M}{R^{n-2}}\right)^{1/n} \rho; \quad t = \left(\frac{w_n M}{R^{n-2}}\right)^{-1/n} \tau,$$

and  $M \rightarrow \infty$ . Then  $(dx_i = (w_n M / R^{n-2})^2 d\Omega_i)$

$$ds^2 = \left(\frac{\rho^2}{R^2} - \frac{R^{n-2}}{\rho^{n-2}}\right) d\tau^2 + \frac{d\rho^2}{\frac{\rho^2}{R^2} - \frac{R^{n-2}}{\rho^{n-2}}} + \rho^2 \sum_{i=1}^{n-1} dx_i^2,$$

- The temperature is found from the period of  $\tau$ , now

$$\beta_1 = \frac{4\pi R}{n} \Rightarrow T = \frac{R}{\beta_1} = \frac{n}{4\pi}.$$

- For  $n = 4$  dim., the metric becomes

$$ds^2 = \frac{\rho^2}{R^2} \left[ \left( 1 - \frac{R^4}{\rho^4} \right) d\tau^2 + R^2 d\vec{x}^2 \right] + R^2 \frac{d\rho^2}{\rho^2 \left( 1 - \frac{R^4}{\rho^4} \right)},$$

and after  $\frac{\rho}{R} = \frac{U}{U_0}$ ;  $\tau = t \frac{U_0}{R}$ ;  $\vec{x} = \vec{y} \frac{U_0}{R^2}$ , and adding back in  $R^2 d\Omega_5^2$ , we find

$$ds^2 = \frac{U^2}{R^2} \left[ -f(U) dt^2 + d\vec{y}^2 \right] + R^2 \frac{dU^2}{U^2 f(U)} + R^2 d\Omega_5^2$$

$$f(U) \equiv 1 - \frac{U_0^4}{U^4}.$$

- This is the nonextremal  $AdS_5 \times S^4$  in Poincaré (!) coords. But that was near-horizon of D3-brane, so this can be obtained also as near-horizon of near-extremal D3-brane.

- Moreover, after  $U/R = R/z$  and  $U_0/R = R/z_0$  as usual, we find finite  $T$  version of Poincaré-AdS

$$ds^2 = \frac{R^2}{z^2} \left[ -f(z)dt^2 + d\vec{y}^2 + \frac{dz^2}{f(z)} \right] + R^2 d\Omega_5^2$$

$$f(z) = 1 - \frac{z^4}{z_0^4},$$

with temperature  $T = 1/(\pi z_0)$  (consistent with previous,  $\beta_T = \pi R \Rightarrow \beta_t = \pi z_0$ )

- So putting a large  $M$  black hole in AdS space  $\leftrightarrow$  putting the boundary field theory at finite temperature.
- Interpretation: It takes radiation a finite time to get to  $\infty$  and back  $\Rightarrow$  radiation of black hole gets back in: stability (unlike flat space, where the time is infinite, so only BH is at finite  $T$ ).

- In AdS-BH, susy is broken. Fermions antiperiodic around Euclidean time (which is an  $S^1$ ), so we KK reduce  $\mathcal{N} = 4$  SYM to 3d.
- Fermions are massive, gauge fields are massless (protected by gauge inv.), but scalars, classically massless, become massive through a quantum fermion loop. Then we have **3d pure glue theory** ( $A_\mu^a$ )!
- Can we understand **mass gap in pure glue theory from AdS/CFT**?  $\rightarrow$  spontaneous appearance of mass for quantum physical states in QFT  $\rightarrow$  of classical physical states in AdS.
- Scalar field sol. to  $\square\phi = 0$  can be put in factorized form

$$\phi(\rho, \vec{x}, \tau) = f(\rho)e^{i\vec{k}\cdot\vec{x}}.$$

- Horizon: bd. cond. that sol. is smooth,  $df/d\rho = 0$  (horizon = like origin of plane in cyl. coords.). At  $\rho \rightarrow \infty$ , impose normalizability (state = physical), so  $f \sim 1/\rho^4$ . The 2 conditions give a quantization condition on parameters,  $\vec{k}^2 = m^2 \Rightarrow$  discrete spectrum.
- Effective QM box between  $r_{horizon} = r_{min}$  and  $r = \infty$  (light takes a finite time)  $\Rightarrow$  discrete modes  $m_n \leftrightarrow$  masses of nonperturbative objects = glueballs in QFT. **Simplest model with a mass gap!**

- Black hole horizon at finite  $r \Rightarrow$  cuts out a small cylinder from the middle of AdS  $\rightarrow$  like the case of mass gap described before:

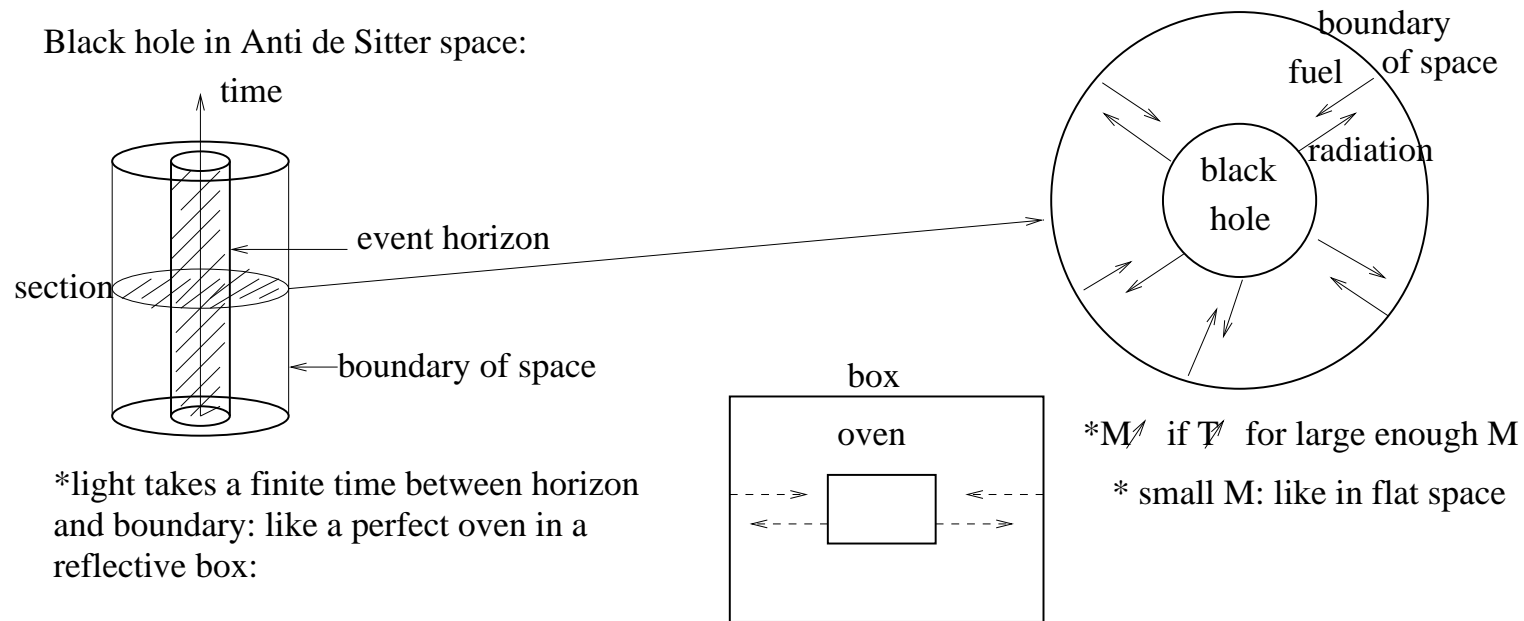

$\rightarrow$  Black hole can be in equilibrium with Anti de Sitter  
 $\rightarrow$  fixed temperature inside Anti de Sitter  
 Black hole in AdS  $\leftrightarrow$  fixed, finite temperature in flat 4 dimensional world (Witten, 1998)

## $\mathcal{N} = 4$ SYM plasma from AdS/CFT

- Without dim. red. to 3d,  $\mathcal{N} = 4$  SYM at finite  $T$ : very different from QCD. Nevertheless, find that various results in  $\mathcal{N} = 4$  SYM at finite  $T$  are similar to QCD at finite  $T$ : universality?
- Brookhaven's RHIC and LHC's (CERN) ALICE, one obtains sQGP (strongly-coupled quark-gluon plasma). Even though dynamical and spatially bounded, we can use the previous methods to good approx. But they have also finite density  $\rho$ , finite chem. pot.  $\mu$ , and magnetic  $B$  fields important, so need to describe.

**Bulk properties:** Entropy of 5d BH: Bekenstein-Hawking:

$$S = \frac{A}{4G_N},$$

and should equal QFT's entropy. But area of horizon,  $A = \frac{R^3}{z_0^3} \int dy_1 dy_2 dy_3$  is  $\infty$ , Therefore the entropy density is

$$s = \frac{S}{\int dy_1 dy_2 dy_3} = \frac{R^3}{4G_{N,5} z_0^3}.$$

- But  $2\kappa_N^2 = 16\pi G_{N,10} = (2\pi)^7 g_s^2 \alpha'^4$  and in  $AdS_5 \times S^5$ ,  $R^4 = \alpha'^2 g_{YM}^2 N = \alpha'^2 (4\pi g_s) N$ .

- Then reducing on an  $S^5$  of radius  $R$ , with  $\Omega_5 = \pi^3$  gives

$$G_{N,10} = \frac{\pi^4}{2N^2} R^8 \Rightarrow G_{N,5} = \frac{G_{N,10}}{\Omega_5 R^5} = \frac{\pi}{2N^2} R^3 \Rightarrow s_{\lambda=\infty} = \frac{\pi^2}{2} N^2 T^3.$$

- This is entropy density at  $\infty$  coupling. From  $\sigma = \partial P / \partial T$  and  $\epsilon = -P + Ts$ , we find

$$P_{\lambda=\infty} = \frac{\pi^2}{8} N^2 T^4, \quad \epsilon_{\lambda=\infty} = \frac{3\pi^2}{8} N^2 T^4,$$

at infinite coupling. But at weak coupling, one free bosonic d.o.f has  $s = 2\pi^2 T / 45$ , and one free fermionic d.o.f. has  $7/8$  of that. The for  $\mathcal{N} = 4$  SYM (8 bosonic d.o.f and 8 fermionic d.o.f., all in adjoint of  $SU(N)$ ), we have

$$s_{\lambda=0} = \left(8 + 8 \frac{7}{8}\right) (N^2 - 1) \frac{2\pi^2 T^3}{45} \simeq \frac{2\pi^2}{3} N^2 T^3,$$

so we obtain the ratios (for pressure, we use the same thermod. relations)

$$\frac{s_{\lambda=\infty}}{s_{\lambda=0}} = \frac{3}{4}, \quad \frac{P_{\lambda=\infty}}{P_{\lambda=0}} = \frac{\epsilon_{\lambda=\infty}}{\epsilon_{\lambda=0}} = \frac{3}{4}.$$

- "Experimentally" (in lattice QCD), we find 80%, close to the above 75%.

- **Energy loss: drag on heavy quarks** When a fast heavy quark (would-be "jet") passes through sQGP plasma, loses energy at high rate: "jet quenching": observed experimentally at RHIC and ALICE.

- AdS/CFT: heavy quark is long string stretching between the boundary at  $\infty$  and interior of AdS. Moving heavy quark on straight path: string moving at  $\infty$  on straight path. The other end: asymptotically to the horizon. Force against momentum loss keeps it at constant velocity.

- Ansatz: Boundary endpoint:  $z = 0$  and  $y(t, z) = vt + h(z)$ . Static gauge  $\sigma = z, \tau = t$ , so NG action in AdS-BH is:

$$S = -\frac{R^2}{2\pi\alpha'} \left( \int dt \right) \int \frac{dz}{z^2} \sqrt{\frac{f(z) - v^2 + f(z)^2 h'^2(z)}{f(z)}}.$$

- $S = S[h'(z)] \Rightarrow$  canonical mom. is conserved:

$$P_z^1 = \frac{\delta S}{\delta h'(z)} = \frac{\delta S}{\delta y^{1'}(z)} = -\frac{R^2}{2\pi\alpha'} \frac{1}{z^2} \frac{f^{3/2}(z) h'(z)}{\sqrt{f(z) - v^2 + f(z)^2 h'^2(z)}}.$$

- Solve for  $h'(z)$ . Then denom. and num. =0 at same time, so

$$h'^2(z) = \left( \frac{2\pi\alpha' P_z^1}{R^2} \right)^2 \frac{z^4}{f(z)^2} \frac{f(z) - v^2}{f(z) - \left( \frac{2\pi\alpha' P_z^1}{R^2} \right)^2 z^4}. \Rightarrow P_z^1 = \pm \frac{R^2}{2\pi\alpha' z_0^2} \gamma v.$$



- Finally, integrating  $h'(z)$ , we find

$$h(z) = -\frac{vz_0}{2} \left[ \operatorname{arctanh} \left( \frac{z}{z_0} \right) - \arctan \left( \frac{z}{z_0} \right) \right].$$

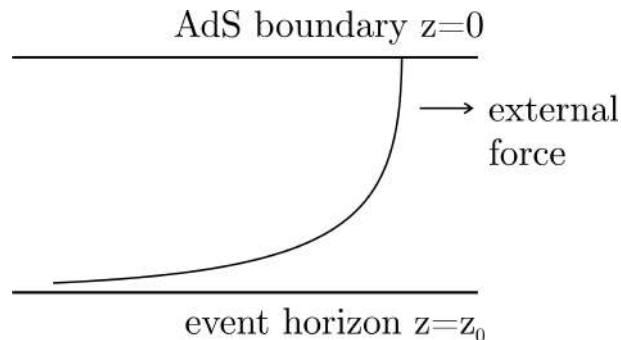

A quark being pulled by an external force at the boundary, and a string trailing behind it, hanging down from the boundary.

- Then momentum loss in the plasma is

$$\frac{dp}{dt} = -P_z^1 = -\frac{R^2}{2\pi\alpha'z_0^2}\gamma v.$$

- In  $\mathcal{N} = 4$  SYM variables,  $R^2/\alpha' = \sqrt{\lambda}$  and  $T = 1/(\pi z_0)$ , so ( $p = M\gamma v$  is the heavy quark momentum,  $\eta_D$  is the drag coefficient)

$$\frac{dp}{dt} = -\frac{\pi}{2}\sqrt{\lambda}T^2\gamma v = -\frac{\pi}{2M}\sqrt{\lambda}T^2p \equiv -\eta_D p.$$

- Reasonable comparison to QCD, if  $g_{YM}^2 \rightarrow g_{QCD}^2(\mu)$ .

• **Adding finite chemical potential**  $\mu \neq 0$ .  $\mathcal{N} = 4$  SYM charge = R-charge (for  $SU(4) = SO(6)$  global symm.). Gravity side: sourced by  $A_\mu^a$ .

• Coupling  $\int d^d x J^\mu a_\mu$ ,  $a_\mu =$  boundary value of  $A_\mu$ . Then charge density  $J^0$  couples to  $a_0$ . Thus boundary condition for nonzero charge is

$$A = A_0(z)dt + \dots, \quad z \rightarrow 0$$

• But source coupling must be  $q\mu$ , so  $A_0(z=0) = a_0 = \mu$ , chemical potential of R-charge. So boundary cond. is  $A \rightarrow \mu dt$  as  $z \rightarrow 0$ .

• Solution with nonzero gauge field at finite temperature: Reissner-Nordstrom-AdS. In Poincaré coords. we just change  $f(z)$  to charged expression, and add the gauge field,

$$ds^2 = \frac{R^2}{z^2} \left( -f(z)dt^2 + d\vec{x}^2 + \frac{dz^2}{f(z)} \right)$$

$$f(z) = 1 - (1 + Kz_+^2\mu^2) \left( \frac{z}{z_+} \right)^d + Kz_+^2\mu^2 \left( \frac{z}{z_+} \right)^{2(d-1)}$$

$$K \equiv \frac{(d-2)\kappa_{N,d+1}^2}{(d-1)g^2R^2}$$

$$A_0 = \mu \left[ 1 - \left( \frac{z}{z_+} \right)^{d-2} \right].$$

• We cannot drop constant part of  $A_0$ , since we need  $A = 0$  at horizon  $z = z_+$  (nonsingular  $A$  at horizon).

- Temperature of BH solution: like before, resulting in

$$T = \frac{1}{4\pi z_+} (d - K(d-2)z_+^2\mu^2).$$

- Thermodynamic potential at constant  $\mu$  (as opposed to constant charge density  $\rho$ ), the grand-canonical potential  $\Omega(\mu, V, T) = U - TS - \mu N$ , is found from the same on-shell sugra action (always the thermod. pot. equals  $S_{\text{on-shell}}$ ),

$$Z_{\text{CFT}} = e^{-\beta\Omega} = Z_{\text{sugra}} = e^{-S_{\text{sugra}}} \Rightarrow \Omega = TS_{\text{sugra}}.$$

- One finds

$$\Omega = -\frac{R^{d-1}}{2\kappa_N^2 z_+^d} (1 + Kz_+^2\mu^2) V_{d-1}.$$

- The charge density is a one-point function,

$$\rho = \langle J^0 \rangle = \left. \frac{\delta S_{\text{sugra}}}{\delta a_0} \right|_{a_0=0}.$$

- Alternative: keep fixed charge density  $\rho$ , so thermod. pot. is  $F = \Omega + \mu Q$ . Thus add a term linear in  $\mu = a_0$  to  $S_{\text{on-shell}}$ : boundary term ( $h_{ab}$  = boundary metric)

$$+\frac{1}{g^2} \int_{z \rightarrow 0} d^d x \sqrt{-h} n^a F_{ab} A^b,$$

- So we keep  $n^a F_{ab}$  fixed instead of  $A_a$  on boundary, hence the conjugate of  $a_0 = \mu$ , i.e.,  $\rho$ .

- **Adding magnetic field**  $B \neq 0$ . Magnetic field in gauge theory is magnetic field in the bulk: Magnetic field: *gauge* the  $U(1) \subset SU(4)$  symm. by coupling the current to a gauge field  $\in J^\mu a_\mu$  (without kinetic term for  $a_\mu$ : external magnetic field): same as  $\int J^\mu a_\mu$  coupling to bulk.

- $AdS_5$  more complicated ( $F = B dx^1 \wedge dx^2$  breaks isotropy), so show  $AdS_4$ : generalize previous sol. (for  $d = 3$ ) to  $A = A_0(z)dt + B(z)xdy$ . Then replace  $f(z)$  with electric-magnetic duality inv.

$$\begin{aligned}
 f(z) &= 1 - [1 + K(z_+^2 \mu^2 + z_+^4 B^2)] \left(\frac{z}{z_+}\right)^3 + K(z_+^2 \mu^2 + z_+^4 B^2) \left(\frac{z}{z_+}\right)^4 \\
 &= 1 - [1 + h^2 + q^2] \left(\frac{z}{z_+}\right)^3 + (h^2 + q^2) \left(\frac{z}{z_+}\right)^4,
 \end{aligned}$$

and add gauge field

$$A = \mu \left[1 - \frac{z}{z_+}\right] dt + Bxdy \Rightarrow F = \frac{1}{z_+^2 \sqrt{K}} [h dx \wedge dy + q dt \wedge dz].$$

- Both  $\vec{E}$  and  $\vec{B}$  finite at boundary, but  $\vec{B}$ =external magnetic field, and  $\vec{E}$ =source for charge density.

- Temperature and thermodynamical pot. (grand-canonical) are

$$\begin{aligned}
 T &= \frac{1}{4\pi} [3 - K(z_+^2 \mu^2 + z_+^4 B^2)] \\
 \Omega &= -\frac{R^2}{2\kappa_N^2 z_+^3} [1 + K(z_+^2 \mu^2 - 3z_+^4 B^2)] V_2.
 \end{aligned}$$

## Lecture 7

# Solitons and probes in AdS/CFT

## Instantons vs. D-instantons

- Instantons in  $G$  gauge theories: BPST  $SU(2)$  instantons, embedded in  $G$ . YM action

$$\frac{1}{4g^2} \int d^4x (F_{\mu\nu}^a)^2 = \int d^4x \left[ \frac{1}{4g^2} F_{\mu\nu}^a * F^{a\mu\nu} + \frac{1}{8g^2} (F_{\mu\nu}^a - *F_{\mu\nu}^a)^2 \right],$$

- is minimized on self-dual configurations,  $F_{\mu\nu}^a = *F_{\mu\nu}^a$ , which are real only in Euclidean space: BPS bound. But

$$n = \frac{g^2}{16\pi^2} \int d^4x \text{Tr} [F_{\mu\nu} * F^{\mu\nu}]$$

is a topological invariant = instanton nr. or Pontryagin index. [It's topological since  $\text{Tr} [F_{\mu\nu} * F^{\mu\nu}] = 4 \text{Tr} [F \wedge F]$  and  $\text{Tr} [F \wedge F] = d\mathcal{L}_{\text{CS}} = d \left[ AdA + \frac{2}{3} A \wedge A \wedge A \right]$ .

- BPST instanton solution (quantum properties: 't Hooft) is

$$A_{\mu}^a = \frac{2}{g} \frac{\eta_{\mu\nu}^a (x - x_i)_{\nu}}{(x - x_i)^2 + \rho^2},$$

where  $\eta_{ij}^a$  is 't Hooft symbol,  $\eta_{ij}^a = \epsilon^{aij}$ ,  $\eta_{i4}^a = \delta_i^a$ ,  $\eta_{4i}^a = -\delta_i^a$ .  
Then  $-\frac{1}{2} \text{Tr} [F_{\mu\nu} F^{\mu\nu}] = \frac{48}{g^2} \frac{\rho^4}{[(x - x_i)^2 + \rho^2]^4} \Rightarrow S_{\text{inst}} = \frac{8\pi^2}{g^2}$ .

- Euclidean instanton action gives transition probabilities, between static configurations at  $x_4 = -\infty$  and  $x_4 = +\infty$ , = configs. of different winding numbers. Probability  $\simeq e^{-S_{\text{inst}}}$ .

• D-instantons in string theory: D(-1)-branes: Neumann bd. cd. in all directions. But D<sub>p</sub>-brane = source for A<sub>p+1</sub>, so D-instanton = source for IIB axion scalar *a*. In flat space,  $e^\phi = H_{-1}$  and  $a - a_\infty = H_{-1}^{-1} - 1 \propto e^{-\phi} - 1/g_s$ .

• D-instantons in AdS<sub>5</sub> × S<sup>5</sup>, near the boundary of AdS<sub>5</sub> (x<sub>0</sub> = 0) is found to be

$$e^\phi = g_s + \frac{24\pi}{N^2} \frac{x_0^4 \tilde{x}_0^4}{[\tilde{x}_0^2 + |\vec{x} - \vec{x}_a|^2]^4} + \dots$$

$$a = a_\infty + e^{-\phi} - \frac{1}{g_s}.$$

• The variation of the on-shell dilaton action gives

$$\delta S = -\frac{1}{2\kappa_5^2} \int d^4x \frac{R^3}{z^3} \delta\phi \partial_z \phi|_{z=0}.$$

• For the dilaton profile of the D-instanton, with  $R^3 = \kappa_5^2 N^2 / (4\pi^2)$ ,

$$\frac{\delta S}{\delta\phi_0(\vec{x})} = -\frac{48}{4\pi g_s} \frac{\tilde{z}^4}{[\tilde{z}^2 + |\vec{x} - \vec{x}_a|^2]^4}$$

$$= \frac{1}{2g_{YM}^2} \langle \text{Tr} [F_{\mu\nu}^2(\vec{x})] \rangle,$$

so with  $4\pi g_s = g_{YM}^2$ , we find the instanton bgr., with  $\rho = \tilde{z}$ ,

$$-\frac{1}{2g_{YM}^2} \langle \text{Tr} [F_{\mu\nu}^2(\vec{x})] \rangle = \frac{48}{g_{YM}^2} \frac{\tilde{z}^4}{[\tilde{z}^2 + |\vec{x} - \vec{x}_a|^2]^4}.$$

## Baryons as solitons via AdS/CFT

- Mesons in  $SU(N_c)$  gauge theory with fundamental quarks:  $M^{IJ} = \bar{q}_i^I q^{Ji}$  (group inv.  $\delta_i^j$ ). Baryons: with group invariant  $\epsilon_{i_1 \dots i_N}$ , in QCD ( $N_c = 3$ ),  $\epsilon_{ijk}$ :

$$B^{I_1 \dots I_N} = \epsilon_{i_1 \dots i_N} q^{I_1 i_1} \dots q^{I_N i_N}; \quad \text{QCD: } B^{IJK} = \epsilon_{ijk} q^{Ii} q^{Jj} q^{Kk}$$

- In  $SU(N_c)$  gauge theory without quarks (like  $\mathcal{N} = 4$  SYM), define *baryon vertex*, connection  $N$  external (heavy, non-dynamical) quarks, formally  $\epsilon_{i_1 \dots i_N}$  above. The baryon vertex has (solitonic) energy, even in the presence of external quarks only.

- **Baryons as solitons in Skyrme model:** Low energy QCD: theory of pions  $\vec{\pi}$  (Goldstone bosons for  $SU(2)_A$  breaking); together with  $\sigma$  ("Higgs" for breaking), element in  $SO(4) \simeq SU(2)_L \times SU(2)_R$  global symm. group:

$$U = \exp \left[ \frac{i}{f_\pi} (\sigma + \vec{\pi} \cdot \vec{\tau}) \right].$$

- Low energy QCD action in terms of  $L_\mu = U^{-1} \partial_\mu U$ :

$$\mathcal{L} = \mathcal{L}_{\text{kin}} + \mathcal{L}_{\text{int}}, \quad \mathcal{L}_{\text{kin}} = \frac{f_\pi^2}{4} \text{Tr} [L_\mu L^\mu], \quad \text{e.g. of } \mathcal{L}_{\text{int}} = \frac{\epsilon^2}{4} \text{Tr} ([L_\mu, L_\nu]^2)$$



- Conserved topological current and charge:

$$B^\mu = \frac{1}{24\pi^2} \epsilon^{\mu\nu\rho\sigma} \text{Tr} [L_\nu L_\rho L_\sigma], \quad B = \frac{1}{24\pi^2} \int d^3x \epsilon^{ijk} \text{Tr} [L_i L_j L_k].$$

- For small fields  $\vec{\pi}$  we obtain an explicit map between  $SU(2) \simeq SO(3)$  of group (index  $a$ ) and  $SO(3)$  of spatial rotations (index  $i$ ), so  $B$  counts wrappings of the former on the latter:

$$B \simeq \frac{1}{12\pi^2 f_\pi^3} \epsilon^{ijk} \epsilon_{abc} \partial_i \pi^a \partial_j \pi^b \partial_k \pi^c + \dots,$$

- Configuration with  $B \neq 0 =$  soliton, identified with baryon: hedgehog configuration,

$$U = \exp [iF(r) \vec{n} \cdot \vec{\tau}], \quad n \equiv \frac{\vec{r}}{r}$$

- **Baryon as wrapped branes in AdS/CFT:** Strings ending on D-branes with  $|i\bar{j}\rangle$  in  $N \otimes \bar{N}$ . External fundamental quark: long and massive: one end on a separated D-brane. In AdS/CFT: one end at infinity, the other in AdS.

- Baryon vertex: in AdS, place where  $N$  fundamental strings end  $\Rightarrow$  must be a D-brane. In fact: D5-brane at a point in  $AdS_5$  and wrapping  $S^5$ . Indeed, it *needs* exactly  $N$  strings to end on it. But in  $AdS_5$ ,  $\int_{S^5} d^5x \epsilon^{\mu_1 \dots \mu_5} \frac{F_{\mu_1 \dots \mu_5}^+}{2\pi} = N$ , so from WZ term on D5-brane,

$$\frac{1}{2\pi} \int_{S^5 \times \mathbb{R}} d^6x \epsilon^{\mu_1 \dots \mu_6} A_{\mu_1} F_{\mu_2 \dots \mu_6}^+ = N \int_{\mathbb{R}_\tau} dx^\mu A_\mu ,$$

$N$  units of  $A_\mu$  charge on  $S^5$ , that *need* to be absorbed by  $N$  strings. Also, vertex energy  $\propto \frac{1}{g_s} \sim N$ . OK!

## Wilson loops in QCD and AdS/CFT

- QCD: dynamical quarks, but we can also consider external (very heavy) quarks. Yet only in gauge invariant combinations:  $N_c$  quarks + baryon vertex (before), or quark-antiquark (since QCD is *confining*). Very heavy quarks  $\Rightarrow$  fixed: define contour. Observable:  $q\bar{q}$  potential,  $V_{q\bar{q}}(L)$ .

- Define *Wilson line* = path ordered exponential in a gauge theory,

$$\Phi(y, x; P) = P \exp \left\{ i \int_x^y A_\mu(\xi) d\xi^\mu \right\} \equiv \lim_{n \rightarrow \infty} \prod_n e^{i A_\mu(\xi_n^\mu - \xi_{n-1}^\mu)} .$$

- Under an (Abelian or non-Abelian) gauge transf. with  $\Omega = e^{i\chi(x)}$ , it transforms as

$$\Phi(y, x; P) \rightarrow e^{i\chi(y)} \Phi(y, x; P) e^{-i\chi(x)} .$$

- It provides parallel transport along the curve, since, for a charged scalar field,

$$\phi(x) \rightarrow e^{i\chi(x)} \phi(x) \Rightarrow e^{i\chi(y)} (\Phi(y, x; P) \phi(x)) .$$

- For a closed path ( $y = x$ ) AND taking the trace, the *Wilson loop* is gauge invariant and indep. on  $x$ , only on the curve  $C$ ,

$$W(C) = \text{Tr} \Phi(x, x; C) ,$$

due to cyclicity under the trace.

- In Abelian case, for  $x = y$ , we can put  $\Phi$  in explicitly gauge inv. form,

$$\Phi_C = e^{i \int_{C=\partial\Sigma} A_\mu d\xi^\mu} = e^{i \int_\Sigma F_{\mu\nu} d\sigma^{\mu\nu}},$$

and in the non-Abelian case only  $W[C]$  can be put, to first nontrivial order,

$$\Phi_{\square_{\mu\nu}} = e^{ia^2 F_{\mu\nu}} + O(a^4) \Rightarrow W_{\square_{\mu\nu}} = \frac{1}{N} \text{Tr} \{ \Phi_{\square_{\mu\nu}} \} = 1 - \frac{a^4}{2N} \text{Tr} \{ F_{\mu\nu} F_{\mu\nu} \} + O(a^6).$$

- Define the Wilson loop for the calc. of  $q\bar{q}$  potential, a very long rectangle in the time direction (and short in the spatial one).

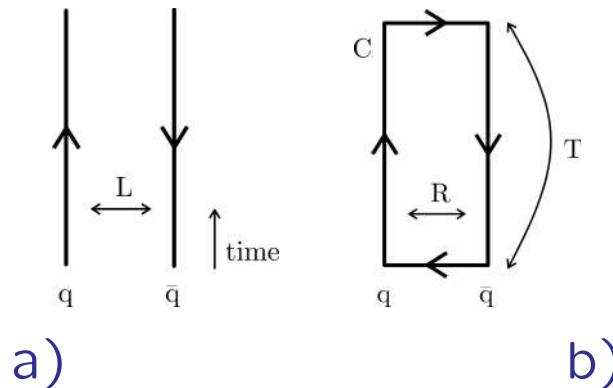

a) Heavy quark and antiquark staying at a fixed distance  $L$ . b) Wilson loop contour  $C$  for the calculation of the quark-antiquark potential.

- Then from the VEV of the Wilson loop, as  $T \rightarrow \infty$ , extract  $q\bar{q}$  potential,

$$\langle W(C) \rangle_0 \propto e^{-V_{q\bar{q}}(R)T}.$$

- Confining theory: constant force  $\rightarrow$  linear potential,

$$V_{q\bar{q}}(R) \sim \sigma R,$$

$\sigma =$  QCD string tension. QCD string = flux tube of constant cross section.

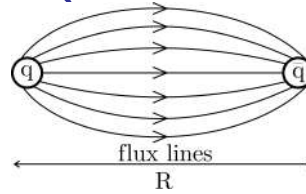

Between a quark and an antiquark in QCD, flux lines are confined: they live in a flux tube.

- For a conformal (scale inv.) theory, like QED, Coulomb potential,

$$V_{q\bar{q}}(R) \sim \frac{\alpha}{R},$$

- Then in a confining theory like QCD, *area law*,

$$\langle W(C) \rangle_0 \propto e^{-\sigma T \cdot R} = e^{-\sigma A(C)},$$

while in a conformal theory like QED, *conf. inv. result*, e.g.

$$\langle W(C) \rangle_0 \propto e^{-\alpha \frac{T}{R}}.$$

- Separate one D-brane to obtain  $U(N)$  fundamental quarks, with Chan-Paton state  $|N+1\rangle \otimes |i\rangle$ .
- AdS/CFT: Mass  $M = \frac{r}{2\pi\alpha'} = \frac{U}{2\pi}$ . One end is at infinity (separated D-brane), one in AdS (the rest of the D-branes). Infinite mass:  $U \rightarrow \infty$ . From the point of view of  $U(N+1)$  gauge theory, string is a "W boson" (vector field made massive by Higgsing to  $U(N) \times U(1)$  via (bi-)fundamental scalar).
- For Wilson loop then, put Wilson contour  $C$  at infinity (boundary condition). String stretches inside AdS and forms a smooth surface. Indeed, there is a gravitational potential. Qualitatively, compare with Newtonian approx. to see that there is a potential leading to minimum  $U$ :

$$ds^2 = \alpha' \frac{U^2}{R^2/\alpha'} (-dt^2 + d\vec{x}^2) + \dots \leftrightarrow ds^2 = (1 + 2V)(-dt^2 + \dots).$$

So string at  $U = \infty$  drops down to  $U = U_0$ , where it is held back by its tension.

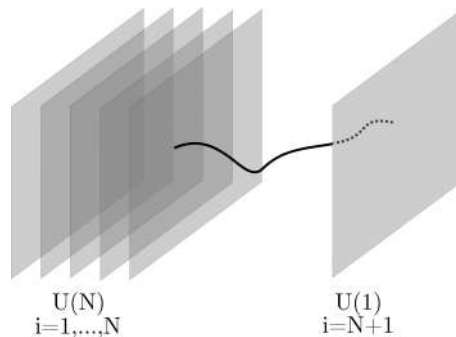

One D-brane separated from the rest ( $N$ ) D-branes acts as a probe on which the Wilson loop is located.

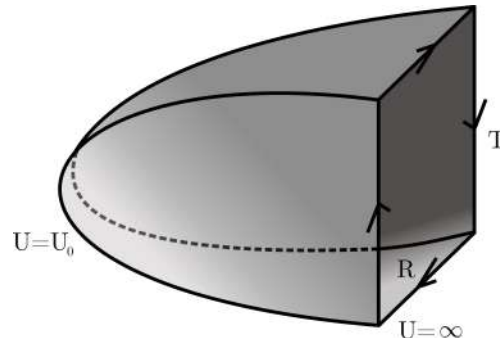

a)

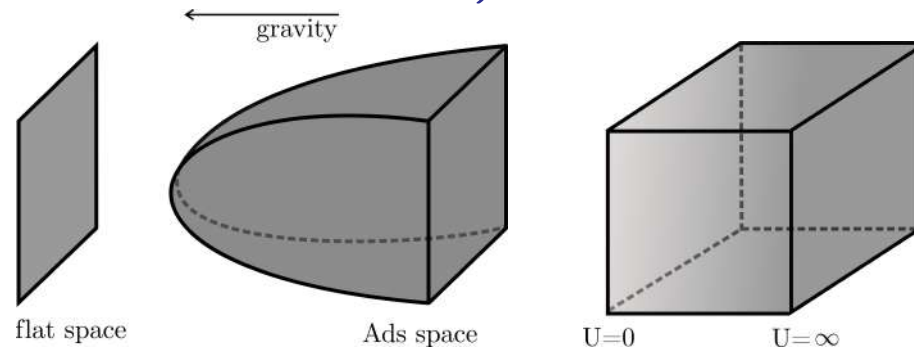

b)

c)

a) The Wilson loop contour  $C$  is located at  $U = \infty$  and the string worldsheet ends on it and stretches down to  $U = U_0$ . b) In flat space, the string worldsheet would form a flat surface ending on  $C$ , but in AdS space 5 dimensional gravity pulls the string inside AdS. c) The free "W bosons" are strings that would stretch in all of the AdS space, from  $U = \infty$  to  $U = 0$ , straight down, forming an area proportional to the perimeter of the contour  $C$ .

• But strings situated also on  $S^5$ , with coordinates  $\theta^I \leftrightarrow X^I$ , scalars of  $\mathcal{N} = 4$  SYM, transf. under  $SO(6)$  R-symmetry. Then, string worldsheet is source for *susy generalized Wilson loop*,

$$W[C] = \frac{1}{N} \text{Tr} P \exp \left[ \oint \left( iA_\mu \dot{x}^\mu + \theta^I X^I(x^\mu) \sqrt{\dot{x}^2} \right) d\tau \right] .$$

$x^\mu(\tau)$  : loop,  $\theta^I$ : on unit  $S^5$ . We consider only  $\theta^I = \text{const.}$ : rectangular Wilson loop is 1/2 susy. (invariant under susy transf.). It is always *locally* susy,

$$\delta_{\text{susy}} W[C](x) \propto \left( i\delta A_\mu \dot{x}^\mu + \theta^I \delta X^I(x^\mu) \sqrt{\dot{x}^2} \right) = 0 ,$$

but *globally* susy only if variations at each point commute.

• Then the Maldacena prescription in sugra limit ( $g_s \rightarrow 0$ ,  $g_s N$  fixed and large) is derived

$$\langle W[C] \rangle = Z_{\text{string}}[C] = e^{-S_{\text{string}}[C]} ,$$

but the naive result is infinite, since  $U$  goes from  $\infty$  to  $U_0$ . But: must subtract the "free W boson" (no  $\mathcal{N} = 4$  SYM interactions) mass term, from  $U = \infty$  straight down (parallel to  $C$ ) to  $U = 0$ . Then true prescription is

$$\langle W[C] \rangle = e^{-(S_\phi - l\phi)} .$$



• **Calculating the  $q\bar{q}$  potential.** Contour  $C$  with  $q$  at  $x = -L/2$  and  $\bar{q}$  at  $x = +L/2$ , and (since  $T \rightarrow \infty$ ) *approximate* worldsheet as time-translation inv. Then, using Euclidean  $AdS_5 \times S^5$  with Euclidean NG string action, and static gauge  $\sigma = x, \tau = t$ , then single variable is  $U(x)$ , and the action becomes ( $\tilde{R}^2 = R^2/\alpha'$ )

$$S_{\text{string}} = \frac{1}{2\pi} T \int dx \sqrt{(\partial_x U)^2 + \frac{U^4}{\tilde{R}^4}}.$$

• Then implicit solution for  $x = x(y, U_0), y = U/U_0$ , and the corresponding  $L/2 = x(\infty, U_0)$  is

$$x = \frac{\tilde{R}^2}{U_0} \int_1^{U/U_0} \frac{dy}{y^2 \sqrt{y^4 - 1}}, \quad \frac{L}{2} = \frac{\tilde{R}^2}{U_0} \int_1^\infty \frac{dy}{y^2 \sqrt{y^4 - 1}} = \frac{\tilde{R}^2 \sqrt{2} \pi^{3/2}}{U_0 \Gamma(1/4)^2}.$$

• Finally we find

$$\begin{aligned} TV_{q\bar{q}}(L) &= S_\phi - l\phi = T \frac{2U_0}{2\pi} \left[ \int_1^\infty dy \left( \frac{y^2}{\sqrt{y^4 - 1}} - 1 \right) - 1 \right] \\ &= -T \cdot \frac{4\pi^2}{\Gamma(1/4)^4} \frac{\sqrt{2g_{YM}^2 N}}{L}. \end{aligned}$$

so a nonperturbative result  $\propto \sqrt{g_{YM}^2 N}$ .

• Nonsusy (regular) Wilson loop (Alday+Maldacena, 2007): same prescription, except Neumann bd. cond. on  $S^5$ , instead of Dirichlet.

**Brane probes in AdS/CFT:** We have seen that some solitonic branes, like D5 wrapped on  $S^5$ , correspond to solitons in QFT.

- But a single moving brane can probe the QFT. If motion in  $U$ : can probe different energies (in non-conformal gauge/gravity duality). Brane excitations (fluctuations): meson spectra: massless scalar = pion, massive vectors: vector mesons, etc.

- Also baryons can be understood, but as solitonic solutions on the probe brane.

- Then motion in  $U$ : (Hamiltonian motion on the) RG flow, for the various hadrons.

## "Hard-wall" model for QCD and Polchinski-Strassler scenario for scattering

- QCD in the UV: approx. conformal  $\Rightarrow$  gravity dual should be approx.  $AdS_5 \times X^5$  at large  $r$  (fifth dimension). Modified in some way at small  $r$ . Simplest: hard cut-off at  $r = r_{\min}$  (space terminates).

$$\begin{aligned} ds^2 &= \frac{r^2}{R^2} d\vec{x}^2 + R^2 \frac{dr^2}{r^2} + R^2 ds_X^2 \\ &= e^{-2y/R} d\vec{x}^2 + dy^2 + R^2 ds_X^2. \end{aligned}$$

- Momenta  $p_i = -i\partial_i$  in QCD are related to 10d momenta  $\tilde{p}_i$  by

$$\tilde{p}_\mu = \frac{R}{r} p_\mu.$$

- A characteristic mom. scale in 10d is  $\tilde{p} \sim 1/R$ , so QCD mom.  $p \sim r/R^2$ . But the characteristic QCD momentum scale is  $\Lambda_{\text{QCD}}$ , so

$$r_{\min} = R^2 \Lambda_{\text{QCD}}.$$

- Scattering in this "hard-wall" model: AdS fields (states): glueballs or mesons/baryons, coupling to glueball operators in QFT.

- Wavefunction for glueball  $e^{ik \cdot x}$  mapped to gravity state wavefunction in  $AdS_5 \times X^5$ ,

$$\Phi = e^{ik \cdot x} \times \Psi(\rho, \vec{\Omega}_{X^5}).$$

- Assume gravitational states scatter locally as in flat space, ansatz for scattering (Polchinski+Strassler, 2001):

$$A_{\text{QCD}}(p_i) = \int dr d^5 \Omega_{X^5} \sqrt{-g} \mathcal{A}_{\text{string}}(\tilde{p}_i) \prod_i \Psi_i(r, \vec{\Omega}_{X^5}).$$

- Define a "QCD string scale"  $\hat{\alpha}'$  in hard-wall model,

$$\hat{\alpha}' = (g_{YM}^2 N)^{-1/2} \Lambda^{-2}, \text{ such that } \sqrt{\alpha' \tilde{p}} = \sqrt{\hat{\alpha}' p} \left( \frac{r_{\text{min}}}{r} \right) \leq \sqrt{\hat{\alpha}' p}.$$

- Also, since  $M_{\text{Pl}}^8 \sim 1/(g_s^2 \alpha'^4)$ , we define a "QCD Planck scale",

$$\hat{M}_{\text{Pl}} = g_s^{-1/4} \hat{\alpha}'^{-1/2} = g_{YM}^{-1/2} \Lambda (g_{YM}^2 N)^{1/4} = N^{1/4} \Lambda.$$

- **Regge behaviour:** When  $s \gg -t > 0$ , gauge theories expected to have *Regge behaviour*,

$$\mathcal{A}(s, t) \simeq \beta(t) s^{\alpha(t)}, \quad \alpha(t) = \alpha_0 + \frac{\tilde{\alpha}'}{2} t.$$

- But string  $2 \rightarrow 2$  flat space amplitude (Virasoro-Shapiro),

$$\mathcal{A}_{\text{string}} = g_s^2 \alpha'^3 \left[ \prod_{x=s,t,u} \frac{\Gamma(-\alpha' \tilde{x}/4)}{\Gamma(1 + \alpha' \tilde{x}/4)} \right] K(\sqrt{\alpha' \tilde{p}})$$

becomes in the Regge limit  $\alpha' s \gg 1, \alpha' |t|$  fixed, of the same Regge form,

$$\mathcal{A}_{\text{string}}(s, t) \simeq g_s^2 \alpha'^3 [\text{polariz. tensors}] (\alpha' s)^{\alpha' t/2 + 2} \frac{\Gamma(-\alpha' t/4)}{\Gamma(1 + \alpha' t/4)}.$$

- But, doing the PS integral in the "hard-wall" of the Regge limit, the integral is dominated by lowest  $r = r_{\min}$ , so by the integrand there = flat space amplitude. So: QCD has Regge behaviour:

$$\mathcal{A}_{\text{QCD}}(p) \sim \beta(t) (\tilde{\alpha}' s)^{2 + \tilde{\alpha}' t/2}.$$

## Gravitational shockwave scattering as a model of QCD high energy scattering

- High energy scattering in gravity: particles become grav. shockwaves of "parallel plane" (pp) type. In flat space: Aichelburg-Sexl:

$$ds^2 = 2dx^+ dx^- + H(x^+, x^i)(dx^+)^2 + \sum_i dx_i^2,$$

which is an *exact* solution to Einstein's equations with a massless pointlike source, reducing to

$$R_{++} = -\frac{1}{2}\partial_i^2 H(x^+, x^i) = 8\pi G T_{++} = p\delta^{d-2}(x^i)\delta(x^+).$$

Then the solution is

$$H(x^+, x^i) = \delta(x^+)\Phi(x^i), \quad \partial_i^2 \Phi(x^i) = -16\pi G_{N,d} p \delta^{d-2}(x^i),$$

leading in flat space to

$$\begin{aligned}\Phi &= -4G_{N,4} \ln \rho^2, \quad (d=4) \\ \Phi &= \frac{16\pi G_{N,d}}{\Omega_{d-3}(d-4)} \frac{p}{\rho^{d-4}}, \quad (d>4).\end{aligned}$$

- Note that for pp wave solutions,  $\nexists \alpha'$  corrections: all  $R^2$  corr. vanish on-shell, so: Exact string solutions!
- Then for scattering with  $G_{Ns} \sim 1$ , but  $G_{Ns} < 1$ , we have one particle an A-S wave, the other moving in it. For  $G_{Ns} > 1$ , both particles are A-S waves. *Before collision,*

$$ds^2 = 2dx^+ dx^- + dx_i^2 + (dx^+)^2 \Phi_1(x^i) + (dx^-)^2 \Phi_2(x^i).$$

- Then (Penrose, at  $b = 0$ , Eardley+Giddings at  $0 < b \leq b_{\max}$ ), a "marginally trapped surface" forms at collision point  $x^+ = x^- = 0$  (Schwarzschild BH:  $r_H = 2MG_N$  is a marginally trapped surface), so (GR theorem): BH must form in the future of the collision. Then, BH formation in collision, with  $\sigma_{\text{BH}} \geq \pi b_{\max}^2$ .
- In hard-wall model (cut-off  $AdS_5 \times X^5$ : curved space): same mechanism. Then, use PS formula to related to QCD. But: need gravity amplitude corresponding to  $b_{\max}$ . This is obtained in the *black disk eikonal approx.*,  $S = e^{i\delta}$ , with  $\text{Re}[\delta(b, s)] = 0$ ,  $\text{Im}[\delta(b, s)] = 0$  for  $b > b_{\max}$ ,  $\text{Im}[\delta(b, s)] = \infty$  for  $b \leq b_{\max}$ . Then the amplitude is

$$\begin{aligned} \frac{1}{s} \mathcal{A}(s, t) &= -i \int d^2 b e^{i\vec{q} \cdot \vec{b}} (e^{i\delta} - 1) = i \int_0^{b_{\max}(s)} b db \int_0^{2\pi} d\theta e^{iqb \cos \theta} \\ &= 2\pi i \frac{b_{\max}(s)}{\sqrt{t}} J_1 \left( \sqrt{t} b_{\max}(s) \right). \end{aligned}$$

- Energy regime in gravity dual ("hard-wall") of QCD:  $\Lambda_{\text{QCD}} < (\hat{\alpha}_s)^{-1/2} = (g_{YM}^2 N)^{1/2} \Lambda_{\text{QCD}} < \hat{M}_P = N^{1/4} \Lambda_{\text{QCD}}$ . For  $\sqrt{s} > \hat{M}_P$ , in dual we create small black holes. But for  $E > E_R = M_P^8 R^7$  in gravity dual, so  $\sqrt{s} > \hat{E}_R = N^2 \Lambda_{\text{QCD}}$  in QCD, BH of size larger than  $R_{\text{AdS}}$ .

- Yet  $\exists$  higher energy scale in QCD, depending on the details of the gravity dual:  $E_F \leftrightarrow \hat{E}_F$ , such that BH is effectively on the IR cut-off  $r_{\text{min}}$  itself. Then, in QCD, *Froissart unitarity bound*,

$$\sigma_{\text{tot}} \leq C \ln^2 \frac{s}{s_0}; \quad C \leq \frac{\pi}{m_\pi^2},$$

where  $m_\pi$  is lowest energy state in theory.

- Describe this via collision of 2 (A-S-type) gravitational shockwaves on the IR cut-off = IR brane, in a symmetrical situation (IR brane position acts as a pion field, see before),

$$ds^2 = e^{\frac{2|y|}{R}} d\vec{x}^2 + dy^2 + R^2 ds_X^2.$$



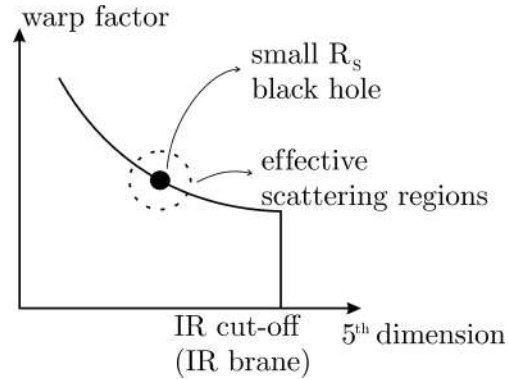

a)

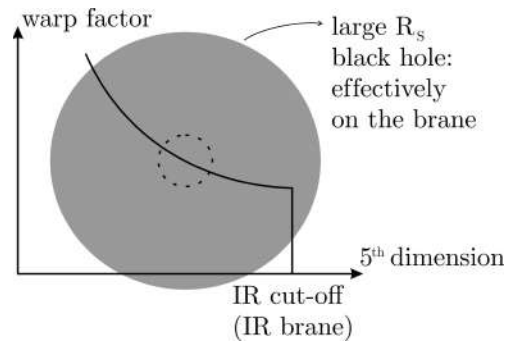

b)

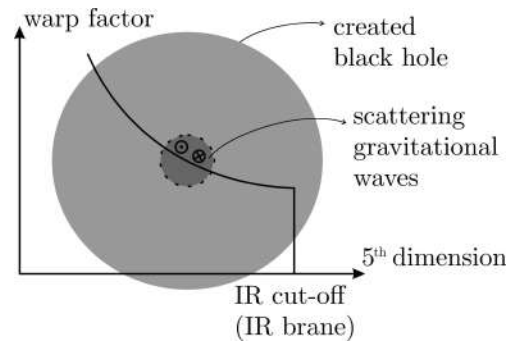

c)

a) At small enough energies, the created black hole is small, and fluctuates (is created at a random point) inside a small region of effective scattering. b) At large enough energies, the created black hole is so large, that it is effectively fixed (has small fluctuations) and it looks like it sits on the IR brane. c) At these large energies, the process is effectively classical: two shockwaves going in opposite directions scatter creating a black hole larger than the scattering region.

- The shockwave profile is found to be ( $M_1$  is the first KK mode when reducing 5d theory onto IR brane,  $R_s = G_{N,4}\sqrt{s}$ )

$$\Phi(r, y) = \frac{4G_{N,d+1}p e^{-\frac{d|y|}{2R}}}{(2\pi)^{\frac{d-4}{2}} r^{\frac{d-4}{2}}} \int_0^\infty dq q^{\frac{d-4}{2}} J_{\frac{d-4}{2}}(qr) \frac{I_{d/2}\left(e^{-\frac{|y|}{R}}Rq\right)}{I_{d/2-1}(Rq)}$$

$$\Phi(r, y=0) \simeq R_s \sqrt{\frac{2\pi R}{r}} C_1 e^{-M_1 r}, \quad M_1 = \frac{j_{1,1}}{R}.$$

- $\exists$  Exact analysis, but simple arg.:  $\Phi \sim \sqrt{s} e^{-M_1 r}$ , so for 2 A-S waves at impact parameter  $b$ , emitted energy  $\propto \sqrt{s} e^{-M_1 r}$ . Minimum energy =  $\hat{M}_P$ , reached at  $b_{\max}$ , so

$$b_{\max} \sim \frac{1}{M_1} \ln \frac{s}{\hat{M}_{PI}} \Rightarrow \sigma_{\text{tot}} = \pi b_{\max}^2 \sim \frac{\pi}{M_1^2} \ln^2 \frac{s}{\hat{M}_{PI}}.$$

- Description matches 1952 Heisenberg model for nucleon-nucleon high energy collisions.  $\Phi \rightarrow$  pion wavefunction (indeed, IR brane position = pion field). But, Heisenberg: pion field overlap  $\sim e^{-\mu_\pi b}$ , so emitted energy  $\sim \sqrt{s} e^{-m_\pi b}$ .  $b_{\max}$ : when emitted energy = average per pion emitted energy  $\langle E_0 \rangle$ , which is  $\simeq$  constant only for DBI action (action of IR brane), whereas for canonical scalar with polynomial  $V$ ,  $\langle E_0 \rangle \propto \sqrt{s}$ . Then

$$\sqrt{s} e^{-m_\pi b_{\max}} = \langle E_0 \rangle \Rightarrow b_{\max} = \frac{1}{m_\pi} \ln \frac{\sqrt{s}}{\langle E_0 \rangle} \Rightarrow$$

$$\sigma_{\text{tot}} = \pi b_{\max}^2 = \frac{\pi}{m_\pi^2} \ln^2 \frac{\sqrt{s}}{\langle E_0 \rangle}.$$



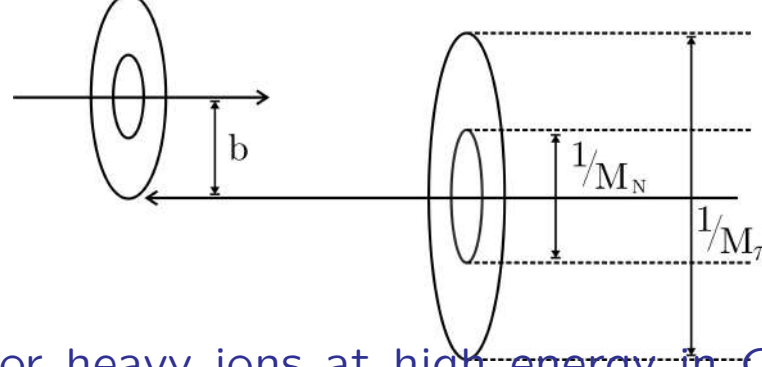

Scattering of nuclei or heavy ions at high energy in QCD described by the Heisenberg model.

- Lower bound on entropy formed in collisions:

$$A_{\text{ev.hor.}} \geq A_{\text{marg.trap.}} \Rightarrow S_{\text{emitted}} = S_{\text{BH}} = \frac{A_{\text{ev.hor.}}}{4G_{N,5}} \geq \frac{A_{\text{marg.trap.}}}{4G_{N,5}}.$$

- Gubser et al.: shockwave with  $T_{++} = E\delta(x^+)\delta(z - R)\delta^{d-2}(x^i)$ ,

$$ds^2 = \frac{R^2}{z^2} (2dx^+ dx^- + (dx^1)^2 + (dx^2)^2 + dz^2) + \frac{R}{z} \Phi(x^1, x^2, z) \delta(x^+) (dx^+)^2 \Rightarrow$$

$$\Phi(x^1, x^2, z) = \frac{2G_{N,5}E}{R} \frac{1 + 8q(1 + q) - 4\sqrt{q(1 + q)}(1 + 2q)}{\sqrt{q(1 + q)}}, \quad q \equiv \frac{(x^1)^2 + (x^2)^2 + (z - R)^2}{4zR}.$$

- Treating  $\delta g_{ij} = R/z\Phi(x^1, x^2, z)\delta(x^+)$  as a perturbation,

$$\langle T_{ij}(\vec{x}) \rangle = \frac{R^3}{4\pi G_{N,5}} \lim_{z \rightarrow 0} \frac{1}{z^4} \delta g_{ij} = \frac{2R^4 E}{\pi [R^2 + (x^1)^2 + (x^2)^2]^3} \delta(x^+).$$

## Lecture 8

# The pp wave correspondence and spin chains

## The Penrose limit and pp waves

- PP waves: Linearized solution is exact! Only nontrivial Ricci is  $R_{++} = -\frac{1}{2}\partial_i^2 H(x^+, x^i)$ . For shockwaves,  $T_{++} \propto \delta(x^+)$ , so  $H(x^+, x^i) = \delta(x^+)\Phi(x^i)$ , but here: waves not localized in  $x^+$ .
- In supergravity: 11d sugra, pp wave solutions with

$$F_4 = dx^+ \wedge \phi : \quad F_{(4)+\mu_1\mu_2\mu_3} = \phi_{(3)\mu_1\mu_2\mu_3}$$

$$d\phi = 0, \quad d*\phi = 0, \quad -\partial_i^2 H = |\phi|^2.$$

- For  $H = \sum_{ij} A_{ij}x^i x^j$ ,  $-2\text{Tr} A = |\phi|^2$ , we have solutions with 1/2 susy, but there is a unique sol. with ALL susy,

$$H = \sum_{i,j} A_{ij}x^i x^j = - \sum_{i=1,2,3} \frac{\mu^2}{9} x_i^2 - \sum_{i=4}^9 \frac{\mu^2}{36} x_i^2$$

$$\phi = \mu dx^1 \wedge dx^2 \wedge dx^3.$$

- In 10d IIB sugra, pp wave solutions with

$$F_5 = dx^+ \wedge (\omega + *\omega) : \quad F_{+\mu_1\dots\mu_4} = \omega_{\mu_1\dots\mu_4}; \quad F_{+\mu_5\dots\mu_8} = \omega_{\mu_5\dots\mu_8}$$

$$H = \sum_{ij} A_{ij}x^i x^j; \quad \phi = \phi_0, \quad d\omega = 0, \quad d*\omega = 0, \quad \partial_i^2 H = -|\omega|^2.$$

- Again, sols. have 1/2 susy, but  $\exists!$  sol. with full susy,

$$H = -\frac{\mu^2}{64} \sum_i x_i^2; \quad \omega = \frac{\mu}{2} dx^1 \wedge dx^2 \wedge dx^3 \wedge dx^4.$$

• **Penrose limit:** Penrose theorem: near a null geodesic in any metric, the spacetime becomes a pp wave. Null geodesic defined by  $V = Y^i = 0, U = \tau$ , we can always put the metric in form (Penrose):

$$ds^2 = dV \left( dU + \alpha dV + \sum_i \beta_i dY^i \right) + \sum_{ij} C_{ij} dY^i dY^j ,$$

where  $U, V$  are lightcone coords., and take the limit

$$U = u; \quad V = \frac{v}{R^2}; \quad Y^i = \frac{y^i}{R}; \quad R \rightarrow \infty ,$$

to obtain a pp wave in  $u, v, y^i$ , but in Rosen coordinates,

$$ds^2 = 2dudv + g_{ij}(u) dy^i dy^j , \quad g_{ij}(u) = C_{ij}(U = u, V = 0, Y^i = 0).$$

• To go to the standard Brinkmann coordinates form, write  $g_{ij}(u) = e_i^a(u) e_j^b(u) \delta_{ab}$ , then

$$u = x^+ , \quad v = x^- + \frac{1}{2} \dot{e}_{ai} e_b^i x^a x^b , \quad y^i = e_a^i x^a ,$$

then obtain  $A_{ab} = \ddot{e}_{ai} e_b^i$ . Interpretation of Penrose limit: boost along direction  $x$ , while taking the overall scale of metric to infinity:

$$\begin{aligned} t' &= \cosh \beta t + \sinh \beta x; & x' &= \sinh \beta t + \cosh \beta x \Rightarrow \\ x' - t' &= e^{-\beta} (x - t); & x' + t' &= e^{\beta} (x + t) , \end{aligned}$$

then scale all coords. by  $1/R$  and identify  $e^{\beta} = R \rightarrow \infty$ .

- Penrose limit of  $AdS_5 \times S^5$ : boost along an equator of  $S^5$  defined by  $\theta = 0$  and stay at center of  $AdS_5$  at  $\rho = 0$  (is a null geodesic).

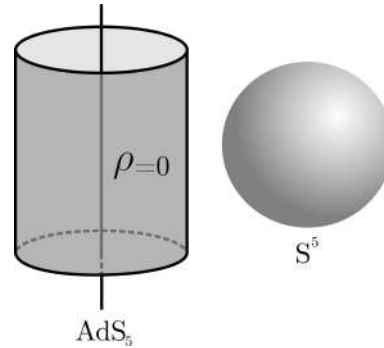

Null geodesic in  $AdS_5 \times S_5$  for the Penrose limit giving the maximally supersymmetric wave. It is in the center of  $AdS_5$ , at  $\rho = 0$ , and on an equator of  $S_5$ , at  $\theta = 0$ .

$$\begin{aligned}
 ds^2 &= R^2 \left( -\cosh^2 \rho d\tau^2 + d\rho^2 + \sinh^2 \rho d\Omega_3^2 \right) + R^2 \left( \cos^2 \theta d\psi^2 + d\theta^2 + \sin^2 \theta d\Omega'_3{}^2 \right) \\
 &\simeq R^2 \left[ - (1 + \rho^2) d\tau^2 + d\rho^2 + \rho^2 d\Omega_3^2 \right] + R^2 \left[ (1 - \theta^2) d\psi^2 + d\theta^2 + \theta^2 d\Omega'_3{}^2 \right].
 \end{aligned}$$

- Then define null coords.  $\tilde{x}^\pm = (\tau \pm \psi)/\sqrt{2}$ , and rescale to obtain the pp wave,

$$\begin{aligned}
 \tilde{x}^+ &= x^+; \quad \tilde{x}^- = \frac{x^-}{R^2}; \quad \rho = \frac{r}{R}; \quad \theta = \frac{y}{R} \Rightarrow \\
 ds^2 &= -2dx^+ dx^- - \mu^2 (r^2 + \bar{y}^2) (dx^+)^2 + d\bar{y}^2 + d\bar{r}^2.
 \end{aligned}$$



## Penrose limit of AdS/CFT: large R-charge Berenstein, Maldacena, Nastase, 2002

- $E = i\partial_\tau$  in global  $AdS_5$ , and  $J = -i\partial_\psi$  (for rot.  $X^5 \leftrightarrow X^6$ ).
- But  $E \leftrightarrow \Delta$  and  $J \leftrightarrow U(1) \subset SU(4) = SO(6)$  R-charge rotating  $X^5 \leftrightarrow X^6$ .
- Penrose limit

$$p^- = -p_+ = i\partial_{x^+} = i\partial_{\tilde{x}^+} = \frac{i}{\sqrt{2}}(\partial_\tau + \partial_\psi) = \frac{1}{\sqrt{2}}(\Delta - J)$$

$$p^+ = -p_- = i\partial_{x^-} = i\frac{\partial_{\tilde{x}^-}}{R^2} = \frac{i}{\sqrt{2}R^2}(\partial_\tau - \partial_\psi) = \frac{\Delta + J}{\sqrt{2}R^2}.$$

- Rescale  $p^-$  by  $\mu\sqrt{2}$  and  $p^+$  by  $1/\mu\sqrt{2}$ :

$$\frac{p^-}{\mu} = \Delta - J; \quad 2\mu p^+ = \frac{\Delta + J}{R^2}.$$

- For string theory on pp wave,  $p^+, p^-$  finite, so as  $R \rightarrow \infty$ , keep  $\Delta - J$  and  $(\Delta + J)/R^2$  fixed, so  $\Delta \simeq J \sim R^2 \rightarrow \infty$ . Thus *Penrose limit is large R-charge limit in AdS/CFT!*

- In  $\mathcal{N} = 4$  SYM,  $\frac{R^2}{\alpha'} = \sqrt{4\pi g_s N} = \sqrt{g_{YM}^2 N}$ , so for  $g_s$  fixed, we have  $J \sim R^2 \sim \sqrt{N}$ , so

$$\frac{J}{\sqrt{N}} = \text{fixed} \quad \text{and} \quad \frac{g_{YM}^2 N}{J^2} = \text{fixed}.$$

## String quantization and Hamiltonian on pp wave

- Polyakov action on pp wave ( $x^i = (\vec{r}, \vec{y})$ )

$$S = -\frac{1}{2\pi\alpha'} \int_0^l d\sigma \int d\tau \frac{1}{2} \sqrt{-\gamma} \gamma^{ab} [-2\partial_a x^+ \partial_b x^- - \mu^2 x_i^2 \partial_a x^+ \partial_b x^+ + \partial_a x^i \partial_b x^i].$$

- In conf. gauge,  $\sqrt{-\gamma} \gamma^{ab} = \eta^{ab}$ , light-cone gauge  $x^+(\sigma, \tau) = \tau$  (rescale  $\tau$  by  $\alpha' p^+$ ), and then  $l = 2\pi\alpha' p^+$ ,

$$S = -\frac{1}{2\pi\alpha'} \int d\tau \int_0^{2\pi\alpha' p^+} d\sigma \left[ \frac{1}{2} (-(\dot{x}^i)^2 + (x'^i)^2) + \frac{\mu^2}{2} x_i^2 \right].$$

- The equations of motion and solutions are

$$(-\partial_\tau^2 + \partial_\sigma^2)x^i - \mu^2 x^i = 0. \Rightarrow x^i \propto e^{-i\omega_n \tau + ik_n \sigma}, \quad \omega_n^2 = k_n^2 + \mu^2.$$

- In flat space  $\mu = 0$ ,  $\omega_n = k_n = n$ , but now we rescaled by  $\alpha' p^+$ , so

$$\omega_n = \sqrt{\mu^2 + \frac{n^2}{(\alpha' p^+)^2}}.$$

- Light-cone Hamiltonian  $H_{l.c.} = p^-$  has no 0-modes  $p^i$  ( $x^i$  massive), so

$$H = \sum_{n \in \mathbb{Z}} N_n \omega_n, \quad N_n = \sum_i a_n^{i\dagger} a_n^i + \sum_\alpha b_n^{\alpha\dagger} b_n^\alpha.$$

- As for flat space, transl. inv.:  $P = \sum_n n N_n = 0$ . In  $\mathcal{N} = 4$  SYM,  $E/\mu = \Delta - J$ ,  $2\mu p^+ \simeq 2J/R^2$ , so

$$(\Delta - J)_n = \frac{\omega_n}{\mu} = \sqrt{1 + \frac{g_{YM}^2 N n^2}{J^2}}.$$

### String states from $\mathcal{N} = 4$ SYM; BMN operators

- Vacuum:  $E = 0$ , so  $\Delta - J = 0$ . Oscillators at  $g_{YM} = 0$ :  $\Delta - J = 1$ . Construct operators out of fields with  $\Delta - J = 1$ , on top of operator with  $\Delta - J = 0$ .
- Field with  $\Delta = J = 1$ :  $Z = \Phi^5 + i\Phi^5$ : unique! (charged under  $J$ ). ( $\bar{Z}$  has  $\Delta = -J = 1$ , so  $\Delta - J = 2$ ).
- Fields with  $J = 0$  and  $\Delta = 1$  (so  $\Delta - J = 1$ ):  $\Phi^m$ ,  $m = 1, \dots, 4$  and  $D_\mu Z = \partial_\mu Z + [A_\mu, Z]$  (bosonic) and  $\chi_{J=+1/2}^a$  (fermionic, 8 comps.; other 8:  $\chi_{J=-1/2}^a$ ).

- Vacuum, with  $\mu p^+ = J/R^2$ :

$$|0, p^+\rangle = \frac{1}{\sqrt{J} N^{J/2}} \text{Tr} [Z^J].$$

- Oscillators with  $n = 0$  (BPS operators, with  $\Delta - J$  indep. of  $g_{YM}$ ), obtained by inserting  $a_{0,r}^\dagger = \Phi^r = (D_\mu Z, \Phi^m)$  or  $b_{0,b}^\dagger = \chi_{J=-1/2}^a$  in it, e.g.

$$a_{0,r}^\dagger b_{0,b}^\dagger |0, p^+\rangle = \frac{1}{N^{J/2+1} \sqrt{J}} \sum_{l=1}^J \text{Tr} [\Phi^r Z^l \psi_{J=1/2}^b Z^{J-l}].$$

- Excited levels ( $n \geq 1$ ): add momentum wavefunction  $e^{\frac{2\pi i n x}{L}}$  around the closed string, so, e.g.  $a_{n,4}^\dagger$  insertion is

$$a_{n,4}^\dagger |0, p^+\rangle = \frac{1}{\sqrt{J}} \sum_{l=1}^J \frac{1}{\sqrt{J} N^{J/2+1/2}} \text{Tr} [Z^l \Phi^4 Z^{J-l}] e^{\frac{2\pi i n l}{J}}.$$

- But this vanishes by cyclicity. Nonzero: at least two excitations, so that  $P = \sum_n n N_n = 0$ , e.g.

$$a_{n,4}^\dagger a_{-n,3}^\dagger |0, p^+\rangle = \frac{1}{\sqrt{J}} \sum_{l=1}^J \frac{1}{N^{J/2+1}} \text{Tr} [\Phi^3 Z^l \Phi^4 Z^{J-l}] e^{\frac{2\pi i n l}{J}}.$$

- These are "BMN operators". Study "dilute gas approx.": few "impurities" among  $Z$ 's.

## Discretized string action from $\mathcal{N} = 4$ SYM

- Operator-state correspondence in CFT:  $z_{a_1 \dots a_m}^{(m)} \sim \partial_{a_1} \dots \partial_{a_m} Z$  on  $\mathbb{R}^4 \rightarrow$  KK states on  $\mathbb{R}_t \times S^3$ , so constant  $Z$ : energy 1 = harmonic osc. of  $\omega = 1$ , with cr.op.  $(b^\dagger)^i_j$ . Similarly, for  $\Phi$ ,  $(a^\dagger)^i_j$ , so states

$$|a_l^\dagger\rangle \equiv \text{Tr} \left[ (b^\dagger)^l a^\dagger (b^\dagger)^{J-l} \right] |0\rangle.$$

- Interacting Hamiltonian

$$H_{\text{int}} = -g_{YM}^2 \text{Tr} \sum_{I>J} \left\{ [\Phi^I, \Phi^J] [\Phi_I, \Phi_J] \right\},$$

has then term that can act on operators  $\mathcal{O}$ ,

$$H_{\text{int}} = -g_{YM}^2 \text{Tr} \left\{ [Z, \Phi^m] [\bar{Z}, \Phi^m] \right\} \rightarrow 2g_{YM}^2 N [b^\dagger, \phi] [b, \phi]; \quad \phi = \frac{a + a^\dagger}{\sqrt{2}},$$

whose action is through Feynman diagrams, as

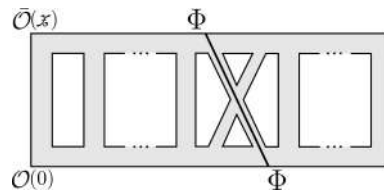

Feynman diagram for the 2-point function of  $\mathcal{O}(x)$  at one-loop.

• 't Hooft limit  $\Rightarrow$  only planar diagrams.

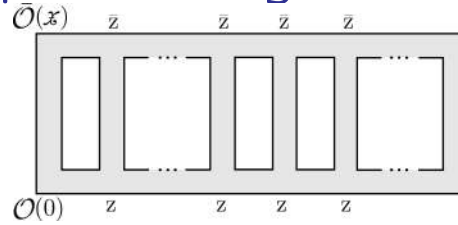

a)

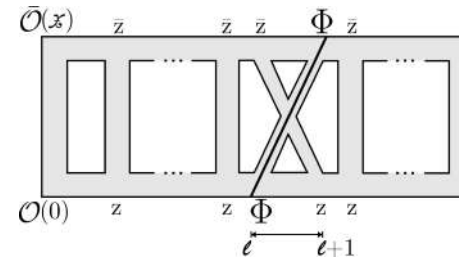
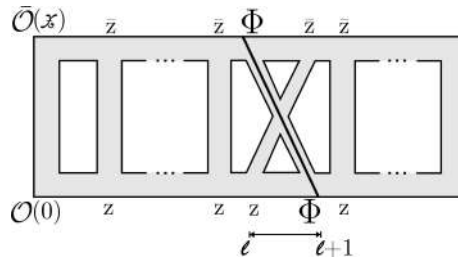

b)

c)

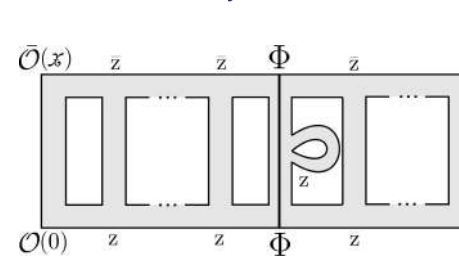
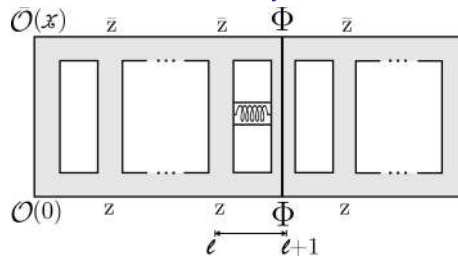

d)

e)

Planar Feynman diagrams for the 2-point function of  $\mathcal{O}$ . a) The planar tree level diagram. b) Planar one-loop Feynman diagram with hopping from  $l + 1$  to  $l$ . c) Planar one-loop diagram with hopping from  $l$  to  $l + 1$ . d) One-loop planar diagram with gluon exchange e) One-loop planar diagram with scalar self-energy.

- After a calculation, find the Hamiltonian (when acting on states  $\leftrightarrow$  operators)

$$H = \sum_{j=1}^J \frac{a_j^\dagger a_j + a_j a_j^\dagger}{2} + \frac{\lambda}{(2\pi)^2} \sum_{j=1}^J (\phi_j - \phi_{j+1})^2.$$

- Continuum version of Hamiltonian = light-cone string on pp wave,

$$H = \int_0^L d\sigma \frac{1}{2} [\dot{\phi}^2 + \phi'^2 + \phi^2], \quad L = \frac{2\pi J}{\mu\sqrt{\lambda}} = 2\pi\alpha' p^+,$$

so as a discrete "spin chain"

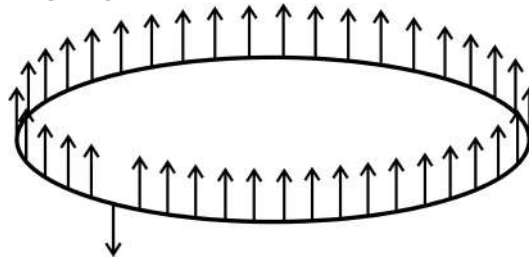

A periodic spin chain of the type that appears in the pp wave string theory. All spins are up, except one excitation has one spin down.

- But: made up of Cuntz oscillators, or rather, indep. Cuntz oscillators at each site:

$$a_i |0\rangle = 0, \quad a_i a_j^\dagger = \delta_{ij}, \quad \sum_{i=1}^n a_i^\dagger a_i = 1 - |0\rangle\langle 0| \rightarrow$$

$$[a_i, a_j] = [a_i^\dagger, a_j] = [a_i^\dagger, a_j^\dagger] = 0, \quad i \neq j$$

$$a_i a_i^\dagger = 1, \quad a_i^\dagger a_i = 1 - (|0\rangle\langle 0|)_i; \quad a_i |0\rangle_i = 0.$$

- Defining Fourier modes for the Cuntz oscillators,

$$a_j = \frac{1}{\sqrt{J}} \sum_{n=1}^J e^{\frac{2\pi i j n}{J}} a_n.$$

and acting on states in the "dilute gas approx.",  $|\psi_{\{n_i\}}\rangle = |0\rangle_1 \dots |n_{i_1}\rangle \dots |n_{i_k}\rangle \dots |0\rangle_J$ , so that the commutators become almost the usual ones,  $[a_n, a_m^\dagger] |\psi_{\{n_i\}}\rangle \simeq (\delta_{nm} + \mathcal{O}(1/J)) |\psi_{\{n_i\}}\rangle$ , we can further write superpositions of the left- and right-moving modes, and finally diagonalize by a Bogoliubov transformation,

$$a_n = \frac{c_{n,1} + c_{n,2}}{\sqrt{2}} \quad a_{J-n} = \frac{c_{n,1} - c_{n,2}}{\sqrt{2}}$$

$$\tilde{c}_{n,1} = a_n c_{n,1} + b_n c_{n,1}^\dagger \quad \tilde{c}_{n,2} = a_n c_{n,1} - b_n c_{n,1}^\dagger,$$

to obtain the eigenfrequencies

$$\omega_n = \sqrt{1 + 4|\alpha_n|} = \sqrt{1 + \frac{g_{YM}^2 N}{\pi^2} \sin^2 \frac{\pi n}{J}},$$

with the corresponding Fock states

$$c_{n,1/2}^\dagger |0\rangle = \frac{a_n^\dagger \pm a_{J-n}^\dagger}{\sqrt{2}} |0\rangle = \frac{1}{\sqrt{J}} \sum_{j=1}^J \frac{e^{\frac{2\pi i j n}{J}} \pm e^{-\frac{2\pi i j n}{J}}}{\sqrt{2}} a_j^\dagger |0\rangle,$$



- Fock states mapped to the BMN operators

$$\frac{1}{\sqrt{J}} \sum_{l=1}^J \frac{1}{N^{\frac{J}{2}+1}} \text{Tr} [\Phi^1 Z^l \Phi^1 Z^{J-l}] \left[ \cos \left( \frac{2\pi i n l}{J} \right) \text{ or } i \sin \left( \frac{2\pi i n l}{J} \right) \right].$$

- Note that for  $n \ll J$ , both  $\omega_n$  and the states match the string on pp wave. For  $n \sim J$ , we also have a match, but not to the pp wave (Penrose limit of  $AdS_5 \times S^5$ ), but a different limit.
- Note that  $\omega_n$  is valid *to all orders in  $\lambda$*  (even though the Hamiltonian was one-loop, i.e.  $\lambda^1$ ), though only for few impurities ( $M \ll J$ ). Why? It seems to resum all interactions.

**One loop: spin chain interpretation**  $\Phi^m \rightarrow a^\dagger$ ,  $Z \rightarrow b^\dagger$ : like a spin chain of length  $J$ , with spins "up"  $|\uparrow\rangle$  for  $Z$  and "down"  $|\downarrow\rangle$  for  $\Phi$ . Though until now, only "dilute gas" analysis.

- The interaction Lagrangian (or Hamiltonian, as before)

$$\mathcal{L}_{\text{int}} = 2g_{YM}^2 \text{Tr} [Z, \Phi^m] [\bar{Z}, \Phi^m] = 2g_{YM}^2 (2\text{Tr} [\Phi^m Z \Phi^m \bar{Z}] - \text{Tr} [(Z\bar{Z} + \bar{Z}Z)\Phi^m \Phi^m])$$

leads, through Feynman diagrams for "hopping" acting on operators, to 1-loop 2-point function

$$\langle \mathcal{O}(x) \mathcal{O}^*(0) \rangle = \frac{\mathcal{N}}{|x|^{2J+2}} \left[ 1 + g_{YM}^2 N I(x) \left( e^{\frac{2\pi i n}{J}} + e^{-\frac{2\pi i n}{J}} \right) \right],$$

where

$$I(x) = \frac{|x|^4}{(4\pi^2)^2} \int d^4 y \frac{1}{y^4 (x-y)^4} \sim \frac{1}{4\pi^2} \log(|x|\Lambda) + \text{finite.}$$

• Then we can deduce the one-loop  $\omega_n$  as

$$\begin{aligned} \langle \mathcal{O}(x) \mathcal{O}^*(0) \rangle &= \frac{\mathcal{N}}{|x|^{2J+2}} \left[ 1 - 2g_{YM}^2 N \left( \cos\left(\frac{2\pi n}{J}\right) - 1 \right) \frac{1}{4\pi^2} \log(|x|\Lambda) \right] \\ &= \frac{\mathcal{N}}{|x|^{2(J+1+(\Delta-J)[g^2 N])}} \\ &\simeq \frac{\mathcal{N}}{|x|^{2(J+1)}} \left[ 1 + 2(\Delta - J)[g^2 N] \ln(|x|) + \dots \right] \Rightarrow \\ (\Delta - J)_n &= \left[ 1 + \frac{g_{YM}^2 N}{2\pi^2} \sin^2\left(\frac{\pi n}{J}\right) \right]. \end{aligned}$$

• This matches the first order expansion of the exact Cuntz result.

## Spin chains

- Full spin chain:  $SO(6)$ , for the 6 scalars  $\Phi^I$ , with operators  $\mathcal{O}[\psi] = \psi^{I_1 \dots I_L} \text{Tr} [\Phi_{I_1} \dots \Phi_{I_L}]$ , defined through: the identity operator, the trace operator  $K$  (from contractions of fields of the same operator) and the permutation operator  $P$  (from contractions of fields of different operators, hopping one site),

$$K_{I_l I_{l+1}}^{J_l J_{l+1}} = \delta_{I_l, I_{l+1}} \delta^{J_l, J_{l+1}}, \quad P_{I_l, I_{l+1}}^{J_l, J_{l+1}} = \delta_{I_l}^{J_{l+1}} \delta_{I_{l+1}}^{J_l}.$$

- Renormalization of operators, with anomalous dimension matrix  $\Gamma$ , is

$$\mathcal{O}_{\text{ren}}^A = Z^A_B \mathcal{O}^B, \quad \Gamma = \frac{dZ}{d \ln \Lambda} \cdot Z^{-1},$$

and leads to 2-point functions of eigenvectors of  $\Gamma$  as

$$\langle \mathcal{O}_n^{\text{ren}}(x) \mathcal{O}_n^{\text{ren}}(y) \rangle = \langle Z \cdot \mathcal{O} Z \cdot \mathcal{O} \rangle = \frac{\text{const.}}{|x - y|^{2(L + \gamma_n)}}.$$

- Then for  $\mathcal{N} = 4$  SYM at one-loop, one finds the Hamiltonian

$$\begin{aligned} Z_{\dots I_l I_{l+1} \dots}^{J_l J_{l+1} \dots} &= 1 - \frac{g_{YM}^2 N}{16\pi^2} \ln \Lambda \left( \delta_{I_l I_{l+1}} \delta^{J_l J_{l+1}} + 2\delta_{I_l}^{J_l} \delta_{I_{l+1}}^{J_{l+1}} - 2\delta_{I_l}^{J_{l+1}} \delta_{I_{l+1}}^{J_l} \right) \Rightarrow \\ \text{" } H \text{"} &= \Gamma = \frac{g_{YM}^2 N}{16\pi^2} \sum_{l=1}^L (K_{l, l+1} + 2 - 2P_{l, l+1}). \end{aligned}$$

## $SU(2)$ sector and $H_{XXX}$ from $\mathcal{N} = 4$ SYM

- We can construct a sub-spin chain that is the extension of the dilute gas approx. one, in an  $SU(2)$  sector with 2 scalars, corresponding to "spin up" and "spin down",

$$Z = \Phi^1 + i\Phi^2; \quad \text{and} \quad W = \Phi^3 + i\Phi^4,$$

acting on operators (and their generalizations with "magnon" momenta)

$$\mathcal{O}_\alpha^{J_1, J_2} = \text{Tr} [Z^{J_1} W^{J_2}] + \dots (\text{permutations}).$$

- The interaction Hamiltonian in this subsector is

$$H_{\text{int}} = -g_{YM}^2 [Z, W] \text{Tr} [\bar{Z}, \bar{W}],$$

so the renormalization factor and the one-loop Hamiltonian are

$$\begin{aligned} Z_{\dots I_l I_{l+1} \dots}^{J_l J_{l+1} \dots} &= 1 + \frac{g_{YM}^2 N}{16\pi^2} \ln \Lambda \, 2 \left( \delta_{I_l}^{J_l} \delta_{I_{l+1}}^{J_{l+1}} - \delta_{I_l}^{J_{l+1}} \delta_{I_{l+1}}^{J_l} \right) \Rightarrow \\ H_{\text{planar}}^{(1)} &= \Gamma_{\text{planar}}^{(1)} = \frac{g_{YM}^2 N}{16\pi^2} \sum_{l+1}^L 2 \left( 1 - P_{l, l+1} \right). \end{aligned}$$

- A more precise concept of Hamiltonian, extendable to higher loops, is of a *dilatation operator*  $\mathcal{D}$ , obtained by attaching Feynman diagrams to operators,

$$\mathcal{D} \circ \mathcal{O}_\alpha^{J_1, J_2}(x) = \sum_\beta \mathcal{D}_{\alpha\beta} \mathcal{O}_\beta^{J_1, J_2}(x) ,$$

and can be written in terms of adding and removing fields in the operator, using  $\check{Z}_{ij} \equiv \frac{d}{dZ_{ji}}$ , so that

$$\mathcal{D}^{(0)} = \text{Tr} (Z\check{Z} + W\check{W}) , \quad \mathcal{D}^{(1)} = -\frac{g_{YM}^2}{8\pi^2} \text{Tr} [Z, W][\check{Z}, \check{W}] .$$

- Then the dilatation operator acts on operators as spin chains as

$$\mathcal{D}_{\text{planar}}^{(1)} = \frac{g_{YM}^2 N}{8\pi^2} \sum_{l+1}^L (1_{l, l+1} - P_{l, l+1}) ,$$

which is the Heisenberg  $XXX_{1/2}$  Hamiltonian, with  $J = g_{YM}^2 N / (16\pi^2)$ . Indeed, that is

$$H = -J \sum_{j=1}^L \vec{\sigma}_j \cdot \vec{\sigma}_{j+1} = -2J \sum_{j=1}^L (P_{j, j+1} - 1) ,$$

where we have used that on the  $|\uparrow\rangle, |\downarrow\rangle$  basis on the chain, the permutation operator is  $P_{ij} = \frac{1}{2} + \frac{1}{2} \vec{\sigma}_i \cdot \vec{\sigma}_j$ .

## Coordinate Bethe ansatz

• Denote  $|x_1, \dots, x_M\rangle$  state with spins down at positions  $x_1, \dots, x_M$  along the chain. Then the "one-magnon" eigenstate of  $H_{XXX}$  and its energy are

$$|\psi(p_1)\rangle = \sum_{x=1}^L e^{ip_1x} |x\rangle, \quad E(p_1) = 8J \sin^2(p_1/2) |\psi(p_1)\rangle.$$

• The 2-magnon state is

$$|\psi(p_1, p_2)\rangle = \sum_{1 \leq x_1 < x_2 \leq L} \psi(x_1, x_2) |x_1, x_2\rangle$$
$$\psi(x_1, x_2) = e^{i(p_1x_1 + p_2x_2)} + S(p_2, p_1) e^{i(p_2x_1 + p_1x_2)},$$

where  $E = E(p_1) + E(p_2)$  and the 2-body S-matrix is

$$S(p_1, p_2) = \frac{\phi(p_1) - \phi(p_2) + i}{\phi(p_1) - \phi(p_2) - i}, \quad \phi(p) = \frac{1}{2} \cot \frac{p}{2} \equiv u.$$

• For  $M$  magnons, in terms of  $\phi(p) = u =$  rapidities (for true magnon momenta,  $u$  called Bethe roots), the energy is

$$E = \sum_{j=1}^M 8J \sin^2 \frac{p_j}{2} = \sum_{j=1}^M 2J \frac{1}{u_j^2 + 1/4}.$$

• For 2 magnons, from periodicity of  $\psi(x_1, x_2)$  we have the *Bethe equations*

$$\begin{aligned} e^{ip_1 L} &= S(p_1, p_2) = \frac{\cot p_1/2 - \cot p_2/2 + 2i}{\cot p_1/2 - \cot p_2/2 - 2i} \\ e^{ip_2 L} &= S(p_2, p_1) = \frac{\cot p_2/2 - \cot p_1/2 + 2i}{\cot p_2/2 - \cot p_1/2 - 2i}, \end{aligned}$$

• so  $p_1 + p_2 = \frac{2\pi n}{L}$ , and for real  $p_2 = -p_1$ ,  $p_1 = \frac{2\pi n}{L-1}$ . In this case, the 2-magnon wavefunction is

$$|\psi(n)\rangle \equiv |\psi(p_1(n), -p_1(n))\rangle = C_n \sum_{l=1}^L \cos\left(\pi n \frac{2l+1}{L-1}\right) |x_2 + l, x_2\rangle, \quad C_n = 2e^{-\frac{i\pi n}{L-1}},$$

and this corresponds to a  $\mathcal{N} = 4$  SYM operator (eigenstate of  $\mathcal{D}^{(1)}$ ) that for  $n \ll L, L \rightarrow \infty$  becomes the BMN operator,

$$\begin{aligned} \mathcal{O}_n^{J,2} &= C_n \sum_{l=0}^{L-1} \cos\left[\pi n \frac{2l+1}{L-1}\right] \text{Tr} [W Z^l W Z^{J-l}] \Rightarrow \\ \mathcal{O}_n^{J,2} &\rightarrow C_n \sum_{l=0}^{L-1} \cos \frac{2\pi n l}{L} \text{Tr} [W Z^l W Z^{L-l}]. \end{aligned}$$

• For  $M \ll L, n \ll L$ , we obtain the spectrum of operators by acting with  $a_n^\dagger = \frac{1}{\sqrt{L}} \sum_{l=1}^L e^{\frac{2\pi i n l}{L}} \sigma_l^-$ , and, for momenta  $p_k \simeq 2\pi n_k/L$ , the anomalous dimension in SYM is

$$\gamma = \Delta - L - M = \frac{\lambda}{16\pi^2} \sum_{k=1}^M 8 \sin^2 \frac{p_k}{2} \simeq \frac{\lambda}{8\pi^2} \sum_{k=1}^M p_k^2 = \frac{\lambda}{2L^2} \sum_{k=1}^M n_k^2.$$





- For  $M$  magnons, the wavefunction is

$$\psi(x_1, \dots, x_M) = \sum_{P \in \text{Perm}(M)} \exp \left[ i \sum_{i=1}^M p_{P(i)} x_i + \frac{i}{2} \sum_{i < j} \delta_{P(i)P(j)} \right], \quad S(p_i, p_j) \equiv e^{i\delta_{ij}},$$

and the Bethe ansatz equations are (again from periodicity)

$$e^{ip_k L} = \prod_{i \neq k, i=1}^M S(p_k, p_i) \Rightarrow \left( \frac{u_k - i/2}{u_k + i/2} \right)^L = \prod_{j \neq k, j=1}^M \left( \frac{u_k - u_j - i}{u_k - u_j + i} \right), \quad k = 1, \dots, M.$$

- Their solutions are called *Bethe roots*, and need not be real, only the energies need be real. Then  $u_k$  root implies  $u_k^*$  root.
- **Thermodynamic limit** In the limit  $L \rightarrow \infty, M \rightarrow \infty$ , taking the log of the BEA, and since  $p_i \sim 1/L, u_i \sim L$ , so  $xI = u_i/L$  finite, we have

$$\frac{1}{x_i} + 2\pi n_i = \frac{2}{L} \sum_{k \neq i, k=1}^M \frac{1}{x_i - x_k}.$$

Then also  $u_k = u_i \pm i$ , so  $u_k = \text{Re}(u) + ik$  form *Bethe strings*, that curve a bit for  $M \rightarrow \infty$  as well. They satisfy (and other equations)

$$2P \int_{\mathcal{C}} dy \frac{\rho(y)}{y - x} = -\frac{1}{x} + 2\pi n_{\mathcal{C}(u)}; \quad x \in \mathcal{C}.$$

## Spin chains and Bethe strings from AdS

• Strings moving in  $S^3 \subset S^5$  defined by  $X^i X^i = 1$ ,  $i = 1, \dots, 4$ , with  $Z = X^1 + iX^2$ ,  $W = X^3 + iX^4$ , and then  $SU(2)$  element

$$g = \begin{pmatrix} Z & W \\ -\bar{W} & \bar{Z} \end{pmatrix}, \text{ and matrix currents}$$

$$j_a = g^{-1} \partial_a g \Rightarrow \text{Tr} (j_a)^2 = -2 \sum_{i=1}^4 (\partial_a X^i)(\partial_a X^i),$$

so the string action in conformal gauge, moving in  $S^3$  is

$$S = -\frac{\sqrt{\lambda}}{4\pi} \int_0^{2\pi} d\sigma \int d\tau \left[ \frac{\text{Tr} (j_a)^2}{2} + (\partial_a X^0)^2 \right].$$

and has as eq. of m.  $\partial_+ j_- + \partial_- j_+ = 0$ . We can then check that

$$\begin{aligned} \partial_+ j_- - \partial_- j_+ + [j_+, j_-] &= 0, \quad J_{\pm} = \frac{j_{\pm}}{1 \mp x} \Rightarrow \\ \partial_+ J_- - \partial_- J_+ + [J_+, J_-] &= 0, \quad \forall x. \end{aligned}$$

• That means that  $J_a$  is a flat connection, with monodromy

$$\Omega(x) \equiv P \exp \left[ - \int_0^{2\pi} d\sigma J_{\sigma} \right] = P \exp \left[ \int_0^{2\pi} d\sigma \frac{1}{2} \left( \frac{j_+}{x-1} + \frac{j_-}{x+1} \right) \right].$$

• Define then

$$\text{Tr } \Omega(x) \equiv 2 \cos p(x) = e^{ip(x)} + e^{-ip(x)} \Rightarrow p(x) \simeq -\frac{\pi\kappa}{x \pm 1} + \dots, \quad x \rightarrow \mp 1$$

$$G(x) \equiv p(x) + \frac{\pi\kappa}{x+1} + \frac{\pi\kappa}{x-1},$$

$$G(x+i0) - G(x-i0) \equiv 2\pi i \rho(x).$$

• Then  $\rho(x)$  satisfies, after rescaling  $x \rightarrow 4\pi Lx/\sqrt{\lambda}$ ,

$$\begin{aligned} 2P \int dy \frac{\rho(y)}{x-y} &= \frac{x}{x^2 - \frac{\lambda}{16\pi^2 L^2}} \frac{\Delta}{L} + 2\pi n_k \\ \int dx \rho(x) &= \frac{M}{L} + \frac{\Delta - L}{2L} \\ \int dx \frac{\rho(x)}{x} &= 2\pi m \\ \frac{\lambda}{8\pi^2 L} \int dx \frac{\rho(x)}{x^2} &= \Delta + L = \frac{\lambda}{8\pi^2} H^{(1\text{-loop})}, \end{aligned}$$

which in the thermodynamic limit  $\lambda/L^2 \rightarrow 0$ ,  $\frac{\Delta-L}{L} \rightarrow 0$ ,  $\frac{\Delta}{L} \rightarrow 1$  gives the same equations as for the Bethe strings. Thus each *Bethe strings* corresponds to an individual macroscopic string in *AdS*.

## Lecture 9

Applications to condensed matter:  
AdS/CMT

- AdS/CMT: phenomenological approach. "Top-down": define some known duality, see if physics matches anything. OR: "bottom-up": construct AdS theory that, given holographic map, would imply wanted properties for the field theory, and then calculate other properties.

### Gravity dual of Lifshitz points

- CMT: usually nonrelativistic. Construct nonrelativistic gravity dual. E.G.: "Lifshitz scaling":

$$t \rightarrow \lambda^z t, \quad \vec{x} \rightarrow \lambda \vec{x}.$$

$z$ =dynamical critical exponent. Model example:

$$\mathcal{L} = \int d^2x dt \left[ (\partial_t \phi)^2 - k(\vec{\nabla}^2 \phi)^2 \right].$$

- Then, phenomenological gravity bgr. for Lifshitz scaling,

$$ds_{d+1}^2 = R^2 \left( -\frac{dt^2}{u^{2z}} + \frac{d\vec{x}^2}{u^2} + \frac{du^2}{u^2} \right)$$

(obs.: geodesically incomplete for  $z \neq 1$  at  $u = \infty$ ) has scaling invariance

$$t \rightarrow \lambda^z t, \quad \vec{x} \rightarrow \lambda \vec{x}, \quad u \rightarrow \lambda u,$$

with generator (Killing vector)

$$D = -i(zt\partial_t + x^i\partial_i + u\partial_u).$$

- Other generators (Killing vectors)

$$M_{ij} = -i(x^i\partial_j - x^j\partial_i); \quad P_i = -i\partial_i; \quad H = -i\partial_t,$$

forming together the Lifshitz algebra,

$$\begin{aligned} [D, H] &= z\partial_t = izH \\ [D, P_i] &= \partial_i = iP_i; \quad [D, M_{ij}] = 0 \\ [M_{ij}, P_k] &= \delta_k^i\partial_j - \delta_k^j\partial_i = i(\delta_k^i P_j - \delta_k^j P_i) \\ [M_{ij}, M_{kl}] &= i(\delta_{ik}M_{jl} - \delta_{jk}M_{il} - \delta_{il}M_{jk} + \delta_{jl}M_{ik}) \\ [P_i, P_j] &= 0. \end{aligned}$$

- The background is a solution to several *relativistic* actions, e.g.,

$$S = \frac{1}{2\kappa_N^2} \int dt d^D x dr \sqrt{-g} \left[ R - 2\Lambda - \frac{1}{4} F_{\mu\nu} F^{\mu\nu} - \frac{1}{2} m^2 A_\mu A^\mu \right],$$

or in non-relativistic gravity, e.g. Horava gravity.

## Gravity dual to Galilean and Schrödinger symmetries

- Larger algebras: *-conformal Galilean algebra*:  $M_{ij}, P_i, H, D$ , but also conserved rest mass, or particle number  $N$  and Galilean boosts

$$t \rightarrow t, \quad x_i \rightarrow x_i - v_i t .$$

- For  $z = 2$ , extra generator  $C$ , special conformal generator: *Schrödinger algebra* (symmetry of the Schrödinger equation of a free particle).
- AdS/CFT realization (geometrical):  $d + 2$ -dimensional gravity dual ( $\xi, u$  extra):

$$ds^2 = R^2 \left( -\frac{dt^2}{u^{2z}} + \frac{d\vec{x}^2}{u^2} + \frac{du^2}{u^2} + \frac{2dt d\xi}{u^2} \right) .$$

- Not time-reversal invariant ( $t \leftrightarrow -t$ ), nonsingular: conformal to pp wave:

$$ds^2 = \frac{R^2}{u^2} \left( -dt^2 u^{2(1-z)} + 2dt d\xi + d\vec{x}^2 + du^2 \right) .$$

- Invariant under scaling

$$t' = \lambda^z t, \quad \vec{x}' = \lambda \vec{x}, \quad u' = \lambda u, \quad \xi' = \lambda^{2-z} \xi ,$$

for generator

$$D = -i(zt\partial_t + x^i\partial_i + u\partial_u + (2-z)\xi\partial_\xi) .$$

- Extra symmetry: Galilean boost  $K_i$ ,

$$\vec{x}' = \vec{x} - vt, \quad \xi' = \xi + \frac{1}{2}(2\vec{v} \cdot \vec{x} - v^2t), \quad K_i = -i(x^i \partial_\xi - t \partial_i).$$

and particle number  $N = -i\partial_\xi$ , so that the (conformal Galilean) algebra is

$$\begin{aligned} [K_i, P_j] &= \delta_{ij} \partial_\xi = i\delta_{ij} N \\ [D, K_i] &= zt \partial_i - x^i \partial_\xi + (2-z)x^i \partial_\xi - t \partial_i = (1-z)iK_i \\ [K_k, M_{ij}] &= t(\delta_{ik} \partial_j - \delta_{jk} \partial_i) + \delta_{jk} x^i \partial_\xi - \delta_{ik} x^j \partial_\xi = i(\delta_{jk} K_i - \delta_{ik} K_j) \\ [K_i, H] &= -\partial_i = -iP_i \\ [D, N] &= (2-z)\partial_\xi = (2-z)iN \\ [K_i, N] &= [H, N] = [P_i, N] = [M_{ij}, N] = 0. \end{aligned}$$

- For  $z = 2$ , extra *special conformal generator*  $C$ , for

$$\begin{aligned} u &\rightarrow (1-at)u, & x^i &\rightarrow (1-at)x^i \\ t &\rightarrow (1-at)t, & \xi &\rightarrow \xi - \frac{a}{2}(\vec{x}^2 + u^2). \end{aligned}$$

Then the extra commutation relations for  $C$  give the Schrödinger algebra,

$$[D, C] = -2iC, \quad [H, C] = -iD, \quad [M_{ij}, C] = 0 = [K_i, C].$$



- String theory realization of Galilean algebra, by "null Melvin twist" on  $AdS_5 \times S^5$  with temperature  $T$ ,

$$ds^2 = r^2 \left[ -\frac{\beta^2 r^2 f(r)}{k(r)} (dt + dy)^2 - \frac{f(r)}{k(r)} dt^2 + \frac{dy^2}{k(r)} + d\vec{x}^2 \right] + \frac{dr^2}{r^2 f(r)} + \frac{(d\psi + A)^2}{k(r)} + d\Sigma_4^2$$

$$f(r) = 1 - \frac{r_+^4}{r^4}, \quad k(r) = 1 + \frac{\beta^2 r_+^4}{r^2}, \quad T = \frac{r_+}{\pi\beta}.$$

- For  $T = 0, k = f = 1$  and KK reducing on  $\psi$  and  $\Sigma_4$  gives  $z = 2$  metric (Schrödinger).

## Spectral functions

- Retarded Green's functions for observables  $\mathcal{O}_A, \mathcal{O}_B$ ,

$$G_{\mathcal{O}_A \mathcal{O}_B}^R(\omega, k) = -i \int d^{d-1}x dt e^{i\omega t - i\vec{k} \cdot \vec{x}} \theta(t) \langle [\mathcal{O}_A(t, x), \mathcal{O}_B(0, 0)] \rangle,$$

describe the time evolution of small pert. about equilibrium, in linear response theory,

$$\delta \langle \mathcal{O}_A \rangle(\omega, k) = G_{\mathcal{O}_A \mathcal{O}_B}^R(\omega, k) \delta \phi_{B(0)}(\omega, k).$$

- Retarded ( $\exists \theta(t)$ )  $\Rightarrow$  2 conditions (close  $\omega$  contour in complex upper-half plane):

- 1)  $G_{\mathcal{O}_A \mathcal{O}_B}^R(\omega, k)$  is analytic in the complex  $\omega$  plane for  $Im(\omega) > 0$ .
- 2)  $G_{\mathcal{O}_A \mathcal{O}_B}^R(\omega, k) \rightarrow 0$  for  $|\omega| \rightarrow 0$ .

- Conditions imply representation as  $\Gamma$  contour integral (real line, closed by semicircle at  $\infty$  in upper-half plane) in  $\zeta$  or  $z$ ,

$$G^R(z) = \oint_{\Gamma} \frac{d\zeta}{2\pi i} \frac{G^R}{\zeta - z},$$

giving the *Kramers-Kronig relations*,

$$\begin{aligned} \text{Re}G^R(\omega) &= P \int_{-\infty}^{+\infty} \frac{d\omega'}{\pi} \frac{\text{Im}G^R(\omega')}{\omega' - \omega} \\ \text{Im}G^R(\omega) &= -P \int_{-\infty}^{+\infty} \frac{d\omega'}{\pi} \frac{\text{Re}G^R(\omega')}{\omega' - \omega}, \end{aligned}$$

and the  $\omega \rightarrow 0$  limit gives a thermodynamic "sum rule" ( $G^R$  both inside and outside the  $f$ ),

$$\chi \equiv \lim_{\omega \rightarrow 0+i0} G_{\mathcal{O}_A \mathcal{O}_B}^R(\omega, x) = \int_{-\infty}^{+\infty} \frac{d\omega'}{\pi} \frac{\text{Im}G_{\mathcal{O}_A \mathcal{O}_B}^R(\omega', x)}{\omega'},$$

while  $\chi$  is a static thermodynamic susceptibility (like  $\chi = \partial D / \partial E$ ),

$$\chi_{AB} = \frac{\partial \langle \mathcal{O}_A \rangle}{\partial \phi_{B(0)}}.$$

- Spectral function for  $\chi_{AB}$  is

$$\chi_A = -\text{Im}G_{\mathcal{O}_A\mathcal{O}_B}^R(\omega, \vec{k}) .$$

- Advanced Green's function

$$G_{\mathcal{O}_A\mathcal{O}_B}^A(t, \vec{x}) = +i\theta(-t)\langle[\mathcal{O}_A(t, \vec{x}), \mathcal{O}_B(0, 0)]\rangle ,$$

and from it the spectral function  $\rho_{\mathcal{O}_A\mathcal{O}_B}(\omega, \vec{k})$ ,

$$\begin{aligned} \rho_{\mathcal{O}_A\mathcal{O}_B}(t, \vec{x}) &= \langle[\mathcal{O}_A(t, \vec{x}), \mathcal{O}_B(0, 0)]\rangle = i(G_{\mathcal{O}_A\mathcal{O}_B}^R(t, \vec{x}) - G_{\mathcal{O}_A\mathcal{O}_B}^A(t, \vec{x})) \Rightarrow \\ \rho_{\mathcal{O}_A\mathcal{O}_B}(\omega, \vec{k}) &= \int d^{d-1}x dt e^{i\omega t - i\vec{k}\cdot\vec{x}} \langle[\mathcal{O}_A(t, \vec{x}), \mathcal{O}_B(0, 0)]\rangle = i(G^R - G^A)(\omega, \vec{k}) , \end{aligned}$$

since

$$\begin{aligned} G^{R,A}(\omega, \vec{k}) &= \int \frac{d\omega'}{2\pi} \frac{\rho(\omega', \vec{k})}{\omega - \omega' \pm i\epsilon} \Rightarrow \\ \text{Re}G^R(\omega, \vec{k}) &= \text{Re}G^A(\omega, \vec{k}) = P \int \frac{d\omega'}{2\pi} \frac{\rho(\omega', \vec{k})}{\omega - \omega'} \\ \text{Im}G^R(\omega, \vec{k}) &= -\text{Im}G^A(\omega, \vec{k}) = -\frac{1}{2}\rho(\omega, \vec{k}). \end{aligned}$$

## Transport

- **Kubo formula for electric conductivity:** In gauge  $A_0 = 0$ , electric field source  $E_j = F_{0j} = -\partial_t \delta A_j$ , in momentum space  $E_j = -i\omega \delta A_{j(0)}$ . Linear response for  $J_x$ :

$$\begin{aligned} \langle J_x \rangle &= \sigma E_x = -i\omega \sigma \delta A_{x(0)} \Rightarrow \\ \sigma(\omega, \vec{k}) &= \frac{iG_{J_x J_x}^R(\omega, \vec{k})}{\omega}. \end{aligned}$$

- The (real part of the) DC conductivity is then

$$\sigma(0, \vec{k}) = - \lim_{\omega \rightarrow 0} \frac{\text{Im} G_{J_x J_x}^R(\omega, \vec{k})}{\omega}.$$

- **Kubo formula for shear viscosity:** Shear viscosity, in relativistic theory  $\rightarrow$  from expansion of  $T_{\mu\nu}$ , solving  $\nabla_\mu T^{\mu\nu} = 0$  as expansion in derivatives. For dissipative fluid, to first nontrivial order,

$$\begin{aligned} T^{\mu\nu} &= \rho u^\mu u^\nu + P P^{\mu\nu} + \Pi_{(1)}^{\mu\nu} \\ &= \rho u^\mu u^\nu + P(g^{\mu\nu} + u^\mu u^\nu) + 2\eta \sigma^{\mu\nu} - \zeta \theta P^{\mu\nu}, \end{aligned}$$

where  $P^{\mu\nu} = g^{\mu\nu} + u^\mu u^\nu$  and  $\sigma^{\mu\nu}, \theta$  are from decomposition of  $\nabla^\nu u^\mu$ , in the Landau frame  $\pi_{(1)}^{\mu\nu} u_\mu = 0$ ,

$$\nabla^\nu u^\mu = -a^\mu u^\nu + \sigma^{\mu\nu} + \omega^{\mu\nu} + \frac{1}{d-1} \theta P^{\mu\nu}$$

$$a^\mu = u^\nu \nabla_\nu u^\mu$$

$$\theta = \nabla_\mu u^\mu = P^{\mu\nu} \nabla_\mu u_\nu$$

$$\sigma^{\mu\nu} = \nabla^\mu u^\nu + \nabla^\nu u^\mu - \frac{1}{d-1} \theta P^{\mu\nu}$$

$$\omega^{\mu\nu} = \nabla^{[\mu} u^{\nu]} + \nabla u^{[\mu} a^{\nu]}$$

• For  $h_{xy}$  perturbation on fluid at rest,

$$\begin{aligned} T_{xy} &= P h_{xy} + \eta \partial_t h_{xy} + \mathcal{O}(h_{xy}^2) + \mathcal{O}(\partial^2 h_{xy}) \Rightarrow \\ T_{xy}(\omega) &= -\eta i \omega h_{xy} + \mathcal{O}(h_{xy}^2) + \mathcal{O}(\partial^2 h_{xy}), \end{aligned}$$

(ignoring  $\delta$  fct. coming from const. term), we get the Kubo formula for shear viscosity,

$$\eta(\omega, \vec{k}) = \frac{i G_{T_{xy} T_{xy}}^R(\omega, \vec{k})}{\omega},$$

or, for the (real part of the) static shear viscosity,

$$\eta(0, \vec{0}) = - \lim_{\omega \rightarrow 0} \frac{\text{Im} G_{T_{xy} T_{xy}}^R(\omega, \vec{0})}{\omega}.$$

- **AdS/CFT in Minkowski space at finite temperature** Son, Starinets, 2002. If we can write the on-shell sugra action in asympmt. AdS space as a function of the *boundary value*  $\phi_{(0)}$  as the boundary term

$$S_{\text{on-shell}} = \int \frac{d^d k}{(2\pi)^d} \phi_0(-\vec{k}) \mathcal{F}(\vec{k}, z) \phi_0(\vec{k}) \Big|_{z=z_B}^{z=z_H},$$

the the prescription for the retarded Green's function is

$$G^R(\vec{k}) = -2\mathcal{F}(\vec{k}, z)|_{z=z_B}.$$

- **Equivalent formulation:**  $S_{\text{ren.}} = S[\partial_\mu \phi] + S_{\text{boundary}}$ , so

$$\langle \mathcal{O} \rangle = \lim_{z \rightarrow 0} \left( \frac{R}{z} \right)^\Delta \frac{1}{\sqrt{\gamma}} \left( -\frac{\delta S[\phi_{(0)}]}{\delta \partial_z \phi_{(0)}(z)} - \frac{\delta S_{\text{boundary}}}{\delta \phi_{(0)}(z)} \right),$$

while we saw

$$S_{\text{boundary}} = \frac{\Delta - d}{2R} \int_{z \rightarrow 0} d^d x \sqrt{\gamma} \phi^2$$

$$\phi(z) = \left( \frac{z}{R} \right)^{d-\Delta} \phi_{(0)} + \left( \frac{z}{R} \right)^\Delta \phi_{(2\Delta-d)} + \dots,$$

•Then:

$$\begin{aligned}
 \langle \mathcal{O} \rangle &= - \lim_{z \rightarrow 0} \left( \frac{R}{z} \right)^\Delta \left[ \frac{z}{R} \partial_z \phi |_{\phi(0)=0} + \frac{\Delta - d}{2R} 2\phi |_{\phi(0)=0} \right] \\
 &= - \frac{2\Delta - d}{R} \phi(2\Delta - d) \Rightarrow \\
 G_{\mathcal{O}_A \mathcal{O}_B}^R &= \frac{\delta \langle \mathcal{O}_A \rangle}{\delta \phi_{B(0)} |_{\delta \phi(0)=0}} = - \frac{2\Delta_A - d}{R} \frac{\delta \phi_{A(2\Delta - d)}}{\delta \phi_{B(0)}}.
 \end{aligned}$$

**Kubo relations for other transport properties:** For  $\mu \neq 0$ , so charge density  $\rho \neq 0$ , heat and electric currents mix, so

$$\begin{pmatrix} \langle J_x \rangle \\ \langle Q_x \rangle \end{pmatrix} = \begin{pmatrix} \sigma & \alpha T \\ \alpha T & \bar{\kappa} T \end{pmatrix} \begin{pmatrix} E_x \\ -\frac{\nabla_x T}{T} \end{pmatrix}.$$

•Then similarly, Kubo formulae:

$$\begin{aligned}
 \alpha(\omega) T &= i \frac{G_{Q_x J_x}^R(\omega)}{\omega} \\
 \bar{\kappa}(\omega) T &= i \frac{G_{Q_x Q_x}^R(\omega)}{\omega}.
 \end{aligned}$$

**Viscosity over entropy density from dual black holes:** Witten metric (AdS-BH in Poincaré c.):

$$ds^2 = \frac{r^2}{R^2} \left( - \left( 1 - \frac{r_0^4}{r^4} \right) dt^2 + d\vec{x}_3^2 \right) + \frac{R^2}{r^2} \frac{dr^2}{1 - \frac{r_0^4}{r^4}},$$

and change coordinates  $u = r_0^2/r^2$  so that

$$ds^2 = \frac{r_0^2}{R^2} \frac{1}{u} (-f(u) dt^2 + d\vec{x}_3^2) + \frac{R^2}{4} \frac{du^2}{u^2 f(u)}; \quad f(u) = 1 - u^2,$$

giving a perturbation

$$h_{xy}(\vec{x}, u) = \frac{r_0^2}{R^2 u} e^{-i\omega t + i\vec{q} \cdot \vec{x}} \phi_q(u),$$

and vary  $\phi_{A(2\Delta-d)}$  in the exact solution w.r.t. it. But: hard. Instead,  $\eta$  at horizon  $\simeq$  at boundary, so calculate approx. sol. at horizon,

$$\phi_q^\pm = \phi_0 (1 - u)^{\pm i \frac{\omega}{4\pi T}},$$

and selecting infalling sols. ("−"), we find

$$G^R(\omega, \vec{k}) = -2\mathcal{F}(\omega, \vec{k}, u)_{u=1} \Rightarrow$$

$$\eta = - \lim_{\omega \rightarrow 0} \frac{\text{Im} G^R(\omega, \vec{0})}{\omega} = \frac{r_0^3/R^3}{16\pi G_{N,5}} = \frac{\pi}{8} N^2 T^3.$$



- Since  $s = \pi^2/2N^2T^3$ , we find (conjectured to be lower bound, but it is not)

$$\frac{\eta}{s} = \frac{1}{4\pi}.$$

**The holographic superconductor** Gubser, 2008; Hartnoll, Herzog, Horowitz, 2008

- Ingredients: a)  $AdS_4$  background: CFT near transition point. High  $T_c$  superconductors (non-Fermi liquids) are 2+1d. b) charge transport: conserved  $U(1)$   $J_\mu$ , dual to  $A_\mu$ . c) Temperature, so black hole in  $AdS_4$ . d) symmetry breaking, so  $\langle \mathcal{O} \rangle \neq 0$ , for a complex field charged under  $U(1)$ .  $s$  wave superconductors  $\Rightarrow$  charged scalar  $\psi$ .
- Lagrangian for gravity theory ( $d = 3$ )

$$\mathcal{L} = \frac{1}{2\kappa^2} \left( R + \frac{d(d-1)}{R^2} \right) - \frac{1}{4g^2} F_{\mu\nu}^2 - |(\partial_\mu - iqA_\mu)\psi|^2 - m^2\psi^2 - V(\psi),$$

for  $V = 0$ ,  $m^2R^2 \geq -\frac{d^2}{4R^2} = -9/4$  (BF bound) (scalar stable at  $\infty$ ).

- We want  $\psi \neq 0$  near BH horizon, for  $T < T_c$ , and  $\psi = 0$ ,  $T > T_c$ .

- Superconducting ansatz:

$$ds^2 = g_{tt}(r)dt^2 + g_{rr}(r)dr^2 + ds_2^2(r), \quad A_\mu dx^\mu = \Phi(r)dt, \quad \psi = \psi(r).$$

- Then we obtain an *effective mass* in  $\mathcal{L}$ ,

$$-|(\partial_\mu - iqA_\mu)\psi|^2 - m^2|\psi|^2 \rightarrow -g^{rr}|\partial_r\psi|^2 - m_{\text{eff}}^2|\psi|^2, \quad m_{\text{eff}}^2 = m^2 + g^{tt}q^2\Phi^2,$$

but we want  $\Phi = 0$  at horizon, yet  $m_{\text{eff}}^2 < -9/4$  (BF bound), so unstable at horizon. The scalar operator VEV is

$$\langle \mathcal{O} \rangle = \frac{2\Delta - d}{R} \psi_{(2\Delta-d)},$$

so we need a normalizable mode  $\psi_{(2\Delta-d)} \neq 0$  for  $T < T_c$ .

- Two possible backgrounds: AdS-Reissner-Nordstrom (Gubser),

$$ds^2 = -f(r)dt^2 + \frac{dr^2}{f(r)} + r^2 d\Omega_{2,k}^2, \quad f(r) = k - \frac{2M}{r} + \frac{Q^2}{4r^2} + \frac{r^2}{R^2}$$

$$\Phi(r) = \frac{Q}{r} - \frac{Q}{r_H}, \quad \psi = 0,$$

or neutral AdS-BH (Hartnoll, Herzog, Horowitz),  $k = 0$ , so  $d\Omega_{2,k}^2 = dx^2 + dy^2$ , and  $Q = 0$ , so

$$f(r) = \frac{r^2}{R^2} - \frac{2M}{r}, \quad \Phi = \psi = 0.$$

- The scalar  $\psi$  is a probe in background. Boundary conditions

$$\psi = \frac{\psi^{(1)}}{r} + \frac{\psi^{(2)}}{r^2} + \dots, \quad \Phi = \mu - \frac{\rho}{r} + \dots,$$

- but both  $\psi_1, \psi_2$  normalizable. Then, condensates

$$\langle \mathcal{O}_i \rangle = \sqrt{2} \psi^{(i)}, \quad i = 1, 2.$$

and numerically, one finds near  $T \simeq T_c$ ,

$$\begin{aligned} \langle \mathcal{O}_1 \rangle &\simeq 9.3 T_c (1 - T/T_c)^{1/2} \\ \langle \mathcal{O}_2 \rangle &\simeq 144 T_c^2 (1 - T/T_c)^{1/2}, \quad T \simeq 0.118 \sqrt{\rho}. \end{aligned}$$

- **Effective mass at horizon:** needs to be smaller than BF bound *at horizon*, for instability.

$$m_{\text{eff}}^2 = m^2 - \frac{\gamma^2 q^2}{2R^2} < m^2, \quad \gamma^2 = \frac{g^2 2R^2}{\kappa_{N,4}^2}.$$

- Horizon:  $AdS_2 \times S^2$ , with  $AdS_2$  BF bound  $m^2 R_2^2 = m^2 R^2 / 6 \geq -1/4$  (stronger than at infinity, where  $m^2 R^2 \geq -9/4$ ).

- Electric conductivity: Perturbation  $\delta A_x = \delta A_x(r)e^{-i\omega t}$ , such that at boundary,

$$\delta A_x = \delta A_x^{(0)} + \frac{\langle J_x \rangle}{r} + \dots,$$

where  $\langle J_x \rangle = \delta A_x^{(1)}$  is the normalizable mode. Then

$$\sigma(\omega) = \frac{\langle J_x \rangle}{E_x} = -i \frac{\langle J_x \rangle}{\omega \delta A_x} = -i \frac{\delta A_x^{(1)}}{\omega \delta A_x^{(0)}},$$

and numerically, one finds a mass gap:  $\sigma = 0$  for  $\omega < \omega_g$ , and

$$\omega_g \approx (q\langle \mathcal{O} \rangle)^{\frac{1}{\Delta}}, \quad \frac{\omega_g}{T_c} \simeq 8.4,$$

approx. matching exp. data. for high  $T_c$  supercond.

- BUT: weakly coupled supercond.  $\omega_g = 2E_g$  ( $E_g$  = energy gap in charged spectrum), while for high  $T_c$  (strongly coupled),  $E_g \neq \omega_g/2$ . Holographic: true, *except* for  $\Delta = 1$  or  $2$ , when  $E_g = \omega_g/2$ . Puzzle!

## Transport properties in strongly coupled systems via AdS/CFT

- Region (“membrane”) near black hole horizon in gravity dual → has fluid properties (gravity/fluid correspondence): “membrane paradigm”.
- Membrane paradigm → calculation: quantities are  $r$ -indep. (should be calculated at  $\infty$ , but calculated at horizon). Linear response to perturbations of background  $\Rightarrow$  transport.
- Calculate electric and heat conductivities (AdS/CFT: either Kubo formulas, or membrane paradigm: at the horizon)

$$\begin{aligned} j_i &= \sigma_{ij} E^j - \alpha_{ij} (\nabla_j T) \\ Q_i &= T \alpha_{ij} - \bar{\kappa}_{ij} \nabla_j T, \quad \kappa_{ij} = \bar{\kappa}_{ij} - T \alpha_{ik} (\sigma^{-1})_{kl} \alpha_{lj}. \end{aligned}$$

- Also, effect of other parameters on transport ( $\eta, \zeta$  for fluid, for instance). But we have 
$$\begin{pmatrix} \sigma & \alpha \\ \alpha T & \bar{\kappa} \end{pmatrix} = D \chi_s,$$

where  $D =$  diffusivity matrix,  $\chi_s =$  susceptibility matrix, obtained from thermod. pot.  $\Omega$  (and then we can derive  $D$ ),

$$\chi_s = \begin{pmatrix} -\frac{1}{V} \frac{\partial^2 \Omega}{\partial \mu^2} \Big|_{B,T} & -\frac{1}{V} \frac{\partial^2 \Omega}{\partial T \partial \mu} \Big|_B \\ -\frac{T}{V} \frac{\partial^2 \Omega}{\partial \mu \partial T} \Big|_B & -\frac{T}{V} \frac{\partial^2 \Omega}{\partial T^2} \Big|_{B,\mu} \end{pmatrix},$$

## Transport properties of strongly coupled 2+1d CFTs from properties of 4d AdS-black hole solutions

- Gravity theory in 4d: + scalars (dilaton  $\phi$ , axions  $\chi_1, \chi_2$ ) + electromagnetic ( $A_\mu \Rightarrow F_{\mu\nu}$ ) (e.g., L. Alejo, P. Goulart, HN, 2019; D. Melnikov, HN, 2021)

$$S = \int d^4x \sqrt{-g} \left[ \frac{1}{16\pi G_N} \left( R - \frac{1}{2} [(\partial\phi)^2 + \Phi(\phi) ((\partial\chi_1)^2 + (\partial\chi_2)^2)] - V(\phi) \right) - \frac{Z(\phi)}{4g_4^2} F_{\mu\nu}^2 - W(\phi) F_{\mu\nu} \tilde{F}^{\mu\nu} \right].$$

- Background solution: black hole  $\Rightarrow$  has event horizon at  $r = r_H$ .  $\chi_1 = k_1 x$ ,  $\chi_2 = k_2 y$  breaks translational invariant in 2 spatial directions of field theory.

$$ds^2 = -U(r)(dt + B_1 y dx)^2 + \frac{dr^2}{U(r)} + e^{2V(r)}(dx^2 + dy^2)$$

$$A_t = a(r), \quad A_x = -B y + (a(r) - \mu) B_1 y$$

$$\chi_1 = k_1 x, \quad \chi_2 = k_2 y, \quad \phi = \phi(r)$$

- Event horizon:  $U(r_H) = 0$ ,  $U(r) \simeq (r - r_H)U'(r_H)$ , temperature  $T = \frac{U'(r_H)}{4\pi}$ .
- 4d  $A_x = -By$  source gives magnetic field  $B$  in 2+1d dimensions.  $B_1$  generates energy magnetization density,  $M_E = -\frac{1}{\text{Vol}} \frac{\partial S_E}{\partial B_1} \Big|_{B_1=0}$ ,  $\mu$ =chemical potential.
- Then, add perturbations  $(-E + \xi a(r))t$  in  $A_x$  and  $-\xi t U(r)$  in  $g_{tx}$ , where  $E_i = E\delta_{ix}$  and  $\frac{1}{T}\nabla_i T = \xi\delta_{ix}$  is field perturbation  $\Rightarrow$  generate response,  $\delta$  fields, in order to satisfy eqs. of motion.
- Membrane paradigm:  $r$ -indep. (electric) currents

$$\mathcal{J}^x = \frac{Z(\phi)}{g_4^2} \sqrt{-g} F^{xr} + 4\sqrt{-g} W(\phi) \tilde{F}^{xr},$$

$$\mathcal{J}^y = \frac{Z(\phi)}{g_4^2} \sqrt{-g} F^{yr} + 4\sqrt{-g} W(\phi) \tilde{F}^{yr} - \xi M(r),$$

but at  $\infty$ ,  $M(r) = M$ , and we obtain the usual transport currents,

$$\mathcal{J}^i(r = r_H) = \mathcal{J}^i(r \rightarrow \infty) = j^{i(\text{tot})} - \xi M = j^i,$$

while at  $r_H$  easier to calculate. Similar for heat currents.

- Then: Find currents as functions of  $E, \xi$ : e.g.,  $j_x$  from  $\delta g_{tx}, \delta A_x, \delta h_{ry}$ , related from the eqs. of motion to  $E$  and  $\xi = \frac{|\vec{\nabla} T|}{T}$ .

- Then, derive the transport coefficients:

$$\begin{aligned}
\sigma_{xx} &= \left. \frac{e^{2V} k^2 \Phi (2\kappa_4^2 g_4^4 \rho^2 + 2\kappa_4^2 B^2 Z^2 + g_4^2 Z e^{2V} k^2 \Phi)}{4\kappa_4^4 g_4^4 B^2 \rho^2 + (2\kappa_4^2 B^2 Z + g_4^2 e^{2V} k^2 \Phi)^2} \right|_{r_H}, \\
\sigma_{xy} &= 4\kappa_4^2 B \rho \left. \frac{\kappa_4^2 g_4^4 \rho^2 + \kappa_4^2 B^2 Z^2 + g_4^2 Z e^{2V} k^2 \Phi}{4\kappa_4^4 g_4^4 B^2 \rho^2 + (2\kappa_4^2 B^2 Z + g_4^2 e^{2V} k^2 \Phi)^2} - 4W \right|_{r_H}, \\
\alpha_{xx} &= \left. \frac{2\kappa_4^2 g_4^4 s \rho e^{2V} k^2 \Phi}{4\kappa_4^4 g_4^4 B^2 \rho^2 + (2\kappa_4^2 B^2 Z + g_4^2 e^{2V} k^2 \Phi)^2} \right|_{r_H}, \\
\alpha_{xy} &= 2\kappa_4^2 s B \left. \frac{2\kappa_4^2 g_4^4 \rho^2 + 2\kappa_4^2 B^2 Z^2 + g_4^2 Z e^{2V} k^2 \Phi}{4\kappa_4^4 g_4^4 B^2 \rho^2 + (2\kappa_4^2 B^2 Z + g_4^2 e^{2V} k^2 \Phi)^2} \right|_{r_H}, \\
\frac{\bar{\kappa}_{xx}}{T} &= (2\kappa_4^2) s^2 \frac{g_4^2 [(2\kappa_4^2) B^2 Z + g_4^2 e^{2V} k^2 \Phi]}{(2\kappa_4^2)^2 g_4^4 \rho^2 B^2 + ((2\kappa_4^2) B^2 Z + g_4^2 e^{2V} k^2 \Phi)^2}, \\
\frac{\bar{\kappa}_{xy}}{T} &= (2\kappa_4^2) s^2 \frac{g_4^2 (2\kappa_4^2) g_4^2 \rho B}{(2\kappa_4^2)^2 g_4^4 \rho^2 B^2 + ((2\kappa_4^2) B^2 Z + g_4^2 e^{2V} k^2 \Phi)^2}.
\end{aligned}$$

- Here  $\rho = -Z e^{2V} a'$  is field theory charge density ( $A_t = a(r) \simeq a'(r_H)(r - r_H) \propto \rho$ ).

- Find interesting properties of strongly coupled transport, like S-duality, part of  $Sl(2, \mathbb{Z})$  group.



- S-duality acting on  $\sigma \equiv \sigma_{xy} + i\sigma_{xx}$  as  $\sigma \rightarrow \sigma' = -\frac{1}{\sigma}$ , or  $\sigma'_{xx} = \frac{\sigma_{xx}}{\sigma_{xx}^2 + \sigma_{xy}^2} = \rho_{xx}$ ,  $\sigma'_{xy} = -\frac{\sigma_{xy}}{\sigma_{xx}^2 + \sigma_{xy}^2} = \rho_{xy}$ .
- At  $\rho = B = 0$ ,  $\Phi$  finite,  $\sigma_{xx} = Z(r_H)$ ,  $\sigma_{xy} = -4W(r_H) \Rightarrow$  transformation on  $Z, W$  that leaves gravitational action invariant:

$$F_{\mu\nu} \rightarrow Z(\phi)\tilde{F}_{\mu\nu} - \bar{W}(\phi)F_{\mu\nu} \equiv Z(\phi)\frac{1}{2}\epsilon_{\mu\nu\rho\sigma}F^{\rho\sigma} - \frac{W(\phi)}{4}$$

$$Z(\phi) \rightarrow -\frac{Z(\phi)}{Z(\phi)^2 + \bar{W}(\phi)^2}, \quad \bar{W}(\phi) \rightarrow \frac{\bar{W}(\phi)}{Z(\phi)^2 + \bar{W}(\phi)^2}.$$

- Transport formulas match 2+1d CMT strongly coupled model for near-transition supercond.-insulator of Hartnoll, Kovtun, Muller, Sachdev (2007), for  $\omega \rightarrow \omega + \frac{i}{\tau_{\text{imp}}} \rightarrow \frac{e^2 V k^2}{2\kappa_4^2 s T} \Phi$ .
  - S-duality extended; also  $\rho \rightarrow B$ ,  $B \rightarrow -\rho$ .
  - Translational invariance breaking  $\lambda \propto \Phi$  acts as an RG scale for an RG flow.  $\sigma_Q = \frac{Z(r_H)}{g_4^2}$  is the critical point (UV) conductivity.
  - A generalized Wiedemann-Franz law  $L = \frac{\kappa_{xy}/T}{\sigma_{xy}} \rightarrow \frac{\pi^2}{3} c \frac{g_4^2}{Z} + \mathcal{O}(T)$ .
- Also  $L_{xx} = \frac{\kappa_{xx}/T}{\sigma_{xx}} = L$  if  $B = 0$ ,  $\Phi \neq 0$ , but very small.

- Toy model in 3d: ABJM model: 3d  $\mathcal{N} = 6$  susy CS gauge theory with group  $SU(N) \times SU(N)$ , gauge fields  $A_\mu, \tilde{A}_\mu$ , 4 complex bifundamental scalars  $C^I$ , 4 fermions  $\psi^I$ ,  $I = 1, 2, 3, 4.$ , in the global R-symmetry group  $SU(4) = SO(6)$  (full R-symm.  $SU(4) \times U(1)$ ), with

$$S = \int d^{2+1}x \left[ \frac{k}{4\pi} \epsilon^{\mu\nu\rho\sigma} \text{Tr} \left( A_\mu \partial_\nu A_\rho + \frac{2i}{3} A_\mu A_\nu A_\rho - \hat{A}_\mu \partial_\nu \hat{A}_\rho - \frac{2i}{3} \hat{A}_\mu \hat{A}_\nu \hat{A}_\rho \right) - \text{Tr} (D_\mu C_I^\dagger D^\mu C^I) - i \text{Tr} (\psi^{I\dagger} \gamma^\mu D_\mu \psi_I) + V_6(C^I) + \text{Tr} (CC^\dagger \psi \psi^\dagger \text{ term}) \right],$$

and  $\mathcal{N} = 6$  enhanced to  $\mathcal{N} = 8$  for  $k = 1$  or  $N = 2$ .  $\exists$  mass deformation that preserves  $\mathcal{N} = 6$ .

- Gravity dual of ABJM: string theory in  $AdS_4 \times \mathbb{CP}^3$ , obtained as  $\mathbb{CP}^3 = S^7 / \mathbb{Z}_k$  for  $k \rightarrow \infty$ .
- $S^7$  defined by constraint  $\sum_{i=1}^4 |Z^i|^2 = 1$ , obtained as a Hopf fibration with fiber  $S^1$ , over  $\mathbb{CP}^3$ ,  $S^1$  fiber: phase  $Z^i \rightarrow e^{i\alpha} Z^i, i = 1, \dots, 4$ . Action of  $\mathbb{Z}_k$ :  $Z^i \rightarrow e^{\frac{2\pi i n}{k}} Z^i, n = 0, 1, \dots, k - 1$ .
- ABJM at finite temperature:  $AdS_4$ -BH,  $\times \mathbb{CP}^3$ . Hence toy model for 3d CFTs.

# Lecture 10

## Applications to QCD

- Two large classes of models: "top-down" (dualities derived from decoupled systems of branes) and "bottom-up" (phenomenological models: cook up a gravity dual with desired properties).

## Top-down models

- **Finite temperature (Witten) model:** toy model for  $QCD_3$  (pure glue)

$$\begin{aligned}
 ds^2 &= \left( \frac{\rho^2}{R^2} - \frac{R^{n-2}}{\rho^{n-2}} \right) d\tau^2 + \frac{d\rho^2}{\frac{\rho^2}{R^2} - \frac{R^{n-2}}{\rho^{n-2}}} + \rho^2 \sum_{i=1}^{n-1} dx_i^2 \Rightarrow \\
 ds^2 &= \frac{r^2}{R^2} \left[ -dt^2 \left( 1 - \frac{r_0^n}{r^n} \right) + d\vec{y}_{(n-1)}^2 \right] + R^2 \frac{dr^2}{r^2 \left( 1 - \frac{r_0^n}{r^n} \right)},
 \end{aligned}$$

for  $n = 3$ , and adding  $S^5$  metric. It satisfies the minimal ingredients and general features for QCD-like duals.

- **Cut-off  $AdS_5$ : modified "hard-wall"**. Cut-off at  $r_{\min} = R^2 \Lambda_{\text{QCD}}$ .

- **Improvement:** cut-off dynamical, as D-brane at  $r_{\min}$ . Then, modes on D-brane: source pion-like operators. Position: model for the pion, for a precise version of the Froissart bound saturation (with  $m_\pi$  in it).

● **Polchinski-Strassler solution:** gravity dual of  $\mathcal{N} = 1^*$  SYM = massive def. of  $\mathcal{N} = 4$  SYM. Toy model for  $\mathcal{N} = 1$  SYM and QCD. Brane config.: D3-branes "polarizing" ("puffing up", extra space appears) due to nonzero flux. Mass gap appears similarly to finite temp.  $AdS_5 \times S^5$ .

$$ds_{\text{string}}^2 = Z_x^{-1/2} d\vec{x}_{3+1}^2 + Z_y^{1/2} (dy^2 + y^2 d\Omega_y^2 + dw^2) + Z_\Omega^{1/2} w^2 d\Omega_w^2$$

$$Z_x = Z_y = Z_0 = \frac{R^4}{\rho_+^2 \rho_-^2}; \quad Z_\Omega = Z_0 \left[ \frac{\rho_-^2}{\rho_-^2 + \rho_c^2} \right]^2$$

$$\rho_\pm = (y^2 + (w \pm r_0)^2)^{1/2}; \quad R^4 = 4\pi g_s N; \quad \rho_c = \frac{2g_s r_0 \alpha'}{R^2}; \quad r_0 = \pi \alpha' m N$$

$$e^{2\Phi} = g_s^2 \frac{\rho_-^2}{\rho_-^2 + \rho_c^2}.$$

● Metric goes over to  $AdS_5 \times S^5$  at large  $\rho = \rho_- \simeq \rho_+$ . Near-core is  $\rho \sim r_0$ : typical warp factor  $Z^{1/2}$  finite.

● **Klebanov-Strassler solution:**  $\mathcal{N} = 1$  susy  $SU(N+M) \times SU(N)$ , with two chiral bifundamental  $A_1, A_2$  in  $(N+M, \bar{N})$  and two  $B_1, B_2$  in  $(\bar{(N+M)}, N)$ . Brane config.:  $M$  "fractional D3-branes" on a conifold point in the near horizon.

• Has "duality cascade": Apply "Seiberg duality (strongly c.  $SU(N_c)$  with  $N_f$  flavors into weakly c.  $SU(N_f - N_c)$  with  $N_f$  flavors). Reduce thus gauge group, successively:  $SU(N + M) \times SU(N) \rightarrow SU(N) \times SU(N - M) \rightarrow \dots$  minimum groups, at different energy scale  $\Rightarrow$  cascade. Metric:

$$ds_{10}^2 = h^{-1/2}(\tau) d\vec{x}^2 + h^{1/2}(\tau) ds_6^2$$

$$ds_6^2 = \frac{1}{2} \epsilon^{4/3} K(\tau) \left[ \frac{1}{3K^3(\tau)} (d\tau^2 + (g_5)^2) + \cosh^2\left(\frac{\tau}{2}\right) ((g_3)^2 + (g_4)^2) + \sinh^2\left(\frac{\tau}{2}\right) ((g_1)^2 + (g_2)^2) \right]$$

$$K(\tau) = \frac{(\sinh(2\tau) - 2\tau)^{1/3}}{2^{1/3} \sinh \tau}$$

$$h(\tau) = \alpha \frac{2^{2/3}}{4} \int_{\tau}^{\infty} dx \frac{x \coth x - 1}{\sinh^2 x} (\sinh(2x) - 2x)^{1/3}.$$

• At large  $\tau$ , log-corrected  $AdS_5 \times T^{1,1}$ , in terms of  $r \sim [\epsilon^2 e^{\tau}]^{1/3}$ ,

$$ds^2 = h^{-1/2}(r) d\vec{x}^2 + h^{1/2}(r) (dr^2 + r^2 ds_{T^{1,1}}^2)$$

$$h(r) \sim \frac{(g_s M)^2 \ln(r/r_s)}{r^4}$$

$$ds_{T^{1,1}}^2 = \frac{1}{9} \left( d\psi^2 + \sum_{i=1,2} \cos \theta_i d\phi_i \right)^2 + \frac{1}{6} \sum_{i=1,2} (d\theta_i^2 + \sin^2 \theta_i d\phi_i^2)$$

$$= \frac{1}{9} (g_5)^2 + \sum_{i=1}^4 (g_i)^2.$$



- Dilaton approx. const.,  $\phi = \phi_0$ . Again, log-corrected  $AdS_5 \times X_5$ .
- Log correction related to renormalization of QFT = running coupling const.
- In the QFT IR, at small  $\tau$ , metric terminates smoothly and warp factor  $a_0^{1/2}$  remains finite,

$$ds^2 = a_0^{-1/2} d\vec{x}^2 + a_0^{1/2} \left( \frac{d\tau^2}{2} + d\Omega_3^2 + \frac{\tau^2}{4} ((g_1)^2 + (g_2)^2) \right).$$

- **Maldacena-Núñez solution:** 4d  $\mathcal{N} = 1$  SYM + massive modes. Brane config.: type IIB NS5-branes (S-dual to D5-branes) wrapped on  $S^2$ . String frame metric and dilaton:

$$ds_{10}^2 = ds_{7,string}^2 + \alpha' N \frac{1}{4} (\tilde{w}^a - A^a)^2$$

$$H = N \left[ -\frac{11}{46} \epsilon_{abc} (\tilde{w}^a - A^a) \wedge (\tilde{w}^b - A^b) \wedge (\tilde{w}^c - A^c) + \frac{1}{4} F^a \wedge (\tilde{w}^a - A^a) \right]$$

$$ds_{7,string}^2 = d\vec{x}_{3+1}^2 + \alpha' N [d\rho^2 + R^2(\rho) d\Omega_2^2]$$

$$A = \frac{1}{2} [\sigma^1 a(\rho) d\theta + \sigma^2 a(\rho) \sin \theta d\phi + \sigma^3 \cos \theta d\phi]; \quad a(\rho) = \frac{2\rho}{\sinh 2\rho}$$

$$R^2(\rho) = \rho \coth(2\rho) - \frac{\rho^2}{\sinh^2(2\rho)} - \frac{1}{4}$$

$$e^{2\phi} = e^{2\phi_0} \frac{2R(\rho)}{\sinh(2\rho)}.$$



- 10d sol.: uplift sol. of  $\mathcal{N} = 1$  7d sugra on  $S^3$  transverse to 5-branes.  $\tilde{w}^a$ : left-inv. forms on  $S^3$ . D5-brane metric is S-dual:  $\phi \rightarrow \phi_D = -\phi$ ,  $g_{\mu\nu}^E \rightarrow g_{\mu\nu}^E$ , so:

$$ds_{\text{string}}^2 = e^{\phi_D} \left[ dx_{(4)}^2 + \alpha' N \left( d\rho^2 + R^2(\rho) d\Omega_2^2 + \frac{1}{4} \sum_a (\tilde{w}^a - A^a)^2 \right) \right]$$

$$e^{2\phi_D} = e^{2\phi_{D,0}} \frac{\sinh(2\rho)}{2R(\rho)}.$$

- QCD string tension  $T_s = \frac{e^{\phi_{D,0}}}{2\pi\alpha'}$ , and  $M_{\text{glueballs}}^2 \sim M_{KK}^2 \sim \frac{1}{R_2^2} \sim \frac{1}{N\alpha'}$ , so decoupling of KK states would mean  $T_s \ll M_{KK}^2 \rightarrow e^{\phi_{D,0}} N \ll 1$ .

- BUT: sugra approx.  $\rightarrow$  curvature small in string units  $\rightarrow e^{\phi_{D,0}} N \gg 1$ : opposite. So can't decouple KK modes.

- UV of QFT:  $\rho \rightarrow \infty$ ,

$$R^2 \simeq \rho; \quad a \simeq 2\rho e^{-2\rho}; \quad \phi \simeq \phi_0 - \rho + \frac{\log \rho}{4} \Rightarrow$$

$$ds^2 = d\vec{x}_{3+1}^2 + \alpha' N \left[ d\rho^2 + \rho d\Omega_2^2 + \frac{1}{4} (\tilde{w}^a - A^a)^2 \right]$$

$$= d\vec{x}_{3+1}^2 + \alpha' N \left[ \frac{dz^2}{z^2} + (-\log z) d\Omega_2^2 + \frac{1}{4} (\tilde{w}^a - A^a)^2 \right].$$

• But dilaton nontrivial, so is actually equiv. to log-corrected  $AdS_5 \times X_5$ :

$$S = \frac{1}{2\kappa_N^2} \int d^5x \sqrt{-g_5} \left( \int_{X_5} \sqrt{g_{X_5}} \right) g^{\mu\nu} e^{-2\phi} [R_{\mu\nu} - \partial_\mu X \partial_\nu X + \dots],$$

$$ds^2 = e^{2A(\rho)} d\vec{x}_{3+1}^2 + d\rho^2 + ds_{X_5}^2 = e^{2A(z)} d\vec{x}_{3+1}^2 + \frac{dz^2}{z^2} + ds_{X_5}^2 \Rightarrow$$

$$S = \frac{1}{2\kappa_N^2} \int d^4x d\rho \left( \int_{X_5} \sqrt{g_{X_5}} \right) e^{2(A-\phi)} \delta^{\mu\nu} [R_{\mu\nu} - \partial_\mu X \partial_\nu X + \dots],$$

so the condition for log-corr.  $AdS_5 \times X_5$  is in fact

$$\phi - \phi_0 - A \xrightarrow{\rho \rightarrow \infty} -\rho (+ \text{log corrections}) = + \log z (+ \text{corrections}),$$

and is satisfied ( $A = 0$ ,  $\phi = \phi_0 - \rho + \dots = \phi_0 + \log z + \dots$ ). So UV: OK.

• IR of QFT: at  $\rho \rightarrow 0$ , the *effective* warp factor  $e^{2(A-\phi)}$  is constant,

$$R^2 = \rho^2 + \mathcal{O}(\rho^4); \quad a = 1 + \mathcal{O}(\rho^2); \quad \phi = \phi_0 + \mathcal{O}(\rho^2).$$

• **Maldacena-Nāstase solution:** analog of Maldacena-Núñez for 3d: 3d  $\mathcal{N} = 1$  SYM, with a Chern-Simons coupling, coupled to other massive modes. Brane config.: NS5-branes wrapped on  $S^3$ . CS level  $k$ : gravity dual  $k = N/2$ . Index comp.:  $\exists$  unique vacuum, confining. Solution:

$$ds_{10}^2 = ds_{7,string}^2 + \alpha' N \frac{1}{4} (\tilde{w}^a - A^a)^2$$

$$H = N \left[ -\frac{11}{46} \epsilon_{abc} (\tilde{w}^a - A^a) \wedge (\tilde{w}^b - A^b) \wedge (\tilde{w}^c - A^c) + \frac{1}{4} F^a \wedge (\tilde{w}^a - A^a) \right] + h$$

$$ds_{7,string}^2 = d\vec{x}_{2+1}^2 + \alpha' N [d\rho^2 + R^2(\rho) d\Omega_3^2]$$

$$A = \frac{w(\rho) + 1}{2} w_L^a$$

$$h = N [w^3(\rho) - 3w(\rho) + 2] \frac{1}{166} \epsilon_{abc} w^a \wedge w^b \wedge w^c ,$$

$w^a$  are left-inv. forms on  $S^3$  for  $d\Omega_3^2$ ,  $\tilde{w}^a$  are same for transverse  $\tilde{S}^3$  and  $w(\rho), R(\rho), \phi(\rho)$  are found numerically.

• QFT UV: large  $\rho$ :

$$R^2(\rho) \sim 2\rho; \quad w(\rho) \sim \frac{1}{4\rho}; \quad \phi = -\rho + \frac{3}{8} \log \rho ,$$

so log-corrected  $AdS_4 \times X_6$ , since

$$\phi - \phi_0 - A \rightarrow -\rho + \log \text{ corrections} .$$

- IR of QFT:  $\rho \rightarrow 0$ ,

$$R^2(\rho) = \rho^2 + \mathcal{O}(\rho^4); \quad w(\rho) = 1 + \mathcal{O}(\rho^2); \quad \phi = \phi_0 + \mathcal{O}(\rho^2),$$

so has finite warp factor,  $e^{2(A-\phi)} = e^{-2\phi_0} + \dots$ .

- Dynamical susy breaking: Put small nr.  $n$  branes ( $n \ll N/2$ ) on noncontractible  $S^3$ , so dual QFT has  $k = N/2 + n$ : susy unbroken if  $n > 0$  (branes), but broken if  $n < 0$  (antibranes).

- Sakai-Sugimoto model**: has quarks (fermions in the fundamental) in the probe approx. (so, no back-reaction). Quarks: either fixed D-branes (e.g., branes at orientifold point for  $\mathcal{N} = 2$  AdS/CFT), or probe D-branes: here.

- $N_c$  Wick-rotated D4-branes at finite temperature, for gravity dual similar to Witten model,

$$ds^2 = \left(\frac{U}{R}\right)^{3/2} (f(U)d\tau^2 + d\vec{x}_{(4)}^2) + \left(\frac{R}{U}\right)^{3/2} \left(\frac{dU^2}{f(U)} + U^2 d\Omega_4^2\right)$$

$$e^\phi = g_s \left(\frac{U}{R}\right)^{3/4}; \quad F_4 = \frac{2\pi N_c}{V_4} \epsilon_4; \quad f(U) = 1 - \frac{U_{KK}^3}{U^3}.$$

- In this background,  $N_f$  D8-brane probes, with transverse coord.  $U$ , dep. on worldvol. coord.  $\tau$ ,  $U = U(\tau)$ . Probe interpreted as  $D8 - \bar{D}8 =$  susy breaking, joined in bulk.

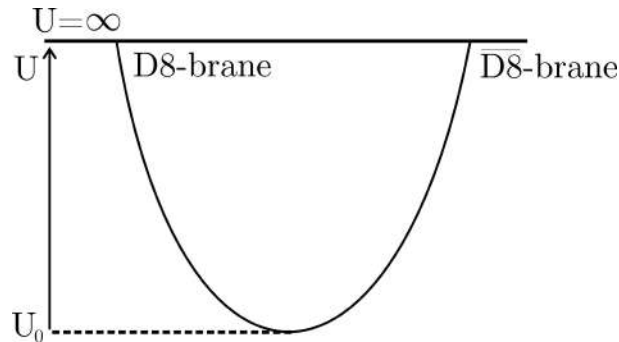

The Sakai-Sugimoto model has a probe D8-brane in the gravity dual, starting from infinity and returning to it. At infinity, it looks like a D8-brane/anti-D8-brane pair (parallel branes of opposite orientation).

- Solution for  $U(\tau)$  to equations of motion:

$$\tau(U) = U_0^4 f(U_0)^{1/2} \int_{U_0}^U \frac{dU}{\left(\frac{U}{R}\right)^{3/2} f(U) \sqrt{U^8 f(U) - U_0^8 f(U_0)}}.$$

- Modes on D8 couple to mesonic ops. (pion-like), charged under global symm.

- Background related to Witten model for  $QCD_4$ : D4-branes at finite  $T$ , (some transf. and) compactify on periodic Euclidean time. Metric at large  $U$  (UV of QFT): in terms of  $\rho = \sqrt{U}$ :

$$ds^2 \sim \rho \left[ \rho^2 (f(\rho) d\tau^2 + d\vec{x}^2) + \frac{d\rho^2}{f(\rho)\rho^2} + d\Omega_4^2 \right].$$

- Is conformal factor  $\times AdS_6 \times S^4$ : OK for compactif. to 4d theory.. Cut-off at finite  $U = U_{KK}$  in IR of QFT. Obs.:  $\tau$  is compact, and also  $\tau = \tau(U)$ , so D8-brane probes 4d theory.

- **Mass spectra in gravity duals from field eigenmodes.** For a field in AdS space, dual tower of glueball states: tower of discrete modes.

- E.G. Scalar dilaton (massless)  $\Phi$  dual to  $\text{Tr}[F_{\mu\nu}F^{\mu\nu}]$ , glueball  $0^{++}$ , and its excited states.

- Field theory mass: from  $x$  space or  $p$  space 2-point functions of the operator,

$$\langle \mathcal{O}(x)\mathcal{O}(y) \rangle \propto e^{-m_1|x-y|} (+ \# e^{-m_2|x-y|} + \dots).$$

$$\langle \mathcal{O}(p)\mathcal{O}(-p) \rangle \sim \sum_j \frac{A_j}{p^2 + m_j^2}.$$

- In AdS, spectrum of  $\vec{k}^2 = -m^2$  for solutions of the free eq. of  $m$ . for  $\Phi$ .
- Infinite discrete spectrum (with no accumulation points) if light takes finite time from boundary to boundary (horizon).
- For an  $AdS_{n+1} \times S^m$  space, made non-extremal by a blackening function, we have a finite bd. to bd. time,

$$ds^2 = u^\alpha \left[ \left( 1 - \frac{u_T^m}{u^m} \right) d\tau^2 - dt^2 + d\vec{x}_{n-2}^2 \right] + \frac{du^2}{u^2 \left( 1 - \frac{u_T^m}{u^m} \right)} + d\Omega_m^2.$$

- Defining time of flight variable  $x$  by  $dx = d\rho \sqrt{g_{\rho\rho}/g_{tt}}$ , massless KG eq.  $\square\Psi = 0$  becomes 1d QM problem for  $E \equiv m^2 = -k^2$  ( $k$  is 4d momentum),

$$\left[ -\frac{d^2}{dx^2} + (V(x) - E) \right] \tilde{\Psi}(x) = 0.$$

- So  $x_{\max}$  finite means  $V(x)$  has finite support, so  $E_n \equiv m_n^2$  discrete, infinite in nr., with no accumulation points, as for 1d QM box.

- But this is not the only way to obtain mass gap! NS5-branes in flat space have

$$ds_{10,\text{string}}^2 = d\vec{x}_{5+1}^2 + d\rho^2 + d\Omega_3^2, \quad \phi = -\rho.$$

- But  $\square$  contains the Einstein metric. So repeating procedure for  $g_{\mu\nu}^E$ , one finds  $V(x) = 1$ , with  $x$  ranging from 0 to  $\infty$ . So continuous spectrum above a mass gap, though not discrete.
- For Witten's  $QCD_3$  model, one finds  $x$  between 0 and  $x_{\text{max}} = C$ , and  $V(0) \rightarrow -\infty$  ( $V(x) \simeq -1/(4x^2)$ ),  $V(C) \rightarrow +\infty$  ( $V(x) \simeq 15/(4(x-C)^2)$ ). Then one finds  $m^2 R^2 = 6n(n+1)$ , so at large  $n$ ,  $E_n = m_n^2 R^2 \propto n^2$ , like for particle in a box.
- For Polchinski-Strassler, one finds a finite time of flight at infinity, and near the core, one finds a near-shell approx., with a 5-brane throat, so strictly speaking one cannot regulate the divergence.
- For Klebanov-Strassler, again finite time of flight at infinity, but smooth cut-off at small  $r$  (like the plane in spherical coords.), so time of flight is regulated, and spectrum of scalar is discrete.



- For Maldacena-Núñez,  $V(\rho) = 4/3 + \dots$  in the IR and  $V(\rho) \simeq 1 + 1/(2\rho)$  in the UV, whereas for Maldacena-Nastase,  $V(\rho) \simeq 4/(4\rho^2)$  in the IR and  $V(\rho) \simeq 1 + 3/(4\rho)$  in the UV. So continuum of states at high energies above a mass gap, though there could be discrete states as well (if there is an energy well at intermediate energies). Modification of the flat space 5-brane spectrum.

- **Mass spectra in gravity dual from mode expansion on probe branes** Sakai-Sugimoto model: Find worldvolume action for  $A_M$ ,  $M = 0, 1, \dots, 4$ , for the D8-brane KK reduced on  $S^4$ . Use coordinates  $(y, z)$  where the D8-brane is flat, situated at  $y = 0$  (extends in  $z$ ):

$$(y, z) = (\sqrt{U^3 - 1} \cos \tau, \sqrt{U^3 - 1} \sin \tau) .$$

- The DBI+CS action for  $A_M = (A_\mu(x^\nu, z), A_z(x^\nu, z))$  is

$$S = \frac{\lambda N_c}{216\pi^3} \int d^4x dz \text{Tr} \left[ \frac{1}{2} K^{-1/3} F_{\mu\nu}^2 + K F_{\mu z}^2 \right] + \frac{N_c}{24\pi^2} \int_{M^4 \times \mathbb{R}} \omega_{5,CS}(A), \quad K(z) \equiv 1 + z^2.$$

- Expand in complete and orthonormal sets  $\{a_n(z)\}_{n \geq 1}$  and  $\{\phi_n(z)\}_{n \geq 0}$  (such that  $-K^{1/3} \partial_z (K \partial_z a_n) = \mu_n^2 a_n$ ),

$$A_\mu(x^\nu, z) = \sum_{n=1}^{\infty} A_\mu^{(n)}(x^\nu) a_n(z)$$

$$A_z(x^\nu, z) = \varphi^{(0)}(x^\nu) \phi_0(z) + \sum_{n=1}^{\infty} \varphi^{(n)}(x^\nu) \phi_n(z),$$

and obtain the kinetic terms

$$S_{D8}^{\text{DBI}} = \int d^4x \text{Tr} \left[ (\partial_\mu \varphi^{(0)})^2 + \sum_{n=1}^{\infty} \left( \frac{1}{2} (\partial_\mu A_\nu^{(n)} - \partial_\nu A_\mu^{(n)})^2 + \mu_n^2 (A_\mu^{(n)} - \mu_n^{-1} \partial_\mu \varphi^{(n)})^2 \right) \right] + \text{int},$$

allowing us to identify  $\varphi^{(0)}$  with the pion, and  $A_\mu^{(n)}$  become massive by eating  $\varphi^{(n)}$ : vector mesons.

# Phenomenological (bottom-up) gauge/gravity duality: AdS/QCD

- **Extended "hard-wall" model.** Extend hard-wall of Polchinski-Strassler. Ehrlich, Katz, Son, Stephanov, 2005. Add gauge fields  $A_{L\mu}^a, A_{R\mu}^a$  coupling to currents of  $S(N_f)_L \times SU(N_f)_R$  flavor symm.,  $\bar{q}_L \gamma^\mu T^a q_L$  and  $\bar{q}_R \gamma^\mu R^a q_R$ , and bifundamental tachyonic scalar  $X^{\alpha\beta}$  of  $m^2 R^2 = -3 > -4$  (BF bound) coupling to chiral order parameter  $\mathcal{O}_X = \bar{q}_R^\alpha q_L^\beta$ . Action:

$$S = \int d^5x \sqrt{-g} \text{Tr} \left[ -|D_\mu X|^2 + 3|X|^2 - \frac{1}{4g_5^2} (F_{L\mu\nu}^2 + F_{R\mu\nu}^2) \right],$$

where  $D_\mu X = \partial_\mu X - iA_{L\mu} X + iX A_{R\mu}$ ,  $F_{\mu\nu} = \partial_\mu A_\nu - \partial_\nu A_\mu - i[A_\mu, A_\nu]$ .

- Boundary conditions: in the IR:  $(F_L)_{z\mu} = (F_R)_{z\mu} = 0$ ; in the radial gauge  $A_z = 0$  becomes Neumann:  $\partial_z A_{L,R\mu} = 0$ ; also for  $X$  (Neumann or Dirichlet). In the UV ( $z = 0$ ):  $A_{L,R\mu}^a \rightarrow a_{L,R\mu}^a$  (sources for  $J_{L,R\mu}^a$ ), and also ( $\mathcal{O}_X$  has  $\Delta = 3$  in  $d = 4$ ):

$$X \rightarrow z^{d-\Delta} (X_0 + z^{2\Delta-d} X_{(2\Delta-d)}) = zX_0 + z^3 X_{(2)} = \frac{1}{2} Mz + \frac{1}{2} \Sigma z^3,$$

where  $X_0 =$  source for  $\mathcal{O}_X = M^{\alpha\beta}/2$  (quark mass matrix) and  $X_{(2)} = \Sigma^{\alpha\beta}/2$  gives VEV of  $\mathcal{O}_X$ ,  $\Sigma^{\alpha\beta} = \langle \bar{q}_R^\alpha q_L^\beta \rangle$ .

• If  $M = m_q \mathbb{1}$  and  $\Sigma = \sigma \mathbb{1}$ , 4 parameters:  $m_q, \sigma, z_m, g_5$  and 3 fields:  $A_{L\mu}, A_{R\mu}, X$ . Can introduce vector  $V_\mu = (A_{L\mu} + A_{R\mu})/2$  and axial vector  $A_\mu = (A_{L\mu} - A_{R\mu})/2$  coupling to  $\bar{q}\gamma_\mu T^a q$  and  $\bar{q}\gamma_5\gamma_\mu T^a q$ .

• IR+UV conditions imply quantized solutions (discrete spectrum).

• In gauge  $V_z(\vec{x}, z) = 0$ , in Fourier modes for  $\vec{x}$  ( $Q^2 = -\vec{q}^2$ ), we have, from the eqs. of m.,

$$V_\mu(\vec{q}, z) = V(\vec{q}, z)V_{0\mu}(\vec{q}); \quad V(\vec{q}, z = \epsilon) = 1 \Rightarrow V(Q, z) = 1 + \frac{Q^2 z^2}{4} \ln(Q^2 z^2) + \dots$$

• 2-point function for currents:

$$\begin{aligned} \langle J_\mu^a(x) J_\nu^b(0) \rangle &= \frac{\delta^2 S_{\text{sugra}}}{\delta V_{0\mu}^a(x) \delta V_{0\nu}^b(0)} = -\frac{1}{2g_5^2} \frac{\delta^2}{\delta V_{0\mu}^a(x) \delta V_{0\nu}^b(0)} \int_{z=\epsilon} d^4x \left( \frac{1}{z} V_\mu^a \partial_z V^{\mu a} \right) \\ \int d^4x e^{i\vec{q}\cdot\vec{x}} \langle J_\mu^a(x) J_\nu^b(0) \rangle &= \delta^{ab} (q_\mu q_\nu - \vec{q}^2 g_{\mu\nu}) \Pi_V(Q^2) \\ \Pi_V(Q^2) &= -\frac{1}{g_5^2 Q^2} \left. \frac{\partial_z V(\vec{q}, z)}{z} \right|_{z=\epsilon} = -\frac{1}{2g_5^2} \ln Q^2. \end{aligned}$$

• Compare with perturbative result:

$$\Pi_V(Q^2) = -\frac{N_c}{24\pi^2} \ln Q^2 \Rightarrow g_5^2 = \frac{12\pi^2}{N_c}.$$

- Decay constants into vector meson  $\rho_n$  and pol.vector  $\epsilon_n$ , defined by:

$$\langle 0 | J_\mu^a | \rho_n^b \rangle = F_n \delta^{ab} \epsilon_\mu ,$$

- which implies

$$\begin{aligned} \delta_a^a \epsilon_\mu \epsilon^\mu \sum_n \frac{F_n^2}{m_n^2 (\vec{q}^2 - m_n^2 + i\epsilon)} &= \sum_n \langle 0 | J_\mu^a(q) | \rho_n^b \rangle \frac{1}{m_n^2 (\vec{q}^2 - m_n^2 + i\epsilon)} \langle \rho_n^b | J_\mu^a(-q) | 0 \rangle \\ &= \frac{1}{\vec{q}^2} \langle 0 | J_\mu^a(q) J_\mu^a(-q) | 0 \rangle = -3 \delta_a^a \Pi_V(q^2) , \end{aligned}$$

to be matched against ( $\psi_n(z)$  are quantized (discrete) sols. for vector meson states)

$$G(\vec{q}; z, z') = \sum_n \frac{\psi_n(z) \psi_n(z')}{\vec{q}^2 - m_n^2 + i\epsilon} , \Rightarrow \Pi_V(\vec{q}^2) = -\frac{1}{g_5^2} \sum_n \frac{|\psi'(\epsilon)/\epsilon|^2}{(\vec{q}^2 - m_n^2 + i\epsilon) m_n^2} ,$$

leading to

$$F_n^2 = \frac{1}{g_5^2} [\psi'(\epsilon)/\epsilon]^2 \rightarrow \frac{1}{g_5^2} [\psi_n''(0)]^2 .$$

- Other masses, couplings, decay constants can be calculated: fix parameters, then predict others.

- **Soft-wall model for QCD.** Modify background to have good QCD properties for the spectrum. In particular,  $m_n^2 \propto n$  (for hard-wall,  $m_n^2 \propto n^2$  at large  $n$ ) and for high spin  $S \gg 1$ ,  $m_n^2 \propto S$ . More precisely,

$$m_n^2 \sim \sigma n; \quad m_S^2 \sim \sigma S.$$

- Ansatz

$$ds^2 = g_{MN} dx^M dx^N = e^{2A(z)} (\eta_{\mu\nu} dx^\mu dx^\nu + dz^2) = e^{2A(u)} \eta_{\mu\nu} dx^\mu dx^\nu + du^2.$$

- As before, relevant combination is  $\Phi(z) - A(z)$ , so we want boundary conditions:

$$\text{UV } (z \rightarrow 0) : \Phi(z) - A(z) \sim \log z, \quad \text{IR } (z \rightarrow \infty) : \Phi(z) - A(z) \sim z^2.$$

- Simplest solution:

$$\Phi(z) - A(z) = z^2 + \log z.$$

- Action (has dilaton  $\Phi$  extra):

$$S = \int d^5x \sqrt{-g} e^{-\Phi(z)} \text{Tr} \left[ -|D_\mu X|^2 + 3|X|^2 - \frac{1}{4g_5^2} (F_{L\mu\nu}^2 + F_{R\mu\nu}^2) \right].$$

• Boundary conditions appear because: Schrödinger eq. with potential  $V(z)$ , for  $B(z) = \Phi(z) - A(z)$ ,

$$-\psi_n'' + V(z)\psi_n = m_n^2\psi_n, \quad V(z) = \frac{1}{4}(B')^2 - \frac{1}{2}B''.$$

• Then  $V(z) \propto z^2$  at large  $z$  for  $E_n = m_n^2 \propto n$ , implying  $B(z) \propto z^2$ ; also  $B = z^2/z_m^2 + \log z$  gives

$$m_n^2 z_m^2 = E_n = 4(n+1) \Rightarrow V_n(z) = e^{B(z)/2} \psi_n(z) = z^2 \sqrt{\frac{2n!}{(n+1)!}} L_n^1(z^2).$$

• Decay constants become

$$F_n^2 = \frac{1}{g_5^2} [V_n''(0)]^2 = \frac{8(n+1)}{g_5^2}.$$

• To fix  $\Phi$  and  $A$ , not just  $\Phi - A$ , need higher spin ( $S > 2$ ),  $\phi_{M_1 \dots M_S}$ , totally symmetric, with gauge invariance  $\delta \phi_{M_1 \dots M_S} = D_{(M_1} \xi_{M_2 \dots M_S)}$ , and same equations of motion, just with  $B = \Phi - (2S - 1)A$ . Then again  $V(z) \propto z^2$  at large  $z$ , but indep. of  $S$ , so

$$\Phi \simeq \frac{z^2}{z_m^2}, z \rightarrow \infty, \quad A \propto -\log z, z \rightarrow 0. \quad \text{If } \Phi = \frac{z^2}{z_m^2}, \quad A = -\log z \Rightarrow$$

$$V(z) = \frac{z^2}{z_m^4} + \frac{2(S-1)}{z_m^2} + \frac{S^2 - 1/4}{z^2}, \quad E_n \equiv m_{n,S}^2 z_m^2 = 4(n+S).$$

- **Improved holographic QCD**: engineer a scalar potential in the gravity dual to holographically give wanted running coupling constant.

- BUT:  $\lambda(\mu)$  not known, so we need an ansatz: from integrating 2-loop beta function,

$$\mu \frac{d\lambda}{d\mu} = -\frac{d\lambda}{d \log z} = \beta(\lambda) = -b_0 \lambda^2 + b_1 \lambda^3 + b_2 \lambda^4 + \dots \Rightarrow$$

$$\frac{1}{\lambda} \equiv \alpha_s = L - \frac{b_1}{b_0} \log L + \frac{b_1^2}{b_0^2} \frac{\log L}{L} + \mathcal{O}\left(\frac{1}{L^2}\right), \quad L \equiv -b_0 \log(z\Lambda).$$

- Gravity dual (see previous)  $A(z) \simeq -\log z$ ,  $z = 1/E$ , so  $du = e^{A(z)} dz$  gives  $u \simeq \log z$ ,  $du = -d \log E$ .

- Write potential for  $\lambda = N e^\Phi$ , and expand

$$V(\lambda) = \sum_{n=0}^{\infty} V_n \lambda^n = V_0 + \frac{V_1}{L} + \frac{V_2}{L^2} + \frac{b_1}{b_0} V_1 \frac{\log L}{L^2} + \mathcal{O}\left(\frac{1}{L^3}\right).$$

- $V_i$  from Einstein equation for action (coming from sugra plus  $N_f$  effective  $D4 - \bar{D}4$  pairs =  $Dp - \bar{D}p$  wrapped on compact space),

$$S = M_{\text{Pl},5}^3 N_c^2 \int d^5 x \sqrt{-g} \left[ R - \frac{4}{3} \frac{(\partial_\mu \lambda)^2}{\lambda^2} - V(\lambda) \right].$$



- From the equations of motion written in terms of  $\lambda$ , and then in  $L$ , their compatibility requires that

$$V_1 = \frac{8}{9}b_0V_0; \quad V_2 = \frac{23b_0^2 - 36b_1}{3^4}V_0 \Rightarrow V = V_0 \left( 1 + \frac{8}{9}b_0\lambda + \frac{23b_0^2 - 36b_1}{3^4}\lambda^2 \right) + \mathcal{O}(\lambda^3),$$

$$ds^2 = \left[ 1 + \frac{8}{3^2 \log(z\Lambda)} + \frac{4 \left( 26 + 9\frac{b_1}{b_0^2} - 18\frac{b_1}{b_0^2} \log(b_0 \log \frac{1}{z\Lambda}) \right)}{3^4 \log^2(z\Lambda)} + \mathcal{O} \left( \frac{\log^2 \log(z\Lambda)}{\log^3(z\Lambda)} \right) \right] \frac{R^2}{z^2} (dz^2 + d\vec{x}^2).$$

- Obs.: we matched the UV asymptotics, but the IR one (most interested in) needs large  $\lambda$  beta function, for which we have an ansatz: extra layer of phenomenology.