

49
üçüncü
uluslararası
kerpiç
koruma
sempozyumu

third
international
symposium
on
mudbrick (adobe)
preservation

29 eylül september

4 ekim october

1980

ankara

ICOM
ICOMOS

Türkiye Milli Komiteleri Turkish National Committees

Orta Doęu Teknik Üniversitesi Mimarlık Fakóltesi
Basım İřlięinde Basılmıřtır.

Printed at the Offset Printing Workshop
of the Faculty of Architecture, METU.

XIX G 29

üçüncü
uluslararası
kerpiç
koruma
sempozyumu

third
international
symposium
on
mudbrick (adobe)
preservation

29 eylül september

4 ekim october

1980
ankara

ICOM
ICOMOS



22920

III. Uluslararası Kerpiç Koruma Sempozyumu
Third International Symposium on Mud Brick (Adobe) Preservation

III. Uluslararası Kerpiç Koruma Sempozyumu

III. rd. International Symposium on Mud Brick (Adobe) Preservation

Sempozyum Sekreterliği : Pamela French
Secretarial Board : Çetin Anlaşan
Revza Ozil

Derleyenler : Okan Üstüncök
Editors : Emre Madran

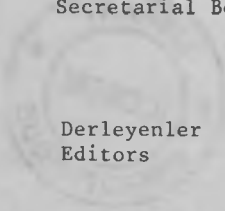

İÇİNDEKİLER
CONTENTS

içindekiler	
table of contents	I
önsöz	
foreword	IV
giriş	
introduction	VI
program	
programme	X
bildiriler	
papers	
restoration of proto-historic ruins of adobe lothal-india	R.Sengupta 1
the form,life and conservation of mud-brick building	John Warren 9
masca mudbrick/adobe conservation interim report	Darrel J.Butterbaugh Vincent C.Pigott19
effectiveness of conservation treatments of a volcanic tuff very similar to adobe	Rafaella Rossi-Manaresi Giacomo Chiari 29
treatment of adobe friezes in Peru	Giacomo Chiari39
the use of raw clay in historic buildings: economic limitation or technological choice	Eugenio Galdieri47
conservation of painted lime plaster on mud brick walls at tumacacori national monument,u.s.a.	Anthony Crosby59
kerpiç eski eserlerin onarımı ve korunmasında bir araştırma	Murat Eriç 79
la conservation des habitats vernaculaires en terre experiences et avenir	Jacques Vérité 87

- experiments in mudbrick conservation at lepe
nush-i jan
Hilary Lewis 109
- mudbrick buildings
the masmak fortress in riyadh-saudi arabia
general criteria of restoration
Marco Albini 119
- les palais royaux d'abomey
république populaire du benin
sauve garde et mise en valeur
André Stevens 139
- structural engineering criteria for adobe construction
S.Tanwir Wasti
Polat Gülkan 151
- the conservation of a chalcolithic mural painting
on mud brick from the site of teleilat ghassul, Jordan
Paul M.Schwartzbaum
Constance S.Silver
Christopher Wheatley...177
- los monumentos de adobe en el peru y los casos
de restauracion efectuados en la zona de cusco
Roberto Samanez Argumendo
201
- adobe bibliography
Alejandro Alva
Giorgio Torraca
Marie Christine Uginet 241
- des preuves sur la brique crue traditionnelle
et stabilisé avec asfalte appliquée dans la
restauration des monuments dans les andes
en Amérique du sud (péru)
Patrick de Sutter 245
- on the technology of the conservation and restoration
of ancient mudbrick walls
Zavene Hatsagortsian .. 259

kararlar-öneriler	
resolutions-recommendations	
Yazd,6-11 March 1976	265
Santa-Fe,3-7 October 1977	273
Ankara,29 September-	. 277
4 October 1980	
özgeçmişler	
curriculum vitae	290
katılanlar	
participants	295
ek	
addendum	307

İnsan
Foreword

Faint, illegible text, likely bleed-through from the reverse side of the page.

önsöz

foreword

Dünyadaki kerpiç yapılar ve kerpiç yapıların bulunduğu arkeolojik alanların korunmasında karşılaşılan sorunların önemi ve tüm ülkeler için ortak yanlarının bulunması, bundan 10 yıl önce konuyla uğraşan bilim adamları ve arkeologların deneyimlerini ve bilgilerini birbirlerine aktararak çabalarında daha başarılı olmak amacıyla uluslararası düzeyde bir araya gelmelerini sağlayacak bir örgüt kurulması gereğini ortaya çıkarmış, böylece Uluslararası Kerpiç Koruma Komitesi oluşturulmuştur. Bu örgütün tek ürünü, 25-30 Kasım 1971 tarihinde İran'ın Yazd kentinde gerçekleştirilen Birinci Uluslararası Kerpiç Anıtları Koruma Sempozyomu ve burada sunulan tebliğlerin yayınlanması olmuştur. Bu konuda yapılan ikinci toplantı gene İranlı meslektaşlarımızın gayretiyle 6-10 Mart 1976 yılında aynı kentte gerçekleştirilmiştir. Kerpiç yapıların ve arkeolojik buluntuların korunması alanında büyük sorunları olan ülkemizde böyle uluslararası bir eylemin gerçekleştirilmesi ve tartışılmasının yararı göz önünde tutularak üçüncü sempozyomun Türkiye'de yapılması önerisi Yazd kentindeki ikinci toplantıda oy birliği ile kabul edilmişti. Bu dilek, yani III.Uluslararası Kerpiç Koruma Sempozyomu 28 Eylül-4 Ekim 1980 tarihleri arasında Ankara'da yerine getirilmiştir. Bu toplantıda sunulmuş olan tebliğler ile alınan kararları bir araya getiren bu kitaba, yararlı olacağı kanısıyla Yazd'da 1976 yılında alınmış ve yayınlanmamış kararlarla, 1977 yılında bölgesel düzeyde olmak üzere Amerika Birleşik Devletleri Santa Fe kentinde yapılmış olan toplantının kararlarını da eklemiş bulunmaktayız.

Kültür Bakanlığının himayesinde ICOM ve ICOMOS Türk Milli Komitelerince düzenlenen bu toplantının gerçekleşmesi, UNESCO Türk Milli Komisyonunun yardımları ile, UNESCO'nun mali desteği ve I.C.C.R.O.M.'un düzenlemede ve teknik alandaki, Orta Doğu Teknik Üniversitesinin dış haberleşme, program ve bu kitabın basılmasındaki, Hacettepe Üniversitesinin R Salonu ve servislerini tahsis etmesiyle yaptıkları katkıları sayesinde olmuştur.

Hazırlığı iki yıldan beri sürdürülen bu toplantının yapılmasında devamlı destek ve yardımlarıyla Kültür Bakanlığı personeli, ICOM ve ICOMOS Türk Milli Komiteleri Üyeleri, özellikle Yönetim Kurulları üyeleri son derece yararlı olmuşlardır. Kendilerine teşekkürlerimizi saygıyla sunarız.

ICOM
Türk Milli Komitesi Başkanlığı

ICOMOS
Türk Milli Komitesi Başkanlığı

The significance and the universality of conservation problems encountered in mudbrick buildings as well as in archaeological sites where remains of mudbrick structures are found has long necessitated an organization whereby scholars and archaeologists in the field could come together to exchange views and experiences at an international level. The International Committee on Conservation of Mudbrick was hence founded ten years ago. The first outcome of the Committee's activities has been the International Symposium on Mudbrick Conservation held at Yazd, Iran, in November 1971. A second symposium on the subject was also realized by Iranian colleagues in March 1976 in the same city. It was unanimously agreed at the end of the Second International Symposium on Mudbrick Conservation that a third conference be held in Turkey where there have long been serious problems in mudbrick conservation. Thus, the Third International Symposium on Mudbrick Conservation was realized in Ankara from September 28 to October 4, 1980.

It was considered useful to add to the present proceedings the so far unpublished resolutions adopted in Yazd in 1976 as well as the resolutions of a regional conference held in Santa Fe, U.S.A., in 1977.

The realization of the Third International Symposium on Mudbrick Conservation, organized jointly by the Turkish National Committees of ICOM and ICOMOS, would not have been successful but for the financial aid of UNESCO received through its National Committee, the technical assistance extended by ICCROM, and the generous contributions of the Middle East Technical University and Hacettepe University, both in Ankara.

The staff of the Turkish Ministry of Culture as well as the members and Executive Boards of the National Committees of ICOM and ICOMOS have also contributed greatly to the organization of the Symposium.

We are indebted to all,

President
ICOM
Turkish National Committee

President
ICOMOS
Turkish National Committee

The following is a list of the names of the persons who have been appointed to the various committees of the Council of the American Psychological Association for the year 1970.

The following is a list of the names of the persons who have been appointed to the various committees of the Council of the American Psychological Association for the year 1970.

The following is a list of the names of the persons who have been appointed to the various committees of the Council of the American Psychological Association for the year 1970.

The following is a list of the names of the persons who have been appointed to the various committees of the Council of the American Psychological Association for the year 1970.

The following is a list of the names of the persons who have been appointed to the various committees of the Council of the American Psychological Association for the year 1970.

The following is a list of the names of the persons who have been appointed to the various committees of the Council of the American Psychological Association for the year 1970.

The following is a list of the names of the persons who have been appointed to the various committees of the Council of the American Psychological Association for the year 1970.

giriş

introduction

The activities of ICOMOS in the field of conservation of mud-brick (adobe) monuments were initiated around 1970 by the late lamented Piero Gazzola (President of ICOMOS at the time).

Professor Gazzola, confronted with the dramatic conditions of buildings and archaeological sites inspected in all regions of the world, came to the conclusion that the sparse preservation efforts by archaeologists and scientists would have greater success if an exchange of ideas and experiences could take place at an international level.

An international effort could be started by arousing the general interest through the circulation of questionnaires and by organizing symposia where information from all active parties could be collected, a fruitful exchange could take place and its results distributed by the publication of proceedings and recommendations.

Professor Gazzola was able to secure the cooperation of one of the few research and field projects active in the late sixties (1968-1971) which was coordinated by Professor G. Gullini (Institute of Archaeology, Turin), with the participation of IRPA-Brussels (R. Sneyers and G. Bultinck), ICCROM (G. Torracca), the Institute of Minerology of Turin (G. Chiari) and the Iraqi-Italian Institute of Baghdad.

In that context Questionnaire N°1 was prepared and distributed in 1971 to the ICOMOS National Committees. The questionnaire was meant to identify the areas where conservation problems existed and the peculiar character of such problems in each region of the world.

The First Symposium on the Conservation of Mud-Brick Monuments was organized by the Iranian Committee of ICOMOS and was held in Yazd (25th to 30th November, 1971); it offered the first occasion to compare conservation practices which were developing at the time in several countries (Iran, Iraq, USA). The proceedings were published, with some delay, in 1976 (they are available at the central ICOMOS office, 75 rue du Temple, 75003 Paris).

The wish to encourage a deeper study of mud-brick structures stimulated the international experts who cooperated with Professor Gazzola and ICOMOS to draft Questionnaire N°2. The second questionnaire was actually a scheme for the examination of a single mud-brick structure, as a preliminary for any conservation treatment.

Questionnaire N°2 should have been completed after the actual examination of a real case, but it required considerable scientific support for the execution of analyses and tests. These technical difficulties caused a sharp reduction in the number of answers which were received when the questionnaire was distributed in 1974 (nine answers in all); the material collected was, however, of technical interest and encouraged the organizers to pursue this line of work, which aimed at a better definition of the properties of mud-brick (adobe) as a building material and a more accurate study of the structures together with their environment.

Also the Second Symposium on the Conservation of Mud-Brick Monuments was organized by the Iranian Committee of ICOMOS and took place again in Yazd (6th to 10th March, 1976). Increased participation of experts and an extensive programme of technical visits allowed an exchange of information of high interest; this was reflected in the resolutions that constitute the most complete statement available to date of preservation problems and conservation policies.

Unfortunately, the proceedings were not published prior to the recent political changes in Iran and now, perhaps, they will not be published at all.

The Second Symposium recommended that the elaboration of the Questionnaire be continued with the aim to produce a document to be used as a guideline for the study of monumental structures and archaeological remains.

Questionnaire N°3 was prepared by ICCROM and then discussed in detail at a Regional Meeting on Adobe Preservation convened in Santa Fe (New Mexico, USA) by the United States ICOMOS Committee (3rd to 7th October, 1977). The large participation of laboratory experts allowed a further expansion of the questionnaire (Revision 2, November 1977), which finally became an elaborate model for the complete investigation of mud-brick (adobe) material in built structures. The document was widely distributed at the end of 1977, but it was not thought that answers would actually be forthcoming because of the difficulty involved in setting up the required laboratory tests.

The main purpose of Questionnaire N°3 was to stimulate testing of the materials and standardization of testing procedures.

The Santa Fe Recommendations underlined also the importance of research and listed problem areas where new data were needed. Current, but faulty, practices in conservation of buildings were explicitly mentioned and condemned (with particular reference to the use of cement plaster over ancient adobe structures). Finally, a recommendation was issued to encourage standardization of testing procedures through the action of an international committee.

Important testing experiments were carried out before and after the Santa Fe meeting (1976 - 1978) at the request of the National Park Service by the National Bureau of Standards (J. Clifton and others) and the results were published. (See Information Sheet N°1 issued by ICCROM.)

On the eve of the Ankara Symposium (28th September to 4th October, 1980) several problems appear to be incumbent, but for some of them a satisfactory solution is not yet in sight.

1) The long range efficiency of partial protection methods (including chemical treatment, capping, coating etc.) is questioned on the basis of recent experience. The cost of such processes is high and they do not provide long range reliable protection unless a maintenance routine is established.

2) Archaeologists and scientists appear now to favour either total protection systems (complete shelters or re-burial) or efficient maintenance routines where practicable.

3) Shelters which are open on the sides do intercept rain (and so they stop the most damaging deterioration factor), but they allow a slow process of crust formation (and successive detachment) which is probably due to humidity/temperature cycles and may be intolerable in the long run (particularly for painted and sculpted surfaces).

4) Scientists keep asking for more testing, but conservators note that testing of unbaked earth materials is time consuming and expensive, while, on the other side, it is not clear what data are really relevant for the establishment of a conservation programme. In view of the fast deterioration rates of the material, it may well happen that when the laboratory tests on a recently excavated structure are completed, the structure in question may already be severely damaged.

5) There is general agreement on the fact that ancient cities and towns built in unbaked earth must be protected against increasing local pressure towards modern concrete technology. It is, however, imperative that conditions for a reasonable quality of life be created inside houses built by the traditional technique.

A substantial progress towards the solution of such problems cannot be expected from a single international symposium. A real improvement in knowledge and technology may arise only from direct experience acquired through research and field work on a large enough scale. The international cooperation may prepare some conditions for such works, but their actual realization can take place only through national organizations entrusted with conservation tasks.

The organization of pilot projects in several regions was one of the recommendations of the 2nd Symposium in Yazd, but only two pilot projects were actually carried out between 1976 and 1980 (Chan-Chan, Peru and Tumacacori, USA); one of them is not active at this moment.

The second decade of the international effort for mud-brick (adobe) conservation does not begin under the best auspices, as further progress requires projects involving great expenditures and sponsorship from national (or international) agencies provided with sufficient spending power. New sponsors are not appearing and some of those active in the first decade withdrew (we hope only temporarily) from the picture. Furthermore, the loss of such an imaginative and brilliant personality as that of Piero Gazzola (who died in September 1979) deprives us of a driving force greatly needed in the present circumstances.

However, it is in such difficult situations that international organizations should prove their usefulness by persisting in their weak but continuous action, until new force is offered by national agencies for the support of basic research and exemplary conservation projects.

Giorgio Torraca
October 1980

29.Eylül.1980 Açılış oturumu

- 09:00 Kayıt
- 10:00 Eski Eserler ve Müzeler Genel Müdürünün konuşması
Kültür Bakanlığı Müsteşarının Konuşması
ICOMOS Uluslararası Kerpiç Komitesi Başkanının Konuşması
- 12:30 Öğle yemeği
Kültür Bakanı tarafından verilecektir.
- 14:00 Hacı Tuğrul Höyük'e hareket
Hareket Yeri: Bulvar Palas Oteli önünden
- 19:00 Hacı Tuğrul Höyük'den Ankara'ya hareket

30.Eylül.1980

KONU: I- Kerpiç Yapılar ve Tarihi Merkezler

- 09:30-09:50 Marco Albini "Kerpiç Yapılar-Riyad'daki Masmak Kalesi (Suudi Arabistan) Genel Onarım Ölçütleri"
- 09:55-10:15 Andre Stevens "Abomey Kral Sarayları. Benin Halk Cumhuriyeti Koruma Projesi"
- 10:20-10:40 Roberto Samanez Argumendo "Peru Kerpiç Anıtları ve Cusco Bölgesi Onarım Çalışmaları"
- 10:40-11:10 Ara
- 11:10-11:30 Murat Eriç "Kerpiç Eski Eserlerin Onarımı ve Korunmasında Bir Araştırma"
- 11:35-11:55 John Warren "Kerpiç Yapının Biçimi, Yaşamı ve Korunması"
- 12:00-12:20 Jacques Vérité "Yöresel Kerpiç Konutların Korunması. Deneyim ve Geleceği"

- 12:25-12:45 Eugenio Galdieri "Tarihi Yapılarda Kil Kullanımı: Ekonomik Sınırlılık veya Teknoloji Seçim"
- 12:45-14:30 Öğle yemeği
- 14:30-14:50 Rafaella Rossi Manaresi, "Kerpiç'e Benzer Volkanik Tüf'deki Konservasyon Uygulamalarının Etkinliği"
- 14:55-15:15 Patrick De Sutter "And Bölgesi Onarım Çalışmaları, İnşaat Gereç ve Yöntemleri El Kitabı"
- 15:20-15:50 Ara
- 15:50-16:10 S.Tanvir Wasti, Polat Gülkan "Kerpiç İnşaat için Mühendislik Ölçütleri"
- 18:30 Orta Doğu Teknik Üniversitesinde Kokteyl
"areket yeri: Bulvar Palas Otelinin önünden"

1.Ekim.1980

KONU: II-Arkeolojik Sit'ler ve Ören Yerleri

- 09:30-09:50 Hilary Lewis "Tepe Nush-i Jan'da Kerpiç Koruma Deneyleri"
- 09:55-10:15 R. Sengupta "Lothal'de Tarih Öncesi Kalıntıların Onarımı (Hindistan)"
- 10:20-10:40 Darrel J. Butterbaugh, Vincent C. Pigott "Masca Kerpiç Onarımı Ara Raporu"
- 10.45-11.15 Zavéne Hatsagortsian "Antik Kerpiç Duvarlardaki Koruma ve Onarım Teknolojisi"
- 11:10-11:40 Ara

KONU: III-Kerpiç Duvar Resimleri ve Kabartmalar

- 11:40-12:00 Giacomo Chiari "Peru Kerpiç Kabartmalarında Uygulamalar"

- 12:05-12:25 Paul Schwartzbaum, Constance Silver ve Christopher Wheatley "Teleilat Ghassul Yerleşme-sindeki Kalkolitik Evre Kerpiç Duvar Resimlerinin Korunması (Ürdün)"
- 12:30-12:50 Anthony Crosby "Tumacacori Ulusal Anıtı Kerpiç Duvarlarındaki Boyalı Sıvanın Korunması(Amerika)"
- 12:55-13:15 Alejandro Alva, Giorgio Torraca ve Marie Christine Uginet "Kerpiç Kaynakçası"
- 13:15-14:30 Öğle yemeği
- 14:30 Eski Yapar'a hareket
Hareket Yeri: Bulvar Palas Oteli önünden
Gece Eski Yapar kazı evinde kalınacaktır.
- 2.Ekim.1980 08:00 Maşat'Höyük'e hareket
14:00 Ürgüp'e hareket
Gece Ürgüp'te kalınacaktır.
- 3.Ekim.1980 09:00 Ürgüp ve yöresinde gezi
13:00 Acem Höyük'e hareket
17:00 Ankara'ya hareket
- 4.Ekim.1980 Kapanış oturumu
- 09:00 Genel Tartışma
- 13:00 Öğle yemeği
- 16:00 Sonuç bildirisinin okunması
Kapanış konuşması: ICOMOS Türkiye Milli Komitesi Başkanı
- 19:00-21:00 Kokteyl
Anadolu Medeniyetleri Müzesinde
Hareket yeri: Bulvar Palas Oteli önünden

- 12.25-14.30 Lunch
- 14.30-14.50 Rafaella Rossi Manaresi, Giacomo Chiari "Effectiveness of Conservation Treatments of a volcanic Tuff very similar to adobe"
- 14.55-15.15 Patrick de Sutter "Ensayo de manual de materiales Y metodos constructivos para la restauracion en la region andina"
- 15.20-15.50 Break
- 15.50-16.10 S.Tanvir Wasti, Polat Gülkan "Structural Engineering criteria for adobe construction"
- 18.30 Cocktail by Rector of Middle East Technical University
Departure from Bulvar Palas Hotel

1st October 1980 THEME: II- Archaeological Sites and Ruins

- 09:30-09.50 Hilary Lewis " Experiments in Mudbrick Conservation at Tepe Nush - I Jan"
- 09.55-10.15 R.Sengupta "Restoration of Proto-historic ruins of Adobe at Lothal, India"
- 10.20-10.40 Darrel J.Butterbaugh, Vincent C.Pigott "Masca Mudbrick/Adobe Conservation interim report"
- 10:45-11:05 Zavéne Hatsagortsian "Sur la technologie de la Conservation et Restauration des Murs Anciens en Briques Crues".
- 11:10-11:40 Break

THEME: III- Paintings and Friezes on
Mudbrick walls

- 11:40-12:00 Giacomo Chiari "Treatment of adobe friezes in Peru"
- 12:05-12:25 Paul Schwartzbaum, Constance Silver and Christopher Wheatley "The Conservation of a chalcolithic mural painting on mudbrick from the site of Teleilat Ghassul, Jordan"

12:30-12:50 Anthony Crosby "Conservation of Painted Lime plaster on mudbrick walls at Tumacacori National Monument, U.S.A."

12:55-13:15 Alejandro Alva, Giorgio Torraca and Marie Christine Uginet "Adobe Bibliography"

13:15-14:30 Lunch

14:30 Departure to Eskişehir
 Departure Place: Bulvar Palas Hotel
 Night in Eskişehir

2nd October 1980

08.00 Departure to Maşathöyük

14.00 Departure to Ürgüp

Night in Ürgüp

3rd October 1980

09.00 Sightseeing in the Ürgüp Region

13.00 Departure to Acemhöyük

17.00 Departure to Ankara

4th October 1980

09.00 General Discussion

13.00 Lunch

16.00 Closing Session
 Adoption of Resolution
 Closing Speech by Chairman of ICOMOS Turkish National Committee

19.00-21.00 Cocktail
 Museum of Anatolian Civilizations

THE UNIVERSITY OF CHICAGO LIBRARY

1950

1951

1952

The University of Chicago Library
has received from the University of Chicago
the following books and articles, which have been
added to the collection of the University of Chicago
Library. The books and articles are as follows:
The University of Chicago Library
has received from the University of Chicago
the following books and articles, which have been
added to the collection of the University of Chicago
Library. The books and articles are as follows:
The University of Chicago Library
has received from the University of Chicago
the following books and articles, which have been
added to the collection of the University of Chicago
Library. The books and articles are as follows:

bildiriler
papers

THE UNIVERSITY OF CHICAGO LIBRARY

RESTORATION OF PROTO-HISTORIC RUINS OF ADOBE LOTHAL, INDIA

R. SENGUPTA ^X

SUMMARY

In following the principle that archaeological remains should be conserved without changing its materials, colour, mass and shape, the exposed ruins of adobe walls of the proto-historic (2450 B.C. - 1600 B.C.) port-town, Lothal (in Gujarat, India) although subjected to surface treatment with preservatives, disintegrated and were lost. The ruins then had to be restored. The paper gives an account of the results of experiments conducted with soil-cement bricks as also the compelling reasons under which a substitute of mud-brick had to be produced. The efficacy of a pozzolonaic cement in the rains (June to September), used at site in early part of the year, will be observed and reported in the symposium.

^X DIRECTOR (CONSERVATION), ARCHAEOLOGICAL SURVEY OF INDIA
NEW DELHI, 5 JULY, 1980.

INTRODUCTION

In the Second International Symposium on adobe at Yazd, in Iran, in March, 1970, an account was given of Indian restorers' efforts to preserve the proto-historic excavated ruins of mud-brick structures at Lothal with soil-cement bricks. In that account the site, the structures and the experiments carried out were discussed in detail. But, as far as I know, the paper was not published and is not available. Since further experimental work was done at the same site, for the sake of presenting a coherent picture of the problem and works done earlier, the relevant portions of that paper are repeated here in brief in their proper sequence.

THE SITE

Lothal (Lat. $22^{\circ} - 30'$: Long. $72^{\circ} - 0'$) is situated on the western coast of India, near the Gulf of Cambay which opens out to the Arabian sea. The mound of ruins, rising to a height of 3.5 m. from the surrounding flat and featureless plains, was discovered in 1953 and excavated between 1954 and 1962. The excavations have established that during its life-span of about 850 years, between 2450 B.C. and 1600 B.C., the habitation was destroyed four times by swelling waters of the two rivers, Sabarmati and Bhogava, flanking the city. The gradual silting up of the estuary also resulted in sheet-flooding.

The typical features of Harappan town planning, alignment of streets and sanitary arrangements are also found at Lothal. Encircled by a protective wall against floods, the town had an acropolis, where the rulers with their kinsmen lived and a lower town, thrice larger than the acropolis, where merchants, craftsmen and others dwelt. The houses, in the Lothal acropolis were built, as at other Harappan settlements, on raised platforms and in the lower town on high plinths because of the danger of floods. On the south-east was a ware-house and to the east a dock-yard, roughly measuring 214 m x 36 m: its walls made of baked bricks (Rao, 1973).

In the residential buildings baked bricks were used only in the floor of baths, drains, manholes and cess-pools. It is worth noting that baked bricks had been used in structures which were to come in contact with water. Constructions like houses and shops were of mud-bricks laid in mud-mortar in headers and stretchers. But moulds of two separate sizes measuring 28 x 14 x 6.5 cm. and 25 x 12.5 x 6 cm. were used for both mud and baked bricks.

THE CLIMATE

The climatic conditions of the site on the whole, are unfavourable for preservation of mud-brick structures. The present annual rainfall is between 70 to 100 cm. But the average annual rainfall between the months of June and September during the first half of the century varies from 91.4 mm. to 112.8 mm. The records, maintained by the Indian Meteorological Department from 1901 to 1950, show that during the month of July, for only 12.5 rainy days (a rainy day has 2.5 mm. or more rainfall) the rainfall was 179.8 mm. These readings were obtained from a station called Dholka which is about 25 km. away from Lothal. Proximity of the site to the Tropic of Cancer affects the temperature; in summer it is about 46°C, though the mercury sometimes shoots up to 49°C. Due to heat the parched land around the site breaks down. In this condition wind-blown sand, by attrition, adds further injury to the dried bricks. The effect of wind is considerable in the open wasteland denuded of trees and shrubs.

THE SOIL

Sampling of silts collected from a pit in the basin of the dock-yard has shown that at the top, concentration of soluble salts (Chloride 5.27, Sulphate 1.31, Hydro Carbonate 0.06, Sodium Potassium 2.46, Magnesium 0.26 and Calcium 0.68) amounts to as much as 10.60%. On the other hand a sample collected from a depth of 85 cm. from the surface of the basin, showed only 0.31% of salt.

It is thus evident that geographical locations, climatic factors, composition of soils and several other considerations had to be taken into account in conducting the experiment. Although initially the products looked as tolerably approximated substitutes, weathering at site altered their look and shape. Not being fully satisfied with the results, we had decided to conduct further tests to make amends in the earlier works, so as to improve upon the products both from the view points of aesthetical presentation and efficacy.

While working on soil-cement bricks, we were still hopefully looking out for an effective soil-stabilizer or preservative which might be discovered by some of our colleagues. From the experiences gained at Yazd and in Santa Fe, one could see that a solution to the problems is still eluding, but the search is still on. The same impression reflects in the Status Report (Clifton, 1977) wherein the results of various experiments have been discussed in an objective manner. It quotes a scientist who after trying for over 20 years, nearly all types of soil-stabilizers, stated: 'no single chemical or combination of chemicals have been found acceptably effective or economical as a major soil stabilizer' (Kinter, 1975) and ended with an optimistic note that planned research may possibly lead to the development of an effective chemical treatment. Sharing his optimism and expecting to be benefitted from the eventual development of a potent chemical, we have filled up the trenches and covered with earth all the adobe-ruins of excavated sites of proto-historic periods, and concentrated our efforts of preservation at the only exposed site of Lothal.

In this paper before an account of further work is given, I may be allowed to indulge in a little digression to explain the philosophy that led us to the use of substitute bricks.

THE PHILOSOPHY

Ancient monuments in India are conserved or preserved and seldom restored. The word 'restoration' is used, with reservation, only in respect of specific cases where restoration work is involved. This attitude agrees with the latest thinking of ICOMOS as reflected in Article 2 of the Venice Charter wherein restoration is defined as a work that is reversible. On the other hand, compared to the modern trend of restoration in European countries, Indian approach to the preservation of archaeological remains might be considered as puritanic. Viewed against the background of orthodox approach restoration work executed at Lothal with a substitute material might appear to be inept. Therefore, for deviating from the established policy and time honoured practice, there must be some overriding factor or compelling reason for us to take an unconventional (in Indian context) step to restore the ruins which had disintegrated and got lost.

In the earlier report it was mentioned that to prevent loss of the exposed surface of the side walls of mud-brick platforms, on which residential houses were built, peripheral walls were erected with water-resistant soil-cement bricks. But the walls of houses being open on both sides, started disintegrating on exposure. The ruins were kept on view, as long as possible, without interfering with the fabric of the structure; only some surface coatings of available preservatives were applied without any success. The discovery of the dock-yard of Lothal, supposed to be the earliest one of its kind exposed so far, made the people of the State feel especially proud of their cultural heritage. They insisted on the ruins being restored so that they and their posterity when they go to visit the site, could have the visual experience and derive pleasure in seeing the handiwork of their forefathers. It needs no reiteration that the object of preservation is primarily to educate the common people of the larger section of the society. To meet the popular demand and in the absence of the original mud-bricks, substitutes or simulated bricks had to be adapted for restorations. But efforts were made to remodel the restorations as realistic as a restorer could render them, subject to the tools (method and materials) available to him at a given time.

Thus in India, restoration of adobe-ruins was attempted for the first time at Lothal, about two decades ago, not as a pre-planned organised project based on any earlier technical experience or available scientific data but as an isolated effort. The work was taken up rather improptu to meet a popular demand - in a democratic system of government, in response and with respect to the aspirations, expectations and desires of the people at large. At the same time it should be noted that the mistake committed at Lothal viz., keeping the excavated ruins

of mud-brick walls exposed before evolving a technique for preservation, was not repeated anywhere subsequently. As a matter of policy, now all the excavated sites are covered with earth to avoid any damage to the structural ruins of adobe. Further experiments and improvements on methods of preservation of adobe are being conducted only at Lothal where no risk of damage to original structures is involved and earlier works with different materials and effects are available for comparison.

THE EXPERIMENTS

Article 9 of the Venice Charter mentions that all additions should harmonize with the original elements but also remain identifiable. In respect of soil-cement bricks, therefore, it was decided that the new material should meet the following conditions:

- (i) the material should merge with the mud-bricks in colour and texture;
- (ii) it should not be washed away by rains;
- (iii) the coastal gale carrying sand may not cause damage to it by attrition; and
- (iv) it should be less prone to the corrosive actions of soluble salts.

The mud-bricks of Lothal are composed of mud, sand, a small percentage of nodules of limestone and occasionally chips of baked bricks. In the preparation of new bricks, these materials were used by volume, in the proportion of 1 cement: 1 lime: 4 sand: 3 gravel which included coarse sand and 5 parts of the chips of baked brick in granular form. The first batch did not prove to be satisfactory. The bricks were not composed of the required quantity of cementing material as a result there was erosion. The mortar (1 cement:4 sand) used in the work being stronger than the bricks, it was not affected to that extent.

In the bricks of the second batch, the proportion of cement was slightly raised (from 1 part to 1.25 parts) and the result achieved was slightly better. In this case again the mistake, of making the mortar strong, was committed. In case of another structure where the mortar was judiciously applied in pointing and kept recessed, looks better. The bricks of the same composition as that of the second batch, though weathered, give a better appearance and is in keeping with the type of ruins.

The look of the fourth example, when compared with an excavated wall, approximates the original. In it, two types of pointing have been applied. The portion treated with recessed pointing produces a better effect than the other portion which had received flush pointing.

In making these bricks the ratio of ingredients used were 1 cement: 2 powdered burnt brick: 4 sand: 6 gravel. Thus the results obtained in the experiments show the efficacy of ordinary portland cement.

In the early part of this year, the ruins of walls of the wharf or

ware-house and of a house in the lower part of the town were re-done with newly manufactured bricks. The bricks were made of 1 pozzolona cement: 2 fly-ash: 1.5 parts river sand and 2.5 parts soil. Laboratory tests of the bricks show the quantity of water absorption as 16.2% and its compressive strength as 44.4 kg./sq.cm. on an area of 418.9 cm².

Earlier, Alumina cement combined with fly-ash free from sulphur compound was recommended for use. But the executive engineer who approached the Associate Cement Companies for supply of Alumina cement, was informed that they produced an Aluminous cement called Calundum which was used for repairs/construction of furnaces and it was not suitable for the repairs to the adobe-ruins of Lothal. They, however, advised the engineer to use pozzolona cement. The engineer in consultation with the archaeologist in-charge who also happened to be the excavator of Lothal, used pozzolona cement.

I have visited the site in late May when I took some photographs of the new works done. The slides will give an idea of the effect they produce. It has to be seen as to how these new bricks fare in the rains and the nature of action of salt on them thereafter. Since the paper is to reach the organizers of the symposium by 15 July and at the time of writing this report (first week of July) the site is having heavy rains, I propose to visit the site in early September to inspect the effects of rain and prepare some slides for a comparative study. As mentioned earlier, the rainy season in the area around Lothal, is from June to September.

CONCLUSIONS

The walls of buildings at Lothal were originally covered with a layer of mud-plaster. But floods and rains ruined the structures along with the plaster. A stump of a ruined wall, therefore, could not have retained its coat of plaster. If applied afresh, the plaster lends to the walls a different appearance which is unlike ruins. At certain excavated sites, the ruins of adobe have been covered with a mud-cement plaster. The visual effect they produce in a visitor can be compared from the slides.

The impact created by the bare brickwork of ruins appears to be more effective, realistic and convincing than the portions protected by 'encapsulation'. The treatment of the broken wall-tops have been finished flushed with a slope for drainage of water. In India the ruins of walls are treated with a broken 'sky-line' retaining the character of broken walls.

In repairing the portions which were eventually 'encapsulated', mud-cement bricks of different dimensions, than those of original ones, were used. The risk involved in this method is that posterity might confuse them to original ones from their apparent look. Studies of archaeological sites have shown that in any given cultural horizon, the size of bricks normally does not remain

the same-there are variations. Sometimes, occupants of a site at a subsequent period, carried out repairs with bricks of a different size which were collected from other sites. I have made a study of brick-size used in India from the proto-historic period up to A.D. 1000. In the proto-historic period (Harappan) nine sizes were recorded. Similarly, during the period from 600 B.C. to 200 B.C. altogether sixteen sizes and in the period from 100 B.C. to A.D. 300 as many as thirty-four sizes of bricks were recorded. Again, in the case of a fifteenth century dome, three sizes of bricks have been used in the original construction.

So, in the use of different sizes of bricks there is an element of risk involved as stated above. To avoid such a contingency, we have decided to use baked bricks of the same size, as was used originally. But to distinguish the new ones from the old there will be a stamp on them with the letters ASI and the year of production. To withstand saline action, the bricks will be slightly over-burnt. In respect of adobe, the bricks being substitutes of original ones with a different composition, there is little likelihood of mistaking them for old. Besides, for the information of visitors, at the site there is a notice which reads:

'Visitors will please note that the exposed ruins of mud bricks having been decayed, the walls have been restored with simulated soil-cement bricks recently manufactured. The walls of burnt-bricks are mostly original; new bricks wherever introduced for repairs bear an inscription 'ASI-1980 i.e., Archaeological Survey of India and the year of manufacture'.

We may have tried to fake the original mud-bricks for aesthetic reasons, but have been honest enough to make it known to the visitors, to avoid any misunderstanding or misinterpretation of the restoration whatsoever.

REFERENCE

- Rao, S.R., 1973. Lothal and The Indus Civilization, Asia Publishing House, Bombay
- Clifton, R. James, 1977. Preservation of Historic Adobe Structures - A Status Report, NB5 Technical Note 934, U.S. Department of Commerce.
- Kinter, E.B., 1975. Development and Evaluation of Chemical Soil Stabilizers, Federal Highway Administrative Report No. FHWA-RD-75-71.

THE FORM, LIFE AND CONSERVATION OF MUD-BRICK BUILDING

JOHN WARREN

This paper explores the conservation of buildings in mud-brick, with particular regard to ethics and the integrity of methods; it compares what may be architecturally sound with what is aesthetically and historically acceptable.

Attention is then given to the various forms which mud-brick building takes, the formation of the basic material, its lifespan, and the causes of its deterioration. Review is then made of the methods available for its restoration and conservation.

John Warren is a member of the Royal Institute of British Architects; a Fellow of the Royal Town Planning Institute; a Master of Literature; and is in private practice in the South of England.

11th July, 1980

Let us, as an intellectual exercise, attempt to combine the basic principles of conservation theory with the special characteristics and difficulties that flow from the use of mud, or unbaked earth.

Conservation is concerned with maintaining the fabric the past has left us. That fabric exists in many senses, two of which are of prime importance to the conservation architect - the outward aspect, and the physical material.

To the planner and sociologist another aspect is of prime concern - the use and the user. Sociologically, a mosque no longer used as a place of worship is historically dead, though architecturally it may be unchanged. That same mosque, however, might retain its outward aspect, so remaining validly conserved so far as the sociologist, town planner and architect are concerned. But nevertheless, through some disaster it might have collapsed and been replaced in concrete block rendered over to simulate exactly the original, with all its detail. To the archeologist the fabric of the building has disappeared - the original vital evidence is no more: and so archeologically, the mosque is dead. Thus the significance of conservation must change with a changing viewpoint.

From the heated debates on conservation and restoration a number of conventions, codes and guidelines are emerging, and from these a key thread that can be drawn is integrity. This relates not only to the actual materials of which the building is made but to its spaces and shapes and to the uses and methods of working of all its components. It may be architecturally clever to wrap an old building in some new synthetic guise; it may be economically effective to insert seven floors behind a facade that apparently presents three storeys to the world; it may be convenient to remove an entire structure and replace it with a replica made in new materials; but all these actions raise questions of doubt as to the integrity of handling a structure. The architect who takes any such action must first have honestly and satisfactorily answered such doubts. Once destroyed,

an ancient fabric can never be re-created: it may be reproduced, but a reproduction is merely a reproduction.

There is a school of thought which regards old buildings as historic material, valid in their own right and venerable for this reason alone. By the values of this present age this is a philosophy which cannot be gainsaid. It therefore follows that any venerable piece of building fabric has an intrinsic worth which depends solely upon its origin, and it equally follows that a simulation of that fabric with intent to deceive is misleading and historically dangerous. A new dimension has entered architecture with this concept - morality based on the intrinsic worth of earlier material which therefore has a priority over added or inserted material.

The more difficult problem arises when adapting an older building for new uses, where it is necessary to make amendments and adjustments. One cannot date-mark a void and it is difficult to complete a damaged wall, vault or column in dissimilar materials and so identify new work. Problems of this sort tax and reveal the skill of the designer. The qualities perhaps most to be sought in these circumstances are sympathy and honesty: sympathy of response to the existing work and honesty in the handling of the new in relation to the old.

Honesty is, of course, a word which has had much currency in architectural criticism. It was an underlying precept of the functionalist philosophies of the modern movement where the principles of clear expression of the material and of the function it performs became the guideline to the aesthetic. While honesty is fundamental in work of conservation and re-use, it now takes on another rather special aspect, suggesting not only honesty in the expression of the material itself but historical honesty in expressing truthfully the period of work.

Where a building is to be retained, it is fundamentally good practice to preserve and enhance every possible part of the structure and to retain, so far as is possible, the original relationship of its component parts. In architectural terms it must always be remembered that the quality of a building derives not only from the physical structure of which it is made, but from the contained and defined space within it and the shapes and aspects of the spaces left between it and other buildings. Thus, to take down a street building, leaving only its facade standing, while grafting a new

structure on to the back of the facade, is the antithesis of conservation so far as the building itself is concerned. The structural integrity of the building and all its internal shapes and spaces will have been destroyed and, so far as the original evidence goes, the building will have been virtually eliminated. However, that very same act of preserving the street facade, regardless of whatever stands behind it, may, in itself, be an important act of conservation in terms of the street and so, in townscape terms, may be entirely justified although the building itself has effectively ceased to exist.

In this initial instance, let us take the viewpoint of the simple architectural conservator. The principles to which he will work generally include the following fundamental criteria:

retention of shape, colour and detail of the structure so that it looks outwardly as similar to the original as may be:

continuance of the use of the structure in a manner compatible with the original:

sympathetic alteration, with due cognizance and record of historic fact:

retention of the historic surroundings so far as this may be achieved in order to satisfy the need for a sympathetic environment:

provision of an accurate factual record of the structure as found and of the alterations made to it:

the use, so far as possible, of reversible techniques which have been proven by time and experience:

avoidance of conjecture:

demonstration of the nature of the alterations, amendments or insertions:

the employment of materials which, if not identical to those replaced, will be similar in behaviour and will be long-lasting.

The philosophy, in other words, is to provide buildings that are not deceptive, are fit for their purposes and continue the ethic and features of the historic construction.

To this problem could be added the archeological factor of authenticity. Architecturally it may be satisfactory to replace an eroded stone with a new one, a worm-eaten timber with a new-sawn baulk, and a lime-washed mud brick pier with concrete blocks rendered and painted. Archeologically it is not. The replaced material is archeologically a fake. It cannot be submitted to analytical tests now or in the future when unthought-of techniques may be applied to answer questions as yet unmarked.

To these criteria must be added one other which we might describe as emotive.

In England, about a hundred years ago, a group of eminent architects, conservers and painters, formed an important society - for the Protection of Ancient Buildings. Their thesis was that a building should preserve its outward appearance, including the venerable evidence of its age and history. Their work was a consequence of the wholesale reconstructions and remodellings which resulted from Victorian English prosperity and affected major historic buildings throughout the land. As a result of this reaction to wholesale renewal there has grown up a school of conservation which works towards repair rather than replacement and seeks to conserve even weathering and plant growth, in order to retain the quality and character of the structure.

In the face of the wholesale alteration of great historic buildings, the founder of the Society, William Morris, lamented, "...alas for the English feeling of reverence, of which we hear so much; alas for those who come after us, whom we shall have robbed of works of art which it was our duty to hand down to them uninjured and unimpaired." His emotive call set a spirit abroad among those who wished to conserve the quality of things past: that spirit aims to keep the outward appearance of buildings as they were when new, and their outward appearance after a period of use. This is an important factor.

When these thought processes are applied to the problems of unbaked earths some rather special considerations emerge.

Firstly, there is the simple problem of size or scale.

Unbaked earths have been used on a colossal scale in the most primitive of conditions and structures. Much of the work to which they have been applied is primarily in the

vernacular. While it may be no less important for that, the very processes of vernacular building often suggest the use of simpler building techniques and the operation of more rapid processes of decay in consequence.

Any technique of conservation which is to help significantly must be capable of being applied on a large scale. Sheer scale must not daunt the conservator, since part of the quality of historic building in unbaked earths is the overwhelming sense of mass, of contiguity with base material and, at its extreme, of an environment where the whole of man's being is moulded by the 'clay of Mother Earth'. Perhaps no other material can be so all-embracing. The city wall, the road surface, the walls, the roofs and domes, everything in such a community may be made of this one material. If the special quality of the place is the universality of it, then this total use becomes in itself part of the task of the conservator.

Secondly, the rapidity of erosion in the material makes it transient. No mud-brick building remains in pristine condition for long unless it is in a virtually waterless and wind-free situation. In practical terms, therefore, the quality of mud-brick building depends either upon a weatherproof skin material or upon frequent renewal of the mud coating. The use of a weather resistant skin disguises much mud-brick architecture. In northern Europe, a region frequently believed devoid of unbaked-earth construction, the disguise is frequently an external rendering or lime-wash coating coupled with stone base-courses and wide-eaved roofs. In consequence the buildings are not recognised for what they are and conservation becomes essentially a matter of maintaining the outer skin. The technical problem, therefore, frequently becomes a matter of dealing with cements and lime-based products applied to an unstable or weak substrate. Where the skin is not self-supporting it usually fails due to the differential movement between it and its background. Cracks in the outer material allow water entry and decay occurs by the removal of slabs or lumps of the external coat. The bond between coat and wall is often weakened by the emergence of salts carried out of the earth wall to its surface by moisture movement. This phenomenon occurs primarily in situations where the damp-proof course is omitted, and this, of course, means almost all historic buildings. Attempts to strengthen the bond between external skin and the wall involve mechanical bondings, the use of keying, stone nodules or even pieces of wood linking the two materials physically. Efforts to strengthen the base material itself by the introduction of cements into the earths

have never been widely adopted. Another method of protection has relied upon surface coatings of a weak or flexible nature, such as paints and, particularly, lime-washes. These protections have always been widely used but depend for their success upon frequent renewal.

Both protections, rigid and flexible, have offered decorative possibilities to builders; and therefore conservation has had much to do with replacing and repairing these decorations. These techniques are, however, secondary and separate by comparison with the regular method of finishing a building constructed of unbaked earths; that is by a rendering of mud itself.

The special merit of mud as a finish to a building of unbaked earths is its compatibility with the substrate, though this is not always total, particularly if wetness and/or salinity are markedly different when the outer layer is applied or if, as may happen, different proportions of clays are contained in the brick-earths used for the wall and the render. Generally the behaviour of the coating and the base material will be the same and failure due to differential movement is rarer.

The snag is in the weakness of the render itself in terms of weathering. The act of applying the wet material, squeezing it under hand pressure, smoothing it and making the surface even, tends to align the micaceous plates in the clays which form part of the earths. The fibrous binders also tend to be aligned by the same actions, so that the material becomes denser and physically more coherent. This makes it more waterproof, of course, and ensures also that the surface bonds to the substrate. A similar process is applied to flat roofs, where the same material forms an effective short-term waterproofer. After heavy or prolonged exposure to rains such roofs are rolled, simply to compact the surface once again after the physical separation of the particles has been increased by the introduction of water between them. The contraction on drying is never as great as the expansion under the pressures of capillary action, so the roof surface and the render become softer and more friable upon prolonged exposure to cycles of wetting and drying. The softened material can be eroded easily and thereafter the normal processes of physical decay set in.

Conservation in these circumstances can consist either of renewal of the render as frequently as necessary to keep the surface in repair or of obtaining an additive which waterproofs the surface, without visually impairing the

building. In earlier times bituminous compounds were used, but without success, except in the short term, due to the leaching out of the volatile oils. Modern technology has produced oil-derived materials, such as silanes and other silicone waxes, which will repel water and might, therefore, seem useful. Their high cost and transience have generally made them unattractive candidates in a field where the essence of the buildings is mass and initial cheapness. As no other significant, large-scale material has come available, the conclusion must be that the only effective method of repair and conservation is the traditional technique of replacement of like with like.

This policy itself introduces a problem. It is one that William Morris, fortunately for him, did not have to face. When a mud-rendered building is repaired with a mud render, the entire face is new - the old has disappeared. There is no avoiding the issue: it is simply a matter of making the best of it. Decorative features must be remodelled, mouldings and string-courses replaced and surface decorations re-applied. This, in its train, brings forward the problem of spontaneity in treatment. Simply, the question is - does one slavishly copy what went before or attempt alternatively to create another art-work in the spirit of the original?

The answer lies with the conservator, and his judgement in the special circumstances of the time.

The third consideration embraces change. Change is inevitable. Even where the building survives the surroundings may unavoidably change. Even when the surroundings also survive, they, in their turn, must meet with the outer world on some boundary; and in the buildings themselves there must be amendment or alteration to accommodate changing use, changing technology or changes in life and living patterns. We no longer expect to use earth closets or live by candlelight. Some essential alterations in the use of buildings affect the materials used. Electric lifts cannot be installed on mud-brick lift shafts, and air conditioners make unsightly additions to the profile of traditional buildings. Perennially we face the discordancies of television aerials, wires and poles, and aluminium windows. The mud surfaces of roads which were self-repairing throughout the centuries are no match for the motor car. They are re-surfaced with asphalt and their sidewalks are covered with pre-cast concrete slabs.

These continual problems are not peculiar to mud brick but they may be particularly intractable in terms of mud-brick conservation. If the ethic of the conservation involves the retention of the whole environment as a living and working entity, then such problems loom large in the mind of the architectural conservator.

In many circumstances it is the admixture of later and earlier techniques which is specially inimical to the very qualities which the conservator may be trying to retain. Imagine a village of domed mud-brick houses where some few were perfectly preserved, among a phalanx of cubic structures built of concrete block, of tarmac roads, of posts and wires. However successful the conservation of any individual building, the environmental effect is disastrous. Acceptable living standards have to be achieved, despite the introduction of modern equipment, if a successful transition to contemporary life is to be made: and the special problem of unbaked earth is its universal application and high rate of wear.

The fourth consideration relates to the simple discipline of recording.

A distinctive visual quality of the use of unbaked earths is its plasticity. Surfaces are rarely true and even. Straight lines are remarkable rather than the rule and the tendency to batter walls (slope them back) and round off corners is as inevitable as it is attractive. The material therefore gives its own soft quality to the architecture in addition to inducing weathering details that give typical local character. A record of these softnesses, rounding-outs and unevennesses demands special techniques which fortunately are now available through the recently-developed science of photogrammetry. The records made by these processes are sufficient to allow the recorded building to be re-created. The labour of identifying its features precisely has been enormously reduced.

So where have these considerations left us, as architectural conservators of buildings and communities faced with the problems of unbaked earths.

With the exception of recording techniques, there is no technical advance which dramatically simplifies our problems. There is no material that can be injected into or sprayed on to great areas of mud-brick to preserve it for long periods. The available materials are all expensive or impractical. So conservation must depend upon the traditional techniques of renewal. That way lies archeological certainty, and safety.

In terms of building techniques, certain simple precautionary techniques are self-evidently necessary, particularly the use of modern methods of damp-coursing. These apart it seems that in the present state of knowledge our endeavours are best concentrated on creating the political and economic conditions which encourage the owners of these buildings to look after them, to repair them by the time-honoured methods, to value them and to carry out work upon them with no less skill and care than previous generations. With the community, meanwhile, must lie the equal problem of protecting and conserving the outer spaces - roads, street-surfaces, neighbouring buildings, and all those manifold aspects of the surroundings that control the quality of a place. The conservation of the planned environment is frequently more important in the case of mud-brick and vernacular buildings than in the case of more robust and durable types of construction. So the climate of conservation must be created in the political field as well.

The key to success lies perhaps with pride. If a community can feel pride in its buildings, particularly its humbler buildings, it will value them. So let the climate of good sense for the conservation of mud-brick buildings include economic and practical help, the use of traditional methods and a recognition that the quality of the environment which these structures represent is significant and should be a matter of pride.

MASCA MUDBRICK / ADOBE CONSERVATION INTERM REPORT

DARREL J. BUTTERBAUGH X
 VINCENT C. PIGOTT X X

SUMMARY

Since 1973 a number of field tests have been undertaken in conjunction with an on-going laboratory program in experimental mudbrick conservation sponsored by MASCA at the University Museum of the University of Pennsylvania. The field test areas include Arizona, Florida, Pennsylvania, Iran and Guatemala.

Both laboratory and field experiments have shown that the soaking of mudbrick in dilute solutions (2-3%) of certain hard and soft methacrylic polymers resulted in significant penetration, binding and waterproofing. Furthermore, the incorporation of acrylic emulsions in mudbrick and mud plaster markedly strengthened brick and surfacing against weathering due to precipitation and cyclical freezing.

X Research Associate, MASCA

XX Research Specialist, MASCA, University Museum, Philadelphia, Pennsylvania

July 4, 1980

MASCA LABORATORY TEST PROCEDURES AND RESULTS

Various laboratory test procedures have been devised by which to investigate the successs of the various polymer treatments. One polymer, A-21, a poly methyl methacrylate of medium molecular weight plus adhesion enhancers, has proven to be of particular importance. Penetration in mudbrick for a 3-4% toluene solution of A-21 generally runs about 2-3 cm. in a period of 30-60 minutes. After several days, during which the toluene has evaporated, depth of penetration is determined by the beading of water droplets.

However, "wick-action" tests by means of a vertical migration of the same polymer solution from the bottom surface of a mudbrick column indicate a solvent wetting rate of:

	3.4 cm. in 30 minutes, total time
Table 1:	4.7 cm. in 60 minutes, total time
	6.0 cm. in 90 minutes, total time

Water beading on the dried column indicated a penetration of 4.0 cm. This test in conjunction with the controlled sand-blast technique, described below, shows that the polymer has indeed penetrated beyond the 4.0 cm. level. Sand-blast abrasion below the 4.0 cm. mark is 20-25% of untreated adobe, but is still 55-70% of untreated above the 4.0 cm. mark. This is support for the belief that a sharp interior boundary between treated and untreated adobe does not exist, and, hence, strains between the two zones will be reduced. A diffuse boundary not prone to strains and/or spalling along the entire treated zone is thought to exist.

Sand-blast testing

Sandblasting of treated adobe, clay and stone samples has been used to evaluate and measure the binding action of polymer treatment and thereby the protection against dry weathering action. The Air-brasive jet unit (Model K) of S. S. White Products Co. has been adapted to produce a controlled sand-blast for abrasion of treated flat surfaces. Each test was quantified by filling the sharp edged erosion cavity in the test sample with a dry abrasive, emptying, and then weighing the powder.

Strengthening of the treated sample was determined by comparing the treated and untreated cavities. Multiple holes were drilled to even out any variability in the structure. In general, A-21 treated adobe and clay blocks exhibit only 10-20% of the erosion of untreated blocks. Mudbricks treated with 3% A-21 solution show only 5-10% erosion. By contrast, mudbricks treated with a silicone waterproofing exhibit 75% erosion, indicating that the dry strength improvement in the A-21 bricks is due to a chemical-binding action, not water-proofing action.

Table 2:

<u>Treatment</u>	<u>Sample type</u>	<u>Erosion %</u>
12% E-330	adobe block (Tuscon)	7.5%
16% E-330	" " "	5.1%
3% A-21	clay block (Florida)	13.0%
3% A-21	" " "	10.2%
3% A-21/6% A-21	" " "	9.0%
3% A-21/Silicone	" " "	14.1%
5% Silicone	" " "	76.6%

We feel that this is a simple, reliable way of evaluating dry strength improvement.

Wet freeze/thaw tests

Wet freeze/thaw tests have been conducted by soaking small adobe and Florida clay blocks in water for 30 minutes, then freezing them in an ordinary food freezer for 18-20 hours, followed again by soaking (in the frozen state) in water to complete one cycle. Failure is equated with easy wet "rub off" of surface grains.

Table 3:

<u>Treatment</u>	<u>Sample type</u>	<u>Failure rate</u>
12% E-330	clay block (Florida)	-failed 20 cycles
16% E-330	" " "	-failed 40 cycles
16% E-330	clay plaster on concrete block (Florida)	-no failure in 150 cycles
3% A-21	clay block (Florida)	-failed 60 cycles
3% A-21	soft sandstone	-160 cycles no deterioration
untreated sandstone		-to powder 15 cycles
untreated mud		-melts in first cycle

Water vapor test

Water vapor passage through an A-21 treated, sand, Florida clay block and stone has been measured by trapping water vapor as it passes

through a treated outer zone from a wet untreated core. These tests were done by wrapping a plastic bag of desiccant around the top of a rectangular Florida clay block that had been only partially treated to leave a large inner core to absorb and transmit water throughout the inner portions of the block. One end of the treated block had been cut off in order to expose this inner core to a water-wet paper wick. The area of the treated block exposed to the desiccant was 96 cm². Desiccant absorbed 5.0g of water in the first 24 hours (desiccant was about 75-80% saturated at this point).

Experiments with A-21 treated soft Chaco sandstone show a very slow absorption of water over 200 hours to a steady state which represents 50-60% of the water normally absorbed by untreated stone in 5-10 minutes. Yet, both treated and untreated stone dry out to original weight at essentially the same rate.

These experiments demonstrate that should water get behind the treated zone of an adobe wall, the wall will still dry in a natural way without buildup of water pressure behind the treated zone. In other words, A-21 treatments with proper penetration will stop water liquid but will allow water vapor to pass through.

FIELD TEST WEATHERING EXPOSURES

Hasanlu Tepe, Iran

This archaeological site is situated in west Azerbaijan province in northwestern Iran. Excavations conducted there for nine seasons between 1957 and 1974 by Dr. Robert H. Dyson, Jr. for the University Museum have revealed an impressive Iron Age citadel capping a 25 meter high mound. The citadel was destroyed in an attack and conflagration about 800 B.C. Much of the Iron Age mudbrick architecture, though fortunately burned in many places, lies exposed to the ravages of erosion by wind, water and frost.

In 1975 a total of 16 different test areas comprising approximately 140 square meters were established at Hasanlu, and since that time field observations were done in 1976 and 1977. We have not had contact with the tests since 1977. Both hard and soft methacrylic polymers, including A-21 in dilute toluene, solution were soaked into selected test areas. Other test areas were covered with a mud plaster mixed with an acrylic emulsion, polymer E-330. A combination of both plaster and wall polymer soaking were used in several instances and two test walls were built using mudbricks made with acrylic emulsion.

Test areas at the site were chosen with the guidance of the excavator and were eroded mudbrick walls in non-critical areas of the site. Failure of the tests in these non-critical areas would not have affected significantly the architectural plan of the site. The present rates of erosion at Hasanlu destroy ordinary water-mud/straw plaster in less than two years. Results of these tests after two years

of exposure, previously published (Pigott and Butterbaugh, 1978), have been corroborated by our on-going tests in other geographical areas and are subsumed in the interim conclusions in this report.

Chimaltenango, Guatemala

These tests started in April 1976 and presently under observation, were set up at the edge of a small corn field owned by an agricultural cooperative in Chimaltenango. The fence and wall have had no supervision since having been established and as a result, the fence was torn down during the past year while the wall still remains. This exposure is in highland Guatemala, where heavy and violent rains occur in the spring and summer rainy season.

Test #1

An adobe wall 45 x 120 x 30 cm. was constructed on the field with local adobe bricks salvaged from a nearby earthquake toppled house. A water-mud mortar was used to lay the courses of bricks. A water-mud cap was formed on this wall to make it shed water. The total surface exposed was 1.8m². No significant cracks in the wall were apparent prior to the start of the test. After drying in the sun for 6 days, this wall was sprayed for 45 minutes to the point of run-off with a 3% toluene solution of A-2. This completed test #1.

After 36 months, the adobe wall cap showed some surface cracks, but erosion did not appear to be occurring in these cracks. Hand smoothing marks were still sharply defined on the side of the wall after 36 months. After 48 months, the cracks had widened somewhat. A large crack on the left end of the wall was caused by human interference early in the test period. The brick had to be repositioned.

Test #2

Test #2 was a double chicken wire fence 1.5 x 1.2 m. stretched between wooden posts, on which a water-wet mixture of local adobe soil and chopped straw was smeared. The plaster was about 2.5 cm. thick. This "adobe" fence was allowed to dry in the sun for 6 days and was then sprayed for 25 minutes on both sides to the point of run-off with a 3% toluene solution of A-21. This completed test #2.

Test #3

A second chicken wire fence of the same dimensions and type was built, and smeared with a wet mixture of adobe soil and a 16% E-330 emulsion to form a 2-5 cm. thick, fence-reinforced wall. The mixture was smoothed by hand and then allowed to sun dry. This completed test #3.

The fences held up for 36 months in excellent condition with hand smoothing marks still sharp on both the E-330 and the A-21 tests. The fences were semiflexible, and moved in the wind.

Casa Grande National Monument, Arizona

The Western Archaeological Center of the U.S. Park Service set up an adobe test at Casa Grande in late 1977 and early 1978. They very generously provided us with two adobe brick walls on which to conduct an A-21 test. The purpose was to evaluate the efficacy of A-21 treatment in controlling ground-water deterioration at the base of an adobe wall. Each wall was monolithic, 115 cm. long, 45 cm. thick, 85 cm. high above ground level, and 25 cm. below ground level. The walls were constructed in a plastic lined pit, 25 cm. deep, in which perforated water pipes delivered water to the wall base from an above ground 220 liter reservoir. The walls were to be soaked at the base for 4 hours each week. However, the head on the system was such that water would break through at a crack in its base, flow out in a stream and erode away large areas of the wall. Thus, the weekly flooding had to be stopped, but the walls remain subject to normal weathering.

The test was conducted by spraying for 50 minutes a 3% toluene solution of A-21 over the total exposed surface of 3 m². of one wall (the other wall served as a control). Application was 9.7 kilos of solution per m². Immediately after the test a cut into the wall showed a toluene penetration to a depth of 3.8 cm. Following one day's drying a water beading test indicated a polymer penetration of at least 2.0 cm. After one day's drying a second short spray of 6% A-21 toluene solution was performed for 10 minutes to provide a hardened surface. Total 6% solution applied to the wall was 2.0 liters. Total 3% and 6% solutions was 30 kilos over 3 m². equal to 10 kilos of solution per m².

Just prior to our treatment, heavy rains fell. The walls were covered with plastic in an attempt to keep them dry, but the ground surface around the test site was thoroughly damp, as well as the base of each wall. This dampness was recorded in pre-treatment photographs and we believe that the dampness was the cause of incomplete penetration of A-21, and hence, the erosion that has occurred around the base of the treated wall.

These walls have now weathered for 28 months. Comparison of 1978 and 1979 photographs show that the upper portions of the treated walls are holding very well vs. the control wall's untreated surfaces. No erosion seem to be occurring other than that of the previously mentioned base of the treated wall.

Boca Raton, Florida

Samples were placed on exposure at various times beginning in 1975 on the campus of Florida Atlantic University in Boca Raton, Florida. They rest on a concrete pad positioned under the edge of an unuttered roof overhang with the drip line cutting across most samples. Thus, in the heavy Florida rains, a sheet of water descends directly on these samples.

E-330 brick started April 1975

Six 10 x 20 x 20 cm. bricks were cast in a wooden mold from a thick but fluid mixture of sandy Florida clay and 12% E-330 emulsion. Following thorough drying, a three tier brick stack was built, using an E-330/Florida clay mortar. After 60 months, these bricks show only one small surface crack and a considerable growth of mildew. There appears to be no significant rain erosion. The mildew can be removed with clorox solution without damaging the E-330 binding action.

3% A-21 adobe block started February 1976

A 10 x 20 x 20 cm. modern adobe block made in Albuquerque, New Mexico was treated by paint brush for 45 minutes with a 3% toluene solution of A-21. Following thorough drying it was mounted in a vertical position for exposure. After 28 months this block had begun to show some surface erosion, but the edges were still sharp and embedded pebbles were still tightly bound in the surface. The most serious erosion was occurring at one spot on the base of the block where the splash from the overhead roof hit the concrete pad. The brick toppled and broke in 3 pieces some time between the 32nd and 35th month. It should be noted that a comparable brick exposed in the same way melted and completely disappeared in two weeks.

3% A-21 Florida clay brick started March 1977

A 5 x 15 x 30 cm. brick was cast with a water-Florida clay mixture. After thorough drying this brick as brush treated for 45 minutes with a 3% A-21 solution. Following drying this brick was mounted on edge on the exposure pad. After 37 months exposure the A-21 treated surface showed no erosion; it is hard and still water repelling. Little or no mildew grows on the A-21 treated samples.

3% A-21/6% A-21 Florida clay brick started March 1977

A water-Florida clay brick was cast in the same fashion previously described. After drying, this brick was first given a 45 minute treatment with 3% A-21 solution, dried overnight, and then given a 10 minute treatment with a 6% A-21 solution. This second treatment produced a hardened surface coat that was more resistant to abrasion. After 37 months exposure no evidence of erosion or cracking is evident. No mildew growth is appearing.

3% A-21/E-330 plaster-Florida clay brick started March 1977

A dried, water-Florida clay brick comparable to the previous one was first brush treated for 45 minutes with 3% A-21 solution, dried thoroughly and then plastered with a 0.5 cm. coat of E-330-Florida clay plaster. The dried brick was placed on edge exposure. After

37 months, no evidence of failure is occurring. As with the other E-330 surfaces this brick is showing some mildew growth. It should be noted that the untreated Florida clay bricks have little natural binding and dissolve completely in the first hard rain.

Philadelphia, Pennsylvania

Two 10 x 20 x 20 cm. E-330 Florida clay bricks identical to the six placed on exposure at Florida Atlantic University, were placed on the roof of the University Museum in Philadelphia in July 1975. One block was placed at a 45 degree angle leaning on another placed flat. After 59 months of exposure to heat, rain and freezing winter weather, both blocks show no deterioration. There is some mildew growth, but much less than in Florida.

A-21 on carved Florida clay brick started November 1977

A water-Florida clay brick 5 by 15 by 25 cm. was carved so as to produce 1.0 cm. raised numbers "10-77". The brick was first brush coated for 30 minutes with 3% A-21 solution, dried overnight and then given a short brush coating for 10 minutes with a 6% A-21 solution. This brick was then placed on roof exposure. After 31 months exposure to both summer and winter weather conditions, the raised numerals are still as sharp as when the brick was first placed on exposure. This brick is an attempt to demonstrate what treatment could be applied to ancient carved or molded surfaces, such as those found at sites in Peru.

INTERIM CONCLUSIONS

Advantages of E-330 treatment (for future testing)

E-330 is a water miscible emulsion which, when mixed with soil, can produce a highly weather resistant mudbrick for wall capping and small scale reconstruction (costs of the emulsion may be limiting on a large scale). E-330 will provide a weather resistant mud plaster and/or grout which can be used successfully, but only under conditions where the subsurface is stable, or has been stabilized with a compatible chemical treatment.

Advantages of A-21 treatment (for future testing)

- strengthens greatly against rain erosion
- strengthens 10-fold against sand-blast erosion
- protects against repeated wet-freeze-thaw
- blocks transmission of water liquid, but passes water vapor
(the walls can "breathe")
- penetrates deeply, 2.4 cm. in 1 hour

- does not fill interstices in mudbrick (only 0.3% by weight of polymer remains in penetrated soil)
- virtually no visible changes as a result of treatment
- treated surface wears away a grain at a time with no crust delamination
- affords a number of benefits at reasonable cost

FINAL THOUGHTS

The level of progress in, and the advantages to our polymer treatment system have been detailed above. Two thoughts merit mention. In those particular situations where mudbrick is being excavated, it is urged that testing begin soon after exposure for the loss of cohesion of soil particles in exposed mudbrick over time only acts to retard the ultimate effectiveness of any treatment applied. Secondly, we would like to suggest that those countries with major, exposed mudbrick complexes in varying states of erosion, who would be willing, should make noncritical areas at these locations available for testing, and also facilitate the implementation of such testing through cooperative efforts. In that field exposure is the ultimate arbiter of the success of mudbrick conservation it is essential that more field opportunities arise for experimentation, and that more advantage be taken of such opportunities.

REFERENCES

Pigott, Vincent, and Butterbaugh, Darrel J., 1978. A programme in experimental mudbrick preservation at Hasanlu Tepe. Iran, 16:161-168

EFFECTIVENESS OF CONSERVATION TREATMENTS OF A VOLCANIC
TUFF VERY SIMILAR TO ADOBE

RAFAELLA ROSSI-MANARESI X

GIACOMO CHIARI XX

SUMMARY

Blocks of volcanic tuff (Cangahua) were used to build the platforms of Cochasquí, Ecuador. Although not man made, this material presents remarkable similarities with adobe, from the conservation point of view, as the analyses of physical properties show. On the basis of the experience of conserving both adobe and stone, treatments with Silester (ethyl silicate), Transkote (aluminum stearate) and a combination of both were tested. The results of the treatments were evaluated by comparing selected physical properties measured on both treated and untreated samples. Accelerated ageing tests by wetting-drying cycles, representative of the major cause of alteration, were also performed.

The treatments tested proved to be very effective in guaranteeing the consolidation and preservation of this material.

x Centro per la Conservazione delle Sculture all'aperto,
Via de' Pignattari 1, 40124 Bologna, Italy.

xx Istituto di Mineralogia dell'Università,
Via San Massimo 22, 10123 Torino, Italy.

INTRODUCTION.

The site of Cochasquī, Ecuador, is in the process of being transformed into an archaeological park. It consists of a great number of "tolas", pyramids or platforms built with blocks cut from a volcanic tuff and put together without mortar. At present the tolas are covered with a tall layer of grass and can hardly be distinguished from natural hills. A small portion was excavated in the seventies, from which the samples used in this paper were taken. The general idea for the park (Oberem, Crespo, Lara, 1975) is of having at least a section of one tola excavated and preserved to be seen as a representative sample of all the others. To achieve that goal several surface protecting treatments were tested on the cangahua. Part of the laboratory results have already been communicated (Rossi-Manaresi, Pellizzer, 1979).

CHARACTERISTICS OF THE MATERIAL AND CAUSES OF ALTERATION.

Sampling. The samples used to determine the characteristics of the material and for the treatments were 4 cm cubes dry-cut from a single block. This allows one to make a comparison between the various measurements.

Petrographic characteristics. Analysis in thin section shows a chaotic aggregate of crystalline and lithic fragments (about 50 % of the rock) immersed in a matrix consisting of consolidated vitreous powder.

The crystalline fragments (0.01 to 3 mm in size) are mainly plagioclase, green hornblende and small quantities of piroxenes. The whole rock is intensely coloured due to the presence of diffuse ferruginous substances, formed as a result of oxidation phenomena (concretions of haematite are visible).

The structural and textural characteristics of the material correspond to those of pyroclastic rocks; on the basis of its mineralogical composition, the rock must be classified as a phenoandesitic tuff.

Physical characteristics. The following physical characteristics were determined: (Working Group ICOMOS/RILEM PEM, 1978)

Bulk density: mass per unit of apparent volume; the volume was determined by hydrostatic weighing of the sample saturated with water under vacuum (pressure 0.1 mm Hg).

Porosity: the total open porosity was determined by the Kobe method based on the evaluation of the volume of air that fills the interconnected pores of the rock. It is expressed as percent of the apparent volume of the sample. The porosity was also determined by saturation with water under vacuum; a mean value of 47.7 vol. % was obtained in agreement with the value obtained with the Kobe method (48.8).

This agreement confirms that for very porous materials, like the one considered here, the water saturation method can give reliable data, but this is not the case when not very porous materials are concerned. (Poggi Brigenti, Ciancabilla, 1973).

Compressive strength: determined perpendicularly to the stratification; expressed in Kg/cm^2 .

Water absorption: determined by measuring the mass of water absorbed by the sample (previously dried at 60°C till constant mass) in 48 hours of immersion at atmospheric pressure. Expressed as per cent of the dry sample mass.

Saturation coefficient: the ratio between the volume of water absorbed by the sample in 48 hours immersion and its total volume of open pores. Expressed in per cent.

Capillarity (water absorption coefficient): determined by measuring at time intervals the mass of water absorbed by the sample immersed to a depth of 2 mm and plotting the mass of water absorbed (in Kg/m^2) as a function of the square root of time (in seconds). The absorption coefficient ($\text{Kg/m}^2 \text{ s}^{0.5}$) corresponds to the slope of the straight line passing through the origin.

The mean values of the results obtained are reported in the first column of table 1.

Causes of alteration. The poor quality of the material is clear from the physical characteristics reported in table 1: the cangahua exhibit very poor cohesion, high porosity and absorbs very quickly large quantities of water (about 10 Kg/m^2 in 3-4 minutes). The fact that after two or three simple immersion in water, the untreated sample completely disintegrated points to the heavy rains typical of the Cochacu climate as the major cause of alteration.

TABLE 1. - Physical characteristics of untreated and treated Cangahua.

	Untreated	Transkote	Silester	Silester + Transkote
Bulk density (Kg/m ³) increase %	1464	1506 (2.9)	1590 (8.6)	1593 (8.8)
Compressive strenght (Kg/cm ²) increase %	15.0	28.3 (87.8)	50.1 (232.8)	60.3 (300.8)
Porosity (vol. %) (+) decrease %	48.8	41.3 (15.3)	42.4 (13.1)	38.4 (21.2)
Water absorption (mass %) decrease %	27.8	6.9 (75.1)	11.0 (60.4)	18.4 (30.4)
Saturation coefficient decrease %	0.83	0.25 (69.9)	0.41 (50.6)	0.76 (8.4)
Water absorption coeff. (Kg/m ² s ^{1/2}) decrease %	0.71	0.01 (98.3)	0.05 (92.9)	0.19 (73.2)

(+) The porosity values reported here are those obtained with the Kobe method. The porosity was also determined by the method of water saturation under vacuum, but the values obtained for the treated samples were evidently distorted due to the water repellency provided by the treatments. The phenomenon has already been observed (Rossi-Manaresi, Alessandrini, Fuzzi, Peruzzi, 1979) and further confirms that when it is necessary to compare the effect of different treatments the determination of the total open porosity by the water saturation method cannot provide reliable results.

The second more important factor of decay is vegetation, which plays, though, an ambivalent role. In the present state of conservation of the tolas the grass roots alter the superficial layer; but also the grass itself constitute a protection from erosion due to rain that would take place at much higher rate on the bare unpreserved monument. A sort of balance has been reached that would be altered for the worse by simple removal of the grass layer. For that part that will eventually be excavated and preserved, on the other hand, special care should be devoted to avoid both grass and lichens.

The action of wind is probably involved too, favouring the drying of the stone (thus accelerating the wetting-drying cycles) and acting as a mechanical removal agent as well.

TREATMENTS.

Three groups of samples (three cubes each) were respectively treated as indicated below. Keeping in mind the probable difficulty of carrying out the treatment on completely dried material "in situ", the samples, after drying to constant weight, were left at room temperature for a week. When treated, they thus contained about 1.9 % of water. The treatments were the following:

1) Silester ZNS (ethyl silicate). The commercial product (P. Carini, Milano) was diluted 1:2 with ethanol; 0.5 ml of HCl 1 N per litre of final solution were added. The samples were treated by immersion, (first partial, then total). The treatment was repeated three times at intervals of 24 hours for a total of 15 hours immersion.

2) Transkote (aluminum stearate), by Sandtex, Trieste. The solution supplied by the firm was used as it was. Treatment was by immersion as indicated above, and repeated a second time after a week. Total immersion time was about 10 hours.

3) Silester + Transkote. The samples were first treated with Silester, with the same procedure indicated in 1). After being left at room temperature for a month, the samples were then treated with Transkote in the way indicated in 2).

ASSESSMENT OF THE EFFECTIVENESS OF THE TREATMENTS.

Physical characteristics. All the physical characteristics previously determined in the untreated samples were also measured in the treated

ones. The results are summarized in Table 1, where the increase per cent of the values with respect to the untreated samples are also reported.

The curves of water absorption by capillarity are reported in figure 1. As shown all treatments drastically reduced the water absorption coefficient, and considerably improve the characteristics of the material. Silester is relatively more effective as a consolidant (greater increase in density and compressive strength) whereas Transkote is probably a better protective agent as it greatly reduces water absorption.

By applying both treatments it was thought that their respective effects would be summed up in some way: in fact this was confirmed for what concerns the increase in the compactness of the material, indicated by the porosity, density and compressive strength; but as regards the water-repellency, this hypothesis was not confirmed. In fact, all the data relative to water absorption indicate that the effect of the two treatments together, for what concerns water-repellency, is less than that of each treatment by itself. This result can be explained by the effect on Transkote of the alcohol used to dilute Silester, which probably had not evaporated completely even after a month. In fact, the alcohol precipitates the aluminum stearate; during the second treatment white spots appeared on the samples, probably due to the precipitation of the aluminum stearate.

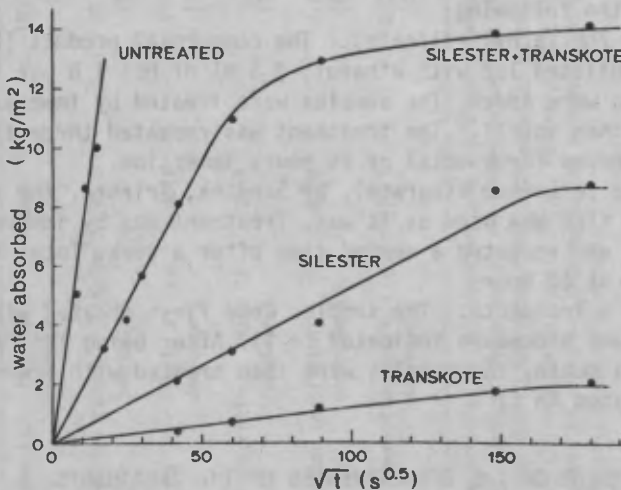

FIGURE 1: Curves of water absorption by capillarity of treated and untreated samples. Kg of water absorbed per square meter as a function of the square root of time (in seconds).

ACCELERATED AGEING TEST.

The treated and untreated samples were then subjected to an accelerated ageing test by wetting-drying cycles, the process which in the first part of this study was found to be the most responsible for the decay of this material. Every cycle consisted of two hours immersion in deionized water, 21 hours at 60°C, one hour cooling at room temperature. At intervals of several cycles, the samples were dried to constant weight in order to assess the loss in weight.

In the untreated samples, a mean loss of 1.5 % weight after the first cycle and 37 % after only two cycles was observed. After three cycles half of the samples investigated were destroyed, and after a fourth cycle the remaining ones were broken up.

The losses of weight as a function of the number of cycles observed in the treated samples are reported in Figure 2. The maximum loss of weight is less than 2 % after 26 cycles for all treated samples. Therefore the protective effectiveness of all the treatments is considerable. However, Transkote appears to limit the destructive effects of water even more than Silester.

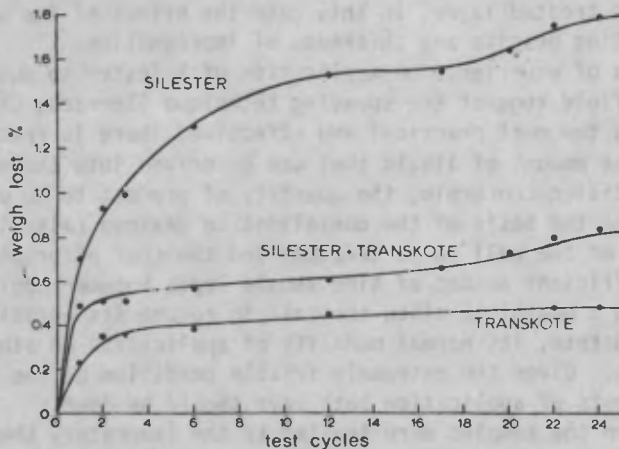

FIGURE 2. Cumulative percent weight loss of treated samples as a function of the number of ageing cycles. (The untreated samples would get out of scale at the second cycle, and are not reported).

METHOD OF APPLICATION.

It must be pointed out that the very good results obtained in the laboratory tests are probably due in part to the total impregnation of the samples obtained by immersion. Had the permeation only be partial, the results would certainly have been worse. On the other hand a treatment 'in situ' can obviously only be superficial. Previous experiences tell us that the conservation problem is shifted from the surface to the plane deviding the treated from the untreated part. The thickness of the consolidated section depends upon many factors: mainly the porosity of the surface (or better the absorption capacity with respect to the permeating agent); the amount of liquid used, which obviously dictates the final cost per square unit of the treatment; and the modalities of application (for example by spraying or with a brush).

To achieve an effective protection the separation surface should not be smooth, but as irregular as possible, to obtain a natural keying effect. A gradient of impregnation (and consequently of physical properties) should also be favoured to avoid sharp distinctions between crust and inner wall. But the most important point is to avoid any weak part on the surface through which water can penetrate inside the wall, beneath the treated layer. In this case the effect of the water would be devastating despite any thickness of impregnation.

Twelve years of experience on application of Silester to mud-brick surfaces in the field suggest the spraying technique (Torraca, Chiari, Gullini, 1972) as the most practical and effective. There is practically no limit to the amount of liquid that can be driven into the wall ; therefore the decision concerning the quantity of product to be used should be taken on the basis of the consolidation desired (also in view of the 'quality' of the wall to be treated) and the cost affordable for that goal. A sufficient amount of time should lapse between applications (15 days to a month) to allow the wall to resume its porosity.

For the Transkote, its normal modality of application on stone surfaces is by brush. Given the extremely friable condition of the cangahua, 'in situ' tests of application both ways should be done.

Finally, when the samples were treated in the laboratory they contained a fairly moderate amount of water; the good results obtained indicate that the material does not necessarily need to be completely dried for the treatment to succeed. However it must be remembered that the treatment should be carried out on materials which are as dry as possible.

CONCLUSIONS.

From all the results obtained, one can conclude that the two products, applied individually, are both very effective in guaranteeing the conservation of this material.

Silester is relatively more effective in imparting compactness and mechanical resistance; Transkote instead is more effective in supplying water-repellency and resistance to the process mainly responsible for the decay.

The successive application of both treatments may possibly produce an overlapping of the single effects of the two individual treatments, but the two applications must be separated by very long periods of time and only used after careful checking.

Finally, whereas ethyl silicate is no longer extractible from the rock structure, although modifying it very little, the aluminum stearate can be extracted with organic solvents, thus guaranteeing the reversibility of the treatment.

ACKNOWLEDGEMENTS.

We acknowledge prof. R. Pellizzer of the Institute of Mineralogy and Petrography of Siena for the petrographic analyses.
 Prof. G. Brighenti of Institute of Mineral Sciences of Bologna for the determination of porosity and measurements of compressive strength.
 P. Carini of Milan for providing the Silester used in the treatment.
 G. Chiari feels in debt to arch. R. Pallares, J. Benavides Solis and H. Crespo Toral for help and friendship during his stay in Ecuador.

REFERENCES.

- Oberem,U., Crespo,H., Lara,J.S., 1975. Cochasquí, Marco de referencia para la creación del Parque Arqueológico y la preservación de los monumentos. Dirección Nacional de Turismo, Ecuador.
- Rossi-Manaresi,R., Pellizzer,R., 1979. The volcanic tuff of the archaeological monuments in Cochasquí, Ecuador: cause of decay and effectiveness of conservation treatments. 3rd International Congress on the Deterioration and Preservation of Stone, Venezia, October 1979 (in the press).
- Working Group ICOMOS/RILEM PEM, 1978. Experimental Methods. Proceedings of International Symposium UNESCO/RILEM. Paris 1978, Publ. C.E.B.T.P.
- Poggi,B., Brighenti,G., Ciancabilla,F., Contributo allo studio sperimentale dei calcari per opere d'arte. Problemi di conservazione, Ed. G. Urbani, Ist. Centrale Restauro, Roma, 1973, pp. 345-358.
- Rossi-Manaresi,R., Alessandrini,G., Fuzzi,S., Peruzzi,R., 1979. Assessment of the effectiveness of some preservatives for marble and limestones. 3rd International Congress on the Deterioration and Preservation of Stone, Venezia, October 1979 (in the press).
- Torraca,G., Chiari,G., Gullini,G., 1972. Report on mud-brick preservation. Mesopotamia VII, 259-287.

TREATMENT OF ADOBE FRIEZES IN PERU

GIACOMO CHIARI^X

SUMMARY

The consolidation technique adopted in the treatment of some painted and unpainted adobe friezes in Peru is here described.

This technique was applied in three UNESCO sponsored projects (1975-77) and is now one of the tools used by the pilot conservation project working in the Tschudi Citadel of Chan Chan.

The process consists of the following steps: a) consolidation of the mud layer underlying the painting using ethyl silicate spaying technique; b) strengthening of the inner part of the wall by injections of an acrylic emulsion (Primal); c) fixing of the painted layer if present, with Paraloid.

The results of the treatments performed five years ago are very encouraging.

^X Assistant Professor at Istituto di Mineralogia
Via San Massimo 22, 10123 Torino, Italy.

June 12 , 1980.

INTRODUCTION.

Perù is one of the countries that exhibit the largest number of adobe friezes, painted and unpainted. The archaeological and artistic importance of these friezes is inestimable. **Being** made of mud, their chances of surviving after excavation for even small periods of time are very limited. Most of the friezes have in effect already disappeared.

In Perù almost all major civilizations extensively used adobe in their constructions. Even the Incas, master in stone masonry, often dealt with mud brick construction in the mountain region. When the expansion of their empire brought them to the coast, they built entire cities, like Tambo Colorado, in adobe, transferring to the mud brick buildings some of the architectural techniques used for stone palaces. Typical examples are the trapezoid doors and windows, consequent to their ignorance of the arch. Very often the walls were plastered and painted in bright colors. (Hence the name Tambo Colorado, meaning the painted city).

Two civilizations excelled above all others in the art of decorating buildings with alto relieve mud friezes: Chavin (1300 B.C. -300 A.D.) and Chimù (1100 - 1450 A.D.). The conservation of one frieze for each of those two civilizations is the subject of this paper.

HUACA GARAGAY, CHAVIN (1300 B.C.)

The ruin is located above the soil level, about half a mile from the Pacific ocean, and five miles from the center of Lima.

The mud bricks are not molded, and do not present sharp edges. They are more like rough spherical blocks about 10-15 cm in diameter. The material used for the bricks was clayish soil surrounding the Huaca. No extra sand or gravel or organic material was added to the soil.

Discovered in 1959, the systematic excavation started in 1974, conducted by the Departamento de Investigación of the Instituto Nacional de Cultura, under the direction of R. Ravinez.

The archaeological complex consists of 5 hills of different sizes, distributed on three sides of a big U shaped square. The rectangular central body is 23 m high, while the two side platforms are smaller. All of it is man made, in mud and stone.

A temple is located on the top of the pyramid, also U shaped and with the opening pointing to the North. The wall of the temple, now 1.4 m high, is made of mud bricks and some random stones. It shows four clay plasters; the first three are about 2 cm thick; the more superficial, made with finer clay, is about 1 cm thick. Above this a series of mistic images were sculpted in relief. The figures were painted in black, white, yellow, blue, red and pink. (J.M. Cabrera, 1977, performed an optical microscopy analysis of the pigments. Independently by X-Ray diffraction I reached the same conclusions which are the following: black is animal and/or vegetal coal; yellow is limonite; red is hematite; white is caolinite and gypsum; pink is a mixture of red and white. In all pigments various amounts of clay minerals are present).

The friezes were repainted many times, almost always using the same colors. In some spots one can find up to ten different layers of painting. The figures are disposed all around the atrium, facing toward the central part of the temple, as in procession.

No roof has survived but there is evidence (bases of wooden poles painted in white, located in front of the friezes) that anciently a roof, probably made with cane and mud, covered the procession. Immediately after the excavation a temporary cane and mud covering was made, substituted by another more permanent roofing, using the same materials. The use of cane and mud is justified by the fact that it blends well with the surroundings of the monument not yet excavated, and also allows cheap maintenance by the workers of the excavation. Special care has been devoted to guarantee enough aeration through a series of shutters that also protect the friezes from direct sunlight. In spite of the fact that the friezes have been consolidated as described below, due to the importance of the remains, it is highly advisable to keep them protected under a roofing.

The climate is very favourable: almost no rain (although one bad storm can be expected every 25 years or so). Very slight seasonal and daily temperature variations (average 15°C in July and 24°C in January; daily variations of about 8-10°C). Relative humidity is very high in winter only. No problems with ground water raise for capillarity, salinity or vegetation. Earthquakes constitute a major risk.

FRIEZE OF CASA VELARDE, CHAN CHAN , CHIMU.

This particular frieze was selected to be shown here because of it's particular beauty. It is also representative of a whole series of unpainted friezes constituting the ornamentation of a great number of walls in the palaces and temples of Chan Chan. Excavated in 1969 and then recovered with fine soil it was occasionally undug to be shown to some important visitor. Every time a few more details were missing. After consolidation it was covered one more time to protect it especially from "huacheros".

It depicts fishing scenes, with men riding on the typical boats made of cane still in use, and a large number of fish and sea food so accurately depicted to be easily recognized, despite the small size of the frieze and the difficulty of sculpting in mud.

The problems connected with the conservation of this and other friezes in Chan Chan are somehow different from Garagay. The climatological conditions are almost the same but here strong evidence of hygroscopic salt deposition are evident. These salts are brought in by winds carrying in suspension small droplets of sea water. The wind is also a major cause of damage by mere erosion helped by the presence of suspended sand. On the other hand the fact that these friezes are not painted constitute an obvious simplification of the treatment.

DESCRIPTION OF THE TREATMENT.

The work in Garagay was fully described in my Unesco report. (Chiari, 1975). I will here therefore simply summarize the main steps of the procedure.

The major problems in the preservation of these friezes are:

- a) extreme friability of the superficial crust.
- b) necessity of conserving the original color.
- c) necessity of anchoring to the interior part of the wall every small detail, even when it was already partially cracked and half detached from the rest.
- d) protection of the entire complex to shelter it from dust deposition, rain and light that could alter the color.

The first step was to consolidate as much as possible the mud brick support of the painting, even before attempting to clean the surface. (Infact in some spots simply cleaning the frieze was impossible

even being very careful, because the painted layer crumbled along with the dust or sand adherent to it.) This was obtained using the ethyl silicate spraying technique (Torraca, Chiari, Gullini, 1972) after reassurance by treatment of small samples already detached from the wall that the treatment would absolutely not change the color of all the pigments. Several applications were performed, a few days apart, to allow the wall to dry out and reassume the porosity necessary to absorb the next application. In this way the chances of damaging the very delicate layer of painting during the application itself were reduced. After three applications the frieze was sufficiently hardened so that the outer laying dust could easily be removed with mechanical tools, without damaging the painted layers.

Ethyl silicate after hydrolisis creates a three dimensional net of polymerized silica chains, bridging in a random intricate way the clay particles present in the mud brick. For sand or dust deposit the consolidation action is almost null, with the advantage in this particular case of facilitating the cleaning operation. It is also true that ethyl silicate does not fix the pigments used in Garagay, which needed therefore an ad hoc consolidation at the very end of the treatment. Infact, while the ethyl silicate allows a following application of painting fixers as Paraloid or Calaton, the reverse is not true.

In the consolidation of well preserved vertical surfaces of mud a treatment with ethyl silicate alone may constitute enough protection especially if the rain water is properly disposed of. If on the other hand a crust is present, or there is evidence of pieces of frieze already detached from the inside wall, then a second more delicate treatment is needed. Infact ethyl silicate has a big disadvantage as surface protection material, of not being able to glue together pieces of adobe already detached. To anchor the crust once consolidated to the interior of the wall a series of injections of a 10 % water emulsion of Primal AC 33 were performed. To avoid drilling new holes into the frieze the preexisting cracks were used as injection points. The acrylic resin could not be injected under pressure both because of the serious possibility that the superficial crust would fall during the treatment, and the tendency of the liquid to leak from the crack producing a drip on the painted layer, which would be very difficult to take off without damaging the painting itself. These drawbacks were partially avoided using a large number of small plastic siringes with a fine needle, left in place and refilled with the emulsion as soon as it penetrates into the wall. In this way a slow but constant flow of liquid was assured, without a great loss of time by the operator. Some holes absorbed much more solution than others ;

that only means that different parts of the wall need a different amount of liquid to be consolidated. With the use of the syringes this different distribution is realized automatically.

The final touch was given by an application of Paraloid (performed by R. Vallin, Unesco expert) to fix the superficial layers of painting.

In the case of Casa Velarde the injections of Primal were not needed, although small repairs were done mainly to maintain details of the frieze. In this case the small holes present were filled with mud before the application of ethyl silicate, obtaining a good solidity of the ensemble.

CONCLUSIONS.

The advantages in the use of this mixed technique are, in my opinion, that one can exploit the best properties of each product, avoiding most of the drawbacks. For example, acrylic or polyvinyl resin do not perform too well on the surface because of their tendency to form thin films and to change the color, the texture and other physical properties such as thermal dilatation coefficient of the treated material. When injected inside the wall instead, they do work very well as binding agents, while the above mentioned changes become obviously not important. Conversely, the ethyl silicate performs well only in surface.

In conclusion, after a few years have passed one can state that "the frieze appears to be in a condition which is sufficiently stable to guarantee preservation in the present situation".(Torraca,1978).

ACKNOWLEDGEMENTS.

I would like to acknowledge UNESCO for financing my three missions to Perù and providing the material for the treatment. Silvio Mutal, José Correa and Rogger Ravinez in Lima, and Cristobal Campana and Ricardo Morales in Trujillo for their support and warm friendship. Also all other friends in Perù whose list here would be too long.

REFERENCES.

- Cabrera, J. M., 1977. Optical analysis of Garagay pigments. (Personal communication).
- Chiari, G., 1975. Perù- Conservación de los monumentos arqueológicos en adobe - UNESCO - RLA/047/72.
- Torraca, G., Chiari, G., Gullini, G., 1972. Report on mud brick preservation. MESOPOTAMIA VII , pp. 259-287.
- Torraca, G. 1978. Mission to Perù , final report. UNESCO.

THE USE OF RAW CLAY IN HISTORIC BUILDINGS:
ECONOMIC LIMITATION OR TECHNOLOGICAL CHOICE?

EUGENIO GALDIERI ^X

SUMMARY

Since long time ago man uses raw clay as a building material in geographic areas which have been found to be vast. This materials has been condemed to disappearance, for a reason that, among others, is that of considering it as poor and weak. But if we pay close attention to the major examples of raw clay constructions built through centuries, it is possible to identify some fundamental facts; the use of raw clay has conditioned only minimally the architectural and structural forms of buildings; the survival of many examples of these buildings proves that this material is much more resistant than what is thought to be; its use in the cases in which economic limitations didn't exist proves that it's a precise technological choice. It is on this fact that we should base our conservation strategy.

^X Architect, responsible of the restoration programmes,
Istituto Italiano per il Medio ed Estremo Oriente, Roma.
(ISMEO) (Italian Institute for the Middle and Far East, Rome).

July, 10th., 1980

Il semble presque inutile, dans un colloque consacré à la conservation de la brique crue et qui s'adresse par conséquent à des spécialistes de la question, de rappeler que l'homme utilise l'argile crue sous ses divers modes d'application comme matériau de construction depuis les temps les plus reculés jusqu'à nos jours. Tout aussi inutile serait de rappeler que l'aire géographique des constructions en brique crue est extrêmement vaste et qu'elle recouvre bonne partie du globe; une carte du monde indiquant l'aire de diffusion des constructions en argile crue - soit celles du passé lointain, soit celles encore utilisées ou même en expansion - présenterait à peu près cet aspect (Fig. 1). Il s'agit d'une carte que Pierre Vidal de la Blache dessina en 1918 et qui fut publiée en 1948 dans son manuel de géographie humaine. J'y ai apporté les mises à jour nécessaires à l'occasion de ce colloque. Il me paraît cependant utile d'attirer dès maintenant l'attention précisément sur ces deux facteurs - continuité dans le temps et extension dans l'espace - pour souligner l'importance du phénomène au niveau historique comme au niveau social et par conséquent à la double responsabilité qui en découle pour les conservateurs.

Il s'agit d'un mode de construction né avec les débuts de l'activité de l'homme et qui n'est pas encore abandonné: bien plus, dans certaines régions, il est en plein développement; un mode de construction répandu sur une grande partie du globe, y compris dans certaines régions relativement humides et de moyenne séismicité (on remarquera que plus de 60% des régions concernées sont situées entre le tropique du cancer et le 50e parallèle Nord); un mode de construction que nous pouvons aujourd'hui connaître et analyser grâce aux innombrables témoignages survivus au temps, à la pluie, à la guerre et à l'homme. Un tel mode de construction ne peut certes être négligé, ni du point de vue monumental et historique, ni du point de vue humain et social. Les constructions en argile crue ne se sont pas dissoutes en raison de leur incontestable et intrinsèque faiblesse: nous les avons nous-mêmes condamnées à une mort plus rapide en les jugeant pauvres et faibles et, dans un certain sens, en admettant leur désagrégation comme un fait inéluctable. Le fondement de ce faux jugement est la conviction tout aussi fautive, profondément enracinée dans

le passé mais malheureusement encore diffuse aujourd'hui, selon laquelle une construction en argile crue, sauf rares et spectaculaires exceptions, correspond à un état de misère économique et social et représente par conséquent l'unique possibilité expressive de cultures dépourvues d'autres moyens. Ceci est vrai, et encore pas entièrement, seulement dans des cas anachroniques, c'est à dire quand la construction en terre n'est plus l'expression traditionnelle d'un milieu; en revanche, lorsqu'il s'agit d'une phase d'expression directe et habituelle d'un milieu les aspects économiques et sociaux ne doivent pas seulement être recherchés dans le matériau de construction mais dans le type de structure et dans l'usage plus ou moins avancé qui est fait du matériau. Osvaldo Baldacci, géologue et ethnologue italien, écrit: "D'un point de vue culturel la maison de terre est grossière comme peut l'être une maison faite avec des troncs d'arbre dans une zone forestière ou avec des pierres non équarries dans une zone montagnaise. Le progrès apparaît quand l'argile crue, le bois, la pierre sont travaillés, quand une force technique affirme sur eux le pouvoir de l'intelligence..." "On peut dès lors, je suppose, parler d'une civilisation de l'argile crue, de la brique, du ciment etc..., dans toute l'ampleur de la signification culturelle".

A des mots aussi clairs je ne peux ajouter qu'une petite observation: la civilisation de l'argile crue atteint ses plus hauts sommets chaque fois qu'elle parvient à se libérer du conditionnement - davantage psychologique que technique - du matériau, en se lançant dans des formes et des structures propres aux matériaux plus résistants tout en restant fidèle à son esprit.

Examinons maintenant les innombrables exemples historiques, en particulier ceux de l'aire très vaste qui s'étend du bassin méditerranéen jusqu'à l'Océan indien et qui, des côtes de l'Afrique du Nord, à travers la Turquie et l'Iran, arrive aux confins de l'Afghanistan. Ces exemples nous démontrent comment les anciens constructeurs ont su réaliser avec l'argile crue les formes architectoniques les plus variées et les plus complexes, parfois même les plus audacieuses, sans qu'elles soient aucunement conditionnées par la nature du matériau.

Et puisque j'ai fait allusion au bassin méditerranéen qu'il me soit permis de saisir l'occasion pour dresser un bilan rapide des constructions en brique crue en Italie avant de passer à la zone bien plus importante que j'ai choisie comme thème. Si je fais allusion à l'Italie ce n'est pas seulement parce que c'est mon pays mais surtout parce que, bien qu'étant pauvre d'exemples célèbres de construction en argile crue, elle n'en est pas totalement privée comme beaucoup le pensent. J'ai dû moi-même faire un long travail avant de réunir les quelques informations

dont je vous fais part, étant donné l'extrême dispersion de celles-ci. Une autre raison est que ce ne sont pas les historiens de l'architecture ou les archéologues qui recueillent des données sur les constructions en argile crue en Italie (ces derniers se limitent le plus souvent à constater qu'un matériel de fouille donné est fait d'argile crue), mais plutôt les spécialistes de géographie, d'ethnologie ou même de folklore.

Donc, si nous excluons la présence d'argile crue à l'époque préhistorique ou protohistorique (des constructions d'argile et de brique crues sont connues déjà à partir du néolithique) nous pouvons dresser pour l'Italie un tableau relativement riche d'informations et qui est confirmé pour l'Antiquité classique par des descriptions précises de Vitruve, Pline, Tacite, Varron etc. Ce tableau montre l'usage largement répandu d'un mélange d'argile et de brique crue proprement dite - en particulier dans les murs des remparts des villes - au temps de la colonisation grecque (importants exemples à Gela et à Eraclea Minoa en Sicile, à Velia près de Salerne), dans de nombreux exemples étrusque (Vetulonia, Pérouse, remparts d'Arezzo), dans quelques exemples romains comme en Sabine, à Ostie etc. On n'a gardé que des témoignages littéraires des exemples médiévaux: grâce à eux on sait que le pisé, c'est à dire les murs d'argile comprimée, était un des matériaux les plus répandues, par exemple dans la Milan médiévale ou à Alexandrie en Piémont, dans la plaine du Pô, etc. A partir du XVIe siècle l'usage de la brique crue ou de l'argile comprimée recommence à se répandre mais plus spécialement dans les constructions rurales; cela signifie qu'elle tend à s'identifier avec les constructions considérées plus pauvres d'un point de vue social. On trouve des constructions en argile crue de type urbain, donc relatives à des couches sociales capables de choisir également d'autres matériaux, en Piémont, en Calabre mais surtout en Sardaigne où les motifs architectoniques atteignent une remarquable expression artistique. Il faut remarquer que ces deux dernières zones géographiques, c'est à dire la Calabre et la Sardaigne, sont particulièrement riches en pierre et c'est justement en pierre que sont les constructions les plus connues - "nuraghi" et médiévales - et qui sont considérées caractéristiques de ces zones. A une époque relativement récente (il y a environ une vingtaine d'années) les centres urbains du Campidano, entièrement construits en terre crue, continuaient à s'agrandir selon le même système traditionnel. On enregistre également la présence d'importantes constructions en brique crue dans les Marches, en Ligurie, dans les Abruzzes, en Lucanie, en Ombrie etc. Nous présentons ici un graphique (Fig. 2) qui réunit les exemples du passé et les persistances actuelles et permet de mieux présenter la situation sur l'ensemble du territoire italien. Il faut enfin remarquer

que Vidal de la Blache n'avait même pas considéré l'Italie dans sa carte de 1918.

Après cette parenthèse italienne retournons aux riches régions de l'aire de l'Asie moyenne. Il serait certainement hors de propos, outre que cela risque d'être long et ennuyeux, de décrire en détail les importantes constructions en argile crue de ces régions: la plupart sont tellement connues qu'elles méritent ici à peine une allusion. Je me limiterai donc à passer en revue quelques unes parmi celles que j'ai connues ou étudiées directement et que j'ai choisies selon un critère absolument arbitraire et personnel afin de soutenir la thèse développée dans cette communication; c'est à dire démontrer a) qu'on a réalisé en argile crue des oeuvres architecturales qui ne sont certainement pas inférieures par la fantaisie, la complexité et l'audace structurelle à celles construites dans les mêmes régions avec des matériaux plus "nobles" et plus résistants; b) que si ont disparu les témoignages relatifs à de nombreuses constructions en terre crue, d'autres constructions, que leurs bâtisseurs considéraient "éternelles" parce que réalisées en brique, en pierre, en marbre, ont connu une fin semblable; peut-être étaient-elles davantage exposées au saccage et au pillage en raison même de leurs matériaux; c) que des classes sociales différentes, surtout autrefois, ont utilisé l'argile crue afin de réaliser leurs constructions pour des raisons qui vont au-delà de la commodité de repérage du matériau; d) enfin que l'usage massif de l'argile crue dans certaines constructions monumentales anciennes - réalisées sans aucune préoccupation de caractère économique - démontre clairement qu'il ne s'est presque jamais traité d'une solution de repli pour des motifs pratiques et donc de conditionnement purement économique, mais au contraire d'un choix technologique précis et motivé, qui, certainement, fut aussi déterminé par le coût relativement bas du matériau. Il existait peu de matériaux qui, comme l'argile crue, pouvaient fournir en même temps autant de caractéristiques positives (facilité de repérage et de travail, souplesse de structure, très haut potentiel cohabitant) au point qu'elle était préférée à d'autres matériaux plus durables. Les caractéristiques négatives sont nombreuses, surtout lorsque vient à manquer la protection de l'enduit: mais elles ne semblent pas avoir limité de façon excessive la fantaisie créative des constructeurs et n'ont pas empêché, je le répète encore une fois, que des milliers de témoignages parviennent jusqu'à nous presque entiers ou du moins suffisamment lisibles.

La plupart des exemples que j'ai l'intention d'exposer sont situés dans le centre de l'Iran, mais il n'en manque pas d'autres également significatifs choisis dans le centre de l'Afghanistan, ainsi que quelques

uns enregistrés dans le Yémen du Nord. Afin de dissiper toute équivoque je rappelle qu'il s'agit d'un choix personnel indépendant des valeurs intrinsèques historico-artistiques des édifices présentés et fait sur des constructions que j'ai personnellement connues ou étudiées.

Voici la liste des exemples classés selon l'ordre chronologique dégressif:

- 1) Maisons rurales récentes dans le Mazanderan (Iran, XXe siècle)
- 2) Village fortifié de classe sociale moyenne à Ghazni (Afghanistan, XIXe s.)
- 3) Village fortifié pauvre à Rauza (Afghanistan, XIXe s.)
- 4) Maison rurale avec pièces-séchoirs pour le raisin à Jalalabad (Afghanistan, XVIIIe s.)
- 5) Maisons d'habitation avec tours de ventilation à Yazd (Iran, XVIIIe s.)
- 6) Caravansérails à Ispahan (Iran, XVIIIe s.)
- 7) Dépôt communautaire pour la glace à Yazd (Iran, XVIIe s.)
- 8) Tours colombières, plaine du Zayandehrud (Iran, XVIIe s.)
- 9) Maisons d'habitation à Radâ (Yemen du Nord, XVIIe s.)
- 10) Mausolées de campagne à Rauza (Afghanistan, XVIe s.)
- 11) Murs de la citadelle de Ghazni (Afghanistan, XVe s.)
- 12) Château de Fahraj près de Yazd (Iran, XVe s.)
- 13) Agrandissements ilkhanides à la mosquée de Bersian (Iran, XIVe s.)
- 14) Cimetière hébraïque et synagogue à Lenjan (Iran, XIVe s.)
- 15) Tombe dite d'Iskandar à Kerman (Iran, XIVe s.)
- 16) Murs de la ville de Yazd (Iran, XII-XIIIe s.)
- 17) Restes de la mosquée seldjoukide à Sharestan (Iran, XIIe s.)
- 18) Musalla bouyide a Ispahan (Iran, XIe s.)
- 19) Mosquée de Nayin (Iran, X-XIe s.)
- 20) Mosquée de Fahraj (Iran, Xe s.)
- 21) Village de Tar (Iran, IX-Xe s.)
- 22) Château de Muhammadieh, près de Nayin (Iran, Xe s.)
- 23) Mosquée Jum'a d'Ispahan (Iran, IXe s.)
- 24) Palais fortifié de Norang-Qal'a (Iran, IXe s.)
- 25) Citadelle et murs de Bam (Iran, VIII-IXe s.)
- 26) Citadelle de Mahyar (Iran, VIIIe s.)
- 27) Village fortifié de Yazdekhist (Iran, VIIIe s.)
- 28) Monastère bouddhiste de Tapa Sardar (Afghanistan, VII-VIIIe s.)
- 29) Persépolis, palais et corps de garde (Iran, Ve s. av. J.-C.)

Je désire attirer l'attention en particulier sur quatre des nombreux exemples rapportés ici; quelques unes des caractéristiques relevées plus haut s'y manifestent de façon plus évidente:

- a) Les tours colombières (Perse, VIII^e siècle) offrent incontestablement un heureux exemple de fusion entre fonctionnalité et fantaisie expressive: à l'aspect extérieur presque sévère correspond un intérieur vibrant, d'une extrême richesse, où la plus rigoureuse fonctionnalité atteint des effets plastiques d'une vigueur exceptionnelle. On remarquera la technique avec laquelle sont réalisés les couloirs annulaires voûtés et les milliers de petites cellules qui abritent les pigeons.
- b) Le cas du château de Fahraj (Perse, XV^e siècle) me paraît un exemple particulièrement significatif de complexité typologique et structurale: une véritable ville en miniature, organisée pour abriter un nombre considérable de personnes pendant de longs sièges et distribuée sur trois ou quatre niveaux: ceux-ci sont reliés par une série de pièces voûtées et entourées d'une enveloppe compacte mais vive et recherchée.
- c) La liberté de création, qui entre de force dans le domaine de la sculpture outre que dans celui de l'architecture, est bien représentée dans l'ensemble monastique bouddhiste de Tapa Sardar (Afghanistan, environ VII-VIII^e siècles): les centaines de statues sacrées et les terrasses qui ornent le monastère et transforment une colline aride en véritable "montagne sacrée" sont faites d'argile crue peinte ou même recouverte de feuille d'or.
- d) Le choix technique: tous les murs extérieurs des grands palais de Persépolis compris entre des montants de pierre étaient faits d'argile crue. Il en reste de nombreux témoignages dans la partie Est de l'Apadana, dans la cour des cent colonnes, etc... Les quartiers militaires, dont des fouilles récentes ont mis à jour des édifices et des rues internes, étaient également en argile crue. Les gigantesques chambranles de pierre et les riches décorations en métaux précieux qui les ornent, les hautes colonnes raffinées, les couvertures en bois de très grande portée aujourd'hui disparues montrent bien qu'un ensemble comme celui de Persépolis (Perse, Ve siècle av. J.-C.) ne subissait pas de conditionnement de nature économique. Si l'exemple de Persépolis est parmi les plus spectaculaires du choix raisonnée de l'argile crue, il n'est certes pas le seul. La royale demeure de Darius, ou celle de Cyrus, se serait transformée en une immense fournaise pendant le long été de Persépolis sans les épais murs d'argile, sans les grandes couvertures en bois protégées par l'argile et la paille. A Persépolis, comme dans des dizaines d'autres cas que nous avons relevés, il y avait de la pierre en abondance et les carrières étaient toute

proches: on l'a donc délibérément écartée et soigneusement exclue de certaines fonctions pour la remplacer de façon plus efficace par un autre matériau, mieux adapté au but recherché et, par hasard, plus économique.

Pour conclure je veux faire remarquer que c'est grâce à une conscience précise des avantages de l'argile crue, et non avec la commisération pour ses inconvénients évidents, que peut et doit être engagée une stratégie globale de conservation; nous devons agir dans la voie de la conservation intégrale de la matière, de son esprit, de l'art antique avec laquelle elle a été utilisée (plutôt que la simple conservation de ses formes actuelles); il faut renoncer aux tentations faciles de la technologie - qui sont encore loin d'approcher la perfection - susceptible de transformer miraculeusement le matériau.

La richesse et l'importance des témoignages en terre crue - depuis les grands palais assyriens jusqu'aux maisons paysannes récentes - résident précisément dans l'intelligence avec laquelle on a su utiliser un matériau pauvre et humble certes, mais capable malgré tout de défier le cours des siècles.

Bibliographie sommaire des
exemples exposés

Pour l'Iran et l'Afghanistan:

Pour la citadelle de Bam, les murs de Yazd et les autres oeuvres défensives d'argile crue en Iran voir: A.V. Pope, Islamic architecture; M. Bridges, Fortifications and caravanserais, dans Survey of Persian Art, 2nd ed., pp. 1241-1245.

Sur le triple système d'application de l'argile crue à la période ilkhanide en Iran cf. une allusion brève mais précise dans D.N. Wilber, The architecture of islamic Iran. The Il Khânid period. Princeton, 1955, p. 49.

Pour le Sistan iranien: G. Gullini, Architettura iranica dagli Achemenidi ai Sasanidi. Il palazzo di Kuh-i Kwajia, Seistan. Torino, 1964; L. Mariani, Conservation of the mud-brick structures in the sacred building QN3 at Dahan-i Ghulaman... Roma, s.d. [1977].

Pour la Musalla d'Ispahan, cf. E. Galdieri, A hitherto unreported architectural complex at Isfahân: the so-called Lesan al-'arz dans East and West, 23 (1973), pp. 259-264.

Pour le grand ensemble fortifié dit Norang Qal'a à Nayin et pour d'autres exemples de constructions défensives en argile crue dans le centre de l'Iran entre le VIIe et le XVIIe siècle, voir: E. Galdieri, Notes for a history of military architecture in Persia dans Bulletin of the International Castles Institute, 34 (1978), pp. 52-74.

Pour les tours colombières voir E. Beazley, Pidgeon towers at Esfahan dans Iran, 4 (1966); A. Dimici, Kabutarxanehay-e Esfahan dans Honar va mardom, 115 (1977), pp. 34-37; A.B. Shirazy, Kabutar va kabutarxanehay-e Esfahan dans Athar-e bastani-e gamnan, s.d. [1975]; E. Galdieri, Curiosità di architettura minore persiana: le torri dei piccioni dans Bollettino del Centre studi per la storia dell'architettura, 24 (1976), pp. 49-53.

Sur la technique d'exécution de l'argile crue et son emploi à l'époque moderne en Iran voir le très connu H.E. Wulff, The traditional crafts of Persia. Cambridge, 1966, pp. 109-111 et les photographies 161 à 168.

Pour l'architecture mineure en argile crue en Afghanistan voir: A. Bruno, Case-forti in Afghanistan dans Castellum, 2 (1970), pp. 69-70; E. Galdieri, A few conservation problems concerning several islamic monuments in Ghazni. Roma, 1978, pp. 15-26.

Pour les ouvrages en argile crue dans le site archéologique de Tapa Sardar (Afghanistan) voir M. Taddei, Tapa Sardar. First preliminary report dans East and West, 16 (1968), pp. 109-124; M. Taddei - Verardi, G., Tapa Sardar. Second preliminary report dans East and West, 28 (1978), pp. 33-135.

Pour l'Italie:

- G. Sordini, Vetulonia, studi e ricerche. Spoleto, 1894.
- A. Lorenzi, Tipo dei cassinotti d'argilla della Fraschevera dans Rivista geografica italiana, 21 (1914).
Monumenti antichi dei Lincei, 23 (1915).
- L. Pernier, Antiche mura urbane in Arezzo dans Notizie di scavi, 1920.
- P. De Grazia, Case rurali e suburbane di argilla a Senise (Potenza) dans Bollettino della Societa geografica italiana, serie VI, 9 (1932).
- A. Coppa-Patrini, Costruzioni di terra nel territorio della Frascheta (Alessandria) dans Il R. liceo-ginnasio G. Plana in Alessandria, Alessandria, 1935.
- C. Santoponio Emiliani, Dimore primitive nelle Marche dans Bollettino della Societa geografica italiana, serie VII, 6 (1941).
- E. Piccirillo, Le case di terra del Cortonese dans Rivista di etnografia, 4 (1950).
- S. Zavatti, La casa rurale nel comune di Potenza Picena (Macerata) dans Attes du XIVe congrès international de sociologie, Roma, 1950.
- O. Baldacci, La casa rurale in Sardegna. Firenze, Centro studi geogr. etnol., 1952.
- P. Griffo, dans Atti dell'Accademia di scienze, lettere e arti di Agrigento, 3 (1953-54).
- O. Baldacci, L'ambiente geografico della casa in terra in Italia dans Rivista geografica italiana, 65 (1958), supplemento.
- G. Carpinello Catellani, Strutture murarie in terra battuta nelle case di Novi Ligure dans Palladio, 23-25 (1974).

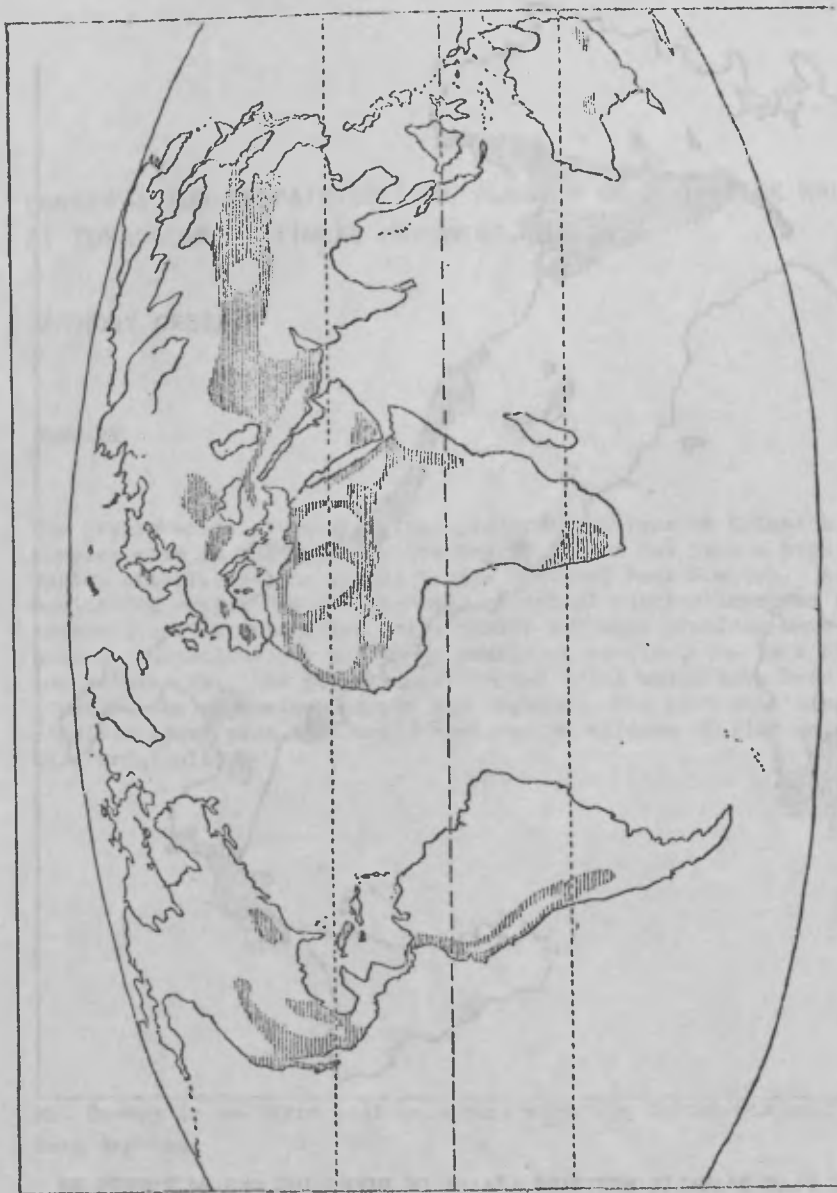

FIG. 1-PLANISPHÈRE MONTRANT L'AIRE DE DIFFUSION DES BÂTIMENTS EN ARGILE CRUE
(HISTORIQUES ET MODERNES)



FIG.2-PLAN D'ITALIE MONTRANT L'AIRE DE DIFFUSION DES BATIMENTS EN ARGILE CRUE (HISTORIQUES MODERNES)

CONSERVATION OF PAINTED LIME PLASTER ON MUD BRICK WALLS
AT TUMACACORI NATIONAL MONUMENT, U.S.A.

ANTHONY CROSBY

SUMMARY

The preservation of painted lime plaster at a Spanish Colonial Mission Complex site in the southwestern United States has been a high preservation priority of the United States National Park Service. A monitoring system has isolated the principal factors involved in the cause-effect deterioration relationship and many problems have been solved. Solutions for the major remaining problem, the lack of bonding between the lime plaster and the mud brick walls have been investigated, but no obvious answer has emerged. The most promising are flexible epoxy pins that would replace the effects of plaster keys used originally.

Mr. Crosby is an Historical Architect with the United States National Park Service.

JULY, 1980

INTRODUCTION

The United States National Park Service began an extensive preservation program at Tumacacori National Monument to determine the causes of the continuing deterioration of an important mud brick Christian Mission complex established in what was Spanish Colonial Mexico.

The historical resource, San Jose de Tumacacori, was founded in 1691 by Padre Eusebio Francisco Kino in the northern part of New Spain known as the Pimeria Alta, an area that includes the Mexican State of Sonora as well as the southern portion of the state of Arizona, U.S.A.

In 1767 the Jesuits were expelled from the New World and the Franciscan Order was placed in charge of this mission area. The Franciscans probably utilized the existing Jesuit structures at Tumacacori until the last years of the 18th century. By ca. 1790 they had begun work on new adobe buildings and had undertaken a major alteration of the existing structures at the same location. Construction continued intermittently on this complex until about 1827 when the recently established country of Mexico ordered the expulsion of all Spaniards from Mexican lands. The church was never completed, and the associated village was finally abandoned by the indigenous people in 1848 (Figure 1) (Kessell, 1976, p. 308).

The mission in ca. 1820 consisted of a complex of church, convento, cemetery, indigenous housing and working areas, a water system, orchards, and numerous fields which undoubtedly stretched for miles. There were approximately 75 rooms in this complex of which only the church, three rooms of the convento, and a small chapel in the cemetery exist above grade today. The church was originally cruciform in plan but the transepts were closed by 1820 resulting in a single nave church whose interior dimensions are approximately 31 meters long, 6 meters wide, with a flat roof 8 meters above the nave floor. A dome and vault constructed of low fired brick that vary in size span the Sanctuary on the church, respectively. The walls of the church are nearly 2 meters thick, although the normal wall thickness of the other structures is either 0.6 meters or 1.2 meters. The mud bricks used for the construction are 30 centimeters wide, 6 centimeters thick and 60 centimeters long and were formed in wood molds.

The procedure for finishing the church was the application of two coats of lime plaster directly to adobe walls and to the fired bricks of the domes and vault. Lime wash or slips, were applied over the finish plaster, both on the interior and portions of the exterior. The

paint was then applied to the dry wash. On the interior the paint was applied primarily as a mineral pigment in an aqueous solution on a dry gypsum wash. The gypsum wash was applied on the second of two coats of lime plaster, which covered the adobes of the walls and the fired bricks of the dome. During the restoration work in the first half of the twentieth century most of the exterior lime plaster was replaced with a portland type cement stucco.

Between the mid-nineteenth century and the first years of the twentieth century, the complex suffered a great deal of deterioration from weathering and vandalism. In 1908, the site was declared a National Monument and placed under the protection of the United States Forest Service, but it was not until 1918 when an employee from the U.S. Department of Interior, National Park Service, was assigned to the site that deliberate destruction was finally brought to a halt.

When the present preservation project got underway in the fall of 1975, there were many specific questions that could not be answered, but whose resolution was necessary to insure that any preservation action would be beneficial rather than deleterious. For example, did the deterioration that could be seen on some wall surfaces extend significantly deeper into the walls? The extensive amount of stabilization work completed over the past 60 years was affecting the structure, but what was the extent of the adverse effect? Were the structural cracks in the dome still active or simply stress adjustments that occurred soon after the building was constructed?

Another obvious problem and the one dealt with in depth here was the loss of the paint in the Sanctuary of the church as it flaked off and fell to the floor. The paint in the Sanctuary is all that is visible of a much more extensive decorative scheme; consequently its preservation was of a high priority (Figure 2). However, it was simply not feasible to begin any extensive conservation work before knowing the actual conditions that led to the loss of the paint. A related problem that has proved more difficult to solve is the loss of the integrity of the bond between the lime plaster ground to the mud brick walls.

Because of the wide range and complexity of the preservation problems, the need for a well designed system to gather pertinent information was recognized early. Consequently, the monitoring system in use began by utilizing a combination of some methods and devices that had been used to monitor building conditions previously at other sites, and other methods and devices which had not been used before. Some of the methods are extremely simple, such as photographing specific decorative features on a schedule. Some devices, such as hygrothermographs and psychrometers used to measure ambient temperature and humidity had been designed specifically for that job and were readily available. Still other devices, such as electronic crack monitoring gages and internal wall moisture sensors, had been designed to meet other than preservation monitoring needs but were adapted to the problems at Tumacacori (Crosby, 1978).

HISTORY OF CONSERVATION WORK

Early stabilization work in the 1920's and 1930's consisted of filling holes in the plaster with cement, rebuilding small architectural elements such as moldings, and giving support to rough plaster edges. These stabilization attempts do provide some information about the rate of deterioration since approximate dates for most of this work is known. However, the best bench mark was the extensive work done by R. J. Gettens and Charles R. Steen in 1949. Their investigation and evaluation was thorough and the work resulting from the research is accurately described (Steen, 1962).

The work by Gettens and Steen consisted of cleaning and stabilizing painted surfaces and supporting loose plaster with a PVA solution. Many of these treated areas can be identified by a highly reflective sheen. Other areas which were treated do not exhibit the same sheen, and until recently it was thought that in these areas the "solution" had simply disappeared.

A recent evaluation of this work has clarified the knowledge of both the techniques of application and the performance of the PVA. The application, as described, was accomplished with a spray technique that often resulted in incomplete coverage. In some of the areas where the plaster wash or paint was covered by the PVA, penetration was not achieved and the adhesive material remained only on the surface. In other areas, particularly on the interior surface of the Sanctuary's dome, the PVA penetrated through the first layer of paint only to concentrate on the surface of the next layer. On other areas of high soluble salt concentrations the PVA remains only as a thin, extremely friable film that often hangs down like a thin net from the plaster surface (Figure 3).

After the time of the work by Gettens and Steen, more deterioration took place. Dust accumulated on all horizontal or vertical surfaces to some degree. Plaster continued to become friable and fall from the dome. Efflorescence occurred over large areas, especially in the northwest corner, the north, and the west side of the dome. Paint continued to flake off of the plaster base and fall to the floor.

A critical situation developed which resulted in the accelerated loss of a section of original painted plaster located in the Sanctuary of the church at Tumacacori. The specific area affected is the north-west pendentive. It was investigated by a conservator, Walter Nitkiewicz, of the National Park Service's Harpers Ferry Center in March, 1976, and it was noted that a loss of approximately ten percent of the paint had occurred up to that time. There was some additional loss of perhaps another five percent until January of 1977 when the rate of deterioration accelerated tremendously resulting in a loss of another 35 percent by the first of March, 1977 (Crosby, 1976).

January, 1977 was an extremely wet month at Tumacacori. Later information showed that the accelerated deterioration could be traced to rainfall percolating down and surfacing at the affected spot.

The affected area was examined by the project architect, another National Park Service architect familiar with conservation techniques of painted surfaces, and a private conservator. The recommendations of each of these professionals, as well as the Harpers Ferry Center conservator who examined the painted walls in 1976 was to remove the remaining paint film from the plaster of the pendentive. It was felt that the determination of the exact causes of deterioration could not be made in time to preserve the paint in situ and the removal of the paint film was the only possible way to save it.

An attempt was made to reattach a few square inches of paint by Mr. Nitkiewicz in March of 1976. This was done in an area where the paint had lost its adhesion to the plaster (Figure 4). The treatment was not successful as the paint in the treated area soon became detached. This was the result of a significant amount of moisture moving through the plaster from the interior of the wall.

The actual removal of the paint film was carried out by a conservator, Gloria Fraser Giffords, using the strappo method. The friable paint film was first stabilized with a diluted solution of a polyvinyl acetate, AYAF. A facing of cheesecloth and muslin was then attached to the paint film and removed, taking the film with it. Because of the extremely friable nature of the paint, some loss occurred both during the initial preparation and the actual removal. However, the removal of the film was considered successful and the film itself was later attached to a fiberglass backing as a permanent method of support (Giffords 1977,1979).

EXISTING CONDITIONS

Paint

Flaking paint that occurs without an accompanying deterioration of the plaster ground was limited primarily to the area around the northwest pendentive, above the cornice on the west side of the dome, and a small area over the transverse arch between the Sanctuary and the nave. The paint film is thin and after it pulled away from the plaster, even a slight breeze would cause it to fall to the floor. Efflorescence that formed on the plaster in much of these same areas, often pushed the paint film away from the wall (Figure 5).

Some paint deteriorated as soluble salts accumulated within the paint film literally tearing the film apart. In these situations, the film contained as much as 75% soluble salt in weight.

The source of the problem of course was moisture. Moisture migrated through the dome transporting soluble salts which recrystallized in the form of efflorescence and subflorescence. In the case of efflorescence,

the salts recrystallized on the surface of the plaster, forcing the paint film away from the wall. In the case of subflorescence, the salts recrystallized in the plaster, creating pressures which fractured the plaster causing it to simply fall as it became friable. The recrystallized salts also acted hygroscopically resulting in more ambient moisture being drawn to the area of salt concentration. During the time of the accelerated loss of paint from the northwest pendentive, heavy efflorescence would reappear in a small cleaned area in only two or three days. The efflorescence appeared as recrystallized salts with chloride and nitrate anions.

Over fifty samples of efflorescence and subflorescence from the dome were evaluated for the type of anionic salts. These samples were taken from areas where various conditions existed. In some areas the sample developed on the surface of the paint film; on others, the sampled salt had actually forced the paint film from the plaster. In still other areas, the salts were occurring as subflorescence in the plaster. An ultra-violet light was also used to evaluate the efflorescence and proved valuable in further delineating areas not readily visible under natural light conditions. Under the ultra-violet light some of the efflorescence appeared fluorescent and some did not. Samples were taken to try to further evaluate if these differences were significant.

Comparing the results of the salt evaluations led to no significant new theories as to the actual causes of deterioration. A large amount of nitrates appearing at this elevation in the dome (approximately 8 meters above the exterior grade) prompted a consideration of the effects that an electrical potential difference could have on increasing the vertical capillary flow in the mud brick walls. This is based on the fact that an electrical current flowing in the opposite direction of the capillary moisture movement will increase the force of the capillary suction. The electrical current can be produced by an external power supply or in the wall by the chemical reactions of various minerals dissolved in the water.

Tests were conducted in an attempt to determine the electrical potential difference from the lower to the higher portions of the wall. The results, while not totally conclusive, indicated that while electrical potential differences did exist, they probably had as much effect on reducing the upward movement as they did on increasing it.

Further investigation after the removal of non-historic cement stucco on the exterior surface of the dome indicated the source of the anionic nitrate salts. A substantial part of the building mass originally constructed to receive the thrust from the dome consisted of earth fill. This fill contained a significant amount of decaying, or decayed organic matter relatively high in concentration of nitrates. The cracked exterior cement stucco allowed moisture to penetrate down to this earth fill material and then, eventually to surface on the interior of the dome.

Another indication that moisture was moving through the dome from exterior to interior at that corner was a light yellow-green discoloration which appeared in concentric rings on the pendentive. The efflores-

cence always formed on the outer edges of this stain. It was at first thought that the stain could be organic but later was determined by proton induced x-ray emission to contain trace amounts of copper and nickel. Apparently, the minerals appeared in a spot on the pendentive and created the stain as moisture moved from within the masonry mass of the pendentive to the interior surface.

Recently, horizontal holes were drilled to a lateral depth of two feet in the area of the northwest pendentive from the exterior of the structure. Material samples were taken and a determination of moisture content made. At the two feet depth, lime plaster or mortar was encountered which was probably the interior portion of the pendentive where it was set into the mud brick wall. The moisture content was approximately ten percent at that depth. This leaves little doubt that water was percolating down from above and was migrating to both the exterior surface of the adobe wall and the interior surfaces of the pendentive, dome and wall.

Ambient Conditions

Conditions inside the Sanctuary were monitored to determine if there were causes of deterioration in addition to rain water moving through the dome. The elements of the monitoring were: (1) recording of relative humidity and temperature at both the floor and dome levels, (2) recording the surface temperatures of the dome on the north, south, east and west, (3) recording relative surface moisture, (4) recording the amount of air movement at critical points, and (5) recording the amount of total solar radiation on vertical planes at the northwest, northeast, and southwest corners of the interior of the Sanctuary.

The purpose of recording the relative humidity was to determine, in combination with the recording of the surface temperatures, whether or not conditions exist which would lead to condensation of ambient moisture on the dome or wall surface. At no time was the relative humidity in the dome ever over 60 percent during the recording period and the normal was closer to 40 percent. A maximum differential between the ambient temperature in the Sanctuary and the surfaces was five to six degrees Fahrenheit. This difference occurred on the north portion of the dome surface. For condensation to form a combination of a six degree Fahrenheit temperature differential at approximately 90 percent relative humidity is required. At 60 percent relative humidity the temperature on the surface would have to be approximately 15 degrees cooler than the air. Obviously, the conditions did not exist for condensation to take place on surfaces unaffected by the hygroscopic salts of efflorescence.

A relationship between the relative humidity near the floor of the Sanctuary and up within the dome has been established. At high relative humidities near the floor in the 60-80 percent range, the relative humidity at the dome will be between 30-45 percent. When the Sanctuary floor range is 30-45 percent relative humidity, the dome relative humidity will be in the 15-30 percent range. The surprisingly large

difference cannot be attributed to temperature difference since they will only vary a few degrees. In fact, at times the temperature immediately below the dome will be a few degrees lower. This apparent heat loss can probably be attributed to convection. A curved surface has a larger convection heat-transfer area and since much more heat is lost by convection than by radiation, a curved roof is more easily cooled.

The temperature difference from the sun side to the shade side on the interior surface of the dome is related directly to the exaggerated difference on the exterior surface of the dome. This temperature difference of more than 60 degrees Fahrenheit or 33 degrees Centigrade has been recorded and a difference of 50 degrees Fahrenheit is quite common on the exterior. This difference is the reason for many of the cracks in the cement stucco that covered the dome. A temperature difference of as much as 50 degrees Fahrenheit between the cement stucco and the original dome also contributed to the loss of bond between the two. However, the temperature difference on the interior surface of the dome from one quadrant to another is never more than three degrees Centigrade.

The relative amounts of surface moisture were measured several times on the interior of the dome with a surface resistivity meter. However, this aspect of the monitoring in this particular case contributed little. Those areas which exhibit the greatest amount of deterioration gave higher readings, indicating a relatively greater amount of surface moisture. These areas also have the greatest amount of recrystallized salts on the surface which would give a higher reading with the same amount of moisture as areas which had less surface salts. The surface surveys did seem to indicate that some areas which had deteriorated greatly in the past had become somewhat stabilized with less of an indication of surface moisture.

The movement of air in and just below the volume defined by the dome appears to be minimal. On several different occasions the amount of air moving near the northwest corner was measured and compared to the movement of air through the sacristy door and along the nave wall. At no time was the movement up in the dome greater than one kilometer-per-hour and an average over a period of several hours would be significantly less than that. Over the same period of time the air movement through the sacristy door would average five kilometers-per-hour, being greater than seven kilometers-per-hour on occasion. The movement in the nave would average approximately one to two kilometers.

As previously mentioned it is difficult to explain the relationship of the relative humidities to the dome and near the Sanctuary floor. Obviously, the air in the lower portion of the Sanctuary is not being mixed well with the air in the upper portion. One reason would be that the air moves from the open sacristy in through the Sanctuary, down the nave, and out the front door with little obstruction. Of course, the reverse air movement also occurs. In either case the air in the dome apparently moves very little, not being influenced either by the lower air movement.

From the standpoint of conservation, the more stable conditions in the upper portions of the dome are preferable. It is undesirable to increase the air movement in this area and in fact it is more desirable to decrease the movement of air through the lower portion as well. Air moving through the Sanctuary has deposited a large amount of soil particles over the past 30 years and will continue to do so. Closing off the access of exterior air would certainly minimize the amount of particles deposited in the dome area but minimal air movement may be desirable.

Plaster

A significant amount of plaster sounds hollow when tapped. This hollow sound has been interpreted in the past as a sign of the lack of bonding between the plaster and the mud brick or fired brick. This interpretation is not entirely correct since a variation in plaster thickness will also produce a variation in the response. There is no doubt that some of the hollow response reflects a lack of bonding, but even in many of these areas the plaster is soundly attached to the wall by effective plaster keys at the mortar joints. These keys are the results of the mud mortar joints being cleaned out, often to a depth of 5-7 centimeters and the base coat forced into these voids during the original application of plaster.

The lime plaster in the past has fallen from the face of the wall when, either rain water erodes away these plaster keys, or the keys have been sheared as differential movement occurs between the plaster face and the mud brick walls. A combination of these two factors are normally involved as the load carried by a plaster key is increased beyond its carrying capacity when adjoining keys are eroded away. This particular situation has not resulted in the loss of any plaster over the past 60 years, or since the church was reroofed and the interior surface was no longer subject to extensive rain water. However, a significant amount of plaster appears to be unstable and this is today the primary conservation concern.

The problem has been dealt with in the past at Tumacacori in two ways. The most prevalent method was to apply a cement bead around all the exposed edges attaching this bead to the walls by some mechanical device such as pins. Much larger steel pins were also used in one section of plaster to replace the effects of original plaster keys that were feared to be of questionable integrity (Sudderth, 1973). Holes were drilled through the plaster and into the mud brick walls. The exterior edge of the hole and the plaster itself were grouted in an attempt to attach the head of the steel pin to the plaster (Figure 6).

The results of this work have been ineffective. In addition, several adverse side effects have arisen and contributed to the deterioration of the plaster. Initially, there was a separation between the steel and the grouted plaster, probably because of the difference in the coefficients of thermal expansion of the two materials. The second and the most

deleterious effect was the deterioration of the plaster in an area approximately 10 centimeters in diameter around the head of the pin. This was caused by the condensation of internal wall moisture on the steel and its concentrated movement from the inside of the wall to the plastered wall surface.

A recent extensive survey of the conditions identified four relatively large sections of plaster that appear unstable. The largest of these is approximately three square meters in size. Many other smaller areas up to one square meter in size, most of which are located in the Sanctuary, also appear unstable. This evaluation is based on visual observations, soundings, and the injection of extremely low air pressure behind the plaster in areas of suspect integrity. Earlier, a microwave survey had been conducted in an attempt to determine whether or not voids existed behind plaster. While valuable information was produced related to internal wall moisture, small voids or the delamination of lime plaster from the wall could not be determined using this particular system. Interestingly enough this microwave system was sensitive enough to distinguish between the mud bricks and the mud mortar used to bind them together (Belsher, 1979).

Another condition existed primarily on the plaster in the Sanctuary that was causing significant damage. Because of inadequate preparation originally, large nodules of calcium carbonate, from two to five millimeters in diameter existed in the layer of finish plaster. These nodules would expand as free moisture came in contact with them as it moved from the interior of the wall to the wall surface. The expansion of the nodules resulted in small pock marks on the surface of the plaster as they disintegrated or were extruded. At the time when the moisture movement was at its greatest, new pock marks could be detected daily.

TREATMENT OF PROBLEMS

Various treatments have been undertaken or completed that deal with specific problems while other possible treatments are still being evaluated. The actual treatments are also being evaluated and will continue to be monitored as to their appropriateness.

Removal of Inappropriate Cement Stucco

As has been mentioned previously, most of the exterior surface of the mud brick walls and the Sanctuary had been covered with a portland type cement stucco during the 1940's and 1950's. The principal effect of this relatively impervious surface coating was to increase the capillary rise in the walls by decreasing the natural evaporation of moisture on the vertical surfaces.

The effect on the painted plaster in the Sanctuary was quite drastic as rain water penetrated through the cement stucco and then eventually moved through the mass of the dome, since evaporation up through the cement stucco was restricted.

The cement stucco was removed from the mud brick walls during the summer of 1978 and was replaced with a lime-sand plaster that closely resembles the original plaster in color and texture as well as its important characteristics related to moisture movement. Since this time, the walls have continued to dry even though the capillary movement in the walls from the ground has not been completely eliminated.

The cement stucco on the dome was removed and replaced with the same lime-sand plaster used on the wall surfaces. The earth fill which proved to be the source of the nitrate anions was removed and replaced with low fired bricks set in lime mortar (Figure 7).

Immediately after the dome area was replastered there was a drastic reduction in the amount of efflorescence that formed on the interior surface. This immediate change reflects more the removal of the damp earth fill than it does the effectiveness of the new lime plaster. However, the effectiveness of this more appropriate covering will be more evident in the future.

Cleaning the Interior Plaster Surfaces

In January of this year the large accumulations of dust and dirt were removed from all vertical and horizontal surfaces during the extensive survey of the interior plaster. The salt incrustations on the interior surface of the dome were not removed, but will be in the immediate future. The cleaning was accomplished with soft bristle brushes of various sizes often in association with a vacuum so that the loosened particles would not recirculate, simply to settle again later. It was discovered at the time of the investigation that the earlier cleaning technique used in 1949 during the work by Gettens and Steen was essentially to abrade away the soiled areas with stiff bristle brushes that more often than not also removed some of the historic wash. Small knives and picks were used this year in some areas, also, but some of these will require more attention. The areas needing more attention were identified and recorded for more extensive work later.

Several solvents such as acetone and toluene were used on areas of the wall to reduce the sheen which remained from the PVA applied in 1949. Cellosolve, a trade name for ethylene glycol monoethyl ether, was also used as it was one of the solvents used originally. Solvents were also used in stained areas which were suspected to have caused by, or influenced by the PVA.

An attempt was also made to use water to remove some of the accumulated particles and stains. It did not prove to be viable however as the water was difficult to control and more often had the tendency to carry small particles into the surface plaster wash, especially if

associated with any abrasive action. The outer portions of some large streams of mud, some up to 5 millimeters thick on the vertical wall surface that were caused by rain water from a leaking roof, could be removed more easily with water. However, extreme controls were necessary to localize the water to keep it away from the plaster itself and since there was little real advantage over the use of the soft brushes, the use of the water was not pursued.

Reattachment of the Paint Film

Experiments are currently being conducted to determine the most appropriate methods and materials to reattach the paint film in the Sanctuary to its plaster ground. Some materials such as soluble nylon do not appear to be strong enough to be effective in most situations. A 10% solution of Acryloid B72 in toluene was also used on several test areas. Earlier, a 25% solution of Acryloid 134 was used and showed some promise. These as well as ethyl silicate solutions will continue to be evaluated until the next phase of the conservation work is undertaken this winter.

In any case, a treatment of overall coverage, similar to the earlier work will not be done this time. Localized treatment of friable and loose edges, or limited area coverage is more appropriate so that natural moisture movement in and through the material will be influenced only minimally.

Filling of Pock Marks

Pock marks resulting primarily from the hydration of nodules of calcium carbonate are being filled to eliminate a cavity where air borne particles could more easily accumulate. This is not done as part of a restoration program since restoration or painting reconstruction is not being undertaken here, but rather from the perspective of conservation.

Experiments have been conducted using several material combinations with lime grout as the basic ingredient and are being evaluated. However, the most promising material has been a cellulose filler manufactured under the trade name of Polyfiller. This material holds together well while being used and because of the rather difficult working conditions often encountered, proved to be an advantage over some lime grouts and putties. Pigments can also be added and in some situations at Tumacacori, this is desirable. There is also no shrinkage and that is extremely important in many use situations.

Reattachment of Lime Plaster

The primary problem that remains unresolved at Tumacacori is finding a solution to the lack of bonding of specific areas of lime plaster to

mud brick walls. The steel pins used previously were not successful, although the use of pins to simulate the effect of the original plaster keys seems to be logical.

Several techniques and materials have been used in an attempt to reattach the entire back surface of plaster to the adobe surface but only one has showed any promise. The common application method for these is the injection of the adhesive, or adhesive-consolidant into a void between the plaster and the wall.

The surface of mud bricks onto which the plaster is attached is normally extremely friable and most adhesive materials simply would not bond to the adobe. In contrast most materials adhered to the back side of the plaster adequately.

The only injected material that was successful was a flexible epoxy resin. This specific epoxy resin was first used for this purpose at Fort Bowie National Historic Site in 1973 (Kriegh, Sultan, 1974). The conditions of the mud brick walls at Tumacacori and Fort Bowie are quite similar. The environmental conditions are also quite similar as they are both located in the same general geographic area. The integrity of the reattached lime plaster and the epoxy resin appeared sound after six years. This same formulation was used on an experimental basis at Tumacacori in 1979 and was highly successful in penetrating into and consolidating the friable surface of the mud bricks as well as the lime plaster. Penetration into the walls was in the range of 8-10 millimeters and up to 20 millimeters into the lime plaster. In one case the epoxy resin actually penetrated completely through a thinner section of plaster. This is a potential problem that will have to be addressed during future applications. The primary disadvantage encountered pertained to the actual injection process and the actual conditions of the plaster and associated mud brick wall. Often the void between the plaster and bricks was extremely large and filled with friable material from both the brick and plaster. Some of this could be removed with a suction or vacuum tube but it was never possible to remove all this material. Consequently that that remained normally prevented the plaster from being pressed back against the wall to reduce the size of the void. Consequently, greater amounts of the epoxy resin had to be used and care had to be taken not to increase the pressure against the inside surface of the plaster causing it to be pushed off even more.

The epoxy resin formulation consists of:

Epirez 5081	100 parts by weight (pbw)
Colma Dur LV Curing Agent	35 (pbw)

Epirez 5081 is manufactured by Celanese Coatings Company, Louisville, Kentucky. The Colma Dur LV curing agent is manufactured by Sika Chemical Corporation of Lynhurst, New Jersey.

Another possibility being evaluated currently is a combination of materials, one used to consolidate the friable mud brick surface and another used to adhere to both the consolidated wall and the lime plaster. One problem with this particular technique is its use in areas that are behind large expanses of plaster and cannot be seen directly or the materials manipulated easily.

Epoxy resin pins of the formulation given above have also been used on an experimental basis. This seems to give the best promise for a permanent solution. The principal is to simply replace the effect of original plaster keys where they are missing, and to rely on the tensile strength of the plaster in the areas where the pins are not placed (Figure 8). The ability of the epoxy resin to consolidate both materials will make it possible for the resin itself to hold the plaster surface to the pin. If one does not exist, it will be necessary to drill a hole through the plaster and into the brick, but this hole can be filled with a lime grout or another appropriate material such as the cellulose filler.

The depth of the pins into the wall will vary depending on the integrity of the bricks near the surface. In some unusual cases it seemed necessary to extend the pins as much as 30-45 centimeters into the wall. However, in most situations a depth of 10-15 centimeters seems more appropriate. Of course the length of the pins and its depth in the wall will also depend somewhat on the amount of plaster that is being supported.

CONCLUSION

Because of the rather limited extent of this particular site and because of the size of the extant buildings many preservation problems at Tumacacori can and are being dealt with from a standpoint of cyclic maintenance. If it is technically or financially impractical to totally eliminate a cause of deterioration, such as the total elimination of capillary moisture in the church walls, the affected area is repaired periodically. In fact, a totally static situation when no further change to the material would ever take place is not necessarily desirable even if it were possible. Consequently, repair to the mud bricks is done using traditional methods and materials if they do not accelerate deterioration in other areas.

The painted lime plaster on the interior of the church is somewhat different in that it cannot simply be repaired when further deterioration takes place. In this case the elimination of the causes of deterioration is the goal. Repair, such as the reattachment of lime plaster to mud brick walls, is different than simply replacing eroded mud with more mud. It is more permanent and more importantly, it involves adding a new material to replace a function, rather than a new material to replace an older material.

Where there are problems involved with the use of a flexible epoxy resin to replace the function of the keying of the plaster to the walls, it appears at this point to have the most promise. Still the problem of the reattachment of the lime plaster is seen as the most significant problem to be totally solved at this particular site.

REFERENCES

- Belsher, D. R., 1979. Feasibility Study on the Use of a Microwave System for the Nondestructive Evaluation of Historic' Adobe Structures. NBSIR 79-1610, U.S. Department of Commerce, National Bureau of Standards.
- Crosby, Anthony, 1978. Bulletin. The Association for Preservation Technology. Vol. X, No. 2.
- Crosby, Anthony, 1976. Preliminary Report on the Preservation Project at Tumacacori National Monument. Unpublished report. U.S. National Park Service.
- Giffords, Gloria Fraser, May, 1977. Removal of Paint Film from the Northwest Pendentive at Tumacacori National Monument. Letter report to U.S. National Park Service.
- Giffords, Gloria Fraser, 1979. Reattachment of the Plaster and Painted Mural from Tumacacori Pendentive to a Fiberglass Support. Letter report to the U.S. National Park Service.
- Kessell, John L., 1976. Friars, Soldiers, and Reformers: Hispanic Arizona and the Sonora Mission Frontier 1767-1856. The University of Arizona Press, Tucson, Arizona.
- Kriegh, James P., and Sultan, Hassan A., Dec., 1974. Final Report, Feasibility Study in Adobe Preservation. Casa Grande National Monument and Fort Bowie National Historic Site. Tucson, Arizona.
- Steen, Charlie R., and Gettens, Rutherford J., 1962. Tumacacori Interior Decorations, and Report on Inspection and Recommendations for Treatment of Plaster Walls and Wall Painting. *Arizoniana* 3: 7:33.
- Sudderth, W. E., 1973. The Nave and Bell Tower Tumacacori National Monument Arizona. Typescript in Western Archeological Center, Tucson, Arizona.

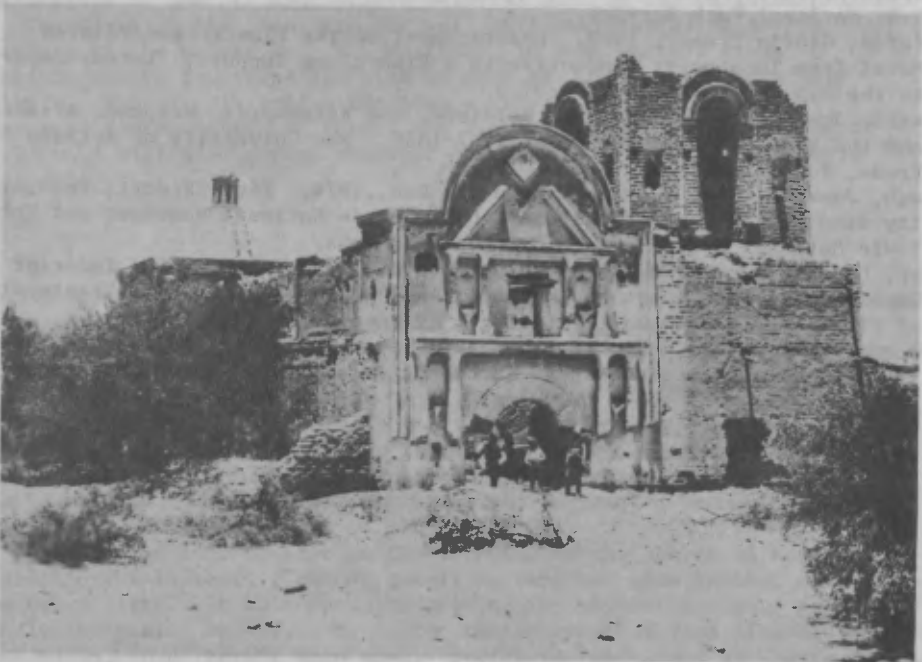

Figure 1: Church at Tumacacori in 1889. Photograph #2546, Arizona Historical Society, Tucson, Arizona.



Figure 2: Painted retablo of main altar in Sanctuary of the church, HABS photograph, 1937.

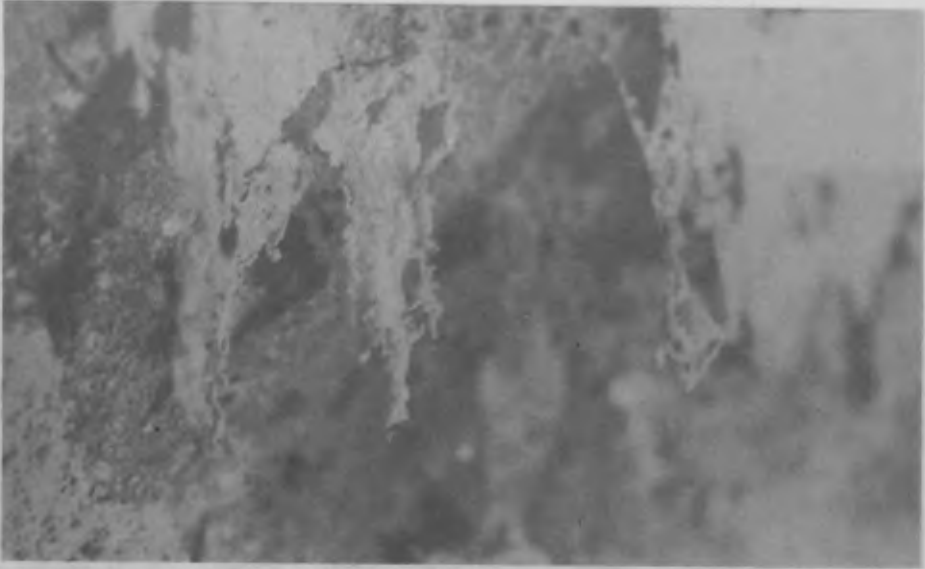

Figure 3: Deteriorated dome plaster with PVA applied in 1949 hanging from the surface in thin net. NPS photograph, 1979.



Figure 4: Painted plaster in Sanctuary. Note the paper along the top edge of the painted volute that was used in an attempt to temporarily reattach the paint film to the plaster ground. NPS photograph, 1976.



Figure 5: Plaster surface with extensive deterioration by efflorescence forming on the surface and immediately beneath the paint film. NPS photograph, 1979.

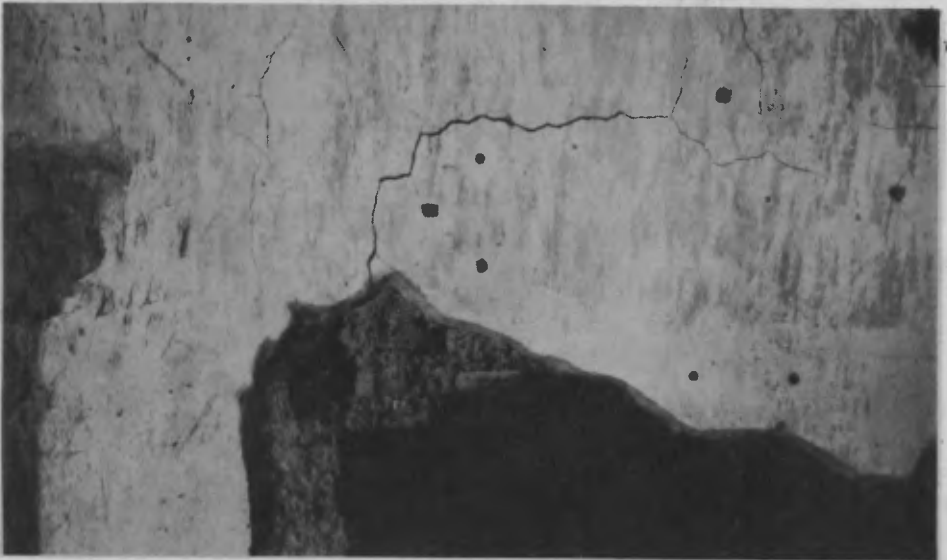

Figure 6: Plaster on interior surface west of the nave wall. Small dark spots are the locations of the steel pins used to secure the plaster to the mud brick walls.

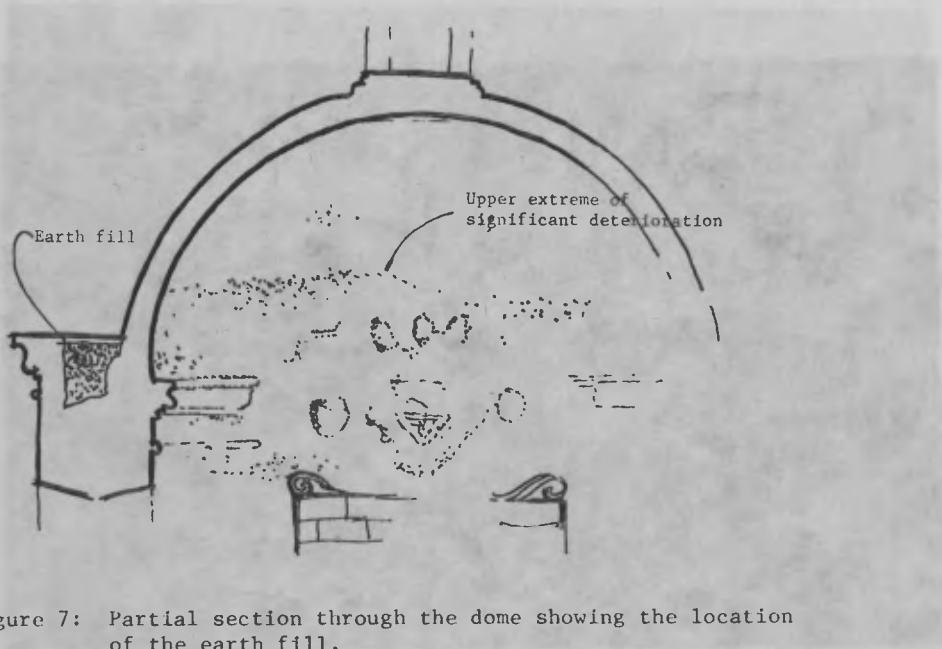

Figure 7: Partial section through the dome showing the location of the earth fill.

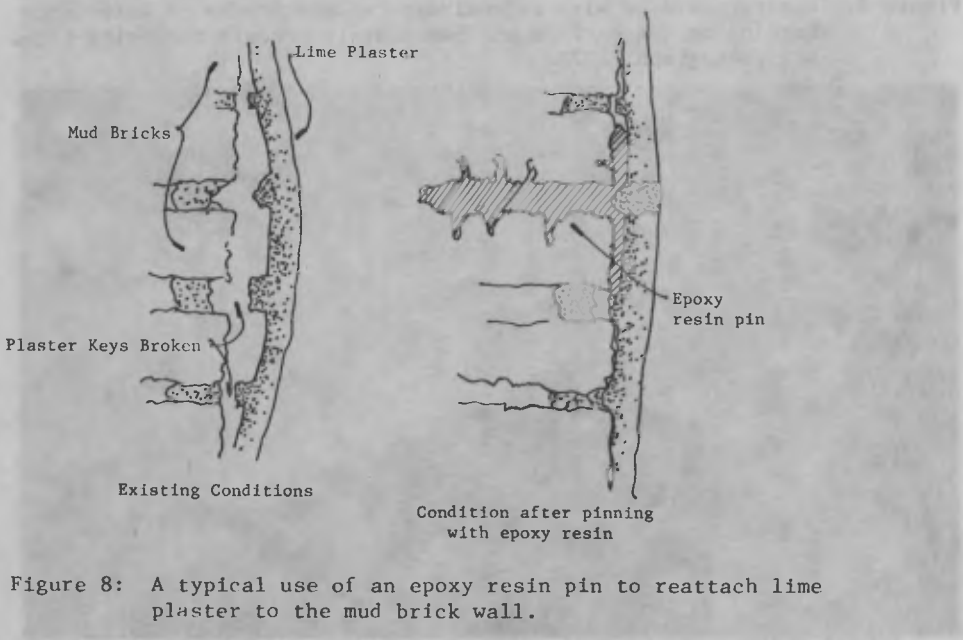

Figure 8: A typical use of an epoxy resin pin to reattach lime plaster to the mud brick wall.

KERPİÇ ESKİ ESERLERİN ONARIMI VE KORUNMASINDA BİR ARAŞTIRMA

MURAT ERİÇ^X

SUMMARY

After dealing with restoration and conditions of preservation of adobe buildings in general, the paper describes the special qualities and the usage of mud-bricks of the historical adobe Turkish buildings throughout ages. While dealing with restoration and preservation of adobe buildings, taking into consideration the special qualities of the mud-bricks, it is necessary to avoid using materials unsuitable with them. Studies and research done by our section during the years 1979-1980 to ameliorate the quality of the mud-brick with the help of natural materials, the pressure resistance has been raised from 2-20 to 40-120 kg/cm² and the material (mud-bricks) that can dissolve utmost in sixty minutes, becomes completely resistant to water. We will be happy if this improved material is used in restoration and preservation of the old adobe buildings.

^X Doç.Dr. D.G.S.A. Mimarlık Fakültesi. Yapı Fiziği ve Malzeme Kürsüsü Başkanı.

GİRİŞ

Türkiyemiz eski eserler ve tarihi değerler açısından zengin bir ülkedir. Çeşitli medeniyetlerin izlerini taşıyan Anadolu'da coğrafi özelliklere, mimari eserlerin niteliklerine ve yerel malzeme kullanım özelliklerine göre taş, ahşap ve pişmiş toprak malzemelerin veya bu tür malzemelerin karma bir şekilde yer alması ile oluşturulmuş çeşitli nitelikteki eski eserler rastlamak mümkündür. Günümüze kadar yapılan çeşitli kazılar ve tesbit çalışmaları ile birçok tarihi kıymetimiz değerlendirilmiş, ancak doğal koruyucu örtüleri altında kazılarla açığa çıkartılan veya asırlarca buldukları yerde dış etkilerin devamlı tahribatına maruz kalan eserler için gereken sürekli bakım ve koruma önlemlerinin de ele alınması gerekir.

Bir eski eserin restorasyonu ve korunmasında uygulanan yöntemleri ilke olarak, eski malzemeden tamamen farklı veya eskisine benzer bir malzeme ile tamamlama olarak iki ana grupta, koruma yöntemlerini de mevcudun üzerini farklı ve yapay bir kabukla örtmek veya eski eserin yüzeyine sentetik esaslı koruyucu, saydam tabakalar uygulamak şeklinde yine iki ana grupta toplayabiliriz. Günümüzde gerek restorasyon, gerekse koruma yöntemlerinin her iki gurubu ile de çeşitli uygulamalar yapılmış ancak yeni uygulanan ile eski malzemenin birbirine göre farklı olabilecek özellikleri ve yan yana geldiğinde görünümündeki uygunsuzlukları üzerinde titizlikle durmamız gereken konular olarak karşımıza çıkmaktadır.

TÜRKİYE DE YER ALAN KERPIÇ ESKİ ESERLER

Ülkemizde yer alan kerpiç eski eserler coğrafi bölge olarak daha çok iç, güney ve doğu Anadolu bölgelerinde, özellikle kara ikliminin hüküm sürdüğü ağaçsız, kıraç topraklarda görülmektedir. Nitelikleri daha çok kale, sur gibi askeri, tapınak, saray ve ev gibi sivil mimari eserleri kapsamı içinde kalmaktadır. Kerpiç malzemeye gidilmesinde bölgede ahşap ve taşın yeterince olmayışının büyük bir rolü vardır. Ayrıca yazı ve kışı sert geçen bu iklim bölgeleri için kerpiç ısı tutuculuğu açısından en olumlu sonuçları verebilecek bir malzeme olmuştur. Örneğin 5900-4000 yıllarına ait Çatalhöyük, Hacılar, Beycesultan, Mersin kazılarından tesbit edilen ev kalıntıları, 2300-1200 yıllarına ait Truva'dan

sur ve kale kalıntıları ve 1900-1200 yıllarına ait Alişar ve Boğazköy'-den ev ve kale kalıntıları ile MÖ 9-6 yüzyıllar arası yaşayan Urartu devletine ait Van,Çavuştepe,Toprakkale ve Adilcavaz'da ortaya çıkartılan yerleşme merkezleri ile kalelere ait çeşitli kazılardan elde edilen kalıntıları,bilinen en eski eserler olarak belirtmek mümkündür. Ancak kerpiç malzemenin doğa etkileri karşısında taş ve ahşap malzemelere oranla daha dayanıksız oluşu, günümüze kadar kalabilen örneklerin azlığına bir nedendir.

Ayrıca bu Arkaik dönem eserleri yanında, geçmişleri 200 seneyi bulmayan ancak halk mimarisinin güzel örnekleri sayılabilecek ve eskinin yapı teknolojisinin günümüze ulaşımını sağlayan Karaman, Harput,Balaban,Urfa ve Van yörelerinde görebildiğimiz belirgin özelliklere sahip bazı kerpiç ve hımış evleri de, artık korunması gereken mimari dokular olarak kabul etmemiz gerekmektedir.

KERPIÇ MALZEMENİN ÖZELLİKLERİ VE YAPIDAKİ KULLANIM BİÇİMLERİ

Kerpiç malzemenin özelliklerine kısaca bir göz atacak olursak, üretiminde killi ve uygun nitelikteki toprağın içine kil,saman veya çeşitli bitkiler karıştırılıp su ile yoğrulduğunu ve kalıplara döküldükten sonra açık havada kurutulduğunu görürüz. Kerpiğin birim hacim ağırlığı 1.2-1.6 gr/cm³, basınç mukavemeti 3-20 kg/cm², ısı geçirimsizlik katsayısı 0.40 kcal/m.h.C,suda çözülme ise 20-45 dakika arasında değişmektedir. Ayrıca malzemenin özellikleri, kerpiç toprağının cinsine,su miktarına,bitkisel katkı miktarına,kalıplama ve kurutmadaki yöntem ve sürelerine bağlı olarak farklılık gösterebilmektedir.

Killi kerpiç toprağının kimyasal bileşimi bir alüminyum silikattır. Ayrıca bünyesinde demir,magnezyum,titan oksit gibi çeşitli metal oksitlerde bulunabilmektedir. Ancak bitkisel ve organik maddeli toprakların kerpiç üretiminde kullanılmadığı görülmüştür. İçinde şist ve ince kum tanecikleri bulunan killerin de su ile yoğrulduklarında gösterdikleri plastiklik özelliği yeterince yüksek olmaktadır.

Özellikle iyi bir kerpiç toprağının yüzde 40'ı 0.063 mm.lik elekten geçmeli ve içinde 3 cm. den büyük taş parçacıkları bulunmamalıdır. Kilin bir özelliği de su ile yoğrulduğunda istenilen şekli alması ve suyun bünyeyi terketmesiylekohezyon özelliği sonucu kazandığı şekli aynen korumasıdır. Su kaybı sonucu kilde oluşan rötre kil tanecikleri hareket edemez hale geldiğinde durmakta ve kilin plastikliği de kaybolmaktadır. Isının kil üzerindeki etkisi incelendiğinde kilin kimyasal bileşiminde yer alan çeşitli metal oksitlerin silisyum oksitle ayrı ayrı bileşikler oluşturmasıyla mukavemetin gerçekleştiği görülür.

Tarihsel süreç içinde ve de halen geleneksel olarak uygulanmakta olan kerpiğin üretim ve yapıdaki kullanım biçimlerini,kerpiç blok,dövme

kerpiç, omurgalı kerpiç ve yığma kerpiç olarak 4 grupta sınıflandırabiliriz. Kerpiç blokları genellikle 40-30 cm. uzunluğunda, 40-20 cm. eninde ve 15-8 cm. kalınlığında kalıptan çıkmış ve güneşte kurutulmuş malzemelerdir. Yapıdaki kullanımını iki şekildedir. Birincisinde tüm duvarlar bloklarla örülmüş, yer yer yatay ahşap hatıllar konulmuş ve duvarlar tamamen taşıyıcı nitelik kazanmıştır. İkincisinde ise düşey ve yataylardan kurulmuş bir ahşap konstrüksiyon içine kerpiç bloklar yerleştirilmiş ve kerpiç dolgu niteliği kazanmıştır. Dövme kerpiçin kullanımı, duvar boyutlarına göre yapı yerinde hazırlanmış kalıplara su oranı düşük kerpiç hamurunun sıkıştırılarak yerleştirilmesi şeklinde yapılmıştır. Ancak yapıyı çepeçevre dolaşacak şekilde ve büyük hacimli kerpiçin bir defa dökülmesi nedeniyle kalıp yüksekliğinin kademeli olarak değiştiği izlenmektedir. Omurgalı kerpiç uygulamasında dökülen kerpiç tabakaları arasına duvar eninden biraz kısa ahşap elemanların yanyana bağlanarak bir armatür göreviyle serildiği görülmektedir. Ayrıca çok önemsenmeyen işler için bitkisel katkı miktarı fazlaca olan bir kerpiç hamurunun taş bir temel üzerinde üst üste yığıldığı ve daha sonra duvar şeklinde kesilerek düzeltildiği yığma kerpiç uygulamalarına da rastlanmaktadır. Genel çizgileri ile incelediğimiz bu kullanım biçimleri kazılardan elde edilen bilgiler ışığı altında ve halen günümüzde devam eden geleneksel uygulamalara bakılarak özetlenmiştir.

KERPIÇ ESKİ ESERLERDE ONARIM VE KORUMA YÖNTEMİ ÜZERİNE BİR ARAŞTIRMA

Yazımın giriş bölümünde ilke olarak belirttiğim restorasyon yöntemleri içinden görüşümüze göre kerpiç eski eserlere uygulanması gereken, eski eserin belli bir noktaya kadar tamamen kendine benzer, ancak kalite standartlarını, özellikle basınç mukavemeti ve suda çözülme özelliği üst limitlere getirilmiş yeni kerpiç üretimiyle, tamamlanmasıdır. Budüşünceye varmamızda etkili olan faktörler olarak, eski kerpiç kalıntılarının doğal malzemesinden ötürü mevcut toprakla karıştırılması ve dolayısıyla bir ziyaretçi gözünde gerçek değerinin kaybolabileceği ayrıca beton, plastik gibi yapay ve çağdaş bir malzeme ile yan yana getirildiğinde, ısı genleşmesi, ısı geçirimsizlik ve buhar geçirimsizlik gibi özelliklerin büyük farklılıklar göstermesi sonucu çok kısa bir sürede ve eskisinden daha çabuk tahrip olabileceği gibi çeşitli etkenleri sayabiliriz.

Kürsümüzde 1979-1980 seneleri arasında asistanlarımdan yardımcıları ve öğrencilerimizin katılımıyla gerçekleştirdiğimiz bir seminer ile mevcut kerpiç malzemenin kalite standardının yükseltilmesi için bir araştırmaya başladık. Bu araştırmadan elde edeceğimiz olumlu değerlerin, kerpiç eskieserlerin korunması yanında Türkiye'nin kırsal

bölgelerinde halen eskinin geleneksel yöntemleri ile üretilmekte ve kullanılmakta olan kerpiç malzemeye uygulayıcı açısından da pratik sonuçlar getireceği inancımız vardı. Araştırmaya öğrencilerimizin Silivri, Pendik, Gemlik, Edirne ve Bozhöyük gibi çeşitli yörelerden getirdikleri genelde 40-32 cm.boyunda, 20-15 cm. eninde ve 12-10 cm. kalınlığında çeşitli kerpiç örneklerin kotlanması ve ilk tesbit çalışmaları ile başlanmış, 7x7x7 cm.lik standard deney örnekleri üzerinde öncelikle bitkisel katkı ve kireç olup olmadığı araştırılmış daha sonra da TS 2514-2515 te belirtilen koşullara göre birim hacim ağırlık, basınç mukavemeti ve suda çözülme deneyleri yapılmıştır.

Buradan ilk elde edilen değerlere göre basınç mukavemeti 3.94-11.40 kg/cm², suda çözülme ise 17-60 dakika arasında bulunmuş ve yüksek değerlerin kireçsiz, içinde bitkisel katkı bulunmayan eski kerpiç örneklerden gelmesi dikkatimizi çekmiştir. Aynı kaliteye sahip eski ve yeni kerpiçlerdeki bu farklılaşmanın, eski yapıda yapı ağırlığının getirdiği bir sıkışmadan olabileceği görüşüne varılmıştır. Bundan sonraki aşamada bitkisel lif katkıların (saman) basınç mukavemeti üzerindeki etkisi araştırılmış ve yüzde 3 saman katkısının, katkısız oranla basınç mukavemetini 34.24'den 30.51 kg/cm²'ye düşürdüğü, suda çözülmenin ise 100 dakikadan 80 dakikaya indiği saptanmıştır. Deneylerin ikinci aşamasında 1 mm.lik elekten elenerek hazırlanan farklı tiplerdeki kerpiç topraklarına yüzde 5 ve 10 alçı ile kireç katılarak devam edilmiştir. Akıcı kıvamda hazırlanan örnekler 24 saat kalıpta, 1 hafta açık havada ve daha sonra da 80 C^o lik ısı altında 24 saat süreyle etüvde kurutulmuştur. Bu deneyler sonucu elde edilen ön bilgilere göre, basınç mukavemetinde kerpiçe yüzde 5-10 alçı katılmasıyla, yüzde 5-10 kireç katılmasından daha yüksek değerler elde edildiği ancak bu değerlerin ilk tesbit çalışmalarında bulduğumuz değerlere göre yüksek çıkmadığı belirlenmiştir. Buradan akıcı kıvamda hazırlanan kerpiç hamurunda alçı veya kireç katkısının basınç mukavemeti ve suda çözülme süreleri üzerinde belirgin bir artış sağlayamadığı sonucuna varılmıştır. Bu sonucun suyun oluşturduğu boşlukların fazla olmasından kaynaklandığı görüşüyle yeni yapılacak örneklerde su oranının azaltılarak kuru kıvamda hamura, gidilmesi ve pratikte de uygulanması mümkün olabilecek 5-10 kg/cm² lik bir kuvvetle preslenmesi öngörülmüştür. Farklı toprak tipleri ile ve katkı maddeleri yüzde 15'e çıkartılarak yapılan 120 deney sonucu en yüksek basınç mukavemetinin yüzde 15 alçı katkılı ve 10 kg/cm² lik sıkıştırılmış örneklerde en fazla 120 kg/cm² olarak elde edildiği, yüzde 15 kireç katkılı sıkıştırılmamış ve sıkıştırılmış örneklerde de suda çözülmenin tamamen yok olduğu sonuçları ortaya çıkmıştır. Bu arada yüzde 10 alçı ve yüzde 10 kireç katılarak sıkıştırılmış örneklerde belki daha iyi sonuç alınabileceği düşünülmüş ise de yapılan deneyler sonucu suda çözülmeye 5 gün dayandığı, basınç mukavemetinin ise bir önce bulunan değerlere erişmediği saptanmıştır.

SONUÇ

Kerpiç malzemenin kalitesinin yükseltilmesi konusunda yaptığımız araştırmada bulguların genel irdelemesi yapıldığında :

1- Kerpiç malzemede saman türü bitkisel katkıların basınç mukavemeti ve suda çözülme değerlerini olumsuz etkilediği,

2- Kerpiç hamuruna katılan fazla suyun basınç mukavemetini düşürdüğü,

3- Alçı ve kireç katkı malzemelerinin kerpiçe katılması ile basınç mukavemetinin yükseldiği ancak en büyük artışın yüzde 15'den sonra başladığı,

4- Basınç mukavemetini arttırmak için katkı maddelerinin sıkıştırma ile birlikte uygulanmasının gerekliliği,

5- Sıkıştırmada pratik geçerliliği olan başit bir kaldırma sisteminden yararlanılarak sağlanacak 10 kg/cm² lik bir basınç kuvvetinin yararı,

6- Kerpiç malzemeye yüzde 15 alçı katılıp sıkıştırılarak basınç mukavemetinin 2-20 kg/cm² den 40-120 kg/cm² ye kadar yükseltilebileceği,

7- Kerpiç malzemeye yüzde 15 kireç katılarak sıkıştırılmadan da 10-60 dakika olan suda çözülmesinin tamamen ortadan kaldırılacağı şeklinde çok önemli sonuçlar elde edilmiştir.

Bu araştırmamızın ışığı altında kerpiç eski eserleri onarmak için görünümünü bozmayacak ve farklı özelliklere sahip iki malzemenin yan yana gelmesiyle ileride ortaya çıkabilecek sorunları tamamen ortadan kaldırıcı nitelikler taşıyan, yüzde 15 alçı katkılı ve presli kerpiç bloklardan yararlanılması dış yüzeyinde suda çözünmezlik özelliğine sahip yüzde 15 kireç katkılı bir kerpiç sıva tabakasıyla korunması tarafımızca en uygun çözüm olacaktır.

FAYDALANILAN KAYNAKLAR

- Clifton, J.R., Brown, P.W. 1978. Adobe I. The properties of Adobe. Studies in conservation. The journal of the international institute for conservation of historic and artistic works. Vol.23, Num.4.
- Clifton, J.R., Brown, P.W. 1979. Adobe II. Factors affecting the durability of adobe structures. Studies in conservation. The journal of the international institute for conservation of historic and artistic works. Vol.24, Num.1.
- Davey, N. 1965. A History of Building materials. Phoenix house. London.
- Eriç, M., Anıl, Ü., Çorapçioğlu, K. 1980. Kerpiç malzemenin Türkiye koşullarında rasyonel kullanımını sağlamak amacı ile kalitesinin yükseltilmesi konusunda bir araştırma. İDGSA.Mim. Fak. Yapı Fizigi ve Malzeme Kürsüsü yay. İstanbul.
- Eriç, M. 1979. Yapı Malzemeleri II. Kazmaz mat. İstanbul.
- Eriç, M. 1979. Geleneksel Türk mimarisinde malzeme seçim ve kullanımı. Yapı Dergisi No: 33, s.42, İstanbul.
- Kömürcüoğlu, E.A. 1962. Yapı Malzemesi olarak kerpiç ve kerpiç inşaat sistemleri. İTÜ Mat.
- Naumann, R. (çeviren: Madra, B.) 1975. Eski Anadolu mimarlığı. Türk Tarih Kurumu yay. IV. sa. 9. Ankara. s. 45-92.
- Torroca, G. An international project for the study of mud-brick preservation. Preprints of the contributions to the Newyork Conference on conservation of stone and wooden objects. 7-3 June 1970. Vol.1.



Van kalesi ve Çavuştepe'den Urartulara ait eski kerpiç örnekleri



Kerpiç blok ve hımsş üzerinde geleneksel uygulama örnekleri.

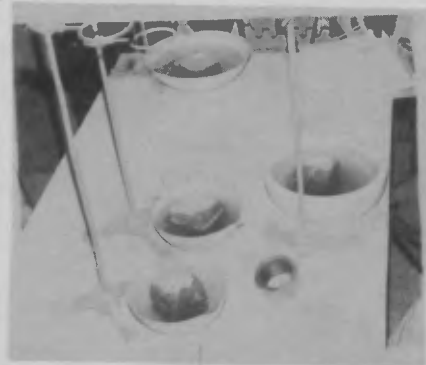
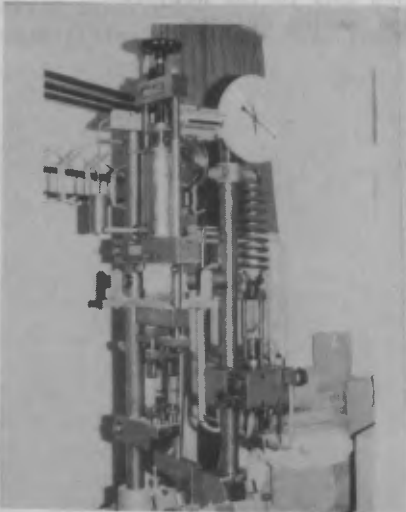

Kerpiç arařtırmamızda basınç ve suda çözümlme deneylerine ait örnekler

LA CONSERVATION DES HABITATS VERNACULAIRES EN TERRE
EXPERIENCES ET AVENIR

JACQUES VERITE ^X

SUMMARY

Due to the continuing depopulation of rural areas and the economic and social problems which exist in a number of countries mud built vernacular dwellings are being abandoned at the same time as their inner quality and value as a cultural inheritance are being recognized. Through a description of the Drâa (Marocco valley) project for the renovation of rural dwellings together with an analysis of buildings in mud based materials it will be shown that conservation work on vernacular dwellings, taking into account the whole of a given region have little chance of succes unless appropriate technologies are used.

X

- architecte spécialisé en conservation de sites et de monuments
- expert consultant de l'Unesco

JUIN 1980

PRESENTATION

De part certaines de ses fonctions , l'auteur est directement concerné par la recherche d'un produit permettant la conservation des briques de terre. Une des raisons essentielles de sa participation à ce congrès est de s'informer des progrès réalisés dans l'utilisation de ces produits pour pouvoir intervenir sur la conservation des vestiges puniques en terre (briques et pisés) de Carthage.

Mais l'objectif de cette communication est d'esquisser la problématique de la conservation des habitats vernaculaires en terre, d'essayer de montrer que ce problème débouche sur l'habitat du grand nombre et que, malgré nos conclusions pessimistes, il ne s'agit plus de sauver quelques ruines mais des régions entières.

INTRODUCTION

La prise de conscience de la valeur des architectures vernaculaires peut être datée de 1964 année de la publication du livre: " Architectures sans architectes ". Depuis l'intérêt qu'elles ont suscité mais aussi le constat de leur dégradation sont à l'origine de nombreux textes et recommandations visant à les étudier, les restaurer ou les conserver. (Exemples: 1- " La commission a été unanime à demander que soient prises par tous les Etats africains des mesures visant à la préservation et à l'amélioration de l'environnement bâti"...;Accra 1975; 2- " La Conférence.... recommande aux Etats membres.... qu'ils promulguent des lois visant à préserver les centres urbains historiques et les ensembles ruraux du continent actuellement menacés de destruction par les conséquences d'un développement mal compris." Bogota 1978).

Des textes certes, mais peu d'actions effectives. Les architectures de terre, parce qu'elles sont les plus fragiles devraient être protégées en priorité car il en est qui disparaissent tous les jours.



"Inoubliable Maroc". Publicité de vacances in: " Jours de France" du 22 mars 1980. La kasba intacte en 1976 est très dégradée et semble irrémédiablement condamnée.

Parce qu'elle semble unique - et révélatrice - l'expérience de rénovation de l'habitat rural marocain mérite une étude attentive. On partira de l'analyse de cette tentative pour essayer de dégager les critères essentiels nécessaires à une opération cohérente de conservation de l'habitat vernaculaire.

Pour trouver une explication à ses échecs on étudiera non pas d'autres opérations similaires puisqu'il semble y en avoir très peu mais quelques cas de construction en matériaux à base de terre.

On tentera alors d'établir une prospective de la conservation des habitats vernaculaires en terre.

LE PROJET DE RENOVATION DE L'HABITAT

RURAL APPUYE PAR LE P.A.M. (MAROC).

Sans vouloir aborder tous les problèmes posés par une programmation qui visait une action sur une région toute entière et une réalisation qui a porté sur 5000 habitats, on décrira ci-dessous les aspects essentiels du projet en insistant particulièrement sur les choix technologiques. On tentera ensuite, en conclusion, de montrer quelle peut-être la place des technologies appropriées et, à travers ses réussites et ses échecs, quelles sont les possibilités d'utilisation de cette expérience dans tout projet de conservation de l'habitat vernaculaire.

L'origine du projet.

Dans le cadre du plan quinquennal 1968-1972 les Services de l'Habitat et de l'Urbanisme du Ministère de l'Intérieur avaient prévu, avec la participation du Programme Alimentaire Mondial (F.A.O.), la réalisation de 60 000 logements neufs et la rénovation de 30 000 logements localisés dans les vallées présahariennes du Drâa et du Ziz.

Avec l'intention de participer à la lutte contre l'exode rural mais surtout avec pour but de contribuer à réduire les énormes disparités régionales ce programme avait été élaboré à partir des idées suivantes:

- il était conçu comme une action d'accompagnement et de soutien aux actions de mise en valeur agricole.
- il s'agissait de coordonner les actions de tous les départements ministériels dans leur action d'équipement des centres ruraux.
- la construction des logements et des équipements collectifs serait assurée par la mobilisation de l'épargne-travail dégagée par le sous-emploi des campagnes complétée par une assistance de l'Etat.
- le remboursement des sommes investies par l'Etat irait aux communes concernées de manière à introduire un processus d'auto-financement nécessaire à l'entretien des réseaux exécutés, à les compléter et à poursuivre la construction d'habitats.

L'option "rénovation de l'habitat rural" était liée aux conditions particulières des vallées présahariennes ; Les études du C.E.R.F. (Centre d'expérimentation, de recherche, et de formation) avaient montré la grande qualité de l'habitat existant, la vitalité de la construction traditionnelle et des besoins peu importants en habitats nouveaux. Il s'agissait aussi de conserver un patrimoine culturel remarquable dans des zones à vocation touristique tout en favorisant son évolution par des améliorations, des aménagements et des équipements.

On ne traitera ci-dessous que du projet " rénovation de l'habitat rural" dans la zone où nous avons pu l'étudier, c'est à dire la vallée du Drâa.

Les contraintes.

L'action de "rénovation de l'habitat rural a du résoudre les problèmes posés par la situation géographique de la vallée du Drâa, par la typologie de ses habitats, leur mode de construction et leur dégradation.

La vallée du Drâa se trouve sur le versant présaharien du Haut Atlas. D'une altitude élevée, d'une pluviométrie rare et d'un accès malaisé c'est une sorte d'oasis continu sur cent cinquante kilomètres environ jusqu'au moment où le Drâa disparaît dans le désert faute d'un débit suffisant.

Les habitats peuvent être classés en deux catégories: le ksar--collectif-- et la kasba--demeure de notable.

Le ksar. C'est un hameau collectif fortifié. Sa création découle de la volonté d'un groupe qui détermine, dès le début tous les éléments spatiaux du village. Son plan est relativement simple: à l'intérieur d'une robuste muraille pourvue de tours d'angle et parfois de tours de flanquement, une porte en chicane ouvre sur une rue principale. Des rues secondaires en impasse mènent aux différents logements. Les quartiers d'habitation correspondent à un espace privatif. Des règles complexes liées soit à des critères généalogiques ou consanguins soit au statut social des habitants président à leur organisation. Les équipements collectifs se trouvent près de l'entrée: salle de réunion de la jmaa (assemblée des chefs de famille), la maison d'hôte pour les étrangers, l'étable et la bergerie collective, le taureau banal, le caravanserail, le logement du gardien et la mosquée. La gestion de cet ensemble est confiée à la jmaa.

La kasba. Autour d'un patio se développant sur plusieurs étages la kasba se présente extérieurement comme une haute bâtisse à quatre tours d'angles. Les parties hautes sont décorées par un appareillage de briques ou par des dessins linéaires exécutés sur les joints des briques. L'entrée est rarement fortifiée. Il est difficile de dire si ce modèle d'habitat familial est très ancien. Il est possible qu'il ne soit que la conséquence d'un certain type de féodalisation récente et d'appropriation familiale de domaines terriens.

Tous ces habitats sont construits en terre par des maçons professionnels qui sont chargés de la conception technique du bâtiment, de sa préparation et de sa réalisation. Alors que dans l'économie d'échange ils étaient rémunérés en nature, la monétarisation des campagnes a fait qu'ils ne sont plus payés qu'en espèces. La fondation et la base des murs jusqu'à une hauteur de 50 cm est construite avec de gros moellons plats maçonnés à la terre. Les murs sont faits en pisé. La terre soigneusement choisie par le chef maçon est damée en couches successives dans un coffrage de bois appelé "taboute" mesurant environ 80 par 180 cm. L'écartement des deux parois parallèles du coffrage est obtenu par des éléments de serrage en bois qui servent aussi à assurer l'appui des banches sur la partie de mur déjà construite. En diminuant progressivement l'écartement des banches au fur et à mesure que la construction s'élève, les maçons arrivent à construire des murs de très grande hauteur d'une stabilité remarquable. (certaines constructions ont sept étages). On estime qu'un maçon et ses manoeuvres peuvent faire jusqu'à 10 "taboutes" par jour, en été, au moment où le séchage est le plus rapide. Les parties les plus élaborées de la maison: piliers, éléments décoratifs, parties hautes, escaliers, embrasures des portes et

des fenêtres sont faites de briques séchées au soleil obtenues par moulage d'un mélange d'eau, de terre et de paille hachée. Les moules en bois déterminent deux briques de 7x11x22 cm. Une équipe de deux ou trois personnes peut produire 2 000 briques par jour. Les murs sont enduits d'un mélange très liquide de terre et de paille hachée qui est lissé à la main ou taloché. Les planchers sont constitués par des solives de palmier (10x10 cm écartées de 30 cm) reposant, pour les grandes portées sur des troncs ou des demi-troncs, recouvertes d'une nappe de roseaux sur laquelle est damée une couche de terre. La toiture est faite de la même structure mais la couche de terre est plus épaisse et modelée de manière à créer des pentes qui draineront l'eau de pluie vers des gargouilles de bois très saillantes. La partie supérieure des murs est protégée par un couronnement de branchages, de joncs, de planchettes ou de pierres plates retenus par un mortier de terre travaillé parfois en forme de merlons.

Les habitats de terre de la vallée du Drâa sont très dégradés. Ce type de construction exige en effet un entretien permanent qui, lorsqu'il n'est pas fait, les rend très vulnérables: la ruine des couronnements entraîne la chute des enduits et la pénétration des eaux dans les murs; la flèche des solives de terrasse, si elle n'est pas compensée par des apports de terre, provoque la stagnation des eaux puis leur pénétration dans les oeuvres; les eaux de ruissellement sapent les bases des murs. L'habitat de terre et l'organisation spatiale du village correspondaient à une société ancienne dont ils exprimaient la cohérence et intégraient les lentes modifications. La "féodalisation" qui est apparue au début du XX ème siècle avec la pénétration capitaliste n'a pas profondément changé ces structures sociales même si elle marque le début de la paupérisation des habitants. C'est essentiellement depuis la dernière guerre que les modifications économiques et sociales ont été les plus profondes, à la suite de la pénétration de l'Etat jusque dans les zones les plus reculées, de la croissance démographique, de l'exode rural et de la monétarisation des campagnes. Les maisons ne sont plus entretenues parce que les habitants n'en ont pas les moyens financiers et que le relâchement du groupe social fait que les travaux collectifs sur la base d'échanges mutuels n'existent plus en dehors du monde agricole. Pour la même raison les équipements communs sont laissés à l'abandon. La jmaa, dont l'autorité a été transférée à l'Etat, n'a plus la possibilité de jouer son rôle au sein de la collectivité. Les nouvelles valeurs sociales font que le modèle dominant est celui des villes. Les bourgeoisies spéculent sur les terrains autrefois concédés gratuitement par la jmaa et leurs constr-

-uctions sont faites de béton et d'agglomérés de ciment. L'architecture de terre n'est plus que celle des pauvres. Elle ne persiste que parce que les édifices sont" généralement plus durables que les rapports sociaux qui les ont créés, en raison de la rigidité, de l'inaltérabilité relative et du coût des matériaux" (Pascon, 1968).

Les choix décisionnels.

Le maître d'oeuvre des études et de la programmation des travaux a abordé toutes ces contraintes en faisant des choix que l'on peut qualifier de technocratiques. Pour mieux comprendre cette attitude il faut insister sur le fait qu'il dépendait d'un Service d'Urbanisme et que l'opération envisagée portait sur 30 000 habitats. Si la notion de conservation du patrimoine culturel a été prise en compte c'est certes à cause de la grande beauté des architectures de la vallée du Drâa mais aussi parce que les conditions économiques et sociales particulières faisaient que la construction de nouveaux habitats n'était pas nécessaire. La volonté dominante qui se dégage des études CERF est celle d'enclencher une mutation profonde où, sur la base des éléments positifs de la tradition serait amenée, chez les habitants, de plus grandes exigences d'habitat et de salubrité. Les choix décisionnels peuvent être ramenés à quatre options essentielles:

1-option sociale: l'action de rénovation est destinée aux moins riches. C'est donc les habitats des ksars qui seront rénovés, les actions complémentaires visant à apporter des éléments de confort (creusement de puits, création ou réparation des salles de réunion, aménagement des places). Une séparation arbitraire classe en monuments historiques les kasbas et les abandonne à leur sort en attendant qu'une réutilisation éventuelle -- et des crédits -- soient envisagés.

2-option équipement rural: le choix des ksars à restaurer a été établi après des études d'armature rurale établissant une hiérarchie des centres à aménager. Les critères de choix étaient la proximité des routes et la valeur architecturale et urbanistique dans une perspective de mise en valeur touristique. Il s'agissait aussi de faciliter la réalisation des chantiers et la participation de tous aux actions communautaires en concentrant l'action sur quelques ksars à restaurer entièrement plutôt que d'agir de façon incomplète en de nombreux endroits.

3-option "hygiéniste": elle est la base des principes d'aménagement des habitats et de l'espace villageois.

La cohabitation des animaux et des gens est supprimée par la création d'étables collectives situées hors du village (ce principe s'est heurté à de profondes résistances de la part des populations et a très souvent échoué). L'aération des maisons est augmentée par la destruction des habitats ruinés proches. Des fosses sèches sont introduites dans les maisons et un réseau d'assainissement succinct est créé par le biais d'un caniveau dans l'axe des rues.

4-option économique: le faible montant des crédits à disposition a incité à des choix technologiques particuliers. Les technologies traditionnelles ont été étudiées et améliorées pendant qu'une infrastructure la plus légère possible était mise en place pour pourvoir aux approvisionnements en matériaux non disponibles localement et apporter les denrées alimentaires fournies par le P.A.M. .

Ce sont ces réponses technologiques que l'on va étudier en détail ci-dessous .

Les réponses technologiques .

Le CERF avait longuement étudié les technologies traditionnelles du travail de la terre et réussi des expériences d'amélioration de ce matériau notamment sur les chantiers de Ouarzazate (où les maisons, voute comprise, étaient construites à l'aide d'un coffrage unique) et de Marrakech (où les murs étaient faits de blocs de terre stabilisés au ciment et comprimés à la presse Cinva-Ram). Mais pour l'opération de rénovation de l'habitat rural le procédé de stabilisation à la chaux traditionnelle a été choisi car il était le moins coûteux dans le cadre des contraintes économiques particulières du projet. La construction d'un four à chaux ne demandait que quatre jours de maçon (rémunéré en liquide) assisté par des manoeuvres payés par les rations P.A.M. . Il évitait le déboursé de sommes nécessaires à l'achat de chaux locale, de ciment ou de chaux hydraulique dont les coûts auraient été augmentés par des frais de transport importants.

Tous les points sensibles des habitats à reconstruire ou à améliorer ont ainsi été protégés:

- les lits saillants d'acrotère ont été maçonnés avec un mortier de terre et chaux.
- les pentes des terrasses ont été restituées avec le même procédé.
- l'enduit traditionnel de terre et paille hachée a été amélioré par l'adjonction de chaux.

-- les soubassements de murs ont été refaits et surélevés jusqu'à 90 cm de haut par une maçonnerie de pierre liée au mortier de terre et chaux.

-- les rues ont été pavées avec le même procédé.

-- les gargouilles de bois n'ont pas été restaurées. ON leur reprochait d'entraîner la dégradation des murs à proximité du point de chute des eaux de pluie. Il a été préféré un autre système traditionnel: une saignée réalisée dans le mur conduit les eaux de la terrasse au sol. Cette saignée étant le lieu d'une érosion intense a été traitée au mortier de sable et chaux.

Le déroulement du projet.

Avec quelque retard sur les prévisions, la réalisation a débuté en 1969 au moment de la livraison des premières rations P.A.M. . Les débuts ont été relativement lents puisqu'en 1972 on estimait à 837 le nombre d'habitats rénovés (avec un coût à l'unité de 1400 F.F. environ compte tenu des équipements collectifs) . Il s'est poursuivi jusqu'en 1974 date à laquelle 5 000 rénovations avaient été réalisées. Il a été interrompu à cette époque pour, semble-t-il des raisons liées au mauvais fonctionnement de l'intendance.

Conclusion

Le projet de rénovation de l'habitat rural appuyé par le P.a.m. est à notre connaissance l'expérience la plus importante de cette sorte qui ait été réalisée. Il est porteur de leçons pour toute expérience de conservation des architectures vernaculaires.

Trois aspects majeurs nous semblent prédominer parmi les sujets d'intérêt qu'il présente: il s'agit d'un projet qui envisage la conservation de l'habitat dans son ensemble, au niveau régional; les technologies utilisées sont appropriées et l'opération vise à la réinsertion sociale des habitants.

La conservation de l'habitat vernaculaire a été envisagée dès le départ au niveau régional et visait l'ensemble des constructions. Il ne suffit pas, en effet, de conserver quelques maisons pour garder la trace d'une architecture régionale. Chaque maison est différente et ne doit sa forme et sa place que par l'organisation spatiale du village et les relations économiques et sociales interrégionales. On peut seulement regretter la distinction factice qui a été faite entre habitats et monuments historiques. Mais il est vrai que les grandes Kasbas inhabi-

tées posaient le problème de leur réutilisation, qui ne pouvait être résolu dans le cadre du projet.

Les choix technologiques ont conduit à l'utilisation de véritables technologies appropriées ainsi que le montre l'analyse suivante par caractéristiques:

- ils partaient des technologies et du savoir faire traditionnel pour les améliorer.
- ils étaient fortement utilisateurs de main d'oeuvre.
- ils privilégiaient les matériaux locaux.
- ils provoquaient une plus value financière pour les habitants (augmentation de la valeur de l'habitat et plus value due à l'amélioration de l'espace urbain).
- ils revalorisaient socialement les techniques traditionnelles et l'ancienne production du cadre bâti.

Même si ces choix ont été imposés par les conditions particulières du projet on ne peut que cautionner l'utilisation des technologies appropriées. Elles ont démontré, dans ce projet, leur efficacité face aux technologies dominantes.

Elles sont certainement le seul moyen de résoudre économiquement les problèmes posés par la conservation ou la restauration d'architectures régionales. Elles constituent la seule possibilité d'obtenir la participation des habitants et par conséquent de leur faire prendre conscience de la qualité de leur patrimoine culturel, de leur permettre ensuite de le valoriser socialement. Mais on doit envisager d'obtenir la participation des habitants autrement que par une forme aussi aliénante que la distribution de rations alimentaires.

La volonté d'enclencher une mutation économique et sociale est aussi un des critères importants. Il ne suffit pas de refaire les façades d'un habitat - même si cela satisfait le touriste - pour que les occupants puissent en avoir la pleine jouissance. L'exigence systématique d'améliorer tous les habitats d'un ksar mais aussi d'intervenir au niveau du fait urbain en cherchant à élever la condition du groupe social est exemplaire car elle refuse de l'enfermer dans une pseudo " tradition " et tend, au contraire, à le réintégrer dans la modernité.

Tous ces aspects positifs font que l'on comprend mal les raisons qui ont amené à l'interruption des réalisations vers 1974. Afin de les expliquer on va étudier quatre réalisations de constructions en terre qui ont comme point commun avec le projet de rénovation de l'habitat rural l'utilisation du même matériau traditionnel.

QUATRE EXPERIENCES DE CONSTRUCTION EN TERRE

Le village de Gournah (Egypte) de H. Fathy.

On ne reviendra pas sur les détails de cette expérience très connue et largement diffusée par l'ouvrage de H. Fathy:

" Construire avec le peuple ". Ce qui est intéressant dans le cadre de cette étude c'est d'analyser les causes de son échec. Le village de Gournah n'a pu fonctionner pour des raisons économiques et sociales. Son édification s'est systématiquement heurtée à la mauvaise volonté de ce que H. Fathy désigne sous le nom général d'"administration " mais qui nous semble être en réalité l'expression du refus de la classe dominante de s'attacher à des modes de construction qu'elle estime dépassés, expression d'une non-modernité et contestation de ses modèles, à savoir l'architecture internationale. Le déplacement de population qu'il impliquait était irréalisable dans une Egypte où les intérêts privés étaient dominants. Enfin le modèle d'habitat et d'urbanisme proposé par l'architecte correspondait à ses rêves et ses désirs. Sa vision hygiéniste et moderniste, sa conception des espaces extérieurs et intérieurs, l'emploi de voutes (utilisées uniquement à Louqsor pour les édifices religieux) avaient de quoi choquer les populations destinées à habiter à Gournah. Il est caractéristique de voir que les squatters qui occupent actuellement cet habitat l'ont détourné de manière à retrouver leurs modèles habituels en créant, par exemple, des cuisines ou des écuries dans l'espace autrefois prévu pour la rue.

Le village d'archéologues de Karnak (Egypte) .

Sur la rive droite du Nil, à quelques kilomètres du village de Gournah, les archéologues travaillant à la conservation et l'étude des temples de Karnak ont fait construire un village en terre sur le modèle proposé par H. Fathy. A l'opposé de celui de Gournah cet ensemble est en parfait état et remarquablement entretenu. Habité par des étrangers et des hauts spécialistes égyptiens il est la démonstration parfaite des hautes qualités d'un habitat inspiré de l'architecture traditionnelle.

Il faut noter, pour notre démonstration, qu'il a été voulu et construit par des étrangers. Il convient aussi de faire remarquer que sa construction n'a été possible qu'à

partir du moment où la réalisation impliquait une très grande utilisation de ciment et donc la possibilité de bénéfiques confortables pour l'entreprise chargée de son édification. C'est ce qui explique que des fondations en béton ont été descendues jusqu'à 11 mètres de profondeur.

Le projet de construction de 200 logements à Ouarzazate (Maroc)

Ainsi que nous l'avons noté lors de la description du projet de rénovation de l'habitat rural, le CERF avait étudié les possibilités techniques de la terre. Il avait en particulier établi un projet de maison voutée ou l'ensemble de la construction était banchée dans un coffrage unique composé de pièces métalliques. La terre stabilisée (avec 4% de ciment) était utilisée à la limite de ses capacités puisque les murs n'avaient que 20 cm d'épaisseur et la voute ne mesurait que 8 cm à la clé.

Conçu pour résoudre les problèmes d'habitat du grand nombre ce système aurait pu être amorti sur 3000 maisons. Mais le projet de Ouarzazate qui n'en prévoyait que 200 n'a même pas été réalisé puisque seules une quinzaine de maisons ont été construites.

Une fois de plus des réticences diverses ont eu raison d'un projet de construction sociale en terre. la plus couramment énoncée est peut être le refus de la voute qui, au Maroc, n'est utilisée que dans les constructions religieuses. Mais dans la mesure où le CERF avait prévu contre cette objection la pose d'un faux plafond éliminant de l'espace intérieur la perception de la voute , on peut se rendre compte que, comme à Gournah, ces réticences sont plus globales et proviennent des décideurs de la classe dirigeante.

Il y a toujours eu contradiction entre la volonté du CERF - composé presque uniquement d'étrangers "de gauche" - qui désirait que " soient jugulées la crise de l'habitat et l'anarchie urbaine " (Dethier 1970) et l'Etat qui refusait de financer les opérations nécessaires ou qui, placé devant une réalisation qui ne correspondait pas au modèle dominant s'empressait de l'interrompre.

L'opération de resorption de bidonvilles de Marrakech (Maroc).

Réalisée aussi par le CERF cette opération prévoyait la construction de 2200 logements. Sa réussite partielle, plus de 800 logements ont été réalisés, est due au fait que

l'emploi de la terre stabilisée a été strictement limité aux murs (briques de terre stabilisées au ciment compressées à la presse Cinva Ram). Le modèle d'habitat de Marrakech, de part ses formes et des matériaux mis en oeuvre (toitures de béton en particulier) correspond au modèle dominant. Il a donc été accepté. Prévu pour le relogement d'habitants des bidonvilles et destiné à être démoli ensuite il est maintenant l'objet d'une appropriation d'"une petite classe de privilégiés qui disposent d'un emploi stable quand ce n'est pas d'une fonction administrative" (Dethier 1970) et sujet à spéculation immobilière.

La réussite de cette opération utilisant la terre est due au fait que les normes dominantes sont presque respectées.

Conclusion

Ces quatre expériences - on aurait pu en citer de nombreuses autres tout aussi révélatrices - montrent bien le refus des classes dominantes d'utiliser le matériau traditionnel qu'est la terre pour la construction d'habitat social. Les projets ne sont réalisables que s'ils en limitent son emploi ou s'ils sont destinés à des étrangers et à quelques représentants marginaux des bourgeoisies.

La terre est assimilée au passé, comme élément d'une société " inférieure et retardataire " (Laraoui 1970) et perçue à travers une vision folklorique. Or " le folklore récupéré ne représente pas la culture ancienne, authentique opposée à la nouvelle culture factice, née de la pénétration occidentale; en réalité il fait partie lui aussi de cette nouvelle culture " (Laraoui 1970).

C'est ce qui explique à la fois toutes les réticences devant l'utilisation des matériaux traditionnels et la recherche systématique d'une image du passé dans les constructions des pays en voie de développement. La vision folklorique fait que l'on peut voir en de nombreux endroits des habitats ou des hôtels construits en béton qui reproduisent dans leur forme les habitats en terre.

L'AVENIR

A travers l'explication précédente du refus des classes dominantes d'utiliser la terre on comprend mieux l'échec du projet de rénovation de l'habitat rural marocain ou l'habitat vernaculaire était essentiellement perçu comme habitat social.

La prise de conscience de la valeur des habitats vernaculaires en terre intervient au moment où dans la plupart des pays en voie de développement les dirigeants ont quasiment renoncé à toute opération d'urbanisme d'envergure. Après avoir, dans les années qui ont suivi les indépendances, envisagé la résolution des problèmes d'habitat du grand nombre par l'intervention de l'Etat au niveau de la construction d'habitats, ils ont, sous l'influence d'idéologues comme Turner, baissés les bras devant l'immensité de la tâche à accomplir et découvert l'"auto-construction". L'assistance de l'Etat n'aurait plus été que par le biais de trames sanitaires permettant une relative intégration des habitants dans la modernité. Cette notion est même abandonnée de nos jours où, dans certains pays, il n'est plus envisagé que des trames sanitaires succinctes.

On voit mal, dans ces conditions, comment des régions entières, parfois éloignées du siège du pouvoir central, pourraient faire l'objet d'actions de conservation. On risque, au cours des années à venir, de ne voir que des opérations limitées où quelques éléments d'architecture vernaculaire seront conservés, intégrés dans un musée ou un parc. Folklorisés en sorte.

Est-il possible d'envisager une modification des mentalités des classes dominantes sur ce problème? Depuis quelques années - et de façon caractéristique à chaque fois que des difficultés économiques les atteignent - les pays dominants se retournent vers les matériaux traditionnels et la terre en particulier. Les travaux des chercheurs aboutiront un jour à la découverte du matériau miracle de stabilisation de la terre. Soigneusement protégé par des brevets il permettra la construction dans les pays dominants. Et c'est peut être cet exemple qui fera que les pays en voie de développement agiront enfin - s'il n'est pas trop tard - pour conserver leurs habitats vernaculaires en terre.

REFERENCES / BIBLIOGRAPHIE

INTRODUCTION

1- références

- Rudolfsky, B., 1964. Architecture without architects, New York, Museum of Art.
- Accra 1975, Conférence intergouvernementale sur les politiques culturelles en Afrique., Unesco, rapport final, p. 22.
- Bogota 1978, Conférence intergouvernementale sur les politiques culturelles en Amérique Latine et dans les Caraïbes, Unesco, rapport final, p.34.

LE PROJET DE RENOVATION DE L'HABITAT RURAL

1- références

- Pascon P., 1968, Types d'habitat et problèmes d'aménagement du territoire au Maroc, R.G.M. n°13, p.85.

2- bibliographie

- Cerf 1967, Hensens J., Bauer G., Hamburger B., Dethier J., Rénovation de l'habitat de la vallée du Drâa, Ministère de l'Intérieur, Rabat.
- Cerf 1969, Rénovation de l'habitat rural traditionnel dans le Dra. Enquête conjointe Ministère de l'Intérieur/ Ministère de l'Agriculture, Ministère de l'Intérieur Rabat.
- Aménagement urbain et rural 1972., Rapport de la sous-commission; préparation du plan quinquennal 73-77. Ministère de l'Intérieur. Rabat.

QUATRE EXPERIENCES DE CONSTRUCTION EN TERRE

A- le village de Gournah

- Fathy H., 1970, Construire avec le peuple, J. Martineau, Paris.

B- le village d'archéologues de Karnak

- Lauffray J., 1976, Village d'archéologues, Architecture n°400, p.47.

C- le projet de construction de 200 logements de Ouazazate.

1-références

- Craterre, 1979, Construire en terre, Paris, p.71, 72
- Dethier J. 1970, Soixante ans d'urbanisme au Maroc, Princetown University, p.32.

- Masson, 1978, Choix technologiques et problèmes de la construction au Maroc
 D-1'opération de resorbtion de bidonvilles de Marrakech
 1- références
 Dethier J., 1970, op. cit., p.23
 2- bibliographie
 Masson, 1978, op.cit.
 E-conclusion
- Laraoui., 1970, L'idéologie arabe contemporaine, Maspéro, Paris

TRAVAUX PERSONNELS

- Vérité J., 1976, Ksar et kasba entre la terre et le béton, Architecture n°399, p.77 et s.
- Vérité J., 1977, Inventaire ,protection et mise en valeur des architectures traditionnelles du Sud Marocain., Rapport Unesco.
- Vérité J., 1977, Inventaire, protection et mise en valeur des architectures traditionnelles. Un exemple: le sud marocain., maîtrise d'urbanisme, Paris VIII.
- Vérité J., 1978, Construire en terre demain? Dea d'urbanisme, Paris VIII.



Vallée du Drâa: les architectures abandonnées se dégradent rapidement.



Tinzouline: vue d'un ksar restauré



Ouarzazate: opération de rénovation à Taourirt.



Le village de Gournah en 1976. Photo CFETK, A. Bellod.



Le village de Karnak: une des maisons dessinées par l'auteur. Photo CFETK; A. Bellod.



Architecture récente près de Ouarzazate.



Les maisons en terre banchée de Ouarzazate.

EXPERIMENTS IN MUDBRICK CONSERVATION AT TEPE NUSH-I JAN

HILARY LEWIS

SUMMARY

Efforts to conserve the Median site of Tepe Nush-i Jan (north west Iran) have been made since excavation began in 1967.

In this paper I outline the particular damage and decay being suffered by the site's monumental mudbrick buildings, then describe the different techniques adopted and discuss their effectiveness.

I have also included the results of laboratory tests identifying the constituents of brick samples collected when I visited Tepe Nush-i Jan in August 1978.

JULY 1980

EXPERIMENTS IN MUDBRICK CONSERVATION AT TEPE NUSH-I JAN

The experiments in mudbrick conservation carried out on Tepe Nush-i Jan, the Median settlement in the central Zagros region of Iran were first reported on at the Yazd conference in 1972 by David Stronach, the Director of the British Institute of Persian studies. The present paper is the result of my visit to the site in August 1978.

In 1977, the most recent year of excavation since work was begun in 1967 by the Institute, Tepe Nush-i Jan would appear to consist of four major buildings built on the summit of a natural shale outcrop. The outcrop is about 37 meters high and is situated on the fertile Malayer-Jowkar plain, 70 kilometers south of Hamadan.

The area at the top of the mound measures 80 x 30 meters and the buildings erected on it include a Fort, a central Temple, a Western building, and a Columned Hall. They are of monumental proportions with walls standing at 8 meters high now, but probably at 13 meters originally. To accommodate the height, the walls are 1.80 meters wide at base. Round these buildings further structures have been discovered including storage magazines, a North building and on the south and west sides of the site at least, an encircling wall decorated with arches on its inner face. At the centre of the mound, the walls and floors rest on bedrock (the depth of the mudbrick floor being only 25 cms. deep). Elsewhere however, they stand on a mudbrick platform which was constructed to compensate for the unevenness of the mound's summit. Thus, the platform is level with bedrock near the center of the mound but at its outer limits it achieves a height of 2.70 m. (eg. at the south east corner of the fort). Below the floor of the Columned Hall, about three meters below floor level is a rock cut tunnel descending westwards for about 20 m. at an angle of 30 degrees.

Building and occupation of this site lasted for about 150 years from c. 750 B.C. to 600 B.C. when it was abandoned. Although the site was occupied briefly in Achaemenian and Parthian times, there was no further monumental construction. Today, Tepe Nush-i Jan presents not only diverse examples of mudbrick construction, due to the remarkable extent to which the Medes relied on mudbrick as a building material (1), but

it also includes in the Central Temple a unique type of Iranian vaulting characteristic throughout the Median era (2). Furthermore this is still largely intact because prior to abandonment, the occupants filled up the Central Temple with layers of shale and mudbrick and blocked up other parts of the site.

I collected samples of the mudbrick used at Tepe Nush-i Jan and took them to Tehran to be analysed (3). The samples were taken from the blocking at the eastern end of the site. This location was chosen because the bricks here had not been subject to external weathering ever since Median times, being well below the surface and they were therefore in a state of optimum preservation.

The following results were recorded (4):

Shape: rectangular
 Size: 40 x 25 x 30 cms.
 Weight: 19.50 kilos
 Density: 1.5 kilos per cubic cm.
 Composition:
 Clay: 15%
 Silt: 47%
 Sand: 34%
 Gravel: 15%

N.B. It is important to note that the composition of the bricks used at Tepe Nush-i Jan is not uniform. Bricks from the blocking in the east court area used above characteristically contain little shale, in contrast to the Fort where the shale content is very high. Interestingly, the shale content is also particularly high in the lower courses of the walls which suggests that some special advantage was thought to be attached to this.

Fibrous Material: Chopped straw.

This was identified when the brick was saturated with water and disintegrated. Externally this could be deduced from the tiny hollow shells remaining in the brick.

Non-fibrous Organic Material: Pieces of wood
 Charcoal

Rough Inorganic Additions: Occasionally shards
 Much shale, a heavy mixture of
 small pieces.
 Quartz pieces.
 Mica.

Permeability of the foundation material: Very permeable.

There is rising damp from underneath the mudbrick platforms near the surface of the mound up to a height of 1.30 m. in the lower parts of the walls.

Liquid limit: 27%

Mortar: Mud mortar was the only type of mortar used and it contains no organic material. Both brick and mortar are equally subject to spalling and there is no difference in terms of resistance to erosion.

Other materials used:

Whilst the Medes appear to have used mudbrick struts to span areas up to 2.50 m. across, for anything larger and for the columns in the Columned Hall, imported timber was used. No timber now remains.

There is a very small amount of plaster work covering, e.g. the hemi-spherical firebowl in the Central Temple. The firebowl itself is mudbrick and is covered with several layers of fine white plaster.

However, from the point of view of conservation, this is insignificant in relation to the very great need to tackle the progressive damage being suffered by the mudbrick structure itself.

The most difficult problems are being caused by:

1. Rising damp from beneath the mudbrick platforms up to a height of 1.30 m. in the walls. This produces salt efflorescences and spalling or loss of face to a depth of 18 - 20 cms.
2. The impact of wind-driven rain affecting the site's south western aspects in particular.
3. Cracking walls as a result of structural movements. Although the area is one of seismic instability, this particular damage is not being caused by earth tremors, but by a general drying of the surfaces since excavation.
4. Overall decay also caused by surface dehydration is particularly noticeable on the upper walls exposed to most wind. Crumbling and pitted walls are unfortunately recognisable throughout the site.

Damage is also caused by:

- (a) Pigeons: a particular menace because they roost in any crack or animal hole they can find. In antiquity large cats and scavengers excavated layers in places.
- (b) Snow: two measures have been taken to alleviate the serious erosion that is caused to the base of the walls when snow accumulates.

- (i) the construction of protective steel roofs in 1974 (see below).
 - (ii) the appointment of a guardian one of whose duties is to shovel away snow.
- (c) Visitors: surface erosion and damage is caused by the passing of people's feet, hands and shoulders as they brush against the sides of doors etc.

N.B. There has only been one severe case of malicious damage by visitors when the bricks of a low protective mud-brick wall around the deep void of the Central Temple were hurled onto the floor of the cellar, causing damage to the floor and to parts of the mudbrick altar.

Efforts to conserve the site at Tepe Nush-i Jan have been made since excavation began.

At first these were limited to either reburial of excavated structures or where this was impractical, to the addition of thick coats of mud plaster (kaghel).

The first six months made it clear however that mud plaster was insufficient by itself to protect against the severity of the Hamadan climate. In winter temperatures drop to -30°F (-34°C) with snow and heavy frost. At other times of the year wind and driving rain must be contended with, whilst in summer it is hot and dry with temperatures around 100°F (38°C). The prevailing winds come from the south west.

In view of this, in August 1970 experiments were carried out using Epikote lacquers as a method of conservation. Two types of lacquer were developed by the Egham Research Laboratories of Shell Research Limited, London and brought out to the site to be tested:

- (a) a two component lacquer applied by brush (5)
- (b) a heavier two component trowelling composition using mudbrick dust as a filler.

In both cases the chemicals applied impregnated the walls up to a depth of 0.5 cms. and the lacquered surfaces acquired a "stone-like hardness".

Although the treated areas mostly resisted wind and water erosion for two winters, subsequently the extremes of temperature have caused the hard surface to peel off sometimes taking other parts of the wall with it. In order to cope with the effects of thermo expansion and contraction it would seem that much deeper penetration would be necessary: David Stronach suggested to me possibly 5 cms.

Various methods have been employed to protect the larger standing walls.

The brickwork exposed to maximum wind and rain is plastered with a protective skin of kaghel. Elsewhere the walls are

not so protected but instead are capped by layers of stiff reed mats and kaghel, with a layer of guni (sacking soaked in tar or similar bituminous material) laid between. The latter acts as a form of damp course. Wooden slats extend the capping beyond the width of the wall. This method is useful because it is flexible enough to follow the contours of uneven wall surfaces and it has proved to be efficient.

Standard village roofing techniques have been used to protect some of the excavation trenches temporarily. These consist of long wooden poles with smaller cross struts supporting reed matting and kaghel. For extra protection polythene, perforated to prevent condensation, is laid over the first layer of mud and below a second layer.

Where walls have been damaged by erosion, pitting or other types of disturbance and where the appearance of the original wall is certain-Median bricks from the blocked areas of the site are used to build up the line of the walls. It is proposed that all reconstituted areas be demarcated using a thin line as has been done at Masada. Replacement of damaged brickwork helps alleviate further erosion and weather damage in general.

To protect the floors of the large open excavated areas, a layer of sacking is first laid down and then a backfill of up to 40 cms. of earth is added.

In 1974 Silurian steel roofs (28 x 24 m.) on free-standing columns about 7 m. in height were erected over the site. These have been very important in the conservation of the site because they guard against the serious damage caused by rain, snow and the impact of run-off water. Gutters are attached to the roofs and the water collected runs down closed drainpipes. Initially vertical, these drainpipes then slope gently underneath the visitors' walks to the edge of the mound so that the run-off is carried away from the buildings. The pipes are buried because if exposed, they tend to be damaged, displaced or removed altogether and catastrophic results follow.

Finally, a local custodian has been appointed to oversee the site, to be alert to visitors and perform such duties as clearing accumulated snow.

Although the measures taken to protect Tepe Nush-i Jan have succeeded as far as they go, they are nevertheless inadequate to deal with the problems outlined earlier.

For example, whilst the steel roofing holds off vertical rain and snow, wind still blows through persistently. Even though wind erosion itself is slight, nothing prevents the worsening of the cracking and decay being caused by the effects of general dehydration which result. Neither are the problems of rising damp, wind, driving rain or pigeons dealt with.

It is suggested by David Stronach that the central area of the site should be covered with kaghel to preserve the structure. The drawback here of course is that the facade is altered. (The walls at Tepe Nush-i Jan have no overall coating of kaghel so that the masonry is left exposed.)

In conclusion, if Tepe Nush-i Jan is to be saved from irrevocable disintegration it is clear from the above that there is an immediate need to take further action. Not only is it necessary to find a more comprehensive method of protecting the buildings but it is also equally important to find one that does not disguise or detract from their original appearance.

NOTES

1. A full description of the mudbrick architecture discovered at Tepe Nush-i Jan may be found in the Iran Journal vols. VII (1969), XI (1975) and (1978). There have now been five seasons of excavation.
2. This type of vaulting is made up of "two opposed sets of curved mudbrick struts which spring from each of the long walls and meet in the middle of the room". Iran Journal vol. 19. It is a highly unusual method possibly beginning with the Medes. It became important in Iran and is illustrated in later buildings of the Achamaedians at Persepolis, of the Parthians at Shahr-i Qumis (Damghan) and at Kuh-i Khwaja in Sistan, a combination of Parthian and Sassanian.
3. The laboratories of the Mandro Co., 19 Amir Atabak Ave., Teheran were very kindly put at my disposal by Dr. Amir Soleimani and the tests supervised by Dr. Razmara.
4. I had originally hoped to carry out in full the Questionnaire No. 3 prepared by ICCROM (Rev. 2). Unfortunately, due to political events in Iran the extra laboratory facilities required could not be made available.
5. The field trials begun in August 1970 by Mr. David Booker of the Egham Research Laboratories are described in the report of the First International Conference on the Conservation of Mudbrick Monuments (Yazd) 1972 by David Stronach.

ACKNOWLEDGEMENTS

I am very grateful to David Stronach who accompanied me to Tepe Nush-i Jan. His help and comments have been invaluable. I would also like to thank Richard Hughes for his assistance.



Tepe Nush-i Jan

Situated on the Malayer-Jowkar plain 70 km. south of Hamadan



Damage caused by animal scavengers in lower parts of walls
Conservation efforts:

- Note a) replacement of brickwork where original appearance certain
b) protective coating of mudplaster (kaghel)
c) protective roofing using reed and kaghel, extended beyond the limits of the walls by wooden slats.

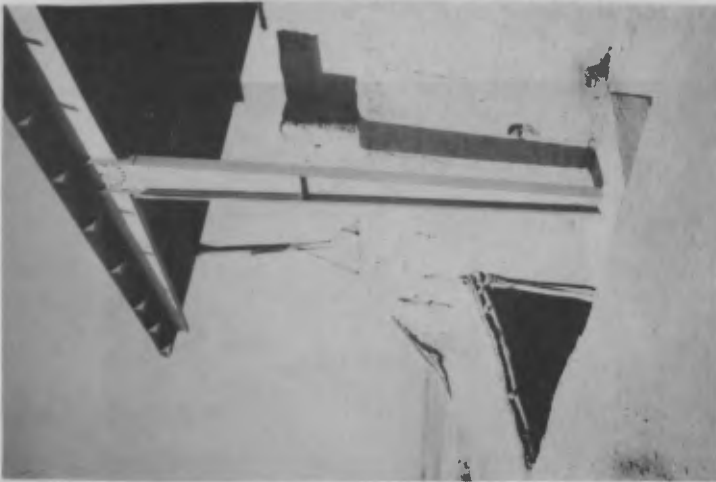

Siluran steel roofing on free-standing columns

Note drainpipe system for carrying water away from the buildings.

Also: standart village roofing temporarily protecting trenches.



Illustrating a) steel roofs

- b) replacements of brickwork
- c) protective coating of kaghel



Illustrating problems of decay
Surface spalling on an interior wall.



Capping using reed mats and kaghel with a layer of guni between.

MUD BRICK BUILDINGS
THE MASMAK FORTRESS IN RIYADH-SAUDI ARABIA
GENERAL CRITERIA OF RESTORATION

MARCO ALBINI X

SUMMARY

Introduction

General description of the Masmak

Distributive characteristics of the Masmak

The decorations

Restoration criteria to be adopted for the Masmak

Immediate phase of execution (demolitions)

2nd phase: sampling

Description of the project

Protection of the mud building structure

X ARCHITECT RESTORATION DESIGNER

30TH JUNE 1980

INTRODUCTION

The work of restoring the Masmak at Riyadh represents an important cultural experience concerned with the conservation of the architectural tradition of the country and of local customs.

In recent years there has developed in some countries of the Middle East, Arabia, Africa and South America a great interest in the conservation of mud architecture.

The conservation of mud architecture is today an important problem: in fact the abandoning of traditional system of construction in favour of imported techniques and an organization of cities inspired by Western models has favoured the depopulation of old urban fabrics and their replacement.

It is important, therefore, that attention should be paid above all to those exemplar which, for architectural, historical or typological reasons, constitute a significant documentation.

GENERAL DESCRIPTION OF THE MASMAK

It is a large building of two floors, constructed in mud bricks covering an area of about 50 m. x 50 m.

It was originally used as a private residence, a citadel, barracks and jail, all at the same time.

According to information it was erected at the end of the 17th century and has been abandoned since the beginning of our century.

Constructed probably in several stages according to the needs and in accordance with local architecture and system prevailing at that time.

It is the place where a famous battle between King Abdul Aziz father of actual King and the Governor of Riyadh took place in 1902.

From the Masmak the unification of the Kingdom started after that date by King Abdul Aziz who was the first King of Saudi Arabia.

The predominant features which draw the attention are the four high towers positioned at the four corners.

Traces of bullets can still be seen in the tower walls and also part of a broken lance is embedded in the only outside door.

Inside the building and centrally situated is another tower higher than the other four and which was probably used for the simultaneous surveillance of the internal and external areas.

The drainage of rain water from the terraces is by means of timber shutes, inserted in openings and adjusted to take the flow of water a short distance away from the walls.

Walls of the first floor do not always coincide with the walls of the ground floor. They are often off set.

There is very little possibility that a part of the floors of the Masmak had been paved, as original methods suggest that floors generally were of compacted soil and often covered with straw matting. By spraying the straw matting with water one obtained a freshness which lasted for a certain period of time.

However, if few rooms had stone or any other form of pavement, this pavement does not exist today.

DISTRIBUTIVE CHARACTERISTICS OF THE MASMAK

The Masmak today differs to a great extent from its original distributive organization.

The building must have consisted of a greater number of nuclei of rooms round open courtyards generally protected by arcades.

The connections between one nucleus and another were characterized by covered passageways, protected against the sun.

The rectilinear staircases indicate, even on the upper storeys, directrices which traverse the palace longitudinally, while the connections with the towers or entrance to the guard walk (nearly completely destroyed or buried under debris) are so narrow that they permit the passage of only one person at a time.

The columns and walls and their arrangement correspond to recurrent constructional techniques connected with the characteristics of the materials, the climate and the way of life.

The soffits are made with main and secondary Tamerix wood beams, irregular in arrangement and section. They thus have the flexibility typical of wooden soffits and great chiaroscuro as a result of the irregularity of the material.

The ends of the wooden beams are not aligned but project in an irregular manner, since, wood being considered a constructional material of great prestige the beams were used in their full length.

The crenellation of the internal walls which do not extend as far as the soffit varies in design according to period. It is more or less elaborate according to the thickness of the mud and the formal characteristics of the merlons.

The openings in the walls, furthermore, play a very significant functional and decorative role.

The rooms are ventilated and kept cool by means of an efficacious distribution of air passages.

The openings, built on the basis of the dimensions of the mud brick, disposed obliquely so as to form a triangle generally in the upper part of the wall, form a geometrical pattern which is sometimes very elaborate and gives a solemn dignity both to the interior and to the exterior.

In other cases the openings in the walls serve to provide a view of the exterior; a view which is limited by the need to keep out the heat and to maintain privacy.

Often we found triangular openings placed at low level in the wall separating two rooms, both for ventilation purposes and for allowing verbal communication between rooms without being seen.

THE DECORATIONS

The beams often reveal bright geometrical painted decorations, as also the doors. The door heads carry more complex decorations; in some cases they are carved and acquire greater relief.

In room No. 68 on the first floor there are wall decorations, the remains of more extensive works, which could throw light on the origins of the palace and on the stylistic influences of the period.

RESTORATION CRITERIA TO BE ADOPTED FOR THE MASMAK

A careful examination of the plans and of the palace in its present conditions has led us to the conclusion that the palace should maintain all its recognizable distributive characteristics, those of the materials employed that form part of the tradition of mud architecture.

We think that the aim should be not to reconstruct the palace in a fanciful way but rather to conserve what remains, foreseeing the addition

of the parts necessary to make the building usable and suitable in the future to serve a purpose. It is in fact important that the restoration should enable the palace to serve a purpose and that, in the parts conserved, it should be possible to read its history and to observe the main architectural elements defining its particular characteristics.

IMMEDIATE PHASE OF EXECUTION (DEMOLITIONS)

The first phase of restoration foresees the demolition of the more evident additions: walling that occludes doors, arcades, openings in general.

2nd PHASE: SAMPLING

We are carrying out an experimental sampling in order to test certain technical solutions and materials. Restoration works in general require great prudence and practical verifications.

New materials to be used with old materials are in general tested under the real atmospheric and climatic conditions in order to ascertain the behaviour and performance of the materials over a period of time.

A restoration sampling in some of the rooms permit the carrying out of experiments which would provide important information and serve subsequently as a term of reference for the execution of the works.

The test assembly structure that we are carrying on includes the following:

Mud brick feature

Bricks are fabricated using soil cement mixture: 1 portion of cement on 8 of soil and straw as indicated in Mr. Chiari report and tested in compression tests and water resistance.

Dimensions of the bricks are 45 x 22 x 12 cm. so that the total thickness of new walls is equal 50 cm. The compression test gives a result of 60 Kg/cm² on 3 samples used after accurate manufacture.

Columns

Columns are made in the same traditional techniques using round stone blocks plastered with local fast hardening material called "jass" which correspond to gypsum. Once mixed with red sand or soil without straw gives a sandy color smooth and hard surface which is indicated for detailed jobs and for the capping on top of walls.

Actually this technique is applied in the local traditional houses to protect the top of walls from rain and gives the characteristic white fascia of the old villages.

Roofs

Roofs are made with tamerix props covered by palm leaves on double layer. On top of this a layer of soil is added at present. One test assembly foresees the use of soil cement layer with an intermediate waterproofing membrane to protect the soil from rain and to avoid maintenance in the future. The top soil cement should be compacted in order to reduce cracking.

Plaster

Samples have been made using soil cement plaster but the result is a deep change of appearance, withish color and cracking. Therefore the normal mud plaster with straw is used and when needed protected with Ethylsilicate 40. Testing of spraying Ethylsilicate 40 are under study at present and results may be collected within two months.

DESCRIPTION OF THE PROJECT

The project envisages the reorganization of the rooms round the courtyards, the reconstruction on the ground and first floors of the nuclei clearly revealed by a study of the plans (and verified on the spot).

While in the rooms round the courtyards A, B and C, by means of the demolitions proposed in the outline of the project, the original organization of the palace is revealed with sufficient clarity, in the case of the courtyard D and the rooms round it we have hypothesized, in the absence of many elements, an organization similar to the nuclei already mentioned, on the basis of the traces of debris of destroyed walling.

The proposal to complete some of the missing parts of the Masmak is made above all with a view to its future utilization.

The courtyard E has not been reconstructed: the absence of elements has led it to be suggested that this ample space be planted with palmtrees and the perimetrical walling be reinforced by a ring of perimetrical buildings to serve in the future for storage and to house hygienic services and possibly a cafeteria.

It is foreseen that the restoration of the walling and of the existing vertical communications will be carried out in accordance with the dimensions and materials already existing in the palace.

Great importance will be given to the planning of the system of rain water removal from both vertical and horizontal surfaces. For the good maintenance of the walling and the terraces it is necessary that the water should be covered away according to a precise system in order to avoid infiltration, puddles and splashing, which can give rise to dangerous erosion phenomena.

The existing paintings on wood will be preserved, as also any other decoration that may come to light.

We think that the beaten earth floors should be retained, to be covered with palm matting in the traditional manner.

The wetting of the mats and floor in the periods of greatest heat leads to a lowering of the temperature as a result of the evaporation of the water: this usage, very common in the country, confirms the reason for many of our choices with regard to materials and constructional solutions, which we wish to reconfirm.

PROTECTION OF THE MUD BUILDING STRUCTURE

The aim of restoration work process in the case of Masmak is to avoid as much as possible the heavy maintenance work that any mud brick building usually needs.

Therefore we take particular care of the protective treatment of the walls both the existing ones and the new ones against the deterioration process caused by the rain.

This requires 3 types of intervention:

- 1) Total control of rainwater and ground water, even in the event of exceptional rainfall. This in turn implies an elaborate study of the hydrogeological situation of the whole area surrounding the monument.
- 2) Protection of the top of the walls by capping system to prevent rain penetration into the cracks and formation of streams running on the surfaces. Capping materials for mud brick walls must satisfy the same requirements specified above for repairs in the wall structure.
- 3) Surface treatment of mud brick walls to be considered only after the problems of repairs, roofing, capping, rain disposal and ground water control are satisfactorily solved.

Concerning surface treatment a serious limitation to any protective treatment of mud bricks is that unless the material is completely permeated and modified by the solution applied, the adhesion of the treated layer to the untreated core material is rather low, as it is not greater than the cohesive force of the material itself.

Actually a surface crust formed by a consolidation treatment is attached to the core of the wall by the sum of all forces attaching the last treated particles to the first untreated ones.

Water can easily overcome them and, by detaching the particles from one another, cause the separation of the entire crust from the core. Thus if water can gain access to the interface between the treated crust and the core, the whole treated surface is easily lost and the rate of damage suffered by the wall may be larger than it would have been if no protective treatment had been applied.

The danger can be reduced if the surface of the treated part is as irregular as possible, achieving a kind of keying effect.

If on the other hand proper material (some sort of chemical that produces a crust with properties as close to the core as possible) is used, the risk of detachment of the crust itself is reduced, and the need to have treatment that goes very deeply into the wall can be avoided.

It is left then to the capping techniques to inhibit access of water behind the crust particularly by protecting the all-important superior edge of the wall.

The collaboration of Prof. Giacomo Chiari of the University of Turin has been very helpful in the determination of the recommended treatment. Prof. Chiari is following the restoration work and testing on site the different techniques. Herewith I am summarizing parts of his report for the site.

Among chemical products existing in the market ethyl silicate was then selected and tested on the field on the basis of the general considerations quoted above. Inside clayish materials ethyl silicate is known to create silica bridges, after hydrolysis, between the individual plates, inducing a kind of polymerization of the clay that sharply reduces swelling in the presence of water and completely inhibits dispersion of the clay in water (R.E. Bisque "Clay polymerization in carbonate rocks; a silification reaction defined", 9th National Conference on Clay Materials, USA, pp. 365).

Since the quantity of ethyl silicate sprayed on the surface is small, and the alcoholic part of it evaporates after hydrolysis, the actual amount of material that remains in the wall is minimal.

This allows the wall to keep, more or less, the same properties it had before the treatment (color, porosity, capillarity, thermal expansion coefficient). A treated surface is not water-proof, in the sense that water can still penetrate into it; but it is water resistant, in the sense that the particles of clay are no longer dispersed in water. This is certainly an advantage of the ethyl silicate impregnation, because it does not inhibit the breathing of the wall, and the possibility of another future treatment, even with other completely different materials. Normally any treatment of art objects or monuments must be reversible.

The ethyl silicate treatment is not reversible but at least it allows the possibility of further intervention with any kind of material that could possibly be discovered in the future. The use of resins or plastic substance, on the contrary, not only is not reversible, but does not allow, for example, the subsequent use of ethyl silicate.

Finally, since there is a gradient of penetration due to the spraying technique of ethyl silicate application, the separation surface between the treated and untreated parts is not so sharp as for resins etc. Furthermore, if some parts of the wall are more ruined (i.e. greater quantity of cracks) than other, the liquid will penetrate more deeply into them, achieving that desirable keying effect I dealt with above.

Tests done with all three types of ethyl silicate showed that the least expensive one, the Ethyl Silicate 40, proved to be the most efficient in the formation of a weather resistant surface.

Two commercial types, more or less with the same characteristics, are available: the Monsanto Silester, produced by the Monsanto Co, and the Ethyl Silicate 40, produced by the Union Carbide Corporation (the second one was used in Peru with comparable results to those obtained in Iraq with the Monsanto Silester).

Laboratory and field tests led to the following formulation of ethyl Silicate for spraying:

Ethyl Silicate 40	66.6 % (in volume)
Ethanol 96 %, commercial	32.6 % (in volume)
Hydrochloric acid (conc.)	0.8 % (in volume)

This solution is mixed thoroughly and left to stand for a short time (it warms up spontaneously during this stage because of the hydrolysis reaction).

The small amount of HCl is added as a hydrolysis catalizer, and the dosage should carefully be checked to avoid a too quick reaction on the surface, which would inhibit further penetration of the liquid. The reaction speed is also influenced by other factors like temperature, salt and water content of the wall.

For spraying the stock solution is diluted 1:1 (volume) with 96 % commercial ethanol. Normal garden sprayers, in plastic and without iron parts, which contain 5 to 7 liters of solution have been proved most effective.

Particular care should be devoted to cleaning the sprayer after its use with alcohol, not water.

While applying the solution, the force of the spray should be regulated. Small droplets (but not so small as to be dispersed in the air) are

desirable to reduce the impact of the liquid and to avoid dripping. The liquid should be equally distributed over a predesignated area of the wall, on which the entire content of the sprayer should be applied. In choosing the area to be sprayed it should be remembered that about 2 liters per square meter of surface are required to form a weather resistant layer of sufficient consistency.

Even better results could be obtained by two applications ten or fifteen days apart. This length of time allows the silica gel which is formed after spraying to contract, reinstating porosity in the crust.

The treatment is rather expensive: the ethyl silicate costs about \$ 4 per liter (depending also upon importation cost); a considerable addition to cost is the price of the ethanol, variable from country to country (cost of the alcohol is comparable to the cost of ethyl silicate).

REFERENCES TO ILLUSTRATIONS

- N° 1 - drg. 424/1 Measurement ground floor plan
- N° 2 - drg. 424/2 Measurement first floor plan
- N° 3 - drg. 424/3 Measurement sections through the building
- N° 4 - drg. 424/11 Measurement sections through the building
- N° 5 - drg. 424/12 Measurement sections through the building
- N° 6 - Outside view of a corner tower
- N° 7 - Inside views showing existing situations and deterioration of structure
- N° 8 - Detail of a tower
- N° 9 - Details of decorations on doors and on walls for ventilation purposes
- N° 10 - Typical column and capitel made with stone and plastered with gypsum

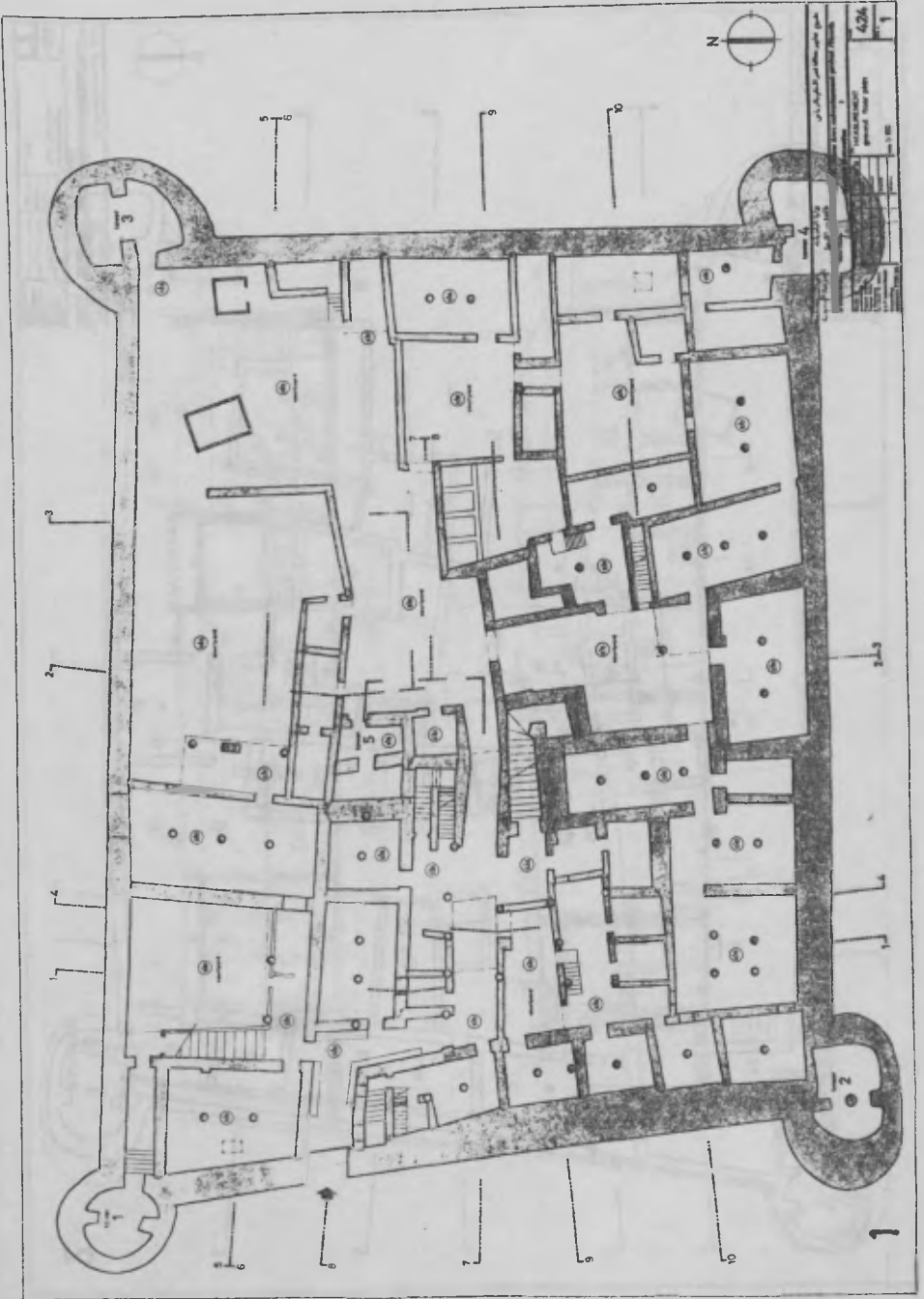

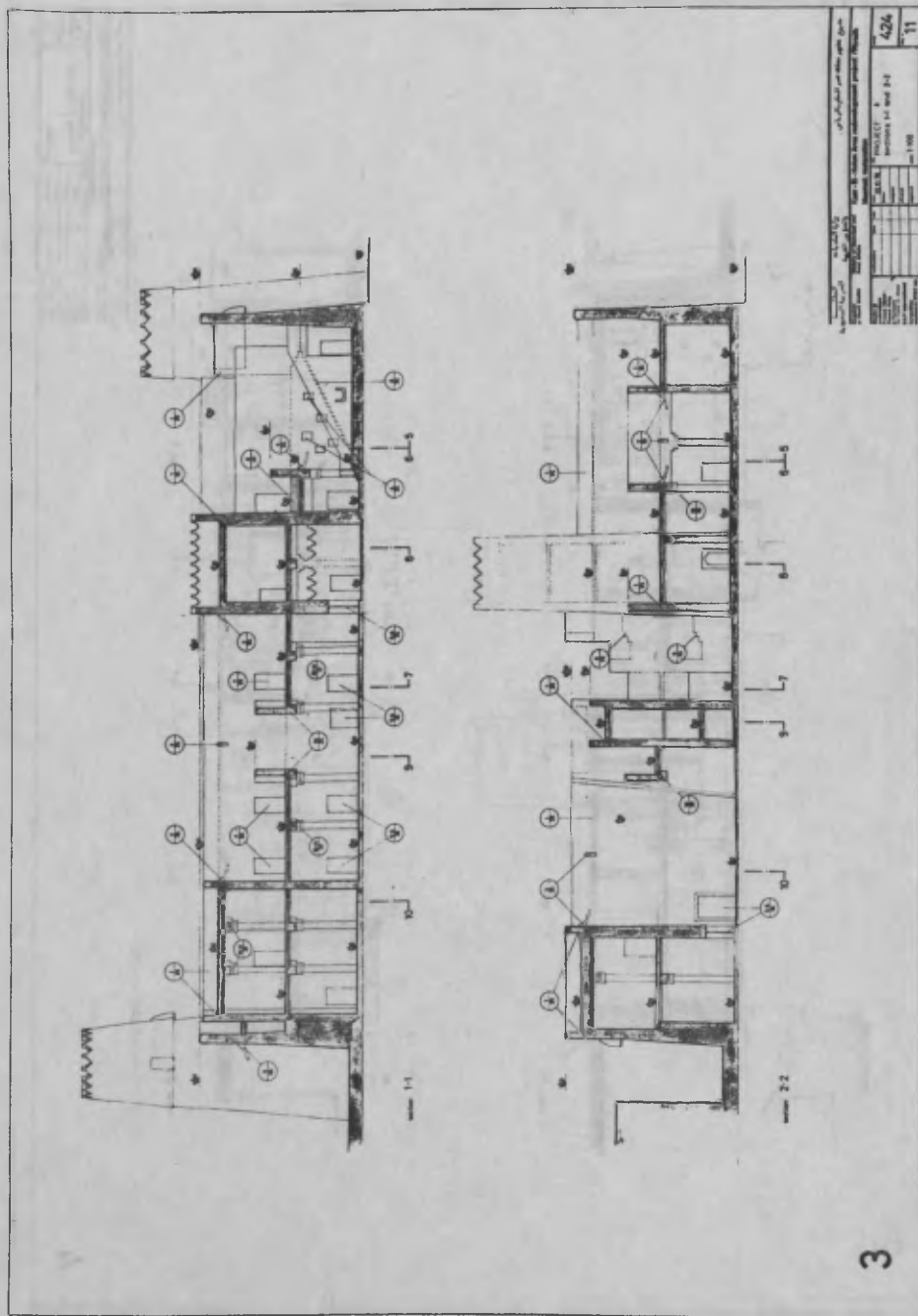

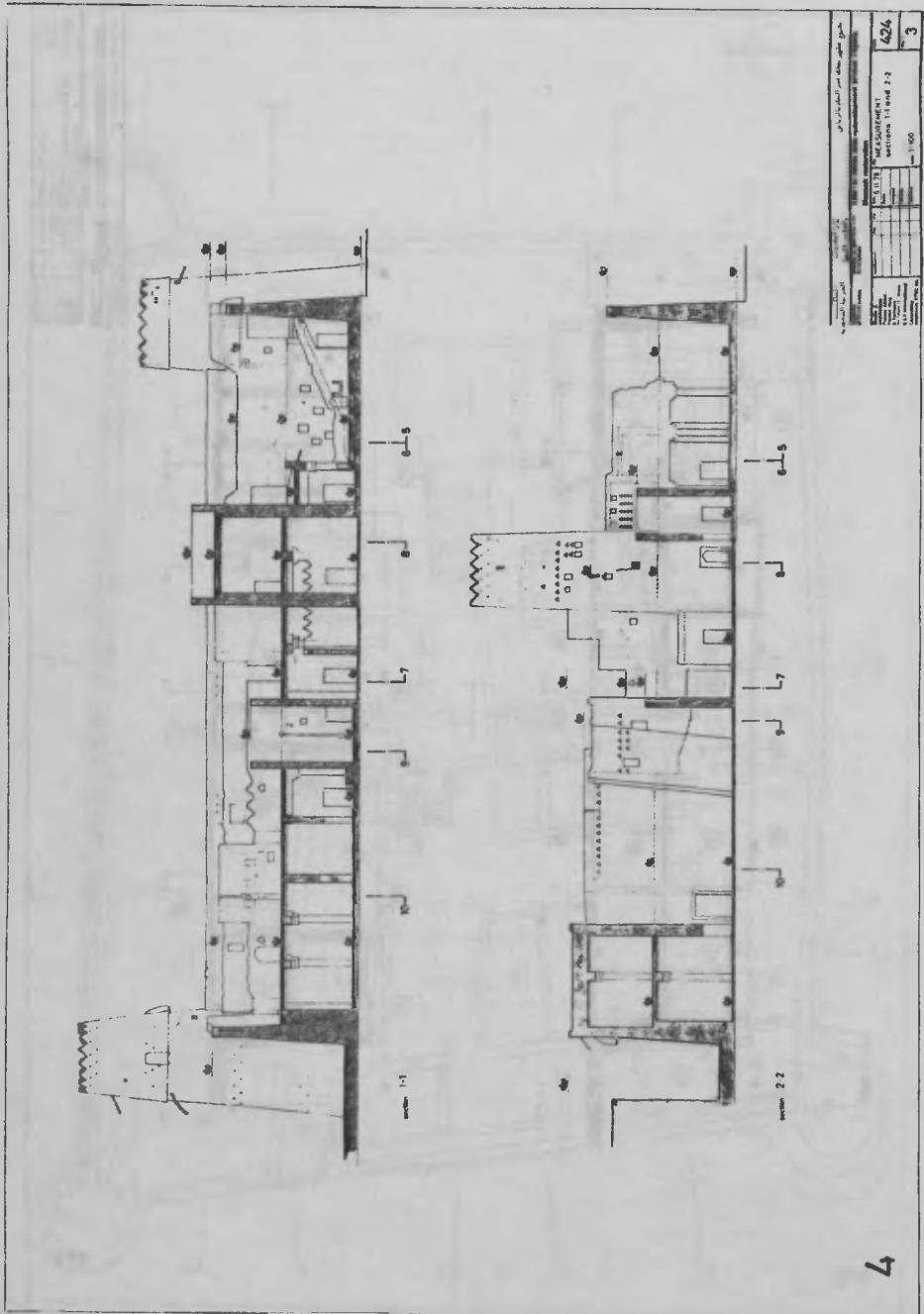

مجلس التخطيط العمراني
 المجلس البلدي
 رقم المشروع: 424
 3

NO. 424	REARRANGEMENT
SECTION 1-1 and 2-2	
DATE	1/8/60
SCALE	1:100
DESIGNED BY	
CHECKED BY	
APPROVED BY	

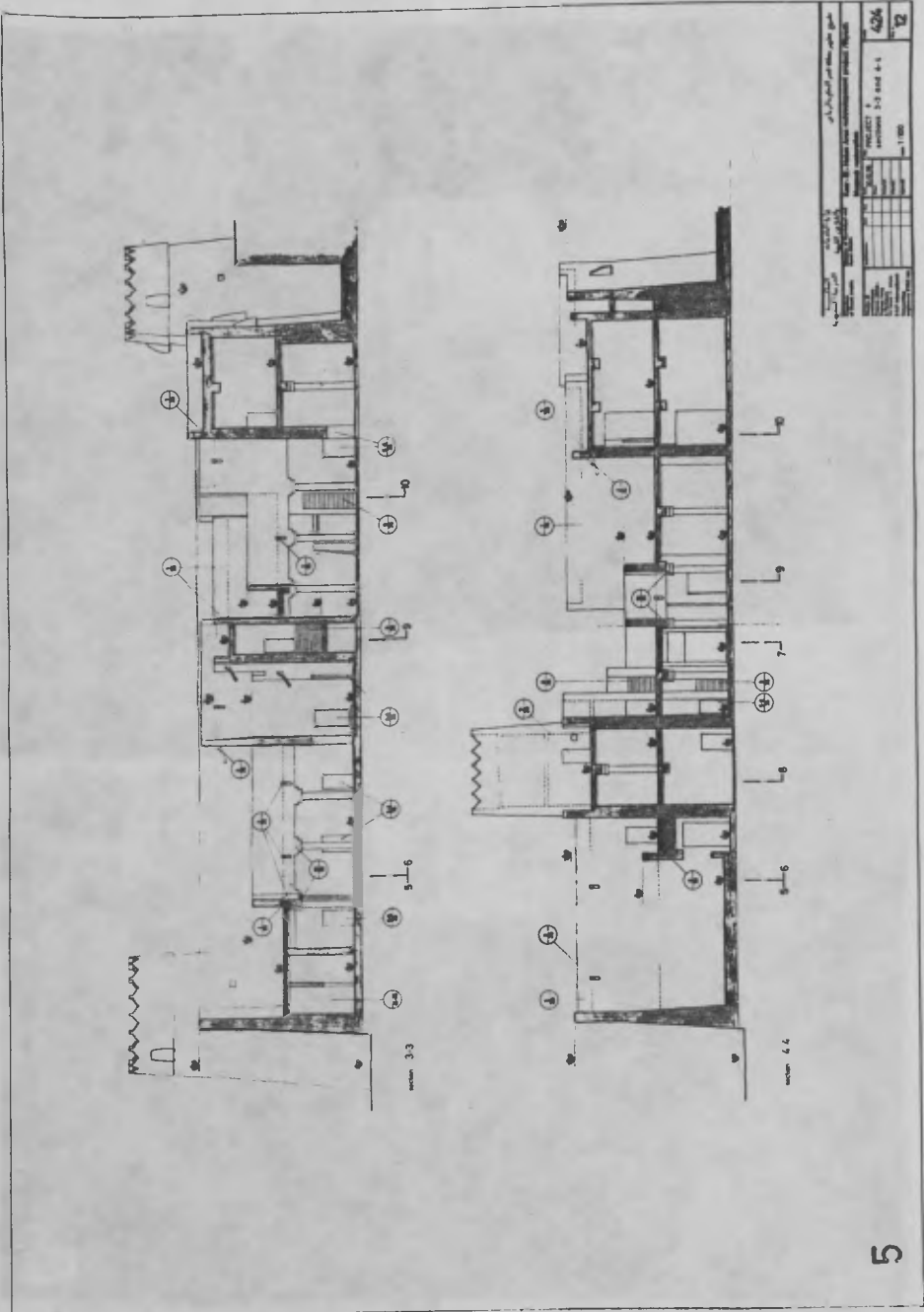

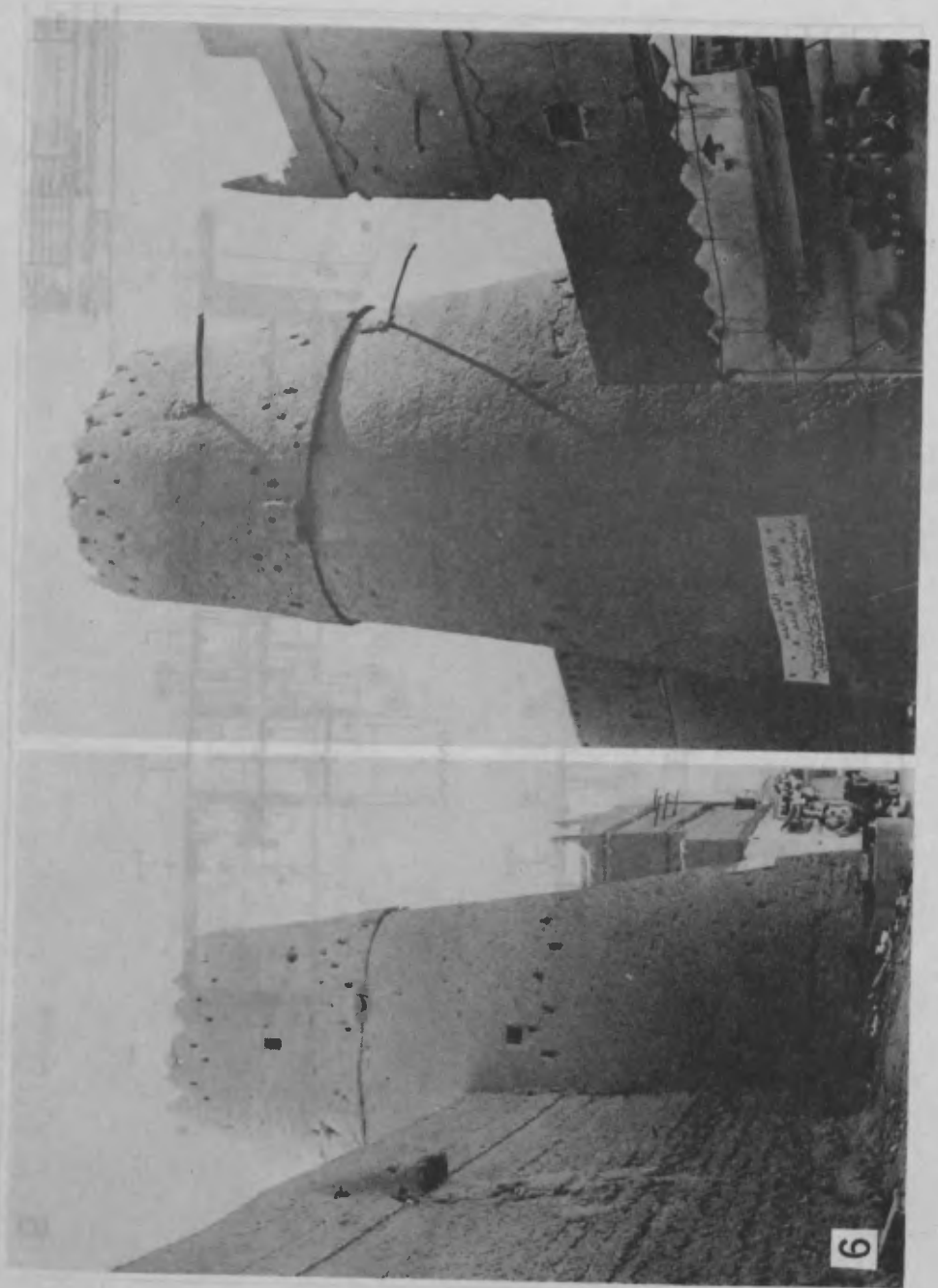





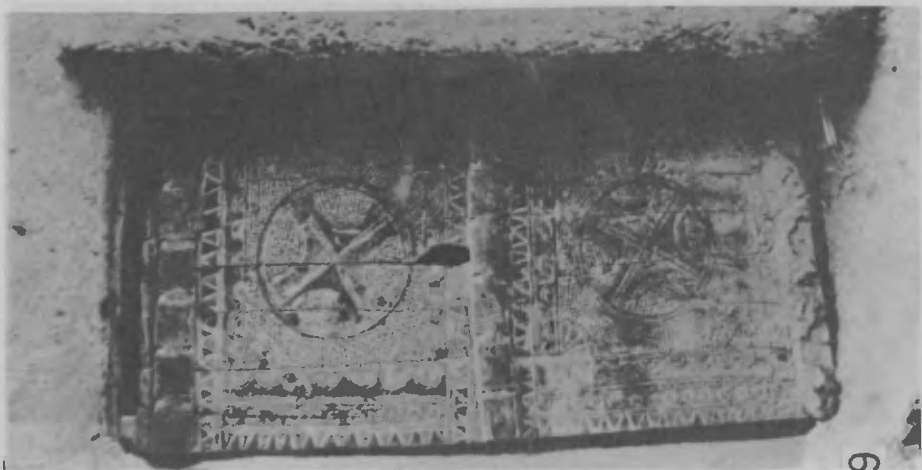
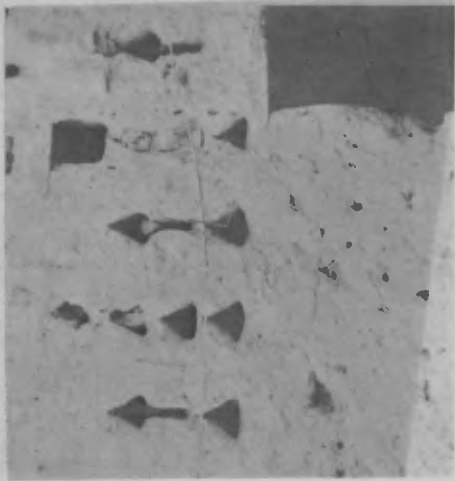
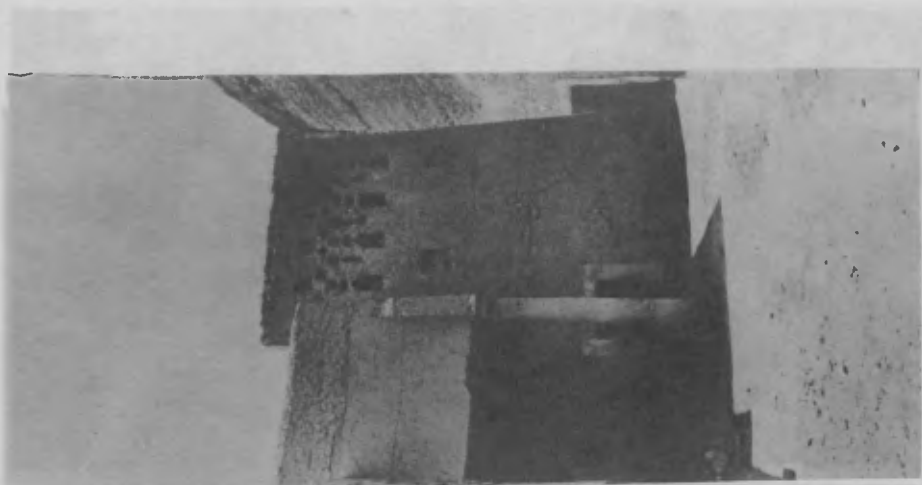

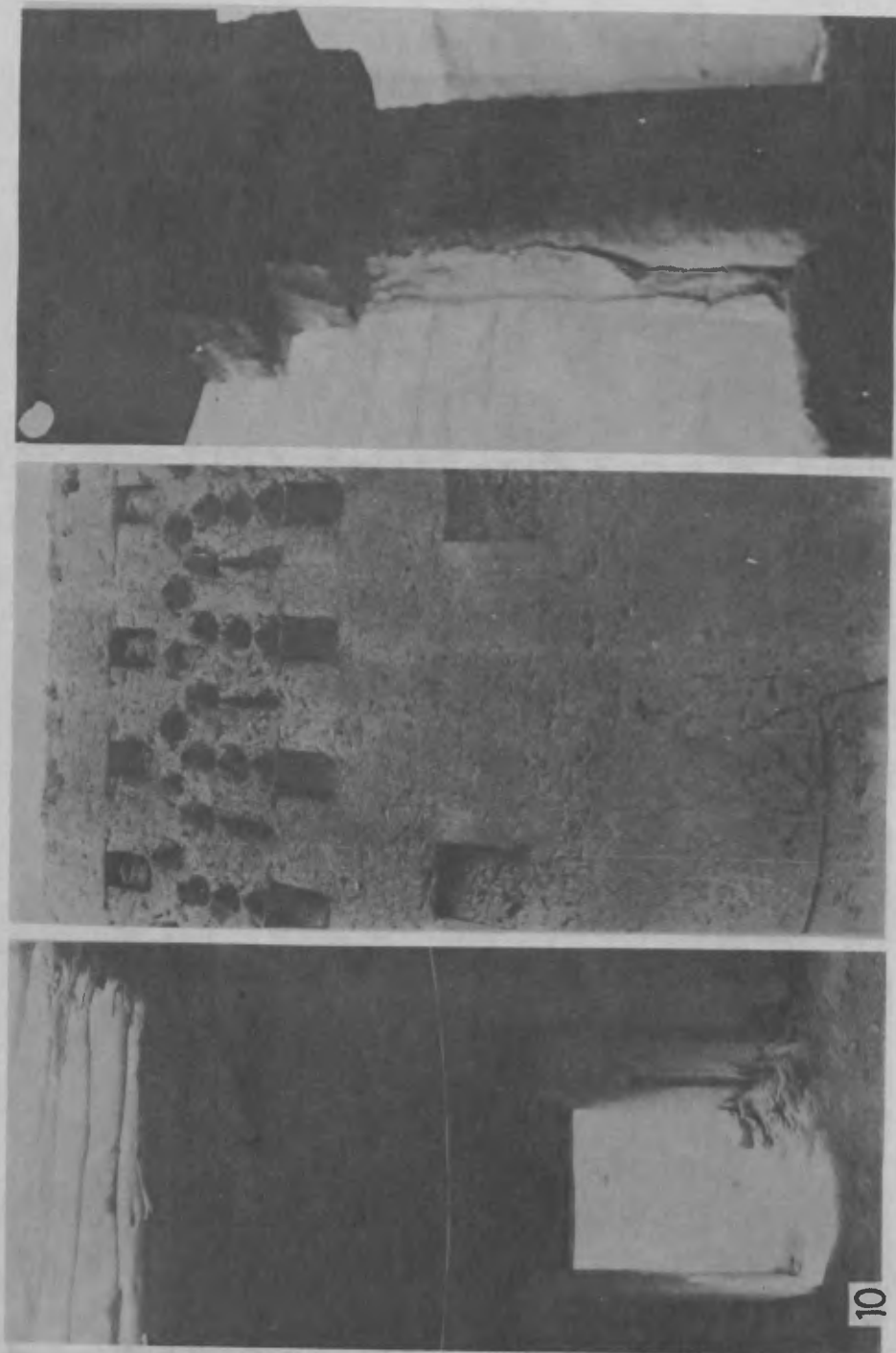

LES PALAIS ROYAUX D'ABOMEY
REPUBLIQUE POPULAIRE DU BENIN
SAUVAGARDE ET MISE EN VALEUR

X

ANDRE STEVENS

SUMMARY

The museum and several other buildings in the 40-hectare site of Abomey, the largest and best preserved historical ensemble of Africa south of the Sahara were severely damaged by torrential rains on 7 April 1977. Since then, at the request of the Government of the People's Republic of Benin, Unesco consultants have advised the authorities on steps to be taken to restore and conserve both the museum collections and the damaged structures. Mrs. Beatrice Coursier from the Musée de l'Homme Paris examined the problems of conserving the objects in the Abomey museum.

In September 1977 a second assignment was carried out by the architect Mr. André Stevens, who was entrusted with the task of assisting the museum authorities in restoration, deciding how much rebuilding was necessary, proposing an overall plan for the fitting out and equipment of the premises and suggesting long-term measures for the safeguarding of the museum.

Under the Participation Programme for 1977-1978 some \$ 50,000 worth of equipment has since been provided: building materials, electric fittings, show-cases, photographic equipment and conservation laboratory chemicals as well.

In October 1978 a third assignment was carried out by the consultant architect, in order to verify the working's progress.

X Engineer-Architect
Consultant Architect International Organizations
Unesco Expert

June 1980

1. Description sommaire du Site Monumental et Naturel.

Un rempart en ruine, d'une longueur approximative de quatre kilomètres, entoure le site qui s'étend sur à peu près quarante hectares.

Le site, monumental et naturel, comprend un musée et un centre artisanal installés dans les palais de Guézo (1818-1858) et de Glélé (1858-1889), ainsi que les ruines des différents palais et sanctuaires qui se sont succédés depuis la fondation du royaume d'Abomey en 1620.

En dehors du musée, quelques cases habitées par les descendants des familles royales et un petit marché subsistent encore, parmi les ruines, les champs et la végétation clairsemée.

Des chemins de terre sillonnent le site, offrant ainsi des raccourcis aux habitants de la ville d'Abomey toute proche.

2. Analyse de la situation (En septembre 1977).

Suite aux tornades de 1975 et d'avril 1977, la plupart des toitures s'étaient envolées ou déplacées, pendant qu'une zone particulière du site était à peine sinistrée.

En fait, les bâtiments sinistrés se développent le long de vastes cours où les plantations se révélèrent insuffisantes pour limiter l'action du vent. Il faut ajouter des défauts de construction comme le débord important de toiture, le mauvais ancrage de la charpente et le manque de faux-plafond pour les auvents.

La zone non sinistrée, par contre, se compose d'une forte densité de bâtiments, d'arbres et de murs de clôture, répartis sur un espace réduit.

Au fil des ans, il s'est créé, sur l'ensemble du site, un abaissement du niveau des terres, accompagné d'un dépôt de terres qui se déplacent au gré des périodes pluvieuses.

Les eaux qui viennent des points les plus hauts du site, rejoignent la place extérieure, en créant des affouillements à la base des murs comme aux points de passage d'une cour à l'autre, c'est-à-dire une perte du niveau d'origine par transfert des terres accompagné de l'érosion du pied du mur de plus en plus exposé à l'eau d'écoulement.





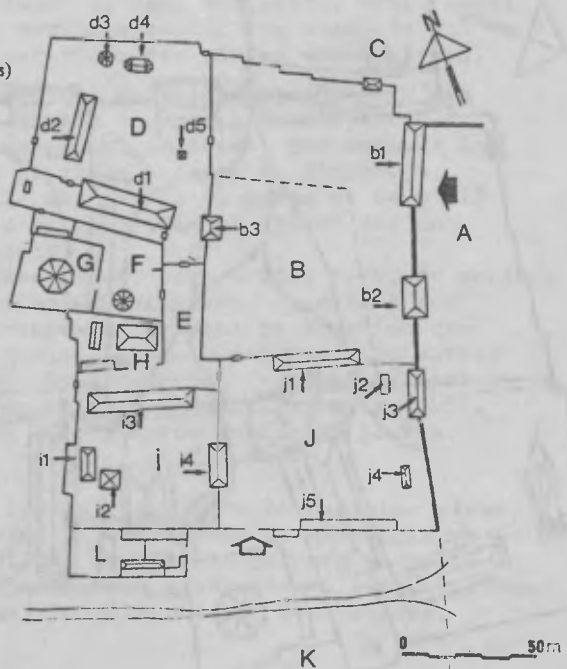

Plan de situation

(Les signes suivent le chemin des visiteurs)

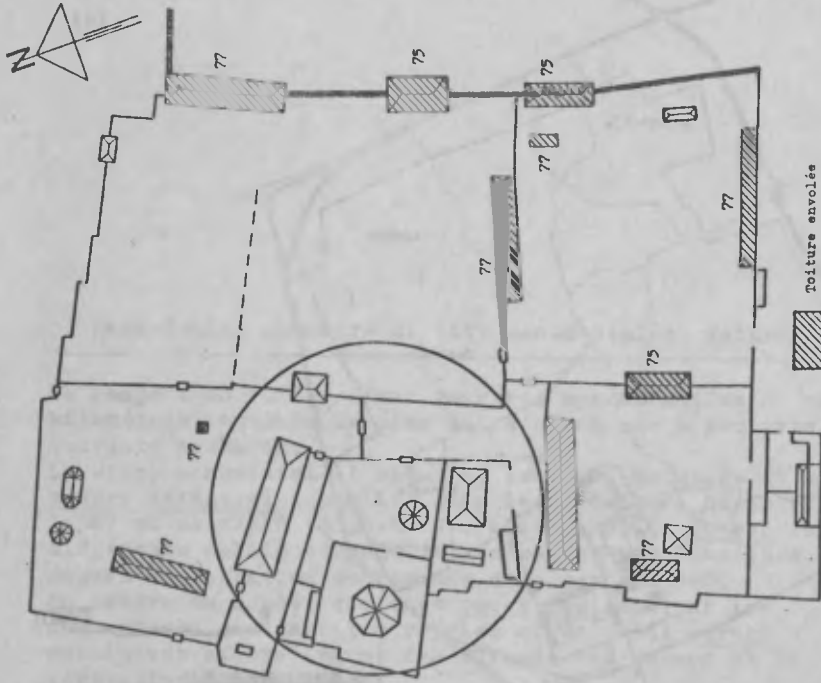
- A Place Singbodji (entrée principale des palais)
- B Place du roi Guezo
- b1 Case à étage de Guezo
- b2 Porte d'entrée du roi Agonglo
- b3 Portique de Guezo
- C Tombes des rois Guezo et Agonglo
- D Cour du palais de Guezo
- d1 Salle des assins (musée)
- d2 Salle des trônes (musée)
- d3 Sanctuaire de Zoindi
- d4 Sanctuaire de Guezo
- d5
- E Cour des canons
- F Tombeau des reines du roi Glele
- G Tombeau du roi Glele
- H Dépôt du matériel d'entictien
- I Cour du palais de Glele
- i1 Salle d'armes (musée)
- i2 Sanctuaire de Glele
- i3 Salle des bijoux (musée)
- i4 Portique de Glele
- J Cour de Glele
- j1 Maison des étrangers (tisserands)
- j2 Auvent pour les tisserands
- j3 Porte d'entrée du roi Glele (cuvriers)
- j4 Case des Legede
- j5 Auvent pour artisans
- K Aire du roi Béhanzin
- L Résidence de Dah Sagbaju Glele, chef de la collectivité royale.





-  Toiture envolée
-  Toiture légèrement déplacée
-  Aire non sinistrée

0 50m

Cheminement des eaux d'écoulement

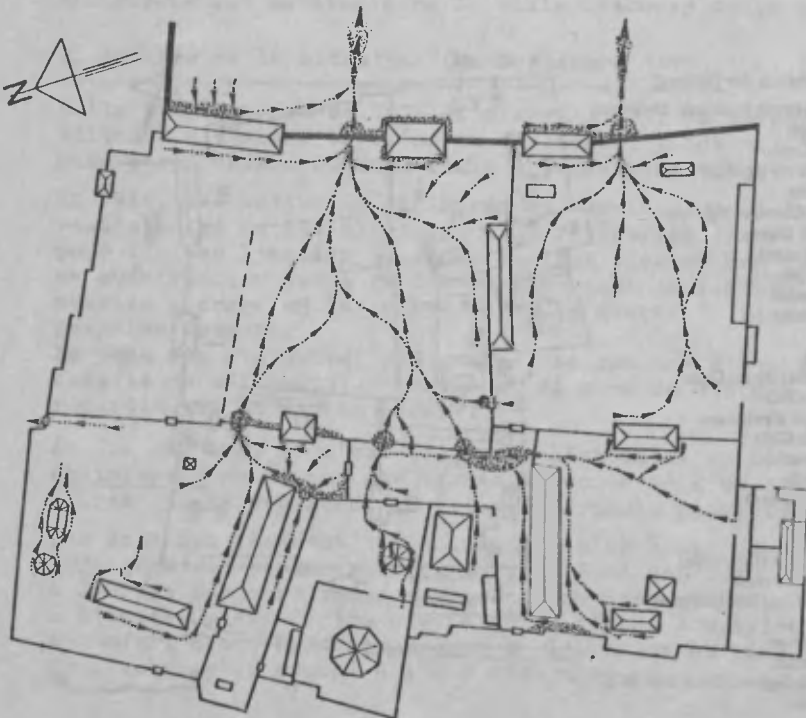

0 50m

Cheminement des eaux d'écoulement

3. Recommandations.

Avant d'envisager un plan à long terme, des mesures prioritaires s'imposaient, relatives à l'abri des collections, la surveillance du site, l'accueil des visiteurs, les conditions de travail des artisans et les moyens de travail du personnel du musée.

Les recommandations générales portaient sur la réfection urgente de quelques constructions, l'installation électrique sur l'ensemble du site visité et la fourniture de vitrines et de mobilier dans les salles d'exposition.

1. En ce qui concerne l'aménagement au sol des eaux d'écoulement, afin de réduire l'affouillement à la base des murs, il y avait lieu d'évacuer le plus directement possible les eaux de pluie, tombées sur l'ensemble du site, vers la place extérieure Singbodji, vaste aire d'évaporation et de résorption des eaux.

La création d'un réseau de drains était peu conseillée, vu le manque de perméabilité du sol.

La création d'un réseau de conduits souterrains, reprenant les eaux de la partie supérieure et les évacuant vers la place extérieure ou dans des puits, était aussi déconseillée, vu le bouchage rapide des conduits et chambres de visite par suite des pluies saisonnières.

La solution préconisée est de relever l'ensemble des niveaux existants dans les cours, et principalement le long des murs, par un apport de terre, par exemple les terres déposées sur la place extérieure Singbodji, depuis que l'ensemble des palais de Guézo et de Glélé n'a plus bénéficié d'un entretien quotidien par une main d'oeuvre abondante.

Le réseau actuel d'écoulement devra être revu, de manière à désengorger les zones mouvementées, en créant des raccourcis et en partageant les eaux en fonction des chemins existants. Enfin, les sols devront être entretenus par un balayage bien compris. Le balai ne sert pas uniquement à rassembler les feuilles mortes, mais aussi à égaliser les terres après de fortes pluies.

2. En ce qui concerne les toitures, dès le sinistre connu, les autorités concernées décidèrent de recouvrir rapidement les constructions décoiffées par une nouvelle toiture composée d'une lourde charpente en bois et d'une couverture en plaques de tôle ondulée d'aluminium.

L'angle de pente de la toiture n'était plus celui d'origine. Il était fonction du matériau de couverture, en l'occurrence la tôle d'aluminium, et de la forme de la charpente réalisée en fonction d'une économie de bois.

En conséquence, pour les constructions importantes, le retour au volume d'origine n'était plus possible. Il était donc recommandable d'appliquer ce système dans le seul esprit de couverture et de mise à l'abri, et non pas dans l'esprit d'une forme compatible avec le volume en terre crue.

La tôle ondulée neuve reflète aveuglément la lumière. Mais avec le temps, elle se patine et prend une couleur gris-rouge mat, qui se confond avec l'environnement. En ce qui concerne les petites constructions, un masque de paille pourrait être appliqué sur la tôle ondulée. Dans ce cas, il est indispensable de créer un vide d'air entre le support et la paille retenue par un réseau de bambou, et non pas par un grillage métallique en contact avec le support en aluminium. Ce procédé demande néanmoins un remplacement de la paille tous les 3 ou 4 ans, et induit le public en erreur, car une couverture en gerbes de paille a toujours un angle de pente important.

Dans ce cas-ci, il était préférable de faire la différence entre la structure authentique des murs en terre crue et leur couverture contemporaine étanche, dont la fonction essentielle est de mettre à l'abri de la pluie les intéressantes collections du musée de même que les artisans qui occupent certaines salles des palais.

3. En ce qui concerne les murs de clôture, il est recommandé de renforcer le sommet par addition de terre mélangée à une faible quantité de ciment ou de chaux, en arrondissant la partie supérieure et en y appliquant un enduit imperméable.

Vu la longueur des murs de clôture et l'entretien que cela nécessite, il serait plutôt vain d'adopter un système de protection composé d'un support en bois et de gerbes de paille ou de tôle ondulée. Un mur de terre s'entretient plus facilement qu'une toiture de paille.

En ce qui concerne les portails, événements des cours et points de passage d'une cour à l'autre, ils pourraient conserver leur bois de charpente et présenter une protection en paille. Il serait alors possible de retrouver, en ces éléments particuliers, l'authenticité d'une forme de couverture.

4. En ce qui concerne les bas-reliefs polychromes, mis à l'abri de la pluie par un important débord de toiture, il conviendra de confier la remise en couleurs à quelques artisans locaux qui connaissent les matériaux et mélanges traditionnels.

4. Analyse de la situation (En octobre 1978) (2ème mission)

Cette mission avait pour objectif de contrôler la bonne marche des travaux de restauration, de construction, d'aménagement et d'équipement en cours, suivant les recommandations prévues par l'architecte-consultant dans son rapport de mission précédent.

Etat des toitures (En octobre 1978) :

Trois expressions visuelles voisinent:

1. La toiture ancienne en plaques d'aluminium.
Couleur: gris mat et trainées rougêatres.
Intégration: couleur rouille proche de celle du sol; matière étrangère; division par plaques rainurées.
2. La toiture nouvelle en plaques d'aluminium.
Couleur: gris brillant, étincelant, aveuglant.
Intégration: nulle; corps étranger en attente d'oxydation; réunion des plaques en un tout éblouissant.
3. La couverture en gerbes de paille sur un support tôle.
Couleur: gris perle séché.
Intégration: alliance avec la flore; forme d'origine mais bords coupés; foule de points fendue de lignes.

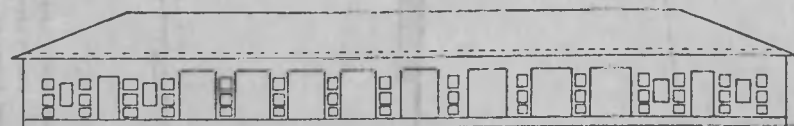

salle des bijoux

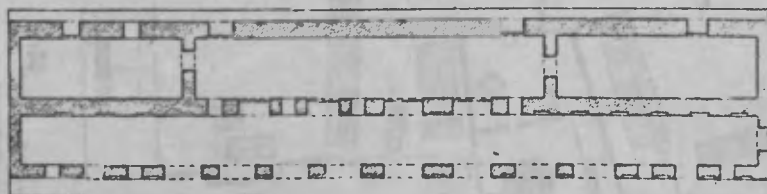

cour du perron de grès

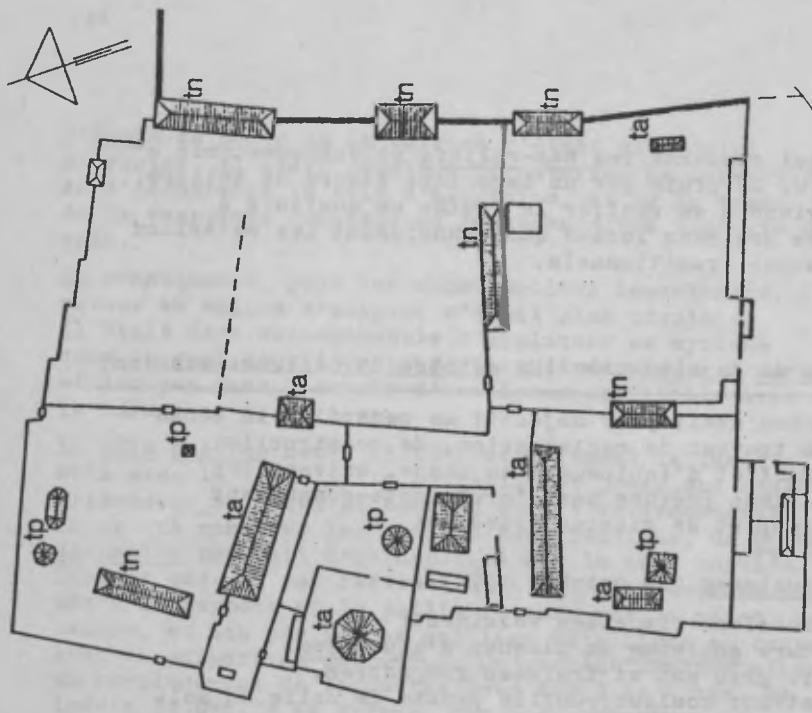

tn = toiture tôlée ancienne (+- 15 ans d'âge)
 ta = toiture tôlée nouvelle (77 et 78)
 tp = toiture tôlée couverte de paille (78)

0 50 m
 Etat des toitures
 en septembre 1976

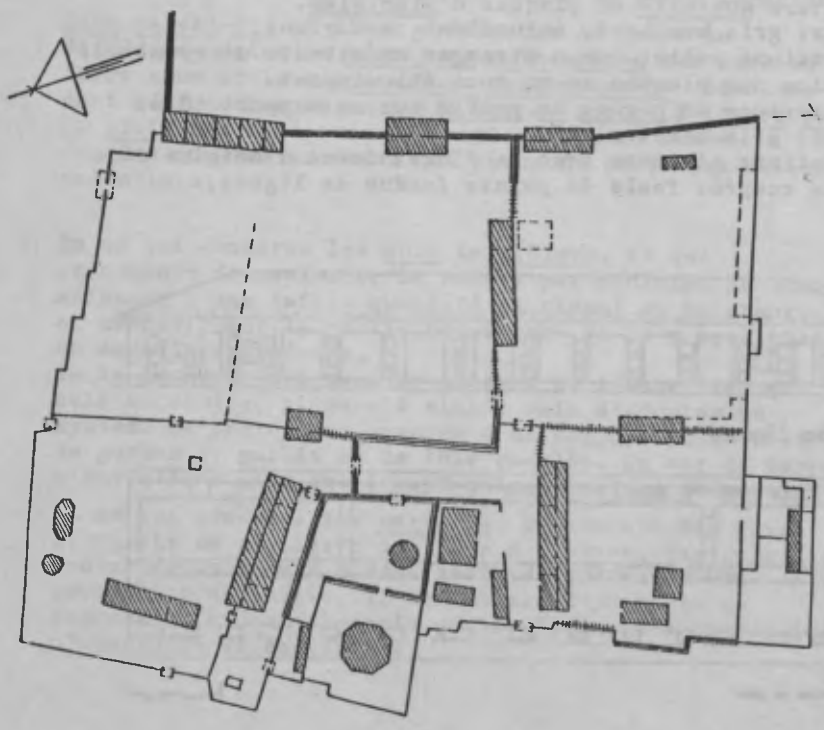

— sommet arrondi (rempart)
 — sommet arrondi (adrets)
 — charpente - tôle
 — bois de charpente

0 50 m
 Etat de la couverture
 des murs de clôture
 en septembre 1978

Bibliographie récente.

- .Rapport technique Unesco, n° FMR/CC/CH/77/197. Paris 1977.
La conservation et la restauration des collections du
musée historique d'Abomey. B. Coursier.
- .Rapport technique Unesco, n° FMR/CC/CH/78/107. Paris 1978.
Les Palais Royaux d'Abomey. André Stevens.
- .Rapport technique Unesco, n° FMR/CC/CH/79/103. Paris 1979.
Les Palais Royaux d'Abomey (suite). André Stevens.
- .Patrimoine culturel de l'humanité (édité par la Division
du Patrimoine culturel, de l'Unesco). Bulletin d'information
n°12. Octobre 1978.
- .Revue "L'Histoire", n°16, Octobre 1979. Paris.
Le royaume d'Abomey (XVIIIe-XIXe siècles) par Catherine
Coquery-Vidrovitch.
- .La pensée symbolique des Fô du Dahomey. Cl. Savary,
Conservateur du musée d'ethnographie de Genève. 1977.

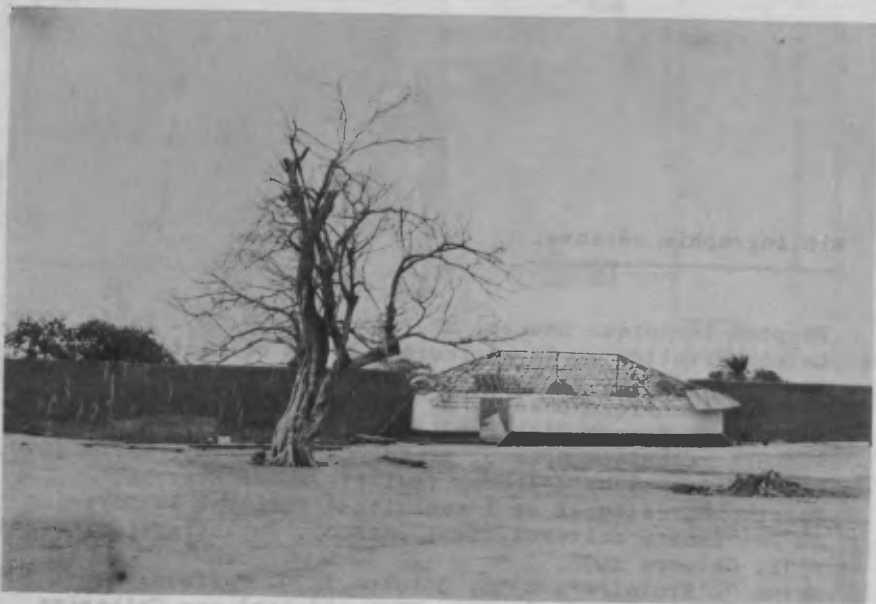

Porte d'entrée du Roi Agonglo. Construction sinistrée.



Maison des étrangers. Détachement de l'enduit à la base des murs. Perte du niveau original du sol de la cour.



La salle des Assins. Cour du palais de Guézo. Oct.78.

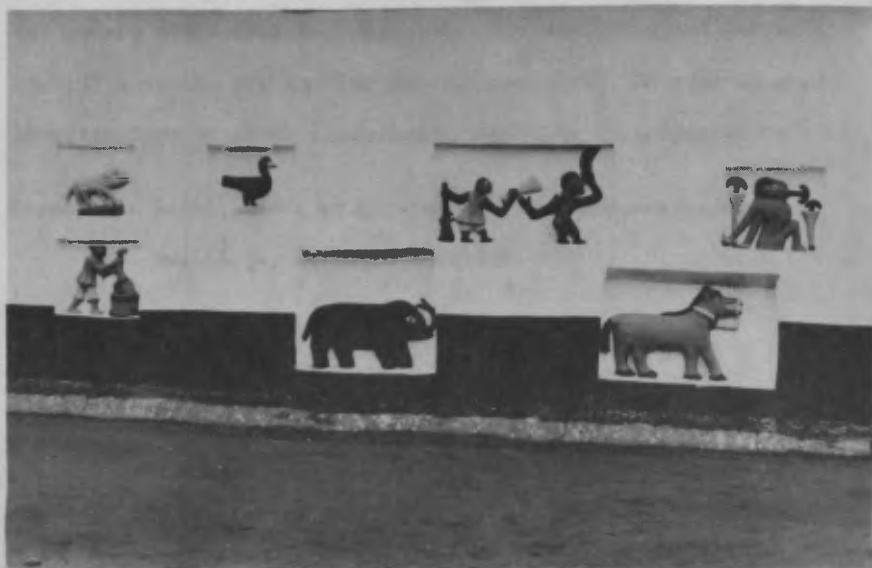

Les Bas-reliefs polychromes (Salle des Assins).

STRUCTURAL ENGINEERING CRITERIA FOR ADOBE CONSTRUCTION

S. TANVIR WASTI X
POLAT GÜLKAN X

SUMMARY

A discussion of the seismic behaviour of adobe construction is presented. Using the provisions of the Uniform Building Code, an attempt is made to ascertain the structural adequacy of a two roomed adobe dwelling to lateral loads. Stress and overall stability checks are carried out for each wall. An experimental investigation of adobe structural components is proposed.

Keywords : Adobe, adobe walls, seismic loads, masonry, rural dwellings, structural design.

X
Civil Engineering Department
Middle East Technical University

Ankara - Turkey

I. INTRODUCTION

Earth, stone and timber are the oldest building materials known to man. Earth is still the most commonly used material of construction in large parts of the world, and in the form of sandy clay puddled with water it is known as adobe. Depending on soil types and climatic conditions, adobe construction can achieve both strength and durability. In low cost construction, especially in rural areas in Asia, Africa and the Americas where individual dwellings and farm structures are often built by the villagers themselves, adobe in some form is often the preferred building material. Construction in adobe ranges from simple one roomed dwellings such as depicted in Fig. 1 taken from a slum area in Lahore, Pakistan, to the ornate timber reinforced mosque from Mopti in Mali, West Africa, which is shown in Fig. 2. It is estimated that a quarter of all houses in the rural areas of Turkey are built of adobe {1}.

As a result of recently acquired knowledge of the behaviour of soils and partly of the increased housing demand in most countries, a vast amount of literature exists on various aspects of earthen construction. The report on Earthen Home Construction {2} lists a total of 294 items in its bibliographies. There is

no doubt that adobe as a construction material will be with us for a long time to come. A thoughtful article by Germen {3} highlights the historical and contemporary architectural importance of this versatile, readily available and relatively inexpensive building material.

Different properties of adobe have been the subject of several research investigations in Turkey. In 1964 an "Adobe Seminar" was held in Ankara under the auspices of the Ministry of Construction and Settlement, wherein a lot of information on the mechanical properties of adobe and the manufacture of adobe blocks was presented. A detailed description of the physical parameters of clay was given by Kumbasar {4} and a discussion on the stabilization of clay was presented by Toğrol {5}. Alkan {1, 6} has continued research on the improvement of adobe blocks by the addition of various stabilizing ingredients. The earlier work of Sönmez {7, 8} also deserves special mention. The Adobe Seminar also incorporates a set of recommendations drawn up for adobe construction by the Turkish Bridge and Structural Engineering Association {9}.

In Fig. 3, an attempt is made to classify the main varieties of adobe used in rural construction.

With reference to Fig. 3, stabilization involves the employment of various physical or chemical additives (straw, lime, cement, bitumen, etc.) to earth in order to improve the

strength, resistance to water or other properties of the resulting adobe. Structural adobe refers to load bearing components such as adobe walls, as opposed to adobe used strictly as an infill in timber framed construction or adobe plastering, which are considered non-structural. Finally, the difference between blocks and rammed earth is essentially one of technique; in rammed earth construction large forms are used and a whole layer of adobe placed and tamped in situ, whereas blocks are individual building bricks made and placed manually.

Adobe construction will probably continue to remain an art and a craft rather than develop into a science, but an engineering appraisal of the advantages and disadvantages of structural adobe and an assessment of some structural parameters related to adobe elements like bricks and walls may indirectly help to substantiate design assumptions that are tacit and traditional. Such an appraisal should seek to investigate whether the structural behaviour of adobe construction is amenable to theoretical approaches of the kind used for the prediction of the load carrying capacity of brick and stone masonry structures. It should be pointed out that the methods for the analysis and design of masonry structures themselves embody considerable departures from the generally established "rational" design procedures for steel, concrete and timber structures.

The present paper will deal mainly with structural engineering aspects of stabilized adobe blocks for structural use only. It may be considered as connected with the preservation of adobe structures only in the sense that stronger adobe bricks and better structural design and detailing lead to longer lasting structures.

II. SEISMIC BEHAVIOUR OF ADOBE STRUCTURES

One of the major defects of adobe as a constructional material lies in its inability to show adequate resistance to earthquake loading. The poor performance of adobe dwellings in seismic zones has been discussed in the case of Turkey by Arıoğlu and Anadol {10}, for Iran by Tchalenko and Ambraseys {11} and for Pakistan by Wasti and Ahmad {12}. These references point out that layers of mud-straw mix added to the roofs of village dwellings each year increase the roof weight, and in the event of an earthquake the heavy roof collapses and causes damage to life and property. As opposed to the unsatisfactory response of load-bearing adobe construction to lateral loads, it has been observed that adobe infilled timber frame construction when properly detailed and executed shows satisfactory behaviour under earthquake loading {13, 14}. In proposals aimed at prevention of roof collapse in adobe and other "brittle" structures during earthquakes, Razani {15} suggests the incorporation of a braced skeleton system within the building. As also mentioned above,

the main cause of destruction in non-engineering rural structures is due to the collapse of the roof and the retrofitting systems of Razani, if implemented, would not only decrease loss of life but help preserve adobe structures from complete failure in the event of an earthquake.

The Turkish Specifications for structures to be built in disaster areas [16] stipulate minimum wall thicknesses for adobe structures although in a separate section a required procedure for calculating lateral forces on structures, such as might be engendered in an earthquake, is also given. However, allowable stresses for adobe construction are not specified, and hence the calculated lateral forces cannot be applied to the design of adobe structural elements. The minimum wall thicknesses in the Specifications are given as 45 cm for load-bearing walls and 30 cm for non-bearing walls. In addition, the specifications require that the lateral stability of all walls be ensured by the provision of perpendicular intersecting walls spaced no further than 4.5 m centre to centre. Other clauses restrict the wall height to a maximum of 2.7 m and the maximum wall height to thickness ratio to 6 for bearing walls.

The measures incorporated in the Turkish Specifications have been drawn mainly from the observed behaviour of adobe structures and masonry structures under earthquake conditions in the past. As such, the recommendations consist of empirical

restrictions intended to increase the safety of such buildings. For example, adobe dwellings are limited to single storey and flat earth roofs prohibited altogether in 1st and 2nd degree earthquake zones. The importance of timber bond beams, both along and transverse to the wall is stressed and limiting dimensions of door and window openings are given.

The 1976 Uniform Building Code {17} offers a slight improvement in that stresses for adobe masonry are specified for different conditions, as shown in Table 1. It should be noted that in the Uniform Building Code, adobe is referred to as "masonry of unburned clay units". Among the general requirements, the minimum wall thickness for adobe is given as 40 cm and the height of an unsupported wall is restricted to a maximum of 10 times the wall thickness. Another difference between the Turkish Specifications and the Uniform Building Code is that the latter stipulates the use of Type M or S cement-lime-aggregate mortar, whereas the former refers to a lime mortar only for the walls.

III. TOWARDS ADOBE STRUCTURAL DESIGN

Considerable research has been carried out with the purpose of providing an engineering framework for brick masonry calculations {18, 19}. The extensive use of brick masonry for residential and office construction in many industrially developed countries has led to refinements such as diaphragm walls consisting of

parallel brick walls whose cavities are braced by transverse brickwork to form a series of box sections, and reinforced masonry, used especially in areas of seismic activity, wherein steel reinforcement is provided in high tension regions in beams and walls.

In his treatise on structural masonry, Sahlin {19} mentions the importance of the following properties separately for bricks and mortar :

- (a) Compressive strength
- (b) Tensile strength
- (c) Modulus of elasticity
- (d) Rate of water absorption

Based on an empirical synthesis of structural theory with experimental results, Sahlin treats the strength and stability of concentrically and eccentrically loaded masonry walls.

The four properties given above also need to be investigated and standardized for adobe blocks, and for mortars used in adobe wall construction. It may then be possible to apply more rigorous analytical approaches to adobe structures.

In a preliminary attempt to ascertain the adequacy of adobe wall thickness specified by the Uniform Building Code to earthquake loads, a one-storey masonry dwelling will be analysed using the allowable unit stresses of Table 1.

The chosen hypothetical structure is shown in Fig. 4. The

objective is to check the design, which in fact does conform to typical dwellings made of adobe in several countries. Only the load-bearing walls are shown ; the problem is intended for the illustration of formal engineering procedures to such a structure, and it is not claimed that the representation is realistic.

III.1. Design Example : Lateral Force Calculation

The overall dimensions of the structure are 9.5m by 6 m. Interior or exterior partition walls or structural appendages like patios or verandahs, if any, are assumed not to contribute to the lateral force resistance of the system. It is also assumed that the flexible roof rafters span in the N-S direction and thus the calculation of forces and stresses need be made only for the more critical E-W direction.

The weight of adobe brick is taken as 2.0 tons/m^3 . The roof of the dwelling is taken to be typical of rural buildings with relatively thick earthen layering, giving a weight of 0.8 tons/m^2 of roof area.

The base lateral shear force V for the dwelling during an earthquake is given by the Uniform Building Code as :

$$V = Z I K C S W$$

where

Z = numerical constant dependent on the seismic zone.

Here a highly seismic zone (Zone 4) will be assumed, for which $Z = 1$.

- I = occupancy importance factor
 = 1.0 for non-essential installations.
- K = system coefficient, depending on ductility and bracing characteristics of the structural systems.

The most unfavourable value (for shear walls without ductile frame) of 1.33 will be taken.

C = "spectral" coefficient

S = soil resonance factor

The Code gives the upper limit for the product of C and S as 0.14, which will be taken. Hence $CS = 0.14$

W = Dead load, taken as weight of the roof and half the weight of the walls.

No snow load is considered for this case.

Assuming 0.5 m overhangs for the roof in the N-S direction, the roof area is $(9.5 + 0.5 + 0.5)(6.0) = 63 \text{ m}^2$ and the weight is $0.8 \times 63 = 50.4 \text{ tons}$.

The wall area in plan is 12.26 m^2 and the height of the walls is 2.70 m. Using the adobe brick weight of 2 tons/m^3 , half the weight of the walls is calculated as 33.1 tons.

For the present structure, therefore, $W = 83.5 \text{ tons}$ and

$$V = (1.0)(1.0)(1.33)(0.14)(83.5)$$

$$= 15.5$$

say $V = 16 \text{ tons}$.

The structural properties of walls A, B, C and D are given in detail in the Appendix. For each wall, the centroidal distance, moment of inertia and critical section modulus have been calculated.

III.2. Design Example : Distribution of Lateral Force

The E-W lateral force shall be distributed only to those portions of the bearing walls A, B, C and D that span in the E-W direction. Because of the assumption of a flexible roof, the lateral force will be distributed to these bearing wall portions in accordance with their tributary areas. Furthermore because the E-W portions of walls A and D are equal in length, they will each carry 50% of their share of lateral load, but the E-W portions of walls B and C will divide their share of the lateral load in the ratio of their lengths. The total lateral load of 16 tons is thus distributed as shown in Table 2.

III.3. Design Example : Calculation of Vertical Loading on Each Wall and Stress Checks

The roof load of 50.4 tons has to be shared by the walls in proportion to their tributary areas. Assuming also a live load contribution of 150 kg/m^2 on the roof, the dead, live and total vertical loading on each wall may be calculated as in Table 3. Values for wall A (North) are equal to those for wall A (South) and values for wall D (North) to those of wall D (South); hence calculations need to be made for the four cases A, B, C and D only.

The stresses to be checked for each wall consist of the axial stress (compressive), the shear stress and the compound axial and flexural stress. Furthermore the overall stability of the wall to the overturning moment caused by the application of the lateral force component horizontally at the top of each wall has to be assessed. The checks are carried out for the walls A, B, C and D in Table 4 and 5.

IV. DISCUSSION

Recalling from Table 1 that the allowable stresses for compression are 2 kg/cm^2 and for shear or tension in flexure are 0.53 kg/cm^2 (with special inspection) the values in Table 5 indicate that all walls are satisfactory from the viewpoint of compressive stress, tensile stress and shear stress. However it is observed that the compression created by the total dead load in wall B is 2.18 kg/cm^2 which is greater than the allowable value of 2.0 kg/cm^2 . As the Code permits an increase in the allowable stresses by 33% for seismic loading this figure is not critical. Furthermore it is observed from Table 4 that wall B is also unsatisfactory when its overturning stability is considered. One solution might be in arranging for the E-W legs of walls B and C to be more nearly equal, by shifting the intermediate door into a central position. However, the present calculations have been made on the basis of cumulatively conservative assumptions, e.g. the wall portions over and under the door and window openings have been taken as contributing no strength

to the structure. In a more exact analysis it is likely that wall B will not be critical.

The roof of the one-storey adobe dwelling has been considered flexible although it is heavy. This is because of its inability to prevent rotation and its lack of in-plane rigidity.

The analysis followed in the design example suffers from omissions and limitations but the steps constitute part of a design process. Increased knowledge of material properties and structural behavior will enable more detailed application of engineering calculations to adobe structures.

V. EXPERIMENTAL INVESTIGATION OF COMPONENT STRUCTURAL ELEMENTS

Much experimental research also needs to be carried out to assess the structural behaviour of adobe dwellings under service loads and also overloads such as seismic loads. Ideally, full scale single storey adobe houses should be tested in the same manner as the masonry structures tested on the University of California, Berkeley shaking table by Gülkan, Mayes and Clough {20}. Initially, however, it is probably more feasible to test structural components such as walls and small panels because simple components are more amenable to analysis and because the number of tests on such elements can be increased.

For brick masonry, earlier tests on component structural elements have been reported in Sahlin. Static and cyclic tests

on masonry walls under axial and shear loads and separately under bending moments and axial forces in order to obtain information on the seismic behaviour of masonry are also being conducted by Anicic {21} in Yugoslavia.

On the basis of the above experimental investigations on brick masonry, the following preliminary tests on adobe wall panels may be proposed :

- 1) The loading of square adobe brick panels (each side measuring approximately 1 m) under different combinations of diagonal and normal loads as shown in Fig. 5 to study the shear strength and possible failure criteria.
- 2) An evaluation of the out-of-plane strength of rectangular panels (measuring up to 1.2 m by 2.5 m) under various combinations of eccentric axial loads and lateral pressure as indicated in Fig. 6. The objective of this type of "bulge" test would be to ascertain the suitability of a concrete-like (moment M -axial force N) interaction diagram for adobe.
- 3) The simulation of a frame enclosing an adobe filler wall may be accomplished most simply as shown in Fig. 7 where a reusable vertical steel column is used to apply lateral loads to adobe masonry walls. The effect of varying the height of the adobe infill on the deflection of the steel column can give an indication of the increase in the stiffness of the system

imparted by the filler wall. It is expected that over the next few years a series of tests along the above lines will be planned and executed in the Civil Engineering Department of Middle East Technical University in cooperation with appropriate government agencies in Turkey.

ACKNOWLEDGEMENTS

The authors wish to thank Dr. Mehmet Uluçaylı of Middle East Technical University, currently on a UNESCO assignment in Mali, West Africa, for the photograph of the Mopti mosque. Acknowledgements are also due to Hediye Boran for the typing and Doğan Talı for the figures.

REFERENCES

1. Alkan, Z., "Improving the mechanical properties of adobe blocks used in rural housing", CENTO Symposium on Rural Housing, Ankara, 1973.
2. Wolfskill, L.A., Dunlap, W.A., and Gallaway, B.M., "Earthen Home Construction", Bulletin No. 18, Texas Transportation Institute, College Station, Texas, 1962.
3. Germen, A., "The endurance of earths as building material — and the discreet but continuous charm of adobe", Journal of the Faculty of Architecture, Middle East Technical University, Vol.5, No.1, Spring 1979.
4. Kumbasar, V., "Physical properties of clay — the basic material for adobe", Adobe Seminar, Ministry of Construction and Settlement, Ankara, 1964 (In Turkish).
5. Toğrol, E., "Improvement of the properties of adobe", Adobe Seminar, Ministry of Construction and Settlement, Ankara, 1964 (In Turkish).
6. Alkan, Z., "Influence of some stabilizing materials on the mechanical properties of adobe", Symposium on the Earthquake Problem in Turkey and Earthquake Engineering, Middle East Technical University, Ankara, 1972 (In Turkish).
7. Sönmez, N., "Research on Adobe — the agricultural building material", Ankara University Agriculture Faculty Publication No.71, 1955 (In Turkish).

8. Sönmez, N., "Use of adobe buildings in agricultural public works, and their characteristics", Ankara University Agriculture Faculty Publication No. 180, 1961 (In Turkish).
9. Turkish Bridge and Structural Engineering Association "Directives for Adobe Construction", Adobe Seminar, Ministry of Construction and Settlement, Ankara 1964 (In Turkish).
10. Arıoğlu, E., and Anadol, K., "Response of rural dwellings to recent destructive earthquakes in Turkey (1967-1977) and Design criteria of earthquake resistant rural dwellings", Proceedings, International Conference on Disaster Area Housing, Istanbul, 1977.
11. Tchalenko, J.S., and Ambraseys, N., "Earthquake Destruction of Adobe Villages in Iran", Annali di Geofisica XXVI, 2-3, 1973.
12. Wasti, S.T., and Ahmad, S.N., "Improvement of the earthquake resistance of rural dwellings in Pakistan", CENTO Symposium on Earthquake Hazard Minimization, Tehran, 1976.
13. Gülkan, P., Wasti, S.T., and Karaesmen, E., "Some aspects of earthquake engineering research in Turkey", Proceedings, First Iranian Civil Engineering Congress, Shiraz, 1974.
14. Aytun, A., "Earthquake safety of rural housing in Turkey", CENTO Symposium on Rural Housing, Ankara, 1973.
15. Razani, R., "Criteria for seismic design of low-rise brittle buildings in developing countries", Proceedings, 2nd U.S. National Conference on Earthquake Engineering, Stanford, California, 1979.

16. Turkish Republic Ministry of Construction and Settlement, Specifications for structures to be built in disaster areas, Ankara, 1975.
17. Uniform Building Code, International Conference of Building Officials, Whittier, California, 1976.
18. Amrhein, J., Reinforced Masonry Engineering Handbook, Masonry Institute of America, Los Angeles, California, 1978.
19. Sahlin, S., Structural Masonry, Prentice Hall, Inc., Englewood Cliffs, N.J., U.S.A., 1971.
20. Gülkan, P., Mayes, R., and Clough, R.W., "Shaking Table Study of Single-Story Masonry Houses", Vols. I and II, Reports No. UCB/EERC-79-23 and 79/24, University of California, Berkeley, California, 1979.
21. Anicic, D., Personal communications, 1979, 1980.

APPENDIX

Structural Properties of Walls : E-W Direction

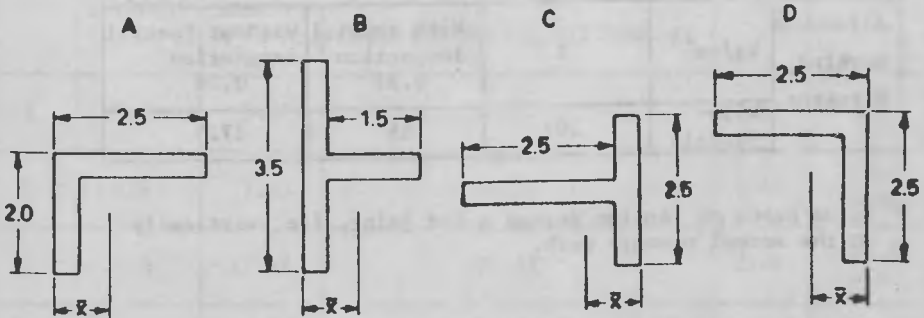

All dimensions in meters. Wall thickness 0.45 m.

Wall Type	Area m^2	Centroidal Distance \bar{x} m	Moment of Inertia I m^4	Section Modulus S m^3
A	1.82	0.85	2.03	1.23
B	2.26	0.52	0.99	0.67
C	2.26	0.96	3.62	1.77
D	2.05	0.78	2.10	1.22

TABLE 1. ALLOWABLE WORKING STRESSES IN ADOBE MASONRY
{UNIFORM BUILDING CODE}

Type of Loading		Compression	Shear or Tension in flexure*	
Type of Mortar		M or S		
Allowable Working Stresses	kg/cm ²	2	With special inspection 0.53	Without Special inspection 0.26
	kilo-Pascals	207	55	27.5

* Value based on tension across a bed joint, i.e. vertically in the normal masonry work.

TABLE 2. DISTRIBUTION OF E-W LATERAL FORCE TO WALLS

WALL	PERCENTAGE OF E-W LATERAL LOAD	LOAD PER WALL (TONS)
A (North)	13%	2.1
D (North)	13%	2.1
B	18%	2.9
C	30%	4.8
A(South)	13%	2.1
D(South)	13%	2.1

TABLE 3. WALL VERTICAL LOADING (TONS)

WALL	DEAD LOAD	LIVE LOAD	DEAD + LIVE LOAD
A	7.2	1.35	8.55
B	9.0	1.69	10.69
C	10.2	1.91	12.11
D	8.4	1.58	9.98

TABLE 4. STABILITY CHECKS

WALL	LATERAL FORCE V (TONS)	OVER- TURNING MOMENT M (T-M) = 0.70V	DEAD LOAD RESISTING MOMENT M_R (WEIGHT OF WALL+DEAD LOAD) TIMES CENTROIDAL DISTANCE \bar{x}	$\frac{M_R}{M_O}$	REMARKS
A	2.1	5.67	14.47	2.55	>1.5 O.K.
B	2.9	7.83	11.03	1.41	<1.5 N.G.
C	4.8	12.96	21.51	1.66	>1.5 O.K.
D	2.1	5.67	15.19	2.68	>1.5 O.K.

TABLE 5. STRESS CHECKS

WALL	LATERAL FORCE V (TONS)	SHEAR STRESS* ₂ τ (KG/CM ²)	COMPRESSIVE STRESS** ₂ σ (KG/CM ²)	COMPOUND STRESS (KG/CM ²) $\sigma \pm \frac{M_O}{\text{SECTION MODULUS } S}$
A	2.1	0.19	1.01	$1.01 + 0.46 = 1.47$ $1.01 - 0.46 = 0.55$
B	2.9	0.32	1.01	$1.01 + 1.17 = 2.18$ $1.01 - 1.17 = -0.16$
C	4.8	0.36	1.08	$1.08 + 0.73 = 1.81$ $1.08 - 0.73 = 0.35$
D	2.1	0.19	1.03	$1.03 + 0.46 = 1.49$ $1.03 - 0.46 = 0.57$

* $\tau = V / \text{AREA OF E-W PORTION OF WALL}$

** $\sigma = \text{DEAD} + \text{LIVE LOAD} / \text{TOTAL WALL AREA}$

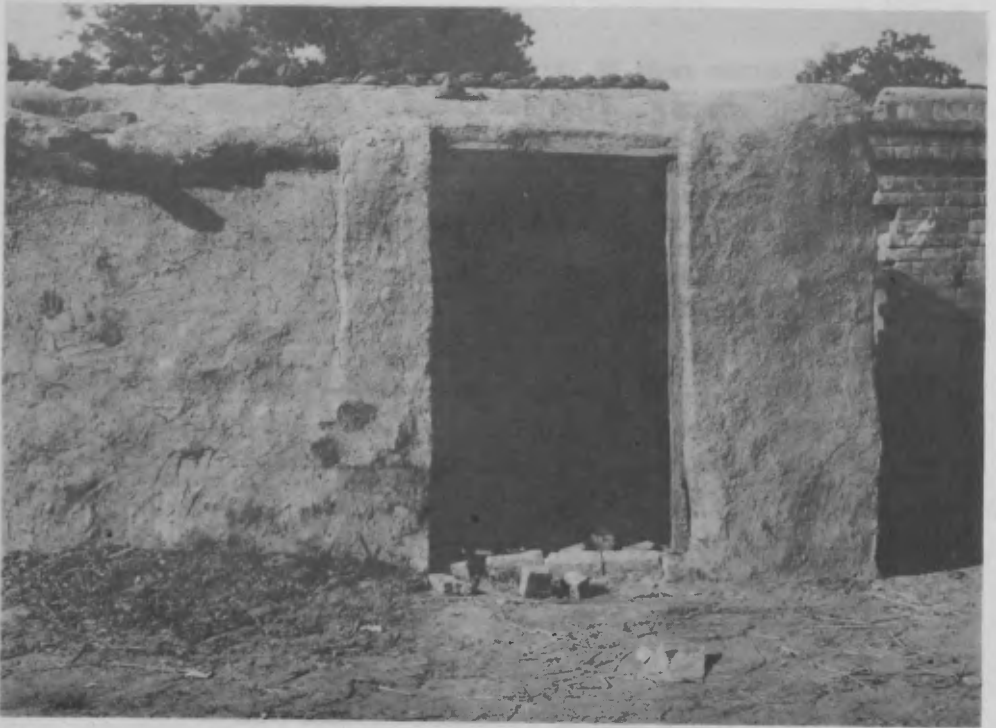

Fig. 1 Simple Adobe Dwelling

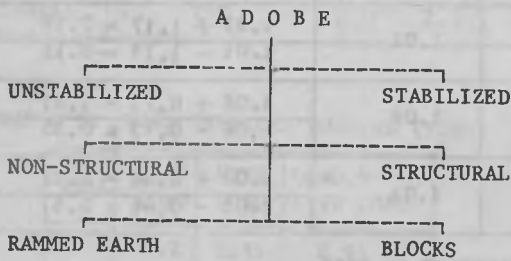
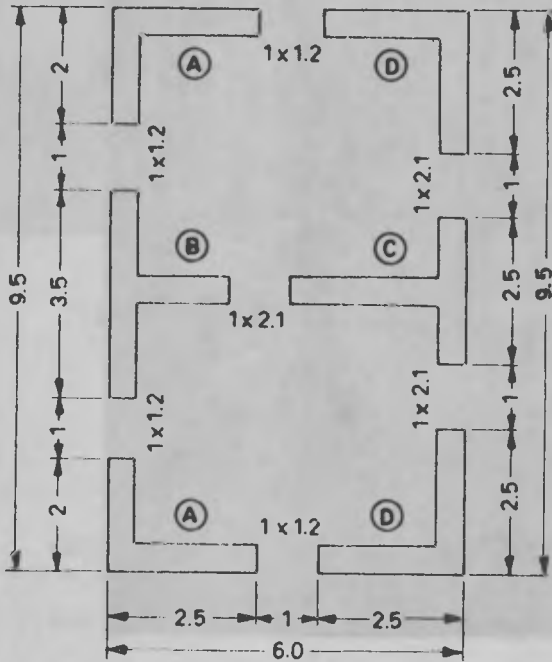
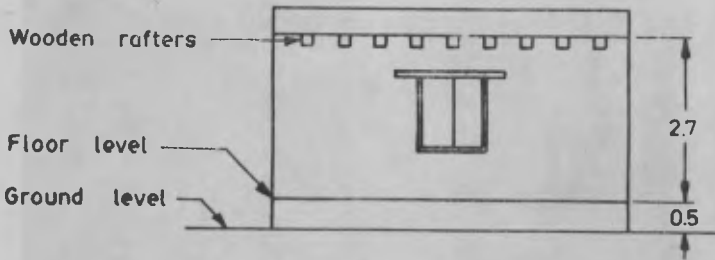

Fig. 3 Different Types of Adobe For Construction Purposes



Fig. 2 Adobe Mosque, Mali, West Africa



All dimensions
in meters

Wall thickness
0.45m.

Fig. 4 Design Example

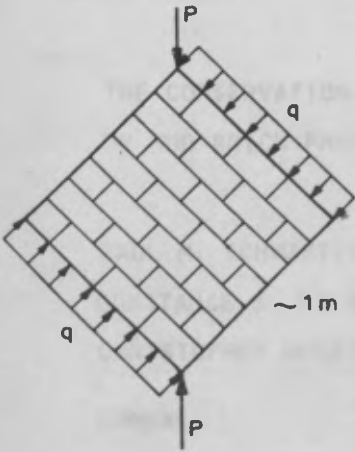

Fig. 5 Adobe Brick Panels

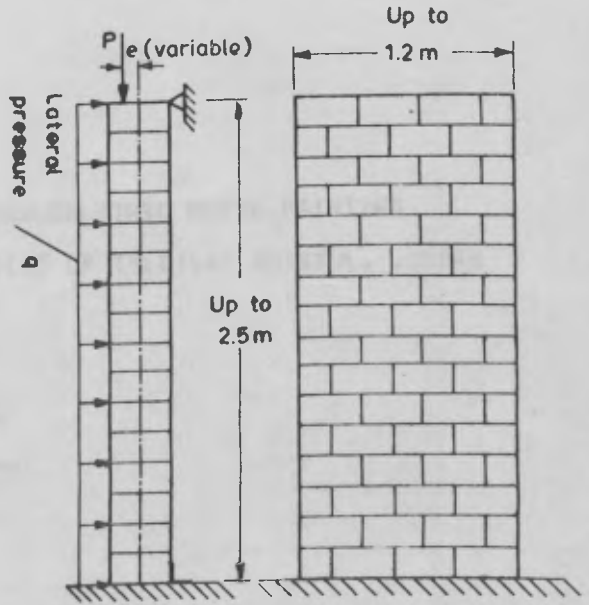

Fig. 6 Bulge Test on Adobe Walls

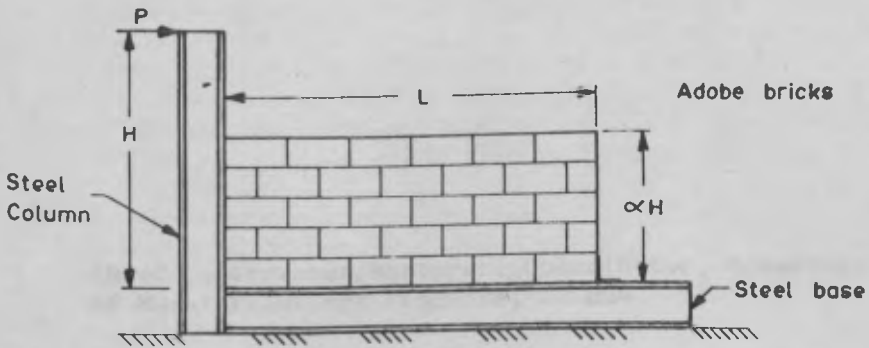

Fig. 7 Simulation of Frame and Infill Wall

THE CONSERVATION OF A CHALCOLITHIC MURAL PAINTING
ON MUD BRICK FROM THE SITE OF TELEILAT GHASSUL, JORDAN

PAUL M. SCHWARTZBAUM *

CONSTANCE S. SILVER **

CHRISTOPHER WHEATLEY ***

SUMMARY

A 4.14m² section of a Chalcolithic (c. 3000 B.C.) mural painting on mud brick was recovered in 1977 from the excavation of Teleilat Ghassul, the Hashemite Kingdom of Jordan.

The mural painting was in 33 major pieces and many fragments. The conservation treatment carried out is described.

* Chief Conservator/Restorer; Coordinator, Conservation of Mural Paintings Projects, ICCROM.

** Former Assistant, ICCROM

*** Conservator, ICCROM

1. INTRODUCTION

The site of Teleilat Ghassul is located about five kilometers north of the Dead Sea, in the Hashemite Kingdom of Jordan. Discovered in the early 1920's, Teleilat Ghassul was initially excavated between 1930-36. Other campaigns were carried out in 1960, 1967 and 1975-77. Now known to cover at least 30-40 hectares, Teleilat Ghassul is recognized as one of the largest and most important sites of the Neolithic and Chalcolithic periods in Palestine (1). Of major importance are the mural paintings which have come to light since the 1931-32 excavation. With the exception of the mural paintings found at Çatal Hüyük, Turkey, those of Teleilat Ghassul, dating from about 3,500 - 3,000 B.C., are the earliest known paintings on a specifically architectural surface, as opposed to paintings executed directly on the walls of caves and rock shelters (2).

In 1977, a major area of mural painting was discovered lying face-down and still attached to a section of fallen wall. Although broken into 33 major pieces and many fragments, this 4.14 m² section presented the first opportunity to conserve a large and representative example of Ghassulian mural painting. Despite its fragmentary state, this mural painting is particularly significant because of its unique subject matter: at least three figures, apparently in ceremonial dress and moving toward a structure, have been postulated (Figure 1).

Under the direction of supervising archaeologist Dr. Basil Hennessy, University of Sydney, the mural painting was lifted and transported from the excavation to Amman. Dr. Adnan Hadidi, Director General, Department of Antiquities, immediately initiated plans to conserve the mural painting, requesting aid from UNESCO. ICCROM, the International Centre for Conservation, Rome, was contacted by UNESCO for technical assistance. In January, 1978, a team from ICCROM examined the mural paintings in Amman.

Following further studies to test materials for consolidating the mud brick and mounting the pieces, two missions under UNESCO contract were carried out by ICCROM (3). The conservation treatment was concluded in April, 1979, with the installation of the mural painting in the Amman Museum (4).

2. PHYSICAL CHARACTERISTICS OF THE TELEILAT GHASSUL MURAL PAINTING

Masonry of sun-dried mud bricks, about 13 cm in thickness, composed the structural support for the mural painting. The wall surface was primed by applying a cream-coloured preparation whose charge consisted largely of crushed sea shells. The naturally occurring pigments, limited to carbon black, sea shell white, yellow and red ochres, were applied to this preparation. The mural painting treated by ICCROM has at least three superimposed strata; each stratum, composed of preparation and pigments, is about 2 mm thick (5).

3. STATE OF PRESERVATION WHEN DISCOVERED AND CONSERVATION INTERVENTIONS PRIOR TO THE ICCROM MISSIONS

Although the mural painting was lying face-down and obscured by dirt, the fractured and friable condition of the mud brick was clearly evident during excavation. Several interventions were thus undertaken to permit the lifting of the pieces and their orderly transport to Amman.

3.1 Documentation

A plan of the mural painting in its original face-down position was made in scale 1 : 10. Each of the pieces was numbered. Obvious lacunae were indicated on the plan (Figure 2). Fragments were labelled and boxed according to their proximity to a numbered piece. In all, ten boxes of fragments, each box measuring about 25 cm x 30 cm were recovered.

3.2 Reinforcement and Lifting

The pieces were reinforced by applying dental plaster, sometimes with the inclusion of gauze or polyethylene to the dusted backs. A border of gauzé,

adhered with polyvinyl acetate emulsion, was also applied to the edges of many pieces.

3.3 Initial Cleaning

The reinforced pieces were transported to the British School of Archaeology, Amman, and arranged face-up according to the field plan. The painted surface, obscured by dirt and surface accretions, was mechanically cleaned.

3.4 Reattachment of Paint

During cleaning, the very fragile state of the paint became more evident. Powdering and flaking paint was reattached by applying a 7 percent solution of Paraloid B72 in acetone (6).

4. CONSERVATION TREATMENT ENACTED BY THE ICCROM MISSIONS

The aims of the conservation intervention were to ensure the survival of the mural painting fragments and to devise a mounting system which would allow the painting to be exhibited. The successful completion of these two goals was complicated by the highly deteriorated state of the mural painting. The mud brick was so lacking in cohesive strength that the pieces cracked if handled and crumbled if immersed in a consolidant (Photograph 3). Moreover, the pigment layer was completely devoid of binder and any consolidant employed changed to some degree the tonality of the painting.

The white pigment, obtained from sea shells, was found to be particularly delicate. The overall treatment was further complicated by the shortness of time available and the handicaps of working under "field" conditions.

After preliminary tests it was decided that to safely treat the fragments the following major operations were required:

- A clear documentation of all of the pieces to ensure their identification as the treatment progressed.
- A thorough support for the pieces during each step of the treatment.

- Removal of the plaster backings applied in the field and a reduction of the thickness of the mud brick, to decrease overall weight and bulk and to facilitate maximum absorption of the consolidant (7).
- Retention of as much of the original support and aspect as possible consistent with maximum penetration of the consolidant.
- Mounting and reassembly of the pieces.
- Installation of the mounted mural painting in the Amman Museum.

The treatment proceeded as follows:

4.1 Documentation

A 1 : 1 tracing of the entire mural painting as found by the ICCROM team in Amman was made with transparent paper (Figure 3 and Photographs 1 and 2). In addition, individual 1 : 1 tracings were made of each of the 33 pieces. These tracings ensured the identification of each piece throughout the treatment and its exact repositioning according to the 1 : 1 master tracing. Moreover, the individual tracings permitted an accurate daily record to be kept of the condition and treatment of each piece as the work progressed.

4.2 Emergency Consolidation to Permit Handling

A 7 percent solution of Paraloid B72 in acetone was used to strengthen the considerable remaining areas of friable paint (Photograph 3).

4.3 Detached Areas

Detached areas were treated by injecting Paraloid B72 (15 percent in acetone) between strata with a syringe.

4.4 Reattachment of Fragments

Detached small fragments along the fractured borders of the pieces were glued into place with polyvinyl acetate emulsion, Viñavil, (50 percent in water).

4.5 Thinning and Consolidation of the Pieces

Each of the 33 pieces required individual consolidation. This entailed six steps:

- 4.5.1 The paint surface of each fragment was protected by applying a double facing of Japanese paper and surgical gauze adhered with a water-soluble cellulose paste (8). A supportive mold of plaster of Paris was then made to fit the faced surface and protect the perimeter of each piece.

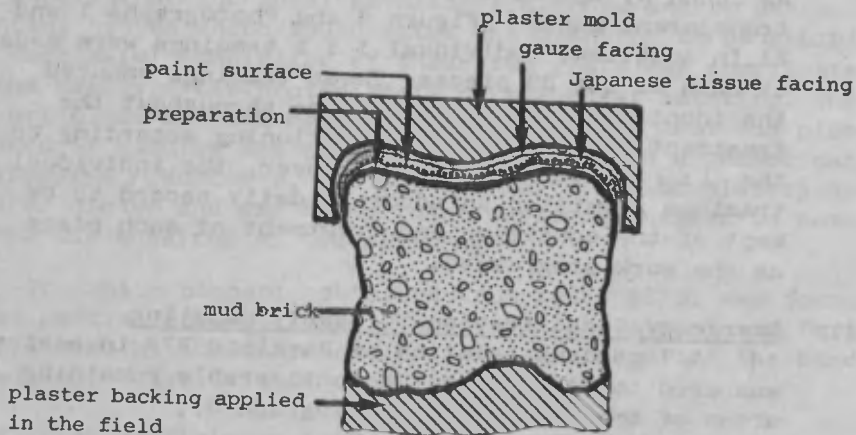

Diagram 1. Stratigraphy of a representative piece of the mural painting following protection of the pigment layer.

- 4.5.2 Supported by the facing and plaster mold, the piece was held rigid and could thus be safely turned face-down to permit removal of the plaster backings applied at the excavation. A bit and a mechanical shaft were used. Each piece was reduced to a uniform thickness of 3 cm to ensure maximum penetration of the consolidant; however, a 5 cm thick border was kept to retain as much of the original edge as possible.

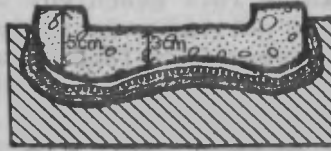

Diagram 2. Section of mural painting after reduction of the mud brick.

- 4.5.3 A new plaster mold was then made to fit the reduced back of the piece to ensure full support during handling and to make an individual receptacle in which the piece would continue to be supported during impregnation with the consolidant. Prior to turning, a piece of polyethylene was placed between the back of the mud brick and the plaster mold to create an impermeable seal.

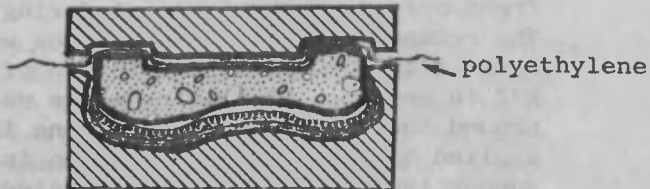

Diagram 3. A new plaster mold made to support reduced back.

4.5.4 The front mold, facings, and any traces of the paste were removed prior to consolidation to ensure that the facings did not become saturated with Paraloid B72 through the action of the Wäcker solvent, which might have prevented their safe removal. The back mold was then filled with a 50% solution of Wäcker Stone Strengthener H, an ethyl silicate, in Wäcker solvent (9). Total absorption of the consolidant occurred through the capillarity of the very porous mud brick. The piece was covered with aluminium foil overnight to retard the speed of solvent evaporation. The consolidated piece was allowed to dry for three days.

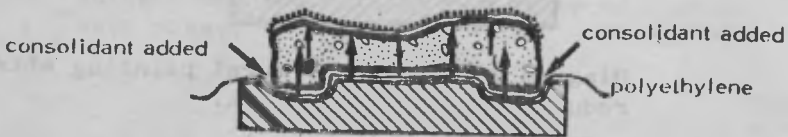

Diagram 4. After turning face-up, the plaster mold of the reduced back is utilized as a receptacle for the infusion of the consolidant.

4.6 Mounting and Assembly

Polyurethane foam was applied to each of the consolidated pieces, reconstituting the original 13 cm support of the painting (10).

4.6.1 The consolidated piece was fitted with its front mold to ensure support during turning. The reduced back of the mud brick was isolated with a 20 percent solution of Paraloid B72 in acetone. Plasticine walls were built around the piece and polyurethane foam was applied to the back to create an individual supportive mount. Thus consolidated and mounted, each piece could be moved and positioned without risk of damage.

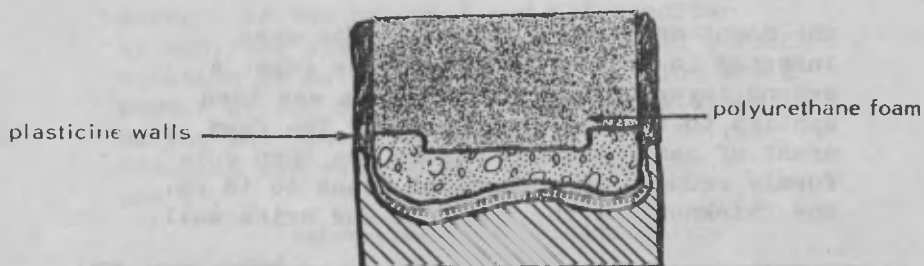

Diagram 5. Polyurethane foam applied to the reduced back of the mud bricks.

- 4.6.2 To facilitate reassembly, the 33 pieces of the mural painting were mounted into five separate blocks. The pieces composing each block were exactly positioned face-up and temporarily secured in place with wedges of plasticine. A master plaster mold was then made of the surface of the block.

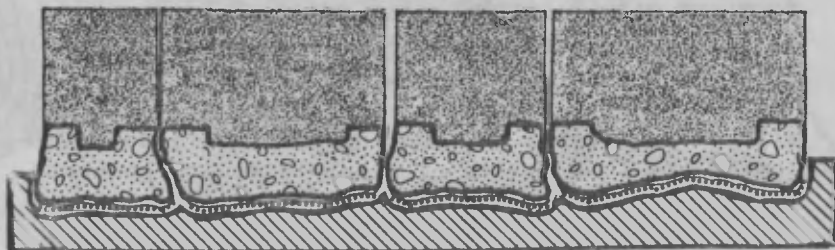
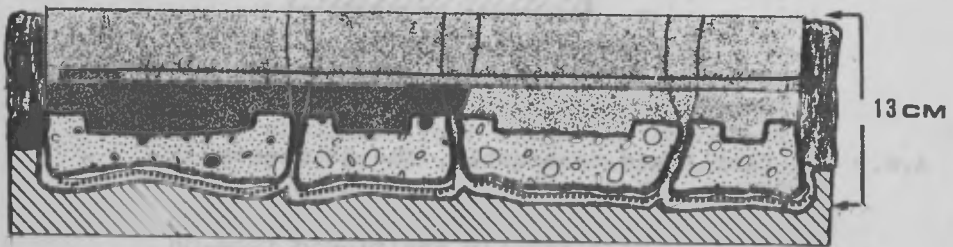

Diagram 6. A master plaster mold is made for each block of pieces.

- 4.6.3 When dry, the master mold was removed and reversed. Each piece of the block was fitted face-down in its respective position in the mold. Plasticine was used to fill all gaps and to make retaining walls between pieces. Polyurethane foam was then applied to the backs and in gaps, thus securing the pieces together as a block (Photograph 4). To make

the mount more rigid, plastic rods were inserted in channels cut into the foam. A second layer of polyethylene foam was then applied to incorporate the rods. The foam mount of each block of pieces was then uniformly reduced by mechanical means to 13 cm, the thickness of the original mud brick wall.



plasticine
walls

Diagram The pieces fitted face down in the master plaster mold and secured together as a block by the application of polyurethane foam and with reinforcing plastic rods.

To increase the rigidity of the support, the edges of the polyurethane mount were externally reinforced with a layer of fiberglass mat adhered with polyester resin. Mounting brackets made by laminating four strata of fiberglass with polyester resin were also incorporated (Photograph 5).

- 4.6.4 A wooden mount for the mural painting was constructed in the Amman Museum. The entire painting was then reassembled, each of its component blocks being independently secured in place by wooden screws inserted through the mounting brackets. The 80° angle of the mount was chosen to provide maximum support (Photograph 6).
- 4.6.5 Large lacunae in the assembled mural painting were filled with polyurethane foam for additional support. Joins between the blocks and lacunae were treated to simulate the

surface of the original mud brick mortar by applying a stucco composed of a 10 percent solution of polyvinyl acetate emulsion and a powder of the original mud brick, retained during the reduction of the pieces. No re-touching was carried out (Photographs 7 and 8).

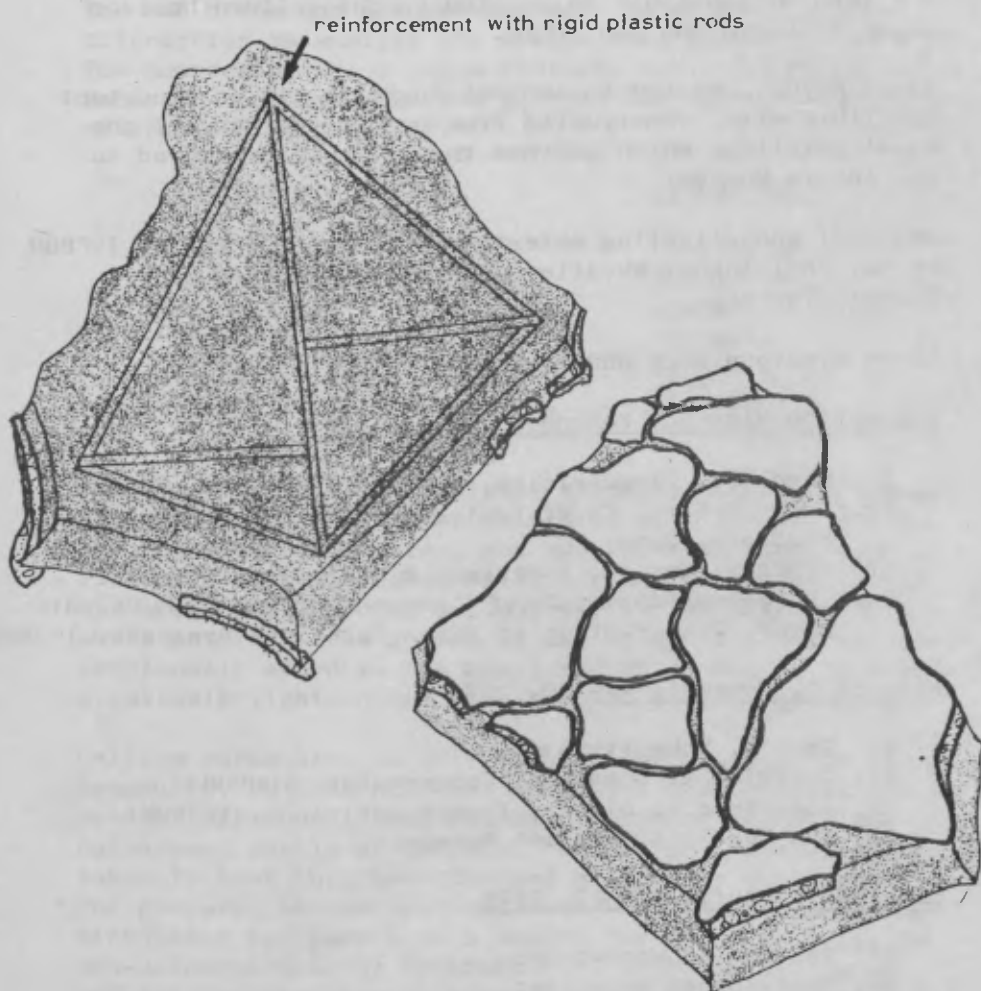

Diagram 8. A block of pieces after mounting with polyurethane foam and prior to reinforcement with fiberglass mat and polyester resin.

FOOTNOTES

1. The term Chalcolithic is applied to the culture horizon which followed the Neolithic.
2. Çatal Hüyük, located in central Anatolia, is an important Neolithic site, constructed from mud brick. Many of the mural paintings which adorned the walls were removed to the Ankara Museum.
3. Tests of consolidating materials were carried out at ICCROM by Mr. Christopher Wheatley under the direction of Dr. Giorgio Torracca.
4. Three missions were undertaken by ICCROM:

Inspection Mission, February 7 - 9, 1978

Dr. Harold J. Plenderleith, Director Emeritus, ICCROM;
 Prof. Paolo Mora, Chief Restorer, Istituto Centrale del
 Restauro, Rome;
 Dr. Giorgio Torracca, Assistant Director, ICCROM;
 Paul M. Schwartzbaum, Chief Conservator/Restorer; Coordi-
 nator, Conservation of Mural Paintings Projects, ICCROM.

Mission I, November 7 - 30, 1978

Mr. Paul M. Schwartzbaum;
 Mr. Christopher Wheatley, Conservator, ICCROM;
 Ms. Constance S. Silver, former Assistant, ICCROM;
 Ms. Ann Searight, British Museum.

Mission II, April 6 - 17, 1979

Mr. Paul M. Schwartzbaum;
 Mr. Christopher Wheatley;
 Ms. Isabelle Dangas, Monuments Historiques, France.

5. A laboratory analysis of the component materials of the Teleilat Ghassul mural painting was carried out by Drs. D. Artioli, C. Meucci, M. Tabasso, Chemical Laboratory, Istituto Centrale del Restauro, Rome.

Mud Brick and Preparation

The mud brick and preparation were examined by X-ray diffraction to analyze the crystalline phases present. The numbers of the + signs indicate the relative abundance of the compound. The + signs indicates the presence of traces of a compound.

Mud Brick

Calcite +++
 Quartz +++
 Dolomite ++
 Gypsum +
 Feldspars +
 Muscovite-Illite +
 Chlorites +

Preparation

Calcite +++
 Quartz +++
 Aragonite ++
 Dolomite +
 Gypsum +
 Feldspars +

The X-ray diffraction analyses strongly suggest a similar provenance for the raw materials of both the mud brick and preparation. However, the mud brick is considerably richer in clay minerals, feldspars and chlorites, while the aragonite is found exclusively in the preparation. A white material, the source of the aragonite, was thus intentionally added to the basic mud brick mortar to create a suitable light-colored preparation for the painting.

Calcium carbonate, in this crystalline phase known as aragonite, is less diffused in nature than calcite and is present often as a constituent of crustaceans and the calcareous shells of animals. Further analyses were undertaken to test this hypothesized origin for the aragonite. The preparation was observed with an electron scanning microscope equipped with a system for micro-analyses by non-dispersive X-ray fluorescence. Many conical forms and fibrous structures characteristic of organic aragonite were clearly observed, thus confirming pulverized shells of animal origin as its source.

The general elemental composition of the white preparation as results from the analyses is:

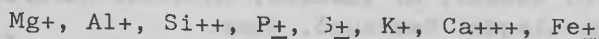

In some areas, traces of chloride are also present. These results accord perfectly with those of the X-ray diffraction.

Pigments

The analyses by non-dispersive X-ray fluorescence with a source of Promethium 147 of an area of red color have shown essentially the presence of iron, indicating the use of simple ochres for the colored pigments.

6. The initial cleaning of the surface and reattachment of the paint were carried out by Ms. Ann Searight, December, 1977.
7. The dental plaster applied in the field was extremely hard, much stronger than the mud brick original material. Its removal which was necessary for facilitating the absorption of the consolidant and reassembly could be accomplished only after a complex rigid facing system had been applied to protect and support the weak painting fragments.
8. A water-soluble paste was employed because the paint surface, after consolidation with Paraloid B72 in the field, proved to be partially soluble in solvents but not in water. Moreover, paste remains easily removable with a light application of water.
9. Wäcker Stone Strengthener H is an ethyl silicate. Its consolidating action is based on the formation of SiO_2 through the hydrolysis of silicate ester:

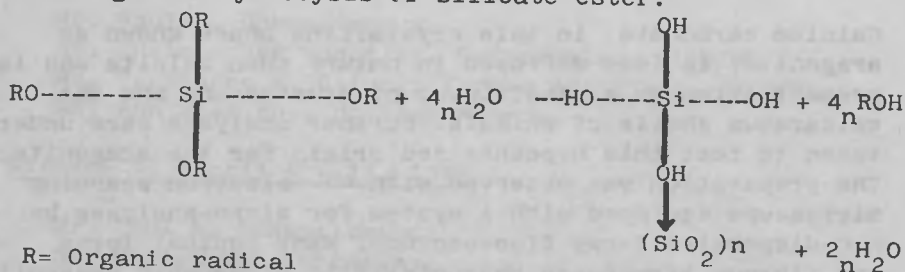

R= Organic radical

Technical data provided by the Wäcker Co., Technical Data Sheet BHS/C/179/A.

10. Isofoam polyurethane foam systems are used to produce a wide range of cellular materials by mixing two components:

1. RES Component, consisting of a polyol mixture blended with catalysts, foam stabilizing agents, flame retardant additives and the flowing agents which cause the mixture to expand.
2. ISO Component, A MDI (diphenyl methane di-isocyanate) composition.

When the two components are mixed, a chemical reaction is initiated which causes the mixture to expand and set into a homogeneous mass within minutes.

Technical data provided by the Baxenden Chemical Co. Ltd., Accrington, U.K.

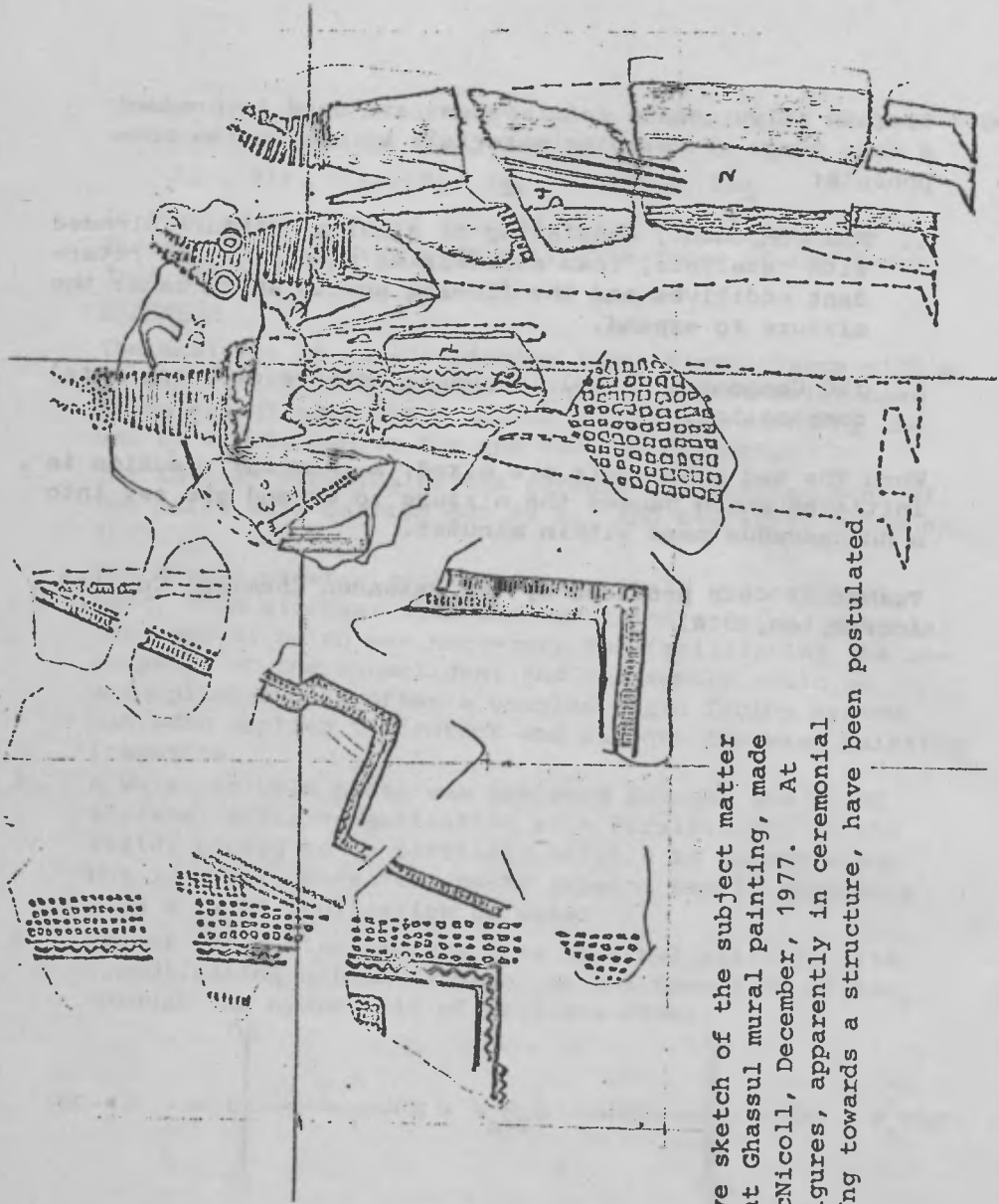

An interpretive sketch of the subject matter of the Teleilat Ghassul mural painting, made by Dr. Tony McNicoll, December, 1977. At least three figures, apparently in ceremonial dress and moving towards a structure, have been postulated.

Figure 1.

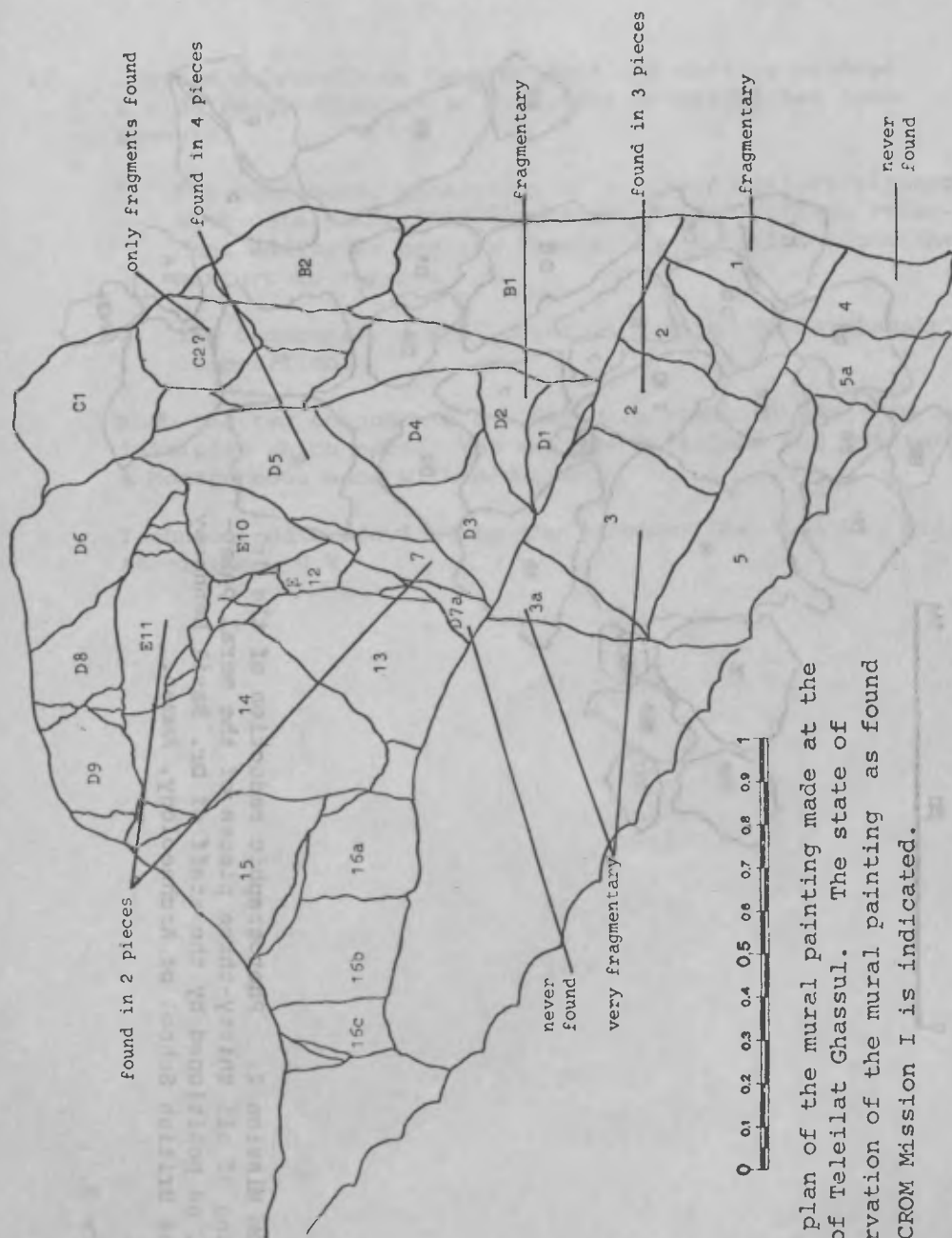

Field plan of the mural painting made at the site of Teleilat Ghassul. The state of preservation of the mural painting as found by ICCROM Mission I is indicated.

Figure 2.

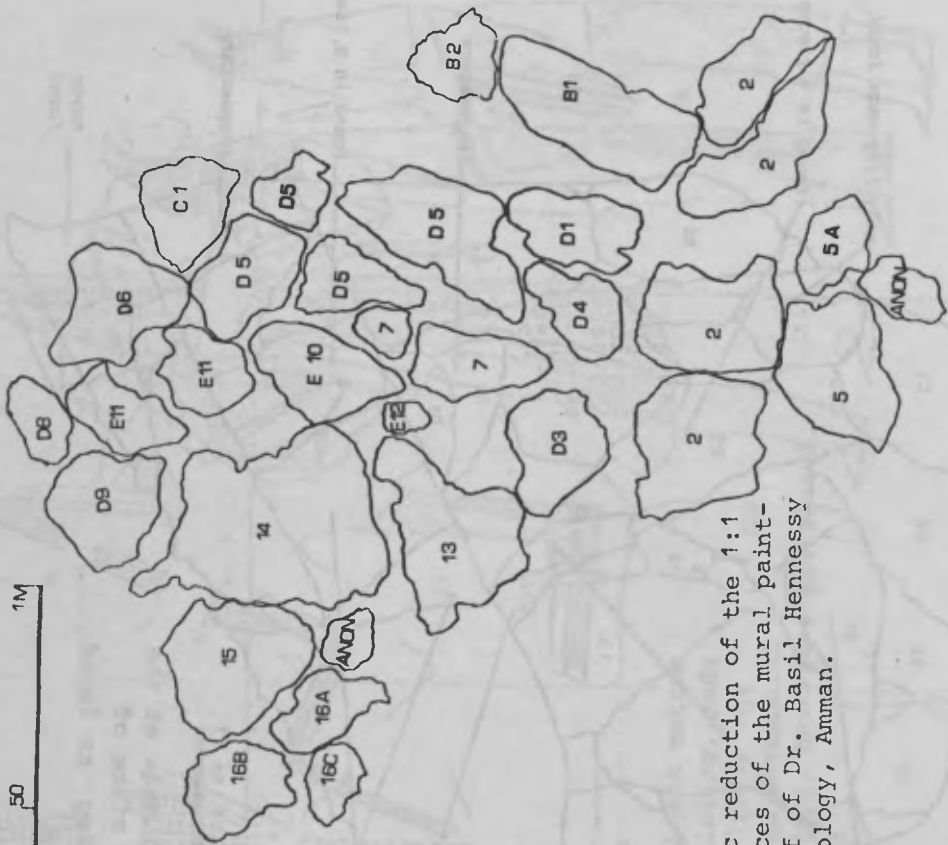

ICCROM Mission I. Photographic reduction of the 1:1 tracing of all thirty-three pieces of the mural painting, as positioned by the staff of Dr. Basil Hennessy at the British School of Archaeology, Amman.

Figure 3.

10. Isofoam polyurethane foam systems are used to produce a wide range of cellular materials by mixing two components:

1. RES Component, consisting of a polyol mixture blended with catalysts, foam stabilizing agents, flame retardant additives and the flowing agents which cause the mixture to expand.
2. ISO Component, A MDI (diphenyl methane di-isocyanate) composition.

When the two components are mixed, a chemical reaction is initiated which causes the mixture to expand and set into a homogeneous mass within minutes.

Technical data provided by the Baxenden Chemical Co. Ltd., Accrington, U.K.

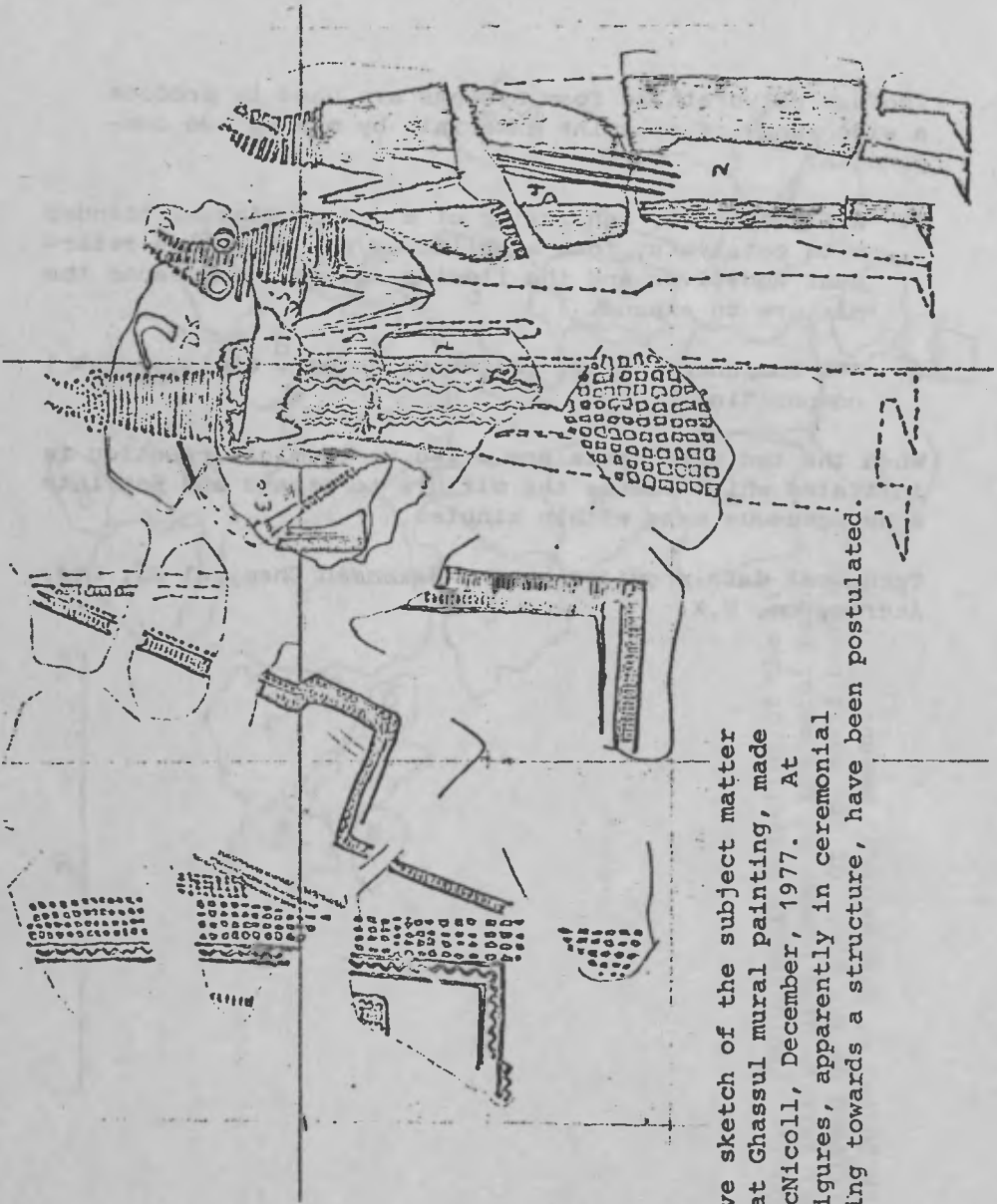

An interpretive sketch of the subject matter of the Teleilat Ghasul mural painting, made by Dr. Tony McNicoll, December, 1977. At least three figures, apparently in ceremonial dress and moving towards a structure, have been postulated.

Figure 1.

mounting bracket

plastic rods



5. The reverse of the block following its reinforcement with fiberglass mat and polyester resin. Note the mounting brackets and the plastic rods.



6. During assembly of the blocks of the mural painting on a specially constructed support in the Amman Museum: note that the lower block (right) and the block to the left have been fabricated completely from polyurethane foam covered with a stucco composed of a powder of the original mud brick.

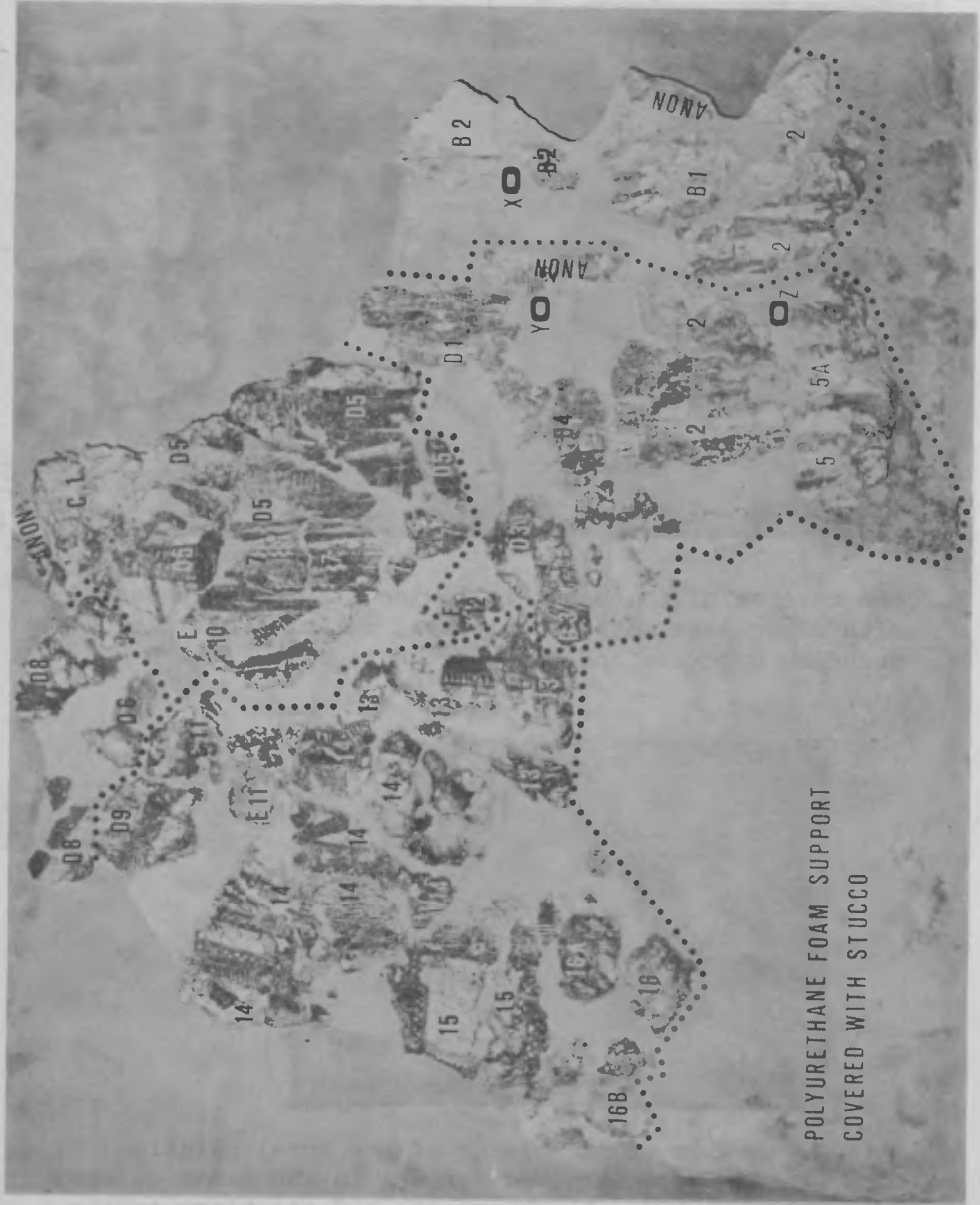

POLYURETHANE FOAM SUPPORT
COVERED WITH STUCCO



7. The mural painting after treatment. The joins between the five component blocks of the mural painting and the large lacunae have been filled with a stucco composed of a powder of the original mud brick.

Note: joins between the five component blocks

XYZ O location of the three blind screws

15 ,D5 etc. indicate the location of each individual piece, designated by its original field number

ANON an anonymous piece found without a number by ICCROM Mission I.

8. The mural painting, after treatment.

LOS MONUMENTOS DE ADOBE EN EL PERU Y LOS CASOS DE
RESTORACION EFECTUADOS EN LA ZONA DE CUSCO

ROBERTO SAMANEZ ARGUMENTO ^X

SUMMARY

- 1.- Introducción .
- 2.- La construcción con adobes en época precolombina.
- 3.- La construcción con adobes en época colonial.
- 4.- La investigación para mejorar la tecnología de la construcción con adobe.
- 5.- Recomendaciones para construir con adobe.
- 6.- La restauración de monumentos construidos con adobe.

X
Arq. Roberto Samanez Argumedo
Director de la Unidad Especial Ejecutora del Instituto Nacional de -
Cultura para la restauración de -
los Monumentos comprendidos en el
Plan COPESCO.

1.- INTRODUCCION

Una visión retrospectiva de la historia de la edificación desde sus antecedentes más remotos nos permite afirmar que a partir de ciertos elementos básicos, cada región y cada época, de acuerdo a factores geográficos, geológicos, sociales e históricos; creó su propia arquitectura caracterizada por sus elementos constitutivos y por la expresión final lograda con ellos.

Factores de influencia como la geografía constituida por el marco físico, el ambiente y el clima; explican la preferencia por el empleo de determinados materiales. La constitución del suelo influye como un factor geológico, al permitir el aprovechamiento de algunos materiales que se pueden encontrar en mayor abundancia que otros. - No menos importancia tienen las influencias entre pueblos y civilizaciones, constituyendo un factor histórico determinante al igual que la organización social.

El caso de la civilización egipcia nos permite ilustrar el determinismo de esos factores, si tenemos en cuenta que desde la etapa más remota del Antiguo Imperio, el período tinita (3500-3000 A.C.) la utilización de paralelepípedos de barro y arcilla secados al sol, - constituyó una respuesta a las condiciones impuestas por esa faja estrecha de clima muy seco y escasas lluvias, donde sólo las crecientes del Nilo proporcionaban la "Tierra negra" que permitió el desarrollo de una civilización de casi tres milenios de duración y que se considera entre las más notables de la historia. El mismo río Nilo anualmente renovaba la capa de arcilla y barro, usados para fabricar adobes.

La sucesión de dinastías que basaron su organización en las estaciones ligadas al régimen del río (inundación, siembra y cosecha) y en el poder total del rey respaldado por una clase sacerdotal poderosa, permitieron una organización vertical y ordenada, que lograría sus más importantes expresiones arquitectónicas con otro material abundante en el valle del Nilo como es la piedra.

Pero el ejemplo es más convincente citando el caso de Mesopotamia, donde la arquitectura se expresa bajo el aspecto de grandes plataformas superpuestas obedeciendo los designios del poder real, que no tenía límites. Como en Egipto, la civilización se dió en función a la producción agrícola generada por la creciente de dos ríos que fertilizaban la planicie ubicada entre ellos. En esa planicie no existía piedra pero sí arcilla abundante que permitió la utilización de adobes y ladrillos. Los zigurat de base cuadrada y escalonados

nada a manera de colina artificial para observaciones astronómicas los palacios y las construcciones del período Asirio entre los siglos IX a VII AC, son exponentes de la técnica desarrollada a base de adobe y piedra.

No constituye ninguna novedad hacer un parangón de esas condiciones con las que se dieron en el territorio en el cual se ubica la actual República del Perú, situado en la parte central de la cordillera de los andes. Su territorio está constituido por tres zonas diferentes: una faja longitudinal de costa bordeando el Océano Pacífico, que se caracteriza por la presencia de una corriente marina de agua fría, que cambia el clima en toda su extensión haciendo lo carente de lluvias y cubierto de nieblas bajas, en lugar de tropical como podría ser por su latitud. En compensación la corriente marina hace aflorar aguas profundas del Océano, determinando la presencia de micro organismos que producen gran riqueza ictiológica.

La Cordillera de los Andes paralela a la costa origina además un determinado número de ríos que al descender hacia el mar forman ricos valles propicios para la agricultura. Por otra parte la Cordillera presenta varios planos altitudinales con valles interandinos y altiplanos hasta llegar a las grandes cumbres con alturas superiores a los seis mil metros, que originan la nacimiento de caudalosos ríos que se bifurcan hacia la costa y hacia la cuenca del Océano Atlántico, a través de la jungla amazónica.

Los antiguos peruanos vivían en un estadio pre-agrícola entre los 22 mil hasta los 7 mil años antes de Cristo, de allí en adelante practicaron formas iniciales de cultivo, para llegar solo hace 3 a 4 mil años al Estadio de Alta Cultura como a la que se había llegado en Mesopotamia hace unos 8 mil años.

Aquí también los factores de influencia condicionaron las expresiones arquitectónicas de los pueblos primitivos y en torno al año 5000 AC. el hombre americano de los Andes Centrales cambió sus hábitos nómadas, para establecerse en los valles costeros en forma estable, haciendo viviendas precarias con elementos vegetales que poco a poco van dando paso al uso de piedras, bastante escasas y de fragmentos de tierra endurecida de la costa árida y seca, elemento que constituirá el antecedente para buscar en el adobe un sustituto tecnológico más evolucionado.

Cada período cultural de la historia de esta región del continente

americano estuvo sujeta a los factores geográficos descritos y el adobe respondió a las necesidades constructivas durante un lapso muy prolongado, que se remonta a los 2000 años AC. Como se verá en las páginas siguientes el adobe adopta diversas formas, tamaños y su proceso de elaboración difiere entre una cultura y otra, pero se trata siempre del mismo recurso tecnológico.

El principal objetivo de este análisis es el de valorar en su real y trascendente dimensión a ese material de apariencia modesta, pero que constituyó para los antiguos peruanos uno de los principales elementos no solo para resolver sus problemas constructivos más inmediatos si no también para sus obras más importantes, que trascendiendo la simple actividad constructiva constituyen verdaderos testimonios arquitectónicos de la creatividad humana.

Si bien el estudio que durante los últimos años ha desarrollado el grupo técnico, que con asistencia de la UNESCO elaboró los proyectos y llevó a cabo las obras de restauración comprendidas dentro del Plan COPESCO, ha estado encaminado exclusivamente al mejoramiento de la tecnología de construcción tradicional con adobes para restaurar los testimonios del pasado construidos con este material, los conocimientos adquiridos trascienden esa actividad y creemos que pueden servir de base para mejorar la edificación con adobes que continua siendo la técnica constructiva de mayor utilización en el Perú y en gran medida la única opción para que sus habitantes asentados en las áreas rurales o emigrados a las ciudades, puedan construir sus viviendas.

2.- LA CONSTRUCCION CON ADOBES EN EPOCA PRECOLOMBINA

Cuando los antiguos peruanos ^{se}establecen en los valles donde estan las tierras productivas, se constituyen comunidades cada vez más organizadas que demuestran su ingenio y habilidad construyendo canales de irrigación y edificaciones religiosas, que por lo general toman formas piramidales y aún hoy se conocen con el nombre de "huacas". Las más primitivas se hacen excavando la tierra dura de la costa árida, pero con el desarrollo de la utilización de la tapia o tierra apisonada y el adobe, la edificación de estos edificios ceremoniales hechos de plataformas superpuestas llega a alcanzar hasta 50 metros sobre el nivel del suelo.

Durante el período histórico denominado formativo inferior, entre los 2000 a 1250 años antes de cristo, se construyeron complejas edificaciones de adobes de forma cónica, como en el caso de Sechín en el valle de Casma, donde se utilizó además la piedra en el perí

metro externo, con motivos figurativos antropomorfos grabados en la cara anterior de monolitos con dimensiones de 1.80 a 4.40 metros de altura. En la sección central del conjunto las paredes están hechas con los referidos adobes cónicos, pintadas de color azul en el interior y de rosado en el exterior.

En otro conjunto arqueológico vecino, asentado en el flanco este del cerro Sechín, se pueden encontrar construcciones con adobes de forma cilíndrica, de 12 centímetros de diámetro por 15 centímetros de altura.

En el mismo valle de Casma existe otro conjunto arqueológico construido con adobes cónicos, denominado Moxeke, que se caracteriza por grandes plataformas de hasta 30 metros de altura, unidas por escaleras y rampas. Las columnas y pisos estaban pintados de colores muy llamativos. En el valle de Nepeña en los sitios de Punkurí y Cerro Blanco también se aprecian características similares de construcción a base de ese tipo de adobes y otros en forma de conos truncados. En estos sitios también los muros de adobe tenían decoraciones en relieve finamente enlucidas y pintadas de colores rojo, amarillo rosado y blanco.

Adobes de esa última forma mencionada, midiendo hasta 45 centímetros de altura se pueden encontrar en el valle de Moche en la costa norte, donde floreció la cultura Mochica, entre los 100 años antes de Cristo y 700 después. Los Mochicas lograron sus mejores expresiones arquitectónicas construyendo grandes pirámides escalonadas con adobes rectangulares, que recuerdan los zigurat de los sumerios. Las llamadas "Huaca del Sol" y "Huaca de la Luna" al sur de la ciudad de Trujillo y las de "Pañamarca" sitio ubicado en el valle de Nepeña, constituyen ejemplos de la técnica de construir grandes edificaciones con adobes, que se colocan alternadamente en forma longitudinal y transversal, para obtener una estructura compacta. Estas edificaciones estuvieron adornadas con pinturas multicolores y en el caso de Pañamarca, la pintura mural representando cortejos religiosos y sacrificios humanos, es de extraordinaria calidad.

Otra variedad de adobes se utilizó en la costa central, en el valle de Chancay, estos son de forma esférica con un promedio de 12 centímetros de diámetro. Adobes en forma de paralelepípedos de pequeñas dimensiones, conocidos como "adobitos" por los arqueólogos, se pueden encontrar en las edificaciones de los valles de Lurin y Rimac, cerca de la ciudad de Lima. Se utilizaban para construir los muros de contención perimétricos de volúmenes en forma piramidal, cuyo núcleo se rellenaba con tierra, grava y piedras de río. En las de-

nominadas huacas "Juliana", "Aramburu" y "Catalina Huanca" al igual que en Pachacamac y Cajamarquilla se encuentran estos adobes que en promedio miden 12 centímetros de largo por 5 de altura.

Existen también adobes que han sido denominados dentiformes, por su forma irregular, como los utilizados en el sitio de Huallamarca en el valle del río Rimac. En la costa sur donde floreció la Cultura Nazca, conocida por los gigantescos dibujos de animales y formas geométricas que dejaron en las planicies áridas, para las construcciones se usaron adobes de forma ovoide.

El uso de la tierra apisonada en grandes moldes que formaban anchos muros con el sistema conocido como tapia, se puede ver en Cajamarquilla en el valle del Rimac y en otros asentamientos contemporáneos a construcciones de adobe.

Entre los años 1200 a 1460 después de Cristo surgió en el valle de Moche el reino Chimú, con su capital en la Ciudad de Chan-Chan que albergaba una población de 100,000 habitantes. Está constituida por ocho ciudadelas, pirámides ceremoniales, templos y viviendas y estaba circundada por altas murallas. El adobe fue el único material de construcción usado en este enorme conjunto urbano, que se caracteriza por la gran calidad de los relieves y frisos de barro con estilizaciones de animales y formas geométricas que recubren los muros. En este conjunto se emplearon adobes de sección trapezoidal en la construcción de murallas de 9 metros de alto y 2.50 metros de ancho en la base y también adobes en forma de paralelepípedos.

La existencia de gran variedad de adobes en cuanto a forma dimensiones y materiales empleados, demuestra la evolución por la que se atravesó desde las edificaciones más primitivas que se hacían con trozos de tierra endurecida y piedras de recolección, pasando a las formas cilíndrica, cónica hasta llegar al paralelepípedo.

Cuando surge el Imperio Inca, cuyo apogeo y expansión máxima se logra en el siglo XVI, décadas antes de la conquista española producida en 1532; se adoptan los conocimientos y la tecnología de los pueblos y culturas conquistadas. El adobe continuó siendo un material de construcción de primera importancia y se utilizó para combinarlo en forma superpuesta a los muros de piedra de extraordinaria factura, que caracterizan a esta cultura. En Cusco la capital del Imperio y otros lugares de la zona de los andes, muros de adobe se levantaban sobre los de piedra de dos a cuatro metros de altura, para llegar hasta el nivel del apoyo de la estructura de los

**CONICAL ADOBE :**

PERIOD * 900-300 B.C.
 LOCATION * BECHIN (VALLE DE CASMA)
 MATERIAL * MUD
 DIMENSIONS * HEIGHT * 42 cm
 DIAMETER * 25 cm (AT BASE)

**ADOBE :**

PERIOD * 900-300 B.C.
 LOCATION * VALLE DEL RIMAC - LIMA
 MATERIAL * WET CLAY (MUD)
 DIMENSIONS * HEIGHT * 18 cm
 WIDTH * 20 cm

**PARALLELIPIPED ADOBE :**

PERIOD * 100 A.D.
 LOCATION * LAMBAYEQUE
 MATERIAL * MUD
 DIMENSIONS * HEIGHT * 18 cm
 WIDTH * 30 cm
 DEPTH * 20 cm

**PARALLELIPIPED ADOBE :**

PERIOD * 200 A.D.
 LOCATION * LAMBAYEQUE
 MATERIAL * MUD
 DIMENSIONS * HEIGHT * 14 cm
 WIDTH * 26 cm
 DEPTH * 18 cm

**PLAIN CONVEX ADOBE :**

PERIOD * 200 A.D.
 LOCATION * VALLE DE CHAO
 MATERIAL * MUD, PEBBLES, SHELLS, CARBON, CERAMIC, BONES
 DIMENSIONS * HEIGHT * 19 cm
 WIDTH * 32 cm

**PARALLELIPIPED ADOBE :**

PERIOD * 300 A.D. - 800 A.D.
 LOCATION * VALLE DEL RIMAC - VALLE CNILLON
 MATERIAL * MUD
 DIMENSIONS * HEIGHT * 7.5 - 10 cm
 WIDTH * 16 - 17 cm
 DEPTH * 11 - 12 cm

**PARALLELIPIPED ADOBE :**

PERIOD * 300-800 A.D.
 LOCATION * VALLE CHILLON
 MATERIAL * MUD
 DIMENSIONS * HEIGHT * 10 cm
 WIDTH * 17 cm
 DEPTH * 11 cm

**PARALLELIPIPED ADOBE :**

PERIOD * 1850 A.D. SPANISH COLONIZATION
 MATERIAL * MUD, STRAW, PEBBLES
 DIMENSIONS * HEIGHT * 18 cm
 WIDTH * 108 cm
 DEPTH * 30 cm

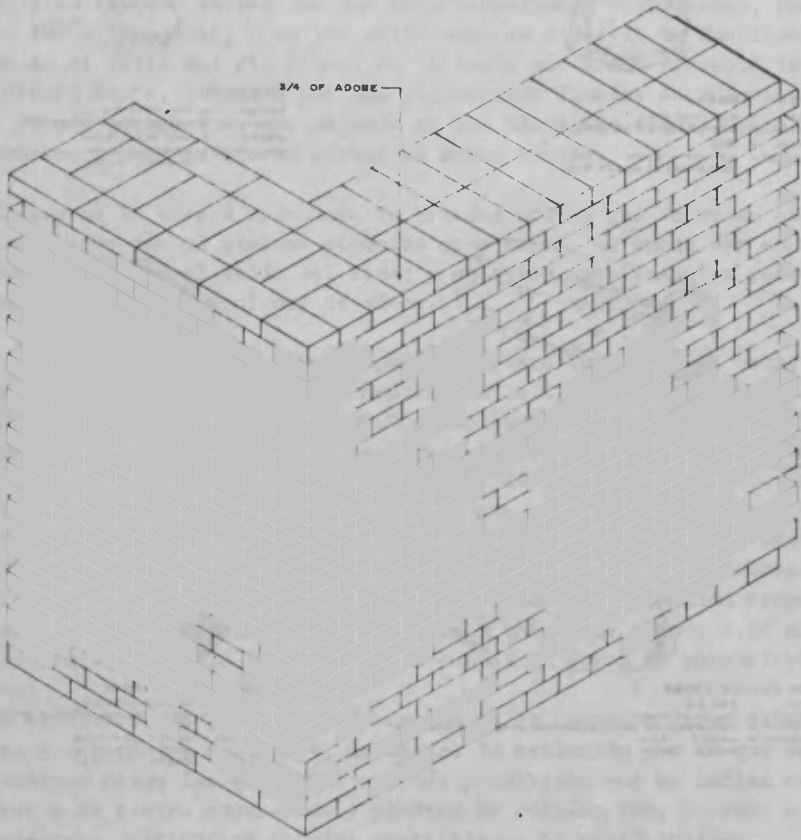

WALL CONSTRUCTED BY TRADITIONAL
IMPROVED METHODS

techos. Los hastiales de forma triangular se hacían también en estos casos con adobes.

En la costa los Incas aceptaron el condicionamiento del clima y edificaron con adobes, usando únicamente piedras rústicas para la cimentación, como en el caso del asentamiento del Tambo Colorado en el valle de Pisco, donde todavía se pueden ver las paredes y nichos trapezoidales pintados de rojo, amarillo y blanco.

Los adobes incaicos usados en la sierra son grandes y alargados con una dimensión que varía entre 45 centímetros y 1.10 metros de longitud, de 10 a 30 centímetros de ancho y entre 6 a 12 centímetros de altura. En la costa son menos largos y de menor altura.

3.- LA CONSTRUCCION CON ADOBES DURANTE EL PERIODO COLONIAL

Con la conquista española producida en 1532 se produce un cambio fundamental en todos los aspectos culturales y tecnológicos que se aplicaron en las colonias, sin embargo el adobe se identifica como un material adecuado a los nuevos usos y requerimientos de los conquistadores. Luego del periodo de luchas internas que sucedió a los primeros años de dominación, se comienzan a construir numerosas iglesias para adoctrinar a los indígenas en la fé católica y casi en su totalidad se hicieron con adobes tanto en la costa como en las poblaciones de los Andes. Aún las catedrales y las iglesias matrices de las ordenes religiosas que llegaron al Virreynato del Perú, se construyeron con adobes. Los sismos y sobre todo la renovación de esas edificaciones para hacerlas más espaciales y más imponentes, fueron los causantes de la desaparición de esos testimonios en gran cantidad de casos.

La arquitectura civil heredera de la tradición andaluza, en la que predominan las casas distribuidas en torno a patios, con uno o dos pisos y la variante de tener techos planos en la costa e inclinados y cubiertos con tejas de arcilla en las zonas andinas; adopta también con facilidad el adobe, que era un material familiar tanto para los colonizadores como para los nativos. La tecnología en la fabricación de los adobes se renueva y estos se hacen agregando estiércol de animales, paja cortada y por lo general se reduce al tamaño de los mismos. En la sierra se usan de 41 a 61 centímetros de longitud, por 19 a 30 centímetros de ancho y entre 10 a 16 centímetros de altura. En la costa las dimensiones son menores.

Durante el período colonial los sismos tan frecuentes en la zona y

sobre todo en la costa, condicionaron los sistemas constructivos y se introdujo la modalidad de la "quincha" consistente en estructuras de madera y caña recubiertas con barro o yeso, para formar arcos, bóvedas y tabiques. La flexibilidad de ese sistema para soportar los efectos de los terremotos y la ausencia de lluvias en la costa, que hacía posible la duración de la madera y la caña, permitió que se generalizará esa forma de construir y en el siglo XVIII se hicieron iglesias con bóvedas de cañon y cúpulas a base de esos materiales, usandolos también en gran escala en los conventos religiosos y en las casas. Por lo general la quincha se combinó con el adobe y en las edificaciones de dos niveles el primero se hacía con adobe, superponiendo el material más ligero encima.

En la zona de la cordillera andina, donde las condiciones de clima no permitían un sistema de esa naturaleza la utilización del adobe posibilitó la construcción de iglesias de grandes proporciones, inclusive con torres de ese mismo material en base a muros de gran espesor y al arriostramiento de ellos con vigas y tirantes del sistema de techos de "par y nudillo", que se difundió con la tradición mudéjar venida de España y afirmó con la difusión del tratado de construcción titulado "Carpintería de lo blanco" de Diego López de Arenas, editado por primera vez en el siglo XVII.

Las construcciones de adobe se continuaron utilizando en el Perú, tanto en la costa como en la sierra durante el período que siguió a la independencia del dominio colonial español. Con la introducción de nuevas expresiones estilísticas acompañando el gusto clásico, las edificaciones adquirieron fisonomía diferente pero el material de construcción no cambió hasta bien avanzado el presente siglo. Aún en la capital de la república el material de construcción usado en casi la totalidad de las viviendas hasta los terremotos producidos en abril de 1939 y mayo de 1940, este último de grado 8.0 en la escala de Mercalli modificada, fué el adobe.

Las estadísticas oficiales sobre el terremoto de 1940 consignaban que fueron casi totalmente destruidas el 38% de las viviendas de quincha y 23% de las de adobe. Esa experiencia y la introducción de sistemas constructivos contemporáneos cambiaron paulatinamente las preferencias en cuanto a materiales de construcción, quedando el adobe circunscrito a la población de menores recursos.

4.- LA INVESTIGACION PARA MEJORAR LA TECNOLOGIA DE LA CONSTRUCCION CON ADOBE

La necesidad de determinar la resistencia de las edificaciones de

adobe ante diferentes intensidades sísmicas y la posibilidad de hacerlas más resistentes, además de susceptibles de ser reparadas - cuando han sido dañadas por terremotos; ha sido en el Perú en los últimos años, el principal objetivo de las investigaciones de Universidades nacionales y extranjeras, Organismos Estatales encargados de la vivienda e inclusive sectores privados como la Asociación de Compañías de Seguros.

En el Ministerio de Vivienda y Construcción, la Oficina de Investigación y Normalización, mediante un convenio con la Carnegie - Mellon University de Pennsylvania USA, ha elaborado un estudio sobre las técnicas de construcción utilizadas en el Perú y las posibilidades de mejorarlas a fin de que duren más y de la tecnología tradicional de construcción con adobe, tapial, piedra y los sistemas introducidos por la colonización española, empleando madera y cañas. Se formularon propuestas para mejorar la calidad usando materiales estabilizantes y sistemas constructivos con refuerzos estructurales.

Todos los estudios realizados han tenido que partir de la sismicidad de áreas determinadas del territorio nacional, que no presenta características homogéneas. El Perú forma parte del Área de influencia del Cinturón Sísmico del Pacífico y recibe la presión de la placa de Nazca que comprime, ocasiona deformaciones y en consecuencia terremotos en la placa continental. Los sismos en la zona tienen por lo general sus epicentros en el Océano Pacífico, llegando en la costa a magnitudes de 6.0 a 7.0 en la escala de Mercalli modificada, mientras que en el interior del país son menos frecuentes y de menor intensidad.

El grado de afectación y daños que pueden sufrir las las edificaciones de adobe depende de la intensidad sísmica a que sean sometidas en función de la magnitud, profundidad focal, distancia epicentral características topográficas y geológicas del suelo. Entre las conclusiones a las cuales han arribado los estudios referidos se puede mencionar que las construcciones de adobe ubicadas sobre suelos rocosos y duros reciben mucho menos daño, que aquellas ubicadas en suelos arcillosos o arenosos, en los cuales las ondas sísmicas sufren ampliación.

En cuanto al comportamiento estructural de los muros de adobe sometidos a acciones sísmicas, las fallas que se presentan se pueden atribuir a la reducida adherencia que existe entre los adobes y el mortero de barro que los aglutina, así como a la poca resistencia de los muros ante esfuerzos de tracción. Las causas y efectos de -

los daños por efectos de sismos se pueden clasificar en los siguientes casos.

- Cuando se presentan pandeos y fisuras verticales, se trata de una falla a la comprensión. La resistencia de un muro de adobe ante la comprensión vertical depende de las características mecánicas del adobe y del mortero de unión. Cabe citar que las experiencias realizadas demuestran^{que} los muros con adobes y mortero estabilizado con asfalto o cemento tienen un 25% más de resistencia a la comprensión. (Fig. 1).
- Cuando se producen fisuras diagonales que en forma escalonada acompañan las juntas entre los adobes, se trata de una falla por esfuerzo cortante producida por las cargas laterales, paralelas al plano del muro que caracterizan a las ondas sísmicas (Fig. 2).
- Cuando la acción de las ondas sísmicas es perpendicular al plano del muro, se producen cargas laterales que ocasionan grietas diagonales desde la parte superior del encuentro de dos muros perpendiculares. También se producen grietas verticales en la parte central de un muro trabajado en sus extremos con otros muros. (Fig. 3).
- En el encuentro de dos muros perpendiculares, las fuerzas laterales que ocasionan los sismos producen una falla por tracción que se caracteriza por la separación de los muros formando una grieta vertical. También se puede presentar una grieta diagonal en la esquina superior del muro, indicando una falla por flexión ocasionada por los esfuerzos perpendiculares a uno de los muros y paralelos al otro. (Fig. 4).

El riesgo que las construcciones de adobe sean dañadas por sismos es bastante grande aumentando cuando la intensidad sísmica sobrepasa el grado 7.0 en la escala de Mercalli modificada y llegando a una destrucción casi total con una intensidad del grado 8.0. Teniendo en cuenta el sub-desarrollo económico del país es imposible, como en muchos otros países situados en zonas sísmicas, erradicar la utilización del adobe en la construcción de viviendas, locales comunales y educativos, por que no existe otro material de bajo costo que pueda reemplazarlo. La alternativa que ha surgido a mediano plazo es la de proporcionar orientación técnica para mejorar la calidad de las construcciones.

El Instituto de Investigación y Acción para la Vivienda, dependiente del Ministerio de Vivienda y Construcción ha preparado y distribuido en los últimos años folletos orientados a la población urbana y rural, que explican en forma gráfica y elemental los métodos de construcción más apropiados para lograr un mejor aprovechamiento y una seguridad adecuada en las construcciones hechas con adobe, incidiendo sobre la mejor forma de ubicar la construcción, de fabricar los adobes y de edificar la vivienda. Se han elaborado en la misma forma recomendaciones técnicas para reparar las construcciones dañadas por movimientos sísmicos, que enseñan cuando debe demolerse un muro afectado, como hacer reparaciones de rajaduras utilizando bastidores de madera con tensores metálicos y otros casos como el refuerzo de dinteles de puertas y ventanas.

Reconociendo que la construcción con adobe tiene una tradición muy antigua y arraigada y que en la mayoría de los casos representa la única alternativa para construir una vivienda, se ha encaminado la investigación a buscar la manera de superar las deficiencias de las construcciones actuales, sobre todo en cuanto a durabilidad y comportamiento ante sismos, mejorando la calidad de los adobes con la adición del 1.5% al 3% de asfalto o una combinación de cemento con asfalto obteniendo el denominado adobe estabilizado, que tiene la propiedad de absorber un mínimo de agua por capilaridad, mejores cualidades aislantes y no ser afectado por los insectos. Para la estabilización de la tierra se puede usar también un componente químico de Calcium-acrylate. En forma general se recomienda el uso de combinaciones que estabilicen la tierra de los adobes y en caso de no poderse contar con asfalto; los suelos arenosos pueden estabilizarse con cemento y los suelos arcillosos con cal. El incremento de resistencia cortante estática que se puede obtener con morteros de unión a base de esos materiales, puede ser del orden de tres veces la obtenida con morteros de barro.

5.- RECOMENDACIONES PARA CONSTRUIR CON ADOBE

La experiencia peruana en el campo de la edificación sobre todo de viviendas con adobe, permite hacer las siguientes recomendaciones generales:

- Que las construcciones de adobe de preferencia se realicen sobre roca o suelos compactos, secos y planos. Se deben evitar los terrenos húmedos o expuestos a inundaciones.
- La cimentación debe tener dimensiones adecuadas para evitar -

- ascentamientos y para aislar al muro de la humedad del suelo.
- Debe hacerse una cuidadosa selección de los materiales para fabricar los adobes y tener en cuenta el procedimiento correcto.
 - En las edificaciones nuevas la forma de la edificación y la disposición de las paredes debe ser proyectada en tal forma que los esfuerzos sean distribuidos uniformemente, para resistir fuerzas laterales en cualquier dirección.
 - A fin de que la estructura se comporte adecuadamente ante sollicitaciones sísmicas se deben buscar diseños simétricos en planta y volumetría. La ubicación y dimensionamiento de los vanos deberá tener en cuenta que la proporción de muros debe ser siempre la que predomine.
 - Se debe contemplar la utilización de contrafuertes o pilares adosados a los encuentros de muros, para tener mayor resistencia en las estructuras de adobe.
 - Finalmente la construcción del techo deberá hacerse evitando sobre cargas y fuerzas horizontales y la construcción debe protegerse con enlucidos, en especial en la parte inferior de los muros.

Aparte de esas precauciones deben reforzarse los puntos críticos como las esquinas de unión de muros, en su parte superior y la parte central de los mismos, donde las tracciones representan una amenaza latente. La colocación de una viga collar dos o tres hiladas debajo de la coronación del muro constituye una buena solución y ésta puede estar hecha de suelo cemento reforzado con cañas, de madera u otros materiales de bajo costo.

En pruebas efectuadas en la Universidad Católica de Lima, se han utilizado alambres de acero uniendo diagonalmente la cimentación y la parte superior de los muros de una vivienda experimental, obteniendo un notable incremento de resistencia ante sollicitaciones estáticas.

6.- LA RESTAURACION DE MONUMENTOS CONSTRUIDOS CON ADOBE.-

En el año 1973 se dió inicio a un Proyecto Especial del Gobierno Peruano y la UNESCO denominado PER-71/539 con el objetivo de estudiar un grupo de monumentos ubicados en una extensión de 500 kilómetros que abarcaba desde el Altiplano y la hoya del Lago Titicaca, próximo de la frontera con Bolivia, hasta el valle cercano -

a la ceja de selva donde se ubica la Ciudad Inca de Machupicchu.- El objetivo era el de preparar los documentos técnicos para inclu- irlos en la formulación de una petición de crédito internacional, para financiar un ambicioso proyecto de desarrollo en función del turismo cultural, conocido como el Plan COPESCO.

En 1975 se dió inicio a las obras de restauración en base a los - estudios preparados anteriormente y que habian permitido que el - Plan COPESCO incorporase el rubro de Restauración de Monumentos - dentro del convenio de préstamo suscrito entre el Gobierno Perua- no y el Banco Interamericano de Desarrollo.

Las obras de restauración emprendidas estaban orientadas a resca- tar del abandono y poner en valor monumentos de época pre-hispáni- ca y colonial. Buena parte de esas edificaciones eran de adobe y los técnicos nacionales secundados por los expertos y consultores de la UNESCO experimentaron los procedimientos y sistemas de con- solidación y restauración más adecuados. En la actualidad muchas de las obras de restauración están concluidas y con el transcurso del tiempo se puede comprobar la bondad de los sistemas utilizados.

Para encarar adecuadamente el problema de conservar los monumentos de adobe de la zona del Proyecto, fué necesario conocer las causas que habían contribuido a su deterioro, entre ellas la acción de - las lluvias y las variaciones de temperaturas, la condensación de la humedad en la superficie, los esfuerzos laterales provocados - por acciones sísmicas, la erosión provocada por el viento y otras causas varias, incluida la acción depredadora del hombre.

La experiencia que existía sobre el adobe estaba circunscrita a - la investigación para mejorar la tecnología de la construcción de viviendas y el Proyecto contó con la colaboración de especialistas que habían participado en esos estudios , los mismos que en for- ma general se han descrito en páginas anteriores.

El tipo de problemas que presenta la restauración de monumentos de adobe no hacian factible un aprovechamiento directo de las experi- encias antes mencionadas. El aumento de resistencia que se puede - obtener con adobes nuevos estabilizados con diversos agregados, no es aplicable por lo general cuando se trata de monumentos de ese - material, por que en lo posible se deben conservar los elementos - originales que componen los paramentos y el agregar en algunas par- tes adobes más resistentes, no proporcionará una estructura homóge- nea ni más resistente.

Con esa premisa se vió que era más importante estudiar los procedimientos constructivos para lograr adobes con técnicas tradicionales, pero con mayor resistencia a la compresión, para reparar con ellos las partes dañadas y colocarlos al lado de los adobes antiguos formando un conjunto homogéneo. La mayor resistencia de los encuentros de los muros, de los dinteles de los vanos o de las cimentaciones, se consideró más conveniente lograr con la adición de llaves de madera, dinteles adicionales o calzaduras de piedra con técnicas adecuadas. Se pensó en todo momento que el objetivo era conservar estructuras existentes, y que no se trataba de reemplazarlas por otras nuevas recién construidas.

Cuando se investigaron los problemas de restauración de los muros de adobe con procedimientos analíticos, se vió que en los materiales antiguos era difícil obtener un rigor numérico comparable con el que se obtiene en materiales modernos. Para superar el problema se consideró que el procedimiento más adecuado era el de determinar la resistencia al colapso que tenía el muro, dividiendo luego entre un factor de seguridad para obtener la resistencia o el esfuerzo admisible. Por ejemplo para diseñar llaves de amarre se analizaron los esfuerzos producidos en los encuentros de muros y para dimensionar dinteles se analizaron los esfuerzos producidos en los vanos.

Los procedimientos de restauración utilizados en los muros de edificaciones construidas con adobe, se pueden reseñar en los siguientes casos:

Calzadura de Cimientos.- Se efectúa para mejorar las características de la cimentación, que puede presentar insuficiencias en cuanto al mortero utilizado para aglutinar las piedras o en el propio dimensionamiento de la base de sustentación. El muro de adobe que se superpone a esa cimentación debe apuntalarse adecuadamente y la operación de calzar las piedras de la base se hace por tramos alternados a fin de evitar asentamientos. Una vez reparados esos tramos se procede a intervenir en los otros tramos y el trabajo se hace por los dos lados del muro.

(Fig. 5)

Calzadura en muros de adobe.- Procedimientos empleados para reemplazar las partes de los muros que presenten deterioro excesivo.

Estando el muro apuntalado convenientemente, se pueden retirar los adobes intemperizados o fracturados, sin afectar a los adobes en buen estado, que se pueden encontrar en las hileras inmediatamente

te superiores. La operación se efectúa con la ayuda de trozos de madera rolliza utilizados como cuñas.

"Costura" de las Fisuras y Lesiones.- Se efectúa en los casos - de lesiones o grietas ver ticales, reemplazando uno a uno los adobes afectados en todo el espesor del muro, siguiendo el trayecto de la grieta. (Fig. 6)

Colocación de Llaves de Amarre.- Se colocan para mejorar la tra- ba en el encuentro de dos muros. Para el cálculo analítico de las dimensiones de las llaves, se - iguala la fuerza actuante con la resistente. En forma general las llaves deben llevar encima el peso de varias hileras de adobes, - para trabajar en forma correcta; por eso se intercalan verticalmen- te cada 1.50 metros. Las llaves adoptaran la forma de una doble - "L" o doble "T" según se trate de un muro de esquina o de dos mu- ros perpendiculares.

Para colocar las llaves en un muro existente, se excavan las ca-- ras del mismo, hasta dejar las piezas de madera en el lugar previs- to y luego se rellenan con un mortero fuerte los espacios entre - los adobes y la madera para lograr el máximo confinamiento.

Una variante de las llaves utilizadas, se obtiene con la utiliza- ción de varillas de hierro ancladas en los extremos en bastidores de madera. Esos tensores metálicos se colocan recubiertos con pin- tura anti-corrosiva y revestidos de un mortero de cemento y arena. (Fig. 7 y Fig. 8)

Refuerzos en los Dinteles de los Vanos.- Tienen como objetivo ha- cer más resistentes los dinteles originales, sin necesidad de reemplazarlos ya que los an- tiguos generalmente presentan maderas trabajadas con azuela, una inclinación o derrame y hasta pintura original que se debe conser- var. El sobre-dintel de refuerzo se calcula suponiendo que actua- sobre él una carga de tipo triangular y una sobre carga que puede ser el peso del techo. Analíticamente se calcula la longitud de - las piezas y el peralte mínimo que deberán tener, considerando - los esfuerzos y las deflexiones en el dintel. (Fig. 9)

Intervenciones Especiales.- Se dan cuando un paramento de adobe- deteriorado en extremo, presenta ele- mentos como estucos o pinturas murales, que es necesario conservar "in situ".

Para estos casos se protegen las superficies del tramo de muro a conservar, con veladuras de papel de arroz o tela de gaza y si -

es necesario se arma un encofrado de madera para evitar la deformación de la hornacina o ventana. Luego se efectúa la calzadura - en torno a ese fragmento, que quedará embebido en un muro de adobes nuevos. Al llevar a cabo esa operación se puede rectificar el plomo del fragmento a conservar, mediante gatas hidráulicas.

(Fig. 1 y Fig. 40)

Comentario sobre algunos ejemplos de obras llevadas a cabo.- En las obras de restauración llevadas a cabo en monumentos de adobe de la zona del Plan, se han aplicado las técnicas descritas en párrafos anteriores y se han presentado muchos casos que demandaban soluciones específicas.

En la restauración del Colegio de San Bernardo, se presentó un problema especial en la iglesia edificada en 1619 sobre los restos de los muros de casas pre-existentes, construidas en el siglo XVI. La iglesia es de planta rectangular muy alargada, midiendo - 6.25 m x 31.80 m. y los muros tienen espesores que varían entre - 1.20 y 1.35 metros, con una altura de 8 metros.

El muro de fachada, que no tenía contrafuertes interiores que contribuyesen a su estabilidad era el que estaba más afectado por el abandono de la iglesia, desprovista de techo y por los efectos de la intemperie durante más de 25 años. Contenía sin embargo, nichos y puertas de la primera construcción del siglo XVI, incorporadas al muro en mención.

Para la restauración se hicieron ensayos y se concluyó que la mejor alternativa de solución a fin de darle estabilidad no solo a ese muro sino también al otro paralelo, sin deformar el conjunto con la adición de contrafuertes, era la incorporación de cuatro pares de columnas de concreto armado empotradas en sus extremos inferiores en vigas de cimentación. Se tuvo en cuenta en forma muy especial que las experiencias llevadas a cabo en diversos lugares en los que se juntó el adobe con el concreto armado, habían dado malos resultados, esto se solucionó con el uso de columnas de forma rectangular en los lados paralelos a las caras del muro y con los otros dos lados ochavados, vaciadas en un espacio cortado en los muros y revestido con yeso, el que a su vez fué revestido con aceite fino. Ese diseño especial hace que el concreto armado no trabaje en acción estática y actúe únicamente en caso de esfuerzos laterales de tipo sísmico, sujetando a la masa de adobe sin golpearla y sin producir concentración de esfuerzos. En toda la altura de la iglesia se introdujeron 5 filas de llaves de madera equidistantes, que sujetan el muro de adobe a las columnas de concreto.

La solución expuesta permitió que en ese recinto de uso público se aumentara la resistencia a los efectos sísmicos.

En otro ejemplo de intervención llevada a cabo en una casa del siglo XVII adquirida por el Banco Central Hipotecario en Cusco, la existencia de importantes pinturas murales, únicas en su género, impedía intervenciones habituales para reparar las deformaciones de uno de los lados de la planta alta. Para solucionar el problema se aprovechó la existencia de dos tabiques delgados de madera y caña, que atravesaban transversalmente ese ambiente y aunque estaban coronados por un hastial pintado, se utilizaron para armar allí estructuras de madera a manera de diafragmas, que sujetan los muros de adobe perpendiculares.

Para sujetar mejor los muros deformados se colocaron vigas de concreto armado en la parte superior de estos, además para dar peso al coronamiento de los muros y obtener mejor comportamiento en casos de movimientos sísmicos.

En el antiguo Hospital de los Betlemitas de la Almudena, construido en el siglo XVIII se aplicaron también algunas soluciones específicas para resolver los problemas que presentaban los muros de adobe. Se enderezó un largo tramo de muro en segundo nivel, retirando y reemplazando los adobes que estaban en la parte inferior, en más de tres metros de altura. Se aprovechó la intervención para enderezar el muro, usando palancas y tracción mecánica para luego trabarlo en forma adecuada a las partes nuevas.

Su conservación era necesaria por la presencia de pinturas murales en el interior. Cabe destacar que la recuperación de la pintura mural con técnicas de desprendimiento actuales, hubiera tenido un costo más elevado que la operación de calzadura y enderezamiento.

Otra solución adoptada en este monumento, consistió en la colocación de una viga collar de dos piezas paralelas de madera de 6 pulgadas, en la parte superior de uno de los lados del primer claustro, a fin de contrarrestar el empuje del techo en los muros, que presentaban inclinaciones hacia el exterior. Esa doble viga constituida por piezas trasladadas aseguradas con abrazaderas de hierro se aseguró al núcleo del muro con anclajes verticales del mismo material.

En la iglesia de Canincunca, edificada en el siglo XVII y cubierta íntegramente de pinturas murales, el muro lateral de la nave con un ancho de 1.10 m., 6 m. de altura y una longitud de 21 m. presentaba una fuerte inclinación hacia el exterior, que había sido conjurada en épocas pasadas con contrafuertes adosados y después con otro muro de adobe adicional. El peso de ese muro y su

cimentación insuficiente estaban produciendo un movimiento de rotación que era necesario detener.

Para solucionar el problema sin afectar la pintura mural, se retiró el muro agregado, se reforzó la cimentación y se repusieron los contrafuertes antiguos cuyas evidencias se hallaron al retirar el muro adosado.

De acuerdo con el cálculo estructural se agregaron dos contrafuertes nuevos y se logró un adecuado arriostramiento lateral del muro inclinado y una correcta distribución de los esfuerzos de flexión, para un posible empuje de cargas laterales en caso de sismo.

Para proporcionar mayor resistencia se colocaron llaves de madera en las esquinas de encuentro con una de las torres y el muro perpendicular del abside de la iglesia. Para no tocar la madera policromada del techo de par y nudillo, se agregó una nueva estructura de madera por encima y se absorbieron los empujes laterales mediante una viga colocada a manera de anillo perimétrico, agregando además cuatro tensores metálicos, por encima de los tirantes de madera, también pintados, que atravesaban la nave como parte de la solución del techo original.

Las soluciones espuestas en forma resumida en las páginas anteriores, demuestran la plena factibilidad de restaurar adecuadamente las estructuras de adobe, aún en los casos más complejos.

La conservación del adobe en los sitios arqueológicos. - En el valle de Yucay cercano a Cusco, se llevó a cabo una experiencia interesante de conservación con productos químicos utilizados en otros lugares, pero por primera vez en las condiciones climáticas de la zona andina.

El monumento escogido fué un recinto de probable uso ceremonial de la época conocida como de transición, es decir construido por los incas en los años inmediatos a la conquista española (1532) - Presentaba un proceso avanzado de deterioro, porque había sido reutilizado como capilla cristiana y después como local industrial, construyendo un horno para cocción de objetos de cerámica. Durante el largo período que el monumento estuvo sin cubierta, la lluvia intensa que se presenta durante cuatro meses al año, hizo sentir su acción degradante y la alternancia de períodos secos y de lluvia originó en los muros de adobe una costra externa por la migración de sustancias disueltas en el interior de los mismos y transportadas al exterior por el agua. Las partes superiores de los muros eran las más afectadas por que el adobe se había disgre

gado por efecto de los factores atmosféricos.

Otro factor de deterioro estuvo constituido por perforaciones que habían hecho los insectos, una variedad de moscardones, para anidar en los muros de adobe. La consolidación de esos orificios se hizo eliminando el polvo y los restos de larvas que había en el interior de cada uno de ellos y se rellenaron con arcilla mezclada con mowilith DMH-1 al 2% y paja cortada. Antes de rellenar cada orificio se aplicó pentaclorofenol muy diluido.

Para la consolidación del adobe se hizo un tratamiento químico superficial con una mezcla 1 a 1 de silicato de etilo y alcohol etílico industrial al 96%, con el agregado de 1% de ácido clorhídrico, como catalizador de la reacción de polimerización. El proceso de aplicación de esa mezcla inflamable y tóxica se hizo con una bomba de aspersión empleando en promedio un litro de silicato por cada metro cuadrado de muro.

Para consolidar estructuralmente los muros se hicieron los trabajos habituales de calzaduras y se agregaron varias hiladas de adobes nuevos colocados en un plano ligeramente posterior al de los adobes antiguos, para acentuar la diferencia del material nuevo. Una vez niveladas las alturas de los muros se hizo una cubierta de madera y paja, sobresaliendo medio metro a cada lado de las caras de los muros para protegerlos, sin necesidad de reconstruir el techo original del recinto.

En este monumento existen hornacinas con restos de pintura mural policromada, representando rostros de incas con sus prendas características cubriendo la cabeza, que fueron consolidados y fijados luego de la limpieza necesaria.

Esa experiencia con silicato no se ha repetido, pese a los buenos resultados obtenidos, por que el alcohol etílico tiene un costo muy elevado y el silicato de etilo debe importarse mediante pedido especial. En la huaca Garagay conjunto ceremonial de época Chavin que data de 1000 años antes de Cristo, ubicada en las inmediaciones de Lima y en el conjunto arqueológico de Chan-Chan en el norte del Perú, también se ha experimentado el silicato de etilo. Observando esos tres casos se puede afirmar que da buenos resultados en los muros de adobe y en los frisos decorativos en relieve que no tienen pintura. La superficie se endurece y deja de desprender polvo.

Los problemas que deben tenerse en cuenta, consisten en evitar u-

na sobre saturación de las superficies tratadas por que se impermeabilizan impidiendo un tratamiento posterior. Un adecuado control de las proporciones y mezclas puede ser suficiente para el caso, debe tenerse en cuenta también que la aplicación del silicato produce un cambio de color en los adobes, dando un tono ligeramente oscuro.

Para el caso de pinturas sobre adobe ha sido más adecuada la aplicación de productos como el Primal, Mowilith, Paraloid y Calaton, que se han experimentado antes con éxito en las pinturas al fresco. El silicato de etilo altera el color de las pinturas, aunque un tratamiento muy cuidadoso evitando el exceso de ácido clorhídrico en la mezcla, puede evitar el cambio de color.

REFERENCIAS BIBLIOGRAFICAS :

- 1.- Asociación de Aseguradores del Perú:
"Comportamiento de las construcciones de adobe ante movimientos sísmicos" Lima 1972.
- 2.- Bueno Mendoza, Alberto:
"Materiales para el estudio de la arquitectura arqueológica"
Editorial Universo, Lima 1977.
- 3.- Carnegie - Mellon University - Pennsylvania, USA:
"Indigenous building Techniques of Perú and their potential
for improvement to better withstand earthquakes" 1980.
- 4.- Concha Bustamante, Oscar:
"Diseño sismo-resistente de muros de adobe" Tesis Universidad Nacional de Ingeniería, Lima.
- 5.- Chiari, Giacomo:
"Informes de Consultor UNESCO para el Proyecto PER 71/539 - Cusco".
- 6.- De Sutter, Patrick:
"Ensayo de materiales y métodos constructivos para la restauración en la Región Andina" Proyecto PER 71/539 INC-UNESCO, Cusco 1978.
- 7.- De Mesa Figueroa, José:
"Un progetto per la valorizzazione dei siti archeologici: - il Piano COPESCO" Enciclopedia Scienza - Tecnica Mondadori, Italia 1975.
- 8.- Samanez Argumedo, Roberto:
"Appropriate Technology and the conservation of adobe" UNESCO - Paris 1980 (en prensa).

"Los sismos y la conservación de los monumentos en la zona-Andina del Perú", Seminario sobre protección de monumentos-en áreas sísmicas, La Antigua - Guatemala, noviembre 1979 - UNESCO/ICOMOS.
- 9.- Sovero Molero, Guillermo:
"Elaboración y aspectos estructurales de las construcciones de adobe" II Forum Regional de vivienda - Cusco Perú, noviembre 1979.
- 10.- Sovero Guillermo y Menendes Juan:

"Informe sobre consolidación estructural de la iglesia de Ca
nincunca" INC-Cusco 1979.

11.- Yamashiro, Ricardo:

"Informes de Consultor UNESCO para el Proyecto PER 71/539 -
Cusco".

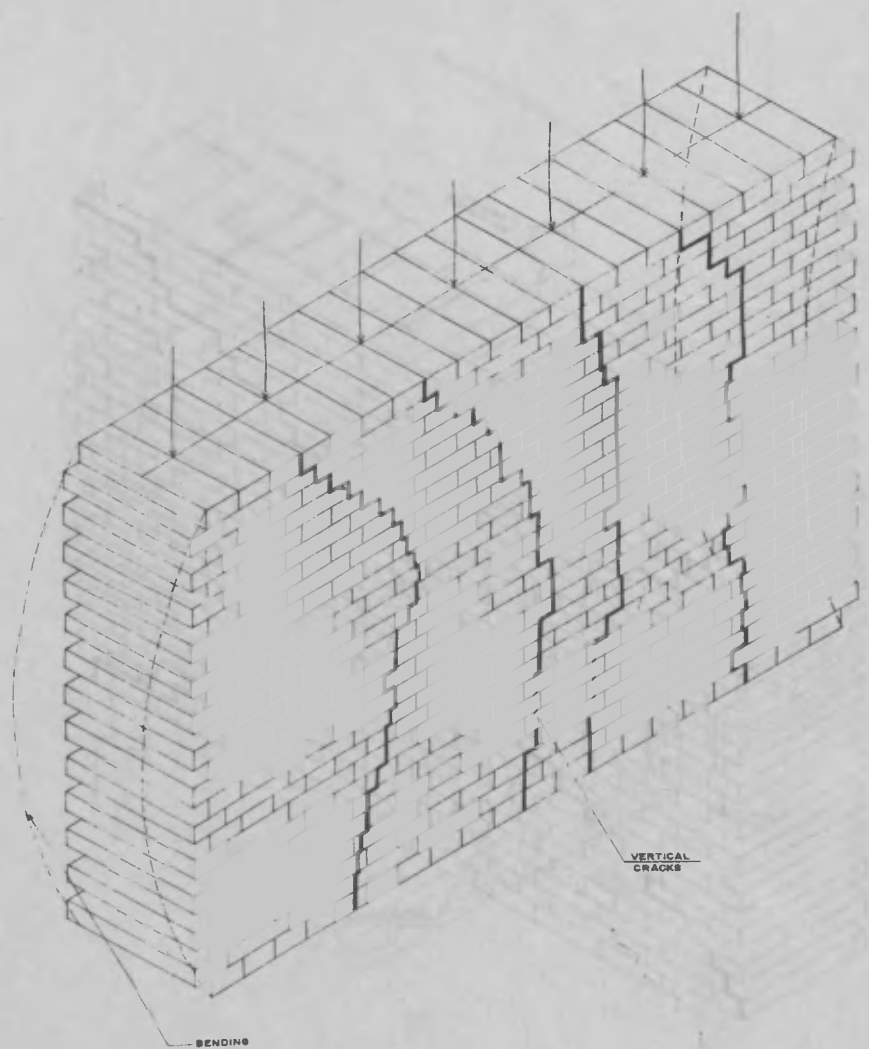

FIGURE 1

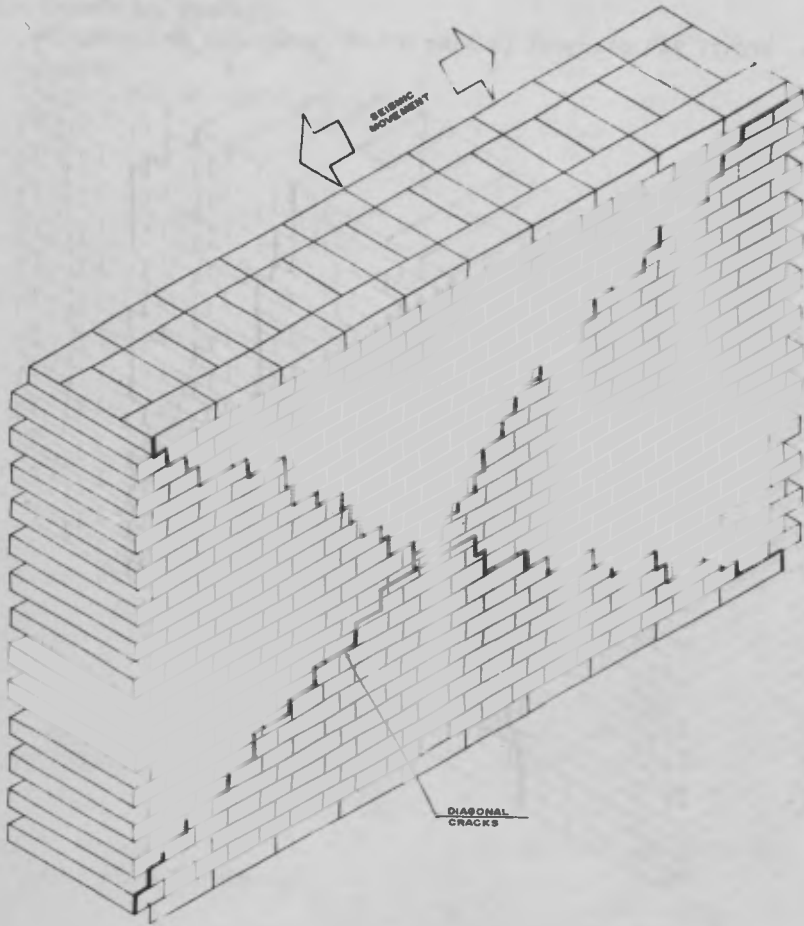

FIGURE 2

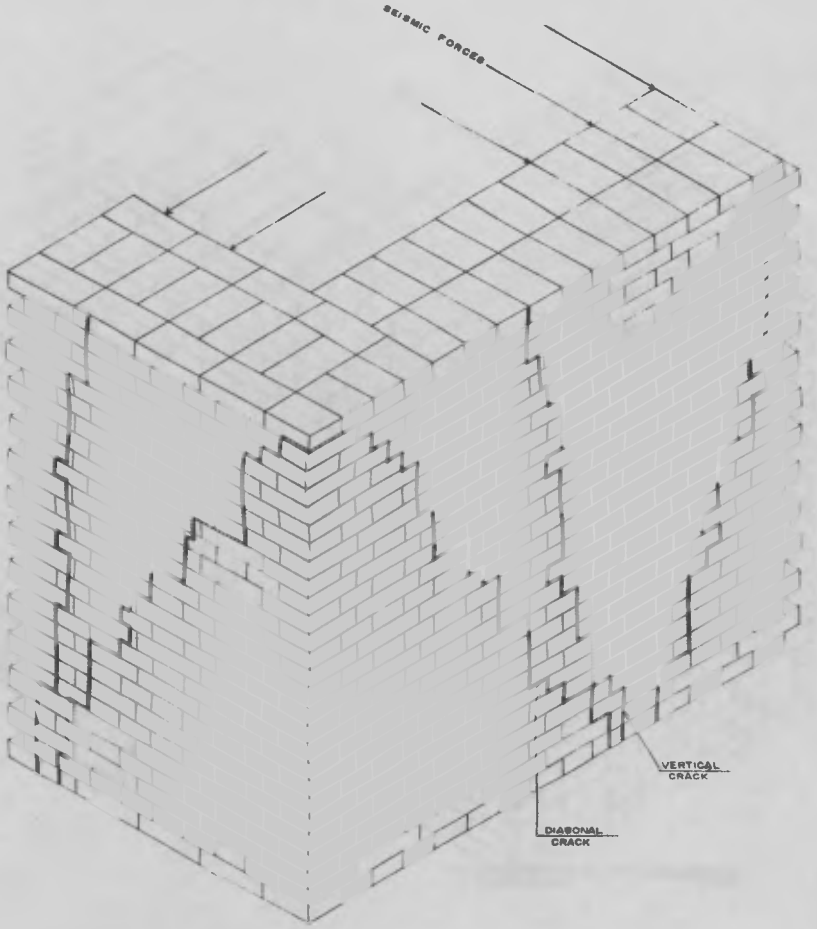

FIGURE 3

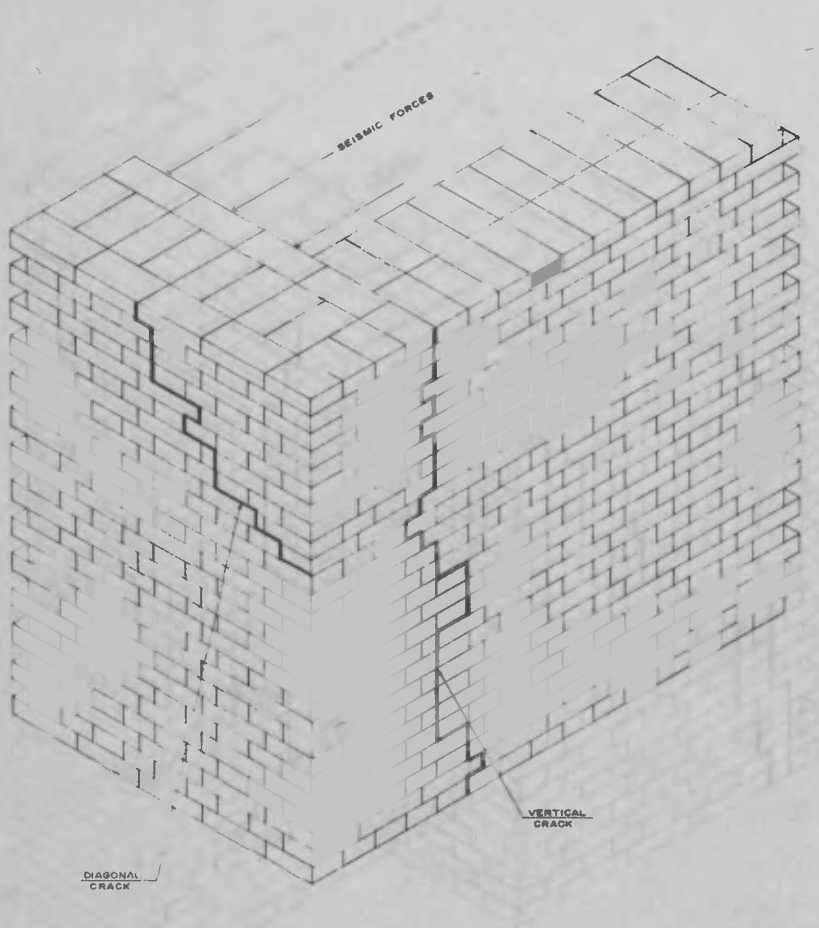
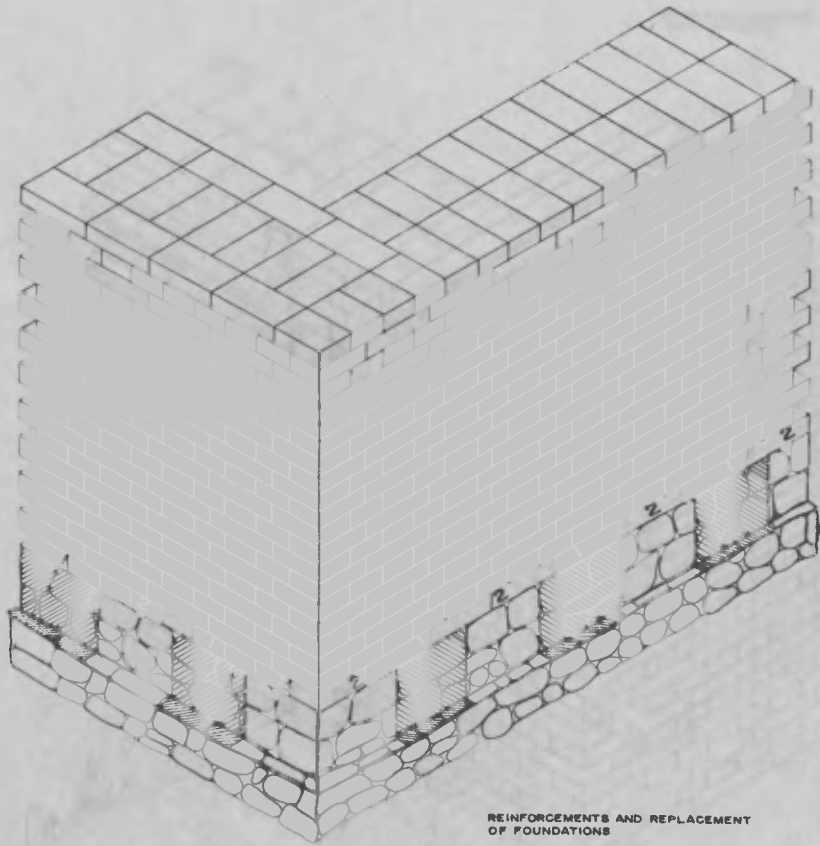

FIGURE 4



REINFORCEMENTS AND REPLACEMENT OF FOUNDATIONS

FIGURE 5

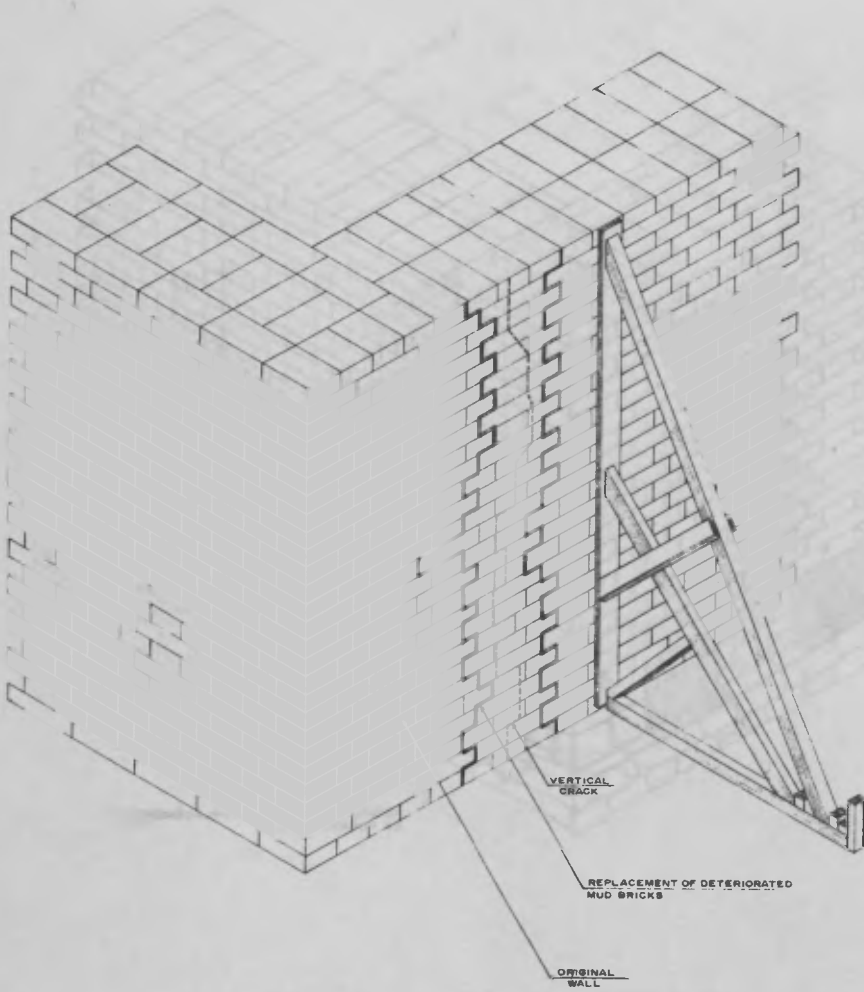

FIGURE 6

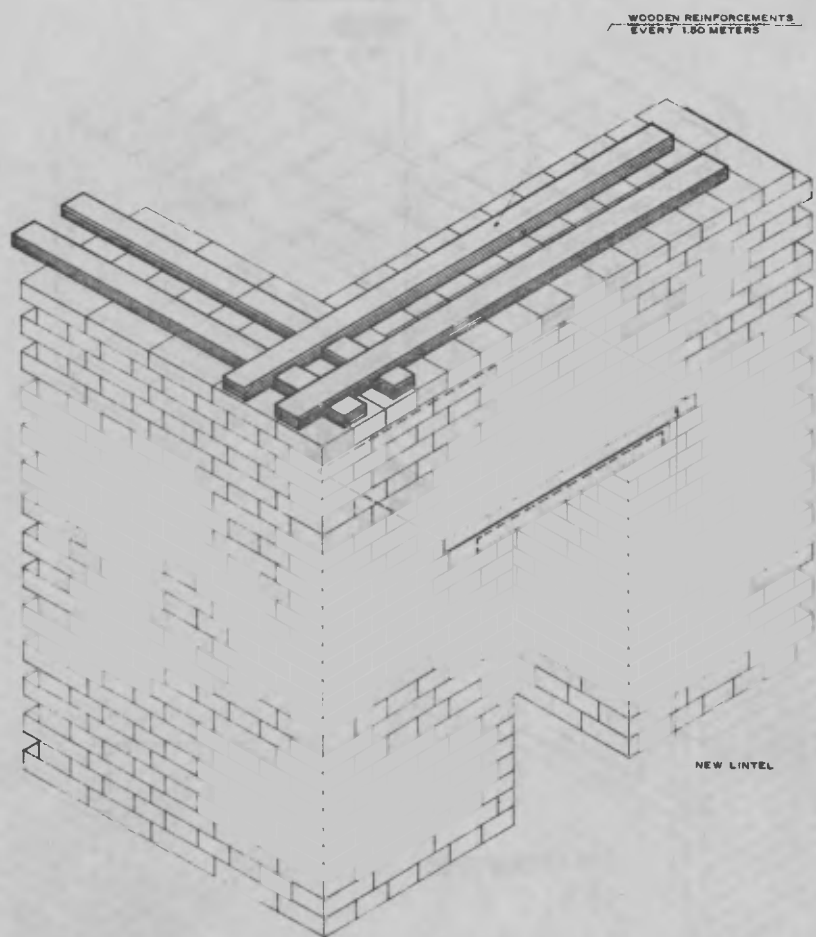

FIGURE 7

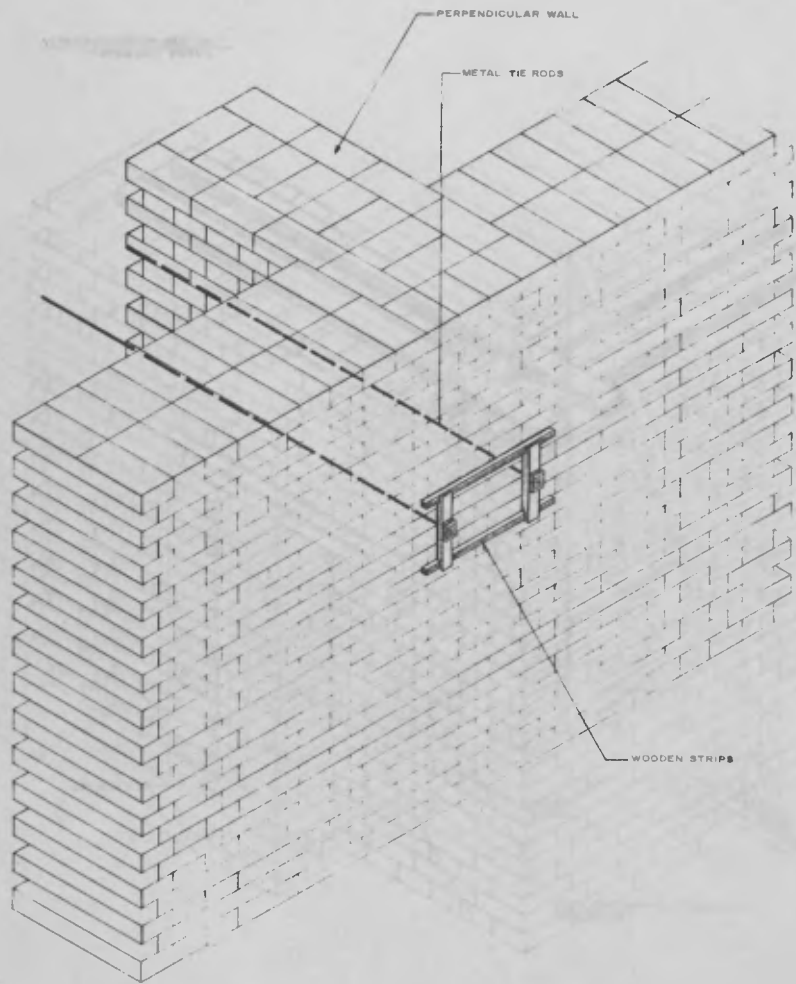

FIGURE 8

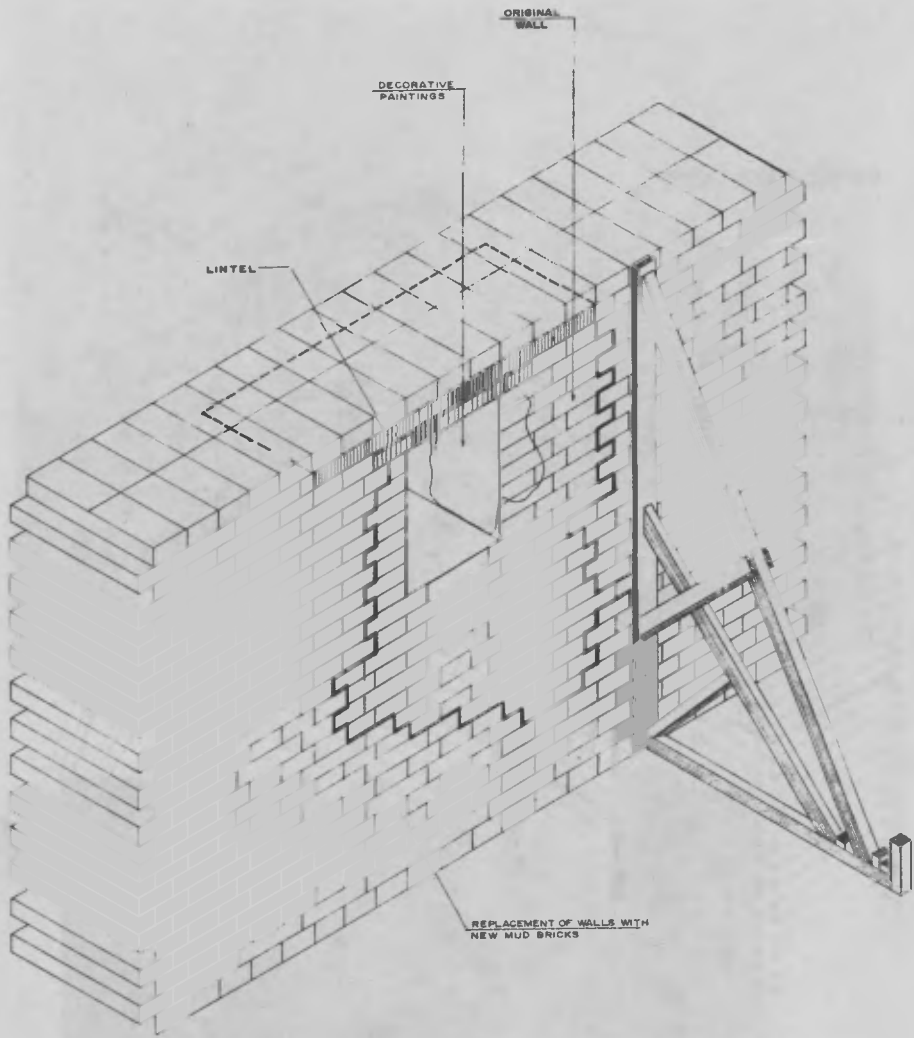

FIGURE 9

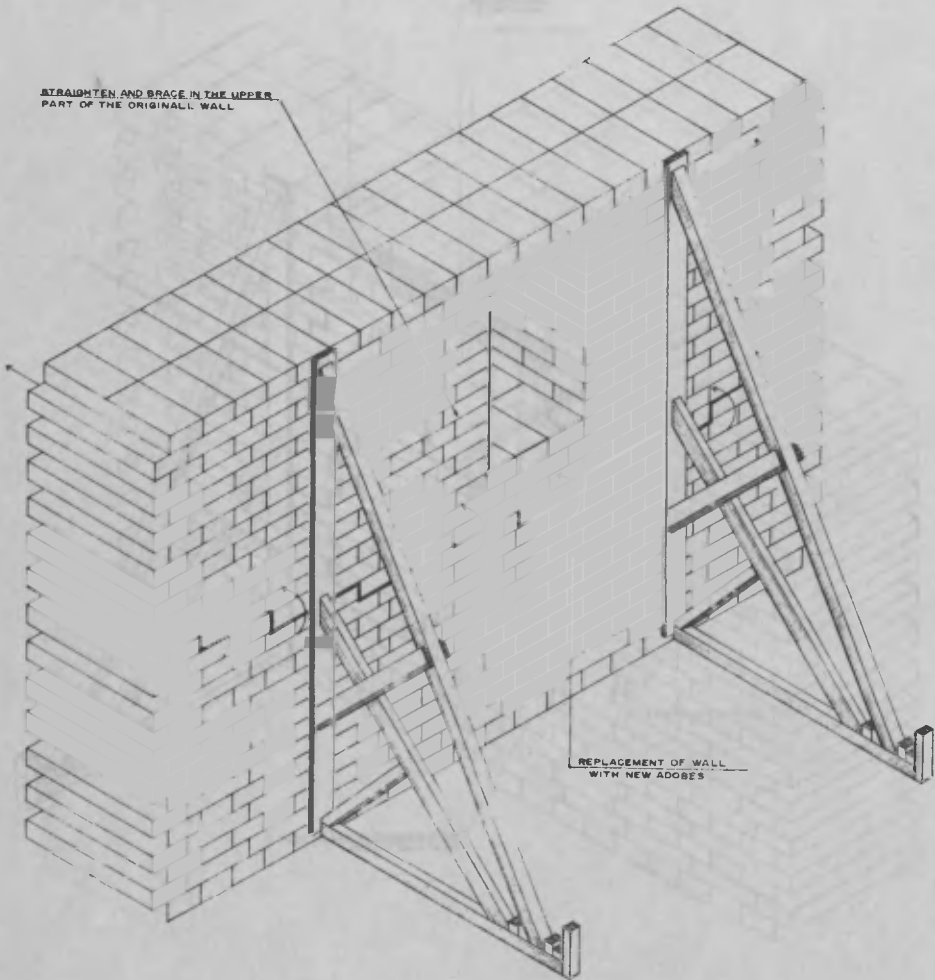
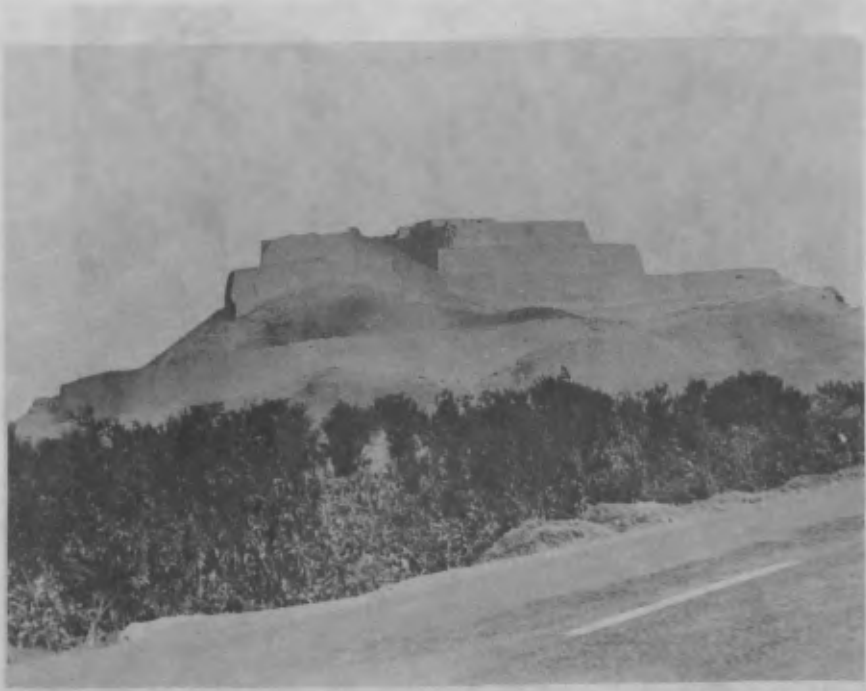

FIGURE 10











RELACION DE FOTOGRAFÍAS QUE ACOMPAÑAN AL TEXTO PRESENTADO

(Nota: Se han armado en forma provisional para permitir una com
paginación más adecuada al traducir el texto.)

Fotografía 1.- Fortaleza de Paramonga construida de adobes en el siglo XV, al inicio del dominio de los Incas sobre el antiguo reino Chimú.

Fotografía 2.- Conjunto arqueológico de Tambo Colorado, representativo de la arquitectura Inca edificada con adobes en la costa.

Fotografía 3.- Palacio de Sayri Tupac ubicado en el Valle de Yucay, cerca de Cusco. Edificación de adobes sobre base de piedra correspondiente al período de transición Inca - Colonial (Siglo XVI).

Fotografía 4.- Casa del Almirante Alderete Maldonado en la Ciudad de Cusco, construida en 1580 utilizando pie
dra y adobe. Se restauró entre los años 1975 - 1978.

Fotografía 5.- Calzadura de muros de piedra que sustentan adobes, utilizando cuadrículas para ubicar el lugar exacto de las piezas.

Fotografía 6.- Calzadura de un muro reemplazando la cimentación y primeras hileras de adobes deteriorados, para conservar la parte superior del muro de ese mismo material.

Fotografía 7.- Intervención especial en el abside de la iglesia de San Bernardo en Cusco, para conservar "in situ" testimonios importantes, que formaban parte de un muro muy deteriorado por el abandono y la intemperie.

Fotografía 8.- Intervención especial en el antiguo Hospital de los Betlemitas de la Almudena en Cusco, para calzar y eliminar la inclinación de un muro con pinturas murales en su cara interior.

ADOBE BIBLIOGRAPHY

ALEJANDRO ALVA (*)

GIORGIO TORRACCA (**)

MARIE CHRISTINE UGINET (***)

SUMMARY

A bibliography of publications and reports on adobe collected by the ICCROM's Library. Documents are arranged following the accession number of the Library (due to lack of space, only two documents are presented here). Author, title and bilingual subject indexes with document reference numbers under each heading are included. Copies of the complete bibliography are available, on request, at the ICCROM's Library (at reproduction cost).

(*) Assistant Co-ordinator, Architectural Conservation Course, ICCROM

(**) Deputy Director, ICCROM

(***) Librarian, ICCROM

July 1980

800710

DOCUMENT NUMBER: 00968800

MISS. PEROU 1975/2

CHIARI, GIACOMO

CONSERVACION DE MONUMENTOS ARQUEOLOGICOS EN
 ADOBE. INFORME DE FIN DE MISION. CONSERVATION
 OF ARCHAEOLOGICAL BUILDING IN ADOBE. FINAL
 REPORT OF MISSION.
 UNESCO, PARIS, 1975, 21, ILL., 30 CM..
 FMR/SHC/DPS/243 (UNDP).

ABSTRACT

THE CAUSES OF ALTERATION AND THE CONSERVATION TREATMENTS
 OF ADOBE RUINS IN PERU ARE REVIEWED. PRESENTATION OF
 INTERVENTION PLANS FOR DIFFERENT SITES: HUACA GARAGAY,
 TANBO COLORADO, LA CENTINELA, SECHIN, CHANCHAN, HUACA EL
 DRAGON, HUACA LA ESMERALDA, SAYRI TUPAC, SAN PEDRO DE
 RACCHE, OLLANTAITAMBO.

CLASSIFICATION

REPORT, MISSION
 RAPPORT, MISSION
 ARCHAEOLOGY, EXCAVATION
 ARCHEOLOGIE, FOUILLE
 ARCHAEOLOGY, SITE CONSERVATION
 ARCHEOLOGIE, SITE CONSERVATION
 ADOBE, BUILDING
 ADOBE, BATIMENT
 ADOBE, CONSERVATION
 ADOBE, CONSERVATION
 ADOBE, RUIN
 ADOBE, RUINE
 ADOBE, TOWN
 ADOBE, VILLE
 ADOBE, CONSERVATION SOIL CEMENT
 ADOBE, CONSERVATION SOL CIMENT

STAND-BY KEYWORDS

ADOBE, CONSERVATION CAPPING

REGION, NATION, PLACE(OBJECT)

SOUTH AMERICA, PERU

MATERIAL(USED OR TESTED)

ETHYL SILICATE; PRIMAL; MOWILITH; PARALOID; CALATON

DESTINATION

ICCR0M78

800710

DOCUMENT NUMBER: 02138700

XIX G 15

CLIFTON, JAMES R. - *DAVIS*, FRANKIE L.

MECHANICAL PROPERTIES OF ADOBE..
WASHINGTON, NATIONAL BUREAU OF STANDARDS,
1979, V + 39, ILL., 28 CM.
(NATIONAL BUREAU OF STANDARDS TECHNICAL NOTE
N. 996)

ABSTRACT

SAMPLES OF SOIL OR MASONRY WERE COLLECTED FROM TWO SITES AND MORTARS WERE MADE OF THEM IN ORDER TO CAST TEST SPECIMENS FOR COMPRESSIVE AND FLEXURAL STRENGTH, MOISTURE CONTENT. STRENGTH INCREASES WITH AGEING AT ROOM TEMPERATURE AND DECREASES WITH MOISTURE CONTENT. WATER CONTENT INCREASES WITH RELATIVE HUMIDITY OF AIR. STRENGTH IS PROGRESSIVELY REDUCED BY WET-DRY CYCLES. CREEP WAS EVALUATED UNDER DRY AND WET CONDITIONS. THE SOILTEST PENETROMETER WAS MODIFIED FOR MEASUREMENT OF PENETRATION RESISTANCE OF MUD BRICK.

CLASSIFICATION

ADOBE, BUILDING MATERIAL
ADOBE, MATERIAU BATIMENT
ADOBE, STUDY TEST
ADOBE, EXAMEN ESSAI

REGION, NATION, PLACE(OBJECT)

NORTH AMERICA, UNITED STATES, TUMACACORI
NORTH AMERICA, UNITED STATES, ESCALANTE

DESTINATION

ICCR0M79

DES PREUVES SUR LA BRIQUE CRUE TRADITIONNELLE ET
STABILISE AVEC ASFALTE APPLIQUE DANS LA RESTAURATION
DES MONUMENTS DANS LES ANDES EN AMERIQUE DU SUD (PEROU).

PATRICK DE SUTTER

summary

CHAPITRE I: FABRICATION DE LA BRIQUE CRUE TRADITIONNELLE(T)
ET STABILISEE AVEC ASFALTE(AP-A)..

CHAPITRE II: LA GRANULOMETRIE DU SOL CHOISI.

CHAPITRE III: DES PREUVES DES SELS.

CHAPITRE IV: DES PREUVES D'IMMERSION DANS L'EAU.

CHAPITRE V: DES PREUVES DE COMPRESSION PAS CONFINÉES.

A) INTRODUCTION.

B) DES PREUVES DES BRIQUES CRUES TRADITIONNELLES (T).

C) DES PREUVES DES BRIQUES CRUES STABILISEES
D'ASFALTE AVEC DE LA PAILLE (AP).

D) DES PREUVES DES BRIQUES CRUES STABILISEES
D'ASFALTE SANS PAILLE(A).

CHAPITRE VI: TABLEAU GENERAL ET CONCLUSIONS.

CHAPITRE I: FABRICATION DE LA BRIQUE CRUE TRADITIONNELLE(T) ET STABILISEES AVEC
 ----- D'ASFALTE(AP-A). -----

- a)- *Définition de la Brique Crue Traditionnelle: On dit la Brique crue, aux éléments du sol naturel cru, tenant en plus du sable et quelques parties d'argile ou du chaux(etc.), mélangé avec de l'eau pour les former en moules avec des diverses dimensions.*
- *Définition de la Brique Crue Stabilisée d'Asphalte: C'est la Brique Crue Traditionnelle commune ou ont a augmenté une petite quantité d'asphalte froid RC-20 RC-250 ou autre matériel, dans une pourcentage qui varie du type du sol ou ambiance climatologique.*
- b)- *Conditions de la Brique Crue y Stabilisée d'asphalte: Les meilleurs sols tiennent entre 60% à 68% du sable et entre 25% à 30% de limon et entre 7% à 10% d'argile. Le pourcentage d'argile ne peut pas être moyen que 15%. Le sol ne peut pas tenir des éléments organiques, ni des sels dans un pourcentage majeur que 0,3%.*
- c)- *La module de rupture pour les briques crues traditionnelles doivent tenir une résistance à la compression de 10 à 15 kg/cm² minimum, à la flexion de 3,5 kg/cm² et une absorption moins que 27% de son poids en sept jours depuis sa fabrication et une humidité moins que 4%.*
- *Pour les briques crues stabilisées d'asphalte, ils doivent tenir une résistance à la compression au moins de 16 à 20 kg/cm² et tout le reste est la même chose que la brique crue traditionnelle.*
- d)- *La fabrication de la brique crue traditionnelle:*
 On prend un sol comme indiqué dans b et on mélange avec de l'eau pur.
 On laisse passer la terre ~~par~~ par une maille assez fine pour le mélanger avec de l'eau qui forme ensuite une boue. On piltine et on secoue toute une journée pour laisser ensuite se reposer une nuit. Le jour suivant on ajoute de la paille de 30 cms de longueur et on secoue et piltine de nouveau toute une journée et on laisse une nuit. Au même temps on trempe les moules

dans l'eau pendant 24 heures. Sur le terrain on met une cope fine du sable pour éviter une possible diminution de la brique crue. Prèsque après trois jours on commence la fabrication de la brique crue. On met le mélange préparé dans une moule encore très mouillé et on pisant assez régulièrement, une fois fait, on termine avec un règle pour niveler la surface. Avant de quitter la moule on pose sur la surface de la brique crue de la paille coupée de 10cm qui ont essayé à dissimuler dans l'ensemble. Tout cela sert à éviter des possibles rayures de la brique crue pour les différences de températures entre jour et nuit. Après cette opération on peut sortir la moule et on laisse sécher au soleil. Après cinq jours on tourne la brique crue sur son côté horizontal. Après quinze jours on tourne la brique crue sur son côté vertical. On laisse sécher pour trente jours minimum au soleil, on ensuite les mettre sous toit ventilé prêt pour se utilisation.

- Pour la brique crue stabilisée d'asphalte on met 2% à 5% d'asphalte froid avec une mélange de terre et de l'eau (boue), pourcentage calculé de l'asphalte sur le poids de la terre en sec. Le reste est la même fabrication.

e)- Avantage de la Brique Crue Stabilisée d'asphalte:

Prèsque imperméable à l'eau.

Ils ont une bonne résistance à l'érosion et compression.

Ils n'ont pas besoin des revêtements, no peinture.

Ils ont des très bonnes qualités comme isolants.

CHAPITRE II: LA GRANULOMETRIE DU SOL CHOISI.

Le matériel tient des caractéristiques suivant: La terre récupérée avec des particules de plâtre, de paille et des petites parties d'argile fines (céramique), d'une couleur brune obscure.

Pourcentage accumulé qui passe la maille:

Maille	%
=====	===
3/8"	100
1/4"	97,9
nr. 4	96,5
nr. 10	91,9
nr. 20	86,3
nr. 30	84,2
nr. 40	81,5
nr. 60	76,5
nr. 100	69,8
nr. 200	61,3

Analise grafique tamisee (voir grafique page 6).

ANALISIS GRANULOMETRICO POR TAMIZADO

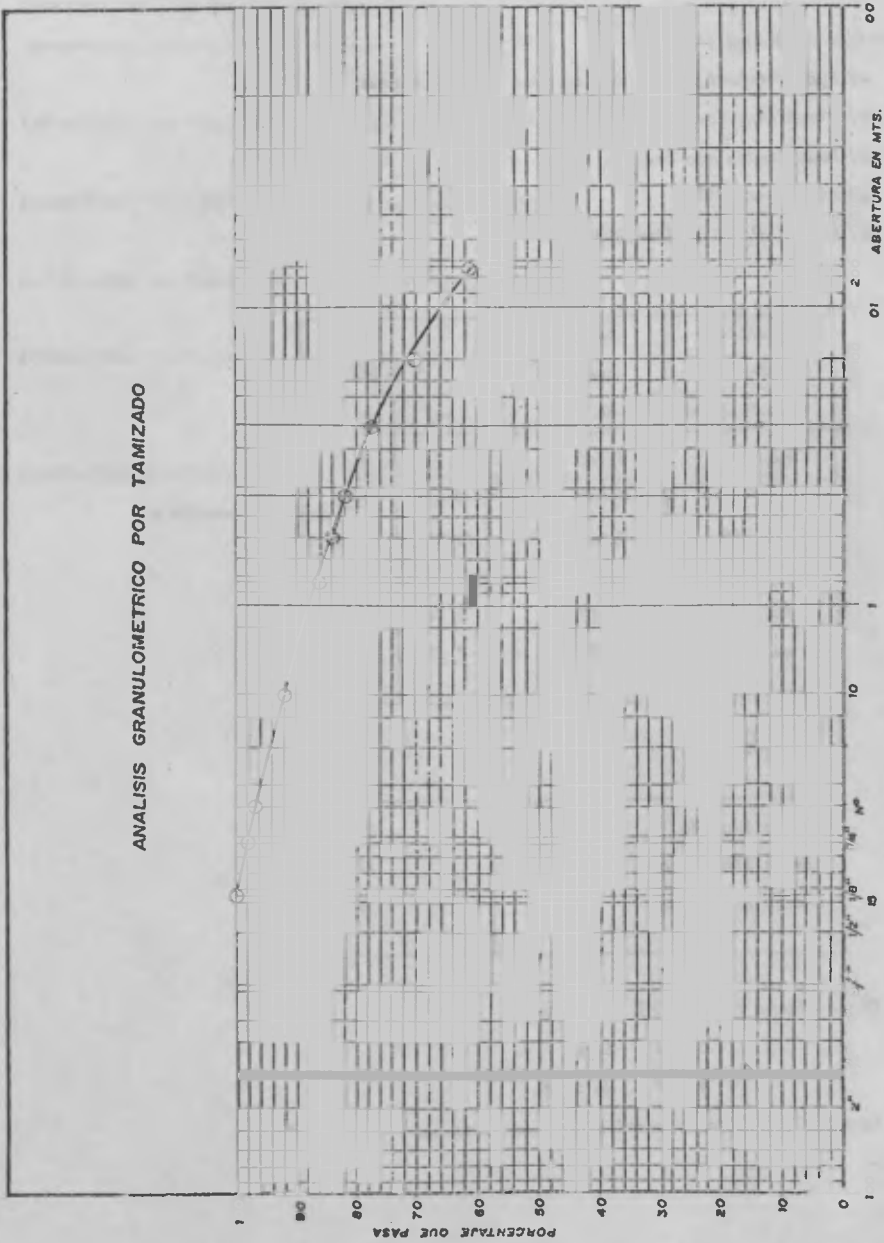

Analyse mécanique tamisée:

a) Type d'échantillon: matériel pour la brique crue

b) Provenance: Couvent Sto, Domingo-Cuzco

c) Pour: Etudes des briques crues

d) Date: Avril 1976

e) Numéro d'échantillon: 2021

maille série américain	ouverture carré en mm	% Poids	
		ref	posse
nr. 4	4,760	3,72	96,5
nr. 10	2,000	4,93	91,3
nr. 40	0,426	10,04	81,5
nr. 60	0,177	6,04	76,5
nr. 100	0,149	9,94	69,8
nr. 200	0,074	7,35	61,3
Posse nr. 200			57,98
Limite liquide			24,0
Limite plastique			17,65
Indice plastique			6,35

Observations : 6,00 % d'argile

51,96 % Linon

42,02 % du Sable

Texture : Franchement Limoneuse Sableuse.

CHAPITRE III: DES PREUVES DES SELS.

Echantillon nr 1: pigments de carbone (c)

Echantillon nr 2: chlorures à la superficie de 0,01%

Echantillon nr 3: présence de quelques sulfates

Echantillon nr 4: matières organiques comme de la paille

Conclusion: Ce sol tient les capacités, parce que le pourcentage du sel n'est pas majeur que 0,3%.

CHAPITRE IV: DES PREUVES D'IMMERSION DANS L'EAU.

A) Les côtes(T) ne résistent pas. Après quelques minutes tout se dissout.

B) Les côtes(A) résistent dans l'eau, pendant sept jours est la preuve.

- Cube nr11: poids avant le procès	= 1,660 kg
poids après 7 jours	= 1,860 kg
% en surplus de poids	= 11,2%
- Cube nr4: poids avant le procès	= 1,640 kg
poids après 7 jours	= 1,830 kg
% en surplus de poids	= 11,1%
- Cube nr7: poids avant le procès	= 1,670 kg
poids après 7 jours	= 1,850 kg
% en surplus de poids	= 11,07%
- Cube nr2: poids avant le procès	= 1,680 kg
poids après 7 jours	= 1,880 kg
% en surplus de poids	= 11,1%
- Moyenne en % = 11,11%	

C) Les côtes(AP) restent dans l'eau pendant sept jours

- Cube nr1: poids avant le procès	= 1,630 kg
poids après le procès	= 1,890 kg
% en surplus de poids	= 15,9%
- Cube nr.5: poids avant le procès	= 1,580 kg
poids après 7 jours	= 1,850 kg
% en surplus de poids	= 1,7%
- Cube nr2: poids avant le procès	= 1,570 kg
poids après 7 jours	= 1,820 kg
% en surplus de poids	= 15,8%
- Cube nr6: poids avant le procès	= 1,610 kg
poids après 7 jours	= 1,850 kg
% en surplus de poids	= 14,2%
- Moyenne en % = 15,7%	

D) Conclusions:

- Les Briques crues traditionnelles ne résistent pas dans l'eau
- Les Briques Crues stabilisées d'asphalte avec de la paille (..P) se déforment un petit peu mais ont une bonne résistance à l'eau, seule 15,7% en plus de son poids original (limite 25%).
- Les Briques Crues Stabilisées d'asphalte sans paille (A) ne se déforment pas et ont une résistance maximum à l'eau, seul 11,11% en plus de son poids original.

CHAPITRE 2: DES PREUVES DE COMPRESSION PAS CONFINÉES.

A) Introduction: Les essais faits sur des échantillons des Briques Crues de

10x10x10 cm ont été préparés avec un capping suivant:

Le mélange du capping était du chaux(1)-plâtre(3)

Carbonate de Calcio(1) - Sulfate de Calcio(3)

1 CaCO₃

3 CaSO₂ 2H₂O

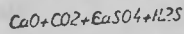

Cette mélange a comme avantage une meilleure élasticité et une réduction d'humidité dans l'échantillon. Les résultats des échantillons dépendaient surtout en grand partie du préparation des deux niveaux horizontales qui devaient être bien nivelés pour permettre une distribution des forces conformes.

B) Des preuves de compression pas confinées sur les briques traditionnelles(T). Les preuves se effectuaient avec deux différentes épesses culées, l'une de 39 jours et l'autre de deux ans.

Tableau de Compression kg/cm² et d'humidité %

Echantillon	Compression kg/cm ²		Humidité %	
	39 jours	deux ans	39 jours	2 ans
nr, 1	9,68	10,01	0,39	0,87
nr, 2	10,36	11,51	0,12	0,22
nr, 3	12,15	11,33	0,29	0,23
nr, 4	7,88	12,44	0,53	0,41
nr, 5	13,79	14,12	0,54	0,27
Moyenne:	10,77kg/cm ²	11,88kg/cm ²	3,7%	4%

C) Des preuves de compression pas confinées sur les briques crues stabilisées d'asphalte avec de la paille (AP). Les briques crues traditionnelles stabilisées avec d'asphalte froid mélangé un 2% du volume de terre. Les preuves s'effectuaient avec deux différents âges des cubes, l'un de 39 jours et l'autre de deux ans.

Tableau de Compression kg/cm² et d'Humidité % (!)

Echantillon	Compression kg/cm ²		Humidité %	
	39 jours	2 ans	39 jours	2 ans
nr, 1	15,90	11,08	0,55	0,05
nr, 2	15,44	11,61	0,27	0,15
nr, 3	19,12	10,90	0,34	0,32
nr, 4	16,15	9,29	0,31	0,35
nr, 5	15,01	12,22	0,32	0,32
Moyenne	16,32kg/cm ²	11,02kg/cm ²	3,6%	2,4%

D) Des preuves de compression pas confinées sur les briques stabilisées d'asphalte sans paille (A). Les briques crues traditionnelles stabilisées d'asphalte froid mélangé un 2% du volume de terre. Les preuves se effectuaient avec deux différents âges des cubes, l'un de 39 jours et l'autre de deux ans.

Tableau de Compression kg/cm² et d'Humidité % (!)

Echantillon	Compression kg/cm ²		Humidité %	
	39 jours	2 ans	39 jours	2 ans
nr, 1	16,62	16,08	0,08	0,13
nr, 2	20,55	16,87	0,50	0,28
nr, 3	23,59	15,37	0,48	0,18
nr, 4	19,84	17,51	0,39	0,04
nr, 5	18,23	17,12	0,44	0,11
Moyenne	19,76kg/cm ²	16,59kg/cm ²	3,8%	1,5%

CHAPITRE VI: TABLEAU GENERAL ET CONCLUSIONS.

a) Tableau Général:

Compression kg/cm ²				Humedad (%) %	
		39 dias	2 ans	39 dias	2 ans
T	1	9,68	10,01	3,9	8,7
	2	10,36	11,51	1,2	2,2
	3	12,15	11,33	2,9	2,3
	4	7,88	12,44	5,3	4,1
	5	13,79	14,12	5,4	2,7
Promedio		10,77	11,88	3,7%	4%
AP	1	15,90	11,08	5,5	0,5
	2	15,44	11,61	2,7	1,5
	3	19,12	10,90	3,4	3,2
	4	16,15	9,29	3,1	3,5
	5	15,01	12,22	3,3	3,2
Promedio		16,3	11,02	3,6%	2,4%
A	1	16,62	16,08	0,8	1,3
	2	20,55	16,08	0,5	2,8
	3	23,59	15,37	4,8	1,8
	4	19,84	17,51	3,9	0,4
	5	18,23	17,12	4,4	1,1
Moyenne		19,76	16,59	3,8%	1,5%

2) Conclusions :

- i) La curve de la compression de la brique crue traditionnelle(7) à la compression augmenté et la curve à l'humidité descend, maintenant c'est de savoir quand ça sera saturé.
- ii) Les résultats de la compression de la brique crue stabilisée d'asphalte nous a surpris parce qu'on a pu constater que les résultats après 39 jours sont très prometteurs mais qu'après deux ans il y a une diminution notable. Peut-être à cause de l'humidité ou l'évaporation de l'asphalte au soleil (3400m d'altitude). Ça sera à chercher pour fabriquer les briques crues stabilisées d'asphalte avec une température assez haute pour permettre une évaporation pour obtenir une constante.
- iii) La brique crue traditionnelle renforcée avec des additifs choisis peuvent donner de bons résultats sur le plan compression, humidité et aussi économique pour sa fabrication dans le secteur du bâtiment rural.

ON THE TECHNOLOGY OF THE CONSERVATION AND RESTORATION
OF ANCIENT MUD BRICK WALLS.

ZAVENE HATSAGORTSIAN X

summary

In Institute of the stone and silicates has been accomplished experiments for impregnation of the mud-brick samples from the fortress Erebooni and Teishebaini (VII-VIII centuries B.C.). Has been impregnated the soluble glass with the addition of fluosilicate of sodium, the silicoorganic silicate (a new binding), the resins epoxide and polyester. The best results has been obtained with the impregnation of the silicate silicoorganic in case the absence of gypse in the brique composition. For mud-brick restauration, that is for moulding of imitating bricks with sufficient stability, has been investigated diverse compositions, including the sand of tuff, cement, metylsiliconate of sodium. It is recommended the optimal ingredients proportion. Has been accomplished an experimental brickwork.

(x) Chef du laboratoire de l'institut de pierre et silicates,
membre du Comité Soviétique de l'ICOMOS.

CONSERVATION

Les murs des bâtiments anciens en briques ou blocs crus, qui sont conservés sous l'épaisseur du sol, se détériorent rapidement après l'ouverture au cours des fouilles archéologiques. C'est pourquoi la question de leurs conservation et restauration est de grande actualité.

Jusqu'à présent il n'y a pas une technologie effective et universellement admise de la conservation des murs en briques crues, ainsi que leur restauration de longue durée.

En U.R.S.S. on a élaboré une technologie de traitement des murs en briques crues par les rayons infra-rouges, qui, au fait, frittent les briques jusqu'à une certaine profondeur, augmentant leurs résistance et stabilité/Fridman, 1980/. Cependant cette procédure change la coloration et la facture de la surface des briques, ce que n'est pas tolérable.

Il est plus effectif d'imprégner les briques crues par les liants liquides qui restent transparents après le durcissement.

A l'Institut de pierre et des silicates nous avons expérimenté sur l'imprégnation des échantillons des briques crues, prises des forteresses ourartéennes Erébouni et Teichébaini(VII-VIII siècles av.J.-C.). Pour l'imprégnation on a utilisé le verre soluble du sodium avec l'addition du fluosilicate du sodium, le silicate silicoorganique(liant nouveau, préparé du verre soluble et tetraoxisilan), les liants polyéster et époxyde.

Les expériences ont montrés qu'après l'imprégnation par le verre soluble des efflorescences sont inévitables, ce qui gêne l'apparence des murs; les liants polyéster et époxyde éliminent l'efflorescence, mais la couleur de la brique deviens un peu sombre, en même temps il existe le danger d'exfoliation de la croûte qui se forme à la surface (surtout quand on imprègne le liant époxyde), puisque elle est imperméable et que la formation des dépôts de sels derrière la croûte est bien possible.

On a obtenu le meilleur effet après imprégnation par la solution du silicate silicoorganique. En ce cas la brique se consolide sans changement de la couleur et sans efflorescence. A cause de la structure poreuse du liant la perméabilité du matériau est bien conservé.

Tels sont les résultats des expériences en cas de l'absence du gypse dans la composition de la brique.

Quand la brique contient une quantité de gypse, on voit l'efflorescence abondante à sa surface après l'imprégnation par le silicate silicoorganique. Pour la prévention de ce phénomène nous cherchons le moyen pour neutraliser le gypse dans la composition de la brique.

En voilà les résultats des essais sur l'échantillon des briques imprégnées. On a déterminé la résistance à la compression, la stabilité à l'action alternative de l'eau, du gel et de la solution du sulfate de sodium.

On voit de cette table: que l'imprégnation de la brique par le silicoorganosilicate augmente brusquement sa résistance et longévité. C'est pourquoi on peut recommander l'utilisation de cette procédure pour consolider les murs anciens en briques crues, quand elles ne contiennent pas de gypse. Or, il est désirable d'ajouter d'une petite quantité de hydrophobisateur à la solution imprégnante.

Liquide d'imprégnation	Présence du gypse dans la brique	Résistance à la compression kg/cm^2	Stabilité à l'action alternative, en cycles(jusqu'à la destruction)		
			de l'eau	du gel	de la solution Na_2SO_4
Le verre soluble	-	25	2	2	1
" "	+	20	2	2	1
La silicate silicoorganique	-	48	100	50	25
" "	+	45	100	50	25
Le polyester	-	50	100	50	25
" "	+	50	100	50	25
L'époxide	-	110	100	50	25
" "	+	120	100	50	25

Table 1

RESTAURATION

Nous avons accomplie aussi les travaux expérimentaux de la restauration des briques crues. On s'est proposé le but de la recherche d'une composition optimale afin de préparer des briques assez résistantes et stables et, en même temps, imitantes les briques anciennes par la couleur et la facture.

Premièrement on a examiné les briques, préparées de la composition argilo-ciment, s'appuyant sur les travaux faits à l'U.R.S.S. aux années trente de notre siècle. Ceux-ci avaient prouvé la possibilité d'obtenir les mortiers argilo-ciment de bonne qualité, si on prépare préalablement un lait d'argile bien dissous. Au but de diminuer les déformations du retrait, nous avons ajouté au mortier argilo-ciment le sable concassé du tuff gris sombre, ce qui a permis la bonne imitation de la couleur générale des briques. Sur la base de cette composition on a préparé les briques expérimentales assez résistante et stable à l'action de l'eau. Cependant, après 30 cycles d'épreuves à l'absorption et séchage alternatives, la surface des échantillons se couvrait d'efflorescence, puisque l'argile utilisé contenait du gypse.

Or, nous avons décidé de nous renoncer l'argile et préparer les briques du mortier tuffo-ciment, ajoutant le liquide hydrophobisateur siliconique (metylsiliconate du sodium). La coloration des briques avait été reproduite par l'utilisation des tuffs de deux couleurs - gris orangeâtre avec l'addition un peu de tuff rouge.

Les résultats des épreuves des compositions diverses de ces mortier sont résumés à la table 2.

Nous avons préparé un nombre de 100 briques de composition N° 7. Après durcissement nous avons impregné la surface des briques par le verre soluble de densité $1,25 \text{ g/cm}^3$. Avec ces briques à la forteresse ancienne d'Erébouni en 1978 nous avons construit un mur experimental sur le socle ancien de pierres (v. photo). Les observations montrent jusqu'aujourd'hui le bon état de la briquetage expérimentale.

Nous jugeons nécessaire de prolonger et d'élargir les expériences sur la conservation et restauration des murs en briques crues.

NN	Composition (par volume) ciment: sable du tuff metil- siliconique du sodium de 3%	Resistance à la compression kg/cm ²			Coefficients		Resis- tance à l'action de la so- lution du Na ₂ SO ₄ (10 cm ³ gles)
		en état sec	en état d'ab- sorb- tion	après 100 ci- cles de con- gélation	de ram- mol- lis- sement	de résis- tance aux gelés	
1	1:3:0	120	100	98	0,83	0,98	à des- truction sensibles
2	1:4:0	115	90	85	0,78	0,94	"
3	1:5:0	90	60	55	0,68	0,91	"
4	1:6:0	65	42	31	0,64	0,73	"
5	1:3:1	120	110	110	0,91	1,00	sans des- tructions sensibles
6	1:4:1,5	120	105	100	0,87	0,95	"
7	1:5:2	95	80	76	0,84	0,95	"
8	1:6:2,5	70	54	48	0,77	0,88	les micro- fissures

Table 2

REFERENCES

- Fridman O.M. 1980. Konservacia syrcovykh kladok v drevnikh gorodishchakh i poseleniakh. "Problemy okhrany pamiatnikov arkheologii v naseljonnykh mestakh". Erévan. pp.114-115.

kararlar - öneriler
resolutions - recommendations

2nd INTERNATIONAL SYMPOSIUM ON THE CONSERVATION
OF MONUMENTS IN MUD BRICK
Yazd, 6-11 March 1976

RESOLUTIONS

1. Archaeological sites

That no archaeological excavations of sites likely to contain the remains of structures in mud brick should be undertaken unless a provisional conservation policy has been established and has been included in the excavation budget agreed upon by archaeologists and the competent authorities. Such a provisional conservation policy should anticipate differing levels of intervention depending upon the importance of the finds. For example,

- a) Sites whose documentary or public importance does not justify the expense of conservation should be backfilled with sand or sieved soil after a complete record has been made including, where appropriate, a photogrammetric survey.
- b) Light shelters should be built as a temporary measure to protect the more important mud brick structures, or as a preliminary to further work when the find forms part of a larger structure to be investigated.
- c) Restoration work should be undertaken for major sites including as necessary, physical stabilisation of the structure, installation of systems of water-proof capping and drainage for horizontal surfaces and refacing for vertical surfaces or chemical treatment in the event of successful results from experiments already in course and after appropriate tests on samples of the material. It should be borne in mind that restoration involves both a heavier initial investment and regular inspection and periodical maintenance work.

All action for the conservation of archaeological sites containing mud brick structures should be undertaken at the earliest opportunity and before decay has set in. Only when sites are adequately guarded can the efficacy of conservation programmes be guaranteed.

2. Ruins

That the conservation of monuments in mud brick subsisting as ruins above ground be undertaken through the application of similar principles with the understanding that a comprehensive survey of such monuments in their existing state is a basic prerequisite of any restoration plan. A stable and coherent structure must be achieved before essential works of drainage and waterproofing (including chemical treatments to satisfy the provisos outlined above) can be undertaken.

3. Buildings in use

That particular attention be given to the need for encouraging and assisting in the regular upkeep of mud brick buildings, especially external plastering, roofing and drainage, as well as such structural repairs as may be necessary. Restoration should respect the spirit of the Venice Charter and only those modifications dictated by the necessity of rehabilitation (see below) should be permitted.

4. Towns and quarters

That the general principles expressed in relevant ICOMOS Resolutions and in the UNESCO draft Recommendation on the Conservation of Towns and Quarters (1976) be applied to the conservation of towns and quarters in mud brick. There should be a detailed survey and assessment, employing the most up-to-date techniques, so as to determine the capacity of such towns and quarters to be rehabilitated and adapted to modern living standards without losing their character, keeping their typical architectural features and changing the interior arrangement of the rooms only when not architecturally interesting. Each building should be equipped with basic modern sanitation, with a new drainage system, with electrical fittings in the walls and with heating plants to assure a modern standard of comfort. Existing streets should be repaved in such a manner as to provide public services such as sewerage, surface drainage and underground wiring, while retaining their role as meeting places and secondary distributors. The fabric and scale of towns should be retained and transport facilities should be planned in such a way as to guarantee communication without either damaging or isolating traditional mud brick quarters or displacing established communities. All new development should be sited in such a way as to enhance rather than to diminish the amenities of traditional quarters whose conservation should enjoy the same fiscal advantages and budgetary and administrative priorities as does the new development.

5. Economic development

That those responsible for development policy in countries possessing a tradition of mud brick architecture be urged to recognize the increasing attractiveness of mud brick and unbaked earth as readily available low-cost building materials for housing construction and subsequently, owing both to the low level of technology required for its use and maintenance and to its excellent thermal performance. For these reasons, they recommend further investment in mud brick construction techniques and in improving the durability of mud bricks.

6. Technical research

A. That an improved questionnaire on problems encountered in the conservation of individual structures in mud brick and on results obtained (to include archaeological sites and ruins above ground as well as buildings in use) be prepared by ICOMOS and the International Centre for Conservation (Rome). This questionnaire should be accompanied by an instruction sheet explaining the significance of the questions asked and the sort of answers which might be appropriate. It should be distributed as widely as possible, through ICOMOS and the International Centre for Conservation, and particular efforts should be made to reach the widest range of people concerned, throughout the world, with the uses and conservation of mud brick and unbaked earth, including those in antiquities offices, universities, building research establishments, housing agencies in developing countries, and individual researchers.

B. That, for the immediate future, laboratory research programmes should put particular emphasis on the following aspects of the conservation of mud brick:

- mechanical tests of the behaviour of mud brick under varying conditions,
- analyses of the composition of mud bricks from a range of sources,
- protection of mud bricks against disintegration and retardation of decay,
- research into materials suitable for repair of structures in mud brick and for preparation of bricks suitable for restoration purposes.

C. That the results of these and other researches should be centralised and disseminated in a suitable way by the ICOMOS Secretariat in Paris.

D. That a very limited number of monuments (e.g. an important archaeological site, a major ruin, such as a ziggurat or fortified enclosure, and a mosque or caravanserai) be chosen as pilot projects to be subjected to an exhaustive series of tests under the supervision of an international working group named by the International Centre for Conservation (Rome) and ICOMOS, and with the aid of one or more laboratories of research institutions.

7. Future meetings

That the generous offer of the Turkish delegation to organize a meeting to study the protection of archaeological sites containing mud brick remains, be accepted and that, in preparation for this and other international activities in the field, appropriate meetings be held through ICOMOS National Committees at the national and the local levels for the study of all aspects of the conservation of mud brick.

2ème COLLOQUE INTERNATIONAL SUR LA CONSERVATION DES
MONUMENTS EN BRIQUE CRUE

Yazd, Iran, du 6 au 9 mars 1976

1. Sites Archéologiques

Que des fouilles dans des sites susceptibles de recéler des vestiges en brique crue ne soient entreprises que si un programme de conservation provisoire a été établi au préalable et compris dans le budget agréé par les archéologues et par les autorités compétents.

Que ce programme prévoit différents niveaux d'intervention, selon l'importance de ces découvertes:

- a) pour les sites dont l'intérêt scientifique ou touristique ne justifie pas le coût de leur conservation, le ré-ensevelissement avec du sable ou de la terre tamisée, après établissement d'une documentation exhaustive (comprenant si possible des relevés photogrammétriques ou pour le moins de stétéo-photographies).
- b) pour les structures en brique crue plus intéressantes, la construction d'abris légers, protection temporaire ou préliminaire à des travaux supplémentaires, surtout lorsqu'il s'agit d'une partie d'une structure plus grande qui doit être mise au jour.
- c) pour les sites majeurs, des travaux de restauration assurant la stabilisation physique de la structure; selon les cas, on procèdera à la mise en place d'un système de "capping" étanche, de drainage des eaux pour toutes les surfaces horizontales, à la pose d'une couche d'enduit et éventuellement - si les expériences en cours donnent des résultats positifs et après des tests appropriés avec des échantillons du matériau - au traitement chimique des surfaces verticales. Il faut tenir compte du fait que la restauration demande non seulement un investissement initial plus important mais aussi des visites d'inspection régulières, et des travaux d'entretien périodiques. Toute intervention pour la conservation de sites con-

tenant des structures en brique crue doit être entreprise le plus tôt possible, avant que la dégradation des structures ne commence. L'efficacité des mesures de conservation ne peut être garantie que si les sites archéologiques sont suffisamment protégés par les services de gardiennage.

2. Structures en ruins

Que des principes similaires soient appliqués à la conservation des ruines de monuments en brique crue qui subsistent au dessus du niveau du sol: le relevé exhaustif de l'état actuel de ces monuments (relevé photographométrique ou prise, pour le moins, de stéréophotographies) doit être entrepris préalablement à tous travaux de restauration. Il est nécessaire de rétablir la stabilité et la cohérence de la structure avant de procéder aux travaux essentiels de drainage et d'étanchéité, y compris les éventuels traitements chimiques, satisfaisant aux conditions énoncées plus haut (1.c).

3. Edifices en état

Que la priorité soit accordée aux programmes pour encourager et aider à l'entretien régulier des édifices en brique crue; en particulier, on veillera aux enduits extérieurs, aux toitures et au drainage, et l'on effectuera les reprises de gros oeuvre éventuellement nécessaires. Les restaurations doivent respecter l'esprit de la Charte de Venise et seules peuvent être admises les modifications dictées par les exigences de l'assainissement (voir ci-dessous, point 4).

4. Villes et quartiers

Que les principes généraux animant les résolutions de l'ICOMOS en la matière, et le projet de Recommandation de l'UNESCO sur la conservation des villes et des quartiers historiques soient appliqués à la conservation des villes et des quartiers construits en brique crue. Un relevé détaillé et une étude appropriée, faisant appel aux techniques les plus récentes, doivent établir leur capacité d'assainissement et d'adaptation aux besoins actuels sans porter atteinte à leur caractère spécifique. Les éléments traditionnels de l'architecture doivent être retenus et la disposition intérieure des pièces ne doit être modifiée que lorsqu'elle ne présente pas d'intérêt du point de vue architectural. Chaque maison doit disposer d'un équipement sanitaire moderne, d'un nouveau système de drainage, de l'installation du courant électrique dans l'épaisseur des murs, d'un système de chauffage afin d'assurer un niveau de confort moderne.

Le pavage des rues existantes doit être prévu de façon à permettre l'installation des réseaux divers essentiels - tels que les égouts, le drainage de surface, des canalisations souterraines (fils électriques, eau, etc.) - tout en sauvegardant leur fonction de lieux de rencontre et de distributeurs secondaires. Le tissu et l'échelle de la ville doivent être maintenus et la planification des transports doit garantir les communications sans pour autant nuire aux quartiers anciens en brique crue, les isoler ou disperser leur population. Tout aménagement nouveau doit être effectué de façon à mettre en valeur les quartiers anciens et à ne pas diminuer leur aménité. Les programmes de conservation de ces quartiers doivent bénéficier des mêmes avantages fiscaux, priorités budgétaires et administratives que les constructions nouvelles.

5. Développement économique

Que les responsables des politiques de développement, dans les pays possédant une tradition d'architecture en brique crue ou en terre crue, prennent conscience que les circonstances économiques actuelles favorisent, de plus en plus, l'emploi pour la construction de logements, de ce matériau, aisément disponible, peu coûteux, et exigeant une main d'oeuvre non spécialisée. Au surplus, la construction et l'utilisation des édifices en brique crue demandent une consommation d'énergie relativement modeste, à cause du bas niveau de technologie requis pour sa mise en oeuvre et son entretien, ainsi que son comportement thermique satisfaisant.

Pour ces raisons, il est souhaité que des investissements plus importants soient consacrés aux recherches nécessaires à la promotion des techniques de construction en brique crue, ainsi qu'à l'augmentation rationnelle de la durabilité de ce matériau.

6. Etudes techniques

A. Qu'un questionnaire plus approfondi sur les problèmes rencontrés dans la conservation de structures en brique crue et sur l'expérience acquise en matière de conservation (y compris les sites archéologiques et les ruines au-dessus du niveau du sol ainsi que les édifices toujours en état) soit rédigé par l'ICOMOS et le Centre International de Conservation (Rome). Ce questionnaire devra être accompagné d'une notice explicative, donnant la signification des différents points et les réponses qui pourraient éventuellement être utiles. Il devra être diffusé le plus largement possible, par l'ICOMOS et le Centre International de Conservation, et des efforts devront être spécialement déployés pour atteindre dans toutes les régions du monde, le plus grand

nombre de personnes concernées par l'emploi et la conservation de la brique et de la terre crue, entre autres: les spécialistes des services d'antiquités, les universités, les instituts de recherche du bâtiment, les agences de logement des pays en voie de développement, et les chercheurs individuels.

B. Que, dans l'avenir immédiat, les programmes de recherches en laboratoire mettent l'accent sur les aspects suivants de la conservation de la brique crue:

- essais mécaniques du comportement de la brique crue sous des conditions diverses,
- analyse de la composition de briques crues provenant de différentes sources,
- consolidation de la brique crue et retardement de son altération,
- étude de produits appropriés à la consolidation de structures et à la fabrication de nouvelles briques pour la restauration des structures anciennes en brique crue.

C. Que les résultats de ces recherches soient centralisés à Paris par le Secrétariat de l'ICOMOS et diffusés par des moyens appropriés.

D. Qu'un nombre très restreint de monuments (par exemple, un site archéologique important, une ruine intéressante telle qu'une ziggourat ou un enclos fortifié, une mosquée ou un caravansérail) soit choisi pour des projets - pilotes et soumis à une série complète d'essais, sous la direction d'un groupe de travail international désigné par l'ICOMOS et le Centre International de Conservation, avec l'aide d'un ou de plusieurs laboratoires ou instituts de recherche.

7. Réunions futures

Que l'offre généreuse de la délégation turque d'organiser une réunion en 1977 ou 1978, pour étudier la protection des sites archéologiques contenant des vestiges en brique ou en terre crue, soit acceptée et que, pour la préparer, d'autres activités ou rencontres internationales dans ce domaine, soient suscitées par les Comités nationaux de l'ICOMOS, au plan national ou local, selon les besoins, pour étudier les différents aspects de la conservation de la brique crue.

RECOMMENDATIONS OF THE US/ICOMOS - ICCROM
ADOBE PRESERVATION WORKING SESSION
October 3-7, 1977, Santa Fe, New Mexico

Research

1. Recommended that historical research be carried out on adobe architecture, including traditional structural systems, methods, practices, techniques, and the reasons for those practices and techniques.
2. Recommended that research be carried out on adobe materials, including the determination of the thermal expansion coefficient of adobe materials, the compatibility (both chemical and physical) with other materials used in conjunction with adobe structures, and the structural analysis of adobe buildings to include response to seismic loading.
3. Recommended that research be carried out to develop a simple non-destructive, field method of determining water content, water distribution, and water movement in adobe masonry. The quantification of moisture studies should make particular reference to plastic deformation of structures, salt transportation, and salt crystallization.
4. Recommended that research on the following conservation techniques be carried out:
 - a) Surface and subsurface drainage of mud-brick structures.
 - b) The feasibility and possible damaging effects of inserting damp-proof courses in mud-brick structures.
 - c) Comparative studies of traditional and modified capping, plastering and in-fill materials, including compatibility with the original structure and materials.
 - d) Chemical surface treatment and consolidation, including compatibility with the original materials - visual and weathering rates, both initial and long range, with particular reference to the protection of decorative elements.
 - e) Injection and grouting techniques for consolidation or weather-proofing.
 - f) Structural stabilization and reinforcement materials and methods.
5. Recommended that a glossary of terms on adobe architecture be developed, published and distributed.

Testing

6. Recommended that an inter-disciplinary international committee be formed to develop a set of standard test methods for both field and laboratory analysis of soil building materials and their relationship to the structure as a whole.
7. Recommended that an international cooperative effort be initiated to utilize the test methods developed by the inter-disciplinary international committee by conducting a series of coordinated pilot studies on selected historic or prehistoric structures.
8. Recommended that the United States Department of the Interior, National Park Service expand its field testing program relating to soil chemistry, soil stabilization, and all other field testing related to adobe preservation.

Information

9. Recommended that an international information program specifically related to historic mud-brick construction be developed. In order to provide a strong base of support for such a program, it is also recommended that a network of individuals and committees representing nations, regions, and organizations be invited to submit regularly pertinent information to the national committees of ICOMOS and to ICCROM.
10. Recommended that information centers on adobe preservation be created by several ICOMOS national committees in close cooperation with the UNESCO-ICOMOS-ICOM Documentation Center and ICCROM to collect and disseminate data on a national and regional basis, and to encourage the compilation and publication of historical, scientific, and other technical information relating to adobe construction. The collection of information should include, but not be limited to, the following:
 - a) Completed copies of the "ICCROM Mud Brick Questionnaire N°3".
 - b) News about researchers in progress.
 - c) Publications (professional, governmental, etc.).
 - d) Unpublished or "in-house" reports or theses, etc.
 - e) Compilation of information about specific subjects such as recording/photogrammetric techniques.

The dissemination of information shall be by transmittal of all such data to ICCROM and ICOMOS via the ICOMOS National Committees. The National Committees would also forward such data to certain other organizations or publications that serve broad technical preservation constituencies, such as APT or IIC. The encouragement of the compilation and publication of relevant information shall include, the preparation

of bibliographies or special compilation of information, the development of regional collections, the preparation of exhibits, films, etc. The format for the submission of such information to the ICOMOS National Committees shall facilitate the filing, retrieval and publication thereof and shall include:

- 1) Author or researcher's name or manufacturer.
- 2) Title of article or research or specific subject.
- 3) Source, including publisher, address, cost (currency required).
- 4) Availability (copyright or restrictions).
- 5) Language of original.
- 6) Abstract of information.
- 7) Contributor's name and address.

Photography and Recording

11. Recommended that historic photographs in the form of glass plate negatives be valued and preserved for their dimensional stability and the possibility of preparing restoration drawings from them by photogrammetric analysis, and that photogrammetry and stereophotography be considered as means for measuring erosion and for recording original historic fabric, in place, before covering or removal for purposes of stabilization, reconstruction, or demolition for continued archeological research.

Guidelines for Adobe Preservation

12. Recommended that the following guidelines be considered when planning any adobe preservation project:

Recommended

The use of new materials which are compatible with the structure and visual properties of the original or earlier materials including texture, color, shape and aging characteristics.

Contemporary intervention that is distinguishable, upon close examination, from original or earlier work.

Not Recommended

The use of new materials which are not compatible with the structure and visual properties of the original or earlier materials including texture, color, shape and aging characteristics.

Contemporary intervention that cannot be distinguished upon close examination from original or earlier work.

The preservation of alterations and additions to a structure that may have acquired historical significance in their own right.

The premature removal of alterations and additions to a structure that may have acquired historical significance in their own right.

The use of shelters or backfilling or other appropriate protective measures, in the case where long term preservation work cannot be undertaken.

Adequate technical, historical, architectural and archeological documentation of the site, prior to initiation of any preservation action.

Initiation of work prior to adequate documentation of site.

The use of photography and stereophotography as a means for measuring erosion and for recording original historic fabric in place prior to any physical intervention.

Giving the control of water a high priority in project planning and implementation.

The installation of drainage systems which adversely affect the resource.

Giving the protection of the integrity of the physical setting of the resource a high priority in project planning and implementation.

The continued use of traditional materials and maintenance techniques wherever possible.

The use of surface coatings that have not received adequate field testing.

ANKARA'DA ONAYLANAN ÖNERİLER
(4 Ekim 1980)

1. KERPIÇ MİMARİ

1.1 TANIMI: KERPIÇ MİMARİ

"Kerpiç Mimari" deyimi, kullanılan ya da terk edilmiş, tarihi ya da çağdaş olan, kısmen ya da tümüyle toprak malzemeyle yapılmış tüm mimarlık ürünleri için geçerlidir. Bu mimari, doğal ya da yapay çevresi ile birlikte düşünülmelidir.

1.2 KERPIÇ MİMARİNİN YOKOLMASI

Kerpiç yapılarıdaki doğal bozulma, kârgir yapılarda görülene benzer süreçlere bağlı olarak ortaya çıkar. Ancak, kerpiçle bu süreçlerin göreceli önemleri farklı, bozulmanın hızı ise çok daha fazladır. İnsanın neden olduğu diğer bozulma süreçleri de kerpiç mimarinin tüm yapay çevre ve diğer malzemelerle olan karmaşık ilişkileri yönünden önemlidir.

1.3 KORUMA GEREKLİLİĞİ

Korunmaları için uluslararası ölçekte ilgiye layık, ulusal ya da uluslararası önem taşıyan, kerpiçten yapılmış anıt örnekleri vardır. Ancak, kendi başına daha az önemli olsa da özgün mimarinin geçmiş dönemleri yansıttığı gibi günümüz toplumundaki değişimleri yansıtan nitelikleri ile önem taşıyan kerpiç mimarlık örnekleri de çoktur.

Ayrıca, tüm yöresel mimarinin korunması gereklidir çünkü yöresel mimari bir kültürü, o kültürün yarattığı göreceli olarak daha az sayıdaki anıtlardan daha iyi temsil etmektedir.

1.4 KORUMA

Tüm koruma etkinlikleri uluslararası ilkelere uygun olmalıdır.

Kerpiç mimarinin korunması için genellikle uygun oldukları için geleneksel yöntem ve gereçlerin kullanılması teşvik edilmelidir. Bu yöntem ve gereçlerin özellikle de içinde yaşayanlar açısından kerpiç mimarinin organik niteliklerine katkıları daha da önemlidir.

Uygun koruma teknikleri konusunda arařtırmalar sürdürülmelidir. Geleneksel yöntem ve gereçlere ağırlık verilmeli ve en az müdahale kavramı akıldan çıkarılmamalıdır. Uygun olduđu kesinlikle belirlendiğinde çağdaş teknoloji kullanılabilir.

Tüm koruma çalışmaları, korunacak belirgin özelliklerin anlaşılmasıyla başlamalıdır. Malzemenin fiziksel özelliklerinin korunması için bir yöntem uygun olabilir. Bir diđer farklı yöntem, kerpiç mimaride bütünlüğün, başlangıçtan günümüze deđin kullanılan geleneksel kavram ve teknikleri de içererek, tümüyle korunması için daha uygun olabilir.

2. ARKEOLOJİK YERLEŐMELER

2.1 KAZI SÜRESİNCE VE KAZI SONRASI İLK KORUMA

Yeni kazılan kerpiç malzemenin önemi tanımlanıp kesin koruma planı saptanıncaya kadar, geçici korunması hemen sağlanmalıdır.

Bu tür geçici koruma öncelikle yöresel olarak elde edilebilen malzeme ve tekniklere dayandırılmalıdır.

En uygun geçici koruma ařađıdaki gereklilikleri yerine getirmelidir:

- Yađmur veya eriyen karın doğrudan aşındırmasına karşı yeterli koruma sağlamalıdır;
- Yođunlaşma veya "ser etkilerini" önlemek için yeterli ısı yalıtımı sağlamalı, tercihan su buharını geçirebilmelidir;
- İnceleme vb. çalışma için gerektiğinde kolaylıkla kaldırılarak yeniden yerine konabilmelidir;
- Bakımı yapılmak koşuluyla, istendiğinde en az 5 yıl dayanmalıdır;
- Koruma planı yađmur suyunun akıtılması için gerekli önlemleri içermeli ve duvar diplerinde aşınma önlenmelidir.

Bu tür geçici koruma önlemleri řunları içerebilir:

- Çamur sıva ile kaplı hasırlar;
- Düşey yüzeyleri yađmur suyundan koruyacak biçimde duvar üstlerinden yeterli miktar taşan harpuřta. Üzerine toprak örtülmüş sazlar (kamış) ya da başka bitkisel malzemeler; bu amaçla kullanılabilir.

Her arkeolojik kazının bütçesi koruyucu uygulamanın giderini de içermeli ve her kazının programında bu tür çalışma için gerekli süre ayrılmalıdır.

Ortaya çıkarılan kerpiç bir yapı iki kazı dönemi arasında hiç bir şekilde çevre şartlarına terkedilmemelidir.

En kısa zamanda geçici korumanın uygulanması bir kazı başkanına,

- a. yapının arkeolojik yönden incelenmesi;
- b. çevresel koşulların ve malzemelerin incelenmesi;
- c. yapının gelecekteki ele alınışı konusunda bir karara varılabilmesi (yeniden doldurma veya sergilene için koruma)

için yeteri kadar zaman süresi verilmesini sağlamak nedeniyledir.

2.2 ÇEVRE ŞARTLARINA TERKEDİLEN SİTLER

Bu tür (koruma tasarımı yokluğundan etkilenen) yerleşmeler uzmanlarca incelenmeli ve yapıların durumu ve yerleşmenin önemi ile bağlantılı olarak bir yön saptanmalıdır. Uygulanabilecek görüşler aşağıdadır:

- a. yeniden hemen doldurma;
- b. aralıklı bakım;
- c. kurtarıcı sağlamlaştırma ve yeniden doldurma;
- d. kurtarıcı sağlamlaştırma ve geçici koruma;
- e. tümüyle koruma.

3. KORUNAKLARIN YAPIMI

- 3.1 Düşük maliyetli korunakların (kısmen ya da tamamen kapalı) yapımı için modüler sistemlerin tasarımına ilişkin çalışmaların yapımı;
 - 3.2 Korunak kavramlarının, değişik dalların (örneğin mimarlık arkeoloji, konservasyon) uzmanlarınca geliştirilmeleri ve elde edilebilen yöresel malzemeler göz önünde tutularak, bu kavramların ortak olarak arazide denenmeleri;
- önerilir.

4. KORUMA UYGULAMALARI KONUSUNDA ARAŞTIRMA

- a. Deney yöntemlerinin standartlaştırılması;
- b. Laboratuvar ve arazide önerilen çeşitli yöntemlerin ilişkili yararlarının denenmeleri için karşılaştırılabilir yüzeylerin kullanılmalığı;
- c. Pilot projelerin, yapıların, tümüyle korunmasına ilişkin sistem denemelerinde kullanılmalığı;

önerilir.

5. KISMEN YANMIŞ KERPIÇ YERLEŞMELER

Dünyanın bazı bölgelerinde pek çok bu tür yerleşmeler yangın geçirdiklerinden, kerpiçler kısmen pişmiştir. Bu nedenle bu tür yerleşmelerin korunması daha farklı ölçütler gerektirmektedir. Geçici koruma, pişmiş tuğlanın daha dayanıklılık gösterdiği yağmurun yarattığı doğrudan fiziksel aşınmadan daha çok, aşırı ısı değişimlerine, donma-erime devrelerine ve kılcal yükselme ile bağlantılı tuz kristallenmesine (ve bunun harekete geçirdiği hacim değişimlerine) karşı koruma önlemleriyle ilgilenmelidir. Bu akılda tutularak, kerpiçler için şimdiye kadar önerilen geçici koruma yöntemleri, malzemenin kısa süre için kalımını sağlamak ve bozulma hızını geciktirmek için uygulanabilir. Kısmen yanık kerpiç yerleşmelerde, geçici koruma önlemleri alınmadan, bazı kurtarıcı yapısal onarımların yapılması gerekebilir.

6. GELECEK TOPLANTI

Peru temsilcilerinin, kerpiç kalıntıları ve/veya yapılar içeren arkeolojik sitlerin korunması konusunda bir toplantı düzenlemelerine ilişkin cömert önerileri kabul edilerek bir sonraki toplantının Peru'da yapılması kararlaştırıldı.

RECOMMENDATIONS APPROVED IN ANKARA (4th October 1980)

1. EARTHEN ARCHITECTURE

1.1 Definition: Earthen Architecture

The term "earthen architecture" is applied to all architecture, whether occupied or abandoned, historic or contemporary, that is constructed partially or completely of earth materials. Such architecture must be considered in relation to its total environment, whether natural or man made.

1.2 The Loss of Earthen Architecture

Natural deterioration of earthen construction is based on processes which are in part similar to those which occur in masonry construction. But the relative importance of such processes is different and the rate of deterioration is much greater. Other deterioration processes introduced by man are significant in the deterioration of earthen architecture in its complex interrelationships with other materials and with the total built environment.

1.3 The Need to Preserve

There are individual monuments built of earth that are of national and international significance and that deserve the commitment of the international community to their preservation. However, there is also much earthen architecture which, while less important per se, is important in the quality that reflects changes in contemporary society, just as the original architecture reflected the society of a former period.

Also, it is important to preserve all vernacular architecture since it is more representative of a culture than the relatively few monuments produced by that culture.

1.4 Preservation

All preservation activities should be guided by internationally accepted principles.

The use of traditional methods and materials should be encouraged because they are often highly appropriate for the preservation of earthen architecture. Even more important is the contribution these methods and materials make to the organic quality of earthen architecture, particularly as it relates to its inhabitants.

Research into appropriate preservation techniques should continue. Emphasis should be on the traditional methods and materials, and the concept of minimal intervention should always be borne in mind. Contemporary technology, if determined to be appropriate, may also be used.

All preservation activities should begin with an understanding of the significant characteristics that are to be preserved. One technique might be appropriate for the preservation of the physical characteristics of the material itself. Another quite different technique might be more appropriate for the preservation of the integrity of earthen architecture as a whole, including the traditional concepts and techniques that were used originally and continue to be used today.

2. ARCHAEOLOGICAL SITES

2.1 Immediate Protection During and After Excavation

Newly excavated mud-brick material must be given immediate temporary protection until such time as its importance is defined and a definite conservation plan is established.

Such temporary protection should rely primarily upon the materials and techniques available locally.

The ideal temporary protection should satisfy the following requirements:

- it should provide adequate protection against direct erosion by rain or melting snow;
- it should afford sufficient thermal insulation to avoid condensation or the "greenhouse effect" and, preferably, be permeable to water vapour;

- it should be easy to remove and to put back in place when study and/or inspection is necessary;
- it should have a minimum useful life of 5 years, with periodic maintenance, if required;
- the protection plan should include provisions to drain rainwater and avoid erosion at the base of walls.

Such temporary protection measures might include:

- straw mats covered with mud plaster;
- capping (coping) projecting sufficiently beyond the top edges of walls so as to avoid the flow of rainwater over the vertical surface. A layer of reeds, or other vegetable matter, covered with soil, could be used for this purpose.

The cost of protective treatment should be included in the budget of any archaeological campaign, and sufficient time should be allotted in the programme of each excavation for such work.

An excavated mud-brick structure should never be left exposed to the environment from one archaeological campaign to another.

Application of temporary protection as soon as possible is meant to provide the director of the excavation with sufficient time to:

- a. complete the archaeological study of the structure;
- b. complete the study of materials and environmental conditions;
- c. reach a decision on the future treatment of the structure (backfill or conservation for exhibition).

2.2 Sites Which Have Been Left Exposed to the Environment

These sites (which have suffered from lack of conservation planning) should be analysed by experts and a policy should be determined in relation to the condition of the structures and the importance of the site. The options available are as follows:

- a. immediate backfill;
- b. periodic maintenance;
- c. emergency consolidation and backfill;
- d. emergency consolidation and temporary protection;
- e. complete conservation.

3. CONSTRUCTION OF SHELTERS

It is recommended:

- 3.1 That the design study of modular systems for the construction of low-cost protective shelters (either full or partial enclosure) be undertaken.

- 3.2 That shelter design concepts should be developed by professionals from different disciplines (i.e. architecture, archaeology, conservation) and tested jointly in the field, with particular attention to materials that are locally available.

4. RESEARCH ON CONSERVATION TREATMENTS

It is recommended:

- a. that methods of testing be standardized;
- b. that comparable surfaces be used to test the relative merits of the various systems proposed, both in the lab and in the field;
- c. that pilot field projects be used to test conservation systems on entire structures.

5. PARTIALLY BURNT MUD-BRICK SITES

In certain parts of the world, many mud-brick sites were destroyed by fire, and consequently the mud-bricks were partially baked. As a result, conservation of such sites calls for somewhat different preservation criteria. Temporary protection should be concerned more with protection against extreme variations of temperature, the freeze-thaw cycle, and capillary rise with salt crystallization (and the subsequent volumetric changes which it provokes) and perhaps less with direct physical erosion produced through the action of rain to which baked brick is more resistant. With this in mind, systems of temporary protection such as those already proposed for mud-bricks could be adapted to retard the rate of deterioration and ensure the short-term survival of the material. In the case of partially baked mud-brick sites, some emergency structural repairs may need to be undertaken before applying temporary protective measures.

6. FUTURE MEETING

That the generous offer of the Peruvian delegation to organize a meeting to study the protection of archaeological sites containing mud brick remains and adobe historic structures accepted.

RECOMMANDATIONS APPROUVEES A ANKARA (4 Octobre 1980)

1. ARCHITECTURE EN TERRE

1.1 Définition: architecture en terre

Le terme "architecture en terre" s'applique à toute architecture, occupée ou abandonnée, historique ou contemporaine, qui est construite entièrement ou en partie de matériaux en terre. Cette architecture doit être considérée en relation avec son environnement, qu'il soit naturel ou construit par l'homme.

1.2 La destruction de l'architecture en terre

L'altération naturelle de la construction en terre est due à des processus qui sont en partie semblables à ceux que l'on rencontre dans les autres constructions en maçonnerie. Mais l'importance relative de ces processus est différente et la vitesse de l'altération est bien plus élevée. D'autres processus d'altération introduits par l'homme sont significatifs dans l'altération de l'architecture en terre, considérant ses relations complexes avec d'autres matériaux et avec l'environnement construit.

1.3 La nécessité de préserver

Il existe des monuments construits en terre qui ont une importance nationale et internationale et qui méritent que la communauté internationale participe à leur conservation.

Cependant il existe aussi de nombreuses constructions en terre qui, bien que moins importantes en soi, sont importantes du fait qu'elles reflètent les changements de la société contemporaine tout comme l'architecture originelle reflète la société d'une période précédente.

C'est pour cela qu'il est important de préserver toute l'architecture vernaculaire puisqu'elle est plus représentative d'une culture que les quelques monuments produits par cette culture.

1.4 Préservation

Toutes les activités de préservation doivent être guidées par des principes internationaux reconnus. On doit encourager l'utilisation des méthodes et matériaux traditionnels parce qu'ils sont souvent parfaitement appropriés à la préservation de l'architecture en terre. Et, fait encore plus important, ils apportent une grande contribution à la qualité organique de l'architecture en terre, en particulier, à cause de leurs rapports avec les habitants.

La recherche de techniques de préservation appropriées doit continuer. On doit insister sur les méthodes et matériaux traditionnels et on doit toujours garder à l'esprit le concept d'intervention minimale. La technologie contemporaine, si elle se révèle appropriée, peut être aussi utilisée.

L'identification des caractéristiques significatives qui doivent être préservées doit précéder toute activité de préservation. Une technique peut être adaptée à la préservation des caractéristiques physiques du matériau lui-même, alors qu'une autre technique complètement différente peut être plus appropriée à la préservation de l'intégrité de l'architecture en terre comme un tout qui comprend les concepts et techniques traditionnelles qui étaient utilisés à l'origine et continuent à être utilisés aujourd'hui.

2. SITES ARCHEOLOGIQUES

2.1 Protection immédiate pendant et après les fouilles

Tout matériau en terre qui vient d'être mis à jour doit recevoir immédiatement une protection temporaire jusqu'à ce que son importance soit définie et un plan définitif de conservation établi.

Une telle protection temporaire doit être choisie en fonction des matériaux et techniques disponibles sur place.

Une protection temporaire idéale devrait remplir les conditions suivantes:

- donner une protection adéquate contre l'érosion directe de la pluie ou de la neige fondue;
- assurer une isolation thermique suffisante pour éviter la condensation ou "l'effet de serre" et, de préférence, être perméable à la vapeur d'eau;
- être facile à enlever et à remettre en place si une étude et/ou une inspection sont nécessaires;
- avoir une durée d'au moins cinq ans avec un entretien périodique en cas de besoin;
- le plan de protection doit inclure des mesures pour l'écoulement des eaux de pluie et la protection de la base des murs contre l'érosion.

Les mesures de protection temporaire pourraient inclure:

- des nattes en paille recouvertes de terre;
- un chaperon qui dépasse suffisamment les bords du sommet du mur pour éviter l'écoulement de l'eau de pluie contre la paroi verticale. Une couche de joncs, ou de tout autre végétal, recouverte de terre, peut être utilisée à cet effet.

Le budget de toute campagne de fouilles doit prévoir le coût du traitement de protection et une période de temps suffisante doit être allouée pour ce travail dans le programme de chaque fouille.

Une structure en terre mise à jour ne doit jamais être laissée exposée aux intempéries entre deux campagnes de fouilles.

L'application dès que possible d'une protection est conçue pour donner au directeur des fouilles assez de temps pour:

- a. compléter l'étude archéologique de la structure;
- b. compléter l'étude des matériaux et des conditions ambiantales;
- c. prendre une décision sur le traitement à appliquer à la structure (comblement de la fouille ou conservation pour l'exposition).

2.2 Sites qui ont été exposés aux intempéries

Ces sites (qui ont souffert du manque d'une politique de conservation) devraient être examinés par des experts et un plan d'action devrait être décidé en fonction de la condition des structures et de l'importance du site. Les décisions possibles sont les suivantes:

- a. comblement immédiat de la fouille;
- b. entretien périodique;
- c. consolidation d'urgence et comblement;
- d. consolidation d'urgence et protection temporaire;
- e. conservation complète.

3. CONSTRUCTION D'ABRIS

On recommande:

- 3.1 d'entreprendre l'étude d'un projet de systèmes modulaires pour la construction d'abris de protection d'un prix modéré (permettant une fermeture complète ou partielle);
- 3.2 que le projet et la conception des abris soient développés par des spécialistes de différentes disciplines (c'est-à-dire architecture, archéologie, conservation) et expérimentés par eux sur le terrain, avec une attention particulière pour les matériaux qui sont disponibles sur place.

4. RECHERCHE SUR LES TRAITEMENTS DE CONSERVATION

On recommande:

- a. que les méthodes d'essai soient normalisées;
- b. que des surfaces comparables soient utilisées pour tester les qualités relatives des différents systèmes proposés, aussi bien dans le laboratoire que sur le terrain;
- c. que des projets pilotes soient choisis pour tester les systèmes de conservation sur d'entières structures.

5. SITES EN TERRE EN PARTIE BRULES

Dans certaines régions du monde, des sites en terre ont été détruits par des incendies et les briques crues ont été partiellement cuites. Par conséquent la conservation de tels sites requiert des critères de préservation différents. La protection

provisoire doit servir plus à la protection contre les variations extrêmes de température, le cycle gel-dégel et la remontée capillaire avec cristallisation des sels (et les changements volumétriques qui en résultent) et peut-être moins à la protection contre l'érosion physique directe due à l'action de la pluie, contre laquelle la brique cuite est plus résistante. C'est pourquoi des systèmes de protection provisoire, comme ceux qui ont été proposés ci-dessus pour les briques crues, devraient être adoptés pour retarder la vitesse de l'altération et assurer dans l'immédiat la subsistance du matériau. Dans le cas de sites de briques crues en partie cuites, il peut être nécessaire de faire quelques réparations structurales d'urgence avant d'appliquer les mesures de protection provisoire.

6. LA REUNION PROCHAINE

L'offre qui a été faite amablement de la part de la Délégation Péruvienne pour organiser la prochaine réunion pour étudier les sites historiques ou demeurent des vestiges en terre cuite et les structures en pisé a été acceptée.

1. *[Faint, illegible text]*

2. *[Faint, illegible text]*

3. *[Faint, illegible text]*

4. *[Faint, illegible text]*

5. *[Faint, illegible text]*

6. *[Faint, illegible text]*

7. *[Faint, illegible text]*

8. *[Faint, illegible text]*

9. *[Faint, illegible text]*

özgeçmişler
curriculum vitae

Alejandro ALVA

- . Architect,
- . Assistant Coordinator of the Architectural Conservation Course at ICCROM.
- . Project Coordinator of the Technical Direction for Conservation of Cultural Property, Inc. Peru
- . Current Lecturer of the ICCROM Architectural Conservation Course

Darrel BUTTERBAUGH

- . Chemist
- . Industrial Chemist between years 1938-1970
- . Presently, Research Associate at University Museum, University of Pennsylvania

Giacomo CHIARI

- . Chemist,
- . Started working in the field of mud brick preservation in 1968, in Iraq. Reports related with this campaign, published in Mesopotamia IV and VII.
- . Between 1975-77 undertook three UNESCO Missions to Peru for preservation of freezes and mudbrick.
- . Currently teaching at Mineralogy Laboratory at the University of Torino.

Murat ERİÇ

- . Architect
- . Head of the chair of Building Science and Construction Materials at the State Fine Arts Academy, Fındıklı, Istanbul.
- . Author of several books and articles on building materials, acoustics in buildings and the use of mudbrick.

Eugenio GALDIERI

- . Architect
- . Expert Consultant de ISMEO (Istituto Italiano per Il Medio ed Estremo Oriente, Rome)
- . Consultant de l'ICCROM

- . Activité de recherche et expériences de restauration en Libye, Grèce, Iran, Sultanate d'Oman, et Yemen du Nord
- . Cours et Séminaires sur ces deux thèmes près de quelques Universités d'Iran
- . Auteur de 35 titres (1965-1980) se référant aux thèmes de la Conservation Architecturale et de l'architecture Islamique.

Polat GÜLKAN

- . Civil Engineer
- . Research activities in the field of earthquake engineering with an emphasis on experimental work.
- . Served as consultant to the Turkish Electricity Authority on nuclear power plant site selection.
- . During 1977-1979 employed at the Earthquake Engineering Research Center as a visiting research associate and conducted studies on the earthquake resistance of measuring structures.
- . Currently on the staff of the Department of Civil Engineering, METU.

Rafaella ROSSI-MANARESI

- . Chemist
- . In 1966, experimental research in conservation of works of art, learning techniques of examination of paintings at National Gallery, London, and collaborating with the Institute of Mineralogy and Petrography of the University of Siena in the field of Conservation of stone.
- . In 1969, joined the Bologna Centre, served ever since responsible for the research laboratory and the advisory service.
- . A number of publications dealing with the Conservation of stone.

Roberto Samanez ARGUMENDO

- . Architect Restorer
- . Acted as National Director of the Project which carried the studies for restoration of monuments in Peru, collaboration with UNESCO.
- . UNESCO Consultant for conservation problems in Bolivia.
- . Lecturer in the Training Programme for restorers of the Andean Region.
- . Currently Director of the Special Executive Unit of the COPESCO Plan, a special Project of UNESCO and Peruvian Government.

Paul SCHWARTZBAUM

- . Conservator
- . Worked as Conservator of Paintings at Delaware, U.S.A. and Coordinator at Conservation of Mural Paintings Course, ICCROM.
- . Coordinated the conservation projects at Göreme (Turkey), Gondar (Ethiopia), Al Aksa Mosque (Jerusalem), also attended the restoration of paintings of San Francesco, Assisi.

André STEVENS

- . Architect
- . Expert in Architectural Earth Designing.
- . Consultant, Visiting-Professor, Invited Expert or Architectural and Photographic Observer in Middle-East, in Africa, in America and in Brussels, Paris and Rome.

Patrick DE SUTTER

- . Architecte Restaurateur
- . Architecte en chef dans les batiments scolaires en Belgique pour le Ministère de l'Education (1971-75).
- . Expert Associé UNESCO dans le Projet au Pérou.
- . Expert de Belgique en Ecuador pour la recherche des vieux methodes y matériaux de construction coloniales pour le Ministère de Culture y éducation depuis (1980).

Johan Pieter TER HEEGE

- . Chemist
- . Worked on development and application of analytical and physico-chemical methods to geological, biological and environmental problems (U.S.A., France, Spain, Greece)
- . Research Associate and docent in Analytical Chemistry and Geochemistry at the University of Utrecht (HOLLAND)
- . Presently Joint the Dutch Ministry of Culture's Central Research Laboratory to study mudbrick preservation methods.

Giorgio TORRACA

- . Chemist
- . Research Assistant at the Engineering School of Rome University (1953-58)

- . Consultant of Istituto Centrale del Restauro (1953-58)
- . Materials and Treatment Department, Selenia SPA (1958-65)
- . Scientific Assistant (1965-70) and Deputy Director (1970 to date) of ICCROM.

Marie Christine UGINET

- . Etudes supérieures d'Histoire à l'Université de Grenoble
- . Diplômée de l'Ecole Vaticane de bibliotéconomie.
- . Bibliothécaire de l'ICCROM depuis 1974.

Jacques VERITE

- . Architect
- . Expert Consultant de l'UNESCO.
- . A réalisé différents travaux de restauration de monuments historiques et d'archéologie en Tunisie (1967), Egypte (1978) et Pérou (1970).
- . En tant qu'expert consultant de l'UNESCO en Tunisie, Algérie et Maroc.

John WARREN

- . Architect
- . In practice as a Consultant since 1962
- . Author of various papers on Byzantine and Muslim Architecture
- . Currently working as consultant on medieval building conservation in Iraq and Saudi Arabia, in addition to general work as a planner and architect.

Syed Tanvir WASTI

- . Civil Engineer
- . Currently teaching and/or research positions at Middle East Technical University, Ankara; The University of Engineering and Technology, Lahore; and the University of California, Berkeley.

1980-1985

1980-1985
1980-1985
1980-1985

1980-1985

1980-1985
1980-1985

1980-1985

1980-1985
1980-1985
1980-1985

1980-1985

1980-1985
1980-1985
1980-1985

1980-1985

1980-1985
1980-1985
1980-1985

1980-1985

1980-1985
1980-1985
1980-1985

1980-1985

1980-1985
1980-1985
1980-1985

1980-1985

1980-1985
1980-1985
1980-1985

1980-1985

1980-1985
1980-1985
1980-1985

1980-1985

1980-1985
1980-1985
1980-1985

katılanlar
participants

Alejandro ALVA

ICCROM, Via Di. S. Michele 13,
00153 ROME
Italy

Sedat ALP

Türk Tarih Kurumu Sıhhiye ANKARA
Turkey

Nemika ALTAN

Eski Eserler ve Müzeler Gn. Müdürlüğü
G.E.E. ve A.Y.K. Şubesi. ULUS
Turkey

Mustafa AKPOLAT

Türkocağı binası onarım mimarı
ANKARA
Turkey

Necva AKÇURA

O.D.T.Ü. Mimarlık Fakültesi
Restorasyon Bölümü ANKARA
Turkey

Özdoğan AKTAR

Sinan kent İnşaat Turizm ve Tic. Şirketi
Halaskargazi Cad. 305-307/1 İSTANBUL
TURKEY

Çetin ANLAÇAN

Eski Eserler ve Müzeler Gn. Müdürlüğü Ulus
ANKARA
Turkey

Tanju ANLAÇAN

Anadolu Medeniyetleri Müzesi ANKARA
Turkey

Halim ASOY

İmar İskan Bakanlığı ANKARA
Turkey

Nadir AVCI

Eski Eserler ve Müzeler Gn. Müdürlüğü Ulus
ANKARA
Turkey

Gül ASATEKİN

Eski Eserler ve Müzeler Gn. Müdürlüğü
Tescil ve Planlama Şb. Ulus ANKARA
Turkey

Ömür BAKIRER

O.D.T.Ü. Mimarlık Fakültesi
Restorasyon Bölümü ANKARA
Turkey

Cevdet BAYBURTLUOĞLU

Dil ve Tarih Coğrafya Fakültesi ANKARA
Turkey

Kemal BALKAN

Dil ve Tarih Coğrafya Fakültesi ANKARA
Turkey

İnci BAYBURTLUOĞLU

Anadolu Medeniyetleri Müzesi ANKARA
Turkey

Sabahattin BAYRAM

Anadolu Medeniyetleri Müzesi ANKARA
Turkey

Darril J. BUTTERBAUCH

P.O. Box 325, WORCESTER, Pa. 19490
U.S.A.

Emin BİLGİÇ

Kültür Bakanlığı Müsteşarı ANKARA
Turkey

Yusuf BOYSAL

Edebiyat Fakültesi Selçuk Üniversitesi
KONYA
Turkey

Nedret BULUCU

Eski Eserler ve Müzeler Gn. Müdürlüğü
Tescil ve Planlama Şb. Ulus ANKARA
Turkey

Emine CANER

O.D.T.Ü. Mimarlık Fakültesi
Restorasyon Bölümü ANKARA
Turkey

Giacomo CHIARI

Istituto Di Mineralogia, Via S.Massimo 22
10123 TORİNO
Italy

Anthony CROSBY

National Park Service, P.O.Box 25287, Denver
COLORADO, 80225
U.S.A.

Meliha COŞKUN

Anadolu Medeniyetleri Müzesi ANKARA
Turkey

Roger CRILB

Antrapolog O.D.T.Ü. ANKARA
Turkey

Hayrunisa ÇAKMALI

Eski Eserler ve Müzeler Gn. Müdürlüğü
Müzeler Şubesi ANKARA
Turkey

Isabelle DANGAS

3.Rue Edgar Quinet, 92290 Malakoff PARIS
France

Cevat ERDER

O.D.T.Ü. Mimarlık Fakültesi
Restorasyon Bölümü ANKARA
Turkey

Murat ERİÇ

Devlet Güzel Sanatlar Akademisi, Yapı Fiziği
ve Malzeme Kürsüsü, Fındıklı İSTANBUL
Turkey

Murat ERDİM

Ege Üniversitesi Güzel Sanatlar Fakültesi
Alsancak İZMİR
Turkey

Semih EREN

Eski Eserler ve Müzeler Gn. Müdürlüğü
Tescil ve Planlama Şb. Ulus ANKARA
Turkey

Zeynep EREN

Eski Eserler ve Müzeler Genel Müdürlüğü
Tescil ve Planlama Şb. Ulus ANKARA
Turkey

Nur FERSAN

İ.T.Ü. Mimarlık Fakültesi
Mimarlık Tarihi ve Restorasyon Kürsüsü
İSTANBUL
Turkey

Pamela FRENCH

İngiliz Arkeoloji Enstitüsü, ANKARA
Turkey

Eugenio GALDIERI

Via Accademia Platonica 12, 00145 ROMA
Italy

Polat GÜLKAN

O.D.T.İnşaat Müh. Bölümü
ANKARA
Turkey

Meral GÜNGÖRDÜ

Anadolu Medeniyetleri Müzesi ANKARA
Turkey

Mehmet Güven GÜLER

Anadolu Medeniyetleri Müzesi ANKARA
Turkey

Ülge GÖKER

İngiliz Arkeoloji Enstitüsü
Büklüm Sokak Kavaklıdere ANKARA
Turkey

Ayşe GÜNEŞ

Eski Eserler ve Müzeler Gn. Müdürlüğü
G.E.E. ve A.Y.K. Şubesi ANKARA
Turkey

Meral GÖZÜBÜYÜK

Eski Eserler ve Müzeler Gn. Müdürlüğü
Kazılar Şubesi ANKARA
Turkey

Alan HALL

Büklüm Sokak 96/15 Kavaklıdere ANKARA
Turkey

Veysel Karani HAZER

Eski Eserler ve Müzeler Gn. Müdürlüğü
Kazılar Şubesi ANKARA
Turkey

Ali Çetin İDİL

O.D.T.Ü. Mimarlık Fakültesi
Restorasyon Bölümü ANKARA
Turkey

Necip İNCELER

Kültür Bakanlığı Dış İlişkiler Dairesi
ANKARA
Turkey

İsmet İLTER

Tarihi Köprüler Dairesi Md.
Karayolları Genel Müdürlüğü ANKARA
Turkey

Nevzat İLHAN

Devlet Mimarlık ve Mühendislik Akademisi
Mimarlık Fakültesi Yıldız İSTANBUL
Turkey

Ahmet İşçimen

Büklüm Sokak 96/15 Kavaklıdere ANKARA
Turkey

Habib KARAÇETİN

Anadolu Medeniyetleri Müzesi ANKARA
Turkey

Nihal KAVAKLILAR

Anadolu Medeniyetleri Müzesi ANKARA
Turkey

Uğurcan KARAMAHTOĞLU

Paris Caddesi 38/19 Kavaklıdere ANKARA
Turkey

Hasan KÖSE

Eski Eserler ve Müzeler Gn. Müdürlüğü
G.E.E. ve A.Y.K. Şubesi ANKARA
Turkey

Ünver KOZANLI

Eski Eserler ve Müzeler Gn. Müdürlüğü
Kazılar Şubesi ANKARA
Turkey

Rafaella Rossi MANARESİ

Centro per la Conservazione Sculture
all'Aperto, Via de' Pignattari 1,
40124 BOLOGNA
Italy

Marc MAMILLAN

C.E.B.T.P., 12 Rue Brancion, PARIS (XV)
France

Emre MADRAN

O.D.T.Ü. Mimarlık Fakültesi
Restorasyon Bölümü ANKARA
Turkey

Ann MURRAY

Büklüm Sokak 96/15 Kavaklıdere ANKARA
Turkey

Kubilay NAYIR

Müze Müdürü MANİSA
Turkey

Zeynep NAYIR

İ.T.Ü. Mimarlık Fakültesi
Mimarlık Tarihi ve Restorasyon Kürsüsü
İSTANBUL
Turkey

Taşkın NAR

İmar İskan Bakanlığı ANKARA
Turkey

Peter NEVE

Boğazkale Kazısı Başkanı, ANKARA
Turkey

Cüneyt ÖLÇER

Eski Eserler ve Müzeler Genel Müdürlüğü
ANKARA
Turkey

Aynur ÖZET

Anadolu Medeniyetleri Müzesi ANKARA
Turkey

Aykut ÖZET

Anıtkabir Müzesi Müdürlüğü ANKARA
Turkey

Tahsin ÖZGÜÇ

Dil ve Tarih Coğrafya Fakültesi ANKARA
Turkey

Nimet ÖZGÜÇ

Dil ve Tarih Coğrafya Fakültesi ANKARA
Turkey

Nuran ÖZAL

Ataköy 1. Mah. C-36 Daire 12 İSTANBUL
Turkey

Coşkun ÖZGÜNEL

Dil ve Tarih Coğrafya Fakültesi ANKARA
Turkey

Tanju ÖZORAL

Eski Eserler ve Müzeler Gn. Müdürlüğü
ANKARA
Turkey

Revza OZİL

Arkeoloji Müzeleri İSTANBUL
Turkey

Yıldız OKÇUOĞLU

Eski Eserler ve Müzeler Gn. Müdürlüğü
Tescil ve Planlama Şubesi ANKARA
Turkey

Nesrin RECEPOĞULLARI

Eski Eserler ve Müzeler Gn. Müdürlüğü
Kazılar Şubesi ANKARA
Turkey

André STEVENS

Brusselsesteenweg 138, 3009 WINKSELE
Belgium

Patrick de SUTTER

P.O. Box 443, QUITO
Ecuador

Paul SCHWARTZBAUM

ICCROM, Via di S. Michale 13, 00153 ROME
Italy

Roberto SAMANEZ

Instituto Nacional de Cultura, Apartado
Postal No. 289, CUSCO
Peru

Tahsin SAATÇI

Anadolu Medeniyetleri Müzesi ANKARA
Turkey

Figen SEYREK

Dilhayat Sok. 22 Etiler İSTANBUL
Turkey

Nora SİRMAN

Nişantaşı İhlamur Yolu 45/15 İSTANBUL
Turkey

Gülşen SİLİNDİR

Eski Eserler ve Müzeler Gn. Müdürlüğü
G.E.E. ve A.Y.K. Şubesi ANKARA
Turkey

Zeynep S. SARI

Eski Eserler ve Müzeler Gn. Müdürlüğü
Kazılar Şubesi ANKARA
Turkey

Veli SARIKAMIŞ

Kültür Bakanlığı Müfettişi ANKARA
Turkey

Beyhan ŞENER

Eski Eserler ve Müzeler Gn. Müdürlüğü
G.E.E. ve A.Y.K. Şubesi ANKARA
Turkey

Raci TEMİZER

ICOM Türkiye Milli Komitesi Başkanı
ANKARA
Turkey

Burhan TEZCAN

Alaçam Sokak Çamlı Apt. 10/3 Kavaklıdere
ANKARA
Turkey

Hüsrev TAYLA

Anıt ve Röleve Bürosu Sultanahmet İSTANBUL
Turkey

Giorgio TORRACA

ICCROM, Via di San Michele 13, 00153 ROME
Italy

Carlo TERSIGNI

c/o ICCROM, Via di San Michele 13, 00153 ROME
Italy

Sevim TUNCER

Anadolu Medeniyetleri Müzesi ANKARA
Turkey

M. Çoşkun TÜTÜNCÜ

Anadolu Medeniyetleri Müzesi ANKARA
Turkey

Ahmet TIRPAN

Anadolu Medeniyetleri Müzesi ANKARA
Turkey

Deniz TÜRKMEN

Anadolu Medeniyetleri Müzesi ANKARA
Turkey

Güler TÜRKÖÇLU

İmar İskan Bakanlığı Yapı Malzemeleri
Genel Müdürlüğü ANKARA
Turkey

Yüksel TUNÇSOY

İmar İskan Bakanlığı Yapı Malzemeleri
Genel Müdürlüğü ANKARA
Turkey

Johan Pieter TER HEEGE

Central Research Laboratory for Objects
of Art and Science, 8 Gabriel Metsustraat
P.:.BOX 5132, 1007 AC AMSTERDAM
Holland

Marie Christine UGINET

ICCROM, Via di S. Michele 13, 00153 ROME
Italy

Nazif UYGUR

Anadolu Medeniyetleri Müzesi ANKARA
Turkey

Hasan Tahsin UÇANKUŞ

Kültür Bakanlığı Müşaviri ANKARA
Turkey

Sibel ULUSOY

Eski Eserler ve Müzeler Gn. Müdürlüğü
Tescil ve Planlama Şubesi ANKARA
Turkey

Okan ÜSTÜNKÖK

O.D.T.Ü. Mimarlık Fakültesi
Restorasyon Bölümü, ANKARA
Turkey

John WARREN

53-55 North Street, Horsham SUSSEX
U.K.

Ayşıl YAVUZ

O.D.T.Ü. Mimarlık Fakültesi
Restorasyon Bölümü ANKARA
Turkey

Hülya YIĞIT

İmar İskan Bakanlığı Yapı Malzemeleri
Genel Müdürlüğü ANKARA
Turkey

Jaques VERITE

88 Boulevard Ney, 75018 PARIS
France

1. The first part of the document...

2. The second part of the document...

3. The third part of the document...

4. The fourth part of the document...

5. The fifth part of the document...

6. The sixth part of the document...

7. The seventh part of the document...

8. The eighth part of the document...

9. The ninth part of the document...

10. The tenth part of the document...

11. The eleventh part of the document...

ekler

addendum

PERSONAL VIEWS

André STEVENS

A few words about a particular method of conservation in historic or archaeological milieu.

Besides appropriate and specialised technologies (and sometimes with the help of both these technologies), a method of conservation could be found in an ARCHITECTURAL INTERVENTION, revertible, significant and contemporary in spirit.

This method can, in particular cases, help to preserve authenticity of existing structures, through a VISUAL SIGN of our time, which continues architecture of the past without disturbing it.

It's important, from the beginning, to select a convenient system of protection, according to its plastic occupation of the site, for a certain duration, and not only for a short period.

More Generally, in historic, archaeological or vernacular milieu, it's most important to preserve the permanent values of the earth architecture and not only of its constituent materials.

Doç.Dr.Murat Eriç

1. Turkey is a rich country from the point of view of its antiquities and historical values. Also, structural technology seen in ancient monuments still continue even today, as traditional examples.
2. Therefore, we should handle this subject in two ways:
 - a) An ancient monument that has survived through history should be exposed and preserved.
 - b) Control and observation of the preservation of a living traditional architectural complex so that it will not become corrupted with the desire of delivery technology.

3. Before a historical ancient mudbrick structure is excavated, its continuous conservation and preservation methods should be specially studied.
4. Living, traditional, mudbrick architectural structure should be maintained without its corruption with the desire of introducing new technology and material and therefore disappearing completely.
5. Maintenance should be applied in such a way that:
 - a) Inhabitants living in such a structural system should have all their proper social status and for special conditions the buildings should gain new social functions in order to survive, and not be deserted.
 - b) Traditional structural techniques used in the past should be developed and their usage areas should become enlarged.
 - c) Mudbrick has different physical characteristics compared with other structural materials, and therefore its present quality should be improved with inorganic based compounds.
6. Archaeologists, architects and chemists should collaborate for the preservation of ancient mudbrick monuments; practical experiments and laboratory researches should be delivered to application zones and aid should be given to specialists in this field in order to raise their technical knowledge.
7. The results of the researches should be extended from technical applicants to simple operators by preparing regulations that contain structural and treatment knowledge, and for the efficiency of these regulations supporting and restricting requirements should be undertaken as soon as possible.

