



22mm Push Button Selection Guide



Allen-Bradley



Bringing Together Leading Brands in Industrial Automation

22mm

Unparalleled Flexibility— 800E Push Buttons



Allen-Bradley's 22 mm 800E Push Buttons are designed to provide unparalleled flexibility and quality to meet the global product needs of our customers.

Variety. Rockwell Automation offers the widest selection of front-of-panel operators and back-of-panel options and accessories in the 22 mm market.

Installation Ease. We designed the 800E line of operators for single person installation to provide installation time savings and total cost savings.

Performance. 800E push buttons carry on the Allen-Bradley tradition of performance, reliability, and safety.

22 mm Push Buttons and Enclosures...

- **Superior Design**
- **Manufactured Quality**
- **Product Flexibility**
- **Time-Tested Reliability**
- **Best Value**
- **World-Wide Solutions**
- **Support**



Application Solutions

Demanding Environments Command Durable Metal Operators.

- *Die-cast metal operators offer ruggedness and durability in demanding applications.*
- *Operator bushings and locking rings are constructed of die-cast zinc alloy and finished with corrosion-resistant chromate plating.*
- *Aluminum bezels with metal finish or black anodized finish.*

Corrosive Environments Require Resistant Plastic Operators.

- *Operator bushing and mounting ring constructed of industrial grade thermoplastic for the best corrosion-resistant solution in the industry.*
- *Bezels constructed of black industrial-grade thermoplastic or aluminum with metal finish.*

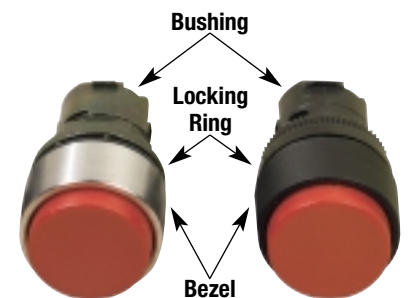

Superior Design



Expect the Best

The 800E line is designed and manufactured to meet demanding performance specifications. Using state-of-the-art solid modeling techniques and finite element analysis, every component built into 800E push buttons are optimized for durability and performance.

Materials

- 800EM and EB lines are constructed of tough, die-cast zinc alloy, finished with corrosion-resistant chromate.
- 800EP, ES, and EQ lines are made of industrial-grade thermoplastic for superior corrosion resistance.
- Illuminated operators have nylon lenses designed for superior UV resistance and strong chemical resistance.

Safety

- Selector switches provide unique positive detent for safe application switching.



Two-Color Plastic Caps

- Saves space and simplifies installation by eliminating the need for separate legend plates.
- Two-color molding is more durable and longer-lasting than surface printing techniques. Lettering is molded in a separate color throughout the entire cap so it will not wear away.

Aesthetics

- Choose from round or square operators to enhance equipment aesthetics.
- Round operators are available with either black or shiny metal bezels.
- Square operators feature black bezels.

World-Wide Solutions

- Designed to meet world wide standards.
- UL Listed, CSA Rated, CE Marked, DEMKO Approved.
- Operator caps, legend plates, and inserts available with international symbols, foreign languages, and custom markings.

Sealing Techniques

We offer IP66 and Type 4/13 ratings across the 800E line with superior sealing techniques. Three types of seals are used on our operators:

Diaphragm Seals

- *Used throughout the 800E line on linear travel devices.*
- *Diaphragm seals flex with the operation of the button.*
- *Life and performance are not dependent on lubrication.*



K-Seals

- *Used on rotating devices like selector switches and twist-to-release operators.*
- *Dual wiping action provides high-pressure sealing performance while lubrication trapping extends sealing life.*

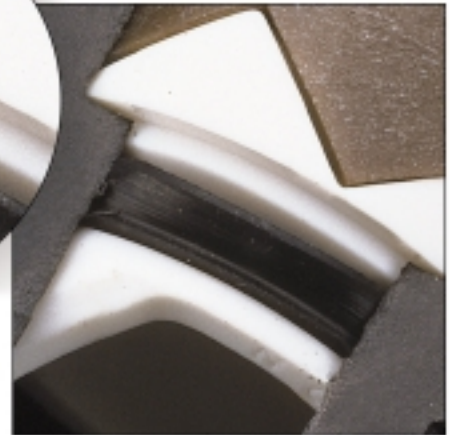

Panel Gasket

- *Installed on all devices.*
- *Oversized, bi-directional gasket seals both panel and mounting hole for superior performance.*
- *Provides operator retention for one person installation.*
- *Ensures Type 4/13, IP66 ratings.*

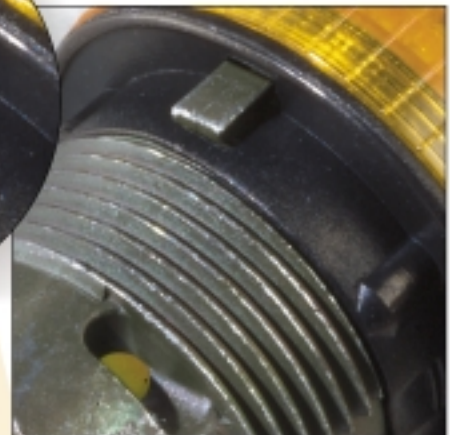

Modular Design



Any Operator + Any Back Of Panel Component = The Greatest Flexibility In The 22 mm Market!

Using a consistent latching approach, any latch can be used with either metal or plastic operators. Permits a wide variety of front-to-back of panel solutions.

Two-Across Latch and Contact Blocks

- Heavy-duty metal
- Screw down contact blocks
- All zinc die-cast metal latch
- 2 blocks across by 3 blocks deep
- Color-coded for contact identification

Three-Across Latch and Contact Blocks

- Heavy-duty plastic snap-on latch
- Rotating collar for easy removal
- Corrosion resistant
- Snap-down contact blocks
- 3 blocks across by 2 blocks deep
- Color-coded for contact block identification



800 EQ
Plastic bushing
Square plastic bezel



800 EB
Metal bushing
Black metal bezel



800 EM
Metal bushing
Aluminum with metal finish bezel



800 EP
Plastic bushing
Plastic bezel



800 ES
Plastic bushing
Aluminum with metal finish bezel

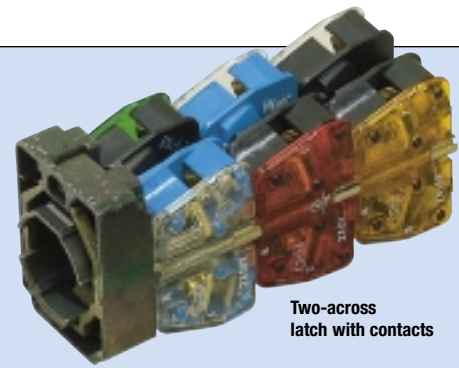

Two-across latch with contacts

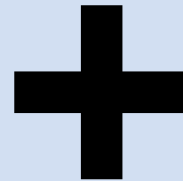

Three-across latch with contacts

Variety and Style

We offer the most extensive line of 22 mm push buttons available anywhere. The combination of colors, styles and sizes is almost limitless – and certain to meet any application requirement.

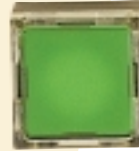

Specialty Operators

- 2-, 3-, 4-position selector switch
- Monolithic pilot light
- 2- and 4-position joy sticks
- Wobble stick
- Reset operators
- Multi-function
- Potentiometers
- Selector/Jog

Back of Panel



The 800E push button system offers a variety of contact block combinations to fit both space and use requirements. What's more, contact and latch assembly is literally a snap – tools are not required.

Two-Across System

- Heavy-duty zinc metal die cast latch.
- 30 x 40 mm (1-3/16" x 1-9/16") mounting matrix.
- One hand latch removal.
- Snap fit, tools not required to attach latch.
- Blocks can be stacked two blocks across by three blocks deep for a total of six circuits.
- Contact blocks can be stacked on full voltage power.
- Screw-down contact blocks provide superior reliability in high vibration environments.
- Power Module Types:
 - Transformer (120V AC...600V AC)
 - Resistor (120V AC/DC and 240V AC)
 - Full Voltage (6V AC/DC...120V AC/DC)
 - Dual Input Diode (24V AC/DC and 120V AC)
- Two-Across Bifurcated Contact Blocks feature:
 - Transparent color coded sides for easy contact inspection and circuit identification.
 - Angled terminal screws provide clear access to stacked blocks for ease of wiring.
 - Excellent contact wiping and optimal switching reliability.
 - Contact blocks available: N.O., N.C., N.O.E.M., N.C.L.B, also see PenTUFF Low Voltage and Self-monitoring contact blocks on proceeding pages.

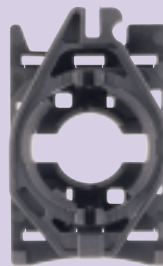
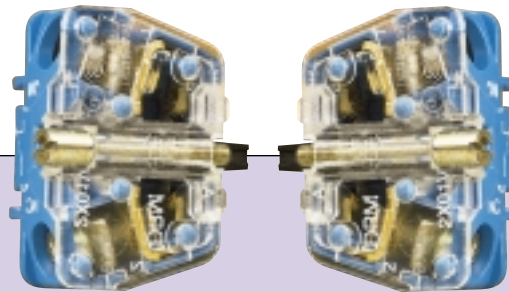

Three-Across System

- 30 x 47.5 mm (1-3/16" x 1-7/8") mounting matrix.
- Heavy-duty molded plastic latch with secure snap fit.
- Rotating collar for easy one-hand latch removal.
- Tools not required to attach contact blocks to latch.
- Blocks can be stacked three blocks across by two blocks deep for a total of six circuits.
- Gold-plated bifurcated contact blocks for optimal switching reliability in low current levels.
- Contact blocks available: N.O., N.C., N.O.E.M., N.C.L.B, low voltage, and self-monitoring
- Two contact block mounting styles (Base and Latch mount).
- Power Module Types:
 - Transformer (120V AC...600V AC)
 - Full Voltage (6V AC/DC...120V AC/DC)
 - Resistor (240V AC)

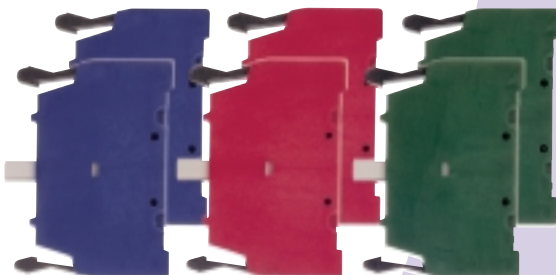

PenTUFF™ – A Low-Voltage PLC Interface Exclusive

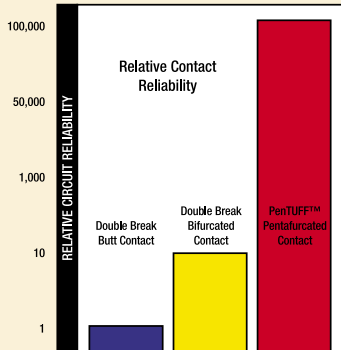

Direct drive pentafurcated contacts are revolutionizing the market for low-voltage switching. Pentafurcated contacts feature spanners with five “fingers” on each side of the spanner allowing 961 different possible current paths. Each path can carry the full rated load of the contact. Pentafurcated contacts features include:

- Self-cleaning contact wiping for increased contact reliability and life.
- No contact bounce between the spanner’s “fingers” and the stationary surface it makes contact with.
- Operates sequentially, with each finger making contact independently.
- A spanner made of an inert precious metal to resist corrosion.
- Are excellent for low voltage applications, like PLC® circuits, with the advantage of a direct drive mechanism.
- Increased communication reliability in PLC®, SLC™, and MicroLogix™ devices.

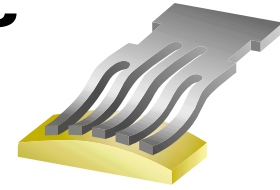

Pentafurcated 5-finger spanner



Self Monitoring™ Contact Blocks – Enhance E-Stop Reliability

Rockwell Automation now offers improved E-Stop reliability for critical process control applications with new Allen-Bradley Self Monitoring™ Contact Blocks (SMCB) for use with 800E push buttons. The **patented** Self Monitoring Contact Blocks monitor whether or not they are properly installed on the E-Stop operator.

Why You Need SMCBs

Proper contact block installation is critical to ensure that the normally closed contacts will open when the E-Stop is actuated. Separation of the contact blocks from the E-Stop operator will prevent the E-Stop from shutting down the controlled process in an emergency. Consider the following dangerous scenarios that could potentially result in contact block separation:

- Contact block mounting screws were not completely tightened and later came loose
- Mounting screws were over-tightened, resulting in stripped threads
- Contact block latch not completely “snapped-on” to the E-Stop operator
- Contact block or latch is accidentally damaged during maintenance
- Contact block or latch is removed and not reinstalled during maintenance

The new Self Monitoring Contact Block eliminates these separation concerns by actually monitoring it’s own installation. If the SMCB is separated from the E-Stop operator for any reason, the controlled circuit will automatically open.



Cat. No. 800E-2LX01LS

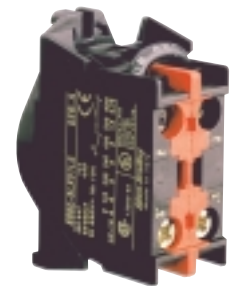

Cat. No. 800E-3LX01S

Additional Product Features

- Same ratings as existing 800E standard contact blocks
- Color-coded yellow for easy identification
- IP2X finger safe protection
- Terminals identified with IEC style markings

Installation Ease



Two-Across System



- No tools required snap-on latch.
- Contact blocks stack two-across by three deep with offset screws for easy terminal access.
- Easy one-hand latch removal.

Three-Across System

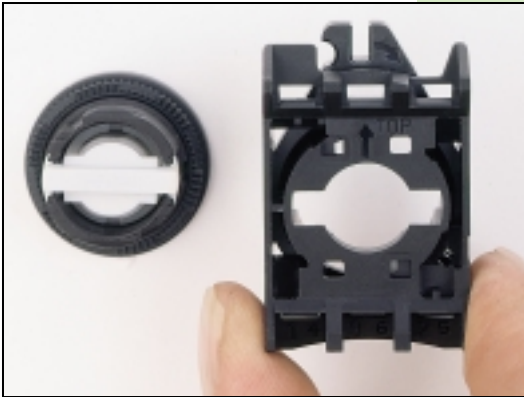

No tools required snap-on installation.

- Operators and latches designed for low installation cost.
- Quick operator and legend changes without disassembly or rewiring the back-of-panel components.



Operators, latches and circuit components are designed for easy removal.

- No tools required snap-on latch.
- Contact blocks stack three-across by two deep.
- Collar rotates to unlatch, remaining unlatched until it is removed from bushing.
- Once latch is off bushing, collar rotates back to install position.



Anti-rotation Bushing Tab

- Provides accurate alignment and eliminates operator and legend plate rotation.
- Tab is easily removed for use in panels without notches.



Mounting Rings

- Metal mounting rings have bonding teeth that cut through paint on metal enclosures to enhance safety and provide a positive grounding point.
- Metal mounting rings tighten with either a standard 15/16" socket or our convenient hand tool.
- Plastic mounting ring tightens by hand or with convenient hand tool.

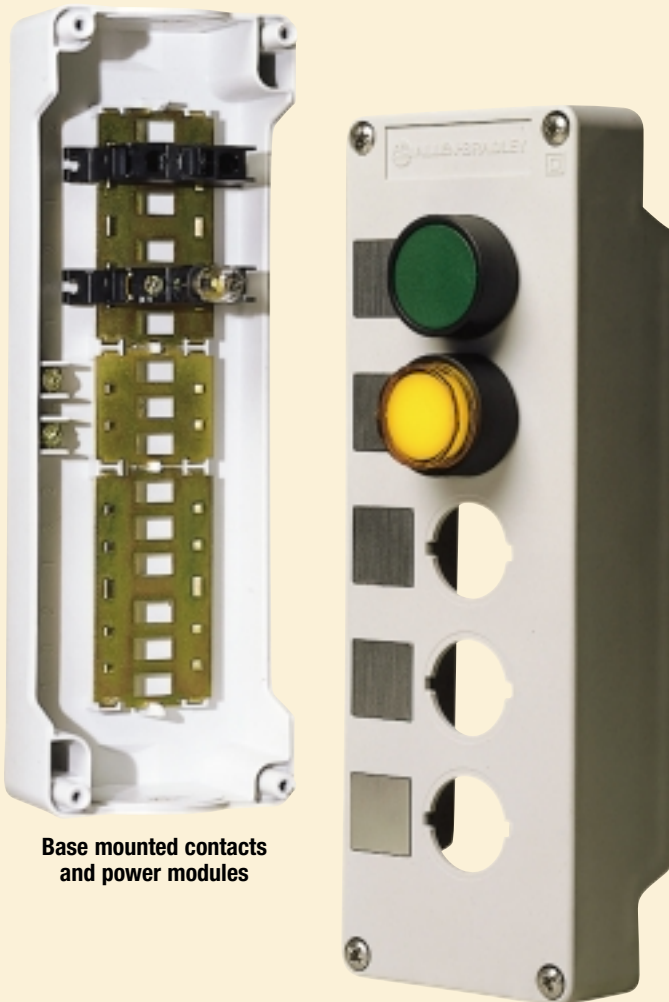

Base mounted contacts and power modules



Base or latch mount configurations

Enclosures

- Available in metal and plastic.
- 1-, 2-, 3- and 5-hole configurations available.
- 1-hole plastic or metal versions available in yellow.
- Metal enclosures accept two- and three-across latch-mounted contact blocks and three-across base-mounted contact blocks with a base mounting adapter.
- Plastic enclosures accept three-across base mounted contact blocks only.
- Metal enclosures rated IP66 and Type 4/13.
- Plastic enclosures rated IP66 and Type 4/4X/13.

Variety Of Illumination



Choose from the largest selection of nylon lens caps in the industry. Allen-Bradley caps have superior resistance to breakage and material degradation. Optical enhancements are molded into lens caps for superior illumination. Diffuser style lens caps are also available. Colors are available in amber, blue, clear, green, red and white.



Power Solutions. Power modules and lamp options are designed to meet all your application needs. And we offer three power solutions: full voltage, resistor, and transformer. Lamp types are available in incandescent and LED.



Illumination Options. Table 1 highlights the variety of lamp types and voltages available. Incandescent lamps are available in three power module types: full voltage, resistor, and transformer, with a voltage range from 6V to 600V. LED lamps are available in full voltage and transformer, from 6V to 600V.

Table 1: Pilot Light Illumination Options

	VOLTAGE										
	6	12	24	32	48	120	130	208	240	480	600
INCANDESCENT											
Full Voltage	●	●	●		●	●	●				
Resistor						●	●		●		
Transformer						●	●	●	●	●	●
LED											
Full Voltage	●	●	●	●	●	●	●	●	●	●	●
Transformer						●		●	●	●	●

Illumination Performance. Table 2 highlights the performance and thermal life expectancy of specific lamps and power modules.



- **Incandescent Lamps** have the widest selection of colors, the highest level of illumination and are the most economical.
- **LED Lamps** offer the greatest value by providing the longest lamp life and the best resistance to shock and vibration. In addition, they have an internal shunt resistor for use with solid state outputs. They last up to 100,000 hours. That's almost 11 years of 24-hour continuous usage!

Table 2: Relative Illumination Performance

	Full Voltage	Resistor	Transformer	LED
Thermal LIFE Chart	5,000	10,000	20,000	Approx. 100,000
Brightness	Best	Good	Best	Good
Shock & Vibration	Fair	Fair	Good	Best
Color Selection	All	All	All	Red, Green, Amber & Blue



Illuminated Operators. Our complete line of illuminated operators feature superior sealing, illumination, and environmental protection. Illuminated operators offer two way communication – push buttons send signals through illumination and receive signals through the operator function.

Accessories



Clear Assembly Instructions

- Assembly instructions are on or in all packages.
- Perforated tear strips allow easy bag opening.
- Clear viewing window allows quick identification of product.

Complete Packages

Complete push button packages are available with easy composite catalog numbering. Packages include:

- Operator
- Latch
- Contact blocks

Legend Plates

- Two-piece style with legend frames and inserts allow you to change legends easily, even after panel assembly.
- One-piece legend plate style features low-tack adhesive to assist the installation process.
- E-Stop legends come in two different sizes: 60 and 90 mm diameter.
- International symbols, foreign languages, and custom markings are available.
- Legends available in five languages.

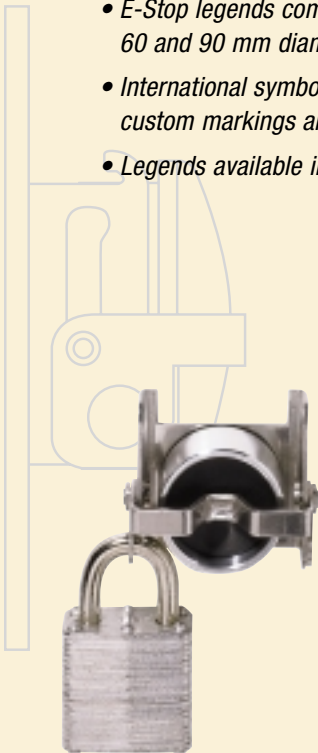

Accessories

- We offer the greatest selection of accessories in the market.
- The selection of security accessories ranges from guards to locking covers and locking attachments.

Emergency Stops



Reliability where it's needed the most. When activated, E-Stops will instantly cut off power to any operating equipment where an unsafe condition may have occurred. Our E-Stops and contact blocks have been tested and certified by a European Testing Agency to meet the EN-418 directive and IEC 947-5-5 specification that relates to machine safety. And they meet NEMA Standard ICS-5-5.

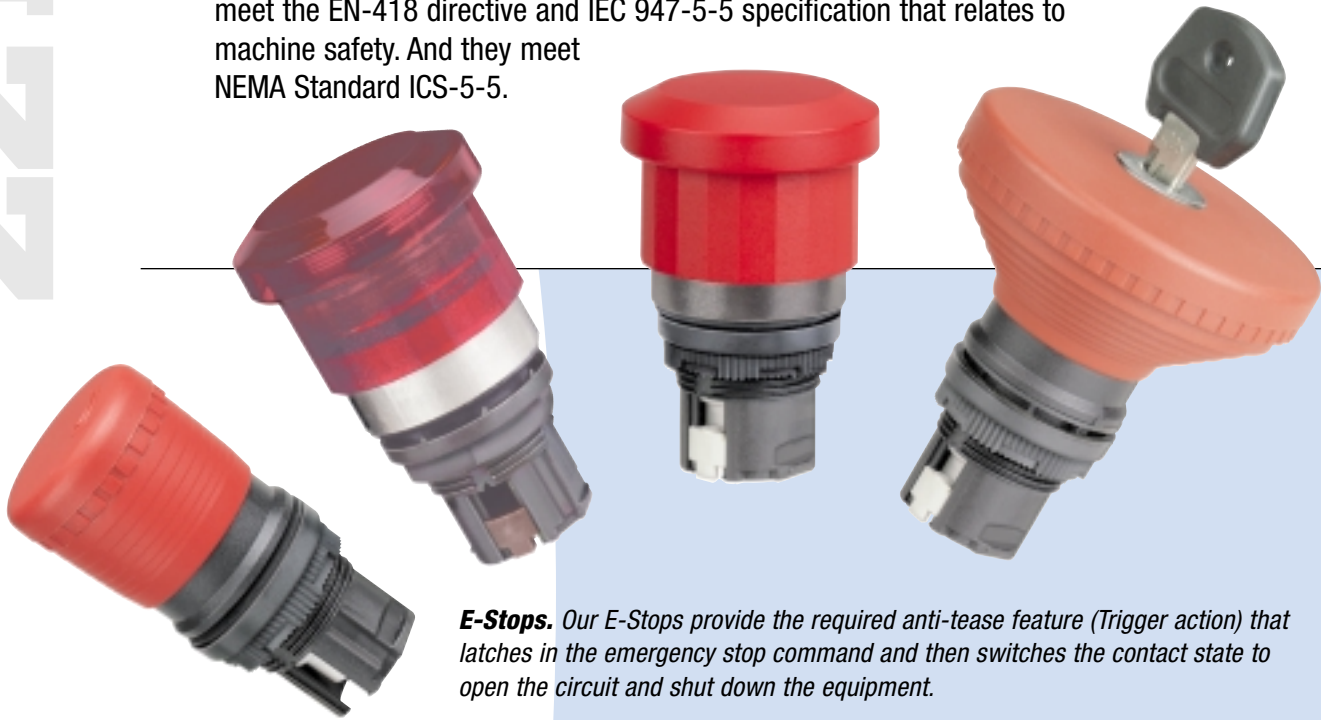

E-Stops. Our E-Stops provide the required anti-tease feature (Trigger action) that latches in the emergency stop command and then switches the contact state to open the circuit and shut down the equipment.



Cat. No. 800E-2LX01



Cat. No. 800E-2LX01LS



Cat. No. 800E-3LX01

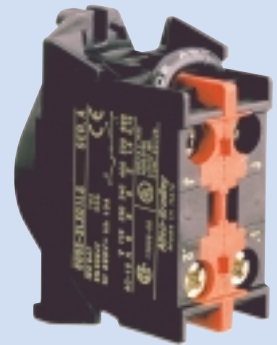

Cat. No. 800E-3LX01S





Bulletin 800E Plastic and Metal Operators

- 22.5 mm Mounting Hole
- IP66 Type 4/4X/13
- Internationally Rated Operators

TABLE OF CONTENTS

Description	Page	Description	Page
Product Overview	16	Joy Stick Operators	77
Specifications	17	Wobble Stick Operators, Non-Illuminated	79
Emergency Stop Push Buttons	20	Reset Operators — with Two-Color Molded Legend Caps	80
Push Buttons, Non-Illuminated		Multi-Operators, Non-Illuminated	
Momentary Contact — Flush, Extended, Guarded	23	2-Function	82
Momentary Contact — with Two-Color Molded Legend Caps	25	3-Function	84
Alternate Action (Maintained) — Flush	27	Multi-Operators, Illuminated	
Momentary Contact — Mushroom	29	2-Function	86
Push-Pull, Non-Illuminated		Potentiometer Operator	88
2-Position — Twist-to-Release, Mushroom	31	Composite Cat. Nos.	89
2-Position — Key Release, Mushroom	33	Non-Illuminated Push Buttons	90
2-Position Trigger Action — Key Release, Mushroom	35	Illuminated Push Buttons	91
3-Position — Mushroom	37	Monolithic Pilot Lights	92
Push Buttons, Illuminated		Pilot Lights	92
Momentary Contact — Flush, Extended, Guarded	39	Non-Illuminated Selector Switch Operators	93
Alternate Action (Maintained) — Flush	41	Non-Illuminated Multi-Function Operators	94
Momentary Contact — Mushroom	43	Illuminated Multi-Function Operators	94
Push-Pull, Illuminated		Emergency Stop Operators — 40 mm Mushroom	95
2-Position — Mushroom	45	Plastic and Metal Enclosures	96
3-Position — Mushroom	47	Complete Assembled Stations	97
Selector Switches, Non-Illuminated		Pendant Stations	
2-Position	49	Specifications — DeviceNet™	99
3-Position	51	Quick Disconnect Cordsets	99
4-Position	53	Accessories	
Selector Switches, Illuminated		2-Across Back-of-Panel Components	100
2-Position	55	3-Across Back-of-Panel Components	102
3-Position	57	3-Across Base-Mounted Components	103
4-Position	59	4-Across Back-of-Panel Components	103
Standard Key Operated Selector Switches, Non-Illuminated		Caps, Diffusers, Lenses	105
2-Position	61	Replacement Knobs/Levers	107
3-Position	63	Locking Attachments and Guards	109
Low Profile Key Operated Selector Switches, Non-Illuminated		Miscellaneous	112
2-Position	65	Replacement Lamps	114
3-Position	67	Legend Plates	115
Selector/Jog Operators, Non-Illuminated	69	Approximate Dimensions	127
Pilot Light Operators			
Optically Enhanced and Diffuser Style	71		
Push-to-Test	73		
Monolithic (Direct Wire)	75		

22.5 mm Push Buttons

IP66, Type 4/4X/13 (Plastic) — IP66, Type 4/13 (Metal)

Product Overview

800EP/EQ/ES Plastic Operators

- NEMA Type 4/13, NEMA Type 4/4X/13, IP65/66
- 2-, 3-, and 4-across mountability
- Engineered grade thermoplastics
- Corrosion-resistant for harsh environments
- Black plastic bezel (800EP/EQ)
- Optional clear anodized shiny metal bezel (800ES)



800EP Round Operators —
Plastic Bushing with Black Plastic Bezel



800EQ Square Operators —
Plastic Bushing with Black Plastic Bezel



800ES Round Operators —
Plastic Bushing with Shiny Metal Bezel

800EM/EB Metal Operators

- NEMA Type 4/13, IP65/66
- 2-, 3-, and 4-across mountability
- Die cast metal construction
- Corrosion-resistant chromate plating
- Clear anodized shiny metal bezel (800EM)
- Optional black anodized metal bezel (800EB)



800EM Round Operators —
Metal Die Cast Bushing with Shiny Metal Bezel



800EB Round Operators —
Metal Die Cast Bushing with Black Anodized Metal Bezel

2-Across x 3-Deep (6 Circuits)

- Heavy-Duty
- Zinc die cast latch
- Screw down stackable contact blocks
- One hand latch removal
- Color-coded contact blocks for contact identification

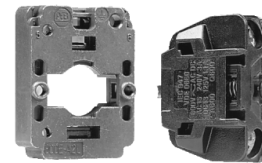

2-Across Mounting Latch

3-Across x 2-Deep (6 Circuits)

- Heavy-Duty
- Engineered grade thermoplastics
- Rugged snap-fit design
- Stackable contact blocks
- Rotating collar for easy one-hand latch removal
- Color-coded contact blocks for contact identification



3-Across Mounting Latch

Specifications ①

Front of Panel (Operators)

Mechanical Ratings		
Description	Plastic (800EP/ES)	Metal (800EM/EB)
Vibration (assembled to panel)	10...2000 Hz, 1.52 mm displacement (peak-to-peak) max./10 G max.	
Shock	1/2 cycle sine wave for 11 ms and no damage at 100 G	
Degree of protection	IP66 (NEMA Type 3/3R/4/4X/12/13) IP65 (potentiometer only) (NEMA Type 4/4X/13) IP40 multi-function without boot IP66 multi-function with boot	IP66 (NEMA Type 3/3R/4/12/13)
Mechanical design life (typical)	10,000,000 Cycles: non-illuminated push buttons 3,000,000 Cycles: illuminated push buttons 3,000,000 Cycles: multi-function operators 500,000 Cycles: mushroom operators, selector operators 200,000 Cycles: illuminated selector operators 100,000 Cycles: mushroom key operators (plastic), push-pull/twist operators, wobble stick, joy stick operators and alternate action push buttons 50,000 Cycles: mushroom key operators (metal)	
Operating forces (typical)	5 N: flush, extended operators	
Environmental		
Temperature range (operating): per IEC 947-1	−25...+55°C (−13...+131°F) ②	
Temperature range (short term storage): per IEC 947-1	−40...+70°C (85°C maximum for 24 hours) −40...+158°F (185°F maximum for 24 hours)	
Humidity	50% to 95% RH from 25...60°C (77...140°F) per: Procedure IV of MIL-STD-810C, Method 507.1 cycling test	
Materials		
Bushings, mounting rings	Glass-filled thermoplastic polyester, rated UL94 V-O	Die-cast zinc; dark olive chromate finish
Legend frames	Glass-filled thermoplastic polyester, rated UL94 V-O	
Bezels	Glass-filled thermoplastic polyester, rated UL94 V-O	Anodized aluminum (EB, EM, ES line)
Seals: diaphragm style	Silicone rubber	
Seals: lip and flat gasket styles	Nitrile rubber	
Illuminated lenses	Transparent nylon Type 12	

① See Performance Data — refer to page Important-2 of the Industrial Controls catalog, publication A113.

② Operating temperatures below 0°C are based on the absence of freezing moisture and liquids.

22.5 mm Push Buttons

IP66, Type 4/4X/13 (Plastic) — IP66, Type 4/13 (Metal)

Specifications ①, Continued

Back-of-Panel Components

Electrical Ratings			
Description	2-Across Style	3-Across Style	4-Across Style
Standard contact block ratings ②	NEMA, EEMAC A600, Q600, VDE 0660 AC 15, DC 13 to IEC 947	NEMA A600, Q600 600V AC AC 15, DC 13 to IEC 947	NEMA, EEMAC A600, Q600, VDE 0660 AC 15, DC 13 to IEC 947
Low voltage contact block ratings	5V, 1mA DC min. R150, C300, AC 15, DC 13 to IEC 947 PenTUFF™ 5-finger spanner	5V, 1 mA DC min. A600, Q600, AC 15, DC 13 to IEC 947 Bifurcated: 2-finger spanner	1 mA DC min. 600V AC NEMA A600, Q600, AC 15, DC 13 to IEC 947 Bifurcated: 2-finger spanner
Thermal current	10 A max. continuous current to UL508, CSA22.2 #14, IEC 947, VDE 0660, part 200	10 A max. without enclosure (40°C ambient) 6 A with enclosure (60°C)	10 A max. continuous current to UL508, CSA22.2 #14, IEC 947, VDE 0660, part 200
Insulation category (minimum)	Group C, 500V to VDE 0110 600V (UL and CSA)		
Terminal marking	Conforming to GENELEC EN50013		
Wire capacity (screw terminal)	Min. of (1) #20 AWG Max. (2) #14 AWG or (1) #12 AWG	#18 to #12 AWG (0.75...2.5 mm ²) Max. (2) #14 AWG or (1) #12 AWG	Min. of (1) #22 AWG Max. (2) #14 AWG or (1) #12 AWG
Wire capacity (stab terminal)	—	—	Integral (1) 0.110" x 0.032" push-on connector for single circuit Double circuit stab kit sold separately
Dielectric strength (minimum)	2,200V for one minute		
Short circuit protection	Standard contacts: 10 A gl or N type cartridge fuse to IEC 269-1, 269-2 (1986) PenTUFF™ contacts: ② 6 A gl or N type cartridge fuse to IEC 269-1, 269-2 (1986)	10 A slow (DT, gl)	10 A gl or N type cartridge fuse to IEC 269-1, 269-2 (1986)
Electrical design life cycles	1,000,000 at 2 A	1,000,000 at 2 A	1,000,000 at 2 A
Electrical shock protection: Per IEC 529	Finger-safe conforming to IP2X		
Mechanical Ratings			
Description	2-Across Style	3-Across Style	4-Across Style
Vibration (assembled to panel)	10...2000 Hz, 1.52 mm displacement (peak-to-peak) max/10 G max. 6 hr	10...150 Hz, 0.15 mm displacement (peak-to-peak) max./2 G max. 6 hr	10...2000 Hz, 1.52 mm displacement (peak-to-peak) max/10 G max. 6 hr
Shock	1/2 cycle sine wave for 11 ms and no damage at 100G min.	1/2 cycle sine wave for 11 ms and no damage at 50 G max.	1/2 cycle sine wave for 11 ms and no damage at 100 G max.
Contact block mechanical design	5,000,000 cycles		
Contact operation	N.O.: slow make, double break N.C.: slow make, double break (positive opening) N.O.E.M.: early make, double break N.C.L.B.: late break, double break (positive opening)	N.O.: slow make, double break N.C.: slow make, double break (positive opening) N.O.E.M.: early make, double break N.C.L.B.: late break, double break (positive opening)	N.O.: slow make, double break N.C.: slow make, double break (positive opening)
Operating forces (typical)	2.78 N: all contact blocks	3.6 N: each N.O. contact block 2.6 N: each N.C. contact block	1.9N: each N.O. contact block 1.7N: each N.C. contact block
2-circuit contact block	—	—	2.9 N: each 2 N.O. 2.6 N: each 2 N.C. or 1 N.O. - 1 N.C.

① See Performance Data — refer to page Important-2 of the Industrial Controls catalog, publication A113.

② Low voltage contacts are recommended for applications below 24V and 100 mA.

Specifications ①, Continued

Back-of-Panel Components

Environmental			
Description	2-Across Style	3-Across Style	4-Across Style
Temperature range (operating) ②③	-25...+55°C (-13...+131°F)		
Temperature range (short term storage) ③	-25...+55°C (70°C max. for 24 hrs) -13...+131°F (158°F max. for 24 hrs)		
Humidity	50% to 95% RH from 25°C...60°C (77...140°F) per: Procedure IV of MIL-STD-810C, Method 507.1 cycling test	40°C (104°F) @ 95% RH for 56 days 23°C (73.4°F), 83% RH/40°C (104°F), 93% RH for 20 cycles	98% RH at 90°C (194°F) for 164 hours
Materials			
Springs	Stainless steel and zinc coated music wire		
Electrical contacts: (Standard)	Silver nickel alloy	Fine silver	Fine silver
(Low voltage)	Palladium silver alloy — spanner gold-plated silver nickel — stationary contacts	Gold-plated over silver	Gold-plated over silver
Terminals: (Screw type) (Push-on type)	Plated steel	Plated steel	Stainless steel Brass
Agency Approvals			
Approvals	UL Listed ④/CSA Certified	UL Listed ④/CSA Certified	UL Listed ④/CSA Certified
Standards conformity	UL508, UL486E CSA22.2 #14, NEMA ICS-1 and ICS-2 (1983), IEC 144, IEC 947-1, IEC 947-5, VDE 0550, VDE 0660, Part 200	NEMA ICS-1 and ICS-2 IEC 204-1, 947; SEV 1005, 1093; VDE 0113, 0660 Part 201; BS 4794; CEE 24; UL 486E, UL 508, CSA22.2 #14	UL508, UL486E CSA22.2 #14, NEMA ICS-1 and ICS-2 (1983), IEC 144, IEC 947-1, IEC 947-5, VDE 0550, VDE 0660, Part 200

- ① See Performance Data — refer to page Important-2 of the Industrial Controls catalog, publication A113.
- ② Operating temperatures below 0° C (32° F) are based on the absence of freezing moisture and liquids.
- ③ Per IEC 947-1.
- ④ UL File & Guide Number E14840.

22.5 mm Push Buttons

Emergency Stop Operators — IP66, Type 4/4X/13 (Plastic) — IP66, Type 4/13 (Metal)

2-Position Push-Pull Operators, Non-Illuminated — Twist-to-Release, Push-Pull



40 mm Trigger Action
Twist-to-Release Mushroom
Cat. No. 800EP-MTS44



40 mm Twist-to-Release Mushroom
Cat. No. 800ES-MT4



40 mm Push-Pull Mushroom
Cat. No. 800ES-MP24



Legend Plate for 40 mm Cap
Cat. No. 800E-15YE112

Color	40 mm Mushroom (Trigger Action) ❶	40 mm Mushroom	40 mm Mushroom
	Twist-to-Release — Round	Push-Pull Twist-to-Release — Round ❷	Push-Pull — Round ❸❸
	Cat. No.	Cat. No.	Cat. No.
Red	800EP-MTS44	800EP-MT4	800ES-MP24
	800EM-MTS44	800EM-MT4	800EM-MP24

- ❶ Trigger action operators are compliant with EN418 Standards and can be used with standard N.C contact blocks.
- ❷ 40 mm plastic or metal color caps (Codes **MP** and **MMP** under Operator Type) available with 800ES and 800EM operators.
- ❸ To be compliant with EN418 standards, N.C.L.B contacts blocks must be used.

Back-of-Panel Components, Non-Illuminated Operators

Mounting Latch and Contact Block Combinations

	Type	Contact	2-Across Mounting	3-Across Mounting
			Cat. No.	Cat. No.
	Late break	1 N.C.L.B.	800E-2LX01L	800E-3LX01L
		1 N.O. - 1 N.C.L.B.	800E-2LX11L	800E-3LX11L
	Self-monitoring	1 S.M.	800E-2LX01LS	800E-3LX01S

2-Position Trigger Action Operators, Non-Illuminated — Key Release ❶



40 mm Key Release Mushroom
Cat. No. 800EP-MKR44



60 mm Key Release Mushroom
Cat. No. 800EP-MKZ64



Legend Plate for 40 mm Cap
Cat. No. 800E-15YE112

Color	2-Position (Trigger Action) Mushroom Key Release			
	Ronis Key Lock		Zadi Key Lock	
	40 mm — Round	60 mm — Round	40 mm — Round	60 mm — Round
	Cat. No.	Cat. No.	Cat. No.	Cat. No.
Red	800EP-MKR44	800EP-MKR64	800EP-MKZ44	800EP-MKZ64

Back-of-Panel Components, Non-Illuminated Operators

Mounting Latch and Contact Block Combinations

	Type	Contact	2-Across Mounting	3-Across Mounting
			Cat. No.	Cat. No.
	Late break	1 N.C.L.B.	800E-2LX01L	800E-3LX01L
		1 N.O. — 1 N.C.L.B.	800E-2LX11L	800E-3LX11L
	Self-monitoring	1 S.M.	800E-2LX01LS	800E-3LX01S

❶ Trigger action operators are compliant with EN418 Standards and can be used with standard N.C. contact blocks.

22.5 mm Push Buttons

Emergency Stop Operators — IP66, Type 4/4X/13 (Plastic) — IP66, Type 4/13 (Metal)

2-Position Push-Pull Operators, Illuminated — Mushroom ④



40 mm Mushroom Push-Pull
Cat. No. 800ES-LMP24



60 mm Jumbo Mushroom Push-Pull
Cat. No. 800ES-LMJP25



Legend Plate for 40 mm Cap
Cat. No. 800E-15YE112

Color	40 mm Mushroom Push-Pull — Round	60 mm Mushroom Push-Pull — Round
	Cat. No.	Cat. No.
Red	800ES-LMP24	800ES-LMJP24
	800EM-LMP24	800EM-LMJP24

Back-of-Panel Components, Illuminated Operators

Full Voltage Power Module with Latch or Integrated LED Module with Latch

	Type	Volts	2-Across Mounting	3-Across Mounting
			Cat. No.	Cat. No.
	No lamp ❶	—	800E-2DL0	800E-3DL0
	Incandescent	24V AC/DC	800E-2DL3	800E-3DL3
		120V AC/DC	800E-2DL5	800E-3DL5
	Integrated LED Module ❷ (red)	24V AC/DC	—	800E-3NL3R
		120V AC	—	800E-3NL5R
		240V AC	—	800E-3NL7R

❶ Lamp must match line voltage. See replacement lamps table on page 114.

Transformer Power Module with Latch

	Type	Volts	2-Across Mounting	3-Across Mounting
			Cat. No.	Cat. No.
	Incandescent	110/120V AC	800E-2TL5	800E-3TL5
		220/240V AC	800E-2TL7	800E-3TL7
	LED ❸ (red)	110/120V AC	800E-2TL5R	800E-3TL5R
		220/240V AC	800E-2TL7R	800E-3TL7R

Contact Blocks

	Type	Contact	2-Across Mounting	3-Across Mounting
			Cat. No.	Cat. No.
	Late break ❹	1 N.C.L.B.	800E-2X01L	800E-3X01L

❷ LEDs are only available in red, green, blue, amber, and white; color cap must match LED color.

❸ Patented PenTUFF contacts supplied only with 2-across mounting; gold-plated contacts supplied only with 3-across mounting.

❹ To be compliant with EN418 standards, N.C.L.B contact blocks must be used.

Accessories — Page 100

Lamp Information — Page 114

Legend Plates — Page 115

Approximate Dimensions — Page 127

22.5 mm Push Buttons

IP66, Type 4/4X/13 (Plastic) — IP66, Type 4/13 (Metal)

Momentary Contact Push Button Operators, Non-Illuminated — Flush, Extended, Guarded



Flush Operator
Cat. No. 800EP-F3



Extended Operator
Cat. No. 800EM-E4



Guarded Operator
Cat. No. 800EP-G3

Color	Flush — Round		Extended — Round		Guarded — Round	
	Plastic	Metal	Plastic	Metal	Plastic	Metal
	Cat. No.	Cat. No.	Cat. No.	Cat. No.	Cat. No.	Cat. No.
Black	800EP-F2	800EM-F2	800EP-E2	800EM-E2	800EP-G2	800EM-G2
Green	800EP-F3	800EM-F3	800EP-E3	800EM-E3	800EP-G3	800EM-G3
Red	800EP-F4	800EM-F4	800EP-E4	800EM-E4	800EP-G4	800EM-G4
No cap	800EP-F9	800EM-F9	800EP-F9	800EM-F9	800EP-G9	800EM-G9

Back-of-Panel Components, Non-Illuminated Operators

Mounting Latch

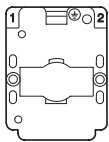
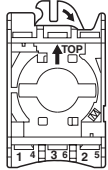
		Contact	2-Across Mounting	3-Across Mounting
			Cat. No.	Cat. No.
 <p>2-Across</p>	 <p>3-Across</p>	Mounting latch	800E-A2L	800E-A3L

Contact Block

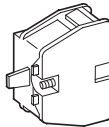
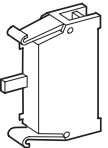
		Type	Contact	2-Across Mounting	3-Across Mounting
				Cat. No.	Cat. No.
 <p>2-Across</p>	 <p>3-Across</p>	Standard	1 N.O.	800E-2X10	800E-3X10
			1 N.C.	800E-2X01	800E-3X01
		Pen TUFF (low voltage) ①	1 N.O.	800E-2X10V	800E-3X10V
			1 N.C.	800E-2X01V	800E-3X01V

Mounting Latch and Contact Blocks

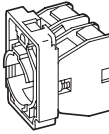
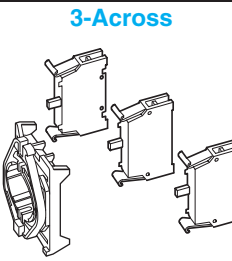
		Type	Contact	2-Across Mounting	3-Across Mounting
				Cat. No.	Cat. No.
 <p>2-Across</p>	 <p>3-Across</p>	Standard	1 N.O.	800E-2LX10	800E-3LX10
			1 N.C.	800E-2LX01	800E-3LX01
			1 N.O. - 1 N.C.	800E-2LX11	800E-3LX11
			2 N.O.	800E-2LX20	800E-3LX20
		Pen TUFF (low voltage) ①	2 N.C.	800E-2LX02	800E-3LX02
			1 N.O.	800E-2LX10V	800E-3LX10V
			1 N.C.	800E-2LX01V	800E-3LX01V
			1 N.O. - 1 N.C.	800E-2LX11V	800E-3LX11V

① Patented Pen TUFF contacts supplied only with 2-across mounting; gold-plated contacts supplied only with 3-across mounting.

22.5 mm Push Buttons

IP66, Type 4/4X/13 (Plastic) — IP66, Type 4/13 (Metal)

Momentary Contact Push Button Operators, Non-Illuminated — Flush, Extended, Guarded

800 **EP** - **F** **3** -
a *b* *c* *d*

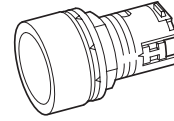

a

Operator Construction	
Code	Description
EP	Round plastic operator (NEMA Type 4/4X/13)
ES	Round plastic operator w/shiny metal bezel (NEMA Type 4/13)
EQ	Square plastic operator (NEMA Type 4/4X/13)
EM	Round metal operator (NEMA Type 4/13)
EB	Round metal operator w/black anodized bezel (NEMA Type 4/13)

b

Operator Type	
Code	Description
F	Flush
E	Extended
G	Guarded

c

Color Cap	
Code	Color
1	White
2	Black
3	Green
4	Red
5	Yellow
6	Blue
8	Gray
9	No cap ❶

d

Packaging	
Code	Description
Blank	1 per package
BP	10 per package

Back-of-Panel Components, Non-Illuminated Operators

Note: To order 4-across back-of-panel components, see page 103.

800E - **2LX** ^{N.O.} **1** ^{N.C.} **0** **V**
a *b* *c* *d*

a

Contact Block/Latch Type	
Code	Type
2LX	2-across mounting
3LX	3-across mounting

b

N.O. (Normally Open Circuits) ❷	
Code	No. of Circuits
0	No contact
1	1 N.O.
2	2 N.O.
3	3 N.O.
4	4 N.O.
5	5 N.O.
6	6 N.O.

c

N.C. (Normally Closed Circuits) ❷	
Code	No. of Circuits
0	No contact
1	1 N.C.
2	2 N.C.
3	3 N.C.
4	4 N.C.
5	5 N.C.
6	6 N.C.

d

Specialty Contact Blocks	
Code	Type
Blank	Standard
V	PenTUFF (low voltage) ❸
E	N.O. early make
L	N.C. late break

❶ To order the no cap option on flush and extended operators, specify code **F9**. Example: **800EP-F9**.

❷ A total of six circuits is the maximum allowable.

❸ Patented PenTUFF contacts supplied only with 2-across mounting; gold-plated contacts supplied only with 3-across mounting.

22.5 mm Push Buttons

IP66, Type 4/4X/13 (Plastic) — IP66, Type 4/13 (Metal)

Momentary Contact Push Button Operators, Non-Illuminated — with Two-Color Molded Legend Caps



Flush Operator
Cat. No. 800EP-F301W



Extended Operator
Cat. No. 800EM-E402W

Button Color	Text Color	Legend Text	Flush — Round		Extended	
			Plastic	Metal	Plastic	Metal
			Cat. No.	Cat. No.	Cat. No.	Cat. No.
White	Black	FORWARD	800EP-F109B	800EM-F109B	800EP-E109B	800EM-E109B
		REVERSE	800EP-F110B	800EM-F110B	800EP-E110B	800EM-E110B
Black	White	FORWARD	800EP-F209W	800EM-F209W	800EP-E209W	800EM-E209W
		REVERSE	800EP-F210W	800EM-F210W	800EP-E210W	800EM-E210W
Green	White	START	800EP-F301W	800EM-F301W	—	—
		ON	800EP-F303W	800EM-F303W	—	—
Red	White	STOP	—	—	800EP-E402W	800EM-E402W
		OFF	—	—	800EP-E404W	800EM-E404W

Back-of-Panel Components, Non-Illuminated Operators

Mounting Latch

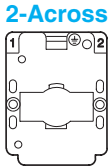
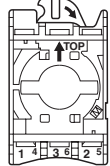
		Contact	2-Across Mounting Cat. No.	3-Across Mounting Cat. No.
		Mounting latch	800E-A2L	800E-A3L

Contact Block

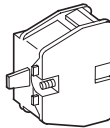
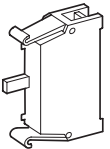
		Type	Contact	2-Across Mounting Cat. No.	3-Across Mounting Cat. No.
		Standard	1 N.O.	800E-2X10	800E-3X10
			1 N.C.	800E-2X01	800E-3X01
		PenTUFF (low voltage) ①	1 N.O.	800E-2X10V	800E-3X10V
			1 N.C.	800E-2X01V	800E-3X01V

Mounting Latch and Contact Blocks

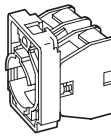
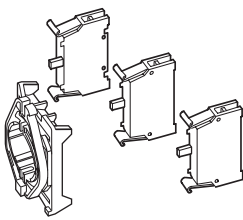
		Type	Contact	2-Across Mounting Cat. No.	3-Across Mounting Cat. No.
		Standard	1 N.O.	800E-2LX10	800E-3LX10
			1 N.C.	800E-2LX01	800E-3LX01
			1 N.O. - 1 N.C.	800E-2LX11	800E-3LX11
			2 N.O.	800E-2LX20	800E-3LX20
			2 N.C.	800E-2LX02	800E-3LX02
		PenTUFF (low voltage) ①	1 N.O.	800E-2LX10V	800E-3LX10V
			1 N.C.	800E-2LX01V	800E-3LX01V
			1 N.O. - 1 N.C.	800E-2LX11V	800E-3LX11V

① Patented PenTUFF contacts supplied only with 2-across mounting; gold-plated contacts supplied only with 3-across mounting.

22.5 mm Push Buttons

IP66, Type 4/4X/13 (Plastic) — IP66, Type 4/13 (Metal)

Momentary Contact Push Button Operators, Non-Illuminated — with Two-Color Molded Legend Caps

800 **EP** - **F** **3** **01** **W** -
a *b* *c* *d* *e* *f*

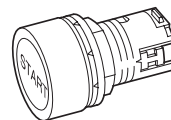

a

Operator Construction	
Code	Description
EP	Round plastic operator (NEMA Type 4/4X/13)
ES	Round plastic operator w/shiny metal bezel (NEMA Type 4/13)
EQ	Square plastic operator (NEMA Type 4/4X/13)
EM	Round metal operator (NEMA Type 4/13)
EB	Round metal operator w/black anodized bezel (NEMA Type 4/13)

b

Operator Type	
Code	Description
F	Flush
E	Extended
G	Guarded

c

Color Cap	
Code	Color
1	White
2	Black
3	Green
4	Red
5	Yellow
6	Blue
8	Gray

d

Legend Text ①	
Code	Text
01	START
02	STOP
03	ON
04	OFF
05	○
06	
07	RESET
08	→ ②
09	FORWARD
10	REVERSE
11	R
12	JOG
13	UP
14	DOWN
15	RAISE
16	LOWER
17	IN
18	OUT
19	⓪
20	Ⓛ
21	Ⓜ

d (cont'd)

Legend Text	
Code	Text
22	STOP/RESET
23	HIGH
24	LOW
25	START/I
26	STOP/O
French	
Code	Text
F01	MARCHE
F02	ARRÊT
F09	AVANT
F10	ARRIÈRE

e

Legend Text	
Code	Color
W	White ③
B	Black ③

f

Packaging	
Code	Description
Blank	1 per package
BP	10 per package

Back-of-Panel Components, Non-Illuminated Operators

Note: To order 4-across back-of-panel components, see page 103.

800E - **2LX** ^{N.O.} **1** ^{N.C.} **0** **V**
a *b* *c* *d*

a

Contact Block/Latch Type	
Code	Type
2LX	2-across mounting
3LX	3-across mounting

b

N.O. (Normally Open Circuits) ⑤	
Code	No. of Circuits
0	No contact
1	1 N.O.
2	2 N.O.
3	3 N.O.
4	4 N.O.
5	5 N.O.
6	6 N.O.

c

N.C. (Normally Closed Circuits) ⑥	
Code	No. of Circuits
0	No contact
1	1 N.C.
2	2 N.C.
3	3 N.C.
4	4 N.C.
5	5 N.C.
6	6 N.C.

d

Specialty Contact Blocks	
Code	Type
Blank	Standard
V	PenTUFF (low voltage) ⑥
E	N.O. early make
L	N.C. late break

- ① Color caps for square operators only available in legend text codes 1...18.
- ② Legend button cap supplied loose for customer installation [→], [↓], [←], [↑].
- ③ Use cap colors black, green, red, blue, and gray only.
- ④ Use cap colors white or yellow only.
- ⑤ A total of six circuits is the maximum allowable.
- ⑥ Patented PenTUFF contacts supplied only with 2-across mounting; gold-plated contacts supplied only with 3-across mounting.

22.5 mm Push Buttons

IP66, Type 4/4X/13 (Plastic) — IP66, Type 4/13 (Metal)

Alternate Action (Maintained) Push Button Operators, Non-Illuminated — Flush ❶



Round Plastic Flush Alternate Action Non-Illuminated
Cat. No. 800EP-FA5



Round Metal Flush Alternate Action Non-Illuminated
Cat. No. 800EM-FA5

Color	Flush Alternate Action — Round	
	Plastic	Metal
	Cat. No.	Cat. No.
Black	800EP-FA2	800EM-FA2
Green	800EP-FA3	800EM-FA3
Red	800EP-FA4	800EM-FA4
No cap	800EP-FA9	800EM-FA9

Back-of-Panel Components, Non-Illuminated Operators

Mounting Latch

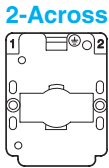
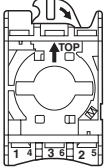
	Contact	2-Across Mounting	3-Across Mounting
		Cat. No.	Cat. No.
 	Mounting latch	800E-A2L	800E-A3L

Contact Block

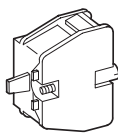
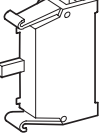
	Type	Contact	2-Across Mounting	3-Across Mounting
			Cat. No.	Cat. No.
 	Standard	1 N.O.	800E-2X10	800E-3X10
		1 N.C.	800E-2X01	800E-3X01
	Pen <i>TUFF</i> (low voltage) ❷	1 N.O.	800E-2X10V	800E-3X10V
		1 N.C.	800E-2X01V	800E-3X01V

Mounting Latch and Contact Blocks

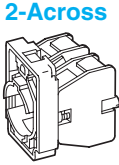
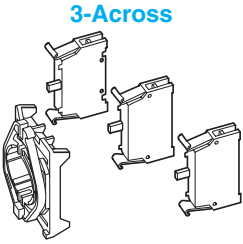
	Type	Contact	2-Across Mounting	3-Across Mounting
			Cat. No.	Cat. No.
 	Standard	1 N.O.	800E-2LX10	800E-3LX10
		1 N.C.	800E-2LX01	800E-3LX01
		1 N.O. – 1 N.C.	800E-2LX11	800E-3LX11
		2 N.O.	800E-2LX20	800E-3LX20
	Pen <i>TUFF</i> (low voltage) ❷	2 N.C.	800E-2LX02	800E-3LX02
		1 N.O.	800E-2LX10V	800E-3LX10V
		1 N.C.	800E-2LX01V	800E-3LX01V
		1 N.O. – 1 N.C.	800E-2LX11V	800E-3LX11V

❶ Alternate action operators cannot be used with base mount contact blocks.

❷ Patented Pen *TUFF* contacts supplied only with 2-across mounting; gold-plated contacts supplied only with 3-across mounting.

22.5 mm Push Buttons

IP66, Type 4/4X/13 (Plastic) — IP66, Type 4/13 (Metal)

Alternate Action (Maintained) Push Button Operators, Non-Illuminated — Flush

800 **EP** - **FA** **3** -
a *b* *c* *d*

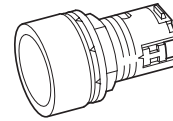

a

Operator Construction	
Code	Description
EP	Round plastic operator (NEMA Type 4/4X/13)
ES	Round plastic operator w/shiny metal bezel (NEMA Type 4/13)
EQ	Square plastic operator (NEMA Type 4/4X/13)
EM	Round metal operator (NEMA Type 4/13)
EB	Round metal operator w/black anodized bezel (NEMA Type 4/13)

b

Operator Type and Description	
Code	Description
FA	Non-illuminated flush, alternate action

d

Packaging	
Code	Description
Blank	1 per package
BP	10 per package

c

Color Cap	
Code	Color
1	White
2	Black
3	Green
4	Red
5	Yellow
6	Blue
8	Gray
9	No cap

Back-of-Panel Components, Non-Illuminated Operators

Note: To order 4-across back-of-panel components, see page 103.

800E - **2LX** ^{N.O.} **1** ^{N.C.} **0** **V**
a *b* *c* *d*

a

Contact Block/Latch Type	
Code	Type
2LX	2-across mounting
3LX	3-across mounting

b

N.O. (Normally Open Circuits) ❶	
Code	No. of Circuits
0	No contact
1	1 N.O.
2	2 N.O.
3	3 N.O.
4	4 N.O.
5	5 N.O.
6	6 N.O.

c

N.C. (Normally Closed Circuits) ❶	
Code	No. of Circuits
0	No contact
1	1 N.C.
2	2 N.C.
3	3 N.C.
4	4 N.C.
5	5 N.C.
6	6 N.C.

d

Specialty Contact Blocks	
Code	Type
Blank	Standard
V	PenTUFF (low voltage) ❷
E	N.O. early make
L	N.C. late break

❶ A total of six circuits is the maximum allowable.

❷ Patented PenTUFF contacts supplied only with 2-across mounting; gold-plated contacts supplied only with 3-across mounting.

22.5 mm Push Buttons

IP66, Type 4/4X/13 (Plastic) — IP66, Type 4/13 (Metal)

Momentary Contact Push Button Operators, Non-Illuminated — Mushroom



60 mm Jumbo Mushroom
Cat. No. 800EP-MJ3



40 mm Mushroom
Cat. No. 800EM-M6



40 mm Metal Mushroom
Cat. No. 800EM-MM4

Color	40 mm Mushroom — Round		40 mm Metal Mushroom — Round	60 mm Jumbo Mushroom — Round	
	Plastic	Metal		Plastic	Metal
	Cat. No.	Cat. No.	Cat. No.	Cat. No.	Cat. No.
Black	800EP-M2	800EM-M2	800EM-MM2	800EP-MJ2	800EM-MJ2
Green	800EP-M3	800EM-M3	800EM-MM3	800EP-MJ3	800EM-MJ3
Red	800EP-M4	800EM-M4	800EM-MM4	800EP-MJ4	800EM-MJ4

Back-of-Panel Components, Non-Illuminated Operators

Mounting Latch

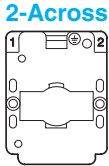
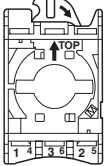
 2-Across	 3-Across	Contact	2-Across Mounting	3-Across Mounting
		Mounting latch	Cat. No.	Cat. No.
			800E-A2L	800E-A3L

Contact Block

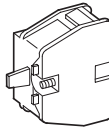
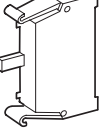
 2-Across	 3-Across	Type	Contact	2-Across Mounting	3-Across Mounting
				Cat. No.	Cat. No.
		Standard	1 N.O.	800E-2X10	800E-3X10
			1 N.C.	800E-2X01	800E-3X01
		PenTUFF (low voltage) ❶	1 N.O.	800E-2X10V	800E-3X10V
			1 N.C.	800E-2X01V	800E-3X01V

Mounting Latch and Contact Blocks

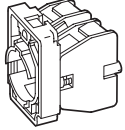
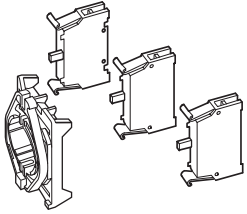
 2-Across	 3-Across	Type	Contact	2-Across Mounting	3-Across Mounting
				Cat. No.	Cat. No.
		Standard	1 N.O.	800E-2LX10	800E-3LX10
			1 N.C.	800E-2LX01	800E-3LX01
			1 N.O. – 1 N.C.	800E-2LX11	800E-3LX11
			2 N.O.	800E-2LX20	800E-3LX20
		PenTUFF (low voltage) ❶	2 N.C.	800E-2LX02	800E-3LX02
			1 N.O.	800E-2LX10V	800E-3LX10V
			1 N.C.	800E-2LX01V	800E-3LX01V
			1 N.O. – 1 N.C.	800E-2LX11V	800E-3LX11V

❶ Patented PenTUFF contacts supplied only with 2-across mounting; gold-plated contacts supplied only with 3-across mounting.

22.5 mm Push Buttons

IP66, Type 4/4X/13 (Plastic) — IP66, Type 4/13 (Metal)

Momentary Contact Push Button Operators, Non-Illuminated — Mushroom

800 **EP** – **M** **3**
a b c

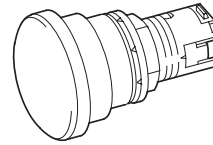

Plastic Cap Operator Construction

a

Operator Construction	
Code	Description
EP	Round plastic operator (NEMA Type 4/4X/13)
ES	Round plastic operator w/shiny metal bezel (NEMA Type 4/13)
EQ	Square plastic operator (NEMA Type 4/4X/13) ❶
EM	Round metal operator (NEMA Type 4/13)
EB	Round metal operator w/black anodized bezel (NEMA Type 4/13)

b

Operator Type	
Momentary Mushroom	
Code	Type
M	40 mm plastic color cap
MM	40 mm metal color cap ❷
MJ	60 mm plastic color cap

c

Color Cap	
Code	Color
1	White ❸
2	Black
3	Green
4	Red
5	Yellow
6	Blue
8	Gray (40 mm plastic color cap) or aluminum (40 mm shiny metal color cap)

Back-of-Panel Components, Non-Illuminated Operators

Note: To order 4-across back-of-panel components, see page 103.

800E – **2LX** ^{N.O.} **1** ^{N.C.} **0** **V**
a b c d

a

Contact Block/Latch Type	
Code	Type
2LX	2-across mounting
3LX	3-across mounting

b

N.O. (Normally Open Circuits) ❹	
Code	No. of Circuits
0	No contact
1	1 N.O.
2	2 N.O.
3	3 N.O.
4	4 N.O.
5	5 N.O.
6	6 N.O.

c

N.C. (Normally Closed Circuits) ❹	
Code	No. of Circuits
0	No contact
1	1 N.C.
2	2 N.C.
3	3 N.C.
4	4 N.C.
5	5 N.C.
6	6 N.C.

d

Specialty Contact Blocks	
Code	Type
Blank	Standard
V	PenTUFF (low voltage) ❺
E	N.O. early make
L	N.C. late break

- ❶ Square plastic operator uses 40 mm color cap only.
- ❷ 40 mm metal color cap available with 800ES and 800EM operators only.
- ❸ White color cap is not available in a metal mushroom head.
- ❹ A total of six circuits is the maximum allowable.
- ❺ Patented PenTUFF contacts supplied only with 2-across mounting; gold-plated contacts supplied only with 3-across mounting.

22.5 mm Push Buttons

IP66, Type 4/4X/13 (Plastic) — IP66, Type 4/13 (Metal)

2-Position Push-Pull Operators, Non-Illuminated — Twist-to-Release, Push-Pull



40 mm Trigger Action
Twist-to-Release Mushroom
Cat. No. 800EP-MTS44



40 mm Twist-to-Release Mushroom
Cat. No. 800EP-MT4



40 mm Push-Pull Mushroom
Cat. No. 800ES-MP24

Color	40 mm Mushroom (Trigger Action) ❶		40 mm Mushroom		40 mm Mushroom ❷	
	Twist-to-Release — Round		Push-Pull Twist-to-Release — Round		Push-Pull — Round	
	Plastic	Metal	Plastic	Metal	Plastic	Metal
	Cat. No.	Cat. No.	Cat. No.	Cat. No.	Cat. No.	Cat. No.
Black	—	—	800EP-MT2	800EM-MT2	800ES-MP22	800EM-MP22
Green	—	—	800EP-MT3	800EM-MT3	800ES-MP23	800EM-MP23
Red	800EP-MTS44	800EM-MTS44	800EP-MT4	800EM-MT4	800ES-MP24	800EM-MP24

❶ Trigger action operators are compliant with EN418 Standards.

❷ 40 mm plastic or metal color caps (Codes **MP** and **MMP** under Operator Type) available with 800ES and 800EM operators.

Back-of-Panel Components, Non-Illuminated Operators

Mounting Latch

	Contact	2-Across Mounting	3-Across Mounting
		Cat. No.	Cat. No.
	Mounting latch	800E-A2L	800E-A3L

Contact Block

	Type	Contact	2-Across Mounting	3-Across Mounting
			Cat. No.	Cat. No.
	Standard	1 N.O.	800E-2X10	800E-3X10
		1 N.C.	800E-2X01	800E-3X01
	Late break	1 N.C.L.B.	800E-2X01L	800E-3X01L
	Pen <i>TUFF</i> (low voltage) ❸	1 N.O.	800E-2X10V	800E-3X10V
		1 N.C.	800E-2X01V	800E-3X01V

❸ Patented Pen *TUFF* contacts supplied only with 2-across mounting; gold-plated contacts supplied only with 3-across mounting.

Mounting Latch and Contact Blocks

	Type	Contact	2-Across Mounting	3-Across Mounting
			Cat. No.	Cat. No.
	Standard	1 N.O.	800E-2LX10	800E-3LX10
		1 N.C.	800E-2LX01	800E-3LX01
		1 N.O. – 1 N.C.	800E-2LX11	800E-3LX11
		2 N.O.	800E-2LX20	800E-3LX20
		2 N.C.	800E-2LX02	800E-3LX02
	Late break	1 N.C.L.B.	800E-2LX01L	800E-3LX01L
		1 N.O. – 1 N.C.L.B.	800E-2LX11L	800E-3LX11L

Accessories — Page 100

Legend Plates — Page 115

Approximate Dimensions — Page 127

22.5 mm Push Buttons

IP66, Type 4/4X/13 (Plastic) — IP66, Type 4/13 (Metal)

2-Position Push-Pull Operators, Non-Illuminated — Twist-to-Release, Push-Pull

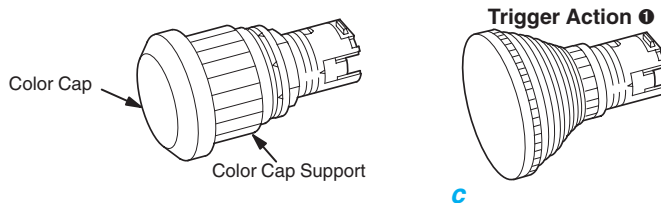
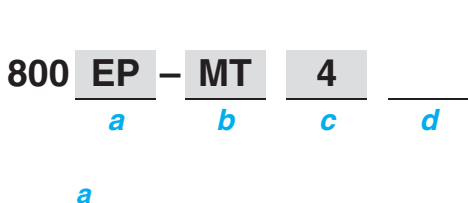

Operator Construction ②	
Code	Description
EP	Round plastic operator (NEMA Type 4/4X/13)
ES	Round plastic operator w/shiny metal bezel (NEMA Type 4/13)
EM	Round metal operator (NEMA Type 4/13)
EB	Round metal operator w/black anodized bezel (NEMA Type 4/13)

Operator Type	
2-Position Push-Pull Twist-to-Release	
Standard	
Code	Type
MT	40 mm plastic color cap
MJT	60 mm plastic color cap ⑤
Trigger Action ④⑥	
Code	Type
MTS3	30 mm plastic color cap
MTS4	40 mm plastic color cap
MTS6	60 mm plastic color cap
2-Position Push-Pull	
Standard	
Code	Type
MP2	40 mm plastic color cap ⑤
MMP2	40 mm metal color cap ⑤
MJP2	60 mm plastic color cap ⑤

Color Cap	
Code	Color
1	White ⑥
2	Black
3	Green
4	Red
5	Yellow
6	Blue
8	Gray (40 mm plastic color cap) or aluminum (40 mm shiny metal color cap)
9	No cap ⑤

Special Color Cap	
Code	Description
E	EMO printing on red color cap ⑤

Back-of-Panel Components, Non-Illuminated Operators

Note: To order 4-across back-of-panel components, see page 103.

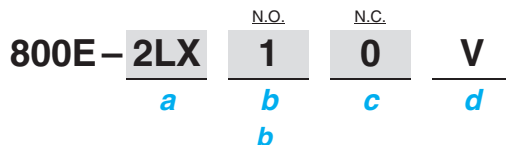

Contact Block/Latch Type	
Code	Type
2LX	2-across mounting
3LX	3-across mounting

N.O. (Normally Open Circuits) ⑧	
Code	No. of Circuits
0	No contact
1	1 N.O.
2	2 N.O.
3	3 N.O.
4	4 N.O.
5	5 N.O.
6	6 N.O.

N.C. (Normally Closed Circuits) ⑧	
Code	No. of Circuits
0	No contact
1	1 N.C.
2	2 N.C.
3	3 N.C.
4	4 N.C.
5	5 N.C.
6	6 N.C.

Specialty Contact Blocks	
Code	Type
Blank	Standard
V	PenTUFF (low voltage) ⑩
E	N.O. early make
L	N.C. late break

- ① Trigger action operators are compliant with EN418 Standards.
- ② **MP**, **MMP**, and **MJP** available with 800ES and 800EM operators only.
- ③ Not available in green and blue color caps.
- ④ Trigger action operators available as 800EP and 800EM only.
- ⑤ Available with a red color cap only.
- ⑥ White color cap is not available in a metal mushroom head.

- ⑦ Only available as **MP2** option.
- ⑧ Only available with 800EP-MTS44 and 800EM-MTS44 option.
- ⑨ A total of six circuits is the maximum allowable.
- ⑩ Patented PenTUFF contacts supplied only with 2-across mounting; gold-plated contacts supplied only with 3-across mounting.

22.5 mm Push Buttons

IP66, Type 4/4X/13 (Plastic) — IP66, Type 4/13 (Metal)

2-Position Push-Pull Operators, Non-Illuminated — Key Release ①



40 mm Key Release Push-Pull Mushroom
Cat. No. 800EM-MK4



60 mm Key Release Mushroom
Cat. No. 800EP-MJK4

Color	2-Position Push-Pull Mushroom Key Release			
	40 mm — Round		60 mm — Round	
	Plastic Cat. No.	Metal Cat. No.	Plastic Cat. No.	Metal Cat. No.
Black	800EP-MK2	800EM-MK2	800EP-MJK2	800EM-MJK2
Green	800EP-MK3	800EM-MK3	800EP-MJK3	800EM-MJK3
Red	800EP-MK4	800EM-MK4	800EP-MJK4	800EM-MJK4

Back-of-Panel Components, Non-Illuminated Operators

Mounting Latch

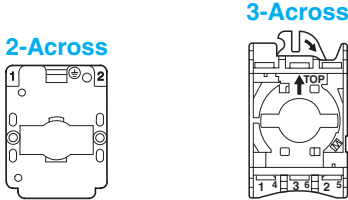
	Contact	2-Across Mounting	3-Across Mounting
		Cat. No.	Cat. No.
	Mounting latch	800E-A2L	800E-A3L

Contact Block

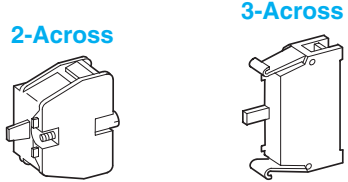
	Type	Contact	2-Across Mounting	3-Across Mounting
			Cat. No.	Cat. No.
	Standard	1 N.O.	800E-2X10	800E-3X10
		1 N.C.	800E-2X01	800E-3X01
	Late break	1 N.C.L.B.	800E-2X01L	800E-3X01L
		PenTUFF (low voltage) ②	1 N.O.	800E-2X10V
			1 N.C.	800E-2X01V

Mounting Latch and Contact Blocks

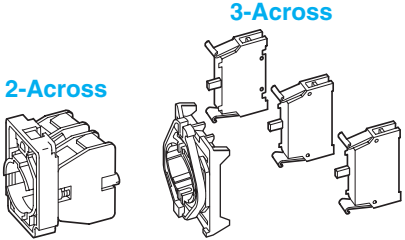
	Type	Contact	2-Across Mounting	3-Across Mounting
			Cat. No.	Cat. No.
	Standard	1 N.O.	800E-2LX10	800E-3LX10
		1 N.C.	800E-2LX01	800E-3LX01
		1 N.O. - 1 N.C.	800E-2LX11	800E-3LX11
		2 N.O.	800E-2LX20	800E-3LX20
	Late break	2 N.C.	800E-2LX02	800E-3LX02
		1 N.C.L.B.	800E-2LX01L	800E-3LX01L
		1 N.O. - 1 N.C.L.B.	800E-2LX11L	800E-3LX11L

① Key release operators are IP66, Type 4/13.

② Patented PenTUFF contacts supplied only with 2-across mounting; gold-plated contacts supplied only with 3-across mounting.

22.5 mm Push Buttons

IP66, Type 4/4X/13 (Plastic) — IP66, Type 4/13 (Metal)

2-Position Push-Pull Operators, Non-Illuminated — Key Release ①②

Note: For standard replacement key (Key No. D018) order 800E-AK1.

800 **EP** – **MK** **3** _____
 a *b* *c* *d*

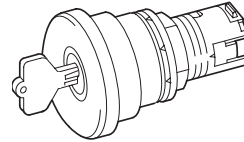

a

Operator Construction	
Code	Description
EP	Round plastic operator (NEMA Type 4/4X/13)
EM	Round metal operator (NEMA Type 4/13)

c

Color Cap	
Code	Color
1	White
2	Black
3	Green
4	Red
5	Yellow
6	Blue
8	Gray (40 mm plastic color cap)

d

Optional Key Lock (Illinois)	
Code	Key No.
Blank	D018
09A	D587
10A	D682
11A	D713
13A	D992

b

Operator/Key Type	
2-Position Key Release	
Code	Description
MK	40 mm plastic color cap
MJK	60 mm plastic color cap

Back-of-Panel Components, Non-Illuminated Operators

Note: To order 4-across back-of-panel components, see page 103.

800E – **2LX** ^{N.O.} **1** ^{N.C.} **0** **V**
 a *b* *c* *d*

a

Contact Block/Latch Type	
Code	Type
2LX	2-across mounting
3LX	3-across mounting

b

N.O. (Normally Open Circuits) ③	
Code	No. of Circuits
0	No contact
1	1 N.O.
2	2 N.O.
3	3 N.O.
4	4 N.O.
5	5 N.O.
6	6 N.O.

c

N.C. (Normally Closed Circuits) ③	
Code	No. of Circuits
0	No contact
1	1 N.C.
2	2 N.C.
3	3 N.C.
4	4 N.C.
5	5 N.C.
6	6 N.C.

d

Specialty Contact Blocks	
Code	Type
Blank	Standard
V	PenTUFF (low voltage) ④
E	N.O. early make
L	N.C. late break

① Key release operators are IP66, Type 4/13.

② Not intended for high security applications. Interoperability is possible with certain key/cylinder lock combinations. Contact your local Allen-Bradley distributor for interoperability information.

③ A total of six circuits is the maximum allowable.

④ Patented PenTUFF contacts supplied only with 2-across mounting, gold-plated contacts supplied only with 3-across mounting.

22.5 mm Push Buttons

IP66, Type 4/4X/13 (Plastic) — IP66, Type 4/13 (Metal)

2-Position Trigger Action Operators, Non-Illuminated — Key Release ①



40 mm Key Release Mushroom
cat. No. 800EP-MKR22



60 mm Key Release Mushroom
Cat. No. 800EP-MKZ64

Color	2-Position (Trigger Action) Mushroom Key Release			
	Ronis Key Lock — Round		Zadi Key Lock — Round	
	40 mm Plastic	60 mm Metal	40 mm Plastic	60 mm Metal
	Cat. No.	Cat. No.	Cat. No.	Cat. No.
Red	800EP-MKR44	800EM-MKR64	800EP-MKZ44	800EM-MKZ64

Back-of-Panel Components, Non-Illuminated Operators

Mounting Latch

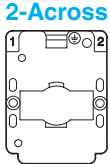
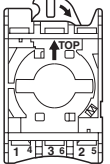
 2-Across	 3-Across	Contact	2-Across Mounting Cat. No.	3-Across Mounting Cat. No.
		Mounting latch	800E-A2L	800E-A3L

Contact Block

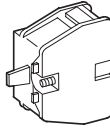
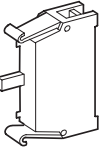
 2-Across	 3-Across	Type	Contact	2-Across Mounting Cat. No.	3-Across Mounting Cat. No.
		Standard	1 N.O. 1 N.C.	800E-2X10 800E-2X01	800E-3X10 800E-3X01
Late break	1 N.C.L.B.	800E-2X01L	800E-3X01L		
Pen <i>TUFF</i> (low voltage) ②	1 N.O.	800E-2X10V	800E-3X10V		
	1 N.C.	800E-2X01V	800E-3X01V		

Mounting Latch and Contact Blocks

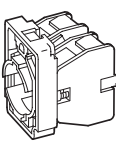
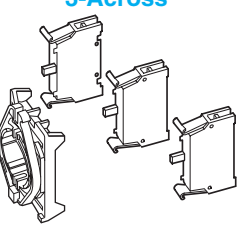
 2-Across	 3-Across	Type	Contact	2-Across Mounting Cat. No.	3-Across Mounting Cat. No.
		Standard	1 N.O.	800E-2LX10	800E-3LX10
1 N.C.	800E-2LX01		800E-3LX01		
1 N.O. – 1 N.C.	800E-2LX11		800E-3LX11		
2 N.O.	800E-2LX20		800E-3LX20		
2 N.C.	800E-2LX02		800E-3LX02		
Late break	1 N.C.L.B.	800E-2LX01L	800E-3LX01L		
	1 N.O. – 1 N.C.L.B.	800E-2LX11L	800E-3LX11L		

① Trigger action operators are compliant with EN418 Standards. Key release operators are IP66, Type 4/13.

② Patented Pen *TUFF* contacts supplied only with 2-across mounting; gold-plated contacts supplied only with 3-across mounting.

22.5 mm Push Buttons

IP66, Type 4/4X/13 (Plastic) — IP66, Type 4/13 (Metal)

2-Position Trigger Action Operators, Non-Illuminated — Key Release ① ②

Note: For Ronis standard replacement key (Key No. 3825) order **800E-AKR3825** and for Zadi (Key No. 006) order **800E-AKZ006**.

800 **EP** – **MKR4** **4**

a *b* *c*

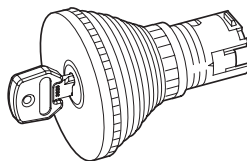

a

Operator Construction	
Code	Description
EP	Round plastic operator (NEMA Type 4/4X/13)
EM	Round metal operator (NEMA Type 4/4X/13)

b

Operator/Key Type	
2-Position Key Release ① (Trigger Action)	
Ronis Key	
Code	Type
MKR3	30 mm plastic color cap
MKR4	40 mm plastic color cap
MKR6	60 mm plastic color cap
Zadi Key (Trigger Action)	
Code	Type
MKZ3	30 mm plastic color cap
MKZ4	40 mm plastic color cap
MKZ6	60 mm plastic color cap

c

Color Cap	
Code	Color
4	Red

Back-of-Panel Components, Non-Illuminated Operators

Note: To order 4-across back-of-panel components, see page 103.

800E – **2LX** **1** **0** **V**

a *b* *c* *d*

a

Contact Block/Latch Type	
Code	Type
2LX	2-across mounting
3LX	3-across mounting

b

N.O. (Normally Open Circuits) ③	
Code	No. of Circuits
0	No contact
1	1 N.O.
2	2 N.O.
3	3 N.O.
4	4 N.O.
5	5 N.O.
6	6 N.O.

c

N.C. (Normally Closed Circuits) ③	
Code	No. of Circuits
0	No contact
1	1 N.C.
2	2 N.C.
3	3 N.C.
4	4 N.C.
5	5 N.C.
6	6 N.C.

d

Specialty Contact Blocks	
Code	Type
Blank	Standard
V	PenTUFF (low voltage) ④
E	N.O. early make
L	N.C. late break

- ① Trigger action operators are compliant with EN418 Standards. Key release operators are IP66, Type 4/13.
- ② Not intended for high security applications. Interoperability is possible with certain key/cylinder lock combinations. Contact your local Allen-Bradley distributor for interoperability information.
- ③ A total of six circuits is the maximum allowable.
- ④ Patented PenTUFF contacts supplied only with 2-across mounting, gold-plated contacts supplied only with 3-across mounting.

22.5 mm Push Buttons

IP66, Type 4/4X/13 (Plastic) — IP66, Type 4/13 (Metal)

3-Position Push-Pull Operators, Non-Illuminated — Mushroom





3-Position Push-Pull
Cat. No. 800ES-MP3R4



3-Position Push-Pull
Cat. No. 800EM-MP3S4

Target Table and Operator Position

Contact Type			
	Out	Center	In
N.O.	O	O	X
N.C.	X	O	O
N.O.E.M.	O	X	X
N.C.L.B.	X	X	O

Note: X = Closed/O = Open

Color	3-Position Push-Pull Mushroom (Mom. Out — Maint. Center — Mom. In)				3-Position Push-Pull Mushroom (Mom. Out — Maint. Center — Maint. In)			
	40 mm Plastic Cat. No.	40 mm Metal Cat. No.	60 mm Plastic Cat. No.	60 mm Metal Cat. No.	40 mm Plastic Cat. No.	40 mm Metal Cat. No.	60 mm Plastic Cat. No.	60 mm Metal Cat. No.
Black	800ES-MP3R2	800EM-MP3R2	800ES-MJP3R2	800EM-MJP3R2	800ES-MP3S2	800EM-MP3S2	800ES-MJP3S2	800EM-MJP3S2
Green	800ES-MP3R3	800EM-MP3R3	800ES-MJP3R3	800EM-MJP3R3	800ES-MP3S3	800EM-MP3S3	800ES-MJP3S3	800EM-MJP3S3
Red	800ES-MP3R4	800EM-MP3R4	800ES-MJP3R4	800EM-MJP3R4	800ES-MP3S4	800EM-MP3S4	800ES-MJP3S4	800EM-MJP3S4

Back-of-Panel Components, Non-Illuminated Operators

Mounting Latch

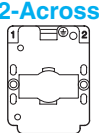
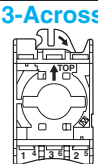
		Contact	2-Across Mounting	3-Across Mounting
			Cat. No.	Cat. No.
		Mounting latch	800E-A2L	800E-A3L

Contact Block

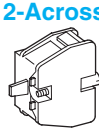
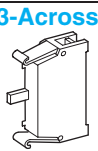
		Type	Contact	2-Across Mounting	3-Across Mounting
				Cat. No.	Cat. No.
		Standard	1 N.O.	800E-2X10	800E-3X10
			1 N.C.	800E-2X01	800E-3X01
		Late break	1 N.C.L.B.	800E-2X01L	800E-3X01L
			Pen TUFF (low voltage) ❶	1 N.O.	800E-2X10V
				1 N.C.	800E-2X01V

❶ Patented Pen TUFF contacts supplied only with 2-across mounting; gold-plated contacts supplied only with 3-across mounting.

Mounting Latch and Contact Blocks

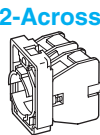
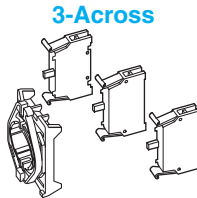
		Type	Contact	2-Across Mounting	3-Across Mounting
				Cat. No.	Cat. No.
		Standard	1 N.O.	800E-2LX10	800E-3LX10
			1 N.C.	800E-2LX01	800E-3LX01
			1 N.O. – 1 N.C.	800E-2LX11	800E-3LX11
			2 N.O.	800E-2LX20	800E-3LX20
			2 N.C.	800E-2LX02	800E-3LX02
			1 N.C.L.B.	800E-2LX01L	800E-3LX01L
		Late break	1 N.O. – 1 N.C.L.B.	800E-2LX11L	800E-3LX11L

22.5 mm Push Buttons

IP66, Type 4/4X/13 (Plastic) — IP66, Type 4/13 (Metal)

3-Position Push-Pull Operators, Non-Illuminated — Mushroom

800 **ES** – **MP3** **R** **3**
a *b* *c* *d*

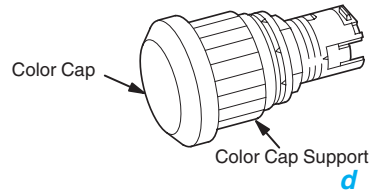

a

Operator Construction	
Code	Description
ES	Round plastic operator w/shiny metal bezel (NEMA Type 4/13)
EM	Round metal operator (NEMA Type 4/13)

b

Operator Type	
3-Position Push-Pull	
Code	Type
MP3	40 mm plastic color cap
MMP3	40 mm metal color cap
MJP3	60 mm plastic color cap

d

Color Cap	
Code	Color
1	White ❶
2	Black
3	Green
4	Red
5	Yellow
6	Blue
8	Gray (40 mm or 60 mm plastic color cap) or aluminum (40 mm shiny metal color cap)
9	No cap ❷

c

Operator Function	
Code	Type
R	Mom. out — maint. center — mom. in
S	Mom. out — maint. center — maint. in

Back-of-Panel Components, Non-Illuminated Operators

Note: To order 4-across back-of-panel components, see page 103.

800E – **2LX** ^{N.O.} **1** ^{N.C.} **0** **V**
a *b* *c* *d*

a

Contact Block/Latch Type	
Code	Type
2LX	2-across mounting
3LX	3-across mounting

b

N.O. (Normally Open Circuits) ❸	
Code	No. of Circuits
0	No contact
1	1 N.O.
2	2 N.O.
3	3 N.O.
4	4 N.O.
5	5 N.O.
6	6 N.O.

c

N.C. (Normally Closed Circuits) ❸	
Code	No. of Circuits
0	No contact
1	1 N.C.
2	2 N.C.
3	3 N.C.
4	4 N.C.
5	5 N.C.
6	6 N.C.

d

Specialty Contact Blocks	
Code	Type
Blank	Standard
V	PenTUFF (low voltage) ❹
E	N.O. early make
L	N.C. late break

❶ White color cap is not available with option MMP3.

❷ Only available as MP3 option.

❸ A total of six circuits is the maximum allowable.

❹ Patented PenTUFF contacts supplied only with 2-across mounting; gold-plated contacts supplied only with 3-across mounting.

22.5 mm Push Buttons

IP66, Type 4/4X/13 (Plastic) — IP66, Type 4/13 (Metal)

Momentary Contact Push Button Operators, Illuminated — Flush, Extended, Guarded



Flush Operator
Cat. No. 800EM-LF5



Extended Operator
Cat. No. 800EP-LE3



Guarded Operator
Cat. No. 800EP-LG3

Color	Flush — Round		Extended — Round		Guarded — Round	
	Plastic	Metal	Plastic	Metal	Plastic	Metal
	Cat. No.	Cat. No.	Cat. No.	Cat. No.	Cat. No.	Cat. No.
Green	800EP-LF3	800EM-LF3	800EP-LE3	800EM-LE3	800EP-LG3	800EM-LG3
Red	800EP-LF4	800EM-LF4	800EP-LE4	800EM-LE4	800EP-LG4	800EM-LG4
Amber	800EP-LF5	800EM-LF5	800EP-LE5	800EM-LE5	800EP-LG5	800EM-LG5
No lens	800EP-LF9	800EM-LF9	800EP-LE9	800EM-LE9	800EP-LG9	800EM-LG9

Back-of-Panel Components,

Illuminated Operators

Full Voltage Power Module with Latch

Type	Volts	2-Across Mounting	3-Across Mounting
		Cat. No.	Cat. No.
No lamp ❶	—	800E-2DL0	800E-3DL0
	Incandescent	24 AC/DC	800E-2DL3
120 AC/DC		800E-2DL5	800E-3DL5
Integrated LED Module ❷ (red)	24 AC/DC	—	800E-3NL3R
	120 AC	—	800E-3NL5R
	240 AC	—	800E-3NL7R

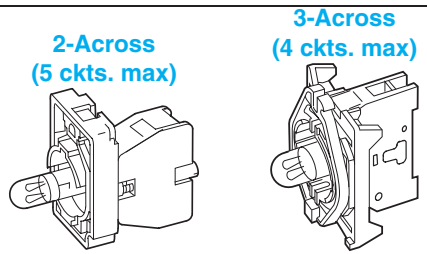

or Integrated LED Module with Latch

Transformer Power Module with Latch

Type	Volts	2-Across Mounting	3-Across Mounting
		Cat. No.	Cat. No.
Incandescent	110/120 AC	800E-2TL5	800E-3TL5
	220/240 AC	800E-2TL7	800E-3TL7
LED ❷ (red)	110/120 AC	800E-2TL5R	800E-3TL5R
	220/240 AC	800E-2TL7R	800E-3TL7R

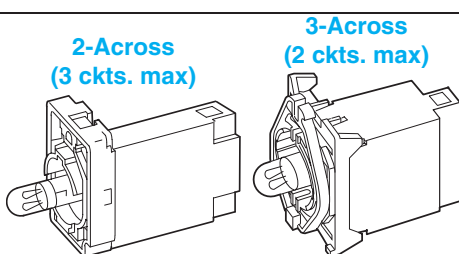

Contact Blocks

Type	Volts	2-Across Mounting	3-Across Mounting
		Cat. No.	Cat. No.
Standard	1 N.O.	800E-2X10	800E-3X10
	1 N.C.	800E-2X01	800E-3X01
PenTUFF (low voltage) ❸	1 N.O.	800E-2X10V	800E-3X10V
	1 N.C.	800E-2X01V	800E-3X01V

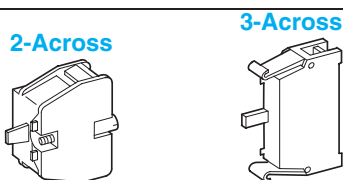

- ❶ Lamp must match line voltage. See replacement lamps table on page 114.
- ❷ LEDs are available in red, green, blue, amber, and white; color cap must match LED color.
- ❸ Patented PenTUFF contacts supplied only with 2-across mounting; gold-plated contacts supplied only with 3-across mounting.

Accessories — Page 100
Legend Plates — Page 115

Approximate Dimensions — Page 127

22.5 mm Push Buttons

IP66, Type 4/4X/13 (Plastic) — IP66, Type 4/13 (Metal)

Momentary Contact Push Button Operators, Illuminated — Flush, Extended, Guarded

800 **EP** - **LE** **3** -

a *b* *c* *d*

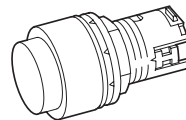

a

Operator Construction	
Code	Description
EP	Round plastic operator (NEMA Type 4/4X/13)
ES	Round plastic operator w/shiny metal bezel (NEMA Type 4/13)
EQ	Square plastic operator (NEMA Type 4/4X/13)
EM	Round metal operator (NEMA Type 4/13)
EB	Round metal operator w/black anodized bezel (NEMA Type 4/13)

b

Operator Type	
Standard	
Code	Description
LF	Flush
LE	Extended
LG	Guarded ①
No Side Illumination	
Code	Description
LFS	Flush

c

Lens Cap Color	
Code	Color
3	Green
4	Red
5	Amber
6	Blue
7	Clear (white diffuser cap)
9	No lens

d

Packaging	
Code	Description
Blank	1 per package
BP	10 per package

Back-of-Panel Components, Illuminated Operators

Note: To order 4-across back-of-panel components, see page 103.

800E - **2** **DL5** **R** **X1** **0** **V**

a *b* *c* *d* *e* *f*

a

Contact Block Matrix	
Code	Type
2	2-across mounting
3	3-across mounting

b

Power Module Type and Voltage	
Full Voltage (Latch Included)	
Code	Description
DL0	No lamp
DL1	6V AC/DC
DL2	12V AC/DC
DL3	24V AC/DC
DL4	48V AC/DC
DL5 ②	120V AC/DC
DL6 ②	130V AC/DC
Transformer (Latch Included)	
Code	Description
TL5	110V 50 Hz/120V 60 Hz
TL6	208V 60 Hz
TL7	220V 50 Hz/240V 60 Hz
TL10	400V 50 Hz
TL14	600V 60 Hz
Resistor (Latch Included)	
Code	Description
RL5 ③	110V 50 Hz/120V 60 Hz
RL7	240V 60 Hz
Integrated LED (Latch Included) ④	
Code	Description
NL3	24V AC/DC
NL5	120V AC
NL7	240V AC

c

Lamp	
Code	Type
Blank	Incandescent or no lamp
R	Red LED ⑤
G	Green LED ⑤
A	Amber LED ⑤
B	Blue LED ⑤
W	White LED ⑥⑥

d

N.O. (Normally Open Circuits)	
Code	No. of Circuits
X0	No contact
X1	1 N.O.
X2	2 N.O.
X3	3 N.O.
X4	4 N.O.
X5	5 N.O.
X6	6 N.O.

e

N.C. (Normally Closed Circuits)	
Code	No. of Circuits
0	No contact
1	1 N.C.
2	2 N.C.
3	3 N.C.
4	4 N.C.
5	5 N.C.
6	6 N.C.

f

Specialty Contact Blocks	
Code	Type
Blank	Standard
V	PenTUFF (low voltage) ⑦
E	N.O. early make
L	N.C. late break

Note:

Max Allowable Circuits for Illuminated Push Buttons and Selector Switches		
Mounting	Full Voltage/Integrated LED	Transformer
2-across	5	3
3-across	4	2

- ① Guarded option not available with square operators.
- ② Option **DL5** does not have a shunting resistor when used with an LED. Option **DL6** has a shunting resistor for LEDs and can be used for 120V DC applications.
- ③ 120V resistor module available in 2-across and 4-across mounting **only**.
- ④ Available in 3-across mounting **only**.
- ⑤ Refer to page for LED selection.
- ⑥ Available in 6V, 24V and 120V AC/DC **only**.
- ⑦ Patented PenTUFF contacts supplied **only** with 2-across mounting; gold-plated contacts supplied **only** with 3-across mounting.

22.5 mm Push Buttons

IP66, Type 4/4X/13 (Plastic) — IP66, Type 4/13 (Metal)

Alternate Action (Maintained) Push Button Operators, Illuminated — Flush



Round Flush Alternate Action Illuminated
Cat. No. 800EP-LFA5



Alternate Action Metal
Cat. No. 800EM-LFA5

Color	Flush Alternate Action — Round	
	Plastic Cat. No.	Metal Cat. No.
Green	800EP-LFA3	800EM-LFA3
Red	800EP-LFA4	800EM-LFA4
Amber	800EP-LFA5	800EM-LFA5
No lens	800EP-LFA9	800EM-LFA9

Back-of-Panel Components, Illuminated Operators

Full Voltage Power Module with Latch or Integrated LED Module with Latch

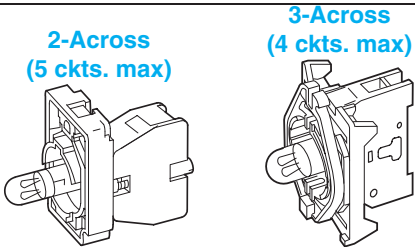
	Type	Volts	2-Across Mounting	3-Across Mounting
			Cat. No.	Cat. No.
	No lamp ❶	—	800E-2DL0	800E-3DL0
	Incandescent	24 AC/DC	800E-2DL3	800E-3DL3
		120 AC/DC	800E-2DL5	800E-3DL5
	Integrated LED Module ❷ (red)	24 AC/DC	—	800E-3NL3R
		120 AC	—	800E-3NL5R
		240 AC	—	800E-3NL7R

Transformer Power Module with Latch

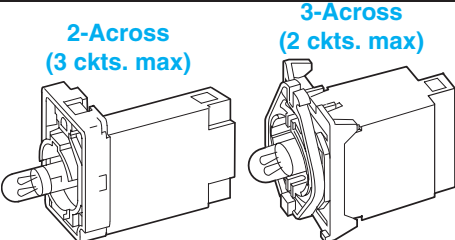
	Type	Volts	2-Across Mounting	3-Across Mounting
			Cat. No.	Cat. No.
	Incandescent	110/120 AC	800E-2TL5	800E-3TL5
		220/240 AC	800E-2TL7	800E-3TL7
	LED ❸ (red)	110/120 AC	800E-2TL5R	800E-3TL5R
		220/240 AC	800E-2TL7R	800E-3TL7R

Contact Blocks

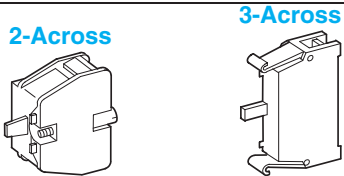
	Type	Contact	2-Across Mounting	3-Across Mounting
			Cat. No.	Cat. No.
	Standard	1 N.O.	800E-2X10	800E-3X10
		1 N.C.	800E-2X01	800E-3X01
	PenTUFF (low voltage) ❹	1 N.O.	800E-2X10V	800E-3X10V
		1 N.C.	800E-2X01V	800E-3X01V

❶ Lamp must match line voltage. See replacement lamps table on page 114.

❷ LEDs are available in red, green, blue, amber, and white; color cap must match LED color.

❸ Patented PenTUFF contacts supplied only with 2-across mounting; gold-plated contacts supplied only with 3-across mounting.

22.5 mm Push Buttons

IP66, Type 4/4X/13 (Plastic) — IP66, Type 4/13 (Metal)

Alternate Action (Maintained) Push Button Operators, Illuminated — Flush

800 EP - LFA 3 -

a *b* *c* *d*

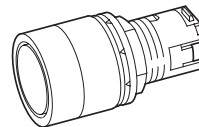

a

Operator Construction	
Code	Description
EP	Round plastic operator (NEMA Type 4/4X/13)
ES	Round plastic operator w/shiny metal bezel (NEMA Type 4/13)
EQ	Square plastic operator (NEMA Type 4/4X/13)
EM	Round metal operator (NEMA Type 4/13)
EB	Round metal operator w/black anodized bezel (NEMA Type 4/13)

b

Operator Type and Description	
Code	Description
LFA	Illuminated flush, alternate action

d

Packaging	
Code	Description
Blank	1 per package
BP	10 per package

c

Lens Cap Color	
Code	Color
3	Green
4	Red
5	Amber
6	Blue
7	Clear (white diffuser cap)
9	No lens

Back-of-Panel Components, Illuminated Operators

800E - 2 DL5 R X1 0 V

a *b* *c* *d* *e* *f*

a

Contact Block Matrix	
Code	Type
2	2-across mounting
3	3-across mounting

c

Lamp	
Code	Type
Blank	Incandescent or no lamp
R	Red LED ①
G	Green LED ②
A	Amber LED ③
B	Blue LED ④
W	White LED ⑤⑥

e

N.C. (Normally Closed Circuits)	
Code	No. of Circuits
0	No contact
1	1 N.C.
2	2 N.C.
3	3 N.C.
4	4 N.C.
5	5 N.C.
6	6 N.C.

b

Power Module Type and Voltage	
Full Voltage (Latch Included)	
Code	Description
DL0	No lamp
DL1	6V AC/DC
DL2	12V AC/DC
DL3	24V AC/DC
DL4	48V AC/DC
DL5 ①	120V AC/DC
DL6 ①	130V AC/DC

Transformer (Latch Included)	
Code	Description
TL5	110V 50 Hz/120V 60 Hz
TL6	208V 60 Hz
TL7	220V 50 Hz/240V 60 Hz
TL10	400V 50 Hz
TL14	600V 60 Hz

Resistor (Latch Included)	
Code	Description
RL5 ②	110V 50 Hz/120V 60 Hz
RL7	240V 60 Hz

Integrated LED (Latch Included) ③	
Code	Description
NL3	24V AC/DC
NL5	120V AC
NL7	240V AC

d

N.O. (Normally Open Circuits)	
Code	No. of Circuits
X0	No contact
X1	1 N.O.
X2	2 N.O.
X3	3 N.O.
X4	4 N.O.
X5	5 N.O.
X6	6 N.O.

f

Specialty Contact Blocks	
Code	Type
Blank	Standard
V	PenTUFF (low voltage) ⑥
E	N.O. early make
L	N.C. late break

Note:

Max Allowable Circuits for Illuminated Push Buttons and Selector Switches		
Mounting	Full Voltage/Integrated LED	Transformer
2-across	5	3
3-across	4	2

- ① Option DL5 does not have a shunting resistor when used with an LED. Option DL6 has a shunting resistor for LEDs and can be used for 120V DC applications.
- ② 120V resistor module available in 2-across and 4-across mounting only.
- ③ Available in 3-across mounting only.
- ④ Refer to page 114 for LED selection.
- ⑤ Available in 6V, 24V and 120V AC/DC only.
- ⑥ Patented PenTUFF contacts supplied only with 2-across mounting gold-plated contacts supplied only with 3-across mounting.

22.5 mm Push Buttons

IP66, Type 4/4X/13 (Plastic) — IP66, Type 4/13 (Metal)

Momentary Contact Push Button Operators, Illuminated — Mushroom



40 mm Mushroom
Cat. No. 800ES-LM4



60 mm Jumbo Mushroom
Cat. No. 800EM-LMJ5

Color	40 mm Mushroom — Round		60 mm Jumbo Mushroom — Round	
	Plastic	Metal	Plastic	Metal
	Cat. No.	Cat. No.	Cat. No.	Cat. No.
Green	800ES-LM3	800EM-LM3	800ES-LMJ3	800EM-LMJ3
Red	800ES-LM4	800EM-LM4	800ES-LMJ4	800EM-LMJ4
Amber	800ES-LM5	800EM-LM5	800ES-LMJ5	800EM-LMJ5

Back-of-Panel Components, Illuminated Operators

Full Voltage Power Module with Latch or Integrated LED Module with Latch

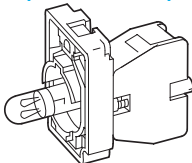
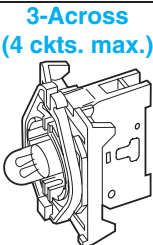
	Type	Volts	2-Across Mounting	3-Across Mounting
			Cat. No.	Cat. No.
 	No lamp ❶	—	800E-2DL0	800E-3DL0
	Incandescent	24 AC/DC	800E-2DL3	800E-3DL3
		120 AC/DC	800E-2DL5	800E-3DL5
	Integrated LED Module ❷ (red)	24 AC/DC	—	800E-3NL3R
		120 AC	—	800E-3NL5R
		240 AC	—	800E-3NL7R

Transformer Power Module with Latch

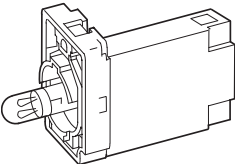
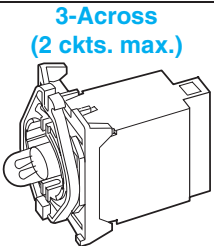
	Type	Volts	2-Across Mounting	3-Across Mounting
			Cat. No.	Cat. No.
 	Incandescent	110/120 AC	800E-2TL5	800E-3TL5
		220/240 AC	800E-2TL7	800E-3TL7
	LED ❸ (red)	110/120 AC	800E-2TL5R	800E-3TL5R
		220/240 AC	800E-2TL7R	800E-3TL7R

Contact Blocks

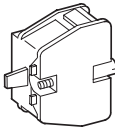
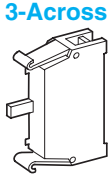
	Type	Contact	2-Across Mounting	3-Across Mounting
			Cat. No.	Cat. No.
 	Standard	1 N.O.	800E-2X10	800E-3X10
		1 N.C.	800E-2X01	800E-3X01
	PenTUFF (low voltage) ❹	1 N.O.	800E-2X10V	800E-3X10V
		1 N.C.	800E-2X01V	800E-3X01V

❶ Lamp must match line voltage. See replacement lamps table on page 114.

❷ LEDs are available in red, green, blue, amber, and white; color cap must match LED color.

❸ Patented PenTUFF contacts supplied only with 2-across mounting; gold-plated contacts supplied only with 3-across mounting.

Accessories — Page 100

Approximate Dimensions — Page 127

Legend Plates — Page 115

22.5 mm Push Buttons

IP66, Type 4/4X/13 (Plastic) — IP66, Type 4/13 (Metal)

Momentary Contact Push Button Operators, Illuminated — Mushroom

800 **ES** – **LM** **3**
a *b* *c*

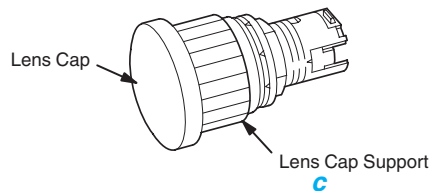

Operator Construction	
Code	Description
ES	Round plastic operator w/shiny metal bezel (NEMA Type 4/13)
EM	Round metal operator (NEMA Type 4/13)

Operator Type	
Momentary Mushroom	
Code	Type
LM	40 mm plastic lens
LMJ	60 mm plastic lens

Lens Cap Color	
Code	Color
1	White
3	Green
4	Red
5	Amber
6	Blue
7	Clear
9	No lens cap ①

Back-of-Panel Components, Illuminated Operators

Note: To order 4-across back-of-panel components, see page 103.

800E – **2** **DL5** **R** **X1** **0** **V**
a *b* *c* *d* *e* *f*

Contact Block Matrix	
Code	Type
2	2-across mounting
3	3-across mounting

Power Module Type and Voltage	
Full Voltage (Latch Included)	
Code	Description
DL0	No lamp
DL1	6V AC/DC
DL2	12V AC/DC
DL3	24V AC/DC
DL4	48V AC/DC
DL5 ②	120V AC/DC
DL6 ②	130V AC/DC

Transformer (Latch Included)	
Code	Description
TL5	110V 50 Hz/120V 60 Hz
TL6	208V 60 Hz
TL7	220V 50 Hz/240V 60 Hz
TL10	400V 50 Hz
TL14	600V 60 Hz

Resistor (Latch Included)	
Code	Description
RL5 ③	110V 50 Hz/120V 60 Hz
RL7	240V 60 Hz

Integrated LED (Latch Included) ④	
Code	Description
NL3	24V AC/DC
NL5	120V AC
NL7	240V AC

Lamp	
Code	Type
Blank	Incandescent or no lamp
R	Red LED ⑤
G	Green LED ⑤
A	Amber LED ⑤
B	Blue LED ⑤
W	White LED ⑤⑥

N.O. (Normally Open Circuits)	
Code	No. of Circuits
X0	No contact
X1	1 N.O.
X2	2 N.O.
X3	3 N.O.
X4	4 N.O.
X5	5 N.O.
X6	6 N.O.

N.C. (Normally Closed Circuits)	
Code	No. of Circuits
0	No contact
1	1 N.C.
2	2 N.C.
3	3 N.C.
4	4 N.C.
5	5 N.C.
6	6 N.C.

Specialty Contact Blocks	
Code	Type
Blank	Standard
V	PenTUFF (low voltage) ⑦
E	N.O. early make
L	N.C. late break

Note:

Max. Allowable Circuits for Illuminated Push Buttons and Selector Switches		
Mounting	Full Voltage/Integrated LED	Transformer
2-across	5	3
3-across	4	2

- ① Only available as LM option. Supplied only with clear lens cap support.
- ② Option DL5 does not have a shunting resistor when used with an LED. Option DL6 has a shunting resistor for LEDs and can be used for 120V DC applications.
- ③ 120V resistor module available in 2-across and 4-across mounting only.
- ④ Available in 3-across mounting only.
- ⑤ Refer to page for LED selection.
- ⑥ Available in 6V, 24V and 120V AC/DC only.
- ⑦ Patented PenTUFF contacts supplied only with 2-across mounting; gold-plated contacts supplied only with 3-across mounting.

22.5 mm Push Buttons

IP66, Type 4/4X/13 (Plastic) — IP66, Type 4/13 (Metal)

2-Position Push-Pull Operators, Illuminated — Mushroom



40 mm Mushroom Push-Pull
Cat. No. 800ES-LMP24



60 mm Jumbo Mushroom Push-Pull
Cat. No. 800EM-LMJP25

Color	40 mm Mushroom Push-Pull — Round		60 mm Mushroom Push-Pull — Round	
	Plastic	Metal	Plastic	Metal
	Cat. No.	Cat. No.	Cat. No.	Cat. No.
Green	800ES-LMP23	800EM-LMP23	800ES-LMJP23	800EM-LMJP23
Red	800ES-LMP24	800EM-LMP24	800ES-LMJP24	800EM-LMJP24
Amber	800ES-LMP25	800EM-LMP25	800ES-LMJP25	800EM-LMJP25
No lens	800ES-LMP29	800EM-LMP29	800ES-LMJP29	800EM-LMJP29

Back-of-Panel Components, Illuminated Operators

Full Voltage Power Module with Latch or Integrated LED Module with Latch

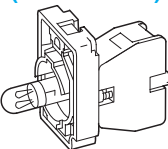
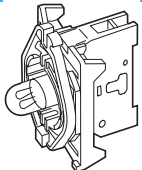
 2-Across (5 ckts. max.)	 3-Across (4 ckts. max.)	Type	Volts	2-Across Mounting	3-Across Mounting
				Cat. No.	Cat. No.
		No lamp ❶	—	800E-2DL0	800E-3DL0
		Incandescent	24 AC/DC	800E-2DL3	800E-3DL3
			120 AC/DC	800E-2DL5	800E-3DL5
		Incandescent LED Module ❷ (red)	24 AC/DC	—	800E-3NL3R
			120 AC	—	800E-3NL5R
			240 AC	—	800E-3NL7R

Transformer Power Module with Latch

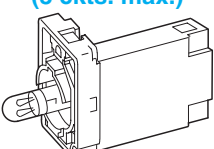
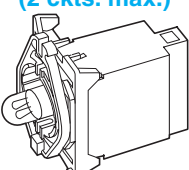
 2-Across (3 ckts. max.)	 3-Across (2 ckts. max.)	Type	Volts	2-Across Mounting	3-Across Mounting
				Cat. No.	Cat. No.
		Incandescent	110/120 AC	800E-2TL5	800E-3TL5
			220/240 AC	800E-2TL7	800E-3TL7
		LED ❸ (red)	110/120 AC	800E-2TL5R	800E-3TL5R
			220/240 AC	800E-2TL7R	800E-3TL7R

Contact Blocks

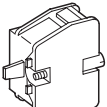
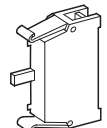
 2-Across	 3-Across	Type	Contact	2-Across Mounting	3-Across Mounting
				Cat. No.	Cat. No.
		Standard	1 N.O.	800E-2X10	800E-3X10
			1 N.C.	800E-2X01	800E-3X01
		Late break	1 N.C.L.B.	800E-2X01L	800E-3X01L
		PenTUFF (low voltage) ❹	1 N.O.	800E-2X10V	800E-3X10V
			1 N.C.	800E-2X01V	800E-3X01V

❶ Lamp must match line voltage. See replacement lamps table on page 114.

❷ LEDs are available in red, green, blue, amber, and white; color cap must match LED color.

❸ Patented PenTUFF contacts supplied only with 2-across mounting; gold-plated contacts supplied only with 3-across mounting.

Accessories — Page 100

Approximate Dimensions — Page 127

Legend Plates — Page 115

22.5 mm Push Buttons

IP66, Type 4/4X/13 (Plastic) — IP66, Type 4/13 (Metal)

2-Position Push-Pull Operators, Illuminated — Mushroom

800 **ES** – **LMP2** **3**
a *b* *c*

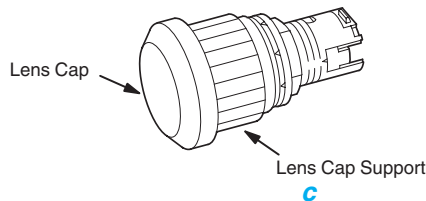

a

Operator Construction	
Code	Description
ES	Round plastic operator w/shiny metal bezel (NEMA Type 4/13)
EM	Round metal operator (NEMA Type 4/13)

b

Operator Type	
Mushroom 2-Position Push-Pull	
Code	Type
LMP2	40 mm plastic color cap
LMJP2	60 mm plastic color cap

c

Lens Cap Color	
Code	Color
1	White
3	Green
4	Red
5	Amber
6	Blue
7	Clear
9	No lens cap ❶

Back-of-Panel Components, Illuminated Operators

Note: To order 4-across back-of-panel components, see page 103.

800E – **2** **DL5** **R** **X1** **0** **V**
a *b* *c* *d* *e* *f*

a

Contact Block Matrix	
Code	Type
2	2-across mounting
3	3-across mounting

b

Power Module Type and Voltage	
Full Voltage (Latch Included)	
Code	Description
DL0	No lamp
DL1	6V AC/DC
DL2	12V AC/DC
DL3	24V AC/DC
DL4	48V AC/DC
DL5 ❷	120V AC/DC
DL6 ❸	130V AC/DC

Transformer (Latch Included)	
Code	Description
TL5	110V 50 Hz/120V 60 Hz
TL6	208V 60 Hz
TL7	220V 50 Hz/240V 60 Hz
TL10	400V 50 Hz
TL14	600V 60 Hz

Resistor (Latch Included)	
Code	Description
RL5 ❹	110V 50 Hz/120V 60 Hz
RL7	240V 60 Hz

Integrated LED (Latch Included) ❺	
Code	Description
NL3	24V AC/DC
NL5	120V AC
NL7	24V AC

c

Lamp	
Code	Type
Blank	Incandescent or no lamp
R	Red LED ❶
G	Green LED ❶
A	Amber LED ❶
B	Blue LED ❶
W	White LED ❶❷

d

N.O. (Normally Open Circuits)	
Code	No. of Circuits
X0	No contact
X1	1 N.O.
X2	2 N.O.
X3	3 N.O.
X4	4 N.O.
X5	5 N.O.
X6	6 N.O.

e

N.C. (Normally Closed Circuits)	
Code	No. of Circuits
0	No contact
1	1 N.C.
2	2 N.C.
3	3 N.C.
4	4 N.C.
5	5 N.C.
6	6 N.C.

f

Specialty Contact Blocks	
Code	Type
Blank	Standard
V	PenTUFF (low voltage) ❷
E	N.O. early make
L	N.C. late break

Note:

Max. Allowable Circuits for Illuminated Push Buttons and Selector Switches		
Mounting	Full Voltage/Integrated LED	Transformer
2-across	5	3
3-across	4	2

- ❶ Only available as **LMP2** option. Supplied only with clear lens cap support.
- ❷ Option **DL5** does not have a shunting resistor when used with an LED. Option **DL6** has a shunting resistor for LEDs and can be used for 120V DC applications.
- ❸ 120V resistor module available in 2-across and 4-across mounting **only**.
- ❹ Available in 3-across mounting **only**.
- ❺ Refer to page 114 for LED selection.
- ❻ Available in 6V, 24V and 120V AC/DC **only**.
- ❼ Patented PenTUFF contacts supplied **only** with 2-across mounting; gold-plated contacts supplied **only** with 3-across mounting.

22.5 mm Push Buttons

IP66, Type 4/4X/13 (Plastic) — IP66, Type 4/13 (Metal)

3-Position Push-Pull Operators, Illuminated — Mushroom





Illuminated 3-Position Push-Pull
Cat. No. 800ES-LMP3R4



Illuminated 3-Position Push-Pull
Cat. No. 800EM-LMP3R5

Target Table and Operator Position

			
Contact Type	Out	Center	In
N.O.	O	O	X
N.C.	X	O	O
N.O.E.M.	O	X	X
N.C.L.B.	X	X	O

Color	40 mm Mushroom Push-Pull (Momentary Out — Maintained Center — Momentary In) — Round				40 mm Mushroom Push-Pull (Momentary Out — Maintained Center — Maintained In) — Round			
	40 mm Plastic	40 mm Metal	60 mm Plastic	60 mm Metal	40 mm Plastic	40 mm Metal	60 mm Plastic	60 mm Metal
	Cat. No.	Cat. No.	Cat. No.	Cat. No.	Cat. No.	Cat. No.	Cat. No.	Cat. No.
Green	800ES-LMP3R3	800EM-LMP3R3	800ES-LMJP3R3	800EM-LMJP3R3	800ES-LMP3S3	800EM-LMP3S3	800ES-LMJP3S3	800EM-LMJP3S3
Red	800ES-LMP3R4	800EM-LMP3R4	800ES-LMJP3R4	800EM-LMJP3R4	800ES-LMP3S4	800EM-LMP3S4	800ES-LMJP3S4	800EM-LMJP3S4
Amber	800ES-LMP3R5	800EM-LMP3R5	800ES-LMJP3R5	800EM-LMJP3R5	800ES-LMP3S5	800EM-LMP3S5	800ES-LMJP3S5	800EM-LMJP3S5

Note: X = Closed/O = Open

Back-of-Panel Components, Illuminated Operators

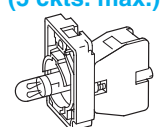
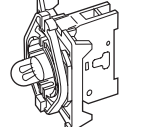

Full Voltage Power Module with Latch or Integrated LED Module with Latch

		Type	Volts	2-Across Mounting	3-Across Mounting
				Cat. No.	Cat. No.
		No lamp ❶	—	800E-2DL0	800E-3DL0
		Incandescent	24 AC/DC	800E-2DL3	800E-3DL3
			120 AC/DC	800E-2DL5	800E-3DL5
		Integrated LED Module ❷ (red)	24 AC/DC	—	800E-3NL3R
			120 AC	—	800E-3NL5R
			240 AC	—	800E-3NL7R

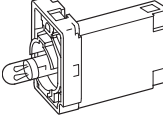
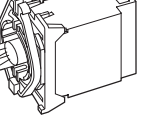
Transformer Power Module with Latch

		Type	Volts	2-Across Mounting	3-Across Mounting
				Cat. No.	Cat. No.
		Incandescent	110/120 AC	800E-2TL5	800E-3TL5
			220/240 AC	800E-2TL7	800E-3TL7
		LED ❸ (red)	110/120 AC	800E-2TL5R	800E-3TL5R
			220/240 AC	800E-2TL7R	800E-3TL7R

Contact Blocks

		Type	Contact	2-Across Mounting	3-Across Mounting
				Cat. No.	Cat. No.
		Standard	1 N.O.	800E-2X10	800E-3X10
			1 N.C.	800E-2X01	800E-3X01
		Late break	1 N.C.L.B.	800E-2X01L	800E-3X01L

❶ Lamp must match line voltage. See replacement lamps table on page 114.

❷ LEDs are available in red, green, blue, amber, and white; color cap must match LED color.

Accessories — Page 100

Legend Plates — Page 115

Approximate Dimensions — Page 127

22.5 mm Push Buttons

IP66, Type 4/4X/13 (Plastic) — IP66, Type 4/13 (Metal)

3-Position Push-Pull Operators, Illuminated — Mushroom

800 **ES** – **LMP3** **R** **3**

a *b* *c* *d*

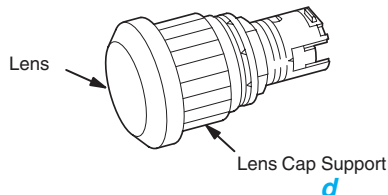

a

Operator Construction	
Code	Description
ES	Round plastic operator w/shiny metal bezel (NEMA Type 4/13)
EM	Round metal operator (NEMA Type 4/13)

b

Operator Type	
3-Position Push-Pull	
Code	Type
LMP3	40 mm plastic lens
LMJP3	60 mm plastic lens

d

Lens Cap Color	
Code	Color
1	White
3	Green
4	Red
5	Amber
6	Blue
7	Clear
9	No lens cap ❶

c

Operator Function	
Code	Type
R	Mom. out — maint. center — mom. in
S	Mom. out — maint. center — maint. in

Back-of-Panel Components, Illuminated Operators

Note: To order 4-across back-of-panel components, see page 103.

800E – **2** **DL5** **R** ^{N.O.} **X1** ^{N.C.} **0** **V**

a *b* *c* *d* *e* *f*

a

Contact Block Matrix	
Code	Type
2	2-across mounting
3	3-across mounting

b

Power Module Type and Voltage	
Full Voltage (Latch Included)	
Code	Description
DL0	No lamp
DL1	6V AC/DC
DL2	12V AC/DC
DL3	24V AC/DC
DL4	48V AC/DC
DL5 ❷	120V AC/DC
DL6 ❸	130V AC/DC

Transformer (Latch Included)	
Code	Description
TL5	110V 50 Hz/120V 60 Hz
TL6	208V 60 Hz
TL7	220V 50 Hz/240V 60 Hz
TL10	400V 50 Hz
TL14	600V 60 Hz

b, (cont'd)

Resistor (Latch Included)	
Code	Description
RL5 ❹	110V 50 Hz/120V 60 Hz
RL7	240V 60 Hz

Integrated LED (Latch Included) ❺	
Code	Description
NL3	24V AC/DC
NL5	120V AC
NL7	240V AC

c

Lamp	
Code	Type
Blank	Incandescent or no lamp
R	Red LED ❻
G	Green LED ❻
A	Amber LED ❻
B	Blue LED ❻
W	White LED ❻❼

d

N.O. (Normally Open Circuits)	
Code	No. of Circuits
X0	No contact
X1	1 N.O.
X2	2 N.O.
X3	3 N.O.
X4	4 N.O.
X5	5 N.O.
X6	6 N.O.

e

N.C. (Normally Closed Circuits)	
Code	No. of Circuits
0	No contact
1	1 N.C.
2	2 N.C.
3	3 N.C.
4	4 N.C.
5	5 N.C.
6	6 N.C.

f

Specialty Contact Blocks	
Code	Type
Blank	Standard
V	PenTUFF (low voltage) ❶
E	N.O. early make
L	N.C. late break

Note:

Max. Allowable Circuits for Illuminated Push Buttons and Selector Switches		
Mounting	Full Voltage/Integrated LED	Transformer
2-across	5	3
3-across	4	2

- ❶ Only available as **LMP3** option. Supplied only with clear lens cap support.
- ❷ Option **DL5** does not have a shunting resistor when used with an LED. Option **DL6** has a shunting resistor for LEDs and can be used for 120V DC applications.
- ❸ 120V resistor module available in 2-across and 4-across mounting **only**.
- ❹ Available in 3-across only.
- ❺ Refer to page 114 for LED selection.
- ❻ Available in 6V, 24V and 120V AC/DC only.
- ❼ Patented PenTUFF contacts supplied only with 2-across mounting; gold-plated contacts supplied only with 3-across mounting.

2-Position Selector Switch Operators, Non-Illuminated



Standard Knob
Cat. No. 800EP-SM23



Knob Lever
Cat. No. 800EB-HM23

Switching Angles

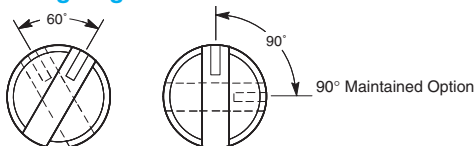

Target Table and Operator Position ① (60° Switching Angle)		
Contact Type		
N.O.	O	X
N.C.	X	O

Note: X = Closed/O = Open

Color	Operator Type M = Maintained S = Spring Return	Standard Knob — Round		Knob Lever — Round	
		Plastic	Metal	Plastic	Metal
		Cat. No.	Cat. No.	Cat. No.	Cat. No.
Black knob with white insert	M M	800EP-SM22	800EM-SM22	800EP-HM22	800EM-HM22
	M←S	800EP-SR22	800EM-SR22	800EP-HR22	800EM-HR22
	S→M ①	800EP-SL22	800EM-SL22	800EP-HL22	800EM-HL22

① Target table for spring return from left is reversed from what is shown in the table.

Back-of-Panel Components, Non-Illuminated Operators

Mounting Latch

 2-Across	 3-Across	Contact	2-Across Mounting Cat. No.	3-Across Mounting Cat. No.
		Mounting latch	800E-A2L	800E-A3L

Contact Block

 2-Across	 3-Across	Type	Contact	2-Across Mounting Cat. No.	3-Across Mounting Cat. No.
		Standard	1 N.O.	800E-2X10	800E-3X10
1 N.C.	800E-2X01		800E-3X01		
Pen TUFF (low voltage) ②	1 N.O.		800E-2X10V	800E-3X10V	
	1 N.C.		800E-2X01V	800E-3X01V	

Mounting Latch and Contact Blocks

 2-Across	 3-Across	Type	Contact	2-Across Mounting Cat. No.	3-Across Mounting Cat. No.
		Standard	1 N.O.	800E-2LX10	800E-3LX10
1 N.C.	800E-2LX01		800E-3LX01		
1 N.O. - 1 N.C.	800E-2LX11		800E-3LX11		
2 N.O.	800E-2LX20		800E-3LX20		
2 N.C.	800E-2LX02		800E-3LX02		
Pen TUFF (low voltage) ②	1 N.O.		800E-2LX10V	800E-3LX10V	
	1 N.C.	800E-2LX01V	800E-3LX01V		
	1 N.O. - 1 N.C.	800E-2LX11V	800E-3LX11V		

② Patented Pen TUFF contacts supplied only with 2-across mounting; gold-plated contacts supplied only with 3-across mounting.

Accessories — Page 100

Legend Plates — Page 115

Approximate Dimensions — Page 127

22.5 mm Push Buttons

IP66, Type 4/4X/13 (Plastic) — IP66, Type 4/13 (Metal)

2-Position Selector Switch Operators, Non-Illuminated

800 **EP** - **S** **M2** **2** -
a *b* *c* *d* *e*

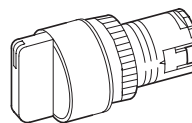

a

Operator Construction	
Code	Description
EP	Round plastic operator (NEMA Type 4/4X/13)
ES	Round plastic operator w/shiny metal bezel (NEMA Type 4/13)
EQ	Square plastic operator (NEMA Type 4/4X/13)
EM	Round metal operator (NEMA Type 4/13)
EB	Round metal operator w/black anodized bezel (NEMA Type 4/13)

b

Operator Type	
Code	Type
S	Standard knob
H	Knob lever

c

Operator Function	
Code	Type
M2	Maintained (60° switching angle)
N2	Maintained (90° switching angle) ❶
L2	Spring return from left (60° switching angle)
R2	Spring return from right (60° switching angle)

d

Knob/Insert Color		
Code	Knob Color	Insert Color
1	White	Black
2	Black	White
3	Green	White
4	Red	White
5	Yellow	Black
6	Blue	White
8	Gray	White
9	No knob ❷	

e

Packaging	
Code	Description
Blank	1 per package
BP	10 per package

Back-of-Panel Components, Non-Illuminated Operators

Note: To order 4-across back-of-panel components, see page 103.

800E - **2LX** ^{N.O.} **1** ^{N.C.} **0** **V**
a *b* *c* *d*

a

Contact Block/Latch Type	
Code	Type
2LX	2-across mounting
3LX	3-across mounting

b

N.O. (Normally Open Circuits) ❸	
Code	No. of Circuits
0	No contact
1	1 N.O.
2	2 N.O.
3	3 N.O.
4	4 N.O.
5	5 N.O.
6	6 N.O.

c

N.C. (Normally Closed Circuits) ❸	
Code	No. of Circuits
0	No contact
1	1 N.C.
2	2 N.C.
3	3 N.C.
4	4 N.C.
5	5 N.C.
6	6 N.C.

d

Specialty Contact Blocks	
Code	Type
Blank	Standard
V	PenTUFF (low voltage) ❹
E	N.O. early make
L	N.C. late break

❶ 30 mm hole spacing will not work if a knob lever is used. See page 123 for recommended operator panel spacing.

❷ Selecting option 9 (no knob) is only valid when ordering option S (standard knob).

❸ A total of six circuits is the maximum allowable.

❹ Patented PenTUFF contacts supplied only with 2-across mounting; gold-plated contacts supplied only with 3-across mounting.

22.5 mm Push Buttons

IP66, Type 4/4X/13 (Plastic) — IP66, Type 4/13 (Metal)

3-Position Selector Switch Operators, Non-Illuminated



Standard Knob
Cat. No. 800EP-SM33



Knob Lever
Cat. No. 800EM-HM33

Switching Angles

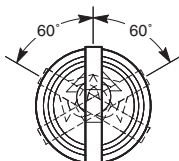

Target Table and Operator Position (60° Switching Angle)					
Contact Type	Position on Mounting Latch	Standard Knob — Round		Knob Lever — Round	
		Left	Right	Left	Right
N.O.	Left	X	O	O	O
N.O.	Right	O	O	O	X
N.C.	Left	O	X	X	X
N.C.	Right	X	X	X	O

Note: X = Closed/O = Open

Color	Operator Type			Standard Knob — Round		Knob Lever — Round	
	M = Maintained S = Spring Return			Plastic	Metal	Plastic	Metal
				Cat. No.	Cat. No.	Cat. No.	Cat. No.
Black knob with white insert	M	M	M	800EP-SM32	800EM-SM32	800EP-HM32	800EM-HM32
	M	M←S		800EP-SR32	800EM-SR32	800EP-HR32	800EM-HR32
	S→M	M		800EP-SL32	800EM-SL32	800EP-HL32	800EM-HL32
	S→M←S			800EP-SB32	800EM-SB32	800EP-HB32	800EM-HB32

Back-of-Panel Components, Non-Illuminated Operators

Mounting Latch

		Contact	2-Across Mounting	3-Across Mounting
			Cat. No.	Cat. No.
		Mounting latch	800E-A2L	800E-A3L

Contact Block

		Type	Contact	2-Across Mounting	3-Across Mounting
				Cat. No.	Cat. No.
		Standard	1 N.O.	800E-2X10	800E-3X10
			1 N.C.	800E-2X01	800E-3X01
		PenTUFF (low voltage) ①	1 N.O.	800E-2X10V	800E-3X10V
			1 N.C.	800E-2X01V	800E-3X01V

Mounting Latch and Contact Blocks ②

		Type	Contact	2-Across Mounting	3-Across Mounting
				Cat. No.	Cat. No.
		Standard	1 N.O.	800E-2LX10	800E-3LX10
			1 N.C.	800E-2LX01	800E-3LX01
			1 N.O. - 1 N.C.	800E-2LX11	800E-3LX11
			2 N.O.	800E-2LX20	800E-3LX20
		PenTUFF (low voltage) ①	2 N.C.	800E-2LX02	800E-3LX02
			1 N.O.	800E-2LX10V	800E-3LX10V
			1 N.C.	800E-2LX01V	800E-3LX01V
			1 N.O. - 1 N.C.	800E-2LX11V	800E-3LX11V

① Patented PenTUFF contacts supplied only with 2-across mounting; gold-plated contacts supplied only with 3-across mounting.

② 2-across mounting latch and contact block combinations are factory assembled. When one contact block is specified, it is mounted in position 2 (right side/viewed from back). When 1 N.O. and 1 N.C. contacts are specified, the N.O. is mounted in position 2, and the N.C. is mounted in position 1 (left side/viewed from the back).

22.5 mm Push Buttons

IP66, Type 4/4X/13 (Plastic) — IP66, Type 4/13 (Metal)

3-Position Selector Switch Operators, Non-Illuminated

800 **EP** - **S** **M3** **3** - -

a *b* *c* *d* *e* *f*

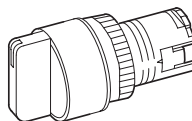

a

Operator Construction	
Code	Description
EP	Round plastic operator (NEMA Type 4/4X/13)
ES	Round plastic operator w/shiny metal bezel (NEMA Type 4/13)
EQ	Square plastic operator (NEMA Type 4/4X/13)
EM	Round metal operator (NEMA Type 4/13)
EB	Round metal operator w/black anodized bezel (NEMA Type 4/13)

b

Operator Type	
Code	Type
S	Standard knob
H	Knob lever

c

Operator Function	
Code	Type
M3	Maintained
L3	Spring return from left
R3	Spring return from right
B3	Spring return from left and right

d

Knob/Insert Color		
Code	Knob Color	Insert Color
1	White	Black
2	Black	White
3	Green	White
4	Red	White
5	Yellow	Black
6	Blue	White
8	Gray	White
9	No knob ①	

e

Optional Cam Code and Target Table																
Operator Position Viewed from the Front	C1			C2		C3		C4		C5		C6		C7 ②③		
	Contact Block Mounting Position on Latch as Viewed from the Back															
	↙	↑	↘	Left Side	Right Side	Left Side	Right Side	Left Side	Right Side	Left Side	Right Side	Left Side	Right Side	Left Side	Right Side	Left Side
X	O	O	—	N.O.	N.C. or N.C.		N.C. or N.O.		—	N.C.	—	—	N.O. or N.O.		—	N.O.
O	X	O	N.C. or N.C.		—	—	—	N.C.	N.C.	—	N.C. or N.C.		N.C. or N.C.		N.C.	—
O	O	X	N.O.	—	N.O. or N.O.		N.O.		N.O. or N.O.		N.O. or N.O.		—	—	—	N.C.
X	X	O	N.C.L.B.	—	N.C.L.B. or N.C.L.B.		N.C.L.B.		N.C.L.B. or N.C.L.B.		N.C.L.B. or N.C.L.B.		—	—	—	—
O	X	X	—	N.C.L.B.	N.O.E.M. or N.O.E.M.		N.O.E.M. or N.C.L.B.		—		N.O.E.M.		—		N.C.L.B. or N.C.L.B.	
X	O	X	N.O.E.M. or N.O.E.M.		—	—	—	N.O.E.M.	N.O.E.M.	—	N.O.E.M. or N.O.E.M.		N.O.E.M. or N.O.E.M.		—	—

Note: X = Closed/O = Open

f

Packaging	
Code	Description
Blank	1 per package
BP	10 per package

2-Across Mounting Latch

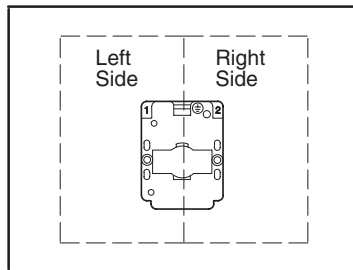

3-Across Mounting Latch

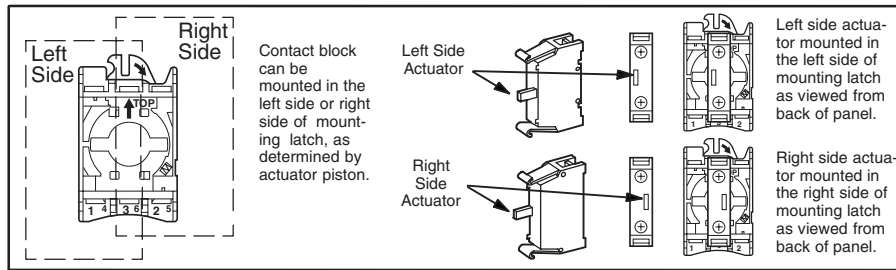

Back-of-Panel Components, Non-Illuminated Operators

See page 24 for back-of-panel components configurator tables.

Note: To order 4-across back-of-panel components, see page 103.

- ① Selecting option 9 (no knob) is only valid when ordering option S (standard knob).
- ② Operators with an overlapping cam allow selector switch contacts to make before the contacts of the previous position break. The overlap will occur in both directions.
- ③ Overlapping cams are not valid with spring return operator functions.

4-Position Selector Switch Operators, Non-Illuminated



Non-Illuminated Standard Knob



Non-Illuminated Knob Lever

Target Table and Operator Position (45° Switching Angle for Standard Cam)

Contact Type	Position on Mounting Latch				
N.O.	Right	X	O	O	O
N.C.	Right	O	X	O	O
N.O.	Left	O	O	X	O
N.C.	Left	O	O	O	X

Note: X = Closed/O = Open

Color	Operator Type M = Maintained S = Spring Return				Standard Knob — Round		Knob Lever — Round	
					Plastic	Metal	Plastic	Metal
					Cat. No.	Cat. No.	Cat. No.	Cat. No.
Black knob with white insert	M	M	M	M	800EP-SM42	800EM-SM42	800EP-HM42	800EM-HM42
	S→M	M	M		800EP-SL42	800EM-SL42	800EP-HL42	800EM-HL42
	M	M	M←S		800EP-SR42	800EM-SR42	800EP-HR42	800EM-HR42
	S→M	M←S			800EP-SB42	800EM-SB42	800EP-HB42	800EM-HB42

Back-of-Panel Components, Non-Illuminated Operators

Mounting Latch

		Contact	2-Across Mounting Cat. No.	3-Across Mounting Cat. No.
		Mounting latch	800E-A2L	800E-A3L

Contact Block

		Type	Contact	2-Across Mounting Cat. No.	3-Across Mounting Cat. No.
		Standard	1 N.O.	800E-2X10	800E-3X10
			1 N.C.	800E-2X01	800E-3X01
		Pen TUFF (low voltage) ①	1 N.O.	800E-2X10V	800E-3X10V
			1 N.C.	800E-2X01V	800E-3X01V

Mounting Latch and Contact Blocks ②

		Type	Contact	2-Across Mounting Cat. No.	3-Across Mounting Cat. No.
		Standard	1 N.O.	800E-2LX10	800E-3LX10
			1 N.C.	800E-2LX01	800E-3LX01
			1 N.O. - 1 N.C.	800E-2LX11	800E-3LX11
			2 N.O.	800E-2LX20	800E-3LX20
		Pen TUFF (low voltage) ①	1 N.O.	800E-2LX10V	800E-3LX10V
			1 N.C.	800E-2LX01V	800E-3LX01V
			1 N.O. - 1 N.C.	800E-2LX11V	800E-3LX11V

① Patented Pen TUFF contacts supplied only with 2-across mounting; gold-plated contacts supplied only with 3-across mounting.

② 2-across mounting latch and contact block combinations are factory assembled. When one contact block is specified, it is mounted in position 2 (right side/viewed from back). When 1 N.O. and 1 N.C. contacts are specified, the N.O. is mounted in position 2, and the N.C. is mounted in position 1 (left side/viewed from the back).

22.5 mm Push Buttons

IP66, Type 4/4X/13 (Plastic) — IP66, Type 4/13 (Metal)

4-Position Selector Switch Operators, Non-Illuminated

800 **EP** - **S** **M4** **2** **C31** -

a b c d e f

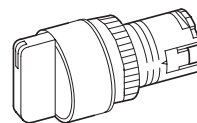

a

Operator Construction	
Code	Description
EP	Round plastic operator (NEMA Type 4/4X/13)
ES	Round plastic operator w/shiny metal bezel (NEMA Type 4/13)
EQ	Square plastic operator (NEMA Type 4/4X/13)
EM	Round metal operator (NEMA Type 4/13)
EB	Round metal operator w/black anodized bezel (NEMA Type 4/13)

b

Operator Type	
Code	Type
S	Standard knob
H	Knob lever

d

Knob/Insert Color		
Code	Knob Color	Insert Color
1	White	Black
2	Black	White
3	Green	White
4	Red	White
5	Amber	Black
6	Blue	White
9	No knob ①	

c

Operator Function	
Code	Type
M4	Maintained
L4	Spring return from pos. 1 to pos. 2
R4	Spring return from pos. 4 to pos. 3
B4	Spring return from pos. 1 to pos. 2 and from pos. 4 to pos. 3

e

Optional Cam Code and Target Table														
Operator Position Viewed from the Front				C31		C32		C33		C34		C35 ②③		
Pos. 1	Pos. 2	Pos. 3	Pos. 4	Contact Block Mounting Position on Latch as Viewed from the Back								Overlapping Cam		
				Left Side	Right Side	Left Side	Right Side	Left Side	Right Side	Left Side	Right Side	Left Side	Right Side	
X	O	O	O	N.O.	—	—	N.O.	N.O.	—	—	—	N.C.	—	
O	X	O	O	—	—	N.O.	—	—	N.O.	—	—	—	N.O.	
O	O	X	O	—	—	N.O.	—	—	—	—	—	N.O.	—	
O	O	O	X	N.C.	—	N.C.	—	—	N.C.	—	—	—	N.C.	
X	X	O	O	—	N.C.	—	—	N.O.E.M.	—	—	N.C.	—	—	
O	X	X	O	—	—	—	N.C.	—	—	N.C.	—	—	—	
X	O	O	X	—	—	—	N.O.E.M.	—	—	N.O.	—	—	—	
O	O	X	X	—	N.O.E.M.	—	—	N.C.	—	—	N.O.	—	—	
X	X	X	O	N.O.E.M.	—	N.O.E.M.	—	—	N.O.E.M.	—	—	—	—	
X	X	O	X	—	N.C.L.B.	—	—	—	—	—	—	—	—	
X	O	X	X	—	—	N.C.L.B.	—	—	N.C.L.B.	—	—	—	—	
O	X	X	X	N.C.L.B.	—	—	N.C.L.B.	N.C.L.B.	—	—	—	—	—	

Note: X = Closed/O = Open

f

Packaging	
Code	Description
Blank	1 per package
BP	10 per package

- ① Selecting option 9 (no knob) is only valid when ordering option S (standard knob).
- ② Operators with an overlapping cam allow selector switch contacts to make before the contacts of the previous position break. The overlap will occur in both directions.
- ③ Overlapping cams are not valid with spring return operator functions.

2-Across Mounting Latch

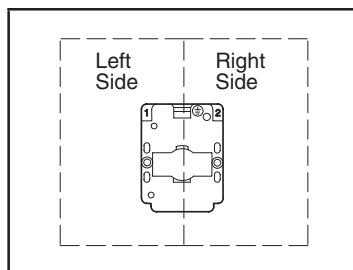

3-Across Mounting Latch

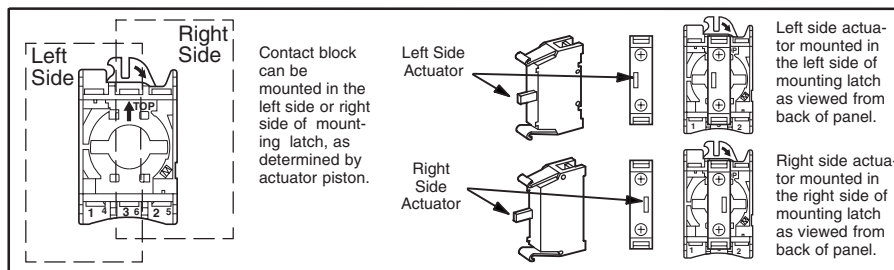

Back-of-Panel Components, Non-Illuminated Operators

See page 24 for back-of-panel components configurator tables.

Note: To order 4-across back-of-panel components, see page 103.

2-Position Selector Switch Operators, Illuminated



Standard Knob
Cat. No. 800EP-LSM26



Standard Knob
Cat. No. 800EM-LSM24

Switching Angles

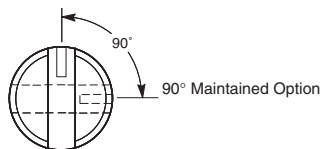
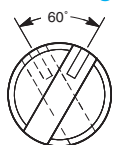

Target Table and Operator Position ① (60° Switching Angle)		
Contact Type		
N.O.	O	X
N.C.	X	O

Note: X = Closed/O = Open

Color	Operator Type		Standard Knob — Round		Knob Lever — Round	
	M = Maintained S = Spring Return		Plastic	Metal	Plastic	Metal
			Cat. No.	Cat. No.	Cat. No.	Cat. No.
Red	M	M	800EP-LSM24	800EM-LSM24	800EP-LHM24	800EM-LHM24
	M	S	800EP-LSR24	800EM-LSR24	800EP-LHR24	800EM-LHR24
	S	M	800EP-LSL24	800EM-LSL24	800EP-LHL24	800EM-LHL24

① Target table for spring return from left is reversed from what is shown in the table.

Back-of-Panel Components, Illuminated Operators

Full Voltage Power Module with Latch or Integrated LED Module with Latch

 2-Across (5 ckt. max.)	 3-Across (4 ckt. max.)	Type	Volts	2-Across Mounting	3-Across Mounting
				Cat. No.	Cat. No.
		No lamp ②	—	800E-2DL0	800E-3DL0
		Incandescent	24 AC/DC	800E-2DL3	800E-3DL3
			120 AC/DC	800E-2DL5	800E-3DL5
		Integrated LED Module ③ (red)	24 AC/DC	—	800E-3NL3R
			120 AC	—	800E-3NL5R
			240 AC	—	800E-3NL7R

Transformer Power Module with Latch

 2-Across (3 ckt. max.)	 3-Across (2 ckt. max.)	Type	Volts	2-Across Mounting	3-Across Mounting
				Cat. No.	Cat. No.
		Incandescent	110/120 AC	800E-2TL5	800E-3TL5
			220/240 AC	800E-2TL7	800E-3TL7
		LED ③ (red)	110/120 AC	800E-2TL5R	800E-3TL5R
			220/240 AC	800E-2TL7R	800E-3TL7R

Contact Blocks

 2-Across	 3-Across	Type	Contact	2-Across Mounting	3-Across Mounting
				Cat. No.	Cat. No.
		Standard	1 N.O.	800E-2X10	800E-3X10
			1 N.C.	800E-2X01	800E-3X01
		PenTUFF (low voltage) ④	1 N.O.	800E-2X10V	800E-3X10V
			1 N.C.	800E-2X01V	800E-3X01V

② Lamp must match line voltage. See replacement lamps table on page 114.

③ LEDs are available in red, green, blue, amber, and white; color cap must match LED color.

④ Patented PenTUFF contacts supplied only with 2-across mounting; gold-plated contacts supplied only with 3-across mounting.

Accessories — Page 100

Approximate Dimensions — Page 127

Legend Plates — Page 115

22.5 mm Push Buttons

IP66, Type 4/4X/13 (Plastic) — IP66, Type 4/13 (Metal)

2-Position Selector Switch Operators, Illuminated

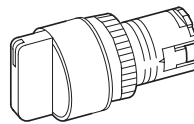

a

Operator Construction	
Code	Description
EP	Round plastic operator (NEMA Type 4/4X/13)
ES	Round plastic operator w/shiny metal bezel (NEMA Type 4/13)
EQ	Square plastic operator (NEMA Type 4/4X/13)
EM	Round metal operator (NEMA Type 4/13)
EB	Round metal operator w/black anodized bezel (NEMA Type 4/13)

b

Operator Type	
Code	Type
LS	Standard knob
LH	Knob lever

c

Operator Function	
Code	Type
M2	Maintained (60° switching angle)
N2	Maintained (90° switching angle) ①
L2	Spring return from left (60° switching angle)
R2	Spring return from right (60° switching angle)

d

Knob/Insert Color		
Code	Knob Color	Insert Color
1	White	Black
3	Green	White
4	Red	White
5	Amber	Black
6	Blue	White
7	Clear	Black
9	No knob ②	

e

Packaging	
Code	Description
Blank	1 per package
BP	10 per package

Back-of-Panel Components, Illuminated Operators

Note: To order 4-across back-of-panel components, see page 103.



a

Contact Block Matrix	
Code	Type
2	2-across mounting
3	3-across mounting

b

Power Module Type and Voltage	
Full Voltage (Latch Included)	
Code	Description
DL0	No lamp
DL1	6V AC/DC
DL2	12V AC/DC
DL3	24V AC/DC
DL4	48V AC/DC
DL5 ③	120V AC/DC
DL6 ④	130V AC/DC

Transformer (Latch Included)	
Code	Description
TL5	110V 50 Hz/120V 60 Hz
TL6	208V 60 Hz
TL7	220V 50 Hz/240V 60 Hz
TL10	400V 50 Hz
TL14	600V 60 Hz

Resistor (Latch Included)	
Code	Description
RL5 ⑤	110V 50 Hz/120V 60 Hz
RL7	240V 60 Hz

Integrated LED (Latch Included) ⑥	
Code	Description
NL3	24V AC/DC
NL5	120V AC
NL7	240V AC

c

Lamp	
Code	Type
Blank	Incandescent or no lamp
R	Red LED ⑦
G	Green LED ⑧
A	Amber LED ⑧
B	Blue LED ⑧
W	White LED ⑧⑨

d

N.O. (Normally Open Circuits) ⑩	
Code	No. of Circuits
X0	No contact
X1	1 N.O.
X2	2 N.O.
X3	3 N.O.
X4	4 N.O.
X5	5 N.O.
X6	6 N.O.

e

N.C. (Normally Closed Circuits) ⑩	
Code	No. of Circuits
0	No contact
1	1 N.C.
2	2 N.C.
3	3 N.C.
4	4 N.C.
5	5 N.C.
6	6 N.C.

f

Specialty Contact Blocks	
Code	Type
Blank	Standard
V	PenTUFF (low voltage) ⑪
E	N.O. early make
L	N.C. late break

Note:

Max. Allowable Circuits for Illuminated Push Buttons and Selector Switches		
Mounting	Full Voltage/Integrated LED	Transformer
2-across	5	3
3-across	4	2

- ① 30 mm hole spacing will not work if a knob lever is used. See page 123 for recommended operator panel spacing.
- ② Selecting option 9 (no knob) is only valid when ordering option LS (standard knob).
- ③ Option DL5 does not have a shunting resistor when used with an LED. Option DL6 has a shunting resistor for LEDs and can be used for 120V DC applications.
- ④ 120V resistor module available in 2-across and 4-across mounting only.

- ⑤ Available in 3-across mounting only.
- ⑥ Refer to page 114 for LED selection.
- ⑦ Available in 6V, 24V and 120V AC/DC only.
- ⑧ If contact blocks on both sides of the latch are required, full voltage module must be used.
- ⑨ Patented PenTUFF contacts supplied only with 2-across mounting; gold-plated contacts supplied only with 3-across mounting.

22.5 mm Push Buttons

IP66, Type 4/4X/13 (Plastic) — IP66, Type 4/13 (Metal)

3-Position Selector Switch Operators, Illuminated



Standard Knob
Cat. No. 800EP-LSM26



Standard Knob
Cat. No. 800EM-LSM34

Switching Angles

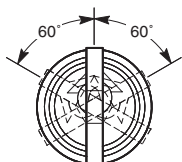

Target Table and Operator Position (60° Switching Angle)				
Contact Type	Position on Mounting Latch			
N.O.	Left	X	O	O
N.O.	Right	O	O	X
N.C.	Left	O	X	X
N.C.	Right	X	X	O

Note: X = Closed/O=Open

Color	Operator Type			Standard Knob — Round		Knob Lever — Round	
	M = Maintained S = Spring Return			Plastic	Metal	Plastic	Metal
				Cat. No.	Cat. No.	Cat. No.	Cat. No.
Red	M	M	M	800EP-LSM34	800EM-LSM34	800EP-LHM34	800EM-LHM34
	M	M	S	800EP-LSR34	800EM-LSR34	800EP-LHR34	800EM-LHR34
	S	M	M	800EP-LSL34	800EM-LSL34	800EP-LHL34	800EM-LHL34
	S	M	S	800EP-LSB34	800EM-LSB34	800EP-LHB34	800EM-LHB34

Back-of-Panel Components, Illuminated Operators

Full Voltage Power Module with Latch or Integrated LED Module with Latch

		Type	Volts	2-Across Mounting	3-Across Mounting
				Cat. No.	Cat. No.
		No lamp ❶	—	800E-2DL0	800E-3DL0
		Incandescent	24 AC/DC	800E-2DL3	800E-3DL3
			120 AC/DC	800E-2DL5	800E-3DL5
		Integrated LED Module ❷ (red)	24 AC/DC	—	800E-3NL3R
			120 AC	—	800E-3NL5R
			240 AC	—	800E-3NL7R

Transformer Power Module with Latch

		Type	Volts	2-Across Mounting	3-Across Mounting
				Cat. No.	Cat. No.
		Incandescent	110/120 AC	800E-2TL5	800E-3TL5
			220/240 AC	800E-2TL7	800E-3TL7
		LED ❸ (red)	110/120 AC	800E-2TL5R	800E-3TL5R
			220/240 AC	800E-2TL7R	800E-3TL7R

Contact Blocks

		Type	Contact	2-Across Mounting	3-Across Mounting
				Cat. No.	Cat. No.
		Standard	1 N.O.	800E-2X10	800E-3X10
			1 N.C.	800E-2X01	800E-3X01
		PenTUFF (low voltage) ❹	1 N.O.	800E-2X10V	800E-3X10V
			1 N.C.	800E-2X01V	800E-3X01V

❶ Lamp must match line voltage. See replacement lamps table on page 114.

❷ LEDs are available in red, green, blue, amber, and white; color cap must match LED color.

❸ Patented PenTUFF contacts supplied only with 2-across mounting; gold-plated contacts supplied only with 3-across mounting.

Accessories — Page 100

Legend Plates — Page 115

Approximate Dimensions — Page 127

22.5 mm Push Buttons

IP66, Type 4/4X/13 (Plastic) — IP66, Type 4/13 (Metal)

3-Position Selector Switch Operators, Illuminated

800 EP - LS M3 3 - -

a b c d e f

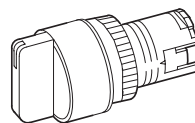

a

Operator Construction	
Code	Description
EP	Round plastic operator (NEMA Type 4/4X/13)
ES	Round plastic operator w/shiny metal bezel (NEMA Type 4/13)
EQ	Square plastic operator (NEMA Type 4/4X/13)
EM	Round metal operator (NEMA Type 4/13)
EB	Round metal operator w/black anodized bezel (NEMA Type 4/13)

b

Operator Type	
Code	Type
LS	Standard knob
LH	Knob lever

c

Operator Function	
Code	Type
M3	Maintained
L3	Spring return from left
R3	Spring return from right
B3	Spring return from left and right

d

Knob/Insert Color		
Code	Knob Color	Insert Color
1	White	Black
3	Green	White
4	Red	White
5	Amber	Black
6	Blue	White
7	Clear	Black
9	No knob ①	

e

Optional Cam Code and Target Table																
Operator Position Viewed from the Front	C1 ②		C2 ②		C3 ②		C4 ②		C5 ②		C6 ②		C7 ②③			
	Contact Block Mounting Position on Latch as Viewed from the Back														Overlapping Cam	
	↙	↑	↘	Left Side	Right Side	Left Side	Right Side	Left Side	Right Side	Left Side	Right Side	Left Side	Right Side	Left Side	Right Side	
X	O	O	—	N.O.	N.C. or N.C.		N.C. or N.O.		—	N.C.	—	—	N.O. or N.O.		—	N.O.
O	X	O	N.C. or N.C.		—	—	—	N.C.	N.C.	—	N.C. or N.C.		N.C. or N.C.	N.C.	—	—
O	O	X	N.O.	—	N.O. or N.O.		N.O.	—	N.O. or N.O.		N.O. or N.O.	—	—	—	—	N.C.
X	X	O	N.C.L.B.	—	N.C.L.B. or N.C.L.B.		N.C.L.B.	—	N.C.L.B. or N.C.L.B.		N.C.L.B. or N.C.L.B.	—	—	—	—	—
O	X	X	—	N.C.L.B.	N.O.E.M. or N.O.E.M.		N.O.E.M. or N.C.L.B.		—	N.O.E.M.	—	—	N.C.L.B. or N.C.L.B.		—	—
X	O	X	N.O.E.M. or N.O.E.M.		—	—	—	N.O.E.M.	N.O.E.M.	—	N.O.E.M. or N.O.E.M.		N.O.E.M. or N.O.E.M.		—	—

Note: X = Closed/O = Open

f

Packaging	
Code	Description
Blank	1 per package
BP	10 per package

- ① Selecting option 9 (no knob) is only valid when ordering standard knob operators.
- ② If contact blocks on both sides of the latch are required, full voltage module must be used.
- ③ Available with 2-across full voltage only.
- ④ Overlapping cams are not valid with spring return operator functions.

2-Across Mounting Latch

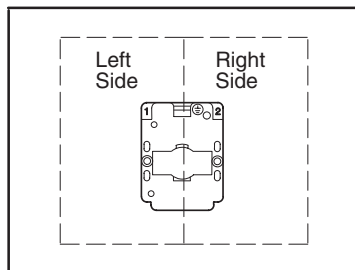

3-Across Mounting Latch

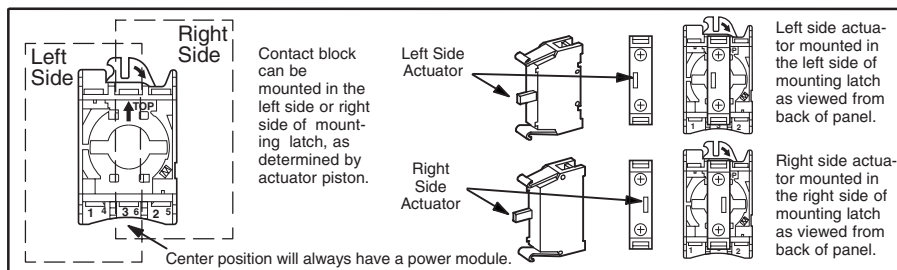

Back-of-Panel Components, Illuminated Operators

See page 24 for back-of-panel components configurator tables.

Note: To order 4-across back-of-panel components, see page 103.

4-Position Selector Switch Operators, Illuminated



Illuminated Standard Knob



Illuminated Knob Lever

Target Table and Operator Position (45° Switching Angle for Standard Cam)

Contact Type	Position on Mounting Latch				
N.O.	Right	X	O	O	O
N.C.	Right	O	X	O	O
N.O.	Left	O	O	X	O
N.C.	Left	O	O	O	X

Note: X = Closed/O = Open

Color	Operator Type M = Maintained S = Spring Return				Standard Knob — Round		Knob Lever — Round	
					Plastic	Metal	Plastic	Metal
					Cat. No.	Cat. No.	Cat. No.	Cat. No.
Red knob with white insert	M	M	M	M	800EP-LSM44	800EM-LSM44	800EP-LHM44	800EM-LHM44
	S→M	M	M		800EP-LSL44	800EM-LSL44	800EP-LHL44	800EM-LHL44
	M	M	M←S		800EP-LSR44	800EM-LSR44	800EP-LHR44	800EM-LHR44
	S→M	M←S			800EP-LSB44	800EM-LSB44	800EP-LHB44	800EM-LHB44

Back-of-Panel Components, Illuminated Operators

Full Voltage Power Module with Latch or Integrated LED Module with Latch

		Type	Volts	2-Across Mounting	3-Across Mounting
				Cat. No.	Cat. No.
		No lamp ❶	—	800E-2DL0	800E-3DL0
		Incandescent	24 AC/DC	800E-2DL3	800E-3DL3
			120 AC/DC	800E-2DL5	800E-3DL5
		Integrated LED Module ❷ (red)	24 AC/DC	—	800E-3NL3R
			120 AC	—	800E-3NL5R
			240 AC	—	800E-3NL7R

Transformer Power Module with Latch

		Type	Volts	2-Across Mounting	3-Across Mounting
				Cat. No.	Cat. No.
		Incandescent	110/120 AC	800E-2TL5	800E-3TL5
			220/240 AC	800E-2TL7	800E-3TL7
		LED ❸ (red)	110/120 AC	800E-2TL5R	800E-3TL5R
			220/240 AC	800E-2TL7R	800E-3TL7R

Contact Blocks

		Type	Contact	2-Across Mounting	3-Across Mounting
				Cat. No.	Cat. No.
		Standard	1 N.O.	800E-2X10	800E-3X10
			1 N.C.	800E-2X01	800E-3X01
		Pen <i>TUFF</i> (low voltage) ❹	1 N.O.	800E-2X10V	800E-3X10V
			1 N.C.	800E-2X01V	800E-3X01V

❶ Lamp must match line voltage. See replacement lamps table on page 114.

❷ LEDs are available in red, green, blue, amber, and white; color cap must match LED color.

❸ Patented Pen *TUFF* contacts supplied only with 2-across mounting; gold-plated contacts supplied only with 3-across mounting.

Accessories — Page 100

Approximate Dimensions — Page 127

Legend Plates — Page 115

22.5 mm Push Buttons

IP66, Type 4/4X/13 (Plastic) — IP66, Type 4/13 (Metal)

4-Position Selector Switch Operators, Illuminated

800 **EP** - **LS** **M4** **4** **C31** -

a *b* *c* *d* *e* *f*

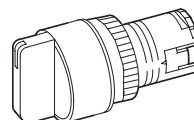

a

Operator Construction	
Code	Description
EP	Round plastic operator (NEMA Type 4/4X/13)
ES	Round plastic operator w/shiny metal bezel (NEMA Type 4/13)
EQ	Square plastic operator (NEMA Type 4/4X/13)
EM	Round metal operator (NEMA Type 4/13)
EB	Round metal operator w/black anodized bezel (NEMA Type 4/13)

b

Operator Type	
Code	Type
LS	Standard knob
LH	Knob lever

d

Knob/Insert Color		
Code	Knob Color	Insert Color
1	White	Black
3	Green	White
4	Red	White
5	Amber	Black
6	Blue	White
7	Clear	Black
9	No knob ①	

c

Operator Function	
Code	Type
M4	Maintained
L4	Spring return from pos. 1 to pos. 2
R4	Spring return from pos. 4 to pos. 3
B4	Spring return from pos. 1 to pos. 2 and from pos. 4 to pos. 3

e

Optional Cam Code and Target Table															
Operator Position Viewed from the Front				Contact Block Mounting Position on Latch as Viewed from the Back											
Pos. 1	Pos. 2	Pos. 3	Pos. 4	C31 ②		C32 ②		C33 ②		C34 ②		C35 ②③④			
				Left Side		Right Side		Left Side		Right Side		Left Side		Right Side	
				N.O.	—	—	N.O.	N.O.	—	—	—	—	N.C.	—	
				—	—	N.O.	—	—	N.O.	—	—	—	—	N.O.	
				—	N.O.	—	—	—	—	—	—	—	N.O.	—	
				N.C.	—	N.C.	—	—	N.C.	—	—	—	—	N.C.	
				—	—	N.C.	—	N.O.E.M.	—	—	N.C.	—	—	—	
				—	—	—	N.C.	—	—	N.C.	—	—	—	—	
				—	—	N.O.E.M.	—	—	—	N.O.	—	—	—	—	
				N.O.E.M.	—	—	N.C.	—	—	—	N.O.	—	—	—	
				—	N.C.L.B.	—	—	—	—	—	—	—	—	—	
				—	—	N.C.L.B.	—	—	—	N.C.L.B.	—	—	—	—	
				N.C.L.B.	—	—	N.C.L.B.	N.C.L.B.	—	—	—	—	—	—	

Note: X = Closed/O = Open

f

Packaging	
Code	Description
Blank	1 per package
BP	10 per package

- ① Selecting option 9 (no knob) is only valid when ordering option LS (standard knob).
- ② If contact blocks on both sides of the latch are required, full voltage module must be used.
- ③ Available with 2-across full voltage only.
- ④ Overlapping cams are not valid with spring return operator functions.

2-Across Mounting Latch

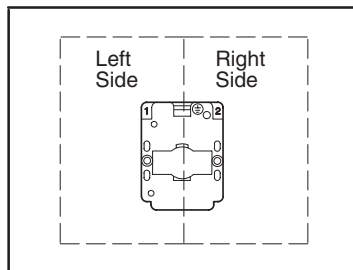

3-Across Mounting Latch

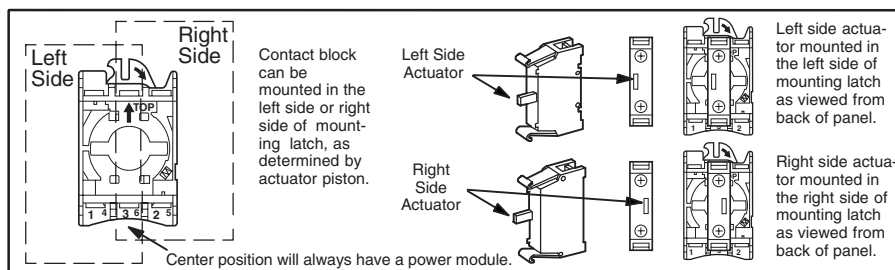

Back-of-Panel Components, Illuminated Operators

See page 24 for back-of-panel components configurator tables.
 Note: To order 4-across back-of-panel components, see page 103.

22.5 mm Push Buttons

IP66, Type 4/4X/13 (Plastic) — IP66, Type 4/13 (Metal)

2-Position Key Operated Selector Switches, Non-Illuminated ①



Key Operated Selector Switch
Cat. No. 800EP-KM21

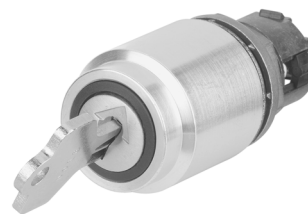

Key Operated Selector Switch
Cat. No. 800EM-KM21

Switching Angles



Target Table and Operator Position θ (60° Switching Angle)		
Contact Type		
N.O.	O	X
N.C.	X	O

Note: X = Closed/O = Open

Key Removal Position	Operator Type		Selector Switch Operators — Round	
	M = Maintained S = Spring Return		Plastic	Metal
			Cat. No.	Cat. No.
Left	M	M	800EP-KM21	800EM-KM21
Left	M	S	800EP-KR21	800EM-KR21
Right	S	M	800EP-KL22	800EM-KL22

Back-of-Panel Components, Non-Illuminated Operators

Mounting Latch

2-Across 3-Across	Contact	2-Across Mounting	3-Across Mounting
		Cat. No.	Cat. No.
	Mounting latch	800E-A2L	800E-A3L

Contact Block

2-Across 3-Across	Type	Contact	2-Across Mounting	3-Across Mounting
			Cat. No.	Cat. No.
	Standard	1 N.O.	800E-2X10	800E-3X10
		1 N.C.	800E-2X01	800E-3X01
	PenTUFF (low voltage) ③	1 N.O.	800E-2X10V	800E-3X10V
		1 N.C.	800E-2X01V	800E-3X01V

Mounting Latch and Contact Blocks

2-Across 3-Across	Type	Contact	2-Across Mounting	3-Across Mounting
			Cat. No.	Cat. No.
	Standard	1 N.O.	800E-2LX10	800E-3LX10
		1 N.C.	800E-2LX01	800E-3LX01
		1 N.O. - 1 N.C.	800E-2LX11	800E-3LX11
		2 N.O.	800E-2LX20	800E-3LX20
	PenTUFF (low voltage) ③	2 N.C.	800E-2LX02	800E-3LX02
		1 N.O.	800E-2LX10V	800E-3LX10V
		1 N.C.	800E-2LX01V	800E-3LX01V
		1 N.O. - 1 N.C.	800E-2LX11V	800E-3LX11V

① Keyed operators are IP66, Type 4/13.

② Target table for spring return from left is reversed from what is shown in the table.

③ Patented PenTUFF contacts supplied only with 2-across mounting; gold-plated contacts supplied only with 3-across mounting.

Accessories — Page 100

Approximate Dimensions — Page 127

Legend Plates — Page 115

22.5 mm Push Buttons

IP66, Type 4/4X/13 (Plastic) — IP66, Type 4/13 (Metal)

2-Position Key Operated Selector Switches, Non-Illuminated^①

Note: For standard replacement key (Key No. D018) order 800E-AK1.

800 **EM** – **KM2** **1** _____
a *b* *c* *d*

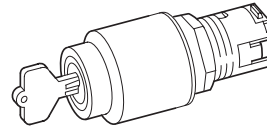

a

Operator Construction	
Code	Description
EP	Round plastic operator (NEMA Type 4/13)
ES	Round plastic operator w/shiny metal bezel (NEMA Type 4/13)
EM	Round metal operator (NEMA Type 4/13)
EB	Round metal operator w/black anodized bezel (NEMA Type 4/13)

c

Key Removal Position ^②	
Code	Position
1	Left
2	Right
3	Both

d

Optional Key Lock			
Illinois Key Lock			
Code	Key No.	Code	Key No.
Blank	D018 (Std.)	15A	T112
02A	CH501	16A	T115
03A	D020	17A	T324
04A	D025	18A	T382
05A	D335	19A	T404
06A	D429	20A	T171
07A	D461	21A	T484
08A	D111	22A	T547
09A	D587	23A	T569
10A	D682	24A	T692
11A	D713	25A	T752
12A	D900	26A	T178
13A	D992	28A	T107
14A	D118	—	—

b

Operator Type	
Code	Type
KM2	Maintained (60° switching angle)
KL2	Spring return from left (60° switching angle)
KR2	Spring return from right (60° switching angle)

Illinois Master Keys:
 D Type master key Part No. **X433358**.
 No master for D018.
 T Type master key Part No. **X433359**.
 No master for CH501.

Back-of-Panel Components, Non-Illuminated Operators

Note: To order 4-across back-of-panel components, see page 103.

800E – **2LX** ^{N.O.} **1** ^{N.C.} **0** **V**
a *b* *c* *d*

a

Contact Block/Latch Type	
Code	Type
2LX	2-across mounting
3LX	3-across mounting

b

N.O. (Normally Open Circuits) ^③	
Code	No. of Circuits
0	No contact
1	1 N.O.
2	2 N.O.
3	3 N.O.
4	4 N.O.
5	5 N.O.
6	6 N.O.

c

N.C. (Normally Closed Circuits) ^③	
Code	No. of Circuits
0	No contact
1	1 N.C.
2	2 N.C.
3	3 N.C.
4	4 N.C.
5	5 N.C.
6	6 N.C.

d

Specialty Contact Blocks	
Code	Type
Blank	Standard
V	PenTUFF (low voltage) ^④
E	N.O. early make
L	N.C. late break

- ① Not intended for high security applications. Interoperability is possible with certain key/cylinder lock combinations. Contact your local Allen-Bradley distributor for interoperability information.
- ② Key removal in maintained positions only.
- ③ A total of six circuits is the maximum allowable.
- ④ Patented PenTUFF contacts supplied only with 2-across mounting; gold-plated contacts supplied only with 3-across mounting.

22.5 mm Push Buttons

IP66, Type 4/4X/13 (Plastic) — IP66, Type 4/13 (Metal)

3-Position Key Operated Selector Switches, Non-Illuminated ①



Key Operated Selector Switch
Cat. No. 800EP-KM34



Key Operated Selector Switch
Cat. No. 800EM-KM31

Switching Angles

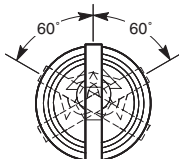

Target Table and Operator Position (60° Switching Angle)				
Contact Type	Position on Mounting Latch			
N.O.	Left	X	O	O
N.O.	Right	O	O	X
N.C.	Left	O	X	X
N.C.	Right	X	X	O

Note: X = Closed/O = Open

Key Removal Position	Operator Position M = Maintained S = Spring Return			Selector Switch Operators — Round	
				Plastic	Metal
				Cat. No.	Cat. No.
Left	M	M	M	800EP-KM31	800EM-KM31
Left	M	M←S		800EP-KR31	800EM-KR31
Right	S→M	M		800EP-KL32	800EM-KL32
Center	S→M←S			800EP-KB34	800EM-KB34

Back-of-Panel Components, Non-Illuminated Operators

Mounting Latch

		Contact	2-Across Mounting Cat. No.	3-Across Mounting Cat. No.
		Mounting latch	800E-A2L	800E-A3L

Contact Block

		Type	Contact	2-Across Mounting Cat. No.	3-Across Mounting Cat. No.
		Standard	1 N.O.	800E-2X10	800E-3X10
			1 N.C.	800E-2X01	800E-3X01
		Pen TUFF (low voltage) ②	1 N.O.	800E-2X10V	800E-3X10V
			1 N.C.	800E-2X01V	800E-3X01V

Mounting Latch and Contact Blocks ③

		Type	Contact	2-Across Mounting Cat. No.	3-Across Mounting Cat. No.
		Standard	1 N.O.	800E-2LX10	800E-3LX10
			1 N.C.	800E-2LX01	800E-3LX01
			1 N.O. - 1 N.C.	800E-2LX11	800E-3LX11
			2 N.O.	800E-2LX20	800E-3LX20
		Pen TUFF (low voltage) ②	2 N.C.	800E-2LX02	800E-3LX02
			1 N.O.	800E-2LX10V	800E-3LX10V
			1 N.C.	800E-2LX01V	800E-3LX01V
			1 N.O. - 1 N.C.	800E-2LX11V	800E-3LX11V

① Keyed operators are IP66, Type 4/13.

② Patented Pen TUFF contacts supplied only with 2-across mounting; gold-plated contacts supplied only with 3-across mounting.

③ 2-across mounting latch and contact block combinations are factory assembled. When one contact block is specified, it is mounted in position 2 (right side/viewed from back). When 1 N.O. and 1 N.C. contacts are specified, the N.O. is mounted in position 2, and the N.C. is mounted in position 1 (left side/viewed from the back).

Accessories — Page 100

Legend Plates — Page 115

Approximate Dimensions — Page 127

22.5 mm Push Buttons

IP66, Type 4/4X/13 (Plastic) — IP66, Type 4/13 (Metal)

3-Position Key Operated Selector Switches, Non-Illuminated

Note: For standard replacement key (Key No. D018) order 800E-AK1.

800 **EM** – **KM3** **2** _____

a b c d e

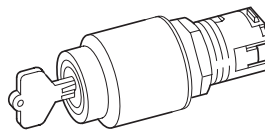

a

Operator Construction	
Code	Description
EP	Round plastic operator (NEMA Type 4/13)
ES	Round plastic operator w/shiny metal bezel (NEMA Type 4/13)
EM	Round metal operator (NEMA Type 4/13)
EB	Round metal operator w/black anodized bezel (NEMA Type 4/13)

c

Key Removal Position Ⓣ	
Code	Position
1	Left
2	Right
3	All
4	Center
5	Left/center
6	Left/right
7	Right/center

d

Optional Key Lock			
Illinois Key Lock			
Code	Key No.	Code	Key No.
Blank	D018 (Std.)	15A	T112
02A	CH501	16A	T115
03A	D020	17A	T324
04A	D025	18A	T382
05A	D335	19A	T404
06A	D429	20A	T171
07A	D461	21A	T484
08A	D111	22A	T547
09A	D587	23A	T569
10A	D682	24A	T692
11A	D713	25A	T752
12A	D900	26A	T178
13A	D992	28A	T107
14A	D118	—	—

b

Operator Type	
Code	Type
KM3	Maintained
KR3	Spring return from right
KL3	Spring return from left
KB3	Spring return from both

Illinois Master Keys:
 D Type master key Part No. **X433358**.
 No master for D018.
 T Type master key Part No. **X433359**.
 No master for CH501.

e

Optional Cam Code and Target Table														
Operator Position Viewed from the Front			C1		C2		C3		C4		C5		C6	
			Left Side	Right Side	Left Side	Right Side	Left Side	Right Side	Left Side	Right Side	Left Side	Right Side	Left Side	Right Side
Contact Block Mounting Position on Latch as Viewed from the Back														
X	O	O	—	N.O.	N.C. or N.C.		N.C. or N.O.		—	N.C.	—	—	N.O. or N.O.	
O	X	O	N.C. or N.C.		—	—	—	N.C.	N.C.	—	N.C. or N.C.		N.C. or N.C.	
O	O	X	N.O.	—	N.O. or N.O.		N.O.	—	N.O. or N.O.		N.O. or N.O.		—	—
X	X	O	N.C.L.B.	—	N.C.L.B. or N.C.L.B.		N.C.L.B.	—	N.C.L.B. or N.C.L.B.		N.C.L.B. or N.C.L.B.		—	—
O	X	X	—	N.C.L.B.	N.O.E.M. or N.O.E.M.		N.O.E.M. or N.C.L.B.		—	N.O.E.M.	—	—	N.C.L.B. or N.C.L.B.	
X	O	X	N.O.E.M. or N.O.E.M.		—	—	N.O.E.M.		N.O.E.M.	—	N.O.E.M. or N.O.E.M.		N.O.E.M. or N.O.E.M.	

Note: X = Closed/O = Open

2-Across Mounting Latch

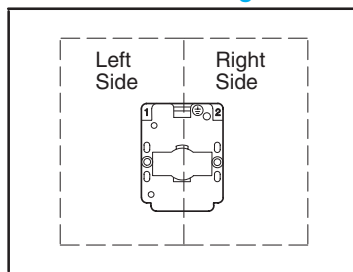

3-Across Mounting Latch

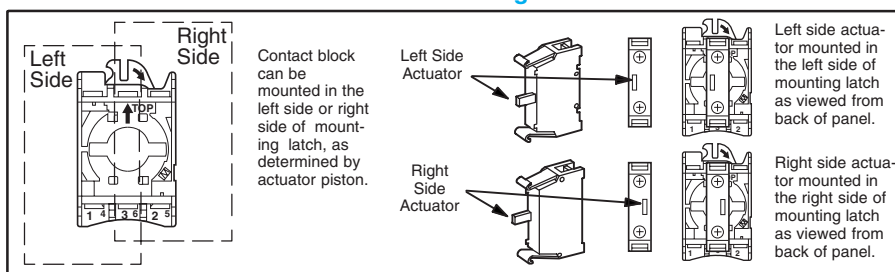

Back-of-Panel Components, Non-Illuminated Operators

See page 24 for back-of-panel components configurator tables.

Note: To order 4-across back-of-panel components, see page 103.

- ❶ Not intended for high security applications. Interoperability is possible with certain key/cylinder lock combinations. Contact your local Allen-Bradley distributor for interoperability information.
- ❷ Key removal in maintained positions only.

22.5 mm Push Buttons

IP66, Type 4/4X/13 (Plastic) — IP66, Type 4/13 (Metal)

Low Profile 2-Position Key Operated Selector Switches, Non-Illuminated ①



Round Low Profile Selector Switch
Cat. No. 800EP-KM2R1



Low Profile Selector Switch
Cat. No. 800EM-KM2R1

Switching Angles

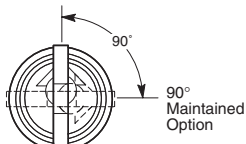
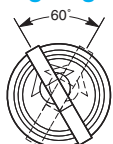

Target Table and Operator Position ② (60° Switching Angle)		
Contact Type		
N.O.	O	X
N.C.	X	O

Note: X = Closed/O = Open

Key Removal Position	Operator Type M = Maintained S = Spring Return		Low Profile Selector Switch Operators — Round	
			Plastic with Ronis Option	Metal with Zadi Option
			Cat. No.	Cat. No.
Left	M	M	800EP-KM2R1	800EM-KM2Z1
Left	M	S	800EP-KR2R1	800EM-KR2Z1
Right	S	M	800EP-KL2R2	800EM-KL2Z2

Back-of-Panel Components, Non-Illuminated Operators

Mounting Latch

		Contact	2-Across Mounting Cat. No.	3-Across Mounting Cat. No.
		Mounting latch	800E-A2L	800E-A3L

Contact Block

		Type	Contact	2-Across Mounting Cat. No.	3-Across Mounting Cat. No.
		Standard	1 N.O.	800E-2X10	800E-3X10
			1 N.C.	800E-2X01	800E-3X01
		PenTUFF (low voltage) ③	1 N.O.	800E-2X10V	800E-3X10V
			1 N.C.	800E-2X01V	800E-3X01V

Mounting Latch and Contact Blocks

		Type	Contact	2-Across Mounting Cat. No.	3-Across Mounting Cat. No.
		Standard	1 N.O.	800E-2LX10	800E-3LX10
			1 N.C.	800E-2LX01	800E-3LX01
			1 N.O. - 1 N.C.	800E-2LX11	800E-3LX11
			2 N.O.	800E-2LX20	800E-3LX20
			2 N.C.	800E-2LX02	800E-3LX02
		PenTUFF (low voltage) ③	1 N.O.	800E-2LX10V	800E-3LX10V
			1 N.C.	800E-2LX01V	800E-3LX01V
			1 N.O. - 1 N.C.	800E-2LX11V	800E-3LX11V

① Keyed operators are IP66, Type 4/13.

② Target table for spring return from left is reversed from what is shown in the table.

③ Patented PenTUFF contacts supplied only with 2-across mounting; gold-plated contacts supplied only with 3-across mounting.

Accessories — Page 100

Approximate Dimensions — Page 127

Legend Plates — Page 115

22.5 mm Push Buttons

IP66, Type 4/4X/13 (Plastic) — IP66, Type 4/13 (Metal)

Low Profile 2-Position Key Operated Selector Switches, Non-Illuminated^①

Note: For Ronis standard replacement key (Key No. 3825) order **800E-AKR3825** and for Zadi (Key No. 006) order **800E-AKZ006**.

800 **EM** – **KM2** **R** **1** – **1**

a *b* *c* *d* *e* *f*

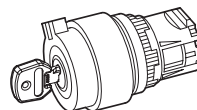

a

Operator Construction	
Code	Description
EP	Round plastic operator (NEMA Type 4/13)
ES	Round plastic operator w/shiny metal bezel (NEMA Type 4/13)
EQ	Square plastic operators (NEMA Type 4/13)
EM	Round metal operator (NEMA Type 4/13)
EB	Round metal operator w/black anodized bezel (NEMA Type 4/13)

c

Key Type	
Code	Description
R	Ronis
Z	Zadi

e

Optional Key Lock			
Ronis Key Lock		Zadi Key Lock	
Code	Key No.	Code	Key No.
Blank	3825 (Std.)	Blank	006 (Std.)
R	455	01Z	001
01R	3801	02Z	002
02R	3802	03Z	003
03R	3803	04Z	004
04R	3804	05Z	005
05R	3805	07Z	007
06R	3806	08Z	008
27R	4001	09Z	009
28R	4002	10Z	010
29R	4003	11Z	011
30R	4004	12Z	012
31R	4005	13Z	013
32R	4006	14Z	014
33R	4007	—	—

b

Operator Type	
Code	Type
KM2	Maintained (60° switching angle)
KN2	Maintained (90° switching angle)
KL2	Spring return from left (60° switching angle)
KR2	Spring return from right (60° switching angle)

d

Key Removal Position ^②	
Code	Position
1	Left
2	Right
3	Both

f

Packaging	
Code	Description
Blank	1 per package
BP	10 per package

Back-of-Panel Components, Non-Illuminated Operators

Note: To order 4-across back-of-panel components, see page 103.

800E – **2LX** ^{N.O.} **1** ^{N.C.} **0** **V**

a *b* *c* *d*

a

Contact Block/Latch Type	
Code	Type
2LX	2-across mounting
3LX	3-across mounting

b

N.O. (Normally Open Circuits) ^③	
Code	No. of Circuits
0	No contact
1	1 N.O.
2	2 N.O.
3	3 N.O.
4	4 N.O.
5	5 N.O.
6	6 N.O.

c

N.C. (Normally Closed Circuits) ^③	
Code	No. of Circuits
0	No contact
1	1 N.C.
2	2 N.C.
3	3 N.C.
4	4 N.C.
5	5 N.C.
6	6 N.C.

d

Specialty Contact Blocks	
Code	Type
Blank	Standard
V	PenTUFF (low voltage) ^④
E	N.O. early make
L	N.C. late break

- ① Not intended for high security applications. Interoperability is possible with certain key/cylinder lock combinations. Contact your local Allen-Bradley distributor for interoperability information.
- ② Key removal in maintained positions only.
- ③ A total of six circuits is the maximum allowable.
- ④ Patented PenTUFF contacts supplied only with 2-across mounting; gold-plated contacts supplied only with 3-across mounting.

22.5 mm Push Buttons

IP66, Type 4/4X/13 (Plastic) — IP66, Type 4/13 (Metal)

Low Profile 3-Position Key Operated Selector Switches, Non-Illuminated ①



Round Low Profile Selector Switch
Cat. No. 800EP-KM3R1



Low Profile Key Operated Selector Switch
Cat. No. 800EM-KM3R1

Switching Angles

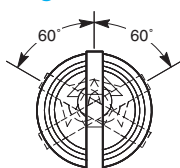

Target Table and Operator Position (60° Switching Angle)				
Contact Type	Position on Mounting Latch			
N.O.	Left	X	O	O
N.O.	Right	O	O	X
N.C.	Left	O	X	X
N.C.	Right	X	X	O

Note: X = Closed/O = Open

Key Removal Position	Operator Position M = Maintained S = Spring Return			Low Profile Selector Switch Operators — Round	
				Plastic with Ronis Option	Metal with Zadi Option
				Cat. No.	Cat. No.
Left	M	M	M	800EP-KM3R1	800EM-KM3Z1
Left	M	M←S		800EP-KR3R1	800EM-KR3Z1
Right	S→M	M		800EP-KL3R2	800EM-KL3Z2
Center	S→M←S			800EP-KB3R4	800EM-KB3Z4

Back-of-Panel Components, Non-Illuminated Operators

Mounting Latch

		Contact	2-Across Mounting Cat. No.	3-Across Mounting Cat. No.
		Mounting latch	800E-A2L	800E-A3L

Contact Block

		Type	Contact	2-Across Mounting Cat. No.	3-Across Mounting Cat. No.
		Standard	1 N.O.	800E-2X10	800E-3X10
			1 N.C.	800E-2X01	800E-3X01
		PenTUFF (low voltage) ②	1 N.O.	800E-2X10V	800E-3X10V
			1 N.C.	800E-2X01V	800E-3X01V

Mounting Latch and Contact Blocks ③

		Type	Contact	2-Across Mounting Cat. No.	3-Across Mounting Cat. No.
		Standard	1 N.O.	800E-2LX10	800E-3LX10
			1 N.C.	800E-2LX01	800E-3LX01
			1 N.O. - 1 N.C.	800E-2LX11	800E-3LX11
			2 N.O.	800E-2LX20	800E-3LX20
			2 N.C.	800E-2LX02	800E-3LX02
			1 N.O.	800E-2LX10V	800E-3LX10V
		PenTUFF (low voltage) ②	1 N.C.	800E-2LX01V	800E-3LX01V
			1 N.O. - 1 N.C.	800E-2LX11V	800E-3LX11V

① Keyed operators are IP66, Type 4/13.

② Patented PenTUFF contacts supplied only with 2-across mounting; gold-plated contacts supplied only with 3-across mounting.

③ 2-across mounting latch and contact block combinations are factory assembled. When one contact block is specified, it is mounted in position 2 (right side/viewed from back). When 1 N.O. and 1 N.C. contacts are specified, the N.O. is mounted in position 2, and the N.C. is mounted in

Accessories — Page 100

Legend Plates — Page 115

Approximate Dimensions — Page 127

22.5 mm Push Buttons

IP66, Type 4/4X/13 (Plastic) — IP66, Type 4/13 (Metal)

Low Profile 3-Position Key Operated Selector Switches, Non-Illuminated ①

Note: For Ronis standard replacement key (Key No. 3825) order **800E-AKR3825** and for Zadi (Key No. 006) order **800E-AKZ006**.

800 **EM** - **KM3** **R** **2** -

a *b* *c* *d* *e* *f* *g*

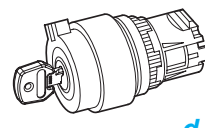

Operator Construction	
Code	Description
EP	Round plastic operator (NEMA Type 4/13)
ES	Round plastic operator w/shiny metal bezel (NEMA Type 4/13)
EQ	Square plastic operator (NEMA Type 4/13)
EM	Round metal operator (NEMA Type 4/13)
EB	Round metal operator w/black anodized bezel (NEMA Type 4/13)

Operator Type	
Code	Type
KM3	Maintained
KR3	Spring return from right
KL3	Spring return from left
KB3	Spring return from both

Key Removal Position ②	
Code	Position
1	Left
2	Right
3	All
4	Center
5	Left/center
6	Left/right
7	Right/center

Key Type	
Code	Description
R	Ronis
Z	Zadi

See page 66 for optional key codes

Optional Cam Code and Target Table																
Operator Position Viewed from the Front	C1		C2		C3		C4		C5		C6		C7 ④			
	Contact Block Mounting Position on Latch as Viewed from the Back														Overlapping Cam	
	Left Side	Right Side	Left Side	Right Side	Left Side	Right Side	Left Side	Right Side	Left Side	Right Side	Left Side	Right Side	Left Side	Right Side	Left Side	Right Side
X O O	—	N.O.	N.C. or N.C.		N.C. or N.O.		—	N.C.	—	—	N.O. or N.O.		—	N.O.	—	N.O.
O X O	N.C. or N.C.		—	—	—	N.C.	N.C.	—	N.C. or N.C.		N.C. or N.C.		N.C.	—	—	—
O O X	N.O.	—	N.O. or N.O.		N.O.	—	N.O. or N.O.		N.O. or N.O.		—	—	—	—	—	N.C.
X X O	N.C.L.B.	—	N.C.L.B. or N.C.L.B.		N.C.L.B.	—	N.C.L.B. or N.C.L.B.		N.C.L.B. or N.C.L.B.		N.C.L.B. or N.C.L.B.		—	—	—	—
O X X	—	N.C.L.B.	N.O.E.M. or N.O.E.M.		N.O.E.M. or N.C.L.B.		—	N.O.E.M.	N.O.E.M.		—	—	N.C.L.B. or N.C.L.B.		—	—
X O X	N.O.E.M. or N.O.E.M.		—	—	—	N.O.E.M.	N.O.E.M.	—	N.O.E.M. or N.O.E.M.		N.O.E.M. or N.O.E.M.		N.O.E.M. or N.O.E.M.		—	—

Note: X = Closed/O = Open

Packaging	
Code	Description
Blank	1 per package
BP	10 per package

2-Across Mounting Latch

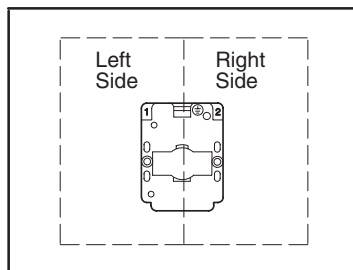

3-Across Mounting Latch

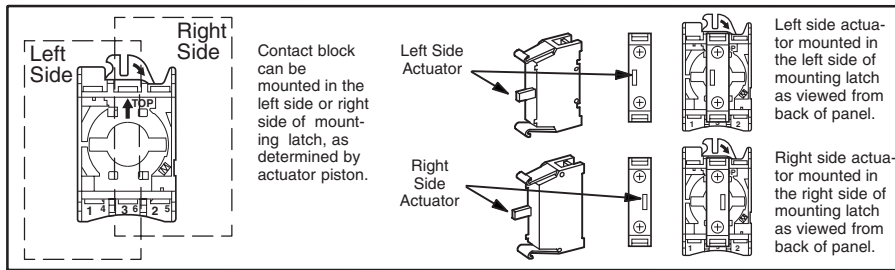

Back-of-Panel Components, Non-Illuminated Operators

See page 24 for back-of-panel components configurator tables.

Note: To order 4-across back-of-panel components, see page 103.

- ① Not intended for high security applications. Interoperability is possible with certain key/cylinder lock combinations. Contact your local Allen-Bradley distributor for interoperability information.
- ② Key removal in maintained positions only.
- ③ Operators with an overlapping cam allow selector switch contacts to make before the contacts of the previous position break. The overlap will occur in both directions.
- ④ Overlapping cams are not valid with spring return operator functions.

22.5 mm Push Buttons

IP66, Type 4/4X/13 (Plastic) — IP66, Type 4/13 (Metal)

Selector/Jog Operators, Non-Illuminated



Selector/Jog Operator
Cat. No. 800EP-SJ24



Selector/Jog Operator
Cat. No. 800EM-SJ23

Switching Angle

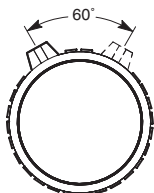

Contact Type	Position on Mounting Latch	Operator Position (Viewed From Front)			
		Selector Left		Selector Right	
		Free	Depressed	Free	Depressed
N.O.	Left	O	X	O	O
N.O.	Right	O	O	O	X
N.C.	Left	X	O	X	X
N.C.	Right	X	X	X	O

Note: X = Closed/O = Open

Color	Selector/Jog Operators — Round	
	Plastic Cat. No.	Metal Cat. No.
Black	800EP-SJ22	800EM-SJ22
Green	800EP-SJ23	800EM-SJ23
Red	800EP-SJ24	800EM-SJ24

Back-of-Panel Components, Non-Illuminated Operators

Mounting Latch

		Contact	2-Across Mounting Cat. No.	3-Across Mounting Cat. No.
		Mounting latch	800E-A2L	800E-A3L

Contact Block

		Type	Contact	2-Across Mounting Cat. No.	3-Across Mounting Cat. No.
		Standard	1 N.O.	800E-2X10	800E-3X10
			1 N.C.	800E-2X01	800E-3X01
		Pen <i>TUFF</i> (low voltage) ❶	1 N.O.	800E-2X10V	800E-3X10V
			1 N.C.	800E-2X01V	800E-3X01V

Mounting Latch and Contact Blocks

		Type	Contact	2-Across Mounting Cat. No.	3-Across Mounting Cat. No.		
		Standard	1 N.O.	800E-2LX10	800E-3LX10		
			1 N.C.	800E-2LX01	800E-3LX01		
			1 N.O. - 1 N.C.	800E-2LX11	800E-3LX11		
			2 N.O.	800E-2LX20	800E-3LX20		
				2 N.C.	800E-2LX02	800E-3LX02	
				Pen <i>TUFF</i> (low voltage) ❶	1 N.O.	800E-2LX10V	800E-3LX10V
					1 N.C.	800E-2LX01V	800E-3LX01V
					1 N.O. - 1 N.C.	800E-2LX11V	800E-3LX11V

❶ Patented Pen *TUFF* contacts supplied only with 2-across mounting; gold-plated contacts supplied only with 3-across mounting.

22.5 mm Push Buttons

IP66, Type 4/4X/13 (Plastic) — IP66, Type 4/13 (Metal)

Selector/Jog Operators, Non-Illuminated

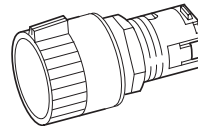

a

Operator Construction	
Code	Description
EP	Round plastic operator (NEMA Type 4/4X/13)
ES	Round plastic operator w/shiny metal bezel (NEMA Type 4/13)
EM	Round metal operator (NEMA Type 4/13)
EB	Round metal operator w/black anodized bezel (NEMA Type 4/13)

b

Operator Type	
Code	Type
SJ2	2-position selector/jog

c

Button Color	
Code	Color
1	White
2	Black
3	Green
4	Red
5	Yellow
6	Blue
8	Gray

d

Optional Cam Code and Target Table																			
Operator Position Viewed from the Front				C20		C21		C22		C23		C24		C25		C26		C27	
Selector Left		Selector Right																	
Button Position		Button Position		Left		Right		Left		Right		Left		Right		Left		Right	
Free	Dep.	Free	Dep.	Left	Right	Left	Right	Left	Right	Left	Right	Left	Right	Left	Right	Left	Right	Left	Right
O	O	O	X	—	—	—	—	—	—	—	—	—	N.O.	—	N.O.	—	—	—	—
O	O	X	X	—	—	—	—	—	—	—	—	—	—	—	N.O.E.M.	—	N.O.	—	N.O.
O	X	O	X	—	—	N.O.	—	N.O.	N.O.	—	—	N.O.	—	N.O.	—	N.O.	—	N.O.	—
O	O	X	O	—	N.C.	—	N.C.	—	—	N.C.	N.C.	—	—	—	—	N.C.	—	—	—
O	X	O	O	N.O.	—	—	—	—	—	—	—	—	—	—	—	—	—	—	—
X	X	X	O	—	—	—	—	—	—	—	—	—	—	N.C.	—	N.C.L.B.	—	—	—
X	X	O	O	—	—	—	—	—	—	—	—	—	—	—	N.C.	—	N.C.	—	N.C.
X	X	O	X	—	N.O.	—	N.O.	—	—	N.O.	N.O.	—	—	—	—	N.O.E.M.	—	—	—
X	O	X	X	N.C.	—	—	—	—	—	—	—	—	—	—	—	—	—	—	—
X	O	X	O	—	—	N.C.	—	N.C.	N.C.	—	—	N.C.	—	N.C.L.B.	—	N.C.L.B.	—	N.C.	—
X	O	O	O	—	—	—	—	—	—	—	—	—	—	N.C.	—	—	—	—	—
O	X	X	X	—	—	—	—	—	—	—	—	—	—	N.O.E.M.	—	—	—	—	—

Note: X = Closed/O = Open

e

Packaging	
Code	Description
Blank	1 per package
BP	10 per package

Back-of-Panel Components, Non-Illuminated Operators

See page 24 for back-of-panel components configurator tables.

Note: To order 4-across back-of-panel components, see page 103.

22.5 mm Push Buttons

IP66, Type 4/4X/13 (Plastic) — IP66, Type 4/13 (Metal)

Pilot Light Operators — Optically Enhanced and Diffuser Style



Optically Enhanced Pilot Light
Cat. No. 800EP-PL5



Diffuser Style Pilot Light
Cat. No. 800EM-P4

Color	Optically Enhanced — Round		Diffuser Style — Round	
	Plastic	Metal	Plastic	Metal
	Cat. No.	Cat. No.	Cat. No.	Cat. No.
Green	800EP-PL3	800EM-PL3	800EP-P3	800EM-P3
Red	800EP-PL4	800EM-PL4	800EP-P4	800EM-P4
Amber	800EP-PL5	800EM-PL5	800EP-P5	800EM-P5
No lens	800EP-P9	800EM-P9	800EP-P9	800EM-P9

Back-of-Panel Components, Illuminated Operators

Full Voltage Power Module with Latch or Integrated LED Module with Latch

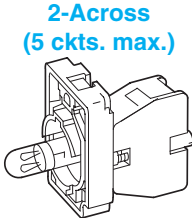
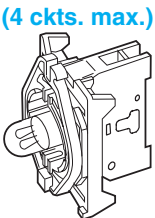
 2-Across (3 cpts. max.)	 3-Across (4 cpts. max.)	Type	Volts	2-Across Mounting	3-Across Mounting
				Cat. No.	Cat. No.
		No lamp ❶	—	800E-2DL0	800E-3DL0
		Incandescent	24 AC/DC	800E-2DL3	800E-3DL3
			120 AC/DC	800E-2DL5	800E-3DL5
			24 AC/DC	—	800E-3NL3R
		Integrated LED Module ❷ (red)	120 AC	—	800E-3NL5R
			240 AC	—	800E-3NL7R
			24 AC/DC	—	800E-3NL3G
		Integrated LED Module ❷ (green)	120 AC	—	800E-3NL5G
			240 AC	—	800E-3NL7G
			24 AC/DC	—	800E-3NL3A
		Integrated LED Module ❷ (amber)	120 AC	—	800E-3NL5A
			240 AC	—	800E-3NL7A

Transformer Power Module with Latch

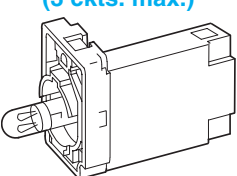
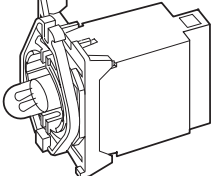
 2-Across (3 cpts. max.)	 3-Across (2 cpts. max.)	Type	Volts	2-Across Mounting	3-Across Mounting
				Cat. No.	Cat. No.
		Incandescent	110/120 AC	800E-2TL5	800E-3TL5
			220/240 AC	800E-2TL7	800E-3TL7
		LED ❷ (red)	110/120 AC	800E-2TL5R	800E-3TL5R
			220/240 AC	800E-2TL7R	800E-3TL7R
		LED ❷ (green)	110/120 AC	800E-2TL5G	800E-3TL5G
			220/240 AC	800E-2TL7G	800E-3TL7G
		LED ❷ (amber)	110/120 AC	800E-2TL5A	800E-3TL5A
			220/240 AC	800E-2TL7A	800E-3TL7A

❶ Lamp must match line voltage. See replacement lamps table on page 114.

❷ LEDs are available in red, green, blue, amber, and white; color cap must match LED color.

Accessories — Page 100

Legend Plates — Page 115

Approximate Dimensions — Page 127

22.5 mm Push Buttons

IP66, Type 4/4X/13 (Plastic) — IP66, Type 4/13 (Metal)

Pilot Light Operators — Optically Enhanced and Diffuser Style

800 **EP** - **PL** **3** - _____
a *b* *c* *d*

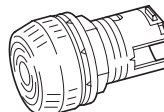

a

Operator Construction	
Code	Description
EP	Round plastic operator (NEMA Type 4/4X/13)
EQ	Square plastic operator ① (NEMA Type 4/4X/13)
EM	Round metal operator (NEMA Type 4/13)

b

Operator Type ①	
Code	Description
P	White diffuser
PL	Optically enhanced lens

c

Lens Cap Color	
Code	Color
1	White ②
3	Green
4	Red
5	Amber
6	Blue
7	Clear
9	No lens ③

d

Packaging	
Code	Description
Blank	1 per package
BP	10 per package

Back-of-Panel Components, Illuminated Operators

Note: To order 4-across back-of-panel components, see page 103.

800E - **2** **DL5** **R**
a *b* *c*
b (cont'd)

a

Contact Block Matrix	
Code	Type
2	2-across mounting
3	3-across mounting

b

Power Module Type and Voltage	
Full Voltage (Latch Included)	
Code	Description
DL0	No lamp
DL1	6V AC/DC
DL2	12V AC/DC
DL3	24V AC/DC
DL4	48V AC/DC
DL5 ⑤	120V AC/DC
DL6 ⑥	130V AC/DC

Transformer (Latch Included)	
Code	Description
TL5	110V 50 Hz/120V 60 Hz
TL6	208V 60 Hz
TL7	220V 50 Hz/240V 60 Hz
TL10	400V 50 Hz
TL14	600V 60 Hz

Resistor (Latch Included)	
Code	Description
RL5 ⑦	110V 50 Hz/120V 60 Hz
RL7	240V 60 Hz

Integrated LED (Latch Included) ⑧	
Code	Description
NL3	24V AC/DC
NL5	120V AC
NL7	240V AC

c

Lamp Type	
Code	Type
Blank	Incandescent or no lamp
R	Red LED ⑦
G	Green LED ⑦
A	Amber LED ⑦
B	Blue LED ⑦
W	White LED ⑦⑧

- ① Square operators available in diffuser style only.
- ② White lens supplied on optically enhanced lens only.
- ③ To order the diffuser style or optically enhanced without lens, specify code **P9**. Example: **800EP-P9**.
- ④ Option **DL5** does not have a shunting resistor when used with an LED. Option **DL6** has a shunting resistor for LEDs and can be used for 120V DC applications.

- ⑤ 120V resistor module available in 2-across mounting only.
- ⑥ Available in 3-across mounting only.
- ⑦ Refer to page 114 for LED selection.
- ⑧ Available in 6V, 24V and 120V AC/DC only.

22.5 mm Push Buttons

IP66, Type 4/4X/13 (Plastic) — IP66, Type 4/13 (Metal)

Pilot Light Operators — Push-to-Test



Push-to-Test Pilot Light
Cat. No. 800EP-LE3



Push-to-Test Pilot Light
Cat. No. 800EM-LE3

Color	Push-to-Test — Round	
	Plastic	Metal
	Cat. No.	Cat. No.
Green	800EP-LE3	800EM-LE3
Red	800EP-LE4	800EM-LE4
Amber	800EP-LE5	800EM-LE5
No lens	800EP-LE9	800EM-LE9

Back-of-Panel Components, Illuminated Push-to-Test Operators

Full Voltage Power Module with Latch

	Type	Volts	2-Across Mounting	3-Across Mounting
			Cat. No.	Cat. No.
	No lamp ❶	—	800E-2DLT0X11	800E-3DLT0X11
	Incandescent	24 AC/DC	800E-2DLT3X11	800E-3DLT3X11
		120 AC/DC	800E-2DLT5X11	800E-3DLT5X11
	LED ❷ (red)	24 AC/DC	800E-2DLT3RX11	800E-3DLT3RX11
		120 AC	800E-2DLT5RX11	800E-3DLT5RX11
	LED ❷ (green)	24 AC/DC	800E-2DLT3GX11	800E-3DLT3GX11
		120 AC	800E-2DLT5GX11	800E-3DLT5GX11
	LED ❷ (amber)	24 AC/DC	800E-2DLT3AX11	800E-3DLT3AX11
		120 AC	800E-2DLT5AX11	800E-3DLT5AX11

Transformer Power Module with Latch

	Type	Volts	2-Across Mounting	3-Across Mounting
			Cat. No.	Cat. No.
	Incandescent	110/120 AC	800E-2TLT5X11	800E-3TLT5X11
		220/240 AC	800E-2TLT7X11	800E-3TLT7X11
	LED ❷ (red)	110/120 AC	800E-2TLT5RX11	800E-3TLT5RX11
		220/240 AC	800E-2TLT7RX11	800E-3TLT7RX11
	LED ❷ (green)	110/120 AC	800E-2TLT5GX11	800E-3TLT5GX11
		220/240 AC	800E-2TLT7GX11	800E-3TLT7GX11
	LED ❷ (amber)	110/120 AC	800E-2TLT5AX11	800E-3TLT5AX11
		220/240 AC	800E-2TLT7AX11	800E-3TLT7AX11

❶ Lamp must match line voltage. See replacement lamps table on page 114.

❷ LEDs are available in red, green, blue, amber, and white; color cap must match LED color.

Accessories — Page 100

Legend Plates — Page 115

Approximate Dimensions — Page 127

22.5 mm Push Buttons

IP66, Type 4/4X/13 (Plastic) — IP66, Type 4/13 (Metal)

Pilot Light Operators — Push-to-Test

800 **EP** - **LE** **3** - _____
a *b* *c* *d*

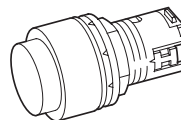

a

Operator Construction	
Code	Description
EP	Round plastic operator (NEMA Type 4/4X/13)
ES	Round plastic operator w/shiny metal bezel (NEMA Type 4/13)
EQ	Square plastic operator (NEMA Type 4/4X/13)
EM	Round metal operator (NEMA Type 4/13)
EB	Round metal operator w/black anodized bezel (NEMA Type 4/13)

b

Operator Type	
Code	Type
LE	Push-to-test pilot light

d

Packaging	
Code	Description
Blank	1 per package
BP	10 per package

c

Lens Cap Color	
Code	Color
3	Green
4	Red
5	Amber
6	Blue
7	Clear (white diffuser cap)
9	No lens

Push-to-Test Pilot Light Device Schematic

See applicable Codes and Laws

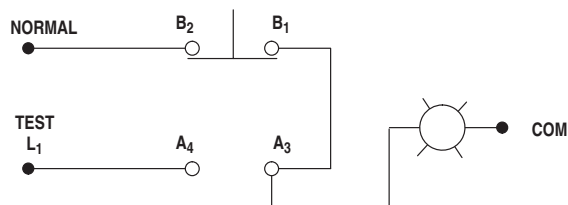

Back-of-Panel Components, Illuminated Push-to-Test Operators

Note: To order 4-across back-of-panel components, see page 103.

800E - **2** **DLT5** **R** **X11**
a *b* *c* *d*

a

Contact Block Matrix	
Code	Type
2	2-across mounting
3	3-across mounting

b

Power Module Type and Voltage	
Full Voltage (Latch Included)	
Code	Description
DLT0	No lamp
DLT1	6V AC/DC
DLT2	12V AC/DC
DLT3	24V AC/DC
DLT4	48V AC/DC
DLT5 ①	120V AC/DC
DLT6 ②	130V AC/DC

b (cont'd)

Transformer (Latch Included)	
Code	Description
TLT5	110V 50 Hz/120V 60 Hz
TLT6	208V 60 Hz
TLT7	220V 50 Hz/240V 60 Hz
TLT10	400V 50 Hz
TLT14	600V 60 Hz

Resistor (Latch Included)	
Code	Description
RLT5 ③	110V 50 Hz/120V 60 Hz
RLT7	240V 60 Hz

c

Lamp Type	
Code	Type
Blank	Incandescent or no lamp
R	Red LED ④
G	Green LED ④
A	Amber LED ④
B	Blue LED ④
W	White LED ④⑤

d

Contact Block(s)	
Standard Contacts	
Code	Type
X11	1 N.O. - 1 N.C.

PenTUFF (Low Voltage) Contacts ⑥	
Code	Type
X11V	1 N.O. - 1 N.C.

- ① Option **DLT5** does not have a shunting resistor when used with an LED. Option **DLT6** has a shunting resistor for LEDs and can be used for 120V DC applications.
- ② 120V resistor module available in 2-across mounting **only**.
- ③ Refer to page 114 for LED selection.
- ④ Available in 6V, 24V and 120V AC/DC only.
- ⑤ Patented PenTUFF contacts supplied only with 2-across mounting; gold-plated contacts supplied only with 3-across mounting.

22.5 mm Push Buttons

IP66, Type 4/4X/13 (Plastic) — IP66, Type 4/13 (Metal)

Monolithic (Direct Wire) Pilot Light Operators — Optically Enhanced and Diffuser Style



*Optically Enhanced Monolithic Pilot Light
Cat. No. 800EP-PLM3D5*



*Diffuser Style Monolithic Pilot Light
Cat. No. 800EQ-PM4D5*

Lens Color	Volts/Lamp ❶	Optically Enhanced	Diffuser Style	
		Round	Round	Square
		Cat. No.	Cat. No.	Cat. No.
Green	No lamp	800EP-PLM3D0	800EP-PM3D0	800EQ-PM3D0
	24 AC/DC incandescent	800EP-PLM3D3	800EP-PM3D3	800EQ-PM3D3
	120 AC/DC incandescent	800EP-PLM3D5	800EP-PM3D5	800EQ-PM3D5
Red	No lamp	800EP-PLM4D0	800EP-PM4D0	800EQ-PM4D0
	24 AC/DC incandescent	800EP-PLM4D3	800EP-PM4D3	800EQ-PM4D3
	120 AC/DC incandescent	800EP-PLM4D5	800EP-PM4D5	800EQ-PM4D5
Amber	No lamp	800EP-PLM5D0	800EP-PM5D0	800EQ-PM5D0
	24 AC/DC incandescent	800EP-PLM5D3	800EP-PM5D3	800EQ-PM5D3
	120 AC/DC incandescent	800EP-PLM5D5	800EP-PM5D5	800EQ-PM5D5
No lens	No lamp	800EP-PM9D0	800EP-PM9D0	800EQ-PM9D0

❶ Lamp must match line voltage. See replacement lamps table on page 114.

22.5 mm Push Buttons

IP66, Type 4/4X/13 (Plastic) — IP66, Type 4/13 (Metal)

Monolithic (Direct Wire) Pilot Light Operators — Optically Enhanced and Diffuser Style

800 **EP** - **PM** **3** **D3** **G** -

a *b* *c* *d* *e* *f*

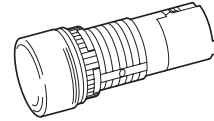

a

Operator Construction	
Code	Description
EP	Round plastic operator (NEMA Type 4/4X/13)
EQ	Square plastic operator (NEMA Type 4/4X/13)

b

Operator Type ①	
Code	Type
PM	Diffuser style
PLM	Optically enhanced

c

Lens Color Cap	
Code	Color
1	White ②
3	Green
4	Red
5	Amber
6	Blue
7	Clear ③
9	No lens ④

d

Operator Construction	
Power Supply	
Code	Lamp/Voltage
D0	No lamp
D1	6V AC/DC
D2	12V AC/DC
D3	24V AC/DC
D4	48V AC/DC
D5 ⑤	120V AC/DC
D6 ⑥	130V AC/DC

e

Lamp Type	
Code	Type
Blank	Incandescent or no lamp
R	Red LED ⑦
G	Green LED ⑧
A	Amber LED ⑧
B	Blue LED ⑧
W	White LED ⑧⑨

f

Packaging	
Code	Description
Blank	1 per package
BP	10 per package

- ① Square operators available in diffuser style only.
- ② White lens supplied on optically enhanced lens only.
- ③ The **PM** diffuser style operator uses a white diffuser cap behind the clear lens.
- ④ To order the diffuser style or optically enhanced without lens, specify code **P9**. Example: **800EP-PM9D_**.

- ⑤ Option **D5** does not have a shunting resistor when used with an LED. Option **D6** has a shunting resistor for LEDs and can be used for 120V DC applications.
- ⑥ Refer to page **114** for LED selection.
- ⑦ Available in 6V, 24V and 120V AC/DC only.

Joy Stick Operators

Joy Stick Operator
Cat. No. 800EM-JM2Joy Stick Operator with Interlock
Cat. No. 800EM-JLM2

Operator Type	Joy Stick Operators	
	Cat. No.	Joy Stick with Center Interlock Cat. No.
2-position maintained	800EM-JM2	800EM-JLM2
2-position spring return	800EM-JR2	800EM-JLR2
4-position maintained	800EM-JM4	800EM-JLM4
4-position spring return	800EM-JR4	800EM-JLR4

Back-of-Panel Components, Non-Illuminated Operators

Mounting Latch

	Contact	2-Across Mounting	3-Across Mounting
		Cat. No.	Cat. No.
 	Mounting latch	800E-A2L	800E-A3L

Contact Block

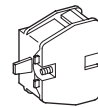
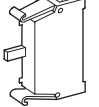
	Type	Contact	2-Across Mounting	3-Across Mounting
			Cat. No.	Cat. No.
 	Standard	1 N.O.	800E-2X10	800E-3X10
		1 N.C.	800E-2X01	800E-3X01
	PenTUFF (low voltage) ①	1 N.O.	800E-2X10V	800E-3X10V
		1 N.C.	800E-2X01V	800E-3X01V

Mounting Latch and Contact Blocks

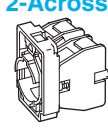
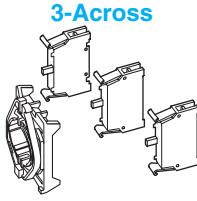
	Type	Contact	2-Across Mounting	3-Across Mounting
			Cat. No.	Cat. No.
 	Standard	1 N.O.	800E-2LX10	800E-3LX10
		1 N.C.	800E-2LX01	800E-3LX01
		1 N.O. - 1 N.C.	800E-2LX11	800E-3LX11
		2 N.O.	800E-2LX20	800E-3LX20
		2 N.C.	800E-2LX02	800E-3LX02
	PenTUFF (low voltage) ①	1 N.O.	800E-2LX10V	800E-3LX10V
		1 N.C.	800E-2LX01V	800E-3LX01V
		1 N.O. - 1 N.C.	800E-2LX11V	800E-3LX11V

① Patented PenTUFF contacts supplied only with 2-across mounting; gold-plated contacts supplied only with 3-across mounting.

22.5 mm Push Buttons

IP66, Type 4/4X/13 (Plastic) — IP66, Type 4/13 (Metal)

Joy Stick Operators

800 **EM** – **JM** **2**
a *b* *c*

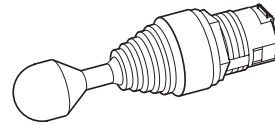

a

Operator Construction	
Code	Description
EM	Round metal operator (NEMA Type 4/13)

b

Operator Type	
Code	Description
JM	Maintained
JLM	Interlock — maintained
JR	Spring return
JLR	Interlock — spring return

c

Operator Positions	
Code	Color
2	2-position
4	4-position

Back-of-Panel Components, Non-Illuminated Operators

Note: To order 4-across back-of-panel components, see page 103.

800E – **2LX** ^{N.O.} **1** ^{N.C.} **0** **V**
a *b* *c* *d*

		Target Table and Operator Position							
Contact Type	Position on Mounting Latch	2-Position Operator				4-Position Operator			
N.O.	Left	O	O	X	X	O	O	O	O
N.O.	Right	X	O	O	O	X	O	O	O
N.C.	Left	X	O	O	O	O	O	X	O
N.C.	Right	O	O	X	O	O	O	O	X

Note: X = Closed/O = Open

2-Across Mounting Latch

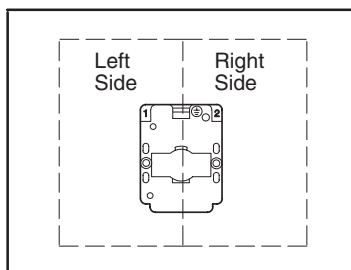

3-Across Mounting Latch

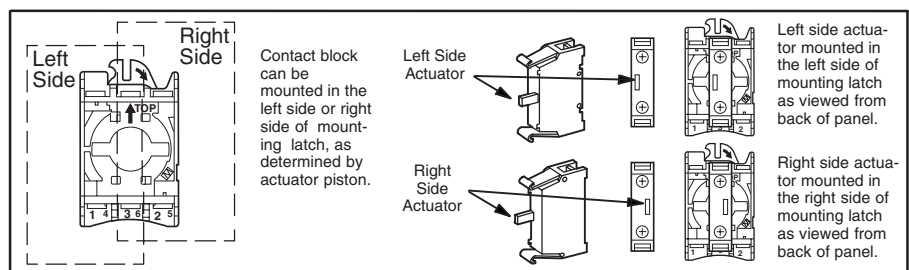

22.5 mm Push Buttons

IP66, Type 4/4X/13 (Plastic) — IP66, Type 4/13 (Metal)

Wobble Stick Operators



Wobble Stick Operator
Cat. No. 800EP-W4



Wobble Stick Operator
Cat. No. 800EM-W4

Material/Handle Color	Wobble Stick Operators — Round	
	Plastic	Metal
	Cat. No.	Cat. No.
Plastic/red	800EP-W4	800EM-W4
Aluminum/shiny	—	800EM-W8

Back-of-Panel Components, Non-

Illuminated Operators

Mounting Latch

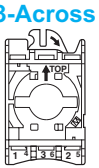
 2-Across	 3-Across	Contact	2-Across Mounting	3-Across Mounting
			Cat. No.	Cat. No.
		Mounting latch	800E-A2L	800E-A3L

Contact Block

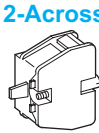
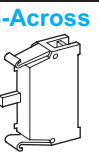
 2-Across	 3-Across	Type	Contact	2-Across Mounting	3-Across Mounting
				Cat. No.	Cat. No.
		Standard	1 N.O.	800E-2X10	800E-3X10
			1 N.C.	800E-2X01	800E-3X01
		PenTUFF (low voltage) ❶	1 N.O.	800E-2X10V	800E-3X10V
			1 N.C.	800E-2X01V	800E-3X01V

Mounting Latch and Contact Blocks

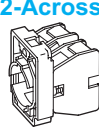
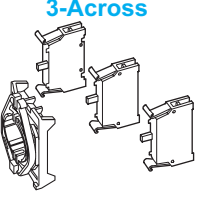
 2-Across	 3-Across	Type	Contact	2-Across Mounting	3-Across Mounting
				Cat. No.	Cat. No.
		Standard	1 N.O.	800E-2LX10	800E-3LX10
			1 N.C.	800E-2LX01	800E-3LX01
			1 N.O. - 1 N.C.	800E-2LX11	800E-3LX11
			2 N.O.	800E-2LX20	800E-3LX20
			2 N.C.	800E-2LX02	800E-3LX02
			1 N.O.	800E-2LX10V	800E-3LX10V
		PenTUFF (low voltage) ❶	1 N.C.	800E-2LX01V	800E-3LX01V
			1 N.O. - 1 N.C.	800E-2LX11V	800E-3LX11V

❶ Patented PenTUFF contacts supplied only with 2-across mounting; gold-plated contacts supplied only with 3-across mounting.

22.5 mm Push Buttons

IP66, Type 4/4X/13 (Plastic) — IP66, Type 4/13 (Metal)

Reset Operators — with Two-Color Molded Legend Caps



Reset Operator
Cat. No. 800EM-R607W



Threaded Reset Rod 10 mm Pusher
Cat. No. 800E-ATR19

Button Color	Text Color	Legend Text	Flush — Round	
			Plastic	Metal
			Cat. No.	Cat. No.
White	Black	RESET	800EP-R107B	800EM-R107B
		R	800EP-R111B	800EM-R111B
Yellow	Black	RESET	800EP-R507B	800EM-R507B
		R	800EP-R511B	800EM-R511B
Blue	White	RESET	800EP-R607W	800EM-R607W
		R	800EP-R611W	800EM-R611W

Back-of-Panel Components, Non-Illuminated Operators

Mounting Latch

		Contact	2-Across Mounting	3-Across Mounting
			Cat. No.	Cat. No.
 2-Across	 3-Across	Mounting latch	800E-A2L	800E-A3L

Contact Block

		Type	Contact	2-Across Mounting	3-Across Mounting
				Cat. No.	Cat. No.
 2-Across	 3-Across	Standard	1 N.O.	800E-2X10	800E-3X10
			1 N.C.	800E-2X01	800E-3X01
		PenTUFF (low voltage) ①	1 N.O.	800E-2X10V	800E-3X10V
			1 N.C.	800E-2X01V	800E-3X01V

Mounting Latch and Contact Blocks

		Type	Contact	2-Across Mounting	3-Across Mounting
				Cat. No.	Cat. No.
 2-Across	 3-Across	Standard	1 N.O.	800E-2LX10	800E-3LX10
			1 N.C.	800E-2LX01	800E-3LX01
1 N.O. - 1 N.C.	800E-2LX11		800E-3LX11		
2 N.O.	800E-2LX20		800E-3LX20		
2 N.C.	800E-2LX02		800E-3LX02		
1 N.O.	800E-2LX10V		800E-3LX10V		
		PenTUFF (low voltage) ①	1 N.C.	800E-2LX01V	800E-3LX01V
			1 N.O. - 1 N.C.	800E-2LX11V	800E-3LX11V

① Patented PenTUFF contacts supplied only with 2-across mounting; gold-plated contacts supplied only with 3-across mounting.

22.5 mm Push Buttons

IP66, Type 4/4X/13 (Plastic) — IP66, Type 4/13 (Metal)

Wobble Stick Operators, Non-Illuminated

800 **EM** – **W** **4**
a *b* *c*

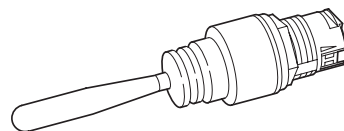

Operator Construction	
Code	Description
EP	Round plastic operator (NEMA Type 4/4X/13)
EM	Round metal operator (NEMA Type 4/13)

Operator Type	
Code	Description
W	Wobble

Wobble Stick	
Code	Material/Color
4	Plastic/red
8	Aluminum/shiny ❶

Reset Operators — with Two-Color Molded Legend Caps

800 **EM** – **R** **6** **07W**
a *b* *c* *d*

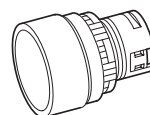

Operator Construction	
Code	Description
EP	Round plastic operator (NEMA Type 4/4X/13)
ES	Round plastic operator w/shiny metal bezel (NEMA Type 4/13)
EQ	Square plastic operator (NEMA Type 4/4X/13)
EM	Round metal operator (NEMA Type 4/13)
EB	Round metal operator w/black anodized bezel (NEMA Type 4/13)

Operator Type	
Code	Type
R	Reset

Color Cap	
Code	Color
1	White ❷
2	Black ❸
3	Green ❸
4	Red ❸
5	Yellow ❸
6	Blue ❸
8	Gray ❸
9	No cap

Legend Text	
Code	Text and Color
Blank	No text
07W	RESET, white
11W	R, white
07B	RESET, black
11B	R, black

Threaded Reset Rod For Momentary Contact Reset Operators

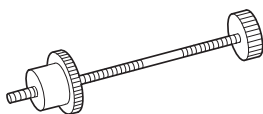

Threaded Reset Rod with 10 mm Pusher

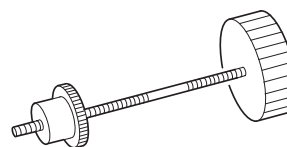

Threaded Reset Rod with 35 mm Pusher

Rod Length	Rod Length Adjustability	Threaded Reset Rod	
		10 mm Pusher	35 mm Pusher
		Cat. No.	Cat. No.
1.50" (38 mm)	1.35...2.05" (34...52 mm)	800E-ATR01	800E-ATR01L
2.10" (53 mm)	1.95...2.65" (50...67 mm)	800E-ATR02	800E-ATR02L
2.70" (69 mm)	2.55...3.25" (65...83 mm)	800E-ATR03	800E-ATR03L
3.30" (84 mm)	3.15...3.85" (80...98 mm)	800E-ATR04	800E-ATR04L
3.90" (99 mm)	3.75...4.45" (95...113 mm)	800E-ATR05	800E-ATR05L
4.50" (114 mm)	4.35...5.05" (110...128 mm)	800E-ATR06	800E-ATR06L
5.10" (130 mm)	4.95...5.65" (126...144 mm)	800E-ATR07	800E-ATR07L
5.70" (145 mm)	5.55...6.25" (141...159 mm)	800E-ATR08	800E-ATR08L
12.30" (312 mm)	6.18...12.83" (157...326 mm)	800E-ATR19 ❹	800E-ATR19L ❹

- ❶ Not available with EP option.
- ❷ Available in black legend text only.
- ❸ Available in white legend text only.
- ❹ Rod is threaded along its entire length. Fully threaded rod can be provided after cutting.

22.5 mm Push Buttons

IP40, Type 1

Momentary 2-Function Multi-Operator, Non-Illuminated



2-Function Multi-Operator Non-Illuminated
Cat. No. 800EP-U2C0

Top Button			Bottom Button			2-Function Multi-Operator
Color	Type	Text	Color	Type	Text	Cat. No.
Green	Flush	I	Green	Flush	II	800EP-U2A1
		→			←	800EP-U2A2
		↑			↓	800EP-U2A3
		+			—	800EP-U2A4
		Blank	Red	Extended	Blank	800EP-U2C0
		I			O	800EP-U2C21
		ON			OFF	800EP-U2C22
		START			STOP	800EP-U2C23
		START/I			STOP/O	800EP-U2C24



Note: Multi-function operators are rated IP40, NEMA Type 1. To achieve IP66 NEMA Type 4, add boot accessory Cat. No. 800E-AUB2 or 800E-AUB3.

Back-of-Panel Components, Non-Illuminated Operators

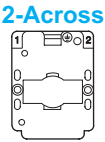
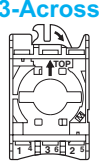
Mounting Latch

		Contact	2-Across Mounting Cat. No.	3-Across Mounting Cat. No.
		Mounting latch	800E-A2L	800E-A3L

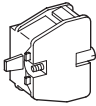
Contact Block

		Type	Contact	2-Across Mounting Cat. No.	3-Across Mounting Cat. No.
		Standard	1 N.O.	800E-2X10	800E-3X10
			1 N.C.	800E-2X01	800E-3X01
		PenTUFF (low voltage) ❶	1 N.O.	800E-2X10V	800E-3X10V
			1 N.C.	800E-2X01V	800E-3X01V

Mounting Latch and Contact Blocks

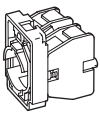
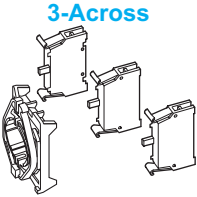
		Type	Contact	2-Across Mounting Cat. No.	3-Across Mounting Cat. No.
		Standard	1 N.O.	800E-2LX10	800E-3LX10
			1 N.C.	800E-2LX01	800E-3LX01
			1 N.O. - 1 N.C.	800E-2LX11	800E-3LX11
			2 N.O.	800E-2LX20	800E-3LX20
			2 N.C.	800E-2LX02	800E-3LX02
			1 N.O.	800E-2LX10V	800E-3LX10V
		PenTUFF (low voltage) ❶	1 N.C.	800E-2LX01V	800E-3LX01V
			1 N.O. - 1 N.C.	800E-2LX11V	800E-3LX11V

❶ Patented PenTUFF contacts supplied only with 2-across mounting; gold-plated contacts supplied only with 3-across mounting.

Momentary 2-Function Multi-Operator, Non-Illuminated

800EP – **U2** **C** **23** - _____ *Text*
 a *b* *c* *d*

800EP – **U2** **X** **14** - _____ *No Text*
 a *b* *c* *d*

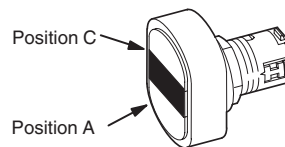

a

Operator Type	
Code	Description
U2	Two-function (IP40, Type 1) ①

b

Button Color and Type (Position C/Position A)	
Code	Color Caps with Text
A	Green flush/green flush
B	Green flush/red flush
C	Green flush/red extended
D	White flush/white flush
E	White flush/black flush
F	White flush/black extended
X	Color Caps without Text

c

Button Caps with Text Green/Green or White/White		
Code	Text	
	Position C (Green)	Position A (Green)
1	I	II
2	→	←
3	↑	↓
4	+	—
5	RIGHT	LEFT
6	UP	DOWN
7	FORWARD	REVERSE

**Button Caps without Text
Flush/Flush (only)**

Code	Position C (Color)	Code	Position A (Color)
1	White	1	White
2	Black	2	Black
3	Green	3	Green
—	—	4	Red
5	Yellow	5	Yellow
6	Blue	6	Blue
8	Gray	8	Gray

c (cont'd)

Button Caps with Text Green/Red or White/Black — with Text		
Code	Text	
	Position C (Green)	Position A (Red)
21	I	O
22	ON	OFF
23	START	STOP
24	START/I	STOP/O

d

Packaging	
Code	Description
Blank	1 per package
BP	10 per package

Back-of-Panel Components, Non-Illuminated Operators

800E – **2LX** ^{N.O.} **1** ^{N.C.} **0** **V**
 a *b* *c* *d*

a

Contact Block/Latch Type ②	
Code	Type
2LX	2-across mounting
3LX	3-across mounting

b

N.O. (Normally Open Circuits) ③	
Code	No. of Circuits
0	No contact
1	1 N.O.
2	2 N.O.
3	3 N.O.
4	4 N.O.
5	5 N.O.
6	6 N.O.

c

N.C. (Normally Closed Circuits) ③	
Code	No. of Circuits
0	No contact
1	1 N.C.
2	2 N.C.
3	3 N.C.
4	4 N.C.
5	5 N.C.
6	6 N.C.

d

Specialty Contact Blocks	
Code	Type
Blank	Standard
V	PenTUFF (low voltage) ④
E	N.O. early make
L	N.C. late break

- ① To achieve IP66 NEMA Type 4, add protective boot accessory **Cat. No. 800E-AUB2** or **800E-AUB3**.
- ② Position 1 of the latch (left position when viewed from the back) corresponds to position **C** of the operator. Position 2 of the latch (right position when viewed from the back) corresponds to position **A** of the operator.
- ③ A total of six circuits is the maximum allowable.
- ④ Patented PenTUFF contacts supplied only with 2-across mounting; gold-plated contacts supplied only with 3-across mounting.

22.5 mm Push Buttons

IP40, Type 1

3-Function Multi-Operator, Non-Illuminated



3-Function Multi-Operator Non-Illuminated
Cat. No. 800EP-U3A00

Top Button			Center Button			Bottom Button			3-Function Multi-Operator
Color	Type	Text	Color	Type	Text	Color	Type	Text	Cat. No.
Green	Flush	Blank	Red	Extended	Blank	Green	Flush	Blank	800EP-U3A00
		→			Blank			←	800EP-U3A20
		↑			Blank			↓	800EP-U3A30
		I			O			II	800EP-U3A11
		+			O			—	800EP-U3A41
		RIGHT			STOP			LEFT	800EP-U3A53
		UP			STOP			DOWN	800EP-U3A63
		FORWARD			STOP			REVERSE	800EP-U3A73

Note: Multi-function operators are rated IP40, NEMA Type 1. To achieve IP66 NEMA Type 4, add boot accessory Cat. No. 800E-AUB1.

Back-of-Panel Components, Non-Illuminated Operators

Mounting Latch

	Contact	3-Across Mounting
		Cat. No.
<p>3-Across</p>	Mounting latch	800E-A3L

Contact Block

	Type	Contact	3-Across Mounting
			Cat. No.
<p>3-Across</p>	Standard	1 N.O.	800E-3X10
		1 N.C.	800E-3X01

Mounting Latch and Contact Blocks

	Type	Contact	3-Across Mounting
			Cat. No.
<p>3-Across</p>	Standard	1 N.O.	800E-3LX10
		1 N.C.	800E-3LX01
		1 N.O. - 1 N.C.	800E-3LX11
		2 N.O.	800E-3LX20
		2 N.C.	800E-3LX02
	Specialty	1 N.C.L.B.	800E-3LX01L
		1 N.O. - 1 N.C.L.B.	800E-3LX11L

3-Function Multi-Operator, Non-Illuminated

800EP – **U3** **A** **1** **1** - _____ *Text*
a *b* *c* *d* *e*

800EP – **U3** **X** **1** - _____ *No Text*
a *b* *c* *e*

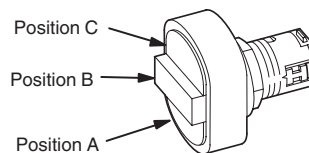

Operator Type	
Code	Description
U3	Three-function (IP40, Type 1) ❶

Button Color and Type (Position A/Position B/Position C)	
Code	Color Caps with Text
A	Green flush/red extended/green flush
D	White flush/black extended/white flush
Code	Color Caps without Text
Y	Color cap no text/black center cap/ color cap no text
X	Color cap no text/red center cap/ color cap no text

Button Caps with Text Green/Green or White/White		
Code	Text	
	Position C	Position A
1	I	II
2	→	←
3	↑	↓
4	+	—
5	RIGHT	LEFT
6	UP	DOWN
7	FORWARD	REVERSE

Button Caps without Text Flush/Flush (only)			
Code	Position C (Color)	Code	Position A (Color)
1	White	1	White
2	Black	2	Black
3	Green	3	Green
—	—	4	Red
5	Yellow	5	Yellow
6	Blue	6	Blue
8	Gray	8	Gray

Center Button Text	
Code	Text (Position B Only)
0	Blank
1	O
2	OFF
3	STOP

Packaging	
Code	Description
Blank	1 per package
BP	10 per package

Back-of-Panel Components, Non-Illuminated Operators

800E – **3LX** **1** **0** **V**
a *b* *c* *d*

Contact Block/Latch Type	
Code	Type ❷❸
3LX	3-across mounting only

N.O. (Normally Open Circuits) ❹	
Code	No. of Circuits
0	No contact
1	1 N.O.
2	2 N.O.
3	3 N.O.
4	4 N.O.
5	5 N.O.
6	6 N.O.

N.C. (Normally Closed Circuits) ❹	
Code	No. of Circuits
0	No contact
1	1 N.C.
2	2 N.C.
3	3 N.C.
4	4 N.C.
5	5 N.C.
6	6 N.C.

Specialty Contact Blocks	
Code	Type
Blank	Standard
V	Low voltage ❺
E	N.O. early make
L	N.C. late break

- ❶ To achieve IP66 NEMA Type 4, add protective boot accessory **Cat. No. 800E-AUB1**.
- ❷ Position 1 of the latch (left position when viewed from the back) corresponds to position **C** of the operator. Position 2 of the latch (right position when viewed from the back) corresponds to position **A** of the operator. Position 3 of the latch (center position when viewed from the back) corresponds to position **B** of the operator.
- ❸ 3-across back-of-panel components only.
- ❹ A total of six circuits is the maximum allowable.
- ❺ Supplied with gold-plated contacts.

22.5 mm Push Buttons

IP40, Type 1

2-Function Multi-Operator, Illuminated



2-Function Multi-Operator Illuminated
Cat. No. 800EP-LU2A0

Top Button			Center Button	Bottom Button			2-Function Multi-Operator ❶
Color	Type	Text	Type	Color	Type	Text	Cat. No.
Green	Flush		White Pilot Light	Green	Flush		800EP-LU2A1
		→				←	800EP-LU2A2
		↑				↓	800EP-LU2A3
		+				—	800EP-LU2A4
		Blank				Blank	800EP-LU2C0
						○	800EP-LU2C21
		ON				OFF	800EP-LU2C22
		START				STOP	800EP-LU2C23
		START/I				STOP/O	800EP-LU2C24

Note: Multi-function operators are rated IP40, NEMA Type 1. To achieve IP66 NEMA Type 4, add boot accessory Cat. No. 800E-AUB2 or 800E-AUB3.

Back-of-Panel Components, Illuminated Operators

Full Voltage Power Module with Latch or Integrated LED Module with Latch

	Type	Color	Volts	3-Across Mounting ❶
				Cat. No.
<p>3-Across</p>	No lamp ❷	—	—	800E-3DL0
	Incandescent	—	24 AC/DC	800E-3DL3
			120 AC/DC	800E-3DL5
			24 AC/DC	800E-3NL3R
	Integrated LED Module ❸	Red	120 AC	800E-3NL5R
			240 AC	800E-3NL7R
			24 AC/DC	800E-3NL3G
		Green	120 AC	800E-3NL5G
			240 AC	800E-3NL7G
			24 AC/DC	800E-3NL3A
Amber		120 AC	800E-3NL5A	
		240 AC	800E-3NL7A	

Contact Block

	Type	Contact	3-Across Mounting ❶
			Cat. No.
<p>3-Across</p>	Standard	1 N.O.	800E-3X10
		1 N.C.	800E-3X01

❶ Illuminated multi-function operators cannot be used with 2-across back-of-panel devices.

❷ Lamp must match line voltage. See replacement lamps table on page 114.

❸ LEDs are available in red, green, blue, amber, and white.

2-Function Multi-Operator, Illuminated

800EP – **LU2** **C** **23** - _____ *Text*
 a *b* *c* *d*

800EP – **LU2** **X** **14** - _____ *No Text*
 a *b* *c* *d*

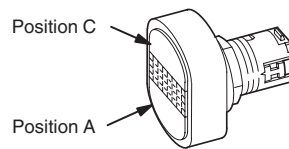

a

c

c (cont'd)

Operator Type	
Code	Description
LU2	Two-function (IP40, Type 1) ①

b

Button Color and Type Position C/Position A	
Code	Color Caps with Text
A	Green flush/green flush
B	Green flush/red flush
C	Green flush/red extended
D	White flush/white flush
E	White flush/black flush
F	White flush/black extended
X	Color Caps without Text

Button Caps with Text Green/Green or White/White		
Code	Text	
	Position C	Position A
1		
2	→	←
3	↑	↓
4	+	—
5	RIGHT	LEFT
6	UP	DOWN
7	FORWARD	REVERSE

Button Caps without Text Flush/Flush (only)			
Code	Position C (Color)	Code	Position A (Color)
1	White	1	White
2	Black	2	Black
3	Green	3	Green
—	—	4	Red
5	Yellow	5	Yellow
6	Blue	6	Blue
8	Gray	8	Gray

Button Caps with Text Green/Red or White/Black		
Code	Text	
	Position C	Position A
21		O
22	ON	OFF
23	START	STOP
24	START/I	START/O

Packaging	
Code	Description
Blank	1 per package
BP	10 per package

d

Back-of-Panel Components, Illuminated Operators

800E – **3** **DL5** **R** **X1** **0** **V**
 a *b* *c* *d* *e* *f*

a

Contact Block Matrix	
Code	Type
3	3-across mounting only ②

b

Power Module Type and Voltage Full Voltage (Latch Included)	
Code	Description
DL0	No lamp
DL1	6V AC/DC
DL2	12V AC/DC
DL3	24V AC/DC
DL4	48V AC/DC
DL5 ③	120V AC/DC
DL6 ③	130V AC/DC

Resistor (Latch Included)	
Code	Description
RL7	240V 60 Hz

Integrated LED (Latch Included) ④	
Code	Description
NL3	24V AC/DC
NL5	120V AC
NL7	240V AC

c

Lamp	
Code	Type
Blank	Incandescent or no lamp
R	Red LED ⑤
G	Green LED ⑤
A	Amber LED ⑤
B	Blue LED ⑤
W	White LED ⑥⑦

d

N.O. (Normally Open Circuits)	
Code	No. of Circuits
X0	No contact
X1	1 N.O.
X2	2 N.O.
X3	3 N.O.
X4	4 N.O.
X5	5 N.O.

e

N.C. (Normally Closed Circuits)	
Code	No. of Circuits
0	No contact
1	1 N.C.
2	2 N.C.
3	3 N.C.
4	4 N.C.
5	5 N.C.

f

Specialty Contact Blocks	
Code	Type
Blank	Standard
V	Low voltage ⑧
E	N.O. early make
L	N.C. late break

- ① To achieve IP66 NEMA Type 4, add protective boot accessory **Cat. No. 800E-AUB2** or **800E-AUB3**.
- ② Position 1 of the latch (left position when viewed from the back) corresponds to position **C** of the operator. Position 2 of the latch (right position when viewed from the back) corresponds to position **A** of the operator. Position 3 of the latch (center position when viewed from the back) is reserved for the power module.

- ③ Option **DL5** does not have a shunting resistor when used with an LED. Option **DL6** has a shunting resistor for LEDs and can be used for 120V DC applications.
- ④ Available in 3-across mounting only.
- ⑤ Refer to page 114 for LED selection.
- ⑥ Available in 6V, 24V and 120V AC/DC only.
- ⑦ Supplied with gold-plated contacts.

22.5 mm Push Buttons

IP66, Type 4/4X/13 (Plastic) — IP66, Type 4/13 (Metal)

Single Turn Potentiometer Operator

Potentiometer Operator
Cat. No. 800EP-POT1

Note: Resistive elements used with potentiometers must have a shaft diameter of 6.0 mm (15/64") and a shaft length of 50 mm (1-31/32"), or a shaft diameter of 6.4 mm (1/4") and a shaft length of 22.5 mm (7/8"). This operator is used with Type **J** potentiometers only.

Potentiometer	
Resistive Element	Cat. No.
Operator only (without resistive element)	800EP-POT
150 Ω single turn	800EP-POT1 ①
500 Ω single turn	800EP-POT2 ①
1,000 Ω single turn	800EP-POT3 ①
2,500 Ω single turn	800EP-POT4 ①
5,000 Ω single turn	800EP-POT5 ①
10,000 Ω single turn	800EP-POT6 ①

① Specifications for resistive elements:

Input voltage	300V AC and 100V DC max.
Maximum power	2 W with max. wiper current of 200 mA
Rotational torque	14 in.-oz
Stopping torque	7 in.-lbs

22.5 mm Push Buttons

IP66, Type 4/4X/13 (Plastic) — IP66, Type 4/13 (Metal)

Composite Cat. Nos.

Ordering Information

You can order Bulletin 800E operators with power modules and/or contact blocks shipped in one package. Operators, power modules, and/or contact blocks are shipped in one package, unassembled. To order, use a composite cat. no. Select appropriate operator from this publication and add desired code(s) as shown below.

For cat. no. combinations not shown, consult your local Allen-Bradley distributor.



Non-Illuminated Operator
Cat. No. 800EP-F33LX20



Illuminated Operator
Cat. No. 800EM-LE52DL3X01

Non-Illuminated Operators		
Operator Type		
Push buttons		
Push-pull units		
Selector switch units		
Key operated selector switch		
Selector jog		
Wobble stick		
+		
Contact Blocks with Latch		
Type	2-Across Code No.	3-Across Code No.
1 N.O.	2LX10	3LX10
1 N.C.	2LX01	3LX01
1 N.O. - 1 N.C.	2LX11	3LX11
2 N.O.	2LX20	3LX20
2 N.C.	2LX02	3LX02

Illuminated Operators		
Operator Type		
Push buttons		
Push-pull units		
Selector switch units		
Pilot lights		
+		
Power Modules		
Type	2-Across Code No.	3-Across Code No.
6V full voltage	2DL1	3DL1
12V full voltage	2DL2	3DL2
24V full voltage	2DL3	3DL3
120V full voltage	2DL5	3DL5
120V transformer	2TL5	3TL5
240V transformer	2TL7	3TL7
120V resistor	2RL5	3RL5
240V resistor	2RL7	3RL7
+		
Contact Blocks		
Type	2-Across Code No.	3-Across Code No.
1 N.O.	X10	X10
1 N.C.	X01	X01
1 N.O. - 1 N.C.	X11	X11
2 N.O.	X20	X20
2 N.C.	X02	X02

Example Composite Cat. Nos.

To order a plastic, flush, green, non-illuminated push button with 2 single circuit N.O. 3-across contacts:

$$\underbrace{800EP-F3}_{\text{Operator from page 27.}} + \underbrace{3LX20}_{\text{Code from table above.}} = 800EP-F33LX20$$

To order a metal, amber, extended head push button with a 24V full voltage module and 1 N.C. 2-across contact:

$$\underbrace{800EM-LE5}_{\text{Operator from page 39.}} + \underbrace{2DL3}_{\text{Code from table above.}} + \underbrace{X01}_{\text{Code from table above.}} = 800EM-LE52DL3X01$$

22.5 mm Push Buttons**Complete Units — Round Operator with Latch and Contact Blocks****Composite Cat. Nos., Continued****Non-Illuminated Push Buttons (Plastic Operator)**

To order additional contact blocks, see Accessories, page 100.



Shown with 3-Across Back-of-Panel Component

Contact Block	Color	Text	Momentary Flush, Black Plastic Bezel	
			2-Across Back-of-Panel	3-Across Back-of-Panel
			Cat No.	Cat No.
	Green	— START	800EP-F32LX10 800EP-F306W2LX10 800EP-F301W2LX10	800EP-F33LX10 800EP-F306W3LX10 800EP-F301W3LX10
	White	— START	800EP-F12LX10 800EP-F106B2LX10 800EP-F101B2LX10	800EP-F13LX10 800EP-F106B3LX10 800EP-F101B3LX10
	Red	— O STOP	800EP-F42LX01 800EP-F405W2LX01 800EP-F402W2LX01	800EP-F43LX01 800EP-F405W3LX01 800EP-F402W3LX01
	Red	—	800EP-F42LX10	800EP-F43LX10
	Black	— O STOP	800EP-F22LX01 800EP-F205W2LX01 800EP-F202W2LX01	800EP-F23LX01 800EP-F205W3LX01 800EP-F202W3LX01
	Black	—	800EP-F22LX10	—
	Yellow	—	800EP-F52LX10	800EP-F53LX10
	Blue	— R RESET	800EP-F62LX10 800EP-F611W2LX10 800EP-F607W2LX10	800EP-F63LX10 800EP-F611W3LX10 800EP-F607W3LX10
Contact Block	Color	Text	Momentary Extended, Black Plastic Bezel	
			2-Across Back-of-Panel	3-Across Back-of-Panel
			Cat No.	Cat No.
	Red	— O STOP	800EP-E42LX01 800EP-E405W2LX01 800EP-E402W2LX01	800EP-E43LX01 800EP-E405W3LX01 800EP-E402W3LX01

Composite Cat. Nos., Continued

Illuminated Push Buttons (Plastic Operator)

To order additional contact blocks, see Accessories, page 100. To order incandescent lamp or LEDs separately, see Accessories, page 100.



Shown with 3-Across Back-of-Panel Component

Contact Block and Lamp Element	Lamp	Color	Momentary, Black Plastic Bezel with Full Voltage Module	
			2-Across	3-Across
			Cat. No. ❶	Cat. No. ❶
	None	Green	800EP-LF32DL0X10	800EP-LF33DL0X10
		Red	800EP-LF42DL0X01	800EP-LF43DL0X01
		Red	800EP-LF42DL0X10	800EP-LF43DL0X10
		Amber	800EP-LF52DL0X10	800EP-LF53DL0X10
		Blue	800EP-LF62DL0X10	800EP-LF63DL0X10
		Clear	800EP-LF72DL0X10	800EP-LF73DL0X10

❶ To order the metal operator with shiny metal front bezel, replace EP with EM. Example: Cat. No. 800EP-LF33DL0X10 becomes Cat. No. 800EM-LF33DL0X10.

Contact Block and Lamp Element	Lamp	Color	Momentary, Black Plastic Bezel with Transformer	
			2-Across	3-Across
			Cat. No.	Cat. No.
	6V	Green	800EP-LF32TL5X10	800EP-LF33DL0X10
		Red	800EP-LF42TL5X10	800EP-LF43DL0X01
		Red	800EP-LF42TL5X01	800EP-LF43DL0X10
		Amber	800EP-LF52TL5X10	800EP-LF52DL0X10
		Blue	800EP-LF62TL5X10	800EP-LF62DL0X10
		Clear	800EP-LF72TL5X10	800EP-LF72DL0X10

22.5 mm Push Buttons

Complete Units — Round Operator with Latch and Contact Blocks

Composite Cat. Nos., Continued

Monolithic Pilot Lights

To order incandescent lamps or LEDs separately, see Accessories, page 100.

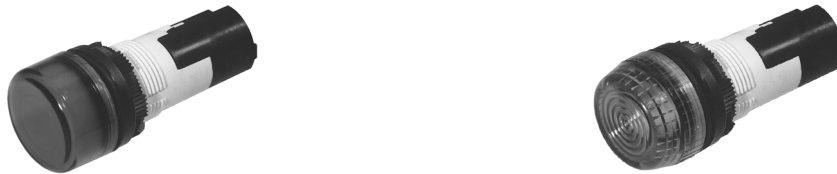

Direct Wire	Color	Standard	Optically Enhanced
		Cat. No.	Cat. No.
	Green, 120V	800EP-PM3D5	800EP-PLM3D5
	Red, 120V	800EP-PM4D5	800EP-PLM4D5
	Amber, 120V	800EP-PM5D5	800EP-PLM5D5
	Blue, 120V	800EP-PM6D5	800EP-PLM6D5
	Clear, 120V	800EP-PM7D5	800EP-PLM7D5

Pilot Lights

To order incandescent lamps or LEDs separately, see Accessories, page 100.



Shown with 3-Across Back-of-Panel Component

Color	Diffuser Style	
	2-Across	3-Across
	Cat. No.	Cat. No.
Green	800EP-P32DL0	800EP-P33DL0
	800EP-P32DL3	800EP-P33DL3
	800EP-P32DL5	800EP-P33DL5
Red	800EP-P42DL0	800EP-P43DL0
	800EP-P42DL3	800EP-P43DL3
	800EP-P42DL5	800EP-P43DL5
Amber	800EP-P52DL0	800EP-P53DL0
	800EP-P52DL3	800EP-P53DL3
	800EP-P52DL5	800EP-P53DL5
Blue	800EP-P62DL0	800EP-P63DL0
	800EP-P62DL3	800EP-P63DL3
	800EP-P62DL5	800EP-P63DL5
Clear	800EP-P72DL0	800EP-P73DL0
	800EP-P72DL3	800EP-P73DL3
	800EP-P72DL5	800EP-P73DL5

Composite Cat. Nos., Continued

Non-Illuminated Selector Switch Operators (Plastic Operator)

To order additional contact blocks, see Accessories, page 100.



Shown with 3-Across Back-of-Panel Component

Contact Block	Switch Angles	Color	Maintained, Black Plastic Bezel	
			2-Across	3-Across
			Cat. No.	Cat. No.
	90°	Black	800EP-SN222LX10	800EP-SN223LX10
	60°		800EP-SM222LX10	800EP-SM223LX10
	2 x 60°		800EP-SM322LX20	800EP-SM323LX20



Shown with 3-Across Back-of-Panel Component

Contact Block	Switch Angles	Locking Position	Maintained (Ronis), Black Plastic Bezel	
			2-Across	3-Across
			Cat. No.	Cat. No.
	90°	Left	800EP-KN2R12LX10	800EP-KN2R13LX10
	2 x 60°	Center	800EP-KM3R42LX20	800EP-KM3R43LX20

22.5 mm Push Buttons

Complete Units — Round Operator with Latch and Contact Blocks

Composite Cat. Nos., Continued

Non-Illuminated Multi-Function Operators



Shown with 3-Across Back-of-Panel Component

Position C			Position B			Position A			3-Across Black Front Bezel
Contact	Cap	Text	Contact	Cap	Text	Contact	Cap	Text	Cat. No.
	Green		Blank cap			Red	O		800EP-U2B213LX11
			Blank cap			Red ext.	O		800EP-U2C213LX11
				Red ext.		O		Green	
	Blank cap			Black		O		800EP-U2E213LX11	
	Blank cap			Black ext.		O		800EP-U2F213LX11	
			Black ext.	O			Black		800EP-U3D113LX21

Illuminated Multi-Function Operators

To order incandescent lamps or LEDs separately, see Accessories, page 100.

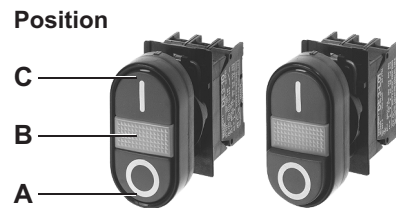

Shown with 3-Across Back-of-Panel Component



Position C			Position B		Position A			3-Across Black Front Bezel
Contact	Cap	Text	Lamp Element — Supply Voltage		Contact	Cap	Text	Cat. No.
	Green			Max. 250V, 2 W		Red	O	800EP-LU2B213DL0X11
	White					Red Ext.		800EP-LU2C213DL0X11
						Black		800EP-LU2E213DL0X11
						Black Ext.		800EP-LU2F213DL0X11



Composite Cat. Nos., Continued

Emergency Stop Operators — 40 mm Mushroom



Shown with 3-Across Back-of-Panel Component

2-Across Contact Block	Color	Twist-to-Release	Key Release (Ronis)	Key Release (Zadi)
		Cat. No.	Cat. No.	Cat. No.
No contacts (only operator with mounting ring nut)	Red	800EP-MTS44 ①	800EP-MKR44 ①	800EP-MKZ44 ①
		800EP-MTS442LX01 ①	800EP-MKR442LX01 ①	800EP-MKZ442LX01 ①
		800EP-MTS442LX11 ①	800EP-MKR442LX11 ①	800EP-MKZ442LX11 ①
		800EP-MTS442LX02 ①	—	—

3-Across Contact Block	Color	Twist-to-Release	Key Release (Ronis)	Key Release (Zadi)
		Cat. No.	Cat. No.	Cat. No.
No contacts (only operator with mounting ring nut)	Red	800EP-MTS44 ①	800EP-MKR44 ①	800EP-MKZ44 ①
		800EP-MTS443LX01 ①	800EP-MKR443LX01 ①	800EP-MKZ443LX01 ①
		800EP-MTS443LX11 ①	800EP-MKR443LX11 ①	800EP-MKZ443LX11 ①
		800EP-MTS443LX02 ①	—	—

① To order the metal operator with shiny metal front bezel, replace EP with EM. Example: Cat. No. 800EP-MTS34 becomes Cat. No. 800EM-MTS34.

22.5 mm Push Buttons

IP66, Type 4/4X/13 (Plastic) — IP66, Type 4/13 (Metal)

Plastic and Metal Enclosures

For pendant stations, see page 99.



Plastic Enclosure
Cat. No. 800E-5P



Metal Enclosure
Cat. No. 800E-3M

Plastic Enclosures (Base Mounting)

- Feed-through design
- Knock out sizes for 1, 2, and 3 hole enclosures: PG11/16 (top and bottom), PG16/21 (sides)
- Knock out sizes for 5 hole enclosures: PG16 (top and bottom), PG16/21 (sides)

Metal Enclosures (Latch or Base Mounting)

- Feed-through design, supplied with closing plug
- Conduit openings are PG16
- For base mounting adapter, see page 103

Type	Enclosures		
	Plastic ①②③ (IP66, NEMA 4/4X/13)	Metal — Die Cast ④⑤ (IP66, NEMA 4/13)	
	Base Mount Only ⑥	With Base Mount Adapter ⑥⑥	Without Base Mount Adapter
	Cat. No.	Cat. No.	Cat. No.
1 Hole	800E-1P	800E-1M	800E-1L
2 Hole	800E-2P	800E-2M	800E-2L
3 Hole	800E-3P	800E-3M	800E-3L
5 Hole	800E-5P	800E-5M	800E-5L
1 Hole (Yellow)	800E-1PY	800E-1MY	800E-1LY
2 Hole (Yellow)	800E-2PY	—	—
3 Hole (Yellow)	800E-3PY	—	—
5 Hole (Yellow)	800E-5PY	—	—

- Use square legends for base mounting only, **Cat. No. 800E-19AE100**.
- Legend plates will not function with base mounted contact blocks; use two-color molded legend cap operators.
- 4-across contact blocks, or power modules, cannot be installed in these enclosures.
- When legend plates are specified, the enclosure must be mounted horizontally and latch mounted contact blocks must be used.
- 2-across transformer modules, or two levels of 2-across contact blocks, cannot be installed in these enclosures.
- Do not install base mount contact blocks in center position when using non-illuminated push buttons.

Base Mounting Only

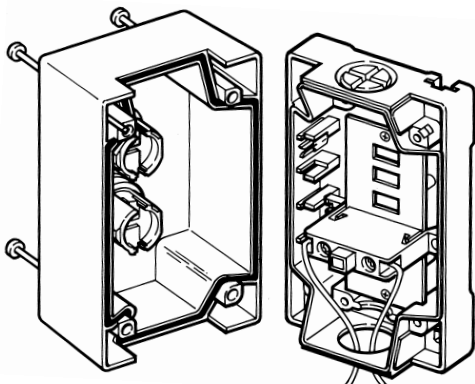

Latch Mounting or Base Mounting with Adapter, Cat. No. 800E-A3BA

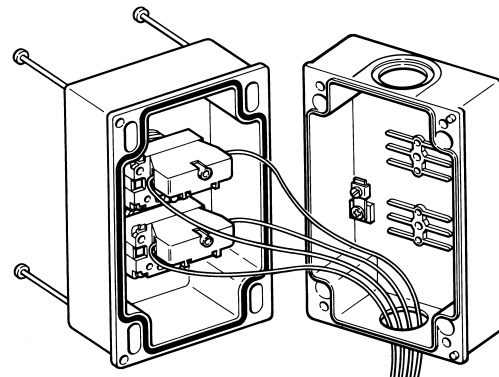

Accessories — Page 100
Legend Plates — Page 115

Approximate Dimensions — Page 127

Complete Assembled Stations

- Uses 800E 22 mm push button operators.
- Base-mounted 3-across contact blocks and power modules designed to be finger-safe — IP2X rated to meet global standards.
- Horizontal or vertical mounted assembled stations.
- Ratings — Type 4/4X, 12, and 13, and IP66 for plastic enclosures and 800EP operators. CE marked.



Cat. No. 800E-3PB8



Cat. No. 800E-1PB1

Enclosure Type	Contact Blocks	Lamp Voltage	Description	Cat. No. ❶
One-hole	Self-monitoring	—	E-stop with yellow enclosure	800E-1PL1
	N.O. - N.C.	—	E-stop with yellow enclosure	800E-1PB1
	N.C.	—	E-stop with yellow enclosure	800E-1PB2
	N.O.	—	Black push button — no text	800E-1PB3
	N.O.	—	"0...1" 2-position selector switch	800E-1PxB4 ❷
	N.O. - N.O.	—	HAND-O-AUTO 3-position selector switch	800E-1PxB5 ❷
Two-hole	N.O. - N.C.	—	START and STOP push buttons	800E-2PxB1 ❷
	N.O. - N.C.	—	"0...1" push button	800E-2PxB2 ❷
	N.O. - N.C.	—	Green and red push buttons — no text	800E-2PB3
	N.O. - N.O.	—	Black push buttons — no text	800E-2PB4
	N.O. - N.O.	—	Arrow-arrow	800E-2PxB5 ❷
	N.O.	24V AC	Red pilot, "0...1" 2-position selector switch	800E-2PxB6 ❷
	N.O.	120V AC	Red pilot, "0...1" 2-position selector switch	800E-2PxB7 ❷
	N.O.	240V AC	Red pilot, "0...1" 2-position selector switch	800E-2PxB8 ❷
	N.O. - N.O.	24V AC	Red pilot, HAND-O-AUTO 3-position selector switch	800E-2PxB9 ❷
	N.O. - N.O.	120V AC	Red pilot, HAND-O-AUTO 3-position selector switch	800E-2PxB10 ❷
	N.O. - N.O.	240V AC	Red pilot, HAND-O-AUTO 3-position selector switch	800E-2PxB11 ❷
Three-hole	N.O. - N.C.	24V AC	Red pilot, START and STOP push button	800E-3PxB1 ❷
	N.O. - N.C.	120V AC		800E-3PxB2 ❷
	N.O. - N.C.	240V AC		800E-3PxB3 ❷
	N.O. - N.C.	24V AC	Red pilot, "0...1" push button	800E-3PxB4 ❷
	N.O. - N.C.	120V AC		800E-3PxB5 ❷
	N.O. - N.C.	240V AC		800E-3PxB6 ❷
	N.O. - N.C.	24V AC	Red pilot, green and red push button —no text	800E-3PB7
	N.O. - N.C.	120V AC		800E-3PB8
	N.O. - N.C.	240V AC		800E-3PB9
	N.O. - N.C. - N.O.	—		Arrow, 0, arrow

❶ The cat. no. as listed is incomplete. Replace **x** with **H** for horizontal mount or **V** for vertical mounting. Example: **Cat. No. 800E-PxB3** becomes **Cat. No. 800E-PHB3** for a horizontal mounting station.

❷ Selector switch is horizontally mounted, but legend text is oriented for vertical mounting of station.

DeviceNet™ Push Button Stations with DeviceLogix™

- Uses 800EP operators with three-across pack-of-panel components
- NEMA 4/4X/13, IP66 — Dependent on operators
- Available as horizontal or vertical configuration
- UL and cUL listed, CE marked, and ODVA certified (DeviceNet)

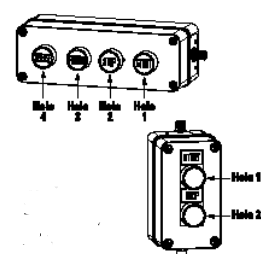
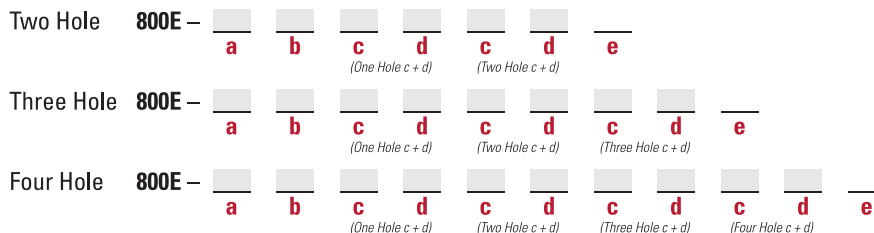
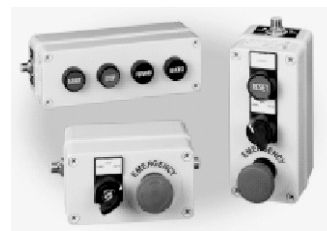

a		b		c	
Orientation		Enclosure Style/Legends ④		Operator Type	
Code	Description	Code	Description	Code	Description
V	Vertical ①	A	2-Hole with Legend Frame	A	Non-Illuminated Flush Push Button (800EP-F*)
H	Horizontal	B	3-Hole with Legend Frame	B	Non-Illuminated Extended Push Button (800EP-G*)
		C	4-Hole with Legend Frame	C	Non-Illuminated Guarded Push Button (*800EP-G*)
		D	2-Hole/No Legend Frame	D	Illuminated Flush Push Button (800EP-LF*)
		E	3-Hole/No Legend Frame	E	Illuminated Extended Push Button (800EP-LE*)
		F	4-Hole/No Legend Frame	F	Illuminated Guarded Push Button (800EP-LG*)
		G	2-Hole/E-Stop Only with Legend Frame ⑤	G	Non-Illuminated 2-Position Maintained Selector (800EP-SM2*)
		H	2-Hole/E-Stop Only/No Legend Frame ⑤	H	Non-Illuminated 3-Position Maintained Selector (800EP-SM3*)
				J	Optically-Enhanced Pilot Light (800EP-PL*)
				K	Non-Illuminated E-Stop Twist-to-Release, Push/Pull (800EP-MT4) ⑥⑦
				L	Non-Illuminated E-Stop Twist-to-Release (800EP-MTS44) ⑥⑦
				M	Non-Illuminated 2-Position Push/Pull Operator (800ES-MP2*) ⑧
				N	2-Position Low Profile Key Selector (800EP-KM2R3*) ⑧
				P	3-Position Low Profile Key Selector (800EP-KM3R3*) ⑧
				Q	Non-Illuminated Flush Alternate Action Push Button (800EP-FA*)
				R	Non-Illuminated Momentary Mushroom 40 mm Push Button (800EP-M*)
				T	Non-Illuminated E-Stop Key Release (800EP-MKR44*) ⑥⑦
				U	Non-Illuminated 3-Position Push/Pull Operator (800ES-MP3R*)
				V	Illuminated Flush Alternate Action Push Button (800EP-LFA*)
				W	Illuminated 2-Position Push/Pull Operator (800ES-LMP2*)
				X	Illuminated 2-Position Maintained Selector (800EP-LSM2*)
				Y	Illuminated 3-Position Maintained Selector (800EP-LSM3*)
				Z	Illuminated Momentary Mushroom 40 mm Push Button (800ES-LM*)

d		e	
Color/Text		External I/O Version ⑥	
Code	Description	Code	Description
1	White	Blank	No External I/O
2	Black	A	1 Input/1 Output (Sinking)
3	Green	B	1 Input/1 Output (Sourcing)
4	Red	C	2 Input
5	Yellow	D	2 Output (Sinking)
6	Blue	E	2 Output (Sourcing)
7	Clear	F	1 E-Stop Block ⑦
8	Gray	G	2 E-Stop Blocks ⑦
9	No Cap	H	2 Input + 2 Output
A	Start (Green Background/White Text) ②	J	2 Input + 2 Output (Sinking)
B	Stop (Red Background/White Text) ②	K	2 Input + 2 Output (Sourcing)
C	Forward (Black Background/White Text) ②	L	1 Input/1 Output (Sinking) + 1 E-Stop Block ⑦
D	Reverse (Black Background/White Text) ②	M	1 Input/1 Output (Sourcing) + 1 E-Stop Block ⑦
E	Up (Black Background/White Text) ②	N	1 Input/1 Output (Sinking) + 2 E-Stop Blocks ⑦
F	Down (Black Background/White Text) ②	P	1 Input/1 Output (Sinking) + 2 E-Stop Blocks ⑦
G	1 (Green Background/White Text) ②	Q	2 Input + 1 E-Stop Block ⑦
H	0 (Red Background/White Text) ②	R	2 Input + 2 E-Stop Blocks ⑦
J	On (Green Background/White Text) ②	T	2 Output (Sinking) + 1 E-Stop Block ⑦
K	Off (Red Background/White Text) ②	U	2 Output (Sourcing) + 1 E-Stop Block ⑦
L	Reset (Blue Background/White Text) ②	V	2 Output (Sinking) + 2 E-Stop Blocks ⑦
X	N/A (Key Selector Switch) ③	W	2 Output (Sourcing) + 2 E-Stop Blocks ⑦
		X	2 Input + 1 Input/1 Output (Sinking)
		Y	2 Input + 1 Input/1 Output (Sourcing)

- ① Selector Switches in a vertical mount enclosure will be mounted with a horizontal orientation.
- ② Legended color cap options A through L from Table d can only be used with Operator Type options A, B, and C from Table c.
- ③ Operator Types N and P from Table c must choose Color/Text option X from Table d.
- ④ Legend Frame provided is 800E-120; legend insert needs to be ordered separately.
- ⑤ Enclosure Style/Legend options G and H from Table b can only select one operator from Table c. Valid options are K, L, M, and T. Also see Note 4.
- ⑥ This is an 8-in/4-out device. 2-in and 1-out are assigned to each hole position in the enclosure. If a 2-hole enclosure is selected, 4-in and 2-out are assigned internally and up to 4 unassigned I/O points can be assigned to external connectors. This device contains up to two physical external I/O connectors. The "+" symbol in the Description field of Table e indicates that two external connectors exist. If an E-Stop connector is used, 2 unassigned I/O points can be assigned to the other connector.
- ⑦ External I/O Versions F, L, M, Q, T, and U receive only one contact block for the external E-Stop string. These connectors are rated to 3 A. If more than 3 A of current is needed or if there are two E-Stop strings, use External I/O Versions G, N, P, R, V, and W. These versions receive two contact blocks. This allows for 6 A of switching or for two E-Stop strings.
- ⑧ Operator Types K, L, M, and T from Table c may be used as E-Stops. To be valid as an E-Stop, the operators must use Color/Text option 4 from Table d and it must be placed in the last hole position in the enclosure. An E-Stop connector also must be chosen from Table e. Also see Note 8.
- ⑨ Operator Types K, L, and T from Table c only available in red - Color/Text Option 4 from Table d.

Pendant Stations



Cat. No. 800E-P254



Cat. No. 800E-PN2

Description		Enclosure Color	Legend Cap Marking	Cat. No.
Pendant enclosure only	One hole in face	Black	Blank	800E-P12
	Two holes in face			800E-P22
	One hole in bottom			800E-P32
	One hole in face, one hole in bottom			800E-P42
	One hole in face	Yellow		800E-P15
	Two holes in face			800E-P25
	One hole in bottom			800E-P35
	One hole in face, one hole in bottom			800E-P45

Description		Enclosure Color	Legend Cap Marking	Contacts	Cat. No.
Prewired station with mini quick disconnect connector — two push buttons on front face of pendant		Yellow	UP-DOWN (arrows)	N.O. - N.O.	800E-P251
			FORWARD-REVERSE	N.O. - N.O.	800E-P252
			ON-OFF	N.O. - N.C.	800E-P253
			START-STOP	N.O. - N.C.	800E-P254
			Two no-legend black caps	N.O. - N.O.	800E-P255
Station with mini quick disconnect connector — 24V AC/DC	Bottom button is momentary illuminated extended red LED push button. Front face has no operator.	Yellow	Blank	N.O.	800E-PN1
	Bottom pilot light is red LED. Front face has momentary non-illuminated, flush green push button.		Blank	N.O.	800E-PN2
DeviceNet™ station with mini quick disconnect connector — 24V DC	Bottom button is momentary illuminated extended red LED push button. Front face has no operator.		Blank	N.O.	800E-PND1
	Bottom pilot light is red LED. Front face has momentary non-illuminated, flush green push button.		Blank	N.O.	800E-PND2

Specifications — DeviceNet™

Current drain	50 mA RMS, 100 mA peak @ 24V DC							
Operating voltage	11...25V DC							
Approvals	UL listed, cUL certified, and CE marked for all applicable directives							
Degree of protection	IP66 (IEC 529)/Type 4/4X/13							
Connections	Quick disconnect: 5-pin mini-style							
Operating temperature	-25°C...+55°C (-13°F...+131°F)							
Shock	50 G, 1/2 cycle sine wave for 11 ms							
Vibration	10...2000 Hz, 0.76 mm displacement (peak-to-peak) max., 5 G max.							
Strobe and change of state output	Bit 0	Bit 1	Bit 2	Bit 3	Bit 4	Bit 5	Bit 6	Bit 7
Input byte	Input	Reserved	Reserved	Output Status	—	—	—	—
Output byte	Output activate	—	—	—	—	—	—	—

Quick Disconnect Cordsets



Standard 4-Pin Straight Quick Disconnect Cable — Mini			DeviceNet™ 5-Pin Straight Quick Disconnect Cable — Mini		
Length	Cat. No.		Length	Cat. No.	
1.8 m	889N-F4AF-6F		1 m	1485R-P1N5-C	
3.7 m	889N-F4AF-12F		2 m	1485R-P2N5-C	
6.1 m	889N-F4AF-20F		3 m	1485R-P3N5-C	

Note: For more cabling options, see the C113 Sensors Catalog and the DN-2.15 DeviceNet™ Catalog.

22.5 mm Push Buttons

IP66, Type 4/4X/13 (Plastic) — IP66, Type 4/13 (Metal)

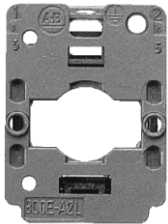
Accessories**2-Across Back-of-Panel Components**

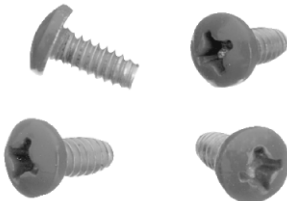
	Description	Cat. No.
	<p>2-Across Mounting Latch These are zinc-plated, metal die cast mounting latches. Sold only in multiples of 10. Order (quantity of) 10 to receive one package of 10 pieces.</p>	800E-A2L
	<p>Dove Tail Interlock Provides an extra level of stability by interlocking common levels of contact blocks and/or power modules. Sold only in multiples of 100. Order (quantity of) 100 to receive one package of 100 pieces.</p>	800E-A2DT
	<p>Lamp Socket Assembly Sold only in multiples of 10. Order (quantity of) 10 to receive package of 10 pieces.</p>	800E-ABS2
	<p>Ground Screws These are self-tapping #6-32 (M3.5) green ground screws for metal latches. Sold only in multiples of 10. Order (quantity of) 10 to receive one package of 10 pieces.</p>	800E-AGS1

Accessories, Continued

2-Across Back-of-Panel Components

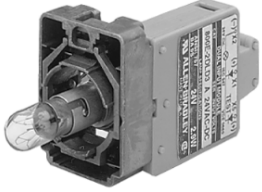
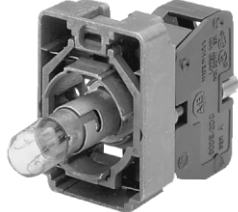
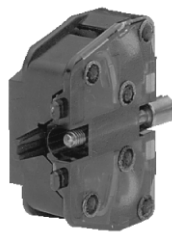
	Description	Volts	Cat. No.
	Transformer Module with Latch Transformers are used to extend lamp life. Transformer module is available in a wide variety of voltages. Includes latch and 6V incandescent lamp.	120 AC 50/60 Hz	800E-2TL5
		208 AC 60 Hz	800E-2TL6
		240 AC 50/60 Hz	800E-2TL7
		400 AC 50 Hz	800E-2TL10
		440/480 AC 50/60 Hz	800E-2TL12
		600 AC 60 Hz	800E-2TL14
	Dual Input Diode Module with Latch Dual input diode module includes latch and lamp.	24 AC/DC	800E-2DDL3
		120 AC	800E-2DDL5
	Full Voltage Module with Latch Full voltage module includes latch. Available in a wide variety of voltages.	No bulb	800E-2DL0
		6 AC/DC	800E-2DL1
		12 AC/DC	800E-2DL2
		24 AC/DC	800E-2DL3
		48 AC/DC	800E-2DL4
		120 AC/DC	800E-2DL5
		130 AC/DC	800E-2DL6
Resistor Module with Latch Note: 120V resistor module drops voltage 10% to extend lamp life. 240V module cuts voltage in half to allow usage with 130V lamp. Includes latch and lamp.	120 AC/DC	800E-2RL5 ❶	
	240 AC	800E-2RL7 ❶	
	Contact Block Sold only in multiples of 10. Order (quantity of) 10 to receive one package of 10 pieces. Sold only in multiples of 50. Order (quantity of) 50 to receive one package of 50 pieces.	N.O.	800E-2X10
		N.C.	800E-2X01
		N.O.E.M. ❷	800E-2X10E
		N.C.L.B. ❷	800E-2X01L
		Self-monitoring (with latch) ❸	800E-2LX01LS
		N.O. PenTUFF (low voltage)	800E-2X10V
		N.C. PenTUFF (low voltage)	800E-2X01V
		N.O.	800E-2X10-BP
		N.C.	800E-2X01-BP

❶ Resistor module cannot be used with LEDs.

❷ N.O.E.M. means its contacts will close before the N.O. contacts close, or before the N.C.L.B. contacts open. N.C.L.B. means its contacts will open after the N.C. contacts open, or after the N.O.E.M. contacts close.





❸ Sold 1per package.

22.5 mm Push Buttons

IP66, Type 4/4X/13 (Plastic) — IP66, Type 4/13 (Metal)

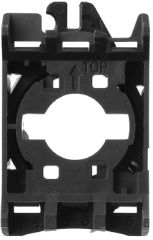
Accessories, Continued

3-Across Back-of-Panel Components

	Description	Cat. No.	
	3-Across Mounting Latch Sold only in multiples of 10. Order (quantity of) 10 to receive one package of 10 pieces.	800E-A3L	
	Sold only in multiples of 50. Order (quantity of) 50 to receive one package of 50 pieces.	800E-A3L-BP	
	Description	Volts	Cat. No.
	Transformer Module with Latch Transformers are used to extend lamp life. Transformer module is available in a wide variety of voltages. Includes latch and 6V incandescent lamp.	120 AC 50/60 Hz	800E-3TL5
		208 AC 60 Hz	800E-3TL6
		240 AC 50/60 Hz	800E-3TL7
		400 AC 50 Hz	800E-3TL10
		440/480 AC 50/60 Hz	800E-3TL12
		600 AC 60 Hz	800E-3TL14
	Full Voltage Module with Latch Full voltage module includes latch. Available in a wide variety of voltages.	No bulb	800E-3DL0
		6 AC/DC	800E-3DL1
		12 AC/DC	800E-3DL2
		24 AC/DC	800E-3DL3
		48 AC/DC	800E-3DL4
		120 AC/DC	800E-3DL5
		130 AC/DC	800E-3DL6
	Integrated LED Module Integrated LED module can be ordered with or without a latch.	24V AC/DC w/latch	800E-3NL3 ④
		24V AC/DC w/o latch	800E-3N3 ④⑤
		120V AC w/latch	800E-3NL5 ④
		120V AC w/o latch	800E-3N5 ④⑤
		240V AC w/latch	800E-3NL7 ④
		240V AC w/o latch	800E-3N7 ④⑤
	Resistor Module with Latch 240V module cuts voltage in half to allow usage with 130V lamp. Includes latch and lamp. Includes latch and lamp.	240 AC	800E-3RL7 ①
	Description	Contact Type	Cat. No.
	Contact Block Sold only in multiples of 10. Order (quantity of) 10 to receive one package of 10 pieces.	N.O.	800E-3X10
		N.C.	800E-3X01
		N.O.E.M. ②	800E-3X10E
		N.C.L.B.	800E-3X01L
		Self-monitoring (with latch)	800E-3LX01S
		N.O. Low Voltage	800E-3X10V
	N.C. Low Voltage	800E-3X01V	
	Contact Block Sold only in multiples of 50. Order (quantity of) 50 to receive one package of 50 pieces.	N.O.	800E-3X10-BP
		N.C.	800E-3X01-BP

① Resistor module cannot be used with LEDs.

② N.O.E.M. means its contacts will close before the N.O. contacts close, or before the N.C.L.B. contacts open. N.C.L.B. means its contacts will open after the N.C. contacts open, or after the N.O.E.M. contacts close.



③ Sold 1 per package

④ Add LED color choice: Amber=A, Red=R, Green=G, Blue=B, White=W.

⑤ Sold 10 per package.

Accessories, Continued

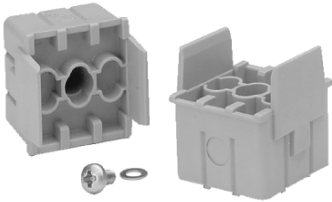
3-Across Base Mounted Components

	Description	Cat. No.
	<p>Base Mount Adapter Base mount adapter is only required on metal enclosures when base mounting is specified. Sold only in multiples of 10. Order (quantity of) 10 to receive one package of 10 pieces.</p>	800E-A3BA
	Description	Contact Type
	<p>Base Mounted Contact Block Base mounted contact blocks are used in base mounted plastic or metal enclosures. They cannot be used with alternate action twist-to-release and push-pull operators. Sold only in multiples of 10. Order (quantity of) 10 to receive one package of 10 pieces.</p>	N.O.
		N.C.
		N.O.E.M. ①
		N.C.L.B. ①
	Description	Volts
	<p>Base Mounted Full Voltage Module Base mounted full voltage modules are used in base mounted plastic or metal enclosures.</p>	No bulb
		6 AC/DC
		12 AC/DC
		24 AC/DC
		48 AC/DC
		120 AC/DC
	Base Mount Resistor Module	
	<p>Note: This module cuts voltage in half to allow usage with 130V lamp. Lamp not included.</p>	240 AC

4-Across Back-of-Panel Components

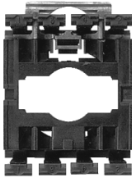
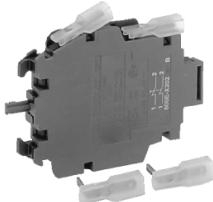
	Description	Cat. No.
	<p>4-Across Mounting Latch Sold only in multiples of 10. Order (quantity of) 10 to receive one package of 10 pieces.</p>	800E-A4L
	<p>Sold only in multiples of 50. Order (quantity of) 50 to receive one package of 50 pieces.</p>	800E-A4L-BP
	<p>Stab Kit Connector Provides stab terminations (0.110" x 0.032") push-on connector for Bulletin 800E contact blocks that are not typically furnished with stab connectors. Sold only in multiples of 100. Order (quantity of) 100 to receive one package of 100 pieces.</p>	800E-ATK1

- ① N.O.E.M. means its contacts will close before the N.O. contacts close, or before the N.C.L.B. contacts open.
N.C.L.B. means its contacts will open after the N.C. contacts open, or after the N.O.E.M. contacts close.
- ② Resistor module cannot be used with LEDs.

22.5 mm Push Buttons

IP66, Type 4/4X/13 (Plastic) — IP66, Type 4/13 (Metal)

Accessories, Continued

4-Across Back-of-Panel Components

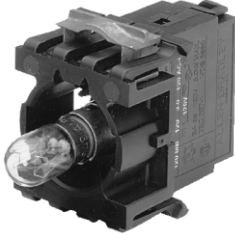
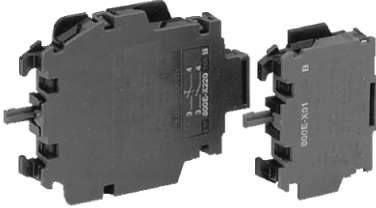
		Description	Volts	Cat. No.	
 <p>Short Transformer</p>	<p>Transformer Module with Latch Transformers are used to extend lamp life. These transformer modules are available in a wide variety of voltages. Includes latch and 6V incandescent lamp.</p>	Short transformer	110AC 50Hz 120AC 60Hz	800E-4TL5 ❶	
			208AC 60Hz	800E-4TL6 ❶	
			220AC 50Hz 240AC 60Hz	800E-4TL7 ❶	
		Long transformer		277AC 60Hz	800E-4T9 ❶
				380AC 50Hz	800E-4T10 ❶
				415AC 50Hz	800E-4T11 ❶
				440AC 50Hz 480AC 60Hz	800E-4T12 ❶
				500AC 50Hz	800E-4T13 ❶
				600AC 50Hz	800E-4T14 ❶
					<p>Resistor Module with Latch 120V resistor module drops voltage 10% to extend lamp life. 240V module cuts voltage in half to allow usage with 130V lamp. Includes latch and lamp.</p>
240 AC	800E-4RL7 ❶❷				
	<p>Full Voltage Module with Latch These full voltage modules are available in a wide variety of voltages.</p>	No bulb	800E-4DL0		
		6 AC/DC	800E-4DL1		
		12 AC/DC	800E-4DL2		
		24 AC/DC	800E-4DL3		
		48 AC/DC	800E-4DL4		
		120 AC/DC	800E-4DL5		
		Description	Contact Type	Cat. No.	
	<p>Contact Block</p> <p>Sold only in multiples of 10. Order (quantity of) 10 to receive one package of 10 pieces.</p> <p>Sold only in multiples of 50. Order (quantity of) 50 to receive one package of 50 pieces.</p>	N.O.	800E-4X10		
		N.C.	800E-4X01		
		N.O. low voltage	800E-4X10V		
		N.C. low voltage	800E-4X01V		
		1 N.O. - 1 N.C.	800E-4X211		
		1 N.O. - 1 N.C. low voltage	800E-4X211V		
		2 N.O.	800E-4X220		
		2 N.C.	800E-4X202		
		2 N.O. low voltage	800E-4X220V		
		2 N.C. low voltage	800E-4X202V		
		N.C.	800E-4X01-BP		
		N.O.	800E-4X10-BP		

❶ Not recommended for use with illuminated alternate action push buttons.

❷ Resistor module cannot be used with LEDs.

22.5 mm Push Buttons

IP66, Type 4/4X/13 (Plastic) — IP66, Type 4/13 (Metal)

Accessories, Continued

Replacement Color Caps

Color caps listed below are for field replacement on installed devices or for completion of devices ordered with color caps omitted.



Color Caps, Non-Illuminated ❶				
Color	Round		Square	
	Extended	Flush and Guarded	Extended	Flush and Guarded
	Cat. No.	Cat. No.	Cat. No.	Cat. No.
White	800E-AE1	800E-AF1	800EQ-AE1	800EQ-AF1
Black	800E-AE2	800E-AF2	800EQ-AE2	800EQ-AF2
Green	800E-AE3	800E-AF3	800EQ-AE3	800EQ-AF3
Red	800E-AE4	800E-AF4	800EQ-AE4	800EQ-AF4
Yellow	800E-AE5	800E-AF5	800EQ-AE5	800EQ-AF5
Blue	800E-AE6	800E-AF6	800EQ-AE6	800EQ-AF6
Gray	800E-AE8	800E-AF8	800EQ-AE8	800EQ-AF8

❶ Order in multiples of 10. Order (quantity of) 10 to receive one package of 10 pieces.

Replacement Color Caps and Push-Pull Caps



Mushroom Color Caps ❷		Non-Illuminated Push-Pull Caps					
40 mm Metal		40 mm Metal		40 mm Plastic		60 mm Plastic	
Color	Cat. No.	Color	Cat. No.	Color	Cat. No.	Color	Cat. No.
Black	800E-AMM2	Black	800E-AMMP2	White	800E-AMP1	White	800E-AMJP1
Green	800E-AMM3	Green	800E-AMMP3	Black	800E-AMP2	Black	800E-AMJP2
Red	800E-AMM4	Red	800E-AMMP4	Green	800E-AMP3	Green	800E-AMJP3
Yellow	800E-AMM5	Yellow	800E-AMMP5	Red	800E-AMP4	Red	800E-AMJP4
Blue	800E-AMM6	Blue	800E-AMMP6	Yellow	800E-AMP5	Yellow	800E-AMJP5
Aluminum	800E-AMM8	Aluminum	800E-AMMP8	Blue	800E-AMP6	Blue	800E-AMJP6
		—	—	Gray	800E-AMP8	Gray	800E-AMJP8

❷ Plastic non-illuminated momentary color caps are not replaceable.

Replacement Color Caps -- Multi-Function Operators



Color Caps, Non-Illuminated ❸			
Color	Flush	Extended	Text
	Cat. No.	Cat. No.	
White	800E-AFU1	—	—
Black	800E-AFU2	—	—
Green	800E-AFU3	—	—
Green	800E-AFUC3PEO1W	—	START
Yellow	800E-AFU5	—	—
Red	800E-AFU4	—	—
Red	—	800E-AEUA4REO4W	STOP
Red	—	800E-AEU4	—
Blue	800E-AFU6	—	—
Gray	800E-AFU8	—	—

❸ Order in multiples of 10. Order (quantity of) 10 to receive one package of 10 pieces.

22.5 mm Push Buttons

IP66, Type 4/4X/13 (Plastic) — IP66, Type 4/13 (Metal)

Accessories, Continued

Replacement Color Lens Caps and Pilot Light Lenses



Standard Lens



Optically Enhanced Lens



Color Lens Caps			Pilot Light Lenses			
Color	Flush, Extended, Guarded, and Push-to-Test		Color	Round Ⓣ		Square
	Round ①②	Square ①②		Standard Lens ①	Optically Enhanced Lens	Standard Lens ①②
	Cat. No.	Cat. No.		Cat. No.	Cat. No.	Cat. No.
Green	800E-ALF3	800EQ-ALF3	White	—	800E-APL1	—
Red	800E-ALF4	800EQ-ALF4	Green	800E-AP3	800E-APL3	800EQ-AP3
Amber	800E-ALF5	800EQ-ALF5	Red	800E-AP4	800E-APL4	800EQ-AP4
Blue	800E-ALF6	800EQ-ALF6	Amber	800E-AP5	800E-APL5	800EQ-AP5
Clear	800E-ALF7	800EQ-ALF7	Blue	800E-AP6	800E-APL6	800EQ-AP6
			Clear	800E-AP7	800E-APL7	800EQ-AP7

① Includes diffuser. See operator diffusers table.

② Sold only in multiples of 10. Order (quantity of) 10 to receive one package of 10 pieces.

Replacement Illuminated Mushroom Head Caps and Push-Pull Caps

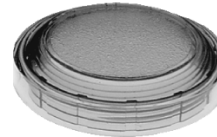

Illuminated Mushroom Head Caps			Illuminated Push-Pull Caps		
Color	40 mm Mushroom Head Lens	60 mm Mushroom Head Lens	Color	40 mm Push-Pull Lens	60 mm Push-Pull Lens
	Cat. No.	Cat. No.		Cat. No.	Cat. No.
White	800E-ALM1	800E-ALMJ1	White	800E-ALMP1	800E-ALMJP1
Green	800E-ALM3	800E-ALMJ3	Green	800E-ALMP3	800E-ALMJP3
Red	800E-ALM4	800E-ALMJ4	Red	800E-ALMP4	800E-ALMJP4
Amber	800E-ALM5	800E-ALMJ5	Amber	800E-ALMP5	800E-ALMJP5
Blue	800E-ALM6	800E-ALMJ6	Blue	800E-ALMP6	800E-ALMJP6
Clear	800E-ALM7	800E-ALMJ7	Clear	800E-ALMP7	800E-ALMJP7

Operator Diffusers



Cat. No. 800E-AD2



Cat. No. 800EQ-AD2

Diffusers ②			
Round		Square	
Description	Cat. No.	Description	Cat. No.
Illuminated Buttons	800E-AD2	Illuminated Push Buttons	800EQ-AD2
Pilot Lights 800EP/EM	800E-AD3	Pilot Lights 800EQ	800EQ-AD3

② Sold only in multiples of 10. Order (quantity of) 10 to receive one package of 10 pieces.

Accessories, Continued

Replacement Knobs — Round Operators



Replacement Knobs — Round Operators

Non-Illuminated				Illuminated			
Color	Plastic	Metal		Color	Plastic	Metal	
	Cat. No.	Round Metal Operator ❶	Round Metal Operator w/Black Anodized Bezel		Cat. No.	Round Metal Operator ❶	Round Metal Operator w/Black Anodized Bezel
		Cat. No.				Cat. No.	
White	800EP-AS1	800EM-AS1	800EB-AS1	White	800EP-ALS1	800EM-ALS1	800EB-ALS1
Black	800EP-AS2	800EM-AS2	800EB-AS2	Green	800EP-ALS3	800EM-ALS3	800EB-ALS3
Green	800EP-AS3	800EM-AS3	800EB-AS3	Red	800EP-ALS4	800EM-ALS4	800EB-ALS4
Red	800EP-AS4	800EM-AS4	800EB-AS4	Amber	800EP-ALS5	800EM-ALS5	800EB-ALS5
Yellow	800EP-AS5	800EM-AS5	800EB-AS5	Blue	800EP-ALS6	800EM-ALS6	800EB-ALS6
Blue	800EP-AS6	800EM-AS6	800EB-AS6	Clear	800EP-ALS7	800EM-ALS7	800EB-ALS7
Gray	800EP-AS8	800EM-AS8	800EB-AS8	—	—	—	—

❶ Use these same devices for 800ES style selector switches.

❷ See page 123 for recommended operator panel spacing.

Replacement Knob Levers — Round Operators ❷



Replacement Knob Levers — Round Operators

Non-Illuminated				Illuminated			
Color	Plastic	Metal		Color	Plastic	Metal	
	Cat. No.	Round Metal Operator ❶❷	Round Metal Operator w/Black Anodized Bezel		Cat. No.	Round Metal Operator ❶❷	Round Metal Operator w/Black Anodized Bezel
		Cat. No.				Cat. No.	
White	800EP-AH1	800EM-AH1	800EB-AH1	White	800EP-ALH1	800EM-ALH1	800EB-ALH1
Black	800EP-AH2	800EM-AH2	800EB-AH2	Green	800EP-ALH3	800EM-ALH3	800EB-ALH3
Green	800EP-AH3	800EM-AH3	800EB-AH3	Red	800EP-ALH4	800EM-ALH4	800EB-ALH4
Red	800EP-AH4	800EM-AH4	800EB-AH4	Amber	800EP-ALH5	800EM-ALH5	800EB-ALH5
Yellow	800EP-AH5	800EM-AH5	800EB-AH5	Blue	800EP-ALH6	800EM-ALH6	800EB-ALH6
Blue	800EP-AH6	800EM-AH6	800EB-AH6	Clear	800EP-ALH7	800EM-ALH7	800EB-ALH7
Gray	800EP-AH8	800EM-AH8	800EB-AH8	—	—	—	—

❶ Use these same devices for 800ES style selector switches.

❷ See page 123 for recommended operator panel spacing.

22.5 mm Push Buttons

IP66, Type 4/4X/13 (Plastic) — IP66, Type 4/13 (Metal)

Accessories, Continued

Replacement Knobs and Knob Levers — Square Operators







Replacement Knobs — Square Operators				Replacement Knob Levers — Square Operators			
Non-Illuminated		Illuminated		Non-Illuminated ❶		Illuminated ❶	
Color	Cat. No.	Color	Cat. No.	Color	Cat. No.	Color	Cat. No.
White	800EQ-AS1	White	800EQ-ALS1	White	800EQ-AH1	White	800EQ-ALH1
Black	800EQ-AS2	Green	800EQ-ALS3	Black	800EQ-AH2	Green	800EQ-ALH3
Green	800EQ-AS3	Red	800EQ-ALS4	Green	800EQ-AH3	Red	800EQ-ALH4
Red	800EQ-AS4	Amber	800EQ-ALS5	Red	800EQ-AH4	Amber	800EQ-ALH5
Yellow	800EQ-AS5	Blue	800EQ-ALS6	Yellow	800EQ-AH5	Blue	800EQ-ALH6
Blue	800EQ-AS6	Clear	800EQ-ALS7	Blue	800EQ-AH6	Clear	800EQ-ALH7
Gray	800EQ-AS8			Gray	800EQ-AH8		

❶ See page 123 for recommended operator panel spacing.

Accessories, Continued

Locking Attachments and Guards



	Description	Cat. No.	
	<p>Flush Non-Illuminated Locking Attachment Used to lock push button in the depressed position. In the depressed position, N.C. contacts are open, N.O. contacts may or may not be open, N.C.L.B. contacts may or may not be closed, and N.O.E.M. contacts are closed.</p>	800E-AFL1	
	<p>Extended Non-Illuminated Locking Attachment Used to lock push button in the depressed position. In the depressed position, N.C. contacts are open, N.O. contacts may or may not be open, N.C.L.B. contacts may or may not be closed, and N.O.E.M. contacts are closed.</p>	800E-AEL1	
	Description	Lock Position	Cat. No.
	<p>2-Position Selector Switch Locking Attachment Used to lock selector switch in specified position.</p>	Right	800E-ASL2R
		Left	800E-ASL2L
		90° right	800E-ASL2NR
	<p>3-Position Selector Switch Locking Attachment Used to limit either one or two of the three possible positions of the selector.</p>	Left	800E-ASL3L
		Center	800E-ASL3C
		Right	800E-ASL3R
		Left/center	800E-ASL3LC
		Right/center	800E-ASL3RC

22.5 mm Push Buttons

IP66, Type 4/4X/13 (Plastic) — IP66, Type 4/13 (Metal)

Accessories, Continued





Locking Attachments and Guards

	Description	Cat. No.		
	<p>Mushroom Locking Attachment Used to lock momentary mushroom push buttons in the depressed position. In the depressed position, N.C. contacts are open, N.O. contacts may or may not be open, N.C.L.B. (late break) contacts may or may not be open, and N.O.E.M. (early break) contacts are closed. This device is used with the following operators: 800E_-M_ 800E_-MT_</p>	800E-AML1		
	<p>800E_-MP2_ 800E_-MMP2_ 800E_-MP3_ 800E_-MMP3_ 800E_-LM_ 800E_-LMP2 800E_-LMP3 800E_-MM_ 800E_-MTS3_ 800E_-MTS4_ 800E_-MTS6</p>	800E-AML2		
	800E_-MJT_❶	800E-AMLJ1		
	800E_-MJ_❶	800E-AMLJ2		
	<p>800E_-MTS6_ 800E_-MJP2_ 800E_-MJP3_ 800E_-LMJ_ 800E_-LMJP2_ 800E_-LMJP3_</p>	800E-AMLJ3		
		<p>Locking Cover Used on flush, extended, and guarded momentary and alternate action operators, standard knob selector switch operators, and potentiometer operators.</p>	800E-AL01	
		<p>Plastic Bezel Ring Clear plastic bezel rings are meant as replacements for all 800E round illuminated flush push buttons. Black plastic bezel rings are meant as replacements for 800EP guarded non-illuminated push buttons. Plastic bezel rings are sold in multiples of 10. Order (quantity of) 10 to receive one package of 10 pieces.</p>	<p>Clear plastic</p> <p>Black plastic</p>	<p>800E-ALB1</p> <p>800EP-AG1</p>

❶ The last position in the catalog string is numeric only (i.e., 1, 2, 3, 4, 5, 6, or 8).

Accessories, Continued

Locking Attachments and Guards

	Description	Type	Cat. No.
	Plastic Guard Plastic guard for the following operators: <ul style="list-style-type: none"> • 40 mm E-stop (SEMI standards compliant) • 40 mm illuminated/non-illuminated alternate action and momentary operators • 60 mm illuminated/non-illuminated momentary operators • Low profile key operated selector switches 	Yellow	800E-A6PR5
		Yellow Oval ①	800E-A4PG5
		Black Round	800E-A6PR2
	Description	Type	Cat. No.
	Guarded Metal Bezel Used with illuminated push buttons.	Shiny metal	800E-ALG1
		Black anodized	800E-ALG2
		Lower shiny metal bezel	800E-ALG3
	40 mm Protective Guard Used with illuminated and non-illuminated 2 position push-pull, and non-illuminated momentary mushroom operators (40 mm) only.	Shiny metal protective ring	800E-AMRG
		Black metal protective ring	800E-AMRGB
	40 mm Protective Guard Used with illuminated and non-illuminated momentary mushroom operators (40 mm) only. Note: 800E-AMMG-BP Protective Guards are sold only in multiples of 30. Order (quantity of) 30 to receive one package of 30 pieces.	Shiny metal protective ring	800E-AMMG
		Shiny metal protective ring	800E-AMMG-BP
		Black metal protective ring	800E-AMMB





①Only for use on 40 mm products.

22.5 mm Push Buttons

IP66, Type 4/4X/13 (Plastic) — IP66, Type 4/13 (Metal)

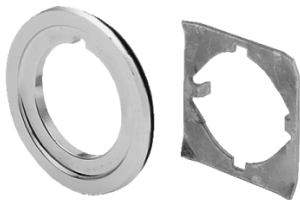

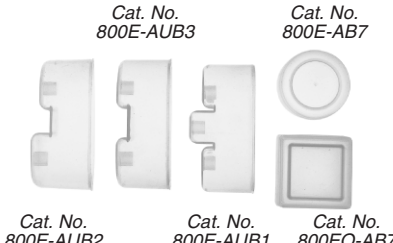

Accessories, Continued

Miscellaneous

	Description	Type	Cat. No.
	30 mm to 22 mm Hole Size Adapter This adapter allows a 22 mm push button operator to be installed in a panel with existing 30 mm mounting holes.	Shiny metal	800E-AHA1
		Black metal	800E-AHA2
 <p>Cat. No. 800E-AR1</p> <p>Cat. No. 800E-AR3</p> <p>Cat. No. 800E-AR2</p>	Replacement Mounting Ring and Ring Nuts All replacement mounting rings are sold only in multiples of 10. Order (quantity of) 10 to receive one package of 10 pieces. This mounting ring is used for thick panels. All replacement mounting rings are sold only in multiples of 10. Order (quantity of) 10 to receive one package of 10 pieces.	Plastic	800E-AR1
		Metal	800E-AR2
		Metal	800E-AR3
 <p>Cat. No. 800EQ-N2</p> <p>Cat. No. 800E-N8</p>	22.5 mm Hole Plugs These hole plugs are used to plug 22.5 mm holes.	Color	Cat. No.
		Square hole plugs	
		Black	800EQ-N2
		Gray	800EQ-N8
		Round hole plugs	
		Black	800E-N2
		Green	800E-N3
		Red	800E-N4
		Blue	800E-N6
Gray	800E-N8		
 <p>Cat. No. 800E-AUB3</p> <p>Cat. No. 800E-AB7</p> <p>Cat. No. 800E-AUB2</p> <p>Cat. No. 800E-AUB1</p> <p>Cat. No. 800EQ-AB7</p>	Protective Boots Clear silicone protective boot used on illuminated and non-illuminated, flush and extended operators. 800E boots are sold only in multiples of 10. Order (quantity of) 10 to receive one package of 10 pieces.	Multi-function — two flush buttons	800E-AUB3
		Multi-function — one flush button and one extended	800E-AUB2
		Multi-function — two flush buttons with center button extended	800E-AUB1
		Square operators	800EQ-AB7
		Flush round operators	800E-AB7
		Extended round illuminated and non-illuminated	800E-ABE7
			Selector Switch Cover Push-on cover used with illuminated selector switches for extra dust protection. Order (quantity of) 10 to receive one package of 10 pieces.

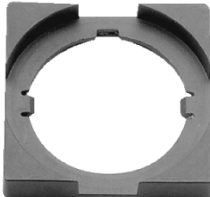
Accessories, Continued

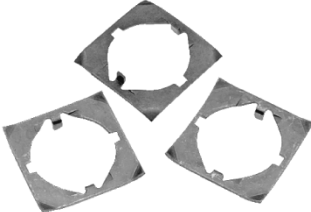

Miscellaneous

	Description		Cat. No.
	Mounting Ring Wrench This mounting ring wrench is used to tighten plastic or metal mounting rings quickly and securely.		800E-AW2
	Square Bezel Gives round operator a square appearance. This item is made of plastic. Note: Sold only in multiples of 10. Order (quantity of) 10 to receive one package of 10 pieces.		800E-ABZ1
	Lens/Bulb Removal Tool The large end of this tool provides quick and easy removal of an illuminated push button lens. The small end of this tool provides quick and easy removal of an incandescent or LED lamp.		800E-ALR1
	Locking Washer (Anti-Rotation Washer) This item provides an extra anti-rotation feature. Note: Sold only in multiples of 10. Order (quantity of) 10 to receive one package of 10 pieces.		800E-ALC1
	Ground Screw Kit This accessory is used on 800EP plastic enclosures only. Note: Sold only in multiples of 10. Order (quantity of) 10 to receive one package of 10 pieces.		800E-AGS2
	Description	Operator Description	Cat. No.
	Replacement Resistive Elements Replacement resistive elements for the 800EP potentiometer operator.	150 Ω	800E-AC1
		500 Ω	800E-AC2
		1,000 Ω	800E-AC3
		2,500 Ω	800E-AC4
		5,000 Ω	800E-AC5
		10,000 Ω	800E-AC6

22.5 mm Push Buttons

IP66, Type 4/4X/13 (Plastic) — IP66, Type 4/13 (Metal)

Replacement Lamps

Lamp	Type	Typical Current	Voltage	ANSI No.	Cat. No.
Incandescent 	Full voltage	150 mA	6 AC/DC	755	800E-N65 ❶
		80 mA	12 AC/DC	756	800E-N141 ❶
		70 mA	24 AC/DC	757	800E-N157 ❶
		50 mA	48 AC/DC	1835	800E-N48 ❶
		22 mA	130 AC/DC	949	800E-N130 ❶
	Transformer	150 mA	6 AC	755	800E-N65 ❶
	Flashing	150 mA	6 AC	267	800E-N212 ❶
	Resistor	20 mA	130 AC/DC	949	800E-N130 ❶
	Dual-input diode	57 mA	24 AC/DC	24MB	800E-N180 ❶
21 mA		120 AC	90MB	800E-N261 ❶	
Lamp	Type	Typical Current ❷	Voltage	Leakage Current	Cat. No.
LED  	Full voltage	14 mA/48 mA	6 AC/DC	14 mA	800E-N65x ❸
		13 mA/22 mA	12 AC/DC	3.5 mA	800E-N141x ❸
		13 mA/21 mA	24 AC/DC	3.5 mA	800E-N157x ❸
		12 mA/17 mA	32 AC/DC	3 mA	800E-N363x ❸
		9 mA/14 mA	48 AC/DC	3 mA	800E-N48x ❸
		3.3 mA/6 mA	120 AC	—	800E-N169x ❸
		4.5 mA/6.2 mA	130 AC/DC	2.2 mA	800E-N321x ❸
	Transformer	14 mA/48 mA	6 AC	14 mA	800E-N65x ❸
	2 Hz flashing	18 mA	24 AC/DC	—	800E-N157Fx ❹❸

❶ Sold in multiples of 10. Order (quantity of) 10 to receive one package of 10 pieces.

❷ Typical current draw varies with LED color. The first mA value is for a green, blue or white LED and the second mA value is for a red or amber LED.

❸ To complete the cat. no. replace the **x** with the first letter of the desired color: **A**mber, **G**reen, **R**ed, **B**lue, or **W**hite. **Note:** White LEDs available in 6V, 24V and 120V AC/DC only.

❹ To order 6V and 120V flashing LEDs, consult your local Allen-Bradley distributor for availability.

Pilot Light Wiring Diagrams

See Applicable Codes and Laws

Push-to-Test Pilot Light Device Schematic

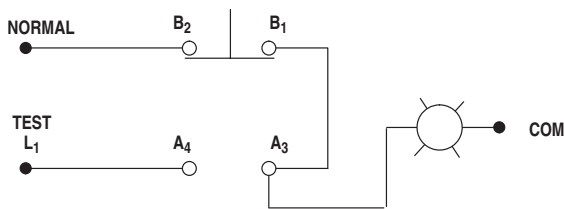

Dual Input Pilot Light Diode Type Device Schematic

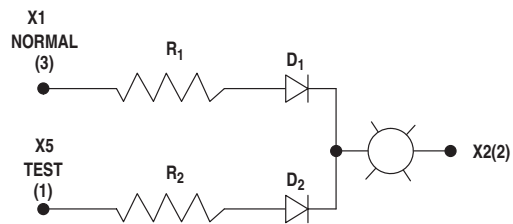

Dual Input Pilot Light Typical Application Wiring Diagram

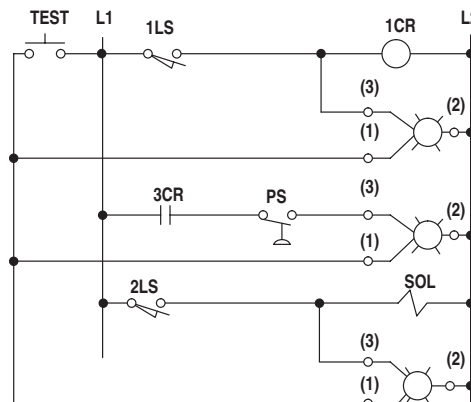

Note: Incandescent bulbs maximum power rating is 9 A.

Legend Plates

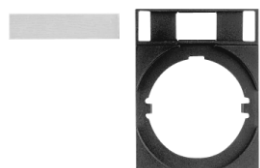

30 x 40 mm



30 x 50 mm

Legend Plate Frame and Snap-In Legend Plate

Type	Legend Plates without Text ❶		Legend Plates with Text
	Description	Cat. No.	Cat. No.
30 x 40 mm standard 2-piece snap-in	White with black legend text	800E-11WE100	800E-11W□□□□
	Black with white legend text	800E-11BE100	800E-11B□□□□
	Yellow with black legend text	800E-11YE100	800E-11Y□□□□
	Red with white legend text	800E-11RE100	800E-11R□□□□
30 x 50 mm standard 2-piece snap-in	White with black legend text	800E-12WE100	800E-12W□□□□
	Black with white legend text	800E-12BE100	800E-12B□□□□
	Yellow with black legend text	800E-12YE100	800E-12Y□□□□
	Red with white legend text	800E-12RE100	800E-12R□□□□
30 x 40 mm square appearance 2-piece snap-in	White with black legend text	800E-13WE100	800E-13W□□□□
	Black with white legend text	800E-13BE100	800E-13B□□□□
	Yellow with black legend text	800E-13YE100	800E-13Y□□□□
	Red with white legend text	800E-13RE100	800E-13R□□□□
30 x 50 mm square appearance 2-piece snap-in	White with black legend text	800E-14WE100	800E-14W□□□□
	Black with white legend text	800E-14BE100	800E-14B□□□□
	Yellow with black legend text	800E-14YE100	800E-14Y□□□□
	Red with white legend text	800E-14RE100	800E-14R□□□□

Snap-In Legend Plate

Type	Legend Plates without Text ❶		Legend Plates with Text
	Description	Cat. No.	Cat. No.
30 x 40 mm snap-in legend plate	White with black legend text	800E-17WE100	800E-17W□□□□
	Black with white legend text	800E-17BE100	800E-17B□□□□
	Yellow with black legend text	800E-17YE100	800E-17Y□□□□
	Red with white legend text	800E-17RE100	800E-17R□□□□
30 x 50 mm snap-in legend plate	White with black legend text	800E-18WE100	800E-18W□□□□
	Black with white legend text	800E-18BE100	800E-18B□□□□
	Yellow with black legend text	800E-18YE100	800E-18Y□□□□
	Red with white legend text	800E-18RE100	800E-18R□□□□

Legend Plate Frame ❶

Type	Description	Cat. No.
30 x 40 mm carrier	Legend plate frame	800E-110
30 x 50 mm carrier	Legend plate frame	800E-120
30 x 40 mm square	Legend plate frame	800E-130
30 x 50 mm square	Legend plate frame	800E-140

Specials: For custom text, special symbols, special fonts, or other languages, see pages 117...120.

Ordering Information: 1. Select cat. no. for appropriate legend size and color from Legend Plate with Text column.

2. Complete cat. no. by adding suffix no. selected from pages 117...119.

Example: **Cat. No. 800E-11YE101** identifies a yellow, 30 x 40 mm legend plate with AUTO engraved on it.

❶ All legend plates without text and all legend plate frames are sold only in multiples of 10. Order (quantity of) 10 to receive one package of 10 pieces.

22.5 mm Push Buttons

IP66, Type 4/4X/13 (Plastic) — IP66, Type 4/13 (Metal)

Legend Plates, Continued



Cat. No. 800E-34GE100



Cat. No. 800E-35BE128

Legend Plates without Text ❶			Legend Plates with Text
Type	Description	Cat. No.	Cat. No.
30 x 40 mm 1-piece legend	White with black legend text	800E-34WE100	800E-34W□□□□
	Black with white legend text	800E-34BE100	800E-34B□□□□
	Gray with white legend text	800E-34GE100	800E-34G□□□□
	Yellow with black legend text	800E-34YE100	800E-34Y□□□□
	Red with white legend text	800E-34RE100	800E-34R□□□□
	Aluminum with black legend text	800E-34AE100	800E-34A□□□□
30 x 50 mm 1-piece legend	White with black legend text	800E-35WE100	800E-35W□□□□
	Black with white legend text	800E-35BE100	800E-35B□□□□
	Gray with white legend text	800E-35GE100	800E-35G□□□□
	Yellow with black legend text	800E-35YE100	800E-35Y□□□□
	Red with white legend text	800E-35RE100	800E-35R□□□□
	Aluminum with black legend text	800E-35AE100	800E-35A□□□□

Specials: For custom text, special symbols, special fonts, or other languages, see pages 117...120.

Ordering Information: 1. Select cat. no. for appropriate legend size and color from Legend Plate with Text column.

2. Complete cat. no. by adding suffix no. selected from pages 117...119.

Example: **Cat. No. 800E-34YE101** identifies a yellow, 30 x 40 mm legend plate with AUTO engraved on it.



Cat. No. 800E-15Y



Cat. No. 800E-19AE100









Cat. No. 800E-15YE112

Legend Plates without Text ❶			Legend Plates with Black Text ❶
Type	Description	Cat. No.	Cat. No.
60 mm — round	Yellow	800E-15Y	800E-15YE112
90 mm — round		800E-16Y	800E-16YE112
Plastic enclosure legend plates	Aluminum	800E-19AE100	—

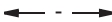
❶ Sold only in multiples of 10. Order (quantity of) 10 to receive one package of 10 pieces.

Legend Texts

Universal

Marking	Suffix No.	Marking	Suffix No.
	U226L	I-O-II	U234L
	U227L	I-II-III	U240L
O	U228L		U241L
I	U229L		U242L
II	U230L	III	U249L
I-O	U232L		U244L
I-II	U233L		U245L
O-I-II-III ❶	U286L	O-I-II-III ❷	U287L
O-1-2	U285L	I-O-I	U282L

English

One-Word Marking

Marking	Suffix No.	Marking	Suffix No.
AUTO	E101	ON	E166
CLOSE	E107	OPEN	E170
DOWN	E110	OUT	E173
EMERGENCY STOP	E112	POWER ON	E178
FAULT	E113	PUSH-TO-TEST ❸	E181
FAST	E114	RAISE	E182
FORWARD	E120	RESET	E186
HAND	E126	REVERSE	E188
HIGH	E129	RIGHT	E191
IN	E132	RUN	E193
INCH	E134	SLOW	E201
JOG	E138	START	E208
LEFT	E145	STOP	E212
LOW	E148	UP	E223
LOWER	E152	PUSH TO STOP-TWIST OR PULL RELEASE ❹	E262K
OFF	E163	HAND-O-AUTO	E283

Two-Word Marking

Marking	Suffix No.	Marking	Suffix No.
FOR-REV	E253	LEFT-RIGHT	E146
HAND-AUTO	E127	OFF-ON	E165
HIGH-LOW	E130	OPEN-CLOSE	E171
INCH-REVERSE ❸	E135	RAISE-LOWER	E183
JOG-FOR	E255	SLOW-FAST	E204
JOG-REV	E256	START-STOP	E211
JOG-RUN	E142	UP-DOWN	E224

Three-Word Marking

Marking	Suffix No.	Marking	Suffix No.
FOR-STOP-REV ❸	E254	LOW-OFF-HIGH ❸	E150
FOR-OFF-REV ❸	E261	RAISE-OFF-LOWER ❸	E184
HAND-OFF-AUTO ❸	E128	SLOW-OFF-FAST ❸	E205
JOG-STOP-RUN ❸	E144	SLOW-OFF-START ❸	E207

Four-Word Marking

Marking	Suffix No.	Marking	Suffix No.
OFF-LOW-MED-HIGH ❶	E280	OFF-LOW-MED-HIGH ❷	E281

❶ Must not be used with 800EQ operators. Available only on 30 x 40 mm legend plates.

❷ For 800EQ operators only. Available only on 30 x 40 mm legend plates.

❸ Standard size engraving for three-word text is not available on 30 x 40 mm legend plates. The letter **K** must be added to the completed cat. no. to specify smaller font size.

❹ Available only in small size font on 30 x 50 mm legend plates.

22.5 mm Push Buttons

IP66, Type 4/4X/13 (Plastic) — IP66, Type 4/13 (Metal)

Legend Texts, Continued**French**

Marking	Suffix No.	Marking	Suffix No.
Auto	F101	Ouvrir	F170
Fermer	F107	Monter	F182
Descendre	F110	Arrière	F188
Arrêt D'urgence	F112	Droit	F191
Panne	F113	Régler	F198
Rapide	F114	Lent	F201
Avant	F120	Marche-Arrêt	F211
Avant-Arrêt-Arrière ❶	F122	Hors Circuit	F244
Avant-Arrière	F124	En Circuit	F245
Manuel	F126	Hors	F246
Manuel-Auto	F127	En	F247
Manuel-Arrêt-Auto ❶	F128	Hors-En	F248
Haut	F129	Hors Manuel	F249
Gauche	F145	En Manuel	F250
Bas	F148	Arrêt-Manuel	F251
Bas-Arrêt-Haut ❶	F150	Demar. Man.	F252
Arrêt	F163	Av-Hors-Arr	F253
Arrêt-Marche	F165	Surcharge	F254
Marche	F166	M Forcee	F284

German

Marking	Suffix No.	Marking	Suffix No.
Zu	G107	Niedrig	G148
Ab	G110	Niedrig-Aus-Hoch ❶	G150
Not Aus	G112	Senken	G152
Störung	G113	Aus	G163
Schnell	G114	Aus-Ein	G165
Vor	G120	Ein	G166
Vor-Aus-Zurück ❶	G122	Heben	G182
Vor-Zurück	G124	Zurück	G188
Hand	G126	Rechts	G191
Hand-Auto	G127	Langsam	G201
Hand-Aus-Auto ❶	G128	Auf	G223
Hoch	G129	Betrieb	G243
Links	G145	—	—

❶ Standard size engraving for three-word text is not available on 30 x 40 mm legend plates. The letter **K** must be added to the completed cat. no. to specify smaller font size.

Legend Texts, Continued

Italian

Marking	Suffix No.	Marking	Suffix No.
Automatico	T101	Disinserito	T163
Chiudere	T107	Disins-Ins	T165
Discesa	T110	Inserito	T166
Arresto, Emergenza	T112	Salita	T182
Disturbo	T113	Indietro	T188
Rapido	T114	Destra	T191
Avanti	T120	Preparare	T198
Avanti-Disins-Indietro ❶	T122	Lento	T201
Avanti-Indietro	T124	Marcia	T208
Manuale	T126	Marcia-Arresto	T211
Manuale-Auto	T127	Arresto	T212
Manuale-Disins-Auto ❶	T128	Aprire	T223
Alto	T129	In Servizio	T243
Sinistra	T145	Rotazione CW	T246
Basso	T148	Rotazione CCW	T247
Basso-Disins-Alto ❶	T150	Emergenza	T248
Abbassare	T152	—	—

Spanish

Marking	Suffix No.	Marking	Suffix No.
Cerrar	S107	Abrir	S170
Parada de Emergencia	S112	Subida	S182
Adelante	S120	Atrás	S188
Adelante-Parada-Atrás ❶	S123	Derecha	S191
Adelante-Atrás	S124	Marcha	S208
Manual	S126	Marcha-Parada	S211
Manual-Auto	S127	Parada	S212
Izquierda	S145	En Servicio	S243
Bajada	S152	—	—

❶ Standard size engraving for three-word text is not available on 30 x 40 mm legend plates. The letter **K** must be added to the completed cat. no. to specify smaller font size.

22.5 mm Push Buttons

IP66, Type 4/4X/13 (Plastic) — IP66, Type 4/13 (Metal)

Special Fonts

When ordering special font sizes for standard text or ordering special engravings, do not exceed the maximum letters and lines listed in the table below.

Type of Legend Plate						
Font Size	One-Piece			Two-Piece		
	Maximum Characters per Line	Maximum Number of Lines ❶		Maximum Characters per Line	Maximum Number of Lines ❶	
		30 x 40	30 x 50		30 x 40	30 x 50
Small	16	2	5	15	2	5
Standard	14	2	3	13	1	3
Large	10	1	3	9	1	3

❶ Two lines are the recommended maximum to use with mushroom operator.

The standard legend texts listed on pages 117...119 are available in other font sizes. To order, select the desired legend plate with text from pages 115...119 and add the desired font code from the table below to the cat. no.

Special Font Code ❷		
Font Size	Approximate Size	Font Code
Small	SAMPLE	K
Standard ❸	SAMPLE	S
Large	SAMPLE	L

❷ A code from this table **must** be entered into the cat. no. for special engraving.

❸ Character height used on standard engraving.

Special Engraving

Besides the standard text and symbols listed on pages 117...119, special legend plates are readily available.

To order:

1. Select desired legend plate without text from pages 115 and 116.
2. Add desired font code from the table above.
3. Specify desired text.

800E-11WE100 K STARTER

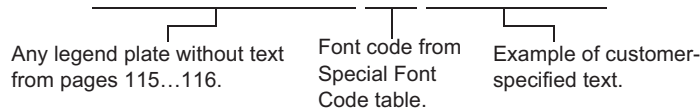

Worldwide Capabilities

For worldwide exporters, Rockwell Automation has legend plates available in English, Spanish, French, Italian, and German and in a wide range of international symbols. For more information, consult your local Allen-Bradley distributor.

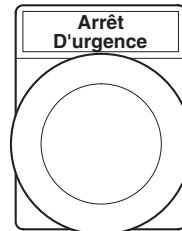
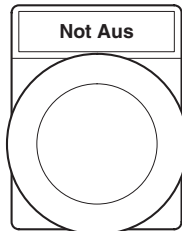

To order a 30 x 50 mm white legend plate with the standard text AUTO in large font, order **Cat. No. 800E-12WE101L**.

To order a 30 x 40 mm white legend plate with the word PUMP in a standard font, order special **Cat. No. 800E-11WE100S**.

Clear Legend Inserts for Illuminated Diffuser Type Operators

800E – 21WE100 (Round Operators)

800EQ – 21WE208 (Square Operators)

English ①②				Movement Symbols ①					
Marking	Code	Marking	Code	Marking	Code	Marking	Code		
Blank	21WE100	OFF	21WE163		Rectilinear motion	21WE700		Reduced speed	21WE723
AUTO	21WE101	ON	21WE166		Vert. rect. motion	21WE702		Rapid feed	21WE724
CLOSE	21WE107	OPEN	21WE170		Int. rect. motion	21WE703		Normal feed	21WE725
DOWN	21WE110	RAISE	21WE182		Ltd. rect. motion	21WE704		Longitudinal feed	21WE726
FAULT	21WE113	REVERSE	21WE188		Ltd. motion & ret.	21WE705		Transverse feed	21WE727
FAST	21WE114	RIGHT	21WE191		Osc. motion, ret.	21WE706		Rapid transverse	21WE728
FORWARD	21WE120	SLOW	21WE201		Cont. rot. right	21WE707		Threading	21WE729
HAND	21WE126	START	21WE208		Cont. rot. left	21WE708		Increase	21WE730
HIGH	21WE129	STOP	21WE212		Dir. int. rot. left	21WE710		Decrease	21WE731
LEFT	21WE145	UP	21WE223		Dir. int. rot. right	21WE711		Conv. milling	21WE736
LOW	21WE148	RESET	21WE186		Dir. spindle speed	21WE717		Climb milling	21WE737
LOWER	21WE152	—	—		Feed	21WE720	—	—	—

Function Symbols ①				Equipment Symbols ①		Miscellaneous Symbols ①	
Marking	Code	Marking	Code	Marking	Code	Marking	Code
	21WE900		21WE912		21WE800		21WE875
	21WE901		21WE913		21WE803		21WE876
	21WE902		21WE914		21WE804		21WE877
	21WE903		21WE917		21WE805		21WE878
	21WE904		21WE918		21WE806		21WE879
	21WE905		21WE919		21WE807		21WE880
	21WE906		21WE920		21WE808		21WE881
	21WE907	—	—		21WE809		21WE882
	21WE908	—	—		21WE810		21WE883
	21WE909	—	—		21WE811		21WE884
	21WE910	—	—		21WE812	—	—

Caution Symbols ①							
Marking	Code	Marking	Code	Marking	Code	Marking	Code
	21WE850		21WE852		21WE853		21WE854
	21WE851	—	—	—	—	—	—

Note: Legend inserts are for use in illuminated push buttons or standard pilot lights. All legend inserts sold in multiples of 10.

- ① Standard order quantity is 10. Order (quantity of) 10 to receive 1 package of 10 pieces. Otherwise, add “-BP” to cat. no. to receive one sheet of 50 legends.
- ② For more English or other language texts, substitute last four characters with the code from desired language shown on pages 117 thru 119.

Joy Stick Legend Plate Inserts

Joy Stick Legend Plate		
Type	Description	Cat. No.
30 x 50mm 1-piece legend plate	White with black legend text	800E-35WJ□□□
	Black with white legend text	800E-35BJ□□□
	Gray with white legend text	800E-35GJ□□□
	Yellow with black legend text	800E-35YJ□□□
	Red with white legend text	800E-35RJ□□□
	Aluminum with black legend text	800E-35AJ□□□

Ordering Information: 1. Select cat. no. for appropriate text and legend color from table above.
 2. Complete cat. no. by adding suffix number selected from table below.

Example: **Cat. No. 800E-35WJ503** identifies a white, 30 x 50mm legend insert with left/right arrows engraved on it.

Engraved Marking for Joy Stick Legend Plate					
Type	Engraved Marking	Suffix No.	Type	Engraved Marking	Suffix No.
Engraved joy stick legend plates		501	Engraved joy stick legend plates		505
		502			506
		503			507
		504			508

Two-Color Molded Legend Caps for Non-Illuminated Push Buttons ①

800 E - AF 3 01 W
 a b c d e



Cat. No. 800E-AF303W



Cat. No. 800E-AF402W

d (cont'd)

a

Operator Type		
Code	Description	*
E	Round	
EQ	Square ②	

b

Button Cap Type		
Code	Description	*
AF	Flush	
AE	Extended	

c

Color Cap		
Code	Color	*
1	White	
2	Black	
3	Green	
4	Red	
5	Yellow	
6	Blue	
8	Gray	

d

Legend Text ③		
Code	English	*
01	START	
02	STOP	
03	ON	
04	OFF	
05	O	
06	I	
07	RESET	
08	→ ④	
09	FORWARD	
10	REVERSE	
11	R	
12	JOG	
13	UP	
14	DOWN	
15	RAISE	
16	LOWER	
17	IN	
18	OUT	
19		
20		

Legend Text ③		
Code	English	*
21		
22	STOP/RESET	
23	HIGH	
24	LOW	
25	START/I	
26	STOP/O	
French		
Code	Text	*
F01	MARCHE	
F02	ARRÊT	
F09	AVANT	
F10	ARRIÈRE	

e

Legend Text		
Code	Color	*
W	White ⑤	
B	Black ⑤	

① All legend caps sold in multiples of 10.
 ② Legend caps for square operators only available in legend text codes 1...18.

③ Legend button cap supplied loose for customer installation [→], [↑], [←], [↓].
 ④ Use cap colors black, green, red, blue, and gray **only**.
 ⑤ Use cap colors white or yellow **only**.

22.5 mm Push Buttons

IP66, Type 4/4X/13 (Plastic) — IP66, Type 4/13 (Metal)

Approximate Dimensions for Round and Square Operators

Dimensions in millimeters (inches). Dimensions are not intended to be used for manufacturing purposes.

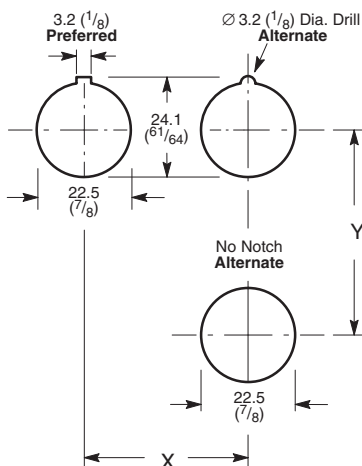

Note: Panel thickness range 1.0...6.0 mm (3/64...15/64"). Maximum panel thickness reduced when optional legend plates are used.

Panel Hole Spacing (Minimum)			
Operator	Legend Plate Used	X	Y
Standard with single circuit contact	None/30x40 mm legend plate ❶	30 (1-3/16)	40 (1-37/64)
	30x50 mm legend plate	30 (1-3/16)	50 (1-31/32)
Standard with double circuit contact	Any	30 (1-3/16)	50 (1-31/32)
40 mm push-pull/T-T-R, mushroom/mushroom with single circuit contact ❷	None/30x40 mm legend plate ❶	40 (1-37/64)	40 (1-37/64)
	30x50 mm legend plate	40 (1-37/64)	50 (1-31/32)
40 mm push-pull/T-T-R, mushroom/mushroom key release w/double circuit contact ❷	Any	40 (1-37/64)	50 (1-31/32)
Knob lever selector switch with single circuit contact	None/30x40 mm legend plate ❶	48 (1-57/64)	40 (1-37/64)
	30x50 mm legend plate	48 (1-57/64)	50 (1-31/32)
Knob lever selector switch with double circuit contact	Any	48 (1-57/64)	50 (1-31/32)
Any	60 mm round legend plate	60 (2-3/8)	60 (2-3/8)
	90 mm round legend plate	90 (3-9/16)	90 (3-9/16)

- ❶ If a 3X latch is used a 30 x 50 mm minimum spacing is required.
- ❷ If a 60 mm operator is used a 60 x 60 mm minimum spacing is required.

Approximate Dimensions for Round Operators

Non-Illuminated Flush Head Push Button Operators

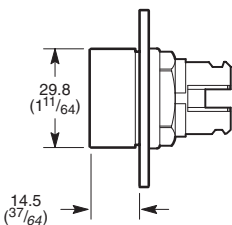

Shipping Wt. 19 g (0.7 oz.) Plastic
Shipping Wt. 42 g (1.5 oz.) Metal

Illuminated Flush Head Push Button Operators

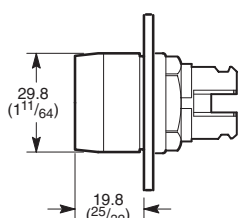

Shipping Wt. 19 g (0.7 oz.) Plastic
Shipping Wt. 42 g (1.5 oz.) Metal

Illuminated and Non-Illuminated Extended Head Push Button Operators

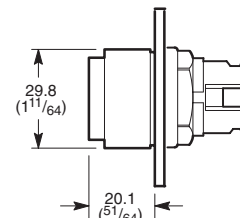

Shipping Wt. 20 g (0.7 oz.) Plastic
Shipping Wt. 43 g (1.5 oz.) Metal

Non-Illuminated Guarded Push Button Operators

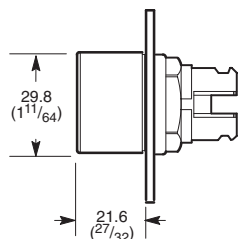

Shipping Wt. 30 g (1.1 oz.) Plastic
Shipping Wt. 45 g (1.6 oz.) Metal

Illuminated Guarded Head Push Button Operators

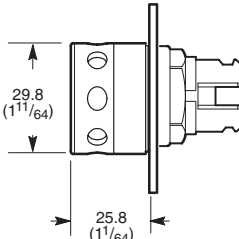

Shipping Wt. 28 g (1.0 oz.) Plastic
Shipping Wt. 46 g (1.6 oz.) Metal

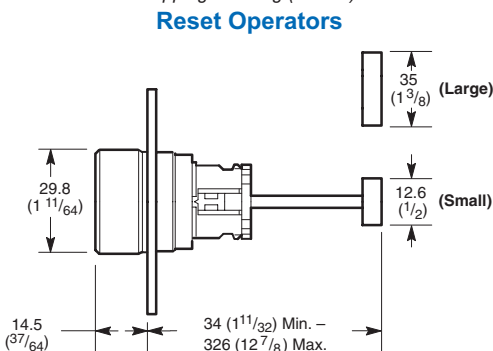

Shipping Wt. 20 g (0.7 oz.) Plastic
Shipping Wt. 42 g (1.5 oz.) Metal

Non-Illuminated Alternate Action Push Button Operators

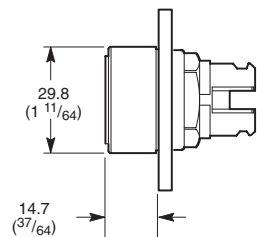

Shipping Wt. 19 g (0.7 oz.) Plastic
Shipping Wt. 42 g (1.5 oz.) Metal

Illuminated Alternate Action Push Button Operators

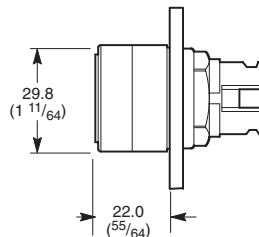

Shipping Wt. 19 g (0.7 oz.) Plastic
Shipping Wt. 42 g (1.5 oz.) Metal

Pilot Light Operators without Optics

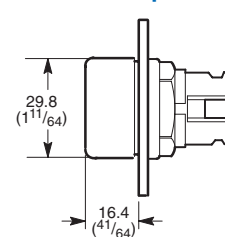

Shipping Wt. 13 g (0.5 oz.) Plastic
Shipping Wt. 30 g (1.1 oz.) Metal

22.5 mm Push Buttons

IP66, Type 4/4X/13 (Plastic) — IP66, Type 4/13 (Metal)

Approximate Dimensions for Round Operators, Continued

Dimensions in millimeters (inches). Dimensions are not intended to be used for manufacturing purposes.

Pilot Light Operators with Optics

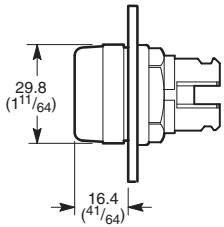

Shipping Wt. 14 g (0.5 oz.) Plastic
Shipping Wt. 32 g (1.1 oz.) Metal

Non-Illuminated Momentary Mushroom Head Operators 40 mm and 60 mm

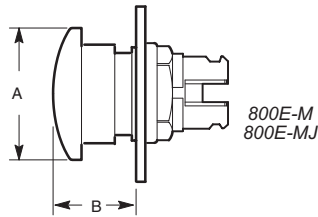

Shipping Wt. 29 g (1.0 oz.) Plastic
Shipping Wt. 54 g (1.9 oz.) Metal

Twist-to-Release Mushroom Operators 40 mm and 60 mm

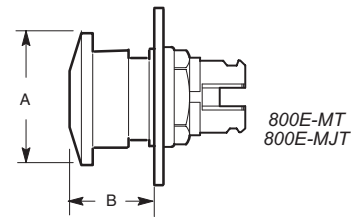

Shipping Wt. 31 g (1.1 oz.) 40 mm Plastic
Shipping Wt. 58 g (2.0 oz.) 40 mm Metal

A	B	
	Out	In
40 (1-9/16)	27 (1-1/16)	22.8 (57/64)
60 (2-23/64)	27 (1-1/16)	22.8 (57/64)

A	B	
	Out	In
40 (1-9/16)	27 (1-1/16)	22.8 (57/64)
60 (2-11/32)	27 (1-1/16)	22.8 (57/64)

Knob Selector Switch Operators Illuminated and Non-Illuminated

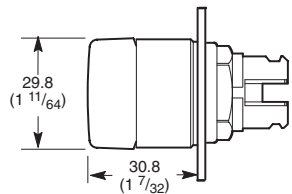

Shipping Wt. 22 g (0.8 oz.) Plastic
Shipping Wt. 60 g (2.1 oz.) Metal

Knob Lever Selector Switch Operators Illuminated and Non-Illuminated

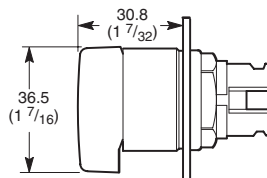

Shipping Wt. 24 g (0.8 oz.) Plastic
Shipping Wt. 62 g (2.2 oz.) Metal

Selector-Jog Push Button Operators

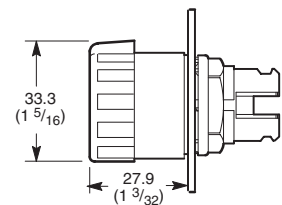

Shipping Wt. 28 g (1.0 oz.) Plastic
Shipping Wt. 64 g (2.3 oz.) Metal

Joy Stick Operators

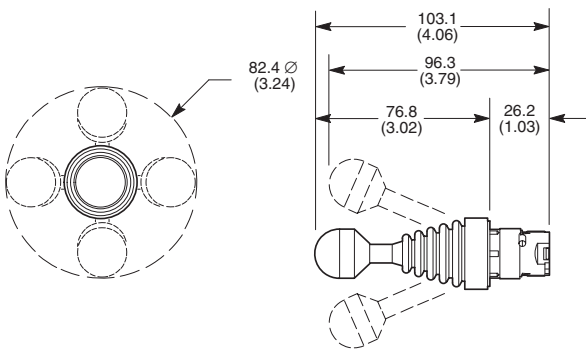

Shipping Wt. 65 g (2.3 oz.)

Multi-Function Push Button Operators

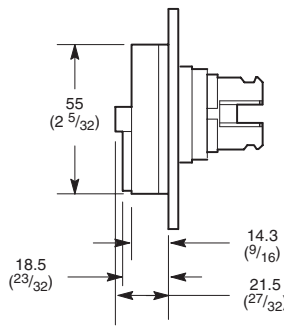

Shipping Wt. 22 g (0.8 oz.)
Note: Face width is 30 (1.2)

Monolithic Pilot Light

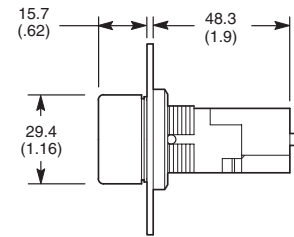

Shipping Wt. 28 g (1.0 oz.)

Wobble Stick Operators

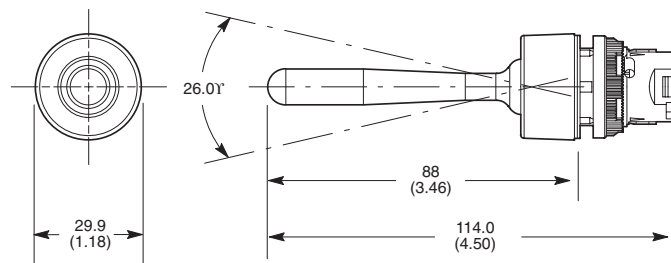

Shipping Wt. 53 g (1.9 oz.)

Potentiometer

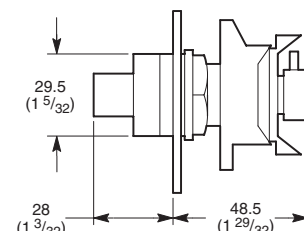

Shipping Wt. 48 g (1.7 oz.)

22.5 mm Push Buttons

IP66, Type 4/4X/13 (Plastic) — IP66, Type 4/13 (Metal)

Approximate Dimensions for Round Operators, Continued

Dimensions in millimeters (inches). Dimensions are not intended to be used for manufacturing purposes.

2-Position Push-Pull Mushroom Operators Illuminated and Non-Illuminated 40 mm and 60 mm

800E-MP
800E-LMP
800E-LMJ

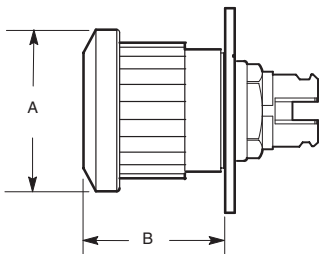

3-Position Push-Pull Mushroom Operators Illuminated and Non-Illuminated 40 mm and 60 mm

800E-MP3
800E-MJP3
800E-LMP3
800E-LMJP3

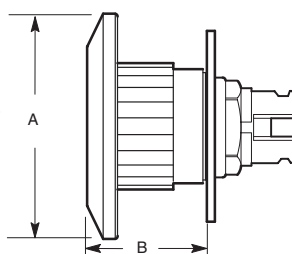

Shipping Wt. 76 g (2.7 oz.) 60m Metal

Momentary Mushroom Operators Illuminated 40 mm and 60 mm and Non-Illuminated 40 mm Metal Head Mushroom Operator

800E-LMJ
800E-MM
800E-LM

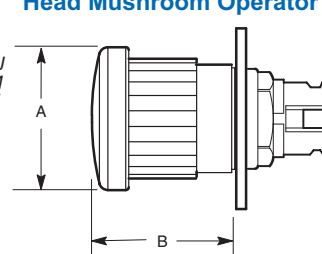

A	B	
	Out	In
40 (1-37/64)	37.9 (1-31/64)	32.9 (1-19/64)
60 (2-23/64)	37.9 (1-31/64)	32.9 (1-19/64)

A	B		
	Out	Center	In
40 (1-37/64)	37.9 (1-31/64)	35.3 (1-25/64)	32.9 (1-19/64)
60 (2-23/64)	37.9 (1-31/64)	35.3 (1-25/64)	32.9 (1-19/64)

A	B	
	Out	In
40 (1-37/64)	37.9 (1-31/64)	33.2 (1-5/16)
60 (2-23/64)	37.9 (1-31/64)	33.2 (1-5/16)

2-Position Trigger Action Twist-to-Release Operator 30 mm and Mushroom Key Release Operator 30 mm

800E-MTS3

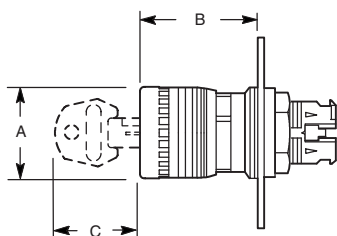

Shipping Wt. 30 g (1.1 oz.) Plastic
Shipping Wt. 65 g (2.4 oz.) Metal

2-Position Trigger Action Mushroom and Mushroom Key Release Operator 40 mm

800E-MTS4

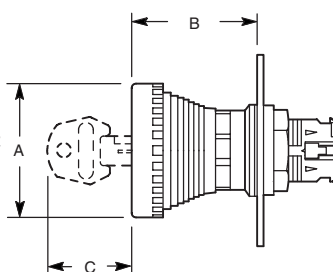

Shipping Wt. 64 g (2.3 oz.) Plastic
Shipping Wt. 101 g (3.7 oz.) Metal

2-Position Trigger Action Mushroom and Mushroom Key Release Operator 60 mm

800E-MTS6

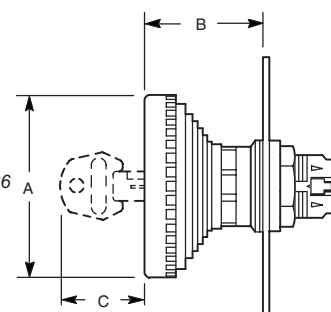

Shipping Wt. 78 g (2.9 oz.) Plastic
Shipping Wt. 114 g (4.2 oz.) Metal

A	B		C	
	Out	In	Ronis	Zadi
30 (1.2)	41 (1.6)	36 (1.4)	27 (1.1)	24 (0.94)

A	B		C	
	Out	In	Ronis	Zadi
40 (1.6)	41 (1.6)	36 (1.4)	27 (1.1)	24 (.94)

A	B		C	
	Out	In	Ronis	Zadi
60 (2.4)	41 (1.6)	36 (1.4)	27 (1.1)	24 (.94)

E-Stop Key Release Mushroom Operators 40 mm and 60 mm

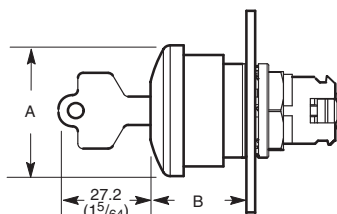

Shipping Wt. 111 g (3.9 oz.) 40 mm Metal

A	B	
	Out	In
40 (1-9/16)	34 (1-11/32)	29.2 (1-9/64)
60 (2-19/64)	34 (1-11/32)	29.2 (1-9/64)

Key Selector Switch Operators

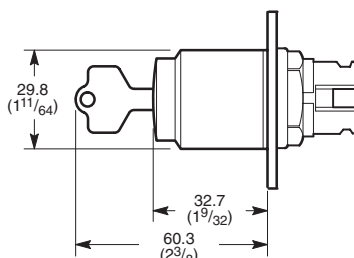

Low Profile Key Selector Switch Operators

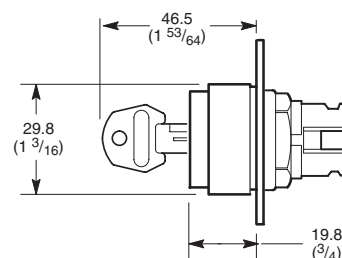

Shipping Wt. 50 g (1.8 oz.) Plastic
Shipping Wt. 63 g (2.2 oz.) Metal

① Trigger action operators are compliant with EN418 Standards.

22.5 mm Push Buttons

IP66, Type 4/4X/13 (Plastic) — IP66, Type 4/13 (Metal)

Approximate Dimensions for Square Operators

Dimensions in millimeters (inches). Dimensions are not intended to be used for manufacturing purposes.

**Non-Illuminated
Extended Head Operators**

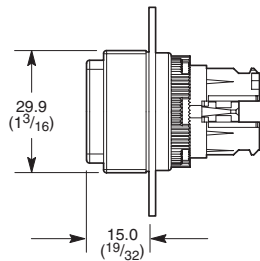

Shipping Wt. 21 g (0.7 oz.)

**Non-Illuminated Alternate Action
Flush Head Operators**

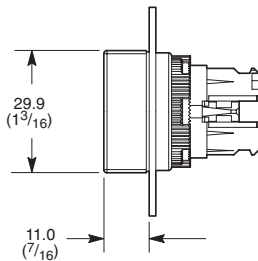

Shipping Wt. 19 g (0.7 oz.)

**Illuminated Alternate Action
Flush Head Operators**

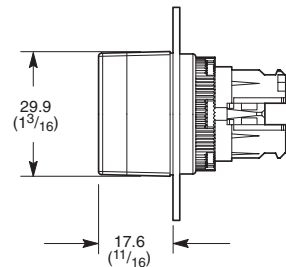

**Illuminated
Extended Head Operators**

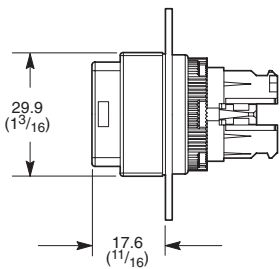

Selector Switch Operators

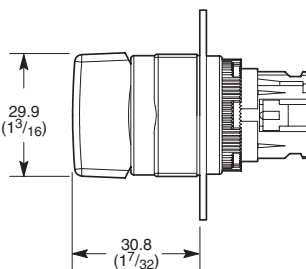

Shipping Wt. 64 g (2.3 oz.)

**Key Operated
Selector Switch Operators**

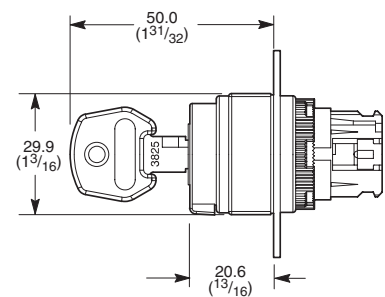

Mushroom Head Operators

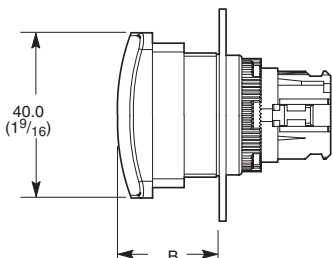

Shipping Wt. 28 g (1.0 oz.) Plastic

Reset Operators

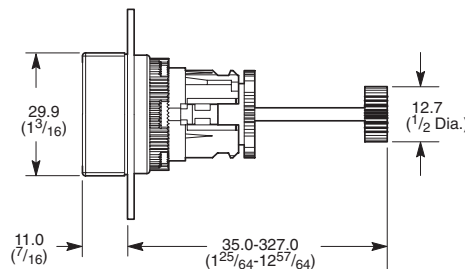

**Non-Illuminated
Guarded Operators**

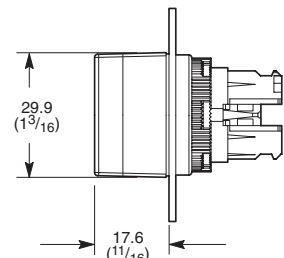

B	
Out	In
24.4 (31/32)	19.6 (49/64)

Monolithic Pilot Light Operators

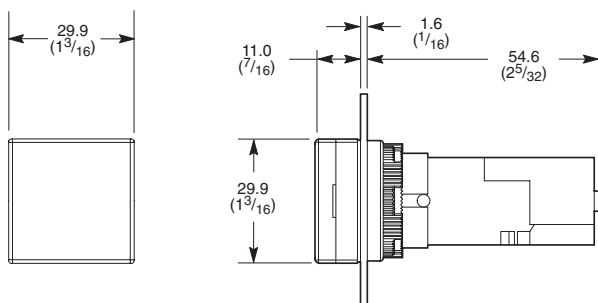

Shipping Wt. 29 g (1.0 oz.)

Pilot Light Operators

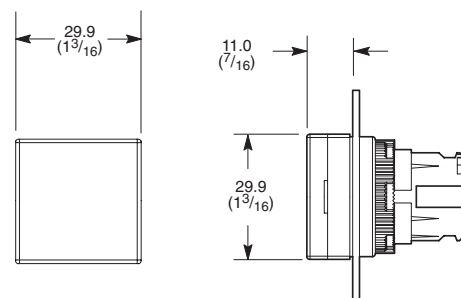

Shipping Wt. 15 g (0.5 oz.)

22.5 mm Push Buttons

IP66, Type 4/4X/13 (Plastic) — IP66, Type 4/13 (Metal)

Approximate Dimensions

Dimensions in millimeters (inches). Dimensions are not intended to be used for manufacturing purposes.

Back-of-Panel Components, 2-Across (2X) — Latch Width is 29.5 (1.16)

Full Voltage Module with Latch

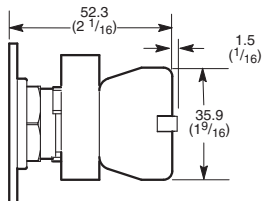

Shipping Wt. 50 g (1.8 oz.)

Dual Input Diode Module with Latch

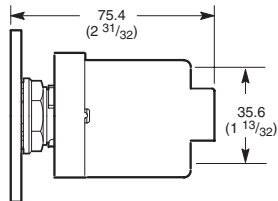

Shipping Wt. 100 g (3.5 oz.)

Transformer or Resistor Module with Latch

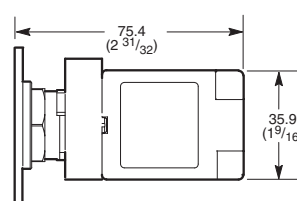

Shipping Wt. 95 g (3.4 oz.)

Contact Cartridges with Latch (Maximum of 3 Deep)

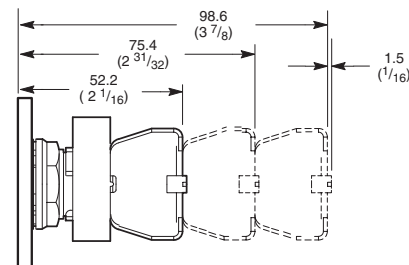

Shipping Wt. 33 g (1.2 oz.) Latch
Shipping Wt. 15 g (0.53 oz.) One Contact Block

Note: Latch width for all 2-across back-of-panel components is 29.5 (1-5/32).

Back-of-Panel Components, 3-Across (3X) — Latch Width is 29.7 (1.17)

Contact Cartridges with Latch (Maximum of 2 Deep)

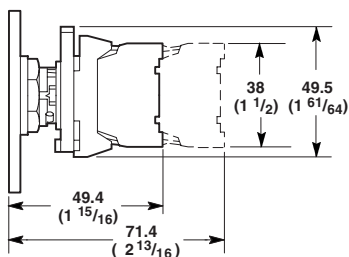

Shipping Wt. 10 g (0.4 oz.) Latch
Shipping Wt. 11 g (0.4 oz.) One Contact Block

Full Voltage or Resistor Module with Latch

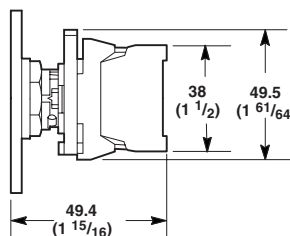

Shipping Wt. 23 g (0.8 oz.)

Transformer Module with Latch

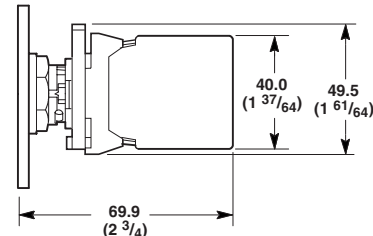

Shipping Wt. 70 g (2.5 oz.)

Note: Latch width for all 3-across and 4-across back-of-panel components is 29.7 (1-11/64).

Back-of-Panel Components, 4-Across (4X) — Latch Width is 29.7 (1.17)

Contact Cartridges with Latch

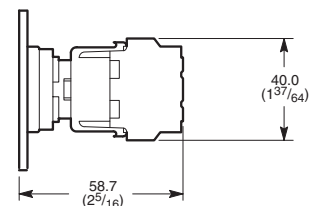

Shipping Wt. 13 g (0.5 oz.) Latch
Shipping Wt. 10 g (0.4 oz.) One Contact Block

2-Circuit Contact Cartridge with Latch

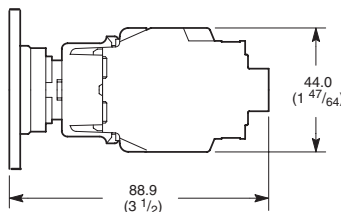

Shipping Wt. 20 g (0.7 oz.)

Full Voltage Module with Latch (Also applies to latch with full voltage module and contacts.)

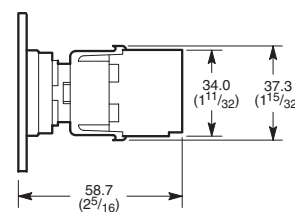

Shipping Wt. 10 g (0.4 oz.)

Tall Transformer (277V-600V) Module (Latch Built-in)

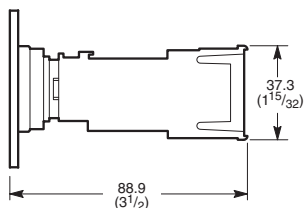

Compact Transformer or Resistor Modules with Latch

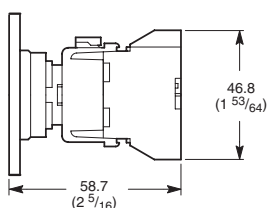

Tall Transformer Module with Contacts (Latch Built-in)

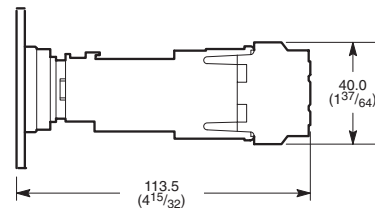

22.5 mm Push Buttons

IP66, Type 4/4X/13 (Plastic) — IP66, Type 4/13 (Metal)

Approximate Dimensions, Continued

Dimensions in millimeters (inches). Dimensions are not intended to be used for manufacturing purposes.

Square Bezel

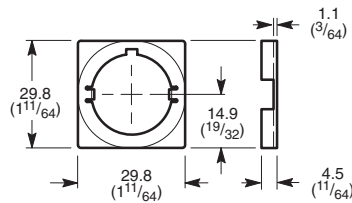

Cat. No. 800E-ABZ1

30 x 40 mm Standard Legend Plate

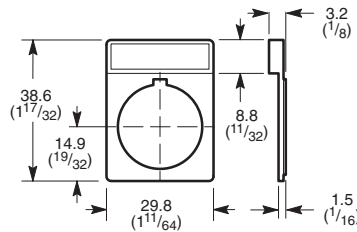

Shipping Wt. 2 g (0.1 oz.)
Cat. No. 800E-11_____

30 x 40 mm Legend Plate Square Appearance

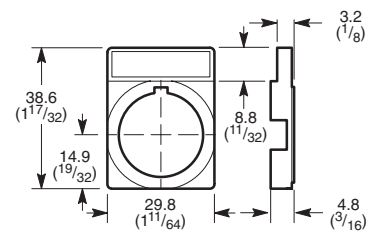

Shipping Wt. 3 g (0.1 oz.)
Cat. No. 800E-13_____

30 x 50 mm Standard Legend Plate

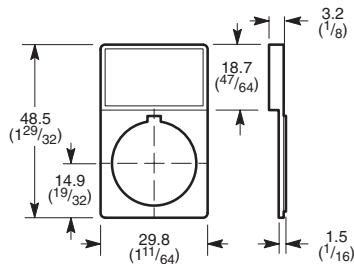

Cat. No. 800E-12_____

30 x 50 mm Legend Plate Square Appearance

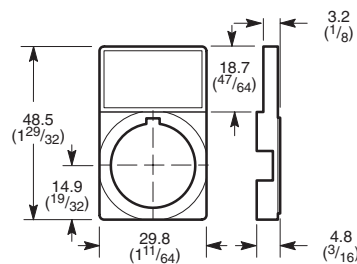

Cat. No. 800E-14_____

60 mm Round Legend

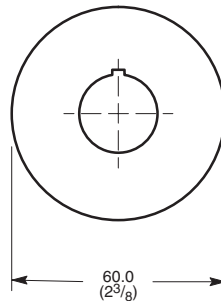

Cat. No. 800E-15Y_____

90 mm Round Legend

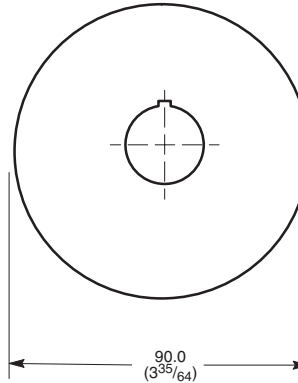

Cat. No. 800E-16Y_____

30 x 40 mm One-Piece Legend Plate

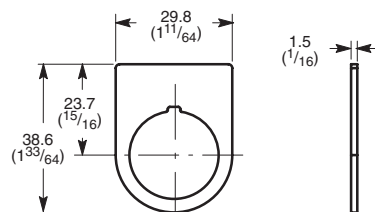

Shipping Wt. 2 g (0.1 oz.)
Cat. No. 800E-34_____

30 x 50 mm One-Piece Legend Plate

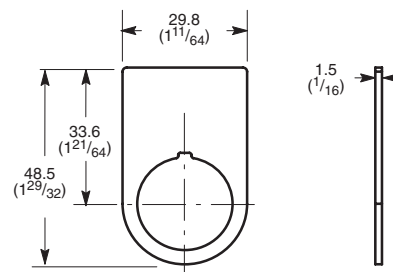

Shipping Wt. 2 g (0.1 oz.)
Cat. No. 800E-35_____

Note: Panel thickness range from 1.0 (3/64) to 6.0 (15/16) maximum.
Panel thickness reduced to 4.5 (11/64) when optional legend plates are used.

22.5 mm Push Buttons

IP66, Type 4/4X/13 (Plastic) — IP66, Type 4/13 (Metal)

Approximate Dimensions, Continued

Dimensions in millimeters (inches). Dimensions are not intended to be used for manufacturing purposes.

Flush Non-Illuminated Push Button Locking Attachment

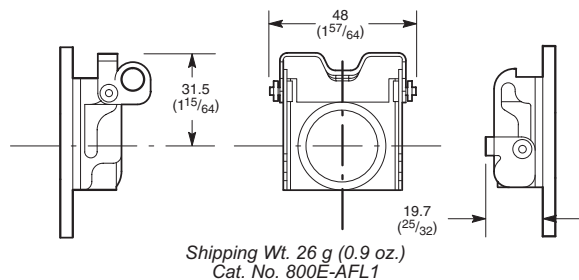

Extended Non-Illuminated Push Button Locking Attachment

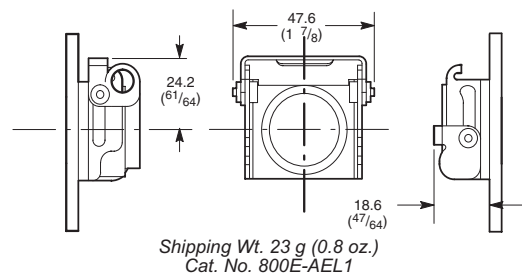

Locking Cover

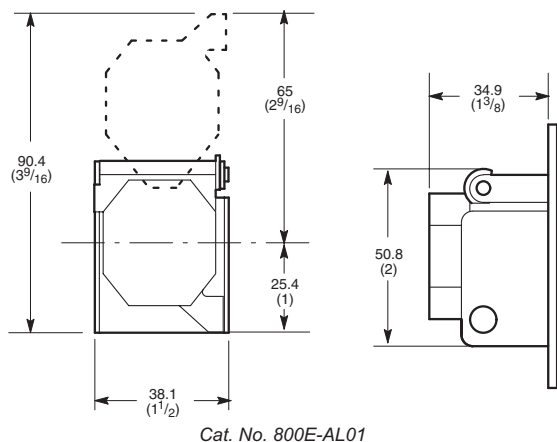

2- and 3-Position Selector Switch Locking Attachment ①

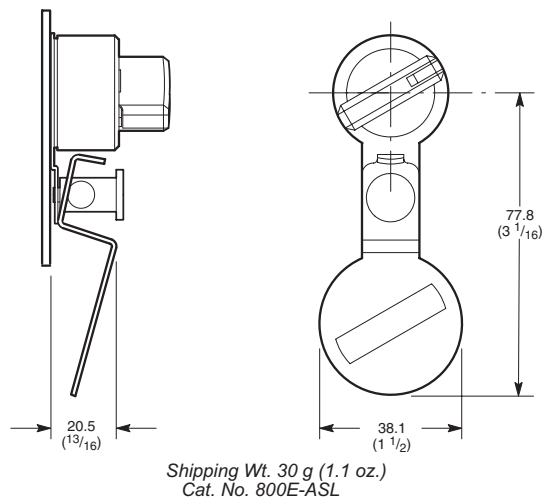

40 mm Mushroom Push-Pull Protective Ring (Stainless Steel)

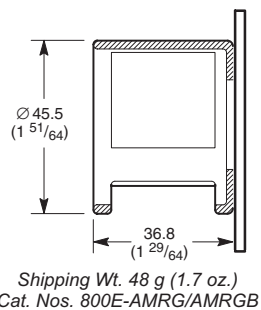

Plastic Guard

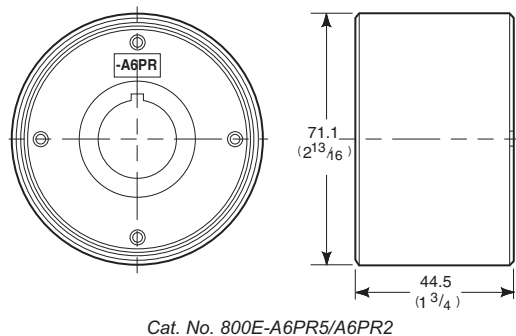

① This locking attachment may interfere with the operation of operators located beneath.

22.5 mm Push Buttons

IP66, Type 4/4X/13 (Plastic) — IP66, Type 4/13 (Metal)

Approximate Dimensions, Continued

Dimensions in millimeters (inches). Dimensions are not intended to be used for manufacturing purposes.

40 mm Mushroom Style Operator Locking Attachments (see table below)

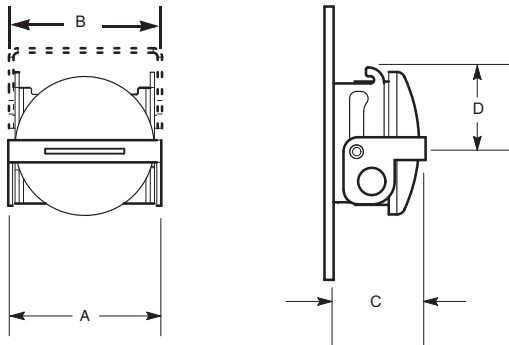

Cat. No. 800E-AML_

Cat. No.	A	B	C	D
800E-AML1	49.5 (1-15/16)	54.2 (2-1/8)	25.7 (1-1/32)	24.8 (31/32)
800E-AML2	49.5 (1-15/16)	54.2 (2-1/8)	36.0 (1-13/32)	32.4 (1-9/32)
800E-AMLJ1	68.6 (2-11/16)	73.3 (2-7/8)	23.4 (15/16)	32.9 (1-5/16)
800E-AMLJ2	68.6 (2-11/16)	73.3 (2-7/8)	24.9 (31/32)	32.9 (1-5/16)
800E-AMLJ3	68.6 (2-11/16)	73.3 (2-7/8)	35.9 (1-13/32)	30.8 (1-7/32)

22.5 mm Round Hole Plugs

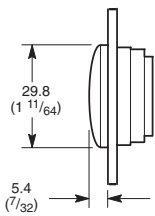

Cat. No. 800E-N_

22.5 mm Square Hole Plugs

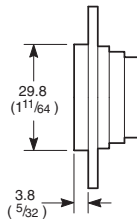

Cat. No. 800E-N_

30 mm to 22.5 mm Hole Adapter

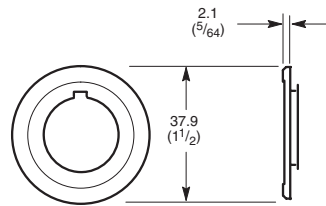

Cat. No. 800E-AHA_

Anti-Rotation Washer

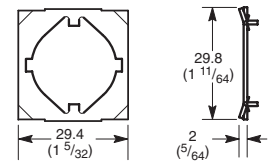

Cat. No. 800E-ALC1

22.5 mm Push Buttons

IP66, Type 4/4X/13 (Plastic) — IP66, Type 4/13 (Metal)

Approximate Dimensions, Continued

Dimensions in millimeters (inches). Dimensions are not intended to be used for manufacturing purposes.

Plastic Enclosures

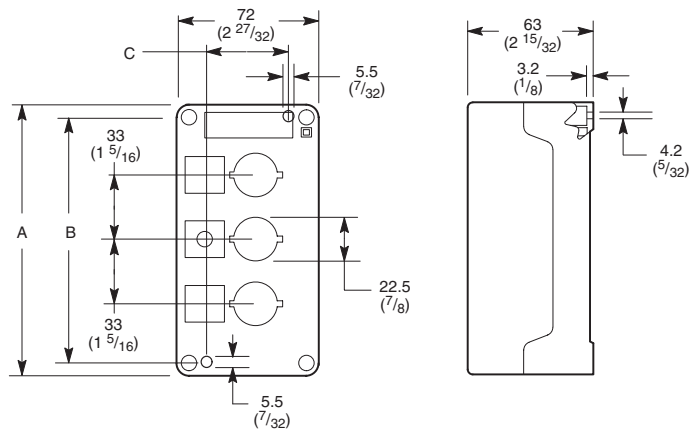

Aluminum Enclosures

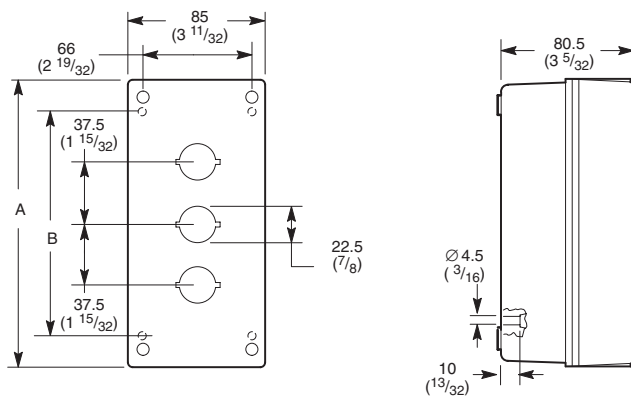

Plastic Enclosures

Cat. No.	No. of Units (Holes)	A	B	C	Weight
800E-1P 800E-1PY	1	72 (2-27/32)	59 (2-5/16)	41 (1-5/8)	95 g (3.5 oz.)
800E-2P	2	105 (4-1/8)	92 (3-5/8)	41 (1-5/8)	140 g (4.9 oz.)
800E-3P	3	138 (5-7/16)	125 (4-29/32)	41 (1-5/8)	169 g (6.2 oz.)
800E-5P	5	215 (8-15/32)	184 (7-1/4)	59 (2-5/16)	238 g (8.7 oz.)

Aluminum Enclosures

Cat. No.	No. of Units (Holes)	A	B	Weight
800E-1L 800E-1LY 800E-1M 800E-1MY	1	99 (3-9/32)	62 (2-7/16)	465 g (16.4 oz.)
800E-2L 800E-2M	2	137 (5-13/32)	100 (3-15/16)	550 g (19.4 oz.)
800E-3L 800E-3M	3	174 (6-27/32)	137 (5-13/32)	670 g (23.7 oz.)
800E-5L 800E-5M	5	249 (9-13/16)	212 (8-11/32)	850 g (30 oz.)

DeviceNet Pendant Stations

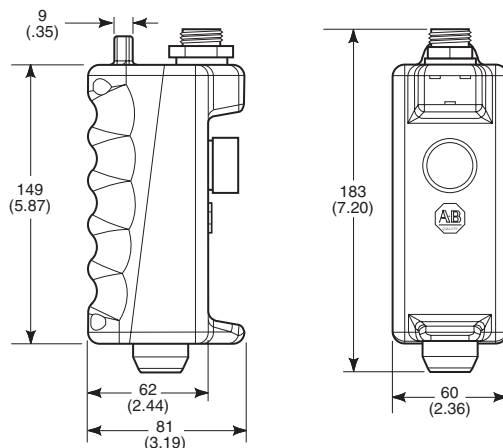

22.5 mm Push Buttons

Note:

22.5 mm Push Buttons

Note:

EC Declaration of Conformity

The undersigned, representing the following supplier and the authorized representative established within the Community:

Rockwell Automation
1201 South Second Street
Milwaukee, Wisconsin 53204 USA

**Rockwell Automation, subsidiary of
Rockwell International GmbH**
Düsseldorfer Str. 15
D-42781 Hain Germany

hereby declare that the Products **IEC 22.5 mm Push Buttons**

Product identification (brand and catalogue number/part number): **Allen-Bradley 800E**
(reference the attached list of catalogue numbers)

are in conformity with the provisions of the following EC Directive(s) when installed in accordance with the installation instructions contained in the product documentation:

73/23/EEC Low Voltage Directive as amended by 93/68/EEC

and that the standards and/or technical specifications referenced below have been applied:

- EN 60947-5-1: 1997 Low voltage switchgear and controlgear - Part 5: Control circuit devices and switching elements - Section 1: Electromechanical control circuit devices
- EN 418: 1994 Safety of Machinery - Emergency stop equipment, functional aspects - Principles for Design
- EN 60947-5-5: 1997 Low voltage switchgear and controlgear - Part 5: Control circuit devices and switching elements - Section 5: Electrical emergency stop devices with mechanical latching function

Year of CE Marking 1993
Supplier: *Rockwell Automation*

Authorized Representative in the Community:

Beith Peterson
Signature Name: *Beith Peterson* Vice President
Position: Director, Quality Assurance
Date: 28-Feb-2000

Michael Schiffer
Signature Name: *Michael Schiffer* Vice President
Position: Engineering Manager
Date: 01-Mar-2000

Catalogue number	Series ¹	Standard	Description
800E - AC	A	EN 60947-5-1	Reactive element
800E - 2	A	EN 60947-5-1	Contact block and/or power module
800E - 3	A, B	EN 60947-5-1	Contact block and/or power module
800E - 4	A, B	EN 60947-5-1	Contact block and/or power module
800E - E	A	EN 60947-5-1	Contact block with an operator
800E - F	A	EN 60947-5-1	Contact block with an operator
800E - G	A	EN 60947-5-1	Contact block with an operator
800E - H	A	EN 60947-5-1	Contact block with an operator
800E - J	A, B	EN 60947-5-1	Contact block with an operator
800E - K	A	EN 60947-5-1	Contact block with an operator
800E - L	A, B	EN 60947-5-1	Contact block and operator with or without power module
800E - LMP24	A	EN 418, EN 60947-5-5	Contact block and operator with or without power module
800E - LMP24	A	EN 418, EN 60947-5-5	Contact block and operator with or without power module
800E - M	A	EN 60947-5-1	Contact block with an operator
800E - MT4	A	EN 418, EN 60947-5-5	Contact block with an operator
800E - MPT4	A	EN 418, EN 60947-5-5	Contact block with an operator
800E - MP24	A	EN 418, EN 60947-5-5	Contact block with an operator
800E - MMP24	A	EN 418, EN 60947-5-5	Contact block with an operator
800E - MIP24	A	EN 418, EN 60947-5-5	Contact block with an operator
800E - MTS	A	EN 418, EN 60947-5-5	Contact block with an operator
800E - MK4	A	EN 418, EN 60947-5-5	Contact block with an operator
800E - MKR4	A	EN 418, EN 60947-5-5	Contact block with an operator
800E - MKR	A	EN 418, EN 60947-5-5	Contact block with an operator
800E - MKZ	A	EN 418, EN 60947-5-5	Contact block with an operator
800E - P	A	EN 60947-5-1	Operator with or without power module or resistive
800E - R	A	EN 60947-5-1	Contact block and/or power module with an operator
800E - S	A	EN 60947-5-1	Contact block and/or power module with an operator
800E - U	A	EN 60947-5-1	Contact block and/or power module with an operator
800E - W	A	EN 60947-5-1	Contact block and/or power module with an operator
800E - 1P	A, B	EN 60947-5-1	Enclosure with operating elements
800E - 2P	A, B	EN 60947-5-1	Enclosure with operating elements
800E - 3P	A, B	EN 60947-5-1	Enclosure with operating elements
800E - 4P	A, B	EN 60947-5-1	Enclosure with operating elements
800E - 5P	A, B	EN 60947-5-1	Enclosure with operating elements
800E - 1M	A	EN 60947-5-1	Enclosure with operating elements
800E - 2M	A	EN 60947-5-1	Enclosure with operating elements
800E - 3M	A	EN 60947-5-1	Enclosure with operating elements
800E - 4M	A	EN 60947-5-1	Enclosure with operating elements
800E - 5M	A	EN 60947-5-1	Enclosure with operating elements
800E - 1L	A	EN 60947-5-1	Enclosure with operating elements
800E - 2L	A	EN 60947-5-1	Enclosure with operating elements
800E - 3L	A	EN 60947-5-1	Enclosure with operating elements
800E - 4L	A	EN 60947-5-1	Enclosure with operating elements
800E - 5L	A	EN 60947-5-1	Enclosure with operating elements

¹ If no series number is given, then all series are covered

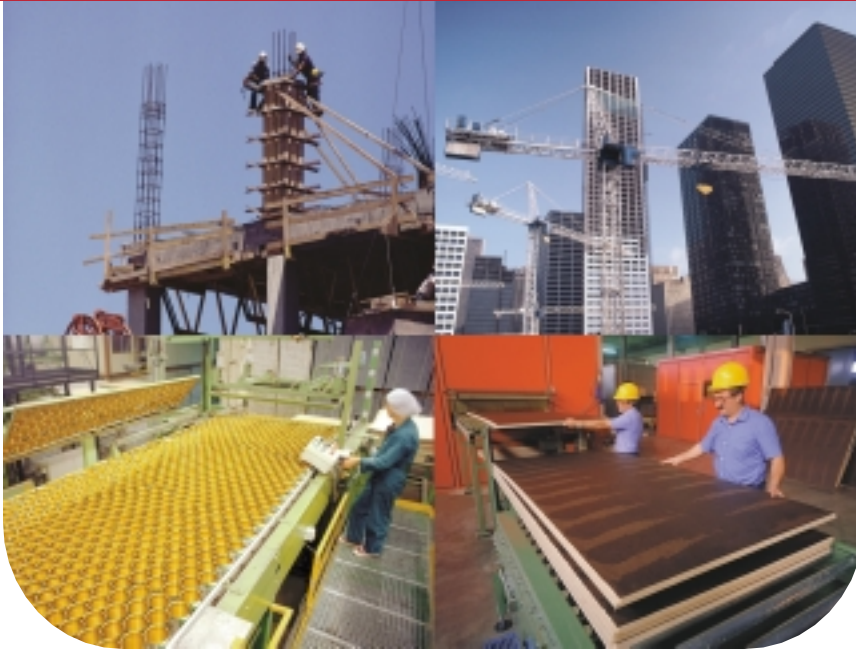

Allen-Bradley push button products serve the world's industries with a proud tradition of quality and rugged design. We continue to set the standards in product value and quality by keeping the needs of our customers foremost in mind.

www.rockwellautomation.com

Corporate Headquarters

Rockwell Automation, 777 East Wisconsin Avenue, Suite 1400, Milwaukee, WI, 53202-5302 USA, Tel: (1) 414.212.5200, Fax: (1) 414.212.5201

Headquarters for Allen-Bradley Products, Rockwell Software Products and Global Manufacturing Solutions

Americas: Rockwell Automation, 1201 South Second Street, Milwaukee, WI 53204-2496 USA, Tel: (1) 414.382.2000, Fax: (1) 414.382.4444

Europe: Rockwell Automation SA/NV, Vorstlaan/Boulevard du Souverain 36-BP 3A/B, 1170 Brussels, Belgium, Tel: (32) 2 663 0600, Fax: (32) 2 663 0640

Asia Pacific: Rockwell Automation, 27/F Citicorp Centre, 18 Whitfield Road, Causeway Bay, Hong Kong, Tel: (852) 2887 4788, Fax: (852) 2508 1846

Headquarters for Dodge and Reliance Electric Products

Americas: Rockwell Automation, 6040 Ponders Court, Greenville, SC 29615-4617 USA, Tel: (1) 864.297.4800, Fax: (1) 864.281.2433

Europe: Rockwell Automation, Brühlstraße 22, D-74834 Elztal-Dallau, Germany, Tel: (49) 6261 9410, Fax: (49) 6261 17741

Asia Pacific: Rockwell Automation, 55 Newton Road, #11-01/02 Revenue House, Singapore 307987, Tel: (65) 351 6723, Fax: (65) 355 1733