

~~FOR OFFICIAL USE ONLY~~

NOVEMBER 2004
Inventory of Personnel Security Details

(b)(6)		(b)(6)		(b)(6)		(b)(6)	
MG Gary Sparks	DOG CFLOCC	Major General, USA	Army CID/ Military Police	F/T	OCONUS based; no CONUS PSD		
LTC Ricardo Sanchez	V Corps CDR	Lieutenant General, USA	Army CID/ Military Police	F/T	OCONUS based; no CONUS PSD		
LTC Thomas F. Metz	III Corps CDR	Lieutenant General, USA	Army CID/ Military Police	F/T	OCONUS based; no CONUS PSD		
LTC David Bezno	CG, CFC-A	Lieutenant General, USA	Army CID/ Military Police	F/T	OCONUS based; no CONUS PSD		
BG(F) Lloyd Austin	CG, CJTF-180	Brigadier General(F), USA	Army CID/ Military Police	F/T	OCONUS based; no CONUS PSD		
MAJ Gen Craig P. Weston	C, OMC-A	Major General, USAF	Army CID/ Military Police	F/T	OCONUS based; no CONUS PSD		

Department of Navy

(b)(6)		(b)(6)		(b)(6)	
HON Gordon England	Secretary of the Navy	PAS Level II	NCIS	F/T	CONUS/OCONUS
ADM Vernon Clark, USN	Chief of Naval Operations	Admiral, USN	NCIS	F/T	CONUS/OCONUS
GEN Michael Hight, USMC	Commandant of the Marine Corps	General, USMC	NCIS	F/T	CONUS/OCONUS

~~FOR OFFICIAL USE ONLY~~
11-L-0559/OSD/51866

~~FOR OFFICIAL USE ONLY~~

NOVEMBER 2004
Inventory of Personnel Security Details

ADM Michael G. Mullan	COMUSNAVEUR (Italy)	(b)(6)	Admiral, USN	NCIS	F/T	OCONUS based; no CONUS PSD
VADM Harry Ulrich	CDR, US Sixth Fleet		Vice Admiral, USN	NCIS	F/T	OCONUS based; no CONUS PSD
ADM Walter Dunn	CDR, USPACFLT		Admiral, USN	NCIS	F/T	OCONUS based; no CONUS PSD
VADM Jonathan Greenert	CDR, US Seventh Fleet		Vice Admiral, USN	NCIS	F/T	OCONUS based; no CONUS PSD
7 BGEN Larry New, USAF	Deputy Commander, Combined Air Operations Center 7		Brigadier General, USAF	NCIS	F/T	OCONUS based; no CONUS PSD

Department of Air Force

Dr. James D. Rocha	Secretary of the Air Force	(b)(6)	PAS Level II	AFOSI	F/T	CONUS/OCONUS
Peter B. Teets	Under Secretary of the Air Force		PAS Level IV	AFOSI	F/T	CONUS/OCONUS
GEN John P. Jumper	Chief of Staff of the Air Force		General, USAF	AFOSI	F/T	CONUS/OCONUS
7 GEN T. Michael Moseley	Vice Chief of Staff of the Air Force		General, USAF	AFOSI	F/T	CONUS/OCONUS

~~FOR OFFICIAL USE ONLY~~

-FOR OFFICIAL USE ONLY-

NOVEMBER 2004
Inventory of Personnel Security Details

(b)(6)	US Air Forces in Europe Commander	General, USAF	APOSI	F/T	CONUS/OCONUS
GEN Robert Foglesong	Air Combat Command Commander	General, USAF	APOSI	P/T	Some CONUS ¹ ; All OCONUS
GEN Donald G. Cook	Air Education and Training Command Commander	General, USAF	APOSI	P/T	Some CONUS ¹ ; All OCONUS
GEN Gregory S. March	Air Force Materiel Command Commander	General, USAF	APOSI	P/T	Some CONUS ¹ ; All OCONUS
GEN Lance W. Lord	Air Force Space Command Commander	General, USAF	APOSI	P/T	Some CONUS ¹ ; All OCONUS
GEN Paul V. Hunter	Pacific Air Forces Commander	General, USAF	APOSI	P/T	Some CONUS ¹ ; All OCONUS

We are seeking an inventory of both political and career agency officials possessing full-time, part-time or conditional (i.e. foreign based only, etc.) personal security details. In each case, we would like to know which organizations are providing security services.

Please return completed form(s) to Peter Sobich at the Office of Cabinet Affairs (psobich@omb.eop.goa) by COB Monday.

¹ Provides personal security detail as necessary in CONUS.

-FOR OFFICIAL USE ONLY-

11-L-0559/OSD/51868

10/24

JOM approved
w/ attached
SO.Ds.

THE UNDER SECRETARY OF DEFENSE (POLICY)

Security Details

Rangel

of Administration and Management (DA&M) to look
Security Details. These are critical assets we need to

conducted a revision

Robert Rangel

10/24

and that we haven't published adequate Department-wide
it indicates that staff members in the Office of the
Defense for Special Operations and Low Intensity Conflict
in with their counterparts in the Joint Staff, on policy
Department of Defense High Risk Personnel (HRP) program.

IN ORDER TO

ENERGIZE

Chairman and help shape the effort your staff is
engaged in. I want to put out good policy guidance for a HRP program that is
appropriate to the current threat and focuses our assets accordingly.

I'd like you to brief me on the effort in early November, so I can see how
we are doing. I'd like to have Department of Defense-wide guidance published
shortly after the New Year.

by the end of

evaluate how

ECONOMIZED RESOURCES
WHERE POSSIBLE,

cc:
Chairman of the Joint Chiefs of Staff





SECRETARY OF DEFENSE
1000 DEFENSE PENTAGON
WASHINGTON, DC 20301-1000

OCT 25 2005

380.01

MEMORANDUM FOR UNDER SECRETARY OF DEFENSE FOR POLICY

SUBJECT: Personal Security Details

At my request, the Director of Administration and Management (DA&M) conducted a review of how we assign Personal Security Details. These are critical assets we need to manage carefully.

The DA&M reported that we haven't published adequate Department-wide policy guidance. His report indicates that staff members in the Office of the Assistant Secretary of Defense for Special Operations and Low Intensity Conflict are working, in conjunction with their counterparts in the Joint Staff, on policy guidance for the Department of Defense High Risk Personnel (HRP) program.

Please get with the Chairman in order to shape and energize the effort your staff is engaged in. I want to put out good policy guidance for a HRP program that is appropriate to the current threat, economizes resources where possible, and focuses our assets accordingly.

I'd like you to brief me on the effort by the end of November, so I can evaluate how we are doing. I'd like to have Department of Defense-wide guidance published shortly after the New Year.

cc:
Chairman of the Joint Chiefs of Staff

OSD 18237-05

95 OCT 05

98 SEP 05



SEP 08 2005

Action Memo

A/DSD _____

USDP *Copy Forwarded*

I-05/012033-STRAT

I-05/012016 ES-4138

335 SD

FOR SECRETARY OF DEFENSE

FROM: Peter W. Rodman, Assistant Secretary of State (ISA) *ma...* (b)(6) 8 SEP 2005

SUBJECT: Notes to MoDs of Countries Offering Help

- As tasked at Tab A, we drafted thank you letters to Ministers of Defense for their offers of military support for hurricane Katrina relief operations (Tab B)
- We will continue to write **thank** you letters for offers of military support as they come in.

RECOMMENDATION: Sign the letters at Tab B.

SecDef Decision:

Sign letters _____ Sign w/edits _____ Do not sign _____

Attachments: as stated

8 Sep 05

Prepared by Mike Niles, OSD/ISA/Coalition Affairs, (b)(6)

6 Sep 05

MA SD		SMA DSD	
TSA SD		SA DSD	
EXEC SEC			
ESR MA	<i>KSU</i>	<i>9-9-05</i>	<i>163</i>

OSD 18243-05

-0559/OSD/51871

OFFICE OF THE SECRETARY OF DEFENSE

The Military Assistant

Mr. Secretary,

Attached are letters of
thank you to the various
MOD's ref: Katrina
Support.

Standing-by for your
review/edits. We'll
launch them when we
get your OK.

v/r
LtCol Lengyel



THE SECRETARY OF DEFENSE
1000 DEFENSE PENTAGON
WASHINGTON, DC 20301-1000

The Honorable Yoshinori Ohno
Minister of State for Defense
Japan Defense Agency
5-1 Ichigaya, Honmura-cho
Shinjuku-ku, Tokyo 162-8801
Japan

Dear Minister Ohno:

Thank you for your kind offers of support for relief operations in the aftermath of Hurricane Katrina. It is enormously gratifying to know that the American people have a committed friend in Japan. We appreciate your swift assistance, which will be critical in helping so many families recover from the devastation of Hurricane Katrina.

Sincerely,

A handwritten signature in black ink, appearing to be the initials "DR" or similar, written in a cursive style.



11-L-0559/OSD/51873



SECRETARY OF DEFENSE
1000 DEFENSE PENTAGON
WASHINGTON, DC 20301-1000

Sergey Ivanov
Minister of Defense
Russian Federation
Moscow, Russia

Dear **Sergey**:

Thank you for your government's generous offer of assistance for the Hurricane Katrina relief effort. The delivery of Meals-Ready-to-Eat (MREs), bottled water, medical supplies, tents, blankets, and generators by two Russian IL-76 aircraft was warmly received at Little Rock Air Force Base, Arkansas.

We appreciate your swift assistance, which will be critical in helping so many families recover from the devastation of Hurricane Katrina.

I look forward to seeing you in Berlin.

Best wishes,

D/C



11-L-0559/OSD/51874



THE SECRETARY OF DEFENSE
1000 DEFENSE PENTAGON
WASHINGTON, DC 20301-1000

His Excellency
Mr. Kamel Morjane
Minister of National Defense
Republic of Tunisia
Tunis, Tunisia

Dear Minister Morjane:

Thank you for your offer to provide two C-130 aircraft loaded with relief supplies to the relief operations in the aftermath of Hurricane Katrina. It is enormously gratifying to know that the American people have a committed friend in Tunisia. We appreciate your swift assistance, which will be critical in helping so many families recover from the devastation of Hurricane Katrina.

Sincerely,



11-L-0559/OSD/51875



THE SECRETARY OF DEFENSE
1000 DEFENSE PENTAGON
WASHINGTON, DC 20301-1000

His Royal Highness King Abdullah II
The Royal Court
The Hashemite Kingdom of Jordan

Your Royal Highness

Thank you for your kind offer to deploy Jordanian field hospitals to aid the relief operations in the aftermath of Hurricane Katrina. It is enormously gratifying to know that the American people have a committed friend in Jordan.

I look forward to seeing you in Washington later **this** month.

Sincerely,



11-L-0559/OSD/51876



THE SECRETARY OF DEFENSE
1000 DEFENSE PENTAGON
WASHINGTON, DC 20301-1000

His Excellency
Pranab Mukherjee
Minister of Defence
Government of India
Ministry of Defence
New Delhi 110011 India

Dear Minister Mukherjee:

Thank you for your generous offers of the army medical corps team, Meals-Ready-to-Eat (MRE), IL-76 aircraft loaded with relief supplies and Navy divers to the relief operations in the aftermath of Hurricane Katrina. It is enormously gratifying to know that the American people have a committed friend in India. We appreciate your swift assistance, which will be critical in helping so many families recover from the devastation of Hurricane Katrina.

Sincerely,



11-L-0559/OSD/51877



SECRETARY OF DEFENSE
1000 DEFENSE PENTAGON
WASHINGTON, DC 20301-1000

Karel Kuhl
Minister of Defense
Czech Republic
Tychonova 1
Praha 6

Dear Minister Kuhl:

Thank you for your government's offer to provide medical, materiel and logistical support to the relief operations in the aftermath of Hurricane Katrina. We are currently conducting **an** assessment of our needs. **It is** enormously gratifying to know that the American people have a committed friend in the Czech Republic.

Sincerely,



11-L-0559/OSD/51878



THE SECRETARY OF DEFENSE
1000 DEFENSE PENTAGON
WASHINGTON, DC 20301-1000

His Excellency Søren Gade
Minister of Defence
Ministry of Defense
Holmens Kanal 42
DK-1060 Copenhagen
Denmark

Dear Minister Gade:

Thank you for your kind offer of water purification units for the relief operations in the aftermath of Hurricane Katrina. It is enormously gratifying to know that the American people have a committed ally in Denmark.

Sincerely,



11-L-0559/OSD/51879



THE SECRETARY OF DEFENSE
1000 DEFENSE PENTAGON
WASHINGTON, DC 20301-1000

His Excellency David Oddsson
Minister of Foreign Affairs
Ministry of Foreign Affairs
Raudararstigur 25
150 Reykjavik
Iceland

Dear Minister Oddsson:

Thank you for your kind offer of ~~drinking~~ water and a search and rescue team for the relief operations in the aftermath of Hurricane Katrina. It is enormously gratifying to know that the American people have a committed ally in Iceland.

Sincerely,



11-L-0559/OSD/51880



SECRETARY OF DEFENSE
1000 DEFENSE PENTAGON
WASHINGTON, DC 20301-1000

Her Excellency Leni Bjorklund
Minister of Defense
Ministry of Defense
Jakobsgatan 9
103 33 Stockholm
Sweden

Dear Minister Bjorklund

Thank you for your kind offer of water purification equipment, materiel and electric power generators for the relief operations in the aftermath of Hurricane Katrina. It is enormously gratifying to know that the American people have a committed friend in Sweden.

Sincerely,



11-L-0559/OSD/51881



SECRETARY OF DEFENSE
1000 DEFENSE PENTAGON
WASHINGTON, DC 20301-1000

His Excellency Seppo Kääriäinen
Minister of Defense
Ministry of Defense
Eteläinen Makasiinikatu 8
PO Box 31
FIN-00131 Helsinki
Finland

Dear Minister Kääriäinen:

Thank you for your kind offer of water purification units, first aid kits, and a search and recovery team for the relief operations in the aftermath of Hurricane Katrina. It is enormously gratifying to know that the American people have a committed friend in Finland. We appreciate your swift assistance, which will be critical in helping so many families recover from the devastation of Hurricane Katrina.

Sincerely,



11-L-0559/OSD/51882



SECRETARY OF DEFENSE
1000 DEFENSE PENTAGON
WASHINGTON, DC 20301-1000

Ferenc Juhasz
Minister of Defense
Republic of Hungary
Balaton u 7-11
1055 Budapest

Dear Minister Juhasz:

Thank you for your government's offer to provide a nine member rescue team, forensics assistance and materiel to the relief operations in the aftermath of Hurricane Katrina. We are currently conducting an assessment of our needs. It is enormously gratifying to know that the American people have a committed friend in the Republic of Hungary.

Sincerely,



THE SECRETARY OF DEFENSE
1000 DEFENSE PENTAGON
WASHINGTON, DC 20301-1000

The Honorable Einars Repše
Minister of Defense
Ministry of Defense
Kr. Valdemara 10/12
Riga LV 1473
Latvia

Dear Mr. Minister:

Thank you for Latvia's offer of support to the relief operations in the aftermath of Hurricane Katrina. It is enormously gratifying to know that the American people have committed friends in the people of Latvia. We appreciate your swift offer of assistance, which will be critical in providing comfort to so many families as they seek to recover from the devastation of Hurricane Katrina.

Sincerely,



11-L-0559/OSD/51884



THE SECRETARY OF DEFENSE
1000 DEFENSE PENTAGON
WASHINGTON, DC 20301-1000

The Honorable Spilios Spiliotopoulos
Minister for Defence
Hellenic Republic
151 Mesogeion Avenue
15500 Holargos
Athens, Greece

Dear Minister Spiliotopoulos:

Thank you for your offer to provide a cargo ship and two cruise ships in the aftermath of Hurricane Katrina. We look forward to working with you in expediting the deployment of the cruise ships to reach those in need. I also thank you for your government's generous offer of an emergency rescue team. We are still evaluating our needs and will communicate with you soon regarding these kind offers.

It is enormously gratifying to know that the American people have a committed friend in Greece. We appreciate your swift assistance, which will be critical in helping so many families recover from the devastation of Hurricane Katrina.

Sincerely,



11-L-0559/OSD/51885



SECRETARY OF DEFENSE
1000 DEFENSE PENTAGON
WASHINGTON, DC 20301-1000

His Excellency Mehmet Vecdi Gonul
Minister of National Defense
Republic of Turkey
Miillisavunma Bakanligi
Ankara, Turkey

Dear Minister Gonul:

Thank you for your government's generous offer to provide a search and rescue team in the aftermath of Hurricane Katrina. We are still evaluating our needs and will communicate with you soon regarding these kind offers.

It is enormously gratifying to know that the American people have a committed friend in Turkey. We appreciate your swift assistance, which will be critical in helping so many families recover from the devastation of Hurricane Katrina.

Sincerely,



11-L-0559/OSD/51886



THE SECRETARY OF DEFENSE
1000 DEFENSE PENTAGON
WASHINGTON, DC 20301-1000

Mr. Teo Chee Hean
Minister for Defence
Republic of Singapore
Ministry of Defence
303 Gombak Drive
Singapore 669645

Dear Minister Teo:

Thank you for providing your three Chinook helicopters and support personnel to the relief operations in the aftermath of Hurricane Katrina. It is enormously gratifying to know that the American people have a committed friend in Singapore. We appreciate your swift assistance, which will be critical in helping so **many** families recover from the devastation of Hurricane Katrina.

Sincerely,



11-L-0559/OSD/51887



SECRETARY OF DEFENSE
1000 DEFENSE BUILDING
WASHINGTON, DC 20301-1000

The Honorable Günther Platter
Minister of Defense
Ministry of Defense
Austria

Dear Minister Platter:

Thank you for your kind offer to provide a disaster relief group specializing in water purification, 3 special elite police units and military personnel to the relief operations in the aftermath of Hurricane Katrina. It is enormously gratifying to know that the American people have a committed friend in Austria.

Sincerely,



11-L-0559/OSD/51888



SECRETARY OF DEFENSE
1000 DEFENSE PENTAGON
WASHINGTON, DC 20301-1000

General Gerardo Clemente Ricardo Vega
Secretary of National Defense of Mexico
Mexico City, Mexico

Dear Mr. Minister:

Thank you for your government's generous offer of the Hospital/cargo ship "Huasteco", vehicles, and Mexican soldiers to support relief operations in the aftermath of Hurricane Katrina. It is gratifying to know that the American people have a committed friend in Mexico. We appreciate your offer, which will be critical in helping so many families recover from the devastation of Hurricane Katrina.

Sincerely,



11-L-0559/OSD/51889



SECRETARY OF DEFENSE
1000 DEFENSE PENTAGON
WASHINGTON, DC 20301-1000

The Honorable Avil Ramirez
Minister of Defense of the Republic of Nicaragua
Managua, Nicaragua

Dear Mr. Minister:

Thank you for your government's generous offer to provide support in the aftermath of Hurricane Katrina. We are still evaluating our needs and will communicate with you soon regarding these kind offers.

It is gratifying to know that the American people have a committed friend in Nicaragua. We appreciate your offer, which will be critical in helping so many families recover from the devastation of Hurricane Katrina.

Sincerely,



11-L-0559/OSD/51890



SECRETARY OF DEFENSE
1000 DEFENSE PENTAGON
WASHINGTON, DC 20301-1000

Major General Otto Alejandro Romero
Minister of Defense of the Republic of El Salvador
San Salvador, El Salvador

Dear Mr. Minister:

Thank you for your government's generous offer to provide over 100 military personnel specializing in medical, engineering, and military police support in the aftermath of Hurricane Katrina. We are still evaluating our needs and will communicate with you soon regarding these kind offers.

It is gratifying to know that the American people have a committed friend in El Salvador. We appreciate your offer, which will be critical in helping so many families recover from the devastation of Hurricane Katrina.

Sincerely,



11-L-0559/OSD/51891



SECRETARY OF DEFENSE
1 000 DEFENSE PENTAGON
WASHINGTON, DC 20301-1000

The Honorable Vildo Marin
Minister of Defense of Belize
Belmopan, Belize

Dear Mr. Minister:

Thank you for your government's generous offer to provide support in the aftermath of Hurricane Katrina. We are still evaluating our needs and will communicate with you soon regarding these **kind** offers.

It is gratifying to know that the American people have a committed friend in Belize. We appreciate your offer, which will be critical in helping so many families recover from the devastation of Hurricane Katrina.

Sincerely,



11-L-0559/OSD/51892



SECRETARY OF DEFENSE
1000 DEFENSE PENTAGON
WASHINGTON, DC 20301-1000

The Honorable Roosevelt Skerrit
Prime Minister of the Commonwealth of Dominica
Roseau, Dominica

Dear **Mr.** Prime Minister:

Thank you for your government's generous offer to provide **support** in the aftermath of Hurricane Katrina. We are still evaluating our needs and will communicate with you soon regarding these kind offers.

It is gratifying to know that the American people have a committed friend in Dominica. We appreciate your offer, which will be critical in helping so many families recover from the devastation of Hurricane Katrina.

Sincerely,



11-L-0559/OSD/51893



SECRETARY OF DEFENSE
1000 DEFENSE PENTAGON
WASHINGTON, DC 20301-1000

His Excellency
Federal Minister Samuel Schmid
President of the Swiss Confederation
Bundesthaus Ost
3003 Bern
Switzerland

Dear President Schmid:

Thank you for your generous offer of disaster relief platoons and materiel to the relief operations in the aftermath of Hurricane Katrina. It is enormously gratifying to know that the American people have a committed friend in Switzerland. We appreciate **your** swift assistance, which will be critical in helping *so* many families recover from the devastation of Hurricane Katrina.

Sincerely,



11-L-0559/OSD/51894



THE SECRETARY OF DEFENSE
1000 DEFENSE PENTAGON
WASHINGTON, DC 20301-1000

The Honorable Teodor Atanasiu
Minister of Defense
Romanian Ministry of Defence
Izvor St 13-15, Sector 5
70642 Bucharest
Romania

Dear Minister Atanasiu:

Thank you for your offer of medical personnel to support relief operations in the aftermath of Hurricane Katrina. It is enormously gratifying to know that the American people have a committed friend in Romania. We are currently giving your offer significant consideration. We appreciate your prompt offer of assistance and your willingness to help so many American families recover from the devastation of Hurricane Katrina.

Sincerely,



11-L-0559/OSD/51895



SECRETARY OF DEFENSE
1000 DEFENSE PENTAGON
WASHINGTON, DC 20301-1000

The Honorable Luc Frieden
Minister of Defense of Luxembourg
6, rue de l'ancien Athénée
L-1144 Luxembourg

Dear Minister Frieden,

Thank you for your generous offer of a search and rescue team, support personnel and supplies to the relief operations in the aftermath of Hurricane Katrina. It is enormously gratifying to know that the American people have a committed friend in Luxembourg. We appreciate your swift assistance, which will be critical in helping so many families recover from the devastation of Hurricane Katrina.

Sincerely,



11-L-0559/OSD/51896



SECRETARY OF DEFENSE
1000 DEFENSE PENTAGON
WASHINGTON, DC 20301-1000

Karl Erjavec
Minister of Defense
Republic of Slovenia
Kardeljeva P125
1000Ljubljana

Dear Minister Erjavec:

Thank you for your government's generous offer to provide water pumps, first aid kits and materiel to the relief operations in the aftermath of Hurricane Katrina. We are currently conducting an assessment of our needs. It is enormously gratifying to know that the American people have a committed friend in the Republic of Slovenia.

Sincerely,



11-L-0559/OSD/51897



SECRETARY OF DEFENSE
1000 DEFENSE PENTAGON
WASHINGTON, DC 20301-1000

Sergey Ivanov
Minister of Defense
Russian Federation
Moscow, Russia

Dear Sergey:

Thank you for your government's generous offer of assistance for the Humcane Katrina relief effort. ~~The delivery of Meals-Ready-to-Eat (MREs), bottled water, medical supplies, tents, blankets, and generators~~ by two Russian IL-76 aircraft was warmly received at Little Rock Air Force Base, Arkansas.

We appreciate your swift assistance, which will be critical in helping so many families recover from the devastation of Humcane Katrina.

I look forward to seeing you in Berlin.

Best wishes,

A handwritten signature in black ink, appearing to be "R. M. Gates", written in a cursive style.



11-L-0559/OSD/51898



SECRETARY OF DEFENSE
1000 DEFENSE PENTAGON
WASHINGTON, DC 20301-1000

Sergey Ivanov
Minister of Defense
Russian Federation
Moscow, Russia

Dear Sergey:

Thank you for your government's generous offer of assistance for *the* Hurricane Katrina relief effort. The delivery of Meals-Ready-Eat (MREs), bottled water, medical supplies, tents, blankets, and generators by two Russian IL-76 aircraft was warmly received at Little Rock Air Force Base, Arkansas.

We appreciate your swift assistance, which will be critical in helping so many families recover from the devastation of Hurricane Katrina.

I look forward to seeing you in Berlin.

Best wishes,



THE SECRETARY OF DEFENSE
1000 DEFENSE PENTAGON
WASHINGTON, DC 20301-1000

AS
9/12

The Honorable Dr. Peter Struck
Federal Minister of Defense
Federal Ministry of Defense
D-11055 Berlin
Germany

Dear Minister Struck:

Thank you for providing your Meals-Ready-to-Eat (MRE) to the relief operations in the aftermath of Hurricane Katrina. ~~It is enormously gratifying to know that the American people have a committed friend in Germany.~~ We appreciate your swift assistance, which will be critical in helping so many families recover from the devastation of Hurricane Katrina.

Sincerely,

Revise there
As shown
See edits





THE SECRETARY OF DEFENSE
1000 DEFENSE PENTAGON
WASHINGTON, DC 20301-1000

Her Excellency Kristin Krohn Devold
Minister of Defense
Ministry of Defense
Myntgata 1
N-0032 Oslo
Norway

Dear ~~Minister Devold:~~

Kristin

Thank you for Norway's generous offer of blankets, tents, medicine, divers and cash assistance to the relief operations in the aftermath of Hurricane Katrina. It is enormously gratifying to know that the American people have a committed ally in Norway. We appreciate your swift assistance, which will be critical in helping so many families recover from the devastation of Hurricane Katrina.

I look forward to seeing you in Berlin

Sincerely, Bob



11-L-0559/OSD/51901



THE SECRETARY OF DEFENSE
1000 DEFENSE PENTAGON
WASHINGTON, DC 20301-1000

Her Excellency Kristin Krohn Devold
Minister of Defense
Ministry of Defense
Myntgata 1
N-0032 Oslo
Norway

Dear ~~Minister Devold~~:

Kristin

Thank you for Norway's generous offer of blankets, tents, medicine, divers and cash assistance *to* the relief operations in the aftermath of Hurricane Katrina. It is enormously gratifying to know that the American people have a committed ally in Norway. We appreciate your swift assistance, which will be critical in helping so many families recover from the devastation of Hurricane Katrina.

I look forward to seeing you in Berlin

Sincerely, *Bob*



11-L-0559/OSD/51902



SECRETARY OF DEFENSE
1000 DEFENSE PENTAGON
WASHINGTON, DC 20301-1000

The Honorable Andre Flahaunt
Minister of Defense of the Kingdom of Belgium
Rue Lambermont 8
1000 Brussels
Belgium

Dear Minister Flahaunt,

Thank you for your generous offers of medical and support personnel and equipment to the relief operations in the aftermath of Hurricane Katrina. It is enormously gratifying to know that the American people have a committed friend in Belgium. We appreciate your swift offers of assistance, which will be critical in helping so many families recover from the devastation of Hurricane Katrina.

Sincerely,



11-L-0559/OSD/51903



THE SECRETARY OF DEFENSE
1000 DEFENSE PENTAGON
WASHINGTON, DC 20301-1000

Mr. Honorable William Graham
Minister for National Defense
Department of National Defense
101 Colonel By Drive
Ottawa, Ontario K1A 0K2
Canada

Dear Minister Graham:

Thank you for your generous contribution of helicopters, *air* transport and personnel to the relief operations in the aftermath of Hurricane Katrina. Your swift offers of military collaboration and assistance will be critical in helping the many families working to recover from the devastation of Hurricane Katrina and serve as an example of the special relationship between our two nations.

Sincerely,



11-L-0559/OSD/51904



THE SECRETARY OF DEFENSE
1000 DEFENSE PENTAGON
WASHINGTON, DC 20301-1000

His Excellency
Antonio Martino
Minister for Defence
Via XX, Settembre 8
00187 Rome, Italy

Dear Minister Martino: *Antonio*

Thank you for Italy's offer of camp beds, blankets, tents, water purification systems, medical supplies and a field hospital to the relief operations in the aftermath of Hurricane Katrina. It is enormously gratifying to know that the American people have a committed friend in Italy. We appreciate your swift assistance, which will be critical in helping *so* many families recover from the devastation of Hurricane Katrina.

I look forward to seeing you in Berlin

Sincerely,



11-L-0559/OSD/51905



SECRETARY OF DEFENSE
1000 DEFENSE PENTAGON
WASHINGTON, DC 20301-1000

The Honorable Henk Kamp
Minister of Defense of the Kingdom of the Netherlands
P.O. Box 20701
2500 ES The Hague
The Netherlands

Dear Minister ~~Kamp~~, *Henk.*

Thank you for your generous offer of aircraft, ships, medical supplies and support personnel to the relief operations in the aftermath of Hurricane Katrina. It is enormously gratifying to know that the American people have a committed friend in the Netherlands. We appreciate your swift assistance, which will be critical in helping so many families recover from the devastation of Hurricane Katrina.

Sincerely,



11-L-0559/OSD/51906

~~FOUO~~

September 06, 2005

TO: Eric Edelman

05/01/2016
ES-4138

FROM: Donald Rumsfeld *DR*

SUBJECT: Notes *to* MoDs of Countries Offering Help

I think I ought to get a thank you **note off** to the MoDs of all the countries that have offered help for the Katrina crisis.

335 80

Thanks.

DHR:dh
090605-07

.....
Please Respond By 09/15/05

6 Sep 05

~~FOUO~~

11-L-0559/OSD/51907

-050 18243-05



THE SECRETARY OF DEFENSE
1000 DEFENSE PENTAGON
WASHINGTON, DC 20301-1000

SEP 12 2005

The Honorable Yoshinori Ohno
Minister of State for Defense
Japan Defense Agency
5-1 Ichigaya, Honmura-cho
Shinjuku-ku, Tokyo 162-8801
Japan

Dear Minister Ohno:

Thank you for your kind offers of support for relief operations in the aftermath of Hurricane Katrina. It is enormously gratifying to know that the American people have a committed friend in Japan. We appreciate your swift assistance, which will be critical in helping so many families recover from the devastation of Hurricane Katrina.

Sincerely,

335 SD

12 Sep 05

6 Sep 05



OSD 18243-05

11-L-0559/OSD/51908



SECRETARY OF DEFENSE
1000 DEFENSE PENTAGON
WASHINGTON, DC 20301-1000

SEP 12 2005

His Excellency Sergey Ivanov
Minister of Defense
Russian Federation
Moscow, Russia

Dear Sergey:

Thank you for your government's generous offer of assistance for the Hurricane Katrina relief effort. The delivery of Meals-Ready-to-Eat (MREs), tents, and blankets by two Russian **IL-76** aircraft was warmly received at Little Rock Air Force Base, Arkansas.

We appreciate your swift assistance, which will be critical in helping *so* many families recover from the devastation of Hurricane Katrina.

I look forward to seeing you in Berlin.

Best wishes,

A handwritten signature in black ink, appearing to be "Z. R. ...".





THE SECRETARY OF DEFENSE
1000 DEFENSE PENTAGON
WASHINGTON, DC 20301-1000

SEP 12 2005

Ais Excellency
Mr. Kamel Morjane
Minister of National Defense
Republic of Tunisia
Tunis, Tunisia

Dear Minister Mojane:

Thank you for your offer to provide two C-130 aircraft loaded with relief supplies to the relief operations in the aftermath of Hurricane Katrina. It is enormously gratifying to know that the American people have a committed friend in Tunisia. We appreciate your swift assistance, which will be critical in helping so many families recover from the devastation of Hurricane Katrina.

Sincerely,

A handwritten signature in black ink, appearing to be "R. M. Gates", written in a cursive style.



11-L-0559/OSD/51910



SECRETARY OF DEFENSE
1000 DEFENSE PENTAGON
WASHINGTON, DC 20301-1000

SEP 12 2005

His Royal Highness King Abdullah II
The Royal Court
The Hashemite Kingdom of Jordan

Your Royal Highness:

Thank you for your kind offer to deploy Jordanian field hospitals to aid the relief operations in the aftermath of Hurricane Katrina. It is enormously gratifying to know that the American people have a committed friend in Jordan.

I look forward to seeing you in Washington later this month.

Sincerely,

A handwritten signature in black ink, appearing to read "D. Rumsfeld".



THE SECRETARY OF DEFENSE
1000 DEFENSE PENTAGON
WASHINGTON, DC 20301-1000

SEP 12 2005

His Excellency
Pranab Mukherjee
Minister of Defence
Government of India
Ministry of Defence
New Delhi 110011 India

Dear Minister Mukherjee:

Thank you for your generous offers of the army medical corps team, Meals-Ready-to-Eat (MRE), IL-76 aircraft loaded with relief supplies and Navy divers to the relief operations in the aftermath of Hurricane Katrina. It is enormously gratifying to know that the American people have a committed friend in India. We appreciate your swift assistance, which will be critical in helping so many families recover from the devastation of Hurricane Katrina.

Sincerely,

A handwritten signature in black ink, appearing to read "R. M. Gates", written in a cursive style.



11-L-0559/OSD/51912



SECRETARY OF DEFENSE
1000 DEFENSE PENTAGON
WASHINGTON, DC 20301-1000

SEP 12 2005

His Excellency Søren Gade
Minister of Defence
Ministry of Defence
Holmens Kanal 42
DK-1060 Copenhagen
Denmark

Dear Minister Gade:

Thank you for your kind offer of water purification units for the relief operations in the aftermath of Hurricane Katrina. It is enormously gratifying to know that the American people have a committed ally in Denmark.

Sincerely,

A handwritten signature in black ink, appearing to read "Rumsfeld".



THE SECRETARY OF DEFENSE
1000 DEFENSE PENTAGON
WASHINGTON, DC 20301-1000

SEP 12 2005

His Excellency David Oddsson
Minister of Foreign Affairs
Ministry of Foreign Affairs
Raudararstigur 25
150 Reykjavik
Iceland

Dear Minister Oddsson:

Thank you for your kind offer of drinking water and a search and rescue team for the relief operations in the aftermath of Hurricane Katrina. It is enormously gratifying to know that the American people have a committed ally in Iceland.

Sincerely,

A handwritten signature in black ink, appearing to be "R. M. Gates".



11-L-0559/OSD/51914



SECRETARY OF DEFENSE
1000 DEFENSE PENTAGON
WASHINGTON, DC 20301-1000

SEP 12 2005

Her Excellency Leni Bjorklund
Minister of Defense
Ministry of Defense
Jakobsgatan 9
10333 Stockholm
Sweden

Dear Minister Bjorklund:

Thank you for your kind offer of water purification equipment, materiel and electric power generators for the relief operations in the aftermath of Hurricane Katrina. It is enormously gratifying to know that the American people have a committed friend in Sweden.

Sincerely,

A handwritten signature in black ink, appearing to be "R. M. Gates", written in a cursive style.



11-L-0559/OSD/51915



SECRETARY OF DEFENSE
1000 DEFENSE PENTAGON
WASHINGTON, DC 20301-1000

SEP 12 2005

His Excellency Seppo Kääriäinen
Minister of Defense
Ministry of Defense
Etelainen Makasiinikatu 8
PO Box 31
FIN-00131 Helsinki
Finland

Dear Minister Kääriäinen:

Thank you for your kind offer of water purification units, first aid kits, and a search and recovery team for the relief operations in the aftermath of Hurricane Katrina. It is enormously gratifying to know that the American people have a committed friend in Finland. We appreciate your swift assistance, which will be critical in helping so many families recover from the devastation of Hurricane Katrina.

Sincerely,

A handwritten signature in black ink, appearing to be "R. M. Gates", written in a cursive style.



SECRETARY OF DEFENSE
1000 DEFENSE PENTAGON
WASHINGTON, DC 20301-1000

SEP 12 2005

Ferenc Juhasz
Minister of Defense
Republic of Hungary
Balaton u 7-11
1055 Budapest

Dear Minister Juhasz:

Thank you for your government's offer to provide a nine member rescue team, forensics assistance and materiel to the relief operations in the aftermath of Humcane Katrina. We are currently conducting an assessment of our needs. It is enormously gratifying to know that the American people have a committed friend in the Republic of Hungary.

Sincerely,

A handwritten signature in black ink, appearing to be "R. M. Gates", written in a cursive style.





THE SECRETARY OF DEFENSE
1000 DEFENSE PENTAGON
WASHINGTON, DC 20301-1000

SEP 12 2005

The Honorable Einars RepSe
Minister of Defense
Ministry of Defense
Kr. Valdemara 10/12
Riga LV 1473
Latvia

Dear Mr. Minister:

Thank you for Latvia's offer of support to the relief operations in the aftermath of Hurricane Katrina. It is enormously gratifying to know that the American people have committed friends in the people of Latvia. We appreciate your swift offer of assistance, which will be critical in providing comfort to so many families as they seek to recover from the devastation of Hurricane Katrina.

Sincerely,

A handwritten signature in black ink, appearing to be "R. M. Gates", written in a cursive style.



11-L-0559/OSD/51918



SECRETARY OF DEFENSE
1000 DEFENSE PENTAGON
WASHINGTON, DC 20301-1000

SEP 12 am

The Honorable Spilios Spiliotopoulos
Minister of Defence
Hellenic Republic
151 Mesogeion Avenue
15500 Holargos
Athens, Greece

Dear Minister Spiliotopoulos:

Thank you for your offer to provide a cargo ship and two cruise ships in the aftermath of Hurricane Katrina. We look forward to working with you in expediting the deployment of the cruise ships to reach those in need. I also thank you for your government's generous offer of an emergency rescue team. We are still evaluating our needs and will communicate with you soon regarding these kind offers.

It is enormously gratifying to know that the American people have a committed friend in Greece. We appreciate your swift assistance, which will be critical in helping so many families recover from the devastation of Hurricane Katrina.

Sincerely,

A handwritten signature in black ink, appearing to read "R. M. Gates".



11-L-0559/OSD/51919



SECRETARY OF DEFENSE
1000 THE PENTAGON
WASHINGTON, DC 20301-1000

SEP 12 2005

His Excellency Mehmet Vecdi Gonul
Minister of National Defense
Republic of Turkey
Miillisavunma Bakanligi
Ankara, Turkey

Dear Minister Gonul:

Thank you for your government's generous offer to provide a search and rescue team in the aftermath of Hurricane Katrina. We are still evaluating our needs and will communicate with you soon regarding these kind offers.

It is enormously gratifying to know that the American people have a committed friend in Turkey. We appreciate your swift assistance, which will be critical in helping so many families recover from the devastation of Hurricane Katrina.

Sincerely,

A handwritten signature in black ink, appearing to be "D. Rumsfeld".





THE SECRETARY OF DEFENSE
1000 DEFENSE PENTAGON
WASHINGTON, DC 20301-1000

SEP 12 2005

Mr. Teo Chee Hean
Minister for Defence
Republic of Singapore
Ministry of Defence
303 Gombak Drive
Singapore 669645

Dear Minister Teo:

Thank you for providing your three Chinook helicopters and support personnel to the relief operations in the aftermath of Hurricane Katrina. It is enormously gratifying to know that the American people have a committed friend in Singapore. We appreciate your swift assistance, which will be critical in helping so many families recover from the devastation of Hurricane Katrina.

Sincerely,

A handwritten signature in black ink, appearing to be "R. M. Gates", written in a cursive style.



11-L-0559/OSD/51921



SECRETARY OF DEFENSE
1000 DEFENSE PENTAGON
WASHINGTON, DC 20301

SEP 12 2005

The Honorable Günther Platter
Minister of Defense
Ministry of Defense
Austria

Dear Minister Platter:

Thank you for your kind offer to provide a disaster relief group specializing in water purification, 3 special elite police units and military personnel to the relief operations in the aftermath of Hurricane Katrina. It is enormously gratifying to know that the American people have a committed friend in Austria.

Sincerely,

A handwritten signature in black ink, appearing to be "R. M. Gates", written in a cursive style.



SECRETARY OF DEFENSE
1000 DEFENSE PENTAGON
WASHINGTON, DC 20301-1000

SEP 12 2005

General Gerardo Clemente Ricardo Vega
Secretary of National Defense of Mexico
Mexico City, Mexico

Dear **Mr. Minister**:

Thank you for your government's generous offer of the Hospital/cargo ship "Huasteco", vehicles, and Mexican soldiers to support relief operations in the aftermath of Hurricane Katrina. It is gratifying to know that the American people have a committed friend in Mexico. We appreciate your offer, which will be critical in helping so many families recover from the devastation of Hurricane Katrina.

Sincerely,

A handwritten signature in black ink, appearing to be "R. M. Gates", written in a cursive style.



11-L-0559/OSD/51923



SECRET
100C 01
ASHI G

DEFEN
ENTAGON
DC 20301-100

SEP 12 2005

The Honorable Avil Ramirez
Minister of Defense of the Republic of Nicaragua
Managua, Nicaragua

Dear Mr. Minister:

Thank you for your government's generous offer to provide support in the aftermath of Hurricane Katrina. We are still evaluating our needs and will communicate with you soon regarding these kind offers.

It is gratifying to know that the American people have a committed friend in Nicaragua. We appreciate your offer, which will be critical in helping so many families recover from the devastation of Hurricane Katrina.

Sincerely,

A handwritten signature in black ink, appearing to be "Z. R. ...".



11-L-0559/OSD/51924



SECRETARY OF DEFENSE
1000 DEFENSE PENTAGON
WASHINGTON, DC 20301-1000

SEP 12 2005

Major General Carlos Aldana
Minister of Defense of the Republic of Guatemala
Guatemala City, Guatemala

Dear Mr. Minister:

Thank you for your government's generous offer to provide a rescue team and military personnel to the relief operations in the aftermath of Hurricane Katrina. We are still evaluating our needs and will communicate with you soon regarding these kind offers.

It is gratifying to know that the American people have a committed friend in Guatemala. We appreciate your **offer**, which will be critical in helping **so** many families recover from the devastation of Hurricane Katrina.

Sincerely,

A handwritten signature in black ink, appearing to be "R. M. Gates", written in a cursive style.



11-L-0559/OSD/51925



SECRETARY OF DEFENSE
1000 DEFENSE PENTAGON
WASHINGTON, DC 20301-1000

SEP 12 2005

Major General Otto Alejandro Romero
Minister of Defense of the Republic of El Salvador
San Salvador, El Salvador

Dear Mr. Minister:

Thank you for your government's generous offer to provide over 100 military personnel specializing in medical, engineering, and military police support in the aftermath of Hurricane Katrina. We are still evaluating our needs and will communicate with you soon regarding these kind offers.

It is gratifying to know that the American people have a committed friend in El Salvador. We appreciate your offer, which will be critical in helping so many families recover from the devastation of Hurricane Katrina.

Sincerely,

A handwritten signature in black ink, appearing to be "R. M. Gates", written in a cursive style.



11-L-0559/USD/51926



SECRETARY OF DEFENSE
1000 DEFENSE PENTAGON
WASHINGTON, DC 20301-1000

SEP 12 2005

The Honorable Vildo Marin
Minister of Defense of Belize
Belmopan, Belize

Dear Mr. Minister:

Thank you for your government's generous offer to provide support in the aftermath of Hurricane Katrina. We are still evaluating our needs and will communicate with you soon regarding these kind offers.

It is gratifying to know that the American people have a committed friend in Belize. We appreciate your offer, which will be critical in helping so many families recover from the devastation of Hurricane Katrina.

Sincerely,

A handwritten signature in black ink, appearing to be "R. M. Gates", written in a cursive style.



11-L-0559/OSD/51927



SECRETARY OF DEFENSE
1000 DEFENSE PENTAGON
WASHINGTON, DC 20301-1000

SEP 12 2005

The Honorable Roosevelt Skerrit
Prime Minister of the Commonwealth of Dominica
Roseau, Dominica

Dear Mr. Prime Minister:

Thank you for your government's generous offer to provide support in the aftermath of Hurricane Katrina. We are still evaluating our needs and will communicate with you soon regarding these kind offers.

It is gratifying to know that the American people have a committed friend in Dominica. We appreciate your offer, which will be critical in helping so many families recover from the devastation of Hurricane Katrina.

Sincerely,

A handwritten signature in black ink, appearing to be "R. M. Gates", written over a horizontal line.



11-L-0559/OSD/51928



SECRETARY OF DEFENSE
1000 DEFENSE PENTAGON
WASHINGTON, DC 20301-1000

SEP 12 2005

His Excellency
Federal Minister Samuel Schmid
President of the Swiss Confederation
Bundesthaus Ost
3003 Bern
Switzerland

Dear President Schmid:

Thank you for your generous offer of disaster relief platoons and materiel to the relief operations in the aftermath of Hurricane Katrina. It is enormously gratifying to know that the American people have a committed friend in Switzerland. We appreciate your swift assistance, which will be critical in helping so many families recover from the devastation of Hurricane Katrina.

Sincerely,

A handwritten signature in black ink, appearing to be "R. M. Gates", written in a cursive style.



11-L-0559/OSD/51929



SECRETARY OF DEFENSE
1000 DEFENSE PENTAGON
WASHINGTON, DC 20301-1000

SEP 12 2005

The Right Honourable Dr. John Reid MP
Secretary of State for Defence
Ministry of National Defence
Main Building Level 5 Zone D
Whitehall London SW1A 2HB
United Kingdom

Dear John:

Thank you for your generous offers of personnel, supplies, and equipment to the relief operations in the aftermath of Hurricane Katrina. Your contribution of meals-ready-to-eat and the 500-person tent city will be critical to the many families who now work to recover from the devastation of Hurricane Katrina. Your immediate and significant offers of assistance are another example of the special relationship enjoyed by our two nations.

Sincerely,

A handwritten signature in black ink, appearing to be "R. M. Gates", written in a cursive style.





THE SECRETARY OF DEFENSE
1000 DEFENSE PENTAGON
WASHINGTON, DC 20301-1000

SEP 12 2005

Mr. Jaak Jõerüüt
Minister of Defense
Estonian Ministry of Defense
Sakala 1
15094 Tallinn
Estonia

Dear Mr. Minister:

Thank you for Estonia's offer of support to the relief operations in the aftermath of Hurricane Katrina. It is enormously gratifying to know that the American people have a committed friend in Estonia. We appreciate your swift offer of assistance, which will be critical in providing comfort to so many families as they seek to recover from the devastation of Hurricane Katrina.

Sincerely,

A handwritten signature in black ink, appearing to be "R. M. Gates", written in a cursive style.



11-L-0559/OSD/51931



THE SECRETARY OF DEFENSE
1000 DEFENSE PENTAGON
WASHINGTON, DC 20301-1000

SEP 12 2005

The Honorable Teodor Atanasiu
Minister of Defense
Romanian Ministry of Defence
Izvor St 13-15, Sector 5
70642 Bucharest
Romania

Dear Minister Atanasiu:

Thank you for your offer of medical personnel to support relief operations in the aftermath of Hurricane Katrina. It is enormously gratifying to **know** that the American people have a committed friend in Romania. We are currently giving your offer significant consideration. We appreciate your prompt offer of assistance and your willingness to help so many American families recover from the devastation of Hurricane Katrina.

Sincerely,

A handwritten signature in black ink, appearing to be "R. M. Gates".



11-L-0559/OSD/51932



SECRETARY OF DEFENSE
1000 DEFENSE PENTAGON
WASHINGTON, DC 20301-1000

SEP 12 2005

The Honorable Luc Frieden
Minister of Defense of Luxembourg
6, rue de l'ancien Athénée
L-1144 Luxembourg

Dear Minister Frieden,

Thank you for your generous offer of a search and rescue team, support personnel and supplies to the relief operations in the aftermath of Hurricane Katrina. It is enormously gratifying to know that the American people have a committed friend in Luxembourg. We appreciate your swift assistance, which will be critical in helping so many families recover from the devastation of Hurricane Katrina.

Sincerely,

A handwritten signature in black ink, appearing to be "R. M. Gates", written in a cursive style.





SECRETARY OF DEFENSE
1000 DEFENSE PENTAGON
WASHINGTON, DC 20301-1000

SEP 12 2005

Karl Erjavec
Minister of Defense
Republic of Slovenia
Kardeljeva P125
1000 Ljubljana

Dear Minister Erjavec:

Thank you for your government's generous offer to provide water pumps, first aid kits **and** materiel to the relief operations in the aftermath of Hurricane Katrina. We are currently conducting an assessment of our needs. It is enormously gratifying to know that the American people have a committed friend in the Republic of Slovenia.

Sincerely,

A handwritten signature in black ink, appearing to be "R. M. Gates", written in a cursive style.





SECRETARY OF DEFENSE
1000 DEFENSE PENTAGON
WASHINGTON, DC 20301-1000

SEP 12 2005

The Honorable Henk Kamp
Minister of Defense of the Kingdom of the Netherlands
P.O. **Box 20701**
2500 ES The Hague
The Netherlands

Dear Henk:

Thank you for your generous offer of aircraft, ships, medical supplies and support personnel to the relief operations in the aftermath of Hurricane Katrina. It is enormously gratifying to know that the American people have a committed friend in the Netherlands. We appreciate your swift assistance, which will be critical in helping so many families recover from the devastation of Hurricane Katrina.

Sincerely,

A handwritten signature in black ink, appearing to read "R. M. Gates", written over a horizontal line.



SECRETARY OF DEFENSE
1000 DEFENSE PENTAGON
WASHINGTON, DC 20301-1000

SEP 12 2005

His Excellency Antonio Martino
Minister of Defense
Ministry of Defense
Via xx, Settembre 8
00187 Rome, Italy

Dear Antonio:

Thank you for Italy's offer of camp beds, blankets, tents, water purification systems, medical supplies and a field hospital to the relief operations in the aftermath of Hurricane Katrina. It is enormously gratifying to know that the American people have a committed friend in Italy. We appreciate your swift assistance, which will be critical in helping so many families recover from the devastation of Hurricane Katrina.

I **look** forward to seeing you in Berlin.

Sincerely,

A handwritten signature in black ink, appearing to read "D. Rumsfeld".





SECRETARY OF DEFENSE
1000 DEFENSE PENTAGON
WASHINGTON, DC 20301-1000

SEP 12 2005

The Honorable Dr. Peter Struck
Federal Minister of Defense
Federal Ministry of Defense
D-11055 Berlin
Germany

Dear Minister Struck:

Thank you for providing your Meals-Ready-to-Eat (MRE) to the relief operations in the aftermath of Hurricane Katrina. We appreciate your swift assistance, which will be critical in helping so many families recover from the devastation of Hurricane Katrina.

Sincerely,

A handwritten signature in black ink, appearing to be "R. M. Gates", written in a cursive style.





SECRETARY OF DEFENSE
1000 DEFENSE PENTAGON
WASHINGTON, DC 20301-1000

SEP 12 2005

Her Excellency Kristin Krohn Devold
Minister of Defense
Ministry of Defense
Myntgata 1
N-0032 Oslo
Norway

Dear Kristin:

Thank you for Norway's generous offer of blankets, tents, medicine, divers and cash assistance to the relief operations in the aftermath of Hurricane Katrina. It is enormously gratifying to know that the American people have a committed ally in Norway. We appreciate your swift assistance, which will be critical in helping so many families recover from the devastation of Hurricane Katrina.

I look forward to seeing you in Berlin.

Best,

A handwritten signature in black ink, appearing to read "D. Rumsfeld".



11-L-0559/OSD/51938



SECRETARY OF DEFENSE
1000 DEFENSE PENTAGON
WASHINGTON, DC 20301-1000

SEP 12 2005

Karel Kuhl
Minister of Defense
Czech Republic
Tychonova 1
Praha 6

Dear Minister Kuhl:

Thank you for your government's offer to provide medical, materiel and logistical support to the relief operations in the aftermath of Hurricane Katrina. We are currently conducting an assessment of our needs. It is enormously gratifying to know that the American people have a committed friend in the Czech Republic.

Sincerely,

A handwritten signature in black ink, appearing to be "R. M. Gates", written in a cursive style.



11-L-0559/OSD/51939



SECRETARY OF DEFENSE
1000 DEFENSE PENTAGON
WASHINGTON, DC 20301-1000

SEP 12 2005

Her Excellency Michele Alliot-Marie
Minister of Defense of the French Republic
14 Rue Saint-Dominique
00450 Armees
Paris, France

Dear Madame Minister:

Thank you for your generous offers of aircraft, ships and supplies to the relief operations in the aftermath of Hurricane Katrina. The tents, generators and supplies you have sent will be critical in helping the many families working to recover from the devastation of Hurricane Katrina.

Sincerely,

A handwritten signature in black ink, appearing to be "Z. R. ...".





SECRETARY OF DEFENSE
1000 DEFENSE PENTAGON
WASHINGTON, DC 20301-1000

SEP 12 2005

The Honorable William Graham
Minister for National Defense
Department of National Defense
101 Colonel By Drive
Ottawa, Ontario K1A 0k2
Canada

Dear Minister Graham:

Thank you for your generous contribution of helicopters, air transport and personnel to the relief operations in the aftermath of Hurricane Katrina. Your swift offers of military collaboration and assistance will be critical in helping the many families working to recover from the devastation of Hurricane Katrina and serve as an example of the relationship between our two nations.

Sincerely,

A handwritten signature in black ink, appearing to be "Z. R. ...".



SECRETARY OF DEFENSE
1000 DEFENSE PENTAGON
WASHINGTON, DC 20301-1000

SEP 12 2005

The Honorable Andre Flahaunt
Minister of Defense of the Kingdom of Belgium
Rue Lambermont 8
1000 Brussels
Belgium

Dear Minister Flahaunt:

Thank you for your generous offers of medical and support personnel and equipment to the relief operations in the aftermath of Hurricane Katrina. We appreciate your swift offers of assistance, which will be critical in helping so many families recover from the devastation of Hurricane Katrina.

Sincerely,





DEPARTMENT OF DEFENSE
WASHINGTON HEADQUARTERS SERVICES
EXECUTIVE SERVICES DIRECTORATE

335SD

September 12, 2005

MEMORANDUM FOR CABLES DUTY OFFICER

SUBJECT: Release of Message – SECDEF Letter to various MODs on Hurricane Katrina Relief

The attached package contains 35 messages/cables to be released via the Defense Messaging System (DMS).

The text of the messages has been reviewed and cleared for release.

Please return a copy of this memo along with a copy of the transmitted messages to the Correspondence Control Division.

Thank you.

Executive Services Directorate

Correspondence Analyst

Attachments:
As stated

OSD 18243-05

(65EARS)

11-L-0559/OSD/51943

ROUTINE

INFO: AMEMBASSY HELSINKI FI
STATE DEPARTMENT WASHINGTON DC

UNCLASS

SUBJECT: LETTER FROM SECRETARY OF DEFENSE RUMSFELD TO HIS FINNISH
COUNTERPART

1. PLEASE DELIVER THE FOLLOWING LETTER FROM SECRETARY RUMSFELD TO
MINISTER KAARIANEN. ORIGINAL WILL BE DELIVERED BY POST.

2. BEGIN TEXT

HIS EXCELLENCY SEPPOKÄÄRIÄNEN
MINISTER OF DEFENSE
MINISTRY OF DEFENSE
ETELAINEN MAKASIINIKATU 8
PO BOX 31
FIN-00131 HELSINKI
FINLAND

DEAR MINISTER KÄÄRIÄNEN:

(PARA) THANK YOU FOR YOUR KIND OFFER OF WATER PURIFICATION
UNITS, FIRST AID KITS, AND A SEARCH AND RECOVERY TEAM FOR THE
RELIEF OPERATIONS IN THE AFTERMATH OF HURRICANE KATRINA. IT IS
ENORMOUSLY GRATIFYING TO KNOW THAT THE AMERICAN PEOPLE HAVE
A COMMITTED FRIEND IN FINLAND. WE APPRECIATE YOUR SWIFT
ASSISTANCE, WHICH WILL BE CRITICAL IN HELPING SO MANY FAMILIES
RECOVER FROM THE DEVASTATION OF HURRICANE KATRINA.

SINCERELY,

//SIGNED DONALD H. RUMSFELDI

3. END TEXT.

11-L-0559/OSD/51944

OSD 18243-05

Drafter's Name: CDR SCOTT E. ORGAN.
Office/Phone: OSD/ISA/WHA, (b)(6)
Releaser's Info: DONALD H. RUMSFELD, SECDEF

*For CDR's on
delete
to marked
on addresses
pkf*

Classification: UNCLAS

Precedence: ROUTINE

From: SECDEF WASHINGTON DC
To: USDAO TEGUCIGALPA
SECSTATE WASHINGTON DC
SECDCS WASHINGTON DC
CJCS WASHINGTON DC
NSC WASHINGTON DC
JOINT STAFF WASHINGTON DC//J5//
AMEMBASSY BELIZE CITY
Info: ~~US COMMANDER SOUTHCOM MIAMI FL~~
~~USUN NEW YORK NY~~
DIA WASHINGTON DC
SECDEF WASHINGTON DC//USDP/DSCA//
SECDEF WASHINGTON DC//USDP:CHAIRS//

UNCLASSIFIED

SUBJECT: THANK YOU LETTER TO BELIZE MINISTER OF DEFENSE VILDO MARIN

1. SECRETARY RUMSFELD HAS SIGNED THE FOLLOWING LETTER TO MINISTER OF DEFENSE VILDO MARIN. REQUEST THAT THE TEXT OF THE LETTER BE PROVIDED TO MINISTER OF DEFENSE VILDO MARIN AS SOON AS POSSIBLE. ORIGINAL SIGNED LETTER WILL BE FORWARDED VIA DIPLOMATIC POUCH.

THE HONORABLE VILDO MARIN
MINISTER OF DEFENSE OF BELIZE
BELMOPAN, BELIZE

DEAR MR. MINISTER:

THANK YOU FOR YOUR GOVERNMENT'S GENEROUS OFFER TO PROVIDE SUPPORT IN THE AFTERMATH OF HURRICANE KATRINA. WE ARE STILL EVALUATING OUR NEEDS AND WILL COMMUNICATE WITH YOU SOON REGARDING THESE KIND OFFERS.

IT IS GRATIFYING TO KNOW THAT THE AMERICAN PEOPLE HAVE A COMMITTED FRIEND IN BELIZE. WE APPRECIATE YOUR OFFER, WHICH WILL BE CRITICAL IN HELPING SO MANY FAMILIES RECOVER FROM THE DEVASTATION OF HURRICANE KATRINA.

SINCERELY,
//DONALD H. RUMSFELD//

(END TEXT)

Drafter's Name: CDR SCOTTE. ORGAN.
Office/Phone: OSDIISA1WHA (b)(6)
Releaser's Info: DONALD H. RUMSFELD, SECDEF

Classification: UNCLAS

Precedence: ROUTINE

From: SECDEF WASHINGTON DC
To: USDAO MANAGUA
SECSTATE WASHINGTON DC
SEC DHS WASHINGTON DC
CJCS WASHINGTON DC
NSC WASHINGTON DC
JOINT STAFF WASHINGTON DC//J5//
AMEMBASSY MANAGUA
Info: ~~US COMMANDER SOUTHCOM MIAMI FL~~
~~USUN NEW YORK NY~~
DIA WASHINGTON DC
SECDEF WASHINGTON DC//USDP/DSCA//
SECDEF WASHINGTON DC//USDP:CHAIRS//

UNCLASSIFIED

SUBJECT: THANK YOU LETTER TO NICARAGUA MINISTER OF DEFENSE AVIL RAMIREZ

1. SECRETARY RUMSFELD HAS SIGNED THE FOLLOWING LETTER TO AVIL RAMIREZ. REQUEST THAT THE TEXT OF THE LETTER BE PROVIDED TO AVIL RAMIREZ AS SOON AS POSSIBLE. ORIGINAL SIGNED LETTER WILL BE FORWARDED VIA DIPLOMATIC POUCH.

THE HONORABLE AVIL RAMIREZ
MINISTER OF DEFENSE OF THE REPUBLIC OF NICARAGUA
MANAGUA, NICARAGUA

DEAR MR. MINISTER:

THANK YOU FOR YOUR GOVERNMENT'S GENEROUS OFFER TO PROVIDE SUPPORT IN THE AFTERMATH OF HURRICANE KATRINA. WE ARE STILL EVALUATING OUR NEEDS AND WILL COMMUNICATE WITH YOU SOON REGARDING THESE KIND OFFERS.

IT IS GRATIFYING TO KNOW THAT THE AMERICAN PEOPLE HAVE A COMMITTED FRIEND IN NICARAGUA. WE APPRECIATE YOUR OFFER, WHICH WILL BE CRITICAL IN HELPING SO MANY FAMILIES RECOVER FROM THE DEVASTATION OF HURRICANE KATRINA.

SINCERELY,
//DONALD H. RUMSFELD//

11-L-0559/OSD/51946

OSD 18243-05

Drafter's Name: CDR SCOTT E. ORGAN,
Office/Phone: OSD/ISA/WHA, (b)(6)
Releaser's Info: DONALD H. RUMSFELD, SECDEF

Classification: UNCLAS

Precedence: ROUTINE

From: SECDEF WASHINGTON DC
To: USDAO MEXICO CITY
SECSTATE WASHINGTON DC
SEC DHS WASHINGTON DC
CJCS WASHINGTON DC
NSC WASHINGTON DC
JOINT STAFF WASHINGTON DC//J5//
AMEMBASSY MEXICO CITY
Info: ~~US COMMANDER SOUTHCOM MIAMI FL~~
~~USCN NEW YORK NY~~
DIA WASHINGTON DC
SECDEF WASHINGTON DC//USDP/DSCA//
SECDEF WASHINGTON DC//USDP/CHAIRS//

UNCLASSIFIED

SUBJECT: THANK YOU LETTER TO MEXICO SECRETARY OF NATIONAL DEFENSE
GENERAL GERARDO CLEMENTE RICARDO VEGA

1. SECRETARY RUMSFELD HAS SIGNED THE FOLLOWING LETTER TO GENERAL
GERARDO CLEMENTE RICARDO VEGA. REQUEST THAT THE TEXT OF THE LETTER
BE PROVIDED TO GENERAL GERARDO CLEMENTE RICARDO VEGA AS SOON AS
POSSIBLE. ORIGINAL SIGNED LETTER WILL BE FORWARDED VIA DIPLOMATIC
POUCH.

GENERAL GERARDO CLEMENTE RICARDO VEGA
SECRETARY OF NATIONAL DEFENSE OF MEXICO
MEXICO CITY, MEXICO

DEAR MR. MINISTER:

THANK YOU FOR YOUR GOVERNMENT'S GENEROUS OFFER OF THE
HOSPITAL/CARGO SHIP "HUASTEKO, VEHICLES, AND MEXICAN SOLDIERS TO
SUPPORT RELIEF OPERATIONS IN THE AFTERMATH OF HURRICANE KATRINA. IT
IS GRATIFYING TO KNOW THAT THE AMERICAN PEOPLE HAVE A COMMITTED
FRIEND IN MEXICO. WE APPRECIATE YOUR OFFER, WHICH WILL BE CRITICAL IN

HELPING SO MANY FAMILIES RECOVER FROM THE DEVASTATION OF HURRICANE
KATRINA.

SINCERELY,
DONALD H. RUMSFELDI

(END TEXT)

Drafter's Name: CDR SCOTT E. ORGAN,
Office/Phone: OSD/ISA/WHA (b)(6)
Releaser's Info: DONALD H. RUMSFELD, SECDEF

Classification: UNCLAS

Precedence: ROUTINE

From: SECDEF WASHINGTON DC
To: USDAO SAN SALVADOR
SECSTATE WASHINGTON DC
SEC DHS WASHINGTON DC
CJCS WASHINGTON DC
NSC WASHINGTON DC
JOINT STAFF WASHINGTON DC//J5//
AMEMBASSY SAN SALVADOR
Info: ~~US COMMANDER SOUTH COM MIAMI FL~~
~~USUN NEW YORK NY~~
DIA WASHINGTON DC
SECDEF WASHINGTON DC//USDP/DSCA//
SECDEF WASHINGTON DC//USDP:CHAIRS//

UNCLASSIFIED

SUBJECT: THANK YOU LETTER TO EL SALVADOR MINISTER OF DEFENSE MAJOR
GENERAL OTTO ALEJANDRO ROMERO

1. SECRETARY RUMSFELD HAS SIGNED THE FOLLOWING LETTER TO MAJOR GENERAL
OTTO ALEJANDRO ROMERO. REQUEST THAT THE TEXT OF THE LETTER BE PROVIDED
TO MAJOR GENERAL OTTO ALEJANDRO ROMERO AS SOON AS POSSIBLE. ORIGINAL
SIGNED LETTER WILL BE FORWARDED VIA DIPLOMATIC POUCH.

MAJOR GENERAL OTTO ALEJANDRO ROMERO
MINISTER OF DEFENSE OF THE REPUBLIC OF EL SALVADOR
SAN SALVADOR, EL SALVADOR

DEAR MR MINISTER:

THANK YOU FOR *YOUR* GOVERNMENT'S GENEROUS OFFER TO PROVIDE OVER 100
MILITARY PERSONNEL SPECIALIZING IN MEDICAL, ENGINEERING, AND MILITARY
POLICE SUPPORT IN THE AFTERMATH OF HURRICANE! KATRINA. WE ARE STILL
EVALUATING OUR NEEDS AND WILL COMMUNICATE WITH YOU SOON REGARDING
THESE KIND OFFERS.

IT IS GRATIFYING TO KNOW THAT THE AMERICAN PEOPLE HAVE A COMMITTED FRIEND
IN EL SALVADOR. WE APPRECIATE *YOUR* OFFER, WHICH WILL BE CRITICAL IN HELPING
SO MANY FAMILIES RECOVER FROM THE DEVASTATION OF HURRICANE KATRINA.

11-L-0559/OSD/51949

OSD 18243-05

SINCERELY,
//DONALD H. RUMSFELDN

(END TEXT)

Drafter's Name: CDR SCOTTE. ORGAN,
Office/Phone: OSD/ISA/WHA, (b)(6)
Releaser's Info: DONALD H. RUMSFELD, SECDEF

Classification: UNCLAS

Precedence: ROUTINE

From: SECDEF WASHINGTON DC
To: USDAO GUATEMALA CITY
SECSTATE WASHINGTON DC
SEC DHS WASHINGTON DC
CJCS WASHINGTON DC
NSC WASHINGTON DC
JOINT STAFF WASHINGTON DC//J5//
AMEMBASSY GUATEMALA CITY
Info: ~~US COMMANDER SOUTHCOM MIAMI FL~~
~~USUN NEW YORK NY~~
DIA WASHINGTON DC
SECDEF WASHINGTON DC//USDP/DSCA//
SECDEF WASHINGTON DC//USDP:CHAIRS//

UNCLASSIFIED

SUBJECT: THANK YOU LETTER TO GUATEMALA MINISTER OF DEFENSE

1. SECRETARY RUMSFELD HAS SIGNED THE FOLLOWING LETTER TO MAJOR GENERAL CARLOS ALDANA. REQUEST THAT THE TEXT OF THE LETTER BE PROVIDED TO MAJOR GENERAL CARLOS ALDANA AS SOON AS POSSIBLE. ORIGINAL SIGNED LETTER WILL BE FORWARDED VIA DIPLOMATIC POUCH.

MAJOR GENERAL CARLOS ALDANA
MINISTER OF DEFENSE OF THE REPUBLIC OF GUATEMALA
GUATEMALA CITY, GUATEMALA

DEAR MR. MINISTER:

THANK YOU FOR YOUR GOVERNMENT'S GENEROUS OFFER TO PROVIDE A RESCUE TEAM AND MILITARY PERSONNEL TO THE RELIEF OPERATIONS IN THE AFTERMATH OF HURRICANE KATRINA. WE ARE STILL EVALUATING *OUR* NEEDS AND WILL COMMUNICATE WITH YOU SOON REGARDING THESE KIND OFFERS.

IT IS GRATIFYING TO KNOW THAT THE AMERICAN PEOPLE HAVE A COMMITTED FRIEND IN GUATEMALA. WE APPRECIATE YOUR OFFER, WHICH WILL BE CRITICAL IN HELPING SO MANY FAMILIES RECOVER FROM THE DEVASTATION OF HURRICANE KATRINA.

11-L-0559/OSD/51951

OSD 18243-05

SINCERELY,
//DONALD H. RUMSFELD//

(END TEXT)

Drafter's Name: CDR SCOTTE E. ORGAN,

Office/Phone: OSDIISAIWHA, (b)(6)

Releaser's Info: DONALD H. RUMSFELD, SECDEF

Classification: UNCLAS

Precedence: ROUTINE

From: SECDEF WASHINGTON DC

To: ~~USDAO ROSEAU~~

SECSTATE WASHINGTON DC

SEC DHS WASHINGTON DC

CJCS WASHINGTON DC

NSC WASHINGTON DC

JOINT STAFF WASHINGTON DC//J5//

AMEMBASSY ROSEAU *Bridgeport*

Info: ~~US COMMANDER SOUTHCOM MIAMI FL~~

~~USUN NEW YORK NY~~

DIA WASHINGTON DC

SECDEF WASHINGTON DC//USDP/DSCA//

SECDEF WASHINGTON DC//USDP/CHAIRS//

UNCLASSIFIED

SUBJECT: THANK YOU LETTER TO DOMINICA PRIME MINISTER ROOSEVELT SKERRIT

1. SECRETARY RUMSFELD HAS SIGNED THE FOLLOWING LETTER TO PRIME MINISTER ROOSEVELT SKERRIT. REQUEST THAT THE TEXT OF THE LETTER BE PROVIDED TO PRIME MINISTER ROOSEVELT SKERRIT AS SOON AS POSSIBLE. ORIGINAL SIGNED LETTER WILL BE FORWARDED VIA DIPLOMATIC POUCH.

THE HONORABLE ROOSEVELT SKERRIT
PRIME MINISTER OF THE COMMONWEALTH OF DOMINICA
ROSEAU, DOMINICA

DEAR MR. MINISTER:

THANK YOU FOR YOUR GOVERNMENT'S GENEROUS OFFER TO PROVIDE SUPPORT IN THE AFTERMATH OF HURRICANE KATREVA. WE ARE STILL EVALUATING OUR NEEDS AND WILL COMMUNICATE WITH YOU SOON REGARDING THESE KIND OFFERS.

IT IS GRATIFYING TO KNOW THAT THE AMERICAN PEOPLE HAVE A COMMITTED FRIEND IN DOMINICA. WE APPRECIATE YOUR OFFER, WHICH WILL BE CRITICAL IN HELPING SO MANY FAMILIES RECOVER FROM THE DEVASTATION OF HURRICANE KATRINA.

SINCERELY,
//DONALD H. RUMSFELD//

(END TEXT)

FM: SECDEF WASHINGTON DC
TO: USDAO VIENNA AU
INFO: AMEMBASSY VIENNA AU
OSD CHAIRS WASHINGTON DC

UNCLAS

SUBJ: LETTER FROM SECRETARY OF DEFENSE RUMSFELD TO HIS
AUSTRIAN COUNTERPART

1. PLEASE DELIVER THE FOLLOWING LETTER FROM SECRETARY
RUMSFELD TO MINISTER PLATTER. ORIGINAL WILL BE DELIVERED BY
POST.

2. BGINTEXT

THE HONORABLE GUENTHER PLATTER
MINISTER OF DEFENSE
MINISTRY OF DEFENSE
AUSTRIA

DEAR MINISTER PLATTER:

(PARA) THANK YOU FOR YOUR KIND OFFER TO PROVIDE A DISASTER
RELIEF GROUP SPECIALIZING IN WATER PURIFICATION, 3 SPECIAL ELITE
POLICE UNITS AND MILITARY PERSONNEL TO THE RELIEF OPERATIONS IN
THE AFTERMATH OF HURRICANE KATRINA. IT IS ENORMOUSLY
GRATIFYING TO KNOW THAT THE AMERICAN PEOPLE HAVE A COMMITTED
FRIEND IN AUSTRIA.

SINCERELY,

//SIGNED//DONALD H. RUMSFELD//

3. END TEXT

FM: SECDEF WASHINGTON DC
TO: USDAO BERLIN GE
INFO: AMEMBASSY BERLIN GE
OSD CHAIRS WASHINGTON DC

UNCLAS

SUBJ: LETTER FROM SECRETARY OF DEFENSE RUMSFELD TO HIS GERMAN
COUNTERPART.

1. PLEASE DELIVER THE FOLLOWING LETTER FROM SECRETARY
RUMSFELD TO MINISTER STRUCK. ORIGINAL WILL BE DELIVERED BY
POST.

BEGIN TEXT

THE HONORABLE DR. PETER STRUCK
FEDERAL MINISTER OF DEFENSE
FEDERAL MINISTRY OF DEFENSE
D-11055 BERLIN
GERMANY

DEAR MINISTER STRUCK:

(PARA) THANK YOU FOR PROVIDING YOUR MEALS-READY-TO-EAT (MRE)
TO THE RELIEF OPERATIONS IN THE AFTERMATH OF HURRICANE
KATRINA. WE APPRECIATE YOUR SWIFT ASSISTANCE, WHICH WILL BE
CRITICAL IN HELPING SO MANY FAMILIES RECOVER FROM THE
DEVASTATION OF HURRICANE KATRINA.

SINCERELY,

//SIGNED//DONALD H. RUMSFELD//
END TEXT

FM: SECDEF WASHINGTON DC
TO: USDAO BERN
INFO: AMEMBASSY BERN
OSD CHAIRS WASHINGTON DC

UNCLAS

SUBJ: LETTER FROM SECRETARY OF DEFENSE RUMSFELD TO HIS SWISS
COUNTERPART

1. PLEASE DELIVER THE FOLLOWING LETTER FROM SECRETARY
RUMSFELD TO PRESIDENT SCHMID. ORIGINAL WILL BE DELIVERED BY
POST.

2. BEGINTEXT

HIS EXCELLENCY
FEDERAL MINISTER SAMUEL SCHMID
PRESIDENT OF THE SWISS CONFEDERATION
BUNDESTHAUS OST
3003 BERN
SWITZERLAND

DEAR PRESIDENT SCHMID:

(PARA) THANK YOU FOR YOUR GENEROUS OFFER OF DISASTER RELIEF
PLATOONS AND MATERIEL TO THE RELIEF OPERATIONS IN THE
AFTERMATH OF HURRICANE KATRINA. IT IS ENORMOUSLY GRATIFYING
TO KNOW THAT THE AMERICAN PEOPLE HAVE A COMMITTED FRIEND IN
SWITZERLAND. WE APPRECIATE YOUR SWIFT ASSISTANCE, WHICH WILL
BE CRITICAL IN HELPING SO MANY FAMILIES RECOVER FROM THE
DEVASTATION OF HURRICANE KATRINA.

SINCERELY,

//SIGNED//DONALD H. RUMSFELD//

3. END TEXT

UNCLASSIFIED

PRECEDENCE: PRIORITY

TO:
USDAO MOSCOW
OSD CHAIRS

INFO:
SECDEF WASHINGTON DC
SECSTATE WASHINGTON DC
DIRECTOR JOINT STAFF
AMEMBASSY MOSCOW
HOMELAND SECURITY
CDR USEUCOM
DCDR USEUCOM

ACTION USDAO MOSCOW

TRANSLATE AND DELIVER THE FOLLOWING LETTER FROM SECDEF
TO MOD IVANOV ON THANK YOU FOR HURRICANE RELIEF AT
EARLIEST POSSIBLE CONVENIENCE.

(BEGIN TEXT)

HIS EXCELLENCY SERGEY IVANOV
MINISTER OF DEFENSE
RUSSIAN FEDERATION
MOSCOW, RUSSIA

DEAR SERGEY:

THANK YOU FOR YOUR GOVERNMENT'S GENEROUS OFFER OF
ASSISTANCE FOR THE HURRICANE KATRINA RELIEF EFFORT. THE
DELIVERY OF MEALS-READY-TO-EAT (MRFS), TENTS, AND
BLANKETS BY TWO RUSSIAN IL-76 AIRCRAFT WAS WARMLY
RECEIVED AT LITTLE ROCK AIR FORCE BASE, ARKANSAS.

11-L-0559/OSD/51957

OSD 18243-05

ROUTINE

FM: SECDEF WASHINGTON DC//USDP EURNATO//
TO: USDAO PRAGUE EZ
INFO: AMEMBASSY PRAGUE
USMISSION USNATO
SECSTATE WASHINGTON DC
JOINT STAFF WASHINGTON DC
DEFENSE INTELLIGENCE AGENCY WASHINGTON DC
NATIONAL SECURITY COUNCIL WASHINGTON DC
OSD CHAIRS
USEUCOM ALT SHAPE BE

UNCLASSIFIED

SUBJECT: SECRETARY OF DEFENSE RUMSFELD LETTER THANKING
MINISTER OF DEFENSE FOR OFFER OF SUPPORT FOR HURRICANE KATRINA
RELIEF OPERATION.

1. ACTION REQUEST: PLEASE DELIVER LETTER BELOW TO MINISTER OF
DEFENSE. SIGNED LETTER WILL FOLLOW.

2. TEXT BEGINS:

KAREL KUHLN
MINISTER OF DEFENSE
CZECH REPUBLIC
TYCHONOVA 1
PRAHA 6

DEAR MINISTER KUHLN:

(PARA) THANK YOU FOR YOUR GOVERNMENT'S OFFER TO PROVIDE
MEDICAL, MATERIEL AND LOGISTICAL SUPPORT TO THE RELIEF
OPERATIONS IN THE AFTERMATH OF HURRICANE KATRINA. WE ARE
CURRENTLY CONDUCTING AN ASSESSMENT OF OUR NEEDS. IT IS
ENORMOUSLY GRATIFYING TO KNOW THAT THE AMERICAN PEOPLE
HAVE A COMMITTED FRIEND IN THE CZECH REPUBLIC.

SINCERELY,

//DONALD H. RUMSFELD//

3. END TEXT.

11-L-0559/OSD/51958

OSD 18243-05

UNCLASSIFIED

ROUTINE

FM SECDEF WASHINGTONDC//USDP EURNATO//
TO USDAO ATHENS GR
INFO AMEMBASSY ATHENS GR

SUBJECT: SECDEF LETTER TO MOD SPILIOTOPOULOS

PLEASE TRANSMIT THE FOLLOWING LETTER FROM SECDEF TO MOD
SPILIOTOPOULOS. ORIGINAL LETTER WILL FOLLOW.

(BEGIN TEXT)

THE HONORABLE SPILIOS SPILIOTOPOULOS
MINISTER FOR DEFENCE
HELLENIC REPUBLIC
151 MESOGEION AVENUE
15500 HOLARGOS
ATHENS, GREECE

DEAR MINISTER SPILIOTOPOULOS:

(PARA) THANK YOU FOR YOUR OFFER TO PROVIDE A CARGO SHIP AND TWO CRUISE SHIPS IN THE AFTERMATH OF HURRICANE KATRINA. WE LOOK FORWARD TO WORKING WITH YOU IN EXPEDITING THE DEPLOYMENT OF THE CRUISE SHIPS TO REACH THOSE IN NEED. I ALSO THANK YOU FOR YOUR GOVERNMENT'S GENEROUS OFFER OF AN EMERGENCY RESCUE TEAM. WE ARE STILL EVALUATING OUR NEEDS AND WILL COMMUNICATE WITH YOU SOON REGARDING THESE KIND OFFERS.

(PARA) IT IS ENORMOUSLY GRATIFYING TO KNOW THAT THE AMERICAN PEOPLE HAVE A COMMITTED FRIEND IN GREECE. WE APPRECIATE YOUR SWIFT ASSISTANCE, WHICH WILL BE CRITICAL IN HELPING SO MANY FAMILIES RECOVER FROM THE DEVASTATION OF HURRICANE KATRINA.

SINCERELY,

//DONALD RUMSFELD//

(END TEXT)

OSD 18243-05

11-L-0559/OSD/51959

ROUTINE

FROM: SECDEF WASHINGTON DC//USDP BURNATO//
TO: USDAO BUDAPEST HU
INFO: AMEMBASSY BUDAPEST
USMISSION USNATO
SECSTATE WASHINGTON DC
JOINT STAFF WASHINGTON DC
DEFENSE INTELLIGENCE AGENCY
NATIONAL SECURITY COUNCIL WASHINGTON DC
OSD CHAIRS
USEUCOM ALT SHAPE BE

UNCLASSIFIED

SUBJECT: SECRETARY OF DEFENSE RUMSFELD LETTER THANKING
MINISTER OF DEFENSE FOR OFFER OF SUPPORT FOR HURRICANE KATRINA
RELIEF OPERATION.

1. ACTION REQUEST: PLEASE DELIVER LETTER BELOW TO MINISTER OF
DEFENSE. SIGNED LETTER WILL FOLLOW.

2. TEXT BEGINS:

FERENC JUHASZ
MINISTER OF DEFENSE
REPUBLIC OF HUNGARY
BALATON U 7-11
1055 BUDAPEST

DEAR MINISTER JUHASZ:

(PARA) THANK YOU FOR YOUR GOVERNMENT'S OFFER TO PROVIDE A
NINE MEMBER RESCUE TEAM, FORENSICS ASSISTANCE AND MATERIEL TO
THE RELIEF OPERATIONS IN THE AFTERMATH OF HURRICANE KATRINA.
WE *ARE* CURRENTLY CONDUCTING AN ASSESSMENT OF OUR NEEDS. IT IS
ENORMOUSLY GRATIFYING TO KNOW THAT THE AMERICAN PEOPLE HAVE
A COMMITTED FRIEND IN THE REPUBLIC OF HUNGARY.

SINCERELY,

//DONALD H. RUMSFELD//

3. END OF TEXT.

OSD 18243-05

11-L-0559/OSD/51960

ROUTINE

FM: SECDEF WASHINGTON DC//USDP EURNATO//
TO: USDAO LJUBLJANA SI
INFO: AMEMBASSY LJUBLJANA
USMISSION USNATO
SECSTATE WASHINGTON DC
JOINT STAFF WASHINGTON DC
DEFENSE INTELLIGENCE AGENCY WASHINGTON DC
NATIONAL SECURITY COUNCIL WASHINGTON DC
OSD CHAIRS
USEUCOM ALT SHAPE BE

UNCLASSIFIED

SUBJECT: SECRETARY OF DEFENSE RUMSFELD LETTER THANKING
MINISTER OF DEFENSE FOR OFFER OF SUPPORT FOR HURRICANE KATRINA
RELIEF OPERATION.

1. ACTION REQUEST: PLEASE DELIVER LETTER BELOW TO MINISTER OF
DEFENSE. SIGNED LETTER WILL FOLLOW.

2. TEXT BEGINS:

KARL ERJAVEC
MINISTER OF DEFENSE
REPUBLIC OF SLOVENIA
KARDELJEVA PL 25
1000 LJUBLJANA

DEAR MINISTER ERJAVEC:

THANK YOU FOR YOUR GOVERNMENT'S GENEROUS OFFER TO PROVIDE
WATER PUMPS, FIRST AID KITS AND MATERIEL TO THE RELIEF
OPERATIONS IN THE AFTERMATH OF HURRICANE KATRINA. WE ARE
CURRENTLY CONDUCTING AN ASSESSMENT OF OUR NEEDS. IT IS
ENORMOUSLY GRATIFYING TO KNOW THAT THE AMERICAN PEOPLE HAVE
A COMMITTED FRIEND IN THE REPUBLIC OF SLOVENIA.

SINCERELY,

//DONALD H. RUMSFELD//

3. END OF TEXT.

UNCLASSIFIED

ROUTINE

FM SECDEF WASHINGTONDC//USDP EURNATO//
TO USDAO ANKARA TU
INFO AMEMBASSY ANKARA TU

SUBJECT: SECDEF LETTER TO MOD GONUL

PLEASE TRANSMIT THE FOLLOWING LETTER FROM SECDEF TO MOD
GONUL. ORIGINAL LETTER WILL FOLLOW.

(BEGIN TEXT)

HIS EXCELLENCY MEHMET VECDI GONUL
MINISTER OF NATIONAL DEFENSE
REPUBLIC OF TURKEY
MILLISAVUNMA BAKANLIGI
ANKARA, TURKEY

DEAR MINISTER GONUL:

(PARA) THANK YOU FOR YOUR GOVERNMENT'S GENEROUS OFFER TO
PROVIDE A SEARCH AND RESCUE TEAM IN THE AFTERMATH OF
HURRICANE KATRINA. WE ARE STILL EVALUATING OUR NEEDS AND WILL
COMMUNICATE WITH YOU SOON REGARDING THESE KIND OFFERS.

(PARA) IT IS ENORMOUSLY GRATIFYING TO KNOW THAT THE AMERICAN
PEOPLE HAVE A COMMITTED FRIEND IN TURKEY. WE APPRECIATE YOUR
SWIFT ASSISTANCE, WHICH WILL BE CRITICAL IN HELPING SO MANY
FAMILIES RECOVER FROM THE DEVASTATION OF HURRICANE KATRINA.

SINCERELY,

//DONALD RUMSFELDI

(END TEXT)

FROM: SECDEF WASHINGTON DC
TO: USDAO TALLINN EN
INFO AMEMBASSY TALLINN
STATE DEPT WASHINGTON DC
OSD CHAIRS WASHINGTON DC

UNCLASS

SUBJECT: LETTER FROM SECRETARY OF DEFENSE RUMSFELD TO HIS ESTONIAN
COUNTERPART

1. PLEASE DELIVER THE FOLLOWING LETTER FROM SECRETARY RUMSFELD TO
MINISTER JÕERÛÛT. ORIGINAL WILL BE DELIVERED BY POST.

2. BEGIN TEXT

THE HONORABLE JAAK JÕERÛÛT
MINISTER OF DEFENSE
ESTONIAN MINISTRY OF DEFENSE
SAKALA 1
15094 TALLINN
ESTONIA

DEAR MINISTER JÕERÛÛT:

(PARA) THANK YOU FOR ESTONIA'S OFFER OF SUPPORT TO THE RELIEF
OPERATIONS IN THE AFTERMATH OF HURRICANE KATRINA. IT IS
ENORMOUSLY GRATIFYING TO KNOW THAT THE AMERICAN PEOPLE HAVE
A COMMITTED FRIEND IN ESTONIA. WE APPRECIATE YOUR SWIFT OFFER
OF ASSISTANCE, WHICH WILL BE CRITICAL IN PROVIDING COMFORT TO SO
MANY FAMILIES AS THEY SEEK TO RECOVER FROM THE DEVASTATION OF
HURRICANE KATRINA.

SINCERELY,

//SIGNED DONALD H. RUMSFELD//

3. END TEXT.

11-L-0559/OSD/51963

OSD 18243-05

FROM: SECDEF WASHINGTON DC

TO: AMEMB NEW DELHI

INFO: SECSTATE WASHINGTON DC
JOINT STAFF WASHINGTON DC
SECDEF WASHINGTON DC//USDP/ISA/NESA/CHAIRS//
NSC WASHINGTON DC
USDAO NEW DELHI IN

SUBJECT: SECRETARY OF DEFENSE LETTER TO MINISTER MUKHERJEE

1. PLEASE DELIVER THE FOLLOWING LETTER FROM SECRETARY OF DEFENSE RUMSFELD TO MINISTER MUKHERJEE. THE LETTER IS IN RESPONSE TO INDIA'S OFFER TO PROVIDE RELIEF SUPPLIES TO THE RELIEF OPERATIONS IN THE AFTERMATH OF HURRICANE KATRINA.

QUOTE:

HIS EXCELLENCY
PRANAB MUKHERJEE
MINISTER OF DEFENCE
GOVERNMENT OF INDIA
MINISTRY OF DEFENCE
NEW DELHI 110011 INDIA

DEAR MINISTER MUKHERJEE:

(PARA) THANK YOU FOR YOUR GENEROUS OFFERS OF THE ARMY MEDICAL CORPS TEAM, MEALS-READY-TO-EAT (MRE), IL-76 AIRCRAFT LOADED WITH RELIEF SUPPLIES AND NAVY DIVERS TO THE RELIEF OPERATIONS IN THE AFTERMATH OF HURRICANE KATRINA. IT IS ENORMOUSLY GRATIFYING TO KNOW THAT THE AMERICAN PEOPLE HAVE A COMMITTED FRIEND IN INDIA. WE APPRECIATE YOUR SWIFT ASSISTANCE, WHICH WILL BE CRITICAL IN HELPING SO MANY FAMILIES RECOVER FROM THE DEVASTATION OF HURRICANE KATRINA.

SINCERELY, DONALD H. RUMSFELD

11-L-0559/OSD/51964

ncn 1 02 1 3 - 05

END OF QUOTE.

2. HARD COPY TO FOLLOW.

FROM: SECDEF WASHINGTON DC
TO: USDAO PARIS FR
INFO AMEMBASSY PARIS FR
STATE DEPT WASHINGTON DC
OSD CHAIRS

UNCLASS

SUBJECT: LETTER FROM SECRETARY OF DEFENSE RUMSFELD TO HIS FRENCH
COUNTERPART

1. PLEASE DELIVER THE FOLLOWING LETTER FROM SECRETARY RUMSFELD TO
MINISTER ALLIOT-MARIE. ORIGINAL WILL BE DELIVERED BY POST.

2. BEGIN TEXT

HER EXCELLENCY MICHELE ALLIOT-MARIE
MINISTER OF DEFENSE OF THE FRENCH REPUBLIC
14 RUE SAINT-DOMINIQUE
00450 ARMEES
PARIS, FRANCE

DEAR MADAME MINISTER:

THANK YOU FOR YOUR GENEROUS OFFERS OF AIRCRAFT, SHIPS AND
SUPPLIES TO THE RELIEF OPERATIONS IN THE AFTERMATH OF HURRICANE
KATRINA. THE TENTS, GENERATORS AND SUPPLIES YOU HAVE SENT WILL
BE CRITICAL IN HELPING THE MANY FAMILIES WORKING TO RECOVER
FROM THE DEVASTATION OF HURRICANE KATRINA.

SINCERELY,

//SIGNED DONALD H. RUMSFELD//

3. END TEXT.

FROM: SECDEF WASHINGTON DC
TO: USDAO OTTAWA CN
INFO: AMEMBASSY OTTAWA CN
STATE DEPT WASHINGTON DC
OSD CHAIRS WASHINGTON DC

UNCLASS

SUBJECT: LETTER FROM SECRETARY OF DEFENSE RUMSFELD TO HIS CANADIAN
COUNTERPART

1. PLEASE DELIVER THE FOLLOWING LETTER FROM SECRETARY RUMSFELD TO
MINISTER GRAHAM. ORIGINAL WILL BE DELIVERED BY POST.

2. BEGIN TEXT

THE HONORABLE WILLIAM GRAHAM
MINISTER FOR NATIONAL DEFENSE
DEPARTMENT OF NATIONAL DEFENSE
101 COLONEL BY DRIVE
OTTAWA, ONTARIO K1A 0K2
CANADA

DEAR MINISTER GRAHAM:

(PARA) THANK YOU FOR YOUR GENEROUS CONTRIBUTION OF
HELICOPTERS, AIR TRANSPORT AND PERSONNEL TO THE RELIEF
OPERATIONS IN THE AFTERMATH OF HURRICANE KATRINA. YOUR SWIFT
OFFERS OF MILITARY COLLABORATION AND ASSISTANCE WILL BE
CRITICAL IN HELPING THE MANY FAMILIES WORKING TO RECOVER FROM
THE DEVASTATION OF HURRICANE KATRINA AND SERVE AS AN EXAMPLE
OF THE RELATIONSHIP BETWEEN OUR TWO NATIONS.

SINCERELY,

//SIGNED DONALD H. RUMSFELD//

3. END TEXT.

ROUTINE

FROM: SECDEF WASHINGTON DC:
TO: USDAO COPENHAGEN DK
INFO: AMEMBASSY COPENHAGEN DK
STATE DEPT WASHINGTON DC
OSD CHAIRS WASHINGTON DC

UNCLASS

SUBJECT: LETTER FROM SECRETARY OF DEFENSE RUMSFELD TO HIS DANISH
COUNTERPART

1. PLEASE DELIVER THE FOLLOWING LETTER FROM SECRETARY RUMSFELD TO
MINISTER GADE. ORIGINAL WILL BE DELIVERED BY POST.

2. BEGIN TEXT

HIS EXCELLENCY SØREN GADE
MINISTER OF DEFENCE
MINISTRY OF DEFENCE
HOLMENS KANAL 42
DK-1060 COPENHAGEN
DENMARK

DEAR MINISTER GADE:

(PARA) THANK YOU FOR YOUR KIND OFFER OF WATER PURIFICATION
UNITS FOR THE RELIEF OPERATIONS IN THE AFTERMATH OF HURRICANE
KATRINA. IT IS ENORMOUSLY GRATIFYING TO KNOW THAT THE
AMERICAN PEOPLE HAVE A COMMITTED ALLY IN DENMARK.

SINCERELY,

//SIGNED//
DONALD H. RUMSFELD

3. END TEXT.

ROUTINE

FROM: SECDEF WASHINGTON DC;
TO: AMEMBASSY REYKJAVIK IC
INFO: USDAO OSLO NO
STATE DEPT WASHINGTON DC
OSD CHAIRS WASHINGTON DC

UNCLASS

SUBJECT: LETTER FROM SECRETARY OF DEFENSE RUMSFELD TO THE
ICELANDIC FOREIGN MINISTER

1. PLEASE DELIVER THE FOLLOWING LETTER FROM SECRETARY RUMSFELD TO
MINISTER ODDSSON. ORIGINAL WILL BE DELIVERED BY POST.

2. BEGIN TEXT

HIS EXCELLENCY DAVID ODDSSON
MINISTER OF FOREIGN AFFAIRS
MINISTRY OF FOREIGN AFFAIRS
RAUDARARSTIGUR 25
150 REYKJAVIK
ICELAND

DEAR MINISTER ODDSSON:

(PARA) THANK YOU FOR YOUR KIND OFFER OF DRINKING WATER AND A
SEARCH AND RESCUE TEAM FOR THE RELIEF OPERATIONS IN THE
AFTERMATH OF HURRICANE KATRINA. IT IS ENORMOUSLY GRATIFYING
TO KNOW THAT THE AMERICAN PEOPLE HAVE A COMMITTED ALLY IN
ICELAND.

SINCERELY,

//SIGNED DONALD H. RUMSFELDII

3. END TEXT.

FROM: SECDEF WASHINGTON DC
TO: AMEMBASSY LUXEMBOURG
INFO USDAO PARIS FR
STATE DEPT WASHINGTON DC
OSD CHAIRS WASHINGTON DC

UNCLASS

SUBJECT: LETTER FROM SECRETARY OF DEFENSE RUMSFELD TO HIS
LUXEMBOURG COUNTERPART

1. PLEASE DELIVER THE FOLLOWING LETTER FROM SECRETARY RUMSFELD TO
MINISTER FRIEDEN. ORIGINAL WILL BE DELIVERED BY POST.

2. BEGIN TEXT

THE HONORABLE LUC FRIEDEN
MINISTER OF DEFENSE OF LUXEMBOURG
6, RUE DE L'ANCIEN ATHENEE
L-1144 LUXEMBOURG

DEAR MINISTER FRIEDEN:

(PARA) THANK YOU FOR YOUR GENEROUS OFFER OF A SEARCH AND
RESCUE TEAM, SUPPORT PERSONNEL AND SUPPLIES TO THE RELIEF
OPERATIONS IN THE AFTERMATH OF HURRICANE KATRINA. IT IS
ENORMOUSLY GRATIFYING TO KNOW THAT THE AMERICAN PEOPLE HAVE
A COMMITTED FRIEND IN LUXEMBOURG. WE APPRECIATE YOUR SWIFT
ASSISTANCE, WHICH WILL BE CRITICAL IN HELPING SO MANY FAMILIES
RECOVER FROM THE DEVASTATION OF HURRICANE KATRINA.

SINCERELY,

//SIGNED DONALD H. RUMSFELD II

3. END TEXT.

FROM: SECDEF WASHINGTON DC
TO: USDAO THE HAGUE NE
INFO: AMEMBASSY THE HAGUE NE
STATE DEPT WASHINGTON DC
OSD CHAIRS WASHINGTON DC

UNCLASS

SUBJECT: LETTER FROM SECRETARY OF DEFENSE RUMSFELD TO HIS DUTCH
COUNTERPART

1. PLEASE DELIVER THE FOLLOWING LETTER FROM SECRETARY RUMSFELD TO
MINISTER KAMP. ORIGINAL WILL BE DELIVERED BY POST.

2. BEGIN TEXT

THE HONORABLE HENK KAMP
MINISTER OF DEFENSE OF THE KINGDOM OF THE NETHERLANDS
P.O. BOX 20701
2500 ES THE HAGUE
THE NETHERLANDS

DEAR HENK:

(PARA) THANK YOU FOR YOUR GENEROUS OFFER OF AIRCRAFT, SHIPS,
MEDICAL SUPPLIES AND SUPPORT PERSONNEL TO THE RELIEF
OPERATIONS IN THE AFTERMATH OF HURRICANE KATRINA. IT IS
ENORMOUSLY GRATIFYING TO KNOW THAT THE AMERICAN PEOPLE HAVE
A COMMITTED FRIEND IN THE NETHERLANDS. WE APPRECIATE YOUR
SWIFT ASSISTANCE, WHICH WILL BE CRITICAL IN HELPING SO MANY
FAMILIES RECOVER FROM THE DEVASTATION OF HURRICANE KATRINA.

SINCERELY,

//SIGNED DONALD H. RUMSFELD//

3. END TEXT.

ROUTINE

FROM: SECDEF WASHINGTON DC:
TO: USDAO OSLO NO
INFO: AMEMBASSY OSLO NO
STATE DEPT WASHINGTON DC
OSD CHAIRS WASHINGTON DC

UNCLASS

SUBJECT: LETTER FROM SECRETARY OF DEFENSE RUMSFELD TO HIS
NORWEGIAN COUNTERPART

1. PLEASE DELIVER THE FOLLOWING LETTER FROM SECRETARY RUMSFELD TO
MINISTER DEVOLD. ORIGINAL WILL BE DELIVERED BY POST.

2. BEGIN TEXT

HER EXCELLENCY KRISTIN KROHN DEVOLD
MINISTER OF DEFENSE
MINISTRY OF DEFENSE
MYNTGATA 1
N-0032 OSLO
NORWAY

DEAR KRISTIN:

(PARA) THANK YOU FOR NORWAY'S GENEROUS OFFER OF BLANKETS,
TENTS, MEDICINE, DIVERS AND CASH ASSISTANCE TO THE RELIEF
OPERATIONS IN THE AFTERMATH OF HURRICANE KATRINA. IT IS
ENORMOUSLY GRATIFYING TO KNOW THAT THE AMERICAN PEOPLE HAVE
A COMMITTED ALLY IN NORWAY. WE APPRECIATE YOUR SWIFT
ASSISTANCE, WHICH WILL BE CRITICAL IN HELPING SO MANY FAMILIES
RECOVER FROM THE DEVASTATION OF HURRICANE KATRINA.

(PARA) I LOOK FORWARD TO SEEING YOU IN BERLIN.

BEST,
//SIGNED//
DONALD H. RUMSFELD

3. END TEXT.

ROUTINE

UNCLASSIFIED

FROM: SECDEF WASHINGTON DC:
TO: USDAO STOCKHOLM SW
INFO: AMEMBASSY STOCKHOLM SW
STATE DEPT WASHINGTON DC
OSD CHAIRS WASHINGTON DC

UNCLASS

SUBJECT: LETTER FROM SECRETARY OF DEFENSE RUMSFELD TO HIS SWEDISH
COUNTERPART

1. PLEASE DELIVER THE FOLLOWING LETTER FROM SECRETARY RUMSFELD TO
MINISTER BJORKLUND. ORIGINAL WILL BE DELIVERED BY POST.
2. BEGIN TEXT

HER EXCELLENCY LENI BJORKLUND
MINISTER OF DEFENSE
MINISTRY OF DEFENSE
JAKOBSGATAN 9
103 33 STOCKHOLM
SWEDEN

DEAR MINISTER BJORKLUND:

THANK YOU FOR YOUR KIND OFFER OF WATER PURIFICATION
EQUIPMENT, MATERIEL AND ELECTRIC POWER GENERATORS FOR THE
RELIEF OPERATIONS IN THE AFTERMATH OF HURRICANE KATRINA. IT IS
ENORMOUSLY GRATIFYING TO KNOW THAT THE AMERICAN PEOPLE HAVE
A COMMITTED FRIEND IN SWEDEN.

SINCERELY, // SIGNED DONALD H. RUMSFELD II

3. END TEXT.

OSD 18243-05

11-L-0559/OSD/51973

FROM: SECDEF WASHINGTON DC
TO: USDAO LONDON UK
INFO: AMEMBASSY LONDON UK
STATE DEPT WASHINGTON DC
OSD CHAIRS WASHINGTON DC

UNCLASS

SUBJECT: LETTER FROM SECRETARY OF DEFENSE RUMSFELD TO HIS UK
COUNTERPART

1. PLEASE DELIVER THE FOLLOWING LETTER FROM SECRETARY RUMSFELD TO
SECRETARY REID. ORIGINAL WILL BE DELIVERED BY POST.

2. BEGIN TEXT

THE RIGHT HONORABLE DR. JOHN REID MP
SECRETARY OF STATE FOR DEFENCE
MINISTRY OF DEFENCE
MAIN BUILDING LEVEL 5 ZONE D
WHITEHALL LONDON SW1A 2HB
UNITED KINGDOM

DEAR JOHN:

(PARA) THANK YOU FOR YOUR GENEROUS OFFERS OF PERSONNEL,
SUPPLIES AND EQUIPMENT TO THE RELIEF OPERATIONS IN THE
AFTERMATH OF HURRICANE KATRINA. YOUR CONTRIBUTION OF MEALS
READY TO EAT AND THE 500-PERSON TENT CITY WILL BE CRITICAL TO
THE MANY FAMILIES WHO NOW WORK TO RECOVER FROM THE
DEVASTATION OF HURRICANE KATRINA. YOUR IMMEDIATE AND
SIGNIFICANT OFFERS OF ASSISTANCE ARE ANOTHER EXAMPLE OF THE
SPECIAL RELATIONSHIP ENJOYED BY OUR TWO NATIONS.

SINCERELY,

//SIGNED DONALD H. RUMSFELD//

3. END TEXT.

11-L-0559/OSD/51974

OSD 18243-05

ROUTINE

FROM: SECDEF WASHINGTON DC:
TO: USDAO RIGA LG
INFO: AMEMBASSY RIGA
STATE DEPT WASHINGTON DC
OSD CHAIRS WASHINGTON DC

UNCLASS

SUBJECT: LETTER FROM SECRETARY OF DEFENSE RUMSFELD TO HIS LATVIAN
COUNTERPART

1. PLEASE DELIVER THE FOLLOWING LETTER FROM SECRETARY RUMSFELD TO
MINISTER REPŠE. ORIGINAL WILL BE DELIVERED BY POST.

2. BEGIN TEXT

THE HONORABLE EINARS REPŠE
MINISTER OF DEFENSE
MINISTRY OF DEFENSE
KR. VALDEMARA 10112
RIGA LV 1473
LATVIA

DEAR MINISTER REPŠE:

(PARA) THANK YOU FOR LATVIA'S OFFER OF SUPPORT TO THE RELIEF
OPERATIONS IN THE AFTERMATH OF HURRICANE KATRINA. IT IS
ENORMOUSLY GRATIFYING TO KNOW THAT THE AMERICAN PEOPLE HAVE
COMMITTED FRIENDS IN THE PEOPLE OF LATVIA. WE APPRECIATE YOUR
SWIFT OFFER OF ASSISTANCE, WHICH WILL BE CRITICAL IN PROVIDING
COMFORT TO SO MANY FAMILIES AS THEY SEEK TO RECOVER FROM THE
DEVASTATION OF HURRICANE KATRINA.

SINCERELY,

//SIGNED DONALD H. RUMSFELDI

3. END TEXT.

11-L-0559/OSD/51975

OSD 18243-05

FROM: SECDEF WASHINGTON DC
TO: USDAO BUCHAREST ROMANIA
INFO: AMEMBASSY BUCHAREST ROMANIA
STATE DEPT WASHINGTON DC
OSD CHAIRS WASHINGTON DC

UNCLASS

SUBJECT: LETTER FROM SECRETARY OF DEFENSE RUMSFELD TO HIS
ROMANIAN COUNTERPART

1. PLEASE DELIVER THE FOLLOWING LETTER FROM SECRETARY RUMSFELD TO
MINISTER ANTANASIU. ORIGINAL WILL BE DELIVERED BY POST.

2. BEGIN TEXT

THE HONORABLE TEODOR ATANASIU
MINISTER OF DEFENSE
ROMANIAN MINISTRY OF DEFENSE
IZVOR ST 13-15, SECTOR 5
70642 BUCHAREST
ROMANIA

DEAR MINISTER ANTANASIU:

(PARA) THANK YOU FOR YOUR OFFER OF MEDICAL PERSONNEL TO
SUPPORT RELIEF OPERATIONS IN THE AFTERMATH OF HURRICANE
KATRINA. IT IS ENORMOUSLY GRATIFYING TO KNOW THAT THE
AMERICAN PEOPLE HAVE A COMMITTED FRIEND IN ROMANIA. WE ARE
CURRENTLY GIVING YOUR OFFER SIGNIFICANT CONSIDERATION. WE
APPRECIATE YOUR PROMPT OFFER OF ASSISTANCE AND YOUR
WILLINGNESS TO HELP SO MANY AMERICAN FAMILIES RECOVER FROM
THE DEVASTATION OF HURRICANE KATRINA.

SINCERELY.

//SIGNED DONALD H. RUMSFELDI
3. END TEXT.

UNCLASSIFIED

INFO SECDEF WASHDC
AMEMBASSY TOKYO
USDAO TOKYO
HQ USPACOM HONOLULU HI//J5//
SECSTATE WASHDC//EAP:J//
JOINT STAFF WASHDC//J5//
COMUSJAPAN YOKOTA AB JA//J5//
SECDEF WASHDC//USDP-CH//

UNCLAS

SUBJ: LETTER TO MINISTER OF STATE FOR DEFENSE OHNO REGARDING HURRICANE KATRINA SUPPORT.

1. THE FOLLOWING IS TEXT OF THE LETTER SENT TO MINISTER OF STATE FOR DEFENSE OHNO. SECDEF REQUESTS THAT AMEMBASSY TOKYO CONVEY THE TEXT SOONEST. HARD COPY TO FOLLOW.

2. BEGIN TEXT FOR HONORABLE YOSHINORI OHNO.

HONORABLE YOSHINORI OHNO
MINISTER OF STATE FOR DEFENSE
JAPAN DEFENSE AGENCY
5-1 ICHIGAYA, HONMURA-CHO
SHINJUKU-KU, TOKYO 162-8801
JAPAN

DEAR MINISTER OHNO:

THANK YOU FOR YOUR KIND OFFERS OF SUPPORT FOR RELIEF OPERATIONS IN THE AFTERMATH OF HURRICANE KATRINA. IT IS ENORMOUSLY GRATIFYING TO KNOW THAT THE AMERICAN PEOPLE HAVE A COMMITTED FRIEND IN JAPAN. WE APPRECIATE YOUR SWIFT ASSISTANCE, WHICH WILL BE CRITICAL IN HELPING SO MANY FAMILIES RECOVER FROM THE DEVASTATION OF HURRICANE KATREVA.

SINCERELY,

/S/ DONALD H. RUMSFELD

3. END TEXT FOR HONORABLE YOSHINORI OHNO.

4. OSD/ISA POC IS JOHN HILL, DSN (b)(6) COMMERCIAL (b)(6)

UNCLASSIFIED

11-L-0559/OSD/51977

OSD 18243-05

PRECEDENCE: PRIORITY

CLASSIFICATION: UNCLASSIFIED

FROM: SECDEF WASHINGTON DC

TO: AMEMBASSY SINGAPORE
USPACOM CAMP H M SMITH HI
JOINT STAFF WASHINGTON DC
SECSTATE WASHINGTON DC
NATIONAL SECURITY COUNCIL WASHINGTON DC
SECDEF WASHINGTON DC//USDP-ISA//

UNCLASSIFIED

SUBJ: SECRETARY OF DEFENSE LETTER TO SINGAPORE'S MINISTER FOR
DEFENCE REGARDING HURRICAN KATRINA

1. SECRETARY OF DEFENSE DONALD RUMSFELD SIGNED THE FOLLOWING
LETTER TO MINISTER TEO. REQUEST THAT THE AMEMBASSY FORWARD THE
TEXT OF THE LETTER TO MINITER TEO AS SOON AS POSSIBLE. ORIGINAL
SIGNED LETTER WILL FOLLOW.

2. BEGIN TEXT OF LETTER TO MINISTER TEO

MR. TEO CHEE HEAN
MINISTER FOR DEFENCE
REPUBLIC OF SINGAPORE
MINISTRY OF DEFENCE
303 GOMBAK DRIVE
SINGAPORE 669645

DEAR MINISTER TEO:

THANK YOU FOR PROVIDING YOUR THREE CHINOOK HELICOPTERS
AND SUPPORT PERSONNEL TO THE RELIEF OPERATIONS IN THE AFTERMATH
OF HURRICANE KATRINA. IT IS ENORMOUSLY GRATIFYING TO KNOW THAT
THE AMERICAN PEOPLE HAVE A COMMITTED FRIEND IN SINGAPORE. WE
APPRECIATE YOUR SWIFT ASSISTANCE, WHICH WILL BE CRITICAL IN

11-L-0559/OSD/51978

OSD 18243-05

FROM: SECDEF WASHINGTON DC
TO: AMEMB TUNIS
INFO: SECSTATE WASHINGTON DC
JOINT STAFF WASHINGTON DC
SECDEF WASHINGTON DC//USDP/ISA/NESA/CHAIRS//
NSC WASHINGTON DC
USDAO TUNIS TU

SUBJECT: SECRETARY OF DEFENSE LETTER TO MINISTER MORJANE

1. PLEASE DELIVER THE FOLLOWING LETTER FROM SECRETARY OF DEFENSE RUMSFELD TO MINISTER MORJANE. THE LETTER IS IN RESPONSE TO TUNISIA'S OFFER TO PROVIDE RELIEF SUPPLIES TO THE RELIEF OPERATIONS IN THE AFTERMATH OF HURRICANE KATRINA.

QUOTE:

HIS EXCELLENCY
MR. KAMEL MORJANE
MINISTER OF NATIONAL DEFENSE
REPUBLIC OF TUNISIA
TUNIS, TUNISIA

DEAR MINISTER MORJANE:

(PARA) THANK YOU FOR YOUR OFFER TO PROVIDE TWO C-130 AIRCRAFT LOADED WITH RELIEF SUPPLIES TO THE RELIEF OPERATIONS IN THE AFTERMATH OF HURRICANE KATRINA. IT IS ENORMOUSLY GRATIFYING TO KNOW THAT THE AMERICAN PEOPLE HAVE A COMMITTED FRIEND IN TUNISIA. WE APPRECIATE YOUR SWIFT ASSISTANCE, WHICH WILL BE CRITICAL IN HELPING SO MANY FAMILIES RECOVER FROM THE DEVASTATION OF HURRICANE KATRINA.

SINCERELY, DONALD H. RUMSFELD

END OF QUOTE.

2. HARD COPY TO FOLLOW.

UNCLASSIFIED
ROUTINE
FM SECDEF WASHINGTON DC
TO USDAO ROME IT
INFO AMEMBASSY ROME IT

SUBJECT: SECDEF LETTER TO MOD MARTINO

PLEASE DELIVER THE FOLLOWING TEXT OF THE MESSAGE TO MOD
MARTINO. ORIGINAL LETTER WILL FOLLOW.

(BEGIN TEXT)

HIS EXCELLENCY
ANTONIO MARTINO
MINISTER OF DEFENSE
MINISTRY OF DEFENSE
VIA XX, SETTEMBRE 8
00187 ROME, ITALY

DEAR ANTONIO:

~~PARA~~ THANK YOU FOR ITALY'S OFFER OF CAMP BEDS, BLANKETS,
TENTS, WATER PURIFICATION SYSTEMS, MEDICAL SUPPLIES AND A
FIELD HOSPITAL TO THE RELIEF OPERATIONS IN THE AFTERMATH OF
HURRICANE KATRINA. IT IS ENORMOUSLY GRATIFYING TO KNOW
THAT THE AMERICAN PEOPLE HAVE A COMMITTED FRIEND IN ITALY.
WE APPRECIATE YOUR SWIFT ASSISTANCE, WHICH WILL BE CRITICAL
IN HELPING SO MANY FAMILIES RECOVER FROM THE DEVASTATION
OF HURRICANE KATTUNA.

(PARA) I LOOK FORWARD TO SEEING YOU IN BERLIN.

SINCERELY,
//DONALD RUMSFELDN
(END TEXT)

FROM: SECDEF WASHINGTON DC
TO: AMEMB AMMAN
INFO: SECSTATE WASHINGTON DC
JOINT STAFF WASHINGTON DC
SECDEF WASHINGTON DC//USDP/ISA/NESA/CHAIRS//
NSC WASHINGTON DC
USDAO AMMAN JO

SUBJECT: SECRETARY OF DEFENSE LETTER TO HIS ROYAL HIGHNESS KING
ABDULLAH

1. PLEASE DELIVER THE FOLLOWING LETTER FROM SECRETARY OF DEFENSE
RUMSFELD TO HIS ROYAL HIGH KING ABDULLAH. THE LETTER IS IN RESPONSE
TO JORDAN'S OFFER TO PROVIDE RELIEF SUPPLIES TO THE RELIEF OPERATIONS
IN THE AFTERMATH OF HURRICANE KATRINA.

QUOTE:

HIS ROYAL HIGHNESS KING ABDULLAH II
THE ROYAL COURT
THE HASHEMITE KINGDOM OF JORDAN

YOUR ROYAL HIGHNESS:

(PARA) THANK YOU FOR YOUR KIND OFFER TO DEPLOY JORDANIAN FIELD
HOSPITALS TO AID THE RELIEF OPERATIONS IN THE AFTERMATH OF
HURRICANE KATRINA. IT IS ENORMOUSLY GRATIFYING TO KNOW THAT
THE AMERICAN PEOPLE HAVE A COMMITTED FRIEND IN JORDAN.

(PARA) I LOOK FORWARD TO SEEING YOU IN WASHINGTON LATER THIS
MONTH.

SINCERELY,

DONALD H. RUMSFELD

END OF QUOTE.

2. HARD COPY TO FOLLOW.

11-L-0559/OSD/51981

OSD 18243-05

FROM: SECDEF WASHINGTON DC
TO: USDAO BRUSSELS BE
INFO AMEMBASSY BRUSSELS BE
STATE DEPT WASHINGTON DC
OSD CHAIRS WASHINGTON DC

UNCLASS

SUBJECT: LETTER FROM SECRETARY OF DEFENSE RUMSFELD TO HIS BELGIAN
COUNTERPART

1. PLEASE DELIVER THE FOLLOWING LETTER FROM SECRETARY RUMSFELD TO
MINISTER FLAHAUT. ORIGINAL WILL BE DELIVERED BY POST.

2. BEGIN TEXT

THE HONORABLE ANDRE FLAHAUNT
MINISTER OF DEFENSE OF THE KINGDOM OF BELGIUM
RUE LAMBERMONT 8
1000 BRUSSELS
BELGIUM

DEAR MINISTER FLAHAUNT:

(PARA) THANK YOU FOR YOUR GENEROUS OFFERS OF MEDICAL AND
SUPPORT PERSONNEL AND EQUIPMENT TO THE RELIEF OPERATIONS IN
THE AFTERMATH OF HURRICANE KATRINA. WE APPRECIATE YOUR SWIFT
OFFERS OF ASSISTANCE, WHICH WILL BE CRITICAL IN HELPING SO MANY
FAMILIES RECOVER FROM THE DEVASTATION OF HURRICANE KATRINA.

SINCERELY,

//SIGNED//
DONALD H. RUMSFELD
3. END TEXT.

UNCLAS

ROUTINE

SecDef / DepSecDef / Spc Ast / ExecSec / USDP / OSDI /
ESD / CCD X DRSO / DIA / POLAD / Cbl Ch / File

PAGE 1 OF 2
USER: rferguso

FOR: 131631Z Sep 05

PREC: R
DTG: 130551Z Sep 05

FROM: SECDEF WASHINGTON DC
SUBJ: THANK YOU LETTER TO MEXICO SECRETARY OF NATIONAL DEFENSE

RAAUZFDY RUEWAFU0314 2560551-UUUU--RUEKQMA.
ZNR UUUUU ZUI RUEKJCS0314 2560551
R 130551Z SEP 05
FM SECDEF WASHINGTON DC
TO RUEHC/SECSTATE WASHINGTON DC
RUEKJCS/CJCS WASHINGTON DC
RUEHAAA/NATIONAL SECURITY COUNCIL WASHINGTON DC
RUEKJCS/JOINT STAFF WASHINGTON DC//J5//
RUEHME/USDAO MEXICO CITY MX
RUEHME/AMEMBASSY MEXICO CITY
INFO RUEKJCS/SECDEF WASHINGTON DC//USDP/DSCA/USDP:CHAIRS//
RHEFDIA/DIA WASHINGTON DC

BT
UNCLAS
SUBJ: THANK YOU LETTER TO MEXICO SECRETARY OF NATIONAL DEFENSE
GENERAL GERARDO CLEMENTE RICARDO VEGA
1. SECRETARY RUMSFELD HAS SIGNED THE FOLLOWING LETTER TO GENERAL
GERARDO CLEMENTE RICARDO VEGA. REQUEST THAT THE TEXT OF THE LETTER BE
PROVIDED TO GENERAL GERARDO CLEMENTE RICARDO VEGA AS SOON AS
POSSIBLE. ORIGINAL SIGNED LETTER WILL BE FORWARDED VIA DIPLOMATIC
POUCH.
GENERAL GERARDO CLEMENTE RICARDO VEGA

PAGE 02 RUEWAFU0314 UNCLAS
SECRETARY OF NATIONAL DEFENSE OF MEXICO
MEXICO CITY, MEXICO
DEAR MR. MINISTER:

THANK YOU FOR YOUR GOVERNMENT'S GENEROUS OFFER OF THE HOSPITAL/CARGO
SHIP HUASTECO, VEHICLES, AND MEXICAN SOLDIERS TO SUPPORT RELIEF
OPERATIONS IN THE AFTERMATH OF HURRICANE KATRINA. IT IS GRATIFYING
TO KNOW THAT THE AMERICAN PEOPLE HAVE A COMMITTED FRIEND IN MEXICO.
WE APPRECIATE YOUR OFFER, WHICH WILL BE CRITICAL IN HELPING SO MANY
FAMILIES RECOVER FROM THE DEVASTATION OF HURRICANE KATRINA.
SINCERELY,
//DONALD H. RUMSFELD//
(END TEXT)
BT

JOINT STAFF V1
ACTION JS (*) (U, S, F) 1
INFO CMAS (*) CMAS (1) JSAMS (*) JCSONNIPRDA (*)
JCSONNIPRDA (*)

SECDEF V2
ACTION SECDEF WASH DC (*) (U, S, F, F) 1
INFO CHAIRS (*) SECDEF-C (1) SECDEF-C (*) USDAO:STE (*)
ASD:PA-SMTP (*) DIR:PAI-RAM (*) USDCOMF (*)
ESC AGENT AMERICAS (*) USDP (*) USDP CHAIRS (*)

UNCLAS
11-L-0559/OSD/51983

UNCLAS

PRIORITY
 SecDef / DepSecDef / Spc Asst / ExecSec / USDP / USDI /
 ESD / CCD X DRSO / DIA / POLAD / Cbl Ch / File

PAGE 1 OF 2
 USER: rfergusc

TOR: 131615Z Sep 05

Prcc: P
 DTG: 130708Z Sep 05

From: SECDEF WASHINGTON DC
 Subj: SECDEF LETTER TO MOD MARTINO

PAUZFDFY RUEWMPU0343 2560709-UUUU--RUEKMA.
 ZNR UUUUU ZUI RUEKJCS0343 2560709
 P 130708Z SEP 05
 FM SECDEF WASHINGTON DC
 TO RUEHRO/USDAO ROME IT
 INFO RUEHRO/AMEMBASSY ROME
 RUEKJCS/SECDEF WASHINGTON DC
 BT
 UNCLAS

SUBJ: SECDEF LETTER TO MOD MARTINO
 PLEASE DELIVER THE FOLLOWING TEXT OF THE MESSAGE TO MOD MARTINO.
 ORIGINAL LETTER WILL FOLLOW.

(BEGIN TEXT)
 HIS EXCELLENCY
 ANTONIO MARTINO
 MINISTER OF DEFENSE
 MINISTRY OF DEFENSE
 VIA XX, SETTEMBRE 6
 00187 ROME, ITALY

DEAR ANTONIO:
 (PARA) THANK YOU FOR ITALYS OFFER OF CAMP BEDS, BLANKETS, TENTS,
 WATER PURIFICATION SYSTEMS, MEDICAL SUPPLIES AND A FIELD HOSPITAL TO

PAGE 02 RUEWMPU0343 UNCLAS
 THE RELIEF OPERATIONS IN THE AFTERMATH OF HURRICANE KATRINA. IT IS
 ENORMOUSLY GRATIFYING TO KNOW THAT THE AMERICAN PEOPLE HAVE A
 COMMITTED FRIEND IN ITALY. WE APPRECIATE YOUR SWIFT ASSISTANCE,
 WHICH WILL BE CRITICAL IN HELPING SO MANY FAMILIES RECOVER FROM THE
 DEVASTATION OF HURRICANE KATRINA.

(PARA) I LOOK FORWARD TO SEEING YOU IN BERLIN.
 SINCERELY,

//DONALD RUMSFELD//
 (END TEXT)
 BT

SECDEF V2
 ACTION SECDEF WASH DC(*) (U,6,7,6)
 INFO CHAIRS(*) SECDEF-C(1) SECDEF-C(*) USDAT:STS(*)
 ASD:PA-SMTP(*) DIR:PAE-SAM(*) USDCOMP(*)
 ESC AGENT EUROPE NATO(*) DACS-ZK:POLAD(*)
 OSDONXIPADA(*) OSDONSEPRADA(*)
 TOTAL COPIES REQUIRED 1

*0343

UNCLAS

ROUTINE
SecDef \ DepSecDef \ Spc Ast \ ExecSec \ USDP \ USDT \
ESD \ CCD \ X DRSO \ DIA \ POLAD \ Cbl Ch \ File \

PAGE 1 OF 2
USER: OSD1

TOR: 130715Z Sep 05

Prec: R
DTG: 130711Z Sep 05

From: SECDEF WASHINGTON DC
Subj: SECRETARY OF DEFENSE LETTER TO HIS ROYAL HIGHNESS KING ABDULLAH

RAAUZYUW RUEWMFU0345 2560711-UUUU--RUEKNMA.
ZNR UUUUU ZUI RUEKJCS0345 2560711
R 130711Z SEP 05
FM SECDEF WASHINGTON DC
TO RUEHAM/AMBASSY AMMAN
INFO RUEHC/SECSTATE WASHINGTON DC
RUEKJCS/JOINT STAFF WASHINGTON DC
RUEKJCS/SECDEF WASHINGTON DC//USDP/ISA/NESA/CHAIRS//
RHEHAAA/NATIONAL SECURITY COUNCIL WASHINGTON DC
RUEHAM/USDAC AMMAN JO

BT
UNCLAS
SUBJ: SECRETARY OF DEFENSE LETTER TO HIS ROYAL HIGHNESS KING ABDULLAH
1. PLEASE DELIVER THE FOLLOWING LETTER FROM SECRETARY OF DEFENSE RUMSFELD TO HIS ROYAL HIGH KING ABDULLAH. THE LETTER IS IN RESPONSE TO JORDANS OFFER TO PROVIDE RELIEF SUPPLIES TO THE RELIEF OPERATIONS IN THE AFTERMATH OF HURRICANE KATRINA.

QUOTE:
HIS ROYAL HIGHNESS KING ABDULLAH II
THE ROYAL COURT
THE HASHEMITE KINGDOM OF JORDAN
YOUR ROYAL HIGHNESS:

PAGE 02 RUEWMFU0345 UNCLAS
(PARA) THANK YOU FOR YOUR KINE OFFER TO DEPLOY JORDANIAN FIELD HOSPITALS TO AID THE RELIEF OPERATIONS IN THE AFTERMATH OF HURRICANE KATRINA. IT IS ENORMOUSLY GRATIFYING TO KNOW THAT THE AMERICAN PEOPLE HAVE A COMMITTED FRIEND IN JORDAN.

(PARA) I LOOK FORWARD TO SEEING YOU IN WASHINGTON LATER THIS MONTH.
SINCERELY,
DONALD H. RUMSFELD

END OF QUOTE.
2. HAPS COPY TO FOLLOW.
BT

JOINT STAFF V1 1
ACTION (U,8)
INFO CMAS(*) CMAS(1) JSAMS(*) JCSONNIPRDA(*)
JCSONSIPRDA(*)

SECDEF V2 1
ACTION SECDEF WASH DC(*) (U,6,8,F)
INFO CHAIRS(*) SECDEF-C(1) SECDEF-C(*) ASD:PA-SMTP(*)
USDP:ESC(*) ESC AGENT NESA(*) USDP(*)
DACS-2K:POLAD(*) OSDONNIPRDA(*) OSDONSIPRDA(*)

TOTAL COPIES REQUIRED 2

#0345

UNCLAS
11-L-0559/OSD/51985

UNCLAS

ROUTINE
 SecDef \ / DepSecDef \ / Spc Ast \ / ExecSec \ / USDP \ / USDI \ /
 ESD \ / CCD ~~X~~ / DRSO \ / DIA \ / POLAD \ / Cbl Ch \ / File \ /

PAGE 1 OF 2
USER: OSD1

TOR: 1307122 Sep 05

Prec: R
DTG: 1307132 Sep 05

From: SECDEF WASHINGTON DC
Subj: LETTER FROM SECRETARY OF DEFENSE RUMSFELD TO HIS BELGIAN

RAAU2YJW RUEWMFU0346 2560713-UUUU--RUEKNMA.
 ZNR UUUUU ZUI RUEXJCS0346 2560713
 R 1307132 SEP 05
 FM SECDEF WASHINGTON DC
 TO RUEHBS/USDAO BRUSSELS BE
 INFO RUEHBS/AMEMBASSY BRUSSELS
 RUEHC/SECSTATE WASHINGTON DC
 RUEXJCS/SECDEF WASHINGTON DC//CHAIRS//
 BT

UNCLAS
 SUBJ: LETTER FROM SECRETARY OF DEFENSE RUMSFELD TO HIS BELGIAN
 COUNTERPART

1. PLEASE DELIVER THE FOLLOWING LETTER FROM SECRETARY RUMSFELD TO
 MINISTER FLAUAUT. ORIGINAL WILL BE DELIVERED BY POST.
 2. BEGIN TEXT
 THE HONORABLE ANDRE FLAUAUT
 MINISTER OF DEFENSE OF THE KINGDOM OF BELGIUM
 RUE LIMBERMONT 8
 1000 BRUSSELS
 BELGIUM
 DEAR MINISTER FLAUAUT:
 (PARA) THANK YOU FOR YOUR GENEROUS OFFERS OF MEDICAL AND SUPPORT

PAGE 02 RUEWMFU0346 UNCLAS
 PERSONNEL AND EQUIPMENT TO THE RELIEF OPERATIONS IN THE AFTERMATH OF
 HURRICANE KATRINA. WE APPRECIATE YOUR SWIFT OFFERS OF ASSISTANCE,
 WHICH WILL BE CRITICAL IN HELPING SO MANY FAMILIES RECOVER FROM THE
 DEVASTATION OF HURRICANE KATRINA.

SINCERELY,
 //SIGNED//
 DONALD H. RUMSFELD
 3. END TEXT.
 BT

SECDEF V2
 ACTION SECDEF WASH DC(*) (U,6,7,8,F)
 INFO CHAIRS(*) SECDEF-C(1) DOTE KWS(*) SECDEF-C(*)
 USDAT:STS(*) ASD:PA-SMTP(*) DIR:PAE-RAM(*)
 USDCOMP(*) ESC AGENT EURASIA(*)
 ESC AGENT EUROPE NATO(*) ESC AGENT PR KWS(*)
 DACS-ZK:POLAD(*) OSDONNIPRDA(*) OSDONNIPRDA(*)
 TOTAL COPIES REQUIRED 1

#0346

UNCLAS
 11-L-0559/OSD/51986

UNCLAS

ROUTINE
SecDef \ DepSecDef \ Spc Ast \ ExecSec \ USDP \ USDI \
ESD \ CCD \ DRSO \ DIA \ POLAD \ Cbl Ch \ Pile

PAGE 1 OF 1
USER: OSD1

TOR: 1306532 Sep 05

Prec: R
DTG: 130654Z Sep 05

From: SECDEF WASHINGTON DC
Subj: LETTER TO MINISTER OF STATE FOR DEFENSE OHNO REGARDING

RAAUZYUW RUEWMFU0340 2560655-UUUU--RUEKNMA.
ZNR UUUU ZUI RUEKJCS0340 2560655
R 130654Z SEP 05
FM SECDEF WASHINGTON DC
TO RUEHKO/AMEMBASSY TOKYO
INFO RUEHKO/USDAO TOKYO JA
RHHMUNA/HQ USPAACOM HONOLULU HI//J5//
RUEHC/SECSTATE WASHINGTON DC//EAP//
RUEKJCS/JOINT STAFF WASHINGTON DC//J5//
RUALSEJ/COMUSJAPAN COMMAND CENTER YOKOTA AB JA//J5//
RUEKJCS/SECDEF WASHINGTON DC//USDP-CH//

BT

UNCLAS

SUBJ: LETTER TO MINISTER OF STATE FOR DEFENSE OHNO REGARDING
HURRICANE KATRINA SUPPORT

1. THE FOLLOWING IS TEXT OF THE LETTER SENT TO MINISTER OF STATE FOR DEFENSE OHNO. SECDEF REQUESTS THAT AMEMBASSY TOKYO CONVEY THE TEXT SOONEST. HARD COPY TO FOLLOW.
2. BEGIN TEXT FOR HONORABLE YOSHINORI OHNO.
HONORABLE YOSHINORI OHNO
MINISTER OF STATE FOR DEFENSE
JAPAN DEFENSE AGENCY

PAGE 02 RUEWMFU0340 UNCLAS
5-1 JCHIGAYA, HONMURA-CHO
SHINJUKU-KU, TOKYO 162-8801
JAPAN

DEAR MINISTER OHNO:

THANK YOU FOR YOUR KINE OFFERS OF SUPPORT FOR RELIEF OPERATIONS IN THE AFTERMATH OF HURRICANE KATRINA. IT IS ENORMOUSLY GRATIFYING TO KNOW THAT THE AMERICAN PEOPLE HAVE A COMMITTED FRIEND IN JAPAN. WE APPRECIATE YOUR SWIFT ASSISTANCE, WHICH WILL BE CRITICAL IN HELPING SO MANY FAMILIES RECOVER FROM THE DEVASTATION OF HURRICANE KATRINA.

SINCERELY,

/S/ DONALD H. RUMSFELD

3. END TEXT FOR HONORABLE YOSHINORI OHNO.

4. OSD/ISA POC IS JOHN HILL, DSN (b)(6) COMMERCIAL

(b)(6)

BT

JOINT STAFF V1

ACTION

(U, B, F)

INFO CMAS(*) CMAS(1) J5(*) JSAMS(*)
DACS-2K:POLAD(*) JCSOINIPRDA(*) JCSOINSIPRDA(*)

1

SECDEF V2

ACTION SECDEF WASH DC(*)

(U, B, F)

INFO CHAIRS(*) SECDEF-C(1) SECDEF-C(*) USDAT:STS(*)

1

UNCLAS

11-L-0559/OSD/51987

UNCLAS

ROUTINE
SecDef \ DepSecDef \ Spc Ast \ ExecSec \ USDP \ USDI \
ESD \ CCD X DRSO \ DIA \ POLAD \ Cbl Ch \ File \

PAGE 1 OF 1
USER: OSD1

TOR: 1307152 Sep 05

Prec: R
DTG: 1307022 Sep 05

From: SECDEF WASHINGTON DC
Subj: SECRETARY OF DEFENSE LETTER TO SINGAPORES MINISTER FOR DEFENCE

RAAUZYUW RUEWMFU0341 2560702-UUUU--RUEKNMA.
ZNR UUUU ZU RUEKJCS0341 2560702
R 1307022 SEP 05
FM SECDEF WASHINGTON DC
TO RUEHGP/AMEMBASSY SINGAPORE
INFO RHEMNA/USPACOM HONOLULU HI
RUEKJCS/JOINT STAFF WASHINGTON DC
RUEHC/SECSTATE WASHINGTON DC
RHEHAA/NATIONAL SECURITY COUNCIL WASHINGTON DC
RUEKJCS/SECDEF WASHINGTON DC//USDP-ISA//
BT

UNCLAS

SUBJ: SECRETARY OF DEFENSE LETTER TO SINGAPORES MINISTER FOR DEFENCE REGARDING HURRICAN KATRINA
USPACOM PASS TO CAMP H M SMITH HI.
1. SECRETARY OF DEFENSE DONALD RUMSFELD SIGNED THE FOLLOWING LETTER TO MINISTER TEO. REQUEST THAT THE AMEMBASSY FORWARD THE TEXT OF THE LETTER TO MINISTER TEO AS SOON AS POSSIBLE. ORIGINAL SIGNED LETTER WILL FOLLOW.
2. BEGIN TEXT OF LETTER TO MINISTER TEO
MR. TEO CHEE HEAN
MINISTER FOR DEFENCE

PAGE 02 RUEWMFU0341 UNCLAS
REPUBLIC OF SINGAPORE
MINISTRY OF DEFENCE
303 GOMBAK DRIVE
SINGAPORE 669645

DEAR MINISTER TEO:

THANK YOU FOR PROVIDING YOUR THREE CHINOOK HELICOPTERS AND SUPPORT PERSONNEL TO THE RELIEF OPERATIONS IN THE AFTERMATH OF HURRICANE KATRINA. IT IS ENORMOUSLY GRATIFYING TO KNOW THAT THE AMERICAN PEOPLE HAVE A COMMITTED FRIEND IN SINGAPORE. WE APPRECIATE YOUR SWIFT ASSISTANCE, WHICH WILL BE CRITICAL IN HELPING SO MANY FAMILIES RECOVER FROM THE DEVASTATION OF HURRICANE KATRINA.

SINCERELY,

DONALD RUMSFELD

3. END OF TEXT

BT

JOINT STAFF V1

ACTION

INFO CMAS(*) CMAS(1) JSAMS(*) JCSONNIPRDA(*)
JCSONSIPRDA(*)

(U, 8)

1

SECDEF V2

ACTION SECDEF WASH DC(*)

INFO CHAIRS(*) SECDEF-C(1) ESC-C(1) ESC-C(*) SECDEF-C(*)

(U, 6, 7, 8, F)

2

UNCLAS

11-L-0559/OSD/51988

UNCLAS

ROUTINE
SecDef \ DepSecDef \ Spc Ast \ ExecSec \ USDP \ USDI \
ESD \ CCD \ DRSO \ DIA \ POLAD \ Cbl Ch \ File \

PAGE 1 OF 2
USER: OSD1

TOR: 1307152 Sep 05

Prec: R
DTG: 1307072 Sep 05

From: SECDEF WASHINGTON DC
Subj: SECRETARY OF DEFENSE LETTER TO MINISTER MORJANE

RAAUZYUW RUEWMFU0342 2560707-UUUU--RUEKNMA.
ZNR UUUUU ZUI RUEKJCS0342 2560707
R 1307072 SEP 05
FM SECDEF WASHINGTON DC
TO RUEHTU/AMEMBASSY TUNIS
INFO RUEHC/SECSTATE WASHINGTON DC
RUEKJCS/JOINT STAFF WASHINGTON DC
RUEKJCS/SECDEF WASHINGTON DC//USDP/ISA/NEA/CHAIRS//
RHEHAA/NATIONAL SECURITY COUNCIL WASHINGTON DC
RUEHTU/USDAO TUNIS IS
BT

UNCLAS

SUBJ: SECRETARY OF DEFENSE LETTER TO MINISTER MORJANE
1. PLEASE DELIVER THE FOLLOWING LETTER FROM SECRETARY OF DEFENSE RUMSFELD TO MINISTER MORJANE. THE LETTER IS IN RESPONSE TO TUNISIA'S OFFER TO PROVIDE RELIEF SUPPLIES TO THE RELIEF OPERATIONS IN THE AFTERMATH OF HURRICANE KATRINA.

QUOTE:
HIS EXCELLENCY
MR. KAMEL MORJANE
MINISTER OF NATIONAL DEFENSE
REPUBLIC OF TUNISIA

PAGE 02 RUEWMFU0342 UNCLAS
TUNIS. TUNISIA
DEAR MINISTER MORJANE:

(PARA) THANK YOU FOR YOUR OFFER TO PROVIDE TWO C-130 AIRCRAFT LOADED WITH RELIEF SUPPLIES TO THE RELIEF OPERATIONS IN THE AFTERMATH OF HURRICANE KATRINA. IT IS ENORMOUSLY GRATIFYING TO KNOW THAT THE AMERICAN PEOPLE HAVE A COMMITTED FRIEND IN TUNISIA. WE APPRECIATE YOUR SWIFT ASSISTANCE, WHICH WILL BE CRITICAL IN HELPING SO MANY FAMILIES RECOVER FROM THE DEVASTATION OF HURRICANE KATRINA.
SINCERELY, DONALD H. RUMSFELD
END OF QUOTE.

2. HARD COPY TO FOLLOW.
BT

JOINT STAFF V1

ACTION
INFO CMAS(*) CMAS(1) JSAMS(*) ASD:PA-SMTP(*)
JCSOINIPRDA(*) JCSOINIPRDA(*)
+US SURVEY DIV SHAPE BE

(U,8)

1

SECDEF V2

ACTION SECDEF WASH DC(*!) (U,6,8,F)
INFO CHAIRS(*) SECDEF-C(1) SECDEF-C(*) USDP:STS(*)
DIR:PAE-RAM(*) DIR:PAE-PF(*) USDCOMP(*) USDP(*)
DACS-ZK:POLAD(*) OSDONNIPRDA(*) OSDONNIPRDA(*)

1

UNCLAS
11-L-0559/OSD/51989

UNCLAS

ROUTINE
 SecDef \ DepSecDef \ Spc Ast \ ExecSec \ USDP \ USDI \
 ESD \ CCD X DRSO \ DIA \ POLAD \ Cbl Ch \ File \

PAGE 1 OF 1
 USER: OSD

TOR: 130650Z Sep 05

Prec: R
 DTG: 1306512 Sep 05

From: SECDEF WASHINGTON DC
 Subj: LETTER FROM SECRETARY OF DEFENSE RUMSFELD TO HIS ROMANIAN

RAAUZYUW RUEWMFU0339 2560651-UUUU--RUEKNMA.
 ZNR UUUUU ZUI RUEKJCS0339 2560651
 R 1306512 SEP 05

FM SECDEF WASHINGTON DC
 TO RUEHBM/USDAO BUCHAREST RO
 INFO RUEHBM/AMEMBASSY BUCHAREST
 RUEHC/SECSTATE WASHINGTON DC
 RUEKJCS/OSD WASHINGTON DC//CHAIRS//
 BT

UNCLAS

SUBJ: LETTER FROM SECRETARY OF DEFENSE RUMSFELD TO HIS ROMANIAN COUNTERPART

1. PLEASE DELIVER THE FOLLOWING LETTER FROM SECRETARY RUMSFELD TO MINISTER ANTANASIU. ORIGINAL WILL BE DELIVERED BY POST.

2. BEGIN TEXT

THE HONORABLE TEODOR ATANASIU
 MINISTER OF DEFENSE
 ROMANIAN MINISTRY OF DEFENSE
 IZVOR ST 13-15, SECTOR 5
 70642 BUCHAREST
 ROMANIA

DEAR MINISTER ANTANASIU:

PAGE 02 RUEWMFU0339 UNCLAS

(PARA) THANK YOU FOR YOUR OFFER OF MEDICAL PERSONNEL TO SUPPORT RELIEF OPERATIONS IN THE AFTERMATH OF HURRICANE KATRINA. IT IS ENORMOUSLY GRATIFYING TO KNOW THAT THE AMERICAN PEOPLE HAVE A COMMITTED FRIEND IN ROMANIA. WE ARE CURRENTLY GIVING YOUR OFFER SIGNIFICANT CONSIDERATION. WE APPRECIATE YOUR PROMPT OFFER OF ASSISTANCE AND YOUR WILLINGNESS TO HELP SO MANY AMERICAN FAMILIES RECOVER FROM THE DEVASTATION OF HURRICANE KATRINA.

SINCERELY,

//SIGNED DONALD H. RUMSFELD//

3. END TEXT.

BT

SECDEF V2

ACTION SECDEF WASH DC(*) (U,6,7,F)
 INFO CHAIRS(*) SECDEF-C(1) SECDEF-C(*) USDAT:STS(*)
 ASD:PA-SMTP(*) DIR:PAE-RAM(*) DIR:PAE-IMAG(*)
 USDCOMP(*) ESC AGENT EUROPE NATO(*)
 ESC AGENT PR KWS(*) DACS-2K:POLAD(*) OSDOMNIPRDA(*)
 OSDONSIPRDA(*)

TOTAL COPIES REQUIRED

1

1

#0339

UNCLAS

11-L-0559/OSD/51990

UNCLAS

ROUTINE
SecDef DepSecDef Spc Ast ExecSec USDP USDI
ESD CCD X DRSO DIA POLAD Cbl Ch File

PAGE 1 OF 1
USER: OSD1

TOR: 1306332 Sep 05

Prec: R
DTG: 1306392 Sep 05

From: SECDEF WASHINGTON DC
Subj: LETTER FROM SECRETARY OF DEFENSE RUMSFELD TO HIS DUTCH

RAAUZYUW RUEWMFU0334 2560640-UUUU--RUEKNMA.
ZNR UUUU ZUI RUEKJCS0334 2560640
R 1306392 SEP 05

FM SECDEF WASHINGTON DC
TO RUEHTC/USDAO THE HAGUE NL
INFO RUEHTC/AMEMBASSY THE HAGUE
RUEHC/SECSTATE WASHINGTON DC
RUEKJCS/OSD WASHINGTON DC//CHAIRS//

BT
UNCLAS
SUBJ: LETTER FROM SECRETARY OF DEFENSE RUMSFELD TO HIS DUTCH
COUNTERPART

1. PLEASE DELIVER THE FOLLOWING LETTER FROM SECRETARY RUMSFELD TO
MINISTER KAMP. ORIGINAL WILL BE DELIVERED BY POST.

2. BEGIN TEXT
THE HONORABLE HENK KAMP
MINISTER OF DEFENSE OF THE KINGDOM OF THE NETHERLANDS
P.O. BOX 20701
2500 ES THE HAGUE
THE NETHERLANDS
DEAR HENK:

(PARA) THANK YOU FOR YOUR GENEROUS OFFER OF AIRCRAFT, SHIPS, MEDICAL

PAGE 02 RUEWMFU0334 UNCLAS
SUPPLIES AND SUPPORT PERSONNEL TO THE RELIEF OPERATIONS IN THE
AFTERMATH OF HURRICANE KATRINA. IT IS ENORMOUSLY GRATIFYING TO KNOW
THAT THE AMERICAN PEOPLE HAVE A COMMITTED FRIEND IN THE NETHERLANDS.
WE APPRECIATE YOUR SWIFT ASSISTANCE, WHICH WILL BE CRITICAL IN
HELPING SO MANY FAMILIES RECOVER FROM THE DEVASTATION OF HURRICANE
KATRINA.

SINCERELY,
//SIGNED DONALD H. RUMSFELD//

3. END TEXT.
BT

SECDEF V2 1
ACTION SECDEF WASH DC(*) (U, 6, 7, F)
INFO CHAIRS(*) SECDEF-C(1) SECDEF-C(*) USDAT:STS(*)
ASD:PA-SMTP(*) DIR:PAE-RAM(*) USDCOMP(*)
ESC AGENT EUROPE NATO(*) ESC AGENT PR KWS(*)
DACS-ZK:POLAD(*) OSDONNIPRDA(*) OSDONSIPRDA(*)
TOTAL COPIES REQUIRED 1

#0334

UNCLAS

ROUTINE
SecDef \ DepSecDef \ Spc Ast \ ExecSec \ USDP \ USDI \
ESD \ CCD X DRSO \ DIA \ POLAD \ Cbl Ch \ File \

PAGE 1 OF 2
USER: OSD1

TCR: 1306432 Sep 05

Prec: R
DTG: 1306452 Sep 05

From: SECDEF WASHINGTON DC
Subj: LETTER FROM SECRETARY OF DEFENSE RUMSFELD TO HIS UK COUNTERPART

RAAUZYJW RUEWMFU0337 2560645-UUUU--RUEKNMA.
ENR UUUU SUI RUEKJCS0337 2560645
R 1306452 SEP 05

FM SECDEF WASHINGTON DC
TO RUEHLO/USDAO LONDON UK
INFO RUEHLO/AMEMBASSY LONDON
RUEHC/SECSTATE WASHINGTON DC
RUEKJCS/OSD WASHINGTON DC//CHAIRS//
BT

UNCLAS

SUBJ: LETTER FROM SECRETARY OF DEFENSE RUMSFELD TO HIS UK COUNTERPART
1. PLEASE DELIVER THE FOLLOWING LETTER FROM SECRETARY RUMSFELD TO SECRETARY REID. ORIGINAL WILL BE DELIVERED BY WST.

2. BEGIN TEXT
THE RIGHT HONORABLE DR. JOHN REID MP
SECRETARY OF STATE FOR DEFENCE
MINISTRY OF DEFENCE
MAIN BUILDING LEVEL 5 ZONE D
WHITEHALL LONDON SW1A 2HB
UNITED KINGDOM
DEAR JOHN:

(PARA) THANK YOU FOR YOUR GENEROUS OFFERS OF PERSONNEL, SUPPLIES AND

PAGE 02 RUEWMFU0337 UNCLAS

EQUIPMENT TO THE RELIEF OPERATIONS IN THE AFTERMATH OF HURRICANE KATRINA. YOUR CONTRIBUTION OF MEALS READY TO EAT AND THE 500-PERSON TENT CITY WILL BE CRITICAL TO THE MANY FAMILIES WHO NOW WORK TO RECOVER FROM THE DEVASTATION OF HURRICANE KATRINA. YOUR IMMEDIATE AND SIGNIFICANT OFFERS OF ASSISTANCE ARE ANOTHER EXAMPLE OF THE SPECIAL RELATIONSHIP ENJOYED BY OUR TWO NATIONS.

SINCERELY,
//SIGNED DONALD H. RUMSFELD//

3. END TEXT.
BT

SECDEF V2

ACTION SECDEF WASH DC (*) (U, 6, F) '1
INFO CHAIRS (*) SECDEF-C(1) SECDEF-C (*) USDAT:STS (*)
ASL:PA-SMTP (*) DIR :PAE-RAN (*) DIR :PAE-IMAG (*)
USDCOMP (*) ESC AGENT EUROPE NATO (*)
ESC AGENT PR KWS (*) DACS-ZX:POLAD (*) OSDONNIPRDA (*)
OSDONSIPRDA (*)

TOTAL COPIES REQUIRED 1

#0337

UNCLAS

11-L-0559/OSD/51992

UNCLAS

ROUTINE

SecDef \ /
ESD \ /

DepSecDef \ /
CCD \ /

Spc Ast \ /
DRSO \ /
DIA \ /

ExecSec \ /
POLAD \ /

USDP \ /
Cbl Ch \ /

USDI \ /
File \ /

PAGE 1 OF 2
USER: OSD1

TCR: 130652Z Sep 05

Prec: R
DTG: 130647Z Sep 05

From: SECDEF WASHINGTON DC
Subj: LETTER FROM SECRETARY OF DEFENSE RUMSFELD TO HIS LATVIAN

RAAUZYUW RUEWMFU0338 2560647-UUUU--RUEKNMA.

ZNR UUUUU ZUI RUEKJCS0338 2560647

R 130647Z SEP 05

FM SECDEF WASHINGTON DC

TO RUEHRA/USDAO RIGA LG

INFO RUEHRA/AMEMBASSY RIGA

RUEHC/SECSTATE WASHINGTON DC

RUEKJCS/CSD WASHINGTON DC//CHAIRS//

BT

UNCLAS

SUBJ: LETTER FROM SECRETARY OF DEFENSE RUMSFELD TO HIS LATVIAN
COUNTERPART

1. PLEASE DELIVER THE FOLLOWING LETTER FROM SECRETARY RUMSFELD TO
MINISTER REP

E. ORIGINAL WILL BE DELIVERED BY POST.

2. BEGIN TEXT

THE HONORABLE EINARS REP

E

MINISTER OF DEFENSE

MINISTRY OF DEFENSE

KR. VALDEMARA 10/12

RIGA LV 1473

PAGE 02 RUEWMFU0338 UNCLAS

LATVIA

DEAR MINISTER REP

E:

(PARA! THANK YOU FOR LATVIAS OFFER OF SUPPORT TO THE RELIEF
OPERATIONS IN THE AFTERMATH OF HURRICANE KATRINA. IT IS ENORMOUSLY
GRATIFYING TO KNOW THAT THE AMERICAN PEOPLE HAVE COMMITTED FRIENDS IN
THE PEOPLE OF LATVIA. WE APPRECIATE YOUR SWIFT OFFER OF ASSISTANCE,
WHICH WILL BE CRITICAL IN PROVIDING COMFORT TO SO MANY FAMILIES AS
THEY SEEK TO RECOVER FROM THE DEVASTATION OF HURRICANE KATRINA.
SINCERELY,

//SIGNED DONALD H. RUMSFELD//

3. END TEXT.

BT

SECDEF V2

ACTION SECDEF WASH DC(*) (U,6,7,F)

INFO CHAIRS(*) SECDEF-C(1) SECDEF-C(*) USDAT:STS(*)

ASD:PA-SMTP(*) DIR:PAE-RAM(*) USDCOMP(*)

ESC AGENT EUROPE NATO(*) DACS-ZK:POLAD(*)

OSDONNIPRDA(*) OSDONSIPRDA(*)

TOTAL COPIES REQUIRED 1

#0338

UNCLAS
11-L-0559/OSD/51993

UNCLAS

ROUTINE						
SecDef \	DepSecDef \	Spc Ast \	ExecSec \	USDP \	USDI \	
ESD \	CCD \	DRSO —	DIA —	POW —	Cbl Ch —	File —

PAGE 1 OF 2
USER: OSD1

TOR: 1306422 Sep 05

Prec: R
DTG: 1306432 Sep 05

From: SECDEF WASHINGTON DC
Subj: LETTER FROM SECRETARY OF DEFENSE RUMSFELD TO HIS SWEDISH

RAAUZYUW RUEWMFU0336 2560643-UUUU--RUEKNMA.
 ZNR UUUUU ZUI RUEKJCS0336 2560643
 R 1306432 SEP 05
 FM SECDEF WASHINGTON DC
 TO RUEHSM/USDAO STOCKHOLM SW
 INFO RUEHSM/AMEMBASSY STOCKHOLM
 RUEHC/SECSTATE WASHINGTON DC
 RUEKJCS/OSD WASHINGTON DC//CHAIRS//
 BT

UNCLAS
SUBJ: LETTER FROM SECRETARY OF DEFENSE RUMSFELD TO HIS SWEDISH COUNTERPART

1. PLEASE DELIVER THE FOLLOWING LETTER FROM SECRETARY RUMSFELD TO MINISTER BJORKLUND. ORIGINAL WILL BE DELIVERED BY POST.
 2. BEGIN TEXT
 HER EXCELLENCY LEVI BJORKLUND
 MINISTER OF DEFENSE
 MINISTRY OF DEFENSE
 JAKOBSGATAN 9
 103 33 STOCKHOLM
 SWEDEN
 DEAR MINISTER BJORKLUND:

PAGE 02 RUEWMFU0336 UNCLAS
 THANK YOU FOR YOUR KIND OFFER OF WATER PURIFICATION EQUIPMENT, MATERIEL AND ELECTRIC POWER GENERATORS FOR THE RELIEF OPERATIONS IN THE AFTERMATH OF HURRICANE KATRINA. IT IS ENORMOUSLY GRATIFYING TO KNOW THAT THE AMERICAN PEOPLE HAVE A COMMITTED FRIEND IN SWEDEN.
 SINCERELY, //SIGNED DONALD H. RUMSFELD//
 3. END TEXT.
 BT

SECDEF V2 2
 ACTION SECDEF WASH DC(*) (U, 6, F)
 INFO CMAS(*) CMAS(1) J4:MRD(*) USSOCOMWO(*) CHAIRS(*)
 SECDEF-C(1) SECDEF-C(*) USDAT:STS(*) ASD:PA-SMTP(*)
 DIR:PAE-RAM(*) USDCOMP(*) ESC AGENT EUROPE NATO(*)
 DACS-ZK:POLAD(*) OSDONNIPRDA(*) OSDONSIPRDA(*)
 TOTAL COPIES REQUIRED 2

#0336

NNNN

UNCLAS
11-L-0559/OSD/51994

UNCLAS

ROUTINE
SecDef \ DepSecDef \ Spc Ast \ ExecSec \ USDP \ USDI \
ESD \ CCD X DRSO \ DIA \ POLAD \ Cbl Ch \ File \

PAGE 1 OF 2
USER: OSD1

TOP: 1306412 Sep 05

Prec: R
DTG: 1306422 Sep 05

From: SECDEF WASHINGTON DC
Subj: LETTER FROM SECRETARY OF DEFENSE RUMSFELD TO HIS NORWEGIAN

RAAUZYUW RUEWMFU0335 2560642-UUUU--RUEKNMA.
ZNR UUUUU ZU RUEKJCS0335 2560642
R 1306422 SEP 05
FM SECDEF WASHINGTON DC
TO RUEHNYUSDAO OSLO NO
INFO RUEHNY/AMEMBASSY OSLO
RUEHC/SECSTATE WASHINGTON DC
RUEKJCS/OSL WASHINGTON DC//CHAIRS//
BT

UNCLAS
SUBJ: LETTER FROM SECRETARY OF DEFENSE RUMSFELD TO HIS NORWEGIAN
COUNTERPART

1. PLEASE DELIVER THE FOLLOWING LETTER FROM SECRETARY RUMSFELD TO
MINISTER DEVOLD. ORIGINAL WILL BE DELIVERED BY POST.

2. BEGIN TEXT
HER EXCELLENCY KRISTIN KROHN DEVOLD
MINISTER OF DEFENSE
MINISTRY OF DEFENSE
MYNIGATA 1
N-0032 OSLO
NORWAY
DEAR KRISTIN:

PAGE 02 RUEWMFU0335 UNCLAS
(PARA) THANK YOU FOR NORWAY'S GENEROUS OFFER OF BLANKETS, TENTS,
MEDICINE, DIVERS AND CASH ASSISTANCE TO THE RELIEF OPERATIONS IN THE
AFTERMATH OF HURRICANE KATRINA. IT IS ENORMOUSLY GRATIFYING TO KNOW
THAT THE AMERICAN PEOPLE HAVE A COMMITTED ALLY IN NORWAY. WE
APPRECIATE YOUR SWIFT ASSISTANCE, WHICH WILL BE CRITICAL IN HELPING
SO MANY FAMILIES RECOVER FROM THE DEVASTATION OF HURRICANE KATRINA.
(PARA) I LOOK FORWARD TO SEEING YOU IN BERLIN.

BEST,
//SIGNED//
DONALD H. RUMSFELD

3. END TEXT
BT

SECDEF V2 1
ACTION SECDEF WASH DC(*) (U,6,F)
INFO CHAIRS(*) SECDEF-C(1) SECDEF-C(*) USDAT:STS(*)
ASD:PA-SMTP(*) DIR:PAE-RAM(*) USDCOMP(*)
ESC AGENT EUROPE NATO(*) DACS-2K:POLAD(*)
OSDONKIPRDA(*) OSDONSIPRDA(*)
TOTAL COPIES REQUIRED 1

#0335

UNCLAS

11-L-0559/OSD/51995

UNCLAS

ROUTINE
SecDef \ DepSecDef \ Spc Ast \ ExecSec \ USDP \ USDI \
ESD \ CCD \ DRSO \ DIA \ POLAD \ Cbl Ch \ File \

PAGE 1 OF 2
USER: OSD1

TOR: 1306382 Sep 05

Prec: R
DTG: 1306382 Sep 05

From: SECDEF WASHINGTON DC
Subj: LETTER FROM SECRETARY OF DEFENSE RUMSFELD TO HIS LUXEMBOURG

RAAUEYUW RUEWMFU0333 2560638-UUUU--RUEXNMA.
ZNR UUUUU ZOI RUEKJCS0333 2560638
R 1306382 SEP 05
FM SECDEF WASHINGTON DC
TO RUEHLE/AMEMBASSY LUXEMBOURG
INFO RUEHFR/USDAO PARIS FR
RUEHC/SECSTATE WASHINGTON DC
RUEKJCS/OSD WASHINGTON DC//CHAIRS//
BT

UNCLAS
SUBJ: LETTER FROM SECRETARY OF DEFENSE RUMSFELD TO HIS LUXEMBOURG
COUNTERPART

1. PLEASE DELIVER THE FOLLOWING LETTER FROM SECRETARY RUMSFELD TO
MINISTER FRIEDEN. ORIGINAL WILL BE DELIVERED BY WST.

2. BEGIN TEXT
THE HONORABLE LOU FRIEDEN
MINISTER OF DEFENSE OF LUXEMBOURG
6, RUE DE L ANCIEN ATHENEE
L-1148 LUXEMBOURG

DEAR MINISTER FRIEDEN:
(PARA) THANK YOU FOR YOUR GENEROUS OFFER OF A SEARCH AND RESCUE
TEAM. SUPPORT PERSONNEL AND SUPPLIES TO THE RELIEF OPERATIONS IN THE

PAGE 02 RUEWMFU0333 UNCLAS
AFTERMATH OF HURRICANE KATRINA. IT IS ENORMOUSLY GRATIFYING TO KNOW
THAT THE AMERICAN PEOPLE HAVE A COMMITTED FRIEND IN LUXEMBOURG. WE
APPRECIATE YOUR SWIFT ASSISTANCE, WHICH WILL BE CRITICAL IN HELPING
SO MANY FAMILIES RECOVER FROM THE DEVASTATION OF HURRICANE KATRINA.

SINCERELY,
//SIGNED DONALD H. RUMSFELD//

3. END TEXT.

BT

SECDEF V2
ACTION SECDEF WASH DC (*) (U, 6, F)
INFO CHAIRS(*) SECDEF-C(1) SECDEF-C(*) USDAT:STS(*)
ASD:PA-SMTP(*) DIR:PAE-RAM(*) USDCOMP(*)
ESC AGENT EURASIA(*) ESC AGENT EUROPE NATO(*)
ESC AGENT PR KWS(*) DACS-ZK:POLAD(*) OSDONNIPRDA(*)
OSDONNIPRDA(*)

1

TOTAL COPIES REQUIRED

1

#0333

UNCLAS
11-L-0559/OSD/51996

UNCLAS

ROUTINE
SecDef \ DepSecDef \ Spc Ast \ ExecSec \ USDP \ USDI \
ESD \ CCD X DRSO — DIA — POLAD — Cbl Ch — File —

PAGE 1 OF 1
USER: OSD1

TOR: 130634Z Sep 05

Prec: R
DTG: 1306362 Sep 05

From: SECDEF WASHINGTON DC
Subj: LETTER FROM SECRETARY OF DEFENSE RUMSFELD TO THE ICELANDIC

RAAUZYUW RUEWMFU0332 2560636-UUUU--RUEKNMA.
ZNR UUUUU ZUI RUEKJCS0332 2560636
R 1306362 SEP 05
FM SECDEF WASHINGTON DC
TO RUEHRK/AMEMBASSY REYKJAVIK
INFO RUEHNY/USDAO OSLO NO
RUEHHC/SECSTATE WASHINGTON DC
RUEKJCS/OSD WASHINGTON DC//CHAIRS//
BT

UNCLAS
SUBJ: LETTER FROM SECRETARY OF DEFENSE RUMSFELD TO THE ICELANDIC
FOREIGN MINISTER

1. PLEASE DELIVER THE FOLLOWING LETTER FROM SECRETARY RUMSFELD TO
MINISTER ODDSSON. ORIGINAL WILL BE DELIVERED BY POST.
2. BEGIN TEXT

HIS EXCELLENCY DAVID ODDSSON
MINISTER OF FOREIGN AFFAIRS
MINISTRY OF FOREIGN AFFAZRS
RAUDARARSTIGUR 25
150 REYKJAVIK
ICELAND
DEAR MINISTER ODDSSON:

PAGE 02 RUEWMFU0332 UNCLAS
(PARA) THANK YOU FOR YOUR KIND OFFER OF DRINKING WATER AND A SEARCH
AND RESCUE TEAM FOR THE RELIEF OPERATIONS IN THE AFTERMATH OF
HURRICANE KATRINA. IT IS ENORMOUSLY GRATIFYING TO KNOW THAT THE
AMERICAN PEOPLE HAVE A COMMITTED ALLY IN ICELAND.
SINCERELY,
//SIGNED DONALD H. RUMSFELD//
3. END TEXT.
BT

SECDEF V2 1
ACTION SECDEF WASH DC (*) (U,6,7,F)
INFO CHAIRS(*) SECDEF-C(1) SECDEF-C(*) USDAO:SPS1*1
ASD:PA-SMTP(*) DIR:PAE-RAM(*) USDCOMP(*)
ESC AGENT EUROPE NATO(*) DACS-ZK:POLAD(*)
OSDCNRIERLA(*) OSDONSIPRDAI*)

TOTAL COPIES REQUIRED 1

#0332

UNCLAS

ROUTINE
SecDef \ _____ DepSecDef \ _____ Spc Ast \ _____ ExecSec \ _____ USDP \ _____ USDF \ _____
ESD \ _____ CCD X DRSO _____ DIA _____ POLAD _____ Cbl Ch _____ File _____

PAGE 1 OF 2
USER: OSD1

TOR: 1306332 Sep 05

Prec: R
DTG: 1306352 Sep 05

From: SECDEF WASHINGTON DC
Subj: LETTER FROM SECRETARY OF DEFENSE RUMSFELD TO HIS DANISH

RAAUZYUW RUEWMFU0331 2560635-UUUU--RUEKNMA.

ZNR UUUUU ZU: RUEKJCS0331 2560635

R 1306352 SEP 05

FM SECDEF WASHINGTON DC
TO RUEHCF/USDAO COPENHAGEN DA
INFO RUEHCP/AMEMBASSY COPENHAGEN
RUEHC/SECSTATE WASHINGTON DC
RUEKJCS/OSD WASHINGTON DC//OSD CHAIRS//
BT

UNCLAS

SUBJ: LETTER FROM SECRETARY OF DEFENSE RUMSFELD TO HIS DANISH
COUNTERPART

1. PLEASE DELIVER THE FOLLOWING LETTER FROM SECRETARY RUMSFELD TO
MINISTER GADE. ORIGINAL WILL BE DELIVERED BY POST.

2. BEGIN TEXT

HIS EXCELLENCY SXREN GADE
MINISTER OF DEFENCE
MINISTRY OF DEFENCE
HOLMEN'S KANAL 42
DK-1060 COPENHAGEN
DENMARK
DEAR MINISTER GADE:

PAGE 02 RUEWMFU0331 UNCLAS

(PARA) THANK YOU FOR YOUR KIND OFFER OF WATER PURIFICATION UNITS FOR
THE RELIEF OPERATIONS IN THE AFTERMATH OF HURRICANE KATRINA. IT IS
ENORMOUSLY GRATIFYING TO KNOW THAT THE AMERICAN PEOPLE HAVE A
COMMITTED ALLY IN DENMARK.

SINCERELY,
//SIGNED//

DONALD H. RUMSFELD

3. END TEXT.

BT

SECDEF V2

ACTION SECDEF WASH DC(*) (U,6,7)

INFO CHAIRS(*) SECDEF-C(1) SECDEF-C(*) USDAT:STS(*)

ASD:PA-SMTP(*) DIR:PAE-RAH(*) USDCOMP(*)

ESC AGENT EUROPE NATO(*) DACS-2X:POLAD(*)

OSDONNIPRDA(*) OSDONSIPRDA(*)

TOTAL COPIES REQUIRED

#0331

1

1

UNCLAS

ROUTINE
 SecDef DepSecDef Spc Ast ExecSec USDP USDI
 ESD CCD X DRSO DIA POLAD Cbl Ch File

PAGE 1 OF 1
USER: OSD1

TOR: 1306322 Sep 05

Prec: R
DTG: 1306332 Sep 05

From: SECDEF WASHINGTON DC
Subj: LETTER FROM SECRETARY OF DEFENSE RUMSFELD TO HIS CANADIAN

RAAUZYUW RUEWMFU0330 2560633-UUUU--RUEKNMA.
ZNR UUUUU ZUI RUEKJCS0330 2560633
R 1306332 SEP 05

FM SECDEF WASHINGTON DC
TO RUEHOT/USDAO OTTAWA ON CAN
INFO RUEHOT/AMEMBASSY OTTAWA
RUEHC/SECSTATE WASHINGTON DC
RUEKJCS/OSD WASHINGTON DC//CHAIRS//
BT

UNCLAS

SUBJ: LETTER FROM SECRETARY OF DEFENSE RUMSFELD TO HIS CANADIAN COUNTERPART

1. PLEASE DELIVER THE FOLLOWING LETTER FROM SECRETARY RUMSFELD TO MINISTER GRAHAM. ORIGINAL WILL BE DELIVERED BY WST.

2. BEGIN TEXT

THE HONORABLE WILLIAY GRAHAM
MINISTER FOR NATIONAL DEFENSE
DEPARTMENT OF NATIONAL DEFENSE
101 COLONEL BY DRIVE
OTTAWA, ONTARIO K1A 0K2
CANADA

DEAR MINISTER GRAHAM:

PAGE 02 RUEWMFU0330 UNCLAS

(PARA) THANK YOU FOR YOUR GENEROUS CONTRIBUTION OF HELICOPTERS, AIR TRANSPORT AND PERSONNEL TO THE RELIEF OPERATIONS IN THE AFTERMATH OF HURRICANE KATRINA. YOUR SWIFT OFFERS OF MILITARY COLLABORATION AND ASSISTANCE WILL BE CRITICAL IN HELPING THE MANY FAMILIES WORKING TO RECOVER FROM THE DEVASTATION OF HURRICANE KATRINA AND SERVE AS AN EXAMPLE OF THE RELATIONSHIP BETWEEN OUR TWO NATIONS.

SINCERELY,

//SIGNED DONALD H. RUMSFELD//

3. END TEXT.

BT

SECDEF V2

ACTION SECDEF WASH DC(*) (U,6,7,8,F) 1
 INFO PJED(*) CHAIRS(*) SECDEF-C(1) SECDEF-C(*)
 USDAF:STS(*) ASD:PA-SMTP(*) DIR:PAE-RAH(*)
 USDCOMP(*) ESC AGENT AMERICAS(*)
 ESC AGENT EUROPE NATO(*) ESC AGENT PR KWS(*)
 DACS-ZK:POLAD(*) OSDONNIPRDA(*) OSDONSIPRDA(*)

TOTAL COPIES REQUIRED 1

#0330

UNCLAS

11-L-0559/OSD/51999

UNCLAS

ROUTINE
 SecDef DepSecDef Spc Ast ExecSec USDP USDI
 ESD CCD X DRSO DIA POLAD Cbl Ch File

PAGE 1 OF 2
USER: OSD1

TCR: 1306312 Sep 05

Prec: R
DTG: 1306322 Sep 05

From: SECDEF WASHINGTON DC
Subj: LETTER FROM SECRETARY OF DEFENSE RUMSFELD TO HIS FRENCH

RAAUZYUW RUEWMFU0329 2560633-UUUU--RUEKNMA.
 ZNR UUUUU ZU: RUEKJCS0329 2560633
 R 1306322 SEP 05
 FM SECDEF WASHINGTON DC
 TO RUEHFR/USDAO PARIS FR
 INFO RUEHFR/AMBASSY PARIS
 RUEHC/SECSTATE WASHINGTON DC
 RUEKJCS/OSD WASHINGTON DC//OSD CHAIRS//
 BT

UNCLAS
 SUBJ: LETTER FROM SECRETARY OF DEFENSE RUMSFELD TO HIS FRENCH
 COUNTERPART

1. PLEASE DELIVER THE FOLLOWING LETTER FROM SECRETARY RUMSFELD TO MINISTER ALLJOT-MARIE. ORIGINAL WILL BE DELIVERED BY POST.

2. BEGIN TEXT
 HER EXCELLENCY MICHHE ALLIOT-MARIE
 MINISTER OF DEFENSE OF THE FRENCH REPUBLIC

14 RUE SAINT-DOMINIQUE
 -00450 ARMEES
 PARIS, FRANCE

DEAR MADAME MINISTER:
 THANK YOU FOR YOUR GENEROUS OFFERS OF AIRCRAFT, SHIPS AND SUPPLIES TO

PAGE 02 RUEWMFU0329 UNCLAS
 THE RELIEF OPERATIONS IN THE AFTERMATH OF HURRICANE KATRINA. THE TENTS, GENERATORS AND SUPPLIES YOU HAVE SENT WILL ~~BE~~ CRITICAL IN HELPING THE MANY FAMILIES WORKING TO RECOVER FROM THE DEVASTATION OF HURRICANE KATRINA.

SINCERELY,
 //SIGNED DONALD H. RUMSFELD//

3. END TEXT.
 BT

SECDEF V2 1
 ACTION SECDEF WASH DC (*) (U,6)
 INFO CHAIRS(*) SECDEF-C(1) SECDEF-C(*) USDAT:STS(*)
 ASD:PA-SMTP(*) DIR:PAE-RAH(*) USDCOMP(*)
 ESC AGENT EURASIA(*) ESC AGENT EUROPE NATO(!)
 DACS-ZK:POLAD(*) OSDORNIIPRA(*) OSDONSIPRA(*)
 TOTAL COPIES REQUIRED 1

#0329

UNCLAS

ROUTINE
SecDef \ DepSecDef \ Spc Ast \ ExecSec \ USDP \ GSDI \
ESD \ CCD X \ DRSO \ DIA \ POLAD \ Cbl Ch \ File \

PAGE 1 OF 2
USER: OSD1

TOR: 1306332 Sep 05

Prec: R
DTG: 1306222 Sep 05

From: SECDEF WASHINGTON DC
Subj: SECRETARY OF DEFENSE RUMSFELD LETTER THANKING MINISTER OF

RAAUCZYUW RUEWMFU0324 2560622-UUUU-~~RU~~EXRMA.
ZNR UUUUU ZUI RUEKJCS0324 2560622
R 1306222 SEP 05
FM SECDEF WASHINGTON DC
TO RUEHUP/USDAO BUDAPEST HU
INFO RUEHNO/USMISSION USNATO
RUEHC/SECSTATE WASHINGTON DC
RUEKJCS/JOINT STAFF WASHINGTON DC
RHEFARL/DIA ARLINGTON VA
RHEHAAA/NATIONAL SECURITY COUNCIL WASHINGTON DC
RHMFISS/CDR USEUCOM ALT SHAPE BE
RUEKJCS/SECDEF WASHINGTON DC//CHAIRS//
RUEHUP/AMEMBASSY BUDAPEST

BT
UNCLAS
SUBJ: SECRETARY OF DEFENSE RUMSFELD LETTER THANKING MINISTER OF
DEFENSE FOR OFFER OF SUPPORT FOR HURRICANE KATRINA RELIEF OPERATION.
1. ACTION REQUEST: PLEASE DELIVER LETTER SELOW TO MINISTER OF
DEFENSE. SIGNED LETTER WILL FOLLOW.
2. TEXT BEGINS:
FERENC JUHASZ
MINISTER OF DEFENSE

PAGE 02 RUEWMFU0324 UNCLAS
REPUBLIC OF HUNGARY
BALATON U 7-11
1055 BUDAPEST

DEAR MINISTER JUHASZ:
(PARA) THANK YOU FOR YOUR GOVERNMENTS OFFER TO PROVIDE A NINE MEMBER
RESCUE TEAM, FORENSICS ASSISTANCE AND MATERIEL TO THE RELIEF
OPERATIONS IN THE AFTERMATH OF HURRICANE KATRINA. WE ARE CURRENTLY
CONDUCTING AN ASSESSMENT OF OUR NEEDS. IT IS ENORMOUSLY GRATIFYING
TO KNOW THAT THE AMERICAN PEOPLE HAVE A COMMITTED FRIEND IN THE
REPUBLIC OF HUNGARY
SINCERELY,
//DONALD E. RUMSFELD//
3. END OF TEXT.
BT

JOINT STAFF V1 2
ACTION (U,8)
INFO SCS-C(*) SCS-C(1) CMAS(*) CMAS(1) JSAMS(*)
USDP:ESC(*) JCSONNIPRDA(*) JCSONSIPRDA(*)
+US SURVEY DIV SHAPE 5E

SECDEF V2 1
ACTION SECDEF WASH DC(*) (U,6,7,8,F)
INFO CHAIRS(*) SECDEF-C(1) SECDEF-C(*) USDAT:STS(*)

UNCLAS
11-L-0559/OSD/52001

UNCLAS

ROUTINE

SecDef
ESD

DepSecDef
CCD X DRSO

Spc Ast
DIA

ExecSec
POLAD

USDP
cbl Ch

USDI
File

PAGE 1 OF 2
USER: OSD

TOR: 1306342 Sep US

Prec: R
DTG: 1306312 Sep 05

From: SECDEF WASHINGTON DC
Subj: SECRETARY OF DEFENSE LETTER TO MINISTER MUKHERJEE

RAUCZYUW RUEWMFU0328 2560631-UUUU--RUEKXMA.
ZNR UUUUU ZUI RUEKJCS0328 2560631
R 1306312 SEP 05
FM SECDEF WASHINGTON DC
TO RUEHNE/AMEMBASSY NEW DELHI
INFO RUEHC/SECSTATE WASHINGTON DC
RUEKJCS/JOINT STAFF WASHINGTON DC
RUEKJCS/SECDEF WASHINGTON DC//USDP/ISA/NESA/CHAIRS//
RHEHAAA/NATIONAL SECURITY COUNCIL WASHINGTON DC
RUEHNE/USDAO NEW DELHI IN

BT
UNCLAS

SUBJ: SECRETARY OF DEFENSE LETTER TO MINISTER MUKHERJEE
1. PLEASE DELIVER THE FOLLOWING LETTER FROM SECRETARY OF DEFENSE RUMSFELD TO MINISTER MUKHERJEE. THE LETTER IS IN RESPONSE TO INDIA'S OFFER TO PROVIDE RELIEF SUPPLIES TO THE RELIEF OPERATIONS IN THE AFTERMATH OF HURRICANE KATRINA.

QUOTE:
HIS EXCELLENCY
PRANAB MUKHERJEE
MINISTER OF DEFENCE
GOVERNMENT OF INDIA

PAGE 02 RUEWMFU0328 UNCLAS
MINISTRY OF DEFENCE
NEW DELHI 110011 INDIA
DEAR MINISTER MUKHERJEE:

(PARA) THANK YOU FOR YOUR GENEROUS OFFERS OF THE ARMY MEDICAL CORPS MEALS-READY-TO-EAT (MRE), IL-76 AIRCRAFT LOADED WITH RELIEF SUPPLIES AND NAVY DIVERS TO THE RELIEF OPERATIONS IN THE AFTERMATH OF HURRICANE KATRINA. IT IS ENORMOUSLY GRATIFYING TO KNOW THAT THE AMERICAN PEOPLE HAVE A COMMITTED FRIEND IN INDIA. WE APPRECIATE YOUR SWIFT ASSISTANCE, WHICH WILL BE CRITICAL IN HELPING SO MANY FAMILIES RECOVER FROM THE DEVASTATION OF HURRICANE KATRINA.
SINCERELY, DONALD H. RUMSFELD

END OF QUOTE.
2. HARD COPY TO FOLLOW.
BT

JOINT STAFF V1

ACTION (U.S)
INFO CMAS(*) CMAS(1) JSAMS(*) JCSONNIPRDA(*)
JCSONSIPRDA(*)

1

SECDEF V2

ACTION SECDEF WASH DC(*) (U,6,8,F)
INFO CHAIRS(*) SECDEF-C(1) SECDEF-C(*) USDAT:STS(*)
ASD:PA-SMTP(*) DIR:PAE-RAM(*) USDCOMP(*) USDP:ESC(*)

1

UNCLAS

11-L-0559/OSD/52002

UNCLAS

ROUTINE
 SecDef \ - DepSecDef \ Spc Ast \ ExecSec \ USDP \ USDI \
 ESD \ CCD X DRSO \ DIA \ POLAD \ Cbl Ch \ File \

PAGE 1 OF 2
USER: OSD1

TOR: 1306342 Sep 05

Prec: R
DTG: 1306272 Sep 05

From: SECDEF WASHINGTON DC
Subj: LETTER FROM SECRETARY OF DEFENSE RUMSFELD TO HIS ESTONIAN

RAAUZYJW RUEWMFU0327 2560627-UUUU--RUEKNMA.
 ZNR UUUUU ZUI RUEKJCS0327 2560627
 R 1306272 SEP 05
 FM SECDEF WASHINGTON DC
 TO RUEHTL/USDAO TALLINN EN
 INFO RUEHTL/AMEMBASSY TALLINN
 RUEHC/DEPT OF STATE WASHINGTON DC
 RUEKJCS/SECDEF WASHINGTON DC//CHAIRS//
 BT

UNCLAS
SUBJ: LETTER FROM SECRETARY OF DEFENSE RUMSFELD TO HIS ESTONIAN COUNTERPART

1. PLEASE DELIVER THE FOLLOWING LETTER FROM SECRETARY RUMSFELD TO MINISTER JUER\T. ORIGINAL WILL BE DELIVERED BY POST.

2. BEGIN TEXT
 THE HONORABLE JAAK JUER\T
 MINISTER OF DEFENSE
 ESTONIAN MINISTRY OF DEFENSE

SAKALA 1
 15094 TALLINN
 ESTONIA

DEAR MINISTER JUER\T:

PAGE 02 RUEWMFU0327 UNCLAS
 (PARA) THANK YOU FOR ESTONIAS OFFER OF SUPPORT TO THE RELIEF OPERATIONS IN THE AFTERMATH OF HURRICANE KATRINA. IT IS ENORMOUSLY GRATIFYING TO KNOW THAT THE AMERICAN PEOPLE HAVE A COMMITTED FRIEND IN ESTONIA. WE APPRECIATE YOUR SWIFT OFFER OF ASSISTANCE, WHICH WILL BE CRITICAL IN PROVIDING COMFORT TO SO MANY FAMILIES AS THEY SEEK TO RECOVER FROM THE DEVASTATION OF HURRICANE KATRINA.

SINCERELY,
//SIGNED DONALD H. RUMSFELD//

3. END TEXT.
BT

SECDEF V2 1
 ACTION SECDEF WASH DC (*) (U,6,7,8,F)
 INFO CHAIRS(*) SECDEF-C(1) SECDEF-C(*) USDAT:STS(*)
 ASD:PA-SMTP(*) DIR:PAE-RAM(*) USDCOMP(*)
 ESC AGENT EUROPE NATO(*) DACS-ZK:POLAD(*)
 OSDONNIPRDA(*) OSDONS1PRDA(*)

TOTAL COPIES REQUIRED 1

#0327

UNCLAS
11-L-0559/OSD/52003

UNCLAS

ROUTINE
 SecDef DepSecDef Spc Ast ExecSec USDP USDI
 ESD CCD DRSO DIA POLAD Cbl Ch File

PAGE 1 OF 1
USER: OSD1

FOR: 1305242 Sep 05

Prec: R
DTG: 1306252 Sep 05

From: SECDEF WASHINGTON DC
Subj: SECDEF LETTER TO MOD GONUL

RAJUZYUW RUEWMFU0326 2560625-UUUU--RUEKNMA.
ZNR UUUU ZOI RUEKJCS0326 2560625
R 1306252 SEP 05

FM SECDEF WASHINGTON DC
TO RUEHAK/USDAO ANKARA TU
INFO RUEHAK/AMEMBASSY ANKARA
RUEKJCS/SECDEF WASHINGTON DC
BT

UNCLAS

SUBJ: SECDEF LETTER TO MOD GONUL
PLEASE TRANSMIT THE FOLLOWING LETTER FROM SECDEF TO MOD GONUL.
ORIGINAL LETTER WILL FOLLOW.

(BEGIN TEXT)
HIS EXCELLENCY MEHMET VECDI GONUL
MINISTER OF NATIONAL DEFENSE
REPUBLIC OF TURKEY
MILLI SAVUNMA BAKANLIGI
ANKARA, TURKEY

DEAR MINISTER GONUL:
(PARA) THANK YOU FOR YOUR GOVERNMENT'S GENEROUS OFFER TO PROVIDE A
SEARCH AND RESCUE TEAM IN THE AFTERATH OF HURRICANE KATRINA. WE ARE
STILL EVALUATING OUR NEEDS AND WILL COMMUNICATE WITH YOU SOON

PAGE 02 RUEWMFU0326 UNCLAS
REGARDING THESE KIND OFFERS.

(PARA) IT IS ENORMOUSLY GRATIFYING TO KNOW THAT THE AMERICAN PEOPLE
HAVE A COMMITTED FRIEND IN TURKEY. WE APPRECIATE YOUR SWIFT
ASSISTANCE, WHICH WILL BE CRITICAL IN HELPING SO MANY FAMILIES
RECOVER FROM THE DEVASTATION OF HURRICANE KATRINA.

SINCERELY,
//DONALD RUNSFELD//
(END TEXT)

BT

SECDEF V2 1
 ACTION SECDEF WASH DC(*) (U,6,7,8)
 INFO CHAIRS(*) SECDEF-C(1) SECDEF-C(*) USDP:STS(*)
 ASD:PA-SMTP(*) DIR:PAE-RAM(*) USDCOMP(*) USDP:ESC(*)
 ESC AGENT EUROPE NATO(*) DDCS-ZK:POLAD(*)
 OSDONNIPRDA(*) OSDONSIPRDA(*)

TOTAL COPIES REQUIRED 1

#0326

UNCLAS

ROUTINE
SecDef 1 DepSecDef 1 Spc Ast 1 ExecSec 1 USDP 1 USDI 1
ESD 1 CCD X DRSO DIA POLAD Cbl Ch File

PAGE 1 OF 2
USER: OSD1

TOR: 130634Z Sep 05

Prec: R
DTG: 130624Z Sep 05

From: SECDEF WASHINGTON DC
Subj: SECRETARY OF DEFENSE RUMSFELD LETTER THANKING MINISTER OF

RAA0ZYUW RUEWMFU0325 2560624-UUUU--RUEKNMA.
ZNR UUUUU ZUI RUEKJCS0325 2560624
R 130624Z SEP 05
FM SECDEF WASHINGTON DC
TO RUEHLJ/USDAO LJUBLJANA SI
INFO RUEHNO/USMISSION USNATO
RUEHC/SECSTATE WASHINGTON DC
RUEKJCS/JOINT STAFF WASHINGTON DC
RHEFARL/DIA ARLINGTON VA
RHEHAAA/NATIONAL SECURITY COUNCIL WASHINGTON DC
RHMFISS/CDR USEUCOM ALT SEAPE BE
RUEKJCS/SECDEF WASHINGTON DC//CHAIRS//
RUEHLJ/AMEMBASSY LJUBLJANA

BT
UNCLAS
SUBJ: SECRETARY OF DEFENSE RUMSFELD LETTER THANKING MINISTER OF
DEFENSE FOR OFFER OF SUPPORT FOR HURRICANE KATRINA RELIEF OPERATION.
1. ACTION REQUEST: PLEASE DELIVER LETTER BELOW TO MINISTER OF
DEFENSE. SIGNED LETTER WILL FOLLOW.
2. TEXT BEGINS:
KARL ERJAVEC
MINISTER OF DEFENSE

PAGE 02 RUEWMFU0325 UNCLAS
REPUBLIC OF SLOVENIA
KARDELJEVA PL 25
1000 LJUBLJANA

DEAR MINISTER ERJAVEC:
THANK YOU FOR YOUR GOVERNMENT'S GENEROUS OFFER TO PROVIDE WATER
PUMPS, FIRST AID KITS AND MATERIEL TO THE RELIEF OPERATIONS IN THE
AFTERMATH OF HURRICANE KATRINA. WE ARE CURRENTLY CONDUCTING AN
ASSESSMENT OF OUR NEEDS. IT IS ENORMOUSLY GRATIFYING TO KNOW THAT
THE AMERICAN PEOPLE HAVE A COMMITTED FRIEND IN THE REPUBLIC OF
SLOVENIA.

SINCERELY,
//DONALD H. RUMSFELD//

3. END OF TEXT.
BT

JOINT STAFF V1
ACTION (U,8) 2
INFO SJS-C(*) SJS-C(1) CMAS(*) CMAS(1) JSAMS(*)
USDP:ESC(*) JCSOINIPRDA(*) JCSONSIPRDA(*)
+US SURVEY DIV SEAPE PE

SECDEF V2
ACTION SECDEF WASH DC(*) (U,6,7,8,F)
INFO CHAIRS(*) SECDEF-C(1) SECDEF-C(*) USDAT:STS(*)

UNCLAS

11-L-0559/OSD/52005

UNCLAS

ROUTINE
SecDef \ DepSecDef \ Spc Ast \ ExecSec \ USDP \ USDI \
ESD \ CCD X DRSO \ DIA \ POLAD \ Cbl Ch \ File \

PAGE 1 OF 1
USER: OSD1

TOR: 130640Z Sep 05

Prec: R
DTG: 130619Z Sep 05

From: SECDEF WASHINGTON DC
Subj: SECRETARY OF DEFENSE RUMSFELD LETTER THANKING MINISTER OF

RAAUENW RUEWMFU0322 2560619-UUUU--RUEKNMA.
ZNR UUUUU ZUI RUEKJCS0322 2560619
R 130619Z SEP 05
FM SECDEF WASHINGTON DC
TO RUEHPG/USDAC PRAGUE EZ
INFO RUEHPG/AMEMBASSY PRAGUE
RUEHNO/USMISSION USNATO
RUEHC/SECSTATE WASHINGTON DC
RUEKJCS/JOINT STAFF WASHINGTON DC
RHEFARL/DIA ARLINGTON VA
RKEBAAA/NATIONAL SECURITY COUNCIL WASHINGTON DC
RHMFISS/CDR USEUCOM ALT SHAPE BE
RUEKJCS/SECDEF WASHINGTON DC//CHAIRS//
BT

UNCLAS

SUBJ: SECRETARY OF DEFENSE RUMSFELD LETTER THANKING MINISTER OF
DEFENSE FOR OFFER OF SUPPORT TOR HURRICANE KATRINA RELIEF OPERATION
1. ACTION REQUEST: PLEASE DELIVER LETTER BELOW TO MINISTER OF
DEFENSE. SIGNED LETTER WILL FOLLOW.
2. TEXT BEGINS:
KAREL KUHNL
MINISTER OF DEFENSE

PAGE 02 RUEWMFU0322 UNCLAS
CZECH REPUBLIC
TYCHONOVA 1
PRAHA 6

DEAR MINISTER KUHNL:
(PARA) THANK YOU FOR YOUR GOVERNMENT'S OFFER TO PROVIDE MEDICAL,
MATERIAL AND LOGISTICAL SUPPORT TO THE RELIEF OPERATIONS IN THE
AFTERMATH OF HURRICANE KATRINA. WE ARE CURRENTLY CONDUCTING AN
ASSESSMENT OF Ob. NEEDS. IT IS ENORMOUSLY GRATIFYING TO KNOW THAT
THE AMERICAN PEOPLE HAVE A COMMITTED FRIEND IN THE CZECH REPUBLIC.
SINCERELY,

//DONALD E. RUMSFELD//

3. END TEXT.

BT

JOINT STAFF V1

ACTION

INFO SJS-C(*) SJS-C(1) CMAS(*) CMAS(1) JSAMS(*)
SECDEF-C(1) SECDEF-C(*) MDA(*) USDP:ESC(*)
JCSOINIPRDA(*! JCSOINIPRDA(*)
+US SURVEY DIV SHAPE BE

(U, 8)

3

SECDEF V2

ACTION SECDEF WASH DC(*)

INFO CEAIRS(*! USDA?: STS(*) ASD:PA-SMTP(*) DIR:PAE-RAM(*)

(U, 6, 7, 8, F)

0

UNCLAS

11-L-0559/OSD/52006

UNCLAS

ROUTINE

SecDef

DepSecDef

Spc Ast

ExecSec

USDP

USDI

ESD

CCD

DRSO

DIA

POLAD

Cbl Ch

File

PAGE 1 OF 2
USER: OSDI

FOR: 130620Z Sep 05

Prec: R
DTG: 1306212 Sep 05

from: SECDEF WASHINGTON DC
Subj: SECDEF LETTER TO MOD SPILIOTOPOULOS

RAAUZYUW RUEWMFU0323 2560621-UUUU--RUEKNMA.
ZNR UUUUU ZUI RUEKJCS0323 2560621
R 1306212 SEP 05
FM SECDEF WASHINGTON DC
TO RUEHTH/USDAO ATHENS GR
INFO RUEHTH/AMBASSY ATHENS
RUEKJCS/SECDEF WASHINGTON DC

BT
UNCLAS

SUBJ: SECDEF LETTER TO MOD SPILIOTOPOULOS
PLEASE TRANSMIT THE FOLLOWING LETTER FROM SECDEF TO MOD
SPILIOTOPOULOS. ORIGINAL LETTER WILL FOLLOW.
(BEGIN TEXT)

THE HONORABLE SPILIOS SPILIOTOPOLILOS
MINISTER FOR DEFENCE
HELLENIC REPUBLIC
151 MESOGEION AVENUE
15500 HOLARGOS
ATHENS, GREECE

DEAR MINISTER SPILIOTOPOULOS:
(PARA) THANK YOU FOR YOUR OFFER TO PROVIDE A CARGO SHIP AND TWO
CRUISE SHIPS IN THE AFTERMATH OF HURRICANE KATRINA. WE LOOK FORWARD

PAGE 02 RUEWMFU0323 UNCLAS
TO WORKING WITH YOU IN EXPEDITING THE DEPLOYMENT OF THE CRUISE SHIPS
TO REACH THOSE IN NEED. I ALSO THANK YOU FOR YOUR GOVERNMENT'S
GENEROUS OFFER OF AN EMERGENCY RESCUE TEAM. WE ARE STILL EVALUATING
OUR NEEDS AND WILL COMMUNICATE WITH YOU SOON REGARDING THESE KIND
OFFERS.

(PARA) IT IS ENORMOUSLY GRATIFYING TO KNOW THAT THE AMERICAN PEOPLE
HAVE A COMMITTED FRIEND IN GREECE. WE APPRECIATE YOUR SWIFT
ASSISTANCE, WHICH WILL BE CRITICAL IN HELPING SO MANY FAMILIES
RECOVER FROM THE DEVASTATION OF HURRICANE KATRINA.

SINCERELY,
//DONALD RUMSFELD//

(END TEXT)
BT

SECDEF V2

ACTION SECDEF WASH DC(*) (U,6,8)
INFO CMAS(*) CMAS(1) CHAIRS(*) SECDEF-C(1) SECDEF-C(*)
USDAT: STS(*) ASD:PA-SMTP(*) DIR:PAE-RAM(*)
USDCOMP(*) USDP:ESC(*) ESC AGENT EUROPE NATO(*)
DACS-2X:POLAD(*) OSDONNIPRDA(*) OSDONSIPRDA(*)

TOTAL COPIES REQUIRED

#0223

UNCLAS

11-L-0559/OSD/52007

UNCLAS

PRIORITY

SecDef /
ESD /

DepSecDef /
CCD /

Spc Ast /
DRSO /
DIA /

ExecSec /
POLAD /

USDP /
Cbl Ch /

USDI /
File /

PAGE 1 OF 2
USER: OSD1

TOR: 130611Z Sep 05

Prec: P
DTG: 130612Z Sep 05

From: SECDEF WASHINGTON DC
Subj: LETTER FROM SECDEF TO MOD IVANOV ON THANK YOU FOR HURRICANE

PAAUZYUW RUEWMFU0321 2560612-UUUU--RUEKNMA.
ZNR UUUUU ZUI RUEKJCS0321 2560612
P 130612Z SEP 05
FM SECDEF WASHINGTON DC
TO RUEHMO/USDAO MOSCOW RS
RUEKJCS/SECDEF WASHINGTON DC
INFO RUEKJCS/SECDEF WASHINGTON DC
RUEKJCS/JOINT STAFF WASHINGTON DC
RUEHMO/AMEMBASSY MOSCOW
RHEFHLC/DEPT OF HOMELAND SECURITY WASHINGTON DC
RHMFISS/CDR USEUCOM VAHINGEN GE//DCDR//
RHKFISS/CDR USEUCOM VAHINGEN GE//DCDR//
RUEHC/SECSTATE WASHINGTON DC

3T
UNCLAS
SUBJ: LETTER FROM SECDEF TO MOD IVANOV ON THANK YOU FOR HURRICANE
RELIEF
ACTION USDAO MOSCOW
TRANSLATE AND DELIVER THE FOLLOWING LETTER FROM SECDEF TO MOD IVANOV
ON THANK YOU FOR HURRICANE RELIEF AT EARLIEST POSSIBLE CONVENIENCE.
(BEGIN TEXT)
HIS EXCELLENCY SERGEY IVANOV

PAGE 02 RUEWMFU0321 UNCLAS
MINISTER OF DEFENSE
RUSSIAN FEDERATION
MOSCOW, RUSSIA

DEAR SERGEY:
THANK YOU FOR YOUR GOVERNMENT'S GENEROUS OFFER OF ASSISTANCE FOR THE
HURRICANE KATRINA RELIEF EFFORT. THE DELIVERY OF MEALS-READY-TO-EAT
(MREs), TENTS, AND BLANKETS BY TWO RUSSIAN IL-76 AIRCRAFT WAS WARMLY
RECEIVED AT LITTLE ROCK AIR FORCE BASE, ARKANSAS.
WE APPRECIATE YOUR SWIFT ASSISTANCE, WHICH WILL BE CRITICAL IN
HELPING SO MANY FAMILIES RECOVER FROM THE DEVASTATION OF HURRICANE
KATRINA.
I LOOK FORWARD TO SEEING YOU IN BERLIN.
BEST WISHES,
//DONALDRUMSFELD//
(END TEXT)
BT

JOINT STAFF VI 1
ACTION (U,8)
INFO CMAS(*) CMAS(1) SHAPE LNO(*) JSAMS(*)
JCSOINIPRDA(*) JCSOINSIPRDA(*)

SECDEF V2 2
ACTION SECDEF WASH DC(*) (U,6,8)

UNCLAS

ROUTINE

SecDef	DepSecDef	Spc Ast	ExecSec	USDP	USDI
ESD	CCD <input checked="" type="checkbox"/>	DRSO	POLAD	Cbl Ch	File

PAGE 1 OF 2
USER: OSD1

TOR: 130602Z Sep 05

Prec: R
DTG: 130603Z Sep 05

From: SECDEF WASHINGTON DC
Subj: LETTER FROM SECRETARY OF DEFENSE RUMSFELD TO HIS SWISS

RAAUZYUW RUEWMFU0320 2560603-UUUU--RUEKNMA.
ZNR UUUUU ZUI RUEKJCS0320 2560603
R 130603Z SEP 05
FM SECDEF WASHINGTON DC
TO RUEHEW/USDAO BERN S2
INFO RUEHFW/AMEMBASSY BERN
RUEKJCS/SECDEF WASHINGTON DC//CHAIRS//

BT

UNCLAS

SUBJ: LETTER FROM SECRETARY OF DEFENSE RUMSFELD TO HIS SWISS
COUNTERPART

1. PLEASE DELIVER THE FOLLOWING LETTER FROM SECRETARY RUMSFELD TO
PRESIDENT SCHMID. ORIGINAL WILL BE DELIVERED BY WST.

2. BEGIN TEXT

HIS EXCELLENCY
FEDERAL MINISTER SAMUEL SCHMID
PRESIDENT OF THE SWISS CONFEDERATION
BUNDESTHAUS OST
3003 BERN
SWITZERLAND

DEAR PRESIDENT SCHMID:

(PARA) THANK YOU FOR YOUR GENEROUS OFFER OF DISASTER RELIEF PLATOONS

PAGE 02 RUEWMFU0320 UNCLAS
AND MATERIEL TO THE RELIEF OPERATIONS IN THE AFTERMATH OF HURRICANE
KATRINA. IT IS ENORMOUSLY GRATIFYING TO KNOW THAT THE AMERICAN
PEOPLE HAVE A COMMITTED FRIEND IN SWITZERLAND. WE APPRECIATE YOUR
SWIFT ASSISTANCE, WHICH WILL BE CRITICAL IN HELPING SO MANY FAMILIES
RECOVER FROM THE DEVASTATION OF HURRICANE KATRINA.

SINCERELY,

//SIGNED//DONALD H. RUMSFELD//

3. END TEXT

BT

SECDEF V2

ACTION SECDEF WASH DC (*) (U, 6, 8, F)

INFO NII (*) CHAIRS (*) SECDEF-C(1) SECDEF-C (*)
C3I-DASD-DCIG (*) USDAT:STS (*) ASD:PA-SMTP (*)
DIR:PAE-RAM (*) USDCOMP (*) USDP:ESC (*)
ESC AGENT EUROPE NATO (*) DACS-ZK:POLAD (*)
OSDONNIPRDA (*) OSDONSIPRDA (*)

TOTAL COPIES REQUIRED

#6320

UNCLAS

11-L-0559/OSD/52009

UNCLAS

ROUTINE						
SecDef	DepSecDef	Spc Ast	ExecSec	USDP	USDI	
ESD	CCD	DRSO	DIA	POLAD	Cbl Ch	File

PAGE 1 OF 1
USER: OSD1

TOR: 1306012 Sep 05

Prec: R
DTG: 1306022 Sep 05

From: SECDEF WASHINGTON DC
Subj: LETTER FROM SECRETARY OF DEFENSE RUMSFELD TO HIS GERMAN

RAAUZYUW RUEWMFU0319 2560602-UUUU--RUEKNMA.
ZNR UUUUU ZUI RUEKJCS0319 2560602
R 1306022 SEP 05

FM SECDEF WASHINGTON DC
TO RUEHRL/USDAO BERLIN GE
INFO RUEHRL/AMEMBASSY BERLIN
RUEKJCS/SECDEF WASHINGTON DC//CHAIRS//
BT

UNCLAS

SUBJ: LETTER FROM SECRETARY OF DEFENSE RUMSFELD TO HIS GERMAN
COUNTERPART.

1. PLEASE DELIVER THE FOLLOWING LETTER FROM SECRETARY RUMSFELD TO
MINISTER STRUCK. ORIGINAL WILL BE DELIVERED BY POST.

BEGIN TEXT

THE HONORABLE DR. PETER STRUCK
FEDERAL MINISTER OF DEFENSE
FEDERAL MINISTRY OF DEFENSE
D-11055 BERLIN
GERMANY

DEAR MINISTER STRUCK:

(PARA) THANK YOU FOR PROVIDING YOUR MEALS-READY-TO-EAT (MRE) TO THE
RELIEF OPERATIONS IN THE AFTERMATH OF HURRICANE KATRINA. WE

PAGE 02 RUEWMFU0319 UNCLAS

APPRECIATE YOUR SWIFT ASSISTANCE, WHICH WILL BE CRITICAL IN HELPING
SO MANY FAMILIES RECOVER FROM THE DEVASTATION OF HURRICANE KATRINA.
SINCERELY,

//SIGNED//DONALD H. RUMSFELD//

END TEXT

BT

SECDEF V2

ACTION	SECDEF WASH DC(*)	(U,6,7,8,F)	1
INFO	CHAIRS(*) SECDEF-C(1) SECDEF-C(*) USDAT:STS(*)		
	ASD:PA-SMTP(*) DIR:PAE-RAM(*) DIR:PAE-IMAG(*)		
	USDCOMP(*) ESC AGENT EUROPE NATO(*) DACS-2K:POLAD(*)		
	OSDONNIPRDA(*) OSDONSIPRDA(*)		

TOTAL COPIES REQUIRED

1

#0319

NNNN

UNCLAS

11-L-0559/OSD/52010

UNCLAS

ROUTINE
 SecDef DepSecDef Spc Ast ExecSec USDP USDI
 ESD CCD DRSO DIA POLAD Cbl Ch File

PAGE 1 OF 1
USER: OSD1

TOR: 1306002 Sep 05

Prec: R
DTG: 1306012 Sep 05

From: SECDEF WASHINGTON DC
Subj: LETTER FROM SECRETARY OF DEFENSE RUMSFELD TO HIS AUSTRIAN

RAAUZYUW RUEWMFU0318 2560601-UUUU--RUEKNMA.
 ZNR UUUUU ZUI RUEKJCS0318 2560601
 R 1306012 SEP 05
 FM SECDEF WASHINGTON DC
 TO RUEHVI/USDAO VIENNA AU
 INFO RUEHVI/AMEMBASSY VIENNA
 RUEKJCS/SECDEF WASHINGTON DC//CHAIRS//

BT
 UNCLAS
 SUBJ: LETTER FROM SECRETARY OF DEFENSE RUMSFELD TO HIS AUSTRIAN
 COUNTERPART

1. PLEASE DELIVER THE FOLLOWING LETTER FROM SECRETARY RUMSFELD TO
MINISTER PLATTER. ORIGINAL WILL BE DELIVERED BY POST.

2. BEGIN TEXT
 THE HONORABLE GUENTHER PLATTER
 MINISTER OF DEFENSE
 MINISTRY OF DEFENSE
 AUSTRIA

DEAR MINISTER PLATTER:
 {PARA} THANK YOU FOR YOUR KIND OFFER TO PROVIDE A DISASTER RELIEF
 GROUP SPECIALIZING IN WATER PURIFICATION, 3 SPECIAL ELITE POLICE
 UNITS AND MILITARY PERSONNEL TO THE RELIEF OPERATIONS IN THE

PAGE 02 RUEWMFU0318 UNCLAS
 AFTERMATH OF HURRICANE KATRINA. IT IS ENORMOUSLY GRATIFYING TO KNOW
 THAT THE AMERICAN PEOPLE HAVE A COMMITTED FRIEND IN AUSTRIA.
 SINCERELY,

//SIGNED//DONALD H. RUMSFELD//

3. END TEXT

BT

SECDEF V2
 ACTION: SECDEF WASH DC(*) II,6,8,F
 INFO NII(*) CHAIRS(*) SECDEF-C(1) SECDEF-C(*)
 C3I-DASD-DCIO(*) USDAT:STS(*) ASD:PA-SMTP(*)
 DIR:PAE-RAM(*) CSDCOMP(*) USDP:ESC(*)
 ESC AGENT EUROPE NATO(*) ESC AGENT PR KWS(*)
 IG-DCIS KWS(*) DACS-ZK:POLAD(*) OSDONNIPRDA(*)
 OSDONSIFRDA(*)

TOTAL COPIES REQUIRED 1

#0318

UNCLAS

11-L-0559/OSD/52011

UNCLAS

ROUTINE
SecDef / DepSecDef / Spc Ast / ExecSec / USDP / USDI /
ESD / CCD X DRSO / DIA / POLAD / Cbl Ch / file

PAGE 1 OF 2
USER: OSD1

FOR: 130645Z Sep 05

Prec: R
DTG: 130558Z Sep 05

From: SECDEF WASHINGTON DC
Subj: THANK YOU LETTER TO DOMINICA PRIME MINISTER ROOSEVELT SKERRIT

RAAUZYUW RUEWMFU0317 2560559-UUUU--RUEKNMA.
ZNR UUUUU 2UI RUEKJCS0317 2560559
R 130558Z SEP 05
FM SECDEF WASHINGTON DC
TO RUEKJCS/SECDEF WASHINGTON DC//USDP/DSCA//USDP:CHAIRS//
RUEHC/SECSTATE WASHINGTON DC
RHEFHLC/DEPT OF HOMELAND SECURITY WASHINGTON DC
RUEKJCS/CJCS WASHINGTON DC
RHEHAAA/NATIONAL SECURITY COUNCIL WASHINGTON DC
RUEKJCS/JOINT STAFF WASHINGTON DC//J5//
RUEHWN/AMEMBASSY BRIDGETOWN
INFO RUEKJCS/SECDEF WASHINGTON DC//USDP/DSCA//USDP:CHAIRS//
RHEFDIA/DIA WASHINGTON DC

BT
UNCLAS
SUBJ: THANK YOU LETTER TO DOMINICA PRIME MINISTER ROOSEVELT SKERRIT
1. SECRETARY RUMSFELD HAS SIGNED THE FOLLOWING LETTER TO PRIME
MINISTER ROOSEVELT SKERRIT. REQUEST THAT THE TEXT OF THE LETTER BE
PROVIDED TO PRIME MINISTER ROOSEVELT SKERRIT AS SOON AS POSSIBLE.
ORIGINAL SIGNED LETTER WILL BE FORWARDED VIA DIPLOMATIC POUCH.
THE HONORABLE ROOSEVELT SKERRIT
PRIME MINISTER OF THE COMMONWEALTH OF DOMINICA

PAGE 02 RUEWMFU0317 UNCLAS

ROSEAU, DOMINICA

DEAR MR. MINISTER:

THANK YOU FOR YOUR GOVERNMENT'S GENEROUS OFFER TO PROVIDE SUPPORT IN
THE AFTERMATH OF HURRICANE KATRINA. WE ARE STILL EVALUATING OUR
NEEDS AND WILL COMMUNICATE WITH YOU SOON REGARDING THESE KIND OFFERS.
IT IS GRATIFYING TO KNOW THAT THE AMERICAN PEOPLE HAVE A COMMITTED
FRIEND IN DOMINICA. WE APPRECIATE YOUR OFFER, WHICH WILL BE CRITICAL
IN HELPING SO MANY FAMILIES RECOVER FROM THE DEVASTATION OF HURRICANE
KATRINA.

SINCERELY,
//DONALD H. RUMSFELD//

(END TEXT)

BT

JOINT STAFF V1 1
ACTION JS(*) (U,7,F)
INFO CMAS(*) & (1) JSAMS(*) JCSONNIPRDA(*)
JCSONSIPRDA(*)

SECDEF VZ 1
ACTION SECDEF WASH DC(*) USDP(*) (U,6,8,F)
INFO CHAIRS(*) SECDEF-C(1) SECDEF-C(*) USDP:STS(*)
ASD:PA-SMTP(*) DIR:PAE-RAM(*) USDCOMP(*)
USDP CHAIRS(*) OSDONNIPRDA(*) OSDONSIPRDA(*)

UNCLAS

11-L-0559/OSD/52012

UNCLAS

ROUTINE
SecDef \ DepSecDef \ Spc Ast \ ExecSec \ USDP \ USDI \
ESD \ CCD \ DRSO \ DIA \ POLAD \ Cbl Ch \ File \

PAGE 1 OF 1
USER: OSD1

TOR: 130644Z Sep 05

Prec: R
DTG: 130555Z Sep 05

From: SECDEF WASHINGTON DC
Subj: THANK YOU LETTER TO GUATEMALA MINISTER OF DEFENSE

RAAUZYUW RUEWMFU0316 2560556-UUUU--RUEKNMA.
ZNR UUUUU ZUI RUEKJCS0316 2560556
R 130555Z SEP 05

FM SECDEF WASHINGTON DC
TO RUEKJCS/SECDEF WASHINGTON DC//USDP/DSCA//USDP:CHAIRS//
RUEHC/SECSTATE WASHINGTON DC
RHEFHLC/DEPT OF HOMELAND SECURITY WASHINGTON DC
RUEKJCS/CJCS WASHINGTON DC
RHEHAAA/NATIONAL SECURITY COUNCIL WASHINGTON DC
RUEKJCS/JOINT STAFF WASHINGTON DC//J5//
RUEHGT/USDAO GUATEMALA CITY GT
RUEHGT/AMEMBASSY GUATEMALA
INFO RUEKJCS/SECDEF WASHINGTON DC//USDP/DSCA//USDP:CHAIRS//
RHEFDIA/DIA WASHINGTON DC

BT

UNCLAS

SUBJ: THANK YOU LETTER TO GUATEMALA MINISTER OF DEFENSE
1. SECRETARY RUMSFELD HAS SIGNED THE FOLLOWING LETTER TO MAJOR GENERAL CARLOS ALDANA. REQUEST THAT THE TEXT OF THE LETTER BE PROVIDED TO MAJOR GENERAL CARLOS ALDANA AS SOON AS POSSIBLE. ORIGINAL SIGNED LETTER WILL BE FORWARDED VIA DIPLOMATIC POUCH.
MAJOR GENERAL CARLOS ALDANA

PAGE 02 RUEWMFU0316 UNCLAS
MINISTER OF DEFENSE OF THE REPUBLIC OF GUATEMALA
GUATEMALA CITY, GUATEMALA

DEAR MR. MINISTER:

THANK YOU FOR YOUR GOVERNMENT'S GENEROUS OFFER TO PROVIDE A RESCUE TELY AND MILITARY PERSONNEL TO THE RELIEF OPERATIONS IN THE AFTERMATH OF HURRICANE KATRINA. WE ARE STILL EVALUATING OUR NEEDS AND WILL COMMUNICATE WITH YOU SOON REGARDING THESE KIND OFFERS.

IT IS GRATIFYING TO KNOW THAT THE AMERICAN PEOPLE HAVE A COMMITTED FRIEND IN GUATEMALA. WE APPRECIATE YOUR OFFER, WHICH WILL BE CRITICAL IN HELPING SO MANY FAMILIES RECOVER FROM THE DEVASTATION OF HURRICANE KATRINA.

SINCERELY,

//DONALD H. RUMSFELD//

(END TEXT)

BT

JOINT STAFF V1
ACTION J5(*) (U,7,F)
INFO CMAS(*) CMAS(1) JSAMS(*) JCSOSSIIPRDA(*)
JCSOSSIIPRDA(*)

1

SECDEF V2
ACTION SECDEF WASH DC(*) USDP(*) (U,8,8,F)
INFO CHAIRS(*) SECDEF-C(1) SECDEF-C(*) USDAT:STS(*)

1

UNCLAS

11-L-0559/OSD/52013

UNCLAS

ROUTINE
SecDef / DepSecDef / Spc Ast / ExecSec / USDP / USDI /
ESD / CCD X DRSO / DIA / POLAD / Cbl Ch / File

PAGE 1 OF 2
USER: OSDI

TOR: 1306432 Sep 05

Prec: R
DTG: 1305532 Sep 05

From: SECDEF WASHINGTON DC
Subj: THANK YOU LETTER TO EL SALVADOR MINISTER OF DEFENSE MAJOR

RAAUZYJW RUEWMFU0315 2560553-UUUU--RUEKNMA.
ZNR UUUUU ZUI RUEKJCS0315 2560553
R 130553Z SEP 05
FM SECDEF WASHINGTON DC
TO RUEKJCS/SECDEF WASHINGTON DC//USDP/DSCA//USDP:CHAIRS//
RUEHC/SECSTATE WASHINGTON DC
RHEFHLC/DEPT OF HOMELAND SECURITY WASHINGTON DC
RUEKJCS/CJCS WASHINGTON DC
RHEHAAA/NATIONAL SECURITY COUNCIL WASHINGTON DC
RUEKJCS/JOINT STAFF WASHINGTON DC//J5//
RUEHSN/USDAC SAN SALVADOR ES
RUEHSN/EMBASSY SAN SALVADOR
INFO RUEKJCS/SECDEF WASHINGTON DC//USDP/DSCA//USDP:CHAIRS//
RHEFDIA/DIA WASHINGTON DC

BT
UNCLAS
SUBJ: THANK YOU LETTER TO EL SALVADOR MINISTER OF DEFENSE MAJOR
GENERAL OTTO ALEJANDRO ROMERO
1. SECRETARY RUMSFELD HAS SIGNED THE FOLLOWING LETTER TO MAJOR
GENERAL OTTO ALEJANDRO ROMERO. REQUEST THAT THE TEXT OF THE LETTER
BE PROVIDED TO MAJOR GENERAL OTTO ALEJANDRO ROMERO AS SOON AS
POSSIBLE. ORIGINAL SIGNED LETTER WILL BE FORWARDED VIA DIPLOMATIC

PAGE 02 RUEWMFU0315 UNCLAS
POUCH.
MAJOR GENERAL OTTO ALEJANDRO ROMERO
MINISTER OF DEFENSE OF THE REPUBLIC OF EL SALVADOR
SAN SALVADOR, EL SALVADOR
DEAR MR MINISTER:

THANK YOU FOR YOUR GOVERNMENT'S GENEROUS OFFER TO PROVIDE OVER 100
MILITARY PERSONNEL SPECIALIZING IN MEDICAL, ENGINEERING, AND
MILITARY POLICE SUPPORT IN THE AFTERMATH OF HURRICANE KATRINA. WE
ARE STILL EVALUATING OUR NEEDS AND WILL COMMUNICATE WITH YOU SOON
REGARDING THESE KIND OFFERS.
IT IS GRATIFYING TO KNOW THAT THE AMERICAN PEOPLE HAVE A COMMITTED
FRIEND IN EL SALVADOR. WE APPRECIATE YOUR OFFER, WHICH WILL BE
CRITICAL IN HELPING SO MANY FAMILIES RECOVER FROM THE DEVASTATION OF
HURRICANE KATRINA.

SINCERELY,
//DONALD E. RUMSFELD//
(END TEXT)
BT

JOINT STAFF VI
ACTION J5(*) (U, F)
INFO CMAS(*) CMAS(1) JSAMS(*) JCSOINIPRDA(*)
JCSOINIPRDA(*)

1

UNCLAS

ROUTINE
SecDef / DepSecDef / Spc Ast / ExecSec / USDP / USDI /
ESD / CCD X DRSO / DIA / POLAD / Cbl Ch / File

1
PAGE 1 OF 2
USER: OSDI

TOR: 130640Z Sep 05

Prec: R
DTG: 130547Z Sep 05

From: SECDEF WASHINGTON DC
Subj: THANK YOU LETTER TO NICARAGUA MINISTER OF DEFENSE AVIL RAMIREZ

RAAUZYUW RUEWMFU0313 2560547-UUUU--RUEKNMA.
ZNR UUUUU ZUI RUEKJCS0313 2560547
R 130547Z SEP 05
FM SECDEF WASHINGTON DC
TO RUEKJCS/SECDEF WASHINGTON DC//USDP/DSCA//USDP:CHAIRS//
RUEHC/SECSTATE WASHINGTON DC
RHEFHLC/DEPT OF HOMELAND SECURITY WASHINGTON DC
RUEKJCS/CJCS WASHINGTON DC
RHEHAAA/NATIONAL SECURITY COUNCIL WASHINGTON DC
RUEKJCS/JOINT STAFF WASHINGTON DC//J5//
RUEHMC/USCAG MANAGUA NU
INFO RUEKJCS/SECDEF WASHINGTON DC//USDP/DSCA//USDP:CHAIRS//
RHEFDIA/DIA WASHINGTON DC

BT
UNCLAS
SUBJ: THANK YOU LETTER TO NICARAGUA MINISTER OF DEFENSE AVIL RAMIREZ
1. SECRETARY RUMSFELD HAS SIGNED THE FOLLOWING LETTER TO AVIL
RAMIREZ. REQUEST THAT THE TEXT OF THE LETTER BE PROVIDED TO AVIL
RAMIREZ AS SOON AS POSSIBLE. ORIGINAL SIGNED LETTER WILL BE FORWARDED
VIA DIPLOMATIC POUCH.
THE HONORABLE AVIL RAMIREZ
MINISTER OF DEFENSE OF THE REPUBLIC OF NICARAGUA

PAGE 02 RUEWMFU0313 UNCLAS

MANAGUA, NICARAGUA

DEAR MR. MINISTER:

THANK YOU FOR YOUR GOVERNMENT'S GENEROUS OFFER TO PROVIDE SUPPORT IN
THE AFTERMATH OF HURRICANE KATRINA. WE ARE STILL EVALUATING OUR
NEEDS AND WILL COMMUNICATE WITH YOU SOON REGARDING THESE KIND OFFERS.
IT IS GRATIFYING TO KNOW THAT THE AMERICAN PEOPLE HAVE A COMMITTED
FRIEND IN NICARAGUA. WE APPRECIATE YOUR OFFER, WHICH WILL BE
CRITICAL IN HELPING SO MANY FAMILIES RECOVER FROM THE DEVASTATION OF
HURRICANE KATRINA.

SINCERELY,
//DONALD E. RUMSFELD//

(END TEXT)

BT

JOINT STAFF V1 1
ACTION J5(*) (U,7,F)
INFO CMAS(*) CMAS(1) JSAMS(*) JCSOINIPRDA(*)
JCSOINIPRDA(*)

SECDEF V2 1
ACTION SECDEF WASH DC(*) USDP(*) (U,6,8,F)
INFO CHAIRS(*) SECDEF-C(1) SECDEF-C(*) USDP:STS(*)
ASD:PA-SMTP(*) DIR:PAE-RAM(*) USDCOMP(*)
ESC AGENT HOMELAND DEFENSE(*) USDP CHAIRS(*)

UNCLAS
11-L-0559/OSD/52015

UNCLAS

ROUTINE
SecDef 1 DepSecDef 1 Spc Ast 1 ExecSec 1 USDP 1 USDI 1
ESD 1 CCD 1 DRSO 1 DIA 1 POLAD 1 Cbl Ch 1 File 1

PAGE 1 OF 2
USER: OSD1

FOR: 130535Z Sep 05

Prec: R
DTG: 130535Z Sep 05

From: SECDEF WASHINGTON DC
Subj: LETTER FROM SECRETARY OF DEFENSE RUMSFELD TO HIS FINNISH

RAAUZYUW RUEWMFU0311 2560535-UUUU--RUEKNMA.

ZNR UUUU ZUI RUEKJCS0311 2560535

R 130535Z SEP 05

FM SECDEF WASHINGTON DC

TO RUEHHE/USDAO HELSINKI FI

RUEKJCS/OSD WASHINGTON DC//CHAIRS//

INFO RUEHHE/AMBASSY HELSINKI

RUEHC/SECSTATE WASHINGTON DC

RUEKJCS/JOINT STAFF WASHINGTON DC//J5//

BT

UNCLAS

SUBJ: LETTER FROM SECRETARY OF DEFENSE RUMSFELD TO HIS FINNISH
COUNTERPART

1. PLEASE DELIVER THE FOLLOWING LETTER FROM SECRETARY RUMSFELD TO
MINISTER KAARIANEN. ORIGINAL WILL BE DELIVERED BY POST.

2. BEGIN TEXT

HIS EXCELLENCY SEFPO KDDRIDNEN

MINISTER OF DEFENSE

MINISTRY OF DEFENSE

ETELDINEN KAKASMINIKATU 8

PO BOX 31

FIN-00131 HELSINKI

PAGE 02 RUEWMFU0311 UNCLAS

FINLAND

DEAR MINISTER KDDRIDNEN:

(PARA) THANK YOU FOR YOUR KINE OFFER OF WATER PURIFICATION UNITS,
FIRST AID KITS, AND A SEARCH AND RECOVERY TEAM FOR THE RELIEF
OPERATIONS IN THE AFTERMATH OF HURRICANE KATRINA. IT IS ENORMOUSLY
GRATIFYING TO KNOW THAT THE AMERICAN PEOPLE HAVE A COMMITTED FRIEND
IN FINLAND. WE APPRECIATE YOUR SWIFT ASSISTANCE, WHICH WILL BE
CRITICAL IN HELPING SO MANY FAMILIES RECOVER FROM THE DEVASTATION OF
HURRICANE KATRINA.

SINCERELY,

//SIGNED DONALD H. RUMSFELD//

3. END TEXT.

BT

JOINT STAFF V1

ACTION

(U, B, F)

1

INFO CMAS(*) CMAS(1) J5(*) JSAMS(*)
JCSOINIPRDA(*) JCSONSIPRDA(*)

SECDEF V2

ACTION CHAIRS(*) SECDEF WASH DC(*)

(U, B, F)

1

INFO SECDEF-C(1) SECDEF-C(*) USDAT:STS(*) ASD:PA-SMTP(*)
DIR:PAE-RAM(*) USDCOMP(*) ESC AGENT EUROPE NATO(*)
DACS-ZK:POLAD(*) OSDONNIPRDA(*) OSDONSIPRDA(*)

UNCLAS

11-L-0559/OSD/52016

UNCLAS

ROUTINE
SecDef / DepSecDef / Spc Ast / ExecSec / USDP / USDI /
ESD / CCD X DRSO / DIA / POLAD / Cbl Ch / File

PAGE 1 OF 2
USER: OSDI

TOR: 1306372 Sep 05

Prec: R
DTG: 1305442 Sep 05

From: SECDEF WASHINGTON DC
Subj: THANK YOU LETTER TO BELIZE MINISTER OF DEFENSE VILDO MARIN

RAAUZYUW RUEWMFU0312 2560544-UUUU--RUEKNMA.
ZNR UUUUU ZUI RUEKJCS0312 2560544
R 1305442 SEP 05
FM SECDEF WASHINGTON DC
TO RUEKJCS/SECDEF WASHINGTON DC//USDP/DSCA//USDP:CHAIRS//
RUEHTG/USDAO TEGUCIGALPA HO
RUEHC/SECSTATE WASHINGTON DC
RHEFHLC/DEPT OF HOMELAND SECURITY WASHINGTON DC
RUEKJCS/CICS WASHINGTON DC
RHEHAAA/NATIONAL SECURITY COUNCIL WASHINGTON DC
RUEKJCS/JOINT STAFF WASHINGTON DC//J5//
RUEHBE/AMBASSY BELIZE
INFO RUEKJCS/SECDEF WASHINGTON DC//USDP/DSCA//USDP:CHAIRS//
RHEFDIA/DIA WASHINGTON DC
BT
UNCLAS

SUBJ: THANK YOU LETTER TO BELIZE MINISTER OF DEFENSE VILDO MARIN
1. SECRETARY RUMSFELD HAS SIGNED THE FOLLOWING LETTER TO MINISTER OF DEFENSE VILDO MARIN. REQUEST THAT THE TEXT OF THE LETTER BE PROVIDED TO MINISTER OF DEFENSE VILDO MARIN AS SOON AS POSSIBLE. ORIGINAL SIGNED LETTER WILL BE FORWARDED VIA DIPLOMATIC POUCH.
THE HONORABLE VILDO MARIN

PAGE 02 RUEWMFU0312 UNCLAS
MINISTER OF DEFENSE OF BELIZE
BELMOPAN, BELIZE
DEAR MR. MINISTER:

THANK YOU FOR YOUR GOVERNMENT'S GENEROUS OFFER TO PROVIDE SUPPORT IN THE AFTERMATH OF HURRICANE KATRINA. WE ARE STILL EVALUATING OUR NEEDS AND WILL COMMUNICATE WITH YOU SOON REGARDING THESE KIND OFFERS. IT IS GRATIFYING TO KNOW THAT THE AMERICAN PEOPLE HAVE A COMMITTED FRIEND IN BELIZE. WE APPRECIATE YOUR OFFER, WHICH WILL BE CRITICAL IN HELPING SO MANY FAMILIES RECOVER FROM THE DEVASTATION OF HURRICANE KATRINA.

SINCERELY,
//DONALD H. RUMSFELD//
(END TEXT)
BT

JOINT STAFF V1
ACTION J5 (*) (U, 7, F)
INFO CMAS (*) CMAS (1) JSAMS (*) JCSONNIPRDA (*)
JCSONSIPRDA (*)
-CCCS NMCC SITE R FT RITCHIE MD
-WHITEHOUSE

1

SECDEF V2
ACTION SXDEF WASH DC (*) USDP (*) (U, 6.5, F)

1

UNCLAS
11-L-0559/OSD/52017

FOUO

2005 09 12 08:13:27

September 02, 2005

TO: Paul McHale
CC: Gen Dick Myers
Eric Edelman

I-05/011957
ES-3886

FROM: Donald Rurnsfeld

DR.

SUBJECT: State Department and Refugees

Condi Rice called me last night and pointed out that the State Department works on refugee situations all the time. This is one of those few times when the United States has refugees.

She wondered if there might be a way State could help on the refugee aspect of Katina.

Please have someone get in touch with the appropriate people at State and see what might be done. Connect them with Homeland Security, which is where they ought to be connected.

Thanks.

DRN:ak
090205-04

.....
Please Respond By 09/08/05

FOUO

09-12-05 14:13:14

11-L-0559/OSD/52018

OSD 18282-05



HOMELAND
DEFENSE

~~FOR OFFICIAL USE ONLY~~

ASSISTANT SECRETARY OF DEFENSE
2600 DEFENSE PENTAGON
WASHINGTON, DC 20301-2600
INFO MEMO

PDMA8013 Copy Provided
DepSecDef ID: 76
USD(P) 4 SEP 09 2005

8 SEP 2005

I-05/011957-ES

ES-413

via Peter E. Verga

FOR SECRETARY OF DEFENSE

FROM: *Paul* McHale, Assistant Secretary of Defense (Homeland Defense)

Principal Deputy

SUBJECT: State Department and Refugees

- The following is provided in response to your September 2, 2005 request, "Please have someone get in touch with the appropriate people at State and see what might be done. Connect them with Homeland Security, which is where they ought to be connected." (TAB A)
- We spoke with senior officials in the State Department, the Federal Emergency Management Agency, and the Department of Homeland Security regarding your conversation with Secretary Rice about assistance that the State Department could provide to people displaced by Katrina. We ensured that all entities have the appropriate contact information for pursuing this proposal. The officials thought it was an approach worth examining.

Attachment:
As stated

Prepared by: Vanessa Mitchell, OASD(HD)/SP&R, (b)(6)

~~FOR OFFICIAL USE ONLY~~

OSD 18282-05

11-L-0509/OSD/52019



FOUO

05/009449
ES-3943

2005 07 11 12:11

July 12, 2005

TO: Doug Feith

FROM: Donald Rumsfeld

D.R.

SUBJECT: Fashion a Program like IMET for Counter-terrorism

I would like you to fashion a program to have foreign nationals come to the U.S. for various types of experiences, including training that has as its focus counter-terrorism. It would be a new 21st century program that DoD would put money into, and we would connect it to military-to-military relations. We should have a fresh IMET approach, with heavy involvement by the Department of Defense.

Let's get some thinking going and see me.

Thanks.

DHR:ss
071205-05

.....
Please Respond By 08/11/05

FOUO

11-L-0559/OSD/52020

OSD 18344-05

Regional Defense Counterterrorism Fellowship Program (CTFP)

September 2, 2005

Program Overview

- Created in FY02
- Codified in 10 U.S.C., Section 2249c
- Managed by OASD SO/LIC
- \$20M annual budget
 - CTFP is not IMET: IMET FY06 budget is \$86.744M
- Provides education and training to help counter ideological support for terrorism
- Wide variety of education and training offered
- Not affected by Article 98

Purpose

- Provide a flexible GWOT education and training tool
- Assist COCOMs to obtain regional goals
- Target senior and mid-level military and civilian officials who play a direct role in support of the WOT
- Synchronize with Regional Centers in support of regional education initiatives

Goals and Objectives

- Create a community of CBT experts and practitioners who share common values and a common language in the fight against terrorism
- Build the CBT capacity and capabilities of countries critical to the WOT
- Encourage countries to cooperate more fully in efforts to end the threat of terrorism worldwide

Success Stories

- > 3,000 students from 86 countries
- First CONUS Iraqi students (CGSC and Infantry Officer Basic course)
- First in-country training for Afghanistan (English language and Legal Aspects of Combating Terrorism mobile courses)
- Tactical HUMINT training for Romania (to help support OIF/OEF)
- Medical evacuation training for Georgia (to help support OIF)

Success Stories

- Mobile course on Legal Aspects of Combating Terrorism in Kenya
- Custom CONUS program for Thai equivalent of Special Operations Commander
- Regional mobile Civil-Military Response to Terrorism course in SOUTHCOM countries participated
- Custom bi-terrorism programs for f

8/24/2005

~~FOR OFFICIAL USE ONLY~~

11-L-0559/OSD/52026

FY06 Funds Allocation Plan

CENTCOM	\$4.1M
EUCOM	\$3.75M
NORTHCOM (Mexico)	\$0.375M
PACOM	\$2.45M
SOUTHCOM	\$1.75M
Regional Centers	\$1M
Invitational Courses	\$6.5M

**Primary funding recipients for FY06 are Afghanistan, Colombia, Indonesia, Iraq, Jordan, Lebanon, Malaysia, Mexico, Pakistan and the Trans-Sahararegion.*

8/24/2005

~~FOR OFFICIAL USE ONLY~~

7

11-L-0559/OSD/52027

*

**Regional Defense Counterterrorism Fellowship Program Participating Countries
(2002-2005)**

Afghanistan	Greece	Oman
Albania	Guatemala	Pakistan
Algeria	Guinea	Panama
Argentina	Honduras	Paraguay
Armenia	Hungary	Peru
Azerbaijan	India	Philippines
Bangladesh	Indonesia	Poland
Belize	Iraq	Romania
Bolivia	Jamaica	Russia
Bosnia	Jordan	Rwanda
Botswana	Kazakhstan	Senegal
Brazil	Kenya	Serbia
Bulgaria	Kyrgyzstan	Sierra Leone
Camhodia	Latvia	Slovenia
Cameroon	Lebanon	South Africa
Chad	Lithuania	Sri Lanka
Chile	Macedonia	Tajikistan
Colombia	Malaysia	Tanzania
Croatia	Mali	Thailand
Czech Republic	Malta	Trinidad and Tobago
Djibouti	Mauritania	Tunisia
Dominican Republic	Mexico	Turkey
Ecuador	Moldova	Ukraine
Egypt	Morocco	Uruguay
El Salvador	Namibia	Uzbekistan
Ethiopia	Nepal	Venezuela
Gabon	Nicaragua	Yemen
Georgia	Niger	Zambia
Ghana	Nigeria	

FOR OFFICIAL USE ONLY

INFO MEMO

06

JSD(P)

SEP 12 2005

I-05/009598-CTP

ES-3943

FOUO copy provided

FOR SECRETARY OF DEFENSE

FROM: Thomas O'Connell, Assistant Secretary of Defense (SO/LIC)

*Howell
9 Sep 05*

SUBJECT: Fashion a Program like IMET for Counterterrorism

- You suggested that Policy fashion an interagency counterterrorism-related program for foreign nationals to come to the U.S. for training, education, and cultural exchange purposes. (Tab A)
- We currently have a program, the Counterterrorism Fellowship Program (CTFP) that addresses this need in part, and on a limited basis. An overview of the CTFP is attached. (Tab B) We believe that CTFP can be readily modified, expanded, and/or used as a template for meeting the larger need your suggestion addressed.
- Since its creation in 2002, CTFP has funded a wide variety of educational programs in CONUS. These include, for example, a Master's degree in Special Operations, an eight-month program at the National Defense University, and courses on intelligence and antiterrorism force protection. In addition, CTFP funds counterterrorism courses using mobile teams in partner countries.
- CTFP is budgeted at \$20M per year. We are seeking an increase of \$2M in FY07, largely to increase the role of the regional centers in countering ideological support for terrorism.
- Since 2002, CTFP helped create a global network of over 3,000 counterterrorism experts from 86 countries who share critical skill-sets and common values. Moreover, the program brought many students to the United States for the first time in their lives, providing a positive first hand experience of life in an open, democratic society. (Tab C) Among other things, the CTFP model could serve as a template for analogous "Train and Equip" and "Stability Operations" programs.

FOR OFFICIAL USE ONLY
11-L-0559/OSD/52029

OSD 183 44 -05

105/009535
ES-3746

FOUO

BCC: RYAN HENRY

2005 07 14 08:17 **July 14, 2005**

TO: Gen Dick Myers
FROM: Donald Rumsfeld *DR*
SUBJECT: Task Force of the Quadrennial Defense Review

We need to get the right people from Homeland Security and Lufi's shop on the QDR task force working on the matters we discussed with Hadley's group at lunch yesterday.

Thanks.

DHR:aa
071305-07

.....
Please Respond By 08/04/05

FOUO

2005 09 12 10:31:16

SEP 12 2005

INFO MEMO

USD(P) *EE*

DSD _____

I-05/009533

ES-3746

FOR SECRETARY OF DEFENSE

FROM: Ryan Henry, Under Secretary of Defense for Policy

Ryan Henry

SEP 08 2005

SUBJECT: Task Force of the Quadrennial Defense Review

- You asked us to get with Homeland Security and Bill Luti's shop on the QDR task force (Tab A). Since late July, we have held multiple meetings with the National Security Council, the Homeland Security Council, DHS and the Office of the Vice President.
- Together with the Department of Homeland Security we are co-chairing the Catastrophic Assessment Task Force. The Task Force worked closely with the White House to develop the Terms of Reference, objectives and questions for a series of Assistant Secretary and Principal level war games this Fall. These efforts are closely linked with the QDR.
- The HSC Deputies Committee on the Catastrophic Assessment Task Force was delayed by Hurricane Katrina and will be rescheduled in the near future.

COORDINATION: ASD HD SR/DASD(SR&P)

Attachment: As stated

Prepared by: Mark Gunzinger, QDR Integration Director, (b)(6)

FOUO

11-L-0559/OSD/52031

OSD 183 63-05

TAB A

ACB

~~FOUO~~

2005 08 13 W 6:00

August 25, 2005

TO Gen Pete Pace

CC Gen Dick Myers
ADM Ed Giambastiani

FROM Donald Rumsfeld *DR*

SUBJECT: Forces in Iraq Chart

Regarding the attached chart, I would think you would put green on the bottom -- which is the Iraqis. That is the base. Then I would put U.S., and then put Coalition on top. The chart needs to be improved.

Thanks.

Attach: 8/22/05 Forces in Iraq Chart

DHR:js
082305-01

.....

Please Respond By 09/08/05

OSD 183 84 -05

~~FOUO~~

Tab A

11-L-0559/OSD/52032

TAB B

Forces in Iraq

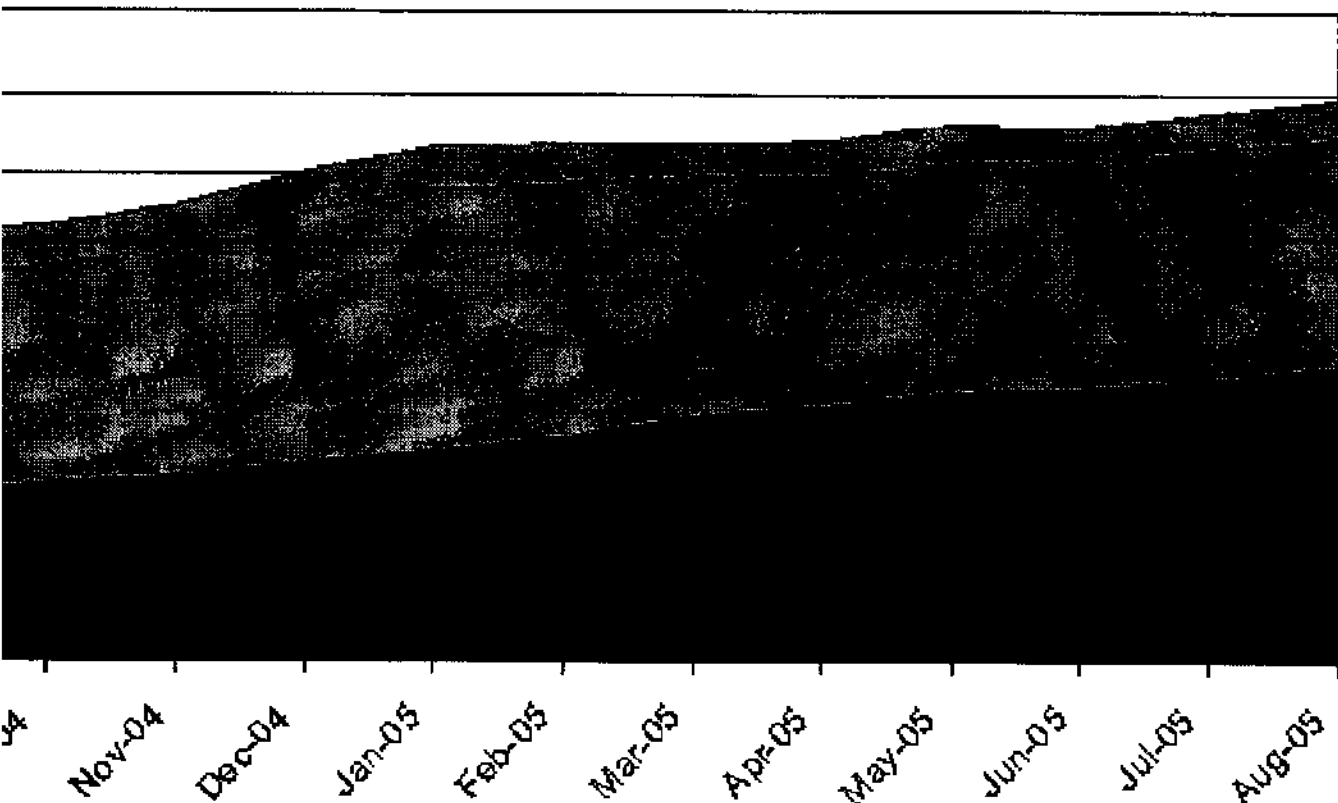

Includes: Multi-national Force-Iraq excluding US forces and NATO Training Mission-Iraq forces.
Does not include all Ministry of Defense and Ministry of Interior forces.

Tab B

~~FOR OFFICIAL USE ONLY~~

CHAIRMAN OF THE JOINT CHIEFS OF STAFF

WASHINGTON, D.C. 20318-9999



CM-2729-05 07 13 11 4:00
12 September 2005

INFO MEMO

FOR: SECRETARY OF DEFENSE

FROM: General Richard B. Myers, CJCS

RM/9/k

SUBJECT: Forces in Iraq Chart

- In response to your request (TAB A), the Forces in Iraq chart contained in the weekly Iraqi Security Forces update has been corrected (TAB B) and will be included in the next update.

COORDINATION: NONE

Attachments:

As stated

Prepared By: Lieutenant General Victor E. Renuart, Jr., USAF; Director, J-5: (b)(6)

(b)(6)

OSD 18384-05

~~FOR OFFICIAL USE ONLY~~

~~FOUO~~

OFFICE OF THE
SECRETARY OF DEFENSE
August 16, 2005
2005 SEP 13 AM 6:39

TO Gen Mike Moseley
CC Pete Geren
Mike Wynne
Ron Sega
FROM Donald Rumsfeld *DR*
SUBJECT: FedEx Material

Sometime back I talked to Gen Jumper about some communications from Fred Smith of FedEx Corporation. He recently sent me this additional material that I thought you might want to be aware of. Once you've had a chance to look at it, please give me a sense of where you think we are.

Thanks.

Attach: 7/14/05 Fred Smith letter to SecDef; SecDef Letter to Fred Smith

DHR.ca
081303-32

.....
Please Respond By September 01, 2005

~~FOUO~~

OSD 10386-05

11-L-0559/OSD/52035

Frederick W. Smith
Chairman of the Board
Chief Executive Officer

962 South Shady Grove Road
Memphis, TN 38120
Telephone: 901.848.7577
Fax: 901.848.1570
Email: Frederick@fedex.com

030-47
205 JUL 22 11 5:13



July 18, 2005

Donald H. Rumsfeld
United States Secretary of Defense
3500 Defense Pentagon
Washington, DC 20301-3500

Dear Secretary Rumsfeld:

As a follow-up to our recent discussion, the attached vignette reinforces the need for the USAF to acquire a more capable tanker/transport like the B777-200LR versus B767/A330.

Planning on our being able to forward base tankers in place like Uzbekistan in the future is a risky assumption at best.

Also, the burden of base protection in such areas creates additional logistical and manpower issues for DOD.

A longer range, more capable tanker/transport would give the U.S. much greater flexibility in projecting military power in the 21st century than simply getting a more modern version of the KC-135.

Best regards,

FWS/nw
140847

Attachment

OSD 14243-05

11-L-0559/OSD/52036

Uzbekistan to rethink future of U.S. air base

Uzbekistan has said it is rethinking the future of the U.S. air base at Hanoy-Khanabad, which is used to support operations and supply maintenance for U.S. forces in Afghanistan. The base, which was built by the U.S. military, was only intended for short-term operations in support of U.S. forces during the operations of the Taliban regime after the Sept. 11, 2001, terrorist attacks in the United States. The state says it and the United States need an agreement on the future of the base and that the U.S. will not be involved in the base's future. The state says it will not be involved in the base's future. The state says it will not be involved in the base's future.

THE SECRETARY OF DEFENSE
WASHINGTON

Mr. Frederick W. Smith
Chairman of the Board
Chief Executive Officer
FedEx Corporation
942 South Shady Grove Road
Memphis, TN 38120

Dear Fred,

Thank you for your letter and attached article on the U.S. air base in Uzbekistan. Since our conversation in May, I've reviewed the briefing you provided to John Jumper. I will see that the Air Force considers all of the alternatives to ensure the crucial air refueling mission is met.

Sincerely,

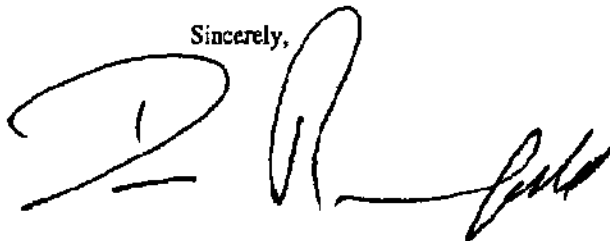
A handwritten signature in black ink, appearing to be "D. R. [unclear]", written in a cursive style.

11-L-0559/OSD/52038

22 March 05

New USAF Tanker/Transport

- Must enhance the expeditionary and force projection capabilities of the U.S. military
- Should incorporate the latest technologies such as fly-by-wire, on board diagnostics, etc. to maximize reliability and minimize maintenance costs
- Should provide significant new capabilities in terms of payload/range and fuel offload to reflect the future scarcity and vulnerability of forward bases
- Should be able to perform multiple missions (tanker, cargo, troop transport, C&C/sensor platform)
- Must be a current production air transport aircraft (like MMA) to provide maximum flexibility for USAF procurement and minimal overhead obligations

13625

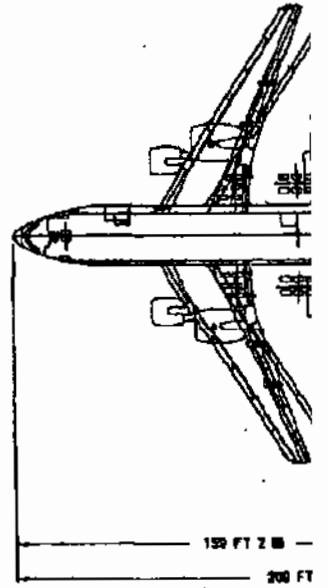
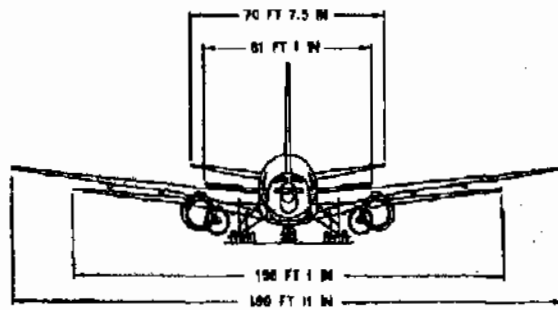

— 767-200
— 777-200

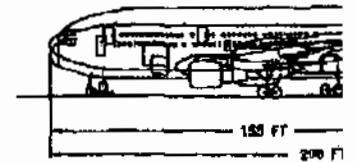

11-L-0559/OSD/52040

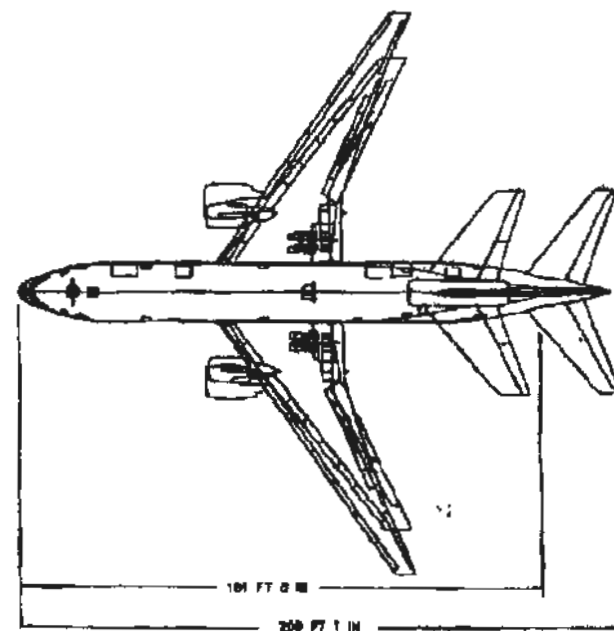
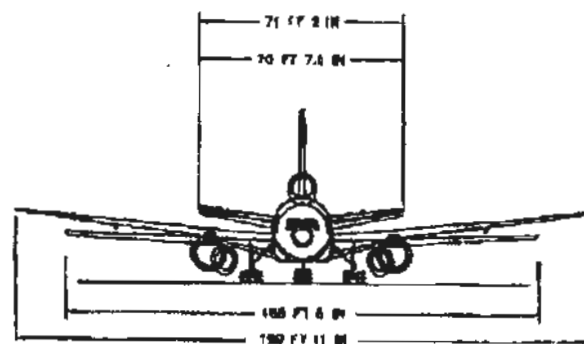

— DC10
— 777-200

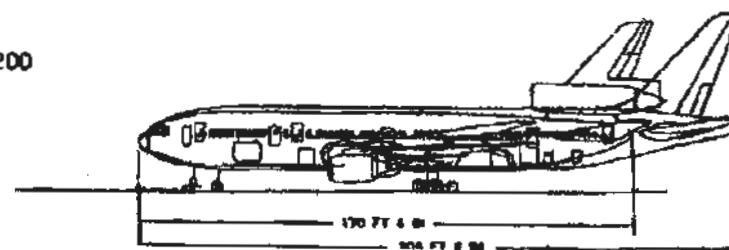

Cross Sections Comparisons 777-200XF/KC-10A/767-200SF

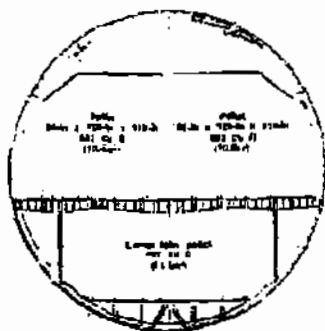

777-200XF
 MTOW 750,000 lb
 ACN 79
 (Rigid Pavement, Medium Subgrade Strength)

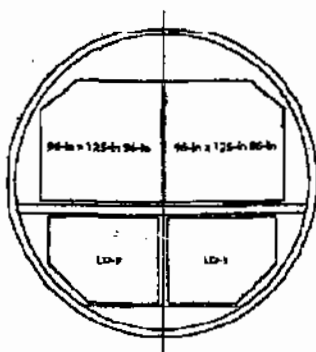
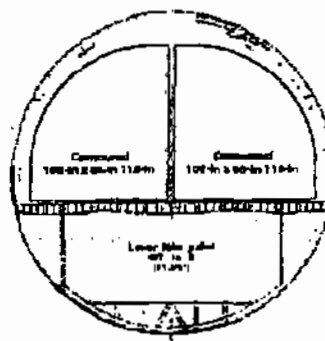

KC-10A
 MTOW 590,000 lb
 ACN 55
 (Rigid Pavement, Medium Subgrade Strength)

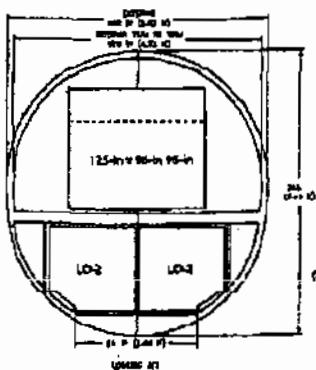
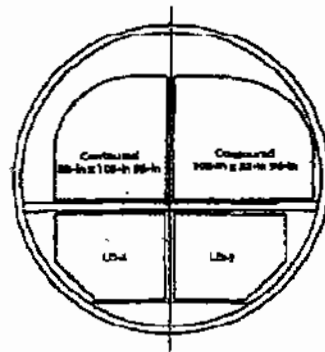

767-200SF
 MTOW 395,000 lb
 ACN 53
 (Rigid Pavement, Medium Subgrade Strength)

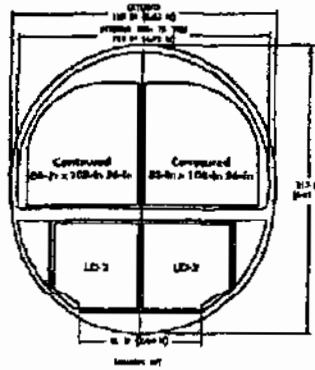

PADE
 ELP
 12/14/05

Plan View Configurations 777-200XF/KC-10A/767-200SF

* Estimated configuration - Not verified

777-200XF MAIN DECK

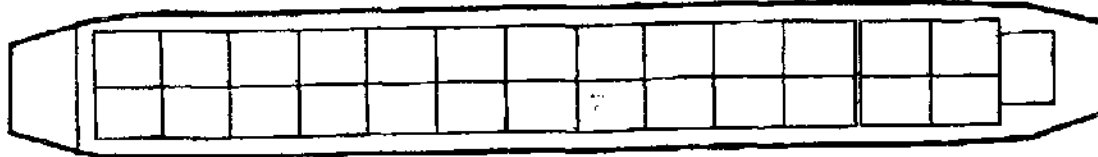

(27 POSITIONS - 96" x 125")

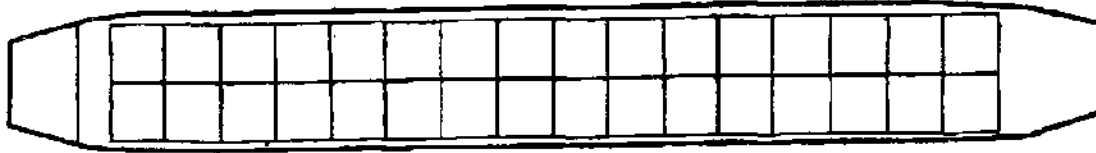

(33 POSITIONS - 88" x 108") *

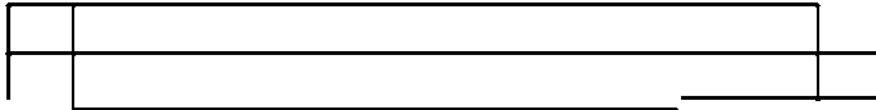
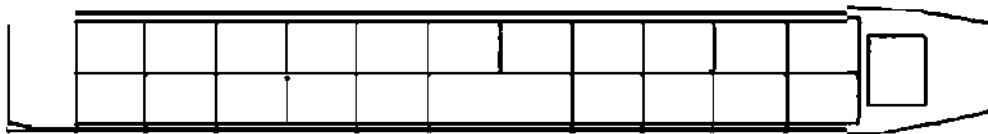

(27 POSITIONS - 88" x 108")

767-2WSF MAIN DECK

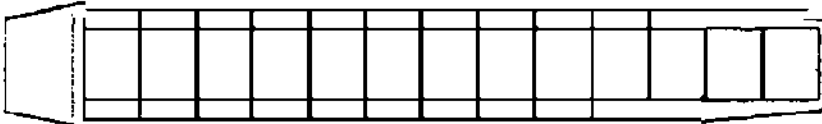

(13 POSITIONS - 96" x 125") *



(19 POSITIONS - 88" x 108")

Doc#
607
12747204



BOEING PROPRIETARY

Evolution of the 777 Family

More Payload and Range Capabilities

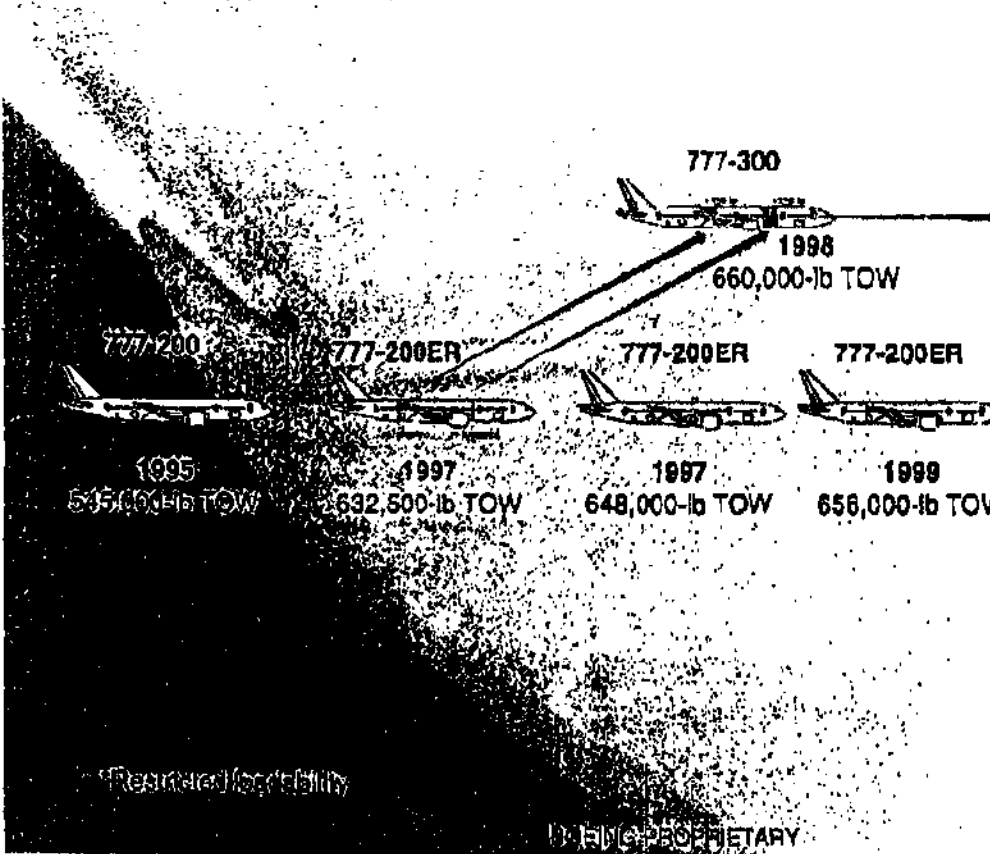

11-L-0559/OSD/52044

BOEING PROPRIETARY

Wide Body Freighter Airplanes

Range of 747 and 777 with A380 Cargo Density

Product Development Study

MAY 4, 2005 2:33PM FWS

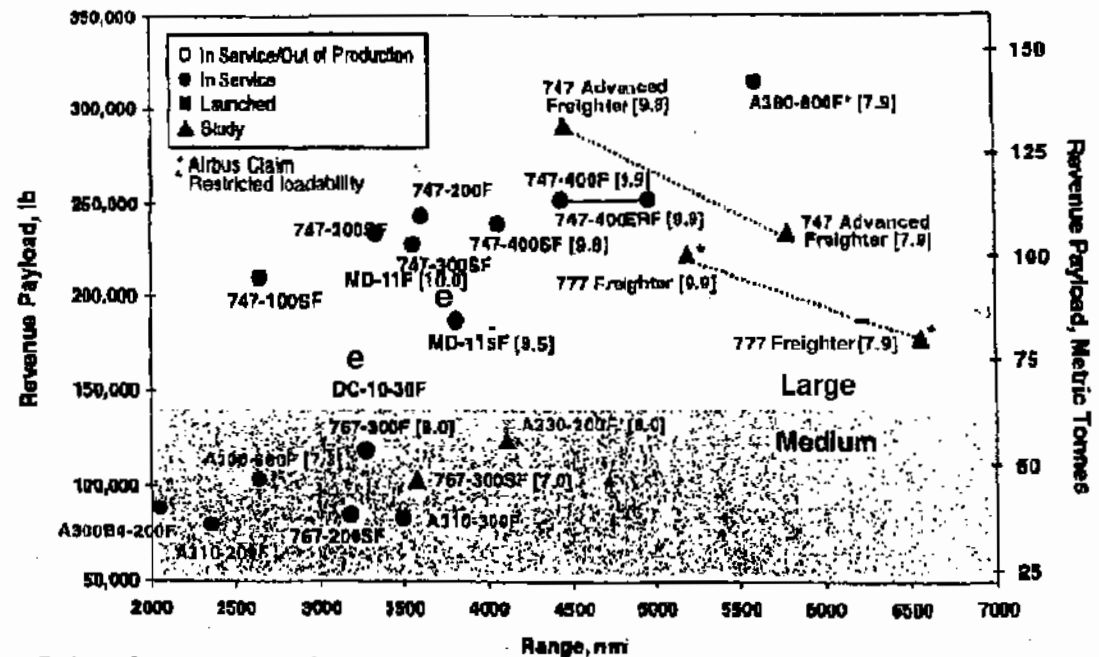

NOTE: Revenue Payload = Structural Payload MZFW - (OEW + Tare)
 () = Average density, lb/ft³, for total volume excluding bulk

BOEING PROPRIETARY



MO 0/5 P. 8/12

BOEING PROPRIETARY

777 Freighter

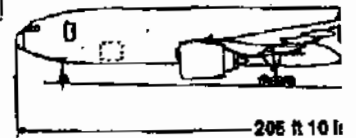
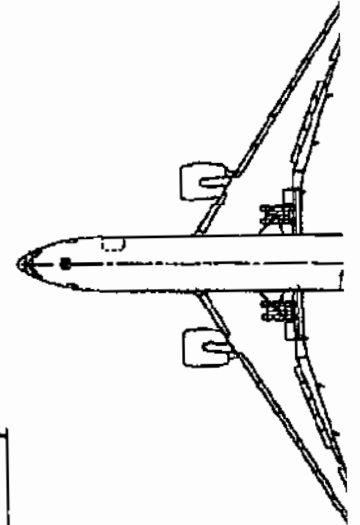
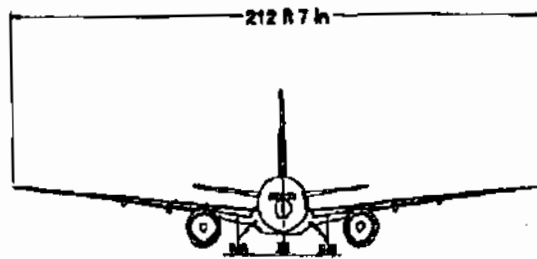

BOEING PROPRIETARY

11-L-0559/OSD/52046

Comparison of Payload vs. Range

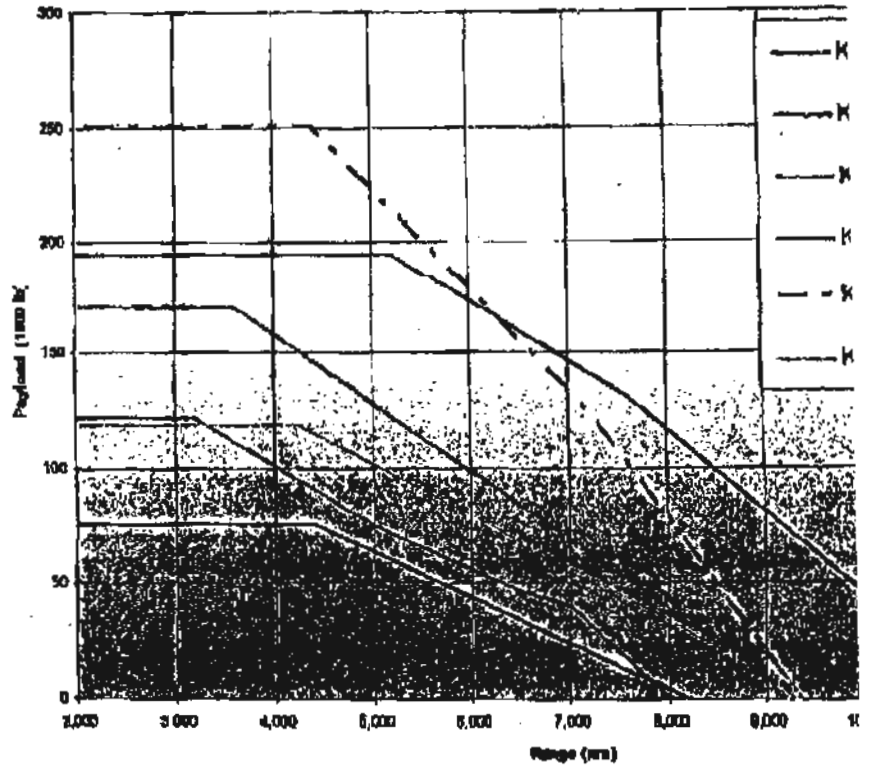

11-L-0559/OSD/52047

Comparison of Fuel Offload vs. Radius Distanc

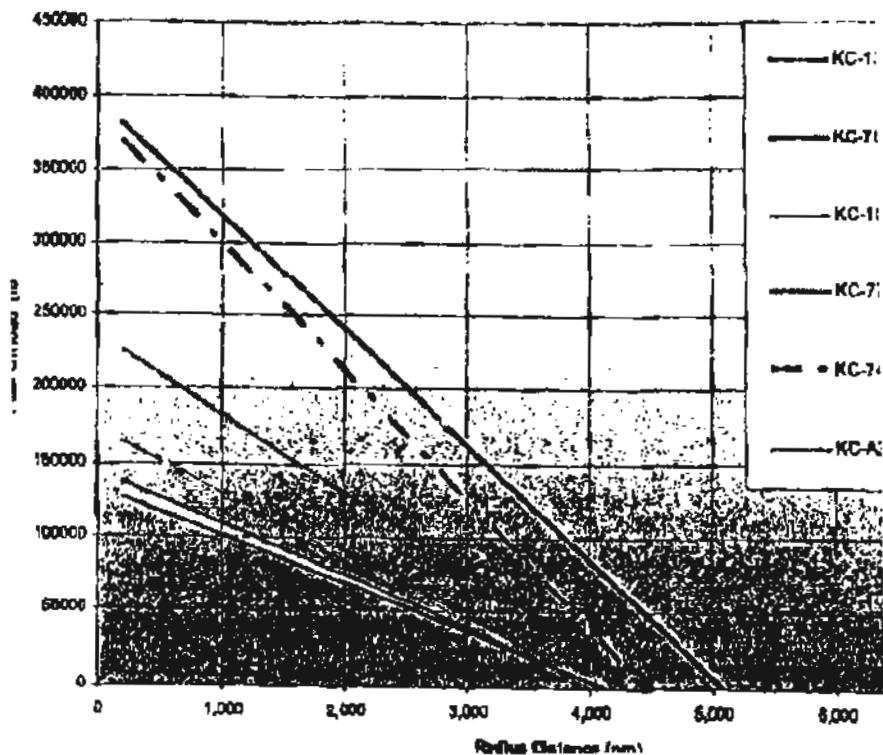

Tanker Configurations

	KC-135R	KC-10A	KC-767-200SF	KC-767-200
MTOW	304,000	590,000	395,000	618,000
GVW	121,600	240,720	194,000	245,000
MBW	165,000	430,000	270,000	330,000
MZFW	122,604	411,000	252,000	370,000
MAX FUEL ON BOARD (LBS)	182,000	349,272	201,000	248,000
MAX FUEL OFFLOADABLE (LBS)	127,200	225,520	157,000	164,000
OPERATING COST PER FLIGHT HR (without flight crew)	3304	4743	2953	3300

* Flight crew costs are not included. Military crew costs are a function of rank and years of service. A

* Operating cost data is based on 2002 historical (actual) data gathered by Strategic Projects. This data DOT Form 41 data escalated to 2002.





FAX TRANSMITTAL SHEET

DATE: 5-4-05 TIME: _____
TO: Jo
COMPANY: GEN. SWAMPER'S OFFICE
FAX NO: (b)(6)
FROM: JANE FITZGERALD
NUMBER OF PAGES INCLUDING COVER: 12

If you need to contact us regarding this fax please:

Phone: (901) 818-7577

Or

FAX: (901) 818-7570

COMMENTS: _____

#52379

11 April, 2002

PM/DTC Applicant Code 1103-421

Mr. William J. Lowell
Director, Office of Defense Trade Controls
Bureau of Political Military Affairs
U.S. Department of State
Annex SA-1
2401 E. Street, 13th Floor
Washington, D.C. 20037



Subject: 767 Tanker Project, "In-Line" Incorporations

Reference: GC 0143-02

Dear Mr. Lowell:

The Boeing Company respectfully requests your concurrence with our approach to the "In-Line" incorporations to facilitate the conversion of a commercial 767 airplane to a modified 767 tanker ready aircraft. These incorporations are necessary to support Boeing's 767 Tanker Project for the U.S. Air Force.

As discussed in our April 9, 2002 conversation, Boeing will ensure that no ineligible foreign nationals participate in the in-line incorporations or have access to 767 Tanker ITAR controlled technical data. Boeing understands ineligible foreign nationals to be from countries defined in 22 CFR 126.1 and/or any other countries to which the United States maintains an Arms Embargo. While these may be Chinese foreign nationals working on Boeing commercial aircraft at its Everett facility, they will not have any access to 767 Tanker ITAR controlled technical data or participate in the in-line incorporation. The 767 Tanker in-line physical incorporation is limited to Boeing's Everett, WA facilities.

Boeing requests an expeditious review of this request to meet the 767 Tanker program timelines of the U.S. Air Force.

Respectfully yours,

Robert J. Ingersoll
Vice President
Contracts and Pricing



United States Department of State

Washington, D.C. 20520

April 12, 2002

By Facsimile

Robert J. Ingersoll
Vice President
Contracts and Pricing
The Boeing Company
1200 Wilson Boulevard
Arlington, VA 22209

Re: QC 0143-02 and 767 Tanker Project

Dear Mr. Ingersoll:

Thank you for your letter dated April 11, 2002, confirming the principal points conveyed orally in our April 9 conference call with regard to in-line structural changes to the 767 aircraft for use by the U.S. Air Force as air refueling tankers.

Pursuant to the authority provided in 22 C.F.R. § 126.1, I have decided to make an exception to the provisions of that subchapter insofar as they contain the requirement for an export license in this matter. In lieu of that requirement, this letter serves as written authorization for the modified 767 tanker program, as follows:

- (1) The 767 tanker in-line changes will be limited to Boeing's Everett, WA facilities;
- (2) No ineligible foreign nationals (22 C.F.R. § 126.2) will participate in the in-line changes;
- (3) No ineligible foreign nationals will have access to ITAR controlled technical data;
- (4) The in-line changes at Everett will be limited to those discussed to date with this Office in several oral briefings and in your February 25, 2002, submission and, specifically, will not include ITAR payloads, equipment or weapons systems (i.e., will not go beyond structural changes and provisioning for ITAR payloads and equipment); and
- (5) This authorization is limited to this specific program for lease and/or sale to the U.S. Air Force.

11-L-0559/OSD/52052

With respect to other matters raised in your original February 15, 2002, submission, it is not necessary for this Office to furnish a final opinion in view of this decision on the 767 tanker matter. That said, please allow me to reiterate what I explained orally to you and other Boeing representatives. The ITAR clearly controls all § 121.2 (Category VIII) aircraft that are "specifically designed, modified, or equipped for military purposes." Your original request for an advisory opinion essentially sought a ruling from this Office that effectively would have excluded from U.S. Munitions List coverage (and worldwide oversight) most, if not all, aircraft and associated defense services when they are "modified" but not "equipped" for military purposes.

In this respect, the Department has long considered both: (1) the provisioning of aircraft for weapons and military avionics and electronics; and (2) specific structural changes to aircraft undertaken solely to ready the aircraft for military purposes to be appropriately within the coverage provided in the U.S. Munitions List at Category VIII. The exception granted herein with regard to the 767 tanker program for USAF is fully consistent with this understanding.

Sincerely,

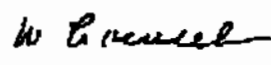

William Lowell
 Director
 Office of Defense Trade Controls

Boeing Proprietary

In-line Incorporation of Airplane Features & Provisions

Boeing Commercial Airplanes

Export Notice: The information disclosed hereunder may include United States origin technical data. Accordingly, the receiving party is responsible for complying with and assures the disclosing party that it will comply with all export regulations of the United States, including the U.S. Department of State International Traffic in Arms Regulations (Title 22 CFR Parts 120-130), the U.S. Department of Commerce Export Administration Regulations (Title 15 CFR 768-799), and any other U.S. Government regulations applicable to the export or disclosure of such controlled technical data (or the products thereof) to Foreign Nationals, whether within or without the U.S., including those employed by or otherwise associated with the receiving party.

Boeing Proprietary

11-L-0559/OSD/52054

Boeing Proprietary

In-Line Incorporation of Airplane Features & Provisions

Boeing Commercial Airplanes

Boeing Proprietary

11-L-0559/OSD/52055

In-Line Incorporation of Airplane Features & Provisions Background

- Commercial Airplane Customization
 - Each commercial airplane that Boeing builds is essentially a custom aircraft designed and built for that individual customer
 - Customization stays within a product family, such as a **737** or a **767**
 - Customization takes place for a group of customers or an individual customer
 - Weight & Balance capabilities
 - Engine thrust
 - Aircraft specific performance
 - Interior configuration
 - Provisions for individual airline customization
 - Airframe structure, wiring provisions, cabin systems, etc.

Boeing Proprietary

Typical Tanker In-Line Structural Changes to a 767

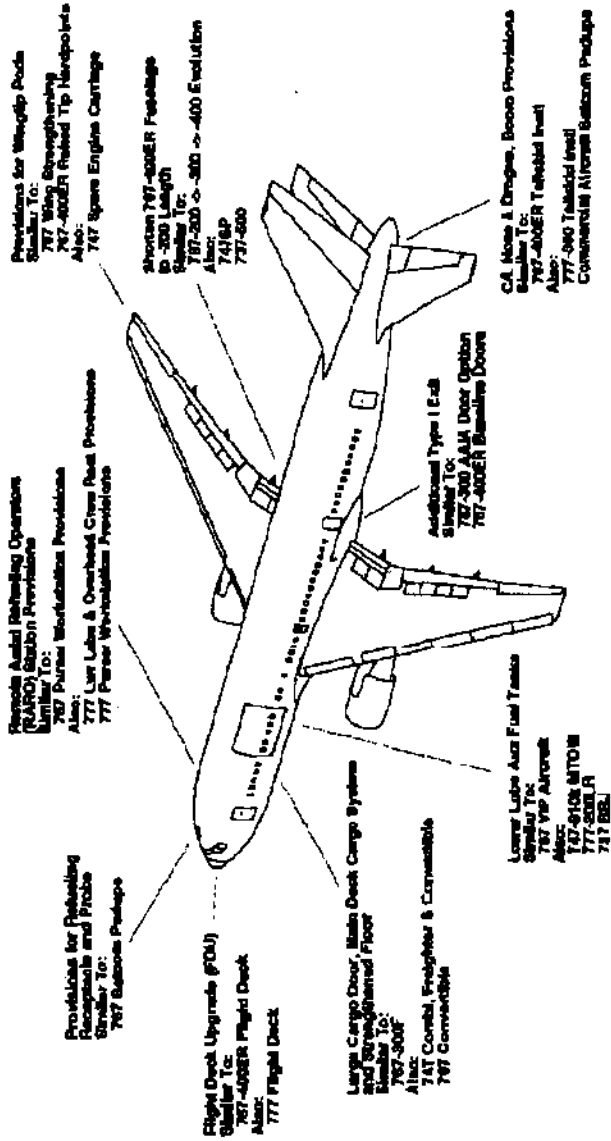

Boeing Proprietary

11-L-0559/OSD/52057

Boeing Proprietary

Typical Tanker In-Line System Changes to a 767

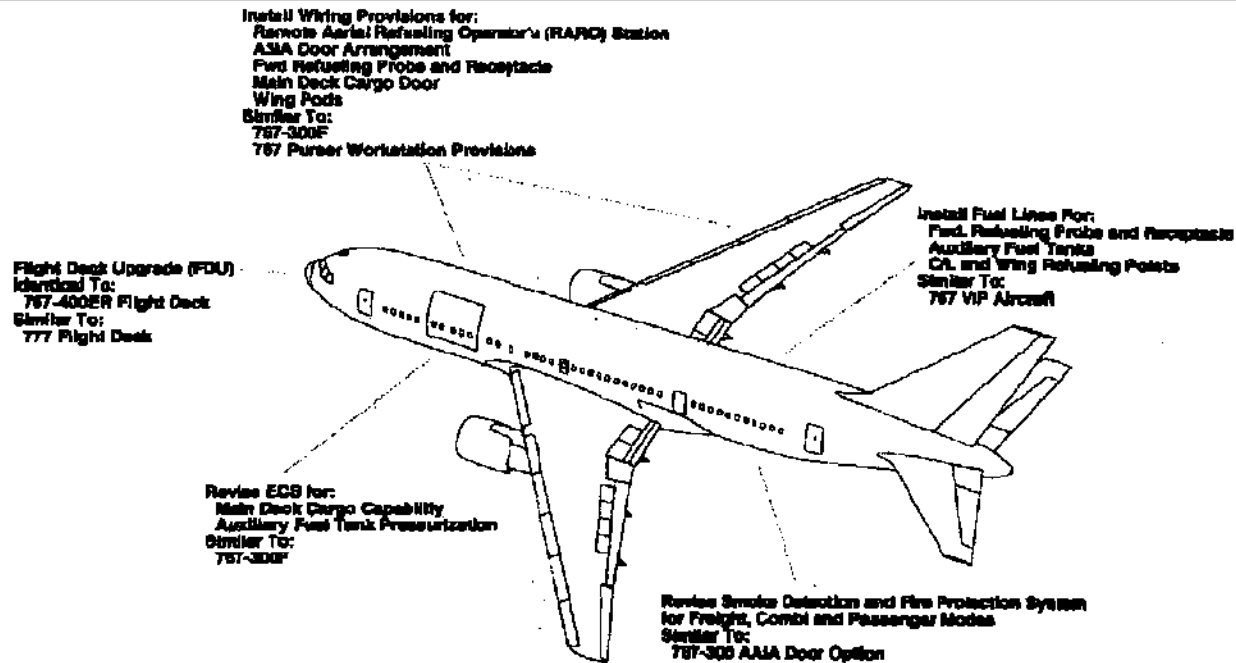

Boeing Proprietary

11-L-0559/OSD/52058

Boeing Proprietary

767-200 Tanker Provisioned Airplane



Baseline Commercial "Green" Airplane

- Zero Occupancy Main Cabin
- No Passenger seats
- Limited Passenger Services & Interior



BCA In-Line Commercial Like-Kind Provisions via EAR

- Structure
- Interior
- Systems
- Wiring



BCA Provisioned Airplane Ready for Final Tanker Completion

EAR

ITAR

4



Tanker Completion via ITAR Control

- Refueling System
- Military Avionics
- Mission Functionality

Boeing Proprietary

Boeing Proprietary

Main Deck Cargo Door

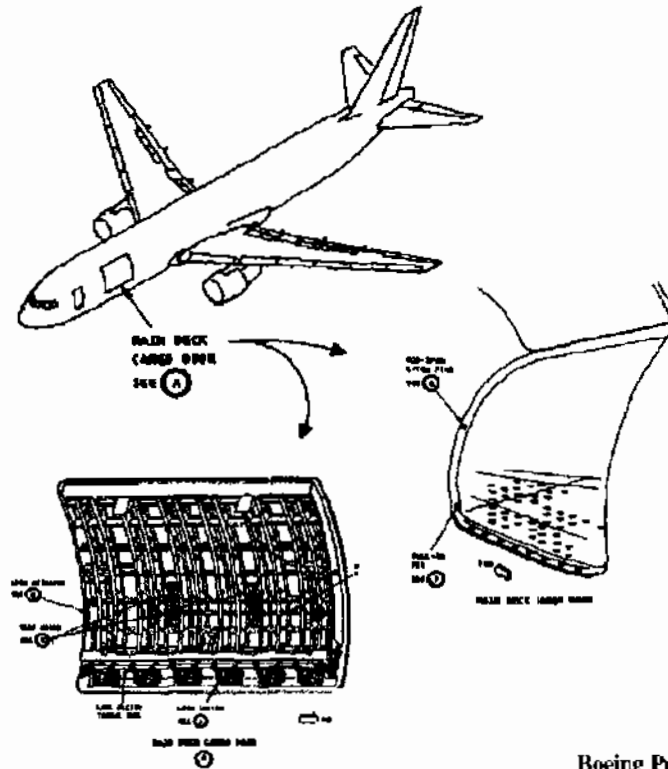

Description of Change:

- One large cargo door (134" x 102") is added at STA 562.
- Modify 767-200ER fuselage section 43 left side panels and install door surround structure to accommodate installation of the large main deck cargo door.
- The cargo door control panel is relocated to a TBD location such that it no longer interferes with the forward lavatory in passenger mode.

Previous Application:

- 767-300F

Similar To:

- 737 Convertible
- 747 Combi, Freighter & Convertible
- 757 Combi

Boeing Proprietary

11-L-0559/OSD/52060

Boeing Proprietary

Type I Exit Door

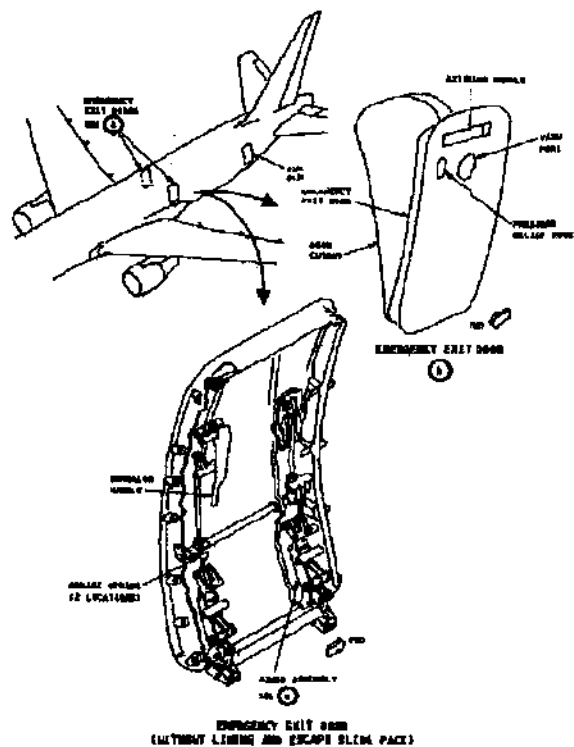

Description of Change:

- Two Type I emergency exit doors are added (one on each side) at STA 1168.2.
- Modify 767-200ER fuselage section 46 left and right side panels and door surround structure to accommodate the Type I emergency exit doors.

Previous Application:

- 767-300ER (AAIA Door Option)
- 767-400ER (Baseline Door Configuration)

Similar To:

- 767-300ER
- 767-400ER

Boeing Proprietary

11-L-0559/OSD/52061

Boeing Proprietary

Strengthened Floor Beams

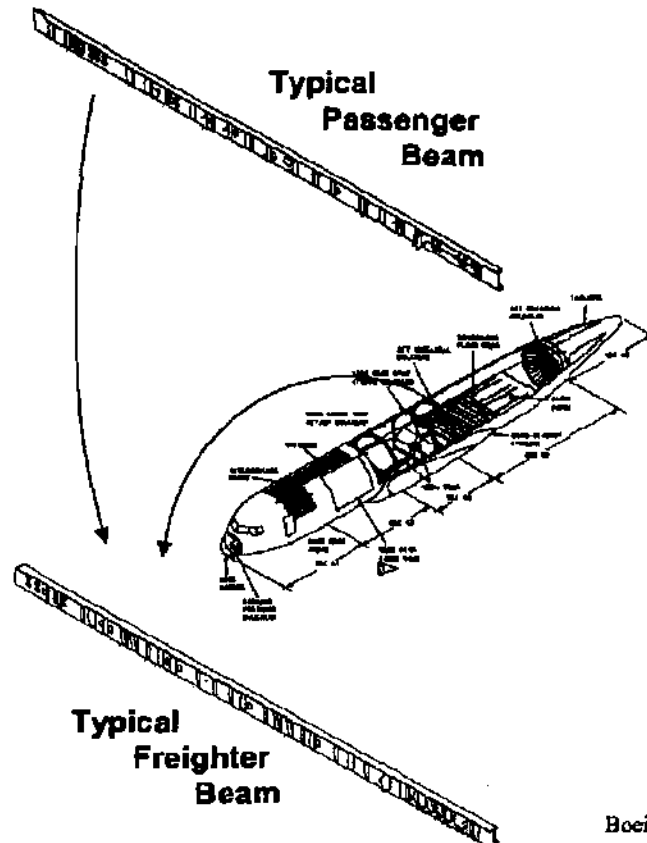

Description of Change:

- Replace Passenger Floor Beams with strengthened Freighter Floor Beams.
- These beams include tie downs for cargo and a left hand notch for systems runs.
- Section 43 main deck floor is modified to accommodate a large main deck cargo door.
- Floor Beam interface with Fuselage is revised to accommodate strengthened Freighter Floor Beams.

Previous Application:

- 767-300F

Similar To:

- 737 Convertible
- 747 Combi, Freighter & Convertible
- 757 Combi

Boeing Proprietary

11-L-0559/OSD/52062

Boeing Proprietary

Cargo Handling System

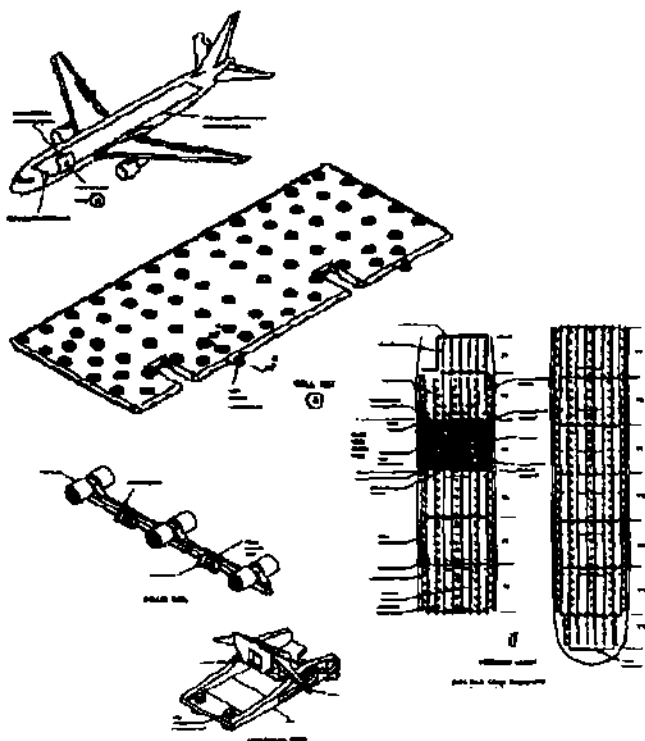

Description of Change:

- A removable main deck manual cargo handling system that includes certain locks, stops and tie downs that meet 9G passenger seating loads will be installed.
- Frames at STA 1461 and 1480 are strengthened to allow installation of a high cargo restraint strap in the aft end of the airplane to protect the aft Type A door counterbalances and control cables from palletized freight.

Previous Application:

- 767-300F

Similar To:

- 737 Convertible
- 747 Combi, Freighter & Convertible
- 757 Combi

Boeing Proprietary

11-L-0559/OSD/52063

Auxiliary Fuel Tanks

Description of Change:

- Support provisions will be added in the forward and aft lower lobe cargo compartments to install auxiliary lower lobe fuel tanks.

Section 43:

- The frame and floor beam at STA 676 in the lower lobe is strengthened for a 9g cargo barrier. Pad ups for 4 body tank sump drain penetrations are added in the keel panel near BL 0. A pad up for the auxiliary tanks fuel line penetration is added to the aft end of the forward lower lobe cargo hold.

Section 48:

- The frame and floor beam at STA 1285 in the lower lobe is strengthened for the 9g cargo barrier. Pad ups for 3 body tank sump drain penetrations are added in the keel panel near BL 0. A pad up for the auxiliary fuel tanks fuel line penetration is added to the forward end of the aft lower lobe cargo hold.

Similar To:

- 737 BBJ
- 747-910k MTOW
- 767 VIP Aircraft

Boeing Proprietary
777-200LR

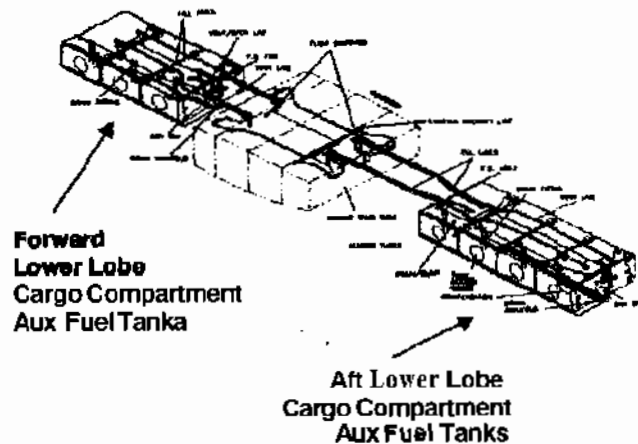

Boeing Proprietary

Skin Pad-ups and Frame Strengthening Commercial Antenna Installation

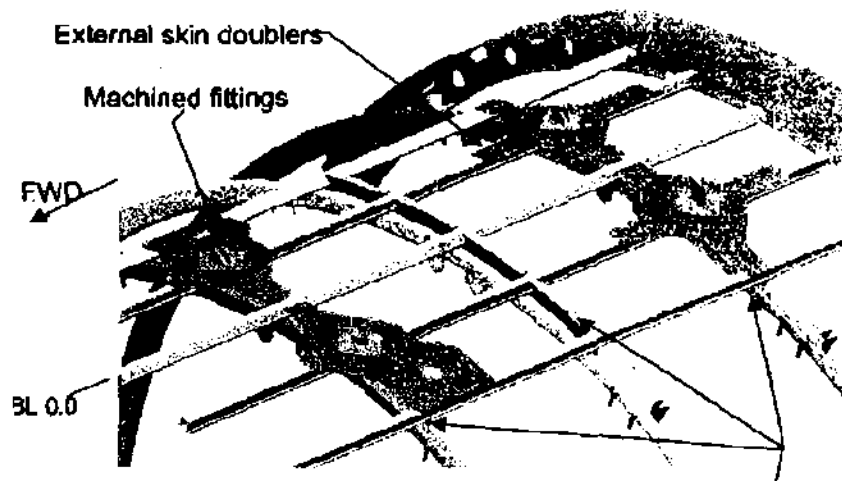

(Crown skin not shown for clarity)

Shear ties & doublers
added to frames

Boeing Proprietary

Description of Change:

- Strengthening of structure and thicker skins to support antenna provisions and/or installations
- Multiple locations on typical commercial installation for VHF, HF, SATCOM and Broadband connectivity

Previous Application:

- 767-300ER
- 767-400ER

Similar To:

- 737
- 747
- 757

Boeing Proprietary

Antenna Doubler and Lug Installation

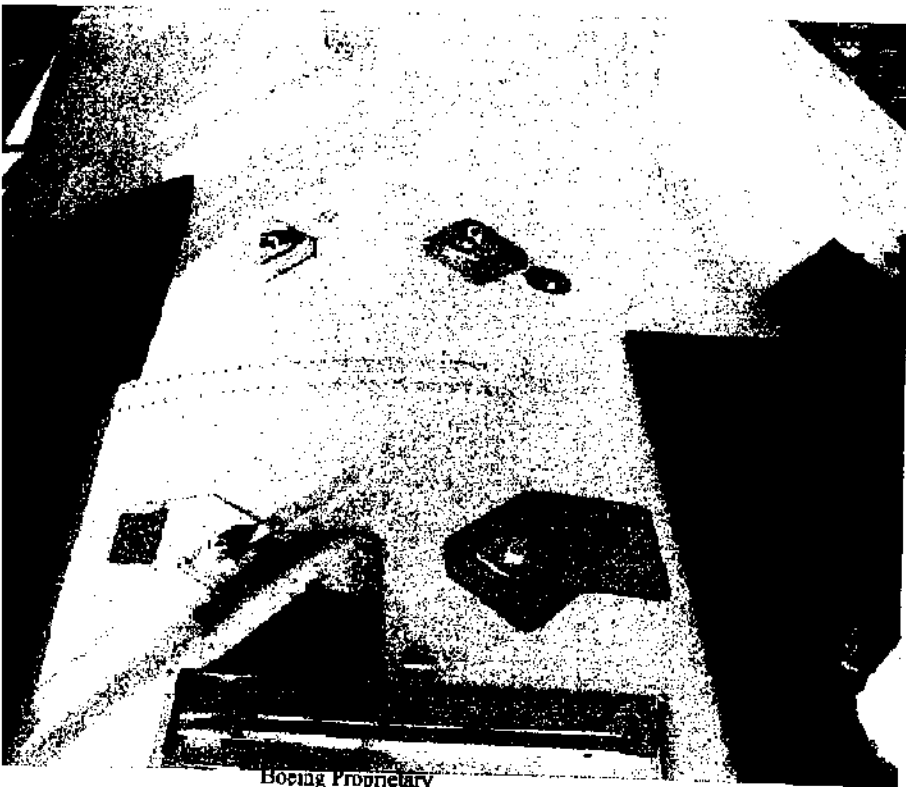

11-L-0559/OSD/52066

Boeing Proprietary

Flight Deck Upgrade



FLIGHT DECK



767 with Current
EFIS Technology



767 with Updated
LFDS Technology

Description of Change:

- Replace current Electronic Flight Instrument System (EFIS) with updated Large Format Display System (LFDS) technology.
- Incorporates "open loop" systems architecture of Primary Flight Displays (PFD), Navigation Displays (ND) and Primary Engine Indicating and Crew Alerting (EICAS) Display
- Provision's Flight Deck for future growth and Incorporation capabilities of Electronic Check Lists, Synoptic Display of Systems and Air Traffic Management Systems.

Previous Application:

- 767-400ER

Similar To:

- 777

Boeing Proprietary

11-L-0559/OSD/52067

Boeing Proprietary

Wiring & Equipment

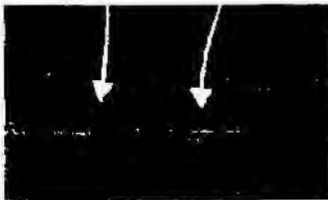
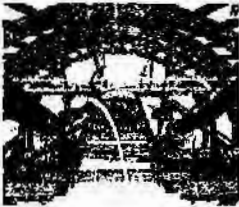

Typical Example:
Overhead Wiring located
from overhead crown
to lower lobe



Typical Example:
Overhead SATCOM relocated
from overhead crown to lower lobe

Description of Change:

- Main Cabin/Deck overhead wiring is relocated to dedicated runs below Main Cabin/Deck floor area.
- Main Cabin/Deck overhead equipment (i.e. SATCOM, Area Distribution Boxes etc.) are relocated to below Main Cabin/Deck floor area.
- Mounting provisions or wiring provisions are added for later component installation

Previous Application:

- 767-300ER
- 767-400ER

Similar To:

- 767-300ER NLI Configurations

Boeing Proprietary

11-L-0559/OSD/52068

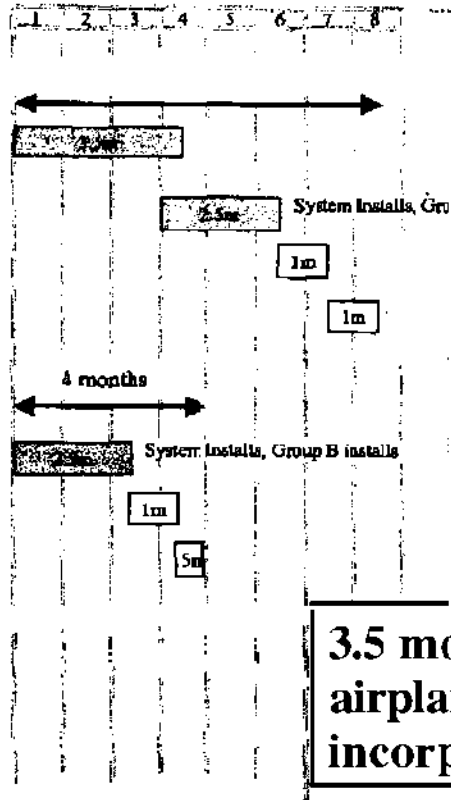

Boeing Proprietary

BOEING 767 Tanker In-Line vs Post BCA Production Flowtime Impact

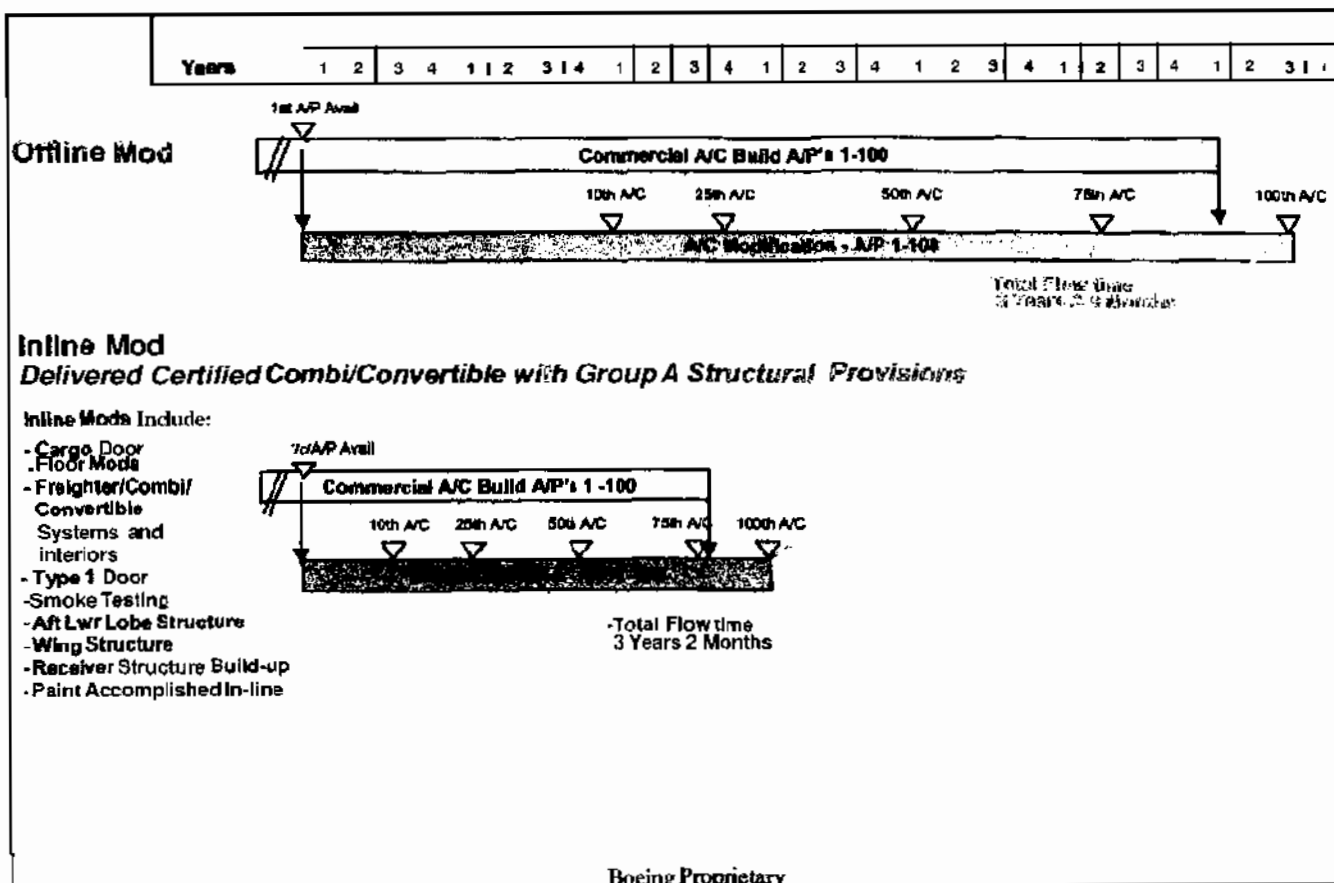

Boeing Proprietary

Summary

Boeing Commercial Airplanes will offer the same customization and provisioning benefits similar to its commercial business to its military customer base via EAR

Offered customization or provisioning will be elements of existing configurations offered to other customers or minor changes to existing customer offerings

No military intelligence or mission system performance capabilities will be incorporated

Boeing Proprietary

11-L-0559/OSD/52071

Export / ITAR Compliance

- **22 CFR 120-130** (Code of Federal Regulations)
- §120.3 Policy on designating and determining defense articles and services.
- An article or service may be designated or determined in the future to be a defense article (see §120.6) or defense service (see §120.9) if it:
 - **(a)** Is specifically designed, developed, configured, adapted, or modified for a military application, and
 - (i) ~~Does not have~~ predominant civil applications, and
 - (ii) ~~Does~~ not have performance equivalent (defined by form, fit and function) to those of an article or service used for civil applications; or
 - **(b)** Is specifically designed, developed, configured, adapted, or modified for a ~~military~~ application, and has significant military or intelligence applicability such that control under this subchapter is necessary.
- The intended use of the article or service after its export (i.e., for a military or civilian purpose) is not relevant in determining whether the article or service is subject to the controls of this subchapter. Any item covered by the U.S. Munitions List must be within the categories of the U.S. Munitions List. The scope of the U.S. Munitions List shall be changed only by amendments made pursuant to section 38 of the Arms Export Control Act (22 USC. 2778).

Export / ITAR Compliance

- Part 121 • The United States Munitions List
 - **121.1** General - Category VIII - Aircraft and Associated Equipment
 - Aircraft ~~specifically designed, modified or configured~~ **for military purposes**
 - Includes bombing, ~~rocket~~ or missile launching, surveillance, reconnaissance, refueling, military liaison, cargo carrying, AEW&C, military training
 - **Components, parts, accessories, attachments** and associated equipment
 - **121.1** General • Category XI • Military Electronics
 - Electronic equipment specifically designed, modified or configured for military application
 - **Components, parts, accessories or attachments** and associated equipment
 - **121.3** Aircraft and related articles
 - Aircraft means aircraft designed, modified or equipped for a military purpose, including aircraft described as “demilitarized”

452 T

Robert Rangel
OFFICE OF M & SECRETARY
THE SPECIAL ASSISTANT 9/13

SD 18386-05 9/13

TO - Pats GEREN

- PER CONVERSATION
- THIS RESPONSE SHOULD HAVE YOUR CAP.
- Needs to be rewritten into Rumsfeld style
- Dispense with metaphors. Only highlighted items

13 Sep 05

16 Aug 05

18386-05

11-L-0559/OSD/52074



DEPARTMENT OF THE AIR FORCE
OFFICE OF THE CHIEF OF STAFF
WASHINGTON, DC

OFFICE OF THE
DEPARTMENT OF DEFENSE
2005 SEP 13 AM 6:39

29 August 2005

HQ USAF/CV
1670 Air Force Pentagon
Washington, DC 20330-1670

The Honorable Donald Rumsfeld
Secretary of Defense
3500 Defense Pentagon
Washington, DC 20301-3500

Dear Mr. Secretary

We have reviewed the briefing that Mr. Fred Smith, FedEx CEO, gave you regarding the Boeing 777 as a possible tanker replacement. He brings out some key points to consider, and he keeps a **keen** focus on the bottom line. FedEx, alongside Southwest Airlines and others in industry, are continually helping to show us how to be more efficient.

In our talks with them, the point they keep bringing home is their focus on shedding their most expensive and least capable assets. Shedding old equipment is a primary mechanism to reduce their operating costs – Herb Kelleher keeps his fleet at an average age of 9 years. Given the steadily increasing age of the USAF fleet, 23.4 years overall (45.4 years for the KC-135 fleet!), it is no surprise our maintenance costs are rising while our capability is decreasing.

We've made sure that all of Mr. Smith's points were considered in the on-going tanker studies. RAND just delivered their Analysis of Alternatives, in which they looked at medium and large class aircraft, including the Boeing 777. The next steps are a sufficiency review by the staff, the follow-up JCIDS capability assessment, IDA's objectivity study, and industrial base considerations.

Our industry leaders have great insights on becoming more efficient, and they are an invaluable resource to the Air Force. We wish Fred and FedEx the best of luck as they negotiate for new aircraft. With steady, hard work the USAF will hopefully award a contract for its tanker replacement by the end of FY06. Together, industry and the Air Force will give our joint warriors the tools they need to kill our Nation's enemies.

Sincerely

T. MICHAEL MOSELEY
General, USAF
Vice Chief of Staff

11-L-0559/OSD/52075

OSD 18386-05

~~FOUO~~

September 13, 2005

TO: President George W. Bush
Vice President Richard B. Cheney
The Honorable Andrew H. Card, Jr.

FROM: Donald Rumsfeld 

SUBJECT: Daily KATRINA Brief

You may find the attached brief helpful. It is produced daily and includes a wide variety of useful information.

Thanks.

Attach:
9/13/05 KATRINA Brief

DMR:ms
091305-01

~~FOUO~~

OSD 18400-05

11-L-0559/OSD/52076

13 0400 EDT Sep 05



Hurricane Katrina

Update

Information in this brief is current as of 0400, 13 Sept 05)

This briefing is classified
UNCLASSIFIED

Prepared by DOD based on current data from a rapidly changing situation.
If your agency finds errors, or has recommendations to improve brief, please e-mail:

hk.teamchief@js.pentagon.mil

11-L-0559/OSD/52077





















UNCLASSIFIED

13 0400 EDT Sep 05



JOA 5 Day Forecast

DEPARTMENT OF DEFENSE
 OFFICE OF THE SECRETARY OF DEFENSE
 OFFICE OF THE ASSISTANT SECRETARY FOR
 OPERATIONS AND TESTS
 OFFICE OF THE ASSISTANT SECRETARY FOR
 ACQUISITION AND SUSTAINMENT
 OFFICE OF THE ASSISTANT SECRETARY FOR
 PERSONNEL AND TRAINING
 OFFICE OF THE ASSISTANT SECRETARY FOR
 TECHNOLOGY AND INFORMATION
 OFFICE OF THE ASSISTANT SECRETARY FOR
 POLICY AND PLANS
 OFFICE OF THE ASSISTANT SECRETARY FOR
 SECURITY AND COMPLIANCE
 OFFICE OF THE ASSISTANT SECRETARY FOR
 SPECIAL OPERATIONS AND
 SUPPORT
 OFFICE OF THE ASSISTANT SECRETARY FOR
 STRATEGIC AND OPERATIONAL
 ANALYSIS
 OFFICE OF THE ASSISTANT SECRETARY FOR
 SYSTEMS AND PROGRAMS
 OFFICE OF THE ASSISTANT SECRETARY FOR
 TEST AND EVALUATION
 OFFICE OF THE ASSISTANT SECRETARY FOR
 TRAINING AND EDUCATION
 OFFICE OF THE ASSISTANT SECRETARY FOR
 VISUAL INFORMATION
 OFFICE OF THE ASSISTANT SECRETARY FOR
 WAREHOUSE AND LOGISTICS
 OFFICE OF THE ASSISTANT SECRETARY FOR
 WORKFORCE MANAGEMENT
 OFFICE OF THE ASSISTANT SECRETARY FOR
 WORKSPACE AND FACILITIES
 OFFICE OF THE ASSISTANT SECRETARY FOR
 WORKSPACE AND FACILITIES
 OFFICE OF THE ASSISTANT SECRETARY FOR
 WORKSPACE AND FACILITIES

	TUE: 13 SEP	WED 14 SEP	THU: 15 SEP	FRI: 16 SEP	SAT: 17 SEP					
A.M.	 MOSTLY SUNNY	 MOSTLY SUNNY	 MOSTLY SUNNY	 MOSTLY SUNNY	 MOSTLY SUNNY					
WINDS	E 5 - 10 Kts	SE 5 - 10 Kts	SW 5 - 10 Kts	SW 5 - 10 Kts	W 5 - 10 Kts					
P.M.	 PARTLY CLOUDY	 PARTLY CLOUDY	 PARTLY CLOUDY	 PARTLY CLOUDY	 PARTLY CLOUDY					
WINDS	SW 5 - 10 Kts	SW 5 - 10 Kts	SW 5 - 10 Kts	SW 5 - 10 Kts	NW 5 - 10 Kts					
SR / SS	0644L / 1908L	0644L / 1907L	0645L / 1905L	0646L / 1904L	0646L / 1903L					
MR / MS	1619L / 0121L	1709L / 0232L	1752L / 0345L	1829L / 0458L	1903L / 0608L					
Illumination	70%	80%	88%	95%	99%					
TEMPS	90°F / 71°F	90°F / 72°F	91°F / 75°F	91°F / 75°F	92°F / 75°F					
	 SUNNY	 PARTLY CLOUDY	 MOSTLY CLOUDY	 CLOUDY	 T-STORMS	 RAIN & SHOWERS	 RAIN & SNOW	 SNOW SHOWERS	 HIGH CLOUDS	 HAZE

UNCLASSIFIED

11-L-0559/OSD/52078

UNCLASSIFIED

13 0400 EDT Sep 05



Worldwide Tropical Overview

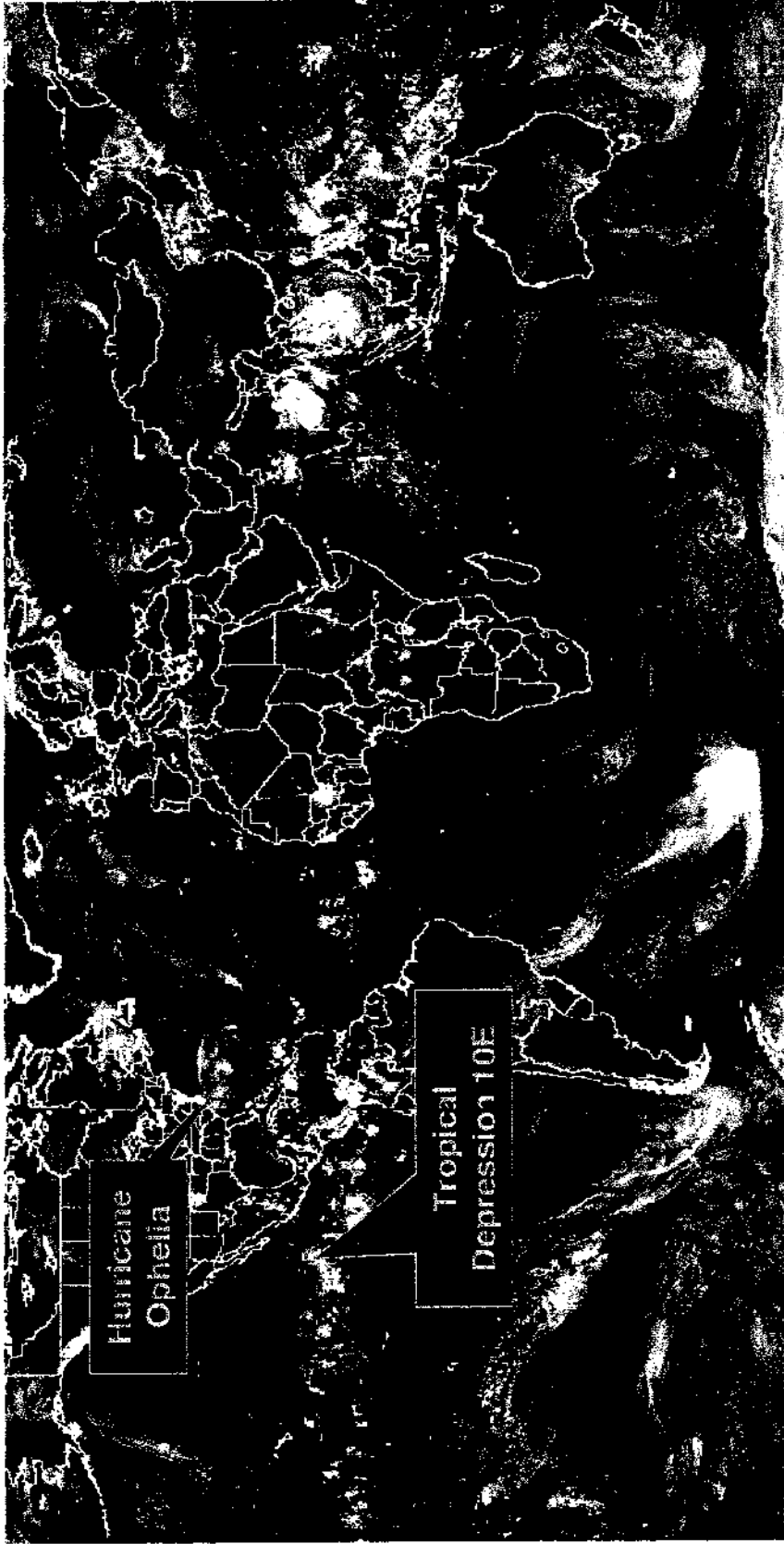

UNCLASSIFIED

11-L-0559/OSD/52079



Situation

NEW ORLEANS

Security

- NSTR

Humanitarian Support

- Two Carnival cruise ships arrived pier side New Orleans 12 Sep. Contracted to provide housing for police, firefighters, Emergency Medical Services personnel and their families

FEMA

- Port of New Orleans not open to commercial traffic; goal is 14 Sep. Port is currently berthing military and relief ships; barge traffic along MS River resumed normal operations
- Airspace restricted to prevent overflight of morgue sites
- EPA setting up household hazardous waste collection centers for affected Parishes
- Un-watering operations are progressing faster than anticipated; Jefferson Parish is almost completely dry and 3 basins are left with standing water; latest rate of un-watering is about 18 inches per day vice previously reported 12 inches per day
- Chemical analyses of flood water show the presence of high levels of E. coli
- Military aerial spraying operations commenced at **1845EDT-2045EDT**, 12 Sep; operations focused on New Orleans area; JTF Katrina distributed mosquito spraying media advisory
- 1.9M customers still need to boil drinking water; 500k getting good water and status of 462 water systems supplying another 500k is unknown



Situation (cont)

LOUISIANA

Security

- NSTR

Humanitarian Support

- 279 reported fatalities (FEMA) as of 12 Sep
- Cumulative 43.2M pounds of ice, 17.3M liters of water, and 11.6M MREs delivered

FEMA

- Approximately 344k without power
- EPA working with USCG to conduct assessments of potential oil spills and chemical releases; currently reporting 15 major oil spills

MISSISSIPPI

Security

- Looting still an issue in heavily damaged areas in Gulfport to Pass Christian

Humanitarian Support

- 155 reported fatalities (FEMA) as of 12 Sep
- FEMA aggressively working to ensure that all evacuees will be in housing as quickly as possible; FEMA's target date is 01 Oct
- Cumulative 90.4M pounds of ice, 34.9M liters of water, and 8.1M MREs delivered

FEMA

- Approximately 91k without power
- ENTERGY reports all customers who can receive power have been restored; MS Power has restored power to all customers
- Fire danger in MS extremely high due to storm-killed vegetation and hot, dry weather



Command and Control

PFO = Principal Federal Official-
VADM Allen
FCO = Federal Coordinating Officer
LA-Mr. Lokey ; MS-Mr. Carwile
EOC = Emergency Ops Center
DCO = Defense Coordinating Officer
JFHQ = Joint Force HQ

SERVICE COMPONENTS
JFACC MAJ GEN MAYES
 TYNDALL AFB
JFMCC RDML KILLKENY
 USS IWO JIMA
COMMARFOR MAJGEN O'DELL
 Katrina NAS New Orleans
 ARFOR MG CALDWELL
 NEW ORLEANS INT AIRPORT

IWO JIMA
 ★ ★ ★
 VADM ALLEN
 PFO
 AND
 JTF KATRINA WEST
 (FWD)
 ★ ★ ★
 LTG HONORE
 AND
 ★
 BG GRAHAM
 DEPUTY

FEMA HQ
 PFO TFCO TDCO
 LA STATE EOC
 JFCOM SJTF. IIHQ

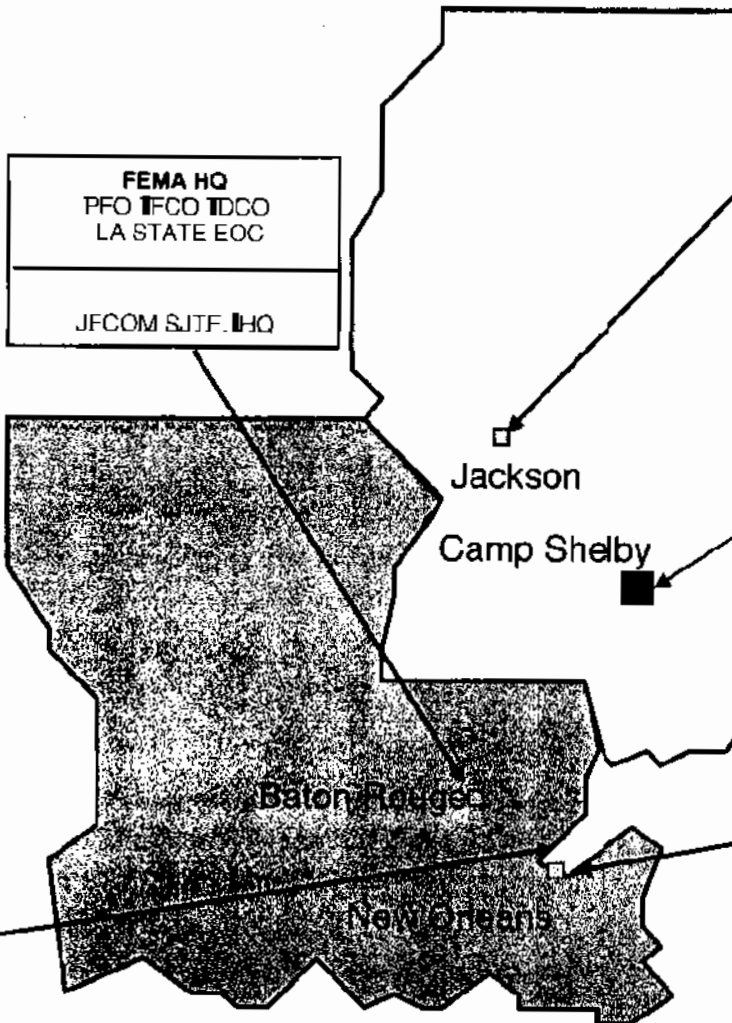

JTF MSNB TAG
 ★ ★ ★
 MG CROSS
 FCO / DCO (E)
 MS STATE EOC

JTF KATRINA EAST (FWD)
 ★ ★
 MG COL GLAZIER
 DEPUTY

JTF LANG TAG
 ★ ★
 MG LANDRENEAU
 AND
 ★ ★
 MG CALDWELL
 82nd ABN DIV
 AND
 ★ ★
 MAJGEN O'DELL
 COMMARFOR Katrina
 AND
 ★
 BG MOULTON
 NORTHCOM SJTF



Significant Events

Significant Events

- FEMA Director resigns
- Principal Federal Official Ops Center now on IWO JIMA
- DJC2 operational; supporting Shore Echelon Commander
- PATUXENT on station JOA, relieved ARCTIC as the duty oiler for JTF Katrina ships
- 27 of 120 installed pumps operating; 38 portable pumps augmenting
- SECDEF directed deployment of Mortuary Affairs teams; 9 teams / 54 personnel with additional 54 personnel available within 48 hours
- JTF Katrina has requested several units be released from relief operations; USNORTHCOM has submitted request
- Louis Armstrong New Orleans International Airport opened for cargo traffic on 11 Sep; limited passenger service expected to resume 13 Sep
- JTF Katrina forces continue to conduct SAR and HA operations; now tracking rural searches in addition to urban (Total New Orleans search complete: 90% hasty / 50% deliberate)

Unaccounted for Personnel: 1,464**(-254)

(Includes AC, Res, DoD Civ)

USN	340 (0 AC, 316 Res, 24 Civ)
USAF	1,114 (4 AC, 1003 Res, 107 Civ)
USMC	0
USA	10 (5 AC, 0 Res, 5 Civ)

**A number of units still have not reported, numbers will continue to fluctuate





Significant Operations

D
E
F
E
N
S
E
C
I
O
N

Operations

- **150 USS WHIDBEY ISLAND** sailors on the beach for the past two days; assisted Salvation Army with distribution of supplies and provided a variety of disaster relief support
- Seabees making minor repairs to **50+** schools in six counties near Gulfport
- USS GRAPPLE conducting obstacle clearance in mouth of Mobile Bay
- Navy SPRINT (Special Psychiatric Intervention Teams) providing stress management support to New Orleans PD and Nat'l Guard
- **123** air missions (search and rescue, evacuation and supplies) in last 24 hours; **2,783** missions to date (active only)
 - **5,521** SAR saves, **27,252** PAX evacuated, **5,610** tons of equipment / supplies, **2,567** persons MEDEVAC
- 2 Major Disaster Portable Morgue Sites
 - Gulfport-Biloxi Municipal Airport, MS and St. Gabrielle, LA





Future Operations

Operations Operations

Ongoing mosquito ops; 2 flights per day for next 7-10 days

SecDef approved VOCO re-deployment of
USS HARRY S. TRUMAN and USS WHIDBEY ISLAND

Pending re-deployment proposals:

UNIT	PERSONNEL
11 th MEU	218
Army UAV Platoon	21
Army Aviation Assets	355
AF Hospital	160
AF Search and Rescue	228
Total:	982





Hurricane Katrina DOD Support

Aviation Response:

- Helicopters: **166** Active
 180 NG/ USCG/ Other
 346 Total
- Fixed Wing: **35** Active
 33 NG/ Reserve/ Other
 68 Total

MS AL

Public Affairs:

JTF Katrina:	43
Combat Camera:	39
NORTHCOM:	29
Afloat / Other:	43
Enroute:	16
Total:	170

TX

LA

JTF-Katrina
Camp Shelby



New Orleans ●

Chaplains:

Title 10:	76
NG:	164
Total:	240

Response:

USN:	19
	6
Total:	25

FL

Personnel:

Total Title 10:	19,337
NG in JOA:	45,871
NG Spt outside JOA:	2,409
Total	67,617

Projected Flow (Next 24-48 Hours):

- National Guard – NSTR
- Active – USS HARRY S. TRUMAN (-3,102) and USS WHIDBEY ISLAND outbound; USA- 54 Mortuary Affairs personnel inbound
- 7 Ready Reserve Fleet ships (ETA: TBD); berthing for **1,500**



Force Projection Timeline

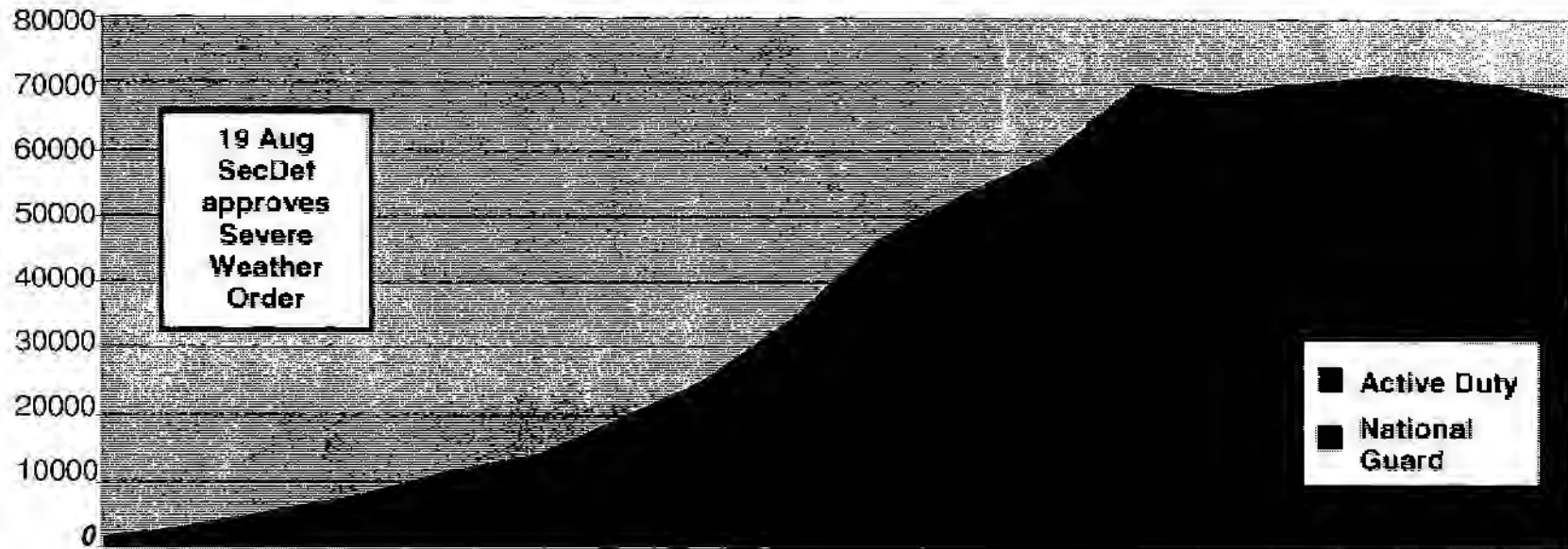



	26-AUG Fri	27-AUG Sat	28-AUG Sun	29-AUG Mon	30-AUG Tues	31-AUG Wed	1-SEP Thu	3-SEP Sat	5-SEP Mon	10-SEP Sun	12-SEP Tue
Guard	930	2,633	5,376	7,522	9,794	11,251	16,232	29,491	39,096	50,116	48,280
Active	0	0	0	0	1,000	2,000	3,000	4,631	14,232	20,991	19,337
Total	930	2,633	5,376	7,522	10,794	13,251	19,232	34,122	53,328	71,107	67,617



Affected Area Assessment: New Orleans / Louisiana / Mississippi Utilities

STATUS	LOCATION	TYPE	LEAD
0%	NEW ORLEANS	ELECTRIC	DEPARTMENT OF ENERGY
		COMMUNICATIONS (WIRELINE)	DEPARTMENT OF HOMELAND SECURITY
		COMMUNICATIONS (WIRELESS)	DEPARTMENT OF HOMELAND SECURITY
		WATER TREATMENT	US ARMY CORPS OF ENGINEERS/ ENVIRONMENTAL PROTECTION AGENCY
		WASTE TREATMENT	US ARMY CORPS OF ENGINEERS/ ENVIRONMENTAL PROTECTION AGENCY
		POSTAL	US POSTAL SERVICE
0%	LOUISIANA	ELECTRIC	DEPARTMENT OF ENERGY
		COMMUNICATIONS (WIRELINE)	DEPARTMENT OF HOMELAND SECURITY
		COMMUNICATIONS (WIRELESS)	DEPARTMENT OF HOMELAND SECURITY
		WATER TREATMENT	US ARMY CORPS OF ENGINEERS / ENVIRONMENTAL PROTECTION AGENCY
		WASTE TREATMENT	US ARMY CORPS OF ENGINEERS / ENVIRONMENTAL PROTECTION AGENCY
		POSTAL	US POSTAL SERVICE
0%	MISSISSIPPI	ELECTRIC	DEPARTMENT OF ENERGY
		COMMUNICATIONS (WIRELINE)	DEPARTMENT OF HOMELAND SECURITY
		COMMUNICATIONS (WIRELESS)	DEPARTMENT OF HOMELAND SECURITY
		WATER TREATMENT	US ARMY CORPS OF ENGINEERS / ENVIRONMENTAL PROTECTION AGENCY
		WASTE TREATMENT	US ARMY CORPS OF ENGINEERS / ENVIRONMENTAL PROTECTION AGENCY
		POSTAL	US POSTAL SERVICE

 0 - 49%
  50-79%
  80 - 100%

IIC IFIED



DOD Preventive Medicine (PM) Footprint

- Health Issues**
- Airborne threats
 - Polluted Flood Water
 - Contaminated Drinking Water Supplies
 - Spoiled Food
 - Sanitation
 - Disease Vectors (Mosquitoes)
 - Large Animal Disposal
 - Communicable Diseases
 - Industrial Contamination
 - Snakes and other Vermin

- Support to Relief Ops**
- Veterinary Support
 - Localized water sampling, and sanitation inspection
 - JTF PM CONOPS being staffed

- PM Measures for Military Personnel**
- Pre-deployment
 - Immunizations (Tetanus / Diphtheria, Hepatitis-A)
 - Pre-deployment Health Surveys assessment
 - Deployment
 - NORTHCOM guidance
 - PM TICCare
 - Post-deployment Health Support

74 PERS in support of relief operations

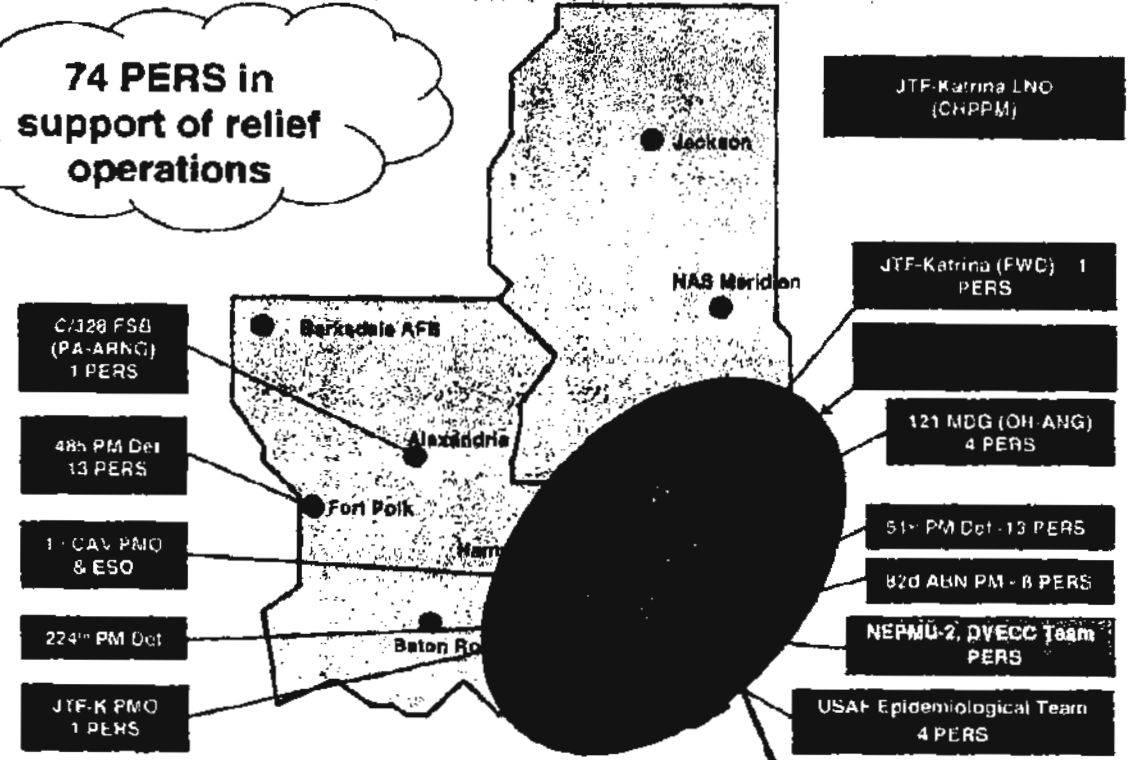

- Planned Joint Area PM Measures**
- Aerial Spraying
 - 12 Sep spraying complete at 2045Z. 15 Sep spraying scheduled.
 - Legal review of EPA and National Environmental Protection Act complete
 - 910th ABN Wing Deployed to Duke Field, FL
 - Prepared to conduct the mission using an EPA approved Disinfectant



Gulf Coast Civilian Hospital Status

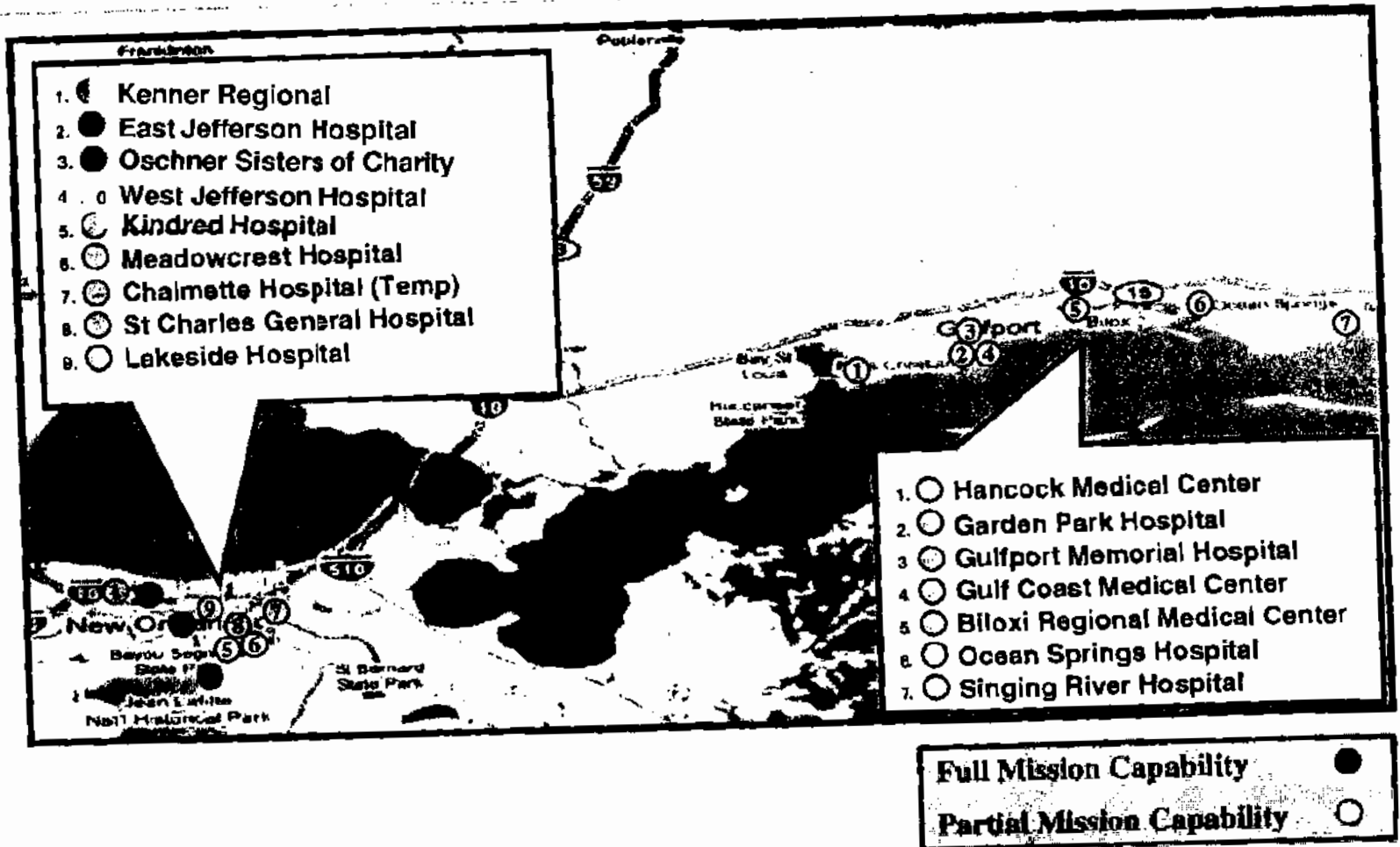

16 Civilian Hospitals Accepting Patients



Lines of Communication

Most state highways open & unrestricted

- Repair of I-10 Pascagoula Bridge, est. completion 10 Oct (2-lane traffic in each direction)
- Contract for repairs to I-10 Slidell Twin Span Bridge awarded on 11 Sep, work begins 12 Sep. Est. completion dates:
 - 26 Oct / Phase I: 1-lane each direction across Lake Pontchartrain (east of New Orleans)
 - 12 Jan / Phase II: 2-lanes each direction across Lake Pontchartrain (east of New Orleans)

Rail lines west of New Orleans open

- Norfolk Southern Lake Pontchartrain railroad bridge
 - Bridge intact, restoring ballast, open "early this week"
 - Provides direct route from East

- Lower Mississippi River open to vessels with 39 foot draft or less, daylight hours only

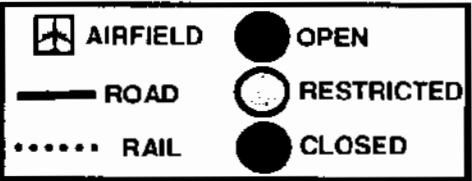
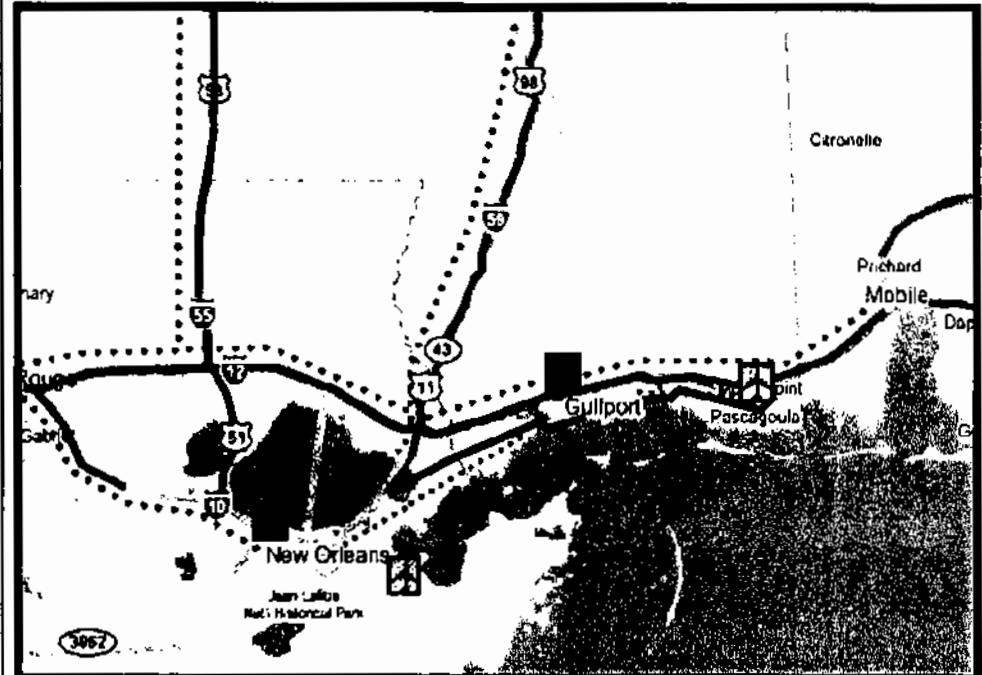

Gulf Coast Main Supply Routes



International Water Pumping Equipment

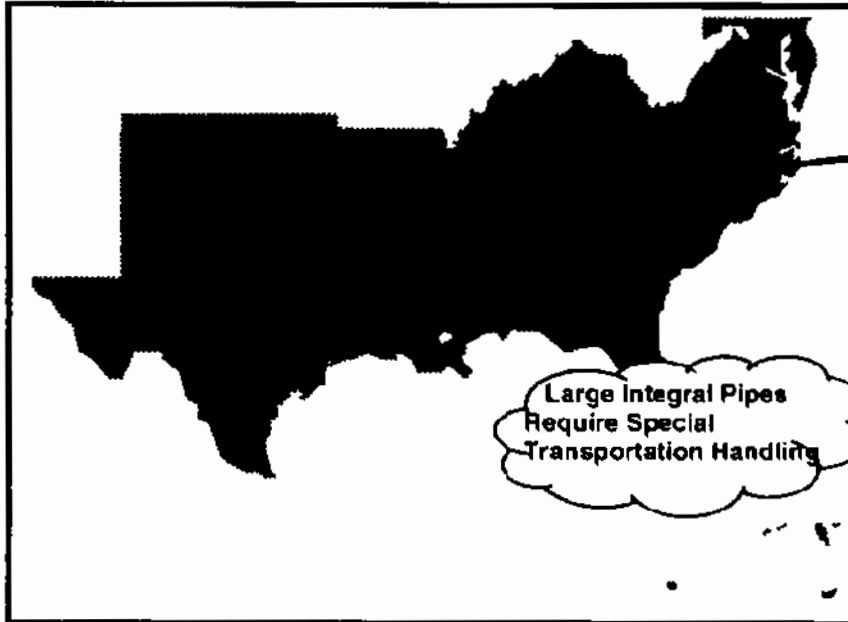

Large Integral Pipes
Require Special
Transportation Handling

- Movement of Dutch and German water pumping equipment
 - Netherlands
 - 3 pumps
 - 3 vehicles
 - 5 pallet train
 - 5 PAX
 - Germany
 - 15 pumps
 - 13 vehicles
 - 94 PAX

• Movement Complete

• Movement Complete
• Pumps operational

Dutch and German Support Missions Closed



Draining Flooded Areas

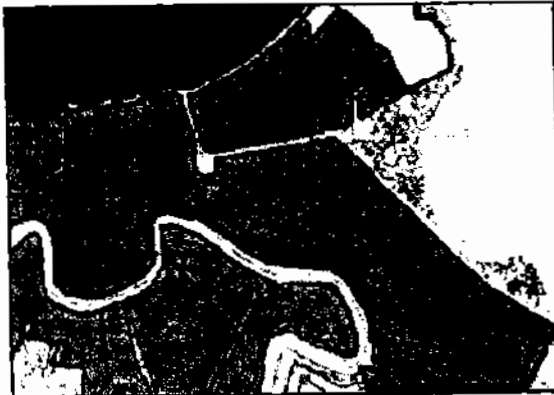

- Pumping operations:
 - 27 of 120 installed pumps operational
 - 47 of 114 portable pumps operational
 - International Assistance
 - Germans pumping in Chalmette
 - Dutch ADVON and pumps on site
- Well ahead of original estimates:
 - Favorable weather
 - Controlled breaches very effective
 - On track for October completion
- Cautious eye on variables **for** the future:
 - Pump reliability and scheduled maintenance
 - Debris
 - Levee integrity and stability
 - Weather
 - Environmental issues with water quality

Ahead of Estimates - But Many Variables May Impact The Future

13 0400 EDT Sep 05

rgy

o Power (Source: DOE)
k improvement over last
ours
Refineries (Source: DOE)
of current capacity
ineries shutdown
extended period
• Represents 5% of total
US capacity

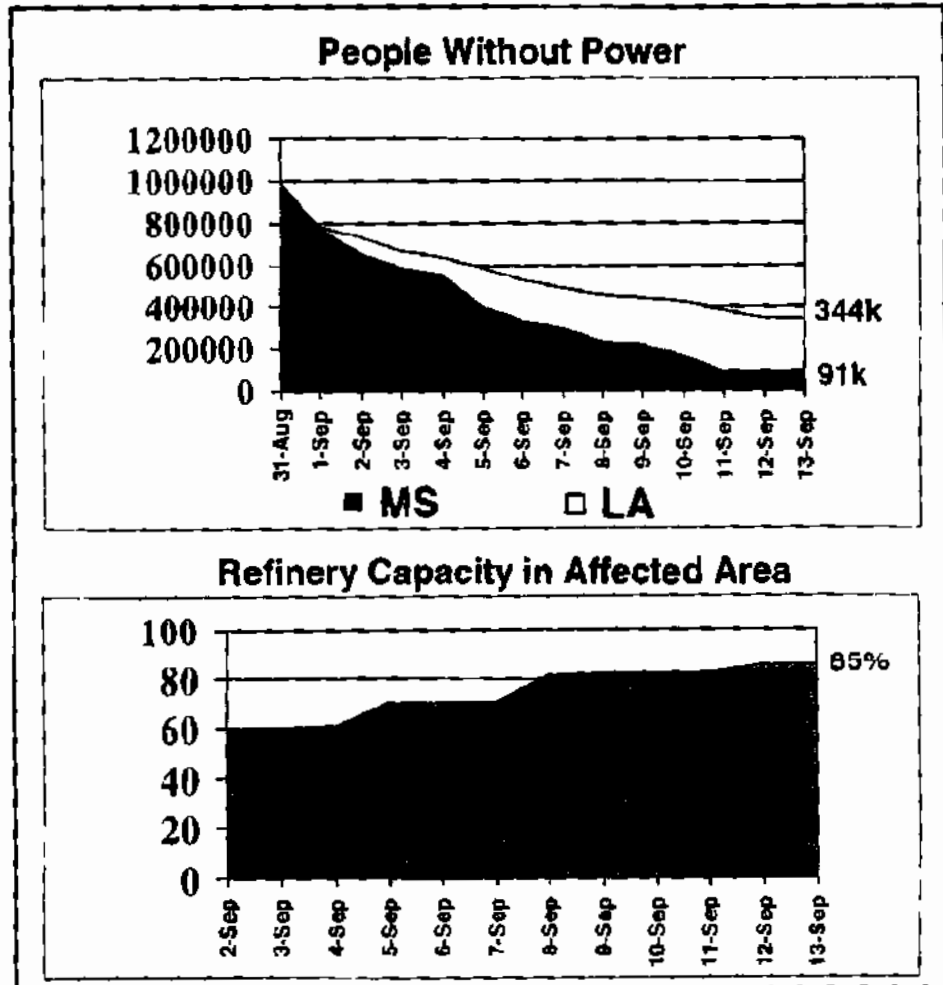

Power and Refining Capacity Continues to Improve (Source: DOE)



International Support Update

- Foreign Assistance Received or Expected to Date:

Cash donations: Afghanistan, Albania, Armenia, Australia, Azerbaijan, Bahamas, Bahrain, Bangladesh, Bosnia-Herzegovina, Brunei, Cambodia, Cameroon, Canada, China, Cyprus, Djibouti, Dominican Republic, Equatorial Guinea, Finland, Gabon, Georgia, Hungary, Iceland, India, Indonesia, Iraq, Ireland, Japan, Kenya, Korea, Kuwait, Liberia, Lithuania, Macedonia, Malaysia, Maldives, Marshall Islands, Mauritania, Mongolia, Morocco, Nepal, New Zealand, Norway, Organization of American States, Pakistan, Palau, Papa New Guinea, Qatar, Rwanda, Samoa, Sao Tome and Principe, Saudi Arabia, Sri Lanka, Taiwan, Togo, UAE, Uganda, Ukraine, Venezuela, Vietnam, Yemen

Aircraft support: Helicopters: Singapore (4) and Canada (4), Mexico (2)

Planes: Air Canada planes for evacuation, Russia,

Naval/ Ship support: Canada (3), Mexico (1), Netherlands (1)

Other: Greece (2) cruise ships for housing

- New offers: 5
- *Total offers: 399
- Countries: 119
- International/ regional organizations: 12
- Countries with offers received or expected to be received: 67
- Cash totaling nearly:
~ \$495.00 M
- **Food: 1.62 million MREs**



International Support Update

- **Foreign Assistance Received or Expected to Date (continued) :**

Disaster assessment & logistics: Belgium

Engineering / reconstruction teams: Korea, Netherlands

Relief supplies beds / bedding, clothing, first-aid kits, generators, pumps, MREs / food items, tents / tarps, water treatment : Austria, Belgium, Canada, Chile, China, Czech Republic, Denmark, Egypt, Finland, France, Germany, India, Israel, Italy, Japan, Korea, Luxemborg, Mexico, Netherlands, Norway , Pakistan, Peru, Romania, Russia, Slovenia, Spain, Switzerland, Taiwan, Thailand, Tunisia, UK

Search & Rescue, divers, forensic experts: Canada

Miscellaneous: Kuwait—Oil products; Sweden—Telecom equipment; Argentina—Mental Health Experts (bilingual)

UNCLASSIFIED

13 0400 EDT Sep 05



International Support: New Offers

- **Argentina: Mental health experts (bilingual)**
- **Cameroon: \$450,000**
- **Macedonia: \$300,000**
- **Rwanda: \$100,000**
- **Togo: \$100,000**



Approved Foreign Military Assistance

13 September 2005

Mode	Country of Origin	Type of Assistance	Destination	Arrival Time	Notes
Sea	Canada	Helicopters	Biloxi, Gulfport, MS	13 Sep	4-Ship Task Force; will be TACON to TF20
Air	UNICEF (Denmark)	Schools supplies	Little Rock AFB	13 1400z	
Air	Sweden	3 Eriksson GSM Cell Networks	Little Rock AFB	13 1945z	
Air	India	3k Hygiene Kits, Blankets, and sheets; 150 tarps	Little Rock AFB	13 0030z	
Air	Russia	16 Metric Tons (MT) Blankets	Little Rock AFB	13 Sep Time TBD	More Info to Follow
Next 72 Hours (14 - 17 Sep)					
Air	South Korea	10 Tons Tarps; Diapers; 5 Tons Cleaning Supplies	Dallas-Fort Worth (DFW)	15 Sep Time TBD	Commercial Flight in DFW will require onward movement assistance
Air	Slovenia (NATO)	780 Blankets, 250 Mattresses, 2000 First Aid Kits	Little Rock AFB	-16 Sep	Second NATO Shipment



C4 Update and Communications Recovery Activities

Military Communications

- DJC2 deployed to Joint Reserve Base New Orleans to support 60-personnel operations cell -on station and operational
- All military comms at JTFHQs, DCOs and outlying sites are GREEN
- NORTHCOM conducting tactical communications mission analysis to support 6 LA Parishes

Civil Communications Infrastructure

- Significant long-haul commercial communications restored - customers out-of-service decreased to 359k from 2.7m on 03 Sep
- Complete cellular coverage of New Orleans and other major cities
- Commercial vendors still have concerns over security for teams



Source: NCS & NORTHCOM



Major Media Ops

Key Media Events Past 24 Hours:

- CNN covered POTUS visit to USS IWO JIMA
- ABC, Reuters – C-130 mosquito spray missions
- Washington Post – Keesler AFB support of federal responders
- Continued international coverage of Naval personnel / assets
- FOX interviewed Commodore, 22nd Naval Construction Regiment



Major Media Ops

Key Media Events Next 24 Hours:

- Bloomberg News to Interview Hurricane Hunters
- Aviation Week / Defense Daily – ROVER teams coverage
- Wall Street Journal / CNN / wires –1st delivery of NATO aid
- CNN to cover Seabees' clean up efforts

Public Affairs:	76 personnel - 5 enroute
Combat Camera:	82 personnel - 7 teams enroute

~~FOUO~~

SEP 13 2005

TO: The Honorable Andrew H Card Jr
FROM: Donald Rumsfeld *DR*
SUBJECT: U.S.G. Facility

Attached is a brief memo on the subject we discussed.

Thanks.

Attach: 7/29/05 Memo (072105-08)

DHR:ss
091205-37

OSD 18401-05

~~FOUO~~

11-L-0559/OSD/52102

~~FOUO~~

July 29, 2005

SUBJECT: U.S.G. Facility west of the State Department

The small U.S. Navy/State Department facility located just west of the State Department is a location that could be made available for selected future senior U.S.G officials who, because they are subject to threats, may require 24 hour protection such as: Secretary of State, Secretary of Defense, DNI and/or the Speaker of the House.

The facility is currently being used by the U.S. Navy and State Department for offices, but the DNI may be looking at it for his headquarters. There are three Navy Flag houses there; the security is manageable and the cost of security would likely be cheaper than what is currently required for the homes of those officials. Any official who decided to use those facilities would pay appropriate rent.

DHR:ss
072105-08

~~FOUO~~

11-L-0559/OSD/52103

FOUO

SEP 13 2005

TO: The Honorable Andrew H Card Jr
FROM: Donald Rumsfeld *DR*
SUBJECT: **U.S.G. Facility**

Attached is a brief memo on the subject we discussed.

Thanks.

Attach: 7/29/05.Memo (072105-08)

DHR.ss
091205-37

OSD 18401-05

FOUO
11-L-0559/OSD/52104

~~FOUO~~

July 29, 2005

SUBJECT: U.S.G. Facility west of the State Department

The small U.S. Navy/State Department facility located just west of the State Department is a location that could be made available for selected future senior U.S.G officials who, because they are subject to threats, may require 24 hour protection such as: Secretary of State, Secretary of Defense, DNI and/or the Speaker of the House.

The facility is currently being used by the U.S. Navy and State Department for offices, but the DNI may be looking at it for his headquarters. There are three Navy Flag houses there; the security is manageable and the cost of security would likely be cheaper than what is currently required for the homes of those officials. Any official who decided to use those facilities would pay appropriate rent.

DHR.ss
072105-08

~~FOUO~~

11-L-0559/OSD/52105

~~FOUO~~

2005 09 08 08:19
September 08, 2005

I-05/012216
ES-4173

TO: Eric Edelman
FROM: Donald Rumsfeld *D.A.*
SUBJECT: National Security Strategy Team

Steve Hadley has Peter Feaver working on the National Security Strategy, and Feaver is going to put a team together. I told Feaver you would be the one to work with to figure out who should be a **part** of that team; probably you and Jim Thomas, or you and Ryan Henry.

Please think about it and see me, so we can decide who should work on his team to be sure the National Security Strategy ties to the QDR and the National Defense Strategy.

Thanks.

DHR.ss
090805-15

OSD 18450-05
.....

11-L-0559/OSD/52106

FOUO

SEP 13 2005

205 13 08 2:19
September 08, 2005

I-05/012216
ES-4173

TO: Eric Edelman
FROM: Donald Rumsfeld *D.R.*
SUBJECT: National Security Strategy Team

Steve Hadley has Peter Feaver working on the National Security Strategy, and Feaver is going to put a team together. I told Feaver you would be the one to work with to figure out **who** should be a part of that team; probably you and Jim Thomas, or you and Ryan Henry.

Please think about it and see me, so we can decide **who** should work on his team to be sure the National Security Strategy ties to the QDR and the National Defense Strategy.

Thanks.

DHR:sm
090815-15

OSD 10458-05

.....

Please Respond By 09/22/05

Mr. Secretary,

I met with Peter Feaver for one hour on Sept. 9. I told him that we needed to keep the NSS knitted up with the QDR and National Defense Strategy. We agreed that I, along with Ryan & Barry Povel would work with Feaver to make sure that happened.

FOUO

EE SEP 13 2005

OSD 10458-05

11-L-0559/OSD/52107

AUG 22 2005

TO: Bill ~~Winkenworder~~

CC: Eric Edelman
David Chu
Dr. John Baxter

FROM: Donald Rumsfeld @

SUBJECT Avian Flu

Please review the attached intelligence on avian flu in Kazakhstan, and give me your thoughts on the potential severity and impact on the country.

Thanks.

Attach.
8/18/05 1 Memo for SecDef,
DHR:dh
081805-1175

.....
Please respond by September 8, 2005

*Aug 22 20
DH*

OSD 18506-05

11-L-0559/OSD/52108

~~For Official Use Only~~

Avian **Influenza**

COORDINATION

DASD(FHP&R)

Ms Ellen Embrey

E/E 9/16/15

CoS, HA

COL Thorn Kurmel

PDASD

Dr. Steve Jones

~~For Official Use Only~~

11-L-0559/OSD/52109



HEALTH AFFAIRS

THE ASSISTANT SECRETARY OF DEFENSE

WASHINGTON, D. C. 20301-1200
~~For Official Use Only~~

DEFENSE
2005 SEP 14 11 08 30

INFO MEMO

SEP 08 2005

FOR: SECRETARY OF DEFENSE

FROM: William Winkenwerder, Jr., M.D., ASD (Health Affairs)
William Winkenwerder, Jr.

SUBJECT: Avian Influenza

- In TAB A, you requested my thoughts on the potential severity and impact on the country of Kazakhstan of the avian influenza as documented in the intelligence report that accompanied your request. The Armed Forces Medical Intelligence Agency has provided you subsequent information on this topic, but it is classified higher than this memorandum.
- Based on the material from the Armed Forces Medical Intelligence Agency, I believe the reports to-date characterize a mild outbreak with negligible impact on the country. There have been no human deaths confirmed by the World Health Organization outside of Southeast Asia.
- Based on data provided by the Food and Agriculture Organization of the United Nations, Kazakhstan is located within two different flyways in the U.S. Central Command area of operations. However, the U.S. Central Command Surgeon assesses the current impact of avian influenza in his area of operations as minimal to none, and assesses the long-term impact as moderate. The current Armed Forces Medical Intelligence Center assessment is that there is a low threat to U.S. forces.

COORDINATION: USD (P&R) *[Signature]*

Attachment:
As stated

Prepared by: Dr. Susan Tilton, DHSD (b)(6) DOCS OPEN 91739, 91740

AUG 22 2005

TO: Bill ~~Winkenwerder~~
CC Eric Edelman
David Chu
Dr. John Baxter
FROM Donald Rumsfeld @,
SUBJECT Avian Flu

Please review the attached intelligence on avian flu in Kazakhstan, and give me your thoughts on the potential severity and impact on the country.

Thanks.

Attach.
8/18/05 1 Memo for SecDef,
DHR:dh
081805-1175

.....
Please respond by September 8, 2005

*Aug 22 20
JK*

OSD 18506-05

11-L-0559/OSD/52111

~~For Official Use Only~~

Avian Influenza

COORDINATION

DASD(FHP&R)

Ms Ellen Embrey

EIE 2/16/15

CoS, HA

COL Thorn Kurnel

PDASD

Dr. Steve Jones

~~For Official Use Only~~

11-L-0559/OSD/52112

FOUO

NOV 03 2005

TO: [REDACTED]
FROM: Donald Rumsfeld *DR*
SUBJECT: Response to Cliff Smith

080

I'm assuming someone has sent a reply to Cliff Smith, who sent the attached letter and cookies.

Thanks.

Attach 9/11/05 Letter from Cliff Smith to SecDef

DHR:ss
110205-03

.....
Please Respond By November 08, 2005

3 Nov 05

PA → talked to them
superschedule 9/27/05
call → (b)(6)
(b)(6)
+ CTRC (PA division) [unclear] [unclear]

PA DID CALL THE GENTLEMAN & THANKED HIM, BUT THEY HAVEN'T RESPONDED FORMALLY ON THE FUNDING

11 Sep 05

OSD 18577-05



OFFICE OF THE
SECRETARY OF THE
DEFENSE



USPS Official Licensed Product
Manufacturer / Distributor

2005 SEP 14 PM 2: 11



September 11, 2005

The Honorable Donald H. Rumsfeld
Secretary of Defense
1000 Defense Pentagon
Washington, DC 20301-1000

Dear Mr. Secretary:

I am writing and providing samples of some cookies that I have been working on that honor those who have served, and currently serve in our military.

My Company, Cookie Club of America (CCA), has created Military Emblem Cookies under written authorization from each branch of our United States Armed Forces. After two years of development Cookie Club of America now embosses the Official Service Emblems of the United States Army, Air Force, Navy, Marine Corps, Coast Guard, Air and Army National Guards on our unique and tasty cookies. Additionally, five percent of the profits help military families through the National Military Family Association (NMFA).

The cookies have been personally presented to the Chairman of the Joint Chiefs of Staff Gen. Richard B. Myers and President George W. Bush on two separate occasions. Both men were duly impressed and have thanked us for our efforts in supporting our troops. I am providing the enclosed cookies to you in recognition for your own service to our country.

The public thinks of our military during two specific times of the year; Veterans Day through the holidays, and May (Military Appreciation Month), Memorial Day, through July 4th. CCA has a special relationship with the founder of National Military Appreciation Month (NMAM), Ms. Alice A. Wax who also believes our military personnel deserve special National recognition.

CCA's problem is that in order to facilitate anything substantial, proper funding is critical and badly needed. Are there any DoD programs that might help the project and if so, where do I turn? I have literally spent ALL of my own money and need assistance to move the program forward.

Side Note (b)(6) Additionally, one of my brothers and West Point Graduate COL Steven J. Smith is now serving in Iraq with the 82nd Airborne as MNC-I Effects Deputy Commander. Colonel Smith is a veteran of the first gulf war and was also involved in 82nd Airborne assault during the removal of Panamanian President Manuel Noriega. Our family is very proud of him and we would be honored to know that you might stop in to see him on your next trip to Baghdad.

COL Steven J. Smith

MNC-I

(b)(6)

Thank you again, Mr. Secretary for your time. Do enjoy the cookies with your coffee or a cold glass of milk and know that I wish you and the fine people of our Armed Forces a successful year.

Sincerely,

Cliff Smith
President & Proud Brother of an Army Man

OSD 18577-05

11717 Stoney Peak Drive, Suite 18, San Diego, CA 92128-4212
Tel: 619-850-0864 | email: cliff@cookieclubofamerica.com | URL: www.cookieclubofamerica.com

11-L-0559/OSD/52114

Clifford J. Smith
President / Founder

Cookie Club of America, Inc.
11717 Stony Peak Dr., #18
San Diego, CA 92128-4212
Ph: 619-850-0864
email: cW&ookieclubofamerica.com
www.cookieclubofamerica.com



Supporting U.S. Troops Worldwide



USPS Official Licensed Product
Manufacturer / Distributor

SECRETARY OF DEFENSE CORRESPONDENCE ACTION REPORT

This form must be completed and forwarded to the Correspondence Control Division (CCD), WHS Room 3A548, Suspense Desk (b)(6) PAX Number (b)(6) Email: suspense_desk@osd.pentagon.mil

Action Agency PA

Suspense Date 27 Sep 2005

-
-
-
-
-
-

- b. REQUEST EXTENSION OF SUSPENSE DATE TO (Justify Below)
- c. INTERIM REPLY HAS BEEN SENT (Copy attached) Extend suspense to (Justify Below)
- d. REQUEST CANCELLATION (Justify below)
- e. REQUEST TRANSFER TO (Justify below / include POC Name & Phone Number)
- f. REQUEST DOWNGRADE TO (Justify Below)

*This is a duplicate of previous request.
Mr. John Cooper spoke with Mr. Cliff Smith following up on with
Ms. Tara Jones OASD/PA-CR&PL.*

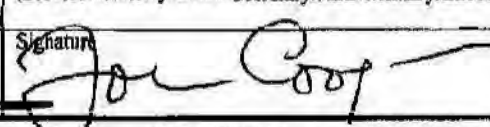
a. ACTION AGENCY <u>PA</u>		e. APPROVING AUTHORITY (Service Secretary/Under Secretary/ASD/Military/Executive Assistant Level)	
b. NAME OF ACTION OFFICER <u>John Cooper</u>		Signature 	Date Signed <u>2 Nov 05</u>
c. TELEPHONE NO. <input type="text"/>	5. ACTION TAKEN (For EXSEC/ Correspondence Control Division Use Only)		
d. DATE <input type="text"/>	a. EXT	<input type="checkbox"/> Approved	<input type="checkbox"/> Disapproved
4. CCD CONTROL # <u>OSD 18577-05</u>	b. CANX	<input type="checkbox"/> Approved	<input type="checkbox"/> Disapproved
	c. DWNGRD	<input type="checkbox"/> Approved	<input type="checkbox"/> Disapproved
	d. TRANSFER	<input type="checkbox"/> Approved	<input type="checkbox"/> Disapproved

SD FORM 391, JAN

B-18577-05

11-L-0559/OSD/52116

080

(11 Sep 05)



THE SECRETARY OF DEFENSE
WASHINGTON

NOV 7 2005

080

Mr. Clifford J. Smith
President and Founder
Cookie Club of America
11717 Stoney Peak Drive
Suite 18
San Diego, CA 92128-4212

Dear Mr. Smith,

Thank you for the letter and the Military Emblem Cookies you sent me. Your company, Cookie Club of America, is helping generate important support for the fine men and women in uniform.

Your brother has my gratitude for his service to our nation. Please know how much I appreciate your efforts to honor those who serve in our military.

Sincerely,

7 Nov 0

11 Sep 05

OSD 18577-05

Mr RANGEL:
THIS WAS TASKED TO
PA FOR APPROPRIATE ACTION
FOR THOSE, UNLESS THEY DRAFT
A LETTER FOR SD RESPONSE, I
NEED SEE WHAT THEY DO.
IN CAREERING, THEY HAVE DONE
NOTHING, WE ARE PUTTING MEAT ON
THEM, IN THE MEANTIME REC THE
LETTER M

Mr. Clifford J. Smith
President and Founder
Cookie Club of America
11717 Stoney Peak Drive
Suite 18
San Diego, CA 92128-4212

Dear Mr. Smith,

Thank you for the letter and the Military Emblem
Cookies you sent me. Your company, Cookie Club of
America, is helping generate important support for the fine
men and women in uniform.

I have asked our ^{support} Public Affairs ^{office} Department to look
into your ~~finding~~ questions and get back with you soon.

Your brother has my gratitude for his service to our
nation. Please know how much I appreciate your efforts to
honor those who serve in our military.

Sincerely,

CSC

Fix PLUS CHANGE
AS YOU MENTIONED IN
YOUR E-MAIL - GO SMOOZE

I think we should
remove this paragraph
based on attached
email re: PA's
contact of him
CSC 11/4

11/3
1230
Mr RANGEL:
WOULD LIKE TO DISCUSS
w/ YOU
M
Robert Rangel 11/3
OK
SSS
R.

Based on information provided
in PA's email (attached) -
I removed the paragraph re:
PA response & his finding
questions. Thx CSC 11/4

~~FOUO~~

SEP 13 2005

013

TO: Jim Haynes
FROM: Donald Rumsfeld 
SUBJECT: Lawsuit

What should I do about that wedding lawsuit? Should I get a personal attorney worrying about that? It certainly is connected to my job. What do you **think**?

Thanks.

DHR:ms
091205-20

.....
Please Respond By September 27, 2005

~~FOUO~~

OSD 18589-05

13 Sep 05

11-L-0559/OSD/52119



GENERAL COUNSEL

GENERAL COUNSEL OF THE DEPARTMENT OF DEFENSE
1600 DEFENSE PENTAGON
WASHINGTON, D. C. 20301-1600

OFFICE OF THE
SECRETARY OF DEFENSE

2005 SEP 14 PM 3:52

INFO MEMO

September 14, 2005 1:30 p.m.

013

FOR: SECRETARY OF DEFENSE

FROM: William J. Haynes II *WJ Haynes II*

SUBJECT: The "Wedding" Lawsuit

- The United States Attorney's office for the Southern District of Ohio reports that the case has been dismissed by the trial judge and that Ms. Jones has filed an appeal.
- We are also told that Ms. Jones told the clerk of court that she was going to send the suit and notice of appeal to the Washington Post.
- The Court of Appeals likely will dismiss the appeal. Should the Court require a pleading before dismissing the claim, I would expect to work with the U.S. Attorney's office in filing a pleading on your behalf.

14 Sep 05

Cc: Larry DiRita

13 Sep 05



11-L-0559/OSD/52120

OSD 18589-05

FOUO

September 13, 2005

2005 09 13 01:07:32

400 112

To: Robert Rangel

CC: (b)(6)

FROM: Donald Rumsfeld *DR*

SUBJECT: White Paper from George Shultz

I am expecting a white paper from *George Shultz* on monomolecular membrane.
Please be sure I see it when it arrives.

Thanks.

DHR:sp
091305-17

.....
Please respond by _____

13 Sep 05

FOUO

OSD 18601-05

11-L-0559/OSD/52121



VIA FACSIMILE

(b)(6)

OFFICE OF THE
SECURITY ASSISTANT
2005 09 -3 AM 10:18

GEORGE P. SHULTZ
THOMAS W. AND BILLY B. FORD
DISTINGUISHED FELLOW

September 28, 2005

Dear Don,

Peter Rodman and his team were out here yesterday and we had what I think was a good discussion of the issues involved in communicating with the world of Islam. Peter has a copy for you of the written material we used.

I also gave him a copy of a book on demographics that I think is very informative. I challenge you to put it in your briefcase sometime when you're going on a trip and take a little time to leaf through it. You will find it genuinely enlightening about how the future may unfold.

I enclose a white paper on desalinization and purification that I mentioned to you on the telephone. The essence is the invention of a nano-nuclear membrane that can be configured in a variety of ways depending on the problem. I think this is pretty exciting stuff that could have broad military and, of course, civilian use. Apparently China's interior ministry is anxious to get its hands on this out of concern for water purification.

With best wishes,

Sincerely yours,

George P. Shultz

The Honorable Donald Rumsfeld
US Secretary of Defense
U.S. Department of Defense
1000 Defense Pentagon, Room 3E880
Washington, D.C. 20330

Enclosure

WHITE PAPER

Nano-Molecular Membranes For Water Desalination and Purification

September 2005

Use and Disclosure of Data

This proposal includes data that shall not be disclosed outside the Government and shall not be duplicated, used, or disclosed -- in whole or in part -- for any purpose other than to evaluate this proposal. However, if a contract is awarded to this offeror as a result of -- or in connection with -- the submission of these data, the Government shall have the right to duplicate, use, or disclose the data to the extent provided in the resulting contract. This restriction does not limit the Government's right to use information contained in these data if they are obtained from another source without restriction. The data subject to this restriction are contained in Sheets 1-15 inclusive.

Agua Via, LLC

agua: water

via: way, path

AGUA VIA, LLC
330 Beach Road
Burlingame, California 94010
Contact: Gayle Pergamit
Phone: 650/227-7777
gayle@aguavia.com

Agua Via, LLC 330 Beach Road, Burlingame, California 94010 650-227-7777

1

Use or disclosure of data contained on this sheet is subject to the restriction on the title page of this proposal.

11-L-0559/OSD/52123

AGUA: water

VIA: way, path

SUMMARY : Based on nanotechnology research work begun in 1997, a novel filtration technology has been developed which has the promise of broadly revolutionizing water purification, water remediation and desalination costs, purity and delivery systems. This technology was designed from its inception to deal with the challenging environmental, performance and financial considerations of this held.

Desalination and water purification based on this Smart Membrane™ technology is anticipated to:

- Deliver **"full spectrum"** filtration: filtering against the full spectrum of contaminants and delivering only pure water.
- Operate under a virtually complete range of environmental conditions and handle a virtually **complete** range of feedstock water
- **Operate at the lowest energy** thermodynamically possible for purification - 1 psi. Systems can be gravity-driven.
- **Drop desalination costs by over 2/3rds** by operating at the **lowest energy** thermodynamically possible for desalination of brackish or seawater - 1 psi plus 10 degrees of temperature change
- Present the smallest footprint theoretically possible. A Smart Membrane filtration cube measuring 165mm (6.5 inches) per side could produce 100,000 gallons of purified water per day at 1 psi
- Be completely scalable from municipal systems to individual use in the field. Individual use for full spectrum filtration could be as simple as a 27" long tube over a filter cartridge, allowing gravity to do the work.
- **Drop** maintenance costs and requirements by the simplest maintenance and operation modes of "filter and forget"™ No cleaning, recharging, backflushing, etc.
- Provide reliability and robustness: purification with no moving parts (except at atomic scale.)
- Introduce potential non-fouling and non-scaling ability by using biological techniques that provide non-fouling filtration in nature
- Deliver commercially-competitive performance lifetimes
- Reduce the cost of desalination to approximately that of water purification
- Replace partial water purification with complete purification at no increased cost.

"Water, like energy in the late 1970s, will probably become the most critical natural resource issue facing most parts of the world by the start of this century:

• The Financial Times of London

SMART MEMBRANE IMPACTS.

This technology is anticipated to make a significant impact on world water crisis, and issues facing the U.S. at home and abroad including hostile contamination of water supplies.

Calculations indicate that these membranes could produce 205 gallons per square foot per day (gfd) operating at < 1 psi, and utilizing techniques other than high pressure to accommodate the osmotic gradient during desalination. At this filtration rate, high volume, high quality water purification and desalination could be provided within a small footprint: a Smart Membrane cube measuring 165mm (6.5 inches) per side could produce 100,000 gallons of purified water per day at 1 psi. For desalination, the cube would double in size and require 1 psi plus 10 degrees of temperature change.

The performance implications are:

- reduction in plant size and cost for both purification and desalination
- provide highest quality water purification at low cost
- eliminate the need for advance testing to identify contaminants.
- useful in a wide range of applications where size and energy are critical such as for peri-urban, rural or remote use off the power grid, emergency and military applications
- useful in a wide range of volume scales: from point of use solutions to small group or individual use in the field, mobile systems and municipal sizes systems in industrial, recreational, commercial, medical, agricultural, municipal, emergency and military settings
- can be packaged as low cost, reliable, low maintenance, easy to use systems which should even be applicable even in extreme rural environments.
- sufficiently low cost that it can be used for waste water remediation, elimination of endemic biologics (e.g., Giardia), toxic solutes (e.g., arsenic) or other pollutants in rural communities worldwide.
- With the complexity built in at the atomic level, the user deals only with simple processes require minimal training and maintenance
- simple and safe technology appropriate for critical environments such as submarines, space applications

It is estimated that purification applications using membranes will be demonstrable in 18 months, and desalination applications ready in approximately three years.

THE NATURE OF THE PROBLEM

Water quality and water quantity are now problems facing the U.S., the rest of the G8, plus the developing world. In natural disasters or operation in extreme environments, such as military encounters, these dual problems are exacerbated,

An abundant supply of high quality fresh water is essential as the basis for individual and community health, agricultural and industrial productivity and prosperity. Historically, the problems of water quality and quantity were considered issues of the developing world.

Agua Via, LLC 330 Beach Road, Burlingame, California 94010 650-227-7777

3

Use of disclosure of data contained in this sheet is subject to the restriction on the title page of this proposal.

Now, however, the definition of "the world water crisis" encompasses 68 countries. The global-wide scientific understanding is that we have reached the end of the era of abundant, cheap, clean groundwater. According to the World Bank, the health and economies of more than 80 countries are threatened by current water shortages. Within the next 15-20 years, that problem will extend worldwide, including the U.S.

Except for a few locales which receive their water exclusively from annual snow pack runoff or from year-round rain, most of the world's fresh water supply is stored underground in aquifers — areas of porous rock which hold water like a sponge. These reservoirs may take on the order of 100,000 to 300,000 years to fill. Higher populations, the irrigated agriculture to feed those populations, and growth of industry during the 20th and 21st centuries have meant increasing water withdrawals from aquifers. These withdrawals exceed the natural recharge provided by rainfall. The wells and pumps used to tap aquifers are drilled ever deeper to chase the falling water levels. This ongoing water debt is independent of reduction in rainfall due to climate change, or cyclical fluctuations in rainfall patterns such as those that caused the Dust Bowl.

Some examples:

- The U.S. Bureau of Reclamation predicts the exhaustion of the aquifers underlying the western and mid-western United States by 2025. These aquifers required an estimated 100,000 years of rainfall to fill.
- In India, water tables are dropping by 30 metres per year.
- The aquifer which provides Australia's fresh water is predicted for exhaustion within 10 years. It is estimated that this aquifer had taken 300,000 years to fill with water. Throughout the continent, rivers are turning saline. The city of Perth (population 4M) is building a 45gigaliter desalination plant to come online in Aug 2006.
- China has officially recognized that approximately 400 out of 600 cities are short of water.

Ogallala Aquifer

Ninety-five percent of the United States fresh water is underground. As farmers in the Texan High Plains pump groundwater faster than rain replenishes it, the water tables are dropping. North America's largest aquifer, the Ogallala, is being depleted at a rate of 12 billion cubic metres (bcm) a year. Total depletion to date amounts to some 325 bcm, a volume equal to the annual flow of 9 Colorado Rivers. The Ogallala stretches from Texas to South Dakota and waters one fifth of US irrigated land.
The BBC

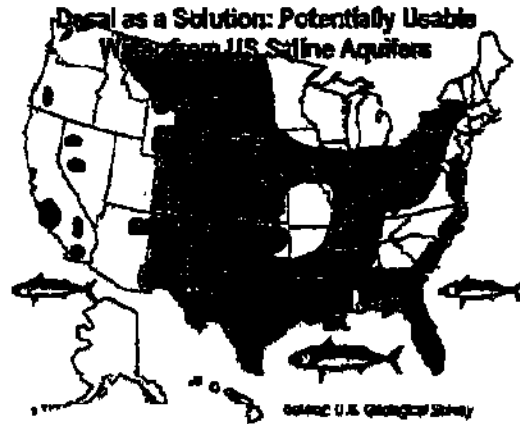
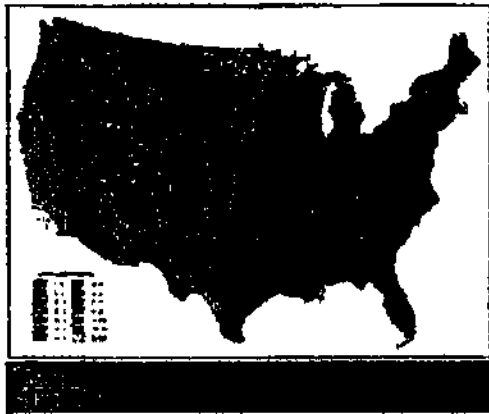

Fresh water could be acquired by "desalinating" high solute wastewater, or by desalinating seawater or the brackish water which underlies most continents. However, today this process is done using reverse osmosis technology whose high energy demands produce fresh water at a price which is 6 to 10 times that of purifying fresh water (not assuming any increase in energy prices from 2004). The impact of such cost increases on industry, which uses 20% of all water, and agriculture - which uses 70+% often at artificially low prices - would be significant.

In contrast, Smart Membrane technology is anticipated to provide desalination of waste water, brackish or seawater at a cost roughly equivalent to that of current fresh water purification.

WATER QUALITY ISSUES

Worldwide, 24% of all fresh water is now polluted and in countries such as China as much of 75% of all water is contaminated. New U.S. rules will require purification of these contaminants, at the cost of billions. Water quality issues derive in part from natural contamination from substances such as boron, bacterial and viral infestations, and from man-made contaminants. For example:

- man-made pollutants, such as chemicals from manufacturing operations, or product residue such as the MBTE which contaminates the Los Angeles water supply. Contamination may be accidental or deliberate, as in terrorist threat.
- bacteria and viruses. Bacteria or viral contamination is often discovered only after illness or fatalities are traced back to the water supply. To date, the largest U.S. problem resulting in disease and death involved 400,000 people in Michigan. Some bacteria and viruses have been further spread by human activity, such as the giardia and cryptosporidium contamination from livestock waste throughout rural US communities with farming operations. According to the EPA, approximately 95% of all U.S. municipalities are small systems serving populations of less than 5,000 and lacking resources to build improved their water purity. Terrorist scenarios envision deliberate contamination.

- novel bacteria and viruses. **Microbiologists** are now concerned about the threat from imported species. Preparation to test for, identify and treat to eliminate a **multitude** of potential new threats is not present.
- arsenic, boron, other **toxic minerals**. **Many** countries, including the US, are now acquiring data which indicates that their ground water contains unacceptable levels of arsenic or borates which cause disease over the long **term**. Although not at high enough levels to produce the immediate diseases and disfigurement seen in Bangladesh, the arsenic will cause **cancer** and other diseases over **time**. Within the U.S. scientific community, debate is now **underway** about the amount of arsenic contamination which will be accepted. Using current technology to clean water to the known safe levels is estimated to cost billions over acceptable budget levels.

Number of People at Risk From Arsenic Poisoning

US - unknown
 Mexico - 400,000
 Chile - 437,000
 Bolivia - 6,000
 Argentina - 2,000,000
 Hungary - 20,000
 Romania - 36,000
 India - 1,000,000
 Bangladesh - 50,000,000
 Thailand - 1,000
 Vietnam - millions
 Taiwan - 200,000
 China - 720,000
 Nepal - unknown
 Source - Jack Ng, University of Queensland, Australia

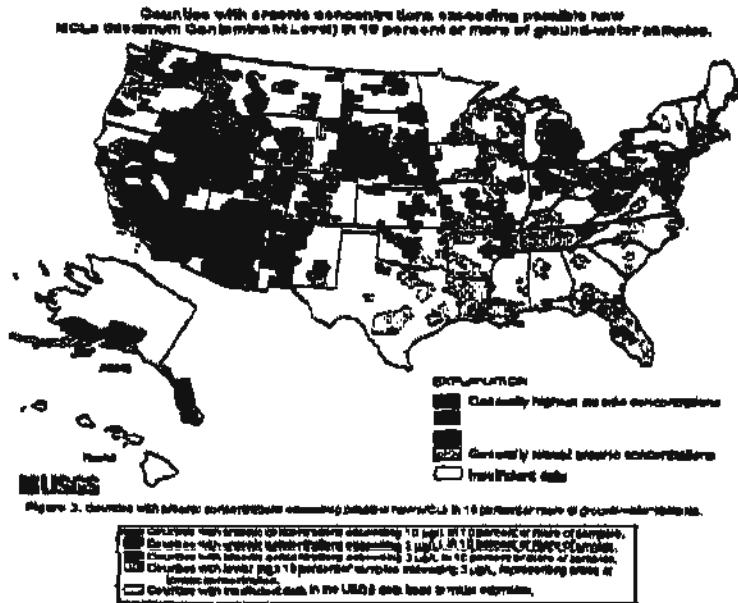

The processes for removing large contaminants from water are well established, efficient and low cost. But as the contaminants to be removed become smaller - as in CBW agents or salts - the cost rises, achieving levels which are not financially sustainable. At present, some levels of desired cleanliness are not attainable because the

problem exists. Municipal water systems usually have tremendous difficulty providing any improvement which increases costs.

Smart Membrane purification, providing full spectrum filtration, **does** not require identification of a new threat or higher cost to provide superior protection. It **does** not require the traditional higher energy used for filtration at the smallest end of the pollutant range. Yet it will provide water purer than that found in medical treatment centers. The definition of the desired potable water end product (water plus earth salts) means that other chemical or biological species are not allowed to pass the membrane. **No testing** is required to determine which chemical, biological or other species of threat is present. In this way, the highest purity water could be consistently provided in the "filter and forget" mode, **and** at no additional cost for the increased purity.

Agua Via products are anticipated to provide such full spectrum filtration to create good, potable water: eliminating all bacteria, viruses, parasites, cysts, amoebas, chemical and biologic warfare agents, poisons, toxins, arsenic, boron, spores of pathogens, nitrogenous waste from commercial fertilizer or excrement, heavy metals, etc. This includes the common problems of dysentery, typhoid, cholera, polio virus, or minerals such as arsenic and fluoride. Good water becomes available at low cost for all needs: drinking, sanitation, hygiene and waste water redemption. Adding Agua Via filtration to municipal systems would eliminate many contamination issues including the pervasive arsenic problem and the threat of contamination posed by terrorists

OTHER TECHNOLOGIES PROVIDE INCREMENTAL IMPROVEMENTS

Conventional technologies date from the 1800's (water purification) through the 1950's (reverse osmosis). Over the decades, conventional technologies have continued to make incremental gains as inventive engineers have found ways to extract bits of efficiency in creative ways. In some cases, such as multi-stage flash far desalination, take advantage of special circumstances, such as building a power plant and a water filtration plant together in order to use the abundant waste heat from the power plant. In general, however, these technologies have been out competed by membrane desalination technologies or conventional water purification techniques.

Water purification, end desalination are demanding applications in demanding environments. Experimental technologies which look good in limited performance environments in the lab commonly fail when tested in the field because of inability to deal with feedstock complexity, or other demands of the in-field environment. Adding the demanding financial requirements for water filtration or desalination can also eliminate a prospective technology or limits its use to a highly confined arena. Currently, carbon nanotubes are enjoying promotion as a water handling technology; they will have to face their limited adsorption capacity - after which small pollutants would just flow through, high manufacturing costs, lack of anti-fouling properties and attendant high maintenance costs to find any broad market acceptance.

In order to provide the necessary order of magnitude improvements to both costs and quality of filtration, truly new technology is needed that is capable of functioning in the demanding worlds of purification and desalination.

DEFINITION OF AN IDEAL PURIFICATION SOLUTION

- a Able to clean up the full spectrum of possible contaminants with a single technology
- Lowest energy thermodynamically possible for water purification, waste water remediation and desalination. In the field, no external power source required.
- a Technically simple and robust
- a Greatest non-fouling and non-scaling capability ever applied to water purification or desalination.
- No ongoing maintenance requirements: eliminating chemicals, backflushing, plant downtime
- a Low cost to manufacture.
- a Scalable from small point-of-use solutions (in the home or field) to handling large volume applications for urban water supplies.
- Long performance lifetime.
- Rapid purification of large volumes of water

SMART MEMBRANE TECHNOLOGY

The Smart Membrane core technology was designed from inception to provide ultra-specific filtration in rigorous real-world environments at the lowest energy and lowest total cost (infrastructure, maintenance, training, etc.) possible. Developing a technology capable of dealing with the highly complex set of issues involved in water purification and desalination was a key consideration in the basic design of Smart Membranes. The implication of working to the rigorous nanotechnology definition of "complete control at the atomic scale" provides unprecedented benefits in such areas as exquisite filtration specificity, high filtration performance, low energy requirements, non-fouling in the face of multiple complex feedstocks and the other criteria need to be an ideal solution to water purification and desalination needs.

Although a Smart Membrane is only a few atomic layers thick (.05-.22 nm), it consists of three distinct parts:

1. A protective top layer is designed to amplify non-fouling characteristics, amplify water ordering to further reduce energy costs, and extend the working life of the Smart Membrane. This protective layer can be custom engineered on an atom-by-atom level of design to provide a specificity previously found only in living systems. As a result, many of nature's successful anti-fouling strategies can be applied for the first time.

2. A one-atomic layer thick nanomembrane is directly under the protective top coating. This is where the work of filtration and separation is carried out. The nanomembrane is designed and built to provide only the desired end product - usually either potable water (water plus earth salts), or water that is completely salt free. This membrane eliminates anything other than the specific class of water that the customer wants. At one atomic layer thick, this membrane offers no impedance to flow.

The one-atom-thick nanomembrane is the key to the benefits which a Smart Membrane can deliver. Unlike the way conventional membranes are constructed through bulk

processes, each nanomembrane self-assembles from a collection of custom designed, pharmacologically-built pores.

Smart Membranes result from the creation of a new class of extremely selective, biomimetic Smart Pores™ which assemble into thin (0.5nanometer-22nanometer) porous nanomembranes. These porous monolayer membranes have specific structures that provide a low energy barrier to the passage of water or specific solutes, while providing a high barrier to other solutes. This technology shows highly specific molecular filtration at the atomic scale and profound transport properties such as exquisite ion selectivity characteristics.

Each pore has been designed and built with complete atomic precision in exactly the same way that a pharmaceutical is designed and built. Often the design of the pore's interior may mimic the active filtration portion in cell membrane proteins, such as aquaporin, nature's water channel. By eliminating the voluminous support structures in the natural aquaporin and building only the "business part" of the molecule, a Smart Pore can move water even faster than its natural counterpart.

Because of this tight atomic design control, a pore need not be built to merely exclude contaminants based on their size, but can also be built to eliminate classes of contaminants based on their complete chemical identity including atomic shape, electrical charge, hydrophobicity, hydrophilicity, etc. This demonstrated ability means, for example, that a complex, mixed waste stream including a wide range of 400,000 different contaminants, earth salts, urea and water can deliver just potable water (water and earth salts). The major technical achievement demonstrated here is that even though the urea (a known toxin) is smaller than the earth salts; urea is rejected based on its electronic characteristics rather than size.

The exterior of each pore has a distinct top, bottom and sides. Think of a Leggo block with a hole in the center. The hole does the filtering work, but the top, bottom and side attachment sites on the Leggo let it snap together with other Leggo blocks. The sides of the pores attach to each other to form the nanomembrane the way the sides of Leggo blocks snap together to form a plane.

On the top surface, this snap-on ability allows the precision building of the protective top layer (discussed above) which can be specifically designed to prevent bacterial fouling, scaling and other forms of fouling while also enhancing water ordering to further reduce energy demands.

On the bottom surface, the snap-on ability allows the pores in the nano-membrane to attach to a thicker, porous substrate.

3. The porous substrate. The porous substrate answers the question of how to handle a nanomembrane that is only one atomic layer thick. The porous substrate is a thin film, much like a thinner version of Saran Wrap, with a regular array of holes in it. The porous substrate is a passive, structural component. Its purpose is strictly to support the nanomembrane, allow for handling during manufacturing and contribute to the working lifespan of the membrane. The nanomembrane does the actual work of filtration: the porous substrate lets the water flow on through.

TECHNOLOGY-DERIVED BENEFITS

This basic technology enables the delivery the application-critical benefits, as exemplified in the following four key areas:

1. Ultra **specificity** in filtration
2. Low maintenance through non-fouling, non-scaling **characteristics**
3. Ultra small **device** footprint coupled with ultra high performance
4. Ultra **low Energy** requirements

1. Specificity. Previously, the ability to create potable **water** by removing urea, even though the urea is smaller than the earth **salts**, was described. This is an unprecedented technical achievement, and a strong demonstration of exquisite **control** over specificity of filtration. Because pores can be built to absolute specification – different **sizes**, shapes, charges, etc. – this **ability can** be tuned to **apply** specific filtration to any class of problem required.

Agua Via products are anticipated to provide such full spectrum filtration to create good, potable water: eliminating all bacteria, viruses, parasites, **cysts**, amoebas, chemical and biologic warfare agents, poisons, toxins, arsenic, boron, spores of pathogens, nitrogenous waste from commercial fertilizer or excrement, heavy metals, **nanobacteria**, etc. This includes the **common** problems of dysentery, typhoid, cholera, **polio virus**, or minerals such as arsenic and fluoride. Good water **becomes** available at low cost for **all** needs: drinking, sanitation, hygiene and waste **water** redemption. Adding Agua Via filtration to municipal systems would eliminate many contamination issues including the pervasive arsenic problem and the threat of contamination **posed** by terrorists.

2 **Low** Maintenance. A membrane, no matter, how perfect its ability to filter, is **useless** if it is dogged. Scale buildup in water with notable mineral content is one **such** problem. Bacteria **are** another **prime** problem: they attach to surfaces and form rock hard **biofilm** which impairs or ends **filter** performance. Conventional membranes are **backflushed** and bleached with harsh chemicals to **kill** bacteria or to **descale**; this requires plant downtime and creates maintenance expense.

The Smart Membrane's ability to **address** problem through specificity at *the* atomic **level** opens unprecedented opportunities to control these problems. For example, **the** technology of the Smart Membrane provides multiple strategies to defeat biofilm formation. Some strategies are at the level of the pores and nanomembrane, and others are employed by the **protective** top coating, creating a total anti-bacterial environment.

One **major** strategy of bacteria is to use the thread-like pili (**seen** here surrounding the main body of an E. coli bacterium) as grappling hooks to establish a **foothold** on a surface. But E. coli's pili, for example, measure 650 angstroms in diameter and **are** too big to snag onto any feature in a Smart Membrane. The pili are 100



times bigger than an individual pore's exterior of 65 angstroms, and 260 times bigger than a purification pore's interior dimensions of 25 angstroms.

Both the nanomembrane and the protective layer above it appear to these bacteria as absolutely smooth, featureless surfaces. The structures of both the protective layer and the nanomembrane are too small to be used by bacteria.

Laminar flow is also known to inhibit bacteria's ability to form biofilm. The environment bacteria encounter is optimized for laminar flow: they are swept along with no ability to attach to a surface.

Other bacteria do not use pili, but colonize by laying down a slime layer. But both classes of bacteria are known to have characteristics which can be used to inhibit biofilm formation. Both classes of bacteria prefer a hydrophobic surface on which to begin colonization. Bacteria are also known to be vulnerable to a range of anti-microbial chemical and pharmaceutical agents. Therefore, among the design requirements for the protective layer is to present a bacteria-hostile, hydrophilic surface studded with anti-microbial destruct points, and optimized for laminar flow.

This ability to design with atomic precision has never been available before. It means that many strategies for preventing fouling and scaling, or strategies for precision filtration are made available for the first time. In addition, this is setup up for continual filtration over a long life span. Unlike bucky tubes, activated charcoal or deionization media which ultimately saturate, a nanomembrane simply filters: undesirable classes of contaminants cannot pass through the membrane and are dumped to waste. Desirable pure filtrate water passes through the pore and is captured

3. Small Footprint, High Performance. Attached to their Saran-Wrap-like porous substrate, the complete Smart Membranes are only 0.5 microns thick, in contrast with conventional membranes which are 35 times thicker. Therefore, a huge amount of filtration capability fits into a very small footprint. Calculations indicate that one square foot of membrane could produce 205 gallons of purified water per day operating at 1 psi. At this filtration rate, high volume water purification could be provided within a small footprint: a Smart Membrane cube measuring 165mm (6.5 inches) per side could produce 100,000 gallons per day at 1 psi. A city of 5 Million people with a 600 giga-liter annual water need could be met with 5,000 such cubes.

4. Low Energy Requirements. Because these membranes are so thin, very little energy is required for their operations. Because these membrane structures are so thin, it is useful to think about them in quantum mechanical terms rather than classical fluid mechanical terms. Dr. William Dean of MIT has described these pores as "orifices" offering no impedance to flow, rather than as conventional "pores."

With low pressure drops across a nanomembrane 0.5 nanometers thick, high flux is produced at very low pressure differential. In fact, the impedance to flow is created by the porous substrate — although its job is to provide support, the rate limit on how fast water can be processed is how long it takes to flow through the "thick" substrate.

In the most energy efficient mode, a filtration cartridge would sit at the bottom of a tube with a 27" head of water. At 1 psi, gravity does the work to purify the water.

SMART MEMBRANES AND DESALINATION

The most expensive form of creating potable water or water completely lacking salt is desalination. Excluding any recent rise in the cost of energy, today desalination of seawater can cost over \$1,000US per acre-foot. Water with less salt in it (brackish water) costs less to dean because the lower salt content drops the amount of pressure required. Although Tampa Bay, Florida had once hoped to desalinate a mix of brackish water and seawater at a cost of only \$650US per acre-foot, the potential cost reduction was due to favorable financing terms, not technical breakthroughs. Even at Tampa Bay's target cost, this still leaves desalination open only to energy and cash rich countries of the First World and the Middle East.

The claims of dramatically lower cost desalination which used to be made by the Tampa Bay, Florida project are now being made by the Ashkelon project in Israel. These numbers, which have even been quoted by the Congressional Budget Office as reflecting the current price of desalination, are again based strictly on financing deals which have been described in the industry experts as brilliant." According to desalination experts within the U.S. Bureau of Redamation, these systems contain no technological contribution to increased efficiency. The true cost of desalination remains unchanged. In fact, Tampa Bay failed to meet its technical performance goals by 50% and is currently undergoing re-engineering.

Energy is the largest cost component of desalination: annually, energy casts generally match capital costs. A \$400M plant can expect to generate a \$400M annual energy bill, assuming no price increases for energy. A dominant percentage of the capital costs are also derived from the energy requirement, e.g., high pressure pumps, energy recovery systems.

The final stage of purification - in which the water and salt are separated - accounts for 99% of the energy cost. Of that energy cost, roughly 2/3rd is due to overcoming 1) the long and 2) tortuous path of the pores in conventional membranes. Only 1/3rd is due to overcoming the osmotic gradient of the salt.

The Smart Membrane's extreme thinness and lack of tortuous paths immediately eliminates the 2/3rd energy penalty experienced by conventional membranes. Significant as this cost reduction is, the impact of moving to a low-energy/low pressure mode ripples through the overall design of any water system, accounting for an additional reduction of both the capital cost and labor casts. Concomitantly, eliminating high pressure pumps, energy recovery systems (little wasted energy to recover), certain pretreatment systems, reducing system complexity and maintenance costs may provide overall cost reductions on the order of 60 or 70% for a Smart Membrane seawater desalination system.

SMART MEMBRANE TECHNOLOGY MODIFICATION AND DESALINATION

The differences between using a Smart Membrane for desalination, as opposed to water purification are:

1. For use in desalination, a smaller pore must be used than the basic water purification pore. A water purification pore can pass up to 4 water molecules at a time. For desalination, the pore must be capable of passing only 2 water molecules at a time.

Agua Via, LLC 330 Beach Road, Burlingame, California 94010 650-227-7777

12

Use or disclosure of data contained on this sheet is subject to the restriction on the title page of this proposal.

2. Further "snap on" chemistry must be used to overcome the osmotic gradient.
3. In addition to the 1 psi energy requirement, 10 degrees of temperature change would be needed
4. The footprint would expand: the equivalent of two 6.5" cubes would now be needed to provide 100,000 gallons of desalinated water, instead of one cube.

OVERCOMING OSMOTIC GRADIENT WITH A SMART MEMBRANE SYSTEM

Conventional desalination today uses reverse osmosis with thick polymer membranes. To push the water through the membrane and leave the salt behind requires pressures ranging from 180 psi (for use with brackish water) up to 1400 psi (for use with seawater). In each case, 2/3rds of the pressure is used to overcome the tortuosity and the thickness of the membranes. The remaining 1/3rd is to overcome the osmotic gradient: with salt water on one side of a membrane and fresh water on the other side, the more concentrated salt solution "wants" to pull more fresh water onto its side until the salt content is evenly balanced between both sides. In reverse osmosis, the additional pressure is placed on the salt side to push fresh water through the membrane and away from the salt.

Because of the Smart Membrane's extreme thinness, the penalty for overcoming the tortuosity and thickness of conventional membranes is eliminated. Therefore, 2/3rds of the pressure requirement and 2/3rds of the energy cost disappear.

This leaves the remaining issue of dealing with osmotic gradient and reducing its attendant costs. Recently, a different technique has been used to eliminate the need for high pressure in dealing with an osmotic gradient: forward osmosis. The most widely known example has been the DoD's use of the technique for rehydrating food packages or sports drinks using a warfighter's urine or waste water. In this technique, a contaminated solution (urine or unsafe water) is placed on one side of the membrane. Sugar is placed on the other side of the membrane. The sugar draws the liquid in the contaminated solution across the membrane until there is an osmotic balance between the two sides. The membrane, to the best of its ability, separates water from contaminants. The user now has a sports drink or a hydrated food package.

Note that this technique produces purified water, not desalinated water (water free from a high solute content).

The disadvantages of this technique which limit its usefulness are:

- unless the desired end product is a sports drink or a hydrated food package, the user now has water contaminated by sugar or some other substance which would require purification.
- once the sugar or food packet is used up, more sugar or another sorbent must be imported to process the next batch of water. This makes the technique expensive and impractical.
- As used today with conventional membranes, urea also passes along with the water and salts into the sports drink or hydrated food package. Urea is a known toxin, and too much exposure will cause kidney failure.

However, moved to a level of atomic precision, this forward osmosis technique can be modified to overcome its disadvantages and made useful for desalination. For desalination with a Smart Membrane, a reusable, high density ("thirsty") molecular sponge can be engineered and snapped onto the base of the Smart Membrane. The sponge would soak up water from the bottom of the pores until saturation is reached. A few degrees of temperature change would be required to "wring" the sponge out and release the water into the catch chamber. The sponge is now ready to soak up another batch of water. As abundantly demonstrated in nature, many other systems commonly load and release over prolonged lifetimes. By designing and building at the atomic scale, these systems can be borrowed and modified for use elsewhere.

SUMMARY

Smart Membranes represent a new technology based on building materials which mimic the way nature performs filtration, selection, and protection against biofilm and scale formation. This technology is anticipated to out perform any known or planned competitors. The benefits include operating in an ultra-low energy mode, and producing highly pure and highly specific filtration.

Smart Membrane technology is anticipated to be applicable and superior for applications in:

- Desalination applications, including both seawater and brackish water.
- Purification applications, ranging from high purity semiconductor, other industrial and medical uses through home drinking water.
- Remediation of both waste water and polluted ground water.

Their specific technical capabilities include:

- Unique "full-spectrum" filtration of any mix of contaminants in the water feedstock
- The highest purity possible
- The lowest cost possible
- The lowest energy requirements possible
- Extreme flexibility of capacity, from municipal scale to hand held units in the field, in an extremely small footprint. A 6.5" cube is anticipated to provide 100,000 gallons of purified water per day.
- "Filter and forget" robustness under tough conditions.

Applying Smart Membranes to the problems of water purification and desalination holds the potential to positively impact the world water crisis and the many dimension which water shortage or impure water represents: health, agricultural productivity, industrial

productivity, and conflict between nations. Because the **technology** combines high performance with **low total costs** (product costs, energy, infrastructure, maintenance, training, etc.), it is anticipated to **have major** impact at opposite ends of the spectrum

- 1. High Performance Venues.** In addition to water users with **high** purity demands, **such** as semiconductor manufacturers or medical applications, organizations such as the US **DoD** services, **whose** needs **encompass** and surpass those requirements **are** anticipated to **derive value from** Smart Membrane technology. The **DoD** **operates** in the **most extreme** environmental and **logistical** conditions, and is required to deal with the **fullest** array of water quality and water **quantity** problems. In addition, their operation is usually **subject** to the strictest footprint, weight, component resupply, volume **issues**, maintenance and **safety** requirements. The range is exemplified by the need for desalination and purification occurring everywhere from submarines at depth to individual warfighters on the ground facing C6W contaminated water, or no liquids at all expect for their own sweat and urine.
- 2. Low Cost/High Volume.** Municipal **systems** and point of use applications **both** in the US, and internationally are anticipated to be used by those seeking **higher** purity fresh water at **low cost**, or desalinated water **at** low cost to **cope** with **water** shortage. At a competitive price point, the **Smart** Membrane technology could provide cost-effective desalination to the American mid-west **as** well as cost-effective water purification against the problems **such** as arsenic, giardia, **etc.** Expressed interest in Smart Membranes has come from Australia, Singapore, China and India in addition to European parties. Introduction in some venues, such as the water-short Middle East, **may** assist in **reducing** tensions and increasing prosperity.

Various new paradigms of how water is delivered may well evolve, and with them new paradigms **for** living, conducting business or military operations. For example, municipal systems **may** become more widely **distributed**. Countries with substandard infrastructure may opt **for home** point of use systems to augment central **municipal** facilities. Military operations may be more flexible **once** the logistical burdens of water provision are lifted.

By combining high performance **with** **low** cost, Smart Membranes hold a potential solution to seemingly intractable problems involving water **quality** and water quantity.

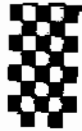

FACSIMILE

GEORGE P. SHULTZ
THOMAS W. AND SUSAN B. FORD
DISTINGUISHED FELLOW

To: The Honorable Donald Rumsfeld

Fax: (b)(6)

From: The Office of George P. Shultz

Date: September 28, 2005

Re: Agua Via Material

Pages to follow: 16

~~FOUO~~

SEP 13 2005
ZBS 15 07:32

400.112

TO: Robert Rangel
CC: (b)(6)
FROM: Donald Rumsfeld *DR*
SUBJECT: White Paper from George Shultz

I am expecting a white paper from George Shultz on monomolecular membrane;
Please be sure I see it when it arrives.

Thanks,

DR:cm
091305-17

.....
Please respond by _____

13 SEP 05

~~FOUO~~

OSD 18601-05

FOUO

RECEIVED THE
ADMIRAL

2005 OCT 13 11 29:38

August 30, 2005

320.2

TO: *Tina Jonas*
~~VADM Jim Stavridis~~

FROM: Donald Rumsfeld *DR*

SUBJECT: Jonas Memo on **Army** End Strength Increase

The attached memo does not contain enough information for me. Do the figures include equipment, training, other costs? **How** long does it take for these people to get on duty?

Please provide me with a more comprehensive look at **this** matter.

Thanks.

Attach: 8/12/05 USD COMPT memo to SecDef

DHR:as
082905-18

.....

Please Respond By 09/13/05

30 Aug 05

11-L-0559/OSD/52140

OSD 18613-05

FOUO



COMPTROLLER

UNDER SECRETARY OF DEFENSE
1100 DEFENSE PENTAGON
WASHINGTON, DC 20301-1100
INFO MEMO

OFFICE OF THE
FENSE

2005 AUG 15 AM 9:25

OH
8/25

August 12, 2005, 5:00 PM

Robert SECRETARY OF DEFENSE
& ACTING DEPUTY SECRETARY OF DEFENSE

e// FROM: Tina W. Jonas *MWJ*

SUBJECT: Army End Strength Increase

- Senators Lieberman and Clinton have introduced legislation (the "United States Army Relief Act of 2005") to increase the Army's active end strength.
- They may offer this legislation **as** a floor amendment to the Defense authorization bill.
- Their bill would add 100,000 troops to the Army by FY 09 (or 80,000 above the FY 05 authorized end strength of 502,400).
- **You** asked what this would cost per year, and whether Congress would include the funding (TAB A).
- The FY 06 cost is about \$10B, roughly **half** in recurring costs and half in one time costs. The total FY 06 to FY 09 cost is about \$63B (**details**, TAB B).
- The Leiberman/Clinton bill did not include funding, or propose a way to pay for the increased end strength.
- **Chairman** Warner's committee reported bill proposes a FY 06 Army end strength of 522,400 (+40,000) -- the same starting point **as** the Leiberman/Clinton bill .. and also did not authorize additional funding for the increase.
- The House Appropriations Committee did not include funds to increase Army end strength. The Senate Appropriations Committee has not completed **mark up**.

Egmont?
strength

COORDINATION None

Attachments:
As stated.

Copy to: ASD(LA), USD(P&R)

Prepared by: Ann Reese, (b)(6)

[Handwritten scribble]

MA SD	<i>8/19</i>	SMA DSD	
TSA SD	<i>8/15</i>	SA DSD	
EXEC SEC	<i>11/8/15</i>	<i>1140</i>	<i>8/16 1000</i>
ESR MA	<i>8/15</i>	<i>1130</i>	

11-L-0559/OSD/52141

OSD 15858-05

Summary of Cost Estimates by Fiscal Year

	FY 06	FY 07	FY 08	FY 09	
<u>Active Army end strength</u>					
Funded in FY 06 President's Budget	482,400	482,400	482,400	482,400	
Sen Clinton/Sen Lieberman proposal	522,400	542,400	562,400	582,400	
Difference	+40,000	+60,000	+80,000	+100,000	
<u>Rough cost estimate (\$ in billions)</u>					Total
Recurring costs					
Pay, allowances and benefits	\$26	\$4.1	\$5.6	\$7.2	\$19.5
Support (recruiting, training, etc.)	\$1.9	\$2.5	\$3.2	\$3.8	\$11.4
Subtotal	\$4.5	\$6.6	\$8.8	\$11.0	\$30.9
One time costs					
Infrastructure (MilCon, housing, etc.)	\$5.4	\$5.5	\$5.6	\$5.7	\$22.2
Equipping (weapons, ammunition, etc.)	\$0.0	\$2.2	\$3.5	\$4.3	\$10.0
Subtotal	\$5.4	\$7.7	\$9.1	\$10.0	\$32.2
Total	\$9.9	\$14.3	\$17.9	\$21.0	\$63.1



UNDER SECRETARY OF DEFENSE
1100 DEFENSE PENTAGON
WASHINGTON, DC 20301-1100

SEP 14 2005 9:39

INFO MEMO

COMPTROLLER

September 14, 2005, 12:00 PM

3202

FOR: SECRETARY OF DEFENSE
ACTING DEPUTY SECRETARY OF DEFENSE

FROM: Tina W. Jonas *TWJ*

SUBJECT: Memo on Army End Strength Increase Proposed in the Senators
Lieberman and Clinton Legislation

- You asked for a more comprehensive look at what the cost figures include for the Army end strength increase and how long it will take to get the additional people on duty. (TAB A)
- The FY 2006 cost is \$9.9 billion. There are no equipment costs in the first year. Included are \$0.6 billion for training, \$5.4 billion for infrastructure, and \$2.6 billion for pay and allowances. Attached is a table that displays all cost categories. (TAB B)
- The total FY 2006–FY 2009 cost is \$63.1 billion. This includes \$10.1 billion for equipment, \$4.2 billion for training, \$22.2 billion for infrastructure, and \$19.5 billion for pay and allowances.
- The proposed legislation phases the increased end strength over a 4-year period from FY 2006 to FY 2009, with increases of 20K people per year.
 - The Army anticipates that it can increase its end strength by an additional 5K to 6K personnel per year based on historical recruiting trends.
 - At this rate, it would take several years instead of 4 years to reach the 582.4K end strength floor proposed in the legislation.

14 Sep 05

COORDINATION: None

Attachments:
As stated

Prepared by: Ann Reese, (b)(6)

30 Aug 05

OSD 18613-05

**Summary of Army End Strength Changes
and Cost Estimates by Fiscal Year**

	<u>(End Strength)</u>			
<u>Active Army Manpower</u>	<u>FY 2006</u>	<u>FY 2007</u>	<u>FY 2008</u>	<u>FY 2009</u>
Funded in FY 06 President's Budget	482,400	482,400	482,400	482,400
Sen Clinton/Sen Lieberman proposal	<u>522,400</u>	<u>542,400</u>	<u>562,400</u>	<u>582,400</u>
Proposed Increase for Active Military	40,000	60,000	80,000	100,000

	<u>(\$ in Millions)</u>				
<u>Funding</u>	<u>FY 2006</u>	<u>FY 2007</u>	<u>FY 2008</u>	<u>FY 2009</u>	<u>Total</u>
<u>Recurring Costs</u>					
Pay and Allowances	2.6	4.1	5.6	7.2	19.5
Recruiting and Advertising	0.8	0.8	0.8	0.7	3.1
Training	0.6	0.9	1.2	1.5	4.2
Base Operations and Support	<u>0.5</u>	<u>0.8</u>	<u>1.2</u>	<u>1.5</u>	<u>4.0</u>
Total Recurring Costs	4.5	6.6	8.8	10.9	30.8
<u>Infrastructure and Equipment Costs</u>					
Installation Infrastructure	5.4	5.5	5.6	5.7	22.2
Equipping Costs	<u>-</u>	<u>2.3</u>	<u>3.5</u>	<u>4.3</u>	<u>10.1</u>
Total Infrastructure & Equipment	5.4	7.8	9.1	10.0	32.3
Total Funding	9.9	14.4	17.9	20.9	63.1

~~FOUO~~

305/011054
ES-3963

2005 08 15 10:11:52

August 15, 2005

TO: David Chu

CC: Gordon England
Eric Edelman
Fran Harvey
Pete Geren

FROM:

SUBJECT: DoD Exchange Programs

I think one of the best things we do is exchanges of military people and career civilians. We ought to think through what additional exchange programs we could fashion, that would develop relationships between the up-and-comers who are mid-level, who would then move onward and upward over the decades and would have the kind of relationships that developed as a result of people coming to our war colleges, and Leavenworth and the like.

One other thought would be to piggy-back on exchange programs and bring in outfits like the Eisenhower Exchange Program or maybe some other U.S. Government Department's program. These folks could come to the Pentagon for some period and make that part of their experience.

Please put together a group of people and give some thought as to how we might do this in a way that might benefit our country. This is clearly one of the most important things we could do in terms of public diplomacy.

Thanks.

DHR.ss
081505-08

.....
Please Respond By 09/07/05

FOUO

OSD 18640-05

11-L-0559/OSD/52145

INFO MEMO

2005 SEP 13 11:52

A/DcpSecDef _____

I-05/011054

ES-3963

FOR SECRETARY OF DEFENSE

FROM: Eric Edelman, Under Secretary of Defense for Policy

 SEP 14 2005

SUBJECT: Exchange Programs

- Your notes (attached) highlight the value of exchange and education programs, particularly those that bring foreign military and civilians to our institutions.
- Your ideas have been driving our efforts with the DoD Regional Centers to expand their target audiences and strengthen their alumni programs.
- We have a legislation proposal on the Hill that would authorize DoD to include non-government participants (such as those from the disaster/humanitarian relief communities, foreign think tanks, media, etc.) in Regional Center programs.
 - This approach would put U.S. military and civilian officials in a common venue with U.S. and foreign government and non-government counterparts.
 - We also are working to increase State Department participation in these programs – representatives from Public Diplomacy and Political-Military Affairs participated in last month's Regional Centers Directors' Roundtable.
 - In addition, we are contacting the Eisenhower Fellowships program to explore opportunities for introducing their fellows to the Regional Centers.
- Incorporating these other critical audiences into the "communities of influence" we are building through the Regional Centers' alumni programs will be key to the Centers' outreach efforts.
- I have begun talking with David Chu on ways to expand other DoD exchange programs.

Attachments: As stated

Prepared by: John Kreul, OSD(P)/Strategy, (b)(6)

11-L-0559/OSD/52146

OSD 18640-05

TAB (A)

~~FOUO~~
OFFICE OF THE
SECRETARY OF DEFENSE
2005 SEP 15 AM 11: 52

JOS/011054
ES-3963

August 15, 2005

TO David Chu
CC: Gordon England
Eric Edelman
Fran Harvey
Pete Geren

FROM

SUBJECT: DoD Exchange Programs

I **think** one of the best things we do is exchanges of military people and **career** civilians. We ought to think through what additional exchange programs we could fashion, that would develop relationships between the up-and-comers who are mid-level, who would then move onward and upward over the decades and **would** have the kind of relationships that developed as a result of people coming to **our war** colleges, and Leavenworth and the like.

One other thought would be to piggy-back **on** exchange programs and bring in outfits **like** the Eisenhower Exchange Program or maybe some **other U.S.** Government Department's program. These folks could come to the Pentagon for some period and make that part of their experience.

Please put together a group of people and give some thought **as** to how we might do this in a way that might benefit **our** country. This is clearly one of the most important **things** we could do in terms of public diplomacy.

Thanks.

DHR:as
081503-08

.....
Please Respond By 09/07/05

~~FOUO~~

OSD 18640-05

11-L-0559/OSD/52148

HOLD



LEGISLATIVE
AFFAIRS

THE ASSISTANT SECRETARY OF DEFENSE

WASHINGTON, DC 20301-1300

OFFICE OF THE
ASSISTANT SECRETARY OF DEFENSE

2005 OCT -7 PM 4:19

ACTION MEMO

October 6, 2005, 1200 p.m.

FOR: SECRETARY OF DEFENSE

FROM: Daniel R. Stanley, Assistant Secretary of Defense
for Legislative Affairs (b)(6)

SUBJECT: Response to Snowflake, Secretary of Defense

- **You** requested for answers to Representatives Clyburn and Jackson Lee following your September 6th briefing to Members of Congress on Hurricane Katrina. (Tab A).
- Representative Clyburn (D-SC) told you that a non-military evacuee family had moved in with a soldier at Fort Jackson, SC, and their children had been refused admittance to the DoD Dependant School on base at Fort Jackson. The Undersecretary of Defense for Personnel and Readiness rectified the situation. The children **are** enrolled in the on base school and have been attending since Monday, September 12th. We have been in touch with Representative Clyburn (personally and with his Chief of Staff) and kept him updated on the situation. Personnel and Readiness is working on a policy to address similar future situations should they arise at other installations with DoD Dependant Schools.
- Rep. Sheila Jackson Lee (D-TX) asked you questions concerning sheltering displaced persons on DoD installations in the wake of Hurricane Katrina. Her questions and the answers follow:
 - Q: What law allows for sheltering displaced persons on DoD installations?
 - A Title 10, Sec. 2556 "*Shelter for Homeless; Incidental Services.*"
 - Q: Is the DoD sheltering displaced persons on DoD installations?
 - A Yes. Examples include NSA New Orleans, NAS Meridian and NAS Pascagoula.
- **This** information was provided to Rep. Jackson Lee on Friday, September 9th and to ~~her~~ Deputy Chief of Staff on September 12th.

032

6 Oct 4

12 Sep 5

OSD 18941-05

11-L-0559/OSD/52149

- Non-DoD Evacuees consist of non-dependant family members who have been sponsored onto base by DoD members, general population evacuees invited onto National Guard bases by the State Governors, and evacuees who have had a prior relationship with the Department of Defense.

RECOMMENDATION: Sign the attached response letters to Representatives Clyburn and Jackson Lee (Tab B)

Attachments:

Tab A - Snowflake#091205-34

Tab B - Responses to **Reps. Clyburn and Lee**

Prepared by: LTC **Roger D. Carstens/OSD (LA)** (b)(6)

11-L-0559/OSD/52150

~~FOUO~~

September 12, 2005

TO: Dan Stanley
FROM: Donald Rumsfeld *DR.*
SUBJECT: Responses to Congressional Members

I've got to get the answers back to folks on the Hill who were so angry that night.
I would like to see who asked the questions, and my answers to them in draft form.

Thanks.

DHR:sl
091205-34

.....
Please Respond By 09/20/05

~~FOUO~~

11-L-0559/OSD/52151

OSD 18941-05



SECRETARY OF DEFENSE
1000 DEFENSE PENTAGON
WASHINGTON, DC 20301-1000

The Honorable Sheila Jackson-Lee
United States House of Representatives
Washington, DC 20515

Dear Representative Jackson Lee:

During the September 6th briefing to Members of Congress on Hurricane Katrina relief efforts, you asked me what law allows for the sheltering of displaced persons on Department of Defense installations and whether or not we were doing so.

Although not invoked, Title 10, Sec. 2556 "*Shelter for Homeless; Incidental Services*," provides authority for the sheltering of displaced persons on DoD installations. We are currently housing persons displaced by Hurricane **Katrina** on military bases throughout the United States. Those evacuees consist of non-dependant family members who have been sponsored onto base by DoD members, general population evacuees invited onto National Guard bases by the State Governors, and evacuees who have had a prior relationship with the Department of Defense.

I appreciate your continuing support for the U.S. Armed Forces.

Sincerely,



SECRETARY OF DEFENSE
1000 DEFENSE PENTAGON
WASHINGTON, DC 20301-1000

The Honorable James Clyburn
United States House of Representatives
Washington, DC 20515

Dear Representative Clyburn:

During the September 6th briefing to Members of Congress on Hurricane Katrina relief efforts, you alerted me to a situation at Fort Jackson, S.C., in which Hurricane Katrina evacuee children were refused admittance to the on-base DoD school because they were not "authorized dependant children."

The Department of Defense, working through our DoD Education Activity (DODEA), rectified the situation. The children are enrolled in the on-base school and have been attending since Monday, September 12.

The Department of Defense is currently working on a policy to address similar future situations should they arise at other installations with DoD Dependant Schools.

I appreciate your continuing support for the U.S. Armed Forces.

Sincerely,



11-L-0559/OSD/52153



LEGISLATIVE
AFFAIRS

THE ASSISTANT SECRETARY OF DEFENSE
WASHINGTON, DC 20301-1300

CLASSIFIED
SECRET

205 227 -4 44 6 31

ACTION MEMO

October 3, 2005, 1200 p.m.

FOR: SECRETARY OF DEFENSE

FROM: Daniel R. Stanley, Assistant Secretary of Defense
for Legislative Affairs (b)(6)

SUBJECT: Response to Snowflake, Secretary of Defense

- You requested for answers to Representatives Clyburn and Jackson Lee following your September 6th briefing to Members of Congress on Hurricane Katrina. (Tab A).
- Representative Clyburn (D-SG) told you that a non-military evacuee family had moved in with a soldier at Fort Jackson, SC, and their children had been refused admittance to the DoD Dependant School on base at Fort Jackson. The Undersecretary of Defense for Personnel and Readiness rectified the situation. The children are enrolled in the on base school and have been attending since Monday, September 12th. We have been in touch with Representative Clyburn (personally and with his Chief of Staff) and kept him updated on the situation. Personnel and Readiness is working on a policy to address similar future situations should they arise at other installations with DoD Dependant Schools.
- Rep. Sheila Jackson Lee (D-TX) asked you questions concerning sheltering displaced persons on DoD installations in the wake of Hurricane Katrina. Her questions and the answers follow:
 - Q: What law allows for sheltering displaced persons on DoD installations?
 - A: Title 10, Sec. 2556 "Shelter for Homeless; Incidental Services."
 - Q: Is the DoD sheltering displaced persons on DoD installations?
 - A Yes. Examples include NSA New Orleans, NAS Meridian and NAS Pascagoula.
- This information was provided to Rep. Jackson Lee on Friday, September 9th and to her Deputy Chief of Staff on September 12th.

OSD 18941-05

11-L-0559/OSD/52154

RECOMMENDATION: Sign *the* attached response letters to ~~R~~ ~~ves~~
Clyburn and Jackson Lee (Tab B)

Attachments:

Tab A - Snowflake #091205-34

Tab B - Responses to ~~Reps.~~ Clyburn and Lee

Prepared by: LTC Roger D. Carstens/OSD(LA) (b)(6)

11-L-0559/OSD/52155

~~FOUO~~

September 12, 2005

TO: Dan Stanley

FROM: Donald Rumsfeld *D.R.*

SUBJECT: Responses to Congressional Members

I've got to get the answers back to folks on the Hill who were so angry that night. I would like to see who asked the questions, and my answers to them in draft form.

Thanks.

DHR:js
091205-34

.....
Please Respond By 09/20/05

FOUO

11-L-0559/OSD/52156



SECRETARY OF DEFENSE
1000 DEFENSE PENTAGON
WASHINGTON, DC 20301-1000

The Honorable J a m Clyburn
United States House of Representatives
Washington, DC 20515

Dear Representative Clyburn:

During the September 6th briefing to Members of Congress on Hurricane Katrina relief efforts, you alerted me to a situation at ~~Fort~~ Jackson, S.C., in which Hurricane Katrina evacuee children were refused admittance to the on-base DoD school because they were not "authorized dependant children."

The Department of Defense, working through our DoD Education Activity (DODEA), rectified the situation. The children are enrolled in the on-base school and have been attending since Monday, September 12.

The Department of Defense is currently working on a policy to address similar future situations should they arise at other installations with DoD Dependant Schools.

I appreciate your continuing support for the U.S. Armed Forces.

Sincerely,



11-L-0559/OSD/52157



SECRETARY OF DEFENSE
1000 DEFENSE PENTAGON
WASHINGTON, DC 20301-1000

The Honorable Sheila Jackson Lee
United States House of Representatives
Washington, DC 20515

Dear Representative Jackson Lee:

During the September 6th briefing to ~~Members~~ of Congress on Hurricane Katrina relief efforts, you asked me what law allows for the ~~sheltering~~ of ~~displaced~~ persons on Department of Defense installations and whether or not we were doing so.

Although not invoked, Title 10, Sec. 2556 "*Shelter for Homeless; Incidental Services*," provides authority for the sheltering of displaced persons on DoD installations. We are currently housing persons displaced by Hurricane Katrina on military bases throughout the United States.

I appreciate your continuing support for the U.S. Armed Forces.

Sincerely,



11-L-0559/OSD/52158



LEGISLATIVE
AFFAIRS

THE ASSISTANT SECRETARY OF DEFENSE

WASHINGTON, DC 20301-1300

OFFICE OF THE
SECURITY COUNSEL

ACTION MEMO

205 SEP 26 PM 12:43

September 22, 2005, 1400p.m.

FOR: SECRETARY OF DEFENSE

FROM: Daniel R. Stanley, Assistant Secretary of Defense
for Legislative Affairs (b)(6)

SUBJECT: Response to Snowflake, Secretary of Defense

- You requested for answers to Representatives Clyburn and Jackson Lee following your September 6th briefing to Members of Congress on Hurricane Katrina. (Tab A).
- Representative Clyburn (D-SC) told you that a non-military evacuee family had moved in with a soldier at Fort Jackson, SC, and their children had been refused admittance to the DoD Dependant School on base at Fort Jackson. The Undersecretary of Defense for Personnel and Readiness rectified the situation. The children are enrolled in the on base school and have been attending since Monday, September 12th. We have been in touch with Representative Clyburn (personally and with his Chief of Staff) and kept him updated on the situation. Personnel and Readiness is working on a policy to address similar future situations should they arise at other installations with DoD Dependant Schools.
- Rep. Sheila Jackson Lee (D-TX) asked you questions concerning sheltering displaced persons on DoD installations in the wake of Hurricane Katrina. Her questions and the answers follow:
 - Q: What law allows for sheltering displaced persons on DoD installations?
A Title 10, Sec. 2556 "~~Shelter for~~ Homeless; Incidental Services."
 - Q: Is the DoD sheltering displaced persons on DoD installations?
A: Yes. Examples include NSA New Orleans, NAS Meridian and NAS Pascagoula.
- This information was provided to Rep. Jackson Lee on Friday, September 9th and to her Deputy Chief of Staff on September 12th.

OSD 18941-05

11-L-0559/OSD/52159

RECOMMENDATION: Sign the attached response letters to Representatives Clyburn and Jackson Lee (Tab B)

Attachments:

Tab A - Snowflake#091205-34

Tab B - Responses to Reps. Clyburn and Lee

Prepared by: LTC Roger D. Carstens/OSD (LA) (b)(6)

11-L-0559/OSD/52160

FOUO

September 12, 2005

TO: Dan Stanley

FROM: Donald Rumsfeld *D.R.*

SUBJECT: Responses to Congressional Members

I've got to get the answers back to folks on the Hill who were so angry that night.
I would like to see who asked the questions, and my answers to them in ~~draft~~ form.

Thanks.

DHR:as
091205-34

.....
*Please Respond **By** 09/20/05*

FOUO

11-L-0559/OSD/52161



SECRETARY OF DEFENSE
1000 DEFENSE PENTAGON
ASHINGTON, DC 20301-100

The Honorable Sheila Jackson Lee
U.S. House of Representatives
Washington, DC 20515

Dear Representative Jackson Lee:

During the September 6th briefing to Members of Congress on Hurricane Katrina relief efforts, you asked me what law allows for the sheltering of displaced persons on Department of Defense installations and whether or not we were doing so.

Title 10, Sec. 2556 "*Shelter for Homeless; Incidental Services*," provides for the sheltering displaced persons on DoD installations. We **are** currently housing persons displaced by Hurricane Katrina on military bases throughout the United States.

I appreciate your continuing support for the U.S. Armed Forces.

Sincerely,



11-L-0559/OSD/52162



THE SECRETARY OF DEFENSE
1000 DEFENSE PENTAGON
WASHINGTON, DC 20301-1000



The Honorable James Clyburn
U.S. House of Representatives
Washington, DC 20515

Dear Representative Clyburn:

During the September 6th briefing to Members of Congress on Hurricane Katrina relief efforts, you alerted me to a situation at Fort Jackson, S.C., in which Hurricane Katrina evacuee children were refused admittance to the on-base DoD school because they were not "authorized dependant children."

The Department of Defense, working ~~through~~ our DoD Education Activity (DODEA), rectified the situation. The children are enrolled in the on base school and have been attending since Monday, September 12.

The Department of Defense is currently working on a policy to address similar future situations should they arise at other installations with DoD Dependant Schools.

I appreciate your continuing support for the U.S. Armed Forces.

Sincerely,



11-L-0559/OSD/52163



LEGISLATIVE AFFAIRS

THE ASSISTANT SECRETARY OF DEFENSE

WASHINGTON, DC 20301-1300

September 20, 2005, 1400 p.m.

RESPONSE TO SNOWFLAKE FOR THE SECRETARY OF DEFENSE

FROM: Daniel R. Stanley, Assistant Secretary of Defense for Legislative Affairs (b)(6)

[Handwritten signature of Daniel R. Stanley]

Request: "I've got to get the answers back to folks on the Hill who were so angry that night. I would like to see who asked the questions, and my answers to them in draft form."

- Representative Clyburn (D-SC) told you that a non-military evacuee family had moved in with a soldier at Fort Jackson, SC, and their children had been refused admittance to the DoD Dependent School on base at Fort Jackson. The Undersecretary of Defense for Personnel and Readiness rectified the situation. The children are enrolled in the on base school and have been attending since Monday, September 12. We have been in touch with Representative Clyburn (personally and with his Chief of Staff) and kept him updated on the situation. Personnel and Readiness is working on a policy to address similar future situations should they arise at other installations with DoD Dependent Schools.
• Rep. Sheila Jackson Lee (D-TX) asked you questions concerning sheltering displaced persons on DoD installations in the wake of Hurricane Katrina. Her questions and the answers follow:

Q: What law allows for sheltering displaced persons on DoD installations?

A: Title 10, Sec. 2556 "Shelter for Homeless; Incidental Services."

Q: Is the DoD sheltering displaced persons on DoD installations?

A: Yes. Examples include NSA New Orleans, NAS Meridian and NAS Pascagoula.

- This information was provided to Rep. Jackson Lee on Friday, September 9 and to her Deputy Chief of Staff on September 12.

Attachments:

Snowflake #091205-34

* Draft Responses to Reps. Clyburn and Lee

Prepared by: LTC Roger D. Carstens/OSD (LA) (b)(6)

OSD 18941-05

11-L-0559/OSD/52164

Handwritten routing table with columns: ESR/MA, EXEC/SEC, TSA/SD, MA/SD, SA/OSD, SMA/OSD. Includes handwritten dates and initials.



THE SECRETARY OF DEFENSE
WASHINGTON, THE DISTRICT OF COLUMBIA

I The Honorable Sheila Jackson Lee
United States House of Representatives
Washington, DC 20515

Dear Ms. Jackson Lee:

During the September 6th briefing to Members of Congress on Hurricane Katrina relief efforts, you asked me what law allows for the sheltering of displaced persons on Department of Defense installations and whether or not we were doing so.

Title 10, Sec. 2556 "*Shelter for Homeless, Incidental Services*," provides for the sheltering displaced persons on DoD installations. We are currently housing persons displaced by Hurricane Katrina on military bases throughout the United States.

I appreciate your continuing support for the U.S. Armed Forces

Sincerely,



THE SECRETARY OF DEFENSE
WASHINGTON, THE DISTRICT OF COLUMBIA

The Honorable James Clyburn
United States House of Representatives
Washington, DC 20515

Dear Mr. Clyburn:

During the September 6th briefing to Members of Congress on Hurricane Katrina relief efforts, you alerted me to a situation at Fort Jackson, S.C., in which Hurricane Katrina evacuee children were refused admittance to the on-base DoD school because they were not "authorized dependant children."

The Department of Defense, working through our DoD Education Activity (DODEA), rectified the situation. The children are enrolled in the on base school and have been attending since Monday, September 12.

The Department of Defense is currently working on a policy to address similar future situations should they arise at other installations with DoD Dependant Schools.

I appreciate your continuing support for the U.S. Armed Forces.

Sincerely,

DRAFT

The Honorable Sheila Jackson Lee
United States House of Representatives
Washington, DC 20515

Dear Representative Jackson Lee:

During the September 6th briefing to Members of Congress on Hurricane Katrina relief efforts, you asked me what law allows for the sheltering of displaced persons on Department of Defense installations and whether or not we are doing so.

Title 10, Sec. 2556 "*Shelter for Homeless; Incidental Services*," provides for the sheltering of displaced persons on DoD installations. In accordance with this authority and consistent with our commitment to support the national response to this disaster, we are currently housing persons displaced by Hurricane Katrina on military bases throughout the United States.

I appreciate your continuing support of the U.S. Armed Forces.

Sincerely,

11-L-0559/OSD/52167

DRAFT

The Honorable James Clyburn
United States House of Representatives
Washington, DC 20515

Dear Representative Clyburn:

During the September 6th briefing to Members of Congress on Hurricane Katrina relief efforts, you alerted me to a situation at Fort Jackson, S.C., in which Hurricane Katrina evacuee children were refused admittance to the on-base DoD school because they were not "authorized dependent children."

The Department of Defense, working through our DoD Education Activity (DODEA), rectified the situation. The children are enrolled in the on base school and have been attending since Monday, September 12.

The Department of Defense is currently working on a policy to address similar future situations should they arise at other installations with DoD Dependent Schools.

I appreciate your continuing support for the U.S. Armed Forces.

Sincerely,

11-L-0559/OSD/52168

FOUO

THE
SECURITY

2005 08 16 AM 11: 52

August 16, 2005

TO: David Chu

CC: Fran Harvey
Gordon England
Pete Geren

FROM: Donald Rumsfeld *DR*

SUBJECT Exchange Programs

Given the value that comes from exchange programs, and training in **OW country** (and elsewhere), I wonder if we ought to:

- come up with a way *to* expand those programs
- consider ways of reducing costs to other countries
- consider ways we can stay in touch with the people who have **graduated** ~~from~~ those efforts, and develop alumni organizations that we then **stay** in touch with

Thanks.

DIR:ss
081505-60

.....
Please Respond By September 07, 2005

OSD 18641-05

11-L-0558/OSD/52169

FOUO
2005 08 19 15:04:02

ES-3990
05/011242

AUG 19 2005

TO ~~Eric Edelman~~
FROM Donald Rumsfeld *TR*
SUBJECT: Article 98 Agreements

Please get me the complete status of our Article 98 agreements around the world.

- How many countries have completed them, and how many countries are there in the world?
- Do we now have more Article 98 agreements than countries that have ratified the Treaty itself?
- Where should we be working hardest to complete agreements, and what else do we need to be doing?

Let's keep the pressure on!

Thanks.

DHR:dh
081805-075

.....
Please respond by September 8, 2005

OSD 18642-05

FOUO

10-05-05 13:03 IN

11-L-0559/OSD/52170

~~FOR OFFICIAL USE ONLY~~

OFFICE OF THE
SECRETARY OF DEFENSE
205 15 51 2 01

A/DSD
USDP *Ze*
1-05/011242 EP 1 4 2005
ES-3990

RLS
9/19

INFO MEMO

RR *9/15*
FOR: **Robert Rango**, SECRETARY OF DEFENSE

FROM: *Dr* Peter Flory, Assistant Secretary of Defense for International Security Policy

SUBJECT: Article 98 Agreements (Ref: ES-3990) (U) *10m 9/13*

- ~~(FOUO)~~ You requested "the complete status of Article 98 Agreements around the world" and asked three questions (Tab A):
 - (U) First, how many countries have signed them? As of August 22, 2005, 101 countries out of 182 target countries have signed an Article 98 agreement with the U.S., of which 90 are officially in force.
 - o Venn Diagram illustrating our global Article 98 effort at Tab B.
 - o List of Article 98 agreements at Tab C.
- ~~(FOUO)~~ Second: "Do we now have more Article 98 Agreements than countries that have ratified the Treaty itself?"
 - Yes. The 101 countries that have signed Article 98 agreements are **two** more than the 99 State's Parties to the ICC Treaty. Forty-two Article 98 signatories are party to the ICC Treaty.
- ~~(FOUO)~~ Third: "Where should we be working hardest to complete agreements, and what else do we need to be doing?"
 - We are developing a strategy with State to target priority countries over the next 6 months that will utilize high-level contacts, including John Bolton's presence at the UN, direct negotiations and guidance cables for Ambassadors and DATTs. Priority countries/areas include:
 - **Latin America.** Of the 33 countries in the region, only 14 have signed an Article 98 Agreement (42%). Another strong push in this region could yield several more Article 98s in the mid-term (next six months).
 - **Anchor Countries.** Concluding Article 98 agreements with these countries would positively influence regional or ideological allies.
 - In Latin America, Brazil and Argentina are key. Brazil has consistently rejected an Article 98 agreement on ideological grounds. Argentina has agreed to lower-level consultations, but is besitant to open formal negotiations.

692.2

(13 Sep 05)

19 Aug 05

MA SD	<i>9/16</i>
TSA SD	<i>22 9/15</i>
EXEC SEC	<i>M 9/15/05 9/16</i>
ESR MA	<i>760 9/15/1447</i>

~~FOR OFFICIAL USE ONLY~~
11-L-0559/OSD/52171

OSD 18642-05

~~FOR OFFICIAL USE ONLY~~

- Africa – South Africa. President Mbeki told POTUS that South Africa would conclude an Article 98 agreement, but *so* far continues to stall.
- Europe – Poland (new EU accession countries). Poland and other EU countries are not opposed to concluding Article 98 agreements, but are under enormous pressure from other EU countries not to sign.
- Asia-Pacific – Australia and Indonesia. Entry-round negotiations with both countries indicate a willingness to consider and work towards Article 98s.
- ~~(FOUO)~~ NSC staff (Crouch) is favorably inclined to DoD's request to waive International Military Education & Training (IMET) sanctions to countries that are prohibited from receiving this assistance under the American Service-Members' Protection Act (ASPA).
 - Crouch will be engaging with Under Secretaries Burns and Joseph in the coming week or two to pitch the idea to State.
 - If the President agrees to waive IMET countries, the NSC will gauge the Hill's reaction, and may ask Congress remove the IMET prohibition from ASPA entirely.
 - While waiving IMET may have some residual negative effect on our Article 98 effort, we believe the benefits of re-establishing IMET cooperation with key partners outweigh that risk.

Prepared by [redacted]

Reviewed by [redacted] (b)(6)

Acting 9 Sep 05

~~FOR OFFICIAL USE ONLY~~

11-L-0559/OSD/52172

United States Global Article 98 Effort

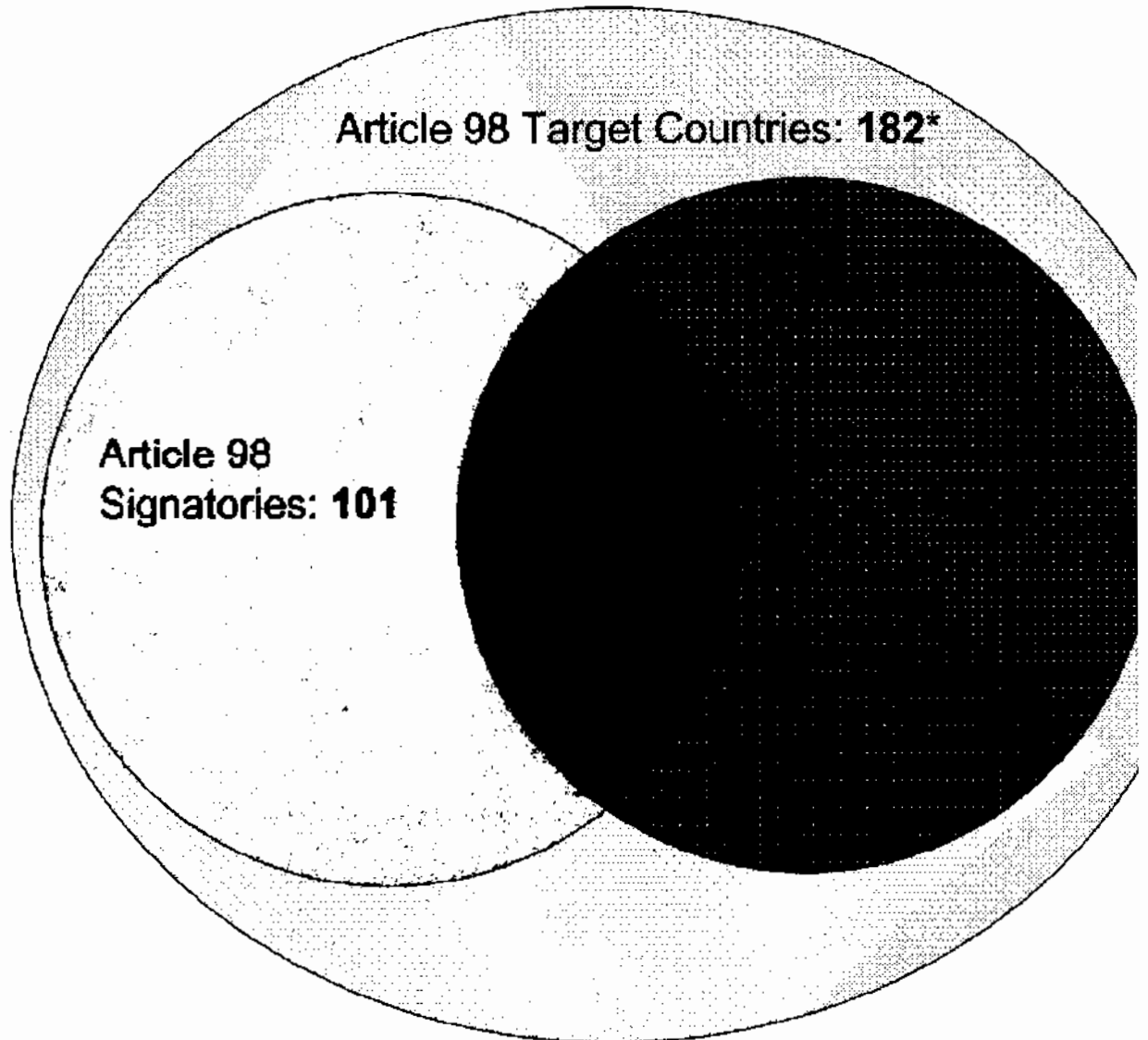

*We are not seeking agreement with 9 countries: Burma, Cuba, DPRK, Iran, Libya, Somalia, Sudan & Zimb

*In addition, we have not sought an agreement with Iraq in order to avoid EU pressure on the new Baghdad

11-L-0559/OSD/52173

For Official Use Only
Article 98
Non-Surrender Agreement

As of: 05/05/05

Country	Rome Statute Only	Party to Rome Statute	Date Signed Article 98 Agreement	Date Article 98 Agreement Entered into Force	Region
1 ROMANIA		X	1-Aug-02		EUR
2 ISRAEL			4-Aug-02	27-Nov-03	NEA
3 EAST TIMOR		X	23-Aug-02	30-Oct-03	EAP
4 TAJIKISTAN		X	26-Aug-02	23-Jun-03	EUR
5 HONDURAS		X	13-Sep-02	12-Aug-04	WHA
6 DOMINICAN REPUBLIC	X		13-Sep-02	12-Aug-04	WHA
7 PALAU			13-Sep-02	7-Jul-03	
8 MAURITANIA			17-Sep-02	6-Jul-03	AF
9 UZBEKISTAN	X		18-Sep-02	7-Jan-03	EUR
10 KOSOVO			20-Sep-02	23-Aug-03	SA
11 AFGHANISTAN		X	20-Sep-02	23-Aug-03	SA
12 MICRONESIA			24-Sep-02	30-Jun-03	EAP
13 GAMBIA		X	5-Oct-02	27-Jun-03	AF
14 EL SALVADOR			25-Oct-02	21-Jun-04	WHA
15 CAMBODIA			26-Dec-02	3-Dec-03	SA
16 INDIA			26-Dec-02	3-Dec-03	SA
17 NEPAL			31-Dec-02	22-Jul-03	SA
18 TUVALU			9-Jan-03	3-Feb-03	EAP
19 DJIBOUTI		X	24-Jan-03	2-Jul-03	AF
20 GUINEA			10-Feb-03	26-Jun-03	EUR
21 GEORGIA		X	10-Feb-03	26-Jun-03	EUR
22 AZERBAIJAN			26-Feb-03	28-Aug-03	EUR
23 NAURU		X	26-Feb-03	4-Dec-03	EAP
24 RWANDA			4-Mar-03	11-Jul-03	AF
25 BURUNDI	X		19-Mar-03	22-Jul-03	AF
26 DEM REP OF CONGO		X	19-Mar-03	22-Jul-03	AF
27 TONGA			21-Mar-03	24-Mar-04	EAP
28 SIERRALEONE		X	31-Mar-03	20-May-03	AF
29 MALDIVES			10-Apr-03	8-Jul-03	SA
30 MALI		X	17-Apr-03	31-Oct-03	AF
31 GHANA		X	17-Apr-03	31-Oct-03	AF
32 MADAGASCAR	X		23-Apr-03	4-Aug-03	AF
33 ALBANIA		X	2-May-03	7-Jul-03	EUR
34 BHUTAN			2-May-03	16-Aug-04	SA
35 CAMBODIA			16-May-03	7-Jul-03	EUR
36 BOSNIA & HERZEGOVINA		X	16-May-03	7-Jul-03	EUR
37 BOLIVIA		X	19-May-03		WHA
38 THAILAND	X		3-Jun-03	3-Jun-03	EAP
39 NICARAGUA			4-Jun-03	12-Sep-03	WHA
40 SENEGAL			5-Jun-03	22-Dec-03	NEA
41 TUNISIA			5-Jun-03	22-Dec-03	NEA
42 MONGOLIA		X	6-Jun-03	27-Jun-03	EAP
43 UGANDA		X	12-Jun-03	23-Oct-03	AF
44 TOGO			13-Jun-03	15-Jan-04	AF
45 PANAMA		X	19-Jun-03	27-Jun-03	AF
46 SENEGAL		X	19-Jun-03	27-Jun-03	AF
47 PANAMA		X	23-Jun-03	6-Nov-03	WHA
48 MOZAMBIQUE	X		24-Jun-03	2-Mar-04	AF
49 MAURITIUS		X	25-Jun-03	30-Jun-03	AF
50 CAMBODIA			30-Jun-03	28-Sep-03	AF
51 BOTSWANA		X	30-Jun-03	28-Sep-03	AF
52 CHAD	X		30-Jun-03	30-Jun-03	AF

For Official Use Only

11-L-0559/OSD/52174

For Official Use Only
Article 98
Non-Surrender Agreement

As of: 05/05/05

53	COTE d'IVOIRE	X		30-Jun-03	16-Oct-03	AF
54	MACEDONIA (FYROM)		X	30-Jun-03	12-Nov-03	EUR
56	ZAMBIA		X	1-Jul-03	2-Jul-03	AF
57	BURUNDI		X	5-Jul-03	24-Jul-03	AF
58	PAKISTAN			21-Jul-03	6-Nov-03	SA
59	BANGLADESH	X		18-Aug-03	29-Mar-04	SA
61	COLOMBIA		X	17-Sep-03	17-Sep-03	WHA
62	SOLOMON ISLANDS	X		19-Sep-03	17-Mar-04	EAP
63	KAZAKHSTAN			22-Sep-03	7-Oct-04	EUR
64	MALAWI		X	23-Sep-03	23-Sep-03	AF
66	EQUATORIAL GUINEA			25-Sep-03	6-May-04	AF
67	ANTIGUA & BARBUDA		X	29-Sep-03	29-Sep-03	WHA
68	BURKINA FASO	X	X	5-Oct-03	14-Oct-03	AF
69	LIBERIA		X	8-Oct-03	3-Nov-03	AF
71	SAO TOME & PRINCIPE	X		13-Nov-03	12-Nov-03	AF
72	CAMEROON	X		1-Dec-03	1-Dec-03	AF
73	BELIZE		X	8-Dec-03	8-Dec-03	WHA
74	GUYANA		X	11-Dec-03	18-May-04	WHA
76	YEMEN	X		18-Dec-03	18-Dec-03	NEA
77	LAOS			24-Dec-03	24-Dec-03	EAP
78	TURKMENISTAN			25-Dec-03	30-Jan-04	EUR
79	HAITI	X		12-Jan-04	12-Jan-04	WHA
81	ARMENIA	X		26-Jan-04	17-Mar-05	EUR
82	UNITED ARAB EMIRATES	X		15-Feb-04	15-Feb-04	NEA
83	KIRIBATI			2-Mar-04	2-Mar-04	EAP
84	BRUNEI			3-Mar-04	3-Mar-04	EAP
86	ALGERIA	X		13-Apr-04	13-Apr-04	NEA
87	CAPEVERDE	X		16-Apr-04	19-Nov-04	AF
88	GUATEMALA			28-Apr-04		WHA
89	DOMINICA		X	10-May-04	10-May-04	WHA
91	COMOROS	X		30-Jun-04	30-Jun-04	AF
92	EFUAKA	X		8-Jul-04	8-Jul-04	AF
93	OMAN	X		1-Aug-04	1-Aug-04	NEA
94	KYRGYZSTAN	X		28-Sep-04		EUR
96	ETHIOPIA			8-Oct-04		AF
97	JORDAN		X	16-Dec-04		NEA
98	ST. KITTS & NEVIS			31-Jan-05	31-Jan-05	WHA
99	GUINEA-BISSAU	X		2-Feb-05		AF
101	BENIN		X	25-Jul-05	25-Aug-05	AF
Totals		30	42	101	90	

For Official Use Only
Article 98
Non-Surrender Agreement

As of: 05/05/05

[REDACTED]			
AF	37	45	82%
EAP	18	28	54%
EUR	12	51	24%
NEA	11	15	73%
SA	8	8	100%
WHA	14	33	42%



ASSISTANT SECRETARY OF DEFENSE
6000 DEFENSE PENTAGON
WASHINGTON, DC 20301-6000

OFFICE OF THE
SECRETARY OF DEFENSE

2005 FEB -7 AM 7:11

2/4/05
2/14/05

ACTION MEMO

NETWORKS AND INFORMATION
INTEGRATION

February 4, 2005, 5:00 PM

FOR: DEPUTY SECRETARY OF DEFENSE

FROM: Lin Wells, Acting ASD(NII)/DoD CIO

SUBJECT: CIO

DEP SEC DEF
HAS SEEN
151 PULJ
MAR 3 2005
HC 1315
Xerox attached
for files

020 NII

After we spoke in December, you asked me to prepare a reply from you to the Secretary on the CIO question. Based on our conversation in the car last week, I've revised a January 7 paper that I'd sent up, and the new version is attached for your consideration (Tab 1). In addition to our two discussions, it reflects recent talks with John Kasich, Pete Geren, Ken Krieg, Steve Cambone, and others.

Per yesterday's discussion, the memo focuses only on the CIO-ASD(NII) combination vice the four organizational options I'd originally proposed.

We have looked at the concept of a Defense Information Board, which you'd raised earlier. It is feasible, but given the difficulties of establishing a new Advisory Board under FACA rules, an Information Sub-Panel of the DSB may be a much easier way to achieve the same goals.

4 Feb 5 05

Next under is an amplification of some of the qualifications you might want in a CIO/ASD(NII)

Will be glad to discuss at your convenience.

RECOMMENDATION: Deputy Secretary of Defense sign correspondence at Tab 1.

COORDINATION: None

Attachments:
As stated

19 Nov 04

Prepared By: LtCol Palermo (b)(6)

MA SD	(SMA DSD)	10/19/04
TSA SD	SA DSD	10/19/04
EXEC SEC	MZL	
ESR MA	TS 176005	

Qualifications for CIO/ASD(NII)

- 1) Experience in managing a very large organization (not just consultant experience)
- 2) At least some knowledge of DoD
- 3) Sufficient technical expertise to understand what is required for success in three critical areas –
 - network operations (not just the old telephone company/comms network ops),
 - network security, and
 - performance in a very large, heterogeneous environmentFailure in any one of these could undo the vision, and
- 4) An ability to implement a collaborative environment and practices (human side) across a very large constituency.

TAB A

November 19, 2004, 4:00 PM

MEMORANDUM FOR SECRETARY OF DEFENSE
DEPUTY SECRETARY OF DEFENSE

FROM: Lin Wells 

SUBJECT: Response to CIO (Kasich Group) Snowflake

I support the points Ken Krieg made to you in his memo of October 25, and have spoken with DepSecDef, the Chairman and Vice Chairman, Steve Cambone, and Mike Wynne as you asked. This memo amplifies Ken's and suggests ways ahead.

How do we empower the CIO for the Department?

All principals supported the concept of a strong, information-age Chief Information Officer (CIO) for DoD, with skills and powers to help transform the Department into an information-age organization. Success will involve leadership, communications, and marketing skills. How empowered he or she will be depends on answers to the questions raised below.

A strong CIO can't succeed without the backing of the Secretary's "full faith and credit," but empowering the CIO requires leadership, not new authorities.

- Both Title 40 and Title 10 give the CIO significant powers regarding budget and program oversight. Despite perceptions that Title 10 perpetuates Service and agency stovepipes, all applicable authorities come together at your level and you can choose how to balance them. Adoption of an enterprise-wide, information-centric focus would be a major change, but wouldn't require new statutes.
- Thus, I agree with Ken that the first question for you to decide is whether or not you personally want to take this issue on. But, if you do take it on, you also have to be willing to follow through. This can't be done just with periodic expressions of support. Key net-centric programs are underway, but they were begun when budgets were growing. Historical patterns don't bode well for continued net-centric transformation in a time of constrained resources without a sustained commitment from the top. As Ken puts it: "In a competition between digits and widgets, the widgets usually win." Supporters of net-centric transformation may wince when their own china starts being broken.

The CIO must become the "enabler" of information age transformation, but not the "doer." He or she must communicate the value of a net-centric environment

and drive and enforce standards, such as configuration, security and data management.

To achieve this, governance is key. Trust must be built before people will be willing to take chances, and to get this trust the CIO must:

- o Establish consistent and clear policies.
- Bring Principal Staff Assistants (**PSAs**) and components along as partners, and empower them to succeed.
- Measure progress.
- Find a big stick to prod the Department along. Industry CIOs point to the leverage provided by clearly enunciated standards, coupled with an ability to report to their Chief Executive Officers (CEOs) on compliance with the standards throughout their organizations.

The qualifications for the CIO will depend on what **you** want from the position

- Given the importance of your personal backing for the CIO, if you decide you're **not** willing to engage on a sustained basis, then leave the model as is. Look primarily to hire a technically oriented ASD/NII with a secondary role as an information-oriented CIO. The NII/CIO staff will do their best to leverage existing authorities to continue promoting information age transformation.
- o Four models of a stronger CIO were proposed during the discussions with principals (no effort is made to rank them here):
 1. Emphasize the CIO role and leave it with NII, but as DoD CIO/ASD(NII).
 2. Dual-hat an Under Secretary as CIO.
 3. Establish a stand-alone CIO. This led to two variants:
 - a. A stand-alone CIO within OSD, which might not be Senate-confirmed.
 - b. A completely new model, in **which** the CIO would have an internal role and also an external one, as Chairman of a DSB-like Defense Information Board, which would serve as an Information Advisory CommitteeEach of the last 3 models may have significant legal and organizational questions to be worked out.

What is the next step for the Kasich Group?

From a long range point of view, the most important element for the Department is to put in place a process for continuous transformation, one that will be hard to roll back and will transcend the tenure of any particular leader. The Kasich Group could provide advice on such approaches.

Once the type of **CIO** is decided, the recruiting process will be a major key to success: **A** world-class search committee should be set **up** to begin the search as soon as the questions above are answered, perhaps with Kasich Group support.

The Kasich Group also could help address some serious issues, such **as**:

- The industry model doesn't work exactly here:
 - DoD is much larger and more complex than any company.
 - If a business fails, it goes out of business. If DoD fails, people die. There are, therefore, reasonable limits to the amount of risk DoD can accept.
 - Our need to use competition makes it hard to impose sole-source standards (industry noted their standards often were product-specific).
 - Industry's two-to-hire, one-to-fire model for component CIOs will need careful monitoring if it is to work within the government's military and civilian personnel systems.

How do we ensure that this effort to produce an Information Age CIO will succeed? If it doesn't, it will be years before someone tries again.

I recommend that:

- **A** small DoD-only group begin addressing the above issues and prepare a short briefing to introduce the CIO issue to the **SLRG**, or a subset, in December.
- **A** longer SLRG session be scheduled in January in which the CEOs and CIOs from, say, two or three of the companies you saw before would spend **30-45** minutes with the SLRG to provide private sector perspectives. The CIO recruiting action would stem from this second session, though candidates could begin to be evaluated earlier against the different organizational models.
- **The Kasich Group** be engaged to help with the preparations for the second session, and also to address some of the issues raised above.
- Execution of the implementation strategy **Ken** recommended be deferred until the new CIO is on board, though **NII** will prepare interim approaches as your direction unfolds.

Hope this helps. **Will** be glad to discuss any of these issues **further**.

FOUO

October 26, 2004

TO: Lin Wells

CC: Paul Wolfowitz
Gen Dick Myers
Gen Pete Pace
Mike Wynne
Steve Cambone

FROM: Donald Rumsfeld *DR*

SUBJECT: CIO

Attached is a memo I sent to Ken Krieg and his response. Lin, please consult with the folks on this list and come back to me with some proposals.

Thanks.

Attach.

10/4/04 SecDef memo to Krieg [100404-19]
10/25/04 Krieg ltr to SecDef

DHR:dh
102504-25

.....
Please respond by 11/19/04

Lin Wells,

In light of the latest E.O.s & the pending critical reform legislation, not to mention TSAT, BIG, etc., the role of a strong CEO is essential.

I'll support an effort toward that end.

RC

FOUO

OCT 27 2004

11-L-0559/OSD/52183

October 25, 2004

MEMORANDUM FOR SECRETARY OF DEFENSE
DEPUTY SECRETARY OF DEFENSE

FROM: Ken Krieg 

SUBJECT: CIO (Kasich Group) Snowflake

This memorandum is in response to your questions in subject snowflake. The views are mine alone. My first question – and the key insight from the roundtable discussion – is will this area be one of your key priorities in the next period of time? The clear consensus was that the effectiveness of the CIOs stemmed from the commitment of their CEOs to this area. Assuming that it will be in the top tier (a crowded level, I realize), here are some thoughts on your two questions.

How do we empower a CIO for the Department?

To be effective, the CIO must be perceived as a DoD vice OSD official. The CIOs worldview has to be broad (operational and business, now and in the future), his focus has to be on customers (joint war fighters and key decision-makers), and his style has to be balanced (integrating strategy vice advocating specific programs). There are three areas of empowerment – perceived authority, actual authority, and the individual's capability to use the authority.

- Perceived authority is derived from the Secretary by the level of the position, in part, and, more fully, by the time and attention you give to it. The CIO is now a dual-hat position with the Assistant Secretary for Networks and Information Integration, I would respectfully argue that the role is a little lost in the noise right now.
- Actual authorities probably could be strengthened in three areas -- by practice more than by legislation:
 1. The establishment of a DoD implementation strategy led by the CIO and agreed to by the SLRG/SEC – setting out direction, standards, and responsibilities. This should be of the 500-day variety vice the “hard-to-measure” grand strategy statements.
 2. The CIO would oversee implementation of the strategy and report regularly to you (and the SLRG/SEC) on performance and accountability.
 3. To add a little pressure to the system, you should establish dual-reporting lines for the component CIOs linking them to both the Component heads (i.e., Service Secretaries, etc.) and the DoD CIO.

11-L-0559/OSD/52184

- o The individual's capability to use that authority will come from picking the right person. This is a key hire.

Much of this is in the Department's control. To work, the CIO will have to be and be seen as a key member of the senior leadership group.

What is the next step in the Kasich Group?

As we work through this issue, I think we can use John and his team in the following ways:

- o As a red team to bounce development ideas off of.
- o Potentially help with the personnel search.
- Use a combination of CIOs plus their chairman for a "seminar discussion" with SLRG at kick-off for a QDR topic.
- o Lastly, you might think about bringing one or two of them on either DBB or DSB.

Hope this helps.

~~FOUO~~

October 4, 2004

TO: Ken Krieg
FROM: Donald Rumsfeld *DR*,
SUBJECT: CIO

What is the next step in the Kasich Group and the CIO for the Department?

And how do we empower a CIO for the Department?

Thanks.

Attach.
8/13/04 Ken Krieg Memo to SecDef re: Snowflake **Response on CIO**

DHR:js
100404-19

.....
Please respond by 10/29/04

*Sir,
Response attached.
✓
LT Col Longyel
10/25*

~~FOUO~~

11-L-0559/OSD/52186

October 26, 2004

TO: Lin Wells

CC: Paul Wolfowitz
Gen Dick Myers
Gen Pete Pace
Mike Wynne
Steve Cambone

FROM: Donald Rumsfeld *[Signature]*

SUBJECT: CJO

Attached is a memo I sent to Ken Krieg and his response. Lin, please consult with the folks on this list and come back to me with some proposals.

Thanks.

Attach.
10/4/04 SecDef memo to Krieg [100404-19]
10/25/04 Krieg ltr to SecDef

DHR:dh
102304-25

.....
Please respond by 11/19/04

Lin Wells,

In light of the latest E.O.s & the pending civil reform legislation, not to mention TSAT, 616, etc., the role of a strong CEO is essential.

I'll support an effort toward that end.

RC

OCT 27 2004

020 NII

26 Oct 04

19 Nov 04

FOUO

October 4, 2004

TO: Ken Krieg
FROM: Donald Rumsfeld *DR*,
SUBJECT: CIO

What is the next step in the Kasich Group and the CIO for the Department?

And how do we empower a CIO for the Department?

Thanks.

Attach.
8/13/04 Ken Krieg Memo to SecDef re: Snowflake Response on CIO

DHR:ss
100404-19

.....
Please respond by 10/29/04

*Sir,
Response attached.
✓h
LT Col Langyel
10/25*

OSD 01970-05

FOUO

11-L-0559/OSD/52188

October 25, 2004

MEMORANDUM FOR SECRETARY OF DEFENSE
DEPUTY SECRETARY OF DEFENSE

FROM: Ken Krieg 

SUBJECT: CIO (Kasich Group) Snowflake

This memorandum is in response to your questions in subject snowflake. The views are mine alone. My first question – and the key insight from the roundtable discussion – is will this area be one of your key priorities in the next period of time? The clear consensus was that the effectiveness of the CIOs stemmed from the commitment of their CEOs to this area. Assuming that it will be in the top tier (a crowded level, I realize), here are some thoughts on your two questions.

How do we empower a CIO for the Department?

To be effective, the CIO must be perceived as a DoD vice OSD official. The CIOs worldview has to be broad (operational and business, now and in the future), his focus has to be on customers (joint war fighters and key decision-makers), and his style has to be balanced (integrating strategy vice advocating specific programs). There are three areas of empowerment – perceived authority, actual authority, and the individual's capability to use the authority.

- Perceived authority is derived from the Secretary by the level of the position, in part, and, more fully, by the time and attention you give to it. The CIO is now a dual-hat position with the Assistant Secretary for Networks and Information Integration. I would respectfully argue that the role is a little lost in the noise right now.
- Actual authorities probably could be strengthened in three areas -- by practice more than by legislation:
 1. The establishment of a DoD implementation strategy led by the CIO and agreed to by the SLRG/SEC – setting out direction, standards, and responsibilities. This should be of the 500-day variety vice the “hard-to-measure” grand strategy statements.
 2. The CIO would oversee implementation of the strategy and report regularly to you (and the SLRG/SEC) on performance and accountability.
 3. To add a little pressure to the system, you should establish dual-reporting lines for the component CIOs linking them to both the Component heads (i.e., Service Secretaries, etc.) and the DoD CIO.

OSD 01970-05

11-L-0559/OSD/52189

- The individual's capability to use that authority will come from picking the right person. This is a key hire.

Much of this is in the Department's control. To work, the CIO will have to be and be seen as a key member of the senior leadership group.

What is the next step in the Kasich Group?

As we work through this issue, I think we can use John and his team in the following ways:

- As a red team to bounce development ideas off of.
- Potentially help with the personnel search.
- Use a combination of CIOs plus their chairman for a "seminar discussion" with SLRG at kick-off for a QDR topic.
- Lastly, you might think about bringing one or two of them on either DBB or DSB.

Hope this helps.

December 1, 2004

TO: Paul Wolfowitz
CC: Paul Butler
FROM: Donald Rumsfeld *DR*
SUBJECT: CIO

Please read this material from Lin Wells, set an appointment, and come to me personally with your recommendation so we can discuss it.

Thanks.

Attach.
11/19/04 Lin Wells memo to SecDef re: CIO

DHR:dh
120104-10

.....
Please respond by 12/21/04

020 NIT

1 Dec 04

19 Nov 04

12/1

OFFICE OF THE
SECRETARY OF DEFENSE

November 19, 2004, 4:00 PM

2004 NOV 22 AM 2:36

MEMORANDUM FOR SECRETARY OF DEFENSE
DEPUTY SECRETARY OF DEFENSE

Paul Butler
pub
11/24

FROM: Lin Wells

SUBJECT: Response to CIO (Kasich Group) Snowflake

I support the points Ken Krieg made to you in his memo of October 25, and have spoken with DepSecDef, the Chairman and Vice Chairman, Steve Cambone, and Mike Wynn as you asked. This memo amplifies Ken's and suggests ways ahead.

How do we empower the CIO for the Department?

All principals supported the concept of a strong, information-age Chief Information Officer (CIO) for DoD, with skills and powers to help transform the Department into an information-age organization. Success will involve leadership, communications, and marketing skills. How empowered he or she will be depends on answers to the questions raised below.

A strong CIO can't succeed without the backing of the Secretary's "full faith and credit," but empowering the CIO requires leadership, not new authorities.

- Both Title 40 and Title 10 give the CIO significant powers regarding budget and program oversight. Despite perceptions that Title 10 perpetuates Service and agency stovepipes, all applicable authorities come together at your level and you can choose how to balance them. Adoption of an enterprise-wide, information-centric focus would be a major change, but wouldn't require new statutes.
- Thus, I agree with Ken that the first question for you to decide is whether or not you personally want to take this issue on. But, if you do take it on, you also have to be willing to follow through. This can't be done just with periodic expressions of support. Key net-centric programs are underway, but they were begun when budgets were growing. Historical patterns don't bode well for continued net-centric transformation in a time of constrained resources without a sustained commitment from the top. As Ken puts it: "In a competition between digits and widgets, the widgets usually win." Supporters of net-centric transformation may wince when their own china starts being broken.

The CIO must become the "enabler" of information age transformation, but not the "doer." He or she must communicate the value of a net-centric environment

TSA SD	11/23
SPMA SD	
MA SD	11/24
EXEC SEC	M/W/22
ESR	2004 11/22

and drive and enforce standards, such as configuration, security and data management.

To achieve this, governance is key. Trust must be built before people will be willing to take chances, and to get this trust the CIO must:

- Establish consistent and clear policies.
- Bring Principal Staff Assistants (PSAs) and components along as partners, and empower them to succeed.
- Measure progress.
- Find a big stick to prod the Department along. Industry CIOs point to the leverage provided by clearly enunciated standards, coupled with an ability to report to their Chief Executive Officers (CEOs) on compliance with the standards throughout their organizations.

The qualifications for the CIO will depend on what you want from the position

- Given the importance of your personal hacking for the CIO, if you decide you're not willing to engage on a sustained basis, then leave the model as is. Look primarily to hire a technically oriented ASD/NII with a secondary role as an information-oriented CIO. The NII/CIO staff will do their best to leverage existing authorities to continue promoting information age transformation.
- Four models of a stronger CIO were proposed during the discussions with principals (no effort is made to rank them here):
 1. Emphasize the CIO role and leave it with NII, but as DoD CIO/ASD(NII).
 2. Dual-hat an Under Secretary as CIO.
 3. Establish a stand-alone CIO. This led to two variants:
 - a. A stand-alone CIO within OSD, which might not be Senate-confirmed.
 - b. A completely new model, in which the CIO would have an internal role and also an external one, as Chairman of a DSB-like Defense Information Board, which would serve as an Information Advisory CommitteeEach of the last 3 models may have significant legal and organizational questions to be worked out.

What is the next step for the Kasich Group?

From a long range point of view, the most important element for the Department is to put in place a process for continuous transformation, one that will be hard to roll back and will transcend the tenure of any particular leader. The Kasich Group could provide advice on such approaches.

Once the type of CIO is decided, the recruiting process will be a major key to success: A world-class search committee should be set up to begin the search as soon as the questions above are answered, perhaps with Kasich Group support.

The Kasich Group also could help address some serious issues, such as:

- The industry model doesn't work exactly here:
 - DoD is much larger and more complex than any company.
 - If a business fails, it goes out of business. If DoD fails, people die. There are, therefore, reasonable limits to the amount of risk DoD can accept.
 - Our need to use competition makes it hard to impose sole-source standards (industry noted their standards often were product-specific).
 - Industry's two-to-hire, one-to-fire model for component CIOs will need careful monitoring if it is to work within the government's military and civilian personnel systems.

How do we ensure that this effort to produce an Information Age CIO will succeed? If it doesn't, it will be years before someone tries again.

I recommend that:

- A small DoD-only group begin addressing the above issues and prepare a short briefing to introduce the CIO issue to the SLRG, or a subset, in December.
- A longer SLRG session be scheduled in January in which the CEOs and CIOs from, say, two or three of the companies you saw before would spend 30-45 minutes with the SLRG to provide private sector perspectives. The CIO recruiting action would stem from this second session, though candidates could begin to be evaluated earlier against the different organizational models.
- The Kasich Group be engaged to help with the preparations for the second session, and also to address some of the issues raised above.
- Execution of the implementation strategy Ken recommended be deferred until the new CIO is on board, though NII will prepare interim approaches as your direction unfolds.

Hope this helps. Will be glad to discuss any of these issues further.

SECRET
November 19, 2004, 4:00 PM

MEMORANDUM FOR SECRETARY OF DEFENSE
DEPUTY SECRETARY OF DEFENSE

FROM: Lin Wells 

SUBJECT: Response to CIO (Kasich Group) Snowflake

I support the points Ken Krieg made to you in his memo of October 25, and have spoken with DepSecDef, the Chairman and Vice Chairman, Steve Cambone, and Mike Wynne as you asked. This memo amplifies Ken's and suggests ways ahead.

How do we empower the CIO for the Department?

All principals supported the concept of a strong, information-age Chief Information Officer (CIO) for DoD, with skills and powers to help transform the Department into an information-age organization. Success will involve leadership, communications, and marketing skills. How empowered he or she will be depends on answers to the questions raised below.

A strong CIO can't succeed without the backing of the Secretary's "full faith and credit," but empowering the CIO requires leadership, not new authorities.

- Both Title 40 and Title 10 give the CIO significant powers regarding budget and program oversight. Despite perceptions that Title 10 perpetuates Service and agency stovepipes, all applicable authorities come together at your level and you can choose how to balance them. Adoption of an enterprise-wide, information-centric focus would be a major change, but wouldn't require new statutes.
- Thus, I agree with Ken that the first question for you to decide is whether or not you personally want to take this issue on. But, if you do take it on, you also have to be willing to follow through. This can't be done just with periodic expressions of support. Key net-centric programs are underway, but they were begun when budgets were growing. Historical patterns don't bode well for continued net-centric transformation in a time of constrained resources without a sustained commitment from the top. As Ken puts it: "In a competition between digits and widgets, the widgets usually win." Supporters of net-centric transformation may wince when their own china starts being broken.

The CIO must become the "enabler" of information age transformation, but not the "doer." He or she must communicate the value of a net-centric environment

and drive and enforce standards, such as configuration, security and data management.

To achieve this, governance is key. Trust must be built before people will be willing to take chances, and to get this trust the CIO must:

- Establish consistent and clear policies.
- Bring Principal Staff Assistants (PSAs) and components along as partners, and empower them to succeed.
- Measure progress.
- Find a big stick to prod the Department along. Industry CIOs point to the leverage provided by clearly enunciated standards, coupled with an ability to report to their Chief Executive Officers (CEOs) on compliance with the standards throughout their organizations.

The qualifications for the CIO will depend on what you want from the position

- Given the importance of your personal backing for the CIO, if you decide you're not willing to engage on a sustained basis, then leave the model as is. Look primarily to hire a technically oriented ASD/NII with a secondary role as an information-oriented CIO. The NII/CIO staff will do their best to leverage existing authorities to continue promoting information age transformation.
- Four models of a stronger CIO were proposed during the discussions with principals (no effort is made to rank them here):
 1. Emphasize the CIO role and leave it with NII, but as DoD CIO/ASD(NII).
 2. Dual-hat an Under Secretary as CIO.
 3. Establish a stand-alone CIO. This led to two variants:
 - a. A stand-alone CIO within OSD, which might not be Senate-confirmed.
 - b. A completely new model, in which the CIO would have an internal role and also an external one, as Chairman of a DSB-like Defense Information Board, which would serve as an Information Advisory CommitteeEach of the last 3 models may have significant legal and organizational questions to be worked out.

What is the next step for the Kasich Group?

From a long range point of view, the most important element for the Department is to put in place a process for continuous transformation, one that will be hard to roll back and will transcend the tenure of any particular leader. The Kasich Group could provide advice on such approaches.

Once the type of CIO is decided, the recruiting process will be a major key to success: A world-class search committee should be set up to begin the search as soon as the questions above are answered, perhaps with Kasich Group support.

The Kasich Group also could help address some serious issues, such as:

- The industry model doesn't work exactly here:
 - DoD is much larger and more complex than any company.
 - If a business fails, it goes out of business. If DoD fails, people die. There are, therefore, reasonable limits to the amount of risk DoD can accept.
 - Our need to use competition makes it hard to impose sole-source standards (industry noted their standards often were product-specific).
 - Industry's two-to-hire, one-to-fire model for component CIOs will need careful monitoring if it is to work within the government's military and civilian personnel systems.

How do we ensure that this effort to produce an Information Age CIO will succeed? If it doesn't, it will be years before someone tries again.

I recommend that:

- A small DoD-only group begin addressing the above issues and prepare a short briefing to introduce the CIO issue to the SLRG, or a subset, in December.
- A longer SLRG session be scheduled in January in which the CEOs and CIOs from, say, two or three of the companies you saw before would spend 30-45 minutes with the SLRG to provide private sector perspectives. The CIO recruiting action would stem from this second session, though candidates could begin to be evaluated earlier against the different organizational models.
- The Kasich Group be engaged to help with the preparations for the second session, and also to address some of the issues raised above.
- Execution of the implementation strategy Ken recommended be deferred until the new CIO is on board, though NII will prepare interim approaches as your direction unfolds.

Hope this helps. Will be glad to discuss any of these issues further.

January 28, 2005

MEMORANDUM FOR DEPUTY SECRETARY OF DEFENSE

FROM:

Lin Wells 

SUBJECT: CIO

After we spoke in December, you asked me to prepare a reply from you to the Secretary on the CIO question. Based on our conversation in the car yesterday, I've revised a January 7 paper that I'd sent up, and the new version is attached for your consideration (Tab 1). In addition to our two discussions, it reflects recent talks with John Kasich, Pete Geren, Ken Krieg, Steve Cambone, and others.

Per yesterday's discussion, the memo focuses only on the CIO-ASD(NII) combination vice the four organizational options I'd originally proposed.

We have looked at the concept of a Defense Information Board, which you'd raised earlier. It is feasible, but given the difficulties of establishing a new Advisory Board under FACA rules, an Information Sub-Panel of the DSB may be a much easier way to achieve the same goals.

Next under is an amplification of some of the qualifications you might want in a CIO/ASD(NII)

Will be glad to discuss at your convenience. I'm leaving for PACOM tomorrow, back on February 3rd, but my staff can make any changes to the memo while I'm gone.

020111

28 ANDS

19 NOV 04

Qualifications for CIO/ASD(NII)

- 1) Experience in managing a very large organization (not just consultant experience)
- 2) At least some knowledge of DoD
- 3) Sufficient technical expertise to understand what is required for success in three critical areas –
 - network operations (not just the old telephone company/comms network ops),
 - network security, and
 - performance in a very large, heterogeneous environmentFailure in any one of these could undo the vision, and
- 4) An ability to implement a collaborative environment and practices (human side) across a very large constituency.

TAB

1

January 28, 2005

MEMORANDUM FOR SECRETARY OF DEFENSE

FROM: Paul Wolfowitz

SUBJECT: CIO

You asked me to take a look at Lin Wells' memo (Tab **A**) on expanding the functions of the DoD CIO. I've done this, with recommendations below.

Both Lin's memo, and Ken Krieg's earlier note, said that you personally would have to devote significant management time if you wanted to empower the CJO to lead the Department's information age transformation. The issue is important, but a realistic **look** at your schedule regrettably causes me to doubt if you will be able to devote such time. That said, I think there is a lot that can and should be done—it really is important to have someone pull the Department's information pieces together, but the industry CJO model may not be entirely appropriate for DoD, given our size and intensity.

Lin's memo teed up various organizational options, but the first step is to decide what you want from the CIO. Lin, Pete Geren and Ken Krieg are working with John Kasich to refine the CIO role for the DoD environment. In the long run, a combined USD(I) and NII focused on information seems the best way to drive the Department's information transformation. However, since that reorganization isn't on the table now, the focus should be on leveraging the CIO function with ASD(NII). The CIO should have both the strategic vision and experience to help lead the transformation of the Department, and also sufficient technical management prowess to deliver an environment that assures acceptable performance for, say, time critical targets in a mobile tactical network.

One way to reduce the demand on your time is to ensure the CIO has enough clout to be able to ensure that your vision for information age transformation is carried out. Once you let the Department know what you expect of the CIO, this approach could let you focus your support for him or her on those occasions when it really would be needed.

11-L-0559/OSD/52201

TAB

A

November 19, 2004, 4:00 PM

MEMORANDUM FOR SECRETARY OF DEFENSE
DEPUTY SECRETARY OF DEFENSE

FROM: Lin Wells 

SUBJECT: Response to CIO (Kasich Group) Snowflake

I support the points Ken Krieg made to you in his memo of October 25, and have spoken with DepSecDef, the Chairman and Vice Chairman, Steve Cambone, and Mike Wynne as you asked. This memo amplifies Ken's and suggests ways ahead.

How do we empower the CIO for the Department?

All principals supported the concept of a strong, information-age Chief Information Officer (CIO) for DoD, with skills and powers to help transform the Department into an information-age organization. Success will involve leadership, communications, and marketing skills. How empowered he or she will be depends on answers to the questions raised below.

A strong CIO can't succeed without the backing of the Secretary's "full faith and credit," but empowering the CIO requires leadership, not new authorities.

- e Both Title 40 and Title 10 give the CIO significant powers regarding budget and program oversight. Despite perceptions that Title 10 perpetuates Service and agency stovepipes, all applicable authorities come together at your level and you can choose how to balance them. Adoption of an enterprise-wide, information-centric focus would be a major change, but wouldn't require new statutes.
- e Thus, I agree with Ken that the first question for you to decide is whether or not you personally want to take this issue on. But, if you do take it on, you also have to be willing to follow through. This can't be done just with periodic expressions of support. Key net-centric programs are underway, but they were begun when budgets were growing. Historical patterns don't bode well for continued net-centric transformation in a time of constrained resources without a sustained commitment from the top. **As** Ken puts it: "In a competition between digits and widgets, the widgets usually win." Supporters of net-centric transformation may wince when their own china starts being broken.

The CIO must become the "enabler" of information age transformation, but not the "doer." He or she must communicate the value of a net-centric environment

and drive and enforce standards, such as configuration, security and data management.

To achieve this, governance is key. Trust must be built before people will be willing to take chances, and to get this trust the CIO must:

- Establish consistent and clear policies.
- Bring Principal Staff Assistants (**PSAs**) and components along as partners, and empower them to succeed.
- Measure progress.
- Find a big stick to prod the Department along. Industry CIOs point to the leverage provided by clearly enunciated standards, coupled with an ability to report to their Chief Executive Officers (CEOs) on compliance with the standards throughout their organizations.

The qualifications for the CIO will depend on what you want from the position

- Given the importance of your personal backing for the CIO, if you decide you're **not** willing to engage on a sustained basis, then leave the model as is. Look primarily to hire a technically oriented ASD/NII with a secondary role as an information-oriented CIO. The NII/CIO staff will do their best to leverage existing authorities to continue promoting information age transformation.
- Four models of a stronger CIO were proposed during the discussions with principals (no effort is made to rank them here):
 1. Emphasize the CIO role and leave it with NII, but as DoD CIO/ASD(NII).
 2. Dual-hat an Under Secretary as CIO.
 3. Establish a stand-alone CIO. This led to **two** variants:
 - a. **A** stand-alone CIO within OSD, which might not be Senate-confirmed.
 - b. **A** completely new model: in which the CIO would have an internal role and also an external one, as Chairman of a DSB-like Defense Information Board, which would serve as an Information Advisory CommitteeEach of the last 3 models may have significant legal and organizational questions to be worked out.

What is the next step for the Kasich Group?

From a long range point of view: the most important element for the Department is to put in place a process for continuous transformation, one that will be hard to roll back and will transcend the tenure of any particular leader. The Kasich Group could provide advice on such approaches.

Once the type of CIO is decided, the recruiting process **will** be a major key to success: **A** world-class search committee should be set up to begin the search **as** soon as the questions above are answered, perhaps with Kasich Group support.

The Kasich Group also could help address some serious issues, such as:

- o The industry model doesn't work exactly here:
 - e DoD is much larger and more complex than any company.
 - If a business fails, it goes out of business. If DoD fails, people die. There are, therefore, reasonable limits to the amount of risk DoD can accept.
 - Our need to use competition makes it hard to impose sole-source standards (industry noted their standards often were product-specific).
 - Industry's two-to-hire, one-to-fire model for component CIOs **will** need careful monitoring if it is to work within the government's military and civilian personnel systems.

How do we ensure that this effort to produce an Information Age CIO will succeed? If it doesn't, it will be years before someone tries again.

I recommend that:

- e **A** small DoD-only group begin addressing the above issues and prepare a short briefing to introduce the CIO issue to the SLRG, or a subset, in December.
- e **A** longer SLRG session be scheduled in January in which the CEOs and CIOs from, say, two or three of the companies you saw before would spend 30-45 minutes with the SLRG to provide private sector perspectives. The CIO recruiting action would stem from this second session, though candidates could begin to be evaluated earlier against the different organizational models.
- o The Kasich Group be engaged to help with the preparations for the second session, and also to address some of the issues raised above.
- e Execution of the implementation strategy Ken recommended be deferred until the new CIO is on board, though NII will prepare interim approaches as your direction unfolds.

Hope this helps. Will be glad to discuss any of these issues further.

October 25, 2004

MEMORANDUM FOR SECRETARY OF DEFENSE
DEPUTY SECRETARY OF DEFENSE

FROM: Ken Krieg 

SUBJECT: CIO (Kasich Group) Snowflake

This memorandum is in response to your questions in subject snowflake. The views are mine alone. My first question – and the key insight from the roundtable discussion – is will this area be one of your key priorities in the next period of time? The clear consensus was that the effectiveness of the CIOs stemmed from the commitment of their CEOs to this area. Assuming that it will be in the top tier (a crowded level, I realize), here are some thoughts on your two questions.

How do we empower a CIO for the Department?

To be effective, the CIO must be perceived as a DoD vice OSD official. The CIOs worldview has to be broad (operational and business, now and in the future), his focus has to be on customers (joint war fighters and key decision-makers), and his style has to be balanced (integrating strategy vice advocating specific programs). There are three areas of empowerment – perceived authority, actual authority, and the individual's capability to use the authority.

- Perceived authority is derived from the Secretary by the level of the position, in part, and, more fully, by the time and attention you give to it. The CIO is now a dual-hat position with the Assistant Secretary for Networks and Information Integration. I would respectfully argue that the role is a little lost in the noise right now.
- Actual authorities probably could be strengthened in three areas -- by practice more than by legislation:
 1. The establishment of a DoD implementation strategy led by the CIO and agreed to by the SLRG/SEC – setting out direction, standards, and responsibilities. This should be of the 500-day variety vice the “hard-to-measure” grand strategy statements.
 2. The CIO would oversee implementation of the strategy and report regularly to you (and the SLRG/SEC) on performance and accountability.
 3. To add a little pressure to the system, you should establish dual-reporting lines for the component CIOs linking them to both the Component heads (i.e., Service Secretaries, etc.) and the DoD CIO.

11-L-0559/OSD/52206

- o The individual's capability to use that authority will come from picking the right person. This is a key hire.

Much of this is in the Department's control. To work, the CIO will have to be and be seen as a **key** member of the senior leadership group.

What is the next step in the Kasich Group?

As we work through this issue, I think we can use John and his team in the following ways:

- o **As** a red team to bounce development ideas off of.
- o Potentially help with the personnel search.
- Use a combination of CIOs plus their chairman for a "seminar discussion" with SLRG at kick-off for a QDR topic.
- Lastly, you might think about bringing one or two of them on either DBB or DSB.

Hope this helps.

October 26, 2004

TO: Lin Wells

CC: Paul Wolfowitz
Gen Dick Myers
Gen Pete Pace
Mike Wynne
Steve Cambone

FROM: Donald Rumsfeld *DR*

SUBJECT: CIO

Attached is a memo I sent to Ken Krieg and his response. Lin, please consult with the **folks** on this list and come back to me with some proposals.

Thanks.

Attach.

10/4/04 SecDef memo to Krieg-[100404-19]
10/25/04 Krieg ltr to SecDef

DHR:dh
102504-25

.....
Please respond by 11/19/04

Lin Wells,

In light of the latest E.O.s & the pending intel reform legislation, not to mention TSAT, GIG, etc., the role of a strong CIO is essential.

I'll support an effort toward that end.

RC

OCT 27 2004

FOUO

October 4, 2004

TO: Ken Krieg
FROM: Donald Rumsfeld *DR*
SUBJECT: CIO

What is the next step in the Kasich Group and the CIO for the Department?

And how do we empower a CIO for the Department?

Thanks.

Attach.
8/13/04 Ken Krieg Memo to SecDef re: Snowflake Response on CIO

DHR:ss
100404-19

.....
Please respond by 10/29/04

*Sir,
Response attached.
✓h
Lt Col Longyel
10/25*

FOUO

11-L-0559/OSD/52209



From the Desk of
Paul Wolfowitz

3/3/05

Sec Def -

I think this fits well
with yesterday's decision
on NII.

Paul W.

020 NSI

3 MAR 05

19 NOV 04

OSD 18673-04

11-L-0559/OSD/52210



THE DEPUTY SECRETARY OF DEFENSE

WASHINGTON, D.C. 20301

MAR - 3 2005

MEMORANDUM FOR SECRETARY OF DEFENSE

FROM: Paul Wolfowitz *PW*

SUBJECT: CIO

You asked me to take a look at Lin Wells' memo (Tab A) on expanding the functions of the DoD CIO. I've done **this**, with recommendations below.

Both Lin's memo, and Ken Krieg's earlier note, said that you personally would have to devote significant management time if you wanted to empower the CIO to lead the Department's information age transformation. The issue is important, but a realistic look at your schedule regrettably causes me to doubt if you will be able to devote such time. That said, I think there is a lot that can and should be done—it really is important to have someone pull the Department's information pieces together, but the industry CIO model may not be entirely appropriate for DoD, given **our** size and intensity.

Lin's memo teed up various organizational options, but the first step is to decide what you want from the CIO. Lin, Pete Geren and Ken Krieg are working with John Kasich to refine the CIO role for the DoD environment. In the long run, a combined USD(I) and NII focused on information seems the best way to drive the Department's information transformation. However, since that reorganization isn't on the table now, the focus should be on leveraging the CIO function with ASD(NII). The CIO should have both the strategic vision and experience to help lead the transformation of the Department, and also sufficient technical management prowess to deliver an environment that assures acceptable performance for, say, time critical targets in a mobile tactical network.

One way to reduce the demand on your time is to ensure the CIO **has** enough clout to be able to ensure that **your** vision for information age transformation is carried out. Once you let the Department know what you expect of the CIO, this approach could let you focus your support for him or her on those occasions when it really would be needed. I can provide more routine backing.

OSD 18673-04

11-L-0559/OSD/52211

MEMORANDUM FOR SECRETARY OF DEFENSE

FROM: Paul Wolfowitz

SUBJECT: CIO

You asked me to take a look at Lin Wells' memo (Tab A) on expanding the functions of the DoD CIO. I've done this, with recommendations below.

Both Lin's memo, and Ken Krieg's earlier note, said that you personally would have to devote significant management time if you wanted to empower the CIO to lead the Department's information age transformation. The issue is important, but a realistic look at your schedule regrettably causes me to doubt if you will be able to devote such time. That said, I think there is a lot that can and should be done—it really is important to have someone pull the Department's information pieces together, but the industry CIO model may not be entirely appropriate for DoD, given our size and intensity.

Lin's memo teed up various organizational options, but the first step is to decide what **you** want from the CIO. Lin, Pete Geren and Ken Krieg are working with John Kasich to refine the CIO role for the DoD environment. In the long run, a combined USD(I) and NII focused on information seems the best way to drive the Department's information transformation. However, since that reorganization isn't on the table now, the focus should be on leveraging the CIO function with ASD(NII). The CIO should have both the strategic vision and experience to help lead the transformation of the Department, and also sufficient technical management prowess to deliver an environment that assures acceptable performance for, say, time critical targets in a mobile tactical network.

One way to reduce the demand on your time is to ensure the CIO has enough clout to be able to ensure that your vision for information age transformation is carried out. Once you let the Department know what you expect of the CIO, this approach could let you focus your support for **him** or her on those occasions when it really would be needed. I can provide more routine backing.

~~FOUO~~

September 15, 2005

TO: The Honorable Dr. Condoleezza Rice
FROM: Donald Rumsfeld *DR*
SUBJECT: Suggestion by German MOD

At my meeting with the German MOD this week, he proposed that Karzai host a conference in Kabul for NATO nations and others on the way ahead. I pushed back and told him that is a matter for the State Department and Karzai to work out.

DHR.ss
091505-03

Flanagan

OSD 18686-05

15 Sep 05

~~FOUO~~

11-L-0559/OSD/52213

~~FOUO~~

2005 08 17 11:10:49

AUG 30 2005

I-05/01162

ES-4075

Uzbekistan

TO: Eric Edelman
FROM: Donald Rumsfeld *DR*
SUBJECT: Abizaid and Uzbekistan

After you have cleared it with State and NSC, please let me know when we have given John Abizaid the okay to go to Uzbekistan.

Thanks,

DEB
082905-23

.....
Please Respond By September 20, 2005

OSD 18699-05

~~FOUO~~

A-8
17

30 AUG 05

11-L-0559/OSD/52214

30-03-05 P06:18 IN

~~FOUO~~

September 16, 2005

TO: Stephen J Hadley
FROM: Donald Rumsfeld *DR*
SUBJECT: ~~Press~~ on Tal Afar Mission

Steve,

The President said he wanted the activity in Tal Afar widely communicated in Iraq and elsewhere around ~~the~~ world.

Attached is a note from George Casey on what was done out of Iraq. There was **also** a great deal done by Larry Di Rita and his crew here at the Pentagon, as Dan Bartlett is fully aware.

Attach Note from GEN Casey to SecDef

DHR:ss
091605-08

Iraq

16 SEP 05

~~FOUO~~

11-L-0559/OSD/52215

SIR —

9/15

From George Casey

Mr. Secretary,

Since you were traveling, you may not have seen the full court press we had on the Tal Afar mission. As you see below, we have had daily events by both Iraqis and us. We alternated between reports directly from Tal Afar and press briefs from Baghdad. We intend to do a close out in the next day or so as the military part of the operation winds down.

v/r

Was tough to penetrate, but we did get out a good story. On the coalition side, they basically picked up the same themes that got out to our media.



v/r George

Sir, below is a list of media engagement going back to announcement of Tal Afar and projected through Saturday.

<u>Date</u>	<u>Event</u>
9 Sep	ITG release on additional security measures in Tal Afar
10 Sep	ITG release on start of operations PM, MOD, MOI press conference TF Freedom DCG/CNN—BG Bergner
11 Sep	MOD press conference MG Lynch CPIC press conference
12 Sep	MOI press conference PM visit to Tal Afar 3 ACR Commander/multiple live feeds w/embeds
13 Sep conference in Tal Afar	3 rd Iraqi Division commander, 3 rd ACR commander, mayor press 3 rd ACR commander Pentagon press brief
14 Sep	Haidar Abadi, LTG Abdel Aziz press conference 1/25 commander Pentagon press brief
15 sep	Haidar Abadi, LTG Abdell-Aziz press confktence MG Lynch CPIC press conference — with Pentagon press
16Sep	None scheduled
17 sep	MOD press conference in Tal Afar

~~FOUO~~

SEP 08 2005
September 08, 2005

2005 09 08 05:43

TO: Dan Stanley
VADM Jim Stavridis
Steve Bucci

FROM: Donald Rumsfeld 

SUBJECT: Tuesday Briefings on Capitol Hill

Next time I go to the Hill I want to set a deadline, and be able to stay a half hour after it.

It is clear that Chertoff, who set **up** the Hill briefings on Tuesday night, did not know enough to do that. The result was, we were there until 10:00 **pm** and everyone was angry. If you set a timetable it works. Someone should have been managing the time, and not letting people talk for an unlimited amount of time. It is as much our fault as theirs.

Thanks.

DHR:ss
090805-06

.....

OSD 18753 - 05

11-L-0559/OSD/52217

FOUO

September 08, 2005
2005-09-08 17:35:44

TO: Dan Stanley
VADM Jim Stavridis
Steve Bucci

FROM: Donald Rumsfeld 

SUBJECT: Tuesday Briefings on Capitol Hill

Next time I go to the Hill I want to set a deadline, and be able to stay a half hour after it.

It *is* clear that Chertoff, who set up the Hill briefings on Tuesday night, did not know enough to do that. The result was, we were there until 10:00 pm and everyone was *angry*. If you set a timetable it works. Someone should have been managing the time, and not letting people talk for *an* unlimited amount of time. It is as much *our* fault as theirs.

Thanks.

DHR^{ss}
090805-06

OSD 18753-05

.....

*No question. This was completely open ended.
In all future events/briefs/meetings we will
set a timetable and an expectation...*

16 SEP 2005

FOUO

11-L-0559/OSD/52218

OSD 18753-05

TAB A
FOUO

CJCS

August 31, 2005

TO: ~~Gorton England~~
~~ADM Ed Giambastiani~~
ADM Ed Giambastiani

FROM: Donald Rumsfeld *DR*

SUBJECT Lessons Learned from Hurricane Response

I think we need to get people in place fast on the hurricane and do a lessons learned, so we capture where the problems are and how we can do these things better.

Thanks.

DHR:dh
083105-18

.....

Please Respond By September 02, 2005

Tab A

OSD 18820-05

~~FOUO~~
11-L-0559/OSD/52219



THE VICE CHAIRMAN OF THE JOINT CHIEFS OF STAFF

WASHINGTON, D.C. 20318-9999

CM-2744-05
16 September 2005
7:52

INFO MEMO

FOR SECRETARY OF DEFENSE

FROM: Admiral Edmund P. Giambastiani, VCIC

ES Giambastiani 9/16

SUBJECT: Lessons Learned from Hurricane Response (SF)

- **Answer.** In response to your issue (TAB A), approximately 18 hours after Hurricane Katrina made landfall on 30 August, we initiated coordination with USNORTHCOM and USJFCOM to form teams to capture lessons learned from the Hurricane Katrina relief efforts. The major collection and analysis effort is being led by the USJFCOM Joint Center for Operational Analysis – Lessons Learned in close coordination with USNORTHCOM and the Joint Staff. Subsequent coordination included the National Guard Bureau, USPACOM, and OASD(HD).
- **Analysis**
 - An initial team of five personnel deployed from USNORTHCOM, USJFCOM, and the Joint Staff to Fort Gillem, 1st Army Headquarters (HQ), on 31 August to collect lessons learned. Four of these personnel joined the Commander, Joint Task Force Katrina (CG 1st Army), at the forward HQ, Camp Shelby on 2 September. By 7 September, nine joint teams totaling 61 personnel were in place, in addition to 24 Service personnel embedded with major units for Service-specific lessons, as listed in the attachment (TAB B).
 - A Joint Staff strategic lessons learned team, in coordination with OASD(HD), will interview senior leaders of the Department of Defense and key federal agencies (TAB C) in support of the National Response Plan. These interviews are critical to capturing DOD strategic lessons to better respond to future major domestic incidents.

COORDINATION: TAB D

Attachments:

As stated

Prepared By: Rear Admiral Richard J. Mauldin, USN; Director, J-7; (b)(6)

~~FOR OFFICIAL USE ONLY~~ OSD 18820-05

11-L-0559/USD/52220

TAB A

CJCS

~~FOUO~~

August 31, 2005

TO: Gordon England
ADM Ed Giambastiani

FROM Donald Rumsfeld *DR*

SUBJECT Lessons Learned from Hurricane Response

I think we need to get people in place fast on the hurricane and do a lessons learned, so we capture where the problems are and how we can do these things better.

Thanks.

DHR:db
083105-18

.....
Please Respond By September 02, 2005

Tab A

OSD 18820-05

~~FOUO~~
11-L-0559/OSD/52221

FINAL DISPOSITION OF LESSONS LEARNED TEAMS

	<u>Personnel</u>
Strategic Lessons	
National Capital Region	20
Strategic/Operational Lessons	
USNORTHCOM HQ	12
Includes Gen Wilhelm, USMC [Ret], as Senior Mentor	
USJFCOM HQ (reach-back analysis)	6
Operational/Tactical Lessons	
1st Army HQ, (Ft Gillem, GA)	4
JTF Katrina Forward (Camp Shelby, MS)	7
Includes VADM Hull, USCG [Ret], as Senior Mentor	
Mississippi (State HQ)	4
Louisiana (State HQ)	4
FEMA Region VI (Denton, TX)	1
Logistics Focus [various]	3
Services (JOA/units)	24

UNCLASSIFIED

TAB C

Hurricane Katrina Lessons Learned Senior Leader Proposed Interview List	
Position	Name
Secretary of Defense	Donald Rumsfeld
Deputy Secretary of Defense	Gordon England
USD (Policy)	Eric Edelman
USD (Personnel & Readiness)	Dr. David Chu
OSD General Counsel	William Haynes
USD (Intelligence)	Stephen Cambone
ASD (Homeland Defense)	Paul McHale
ASD (Public Affairs)	Lawrence DiRita
USD (Comptroller)	Tira Jonas
ASD (Reserve Affairs)	RADM Thomas Hall, USN (Ret)
PDASD (Reserve Affairs)	Craig W. Duehring
ASD (Health Affairs)	Dr. William Winkenwerder
PDASD (Health Affairs)	Dr. Steven Jones
DUSD (Readiness)	Dr. Paul Mayberry
DASD (Readiness, Training and Mobilization)	MG Antonio Taguba
DUSD (Installations and Environment)	Philip Cronc
ASD (Legislative Affairs)	Daniel Stanlev
Assistant Sec Army for Civil Works	Paul Woodley
Chairman, JCS	Gen Richard Myers
Vice Chairman, JCS	ADM Edmund Giambastaini
Assistant to CJCS	LTG Raymond Odierno
Chief of Staff, Army	GEN Peter Schoemaker
Chief of Naval Operations	ADM Michael Mullen
Chief of Staff, Air Force	Gen T. Michael Moseley
Commandant, USMC	Gen Michael Hagee
Chief, National Guard Bureau	LTG H Steven Blum
CDRUSNORTHCOM	ADM Keating
CDRUSSTRATCOM	Gen Cartwright
CDRUSJFCOM	LTG Wagner
Commandant, USCG	ADM Thomas Collins
Director, Army National Guard	MG Clyde Vaughn
cto ; Air National Guard	LT 3 L el Marl's
CDR, USA Corps of Engineers (USACE)	LTG Carl Strock
CDR, Defense Logistics Agency (DLA)	VADM Keith Lippert
Asst. to the CJCS for National Guard Matters	BG(P) Michael Sumrall

UNCLASSIFIED

Asst. to the CJCS for Reserve Matters	Maj Gen Thomas Dyches
OCJCS Legal Counsel	CAPT Hal Dronberger
OCJCS Public Affairs	CAPT Frank Thorn
OCJCS Director, Strategic Communications	Mr. Hanley
Director, Joint Staff	LTG Walter Sharp
Director, Joint Staff/J-1	RADM Donna Crisp
Director, Joint Staff/J-2	RADM David Dorsett
Vice Director, Joint Staff/J-2	Brig Gen Paul Dettmer
Director, Joint Staff/J-3	LtGen James Conway
Vice Director, Joint Staff/J-3	RADM Winns
Joint Staff/J-3/Deputy Director for Anti-Terrorism and Homeland Defense	Brig Gen Terry Scherling
Director, Joint Staff/J4	Lt Gen Duncan McNabb
DDIR for Log Ops/J-4	MG Jacko
DDIR for Log Ops/J-4	MG Jacko
Vice Director, Joint Staff/J-4	RADM Mark Harnitchek
Director, Joint Staff/J-5	Lt Gen Gene Remart
Vice Director, Joint Staff/J-5	RADM Frank Pandolfe
Director, Joint Staff/J-6	LtGen Robert Shea
Vice Director, Joint Staff/J-6	MG Dennis Moran
Director, Joint Staff/J-8	VADM Evan Chanik
Vice Director, Joint Staff/J-8	MG Michael Vane
Joint Staff Surgeon	Maj Gen (Dr.) Jose Kelley
Secretary of Homeland Security	Michael Chertoff
Director, FEMA	Michael Brown
National Security Advisor	Steve Hadley
Deputy National Security Advisor	J. D. Crouch
Secretary of State	Dr. Condoleezza Rice
Under Sec State for Public Diplomacy and Public Affairs	Karen Hughes
Secretary of Transportation	Norman Mineta

UNCLASSIFIED

TAB D

COORDINATION

USNORTHCOM	Mr. Pino (GS-15)	2 September 2005
USJFCOM	BG Cucolo	2 September 2005
NGB	COL Hersey (ARNG)	2 September 2005

UNCLASSIFIED

11-L-0559/OSD/52225

Tab D

FOUO

September 19, 2005

TO: The Honorable Dr. Condoleezza **Rice**
Stephen J. Hadley
The Honorable Dr. J.D. Crouch

cc: Gen Dick Myers
Eric Edelman
Larry DiRita

FROM: Donald Rumsfeld 

SUBJECT: Off-the-Record Media Roundtable Opportunity in London

Devon Cross, a member of the Defense Policy Board, manages an informal, **off-the-record** media roundtable in London.

I stopped in London to participate in a roundtable on the way to **the Berlin NATO Informal Defense Ministerial**. It was time very well spent. The discussion was **serious**, elevated, and useful.

The participants included an array of reporters, columnists, and authors from London-based media and publishing outlets. The group **often** includes prominent Arab journalists based in London.

Devon arranges these seminars for **U.S.** government officials, including some of the senior military commanders, as it fits with their schedules. Often, these officials schedule a seminar when they are otherwise traveling to the U.K., **or** traveling in **or** out of **Europe or** the Middle East.

Please consider encouraging NSC and State Department officials *to* avail themselves of this opportunity. Devon can be reached directly at (b)(6) You also *can* work with Larry Di Rita in the **PA** shop here, and he can help arrange it.

Thanks.

DHR.ss
091905-05

FOUO

11-L-0559/OSD/52226

OSD 18838-05

UK

19 SEP 05

~~FOUO~~

September 19, 2005

TO: GEN John Abizaid

CC: VADM Jim Stavridis
Larry DiRita

FROM: Donald Rumsfeld *DR*

SUBJECT: Briefing on GWOT Worldwide

When you are in town for the Combatant Commanders Conference, I would like to have you brief the principals, and possibly the President on the broader global war on terror worldwide, and in your AOR.

Thanks.

DHR:js
091905-04

.....
Please Respond By 10/04/05

000.5

19 Sep 05

~~FOUO~~

OSD 18839-05

11-L-0559/OSD/52227

FOUO

2005 MAY 18 11:29

May 18, 2005

I-05/006912
ES-3296

TO: Doug Feith
FROM: Donald Rumsfeld *DR*
SUBJECT: Note Regarding Latin America

Attached is a note from Newt Gingrich on Latin America that underlines the problems we have been talking about. We need to keep pushing the interagency.

Attach.
5/14/05 E-mil from Gingrich to SecDef

DHR:ss
051705-19

.....
Please respond by 6/16/05

Latin America

18 May 05

FOUO

OSD 18844-05

11-L-0559/OSD/52228

(b)(6)

CIV, OSD

*OSD
5/18*

From: Thirdwave2@aol.com

Sent: Saturday, May 14, 2005 1:41 PM

To: shadley@nsc.eop.gov, GundersonB@state.gov; libby@ovp.eop.gov

Cc: kr@georgewbush.com

Subject: aljazeera in spanish from newt

we should be very very concerned about developments in latin america

there is a much more coherent network of anti-US activity underway tha we realue

it will presently crystallize in vry powerful ways and we will wonder why e did not notice it. plan for it, or respond to it

this television station is very dangerous and remeber it will reach the US
newt

5/16/2005

11-L-0559/OSD/52229

*CC: VADM STAVRIDIS
LARRY DI RITA
PAUL BUTLER
COL STEVE BUCCI
COL WILL GAWLEY*

(b)(6)

CIV, OSD

From: Terry Balderson [tbalders@tampabay.rr.com]
 Sent: Saturday, May 14, 2005 1:32 PM
 To: undisclosed-recipients
 Subject: Latin strongman rebels against US-centric news

Latin strongman rebels against US-centric news

By Danna Harman | Staffwriter of **The Christian Science Monitor** 13 May 2005



HUGO CHAVEZ. Known for his lengthy TV appearances.
 FRANCISCO BATISTA/AP

CARACAS, VENEZUELA - Television is a window on the world. But if you're sitting in Latin America, that window is more likely to be facing Baghdad than Buenos Aires. Or show Michael Jackson instead of Mexico City. Or offer a clearer view of Ukraine's Orange Revolution than the one in Ecuador last month.

Those networks that do cover regional news, like CNN Español, based in Atlanta, or Spain's TVE, are often considered US- or Eurocentric, with pundits sitting in Washington or Madrid. International news from the Latin American perspective is almost nonexistent, critics say.

"But," says journalist Aram Aharonian, "not for long."

On May 24, Venezuelan President Hugo Chávez will launch a 24-hour hemispheric TV news network, with Mr. Aharonian at the helm. The idea, Mr. Chávez has explained on several occasions, is to offer a "Southern" perspective, and combat what he calls "the conspiracy" by networks to ignore or "distort" information from and about this region.

But critics worry that Televisora del Sur (Telesur), or TV of the South, will be used by Chávez to drown out the free press at home and spread his populist, socialist, and anti-US message and abroad.

"We get enough of him already," says Ana Cristina Nuñez, legal counsel at Globovision, a 24-hour local news station that is critical of Chávez. Globovision, like all channels in Venezuela, functions under a so-called "chain" system, which means it is obligated by law to drop everything and cover Chávez speeches whenever instructed by the government. Those speeches are often hour-long rants about the US or afternoon chats with "the people," during which he has been known to describe President Bush as a "jerk" who wants to invade Venezuela or sing praises of Cuban President Fidel Castro.

Latin America's Al Jazeera?

5/16/2005

11-L-0559/OSD/52230

Comparisons of the new TV venture are being made to Al Jazeera, the Arabic-language network funded by the government of Qatar that has been criticized frequently by US officials for what they call "inflammatory" or "biased" reporting.

Still, "bias" for one person can simply be a well-rounded view for another.

"I am in favor of initiatives that create additional voices in the news," says John Dinges, an associate professor of Journalism at Columbia University in New York. "Al Jazeera, for example, has made an important impact on journalism in the Middle East... Alternative looks at the facts can be positive."

Problems do arise, he warns, when news becomes too political. "Look at Fox TV in the US," he says. "If you create a medium to fill a political need - that's politics, not journalism." If Telesur is going to be a state-sponsored vehicle for Chávez, it will be bad journalism, says Mr. Dinges. "But if it's being done in order to spread an alternative journalistic voice, it will be good journalism and a contribution," he says.

Telesur's programming, which will be available free over the airwaves, will be split between news and "Latin America interest" documentaries, reaching viewers across South and North America, with expansion planned to Western Europe and North Africa for later this year. Promos begin this month with shows starting in July.

Telesur is being described as a regional endeavor: Argentina owns 20 percent, Cuba 19 percent, and Uruguay 10 percent. But Venezuela, with 51 percent, is the main player: The government has provided \$2.5 million in start-up capital. The total cost and source of the money have not been disclosed, but some funding will come from corporate sponsors, not advertising, Aharonian says.

Information Minister Andrés Izarra is the company's president, and headquarters are being constructed here in Caracas. Some 35 staffers are already in the cubicles of the makeshift second-floor office, beepers and cellphones clasped to their jeans. Other offices are being set up in Argentina, Uruguay, Brazil, Bolivia, Colombia, Mexico, Cuba, and in Washington. There is even a news anchor standing by. Ati Kiwa, an indigenous Colombian woman who wears traditional dress.

"We have been trained to see ourselves through foreign eyes," says Aharonian. "Europeans and Americans see us in black and white, and yet this is a technicolor continent"

Navigating Venezuela's media laws

For some, such talk rings hollow. "We all like the idea of a Latin American perspective of news, but not a one-sided view," replies Ms. Nuñez of Globovision. "I am very suspicious that Telesur will represent the voice only of leftist governments in Latin America - and will be an instrument of propaganda for them."

Globovision is not the only private media station in Venezuela hostile to Chávez. During the April 2002 coup that briefly ousted the president, most outlets openly sided with the opposition, providing round-the-clock coverage of anti-Chavez protests while refusing to air footage of massive demonstrations held in support of him. Since then, says Ms. Nuñez, "It has been payback time."

Globovision hired Nuñez four months ago in response to Chávez's new press laws, under which whoever "offends," or "shows disrespect for," or "defames" the president or his top officials, will face fines and punishment of six to 30 months in prison.

Nuñez spends her days now, she says, trying to interpret those terms for the journalists and editors she works with.

"There is no jurisprudence to go by, and people don't know what is allowed and what's a crime," she says. The new laws have already led to widespread self-censorship across the country's half-dozen private channels, she says. Late-night TV jokes about Chávez are out, risqué political talk shows are being canceled, and news reports are being fireily combed before airing. "Telesur is introducing a super-well-funded official voice, just as free-press voices are being fined and intimidated," she says. "Coincidence?"

5/16/2005

11-L-0559/OSD/52231

The French media advocacy group Reporters Without Borders and the New York-based Committee to Protect Journalists are already worried. Both have expressed concerns over the increased regulation of media content. And Human Rights Watch, the international monitor, insists that governments can only restrict certain content if "there is a clear relation between the speech in question and a specific criminal act."

No plans to muzzle media

Aharonian dismisses any suggestion that Telesur is part of some bigger plan to muzzle the media or give Chdvez an open microphone. The programming is not "against or instead of any other," but simply an option, he maintains. "That is what the remote control is for," he says, "so people can pick and choose between different perspectives."

Larry Bims, director of the left-leaning Council on Hemispheric Affairs in Washington is not quite as diplomatic. "Chdvez found himself yielding an important battlefield to anti-Chavista perspective, both from within and from outside the county," he says. "Uruguay and Argentina found a similar lack of ability to communicate- and this is their combined response."

Ultimately, slanted or straight, Telesur's success will depend on whether it's watchable, says Richard Siklos, adjunct professor at New York University's department of culture and communication. "[Chávez] will learn what every media executive in New York has learned: You can put stuff out there, but if people don't watch, you are wasting your money."

[Full HTML version of this story which may include photos, graphics, and related links](#)

5/16/2005

11-L-0559/OSD/52232

~~FOUO~~

SEP 20 2005

000.92

TO: Stephen J. Hadley
CC: Vice President Richard B. Cheney
FROM: Donald Rumsfeld 
SUBJECT: Bottleneck in KATRINA Response

Attached **is** a memo that is self-explanatory. Something is not working.

Attach: 9/8/05Memo

DHR:ss
091905-31

20 SEP 2005

~~FOUO~~

11-L-0559/OSD/52233

OSD 18846-05

②
V.P.

(b)(6)

CIV, OSD

From: Thirdwave2 [thirdwave2@speakingingrich.com]
Sent: Thursday, September 08, 2005 6:58 AM
To: kr@georgewbush.com; libby@ovp.eop.gov; MTaylor@who.eop.gov; ahubbard@who.eop.gov; jbolten@omb.eop.gov
Cc: sschmidt@ovp.eop.gov; Barry_S._Jackson@who.eop.gov
Subject: FW: KATRINA BOTTLENECK

These notes from General Chuck Boyd (air force four star retired) who *is* the head of BENS (business executive for national security) and was head of the Hart-Rudman commission is devastating

Only 200 of 18,000 offers of help have been accepted

As conservatives we want to maximize private sector and civil society activity and minimize government bureaucracy and government dominated activity

In this crisis the exact opposite has been happening

This bottleneck should be reversed immediately and plans and systems set in place for the future to maximize the volunteerism component
 newt

Phase use my new email address Thirdwave2@speakingingrich.com

Newt

From: (b)(6)
Sent: Wednesday, September 07, 2005 6:34 PM
To: Thirdwave2
Subject: KATRINA BOTTLENECK

NEWT

HERE ARE SOME SPECIFIC EXAMPLES. BUT THE NUMBER IS SO HIGH THAT TO COMPILE ANYTHING LIKE A REPRESENTATIVE LIST WOULD BE A MAJOR EFFORT. AS OF 4 PM YESTERDAY, THE DHS COMMAND CTR--WE ARE TOLD--HAD 18,000 OFFERS, OF WHICH 200 HAD BEEN RESPONDED TO. THIS IS REALLY NOT ROCKET SCIENCE. WE HAVE SUBMITTED A PROPOSAL TO DHS OFFERING TO HELP THEM ESTABLISH PUBLIC-PRIVATE SECTOR OFFICES IN 20 REGIONS AROUND THE COUNTRY--SIMILAR TO THOSE WE'VE ESTABLISHED SO SUCCESSFULLY IN NJ, GA, MID-AMERICA, BOSTON ETC, FOR THE PURPOSE OF MARSHALING PRIVATE SECTOR CAPABILITIES FOR USE BY THE STATE IN TIME OF CRISIS. BY ESTABLISHING THE MECHANISM WITH THE STATE AND PARTICIPATING COMPANIES, AND EXERCISING THEM PERIODICALLY, WHEN THE CRISIS HITS THE PRIVATE SECTOR IS IMMEDIATELY INVOLVED. DATA BASES ALREADY EXIST, ETC. DHS, AT LEAST AT THE ODP LEVEL IS VERY ENTHUSIASTIC ABOUT THE PROPOSAL BUT CLAIM THEY HAVE NO MONEY. MY RESPONSE IS THAT THEY WILL SPILL MORE ON A DAILY BASIS THAN THIS PROPOSAL WILL COST. AND STILL NOT BE READY FOR THE PRIVATE SECTOR WHEN THE NEXT ONE

9/8/2005

11-L-0559/OSD/52234

OCCURS.

SO, FIRSTATCH IS JUST A FEW SAMPLES, AND THE SECOND IS A SHORTE-MAIL TO ME FROM ONE OF OUR MEMBERS HIGHLIGHTING A FEMA DICTUM INHIBITING ACCEPTANCE OF PRIVATE SECTOR CONTRIBUTIONS RELAYED FROM A FIRE CHEF IN CALIFORNIA.

From: Em Blackwelder
Sent: Wednesday, September 07, 2005 5:52 PM
To: Charles Boyd
cc: Steve Cheney; Linda Mosley
Subject: Katrina bottleneck

General Bottleneck

Many businesses – some members of BENS, others not – after repeated attempts to donate significant amounts of much-needed capability, have called BENS in frustration seeking our assistance in penetrating the government bureaucracy. In virtually all cases, FEMA was the first intermediary contacted to deploy these offers, but after several days of unsatisfactory action from FEMA, efforts expanded to include other, non-governmental organizations such as the American Red Cross and BENS.

Typical Examples

1. Manufacturer and operator of highly capable mobile telecommunications command centers. On Wednesday, August 31, the company offered to FEMA three command centers, including experience operating teams, at no cost for 90 days. FEMA did not make a decision for approximately four days (citing no legal way to accept the donation), and then agreed to buy one command center, and then two days later agreed to buy several more.
2. Major aircraft manufacturer. On Saturday, September 3, company called BENS after having offered several helicopters and large cargo planes to FEMA without a response. Still no response as of today.
3. Major national aviation association. On Monday, September 5, an organization contacted BENS asking for help in moving FEMA into action. The organization had offered to make a large number of very capable private aircraft available to FEMA and/or others to evacuate residents and deliver food and other essential goods to affected areas from California, Florida and other states. No answer from FEMA after several days. Independent members of organization then began delivering supplies to affected areas without FEMA participation.
4. Major U.S. airline. Airline offer of aircraft to FEMA produced no action after several days and multiple appeals. Airline contacted U.S. Senator last weekend to seek assistance. Resolution unknown.

~~FOUO~~

SEP 20 2005

TO: Dan Bartlett
FROM: Donald Rumsfeld *D,*
SUBJECT: Quotes on Afghanistan

Dan--

The attached is interesting.

Attach.
9/7/05 Afghanistan As "Quagmire"

DHR.dh
091905-49

AFGHANISTAN

20050920

OSD 18901-05

~~FOUO~~

11-L-0559/OSD/52237

Afghanistan As "Quagmire"

- "Now it may be the United States' turn to try a foray into the Afghan quagmire."
-- Kathy Cannon, *the Associated Press*, 9/18/2001 (Before U.S. troops were in Afghanistan)
- "The American road out of quagmire in Central Asia ultimately passes through the United Nations... U.S. political strategy seems to be hogging down."
-- Jim Hoagland, *Washington Post*, 10/24/2001
- in some quarters "one detects the early signs of battle fatigue... the United States may end up wrestling with a tar baby, and that, without a clear exit strategy, another generation of American servicemen may be sucked into a quagmire in a foreign land."
-- *Dallas Morning News*, 10/26/2001
- "The question was suspended like a spore in the autumn air: Are we quagmiring ourselves again?"
-- Maureen Dowd, *New York Times*, 10/28/2001
- "Like an unwelcome specter from an unhappy past, the ominous word 'quagmire' has begun to haunt conversations among government officials and students of foreign policy, both here and abroad. Could Afghanistan become another Vietnam? Is the United States facing another stalemate on the other side of the world? Premature the questions may be, three weeks after the fighting began. Unreasonable they are not... echoes of Vietnam are unavoidable... signs of progress are sparse."
-- H.W. Apple Jr., *New York Times*, 10/31/2001
- "A quagmire looms ahead."
-- Arthur Schlesinger, *The Independent*, 11/2/2001
- "Now we seem to be getting engaged in an Afghan civil war, almost as an end in itself. That could be a quagmire."
-- Zbigniew Brzezinski, *Christian Science Monitor*, 11/2/2001
- "The war effort is in deep trouble. The United States is not headed into a quagmire; it's already in one. The U.S. is not losing the first round against the Taliban; it has already lost it... The U.S. is learning, once again, that an indigenous foe in a remote, inhospitable terrain is proving far more tenacious than it ever anticipated."
-- Jacob Heilbrunn, *Los Angeles Times*, 11/4/2001 (5 Days later Mazar-i Sharif fell)

FOUO

September 20, 2005

AFGHANISTAN

TO: President George W. Bush

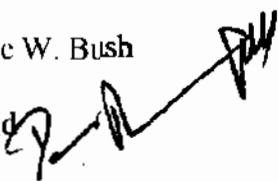
FROM: Donald Rumsfeld 

SUBJECT: Quagmire

Mr. President,

Given the successful elections in Afghanistan on September 18, you might enjoy reading the attached quotes, particularly, notice the dates.

Respectfully,

Attach: *Afghanistan As "Quagmire"*

DHR:ss
091906-53

90 SEP 05

OSD 18902-05

FOUO

11-L-0559/OSD/52239

Afghanistan As "Quagmire"

- "Now it may be the United States' turn to try a foray into the Afghan quagmire."
-- Kathy Gannon, the Associated Press, 9/18/2001 (Before U.S. troops were in Afghanistan)
- "The American road out of quagmire in Central Asia ultimately passes through the United Nations... U.S. political strategy seems to be bogging down."
-- Jim Hoagland, Washington Post, 10/24/2001
- In some quarters "one detects the early signs of battle fatigue... the United States may end up wrestling with a tar baby, and that, without a clear exit strategy, another generation of American servicemen may be sucked into a quagmire in a foreign land."
-- Dallas Morning News, 10/26/2001
- "The question was suspended like a spore in the autumn air: Are we quagmiring ourselves again?"
-- Maureen Dowd, New York Times, 10/28/2001
- "Like an unwelcome specter from an unhappy past, the ominous word 'quagmire' has begun to haunt conversations among government officials and students of foreign policy, both here and abroad. Could Afghanistan become another Vietnam? Is the United States facing another stalemate on the other side of the world? Premature the questions may be, three weeks after the fighting began. Unreasonable they are not... echoes of Vietnam are unavoidable... signs of progress are sparse."
-- R.W. Apple Jr., New York Times, 10/31/2001
- "A quagmire looms ahead."
-- Arthur Schlesinger, The Independent, 11/2/2001
- "Now we seem to be getting engaged in an Afghan civil war, almost as an end in itself. That could be a quagmire."
-- Zbigniew Brzezinski, Christian Science Monitor, 11/2/2001
- "The war effort is in deep trouble. The United States is not headed into a quagmire; it's already in one. The U.S. is not losing the first round against the Taliban; it has already lost it... The U.S. is learning, once again, that an indigenous foe in a remote, inhospitable terrain is proving far more tenacious than it ever anticipated."
-- Jacob Heilbrunn, Los Angeles Times, 11/4/2001 (5 Days later Mazar-i Sharif fell)

~~FOUO~~

September 19, 2005

320.2

TO: Tina Jonas
FROM: Donald Rumsfeld *DR*
SUBJECT: Memo on Army End Strength

Please restructure this memo in a more understandable format. This is not clear enough.

Thanks.

~~Attach~~ 9/14/05 USD COMPT memo to SecDef

DHR:gs
091905.13

.....
Please Respond By 09/22/05

Tina,
If you want to send someone to see me with this, I think I can help. *v/r Jim Stawicki*

19 Sept 05

~~FOUO~~
11-L-0559/OSD/52241

OSD 18919-05



UNDER SECRETARY OF DEFENSE

1100 DEFENSE PENTAGON
WASHINGTON, DC 20301-1100

INFO MEMO

09/20/05 11:00 AM

COMPTROLLER

September 20, 2005, 5:00 PM

320.2

FOR SECRETARY OF DEFENSE
ACTING DEPUTY SECRETARY OF DEFENSE

FROM: Tina W. Jones *Tina W. Jones*

SUBJECT: Army End Strength Increase

- Senators Lieberman and Clinton plan to introduce a floor amendment to the Defense Authorization bill to add 100,000 troops to the Army's active end strength by FY 2009.
- You asked what this would cost **and** if the figures include equipment and training.
- The total FY 2006 to 2009 cost estimate is \$63.1B. This includes:
 - Equipment: \$10.1B
 - Training: \$4.2B
 - Installation infrastructure: \$22.2B
 - Pay and Allowances: \$19.5B
 - Recruiting and Advertising: \$3.1B
 - Base Operations and Support: \$4.0B

20 Sep 05

COORDINATION: None

Prepared by: Ann Reese, (b)(6)

19 Sep 05

~~FOUO~~

SEP 21 2005

TO: Vice Resident Richard B. Cheney
FROM: Donald Rumsfeld *DR*
SUBJECT: Long Term Temporary Housing for Hurricane Victims

620

Attached is a cautionary tale about long-term temporary housing you **might** want to be aware of.

Attach: 9/17/05 Washington Post article by Marc Kaufman

DHR:ss
092005-06

2/5ep05

OSD 18937-05

~~FOUO~~

11-L-0559/OSD/52243

Burke Christopher LtCol HAF/CX

From: Burke Christopher LtCol HAF/CX
Sent: Monday, September 19, 2005 9:28 AM
To: Geren Pete SAF/OS
Cc: Wetekam Donald LtGen AF/IL; Seip Norman Maj Gen AF/AXO; Robinson Lori Col HAF/CX; Polczer Henry Lt Col SAF/OS; Helgeson Robert LtCol AF/IL; Roggero Frederick Brig Gen SAF/PA
Subject: FEMA Trailers (Article Requested by SECAF)

Sir/Ma'am,

This email contains an article on housing people in FEMA trailers from last year's Hurricane Charley.

This article was requested by the SECAF at Monday's Ops Intel briefing.

v/r

Lt Col Christopher Burke
Acting Mil Asst for the SECAF

Hurricane Charley Victims

FEMA's City of Anxiety in Florida

Many Hurricane Charley Victims Still Unsure of Next Step

By Marc Kaufman Washington Post Staff Writer
Saturday, September 17, 2005; Page A01

PUNTA GORDA, Fla. -- "Someone killed my dog," sputtered Royaltee Forman, still livid two weeks later.

"They just threw him out the window and hung him with his own leash," he said, convinced that someone broke into his home while he was out. "I mean, what kind of place has this become?"

Forman's place is FEMA City, a dusty, baking, treeless collection of almost 500 trailers that was set up by the federal emergency agency last fall to house more than 1,500 people made homeless by Hurricane Charley, one of the most destructive storms in recent Florida history. The free shelter was welcomed by thankful survivors back then; almost a year later, most are still there -- angry, frustrated, depressed and increasingly desperate.

"FEMA City is now a socioeconomic time bomb just waiting to blow up," said Bob Hebert, director of recovery for Charlotte County, where most FEMA City residents used to live. "You throw together all these very different people under already tremendous stress, and bad things will happen. And this is the really difficult part: In our county, there's no other place for many of them to go."

As government efforts move forward to relocate and house some of the 1 million people displaced by Hurricane Katrina along the Gulf Coast -- including plans to collect as many as 300,000 trailers and mobile homes for them -- officials here say their experience offers some harsh and sobering lessons about the difficulties ahead.

Most troubling, they said, is that while the badly damaged town of Punta Gorda is beginning to rebuild and even substantially upgrade one year after the storm, many of the area's most vulnerable people are being left badly behind.

The hurricane began that slide, destroying hundreds of modest homes and apartments along both sides of the

Peace River as it enters Charlotte Harbor, and almost all of Punta Gorda's public housing. Then as the apartments were slowly restored -- a process made more costly and time-consuming because of a shortage of contractors and workers -- landlords found that they could substantially increase their rents in the very tight market.

As a result, the low-income working people most likely to have been displaced by the hurricane are now most likely to be displaced by the recovery, too.

The unhappy consequence is that FEMA City's population has barely declined -- its trailers are occupied by 1,500 check-out clerks, nurse's aides, aluminum siding hangers, landscapers and more than a few people too old, too sick or too upset to work. A not-insignificant number of illegal immigrants and ex-convicts live there as well.

To the county's surprise, Hebert said, finding solutions to their ever-increasing problems is now the highest and most frustrating part of the entire hurricane recovery effort.

"Having lived through the last year here, this is my advice to New Orleans and the other Gulf Coast towns: Don't make big camps with thousands of people, because it doesn't work," Hebert said. "It takes a bad situation and, for many people, actually makes it worse."

Hebert was referring to the growing family problems, vandalism and criminal activity at the site, but even more to the deadline looming over FEMA City. By regulation, federal emergency shelter only lasts 18 months after a disaster is declared, and in Charlotte County the emergency period will end on Feb. 13. By then, everyone is supposed to be out of the trailers.

The deadline can sometimes be extended, but FEMA City site manager Roger Larson said no extensions are currently planned in Florida. In fact, more than 50 trailers have been taken out of FEMA City since Katrina hit, all headed to Mississippi and Louisiana. **The prospect of forced evictions is on everyone's minds.**

"Personally, I think there will be riots here if they try to evict people," said Tiffanie Weygart, a high school junior who was spending time last week with some friends on the otherwise-deserted main street of FEMA City, her family's home for most of this year. "We've got old people, we've got a lot of new habies. Where are they supposed to go?"

FEMA City is about 10 miles from Punta Gorda, its rows of white trailers covering 64 acres between the county jail and Interstate 75. The trailers are rent-free, but evacuees must pay for utilities.

The contrast to Punta Gorda, a damaged but pretty waterfront town with many historic homes, is extreme. About 100 miles south of Tampa Bay, Punta Gorda is the only incorporated city in Charlotte County (population 140,000). It was a sleepy place by South Florida standards until Charley came in and performed its version of urban renewal.

"You almost hate to say this because of the difficulties so many people have had, but Charley tore down some buildings that needed to come down and cleared areas for much higher kinds of uses," said City Manager Howard Kunik.

An old, damaged Holiday Inn on the town's waterfront, for instance, has been demolished and will be replaced with an \$80 million condominium-hotel complex, and other upscale projects are moving forward. Many residents are excited by the changes, but others -- especially the poor and some in Punta's Gorda's long-standing African American neighborhood -- worry they will be permanently priced out of their old home town.

Those fears were stoked last month when the city made clear that it plans to tear down a public housing complex on the waterfront to make way for much higher-income people.

"That land was just too valuable to have poor people on it," said community leader Isaac Thomas. He said that the local government is trying to help him and other black leaders save some of the modest but historic homes in

the African-American East End, but that "it's a really uphill **fight**."

This **uneven** recovery started on a far more **promising** note. The Federal Emergency Management Agency got generally **high** marks for its response to Hurricane Charley -- and three other Florida hurricanes last fall -- and that included the quick construction of the trailer **city**.

Tons of gravel, sand and crushed shells were trucked in to build up a low-lying meadow, and electrical and sewer lines were quickly laid. Officials say that last Christmas season, many homes were cheerfully lighted, and a sense of relief and thanks prevailed.

Today, that cheer is gone. That gritty soil makes the south Florida sun even hotter, and few people venture outside except to go to their cars. There are no trees, no shrubs, and only two small playgrounds for several hundred children.

Teenagers have been especially hard-hit -- **drug use**, vandalism, **break-ins** and **tights are widespread**. Young people regularly call FEMA City a prison.

The troubles got so bad in the spring that the entire camp was fenced in, a county police substation was set up, and armed security guards were stationed at the one point where residents were allowed to enter and exit. **Even with that, the number of calls to the county sheriff's office was at an all-time high last month -- 257 calls that resulted in 78 police reports, many of them involving domestic violence, fights, juvenile delinquency and vandalism.** In January, there were **just 154 calls and 40 official actions.**

Some of the vandalism has proven costly. Even after the expanded police deployment, FEMA officials said they had to spend almost \$20,000 recently to cover switches on the street lights because young people were **so** frequently turning them off

FEMA site manager Larson acknowledged the problems, but he said they should not overshadow the **successes.**

Providing shelter for **so** many people is a mammoth and expensive undertaking, he said, and many families have used the time to save money to pay the three-months' rent usually required upfront by landlords. In the past two weeks, he added, FEMA City has experienced its first population decline since opening in November

"We know the rental market is very tough **out there**, but we expect our tenants to make at **least** three calls a month about new housing, and some are succeeding," he said.

But many are not. **FEMA reports that one year after the four Florida storms, it is still providing 7,640 mobile homes or trailers for displaced people, 1,056 of them in Charlotte County. Both statewide and in Charlotte, that means almost half of the people who needed temporary FEMA shelter after the storms still rely on it.**

Melissa Frey, who posts grocery prices at a local Winn-Dixie market, is one of them, and she watched with dread from her **FEMA** City doorway last week as another mobile home was hauled away. She said she **has** been looking for an apartment for herself and her 2-year-old daughter, with no luck. The stress of the hurricane and the aftermath led to a split with her husband and the loss of his income, and **so she** barely has **enough** money to cover expenses without paying rent.

"This is no way to live, and I just wish I could move out," she said. She lives a stone's throw from the **main** security post, but she still regularly finds her tires flattened by nails that she blames on vandals. "But I'm really worried about what's coming in February, and **so** are many other people here."

Others are angry.

"Basically, Charlotte County would be happy to see **us all go**," said Forman, the resident whose dog was strangled. "They think they don't need **us**, and they really don't want us." Adding to his embitterment, the police ruled that the dog had thrown itself out the window, a conclusion his neighbors greeted with disbelief

With the constant troubles at FEMA City and the increased tensions throughout the county caused by its housing crisis, Charlotte County Sheriff's Office spokesman Bob Carpenter said his department has had a real education since Charley. It's hard-won knowledge, he said, that they will share with Hancock County, Miss., one of the hardest-hit areas of the Gulf Coast.

"We're sending some officers over there," he said. "We know what's going to happen, while they don't have a clue."



LEGISLATIVE
AFFAIRS

THE ASSISTANT SECRETARY OF DEFENSE
WASHINGTON, DC 20301-1300

ACTION MEMO

SEP 22 05 12:42

September 22, 2005, 1400p.m.

620

FOR: SECRETARY OF DEFENSE

FROM: Daniel R. Stanley, Assistant Secretary of Defense
for Legislative Affairs, (b)(6)

SUBJECT: Snowflake Response

- You asked about the question from Representative Bennie G. Thompson (D-MS): "One of the questions was from a Member of Congress from Jackson, Mississippi. I cannot recall their name, but they said there are military bases in Mississippi and Louisiana that could temporarily house people, and they asked if we are doing it – and I didn't have an answer." (Tab A)
- Military bases in both Mississippi and Louisiana are currently housing DoD Displaced Personnel, DoD Relief, Non-DoD Relief, and Non-DoD Evacuees.

RECOMMENDATION: Sign the attached response letter to Representative Thompson (Tab B).

22 Sep 05

Attachments:
Snowflake # 091305-15
Draft Response to Rep. Thompson

Prepared by: LTC Roger D. Carstens/OSD (LA) (b)(6)

OSD 18940-05

14 Sep 05

11-L-0559/OSD/52248



SECRETARY OF DEFENSE
1000 DEFENSE PENTAGON
WASHINGTON, DC 20301-1000

The Honorable Bennie G. Thompson
U.S. House of Representatives
Washington, DC 20515

Dear Representative Thompson:

During the September 6th briefing to Members of Congress on Hurricane Katrina relief efforts, you asked me whether or not the Department of Defense could temporarily house people on military bases in Mississippi and Louisiana.

Title 10, Sec. 2556 "*Shelter for Homeless; **Incidental Services***," provides for the sheltering displaced persons on DoD installations. As such, we are currently housing over 3,400 persons displaced by Hurricane Katrina on military bases in Mississippi and Louisiana, as well as a number of other states throughout the Continental United States.

I appreciate your continuing support for the U.S. Armed Forces.

Sincerely,



11-L-0559/OSD/52249



THE ASSISTANT SECRETARY OF DEFENSE

WASHINGTON, DC 20301-1300

ACTION MEMO

October, 3, 2005, 1300p.m.

620

FOR: SECRETARY OF DEFENSE

FROM: Daniel R. Stanley, Assistant Secretary of Defense
for Legislative Affairs, (b)(6)

SUBJECT: Snowflake Response

- You asked me about the question from Representative Bennie G. Thompson (D-MS): "One of the questions was from a Member of Congress from Jackson, Mississippi. I cannot recall their name, but they said there are military bases in Mississippi and Louisiana that could temporarily house people, and they asked if we are doing it - and I didn't have an answer."
- Military bases in both Mississippi and Louisiana are currently housing DoD Displaced Personnel, DoD Relief, Non-DoD Relief, and Non-DoD Evacuees.

3 Oct 05

Attachments:
Snowflake # 091305-15
Draft Response to Rep. Thompson

Prepared by: LTC Roger D. Carstens/OSD (LA) (b)(6)

14 Sep 05

11-L-0559/OSD/52250

OSD 18940-05

~~FOUO~~

SEP 14 2005

680

TO Dan Stanley
FROM Donald Rumsfeld *DA*
SUBJECT: Question about Temporary Housing at Military Bases

One of the questions was from a Member of Congress from Jackson, Mississippi. I cannot recall their name, but they said there are military bases in Mississippi and Louisiana that could temporarily house people, and they asked if we are doing it - and I didn't have an answer.

Please draft a response.

Thanks.

DHR:m
091305-19

.....
Please respond by 9/20/05

~~FOUO~~

14 SEP 05

OSD 18940-05

11-L-0559/OSD/52251



LEGISLATIVE
AFFAIRS

THE ASSISTANT SECRETARY OF DEFENSE
WASHINGTON, DC 20301-1300

September 20, 2005, 1600p.m.

620

RESPONSE TO SNOWFLAKE FOR THE
SECRETARY OF DEFENSE

FROM: Daniel R. Stanley, Assistant Secretary of Defense
for Legislative Affairs, (b)(6)

- Request: "One of the questions was from a Member of Congress from Jackson, Mississippi. I cannot recall their name, but they said there are military bases in Mississippi and Louisiana that could temporarily house people, and they asked if we are doing it – and I didn't have an answer."
- Rep. Bennie G. Thompson (D-MS) posed the question as to whether or not the Department of Defense could temporarily house people on military bases in Mississippi and Louisiana.
- Military bases in both Mississippi and Louisiana are currently housing DoD Displaced Personnel, DoD Relief, Non-DoD Relief, and Non-DoD Evacuees.

20 Sep 05

Attachments:
Snowflake # 091305-15
Draft Response to Rep. Thompson

14 Sep 05

MA SD		SMA DSD	
TSA SD		SA DSD	
EXEC SEC	BM 9/21/05		
CCO MA	9/21	1 < 2	

Roger D. Carstens/OSD(LA) (b)(6)

11-L-0559/OSD/52252

OSD 18940-05



LEGISLATIVE
AFFAIRS

THE ASSISTANT SECRETARY OF DEFENSE
WASHINGTON, DC 20301-1300

HOLD

SECRET OFFICE OF THE

2005 OCT -7 PM 4:19

ACTION MEMO

October 6, 2005, 1200 p.m.

FOR: SECRETARY OF DEFENSE

FROM: Daniel R. Stanley, Assistant Secretary of Defense
for Legislative Affairs, (b)(6)

SUBJECT: Response to Snowflake, Secretary of Defense

- You requested for answers to Representatives Clyburn and Jackson Lee following your September 6th briefing to Members of Congress on Humcane Katrina. (Tab A).
- Representative Clyburn (D-SC) told you that a non-military evacuee family had moved in with a soldier at Fort Jackson, SC, and their children had been refused admittance to the DoD Dependant School on base at Fort Jackson. The Undersecretary of Defense for Personnel and Readiness rectified the situation. The children are enrolled in the on base school and have been attending since Monday, September 12th. We have been in touch with Representative Clyburn (personally and with his Chief of Staff) and kept him updated on the situation. Personnel and Readiness is working on a poliey to address similar future situations should they arise at other installations with DoD Dependant Schools.
- Rep. Sheila Jackson Lee (D-TX) asked you questions concerning sheltering displaced persons on DoD installations in the wake of Hurricane Katrina. Her questions and the answers follow:
 - Q: What law allows for sheltering displaced persons on DoD installations?
A Title 10, Sec. 2556 "Shelter ~~for~~ Homeless; Incidental Services."
 - Q: Is the DoD sheltering displaced persons on DoD installations?
A: Yes. Examples include NSA New Orleans, NAS Meridian and NAS Pascagoula.
- This information was provided to Rep. Jackson Lee on Friday, September and to her Deputy Chief of Staff on September 12th.

032

6 Oct 05 4

128405

OSD 18941-05

11-L-0559/OSD/52253

- Non-DoD Evacuees consist of non-dependant family members who have been sponsored onto base by DoD members, general population evacuees invited onto National Guard bases by the State Governors, and evacuees who have had a prior relationship with the Department of Defense.

RECOMMENDATION: Sign the attached response letters to Representatives Clyburn and Jackson Lee (Tab B)

Attachments:

Tab A - Snowflake #091205-34

Tab B - Responses to Reps. Clyburn and Lee

Prepared by: LTC Roger D. Carstens/OSD (LA) (b)(6)

11-L-0559/OSD/52254



SECRETARY OF DEFENSE
1000 DEFENSE PENTAGON
WASHINGTON, DC 20301-1000

The Honorable Sheila Jackson-Lee
United States House of Representatives
Washington, DC 20515

Dear Representative Jackson Lee:

During the September 6th briefing to Members of Congress on Hurricane **Katrina** relief efforts, you asked me what law allows for the sheltering of displaced persons on Department of Defense installations and whether or not we were doing **so**.

Although not invoked, Title 10, Sec. 2556 "*Shelter for Homeless; Incidental Services*," provides authority for the sheltering of displaced persons on DoD installations. We are currently housing persons displaced by Hurricane Katrina on military bases throughout the United States. Those evacuees consist of non-dependant family members who have been sponsored onto base by DoD members, general population evacuees invited onto National Guard bases by the State Governors, and evacuees who have had a prior relationship with the Department of Defense.

I appreciate your continuing support for the U.S. Armed Forces.

Sincerely,



11-L-0559/OSD/52255



SECRETARY OF DEFENSE
1000 DEFENSE PENTAGON
WASHINGTON, DC 20301-1000

The Honorable James Clyburn
United States House of Representatives
Washington, DC 20515

Dear Representative Clyburn:

During the September 6th briefing to Members of Congress on Hurricane Katrina relief efforts, you alerted me to a situation at Fort Jackson, S.C., in which Hurricane Katrina evacuee children were refused admittance to the on-base DoD school because they were not "authorized dependant children."

The Department of Defense, working through our DoD Education Activity (DODEA), rectified the situation. The children are enrolled in the on-base school and have been attending since Monday, September 12.

The Department of Defense is currently working on a policy to address similar future situations should they arise at other installations with DoD Dependant Schools.

I appreciate your continuing support for the U.S. Armed Forces.

Sincerely,



11-L-0559/OSD/52256



THE ASSISTANT SECRETARY OF DEFENSE
WASHINGTON, DC 20301-1300

CLASSIFIED BY: [REDACTED]
SECRETARY OF DEFENSE
2005 OCT -4 AM 6:34

ACTION MEMO

October 3, 2005, 1200 p.m.

FOR: SECRETARY OF DEFENSE

FROM: Daniel R. Stanley, Assistant Secretary of Defense
for Legislative Affairs (b)(6)

SUBJECT: Response to Snowflake, Secretary of Defense

- You requested for answers to Representatives Clyburn and Jackson Lee following your September 6th briefing to Members of Congress on Hurricane Katrina. (Tab A).
- Representative Clyburn (D-SC) told you that a non-military evacuee family had moved in with a soldier at ~~Fort~~ Jackson, SC, and their children had been refused admittance to the DoD Dependant School on base at Fort Jackson. The Undersecretary of Defense for Personnel and Readiness rectified the situation. The children are enrolled in the on base school and have been attending since Monday, September 12th. We have been in touch with Representative Clyburn (personally and with his Chief of Staff) and kept him updated on the situation. Personnel and Readiness is working on a policy to address similar future situations should they arise at other installations with DoD Dependant Schools.
- Rep. Sheila Jackson Lee (D-TX) asked you questions concerning sheltering displaced persons on DoD installations in the wake of Hurricane Katrina. Her questions and the answers follow:
 - Q: What law allows for sheltering displaced persons on DoD installations?
 - A: Title 10, Sec. 2556 "Shelter ~~for~~ Homeless; Incidental Services."
 - Q: Is the DoD sheltering displaced persons on DoD installations?
 - A: Yes. Examples include NSA New Orleans, NAS Meridian and NAS Pascagoula.
- This information was provided to Rep. Jackson Lee on Friday, September 9 and to her Deputy Chief of Staff on September 12th.

OSD 1894 I-435

11-L-0559/OSD/52257

RECOMMENDATION: Sign the attached response letters to Representatives Clyburn and Jackson Lee (Tab B)

Attachments:

Tab A - Snowflake #091205-34

Tab B - Responses to Reps. Clyburn and Lee

Prepared by: LTC Roger D. Carstens/OSD(LA) (b)(6)

11-L-0559/OSD/52258



SECRETARY OF DEFENSE
1000 DEFENSE
WASHINGTON, DC 20301-1000

The Honorable James Clyburn
United States House of Representatives
Washington, DC 20515

Dear Representative Clyburn:

During the September 6th briefing to Members of Congress on Hurricane Katrina relief efforts, you alerted me to a situation at Fort Jackson, S.C., in which Hurricane Katrina evacuee children were refused admittance to the on-base DoD school because they were not "authorized dependant children."

The Department of Defense, working through our DoD Education Activity (DODEA), rectified the situation. The children are enrolled in the on-base school and have been attending since Monday, September 12.

The Department of Defense is currently working on a policy to address similar future situations should they arise at other installations with DoD Dependiant Schools.

I appreciate your continuing support for the U. S Armed Forces.

Sincerely,



11-L-0559/OSD/52259



SECRETARY OF DEFENSE
1000 DEFENSE PENTAGON
WASHINGTON, DC 20301-1000

The Honorable Sheila Jackson Lee
United States House of Representatives
Washington, DC 20515

Dear Representative Jackson Lee:

During the September 6th briefing to Members of Congress on Hurricane Katrina relief efforts, you asked me what law allows for the **sheltering of displaced** persons on Department of Defense installations and whether or not we were **doing** so.

Although not invoked, Title 10, Sec. **2556** "*Shelter for Homeless; Incidental Services*," provides authority for the sheltering of displaced persons on DoD installations. We are currently housing persons displaced by Hurricane Katrina on military bases throughout the United States.

I appreciate your continuing support for the U.S. Armed Forces.

Sincerely,



11-L-0559/OSD/52260



LEGISLATIVE
AFFAIRS

THE ASSISTANT SECRETARY OF DEFENSE
WASHINGTON, DC 20301-1300

OFFICE OF THE
SECRETARY OF DEFENSE

ACTION MEMO

2005 SEP 23 PM 12:40

September 22, 2005, 1400 p.m.

FOR: SECRETARY OF DEFENSE

FROM: Daniel R. Stanley, Assistant Secretary of Defense
for Legislative Affairs (b)(6)

SUBJECT: Response to Snowflake, Secretary of Defense

- You requested for answers to Representatives Clyburn and Jackson Lee following your September 6th briefing to Members of Congress on Hurricane Katrina. (Tab A).
- Representative Clyburn (D-SC) told you that a non-military evacuee family had moved in with a soldier at Fort Jackson, SC, and their children had been refused admittance to the DoD Dependant School on base at Fort Jackson. The Undersecretary of Defense for Personnel and Readiness rectified the situation. The children are enrolled in the on base school and have been attending since Monday, September 12th. We have been in touch with Representative Clyburn (personally and with his Chief of Staff) and kept him updated on the situation. Personnel and Readiness is working on a policy to address similar future situations should they arise at other installations with DoD Dependant Schools.
- Rep. Sheila Jackson Lee (D-TX) asked you questions concerning sheltering displaced persons on DoD installations in the wake of Hurricane Katrina. Her questions and the answers follow:
 - Q: What law allows for sheltering displaced persons on DoD installations?
 - A: Title 10, Sec. 2556 "*Shelter for Homeless; Incidental Services.*"
 - Q: Is the DoD sheltering displaced persons on DoD installations?
 - A: Yes. Examples include NSA New Orleans, NAS Meridian and NAS Pascagoula.
- This information was provided to Rep. Jackson Lee on Friday, September 9th and to her Deputy Chief of Staff on September 12th.

OSD 18941-05

11-L-0559/OSD/52261

RECOMMENDATION: Sign the attached response letters to Representatives Clyburn and Jackson Lee (Tab B)

Attachments:

Tab A - Snowflake#091205-34

Tab B - Responses to Reps. Clyburn and Lee

Prepared by: LTC Roger D. Carstens/OSD (LA) (b)(6)

11-L-0559/OSD/52262



SECRETARY OF DEFENSE
1000 PENTAGON
WASHINGTON, DC 20301-1000

The Honorable Sheila Jackson Lee
U.S. House of Representatives
Washington, DC 20515

Dear Representative Jackson Lee:

During the September 6th briefing to Members of Congress on Hurricane Katrina relief efforts, you asked me what law allows for the sheltering of displaced persons on Department of Defense installations and whether or not we were doing so.

Title 10, Sec. 2556 "*Shelter for Homeless; Incidental Services*," provides for the sheltering displaced persons on DoD installations. We are currently housing persons displaced by Hurricane Katrina on military bases throughout the United States.

I appreciate your continuing support for the U.S. Armed Forces.

Sincerely,



11-L-0559/OSD/52263



THE SECRETARY OF DEFENSE
1000 DEFENSE PENTAGON
WASHINGTON, DC 20301-1000



The Honorable James Clyburn
U.S. House of Representatives
Washington, DC 20515

Dear Representative Clyburn:

During the September 6th briefing to Members of Congress on Hurricane Katrina relief efforts, you alerted me to a situation at Fort Jackson, S.C., in which Hurricane Katrina evacuee children were refused admittance to the on-base DoD school because they were not "authorized dependant children."

The Department of Defense, working **through** our DoD Education Activity (DODEA), rectified the situation. The children are enrolled in the on base school and have been attending since Monday, September 12.

The Department of Defense is currently working on a policy to address similar future situations should they arise at other installations with DoD Dependat Schools.

I appreciate your continuing support for the US . Armed Forces.

Sincerely,



11-L-0559/OSD/52264



LEGISLATIVE AFFAIRS

THE ASSISTANT SECRETARY OF DEFENSE
WASHINGTON, DC 20301-1300

SEP 20 2005 14:00
135 101 01 11 14

September 20, 2005, 1400p.m.

RESPONSE TO SNOWFLAKE FOR THE
SECRETARY OF DEFENSE

FROM: Daniel R. Stanley, Assistant Secretary of Defense
for Legislative Affairs, (b)(6)

Request: "I've got to get the answers back to folks on the Hill who were so angry that night. I would like to see who asked the questions, and my answers to them in draft form."

- Representative Clyburn (D-SC) told you that a non-military evacuee family had moved in with a soldier at Fort Jackson, SC, and their children had been refused admittance to the DoD Dependent School on base at Fort Jackson. The Undersecretary of Defense for Personnel and Readiness rectified the situation. The children are enrolled in the on base school and have been attending since Monday, September 12. We have been in touch with Representative Clyburn (personally and with his Chief of Staff) and kept him updated on the situation. Personnel and Readiness is working on a policy to address similar future situations should they arise at other installations with DoD Dependent Schools.
- Rep. Sheila Jackson Lee (D-TX) asked you questions concerning sheltering displaced persons on DoD installations in the wake of Hurricane Katrina. Her questions and the answers follow:

Q: What law allows for sheltering displaced persons on DoD installations?

A: Title 10, Sec. 2556 "Shelter for Homeless; Incidental Services."

Q: Is the DoD sheltering displaced persons on DoD installations?

A: Yes. Examples include NSA New Orleans, NAS Meridian and NAS Pascagoula.

- This information was provided to Rep. Jackson Lee on Friday, September 9 and to her Deputy Chief of Staff on September 12.

Attachments:
Snowflake#091205-34
* Draft Responses to Reps. Clyburn and Lee

Prepared by: LTC Roger D. Carstens/OSD (LA) (b)(6)

OSD 18941-05

11-L-0559/OSD/52265

ESR MA	12/1/04	1540	NSA SD	NSA DSU
EXEC SEC	09/12/05	1425 ps	SA DSU	SMA DSU

THE SECRETARY OF DEFENSE
WASHINGTON, THE DISTRICT OF COLUMBIA



The Honorable Sheila Jackson Lee
United States House of Representatives
Washington, DC 20515

Dear Ms. Jackson Lee:

During the September 6th briefing to Members of Congress on Hurricane Katrina relief efforts, you asked me what law allows for the sheltering of displaced persons on Department of Defense installations and whether or not we were doing so.

Title 10, Sec. 2556 "*Shelter for Homeless, Incidental Services*," provides for the sheltering displaced persons on DoD installations. We are currently housing persons displaced by Hurricane Katrina on military bases throughout the United States.

I appreciate your continuing support for the U.S. Armed Forces.

Sincerely,

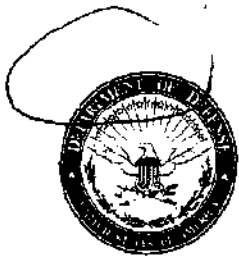

THE SECRETARY OF DEFENSE
WASHINGTON, THE DISTRICT OF COLUMBIA

The Honorable James Clyburn
United States House of Representatives
Washington, DC 20515

Dear Mr. Clyburn:

During the September 6th briefing to Members of Congress on Hurricane Katrina relief efforts, you alerted me to a situation at Fort Jackson, S.C., in which Hurricane Katrina evacuee children were refused admittance to the on-base DoD school because they were not "authorized dependant children."

The Department of Defense, working through our DoD Education Activity (DODEA), rectified the situation. The children are enrolled in the on base school and have been attending since Monday, September 12.

The Department of Defense is currently working on a policy to address similar future situations should they arise at other installations with DoD Dependant Schools.

I appreciate your continuing support for the US. Armed Forces.

Sincerely,

DRAFT

The Honorable Sheila Jackson Lee
United States House of Representatives
Washington, DC 20515

Dear Representative Jackson Lee:

During the September 6th briefing to Members of Congress on Hurricane Katrina relief efforts, you asked me what law allows for the sheltering of displaced persons on Department of Defense installations and whether or not we are doing so.

Title 10, Sec. 2556 "*Shelter for Homeless; Incidental Services*," provides for the sheltering of displaced persons on DoD installations. In accordance with this authority and consistent with our commitment to support the national response to this disaster, we are currently housing persons displaced by Hurricane Katrina on military bases throughout the United States.

I appreciate your continuing support of the U.S. Armed Forces.

Sincerely,

11-L-0559/OSD/52268

DRAFT

The Honorable James Clyburn
United States House of Representatives
Washington, DC 20515

Dear Representative Clyburn:

During the September 6th briefing to Members of Congress on Hurricane Katrina relief efforts, you alerted me to a situation at Fort Jackson, S.C., in which Hurricane Katrina evacuee children were refused admittance to the on-base DoD school because they were not "authorized dependent children."

The Department of Defense, working through our DoD Education Activity (DODEA), rectified the situation. The children are enrolled in the on base school and have been attending since Monday, September 12.

The Department of Defense is currently working on a policy to address similar future situations should they arise at other installations with DoD Dependent Schools.

I appreciate your continuing support for the U.S. Armed Forces.

Sincerely,

11-L-0559/OSD/52269

FOUO

September 12, 2005

032

TO: Dan Stanley

FROM: Donald Rumsfeld *DR*

SUBJECT: Responses to Congressional Members

I've got to get the answers back to folks on the Hill who were so angry that night. I would like to see who asked the questions, and my answers to them in draft form.

Thanks.

DHR.ss
091205-34

.....
Please Respond By 09/20/05

18 SEP 2005

FOUO

11-L-0559/OSD/52270

OSD 18941-05

~~FOUO~~

SEP 21 2005

TRAC

TO: Stephen J. Hadley
Dan Bartlett

cc: Gen Dick Myers
Larry DiRita

FROM: Donald Rumsfeld 

SUBJECT: Road to Airport

Attached is a press article that recounts a changed circumstance along the airport road as observed by this particular reporter.

The article includes some interesting facts, including a discussion about how Coalition forces have made the road a priority and some measures of how effective they have been.

You mentioned this topic recently, and I thought you might find this interesting.

Attach: *USA Today* article "Number of attacks decreases on Baghdad highway to airport"

DIIR.35
092005-01

21 SEP 05

~~FOUO~~

11-L-0559/OSD/52271

FOUO

SEP 21 2005

TO: Stephen J. Hadley
~~Ben~~ Bartlett

CC: Gen Dick Myers
Larry DiRita

FROM: Donald Rumsfeld 

SUBJECT: Road to Airport

Attached is a press article that recounts a changed circumstance along the airport road as observed by this particular reporter.

The article includes some interesting facts, including a discussion about how Coalition forces have made the road a priority and some measures of how effective they have been.

You mentioned this topic recently, and I thought you might find **this** interesting.

Attach USA Today article "Number of attacks decreases on Baghdad highway to airport"

DHR.es
092005-01

OSD 18942-05

FOUO

11-L-0559/OSD/52272

E

Copyright 2005 Gannett Company, Inc.
USA TODAY

September 14, 2005, Wednesday, FINAL EDITION

SECTION: NEWS; Pg. 5A

LENGTH: 657 words

HEADLINE: Number of attacks decreases on Baghdad highway to airport

BYLINE: Kimberly Johnson

DATELINE: BAGHDAD

BODY:

BAGHDAD -- Attacks on and around the 7-mile highway linking Baghdad to its international airport have dropped 41% since May, the result of increased U.S. and Iraqi troop presence and new tactics to battle insurgents along one of the world's most dangerous roads.

There hasn't been a suicide car bombing on the road since April, according to U.S. military statistics through August.

U.S. officers attribute the decline to an influx of Iraqi troops who have been stationed at key points along **Airport Road**, which goes by the military designation Route Irish.

"Route Irish is definitely not the most dangerous road in Iraq any longer, and everyone who uses it knows it," says Lt. Col. Geoffrey Slack, commander of the New York National Guard's 1st Battalion, 69th Infantry Regiment.

In May, insurgents staged 49 attacks on the road and in surrounding neighborhoods, including assaults with deadly roadside bombs and rocket-propelled grenades, according to statistics from Slack's battalion, which was responsible for the area until a recent hand-over.

Violence in the road's area peaked in November 2004. That month, insurgents launched 52 attacks, including 13 car bombs, according to the military statistics. The number of attacks fell to 29 in August, mostly small-arms fire.

Airport worker Hana Abdul Aziz, 28, was on her way to work in a bus with other airport employees one morning last November when the bus came under attack.

Aziz remembers glass and blood flying through the air. A woman sitting next to her was killed in the attack. "She got a bullet in her head and died immediately," she says.

For most of the past year, the New York battalion has been responsible for securing the road and surrounding neighborhoods. U.S. military officials declined to discuss numbers, but American battalions generally number about 800 troops.

11-L-0559/OSD/52273

In June, an Iraqi police commando unit was assigned to work alongside the American troops. Iraqi battalions typically have about 750 troops, says Lt. Col. Fred Weisman, spokesman for the command responsible for training Iraqi troops.

The additional Iraqi troops, along with U.S. counterparts, were deployed at seven armed checkpoints at the entries to the road. The checkpoints are staffed around the clock and can carefully watch vehicles entering the highway.

The airport highway has been hotly contested. It is heavily used by American and coalition forces, contractors, diplomats and Iraqis working with them. Surrounding the airport is a large U.S. military facility that serves as headquarters for coalition forces.

There are few entrances or exits on the road. Most of the traffic is going to or from the airport or the U.S. base, presenting prime targets for insurgents.

"They knew you'd have diplomats traveling on that road," says Maj. Alayne Conway, spokeswoman for the 3rd Infantry Division.

The highway also has symbolic importance as one of the main links between Iraq and the outside world.

During March and April, attacks on the road were so common that U.S. Embassy personnel were banned from using the road.

Dense neighborhoods along the road make ideal hiding places for insurgents who can attack and take cover in the narrow streets.

Coalition forces have struggled to make it safe, highlighting the difficulty of fighting an insurgency in a big city.

Soldiers have cut down date palms that lined the road, cleared trash, moved guardrails and cut weeds to make it difficult to hide roadside bombs, Conway says.

Getting the additional Iraqi troops assigned to the area allowed commanders to set up strong points along the highway and "turned the tables," Slack says.

U.S. officers stop short of saying the problem is fixed. "I don't want to speculate that things are going to stay the same, but obviously with the things that have been done, the road is safer," Conway says.

Contributing: Mona Mahmoud

FOUO

September 19, 2005

2005-09-19 1:00

311

TO: Col Bucc
~~VADM Jim Stavridis~~
CC: Tom Wedige
FROM: Donald Rumsfeld *DR*
SUBJECT: Communication Issues

cc: Joe Wassel
VADM Stavridis

Some problems in Maryland on Saturday:

1. The fax transmission isn't good. The faxes with charts or photos are not readable.
2. The phones wouldn't work
3. I never received the Keating briefing paper

We need to improve the communication linkages.

Finally, two documents came in indicating they should be read that evening (they were dated Friday, September 16), and I didn't see them until 9:00 am Saturday morning. That is not good enough.

Thanks.

DHR:ss
091905-08

.....
Please Respond By 09/29/05

19 Sep 05

FOUO

11-L-0559/OSD/52275

OSD 18972-05

~~FOUO~~

AUG 19 2005

ES-3981
05/011187

TO: Peter Rodman
CC: Eric Edelman
FROM: Donald Rumsfeld *DR*
SUBJECT Alliance for Progress

Someone ought to take a look at the Alliance for Progress - see what it was and if there is any aspect of it that might be done now.

Thanks.

DHR:db
081005-ITS

.....
Please respond by September 8, 2005

~~FOUO~~

11-L-0559/OSD/52276

SEP 15 2005

USE

INFO MEMO 11 01 47

DSD
USDP *246* SEP 20 20
1-05/011187-ES
ES-3981

FOR SECRETARY OF DEFENSE

FROM: Peter W. Rodman, Assistant Secretary of Defense (ISA) *[Signature]*

SEP 19 2005

SUBJECT: Alliance for Progress

- You asked us to take a look at the Alliance for Progress and see if there was anything there that we might do again today (TAB C).
- The information paper at TAB A provides background on the Alliance. Created in 1961 with lofty goals, it is generally regarded as a failure.
- The principal foreign aid initiative of this Administration is the Millennium Challenge Account (MCA), designed to reward nations that make the right choices—before they get any money—to root out corruption, respect human rights, and adhere to the rule of law.
 - o Principal criteria are:
 - Ruling justly;
 - Investing in their people; and
 - Encouraging economic freedom.
 - o President Bush announced the MCA in a speech at the Inter-American Development Bank in March 2002, pledging to reach annual funding levels of \$6 billion in new money over three budget cycles. (TAB B)
 - MCA is underfunded to date - both budget requests and appropriations fall short of this goal.
 - o Western Hemisphere countries currently eligible are Bolivia, Honduras, and Nicaragua.

Attachments: as stated

Prepared by: M. M. MacMurray, ISA/WHA, (b)(6)

OSD 18990-05

11-L-0559/OSD/52277

19-09-05 17:23 JK

INFORMATION PAPER

SUBJECT: Alliance for Progress

BACKGROUND:

- The Alliance for Progress was launched in a March 1961 speech by President Kennedy when he called on the 20 American Republics to “join in a vast cooperative effort...to satisfy the needs of the American people for homes, work, and land, health, and schools.”
- The Charter of the Alliance was signed on August 17, 1961, at a hemispheric meeting in Punta del Este, Uruguay, where the Latin American countries agreed to undertake the drastic social and institutional reforms necessary to ensure that the fruits of economic development would be sustained and broadly distributed.

DISCUSSION:

- Impetus for the Alliance has usually been cast as a U.S. response to counter the spread of communism and Castro’s revolution in the Hemisphere.
 - Origins, however, were the 1958 proposals by Brazil’s President Kubitschek for an *Operacion* Pan America and a realization in the late 1950s that private investment flows were insufficient to correct the chronic poverty of the region without major structural reform.
- Latin American nations pledged to improve health, housing, and sanitation, wipe out illiteracy, modernize tax structures and land tenure, maintain sound fiscal and monetary policies, and stimulate private investments. They also committed to achieve per capita GDP growth rates of 2.5% (actually not very ambitious, but still not universally achieved in the life of the Alliance).
- The Charter recognized it would require at least 20 billion dollars over a decade from external sources, principally public. In the first six years (FY 1962-1967), the U.S. provided \$7.3 billion in various forms of loans and grants.
- By the late 1960s, USG interest turned more toward military and police assistance for Latin America, and interest in social and economic reform dwindled. Vietnam became the predominant national security concern, and commitments to Latin America were reduced.

- Latin American countries were unwilling or unable to implement the required reforms. Most remain unfulfilled today.
- The human, financial, and political resources required to prod Latin America into rapid modernization were probably underestimated. Measured against the region's needs and the Charter's goals, the Alliance's achievements appear relative **unimpressive**. The Alliance is generally regarded as a failure.
 - Success may also have been undermined from the start by the pace of the region's population growth. Birth rates were *too* sensitive a topic for consideration by the Alliance.
 - Also, 13 Latin American governments were overthrown between 1961-1968.
 - Underscores the Alliance's failure to generate political stability and meet the Charter's goal of attaining economic and social progress through the democratic process.
- The OAS committee created to implement the Alliance was disbanded in 1973.

Prepared by: M. M. MacMurray, ISA/WHA (b)(6)



Click to Print
this document 

For Immediate Release
Office of the Press Secretary
March 14, 2002

President Proposes \$5 Billion Plan to Help Developing Nations

Remarks by the President on Global Development
Inter-American Development Bank
Washington, D.C.

[Policy](#) in Focus: Aid to Developing Nations



[Return to Africa Policy](#)

President's Remarks

[View](#)
[Listen](#)

[Policy Accomplishments and Initiatives](#) (pdf)

1:21 P.M. EST

THE PRESIDENT: Thank you all. Asientese. Gracias, Enrique. **It's** about time you invited a President here (Laughter.) It's about time one accepted. (Applause.)

Thank you for the energy and leadership you bring to the challenge of global development. I'm honored to be at the Inter-American Development Bank, which has done a lot of good in our hemisphere over the last 40 years. I appreciate your work and I'm proud of your accomplishments.

Along with many of you, I'll be in Monterrey, Mexico, next week as leaders from around the world focus on the important work of reducing global poverty.

I'm here today to announce a major new commitment by the United States to bring hope and opportunity to the world's poorest people. Along with significant new resources to fight world poverty, we will insist on the reforms necessary to make this a fight we can win. (Applause.)

As you can see, I'm traveling in some pretty good company today: Bono. (Laughter and applause.) We just had a great visit in the Oval Office. Here's what I know about him: first, he's a good musician; secondly, he is willing to use his position in a responsible way. He is willing to lead to achieve what his heart tells him, and that is nobody -- nobody -- should be living in poverty and hopelessness in the world.

Bono, I appreciate your heart and to tell you what an influence you've had, Dick Cheney walked in the Oval Office, he said, "Jesse Helms wants us to listen to Bono's ideas." (Laughter and applause.)

I appreciate Paul O'Neill, Secretary of Treasury. I appreciate his work, I appreciate his advice. He's a fine member of my Cabinet. Cardinal McCarrick, thank you for coming, sir; I'm honored to have you here. Jim Wolfensohn, thank you for your leadership of the World Bank. I appreciate Jose Fourquet. Thank you, Jose, for taking on the responsibility you've done. It's good to see Andrew Natsios here of AID. Thank you, Andrew, for coming. You've done a fine job, by the way, in helping prevent starvation in Afghanistan. I appreciate your work and I appreciate your focus.

I want to thank John Negroponte, Embajador, of the United Nations. I want to thank all the other ambassadors who are here. I look around, I can see many familiar faces. Thank you all for coming today.

I appreciate the members of the United States Congress who are here. I see Frist and DeWine from the United States Senate. I appreciate both senators for coming. I appreciate the Congressman from Puerto Rico; thank you for coming, se?or. I see the Congress lady from Miami, Florida. I see Spencer Bachus, from Alabama. I think

11-L-0559/OSD/52280

<http://wu.w.whitehouse.gov/news/releases/2002/03/print/20020314-7.html>

0170007

that's it; I better-- well, anyway, if anybody else is here -- (laughter) -- Chris Cannon, I think, from Utah is here. Hey, Chris, thank you for coming. And thank you all for taking an interest in this subject; it's an important subject.

As you all know and we all know, America is engaged in a global struggle, a mighty struggle against the forces of terror. Yet, even as we fight to defeat terror, we must also fight for the values that make life worth living: for education, and health, and economic opportunity. This is both the history of our country and it is the calling of our times.

In World War II we fought to make the world safer, then worked to rebuild it. As we wage war today to keep the world safe from terror, we must also work to make the world a better place for all its citizens. (Applause.)

The advances of free markets and trade and democracy and rule of law have brought prosperity to an ever-widening circle of people in this world. During our lifetime, per capita income in the poorest countries has nearly doubled. Illiteracy has been cut by one-third, giving more children a chance to learn. Infant mortality has been almost halved, giving more children a chance to live. Nations from India to Chile have changed old ways and, therefore, found new wealth. Nations from Turkey to Mali have combined Islam with progress.

Yet in many nations, in many regions, poverty is broad and seemingly inescapable, leaving a dark shadow -- a dark shadow -- across a world that is increasingly illuminated by opportunity. Half the world's people still live on less than \$2 a day. For billions, especially in Africa and the Islamic world, poverty is spreading, and per capita income is falling.

In Malawi, thousands of teachers die each year from AIDS, and life expectancy has fallen to only 38 years. In Sierra Leone, nearly one-third of all babies born today will not reach the age of five. And in Sudan, only half the children attend school.

This growing divide between wealth and poverty, between opportunity and misery, is both a challenge to our compassion and a source of instability. We must confront it. We must include every African, every Asian, every Latin American, every Muslim, in an expanding circle of development.

The advance of development is a central commitment of American foreign policy. As a nation founded on the dignity and value of every life, America's heart breaks because of the suffering and senseless death we see in our world. We work for prosperity and opportunity because they're right. It's the right thing to do. We also work for prosperity and opportunity because they help defeat terror.

Poverty doesn't cause terrorism. Being poor doesn't make you a murderer. Most of the plotters of September 11th were raised in comfort. Yet persistent poverty and oppression can lead to hopelessness and despair. And when governments fail to meet the most basic needs of their people, these failed states can become havens for terror.

In Afghanistan, persistent poverty and war and chaos created conditions that allowed a terrorist regime to seize power. And in many other states around the world, poverty prevents governments from controlling their borders, policing their territory, and enforcing their laws. Development provides the resources to build hope and prosperity and security.

Development is not always easy, but the conditions required for sound development are clear. The foundation of development is security, because there can be no development in an atmosphere of chaos and violence. Today, the United States is leading a broad and vast coalition defending global security by defeating global terror. Meeting this commitment is expensive, but securing peace and freedom is never too expensive. (Applause.)

Development also depends upon financing. Contrary to the popular belief, most funds for development do not come from international aid -- they come from domestic capital, from foreign investment, and especially from trade. America buys and imports over \$450 billion in products from the developing world every year -- \$450 billion of purchases every single year. That is more than eight times the amount developing countries receive in aid from all sources. Trade is the engine of development. And by promoting it, we will help meet the needs of the world's poor.

Successful development also requires citizens who are literate, who are healthy, and prepared and able to work.

Development assistance can help poor nations meet these education and health care needs. That's why the United States provides more than \$10 billion a year for development assistance for food and for humanitarian aid. That is also why my administration has committed \$500 million to the global fund to fight AIDS and other infectious diseases.

And we will work with Congress to increase this commitment, to show our love and compassion by increasing our commitment as the fund gets organized, develops a strategy, and shows success. We're spending billions more on AIDS research and other programs, to fight the disease around the world.

Yet many of the old models of economic development assistance are outdated. Money that is not accompanied by legal and economic reform are oftentimes wasted. In many poor nations, corruption runs deep. Private property is unprotected. Markets are closed. Monetary and fiscal policies are unsustainable. Private contracts are unenforceable.

When nations refuse to enact sound policies, progress against poverty is nearly impossible. In these situations, more aid money can actually be counterproductive, because it subsidizes bad policies, delays reform, and crowds out private investment.

The needs of the developing world demand a new approach. In Monterrey, we have a tremendous opportunity to begin acting on a new vision of development. This new vision unleashes the potential of those who are poor, instead of locking them into a cycle of dependence. This new vision looks beyond arbitrary inputs from the rich, and demands tangible outcomes for the poor.

America supports the international development goals in the U.N. Millennium Declaration, and believes that these goals are a shared responsibility of developed and developing countries. To make progress, we must encourage nations and leaders to walk the hard road of political, legal and economic reform, so all their people can benefit.

Today, I call for a new compact for global development, defined by new accountability for both rich and poor nations alike. Greater contributions from developed nations must be linked to greater responsibility from developing nations. The United States will lead by example. We will increase our development assistance by \$5 billion over the three -- over the next three budget cycles. This new money above and beyond existing aid requests -- is above and beyond existing aid requests in the current budget I submitted to the Congress.

These funds will go into a new Millennium Challenge Account. Under this account, among other efforts, we will expand our fight against AIDS; we will bring computer instruction to young professionals in developing nations; we will assist African businesses and their people to sell goods abroad; we will provide textbooks and training to students in Islamic and African countries; we will apply the power of science and technology to increase harvests where hunger is greatest.

These are some of the examples of what we intend to do. The goal is to provide people in developing nations the tools they need to seize the opportunities of the global economy. In return -- in return for this additional commitment, we expect nations to adopt the reforms and policies that make development effective and lasting.

The world's help must encourage developing countries to make the right choices for their own people, and these choices are plain. Good government is an essential condition of development. So the Millennium Challenge Account will reward nations that root out corruption, respect human rights, and adhere to the rule of law. Healthy and educated citizens are the agents of development, so we will reward nations that invest in better health care, better schools and broader immunization.

Sound economic policies unleash the enterprise and creativity necessary for development. So we will reward nations that have more open markets and sustainable budget policies, nations where people can start and operate a small business without running the gauntlets of bureaucracy and bribery.

I've directed Secretary Powell and Secretary O'Neill to reach out to the world community, to develop a set of clear and concrete and objective criteria for measuring progress. And under the Millennium Challenge Account, we will apply these criteria rigorously and fairly.

Countries that live by these three broad standards -- ruling justly, investing in their people, and encouraging economic freedom -- will receive more aid from America. And, more importantly, over time, they will really no longer need it, because nations with sound laws and policies will attract more foreign investment. They will earn more trade revenues. And they will find that all these sources of capital will be invested more effectively and productively to create more jobs for their people.

The evidence shows that where nations adopt sound policies, a dollar of foreign aid attracts \$2 of private investment. And when development aid rewards reform and responsibility, it lifts almost four times as many people out of poverty, compared to the old approach of writing checks without regard to results.

Marrying good policies to greater aid led Mozambique to a 10 percent growth rate in 2001. This approach helped Uganda open its schools to more children, and increased teacher pay by 2,700 percent. Bangladesh, a nation that was once a symbol of famine, has transformed its agricultural economy; rice production is almost up by 70 percent since the mid-'70s.

The new compact I propose would multiply this progress. I challenge other nations, and the development banks, to adopt this approach as well. America's support for the World Bank will increase by almost 20 percent over the next three years. We expect the World Bank to insist on reform and results, measured in improvements in people's lives. All the development banks should adopt a growth agenda, increasing their support for private sector enterprises and focusing more on education, as the Inter-American Development Bank has done.

And I challenge the development banks to provide up to half of the funds devoted to poor nations in the form of grants, rather than loans. (Applause.) Grants instead of loans that may never be repaid. Many have rallied to the idea of dropping the debt. I say let's rally to the idea of stopping the debt.

This new compact for development can produce dramatic gains against poverty and suffering in the world. I have an ambitious goal for the developed world, that we ought to double the size of the world's poorest economies within a decade. (Applause.) I know some may say that's too high a hurdle to cross -- I don't believe so, not with the right reforms and the right policy. This will require tripling of current growth rates, but that's not unprecedented. After all, look at the dramatic growth that occurred in Asia in the 1990s.

With the world's help and the right policies, I know -- I know -- that the developing world can reform their own countries. I know it can happen. And, therefore, better their own lives. They can live in a world where their children's dreams are ignited by liberty and learning, not undermined by poverty and disease. (Applause.) They can live under governments that deliver basic service and protect basic rights. The demands of human dignity know no borders and know no boundaries. They are universal. And so are the gifts of creativity and enterprise that lead to prosperity.

When governments repress and punish those gifts, no amount -- no amount of aid is sufficient to lift people from poverty. When governments honor these gifts, every nation can know the blessings of prosperity.

People across the world are working to relieve poverty and suffering, and I'm proud of their efforts. I appreciate Bono. I appreciate groups like the Sisters of Charity. Some were motivated by simple decency, some serve a God who is impatient with injustice. And all have made this commitment. We cannot leave behind half of humanity as we seek a better future for ourselves. (Applause.) We cannot accept permanent poverty in a world of progress. There are no second-class citizens in the human race. (Applause.)

I carry this commitment in my soul. And I'll carry it with me to Monterrey next week. As the civilized world mobilizes against the forces of terror, we must also embrace the forces of good. By offering hope where there is none, by relieving suffering and hunger where there is too much, we will make the world not only safer, but better.

Thank you very much. (Applause.)

END 1:45 P.M. EST

Return to this article at:

11-L-0559/OSD/52283

<http://www.whitehouse.gov/news/releases/2002/03/print/20020314-7.html>

~~FOUO~~

AUG 19 2005

ES-3979

05/011163

TO: Peter Rodman
CC: Eric Edelman
FROM: Donald Rumsfeld 
SUBJECT: UN Payments

When we get back, we simply have to push hard on getting the UN to pay these folks on time. That is not right. If they ask people to do something like that, they ought to step up and pay promptly and fulfill their promises.

Thanks.

DHR:dh
081805-GTS

.....
Please respond by September 8, 2005

~~FOUO~~

AUG 19 2005 11:32 AM

11-L-0559/OSD/52284



INTERNATIONAL
SECURITY
AFFAIRS

ASSISTANT SECRETARY OF DEFENSE
2400 DEFENSE PENTAGON
WASHINGTON, DC 20301-2400

2005 09 21 10 5: 03

USDP ²⁴ SEP 20 2005

INFO MEMO

1-05/011163-WH
ES -3979

MEMORANDUM FOR SECRETARY OF DEFENSE

FROM: Peter W. Rodman, Assistant Secretary of Defense (ISA) (b)(6) JN2 SEP 20 2005

SUBJECT: UN Payments

Following your trip to Peru, you asked what we could do to ensure that the UN promptly reimburses nations contributing troops to UN peacekeeping missions (Tab A).

The UN's apparent slow payment to Peru for deploying troops to the UN Stabilization Mission in Haiti (MINUSTAH) had three causes:

- The Peruvians themselves are principally responsible. They were not timely in submitting correct invoices to the UN.
- Nations assessed by the UN to reimburse peacekeeping contributors are slow in paying (including the largest contributors, the U.S. and Japan).
- The UN Department of Peacekeeping Operations (UNDPKQ) is a cumbersome bureaucracy that can take up to 6 months to reimburse troop contributors, depending on when the costs occur in the UN's fiscal year.

Despite those impediments, Peru had been reimbursed prior to your visit. Evidently, the Peruvian MOD was misinformed. In May 2005 Peru was reimbursed for its services in Haiti through December 2004, and on 24 June 2005, Peru was paid for its contributions through March, 2005. By the UN's reckoning, its account with Peru is up to date. The UN now intends to request more troops from Peru for MINUSTAH.

Although Peru has been paid, the UN process is cumbersome and requires poor nations to pre-finance peacekeeping operations. We will work with Joint Staff which has liaison officers in the US Mission to the UN to press the UN to streamline and accelerate reimbursement.

11-L-0559 OSD/52285

20-02-02 10:00:00
OSD 18991-05

SEP 10 2005

DepSecDef
USDP
1-05/011156-ES
ES-3976

ACTION MEMO

FOR: SECRETARY OF DEFENSE

FROM: Assistant Secretary of Defense, ISA (Peter W. Rodman, (b)(6))

SEP 15 2005
092.3

SUBJECT: Update on Central America Ministers Conference on Security(U)

You asked about your conference with the Central Americans (TAB A). It is scheduled for Miami, October 11-13. Your decisions on this memo will help finalize preparations.

- The Ministers have met several times to prepare. We expect good ideas from them.
 - o There is such high interest in your conference that some countries asked to send *both* their defense and interior ministers (with the MOD or equivalent as principal).
 - This makes good sense, in view of the countries' stated desire to define military and law enforcement responsibilities clearly and close seams between them (one of your themes from the Quito Defense Ministerial).
 - DASD-WHA Pardo-Maurer has met with the ministers, country ambassadors, and the US ambassadors to help shape the conference.

15 Sep 05

Of note: Colombia has taken up one of our suggestions, and will host a conference on regional security with the Central American ministers two weeks after your conference.

- o So your conference is having positive ripple effects, even before it has happened.
- **DECISION #1.** We have sounded out an overall theme of "*Security and Economic Opportunity*". Everyone likes this, since it will be the first high-level US-Central America meeting after CAFTA ratification, and given your interest in CAFTA.

SecDef Decision: *Approve* — *Disapprove* — *Other* _____

- **DECISION #2.** Based on the Ministers' input, we suggest the following eight items for the principals' agenda.
 - o This allows each of the eight principals to speak on *one* item for 5-10 minutes (2 hours maximum total) in the morning session, to set the stage for the afternoon session and provide guidance for three staff-level Working Groups.

18 Aug 05

~~FOR OFFICIAL USE ONLY~~

Proposed Agenda Items and Presenter:

- | | |
|---|---------------|
| 1. <i>Emerging Non-Traditional Threats</i> | Nicaragua |
| 2. <i>Developing a Common Strategic Picture</i> | Honduras |
| 3. <i>Regional Cooperative Security Mechanisms: Next Step</i> | El Salvador |
| 4. <i>Coordination between Military and Law Enforcement</i> | Belize |
| 5. <i>Maritime Cooperation</i> | Panama |
| 6. <i>Peace Operations</i> | Guatemala |
| 7. <i>Rapid Response to Natural Disasters</i> | Costa Rica |
| 8. <i>Security and Economic Opportunity</i> | United States |

SecDef Decision: *Approve* — *Disapprove* — *Other* _____

- **DECISION #3.** Per above, we suggest you speak on the proposed overall conference theme of "*Security and Economic Opportunity*". Your remarks (5-10 minutes) would draw on your May 2005 speech at the Council of the Americas.

SecDef Decision: *Approve* — *Disapprove* — *Other* _____

- **DECISION #4.** On the margins of the conference, we suggest you hold two bilateral meetings: with El Salvador and Panama.
 - This might be a good opportunity to deliver DoD's response to the Panama Secure Trade and Transportation Initiative.
 - We may have other "deliverables", but will propose those to you separately.

SecDef Decision: *Approve* — *Disapprove* — *Other* _____

- **DECISION #5.** An itinerary (with attendees) for your approval is at TAB B.
 - Not counting meals, this itinerary keeps your time commitment to the following (with breaks):
 - 3 hours for the morning plenary session
 - 1 ½ hours for the afternoon
 - 2 hours for the second day

SecDef Decision: *Approve* — *Disapprove* — *Other* _____

Attachments: As stated

~~FOR OFFICIAL USE ONLY~~

11-L-0559/OSD/52287

FOUO

In reply refer to 05/011150
ES 3976

AUG 18 2005

TO: Eric Edelman
CC: ~~Peter Rodman~~
~~Roger Pardo-Maurer~~
FROM: Donald Rumsfeld *DR*

~~SUBJECT: Preparing for Central American Defense Ministerial~~

~~The Central American Defense Ministerial in October is a very important one for me. We need to have really thought through what we want to accomplish.~~

~~We have to have proposals prepared. We ought to do some advance work with the countries, so they know what is coming and that we have support among the group to achieve what we want.~~

~~This could be exceedingly important, but only if we do the preliminary work.~~

~~Thanks.~~

DER:ah
081703-1078.doc

.....
Please respond by September 8, 2005

FOUO

11-L-0559/OSD/52288

~~FOR OFFICIAL USE ONLY~~
DRAFT as of September 19, 2005

**ITINERARY FOR
CENTRAL AMERICA MINISTERS CONFERENCE ON SECURITY
Key Biscayne, Florida
AM)
VISIT TO U.S. JOINT FORCES COMMAND
Norfolk, Virginia**

OCTOBER 11-14, 2005

Tuesday, October 11, 2005

1100-1500 Ministers arrive in Miami via commercial air

1200-1900 Transport to hotel and check-in

1900-2000 Reception hosted by Secretary of Defense, Cantina poolside

Remain overnight at Ritz-Carlton Key Biscayne

Wednesday, October 12, 2005

0700-0830 Breakfast buffet, Salon 2

0830-0900 Prepare / Assemble for Plenary, Salon 1

0900 Plenary begins

0900-0905 Welcome remarks by Secretary of Defense

Plenary Topic #1: ~~Emerging~~ Non-Traditional Threats

0905-0915 Remarks by Minister (Nicaragua)

0915-0925 Questions and Comments

Plenary Topic #2: Developing a Common Strategic Picture

0925-0935 Remarks by Minister (Honduras)

0935-0945 Questions and Comments

~~FOR OFFICIAL USE ONLY~~
DRAFT as of September 19,2005

Plenary Topic #3: Regional Cooperative Security Mechanisms: Next Steps

0945-0955 Remarks by Minister (El Salvador)

0955-1005 Questions and Comments

Plenary Topic #4: Coordination Between Military and Law Enforcement - Within and Across Borders

1005-1015 Remarks by Minister (Belize)

1015-1025 Questions and Comments

1025-1040 Break, Ballroom prefunction area (outside Salon 1)

Plenary Topic #5: Maritime Cooperation

1040-1050 Remarks by Minister (Panama)

1050-1100 Questions and Comments

Plenary Topic #6: Peace Operations

1100-1110 Remarks by Minister (Guatemala)

1110-1120 Questions and Comments

Plenary Topic #7: Rapid Response to Natural Disasters

1120-1130 Remarks by Minister (Costa Rica)

1130-1140 Questions and Comments

Plenary Topic #8: Security and Economic Opportunity

1140-1150 Remarks by Secretary of Defense (United States)

1150-1200 Discussion

1200-1210 Closing Comments by Ministers (provide guidance to Working Groups on what issues and proposals the Working Groups should discuss)

1210 Plenary ends

~~FOR OFFICIAL USE ONLY~~

DRAFT as of September 19, 2005

1210-1230 Assemble for press photo spread and official photograph, Grand Lawn

1230-1330 Ministers' Lunch hosted by Secretary of Defense, The Boardroom
All other participants: Buffet Lunch, Salon 2

1330-1830 Ministers: Minister-to-Minister meetings and individual office/personal time

Other attendees: Participate in Working Groups, scheduled as follows:

1330-1345 Break / personal time

1345 Working Groups convene

Working Group 1 ("Strategy" Working Group, to discuss Plenary Topics, 1, 2 and 8): Convenes in Salon 3

Working Group 2 ("Coordination" Working Group, to discuss Plenary Topic 4): Convenes in Salon 4

Working Group 3 ("Mechanisms" Working Group, to discuss Plenary Topics 3, 5, 6 and 7): Convenes in Salon 1

1345-1500 Working Group Discussions

1500-1515 Break, Ballroom prefunction area (outside Salon 1)

1515-1730 Working Groups conclude discussions and draft reports (with recommendations / proposals for Ministers)

1730-1830 Office / Personal time

1830-1900 Pre-Dinner Reception, Grand Lawn

1900-2030 Dinner hosted by Secretary of Defense, Salon 2

2030-2300 Personal time and remain overnight at Ritz-Carlton Key Biscayne

Thursday, October 13, 2005

(NOTE FOR TRAVELERS TO NORFOLK: Checkout must be completed, and all luggage must be dropped off at collection point, by 0800).

0700-0830 Breakfast buffet, Ponce De Leon Room

0830-0900 Prepare / Assemble for Plenary, Salon 1

~~FOR OFFICIAL USE ONLY~~
DRAFT as of September 19,2005

0900 Plenary begins

0900-1000 Working groups present reports / recommendations to Ministers; Ministers respond with questions and comments

0900-0920: Working Group 1

0920-0940: Working Group 2

0940-1000: Working Group 3

1000-1040 Concluding remarks by Ministers (five minutes per minister)

1040 Plenary ends

1040-1130 Prepare for Press Conference

1130-1200 Press Conference and Release of Joint Statement, Secretary of Defense and Ministers, Grand Lawn (or Plaza Ballroom 1)

1200-1300 Secretary of Defense and Ministers travel to airport

1300-1500 Ministers fly to Norfolk, SECDEF departs for next destination

1500 Arrive Norfolk International Airport (Piedmont Aviation Terminal)

1500-1530 Travel to LHD (TBD) (No CVNs are in port)

1530-1630 Amphibious Assault Ship (LHD) Tour

1630-1700 Travel to Waterside Marriott Downtown Norfolk

1700-1715 Travel to (Location TBD)

1900 Dinner / Social event at TBD

Friday, October 14,2005

0730-0800 Travel to Joint Warfighting Center (JFWC)

0800-TBD Command Briefing and Continental Breakfast

TBD – 1030 JFWC program TBD (T), including tours and demonstrations at Joint Systems Integration Command (JSIC), Joint Advanced Training Technology Laboratory (JATTL), Joint Futures Lab (JFL)

~~FOR OFFICIAL USE ONLY~~

DRAFT as of September 19, 2005

1030-1100 Travel to Piedmont Aviation Terminal (box lunches staged on plane)

1100-1300 Depart via military aircraft to Miami

1300-1330 Ministers escorted to terminals for departing flights

OFFICIAL PROGRAM CONCLUDES

~~FOR OFFICIAL USE ONLY~~
DRAFT AS OF SEPTEMBER 19, 2005

**DELEGATION LIST FOR
CENTRAL AMERICA MINISTERS CONFERENCE ON SECURITY
OCTOBER 11-13, 2005**

* = Denotes individual traveling to Norfolk, October 13-14

UNITED STATES DELEGATION

Secretary and Personal Staff (4)

- | | |
|------------------------------|---------------------------|
| 1. Hon. Donald Rumsfeld | Secretary of Defense |
| 2. VADM Jim Stavridis, USN | Senior Military Assistant |
| 3. Lt Col Greg Lengyel, USAF | Military Assistant |
| 4. (b)(6) | Confidential Assistant |

Support Staff (10)

- | | |
|-------------------------------|-------------------------------|
| 5. Lt Col Stuart Archer, USAF | Trip Coordinator |
| 6. Mr. Kevin Brown | Director of Personal Security |
| 7. Mr. Joseph Wassel | Director of Communications |
| 8. Ms. Mary Claire Murphy | Director of Protocol |
| 9. Ms. Emily Gray | Assistant for Protocol |
| 10. Dr. John Baxter | Flight Surgeon |
| 11. SA Jeff Lange | Personal Security Officer |
| 12. SA Kevin Darling | Personal Security Officer |
| 13. Mr. Craig Opel | OSD Communications |
| 14. SMSgt Peterson, USAF | OSD Communications |

OSD Policy / International Security Affairs (10)

- | | |
|--------------------------------|---|
| 15. Ms. Mary Beth Long | Principal Deputy Assistant Secretary of
Defense for International Security Affairs |
| 16. Col Jack Shanahan, USAF | Military Assistant to ASD/ISA |
| 17. Mr. Roger Pardo-Maurer* | Deputy Assistant Secretary of
Defense for Western Hemisphere
Affairs |
| 18. Ms. Caryn Hollis | Principal Director, WHA |
| 19. Mr. James Alverson* | Country Director, WHA |
| 20. LTC Linwood Ham, USA | Country Director, WHA |
| 21. Mr. Juan Cardenas | Country Director, WHA |
| 22. Ms. Lon Durham | Country Director, WHA |
| 23. MSgt Kenneth Stevens | Administrative Assistant, WHA |
| 24. Maj Joseph Martinez, USAF* | WHA Staff Assistant |

~~FOR OFFICIAL USE ONLY~~
DRAFT AS OF SEPTEMBER 19,2005

- 71. COL Jorge Madera, USA, U.S. Defense Attache to Nicaragua*
- 72. MAJ Thomas Newman, USA, Acting U.S. Defense Attache to Panama*

US Military Group/ Military Liaison Offices (7)

- 73. LTC David Treleaven, Chief, USMLO Belize*
- 74. CDR Aylwyn Young, USCG, Chief, ODR Costa Rica*
- 75. COL Felix Santiago, USA, Commander, USMILGP El Salvador
- 76. COL Mark Wilkins, USA, Commander, USMILGP Guatemala
- 77. Col Fernando Gonzalez, USAF, Commander, USMILGP Honduras
- 78. LTC Robert Gaddis, USA, Commander, USMLO Nicaragua
- 79. CDR Ernest Hugh, USN, Commander, USODC Panama

DoD Executive Agent (4)

- 80. Lt Col Jeffery Price, USAF, Executive Liaison to the Secretary of Defense*
- 81. LCDR Sean Maybee, USN, Executive Liaison Agent*
- 82. Mr. Allen Shepard, Executive Liaison Agent
- 83. Ms. Sonal Daphtary, Executive Liaison Agent*

**CENTRAL AMERICAN DELEGATIONS AND OTHER COUNTRY
REPRESENTATIVES (32)***

Belize (2)

- 84. Ralph FONSECA, Minister of Home Affairs and Public Utilities*
- 85. BG Lloyd GILLET, Commander, Belize Defense Force*

Costa Rica (4)

- 86. Hon. Rogelio Vicente RAMOS Martinez, Minister of Public Security, Government and Police*
- 87. Colonel Walter NAVARRO, Director of Public Forces*
- 88. Eng. Luis Diego MORALES, Chairman of the National Emergency Committee*
- 89. Mr. Alvaro RAMOS, Advisor to the Minister*

El Salvador (4)

- 90. Major General Otto Alejandro ROMERO Orellana, Minister of Defense*
- 91. COL Roberto Antonio GARAY Saravia, Director of Defense Politics*
- 92. COL Francisco Ramon SALINAS Rivera, Director of Military Politics*
- 93. LTC Eduardo Antonio CARBALLO Majano, Executive Secretary to the Minister of Defense*

Guatemala (4)

- 94. Major General Carlos Humberto ALDANA Villanueva, Minister of Defense*

~~FOR OFFICIAL USE ONLY~~
DRAFT AS OF SEPTEMBER 19, 2005

95. COL Hector Leonel REYES
Caballeros, Aide-de-Camp*

96. COL (ret.) Olmedo Isar
VASQUEZ Toledo, Advisor to
the Minister of Defense*

97. Mr. Mario Rolando CIFUENTES
Alpirez, Advisor to the Minister
of Defense*

Honduras (4)

98. Hon. Federico BREVE Travieso,
Minister of Defense*

99. Ms. Suyapa Georgina CALIX
FIGUEROA, Advisor to the
Minister of Defense and Professor
at the Honduran College of
National Defense*

100. BG Nelson Willys MEJIA
Mejia, Vice Chief, Armed Forces
Joint Staff*

101. COL Mario David
VILLANUEVA Reyes, Director
for Plans, Programs and Policy
(J-5)*

Nicaragua (4)

102. Hon. Avil RAMIREZ Valdivia,
Minister of Defense*

103. Dr. Julio VEGA, Minister of
Government*

104. GEN Moises Omar
HALLESLEVENS Acevedo,
Commander in Chief, Army of
Nicaragua*

105. COL Bayardo Ramon
RODRIGUEZ Ruiz, J-2*

Panama (4)

106. Hon. Hector Bolivar ALEMAN
Estevez, Minister of Government
and Justice*

107. Mr. Rolando Augusto
MIRONES Jr., Director General
of the National Police*

108. Mr. Ricardo TRAAD Porras,
Director General of the National
Maritime Service*

109. Mr. Jaime I. FABREGA,
Director General of the
National Air Service*

DEFENSE ATTACHES to USA (4)

110. CAPT Otto WANTLAND,
Guatemala*

111. BG Juan Manuel GRIJALVA
Torres, El Salvador*

112. Colonel Carlos H. RAMOS,
Honduras*

113. BG Pedro L. MARTINEZ,
Nicaragua*

**OBSERVERS FROM OTHER
WESTERN HEMISPHERE
NATIONS (2)**

114. Colombia [TBD]

115. Mexico [TBD]

~~FOR OFFICIAL USE ONLY~~

COORDINATION PAGE

SOLIC (CN)	R. Newberry (with comment)	8 SEP 05
SOLIC(SO/CT)	MAJ Sparks (with comment)	9 SEP 05
SOLIC(Stability Ops)	Copy provided; official concurrence not received as of 9 SEP 05	

~~FOR OFFICIAL USE ONLY~~

11-L-0559/OSD/52299

Boykin, Jason CIV WHS/ESD

From: Rosson, Beata, SSGT, OSD-POLICY [Beata.Rosson@osd.mil]
Sent: Wednesday, October 05, 2005 2:10 PM
To: Faires, Jay CIV WHS/ESD
cc: Boykin, Jason CIV WHS/ESD
Subject: RE: Pending Signature Report 100504

Sir,
I've received couple updates from the ISA Military Assistant on the following actions from the Pending Signature Report (returned items) from 4 Oct 05:

- OSD 19007-05 - The update was Provided in a prep Session on Monday 26 Sep 05 - *c 6 se*
- ~~OSD 76220-05 - OBE - The Meeting occurred on 23 May 05~~
- OSD 76421-05 - Signed by SD and Delivered to Congress on 18 July 05 (*need work*)
- ~~OSD 07577-04 - OBE - The meeting occurred 14 Jun 04, see scheduling proposal OSD 76685-04~~
- OSD 14804-05 - Done. SD is Going to Korea to do this on his trip this month. *c 6 se*
- ~~OSD 16602-05 - OBE - The meeting occurred 19 Sep 05 -~~
- OSD 18789-05 - OBE This was conducted in Prep sessions for next week's conference *c 6 se*

Please confirm that you can mark them all complete. Thank you,

BEATA H. ROSSON, SSgt, USAF
NCOIC, USD Policy Executive Secretariat

Pentagon 53616
Ph: (b)(6)
DSN: (b)(6)
Unclass Fax: (b)(6)
E-mail: Beata.Rosson@osd.mil

FOUO

In reply refer to 05/011150

ES-3976

AUG 18 2005

TO: Eric Edelman
CC: ~~Peter Rodman~~
~~Roger Pardo-Maurer~~
FROM: Donald Rumsfeld

~~SUBJECT: Preparing for Central American Defense Ministerial~~

~~The Central American Defense Ministerial in October is a very important one for me. We need to have really thought through what we want to accomplish.~~

~~We have to have proposals prepared. We ought to do some advance work with the countries, so they know what is coming and that we have support among the group to achieve what we want~~

~~This could be exceedingly important, but only if we do the preliminary work.~~

Thanks.

DHR:sh
081705-1075.doc

.....
Please respond by September 8, 2005

FOUO

OSD 19007-05

11-L-0559/OSD/52301

0923

18 AUG 05

~~FOR OFFICIAL USE ONLY~~

SEP 19

INFO MEMO

A/DSD
USDP *[Signature]* SEP 21 2005

~~05/012434-WH~~
05/011150 ES-3976

09
3

FOR: SECRETARY OF DEFENSE

FROM: Peter W. Rodman, Assistant Secretary of Defense (ISA) *[Signature]* SEP 20

SUBJECT: Central America Ministers Conference (U)

(U) The attached paper (TAB A) lists our desired outcomes, themes, and major issues for the Central America Ministers Conference that you are hosting Oct 11-13 in Florida.

- Also included is an Action Memo to obtain your guidance on a few outstanding issues.

(U) We are scheduled to brief you on September 26 to provide you an update.

COORDINATION: Tab B
ATTACHMENT: **As** stated

20 Sep 05

18 Aug 05

~~FOR OFFICIAL USE ONLY~~

OSD 19007-05

Prepared and Classified by: *[Redacted]*, D/ASD-WHA *[Redacted]*
Reasons: 1.3(b) and (d). Declassify on: 15 January 2014

11-L-0559/OSD/52302

20-02-05 1343

**PROPOSED SECDEF OBJECTIVES & ACTIONS
US-CENTRAL AMERICA MINISTERS CONFERENCE ON SECURITY**

I. Objective:

The key objective of this conference is for ministers to develop a common strategic vision for US-Central American security cooperation---through regional institutions.

- The backdrop is CAFTA---which we should take as a beginning, not an endpoint. As the overall conference theme, "Security and Economic Opportunity" points out, the U.S. relationship with this region of 40,000,000 people is moving forward on *all* fronts, not just trade.
- Implicit in this objective, which "upgrades" the strategic profile of Central America, is the long-term goal of building a broader trade and security community that links the NAFTA and CAFTA areas (and ultimately the Free Trade Area of the Americas). To this end, Mexico and Colombia have been invited as observers.
 - This conference can help set a good tone for President Bush's participation in the Summit of the Americas, November 3-4, in Argentina.

2. Background:

This conference will be the first high-level US.-Central America meeting following U.S. ratification of CAFTA, and the first ever meeting of *all* seven sitting Central American defense or security ministers with a U.S. Secretary of Defense.

- We will achieve our primary objective if, as we expect, we are able to:
 1. Clarify USG and DoD relationships with the two primary regional integration mechanisms with security portfolios:
 - ✓ **Conference of Central American Armed Forces (CFAC)**, the region's mini "NATO-like" defense integration mechanism. CFAC comprises the militaries of Guatemala, El Salvador, Honduras, and Nicaragua.
 - ✓ **Central American Integration System (SICA)**, the region's mini "European Commission-like" overall integration mechanism. SICA comprises the CFAC countries, and Belize, plus Costa Rica and Panama, which have no military.
 2. Consolidate fledgling regional security institutions (e.g., for peacekeeping, counternarcotics, counterterrorism, natural disaster response) and identify new opportunities for multilateral cooperation.

3. Establish a relationship between CFAC and the Joint Forces Command.
4. Tighten seams between military and law enforcement, and across borders.
5. Help countries agree to coordinate their plans to modernize their security forces.
6. Build a Colombia-Central America security partnership. (Colombia, at our urging, will host a MOD-level conference with Central America two weeks after ours).
7. Encourage closer Mexico-Central American security cooperation, and float the concept of a North American security community "from Panama to the Pole".

3. Bilateral Objectives:

Although the conference will focus on *regional* institutions, it is also an opportunity to work on *bilateral* ties. We suggest that SecDef host the following bilateral meetings:

- o **Panama:** discuss Secure Trade and Transportation Initiative (bilateral).
- o **El Salvador:** encourage continuing participation in Iraq (bilateral).
- o **Guatemala:** encourage joining El Salvador in Iraq. The MOD has told us that he and the president are discussing the possibility of an offer (pull-aside).
- o **Nicaragua:** encourage the military to continue its support for constitutional, democracy, and to **make** progress on destruction of MANPADs (pull-aside).

4. SecDef Actions:

The Central Americans (with input and feedback from us) have made a big upfront effort to craft proposals on how we can help their new *regional* institutions.

We hope SecDef will play the key role in 3 vital areas:

- **Shaping public perceptions** of the event, and giving the media a new perspective on this region and on Administration policy toward Latin America as a whole.
- **As "catalyst"** to encourage the Central Americans to sort out coordination tangles having to do with vaguely defined roles for military and law enforcement, and the interaction between CFAC and SICA. (GEN Craddock can be helpful).
 - o We are working closely with the countries, our Ambassadors, and GEN Craddock to define concrete discussion points and recommendations.

- *Follow-up* (perhaps the most important role): energizing other USG entities to draw on the conference to develop a strategic plan for the region.
 - o We are working with State and others to develop a framework, recommended actions and way-ahead to build on the conference results.

~~FOR OFFICIAL USE ONLY~~

COORDINATION PAGE

SOLIC (CN)	R. Newberry (with comment)	8 SEP 05
SOLIC (SO/CT)	MAJ Sparks (with comment)	9 SEP 05
SOLIC (Stability Ops)	Copy provided; official concurrence not received as of 9 SEP 05	

~~FOR OFFICIAL USE ONLY~~

11-L-0559/OSD/52306

FOUO

COMPLETED

September 21, 2005

TO: GEN John Abizaid
GEN George Casey

c c : Gen Dick Myers

FROM: Donald Rumsfeld *DR*

SUBJECT: *Time Magazine* Piece

Attached is the magazine piece I mentioned that was sent to me. I would be interested in your thoughts.

Regards,

Attach 9/18/05 *Time Magazine* article by Joe Klein

DHR:ss
092105-03

.....
Please Respond By 10/06/05

Iraq

215000

SECOND CABLES DISTRIBUTION				
SECDEF	DEFSEC	DEF ASST	EXSEC/SEC	OSDP
USDI	ESD	OC	CABLECB	FILE

OSD 19054-05

FOUO

11-L-0559/OSD/52307

FROM THE MAGAZINE

Sunday, Sep. 18, 2005

Saddam's Revenge

The secret history of U.S. mistakes, misjudgments and intelligence failures that let the Iraqi dictator and his allies launch an insurgency now ripping Iraq apart

By JOE KLEIN

Five men met in an automobile in a Baghdad park a few weeks after the fall of Saddam Hussein's Baathist regime in April 2003, according to U.S. intelligence sources. One of the five was Saddam. The other four were among his closest advisers. The agenda: how to fight back against the U.S.-led occupation of Iraq. A representative of Saddam's former No. 2, Izzat Ibrahim al-Duri, was there. But the most intriguing man in the car may have been a retired general named Muhammad Yunis al-Ahmed, who had been a senior member of the Military Bureau, a secret Baath Party spy service. The bureau's job had been to keep an eye on the Iraqi military—and to organize Baathist resistance in the event of a coup. Now a U.S. coup had taken place, and Saddam turned to al-Ahmed and the others and told them to start "rebuilding your networks."

The 45-minute meeting was pieced together months later by U.S. military intelligence. It represents a rare moment of clarity in the dust storm of violence that swirls through central Iraq. The insurgency has grown well beyond its initial Baathist core to include religious extremist and Iraqi nationalist organizations, and plain old civilians who are angry at the American occupation. But Saddam's message of "rebuilding your networks" remains the central organizing principle.

More than two years into the war, U.S. intelligence sources concede that they still don't know enough about the nearly impenetrable web of what Iraqis call *ahl al-thiqa* (trust networks), which are at the heart of the insurgency. It's an inchoate movement without a single inspirational leader like Vietnam's Ho Chi Minh—a movement whose primary goal is perhaps even more improbable than the U.S. dream of creating an Iraqi democracy: restoring Sunni control in a country where Sunnis represent just 20% of the population. Intelligence experts can't credibly estimate the rebels' numbers but say most are Iraqis. Foreigners account for perhaps 2% of the suspected guerrillas who have been captured or killed, although they represent the vast majority of suicide bombers. ("They are ordnance," a U.S. intelligence official says.) The level of violence has been growing steadily. There have been roughly 80 attacks a day in recent weeks. Suicide bombs killed more than 200 people, mostly in Baghdad, during four days of carnage last week, among the deadliest since Saddam's fall.

More than a dozen current and former intelligence officers knowledgeable about Iraq spoke with TIME in recent weeks to share details about the conflict. They voiced their growing frustration with a war that they feel was not properly anticipated by the Bush Administration, a war fought with insufficient resources, a war that almost all of them now believe is not winnable militarily.

9/21/2005

11-L-0559/OSD/52308

"We're good at fighting armies, but we don't know how to do this," says a recently retired four-star general with Middle East experience. "We don't have enough intelligence analysts working on this problem. The Defense Intelligence Agency [DIA] puts most of its emphasis and its assets on Iran, North Korea and China. The Iraqi insurgency is simply not top priority, and that's a damn shame."

The intelligence officers stressed these points:

• They believe that Saddam's inner circle--especially those from the Military Bureau--initially organized the insurgency's support structure and that networks led by former Saddam associates like al-Ahmed and al-Duri still provide money and logistical help.

• The Bush Administration's fixation on finding weapons of mass destruction (WMD) in 2003 diverted precious intelligence resources that could have helped thwart the fledgling insurgency.

• From the beginning of the insurgency, U.S. military officers have tried to contact and negotiate with rebel leaders, including, as a senior Iraq expert puts it, "some of the people with blood on their hands."

• The frequent replacement of U.S. military and administrative teams in Baghdad has made it difficult to develop a counterinsurgency strategy.

The accumulation of blunders has led a Pentagon guerrilla-warfare expert to conclude, "We are repeating every mistake we made in Vietnam."

THE WRONG FOCUS

It is no secret that General Tommy Franks didn't want to hang around Iraq very long. As Franks led the U.S. assault on Baghdad in April 2003, his goal--and that of Defense Secretary Donald Rumsfeld--was to get to the capital as quickly as possible with a minimal number of troops. Franks succeeded brilliantly at that task. But military-intelligence officers contend that he did not seem interested in what would come next. "He never once asked us for a briefing about what happened once we got to Baghdad," says a former Army intelligence officer attached to the invasion force. "He said, 'It's not my job.' We figured all he wanted to do was get in, get out and write his book." (Franks, through a spokesman, declined to comment for this article.)

The rush to Baghdad, critics say, laid the groundwork for trouble to come. In one prewar briefing, for example, Lieut. General David McKiernan--who commanded the land component of the coalition forces--asked Franks what should be done if his troops found Iraqi arms caches on the way to Baghdad. "Just put a lock on 'em and go, Dave," Franks replied, according to a former U.S. Central Command (Centcom) officer. Of course, you couldn't simply put a lock on ammunition dumps that stretched for several square miles--dumps that would soon be stripped and provide a steady source of weaponry for the insurgency.

U.S. troops entered Baghdad on April 5. There was euphoria in the Pentagon. The looting in the streets of Baghdad and the continuing attacks on coalition troops were considered temporary phenomena that would soon subside. On May 1, President George W. Bush announced, "Major combat operations in Iraq have ended," on the deck of an aircraft carrier, near a banner that read MISSION ACCOMPLISHED. Shortly thereafter, Franks moved his headquarters from Qatar back to Florida. He was followed there in June by McKiernan, whose Baghdad operation included several hundred intelligence officers who had been keeping track of the situation on the ground. "Allowing McKiernan to leave was the worst decision of the war," says one of his superiors. (The decision, he says, was Franks'.) "We replaced an operational force with a tactical force, which meant generals were replaced by colonels." Major General Ricardo Sanchez, a relatively junior commander and a recent arrival in Iraq, was put in charge. "After McKiernan left, we had fewer than 30 intelligence officers trying to figure who the enemy was," says a top-ranking military official who was in Iraq at the time. "We were starting from scratch, with practically no resources."

On May 23, the U.S. made what is generally regarded as a colossal mistake. L. Paul Bremer--the newly arrived administrator of the U.S. government presence, the Coalition Provisional Authority (CPA)--disbanded the Iraqi army and civil service on Rumsfeld's orders. "We made hundreds of thousands of people very angry at us," says a Western diplomat attached to the CPA, "and they happened to be the people in the country best acquainted with the use of arms." Thousands moved directly into the insurgency--not just soldiers but also civil servants who took with them useful knowledge of Iraq's electrical grid and water and sewage systems. Bremer says he doesn't regret that decision, according to his spokesman Dan Senor. "The Kurds and Shi'ites didn't want Saddam's army in business," says Senor, "and the army had gone home. We had bombed their barracks. How were we supposed to bring them back and separate out the bad guys? We didn't even have enough troops to stop the looting in Baghdad."

A third decision in the spring of 2003--to make the search for WMD the highest intelligence priority--also hampered the U.S. ability to fight the insurgents. In June, former weapons inspector David Kay arrived in Baghdad to lead the Iraq Survey Group (ISG), which had 1,200 intelligence officers and support staff members assigned to search for WMD. They had exclusive access to literally tons of documents collected from Saddam's office, intelligence services and ministries after the regime fell. Kay clashed repeatedly with U.S. military leaders who wanted access not only to the documents but also to some of the resources--analysts, translators, field agents--at his disposal. "I was in meetings where [General John] Abizaid was pounding on the table trying to get some help," says a senior military officer. "But Kay wouldn't budge."

Indeed, a covert-intelligence officer working for the ISG told TIME correspondent Brian Bennett that he had been ordered in August 2003 to "terminate" contact with Iraqi sources not working on WMD. As a result, the officer says, he stopped meeting with a dozen Iraqis who were providing information--maps, photographs and addresses of former Baathist militants, safe houses and stockpiles of explosives--about the insurgency in the Mosul area. "The President's priority--and my mission--was to focus on WMD," Kay told TIME. "Abizaid needed help with the counterinsurgency. He said, 'You have the only organization in this country that's working.' But military guys are not used to people telling them no, and so, yes, there was friction."

Sanchez learned that autumn that there were 38 boxes of documents specifically related to the city of Fallujah, a hotbed of Sunni rebellion. Months later, when military-intelligence officers finally were able to review some of the documents, many of which had been marked NO INTELLIGENCE VALUE, the officers found information that they now say could have helped the U.S. stop the insurgency's spread. Among the papers were detailed civil-defense plans for cities like Fallujah, Samarra and Ramadi and rosters of leaders and local Baathist militia who would later prove to be the backbone of the insurgency in those cities.

U.S. military-intelligence sources say many of the documents still have not been translated or thoroughly analyzed. "You should see the warehouse in Qatar where we have this stuff," said a high-ranking former U.S. intelligence official. "We'll never be able to get through it all. Who knows?" he added, with a laugh. "We may even find the VX [nerve gas] in one of those boxes."

MISJUDGING THE ENEMY

As early as June 2003, the CIA told Bush in a briefing that he faced a "classic insurgency" in Iraq. But the White House didn't fully trust the CIA, and on June 30, Rumsfeld told reporters, "I guess the reason I don't use the term guerrilla war is that it isn't ... anything like a guerrilla war or an organized resistance." The opposition, he claimed, was composed of "looters, criminals, remnants of the Baathist regime" and a few foreign fighters. Indeed, Rumsfeld could claim progress in finding and capturing most of the 55 top members of Saddam's regime--the famous Iraqi deck of cards. (To date, 44 of the 55 have been captured or killed.) Two weeks after Rumsfeld's comment, the Secretary of Defense was publicly contradicted by Centcom commander Abizaid, who said the U.S. indeed faced "a classical guerrilla-type campaign" in Iraq.

In a sense, both Rumsfeld and Abizaid were right. The backbone of the insurgency was thousands of Baathist remnants organizing a guerrilla war against the Americans. According to

documents later seized by the U.S. military, Saddam—who had been changing locations frequently **until** his capture in December 2003—tried to stay in charge of the **rebellion**. **He** fired off frequent letters filed with instructions for his subordinates. Some were pathetic. In one, he explained guerrilla tradecraft to his inner circle—how to keep in touch with **one** another, how to establish new contacts, how to remain clandestine. Of course, the people doing the actual fighting needed **no** such advice, and decisions about whom to attack when and where were made by the cells. Saddam's minions, including al-Duri and al-Ahmed, were away from the front lines, providing money, arms and logistical support for the cells.

But Saddam did make **one** strategic decision that helped alter the course of the insurgency. In early autumn he sent a letter to associates ordering them to change the target focus from coalition forces to Iraqi "collaborators"—that is, to attack Iraqi police stations. The insurgency had already announced its seriousness and lethal intent with a summer bombing campaign. On Aug. 7, a bomb went **off** outside the Jordanian embassy in Baghdad, killing 19 people. Far more ominous was the Aug. 19 blast that destroyed the U.N.'s headquarters in Baghdad, killing U.N. representative Sergio Vieira de Mello and 22 others. Although al-Qaeda leader Abu Mousab al-Zarqawi claimed responsibility for the attack, U.S. intelligence officials believe that remnants of Saddam's Iraqi Intelligence Service (IIS) carried it out. "It was a pure Baathist operation," says a senior U.S. intelligence official. "The Iraqis who served as U.N. security guards simply didn't show up for work that day. It wasn't a suicide bomb. The truck driver left the scene. Our [explosives] team found that the bomb had the distinctive forensics of Saddam's IIS."

On Oct. 27, 2003, the assaults on "collaborators" that Saddam had requested began with attacks **on** four Iraqi police stations--and **on** International Red Cross headquarters--in Baghdad, killing 40 people. The assaults revealed a deadly new alliance between the Baathists and the jihadi insurgents. U.S. intelligence agents later concluded, after interviewing one of the suicide bombers, a Sudanese who failed in his attempt, that the operation had been a collaboration between former Baathists and al-Zarqawi. The Baathists had helped move the suicide bombers into the country, according to the U.S. sources, and then provided shelter, support (including automobiles) and coordination for the attacks.

MISHANDLING THE TRIBES

By almost every account, Sanchez and **Å** Bremer **did** **Å** not get along. The conflict was predictable—the soldiers tended to be realists fighting a nasty war; the civilians, idealists trying to create a new Iraq—but it was troubling nonetheless. The soldiers wanted to try diplomacy and began reaching out to the less extreme elements of the insurgency to bring them into negotiations over Iraq's political future. The diplomats took a harder line, refusing to negotiate with the enemy.

Military-intelligence officers presented the CPA with a plan to make a deal with 19 subtribes of the enormous Dulaimi clan, located in al-Anbar province, the heart of the Sunni triangle. The tribes "had agreed to disarm and keep us informed of traffic going through their territories," says a former Army intelligence officer. "All it would have required from the CPA was formal recognition that the tribes existed—and \$3 million." The money would go toward establishing tribal security forces. "It was a foot in the door, but we couldn't get the CPA to move." Bremer's spokesman Senor says a significant effort was made to reach out to the tribes. But several military officials dispute that. "The standard answer we got from Bremer's people was that tribes are a vestige of the past, that they have no place in the new democratic Iraq," says the former intelligence officer. "Eventually they paid some lip service and set up a tribal office, but it was grudging."

The Baathists, **on** the other hand, were more active in courting the tribes. Starting in November 2003, tribal sheiks and Baathist expatriates held a series of monthly meetings at the Cham Palace hotel in Damascus. They were public events, supposedly meetings to express solidarity with the Iraqi opposition to the U.S. occupation. (The January 2004 gathering was attended by Syrian President Bashar Assad.) Behind the scenes, however, the meetings provided a convenient cover for leaders of the insurgency, including Muhammad Yunis al-Ahmed, the former Military Bureau director, to meet, plan and distribute money. A senior military officer told TIME that U.S. intelligence had an informant—a mid-level Baathist official who belonged to

11-L-0559/OSD/52311

the Dulaimi tribe—attending the meetings and keeping the Americans informed about the insurgents' growing cohesion. But the increased flow of information did not produce a coherent strategy for fighting the **growing** rebellion.

THE DEALMAKING GOES NOWHERE

Saddam was captured on Dec. 13, 2003, in a spider hole on a farm near Tikrit. His briefcase was filled with documents identifying many of the former Baathists running support networks for the insurgency. It was the first major victory of what the U.S. called the postcombat phase of the war: in early 2004, 188 insurgents were captured, many of whom had been mentioned in the seized documents. Although Izzat Ibrahim al-Duri, Saddam's former No. 2, narrowly evaded capture, much of his Mosul and Kirkuk apparatus was rolled up. Baathist financial networks were disrupted in several provinces. The CIA, in fact, believes that Saddam's capture permanently crippled the Baathist wing of the insurgency. "A guy like al-Duri is more symbol than substance at this point," a U.S. intelligence official says. "The parade has passed him by."

Military-intelligence officers who were in Iraq at the time, however, saw evidence that the Baathists regrouped in the spring of 2004, when the U.S. was preoccupied with battling a rebellion led by Shi'ite extremist Muqtada al-Sadr in Iraq's south and with the fight for the rebel-held city of Fallujah in the Sunni triangle. And the U.S. intelligence officials believe that some former regime loyalists began to be absorbed by other rebel groups, including those made up of religious extremists and Iraqi nationalists.

Al-Ahmed, say U.S. intelligence officials, is still running the support network he began building after the meeting with Saddam in the car. In May 2004 al-Ahmed set off on one of his periodic tours of the combat zone, meeting with local insurgent leaders, distributing money and passing along news—a trip later pieced together by U.S. intelligence analysts wading through the mountain of data and intelligence provided by low-level local informants. Al-Ahmed started in his hometown of Mosul, where he had been supervising—from a distance--the rebuilding of the local insurgent network disrupted after Saddam's capture. He moved on to Hawija, where he met a man thought to be a senior financier of the insurgency in north-central Iraq. After a brief stay at a farmhouse near Samarra, he met with military leaders of religious and nationalist rebel groups in Baghdad and with Rashid Taan Kazim, one of the few faces from the deck of cards (al-Duri is another) still at large, who is thought to be running a support network for the insurgency in the north and west of Iraq. Al-Ahmed's final stop was Ramadi, where he distributed \$500,000 to local insurgent leaders.

What is remarkable is the extent to which the U.S. is aware of al-Ahmed's activities. "We know where Muhammad Yunis al-Ahmed lives in Damascus," says a U.S. intelligence official. "We know his phone number. He believes he has the protection of the Syrian government, and that certainly seems to be the case." But he hasn't been aggressively pursued by the U.S. either—in part because there has been a persistent and forlorn hope that al-Ahmed might be willing to help negotiate an end to the Baathist part of the insurgency. A senior U.S. intelligence officer says that al-Ahmed was called at least twice by former Prime Minister Iyad Allawi—an old acquaintance--and that a representative of an "other government agency," a military euphemism that usually means the CIA, "knocked on his door in 2004 and asked if he was willing to talk. He wasn't."

STARTING OVER AGAIN

In the middle of 2004, the U.S. again changed its team in Baghdad. Bremer and Sanchez left, replaced by Ambassador John Negroponte and General George Casey. At the same time, there was a new transitional Iraqi government, led by Iyad Allawi. Negroponte set up a joint military-diplomatic team to review the situation in the country. The consensus was that things were a mess, that little had been accomplished on either the civilian or the military side and that there was no effective plan for dealing with the insurgency. The new team quickly concluded that the insurgency could not be defeated militarily—but that it might be divided. The attempts to engage potential allies like al-Ahmed became the unstated policy as U.S. and Iraqi officials sought ways

to isolate foreign terrorists like al-Zarqawi.

But progress in the effort to defuse the insurgency through dealmaking has been slow--and in some cases has led the U.S. to ease pressure on individuals tied to rebel groups. Consider the careful handling of Harith al-Dhari, chairman of the Association of Muslim Scholars and one of Iraq's most important Sunni leaders. In late 2003, several insurgent groups began to meet regularly in the Umm al-Qura mosque in Baghdad, over which al-Dhari presides. According to U.S. intelligence reports, al-Dhari--who has said he might encourage his organization to take part in the democratic process--did not attend the meetings. But his son Muthanna--who is thought to be an important link between the nationalist and religious strains of the insurgency--did. In August 2004, the son was arrested after his car scanned positive for explosives residue. But he was quickly released, a retired DIA analyst says, under pressure from Iraq's government, to keep channels open to his father. "It would be difficult to lure Harith into the tent if Muthanna were in jail," says the former officer.

By April 2004, U.S. military-intelligence officers were also holding face-to-face talks with Abdullah al-Janabi, a rebel leader from Fallujah. The meetings ended after al-Zarqawi--who had taken up residence in Fallujah--threatened to kill al-Janabi if the talks continued, according to U.S. and Iraqi sources. But attempts to negotiate with other insurgents are continuing, including with Saddam's former religious adviser. So far, the effort has been futile. "We keep hoping they'll come up with a Gerry Adams," says a U.S. intelligence official, referring to the leader of the Irish Republican Army's political wing. "But it just hasn't happened."

CNIL WAR?

The leadership in Baghdad changed yet again this year. Negroponte left Baghdad in March to become director of national intelligence. He was replaced by Zalmay Khalilzad. But the turnover in the Iraqi government was far more important religious Shi'ites, led by Prime Minister Ibrahim al-Jaafari, took charge, a severe irritant to many Sunnis. "The insurgents see al-Jaafari as a traitor, a man who spent the Iran-Iraq war in Iran," says a senior military officer. "And many of the best officers we have trained in the new Iraqi army--Sunnis and secular Shi'ites who served in Saddam's army--feel the same way." Al-Jaafari did not help matters by opening diplomatic ties with Iran, apologizing for Iraq's behavior in the Iran-Iraq war and cutting economic deals with the Iranians.

In fact, some Iraq experts in the U.S. intelligence community have come to the conclusion that Iraqis' courageous recent steps toward democracy--the elections in January and the writing of a constitution that empowers the religious Shi'ites and the Kurds (though it is resoundingly opposed by the Sunnis)--have left the country in a more precarious position. "The big conversation in our shop these days," says a military-intelligence officer, "is whether it would be a good thing if the new constitution is voted down [in the public referendum] next month."

Iraq experts in the intelligence community believe that the proposed constitution, which creates autonomous regions for the Kurds and Shi'ites in the oil-rich north and south, could heighten the chances of an outright civil war. "A lot of us who have followed this thing have come to the conclusion that the Sunnis are the wolves--the real warriors--and the religious Shi'ites are the sheep," says an intelligence officer. "The Sunnis have the power to maintain this violence indefinitely."

Another hot debate in the intelligence community is whether to make a major change in the counterinsurgency strategy--to stop the aggressive sweeps through insurgent-riddled areas, like the recent offensive in Tall 'Afar, and try to concentrate troops and resources with the aim of improving security and living conditions in population centers like Baghdad. "We've taken Samarra four times, and we've lost it four times," says an intelligence officer. "We need a new strategy."

But the Pentagon leadership is unlikely to support a strategy that concedes broad swaths of territory to the enemy. In fact, none of the intelligence officers who spoke with TIME or their

ranking superiors could provide a plausible road map toward stability in Iraq. It is quite possible that the occupation of Iraq was an unwise proposition from the start, as many U.S. allies in the region warned before the invasion. Yet, despite their gloom, every one of the officers favors continuing--indeed, augmenting--the war effort. If the U.S. leaves, they say, the chaos in central Iraq could threaten the stability of the entire Middle East. And al-Qaeda operatives like al-Zarqawi could have a relatively safe base of operations in the Sunni triangle. "We have never taken this operation seriously enough," says a retired senior military official with experience in Iraq. "We have never provided enough troops. We have never provided enough equipment, or the right kind of equipment. We have never worked the intelligence part of the war in a serious, sustained fashion. We have failed the Iraqi people, and we have failed our troops." --With reporting by Brian Bennett/ Washington and Michael Ware/ Baghdad

Copyright © 2005 Time Inc. All rights reserved.
Reproduction in whole or in part without permission is prohibited.
###

~~FOUO~~
Eyes Only Attachment

SEP 23 2005

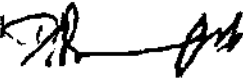
TO: President George W. Bush
CC: Vice President Richard B. Cheney
FROM: Donald Rumsfeld 
SUBJECT: Texture

The attached memo is from a person we have sent into Iraq from time to time essentially to work with the Iraqi police. He is smart, tough and a keen observer. Nonetheless, you have said you like "texture," and this is texture.

He moves in and out of the country, goes out on patrols with the police and the special police commandos, and has been in a number of firefights in the country. I find his views interesting and stimulating, although his perspective, like anyone's, is limited.

I would appreciate it if this were not circulated to anyone else.

Respectfully,

Attach.
9/19/05 Jim Steele memo to SecDef

DHR:dh
092205-13

~~FOUO~~
Eyes Only Attachment
11-L-0559/OSD/52315

OSD 19056-05

EYES ONLY

MEMO TO DON RUMSFELD

19 September 2005

FROM JIM STEELE

SUBJECT: Iraq

I recently returned from Iraq where I had the opportunity to observe the ISF in action as well as spend time with my friend, Sheik Saad Al-Janabi, who is one of the key political players within the Sunni community that worked on the ~~draft~~ constitution. While some of the observations and recommendations that follow may be controversial, they represent my best judgment and are consistent with our past ~~frank~~ and direct discussions.

The accomplishments made by Generals Casey and Petraeus in building the ISF over the past year have been amazing. The sheer size of the forces is well beyond what I thought was achievable during that period. Within the MOI alone, the number of police, commandos, intervention forces and border units is over 140,000. I hesitate to estimate the number of "trained" MOI forces because not only is it highly subjective, but dependent on the quality of the enemy. With notable exceptions, the insurgents are not well trained. I contend the real measure of effectiveness is leadership. Iraqis follow strong leaders. There is a "gang" mentality among Iraqis that must be understood for us to achieve both political and military success. For that reason, the rise of militias is one of my greatest concerns.

Despite their improved operational capability, the ISF is susceptible to sectarian political influence, even control. I witnessed this first hand within the MOI forces, particularly the commandos, public order units and the 8th Mechanized Brigade. There is a systematic effort by SCIRI and its Badr militia to take control of the high-end units within MOI. This effort ranges from assigning Badr officers to command units to protecting thugs like the commander of the Wolf Brigade who has been involved in death squad activities, extortion of detainees and a general pattern of corruption. Nearly all of the new recruits within the commandos are Shia, many of them are Badr members. While this effort by SCIRI may be a hedge designed to create a protective force similar to the Pesh for the Kurds, it has the effect of seriously undermining the government's most effective forces. It also contributes to the possibility of a Lebanon-type scenario where the a civil war ensues with the Sunnis being driven into the arms of the insurgents as their militia. This would put us in an untenable position

It is my opinion that the ISF is sufficiently capable militarily right now to permit withdrawal of some US forces and the redistribution of others to areas like Anbar. I recognize that the timing of such a withdrawal with the referendum and an election pending has strong political implications. However, it is essential that the Iraqis assume the burden of their own security as quickly as possible. In this

regard, Iraqi army units must begin operating more independently. They are highly dependent on their US counterpart units for logistics **as** well as command and control. Changing this has to be a top priority. In order to make such a change, the Iraqis have to develop a functional logistics system. We also have to focus our efforts on the US advisory teams that are assigned to the Iraqi units. These teams will play an increasingly key role **as** we begin the withdrawal process. My first-hand experience with the MOI forces and their advisory teams suggest that we could do better. Without detracting from the courage and sacrifices that these teams are making daily, the qualifications of many of those assigned to this duty are lacking. **Most are** active duty personnel assigned to reserve units with little training or experience in working with indigenous forces. In most cases, they do not live with the Iraqi units they advise and **are** sometimes left behind because they are unaware of pending operations. Working with host country forces is precisely what the Army's Special Forces were initially designed to do. Unfortunately, they have moved away from this critical mission and focused **instead** on direct action.

Most of my comments heretofore have been directed toward military matters. However, the current situation is overshadowed by politics and specifically the pending referendum. My friend, **Saad**, has been working day and night to find common ground between the Sunnis, Kurds and the Shias **so** that the constitution will have the support of all. I **am** less than optimistic that this will occur. However, if the **Sunnis** with the support of strange bedfellows like Moqtada are able to achieve the requisite votes in three provinces to defeat the constitution, there is **a silver lining**. It will show that the **Sunnis** do have political power and can be successful within the system. Regardless of the outcome of the referendum, it is essential that the **Sunnis** are not disenfranchised to the point where they turn to the insurgents on a large scale to protect their interests have left my most controversial and perhaps most important comments for last. Despite the problems, we are making progress in Iraq. I am less confident that we are doing a good job on the home front. **An** axiom of US foreign policy is that military action receives overwhelming support if accomplished quickly. When it stretches out and casualties **mount**, support at home wanes. If one traces military actions with overwhelming public support, there is a common thread that I consider significant. The military leader in charge was renowned. Eisenhower, MacArthur, "Blood and Guts" Patton, even "Stormin' Norman" were household names. **Very** few Americans, even those that are well read, can tell you who is in charge in Iraq. General Casey is smart and has done most things right, but he is not particularly good with the press and he is not the dynamic leader that Americans revere and have confidence that he is going to get **this job** done and get the troops home. I recommend you find that dynamic general, give him some running room and turn him **loose** on the press. Unfortunately, there are not many around, but I can **think** of a few.

Best, Jim

11-L-0559/OSD/52317

~~FOUO~~
Eyes Only Attachment

SEP 23 2005

TO: President George W. Bush
CC: Vice President Richard B. Cheney
FROM: Donald Rumsfeld 
SUBJECT: Texture

The attached memo is from a person we have sent into Iraq from time to time essentially to work with the Iraqi police. He is smart, tough and a keen observer. Nonetheless, you have said you like "texture," and this is texture.

He moves in and out of the country, goes out on patrols with the police and the special police commandos, and has been in a number of firefights in the country. I find his views interesting and stimulating, although his perspective, like anyone's, is limited.

I would appreciate it if this were not circulated to anyone else.

Respectfully,

Attach.
9/19/05 Jim Steele memo to SecDef

DHR:dh
092205-13

OSD 19056-05

~~FOUO~~
Eyes Only Attachment
11-L-0559/OSD/52318

~~FOUO~~

September 08, 2005
2015 10:03 AM 7:29

TO: Mike Wynne
CC: Pete Geren
FROM: Donald Rumsfeld 
SUBJECT: BRAC and Cannon AFB

Senator Domenici called me and said that the BRAC Commission had addressed the Cannon AFB issue, and directed us to look for an alternative mission.

Please come to me with a proposal as to how we can proceed to do *that*, in the event it goes through the Resident and the Congress successfully.

Thanks.

DHR:aj
090805-02

.....
Please Respond By 09/22/05

~~FOUO~~

11-L-0559/OSD/52319

OSD 19058-05

A



ACQUISITION,
TECHNOLOGY AND
LOGISTICS

PRINCIPAL DEPUTY UNDER SECRETARY OF DEFENSE
3015 DEFENSE PENTAGON
WASHINGTON, DC 20301-3015

2005 09 23 10:07:27

INFO MEMO

September 22, 2005

TO: SECRETARY OF DEFENSE
ACTING DEPUTY SECRETARY OF DEFENSE

FROM: MR. MICHAEL W. WYNNE *MW*

SUBJECT: BRAC and Cannon AFB (Clovis, New Mexico)

- o DoD BRAC recommendation was to close Cannon AFB, NM.
- BRAC Commission directed DoD to "seek other newly-identified missions" by December 31, 2009, or Cannon AFB would close.
- In the event the recommendation goes through Congress successfully, the AF will lead a flag level DoD team to determine potential future utilization, to include single service, joint service, and possible inter-agency missions for Cannon AFB. Estimate recommendations by Jun '06.

cc: Acting SECAF
USD (AT&L)

11-L-0530 OSD/52320

OSD 19058-05

~~FOUO~~

SEP 1 8 2005

TO: ADM Ed Giambastiani
Eric Edelman
Tina Jonas

FROM: Donald Rumsfeld 

SUBJECT: Iraqi Budget

There are big discussions going on about the Iraqi budget. I think it is enormously important that we get ground truth on making sure that all the **security** requirements are in the Iraqi budget and defended by the Iraqi government, and by us.

Please come back to me with an approach.

DHR:ss
091505-13

.....
Please Respond By October 12,2005

11-L-0559/OSD/52321



UNDER SECRETARY OF DEFENSE

1100 DEFENSE PENTAGON
WASHINGTON, DC 20301-1100

705 OCT 19 2005 11:42

INFO MEMO

COMPTROLLER

October 19, 2005, 12:00 PM

FOR SECRETARY OF DEFENSE
ACTING DEPUTY SECRETARY OF DEFENSE

FROM: Tina W. Jonas *TWJ*

SUBJECT: Iraqi Budget

- General Casey, working with the Iraqi Ministries of Defense and Interior, developed a 2006 requirement for security forces that totals \$9.23 billion.
- We understand that the Iraqi Minister of Finance has included \$5.36 billion for security forces in the draft Iraqi 2006 budget.
- This leaves a funding shortfall of \$3.87 billion against the \$9.23 billion requirement.
- Eric Edelman and I have discussed the numbers, and he is prepared to present them to the Deputies Committee with the understanding that the Iraqis need to fund the security force requirement.
- We will continue to work with the Joint Staff and General Casey to refine the cost of the requirements.

COORDINATION: Tab B

Attachments: Snowflake dated September 16, 2005 (Tab A)
Coordination Sheet (Tab B)

Prepared By: Mary E. Tompkey, (b)(6)

11-L-0559/OSD/52322

QSD 19085-05

TAB

A

~~FOUO~~

SEP 16 2005

TO: ADM Ed Giambastiani
Eric Edelman
Tina Jonas

FROM: Donald Rumsfeld 

SUBJECT: Iraqi Budget

There are big discussions going on about the Iraqi budget. I think it is enormously important that we get ground truth on making sure that all the security requirements are in the Iraqi budget and defended by the Iraqi government, and by us.

Please come back to me with an approach.

DHR:js
091505-13

.....
Please Respond By October 12,2005

~~FOUO~~
11-L-0559/OSD/52324

OSD 19085-05

TAB

B

UNDER SECRETARY OF DEFENSE (COMPTROLLER)

COORDINATION SHEET

SUBJECT: Iraqi Budget

USD(Policy)	Eric Edelman	October 14, 2005
Joint Staff (J-5)	LTG Gene Renuart Director for Strategic Plans and Policies	October 14, 2005
Joint Staff (J-8)	Rear Admiral Terrance Blake Vice Director for Force Structure, Resources and Assessment	October 14, 2005
Defense Reconstruction Support Office	Joe Benkert Principal Deputy	October 14, 2005



UNDER SECRETARY OF DEFENSE

1100 DEFENSE PENTAGON
WASHINGTON, DC 20301-1100

INFO MEMO

2005 SEP 23 12:00

COMPTROLLER

September 23, 2005, 10:00 **Ah4**

FOR SECRETARY OF DEFENSE
ACTWG DEPUTY SECRETARY OF DEFENSE

FROM: Tina W. Jonas *TWJ*

SUBJECT: Iraqi Budget

- Your note of September 16th emphasized the importance of getting to ground truth on making sure that all security requirements are in the Iraqi budget and defended by both the Iraqis and the U.S. You requested that we come back with an approach to this problem. (TAB A)
- At the interagency level, the approach has been prescribed by the Principal's Committee: The DoD must provide the definitive 2006 security and operations and maintenance requirements by September 30. By October 15, a USG review of options on how to finance the requirements will be complete.
- The USD(P), the Joint Staff, the Defense Reconstruction Support Office (DRSO) and my staff are fully engaged in this issue.
 - A preliminary staff estimate put the 2006 cost in the \$8 billion to \$13 billion range.
 - The timeline to get to a single, defensible estimate is:
 - The Commander, US Central Command (USCENTCOM) is developing an estimate of the 2006 requirement. His initial estimate is due today; we expect it will be refined and supporting data provided early next week.
 - Upon receipt of the USCENTCOM estimate, staff from OUSD(P), the Joint Staff, DRSO, the Army and OUSD(C) will review the estimate for reasonableness.
 - Our goal is to coordinate any changes to USCENTCOM plan by Wednesday (September 28).
- We expect to have a package for your review by Friday, September 30.

COORDINATION: None

Attachments: As stated

Prepared By: Ellen Maldonado, (b)(6) SD/52327

OSD 19085-05

~~FOUO~~

OFFICE OF THE
SECURITY ASSISTANT

2005 SEP 23 PM 12:49
SEP 20 2005

I-05/012652
ES-4256

TO : Paul McHale
CC: Eric Edelman
FROM: Donald Rumsfeld *DR*
SUBJECT: Tuskegee Institute

Please find out if Tuskegee Institute in Alabama suffered any damage from Katrina.

Thanks.

DHR:dh
091905-54

.....
Please Respond By September 26, 2005

~~FOUO~~

OSD 19094-05

11-L-0559/OSD/52328

~~FOR OFFICIAL USE ONLY~~



HOMELAND
DEFENSE

ASSISTANT SECRETARY OF DEFENSE
2600 DEFENSE PENTAGON
WASHINGTON, DC 20301-2600

INFO MEMO

DepSecDef 1-05/012652
21 SEP 2005 USD(P) *EV* SEP 22 2005
1-05/012652

ES-4256
U/R [Signature]

FOR SECRETARY OF DEFENSE

FROM: *Paul* McHale, Assistant Secretary of Defense (Homeland Defense)

Peter F. Verga
Principal Deputy

SUBJECT: Tuskegee Institute

- This is in response to your September 20, 2005 request: "Please find out if Tuskegee Institute in Alabama suffered any damage from Katrina."
- According to the Physical Plant & Facilities office manager at Tuskegee Institute, Hurricane Katrina caused no damage. There was a minor power outage during the height of the storm. Power was restored within hours. In fact, Tuskegee has accepted displaced students from areas affected by Katrina.
- The National Park Service also confirmed that Hurricane Katrina caused no damage to any National Historic sites in Tuskegee.

COORDINATION: NONE

Prepared by: Matt Burgess, OASD(HD) (b)(6)

22-09-02 10:12 10

~~FOR OFFICIAL USE ONLY~~

OSD 19094-05

11-L-0559/OSD/52329

~~FOUO~~

SEP 23 2005

TO: GEN John Abizaid
GEN George Casey

c c : Gen Dick Myers

FROM: Donald Rumsfeld *DR*

SUBJECT: POTUS Visit

Good job on your briefings. It was a tight deadline, and both of your presentations were excellent. We're looking forward to having you back here early next week to help out.

Thanks for all you are both doing for our country.

DHR:dh
092205-24

335 SD

23 SEP 05

OSD 19096-05

~~FOUO~~

11-L-0559/OSD/52330

~~FOUO~~

SEP 23 2005

TO: GEN John Abizaid
GEN George Casey

CC: Gen Dick Myers

FROM: Donald Rumsfeld 

SUBJECT: POTUS Visit

Good job on your briefings. It was a tight deadline, and both of your presentations were excellent. We're looking forward to having you back here early next week to help out.

Thanks for all you are both doing for ~~our~~ country.

DHR:dh
092205-24

OSD 19096-05

~~FOUO~~
11-L-0559/OSD/52331

FOUO

OCT 04 2005

580

TO: Larry DiRita
FROM: Donald Rumsfeld *DR*
SUBJECT: Get Story Out on Medical Evacuations

Let's get this story out on the Hurricane Rita medical evacuations.

Thanks.

Attach.
9/28/05 ASD(Health Affairs) memo to SecDef re: Hurricane Rita Medical Evacuations [OSD 19133-051

DHR:dh
100303-11

.....
Please Respond By October 06, 2005

4 Oct 05

OCT 04 2005

DR

23 SEP 05

FOUO

11-L-0559/OSD/52332

OSD 19133-05

THE ASSISTANT SECRETARY OF DEFENSE

WASHINGTON, D. C. 20301-1200



INFO MEMO

*Henry del Rio
less get this
only out
D/K*

SEP 28 2005

OK 1/3

HEALTH AFFAIRS
Robert Rangel

Re 9/30

FOR: SECRETARY OF DEFENSE
DEPUTY SECRETARY OF DEFENSE

FROM: *William Winkenwerder*
William Winkenwerder, Jr., MD, ASD (Health Affairs)

SUBJECT Hurricane Rita Medical Evacuations

- A major effort has been completed to aero-medically evacuate approximately 3,000 individuals from the coasts of Texas and Louisiana. These persons include the hospitalized sick, **frail** elderly from nursing homes, and those requiring on-going acute medical care. This entire effort was accomplished between 3:00 pm **Thursday, Sep 22** and 1:00 pm (EST) Friday, **Sep 23** using C-130, C-17, and **C-5** fixed wing aircraft.
- The effort was brought about through a coordinated effort involving Texas local and state health offices and multiple federal agencies. Within the Department of Defense, **there** has been a well coordinated effort involving Health Affairs, Homeland Defense, the Joint Staff(J4), U.S. Northern Command, and U.S. Transportation Command
- The effort was led by Brigadier General Paul Selva, Director of Operations for the U.S. Transportation Command. Every party involved has expressed deep appreciation for the superb, rapid, and competent response of U.S. Transportation Command and the aero-medical evacuation teams.
- The results of **this** effort in the medical area are a clear improvement **from** those following Hurricane Katrina and reflect the early pro-active efforts of those at the local and state levels, and much improved coordination at the federal level.
- We are compiling lessons learned **from** this response effort, and will be ready to share them within days.

cc:
 Service Secretaries
 Chairman, Joint Chiefs of Staff
 USD (P&R)
 Vice Chairman, Joint Chiefs of Staff
 ASD (PA)
 ASD (HD)
 ASD (LA)

543 9/29

<i>MA SD</i>	<i>9/29</i>	SMA DSD	
<i>TSA SD</i>	<i>9/29</i>	SA DSD	
EXEC-SEC	<i>M 9/29</i>	<i>0750</i>	
ESR/MA	<i>11</i>	L-0559/OSD	52333

19133-05



HEALTH AFFAIRS

THE ASSISTANT SECRETARY OF DEFENSE

WASHINGTON, D. C. 20301-1200

OFFICE OF THE
ASST. SEC. OF DEFENSE

2005 SEP 23 01 5: 52

INFO MEMO

SEP 23 2005

580

FOR: SECRETARY OF DEFENSE
DEPUTY SECRETARY OF DEFENSE

FROM: *William Winkenwerder, Jr.*
William Winkenwerder, Jr. MD, ASD (Health Affairs)

SUBJECT: Hurricane Rita Medical Evacuations

- A major effort has been completed to aero-medically evacuate approximately 3,000 individuals from the coasts of Texas and Louisiana. These persons include the hospitalized sick, frail elderly from nursing homes, and those requiring out-going acute medical care. This entire effort was accomplished between 3:00 pm Thursday and 1:00 pm (EST) today using C-130, C-17, and C-5 fixed wing aircraft.
- The effort was brought about through a coordinated effort involving Texas local and state health offices, the Department of Health and Human Services, the Department of Transportation, Federal Aviation Administration, Federal Emergency Management Agency, the White House, and the Department of Defense. Within the Department of Defense, there has been a well coordinated effort involving Health Affairs, Homeland Defense, the Joint Staff (J4), U.S. Northern Command, and U.S. Transportation Command.
- The linchpin of this effort was by U.S. Transportation Command under the leadership of Brigadier General Paul Selva. Every party involved has expressed deep appreciation for the superb, rapid, and competent response of U.S. Transportation Command and the aero-medical evacuation teams.
- The coordination was achieved with regular telephone conference calls throughout the time period. The team who has worked to execute this effort, from the local, state, and federal levels, is now beginning to plan for search and rescue and medical evacuations that may possibly be needed in the aftermath of Hurricane Rita.
- The results of this effort are a dramatic improvement from those following Hurricane Katriua and reflect the early pro-active efforts of those at the local and state levels, and much improved coordination at the federal level.

23 SEP 05

OSD 19133-05

11-L-0559/OSD/52334

- We are compiling lessons learned from this response effort, and will be ready to share them within days.

cc:

Service Secretaries

Chairman, Joint Chiefs of Staff

USD (P&R)

Vice Chairman, Joint Chiefs of Staff

ASD (PA)

ASD (HD)

ASD (LA)



THE ASSISTANT SECRETARY OF DEFENSE

WASHINGTON, D. C. 20301-1200

INFO MEMO

SEP 28 2005

HEALTH AFFAIRS

FOR: SECRETARY OF DEFENSE
DEPUTY SECRETARY OF DEFENSE

1 *William Winkenwerder, Jr.*
William Winkenwerder, Jr., MD, ASD (Health Af

SUBJECT: Hurricane Rita Medical Evacuations

- A major effort has been completed to aero-medically evacuate approximately 3,000 individuals from the coasts of Texas and Louisiana. These persons include the hospitalized sick, frail elderly from nursing homes, and those requiring on-going acute medical care. This entire effort was accomplished between 3:00 pm Thursday, Sep 22 and 1:00 pm (EST) Friday, Sep 23 using C-130, C-17, and C-5 fixed wing aircraft.
- The effort was brought about through a coordinated effort involving Texas local and state health offices and multiple federal agencies. Within the Department of Defense, there has been a well coordinated effort involving Health Affairs, Homeland Defense, the Joint Staff (J4), U.S. Northern Command, and U.S. Transportation Command.
- The effort was led by Brigadier General Paul Selva, Director of Operations for the U.S. Transportation Command. Every party involved has expressed deep appreciation for the superb, rapid, and competent response of U.S. Transportation Command and the aero-medical evacuation teams.
- The results of this effort in the medical area are a clear improvement from those following Hurricane Katrina and reflect the early pro-active efforts of those at the local and state levels, and much improved coordination at the federal level.
- We are compiling lessons learned from this response effort, and will be ready to share them within days.

cc:
 Service Secretaries
 Chairman, Joint Chiefs of Staff
 USD (P&R)
 Vice Chairman, Joint Chiefs of Staff
 ASD (PA)
 ASD (HD)
 ASD (LA)

580

28 Sep 05

23 Sep 05

OFFICE OF THE SECRETARY OF DEFENSE
THE SPECIAL ASSISTANT

9/26

TO - Bill WINKERWEIDER

- GREAT STORY AND WORTH TELLING THE SECDEF.
- Pls. see ATTACHED EDITS TO ELIMINATE EXTRANEOUS DETAIL THAT THE SECDEF DOESN'T NEED.
- CONCERNED WITH THE CHARACTERIZATION THAT RITA RESPONSE IS A "DRAMATIC IMPROVEMENT" OVER KATRINA RESPONSE
- ADEQUACY OF KATRINA RESPONSE IS VERY MUCH AN OPEN QUESTION, PARTICULARLY AS IT PERTAINS TO DOD SUPPORT.

Robert Rangel

Robert Rangel

26
30



HEALTH AFFAIRS

THE ASSISTANT SECRETARY OF DEFENSE

WASHINGTON, D. C. 20301-1200

DEFENSE

205 SEP 23 PM 5:52

INFO MEMO

SEP 23 2005

FOR: SECRETARY OF DEFENSE
DEPUTY SECRETARY OF DEFENSE

FROM: *William Winkenwerder, Jr.*
William Winkenwerder, Jr., MD, ASD (Health Affairs)

SUBJECT: Hurricane Rita Medical Evacuations

- A major effort has been completed to aero-medically evacuate approximately 3,000 individuals from the coasts of Texas and Louisiana. These persons include the hospitalized sick, frail elderly from nursing homes, and those requiring on-going acute medical care. This entire effort was accomplished between 3:00 pm Thursday, *Sept. 22* and 1:00 pm (EST) ~~today~~ *Friday, Sept. 23* using C-130, C-17, and C-5 fixed wing aircraft.
- The effort was brought about through a coordinated effort involving Texas local and state health offices, ~~the Department of Health and Human Services, the Department of Transportation, Federal Aviation Administration, Federal Emergency Management Agency, the White House, and the Department of Defense.~~ *and multiple federal agencies.* Within the Department of Defense, there has been a well coordinated effort involving Health Affairs, Homeland Defense, the Joint Staff (J4), U.S. Northern Command, and U.S. Transportation Command.
- The linchpin of this effort was by U.S. Transportation Command *under the leadership of Brigadier General Paul Selva.* Every party involved has expressed deep appreciation for the superb, rapid, and competent response of U.S. Transportation Command and the aero-medical evacuation teams. *- who is this? SD probably involved KRBH HINA*
- The coordination was achieved with regular telephone conference calls throughout the time period. The team who has worked to execute this effort, from the local, state, and federal levels, is now beginning to plan for search and rescue and medical evacuations that may possibly be needed in the aftermath of Hurricane Rita. *in the medical area unclear*
- The results of this effort are a *dramatic* improvement from those following Hurricane Katrina and reflect the early pro-active efforts of those at the local and state levels, and much improved coordination at the federal level. *see comment*

893 7/26

MA SD		SMA DSD	
TSA SD		SA DSD	
EXEC SEC	<i>M 9/26</i>	<i>100</i>	<i>9/27</i>
ESR MA	<i>HH 9/26</i>	<i>0845</i>	

O-SD 19133-05

11-L-0559/OSD/52338

- We are compiling lessons learned from this response effort, and will be ready to share them within days.

cc:

Service Secretaries

Chairman, Joint Chiefs of Staff

USD (P&R)

Vice Chairman, Joint Chiefs of Staff

ASD (PA)

ASD (HD)

ASD (LA)

OFFICE OF THE SECRETARY OF DEFENSE
THE SPECIAL ASSISTANT

9/26

Re Bill Winter ~~memo~~

- Great story and worth telling the Sec Def. 580
- Pls. see attached edits to eliminate extraneous detail that the Sec Def doesn't need.
- CONCERNED WITH THE CHARACTERIZATION THAT RITA RESPONSE IS A "DRAMATIC IMPROVEMENT" OVER KATRINA RESPONSE 26 SEP 05
- ADEQUACY OF KATRINA RESPONSE IS VERY MUCH AN OPEN QUESTION, PARTICULARLY AS IT PERTAINS TO LOD SUPPORT. 23 SEP 05

Robert Rangel

Robert Rangel

26
30



THE ASSISTANT SECRETARY OF DEFENSE

WASHINGTON, D. C. 20301-1200

OFFICE OF THE
SECRETARY OF DEFENSE

2005 SEP 23 PM 5: 52

HEALTH AFFAIRS

INFO MEMO

SEP 23 2005

FOR: SECRETARY OF DEFENSE
DEPUTY SECRETARY OF DEFENSE

FROM: *William Winkenwerder, Jr.*
William Winkenwerder, Jr. MD, ASD (Health Affairs)

SUBJECT: Humane Rita Medical Evacuations

- A major effort has been completed to aereo-medically evacuate approximately 3,000 individuals from the coasts of Texas and Louisiana. These persons include the hospitalized sick, frail elderly from nursing homes, and those requiring on-going acute medical care. This entire effort was accomplished between 3:00 pm Thursday, *Sept. 22* and 1:00 pm (EST) ~~today~~ *Friday, Sept. 23* using C-130, C-17, and C-5 fixed wing aircraft. *and multiple federal agencies.*
- The effort was brought about through a coordinated effort involving Texas local and state health offices, ~~the Department of Health and Human Services, the Department of Transportation, Federal Aviation Administration, Federal Emergency Management Agency, the White House, and the Department of Defense.~~ Within the Department of Defense, there has been a well coordinated effort involving Health Affairs, Homeland Defense, the Joint Staff (J4), U.S. Northern Command, and U.S. Transportation Command.
- The linchpin of this effort was by U.S. Transportation Command *under* the leadership of Brigadier General Paul Selva. Every party involved has expressed deep appreciation for the superb, rapid, and competent response of U.S. Transportation Command and the aereo medical evacuation teams. *- who is this? The SD probably doesn't know him*
- The coordination was achieved with regular telephone conference calls throughout the time period. The team who has worked to execute this effort, from the local, state, and federal levels, is now beginning to plan for search and rescue and medical evacuations that may possibly be needed in the aftermath of Hurricane Rita. *in the medical area*
- The results of this effort ~~are a dramatic~~ *are a dramatic* improvement from those following Hurricane Katrina and reflect the early pro-active efforts of those at the local and state levels, and much improved coordination at the federal level. *see comment*

SPC 9/26

MA SD		SMA DSD	
TSA SD		SA DSD	
EXEC SEC	<i>11/9/05</i>	<i>100</i>	<i>9/27</i>
ESR MA	<i>11/9/05</i>	<i>0845</i>	

OSD 19133-05

11-L-0559/OSD/52341

- We are compiling lessons learned from this response effort, and **will be** ready to share them within days.

cc:

Service Secretaries

Chairman, Joint Chiefs of Staff

USD (P&R)

Vice Chairman, Joint Chiefs of Staff

ASD (PA)

ASD (HD)

ASD (LA)

~~FOUO~~

September 26, 2005

TO: GEN John Abizaid
GEN George Casey

CC: Gen Dick Myers

FROM: Donald Rumsfeld *DR*

SUBJECT: Your Visit to Washington

John and George,

I have reviewed your inputs on the schedule for your visit and they look fine with a few minor exceptions:

- We need you both to do the Sunday talk shows, separately, so that between the two of you, all five talk shows have an appearance by one of you.
- George will do Larry King and John will do the FOX Special Report.
- Finally, George, your time with the *Washington Post* Editorial Board might be better spent doing radio interviews

Thanks for your help.

DHK:ss
082605-10

.....

OSD 19150-05

~~FOUO~~
11-L-0559/OSD/52343

08 77

26 Sept 05

~~FOUO~~

August 26, 2005

340

TO: Fran Harvey
GEN Pete Schoomaker
Gordon England
GEN Mike Hagee

CC: Gen Dick Myers
VADM Jim Stavridis

FROM: Donald Rumsfeld



SUBJECT: Plan for Engaging Returning Soldiers and Marines

With re-enlistment rates **for** deployed units as high as they are, I **imagine** returned deployers are excellent spokespersons for the work being done in **Iraq** and Afghanistan.

I would like to see your plans for how you engage those returning soldiers and Marines with the public.

It would be interesting to learn how you **track** who has gone where and with whom they have engaged.

Thanks

DHR:as
082605-21

.....
Please Respond By 09/22/05

26 AUG 05

~~FOUO~~

OSD 19214-05

11-L-0559/OSD/52344



2005 SEP 26 PM 2:43 IN REPLY REFER TO:

INFO MEMO

FOR SECRETARY OF DEFENSE

FROM: General M. W. Hagee, Commandant of the Marine Corps

SUBJECT: Plan for Engaging Returning Soldiers and Marines

- This responds to your subject memo of 26 August 2005.
- It is standard operating procedure for the Marine Corps to engage returning Marines with the media and the public. I have attached a few examples to illustrate our success in this arena (Tab A).
- We have developed and implemented an updated, comprehensive, Corps-wide plan to engage returning Marines with the public. The highlights of this plan include:
 - No less than 4 weeks prior to redeployment of a Marine unit, base and station public affairs officers (PAOs) contact local and regional media, local community leaders and other community relations points of contact, and local commanders to identify engagement opportunities. These opportunities are disseminated and coordinated via subordinate PAOs.
 - PAOs will identify and proactively seek new speaking venues for recently returned Marines and Sailors. Headquarters Marine Corps provides additional talking points and speech support to major Marine Corps commands.
 - Local base and station PAOs coordinate with their counterparts within Marine Corps Recruiting Command to identify speaking and engagement venues for Marines on recruiter's assistance.
 - PAOs provide copies of events calendars, news releases, plans, and locally generated public affairs guidance to each other via the Intranet.

3400

2 by DT

26 August

OSD 19214-05

11-L-0559/OSD/52345

1150

- We are developing an updated, web-based tracking system for our commanders maintained by Headquarters Marine Corps. This updated system will have initial operating capability on 1 January 2006.

v/r
Chris Hughes

COORDINATION: None.

Attachments:
As stated

Prepared by: Maj. Chris Hughes (b)(6)

Billings Marines return from 7-month Iraq tour
Billings, Montana (Sept 2005)

It took the better part of a year, but on Friday afternoon Linda Fowler, of Helena, got what she's been waiting for.

Her son, U.S. Marine Lance Cpl. Joseph Fowler, finally returned from Iraq.

The soldier was one of nine Marine reservists in a Billings unit who arrived at Billings Logan International Airport after a seven-month tour in Iraq. The Marines were received by a noisy throng of family members, friends and supporters.

In Iraa since February

The group, from Bravo Company, 4th Reconnaissance Battalion, 4th Marines Division in Billings, was activated in January. They were attached to the 1st Force Reconnaissance Company in Camp Pendleton, Calif., and sent to Iraq in early February.

Two other Marines from the group are due to return soon.

"It feels good to be back," Sgt. John Ryder, of Billings, said at a welcome-home party at the Marine drill center in the Armed Forces Reserve Center on Gabel Road.

Gettina reacquainted

The 24-year-old plans to return to Montana State University-Billingsto complete a degree in information systems. First, though, there will be the small matter of learning the new songs on the radio and getting reacquainted with life in Billings.

"There are some new businesses here and there, but for the most part everything looks familiar," Ryder said of his home since 1999.

In Iraq, the Marines were stationed in Al Asad in the Hit-Haditha corridor, identified by the military as a conduit through which insurgents transport people, weaponry and other resources from Syria. Under the cover of nightfall, the soldiers carried out more than 70 missions targeting what they call "high-value individuals" - insurgents or other figures deemed to be security threats.

"The names are probably not anything you or I would recognize," Staff Sgt. Paul Dreyer, 36, of Choteau, said while others enjoyed burgers and brats at the cookout. "But they are the lieutenants and facilitators for the names you hear on TV."

Close calls abounded as the Marines routinely encountered small arms fire, improvised explosive devices, rocket-propelled grenades and other hostilities. In one case, Ryder and other soldiers narrowly escaped injury when their vehicle was struck by an IED. The vehicle was destroyed, Ryder said.

It was in the Haditha region where Pfc. Nicholas Bloem of Belgradewas killed, along with 13 other Marines, when a transport vehicle was hit by a roadside bomb Aug. 3.

While Bloem was serving with a different unit at the time, several of the soldiers who returned Friday had met him or trained with him. They said his death was at once deeply sad and a reminder about the danger of the roads they traveled every day.

"It was tough," said Lance Cpl. Joe Fowler, who trained with Bloem in San Antonio and described him as "an awesome guy" and a dedicated soldier. "All the Marines we leave with we fully intend to return with," he said.

Bloem's death was hard, too, for family members who learned about it while monitoring media reports for any news of their loved ones in Iraq.

"It just rips your heart out because you just know it could be your son," said Butch Bergstrom, of Sheridan, Wyo. His son, Lance Cpl. Jay Bergstrom, is a third-generation Marine with an older brother also in the Corps.

Former student finds inspiration with marine Ohio News/September 2005

Her heart is now at home. Former WSU student Courtney Whitt can breathe easier now that her boyfriend of over a year has returned from the war in Iraq. Although the circumstances under which her Marine returned weren't ideal, Whitt is happy to report that Lance Cpl. Beau Links, also a WSU student, is making a fine recovery.

Originally published on May 25, The Guardian reported that Links was being transported back to the states following injuries sustained while clearing houses of insurgents near the Syrian border. He was shot several times and wounded by a grenade blast.

Here at home, Whitt experienced many emotions because she couldn't get to Links. "I felt hopeless because I couldn't see him. It was very frustrating...a very empty feeling," recalled Whitt.

Along with Links, his two team members were injured. Another team then came and moved them to a house that had already been cleared. Lance Cpl. James Crum, also Links' best friend, tended to his wounds until rescue trucks could take them to safety.

"(Crum)'s got a big hug coming from me when he gets home," Whitt said. "It made me feel better knowing that those two were over there together. They're unstoppable," she added.

In the four months since the incident, Links has made an incredible recovery. He's had multiple surgeries and his last one is Sept. 25 to put a plate and screws in his right arm. He also has physical therapy on weekdays at Wright Patt. In response to Whitt's support, Links was overwhelmed.

"It was unexpected. People don't do the things that she does. She was there when I opened my eyes in the hospital, and she's been there ever since," he said. "She's incredibly patient and understanding. If things are difficult, I can talk to her. She doesn't always try to solve the problem; she's a good listener. She's a keeper," he added with a smile.

"He's very independent so I try to let him do things on his own until he needs me. But I'll do anything for him even if it's something small like going to get him lunch," said Whitt.

Both Links and Whitt stay involved with the Marine Corps by attending family days, e-mailing those that are still in Iraq, attending funerals of fallen Marines and staying in contact with others who are injured. The rest of Links' platoon is estimated to come home in mid October.

Whitt graduated WSU in June and is busy with a job search to put her psychology degree to use. Links is returning to WSU this quarter and is taking on a few classes.

When asked how their relationship has changed, Whitt was quick to answer. "We've learned things about each other that we wouldn't have learned for years. Despite all that has happened, I love where we are. He's my best friend," she said. "Beau is unlike any person I have ever met in my life; he's such an inspiration."

**Marine returns home from Iraq
Benally visits family after duty at Al Asad Air Base
August 2005**

For a while it was a frenzied but feel-good Friday at the Cortez Municipal Airport with friends and family cheering aloud to welcome home a local Marine from his first tour of duty in Iraq.

Marine Pfc. Lyle Benally, of Cortez, received a standing ovation after hopping off a Great Lakes propeller plane as people waved American flags and held up signs of support for the area troop and all U.S. service members.

"I'm just happy to be back and spend time with my family," Benally said after corralling a round of hugs. "I really appreciate everyone being here." About 60 people packed into the airport office and waiting area to display signs that stated "Welcome home Lyle Benally" and "Missed and love you son." Benally, 20, was assigned to the 2nd Low Altitude Air Defense Battalion while serving in Iraq. The main mission of the 2nd LAAD is to provide low altitude air defense to soldiers on the ground and in support of the 2nd Marine Wing.

Benally said the experience was good for him and that the weather was always "hot and dusty."

"(Marine) boot camp helped prepare us well for deployment," he said.

After three months of MREs (meals ready to eat) followed by three months of regular military chow, Benally appeared eager to attend the "welcome home" dinner held in his honor Friday evening at Empire Electric's Calvin Denton Room.

When you're over there you realize how everything is better in the U.S.," he said. "I didn't know how well we had it." Additional duties Benally performed during his Iraqi stint included primary security patrols around the perimeter of the base, searching incoming and outgoing vehicles and personnel, and providing tactical air command support. As an aviation mechanic, the private primarily worked with an EA-6B Prowler, which is a jet aircraft specializing in electronic warfare.

During their six-month mission, the 150 Marines of the 2nd LAAD lost no lives while stationed at the Al Asad Air Base in Iraq, according to Benally, but the unit did suffer two wounded in action.

Benally is a 2003 graduate of Montezuma-Cortez High School. He joined the military soon after graduating and is approximately two years through a five-year enlistment.

The private's father, Larry Benally, said he and his wife, Faye, have had mixed feelings and concerns since their son was deployed last February.

"We've had a lot to think about with him over there," he said. "After hearing the news every day on TV, our worries ran deep and our minds were on him. Sometimes you just have to go outside by yourself and cry things out." Private Benally is scheduled to leave Cortez Wednesday and soon return to duty at his regular station in Cherry Point, N.C. He was not certain whether a second tour of duty to Iraq is forthcoming.

Marine home on leave becomes dad
Witnessed bombing and loss of fellow Marines in ill-fated Lima Company
Dayton Daily News/August 2005

Lance Cpl. Nathan Ryerson, 27, who was sent home from Iraq by his commanders on emergency leave at the request of the Red Cross when his pregnant wife began experiencing complications, is now a father.

The subject of a **Dayton Daily News** article on Tuesday, Ryerson, who was given a middle of the night homecoming reception in his hometown of West Milton on Saturday, and his wife, Suzanne, 27, are parents of a healthy son.

According to family friend Joy Cornelius, the baby is named Thomas Klyne Ryerson, and was born by C-section at 4:09 a.m. Wednesday at the Upper Valley Medical Center in Troy.

"Everyone is doing fine," Cornelius said. Ryerson was the first member of the Lima Company, 3rd Battalion, 25th Marines from Ohio to return home to the states after 14 Marines from the company died in action on Aug. 3.

Ryerson witnessed the bombing and loss of fellow Marines and bunked in the same room with 11 of the victims.

Others in his unit are expected to complete assignments and to be sent home within a month.

Marine home with grateful family
Rocky Mountain Colorado News/August 2005

The afternoon flight from Palm Springs arrived in Denver 15 minutes early Wednesday, but not soon enough for Marine Cpl. Dean Sanchez, who was coming home after serving three tours in Iraq.

"All you think about is family and when you're going to see them," he said. "This is the most scared I've been in a year."

Sanchez, a Denver native, spent the past three years fighting the war in Iraq and was greeted by friends and family at Denver International Airport on Wednesday.

As loved ones rushed to the waving hands of Sanchez in a crowded baggage claim area, the Marine relished being around family and girls again. He also can't wait to eat home-cooked tamales and stuffed sopapillas.

"I'm very grateful. I'm going to watch him and feed him," said his mother, Rose Garcia.

Sanchez, 29, is a member of the 3rd Battalion, 4th Marine Regiment that helped provide security in Fallujah and took part in the takeover of Baghdad. Sanchez said he was one of the Marines that helped topple the statue of Saddam Hussein in Baghdad.

"I wish I could have done more," he said.

Sanchez has received 10 medals including a Purple Heart when he was hit in the shoulder by a ricochet bullet from a sniper last year. Family members jokingly said he wasn't hurt enough to come home then.

"I'm not going to miss the sand. I'm not going to the beach anytime soon," he said.

His twin sister, LeDawn Sanchez, stood in the background and remained quiet as he hugged friends in the airport. She is a minute younger and said she missed their twin connection.

"I think we feel each other's pain," she said. "He called the day I had my baby. He didn't know. Dean was on his way to Germany and he had an intuition."

LeDawn Sanchez brought her 2-year-old son, Latyr McQuarters to the airport. He was dressed in army fatigues and was still learning the Marine yell, "OORAH."

"A lot has changed since he has been gone," she said. "It was hard not being able to talk to him every day and seeing the war on television and not knowing if he was hurt."

Dean Sanchez's arrival comes at a time when anti-war activists have been protesting outside President Bush's Texas ranch for almost two weeks. Cindy Sheehan, who started the protest because her 24-year-old son was killed last year in Iraq, is asking to speak with the president.

Sanchez backs the war effort and sympathizes with the loved ones of those who died, but he said the soldiers know what they get themselves into when they enlist.

"When you put up your left hand, you swear an allegiance," Sanchez said. "We all joined the Marines knowing what we're doing. There was nothing hidden."

Sanchez said he is getting out of the Marines and plans to attend law school after he finishes his bachelor's degree at Metropolitan State College.

But before he starts thinking more about the future, he wants to chow down on menudo and green chile.

"We ate good food out there, but there's no substitute for home-cooked Mexican food," he said.

Local Marine fights for recovery one finger **at a time**
Salem, Ore. July 2005

KEIZER -- She cradles his lifeless wrist with one hand and with the other takes his fingers, one at a time, and bends them until he flinches. Then she bends each one a bit more and holds it in that position for **10** seconds.

Again and again, for about an hour each day, she flexes his crippled fingers during a series of range-of-motion exercises. This is not Erik Sphoon's idea of holding hands with his wife, but the routine is just the beginning for the Marine Corps sergeant.

A sniper's bullet ripped through his hand, wrist and forearm last month while he was on patrol in Ramadi, Iraq, and he faces a year of grueling physical therapy.

"Most of it feels like a good stretch," he says, "but some of it feels like a voodoo death grip.

"I can't just not do it. I want to be able to use my hand again someday."

The exercises are almost as difficult for Christie, his wife.

"I get squeamish because I think about the pain," she says. "I don't want to push too hard or snap anything. My worst fear is I'm going to mess up what they have fixed."

Erik has had more than a dozen surgeries to repair shattered bones, torn tendons and severed nerves. His arm is held together by a 7-inch metal plate and several pins and screws.

"I don't know why it doesn't sound like a robotic arm, because there's so much stuff in there," he says. "It should just be hydraulic."

Almost six weeks have passed since he was wounded, and he barely can wiggle his thumb and his index finger. But the 26-year-old knows he *is* lucky. He could have lost his arm or bled to death.

"**Not** a day goes by that I don't think about it," says Erik, who is home on convalescent leave.

11-L-0559/OSD/52353

Second tour in Iraq

He was shot about three months into his second tour of duty as an infantryman with Alpha Company of the 1st Battalion, 5th Marine Regiment. During his first tour, he was among the first troops to move into Fallujah in April 2004.

"That was just one big gunfight the whole time," says Erik, who grew up in Aumsville and graduated in 1997 from Cascade High School in Turner.

He returned to Iraq this year to find the insurgents even more determined, carrying out more sophisticated attacks. Two members of his platoon were killed in April when an improvised explosive device detonated near their convoy.

Erik had had some close calls -- like the time a roadside bomb exploded across the street from his Humvee -- before getting wounded less than two months later.

Members of his platoon were on patrol June 12 in Ramadi, about 70 miles west of Baghdad. They were escorting a civil-affairs group that was surveying residents in a city that has been the site of frequent attacks that have killed U.S. troops. They were cordoning a city block and establishing what they call "trigger lines," placing a barrier of cones to keep Iraqis at a distance and away from their vehicles. The locals were getting too close in one area, so Erik, the platoon guide, radioed to extend the trigger line. He moved the cones himself and, as he was placing the last one, he heard the shot coming from a bolt-action rifle.

"It felt like my arm was on fire," he says, "and I felt this giant hole."

A swift reaction

Erik dropped his rifle, grabbed his arm to try to stop the bleeding and ran for his Humvee about 20 yards away. His driver, Lance Cpl. Josh Barfield, was waiting with bandages. The bullet entered through the back of his hand, shattered his wrist and exited under his forearm. His ulnar artery was severed, and a chunk of his arm was blown away. He was losing a lot of blood. He remembers that later, when doctors removed his desert camies, they were soaked red.

"The more excited I got, the more blood rushed out of the wound," he says.

Barfield's quick reaction and calming influence were crucial to saving his arm, perhaps even his life.

"He was very cool," Erik says. "He knew what he had to do and just did it. He told me, 'You're going to be all right; it's not that bad.' He was lying to me, but he was calming me down.

"I think -- I know -- he pretty much saved my life."

A medevac vehicle arrived within minutes and transported Erik to a field hospital. He was groggy from a morphine injection but remembers his teary-eyed platoon sergeant coming to visit him.

"On the radio, he thought I had been shot in the head," Erik says, "not the hand."

While Erik was at the field hospital, nurses were able to use Vaseline to remove his titanium wedding band from his swollen hand. It doesn't fit the ring finger on his right hand, so for now, Christie is wearing it on her thumb.

Fearing the worst

Once Erik was stabilized, a medevac crew flew him to Germany, where he underwent surgery, and then to the Navy hospital at Camp Pendleton, the headquarters for the 1st Battalion, 5th Marine Regiment. Much of the first few days was a blur. He was sure he was going to lose his arm and join hundreds of troops who have undergone amputations in the more than two years since the war began in Iraq.

"I thought I was off to Bethesda, where amputees go," Erik says, referring to the National Naval Medical Center in Bethesda, Md.

Instead, Camp Pendleton was his destination. He arrived June 19, one week after being hit by that sniper's bullet.

Family at his bedside

His wife and daughter, his parents, and his younger brother and his wife were there to greet him. The Injured Marine Semper Fi Fund reimbursed much of their travel expenses, allowing them to concentrate on Erik's recovery.

"It's definitely a life-saver for the injured," Erik says, urging people in the Salem-Keizer area to donate a few bucks to the nonprofit organization. "I don't care how tough you think you are; you can't do it alone.

"I'm definitely going to donate to them when we have more money. I'm not the last one who's going to get injured over in Iraq."

Erik underwent surgeries almost every other day while doctors worked to repair the damaged bones, tendons and nerves. Metal plating, pins and screws were inserted to help the wrist heal. Doctors also grafted skin from his upper thigh to replace the tissue that was blown away.

He developed an infection while in Iraq and still needs a full drip bag of antibiotics every six hours. A pick line was surgically inserted into a vein under his right biceps so he doesn't have to be poked for an IV every time.

"If I don't fight it off," Erik says of the infection, "I could potentially still lose my arm."

His father, Tim, the chief of the Aumsville Rural Fire District, helps out with the IV when Christie is at work.

Vital surgery is near

Erik will undergo perhaps his most important surgery next month at the Navy hospital at Camp Pendleton. Doctors will take a piece of nerve from his leg and insert it in his arm where the ulnar nerve was severed. His physical therapist says it might take a year before he can use his hand to pick something up. He might never be able to use his ring finger and pinky.

"As long as I can still play cards," he says, demonstrating the motion of sliding playing cards across the table with his thumb and index and middle fingers.

Texas Hold 'em is his game. He and his buddies spent a lot of their free time in Iraq playing the popular poker game.

"The guys wouldn't want to play with me cause I took all their money," Erik says.

There are other, more important, things he wants to be able to do, such as being able to tie his shoes and tickle his 18-month-old daughter, Alexis, who has his bright blue eyes.

Erik keeps his arm in a sling and rests it on a pillow most of the time. Underneath the sling is a mesh "sock" that covers much of his arm from wrist to elbow, "so I don't have to look at it, so people don't have to see it."

A large, jagged scar juts out from under the mesh sock. A small patch of dressing on the inside of his forearm marks the spot where the skin graft was done. He wears an Isotoner glove, which keeps his joints warm and his fingers from swelling too much. A few days ago, for the first time, he took a long look at the wound.

Changing plans

The scar reminds him that a career with the Marines no longer is in his future. At best, he might regain 80 percent use of his arm, which isn't good enough for an infantryman.

"Sitting behind a desk, in front of a computer, doing paperwork, that's not me," Erik says. "That's not why I joined the Marine Corps."

In another year or so, after completing eight years of service, he expects to be medically discharged. He and his best friend, Devin Hlavinka, plan to start a local

motorcycle custom fabrication shop. Erik wants to go to college when he gets out of the Marines and take courses to learn how to start and run a small business.

His job now is to be faithful to physical therapy, which means spending at least an hour a day with his wife holding his hand and taking him through the range-of-motion exercises.

As his wife presses down on one of his fingers, he closes his eyes and winces. Sometimes he holds his breath and then sighs with relief as she lets up.

"I just don't want to get her on a bad day," he says with a smile.

Semper Fi Fund

A group of Marine Corps spouses started the Injured Marine Semper Fi Fund in April 2004. It is a nonprofit organization that provides financial grants and other assistance to injured Marines, sailors and their families. The fund helps pay for travel and lodging, for example, so families can be at the bedside of their loved ones. The fund has provided more than \$1.7 million to more than 1,000 families.

Marine corporal honored by New Britain Rock Cats August 2005

NEW BRITAIN, Conn. (AP) _ Just a couple of bad hops away from where he played shortstop for the Eastern League co-champions four years ago, Tony Stevens was honored Wednesday by the New Britain Rock Cats for his valor on a much more vital front.

Stevens, a Marine corporal who has served two tours in Iraq, was targeted by roadside bombs 11 times but never badly hurt.

His return to New Britain Stadium elicited an outpouring of love and respect from city and state officials as well as the thousands on hand to see the Rock Cats, part of the Minnesota Twins farm system, play the Portland Sea Dogs.

"It's great that they remember me," Stevens said. "There was a lot of talent on that team."

When the 2001 Eastern League Championship Series between the Rock Cats and the Reading Phillies was canceled because of the Sept. 11 terrorist attacks, Stevens was en route from New Britain to his home near Jacksonville, Fla.

On the way, his family's military background, Americans' patriotic reaction to the attacks and his sense of duty combined to convince him to leave baseball behind.

"No regrets," Stevens said about his decision. "Never had one. When you're in a fight hole and you're in Iraq, you say, 'Wow, I could be in spring training right now.' But no regrets as far as stepping away from the game."

Stevens, who played shortstop, took batting and infield practice with his old team Wednesday.

He received an official welcome from Rock Cats owner/general manager William Dowling and proclamations from state and local officials.

~~Scott~~ Bannell, marketing director of Stanley Tools, announced the establishment of a \$10,000 scholarship fund in Stevens' honor.

Rock Cats manager Stan Cliburn, who also managed the 2001 club, delivered a short speech about Stevens' contribution to that team.

"He was a tremendous baseball player but he's even more tremendous as a (Marine) protecting our country," Cliburn said as he presented Stevens with a red, white and blue jersey that the Rock Cats would wear in his honor.

The visiting Portland Sea Dogs stood attentively along the top step of the third-base dugout. The 2005 Rock Cats, a few of whom played with Stevens during his five years in the Twins organization, acknowledged him from the other side.

Stevens, 26, spoke after a lengthy standing ovation, saying servicemen are not heroes but are just doing their jobs.

He first joined the Rock Cats at the end of the 2000 season. He started the 2001 season with the Class A Fort Myers Miracle but was promoted to Double-A New Britain in June 20.

Stevens will start a third tour in the Middle East in October. He said he would like to give baseball another shot when it's over.

Marine burned in Iraq explosion returns to U.S. with new mission
Patriot News (Pa.)/August 2005

Paul Croom II's life, and his perspective, changed in the violent blast of an improvised explosive device.

That blast tore through an armored vehicle in which Croom, a Marine first lieutenant and 1995 Cumberland Valley High School graduate, was riding near Karibilah, Iraq, on May 11.

Croom, 27, was burned and battered, but comparatively lucky.

Six Marines died in the explosion. Another nine, including Croom, were wounded.

All Croom needs to do to remember that horrifying moment is look at the Purple Heart medal that was pinned to his chest late last month.

He has been a Marine for five years, but the fighting with Iraqi insurgents near the Syrian border during Operation Matador was his first taste of combat.

A public relations officer, Croom had been in Iraq about a month with Regimental Combat Team 2.

He was with a squad of Marines when the explosion ripped their armored amphibious vehicle apart.

"The inside of [the vehicle] turned orange and filled with thick, black smoke as it leaped in the air, violently throwing the passengers about," Croom said. "Everyone was flung upward and I came down hard on my right side.

"I looked to the front of the troop cabin and all I saw was a wall of flames licking the silhouettes of still figures. ...The Marines in front most certainly were killed by the blast, and thereby saved from an even more horrible end."

The interior of the vehicle felt like "a foundry," Croom said. "I knew I had to get out."

He failed three times to pull himself out a top hatch, then dove through a small rear hatch another Marine had forced open.

"As I ran, I looked down at my arms and noticed that I had no skin on my forearms. They were not my normal chocolate color, but instead the color of raw chicken," Croom said.

"My face tingled slightly, but I took no notice of it as loads of adrenaline rushed through my body."

Despite his wounds, Croom said he helped a corpsman treat another injured Marine, whom they dragged to safety as ammunition in the burning vehicle exploded.

It was only when the corpsman yelled, "You're hurt. You need to sit down, sir," that he was treated for burns on his arms and face. Croom said.

After stays in hospitals in Iraq and Germany, he was sent home and is now stationed at Marine Corps Air Station Miramar in San Diego.

Croom, an accomplished musician who performed with the Harrisburg Youth Symphony, joined the Marines after graduating from the University of Colorado, where he studied on a music scholarship.

His father, Paul, of Philadelphia, was a Marine during the Vietnam era and his mother, Ada Long-Croom, is a captain with the Navy Judge Advocate General Corps in San Diego.

His wife, Sara, is a Northern High School graduate, and his in-laws, Kathy and Sam Thuma, live in Susquehanna Twp.

Croom said he once aspired to be a pilot, and before going to Iraq intended to become a military lawyer like his mother.

His experience in the war zone -- he was "awed by the professionalism and dedication" of the U.S. service people, he said -- changed those plans.

He returned home convinced his duty is to help the Marine Corps better tell the story of the troops who risk their lives daily, he said.

Civilian reporters can tell part of the story, he said, but they can't tell it like the Marines who do the fighting.

Croom said his wounds have healed well, but "I still have flashbacks."

His feelings were mixed when he received his Purple Heart during a July 29 ceremony at Miramar.

"Really what you think about as you're getting [the medal] are the guys who are getting it posthumously," Croom said.

Tri-state Marine Receives Bronze Star For Valor

Cincinnati/August 2005

On Saturday a local Marine was honored for his heroism after his actions in Iraq saved lives.

Sergeant Lonnie Douglass Young, of Dry Ridge, was presented with the Bronze Star with a "V" for valor.

When insurgents attacked a base in southern Iraq last year, Young responded with gunfire to repel the assault.

He also pulled a wounded comrade to safety and after being shot in the shoulder himself, he continued to fire on the enemy.

At Saturday's ceremony Young said it felt good to have his whole family there to see him receive the medal – and to feel their pride for him.

"It's a good feeling, yes, to have everybody that you see here today just for me," said Young. "That's a great feeling. It comes from a gruesome time."

Young was married just two months ago.

He was promoted to Sergeant in the spring and has since left active duty.

Marines serve so little brother won't have to Ohio/August 2005

The Cohen boys keep stepping up for their conflicted country. While telling each other not to.

"Why in the world did you?" big brother Aaron asked middle brother Ryan last week.

Aaron, 19, is a fine one to talk -- a Marine reservist with knees hobbled by kicking down doors in Iraq. His injuries may have saved his life, sending him home before attacks early this month killed 13 members of his already bloodied battalion, based in Brook Park.

But Ryan, 18, plunged even deeper. He joined the Marines, shipped out last Tuesday to boot camp at Parris Island, S.C. and figures to be in Iraq soon.

"With the way the war's going, I'm pretty sure they're going to need me," he said.

The two Marines agree on this much: Their little brother Jacob, 12, should never serve.

"He's not going to because me and Ryan are already doing it," Aaron declared.

"Ryan and I." chided their mother, Gloria.

Gloria admires her boys' courage, but prefers to see it up close. "I love them and I want them in my life forever."

Jacob says he's not sure about enlisting. He might just "stay home and protect my parents."

Like so many neighbors, the Cohens are torn about the drawn-out war, which has killed an estimated 26,000 civilians and at least 1,874 American troops, including 48 Marine reservists assigned to the 3rd Battalion, 25th Regiment, based in Brook Park.

The mother blames Iraq's deposed Saddam Hussein for terrorism, though government and independent panels have found otherwise. The father, Bob, divorced and living in Sharon Township, wants "a graceful exit."

Ryan has mixed feelings. "It is good that we are helping in other countries, but we should take care of our country first," he said.

Aaron said he has to guard his views as a Marine. And some of the views he aired were conflicted.

He praised the war for "disarming Saddam from his draconian rule." But he faulted it for estranging allies. Aaron shipped home on July 4 and asked people at a German airport to steer him toward US Airways.

"They wouldn't even look at me," said Aaron. "They'd just point."

Whatever the war's merits, the boys in this comfortable, professional family believe in serving their nation.

"It gives something back to the country that has brought you up and given you a free education," said Aaron.

Aaron was training at Parris Island two years ago when his knees began to ache. He blames fierce drills like the "duck walk" -- running while squatting, a tactic seldom tried in combat.

"There's only one good reason they have you do anything in boot camp," said Aaron. "That's discipline."

After three weeks of treatment and light duty, Aaron recovered enough to finish camp. Then he began attending Ohio State University while serving weekends in Lima Company, a nearby infantry unit assigned to the reserve center in Brook Park.

This March, all five companies of the 3rd Battalion shipped to Iraq. Aaron, his squad's tallest member at 6 feet 2, kicked down doors during searches.

Some occupants welcomed the squad. Others shot at it. No members were wounded, but Aaron's knees grew sorer than before.

He was shipped to Kuwait in May for two surgeries and a little therapy. The knees still balked. So he went home for longer treatment.

"It's one thing to leave a bad situation," he said. "It's another thing knowing your brothers in arms are still there."

Some of the brothers killed this month were friends. Aaron had learned a little Spanish from one of them and had regularly awakened another for a turn on watch.

"These were the guys that were going to come back and take dates to the Marine Corps Ball," said Aaron. "They're not going to be there anymore."

Aaron is still spending many hours in therapy. His prognosis varies from doctor to doctor. He sees no chance of rejoining the battalion before its homecoming, scheduled for September.

Aaron is supposed to spend four more years on active reserve, then two on inactive. He said he may become a military lawyer or a politician.

"There's changes we need to make," he said.

Ryan signed on for four years rather than juggle military and civilian life like Aaron.

"I figured I'd just get in there, get it done, get it over with," Ryan said before shipping out. "I'm nervous, but I'm ready to go. I'm going to try to keep positive the whole way."

Norman, Stokes will go from a war zone to Southern Conference football North Carolina/July 2005

After two tours of duty in Iraq, a three-month football season doesn't seem so imposing for two Appalachian State players.

Wayne Norman and Brian Stokes, two strapping, 26-year-old freshmen, will take the field for the Mountaineers this fall.

"When we open the season against Eastern Kentucky, on each side of that kicker is going to be a Marine running down the middle of that field," Coach Jerry Moore of the Mountaineers said.

Having served four years in the 2nd Battalion, 2nd Marines, Norman and Stokes have endured experiences that few 18-year-old, fuzzy-faced freshmen could comprehend. They were shipped to Iraq in 2003 at the start of Operation Iraqi Freedom and returned last year as things were heating up in Faluja.

As TOW gunners, or anti-tank missile launchers, both progressed from driver to vehicle commander to squad leader, and both attained the rank of sergeant. Now both are living out their dream of playing college football.

They were applauded by the rest of the team when they were introduced last spring.

"As with anything, we've gained a lot of confidence by being over there," Stokes said. "You lead 25 troops in a firefight, that should tell you that you're capable of doing anything you want if you put your mind to it."

Or, as Norman put it: "I think it goes with that mentality of what doesn't kill you just makes you stronger."

Stokes, a Shrine Bowl selection from Burlington Williams High School, went to East Carolina in 1997 as an invited walk-on but tore a tendon in a finger and didn't play. Norman, a two-way starter in high school, enrolled at his home-state University of Massachusetts for a year.

Both faced financial hardship and left college after a year. They worked for a while, then joined the Marine Corps in 2000 with the intention of returning to college afterward with the aid of the GI Bill.

Norman and Stokes met at Camp Geiger right after basic training and hit it off immediately.

"I wound up having to borrow money from him the first day because I didn't know we had to go buy a bunch of stuff at the PX," Norman said.

In 2002, they began a nine-month deployment to Kosovo, Kenya and the United Arab Emirates. They wound up in Iraq in March of 2003 and stayed there 45 days.

"We were actually on our way back to Camp Lejeune when the war started," Norman said. "Everybody was pretty happy about that, and then it was, 'Guess what, we're turning the boat around.'"

Norman and Stokes said that their unit encountered little resistance once there, but that changed in a seven-month follow-up assignment beginning in March 2004. They encountered particularly heavy fighting when approaching Faluja.

"The second time, I couldn't count how many bullets I felt fly by," Stokes said. "We were in probably over 30 fire-fight engagements, and I don't know how many road-side bombings. And every day there was a mortar attack."

Stokes lost some of his hearing during one attack and has applied for a purple heart.

"A 100 kilogram bomb blew up about five feet from my armored truck," Stokes said. "The impact blew the 300-pound doors open."

Norman said: "The first time we got ambushed was so surreal. We had trained with blanks, and you're used to the sound, but it's definitely not the same. We were taking it from both sides of the road in pitch black. It was incredible. We were blessed that none of our guys got hit that day."

Both completed active duty last November, although they remain on reserve and could be recalled. Stokes, who had wanted to attend Appalachian out of high school, decided to pursue football again and confirmed that he would have at least two and possibly three years of eligibility remaining.

"I felt like it was something I left undone at ECU," Stokes said. "I wanted to come back and finish what I started and complete that dream."

Norman came with Stokes on a visit and was sold, too. "I figured it was like riding a bike," he said.

Stokes said: "I had forgotten what practice was like. I was really anxious to get that first hit, to see how it felt. As soon as I did, it was like, 'Yep, that's how it feels.'"

Norman (5-11, 215) nailed down a spot on punt coverage, and Stokes (6-1, 220) on both kickoff teams during spring drills.

"We know we're not going to go out and start right away, but maybe in a year or two we might learn the defense enough or the offensive schemes to be able to compete at that level," Stokes said.

Norman said: "It's a little bit physically demanding because we have aged a bit and we're competing with kids out of high school, but it's not that bad."

Not bad at all, Stokes said.

"We went from having such close friends in the Marines - people we went to war with - and that's what you miss the most when you leave," Stokes said. "We get here, try out for football in January and didn't know anybody, but now it's very similar to the same sort of brotherhood and camaraderie we had over there. I love being around these guys. It's a great bunch."

Marine's tale of survival riveting
Florida/July 2005

11-L-0559/OSD/52365