



June 13, 2007
Patti Speicher
Cumberland Co. Zoning
Fayetteville, NC

Re; Withdrawal of rezoning request for USA Mini-storage -#06-061

Dear Patti;

We are formally withdrawing our petition to have phase II of this project rezoned. We understand that our client will lose his fee but that by this withdrawal, he has the right to come back to the board at any time and re-file for rezoning this property.

Best regards,

A handwritten signature in black ink, appearing to read 'Bradley W. Young', with a long horizontal flourish extending to the right.

Bradley W. Young, RSA, ASLA

CC Duane Degaetano
CC mike Waguespack

LANDSCAPE
ARCHITECTURE
ENGINEERING
PLANNING

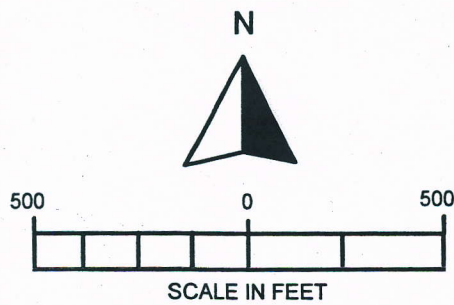
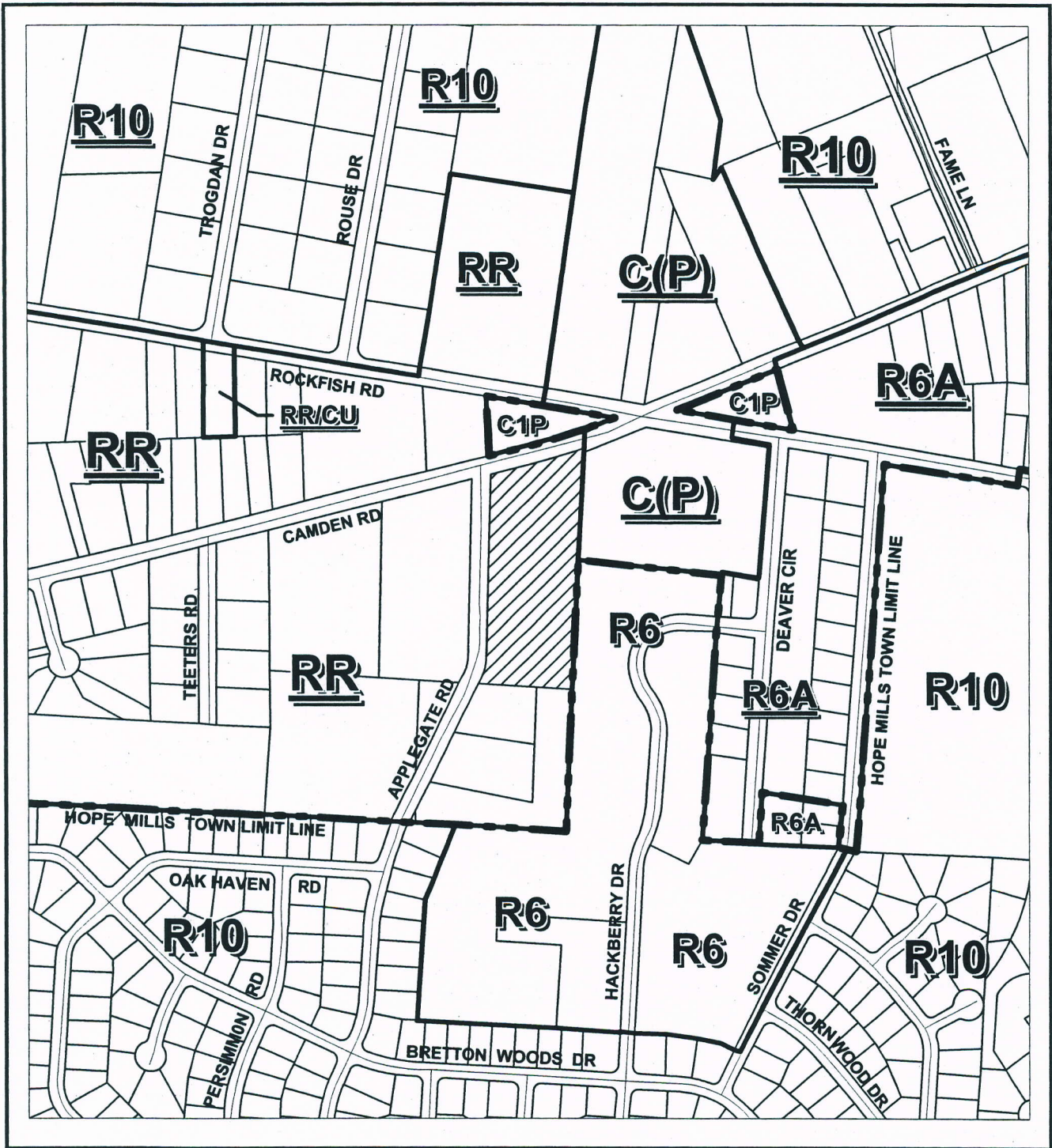

REQUESTED REZONING RR TO C(P)/CUD

| | | |
|-----------------------------|---------------------------|---------------|
| ACREAGE: 5.51 AC.+/- | HEARING NO: P07-10 | |
| ORDINANCE: COUNTY | HEARING DATE | ACTION |
| PLANNING BOARD | | |
| GOVERNING BOARD | | |

PIN: 0404-36-7194

AF
2/16/07

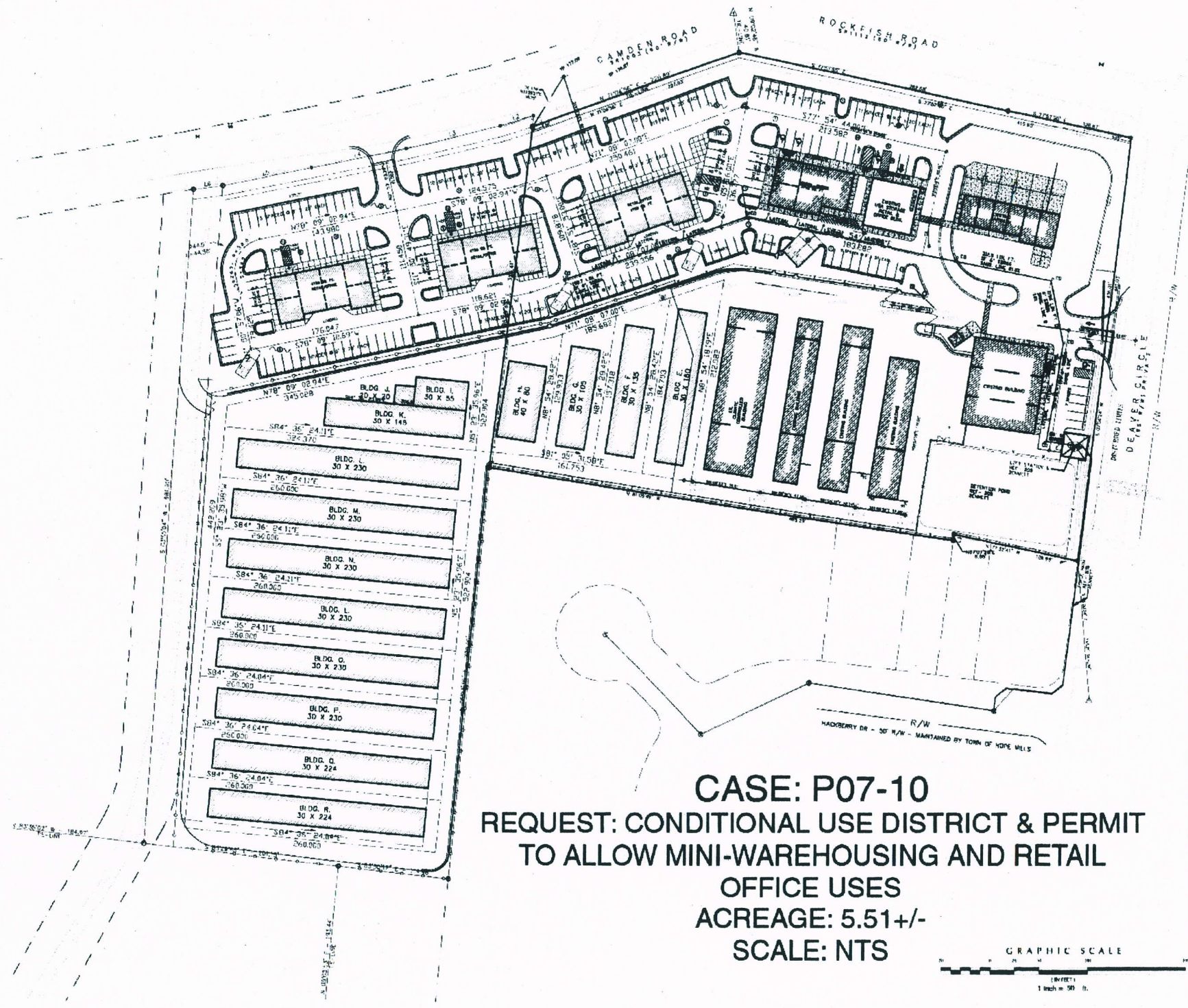

CASE: P07-10
REQUEST: CONDITIONAL USE DISTRICT & PERMIT
TO ALLOW MINI-WAREHOUSING AND RETAIL
OFFICE USES
ACREAGE: 5.51+/-
SCALE: NTS

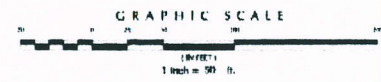

Donovan McLaurin,
Chair
Wade, Falcon & Godwin

Lori Epler,
Vice-Chair
Cumberland County

Garland C. Hostetter,
Town of Spring Lake
Harvey Cain, Jr.,
Town of Stedman
Patricia Hall,
Town of Hope Mills
Charles C. Morris,
Town of Linden



CUMBERLAND
COUNTY



COUNTY of CUMBERLAND

Planning and Inspections Department

Thomas J. Lloyd,
Director

Cecil P. Combs,
Deputy Director

Clifton McNeill, Jr.,
Roy Turner,
Sara E. Piland,
Cumberland County

July 10, 2007

MEMORANDUM

TO: Cumberland County Joint Planning Board

FROM: Planning & Inspections Staff

SUBJECT: Staff Recommendation for July 17, 2007 Board Meeting

P07-52: REZONING OF 2.97 ACRES FROM C(P) TO R5A OR TO A MORE RESTRICTIVE ZONING DISTRICT, ON THE WEST SIDE OF LILLINGTON HIGHWAY, SOUTH OF PINE KNOLL DRIVE, SUBMITTED BY JAMES M. KIZER, OWNED BY HUFF-CAVINNESS, LLC. (SPRING LAKE)

The Planning & Inspections Staff recommends approval of the R5A district based on the following:

1. The request is primarily consistent with the Spring Lake Area Detailed Land Use Plan, which calls for Medium Density Residential and Light Industrial at this location;
2. Rezoning will be compatible with the adjacent zoning, which is R5A; and
3. The subject property is located on a Major Thoroughfare.

The O&I and C1 are other suitable zoning districts to be considered for this site.

Attachments:

- 1 - Site Profile
- 2 - Rezoning Sketch Map

SITE PROFILE

P07-52

REZONING OF 2.97 ACRES FROM C(P) TO R5A OR TO A MORE RESTRICTIVE ZONING DISTRICT, ON THE WEST SIDE OF LILLINGTON HIGHWAY, SOUTH OF PINE KNOLL DRIVE, SUBMITTED BY JAMES M. KIZER, OWNED BY HUFF-CAVINESS, LLC. (SPRING LAKE)

Site Information:

Applicant/Owner: JAMES M. KIZER / HUFF-CAVINESS, LLC

Area: 2.97 acres

Frontage & Location: 310 feet on Lillington Highway

Depth: 300 feet

Jurisdiction: County

Adjacent Property: No

Current Use: Vacant

Initial Zoning: January 7, 1977 (Area 11)

Zoning Violation(s): None

Surrounding Zoning: North-R5A, M1, County limits-CD, RR, R10, R6A, O&I(P), O&I(P)/CU, C1(P), C(P), C(P)/CU, East-County limits-CD, RR, R10, military reservation, South-C3, M1, County limits-RR, R10, R6A, C3, military reservation, and West-R5A, County limits-CD, RR, R10, M(P), military reservation

Surrounding Land Use: Town waste water, apartments, VFW, church, single family residential and vacant

Spring Lake Study Area Detailed Land Use Plan: Medium Density Residential and Light Industrial

Designated 100-Year Floodplain or Floodway: No

Water/Sewer Availability: Spring Lake utilities

Soil Limitations: None

School Capacity/Enrolled: Lillian Black Elementary 278/255, Spring Lake Middle 706/530, Pine Forest High 1750/1659

Subdivisions: Development will require a subdivision and/or group development approval.

Military Impact Area: Yes

Ft Bragg/Pope AFB: Pope AFB has no objections to this case.

Highway Plan: There are no road improvements or new construction specified for this area.

Average Daily Traffic Count (2004): 17,000 on Lillington Highway

Notes:

Density minus 20% for roads: R5A – 17 lots / 42 units

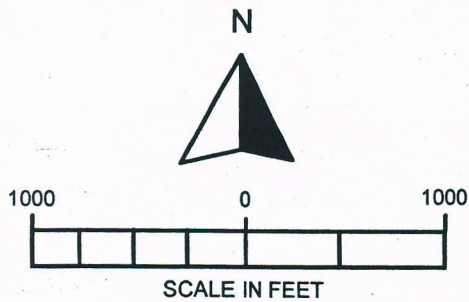
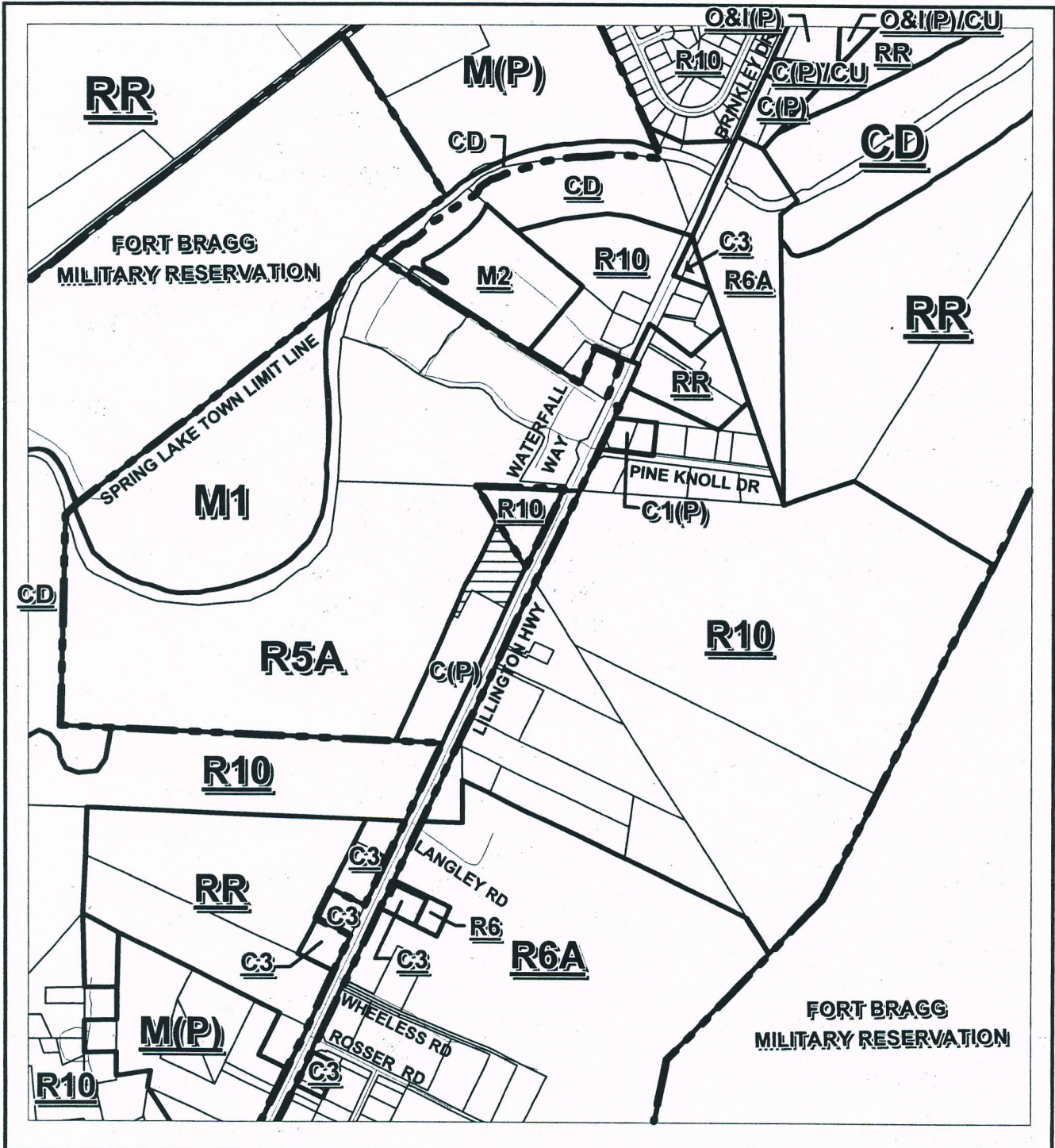

REQUESTED REZONING C(P) TO R5A

| | | |
|------------------------|--------------------|--------|
| ACREAGE: 2.97 AC.+/- | HEARING NO: P07-52 | |
| ORDINANCE: SPRING LAKE | HEARING DATE | ACTION |
| PLANNING BOARD | | |
| GOVERNING BOARD | | |

Donovan McLaurin,
Chair
Wade, Falcon & Godwin

Lori Epler,
Vice-Chair
Cumberland County

Garland C. Hostetter,
Town of Spring Lake
Harvey Cain, Jr.,
Town of Stedman
Patricia Hall,
Town of Hope Mills
Charles C. Morris,
Town of Linden



CUMBERLAND
COUNTY



COUNTY of CUMBERLAND

Planning and Inspections Department

Thomas J. Lloyd,
Director

Cecil P. Combs,
Deputy Director

Clifton McNeill, Jr.,
Roy Turner,
Sara E. Piland,
Cumberland County

July 10, 2007

MEMORANDUM

TO: Cumberland County Joint Planning Board

FROM: Planning & Inspections Staff

SUBJECT: Staff Recommendation for July 17, 2007 Board Meeting

P07-57: REZONING OF .33 ACRES FROM R6 TO C(P) OR TO A MORE RESTRICTIVE ZONING DISTRICT, LOCATED ON THE SOUTH SIDE OF OWEN DRIVE, EAST OF COPE STREET, OWNED BY EDMON AND KATHRYN MONSOUR.

The Planning & Inspections Staff recommends approval of the C(P) district based on the following:

1. The request is consistent with the 2010 Land Use Plan, which calls for Heavy Commercial at this location;
2. The subject property is located on a Major Thoroughfare; and
3. This parcel is adjacent to commercial property.

The O&I(P) and C1(P) are the only other suitable zoning districts to be considered for this site.

NOTE: Due to the subject property being contiguous to the city limits and the nature of the surrounding area, the Planning & Inspections Staff recommends this parcel be considered for annexation into the City of Fayetteville.

Attachments:

- 1 - Site Profile
- 2 - Rezoning Sketch Map

SITE PROFILE

P07-57

REZONING OF .33 ACRES FROM R6 TO C(P) OR TO A MORE RESTRICTIVE ZONING DISTRICT, LOCATED ON THE SOUTH SIDE OF OWEN DRIVE, EAST OF COPE STREET, OWNED BY EDMON AND KATHRYN MONSOUR.

Site Information:

Applicant/Owner: EDMON AND KATHRYN MONSOUR

Area: .33 acres

Frontage & Location: 94 feet on Owen Drive

Depth: 229 feet

Jurisdiction: County

Adjacent Property: Yes

Current Use: Vacant land

Initial Zoning: November 17, 1975 (Area 4)

Zoning Violation(s): None

Surrounding Zoning: North-city limits-R6, P2, C3, M1, M2, East-R6, O&I(P), C3, city limits-C1, C1(P), C3, South-R6, R6A, C3, M(P), city limits-C1(P), C3, M2, and West-R6, R6/CU, R6A, C1(P), C(P), C3, M2

Surrounding Land Use: Auto parts store, gas station, youth center, pipe shop, tattoo parlor, church, salon, unknown commercial, day care facility, bingo parlors (2), real estate company, and single family residential

2010 Land Use Plan: Heavy Commercial

Urban Services Area: Yes

Water/Sewer Availability: PWC / PWC sewer available 300 +/- feet west (mandatory connection to sewer most likely cannot be required)

Soil Limitations: None

Subdivisions: Site plan review will be required prior to any development.

Military Impact Area: No

Highway Plan: Owen Drive is identified as a Major Thoroughfare. This is a multi-lane facility with a current adequate 150 foot right-of-way. No road improvements are included in the MTIP.

Average Daily Traffic Count (2004): 49,000 on Owen Drive

Notes:

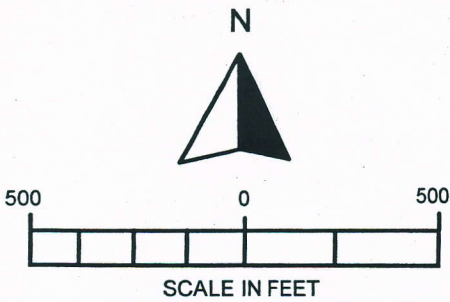
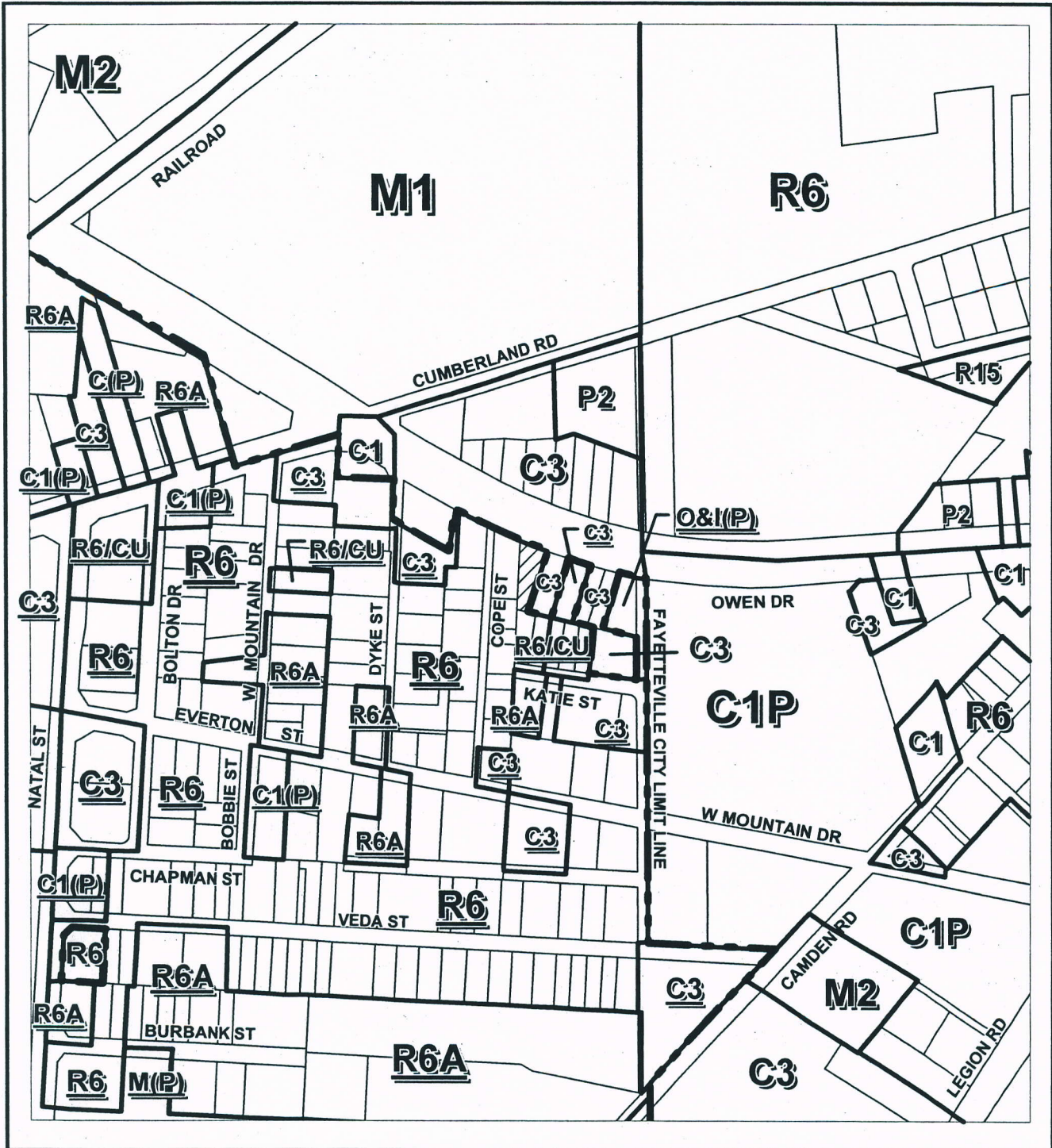

REQUESTED REZONING R6 TO C(P)

| | | | |
|-----------------------------|--|---------------------------|--------|
| ACREAGE: 0.33 AC.+/- | | HEARING NO: P07-57 | |
| ORDINANCE: COUNTY | | HEARING DATE | ACTION |
| PLANNING BOARD | | | |
| GOVERNING BOARD | | | |

PIN: 0426-51-8387

AF
06/25/07
07/10/07

Donovan McLaurin,
Chair
Wade, Falcon & Godwin

Lori Epler,
Vice-Chair
Cumberland County

Garland C. Hostetter,
Town of Spring Lake
Harvey Cain, Jr.,
Town of Stedman
Patricia Hall,
Town of Hope Mills
Charles C. Morris,
Town of Linden



CUMBERLAND
COUNTY



COUNTY of CUMBERLAND

Planning and Inspections Department

Thomas J. Lloyd,
Director

Cecil P. Combs,
Deputy Director

Clifton McNeill, Jr.,
Roy Turner,
Sara E. Piland,
Cumberland County

July 10, 2007

MEMORANDUM

TO: Cumberland County Joint Planning Board

FROM: Planning & Inspections Staff

SUBJECT: Staff Recommendation for July 17, 2007 Board Meeting

P07-58: REZONING OF ONE PARCEL AND A PORTION OF A SECOND PARCEL TOTALING 14.99 ACRES FROM O&I(P) AND R10 TO R5 OR TO A MORE RESTRICTIVE ZONING DISTRICT, LOCATED AT THE NORTH QUADRANT OF RAMSEY STREET AND MCCLOSKEY ROAD, SUBMITTED BY G. NEIL YARBOROUGH, OWNED BY JAMES AND EVA SINGLETARY AND TONYA CLARK, TRUSTEE.

The Planning & Inspections Staff recommends denial of the R5 district and approval of the R5A district based on the following:

1. The request is not consistent with the North Fayetteville Area Detailed Land Use Plan, which calls for Low Density Residential and Open Space at this location; and
2. The existing infrastructure in the area can support the density allowed in the R5A district.

The R7.5 and R6 zoning districts are the only other suitable zoning districts to be considered for this site.

The applicant has given verbal agreement to this recommendation.

Attachments:

- 1 - Site Profile
- 2 - Rezoning Sketch Map

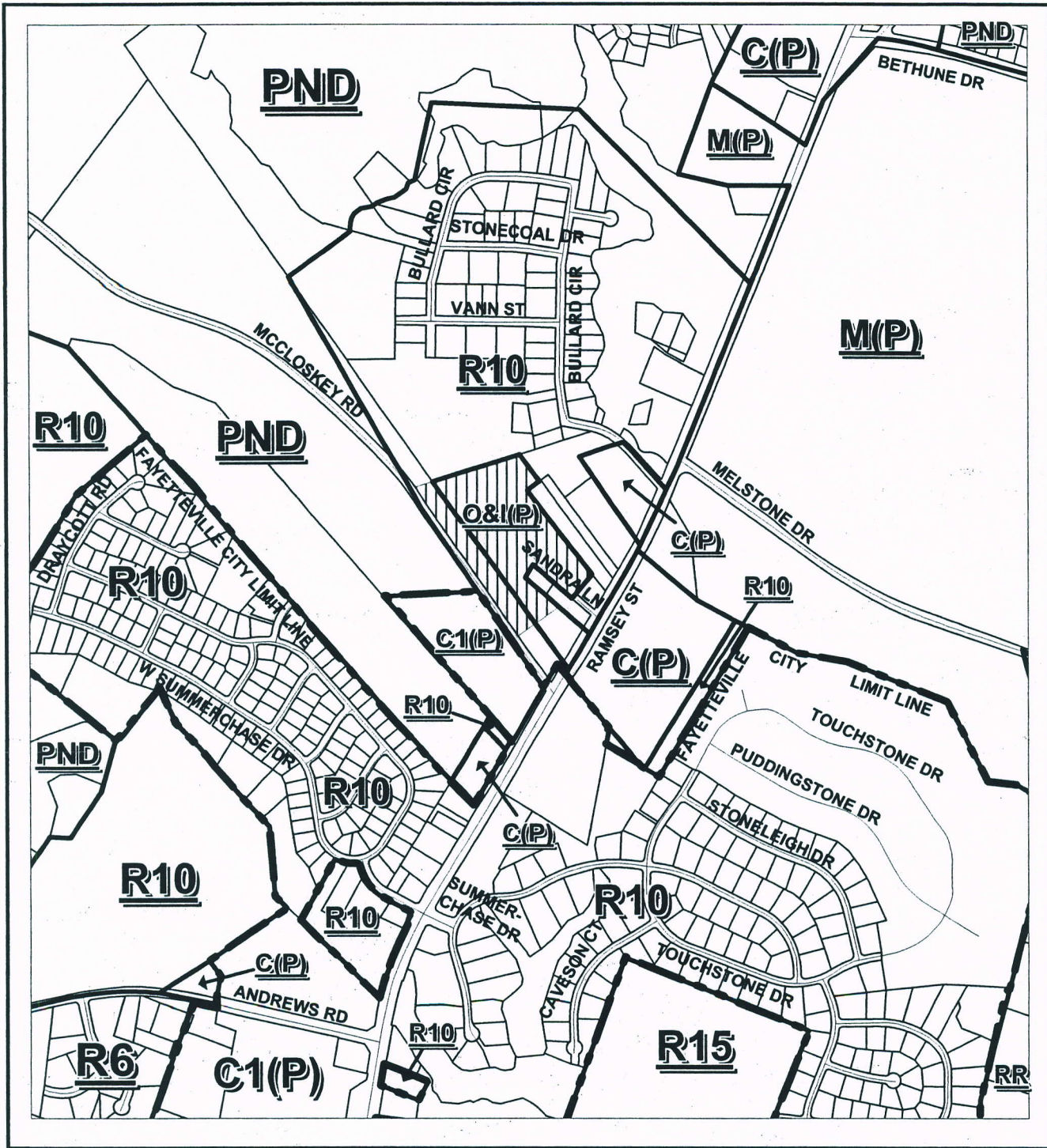

REQUESTED REZONING O&I(P) & R10 TO R5

| | | | |
|-----------------------|--------------|--------------------|--|
| ACREAGE: 14.99 AC.+/- | | HEARING NO: P07-58 | |
| ORDINANCE: COUNTY | HEARING DATE | ACTION | |
| PLANNING BOARD | | | |
| GOVERNING BOARD | | | |

PIN: 0541-05-0506
 PORT. OF PIN: 0531-87-1221

AF
06/25/07

SITE PROFILE

P07-58

REZONING OF ONE PARCEL AND A PORTION OF A SECOND PARCEL TOTALING 14.99 ACRES FROM O&I(P) AND R10 TO R5 OR TO A MORE RESTRICTIVE ZONING DISTRICT, LOCATED AT THE NORTH QUADRANT OF RAMSEY STREET AND MCCLOSKEY ROAD, SUBMITTED BY G. NEIL YARBOROUGH, OWNED BY JAMES AND EVA SINGLETARY AND TONYA CLARK, TRUSTEE.

Site Information:

Applicant/Owner: G. NEIL YARBOROUGH / JAMES AND EVA SINGLETARY AND TONYA CLARK, TRUSTEE

Area: 14.99 acres

Frontage & Location: 158+/- feet on Sandra Lane

Depth: 423 feet (average)

Jurisdiction: County

Adjacent Property: No

Current Use: Vacant

Initial Zoning: August 21, 1972 (Area 1)

Zoning Violation(s): None

Surrounding Zoning: North-R10, PND, C(P), M(P), East-R10, C(P), M(P), city limit-R10, South-R15, R10, R6, C(P), city limit-R10, C1(P), and West-PND, R10, city limit-R10, C1(P)

Surrounding Land Use: Union association, tire company, electric company, day care facility, barber shop, school, single family residential and vacant land

North Fayetteville Area Detailed Land Use Plan: Low Density Residential and Open Space

Watershed Area: Yes

Urban Services Area: Yes

Water/Sewer Availability: PWC / PWC

Soil Limitations: Yes – Coxville loam

School Capacity/Enrolled: Raleigh Road Elementary 258/238, Long Hill Elementary 452/517, Pine Forest Middle 763/761, Pine Forest High 1750/1659

Subdivisions: A recombination plat will be required prior to any development.

Military Impact Area: No

Highway Plan: US Hwy 401 is identified as a Major Thoroughfare. The proposal calls for a multi-lane facility with a 120 foot right-of-way. Road improvements are included in the 2007-2013 MTIP. Right-of-Way and Construction: Unfunded

Average Daily Traffic Count (2004): 17,000 on Ramsey Street

Notes:

The O&I(P) portion was rezoned from R10 on 9/18/06, Case P06-40.

| | |
|------------------------------|----------------------------|
| Density minus 20% for roads: | R7.5 – 69 lots / 87 units |
| | R6 – 87 lots / 161 units |
| | R5A – 104 lots / 216 units |
| | R5 – 104 lots / 429 units |

Donovan McLaurin,
Chair
Wade, Falcon & Godwin

Lori Epler,
Vice-Chair
Cumberland County

Garland C. Hostetter,
Town of Spring Lake
Harvey Cain, Jr.,
Town of Stedman
Patricia Hall,
Town of Hope Mills
Charles C. Morris,
Town of Linden



CUMBERLAND
COUNTY



COUNTY of CUMBERLAND

Planning and Inspections Department

Thomas J. Lloyd,
Director

Cecil P. Combs,
Deputy Director

Clifton McNeill, Jr.,
Roy Turner,
Sara E. Piland,
Cumberland County

July 10, 2007

MEMORANDUM

TO: Cumberland County Joint Planning Board

FROM: Planning & Inspections Staff

SUBJECT: Staff Recommendation for July 17, 2007 Board Meeting

P07-61: REZONING OF A 21.86 ACRE PORTION OF A 51.33 ACRE TRACT FROM RR TO O&I(P) OR TO A MORE RESTRICTIVE ZONING DISTRICT, LOCATED ON THE NORTH SIDE OF CLINTON ROAD, WEST OF MOBIUS ROAD, OWNED BY CUMBERLAND COUNTY.

The Planning & Inspections Staff recommends approval of the O&I(P) district based on the following:

1. Although the request is not consistent with the 2010 Land Use Plan, which calls for Suburban Density Residential at this location, the subject property is located between two Major Thoroughfares; and
2. The subject property is located in an area that currently consists of other public entities.

The Staff also suggests the applicant consider submitting the remainder of this tract for rezoning to O&I(P).

There are no other suitable zoning districts to be considered for this site.

Attachments:

- 1 - Site Profile
- 2 - Rezoning Sketch Map

SITE PROFILE

P07-61

REZONING OF A 21.86 ACRE PORTION OF A 51.33 ACRE TRACT FROM RR TO O&I(P) OR TO A MORE RESTRICTIVE ZONING DISTRICT, LOCATED ON THE NORTH SIDE OF CLINTON ROAD, WEST OF MOBIUS ROAD, OWNED BY CUMBERLAND COUNTY.

Site Information:

Applicant/Owner: CUMBERLAND COUNTY

Area: 21.86 acres

Frontage & Location: 360 +/- feet on Clinton Road

Depth: 1290 +/- feet

Jurisdiction: County

Adjacent Property: Yes

Current Use: Woodland

Initial Zoning: September 3, 1996 (Area 20)

Zoning Violation(s): None

Surrounding Zoning: North-A1, RR, R6, East-A1, RR, HS(P), HS(P)/CU, South-A1, RR, and West-RR, RR/CU, C1(P), C3

Surrounding Land Use: Schools(2), library, single family residential, farmland and woodland

2010 Land Use Plan: Suburban Density Residential

Urban Services Area: Yes

Water/Sewer Availability: PWC / PWC sewer available 700 +/- feet west

Soil Limitations: Yes – Stallings loamy sand and Woodington loamy sand

Subdivisions: Site plan review will be required prior to any development and a subdivision review if the property is to be divided.

Military Impact Area: No

Highway Plan: NC Hwy 24 and Clinton Road are identified as Major Thoroughfares. The proposal calls for NC Hwy 24 to be a multi-lane facility with a 250 foot right-of-way. Road improvements are included in the 2007-2013 MTIP. Planning and Design: In Progress, Mitigation: 09. There are no road improvements or new construction specified for Clinton Road.

Average Daily Traffic Count (2004): 5500 on Clinton Road

Notes:

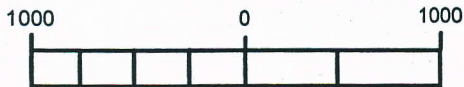
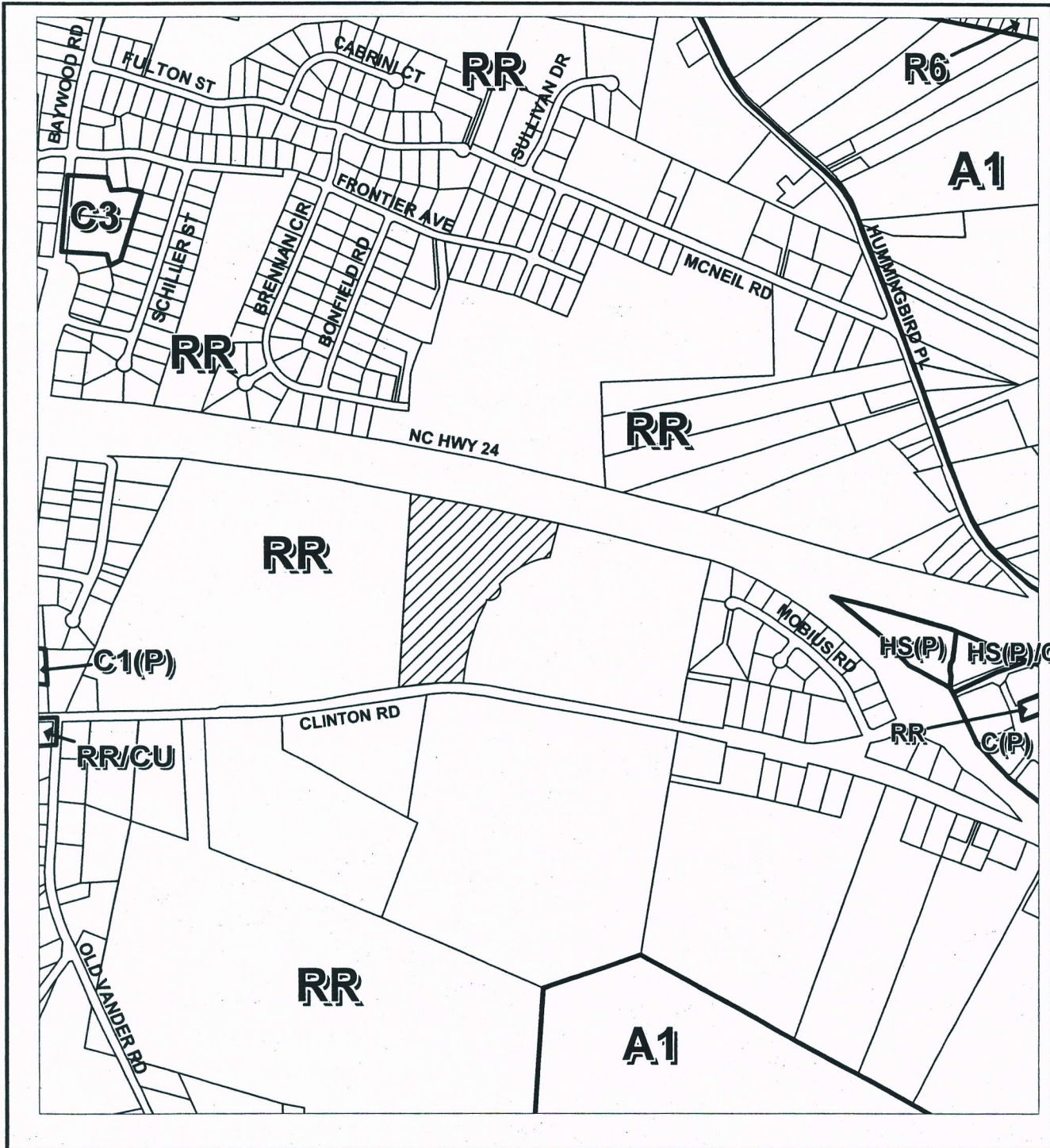

SCALE IN FEET

REQUESTED REZONING RR TO O&I(P)

| | | |
|-----------------------|--------------------|--------|
| ACREAGE: 21.86 AC.+/- | HEARING NO: P07-61 | |
| ORDINANCE: COUNTY | HEARING DATE | ACTION |
| PLANNING BOARD | | |
| GOVERNING BOARD | | |

PORT. OF PIN: 0476-18-2941

AF
06/28/07

Donovan McLaurin,
Chair
Wade, Falcon & Godwin

Lori Epler,
Vice-Chair
Cumberland County

Garland C. Hostetter,
Town of Spring Lake
Harvey Cain, Jr.,
Town of Stedman
Patricia Hall,
Town of Hope Mills
Charles C. Morris,
Town of Linden



CUMBERLAND
COUNTY



COUNTY of CUMBERLAND

Planning and Inspections Department

Thomas J. Lloyd,
Director

Cecil P. Combs,
Deputy Director

Clifton McNeill, Jr.,
Roy Turner,
Sara E. Piland,
Cumberland County

July 10, 2007

MEMORANDUM

TO: Cumberland County Joint Planning Board

FROM: Planning & Inspections Staff

SUBJECT: Staff Recommendation for July 17, 2007 Board Meeting

P02-04: AMENDING A PORTION OF THE PERMIT FOR A PREVIOUSLY APPROVED R10/CONDITIONAL USE OVERLAY, REVISITING CONSTRUCTION OF A PUBLIC RIGHT-OF-WAY FOR AN AREA RESERVED FROM THE ORIGINAL APPROVAL, ON APPROXIMATELY 527 ACRES, LOCATED AT THE SOUTHEAST QUADRANT OF CHICKEN FOOT AND SAND HILL ROADS, SUBMITTED BY JAMES M. KIZER, P.E., P.L.S., OWNED BY BIRCHWOOD FARMS, INC.

This case was originally approved by the Board of Commissioners in February 2001 as a Conditional Use Overlay for a mixed use project. At that time the applicant voluntarily agreed to reserve the area indicated on the current site plan with pink shading and to re-visit the approval of this strip of right-of-way in or around a five year time frame. During the original public hearings on the case, there was considerable opposition from the residents of Ham Road for the direct connection of Celebration Drive to Ham Road.

Currently, the applicant is requesting the approved permit be amended to allow for construction of a street in this area with a sidewalk along the northern boundary as shown on the attached site plan.

The Planning & Inspections Staff recommends approval of the amendment to the Permit as requested provided that the developer constructs a roundabout or other traffic calming measure in the area south of, but in close proximity to, the existing portion of Ham Road and that the sidewalk be constructed as shown on the current site plan. This recommendation is based on the following:

1. The amendment to the Permit will not materially endanger the public health or safety if constructed according to the plan as submitted and recommended – approval of this request will significantly enhance the public health and safety by providing the

proposed Cotton Fire Department Substation with a direct route to Ham Road and the remainder of the Cypress Lakes area; emergency response times will be drastically reduced and the standards of the County development regulations will be complied with to ensure public health and safety are protected;

2. The request meets all required conditions and specifications – subdivision review at Staff level will be required prior plat recordation as an assurance that the development will meet or exceed the minimum standards for development;
3. The request, if approved, will maintain or enhance the value of adjoining or abutting properties – the overall project currently under construction is a quality development and approval of amending the Permit will allow for more convenient access to schools and a future park; and
4. The location and character of the request, if developed according to the plan as submitted and recommended, will be in harmony with the area in which it is to be located and in general conformity with Cumberland County's most recent Land Use Plan and adopted planning policies.

The applicant and property owner have been given a copy of this recommendation and have verbally agreed to install a roundabout or other traffic calming measure.

Attachments:

- 1 - Site Profile
- 2 - Rezoning Sketch Map
- 3 - Site Plan
- 4 - Letter dated June 12, 2007 Requesting Approval of Permit Amendment

SITE PROFILE
P02-04

AMENDING A PORTION OF THE PERMIT FOR A PREVIOUSLY APPROVED R10/CONDITIONAL USE OVERLAY, REVISITING CONSTRUCTION OF A PUBLIC RIGHT-OF-WAY FOR AN AREA RESERVED FROM THE ORIGINAL APPROVAL, ON APPROXIMATELY 527 ACRES, LOCATED AT THE SOUTHEAST QUADRANT OF CHICKEN FOOT AND SAND HILL ROADS, SUBMITTED BY JAMES M. KIZER, P.E., P.L.S., OWNED BY BIRCHWOOD FARMS, INC.

Site Information:

Applicant/Owner: JAMES M. KIZER, P.E., P.L.S. / BIRCHWOOD FARMS, INC.

Area: 527 acres

Frontage and Location: Chicken Foot and Sand Hill Roads

Jurisdiction: County

Current Use: Residential

Initial Zoning: June 25, 1980 (Area 13)

Zoning Violation(s): None

Surrounding Zoning: North-A1, R40, R40A, RR, R20, R20/CU, R15, R10, R6A, C(P), C(P)/CU, Hope Mills city limit-C3, East-A1, RR, R20/DD/CUD, R15, C(P), South-A1, A1/CU, R40, R40A, and West-A1, RR, R10, C(P), C(P)/CU

Surrounding Land Use: AAA Cooper, school, single family residential, woodland and farmland

2010 Land Use Plan: Low Density Residential and Open Space

Urban Services Area: Yes

Water/Sewer Availability: PWC / PWC

Soil Limitations: Yes – Johnston loam

School Capacity/Enrolled: Gallberry Farm Elementary 886/1032, Gray's Creek Middle 495/614, Gray's Creek High 1270/1087

Military Impact Area: No

Highway Plan: Chicken Foot Road is identified as a Major Thoroughfare. The plan calls for widening to a multi-lane facility with a proposed 100 foot right-of-way (Priority 1). Road improvements are not included in the 2007-2013 MTIP.

Average Daily Traffic Count (2004): 7800 on Chicken Foot Road, 5900 on Sand Hill Road, 1900 on Cypress Lakes Road

Notes:

This area was rezoned to allow a mixed use development as a Conditional Use Overlay, Case P02-04, on 2/25/01.

The request is to allow construction of a public right-of-way in an area previously reserved.

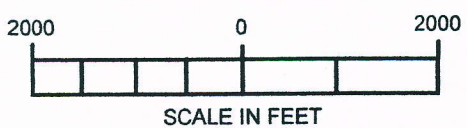
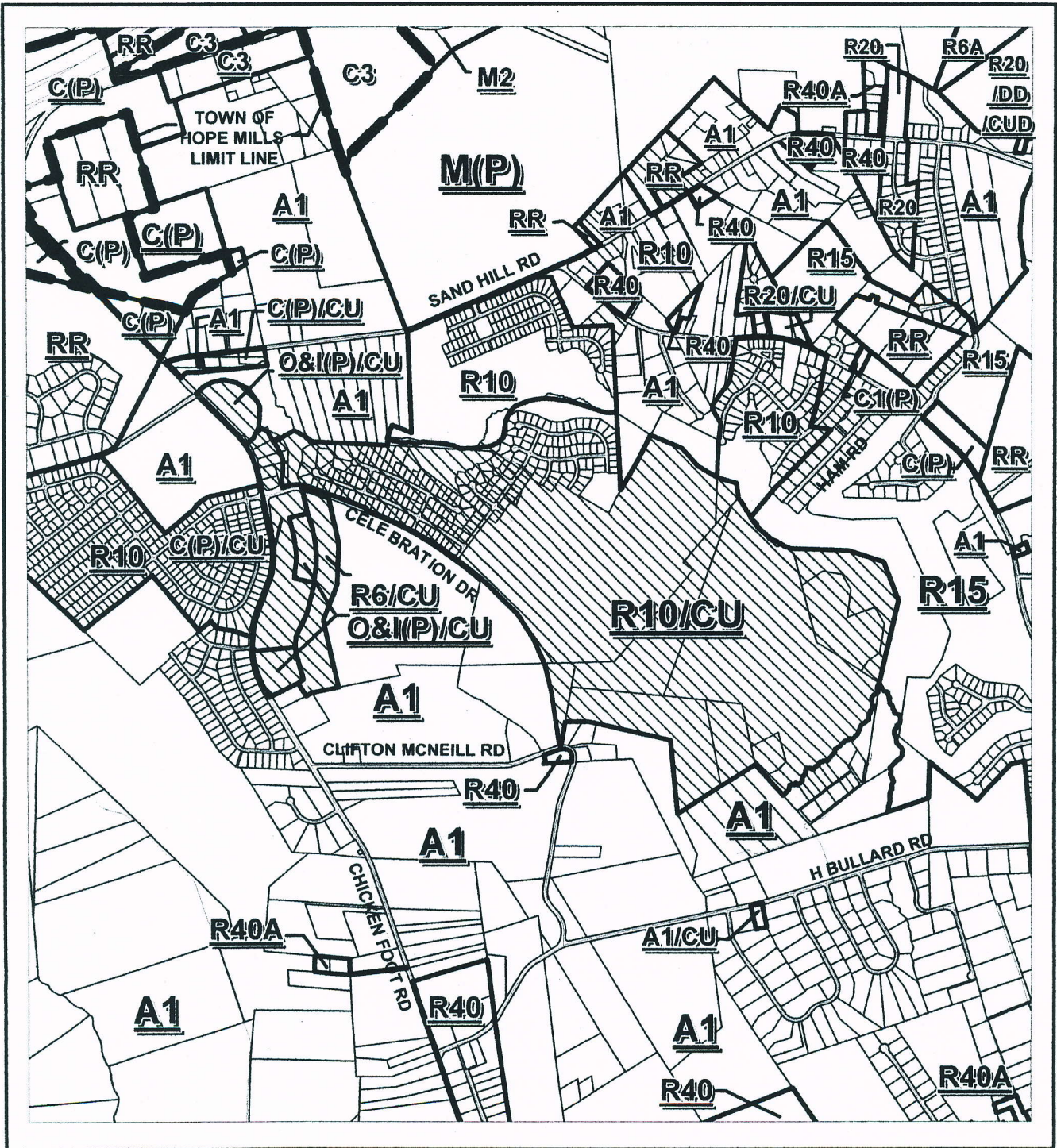

CONDITIONAL USE OVERLAY DISTRICT

| | | | |
|----------------------------|--------------|---------------------------|--|
| ACREAGE: 527 AC.+/- | | HEARING NO: P02-04 | |
| ORDINANCE: COUNTY | HEARING DATE | ACTION | |
| PLANNING BOARD | | | |
| GOVERNING BOARD | | | |

PIN: SEE FILE

MAS
REV. 6-19-2007
REV. 6-25-2007

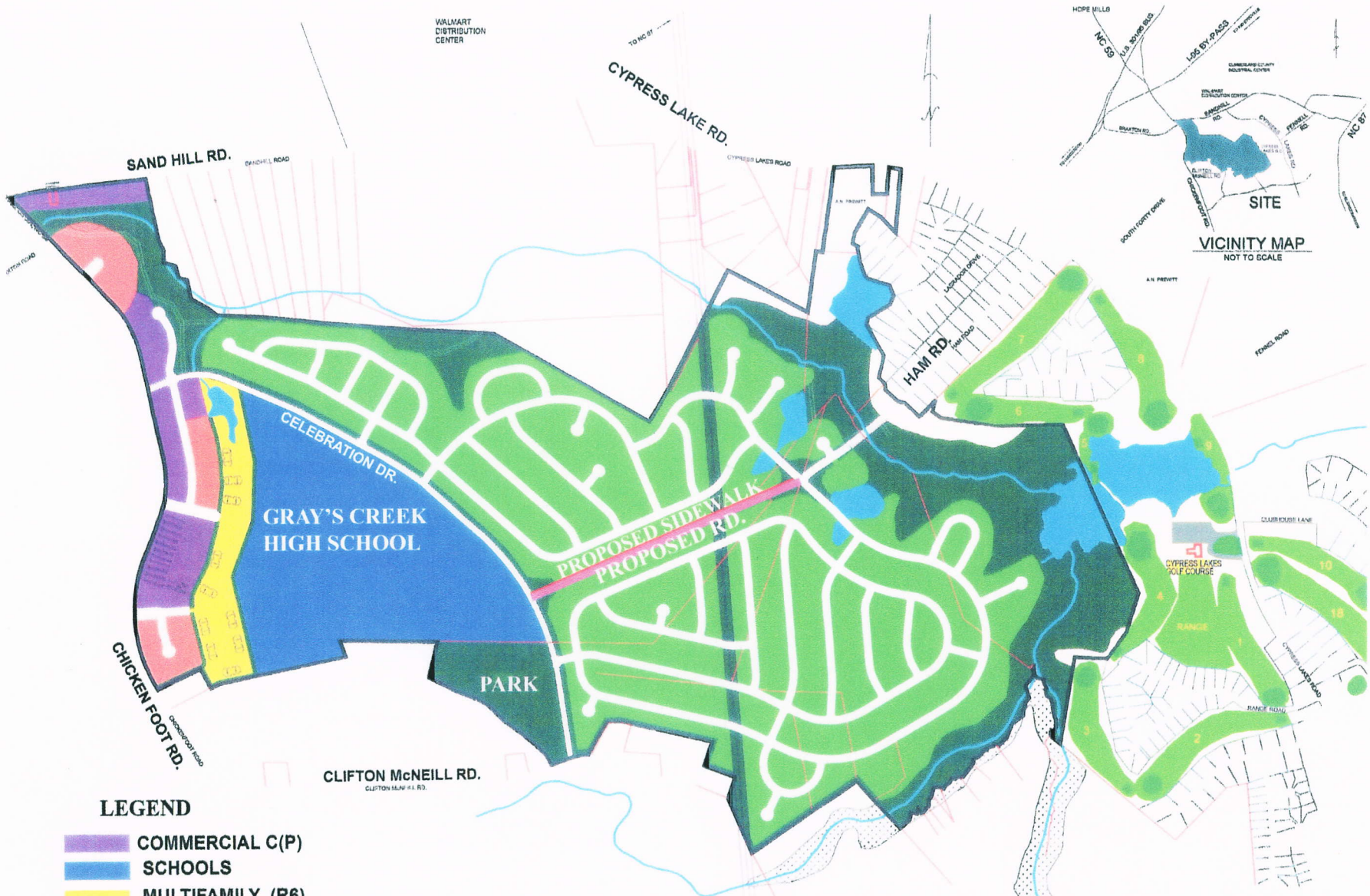

VICINITY MAP
NOT TO SCALE

LEGEND

- COMMERCIAL C(P)
- SCHOOLS
- MULTIFAMILY (R6)
- PROFESSIONAL (O&I)
- SINGLE FAMILY (R10)
- GREENSPACE/PARKS
- LOWLANDS
- EXISTING LAKES AND WATER COURSES

**AMENDMENT TO CONDITIONAL USE PERMIT
CYPRESS LAKES AREA**

CASE NO: P02-04

ACREAGE: 527 +/-

SCALE: NTS

REV. 7/11/2007
REV. 7/10/07
Rev. 6-20-2007

June 12, 2007

Cumberland County Planning Board

Ref: Case P02-04
Conditional Use Amendment
Prewitt Property

Dear Ladies and Gentlemen,

On behalf of Thomas R. Prewitt and William E. Prewitt I am respectfully requesting your favorable considerations to amend the above referenced approved conditional use plan. The original plan approved supported a pedestrian-way to the rear of lots proceeding from Celebration Drive toward Ham Road in a northeasterly direction. For security reasons, we believe that this pedestrian-way would be safer if it was a concrete sidewalk located along a public street in the front of homes.

Therefore, our request is to eliminate the "rear yard pedestrian-way" and substitute - as shown on the proposed plan - a public street with a concrete sidewalk in front of the homes.

Your considerations of this request are appreciated.

Respectfully Requested,
Moorman, Kizer & Reitzel, Inc.

A handwritten signature in black ink, appearing to read 'J. Kizer', with a horizontal line extending to the left and right of the signature.

James M. Kizer, PE, PLS

Donovan McLaurin,
Chair
Wade, Falcon & Godwin

Lori Epler,
Vice-Chair
Cumberland County

Garland C. Hostetter,
Town of Spring Lake
Harvey Cain, Jr.,
Town of Stedman
Patricia Hall,
Town of Hope Mills
Charles C. Morris,
Town of Linden

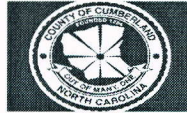

CUMBERLAND
COUNTY



COUNTY of CUMBERLAND

Planning and Inspections Department

Thomas J. Lloyd,
Director

Cecil P. Combs,
Deputy Director

Clifton McNeill, Jr.,
Roy Turner,
Sara E. Piland,
Cumberland County

July 10, 2007

MEMORANDUM

TO: Cumberland County Joint Planning Board

FROM: Planning & Inspections Staff

SUBJECT: Staff Recommendation for July 17, 2007 Board Meeting

P07-44: REZONING OF 2.7+/- ACRES FROM R5 TO C(P) OR TO A MORE RESTRICTIVE ZONING DISTRICT, LOCATED AT THE WEST QUADRANT OF MURCHISON ROAD AND CHARMAIN STREET, SUBMITTED BY BRAD YOUNG, OWNED BY ALBERT AND SHIRLEY NORTON.

The Planning & Inspections Staff requested deferral of this case at the June 19, 2007 Planning Board meeting due to an unforeseen change to information that had been provided. After having reviewed the information, the recommendation of the Planning & Inspections Staff has not changed (see below).

This case was heard by the Planning Board on May 15, 2007. The Board requested the case be deferred to give the applicant time to consider submission of a Conditional Use District and Permit application. The applicant agreed to the deferral.

Originally, the Planning & Inspections Staff reviewed this case on May 8, 2007 and recommended approval of the C(P) District. Upon review of the amended application, the Staff is recommending approval of the C(P)/Conditional Use District for all uses currently allowed in the C(P) zoning district except: Bars/Nightclubs, Club or Lodge, Hazardous Waste Storage/Disposal Facility, Massage and Bodyworks Therapy, and Sexually Oriented Businesses. This recommendation is based on:

1. The request is reasonable and consistent with the existing zoning and land uses within the general area; and
2. The request is consistent with the 2010 Land Use Plan which calls for an "activity node" at this location.

The Staff recommends approval of the Conditional Use Permit based on:

1. The use will not materially endanger the public health or safety if located according to the plan submitted and recommended – the standards of the County development regulations will be complied with to ensure public health and safety are protected;
2. The use meets all required conditions and specifications – site plan review at Staff level will be required prior to any permit application of the site as an assurance that the development will meet or exceed the minimum standards for non-residential development within the County;
3. The use will maintain or enhance the value of adjoining or abutting properties – the developer owns a long lasting, well-established business on the adjacent property and since the subject property is essentially vacant, containing only a billboard, the development of this tract will aid in enhancing the values of adjacent properties;
4. The location and character of the use, if developed according to the plan as submitted and recommended, will be in harmony with the area in which it is to be located and in general conformity with Cumberland County's most recent Land Use Plan and adopted planning polices – as stated above, the request is consistent with the Land Use Plan and is also within keeping of the character of the general area.

The owner/applicant has been given a copy of this recommendation with attachments and has agreed to all ordinance-related conditions.

There are no other suitable zoning districts to be considered for this site.

Attachments:

- 1 - Site Profile w/ Ordinance-Related Conditions
- 2 - Rezoning Sketch Map
- 3 - Site Plan
- 4 - Application

SITE PROFILE

P07-44

REZONING OF 2.7+/- ACRES FROM R5 TO C(P) OR TO A MORE RESTRICTIVE ZONING DISTRICT, LOCATED AT THE WEST QUADRANT OF MURCHISON ROAD AND CHARMAIN STREET, SUBMITTED BY BRAD YOUNG, OWNED BY ALBERT AND SHIRLEY NORTON.

Site Information:

Applicant/Owner: BRAD YOUNG / ALBERT AND SHIRLEY NORTON

Area: 2.7 acres

Frontage & Location: 169 feet on Murchison Road, 383 feet on Charmain Street

Jurisdiction: County

Adjacent Property: Yes

Current Use: Billboard and vacant

Initial Zoning: September 16, 1973 (Area 2A)

Zoning Violation(s): None

Nonconformities: The existing billboard is located in a residentially zoned district.

Surrounding Zoning: North-C(P), C3, C3/CU, M(P), East-C3, M1(P), M(P), City limit-R6, M1, South-R6, R6A, C3, and West-R6A, R6A/CUO, C3

Surrounding Land Use: Manufactured home parks (7), automotive sales (2), vacant commercial businesses (2), tire shop, rental business, electric company, construction company, apartments, and lawn care business

2010 Land Use Plan: Activity Node

Watershed Area: Yes

Urban Services Area: Yes

Water/Sewer Availability: PWC / Septic tank – PWC sewer available on Tammy Street

Military Impact Area: Yes

Ft Bragg/Pope AFB: Pope AFB has no objections to this case

Highway Plan: Murchison Road is identified as a Major Thoroughfare. It has a current 100 foot right-of-way. The proposal calls for a multi-lane facility with an ultimate 110 foot right-of-way. Road improvements are included in the 2007-2013 MTIP. Right-of-Way: Unfunded, Construction: Unfunded

Average Daily Traffic Count (2004): 15,000 on Murchison Road

Notes:

Application Conditions:

1. Uses to be excluded: Bars/nightclubs, club or lodge, hazardous waste storage/disposal facility, massage and bodyworks therapy, and sexually oriented businesses.
2. Hours of Operation: 7 days per week, 10 hours per day.
3. Number of employees: 23 (currently) approximately 40 total

4. Equipment: Light service poles, supplies, and 50 trucks and lift vehicles (estimated).

Conditional Use District & Permit

(Ordinance Related Requirements):

Watershed-Related:

1. An application for a Watershed "No Approval Required" plat must be submitted to the Watershed Review Officer and must be approved by the Watershed Review Officer prior to NAR plat approval and prior to application for any building permits, site plan approval is required.

Permit-Related:

2. Prior to application for any permits, plans must be submitted to the Planning & Inspections Staff for site plan approval.
3. The owner/developer(s) of these lots must obtain detailed instructions on provisions of the County Zoning Ordinance and permits required to place any structure within this development from the County Code Enforcement Section, Room 101 in the Historic Courthouse at 130 Gillespie Street. For additional information, the developer should contact a Code Enforcement Officer.
4. The County Health Department must approve sewer plans prior to application for any permits. Site and soil evaluations must be conducted on the property by the County Environmental Health Department prior to application for permits. (Note: All Health Department requirements must be met prior to issuance of final permits.)
5. Connection to public water is required, the Public Works Commission (PWC) must approve water plans prior to application for any permits.
6. The developer may have to provide the Code Enforcement Section with an approved state sedimentation and erosion control plan (S&E) prior to any application for permits. If any retention/detention basins are required for state approval of this plan, then five copies of a revised plan showing the location of the basin(s) must be submitted and approved by Planning & Inspections prior to application for any permits.

Site-Related:

7. Only those uses, dimensions, and setbacks requested in the Conditional Use District and the Permit will be permitted on this site; also, all other related provisions of the County Subdivision and Zoning Ordinances for the C(P) zoning district must be complied with.
8. The developer must obtain driveway permits from the NC Department of Transportation (NCDOT).
9. The NC Department of Transportation (NCDOT) may require turn lanes to be installed.
10. The location and size of any proposed freestanding sign(s) must be included on the site plan when submitted for Staff review.
11. All lighting is required to be directed internally within this development and comply with the provisions of Section 1102 M, Outdoor Lighting, County Zoning Ordinance.

12. Upon development, lateral access to the adjacent non-residential lots may be required as a condition of the site plan approval.
13. Upon development, a solid buffer must be provided and maintained in accordance with the provisions of Section 1102 G, County Zoning Ordinance, along the entire rear property line. The type of buffer, location and width must be noted on the site plan when submitted for Staff approval.
14. Upon development, the developer will be required to include the required landscaping on the site plan. The minimum landscape requirements are:
 - a. One large shade tree or two small ornamental trees will be required on this tract along the length of the right-of-way of NC HWY 210 (Murchison Road);
 - b. One ornamental tree for every 50 linear feet and two shrubs for every 10 linear feet of any building length or width fronting on NC HWY 210 (Murchison Road) will be required within the building front yard area;
 - c. One large shade trees or two small ornamental trees for every 20 spaces will be required within any parking area having 20 or more spaces;
15. All notes and calculations as shown on the site plan and contained within the application are to be considered as a part of this conditional approval.

Plat-Related:

16. Prior to or along with submission for site plan approval, a recombination plat (also known as a “No Approval Required” or “NAR”) recombining the existing lots must be submitted for review and approval for recording with the County Register of Deeds and must be recorded prior to application for any permits.. (Note: The developer may submit for “Zero Lot Line” approval with their adjacent lot, if desired – contact the Land Use Codes Staff for more information regarding this note.)
17. Dedication of 10 feet and reservation of 10 feet of right-of-way of right-of way along NC HWY 210 (Murchison Road) is required and the metes and bounds for dedication must be shown on the NAR and/or reflected on any future site plans. The location of all improvements, required or otherwise, and all building setback lines are to be measured from the ultimate (reservation) right-of-way line. Note: This condition will require the front yard setback line to be relocated a total of 70 feet from the right-of-way/property line and the revised setback must be reflected on any site plan submitted for this tract.
18. Any/All easements shall be reflected on the NAR and labeled as to type of easement, reference number for document creating the easement, and the name of the agency, individual, etc. who holds the easement.
19. The NC Department of Transportation (NCDOT) stamp must be affixed to the NAR prior to submission for approval for recordation.
20. The notarized signature(s) of all current tax record owner(s) and notary certifications appear on the NAR recombination plat when submitted for final approval.

Plat-Required Statement:

21. All/Any structures (including the billboard) must be shown on the NAR or the NAR must reflect the following statement:

“Nonconforming structures have not been created by this subdivision.”

Other Relevant Conditions:

22. The owner/developer be aware that every deed created for a lot being served by an on-site sewer system must contain the following disclosure when filed with the County Register of Deeds:

“Public sewer services are not available as of the date of the recording of this deed. On-site sewer disposal systems must be approved by the County Health Department.”

23. This conditional approval is not approval of the location of the existing billboard; if the billboard is destroyed by more than 50%, the developer will not be able to replace this billboard under current standards.

If you need clarification and/or negotiation of conditions, please contact Ed Byrne at 910-678-7609 or Patti Speicher at 910-678-7605.

Contact Information (Area Code is 910 unless otherwise stated):

| | | |
|-------------------------------|-----------------|----------------|
| Subdivision/Site Plan/Plat | Ed Byrne | 678-7609 |
| Code Enforcement (Permits): | Ken Sykes | 321-6654 |
| County Health Department: | Danny Soles | 433-3685 |
| PWC: | Heidi Maly | 483-1401 |
| Corp of Engineers (wetlands): | Ronnie Smith | (910) 251-4829 |
| NCDENR (E&S) | | 486-1541 |
| E911 Site-Specific Address: | Ron Gonzales | 678-7616 |
| Tax Parcel Numbers: | | 678-7549 |
| NCDOT (driveways/curb-cuts) | Gary Burton | 486-1496 |
| Transportation Planning | Bobby McCormick | 678 7632 |

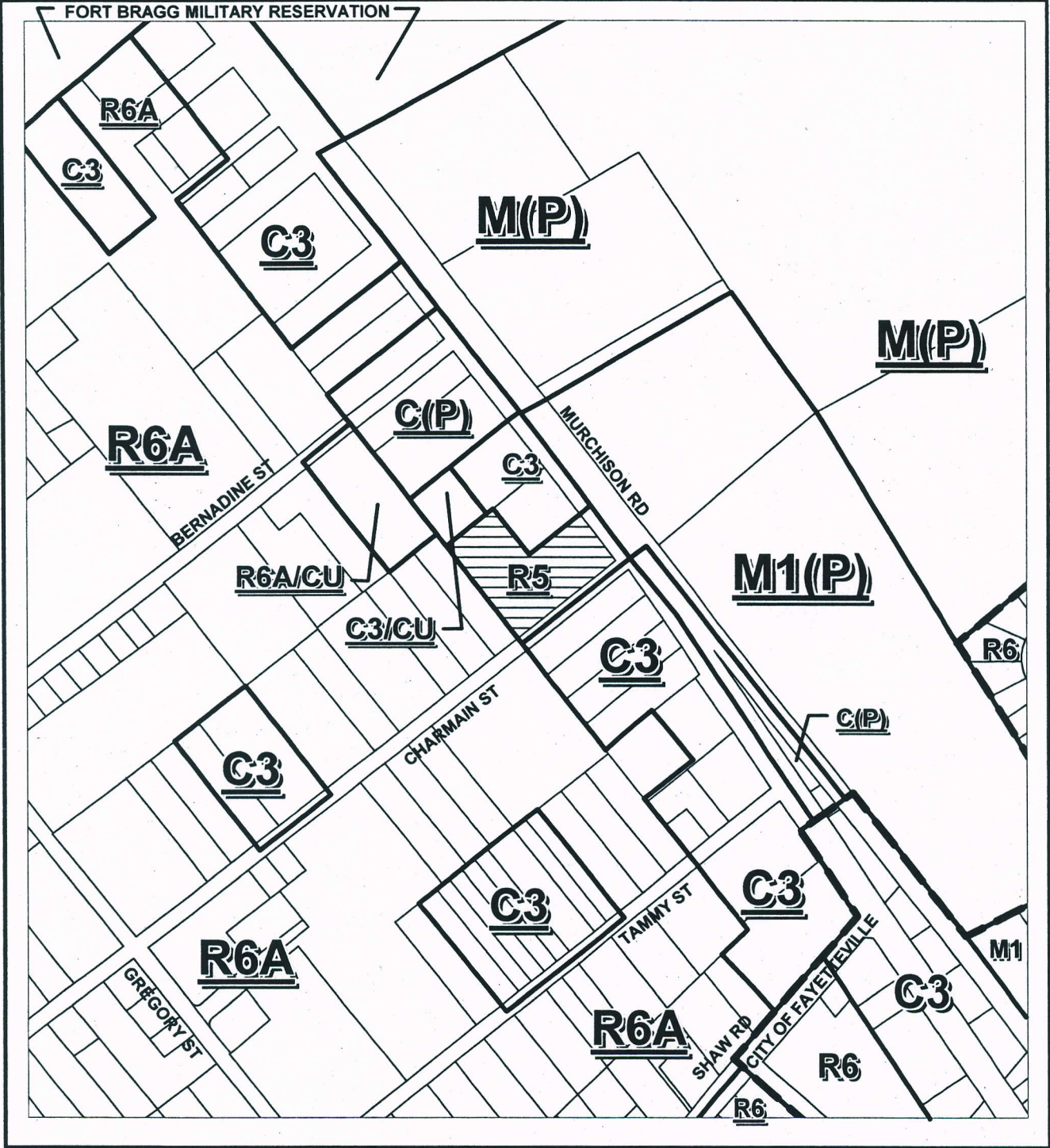

REQUESTED REZONING R5 TO C(P)/CUD

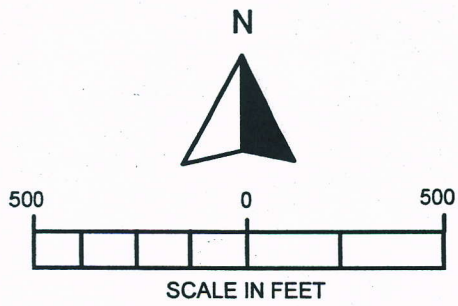

| | | | |
|-----------------------------|--|---------------------------|--------|
| ACREAGE: 2.70 AC.+/- | | HEARING NO: P07-44 | |
| ORDINANCE: COUNTY | | HEARING DATE | ACTION |
| PLANNING BOARD | | | |
| GOVERNING BOARD | | | |

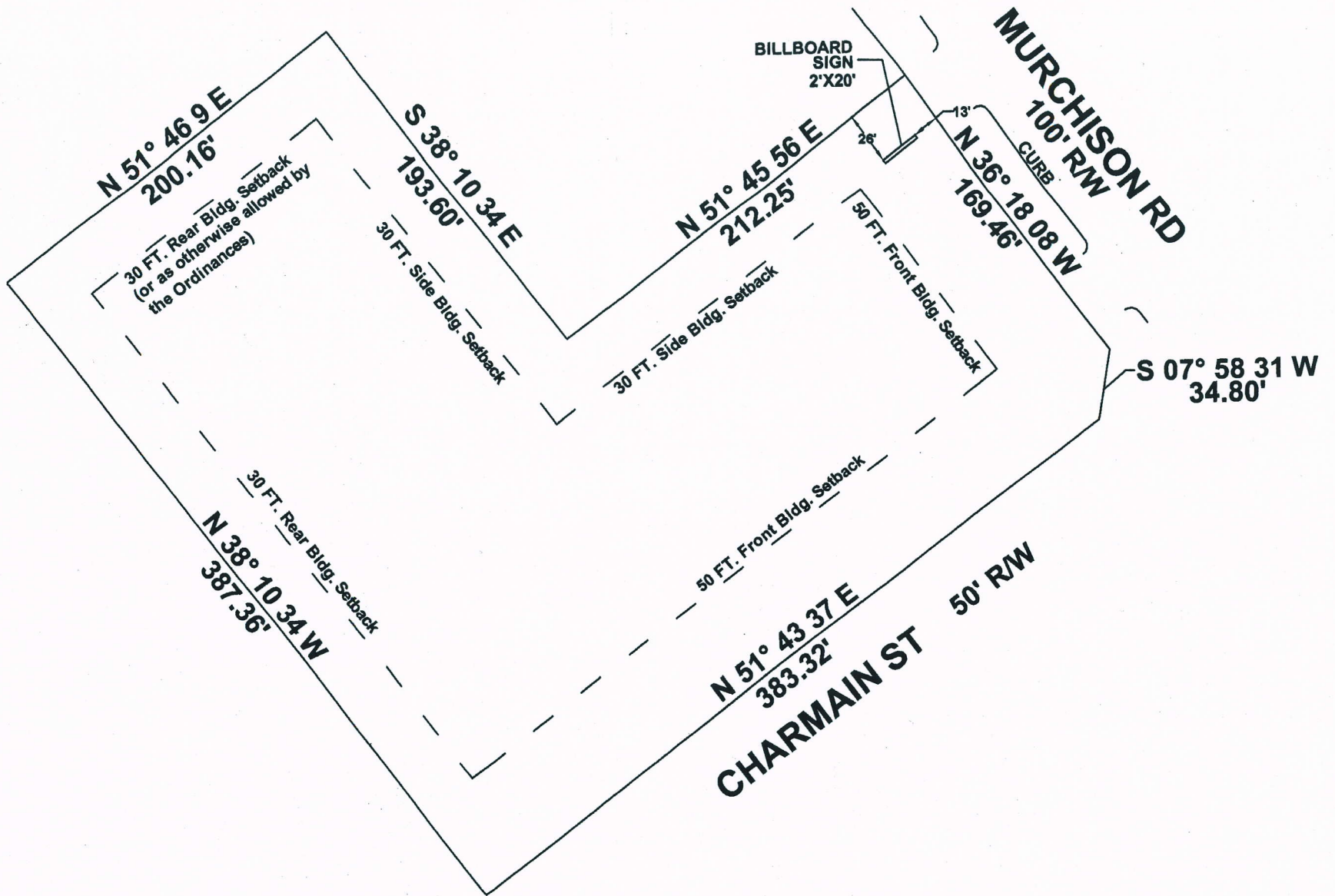

CONDITIONAL USE DISTRICT & PERMIT
REQUEST: TO ALLOW PERMITTED USES WITH EXCLUSIONS
CASE: P07-44 ACREAGE: 2.70±
SCALE: NTS

06-11-07
06-21-07

TO THE CUMBERLAND COUNTY JOINT PLANNING BOARD AND BOARD OF COUNTY COMMISSIONERS OF CUMBERLAND COUNTY, NC:

The undersigned submit application and petition the County Commissioners to amend and change the Cumberland County zoning map as provided for in the Zoning Ordinance, Section 12.5. In support of this, the following is submitted:

Requested Rezoning from R-5 to CP

Address of Property Sought to be Rezoned 6011 MURCHISON RD
Street Address or Route and Box # and Zip Code

Located on CORNER OF MURCHISON ROAD AND CHALMERS ST.
General Directions to Site

Parcel Identification Number 0419 - 97 - 6871
(Obtain from Tax Receipt or Office of the Tax Administrator - (910) 678-7567)

Lot(s) # ^{80, 87} 88, 89 Frontage 170 feet Depth 383 feet Acreage 2.7039

Existing Use of Property (Residential, commercial, etc.) - VACANT
HAS AN EXISTING BILLBOARD ON IT

Proposed Use of Property ELECTRICAL CONTRACTING W/ SHOW ROOM + YARD

Water Provider: Well PWC Other (name) _____

Septage Disposal Provider: Septic Tank PWC

Do you own any property adjacent to or across the street from this property?

Yes No If yes, where? _____

Has a violation been issued on this property? Yes No

A copy of the recorded deed(s) and/or recorded plat map(s) must be provided. If the area is a portion of a parcel, a written legal description by metes and bounds must accompany the deed and/or plat. If more than one zoning classification is requested, a correct metes and bounds legal description of each bounded area must be submitted.

TO THE CUMBERLAND COUNTY JOINT PLANNING BOARD AND THE BOARD OF COUNTY COMMISSIONERS OF CUMBERLAND COUNTY, NC:

I (We), the undersigned, hereby submit this application, and petition the County Commissioners to amend and to change the zoning map of the County of Cumberland as provided for under the provisions of the County Zoning Ordinance. In support of this petition, as hereinafter requested, the following facts are submitted:

1. APPLICANT/AGENT: _____
2. ADDRESS: _____ ZIP CODE: _____
3. TELEPHONE: (Home) _____ (Work) _____
4. Location of Property: _____
5. Parcel Identification Number (PIN #) of subject property: _____
(also known as Tax ID Number or Property Tax ID)
6. Acreage: _____ Frontage: _____ Depth: _____
7. Water Provider: _____
8. Septage Provider: _____
9. Deed Book _____, Page(s) _____, Cumberland County Registry. (Attach copy of deed of subject property as it appears in Registry).
10. Existing use of property: _____
11. Proposed use(s) of the property: _____

NOTE: Be specific and list all intended uses.

12. It is requested that the foregoing property be rezoned FROM: R5

TO: (select one)

- Conditional Use District, with an underlying zoning district of CLP
(Article V)
- Mixed Use/Conditional Use District (Article VI)
- Planned Neighborhood District/Conditional Use District (Article VII)
- Density Development/Conditional Use District, at the _____ Density
(Article VIII)

APPLICATION FOR
CONDITIONAL USE PERMIT

1. PROPOSED USE(S):

* (A.)

to be excluded District
List the use(s) proposed for the Conditional Use Permit. (Use of the underlying district will be restricted only to the use(s) specified in this application.)

B. Density: List the amount of acreage that will be residential, commercial, and/or open space, and the number of lots and/or dwelling units proposed, and the square footage of the non-residential units.

IAW Zoning Ord

2. DIMENSIONAL REQUIREMENTS:

A. Reference either the dimensional requirements of the district, Sec. 1104 or list the proposed setbacks.

as per site plan

B. Off-street parking and loading, Sec. 1202: List the number of spaces, type of surfacing material and any other pertinent information.

IAW Zoning Ord

3. SIGN REQUIREMENTS:

Reference the district sign regulations proposed from Article XIII.

IAW Zoning Ord

4. LANDSCAPE AND BUFFER REQUIREMENTS:

A. For all new non-residential and mixed use development abutting a public street, indicate the number and type of large or small ornamental trees used in the streetscape, yard space, and/or parking areas, plus the number and type of shrubs (Sec. 1102N). NOTE: All required landscaping must be included on the site plan.

IAW zoning ord
(this will be required to be included on individual site plans for staff review)

B. Indicate the type of buffering and approximate location, width and setback from the property lines.

same as "A"

* 5. MISCELLANEOUS: if applicable

List any information not set forth above, such as the days and hours of the operation, number of employees, exterior lighting, noise, odor and smoke, emission controls, etc.

23 CURRENT EMPLOYEES - per AI approx 40 total 6-11-07
Approx. 10 POWER LIGHTS IN SERVICE STORAGE YARD
- operation: 7 DAYS per week - 10 HOURS / DAY approx. per AI 6-11-07
- ESTIMATE 50 TRUCKS AND LIFT VEHICLES AND SUPPLIES

6. SITE PLAN REQUIREMENTS:

The application shall include a site plan drawn to the specifications of Sec. 1402. If the proposed uses involve development subject to the County Subdivision Ordinance, the site plan required may be general in nature, showing a generalized street pattern, if applicable, and the location of proposed uses. If the proposed uses include development not subject to the Subdivision Ordinance, the site plan shall be of sufficient detail to allow the Planning and Inspections Staff and the Planning Board to analyze the proposed uses and arrangement of uses on the site. It shall also include the footprints of all buildings (proposed and existing), the proposed number of stories, location and number of off-street parking and loading spaces, proposed points of access to existing streets and internal circulation patterns. In addition, the location of all proposed buffers and fences and landscaping shall be included on the site plan.

Revised: 10-16-06
Albert E. Norton Jr.

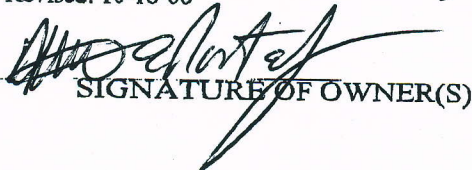
SIGNATURE OF OWNER(S)

Shirley R Norton
Shirley R Norton
SIGNATURE OF OWNER(S)

Albert E. Norton Jr and Shirley R. Norton
NAME OF AGENT, ATTORNEY, APPLICANT (by assign) (PRINT OR TYPE)

2936 George Owen Rd - Fayetteville NC 28306
ADDRESS OF AGENT, ATTORNEY, APPLICANT

910 822 0082 (424.6419) 910.822.0082
HOME TELEPHONE # WORK TELEPHONE #

Albert E. Norton Jr Shirley R. Norton
~~Albert E. Norton Jr~~ Shirley R. Norton
SIGNATURE OF AGENT, ATTORNEY OR APPLICANT

- * **ALL record property owners must sign this petition.**
- * **The contents of this application, upon submission, becomes "public record."**

**CUMBERLAND COUNTY ZONING ORDINANCE
FEE SCHEDULE**

| REQUESTED ZONING DISTRICTS ¹ | LESS THAN 5 ACRES | 5 TO 50 ACRES | 50 TO 100 ACRES | 100+ ACRES |
|---|---|---------------|-----------------|------------|
| CONDITIONAL USE DISTRICTS ² RESIDENTIAL DD/CUD | \$500 | \$500 | \$500 | \$500 |
| CONDITIONAL USE DISTRICTS ² NONRESIDENTIAL PND/CUD MXD/CUD | <u>\$700</u> - 400 pd <u>\$300.00 due</u> | \$800 | \$800 | \$800 |

1 If more than one zoning district is requested in the same application, the highest fee for the district requested will apply.

2 If a general rezoning is requested and based on recommendations of the Planning Board or County Commissioners, the applicant desires to submit a Conditional Use District and Permit application, the original application fee will be credited towards the Conditional Use District and Permit application fee.

Donovan McLaurin,
Chair
Wade, Falcon & Godwin

Lori Epler,
Vice-Chair
Cumberland County

Garland C. Hostetter,
Town of Spring Lake
Harvey Cain, Jr.,
Town of Stedman
Patricia Hall,
Town of Hope Mills
Charles C. Morris,
Town of Linden

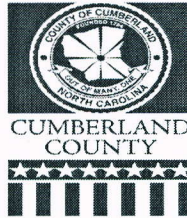

COUNTY of CUMBERLAND
Planning and Inspections Department

Thomas J. Lloyd,
Director

Cecil P. Combs,
Deputy Director

Clifton McNeill, Jr.,
Roy Turner,
Sara E. Piland,
Cumberland County

July 10, 2007

MEMORANDUM

TO: Cumberland County Joint Planning Board
FROM: Planning & Inspections Staff
SUBJECT: Staff Recommendation for July 17, 2007 Board Meeting

P07-56: REZONING OF .94 ACRES FROM C1(P) AND R6A TO C(P) OR TO A MORE RESTRICTIVE ZONING DISTRICT, AT 2972 DUNN ROAD, SUBMITTED BY KIMBERLY AND MICHAEL FOUST, OWNED BY VIVIAN LEWIS, ET AL.

The applicant originally submitted an application requesting the C(P) zoning district. Since then, she amended her request to a C(P)/Conditional Use District and Permit to allow a Heating and Air Conditioning Business and other Permitted Uses.

The Planning & Inspections Staff recommends approval of the C(P)/Conditional Use District excluding: Alcoholic Beverage Control Sales, Bars & Night Clubs, Bus Station Activities, Cemetery, Crematorium, Dwelling-Single & Multiple Family, Funeral Home, Golf Courses, Hotel/Motel, Manufactured Home Sales, Massage & Bodyworks Therapy, Motor Vehicle Service Station Operations, Sexually Oriented Businesses, Theater Productions-Indoor, Theater Productions-Outdoor, Billboards, Detention Facilities/ Prisons and Quarry, based on the following:

- Although the request is not consistent with the 2010 Land Use Plan, which calls for Medium Density Residential at this location, the subject property is located on a Major Thoroughfare and in an area that is transitioning to, and suitable for, non-residential uses.

The Planning & Inspections Staff also recommends approval of the Conditional Use Permit based on the following:

1. The use will not materially endanger the public health and safety if located according to the plan submitted;

2. The use will meet all required conditions and specifications if constructed according to all federal and state mandates, and the County Zoning and Subdivision Ordinances, the requirements of which are attached to this recommendation;
3. The use will maintain or enhance the value of adjoining or abutting properties; and
4. The location and character of the use, if developed according to the plan as submitted, will be in harmony with the area in which it is to be located.

There are no other suitable zoning districts to be considered for this site.

The applicant has been given a copy of this recommendation and has verbally agreed to all Ordinance Related Conditions.

Attachments:

- 1 - Site Profile w/Ordinance Related Conditions
- 2 - Rezoning Sketch Map
- 3 - Site Plan
- 4 - Application

SITE PROFILE

P07-56

REZONING OF .94 ACRES FROM C1(P) AND R6A TO C(P) OR TO A MORE RESTRICTIVE ZONING DISTRICT, AT 2972 DUNN ROAD, SUBMITTED BY KIMBERLY AND MICHAEL FOUST, OWNED BY VIVIAN LEWIS, ET AL.

Site Information:

Applicant/Owner: KIMBERLY AND MICHAEL FOUST / VIVIAN LEWIS, ET AL.

Area: .94 acres

Frontage & Location: 195 feet on Dunn Road

Depth: 210 feet

Jurisdiction: County

Adjacent Property: No

Current Use: Vacant buildings

Initial Zoning: April 26, 1979 (Area 8)

Zoning Violation(s): None

Nonconformities: The structures will become more nonconforming due to dimensional requirements. The applicant has specified all structures will be removed.

Surrounding Zoning: North-A1, RR, R6A, R6A/CU, HS(P), C1(P), C(P), East-A1, R6A, HS(P), C(P), South-A1, RR, HS(P)/CU, and West-A1, RR, R6A

Surrounding Land Use: Duplex, manufactured home park, wholesale business, vacant commercial, rest homes (2), single family residential and vacant land

2010 Land Use Plan: Medium Density Residential

Urban Services Area: Yes

Water/Sewer Availability: ESD / ESD-Sewer available within 12 months

Soil Limitations: Yes – Johnston loam

Subdivisions: Site plan approval will be required prior to development.

Military Impact Area: No

Highway Plan: There are no road improvements or new construction specified for this area.

Average Daily Traffic Count (2004): 7500 on Dunn Road

Notes:

Conditions of the Application

1. Hours of Operation: Mon-Fri, 7:30am-7:30pm
2. Employees: 20 (13 currently)
3. Structure: 5,775sq ft
4. Permitted Uses to be Excluded: Alcoholic Beverage Control Sales, Bars & Night Clubs, Bus Station Activities, Cemetery, Crematorium, Dwelling-Single & Multiple Family, Funeral Home Golf Courses, Hotel/Motel, Manufactured Home Sales, Massage & Bodyworks Therapy, Motor Vehicle Service Station Operations, Sexually Oriented Businesses, Theater Productions-Indoor, and Theater Productions-Outdoor.

5. Special Uses to be Excluded: Billboards
6. Conditional Uses to be Excluded: Detention Facilities/Prisons and Quarry

Conditional Use District & Permit

Ordinance Requirements:

Permit-Related:

1. The owner/developer(s) of these lots must obtain detailed instructions on provisions of the County Zoning Ordinance and permits required to place any structure within this development from the County Code Enforcement Section, Room 101 in the Historic Courthouse at 130 Gillespie Street. For additional information, the developer should contact a Code Enforcement Officer.
2. The County Health Department must approve sewer plans prior to application for any permits. Site and soil evaluations must be conducted on the property by the County Environmental Health Department prior to application for permits. A copy of the Health Department approval must be provided to Code Enforcement at the time of application for building/zoning permit. **(Note: Public sewer provided by the Eastover Sanitary District is expected to become available within 12 to 18 months; if public sewer is available prior to building/zoning permit application, connection to public sewer will be required.)**
3. Connection to public water is required; the Eastover Sanitary District (ESD) must approve water plans prior to application for any permits. A copy of the ESD approval must be provided to Code Enforcement at the time of application for building/zoning permit.
4. The existing structures on this site must be completely removed and properly disposed of prior to any permits being issued for the proposed development.
5. The developer must provide a site-specific address and tax parcel number at the time of building/zoning permit application.
6. The building final inspection cannot be accomplished until a Code Enforcement Officer inspects the site and certifies that the site is developed in accordance with the approved plans.

Site-Related:

7. At the time of any change in use on the subject property, the developer will be required to submit for site plan review and approval by the Planning & Inspections Staff prior to application for any permits and/or prior to commencement of the change in use.
8. All uses indicated within the application, and all dimensions, setbacks and other related provisions of the County Subdivision and Zoning Ordinances for the C(P)/CUD zoning district must be complied with in addition to any condition of the permit.
9. The signage for this development shall be in accordance with the applicable sign regulations as set forth in Article XIII of the County Zoning Ordinance and that the proper permit(s) must be obtained prior to the installation of any permanent signs on the property. (Note: This conditional approval is **not** approval of the size, shape, or location of any signs.)
10. The developer must obtain driveway permit(s) from the NC Department of Transportation (NCDOT).
11. The NC Department of Transportation (NCDOT) may require turn lanes to be installed.

12. All required parking spaces shall be a minimum of 9' x 20' and shall be surfaced, with a permanent material such as asphalt or concrete, and striped prior to application for the final building inspection. A minimum of one off-street space for each vehicle used directly in the conduct of the use, plus two additional spaces for each three employees on the largest shift are required for this development.
13. All lighting is required to be directed internally within this development and comply with the provisions of Section 1102 M, Outdoor Lighting, County Zoning Ordinance.
14. A solid buffer must be provided and maintained along both sides and the rear of the subject property in accordance with the provisions of Section 1102 G, County Zoning Ordinance. The open storage area must be buffered from view from the street and surrounding residential areas.)
15. All dumpster, garbage, and utility areas shall be located on concrete pads and screened on a minimum of three sides.
16. The site must be landscaped as shown on the site plan prior to the building final inspection. In addition:
 - a. All required plant materials shall be maintained by the property owners, including replacing dead or unhealthy trees and shrubs. Trees shall be maintained in a vertical position at all times;
 - b. All planting areas shall be kept free of weeds and debris;
 - c. Healthy existing trees may be used to meet the landscaping requirements; and
 - d. Trees may be clustered.
17. All notes and calculations as shown on the site plan are to be considered as a part of this conditional approval.

Other Relevant Conditions:

18. The open storage may only consist of materials related to the approved use as stated in the application, or any change in use approved in the future.

If you need clarification and/or negotiation of conditions, please contact Ed Byrne at 910-678-7609 or Patti Speicher at 910-678-7605.

Contact Information (Area Code is 910 unless otherwise stated):

| | | |
|-------------------------------|----------------|----------------|
| Subdivision/Site Plan/Plat | Ed Byrne | 678-7609 |
| Code Enforcement (Permits): | Ken Sykes | 321-6654 |
| County Health Department: | Danny Soles | 433-3685 |
| PWC (Quote for Fees): | Heidi Maly | 223-4774 |
| Eastover Sanitary District: | Morgan Johnson | 323-3973 |
| Corp of Engineers (wetlands): | Ronnie Smith | (910) 251-4829 |
| NCDENR (E&S) | | 486-1541 |
| E911 Site-Specific Address: | Ron Gonzales | 678-7616 |
| Tax Parcel Numbers: | | 678-7549 |
| NCDOT (driveways/curb-cuts) | Gary Burton | 486-1496 |

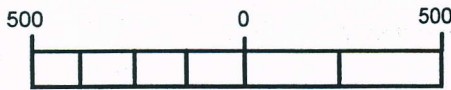
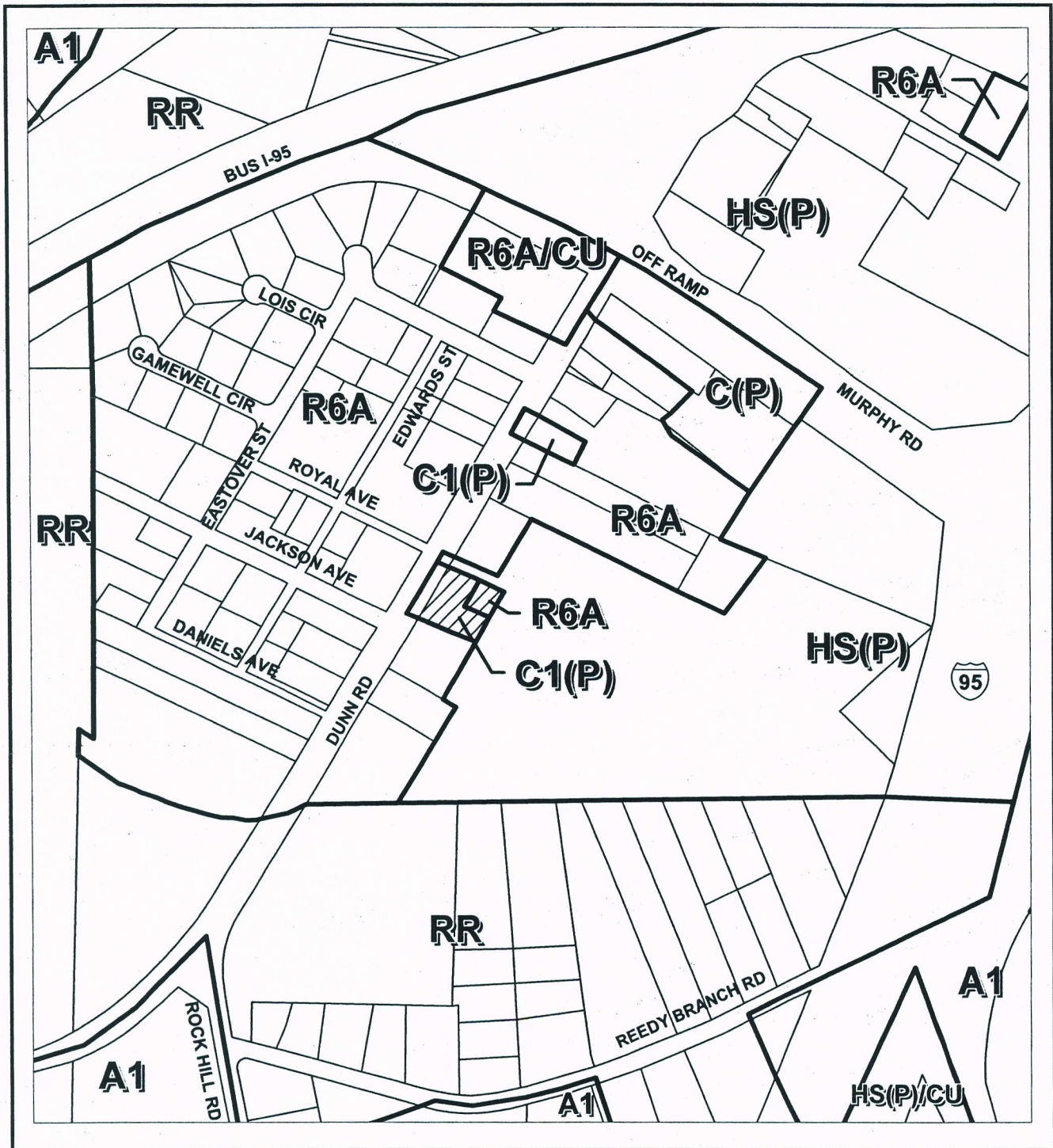

SCALE IN FEET

REQUESTED REZONING: C1(P) & R6A TO C(P)/CUD

| | | | |
|----------------------|--|--------------------|--------|
| ACREAGE: 0.94 AC.+/- | | HEARING NO: P07-56 | |
| ORDINANCE: COUNTY | | HEARING DATE | ACTION |
| PLANNING BOARD | | | |
| GOVERNING BOARD | | | |

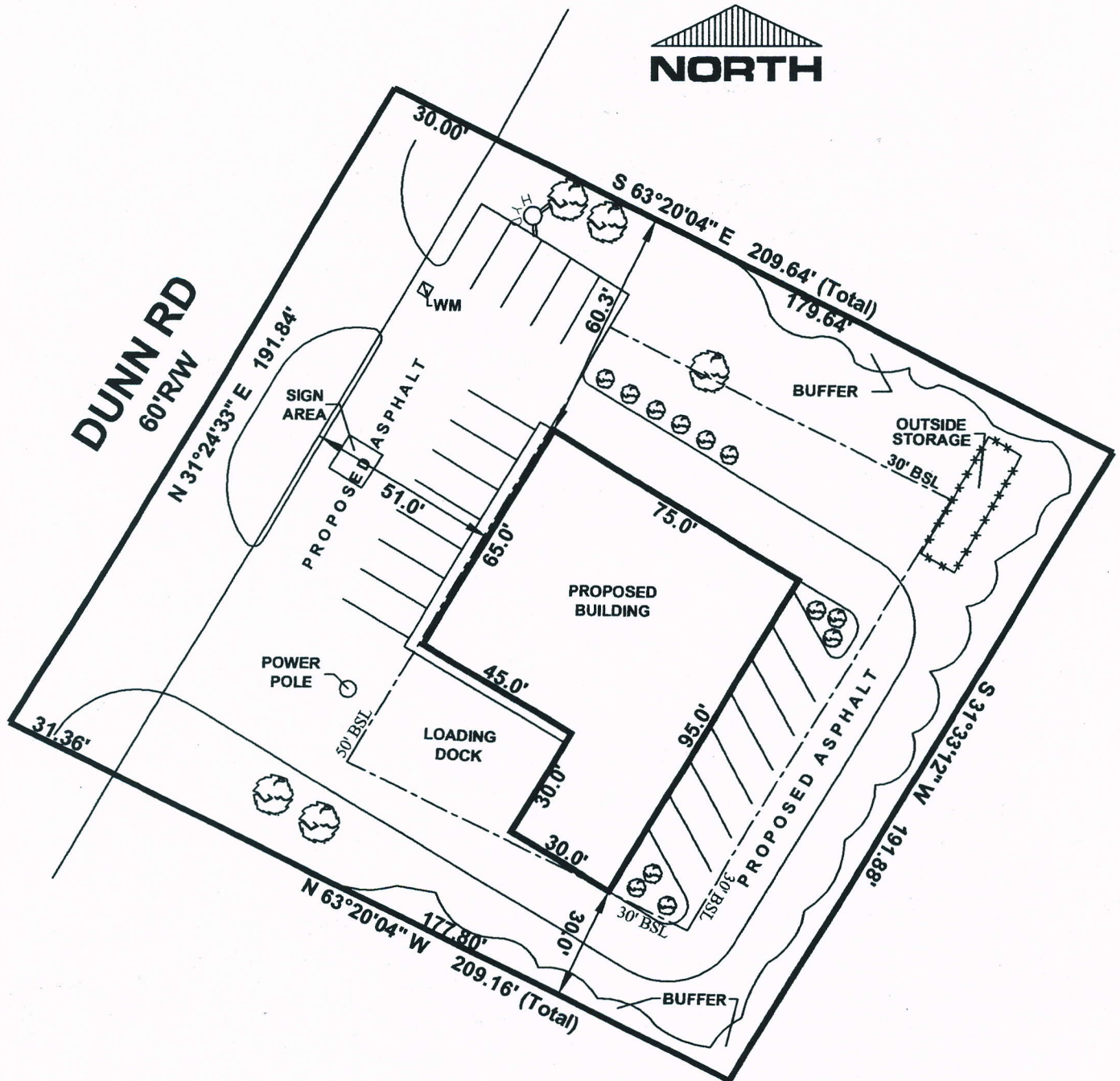

C(P)/CONDITIONAL USE PERMIT

REQUEST: HEATING AND AIR CONDITIONING BUSINESS
AND OTHER PERMITTED USES

CASE: P07-56 ACREAGE: 0.92±

SCALE: 1'=40" PARKING: 19 SPACES SHOWN

TO THE CUMBERLAND COUNTY JOINT PLANNING BOARD AND THE BOARD OF COUNTY COMMISSIONERS OF CUMBERLAND COUNTY, NC:

I (We), the undersigned, hereby submit this application, and petition the County Commissioners to amend and to change the zoning map of the County of Cumberland as provided for under the provisions of the County Zoning Ordinance. In support of this petition, the following facts are submitted:

1. Requested Rezoning from C-1 - RLA to CP Amended to C(P) / CUD E P
2. Address of Property to be Rezoned: 2972 Dunn Road 7-9-07
PSS
3. Location of Property: Legal description: Draughon Lots Cont 94 ac
4. Parcel Identification Number (PIN #) of subject property: 0468-15-7044
(also known as Tax ID Number or Property Tax ID)
5. Acreage: 94/100 Frontage: 195.36 Depth: 209.88
6. Water Provider: Well PWC _____ Other (name) _____
8. Septage Provider: Septic Tank PWC _____
9. Deed Book 06194 03056, Page(s) 00132 00403 03036-00169 02854-0639, Cumberland County Registry. (Attach copy of deed of subject property as it appears in Registry).
10. Existing use of property: vacant - was at one time a restaurant Bunce's
/ Able Heating & Air Conditioning
11. Proposed use(s) of the property: to remove existing buildings and build a new building for a Heating & Air Conditioning Company and Fun fitness and exercise
12. Do you own any property adjacent to or across the street from this property?
Yes _____ No If yes, where? the trailer -> Also a residence
13. Has a violation been issued on this property? Yes _____ No

A copy of the recorded deed(s) and/or recorded plat map(s) must be provided. If the area is a portion of a parcel, a written legal description by metes and bounds, showing acreage must accompany the deed and/or plat. If more than one zoning classification is requested, a correct metes and bounds legal description, including acreage, for each bounded area must be submitted.

The Planning and Inspections Staff is available for advice on completing this application; however, they are not available for completion of the application.

APPLICATION FOR
CONDITIONAL USE PERMIT

1. PROPOSED USE(S):

- A. List the use(s) proposed for the Conditional Use Permit. (Use of the underlying district will be restricted only to the use(s) specified in this application.)

See attached matrix. Initially to be Foust Heating and Air Conditioning.

- B. Density: List the amount of acreage that will be residential, commercial, and/or open space, and the number of lots and/or dwelling units proposed, and the square footage of the non-residential units.

no larger than 5775 sqft

2. DIMENSIONAL REQUIREMENTS:

- A. Reference either the dimensional requirements of the district, Sec. 1104 or list the proposed setbacks.

IAW Siteplan

- B. Off-street parking and loading, Sec. 1202: List the number of spaces, type of surfacing material and any other pertinent information.

per site plan

3. SIGN REQUIREMENTS:

Reference the district sign regulations proposed from Article XIII.

In accordance with section 13.06 paragraph B3 in area shown on site plan.

LANDSCAPE AND BUFFER REQUIREMENTS:

- A. For all new non-residential and mixed use development abutting a public street, indicate the number and type of large or small ornamental trees used in the streetscape, yard space, and/or parking areas, plus the number and type of shrubs (Sec. 1102N). **NOTE: All required landscaping must be included on the site plan.**

IAW site plan

- B. Indicate the type of buffering and approximate location, width and setback from the property lines.

Vegetative buffer

5. MISCELLANEOUS:

List any information not set forth above, such as the days and hours of the operation, number of employees, exterior lighting, noise, odor and smoke, emission controls, etc.

Normal hours of operation are Monday through Friday from 07:30 AM until 7:30 PM, but may vary depending on work load. All lighting will be directed internally. Currently we have thirteen employees, but may expand to twenty.

6. SITE PLAN REQUIREMENTS:

The application shall include a site plan drawn to the specifications of Sec. 1402. If the proposed uses involve development subject to the County Subdivision Ordinance, the site plan required may be general in nature, showing a generalized street pattern, if applicable, and the location of proposed uses. If the proposed uses include development not subject to the Subdivision Ordinance, the site plan shall be of sufficient detail to allow the Planning and Inspections Staff and the Planning Board to analyze the proposed uses and arrangement of uses on the site. It shall also include the footprints of all buildings (proposed and existing), the proposed number of stories, location and number of off-street parking and loading spaces, proposed points of access to existing streets and internal circulation patterns. In addition, the location of all proposed buffers and fences and landscaping shall be included on the site plan.

The undersigned understands that the official zoning map, as originally adopted and subsequently amended, is presumed to be appropriate to the property involved and that the burden of proof for a zoning amendment (change) rests with the petitioner.

The undersigned hereby acknowledge the Planning and Inspections Staff has conferred with the petitioner or assigns, and the application as submitted is accurate and correct.

Land and House has been willed to →

+ Tax Listing owner is Ruby West (deceased)

Vivian Lewis - Margaret Sablan - Thomas I Williams Jr.

NAME OF OWNERS (PRINT OR TYPE)

Vivian Lewis's address and phone number

5701 Percy Strickland Rd Godwin, NC 28344

ADDRESS OF OWNER(S)

980-1714

HOME TELEPHONE #

425-8151

WORK TELEPHONE #

Kimberly Foust Kimberly W Foust + Michael C Foust

NAME OF AGENT, ATTORNEY, APPLICANT (PRINT OR TYPE)

2208 Tom Geddie Road Fayetteville NC 28312

ADDRESS OF AGENT, ATTORNEY, APPLICANT

Fax: 484-5843

323-2653

HOME TELEPHONE #

323-0587

WORK TELEPHONE #

Margaret R. Sablan

SIGNATURE OF OWNER(S)

Kimberly Foust
Kimberly W Foust + Michael C Foust

SIGNATURE OF AGENT, ATTORNEY OR APPLICANT

THOMAS IREY WILLIAMS, JR.

SIGNATURE OF OWNER(S)

Vivian Lewis

The contents of this application, upon submission, becomes "public record."

PLEASE CONTACT ALSO -

Donovan McLaurin,
Chair
Wade, Falcon & Godwin

Lori Epler,
Vice-Chair
Cumberland County

Garland C. Hostetter,
Town of Spring Lake
Harvey Cain, Jr.,
Town of Stedman
Patricia Hall,
Town of Hope Mills
Charles C. Morris,
Town of Linden



COUNTY of CUMBERLAND

Planning and Inspections Department

Thomas J. Lloyd,
Director

Cecil P. Combs,
Deputy Director

Clifton McNeill, Jr.,
Roy Turner,
Sara E. Piland,
Cumberland County

July 13, 2007

MEMORANDUM

TO: County Joint Planning Board

FROM: Edward M. Byrne, Planner II

SUBJECT: Case No. 07-095
Ronnie & Mary Edwards Property
(Group Development Review)

The developer has requested a waiver from Section 3.20.2 "Municipal Influence Area Compliance" (MIA), County Subdivision Ordinance, regarding conditions 9, 10, & 11, on the attached condition sheet. These conditions are related to the development standards specific to the Town of Stedman. The Cumberland County Subdivision Ordinance requires developments within a MIA to meet the standards of that Town. The property is zoned A1 Agricultural District, contains 3.08 +/- acres, and has 278.17 feet of road frontage.

The developer is proposing the placement of a second structure on the existing parcel located on south side of SR 2027 (Beaver Dam Road). Conditions numbered 9, 10, & 11 relate to greenways, sidewalks and street trees.

The Stedman Town Clerk has been authorized by the Town Board of Commissioners to review these cases to determine whether compliance is equitable and warranted on an individual basis. She has recommended in this particular case that the developer not be required to comply with the Town's greenway, sidewalk and street tree provisions. The Stedman Town Board is considering exemption criteria to be added to their Ordinance so that in the future, waivers may not be required for similar cases.

In accordance with Section 6.1, Waivers, Cumberland County Subdivision Ordinance, the Planning Board may waive the requirements of this Ordinance, where it finds by resolution that:

- a. Because of the size of the tract to be subdivided, its topography, the condition or nature of the adjoining areas, or the existence of other unusual physical conditions, strict compliance with the provisions of this Ordinance would cause a special hardship to the property owner and be inequitable, and

- b. The public purposes of the Subdivision Ordinance and the Zoning Ordinance would be served to an equal or greater degree, and**
- c. The property owner would not be afforded a special privilege denied to others.**

The Planning & Inspections Staff recommends approval of the waivers based on the following:

1. Because of the condition and nature of the subject property and the adjoining areas, strict compliance would cause a special hardship to the property owner and be incompatible with the surrounding area since the property owner's proposed development is located in an area which consist primarily of farmland and single family homes on large lots where the sidewalks and other improvements are essentially nonexistent;
2. The public purposes of the Subdivision and Zoning Ordinances is being served to an equal or greater degree because the property owner is in compliance with the standards of the County's regulations and his proposed development is compatible with the surrounding development and land uses in the general area and the Town is recommending approval of the waivers; and
3. The property owner would not be afforded a special privilege denied to others since the Town and the Planning & Inspections Staff are working on exemption standards for the smaller municipalities' ordinances, specifically addressing development standards for areas where increased development is not expected in the foreseeable future.

Attachments: Stedman's Recommendation
Request for Waiver
Conditions of Approval
Sketch Map
Vicinity Map

cc: Ronnie & Mary Edwards, Developer
Grainger Barrett, County Attorney
Connie Spell, Town Administrator
Cecil Combs, Deputy Director
Patti Speicher, Planner III

Town of  *Stedman*

June 13, 2007

Cumberland County Joint Planning Board
PO Box 1829
Fayetteville, NC 28302

Re: CASE No. 07-095 Ronnie & Mary Edwards Property

Dear Planning Board Members:

The above property is located outside the town limits but within our Municipal Influence Area (MIA). According to our Subdivision Ordinance our standards are required to be applied in the MIA.

The Town Board's position is that all development in the MIA should meet the town's standards and they do not agree with the County's position to grant waivers in the Town's MIA.

However, the Board realizes that in this particular case our greenway, curbs and gutters, landscaping and sidewalks standards are economically unrealistic for Ms. Autry's case. Therefore, the town recommends that Ronnie & Mary Edwards - Case No. 07-095 be granted relief from the above mentioned standards.

If you have any questions or need additional information, please feel free to contact me.

Sincerely,



Connie F. Spell
Town Administrator

cc: Will Denning, Planner

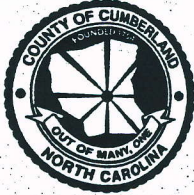

Date Request Submitted: 7-13-07
Planning Board Meeting Date: 7-17-07
Received by: CRB

Cumberland County Subdivision Ordinance

Request for Waiver

Case No.: 07095 Case Name: Mary Edwards
Related Ordinance Section Number(s): SECTION 3.20.2
Summary of Request: Not to have to meet the M/A Compliance

Section 6.1 of the County Subdivision Ordinance governs the Planning Board's authority to waiver provisions of the Subdivision Ordinance. This section reads as follows:

Section 6.1. Waivers

The Planning Board may waive the requirements of this Ordinance where it finds by resolution that:

- a. Because of the size of the tract to be subdivided, its topography, the condition or nature of adjoining areas, problems of access, or the existence of other unusual physical conditions, strict compliance with the provisions of this ordinance would cause a special hardship to the property owner and be inequitable, and*
- b. The public purposes of the Subdivision Ordinance and the Zoning Ordinance would be served to an equal or greater degree, and*
- c. The property owner would not be afforded a special privilege denied to others.*

In granting waivers, the Planning Board may require such conditions as will secure, in so far as practicable, the objectives of the requirements waived. Any waiver, thus granted, is required to be entered in writing in the minutes of the Planning Board and the reasoning upon which departure was justified set forth.

The applicant is strongly encouraged to read the above provisions and relate the written waiver request as closely as possible to the criteria contained within. All supporting documentation for the request shall be submitted along with this request for waiver. For example, if the request is based on topography or soils, the applicant is the responsible

party to submit as evidence 'topo' and/or soils maps or if the request is based on the "condition or nature of adjoining property", the applicant will be required to submit evidence supporting this as basis for the request.

My request should receive favorable consideration by the Planning Board based on the following summary of the basis for this request:

1. Because of the size of the tract to be subdivided, its topography, the condition or nature of adjoining areas, problems of access, or the existence of other unusual physical conditions (at least one of the preceding basis must be addressed in this request), strict compliance with the provisions of this Ordinance would cause a special hardship to the property owner and be inequitable, due to:

farm land no side walks

2. The public purposes of the County Subdivision and County Zoning Ordinances would be served to an equal or greater degree and the applicant agrees to:

willing to comply w/ Co. rules & live in County

3. The property owner would not be afforded a special privilege denied to others, because:

other areas are without side walks etc tree escapes etc.

By signing this request, the applicant is signifying that all statements contained within this request are accurate and true to the best of their knowledge.

Mary Edwards
Printed Name of Applicant/Agent

910-850-6833
Daytime Phone Number

Mary Edwards
Signature of Applicant/Agent

6-13-07
Date Signed

Donovan McLaurin,
Chair
Wade, Falcon & Godwin

Lori Epler,
Vice-Chair
Cumberland County

Garland C. Hostetter,
Town of Spring Lake
Harvey Cain, Jr.,
Town of Stedman
Patricia Hall,
Town of Hope Mills
Charles C. Morris,
Town of Linden



CUMBERLAND
COUNTY



COUNTY of CUMBERLAND

Planning and Inspections Department

Thomas J. Lloyd,
Director

Cecil P. Combs,
Deputy Director

Clifton McNeill, Jr.,
Roy Turner,
Sara E. Piland,
Cumberland County

PLANNING STAFF DECISION: 6-7-07 PLANNING BOARD DECISION: 7-17-07 COMMISSIONERS MEETING: N/A

CASE NO: 07-095 NAME OF DEVELOPMENT: RONNIE & MARY EDWARDS PROPERTY
(GROUP DEVELOPMENT REVIEW) (Stedman MLA)

LOCATION: WEST SIDE OF SR 2027 (BEAVER DAM ROAD), ZONING: A1
NORTH OF SR 2026 (CONCORD CHURCH ROAD) PIN: 0495-52-7440-

OWNER OR DEVELOPER: MARY H. EDWARDS ENGINEER OR DESIGNER: N/A

COUNTY ORDINANCE GODWIN ORDINANCE STEDMAN ORDINANCE SPRING LAKE ORDINANCE FALCON ORDINANCE

PLANNING DEPARTMENT ACTION

PRELIMINARY
 EXTENSION REVISION
 APPROVED CONDITIONALLY
 DENIED

PLANNING BOARD ACTION

PRELIMINARY
 EXTENSION REVISION
 APPROVED CONDITIONALLY
 DENIED

TOWN BOARD

PRELIMINARY FINAL
 EXTENSION REVISION
 APPROVED CONDITIONALLY
 DENIED

The development plat/plan you submitted to this office is conditionally approved. Your approval is subject to the following conditions:

Permit-Related:

1. The owner/developer(s) of these lots must obtain detailed instructions on provisions of the County Zoning Ordinance and permits required to place any structure within this development from the County Code Enforcement Section, Room 101 in the Historic Courthouse at 130 Gillespie Street. For additional information, the developer should contact a Code Enforcement Officer.
2. The County Health Department must approve water and sewer plans prior to application for any permits. Site and soil evaluations must be conducted on the property by the County Environmental Health Department prior to application for permits. (Note: All Health Department requirements must be met prior to issuance of final permits.)
3. The developer must provide a site-specific address and tax parcel number at the time of building/zoning permit application.
4. A *Certificate of Occupancy* will not be issued until a Code Enforcement Officer inspects the site and certifies that the site is developed in accordance with the approved plans.

Site-Related:

5. All uses, dimensions, setbacks and other related provisions of the County Subdivision and Zoning Ordinances for the A1 zoning district must be complied with.
6. "Beaver Dam Road" must be labeled as "SR 2027 (Beaver Dam Road)" on all future plans.
7. All utilities, except for 25kv or greater electrical lines, must be located underground.
8. If driveways are changed or added, the developer must obtain a driveway permit from the NC Department of Transportation (NCDOT).
9. Prior to application for the *Certificate of Occupancy*, a four-foot wide concrete sidewalk, complying with the ADA standards, must be constructed along SR 2027 (Beaver Dam Road), with the sidewalk plans being reviewed and approved by the Town of Stedman- see Section 4.3. g, Stedman Subdivision Ordinance, for more specific details regarding this condition.
10. Prior to application for the *Certificate of Occupancy*, on tree for every 50 linear foot of street frontage must be planted in an area three foot in width from the back of the right-of-way to the sidewalk along SR 027 (Beaver Dam Road) – see Section 4.3.h, Stedman Subdivision Ordinance, for more specific details regarding this condition.

11. Prior to application for the *Certificate of Occupancy*, the developer must comply with the Town of Stedman's *Greenway Standards for Residential Subdivisions*, providing the Code Enforcement Section with a copy of the Town's written approval of the plans – see Section 3.13.2, Stedman Subdivision Ordinance, for more specific details regarding this condition.

Advisories:

12. This tract can not be subdivided with out rezoning the property and under current standards, no additional dwelling units may be permitted to be located on this tract.
13. The applicant is advised to consult an expert on wetlands before proceeding with any development.

Planning Board:

14. The Developer has requested a waiver from Section 3.20.2 "Municipal Influence Area Compliance", Cumberland County Subdivision Ordinance, the Cumberland County Joint Planning Board will hear the case on July 17, 2007.

If you need clarification and/or negotiation of conditions, please contact Ed Byrne at 910-678-7609 or Patti Speicher at 910-678-7605.

Contact Information (Area Code is 910 unless otherwise stated):

| | | |
|-------------------------------|--------------|----------------|
| Subdivision/Site Plan/Plat | Ed Byrne | 678-7609 |
| Code Enforcement (Permits): | Ken Sykes | 321-6654 |
| County Health Department: | Danny Soles | 433-3685 |
| Town of Stedman: | Connie Spell | 323-1892 |
| Corp of Engineers (wetlands): | Ronnie Smith | (910) 251-4829 |
| NCDENR (E&S) | Jody Pace | 433-3300 |
| E911 Site-Specific Address: | Ron Gonzales | 678-7616 |
| Tax Parcel Numbers: | | 678-7549 |
| NCDOT (driveways/curb-cuts) | Gary Burton | 486-1496 |

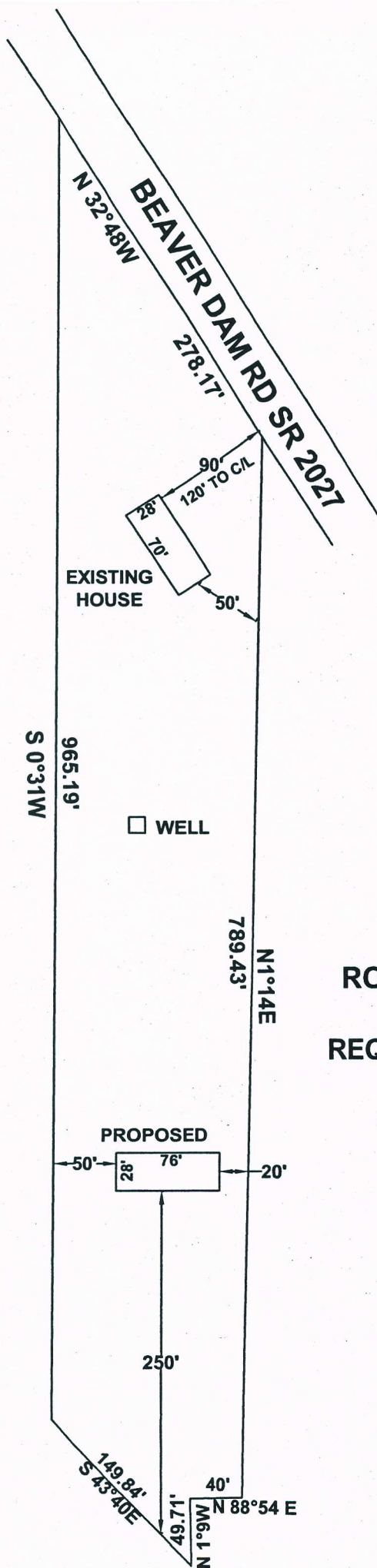

**RONNIE & MARY EDWARDS PROPERTY
GROUP DEVELOPMENT REVIEW
REQUEST: A WAIVER FROM SECTION 3.20.2**

CASE: 07-095 ACREAGE: 3.08ACS

ZONED: A1 SCALE: NTS

**RONNIE & MARY EDWARDS PROPERTY
GROUP DEVELOPMENT REVIEW
CASE NO. 07-095**

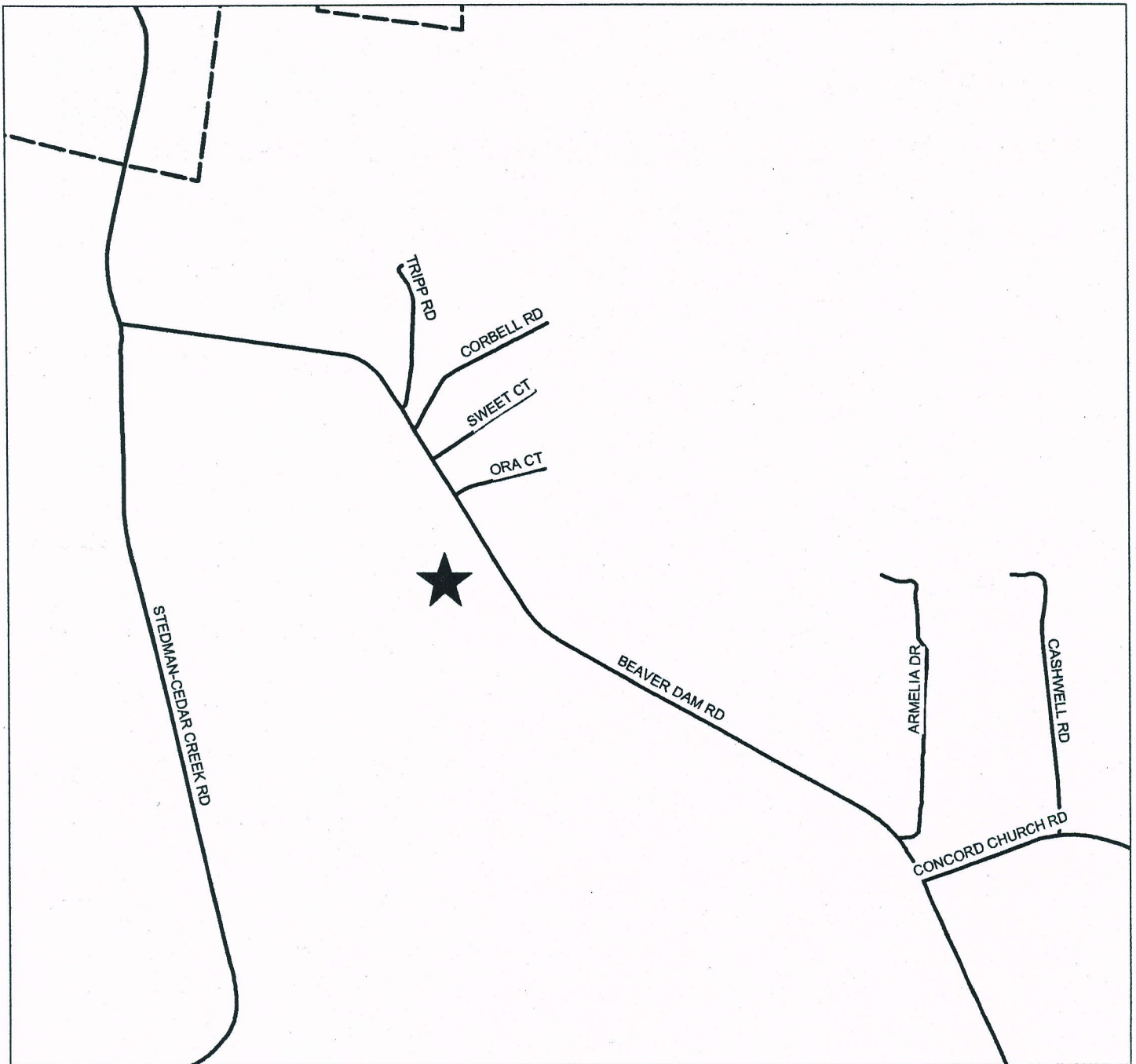

PIN(S): 0495-52-7440
Prepared by pj - CCJPB
May 29, 2007

Map not to scale



Donovan McLaurin,
Chair
Wade, Falcon & Godwin

Lori Epler,
Vice-Chair
Cumberland County

Garland C. Hostetter,
Town of Spring Lake
Harvey Cain, Jr.,
Town of Stedman
Patricia Hall,
Town of Hope Mills
Charles C. Morris,
Town of Linden



COUNTY of CUMBERLAND

Planning and Inspections Department

Thomas J. Lloyd,
Director

Cecil P. Combs,
Deputy Director

Clifton McNeill, Jr.,
Roy Turner,
Sara E. Piland,
Cumberland County

July 10, 2007

MEMORANDUM

TO: County Joint Planning Board

FROM: Edward M. Byrne, Planner II

SUBJECT: Exception to Sewer Extension Requirement
Case No. 93-333, Hillside Baptist Church of Hope Mills
R10 Site Plan Review

The Planning & Inspections Staff favorably recommend the Planning Board make exception to the sewer extension requirement for the above referenced development. Section 4.3.d (2), County Subdivision Ordinance, authorizes the Board to make exception as to when connection to sanitary sewer and public water is required if any of six enumerated conditions warrant.

This development is subject to one of the enumerated conditions listed in the Ordinance:

- The public utility is located beyond the jurisdiction of the Planning Board, and the public utility provider will not agree to extend service – the Public Works Commission (PWC) has stated that “no sewer available” for extension to this development.

The site is to be served by public water. The PWC email and developer’s request for exception, a sketch map, vicinity map and tentative conditions of approval are attached. Also attached is an excerpt from the Ordinance of the text of Section 4.3.d.

Attachments:

cc: Reggie Wallace, Developer
Grainger Barrett, County Attorney
Cecil Combs, Deputy Director
Patti Speicher, Land Use Codes

Reggie Wallace

From: John Allen
Sent: Tuesday, May 29, 2007 8:15 AM
To: Reggie Wallace
Subject: 3807 Legion Road

Reggie:

In reviewing our GIS data of existing PWC water and sewer utilities at the subject location (southeast corner of Legion Road and Heidelberg Drive), water exists in both Legion Road and Heidelberg Drive. The only sewer in this area is a force main located in Legion Road. PWC does not allow connections to force mains by individual parcels. Let me know if you have any questions or need additional information.

Thanks,

John Allen, P.E.
Senior Engineer
Water Resources Engineering
Public Works Commission

To Whom It May Concern:

On behalf of Hillside Baptist Church, I respectfully request an exception to section 4.3 ~~3~~ d. (2) ~~2~~ based on exception No. 2. ~~2~~ PWC will not allow connection to the forced main that is near our property.

Allen R. Wallace
May 30, 2007

NOGS Station
CLUM 36 °
NAD 83 Coordinates
N = 453167.5394
E = 2023529.4498

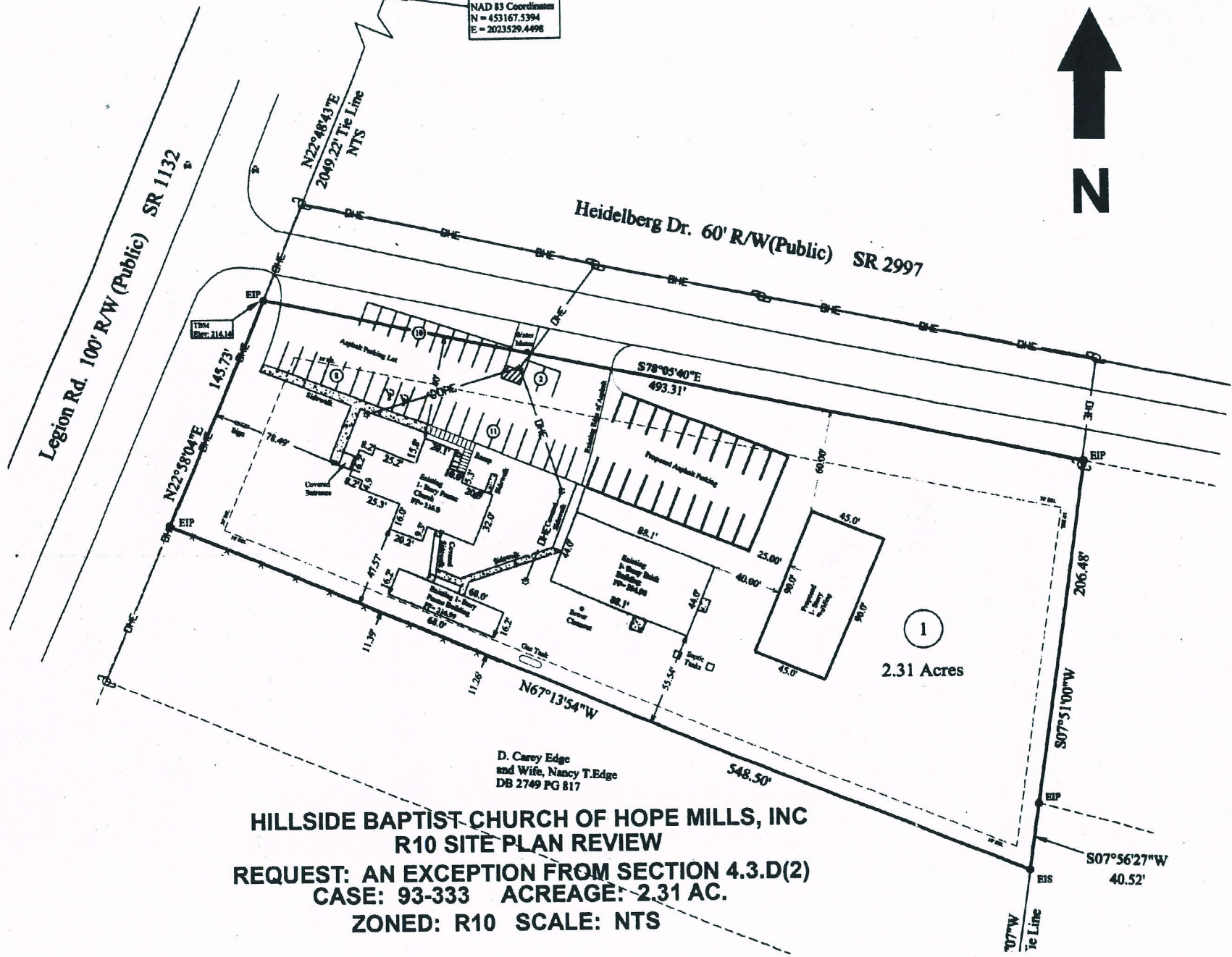

Legion Rd. 100' R/W (Public) SR 1132

N22°48'43"E
2049.22' Tie Line
NTS

Heidelberg Dr. 60' R/W (Public) SR 2997

S78°05'40"E
493.31'

1
2.31 Acres

D. Carey Edge
and Wife, Nancy T. Edge
DB 2749 PG 817

HILLSIDE BAPTIST CHURCH OF HOPE MILLS, INC
R10 SITE PLAN REVIEW
REQUEST: AN EXCEPTION FROM SECTION 4.3.D(2)
CASE: 93-333 ACREAGE: 2.31 AC.
ZONED: R10 SCALE: NTS

S07°56'27"W
40.52'

Te Line

HILLSIDE BAPTSIT CHURCH R10 SITE PLAN REVIEW CASE NO. 93-333



PIN(S): 0425-21-9133-
Prepared by emb - CCJPB
June 21, 2007

Map not to scale



Donovan McLaurin,
Chair
Wade, Falcon & Godwin

Lori Epler,
Vice-Chair
Cumberland County

Garland C. Hostetter,
Town of Spring Lake
Harvey Cain, Jr.,
Town of Stedman
Patricia Hall,
Town of Hope Mills
Charles C. Morris,
Town of Linden



COUNTY of CUMBERLAND

Planning and Inspections Department

Thomas J. Lloyd,
Director

Cecil P. Combs,
Deputy Director

Clifton McNeill, Jr.,
Roy Turner,
Sara E. Piland,
Cumberland County

REVISED: 06-20-07

PLANNING STAFF DECISION: 05-24-07 PLANNING BOARD DECISION: 7-17-07 COUNTY OR COUNCIL MEETING: N/A

CASE NO: 93-333 NAME OF DEVELOPMENT: HILLSIDE BAPTIST CHURCH OF HOPE MILLS, INC (R10 SITE PLAN REVIEW) - ADDITION

LOCATION: AT THE SOUTHEAST INTERSECTION OF SR 1132 (LEGION ROAD) AND ZONING: R10

SR 2997 (HEIDELBERG DRIVE), NORTH OF PIONEER DRIVE PIN: 0425-21-9133-

OWNER OR DEVELOPER: HILLSIDE BAPTIST CHURCH ENGINEER OR DESIGNER: GOODEN & ASSOCIATES

COUNTY ORDINANCE GODWIN ORDINANCE STEDMAN ORDINANCE SPRING LAKE ORDINANCE FALCON ORDINANCE

PLANNING DEPARTMENT ACTION
 PRELIMINARY
 EXTENSION REVISION
 APPROVED CONDITIONALLY
 DENIED

PLANNING BOARD ACTION
 PRELIMINARY
 EXTENSION REVISION
 APPROVED CONDITIONALLY
 DENIED

TOWN BOARD
 PRELIMINARY FINAL
 EXTENSION REVISION
 APPROVED CONDITIONALLY
 DENIED

The development plat/plan you submitted to this office is conditionally approved. Your approval is subject to the following conditions:

Permit-Related:

1. The owner/developer(s) of these lots must obtain detailed instructions on provisions of the County Zoning Ordinance and permits required to place any structure within this development from the County Code Enforcement Section, Room 101 in the Historic Courthouse at 130 Gillespie Street. For additional information, the developer should contact a Code Enforcement Officer.
2. Connection to public water is required, the Public Works Commission must approve water plans prior to application for any permits.
3. The County Health Department must approve sewer plans prior to application for any permits. Site and soil evaluations must be conducted on the property by the County Environmental Health Department prior to application for permits. (Note: All Health Department requirements must be met prior to issuance of final permits.)
4. The developer may have to provide the Code Enforcement Section with an approved state sedimentation and erosion control plan (S&E) prior to any application for permits. If any retention/detention basins are required for state approval of this plan, then five copies of a revised plan must be submitted and approved by Planning & Inspections prior to application for any permits.
5. The NC Department of Transportation (NCDOT) approve the proposed curb-cut(s) and the proper permits must be obtained prior to zoning/building permit application.
6. The developer must provide a site-specific address and tax parcel number at the time of building/zoning permit application.
7. A *Certificate of Occupancy* will not be issued until a Code Enforcement Officer inspects the site and certifies that the site is developed in accordance with the approved plans.
8. Any addition and/or revision to this site plan shall require an additional review and approval by the Planning & Inspections Department prior to application for any permits.

Site-Related:

9. All uses, dimensions, setbacks and other related provisions of the County Subdivision and Zoning Ordinances for the R10- R7.5 zoning district must be complied with.
10. The signage for this development shall be in accordance with the applicable sign regulations as set forth in Article XIII of the County Zoning Ordinance and that the proper permit(s) must be obtained prior to the installation of any permanent signs on the property. (Note: This conditional approval is not approval of the size, shape, or location of any signs.)

11. Reservation of 5 feet of right-of way along Heidelberg Drive is required and the metes and bounds for both dedication and reservation must be shown on the final plat and/or reflected on any future site plans. The location of all improvements, required or otherwise, and all building setback lines are to be measured from the ultimate right-of-way line.
12. If driveways are changed, the developer must obtain a driveway permit from the NC Department of Transportation (NCDOT).
13. All lighting is required to be directed internally within this development and comply with the provisions of Section 1102 M, Outdoor Lighting, County Zoning Ordinance.
14. A solid buffer must be provided and maintained in accordance with the provisions of Section 1102 G, Buffer Requirements, County Zoning Ordinance. (Note: The buffer must be in place by June 20, 2007.)
15. All dumpster, garbage, and utility areas shall be located on concrete pads and screened on a minimum of three sides.
16. All required parking spaces shall be a minimum of 9' x 20' and shall be surfaced, with a permanent material such as asphalt or concrete, and striped prior to application for the *Certificate of Occupancy*. A minimum of one space per 5 seats of seating capacity of off-street parking spaces are required for this development.

Advisories:

17. The applicant is advised to consult an expert on wetlands before proceeding with any development.

Other Requirements:

18. The developer has required an exception to Section 4.3.d (2), Cumberland County Subdivision Ordinance. This case will be heard at the July 17, 2007 Cumberland County Joint Planning Board Meeting.

If you need clarification and/or negotiation of conditions, please contact Ed Byrne at 910-678-7609 or Patti Speicher at 910-678-7605.

Contact Information (Area Code is 910 unless otherwise stated):

| | | |
|-------------------------------|-----------------|----------------|
| Subdivision/Site Plan/Plat | Ed Byrne | 678-7609 |
| Code Enforcement (Permits): | Ken Sykes | 321-6654 |
| PWC: | Heidi Maly | 483-1401 |
| Corp of Engineers (wetlands): | Ronnie Smith | (910) 251-4829 |
| NCDENR (E&S) | Jody Pace | 433-3300 |
| E911 Site-Specific Address: | Ron Gonzales | 678-7616 |
| Tax Parcel Numbers: | | 678-7549 |
| NCDOT (driveways/curb-cuts) | Gary Burton | 486-1496 |
| Transportation Planning | Bobby McCormick | 678 7632 |

Section 4.3. Other Requirements, County Subdivision Ordinance

d. *Public water and sewer systems:*

- (1) *Generally.* Where the installation of public water and/or sewer systems is prerequisite to approval of lot sizes and standards, such systems shall be installed and certified prior to final plat approval or assured to be installed in accordance with the provisions of Section 2.6.
- (2) *When connection to sanitary sewer and public water is required.* Where any portion of a subdivision, group development or mobile home park of two (2) to ten (10) units or lots is within three hundred (300) feet of public water or sewer, the public utilities shall be extended. Where any portion of ten (10) to twenty (20) lots or units is within five hundred (500) feet of public water or sewer, the public utilities shall be extended. For more than twenty (20) lots or units within the Urban Services Area, and where density is greater than two (2) units per acre, the extension of public water and sewer service is required. Where any portion of a subdivision, group development or mobile home park is within 1,000 feet of the Little Rockfish Creek-Bones Creek Sanitary Sewer Interceptor System that was funded by the County of Cumberland or is required to connect to this system based on any of the above regulations, the public utility shall be extended. Prior to all connections to the Little Rockfish Creek-Bones Creek Sanitary Sewer Interceptor System and prior to issuance of any building permits, a connection fee must be made to the County of Cumberland to be administered by the County Engineering Department.

The planning board may make exceptions to these requirements when any of the following conditions warrant:

- (1) Public sanitary sewer is within a different drainage basis or sub basin;
- (2) The public utility is located beyond the jurisdiction of the Planning Board, and the public utility provider will not agree to extend service;
- (3) Crossings of Rockfish Creek, Lower Little River, South River, Cape Fear River, controlled access highways such as Interstate 95, Business 95 and the Fayetteville Outer Loop;
- (4) Extensions exceeding two thousand (2,000) feet from existing public services;
- (5) Property is located outside of municipal governments' approved master plan.
- (6) When determined by the County Engineer that the extension is not feasible, the County may accept a connection fee and waive the 1,000-foot extension requirement. The County Engineer shall submit his written recommendation to the Planning Board.

Donovan McLaurin,
Chair
Wade, Falcon & Godwin

Lori Epler,
Vice-Chair
Cumberland County

Garland C. Hostetter,
Town of Spring Lake
Harvey Cain, Jr.,
Town of Stedman
Patricia Hall,
Town of Hope Mills
Charles C. Morris,
Town of Linden



CUMBERLAND
COUNTY



COUNTY of CUMBERLAND

Planning and Inspections Department

Thomas J. Lloyd,
Director

Cecil P. Combs,
Deputy Director

Clifton McNeill, Jr.,
Roy Turner,
Sara E. Piland,
Cumberland County

July 10, 2007

MEMORANDUM

TO: Cumberland County Joint Planning Board

FROM: Planning & Inspections Staff

SUBJECT: Staff Recommendation for July 17, 2007 Board Meeting

P07-53: REZONING OF 4.33 ACRES FROM A1 TO C(P) OR TO A MORE RESTRICTIVE ZONING DISTRICT, AT 2545 SAND HILL ROAD, SUBMITTED BY ROBERT M. BENNETT, OWNED BY HAROLD J. KIDD.

The Planning & Inspections Staff recommends denial of the C(P) district based on the following:

1. The request is not consistent with the 2010 Land Use Plan, which calls for Low Density Residential at this location;
2. The request, if approved, will encourage the encroachment of non-residential zoning and uses along Sand Hill Road; an area that is primarily residential.

There are no other suitable zoning districts to be considered for this site.

Attachments:

- 1 - Site Profile
- 2 - Rezoning Sketch Map

SITE PROFILE

P07-53

REZONING OF 4.33 ACRES FROM A1 TO C(P) OR TO A MORE RESTRICTIVE ZONING DISTRICT, AT 2545 SAND HILL ROAD, SUBMITTED BY ROBERT M. BENNETT, OWNED BY HAROLD J. KIDD.

Site Information:

Applicant/Owner: ROBERT M. BENNETT / HAROLD J. KIDD

Area: 4.33 acres

Frontage & Location: 325 feet on Sand Hill Road

Depth: 545 feet (average)

Jurisdiction: County

Adjacent Property: No

Current Use: Residential

Initial Zoning: June 25, 1980 (Area 13)

Zoning Violation(s): None

Surrounding Zoning: North-A1, RR, East-A1, RR, R6A, South-A1, RR, C(P), and West-A1, R40A, RR, RR/CU

Surrounding Land Use: Manufactured home parks (2), store, day care facility, shopping center, single family residential, woodland, and farmland

2010 Land Use Plan: Low Density Residential

Urban Services Area: Yes

Water/Sewer Availability: PWC / PWC sewer available on 1100 +/- feet east on NC Hwy 87 South (mandatory connection to sewer most likely cannot be required)

Soil Limitations: Yes – Johnston loam, only on a small portion on the northern end

Subdivisions: A site plan review will be required prior to any development.

Military Impact Area: No

Highway Plan: There are no road improvements or new construction specified for this area.

Average Daily Traffic Count (2004): 810 on Sand Hill Road

Notes:

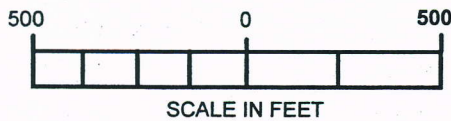
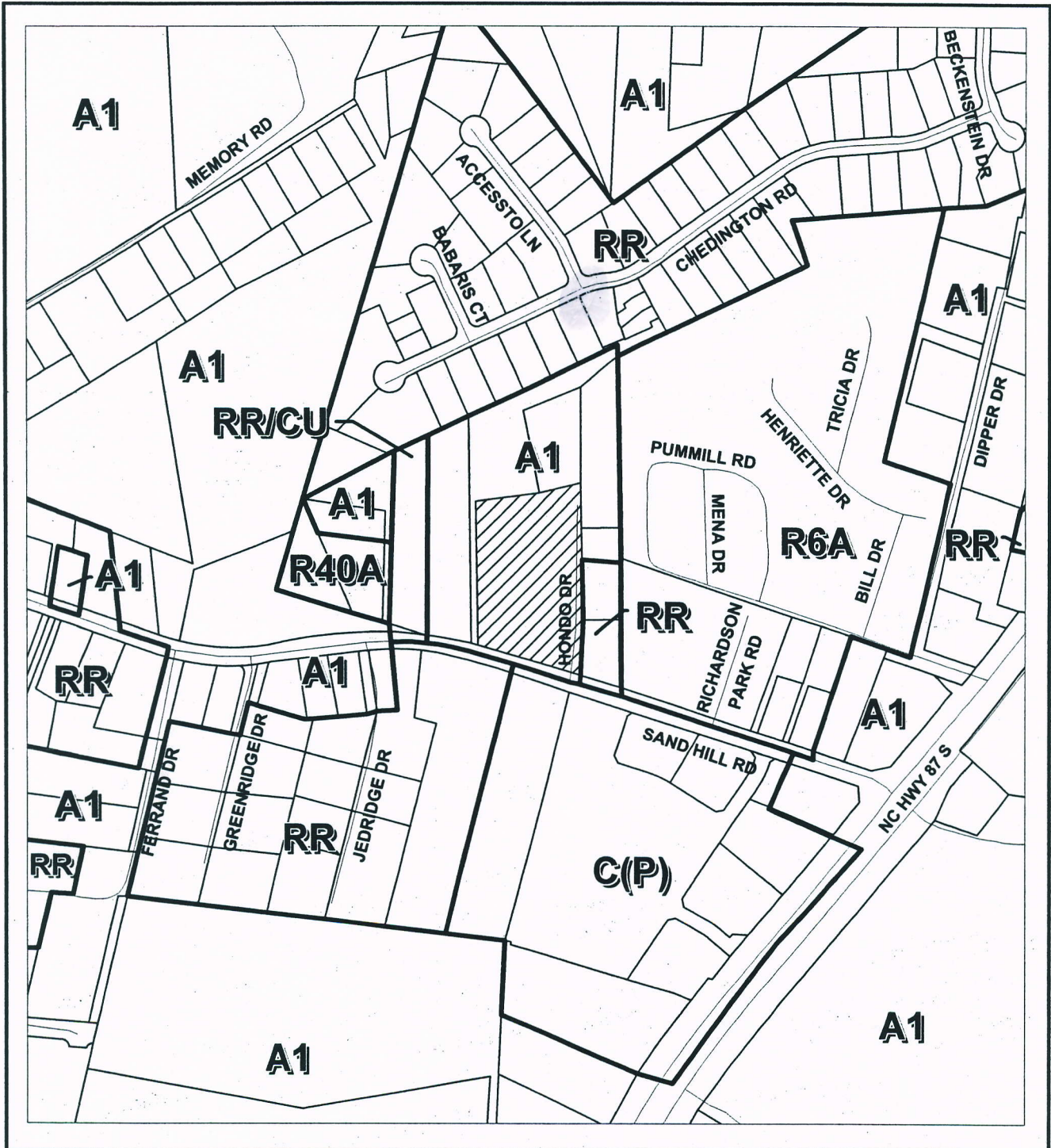

**REQUESTED REZONING:
A1 TO C(P)**

ACREAGE: 4.33 AC.+/-

HEARING NO: P07-53

ORDINANCE: COUNTY

HEARING DATE

ACTION

PLANNING BOARD

GOVERNING BOARD

Donovan McLaurin,
Chair
Wade, Falcon & Godwin

Lori Epler,
Vice-Chair
Cumberland County

Garland C. Hostetter,
Town of Spring Lake
Harvey Cain, Jr.,
Town of Stedman
Patricia Hall,
Town of Hope Mills
Charles C. Morris,
Town of Linden

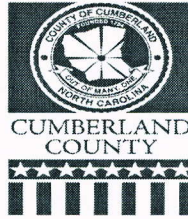

COUNTY of CUMBERLAND

Planning and Inspections Department

Thomas J. Lloyd,
Director

Cecil P. Combs,
Deputy Director

Clifton McNeill, Jr.,
Roy Turner,
Sara E. Piland,
Cumberland County

July 10, 2007

MEMORANDUM

TO: Cumberland County Joint Planning Board

FROM: Planning & Inspections Staff

SUBJECT: Staff Recommendation for July 17, 2007 Board Meeting

P07-54: REZONING OF 20.54 ACRES FROM RR TO R7.5 OR TO A MORE RESTRICTIVE ZONING DISTRICT, LOCATED ON THE EAST SIDE OF HUMMINGBIRD PLACE, SOUTH OF THREE WOOD DRIVE, SUBMITTED BY AVERETTE ENGINEERING COMPANY P.A., OWNED BY CASTLE HAYNE HOMES, LLC.

The Planning & Inspections Staff recommends denial of the R7.5 district based on the following:

1. Although the request is consistent with the Eastover Study Area Detailed Land Use Plan, which calls for Low Density Residential at this location, the entire parcel contains hydric soils;
2. Hummingbird Place is not designed in such a manner that the right-of-way can accommodate a large increase in traffic volume that rezoning to R7.5 or R15 would generate; therefore approval of this request would not be conducive to public safety; and
3. The current zoning or R20 is more consistent with the tentative measures included in the draft 2030 Land Use Plan for this area.

The R20 zoning district is the only other suitable zoning district to be considered for this site.

Attachments:

- 1 - Site Profile
- 2 - Rezoning Sketch Map

SITE PROFILE

P07-54

REZONING OF 20.54 ACRES FROM RR TO R7.5 OR TO A MORE RESTRICTIVE ZONING DISTRICT, LOCATED ON THE EAST SIDE OF HUMMINGBIRD PLACE, SOUTH OF THREE WOOD DRIVE, SUBMITTED BY AVERETTE ENGINEERING COMPANY P.A., OWNED BY CASTLE HAYNE HOMES, LLC.

Site Information:

Applicant/Owner: AVERETTE ENGINEERING COMPANY P.A. / CASTLE HAYNE HOMES, LLC.

Area: 20.54 acres

Frontage & Location: 340 feet on Hummingbird Place

Depth: 2,230 feet

Jurisdiction: County

Adjacent Property: No

Current Use: Vacant

Initial Zoning: August 23, 1994 (Area 19)

Zoning Violation(s): None

Surrounding Zoning: North-A1, RR, R15, R10, East-A1, RR, R6, and South and West-A1, RR

Surrounding Land Use: Golf course, townhouses, nursery, single family residential, farmland and vacant land

Eastover Study Area Detailed Land Use Plan: Low Density Residential

Urban Services Area: Yes

Water/Sewer Availability: PWC / PWC

Soil Limitations: Yes – Stallings loamy sand and Woodington loamy sand

School Capacity/Enrolled: Armstrong Elementary 436/437, Mac Williams Middle 1274/1162, Cape Fear High 1400/1489

Subdivisions: Subdivision review, case 06-074, completed on 5/16/06.

Military Impact Area: No

Highway Plan: There are no road improvements or new construction specified for this area.

Average Daily Traffic Count (2004): 1400 on Hummingbird Place

Notes:

Case 06-074 was revised showing 40 lots; current zoning maximum density is 39 lots.

| | |
|----------------------------------|-----------------|
| Density minus 2.08 ac for roads: | RR – 39 lots |
| (18.23 ac balance) | R15 – 52 lots |
| | R7.5 – 105 lots |

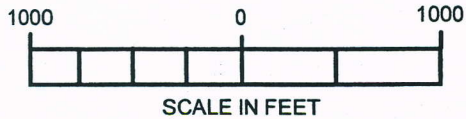
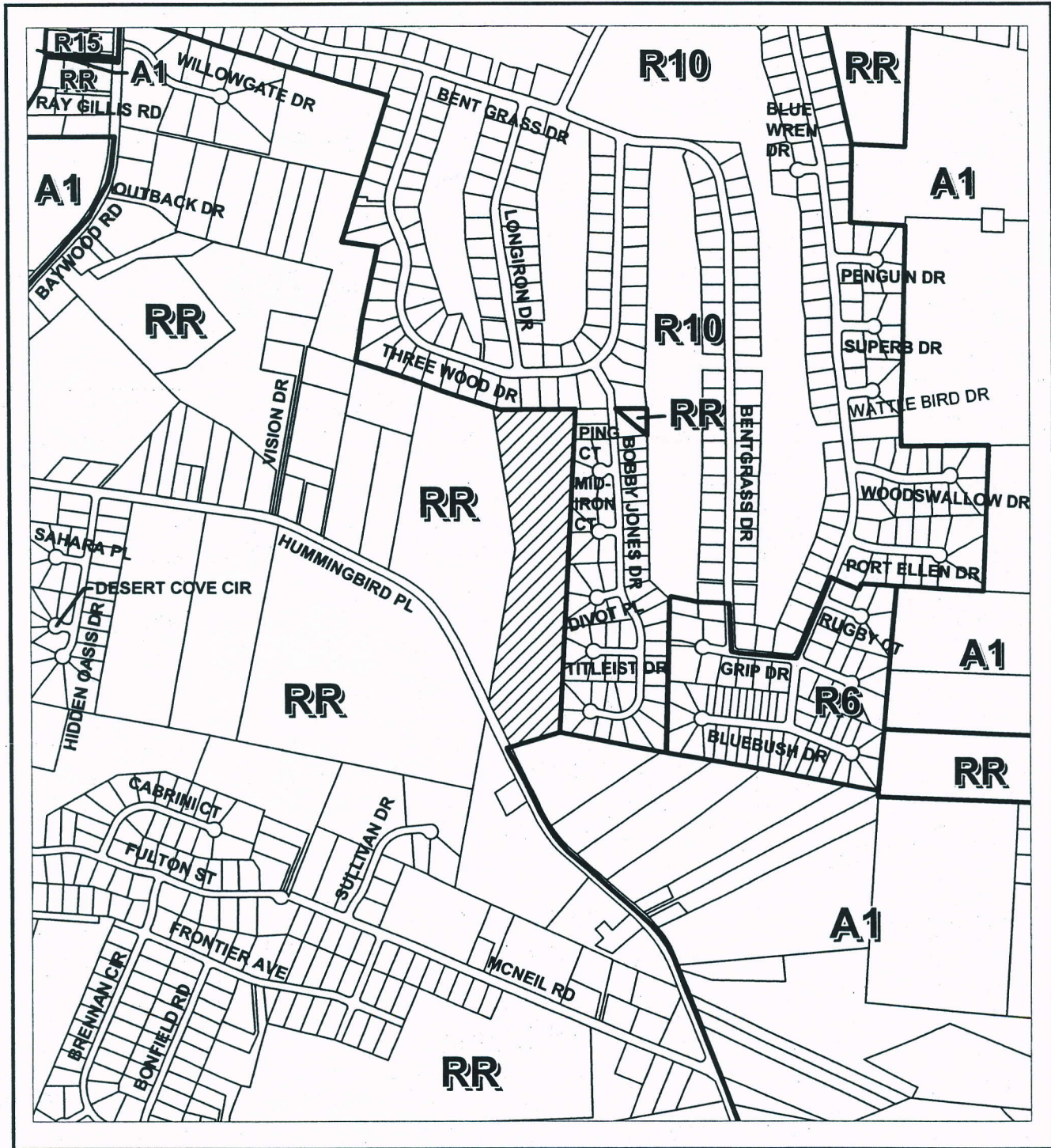

REQUESTED REZONING: RR TO R7.5

| | | |
|------------------------------|---------------------------|--------|
| ACREAGE: 20.54 AC.+/- | HEARING NO: P07-54 | |
| ORDINANCE: COUNTY | HEARING DATE | ACTION |
| PLANNING BOARD | | |
| GOVERNING BOARD | | |

Donovan McLaurin,
Chair
Wade, Falcon & Godwin

Lori Epler,
Vice-Chair
Cumberland County

Garland C. Hostetter,
Town of Spring Lake
Harvey Cain, Jr.,
Town of Stedman
Patricia Hall,
Town of Hope Mills
Charles C. Morris,
Town of Linden

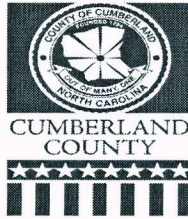

COUNTY of CUMBERLAND
Planning and Inspections Department

Thomas J. Lloyd,
Director

Cecil P. Combs,
Deputy Director

Clifton McNeill, Jr.,
Roy Turner,
Sara E. Piland,
Cumberland County

July 10, 2007

MEMORANDUM

TO: Cumberland County Joint Planning Board

FROM: Planning & Inspections Staff

SUBJECT: Staff Recommendation for July 17, 2007 Board Meeting

P07-59: REZONING OF 1.38 ACRES FROM R6A TO C(P) OR TO A MORE RESTRICTIVE ZONING DISTRICT, AT 2670 JOHN SMITH ROAD, OWNED BY DEAN H. & DAWN SMELCER, JR.

The Planning & Inspections Staff recommends denial of the C(P) district based on the following:

1. The request is not consistent with the 2010 Land Use Plan, which calls for Medium Density Residential at this location;
2. Rezoning is not in character with the zoning in the general area; and
3. Approval of the request will encourage the encroachment of non-residential zoning into an area intended for residential use.

There are no other suitable zoning districts to be considered for this site.

Attachments:

- 1 - Site Profile
- 2 - Rezoning Sketch Map

SITE PROFILE

P07-59

REZONING OF 1.38 ACRES FROM R6A TO C(P) OR TO A MORE RESTRICTIVE ZONING DISTRICT, AT 2670 JOHN SMITH ROAD, OWNED BY DEAN H. & DAWN SMELCER, JR.

Site Information:

Applicant/Owner: DEAN H. & DAWN SMELCER, JR.

Area: 1.40 acres

Frontage & Location: 201 feet on John Smith Road

Depth: 321 feet

Jurisdiction: County

Adjacent Property: None

Current Use: Residential

Initial Zoning: November 17, 1975 (Area 4)

Zoning Violation(s): None

Surrounding Zoning: North-R10, R6A, Hope Mills city limit-R6A, C3, East-RR, R10, R6A, M2, South-R10, M2, city limit-R10, R6A, C1(P), C(P), C3, and West-R6A, city limit-R6A, C3, C(P)

Surrounding Land Use: Car wash, alteration shop, barber shop, strip mall, automotive shop (2), knife shop, woodworking business, no name commercial, contractor's yard, vacant commercial, and single family residential

2010 Land Use Plan: Medium Density Residential

Municipal Influence Area: Hope Mills

Urban Services Area: Yes

Water/Sewer Availability: PWC / PWC

Soil Limitations: None

Subdivisions: A recombination plat and site plan approval will be required prior to any development.

Military Impact Area: No

Highway Plan: There are no road improvements or new construction specified for this area.

Average Daily Traffic Count (2004): 2000 on John Smith Road

Notes:

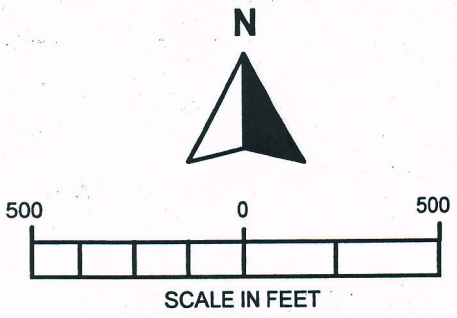
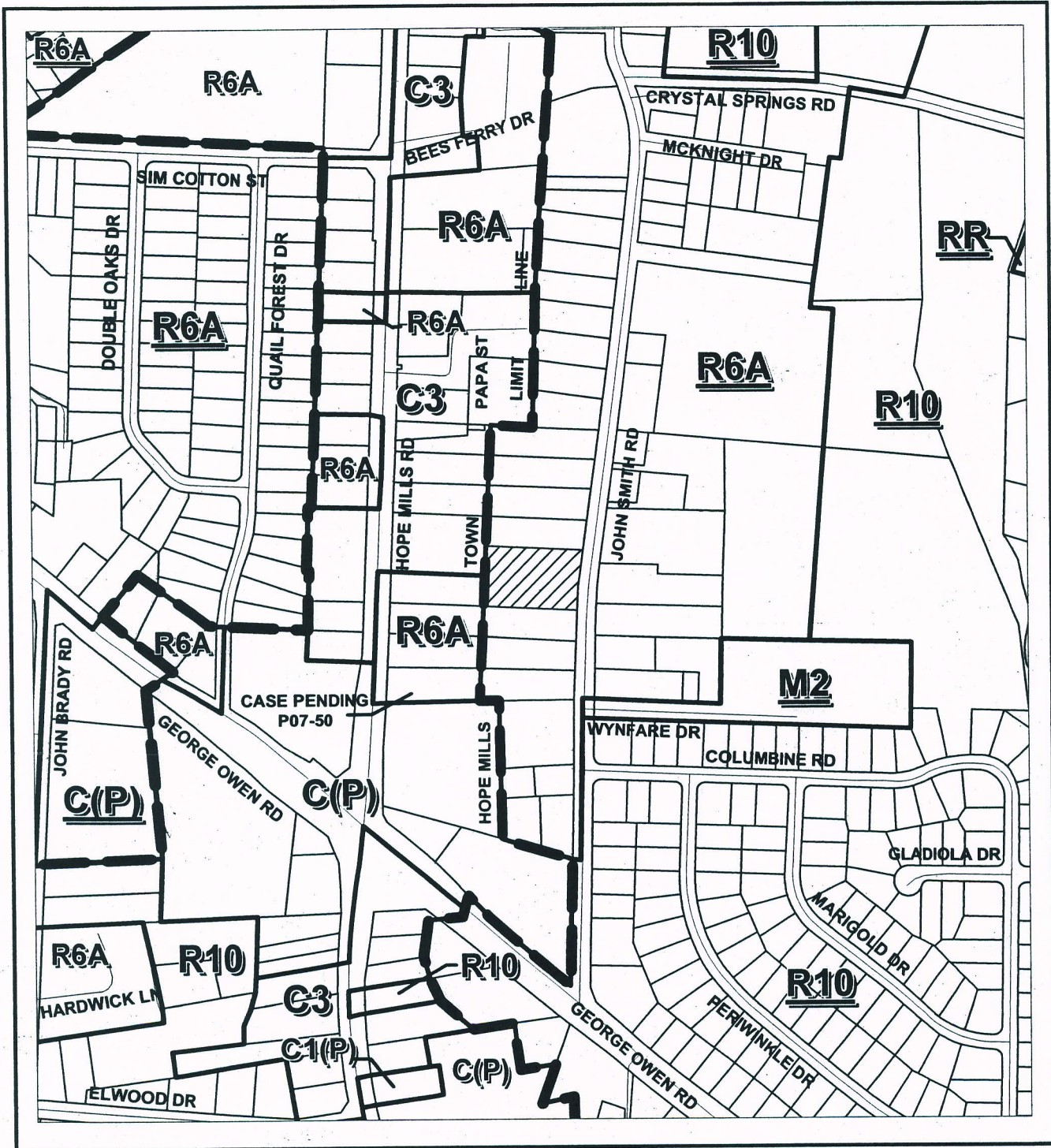

REQUESTED REZONING: R6A TO C(P)

| | | | |
|-----------------------------|--------------|---------------------------|--|
| ACREAGE: 1.38 AC.+/- | | HEARING NO: P07-59 | |
| ORDINANCE: COUNTY | HEARING DATE | ACTION | |
| PLANNING BOARD | | | |
| GOVERNING BOARD | | | |