

Intellian[®]

v60

Installation and Operation Manual

Serial number of the product

This serial number will be required for the all troubleshooting or service inquiries.

Intellian[®]

© 2017 Intellian Technologies, Inc. All rights reserved. Intellian and the Intellian logo are trademarks of Intellian Technologies, Inc., registered in the U.S. and other countries. The v-Series and the v60 are trademarks of Intellian Technologies, Inc. Intellian may have patents, patent applications, trademarks, copyrights, or other intellectual property rights covering the subject matter in this document. Except as expressly provided in any written license agreement from Intellian, the furnishing of this document does not give you any license to these patents, trademarks, copyrights, or other intellectual property.

All other logos, trademarks, and registered trademarks are the property of their respective owners. Information in this document is subject to change without notice.

Every effort has been made to ensure that the information in this manual is accurate. Intellian is not responsible for printing or clerical errors.

INDEX

CERTIFICATIONS	6
INTRODUCTION	9
Introduction to the Intellian v60	10
Features of the Intellian v60	11
System Configuration	12
INSTALLING THE ANTENNA	15
System Package	16
Planning the Installation	20
Antenna Installation	24
INSTALLING THE ACU	37
Mounting the ACU	38
Ship Gyrocompass Connection	40
PC to ACU Communication Setup	43
Wi-Fi Connection	45
OPERATING THE ACU	49
Introduction	50
Normal Mode	51
Setup Mode	55
Installation Settings	56
Antenna Settings	59
Satellite Settings	70
System Settings	77
ANTENNA CONTROL SOFTWARE	85
Introduction to Aptus®	86
Software Installation	87
PC to ACU Communication Setup	88
Toolbar Menus	91
System Property Status Dashboard	94
Work View Tabs	98
APTUS WEB	115
Introduction	116
Main Page	117
Antenna Settings	121
Firmware & Configuration	129
Administration	136
WARRANTY	145
APPENDIX	146
TECHNICAL SPECIFICATION	150
ENVIRONMENT SPECIFICATION	151

CERTIFICATIONS



R&TTE Declaration of Conformity (DoC)

We, Intellian Technologies, Inc. located at 2F Dongik Bldg., 98 Nonhyun-dong, Kangnam-gu, Seoul 135-080, Korea declare under our sole responsibility that the product(s) described in the below to which this declaration relates is in conformity with the *essential requirements* and *other relevant requirements* of the Radio and Telecommunications Terminal Equipment(R&TTE) Directive (1999/5/EC).

Product Information:

Product Name(s):	Intellian v60, 60cm Ku-band Maritime VSAT Antenna System Intellian v110, 105cm Ku-band Maritime VSAT Antenna System Intellian v130, 125cm Ku-band Maritime VSAT Antenna System
Model Number(s):	V1-60-XXX, V1-110-XXX, V1-130-XXX

To provide the presumption of conformity in accordance to Annex III(encompassing Annex II) of Directive 1999/5/EC; the following harmonized standards and normative documents are those to which the product's conformance is declared, and by specific reference to the essential requirements of Article 3 of the Directive 1999/5/EC.

1995/5/EC Article	Standard(s) Applied in Full	Date of Withdraw
SAFETY (Art 3.1.a)	IEC EN 60950-1: 2001 (1 st Edition)	Not Referenced
EMC (Art. 3.1.b)	IEC EN 60945: 2002 ETSI EN 301 489-1 V1.8.1: 2008	Not Referenced
SPECTRUM (Art. 3.2)	ETSI EN 301 428 V1.3.1: 2006-02 ETSI EN 302 340 V1.1.1: 2006-04	Not Referenced

Supplementary Information:

Notified Body Involved: (Testing Organization)	Nemko USA, Inc. 11696 Sorrento Valley Rd. Suite F San Diego, CA 92121-1024, USA ERI EMC Research Institute 66-6, Jeil-RI, Yangji-Myun, Cheoin-Gu, Yongin-Si, Gyeonggi-Do, Korea
Technical/Compliance File Held by:	Intellian Technologies, Inc. (R&D Department) 32-1-4 Block, Jinwi Industrial Park Jinwi-Myeon, Pyeongtaek-Si, Gyeonggi-Do, Korea
Place and Date of issue:	Seoul, Korea on 20 Oct 2010

Authority: Steve Cha
Director,
Research and Development

Signature: 

Date: 20 Oct, 2010

Intellian Technologies USA, Inc.
US Headquarters
9261 Irvine Blvd.
Irvine, CA 92618 USA
Tel: 949 916 4411

Intellian Technologies, Inc.
EMEA & APAC Headquarters
2F Dongik Bldg., 98 Nonhyun-dong
Kangnam-gu, Seoul 135-080, Korea
Tel: +82 2 511 2244

Doc Number IT10-DC1020-01

FCC Declaration of Conformity

Intellian Technologies, manufactures of stabilized maritime VSAT antenna systems for satellite communication at sea, supplies stabilized maritime VSAT antenna systems to the satellite communication service providers for their ESV (Earth Station on Vessels) networks.

FCC §25.222 defines the provisions for blanket licensing of ESV antennas operation in the Ku-band. It defines the antennas radiation, and each article regulates the followings;

§25.222 (a)(1)(i)(A): Regulation for Azimuth Direction & Co Polarization
§25.222 (a)(2)(i)(B): Regulation for Other Direction & Co Polarization
§25.222 (a)(1)(i)(C): Regulation for Cross Polarization

Intellian Technologies, Inc. declares that the below identified products comply with the threshold level as defined in §25.222(a)(1)(i)(A);, and declares that the products are in accordance with all defined regulations from §25.222(a)(1)(i)(B) to §25.222(a)(1)(i)(C) at the below stated input power spectral density, with an N value of 1.

Product description	EIRP spectral density limit
Intellian v60, 60cm Ku-band maritime VSAT antenna system	-22.3 dBW/ 4KHz
Intellian v110, 105cm Ku-band maritime VSAT antenna system	-16.2 dBW/ 4KHz
Intellian v130, 125cm Ku-band maritime VSAT antenna system	-14.0 dBW/ 4KHz

Intellian Technologies, Inc. declares that the above antennas will maintain a pointing error of less than or equal to 0.2 degree under specified ship motion conditions in accordance with the requirements of §25.222 (a)(1)(ii).

Intellian Technologies, Inc. declares that the above antennas will automatically cease the transmission within 100 mute command to the modem within 100 milliseconds if the target satellite and the axis of the main lobe of the ESV antenna exceeds 0.5 degree and will not resume until such angle is less than or equal to 0.2 degree in accordance with the requirements of §25.222 (a)(1)(iii)

Radiation pattern data is available upon request to verify the conformance.

Authority: Steve Cha
Director,
Research and Development

Signature: 

Date: Aug 01, 2010

INTRODUCTION

Introduction to the Intellian v60

Features of the Intellian v60

System Configuration

Introduction to Intellian v60

The Intellian v60 is a 60 centimeter (23.6 inch) Ku-band, three-axis stabilized VSAT antenna system capable of receiving SCPC, MCPC, TDMA or Spread Spectrum transmissions. Designed for ocean vessels in the recreational, commercial or oil and gas market segments, as well as military vessels, the v60 offers "always on" high-quality broadband communications, in even the roughest weather and sea conditions.

The v60 provides seamless, uninterrupted broadband connectivity for worldwide on-demand communications, is compatible with a comprehensive list of service providers and ensures professional mariners and yacht owners reliable, unlimited connectivity at sea.

The v60 offers a wide -10° to 100° elevation range and unlimited azimuth, eliminating cable wrap and the lengthy loss of signal connection as the system unwinds. It is ideal for mission critical operations, such as surveillance or vessel monitoring, that require uninterrupted connectivity, or in Voice over Internet Protocol (VoIP) communication and information downloads where signal loss is unacceptable.

An open platform, the v60 is compatible with any modem and supports 4-, 6- and 8-Watt BUCs, providing owners the flexibility to choose the service and communications speeds that is right for their needs.

The unit is designed to making it easier for owners, operators and installers to add new features when updating firmware, and even offers a "roll back" function that resets the firmware to a previous version. The v60 offers seamless remote monitoring and control and a power switch on the ACU's front panel for your convenience.

Features of Intellian v60

Enjoy always-on broadband connection at sea

Intellian v60 is the most modern communication system that offers a high-speed and always-on broadband connection at sea, where the atmospheric and environmental conditions are often harsh.

Gyro-free satellite search capability

Intellian's new generation gyro-free satellite search function enables the v60 to acquire and lock onto the satellite without requiring a separate input from the ship's gyrocompass.

Wide elevation range

The v60 has a wide elevation range from -10° to 100° , respectively which offer seamless signal reception while the vessel is traveling near the Equator or polar regions.

Dedicated Management Ethernet Port

The Management Ethernet Port on the front of the ACU enables direct and simple network connection between a PC and the ACU. The Management Port supports DHCP network connection by default, allowing automatic IP configuration and quick access to Intellian's remote management solution, the Aptus Web software.

Wireless Connectivity and Aptus Mobile

The built-in Wi-Fi enables the ACU to be wirelessly connected and can be turned on or off. Any kind of wireless devices such as PCs, laptops and smartphones can be used to connect to the ACU and monitor, control and change the settings of the system wirelessly. An Intellian Aptus Mobile App is available for download to access to the ACU via Wi-Fi and operate the antenna from iPhone, iPad or other network devices.

Intellian Network Device Monitoring

Connection between the Intellian LAN port on the ACU to other Intellian antenna systems enables real time monitoring and control of the connected systems from the v60. This function provides an integrated control of multiple devices by a single log-in to the Intellian Aptus Web software.

System Configuration

For your satellite communication system to work properly, the system will have to be connected with all of the provided components properly, as shown in the figure below. Separate purchase of a satellite modem, ship's gyrocompass, and Intellian Dual VSAT Mediator are required.

NOTE: BUC power should set to ON from the modem when you connect to a 4W BUC. BUC power should set to OFF from the modem when you connect to an 8W BUC.

Basic System Configuration (8W BUC)

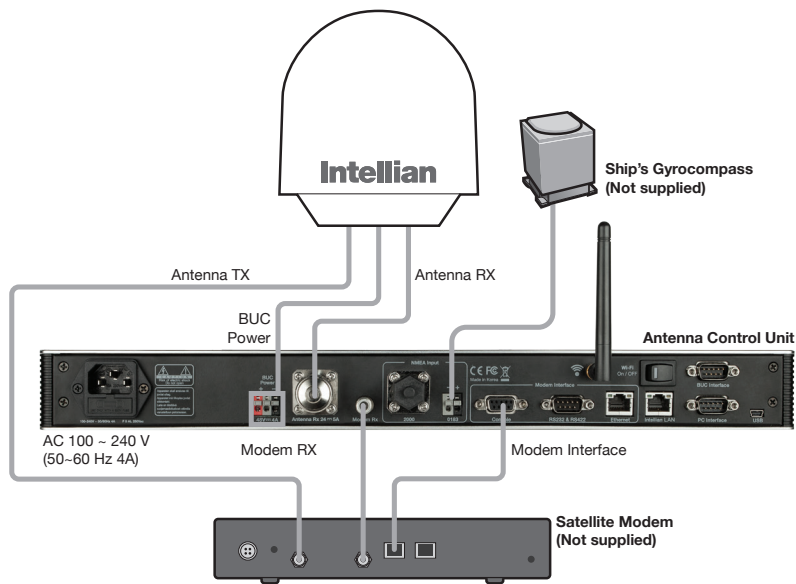

Basic System Configuration (4W BUC)

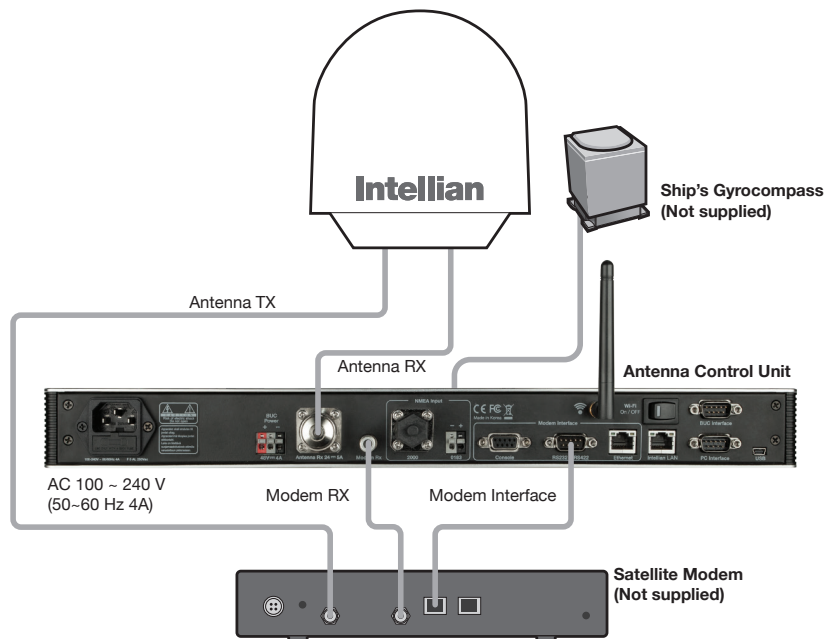

Dual System Configuration
(8W BUC)

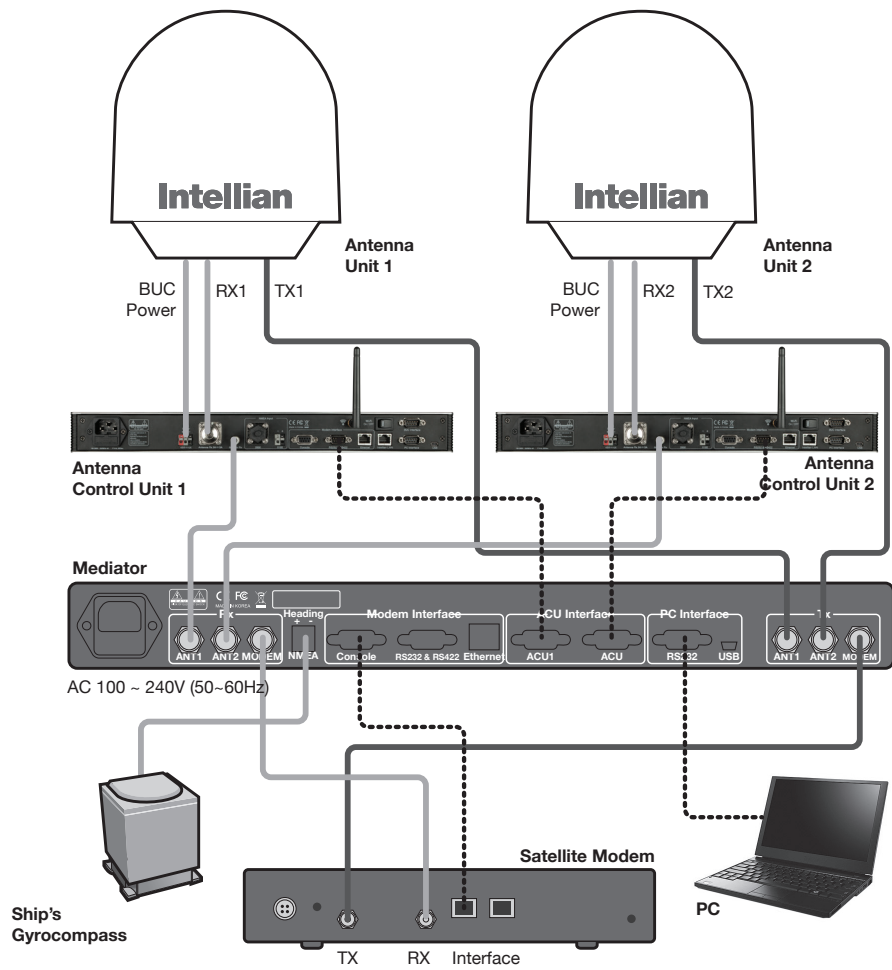

INSTALLING THE ANTENNA

System Package

Antenna Unit

ACU (Antenna Control Unit)

Installation Kit

Planning the Installation

Selection of Antenna Installation Site

Configure Radiation Hazard/Blockage Zones

System Cables

Power Requirement

Tools Required for Installation

Antenna Installation

Unpacking the Wooden Crate

Antenna Dimensions

Antenna Mounting Templates

Installing the system cables

Mounting the Radome

RF Cable Connections

Position the Radome

Mast design recommendation

System Package

The package of the Intellian v60 consists of antenna unit, ACU and installation kit box.

Antenna unit



ACU



Installation kit box

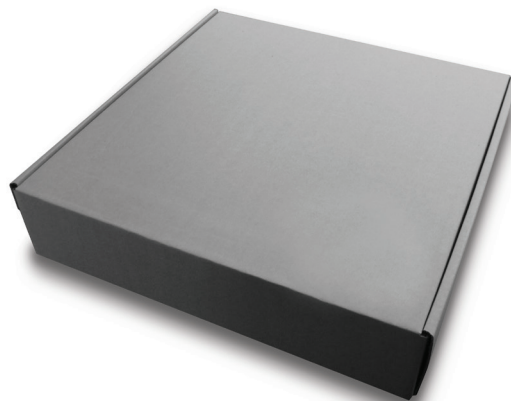

Antenna Unit

The antenna unit includes an antenna pedestal inside a radome assembly. The pedestal consists of a satellite antenna main dish with RF components mounted on a stabilized pedestal. The radome protects the antenna pedestal assembly from the severe marine environment.

Antenna Unit



ACU (Antenna Control Unit)

ACU provides power to the antenna and Block Up Converter (BUC). The digital Vacuum Fluorescent Display (VFD) allows for easy operation of the ACU, even in the dark.

Antenna Control Unit



Rear panel



Front panel



The functions of the ACU are as follows:

- System startup
- Setting the satellite
- Editing satellite information
- Setting the antenna parameter
- Setting the antenna manual search
- Setting the LNB local frequency
- Setting radiation hazard or blockage zone
- Setting modem connections
- Setting GPS and Gyrocompass
- Display power status
- Performing diagnostic tests
- Backup and restore the system settings
- Set up the interface with a PC
- Supports Wi-Fi ACU operation
- Recording antenna activities and firmware upgrade through USB
- Built-in web-based remote control management
- Front panel Management Ethernet port

Installation Kit

Contains the items required for securing the antenna unit and ACU to the vessel.

ACU box			
Description	Q'ty	Size	Remarks
Antenna Control Unit (ACU)	1	43.1 x 38 x 4.4cm	Antenna Control Unit
User Manual	1		
RF Hazard Sticker	1		Radiation Safety Distance Label
Mounting Template	1		
Wi-Fi Antenna	1	110mm	
USB Flash Drive	1		

Other Components

Components box			
Description	Q'ty	Size	Remarks
ACU Bracket (Rack)	2		ACU-19inch Rack
ACU Bracket (Table)	2		ACU-Table
RG6 Cable	1	3m	ACU to Modem
BUC Power Cable	1	15m	Antenna to ACU
AC Power Cord (CEEE7/7)	1	1.5m	ACU Power
AC Power Cord (USA)	1	1.5m	ACU Power
PC Serial Cable	1	1.8m	ACU to PC
USB Cable (A-A)	1	1.8m	ACU to PC
Ethernet Cable (RJ45/LAN)	1	1.5m	ACU to PC
iDirect Interface Cable	1	1.5m	ACU to Modem
D-sub 9 pin Male Connector	2	-	ACU
N to F Adaptor	1		N(Male) to F(Female) Adaptor
Hex. Bolt	5	M8 x 50L	Antenna mounting 4 Sets, Spare 1 Set
Flat Washer	5	M8	
Spring Washer	5	M8	
Hex Head Wrench Bolt	5	M6 x 40L	Radome (Spare Bolts)
Spring Washer and Flat Washer	5	M6	
Self-Tapping Screw	5	Ø4 x 16	Table Mount Bracket
Flat Head Screw	10	M4 x 12L	Rack Mount Bracket ACU
Sems Bolt	5	M3 x 12L	Table Mount Bracket ACU

Planning the Installation

Selection of Antenna Installation Site

Install the antenna in accordance with the following procedures to ensure maximum performance of the antenna. The ideal antenna site has a clear view of the horizon or satellite all around. Please be sure there are no obstacles within 15° above the center of the antenna. Any obstacles can prevent the antenna from transmitting and receiving the satellite signal.

Do not install the antenna near the radar especially on the same plane as the microwave radar transmissions as these will overload the antenna front-end circuits. It is recommended to position the antenna at least 4 feet (1.2 m) above or below the level of the radar and minimum of 15 feet (4.6 m) away from any high power short wave radars.

The mounting platform should be robust enough and not subject to vibration. The movement of the antenna can be minimized by installing at the center of the vessel. If these conditions can be only partially satisfied, find the best compromised installation site between the various considerations.

Elevation Limit
of Obstacles

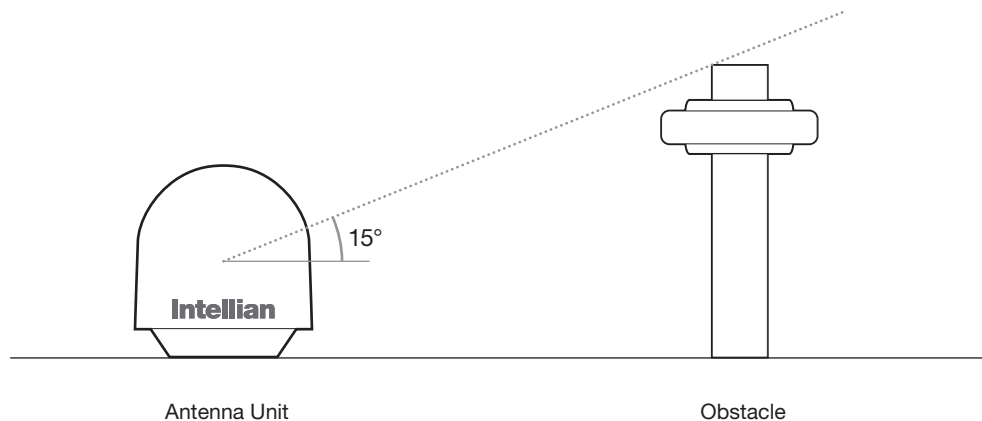

Configure Radiation Hazard/Blockage Zones

It is important to set up the radiation hazard or blockage zones for Intellian VSAT communication systems. The ACU can be programmed with relative azimuth and elevation sectors to create up to five zones where transmit power could endanger personnel who are frequently in that area or blockage exists. Several indications are provided when the antenna is within one of these zones.

1. "BLOCK" will be displayed on the ACU screen.
2. Tracking continues as long as the signal level is greater than the predefined threshold value. When the signal level drops below the threshold value the antenna will wait "Search Wait Time" parameter amount of time and re-target the satellite last targeted. The antenna will continue to re-target the satellite until the satellite is re-acquired and tracking can be resumed.
3. A transmit inhibit output from the ACU will disable/mute the modem transmission.

RF Hazard Precautions

The antenna is designed to be used with radiation transmit equipment manufactured by others. Exposure to RF radiation, including exposure associated with an improper use of the transmit equipment, may be hazardous to persons close to the above deck unit. Ensure safety of personnel who work on the system.

During transmission, ensure to keep the minimum safety distance. The recommended minimum safety distance to the reflector on the focal line is about 15m, based on a radiation level of 5mW/cm² that applies under occupational/controlled environment. No hazard exists >10° below the antenna's mounting plane.

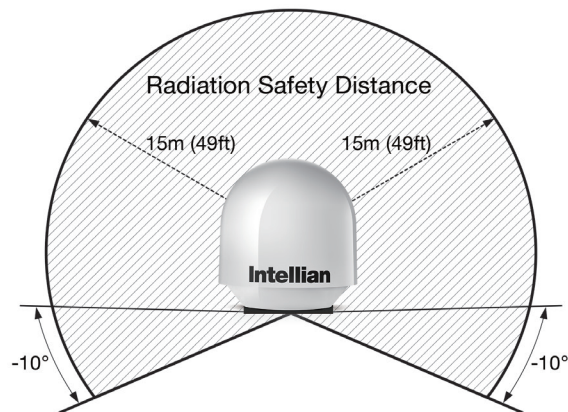

Safe access from radiation hazard

System Cables

Before installing the system cables, you need to take the following points into consideration.

1. All cables need to be well clamped and protected from physical damage and exposure to heat and humidity.
2. Cables with a tight bend radius should be avoided.
3. Where a cable passes through an exposed bulkhead or deck head, a watertight gland or swan neck tube should be used.

• **RF Cable (Customer Supplied)**

Due to the signal losses across the length of the RF coax on L-Band, Intellian recommends the following 50ohm coax cable types for standard system installations. For cables that run longer than 150 meters, please consult Intellian Technologies.

Recommended
RF Cables

Coaxial Cable Type	Attenuation in dB/100M	Attenuation in dB/M	Recommended Cable Length
LMR300	30.3	0.303	35M
LMR400	19.6	0.196	60M
LMR500	15.9	0.159	80M
LMR600	12.8	0.128	100M
LMR900	8.6	0.086	150M
LMR1200	6.5	0.065	200M

• **Gyro Compass / GPS Interface Cable (Customer Supplied)**

Type	Multi-conductor, Shielded
Number of wires	2 conductors for NMEA 0183, 5 conductors for NMEA 2000

Power Requirement

Intellian v60 has been designed to work on a vessel’s power supply rated at 100-240 V AC.

Tools Required for Installation

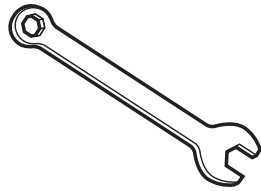

8 mm Spanner

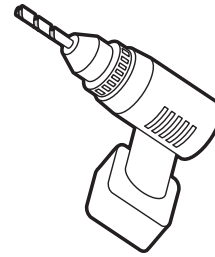

Power Drill

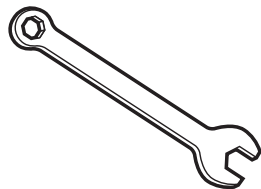

11 mm Spanner

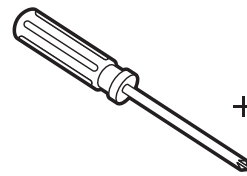

Phillips Head Screwdriver

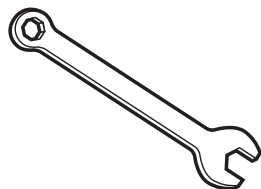

13 mm Spanner

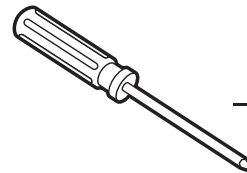

Flat Head Screwdriver

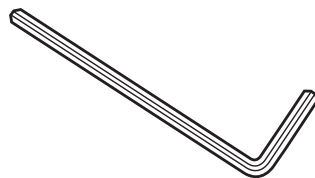

4 mm Allen/Hex key

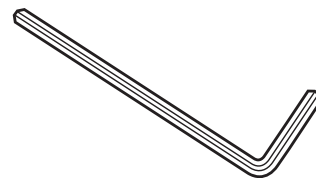

5 mm Allen/Hex key

Antenna Installation

Unpacking the wooden crate of v60

Step 1.

Remove the top panel and 8 pins from the hinges of the wooden crate.

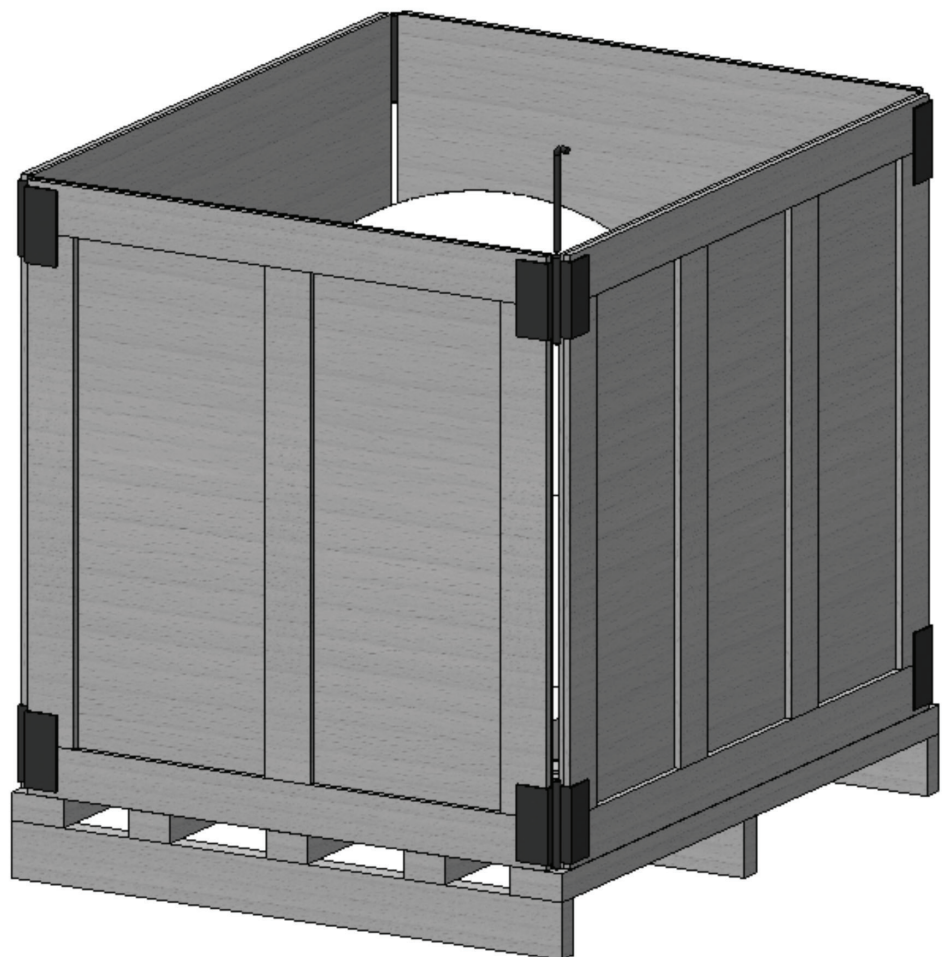

Step 2.
Remove ACU box and installation kit box.

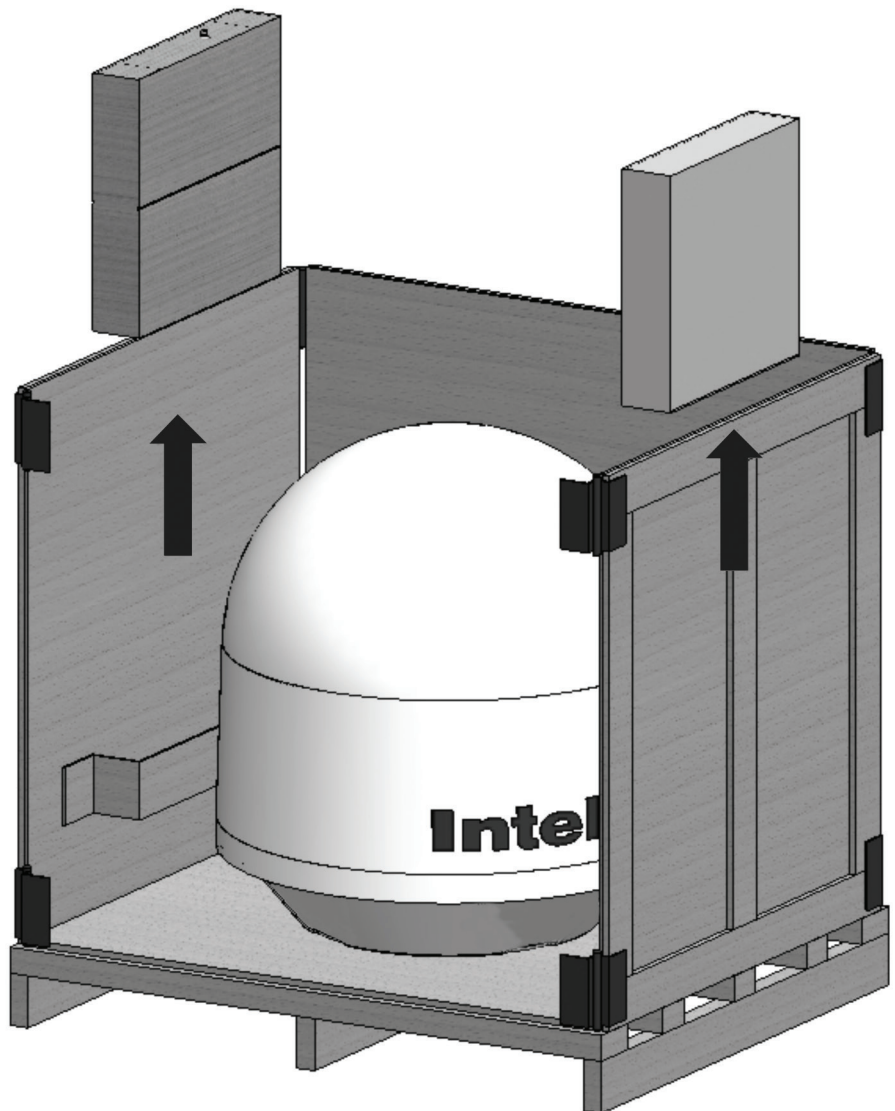

Step 3.

Remove 4 shipping bolts that mount the antenna to the pallet.

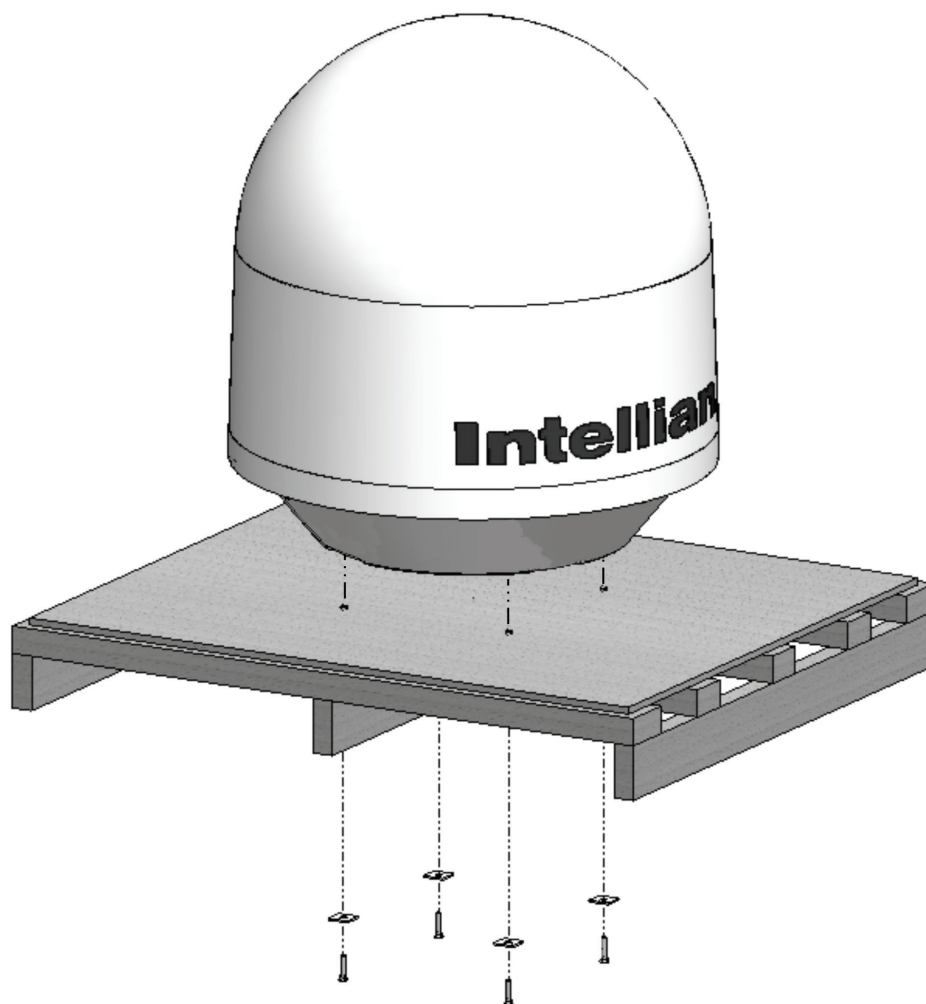

WARNING: When lifting the antenna by using the lifting strap, ensure to disassemble the antenna and the pallet.

Step 4.

Open the top radome and remove the shipping restraints
(bracket mounted to the antenna pedestal and tie wrap fixing the azimuth axis).

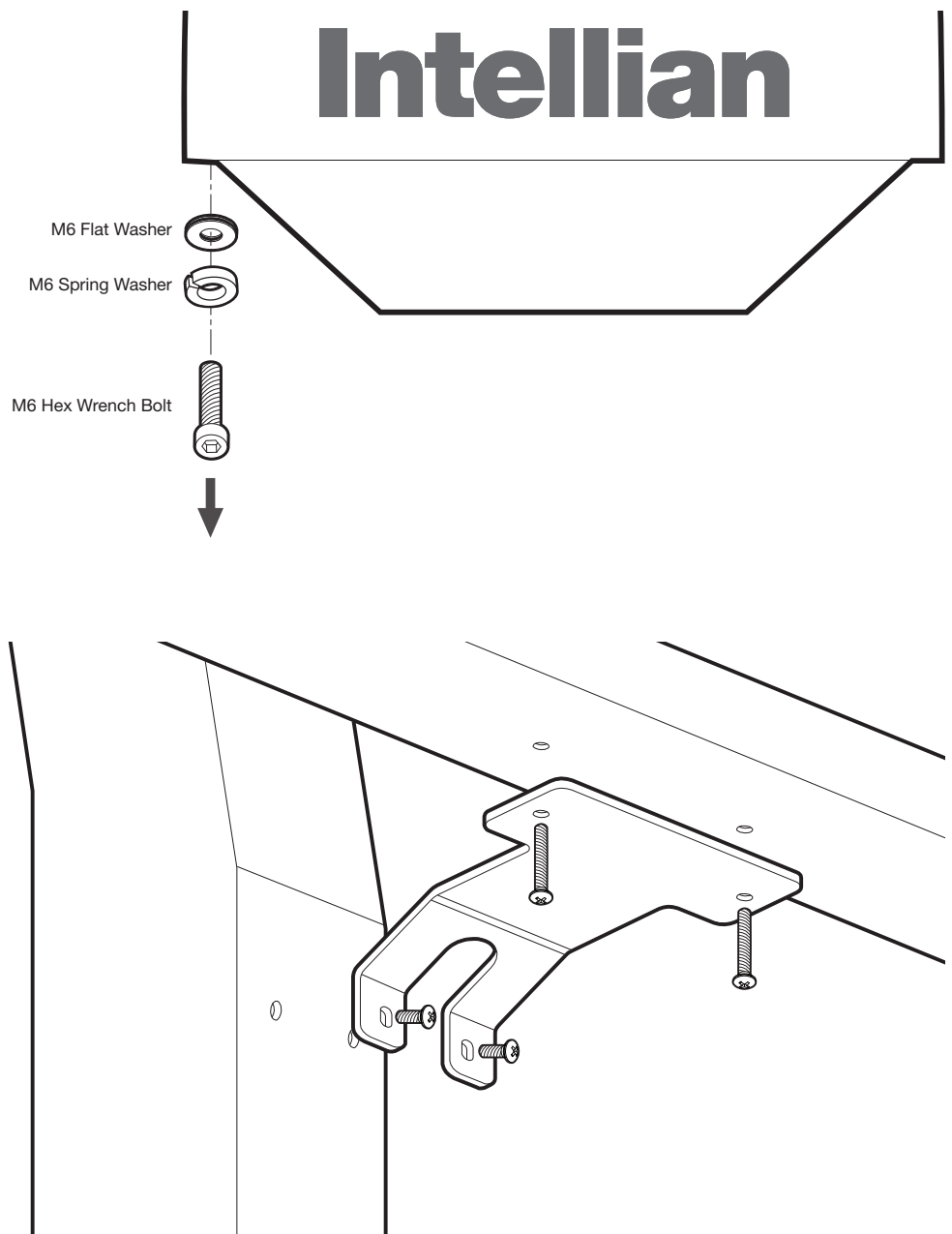

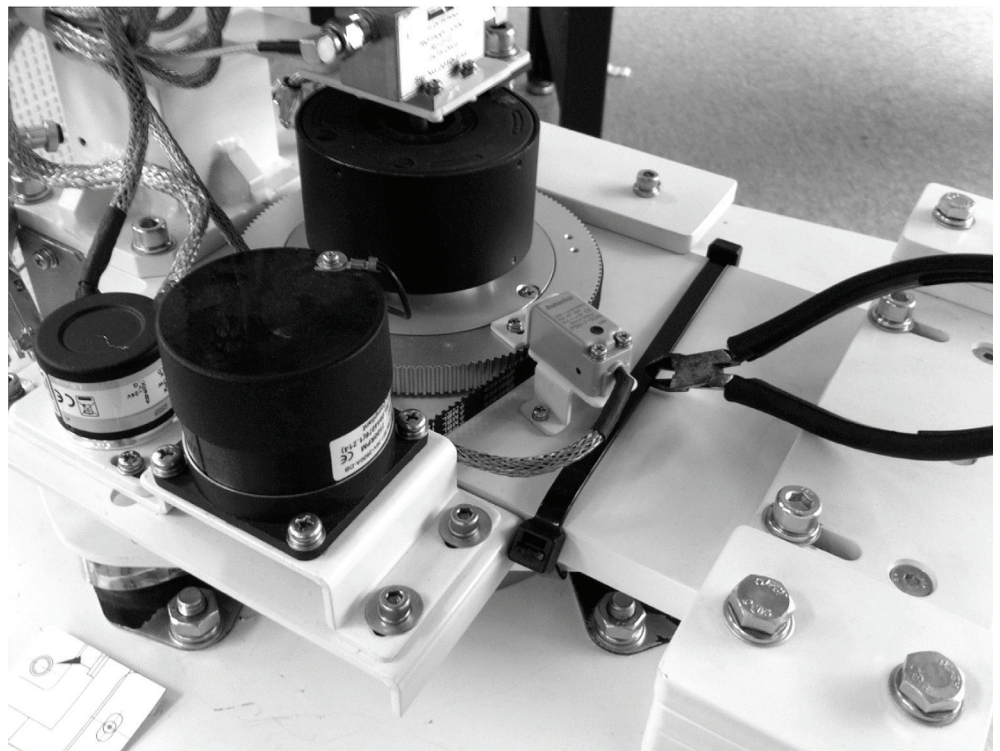

Antenna Dimensions

The method of installation and mounting of antenna may vary with vessel design but the following procedures are applicable in most situations, and will result in a secure and effective installation. Confirm the height and diameter of the antenna before installing it.

Radome Dimensions



Antenna Mounting Templates

The mounting holes must be in the exact same place as shown in the diagram below.

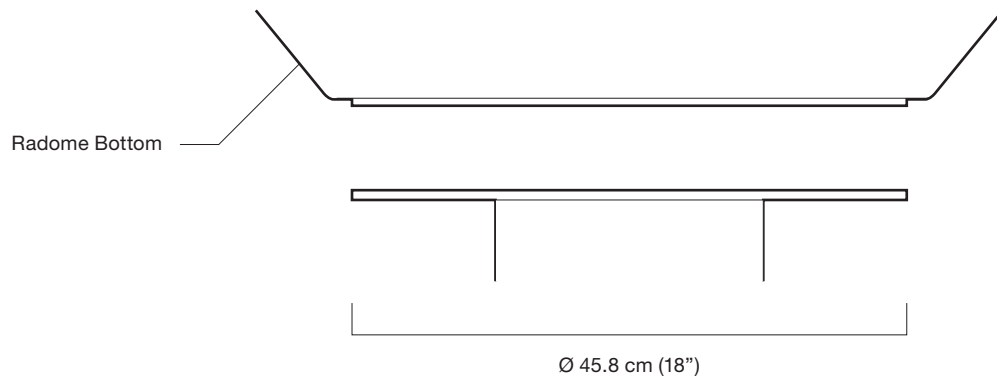
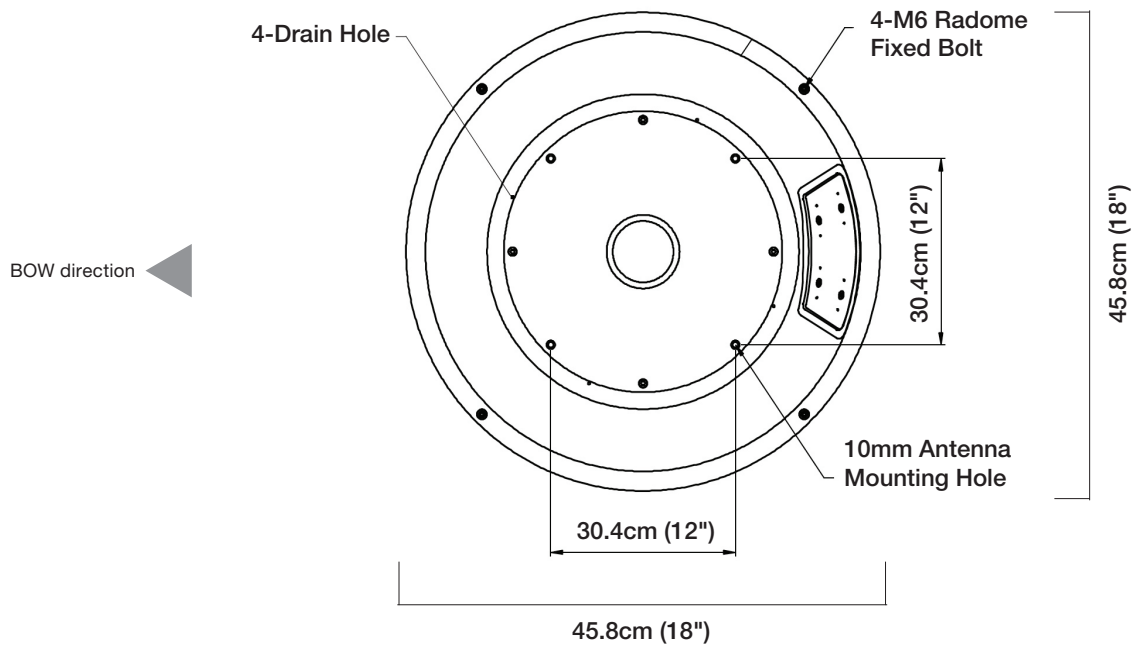

Installing the System Cables

The cables must be routed from the antenna through the deck and through various ship spaces to the antenna control unit. When pulling the cables in place, avoid sharp bends, kinks, and the use of excessive force.

Cable Entry

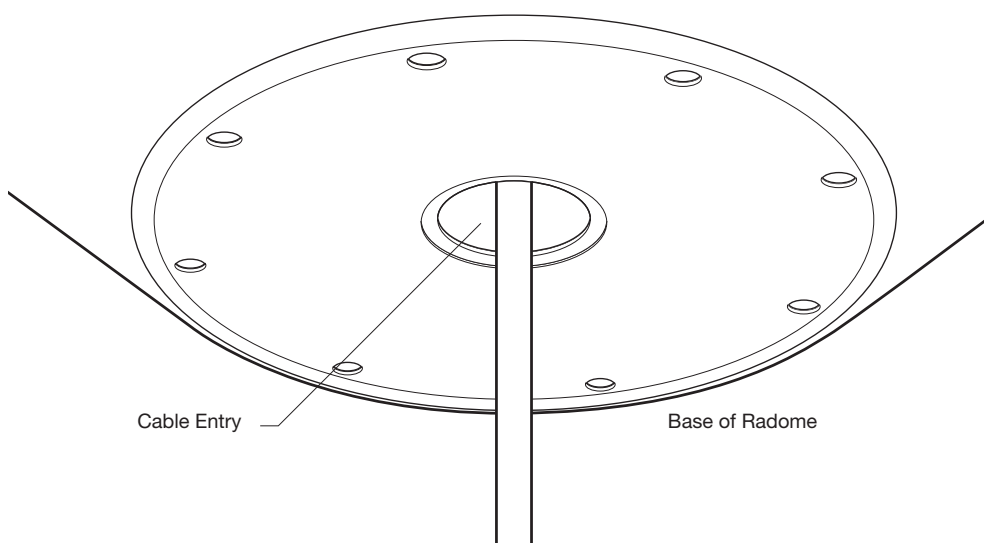

Mounting the Radome

Bolt the radome base directly to the support pedestal. Ensure that the center hole of the radome base should be sealed with waterproofing compound if the radome is not mounted on the support pedestal. Ensure to use the Intellian supplied bolts from the accessory box when you mount the radome.

Mounting the Radome

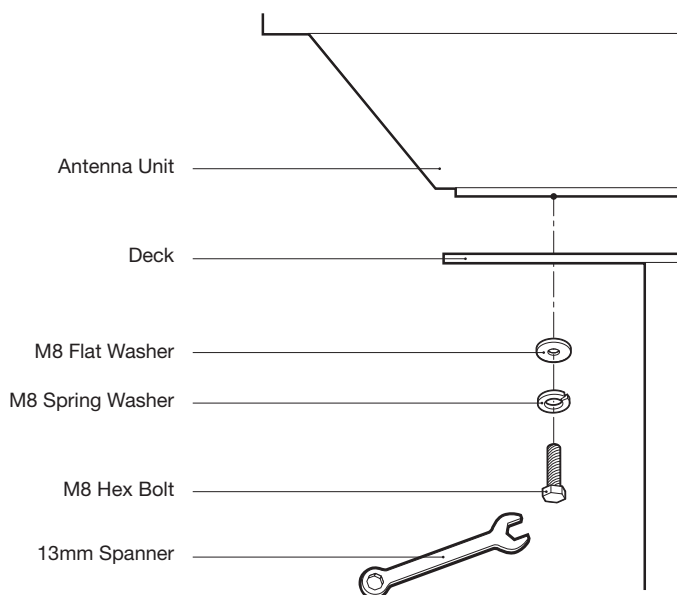

RF Cable Connections

Ensure that the power switch is off during the installation period and all the cables are connected properly between the antenna control unit and the power switch box. Using tie wraps supplied with radome, secure the RF cables connected to the power switch box. When all the hardware and cable have been installed, turn on the power switch.

Cable Connections on Power Switch Box (8W BUC)

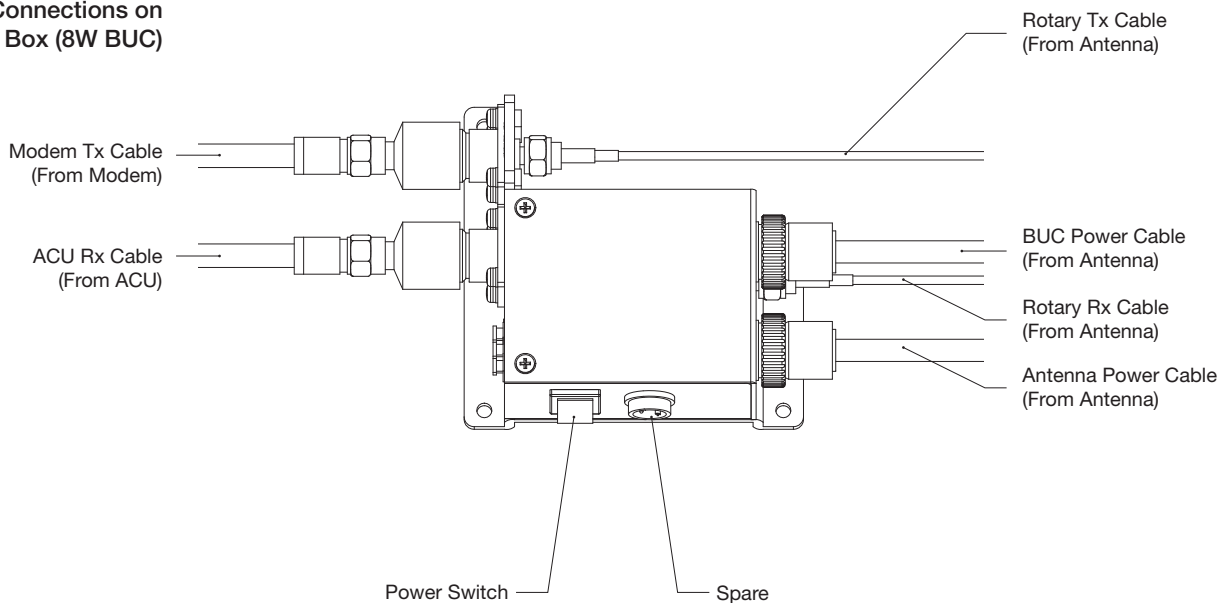

Reinstall the top radome.

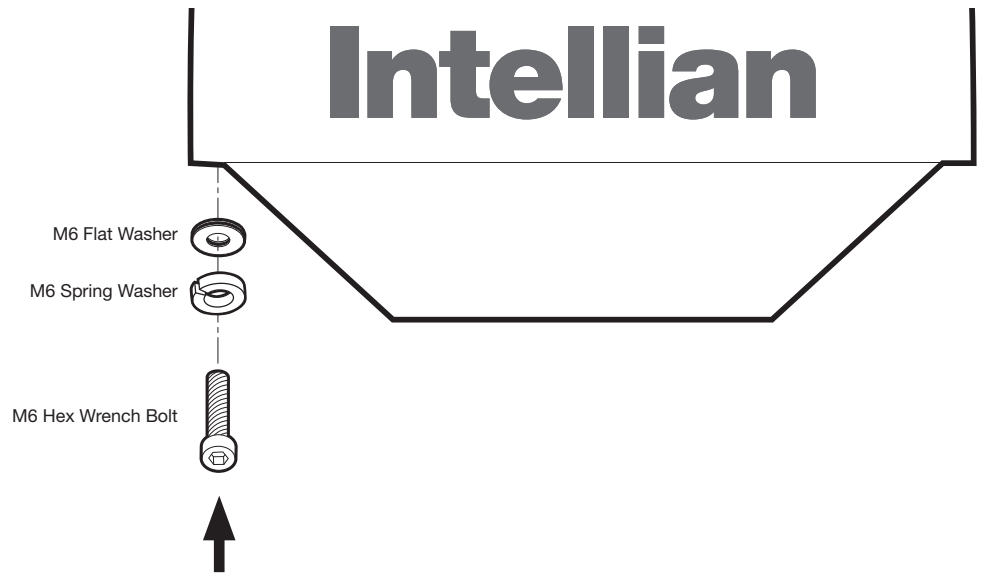

Note: Make sure to use the Intellian supplied bolts from the accessory box when you reinstall the top radome. Apply Loctite #262 or equivalent to the bolt thread, and fasten it to a torque setting of 3.5Nm.



WARNING: The elevation and cross-level motor brakes prevent dish damage while the antenna is in power off mode. However, Intellian strongly recommends to restrain the antenna pedestal properly while underway when power is removed from the antenna. The normal operating condition for the v60 is to remain powered up at all times.

Position the Radome

The radome should be positioned with the BOW marker aligned as closely as possible to the ship's centerline.

Recommended size of the support pedestal

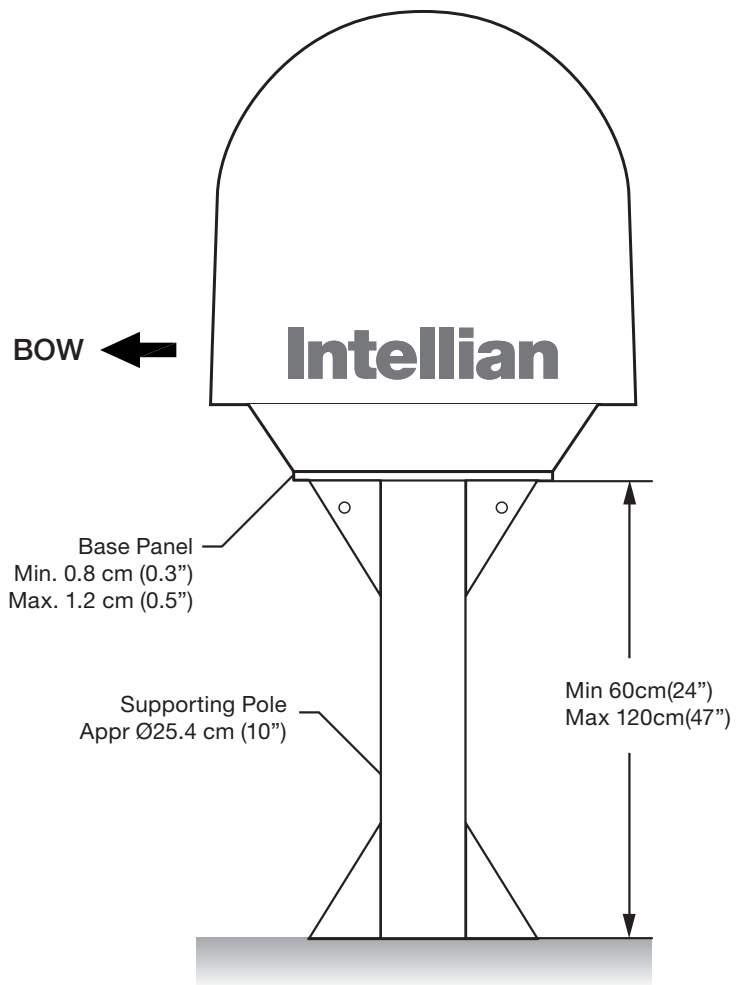

Mast design recommendation

Intellian strongly recommends installing the antenna less than 1200mm (47") above the deck. If the antenna has to be installed more than 1200mm (47") above the deck, be sure to install it in a safe place where there is enough space to set the radome aside in case of repair. But once again, the best place for the antenna would be less than 1200mm (47") above the deck.

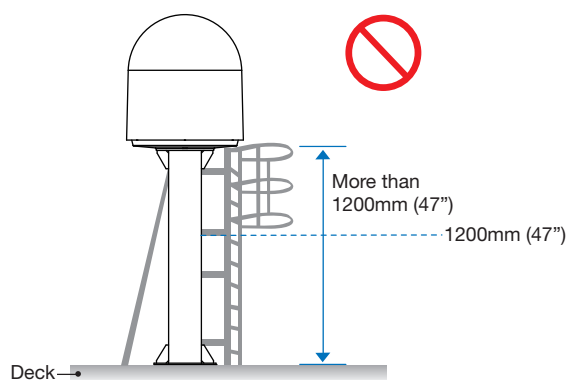
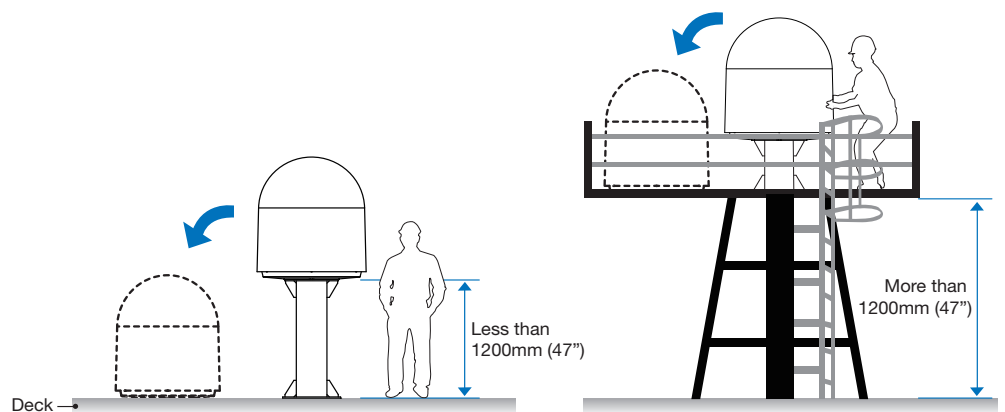

WARNING: Do not install unless you secure enough space to repair. Intellian strongly recommends installing the antenna less than 1200mm (47") above the deck.

INSTALLING THE ACU

Mounting the ACU

19" Rack Mount Type

Table Mount Type

ACU Dimensions

Selection of ACU Installation Site

Ship Gyrocompass Connection

Connecting the System with a Ship's Gyrocompass

Connecting the System without a Ship's Gyrocompass

ACU Connector Guide

PC to ACU Communication Setup

Wi-Fi Connection

Mounting the ACU

Intellian supplies two types of mounting methods (a) 19" Rack Mount Type and (b) Table Mount Type to mount your ACU.

19" Rack Mount Type

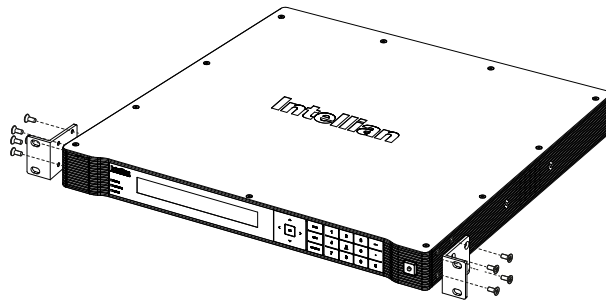

19" Rack Mount Type

- The ACU should be installed using the two supplied Rack Mounting Brackets which allow for a side 19" rack mounting configuration.
- Using the self tapping screws supplied, attach the mounting brackets to the sides of the ACU.
- Place the ACU in the location where it is going to be installed.
- Connect the cables to the rear of the ACU.

Table Mount Type

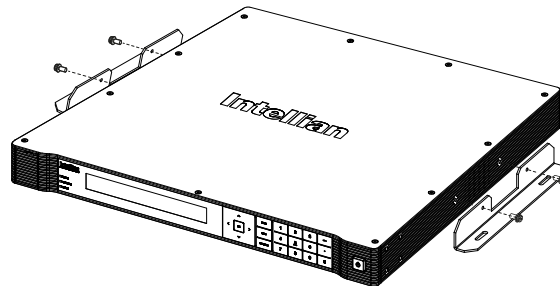

Table Mount Type

- The ACU should be installed using the two supplied Table Mounting Brackets which allow for a top or bottom mounting configuration.
- Using the self tapping screws supplied, attach the mounting brackets to the sides of the ACU.
- Place the ACU in the location where it is going to be installed.
- Using a pencil to mark the 4 hole positions (2 each side), and use the appropriate drill bit to screw down the brackets.
- Connect the cables to the rear of the ACU.



WARNING

WARNING: Ensure that the cables connected to the ACU are long enough to prevent damage when the ACU is pulled out from the rack.

ACU Dimensions

Dimension of ACU

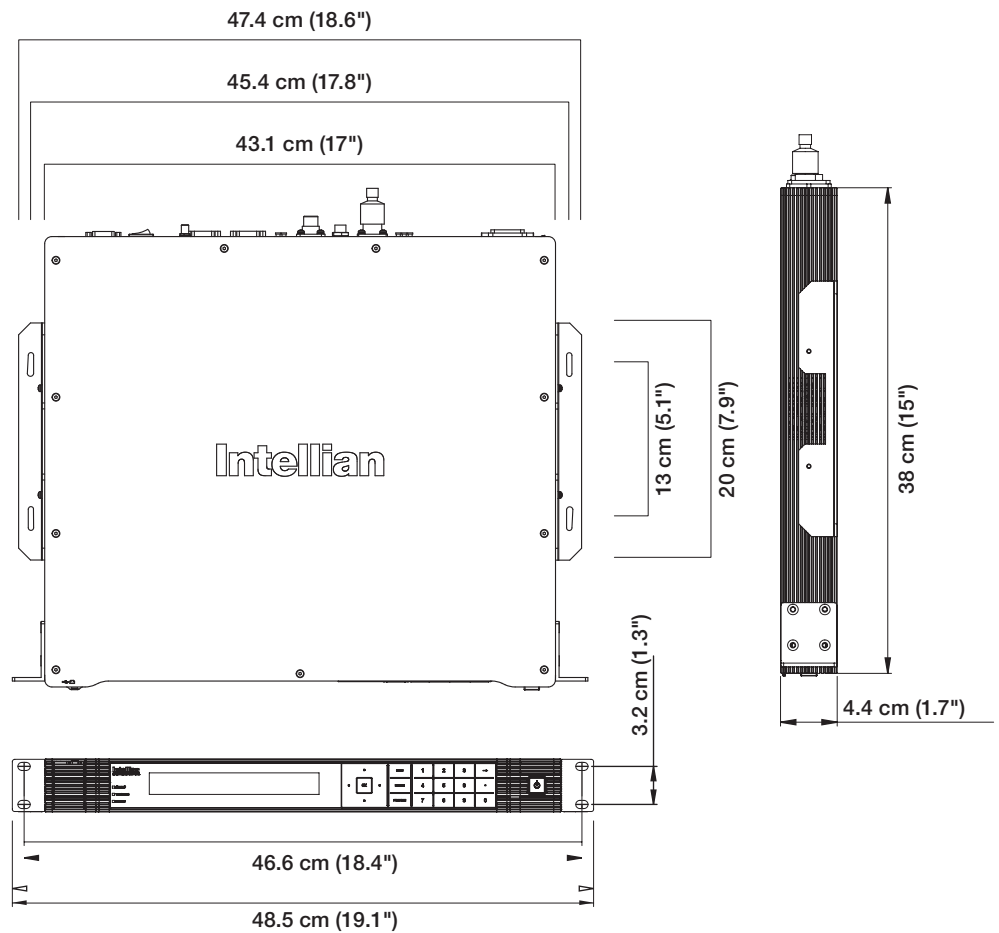

Selection of ACU Installation Site

The ACU should be installed below deck, in a location that is:

- Dry, cool, and ventilated.
- The front panel should be easy accessible to user.

Ship Gyrocompass Connection

Connecting the System with a Ship's Gyrocompass

The ship's gyrocompass provides true heading input to the antenna which easily allows the antenna to target and acquire the desired satellite. Therefore, Intellian always recommend to connect a ship's gyrocompass to the antenna through the gyrocompass interface on the ACU. If the ship's gyrocompass output is other than NMEA 0183 and NMEA 2000, a purchase of an NMEA converter is required.

- NMEA 0183 Gyrocompass Interface Cable (Customer supplied)
- Connector Type: 2 conductors for NMEA 0183, Mini-C 5 pin for NMEA 2000
- NMEA heading sentence: xx HDT (4800 Baud, 8, N,1) If there is no HDT sentence then use HDM sentence instead.
- NMEA 2000 heading PGN Number = 127250 (Vessel Heading)

Ship's Gyro Connection



Strip the cable for 5 mm (0.2")
Do not solder the cable

Connecting the System without a Ship’s Gyrocompass

For a vessel where the ship’s gyrocompass is not installed or is difficult to connect, the Intellian Gyro-Free satellite search function will be automatically enabled to allow the antenna to lock onto the desired satellite without requiring an external heading input.

The table below provides an example of the Gyro-Free satellite search algorithm. The Search 1 or Search 3 satellite search pattern will be triggered according to the existence of heading input and the setting of the heading device.

Search 1: The antenna will search for the target satellite by turning its azimuth angle in CCW(Counter Clockwise) direction until the antenna receives the lock signal from the modem or the DVB(Digital Video Broadcasting) transponder of the target satellite is decoded by the antenna.

Search 3: The antenna will search for the target satellite by turning its azimuth angle directly to the position calculated using the ship’s heading input and lock onto the satellite.

Existence of Heading Data	Setting of Heading Device		
	No Device	NMEA / NMEA 2000	Ground Test
w/ Heading Data	Search 1	Search 3	Search 3
w/out Heading Data	Search 1	Search 1	Search 3

Quick Setup Procedure

- Set the satellite having DVB transponder as the target satellite.
- Set “No Device” to the heading device.
- The antenna will search for the target satellite by turning its azimuth angle in CCW direction and lock onto the satellite signal until the antenna receives a lock signal from the modem or the DVB transponder of the target satellite is decoded.
- Set the heading device as NMEA Enter “Manual search” menu and press
- “Function” key to save the current settings. Intellian ACU will automatically calculate and save the BOW offset.
- Upload the real TARGET satellite pre-configured from the library.

ACU Connector Guide

• Console Port

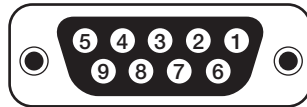

ACU Console Port
D-Sub 9 pin Female

Pin	Signal
1	GND
2	GPS OUT +
3	MODEM_LOCK
4	MODEM_CTRL1 (TX MUTE)
5	GPS IN +

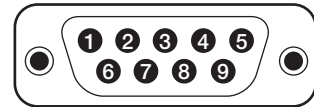

D-Sub 9 pin Male connector
Supplied Component

Pin	Signal
6	GPS OUT -
7	MODEM_SIGNAL_IN
8	MODEM_CTRL2
9	GPS IN -

NOTE: NMEA GPS IN/OUT Sentence: GPGLL (4800 Baud, 8, N, 1)

• RS232 / 422 Connector (Modem & BUC Interface)

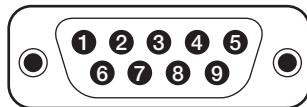

D-Sub 9 pin RS232
Connector

Pin	Signal	Pin	Signal
1	-	6	-
2	RXD	7	-
3	TXD	8	-
4	-	9	-
5	GND		

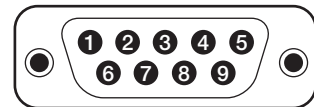

D-Sub 9 pin connector
Supplied Component

Pin	Signal	Pin	Signal
1	-	6	-
2	RXD +	7	RXD -
3	TXD +	8	TXD -
4	-	9	-
5	GND		

• NMEA 2000 Connector

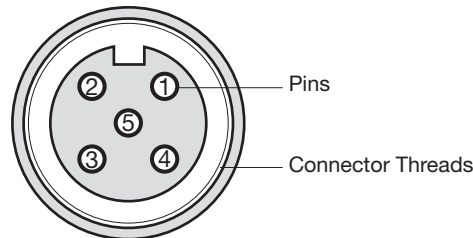

Male Connector

Pin	Signal
1	Shield
2	NET-S, (power supply positive, +V)
3	NET-C, (power supply common, -V)
4	NET-H, (CAN-H)
5	NET-L, (CAN-L)

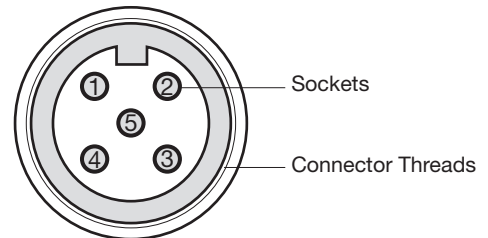

Female Connector

Pin	Signal
1	Shield
2	NET-S, (power supply positive, +V)
3	NET-C, (power supply common, -V)
4	NET-H, (CAN-H)
5	NET-L, (CAN-L)

PC to ACU Communication Setup

You can establish data communication between a PC and the ACU using one of the following methods.

TCP/IP Connection

Connection through Front Panel Management Port

This method is most recommended. The network is automatically configured by DHCP without the need of additional PC IP configuration.

Management Ethernet Port

1. Connect an Ethernet cable from a PC Ethernet port to the Management port on the front of the ACU.
2. Network connection is established.
3. Use the following IP address to access Intellian Aptus® or Aptus Web page.
 - 192.168.2.1 (Default)



Connection through Rear Panel Ethernet Port

This method requires separate IP configuration on a PC.

Ethernet Port

1. Connect an Ethernet cable from a PC Ethernet port to an available LAN port of a Switch/Hub.
2. Go to Control Panel > Network and Sharing Center > Change Adapter Settings and right-click on the Local Area Connection then click Properties
3. Select TCP/IPv4, then click Properties.
4. Change the network settings on a PC;
 - IP: 192.168. 0.222 (Secondary: 10.10.1.2)
 - Subnet Mask: 255.255.255.0
 - Gateway: 192.168.0.223 (Secondary: 10.10.1.1)
5. Use the following IP address to access Intellian Aptus® or Aptus Web page.
 - Default: 192.168.0.223 (Secondary: 10.10.1.1)

Serial/USB Connection

Serial Connection Connection through Serial Port

1. Connect a 9-pin Serial cable from the PC INTERFACE connector on the ACU to the 9-pin serial port on your PC.
2. If there is not a 9-pin serial port on the PC, use a USB-Serial adapter.

USB Connection Connection through USB Port

There are two USB(USB-to-Serial) ports available on the ACU. One is on the front and the other is on the rear.

1. Connect a USB cable from a USB port on your PC to the USB port on the ACU.

Wi-Fi Connection

Setup Wi-Fi Connection

- Setting up the ACU in order to access Wi-Fi
- Setting up the PC (AP Mode) in order to access Wi-Fi
- Aptus Web Confirmation

Setting up the ACU in order to access Wi-Fi



1. Turning on the Wi-Fi switch

Turn on the switch on the back of the ACU, and 30 seconds after enabling the power supply, confirm if a red light appears on the switch.

Setting up the PC in order to access Wi-Fi

1. Setting up my computer's wireless IP address

- Control Panel > Network and Sharing Center > Change Adapter Settings > Right click on the "Local Area Connection" > Click Properties

After selecting TCP/IPv4, click on the properties menu, then select "Obtain an IP address automatically."

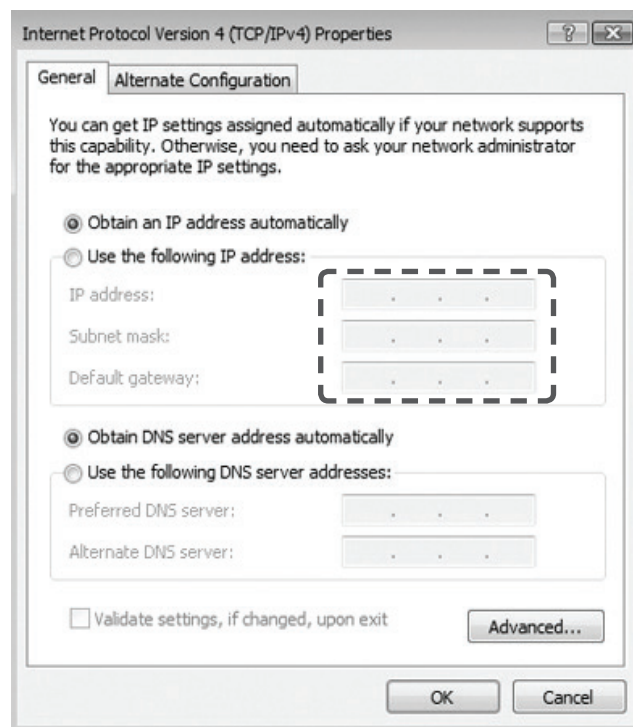

2. To manually change the network settings, click on "Use the following IP address" and use the settings listed below.

Case #1

If iARM Module's IP is known

The iARM module's default IP is 192.168.1.223

PC IP : 192.168.1.222

Subnet Mask : 255.255.255.0

GateWay : 192.168.1.223

Case #2

iARM Module's IP is unknown

The iARM module's secondary IP is 10.10.10.1

PC IP : 10.10.10.2

Subnet Mask : 255.255.255.0

GateWay : 10.10.10.1

3. Connect Wi-Fi in AP mode.

After clicking on the Windows Wireless Connection icon, click on intellian-VSAT (Default).

4. Enter the Network Security Key.

Key: intellian1234 (Default)



5. You can confirm the logo and version data by accessing <http://192.168.1.223>

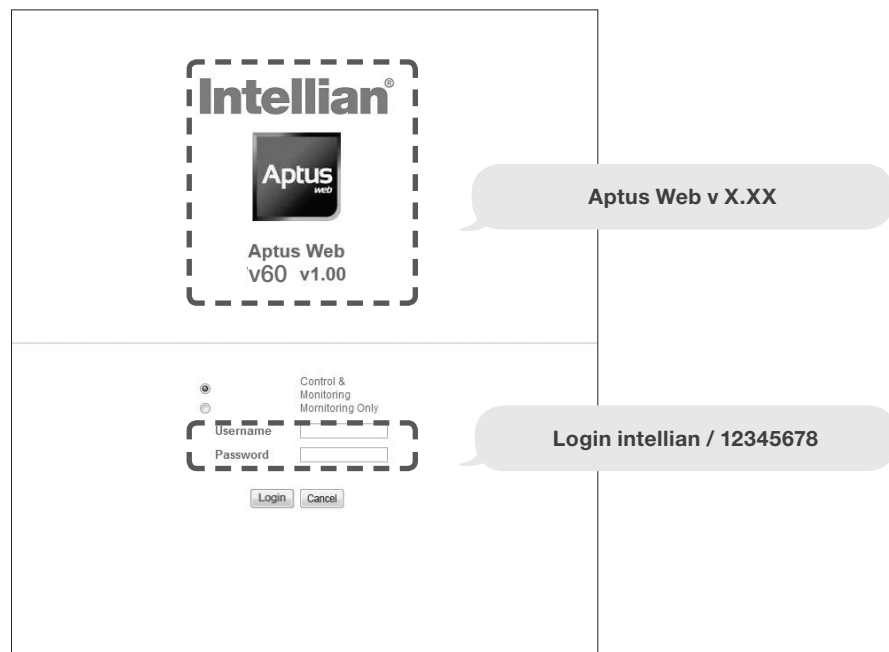

Login by entering the ID / Password listed below.

Username: intellian (Default)

Password: 12345678 (Default)

6. When you login, make sure that all the data within every page is being displayed correctly.

OPERATING THE ACU

Introduction

Normal Mode

Setup Mode

Installation Settings

Antenna Settings

Manual Search

Setup Antenna LNB pol Angle

Search Parameters

Setup Antenna Parameters

Setup Block Zone

Antenna Diagnostic Test

Satellite Settings

Load Satellite

Edit Satellite Information

Add Satellite Information

Check NID

System Settings

Set LNB Local Oscillator Frequency

Set Location

Set Modem Port

System Management

Introduction

This section of the handbook describes how to set up your system after installation using the ACU.

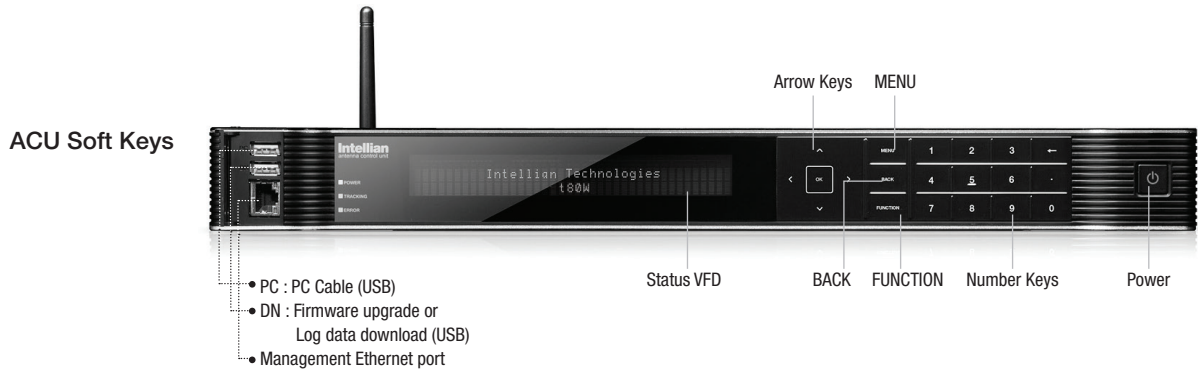

Soft Key Functions

Soft key	Function
MENU	Enter SETUP mode
BACK	In SETUP mode: returns to the previous menu / option or save the adjusted settings. In normal mode: returns to the first page of the antenna's current status.
FUNCTION	Save the adjusted settings.
ARROW KEYS	Select from the alternative options to increase or decrease the selected character to the desired value.
OK	Enter the next step / menu
NUMBER KEYS	Input the numbers



WARNING: Please ensure that your Intellian system is ALWAYS powered ON upon leaving the dock. Failure to follow these instructions could result in damaging mechanical parts in the antenna and/or possibly void your warranty. Intellian strongly recommends to restrain the antenna pedestal properly while underway when power is removed from the antenna. The normal operating condition is to remain powered up at all times.

Normal Mode

Startup

With the system installed and power applied, the ACU screen will show the following sequence.

Start up

```
INTELLIAN TECHNOLOGIES INC.
```

1. The data communication is being established between the antenna and the ACU.

Initialize antenna info

```
INITIALIZE - ANTENNA INFO
INTELLIAN V60
```

2. The ACU receives antenna information.

Initialize elevation &
cross level angle

```
INITIALIZE - EL POSITION
INTELLIAN V60
```

3. The elevation angle and cross level angle are initialized.

Initialize azimuth angle

```
INITIALIZE - AZIMUTH POSITION
INTELLIAN V60
```

4. The azimuth angle is initialized.

Initialize target satellite
position

```
INITIALIZE - SAT POSITION
INTELLIAN V60
```

5. The antenna returns to the target satellite position.

Search status

```
⌘ SEARCH1 138.0E TELST_18 SIG: 301 VL ⌘
AZ: 292.7 ( 202.7) EL: 48.3 SK: -72.0
```

6. The antenna is searching for the target satellite.

Tracking status

```
⌘ TRACKING 138.0E TELST_18 SIG: 501#VL ⌘
AZ: 292.7 ( 202.7) EL: 48.3 SK: -72.0 Fn
```

7. The antenna has locked onto the satellite.

Monitoring Antenna Current Status

When the ACU power is on, it displays the status of the antenna. The current status of the antenna is displayed as shown below.

Current search status

```

# SEARCH1 138.0E TELST_18 SIG: 301 VL #
AZ: 292.7 ( 202.7) EL: 48.3 SK: -72.0
    
```

1. The antenna is searching for the target satellite.

Current tracking status

```

# TRACKING 138.0E TELST_18 SIG: 301#VL #
AZ: 292.7 ( 202.7) EL: 48.3 SK: -72.0 Fn
    
```

2. The antenna has locked onto the target satellite.

Current IF signal level (SIG/AGC) is displayed. SIG will be displayed when NBD (Narrow band detection) mode for TRACKING SIGNAL is chosen to be used and AGC will be displayed when DVB mode of TRACKING SIGNAL is chosen to be used.

The symbol “•” will be only displayed when the satellite signal is strong enough to locked onto. [VL] indicates the LNB's local frequency corresponding to 13V is in use for the signal reception.

VL: 13V + 0 kHz, HL: 18V + 0 kHz, VH: 13V + 22 kHz, HH: 18V + 22 kHz

True azimuth [292.7] position of the antenna is the sum of ships heading 090.0 [HDG] and antenna relative [202.7].

NOTE: However, if the "GYRO TYPE" is set to "NONE" or "NMEA" but without receiving a proper input signal, "---." will be displayed at "True Azimuth"

Save current satellite info

```

SAVE CURRENT SAT INFO ?
# YES NO
    
```

3. Press FUNCTION key to save current satellite information or abort and return to the main display. "Fn" will be displayed only if the antenna is in tracking mode.

```

# TRACKING 138.0E TELST_18 SIG: 301#VL #
AZ: ---. - ( 202.7) EL: 48.3 SK: -72.0 Fn
    
```

4. Press RIGHT arrow key to display NBD, GPS and ship's heading information.

Tracking & Heading information

```
# NBD      F: 1247000  BW: 1000    SIG: 301# #
  004.53E  52.22N  HDG: 090.0  L: 10000 Fr
```

5. NBD, GPS and ship's heading information are shown.

- NBD (Narrow Band Detection) IF tracking frequency: 1247000 kHz
- Detected Band Width: 1000 kHz
- SIG (Signal Level): 301 (When NBD mode for tracking signal is chosen)
- W (West)/E (East) Longitude: 4.53° E
- N (North)/S (South) Latitude: 52.22° N
- HDG (Ship's Heading): 90°
- LNB local oscillator (LO) frequency: 10000 MHz

Power status

```
# [FWR] ANT: 26.4V    LNB: 13V + 0kHz #
      ACU: 27.1V    [POL] TX: V  RX: H
```

6. Press RIGHT arrow key to display the current operation voltage for antenna, ACU and LNB. POL indicates the TX polarity (VERTICAL) and RX polarity (HORIZONTAL).

Antenna & ACU versions

```
# V1-60-A3W  ANT. SERIAL    1.00/1.00 #
  VP-T506    ACU SERIAL    1.00
```

7. Press RIGHT arrow key to display the below information.

- Antenna part number, antenna serial number and PCU firmware version.
- ACU part number, ACU serial number, and ACU firmware version.

Press BACK Key to return to the first page of the antenna current status.

Select USB functions

```
# [USB FUNCTION]  SELECT USB FUNCTION #
                  ▲  UPGRADE FIRMWARE  ▼
```

8. Touch RIGHT arrow key to display the **USB FUNCTION***

This menu will be displayed automatically if a USB flash drive is plugged into the USB port located in the front panel of the ACU.

USB FUNCTION*

- UPGRADE FIRMWARE: upgrade the system by using the firmware files (files format: *.FWP) from the specified folder in the USB flash drive.
- COPY LOG DATA: Copy the up-to-date log data from the system to the USB flash drive.



Upgrade the system

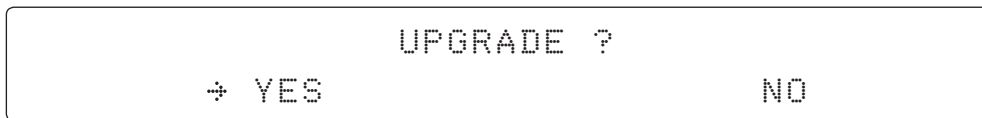

9. Touch OK key to upgrade firmware.

Refer to the error messages below if any errors occur.

UPGRADE FIRMWARE

- FIRMWARE FILE NOT FOUND: the system cannot find the FWP file.
- INVALID FIRMWARE: the file is not in a recognizable FWP format.
- MORE THAN 1 FILE EXIST: there is more than 1 firmware file that exists from the specified folder in the USB flash drive.
- CHECK USB CONNECTION: the USB flash drive is not connected.

COPY LOG DATA

- COPY LOG DATA TO USB [30%]: display the copy progress in percentages.
- NOT ENOUGH SPACE IN USB: USB occupies no memory space.
- CHECK USB CONNECTION: the USB flash drive is not connected.

Real-time diagnostic result

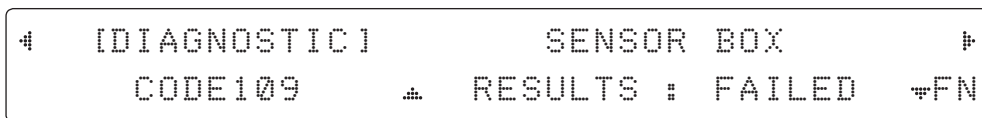

10. Press RIGHT arrow key to display the real-time diagnostic result.

The real-time diagnostic code will be displayed automatically if there is any error found during the system operation. However, this page will not be displayed if there is no error message.

Erase Error message

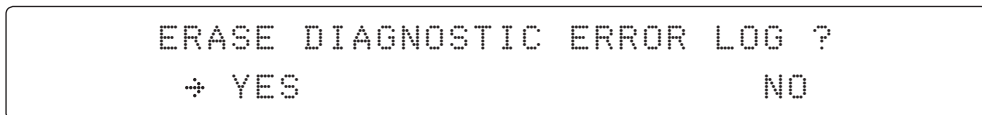

11. Press FUNCTION key to erase diagnostic error message.

Setup Mode

Enter the SETUP mode simply follow the instructions below.

Searching / Tracking mode

```

* TRACKING 138.0E TELST_18 SIG: 301# VL *
  AZ: 292.7 ( 202.7) EL: 48.3 SK: -72.0 Fn
  
```

1. While the antenna is in SEARCHING / TRACKING mode, press MODE key to enter SETUP mode. * indicates the key pad lock function is on (Refer to KEY LOCK menu to setup the key pad lock function). When key pad lock function is activated press MODE key or when “Fn” menu is activated press FUNCTION key the ENTER PASSWORD menu will be displayed.

Enter password

```

                ENTER PASSWORD
                - - - -
  
```

2. If the key pad lock function is on, enter the password before accessing to the SETUP mode. If the key pad lock function is off, access to the SETUP mode directly as Step 3.

Setup mode

```

                SETUP MODE ?
        → YES                                NO
  
```

3. Press LEFT arrow key to move cursor to YES and press OK key to enter SETUP mode or press RIGHT arrow key to move cursor to NO and press OK key to abort and return to the main display.

Exit setup mode

```

                EXIT SETUP MODE ?
        → YES                                NO
  
```

4. While the antenna is in SETUP mode, press FUNCTION key as shortcut key to exit SETUP mode.

Installation Settings

During the first time installation, it is required to setup the installation settings.

Setup mode

```

                SETUP MODE ?
            ↪  YES                      NO
    
```

1. Press LEFT arrow key to move cursor to YES and press OK key to enter SETUP mode

Installation menu

```

    +ANTENNA                      +SATELLITE
    +SYSTEM                        ↪+INSTALLATION
    
```

2. Press arrow keys to move cursor to INSTALLATION menu and press OK key to enter it.

Select satellite

```

                SELECT SATELLITE
            ▲ [1] TELST_18 138.00E ▼
    
```

3. Press UP and DOWN arrow keys to select the satellite that you wish to track and press OK key to load the selected satellite.

Latitude & Longitude

```

    LATITUDE                      LONGITUDE
            ▲ 37.00N ▼                126.53E
    
```

4. Set the current LATITUDE and LONGITUDE
 Press LEFT and RIGHT arrow keys until the desired character is underscored (selected). Press UP and DOWN arrow keys to increase or decrease the value. Or press NUMBER keys to set the desired value directly. Press OK key to set the parameter.

Gyro type

```

    GYRO TYPE                      BOW OFFSET
            ▲  NMEA ▼                000
    
```

5. Set the ship's **GYRO TYPE*** & **BOW OFFSET**.
 A search pattern 1 or 3 will be initiated according to which Gyro Type is selected and the existence of the gyro input. Ensure that the supported Gyro Type is set correctly. If the ship's gyrocompass output is other than NMEA0183 and NMEA2000, a separate purchase of an NMEA converter is required.

A search pattern 1 will be initiated automatically if the gyro input does not exist and the gyro type is selected other than GROUND TEST.

The BOW OFFSET is to offset the angle difference between the antenna's bow and the ship's bow (Range: 0 – 360°).

NOTE: The bow offset will not be saved automatically if Search 1 pattern is initiated. In this case, the antenna will need to retarget the desired satellite using Search 1 every time if the antenna restarts.

Gyro search mode

Existence of Heading Data	Setting of Heading Device		
	No Device	NMEA/ NMEA2000	Ground Test
With Heading Data	Search 1	Search 3	Search 3
Without Heading Data	Search 1	Search 1	Search 3

GYRO TYPE*

NO DEVICE
NMEA / NMEA 2000
GROUND TEST

Modem Type & LNB Local

MODEM TYPE	13V + 0kHz
⬆ IDIRECT-I/O ⬇	10000MHz

6. Set **MODEM TYPE*** and **LNB LOCAL**.

MODEM TYPE is to select a proper data communication port on the ACU to interface with the satellite modem.

MODEM TYPE*

USER SETTING	COMTECH-ROSS
IDIRECT-I/O	HUGHES
IDIRECT-AMIP	SATLINK-SEIRAL
COMTECH-I/O	ELEKTRIKOM-AMIP
	GILAT-SE-II

18V + 0kHz	13V+22kHz
⬆ 10750MHz ⬇	11300MHz

18V +22kHz
⬆ 11300MHz ⬇

7. Set the LNB local oscillator frequency for each voltage power. (13V +0 kHz, 18V +0 kHz, 13V +22 kHz, 18V +22 kHz)

Press LEFT and RIGHT arrow keys until the desired character is underscored (selected). Press UP and DOWN arrow keys to increase or decrease the value. Or press NUMBER keys to set the desired value directly.

Load

```
                                LOAD ?
                                ↪ YES                                NO
```

8. Press BACK key to load the current setting or abort and return to the main display.

Loading settings

```
LOADING ...
DO NOT TURN OFF !      #####00000000
```

9. Setting is being loaded to the system.
The ACU will restart the system automatically after uploading the setting.
DO NOT TURN OFF ACU POWER while the data is being uploaded.

Tracking status

```
4 TRACKING 138.0E TELST_18 SIG: 301# VL #
  AZ: 292.7 ( 202.7) EL: 48.3 SK: -72.0 Fn
```

10. Antenna has locked onto the target satellite.

Antenna Settings

Manual Search

Search the desired satellite manually.

Setup mode

```

          SETUP MODE ?
    ↵ YES                               NO
  
```

1. Press LEFT arrow key to move cursor to YES and press OK key to enter SETUP mode.

Antenna menu

```

    ↵↵ ANTENNA                       +SATELLITE
      +SYSTEM                         +INSTALLATION
  
```

2. Press OK key to enter ANTENNA menu.

Manual search menu

```

    ↵ ↵ +MANUAL SEARCH                 +SET POL ANGLE  ↵
      +SEARCH PARAM                   +SET PARAMETERS
  
```

3. Press OK key to enter MANUAL SEARCH menu.

Antenna movement

```

STEP SIZE  AZIMUTH  ELEVATION  AGC
# 00.2 #  ↵ 231.7  ↵ 48.3  ↵ 301 Fn
  
```

4. Current IF tracking signal level (AGC) / (SIG) is displayed to assist you in manually peaking AZIMUTH (0°-360°) and ELEVATION (0°-90°) angle for best signal level.

Press NUMBER key to change the STEP SIZE (Range: 0.1~99.9). Press LEFT and RIGHT arrow keys to increase or decrease the azimuth angles. Press UP and DOWN arrow keys to increase or decrease the elevation angles.

Press FUNCTION key to save current settings or abort and return to the main display.

Save

```

          SAVE CURRENT SAT INFO?
    ↵ YES                               NO
  
```

5. If the current settings are able to locate the satellite, press FUNCTION key to save “current satellite information”. This will help to reduce the satellite acquisition time after restarting the system. Press LEFT arrow key to move cursor to YES and press the OK key to save the settings.

NOTE: If the gyro type is not ground test or the gyro is not connected to the ACU, the information cannot be saved.

Setup Antenna LNB pol Angle

Setup mode

```

                SETUP MODE ?
            ↪  YES                               NO
    
```

1. Press LEFT arrow key to move cursor to YES and press OK key to enter SETUP mode.

Antenna menu

```

    ↪+ANTENNA                +SATELLITE
      +SYSTEM                +INSTALLATION
    
```

2. Press OK key to enter ANTENNA menu.

Set pol angle menu

```

    ⚡  +MANUAL SEARCH      ↪ +SET POL ANGLE  ⚡
      +SEARCH PARAM        +SET PARAMETERS
    
```

3. Press RIGHT arrow key to move cursor to SET POL ANGLE menu and press OK key to enter it.

LNB pol angle type

```

                SELECT LNB POL. ANGLE MENU
            ⚡                CALIBRATION                ⚡
    
```

4. Press UP and DOWN arrow keys to select the LNB pol angle menu and press OK key to run the selected operation 'CALIBRATION', 'MANUAL ADJUST' or 'RESET MECHANICAL OFFSET.' Select MANUAL ADJUST to control LNB pol angle manually. If the control board, LNB pol potentiometer or belt is replaced, select CALIBRATION to calibrate LNB pol angle.

LNB pol angle Signal

```

    LNB POL ANGLE                SIGNAL: 180
            ⚡ 20.1 ⚡
    
```

5. Press UP and DOWN arrow keys to increase or decrease the LNB pol angle manually and the correspondent SIGNAL level will be displayed next to it. Press BACK key to return to the main display.

NOTE: LNB POL ANGLE menu will be displayed only if MANUAL ADJUST is selected.

Mechanical Skew Offset

```

                SELECT LNB POL. ANGLE MENU
            ⚡                RESET MECHANICAL OFFSET                ⚡
    
```

6. Press OK keys to reset the mechanical skew offset.

Search Parameters

Setup mode

```

                SETUP MODE ?
            ↵ YES                               NO
    
```

1. Press LEFT arrow key to move cursor to YES and press OK key to enter SETUP mode.

Antenna menu

```

    ↵↵ ANTENNA                               +SATELLITE
      +SYSTEM                               +INSTALLATION
    
```

2. Press OK key to enter ANTENNA menu.

Manual search menu

```

    ⏪   +MANUAL SEARCH                       +SET POL ANGLE   ⏩
      ↵↵SEARCH PARAM                       +SET PARAMETERS
    
```

3. Press arrow keys to move cursor to SEARCH PARAM menu and press OK key to enter it.

Search param

```

    SEARCH WAIT TIME      INCREMENT STEP
    ⏪   030               ⏩   0.50
    
```

4. Set SEARCH WAIT TIME and INCREMENT STEP.

Set the time-out for automatic initiation of a search after the signal level drops below the predefined threshold value (Range : 1 - 120 sec) and set increment step size (Range : 0.01 – 5.00 sec)

Search 1 range

```

    SEARCH1 AZ      SEARCH1 EL
    ⏪   400         ⏩   06
    
```

Search 3 range

```

    SEARCH3 AZ      SEARCH3 EL
    ⏪   003         ⏩   04
    
```

4. Set SEARCH 1 and 3 AZ (Azimuth) range and EL (Elevation) range. SEARCH 2 is reserved for future use.

A search pattern 1 or 3 will be initiated according to which GYRO TYPE is selected and the existence of the gyro input.

Search 1: a search pattern 1 will automatically be initiated when the ship's heading input does not exist / is failed. The antenna will go to the relative azimuth position 0° at the calculated elevation and search in the azimuth CCW direction and search up +0.5° & down -0.5° with a total 6°(±3°) in elevation. The search cycle will repeat until the antenna receives the lock signal from the modem or the DVB transponder of the target satellite is decoded by the antenna. If the desired signal is found and above the predefined detect level, the ACU will enter to Search 3. However, the antenna will not initiate Search 3 pattern but go into TRACKING mode immediately if the desired signal is above the predefined tracking threshold level. If the detected signal is below the predefined tracking threshold level, the search 1 will repeat and start 3° away from the current position.

Search 1 (Gyro Free) Search Pattern

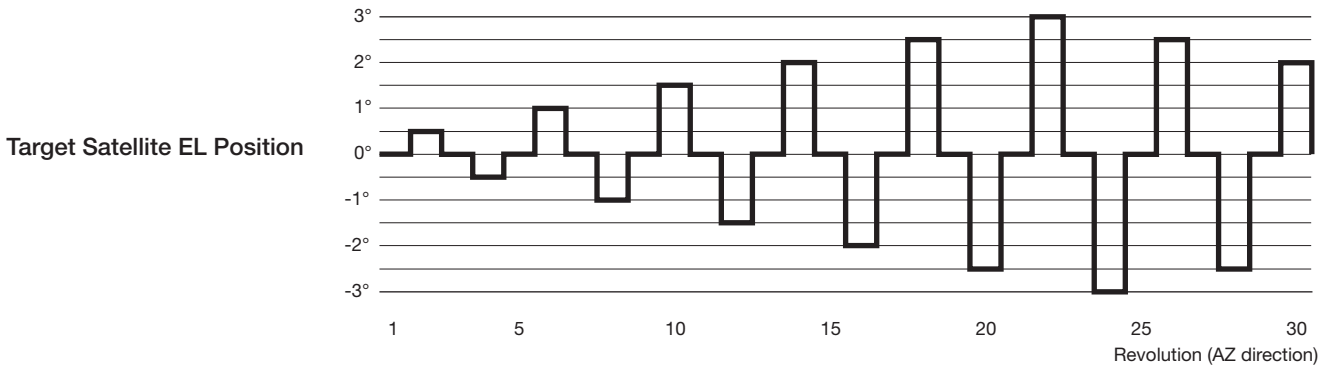

Search 1 antenna motion

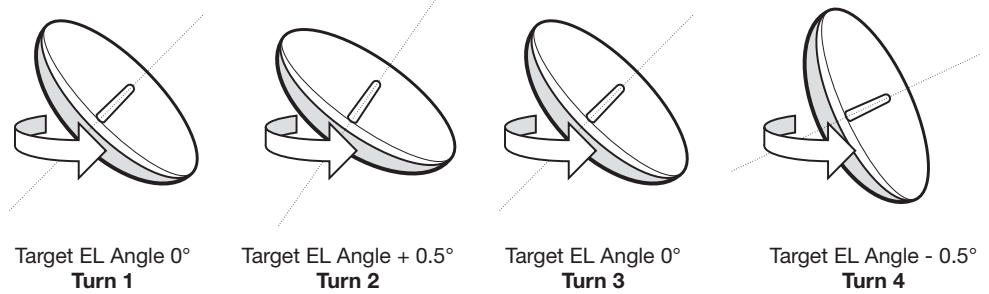

Search 3: a search pattern 3 will automatically be initiated when AGC / SIG falls below the current tracking level threshold value. If the desired signal is found and above the predefined tracking level, the ACU will terminate Search 3 and go into TRACKING mode. A search pattern will automatically be initiated when AGC / SIG falls below the current threshold setting (indicates that satellite signal has been lost). Search is conducted in a two-axis pattern consisting of alternate movements in azimuth (AZ) and elevation (EL) as forming expanding square indicated as below diagram.

Search 3 pattern

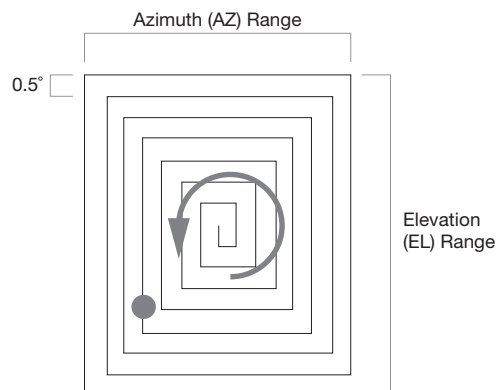

Setup Antenna Parameters

These parameters should only be changed by an authorized service technician. Improper setting of these parameters will cause your system to perform improperly.

Setup mode

```

          SETUP MODE ?
        ↗ YES                NO
  
```

1. Press LEFT arrow key to move cursor to YES and press OK key to enter SETUP mode.

Antenna menu

```

    ↗↗ ANTENNA                ↗ SATELLITE
      ↗ SYSTEM                ↗ INSTALLATION
  
```

2. Press OK key to enter ANTENNA menu.

Set parameters menu

```

    ↗ MANUAL SEARCH                ↗ SET POL ANGLE
    ↗ SEARCH PARAM                ↗↗ SET PARAMETERS
  
```

3. Press arrow keys to move cursor to SET PARAMETERS menu and press OK key to enter it.

Password

```

          ENTER PASSWORD
          - - - -
  
```

4. Press 4 digit password to enter SET PARAMETERS menu (1590).

Setup parameters is only required after installation or repairs of your antenna system.

These parameters should only be changed by an authorized service technician.

Improper setting of these parameters will render your system inoperable.

Set detect & tracking DVB

```

    DETECT DVB                TRACKING DVB
    ↕ 040 ↕                    020
  
```

5. Set DETECT DVB and TRACKING DVB when DVB mode of TRACKING SIGNAL is chosen to be used (Range: 1-200).

DETECT DVB is to set the satellite signal detection level and TRACKING DVB is to set the satellite signal tracking level.

Press LEFT and RIGHT arrow keys until the desired character is underscored (selected). Press UP and DOWN arrow keys to increase and decrease the selected character.

Or press NUMBER keys to set the desired value directly. Press OK key to set the parameter. Press BACK key to select the parameter you wish to edit and press BACK key again to save or abort and return to the main display.

Set detect & tracking NBD



6. Set DETECT NBD and TRACKING NBD when NBD (Narrow band detection) mode of TRACKING SIGNAL is chosen to be used (Range: 1-200).

DETECT NBD is to set the satellite signal detection level and TRACKING NBD is to set the satellite signal tracking level.

Press LEFT and RIGHT arrow keys until the desired character is underscored (selected). Press UP and DOWN arrow keys to increase and decrease the selected character. Or press NUMBER keys to set the desired value directly. Press OK key to set the parameter. Press BACK key to select the parameter you wish to edit and press BACK key again to save or abort and return to the main display.

Detect & tracking level

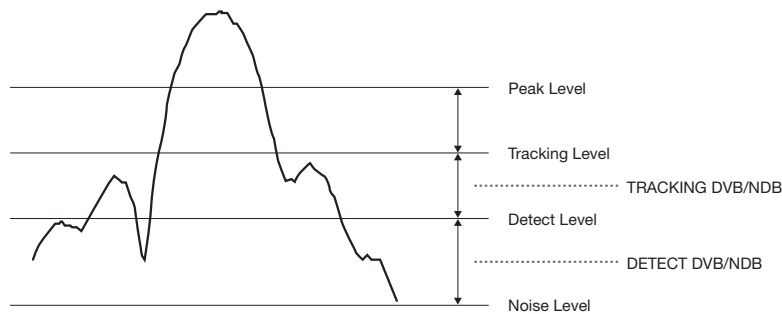

BOW & EL adjust



7. Set BOW OFFSET and EL. ADJUST
 BOW OFFSET is to offset the angle difference between the antenna’s bow and the ship’s bow (Range: 0 – 360°) and EL. ADJUST is to offset the angle difference between the mechanical elevation angle and actual elevation angle (Range: ± 5°).

Press LEFT and RIGHT arrow keys until the desired character is underscored (selected). Press UP and DOWN arrow keys to increase and decrease the selected character. Or press NUMBER keys to set the desired value directly. Press OK key to set the parameter. Press BACK key to select the parameter you wish to edit and press the BACK key again to save or abort and return to the main display.

Select operation process



8. Set OPERATION.

Press UP and DOWN arrow keys to select OPERATION items.

OPERATION*

SAVE
IDLE ON / OFF
REBOOT

SAVE: save and execute the current settings.

The antenna is balanced at factory. However, after disassembly for shipping, maintenance or parts replacements, antenna balance adjustment may be required. The elevation and cross-level motors have a brake mechanism integrated into them, therefore, antenna power and IDLE MODE must be ON to release the motor brakes. Balancing is achieved by adding or removing weight blocks at strategic locations to keep the antenna balanced.

IDLE MODE: Press UP and DOWN arrow keys to turn ON/ OFF IDLE MODE.

The motor brakes will be released while the IDLE MODE is ON. The antenna will restart automatically if IDLE MODE is re-set from ON to OFF or BACK key is pressed to exit SETUP mode.

REBOOT ANTENNA: The antenna will restart automatically if REBOOT ANTENNA is ON.

Setup Block Zone

Up to 5 block or radiation hazard zones can be programmed with relative azimuth and elevation sectors.

Setup mode

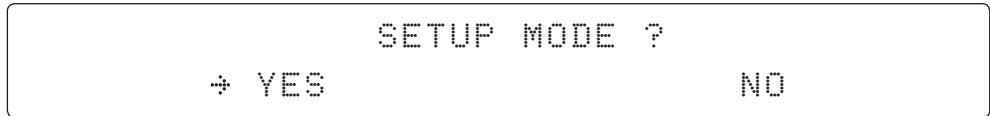

1. Press LEFT arrow key to move cursor to YES and press OK key to enter SETUP mode.

Antenna menu

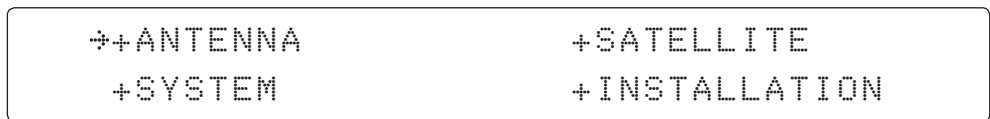

2. Press OK key to enter ANTENNA menu

Block zone menu



3. Press RIGHT arrow key to move cursor to BLOCK ZONE menu and press OK key to enter it. Up to 5 block zones is allowed to be programmed.

Block zone 1



Block zone range

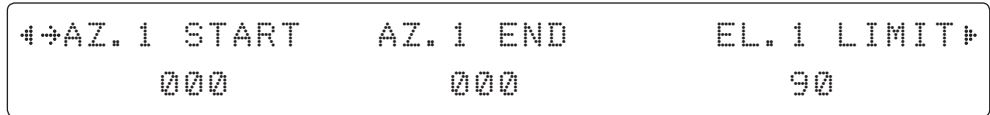

4. Set ZONE 1 BLOCK

Press UP and DOWN arrow keys to select “ON” to setup the block zone for ZONE 1.

Press OK key to use ZONE 1 BLOCK and set zone 1 block range.

Press BACK key to select the parameter you wish to edit and press the BACK key again to save or abort and return to the main display.

Set the AZ.1 START, AZ.1 END and EL.1 LIMIT while ZONE 1 BLOCK is ON.

This is the clockwise of the two points. AZ.1 START is where the relative azimuth starts and AZ.1 END is where the relative azimuth ends (Range: 0- 360°). EL.1 Limit is where the elevation starts (Range 0- 90°).

Press LEFT and RIGHT arrow keys until the desired character is underscored (selected).

Press UP and DOWN arrow keys to increase and decrease the selected character.

Or Press NUMBER keys to set the desired value directly. Press OK key to set the parameter.

Press BACK key to select the parameter you wish to edit and press BACK key again to save or abort and return to the main display.

Block zone 2

```
ZONE 2 BLOCK
  ▲   OFF   ▼
```

5. ZONE 2 to ZONE 5 BLOCK setting is same as ZONE 1 BLOCK.
Press OK key to set ZONE 2 BLOCK and set next parameter.

Save

```
SAVE ?
  + YES                NO
```

6. Press LEFT arrow key to move cursor to YES and press OK key to save and execute the current settings. Or press RIGHT arrow key to move cursor to NO and press OK key to abort and return to the main display.

Antenna Diagnostic Test

Refer to the diagnosis codes for the test results.

Setup mode

```

                SETUP MODE ?
             ↗ YES                NO
    
```

1. Press LEFT arrow key to move cursor to YES and press OK key to enter SETUP mode.

Antenna menu

```

    ↗+ANTENNA                +SATELLITE
     +SYSTEM                +INSTALLATION
    
```

2. Press OK key to enter ANTENNA menu.

Diagnosis menu

```

    ↖  +BLOCK ZONE                ↗+DIAGNOSTIC  ↗
    
```

3. Press arrow keys to move cursor to DIAGNOSIS menu and press OK key to enter it.

Full diagnostic test

```

    DIAGNOSTIC                COMMUNICATION
    ↖ FULL TEST ↗                READY
    
```

4. Press UP and DOWN arrow keys to select a full diagnostic test or single diagnostic test and press OK key to execute the selected diagnostic test.

Menus for DIAGNOSIS are FULL TEST and CODE 101 ~ CODE 116.

Full diagnostic
test result

```

    DIAGNOSTIC                FULL TESTING
    FULL TEST                ████████████████████-██-█
    
```

5. A full diagnostic is successfully completed.

Single diagnostic
test result

```

    DIAGNOSTIC                COMMUNICATION
    CODE 101                RESULT : PASSED
    
```

6. A single diagnostic test is successfully completed.

Diagnosis Code:

CODE 101: The data communication between the antenna and the ACU is tested.

CODE 102: The azimuth motor is tested.

CODE 103: The elevation motor is tested.

CODE 104: The cross-level motor is tested.

CODE 105: The azimuth encoder is tested.

CODE 106: The cross-level encoder is tested.

CODE 107: The rate sensor is tested.

CODE 108: The tilt sensor is tested.

CODE 109: The sensor box motor is tested.

CODE 110: The LNB/NBD is tested.

CODE 111: The LNB pol motor is tested.

CODE 112: The sub-reflector is tested. (Skip for v-Series communication products)

CODE 113: The antenna power is tested.

CODE 114: The ACU power is tested.

CODE 115: The receiver power is tested.

(Skip for v-Series communication products)

CODE 116: The home sensor is tested.

An example of test result: ●2●●●●●●●●●●-●●-●

●: test is passed

2: test is failed (CODE102)

-: test is skipped (TVRO products only)

?: test is in process

Satellite Settings

Load Satellite

Setup mode

```
          SETUP MODE ?
        ↵ YES                NO
```

1. Press LEFT arrow key to move cursor to YES and press OK key to enter SETUP mode.

Satellite menu

```
+ANTENNA                ↵+SATELLITE
+SYSTEM                  +INSTALLATION
```

2. Press RIGHT arrow key to move cursor to SATELLITE and press OK key to enter it.

Load sat menu

```
↵+LOAD SAT.              +EDIT SAT.
+ADD SAT.                 +CHECK NID
```

3. Press OK key to enter LOAD SAT. menu.

Load satellite

```
          LOAD SATELLITE
        ▲ [1] TELST_18 138.00E ▼
```

4. Press UP and DOWN arrow keys to select satellite that you wish to track. Press OK key to load the selected satellite.

Load

```
          LOAD ?
        ↵ YES                NO
```

5. Press LEFT arrow key to move cursor to YES and press OK key to load the selected satellite and execute the current settings. Or press RIGHT arrow key to move cursor to NO and press OK key to abort and return to the main display.

Edit Satellite Information

Setup mode

```

                SETUP MODE ?
            ↪ YES                               NO
    
```

1. Press LEFT arrow key to move cursor to YES and press OK key to enter SETUP mode.

Satellite menu

```

    +ANTENNA                ↪+SATELLITE
    +SYSTEM                  +INSTALLATION
    
```

2. Press RIGHT arrow key to move cursor to SATELLITE and press OK key to enter it.

Edit sat menu

```

    +LOAD SAT.                ↪+EDIT SAT.
    +ADD SAT.                 +CHECK NID
    
```

3. Press RIGHT arrow key and OK key to enter EDIT SAT. menu.

Edit satellite

```

                EDIT SATELLITE
    ▲          [1] TELST_18 138.00E          ▼
    
```

4. Press UP and DOWN arrow keys to select the satellite that you wish to edit and press OK key to edit the selected satellite.

Edit longitude & name

```

    LONGITUDE                EDIT NAME
    ▲ 138.0E                ▼      TELST_18
    
```

5. Edit satellite orbit position, LONGITUDE and satellite NAME.

DVB verify method

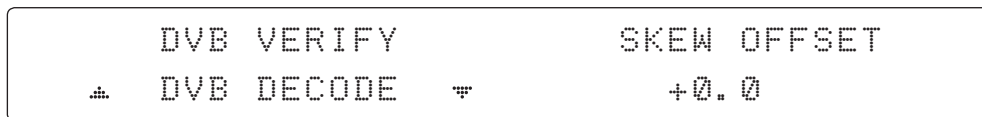

6. Edit satellite **DVB VERIFY*** method and SKEW OFFSET.
 DVB VERIFY will be only activated and applied when DVB mode of TRACKING SIGNAL is chosen to be used. Press UP and DOWN arrow keys to select DVB VERIFY and press OK key to set the parameter.

DVB VERIFY*
 AGC – use signal level for satellite tracking.
 DVB Lock – use DVB Lock for satellite tracking.
 DVB Decode – use DVB Decode for satellite tracking.
 DSS Decode – use DSS Decode for satellite tracking.

Set LNB local frequency

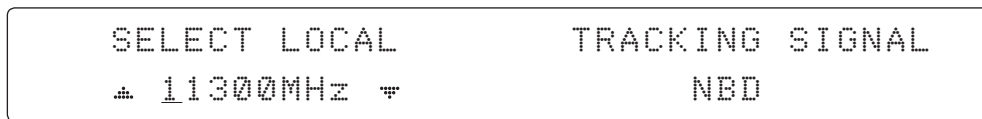

7. Set **SELECT LOCAL*** frequency and **TRACKING SIGNAL***.
 Press LEFT and RIGHT arrow keys until the desired character is underscored (selected).
 Press UP and DOWN arrow keys to increase or decrease the value.
 Press OK key to set the parameter.

SELECT LOCAL*
 The selectable LNB frequencies are depended on the installed LNB type.

TRACKING SIGNAL*
 NBD
 DVB

Set polarity



8. Set RX POL and TX POL
 To select the polarity for both RX (receive) and TX (transmit).
 Press UP and DOWN arrow keys to select VERTICAL or HORIZONTAL.
 Press OK key to set the parameter.

Set DVB tracking frequency

DVB FREQ.	SYMBOL	NID
▲11747MHz▼	21300KSp s	0X00AD

9. Set DVB FREQUENCY, SYMBOL RATE and NID when DVB mode of TRACKING SIGNAL is chosen to be used.

45,000 is the maximum allowed symbol rate value. NID (network ID) range is from 0 x 0000 to 0 x FFFF (hexadecimal digit).

Press LEFT and RIGHT arrow keys until the desired character is underscored (selected). Press UP and DOWN arrow keys to increase or decrease the value. Or press NUMBER keys to set the desired value directly. Press OK key to set the parameter.

Set NBD tracking frequency

NBD FREQ.	BANDWIDTH
▲ 1070.000MHz▼	01.000MHz

10. Set NBD IF FREQUENCY and BANDWIDTH when NBD (Narrow Band Detection) mode of TRACKING SIGNAL is chosen to be used.

Press LEFT and RIGHT arrow keys until the desired character is underscored (selected). Press UP and DOWN arrow keys to increase or decrease the value. Or press NUMBER keys to set the desired value directly. Press OK key to set the parameter.

Save

	SAVE ?	
→ YES		NO

11. Press LEFT arrow key to move cursor to YES and press OK key to save and execute the current settings. Or press RIGHT arrow key to move cursor to NO and press OK key to abort and return to the main display.

Add Satellite Information

Setup mode

```

                SETUP MODE ?
            ↪  YES                               NO
    
```

1. Press LEFT arrow key to move cursor to YES and press OK key to enter SETUP mode.

Satellite menu

```

    +ANTENNA                ↪+SATELLITE
    +SYSTEM                  +INSTALLATION
    
```

2. Press RIGHT arrow key to move cursor to SATELLITE and press OK key to enter it.

Add sat menu

```

    +LOAD SAT.                +EDIT SAT.
    ↪+ADD SAT.                +CHECK NID
    
```

3. Press DOWN arrow key and OK key to enter ADD SAT. menu.

Set longitude & name

```

    #      LONGITUDE          EDIT NAME      #
    ▲      000.00E          ▼      SAT.00
    
```

4. Set satellite LONGITUDE and satellite NAME.

DVB verify method

```

    DVB VERIFY                SKEW OFFSET
    ▲ DVB DECODE ▼          +00.0
    
```

5. Edit the satellite **DVB VERIFY*** and SKEW OFFSET.

DVB VERIFY will be only activated and applied when DVB mode of TRACKING SIGNAL is chosen to be used. Press UP and DOWN arrow keys to select DVB VERIFY and press OK key to set the parameter.

DVB VERIFY*

- AGC – use signal level for satellite tracking.
- DVB Lock – use DVB Lock for satellite tracking.
- DVB Decode – use DVB Decode for satellite tracking.
- DSS Decode – use DSS Decode for satellite tracking.

Set LNB local frequency

```

SELECT LOCAL          TRACKING SIGNAL
 10000MHz            NBD
    
```

6. **SELECT LOCAL*** to set LNB local oscillator frequency and **TRACKING SIGNAL***. Press LEFT and RIGHT arrow keys until the desired character is underscored (selected). Press UP and DOWN arrow keys to increase or decrease the value. Press OK key to set the parameter.

SELECT LOCAL*

The selectable LNB frequencies are depended on the installed LNB type.

TRACKING SIGNAL*

NBD
DVB

Set polarity

```

RX POL              TX POL
  VERT.            HORI.
    
```

7. Set RX POL and TX POL
To select the polarity for both RX (receive) and TX (transmit) pol. Press UP and DOWN arrow keys to select VERTICAL or HORIZONTAL. Press OK key to set the parameter.

Set DVB tracking frequency

```

DVB FREQ.          SYMBOL          NID
 00000MHz         00000KSp/s       0X0000
    
```

8. Set DVB FREQUENCY, SYMBOL RATE and NID when DVB mode of TRACKING SIGNAL is chosen to be used. 45,000 is the maximum allowed symbol rate value. NID (network ID) range is from 0 x 0000 to 0 x FFFF (hexadecimal digit). Press LEFT and RIGHT arrow keys until the desired character is underscored (selected). Press UP and DOWN arrow keys to increase or decrease the value. Or press NUMBER keys to set the desired value directly. Press OK key to set the parameter.

Sat NBD tracking frequency

```

NBD FREQ.          BANDWIDTH
 0000.000MHz       01.000MHz
    
```

9. Set NBD IF FREQUENCY and detection BANDWIDTH when NBD (Narrow band detection) mode of TRACKING SIGNAL is chosen to be used.

Press LEFT and RIGHT arrow keys until the desired character is underscored (selected). Press UP and DOWN arrow keys to increase or decrease the value. Or press NUMBER keys to set the desired value directly. Press OK key to set the parameter.

Save

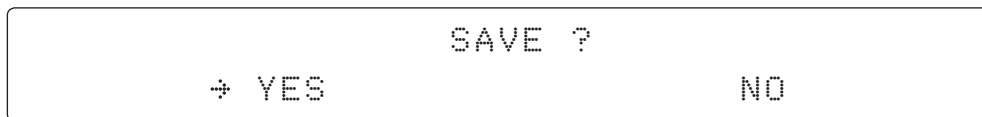

10. Press LEFT arrow key to move cursor to YES and press OK key to save and execute the current settings. Or press RIGHT arrow key to move cursor to NO and press OK key to abort and return to the main display.

Check NID

Setup mode

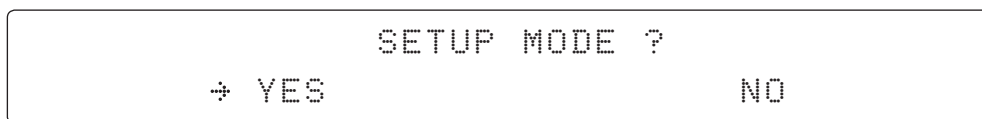

1. Press LEFT arrow key to move cursor to YES and press OK key to enter SETUP mode.

Satellite menu



2. Press RIGHT arrow key to move cursor to SATELLITE menu and press OK key to enter it.

Check NID menu



3. Press DOWN arrow key and OK key to enter CHECK NID menu.

NID verification

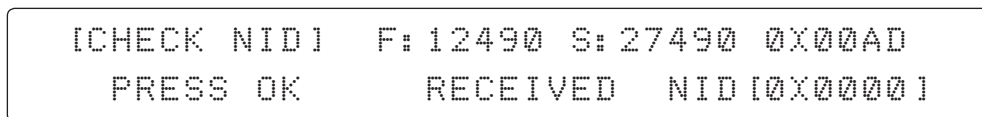

4. CHECK NID is to verify the NID (Network ID) of the current tracking transponder. Press OK key to verify the NID [0 x 0000] only when “PRESS OK” function is activated. “PRESS OK” function will only be activated when DVB Lock signal is confirmed by the antenna. However, “NO LOCK” message will be displayed if DVB Lock signal can’t be confirmed.

System Settings

Set LNB Local Oscillator Frequency

Setup mode

```

                SETUP MODE ?
            ↗ YES                               NO
    
```

1. Press LEFT arrow key to move cursor to YES and press OK key to enter SETUP mode.

System menu

```

    +ANTENNA                                +SATELLITE
    ↗+SYSTEM                                +INSTALLATION
    
```

2. Press DOWN arrow key to move cursor to SYSTEM and press OK key to enter it.

Set local frequency menu

```

    ↖ ↗+SET LOCAL                            +SET LOCATION ↗
        +MODEM PORT                            +MANAGEMENT
    
```

3. Press OK key to enter SET LOCAL menu to set the LNB local frequency.

LNB info

```

    ↖ ↗+13V + 0kHz                            18V + 0kHz ↗
        10000MHz                                11300MHz
    
```

```

        13V + 22kHz                            18V + 22kHz
        10750MHz                                ↖ 09750MHz ↘
    
```

4. Set LNB local oscillator frequency for each correspondent voltage power.
(13V +0 kHz, 18V +0 kHz, 13V +22 kHz, 18V +22 kHz)

Press BACK key and press LEFT and RIGHT arrow keys to select the parameter you wish to edit. Press OK key to edit parameter. Or press BACK key again to return to the main display.

Save

```

                SAVE ?
            ↗ YES                               NO
    
```

5. Press LEFT arrow key to move cursor to YES and press OK key to save current settings. Or move cursor to NO and press OK key to abort and return to the main display.

Set Location

Setup mode

```

                SETUP MODE ?
            ↪  YES                               NO
    
```

1. Press LEFT arrow key to move cursor to YES and press OK key to enter SETUP mode.

System menu

```

        +ANTENNA                               +SATELLITE
    ↪++SYSTEM                               +INSTALLATION
    
```

2. Press DOWN arrow key to move cursor to SYSTEM and press OK key to enter it.

Set location menu

```

    ⚡  +SET LOCAL                               ↪++SET LOCATION  ⚡
        +MODEM PORT                               +MANAGEMENT
    
```

3. Press RIGHT arrow key to move cursor to SET LOCATION and press OK key to enter it.

Gyro type and Baud rate

```

        GYRO TYPE                               BAUD RATE
            NMEA                                 ⚡  4800  ⚡
    
```

4. Set the ship's **GYRO TYPE*** and BAUD RATE

A search pattern 1 or 3 will be initiated according to which GYRO TYPE is selected and the existence of the gyro input. Set the BAUD RATE as 4800, 9600, 19200 or 38400 according to your device.

A search pattern 1 will be initiated automatically if the gyro input does not exist and the gyro type is selected other than GROUND TEST.

NOTE: The bow offset will not be saved automatically if Search 1 pattern is initiated. In this case, the antenna will need to re target the desired satellite using Search 1 every time if the antenna restarts.

Gyro search type

Existence of Heading Data	Setting of Heading Device		
	No Device	NMEA / NMEA2000	Ground Test
With Heading Data	Search 1	Search 3	Search 3
Without Heading Data	Search 1	Search 1	Search 3

GYRO TYPE*

NO DEVICE
NMEA
NMEA2000
GROUND TEST

Latitude & longitude

←	→	LATITUDE	LONGITUDE	→
		37.00N	126.50E	

5. Set the current LATITUDE and LONGITUDE
 Press LEFT and RIGHT arrow keys until the desired character is underscored (selected).
 Press UP and DOWN arrow keys to increase or decrease the value.
 Or press NUMBER keys to set the desired value directly.
 Press the OK key to set the parameter.

Heading

←	HEADING	→
	090.0	

6. Entry of ship's heading is not required when your system is connected to a NMEA(0813) or NMEA2000.
 Ensure that the supported Gyro Type is set correctly. If the ship's gyrocompass output is other than NMEA0183 and NMEA2000, a purchase of an NMEA converter is required.

Save

	SAVE ?	
→	YES	NO

7. Press LEFT arrow key to move cursor to YES and press OK key to save current settings.
 Or move cursor to NO and press OK key to abort and return to the main display.

Set Modem Port

Setup mode

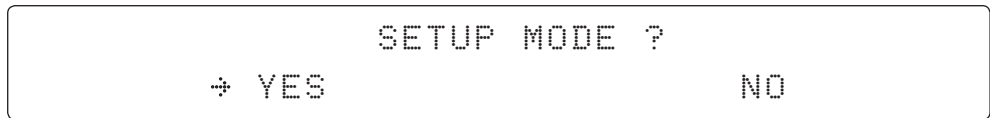

1. Press LEFT arrow key to move cursor to YES and press OK key to enter SETUP mode.

System menu

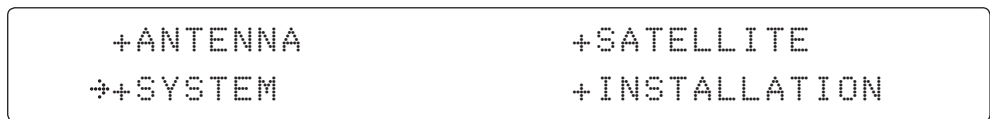

2. Press DOWN arrow key to move cursor to SYSTEM menu and press OK key to enter it.

Modem port menu

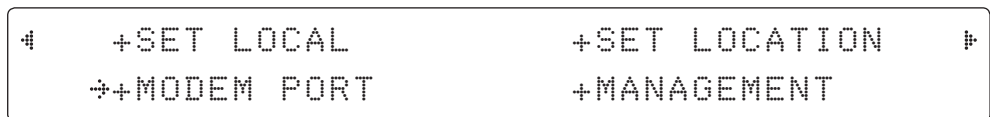

3. Press DOWN arrow keys to move cursor to COM. PORT menu and press OK key to enter it.

Set Mediator & modem type



4. USE MEDIATOR is to enable the usage of MEDIATOR if the antenna is connected to the Intellian Dual VSAT Mediator.

NOTE: USE MEDIATOR must be disabled if there is no MEDIATOR connected to the ACU. Improper setting of this parameter will cause your ACU's modem interface working incorrectly.

MODEM TYPE* is to select a proper data communication port and protocol on the ACU to interface with the satellite modem. The settings related to the modem interface will be set automatically once the modem type is selected. Select "USER SETTING" if a desired modem type is not available in the option.

The options on the next page will be displayed and required to be set if "USER SETTING" is selected.

- MODEM TYPE***
- USER SETTING
- IDIRECT-I/O
- IDIRECT-AMIP
- COMTECH-I/O
- COMTECH-ROSS
- HUGHES
- SATLINK-SERIAL
- SATLINK-VACP
- ELEKTRIKOM-AMIP
- GILAT-SE-II

Set modem protocol

```

MODEM PORT          PROTOCOL
┌──────────┬──────────┐
│  ▲        │          │
│  ETHERNET  │          │
│  ▼        │          │
└──────────┴──────────┘
I/O CONSOLE
    
```

5. **MODEM PORT*** is to select a proper data communication port on the ACU to interface with the modem.

PROTOCOL* is to select a proper communication protocol on the ACU to interface with the modem.

MODEM PORT*

ETHERNET
RS422
RS232

PROTOCOL*

I/O CONSOLE: is a protocol for interchanging of information (GPS Out, TX mute, and modem lock) between the ACU (through Console port) and a modem.

OPEN AMIP: is an ASCII based protocol developed by iDirect for interchanging of information between the ACU and a modem. OpenAMIP is not intended for any purpose except to allow the ACU and a modem to perform synchronized automatic beam switching (ABS).

SERIAL GPS: is a protocol for sending GPS Out information from the ACU (through RS232/422 port) to a modem.

ROSS: ROSS Open Antenna Management (ROAM) protocol is developed by Comtech EF Data Cooperation to offer common management interface for Comtech EF Data's Roaming Oceanic Satellite Server (ROSS) and ACU.

VACP: is the interface between the SatLink mobile VSAT IDU and the Intellian antenna controllers for Intellian mobile antennas.

ELEKTRIKOM-AMIP: is the interface using extended OpenAmip including the console port (modem lock) between the elektrikom ROAM-PC and the Intellian controller.

GILAT-SE-II: is a protocol that generates between the Gilat SkyEdge modem and the Intellian antenna controllers two-channel interfacing based on the NMEA 0183 data protocol. The interfacing occurs via RS232 serial port at 9600-N-8-1 baud.

Use TX mute

```

GPS OUT SENTENCE    USE TX MUTE
┌──────────┬──────────┐
│  ▲        │          │
│  GPGLL    │          │
│  ▼        │          │
└──────────┴──────────┘
YES
    
```

6. **GPS OUT SENTENCE*** is to select the GPS OUT SENTENCE type USE TX MUTE is to select whether or not to USE TX MUTE function from the satellite modem. A transmit inhibit output from the ACU will disable/mute the modem transmit via a voltage whenever the antenna is blocked, searching, or is mis-pointed 0.5 degrees from the peak satellite position.

GPS OUT SENTENCE*

GPGLL
GPGGA
SIMPLE GPGGA

Use EXT.LOCK

USE EXT. LOCK	EXT. LOCK ACTIVE
➤ YES	▼ LOW

6. USE EXT. LOCK is to select whether or not to use external lock signal from the satellite modem. USE EXT. LOCK item will only be activated when PROTOCOL is set as I/O CONSOLE.

EXT. LOCK ACTIVE is referred that modem lock output from the modem provides a logic input through a 5 V (HIGH) or 0 V (LOW), current to the ACU to identify when it is on the correct satellite. EXT. LOCK ACTIVE item will only be activated when PROTOCOL is set as I/O CONSOLE.

TX mute activation

TX MUTE ACTIVE
➤ LOW ▼

7. TX MUTE ACTIVE is a transmit inhibit output from the ACU to disable/mute the modem transmit through a 5 V (HIGH) or 0 V (LOW) current whenever the antenna is blocked, searching, or is mis-pointed 0.5° from peak satellite position. TX MUTE ACTIVE item will only be activated when PROTOCOL is set as I/O CONSOLE.

Save

SAVE ?	
➤ YES	NO

8. Press LEFT arrow key to move cursor to YES and press OK key to save current settings. Or move cursor to NO and press OK key to abort and return to the main display.

System Management

Setup mode

```

                SETUP MODE ?
            → YES                                NO
    
```

1. Press LEFT arrow key to move cursor to YES and press OK key to enter SETUP mode.

System menu

```

        +ANTENNA                                +SATELLITE
    →+SYSTEM                                    +INSTALLATION
    
```

2. Press DOWN arrow key to move cursor to SYSTEM menu and press OK key to enter it.

Backup and restore menu

```

#  +SET LOCAL                                +SET LOCATION  #
    +MODEM PORT                                →+MANAGEMENT
    
```

3. Press arrow keys to move cursor to MANAGEMENT menu and press OK key to enter it.

Select process type

```

                SELECT PROCESS TYPE
            ▲          BACKUP USER DATA          ▼
    
```

4. Press UP and DOWN arrow keys to **SELECT PROCESS TYPE***
Press OK key to set the parameter and the processing message will be displayed.

SELECT PROCESS TYPE*

BACKUP USER DATA: To backup the antenna settings set by user to the ACU.

RESTORE USER DATA: To restore the antenna by using the backup user data stored from the ACU.

DEFAULT ACU-REMOTE P/W: To change the web server module's password to default.

Processing

UPGRADE FROM USB: To upgrade the system by using firmware files (FWP) from a specified folder in a USB flash drive.

COPY LOG TO USB: to copy the antenna log data from the system to a USB flash drive.

BACKUP TO USB: To backup the antenna settings set by user to a USB flash drive.

RESTORE FROM USB: To restore the antenna by using the backup user data from a USB flash drive.

UPGRADE ACU-REMOTE: To upgrade the system using firmware files (FWP) from a specified folder in a USB flash drive.

NOTE: UPGRADE FROM USB, COPY LOG TO USB, BACKUP TO USB, RESTORE FROM USB and UPGRADE ACU-REMOTE options are displayed only if the USB flash drive is plugged into the USB port.

Setup mode

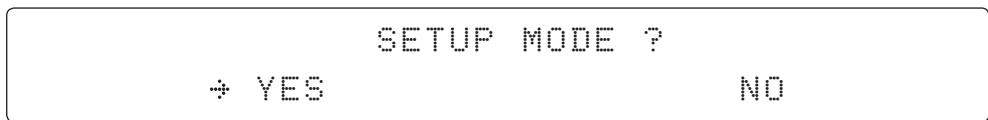

1. Press LEFT arrow key to move cursor to YES and press OK key to enter SETUP mode.

System menu

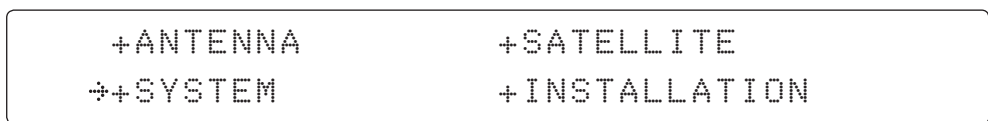

2. Press DOWN arrow key to move cursor to SYSTEM menu and press OK key to enter it.

Key lock menu

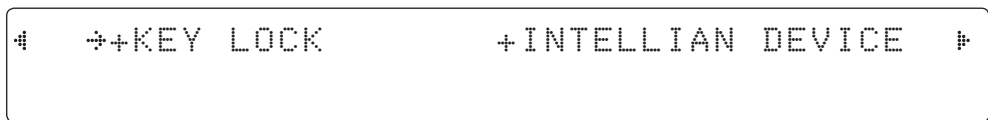

3. Press arrow keys to move cursor to KEY LOCK menu and press OK key to enter it.

Set key lock and password



4. Press UP and DOWN arrow keys to choose whether or not to use key pad lock when entering the SETUP mode or saving the satellite information. Setup the password for entering the key pad lock. The factory default is 1590.

ANTENNA CONTROL SOFTWARE

Introduction to Aptus®

Requirements

Software Installation

PC to ACU Communication Setup

Starting Aptus®

Establishing a data communication

Toolbar Menus

System Property Status Dashboard

Work View Tabs

Antenna - Basic Info.

Antenna - Advanced Info.

Satellite

Graph View

Monitor

Diagnostic/Modem

GUI

Work View Functions

Introduction to Aptus®

Intellian's Antenna PC Controller Software, Aptus® is a next-generation graphically based antenna remote control software. The Aptus® allows users to easily and conveniently set up the antenna by using a personal computer.

The minimum PC hardware and software requirements to install and run Aptus® are as below.

Requirements **Hardware**

Hardware	Requirements
CPU	Intel® Pentium® 4 or higher
Memory	512MB or higher
Video Card	DirectX9.0 or higher supported
	H/W acceleration supported
	Video Memory 128MB or higher
HDD	1GB or higher

Operating System and Software

Software	Requirements
Operating System	Windows XP SP or higher
Framework	Microsoft.Net Framework 3.5 Service Pack 1 or higher

Software Installation

Double click the 'Aptus Setup.exe' icon  to install Aptus® directly onto your computer/ laptop. The InstallShield Wizard will guide you through the program setup process. The installation routine provides an icon on the desktop.

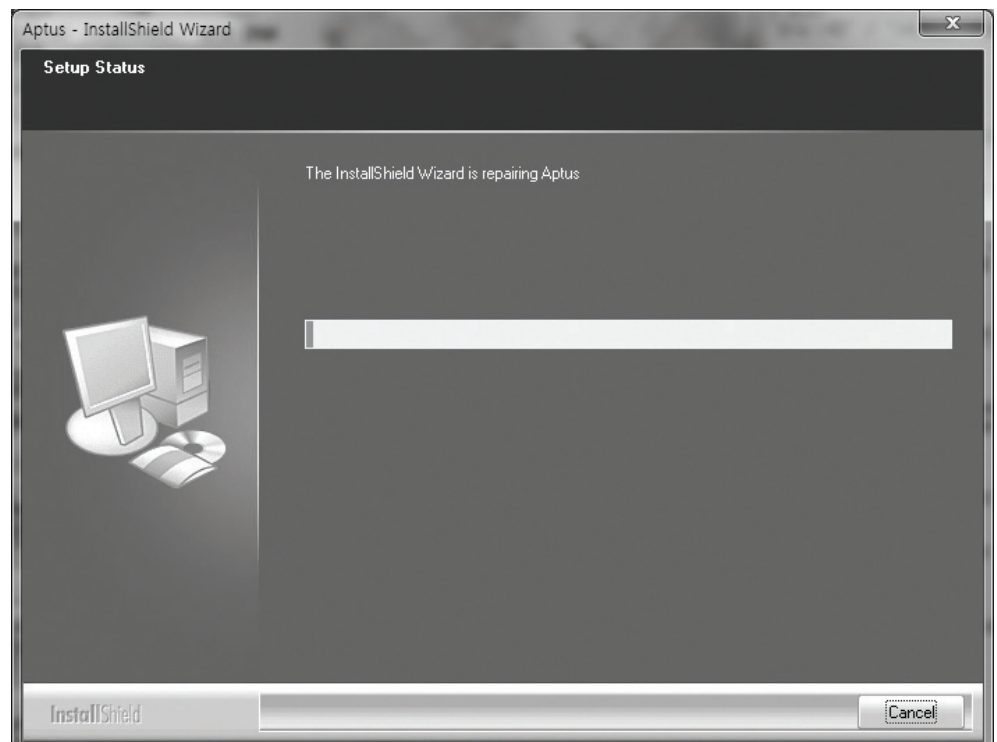

Click the icon to start the software. In addition, Intellian also provides patch files for software upgrade.

PC to ACU Communication Setup

Starting Aptus®

Double-click the Aptus® desktop icon, then Communication Window appears to establish the data communication between your PC and the ACU. Select options of connection method to access your ACU either through the Serial Port Communication or the Network Communication (TCP/IP).

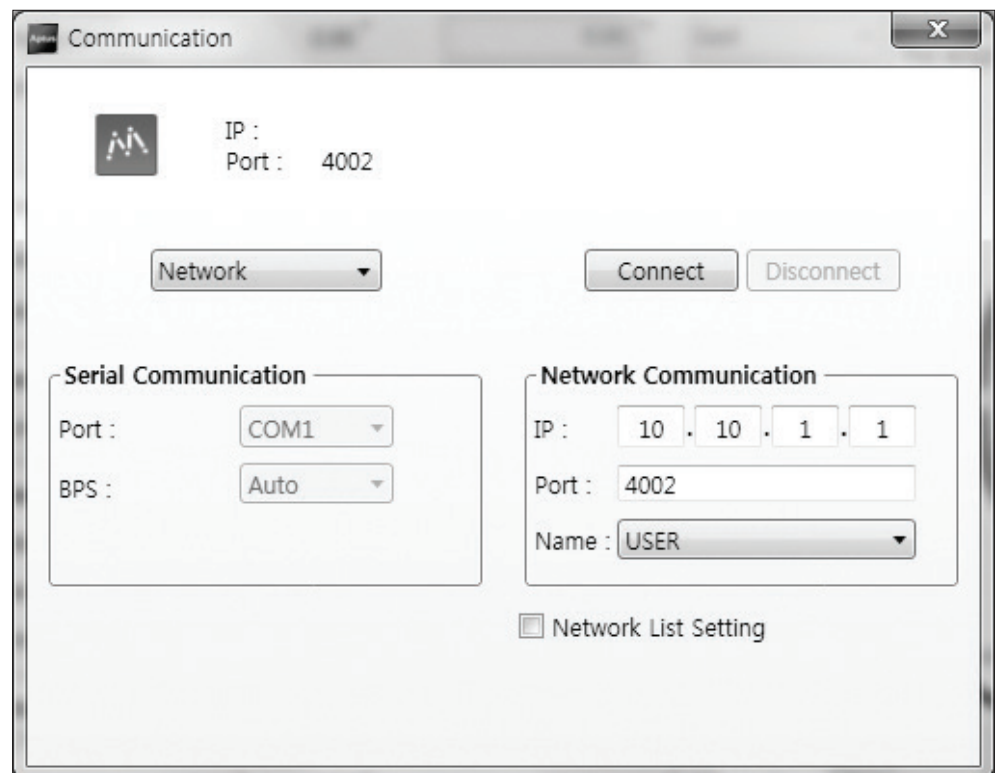

Establish a data communication

Access ACU through Serial Communication

1. Connect a 9 pin Serial cable between the PC INTERFACE connector on the ACU and the 9 pin Serial port on the PC. (Or you can use a USB cable to setup Serial connection between a PC and the USB port on the ACU.)
2. Select Serial at communication type combo-box.
3. The baud rate of the ACU is 19200.
4. Select a COM port which is not occupied by other devices.
5. Click the Connect button.

Access ACU through Network Communication (TCP/IP)

1. Turn off the wireless connection while using this method.
2. Connect your PC to the Management Port.
3. Select Network at communication type combo-box.
4. Enter in the ACU's IP address (Factory default : 192.168.2.1)
5. Enter in the ACU's port number (Factory default : 4002)
6. Click the Connect button then the Authentication window will appear.
7. Login by using the username and password below:
 - Username: intellian (Factory default)
 - Password: 12345678 (Factory default)

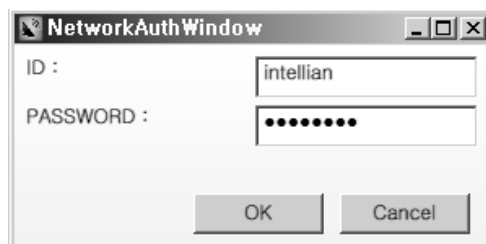

NOTE: If the remote access PC is located in the same network group with the ACU, the ACU can be accessed through the internal IP address. But, if the remote access PC is located outside of the network group, the ACU's IP address should be changed to the IP address assigned by the network service provider.

**WARNING:**

- Do not plug a USB to the ACU while TCP/IP communication is in use. Doing so will disable current PC Software Control because the USB connection has higher priority than TCP/IP connection.
- The amount of data will increase rapidly if Network Communication is in use. Intellian recommends using Aptus Web.

AutoUpdate

Intellian Aptus® checks and notifies the latest version when it is started to maintain up to date software version by AutoUpdate function.

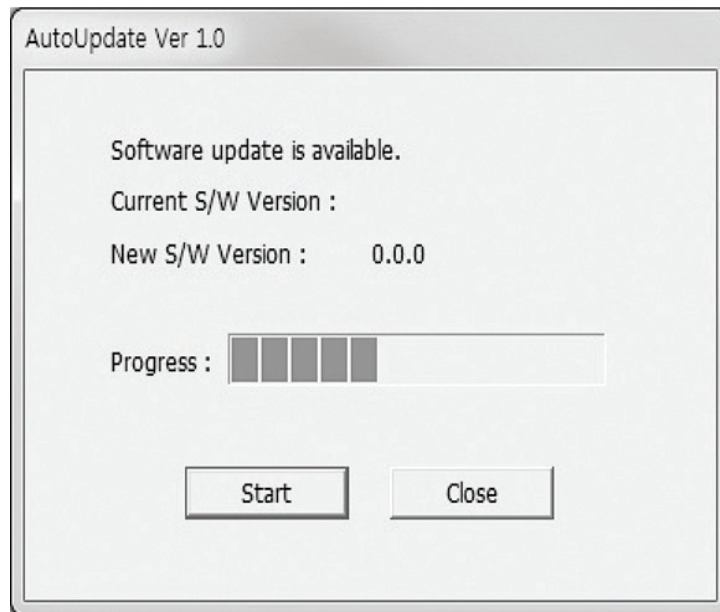

1. When Aptus® is started, it automatically checks the latest software version from the server and runs AutoUpdate if new version is available.
2. Current software version information is displayed.
3. It notifies new software version information.
4. When you click the “start” button, “File downloading...” message is displayed while downloading files from the server.



5. When file downloading is finished, “installing...” message is displayed and Aptus patch runs and the installation starts by InstallShield.
6. Click the “Finish” button when InstallShield installation is finished, then “Run the Aptus” message is displayed and Aptus runs and AutoUpdate is automatically finished.

Toolbar Menus

The toolbar menus at the top of the screen display command buttons of the most commonly used functions of the Aptus®. The toolbar menus consists of 4 main menus; Quick (for quick launch of functions), File (for file backup, restoring and loading), View and Connection.

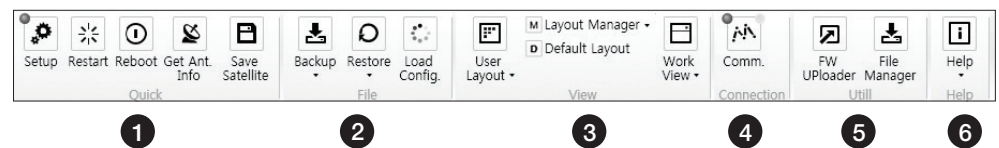

① Quick



Setup: enters Setup mode.



Restart: exits Setup mode and restarts the antenna.



Reboot: reboots the antenna.



Get Ant. Info: obtains the information stored in the antenna



Save Satellite: saves the current bow offset only if the antenna is tracking onto the satellite. The satellite acquisition time can be reduced significantly after the antenna is restarted.

② File



Backup: backups the antenna information to ACU or PC.

- Select 'To ACU' to backup the antenna information to ACU. The backup file (file format: *.ibf) will be stored on the ACU.

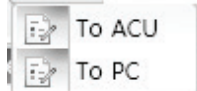

- Select 'To PC' to backup the antenna information to a PC. The backup files (file format: *.rpt and *.ibf) will be generated on the PC.

NOTE: Both *.rpt and *.ibf files contain antenna information. However, while *.ibf file can be used for restoring antenna information, *.rpt file is stored as plain-text for viewing purpose only. Users can open the *.rpt using text editors such as notepad software.

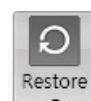

Restore: restores the antenna by using the stored information in ACU or PC.



- Select 'From ACU' to restore the antenna by using the stored information in ACU.

- Select 'From PC' to restore the antenna by using the stored information in PC (file format: *.ibf).



Load Config. : loads the antenna configuration file (file format: *.cfg). The configuration file includes the antenna control parameters which are pre-loaded at the factory and should only be changed by an authorized service technician. Improper setting of these parameters will cause your system to perform improperly.

③ View



- **User Layout:** displays the layout list that the user has previously stored by using Layout Manager. If you select a layout in this list, the selected layout will be constructed in Work View screen. The 'Basic layout' is provided by default.

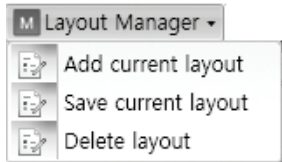

- **Layout Manager:** provides the user with add, delete, and save functionalities in order to manage the user's layouts.
 - Selecting 'Add current layout' opens a pop up window. Type in a desired name of current layout and click Add, then the new name of the current layout will be saved to the list under User Layout menu.
 - When changes are made to the current layout, select 'Save current layout' option. The current layout will be saved with changes.
 - To remove a layout, select 'Delete layout' option. Select a desired layout to remove on the pop up window, then click 'Delete'. Close the window by clicking on 'Close'. The selected layout is removed from the User Layout list.

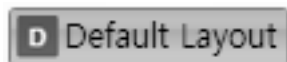

- **Default Layout:** returns the current layout to the default layout.

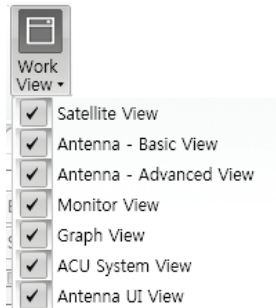

- **Work View:** displays a list of seven pre-constructed Work View Tabs (Satellite View, Antenna Basic View, Antenna Advanced View, Monitor View, Graph View, ACU System View, and Antenna UI View) and also provides the Activate / Close functionalities for each view tab. Activate the work view tab by ticking the checkbox next to it.

④ Connection

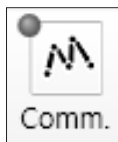

At any time, data communication channel can be re-established between Serial and Network connection. Selecting Comm. Button will display Communication Window to connect to the ACU via Serial or Network communication.

⑤ Util

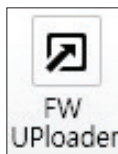

- **Firmware Uploader:** provides the user with the latest firmware version and updates firmware by simple steps.

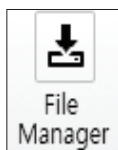

- **File Manager:** display the latest firmware and library file available on Aptus Server. Select a desired firmware and download to the local PC.

⑥ Help

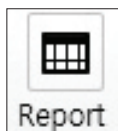

- **Report:** provides e-mail contact to Intellian technical support team to let the user report problems at any time.



- **Information:** displays the information of current Aptus® software version.

System Property Status Dashboard

The property status dashboard on the left pane of the screen provides the antenna status, the availability of TX transmission, signal level, GPS and heading status, software information, product information and error status to be monitored quickly.

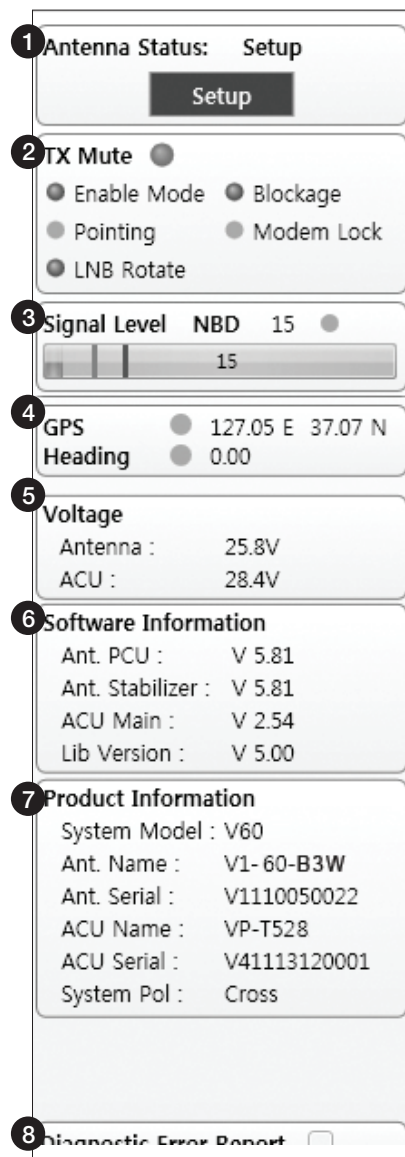

- ① Antenna Status: Displays the status of the current mode of the antenna.
- **Search 1:** A Search 1 pattern will automatically be initiated when the ship's heading input does not exist or if it fails. The search cycle will repeat until the antenna receives the lock signal from the modem or until the DVB transponder of the target satellite is decoded by the antenna.
 - **Search 2:** Search 2 is reserved for future use.

- **Search 3:** Search 3 pattern will automatically be initiated when AGC(DVB mode is in use) or SIG/dB (NBD mode is in use) falls below the current tracking level threshold value. Once the desired signal is found and above the predefined tracking threshold, the ACU will enter to tracking mode.
- **Tracking:** Antenna is tracking the target satellite.
- **Initialize:** Antenna or ACU is initializing.
- **Setup:** Antenna is in SETUP mode.

② TX Mute

Displays the status of TX transmit. If the circle next to the TX Mute shows “Blue”, it means the antenna TX function is enabled. If the circle shows “Red”, it means the antenna TX function is disabled. The TX function will be enabled only if all five factors (Enable Mode, Blockage, Pointing, Modem Lock, and LNB Rotate) listed below show a “Blue” circle. However, if the “Use TX Mute” function in the ‘ACU System’ Work Tab is disabled, the TX function will be enabled regardless the above factors.

- **Enable Mode:** displays whether or not the antenna is transmitting.
- **Blockage:** displays whether or not the antenna is pointing in a predefined block zone(s). If the antenna is pointing in the block zone, the circle next to the Blockage will show “Gray”. If the antenna pointed outside the block zone, the circle next to the Blockage will show “Blue”.
- **Pointing:** displays whether or not the antenna is pointing to the target satellite. If the antenna is mis-pointing to the target satellite, the circle next to the Pointing will show “Gray”. If the antenna is pointing to the target satellite, the circle next to the Pointing will show “Blue”.
- **Modem Lock:** displays whether or not the modem is locked by receiving a confirmation signal from the satellite modem. If the modem is not locked, the circle next to the Modem Lock will show “Gray”. If the modem is locked, the circle next to the Modem Lock will show “Blue”.

NOTE: If the Modem Lock shows “Gray”, check the cable connection between the antenna system and the satellite modem as well as settings on the modem.

- **LNB Rotate:** displays whether or not the LNB is rotating. If the LNB is rotating, the circle next to the LNB Rotate will show “Gray”. If the LNB is not rotating, the circle next to the LNB Rotate will show “Blue”.

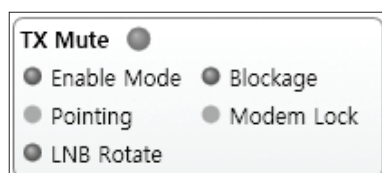

③ Signal Level

Shows “DVB” when DVB mode of tracking signal is in use and “NBD” when NBD mode of tracking signal is in use. The “Red” line indicates the signal “Detect Level Threshold” and the “Orange” line indicates the signal “Tracking Level Threshold”. If the signal level is higher than the tracking level threshold, the signal level bar will display “Blue” color. If the signal level is lower than the tracking level threshold, the signal level bar will display “Orange” color and the antenna will stay in searching mode.

NOTE: If the signal level is not higher than the tracking threshold, decrease the detect and tracking level.

④ GPS and Heading

Displays the current GPS location from the Antenna and Ship’s heading information. The status light flashes green if the system receives a correct input of the GPS and Ship’s heading.

Ant. GPS Status ● (127.05 E , 37.07 N)
Heading Status ● (0.00)

⑤ Voltage: Displays the antenna and the ACU voltage information.

Voltage
Antenna : 25.8V
ACU : 28.4V

⑥ Software Information: Displays the antenna and the ACU firmware versions, and the library version.

Software Information
Ant. PCU : V 5.81
Ant. Stabilizer : V 5.81
ACU Main : V 2.54
Lib Version : V 5.00

⑦ Product Information: Displays the antenna and ACU serial numbers, antenna model and ACU model.

⑧ Diagnostic Error Report

The square button next to the Diagnostic Error Report turns red when the system receives an error. Click the button to see a Diagnostic Report.

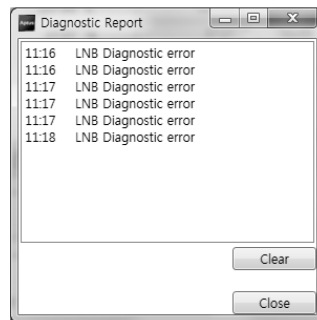

Work View Tabs

Aptus® provides seven Work View Tabs (Satellite View, Antenna Basic View, Antenna Advanced View, Monitor View, Graph View, ACU System View, and Antenna UI View) to manage the Antenna and the Satellite configuration.

How to modify the settings on Work View;



1. Enter the Setup mode by clicking Setup icon.

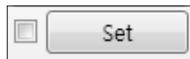

2. Tick the checkbox next to the “Set” button to modify the settings.
3. Enter the desired value then press the Set button to save the settings.

1. Antenna – Basic Info.

This view tab provides information on the Antenna’s Current GPS location, Heading Device, Bow Information, Skew Information, and the Antenna’s Angle. This view tab uses the Antenna’s AZ and EL information as well as the Ship’s Heading information in order to provide a dynamic graphic user interface (UI).

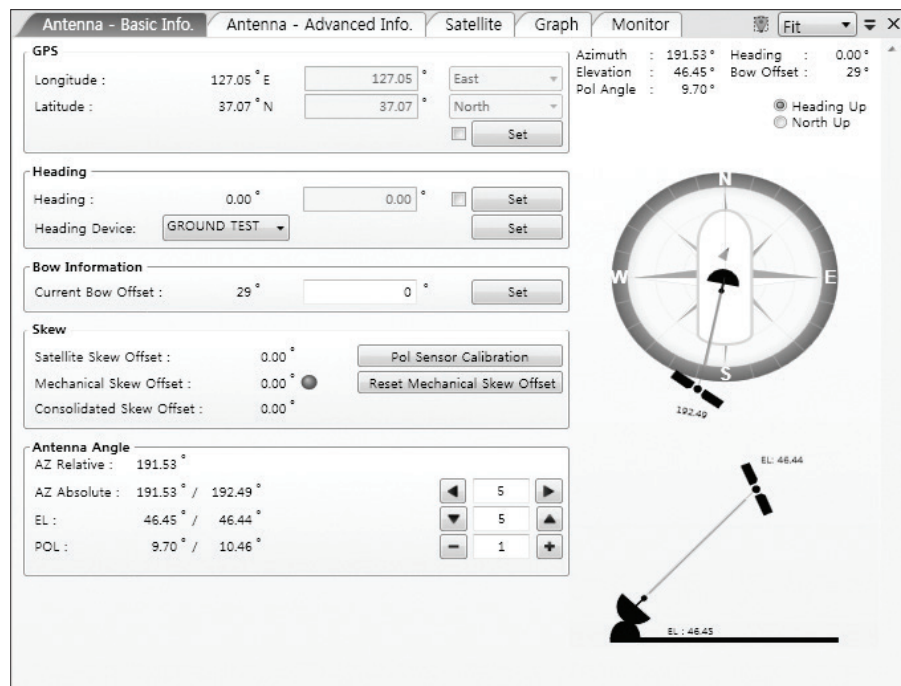

- **GPS:** displays and sets current antenna's GPS.

- **Heading:** displays and sets current ship's heading information.
 - Heading Device: None / NMEA/ NMEA 2000/Ground Test.
The baud rate (4800/ 9600/ 19200/ 38400) must be set if NMEA is selected.

- **Bow Information:** displays and sets current antenna's bow.

- **Skew:** displays current antenna's skew and skew offset.
 - Pol Sensor Calibration: calibrates the sensor (potentiometer).

 - Reset Mechanical Skew Offset: the mechanical skew offset is preset in the factory with a default value (0, 1, or 2) depending on the assembly status. Resetting of the mechanical skew offset may be required when the satellite skew offset is unknown (Consolidated Skew Offset = satellite skew offset + mechanical skew offset). Due to each satellite has its own skew offset, Intellian recommends you check with your service provider or satellite operator to get the satellite skew offset value and input it in Satellite Work Tab rather than resetting the mechanical skew offset directly.

- **Antenna Angle:** displays and sets current antenna's absolute and relative AZ (azimuth) position, EL (elevation) position and LNB Pol angle. You can move antenna azimuth and elevation position and LNB Pol angle by using the arrows or inputting a value to find the desired satellite manually.

2. Antenna – Advanced Info.

This view provides information on the Tilt Sensor Bias, Conical Range, EL Adjust, Rate Sensor, Search Parameter and Block Zone.

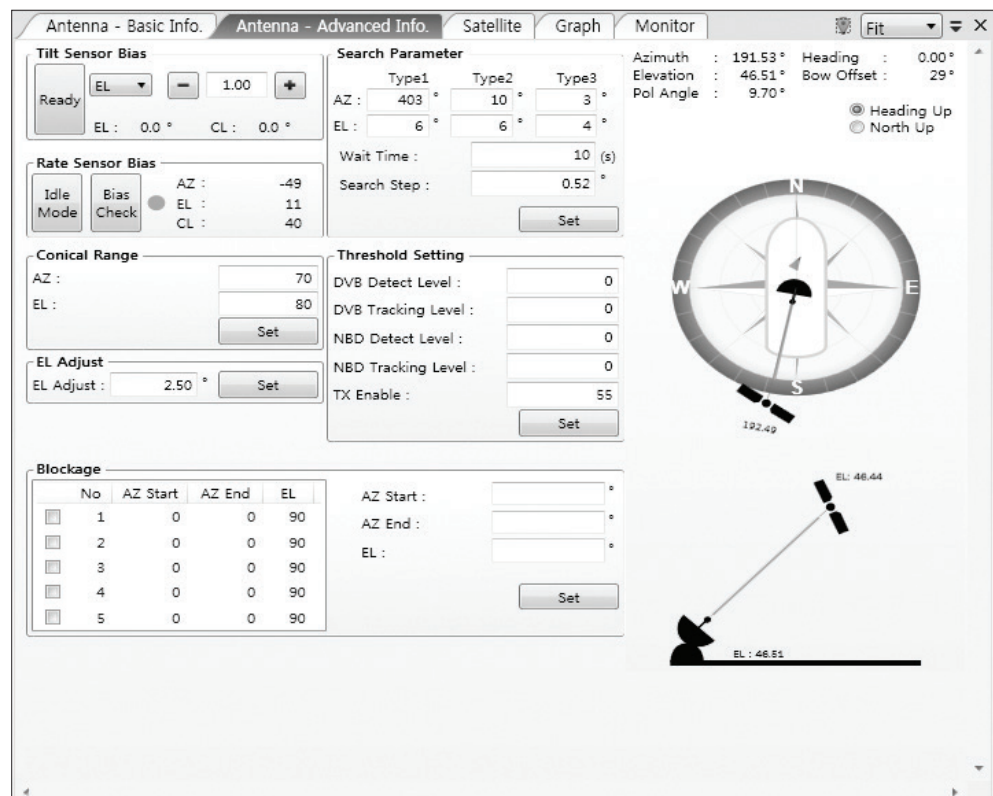

-Tilt Sensor Bias: This maintains the elevation and the cross level axes in order to keep the pedestal parallel to the horizon. Adjust the two solid-state tilt sensors to provide absolute cross-level tilt of the antenna and el elevation feedback to eliminate long-term pointing drift (error). Tilt bias must be adjusted when the antenna control board or sensor box is replaced. If the bubble on the button level located on the sensor box is not centered, follow the following steps to adjust the tilt sensor bias.

- Step 1. Enter Setup mode and press the “Ready” button to bring the elevation and cross-level to 0.
- Step 2. Select “EL” from the drop down list and press Up and Down arrow keys to adjust the bubble until it is located in the center ring of the button level.
- Step 3. Select “CL” from the drop down list and press Up and Down arrow keys to adjust the bubble until it is located in the center ring of the button level.



- Step 4. Press the “Restart” icon to restart the antenna.

- **Rate Sensor:** is used to calibrate the DC voltage output from the three rate sensors (azimuth, elevation, and cross-level). These are used to sense antenna motion that corresponds to the ship’s motion (roll, pitch, and yaw) for stabilizing the pedestal. The DC voltage output from each of the rate sensors may vary by an amount which is directly proportional to the direction and rate of motion induced on it.

Before calibrating the rate sensors located in the Sensor box, make sure that the antenna is placed on a rigid and flat platform. During the calibration process, any motion of the antenna should be avoided as it can affect the antenna’s performance. Proceed with the following steps to perform the calibration.

- Step 1. Enter Setup mode
- Step 2. Press the “Idle Mode” button to release the elevation and cross level motor brakes while the antenna is in Setup mode.
- Step 3. Check whether or not the bubble is located at the center of the button level. If not, move it to the center by following the previous instruction of Tilt Sensor Bias adjustTMent.
- Step 4. Press the “Bias Check” button to calibrate the rate sensor. A blue circle will be displayed next to the Bias Check button if the calibration is completed. A red circle will be displayed if calibration failed. A green circle will be displayed during the calibration process.

- **Conical Range:** The relative force of the motors controlling azimuth and elevation. Set the conical range while the antenna is in tracking mode.

- **EL Adjust:** The elevation adjustTMent is to offset the angle difference between the mechanical elevation angle and actual elevation angle. If this value is not properly adjusted, the antenna may take longer time for satellite search or tracking.

- **Search Parameter:**

- Wait time: set the time-out for automatic initiation of a search after the signal level drops below the pre-defined threshold value.

- Search Step: set increment step size.
- Type 1 & Type 3 (Search 1 & 3) Range: set Search 1 & 3 search range. Search 3 is conducted in a two-axis pattern consisting of alternate movements in azimuth and elevation as it forms an expanding square.
- Type 2 (Search 2) Range: is reserved for future use.

- Block Zone

Displays current block zones by azimuth and elevation sectors. Up to 5 block zones can be programmed. Once the block zone is created, a blue shading area will be displayed in the Antenna UI view on the right.

- Threshold Settings

- DVB Detect Level: displays and sets signal detection threshold level when DVB tracking mode is in use.
- DVB Tracking Level: displays and sets signal tracking threshold level when DVB tracking mode is in use.
- NBD Detect Level: displays and sets signal detection threshold level when NBD tracking mode is in use.
- NBD Tracking Level: displays and sets signal tracking threshold level when NBD tracking mode is in use.
- TX Enable Threshold: displays and sets TX enable threshold.

3. Satellite

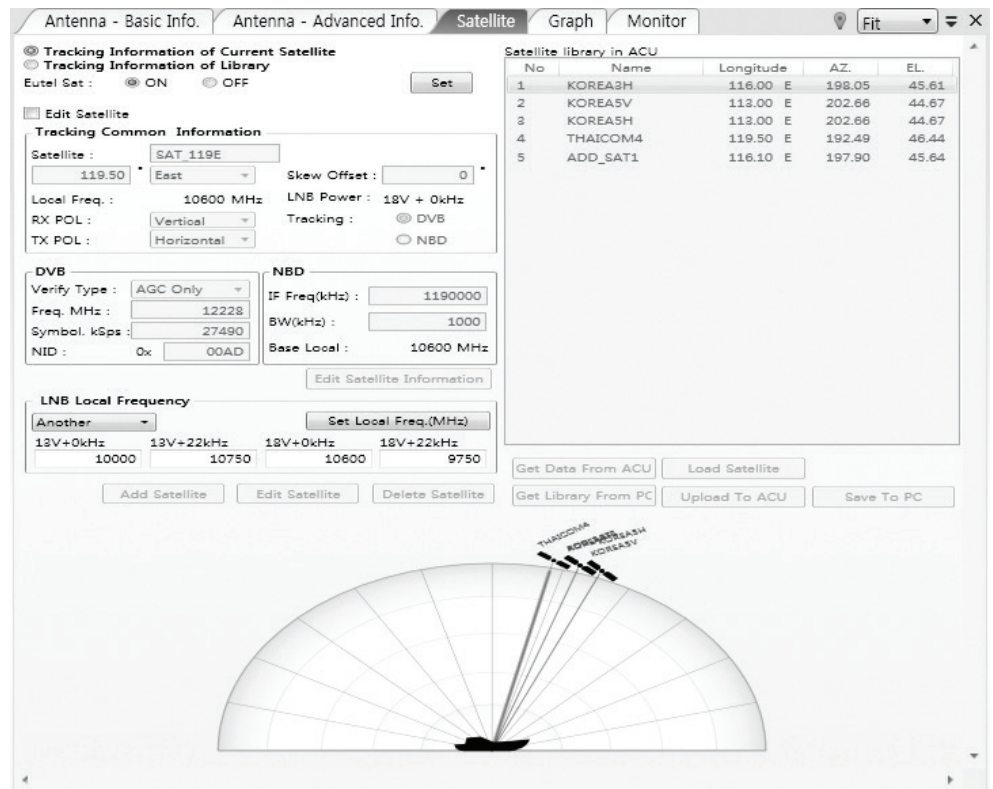

This view provides information on the Satellite's Information, Tracking Common Information, DVB and NBD Tracking Transponder, LNB Local Frequency, and Satellite Library. This view shows a graphic UI of the current satellite that the antenna is pointing at and the satellites that are located at a 180° arc on the horizon with reference to the current position.

NOTE: Based on the satellite EIRP footprint and the size of the antenna, you may not be able to track all the satellites visible in 180° arc.

- **Tracking Information of Current Satellite:** displays the current satellite's name, longitude position, and satellite skew of the satellite in the library.

- **Tracking Common Information:** displays the current LNB local oscillator frequency that is in use and the corresponding voltage supplied. Selects the tracking mode (DVB / NBD) to be used and sets polarization (Horizontal / Vertical) for the RX pol and the TX pol.

- **DVB/NBD:** sets tracking transponder information for either DVB tracking mode (Verification Type, Frequency, Symbol rate, and NID) or NBD tracking mode (Frequency and bandwidth).

NOTE: DVB and NBD parameter settings should only be changed by an authorized service technician. Improper setting of these parameters will render your system inoperable. Consult Intellian for changing antenna parameters.

- **LNB Local Frequency:** Displays or sets LNB local frequency and its corresponding LNB voltage supplied. You may select pre-programmed LNB LO settings from the drop down list. This procedure is same for both the Intellian Global VSAT PLL LNB and any other LNB.

- **Tracking Information of Library:** Selecting this option enables “Add Satellite”, “Edit Satellite” and “Delete Satellite” buttons.

- **Eutelsat:** Select 'ON' when the antenna is tracking an Eutelsat satellite. With this option enabled, a defined skew angle for each Eutelsat satellite is automatically applied without allowing a manual modification to the skew offset value.
- **Get Library From PC :** opens the satellite library file (File format:*.ilf) from the PC.
- **Get Data From ACU:** obtains the satellite information from the ACU.
- **Load Satellite:** uploads the satellite information to the ACU.
- **Upload to ACU:** uploads the satellite library to ACU.
- **Edit Satellite:** edits the satellite information of the selected satellite.
- **Add Satellite:** adds the satellite information as defined in the current settings.
- **Delete Satellite:** deletes the selected satellite from the library.
- **Save to PC:** saves the current library settings to PC.

NOTE: It is required to click the "Save to PC" button after "Edit Satellite", "Add Satellite", or "Delete Satellite" button is clicked.

4. Graph View

This view provides information on Signal, Elevation (EL), Absolute AZ (Azimuth), Relative AZ, Heading, AZ and EL in Single or Multi graph formats.

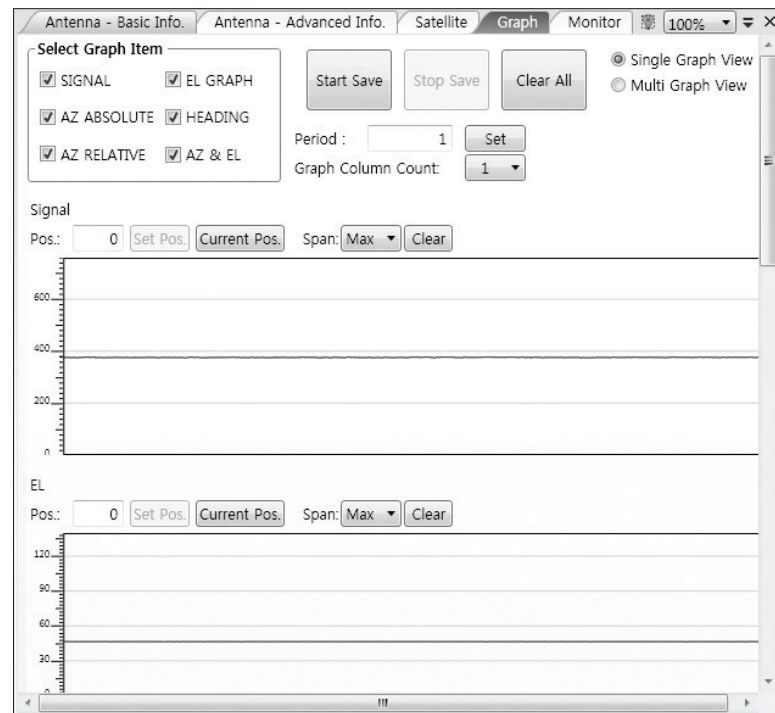

- **Select Graph Item:** shows the graphs of only the checked item(s) in a Single or Multi Graph View.
- **Single Graph View:** shows Graph Views per each single Graph Item selected in 'Select Graph Item'.
- **Multi Graph View:** shows one large integrated Graph View of multiple Graph Items selected in 'Select Graph Item'.
- **Start/Stop Save:** the chosen item is saved within the data log. The data log which stores the information displayed in the graphs can be later used for a service technician to find out a cause of any possible problem to the antenna.
- **Clear All:** clears everything drawn on the Graph View window.
- **Set Pos.:** sets the current position as center value of each Graph Item.
- **Current Pos.:** moves to the location according to values of each Graph Item.
- **Span:** sets the Display Range(s) of each corresponding Graph Item.
- **Period:** displays and sets the signal sampling rate.
- **Graph Column Count:** makes all Graph Views show in either one or two-column format.

5. Monitor

This view provides a UI which can monitor all data that has been received from the ACU.

The screenshot displays the 'Monitor' tab of the software interface. The main window contains a table with the following data:

15:20:51	[S] Tilt[2] [24] -17 (3 300)	16	191.53	191.53	46.49	0	127.05 E 37.07 N
15:20:51	[S] Bias Correction 1	16	191.53	191.53	46.49	0	127.05 E 37.07 N
15:20:51	[P] Result[P1 2] [51 3]	16	191.53	191.53	46.49	0	127.05 E 37.07 N
15:20:54	[S] EL/CL 9 / 1(13)	16	191.53	191.53	46.51	0	127.05 E 37.07 N
15:20:59	[S] EL/CL 3 / -2(13)	16	191.53	191.53	46.44	0	127.05 E 37.07 N
15:21:04	[P] AZ: 19153, EL: 4641, POL: 970	17	191.53	191.53	46.41	0	127.05 E 37.07 N
15:21:04	[S] EL/CL 3 / 2(13)	18	191.53	191.53	46.5	0	127.05 E 37.07 N
15:21:08	[P] RMC: 14-2-17	17	191.5	191.5	46.42	0	127.05 E 37.07 N
15:21:09	[P] Signal: 17(256)	17	191.53	191.53	46.57	0	127.05 E 37.07 N
15:21:10	[S] EL/CL 7 / -5(13)	17	191.53	191.53	46.51	0	127.05 E 37.07 N
15:21:15	[S] EL/CL 12 / -4(13)	17	191.53	191.53	46.48	0	127.05 E 37.07 N
15:21:20	[S] EL/CL 14 / 3(13)	17	191.53	191.53	46.45	0	127.05 E 37.07 N
15:21:25	[S] EL/CL 9 / 4(13)	16	191.53	191.53	46.39	0	127.05 E 37.07 N
15:21:30	[S] EL/CL 11 / -5(13)	17	191.53	191.53	46.45	0	127.05 E 37.07 N
15:21:35	[S] EL/CL 17 / -2(13)	17	191.53	191.53	46.44	0	127.05 E 37.07 N
15:21:35	[P] AZ: 19153, EL: 4644, POL: 970	17	191.53	191.53	46.44	0	127.05 E 37.07 N
15:21:40	[S] EL/CL 14 / -11(13)	16	191.5	191.5	46.47	0	127.05 E 37.07 N
15:21:41	[P] Signal: 16(256)	15	191.53	191.53	46.46	0	127.05 E 37.07 N
15:21:45	[S] EL/CL 4 / 0(13)	18	191.53	191.53	46.44	0	127.05 E 37.07 N

Below the table are three control panels:

- Tracking:** Radio buttons for ON (selected) and OFF.
- Rate Sensor Bias:** Input fields for AZ (-49), EL (11), and CL (40), with a 'Set' button and a 'Save Sensor Bias' button.
- Tilt Sensor Bias:** Input fields for EL Tilt Bias (0.0°) and CL Tilt Bias (0.0°), with a 'Show Param' button and a 'Check NID' button.

At the bottom right, there are buttons for 'Save Debug (Start)', 'Stop DEBUG', and 'Clear View'. A status indicator shows '0x 0000'.

- **Tracking:** turns on or off the dish scan function. If the dish scan function is disabled, the antenna will stop adjusting the antenna pointing angle in order to optimize the receive signal level.
- **Rate Sensor Bias:** is used to calibrate the DC voltage output from the three rate sensors (azimuth, elevation, and cross-level). These are used to sense antenna motion that corresponds to the ship's motion (roll, pitch, and yaw) for stabilizing the pedestal. You can find the same function in Antenna-Advanced View Tab.
- **Show Param:** shows the current antenna parameters.
- **Check NID:** verifies the NID (network ID) of the current tracking transponder. Press the NID button to obtain the NID only if the antenna is locked onto the desired satellite .
- **Debug (Start):** starts the debug log of the antenna. The debug message will be displayed once the debug button is pressed.
- **Stop Debug:** stops debug logging of the antenna.
- **Save Debug (Start/Stop):** starts or stops saving the debug log. This button is enabled once the Start Debug button is pressed.
- **Clear View:** clears the debug message or log data in monitoring window.

6. Diagnostic / Modem

This view provides Antenna Diagnostic Testing and also provides functions to set up the interface between the ACU and the Intellian VSAT Mediator or the satellite modem.

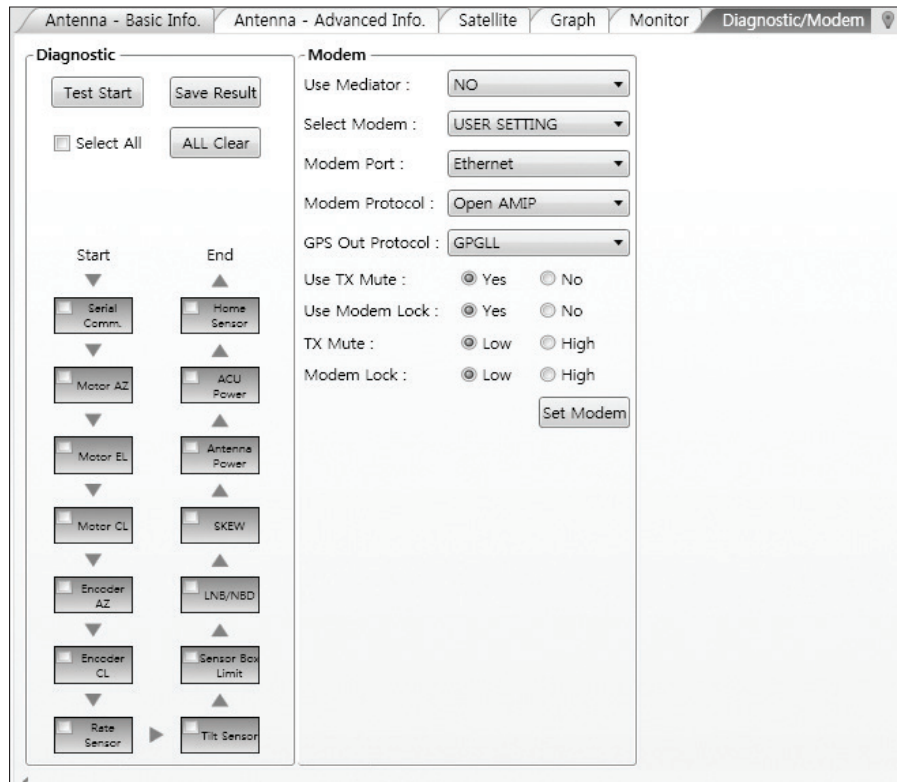

- **Diagnostic** : select to run a full diagnostic test or single diagnostic test. "Green" indicator is displayed for the test under progress. "Blue" indicates the test result as Pass while "Red" indicates the result as Fail. "Yellow" indicates the test has been skipped.

- **Serial Comm.:** tests the data communication between the antenna and the ACU.
- **Motor AZ:** tests the azimuth motor.
- **Motor EL:** tests the elevation motor.
- **Motor CL:** tests the cross-level motor.
- **Encoder AZ:** tests the azimuth encoder.
- **Encoder CL:** tests the cross-level encoder.
- **Rate sensor:** tests the rate sensor.
- **Tilt Sensor:** tests the tilt sensor.
- **Home sensor:** tests the home sensor.
- **ACU power:** tests the ACU power to see whether or not it is within the nominal operating range.

- **Antenna power:** tests the antenna power to see whether or not it is within the nominal operating range.
 - **Skew:** tests the LNB skew motor.
 - **LNB/ NBD:** tests the LNB and NBD (narrow band detector).
 - **Sensor Box Limit:** tests the sensor box motor .
- **Modem:** sets the interface between the ACU and the Intellian Dual VSAT Mediator or the satellite modem.

NOTE: Before setting this function, make sure connection of a RJ45 cable from the Ethernet connector on the ACU to the modem or connect a 9 pin serial cable from the RS232/422 connector on the ACU to the modem.

- **Use Mediator:** enables use of the Intellian Dual VSAT Mediator. Use Mediator must be set to “NO” if there is no MEDIATOR connected to the ACU. Improper setting of this parameter will cause your ACU’s modem interface to work incorrectly.
- **Select Modem:** selects your modem type for loading pre-configuration settings. If the ABS (auto beam switching) function is in use, select either IDIRECT-AMIP or COMTECH-ROSS depending on which type of modem is used.
- **Modem Port:** selects a proper data communications port (RS232/ 422/ Ethernet) to interface with the modem.
- **Modem Protocol:** selects a proper communications protocol on the ACU to interface with the modem (I/O Console/ Open AMIP/ Serial GPS/ ROSS/ VCAP/ ELEKTRIKOM AMIP/ GILAT-SE-II).
- **GPS Out Sentence:** selects GPS out sentence type (GPGLL/ GP GGA/ Simple GPGGA).
- **Use TX Mute:** selects whether or not to use the “TX Mute” function from the satellite modem. A transmit inhibit output from the ACU will disable/ mute the modem transmit via a voltage change whenever the antenna is blocked, searching, or is mis-pointed 0.5 degrees from the peak satellite position.

- **Use Modem Lock:** selects whether or not to use external lock signal from the modem. “Use Modem Lock” will only be activated when the modem protocol is set as I/O Console.
- **TX Mute:** TX Mute is a transmit inhibit output from the ACU to disable /mute the modem transmit through a 5 V (HIGH) or 0 V (LOW) current whenever the antenna is blocked, searching, or is mis-pointed 0.5 degrees from peak satellite position. TX Mute will only be activated when modem protocol is set as I/O console.
- **Modem Lock:** is the modem lock output from the modem. It provides a logic input through a 5V (HIGH) or 0 V (LOW) current to the ACU to identify when the system is on the correct satellite. “Modem Lock” will only be activated when modem protocol is set as I/O Console.

7. GUI

This view shows a graphical representation of the current antenna position which allows you to easily identify whether or not the antenna is aligned properly to the target satellite or is in a block zone. In addition, this view shows the current satellite that the antenna is pointed towards and the satellites that are located at a 180° arc on the horizon, according to the current position.

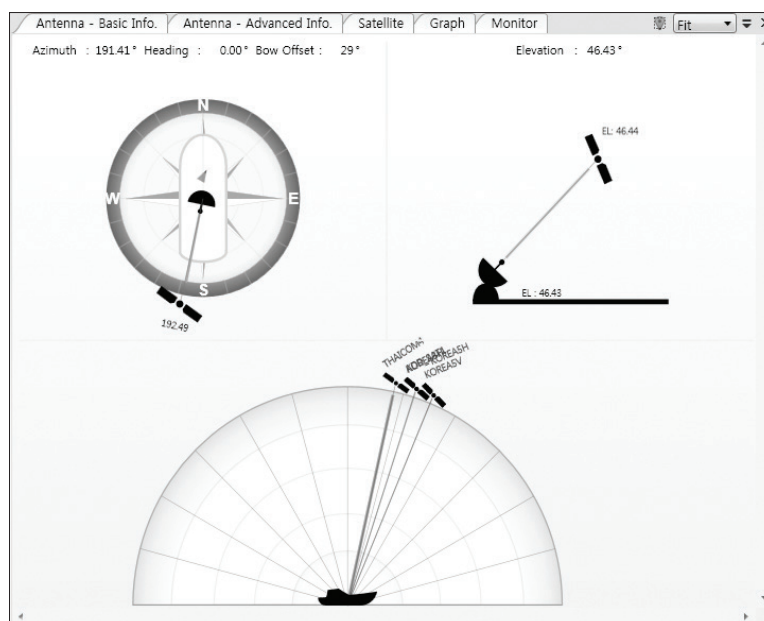

NOTE: Based on the satellite EIRP footprint and the size of the antenna, you may not be able to track all the satellites visible in 180° arc.

8. Work View Functions

The seven Work View Tabs displayed in the Work View can be arranged in customized layouts.

- Layout Formatting

- Each of the Work View Tab can be separated from the rest Tabs. Click and hold the left mouse button on the Work View Tab's header and then drag a desired Tab out. When a Work View Tab is separated from the rest of your Work View Tabs, again click and hold the left mouse button on the Work View Tab's header to display a cross-shaped Navigator icon. While holding the mouse button, bring the selected Work View Tab closer to the Navigator icon and release the mouse button at your desired position (top, left, right or bottom arrow). This time, the selected Tab will be moved to the desired position.

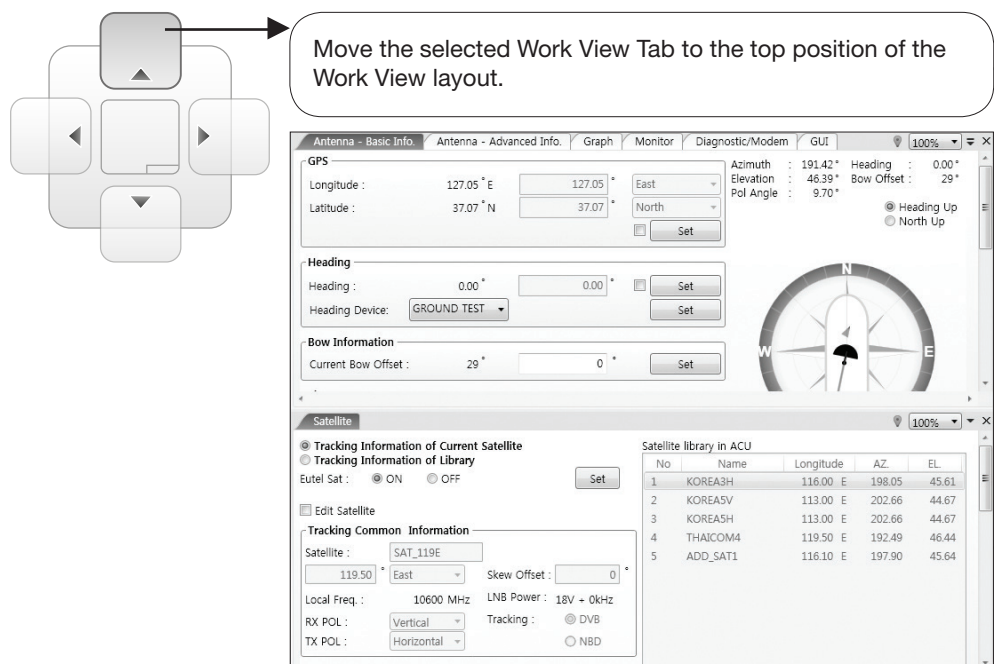

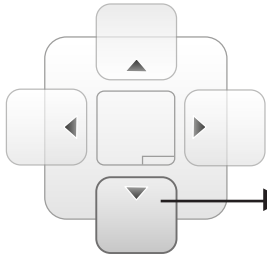

Move the selected Work View Tab to the bottom position of the Work View layout.

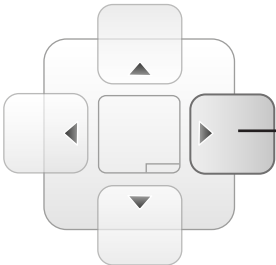

Move the selected Work View Tab to the right position of the Work View layout.

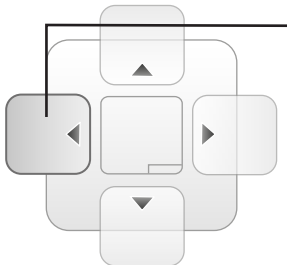

Move the selected Work View Tab to the left position of the Work View layout.

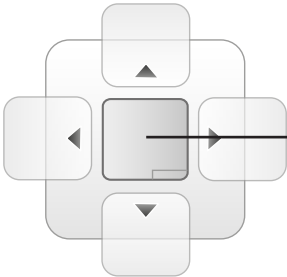

Move the selected Work View Tab to the center position of the Work View layout.

You can also drag multiple Work View Tabs into a customized layout in the same manner. Click and hold left mouse button on each Work View Tab's header and drag it onto a desired arrow on the Navigator icon. Then each Work View Tab can be placed to the desired positions as shown in the figure below.

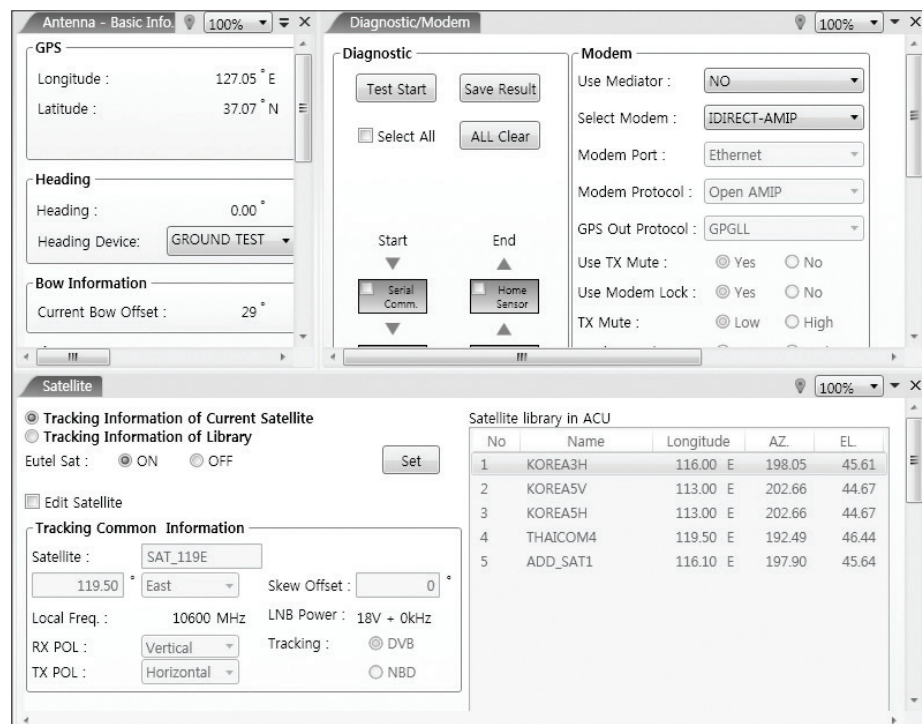

The Navigator will appear in each area your mouse pointer is located. To return to the default layout, select the Default Layout toolbar menu.

- Horizontal or Vertical Tab Group

The Work View Tabs can be also aligned horizontally or vertically. Without dragging them out, right-click the mouse button on a desired Tab header and select 'New Horizontal Tab Group' or 'New Vertical Tab Group' option. Selecting 'New Horizontal Tab Group' will separate a selected Tab from the rest of other Tabs then arrange it in a horizontal format. Likewise, selecting 'New Vertical Tab Group' will separate a selected Tab from the rest of other Tabs then arrange it in a vertical format.

- Closing the Work View Tab

To close the Work View Tab, right-click the mouse button on a desired Tab header and select 'Close' option in the drop down list. To close all Work View Tabs except the selected Tab, select 'Close All But This' option in the drop down list.

- Zoom Tool

Using the Zoom tool, you can easily select the magnification you want by using Zoom In and Zoom Out bar, and Fit in Work View button.



Fit Work View Button: fits the current view to the Work View window size. The button toggles between the fit view and the previous view.

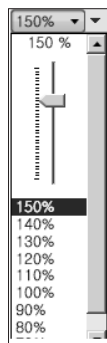

Zoom In and Zoom Out Bar: zooms in and out to expand and reduce the View to the desired size. (The zoom changes in 10% increments.)



View Switch Button: displays a list of the current views in a list. Choosing one of these views will display the selected view in the Work View window.



View Name Button: displays the current Work View name.



Close View Button: closes the current view.

APTUS WEB

Introduction

Main Page

Page Login
Top menus
Dash Board & Information

Antenna Settings

Ship setting
Antenna Position & Parameters
Tracking setting
Modem Setting
Diagnostic
Library Setting

Firmware & Configuration

Antenna Firmware Upgrade
Antenna Log
Antenna Backup & Restore

Administration

Network Setting
SNMP Setting
User Management
iARM Upgrade
iARM Save & Reboot
Antenna Event Log
Intellian Network Devices

Introduction

With embedded Aptus Web software, the v-Series can be monitored, controlled, and diagnosed remotely from anywhere, anytime through the TCP/IP protocol. This not only can save time but also save the cost generated from the hundreds of routine maintenance activities such as operating firmware upgrades, tracking parameters resets, and system diagnostic.

How to access Aptus Web:

1. Connect an Ethernet Cable between your PC and the Management Ethernet Port.
2. Enter the ACU's IP address (192.168.2.1) into your web browser's address bar to login into the ACU's internal HTML page, if this system has not been changed from the ACU's factory default.

NOTE: Aptus Web can be displayed in Internet Explorer 7 or later and is also compatible with Firefox and Chrome web browsers.

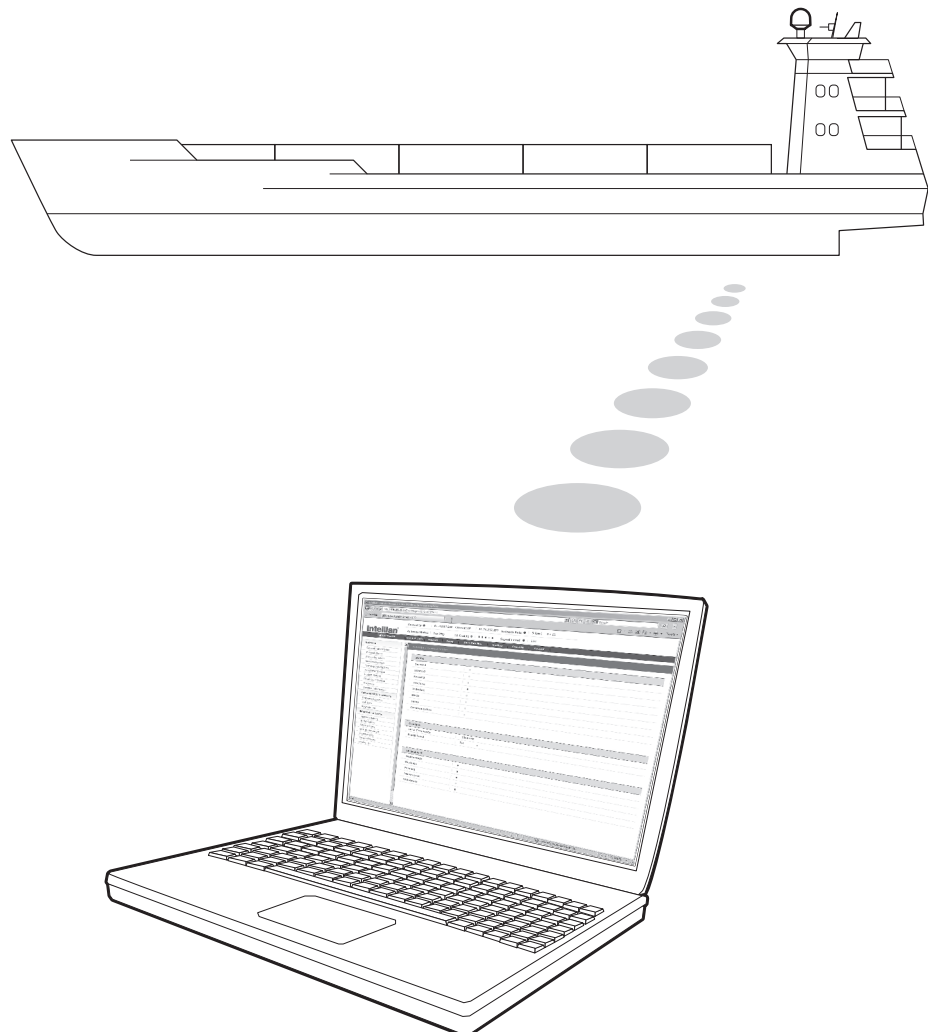

Main Page

Page Login

1. Choose either to Control & Monitor the ACU (Control & Monitoring) or Only Monitor the ACU (Monitoring Only).
2. Log into the ACU by typing in User Name and Password information. If this system has not been changed from the factory default:

- **User Name:** intellian
- **Password:** 12345678



Intellian[®]

Aptus
web

Aptus Web
V60 v1.00

Control & Monitoring
 Monitoring Only

Username

Password



WARNING: The Control & Monitoring Mode will be switched to the Monitoring Only Mode in the following cases;

- If PC Software (Aptus) is connected using TCP/IP Communication while Aptus Web Control is in use.
- If Control & Monitoring Mode is accessed while PC Software is running via TCP/IP Communication. In this case, the web page will display a pop-up message asking if you want to disconnect the PC Software network connection. If you select 'No', the Control & Monitoring Mode will be switched to the Monitoring Only Mode.

Top Menus

Once you log in, the following information and menus are displayed.

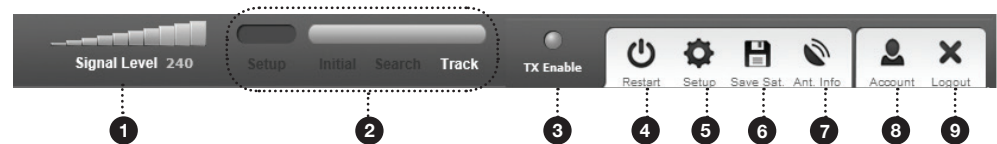

No.	Item	Description
①	Signal Level	Display current signal level.
②	Antenna status	<ul style="list-style-type: none"> - Setup: Displays whether or not the antenna is in SETUP mode. The indicator shows “Blue” in the SETUP mode. - Initial: Antenna or ACU is initialized. - Search: Antenna is searching a target satellite. - Track: Antenna is tracking the target satellite.
③	TX Enable/ TX Disable	Displays whether or not the antenna is able to transmit the data
④	Restart	Restart the antenna system.
⑤	Setup	Enter SETUP mode.
⑥	Save Sat.	Save current satellite settings. Bow offset will be adjusted and saved automatically.
⑦	Ant. Info	Obtain current antenna information.
⑧	Account	Shortcut to User Management menu. Change login ID and Password.
⑨	Logout	Logout the ACU's internal HTML page.

Dash Board & Information

On the left side of the page, Dash Board and Information menus are displayed as below to provide quick monitoring of the antenna status and settings. Other menus are displayed only in the Control & Monitoring mode and their functions will be described in the next sections.

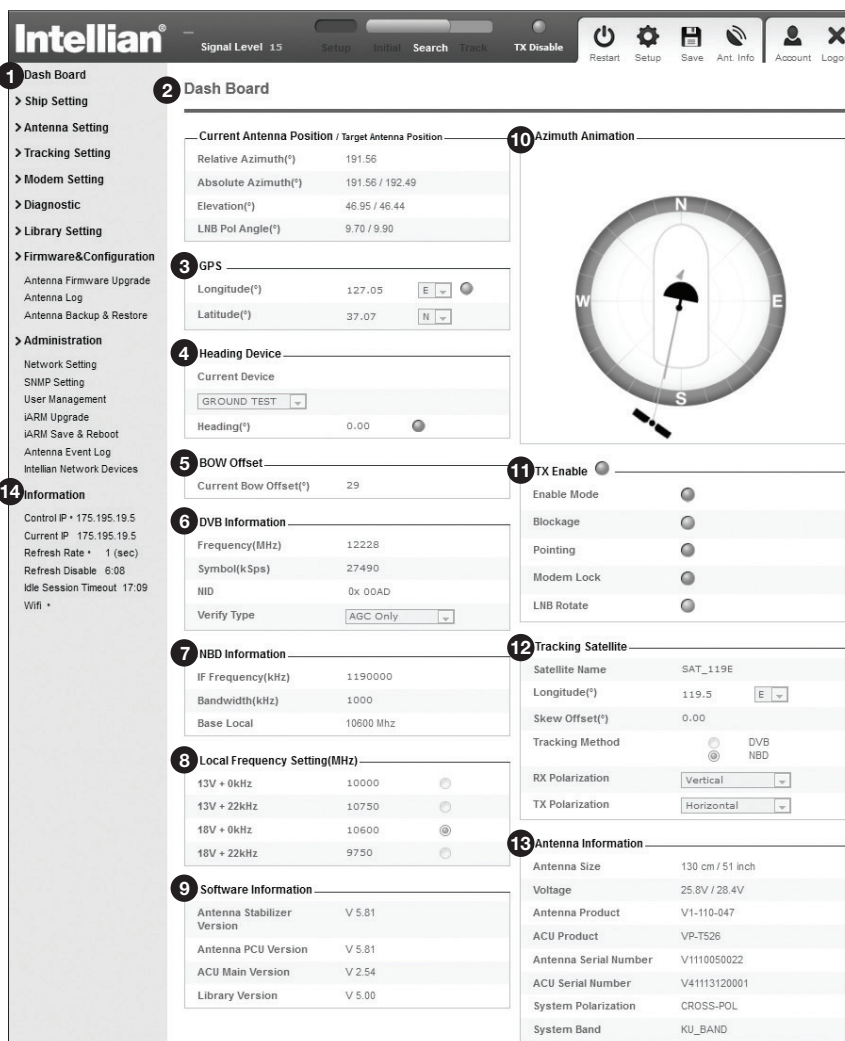

No.	Item	Description
①	Dash Board	Displays current antenna status to be quickly monitored.
②	Current Antenna Position / Target Antenna Position	Displays current antenna position. - Relative Azimuth: displays antenna relative AZ angle. - Absolute Azimuth: displays antenna absolute AZ angle. - Elevation: displays antenna elevation angle. - LNB Pol Angle: displays LNB pol angle. - Heading: displays ship's heading information
③	GPS	Displays current GPS information. - Longitude (East / West) - Latitude (North / South)
④	Heading Device	Displays current Heading Device: NONE, NMEA, NMEA 2000, Ground test If the ship's gyrocompass input is other than NMEA separate purchase of NMEA Converter is required. - Heading: displays ship's heading information.

⑤	BOW Offset	Display current bow offset
⑥	DVB Information	Displays DVB tracking mode's current tracking information. - Frequency: displays tracking frequency. - Symbol rate: displays symbol rate. - NID: displays network ID. - Verify type: displays verification typ (AGC, DVB, DVB Decode)
⑦	NBD Information	Displays NBD tracking mode's current tracking information. - Frequency: displays tracking IF frequency. - Bandwidth: displays detection bandwidth.
⑧	Local Frequency Setting (MHz)	Displays current LNB's local frequency and voltage
⑨	Satellite Information	Displays current Antenna and ACU firmware versions and Satellite Library version installed in the system. - Antenna POL Version (It will display "v-----" if there is no Pol Control Board installed.) - Antenna Stabilizer Version - Antenna PCU Version - ACU Main Version - Library Version
⑩	Azimuth Animation	Shows a graphical representation of the current antenna position to identify whether or not the antenna is aligned properly to the target satellite or is in a block zone.
⑪	TX Enable	Displays whether or not the antenna is able to transmit the data. The TX function will only be enabled (shows BLUE dot) only if all of the factors listed below shows "BLUE" dot. Exception: If "Use TX Mute" is set as "NO", the TX function will be enabled regardless of which factor listed below shows "gray" dot or "red" dot. - Enable Mode: antenna is not in SETUP mode. - Blockage: antenna is not facing the predefined block zone(s). - Pointing: antenna is pointing to the target satellite. - Modem Lock: satellite modem is sending a logic input to the ACU to identify when the antenna tracks on the correct satellite. - LNB Rotate: LNB is not rotating.
⑫	Tracking Satellite	Displays current tracking mode. - Satellite: displays satellite name. - Longitude: displays satellite orbit position. - Skew Offset: displays Skew offset. - Tracking Method: displays current tracking mode (DVB/ NBD). - RX Polarization: displays current RX polarization. - TX Polarization displays current TX polarization.
⑬	Antenna Information	Displays the product information
⑭	Information	- Control IP: Displays current IP that controls the ACU. - Current IP: Displays current IP address.- Refresh Rate: Displays screen refresh rate (default: 1 sec.) - Refresh Disable: Displays time out. The screen will not refresh once the time-out shows 0:00. Exception: If the Refresh Disable Time is set to "OFF" in the Network Setting page, then the clock will show "--:--" and system will keep monitoring all activities regardless of timeout. - Wifi : Displays Wifi on/off switch

Antenna Settings

Ship Setting

No.	Item	Description
①	Ship Setting	Set the ship information and block zone.
②	GPS	Set GPS information. - Longitude (East/West) - Latitude (North/South)
③	Bow Offset	Set Bow Offset if needed.
④	Heading Device	Set ship's heading device (NONE, NMEA, NMEA2000, Ground Test) and ship's heading information
⑤	Blockage	Set the antenna's block zones up to 5 by azimuth and elevation sectors. AZ. START is where the relative azimuth starts and AZ. END is where the relative azimuth ends (Range: 0 - 360°). EL. Limit is where the elevation starts (Range 0 - 90°).



WARNING

WARNING: Enter the SETUP mode for configuration. Tick the checkbox before modifying the settings. After configuration, click 'Set ...' button to submit the settings.

Antenna Position & Parameters

No.	Item	Description
①	Antenna Setting	Set current antenna position and Search and Tracking parameters. These parameters should only be changed by an authorized service technician. Improper setting of these parameters will render your system inoperable.
②	Current Antenna Position/ Target Antenna Position	Display current antenna position. - Relative Azimuth: display antenna relative AZ angle. - Absolute Azimuth: display antenna absolute AZ angle. - Elevation: display antenna elevation angle. - LNB Pol Angle: display LNB pol angle. - Heading: display ship’s heading information.
③	Manual Movement	Move antenna azimuth and elevation angles and LNB pol angle to find the desired satellite manually. LNB Pol Angel can be adjusted at any time either in SETUP Mode or Tracking Mode.
④	LNB Pol Sensor Calibration	Calibrate the LNB pol angle when the control board, potentiometer or belt is replaced.
⑤	Elevation Adjust	Adjust the elevation to offset the angle difference between the mechanical elevation angle and actual elevation angle.
⑥	Conical Range	The relative force of the motors controlling azimuth and elevation. Set the conical range while the antenna is in tracking mode.

No.	Item	Description
⑦	Idle Mode	Release the elevation and cross level motor brakes while the antenna is in SETUP mode. The antenna can be moved manually during the mode.
⑧	Reboot	Reboot the system.
⑨	Search & Tracking Parameter Setting	<p>DVB Detect and Tracking Level Threshold: display / set current detect level threshold and tracking level threshold when DVB tracking mode is chosen to be used.</p> <p>- NBD Detect and Tracking Level Threshold: display / set current detect level threshold and tracking level threshold when NBD tracking mode is chosen to be used. - TX Enable Threshold: display / set TX enable threshold. - Wait time: set the time-out for automatic initiation of a search after the signal level drops below the pre-defined threshold value.</p> <p>- Search Step: set increment step size.</p> <p>- Search 1 & 3 Range: set Search 1 & 3 search range. Search is conducted in a two-axis pattern consisting of alternate movements in azimuth and elevation as forming expanding square.</p> <p>- Search 2 Range: is reserved for future use.</p>
⑩	Tilt Sensor Bias	Adjust the two solid-state tilt sensors used to provide absolute cross-level tilt of the antenna and elevation feedback to eliminate long-term pointing drift (error). Tilt bias is required to be adjusted when the antenna control board or sensor box is replaced. Check to see whether or not the bubble is located at the center of the level vial.
⑪	Rate Sensor Adjust	Calibrate DC voltage output from the three rate sensors used to sense antenna motion in azimuth, elevation and cross-level axes. During the calibration process, the antenna should avoid any motion as it can affect the antenna's performance.



WARNING

WARNING: Tick the checkbox before modifying the settings. After configuration, click 'set...' button to submit the settings.

Tracking Setting

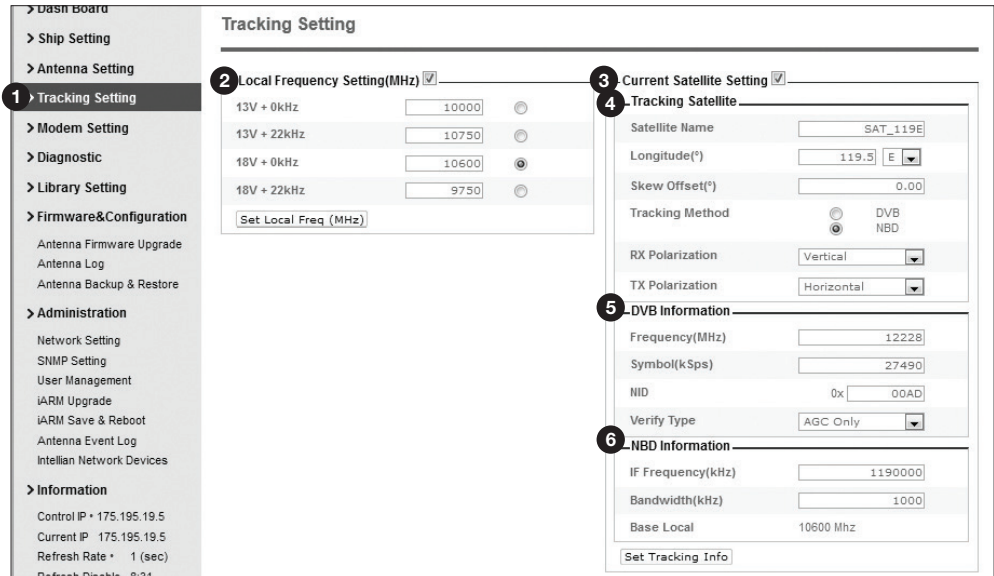

No.	Item	Description
①	Tracking Setting	Display or set current tracking mode and tracking frequency of the target satellite.
②	Local Frequency Setting (MHz)	Display and set LNB’s local frequencies. Display current LNB local frequency which is in use and voltage.
③	Current Satellite Setting	Display and set current satellite setting.
④	Tracking Satellite	Display and set current tracking mode. - Satellite: display and set satellite name. - Longitude: display and set satellite orbit position. - Skew Offset: display and set Skew offset. - Tracking Method: display and set current tracking mode (DVB/ NBD). - RX Polarization: display and set current RX polarization. - TX Polarization display and set current TX polarization.
⑤	DVB Information	Display and set DVB tracking mode’s tracking information. - Frequency: display and set tracking frequency. - Symbol rate: display and set symbol rate. - NID: display and set network ID. - Verify type: display and set verification type (AGC, DVB, DVB Decode)
⑥	NBD Information	Display and set NBD tracking mode’s tracking information. - Frequency: display and set tracking IF frequency. - Bandwidth: display and set detection bandwidth.



WARNING: Tick the checkbox before modifying the settings. After configuration, click 'set...' button to submit the settings.

Modem Setting

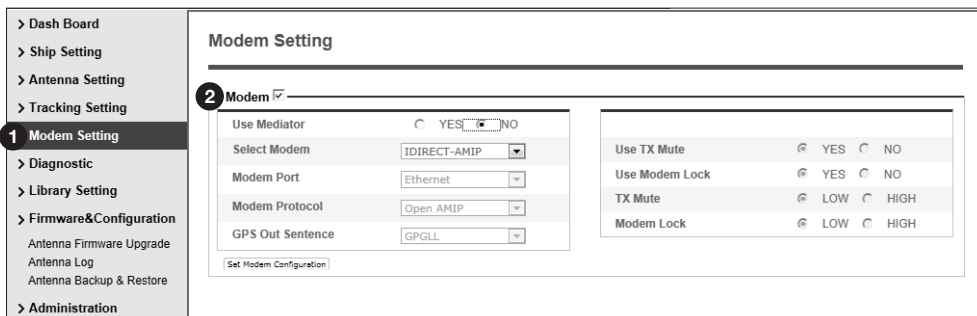

No.	Item	Description
①	Modem Setting	<p>Set the modem interface.</p> <ul style="list-style-type: none"> - Use Mediator: enable the usage of Mediator if the antenna is connected to the Intellian Dual VSAT Mediator. Use Mediator must be set to “NO” if there is no MEDIATOR connected to the ACU. Improper setting of this parameter will cause your ACU’s modem interface to work incorrectly. - Select Modem: is to select a proper data communication port and protocol on the ACU to interface with the satellite modem. The settings related to the modem interface will be set automatically once the modem type is selected (USER SETTING, IDIRECT-I/O, IDRECT-AMIP, COMTECH-I/O, COMTECH-ROSS, HUGHES, SATLINK-SERIAL, SATLINK-VACP, ELEKTRIKOM-AMIP, GILAT-SE-II). However, it is required to set the related settings separately if USER SETTING is selected. - Modem Port: is to select a proper data communication port on the ACU to interface with the satellite modem (RS232/422/Ethernet).
②	Modem	<ul style="list-style-type: none"> - Modem Protocol: is to select a proper communication protocol on the ACU to interface with the modem (I/O Console, OpenAMIP, Serial GPS, ROSS, VACP, ELEKTRIKOM AMIP, GILAT). - GPS Out Sentence: is to select the GPS out sentence type (GPGLL/GPGGA/SIMPLE GPGGA) - USE TX Mute: is to select whether or not to use TX mute function from the satellite modem. - USE Modem Lock: is to select whether or not to use external lock signal from the satellite modem. - TX Mute: is a transmit inhibit output from the ACU to disable/mute the modem transmit through a 5V (High) or 0V(LOW) current whenever the antenna is blocked, searching, or is mispointed 0.5° from peak satellite position. - Modem Lock: is the modem lock output from the modem which provides a logic input through a 5V (High) or 0V(LOW) current to the ACU to identify when it is on the correct satellite. <p>Note: TX Mute and Modem Lock items will only be activated when the modem protocol is set as I/O Console.</p>



WARNING: Ensure to tick the checkbox before modifying the settings. Select 'Set Modem Configuration' to confirm the modem settings configured.

Diagnostic

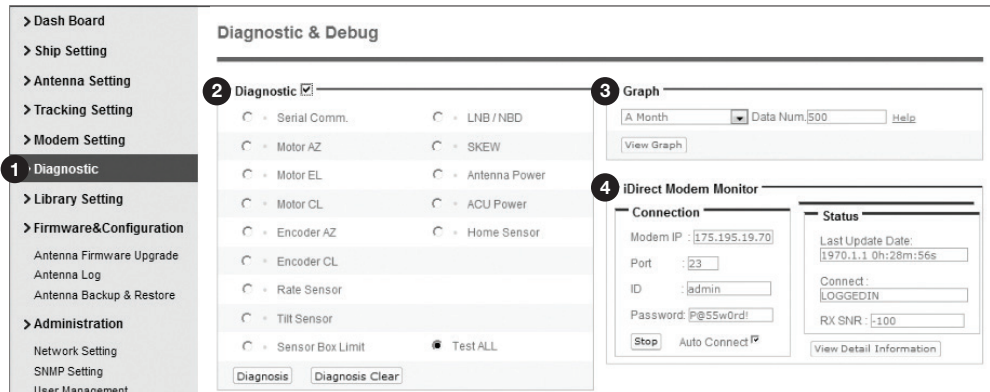

No.	Item	Description
①	Diagnostic	Execute antenna diagnostic test.

Select to run a full diagnostic test or single diagnostic test.

- Serial Comm.: test the data communication between the antenna and the ACU.
- Motor AZ: test the azimuth motor.
- Motor EL: test the elevation motor.
- Motor CL: test the cross-level motor.
- Encoder AZ: test the azimuth encoder.
- Encoder CL: test the cross-level encoder.
- Rate Sensor: test the rate sensor.
- Tilt Sensor: test the tilt sensor.
- Sensor Box Limit: test the sensor box motor.
- LNB/NBD: test the LNB.
- SKEW: test the LNB pol motor.
- Antenna Power: test the antenna power.
- ACU Power: test the ACU power.
- Home Sensor: test the home sensor
- Test ALL: test all devices.

②	Diagnostic	
---	------------	--

Select to view a graph of AZ Absolute, AZ Relative, EL and Heading data of the antenna.

③	Graph	
---	-------	--

- A Month: display all data within a month
- A Week: display all data within a week
- A Day: display all data in a day
- Real-time: display data in real time. Press F5 button to refresh.
- Data Num: set the maximum number of graph data set to be displayed.
- View Graph: select to view the data graph.

④ iDirect Modem Monitor (OpenAMIP only)

Displays iDirect Modem status and control connection. This menu appears only when IDIRECT-AMIP protocol is selected at Modem Setting page.

- Connection: control modem connection.
 - Modem IP: iDirect modem IP
 - Port: Connection ID for telnet
 - Password: Connection password for telnet
 - Start(Stop): Connect to telnet or disconnect
 - Auto Connect: Enabling Auto Connect and rebooting the ACU will save connection data and will auto connect once ACU is powered on next time.
 - Status: Displays iDirect modem status
 - Last Update Date: Displays last updated data and time of the iDirect modem data
 - Connect: Displays connection status (INACTIVE, CONNECTING, LOGGEDIN, Black data indicates being INACTIVE)
 - RX SNR: Displays RX SNR data.
 - View Detail Information: Select to view detail information
 - Status: Displays last update date and connection status.
 - Information : Displays rx snr, tx power, tx power min, rx power, tx power max, tx power, ref, latlong.
 - Option File Information: Displays information about VERSION, MOBILE, LOCAL and ACU PORT
-



WARNING: Tick the checkbox before modifying the settings. Click Diagnosis button to execute diagnostic test. To clear previous diagnosis result, click Diagnosis Clear button.

Library Setting

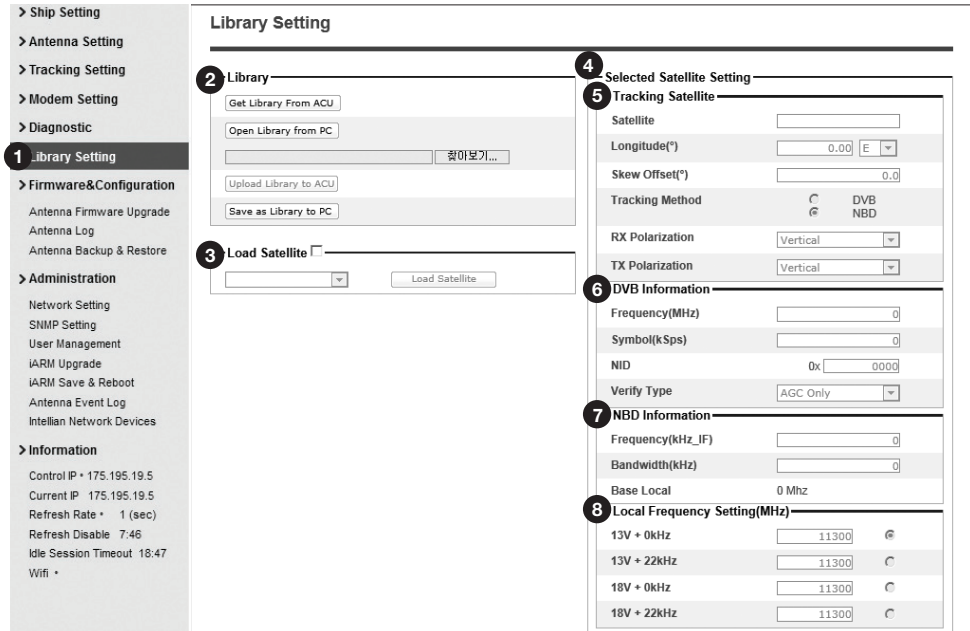

No.	Item	Description
①	Library Setting	Display and set the satellite library information.
②	Library	<ul style="list-style-type: none"> - Get Library from ACU: Obtain satellite information installed in the ACU. - Open Library from PC: open the satellite library file from the supplied Intellian CD or from the external hard drive/PC. (File format: *.ilf) - Upload Library to ACU: upload the satellite library file to ACU. - Save as Library to PC: save the current library setting to the PC.
③	Load Satellite	Select the satellite that you wish to track and press Load Satellite button to load the selected satellite.
④	Selected Satellite Setting	Displays selected satellite information.
⑤	Tracking Satellite	<ul style="list-style-type: none"> - Satellite: displays satellite name. - Longitude: displays satellite orbit position. - Skew offset: displays Skew offset. - Tracking method: displays current tracking mode (DVB/NBD) - RX polarization: displays current RX polarization. - TX polarization: displays current TX polarization.
⑥	DVB Information	<ul style="list-style-type: none"> - Displays DVB tracking mode's tracking information. - Frequency: displays tracking frequency. - Symbol rate: displays tracking symbol rate. - NID: displays network ID. - Verify type: displays verification type (AGC only, DVB lock, DVB decode, DSS decode)
⑦	NBD Information	<ul style="list-style-type: none"> - Displays NBD tracking mode's tracking information. - Frequency: displays tracking frequency. - Bandwidth: displays detection bandwidth.
⑧	Local Frequency Setting (MHz)	Displays LNB local frequency (MHz) and voltage.

Firmware & Configuration

Antenna Firmware Upgrade

- > Dash Board
- > Ship Setting
- > Antenna Setting
- > Tracking Setting
- > Modem Setting
- > Diagnostic
- > Library Setting
- > Firmware&Configuration
- 1 Antenna Firmware Upgrade
- Antenna Log
- Antenna Backup & Restore
- > Administration
- Network Setting
- SNMP Setting
- User Management
- iARM Upgrade
- iARM Save & Reboot
- Antenna Event Log
- Intellian Network Devices
- > Information
- Control IP • 175.195.19.5
- Current IP 175.195.19.5
- Refresh Rate • 1 (sec)
- Refresh Disable 8:12
- Idle Session Timeout 19:13
- Wifi •

Antenna Firmware Update

2 New Antenna Firmware

Browse and select the firmware file to upload.

The update may take a few minutes to complete.
The upload time may vary due to a variety of factors such as the speeds of your network.
Upload an incorrect firmware file may cause serious damage to your antenna and ACU.

Start Upload
Cancel

3 Current Running Version

Current Firmware Version	Antenna STABILIZERv5.81
	Antenna PCU v5.81
	ACU Main v2.54
	Library v5.00

4 Cold Rollback

Previous Package Version v140213	Antenna STABILIZERv5.81	Antenna PCU v5.81	ACU Main v2.54	Rollback
Latest Package Version v140213	Antenna STABILIZERv5.81	Antenna PCU v5.81	ACU Main v2.54	Rollback

No.	Item	Description
①	Antenna Firmware Upgrade	Upgrade antenna and ACU firmware version.
②	New Antenna Firmware	Browse and select the firmware package file to upload and click Start Upload button.
③	Current Running Version	Display current firmware version (Antenna STABILIZER, Antenna PCU, ACU main, Library)
④	Cold Rollback	Display Previous/Latest Package version and rollback firmware to Previous or Latest version. Other functions cannot be operated while rollback is in progress.

129

Upgrade procedures:

1. Select the upgrade package file.
2. Click on “Start Upload” button to transfer the Firmware package file (“*.fwp”) to iARM module.
3. After the package file is transferred, it’ll show “upgrade from vx.xx Version to vx.xx Version”. Enable the check box to select the firmware file that you wish to upgrade. To select all firmware files, click Select All Firmwares.
4. Click on “Start Upgrade” button.

The screenshot displays the 'Antenna Firmware Update' page. On the left is a navigation menu with options: Dash Board, Ship Setting, Antenna Setting, Tracking Setting, Modem Setting, Diagnostic, Library Setting, Firmware&Configuration (highlighted), Antenna Firmware Upgrade, Antenna Log, Antenna Backup & Restore, and Administration. The main content area is titled 'Antenna Firmware Update' and features a sub-header 'The Firmware Package Update Ready'. Below this is a table with three rows of components, each with a checkbox for selection. At the bottom of the table are two buttons: 'Start Update' and 'Select All Firmwares'.

The Firmware Package Update Ready		
Antenna STABILIZER	Update From v5.81 To v5.81 From 0x0109 To 0x0106	<input checked="" type="checkbox"/>
Antenna PCU	Update From v5.81 To v5.81 From 0x010A To 0x0107	<input checked="" type="checkbox"/>
ACU MAIN	Update From v2.54 To v2.54 From 0x0102 To 0x0102	<input checked="" type="checkbox"/>

[Start Update] [Select All Firmwares]

Firmware upgrade status page

<ul style="list-style-type: none"> > Dash Board > Ship Setting > Antenna Setting > Tracking Setting > Modem Setting > Diagnostic > Library Setting <li style="background-color: #cccccc;">> Firmware&Configuration Antenna Firmware Upgrade Antenna Log Antenna Backup & Restore 	<h3 style="margin-top: 0;">Antenna Firmware Upgrade</h3> <hr/> <p>The Firmware Package v120726 Upgrade Status</p> <table border="1" style="width: 100%; border-collapse: collapse;"> <tr> <td style="padding: 2px;">Antenna STABILIZER</td> <td style="padding: 2px;">Upgrade From v0.96 To v0.95 Ready</td> </tr> <tr> <td style="padding: 2px;">Antenna PCU</td> <td style="padding: 2px;">Upgrade From v0.95 To v0.95 Ready</td> </tr> <tr> <td style="padding: 2px;">ACU MAIN</td> <td style="padding: 2px;">Upgrade From v0.95 To v0.95 Ready</td> </tr> </table> <p style="text-align: center; margin-top: 5px;">Back to main page</p>	Antenna STABILIZER	Upgrade From v0.96 To v0.95 Ready	Antenna PCU	Upgrade From v0.95 To v0.95 Ready	ACU MAIN	Upgrade From v0.95 To v0.95 Ready
Antenna STABILIZER	Upgrade From v0.96 To v0.95 Ready						
Antenna PCU	Upgrade From v0.95 To v0.95 Ready						
ACU MAIN	Upgrade From v0.95 To v0.95 Ready						

5. It'll display information about the upgrade process status on full screen.

Upgrade process status page

<h3 style="margin-top: 0;">Antenna Firmware Upgrade</h3> <hr/> <p>The Firmware Package v120726 Upgrade Status</p> <table border="1" style="width: 100%; border-collapse: collapse;"> <tr> <td style="padding: 2px;">Antenna STABILIZER</td> <td style="padding: 2px;">Upgrade From v0.96 To v0.95 Success</td> </tr> <tr> <td style="padding: 2px;">Antenna PCU</td> <td style="padding: 2px;">Upgrade From v0.95 To v0.95 20 %</td> </tr> <tr> <td style="padding: 2px;">ACU MAIN</td> <td style="padding: 2px;">Upgrade From v0.95 To v0.95 Ready</td> </tr> </table> <p style="text-align: center; margin-top: 5px;">Back to main page</p>	Antenna STABILIZER	Upgrade From v0.96 To v0.95 Success	Antenna PCU	Upgrade From v0.95 To v0.95 20 %	ACU MAIN	Upgrade From v0.95 To v0.95 Ready
Antenna STABILIZER	Upgrade From v0.96 To v0.95 Success					
Antenna PCU	Upgrade From v0.95 To v0.95 20 %					
ACU MAIN	Upgrade From v0.95 To v0.95 Ready					

6. If the firmware is successfully upgraded, it'll display "The firmware update is completed."

7. Click on "Back to main page" to go out of the screen.

To verify the upgraded firmware version, go to Dash Board > Software Information.

**Upgrade complete
page**

The Firmware Package v120726 Upgrade Complete

Antenna POL "-----" "Skip"
Antenna STABILIZER "0.95" "Success"
Antenna PCU "0.95" "Success"
ACU MAIN "0.95" "Success"

The firmware update is completed.
If you receive an fail message, please try again.
Please refer to the User Guide if you have trouble connecting to the antenna.

[Back to main page](#)

NOTE: To roll back to the previous firmware package version or latest package version, select Rollback Upgrade menu on the Antenna Firmware Upgrade page.

Antenna Log

- > Dash Board
- > Ship Setting
- > Antenna Setting
- > Tracking Setting
- > Modem Setting
- > Diagnostic
- > Library Setting
- > Firmware&Configuration
- Antenna Firmware Upgrade
- Antenna Log
- Antenna Backup & Restore
- > Administration
- Network Setting
- SNMP Setting
- User Management
- iARM Upgrade
- iARM Save & Reboot
- Antenna Event Log
- Intellan Network Devices
- > Information
- Control IP * 175.195.19.5
- Current IP 175.195.19.5
- Refresh Rate * 1 (sec)
- Refresh Disable 8:21
- Idle Session Timeout 19:21
- Wifi *

Antenna Log

2 GPS Log Option

Enable

3 Antenna Log Download

Execute Start Download button to proceed.
It will open a new pop-up window for log download.

5 Antenna Firmware Log

Date/Time(UTC 00:00)	POL	STAB	PCU	Main
Tue, 30 Jan 2007 09:09:42	1.22 Skip	5.81 Fail	5.81 Fail	2.54 Fail
Tue, 30 Jan 2007 09:07:01	1.22 Skip	5.81 Skip	5.81 Skip	2.54 Fail
Tue, 30 Jan 2007 09:04:37	1.22 Skip	5.81 Skip	5.81 Skip	2.54 Fail
Tue, 30 Jan 2007 07:09:09	1.22 Skip	5.81 Fail	5.81 Fail	2.54 Fail
Tue, 30 Jan 2007 07:04:04	1.22 Skip	5.81 Fail	5.81 Fail	2.54 Fail
Tue, 30 Jan 2007 06:49:24	1.22 Skip	5.81 Fail	5.81 Fail	2.54 Fail
Tue, 30 Jan 2007 05:39:27	1.22 Skip	5.81 Fail	5.81 Fail	2.54 Fail
Tue, 30 Jan 2007 05:28:43	1.22 Skip	5.81 Fail	5.81 Fail	2.54 Fail

No.	Item	Description
①	Antenna Log	Displays antenna log data
②	GPS Log Option	Disable/Enable to save GPS information in the antenna log file.
③	Antenna Log Download	Download the log file. Select start download button to proceed.
④	Start Download	Download the antenna log information.
⑤	Antenna Firmware Log	Display log information of firmware upgrade.

133

Log Download procedures:

1. Select 'Start Download' button.
2. To run Java applications you must have Java Runtime Environment (JRE) version 6.0 and above installed in your PC/ laptop when you access the antenna log page for first time. Click "Run" button on the popup message "The application's digital signature cannot be verified. Do you want to run the application?" to install the Applet. Refer to Appendix for Java Installation Instructions if the system does not display the popup message.

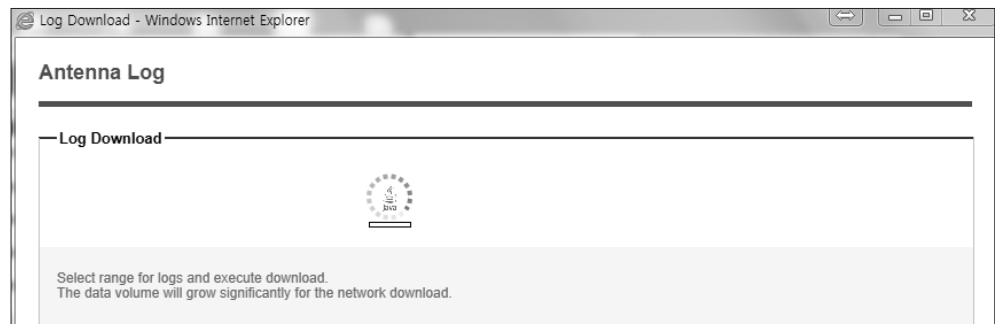

3. Select 'Browse' to browse the target directory of the antenna log file.
4. Select log period for file download.
 - Last 3 Months: download the antenna log information for the past three months.
 - Last 1 Month: download the antenna log information for the past one month.
 - Last 1 week: download the antenna log information for the past one week.
 - Last 1 Day: download the antenna log information for the past one day.
5. Select 'Download' to download the log file to the target directory according to the selected log period.

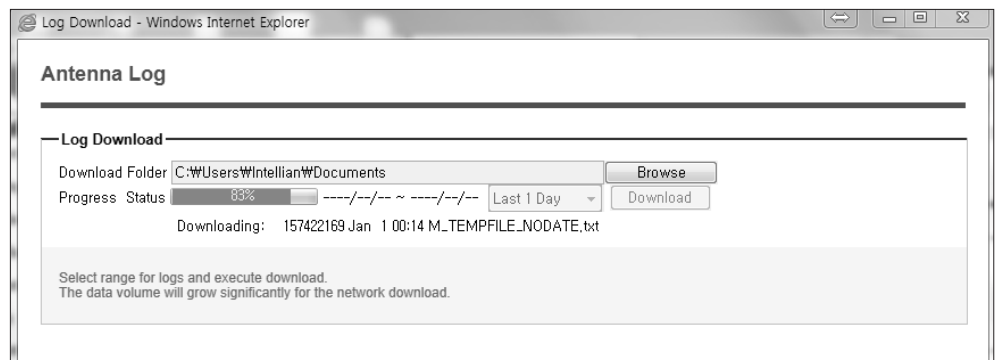

NOTE: You can choose to Enable or Disable the GPS tracking function. Liability for information that is disclosed when GPS is enabled is solely the operators responsibility and it is up to the operator on whether or not to provide their GPS information to third parties. Any issues regarding safety and privacy when turning on the GPS function is solely up to the user. Intellian is not responsible for information that is disclosed when the GPS function is enabled.

Antenna Backup & Restore



No.	Item	Description
①	Antenna Backup & Restore	Enter Backup & Restore page. (Setup mode is required)
②	Target	Backup antenna information to ACU/PC or restore antenna by using the saved information from ACU/PC.
③	Backup	Backup antenna information.
④	Restore	Restore antenna information.

Administration

Network Setting

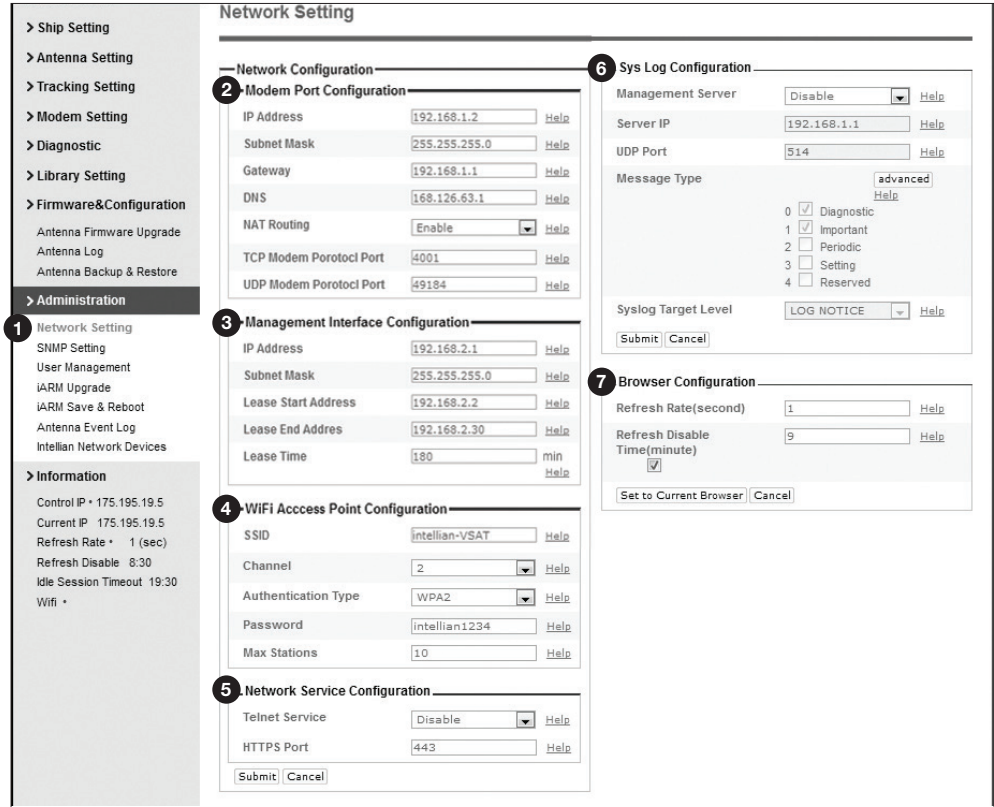

No.	Item	Description
①	Network Setting	Enter network setting page.

Modify ACU's Internal IP address and press Submit button. Go to "Save & Reboot" page and press Save & Reboot button to validate the changes.

- IP Address : Factory default(Primary:192.168.0.223)/ (Secondary:10.10.1.1).
- Subnet Mask : Factory default(255.255.255.0).

②	Modem Port Configuration	<ul style="list-style-type: none"> - Gateway : Factory default(192.168.0.254). - DNS : Current default DNS Address is assigned to. - NAT Routing : Enable/Disable NAT routing. - TCP Modem Protocol Port : TCP port number for modem protocols using TCP as transport. - UDP Modem Protocol Port : UDP port number for modem protocols using UDP as transport.
③	Management Interface Configuration	Modify Management Port's network configuration and press Submit button. Go to "Save & Reboot" page and press Save & Reboot button to validate the changes.

		<ul style="list-style-type: none"> - IP Address : ACU front network port /Factory default(192.168.2.1). - Subnet Mask : Factory default(255.255.255.0). - Lease Start Address : Lease IP address start range. - Lease End Address : Lease IP address end range. - Lease Time : Lease IP address update time.
④	WiFi Access Point Configuration	<ul style="list-style-type: none"> - SSID : The SSID is the network name shared among all devices in a wireless network. The SSID must be identical for all devices in the wireless network. It is case-sensitive and must not exceed 32 alphanumeric characters, which may be any keyboard character. Make sure this setting is the same for all devices in your wireless network. - Channel : Select an appropriate channel from the list provided to correspond with your network settings. All devices in your wireless network must use the same channel in order to function correctly. Try to avoid conflicts with other wireless networks by choosing a channel where the upper and lower three channels are not in use. - Authentication Type : Module supports an authentication mode that the 802.11 device uses when it authenticates and associates with an access point or IBSS cell. - Password : WiFi access password. - Max Stations : Setting max stations.
⑤	Network Service Configuration	<ul style="list-style-type: none"> - Telnet Service : Enable or disable telnet login support. - HTTPS Port : HTTPS port number.
⑥	Sys Log Configuration	<p>Set the system log configuration.</p> <p>Antenna sends log messages according to emergency level. Enabling this function sends the message to your management server.</p> <ul style="list-style-type: none"> - Management Server : Sys log function enable/disable - Server IP : Management server IP address - UDP Port : Management port - Message Type : Select message type (Intellian message level) to send to management server (Lower number indicates higher emergency). - Sys log Target Level : If you select this target level, the management server receives log message equal to or less than this level.
⑦	Browser Configuration	<p>Setting refresh rate and refresh disable time.</p> <ul style="list-style-type: none"> - Refresh Rate : Set the browser refresh rate (Default 1 seconds. Range 1~99). - Refresh Disable Time : Set the browser idle timeout (Default:9 minutes. Range 0~9). To use this function, check the checkbox.

SNMP Setting

No.	Item	Description
①	SNMP Setting	Display and Set SNMP configuration.
②	SNMP V1/V2 Status	Set SNMP mode(Use Attribution Disable, Read Only or Read Write).
③	V1/V2 Community Name	Set SNMP V2 community name.
④	V3 Authentication Type	Set SNMP V3 authentication mode.
⑤	V3 Authentication Encoding	Set SNMP V3 authentication encoding.
⑥	V3 Username	Set the V3 username and password of the SNMP Agent. The password is at least 8 character string.
⑦	V3 Private Encoding	Set SNMP V3 Private Encoding.
⑧	V3 Private Password	Set the V3 password of the SNMP Agent. The Password is at least character string.
⑨	TRAP IP/Port	Set the V3 password of the SNMP Agent. The Password is at least character string.
⑩	TRAP Parameter	Set the SNMP trap specific parameter.

User Management

- > Dash Board
- > Ship Setting
- > Antenna Setting
- > Tracking Setting
- > Modem Setting
- > Diagnostic
- > Library Setting
- > Firmware&Configuration
 - Antenna Firmware Upgrade
 - Antenna Log
 - Antenna Backup & Restore
- > Administration
 - Network Setting
 - SNMP Setting
 - 1 User Management
 - iARM Upgrade
 - iARM Save & Reboot
 - Antenna Event Log
 - Intellian Network Devices
- > Information
 - Control IP * 175.195.19.5
 - Current IP 175.195.19.5
 - Refresh Rate * 1 (sec)
 - Refresh Disable 8:51
 - Idle Session Timeout 19:52
 - Wifi *

User Management

2 Change ID & Password

Change ID

Current ID

New ID

Change Password

Enter Current Password

Enter New Password

Confirm New Password

3 Change User Settings

Password Expire Timeout

Timeout in days day

Idle Session Timeout

for Console login min

for Network login min

No.	Item	Description
①	User Management	Change login ID and Password to access the Aptus Web. This setting can be also accessed by 'Account' icon on the top menu.
②	Change ID & Password	<p>Change your login ID (user name) and password.</p> <ul style="list-style-type: none"> - Change ID : Enter your current login ID (user name) and new login ID. Click the Submit button to validate the changes that are made to the login ID. - Change Password : Enter your current login password and new login password. Click the Submit button to validate the changes that are made to the login password.
③	Change User Settings	<p>Change User Password Expire in days and Idle session timeout.</p> <ul style="list-style-type: none"> - Password Expire Timeout : Set password expire in days. - Idle Session Timeout : Set for Console and for Network Timeout.

iARM Upgrade

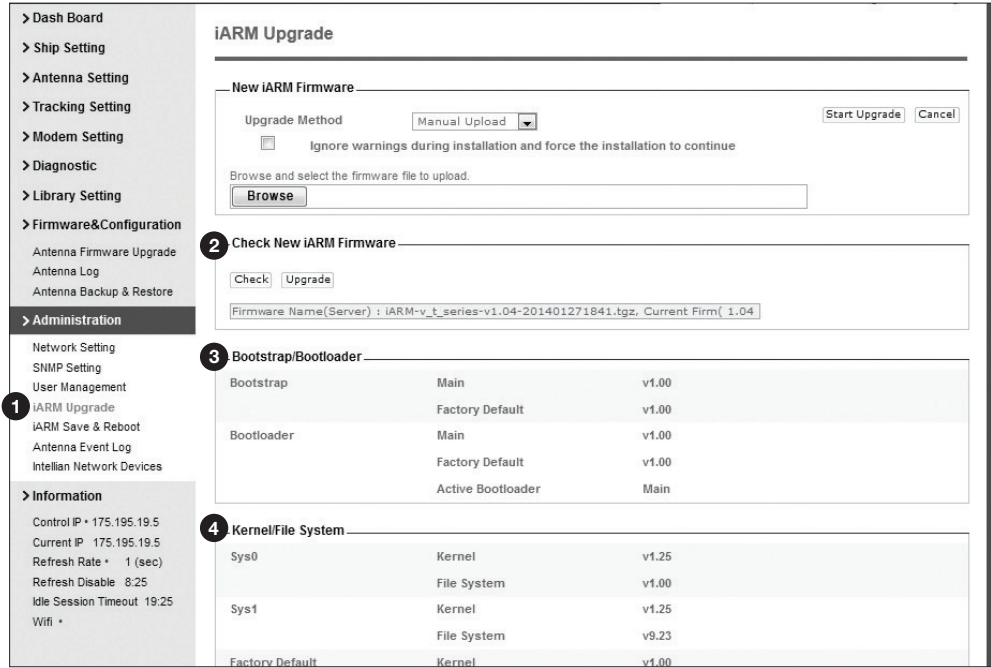

No.	Item	Description
①	iARM Upgrade	Upgrade the firmware of iARM module.
②	Check New iARM Firmware	Check new iARM firmware available on the server.
③	Bootstrap /Bootloader	Displays current bootstrap and bootloader version.
④	Kernel /File System	ACU has 3 storage parts sys0, sys1, Factory Default. Display kernel and file system version and current activated part Information.

iARM firmware upgrade procedures:

1. Click on “Browse” button to select the iARM firmware file (.tgz) that you wish to upgrade.
2. Click on “Start Update” button to update the iARM firmware. Wait until the page is loaded.
3. It'll inform you that the firmware is being uploaded.

Firmware upload in progress

<ul style="list-style-type: none"> > Dash Board > Ship Setting > Antenna Setting > Tracking Setting > Diagnostic > Firmware&Configuration <ul style="list-style-type: none"> Antenna Firmware Upgrade Antenna Log Antenna Backup & Restore <li style="background-color: #333; color: white; padding: 2px;">> Administration <ul style="list-style-type: none"> Network Setting SNMP Setting 	<p style="text-align: center;">Save & Reboot</p> <hr/> <p style="font-size: small;">Now the device will reboot with new firmware. Please refer to the User Guide if you have trouble connecting to the device. This screen will be inaccessible in 10 seconds.</p>
--	---

4. Do not turn off the ACU power if the firmware upgrade page is displayed.

Firmware upgrade in progress

<ul style="list-style-type: none"> > Dash Board > Ship Setting > Antenna Setting > Tracking Setting > Diagnostic > Firmware&Configuration <ul style="list-style-type: none"> Antenna Firmware Upgrade Antenna Log Antenna Backup & Restore <li style="background-color: #333; color: white; padding: 2px;">> Administration <ul style="list-style-type: none"> Network Setting SNMP Setting User Management iARM Upgrade iARM Save & Reboot Antenna Event Log Intellian Network Devices > Information <ul style="list-style-type: none"> Control IP : 192.168.3.5 Current IP : 192.168.3.5 Refresh Rate : 0 (sec) Refresh Disable : 1:31 Idle Session Timeout : 10:31 	<p style="font-size: x-small;">Please wait for updating system...</p> <div style="border: 1px solid #ccc; width: 150px; height: 15px; margin: 0 auto; position: relative;"> <div style="background-color: #333; width: 20px; height: 100%; position: absolute; left: 0;"></div> running </div> <p style="font-size: x-small; margin-top: 5px;">DO NOT TURN OFF ACU.</p>
---	---

5. It'll take around 2 minutes to complete the firmware upgrade. Once the upgrade is completed, the system will reboot automatically.

<ul style="list-style-type: none"> > Dash Board > Ship Setting > Antenna Setting > Tracking Setting > Diagnostic > Firmware&Configuration <ul style="list-style-type: none"> Antenna Firmware Upgrade Antenna Log Antenna Backup & Restore <li style="background-color: #333; color: white; padding: 2px;">> Administration <ul style="list-style-type: none"> Network Setting SNMP Setting User Management iARM Upgrade iARM Save & Reboot Antenna Event Log Intellian Network Devices > Information <ul style="list-style-type: none"> Control IP : 192.168.3.5 Current IP : 192.168.3.5 	<p style="font-size: x-small;">Please wait for file transfer...</p> <div style="border: 1px solid #ccc; width: 150px; height: 15px; margin: 0 auto; position: relative;"> <div style="background-color: #333; width: 20px; height: 100%; position: absolute; left: 0;"></div> running </div>
---	--

iARM Save & Reboot

No.	Item	Description
①	iARM Save & Reboot	Save settings to the ACU and reboot or reboot the system without saving.
②	Save & Reboot	Save the modified settings and reboot the system. Click Save & Reboot button.
③	Reboot without Saving	Reboot the system without saving the modified settings. Click Reboot Only button.

Antenna Event Log

No.	Item	Description
①	Antenna Event Log	Displays user's log information (Data/Time, Login ID and IP)
②	Query Filter	<p>Set the Log message option.</p> <ul style="list-style-type: none"> - Severity : Set urgency level. - Category : Set target that caused the message. - Time Frame : Set time limit that you want to show. - Sorting Order : Sorting based on date (descending or ascending).
③	Event Log	<p>Displays log information (Date/Time, Severity, Category, Log).</p> <ul style="list-style-type: none"> - Save Event Log : Save log message to your PC.

Intellian Network Devices

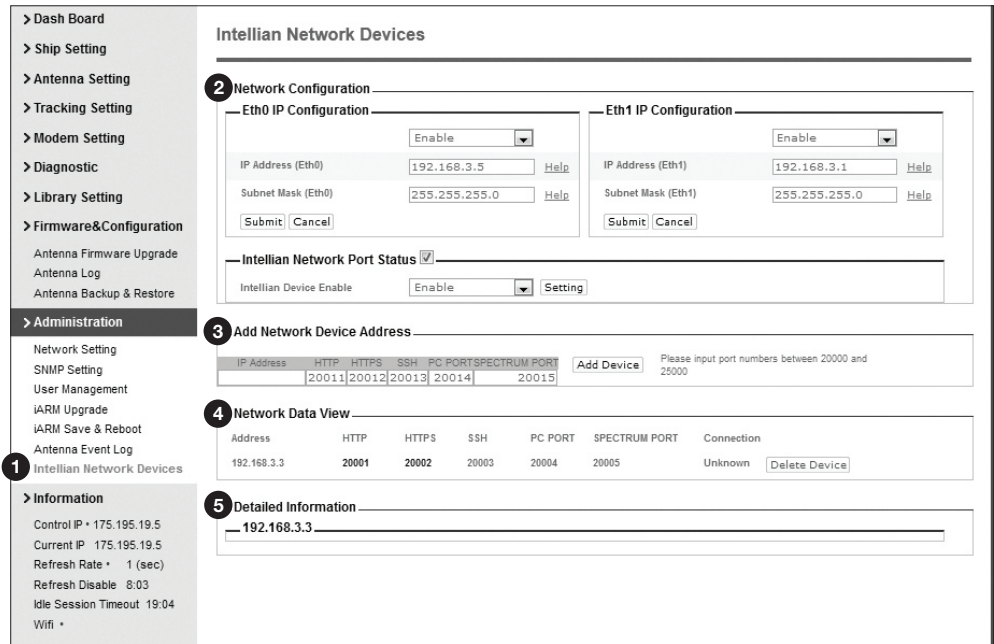

No.	Item	Description
①	Intellian Network Devices	Add up to 8 network devices and enable to monitor real time information of the connected device.
②	Network Configuration	<ul style="list-style-type: none"> Eth0 IP Configuration : ACU network Eth0 IP and subnet mask setting. Eth1 IP Configuration : ACU network Eth1 IP and subnet mask setting. Intellian Network Port Status : not used on t-series.
③	Add Network Device Address	<p>Add Intellian network devices, then you can browse the various information of the device.</p> <ul style="list-style-type: none"> IP Address : IP address of the device to be monitored. HTTP, HTTPS, SSH : Set port number(These port numbers will be matched the http, https or SSH port number of each device).
④	Network Data View	<p>Displays the setting information of the added device (IP address, http, https, SSH port number, current connection).</p> <p>If you click the http/https port number of each device, then you can connect to the device's web page.</p> <p>If you click Delete Device button, then you can't see its information.</p>
⑤	Detailed Information	Displays the information of each device. (Updated every 3 second).

Warranty

This product is warranted by Intellian Technologies Inc., to be free from defects in materials and workmanship for a period of THREE (3) YEARS on parts and TWO (2) YEARS on labor performed at Intellian Technologies, Inc. service center from the purchased date of the product.

Intellian Technologies, Inc. warranty does not apply to product that has been damaged and subjected to accident, abuse, misuse, non-authorized modification, incorrect and/ or non-authorized service, or to a product on which the serial number has been altered, mutilated or removed.

It is required to present a copy of the purchase receipt issued by Intellian Technologies, Inc. that indicates the date of purchase for after-sales service under the warranty period. In case of failure to present the purchase receipt, the warranty period will begin 30 days after the manufacturing production date of the product purchased.

Any product which is proven to be defective in materials or workmanship, Intellian Technologies, Inc. will (at its sole option) repair or replace during the warranty period in accordance with this warranty. All products returned to Intellian Technologies, Inc. under the warranty period must be accompanied by a return material authorization (RMA) number issued by the dealer/distributor from Intellian Technologies, Inc. and a copy of the purchase receipt as a proof of purchased date, prior to shipment. Alternatively, you may bring the product to an authorized Intellian Technologies, Inc. dealer/distributor for repair.

Additional Terms and Conditions;

The warranty(THREE (3) YEARS on parts and TWO (2) YEARS on labor) is effective only for products purchased since January 1st, 2017.

Appendix: Java Download and Install Guide

NOTE: To run Java applications you must have Java Runtime Environment (JRE) version 6.0 and above installed in your PC/laptop.

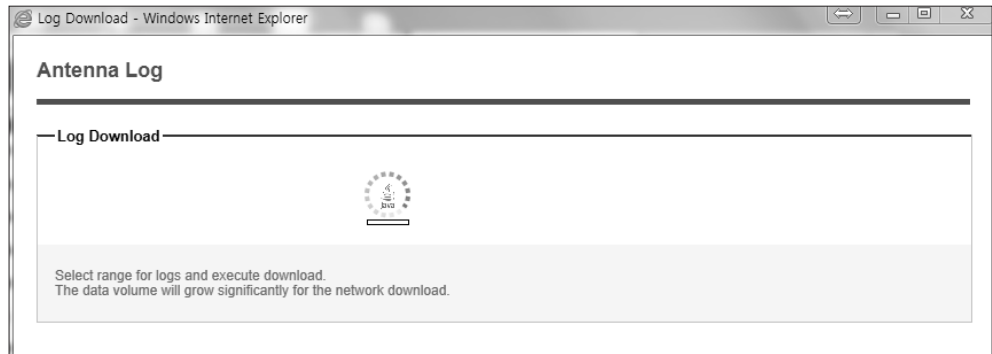

If JRE has not been installed in your PC/laptop, you'll get the below message box. Click Run button to install it through online or offline download and install methods. After installing JRE, Java Applet will be executed automatically when you access the Antenna Log page.



NOTE: The JRE installation guide may vary depending on the operating system installed in your PC/laptop.

Method 1. Online method for downloading and installing <http://www.java.com/en/download/manual.jsp>

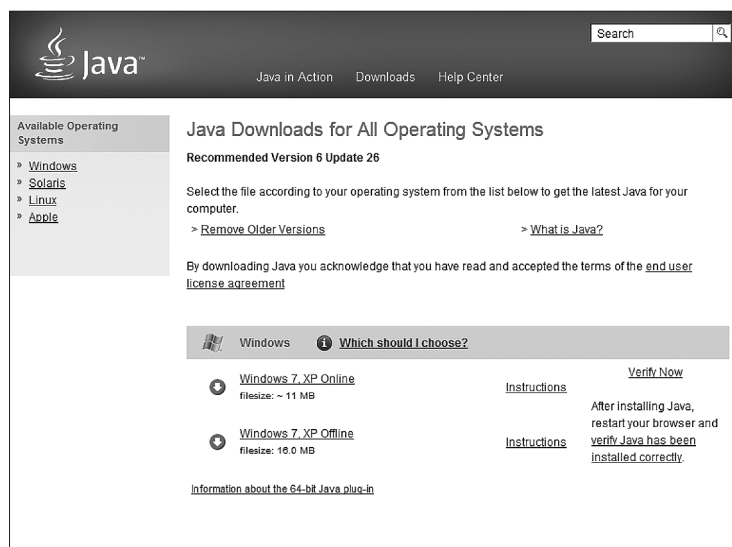

The screenshot shows the Java website's download page. At the top, there is a search bar and navigation links for 'Java in Action', 'Downloads', and 'Help Center'. The main heading is 'Java Downloads for All Operating Systems', with a sub-heading 'Recommended Version 6 Update 26'. Below this, there is a section for 'Available Operating Systems' with a sidebar menu listing 'Windows', 'Solaris', 'Linux', and 'Apple'. The main content area provides instructions on how to select a file based on the operating system and includes links for 'Remove Older Versions' and 'What is Java?'. A disclaimer states that by downloading Java, the user acknowledges the terms of the 'end user license agreement'. A section titled 'Windows' with a sub-heading 'Which should I choose?' lists two options: 'Windows 7_XP Online' (file size: ~ 11 MB) and 'Windows 7_XP Offline' (file size: 16.0 MB). Each option has a corresponding 'Instructions' link. To the right of these options, there is a 'Verify Now' link and a note: 'After installing Java, restart your browser and verify Java has been installed correctly.' At the bottom, there is a link for 'Information about the 64-bit Java plug-in'.

Method 2. Offline method for downloading and installing

http://www.java.com/en/download/help/windows_offline_download.xml

This process requires you to download an executable file that includes all the files needed for the complete installation. You do not need to remain connected to the Internet during the installation. The file can also be copied to a computer that is not connected to the Internet.

1. Go to the Manual download page
2. Click on Windows Offline.
3. The File Download dialog box appears prompting you to run or save the download file. Click Save to download the file to your local system.

Tip: Save the file to a known location on your computer, for example, to your desktop.

4. Close all applications including the browser.
5. Double-click on the saved file to start the installation process.
6. The installation process starts. Click the Install button to accept the license terms and to continue with the installation.



7. Oracle has partnered with companies that offer various products. The installer may present you with option to install these programs when you install Java. After ensuring that the desired programs are selected, click the Next button to continue the installation.



8. A few brief dialogs confirm the last steps of the installation process: click Close button on the last dialog.



9. This will complete Java installation process.

NOTE: You may need to restart (close and re-open) your browser to enable the java installation in your browser.

Technical Specification

General	
Approvals	
CE – conforms to	EU Directive 89/336/EEC
FCC – verified to	CFR47: Part 15
Dimensions	
Satellite antenna unit	78.0 cm x 84.5 cm (30.7" x 33.3")
Antenna dish diameter	60cm (23.6")
Antenna control unit	43.1cm x 38.1cm x 4.4cm (17" x 15" x 1.7")
Weight	
Satellite antenna unit	59.5 kg (131.2 lbs)
Antenna control unit	3.5kg (7.7 lbs)
Antenna system performance	
Tx Frequency	14.0 ~ 14.5 GHz Ku-band
Tx Gain	37 dBi
Rx Frequency	10.95 ~ 12.75 GHz Ku-band
Rx Gain	35.6 dBi
Polarized Feed	Cross-pol / Cross-pol & Co-pol
Skew Control	Automatic Skew-angle Control
Azimuth range	Unlimited
Elevation range	-10° ~ +100°
Cross-level range	±30°
Stabilization Accuracy	0.2° peak mis-pointing @ max ship motion condition
Max Ship's motion	±25°roll, ±15° pitch, ±8°yaw@ 6 sec
Turning rate	Up to 12°/ sec & 5°/ sec ²
BUC	8W
Rack Mount Antenna Control Unit	
Display	2 Line 40 Character Graphic VFD Module
Serial Interface	RS232C (19200 bps 8, N, 1) / USB
Modem Interface	Ethernet port / RS-232C / I/O ports
Remote Access	RJ45, TCP/IP
Input Power	100 ~ 240V AC, 50 ~ 60Hz
Gyrocompass Interface	NMEA2000 / NMEA0183

Environment Specification

Specification	Intellian Standards
1. Temperature	Relative Humidity = Max. 55% -40°C to 80°C
2. Damp Heat	Humidity => 95% 25°C to 55°C
3. Vibration	1. DNV Resonance Search (X, Y, Z axis) - 2 to 13.2Hz : Displacement 3mm - 13.2 to 50Hz : Acceleration 2.1g 2. DNV Resonance Durability (X, Y, Z axis) - 10Hz (Displacement 3mm) : 90min (If no resonance fq) - Highest resonance frequency : 90 min (If Amp factor < 2) - All each resonance frequencies : 90 min (If Amp factor >= 2)
4. Shock	1. Operational Shock - 15g at 11ms (half sine) on X, Y, Z axis - 1,000 times per each +/- direction, total 6,000 times 2. Survival Shock - 27g at 11ms (half sine) on X, Y, Z axis - 10 times per each +/- direction, total 60 times
5. Water Ingress	Resistant to water penetration sprayed from any direction Standard: IPX6
6. Salt Mist	Saline solution : 5 ±1 % NaCl Storage period: 7 Days