

HIGHLIGHTS OF PRESCRIBING INFORMATION

These highlights do not include all the information needed to use AFREZZA® safely and effectively. See full prescribing information for AFREZZA®.

AFREZZA® (insulin human) inhalation powder, for oral inhalation use
Initial U.S. Approval: 2014

WARNING: RISK OF ACUTE BRONCHOSPASM IN PATIENTS WITH CHRONIC LUNG DISEASE

See full prescribing information for complete boxed warning.

- Acute bronchospasm has been observed in patients with asthma and COPD using AFREZZA. (5.1)
- AFREZZA is contraindicated in patients with chronic lung disease such as asthma or COPD. (4)
- Before initiating AFREZZA, perform a detailed medical history, physical examination, and spirometry (FEV₁) to identify potential lung disease in all patients. (2.5), (5.1)

INDICATIONS AND USAGE

- AFREZZA® is a rapid acting inhaled insulin indicated to improve glycemic control in adult patients with diabetes mellitus. (1)
Important limitations of use:
 - In patients with type 1 diabetes, must use with a long-acting insulin. (1)
 - Not recommended for the treatment of diabetic ketoacidosis. (1)
 - Not recommended in patients who smoke (1)

DOSAGE AND ADMINISTRATION

- Administer using a single inhalation per cartridge (2.1)
- Administer at the beginning of a meal (2.2)
- Dosing must be individualized (2.2)
- Before initiating, perform a detailed medical history, physical examination, and spirometry (FEV₁) in all patients to identify potential lung disease (2.5)

DOSAGE FORMS AND STRENGTHS

- AFREZZA is available as single-use cartridges of: (3)
- 4 units
 - 8 units
 - 12 units

CONTRAINDICATIONS

- During episodes of hypoglycemia (4)
- Chronic lung disease, such as asthma, or chronic obstructive pulmonary disease (4)
- Hypersensitivity to regular human insulin or any of the AFREZZA excipients (4)

FULL PRESCRIBING INFORMATION: CONTENTS*

WARNING: RISK OF ACUTE BRONCHOSPASM IN PATIENTS WITH CHRONIC LUNG DISEASE

1 INDICATIONS AND USAGE

2 DOSAGE AND ADMINISTRATION

- 2.1 Route of Administration
- 2.2 Dosage Information
- 2.3 AFREZZA Administration for Doses Exceeding 12 units
- 2.4 Dosage Adjustment due to Drug Interactions
- 2.5 Lung Function Assessment Prior to Administration
- 2.6 Important Administration Instructions

3 DOSAGE FORMS AND STRENGTHS

4 CONTRAINDICATIONS

5 WARNINGS AND PRECAUTIONS

- 5.1 Acute Bronchospasm in Patients with Chronic Lung Disease
- 5.2 Changes in Insulin Regimen
- 5.3 Hypoglycemia
- 5.4 Decline in Pulmonary Function
- 5.5 Lung Cancer
- 5.6 Diabetic Ketoacidosis
- 5.7 Hypersensitivity Reactions
- 5.8 Hypokalemia
- 5.9 Fluid Retention and Heart Failure with Concomitant Use of PPAR-gamma Agonists

6 ADVERSE REACTIONS

- 6.1 Clinical Trials Experience

7 DRUG INTERACTIONS

- 7.1 Drugs That May Increase the Risk of Hypoglycemia
- 7.2 Drugs That May Decrease the Blood Glucose Lowering Effect of AFREZZA

WARNINGS AND PRECAUTIONS

- **Acute Bronchospasm:** Acute bronchospasm has been observed in patients with asthma and COPD. Before initiating, perform spirometry (FEV₁) in all patients. Do not use in patients with chronic lung disease (2.5, 4, 5.1)
- **Change in Insulin Regimen:** Carry out under close medical supervision and increase frequency of blood glucose monitoring. (5.2)
- **Hypoglycemia:** May be life-threatening. Increase frequency of glucose monitoring with changes to: insulin dosage, co-administered glucose lowering medications, meal pattern, physical activity; and in patients with renal or hepatic impairment and hypoglycemia unawareness. (5.3, 6, 7, 8.6, 8.7)
- **Decline in Pulmonary Function:** Assess pulmonary function (e.g., spirometry) before initiating, after 6 months of therapy, and annually, even in the absence of pulmonary symptoms. (2.5, 5.4)
- **Lung Cancer:** AFREZZA should not be used in patients with active lung cancer. In patients with a history of lung cancer or at risk for lung cancer, the benefit of AFREZZA use should outweigh this potential risk. (5.5)
- **Diabetic Ketoacidosis:** More patients using AFREZZA experienced diabetic ketoacidosis in clinical trials. In patients at risk for DKA, monitor and change to alternate route of insulin delivery, if indicated. (5.6)
- **Hypersensitivity Reactions:** Severe, life-threatening, generalized allergy, including anaphylaxis, can occur with insulin products, including AFREZZA. Discontinue AFREZZA, monitor and treat if indicated. (5.7)
- **Hypokalemia:** May be life-threatening. Monitor potassium levels in patients at risk of hypokalemia and treat if indicated. (5.8)
- **Fluid Retention and Heart Failure with Concomitant Use of Thiazolidinediones (TZDs):** Observe for signs and symptoms of heart failure; consider dosage reduction or discontinuation if heart failure occurs. (5.9)

ADVERSE REACTIONS

The most common adverse reactions associated with AFREZZA (2% or greater incidence) are hypoglycemia, cough, and throat pain or irritation (6)
To report SUSPECTED ADVERSE REACTIONS, contact MannKind at 1-877-323-8505 or FDA at 1-800-FDA-1088 or www.fda.gov/medwatch.

DRUG INTERACTIONS

Drugs that Affect Glucose Metabolism: Adjustment of insulin dosage may be needed. (7.1, 7.2, 7.3)

Anti-Adrenergic Drugs (e.g., beta-blockers, clonidine, guanethidine, and reserpine): Signs and symptoms of hypoglycemia may be reduced or absent. (7.3, 7.4)

See 17 for PATIENT COUNSELING INFORMATION and Medication Guide.

Revised: 9/2017

7.3 Drugs That May Increase or Decrease the Blood Glucose Lowering Effect of AFREZZA

7.4 Drugs That May Affect Hypoglycemia Signs and Symptoms

8 USE IN SPECIFIC POPULATIONS

- 8.1 Pregnancy
- 8.2 Lactation
- 8.4 Pediatric Use
- 8.5 Geriatric Use
- 8.6 Hepatic Impairment
- 8.7 Renal Impairment

10 OVERDOSAGE

11 DESCRIPTION

- 11.1 AFREZZA Cartridges
- 11.2 AFREZZA Inhaler

12 CLINICAL PHARMACOLOGY

- 12.1 Mechanism of Action
- 12.2 Pharmacodynamics
- 12.3 Pharmacokinetics

13 NONCLINICAL TOXICOLOGY

- 13.1 Carcinogenesis, Mutagenesis, Impairment of Fertility

14 CLINICAL STUDIES

- 14.1 Overview of Clinical Studies of AFREZZA for Diabetes Mellitus
- 14.2 Type 1 Diabetes
- 14.3 Type 2 Diabetes

16 HOW SUPPLIED/STORAGE AND HANDLING

17 PATIENT COUNSELING INFORMATION

*Sections or subsections omitted from the full prescribing information are not listed.

FULL PRESCRIBING INFORMATION

WARNING: RISK OF ACUTE BRONCHOSPASM IN PATIENTS WITH CHRONIC LUNG DISEASE

- Acute bronchospasm has been observed in patients with asthma and COPD using AFREZZA. [see Warnings and Precautions (5.1)].
- AFREZZA is contraindicated in patients with chronic lung disease such as asthma or COPD. [see Contraindications (4)].
- Before initiating AFREZZA, perform a detailed medical history, physical examination, and spirometry (FEV₁) to identify potential lung disease in all patients [see Dosage and Administration (2.5), Warnings and Precautions (5.1)].

1 INDICATIONS AND USAGE

AFREZZA® is a rapid acting inhaled insulin indicated to improve glycemic control in adult patients with diabetes mellitus.

Limitations of Use

- AFREZZA is not a substitute for long-acting insulin. AFREZZA must be used in combination with long-acting insulin in patients with type 1 diabetes mellitus.
- AFREZZA is not recommended for the treatment of diabetic ketoacidosis [see Warning and Precautions (5.6)].
- The safety and efficacy of AFREZZA in patients who smoke has not been established. The use of AFREZZA is not recommended in patients who smoke or who have recently stopped smoking.

2 DOSAGE AND ADMINISTRATION

2.1 Route of Administration

AFREZZA should only be administered via oral inhalation using the AFREZZA Inhaler. AFREZZA is administered using a single inhalation per cartridge.

2.2 Dosage Information

Administer AFREZZA at the beginning of the meal.

Dosage adjustment may be needed when switching from another insulin to AFREZZA [see Warnings and Precautions (5.2)].

Step 1: Starting Mealtime Dose

- *Insulin Naïve Individuals:* Start on 4 units of AFREZZA at each meal.
- *Individuals Using Subcutaneous Mealtime (Prandial) Insulin:* Determine the appropriate AFREZZA dose for each meal by converting from the injected dose using Figure 1.
- *Individuals Using Subcutaneous Pre-mixed Insulin:* Estimate the mealtime injected dose by dividing half of the total daily injected pre-mixed insulin dose equally among the three meals of the day. Convert each estimated injected mealtime dose to an appropriate AFREZZA dose using Figure 1. Administer half of the total daily injected pre-mixed dose as an injected basal insulin dose.











Step 2: Mealtime Dose Adjustment

Adjust the dosage of AFREZZA based on the individual's metabolic needs, glucose monitoring results and glycemic control goal.

Dosage adjustments may be needed with changes in physical activity, changes in meal patterns (i.e., macronutrient content or timing of food intake), changes in renal or hepatic function or during acute illness [see Warnings and Precautions (5.3), Use in Specific Populations (8.6, 8.7)].

Carefully monitor blood glucose control in patients requiring high doses of AFREZZA. If, in these patients, blood glucose control is not achieved with increased AFREZZA doses, consider use of subcutaneous mealtime insulin.

Figure 1. Mealtime AFREZZA Starting Dose Conversion Table

Injected Mealtime Insulin Dose	AFREZZA® Dose	# of cartridges needed		
		4 unit (blue)	8 unit (green)	12 unit (yellow)
up to 4 units	4 units			
5-8 units	8 units			
9-12 units	12 units		+	 or 
13-16 units	16 units			 
17-20 units	20 units			 + 
21-24 units	24 units			 

2.3 AFREZZA Administration for Doses Exceeding 12 units

For AFREZZA doses exceeding 12 units, inhalations from multiple cartridges are necessary. To achieve the required total mealtime dose, patients should use a combination of 4 unit, 8 unit and 12 unit cartridges. Examples of cartridge combinations for doses of up to 24 units are shown in Figure 1. For doses above 24 units, combinations of different multiple cartridges can be used.

2.4 Dosage Adjustment due to Drug Interactions

Dosage adjustment may be needed when AFREZZA is coadministered with certain drugs [see *Drug Interactions (7)*].

2.5 Lung Function Assessment Prior to Administration

AFREZZA is contraindicated in patients with chronic lung disease because of the risk of acute bronchospasm in these patients. Before initiating AFREZZA, perform a medical history, physical examination and spirometry (FEV₁) in all patients to identify potential lung disease [see *Contraindications (4) and Warnings and Precautions (5.1)*].

2.6 Important Administration Instructions

See Patient Instructions for Use for complete administration instructions with illustrations.

Keep the inhaler level with the white mouthpiece on top and purple base on the bottom after a cartridge has been inserted into the inhaler. Loss of drug effect can occur if the inhaler is turned upside down, held with the mouthpiece pointing down, shaken (or dropped) after the cartridge has been inserted but before the dose has been administered. If any of the above occur, the cartridge should be replaced before use.

3 DOSAGE FORMS AND STRENGTHS

AFREZZA (insulin human) Inhalation Powder is available as 4 unit, 8 unit and 12 unit single use cartridges to be administered via oral inhalation with the AFREZZA Inhaler only. [see *How Supplied/Storage and Handling (16)*].

4 CONTRAINDICATIONS

AFREZZA is contraindicated in patients with the following:

- During episodes of hypoglycemia
- Chronic lung disease, such as asthma or chronic obstructive pulmonary disease (COPD), because of the risk of acute bronchospasm [see *Warnings and Precautions (5.1)*].
- Hypersensitivity to regular human insulin or any of the AFREZZA excipients [see *Warnings and Precautions (5.7)*].

5 WARNINGS AND PRECAUTIONS

5.1 Acute Bronchospasm in Patients with Chronic Lung Disease

Because of the risk of acute bronchospasm, AFREZZA is contraindicated in patients with chronic lung disease such as asthma or COPD [see *Contraindications (4)*].

Before initiating therapy with AFREZZA, evaluate all patients with a medical history, physical examination and spirometry (FEV₁) to identify potential underlying lung disease.

Acute bronchospasm has been observed following AFREZZA dosing in patients with asthma and patients with COPD. In a study of patients with asthma, bronchoconstriction and wheezing following AFREZZA dosing was reported in 29% (5 out of 17) and 0% (0 out of 13) of patients with and without a diagnosis of asthma, respectively. In this study, a mean decline in FEV₁ of 400 mL was observed 15 minutes after a single dose in patients with asthma. In a study of patients with COPD (n=8), a mean decline in FEV₁ of 200 mL was observed 18 minutes after a single dose of AFREZZA. The long-term safety and efficacy of AFREZZA in patients with chronic lung disease has not been established.

5.2 Changes in Insulin Regimen

Glucose monitoring is essential for patients receiving insulin therapy. Changes in insulin strength, manufacturer, type, or method of administration may affect glycemic control and predispose to hypoglycemia [see *Warnings and Precautions (5.3)*] or hyperglycemia. These changes should be made under close medical supervision and the frequency of blood glucose monitoring should be increased. Concomitant oral antidiabetic treatment may need to be adjusted.

5.3 Hypoglycemia

Hypoglycemia is the most common adverse reaction associated with insulins, including AFREZZA. Severe hypoglycemia can cause seizures, may be life-threatening, or cause death. Hypoglycemia can impair concentration ability and reaction time; this may place an individual and others at risk in situations where these abilities are important (e.g., driving or operating other machinery).

The timing of hypoglycemia usually reflects the time-action profile of the administered insulin formulation. AFREZZA has a distinct time action profile [see *Clinical Pharmacology (12)*], which impacts the timing of hypoglycemia. Hypoglycemia can happen suddenly and symptoms may differ across individuals and change over time in the same individual. Symptomatic awareness of hypoglycemia may be less pronounced in patients with longstanding diabetes, in patients with diabetic nerve disease, in patients using certain medications [see *Drug Interactions (7)*], or in patients who experience recurrent hypoglycemia. Other factors which may increase the risk of hypoglycemia include changes in meal pattern (e.g., macronutrient content or timing of meals), changes in level of physical activity, or changes to co-administered medication [see *Drug Interactions (7)*]. Patients with renal or hepatic impairment may be at higher risk of hypoglycemia [see *Use in Specific Populations (8.6, 8.7)*].

Risk Mitigation Strategies for Hypoglycemia

Patients and caregivers must be educated to recognize and manage hypoglycemia. Self-monitoring of blood glucose plays an essential role in the prevention and management of hypoglycemia. In patients at higher risk for hypoglycemia and patients who have reduced symptomatic awareness of hypoglycemia, increased frequency of blood glucose monitoring is recommended.

5.4 Decline in Pulmonary Function

AFREZZA causes a decline in lung function over time as measured by FEV₁. In clinical trials excluding patients with chronic lung disease and lasting up to 2 years, AFREZZA-treated patients experienced a small [40 mL (95% CI: -80, -1)] but greater FEV₁ decline than comparator-treated patients. The FEV₁ decline was noted within the first 3 months, and persisted for the entire duration of therapy (up to 2 years of observation). In this population, the annual rate of FEV₁ decline did not appear to worsen with increased duration of use. The effects of AFREZZA on pulmonary function for treatment duration longer than 2 years has not been established. There are insufficient data in long term studies to draw conclusions regarding reversal of the effect on FEV₁ after discontinuation of AFREZZA. The observed changes in FEV₁ were similar in patients with type 1 and type 2 diabetes.

Assess pulmonary function (e.g., spirometry) at baseline, after the first 6 months of therapy, and annually thereafter, even in the absence of pulmonary symptoms. In patients who have a decline of $\geq 20\%$ in FEV₁ from baseline, consider discontinuing AFREZZA. Consider more frequent monitoring of pulmonary function in patients with pulmonary symptoms such as wheezing, bronchospasm, breathing difficulties, or persistent or recurring cough. If symptoms persist, discontinue AFREZZA. [see *Adverse Reactions (6)*].

5.5 Lung Cancer

In clinical trials, two cases of lung cancer, one in controlled trials and one in uncontrolled trials (2 cases in 2,750 patient-years of exposure), were observed in participants exposed to AFREZZA while no cases of lung cancer were observed in comparators (0 cases in 2,169 patient-years of exposure). In both cases, a prior history of heavy tobacco use was identified as a risk factor for lung cancer. Two additional cases of lung cancer (squamous cell) occurred in non-smokers exposed to AFREZZA and were reported by investigators after clinical trial completion. These data are insufficient to determine whether AFREZZA has an effect on lung or respiratory tract tumors. In patients with active lung cancer, a prior history of lung cancer, or in patients at risk for lung cancer, consider whether the benefits of AFREZZA use outweigh this potential risk.

5.6 Diabetic Ketoacidosis

In clinical trials enrolling subjects with type 1 diabetes, diabetic ketoacidosis (DKA) was more common in subjects receiving AFREZZA (0.43%; n=13) than in subjects receiving comparators (0.14%; n=3). In patients at risk for DKA, such as those with an acute illness or infection, increase the frequency of glucose monitoring and consider delivery of insulin using an alternate route of administration if indicated [see *Indications and Usage (1)*].

5.7 Hypersensitivity Reactions

Severe, life-threatening, generalized allergy, including anaphylaxis, can occur with insulin products, including AFREZZA. If hypersensitivity reactions occur, discontinue AFREZZA, treat per standard of care and monitor until symptoms and signs resolve [see *Adverse Reactions (6)*]. AFREZZA is contraindicated in patients who have had hypersensitivity reactions to AFREZZA or any of its excipients [see *Contraindications (4)*].

5.8 Hypokalemia

All insulin products, including AFREZZA, cause a shift in potassium from the extracellular to intracellular space, possibly leading to hypokalemia. Untreated hypokalemia may cause respiratory paralysis, ventricular arrhythmia, and death. Monitor potassium levels in patients at risk for hypokalemia (e.g., patients using potassium-lowering medications, patients taking medications sensitive to serum potassium concentrations and patients receiving intravenously administered insulin).

5.9 Fluid Retention and Heart Failure with Concomitant Use of PPAR-gamma Agonists

Thiazolidinediones (TZDs), which are peroxisome proliferator-activated receptor (PPAR)-gamma agonists, can cause dose-related fluid retention, particularly when used in combination with insulin. Fluid retention may lead to or exacerbate heart failure. Patients treated with insulin, including AFREZZA, and a PPAR-gamma agonist should be observed for signs and symptoms of heart failure. If heart failure develops, it should be managed according to current standards of care, and discontinuation or dose reduction of the PPAR-gamma agonist must be considered.

6 ADVERSE REACTIONS

The following serious adverse reactions are described below and elsewhere in the labeling:

- Acute bronchospasm in patients with chronic lung disease [see *Warnings and Precautions (5.1)*]
- Hypoglycemia [see *Warnings and Precautions (5.3)*]
- Decline in pulmonary function [see *Warnings and Precautions (5.4)*]
- Lung cancer [see *Warnings and Precautions (5.5)*]
- Diabetic ketoacidosis [see *Warnings and Precautions (5.6)*]
- Hypersensitivity reactions [see *Warnings and Precautions (5.7)*]

6.1 Clinical Trials Experience

Because clinical trials are conducted under widely varying conditions, adverse reaction rates observed in the clinical trials of a drug cannot be directly compared to rates in the clinical trials of another drug and may not reflect the rates observed in practice.

The data described below reflect exposure of 3017 patients to AFREZZA and include 1026 patients with type 1 diabetes and 1991 patients with type 2 diabetes. The mean exposure duration was 8.17 months for the overall population and 8.16 months and 8.18 months for type 1 and 2 diabetes patients, respectively. In the overall population, 1874 were exposed to AFREZZA for 6 months and 724 for greater than one year. 620 and 1254 patients with type 1 and type 2 diabetes, respectively, were exposed to AFREZZA for up to 6 months. 238 and 486 patients with type 1 and type 2 diabetes, respectively, were exposed to AFREZZA for greater than one year (median exposure = 1.8 years). AFREZZA was studied in placebo and active-controlled trials (n = 3 and n = 10, respectively).

The mean age of the population was 50.2 years and 20 patients were older than 75 years of age. 50.8% of the population were men; 82.6% were White, 1.8% were Asian, and 4.9% were Black or African American. 9.7% were Hispanic. At baseline, the type 1 diabetes population had diabetes for an average of 16.6 years and had a mean HbA1c of 8.3%, and the type 2 diabetes population had diabetes for an average of 10.7 years and had a mean HbA1c of 8.8%. At baseline, 33.4% of the population reported peripheral neuropathy, 32.0% reported retinopathy and 19.6% had a history of cardiovascular disease.

Table 1 shows common adverse reactions, excluding hypoglycemia, associated with the use of AFREZZA in the pool of controlled trials in type 2 diabetes patients. These adverse reactions were not present at baseline, occurred more commonly on AFREZZA than on placebo and/or comparator and occurred in at least 2% of patients treated with AFREZZA.

Table 1. Common Adverse Reactions in Patients with Type 2 Diabetes Mellitus (excluding Hypoglycemia) Treated with AFREZZA

	Placebo* (n = 290)	AFREZZA (n = 1991)	Non-placebo comparators (n=1363)
Cough	19.7%	25.6%	5.4%
Throat pain or irritation	3.8%	4.4%	0.9%
Headache	2.8%	3.1%	1.8%
Diarrhea	1.4%	2.7%	2.2%
Productive cough	1.0%	2.2%	0.9%
Fatigue	0.7%	2.0%	0.6%
Nausea	0.3%	2.0%	1.0%

*Carrier particle without insulin was used as placebo [see Description (11.1)].

Table 2 shows common adverse reactions, excluding hypoglycemia, associated with the use of AFREZZA in the pool of active-controlled trials in type 1 diabetes patients. These adverse reactions were not present at baseline, occurred more commonly on AFREZZA than on comparator, and occurred in at least 2% of patients treated with AFREZZA.

Table 2. Common Adverse Reactions in Patients with Type 1 Diabetes Mellitus (excluding Hypoglycemia) Treated with AFREZZA

	Subcutaneous Insulin (n = 835)	AFREZZA (n=1026)
Cough	4.9%	29.4%
Throat pain or irritation	1.9%	5.5%
Headache	2.8%	4.7%
Pulmonary function test decreased	1.0%	2.8%
Bronchitis	2.0%	2.5%
Urinary tract infection	1.9%	2.3%

Hypoglycemia

Hypoglycemia is the most commonly observed adverse reaction in patients using insulin, including AFREZZA [see Warnings and Precautions (5.3)]. The incidence of severe and non-severe hypoglycemia of AFREZZA versus placebo in patients with type 2 diabetes is shown in Table 3. A hypoglycemic episode was recorded if a patient reported symptoms of hypoglycemia with or without a blood glucose value consistent with hypoglycemia. Severe hypoglycemia was defined as an event with symptoms consistent with hypoglycemia requiring the assistance of another person and associated with either a blood glucose value consistent with hypoglycemia or prompt recovery after treatment for hypoglycemia.

Table 3. Incidence of Severe and Non-Severe Hypoglycemia in a Placebo-Controlled Study of Patients with Type 2 Diabetes

	Placebo (N=176)	AFREZZA (N=177)
Severe Hypoglycemia	1.7%	5.1%
Non-Severe Hypoglycemia	30%	67%

Cough

Approximately 27% of patients treated with AFREZZA reported cough, compared to approximately 5.2% of patients treated with comparator. In clinical trials, cough was the most common reason for discontinuation of AFREZZA therapy (2.8% of AFREZZA-treated patients).

Pulmonary Function Decline

In clinical trials lasting up to 2 years, excluding patients with chronic lung disease, patients treated with AFREZZA had a 40 mL (95% CI: -80, -1) greater decline from baseline in forced expiratory volume in one second (FEV₁) compared to patients treated with comparator anti-diabetes treatments. The decline occurred during the first 3 months of therapy and persisted over 2 years (Figure 2). A decline in FEV₁ of ≥ 15% occurred in 6% of AFREZZA-treated subjects compared to 3% of comparator-treated subjects.

Figure 2. Mean (+/-SE) Change in FEV₁ (Liters) from Baseline for Type 1 and Type 2 Diabetes Patients

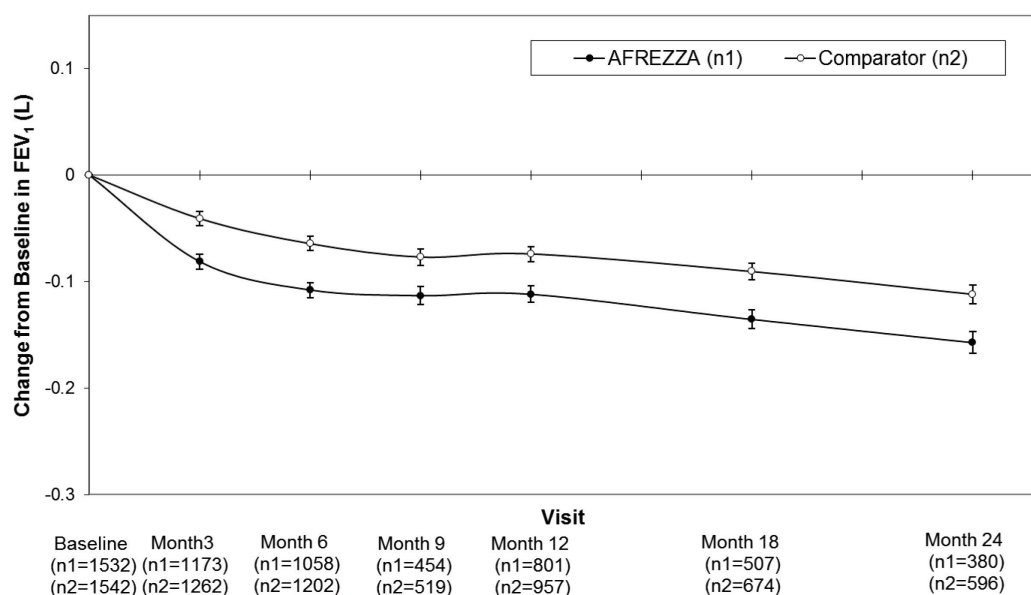

Weight Gain

Weight gain may occur with some insulin therapies, including AFREZZA. Weight gain has been attributed to the anabolic effects of insulin and the decrease in glycosuria. In a clinical trial of patients with type 2 diabetes [see *Clinical Studies (14.3)*], there was a mean 0.49 kg weight gain among AFREZZA-treated patients compared with a mean 1.13 kg weight loss among placebo-treated patients.

Antibody Production

Increases in anti-insulin antibody concentrations have been observed in patients treated with AFREZZA. Increases in anti-insulin antibodies are observed more frequently with AFREZZA than with subcutaneously injected mealtime insulins. Presence of antibody did not correlate with reduced efficacy, as measured by HbA1c and fasting plasma glucose, or specific adverse reactions.

7 DRUG INTERACTIONS

7.1 Drugs That May Increase the Risk of Hypoglycemia

The risk of hypoglycemia associated with AFREZZA use may be increased with antidiabetic agents, ACE inhibitors, angiotensin II receptor blocking agents, disopyramide, fibrates, fluoxetine, monoamine oxidase inhibitors, pentoxifylline, pramlintide, propoxyphene, salicylates, somatostatin analogs (e.g., octreotide), and sulfonamide antibiotics. Dose adjustment and increased frequency of glucose monitoring may be required when AFREZZA is co-administered with these drugs.

7.2 Drugs That May Decrease the Blood Glucose Lowering Effect of AFREZZA

The glucose lowering effect of AFREZZA may be decreased when co-administered with atypical antipsychotics (e.g., olanzapine and clozapine), corticosteroids, danazol, diuretics, estrogens, glucagon, isoniazid, niacin, oral contraceptives, phenothiazines, progestogens (e.g., in oral contraceptives), protease inhibitors, somatropin, sympathomimetic agents (e.g., albuterol, epinephrine, terbutaline) and thyroid hormones. Dose adjustment and increased frequency of glucose monitoring may be required when AFREZZA is co-administered with these drugs.

7.3 Drugs That May Increase or Decrease the Blood Glucose Lowering Effect of AFREZZA

The glucose lowering effect of AFREZZA may be increased or decreased when co-administered with alcohol, beta-blockers, clonidine, and lithium salts. Pentamidine may cause hypoglycemia, which may sometimes be followed by hyperglycemia. Dose adjustment and increased frequency of glucose monitoring may be required when AFREZZA is co-administered with these drugs.

7.4 Drugs That May Affect Hypoglycemia Signs and Symptoms

The signs and symptoms of hypoglycemia may be blunted when beta-blockers, clonidine, guanethidine, and reserpine are co-administered with AFREZZA.

8 USE IN SPECIFIC POPULATIONS

8.1 Pregnancy

Risk Summary

Limited available data with AFREZZA use in pregnant women are insufficient to determine drug-associated risks for adverse developmental outcomes. Available information from published studies with human insulin use during pregnancy has not reported a clear association with human insulin and adverse developmental outcomes (see *Data*). There are risks to the mother and fetus associated with poorly controlled diabetes in pregnancy (see *Clinical Considerations*). In animal reproduction studies, there were no adverse developmental outcomes with subcutaneous administration of carrier particles (vehicle without insulin) to pregnant rats during organogenesis at doses 14-21 times the maximum recommended daily dose (see *Data*).

The estimated background risk of major birth defects is 6-10% in women with pre-gestational diabetes with HbA1c >7 and has been reported to be as high as 20-25% in women with HbA1c >10. The estimated background risk of miscarriage for the indicated population is unknown. In the U.S. general population, the estimated background risk of major birth defects and miscarriage in clinically recognized pregnancies is 2-4% and 15-20%, respectively.

Clinical Considerations

Disease-associated maternal and/or embryo/fetal risk

Poorly controlled diabetes in pregnancy increases the maternal risk for diabetic ketoacidosis, pre-eclampsia, spontaneous abortions, preterm delivery, stillbirth, and delivery complications. Poorly controlled diabetes increases the fetal risk for major birth defects, still birth, and macrosomia-related morbidity.

Data

Human Data

There are limited data with AFREZZA use in pregnant women. Published data do not report a clear association with human insulin and major birth defects, miscarriage, or adverse maternal or fetal outcomes when human insulin is used during pregnancy. However, these studies cannot definitely establish the absence of any risk because of methodological limitations including small sample size and lack of blinding.

Animal Data

In pregnant rats given subcutaneous doses of 10, 30, and 100 mg/kg/day of carrier particles (vehicle without insulin) from gestation day 6 through 17 (organogenesis), no major malformations were observed at up to 100 mg/kg/day (a systemic exposure 14-21 times the human systemic exposure, resulting from the maximum recommended daily dose of 99 mg AFREZZA based on AUC).

In pregnant rabbits given subcutaneous doses of 2, 10, and 100 mg/kg/day of carrier particles (vehicle without insulin) from gestation day 7 through 19 (organogenesis), adverse maternal effects were observed at all dose groups (at human systemic exposure following a 99 mg AFREZZA dose, based on AUC).

In pregnant rats given subcutaneous doses of 10, 30, and 100 mg/kg/day of carrier particles (vehicle without insulin) from gestation day 7 through lactation day 20 (weaning), decreased epididymis and testes weights, however, no decrease in fertility was noted, and impaired learning were observed in pups at ≥ 30 mg/kg/day (a systemic exposure 6 times human systemic exposure at the maximum daily AFREZZA dose of 99 mg based on AUC).

8.2 Lactation

Risk Summary

There are no data on the presence of AFREZZA in human milk, the effects on the breastfed infant, or the effects on milk production. One small published study reported that exogenous insulin was present in human milk. No adverse effects in infants were noted. The carrier particles are present in rat milk (*see Data*). Potential adverse effects that are related to inhalational administration of AFREZZA are unlikely to be associated with potential exposure of AFREZZA through breast milk. The developmental and health benefits of breastfeeding should be considered along with the mother's clinical need for AFREZZA and any potential adverse effects on the breastfed infant from AFREZZA or from the underlying maternal condition.

Data

Subcutaneous administration of the carrier particle in lactating rats resulted in excretion of the carrier particle in rat milk at levels that were approximately 10% of the maternal exposure. Given the results of the rat study, it is highly likely that the insulin and carrier in AFREZZA are excreted in human milk.

8.4 Pediatric Use

AFREZZA has not been studied in patients younger than 18 years of age.

8.5 Geriatric Use

In the AFREZZA clinical studies, 381 patients were 65 years of age or older, of which 20 were 75 years of age or older. No overall differences in safety or effectiveness were observed between patients over 65 and younger patients.

Pharmacokinetic/pharmacodynamic studies to assess the effect of age have not been conducted.

8.6 Hepatic Impairment

The effect of hepatic impairment on the pharmacokinetics of AFREZZA has not been studied. Frequent glucose monitoring and dose adjustment may be necessary for AFREZZA in patients with hepatic impairment [*see Warnings and Precautions (5.3)*].

8.7 Renal Impairment

The effect of renal impairment on the pharmacokinetics of AFREZZA has not been studied. Some studies with human insulin have shown increased circulating levels of insulin in patients with renal failure. Frequent glucose monitoring and dose adjustment may be necessary for AFREZZA in patients with renal impairment [*see Warnings and Precautions (5.3)*].

10 OVERDOSAGE

Excess insulin administration may cause hypoglycemia and hypokalemia [*see Warnings and Precautions (5.3, 5.8)*].

Mild episodes of hypoglycemia can usually be treated with oral glucose. Adjustments in drug dosage, meal patterns, or exercise, may be needed.

Severe episodes of hypoglycemia with coma, seizure, or neurologic impairment may be treated with intramuscular / subcutaneous glucagon or concentrated intravenous glucose. After apparent clinical recovery from hypoglycemia, continued observation and additional carbohydrate intake may be necessary to avoid recurrence of hypoglycemia. Hypokalemia must be corrected appropriately.

11 DESCRIPTION

11.1 AFREZZA Cartridges

AFREZZA consists of single-use plastic cartridges filled with a white powder containing insulin (human), which is administered via oral inhalation using the AFREZZA Inhaler only.

AFREZZA cartridges contain human insulin produced by recombinant DNA technology utilizing a non-pathogenic laboratory strain of *Escherichia coli* (K12). Chemically, human insulin has the empirical formula $C_{257}H_{383}N_{65}O_{77}S_6$ and a molecular weight of 5808. Human insulin has the following primary amino acid sequence:

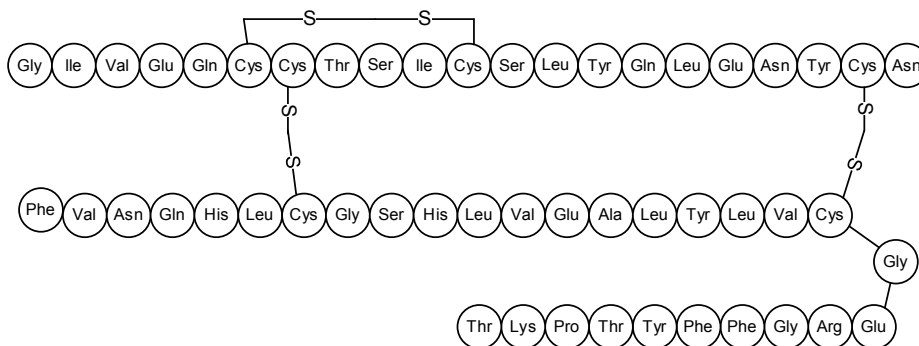

Insulin is adsorbed onto carrier particles consisting of fumaryl diketopiperazine (FDKP) and polysorbate 80.

AFREZZA Inhalation Powder is a dry powder supplied as 4 unit, 8 unit or 12 unit cartridges. The 4 unit cartridge contains 0.35 mg of insulin. The 8 unit cartridge contains 0.7 mg of insulin. The 12 unit cartridge contains 1 mg of insulin.

11.2 AFREZZA Inhaler

The AFREZZA Inhaler is breath-powered by the patient. When the patient inhales through the device, the powder is aerosolized and delivered to the lung. The amount of AFREZZA delivered to the lung will depend on individual patient factors.

12 CLINICAL PHARMACOLOGY

12.1 Mechanism of Action

Insulin lowers blood glucose levels by stimulating peripheral glucose uptake by skeletal muscle and fat, and by inhibiting hepatic glucose production. Insulin inhibits lipolysis in adipocytes, inhibits proteolysis, and enhances protein synthesis.

12.2 Pharmacodynamics

The time course of insulin action (i.e., glucose lowering) may vary considerably in different individuals or within the same individual. The average pharmacodynamic profile [i.e., glucose lowering effect measured by glucose infusion rate (GIR) over time in a euglycemic clamp study] for a single 4, 12, and 48 unit dose of AFREZZA in 30 patients with type 1 diabetes is shown in Figure 3(A), and key characteristics surrounding the timing of the effects are described in Table 4:

Table 4. Timing of insulin effect (i.e., mean pharmacodynamics effect) after administration for a single dose of 4, 12, and 48 units of AFREZZA in patients (N=30) with T1DM and corresponding to the data shown in Figure 3(A)

Parameter for Insulin Effect	AFREZZA 4 units	AFREZZA 12 units	AFREZZA 48 units
Time to first measurable effect	~12 minutes	~12 minutes	~12 minutes
Time to peak effect	~35 minutes	~45 minutes	~55 minutes
Time for effect to return to baseline	~90 minutes	~180 minutes	~270 minutes

Figure 3. Mean Insulin Effect (Baseline-Corrected Glucose Infusion Rate; A) and Pharmacokinetic (Baseline-Corrected Serum Insulin Concentrations; B) profiles after Administration of AFREZZA 4, 12, and 48 units in Type 1 Diabetes Patients (N=30)

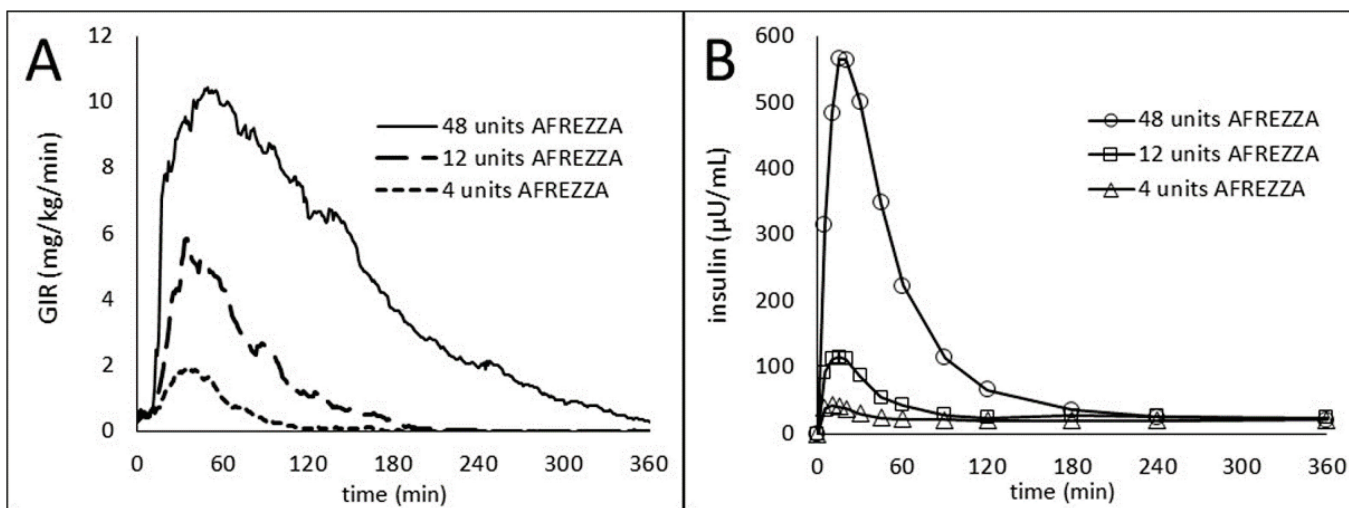

On average, the pharmacodynamics effect of AFREZZA, measured as area under the glucose infusion rate – time curve (AUC GIR) increased linearly with doses up to 48 units (106, 387, and 1581 mg/kg for 4, 12, and 48 units doses, respectively).

Inpatient variability in AUC GIR and GIR_{max} is approximately 28% (95% CI 21-42%) and 27% (95% CI 20-40%), respectively.

12.3 Pharmacokinetics

Absorption

The pharmacokinetic profiles for orally inhaled AFREZZA 4, 12, and 48 units from a study in 30 patients with type 1 diabetes are shown in Figure 3(B). The time to maximum serum insulin concentration ranges from 10-20 minutes after oral inhalation of 4 to 48 units of AFREZZA. Serum insulin concentrations declined to baseline by approximately 60 to 240 minutes for these dose levels.

Disposition

Systemic insulin disposition (apparent terminal half-life) following oral inhalation of 4 to 48 units of AFREZZA was 120-206 minutes.

Dose Proportionality

Insulin exposure (AUC) has been demonstrated to be dose-proportional when using AFREZZA doses up to 48 units.

Variability

Inpatient variability in insulin exposure measured by AUC and C_{max} is approximately 16% (95% CI 12-23%) and 21% (95% CI 16-30%), respectively.

Metabolism and Elimination

The metabolism and elimination of AFREZZA are comparable to regular human insulin.

Carrier Particles

Clinical pharmacology studies showed that carrier particles [see Description (11.1)] are not metabolized and are eliminated unchanged in the urine following the lung absorption. Following oral inhalation of AFREZZA, a mean of 39% of the inhaled dose of carrier particles was distributed to the lungs and a mean of 7% of the dose was swallowed. The swallowed fraction was not absorbed from the GI tract and was eliminated unchanged in the feces.

Drug Interaction: Bronchodilators and Inhaled Steroids

Albuterol increased the AUC insulin administered by AFREZZA by 25% in patients with asthma. Effect of fluticasone on insulin exposures following AFREZZA administration has not been evaluated in patients with asthma; however, no significant change in insulin exposure was observed in a study in healthy volunteers. Frequent glucose monitoring and dose reduction may be necessary for AFREZZA if it is co-administered with albuterol.

13 NONCLINICAL TOXICOLOGY

13.1 Carcinogenesis, Mutagenesis, Impairment of Fertility

In a 104 week carcinogenicity study, rats were given doses up to 46 mg/kg/day of the carrier and up to 1.23 mg/kg/day of insulin, by nose-only inhalation. No increased incidence of tumors was observed at systemic exposures equivalent to the insulin at a maximum daily AFREZZA dose of 99 mg based on a comparison of relative body surface areas across species.

In a 26 week carcinogenicity study, transgenic mice (Tg-ras-H2) given doses up to 75 mg/kg/day of carrier and up to 5 mg/kg/day of AFREZZA. No increased incidence of tumors was observed.

AFREZZA was not genotoxic in Ames bacterial mutagenicity assay and in the chromosome aberration assay, using human peripheral lymphocytes with or without metabolic activation. The carrier alone was not genotoxic in the in vivo mouse micronucleus assay.

In female rats given subcutaneous doses of 10, 30, and 100 mg/kg/day of carrier (vehicle without insulin) beginning 2 weeks prior to mating until gestation day 7, there were no adverse effects on male fertility at doses up to 100 mg/kg/day (a systemic exposure 14-21 times that following the maximum daily AFREZZA dose of 99 mg based on AUC). In female rats there was increased pre- and post-implantation loss at 100 mg/kg/day but not at 30 mg/kg/day (14-21 times higher systemic exposure than the maximum daily AFREZZA dose of 99 mg based on AUC).

14 CLINICAL STUDIES

14.1 Overview of Clinical Studies of AFREZZA for Diabetes Mellitus

AFREZZA has been studied in adults with type 1 diabetes in combination with basal insulin. The efficacy of AFREZZA in type 1 diabetes patients was compared to insulin aspart in combination with basal insulin. AFREZZA has been studied in adults with type 2 diabetes in combination with oral antidiabetic drugs. The efficacy of AFREZZA in type 2 diabetes patients was compared to placebo inhalation.

14.2 Type 1 Diabetes

Patients with inadequately controlled type 1 diabetes participated in a 24-week, open-label, active-controlled study to evaluate the glucose lowering effect of mealtime AFREZZA used in combination with a basal insulin. Following a 4-week basal insulin optimization period, 344 patients were randomized to AFREZZA (n=174) or insulin aspart (n=170) administered at each meal of the day. Mealtime insulin doses were titrated to glycemic goals for the first 12 weeks and kept stable for the last 12 weeks of the study. At Week 24, treatment with basal insulin and mealtime AFREZZA provided a mean reduction in HbA1c that met the pre-specified non-inferiority margin of 0.4%. AFREZZA provided less HbA1c reduction than insulin aspart, and the difference was statistically significant. More subjects in the insulin aspart group achieved the HbA1c target of $\leq 7\%$ (Table 5).

Table 5. Results at Week 24 in an Active-Controlled Study of Mealtime AFREZZA plus Basal Insulin in Adults with Type 1 Diabetes

Efficacy Parameter	AFREZZA + Basal Insulin (N=174)	Insulin Aspart + Basal Insulin (N=170)
HbA_{1c} (%)		
Baseline (adjusted mean ^a)	7.94	7.92
Change from baseline (adjusted mean ^{a,b})	-0.21	-0.40
Difference from insulin aspart (adjusted mean ^{a,b}) (95% CI)	0.19 (0.02, 0.36)	
Percentage of patients achieving HbA _{1c} ≤ 7% ^c	13.8	27.1
Fasting Plasma Glucose (mg/dL)		
Baseline (adjusted mean ^a)	153.9	151.6
Change from baseline (adjusted mean ^{a,b})	-25.3	10.2
Difference from insulin aspart (adjusted mean ^{a,b}) (95% CI)	-35.4 (-56.3, -14.6)	
^a Adjusted mean was obtained using a Mixed Model Repeated Measures (MMRM) approach with HbA _{1c} or FPG as the dependent variable and treatment, visit, region, basal insulin stratum, and treatment by visit interaction as fixed factors, and corresponding baseline as a covariate. An autoregression (1) [AR(1)] covariance structure was used. ^b Data at 24 weeks were available from 131 (75 %) and 150 (88%) subjects randomized to the AFREZZA and insulin aspart groups, respectively. ^c The percentage was calculated based on the number of patients randomized to the trial.		

14.3 Type 2 Diabetes

A total of 479 adult patients with type 2 diabetes inadequately controlled on optimal/maximally tolerated doses of metformin only, or 2 or more oral antidiabetic (OAD) agents participated in a 24-week, double-blind, placebo-controlled study. Following a 6-week run-in period, 353 patients were randomized to AFREZZA (n=177) or an inhaled placebo powder without insulin (n=176). Insulin doses were titrated for the first 12 weeks and kept stable for the last 12 weeks of the study. OADs doses were kept stable. At Week 24, treatment with AFREZZA plus OADs provided a mean reduction in HbA_{1c} that was statistically significantly greater compared to the HbA_{1c} reduction observed in the placebo group (Table 6).

Table 6. Results at Week 24 in a Placebo-Controlled Study of AFREZZA in Adults with Type 2 Diabetes Inadequately Controlled on Oral Antidiabetic Agents

Efficacy Parameter	AFREZZA + Oral Anti-Diabetic Agents (N=177)	Placebo + Oral Anti-Diabetic Agents (N=176)
HbA_{1c} (%)		
Baseline (adjusted mean ^a)	8.25	8.27
Change from baseline (adjusted mean ^{a,b})	-0.82	-0.42
Difference from placebo (adjusted mean ^{a,b}) (95% CI)	-0.40 (-0.57, -0.23)	
Percentage (%) of patients achieving HbA _{1c} ≤ 7% ^c	32.2	15.3
Fasting Plasma Glucose (mg/dL)		
Baseline (adjusted mean ^a)	175.9	175.2
Change from baseline (adjusted mean ^{a,b})	-11.2	-3.8
Difference from placebo (adjusted mean ^{a,b}) (95% CI)	-7.4 (-18.0, 3.2)	
^a Adjusted mean was obtained using a Mixed Model Repeated Measures (MMRM) approach with HbA _{1c} or FPG as the dependent variable and treatment, visit, region, and treatment by visit interaction as fixed factors, and corresponding baseline as a covariate. An autoregression (1) [AR(1)] covariance structure was used. ^b Data at 24 weeks without rescue therapy were available from 139 (79%) and 129 (73%) subjects randomized to the AFREZZA and placebo groups, respectively. ^c The percentage was calculated based on the number of patients randomized to the trial.		

16 HOW SUPPLIED/STORAGE AND HANDLING

AFREZZA (insulin human) Inhalation Powder is available as 4 unit, 8 unit and 12 unit single-use cartridges. Three cartridges are contained in a single cavity of a blister strip. Each card contains 5 blister strips separated by perforations for a total of 15 cartridges. For convenience, the perforation allows users to remove a single strip containing 3 cartridges. Two cards of the same cartridge strength are packaged in a foil laminate overwrap (30 cartridges per foil package).

The cartridges are color-coded, blue for 4 units, green for 8 units and yellow for 12 units. Each cartridge is marked with “afrezza” and “4 units”, “8 units” or “12 units”.

The AFREZZA Inhaler is individually packaged in a clear overwrap. The inhaler is fully assembled with a removable mouthpiece cover. The AFREZZA Inhaler can be used for up to 15 days from the date of first use. After 15 days of use, the inhaler must be discarded and replaced with a new inhaler.

AFREZZA is available in the following configurations:

- NDC 47918-874-90, AFREZZA (insulin human) Inhalation Powder: 90 – 4 unit cartridges and 2 inhalers
- NDC 47918-884-63, AFREZZA (insulin human) Inhalation Powder: 90 cartridges; 60 – 4 unit cartridges and 30 – 8 unit cartridges and 2 inhalers
- NDC 47918-882-36, AFREZZA (insulin human) Inhalation Powder: 90 cartridges; 30 – 4 unit cartridges and 60 – 8 unit cartridges and 2 inhalers
- NDC 47918-894-63, AFREZZA (insulin human) Inhalation Powder: 90 cartridges; 60 – 8 unit cartridges and 30 – 12 unit cartridges and 2 inhalers
- NDC 47918-880-18, AFREZZA (insulin human) Inhalation Powder; 180 cartridges; 90 – 4 unit cartridges and 90 – 8 unit cartridges and 2 inhalers (Titration Pack)

Storage:

Not in Use: Refrigerated Storage 2-8°C (36-46°F)

Sealed (Unopened) Foil Package	May be stored until the Expiration Date*
Sealed (Unopened) Blister Cards + Strips	May be stored for 1 month*

* If a foil package, blister card or strip is not refrigerated, the contents must be used within 10 days.

In Use: Room Temperature Storage 25°C (77°F), excursions permitted 15-30°C (59-86°F)

Sealed (Unopened) Blister Cards + Strips	Must be used within 10 days
Opened Strips	Must be used within 3 days

Do not put a blister card or strip back into the refrigerator after being stored at room temperature

Inhaler Storage:

Store at 2-25°C (36-77°F); excursions permitted. Inhaler may be stored refrigerated, but should be at room temperature before use.

Handling:

Before use, cartridges should be at room temperature for 10 minutes.

17 PATIENT COUNSELING INFORMATION

Advise the patient to read the FDA-approved patient labeling (Medication Guide and Instructions for Use).

Instructions

Instruct patients to read the Medication Guide before starting AFREZZA therapy and to reread it each time the prescription is renewed, because information may change. Instruct patients to inform their healthcare provider or pharmacist if they develop any unusual symptom, or if any known symptom persists or worsens.

Inform patients of the potential risks and benefits of AFREZZA and of alternative modes of therapy. Inform patients about the importance of adherence to dietary instructions, regular physical activity, periodic blood glucose monitoring and HbA1c testing, recognition and management of hypoglycemia and hyperglycemia, and assessment for diabetes complications. Advise patients to seek medical advice promptly during periods of stress such as fever, trauma, infection, or surgery, as medication requirements may change.

Instruct patients to use AFREZZA only with the AFREZZA inhaler.

Inform patients that the most common adverse reactions associated with the use of AFREZZA are hypoglycemia, cough, and throat pain or irritation.

Advise women with diabetes to inform their physician if they are pregnant or are planning to become pregnant while using AFREZZA.

Acute Bronchospasm in Patients with Chronic Lung Disease

Advise patients to inform their physicians if they have a history of lung disease, because AFREZZA should not be used in patients with chronic lung disease (e.g., asthma, COPD, or other chronic lung disease(s)) [see *Contraindications (4) and Warnings and Precautions (5.1)*].

Advise patients that if they experience any respiratory difficulty after inhalation of AFREZZA, they should report it to their physician immediately for assessment.

Hypoglycemia

Instruct patients on self-management procedures including glucose monitoring, proper inhalation technique, and management of hypoglycemia and hyperglycemia especially at initiation of AFREZZA therapy. Instruct patients on handling of special situations such as intercurrent conditions (illness, stress, or emotional disturbances), an inadequate or skipped insulin dose, inadvertent administration of an increased insulin dose, inadequate food intake, and skipped meals.

Instruct patients on the management of hypoglycemia. Inform patients that their ability to concentrate and react may be impaired as a result of hypoglycemia. Advise patients who have frequent hypoglycemia or reduced or absent warning signs of hypoglycemia to use caution when driving or operating machinery [see *Warnings and Precautions (5.3)*].

Decline in Pulmonary Function and Monitoring

Inform patients that AFREZZA can cause a decline in lung function and their lung function will be evaluated by spirometry before initiation of AFREZZA treatment [see *Warnings and Precautions (5.4)*].

Lung Cancer

Inform patients to promptly report any signs or symptoms potentially related to lung cancer [see *Warnings and Precautions (5.5)*].

Diabetic Ketoacidosis

Instruct patients to carefully monitor their blood glucose during illness, infection, and other risk situations for diabetic ketoacidosis and to contact their healthcare provider if their blood glucose control worsens [see *Warnings and Precautions (5.6)*].

Hypersensitivity Reactions

Advise patients that hypersensitivity reactions can occur with insulin therapy including AFREZZA. Inform patients on the symptoms of hypersensitivity reactions [see *Warnings and Precautions (5.7)*].

AFREZZA is a registered trademark owned by MannKind Corporation
Patented: <http://www.mannkindcorp.com/our-technology-patent-notice.htm>

MannKind Corporation
Danbury, CT 06810

Medication Guide
AFREZZA® (uh-FREZZ-uh)
(insulin human) inhalation powder

What is the most important information I should know about AFREZZA?

AFREZZA can cause serious side effects, including:

- **Sudden lung problems (bronchospasms). Do not use AFREZZA if you have long-term (chronic) lung problems such as asthma or chronic obstructive pulmonary disease (COPD).** Before starting AFREZZA, your healthcare provider will give you a breathing test to check how your lungs are working.

What is AFREZZA?

- AFREZZA is a man-made insulin that is breathed-in through your lungs (inhaled) and is used to control high blood sugar in adults with diabetes mellitus.
- AFREZZA is not for use in place of long-acting insulin. AFREZZA must be used with long-acting insulin in people who have type 1 diabetes mellitus.
- AFREZZA is not for use to treat diabetic ketoacidosis.
- It is not known if AFREZZA is safe and effective for use in people who smoke. AFREZZA is not for use in people who smoke or have recently stopped smoking (less than 6 months).
- It is not known if AFREZZA is safe and effective in children under 18 years of age.

Who should not use AFREZZA?

Do not use AFREZZA if you:

- have chronic lung problems such as asthma or COPD.
- are allergic to regular human insulin or any of the ingredients in AFREZZA. See the end of this Medication Guide for a complete list of ingredients in AFREZZA.

What should I tell my healthcare provider before using AFREZZA?

Before using AFREZZA, tell your healthcare provider about all your medical conditions, including if you:

- have lung problems such as asthma or COPD
- have or have had lung cancer
- are using any inhaled medications
- smoke or have recently stopped smoking
- have kidney or liver problems
- are pregnant, planning to become pregnant, or are breastfeeding. AFREZZA may harm your unborn or breastfeeding baby.

Tell your healthcare provider about all the medicines you take, including prescription and over-the-counter medicines, vitamins or herbal supplements.

Before you start using AFREZZA, talk to your healthcare provider about low blood sugar and how to manage it.

How should I use AFREZZA?

- Read the detailed **Instructions for Use** that comes with your AFREZZA.
- Take AFREZZA exactly as your healthcare provider tells you to. Your healthcare provider should tell you how much AFREZZA to use and when to use it.
- Know the strength of AFREZZA you use. **Do not** change the amount of AFREZZA you use unless your healthcare provider tells you to.
- Take AFREZZA at the beginning of your meal.
- **Check your blood sugar levels.** Ask your healthcare provider what your blood sugar should be and when you should check your blood sugar levels.
- **Keep AFREZZA and all medicines out of the reach of children.**

Your dose of AFREZZA may need to change because of:

- Change in level of physical activity or exercise, weight gain or loss, increased stress, illness, change in diet, or because of other medicines you take.

What should I avoid while using AFREZZA?

While using AFREZZA do not:

- drive or operate heavy machinery, until you know how AFREZZA affects you
- drink alcohol or use over-the-counter medicines that contain alcohol
- smoke

What are the possible side effects of AFREZZA?

AFREZZA may cause serious side effects that can lead to death, including:

See “What is the most important information I should know about AFREZZA?”

- **low blood sugar (hypoglycemia).** Signs and symptoms that may indicate low blood sugar include:
 - dizziness or light-headedness, sweating, confusion, headache, blurred vision, slurred speech, shakiness, fast heartbeat, anxiety, irritability or mood change, hunger.
- **decreased lung function.** Your healthcare provider should check how your lungs are working before you start using AFREZZA, 6 months after you start using it and yearly after that.
- **lung cancer.** In studies of AFREZZA in people with diabetes, lung cancer occurred in a few more people who were taking AFREZZA than in people who were taking other diabetes medications. There were too few cases to know if lung cancer was related to AFREZZA. If you have lung cancer, you and your healthcare provider should decide if you should use AFREZZA.
- **diabetic ketoacidosis.** Talk to your healthcare provider if you have an illness. Your AFREZZA dose or how often you check your blood sugar may need to be changed.
- **severe allergic reaction (whole body reaction). Get medical help right away if you have any of these signs or symptoms of a severe allergic reaction:**
 - a rash over your whole body, trouble breathing, a fast heartbeat, or sweating.
- **low potassium in your blood (hypokalemia).**
- **heart failure.** Taking certain diabetes pills called thiazolidinediones or “TZDs” with AFREZZA may cause heart failure in some people. This can happen even if you have never had heart failure or heart problems before. If you already have heart failure it may get worse while you take TZDs with AFREZZA. Your healthcare provider should monitor you closely while you are taking TZDs with AFREZZA. Tell your healthcare provider if you have any new or worse symptoms of heart failure including:
 - shortness of breath, swelling of your ankles or feet, sudden weight gain.Treatment with TZDs and AFREZZA may need to be changed or stopped by your healthcare provider if you have new or worse heart failure.

Get emergency medical help if you have:

- trouble breathing, shortness of breath, fast heartbeat, swelling of your face, tongue, or throat, sweating, extreme drowsiness, dizziness, confusion.

The most common side effects of AFREZZA include:

- low blood sugar (hypoglycemia), cough, sore throat

These are not all the possible side effects of AFREZZA. Call your doctor for medical advice about side effects. You may report side effects to FDA at 1-800-FDA-1088 (1-800-332-1088).

General information about the safe and effective use of AFREZZA.

Medicines are sometimes prescribed for purposes other than those listed in a Medication Guide. Do not use AFREZZA for a condition for which it was not prescribed. Do not give AFREZZA to other people, even if they have the same symptoms that you have. It may harm them.

This Medication Guide summarizes the most important information about AFREZZA. If you would like more information, talk with your healthcare provider. You can ask your pharmacist or healthcare provider for information about AFREZZA that is written for health professionals. For more information, go to www.AFREZZA.com or call sanofi-aventis 1-800-633-1610.

What are the ingredients in AFREZZA?

Active ingredient: human insulin

Inactive ingredients: fumaryl diketopiperazine, polysorbate 80

Manufactured By: MannKind Corporation

AFREZZA® is a registered trademark owned by MannKind Corporation

Patented: <http://www.mannkindcorp.com/our-technology-patent-notice.htm>

MannKind Corporation
Danbury, CT 06810

Distributed by:

sanofi-aventis U.S. LLC
Bridgewater, NJ 08807
A SANOFI COMPANY

Instructions for Use
AFREZZA® (uh-FREZZ-uh)
(insulin human) inhalation powder

Read this Instructions for Use before you start using AFREZZA and each time you get a new AFREZZA inhaler. There may be new information. This information does not take the place of talking to your healthcare provider about your medical condition or your treatment.

Your healthcare provider should show you how to use your AFREZZA inhaler the right way before you use it for the first time.

Important information about AFREZZA:

- **AFREZZA comes in 3 strengths** (See Figure A):
 - 4 units (blue cartridge)
 - 8 units (green cartridge)
 - 12 units (yellow cartridge)

(Figure A)



- If your prescribed AFREZZA dose is higher than 12 units, you will need to use more than 1 cartridge.
- If you need to use more than 1 cartridge for your dose, throw away the used cartridge before getting a new one. You can tell when a cartridge has been used, because the cup has moved to the center.
- **Do not try to open the AFREZZA cartridges.** The AFREZZA Inhaler opens the cartridge automatically during use.
- **AFREZZA cartridges should only be used with the AFREZZA Inhaler. Do not** try to breathe in the AFREZZA insulin powder in any other way. **Do not** put cartridges in your mouth and **do not** swallow cartridges.
- Use only 1 AFREZZA Inhaler at a time. The same inhaler should be used for the 4 unit, 8 unit or 12 unit cartridges.
- Store the inhaler in a clean, dry place with the mouthpiece cover on until your next dose.
- Throw away your AFREZZA Inhaler after 15 days and get a new one.

If you are having problems with your AFREZZA inhaler or if it breaks and you need a new one, call 1-800-633-1610.

Know your AFREZZA[®] inhaler:

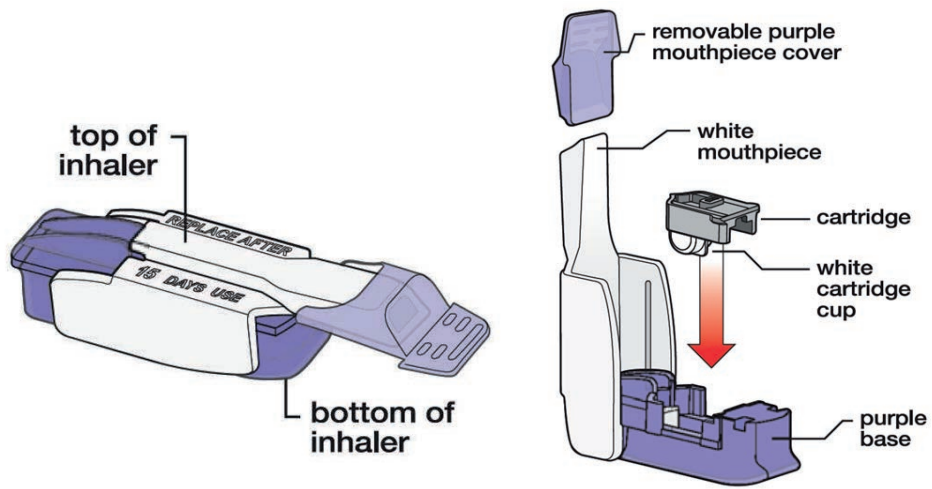

Know your AFREZZA[®] cartridges:

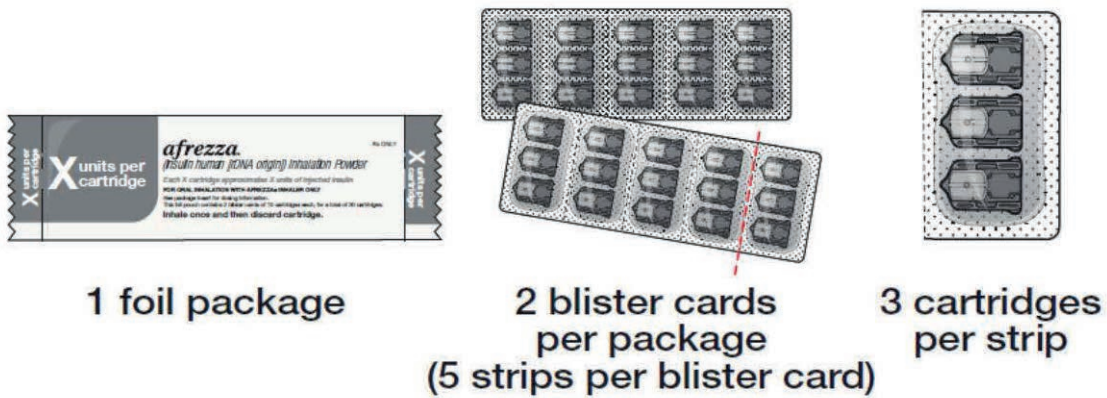

There are three strengths of AFREZZA® cartridges:

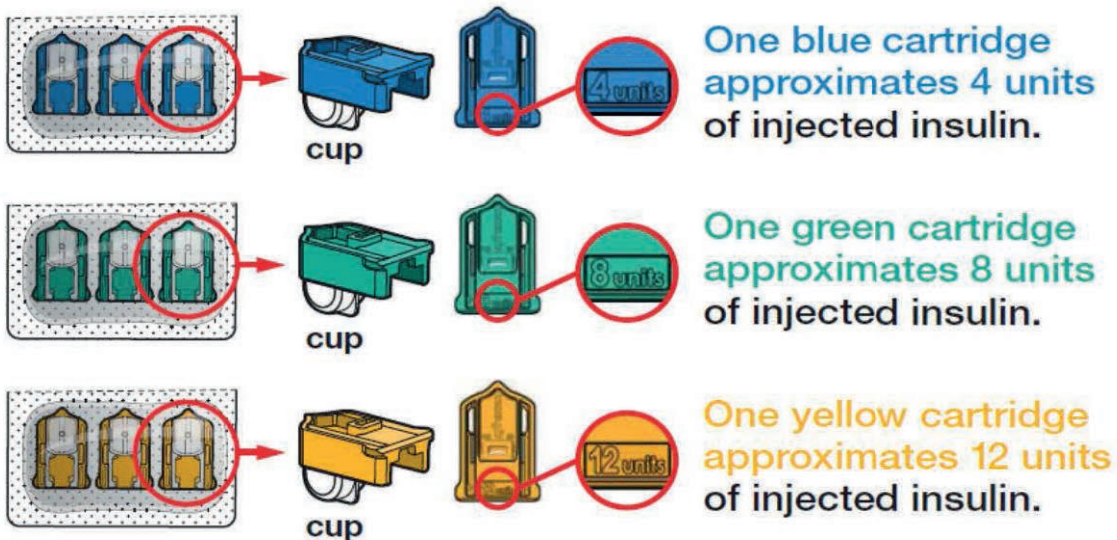

How to take your dose of AFREZZA:

Always be sure you have the right number of AFREZZA cartridges for your dose available before you start. AFREZZA cartridges must only be used with the AFREZZA Inhaler.

Step 1: Select the AFREZZA cartridges for your dose

If your prescribed AFREZZA® dose is 4 units, use...
1 blue cartridge.

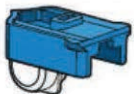

If your prescribed AFREZZA® dose is 8 units, use...
1 green cartridge.

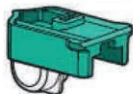



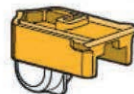







If your prescribed AFREZZA® dose is 12 units, use...
1 yellow cartridge.



If your prescribed AFREZZA® dose is more than 12 units you will need to use **more than 1 cartridge** to get your right dose.

Use the dosage chart below to determine the least number of AFREZZA® cartridges you can use for your dose. Other cartridge combinations can be used.

AFREZZA® Dose	# of cartridges needed		
	4 unit (blue)	8 unit (green)	12 unit (yellow)
4 units			
8 units			
12 units	 +  or / 		
16 units		 	
20 units		 + 	
24 units			 

(Figure B)

Example:

If you need to take 20 units of AFREZZA® you can use...



Select Cartridges

Important: Use the AFREZZA dose chart above (See Figure B) to help you choose the right number of AFREZZA cartridges needed for your dose.



Open Packages

Remove a blister card from the foil package.

Tear along perforation to remove one strip.

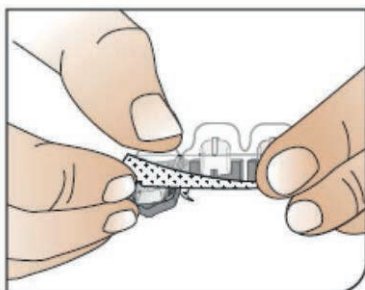



Push Cartridges to Remove

Remove a cartridge from the strip by pressing on the clear side to push the cartridge out. Remove the right number of cartridges for your dose. Pushing on the cup will not damage the cartridge.

AFREZZA cartridges left over in an opened strip must be used within 3 days.



Before use, cartridges and inhaler should be at room temperature for 10 minutes.

ROOM TEMPERATURE



10 mins.

Before Proceeding:

Check that you have the right AFREZZA cartridge(s) for your dose.

Use only 1 inhaler for multiple cartridges. Throw away your AFREZZA inhaler after 15 days and get a new one.

Step 2: Loading a cartridge

Hold Inhaler

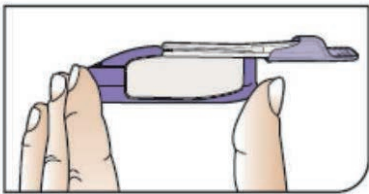

Hold the inhaler level in one (1) hand with the white mouthpiece on the top and purple base on the bottom.

Open Inhaler

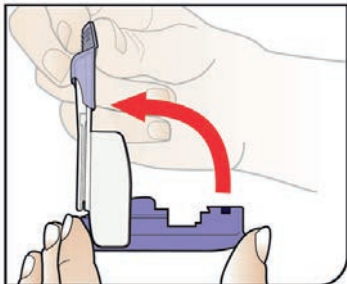

Open the inhaler by lifting the white mouthpiece to a vertical position.

Before you put the AFREZZA cartridge in your inhaler, make sure it has been at **room temperature for 10 minutes**.

Place Cartridge

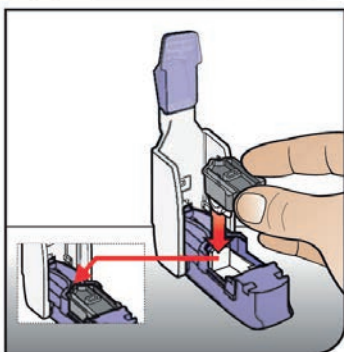

Hold the cartridge with the cup facing down.

Line up the cartridge with the opening in the inhaler. The pointed end of the cartridge should line up with the pointed end in the inhaler.

Place the cartridge into the inhaler. Be sure that the cartridge lies flat in the inhaler.



KEEP INHALER LEVEL



Keep Level Once Loaded!

Now that the cartridge is loaded, keep the inhaler level from this point forward to avoid loss of drug powder.



DO NOT turn inhaler upside down.



DO NOT point the mouthpiece down.



DO NOT shake or drop the inhaler.

This can result in loss of drug powder.

If any of these occur, throw away the cartridge and load a new cartridge.

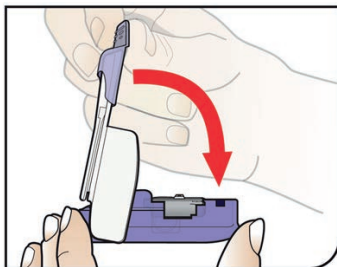

Close Inhaler

Lower the mouthpiece to close the inhaler (this will open the drug cartridge).

You should feel a snap when the inhaler is closed.

Step 3: Inhaling AFREZZA

Remove the Mouthpiece Cover

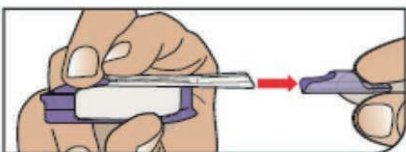

Important: Keep the inhaler level during and after removal of the purple mouthpiece cover.

Check that you are ready to inhale:

- ✓ Purple mouthpiece cover is removed.
- ✓ Inhaler is held level.
- ✓ Fully review the following A-B-C steps prior to beginning the inhale process.

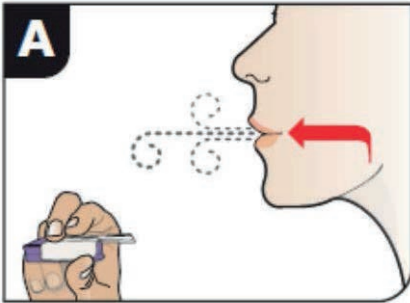

Exhale

Hold the inhaler away from your mouth and fully blow out (exhale).

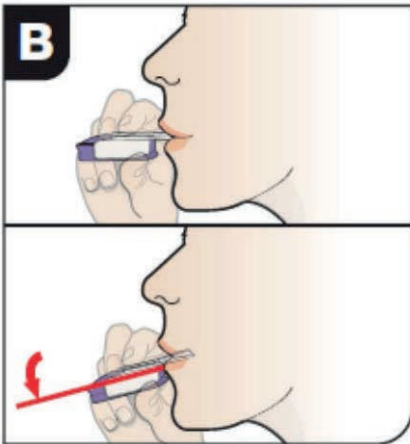

Position Inhaler in Mouth

Keeping your head level, place the mouthpiece in your mouth and **tilt the inhaler down towards your chin, as shown.**

Close your lips around the mouthpiece to form a seal.

Tilt the inhaler downward while keeping your head level.

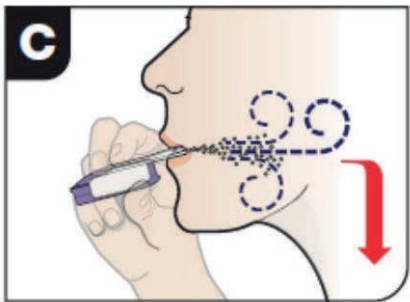

Inhale Deeply and Hold Breath

With your mouth closed around the mouthpiece, **inhale deeply through the inhaler.**

Hold your breath for as long as comfortable and at the same time remove the inhaler from your mouth. After holding your breath, exhale and continue to breathe normally.

Step 4: Removing a used cartridge

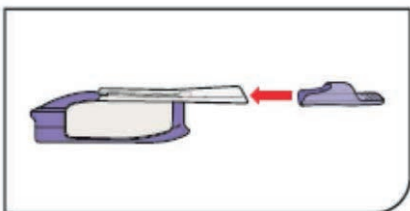

Replace Mouthpiece Cover

Place the purple mouthpiece cover back onto the inhaler.

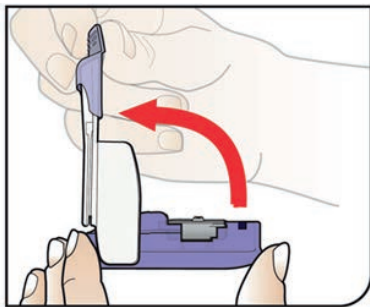

Open Inhaler

Open the inhaler by lifting up the white mouthpiece.

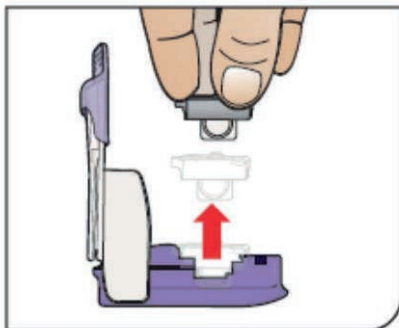

Remove Cartridge

Remove the cartridge from the purple base.

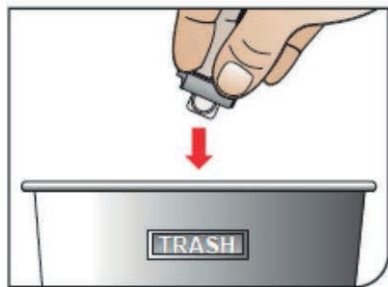

Throw away the Cartridge

Throw away the used cartridge in your regular household trash.

Multiple cartridge dosing

If you need more than one (1) AFREZZA cartridge for your dose, See the AFREZZA dosage chart above (Figure B).

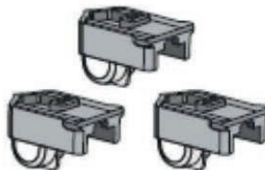

Repeat steps 2 through 4 for each AFREZZA cartridge you need for your prescribed AFREZZA dose.



Be careful not to mix **NEW** cartridges with **USED** cartridges.



NEW



USED





The white cup moves to the middle of the cartridge when it has been used.

How should I store AFREZZA?

Not In Use: Refrigerated Storage

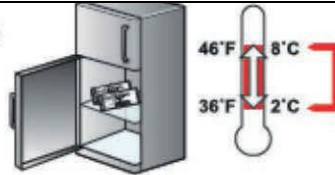
Store unopened drug in a refrigerator 36 – 46°F (2 – 8°C).





		Refrigerated
Foil Packages 	Sealed (Unopened)	May be used until the Expiration Date*
Blister Cards + Strips 	Sealed (Unopened)	Must be used within 1 month

*If a foil package, blister card or strip is not refrigerated, the contents must be used within 10 days

In Use: Room Temperature Storage

Opened Foil Packages



Once a foil package has been opened, see chart below...

		Room Temperature
Blister Cards + Strips 	Sealed (Unopened)	Must be used within 10 Days
Strips 	Opened	Must be used within 3 Days

Do not put a blister card or strip back into the refrigerator after being stored at room temperature



Before use, cartridges and inhaler should be at room temperature for 10 minutes.

ROOM TEMPERATURE 10 mins.

Caring for your AFREZZA inhaler:

Storage Instructions

Once you have taken your full dose, make sure the purple mouthpiece cover has been replaced and the inhaler is closed.



- **Keep the inhaler in a clean, dry place** with the mouthpiece cover on until your next dose.
- May be stored refrigerated, but must be at room temperature before use.
- Never leave or store cartridges in the inhaler.
- Keep out of reach of children.

Care Instructions

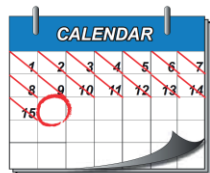

EVERY 15 DAYS

- **Use one inhaler at a time. The same inhaler should be used to take 4 unit or 8 unit cartridges. Replace the inhaler every 15 days to maintain drug delivery.**

Keep track of 15 days from when you start using the inhaler with a calendar, or use the chart on the back of the inhaler box.

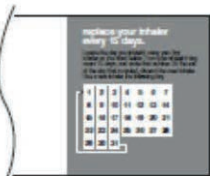

- After taking your dose, powder residue in the mouthpiece is normal, this does not affect your dose.
The outside of the inhaler can be wiped with a clean, dry cloth if needed. Never wash the inhaler. Keep it dry.

Switching between AFREZZA and injected insulin:



Contact your healthcare provider before switching insulins.
AFREZZA® is a mealtime insulin.
Do not switch from AFREZZA to a long acting insulin.
Do not switch from a long acting insulin to AFREZZA®.

To switch from AFREZZA® to injected mealtime insulin...



Find your AFREZZA® dose in the chart.

AFREZZA® Dose	# of cartridges needed			Injected Mealtime Insulin Dose	
	4 unit (blue)	8 unit (green)	12 unit (yellow)		
4 units				4 units	
8 units				8 units	
12 units		+		12 units	
16 units				16 units	
20 units			+		20 units
24 units				24 units	

Find the correct dose of injected insulin.

If you cannot find your injected dose in the chart below, you must talk to a healthcare provider before using AFREZZA®.

To switch from injected mealtime insulin to AFREZZA®...



Find your injected insulin dose in the chart.

Injected Mealtime Insulin Dose	AFREZZA® Dose	# of cartridges needed			
		4 unit (blue)	8 unit (green)	12 unit (yellow)	
up to 4 units	4 units				
5-8 units	8 units				
9-12 units	12 units		+		
13-16 units	16 units				
17-20 units	20 units			+	
21-24 units	24 units				

Find the correct dose of AFREZZA®.

This Medication Guide and Instructions for Use has been approved by the U.S. Food and Drug Administration.

AFREZZA® is a registered trademark owned by MannKind Corporation

Patented: See <http://www.mannkindcorp.com/our-technology-patent-notices.htm>

Manufactured by:

MannKind Corporation
Danbury, CT 06810

Distributed by:

sanofi-aventis U.S. LLC
Bridgewater, NJ 08807
A SANOFI COMPANY

Approved: 09/2015