

Bluetooth Adaptive Frequency Hopping on a R&S CMW

Application Note

Products:

- R&S®CMW500
- R&S®CMW270

This document describes the adaptive frequency hopping mechanism for improved signaling performance in Bluetooth Basic Rate and Enhanced Data Rate devices.

The R&S CMW provides this feature for remote operation in TX, Loopback and Connection test mode. Thereby the R&S CMW acts as a master, while the Equipment under Test (EUT) represents the slave(s) of the piconet.

Note:

Please find the most up-to-date document on our homepage <http://www.rohde-schwarz.com/appnote/1C108>.

This document is complemented by software. The software may be updated even if the version of the document remains unchanged

Table of Contents

1	Introduction	3
2	Basic Ideas	4
2.1	Adaptive Frequency Hopping	4
2.1.1	Hopping characteristics	5
2.1.2	Channel Map	7
2.1.3	Channel Detection on the CMW	9
2.1.4	Channel Reporting Algorithm	10
2.2	BT with a coexisting WLAN signal	11
2.3	Connection States	12
2.3.1	TX Test Mode (ACL Connection)	12
2.3.2	Loopback Test Mode (ACL Connection)	12
2.3.3	Connection Test Mode (ACL Connection)	13
2.3.4	Audio Profile (SCO Connection)	13
3	Test Setups	14
3.1	EUT without USB Port	14
3.2	EUT with USB Port	14
4	Remote Procedures	15
4.1	AFH Remote Commands	15
4.2	AFH Configuration Examples	16
5	Ordering Information	18

1 Introduction

Adaptive Frequency Hopping (AFH), introduced by the Bluetooth® Special Interest Group in the Core Specification Version 1.2, is designed to improve the robustness of Bluetooth radio performance in the unlicensed ISM band at 2.4 GHz. Facing ambient multiple air interface technologies (WLAN, DECT, etc.) AFH performance is dedicated to mitigate against potential impacts of interference and fading.

The R&S CMW¹ performs as a master in Basic Rate / Enhanced Data Rate (BR/EDR) test mode using a predetermined clock and frequency pattern. The Equipment under Test (EUT) acting as slave device(s) is synchronized to the CMW's clock and frequency pattern. The quality of the physical radio channel used by this piconet is commonly assessed by the following parameters via common RX quality measurements:

- Received Signal Strength Indication (RSSI)
- Packet or Bit Error Rate (PER / BER)
- Signal to Noise Ratio (SNR).

The metrics, which are used to determine on air interference, are not exposed in the Bluetooth Signaling firmware application (FWA) on the CMW. Details can be found in section 2.1.3.

A full feature set required for AFH testing is available at the CMW, when remote operated. In future AFH testing will be extended to the Bluetooth Signaling application user interface on the CMW.

The AFH test capability is not supported for Bluetooth Low Energy (LE) testing, since the CMW performs in Direct Test Mode, which is a non-signaling mode.

¹ The R&S®CMW500 or R&S®CMW270 is referred to as CMW in this document.

2 Basic Ideas

2.1 Adaptive Frequency Hopping

Frequency Hopping Spread Spectrum (FHSS) was first introduced by the Bluetooth (BT) Special Interest Group (SIG) in the Core Specification Version 1.2. The basic idea is, that the channel frequency, which is shared by each member of a piconet, is periodically changed. The frequency of a BT radio is changed by frequency hops between channels in the unlicensed ISM band at 2.4 GHz. The hopping process is performed in a pseudo-random manner in order to reduce interference effects and to meet local regulatory requirements.

The channel set comprises 79 channels, each of 1 MHz bandwidth, where the BT device is able to hop onto. The relation between the center frequency f_c of the channel and the channel number k can be summarized to:

$$f_c = 2402 \text{ MHz} + k \cdot 1 \text{ MHz} ; k = 0, 1, \dots, 78$$

Frequency Hopping is used in the BT inquiry and page scan substates with 32 channels available to hop onto at a maximum hop rate of 3200 Hz. It is also used in the BT connection state, thereby restricted to a maximum hop rate of 1600 Hz with the ability to access all the 79 channels. The minimum number N_{\min} of available channels within the piconet is 20.

Adaptive Frequency Hopping (AFH) is available for the BT connection state only. The term *Adaptive* is used to indicate, that during the hopping process channel conditions are permanently monitored to identify occupied or low quality channels, which are stated *bad channels*. The bad channels are excluded from the available channels within the hopping pattern until they become *good channels* again. In order to guarantee, that the number of available channels N is larger or equal N_{\min} , bad channels can be also present within the currently used hopping pattern.

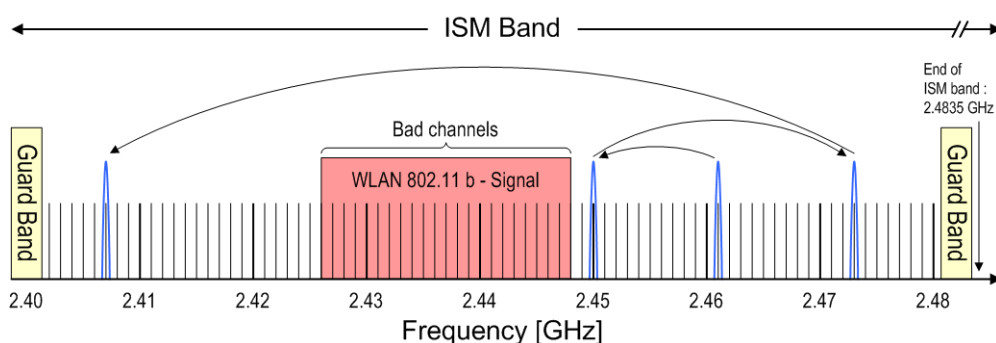

Fig. 2-1: FHSS example in the ISM band & bad channels due to a coexisting WLAN signal

2.1.1 Hopping characteristics

The basic piconet physical channel is characterized by a pseudo-random hopping through all 79 RF channels. The hopping pattern is unique and derived from the clock and BT device address of the master. After establishing the piconet the slave clock is synchronized to the master clock by adding an offset to the slave's native clock. The offsets are updated regularly, since the device clocks are independent.

Thereby all devices within the piconet are time and frequency synchronized. A typical setup with a BT transmitter and a BT receiver both synchronized is shown in the block diagram below.

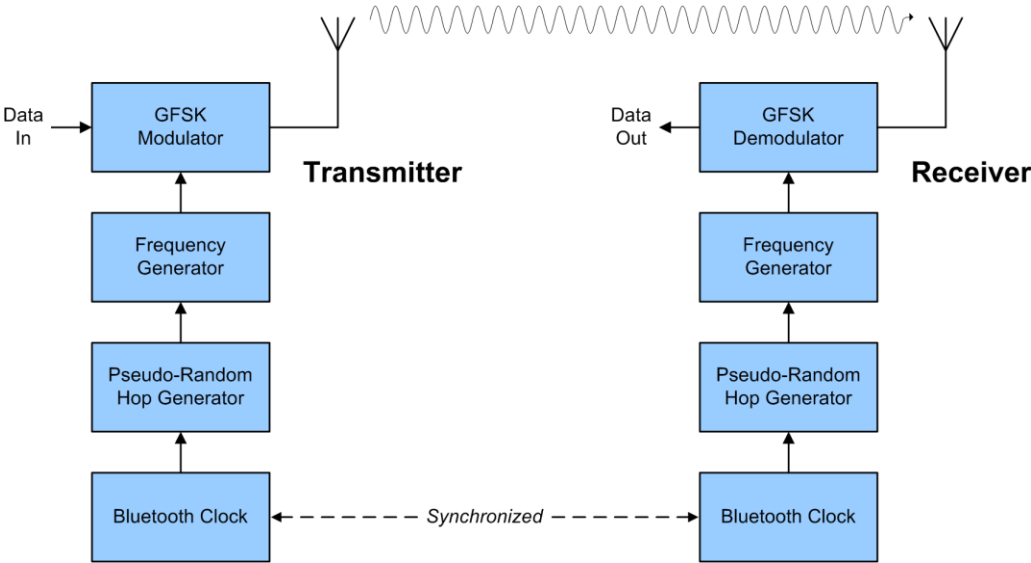

Fig. 2-2: BT Frequency Hopping Spread Spectrum (FHSS) block diagram

Time Slots

BT transmission channels are divided into time slots, each slot being 625 μ s in length and numbered according to the most significant 27 bits of the BT clock. The time slot number, denoted as k , therefore ranges from 0 to $2^{27}-1$. BT packet transmission can extend up to five time slots on the CMW, which is the maximum specified BT standard packet transmission.

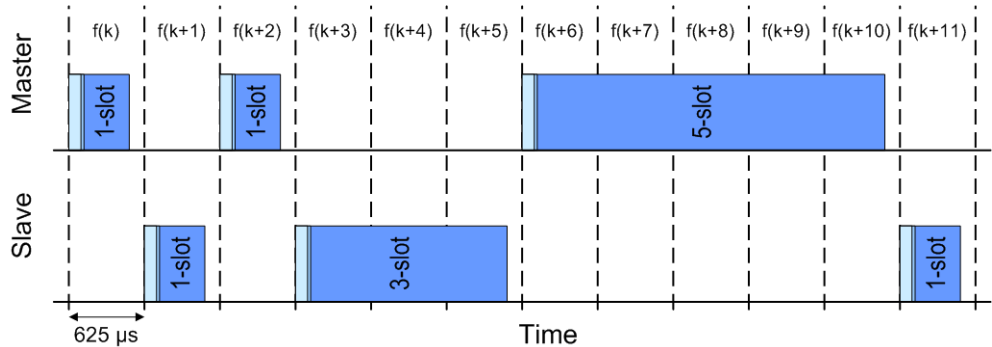

Fig. 2-3: TDD scheme: Multi-slot packet transmission and frequency hops $f(k)$

Hopping Pattern

A Bluetooth device will 'hop' between the 79 frequency channels in a predetermined sequence at a hop frequency, which is directly linked to the number of time slots used for data transmission. Bluetooth transmission channels are divided into time slots, each slot being 625 μs in duration. Packets can be either 1, 3, or 5 slots in duration, i.e. one frequency hop per packet, independent from the number of slots.

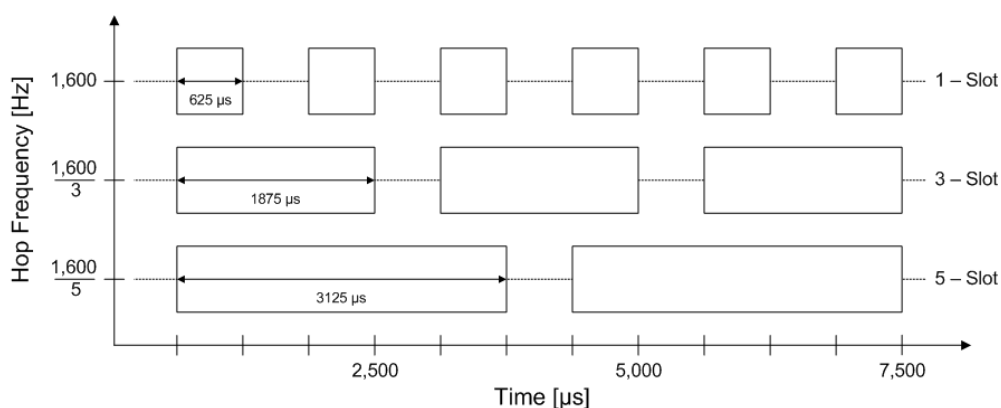

Fig. 2-4: Hopping frequency and time slot duration

The pseudo-random hop generator will repeat itself after a certain number of hops. The hop period during normal piconet communications is 2^{27} hops long. Accordingly the hopping pattern will repeat itself after about 23.3 hours, taking into account that the hop rate is 1600 hops per second. The hop period is long in order to avoid accidental hop synchronization between two different piconets within mutual range. The pre-determined hop sequence is pseudo-random in nature. The master device provides the hop sequence to all slave devices within the piconet during the paging process.

Adaptive hopping

The term 'Adaptive' comes from the ability of the master and all slaves within a piconet to be able to monitor channel conditions and avoid bad channels, if necessary. The channel quality measurements are made by all devices within the piconet, since interference depends on the device location and transmitted power.

Common metrics for making the judgement on RX channel quality are as follows:

- Received Signal Strength Indication (RSSI)
- Packet or Bit Error Rate (PER / BER)
- Signal to Noise Ratio (SNR)

The BT SIG Core Specification does not mandate the method of channel assessment in order to identify the good and bad channels. Instead, the implementation is left up to the chipset vendor to define or optimize. A variation between the EUT implementations is certainly to be expected.

At minimum 20 channels can be used in the hopping pattern. AFH test capability with the CMW is only applicable for the case for BR + EDR due to the fact that LE is tested in DTM (non-signaling mode) only.

2.1.2 Channel Map

The channel map is provided by the master and contains the relevant information about the 79 frequency channels of the piconet:

- A channel classification in *good* or *bad* channels based on:
 - a) Local measurements (e.g. active or passive assessment in the Controller)
 - b) Information from the Host via the Host Controller Interface (HCI)
 - c) Report messages (PDUs) received from the slaves
- A set of used and unused channels in the piconet. On the CMW:
 - Used channels are stated *blocked* with the Return value of 0.
 - Unused channels are stated *clear* with the Return value of 1.

Channel Classification

The following channel classification is taken from the BT SIG Core Specification Version 4.2. Note, that the CMW does not distinguish between an *unknown* channel and a *bad* channel. *Bad* channel is used for both instances.

Classification	Definition
A channel is classified as <i>unknown</i> ,	If the channel assessment measurements are insufficient to reliably classify the channel is not marked bad in the most recent HCI.
A channel is classified as <i>bad</i> ,	If at least one of the following applies: <ol style="list-style-type: none"> a) An asynchronous (ACL) or synchronous (SCO) connection-oriented logical transport throughput failure measure has exceeded a threshold. b) An interference-level measure due to a coexisting radio signal has exceeded a threshold. c) The channel is marked bad in the most recent HCI.
A channel is classified as <i>good</i> ,	If it is neither <i>unknown</i> nor <i>bad</i> .

Table 2-1: BT frequency channel classification

Channel Map Generation

Any channel that shows poor statistics is 'black-listed' via its Local Assessment Scheme (LAS). This information is sent to the master device, which creates an Active Channel Map.

“Active” means, that information is constantly provided, on which channels are clear to use and those that should be avoided. This map is then continuously updated as channels become blocked or un-blocked.

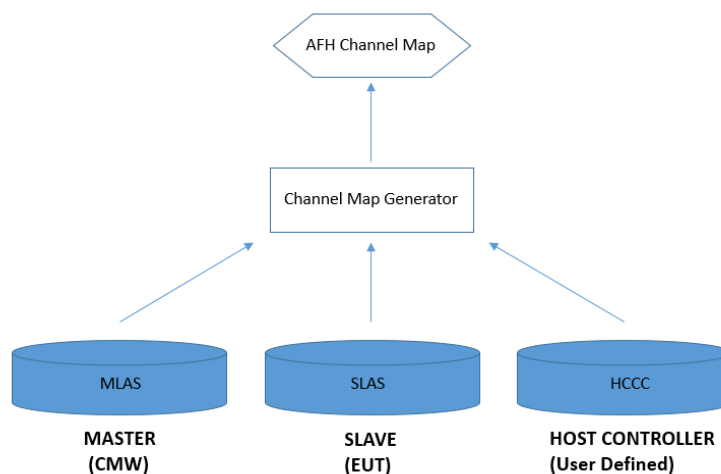

Fig. 2-5: BT channel map generation

Applied on the master (CMW) and the slave (EUT)

The Local Assessment Scheme is well defined for the devices within the piconet:

- **MLAS: Master's Local Assessment Scheme**
The MLAS contains a channel list with the channels to be black-listed based on the RX quality statistics at the master (CMW).
- **SLAS: Slave's Local Assessment Scheme**
The SLAS contains a channel list with the channels to be black-listed based on the RX quality statistics at the slave (EUT).
- **HCCC: Host Controller Channel Classification**
The HCCC contains a channel list with the channels to be black-listed via mechanisms, which are not based on over the air measurements.
E.g. in the case of a PC supporting both Bluetooth and WLAN:
The WLAN channel to be used is known in advance by the host controller (in-device coexistence mitigation). The HCCC mechanism is also referred to as "User Defined" mode. It allows the user to generate a custom channel map.

The **Channel Map Generator** implements a logical OR operation on these three inputs in order to create the final AFH Channel Map utilized.

The CMW supports three AFH scenarios to generate the channel map:

- CMW (MLAS) and EUT (SLAS) combination
- EUT (SLAS) only
- User Defined (HCCC equivalent)

Note: The majority of EUT's are not capable of modifying their AFH LAS, when in RF Test mode. Instead, the Connection Test mode can be used.

2.1.3 Channel Detection on the CMW

Bad Channel Detection

Bad channels may be detected in the following cases:

- CMW (master) alone
- CMW (master) and the EUT (slave) collectively

The BT stack within the CMW contains an error count channel table. For each channel it counts the number of received errors as follows:

- No answer; no packet received
- HEC error
- SCO/eSCO packet not received

Each time an error is detected on a particular channel, the error count is incremented. If the error count on a particular channel reaches a threshold of six, then the channel is classified and marked as a bad channel. Bad channels are temporarily excluded from the channel hopping pattern.

Good Channel Detection

If a valid packet is received on a particular channel then the error count in the error count channel table is reset to zero:

- Valid packet received (DH1, DH3, DH5, etc, or Null/Poll)
- SCO/eSCO packet received

The error count channel table is updated via the channel classification report sent from the EUT (slave) back to the CMW (master). This allows for blocked channels to be reintroduced in the active hopping pattern.

2.1.4 Channel Reporting Algorithm

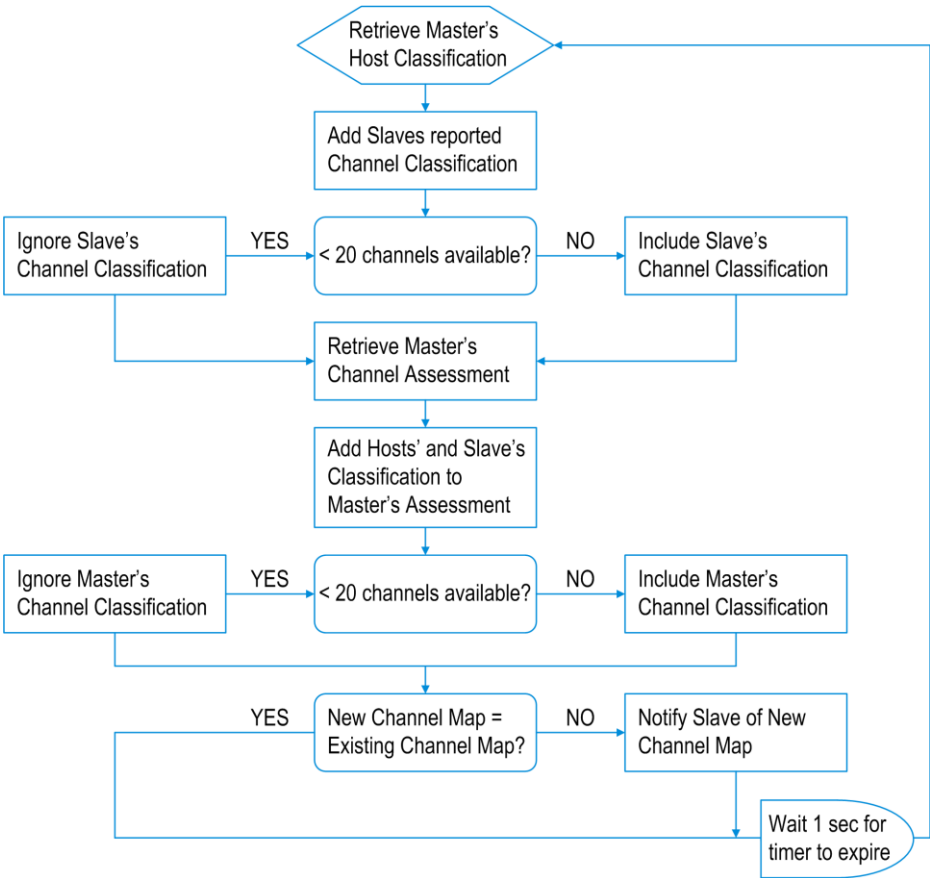

Fig. 2-6: BT channel reporting algorithm on the CMW

2.2 BT with a coexisting WLAN signal

The 2.4 GHz ISM Band is shared by multiple Radio Access Technologies (RATs), with Bluetooth and WLAN being a few of them. The presence of WLAN signals can be mapped within the channel map. Data transmission is stopped for the BT channel's falling within the WLAN signal bandwidth for each time slot.

In the example below a WLAN signal (802.11 b, g or n), located in the sixth WLAN channel at 2.437 GHz is present in the vicinity of the nearby BT piconet. The masters channel map has been modified by black listing the BT channels falling within the WLAN signal bandwidth due to poor RX quality statistics. The hopping pattern will avoid bad channels using the rest of the available spectrum, provided that a minimum of 20 channels is available.

The BT channel characteristics of the piconet are indicated for each particular time slot in the channel map:

- Occupied channels are black
- Blocked channels are yellow
- Available but not used channels are white

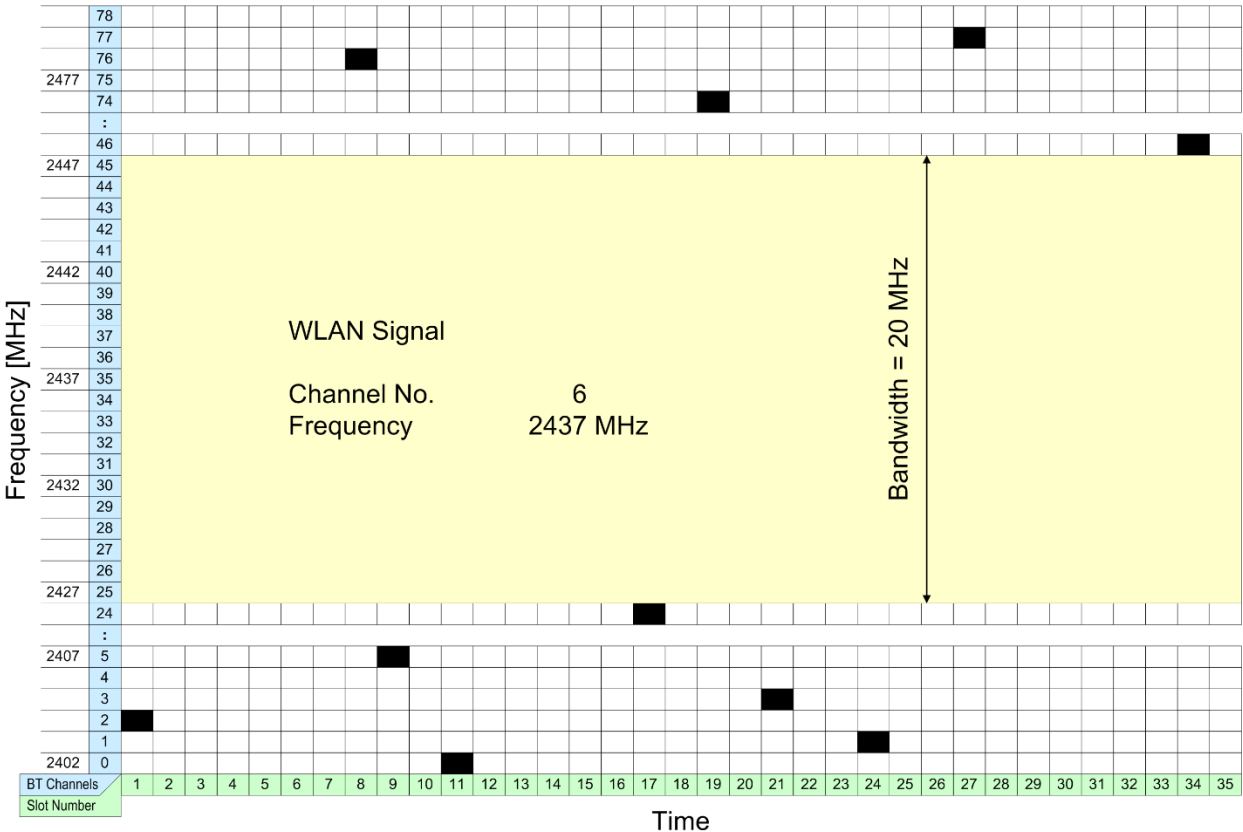

Fig. 2-7: BT channel map displaying BT channels and channel characteristics for each time slot

2.3 Connection States

Since AFH will only affect connected BT devices' channel maps, a brief overview over the relevant connection states is given in the subchapters below. For more information refer to the Bluetooth Firmware Applications User Manual.

2.3.1 TX Test Mode (ACL Connection)

The CMW (master) sends a Poll Packet every X number of slots depending upon the ACL packet type (DH1, DH3, or DH5) to the EUT (slave). The CMW will expect to receive an equivalent packet type response back in the next receive slot.

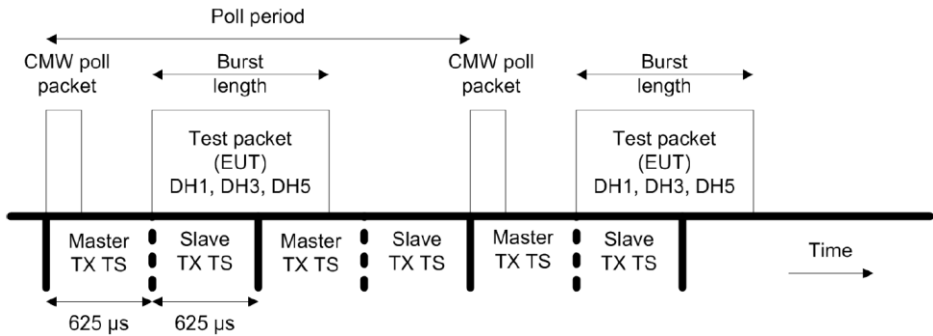

Fig. 2-8: Data transmission and timing of TX tests

2.3.2 Loopback Test Mode (ACL Connection)

The CMW (master) sends DH1, DH3, or DH5 ACL Packets every X number of slots depending upon the ACL packet type (DH1, DH3, or DH5) to the EUT (slave). The CMW will expect to receive an equivalent packet type response back in the next receive slot.

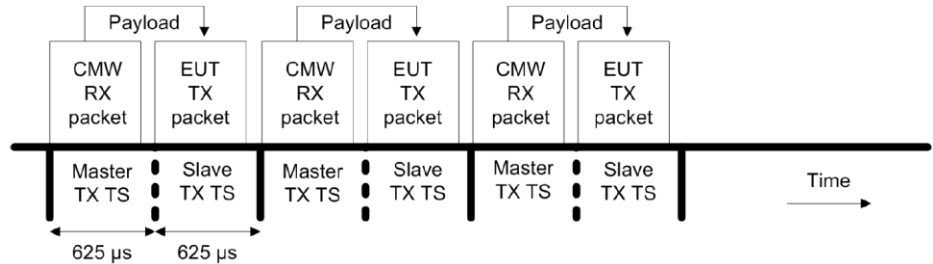

Fig. 2-9: Data transmission and timing of loopback tests

2.3.3 Connection Test Mode (ACL Connection)

For the case of operating mode 'Connection Test' the CMW will send a Poll packet every forty time slots. The CMW will expect to receive a Null packet response back in the next receive slot.

2.3.4 Audio Profile (SCO Connection)

For the case of operating mode Profile' the CMW sends a SCO (HV1, HV2, or HV3) packet every two slots and expects a SCO (HV1, HV2, or HV3) packet back every two slots.

3 Test Setups

Since AFH is available for Bluetooth BR/EDR devices only, the test setups described in the CMW Bluetooth Signaling manual are covering all relevant test modes. A short overview is given below.

3.1 EUT without USB Port

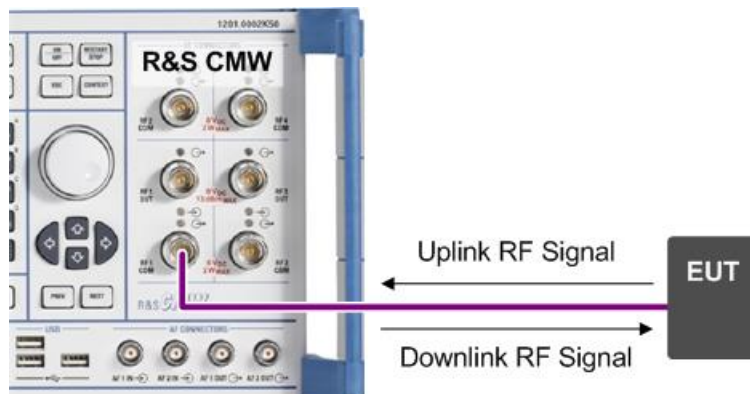

Fig. 3-1: Test setup without USB EUT

3.2 EUT with USB Port

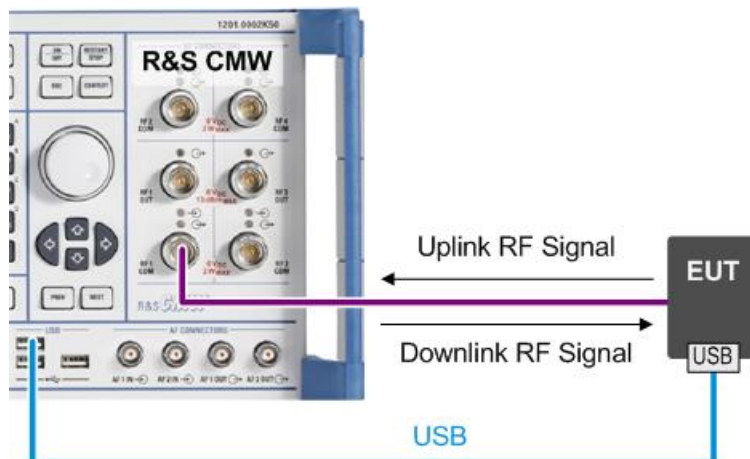

Fig. 3-2: Test setup with USB EUT

Note: Some EUTs can be connected directly with a CMW's USB port without USB cable.

For more information on test setups with EUTs providing a USB port, a serial port or even a 2-wire UART interface see the 1C105 application note.

4 Remote Procedures

For remote operation the **starting situation** for all following configuration tasks is the same:

- The EUT is connected with the CMW.
- The Bluetooth Signaling application is ON.
- One of the connection states in chapter 2.3 is configured.
- AFH is enabled.

4.1 AFH Remote Commands

AFH channel map generation

```
SENSe:BLUetooth:SIGNaling:CMAP?
  <AFHChannelMap>
```

The command queries channels used by AFH and returns the current CSV AFH channel map in use based on:

- The final combination of the EUT(s) in the piconet.
- The combined channel map of the EUT and the CMW.
- A user configured channel map, where the user uses individual settings for each channel.

Return values:

```
<AFHChannelMap> 0|1
                79 comma separated values, one value per channel:
                0: channel is blocked for AFH
                1: channel is released for AFH
```

Note: When retrieving the current channel map in use, an active connection established between the CMW and EUT is required first. In case of no active connection there is no channel map to return. Upon initial power up the channel map will report all 0's, otherwise the last modified channel map will be reported.

Master and slave channel detection

```
CONFigure:BLUetooth:SIGN<i>:RFSettings:AFH
  <CMWandEUTDetect>,NORM
```

The command disables / enables the combined CMW and EUT bad channel detection.

Parameters:

```
<CMWandEUTDetect> OFF|ON
```

Slave only channel detection

```
CONFigure:BLUetooth:SIGN<i>:RFSettings:AFH
  <EUTOnlyDetect>,EUT
```

The command disables / enables EUT mode only bad channel detection.

Parameters:

```
<EUTOnlyDetect>  OFF|ON
```

User defined AFH commands

```
CONFigure:BLUetooth:SIGN<i>:RFSettings:AFH
  <ChannelMap>,USER
```

The command disables / enables the 79 channels of the user defined channel map.

Parameters:

```
<ChannelMap>  OFF|ON
```

```
CONFigure:BLUetooth:SIGNaling:RFSettings:AFH:UCH
  <CMAP>
```

The command specifies the user-defined channels of the channel map. The setting is relevant for mode = USER.

Parameters:

```
<ChannelList>  0|1
```

79 comma separated values, one value per channel:
0: channel is blocked for AFH
1: channel is released for AFH

Note: The ability of the EUT to mark bad channels is dependent upon the CMWs TX level, not only interferer level / bandwidth. Useful input TX levels range from about -15 dBm to -65 dBm.

4.2 AFH Configuration Examples

Example procedure for a user defined AFH configuration

1. Configure the initialisation parameters as required.
2. Enable frequency hopping in test mode.

```
CONF:BLU:SIGN:RFS:HOPP ON
```
3. Set the AFH mode to 'USER' prior to entering BT connected state.

```
CONF:BLU:SIGN:RFS:AFH ON,USER
```
4. Enter RF Test / Loopback mode (or alternatively Connection Test mode).
5. Return the current CSV AFH channel map in use (initial).

```
SENS:BLU:SIGNaling:CMAP?
```

6. Set the User defined CSV AFH channel map prior to entering BT connected state.
CONF:BLU:SIGN:RFS:AFH:UCH <CMAP>
7. A delay of 1 second is set to allow for the new channel map to take effect.
8. Return the current CSV AFH channel map in use (modified).
SENS:BLU:SIGNaling:CMAP?

Note: In the user defined AFH mode configuration a delay is required between setting and returning the channel map. This delay can vary among EUTs. Typically a delay of 1 second is sufficient for AFH testing.

A future BT FWA update will allow the status of the active channel map to be queried.

Example procedure for a EUT AFH configuration

1. Configure the initialisation parameters as required.
2. Enable frequency hopping in test mode.
CONF:BLU:SIGN:RFS:HOPP ON
3. Set the AFH mode to 'EUT' prior to entering BT connected state.
CONF:BLU:SIGN:RFS:AFH ON,EUT
4. Disable the blocking signal, i.e. switch the RF output to OFF state.
5. Enter 'RF Test' Operation Mode and the 'Loopback Test' Test Mode or alternatively 'Connection Test' Operation Mode.
6. Return the current CSV AFH channel map in use (initial).
SENS:BLU:SIGNaling:CMAP?
7. Enable the blocking signal, i.e. switch the RF output to ON state.
8. Wait a delay of 60 seconds to allow the EUT for detection and communication of the new channel map to the master.
9. Return the current CSV AFH channel map in use (modified).
SENS:BLU:SIGNaling:CMAP?

Notes:

- It can take up to 30 seconds or more for the channel map to be modified, which appears to be EUT dependent. Black-listing channels is a much faster process than reintroducing them, typically less than 5 seconds.
- AFH configuration for AFH Mode = EUT in 'RF Test' Operation Mode is not compatible with some of the tested EUTs. In this case the Operation Mode 'Connection Test' is used.

5 Ordering Information

CMW Hardware		
Designation	Type	Order No.
Radio Communication Tester	R&S®CMW500	1201.0002K50
	R&S®CMW270	1201.0002K75
Basic Assembly	CMW-PS503 (CMW500)	1202.5408.02
	CMW-PS272 (CMW270)	1202.9303.02

CMW Software		
Designation	Type	Order No.
Bluetooth Basic Signaling	CMW-KS600	1208.1004.02
Bluetooth BR/EDR Signaling	CMW-KS610	1207.7650.02
Bluetooth, BR/EDR, TX Measurement	CMW-KM610	1203.6350.02

Rohde & Schwarz

The Rohde & Schwarz electronics group offers innovative solutions in the following business fields: test and measurement, broadcast and media, secure communications, cybersecurity, radiomonitoring and radiolocation. Founded more than 80 years ago, this independent company has an extensive sales and service network and is present in more than 70 countries.

The electronics group is among the world market leaders in its established business fields. The company is headquartered in Munich, Germany. It also has regional headquarters in Singapore and Columbia, Maryland, USA, to manage its operations in these regions.

Regional contact

Europe, Africa, Middle East
+49 89 4129 12345
customersupport@rohde-schwarz.com

North America
1 888 TEST RSA (1 888 837 87 72)
customer.support@rsa.rohde-schwarz.com

Latin America
+1 410 910 79 88
customersupport.la@rohde-schwarz.com

Asia Pacific
+65 65 13 04 88
customersupport.asia@rohde-schwarz.com

China
+86 800 810 82 28 | +86 400 650 58 96
customersupport.china@rohde-schwarz.com

Sustainable product design

- Environmental compatibility and eco-footprint
- Energy efficiency and low emissions
- Longevity and optimized total cost of ownership

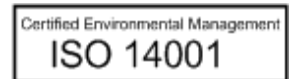

This application note and the supplied programs may only be used subject to the conditions of use set forth in the download area of the Rohde & Schwarz website.

R&S® is a registered trademark of Rohde & Schwarz GmbH & Co. KG; Trade names are trademarks of the owners.