



KOLLMORGEN

AKM Series Motors



Helping you build a better machine, faster.



New Name, Established Brands

Danaher Motion's wide range of motion control systems and components offer customers an unprecedented choice in selecting the right solution for their particular application requirements. Our product innovations have been improving the efficiency and productivity of complex manufacturing operations for over 60 years through trusted brand names such as Dover, Kollmorgen, Pacific Scientific, Portescap and Thomson in industries as diverse as semiconductor, aerospace and defense, mobile-off-highway, packaging, medical and robotics.

Danaher Motion's growing family of leading motion control products tells only half the story. With a worldwide service and support infrastructure, our field service engineers and support teams are available when you need them. It is part of the Danaher Corporation's unrelenting focus on you, our customer. That's why more and more design engineers are turning to Danaher Motion to meet their motion control requirements.

Kollmorgen AKM Motors and Drives – Choice Without Compromise.

Our new Kollmorgen AKM servo motors and drives from Danaher Motion give you unprecedented choice and flexibility from a wide range of standard products so you can select the best servo motor and drive combination optimized for your specifications. Now, selecting the right motion control products has never been easier. Pick from thousands of servo motor/drive combinations outlined in this catalog or go to our Web site to find the best solution for your application. Standard Kollmorgen AKM servo motors and drives offer the best of both worlds – the exact specifications of a custom solution with the faster delivery times and lower cost of a standard catalog product. For your truly unique motion control applications, work with our engineering support team to customize a solution for your machine design. Either way, standard product or customized, you choose the motion control solution that meets your exact requirements.

Continuous Improvement – It's the Danaher Motion Way

At Danaher Motion, we are passionate about continually improving our operations to bring increasing value to our customers. The Danaher Business System (DBS) helps us improve the efficiency of our manufacturing and product development processes. DBS is a team-based approach based on the principles of Kaizen that lets us continuously and aggressively eliminate waste in every aspect of our business operations. The DBS focuses our entire organization on achieving breakthrough results that create competitive advantage in quality, delivery and performance – advantages that we pass on to you, our customer.

Whatever your motion control requirements may be, Danaher Motion has a solution that is right for you. Our unsurpassed product selection and service means faster time to market, higher reliability and increased productivity. Let the experts at Danaher Motion put a world of motion control solutions at your fingertips.



A World of Options.

This Selection Guide outlines the extensive options available with this new advanced motor family. Use this guide to choose from our vast breadth of motor solutions. Our motor products are backed by a complete family of digital drives, offering you the best motion control solution in the marketplace.

Can't find what you're looking for? Beyond the Advanced Kollmorgen Motor series, Danaher Motion offers many other outstanding products, from Direct Drive Rotary and Linear products, to stepper and synchronous solutions. Even better, Danaher Motion can engineer the right solution for your needs. Ask our Customer Support Center today about a custom solution that fits your needs. Let the experts at Danaher Motion put a world of solutions at your fingertips.

www.DanaherMotion.com



AKM11x

The AKM1 Frame Size with "M" option connectivity and SFD (Smart Feedback Device) Feedback.

AKM22x

The AKM2 Frame Size with "B" option connectivity, Commutating Encoder Feedback and optional Brake.



AKM31x

The AKM3 Frame Size with "D" option connectivity and SFD (Smart Feedback Device) Feedback.



AKM41x

The AKM4 Frame Size with "P" option connectivity and SFD (Smart Feedback Device) Feedback.



AKM52x

The AKM5 Frame Size with "C" option connectivity and optional Brake.

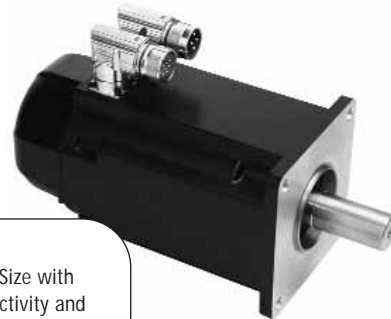

AKM63x

The AKM6 Frame Size with "C" option connectivity.



AKM74x

The AKM7 Frame Size with "C" option connectivity and optional Brake.



Table of Contents:

Danaher Motion Introduction	2-3
A World of Options	4
Table of Contents	5
Introduction To The AKM Motor Series	6
Compatible Drive Products	7
System Overview	8 - 14
AKM Motors & S200 Drives	9
AKM Motors & S300 Drives	10 - 11
AKM Motors & S600 Drives	12- 14
Advanced Motor Design Features	15
Performance Data	16 - 29
AKM1x Frame	16 - 17
AKM2x Frame	18 - 19
AKM3x Frame	20 - 21
AKM4x Frame	22 - 23
AKM5x Frame	24 - 25
AKM6x Frame	26 - 27
AKM7x Frame	28 - 29
L ₁₀ Bearing Fatigue Life and Shaft Loading	30 - 32
AKM Motor Primary Feedback Devices	33
Servomotor Feedback Combinations	34 - 35
AKM Motor Connector Options	36 - 40
AKM Part Number System	41



The advanced Kollmorgen AKM high performance motor series offers a wide range of mounting, connectivity, feedback and other options. These motors offer superb flexibility to meet application needs with:

- 7 frame sizes
- 25 frame/stack combinations
- 77 'standard' windings

AKM motors offer extremely high torque, density and acceleration

Torque

0.16 to 53Nm continuous stall torque (1.4 to 470lb-in) in 25 frame/stack combinations. Specific torques are often available from multiple frame sizes to optimize mounting and inertia matching capabilities.

Speed

Speeds to 8000 rpm meet high speed application requirements. Windings specifically tailored to lower speeds are also available.

Voltage

AKM motors can be applied to all standard global voltages. Windings are specifically tailored to 75 VDC, 120, 240, 400 and 480 VAC.

Mounting

Multiple mounting standards are available to meet common European, North American, and Japanese standards.

Feedback

AKM motors include resolver, encoder (commutating), Sine-Absolute encoder or SFD (Smart Feedback Device) feedback options to meet specific application requirements.

Smoothness

Smooth performance results from low-cog, low-harmonic distortion magnetic designs.

Connectivity

Rugged, rotatable IP65 connectors and low cost IP20 Molex plugs are both available to provide flexibility. Single connectors/Plugs (combined power and feedback) are also available to minimize motor and cable cost (SFD only).

Thermal

Windings are rated conservatively at 100°C rise over a 40°C ambient while using 155°C (class F) insulation materials. Motors meet applicable cURus and CE requirements and include thermistors. Thermal ratings at 60°C rise are also provided to meet the needs of specific applications.

Danaher Motion Cables Offer The Complete Solution

Factory cables are provided for your convenience and offer high reliability to keep your application running day and night. The new "Value" line provides a cost saving option for applications that don't require long distances or encounter extreme environmental conditions. Included in our new "Value" line is a composite cable that combines power and feedback in one cable to aid in faster machine commissioning. Please consult your local sales person or contact the Danaher Motion Customer Support Center to decide which cable option is best suited for your application.

Additional motion control solutions are available with these options.

- Fail-safe brakes
- New, Teflon Shaft seals
- Feedback devices
- Shaft and mounting variations
- Custom windings
- Connectivity

Compatible SERVOSTAR® Drive Products



S200 Series Drives

The S200 is the next generation micro servo drive from Danaher Motion. This compact, high performance drive family supports torque or velocity control in the base configuration. An option card is available to provide position loop closure with indexing, CANopen or DeviceNet support. It is available in AC and DC powered versions and mates with the new AKM servomotors series, which features a smart feedback device that in conjunction with the drive provides auto set-up and tuning which reduces installation time and cost, as well as startup time when the motor or drive is replaced.

Features

Highest performance all digital servo in the industry

Easy set up and tuning with Smart Feedback Device

Optimized performance with AKM motors

Fully Protected

Rugged optically isolated I/O

Meets CE and UL Requirements

Full Digital Design

Very compact footprint

Choice of motor feedback options

Torque and Velocity control standard

Optional CANopen or DeviceNet Position Control

Optional CANopen Support



S300 and S600 Series Drives

The Kollmorgen SERVOSTAR® S300 series is Danaher Motion's full feature, compact drive for 3-10 amp continuous applications. Utilizing the same design features as the established SERVOSTAR® S600 family it offers users all the performance and compatibility of the larger S600 series in a smaller package and is available for 120 VAC and single phase input power applications.

The SERVOSTAR® S600 series is a high performance, high power drive incorporating advanced features for three phase input applications on 208-480 VAC power systems. Available in 3 to 70 amp continuous ratings it provides coverage for a wide range of motors.

Both the S300 and S600 support the new AKM series servomotors as well as the Kollmorgen GOLDLINE® DDR and PLATINUM® DDL series. The S600 also supports the Kollmorgen GOLDLINE® XT and Kollmorgen GOLDLINE® BH series of motors to meet the widest range of requirements.

All S300 and S600 drives support plug-in option cards for I/O expansion, DeviceNet, PROFIBUS, SERCOS and Single Axis Controller capability.

Features

Fully Protected

Meets CE and UL Requirements

Full Digital Design

Small footprint with built-in CE filters standard for 3-20 amp units

Choice of motor feedback options

Torque, Velocity and Position Control standard

Optional DeviceNet, Profibus, SERCOS

Optional Single-axis controller

Standard built-in CANopen Support

Motion Tasking tied to I/O support polling

Advanced Setup software and onboard display with keypad

System Overview

How To Build A Servo Drive & Motor System

System torque/speed information on the following pages is designed to help you select the optimum brushless servo motor/controller combination. The nominal values in this data illustrate performance for the recommended motor/controller systems.

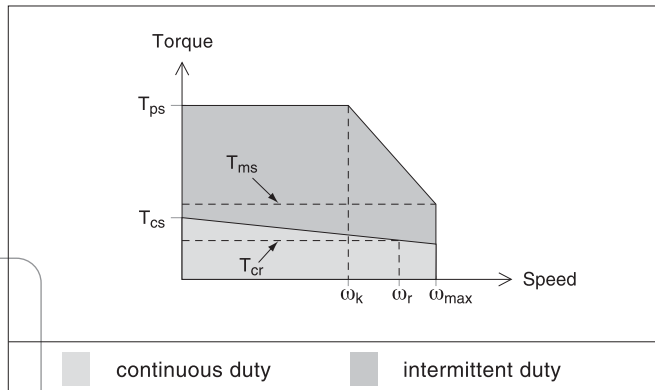

Definitions

- T_{ps} - Peak stall torque for system
- T_{ms} - Peak torque at maximum speed
- T_{cs} - Continuous torque at stall
- T_{cr} - Continuous rated torque (torque at rated power)
- ω_{max} - Maximum speed
- ω_r - Rated speed (speed at rated power)
- ω_k - Speed at knee in peak envelope (intersection of system peak torque with voltage limit line)

Drive & Motor Performance Curves

The performance characteristics of a brushless servo system (motor/controller combination) are described by a torque/speed operating envelope. As shown above, the shaded areas of the curve indicate the continuous duty and intermittent duty zones of the system.

Continuous Duty Zone

The continuous duty zone is bordered by the maximum continuous torque line up to the intersection with the intermittent duty line.

The continuous torque line is set by either the motor's maximum rated temperature, or the controller's rated continuous current output, whichever is less. The system voltage line is set by the voltage rating of the controller, the line voltage supplied, and the motor winding. The system can operate on a continuous basis anywhere within this area, assuming the ambient temperature is 40°C or less. Refer to the Test Conditions on the pages that follow.

Intermittent Duty Zone

The intermittent duty zone is bordered by the peak torque line and the system voltage line. The peak torque line is set by either the controller's peak current rating, which the controller can produce for a limited time, or the maximum rated peak current for the motor, whichever is less. Refer to the Rating Data on the pages that follow. NOTE: higher torque levels may be achievable at higher power levels.

Consult Danaher Motion Customer Support for more details. The system voltage line is set by the voltage rating of the controller, the line voltage applied and the motor winding. Operation in the intermittent zone must be limited to a duty cycle that will produce an RMS system torque falling within the continuous duty area. The RMS torque value is a function of the magnitude of the intermittent torque and the percentage of the time spent at that torque.

Zero - Peak, or RMS?

Current brushless drive technology uses a sinusoidal output. Danaher Motion rates its systems using RMS values to accurately reflect system performance operating with a sinusoidal waveform.

MOTIONEERING® CD-ROM

Don't let sizing and selection slow down your process. MOTIONEERING Application Engine sizing software from Danaher Motion makes it a breeze.

MOTIONEERING is a Windows®-based program that takes a systems approach to the selection of servo and stepper products. This approach to sizing systems considers not only load and motor parameters in the sizing process but also the amplifier voltage and current parameters including the amplifier time constant to deliver peak current.

A wide variety of mechanisms are accommodated including leadscrew, rack and pinion, conveyor, nip rolls, rotary, and direct data entry. Direct Drive Linear (DDL) motors have their own unique sizing algorithms and product databases to search from. The database consists of over 1500 systems including housed brushless and DC servos, frameless brushless servos, direct drive linear brushless servos, stepper motors, and drives.

A separate tutorial is available on the CD-ROM or from the Web site to aid first time users in the use of the software.

Also included on the MOTIONEERING CD-ROM are over 60 of our latest product catalogs in PDF format for easy viewing. A literature browser allows these PDF documents to be quickly found by product category and brand. In addition, the CD-ROM provides company and general product introductions consistent with those in this Selection Guide. Lastly, there is a software tool included on the CD-ROM called MOTIONEERING Toolbar, a general purpose engineering utility that includes a unit converter, inertia calculations, density of materials listing and more.

System Overview - AKM Motors & S200 Drives

Recommended Motor/Drive Systems, 75 VDC bus ①

Servo Motor Model	Servo Drive Model	Peak Stall Torque T_{ps} ② N-m (lb-in)	Peak Torque at Max. Speed T_{ms} N-m (lb-in)	Cont. Stall Torque T_{cs} N-m (lb-in)	Cont. Rated Torque T_{cr} N-m (lb-in)	Speed at Knee ω_k rpm	Rated Speed ω_r rpm	wmax. Speed ω_{max} rpm	Cont. Stall Current I_{cs} A _{rms}	Current@Peak Torque I_{ps} A _{rms}	Inertia ③ J kg-cm ² (lb-in-s ² x 10 ⁻³)
AKM11E	S20330	0.50 (4.45)	0.264 (2.34)	0.19 (1.64)	0.18 (1.56)	3,530	6,000	8,000	2.91	9.0	0.017 (0.015)
AKM12E	S20330	0.90 (8.0)	0.0 (0.0)	0.30 (2.69)	0.30 (2.68)	1,380	3,000	7,180	2.72	9.0	0.031 (0.0274)
AKM13D	S20330	1.29 (11.4)	0.0 (0.0)	0.40 (3.55)	0.40 (3.55)	0	2,000	4,750	2.4	9.0	0.045 (0.0398)
AKM21E	S20330	1.21 (10.7)	0.0 (0.0)	0.48 (4.23)	0.48 (4.21)	1,320	2,000	5,050	3.0	9.0	0.107 (0.0947)
AKM21G	S20630	1.44 (12.7)	0.0 (0.0)	0.50 (4.43)	0.46 (4.05)	2,350	4,000	7,800	4.87	18.0	0.107 (0.0947)
AKM22E	S20330	2.34 (20.7)	0.0 (0.0)	0.87 (7.71)	0.85 (7.55)	0	1,000	2,540	2.73	9.0	0.161 (0.143)
AKM22G	S20630	2.66 (23.6)	0.0 (0.0)	0.88 (7.79)	0.84 (7.39)	1,150	2,500	4,420	4.82	18.0	0.161 (0.143)
AKM23F	S20630	3.88 (34.4)	0.0 (0.0)	1.18 (10.4)	1.15 (10.1)	352	1,500	2,940	4.31	17.2	0.216 (0.191)
AKM24F	S20630	4.82 (42.6)	0.0 (0.0)	1.42 (12.6)	1.39 (12.3)	28	1,000	2,210	3.89	15.6	0.27 (0.239)
AKM31E	S20330	3.24 (28.6)	0.0 (0.0)	1.20 (10.6)	1.19 (10.5)	118	750	1,990	2.99	9.0	0.33 (0.292)
AKM31H	S20630	3.36 (29.7)	0.0 (0.0)	1.23 (10.9)	1.20 (10.6)	1,520	2,000	3,780	5.85	18.0	0.33 (0.292)
AKM32H	S20630	6.22 (55.1)	0.0 (0.0)	2.10 (18.6)	2.06 (18.2)	634	1,200	2,090	5.5	18.0	0.59 (0.522)
AKM33H	S20630	8.56 (75.8)	0.0 (0.0)	2.88 (25.5)	2.82 (25.0)	383	800	1,550	5.62	18.0	0.85 (0.752)
AKM41H	S20630	5.48 (48.5)	0.0 (0.0)	2.06 (18.2)	1.99 (17.6)	604	1,000	2,190	5.6	18.0	0.81 (0.717)

Recommended Motor/Drive Systems, 120 VAC, 160 VDC bus ①

AKM11B	S20260	0.59 (5.27)	0.179 (1.58)	0.18 (1.62)	0.18 (1.60)	290	4,000	8,000	1.16	4.5	0.017 (0.015)
AKM11C	S20260	0.51 (4.49)	0.30 (2.66)	0.19 (1.64)	0.18 (1.56)	4,160	6,000	8,000	1.45	4.5	0.017 (0.015)
AKM12C	S20260	0.85 (7.49)	0.071 (0.628)	0.31 (2.73)	0.30 (2.69)	3,120	4,000	8,000	1.50	4.5	0.031 (0.0274)
AKM12E	S20360	0.90 (8.0)	0.090 (8.0)	0.30 (2.69)	0.27 (2.42)	8,000	8,000	8,000	2.72	9.0	0.031 (0.0274)
AKM13C	S20260	1.16 (10.3)	0.0 (0.0)	0.41 (3.62)	0.41 (3.60)	2,110	3,000	6,160	1.48	4.5	0.045 (0.0398)
AKM13D	S20360	1.37 (12.1)	0.624 (5.52)	0.40 (3.55)	0.36 (3.23)	4,560	7,000	8,000	2.4	9.0	0.045 (0.0398)
AKM21C	S20260	1.17 (10.4)	0.0 (0.0)	0.45 (3.98)	0.45 (3.98)	1,810	2,500	5,630	1.50	4.5	0.107 (0.0947)
AKM21E	S20360	1.21 (10.7)	0.695 (6.15)	0.48 (4.23)	0.41 (3.65)	5,330	7,000	8,000	3.0	9.0	0.107 (0.0947)
AKM22C	S20260	2.34 (20.7)	0.0 (0.0)	0.84 (7.48)	0.83 (7.32)	187	1,000	2,830	1.39	4.5	0.161 (0.143)
AKM22E	S20360	2.42 (21.4)	0.0 (0.0)	0.87 (7.71)	0.81 (7.13)	2,240	3,500	5,410	2.73	9.0	0.161 (0.143)
AKM23C	S20260	3.20 (28.4)	0.0 (0.0)	1.13 (10.0)	1.11 (9.81)	53	1,000	2,130	1.41	4.5	0.216 (0.191)
AKM23D	S20360	3.84 (33.9)	0.0 (0.0)	1.16 (10.2)	1.12 (9.93)	638	1,500	3,270	2.19	8.8	0.216 (0.191)
AKM24D	S20360	4.76 (42.1)	0.0 (0.0)	1.41 (12.4)	1.36 (12.1)	529	1,500	2,710	2.21	8.8	0.27 (0.239)
AKM31E	S20360	3.24 (28.6)	0.0 (0.0)	1.2 (10.7)	1.17 (10.4)	1,940	2,500	4,240	2.99	9.0	0.33 (0.292)
AKM32D	S20360	7.05 (62.4)	0.0 (0.0)	2.04 (18.0)	2.00 (17.7)	165	1,000	1,870	2.23	8.9	0.59 (0.522)
AKM41E	S20360	5.33 (47.2)	0.0 (0.0)	2.02 (17.8)	1.94 (17.2)	778	1,200	2,430	2.85	9.0	0.81 (0.717)

Recommended Motor/Drive Systems, 240 VAC, 320 VDC bus ①

AKM11B	S20260	0.59 (5.27)	0.59 (5.27)	0.18 (1.62)	0.17 (1.47)	8,000	8,000	8,000	1.16	4.5	0.017 (0.015)
AKM12C	S20260	0.85 (7.49)	0.85 (7.43)	0.31 (2.73)	0.28 (2.47)	8,000	8,000	8,000	1.50	4.5	0.031 (0.0274)
AKM13C	S20260	1.16 (10.3)	1.06 (9.38)	0.41 (3.62)	0.36 (3.22)	7,600	8,000	8,000	1.48	4.5	0.045 (0.0398)
AKM21C	S20260	1.17 (10.4)	0.75 (6.64)	0.45 (3.98)	0.39 (3.42)	5,810	8,000	8,000	1.50	4.5	0.107 (0.0947)
AKM22C	S20260	2.34 (20.7)	0.0 (0.0)	0.84 (7.48)	0.78 (6.92)	2,470	3,500	5,660	1.39	4.5	0.161 (0.143)
AKM22E	S20360	2.42 (21.4)	1.61 (14.2)	0.87 (7.71)	0.70 (6.18)	6,010	8,000	8,000	2.73	9.0	0.161 (0.143)
AKM23C	S20260	3.2 (28.4)	0.0 (0.0)	1.13 (10.0)	1.08 (9.52)	1,900	2,500	4,270	1.41	4.5	0.216 (0.191)
AKM23D	S20360	3.84 (34.0)	0.0 (0.0)	1.16 (10.2)	1.03 (9.08)	3,020	5,000	6,540	2.19	8.8	0.216 (0.191)
AKM24C	S20260	3.94 (34.9)	0.0 (0.0)	1.38 (12.2)	1.32 (11.7)	1,620	2,000	3,540	1.42	4.5	0.27 (0.239)
AKM24D	S20360	4.76 (42.1)	0.0 (0.0)	1.41 (12.4)	1.29 (11.4)	2,620	4,000	5,420	2.21	8.8	0.27 (0.239)
AKM31C	S20260	3.34 (29.6)	0.0 (0.0)	1.15 (10.2)	1.12 (9.94)	1,630	2,500	4,060	1.37	4.5	0.33 (0.292)
AKM31E	S20360	3.24 (28.6)	0.77 (6.82)	1.2 (10.6)	0.95 (8.41)	5,000	6,000	8,000	2.99	9.0	0.33 (0.292)
AKM32C	S20260	5.74 (50.8)	0.0 (0.0)	2.0 (17.7)	1.95 (17.2)	1,010	1,500	2,470	1.44	4.5	0.59 (0.522)
AKM32D	S20360	7.05 (62.4)	0.0 (0.0)	2.04 (18.0)	1.93 (17.1)	1,670	2,500	3,750	2.23	8.9	0.59 (0.522)
AKM33C	S20260	7.83 (69.3)	0.0 (0.0)	2.71 (24.0)	2.64 (23.4)	689	1,000	1,840	1.47	4.5	0.85 (0.752)
AKM33E	S20360	8.95 (79.3)	0.0 (0.0)	2.79 (24.7)	2.62 (23.2)	1,640	2,000	3,140	2.58	9.0	0.85 (0.752)
AKM41C	S20260	5.12 (45.3)	0.0 (0.0)	1.95 (17.3)	1.88 (16.6)	880	1,200	2,560	1.46	4.5	0.81 (0.717)
AKM41E	S20360	5.33 (47.2)	0.0 (0.0)	2.02 (17.8)	1.82 (16.1)	2,140	3,000	4,850	2.85	9.0	0.81 (0.717)
AKM42E	S20360	9.72 (86.0)	0.0 (0.0)	3.42 (30.3)	3.12 (27.6)	1,260	1,800	2,740	2.74	9.0	1.45 (1.28)
AKM43E	S20360	13.6 (120)	0.0 (0.0)	4.7 (41.6)	4.24 (37.6)	937	1,500	2,000	2.76	9.0	2.09 (1.85)
AKM44E	S20360	16.5 (146)	0.0 (0.0)	5.76 (51.0)	5.2 (46.0)	834	1,200	1,680	2.85	9.0	2.73 (2.42)

① See detailed motor specifications beginning on page 16.

② Peak torque ratings are for 5 seconds.

③ Includes resolver feedback inertia.

System Overview - AKM Motors & S300 Drives

Recommended Motor/Drive Systems, 240 VAC, 320 VDC bus ^①

Servo Motor Model	Servo Drive Model	Peak Stall Torque T_{ps} N-m (lb-in)	Peak Torque at Max. Speed T_{ms} N-m (lb-in)	Cont. Stall Torque T_{cs} N-m (lb-in)	Cont. Rated Torque T_{cr} N-m (lb-in)	Speed at Knee ω_k rpm	Rated Speed ω_r rpm	wmax. Speed ω_{max} rpm	Cont. Stall Current I_{cs} A _{rms}	Current@Peak Torque I_{ps} A _{rms}	Inertia ^③ J kg-cm ² (lb-in-s ² × 10 ⁻³)
AKM11B	S30361	0.61 (5.39)	0.584 (5.17)	0.18 (1.62)	0.17 (1.47)	7,700	8,000	8,000	1.16	4.7	0.017 (0.015)
AKM12C	S30361	1.08 (9.54)	1.05 (9.29)	0.31 (2.74)	0.28 (2.47)	7,880	8,000	8,000	1.51	6.1	0.031 (0.0274)
AKM13C	S30361	1.46 (12.9)	1.06 (9.38)	0.41 (3.62)	0.36 (3.22)	6,080	8,000	8,000	1.48	5.9	0.045 (0.0398)
AKM22E	S30361	2.42 (21.4)	1.61 (14.2)	0.87 (7.71)	0.7 (6.18)	6,010	8,000	8,000	2.73	9.0	0.161 (0.143)
AKM23D	S30361	3.84 (34)	0.0 (0.0)	1.16 (10.2)	1.03 (9.08)	3,020	5,000	6,540	2.19	8.8	0.216 (0.191)
AKM23F	S30661	3.52 (31.2)	3.28 (29.0)	1.18 (10.4)	0.94 (8.28)	7,670	8,000	8,000	4.31	15.0	0.216 (0.191)
AKM24D	S30361	4.76 (42.1)	0.0 (0.0)	1.41 (12.4)	1.29 (11.4)	2,620	4,000	5,420	2.21	8.8	0.27 (0.239)
AKM24F	S30661	4.68 (41.4)	2.42 (21.4)	1.42 (12.6)	1.12 (9.91)	5,570	8,000	8,000	3.89	15.0	0.27 (0.239)
AKM31E	S30361	3.24 (28.6)	0.77 (6.82)	1.2 (10.7)	0.95 (8.41)	5,000	6,000	8,000	2.99	9.0	0.33 (0.292)
AKM32D	S30361	7.05 (62.4)	0.0 (0.0)	2.04 (18.0)	1.93 (17.1)	1,670	2,500	3,750	2.23	8.9	0.59 (0.522)
AKM32H	S30661	5.36 (47.5)	2.87 (25.4)	2.1 (18.6)	1.45 (12.8)	6,560	7,000	8,000	5.5	15.0	0.59 (0.522)
AKM33E	S30361	8.95 (79.3)	0.0 (0.0)	2.79 (24.7)	2.62 (23.2)	1,640	2,000	3,140	2.58	9.0	0.85 (0.752)
AKM33H	S30661	7.35 (65.0)	0.0 (0.0)	2.88 (25.5)	2.27 (20.1)	5,040	5,500	6,630	5.62	15.0	0.85 (0.752)
AKM41E	S30361	5.33 (47.2)	0.0 (0.0)	2.02 (17.8)	1.82 (16.1)	2,140	3,000	4,850	2.85	9.0	0.81 (0.717)
AKM41H	S30661	4.78 (42.3)	3.8 (33.6)	2.06 (18.2)	1.62 (14.3)	5,070	6,000	6,000	5.6	15.0	0.81 (0.717)
AKM42E	S30361	9.72 (86.0)	0.0 (0.0)	3.42 (30.3)	3.12 (27.6)	1,260	1,800	2,740	2.74	9.0	1.45 (1.28)
AKM42G	S30661	9.56 (84.6)	0.0 (0.0)	3.53 (31.2)	2.9 (25.7)	2,530	3,500	4,660	4.8	15.0	1.45 (1.28)
AKM42J	S31061	7.75 (68.6)	6.52 (57.7)	3.56 (31.5)	2.38 (21.0)	5,460	6,000	6,000	8.4	20.0	1.45 (1.28)
AKM43G	S30661	13.2 (116)	0.0 (0.0)	4.8 (42.5)	4.0 (35.4)	2,000	2,500	3,470	4.87	15.0	2.09 (1.85)
AKM43K	S31061	9.66 (85.5)	5.44 (48.1)	4.9 (43.4)	2.62 (23.2)	5,120	6,000	6,000	9.6	20.0	2.09 (1.85)
AKM44G	S30661	16.1 (142)	0.0 (0.0)	5.88 (52.0)	4.9 (43.4)	1,760	2,000	2,890	5	15.0	2.73 (2.42)
AKM44J	S31061	12.9 (114)	0.0 (0.0)	6.0 (53.1)	3.84 (34)	3,800	4,000	5,010	8.8	20.0	2.73 (2.42)
AKM51G	S30661	11.7 (104)	0.0 (0.0)	4.75 (42.1)	4.03 (35.6)	1,910	2,500	3,480	4.84	14.5	3.42 (3.03)
AKM51K	S31061	9.22 (81.6)	4.43 (39.2)	4.9 (43.4)	2.35 (20.8)	4,740	5,500	6,000	9.4	20.0	3.42 (3.03)
AKM52G	S30661	21.5 (191)	0.0 (0.0)	8.43 (74.6)	7.69 (68.1)	1,110	1,500	1,920	4.72	14.2	6.22 (5.51)
AKM52K	S31061	16.9 (150)	0.0 (0.0)	8.6 (76.1)	6.8 (60.2)	2,820	3,000	3,690	9.3	20.0	6.22 (5.51)
AKM53K	S31061	22.9 (203)	0.0 (0.0)	11.6 (103)	10.1 (88.9)	2,220	2,000	2,780	9.4	20.0	9.12 (8.07)
AKM54K	S31061	28.1 (249)	0.0 (0.0)	14.4 (127)	12.7 (112)	1,880	1,800	2,290	9.7	20.0	11.9 (10.6)
AKM62K	S31061	22.7 (201)	0.0 (0.0)	12.2 (108)	10.4 (92)	1,870	2,000	2,700	9.6	20.0	16.9 (15.0)
AKM63K	S31061	31 (274)	0.0 (0.0)	16.8 (149)	14.9 (131)	1,510	1,500	2,020	9.9	20.0	24.2 (21.4)

- ① See definitions of ratings beginning on page 8.
- ② Peak torque ratings are for 5 seconds.
- ③ Includes resolver feedback inertia.

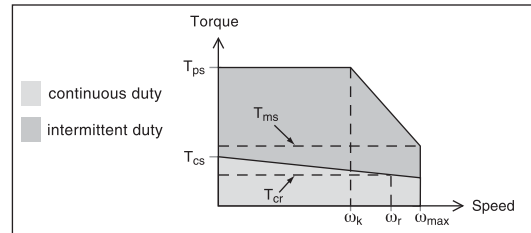

System Overview - AKM Motors & S300 Drives

Recommended Motor/Drive Systems, 400 VAC, 560 VDC bus ①

Servo Motor Model	Servo Drive Model	Peak Stall Torque T_{ps} @ N-m (lb-in)	Peak Torque at at Max. Speed T_{ms} N-m (lb-in)	Cont. Stall Torque T_{cs} N-m (lb-in)	Cont. Rated Torque T_{cr} N-m (lb-in)	Speed at Knee ω_k rpm	Rated Speed ω_r rpm	wmax. Speed ω_{max} rpm	Cont. Stall Current I_{cs} A _{rms}	Current@Peak Torque I_{ps} A _{rms}	Inertia ③ J kg-cm ² (lb-in-s ² x 10 ⁻³)
AKM22C	S30101	2.34 (20.7)	1.3 (11.5)	0.84 (7.48)	0.68 (5.99)	5,510	8,000	8,000	1.39	4.5	0.161 (0.143)
AKM23C	S30101	3.20 (28.4)	0.0 (0.0)	1.13 (10.0)	0.99 (8.79)	4,370	5,500	7,470	1.41	4.5	0.216 (0.191)
AKM23D	S30301	3.42 (30.2)	2.84 (25.1)	1.16 (10.2)	0.92 (8.11)	7,040	8,000	8,000	2.19	7.5	0.216 (0.191)
AKM24C	S30101	3.94 (34.9)	0.0 (0.0)	1.38 (12.2)	1.25 (11.0)	3,780	4,500	6,200	1.42	4.5	0.27 (0.239)
AKM24D	S30301	4.22 (37.3)	2.51 (22.2)	1.41 (12.4)	1.11 (9.81)	6,130	8,000	8,000	2.21	7.5	0.27 (0.239)
AKM31C	S30101	3.34 (29.6)	0.0 (0.0)	1.15 (10.2)	1.00 (8.86)	3,820	5,000	7,110	1.37	4.5	0.33 (0.292)
AKM32C	S30101	5.74 (50.8)	0.0 (0.0)	2.00 (17.7)	1.86 (16.5)	2,540	3,000	4,320	1.44	4.5	0.59 (0.522)
AKM32D	S30301	6.18 (54.7)	0.0 (0.0)	2.04 (18.0)	1.65 (14.6)	4,150	5,500	6,570	2.23	7.5	0.59 (0.522)
AKM33C	S30101	7.83 (69.3)	0.0 (0.0)	2.71 (24.0)	2.54 (22.5)	1,900	2,000	3,230	1.47	4.5	0.85 (0.752)
AKM33E	S30301	7.70 (68.2)	0.0 (0.0)	2.79 (24.7)	2.34 (20.7)	3,920	4,500	5,490	2.58	7.5	0.85 (0.752)
AKM41C	S30101	5.12 (45.3)	0.0 (0.0)	1.95 (17.3)	1.77 (15.6)	2,000	3,000	4,490	1.46	4.5	0.81 (0.717)
AKM41E	S30301	4.64 (41.0)	3.33 (29.5)	2.02 (17.8)	1.58 (14.0)	4,710	6,000	6,000	2.85	7.5	0.81 (0.717)
AKM42C	S30101	9.37 (82.9)	0.0 (0.0)	3.35 (29.6)	3.10 (27.4)	1,150	1,500	2,510	1.4	4.5	1.45 (1.28)
AKM42E	S30301	8.41 (74.4)	0.0 (0.0)	3.42 (30.3)	2.81 (24.9)	2,900	3,500	4,790	2.74	7.5	1.45 (1.28)
AKM42G	S30601	7.99 (70.7)	6.79 (60.1)	3.53 (31.2)	2.35 (20.8)	5,440	6,000	6,000	4.8	12.0	1.45 (1.28)
AKM43E	S30301	11.7 (104)	0.0 (0.0)	4.70 (41.6)	3.92 (34.7)	2,210	2,500	3,500	2.76	7.5	2.09 (1.85)
AKM43G	S30601	10.9 (96.8)	1.18 (10.4)	4.80 (42.5)	3.01 (26.6)	4,290	5,000	6,000	4.87	12.0	2.09 (1.85)
AKM44E	S30301	14.1 (125)	0.0 (0.0)	5.76 (51.0)	4.80 (42.5)	1,970	2,000	2,950	2.85	7.5	2.73 (2.42)
AKM44G	S30601	13.3 (118)	0.0 (0.0)	5.88 (52.0)	3.76 (33.3)	3,760	4,000	5,060	5	12.0	2.73 (2.42)
AKM51E	S30301	10.9 (96.1)	0.0 (0.0)	4.70 (41.6)	3.98 (35.3)	2,070	2,500	3,510	2.75	7.5	3.42 (3.03)
AKM51G	S30601	10.2 (90.4)	1.29 (11.4)	4.75 (42.1)	2.62 (23.2)	4,060	5,000	6,000	4.84	12.0	3.42 (3.03)
AKM52E	S30301	18.5 (164)	0.0 (0.0)	8.34 (73.8)	7.61 (67.4)	1,440	1,500	2,160	2.99	7.5	6.22 (5.51)
AKM52G	S30601	18.9 (168)	0.0 (0.0)	8.43 (74.6)	7.06 (62.5)	2,370	2,500	3,360	4.72	12.0	6.22 (5.51)
AKM53G	S30601	25.8 (229)	0.0 (0.0)	11.4 (101)	9.85 (87.2)	1,860	2,000	2,520	4.77	12.0	9.12 (8.07)
AKM54G	S30601	31.7 (280)	0.0 (0.0)	14.3 (126)	12.9 (114)	1,600	1,500	2,090	4.98	12.0	11.9 (10.5)
AKM62G	S30601	25.6 (227)	0.0 (0.0)	11.9 (106)	10.7 (94.4)	1,530	1,800	2,440	4.85	12.0	16.9 (15)
AKM63G	S30601	38.4 (340)	0.0 (0.0)	16.5 (146)	15.3 (136)	1,030	1,200	1,630	4.48	12.0	24.2 (21.4)

Recommended Motor/Drive Systems, 480 VAC, 640 VDC bus ①

Servo Motor Model	Servo Drive Model	Peak Stall Torque T_{ps} @ N-m (lb-in)	Peak Torque at at Max. Speed T_{ms} N-m (lb-in)	Cont. Stall Torque T_{cs} N-m (lb-in)	Cont. Rated Torque T_{cr} N-m (lb-in)	Speed at Knee ω_k rpm	Rated Speed ω_r rpm	wmax. Speed ω_{max} rpm	Cont. Stall Current I_{cs} A _{rms}	Current@Peak Torque I_{ps} A _{rms}	Inertia ③ J kg-cm ² (lb-in-s ² x 10 ⁻³)
AKM22C	S30101	2.34 (20.7)	1.76 (15.5)	0.84 (7.48)	0.68 (5.99)	6,500	8,000	8,000	1.39	4.5	0.161 (0.143)
AKM23C	S30101	3.20 (28.4)	0.85 (7.51)	1.13 (10.0)	0.95 (8.39)	5,190	7,000	8,000	1.41	4.5	0.216 (0.191)
AKM23D	S30301	3.42 (30.2)	0.0 (0.0)	1.16 (10.2)	0.92 (8.11)	8,000	8,000	8,000	2.19	7.5	0.216 (0.191)
AKM24C	S30101	3.94 (34.9)	0.0 (0.0)	1.38 (12.2)	1.22 (10.8)	4,490	5,500	7,090	1.42	4.5	0.27 (0.239)
AKM24D	S30301	4.22 (37.3)	3.51 (31.1)	1.41 (12.4)	1.11 (9.81)	7,160	8,000	8,000	2.21	7.5	0.27 (0.239)
AKM31C	S30101	3.34 (29.6)	0.26 (2.34)	1.15 (10.2)	0.91 (8.07)	4,530	6,000	8,000	1.37	4.5	0.33 (0.292)
AKM32C	S30101	5.74 (50.8)	0.0 (0.0)	2.00 (17.7)	1.83 (16.2)	3,040	3,500	4,930	1.44	4.5	0.59 (0.522)
AKM32D	S30301	6.18 (54.7)	0.0 (0.0)	2.04 (18.0)	1.58 (14.0)	4,870	6,000	7,510	2.23	7.5	0.59 (0.522)
AKM33C	S30101	7.83 (69.3)	0.0 (0.0)	2.71 (24.0)	2.50 (22.1)	2,300	2,500	3,690	1.47	4.5	0.85 (0.752)
AKM33E	S30301	7.70 (68.2)	0.0 (0.0)	2.79 (24.7)	2.27 (20.1)	4,590	5,000	6,280	2.58	7.5	0.85 (0.752)
AKM41C	S30101	5.12 (45.3)	0.0 (0.0)	1.95 (17.3)	1.74 (15.4)	2,370	3,500	5,130	1.46	4.5	0.81 (0.717)
AKM41E	S30301	4.64 (41.0)	4.08 (36.1)	2.02 (17.8)	1.58 (14.0)	5,440	6,000	6,000	2.85	7.5	0.81 (0.717)
AKM42C	S30101	9.37 (82.9)	0.0 (0.0)	3.35 (29.6)	3.02 (26.8)	1,380	2,000	2,870	1.4	4.5	1.45 (1.28)
AKM42E	S30301	8.41 (74.4)	0.0 (0.0)	3.42 (30.3)	2.72 (24.0)	3,370	4,000	5,480	2.74	7.5	1.45 (1.28)
AKM43E	S30301	11.7 (104)	0.0 (0.0)	4.70 (41.6)	3.76 (33.3)	2,570	3,000	4,000	2.76	7.5	2.09 (1.85)
AKM43G	S30601	10.9 (96.8)	6.75 (59.7)	4.80 (42.5)	2.57 (22.7)	4,950	6,000	6,000	4.87	12.0	2.09 (1.85)
AKM44E	S30301	14.1 (125)	0.0 (0.0)	5.76 (51.0)	4.56 (40.4)	2,300	2,500	3,370	2.85	7.5	2.73 (2.42)
AKM44G	S30601	13.3 (118)	0.0 (0.0)	5.88 (52.0)	3.19 (28.2)	4,350	5,000	5,790	5	12.0	2.73 (2.42)
AKM51E	S30301	10.9 (96.1)	0.0 (0.0)	4.70 (41.6)	3.80 (33.6)	2,420	3,000	4,010	2.75	7.5	3.42 (3.03)
AKM51G	S30601	10.2 (90.4)	5.94 (52.6)	4.75 (42.1)	1.94 (17.2)	4,680	6,000	6,000	4.84	12.0	3.42 (3.03)
AKM52E	S30301	18.5 (164)	0.0 (0.0)	8.34 (73.8)	7.28 (64.4)	1,690	2,000	2,470	2.99	7.5	6.22 (5.51)
AKM52G	S30601	18.9 (168)	0.0 (0.0)	8.43 (74.6)	6.66 (59.0)	2,750	3,000	3,840	4.72	12.0	6.22 (5.51)
AKM53G	S30601	25.8 (229)	0.0 (0.0)	11.4 (101)	9.85 (87.2)	2,160	2,400	2,880	4.77	12.0	9.12 (8.07)
AKM54G	S30601	31.7 (280)	0.0 (0.0)	14.3 (126)	12.3 (109)	1,860	2,000	2,390	4.98	12.0	11.9 (10.5)
AKM62G	S30601	25.6 (227)	0.0 (0.0)	11.9 (106)	10.2 (90.1)	1,780	2,000	2,790	4.85	12.0	16.9 (15)
AKM63G	S30601	38.4 (340)	0.0 (0.0)	16.5 (146)	14.6 (129)	1,200	1,500	1,860	4.48	12.0	24.2 (21.4)

System Overview - AKM Motors & S600 Drives

Recommended Motor/Drive Systems, 240 VAC, 320 VDC bus ①

Servo Motor Model	Servo Drive Model	Peak Stall Torque T_{ps} ② N-m (lb-in)	Peak Torque at at Max. Speed T_{ms} N-m (lb-in)	Cont. Stall Torque T_{cs} N-m (lb-in)	Cont. Rated Torque T_{cr} N-m (lb-in)	Speed at Knee ω_k rpm	Rated Speed ω_r rpm	wmax. Speed ω_{max} rpm	Cont. Stall Current I_{cs} A _{rms}	Current@Peak Torque I_{ps} A _{rms}	Inertia ③ J kg-cm ² (lb-in-s ² x 10 ⁻³)
AKM11B	S60300	0.61 (5.39)	0.584 (5.17)	0.18 (1.62)	0.17 (1.47)	7,700	8,000	8,000	1.16	4.7	0.017 (0.015)
AKM12C	S60300	1.07 (9.47)	1.06 (9.38)	0.31 (2.74)	0.28 (2.47)	7,950	8,000	8,000	1.51	6.0	0.031 (0.0274)
AKM13C	S60300	1.46 (12.9)	1.06 (9.38)	0.41 (3.62)	0.36 (3.22)	6,080	8,000	8,000	1.48	5.9	0.045 (0.0398)
AKM22E	S60300	1.76 (15.6)	1.61 (14.2)	0.87 (7.71)	0.70 (6.18)	7,750	8,000	8,000	2.73	6.0	0.161 (0.143)
AKM23D	S60300	2.87 (25.4)	0.0 (0.0)	1.16 (10.2)	1.03 (9.08)	4,090	5,000	6,540	2.19	6.0	0.216 (0.191)
AKM23F	S60600	2.96 (26.2)	2.96 (26.2)	1.18 (10.4)	0.94 (8.28)	8,000	8,000	8,000	4.31	12.0	0.216 (0.191)
AKM24D	S60300	3.52 (31.2)	0.0 (0.0)	1.41 (12.4)	1.29 (11.4)	3,500	4,000	5,420	2.21	6.0	0.27 (0.239)
AKM24F	S60600	3.94 (34.9)	2.41 (21.3)	1.42 (12.6)	1.12 (9.91)	6,410	8,000	8,000	3.89	12.0	0.27 (0.239)
AKM32D	S60300	5.14 (45.5)	0.0 (0.0)	2.04 (18.0)	1.93 (17.1)	2,330	2,500	3,750	2.23	6.0	0.59 (0.522)
AKM33E	S60300	6.35 (56.2)	0.0 (0.0)	2.79 (24.7)	2.62 (23.2)	2,170	2,000	3,140	2.58	6.0	0.85 (0.752)
AKM41E	S60300	3.87 (34.2)	0.0 (0.0)	2.02 (17.8)	1.82 (16.1)	2,930	3,000	4,850	2.85	6.0	0.81 (0.717)
AKM41H	S60600	3.99 (35.3)	3.83 (33.9)	2.06 (18.2)	1.62 (14.3)	5,900	6,000	6,000	5.6	12.0	0.81 (0.717)
AKM42E	S60300	6.97 (61.7)	0.0 (0.0)	3.42 (30.3)	3.12 (27.6)	1,730	1,800	2,740	2.74	6.0	1.45 (1.28)
AKM42G	S60600	7.99 (70.7)	0.0 (0.0)	3.53 (31.2)	2.9 (25.7)	2,950	3,500	4,660	4.8	12.0	1.45 (1.28)
AKM42J	S61000	7.75 (68.6)	6.52 (57.7)	3.56 (31.5)	2.38 (21.0)	5,460	6,000	6,000	8.4	20.0	1.45 (1.28)
AKM42J	S610-3000	10.7 (94.5)	6.52 (57.7)	3.56 (31.5)	2.38 (21.0)	4,160	6,000	6,000	8.4	30.0	1.45 (1.28)
AKM43E	S60300	9.67 (85.6)	0.0 (0.0)	4.7 (41.6)	4.24 (37.6)	1,280	1,500	2,000	2.76	6.0	2.09 (1.85)
AKM43G	S60600	10.9 (96.8)	0.0 (0.0)	4.8 (42.5)	4.0 (35.4)	2,310	2,500	3,470	4.87	12.0	2.09 (1.85)
AKM43K	S61000	9.66 (85.5)	5.44 (48.1)	4.9 (43.4)	2.62 (23.2)	5,120	6,000	6,000	9.6	20.0	2.09 (1.85)
AKM43K	S610-3000	13.6 (120)	5.41 (47.9)	4.9 (43.4)	2.62 (23.2)	4,090	6,000	6,000	9.6	30.0	2.09 (1.85)
AKM44E	S60300	11.6 (103)	0.0 (0.0)	5.76 (51)	5.2 (46)	1,120	1,200	1,680	2.85	6.0	2.73 (2.42)
AKM44G	S60600	13.3 (118)	0.0 (0.0)	5.88 (52.0)	4.9 (43.4)	2,010	2,000	2,890	5.0	12.0	2.73 (2.42)
AKM44J	S61000	12.9 (114)	0.0 (0.0)	6.0 (53.1)	3.84 (34)	3,800	4,000	5,010	8.8	20.0	2.73 (2.42)
AKM44J	S610-3000	18.1 (160)	0.0 (0.0)	6.0 (53.1)	3.84 (34)	3,030	4,000	5,010	8.8	30.0	2.73 (2.42)
AKM51E	S60300	9.14 (80.9)	0.0 (0.0)	4.7 (41.6)	4.41 (39)	1,210	1,200	2,010	2.75	6.0	3.42 (3.03)
AKM51G	S60600	10.2 (90.4)	0.0 (0.0)	4.75 (42.1)	4.03 (35.6)	2,180	2,500	3,480	4.84	12.0	3.42 (3.03)
AKM51K	S61000	9.22 (81.6)	4.47 (39.6)	4.9 (43.4)	2.35 (20.8)	4,740	5,500	6,000	9.4	20.0	3.42 (3.03)
AKM51K	S610-3000	12.0 (106)	4.45 (39.4)	4.9 (43.4)	2.35 (20.8)	3,830	5,500	6,000	9.4	28.3	3.42 (3.03)
AKM52G	S60600	18.9 (168)	0.0 (0.0)	8.43 (74.6)	7.69 (68.1)	1,240	1,500	1,920	4.72	12.0	6.22 (5.51)
AKM52K	S61000	16.9 (150)	0.0 (0.0)	8.6 (76.1)	6.8 (60.2)	2,820	3,000	3,690	9.3	20.0	6.22 (5.51)
AKM52K	S610-3000	21.9 (194)	0.0 (0.0)	8.6 (76.1)	6.8 (60.2)	2,370	3,000	3,690	9.3	27.8	6.22 (5.51)
AKM52M	S61400	16.7 (148)	0.0 (0.0)	8.6 (76.1)	5.2 (46.0)	4,110	4,500	5,230	13.1	28.0	6.22 (5.51)
AKM53G	S60600	25.8 (229)	0.0 (0.0)	11.4 (101)	10.7 (94.5)	959	1,000	1,440	4.77	12.0	9.12 (8.07)
AKM53K	S61000	22.9 (203)	0.0 (0.0)	11.6 (103)	10.1 (89)	2,220	2,000	2,780	9.4	20.0	9.12 (8.07)
AKM53K	S610-3000	30.2 (267)	0.0 (0.0)	11.6 (103)	10.1 (89)	1,880	2,000	2,780	9.4	28.1	9.12 (8.07)
AKM53M	S61400	22.1 (196)	0.0 (0.0)	11.4 (101)	8.72 (77.2)	3,360	3,000	4,050	13.4	28.0	9.12 (8.07)
AKM53P	S62000	22.2 (196)	0.0 (0.0)	11.4 (101)	5.88 (52.0)	4,900	5,000	5,770	19.1	40.0	9.12 (8.07)
AKM54K	S61000	28.1 (249)	0.0 (0.0)	14.4 (127)	12.7 (112)	1,880	1,800	2,290	9.7	20.0	11.9 (10.5)
AKM54K	S610-3000	38.4 (340)	0.0 (0.0)	14.4 (127)	12.7 (112)	1,590	1,800	2,290	9.7	29.2	11.9 (10.5)
AKM54L	S61400	29.5 (261)	0.0 (0.0)	14.1 (125)	11.5 (101)	2,500	2,500	3,040	12.5	28.0	11.9 (10.5)
AKM54N	S62000	29.6 (262)	0.0 (0.0)	14.1 (125)	9.85 (87.2)	3,580	3,500	4,320	17.8	40.0	11.9 (10.5)
AKM62K	S61000	22.7 (201)	0.0 (0.0)	12.2 (108)	10.4 (92)	1,870	2,000	2,700	9.6	20.0	16.9 (15)
AKM62K	S610-3000	30.1 (267)	0.0 (0.0)	12.2 (108)	10.4 (92)	1,480	2,000	2,700	9.6	28.7	16.9 (15)
AKM62M	S61400	22.8 (201)	0.0 (0.0)	12.2 (108)	9.5 (84.1)	2,650	3,000	3,770	13.4	28.0	16.9 (15)
AKM62P	S62000	23.2 (206)	0.0 (0.0)	12.3 (109)	8.1 (71.7)	3,760	4,500	5,250	18.8	40.0	16.9 (15)
AKM63K	S61000	31 (274)	0.0 (0.0)	16.8 (149)	14.9 (131)	1,510	1,500	2,020	9.9	20.0	24.2 (21.4)
AKM63K	S610-3000	42.6 (377)	0.0 (0.0)	16.8 (149)	14.9 (131)	1,200	1,500	2,020	9.9	29.7	24.2 (21.4)
AKM63M	S61400	31.4 (278)	0.0 (0.0)	17 (150)	14.3 (127)	2,120	2,000	2,770	13.8	28.0	24.2 (21.4)
AKM63N	S62000	34.8 (308)	0.0 (0.0)	17 (150)	13 (115)	2,550	3,000	3,500	17.4	40.0	24.2 (21.4)
AKM64K	S61000	41.2 (365)	0.0 (0.0)	20.8 (184)	19.2 (170)	1,120	1,200	1,510	9.2	20.0	31.6 (28)
AKM64L	S61400	41.9 (371)	0.0 (0.0)	21 (186)	18.4 (163)	1,590	1,500	2,080	12.8	28.0	31.6 (28)
AKM64P	S62000	40.2 (355)	0.0 (0.0)	20.4 (180)	16.0 (142)	2,480	2,500	3,120	18.6	40.0	31.6 (28)
AKM65K	S61000	46.8 (414)	0.0 (0.0)	24.8 (219)	22.8 (202)	1,060	1,000	1,350	9.8	20.0	40.0 (35.4)
AKM65M	S61400	47.6 (421)	0.0 (0.0)	25 (221)	21.9 (194)	1,500	1,500	1,860	13.6	28.0	40.0 (35.4)
AKM65N	S62000	50.2 (444)	0.0 (0.0)	24.3 (215)	19.8 (175)	1,980	2,000	2,500	17.8	40.0	40.0 (35.4)
AKM72P	S62000	58.4 (516)	0.0 (0.0)	29.4 (260)	23.8 (211)	1,590	1,800	2,170	18.7	40.0	64.5 (57.1)
AKM73P	S62000	79.4 (702)	0.0 (0.0)	41.6 (368)	34.7 (307)	1,250	1,300	1,610	19.5	40.0	92.1 (81.5)

System Overview - AKM Motors & S600 Drives

Recommended Motor/Drive Systems, 400 VAC, 560 VDC bus ①

Servo Motor Model	Servo Drive Model	Peak Stall Torque T_{ps} N-m (lb-in)	Peak Torque at Max. Speed T_{ms} N-m (lb-in)	Cont. Stall Torque T_{cs} N-m (lb-in)	Cont. Rated Torque T_{cr} N-m (lb-in)	Speed at Knee ω_k rpm	Rated Speed ω_r rpm	wmax. Speed ω_{max} rpm	Cont. Stall Current I_{cs} A _{rms}	Current@Peak Torque I_{ps} A _{rms}	Inertia ③ J kg-cm ² (lb-in-s ² x 10 ⁻³)
AKM23D	S60300	2.87 (25.4)	2.87 (25.4)	1.16 (10.2)	0.92 (8.11)	8,000	8,000	8,000	2.19	6.0	0.216 (0.191)
AKM24D	S60300	3.52 (31.2)	2.48 (21.9)	1.41 (12.4)	1.11 (9.81)	6,930	8,000	8,000	2.21	6.0	0.27 (0.239)
AKM32D	S60300	5.14 (45.5)	0.0 (0.0)	2.04 (18.0)	1.65 (14.6)	4,710	5,500	6,570	2.23	6.0	0.59 (0.522)
AKM33E	S60300	6.35 (56.2)	0.0 (0.0)	2.79 (24.7)	2.34 (20.7)	4,330	4,500	5,490	2.58	6.0	0.85 (0.752)
AKM41E	S60300	3.87 (34.2)	3.29 (29.1)	2.02 (17.8)	1.58 (14.0)	5,470	6,000	6,000	2.85	6.0	0.81 (0.717)
AKM42E	S60300	6.97 (61.7)	0.0 (0.0)	3.42 (30.3)	2.81 (24.9)	3,320	3,500	4,790	2.74	6.0	1.45 (1.28)
AKM42G	S60600	7.99 (70.7)	6.71 (59.4)	3.53 (31.2)	2.35 (20.8)	5,440	6,000	6,000	4.8	12.0	1.45 (1.28)
AKM43E	S60300	9.67 (85.6)	0.0 (0.0)	4.7 (41.6)	3.92 (34.7)	2,510	2,500	3,500	2.76	6.0	2.09 (1.85)
AKM43G	S60600	10.9 (96.8)	1.25 (11.1)	4.8 (42.5)	3.01 (26.6)	4,290	5,000	6,000	4.87	12.0	2.09 (1.85)
AKM44E	S60300	11.6 (103)	0.0 (0.0)	5.76 (51)	4.8 (42.5)	2,210	2,000	2,950	2.85	6.0	2.73 (2.42)
AKM44G	S60600	13.3 (118)	0.0 (0.0)	5.88 (52.0)	3.76 (33.3)	3,760	4,000	5,060	5.0	12.0	2.73 (2.42)
AKM44J	S610-3000	18.1 (160)	16 (142)	6 (53.1)	2.75 (24.3)	5,550	6,000	6,000	8.8	30.0	2.73 (2.42)
AKM51E	S60300	9.14 (80.9)	0.0 (0.0)	4.7 (41.6)	3.98 (35.3)	2,380	2,500	3,510	2.75	6.0	3.42 (3.03)
AKM51G	S60600	10.2 (90.4)	1.26 (11.2)	4.75 (42.1)	2.62 (23.2)	4,060	5,000	6,000	4.84	12.0	3.42 (3.03)
AKM52E	S60300	15.4 (136)	0.0 (0.0)	8.34 (73.8)	7.61 (67.4)	1,620	1,500	2,160	3.0	6.0	6.22 (5.51)
AKM52G	S60600	18.9 (168)	0.0 (0.0)	8.43 (74.6)	7.06 (62.5)	2,370	2,500	3,360	4.72	12.0	6.22 (5.51)
AKM52K	S61000	16.9 (150)	8.52 (75.4)	8.6 (76.1)	3.9 (34.5)	5,120	5,500	6,000	9.3	20.0	6.22 (5.51)
AKM52K	S610-3000	21.9 (194)	8.54 (75.6)	8.6 (76.1)	3.9 (34.5)	4,340	5,500	6,000	9.3	27.8	6.22 (5.51)
AKM53G	S60600	25.8 (229)	0.0 (0.0)	11.4 (101)	9.85 (87.2)	1,860	2,000	2,520	4.77	12.0	9.12 (8.07)
AKM53K	S61000	22.9 (203)	0.0 (0.0)	11.6 (103)	7.65 (67.7)	4,050	4,000	4,860	9.4	20.0	9.12 (8.07)
AKM53K	S610-3000	30.2 (267)	0.0 (0.0)	11.6 (103)	7.65 (67.7)	3,480	4,000	4,860	9.4	28.1	9.12 (8.07)
AKM54G	S60600	31.7 (280)	0.0 (0.0)	14.3 (126)	12.9 (114)	1,600	1,500	2,090	5.0	12.0	11.9 (10.6)
AKM54K	S61000	28.1 (249)	0.0 (0.0)	14.4 (127)	10.1 (89)	3,440	3,500	4,020	9.7	20.0	11.9 (10.6)
AKM54K	S610-3000	38.4 (340)	0.0 (0.0)	14.4 (127)	10.1 (89)	2,950	3,500	4,020	9.7	29.2	11.9 (10.6)
AKM54L	S61400	29.5 (261)	0.0 (0.0)	14.1 (125)	8.13 (72)	4,540	4,500	5,320	12.5	28.0	11.9 (10.6)
AKM62G	S60600	25.6 (227)	0.0 (0.0)	11.9 (106)	10.4 (91.9)	1,530	1,800	2,440	4.85	12.0	16.9 (15)
AKM62K	S61000	22.7 (201)	0.0 (0.0)	12.2 (108)	9.01 (79.7)	3,390	3,500	4,720	9.6	20.0	16.9 (15)
AKM62K	S610-3000	30.1 (267)	0.0 (0.0)	12.2 (108)	9.01 (79.7)	2,720	3,500	4,720	9.6	28.7	16.9 (15)
AKM62M	S61400	22.8 (202)	11.4 (101)	12.2 (108)	5.74 (50.8)	4,770	6,000	6,000	13.4	28.0	16.9 (15)
AKM63G	S60600	38.4 (340)	0.0 (0.0)	16.5 (146)	15 (133)	1,030	1,200	1,630	4.48	12.0	24.2 (21.4)
AKM63K	S61000	31 (274)	0.0 (0.0)	16.8 (149)	12.9 (114)	2,760	3,000	3,530	9.9	20.0	24.2 (21.4)
AKM63K	S610-3000	42.6 (377)	0.0 (0.0)	16.8 (149)	12.9 (114)	2,230	3,000	3,530	9.9	29.7	24.2 (21.4)
AKM63M	S61400	31.4 (278)	0.0 (0.0)	17 (150)	11.3 (100)	3,830	4,000	4,850	13.8	28.0	24.2 (21.4)
AKM63N	S62000	34.8 (308)	7.75 (68.6)	17 (150)	9.6 (85)	4,580	5,000	6,000	17.4	40.0	24.2 (21.4)
AKM64K	S61000	41.2 (365)	0.0 (0.0)	20.8 (184)	17.2 (152)	2,080	2,000	2,650	9.2	20.0	31.6 (28)
AKM64K	S610-3000	53.5 (473)	0.0 (0.0)	20.8 (184)	17.2 (152)	1,770	2,000	2,650	9.2	27.5	31.6 (28)
AKM64L	S61400	41.9 (371)	0.0 (0.0)	21 (186)	15.6 (138)	2,900	3,000	3,640	12.8	28.0	31.6 (28)
AKM64P	S62000	40.2 (355)	0.0 (0.0)	20.4 (180)	11.9 (106)	4,470	4,500	5,460	18.6	40.0	31.6 (28)
AKM65K	S61000	46.8 (414)	0.0 (0.0)	24.8 (219)	20.2 (179)	1,960	2,000	2,370	9.8	20.0	40.0 (35.4)
AKM65K	S610-3000	64.5 (571)	0.0 (0.0)	24.8 (219)	20.2 (179)	1,640	2,000	2,370	9.8	29.4	40.0 (35.4)
AKM65M	S61400	47.6 (421)	0.0 (0.0)	25 (221)	19.2 (170)	2,710	2,500	3,250	13.6	28.0	40.0 (35.4)
AKM65N	S62000	50.2 (444)	0.0 (0.0)	24.3 (215)	16.0 (142)	3,590	3,500	4,370	17.8	40.0	40.0 (35.4)
AKM72K	S61000	59.4 (526)	0.0 (0.0)	29.7 (263)	25.1 (222)	1,350	1,500	1,860	9.3	20.0	64.5 (57.1)
AKM72K	S610-3000	79.2 (701)	0.0 (0.0)	29.7 (263)	25.1 (222)	1,110	1,500	1,860	9.3	27.8	64.5 (57.1)
AKM72M	S61400	59.8 (529)	0.0 (0.0)	30 (266)	23.6 (209)	1,900	2,000	2,590	13	28.0	64.5 (57.1)
AKM72P	S62000	58.4 (516)	0.0 (0.0)	29.4 (260)	20.1 (178)	2,850	3,000	3,800	18.7	40.0	64.5 (57.1)
AKM73M	S61400	80.7 (714)	0.0 (0.0)	42 (372)	33.8 (299)	1,510	1,500	1,940	13.6	28.0	92.1 (81.5)
AKM73P	S62000	79.4 (702)	0.0 (0.0)	41.6 (368)	28.5 (252)	2,240	2,400	2,830	19.5	40.0	92.1 (81.5)
AKM74L	S61400	108 (952)	0.0 (0.0)	53 (469)	45.5 (403)	1,120	1,200	1,460	12.9	28.0	120.0 (106)
AKM74P	S62000	106 (936)	0.0 (0.0)	52.5 (464)	37.6 (333)	1,680	1,800	2,120	18.5	40.0	120.0 (106)

- ① See definitions of ratings beginning on page 8.
- ② Peak torque ratings are for 5 seconds.
- ③ Includes resolver feedback inertia.

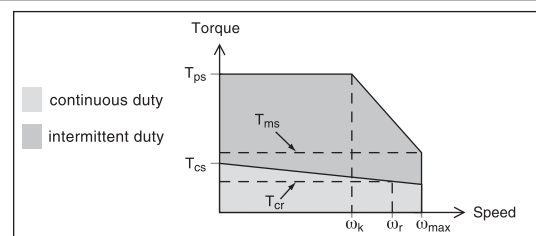

System Overview - AKM Motors & S600 Drives

Recommended Motor/Drive Systems, 480 VAC, 640VDC ①

Servo Motor Model	Servo Drive Model	Peak Stall Torque T_{ps} ② N-m (lb-in)	Peak Torque at Max. Speed T_{ms} N-m (lb-in)	Cont. Stall Torque T_{cs} N-m (lb-in)	Cont. Rated Torque T_{cr} N-m (lb-in)	Speed at Knee ω_k rpm	Rated Speed ω_r rpm	wmax. Speed ω_{max} rpm	Cont. Stall Current I_{cs} A _{rms}	Current@Peak Torque I_{ps} A _{rms}	Inertia ③ J kg-cm ² (lb-in-s ² x 10 ⁻³)
AKM23D	S60300	2.87 (25.4)	2.87 (25.4)	1.16 (10.2)	0.92 (8.11)	8,000	8,000	8,000	2.19	6.0	0.216 (0.191)
AKM24D	S60300	3.52 (31.2)	3.52 (31.2)	1.41 (12.4)	1.11 (9.81)	8,000	8,000	8,000	2.21	6.0	0.27 (0.239)
AKM32D	S60300	5.14 (45.5)	0.0 (0.0)	2.04 (18.0)	1.58 (14)	5,500	6,000	7,510	2.23	6.0	0.59 (0.522)
AKM33E	S60300	6.35 (56.2)	0.0 (0.0)	2.79 (24.7)	2.27 (20.1)	5,050	5,000	6,280	2.58	6.0	0.85 (0.752)
AKM41E	S60300	3.87 (34.2)	3.87 (34.2)	2.02 (17.8)	1.58 (14.0)	6,000	6,000	6,000	2.85	6.0	0.81 (0.717)
AKM42E	S60300	6.97 (61.7)	0.0 (0.0)	3.42 (30.3)	2.72 (24.1)	3,850	4,000	5,480	2.74	6.0	1.45 (1.28)
AKM42G	S60600	7.99 (70.7)	7.99 (70.7)	3.53 (31.2)	2.35 (20.8)	6,000	6,000	6,000	4.8	12.0	1.45 (1.28)
AKM43E	S60300	9.67 (85.6)	0.0 (0.0)	4.7 (41.6)	3.76 (33.3)	2,910	3,000	4,000	2.76	6.0	2.09 (1.85)
AKM43G	S60600	10.9 (96.8)	6.7 (59.3)	4.8 (42.5)	2.57 (22.7)	4,950	6,000	6,000	4.87	12.0	2.09 (1.85)
AKM44E	S60300	11.6 (103)	0.0 (0.0)	5.76 (51)	4.56 (40.4)	2,570	2,500	3,370	2.85	6.0	2.73 (2.42)
AKM44G	S60600	13.3 (118)	0.0 (0.0)	5.88 (52.0)	3.19 (28.2)	4,350	5,000	5,790	5.0	12.0	2.73 (2.42)
AKM44J	S610-3000	18.1 (160)	18.1 (160)	6.0 (53.1)	2.75 (24.3)	6,000	6,000	6,000	8.8	30.0	2.73 (2.42)
AKM51E	S60300	9.14 (80.9)	0.0 (0.0)	4.7 (41.6)	3.8 (33.7)	2,770	3,000	4,010	2.75	6.0	3.42 (3.03)
AKM51G	S60600	10.2 (90.4)	5.9 (52.2)	4.75 (42.1)	1.94 (17.2)	4,680	6,000	6,000	4.84	12.0	3.42 (3.03)
AKM52E	S60300	15.4 (136)	0.0 (0.0)	8.34 (73.8)	7.28 (64.4)	1,890	2,000	2,470	3.0	6.0	6.22 (5.51)
AKM52G	S60600	18.9 (168)	0.0 (0.0)	8.43 (74.6)	6.66 (59)	2,750	3,000	3,840	4.72	12.0	6.22 (5.51)
AKM52K	S61000	16.9 (150)	15.8 (140)	8.6 (76.1)	3.25 (28.8)	5,890	6,000	6,000	9.3	20.0	6.22 (5.51)
AKM52K	S610-3000	21.9 (194)	15.7 (139)	8.6 (76.1)	3.25 (28.8)	4,990	6,000	6,000	9.3	27.8	6.22 (5.51)
AKM53G	S60600	25.8 (229)	0.0 (0.0)	11.4 (101)	9.5 (84)	2,160	2,400	2,880	4.77	12.0	9.12 (8.07)
AKM53K	S61000	22.9 (203)	0.0 (0.0)	11.6 (103)	6.85 (60.6)	4,650	4,500	5,550	9.4	20.0	9.12 (8.07)
AKM53K	S610-3000	30.2 (267)	0.0 (0.0)	11.6 (103)	6.85 (60.6)	4,014	4,500	5,550	9.4	28.1	9.12 (8.07)
AKM54G	S60600	31.7 (280)	0.0 (0.0)	14.3 (126)	12.3 (109)	1,860	2,000	2,390	5.0	12.0	11.9 (10.6)
AKM54K	S61000	28.1 (249)	0.0 (0.0)	14.4 (127)	9.25 (81.9)	3,960	4,000	4,590	9.7	20.0	11.9 (10.6)
AKM54K	S610-3000	38.4 (340)	0.0 (0.0)	14.4 (127)	9.25 (81.9)	3,410	4,000	4,590	9.7	29.2	11.9 (10.6)
AKM62G	S60600	25.6 (227)	0.0 (0.0)	11.9 (106)	10.2 (90.1)	1,780	2,000	2,790	4.85	12.0	16.9 (15)
AKM62K	S61000	22.7 (201)	0.0 (0.0)	12.2 (108)	8.02 (71)	3,900	4,500	5,400	9.6	20.0	16.9 (15)
AKM62K	S610-3000	30.1 (267)	0.0 (0.0)	12.2 (108)	8.02 (71)	3,130	4,500	5,400	9.6	28.7	16.9 (15)
AKM62M	S61400	22.8 (201)	18.8 (166)	12.2 (108)	5.74 (50.8)	5,480	6,000	6,000	13.4	28.0	16.9 (15)
AKM63G	S60600	38.4 (340)	0.0 (0.0)	16.5 (146)	14.6 (128)	1,200	1,500	1,860	4.48	12.0	24.2 (21.4)
AKM63K	S61000	31 (274)	0.0 (0.0)	16.8 (149)	12 (106)	3,170	3,500	4,030	9.9	20.0	24.2 (21.4)
AKM63K	S610-3000	42.6 (377)	0.0 (0.0)	16.8 (149)	12 (106)	2,580	3,500	4,030	9.9	29.7	24.2 (21.4)
AKM63M	S61400	31.4 (278)	0.0 (0.0)	17 (150)	10.5 (92.9)	4,400	4,500	5,550	13.8	28.0	24.2 (21.4)
AKM63N	S62000	34.8 (308)	24.6 (218)	17 (150)	7.0 (62)	5,260	6,000	6,000	17.4	40.0	24.2 (21.4)
AKM64K	S61000	41.2 (365)	0.0 (0.0)	20.8 (184)	16.3 (145)	2,400	2,500	3,030	9.2	20.0	31.6 (28)
AKM64K	S610-3000	53.5 (474)	0.0 (0.0)	20.8 (184)	16.3 (145)	2,050	2,500	3,030	9.2	27.5	31.6 (28)
AKM64L	S61400	41.9 (371)	0.0 (0.0)	21 (186)	14.4 (127)	3,340	3,500	4,160	12.8	28.0	31.6 (28)
AKM64P	S62000	40.2 (355)	15.6 (138)	20.4 (180)	9.02 (79.8)	5,130	5,500	6,000	18.6	40.0	31.6 (28)
AKM65K	S61000	46.8 (414)	0.0 (0.0)	24.8 (219)	19.7 (175)	2,260	2,200	2,710	9.8	20.0	40.0 (35.4)
AKM65K	S610-3000	64.5 (571)	0.0 (0.0)	24.8 (219)	19.7 (175)	1,900	2,200	2,710	9.8	29.4	40.0 (35.4)
AKM65M	S61400	47.6 (421)	0.0 (0.0)	25 (221)	18.1 (160)	3,120	3,000	3,720	13.6	28.0	40.0 (35.4)
AKM65N	S62000	50.2 (444)	0.0 (0.0)	24.3 (215)	14.7 (131)	4,120	4,000	5,000	17.8	40.0	40.0 (35.4)
AKM72K	S61000	59.4 (526)	0.0 (0.0)	29.7 (263)	24 (213)	1,560	1,800	2,130	9.3	20.0	64.5 (57.1)
AKM72K	S610-3000	79.2 (701)	0.0 (0.0)	29.7 (263)	24 (213)	1,280	1,800	2,130	9.3	27.8	64.5 (57.1)
AKM72M	S61400	59.8 (529)	0.0 (0.0)	30 (266)	22.1 (196)	2,180	2,500	2,960	13	28.0	64.5 (57.1)
AKM72P	S62000	58.4 (516)	0.0 (0.0)	29.4 (260)	18.2 (161)	3,280	3,500	4,350	18.7	40.0	64.5 (57.1)
AKM73M	S61400	80.7 (714)	0.0 (0.0)	42 (372)	32.1 (284)	1,740	1,800	2,220	13.6	28.0	94.1 (81.5)
AKM73P	S62000	79.4 (702)	0.0 (0.0)	41.6 (368)	26.3 (233)	2,570	2,800	3,230	19.5	40.0	94.1 (81.5)
AKM74L	S61400	108 (952)	0.0 (0.0)	53 (469)	41.5 (367)	1,300	1,400	1,660	12.9	28.0	120.0 (106)
AKM74P	S62000	106 (936)	0.0 (0.0)	52.5 (464)	35.9 (318)	1,930	2,000	2,420	18.5	40.0	120.0 (106)

① See definitions of ratings beginning on page 8.

② Peak torque ratings are for 5 seconds.

③ Includes resolver feedback inertia.

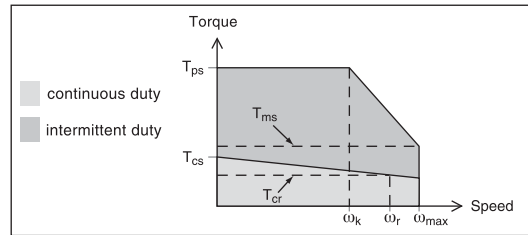

Advanced Motor Design Features

The AKM series of motors offers a wide range of options for mounting, connectivity, feedback and other options

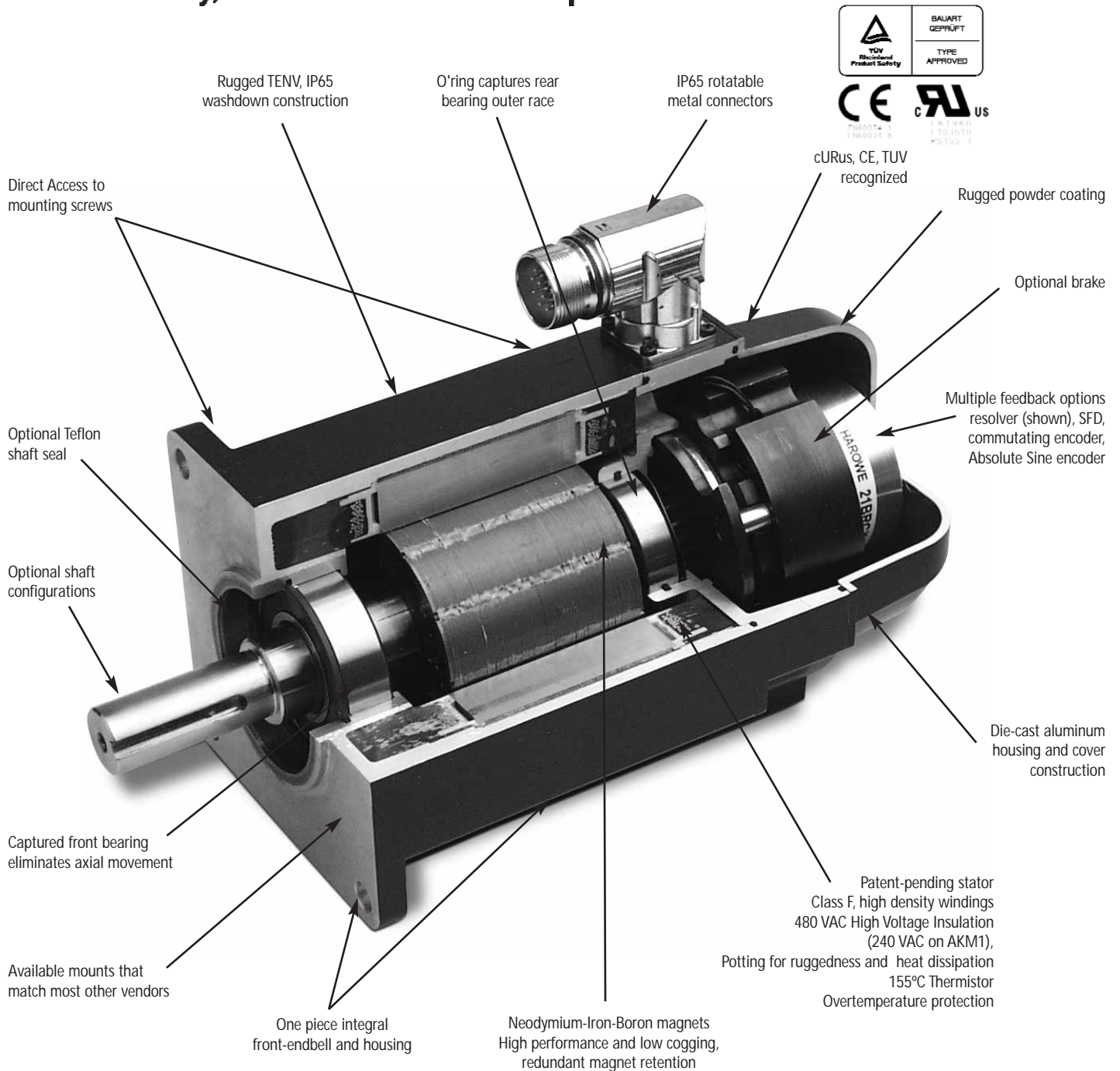

Performance Data - AKM1x Frame

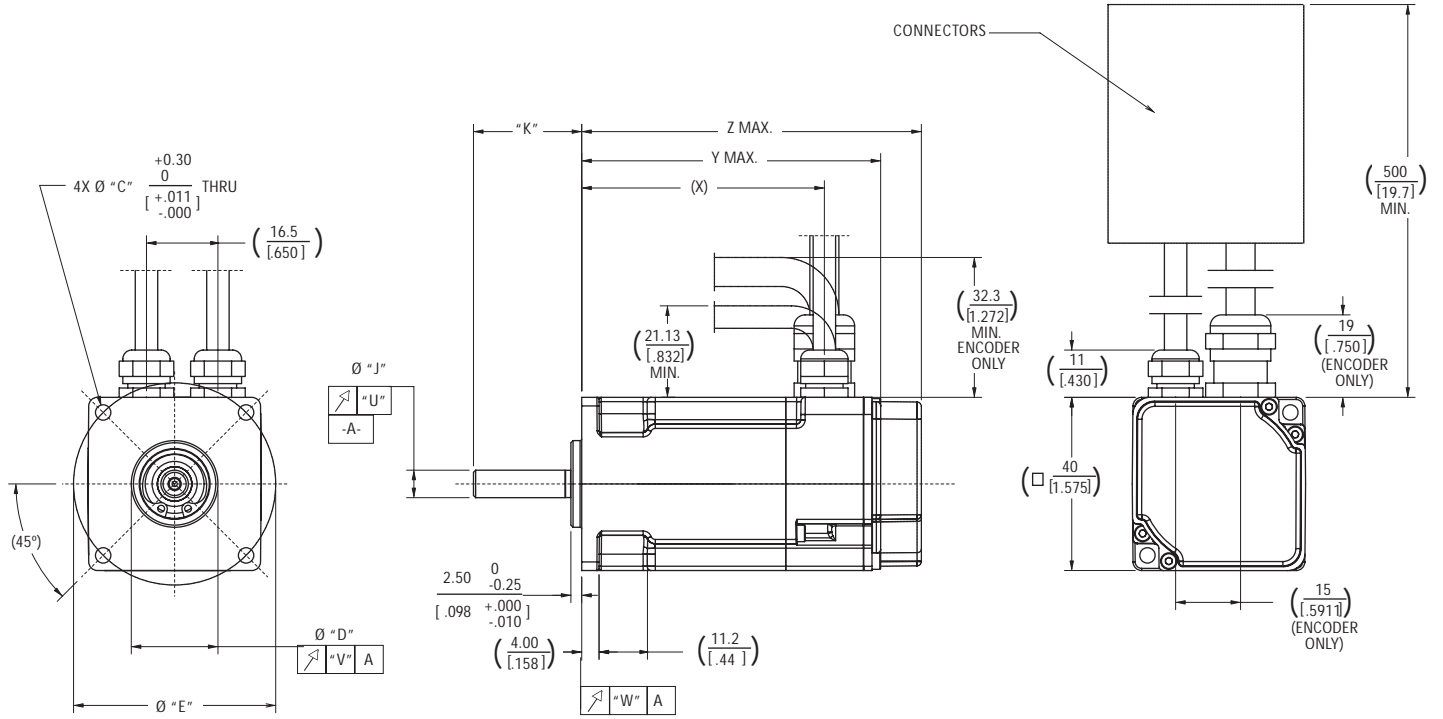

MOUNTING CODE	"C"	"D"	"E"	"F"	"H"	"J"	"K"	"L"	"M"	"N"
AK	4.30 [.169]	$30 \begin{smallmatrix} 0 \\ -0.021 \\ [1.1811 \text{ } +0.0009 \\ -0.0008 \end{smallmatrix} h7$	46 [1.811]	-	-	$8 \begin{smallmatrix} 0 \\ -0.015 \\ [0.3150 \text{ } +0.0009 \\ -0.0006 \end{smallmatrix} h7$	25.0 [.984]	$9.20 \begin{smallmatrix} 0 \\ -0.13 \\ [0.362 \text{ } +.009 \\ -.008 \end{smallmatrix}$	$3 \begin{smallmatrix} 0 \\ -0.025 \\ [1.181 \text{ } +.0009 \\ -0.0018 \end{smallmatrix}$	$14 \begin{smallmatrix} 0 \\ -0.2 \\ [0.551 \text{ } +.009 \\ -0.008 \end{smallmatrix}$
AN	4.30 [.169]	$30 \begin{smallmatrix} 0 \\ -0.021 \\ [1.1811 \text{ } +0.0009 \\ -0.0008 \end{smallmatrix} h7$	46 [1.811]	-	-	$8 \begin{smallmatrix} 0 \\ -0.015 \\ [0.3150 \text{ } +0.0009 \\ -0.0006 \end{smallmatrix} h7$	25 [.984]	-	-	-
BN	3.56 [.140]	20.02 ± 0.02 [.788 ± .001]	46.69 [1.838]	-	-	$6.350 \begin{smallmatrix} 0 \\ -0.012 \\ [0.2500 \text{ } +.0009 \\ -0.0005 \end{smallmatrix}$	25 [.984]	-	-	-
CK	3.40 [.134]	$30 \begin{smallmatrix} 0 \\ -0.021 \\ [1.1811 \text{ } +0.0009 \\ -0.0008 \end{smallmatrix} h7$	45 [1.772]	-	-	$8 \begin{smallmatrix} 0 \\ -0.015 \\ [0.3150 \text{ } +0.0009 \\ -0.0006 \end{smallmatrix} h7$	25 [.984]	$9.20 \begin{smallmatrix} 0 \\ -0.13 \\ [0.362 \text{ } +.009 \\ -.008 \end{smallmatrix}$	$3 \begin{smallmatrix} 0 \\ -0.025 \\ [1.181 \text{ } +.0009 \\ -0.0018 \end{smallmatrix}$	$14 \begin{smallmatrix} 0 \\ -0.2 \\ [0.551 \text{ } +.009 \\ -0.008 \end{smallmatrix}$
CN	3.40 [.134]	$30 \begin{smallmatrix} 0 \\ -0.021 \\ [1.1811 \text{ } +0.0009 \\ -0.0008 \end{smallmatrix} h7$	45 [1.772]	-	-	$8 \begin{smallmatrix} 0 \\ -0.015 \\ [0.3150 \text{ } +0.0009 \\ -0.0006 \end{smallmatrix} h7$	25 [.984]	-	-	-

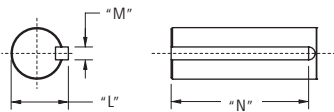

Dimensions are in mm [inches].
Product designed in metric.
English conversions provided for reference only.

(X)	Y MAX. (W/ RESOLVER)	Z MAX. (W/ SFD OR ENCODER)	MODEL
56.1 [2.21]	69.6 [2.74]	79.0 [3.11]	AKM11
75.1 [2.96]	88.6 [3.49]	98.0 [3.86]	AKM12
94.1 [3.70]	107.6 [4.24]	117.0 [4.61]	AKM13

Performance Data - AKM1x Frame

AKM1x - Up to 320 VDC

See system data beginning on page 8 for typical torque/speed performance.

Parameter	Tol	Symbol	Units	AKM11			AKM12		AKM13	
				B	C	E	C	E	C	D
Max Rated DC Bus Voltage	Max	V _{bus}	Vdc	320	160	75	320	160	320	160
Continuous Torque (Stall) for ΔT winding = 100°C ①②⑦⑧	Nom	T _{CS}	N-m lb-in	0.183 1.62	0.185 1.64	0.185 1.64	0.310 2.74	0.310 2.74	0.409 3.62	0.401 3.55
Continuous Current (Stall) for ΔT winding = 100°C ①②⑦⑧	Nom	I _{CS}	A _{RMS}	1.16	1.45	2.91	1.51	2.72	1.48	2.40
Continuous Torque (Stall) for ΔT winding = 60°C ②	Nom	T _{CS}	N-m lb-in	0.146 1.29	0.148 1.31	0.148 1.31	0.248 2.19	0.248 2.19	0.327 2.89	0.320 2.83
Max Mechanical Speed ⑤	Nom	N _{max}	rpm	8000	8000	8000	8000	8000	8000	8000
Peak Torque ①②	Nom	T _p	N-m lb-in	0.609 5.39	0.614 5.43	0.611 5.41	1.08 9.6	1.08 9.6	1.46 12.9	1.44 12.7
Peak Current	Nom	I _p	A _{RMS}	4.65	5.79	11.6	6.06	10.9	5.93	9.6
75VDC	Rated Torque (speed) ①②⑦⑧⑨	T _{rtd}	N-m lb-in	- -	- -	0.176 1.56	- -	0.309 2.73	- -	0.401 3.55
	Rated Speed	N _{rtd}	rpm	-	-	6000	-	3000	-	2000
	Rated Power (speed) ①②⑦⑧	P _{rtd}	kW Hp	- -	- -	0.11 0.15	- -	0.10 0.13	- -	0.08 0.11
	Rated Torque (speed) ①②⑦⑧⑨	T _{rtd}	N-m lb-in	0.180 1.59	0.176 1.56	- -	0.304 2.69	0.279 2.47	0.407 3.60	0.365 3.23
160VDC	Rated Speed	N _{rtd}	rpm	4000	6000	-	4000	8000	3000	7000
	Rated Power (speed) ①②⑦⑧	P _{rtd}	kW Hp	0.08 0.10	0.11 0.15	- -	0.13 0.17	0.23 0.31	0.13 0.17	0.27 0.36
320VDC	Rated Torque (speed) ①②⑦⑧⑨	T _{rtd}	N-m lb-in	0.167 1.48	- -	- -	0.279 2.47	- -	0.364 3.22	- -
	Rated Speed	N _{rtd}	rpm	8000	-	-	8000	-	8000	-
	Rated Power (speed) ①②⑦⑧	P _{rtd}	kW Hp	0.14 0.19	- -	- -	0.23 0.31	- -	0.30 0.41	- -
	Rated Torque (speed) ①②⑦⑧⑨	T _{rtd}	N-m lb-in	x x	x x	x x	x x	x x	x x	x x
560VDC	Rated Speed	N _{rtd}	rpm	x	x	x	x	x	x	x
	Rated Power (speed) ①②⑦⑧	P _{rtd}	kW Hp	x x	x x	x x	x x	x x	x x	x x
640VDC	Rated Torque (speed) ①②⑦⑧	T _{rtd}	N-m lb-in	x x	x x	x x	x x	x x	x x	x x
	Rated Speed	N _{rtd}	rpm	x	x	x	x	x	x	x
	Rated Power (speed) ①②⑦⑧	P _{rtd}	kW Hp	x x	x x	x x	x x	x x	x x	x x
	Torque Constant ①	±10%	K _t	N-m/A _{RMS} lb-in/A _{RMS}	0.158 1.40	0.129 1.14	0.064 0.57	0.207 1.83	0.112 0.99	0.278 2.46
Back EMF constant ⑥	±10%	K _e	V/k _r rpm	10.2	8.3	4.1	13.3	7.2	17.9	10.9
Resistance (line-line) ⑥	±10%	R _m	Ω	20.2	13.1	3.0	12.4	3.9	13.5	5.21
Inductance (line-line)		L	mH	12.5	8.3	2.04	9.1	2.7	10.3	3.8
Inertia (includes Resolver feedback) ③		J _m	kg-cm ² lb-in-s ²		0.017 1.5E-05		0.031 2.7E-05		0.045 4.0E-05	
Optional Brake Inertia (additional)		J _m	kg-cm ² lb-in-s ²		x x		x x		x x	
Weight		W	kg lb		0.35 0.8		0.49 1.1		0.63 1.4	
Static Friction ①⑨		T _f	N-m lb-in		0.0011 0.01		0.0021 0.02		0.0031 0.03	
Viscous Damping ①		K _{dv}	N-m/k _r rpm lb-in/k _r rpm		0.0005 0.004		0.001 0.009		0.0015 0.013	
Thermal Time Constant		TCT	minutes		4		6		7	
Thermal Resistance		R _{thw-a}	°C/W		1.75		1.69		1.62	
Pole Pairs					3		3		3	
Heatsink Size					10x10x1/4" Alum. Plate		10x10x1/4" Alum. Plate		10x10x1/4" Alum. Plate	

Notes:

- Motor winding temperature rise, ΔT=100°C, at 40°C ambient.
- All data referenced to sinusoidal commutation.
- Add parking brake if applicable for total inertia.
- Motor with standard heatsink.
- May be limited at some values of V_{bus}.
- Measured at 25°C.
- No brake motor option on AKM1.
- For non-Resolver feedback options: no continuous torque reduction.
- For motors with optional shaft seal, reduce torque shown by 0.021 N-m (0.19lb-in), and increase T_f by the same amount.

Performance Data - AKM2x Frame

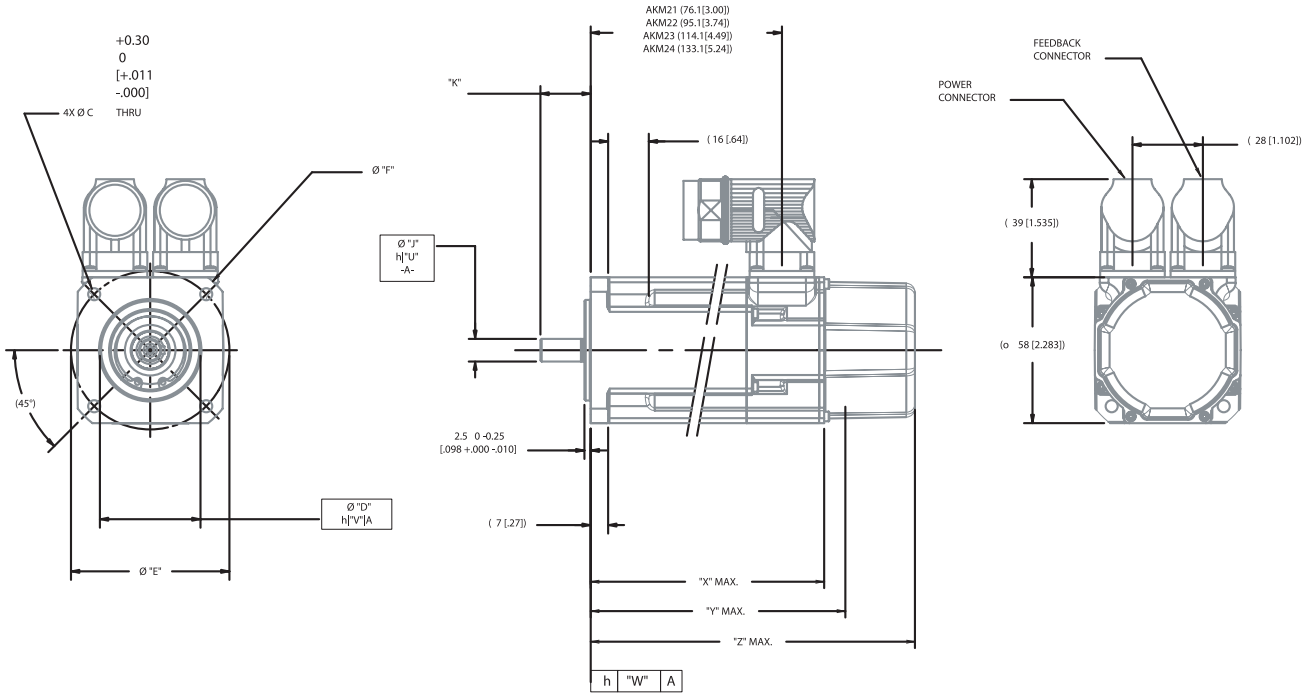

MOUNTING CODE	"C"	"D"	"E"	"F"	"H"	"J"	"K"	"L"	"M"	"N"
AC	4.80 [.189]	40 ^{+0.011} _{-0.005} [1.5748 ^{+0.004} _{-0.002}]	63 [2.480]	74 [2.913]	D M3 DIN 332	9 ^{+0.010} _{+0.001} [.3543 ^{+0.004} _{+0.000}]	20.0 [.79]	-	-	-
AN	4.80 [.189]	40 ^{+0.011} _{-0.005} [1.5748 ^{+0.004} _{-0.002}]	63 [2.480]	74 [2.913]	D M3 DIN 332	9 ^{+0.010} _{+0.001} [.3543 ^{+0.004} _{+0.000}]	20.0 [.79]	-	-	-
BN	5.10 [.201]	38.10 ⁰ _{-0.05} [1.500 ^{+0.000} _{-0.002}]	66.68 [2.625]	-	-	9.525 ⁺⁰ _{-0.013} [.3750 ^{+0.000} _{-0.005}]	31.75 ± 0.79 [1.250 ± .031]	-	-	-
CK	5.80 [.228]	50 ⁰ _{-0.016} [1.9685 ^{+0.000} _{-0.006}]	70 [2.756]	-	-	14 ⁺⁰ _{-0.011} [.5512 ^{+0.000} _{-0.004}]	30.0 [1.181]	16 ⁰ _{-0.13} [.630 ^{+0.000} _{-0.005}]	5 ⁰ _{-0.03} [.197 ^{+0.000} _{-0.007}]	20 ⁰ _{-0.02} [.787 ^{+0.000} _{-0.008}]
DC	5.80 [.228]	40 ^{+0.011} _{-0.005} [1.5748 ^{+0.004} _{-0.002}]	65 [2.559]	-	D M3 DIN 332	9 ^{+0.010} _{+0.001} [.3543 ^{+0.004} _{+0.000}]	20.0 [.79]	-	-	-
DN	5.80 [.228]	40 ^{+0.011} _{-0.005} [1.5748 ^{+0.004} _{-0.002}]	65 [2.559]	-	D M3 DIN 332	9 ^{+0.010} _{+0.001} [.3543 ^{+0.004} _{+0.000}]	20.0 [.79]	-	-	-
EN	5.10 [.201]	38.10 ⁰ _{-0.05} [1.500 ^{+0.000} _{-0.002}]	66.68 [2.625]	-	-	9.525 ⁺⁰ _{-0.013} [.3750 ^{+0.000} _{-0.005}]	20.57 ± 0.25 [0.810 ± 0.010]	-	-	-

MOUNTING CODE	"P"	"R"	"S"	"T"	"U"	"V"	"W"
AC	10.2 ⁰ _{-0.13} [.402 ^{+0.000} _{-0.005}]	3 ⁰ _{-0.025} [.1181 ^{+0.000} _{-0.010}]	3.00 [.118]	12 ⁰ _{-0.20} [.472 ^{+0.000} _{-0.008}]	0.030 [.0011]	0.060 [.0023]	0.060 [.0023]
AN	-	-	-	-	0.030 [.0011]	0.060 [.0023]	0.060 [.0023]
BN	-	-	-	-	0.051 [.0020]	0.10 [.004]	0.10 [.004]
CK	-	-	-	-	0.035 [0.0013]	0.080 [0.0031]	0.080 [.0031]
DC	10.2 ⁰ _{-0.13} [.402 ^{+0.000} _{-0.005}]	3 ⁰ _{-0.025} [.1181 ^{+0.000} _{-0.010}]	3.00 [.118]	12 ⁰ _{-0.20} [.472 ^{+0.000} _{-0.008}]	0.030 [.0011]	0.060 [.0023]	0.060 [.0023]
DN	-	-	-	-	0.030 [.0011]	0.060 [.0023]	0.060 [.0023]
EN	-	-	-	-	0.051 [.0020]	0.10 [.004]	0.10 [.004]

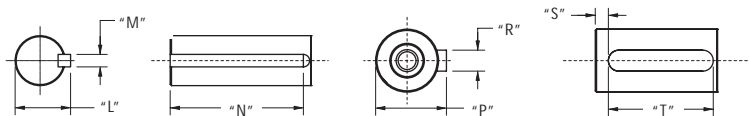

Dimensions are in mm [inches].
Product designed in metric.
English conversions provided for reference only.

X MAX. (C CONNECTOR OPTION W/ RESOLVER)	Y MAX.	Z MAX. (W/ BRAKE)	MODEL
86.2 [3.39]	95.4 [3.76]	129.5 [5.10]	AKM21
105.2 [4.14]	114.4 [4.50]	148.5 [5.85]	AKM22
124.2 [4.89]	133.4 [5.25]	167.5 [6.59]	AKM23
143.2 [5.64]	152.4 [6.00]	186.5 [7.34]	AKM24

Performance Data - AKM2x Frame

AKM2x - Up to 640 VDC

See system data beginning on page 8 for typical torque/speed performance.

				AKM21			AKM22			AKM23			AKM24			
PARAMETER	Tol	SYMBOL	UNITS	C	E	G	C	E	G	C	D	F	C	D	F	
Max Rated DC Bus Voltage	Max	V _{bus}	Vdc	320	160	75	640	320	160	640	640	320	640	640	320	
Continuous Torque (Stall) for ΔT winding = 100°C ①②⑦⑧⑨	Nom	T _{CS}	N-m	0.48	0.50	0.50	0.84	0.87	0.88	1.13	1.16	1.18	1.38	1.41	1.42	
			lb-in	4.2	4.4	4.4	7.4	7.7	7.8	10.0	10.3	10.4	12.2	12.5	12.6	
Continuous Current (Stall) for ΔT winding = 100°C ①②⑦⑧⑨	Nom	I _{CS}	A _{rms}	1.58	3.11	4.87	1.39	2.73	4.82	1.41	2.19	4.31	1.42	2.21	3.89	
Continuous Torque (Stall) for ΔT winding = 60°C ②	Nom	T _{CS}	N-m	0.38	0.40	0.40	0.67	0.70	0.70	0.90	0.92	0.94	1.10	1.13	1.14	
			lb-in	3.4	3.5	3.5	5.9	6.2	6.2	8.0	8.2	8.4	9.8	10.0	10.1	
Max Mechanical Speed ⑤	Nom	N _{max}	rpm	8000	8000	8000	8000	8000	8000	8000	8000	8000	8000	8000	8000	
Peak Torque ①②	Nom	T _p	N-m	1.47	1.49	1.51	2.73	2.76	2.79	3.77	3.84	3.88	4.73	4.76	4.82	
			lb-in	13.0	13.2	13.4	24.2	24.4	24.7	33.4	34.0	34.3	41.9	42.1	42.7	
Peak Current	Nom	I _p	A _{rms}	6.3	12.4	19.5	5.6	10.9	19.3	5.6	8.8	17.2	5.7	8.8	15.6	
75VDC		T _{rtd}	N-m	-	0.48	0.46	-	0.85	0.83	-	-	1.15	-	-	1.39	
			lb-in	-	4.2	4.1	-	7.5	7.4	-	-	10.2	-	-	12.3	
160VDC		N _{rtd}	rpm	-	2000	4000	-	1000	2500	-	-	1500	-	-	1000	
320VDC		P _{rtd}	kW	-	0.10	0.19	-	0.09	0.22	-	-	0.18	-	-	0.15	
			Hp	-	0.13	0.26	-	0.12	0.29	-	-	0.24	-	-	0.20	
560VDC		T _{rtd}	N-m	0.46	0.41	-	0.83	0.81	0.74	1.11	1.12	1.07	-	1.36	1.33	
			lb-in	4.0	3.7	-	7.3	7.1	6.5	9.8	9.9	9.5	-	12.0	11.8	
640VDC		N _{rtd}	rpm	2500	7000	-	1000	3500	7000	1000	1500	4500	-	1500	3000	
75VDC		P _{rtd}	kW	0.12	0.30	-	0.09	0.30	0.54	0.12	0.18	0.50	-	0.21	0.42	
			Hp	0.16	0.41	-	0.12	0.40	0.72	0.16	0.24	0.68	-	0.29	0.56	
160VDC		T _{rtd}	N-m	0.39	-	-	0.78	.70	-	1.08	1.03	0.94	1.32	1.29	1.12	
			lb-in	3.4	-	-	6.9	6.2	-	9.6	9.1	8.3	11.7	11.4	9.9	
320VDC		N _{rtd}	rpm	8000	-	-	3500	8000	-	2500	5000	8000	2000	4000	8000	
560VDC		P _{rtd}	kW	0.32	-	-	0.29	0.59	-	0.28	0.54	0.79	0.28	0.54	0.94	
			Hp	0.43	-	-	0.38	0.79	-	0.38	0.72	1.06	0.37	0.72	1.26	
640VDC		T _{rtd}	N-m	-	-	-	0.68	-	-	0.99	0.92	-	1.25	1.11	-	
			lb-in	-	-	-	6.0	-	-	8.8	8.1	-	11.1	9.8	-	
75VDC		N _{rtd}	rpm	-	-	-	8000	-	-	5500	8000	-	4500	8000	-	
160VDC		P _{rtd}	kW	-	-	-	0.57	-	-	0.57	0.77	-	0.59	0.93	-	
			Hp	-	-	-	0.76	-	-	0.76	1.03	-	0.79	1.25	-	
320VDC		T _{rtd}	N-m	-	-	-	0.68	-	-	0.95	0.92	-	1.22	1.11	-	
			lb-in	-	-	-	6.0	-	-	8.4	8.1	-	10.8	9.8	-	
560VDC		N _{rtd}	rpm	-	-	-	8000	-	-	7000	8000	-	5500	8000	-	
640VDC		P _{rtd}	kW	-	-	-	0.57	-	-	0.70	0.77	-	0.70	0.93	-	
			Hp	-	-	-	0.76	-	-	0.93	1.03	-	0.94	1.25	-	
Torque Constant ①	±10%	K _t	N-m/A _{rms} lb-in/A _{rms}	0.30 2.7	0.16 1.4	0.10 0.9	0.61 5.4	0.32 2.8	0.18 1.6	0.80 7.1	0.52 4.6	0.27 2.4	0.97 8.6	0.63 5.6	0.36 3.2	
Back EMF constant ⑥	±10%	K _e	V/k _r rpm	19.5	10.2	6.6	39	20.4	11.7	51.8	33.8	17.6	62.4	40.8	23.4	
Resistance (line-line) ⑥	±10%	R _m		13.0	3.42	1.44	19.4	5.09	1.69	20.3	8.36	2.23	20.4	8.4	2.77	
Inductance (line-line)		L	mH	19	5.2	2.18	35.5	9.7	3.19	40.7	17.3	4.68	43.8	18.7	6.16	
Inertia (includes Resolver feedback) ③		J _m	kgcm ² lb-in-s ²		0.11 9.5E-05			0.16 1.4E-04			0.22 1.9E-04			0.27 2.4E-04		
		J _m	kg-cm ² lb-in-s ²		0.012 1.1E-05			0.012 1.1E-05			0.012 1.1E-05			0.012 1.1E-05		
Optional Brake Inertia (additional)		J _m	kg-cm ² lb-in-s ²		0.012 1.1E-05			0.012 1.1E-05			0.012 1.1E-05			0.012 1.1E-05		
		J _m	kg-cm ² lb-in-s ²		0.012 1.1E-05			0.012 1.1E-05			0.012 1.1E-05			0.012 1.1E-05		
Weight		W	kg lb		0.82 1.8			1.1 2.4			1.38 3.0			1.66 3.7		
		T _f	N-m lb-in		0.002 0.02			0.005 0.04			0.007 0.06			0.01 0.09		
Viscous Damping ①		K _{dv}	N-m/k _r rpm lb-in/k _r rpm		0.0046 0.04			0.0055 0.05			0.0065 0.06			0.0074 0.07		
		TCT	minutes		8			9			10			11		
Thermal Resistance		R _{thw-a}	°C/W		1.48			1.28			1.19			1.17		
Pole Pairs					3			3			3			3		
Heatsink Size					10x10x1/4" Aluminum Plate			10x10x1/4" Aluminum Plate			10x10x1/4" Aluminum Plate			10x10x1/4" Aluminum Plate		

Notes:

- Motor winding temperature rise, ΔT=100°C, at 40°C ambient.
- All data referenced to sinusoidal commutation.
- Add parking brake if applicable for total inertia.
- Motor with standard heatsink.
- May be limited at some values of V_{bus}.
- Measured at 25°C.

7. Brake motor option reduces continuous torque ratings by:

- AKM21 = 0.00
- AKM22 = 0.01 N-m
- AKM23 = 0.02 N-m
- AKM24 = 0.05 N-m

8. For non-Resolver feedback options:
no continuous torque reduction.

9. Motors with non-Resolver feedback and Brake option, reduce continuous torque by:

- AKM21 = 0.00
- AKM22 = 0.02 N-m
- AKM23 = 0.05 N-m
- AKM24 = 0.12 N-m

10. For motors with optional shaft seal, reduce torque shown by 0.047 N-m (0.41lb-in), and increase T_f by the same amount.

Performance Data - AKM3x Frame

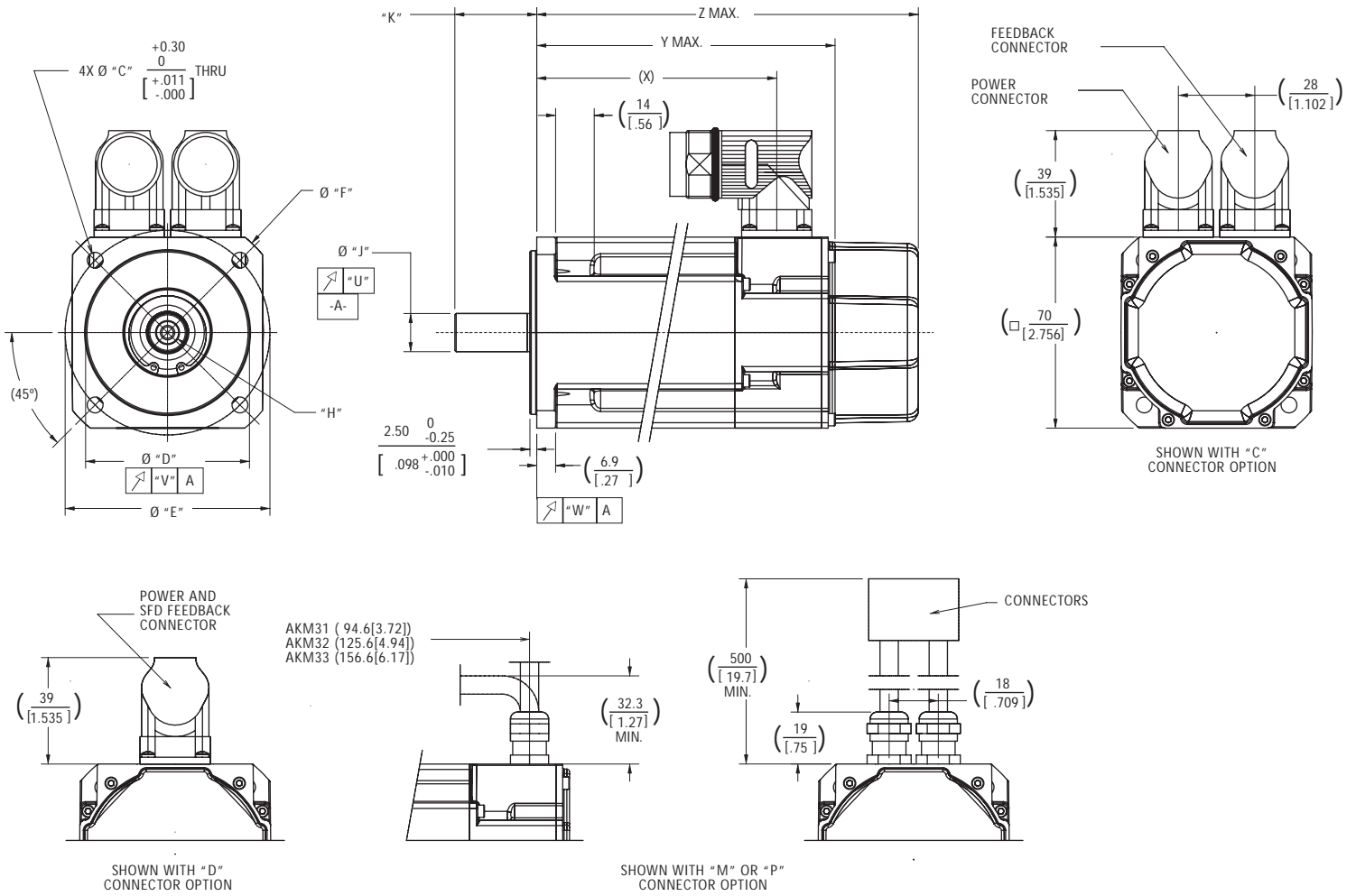

MOUNTING CODE	"C"	"D"	"E"	"F"	"H"	"J"	"K"
AC	5.80 [2.28]	$\begin{matrix} 60 \\ -0.012 \\ -0.007 \\ [2.3622 \\ +0.004 \\ -0.002] \end{matrix}$ j6	75 [2.953]	90 [3.543]	D M5 DIN 332	$\begin{matrix} 14 \\ +0.012 \\ +0.001 \\ [5.512 \\ +0.005 \\ +0.000] \end{matrix}$ k6	30.0 [1.181]
AN	5.80 [2.28]	$\begin{matrix} 60 \\ -0.012 \\ -0.007 \\ [2.3622 \\ +0.004 \\ -0.002] \end{matrix}$ j6	75 [2.953]	90 [3.543]	D M5 DIN 332	$\begin{matrix} 14 \\ +0.012 \\ +0.001 \\ [5.512 \\ +0.005 \\ +0.000] \end{matrix}$ k6	30.0 [1.181]
CC	5.80 [2.28]	$\begin{matrix} 60 \\ -0.012 \\ -0.007 \\ [2.3622 \\ +0.004 \\ -0.002] \end{matrix}$ j6	85 [3.346]	-	D M5 DIN 332	$\begin{matrix} 14 \\ +0.012 \\ +0.001 \\ [5.512 \\ +0.005 \\ +0.000] \end{matrix}$ k6	30.0 [1.181]
CN	5.80 [2.28]	$\begin{matrix} 60 \\ -0.012 \\ -0.007 \\ [2.3622 \\ +0.004 \\ -0.002] \end{matrix}$ j6	85 [3.346]	-	D M5 DIN 332	$\begin{matrix} 14 \\ +0.012 \\ +0.001 \\ [5.512 \\ +0.005 \\ +0.000] \end{matrix}$ k6	30.0 [1.181]

MOUNTING CODE	"P"	"R"	"S"	"T"	"U"	"V"	"W"
AC	$\begin{matrix} 16 \\ 0 \\ -0.13 \\ [6.30 \\ +0.000 \\ -0.005] \end{matrix}$	$\begin{matrix} 5 \\ 0 \\ -0.03 \\ [1.97 \\ +0.000 \\ -0.001] \end{matrix}$ N9	5.00 [1.97]	$\begin{matrix} 20 \\ 0 \\ -0.20 \\ [7.87 \\ +0.000 \\ -0.008] \end{matrix}$	0.035 [0.0013]	0.080 [0.0031]	0.080 [0.0031]
AN	-	-	-	-	0.035 [0.0013]	0.080 [0.0031]	0.080 [0.0031]
CC	$\begin{matrix} 16 \\ 0 \\ -0.13 \\ [6.30 \\ +0.000 \\ -0.005] \end{matrix}$	$\begin{matrix} 5 \\ 0 \\ -0.03 \\ [1.97 \\ +0.000 \\ -0.001] \end{matrix}$ N9	5.00 [1.97]	$\begin{matrix} 20 \\ 0 \\ -0.20 \\ [7.87 \\ +0.000 \\ -0.008] \end{matrix}$	0.035 [0.0013]	0.080 [0.0031]	0.080 [0.0031]
CN	-	-	-	-	0.035 [0.0013]	0.080 [0.0031]	0.080 [0.0031]

(X)	Y MAX.	Z MAX. (W/ BRAKE)	MODEL
87.9 [3.46]	109.8 [4.32]	140.3 [5.52]	AKM31
118.9 [4.68]	140.8 [5.54]	171.3 [6.74]	AKM32
149.9 [5.90]	171.8 [6.76]	202.3 [7.97]	AKM33

Dimensions are in mm [inches].
Product designed in metric.
English conversions provided for reference only.

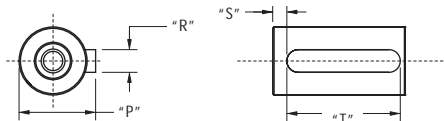

Performance Data - AKM3x Frame

AKM3x - Up to 640 VDC

See system data beginning on page 8 for typical torque/speed performance.

				AKM31			AKM32			AKM33		
PARAMETER	Tol	SYMBOL	UNITS	C	E	H	C	D	H	C	E	H
Max Rated DC Bus Voltage	Max	Vbus	Vdc	640	320	160	640	640	320	640	640	320
Continuous Torque (Stall) for ΔT winding = 100°C ①②⑦⑧⑨	Nom	T _{CS}	N-m lb-in	1.15 10.2	1.20 10.6	1.23 10.8	2.00 17.7	2.04 18.1	2.10 18.6	2.71 24.0	2.79 24.7	2.88 25.5
Continuous Current (Stall) for ΔT winding = 100°C ①②⑦⑧⑨	Nom	I _{CS}	A _{RMS}	1.37	2.99	5.85	1.44	2.23	5.50	1.47	2.58	5.62
Continuous Torque (Stall) for ΔT winding = 60°C ②	Nom	T _{CS}	N-m lb-in	0.92 8.1	0.96 8.5	0.98 8.7	1.60 14.2	1.63 14.4	1.68 14.9	2.17 19.2	2.23 19.7	2.30 20.4
Max Mechanical Speed ⑤	Nom	N _{max}	rpm	8000	8000	8000	8000	8000	8000	8000	8000	8000
Peak Torque ①②	Nom	T _p	N-m lb-in	3.88 34.3	4.00 35.4	4.06 35.9	6.92 61.2	7.05 62.4	7.26 64.3	9.76 86.4	9.96 88.1	10.22 90.5
Peak Current	Nom	I _p	A _{RMS}	5.5	12.0	23.4	5.7	8.9	22.0	5.9	10.3	22.5
75VDC	Rated Torque (speed) ①②⑦⑧⑨ ⑩	T _{rtd}	N-m lb-in	- -	1.19 10.5	1.20 10.6	- -	- -	2.06 18.2	- -	- -	2.82 24.6
	Rated Speed	N _{rtd}	rpm	-	750	2000	-	-	1200	-	-	800
	Rated Power (speed) ①②⑦⑧⑨	P _{rtd}	kW Hp	- -	0.09 0.13	0.25 0.34	- -	- -	0.26 0.35	- -	- -	0.24 0.32
160VDC	Rated Torque (speed) ①②⑦⑧⑨ ⑩	T _{rtd}	N-m lb-in	- -	1.17 10.3	0.97 8.6	- -	2.00 17.7	1.96 17.4	- -	- -	2.66 23.5
	Rated Speed	N _{rtd}	rpm	-	2500	6000	-	1000	3000	-	-	2500
	Rated Power (speed) ①②⑦⑧⑨	P _{rtd}	kW Hp	- -	0.31 0.41	0.61 0.82	- -	0.21 0.28	0.62 0.83	- -	- -	0.70 0.93
320VDC	Rated Torque (speed) ①②⑦⑧⑨ ⑩	T _{rtd}	N-m lb-in	1.12 9.9	0.95 8.4	- -	1.95 17.3	1.93 17.1	1.45 12.8	2.64 23.4	2.62 23.2	2.27 20.1
	Rated Speed	N _{rtd}	rpm	2500	6000	-	1500	2500	7000	1000	2000	5500
	Rated Power (speed) ①②⑦⑧⑨	P _{rtd}	kW Hp	0.29 0.39	0.60 0.80	- -	0.31 0.41	0.51 0.68	1.06 1.42	0.28 0.37	0.55 0.74	1.31 1.75
560VDC	Rated Torque (speed) ①②⑦⑧⑨ ⑩	T _{rtd}	N-m lb-in	1.00 8.9	- -	- -	1.86 16.5	1.65 14.6	- -	2.54 22.5	2.34 20.7	- -
	Rated Speed	N _{rtd}	rpm	5000	-	-	3000	5500	-	2000	4500	-
	Rated Power (speed) ①②⑦⑧⑨	P _{rtd}	kW Hp	0.52 0.70	- -	- -	0.58 0.78	0.95 1.27	- -	0.53 0.71	1.10 1.48	- -
640VDC	Rated Torque (speed) ①②⑦⑧⑨ ⑩	T _{rtd}	N-m lb-in	0.91 8.1	- -	- -	1.83 16.2	1.58 14.0	- -	2.50 22.1	2.27 20.1	- -
	Rated Speed	N _{rtd}	rpm	6000	-	-	3500	6000	-	2500	5000	-
	Rated Power (speed) ①②⑦⑧⑨	P _{rtd}	kW Hp	0.57 0.77	- -	- -	0.67 0.90	0.99 1.33	- -	0.65 0.88	1.19 1.59	- -
Torque Constant ①	±10%	K _t	N-m/A _{RMS} lb-in/A _{RMS}	0.85 7.5	0.41 3.6	0.21 1.9	1.40 12.4	0.92 8.1	0.39 3.5	1.86 16.5	1.10 9.7	0.52 4.6
Back EMF constant ⑥	±10%	K _e	V/k _r rpm	54.5	26.1	13.7	89.8	59.0	24.8	120	70.6	33.4
Resistance (line-line) ⑥	±10%	R _m		21.4	4.58	1.25	23.0	9.57	1.64	25.4	8.36	1.82
Inductance (line-line)		L	mH	37.5	8.6	2.4	46.5	20.1	3.55	53.6	18.5	4.1
Inertia (includes Resolver feedback) ③		J _m	kg-cm ² lb-in-s ²		0.33 2.9E-04			0.59 5.2E-04			0.85 7.5E-04	
Optional Brake Inertia (additional)		J _m	kg-cm ² lb-in-s ²		0.012 1.1E-05			0.012 1.1E-05			0.012 1.1E-05	
Weight		W	kg lb		1.55 3.4			2.23 4.9			2.9 6.4	
Static Friction ①⑩		T _f	N-m lb-in		0.014 0.12			0.02 0.18			0.026 0.23	
Viscous Damping ①		K _{dv}	N-m/k _r rpm lb-in/k _r rpm		0.002 0.02			0.003 0.03			0.004 0.04	
Thermal Time Constant		TCT	minutes		14			17			20	
Thermal Resistance		R _{thw-a}	°C/W		1.19			1.01			0.88	
Pole Pairs					4			4			4	
Heatsink Size				10x10x ¹ / ₄ Aluminum Plate			10x10x ¹ / ₄ Aluminum Plate			10x10x ¹ / ₄ Aluminum Plate		

Notes:

- Motor winding temperature rise, $\Delta T=100^\circ\text{C}$, at 40°C ambient.
- All data referenced to sinusoidal commutation.
- Add parking brake if applicable for total inertia.
- Motor with standard heatsink.
- May be limited at some values of Vbus.
- Measured at 25°C .

7. Brake motor option reduces continuous torque ratings by:

$$\text{AKM31} = 0.0 \text{ N-m} \quad \text{AKM32} = 0.05 \text{ N-m} \\ \text{AKM33} = 0.1 \text{ N-m}$$

8. For non-Resolver feedback options:
no continuous torque reduction.

9. Motors with non-Resolver feedback and Brake option, reduce continuous torque by:

$$\text{AKM31} = 0.0 \text{ N-m} \quad \text{AKM32} = 0.1 \text{ N-m} \\ \text{AKM33} = 0.2 \text{ N-m}$$

10. For motors with optional shaft seal, reduce torque shown by 0.047 N-m (0.41lb-in), and increase T_f by the same amount.

Performance Data - AKM4x Frame

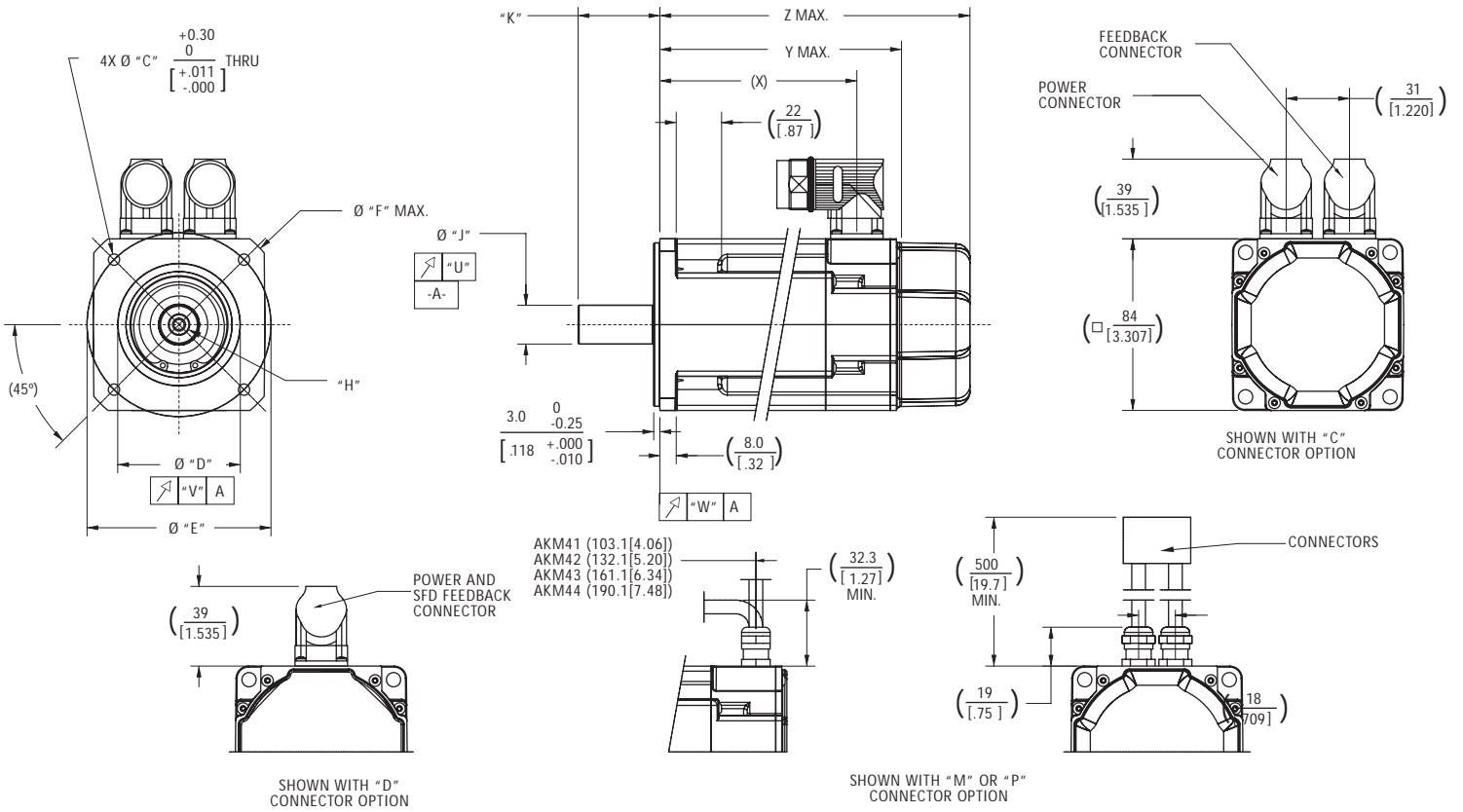

MOUNTING CODE	"C"	"D"	"E"	"F"	"H"	"J"	"K"	"L"	"M"	"N"
AC	7 [.276]	$80 \begin{matrix} +0.012 \\ -0.007 \\ [3.1496 \quad +.0004 \quad -.0002] \end{matrix}$ j6	100 [3.937]	-	D M6 DIN 332	$19 \begin{matrix} +0.015 \\ -0.002 \\ [7.480 \quad +.0006 \quad +.0001] \end{matrix}$ k6	40.0 [1.57]	-	-	-
AN	7 [.276]	$80 \begin{matrix} +0.012 \\ -0.007 \\ [3.1496 \quad +.0004 \quad -.0002] \end{matrix}$ j6	100 [3.937]	-	D M6 DIN 332	$19 \begin{matrix} +0.015 \\ -0.002 \\ [7.480 \quad +.0006 \quad +.0001] \end{matrix}$ k6	40.0 [1.57]	-	-	-
BK	5.54 [.218]	$73.025 \begin{matrix} 0 \\ -0.051 \\ [2.8750 \quad +.0000 \quad -.0002] \end{matrix}$	98.43 [3.875]	-	-	$15.875 \begin{matrix} 0 \\ -0.013 \\ [6.250 \quad +.0000 \quad -.0005] \end{matrix}$	52.40 ± 0.79 [2.063 ± .031]	$17.92 \begin{matrix} 0 \\ -0.43 \\ [7.06 \quad +.000 \quad -.017] \end{matrix}$	$4.762 \begin{matrix} 0 \\ -0.050 \\ [1.875 \quad +.0000 \quad -.0020] \end{matrix}$	34.93 ± 0.25 [1.375 ± .010]
CC	5.54 [.218]	$60 \begin{matrix} +0.012 \\ -0.007 \\ [2.3622 \quad +.0004 \quad -.0002] \end{matrix}$ j6	90 [3.543]	109 [4.291]	D M6 DIN 332	$19 \begin{matrix} +0.015 \\ -0.002 \\ [7.480 \quad +.0006 \quad +.0001] \end{matrix}$ k6	40.0 [1.57]	-	-	-
CN	5.54 [.218]	$60 \begin{matrix} +0.012 \\ -0.007 \\ [2.3622 \quad +.0004 \quad -.0002] \end{matrix}$ j6	90 [3.543]	109 [4.291]	D M6 DIN 332	$19 \begin{matrix} +0.015 \\ -0.002 \\ [7.480 \quad +.0006 \quad +.0001] \end{matrix}$ k6	40.0 [1.57]	-	-	-
EK	5.54 [.218]	$73.025 \begin{matrix} 0 \\ -0.051 \\ [2.8750 \quad +.0000 \quad -.0020] \end{matrix}$	98.43 [3.875]	-	-	$12.700 \begin{matrix} 0 \\ -0.013 \\ [5.000 \quad +.0000 \quad -.0005] \end{matrix}$	31.75 ± 0.25 [1.250 ± .010]	$14.09 \begin{matrix} 0 \\ -0.43 \\ [5.55 \quad +.000 \quad -.017] \end{matrix}$	$3.175 \begin{matrix} 0 \\ -0.050 \\ [1.250 \quad +.0000 \quad -.0020] \end{matrix}$	19.05 ± 0.25 [.750 ± .010]

MOUNTING CODE	"P"	"R"	"S"	"T"	"U"	"V"	"W"
AC	$21.5 \begin{matrix} 0 \\ -0.13 \\ [.846 \quad +.000 \quad -.005] \end{matrix}$	$6 \begin{matrix} 0 \\ -0.03 \\ [.236 \quad +.000 \quad -.001] \end{matrix}$ N9	4.00 [1.57]	$32 \begin{matrix} 0 \\ -0.30 \\ [1.260 \quad +.000 \quad -.012] \end{matrix}$	0.040 [.0015]	0.080 [.0031]	0.080 [.0031]
AN	-	-	-	-	0.040 [.0015]	0.080 [.0031]	0.080 [.0031]
BK	-	-	-	-	0.051 [.0020]	0.10 [.004]	0.10 [.004]
CC	$21.5 \begin{matrix} 0 \\ -0.13 \\ [.846 \quad +.000 \quad -.005] \end{matrix}$	$6 \begin{matrix} 0 \\ -0.03 \\ [.236 \quad +.000 \quad -.001] \end{matrix}$ N9	4.00 [1.57]	$32 \begin{matrix} 0 \\ -0.30 \\ [1.260 \quad +.000 \quad -.012] \end{matrix}$	0.040 [.0015]	0.080 [.0031]	0.080 [.0031]
CN	-	-	-	-	0.040 [.0015]	0.080 [.0031]	0.080 [.0031]
EK	-	-	-	-	0.051 [.0020]	0.10 [.004]	0.10 [.004]

(X)	Y MAX.	Z MAX. (W/ BRAKE)	MODEL
96.4 [3.80]	118.8 [4.68]	152.3 [6.00]	AKM41
125.4 [4.94]	147.8 [5.82]	181.3 [7.14]	AKM42
154.4 [6.08]	176.8 [6.96]	210.3 [8.28]	AKM43
183.4 [7.22]	205.8 [8.10]	239.3 [9.42]	AKM44

Dimensions are in mm [inches].
Product designed in metric.
English conversions provided for reference only.

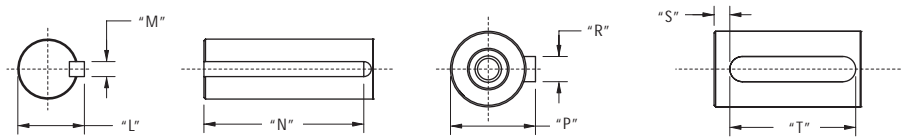

Performance Data - AKM4x Frame

AKM4x - Up to 640 VDC

See system data beginning on page 8 for typical torque/speed performance.

PARAMETER	Tol	SYMBOL	UNITS	AKM41			AKM42				AKM43			AKM44		
				C	E	H	C	E	G	J	E	G	K	E	G	J
Max Rated DC Bus Voltage	Max	Vbus	Vdc	640	640	320	640	640	640	320	640	640	320	640	640	640
Continuous Torque (Stall) for ΔT winding = 100°C ①②⑦⑧⑨	Nom	T _{CS}	N-m lb-in	1.95 17.3	2.02 17.9	2.06 18.2	3.35 29.6	3.42 30.3	3.53 31.2	3.56 31.5	4.70 41.6	4.80 42.5	4.90 43.4	5.76 51.0	5.88 52.0	6.00 53.1
Continuous Current (Stall) for ΔT winding = 100°C ①②⑦⑧⑨	Nom	I _{CS}	A _{rms}	1.46	2.85	5.60	1.40	2.74	4.80	8.40	2.76	4.87	9.60	2.9	5.0	8.8
Continuous Torque (Stall) for ΔT winding = 60°C ②	Nom	T _{CS}	N-m lb-in	1.56 13.8	1.62 14.3	1.65 14.6	2.68 23.7	2.74 24.2	2.82 25.0	2.85 25.2	3.76 33.3	3.84 34.0	3.92 34.7	4.61 40.8	4.70 41.6	4.80 42.5
Max Mechanical Speed ⑤	Nom	N _{max}	rpm	6000	6000	6000	6000	6000	6000	6000	6000	6000	6000	6000	6000	6000
Peak Torque ①②	Nom	T _p	N-m lb-in	6.12 54.2	6.28 55.6	6.36 56.3	11.1 98.8	11.3 99.7	11.5 102	11.6 103	15.9 141	16.1 142	16.3 144	19.9 176	20.2 179	20.4 181
Peak Current	Nom	I _p	A _{rms}	5.8	11.4	22.4	5.61	11.0	19.2	33.7	11.0	19.5	38.3	11.4	20.0	35.2
75VDC	Rated Torque (speed) ①②⑦⑧⑨	T _{rtd}	N-m lb-in	-	-	1.99 17.6	-	-	-	-	-	-	-	-	-	-
	Rated Speed	N _{rtd}	rpm	-	-	1000	-	-	-	-	-	-	-	-	-	-
	Rated Power (speed) ①②⑦⑧⑨	P _{rtd}	kW Hp	-	-	0.21 0.28	-	-	-	-	-	-	-	-	-	-
160VDC	Rated Torque (speed) ①②⑦⑧⑨	T _{rtd}	N-m lb-in	-	1.94 17.2	1.86 16.5	-	-	-	3.03 26.8	-	-	4.08 36.1	-	-	-
	Rated Speed	N _{rtd}	rpm	-	1200	3000	-	-	-	3000	-	-	2500	-	-	-
	Rated Power (speed) ①②⑦⑧⑨	P _{rtd}	kW Hp	-	0.24 0.33	0.58 0.78	-	-	-	0.95 1.28	-	-	1.07 1.43	-	-	-
320VDC	Rated Torque (speed) ①②⑦⑧⑨	T _{rtd}	N-m lb-in	1.88 16.6	1.82 16.1	1.62 14.3	-	3.12 27.6	2.90 25.7	2.38 21.1	4.24 37.5	4.00 35.4	2.62 23.2	5.22 46.2	4.90 43.4	3.84 34.0
	Rated Speed	N _{rtd}	rpm	1200	3000	6000	-	1800	3500	6000	1500	2500	6000	1200	2000	4000
	Rated Power (speed) ①②⑦⑧⑨	P _{rtd}	kW Hp	0.24 0.32	0.57 0.77	1.02 1.36	-	0.59 0.79	1.06 1.42	1.50 2.00	0.67 0.89	1.05 1.40	1.65 2.21	0.66 0.88	1.03 1.38	1.61 2.16
560VDC	Rated Torque (speed) ①②⑦⑧⑨	T _{rtd}	N-m lb-in	1.77 15.7	1.58 14.0	-	3.10 27.4	2.81 24.9	2.35 20.8	-	3.92 34.7	3.01 26.6	-	4.80 42.5	3.76 33.3	2.75 24.3
	Rated Speed	N _{rtd}	rpm	3000	6000	-	1500	3500	6000	-	2500	5000	-	2000	4000	6000
	Rated Power (speed) ①②⑦⑧⑨	P _{rtd}	kW Hp	0.56 0.75	0.99 1.33	-	0.49 0.65	1.03 1.38	1.48 1.98	-	1.03 1.38	1.58 2.11	-	1.01 1.35	1.57 2.11	1.73 2.32
640VDC	Rated Torque (speed) ①②⑦⑧⑨	T _{rtd}	N-m lb-in	1.74 15.4	1.58 14.0	-	3.02 26.7	2.72 24.1	2.35 20.8	-	3.76 33.3	2.57 22.7	-	4.56 40.4	3.19 28.2	2.75 24.3
	Rated Speed	N _{rtd}	rpm	3500	6000	-	2000	4000	6000	-	3000	6000	-	2500	5000	6000
	Rated Power (speed) ①②⑦⑧⑨	P _{rtd}	kW Hp	0.64 0.85	0.99 1.33	-	0.63 0.85	1.14 1.53	1.48 1.98	-	1.18 1.58	1.61 2.16	-	1.19 1.60	1.67 2.24	1.73 2.32
Torque Constant ①	±10%	K _t	N-m/A _{rms} lb-in/A _{rms}	1.34 11.9	0.71 6.3	0.37 3.3	2.40 21.2	1.26 11.2	0.74 6.5	0.43 3.8	1.72 15.2	0.99 8.8	0.52 4.6	2.04 18.1	1.19 10.5	0.69 6.1
Back EMF constant ⑥	±10%	K _e	V/k _r rpm	86.3	45.6	23.7	154	80.9	47.5	27.5	111	63.9	33.2	132	76.6	44.2
Resistance (line-line) ⑥	±10%	R _m		21.7	5.7	1.51	27.52	7.22	2.38	0.80	8.04	2.61	0.70	8.08	2.65	0.88
Inductance (line-line)		L	mH	66.1	18.4	5.0	97.4	26.8	9.2	3.1	32.6	10.8	2.9	33.9	11.5	3.8
Inertia		J _m	kg-cm ² lb-in-s ²		0.81			1.5				2.1			2.7	
(includes Resolver feedback) ③						7.2E-04			1.3E-03			1.8E-03			2.4E-03	
Optional Brake Inertia		J _m	kg-cm ² lb-in-s ²		0.068			0.068				0.068			0.068	
(additional)						6.0E-05			6.0E-05			6.0E-05			6.0E-05	
Weight		W	kg lb		2.44			3.39				4.35			5.3	
Static Friction ①⑩		T _f	N-m lb-in		5.4			7.5				9.6			11.7	
					0.14			0.26				0.38			0.05	
Viscous Damping ①		K _{dv}	N-m/k _r rpm lb-in/k _r rpm		0.009			0.013				0.017			0.021	
					0.08			0.12				0.15			0.19	
Thermal Time Constant		TCT	minutes		13			17				20			24	
Thermal Resistance		R _{thw-a}	°C/W		1.04			0.89				0.78			.71	
Pole Pairs					5			5				5			5	
Heatsink Size					10x10x1/4" Aluminum Plate			10x10x1/4" Aluminum Plate			10x10x1/4" Aluminum Plate			10x10x1/4" Aluminum Plate		

Notes:

- Motor winding temperature rise, ΔT=100°C, at 40°C ambient.
- All data referenced to sinusoidal commutation.
- Add parking brake if applicable for total inertia.
- Motor with standard heatsink.
- May be limited at some values of Vbus.
- Measured at 25°C.

7. Brake motor option reduces continuous torque ratings by 0.12 N-m.

8. Non-Resolver feedback options reduces continuous ratings by:
 AKM41 = 0.1 N-m
 AKM42 = 0.2 N-m

AKM43 = 0.1 N-m
 AKM44 = 0.3 N-m

9. Motors with non-Resolver feedback and Brake option, reduce continuous torque by:

AKM41 = 0.22 N-m
 AKM42 = 0.36 N-m
 AKM43 = 0.55 N-m
 AKM44 = 0.76 N-m

10. For motors with optional shaft seal, reduce torque shown by 0.071 N-m (0.63lb-in), and increase T_f by the same amount.

Performance Data - AKM5x Frame

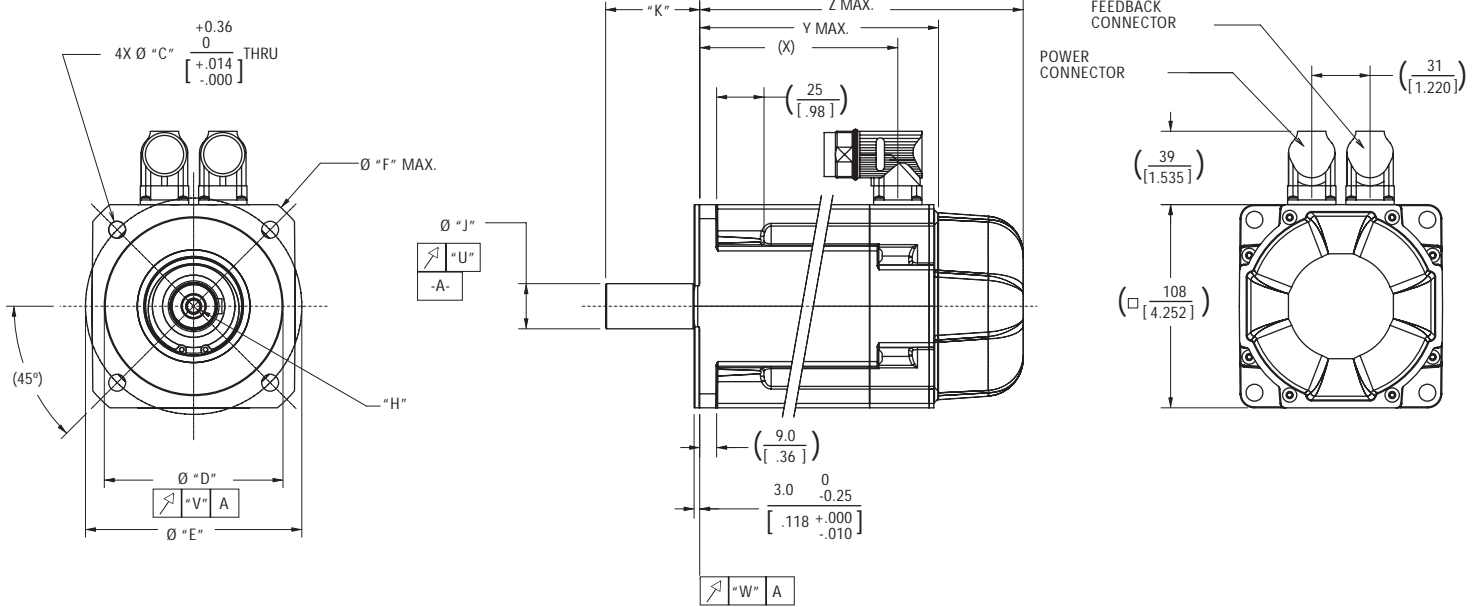

MOUNTING CODE	"C"	"D"	"E"	"F"	"H"	"J"	"K"	"L"	"M"	"N"
AC	9 [.354]	$110 \begin{matrix} +0.013 \\ -0.009 \\ [4.3307 \pm .0003] \end{matrix}$ j6	130 [5.118]	-	D M8 DIN 332	$24 \begin{matrix} +0.015 \\ +0.002 \\ [-9.449 \pm .0006] \end{matrix}$ k6	50.0 [1.97]	-	-	-
AN	9 [.354]	$110 \begin{matrix} +0.013 \\ -0.009 \\ [4.3307 \pm .0003] \end{matrix}$ j6	130 [5.118]	-	D M8 DIN 332	$24 \begin{matrix} +0.015 \\ +0.002 \\ [-9.449 \pm .0006] \end{matrix}$ k6	50.0 [1.97]	-	-	-
BK	8.33 [.328]	$55.563 \begin{matrix} 0 \\ -0.051 \\ [2.1874 \pm .0020] \end{matrix}$ j6	125.73 [4.950]	-	-	$19.05 \begin{matrix} 0 \\ -0.013 \\ [7.500 \pm .0005] \end{matrix}$	57.15 ± 0.79 [2.250 ± .031]	$21.15 \begin{matrix} 0 \\ -0.43 \\ [8.33 \pm .017] \end{matrix}$	$4.763 \begin{matrix} 0 \\ -0.050 \\ [1.875 \pm .0026] \end{matrix}$	38.1 ± 0.25 [1.500 ± .010]
CC	9 [.354]	$95 \begin{matrix} +0.013 \\ -0.009 \\ [3.7402 \pm .0003] \end{matrix}$ j6	115 [4.528]	140 [5.512]	D M8 DIN 332	$24 \begin{matrix} +0.015 \\ +0.002 \\ [-9.449 \pm .0006] \end{matrix}$ k6	50.0 [1.97]	-	-	-
CN	9 [.354]	$95 \begin{matrix} +0.013 \\ -0.009 \\ [3.7402 \pm .0003] \end{matrix}$ j6	115 [4.528]	140 [5.512]	D M8 DIN 332	$24 \begin{matrix} +0.015 \\ +0.002 \\ [-9.449 \pm .0006] \end{matrix}$ k6	50.0 [1.97]	-	-	-
DK	8.33 [.328]	$63.5 \begin{matrix} 0 \\ -0.05 \\ [2.500 \pm .002] \end{matrix}$ j6	127 [5.000]	-	-	$19.05 \begin{matrix} 0 \\ -0.013 \\ [7.500 \pm .0005] \end{matrix}$	57.15 ± 0.79 [2.250 ± .031]	$21.15 \begin{matrix} 0 \\ -0.43 \\ [8.33 \pm .017] \end{matrix}$	$4.763 \begin{matrix} 0 \\ -0.050 \\ [1.875 \pm .0026] \end{matrix}$	38.1 ± 0.25 [1.500 ± .010]

MOUNTING CODE	"p"	"R"	"S"	"T"	"U"	"V"	"W"
AC	$27 \begin{matrix} 0 \\ -0.29 \\ [1.063 \pm .011] \end{matrix}$	$8 \begin{matrix} 0 \\ -0.036 \\ [0.3150 \pm .0014] \end{matrix}$ N9	5.00 [1.97]	$40 \begin{matrix} 0 \\ -0.30 \\ [1.575 \pm .012] \end{matrix}$	0.040 [.0015]	0.100 [.0039]	0.100 [.0039]
AN	-	-	-	-	0.040 [.0015]	0.100 [.0039]	0.100 [.0039]
BK	-	-	-	-	0.051 [.0020]	0.10 [.004]	0.10 [.004]
CC	$27 \begin{matrix} 0 \\ -0.29 \\ [1.063 \pm .011] \end{matrix}$	$8 \begin{matrix} 0 \\ -0.036 \\ [0.3150 \pm .0014] \end{matrix}$ N9	5.00 [1.97]	$40 \begin{matrix} 0 \\ -0.30 \\ [1.575 \pm .012] \end{matrix}$	0.040 [.0015]	0.080 [.0031]	0.080 [.0031]
CN	-	-	-	-	0.040 [.0015]	0.080 [.0031]	0.080 [.0031]
DK	-	-	-	-	0.051 [.0020]	0.05 [.002]	0.10 [.004]

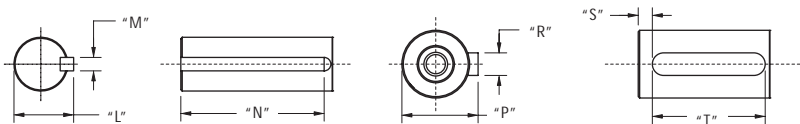

Dimensions are in mm [inches].
Product designed in metric.
English conversions provided for reference only.

Z MAX. SINE ENCODER (NO BRAKE)	Z MAX. SINE ENCODER (W/ BRAKE)	(X)	Y MAX.	Z MAX. (W/ BRAKE)	MODEL
146.0 [5.75]	189.0 [7.44]	105.3 [4.15]	127.5 [5.02]	172.5 [6.79]	AKM51
177.0 [6.97]	220.0 [8.66]	136.3 [5.37]	158.5 [6.24]	203.5 [8.01]	AKM52
208.0 [8.19]	251.0 [9.88]	167.3 [6.59]	189.5 [7.46]	234.5 [9.23]	AKM53
239.0 [9.41]	282.0 [11.10]	198.3 [7.81]	220.5 [8.68]	265.5 [10.45]	AKM54

Performance Data - AKM5x Frame

AKM5x - Up to 640 VDC

See system data beginning on page 8 for typical torque/speed performance.

PARAMETER	Tol	SYMBOL	UNITS	AKM51			AKM52				AKM53				AKM54				
				E	G	K	E	G	K	M	G	K	M	P	G	K	L	N	
Max Rated DC Bus Voltage	Max	Vbus	Vdc	640	640	320	640	640	640	320	640	640	320	320	640	640	560	320	
Continuous Torque (Stall) for ΔT winding = 100°C ①②⑦⑧⑨	Nom	T _{CS}	N-m lb-in	4.70 41.6	4.75 42.0	4.90 43.4	8.34 73.8	8.43 74.6	8.60 76.1	8.60 76.1	11.4 101	11.6 103	11.4 101	11.4 101	14.3 126	14.4 127	14.1 125	14.1 125	
Continuous Current (Stall) for ΔT winding = 100°C ①②⑦⑧⑨	Nom	I _{CS}	A _{rms}	2.75	4.84	9.4	2.99	4.72	9.3	13.1	4.77	9.4	13.4	19.1	5.0	9.7	12.5	17.8	
Continuous Torque (Stall) for ΔT winding = 60°C ②	Nom	T _{CS}	N-m lb-in	3.76 33.3	3.80 33.6	3.92 34.7	6.67 59.0	6.74 59.7	6.88 61.0	6.88 61.0	9.10 80.5	9.28 82.1	9.10 80.5	9.10 80.5	11.4 101	11.5 102	11.3 100	11.3 100	
Max Mechanical Speed ⑤	Nom	N _{max}	rpm	6000	6000	6000	6000	6000	6000	6000	6000	6000	6000	6000	6000	6000	6000	6000	
Peak Torque ①②	Nom	T _P	N-m lb-in	11.6 103	11.7 104	12.0 106	21.3 189	21.5 190	21.9 194	21.9 194	29.7 263	30.1 266	29.8 264	29.8 264	37.8 335	38.4 340	37.5 332	37.6 333	
Peak Current	Nom	I _P	A _{rms}	8.24	14.5	28.3	9.00	14.2	27.8	39.4	14.3	28.1	40.3	57.4	14.9	29.2	37.5	53.4	
75VDC	Rated Torque (speed) ①②⑦⑧⑨	T _{rtd}	N-m lb-in	-	-	-	-	-	-	-	-	-	-	-	-	-	-	-	
	Rated Speed	N _{rtd}	rpm	-	-	-	-	-	-	-	-	-	-	-	-	-	-	-	
	Rated Power (speed) ①②⑦⑧⑨	P _{rtd}	kW Hp	-	-	-	-	-	-	-	-	-	-	-	-	-	-	-	
160VDC	Rated Torque (speed) ①②⑦⑧⑨	T _{rtd}	N-m lb-in	-	-	4.15 36.7	-	-	-	-	-	-	-	-	-	-	-	-	
	Rated Speed	N _{rtd}	rpm	-	-	2500	-	-	-	-	-	-	-	-	-	-	-	-	
	Rated Power (speed) ①②⑦⑧⑨	P _{rtd}	kW Hp	-	-	1.09 1.46	-	-	-	-	-	-	-	-	-	-	-	-	
320VDC	Rated Torque (speed) ①②⑦⑧⑨	T _{rtd}	N-m lb-in	4.41 39.0	4.02 35.6	2.35 20.8	-	7.69 68.1	6.80 60.2	5.20 46.0	10.7 94.5	10.1 89.4	8.72 77.2	5.88 52.0	-	12.7 112	11.5 102	9.85 87.2	
	Rated Speed	N _{rtd}	rpm	1200	2500	5500	-	1500	3000	4500	1000	2000	3000	5000	-	1800	2500	3500	
	Rated Power (speed) ①②⑦⑧⑨	P _{rtd}	kW Hp	0.55 0.74	1.05 1.41	1.35 1.81	-	1.21 1.62	2.14 2.86	2.45 3.28	1.12 1.50	2.12 2.84	2.74 3.67	3.08 4.13	-	2.39 3.20	3.00 4.03	3.61 4.84	
560VDC	Rated Torque (speed) ①②⑦⑧⑨	T _{rtd}	N-m lb-in	3.98 35.2	2.62 23.2	-	7.61 67.3	7.06 62.5	3.90 34.5	-	9.85 87.2	7.65 67.7	-	-	12.9 114	10.05 88.9	8.13 72.0	-	
	Rated Speed	N _{rtd}	rpm	2500	5000	-	1500	2500	5500	-	2000	4000	-	-	1500	3500	4500	-	
	Rated Power (speed) ①②⑦⑧⑨	P _{rtd}	kW Hp	1.04 1.40	1.37 1.84	-	1.20 1.60	1.85 2.48	2.25 3.01	-	2.06 2.77	3.20 4.30	-	-	2.03 2.72	3.68 4.94	3.83 5.14	-	
640VDC	Rated Torque (speed) ①②⑦⑧⑨	T _{rtd}	N-m lb-in	3.80 33.6	1.94 17.2	-	7.28 64.4	6.66 58.9	3.25 28.7	-	9.50 84.0	6.85 60.8	-	-	12.3 109	9.25 81.9	-	-	
	Rated Speed	N _{rtd}	rpm	3000	6000	-	2000	3000	6000	-	2400	4500	-	-	2000	4000	-	-	
	Rated Power (speed) ①②⑦⑧⑨	P _{rtd}	k-W Hp	1.19 1.60	1.22 1.63	-	1.52 2.04	2.09 2.74	2.04 2.74	-	2.39 3.20	3.23 4.33	-	-	2.57 3.45	3.87 5.19	-	-	
Torque Constant ①	±10%	K _t	N-m/A _{rms} lb-in/A _{rms}	1.72 15.2	0.99 8.8	0.52 4.6	2.79 24.7	1.79 15.8	0.93 8.2	0.66 5.8	2.39 21.2	1.24 11.0	0.85 7.5	0.60 5.3	2.88 25.5	1.50 13.3	1.13 10.0	0.80 7.1	
Back EMF constant ⑥	±10%	K _e	V/krpm	110	63.6	33.5	179	115	60.1	42.4	154	79.8	54.7	38.4	185	96.6	72.9	51.3	
Resistance (line-line) ⑥	±10%	R _m		8.47	2.75	0.75	8.59	3.47	0.93	0.48	3.75	1	0.51	0.27	3.8	1.02	0.63	0.33	
Inductance (line-line)		L	mH	36.6	12.1	3.4	44.7	18.5	5.0	2.5	21.3	5.7	2.7	1.3	22.9	6.2	3.5	1.8	
Inertia (includes Resolver feedback) ③		J _m	kg-cm ² lb-in-s ²		3.4 3.0E-03			6.2 5.5E-03				9.1 8.1E-03				12 0.011			
Optional Brake Inertia (additional)		J _m	kg-cm ² lb-in-s ²		0.17 1.5E-04			0.17 1.5E-04				0.17 1.5E-04				0.17 1.5E-04			
Weight		W	kg lb		4.2 9.3			5.8 12.8				7.4 16.3				9 19.8			
Static Friction ①⑩		T _f	N-m lb-in		0.022 0.19			0.04 0.35				0.058 0.51				0.077 0.68			
Viscous Damping ①		K _{dv}	N-m/krpm lb-in/krpm		0.033 0.29			0.042 0.37				0.052 0.46				0.061 0.54			
Thermal Time Constant		TCT	minutes		20			24				28				31			
Thermal Resistance		R _{thw-a}	°C/W		0.75			0.62				0.55				0.50			
Pole Pairs					5			5				5				5			
Heatsink Size					12x12x1/2 Aluminum Plate			12x12x1/2 Aluminum Plate				12x12x1/2 Aluminum Plate				12x12x1/2 Aluminum Plate			

- Notes:
- Motor winding temperature rise, ΔT=100°C, at 40°C ambient.
 - All data referenced to sinusoidal commutation.
 - Add parking brake if applicable for total inertia.
 - Motor with standard heatsink.
 - May be limited at some values of Vbus.
 - Measured at 25°C.
 - Brake motor option reduces continuous torque ratings by:
 - AKM51 = 0.15 N-m
 - AKM52 = 0.26 N-m
 - AKM53 = 0.35 N-m
 - AKM54 = 0.43 N-m
 - Non-Resolver feedback options reduce continuous torque ratings by:
 - AKM51 = 0.15 N-m
 - AKM52 = 0.34 N-m
 - AKM53 = 0.58 N-m
 - AKM54 = 0.86 N-m
 - Motors with non-Resolver feedback and Brake option, reduce continuous torque by:
 - AKM51 = 0.39 N-m
 - AKM52 = 0.76 N-m
 - AKM53 = 1.13 N-m
 - AKM54 = 1.55 N-m
 - For motors with optional shaft seal, reduce torque shown by 0.013 N-m (0.1.2lb-in), and increase T_f by the same amount.

Performance Data - AKM6x Frame

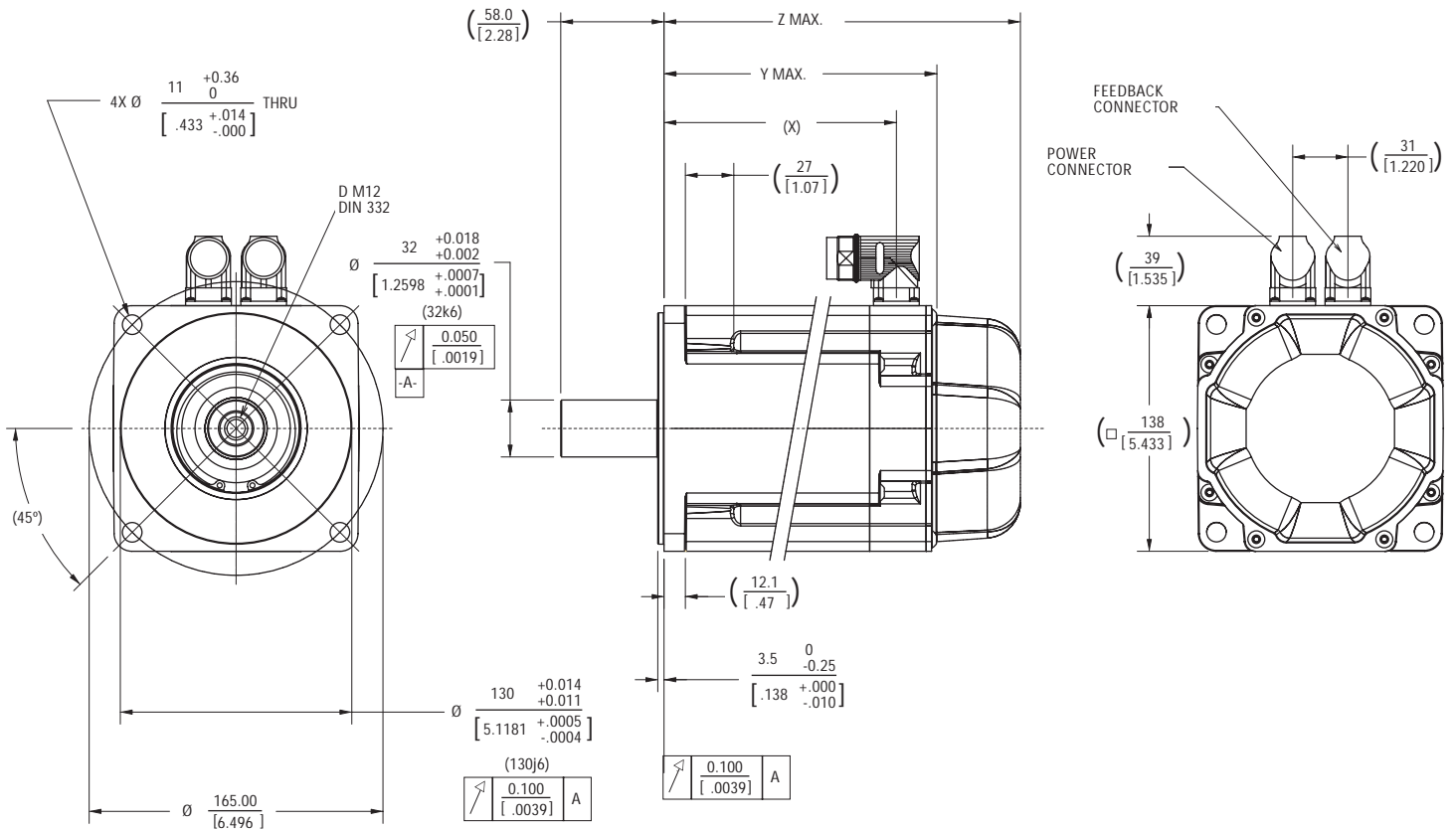

MOUNTING CODE	"T"	"U"	"V"	"W"
AC	$10 \begin{matrix} 0 \\ -0.036 \\ +.0000 \\ -.0014 \end{matrix} \text{ N9}$	$35 \begin{matrix} 0 \\ -0.29 \\ +.000 \\ -.011 \end{matrix}$	$5.00 \begin{matrix} 0 \\ -.197 \end{matrix}$	$45 \begin{matrix} 0 \\ -0.30 \\ +.000 \\ -.012 \end{matrix}$
AN	-	-	-	-

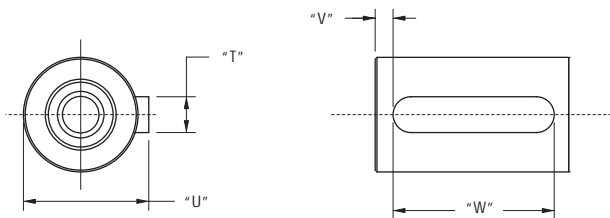

Dimensions are in mm [inches].
Product designed in metric.
English conversions provided for reference only.

Z MAX. SINE ENCODER (NO BRAKE)	Z MAX. SINE ENCODER (W/ BRAKE)	(X)	Y MAX.	Z MAX. (W/ BRAKE)	MODEL
172.2 [6.78]	218.7 [8.85]	130.5 [5.14]	153.7 [6.05]	200.7 [7.90]	AKM62
197.2 [7.76]	224.7 [9.63]	155.5 [6.12]	178.7 [7.04]	225.7 [8.89]	AKM63
222.2 [8.75]	268.7 [10.62]	180.5 [7.11]	203.7 [8.02]	250.7 [9.87]	AKM64
247.2 [9.73]	294.7 [11.60]	205.5 [8.09]	228.7 [9.00]	275.7 [10.85]	AKM65

Performance Data - AKM6x Frame

AKM6x - Up to 640 VDC

See system data beginning on page 8 for typical torque/speed performance.

PARAMETER	Tol	SYMBOL	UNITS	AKM62				AKM63				AKM64			AKM65		
				G	K	M	P	G	K	M	N	K	L	P	K	M	N
Max Rated DC Bus Voltage	Max	V _{bus}	V _{dc}	640	640	640	320	640	640	640	640	640	640	640	640	640	640
Continuous Torque (Stall) for ΔT winding = 100°C ①②⑦⑧⑨	Nom	T _{cs}	N-m lb-in	11.9 105	12.2 108	12.2 108	12.3 109	16.5 146	16.8 149	17.0 150	17.0 150	20.8 184	21.0 186	20.4 181	24.8 219	25.0 221	24.3 215
Continuous Current (Stall) for ΔT winding = 100°C ①②⑦⑧⑨	Nom	I _{cs}	A _{rms}	4.9	9.6	13.4	18.8	4.5	9.9	13.8	17.4	9.2	12.8	18.6	9.8	13.6	17.8
Continuous Torque (Stall) for ΔT winding = 60°C ②	Nom	T _{cs}	N-m lb-in	9.49 84.0	9.72 86.0	9.72 86.0	9.83 87.0	13.2 117	13.4 119	13.6 120	13.6 120	16.6 147	16.8 149	16.3 144	19.8 175	20.0 177	19.4 172
Max Mechanical Speed ⑤	Nom	N _{max}	rpm	6000	6000	6000	6000	6000	6000	6000	6000	6000	6000	6000	6000	6000	6000
Peak Torque ①②	Nom	T _p	N-m lb-in	29.8 264	30.1 266	30.2 267	30.4 269	41.8 370	42.6 377	43.0 381	43.0 381	53.5 473	54.1 479	52.9 468	64.5 571	65.2 577	63.7 564
Peak Current	Nom	I _p	A _{rms}	14.6	28.7	40.3	56.5	13.4	29.7	41.4	52.2	27.5	38.4	55.9	29.4	40.9	53.3
75VDC	Rated Torque (speed) ①②⑦⑧⑨	T _{rtd}	N-m lb-in	-	-	-	-	-	-	-	-	-	-	-	-	-	-
	Rated Speed	N _{rtd}	rpm	-	-	-	-	-	-	-	-	-	-	-	-	-	-
	Rated Power (speed) ①②⑦⑧⑨	P _{rtd}	kW Hp	-	-	-	-	-	-	-	-	-	-	-	-	-	-
160VDC	Rated Torque (speed) ①②⑦⑧⑨	T _{rtd}	N-m lb-in	-	-	-	-	-	-	-	-	-	-	-	-	-	-
	Rated Speed	N _{rtd}	rpm	-	-	-	-	-	-	-	-	-	-	-	-	-	-
	Rated Power (speed) ①②⑦⑧⑨	P _{rtd}	kW Hp	-	-	-	-	-	-	-	-	-	-	-	-	-	-
320VDC	Rated Torque (speed) ①②⑦⑧⑨	T _{rtd}	N-m lb-in	-	10.4 92.0	9.50 84.1	8.10 71.7	-	14.9 132	14.3 127	13.0 115	18.8 166	18.4 163	16.0 142	22.8 202	21.9 194	19.8 175
	Rated Speed	N _{rtd}	rpm	-	2000	3000	4500	-	1500	2000	3000	1200	1500	2500	1000	1500	2000
	Rated Power (speed) ①②⑦⑧⑨	P _{rtd}	kW Hp	-	2.18 2.92	2.98 4.00	3.82 5.12	-	2.34 3.14	2.99 4.01	4.08 5.47	2.36 3.17	2.89 3.87	4.19 5.62	2.39 3.20	3.44 4.61	4.15 5.56
560VDC	Rated Torque (speed) ①②⑦⑧⑨	T _{rtd}	N-m lb-in	10.4 92.0	9.00 79.7	5.70 50.4	-	14.9 132	12.9 114	11.3 100	9.60 85.0	17.2 152	15.6 138	11.9 105	20.2 179	19.2 170	16.0 142
	Rated Speed	N _{rtd}	rpm	1800	3500	6000	-	1200	3000	4000	5000	2000	3000	4500	2000	2500	3500
	Rated Power (speed) ①②⑦⑧⑨	P _{rtd}	kW Hp	1.96 2.63	3.30 4.42	3.58 4.80	-	1.87 2.51	4.05 5.43	4.73 6.34	5.03 6.74	3.60 4.83	4.90 6.57	5.61 7.52	4.23 5.67	5.03 6.74	5.86 7.86
640VDC	Rated Torque (speed) ①②⑦⑧⑨	T _{rtd}	N-m lb-in	10.2 90.3	8.00 70.8	5.70 50.4	-	14.6 129	12.0 106	10.5 92.9	7.00 62.0	16.3 144	14.4 127	9.00 80.0	19.7 174	18.1 160	14.7 130
	Rated Speed	N _{rtd}	rpm	2000	4500	6000	-	1500	3500	4500	6000	2500	3500	5500	2200	3000	4000
	Rated Power (speed) ①②⑦⑧⑨	P _{rtd}	kW Hp	2.14 2.86	3.77 5.05	3.58 4.80	-	2.29 3.07	4.40 5.90	4.95 6.63	4.40 5.90	4.40 5.72	4.27 7.07	5.28 6.95	5.18 6.95	4.54 6.08	5.69 7.62
Torque Constant ①	±10%	K _t	N-m/A _{rms} lb-in/A _{rms}	2.47 21.9	1.28 11.3	0.91 8.1	0.66 5.8	3.70 32.7	1.71 15.1	1.24 11.0	0.98 8.7	2.28 20.2	1.66 14.7	1.10 9.7	2.54 22.5	1.85 16.4	1.38 12.2
Back EMF constant ⑥	±10%	K _e	V/k _r rpm	159	82.1	58.8	42.2	238	110	79.9	63.3	147	107	71.0	164	119	88.8
Resistance (line-line) ⑥	±10%	R _m	Ω	3.94	1.05	0.55	0.30	5.16	1.09	0.58	0.38	1.34	0.71	0.36	1.27	0.68	0.42
Inductance (line-line)		L	mH	31.7	8.5	4.4	2.2	43.5	9.3	4.9	3.1	11.8	6.2	2.8	11.4	6.1	3.4
Inertia (includes Resolver feedback) ③		J _m	kg-cm ² lb-in-s ²	17 0.015				24 0.021				32 0.028			40 0.035		
Optional Brake Inertia (additional)		J _m	kg-cm ² lb-in-s ²	0.61 5.4E-04				0.61 5.4E-04				0.61 5.4E-04			0.61 5.4E-04		
Weight		W	kg lb	8.9 19.6				11.1 24.4				13.3 29.3			15.4 33.9		
Static Friction ①⑩		T _f	N-m lb-in	0.05 0.44				0.1 0.9				0.15 1.3			0.2 1.8		
Viscous Damping ①		K _{dv}	N-m/k _r rpm lb-in/k _r rpm	0.04 0.35				0.06 0.53				0.08 0.71			0.1 0.9		
Thermal Time Constant		TCT	minutes	20				25				30			35		
Thermal Resistance		R _{thw-a}	°C/W	0.48				0.44				0.41			0.38		
Pole Pairs				5				5				5			5		
Heatsink Size				18x18x1/2" Aluminum Plate				18x18x1/2" Aluminum Plate				18x18x1/2" Aluminum Plate			18x18x1/2" Aluminum Plate		

Notes:

- Motor winding temperature rise, ΔT=100°C, at 40°C ambient.
- All data referenced to sinusoidal commutation.
- Add parking brake if applicable for total inertia.
- Motor with standard heatsink.
- May be limited at some values of V_{bus}.
- Measured at 25°C.
- Brake motor option reduces continuous torque ratings by:
AKM62 = 0.5 N-m AKM63 = 0.9 N-m
AKM64 = 1.3 N-m AKM65 = 1.7 N-m
- Non-Resolver feedback options reduce continuous torque ratings by:
AKM62 = 0.9 N-m AKM63 = 1.2 N-m
AKM64 = 1.5 N-m AKM65 = 1.8 N-m
- Motors with non-Resolver feedback and Brake option, reduce continuous torque by:
AKM62 = 1.6 N-m AKM63 = 2.4 N-m
AKM64 = 3.1 N-m AKM65 = 4.0 N-m
- For motors with optional shaft seal, reduce torque shown by 0.25 N-m (2.21 lb-in), and increase T_f by the same amount.

Performance Data - AKM7x Frame

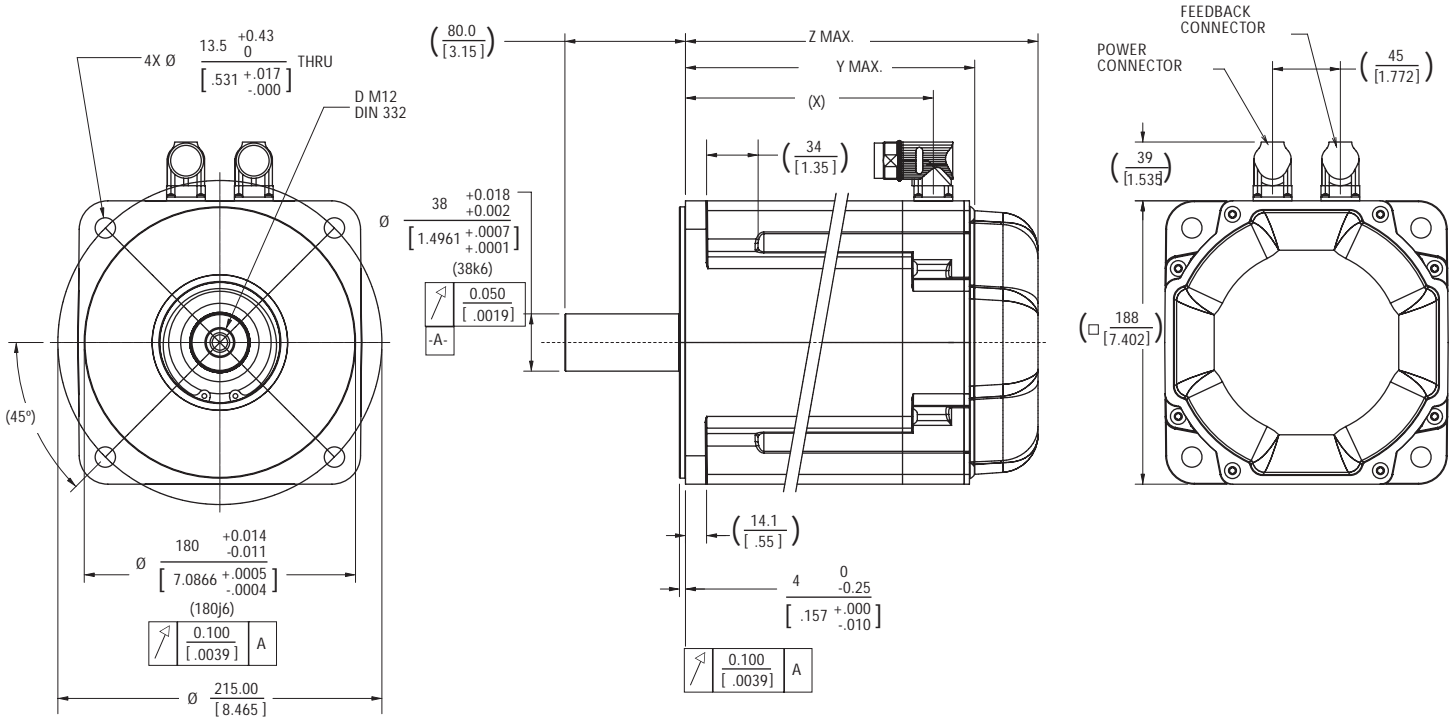

MOUNTING CODE	"T"	"U"	"V"	"W"
AC	10 ⁰ _{-0.036} N9 [.3937 +.0000/-0.0014]	41 ⁰ _{-0.29} [1.614 +.000/-0.11]	5.00 [.197]	70 ⁰ _{-0.30} [2.756 +.000/-0.12]
AN	-	-	-	-

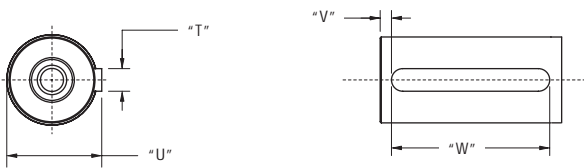

Dimensions are in mm [inches].
Product designed in metric.
English conversions provided for reference only.

Z MAX. SINE ENCODER (NO BRAKE)	Z MAX. SINE ENCODER (W/ BRAKE)	(X)	Y MAX.	Z MAX. (W/ BRAKE)	MODEL
201.7 [7.94]	253.3 [9.97]	164.5 [6.48]	192.5 [7.58]	234.5 [9.23]	AKM72
235.7 [9.38]	287.3 [11.31]	198.5 [7.81]	226.5 [8.92]	268.5 [10.57]	AKM73
269.7 [10.62]	321.3 [12.65]	232.5 [9.15]	260.5 [10.26]	302.5 [11.91]	AKM74

Performance Data - AKM7x Frame

AKM7x - Up to 640 VDC

See system data beginning on page 8 for typical torque/speed performance.

PARAMETER	Tol	SYMBOL	UNITS	AKM72			AKM73		AKM74	
				K	M	P	M	P	L	P
Max Rated DC Bus Voltage	Max	V _{bus}	V _{dc}	640	640	640	640	640	640	640
Continuous Torque (Stall) for ΔT winding = 100°C ①②⑦⑧⑨	Nom	T _{CS}	N-m lb-in	29.7 263	30.0 266	29.4 260	42.0 372	41.6 368	53.0 469	52.5 465
Continuous Current (Stall) for ΔT winding = 100°C ①②⑦⑧⑨	Nom	I _{CS}	A _{rms}	9.3	13.0	18.7	13.6	19.5	12.9	18.5
Continuous Torque (Stall) for ΔT winding = 60°C ②	Nom	T _{CS}	N-m lb-in	23.8 211	24.0 212	23.5 208	33.6 297	33.3 295	42.4 375	42.0 372
Max Mechanical Speed ⑤	Nom	N _{max}	rpm	6000	6000	6000	6000	6000	6000	6000
Peak Torque ①②	Nom	T _p	Nm lb-in	79.2 701	79.7 705	78.5 695	113 997	111 985	143 1269	142 1253
Peak Current	Nom	I _p	A _{rms}	27.8	38.9	56.1	40.8	58.6	38.7	55.5
75VDC	Rated Torque (speed) ①②⑦⑧⑨ ⑩	T _{rtd}	N-m lb-in	-	-	-	-	-	-	-
	Rated Speed	N _{rtd}	rpm	-	-	-	-	-	-	-
	Rated Power (speed) ①②⑦⑧⑨	P _{rtd}	kW Hp	-	-	-	-	-	-	-
160VDC	Rated Torque (speed) ①②⑦⑧⑨ ⑩	T _{rtd}	N-m lb-in	-	-	-	-	-	-	-
	Rated Speed	N _{rtd}	rpm	-	-	-	-	-	-	-
	Rated Power (speed) ①②⑦⑧⑨	P _{rtd}	kW Hp	-	-	-	-	-	-	-
320VDC	Rated Torque (speed) ①②⑦⑧⑨ ⑩	T _{rtd}	N-m lb-in	-	-	23.8 211	-	34.7 307	-	-
	Rated Speed	N _{rtd}	rpm	-	-	1800	-	1300	-	-
	Rated Power (speed) ①②⑦⑧⑨	P _{rtd}	kW Hp	-	-	4.49 6.01	-	4.72 6.33	-	-
560VDC	Rated Torque (speed) ①②⑦⑧⑨ ⑩	T _{rtd}	N-m lb-in	25.1 222	23.6 209	20.1 178	33.8 299	28.5 252	43.5 385	39.6 350
	Rated Speed	N _{rtd}	rpm	1500	2000	3000	1500	2400	1200	1800
	Rated Power (speed) ①②⑦⑧⑨	P _{rtd}	kW Hp	3.94 5.29	4.94 6.63	6.31 8.46	5.31 7.12	7.16 9.60	5.47 7.33	7.46 10.01
640VDC	Rated Torque (speed) ①②⑦⑧⑨ ⑩	T _{rtd}	N-m lb-in	24.0 212	22.1 196	18.2 161	32.1 284	26.3 233	41.5 367	35.9 318
	Rated Speed	N _{rtd}	rpm	1800	2500	3500	1800	2800	1400	2000
	Rated Power (speed) ①②⑦⑧⑨	P _{rtd}	kW Hp	4.52 6.06	5.79 7.76	6.67 8.94	6.05 8.11	7.71 10.34	6.08 8.16	7.52 10.08
Torque Constant ①	±10%	K _t	N-m/A _{rms} lb-in/A _{rms}	3.23 28.6	2.33 20.6	1.58 14.0	3.10 27.4	2.13 18.9	4.14 36.6	2.84 25.1
Back EMF constant ⑥	±10%	K _e	V/k _r rpm	208	150	102	200	137	266	183
Resistance (line-line) ⑥	±10%	R _m		1.22	0.64	0.33	0.68	0.35	0.85	0.43
Inductance (line-line)		L	mH	20.7	10.8	5.0	12.4	5.9	16.4	7.7
Inertia (includes Resolver feedback) ③		J _m	kg-cm ² lb-in-s ²		65 0.057		92 0.082		120 0.11	
Optional Brake Inertia (additional)		J _m	kg-cm ² lb-in-s ²		1.64 1.46 x 10 ⁻³		1.64 1.46 x 10 ⁻³		1.64 1.46 x 10 ⁻³	
Weight		W	kg lb		19.7 43.4		26.7 58.8		33.6 74.0	
Static Friction ①⑩		T _f	N-m lb-in		0.16 1.4		0.24 2.1		0.33 2.9	
Viscous Damping ①		K _{dv}	N-m/k _r rpm lb-in/k _r rpm		0.06 0.5		0.13 1.2		0.2 1.8	
Thermal Time Constant		TCT	minutes		46		53		60	
Thermal Resistance		R _{thw-a}	°C/W		0.43		0.37		0.33	
Pole Pairs					5		5		5	
Heatsink Size					18"x18"x½" Aluminum Plate		18"x18"x½" Alum. Plate		18"x18"x½" Alum. Plate	

Notes:

- Motor winding temperature rise, ΔT=100°C, at 40°C ambient.
- All data referenced to sinusoidal commutation.
- Add parking brake if applicable for total inertia.
- Motor with standard heatsink.
- May be limited at some values of V_{bus}.
- Measured at 25°C.

- Brake motor option reduces continuous torque ratings by 1 N-m.
- Non-Resolver feedback options reduce continuous torque ratings by:
AKM72 = 2.0 N-m AKM73 = 2.7 N-m
AKM74 = 3.4 N-m

- Motors with non-Resolver feedback and Brake option, reduce continuous torque by:

AKM72 = 3.9 N-m AKM73 = 5.1 N-m
AKM74 = 6.2 N-m

- For motors with optional shaft seal, reduce torque shown by 0.25 N-m (2.21 lb-in), and increase T_f by the same amount.

Bearing Fatigue Life (L_{10})

AKM1 MOTORS
20,000 HOURS L_{10} BEARING LIFE

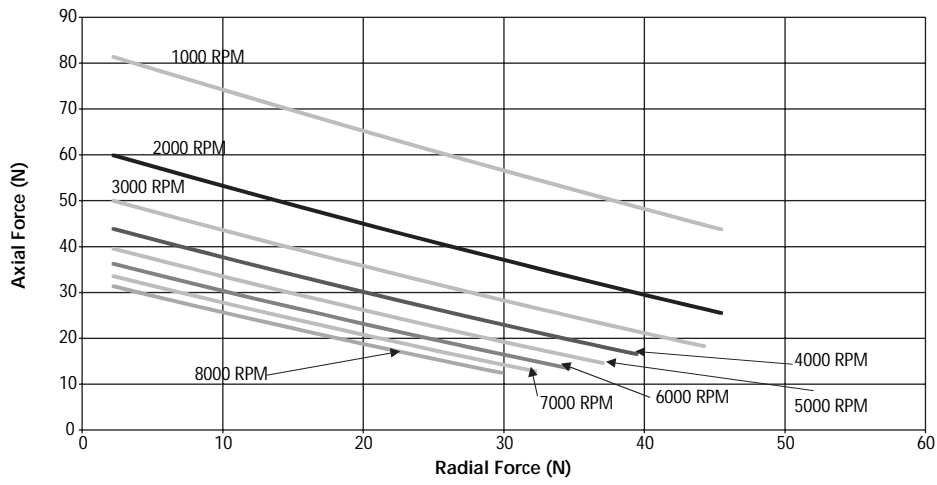

AKM2 MOTORS
20,000 HOURS L_{10} BEARING LIFE

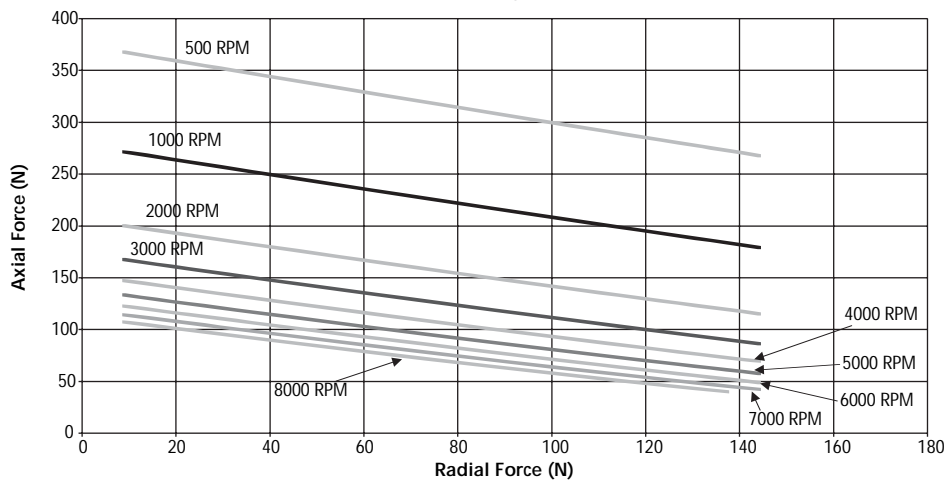

AKM3 MOTORS
20,000 HOURS L_{10} BEARING LIFE

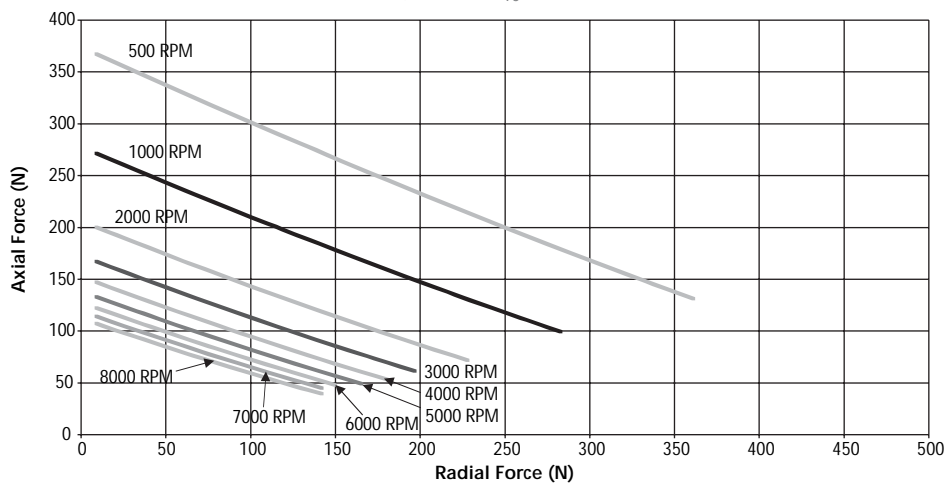

Bearing Fatigue Life (L₁₀)

AKM4 MOTORS
20,000 HOURS L₁₀ BEARING LIFE

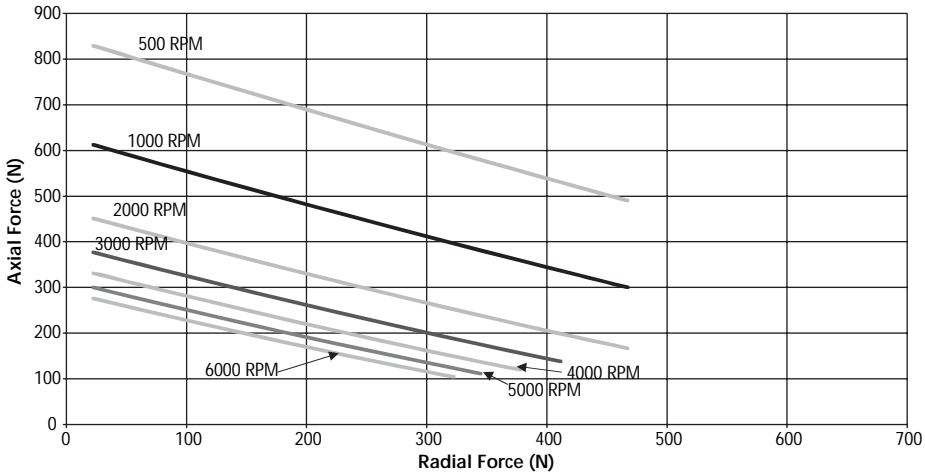

AKM5 MOTORS
20,000 HOURS L₁₀ BEARING LIFE

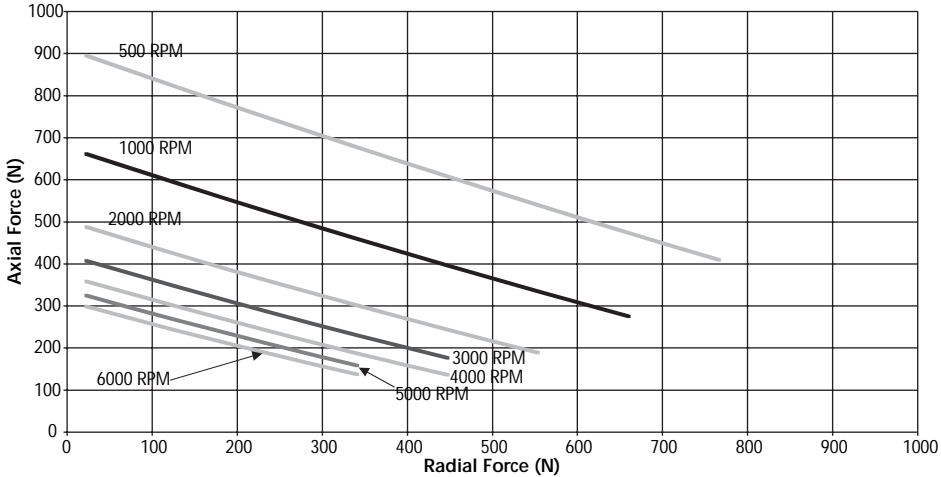

AKM6 MOTORS
20,000 HOURS L₁₀ BEARING LIFE

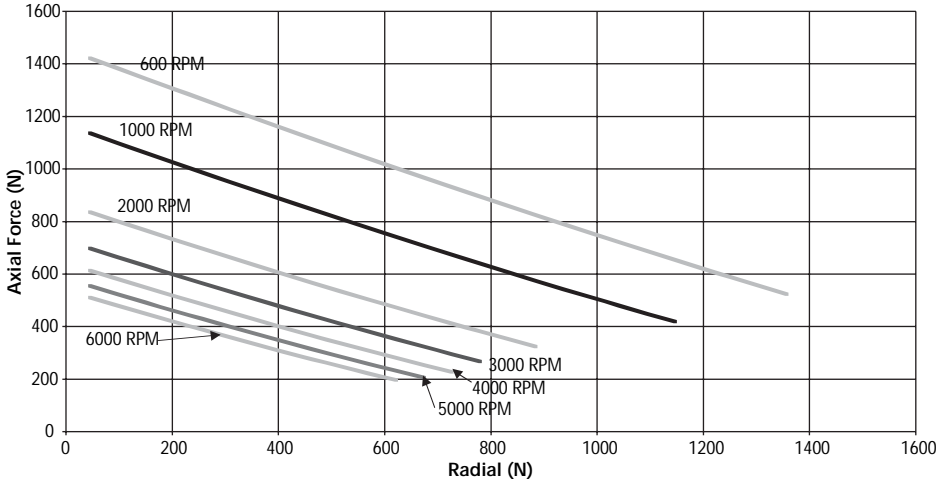

Bearing Fatigue Life (L₁₀)

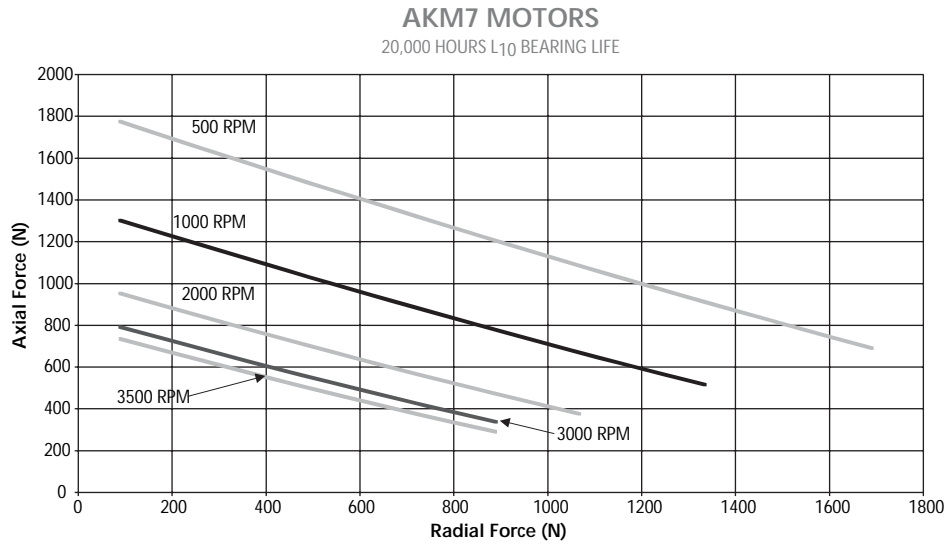

Shaft Loading

MOTOR	MAX RADIAL FORCE (N)	MAX AXIAL FORCE (N)
AKM1	48	200
AKM2	150	600
AKM3	340	600
AKM4	500	1400
AKM5	830	1740
AKM6	1940	2200
AKM7	2300	3000

The maximum radial load ratings reflect the following assumptions:

1. Motors are operated with peak torque of the longest member of the frame size.
2. Fully reversed load applied to the end of the smallest diameter standard mounting shaft extension.
Excluding AKM4X-EK which is rated at 240N max. radial force.
3. Infinite life with 99% reliability.
4. Safety factor = 2.

TEFLON SHAFT SEALS

There is a normal break in period for our Teflon shaft seals. Best conditions during the break-in period would be at the operational temperature and speed that would be typical for the application.

During the break-in period, some "shedding" of Teflon material is normal. The debris is not a sign of seal deterioration or failure. The material "shed" should be reduced with usage.

Typically, a few hours at operational speed is enough to break-in the shaft seal.

AKM Motor Primary Feedback Devices

Phasing Diagram - All Motors

MOTOR WINDING CONFIGURATION

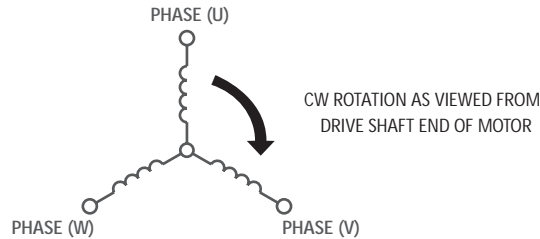

General notes:

- 1 When motor is rotated CW (viewed from drive shaft end), these waveforms result:
Voltage U , leads V , leads W.
Voltage U-W leads Voltage V-W by 60° electrical.
- 2A PTC thermistor (155°C ± 5°C switching temperature) installed.
Resistance at 25°C: ≤550 ohms.
Switching Resistance: ≥1330 ohms within ±5°C of switch temperature.
- 2B Optional KTY84-130 Nominal Resistance at 25°C, 603 ohms.
- 2C Optional KTY83-110 Nominal Resistance at 25°C, 1000 ohms.
- 3 When optional shaft seal is included on front shaft extension, note that static friction stated in catalog or on winding data sheet is measured without shaft seal installed.
- 4 Standard outline drawings showing mounting dimensions and standard winding information are available on our Web site at www.Danahermotion.com or by calling the Danaher Motion Assistance Center at 1-540-633-3400.

RESOLVER (PRIMARY FEEDBACK)

RESOLVER DATA	UNITS	AKM 1	AKM 2,3,4	AKM 5,6,7
TYPE		1 SPEED	1 SPEED	1 SPEED
INPUT VOLTAGE	V _{RMS}	7.0	7.0	7.0
	k Hz	10	10	10
INPUT CURRENT MAX.	mA	30	30	30
TRANSFORMATION RATIO	10 %	0.5	0.5	0.5
NULL VOLTAGE	mVrms	50	50	50
MAX. ERROR (pk-pk)	MINS.	30	16	16
PHASE SHIFT		TBD	TBD	TBD
OPERATING TEMP.	°C	-55° to 155°	-55° to 155°	-55° to 155°
ROTOR INERTIA MAX.	kg cm ²	0.002	0.046	0.497

RESOLVER WINDING CONFIGURATION

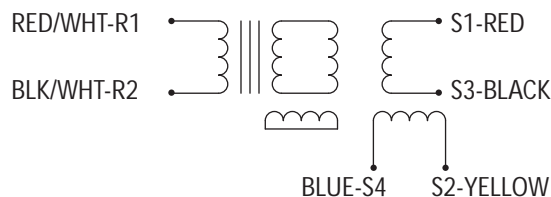

$$E_{R1-R2} = E \sin(\omega T)$$

$$E_{S1-S3} = K E_{R1-R2} \sin\theta$$

$$E_{S2-S4} = K E_{R1-R2} \cos\theta$$

RESOLVER ALIGNMENT

With positive DC current into phase W and out of phase V (U floats) the resolver is aligned to electrical zero ±5 counts. ie. Voltage S1-S3 set to null voltage S2-S4 max in phase with reference (R1-R2).

Servomotor Feedback Combinations

**AKM Series Motors with SFD
(Smart Feedback Device)**

The Smart Feedback Device (SFD) communicates with the drive over a 4 wire interface. Two wires supply +5V power at <150 mA and the second pair is an RS-485 digital communications link. The device includes EEPROM memory to save motor parameters.

ANGLE MEASUREMENT:

- Resolution: $2^{24} = 16,777,216$ counts per rev
= 0.0013 arc-min
- Accuracy: < +/- 0.75 arc-min electrical + sensor error
- Size 10 sensor +/- 16 arc-min net
- Size 15 sensor +/- 9 arc-min net
- Size 21 sensor +/- 9 arc-min net
- Electrical Noise: < 2^{-17} Rev rms at full bandwidth
- Bandwidth: > 2000 Hz at -3 dB
> 1000 Hz at -45° phase lag
- Max Tracking Rate: > 50,000 RPM
- Velocity Ripple: < 0.2% p-p electronics only
- Size 10 sensor < 2.5% p-p net (AKM 1)
- Size 15 sensor < 1.5% p-p net (AKM 2,3,4)
- Size 21 sensor < 1.5% p-p net (AKM 5,6,7)
- Velocity Noise: < 4 RPM rms at full bandwidth

DIGITAL COMMUNICATIONS:

- Baud Rate: 2.5 Mbaud
- Signaling: RS-485 differential, 8 bit data with odd parity compatible with standard UARTs
- Update Period: Once every 51.2 uSec new position sample
- Error Detection: 5 bit CRC in addition to parity check
- EEPROM Memory: Does a data dump when the unit powers up.

POWER SUPPLY:

- Supply at Drive: 5.0 V +/- 0.25V (+/-5%)
- Supply at SFD in motor: 4.25V to 5.25V
- Nominal Supply Current: 120 mA
- Worst Case Supply: 150 mA
- Cable Resistance: +5V, Rtn: < 3.3 Ohm net

ENVIRONMENTAL:

- Operating Ambient: -20 to 120° C
- Humidity: 10% to 90% non-condensing
- Storage Temperature: -40 to 135° C

**AKM Series Motors with
Commutating Encoder Option**

COMMUTATING ENCODER

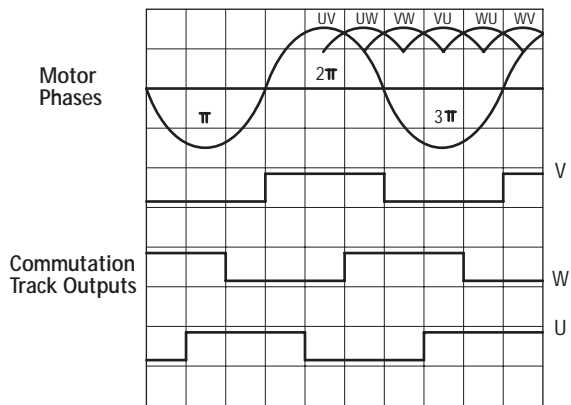
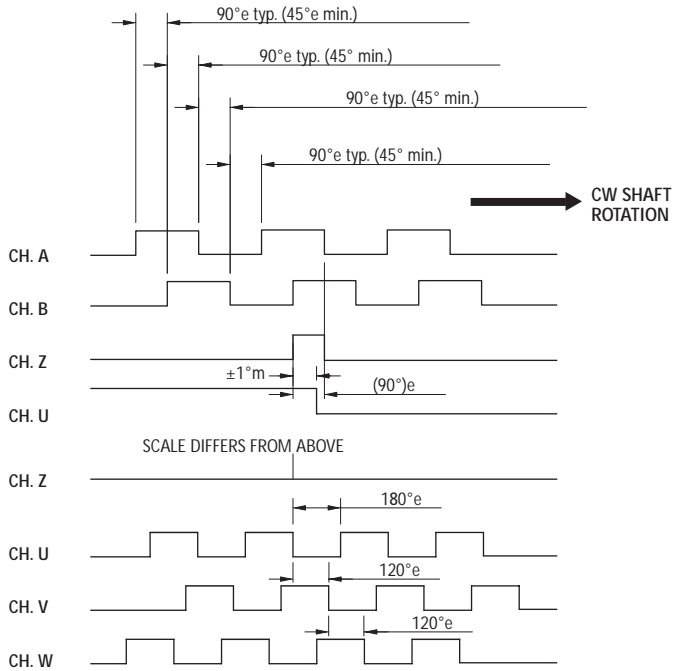

Max. Misalignment between rising edge of commutation track V & zero crossing of back EMF UV <= 5° electrical.

Motor Connections

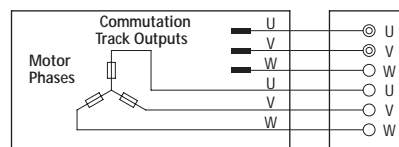

OUTPUT COMM: OPEN COLLECTOR W 2.2 k OHMS
EXTERNAL PULL UPS
(SINK 8 mA MAX.)

Servomotor Feedback Combinations

AKM Series Motors with Commutating Encoder Option (cont'd)

ENCODER DATA (TYPICAL PERFORMANCE DATA @ 25°C)

PARAMETER	UNITS	1-	2-	ED	EE	EF (AKM2-4)	EF (AKM5-7)	EG	EM	EH	EN (AKM5-7)	EJ (AKM5-7)	
INPUT VOLTAGE	V DC ±10%	5											
OUTPUT DATA		26LS31 DIFF. LINE DRIVER. SINK/SOURCE 40mA MAX											
LINE COUNT		1024	2048	500	1000	2000	2000	2500	4096	5000	8192	10,000	
FREQUENCY RESPONSE	KHz	300	300	250	250	500	250	500	500	500	500	500	
MAX. SPEED	RPM	12,000	12,000	12,000	12,000	12,000	7,500	12,000	7,324	8,000	3,662	3,000	
MIN. EDGE SEPARATION OF INCREMENTAL CHANNEL	°e MIN.	45											
INDEX TO U COMM CHANNEL		±1°m INDEX CENTER TO U RISING EDGE											
INDEX PULSE WIDTH		GATED WITH A HIGH AND B HIGH											
INCREMENTAL CHANNEL ACCURACY		±2.5 ARC MIN. MAX xxx TO ANY EDGE											
MAX. ACCELERATION	Rad/s ²	100,000											
OPERATING TEMPERATURE	°C	0-120											
STORAGE TEMPERATURE	°C	0-120			-40 - 120								

	TYPE	AKM 1	AKM 2	AKM 3	AKM 4	AKM 5,6,7
COMMUTATING CHANNEL	ALL	6 POLE 60°m ±6 MIN.	6 POLE 60°m ±6 MIN.	8 POLE 45°m ±6 MIN.	10 POLE 36°m ±6 MIN.	10 POLE 36°m ±6 MIN.
MOMENT OF INERTIA (kg-cm ²)	1-, 2- ALL EX	1.6 NA	2.5 0.0058	2.5 0.0058	2.5 0.0058	18.8 0.0373

Failsafe, Holding Brake

The holding brake is designed to provide static holding torque to the motor shaft with the brake coil de-energized. The brake must first be released (coil energized) prior to commanding motor rotation as determined by its drop-out time. The brake is intended for holding or "parking" of a stationary motor. Not intended for dynamic braking. There should be absolutely no motion of the rotor when power is removed from the brake coil.

AKM Motor Brake Options

Motor Family	Minimum Static Torque @120° C		Weight		Power Consumption @24V, 20° C	Current @24V, 20° C	Inertia		Closing Time (engage)	Opening Time (release)	Backlash ?	
	N-m	lb-in	Kg	lbs	Watts +/- 7%	ADC	kgcm ²	lb-in-sec ²	msec	msec	Maximum deg.	Typical deg.
AKM2	1.42	12.6	0.27	0.59	8.4	0.35	0.011	0.97E-05	18	20	1.01	0.46
AKM3	2.5	22.1	0.35	0.77	10.1	0.42	0.011	0.97E-05	10	25	1.01	0.46
AKM4	5.3	46.9	0.63	1.39	12.8	0.53	0.068	6.02E-05	15	35	0.81	0.37
AKM5	14.5	128	1.1	2.42	19.5	0.82	0.173	1.53E-04	15	80	0.71	0.31
AKM6	25	221	2	4.4	25.7	1.07	0.605	5.35E-04	20	105	0.51	0.24
AKM7	53	469	2.9	6.38	35.6	1.48	1.644	1.46E-03	35	110	0.44	0.20

1. Contamination of the motor internal compartment by oil or other foreign materials will result in failure of the brake. Check the suitability of motor sealing for the working environment.

2. Operating Voltage: 24 VDC +/- 10%.

3. Maximum backlash is calculated using worst-case tolerancing, and typical backlash is calculated using statistical tolerancing.

Absolute Sine Encoder Option

Sine Encoder

Option DA " = Single-Turn Absolute

Option "DB" = Multi-Turn Absolute

"C" Connector

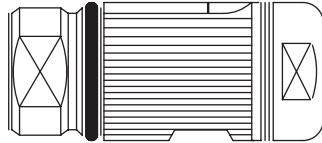

CABLE OPTION
(AKM 2 ONLY)

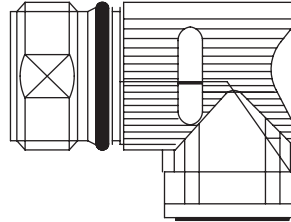

MOTOR MOUNTED OPTION
(AKM 3, 4, 5, 6, & 7 ONLY)
("B" connector option for AKM 2x)

* NOTE: INTERCONTEC PART NUMBERS

"DA" & "DB" POWER CONNECTOR

(VIEW FACING FRONT)

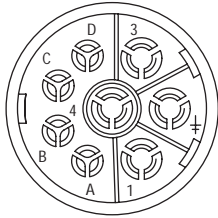

CONNECTOR PART NUMBER		
BKUA-199-NN-00-11-0035-000 (FOR AKM 2)		
BEDC-089-NN-00-00-0005-000 (FOR AKM 3, 4, 5, 6 & 7)		
PIN	FUNCTION	COLOR
1	U	BLUE
+	PE	GRN/YEL
3	W	VIOLET
4	V	BROWN
A	BRAKE +	BLACK
B	BRAKE -	BLACK
C	N/C	
D	N/C	

SHIELD CONNECTED TO MOTOR
GROUND INTERNAL TO MOTOR
(For AKM2)

SUGGESTED MATING CONNECTOR	
BSTA-108-NN-00-08-0036-000	

"DA" & "DB" ABSOLUTE ENCODER

(VIEW FACING FRONT)

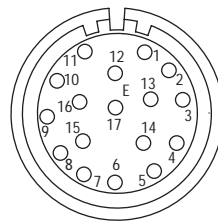

CONNECTOR PART NUMBER			
AKUA-034-NN-00-09-0035-000 (FOR AKM 2)			
AEDC-113-NN-00-00-0012-000 (FOR AKM 3, 4, 5, 6 & 7)			
PIN	FUNCTION	COLOR	
		AKM2	AKM3, 4, 5, 6, 7 (Motor-mounted connector)
1	B -	RED/BLK	RED/BLK
2	GND	WHT/GRN	WHT/GRN
3	A -	YEL/BLK	YEL/BLK
4	Vcc (5VDC)	BRN/GRN	BRN/GRN
5	DATA	GRAY	GRAY
6	N/C		
7	THERMAL SENSOR +	GREEN	BLUE
8	CLOCK	VIOLET	VIOLET
9	B +	BLU/BLK	BLU/BLK
10	Un SENSE (COMMON)	WHITE	WHITE
11	A +	GRN/BLK	GRN/BLK
12	Up SENSE (VCC)	BLUE	BLUE
13	DATA	PINK	PINK
14	THERMAL SENSOR -	BROWN	BLACK
15	CLOCK	YELLOW	YELLOW
16	N/C		
17	N/C		

SHIELD IS NOT CONNECTED
AT MOTOR END

SUGGESTED MATING CONNECTOR	
ASTA-035-NN-00-10-0035-000	

If dimensionals are required for connectors,
refer to catalog or contact Customer Service.

Absolute Sine Encoder Option

"M" Connector with "D" Feedback Option

(AKM 2, 3, & 4 ONLY)

POWER CONNECTOR

(NON BRAKE)

(VIEW FACING FRONT)

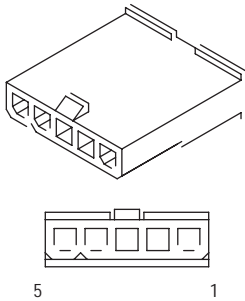

CONNECTOR PART NUMBER MOLEX 39-01-4056 (ENG NO. 5559-05P3)		
PIN	FUNCTION	COLOR
1	U	BLUE
2	V	BROWN
3	W	VIOLET
4	GND	GRN/YEL
5	SHIELD	

SHIELD CONNECTED TO MOTOR
GROUND INTERNAL TO MOTOR

SUGGESTED MATING CONNECTOR	
MOLEX 39-01-4050	

POWER CONNECTOR

(BRAKE)

(VIEW FACING FRONT)

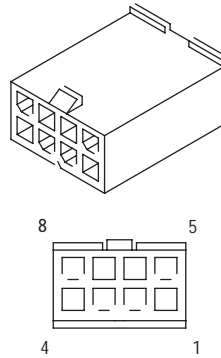

CONNECTOR PART NUMBER MOLEX 39-01-3083 (ENG NO. 5559-08P1)		
PIN	FUNCTION	COLOR
1	U	BLUE
2	V	BROWN
3	W	VIOLET
4	GND	GRN/YEL
5	SHIELD	
6	BRAKE +	BLACK
7	BRAKE -	BLACK
8	N/C	

SHIELD CONNECTED TO MOTOR
GROUND INTERNAL TO MOTOR

SUGGESTED MATING CONNECTOR	
MOLEX 39-01-2080	

"DA" & "DB" ABSOLUTE ENCODER

(VIEW FACING FRONT)

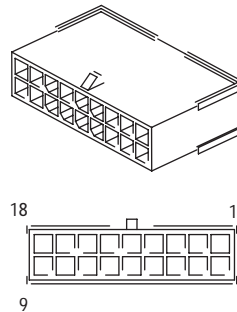

CONNECTOR PART NUMBER MOLEX 43020-1801		
PIN	FUNCTION	COLOR
1	B -	RED/BLK
2	GND	WHT/GRN
3	A -	YEL/BLK
4	Vcc (5VDC)	BRN/GRN
5	DATA	GRAY
6	N/C	
7	THERMAL SENSOR +	GREEN
8	CLOCK	VIOLET
9	B +	BLU/BLK
10	Un SENSE (COMMON)	WHITE
11	A +	GRN/BLK
12	Up SENSE (VCC)	BLUE
13	DATA	PINK
14	THERMAL SENSOR -	BROWN
15	CLOCK	YELLOW
16	N/C	
17	N/C	
18	SHIELD	

SHIELD IS NOT CONNECTED
AT MOTOR END

SUGGESTED MATING CONNECTOR	
MOLEX 43025-1800	

If dimensionals are required for connectors, refer to catalog or contact Customer Service.

AKM Series Motors with Absolute Sine Encoder Option

TYPE		SINGLE-TURN "DA"		MULTI-TURN "DB"	
FRAME SIZE		AKM 2, 3, 4	AKM5, 6, 7	AKM2, 3, 4	AKM5, 6, 7
PULSES PER REVOLUTION		512	2048	512	2048
INPUT VOLTAGE	VDC ±5°	5	5	5	5
CURRENT CONSUMPTION	mA MAX.	160	150	200	250
OPERATING TEMPERATURE	°C	-40/155	-30/115	-40/115	-30/115
INERTIA	kg cm ²	0.040	0.260	0.040	0.260
OUTPUT INTERFACE		HEIDENHAIN EnDat			
TYPE		ECN1113	ECN1313	EQN1125	EQN1325

Encoder Alignment

With positive DC current into phase W and out of phase V (U floats) the encoder is aligned to ±1 electrical degree.

AKM Motor Connector Options

"C" Connector Options



CABLE OPTION
(AKM 1 & 2 ONLY)

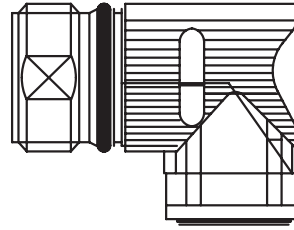

MOTOR MOUNTED OPTION
(AKM 3, 4, 5, 6, & 7 ONLY)
("B" CONNECTOR OPTION FOR AKM 2x)

POWER CONNECTOR
(VIEW FACING FRONT)

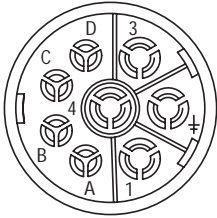

CONNECTOR PART NUMBER		
BKUA-199-NN-00-11-0035-000 (FOR AKM 1 & 2)		
BEDC-089-NN-00-00-0005-000 (FOR AKM 2, 3, 4, 5, 6 & 7)		
PIN	FUNCTION	COLOR
1	U	BLUE
+	PE	GRN/YEL
3	W	VIOLET
4	V	BROWN
A	BRAKE +	BLACK
B	BRAKE -	BLACK
C	N/C	
D	N/C	

SHIELD CONNECTED TO MOTOR
GROUND INTERNAL TO MOTOR
(For AKM1 and 2)

SUGGESTED MATING CONNECTOR	
Intercontec BSTA-108-NN-00-08-0036-000	

SFD FEEDBACK
(VIEW FACING FRONT)

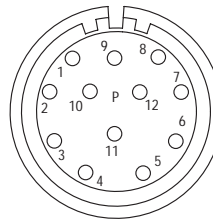

CONNECTOR PART NUMBER		
AKUA-020-NN-00-09-0035-000 (FOR AKM 1 & 2)		
AEDC-052-NN-00-00-0012-000 (FOR AKM 2, 3, 4, 5, 6 & 7)		
PIN	FUNCTION	COLOR
1	SFD +5V	RED
2	SFD +5V RTN	BLACK
3	SFD COM-	YELLOW
4	SFD COM+	BLUE
5	SFD COM SHIELD (AKM 1,2)	
6	N/C	
7	N/C	
8	N/C	
9	N/C	
10	N/C	
11	N/C	
12	N/C	

SHIELD IS NOT CONNECTED
AT MOTOR END

SUGGESTED MATING CONNECTOR	
Intercontec ASTA-021-NN-00-10-0035-000	

COMMUTATING ENCODER
(VIEW FACING FRONT)

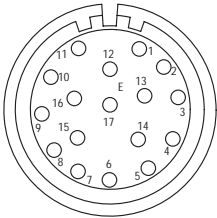

CONNECTOR PART NUMBER		
AKUA-034-NN-00-09-0035-000 (FOR AKM 1 & 2)		
AEDC-113-NN-00-00-0012-000 (FOR AKM 2, 3, 4, 5, 6 & 7)		
PIN	FUNCTION	COLOR
1	B	GREEN
2	B'	GRN/BLK
3	A	BLUE
4	A'	BLUE/BLK
5	Z	VIOLET
6	Z'	VIOLET/BLK
7	GND	BLACK
8	THERMAL SENSOR	BLUE
9	THERMAL SENSOR	BLACK
10	Vcc	RED
11	N/C	
12	N/C	
13	N/C	
14	N/C	
15	U	BROWN
16	V	GREY
17	W	WHITE

SHIELD IS NOT CONNECTED
AT MOTOR END

SUGGESTED MATING CONNECTOR	
Intercontec ASTA-035-NN-00-10-0035-000	

RESOLVER
(VIEW FACING FRONT)

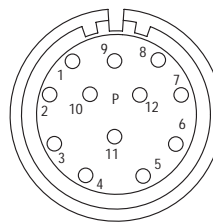

CONNECTOR PART NUMBER		
AKUA-020-NN-00-09-0035-000 (FOR AKM 1 & 2)		
AEDC-052-NN-00-00-0012-000 (FOR AKM 2, 3, 4, 5, 6 & 7)		
PIN	FUNCTION	COLOR
1	N/C	
2	THERMAL SENSOR	BLUE
3	S4 , COS-	BLUE
4	S3 , SIN-	BLACK
5	R2 , REF-	BLK/WHT
6	THERMAL SENSOR	BLACK
7	S2 , COS+	YELLOW
8	S1 , SIN+	RED
9	R1 , REF+	RED/WHT
10	N/C	
11	N/C	
12	N/C	

SHIELD IS NOT CONNECTED
AT MOTOR END

SUGGESTED MATING CONNECTOR	
Intercontec ASTA-021-NN-00-10-0035-000	

If dimensionals are required for connectors, refer to catalog or contact Customer Service.

AKM Motor Connector Options

"M" Connector Options

(AKM 1, 2, 3, & 4 ONLY)

POWER CONNECTOR (NON BRAKE)

(VIEW FACING FRONT)

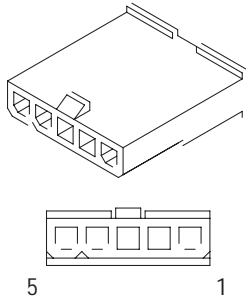

CONNECTOR PART NUMBER MOLEX 39-01-4056 (ENG NO. 5559-05P3)		
PIN	FUNCTION	COLOR
1	U	BLUE
2	V	BROWN
3	W	VIOLET
4	GND	GRN/YEL
5	SHIELD	

SHIELD CONNECTED TO MOTOR
GROUND INTERNAL TO MOTOR

SUGGESTED MATING CONNECTOR	
MOLEX 39-01-4050	

POWER CONNECTOR (BRAKE)

(VIEW FACING FRONT)

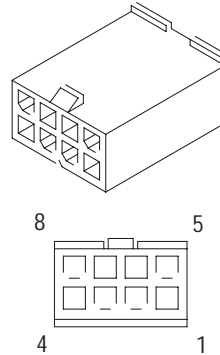

CONNECTOR PART NUMBER MOLEX 39-01-3083 (ENG NO. 5559-08P1)		
PIN	FUNCTION	COLOR
1	U	BLUE
2	V	BROWN
3	W	VIOLET
4	GND	GRN/YEL
5	SHIELD	
6	BRAKE +	BLACK
7	BRAKE -	BLACK
8	N/C	

SHIELD CONNECTED TO MOTOR
GROUND INTERNAL TO MOTOR

SUGGESTED MATING CONNECTOR	
MOLEX 39-01-2080	

SFD

(VIEW FACING FRONT)

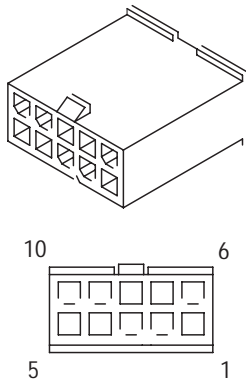

CONNECTOR PART NUMBER MOLEX 43020-1001		
PIN	FUNCTION	COLOR
1	SFD +5V	RED
2	SFD +5V RTN	BLACK
3	SFD COM-	YELLOW
4	SFD COM+	BLUE
5	SFD COM SHIELD	
6	N/C	
7	N/C	
8	N/C	
9	N/C	
10	N/C	

SHIELD IS NOT CONNECTED
AT MOTOR END

SUGGESTED MATING CONNECTOR	
MOLEX 43025-1000	

COMMUTATING ENCODER

(VIEW FACING FRONT)

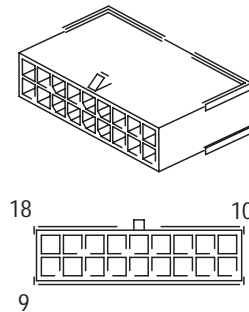

CONNECTOR PART NUMBER MOLEX 43020-1801		
PIN	FUNCTION	COLOR
1	B	GREEN
2	B	GRN/BLK
3	A	BLUE
4	A	BLUE/BLK
5	Z	VIOLET
6	Z	VIOLET/BLK
7	GND	BLACK
8	THERMAL SENSOR	BLUE
9	THERMAL SENSOR	BLACK
10	Vcc	RED
11	N/C	
12	N/C	
13	N/C	
14	N/C	
15	U	BROWN
16	V	GREY
17	W	WHITE
18	SHIELD	

SHIELD IS NOT CONNECTED
AT MOTOR END

SUGGESTED MATING CONNECTOR	
MOLEX 43025-1800	

RESOLVER

(VIEW FACING FRONT)

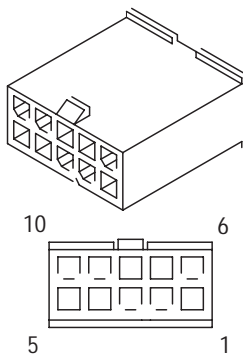

CONNECTOR PART NUMBER MOLEX 43020-1001		
PIN	FUNCTION	COLOR
1	N/C	
2	THERMAL SENSOR	BLUE
3	S4, COS-	BLUE
4	S3, SIN-	BLACK
5	R2, REF-	BLK/WHT
6	THERMAL SENSOR	BLACK
7	S2, COS+	YELLOW
8	S1, SIN+	RED
9	R1, REF+	RED/WHT
10	SHIELD	

SHIELD IS NOT CONNECTED
AT MOTOR END

SUGGESTED MATING CONNECTOR	
MOLEX 43025-1000	

If dimensionals are required for connectors, refer to catalog or contact Customer Service.

AKM Motor Connector Options

"D" Connector Options

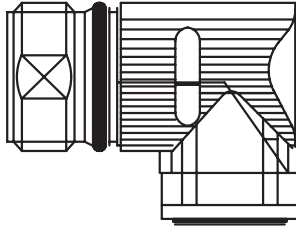

MOTOR MOUNTED OPTION
(AKM 2, 3 & 4 ONLY)

COMBINED POWER & SFD FEEDBACK
(VIEW FACING FRONT)

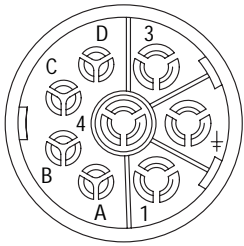

CONNECTOR PART NUMBER BEDC-089-NN-00-00-0005-000		
PIN	FUNCTION	COLOR
1	U	BLUE
+	PE	GRN/YEL
3	W	VIOLET
4	V	BROWN
A	SFD +5V	RED
B	SFD +5V RTN	BLACK
C	SFD COM-	YELLOW
D	SFD COM+	BLUE

SUGGESTED MATING CONNECTOR	
Intercontec BSTA-108-NN-00-08-0036-000	

MATING CONNECTOR KITS
(FOR USE ON MOTORS WITH "C" CONNECTORS ONLY)

FEEDBACK TYPE	CK AMPS	K-E1 AMPS
RESOLVER	CKT-T1A-SRE	CKT-T1B-SRE
ENCODER	CKT-T1A-SCE	CKT-T1B-SCE

MATING CONNECTOR KITS INCLUDE BOTH POWER AND FEEDBACK CABLES.

"P" Connector Options

(AKM 1, 2, 3, & 4 ONLY)

COMBINED POWER & SFD FEEDBACK
(NOT AVAILABLE FOR BRAKE MOTORS)
(VIEW FACING FRONT)

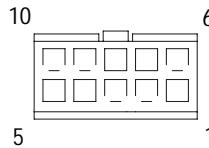
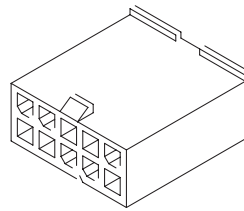

CONNECTOR PART NUMBER MOLEX 39-01-3103 (ENG NO. 5559-10P1)		
PIN	FUNCTION	COLOR
1	SFD +5V	RED
2	SFD +5V RTN	BLACK
3	POWER SHIELD	
4	GROUND	GRN/YEL
5	U	BLUE
6	SFD COM-	YELLOW
7	SFD COM+	BLUE
8	SFD COM SHIELD	
9	V	BROWN
10	W	VIOLET

POWER SHIELD CONNECTED TO
MOTOR GROUND INTERNAL TO MOTOR
FEEDBACK SHIELD IS NOT
CONNECTED AT MOTOR END

SUGGESTED MATING CONNECTOR	
MOLEX 39-01-2100	

If dimensionals are required for connectors,
Refer to catalog or contact Customer Service.

AKM Part Number System

AKM Series Brushless Servomotors

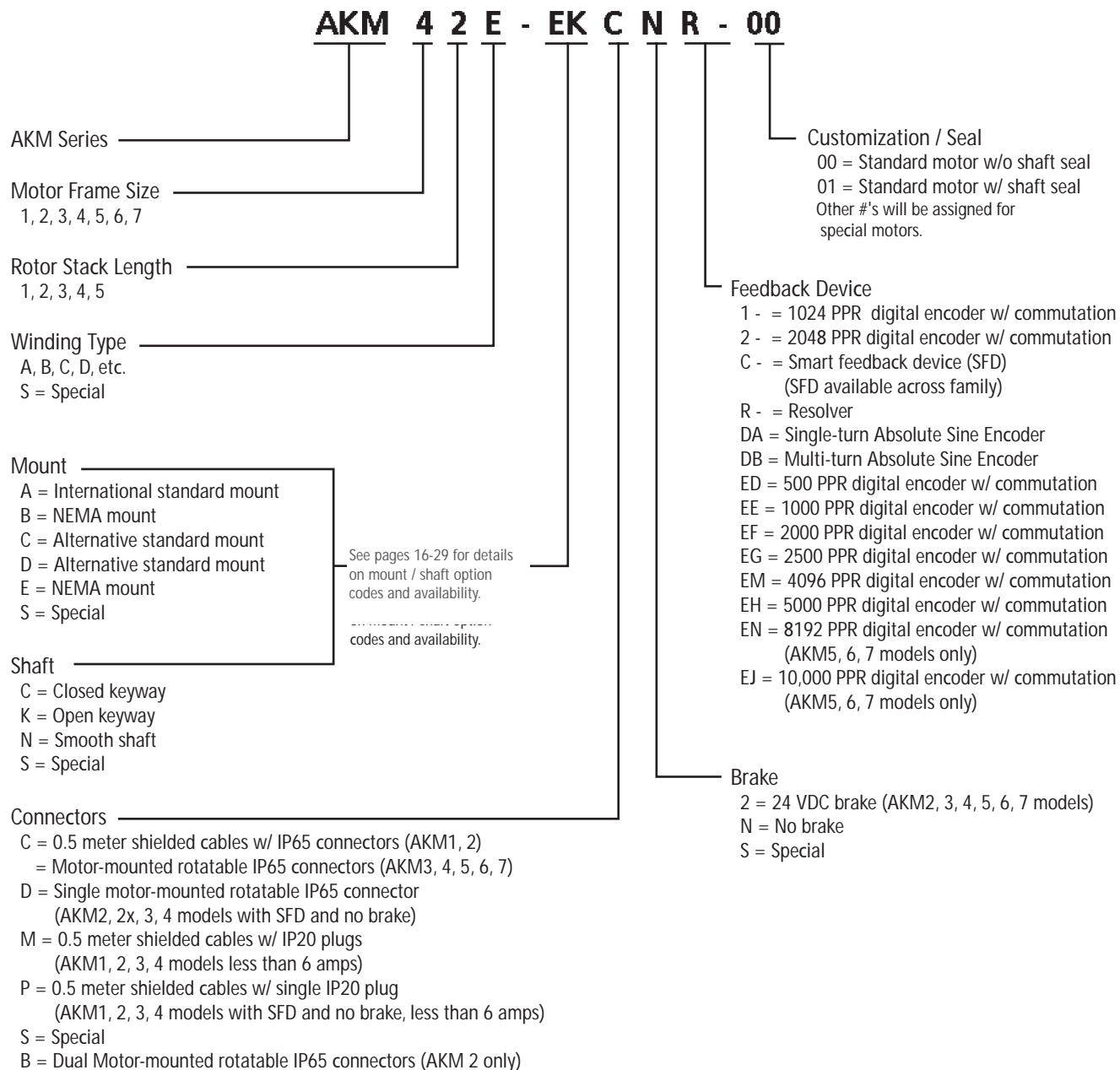

Notes

Notes

USA, CANADA or MEXICO

Danaher Motion
 203A West Rock Road
 Radford, VA 24141 USA
 Phone: 1-540-633-3400
 Fax: 1-540-639-4162
 E-mail: DMAC@danahermotion.com
 Literature: LitRequest@danahermotion.com

ASIA**China**

Danaher Motion
 Rm 2205, Scitech Tower
 22 Jianguomen Wai Street
 Beijing, China, 100004
 Phone: +86 10 6515 0260
 Fax: +86 10 6515 0263
 email: chinainfo@danahermotion.com.cn

Japan

Danaher Motion Japan
 3F, 2nd Nagaoka Bldg
 2-8-5, Hacchobori, Chuo-ku
 Tokyo 104-0032 Japan
 Phone: +81-3-6222-1051
 Fax: +81-3-6222-1055
 Email: info@danahermotion.com

EUROPE**UK**

Danaher Motion
 Chartmoor Road,
 Chartwell Business Park
 Leighton Buzzard, Bedfordshire
 LU7 4WG. United Kingdom
 Phone: +44 (0) 1525 243 243
 Fax: +44 (0) 1525 243 244
 Email: uksales@danahermotion.com

Find Additional AKM Servomotor product information

DanaherMotion.com offers many new tools to help you serve your needs. We've developed an intuitive Web-based system to increase your knowledge of motion control, search our vast product selection by product attribute (using our New Product Advisors), and easily locate your nearest Danaher Motion distributor or Sales office. Visit www.DanaherMotion.com for more information and see our latest tools. Danaher Motion makes every attempt to ensure accuracy and reliability of the specifications in this publication. Specifications are subject to change without notice. Danaher Motion provides this information 'AS IS' and disclaims all warranties, express or implied, including, but not limited to, implied warranties of merchantability and fitness for a particular purpose. It is the responsibility of the product user to determine the suitability of this product for a specific application.

EUROPE**France**

Danaher Motion
 C.P. 80018
 12, Rue Antoine Becquerel - Z.I. Sud
 F-72026 Le Mans Cedex 2
 France
 Phone: +33 (0) 243 50 03 30
 Fax: +33 (0) 243 50 03 39
 Email: sales.france@tollo.com

Germany

Danaher Motion GmbH
 Wacholderstr. 40-42
 D-40489 Düsseldorf
 Germany
 Phone: +49 (0) 203 9979-0
 Fax: +49 (0) 203 9979-155
 Email: sales.germany@danahermotion.com

Italy

Danaher Motion srl
 Largo Brughetti ZI
 20030 Bovisio Masciago (MI)
 Italy
 Phone: +39 0362 59 42 60
 Fax: +39 0362 59 42 63
 Email: info@danahermotion.it

Sweden

Danaher Motion
 Box 9053
 SE-29109 Kristianstad
 Sweden
 Phone: +46 (0) 44 24 67 00
 Fax: +46 (0) 44 24 40 85
 Email: helpdesk@tollo.com

