

D 01DETALLE DE CUBIERTA

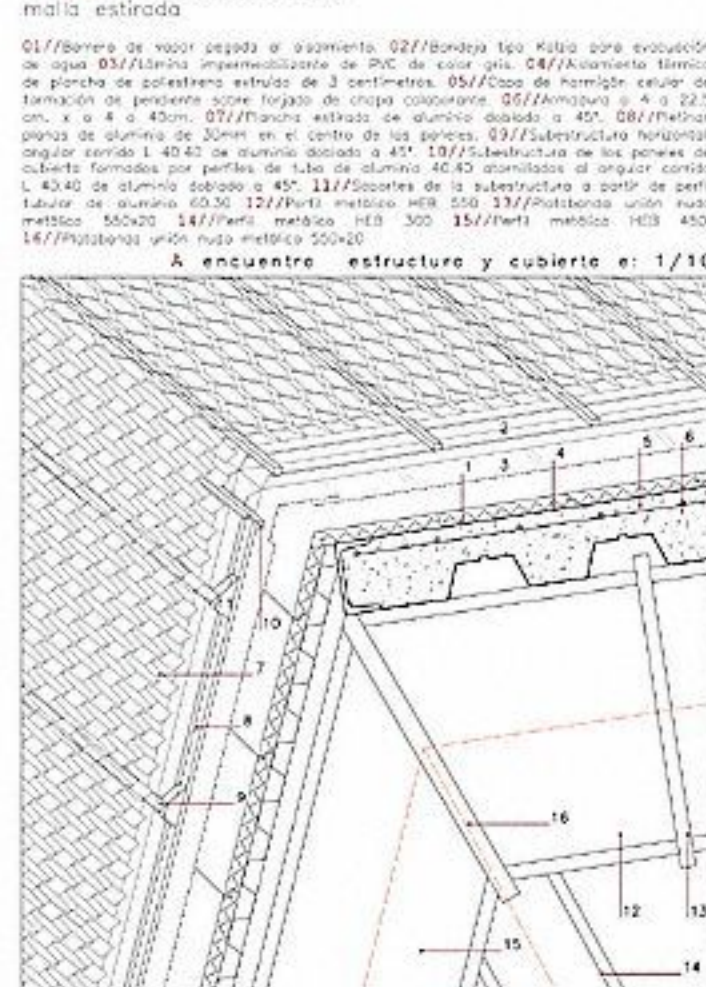

D 02DETALLE DE TRANTES

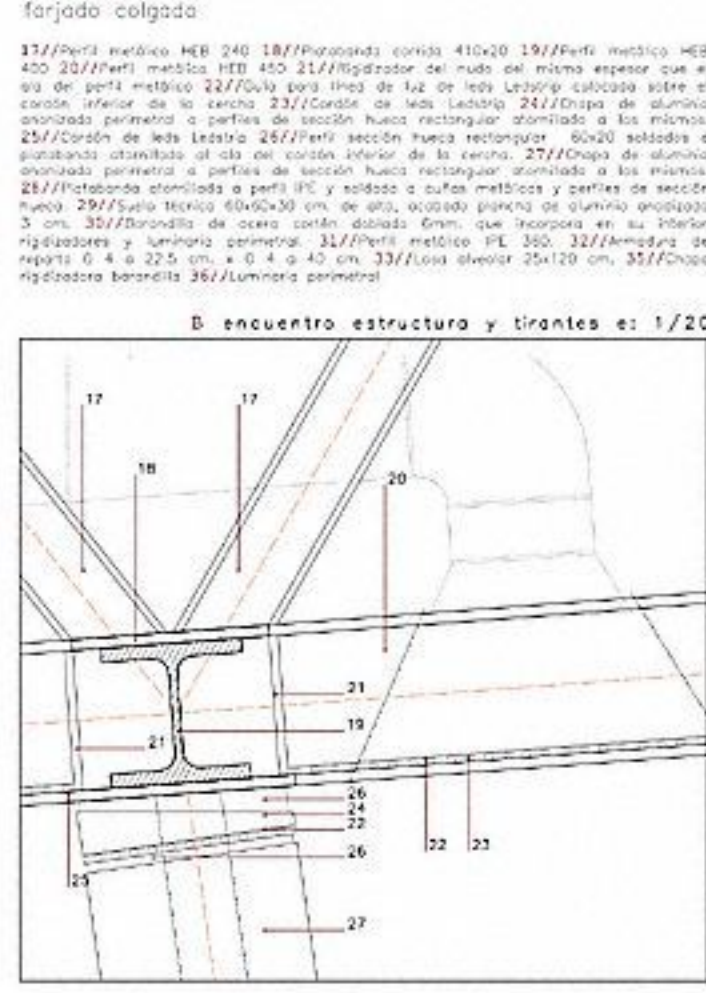

C forjado colgado y trantes a 1/20 ALZADO

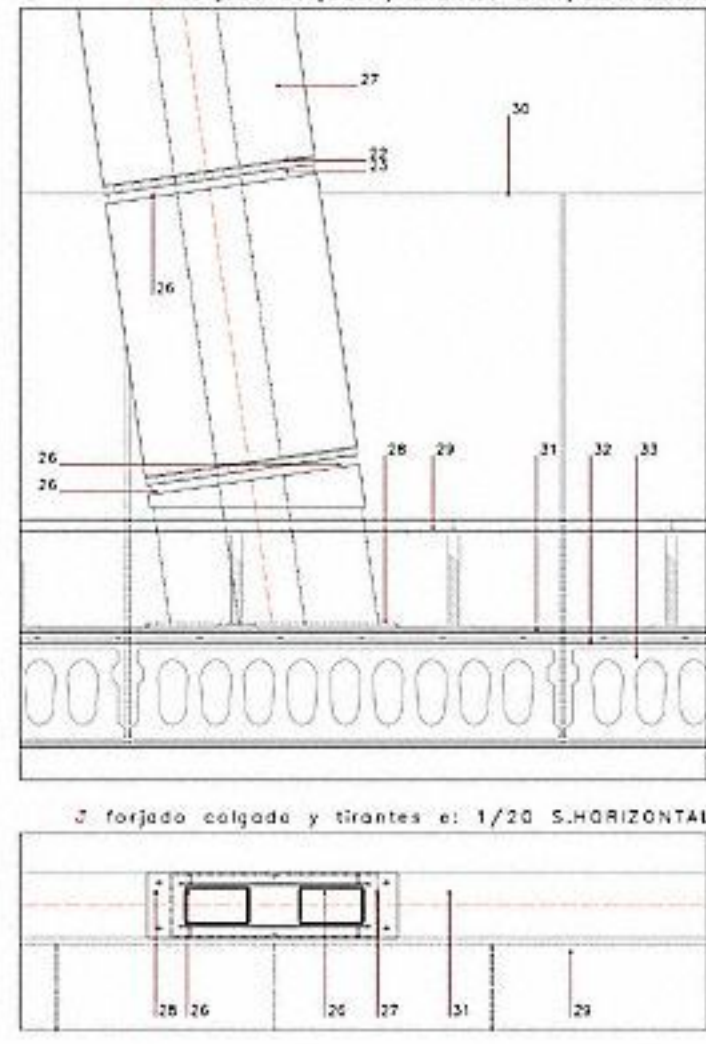

7 forjado colgado y trantes a 1/20 S.HORIZONTA

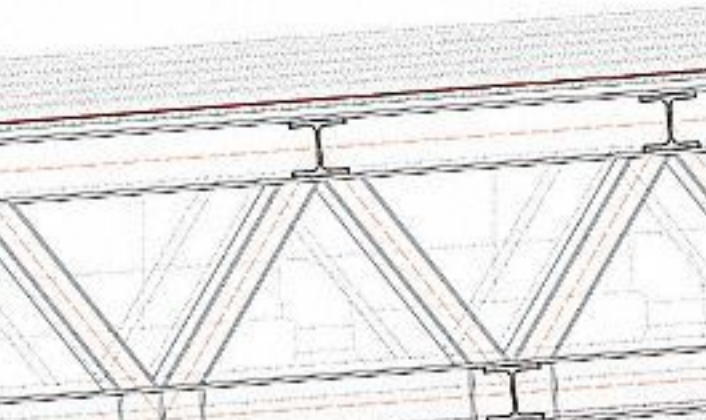

D 03DETALLE DE FORJADO COLGADO

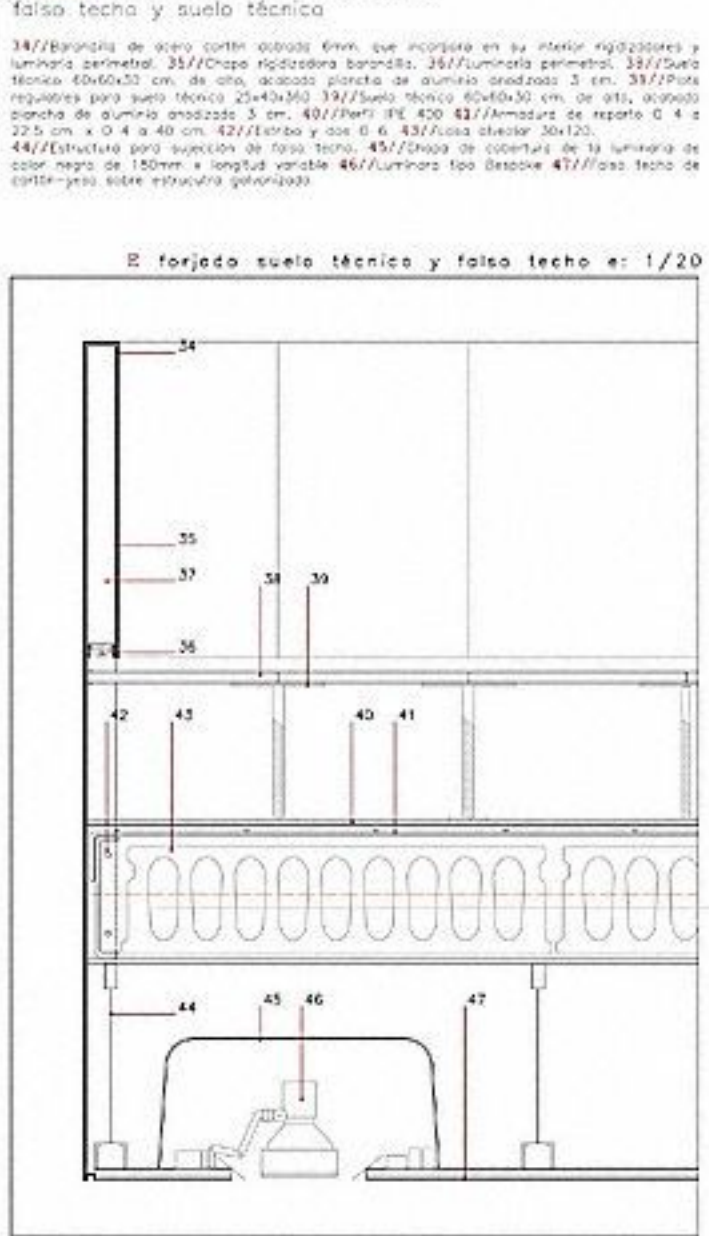

6 encuentro estructura y trantes a 1/20

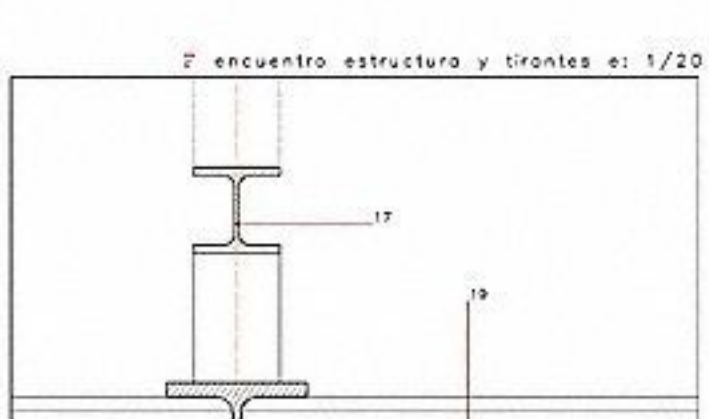

7 encuentro estructura y trantes a 1/20

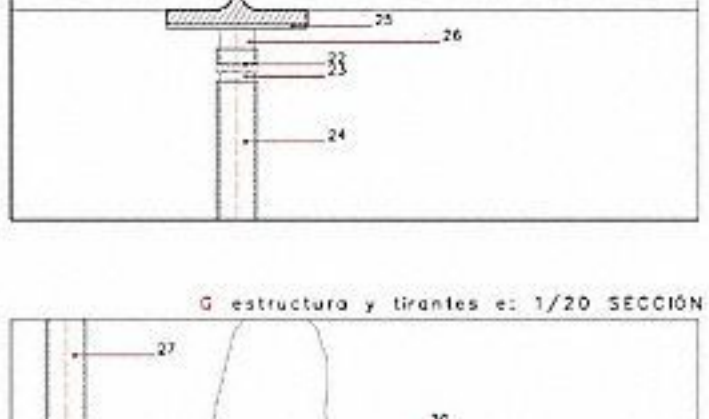

8 estructura y trantes a 1/20 SECCION

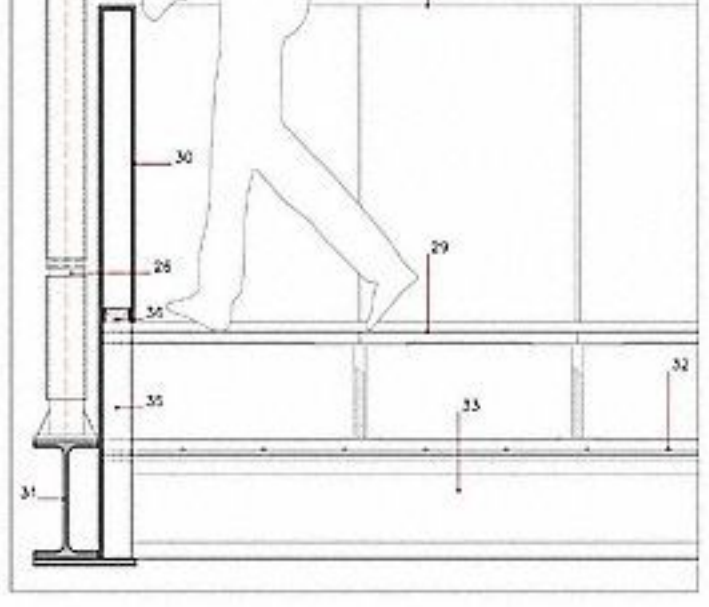

D 04DETALLE DE MUEBLE EQUIPADO

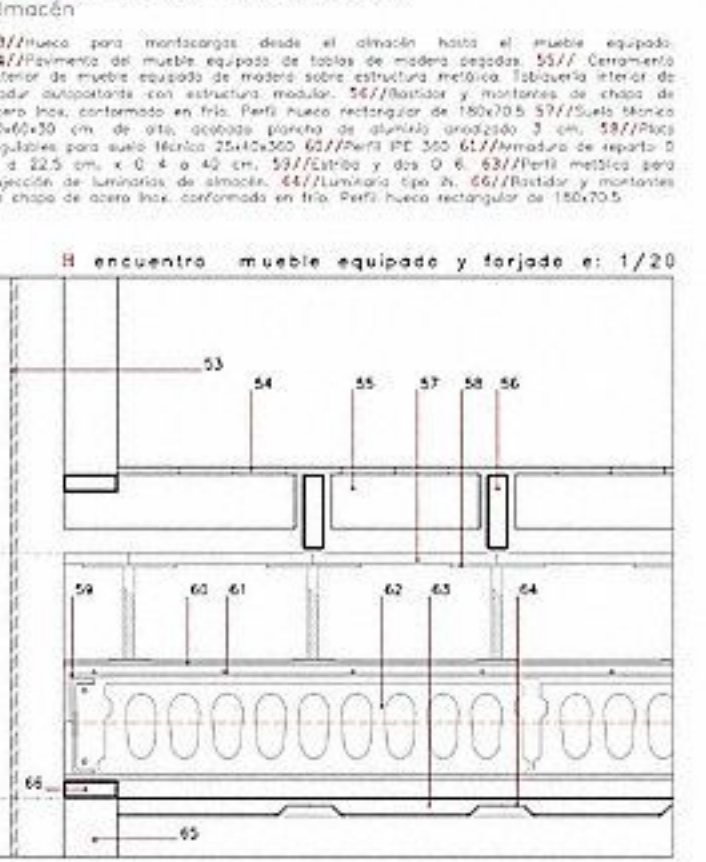

2 detalle cuevas forjados

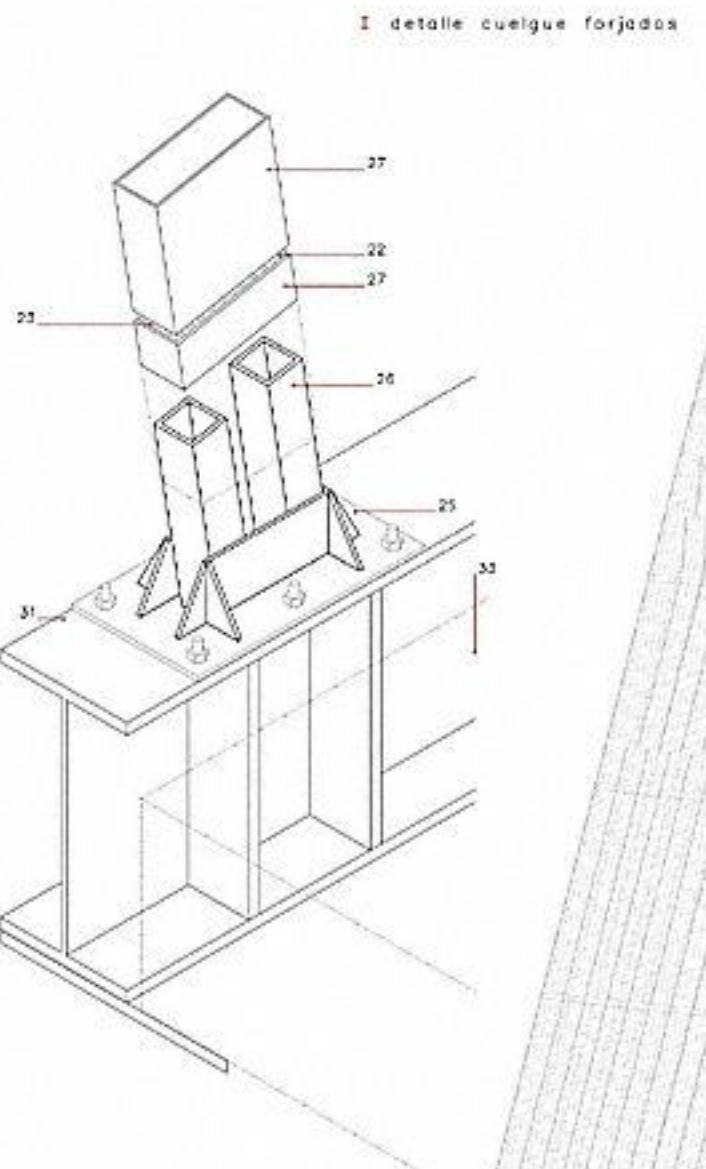

3 detalle cuevas forjados

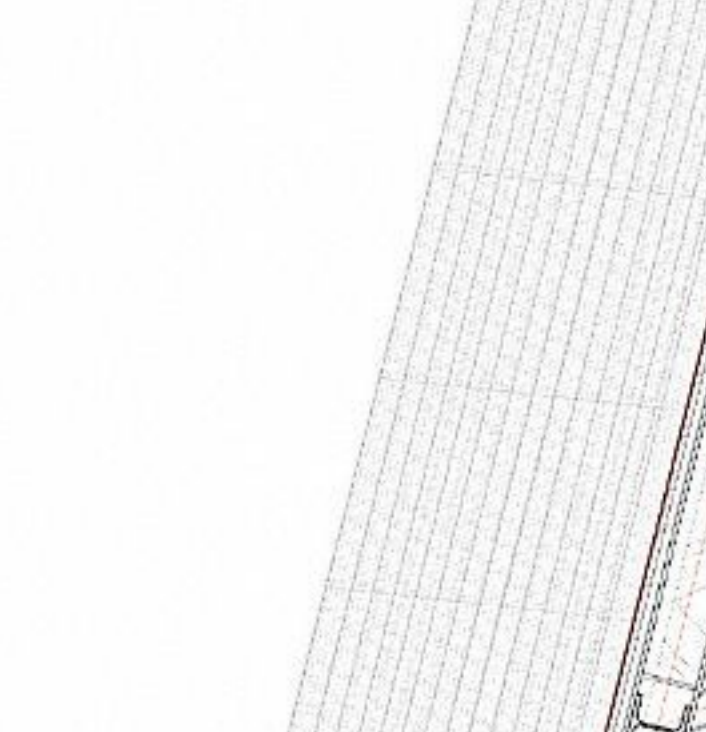

D 05DETALLE DE CERRAMIENTO

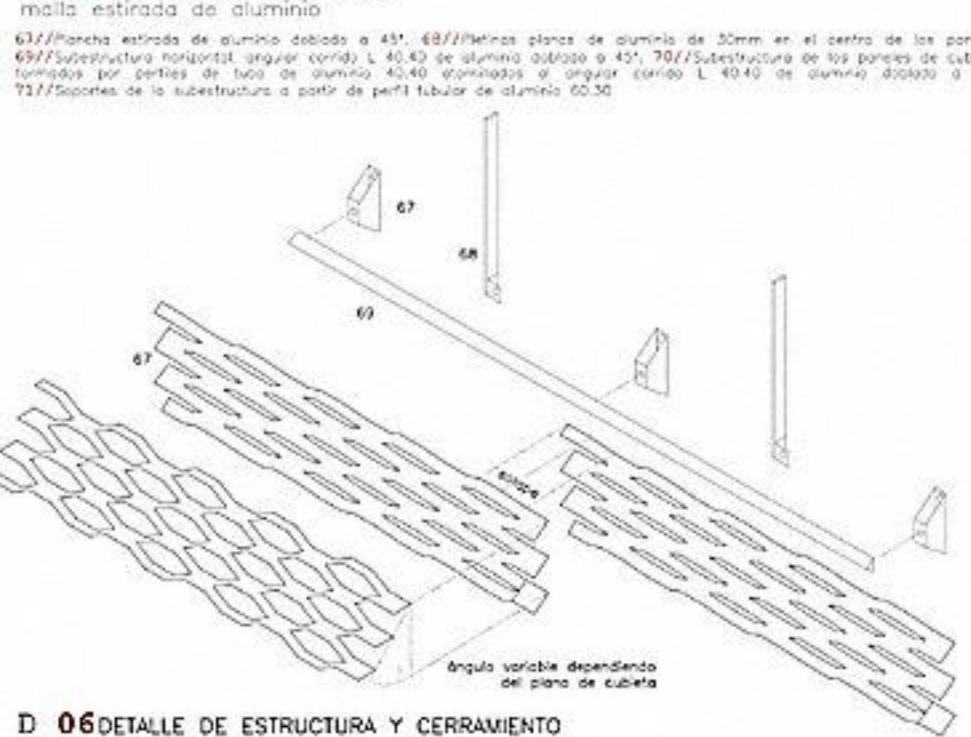

D 06DETALLE DE ESTRUCTURA Y CERRAMIENTO

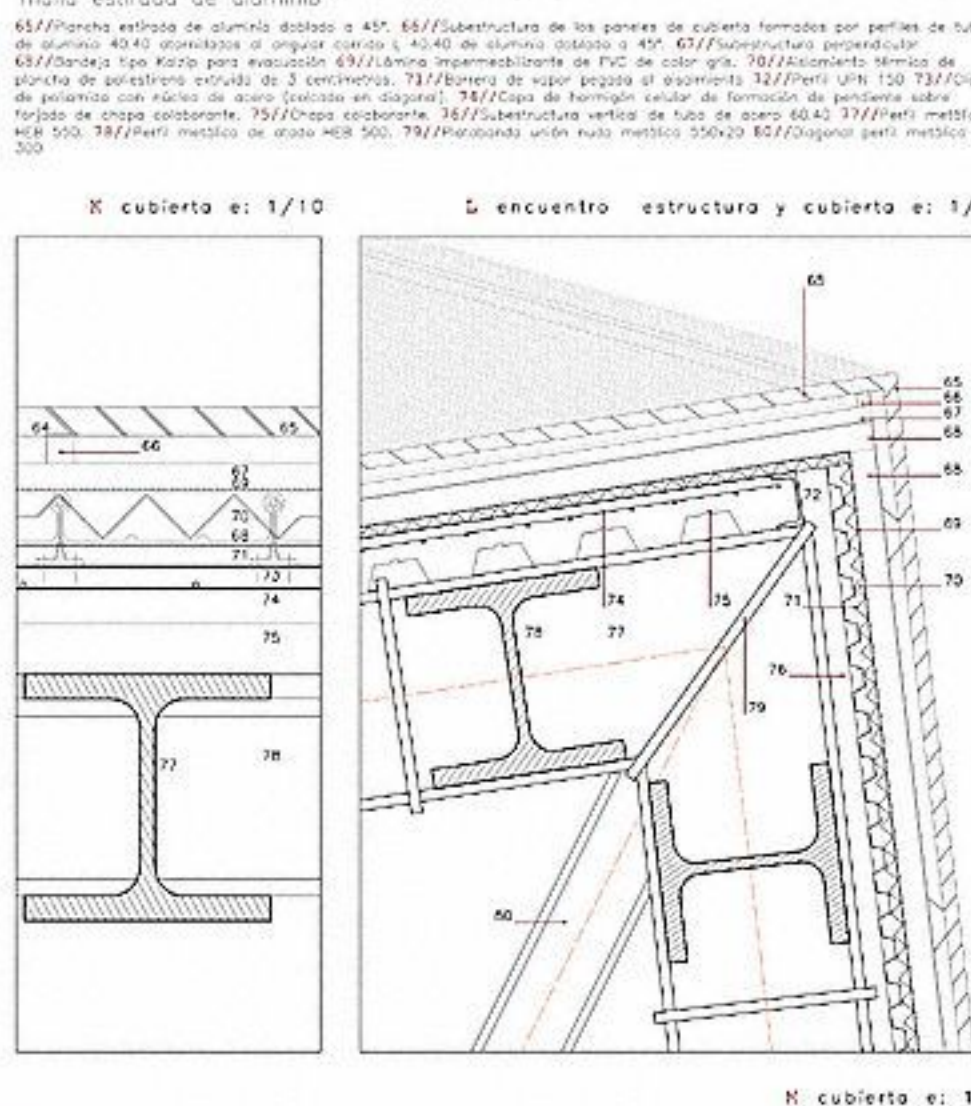

K cubierta a 1/10



L encuentro estructura y cubierta a 1/10



D 07DETALLE DE ESTRUCTURA Y CERRAMIENTO

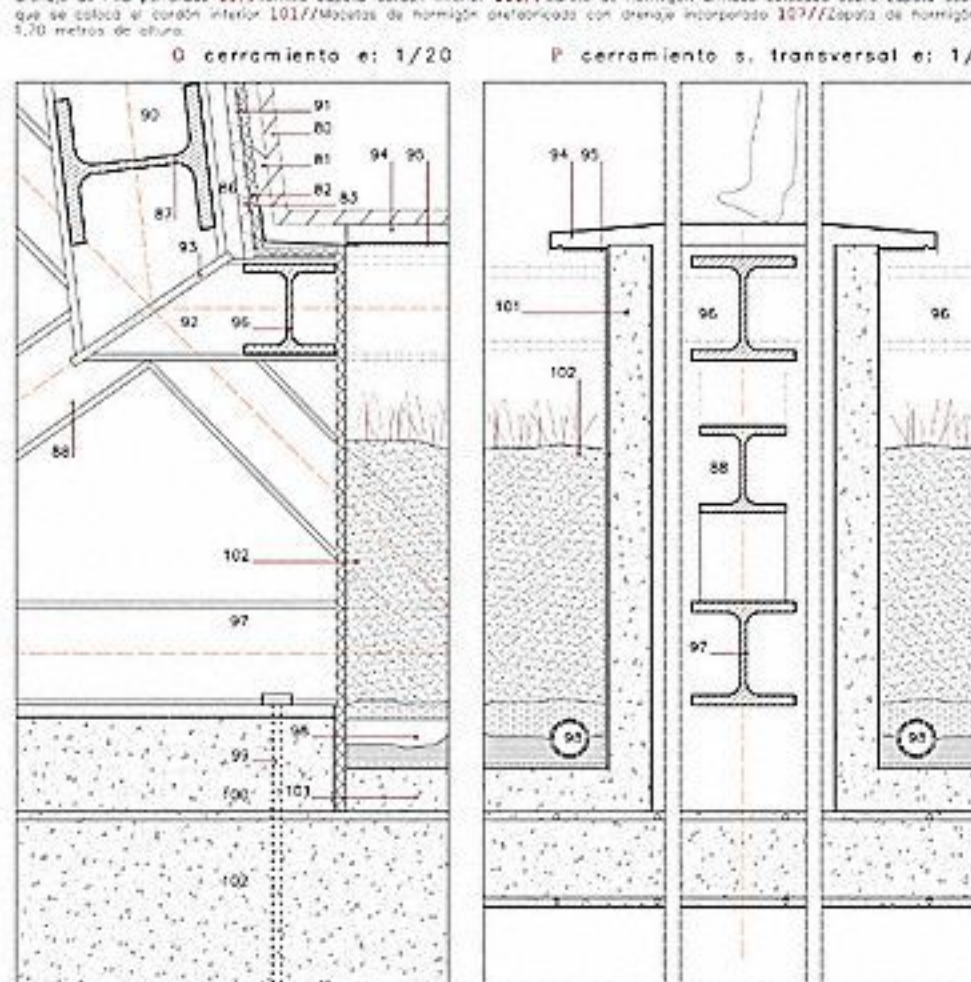

O cerramiento a 1/20



P cerramiento a transversal a 1/20

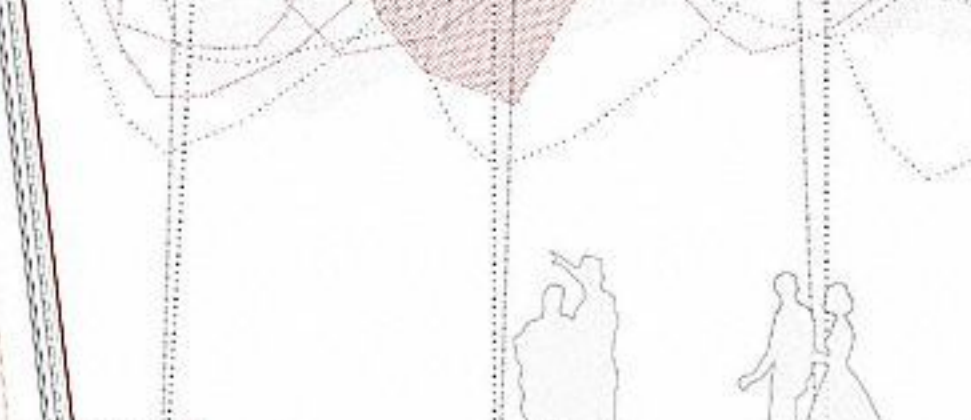

Q cerramiento a transversal a 1/20

