

TIR # 720-S-0006  
DECEMBER 8, 1970

*MSC-13917*



**CONTROL OF A LIQUID COOLING  
GARMENT FOR EXTRAVEHICULAR  
ASTRONAUTS BY CUTANEOUS AND EXTERNAL  
AUDITORY MEATUS TEMPERATURES**

BY  
CLAY W. G. FULCHER

PREPARED UNDER CONTRACT NO. NAS 9-10963

71-34077  
328  
2-1512

SEARCHED  
INDEXED  
SERIALIZED  
FILED



**GENERAL ELECTRIC**  
APOLLO SYSTEMS  
HOUSTON PROGRAMS



CR-115122

## PREFACE

This research evolved as part of a coordinated National Aeronautics and Space Administration investigation of certain temperature regulation aspects of man in a space environment. When preliminary work on this task was first initiated in 1968 three methods of automatically controlling an extravehicular astronaut's liquid cooling garment inlet water temperature or flow rate had been proposed or investigated. These three methods utilized metabolic oxygen consumption rate, rate of metabolic heat removal via the liquid cooling garment with mean skin temperature feedback, and heart rate. It was believed at that time that there might be other physiological parameters, not yet identified for thermal controller purposes, which corresponded to human cooling needs in a direct fashion and which would require less modification to the design of extravehicular crew equipment. This research was then commenced with a goal of determining if such other parameters exist and also of demonstrating the feasibility of their use if any were identified.

A review of liquid cooling garment controller research and development is presented in Chapter II to provide a background of recent developments in the field. This is followed by a discussion of thermal regulation in man at a level of detail pertinent to the understanding of the responses evoked in man by his working in a space environment. Man's thermoregulatory responses are time-dependent and highly

interreactive. They are responsive to influences of heredity, adaptation, hydration, electrolyte balance and many other factors. Thus Chapter III is limited to a summary of those aspects which were believed to be of <sup>principal</sup>~~principle~~ interest in determining automatic controller feasibility from a physiological viewpoint and in identifying candidate physiological parameters.

Controller design considerations, constraints, and assumptions are discussed in Chapter IV which completes the background coverage leading to control algorithm synthesis. Discussions of valve command philosophy, temperature measurement, system computer simulation and fluid and electronic systems breadboard designs are included. The simulation algorithm is converted to a form useful for electronic breadboard design in Chapter V and laboratory experimental methods are outlined in Chapter VI. Material which could be relegated to Appendices without compromising the main theme, e.g., derivations, sample calculations and equipment listings, appear there.

Houston, Texas  
December, 1970

Clay W. G. Fulcher

## ABSTRACT

An improved temperature control concept is developed for liquid cooling garments used during astronaut extravehicular activity. Several modifications and extensions to previously known physiological parameter measurement techniques and control approaches are implemented to provide an automatic controller which responds directly to man's thermoregulatory requirements for cooling during work.

The temperature of the wall of the external auditory meatus and four averaged, unweighted skin temperatures are used as input signals to a controller of liquid cooling garment inlet water temperature. The absolute change in derived mean body temperature from a setpoint and its time rate of change are sensed and used to control the temperature of water to an Apollo liquid cooling garment.

A crewman metabolic transient thermal computer simulation is conducted to demonstrate feasibility and to supply design parameters for a prototype system. The prototype controller is described and unmanned and manned test data are provided.

It is concluded that minimizing variations in test subject mean body temperature from a thermally neutral setpoint during work provides subjective comfort and low thermal strain. Standard deviations in mean body temperature using the controller developed range from 0.07 - 0.32°F for one hour treadmill tests at high and moderate working levels and selected controller gains.

## TABLE OF CONTENTS

CHAPTER	PAGE
I. INTRODUCTION	1
II. CRITICAL REVIEW OF PERTINENT GARMENT CONTROLLER LITERATURE	6
III. TEMPERATURE REGULATION MECHANISMS IN MAN	15
Heat Storage	15
Sweating	21
Cardiovascular	26
IV. DESIGN CONSIDERATIONS	30
Control Philosophy	30
Temperature Measurements	34
Electronic System Breadboard	37
Fluid System Test Stand	39
System Computer Simulation	42
V. CONTROL ALGORITHM SYNTHESIS	45
VI. METHODS	47
Preliminary Adjustments	57
Unmanned Tests	58
Manned Tests	63
Laboratory Experiment Design	66
Quarter Replicate and Final Manned Tests	72

VII. RESULTS	76
Initial System Adjustments	76
Performance Verification Test	79
Preliminary Manned Tests	85
Quarter Replicate and Final Manned Tests	112
VIII. DISCUSSION	132
Performance Verification Test	132
Preliminary Manned Tests	133
Quarter Replicate Tests	146
REFERENCES	153
Appendices	
1. Near Body Temperature Coefficients	160
2. Algorithm Coefficient Identification	164
3. Controller Breadboard Operational Description	169
4. Sample Calculations	181
5. Typical Simulation Results	187
6. Procedures for Preliminary Manned Tests	195
7. Laboratory Equipment Listing	219

## LIST OF TABLES

<u>Table</u>		<u>Page</u>
1	Factors Affecting Heat Balance	19
2	Experiment Factors	68
3	Example of Quarter-Replicate Research Design	69
4	Example of Factorial Design for Five Factors at Two Levels	70
5	Voltage Input to U <sub>4</sub> versus Preset Input Dial Reading	77
6	Data for U <sub>4</sub> , U <sub>5</sub> , and U <sub>6</sub> Stability Test	79
7	Data for U <sub>1</sub> , U <sub>2</sub> , and U <sub>3</sub> Stability Test	80
8	Data for Dynamic System Test	81
9	Comparison of Subjective Comments with Selected Physiological Parameters	103
10	Experiment Factors and Levels	113
11	Design of Experiment and Performance Scores	114
12	Temperature Data	126
13	Effects of Main Factors and Two-Factor Interactions	127
14	Interaction "BC" for Mean Body Temperature Criteria of Analysis	128
15	Interaction "BD" for Mean Body Temperature Criteria of Analysis	129
16	Interaction Summary for "BC" and "BD"	129
17	Comparison of Metabolic Rates of Test Subjects	131



## LIST OF ILLUSTRATIONS

<u>Figure</u>		<u>Page</u>
1	General Curve of Thermogenesis in Homeotherms (Gelineo, 1964)	18
2	Liquid Cooling Garment Cooling Water Loop	33
3	Schematic of Ear Cross-Section Showing Ear Mold	36
4	Liquid Cooling Garment Automatic Thermal Controller Schematic	38
5	Fluid System Breadboard Schematic	40
6	Location of Controller Skin Temperature Thermistors	51
7	Manual Input Dial Reading and TP20 Voltage Relation- ship	54
8	Preset Input Dial Reading and TP10 Voltage Relation- ship	55
9	Performance Verification Test Arrangement	62
10	Relationship of Preset Input Dial Reading and Voltage Input to Summing Amplifier	78
11	TP13 Dynamic System Test Oscilloscope Trace	82
12	TP20 Dynamic System Test Oscilloscope Trace	83
13	TP17 Dynamic System Test Oscilloscope Trace	84
14	Comparison of March 2 and March 23 Test Results	89
15	Preliminary Test No. 3 Temperature Data	91
16	Preliminary Test No. 4 Temperature Data	93
17	Preliminary Test No. 5 Temperature Data	95
18	Preliminary Test No. 6 Temperature Data	98
19	Preliminary Test No. 7 Temperature Data	100

<u>Figure</u>	<u>Page</u>
20 Preliminary Test No. 8 Temperature Data	102
21 Preliminary Test No. 9 Temperature Data	106
22 Preliminary Test No. 10 Temperature Data	109
23 Preliminary Test No. 11 Temperature Data	111
24 Quarter Replicate Test Data (9/4/70)	115
25 Quarter Replicate Test Data (9/9/70, Run #1)	116
26 Quarter Replicate Test Data (9/9/70, Run #2)	117
27 Quarter Replicate Test Data (9/10/70)	118
28 Quarter Replicate Test Data (9/11/70, Run #1)	119
29 Quarter Replicate Test Data (9/11/70, Run #2)	120
30 Quarter Replicate Test Data (9/15/70, Run #1)	121
31 Quarter Replicate Test Data (9/15/70, Run #2)	122
32 Final Test Temperature Data (9/18/70, E. Scott)	123
33 Final Test Temperature Data (9/18/70, C. Pate)	124
34 Final Test Temperature Data (10/1/70, K. Dupree)	125
35 Core and Skin Amplifier Output Voltages versus Water Bath Temperature	182
36 Astronaut Work Profile from Computer Simulation	190
37 Valve Response From Computer Simulation	191
38 Liquid Cooling Garment Inlet and Outlet Temperatures from Computer Simulation	192
39 Astronaut Core and Mean Skin Temperature Profile from Computer Simulation	193
40 Astronaut Heat Storage Profile from Computer Simulation	194

<u>Figure</u>		<u>Page</u>
20	Preliminary Test No. 8 Temperature Data	102
21	Preliminary Test No. 9 Temperature Data	106
22	Preliminary Test No. 10 Temperature Data	109
23	Preliminary Test No. 11 Temperature Data	111
24	Quarter Replicate Test Data (9/4/70)	115
25	Quarter Replicate Test Data (9/9/70, Run #1)	116
26	Quarter Replicate Test Data (9/9/70, Run #2)	117
27	Quarter Replicate Test Data (9/10/70)	118
28	Quarter Replicate Test Data (9/11/70, Run #1)	119
29	Quarter Replicate Test Data (9/11/70, Run #2)	120
30	Quarter Replicate Test Data (9/15/70, Run #1)	121
31	Quarter Replicate Test Data (9/15/70, Run #2)	122
32	Final Test Temperature Data (9/18/70, E. Scott)	123
33	Final Test Temperature Data (9/18/70, C. Pate)	124
34	Final Test Temperature Data (10/1/70, K. Dupree)	125
35	Core and Skin Amplifier Output Voltages versus Water Bath Temperature	182
36	Astronaut Work Profile from Computer Simulation	190
37	Valve Response From Computer Simulation	191
38	Liquid Cooling Garment Inlet and Outlet Temperatures from Computer Simulation	192
39	Astronaut Core and Mean Skin Temperature Profile from Computer Simulation	193
40	Astronaut Heat Storage Profile from Computer Simulation	194

## CHAPTER I

### INTRODUCTION

Among the significant medical results which were reported following the Gemini space program were recognition of a moderate loss of exercise capacity and a high metabolic cost of extravehicular activity in the zero-gravity environment (Berry, 1969). National Aeronautics and Space Administration (NASA) scientists observed an inability of astronauts to judge their own body thermal state when working in reduced gravity space environments, particularly when extravehicular, and the Russians verified the problem following extravehicular transfer of cosmonauts between space vehicles (Billingham, 1970). The Gemini space suit was gas-cooled, however, and was designed for lower levels of metabolic heat production than the system was subjected to during some extravehicular activities (Nelson, Brown and Krumland, 1964). Complications which included heavy sweating and visor fogging eventually resulted in early termination of Gemini extravehicular activity in two instances.

The first report that water cooling could be used effectively to overcome some of the deficiencies of gas-cooled suits (Burton and Collier, 1964) was followed by several studies which developed the technology used in designing an Apollo liquid cooling garment. These early liquid cooling garment researchers include Crocker, Webb and Jennings (1964); Burton and Collier (1965); Waligora and Michel (1966) and others. The

technique of water cooling proved to be effective at all work rates likely to be encountered during lunar surface activities and intensive development was initiated. The present Apollo garment features a network of polyvinyl chloride tubing stitched to the inside of a long-sleeved undergarment worn by the crewman beneath his pressure suit. A continuous flow of temperature-controlled water is supplied to the liquid cooling garment by the Apollo Portable Life Support System (PLSS). Temperature control of the inlet water to the liquid cooling garment is achieved using a manually controlled three-position valve.

Discussions were held with members of the Manned Spacecraft Center's Medical Research and Operations Directorate late in 1968 to identify a research topic having potential benefits to the space program, and automatic control of inlet water temperature to an extravehicular astronaut's liquid cooling garment was suggested as a research problem of current interest. Webb has done definitive work in identifying biothermal responses of working men wearing liquid cooling garments (Webb and Annis, 1966) and has investigated automatic liquid cooling garment inlet water temperature control. Concepts studied by Webb include the use of oxygen consumption in an open loop fashion in one case and rate of heat removal via the liquid cooling garment and mean skin temperature in a second investigation (Webb, Annis and Troutman, 1968). An extension of this work led to development of an automatic suit cooling controller using heart rate input (Troutman and Webb, 1970). Contemporary developments include a Honeywell Systems and Research Division

fluidic device for control of liquid cooled flight suits. A review of these investigations is in Chapter II.

The scope of the investigation to be conducted in this new effort was more demanding in that it required the identification of physiological parameters which could be used as controller inputs but which would have a lesser impact on present and future life support systems and suit assembly designs and which were less likely to be influenced by disturbance functions such as emotional state. More concisely, the objective of the investigation was to determine if there were physiological parameters which could be measured easily and used and which were directly related to man's cooling needs. Minimizing the impact on Apollo designs was desirable to enhance the possibility of concept evolution and development of flight-prototype hardware.

Test results obtained by Webb and Annis (1966) suggest a need for improved cooling control. Premature or excessive cooling causes cutaneous vasoconstriction and sensations of chilling combined with subjective feelings of excessive internal heat buildup sometimes accompanied by heavy sweating and/or cramping of muscles. If insufficient cooling is supplied or if sufficient cooling is not applied in time by a test subject heat storage begins and sweating and discomfort build up quickly. It is clear that the human body together with its subjective likes and dislikes and feelings of comfort and discomfort constitutes a very complex plant whose control, in the broadest sense, is being attempted. To synthesize an effective man-machine system knowledge of the "plant" is required, including its dynamic response to certain vents.

In this case the "plant" is the human body. Philosophically one must ask: 'What should a liquid cooling garment inlet water temperature controller try to accomplish?' In seeking an answer to this question one might consider that there are many examples of physiological control systems within the human body and all the physiological processes which deal with exchanges of materials and energy seem bound together and inextricably linked to the idea of homeostasis. According to Yamamoto (1965) the cluster of ideas centering about this word has a strong claim to being one of the "few truly general and basic principles of physiology." Berry (1969) states, "Man's physiology is such that it is constantly striving to maintain a state of balance and well being in the various body systems thus maintaining a state of homeostasis."

Homeostasis has come to have two meanings in physiology, either to designate the stability which the body maintains, notably in the composition of its fluids, or the processes by which such constancy is preserved. Man evolved from a primitive state and physiologically speaking is a product of his environment. Many complex anatomical elements function as parts of interrelated control and regulation systems to preserve man's genetically derived homeostasis following environmental changes and/or introduction of disturbance functions such as work. Generally speaking the liquid cooling garment thermal controller can be viewed as an aid to natural homeostasis, i.e., the controller should promote or assist those biological functions attempting to maintain the state of balance and well being in the various body systems.

The mechanisms of thermal regulation are discussed in Chapter III and a matching of technological control concepts with physiological thermal regulation principles leads to a concept for controlling the liquid cooling garment's inlet water temperature as a function of physiological need. The coverage which follows is representative of a "systems engineering approach" to design. Available data is analyzed; comfort and design criteria are incorporated; a simulation is conducted to demonstrate feasibility and a breadboard or prototype system is designed, fabricated and tested.



## CHAPTER II

### CRITICAL REVIEW OF PERTINENT GARMENT CONTROLLER LITERATURE

Unpublished NASA data (Waligora, 1967b) indicates that both control of cooling water flow rate to the liquid cooling garment at constant temperature (flow control) and control of cooling water inlet temperature at a constant flow rate (temperature control) are acceptable methods of astronaut thermal comfort control. Based upon subjective comments of test subjects, temperature control with a constant flow rate was recommended by Waligora for all applications of the liquid cooling garment. This mode of control was selected by the NASA for its Apollo portable life support system and is the mode used in this research.

The Air Force and the Navy (e.g., Starr and Merrill, 1968) are generally concerned with the comfort of crew air members not engaged in the levels of activities encountered by extravehicular astronauts although unpublished classified data from the Air Force's Manned Orbiting Laboratory program and the Navy's development of deep submergence life support systems probably exists.

In some of Webb's early work for NASA Headquarters (Webb and Annis, 1966) removal of metabolic heat resulting from heavy work using water cooled clothing was investigated. Cooling requirements for several work levels up to 3600 Btu/hr, using fixed flow rates of 3.3 lbs/min were studied. Water inlet temperatures were adjusted manually so that test subjects "neither sweated nor became chilled." Webb observed that

cooling applied too sparingly or too late resulted in test subject heat storage and early sweating. Conversely, cooling applied too generously or too soon caused overcooling highlighted by cutaneous constriction, sensations of chilling and occasional muscle cramps. A significant finding by Webb as far as this research is concerned is reported in a single statement in his summary, i.e., "Mean body temperatures computed from rectal and mean skin temperatures show that in most experiments the body heat content was held nearly constant." This relates comfort, which Webb used as a basis for cooling commands, to a thermal state. Gagge (1969) reports that both comfort and thermal sensations are related to rise in mean body temperature during thermal transients at the beginning of exercise. In laboratory ambient tests with test subjects dressed in shorts, Gagge found that after 30-40 minutes of exercise temperature sensations ranging from "cool" to "hot" were related primarily to skin and ambient air temperatures and unrelated to metabolic rate, muscle and rectal temperatures. Warm discomfort is found to be related primarily to skin sweating and skin conductance and is affected either by air temperature and metabolism or by both skin and rectal temperature. Gagge concluded that during steady state exercise the judgment of temperature is dominated by sensor mechanisms in the skin and that warm discomfort is governed primarily by thermoregulatory effector mechanisms, i.e., sweating and skin blood flow.

One feature of Webb's early experiments appears in retrospect to have influenced test subject comfort. This is the fact that the test subject's head was cooled. The Apollo liquid cooling garment used in

the final stages of this research covers arms, legs and torso and little significance was attached to Webb's head cooling when this project was commenced. During manned tests, however, test subjects occasionally reported that the treadmill room seemed "stuffy," that they felt they needed "more cooling," and perspiration about the head was occasionally heavy, even when little if any heat storage had occurred and skin temperature was quite low. When the astronaut is wearing a complete pressure garment with his helmet on, a steady flow of oxygen is directed to the inside of his helmet, and the absence of this air flow was noticeable to test subjects. The reason for the different subjective feelings is clear when the work done by Shvartz (1970) is considered. Shvartz worked his test subjects in a hot environment with no cooling, wearing a cooling hood, or wearing the hood and a liquid cooling garment. He found that use of the hood alone reduced physiological strain by one-half compared with the hood and suit although the liquid cooling garment alone covered about 60% of the body whereas the hood covered only 2-3% of the body. He concluded that cooling the head and neck is more effective and efficient than cooling other parts of the body.

In general, this work by Webb (1966) is helpful in creating both a qualitative and quantitative feel for cooling garment control requirements.

Webb (1966) commented on existence of a device in the portable life support system for continuously monitoring oxygen consumption and proposed

that the signal from this device be used to control cooling as the reference input to an open loop control system. There is in fact only an oxygen bottle pressure sensor which is unsuitable for the purpose suggested but due to more general considerations Webb's initial work was followed by detailed analysis, design, fabrication and testing of such an oxygen consumption controller (Webb, 1968). A motor driven blower draws ambient air through the test subject's face-mask assembly. The blower speed is servo-controlled by a polarographic cell (oxygen sensor) located in the path of the expired air-ambient air mixture. As the oxygen partial pressure sensed by the cell decreases, the blower is made to speed up, increasing the ambient air flow into the face-mask and thereby raising the expired air-ambient air oxygen partial pressure toward that of ambient air. The blower speed and its input voltage are proportional to the volume flow and oxygen consumption. This voltage signal is then used to control inlet water temperature and yields good overall thermal control of test subjects engaged in a variety of tasks. Use of the oxygen consumption controller in space lacks feasibility at the present time, however. Sampling of the oxygen partial pressure difference between inspired and expired gas would be necessary since the present life support system oxygen loop recirculates expired gas through a lithium hydroxide canister. The resulting  $\text{CO}_2$  partial pressure in the loop varies with work rate, lithium hydroxide age and history, and elapsed time of extravehicular activity. Cooling, however, should be independent of everything except oxygen consumption of the astronaut.

If rate of make-up oxygen supplied by the demand regulator could be sensed, it could be used in such a control technique under ideal conditions. Astronaut pressure garments leak, however, at rates depending upon suit age, usage, astronaut activity and whether a hole has been introduced unexpectedly, and cooling must be independent of these features. The oxygen controller tends toward instability if it is set for slight overcooling when the test subject is at rest. Shivering, which eventually results, causes increased oxygen consumption and a command for additional cooling. Finally, since the controller is an open loop system, neither drift nor accumulative error are corrected. In short, it is not practical to introduce the equipment necessary to measure actual oxygen uptake at this time, and secondary techniques of measuring oxygen consumption by the crewman are, at best, indirect measurements of his metabolic activity and subject to unacceptable error.

Webb recognized most of these shortcomings and has investigated three alternate controllers (Troutman and Webb, 1970). One is based upon change in cooling water temperature across the man with a skin temperature feedback; one is based upon heart rate with feedback proportional to change in cooling water temperature across the man, and the final approach uses heart rate alone. Tests of these three concepts included use of an Apollo liquid cooling garment without a water cooled hood. Six cubic feet per minute air flow was introduced into the outer garment assembly helmet directly above the test subject's forehead and toward his face. In contrast, the Apollo pressure helmet vent pad and

and duct assembly acts as a ventilator flow manifold directing the flow of gas around the sides and down over the top of the inside of the helmet to the oral-nasal area. Although little heat is actually removed by the gas flow it is likely that it is a factor in subjective comfort evaluation based upon test subject comments. The first two controller concepts were tested by Webb and reported to be satisfactory.

Webb's results to date for two controllers have been summarized (Webb, et al, 1970) with the  $\Delta T$  controller, i.e., the concept using change of cooling loop water temperature across the astronaut, being of particular interest. Suppression of sweating even at high work rates was reported while test subjects remained subjectively comfortable. This is significant and in contrast to the observations of Chato, et al (1968) who found that test subjects engaged in much lower levels of activity (1330 Btu/hr. vs 3600 Btu/hr.) had sweat rates which were above Webb's desired minimal and in at least one case sweating was very heavy despite effective water cooling which was accomplished using twelve shower heads to obtain full body drenching (with the test subject dressed in a lightweight waterproof garment). Chato concludes that at least occasional sweating of astronauts should be expected and provisions for handling the situation provided. He reports that the individual responsible for heavy sweating in his tests was partially acclimated to heat through concurrent participation in hot room studies and suggests that the heavier sweating may have been due to that fact.

Some of this investigator's early manned tests showed that thermal comfort had to be sacrificed to a large degree, upon occasion, in order to inhibit sweating with certain test subjects. During one of these tests skin temperature was dropped to the point that the test subject was shivering yet he observed that he "could feel internal heat building up" and moderate sweating took place. The same test and work conditions at a later date resulted in the test subject feeling comfortable without significant sweating even with a higher skin temperature. This may indicate test subject pre-test history (e.g., his alcohol consumption the evening before, his degree of training for the particular exercise imposed during a test, his psychological outlook, and his state of health at the time of the test) and other factors may influence subjective feelings of comfort and perspiration rates during a test. Wurster and McCook (1969), for example, reported inhibition of sweating by rapid decrease in skin temperature but observed cases in which sweating occurred despite low skin temperatures and declining central temperatures as the rate of decline of skin temperature approached zero. They also observed cases where total suppression of sweating was effected and others in which the suppression was only temporary. In short, reliable achievement of subjective comfort with an automatic device is most difficult to attain due to complexities of the human body which are not well understood.

Conceptually, Webb's  $\Delta T$  controller (Webb, et al, 1970) appears to have some of the undesirable features of the oxygen consumption controller although it appears to have performed well in laboratory tests conducted

by Webb. The main objection would seem to be that the controller bases its operation upon a measurement which can be related to a need for cooling under certain circumstances but which is not reliable as a direct measurement of cooling requirements. First of all, failures in system insulation in the space environment, thermal shorts, and other factors can change the inlet and outlet water  $\Delta T$  without regard to metabolic activity. Changes in heat transfer to the liquid cooling garment can occur due to changes in astronaut body attitude or changes in overall heat transfer coefficient due to moisture. In other words, the temperature difference used is not a direct measurement of changing thermal stress in the astronaut. The heart rate controller being investigated by Webb (1970) does not seem appropriate for use outside a spacecraft either for several reasons. Under working conditions which astronauts have faced and can be expected to face in the future emotional stress can significantly affect heart rate for appreciable lengths of time. Deconditioning in a low gravity environment during long term missions can also make correlation between heart rate and metabolic activity difficult to predict in advance. Again, heart rate is not a direct measurement of thermal stress.

An interesting application of fluidic device principles is described by Zoerb (1968) who discusses a Navy-sponsored development for the control of liquid cooling garment inlet water temperature. The device tested is capable of controlling cooling garment inlet water temperature in such a fashion that skin temperature is maintained essentially constant. Unmanned tests showed that it could control inlet water



temperature of a liquid cooling garment fitted to a copper manikin so that simulated skin temperature was maintained within 2°F of a desired value over a heat rejection range of 500 to 1500 Btu/hr. Minimum inlet water temperature was 57°F which together with heat transfer coefficients between manikin and garment set the upper limit. During manned tests involving a single test subject skin temperature of 88°F was desired and "during an exercise period of 15 minutes, in which the subject exercised until near exhaustion, the skin temperature was regulated at 89°F." Most remarkably, in light of research previously discussed, "throughout this period and particularly at the time of peak exercise the subject commented favorably on how comfortable he felt." A similar device developed for the Apollo Applications Program appears to be effective in maintaining skin temperature at whatever value the crewman selects, but one of the objects in developing an automatic controller is to supply cooling according to physiological temperature regulation needs instead of what a crewman thinks his needs are for reasons previously discussed.

## CHAPTER III

### TEMPERATURE REGULATION MECHANISMS IN MAN

The definition of temperature regulation which seems to most closely fit here is that of Hardy and Hammel (1963):

"The maintenance of a temperature within a prescribed range under conditions of varying thermal loads can be termed temperature regulation. This does not necessarily mean maintenance of a constant heat content, i.e., no heat storage."

The means by which man's thermoregulatory system responds to heat and cold stress, i.e., any deviation from some nominal condition, is one of the most fascinating aspects of physiology connected with cooling garment controller research. It leads directly to application of control theory to simulate and study human responses and to control man's environment to satisfy his needs.

The conspicuous mechanisms concerned with heat loss in man are related to his ability to vasodilate the vessels in the skin, to store heat in the body, and to sweat. Thermoregulation is concerned with the control of these mechanisms which will be examined briefly.

#### Heat Storage

Nearly constant body temperature is maintained in man by the regulation of heat production and of heat loss. Changes in the environmental temperature induce changes in heat production and heat loss. As the external temperature is lowered both heat production and heat loss

are greater in a resting man. During work heat production increases above that during rest and generally results in higher levels of body temperature. The heat production in homeotherms that serves to maintain the relative constancy of the body temperature has been called chemical regulation as distinct from physical regulation, the regulation of the body heat loss. Chemical thermoregulation at a given temperature is often considered to be the sum of thermogeneses in all tissues used for homeothermy. Physical thermoregulation may be determined by direct calorimetry; chemical thermoregulation by the quantity of oxygen consumed and carbon dioxide produced. Either value depends on factors such as the environmental temperature, the animal species, and the physical state of the body.

Chemical thermoregulation is increased as the external temperature is lowered. In man it may be three to four times higher than the basal metabolic rate. Basal metabolic rate is considered to be the minimal metabolism measured at the temperature of thermal neutrality in a resting homeotherm with normal body temperature several hours after a meal and not immediately after hypothermia. Recent investigations consider the basal metabolic rate as a sum of basic energy requirements of prolonged influence of the surrounding temperature.

Heat loss from man occurs by radiation, by conduction and convection, and by evaporation of water from the body surfaces. The relative percentages of heat transfer by each mode depend upon the characteristics of the environment to which man is exposed as well as

man's own characteristics. Physical thermoregulation consists of control of these heat transfer processes, and of the circulation rate by constricting or diluting a smaller or a greater number of peripheral blood vessels engaged in the transport of heat to the body surface.

Man's thermoregulatory system operates schematically as shown by Figure 1 (Gelineo, 1964). The deep body temperature varies with external temperatures. From the upper to the lower critical temperature, it is normal (homeothermy). The zone of hyperthermia is above the upper critical temperature where man may die from heat. Below the lower critical temperature lies the zone of hypothermia where he may die from cold.

Heat production varies as follows. In the zone of thermal neutrality, a resting and fasting man lives at his basal metabolic rate. Above thermal neutrality up to the upper critical temperature, there is a narrow zone in which the body successfully fights against overheating by sweating. There is also a transitory reduction of heat production known as the "second chemical thermoregulation" of Wolpert. From the thermal neutrality to lower temperatures the body preserves its temperature mostly by chemical thermoregulation. At the point below which the body temperature begins to fall, man develops his peak metabolism. The highest heat production in the cold, the so-called maximal metabolism, is developed by man in the zone of hypothermia.

The zone of predominantly physical thermoregulation begins somewhat above the zone of thermal neutrality and extends into the zone of hyperthermia. Panting and sweating are the predominant mechanisms in this zone, but body temperature may still rise above normal.

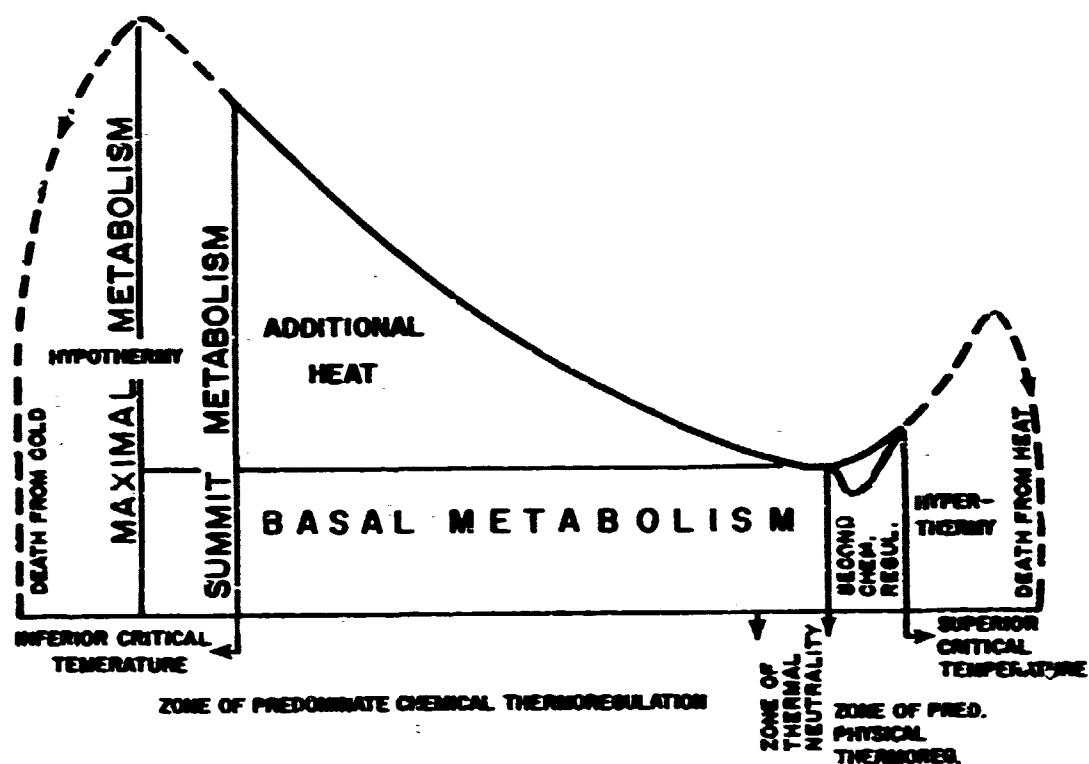

FIGURE 1. GENERAL CURVE OF THERMOGENESIS IN HOMEOTHERMS (GELINEO, 1964)

Man's body temperature is maintained at a relatively constant level in his normal environment because of the balance which nominally exists between heat production and heat loss. Contributing mechanisms include those shown by Table 1.

**TABLE 1**  
**FACTORS AFFECTING HEAT BALANCE**

Factors Increasing Heat Production Over Basal Metabolic Rate

1. Exercise and shivering
2. Imperceptible muscle tensing
3. Chemical increase of metabolic rate
4. Eating
5. Fever

Factors Affecting Heat Loss and Gain

1. Shifts in blood distribution, including those caused by vasodilation, vasoconstriction, counter-current heat exchange
2. Changes in tissue conductance
3. Environmental temperature
4. Environmental humidity
5. Insensible water loss
6. Changes in radiating surface area
7. Changes in air movement
8. Changes in clothing

The mechanism of storing body heat is illustrated in the extreme circumstances by men being exposed to heat and dehydration at the same time; their body temperatures rise quickly. After as little as 1-2 percent reduction of body weight due to dehydration the rectal temperature of man increases in a linear manner with progressing water deficit (Robinson, 1963). Although some investigators consider that this increase in body temperature with progressing dehydration is a failure in heat dissipation, Schmidt-Nielsen takes the view that a rise in body temperature reduces the heat load in a hot environment because the difference in temperature between the environment and cooler body is diminished (Adolph, 1947). The heat flow from the environment is roughly proportional to the temperature difference and goes down as the difference gets smaller. He points out that the rise in body temperature has both advantages and disadvantages, but it is probably better to avoid classifying it as a failure of heat regulation.

In general, the mechanisms for heat storage are reciprocal measures for heat loss: peripheral blood flow is reduced which in turn reduces convective heat transfer to the skin surface, and/or perspiration is reduced which in turn reduces evaporative transfer. In the case of a resting man in a liquid cooling garment, onset of exercise may yield a rapid drop in skin temperature (perspiration may or may not take place) as blood is shunted to the major muscles. Convective transfer by the blood to the environment is thereby reduced, but conductive transfer may tend to reduce the loss of transport capacity to some extent in a cool environment due to the resulting increased temperature gradients

across the body. Variations in respiration rate and depth of breathing are also factors in heat storage.

### Sweating

Sweating is a costly physiological event and leads to astronaut and test subject discomfort at best. Elevation of body temperatures and increased heart rates can result if dehydration occurs. For these reasons a criterion to be considered during thermal garment temperature controller development is minimization or elimination of perceptible sweating due to proper cooling water temperature control.

Perspiration consists of insensible water loss (diffusion and expiration), nonthermal sweat and thermal sweat. The first two are rather subtle when extreme heat is concerned and will not be considered further here. The production of thermal sweat, however, is the conspicuous and costly physiological event referred to which can be a factor in the upset of homeostasis. It is costly in the sense that large quantities of body water are involved. Investigators report perspiration rates varying from 0.5 to 4.2 liters per hour under hot conditions, where the latter rate is of the same order of magnitude as the total amount of water in the body. These rates are not maintained (and the mechanism of reduction is an interesting area of investigation itself), but researchers have observed men in good condition after sweating at rates of 3 liters per hour for 4 hours. Although this water is taken from the blood as it passes through the capillaries of the sweat glands, the loss is replaced indirectly from other body compartments. Such a



high loss of water cannot be sustained without replacement in the form of drinking water. Nevertheless the rate of sweating is not modified by moderate dehydration, but is adjusted according to the need for heat dissipation. Furthermore, drinking in excess does not increase the rate of sweating.

Hertzman (1963) has studied and discussed sweating and blood flow and the effects of dehydration on circulation. He reports that the rise in body temperature during dehydration accompanying heat exposure is attributed by Adolph, et al (1947) to a failure of the peripheral circulation. Hertzman assigns the principle role in heat storage to a rising threshold of sweating and discounts peripheral circulatory failures as directly related to the increase in body temperature. He reports that there is no evidence that cutaneous blood flow decreases sufficiently to prevent an adequate vascular convection of heat. The failure of the cutaneous blood flow to increase as body temperatures rise indicated to him that the vasodilating effect of heat was being offset by a vasoconstrictor influence which was not identified. The fact that a rise in skin and core temperatures failed to elicit further cutaneous vasodilation and sweating as would have been true in the normally hydrated subject exposed to the same ambient temperature probably is significant. Hertzman reiterates suggestions by other researchers that the information supplied by the thermoreceptors, osmoreceptors, and volume receptors may be mutually contradictory and may correspondingly modify the influences of the sudomotor and vasomotor systems.

Randall (1963) has published a definitive paper, "Sweating and Its Neural Control," related to the thermoregulatory functions of sweating. He observed appearance of sweating appearing on different parts of the body and with varying levels of profusion depending upon the state of heat stress. These and other responses led him to conclude that mediation occurs at spinal levels as opposed to the hypothalamus selectively activating sweat glands of different skin regions in an ascending fashion over the body surface.

As heat stress increases, Randall observed that there occurs within a given area an increase in the number of active sweat glands, and additional glands are recruited in previously nonsweating areas. Still more severe stress leads to recruitment of sweating on all skin surfaces, and those glands which are already active may show greater output of sweat per unit time. Sweating was observed to be a discontinuous process, marked by high and low levels of sweating activity.

Wide variations in skin temperature can be measured from one region to another, even though sweating may be general, and it is considered doubtful that local sweating is governed exclusively by local skin temperature.

It is generally agreed that the main control of those mechanisms associated with heat loss is regulated by the anterior hypothalamus. The hypothalamus is normally cooled by arterial blood, and being sensitive to an elevated temperature, it apparently increases nerve impulse

traffic to the sweat glands and decreases traffic to cutaneous blood vessels by way of the sympathetic nervous system. Randall reports that there is some evidence that the hypothalamus may act to dilate direct shunt vessels between skeletal muscles and the overlying skin.

In summary, Randall suggests that thermoregulatory sweating is elicited in two ways:

- (1) By impulses emanating from the anterior hypothalamus which acts as an internal thermal sensing organ, and
- (2) by afferent nerve impulses, arriving from the periphery, which stimulate the same centers via long reflex mechanisms.

The second mechanism has been challenged in the literature. Randall quotes Filehne as having observed that thermal sweating can be stopped by placing one's hands in cold water with no detectable change in body temperature, and as having concluded that cutaneous receptors are responsible. Hill (1920) believed that the blood was cooled, however, which implied that afferent impulses were not a necessary assumption. At least one group of researchers has concluded that cutaneous receptors elicit reflex sweating and the hypothalamus controls the intensity (Folk, 1966).

Randall found that sweating is recruited successively from the lower extremities upwards and that the sensation of heat first appears on the head and then successively on lower areas. The various observations argue for more than a single type of heat receptor but much apparently still remains to be learned regarding their exact nature.

The effect of rate of change of skin temperature in heat storage and sweat inhibition is of importance in the study of thermal control concepts. Wurster and McCook (1969) caused perspiration rates in resting subjects to approach zero for varying time increments by introducing step changes in their environmental temperatures. As rates of decline of skin temperature approached zero, sweating increased despite lowered skin temperatures and declining tympanic membrane and oral temperatures. The authors explain the observed responses on the basis of central temperature sensors, their relative sensitivities, rate of change of skin temperature and steady state skin temperature attained after the step change in environment.

One thing that is clear is that at the point of incipient thermal sweating a need exists for the skin blood flow to increase as the heat load rises to transport more heat from the core to the periphery where it can be dissipated to the environment. This leads naturally into the cardiovascular system although there are areas of secondary interest with respect to this research which have not been discussed, e.g., the sweat glands, functions of electrolytes and required levels, so-called sweat gland fatigue, fluid demand priority, fluid replacement, and osmotic pressure. In short, the sweating mechanism is considered by some to be the key to effective thermoregulation in man. As test subjects become acclimated to work in the heat they produce up to 10% more sweat, its onset is sooner and at lower body temperature, heart rates are lower (discussed next), skin temperatures are lower, rectal

temperatures are lower and the subjects consume less oxygen. Even if acclimation exists at the beginning of an extended space mission it will be lost as the crewman adjusts to work in a controlled environment, i.e., the space station or his space suit. Physiological responses can be expected to change with time and if thermal control fails or proves inadequate during a mission, classical symptoms of heat stress can be anticipated.

#### Cardiovascular

Blood is the primary heat transport medium between the major muscles and inner elements and man's external environment, and its temperature stimulates groups of neurons that respond directly to temperature. These neurons are located in the hypothalamus which can be divided into two major functional areas: The anterior portion, in the preoptic area, causes the body to respond to reduce stored heat by vasodilation, sweating and/or decreased muscle tone when it is stimulated and it is known as the 'heat losing center.' The posterior portion causes the body to store heat by vasoconstriction, increased metabolism, shivering, and/or decreased sweating when stimulated and it is known as the "heat promoting center." When blood temperature changes, the rates of discharge of these cells also change. The precise relationships between groups of cells within one center or the other and their communication codes are not understood. What is known is that when blood at below normal temperature is passed through the preoptic region of the hypothalamus the heat promoting region is strongly activated and the

mechanisms described are automatically activated. Conversely, external heating of the hypothalamus or passage of blood at above normal temperature through the preoptic region stimulates the heat losing center and its corresponding mechanisms are activated. The cardiovascular system therefore involves management of the primary heat transfer medium whose temperature and possibly temperature change rate initiate certain thermoregulatory control actions. For that reason events which affect circulation are of interest in cooling garment controller research.

Many factors affect circulation directly and indirectly but the two factors which are perhaps the most important to garment controller research are test subject physical conditioning, and active vasodilator control of blood flow to the periphery depending to some degree on local surface temperature. Benzinger's view that afferent pathways from the skin to the hypothalamus do not exist contradicts the interpretations of other researchers and has been the subject of repeated challenge (Randall, 1963).

Regarding the cardiovascular aspects of acclimation Bass (1963) is representative of much of the literature. In general, upon first exposure to work in heat man undergoes excessive vascular bed expansion without adequate blood volume increase. Erect posture and exercise both exaggerate the deficiency in blood volume because of pooling and increased flow to the muscles. Cardiovascular inadequacy with subjective stress and rapid pulse may be present even with moderate work. The heart is capable of increasing its output but does not, and Bass

suggests that inhibitory influences may be at work. Fluid dislocation encourages water and salt retention by the kidneys until plasma and extracellular fluid volumes are raised within a few days to levels where proper fluid distribution is experienced during exercise. The sweating mechanism is inadequate during this period and thus combined with inadequate convection blood flow following pooling probably contributes to distress, and hyperthermia in extreme conditions. The circulatory embarrassment disappears on repeated exposures to work under hot conditions, but acclimation is lost if more than a few days pass without exposure once it is attained. During investigation of various garment temperature control parameters situations inevitably develop whereby inadequate cooling is provided. If the test subjects do not maintain acclimation, the classical physiological responses described probably will be observed.

Alternatively, since an astronaut would not be expected to maintain acclimation in the normal temperature regulation sense during an extended space mission, the function of the liquid cooling garment becomes that of maintaining homeostasis and "appropriate" comfort during extravehicular activity. Appropriate is emphasized here since there are indications that a relationship exists between stored body heat and work rate (Waligora, 1967a) and because there are differences between the degrees of vasoconstriction and sweating desired and/or considered acceptable by different people during work. Sufficient information concerning the nature of the physiological responses to work and responses observed during other garment controller investigations

exists at this point, however, to make necessary assumptions and identify controller design requirements.



## CHAPTER IV

### DESIGN CONSIDERATIONS

The first consideration which will be addressed in this chapter is control philosophy. Once a control philosophy is established, it is frequently useful to demonstrate feasibility with a computer simulation, so other considerations to be examined in this section will be requirements imposed for computer simulation and ultimately a breadboard design. Such a design must be capable of simulating with hardware the total system operation accurately enough to reveal any major problem areas. Breadboard demonstration, therefore, is the second step in demonstrating feasibility and satisfies the objectives of this research project.

The next step in the design process, assuming satisfactory performance during the first two steps, is reduction of the electronic controller breadboard and water control valve to flight prototype designs and hardware and integration of these elements into an actual life support system for unmaned and manned testing.

#### Control Philosophy

Minard and Copman (1963) review the work of Blockley, McCutchan and Taylor (1954) and Blockley, et al (1954) and conclude that change in mean body temperature,  $T_{MB}$ , is an effective index of heat tolerance since, under transient heat loads,  $T_{MB}$  rises as a linear function of heat stress. The mean body temperature referred to by Minard and Copman is

calculated from the formula of Burton (1935):

$$T_{MB} = 0.67 T_R + 0.33 T_S,$$

where,

$T_R$  = rectal temperature

$T_S$  = unweighted mean of ten skin temperatures.

Consideration in detail of the physiological functions of thermoregulation discussed in Chapter III, a large amount of research related to man's responses to work under different environmental conditions, and Webb's data (1966), leads to the conclusion that reliable control of man's mini-environment, i.e., the liquid cooling garment, should be keyed to minimizing heat stress, changes of which are reflected by changes in mean body temperature. Reliability in this context refers to the control of cooling according to actual physiological needs without sensitivity to astronaut emotions (which can affect heart and respiration rates) and other variables which indirect methods are subject to.

A degree of anticipation is needed in the cooling command to counter thermal inertia of the human body which can lead to buildup of stored heat and sweating if cooling is delayed sufficiently after onset of work. The control philosophy investigated therefore incorporates control of liquid cooling garment inlet water temperature based upon mean body temperature and its time rate of change.

#### Hardware Features

Other considerations include opinions of the astronauts that manual and electronic override features should be available for emergency use

and fine adjustment and that there should be provisions to accommodate day to day and week to week metabolic variations. In terms of the control philosophy described these variations can be interpreted as variations in mean body temperature corresponding to subjective evaluations of thermal neutrality and are related to variables such as ambient humidity, ambient gas composition and other factors. Investigation of this feature in detail represents a matter of some interest and complexity, but the ability to provide different mean body temperature set points in the controller can be and is provided. In a final flight configuration it is desirable to have no more than a single "screwdriver" or null adjustment required to make the system operational, and the setpoint temperature or "Preset" adjustment is admissible.

For a breadboard version it is desirable to be able to adjust important signal gains and time constants during a feasibility study. This requirement is imposed yielding a greatly enlarged version of what could be a cigarette package-sized device for flight. A micro-miniaturized version of the controller studied would be compatible with portable life support system power and packaging constraints.

#### Valve Command

Figure 2 shows the liquid cooling garment liquid loop in schematic with the present manual diverter valve. Different valve commands which are possible in an automatic system include an infinitely modulating valve, i e., one that varies continuously from zero to full flow through the

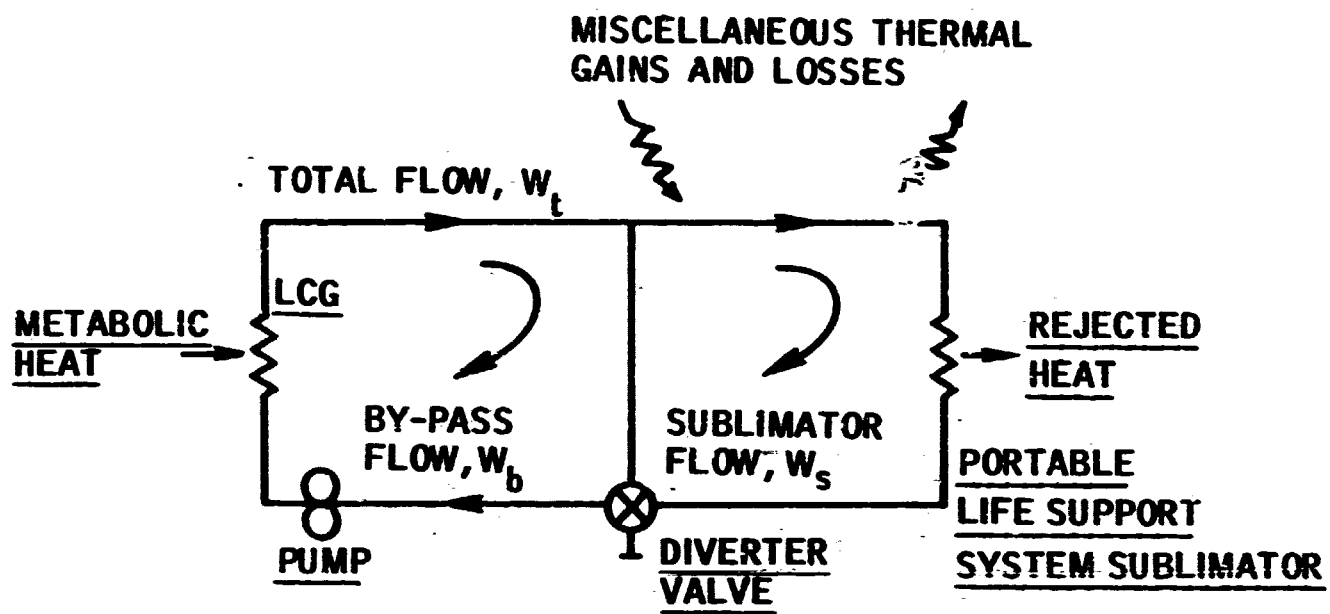

FIGURE 2. LIQUID COOLING GARMENT COOLING WATER LOOP SHOWING LCG & PLSS PUMP, DIVERTER VALVE, & SUBLIMATOR

bypass; a stepping-valve which would open and close in discrete increments; and a two position valve capable only of full-open or full-closed positions. In the computer simulation the valve is made to open and close in discrete amounts at prescribed rates, but in the breadboard simulation an air-controlled valve capable of smooth operation was chosen since it was available in the laboratory and its operational mode was of interest. Any one of the three modes is acceptable in a functional sense and other modes are possible. From a power duty-cycle viewpoint, a stepping mode or full-open and full-closed mode with appropriate signal integrating features and time-functions may be desirable.

#### Temperature Measurements

There are many different "core" or "central" temperature measurements in the human body and the same applies to skin temperature. They are different not only in value, but they respond in different ways and with different rates to disturbance functions such as work, external cooling, and other factors. Burton (1935) and later investigators generally use rectal temperature in estimating mean body temperature, but rectal temperature instrumentation promotes a feeling of discomfort and there are unique design problems in providing flight equipment. Benzinger (1963); Cooper, et al (1964); Strydom, et al (1964); and Libbons (1967) are among investigators who have studied use of the tympanic membrane, external auditory meatus and oral temperatures for assessing heat stress in humans. Other possibilities exist for measuring central temperatures but they are not practical for use in space activities. Cooper, et al, found that there

is considerable temperature gradient down the wall of the meatus, which negates its usefulness for certain purposes, but changes in ear temperature correlated well with cutaneous vasomotor responses induced by body heating. Ear temperature measurement is more comfortable than either tympanic membrane or rectal measurements and more reliable than oral measurements which are affected by respiration and talking. Since use of an ear mold, similar to that of a hearing aid, has been proposed for use in advanced mission extravehicular activity, and addition of a small thermistor is a relatively simple matter, change in ear temperature was selected as the means for detecting changes induced by body heating. A schematic diagram of an ear with ear mold in place is shown by Figure 3. The very first manner tests using a similar device showed that system response is very sensitive to changes in ear canal temperature caused by ambient air movement across the face and the astronaut's communication cap was introduced as an item of test subject clothing to stabilize the system. For computer simulations the existing computer program's "core temperature" was used to calculate mean body temperature without difficulty.

Several skin temperature locations beneath the liquid cooling garment were tried early in this project's manned testing without too much detectable difference in system response. For operational reasons it is desirable to minimize the number of skin sensors used to establish "average" skin temperature, and the numbers generally used by other investigators were arbitrarily reduced from 10-20 to four. It was

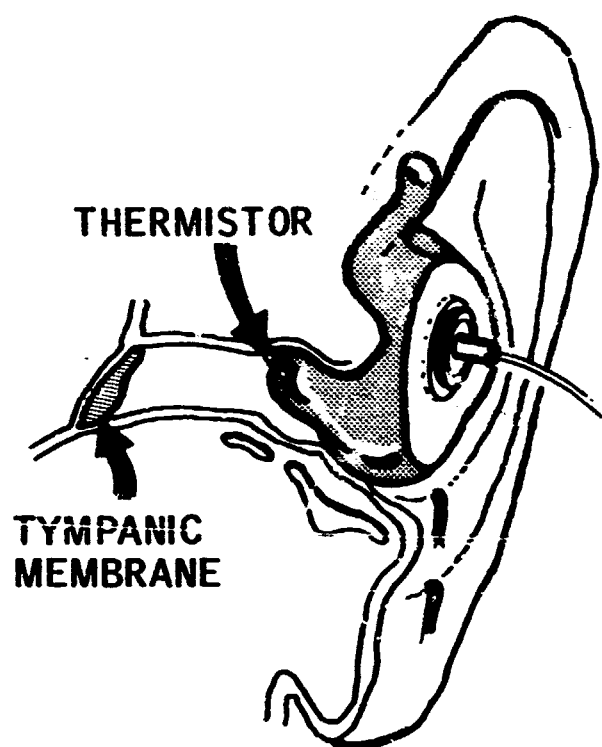

**FIGURE 3. SCHEMATIC OF THE EARMOLD AND THERMISTOR USED TO MEASURE TEMPERATURE OF THE EAR CANAL**

theorized in identifying both skin and core temperature measurement locations that part of the function of the controller electronics, or breadboard, should the computer simulations prove to be effective, would be to allow investigation of temperature signal gains and time constants for overall satisfactory performance. This proved to be a valid assumption.

#### Electronic System Breadboard

The prototype liquid cooling garment water temperature controller, or breadboard, shown by Figure 4 was fabricated and tested as described in Chapter VI. Functionally, the system senses ear canal temperature with a single standard precision Yellow Springs Instrument Company No. 44011 thermistor (TR 1) and skin temperature with four of the same thermistors in series (TR 2). The YSI No. 44011 thermistor has a time constant of one second or less when suspended by its leads in a well-stirred oil bath and a maximum of ten seconds when suspended by its leads in still air. Its dissipation constant, or the amount of power in milliwatts required to raise the thermistor  $1^{\circ}\text{C}$  above the surrounding temperature is  $8 \text{ mw}/^{\circ}\text{C}$  for a well-stirred oil bath and  $1 \text{ mw}/^{\circ}\text{C}$  for still air. The thermistor tip is sealed in epoxy and the leads are #32 tinned copper wire. Resistance is 100,000 ohms at  $25^{\circ}\text{C}$ .

Bridge circuit output signals are amplified by elements U6 and U5 and amplified and summed by U4 to yield a voltage proportional to "mean body temperature." The weighting given each temperature, ear and skin, is



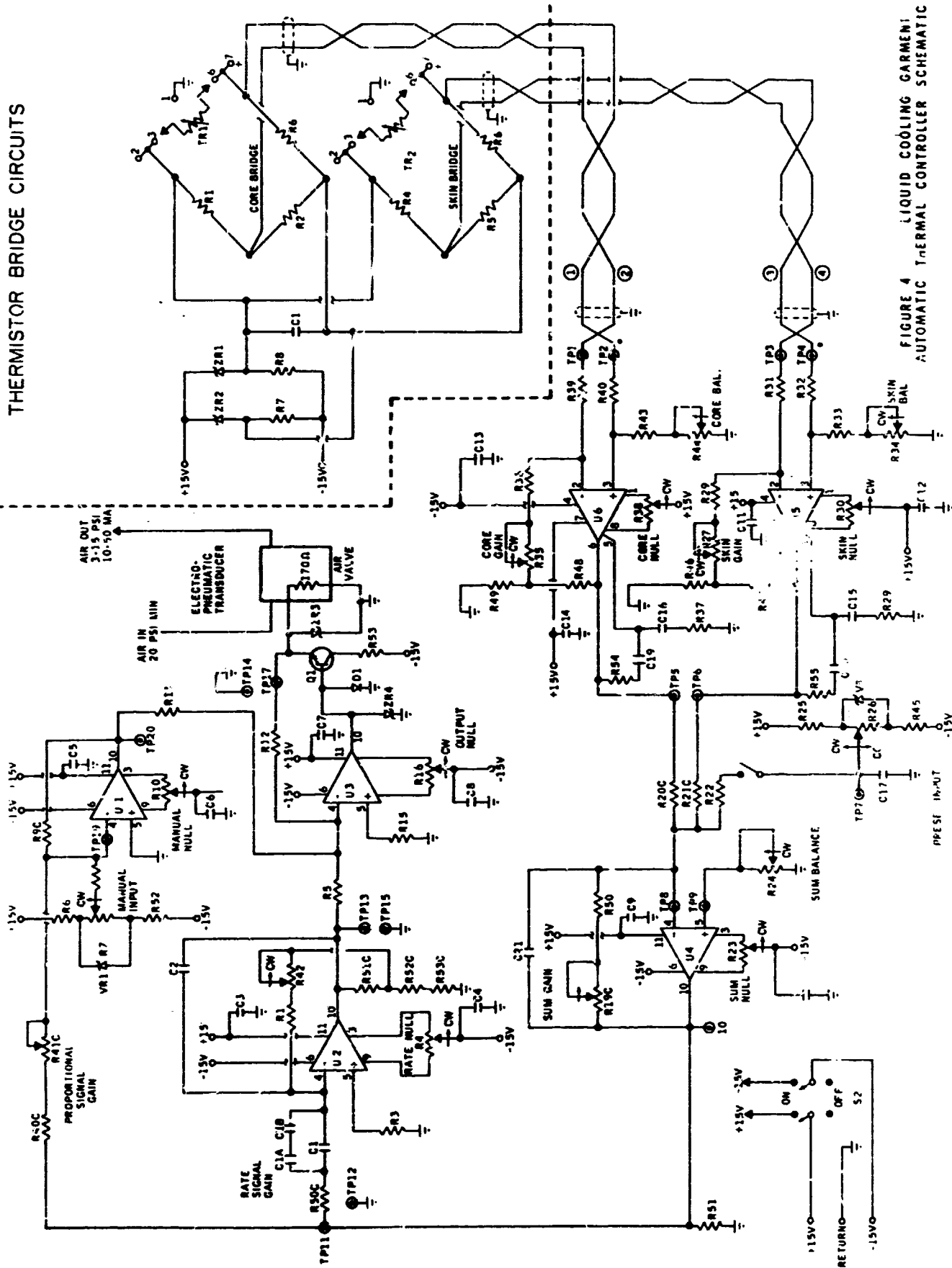

determined by the gain settings for U5 and U6. Examples for setting all circuit gains are given in Appendix 4.

A voltage proportional to the desired mean body temperature setpoint is provided by the "Preset" circuit shown by Figure 4. The output of the summing amplifier, U4, is fed into amplifier U2 whose output is proportional to time rate of change of mean body temperature and into U1 whose output is proportional to mean body temperature. The output of U1 and U2 are summed at the input to U3, an inverting amplifier. A "manual input," or bias, can be introduced by the potentiometer R7. The output of U3 is fed into an electropneumatic transducer whose output is a 3-15 psig air source with pressure proportional to input voltage. This air source controls the flow through a three-way diaphragm operated valve which simulates the action of the portable life support system diverter valve. Changes in ear and core temperature are amplified, summed, and converted to a diverter valve command proportional to the deviation of the summed signal from a setpoint value and to the rate of change of the summed signal from its setpoint. The air valve acts as the link between the controller and the heat transport system described in the next section.

#### Fluid System Test Stand

Hamilton Standard Division of United Aircraft, designer and manufacturer of the Apollo portable life support system, designed and built a fluid system test stand capable of simulating the water transport loop of the PLSS. A schematic of the system is illustrated by Figure 5. The

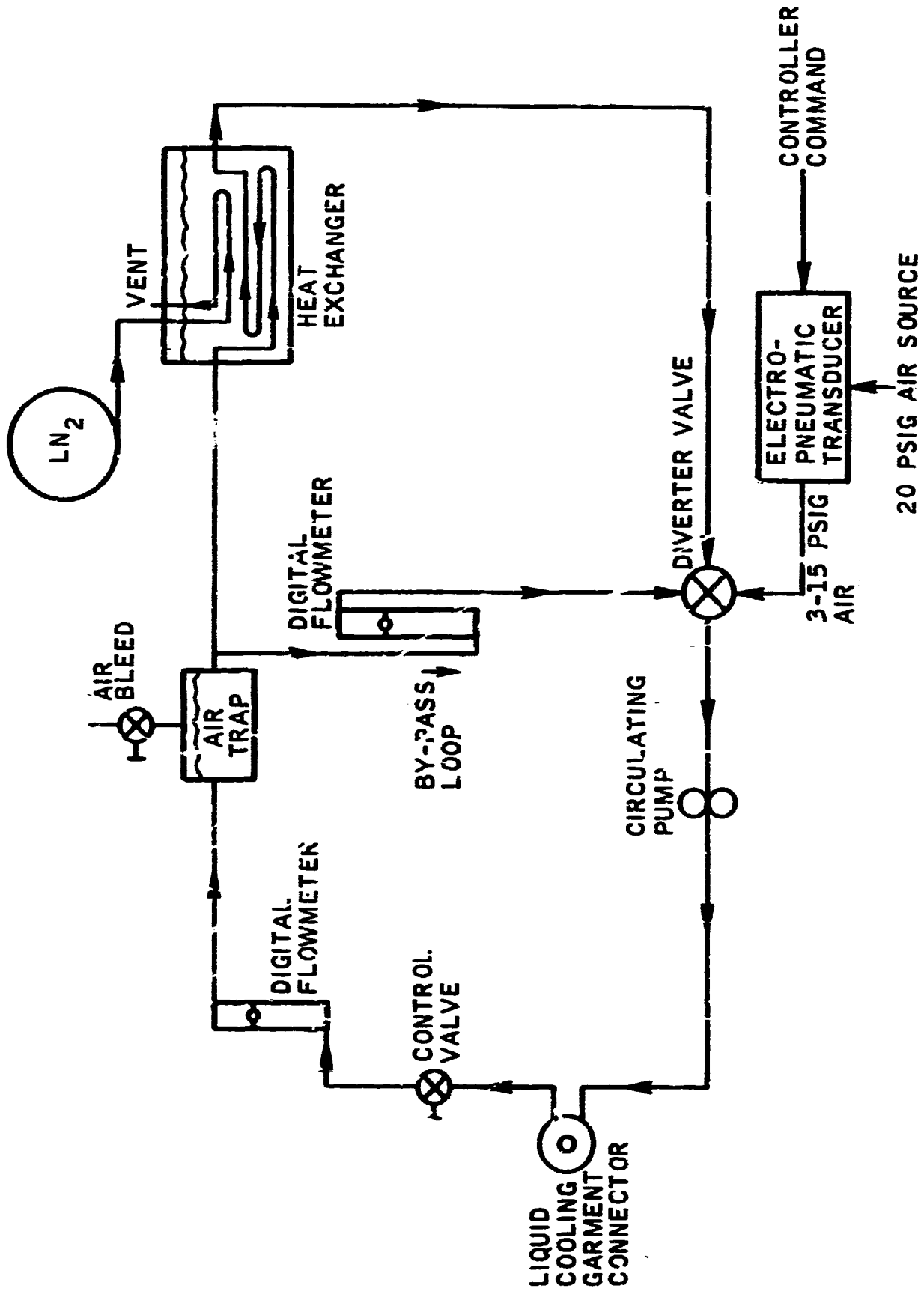

FIGURE 5. FLUID SYSTEM BREADBOARD - SCHEMATIC

electropneumatic transducer, a Foxboro Model 69TA-2R current-to-air transducer, receives controller commands from the electronic breadboard and converts them to air valve pressure commands. The air valve is a Precision Products and Controls, Inc. Type 73N-Standard 3-way valve. When the air, or diverter, valve is closed, full flow bypasses the heat exchanger simulating the PLSS sublimator and recirculates through the crewman's liquid cooling garment. As the valve is opened on command, flow in the bypass loop is closed off proportional to the flow passing through the heat exchanger. When the valve is fully open, all flow passes through the heat exchanger which is chilled with liquid nitrogen. Digital flowmeters are provided in the bypass loop and downstream from the water circulating pump. The flowmeters are Cox Instrument Division, Detroit, Michigan, Model LF6-1's, serial numbers 9732 and 9734. Their outputs are supplied to Foxboro Frequency-to-DC Converters, Model FR-320-3-5, serial numbers 37290 and 37293. The linear response and flow rate versus output voltage of each flowmeter and its converter were verified by the MSC Brown and Root-Northrup Instrument Laboratory. Power was supplied to the flowmeter converters by a Harrison Laboratories, Inc., Berkeley Heights, N. J., 0-36 v., 0-5 amp, Model 808A power supply, NASA serial No. 12017. An air trap, air bleed valve, water recharge fitting, and miscellaneous thermocouples and pressure transducers complete the basic test stand elements. Pump outlet flow rate is nominally 3.6 pounds/minute. Water bath temperature in the heat exchanger was maintained at the freezing point.

### System Computer Simulation

An effective method of testing the feasibility of the proposed concept was devised using a National Aeronautics and Space Administration digital computer, fourteen node simulation of the heat transfer within a man and the heat exchange between an astronaut and his environment. The environmental modes include shirt-sleeve, suited, suited extravehicular and suited with helmet off. In the program, titled Transient Metabolic Simulation Program, the use of the liquid cooling garment and postlanding environmental conditions are optional. Programmed in Fortran IV for the NASA/MSC Univac 1108, the simulation accepts as inputs metabolic and environmental data and the environmental mode desired. The transient thermal properties of the man and his environment are calculated and the output is printed at scheduled intervals. The output describes the response of the astronaut to the environment and the response of the environment to the astronaut. This program was modified to simulate a portable life support system diverter valve capable of modulating flow through the sublimator from zero to full flow. The present valve, and the original simulation, is capable of directing flow through the sublimator at only three different rates.

The program was also changed so that, when directed, it would cause the diverter valve to open and close at specified rates as required to maintain astronaut stored body heat within twenty BTU of the comfort tolerance midpoint defined by Waligora (Figure 1, 1967a) for each specified work rate. In this mode of operation the simulation generates data

for identification of coefficients by regression analysis as described in the following section and Appendices 1 and 2.

Diagrammatically the portable life support system cooling water loop is shown by Figure 5. Defining "By-pass Ratio,"  $\Theta$ , as the ratio of sublimator to total flow,  $W_s/W_t$ , the control algorithm described previously becomes

$$\Theta = C_1 + C_2 (T) + C_3 (\dot{T}),$$

where,

$C_i$  = Coefficients to be identified

$T$  =  $T_{MB} - T_{MBS}$ , change in mean body temperature,  $T_{MB}$ , from a specified mean body temperature setpoint,  $T_{MBS}$

$$T_{MB} = C_4 (T_C) + C_5 (T_S)$$

$T_C$  = Core temperature

$T_S$  = Unweighted mean skin temperature

$\dot{T}$  = Time rate of change of  $T$

To obtain approximations of coefficients  $C_4$  and  $C_5$  for subsequent simulations, the modified Transient Metabolic Simulation was run using a number of different work profiles. In each case values of core temperature and skin temperature observed at intervals throughout the program were used to calculate  $C_4$  and  $C_5$  using regression analysis as described by Appendix 1.

Derived values of core and skin temperature and the diverter valve setting at each calculation interval were then used to identify coefficients  $C_1$ ,  $C_2$  and  $C_3$  using regression analysis as shown by Appendix 2. The coefficients,  $C_1$ , were thus derived for a number of

different work profiles. The values were then used as inputs for a series of computer simulations using new work profiles to verify that the valve command algorithm, based upon the astronaut's simulated mean body temperature, provided stable operation with fast physiological recovery and acceptable heat storage. Appendix 5 contains typical simulation output curves. Shown are a metabolic rate profile imposed for a two hour simulated lunar surface activity and the physiological and critical system variables. Core and average skin temperatures, heat stored, liquid cooling garment inlet and outlet temperatures, and valve bypass ratio versus time are shown. Performance was excellent and an electronic controller breadboard was designed utilizing the ranges of values for the coefficients derived from the simulations plus some additional leeway to allow for differences between test subjects and other variables. Figure 4 is a schematic of the breadboard designed to collect actual core and skin temperature and provide water valve command signals according to the control algorithm.

## CHAPTER V

### CONTROL ALGORITHM SYNTHESIS

The control philosophy proposed in Chapter IV incorporated a mixing valve command proportional to change in mean body temperature from a set-point and time rate of change of that temperature difference. This relationship is shown in Appendix 2 as

$$\Theta = C_0 + C_1 T + C_2 \dot{T}$$

where the coefficients  $C_i$  are derived in simulations by regression techniques. Analysis and computer simulations suggested values of  $C_i$  as follows:

$$C_0 = 0.138$$

$$C_1 = 1.024$$

$$C_2 = 1.319$$

$\Theta$  is dimensionless. The units of  $T$  and  $\dot{T}$  are  $^{\circ}\text{F}$  and  $^{\circ}\text{F}/\text{min.}$ , respectively, so that the units of  $C_1$  and  $C_2$  are  $\frac{1}{^{\circ}\text{F}}$  and  $\frac{\text{min.}}{^{\circ}\text{F}}$ , respectively. Note that where  $T$  and  $\dot{T}$  are both zero 13.8% of the total ICG flow is still passing through the sublimator. Since the upper limit of  $\Theta$  is unity, full sublimator flow is achieved when  $\dot{T} = 0.65^{\circ}\text{F}/\text{min}$  and there is a zero temperature difference ( $T = 0$ ). Likewise, with  $\dot{T} = 0$ , a temperature difference of  $T = 0.84^{\circ}\text{F}$  yields full flow through the sublimator.

Setting the electropneumatic transducer so that it is fully closed until the voltage at test point 17 (TP 17),  $e_{17} = 2.6$  v. and so that it opens linearly until  $e_{17} = 6.6$  v., the voltage span is 4.0 volts.



Thus  $\Theta = 1$  corresponds to 4.0 volts. Writing  $\Theta$  as a voltage,

$$\begin{aligned}\Theta_e &= 4\Theta + 2.6 \\ &= 3.152 + 4.096T + 5.276\dot{T}.\end{aligned}$$

This says that with  $T = 0$  and  $\dot{T} = 1^\circ\text{F}/\text{min}$ .  $\Theta_e = 5.3$  v., neglecting the 3.15 v. bias. Referring to the maximum gains derived in Appendix 4 for  $1.0^\circ\text{F}/\text{min}$ . increase in core and  $0^\circ\text{F}/\text{min}$ . increase in skin temperatures with  $T = 0$  and no Preset bias or Manual Input,

$$e_{17} = \frac{(0.05)(15)(9.33)(391)}{60} = 45.6 \text{ v.},$$

where the increased gain compared to the simulations was found to be necessary during manned runs. This corresponds to full sublimator flow with  $\dot{T} = (6.6/45.6) = 0.15^\circ\text{F}/\text{min}$ . at the maximum gain settings and no bias. With  $\dot{T} = 0$ , and  $T = 1^\circ\text{F}$ , corresponding to a  $1^\circ\text{F}$  increase in core temperature and no change in skin temperature, neglecting Preset Input and Manual Input,

$$e_{17} = (0.05)(5)(6)(1) = 1.5 \text{ v.},$$

with minimum gain settings. With maximum gain

$$e_{17} = (0.05)(15)(9.33)(6) = 45 \text{ v.},$$

which leaves adequate leeway for optimizing proportional signal gain. A combination of gains commonly used during manned tests with good results was as follows:

$$\text{Core: } G_c = 15$$

$$\text{Core Sum: } G_{CS} = 6$$

$$\text{Proportional: } G_p = 1$$

For the same temperature rise

$$e_{17} = (0.05)(15)(6) = 4.5 \text{ v.}$$

compared to the simulation value of 4.1 v.

## CHAPTER VI

### METHODS

Tests conducted during this research can be classified as manned and unmanned, referring to whether the test procedures require temperature signal inputs to the controller from a test subject in a liquid cooling garment or not. In manned tests, the controller output is translated into control of water temperature at the liquid cooling garment inlet manifold.

Unmanned tests can be classified further as Initial System Test, Overall System Test, and Performance Verification Test. All manned and unmanned tests are preceded by Preliminary Adjustments to protect the system from overloads and surges.

The purpose of the Initial System Test is to assure that the Manual Input and Preset Input bias circuits are properly zeroed and that the output signal of each amplifier circuit is zero for zero input.

The Overall System Test provides a short series of checks to assure that given signal inputs of the bridge circuits, Preset Input and Manual Input are properly amplified and transmitted throughout the controller electronics.

The controller Performance Verification Test is a longer, more detailed test which verifies proper operation and long term stability of the electronic circuitry.

Manned tests which were conducted during this research can be divided into three categories. Nine test subjects were used to investigate controller action and test subject responses. Twenty early tests were relatively unstructured and consisted mainly of working test subjects on a bicycle ergometer or treadmill while observing system, physiological and subjective responses with different combinations of controller settings, work-rest profiles and garments. They are referred to in this research as Preliminary Manned Tests and they served to narrow down the wide ranges and large number of combinations of controller settings to practical levels.

The second category of manned tests was structured to maximize the usefulness of the experimental data collected during a series of eight tests referred to as the Quarter Replicate Test. The Quarter Replicate Test was followed by three manned tests referred to as Final Tests.

Each manned test was preceded by the Preliminary Adjustments and by one or more of the unmanned system tests if required.

The methods used in each test are described in the balance of this section as well as the method used to design a quarter replicate  $2^5$  experiment.

Ear and skin thermistor voltage-temperature relationships were established using Arthur H. Thomas Company's Constant Temperature Bath, Infrared Research Model, Model 992 6-D, accurate to within  $\pm 0.005^\circ\text{C}$ .

Temperature-voltage relationships, indicated by the mercury-in-glass bath thermometer and a digital voltmeter sensing voltages at TP 5 and TP 6, Figure 4, were linear to the level of accuracy desired and are given in Appendix 4.

Ear temperature is used as a controller input signal and is recorded continuously on a Sanborn strip recorder. Ear temperature was measured using a Yellow Springs No. 44011 thermistor encapsulated in epoxy by the MSC Crew Systems Division Bioinstrumentation Laboratory. A Mid States Laboratories, Inc. (Wichita, Kansas) earmold, custom molded for each test subject, was drilled out by the Crew Systems Division Bioinstrumentation Laboratory and the thermistor inserted as shown by Figure 3. The thermistor bead was allowed to protrude from the earmold approximately 1/16 inch to assure firm contact with the canal wall. Slight discomfort due to bead irritation was reported by two test subjects the first time the earmold was worn and the bead was withdrawn slightly to relieve discomfort. No degradation of response was noted.

Controller output voltages command changes in air pressure transmitted to the life support system diverter valve. The diverter valve controls the proportion of total flow passing through the liquid cooling garment which is shunted through a simulated sublimator (heat exchanger) and cooled as shown by Figure 5. Early tests revealed that valve action was affected by variations in ambient air flow passing by the test subject's ear, and subsequent tests were conducted with test subjects wearing the astronaut's communication cap which corrected the problem. The earmold should be

inserted into the test subject's ear at least 30 minutes before testing begins to allow its temperature to stabilize.

Skin temperature was measured as an unweighted average of four Yellow Springs No. 44011 thermistors in series forming one leg of the bridge circuit shown by Figure 4. Each thermistor bead was encapsulated in epoxy by the Crew System Division Biointstrumentation Laboratory and attached to the test subject with micro-pore adhesive-backed tape. Following each test the skin thermistor emplacements were inspected to assure that good skin contact was maintained. Test subject movements and improper placement of wiring resulted in thermistors being pulled loose from the skin in early tests.

Four arrangements of the four skin thermistors were used. A dispersed arrangement is shown by Figure 6. Other arrangements whereby all four thermistors were placed over the right femoral vein, on the right biceps, and on the right upper chest to provide the signal change equivalent to a single sensor were also investigated. This procedure was followed as the desirable alternative to modifying the controller bridge design. The unweighted mean skin temperature is used as a controller input signal and was recorded continuously on the Sanborn recorder.

A variety of liquid cooling garment designs were tested with the final series of eleven manned tests being conducted using the current Apollo LCG, Model A67-400000-1002A, Serial No. 62 (Astronaut Tom Stafford's). Test subjects donned the LCG over a pair of shorts or bathing suit. Cotton

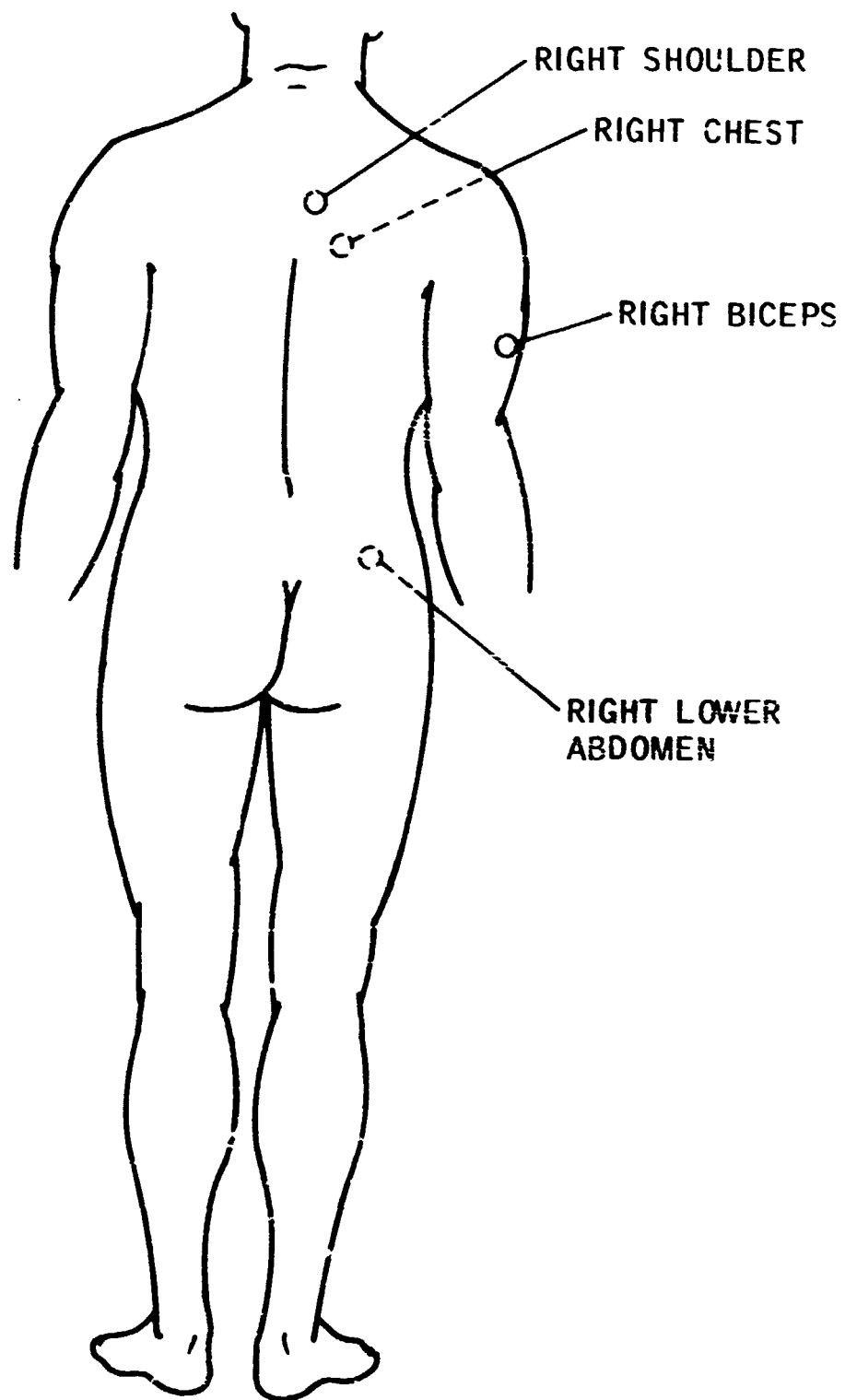

FIGURE 6. LOCATION OF CONTROLLER SKIN TEMPERATURE THERMISTORS

socks are sewn into the LCG and some test subjects donned a second pair of socks before putting on gym shoes. A three inch piece of adhesive-backed tape was wrapped around each test subject's midsection during later tests to support the electrical harness and to assure good contact between the LCG cooling tubes and skin in that area. The LCG tends to drape from the shoulders to the hips on some subjects, reducing heat transfer where the cooling tubing does not make contact with the skin, if provisions are not made.

With the test subject sitting quietly in a chair on the treadmill, ear and skin temperatures were observed to assure relative stability before a test was commenced. The first time a test subject is used it is useful to allow him to sit long enough, and to vary the ambient temperature as required, to achieve thermal neutrality. Controller voltage at TP 10 (Figure 4) is then nulled to zero using the Preset Input bias. The Preset Input voltage then corresponds to mean body temperature at thermal neutrality for the controller core and skin gain settings used. The settings observed were repeatable for a given test subject over a period of time and are identical or very close for most test subjects. Good results were achieved using this Preset value even when different combinations of core and skin gain were used and considerable liberties were taken in setting it before a test as experience was gained. Unless a test subject was fairly overheated when he entered the treadmill room or began to overheat while waiting for a test to start, the TP 10 voltage was frequently nulled just before a test began. If the other gains were optimum for the test subject, good results were achieved. If the test subject was

uncomfortably warm when the TP 10 voltage was nulled, however, the controller tended to drive to that point and response was not as good, even with optimum gains, and best results were achieved with excessively warm subjects using the predetermined value.

Before the test subject's thermistor leads were connected to the controller, and with dummy loads connected to the controller in their place, the Manual Input was adjusted to cause the valve to be on the verge of opening as revealed by the bypass flowmeter recording on the Sanborn. The potentiometer dial reading was usually about 4.1 with the voltage relationship shown by Figure 7. The Preset Input voltage relationships are given by Figure 8.

When desired gains were set into the controller, and all equipment checks completed, tests were commenced.

During early tests a compact heat exchanger utilizing water from melting ice was used as the heat sink to simulate the PLSS sublimator (Figure 5) and was quite adequate for moderate work rates. For a final series of tests conducted at higher work rates, lower liquid cooling garment inlet water temperatures were needed to maintain test subject comfort. A new heat exchanger was fabricated with the ICG water now passing through coils having several times greater total area and immersed in a water bath cooled to the freezing point using liquid nitrogen. This proved to be satisfactory in most circumstances. Some test subjects seem to need one or two tests to adjust to the work profile and to settle what is perhaps an unconscious apprehension before consistent results are achieved.



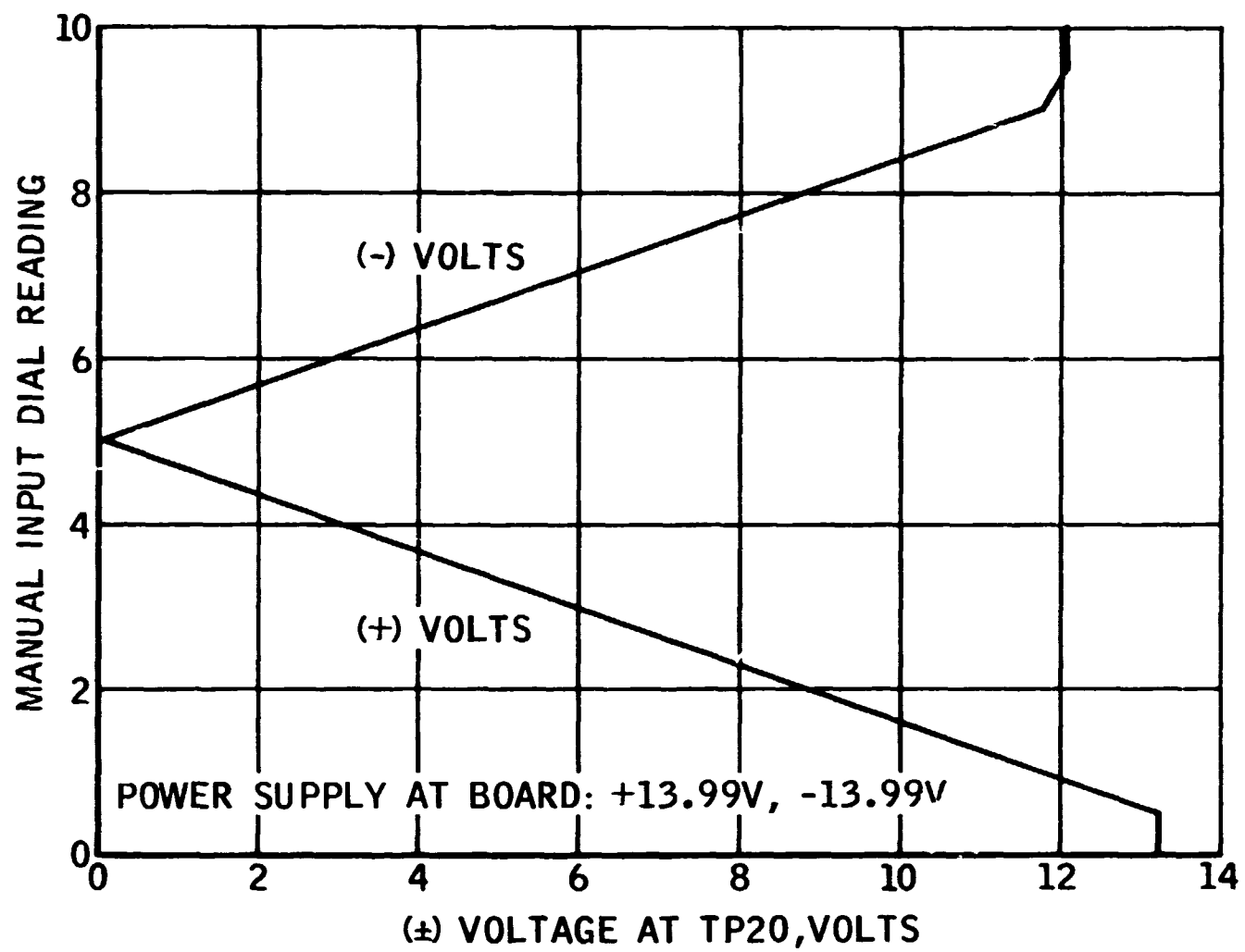

FIGURE 7. MANUAL INPUT DIAL READING AND TP-20 VOLTAGE RELATIONSHIP

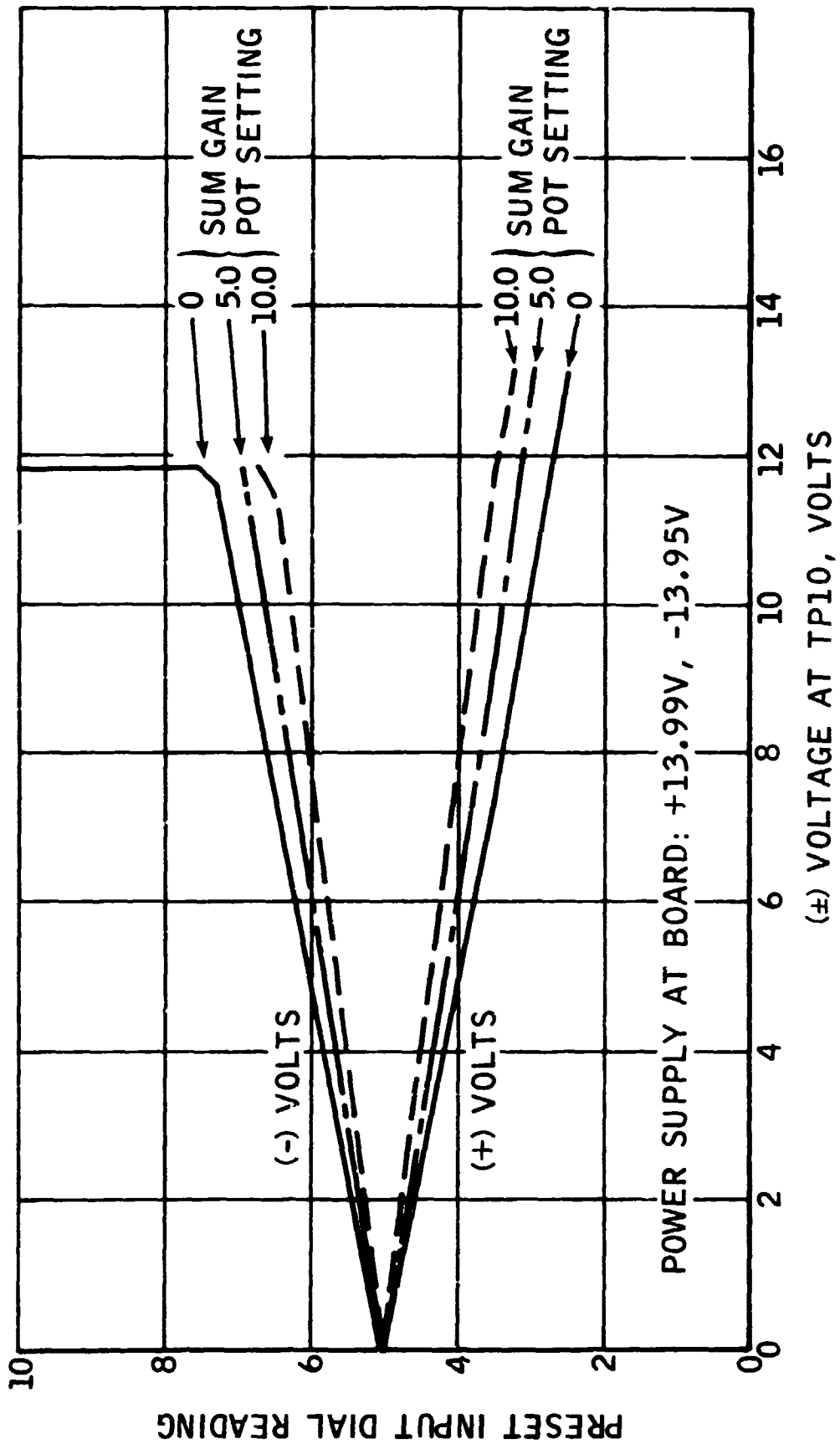

FIGURE 8. PRESET INPUT DIAL READING AND TP-10 VOLTAGE RELATIONSHIP

Liquid nitrogen was introduced into the atmospherically vented nitrogen coils about one hour before a test was begun. LCG water was circulated occasionally or continuously through the LCG loop to prevent freezing of the water using a shunted connector in place of the actual LCG. Before a test was begun, water circulation was stopped, the LCG connected to the simulated PLSS, and water circulation commenced concurrently with work onset.

After a prescribed work-rest profile was completed, the test subject was allowed to sit in a chair until recovery commenced and the valve began responding properly to the reduction of work rate and stored heat.

Preliminary Adjustments

Two regulated 15 vdc power supplies, 250 ma or less each, were required to operate the controller breadboard. Preliminary adjustments are made before connection or turn-on of the power supplies to assure proper protection and operation of the system. Power supplies used during tests at the Manned Spacecraft Center included 0-40 vdc, 0-500 ma, constant voltage/constant current units with NASA serial numbers 48399 and 46397.

The following controls as designated on the front panel of the breadboard are set as specified:

	<u>CONTROL</u>	<u>DIAL SETTING</u>
a)	Core gain	500
b)	Skin gain	500
c)	Core balance	500
d)	Skin balance	500
e)	"Preset" switch	OFF
f)	"Preset"	500
g)	Sum gain	0
h)	Sum balance	500
i)	Rate Diff	500
j)	Rate Int	500
k)	Manual Input	500

If an Initial System Test is to be performed, the following elements are removed as indicated:

- l) Remove C2. Short across C1.
- m) Remove (U1), (U2), (U4), (U5) and (U6).

Unmanned TestsInitial System Test

The following steps are performed in sequence after completing

(a) through (m) of the Preliminary Adjustments.

- a) Turn S2 power "on" switch to "on".
  - b) Connect digital voltmeter to TP 17 - TP 14.
  - c) Adjust R16 Output Null for  $0v \pm 1$  mv.
  - d) Turn S2 "off".
  - e) Insert U1.
  - f) Turn S2 "on".
  - g) Place digital voltmeter between TP 19 - TP 14.
  - h) Turn Manual Input dial until voltmeter reads  $0v \pm 1$  mv.
  - i) If necessary center Manual Input dial to read 500.
  - j) Remove voltmeter and place between TP 20 - TP 14.
  - k) Place shorting strap between TP 18 - TP 14.
  - l) Adjust R10 Manual Null for  $0v \pm 1$  mv.
  - m) Place voltmeter between TP 17 - TP 14.
  - n) Turn S2 "off".
  - o) Insert U2.
  - p) Turn S2 "on".
  - q) Adjust R4 Rate Null for  $0v \pm 1$  mv.
  - r) Remove shorting strap between TP 19 - TP 14.
  - s) Voltage should remain  $0 \pm 1$  mv with Manual Input dial at (500).
  - t) Set Preset dial to read 500.
  - u) Turn on Preset switch.
  - v) Place voltmeter between TP 7 and TP 14.
  - w) Voltmeter should read  $0v \pm 1$  mv. If it does not, turn Preset Input dial until it does and reset dial for a reading of (500).
  - x) Turn Preset switch "off".
  - y) Turn S2 "off".
  - z) Insert U4.
- 
- aa) Place voltmeter between TP 10 - TP 14.
  - bb) Turn S2 "on".
  - cc) Adjust R23 Sum Null for  $0v \pm 1$  mv.
  - dd) Turn S2 "off".
  - ee) Remove U3.
  - ff) Turn S2 "on".
  - gg) Turn Preset "on".
  - hh) Place voltmeter between TP 7 - TP 14.  
Plot a Preset dial reading vs voltage graph.
  - ii) Return Preset dial to 500.
  - jj) Turn Preset switch "off".
  - kk) Turn S2 "off".
  - ll) Insert U3 and U6.
  - mm) Short TP 1 to TP 2.

- nn) Place voltmeter from TP 5 - TP 14.
- oo) Turn S2 "on".
- pp) Adjust Core Null R38 to  $0v \pm 1$  mv.
- qq) Short TP 3 - TP 4.
- rr) Turn S2 "off".
- ss) Insert U5.
- tt) Turn S2 "on".
- uu) Place voltmeter between TP 6 - TP 14.
- vv) Adjust R30 Skin Null for  $0v \pm 1$  mv.
- ww) Turn S2 "off".
- xx) Remove shorting straps between TP 1 - TP2, TP 3 - TP 4, and across C1.
- zz) Replace C2.

During Initial System Tests at the Manned Spacecraft Center a Beckman Model 4910P digital voltmeter, NASA Serial No. S-14656, was used.

#### Overall System Test

Before beginning the Overall System Test all items listed under Preliminary Adjustments must be accomplished. When the preliminary adjustments are completed the following steps are accomplished:

- a) Insert a 50k trimpot and a 20k resistor in series for thermistor TR1.
- b) Insert a 50k trimpot and a 250k resistor for thermistor TR2.
- c) Place digital voltmeter between TP 1 - TP 2.
- d) Turn S2 "on".
- e) Adjust TR1 pot for + 0.0108 volts. Some noise will be noted.
- f) Place voltmeter between TP 3 - TP 4.
- g) Adjust TR2 pot for + 0.0108 volts. Some noise will be noted.
- h) Observe TP 5. It should be + 0.114 volts. If not, adjust TR1 pot until it does.
- i) Observe TP 6. It should read + -.108 volts. If not, adjust TR2 pot until it does.
- j) Observe TP 10. It should be - 0.90 v  $\pm$  2%.
- k) Observe TP 17. It should be - 1.539 v  $\pm$  3%.
- l) Turn Sum Gain control dial to read 301. TP 17 should now read - 1.80 v  $\pm$  3%.
- m) Turn Preset switch to "on".
- n) Turn Preset dial to 550.
- o) TP 17 should now read - 5.62 v  $\pm$  3%.
- p) Turn Preset switch "off".
- q) Turn Manual dial to read 550.
- r) TP 17 should now read - 0.38 v  $\pm$  3%.
- s) Turn S2 "off". This completes preliminary alignment.

### Performance Verification Test

One Performance Verification Test was conducted on the breadboard electronics during this research to verify operational and long-term stability. This test was conducted at the General Electric, Houston Programs Laboratory, using the following bench-test equipment:

- a) Tektronic oscilloscope Model 555 (1 ea) NASA Serial No. 10162. CA type plug in (1 ea) NASA Serial No. 11854.
- b) Hewlett-Packard Function Generator. Model No. 3300A, NASA Serial No. P20231.
- c) Voltmeter (Digital) Auto polarity and ranging. Hewlett-Packard Model 405CR. NASA Serial No. 10333.
- d) Oscilloscope Camera. NASA Serial No. 10193.
- e) Two voltage divider networks (Figure 9).

Two voltage divider networks were fabricated and the controller breadboard was set up as shown by Figure 9. Isolation transformers are required only if power supply returns are grounded. One-half hour was allowed for system warm-up. The test can be reconducted in three phases as follows:

#### Phase I: Drift Stability Test for U4, U5, and U6

Adjust breadboard as follows:

- a) Core gain = 10.0 = core balance
- b) Skin gain = 10.0 = skin balance
- c) Preset in OFF position
- d) Sum gain = 1.99 = sum balance
- e) Power: + 14.4 volts
- f) R20C = 3010 ohms
- g) R21C = 9020 ohms
- h) R50C = R50 + 15,000 ohms
- i) Null the U4, U5 and U6 amplifiers.
- j) Record the data for TP 5, TP 6, and TP 10 initially and prior to concluding overnight test.

#### Phase II: Drift Stability Test for U1, U2 and U3

Adjust breadboard as follows:

- a) Remove U4 and short TP 10 to TP 14.
- b) Null the amplifiers U1, U2, and U3.
- c) Record data for TP 10, TP 13, TP 17 and TP 20 initially and before concluding test.

### Phase III. Dynamic System Test

Adjust breadboard as follows:

- a) Core gain = 10.0 = core balance
- b) Skin gain = 0.00 = skin balance
- c) Preset in OFF position.
- d) Sum gain = 0.05.
- e) Sum balance = 1.10.
- f) Rate Diff = 8.90.
- g) Rate Int = 5.87.
- h) Manual = 5.00.

Input, differentially at TP 1 and TP 2, a positive and negative going ramp of 0.0158 volts amplitude with a 100 second period.

This is equivalent to a  $\pm 0.01586$  v/25 second slope. Input, differentially, at TP 3 and TP 4, the above mentioned ramp of + 0.015 volt amplitude.

Photograph TP 13, TP 17 and TP 20.

- a) Connect the function generator output to the oscilloscope horizontal axis and calibrate for 10 second/cm sweep.
- b) Place the function generator signal on all pictures.



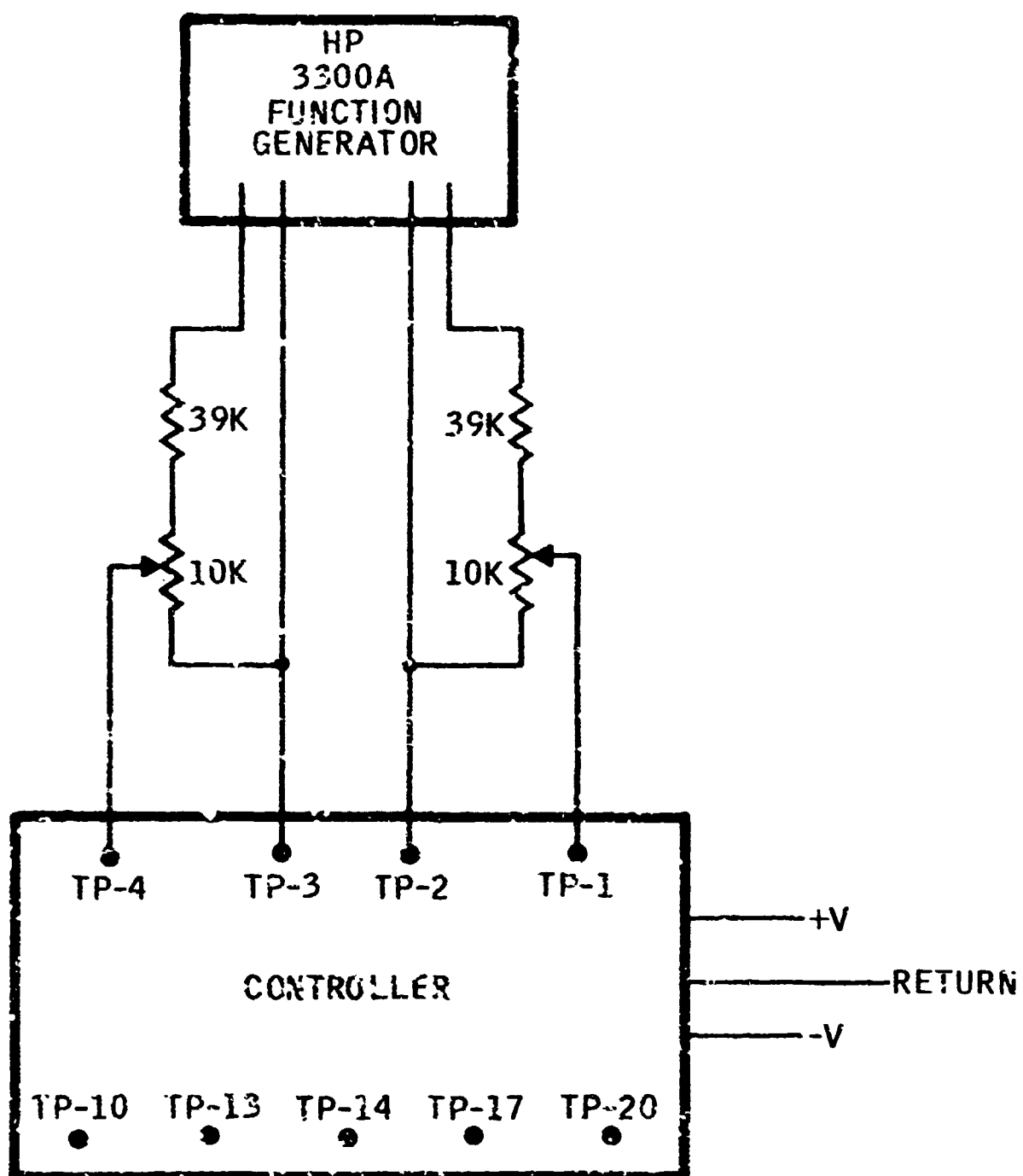

FIGURE 9. PERFORMANCE VERIFICATION TEST ARRANGEMENT

Manned TestsGeneral Procedures and Support Equipment

All manned tests were preceded by accomplishment of the Preliminary Adjustments previously described. In addition, strip chart recorders, power supplies, frequency-to-DC converters, telethermometers, the analog computer and the ECG recorder were energized at least one-half hour before each manned test to allow for warm-up.

A Sanborn 350 Series Eight-Channel Recorder, NASA Serial No. 42870, was used during all manned testing to record the following controller signals:

- a) TP 5. Core temperature.
- b) TP 6. Mean skin temperature.
- c) TP 10. Summation of TP 5, TP 6 and Preset Input with Sum Gain applied to each signal.
- d) TP 13. Differentiated output of TP 10.
- e) TP 20. TP 10 signal with Rate Diff gain applied and Manual Input bias added.
- f) TP 17. Controller output signal to electropneumatic transducer. The transducer output controls diverter valve position.
- b) By-Pass Flow Meter Output. Flow through the heat exchanger is inversely proportional to the output voltage.
- c) Pump Output Flow Meter. Total flow through the LCG is proportional to output voltage.

A Bristol Dynamaster 24-Channel Recorder, Model 24P12H13X591-51-T374X-T188X, Serial No. 63A 12, 585, NASA Serial No. 36155, was used during the initial Preliminary Manned Tests to record liquid cooling garment inlet and outlet water temperature. This practice was discontinued due to a signal feedback into the controller when the recorder printed. During the Quarter Replicate tests LCG inlet and outlet water temperatures at the LCG connector were observed using a manually indexed Yellow Springs Instrument Company Telethermometer, Model 46TUC, Serial No. 273, 0-40°C range, NASA Serial No. P4148. Just prior to beginning these tests the R42 Rate Diff 10-turn potentiometer failed and was replaced by a General Radio Company, Concord, Massachusetts, 0-100K ohms Decade Resistor, Type 1432-Y, Serial No. 37464, NASA Serial No. 36704.

Nine skin temperatures were sensed during selected Quarter Replicate tests using an Applied Research Austin, Austin, Texas, ARA SD-20 scanner, NASA Serial Nos. 82883 and 82884, in conjunction with an EAI 680 Scientific Computing System Analog Computer. The resulting unweighted average skin temperature was recorded at 50 second intervals on the Sanborn recorder using the channel previously used to record LCG water flow.

Before each manned test the LCG was connected to the fluid system breadboard and the cooling water loop was purged of air using a portable pressurized source of distilled water. The LCG can be disconnected, donned and reconnected with negligible loss of water. Purging is accomplished at 5-7 psig with the water circulating pump in operation.

A Sanborn Company, Waltham, Massachusetts, ECG Recorder, Model 296, NASA Serial No. 42871, was used to record cardiac activity for calculation of heart rate during manned tests.

#### Preliminary Manned Tests

Early manned tests were conducted to study system stability under different physiological conditions, i.e., subcooled, normal, and uncomfortably warm man engaged in resting and working. Different combinations of gains and procedures were used to study the effects on system response, the system in this respect being the man, electronics, and fluid subsystems. The results of eleven preliminary tests are presented in the next chapter. In order to properly interpret these results the detailed procedures for each test must be known. The methods are repetitious in some cases and lengthy and have therefore been placed in Appendix 6.

Laboratory Experiment Design

A complete factorial experiment, in which all possible combinations of all levels of the different factors are investigated, would involve a large number of laboratory tests, i.e., in the thousands. Test set-up time, test subject recovery, i.e., the time required during each test to return the test subject to a base-line physiological condition, and data analysis time would be prohibitive, and an alternate, but adequate approach is required. It will be shown that it is possible to investigate the main effects of the most significant factors and their more important interactions in a fraction of the number of tests required for a complete factorial experiment sequence. An experimental design due to Box, et al, (1960) is described, with examples showing the method of analysis included in Chapter VII, Results.

Introduction

A complete factorial design

- (i) permits the main effects of every factor to be estimated independently of one another,
- (ii) permits the dependence of the effect of every factor upon the levels of the others, i.e., the interactions, to be determined,
- (iii) permits the effects to be determined with maximum precision, and,
- (iv) supplies an estimate of the experimental error for the purpose of assessing the significance of the effects, and permits confidence limits to be established.

When the number of factors is as large as in this investigation, the number of trials required becomes prohibitive. The term "factor" is used

in a general sense to denote any feature of the experimental conditions which may be assigned at will from one trial to another. A preliminary list of factors related to this research is given by Table 2. The high degree of accuracy in the estimates of the effects which is possible with a complete factorial design is not required, and previous testing has indicated that certain reactions probably are not appreciable. Thus, the factors listed in Table 2 have been reduced to five, but even an investigation of five factors, each at two levels, entails  $2^5 = 32$  observations, each with a different set of experimental conditions. The question is, can the same conclusions be reached using a smaller number of observations to a reliable degree? To do so involves obtaining information on the main effects, and as many of the interactions as seems necessary, with a smaller number of observations than is required by the complete design.

There are two approaches to the problem of obtaining a suitable design. One can begin with a full factorial design for the number of factors involved, and by confounding interactions which are likely to be small or unimportant with one another and with other interactions considered worth measuring one can arrive at a design in which all or almost all of the comparisons are made between effects likely to be important. Confounding refers to a process by which unimportant comparisons are deliberately confused for the purpose of assessing the more important comparisons with greater precision. The number of observations required will depend on the number of such comparisons. Alternatively, one can begin with the full factorial design corresponding to a number of factors lesser in number than is actually under investigation and substitute the remaining factors for those comparisons which measure effects considered unlikely to be appreciable.

TABLE 2  
EXPERIMENT FACTORS

Test subject
Skin sensor quantity and arrangement
Core/Skin temperature weighting factors
Proportional signal gain
Rate signal gain
Preset input voltage
Power supply voltage
Manual input voltage
Test protocol
ICG design
Environmental conditions
Test subject clothing
Work profile
Core signal gain
Skin signal gain
Test date

Design of Eight Observations with Two Level Factors

The type of investigation considered here is one in which the investigator requires to know system performance difference as a function of several factors, each having a defined range, and beginning with two levels only. As the experiments are conducted the investigator retains the flexibility to expand the matrix, or to reduce it, as results become

known. Also, once the major effects are known additional tests can be conducted to optimize the major factor levels.

Table 3 represents one quarter of a  $2^5$  factorial design, i.e., a quarter-replicate, the type conducted during this research.

TABLE 3  
EXAMPLE OF QUARTER-REPLICATE RESEARCH DESIGN  
FIVE FACTORS AT TWO LEVELS

	(A)	(B)	(C)	(E)	(D)	
Observation	Test Subject	Skin Sensor Mode	Core/Skin Temp. Weighting	Proportional Signal Gain	Rate Signal Gain	Design Combination
1	-	-	-	+	-	e
2	+	-	-	+	+	a e d
3	-	+	-	-	+	b d
4	+	+	-	-		a b
5	-	-	+	-	+	c d
6	+	-	+	-	-	a c
7	-	+	+	+	-	b c e
8	+	+	+	+	+	a b c d e

The (+) and (-) apply both to qualitative as well as quantitative factors. For example, the two test subjects are denoted (+) and (-) as well as high and low levels of proportional signal gain. By convention, the "Design Combination" denotes the (+) levels of factors in each observation. For comparison, Table 4 presents the full factorial design.



In theory, each quarter replicate block is equally suitable and the selection should be made at random, but in practice it is desirable to select certain combinations of levels to maximize the information derived. The actual combinations selected are depicted in Chapter VII, Results.

TABLE 4

EXAMPLE OF FACTORIAL DESIGN FOR FIVE FACTORS AT TWO LEVELS

Test Subject	Skin Sensor Mode	Core/Skin Temp. Weighting	Proportional Signal Gain	Rate Signal Gain	Observation
+	+	+	+	+	1
			-	-	2
			+	+	3
			-	-	4
		-	+	+	5
			-	-	6
			+	+	7
			-	-	8
	-	+	+	+	9
			-	-	10
			+	+	11
			-	-	12
		-	+	+	13
			-	-	14
			+	+	15
			-	-	16
-	+	+	+	+	17
			-	-	18
			+	+	19
			-	-	20
		-	+	+	21
			-	-	22
			+	+	23
			-	-	24
	-	+	+	+	25
			-	-	26
			+	+	27
			-	-	28
		-	+	+	29
			-	-	30
			+	+	31
			-	-	32

### Confusion of Effects in a Fractional Design and Aliases

Assuming that interactions of all orders are real, it follows that in a quarter-replicate the effects, or the changes in response produced by changes in factor levels, occur in sets of four and each effect is confused with three others as illustrated in (i-iv) below. The effects which are confused in this way are termed "aliases." It is necessary to determine the aliases for any proposed fractional design to avoid confusion of important effects. These aliases may be found from the design by multiplying the columns of signs in all possible ways and grouping the effects measured by the same comparison, i.e., which have the same signs or have all the signs reversed. Two comparisons which differ in sign only clearly measure the same effects apart from sign. Applying these considerations to Table 3 shows that the following columns and products of columns have the same signs:

- (i) A, BCD, ABCE, DE
- (ii) C, ACD, CE, ABDE
- (iii) C, ABD, BE ACDE
- (iv) AB, CD, ACE, BDE, etc.

### Analysis of Results

The desired end result of a final series of manned experiments is a recommended set of controller parameters, preferably applicable to all likely test subjects. The use of two-way tables of interactions to assist in identifying levels of factors for further investigation is demonstrated in the next chapter.

Quarter Replicate and Final Manned Tests

The procedures followed during the final stages of manned testing evolved from the earlier trials. Eleven tests were conducted during this phase and identical procedures were followed with three exceptions. Tests number 3, 6 and 8 were the second of back-to-back runs, i.e., Test No. 2 was conducted one morning and Test No. 3 was conducted after lunch by the same test subject. Test No. 5 was conducted one morning by a test subject and Test No. 6 was conducted by the same subject 30 minutes after the completion of Test No. 5. The same procedure was followed in conducting Tests number 7 and 8. It is believed that the performance evaluation criteria chosen to compare the performance of the controller with different settings reduces any overall undesirable effects of these procedures and the results of Test 9 and 10 tend to confirm this conclusion.

Since the same detailed procedures were used for each of the last eleven manned experiments, they will be described only once.

Test Dates: September 4, 9(2), 10, 11(2), 15(2), 18(2), 1970;  
October 1, 1970.

Test Location: MSC Environmental Physiology Laboratory

Test Subjects: C. Pate, G. Scott, K. Dupree

Test Objectives:

Obtain physiological temperature data to be used to identify preferred controller settings.

Test Procedures:

1. Completed Preliminary Adjustments at least one hour before test. Turned on Sanborn recorder, power supplies, digital voltmeter, telethermometers and analog computer for warm-up.
2. Assured adequate supply of liquid nitrogen for test (at least one-half of a 110 l. dewar). Commenced cool down of water bath after checking for at least one inch LN<sub>2</sub> - LCG cooling coil clearance in the water bath. The LN<sub>2</sub> dewar shut-off valve was opened until frost just began to form in the exhaust gas stream. Cool-down continued without interruption until bath temperature approached the freezing point as indicated by the Yellow Springs Instrument Company Model 46TUC (0-40°C) Telethermometer. At that time the gas was throttled down to hold a steady bath temperature. Periodic circulation of water through the LCG loop precluded ice formation and blockage of the loop but did not add excessive amounts of heat to the water bath, i.e., the bath can be cooled faster when LCG water is not circulated continuously through it.
3. Performed pre-test check and maintenance of mechanical and electrical components. Greased pump bearings and checked all connectors. Pressurized distilled water container to 5-7 psig and purged air from liquid loop. Attached LCG to liquid loop and repeated as required.
4. Set A. R. Young Power Transmission Engineers treadmill at 9% grade. Commenced warm-up of Pacific Industrial Controls Model VT 100 Motor Speed Control.
5. Supplied clean, dry laboratory air at 100 psig to pressure regulator. Opened regulator until 15-20 psig was available at the air valve.

Moved Manual Input control on breadboard to cause valve to shift from full open to full closed as revealed by flowmeter data on Sanborn recorder. Valve was fully closed with TP 17 at 2.6 v and fully open with TP 17 at 6.6 v.

6. Set all controller values as required by test matrix. (See Results, Chapter VII.)

7. Checked zeros and calibration of Sanborn recorder.

8. When the test subject arrived at the laboratory, his earmold was inserted to bring it to body temperature. After the test subject donned swimming trunks or gym shorts, controller skin sensors were attached with tape as required by the test procedure and the LCG was donned. Additional skin sensors whose outputs were only monitored and which did not interface with the controller were attached to the test subject during selected tests. The test subjects wore gym shoes and some wore an extra pair of wool socks over the cotton socks forming the feet of the LCG.

9. Test subjects were then escorted to the treadmill where they were seated in a chair placed on the treadmill. Electrical connection was made between the ECG sensors and recorder and the electrical harness was secured to the test subject using a strip of three inch tape wrapped completely around the man. This served also to keep the LCG in contact with skin in an area where the fit was not always adequate. A communication cap was donned by the test subject.

10. The test subject's ear sensor and skin temperature control sensor leads were connected to the controller with power off. The controller was then energized and the Sanborn recorder started at a speed of 1 mm/second.

11. When the test subject's temperatures stabilized, usually in 15-20 minutes, the voltage at TP 10 was nulled using the Preset Input. It was accomplished using the Sanborn output for gross adjustment and the digital voltmeter attached directly to the test point for fine adjustment. The Manual Input was set at 4.10 for each test. (For Test No. 8 and 9 the same Preset was used.)

12. The test subject was then connected to the cooling water source and the treadmill was started. The work/rest profile required one hour and was the same for each test subject. Three five minute work periods with the treadmill at 9% grade and 3.5 mph were followed by five minute rest periods. A fourth five minute work period at the same level was followed by a twenty-five minute period with the treadmill at the same grade but slowed to 2.0 mph.

13. At the completion of the final work period, the test subject was disconnected after de-energizing the controller and ECG recorder and turning off the circulating pump.

## CHAPTER VII

### RESULTS

Results which are presented in this section include typical data derived from the Initial System Adjustments, Performance Verification Test, Preliminary Manned Tests, Quarter Replicate Tests, and Final Manned Tests. Discussion of these test results appears in Chapter VIII, Discussion.

#### Initial System Adjustments

Step (hh) of the Initial System Adjustments requires the recording of voltage measured between TP8 and TP9 as a function of the Preset Input dial reading. Data from this check is tabulated below and when plotted appears as shown by Figure 10.

TABLE 5

VOLTAGE INPUT TO U<sup>4</sup> VERSUS PRESET INPUT DIAL READING

<u>Preset Input Dial Reading</u>	<u>Voltage Input to U<sup>4</sup></u>
0	-6.67
50	-5.26
100	-4.23
150	-3.40
200	-2.73
250	-2.15
300	-1.66
350	-1.21
400	-0.800
450	-0.400
500	-0.015
550	+0.372
600	+0.768
650	+1.17
700	+1.62
750	+2.12
800	+2.68
850	+3.36
900	+4.17
950	+5.22
1000	+6.58



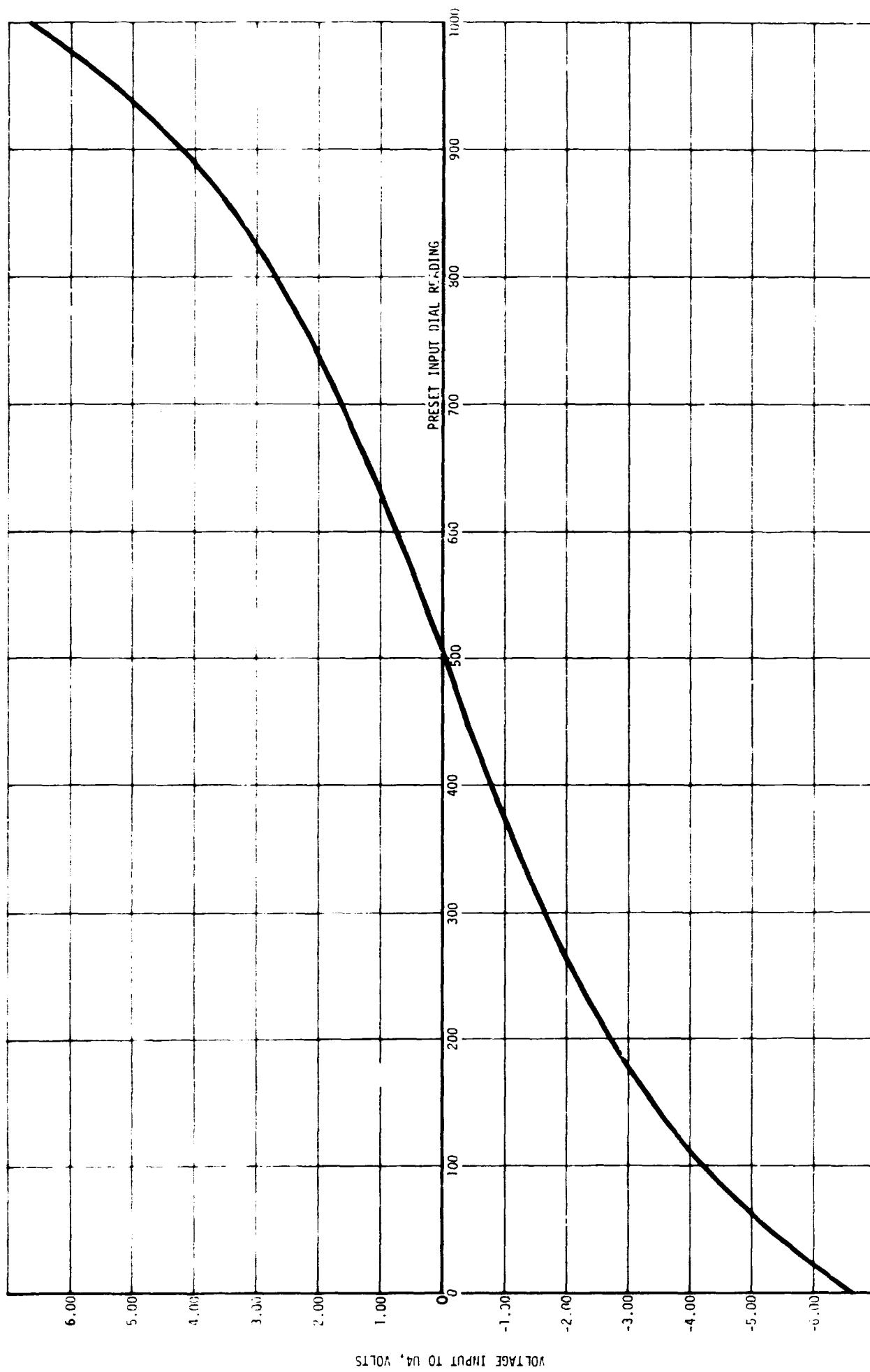

FIGURE 10. RELATIONSHIP OF PRESET INPUT DIAL READING AND VOLTAGE INPUT TO SUMMING AMPLIFIER

Performance Verification Test

The Performance Verification Test was performed from February 1-4, 1970, at General Electric's Apollo Systems, Houston Programs, laboratory, 1830 NASA Boulevard, Houston, Texas. The test described in the preceding section, was performed in three phases, a Drift Stability Test for U4, U5, and U6, a Drift Stability Test for U1, U2, and U3, and a Dynamic System Test. Results of the tests are tabulated below as Tables 6, 7, and 8. Figures 11, 12 and 13 show sketches of the oscilloscope traces of voltages at TP13, TP20, and TP17 resulting from the input ramp functions shown.

TABLE 6

DATA FOR U4, U5 AND U6 STABILITY TEST

1. Settings

- a. Core gain = 10.0 = core balance
- b. Skin gain = 10.0 = skin balance
- c. Pre-set in OFF position
- d. Sum gain = 1.99 = sum balance.

2. DATA

<u>Test Point</u>	<u>Readings</u>	
TP-5	0.000v	0.000v
TP-6	0.000v	0.000v
TP-10	0.000v	0.001v
+V	+14.4v	+13.5v
-V	-14.4v	-14.4v
Time	5:30 PM	8:44 AM
Date	2/1/70	2/2/70

TABLE 7

## DATA FOR U1, U2 AND U3 STABILITY TEST

## 1. Settings:

Rate Int = 5.00  
 Rate Diff = 5.00  
 Manual Input = 4.99

## 2. TP-10 shorted to TP-14 and U4 is removed.

<u>Test Point</u>	<u>Readings</u>	
TP-10	0.000v	0.000v
TP-13	+ 0.008v	+ 0.004v
TP-17	- 0.004v	- 0.104v
TP-18	+ 0.000v	+ 0.042v
TP-20	+ 0.000v	+ 0.103v
+V	+14.4v	+14.4v
-V	-14.4v	-14.4v
Time	9:15 AM	1:00 PM
Date	2/4/70	2/4/70

TABLE 8

## DATA FOR DYNAMIC SYSTEM TEST

## 1. Settings:

- a. Core gain = 10.0 = core balance
- b. Skin gain = 0.00 = skin balance
- c. Pre-set in OFF position
- d. Sum gain = 0.05
- e. Sum balance = 1.10
- f. Rate Diff = 8.90
- g. Rate Int = 8.90
- h. Manual = 5.00

## 2. DATA

<u>Test Point</u>	<u>Calculated Readings</u>	<u>Actual Readings</u>	<u>Maximum % Error</u>
TP-5	+ 0.238v	-0.241v, + 0.244v	2.52%
TP-6	+ 0.075v	-0.075v, + 0.077v	2.62%
TP-10	+ 1.58v	-1.65v, + 1.61v	4.43%
TP-13	+ 5.382v	-5.42v, + 5.48v	1.82%
*TP-17	0 to -7.122v	0 to -7.21v	1.24%
TP-20	+ 1.74v	+1.82v, -1.89	8.62%

\*CONTROLLER OUTPUT TO REGULATOR VALVE

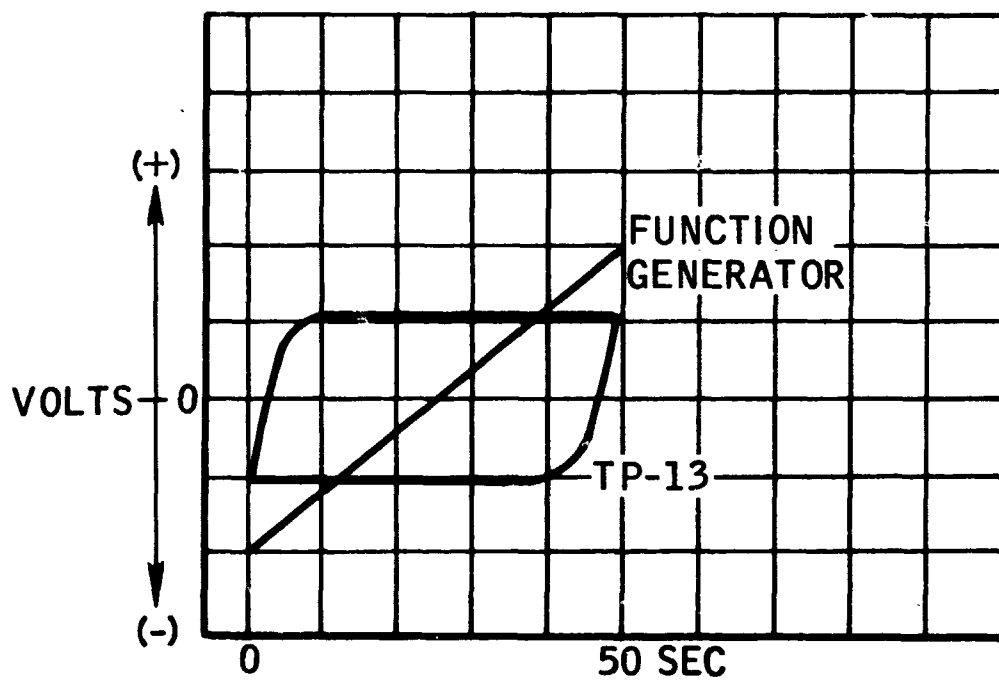

FUNCTION GENERATOR  
 OSCILLOSCOPE SETTING  
 0.2 V/CM  
 10 SEC/CM

TP-13

DIFFERENTIATING CIRCUIT OUTPUT  
 OSCILLOSCOPE SETTING  
 5 V/CM  
 10 SEC/CM

FIGURE 11. TP-13 DYNAMIC SYSTEM TEST OSCILLOSCOPE TRACE

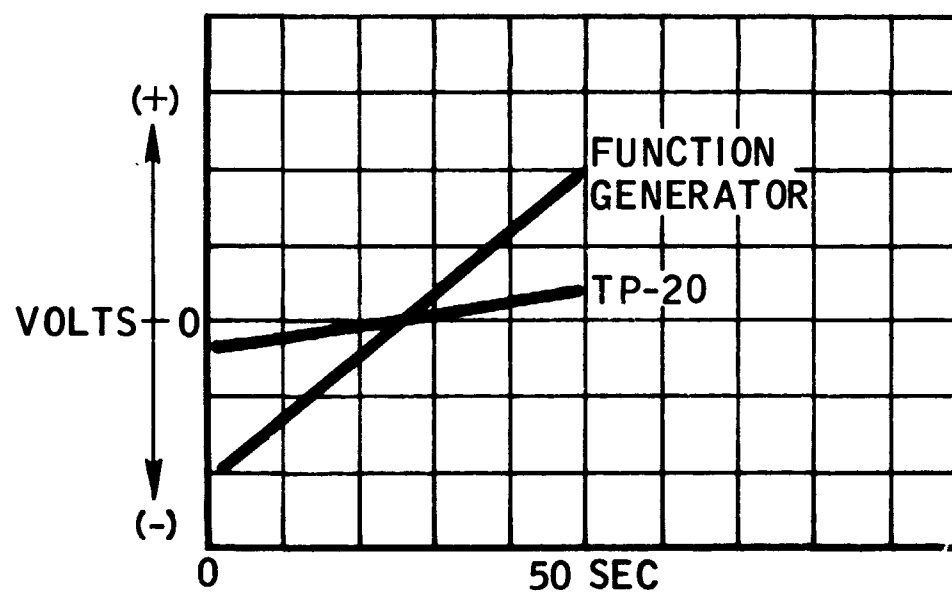

FUNCTION GENERATOR  
 OSCILLOSCOPE SETTING  
 .2 V/CM  
 10 SEC/CM

TP-20

OSCILLOSCOPE SETTING  
 5 V/CM  
 10 SEC/CM

FIGURE 12. TP-20 DYNAMIC SYSTEM TEST OSCILLOSCOPE TRACE

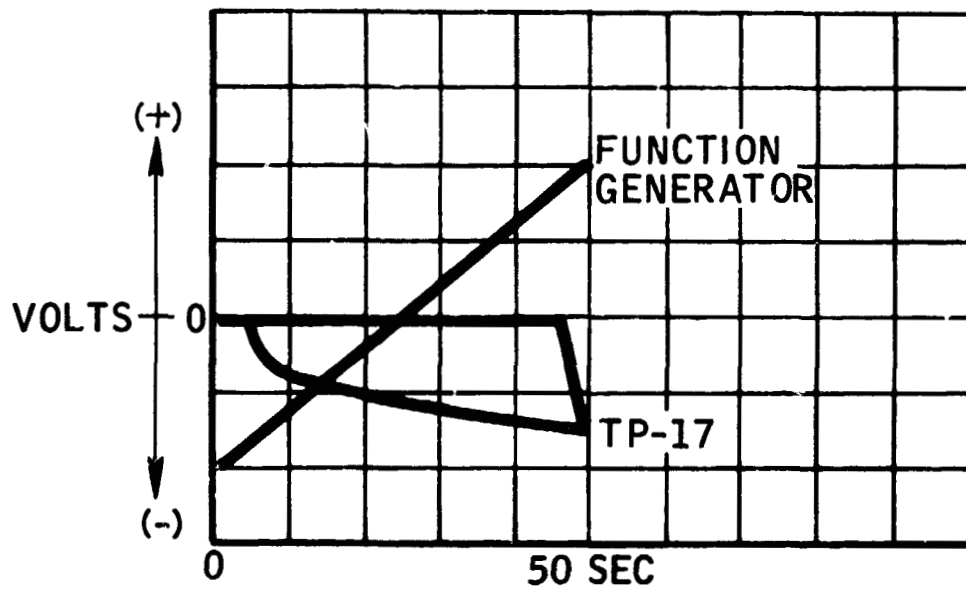

FUNCTION GENERATOR  
 OSCILLOSCOPE SETTING  
 .2 V/CM  
 10 SEC/CM

---

TP-17

REGULATOR VALVE CONTROL VOLTAGE  
 OSCILLOSCOPE SETTING  
 5 V/CM  
 10 SEC/CM

FIGURE 13. TP-17 DYNAMIC SYSTEM TEST OSCILLOSCOPE TRACE

Preliminary Manned TestsPreliminary Test No. 1

- (1) The test subject was observed in a resting condition and while walking at 2 mph and 3.5 mph. During this period of time, core<sup>1</sup>, skin<sup>2</sup>, and mean body<sup>3</sup> temperatures varied as follows:

		<u>Skin, °F</u>	<u>Core, °F</u>	<u>Mean Body, °F</u>
Resting - No Cooling		92.4	96.3	95.9
Resting - Cooling		90.9	96.3	95.8
2 mph	(a)	88.6	96.2	95.4
	(b)	87.4	96.3	95.4
3.5 mph	(a)	86.7	96.3	95.3
	(b)	84.8	96.6	95.4

One adjustment was made to the breadboard during the 2.0 mph period and one adjustment during the 3.5 mph period as described below.

- (2) During a rest period, before cooling water was supplied to the ICG, core and skin temperatures leveled off at 96.3°F and 91°F, respectively. The test area was very cool and the core temperature much lower than expected initially. After the test subject donned wool cap and insulated underwear his temperatures rose to the above values.

---

<sup>1</sup>External auditory meatus.

<sup>2</sup>Average of four sensors placed on upper left chest.

<sup>3</sup>Calculated as (0.9) (core temperature) + (0.1) (skin temperature).



- (3) When cooling water was started through the LCG (short sleeves) skin temperature dropped to 90.95°F. Core showed negligible change. The test subject sat quietly. Skin temperature continued to drop for another 4-3/4 minutes to 90.86°F and stabilized. During this period, the valve was open 10.5% of the time. Calculated mean body temperature was 95.76°F.
- (4) Upon temperature stabilization the test subject began walking at 2.0 mph on the treadmill. Skin temperature dropped to 88.61°F in 4 4 minutes. Following onset of exercise, core temperature rose to a maximum of 96.98°F in 3.1 minutes, leveled off, and dropped to a steady 96.17°F 5-3/4 minutes later. During this latter period the valve was modulating open approximately 7.25% of the time.

Questioning the test subject at this time revealed that he was "comfortably warm." The skin and core temperature signals were nulled to approximately zero at this point and skin temperature was reduced to 87.35°F over the next 7-1/2 minutes. The test subject reported becoming "comfortably cool" almost immediately after the adjustment. Core temperature increased slowly and stabilized at 96.3°F giving a mean body temperature of 95.41°F.

- (5) Treadmill speed was increased to 3.5 mph. Skin temperature decreased and stabilized at 86.72°F and core temperature stabilized at 96.3°F. Mean body temperature was 95.34°F. At this point the heat exchanger circulating pump drive motor muffler came off due to vibration and the motor became very noisy. During a 40 second period while the cooling pump was shut down and while the test

subject did not know what was happening, his skin temperature dropped sharply to 86.49°F. His core temperature was steady. As soon as the muffler was replaced and the pump turned on again his skin temperature rose to the level it was before the incident. After the pump was turned back on the test subject reported that he had "over heated" while the pump was off and he "did not feel that he was being cooled down fast enough." Core and skin temperatures showed no change from before the incident, but 1.8 volts of bias was applied to the valve controller which was equivalent to 26.5% of valve range. Skin temperature dropped sharply to 84.33°F. Core temperature increased slowly and stabilized at 96.57°F by the end of the test, giving a final mean body temperature of 95.39°F. During a typical one minute period at the end of the test the valve was open 100% of the time at an average setting of 59.3% of full flow through the heat exchanger.

Preliminary Test No. 2

- (1) The test subject was observed in a resting condition and while walking at 2 mph and 3.5 mph. During this period of time the controller adjustments were not touched and the test subject reported being "comfortably cool" during the entire run. External auditory meatus, skin (average of four sensors placed on lower left chest) and mean body temperatures varied as follows:

	<u>Skin, °F</u>	<u>Ear, °F</u>	<u>Mean Body, °F</u>
Resting - Standing	90.7	95.2	94.7
2 mph	87.1	95.6	94.8
3.5 mph	88.8	96.2	95.5
Resting - Cooling	86.4	95.9	94.9

Mean body temperature is calculated as follows:

$$T_{mb} = (0.9)(\text{ear temperature}) + (0.1)(\text{skin temperature}).$$

- (2) A comparison of typical test results from the March 2 and 23 tests are graphically illustrated by Figure 14.

The dotted portion of the March 2 skin graph represents a region where problems were incurred in the strip chart recorder and the data is not complete.

During the 3.5 mph portion of the March 23 test an amplifier oscillation occurred which reduced the flow of cooling water to the test subject and caused a rise in skin temperature, although the test subject reported that he was comfortably cool. The amplifier was replaced after the test.

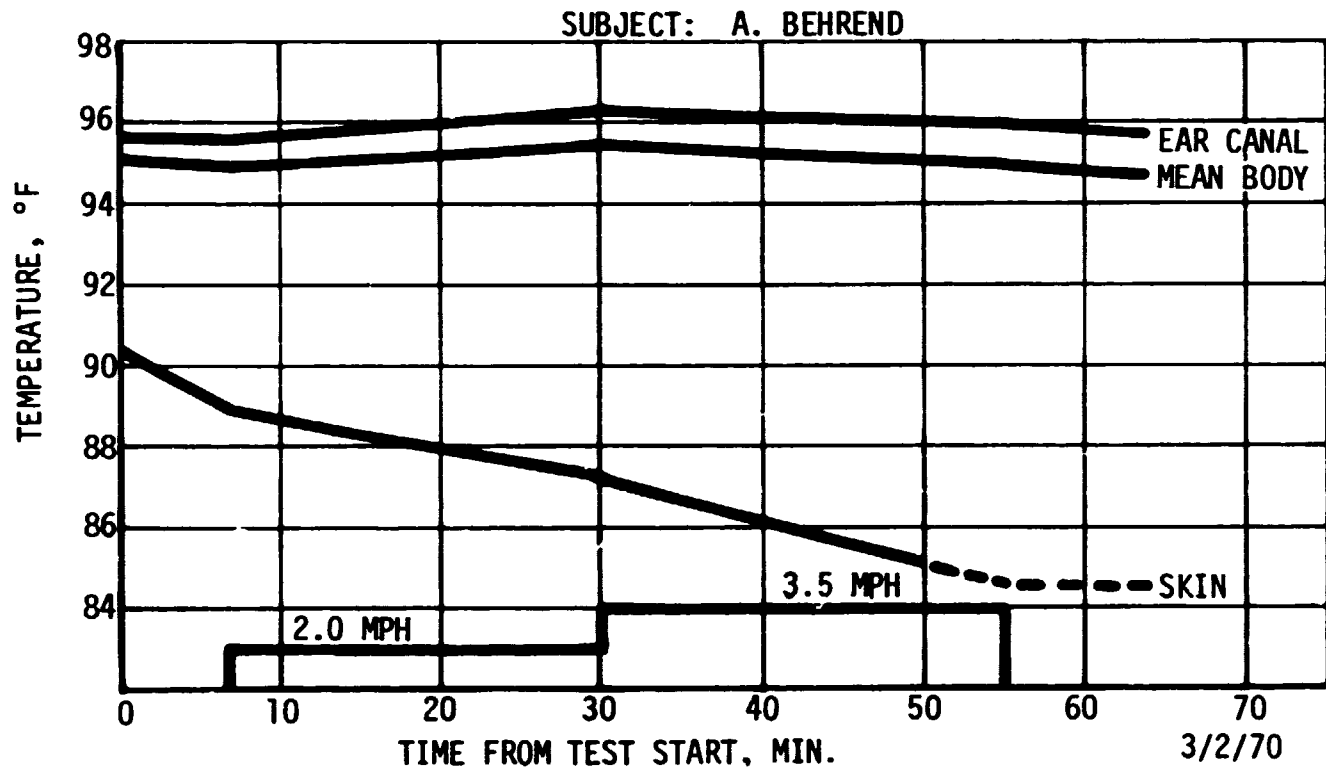
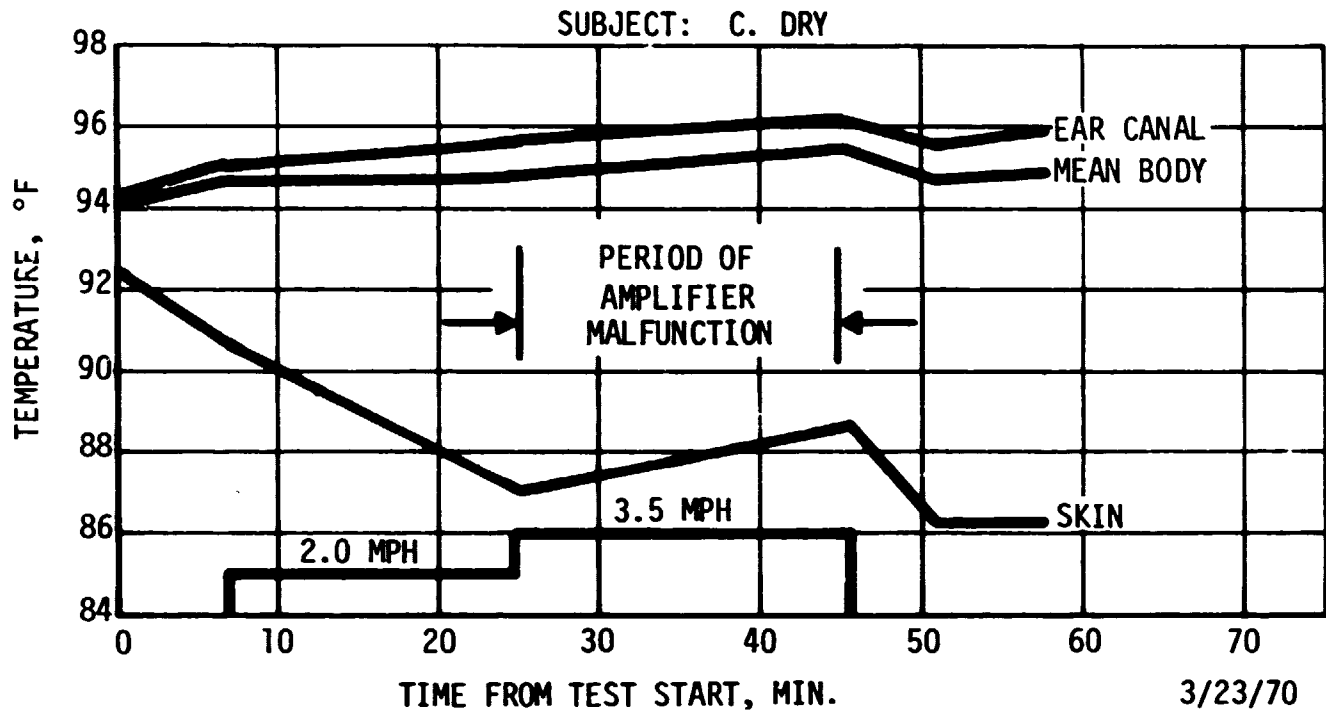

FIGURE 14. COMPARISON OF MARCH 2 AND MARCH 23 DATA

Preliminary Test No. 3

The wearing of a wool cap brought sensed ear temperature up 4<sup>o</sup>F as shown by Figure 15 and stabilized controller output. Water pump drive motor coupling slippages and a defective IC amplifier contributed to less than good performance. Cooling was not timely nor sufficient for this test subject and following exercise it was not reduced in time to prevent chilling him.

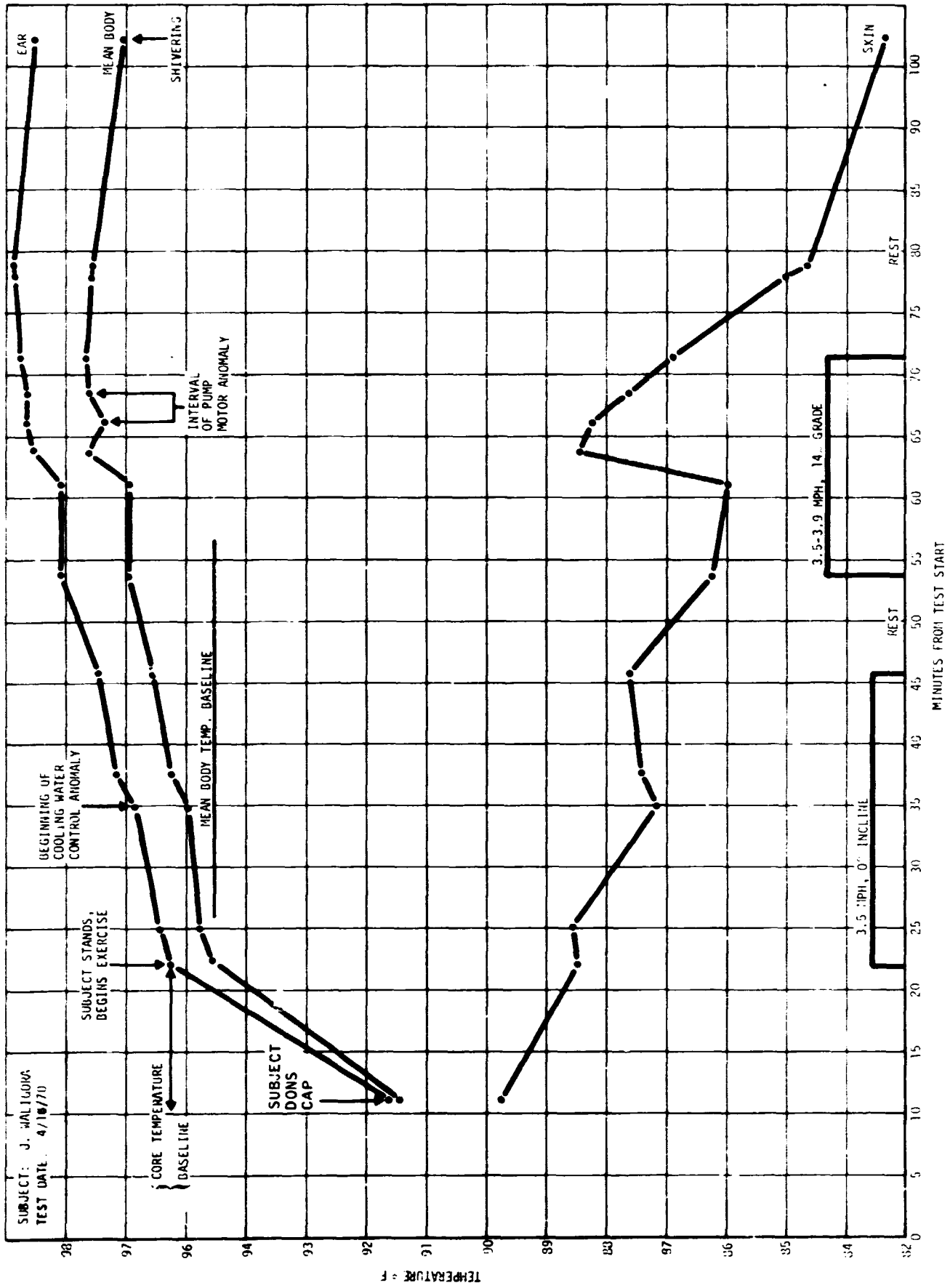

FIGURE 15. PRELIMINARY TEST NO. 3 TEMPERATURE DATA

Preliminary Test No. 4

The same controller settings utilized for the previous test were used again and a very well trained test subject was employed this time. Results are shown by Figure 16. Oral temperatures were taken to compare with measured ear temperatures and are shown in brackets. The test subject felt warm toward the end of the second work period but cooling was not reduced in time after work stopped to prevent chilling.

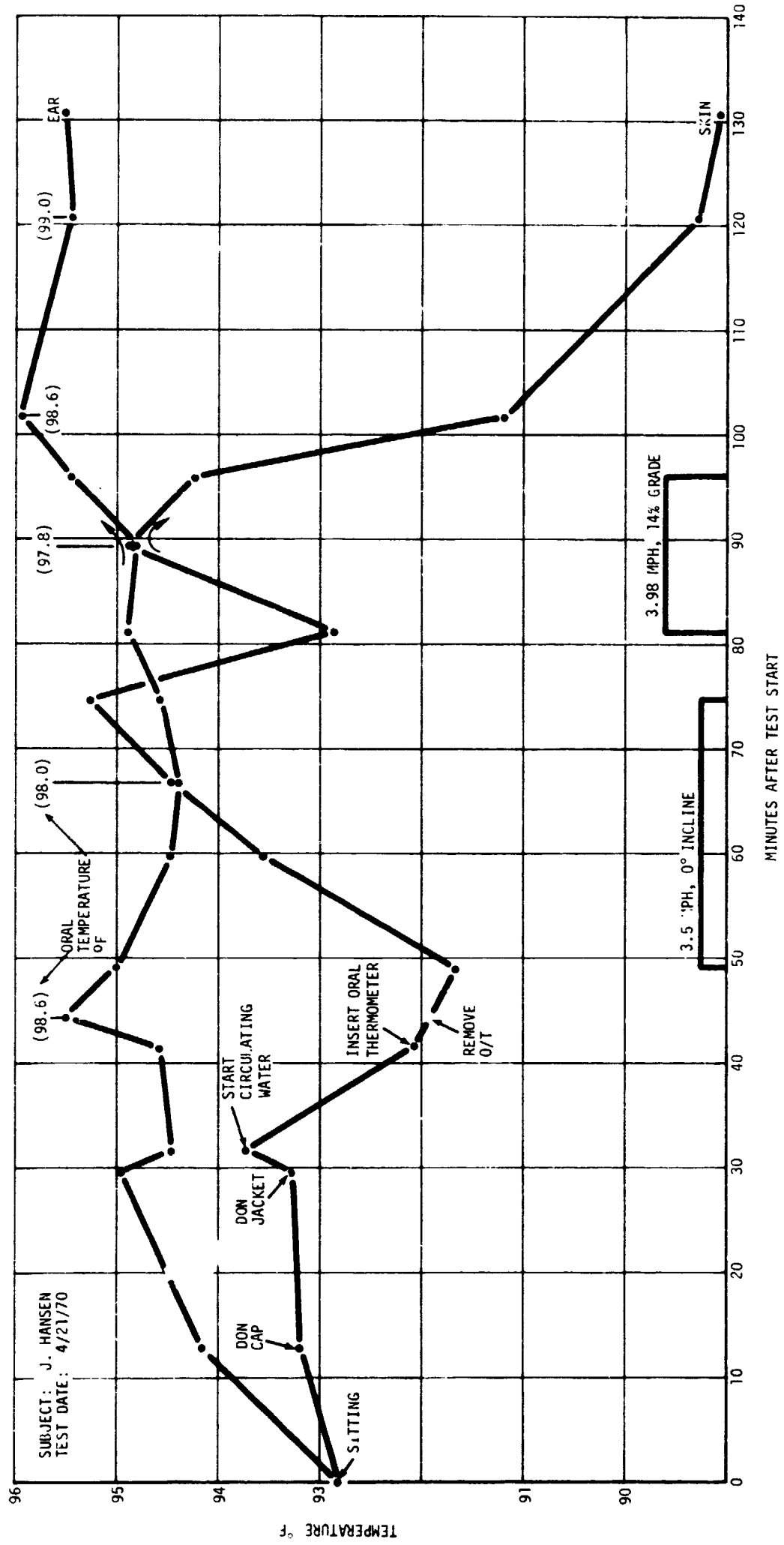

FIGURE 16. PRELIMINARY TEST NO. 4 TEMPERATURE DATA



Preliminary Test No. 5

Approximately 5 minutes into the work cycle (est. 2113 Btu/hr), the rate of change of ear temperature initiated valve modulation. At  $0.4^{\circ}\text{F}$  above the core baseline temperature ( $95.54^{\circ}\text{F}$ ) the valve was full open and remained so for about 57 minutes as shown by Figure 17. Seventeen and one half minutes after the valve opened full and five minutes after cessation of work, ear temperature reached a plateau of approximately  $97.1^{\circ}\text{F}$  and remained there for 35 minutes while the skin temperature trended downward. As core temperature began to drop off, i.e., when the ear temperature had dropped  $0.2^{\circ}\text{F}$  from the core plateau temperature, valve modulation began and continued for about 14.5 minutes. At that point core temperature had dropped  $0.56^{\circ}\text{F}$  below the plateau and the valve was fully closed and remained so until the end of the test. Inspection of the relative values and trends of core and skin temperatures suggests a possible undershoot of baseline core temperature of about  $0.3^{\circ}\text{F}$  before skin temperature would have reached its baseline. The maximum core temperature rise above baseline was  $1.6^{\circ}\text{F}$  and the minimum recorded skin temperature gave a baseline delta for the skin of  $10.9^{\circ}\text{F}$ .

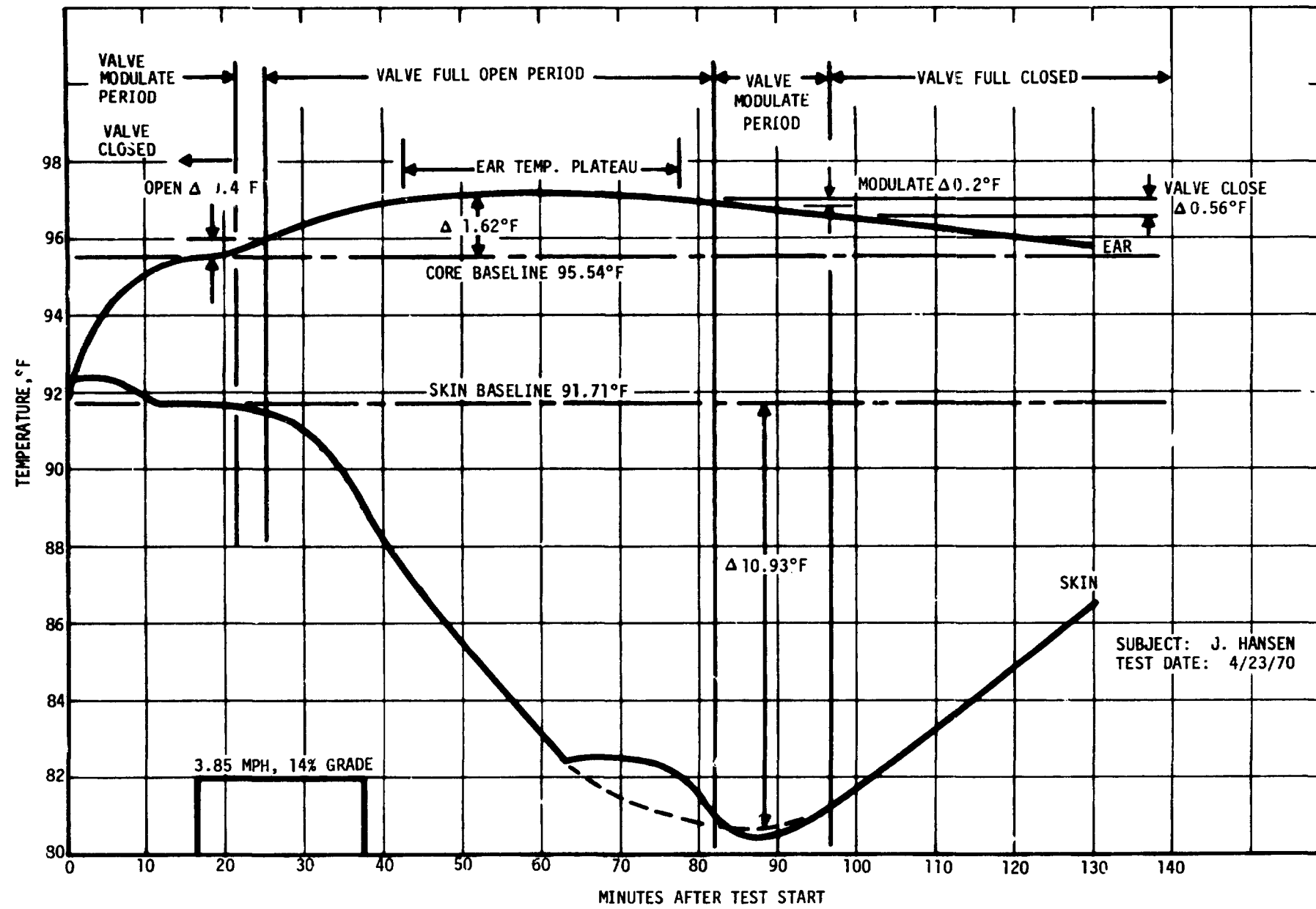

FIGURE 17. PRELIMINARY TEST NO. 5 TEMPERATURE DATA

Preliminary Test No. 6

- (1) Graphical results are shown by Figure 18 which shows data from both the April 23 and May 7 tests. A lower setpoint mean body temperature was used on May 7 compared to April 23 and the gains of both the rate circuit and proportional signal circuit were increased for the May 7 test compared to settings for April 23.
- (2) There is an increase in ear temperature as the ear plug approaches body temperature before work commencement. During the same period skin temperature rises due to the insulated garment and activity.
- (3) When water was started circulating through the LCG a steep drop in skin temperature was recorded although the water was only at room temperature. Very little cooling of LCG water occurred before fifteen minutes of test time had elapsed. From that point until work commenced a slight amount of LCG water cooling took place, and skin temperature showed a drop of 3°F from the peak value.
- (4) Until about ten minutes after work started both skin and ear temperature were fairly steady and the valve was modulating open slightly. There began a rise in ear temperature and the valve snapped full open. Skin temperature began an immediate drop and continued to do so until just before work stoppage. At that point ear temperature began to level out again and skin temperature started to rise even though the valve was still full open. Note that the same thing occurred April 23. It was thought following the April 23 test that perhaps a skin sensor had come loose and had not made good skin contact.

At the completion of work, ear temperature increased and skin temperature continued to drop although not as low as on April 23. The minimum temperature was reached twenty-five minutes earlier with a beginning of return to normal skin temperature occurring much sooner than previously. Extrapolation of data indicated a possibility of 25% faster recovery compared to the previous test.

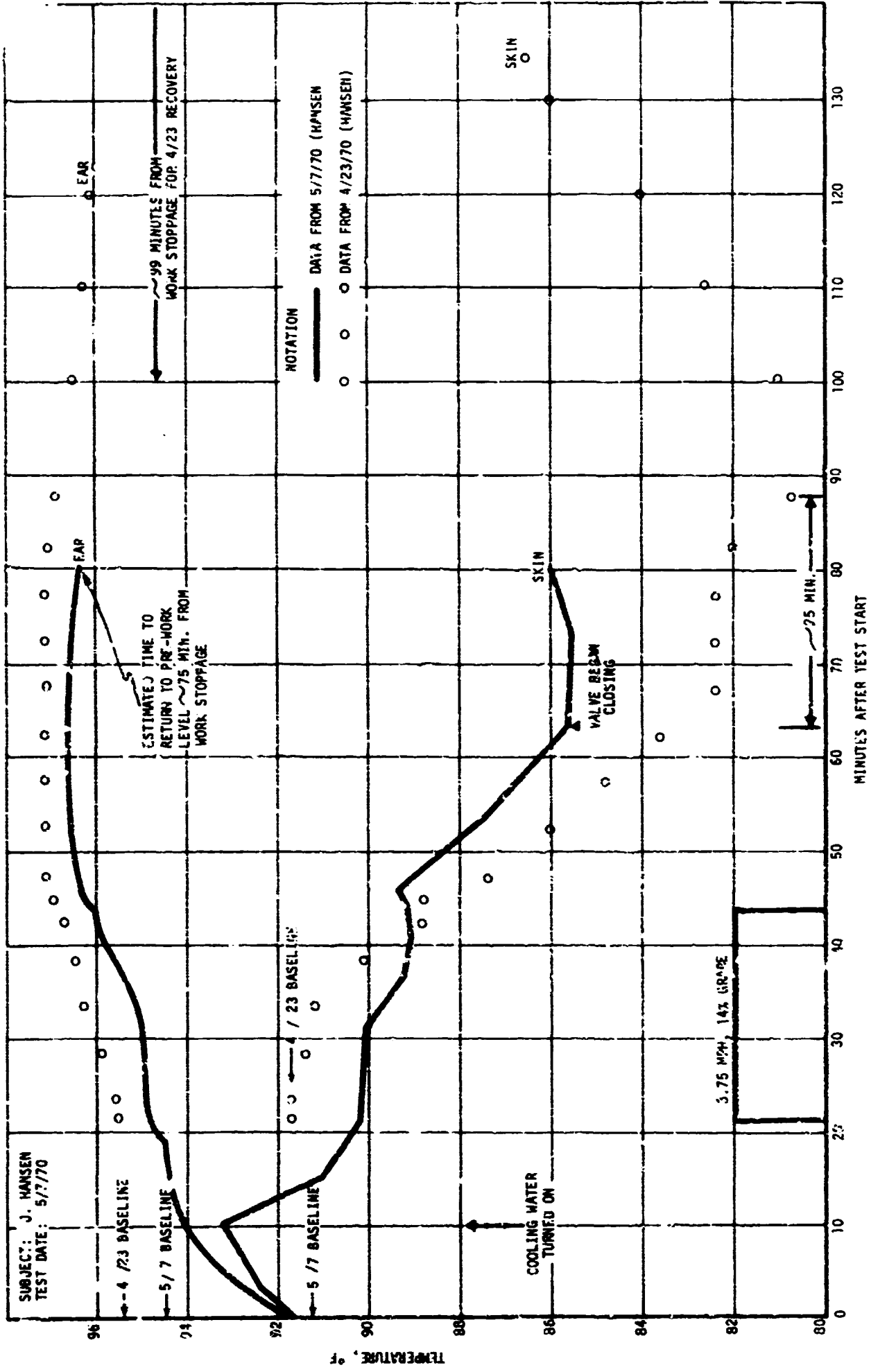

FIGURE 18. PRELIMINARY TEST NO. 6 TEMPERATURE DATA

Preliminary Test No. 7

- (1) Results are graphically illustrated by Figure 19. The first set of data, labeled "Semi-Clothed" was taken while the test subject was sitting in the treadmill room, shirt off, and with slacks and shoes on. The equilibrium ear and biceps temperatures were approximately 96°F and 90°F respectively.
- (2) After the ICG and insulated garment were donned there was slightly more than 0.1°F increase in ear temperature and about a 1.5°F increase in skin temperature, which continued to increase sharply until room temperature water was started circulating in the ICG. A slight rise in skin temperature occurred as the test subject stood up and moved to his position on the treadmill. At that point air was supplied to the diverter valve which promptly opened full allowing ICG water to flow through the heat exchanger which had been chilled before the test began. No chilled water was circulating through the other side of the heat exchanger at this time but the residual water on the cold side was sufficient to drop both skin and core temperature. When the test subject reported that he could begin to feel the "heat build up" chilled water was started circulating through the cold side of the heat exchanger. Note that both core and skin temperature are below their initial values at this point (25 minutes).  
The apparently anomalous rise in skin temperature is noted during the work period occurring at the same time as during some previous tests.

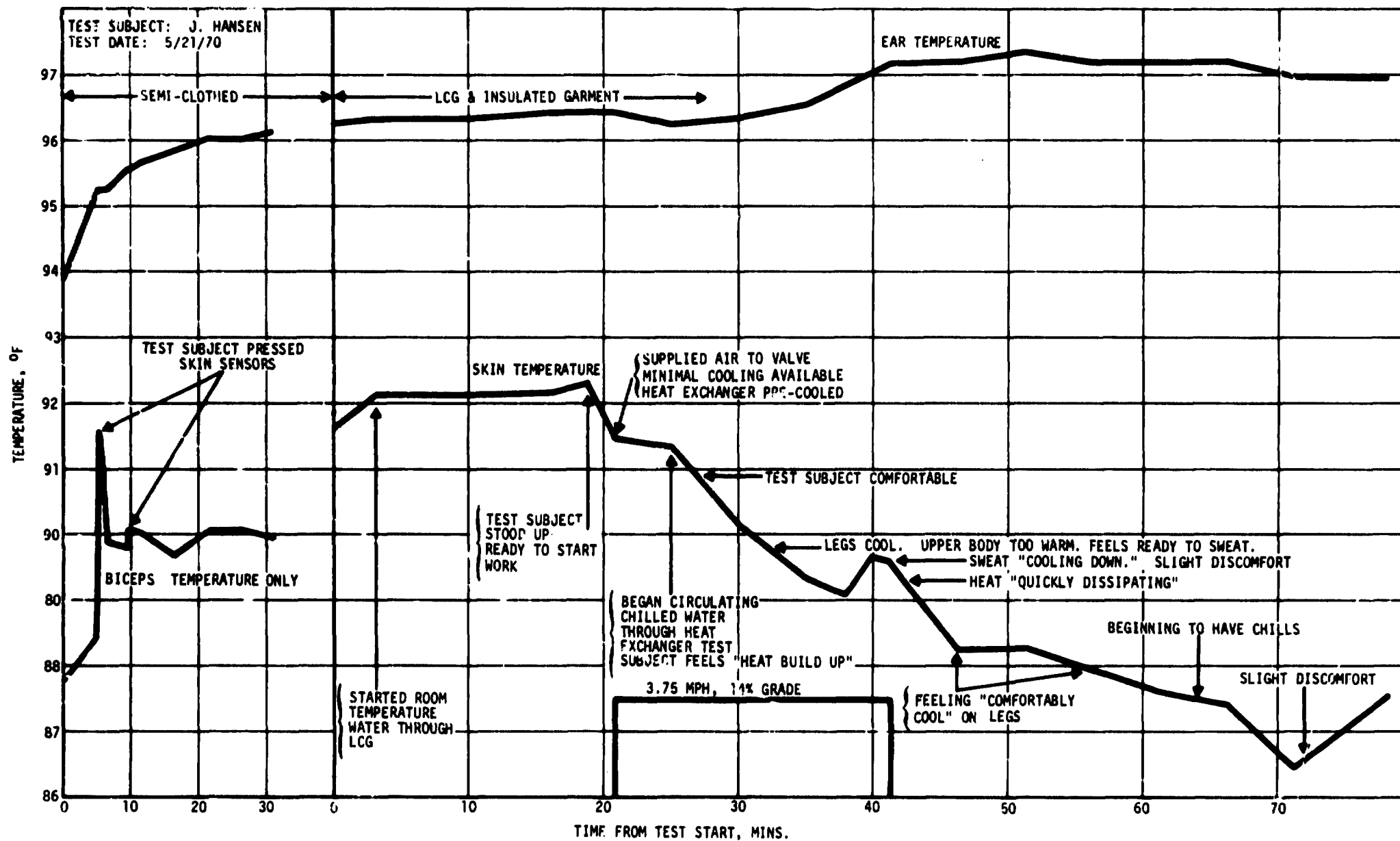

FIGURE 19. PRELIMINARY TEST NO. 7 TEMPERATURE DATA

Preliminary Test No. 8

A long-sleeved ICG and higher capacity ICG water pump were used for this test and the voltage at TP10 was nulled just prior to starting the treadmill. Results are shown graphically by Figure 20 which includes test subject comments as a function of time.

At point (a) shown on the abscissa the test subject reports that he is beginning to feel "heat building up," having felt comfortable to this point. Four minutes later the work period ended and the test subject reported a fast dissipation of "excessive heat." Nine minutes after the cessation of work he had progressed from a comfortable condition to a "threshold of chill," point (b). Following a period during which all temperatures continued to drop, a new work cycle was commenced and shortly thereafter, at point (c), the test subject reported feeling comfortable again. There was an internal heat buildup until the subject felt on the threshold of being uncomfortably warm, but he did not report actually becoming uncomfortable at any point during this test sequence. After cessation of work he felt progressively comfortable, on the threshold of chill, and chilly. A tabular presentation and columnar comparison of pertinent data helps to create an image of the problem a controller has to cope with.



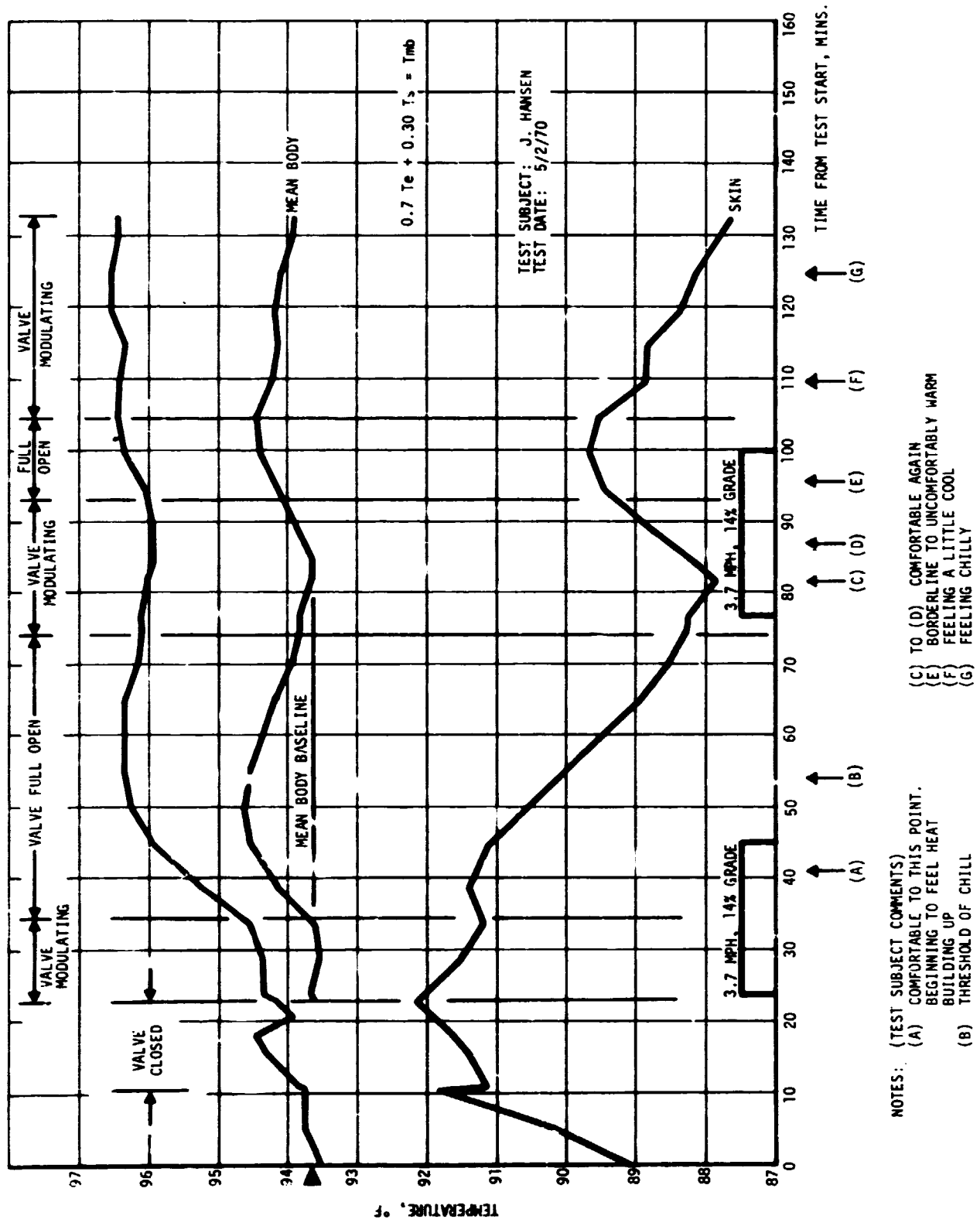

NOTES: (TEST SUBJECT COMMENTS)  
 (A) COMFORTABLE TO THIS POINT.  
 BEGINNING TO FEEL HEAT  
 BUILDING UP  
 (B) THRESHOLD OF CHILL

(C) TO (D) COMFORTABLE AGAIN  
 (E) BORDERLINE TO UNCOMFORTABLY WARM  
 (F) FEELING A LITTLE COOL  
 (G) FEELING CHILLY

FIGURE 20. PRELIMINARY TEST NO. 8 TEMPERATURE DATA

TABLE 9

COMPARISON OF OBJECTIVE COMMENTS WITH  
SELECTED PHYSIOLOGICAL PARAMETERS

Physiological Parameters	Subjective Threshold			
	Heat	Chill	Comfort	Chill
$T_e, ^\circ\text{F}$ (Ear)	95.5	96.3	96.04	95.48
$T_s, ^\circ\text{F}$ (Skin)	91.3	90.1	87.89	88.84
$T_m, ^\circ\text{F}$ (Mean Body)	94.3	94.6	93.68	94.26
$\dot{T}_e, ^\circ\text{F}/\text{min.}$	0.11	0.02	-0.02	-0.03
$\dot{T}_s, ^\circ\text{F}/\text{min.}$	-0.04	-0.11	-0.08	0
$\dot{T}_m, ^\circ\text{F}/\text{min.}$	0.06	-0.02	-0.04	-0.02
Figure 20 Location	(a)	(b)	(c)	(f)

Several factors which do not appear in Table 9 undoubtedly influence the subjective feelings of comfort. For example, at approximately point (a), some light perspiration may have occurred. Moisture cools off quickly after a work cycle and contributes to a "clammy" feeling which promotes a feeling of discomfort, even though the subject may feel comfortable at lower skin and core temperatures if he is kept dry.

In summary, the results were quite satisfactory. Points of interest include the following:

- a. The test subject was never uncomfortably warm or cool to the point of shivering.

- b. Although the test subject commented that his skin felt cool, he perspired lightly late in both work cycles.
- c. The test subject said he thought that the LCG might not be making good contact as he walked. The sensation of cooling was only apparent at some body locations when he pressed it against his skin.
- d. A study to identify controller settings, which would cause termination of cooling sooner following cessation of work, was initiated.

Preliminary Test No. 9

The object of Preliminary Test No. 9 was to: (a) increase the relative weighting of mean body temperature rate of change signal by decreasing the gain of the mean body temperature signal; (b) compare the responses during identical work periods using a greater weighting on skin signal during the second period; and, (c) reduce treadmill speed to 1.0 mph following the second work period to study the effect of light exercise on test subject recovery and comfort.

The results are illustrated by Figure 21.

- (1) In general, the system provided the most comfortable environment for the test subject to date, both during and after work periods. Maximum core temperature excursion ( $1.6^{\circ}\text{F}$ ) above set point for the work cycle and minimum skin temperature depression below set point following work ( $1.4^{\circ}\text{F}$ ) was considered satisfactory at that stage of the investigation.
- (2) At the beginning of the test, the test subject was slightly subcooled. The laboratory ambient was comfortably cool in normal street clothes, but became too cool to him when he disrobed. This condition was aggravated by his donning of the LCG which contained water in its tubes at lab ambient temperature. The net effect is seen as a depressed average skin temperature at the beginning of the test ( $89.5^{\circ}\text{F}$ ). Pretest core temperature was about average for this test subject ( $95.6^{\circ}\text{F}$ ). The system was nulled at these two temperatures before work was started.

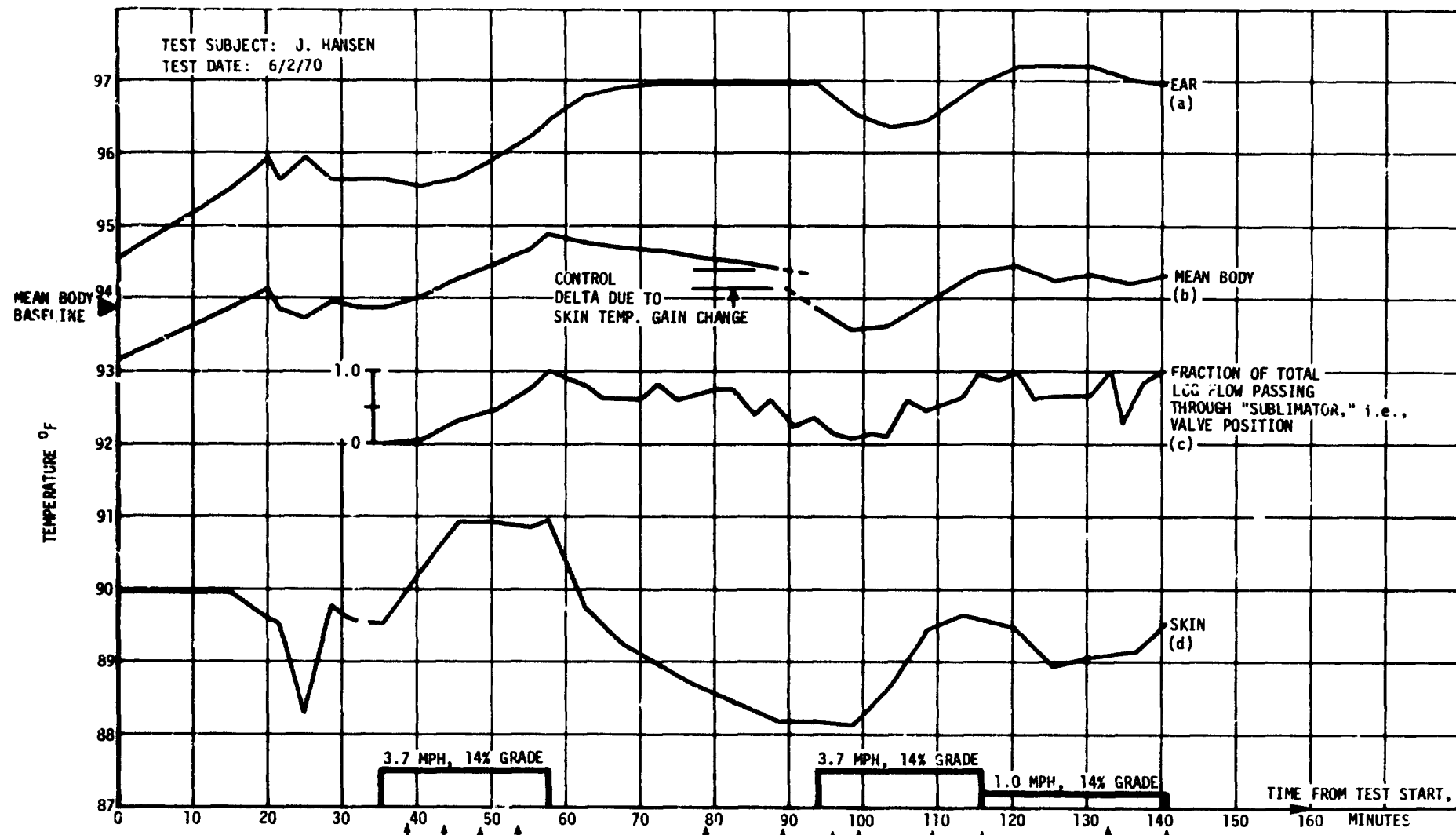

NOTES: (TEST SUBJ. COMMENTS)

(A) TOO COOL TO THIS POINT. GETTING COMFORTABLE.

(B) BACK IS COOL. LITTLE SHIVERS. INTERNAL HEAT BUILD UP. INCIPIENT SWEATING.

(C) SAME AS (B). BACK & UNDERARMS COOL. POSSIBLE SWEAT ON CHEST, STOMACH & BACK.

(D) GETTING COMFORTABLY WARMER. SKIN STILL A LITTLE COOL.

(E) SLIGHTLY UNCOMFORTABLY COOL.

(F) INCREASED SKIN GAIN.

(G) BEGINNING TO GET COMFORTABLE.

(H) COMFORTABLE. FEELS PERFECT.

(I) BEGINNING OF DISCOMFORT.

(J) LIGHT SWEAT.

(K) FEELS GOOD. SKIN COOL.

(L) COOL BUT COMFORTABLE.

FIGURE 21. PRELIMINARY TEST NO. 9 TEMPERATURE DATA

- (3) In less than four minutes following onset of work, the test subject began feeling comfortably cool (Figure 21), ear temperature was stable and skin temperature had been stable. At this point, skin temperature began increasing, and within five minutes, the test subject began to feel some internal heat build-up, although his skin felt cool to the extent that he could feel little shivers in the area of the small of his back. Mean body temperature began increasing due to the influence of skin temperature. There was an increase in valve activity almost proportional to the increase in mean body temperature during this period. At approximately 57 minutes into the test, at the end of the first work cycle, mean body temperature is seen to drop off, as does valve command, but not sufficiently to prevent a sharp skin temperature drop.
- (4) After the second work period, the treadmill was slowed to 1 mph to simulate more closely probable lunar surface EV activities, a heavy work load, followed by a light work load rather than a motionless sitting condition. The test subject felt quick dissipation of excess heat and remained comfortably cool for the remainder of the test.

Preliminary Test No. 10

A controller design modification was accomplished prior to this test giving the system more sensitivity to rate of mean body temperature change. The results are shown by Figure 22.

- (1) This was the most successful test to date from the standpoint of test subject comfort during rest and moderate working conditions. The test subject reported being very comfortable during the entire test with one exception. After ten minutes of exercise at the high work rate, at which point the controller was providing maximum flow through the heat exchanger, he began to feel as if he were about to sweat. Reference to Figure 22 would seem to verify that at that point, 94 minutes into the test, the capacity of the system was reached. Prior to that valve modulation had kept mean body temperature within  $0.8^{\circ}\text{F}$  of the control set point value, but at that point a full flow command was realized and sustained. The treadmill was stopped at the planned time without significant sweating having occurred. The LCG liner was very lightly moisture-laden at the end of the test.
- (2) Immediately following cessation of work at the high rate the subject reported feeling comfortable and he continued to feel comfortable until the test was terminated. Skin temperature began approaching the set point.
- (3) At the point that maximum valve opening was ordered and sustained (94 minutes) the test subject reported that the treadmill room seemed quite "stuffy".

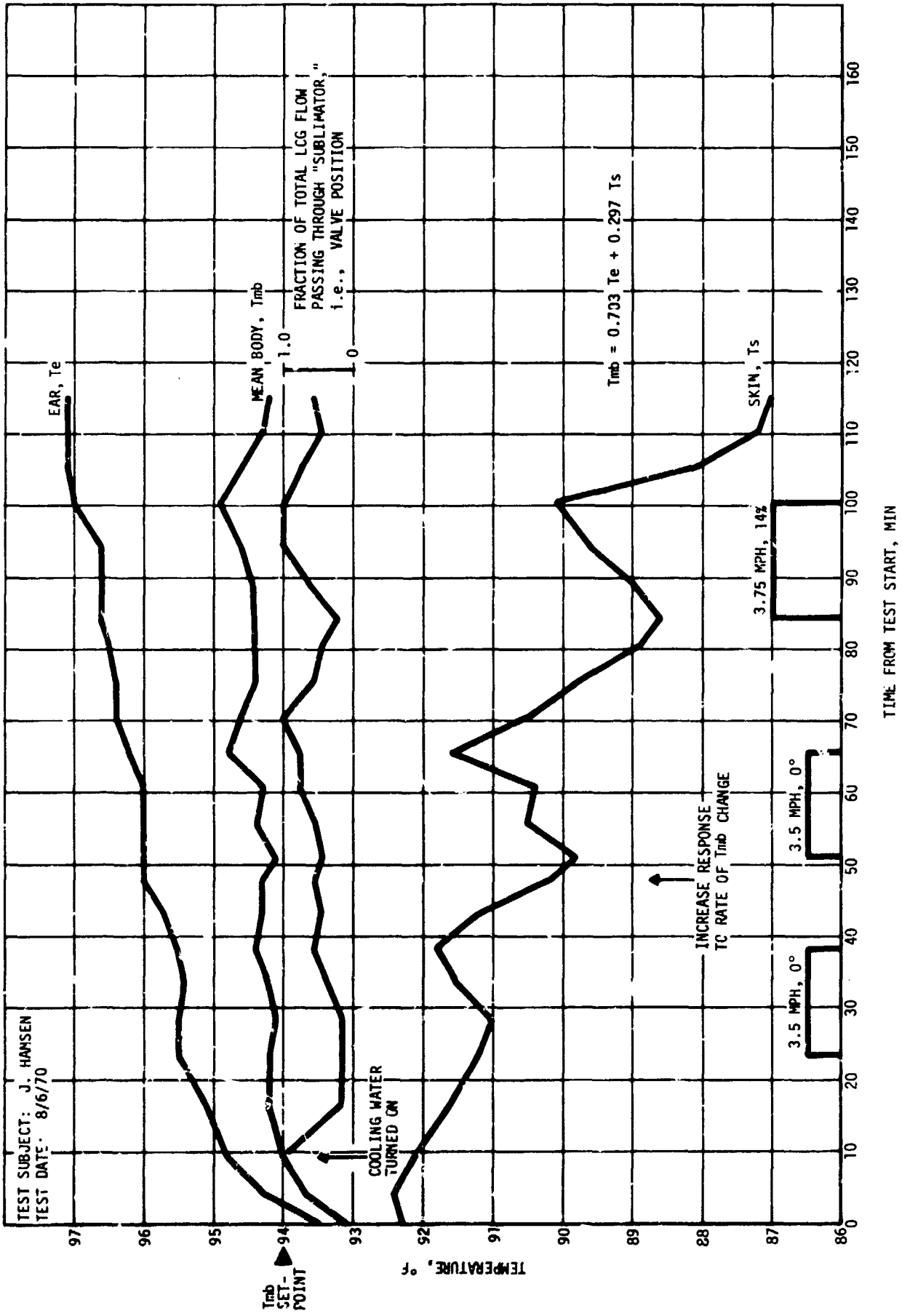

FIGURE 22. PRELIMINARY TEST NO. 10 TEMPERATURE DATA



Preliminary Test No. 11

The object of Preliminary Test No. 11 was to (a) identify the test subject's metabolic rates associated with specified treadmill speeds and inclinations to be used for the quarter replicate test series, (b) verify feasibility of using a 9-sensor temperature sensor harness for establishing average skin temperature independently from control system sensors, and, (c) verify the test protocol expected to be used during the final testing.

Results are illustrated by Figure 23. The test subject's maximum work rate was 3464 Btu/hr. The test subject was comfortable during the five minute rest periods and for about one-half of each five minute work cycle. He reported that he would liked to have had colder water during the latter part of each five minute work cycle.

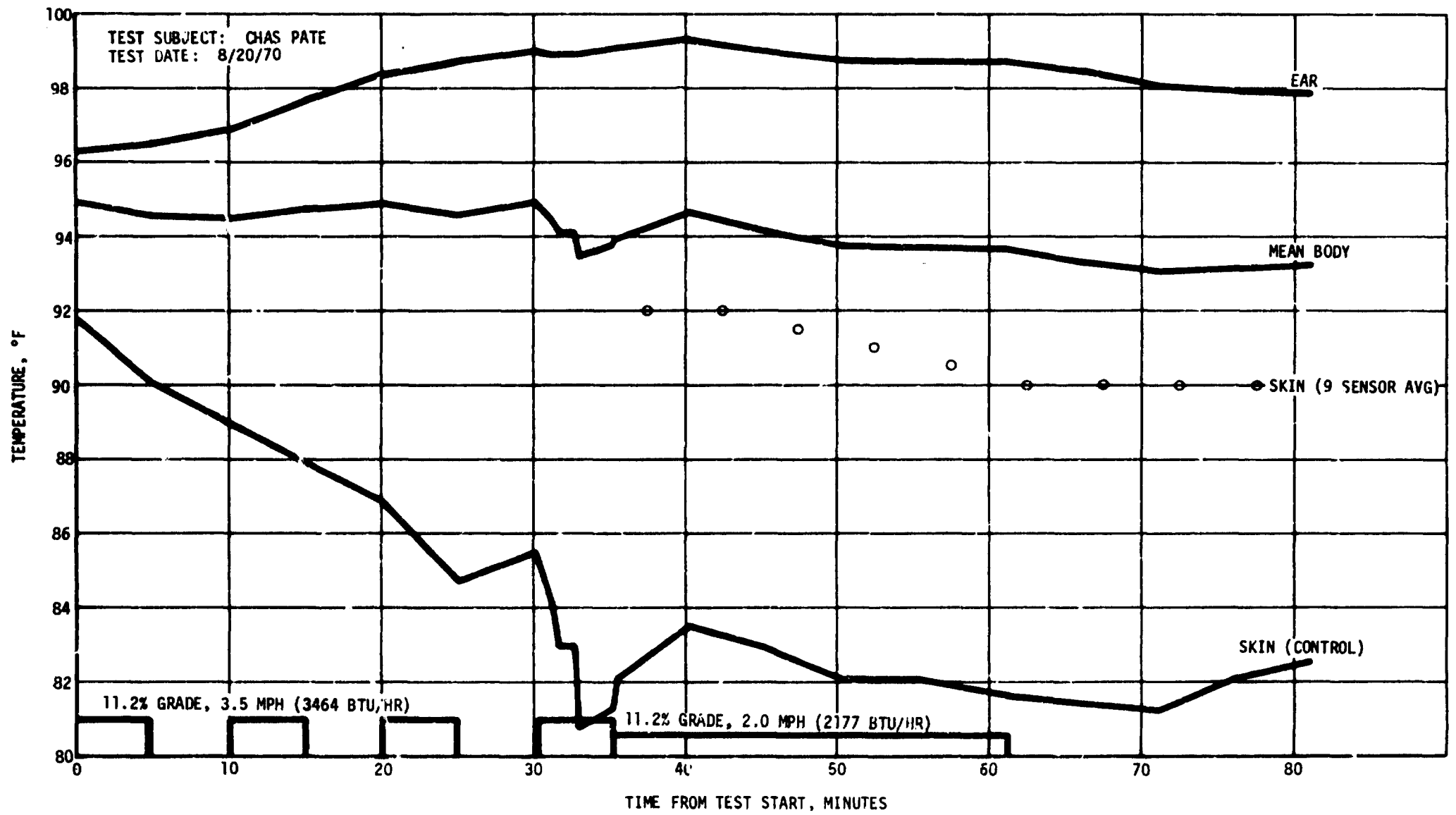

FIGURE 23. PRELIMINARY TEST NO. 11 TEMPERATURE DATA

Quarter Replicate and Final Manned Tests

The five factors or experimental conditions which were investigated in a final test series and their descriptions are illustrated by Table 10. Two values of each factor were investigated, each value being arbitrarily assigned an identification of (+) or (-), yielding a  $2^5$  experiment, viz., there are  $2^5$  combinations of factors at two levels of value. The values of the factors shown in Table 10 were chosen based upon preliminary manned tests conducted in the Manned Spacecraft Center Environmental Physiology Laboratory as part of this research and were within ranges expected to provide satisfactory man-machine system performance. One objective of this research was to identify a combination of factor value levels suitable for further investigation plus any significant differences between overall system performances using different test subjects. Chapter VI, Methods, describes the experimental design approach.

Eight one-hour manned tests were conducted with the experimental conditions shown by Table 11, followed by three additional one-hour tests indicated as tests number 9, 10, and 11. Tests 1 through 8 were scored as shown by column 7. Performance graphs are shown by Figures 24 through 34 and illustrate the work profile followed.

TABLE 10  
EXPERIMENT FACTORS AND LEVELS

Factor	Description	( + )	( - )
A	Test subject	E. Scott	C. Pate
B	Skin sensor mode	1 Sensor each on arm, chest, thigh, back. See Figure 6.	1 Sensor on thigh
C	Ear/Skin temperature Weighting	0.84 (Ear Temperature) +0.16 (Skin Temperature)	0.7 (Ear Temperature) +0.3 (Skin Temperature)
D	Proportional Signal Gain	Medium Gain. Potentiometer Setting = 5.0	Low Gain. Potentiometer Setting = 10.0
E	Rate Signal Gain	Moderately high gain. Potentiometer setting = 8.0	Moderately low gain. Potentiometer setting = 5.0

TABLE 11

## DESIGN OF EXPERIMENT AND PERFORMANCE SCORES

Test Number	Levels of Factor					Scores	
	A Test Subject	B Skin Sensor Mode	C Ear/Skin Temperature Weighting	D Proportional Signal Gain	E Rate Signal Gain	Mean Body Temperature Standard Deviation, OF	
1	-	-	-	-	-	0.52	
2	-	+	+	+	+	1.41	
3	-	+	-	-	-	0.43	
4	-	-	+	+	+	0.88	
5	+	-	-	+	-	0.43	
6	+	-	+	+	-	0.22	
7	+	+	+	-	+	0.84	
8	+	+	-	-	+	0.07	
9	+	+	-	-	+	0.18	
10	-	+	-	-	+	0.32	
11	K.D.	-	+	+	-	1.25	

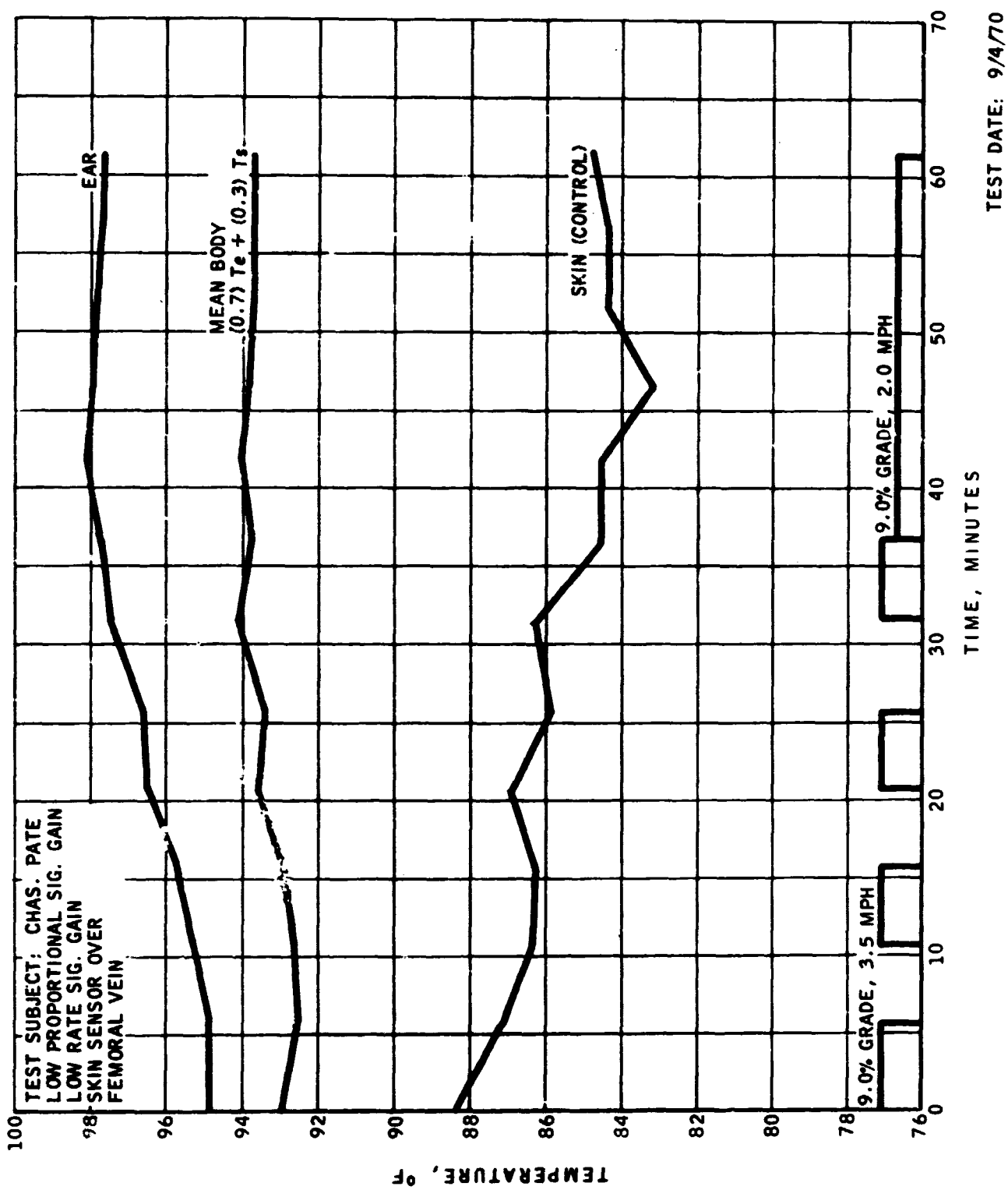

FIGURE 24. QUARTER REPLICATE TEST DATA

TEST DATE: 9/4/70

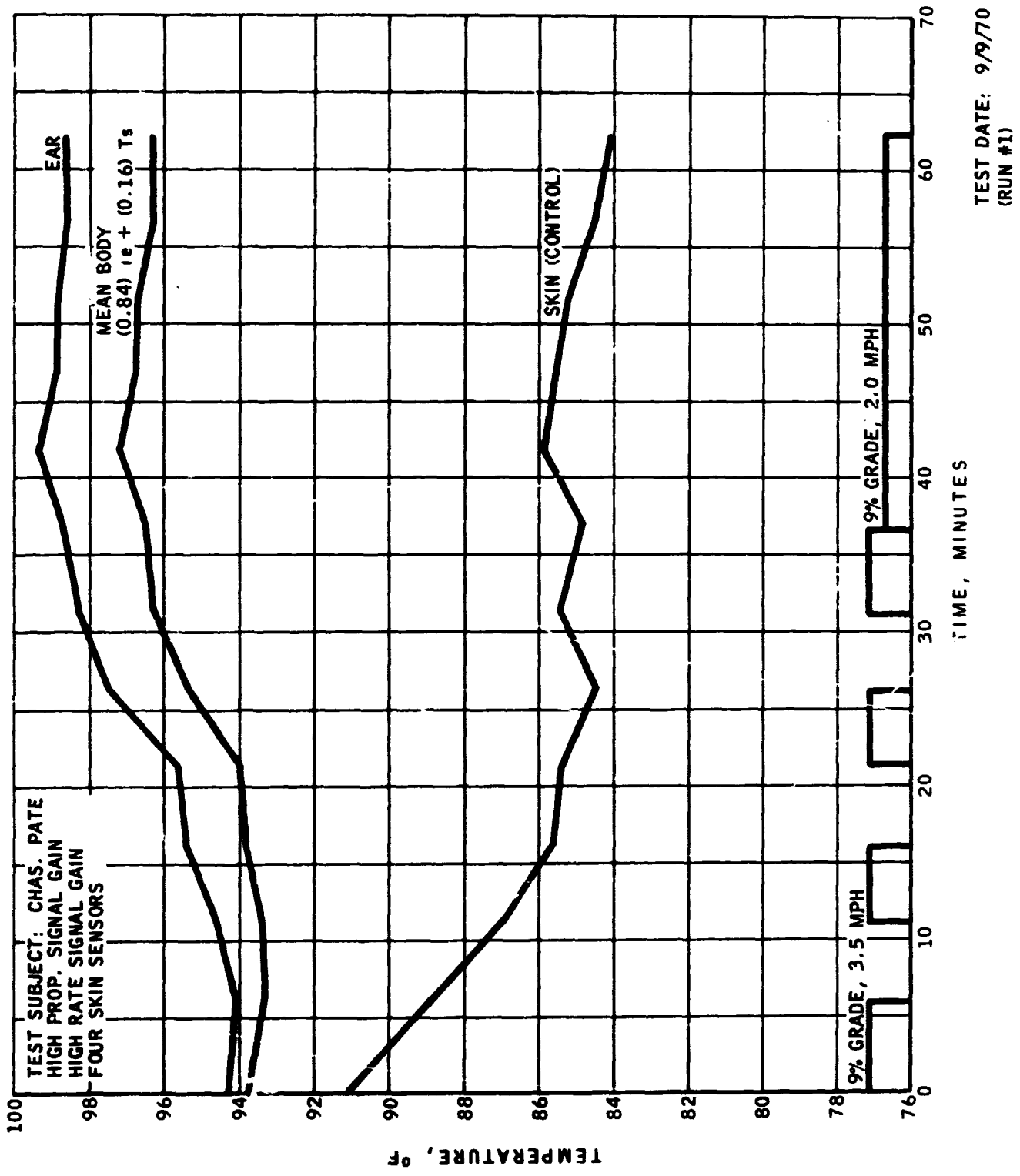

FIGURE 25. QUARTER REPLICATE TEST DATA

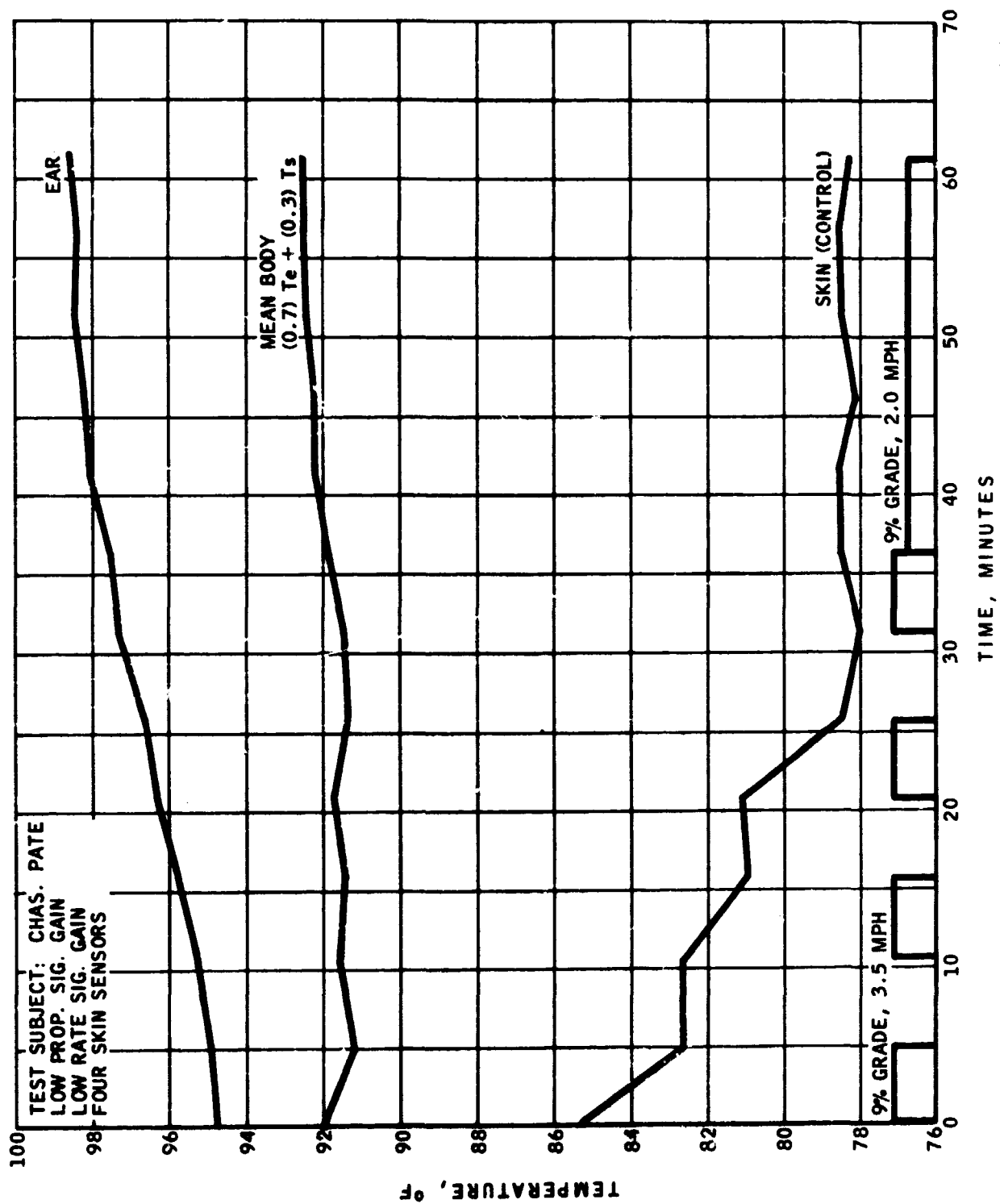

FIGURE 26. QUARTER REPLICATE TEST DATA



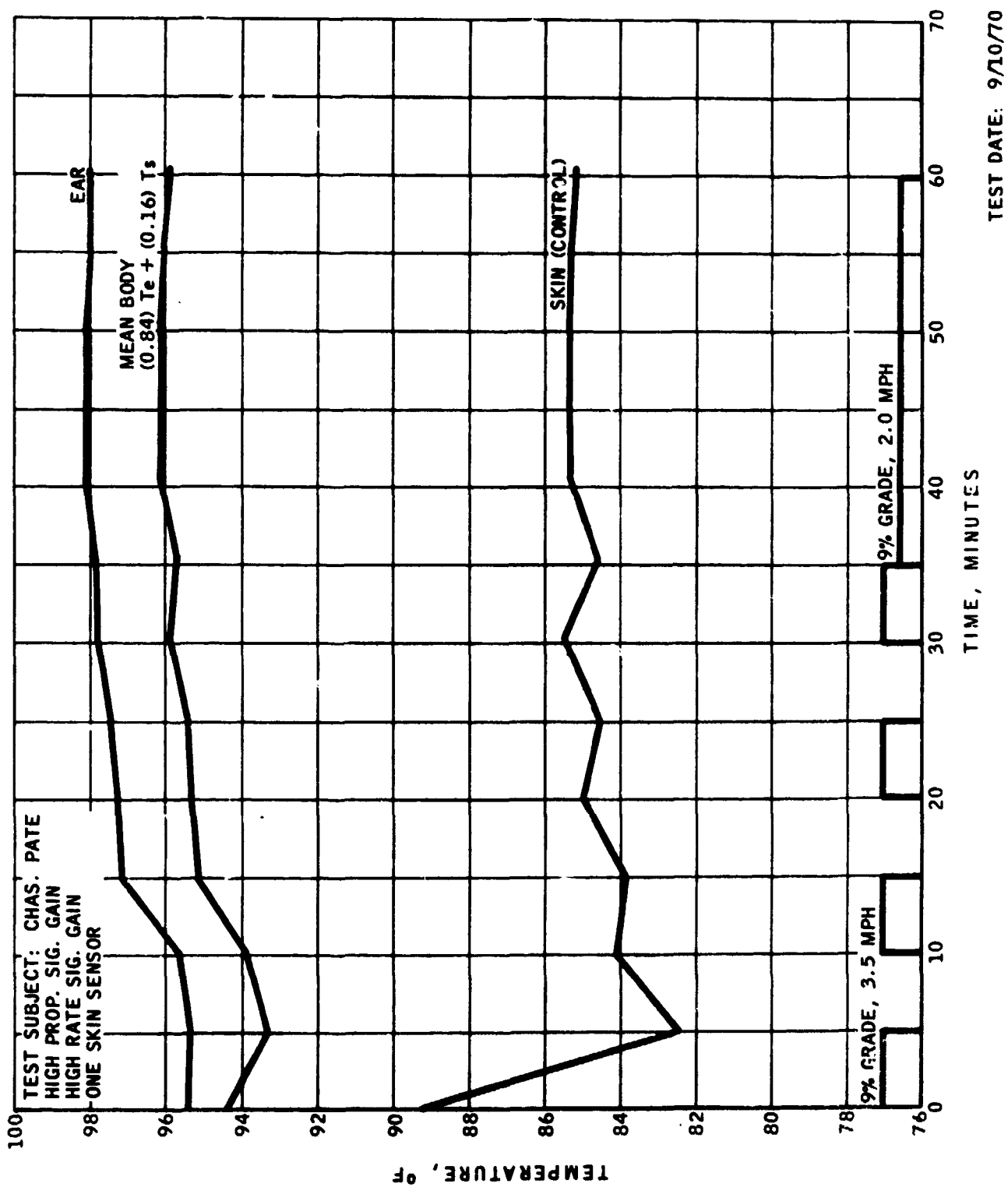

FIGURE 27. QUARTER REPLICATE TEST DATA

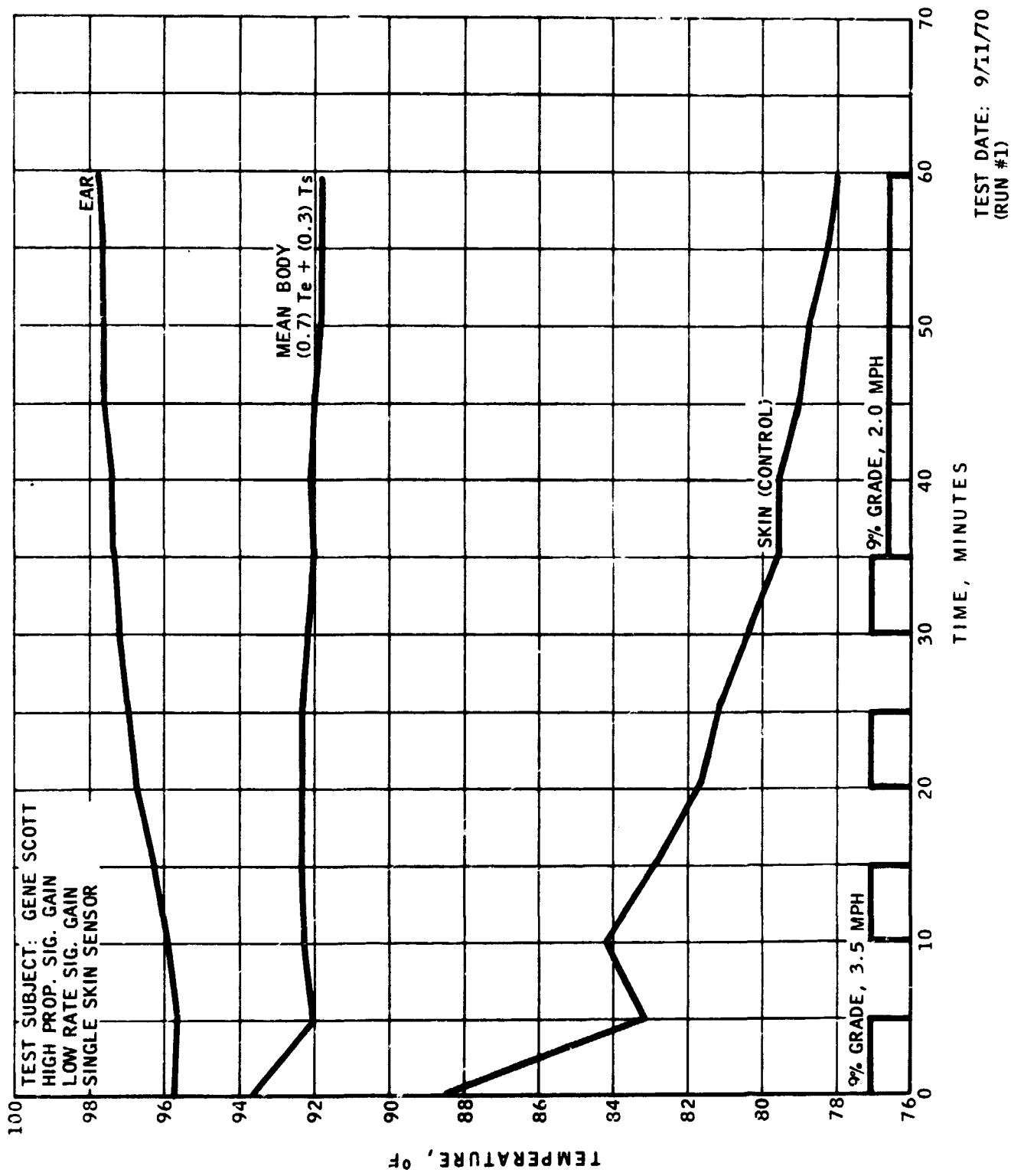
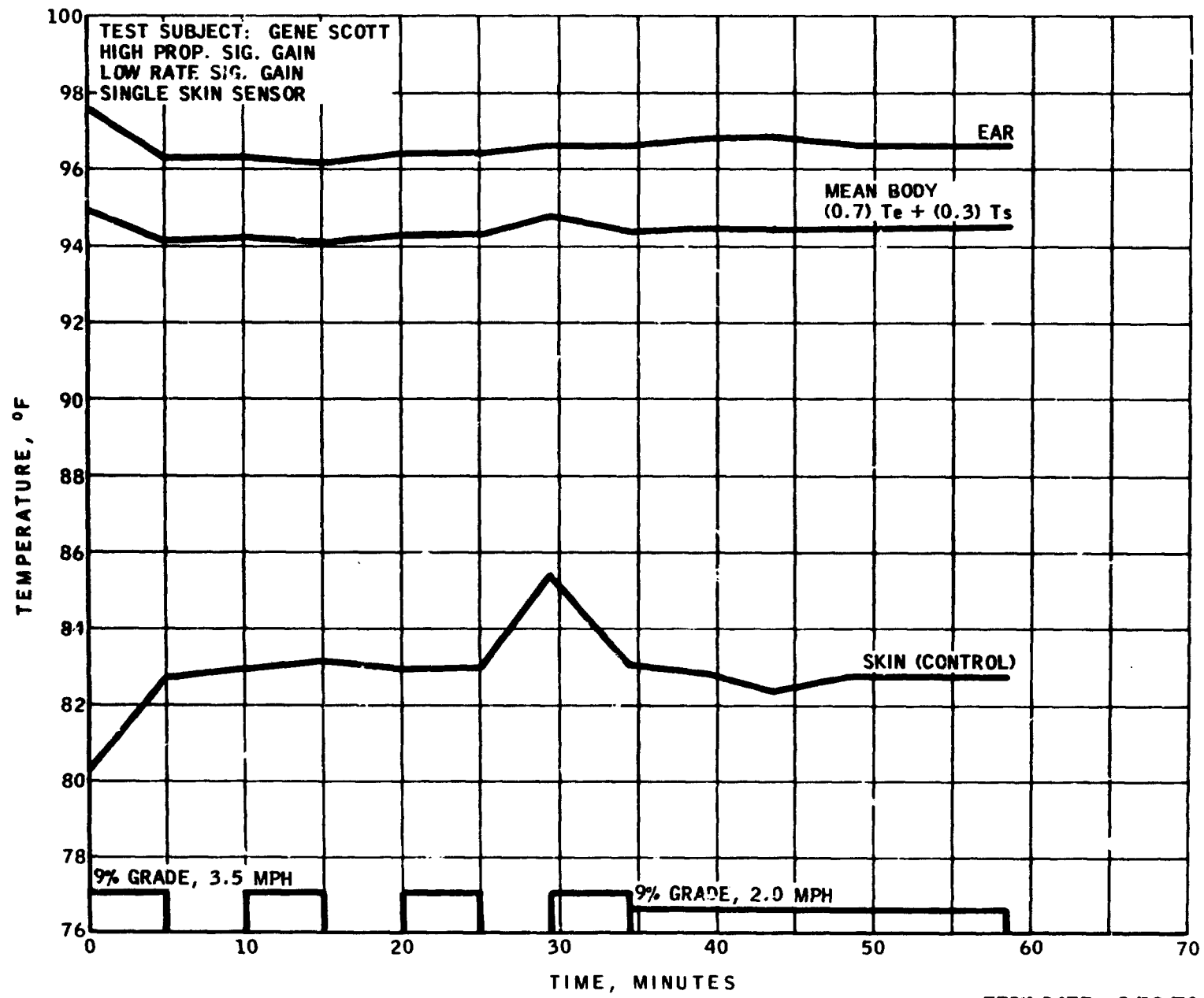
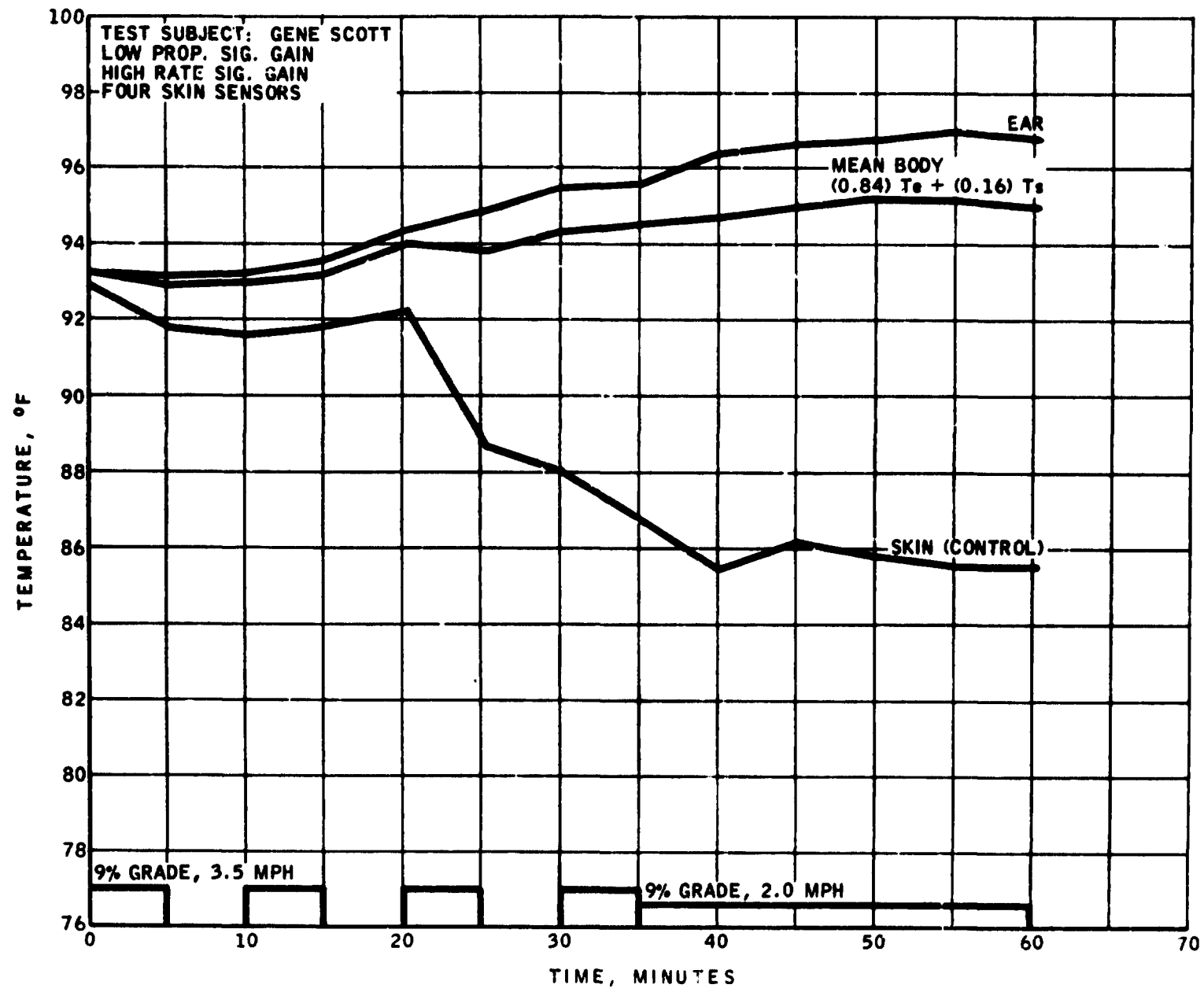

FIGURE 28. QUARTER REPLICATE TEST DATA



TEST DATE: 7/11/70  
(RUN #2)

FIGURE 29. QUARTER REPLICATE TEST DATA



TEST DATE: 9/15/70  
 (RUN #1)

FIGURE 30. QUARTER REPLICATE TEST DATA

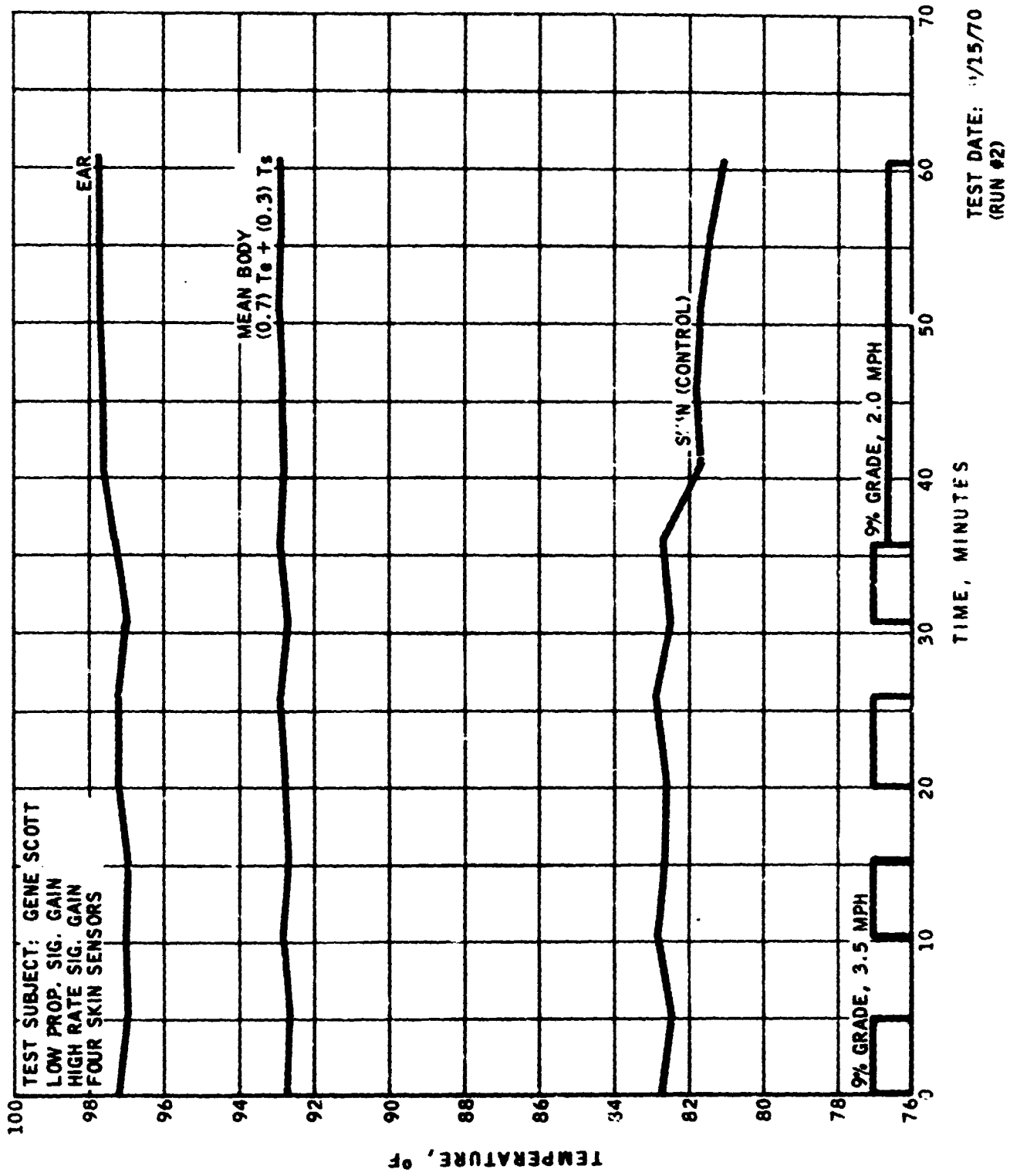
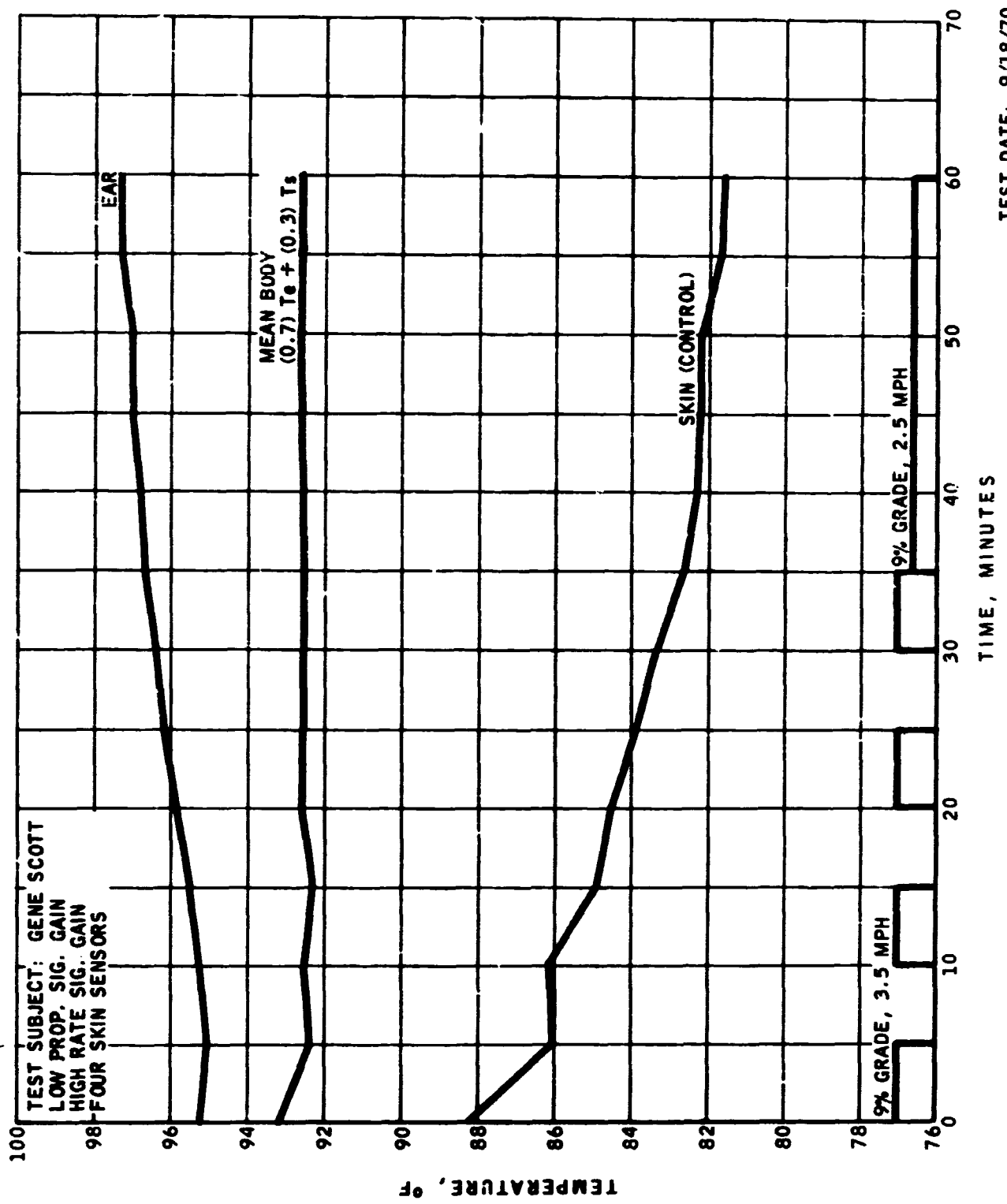

FIGURE 31. QUARTER REPLICATE TEST DATA



TEST DATE: 9/18/70

FIGURE 32. FINAL TEST DATA

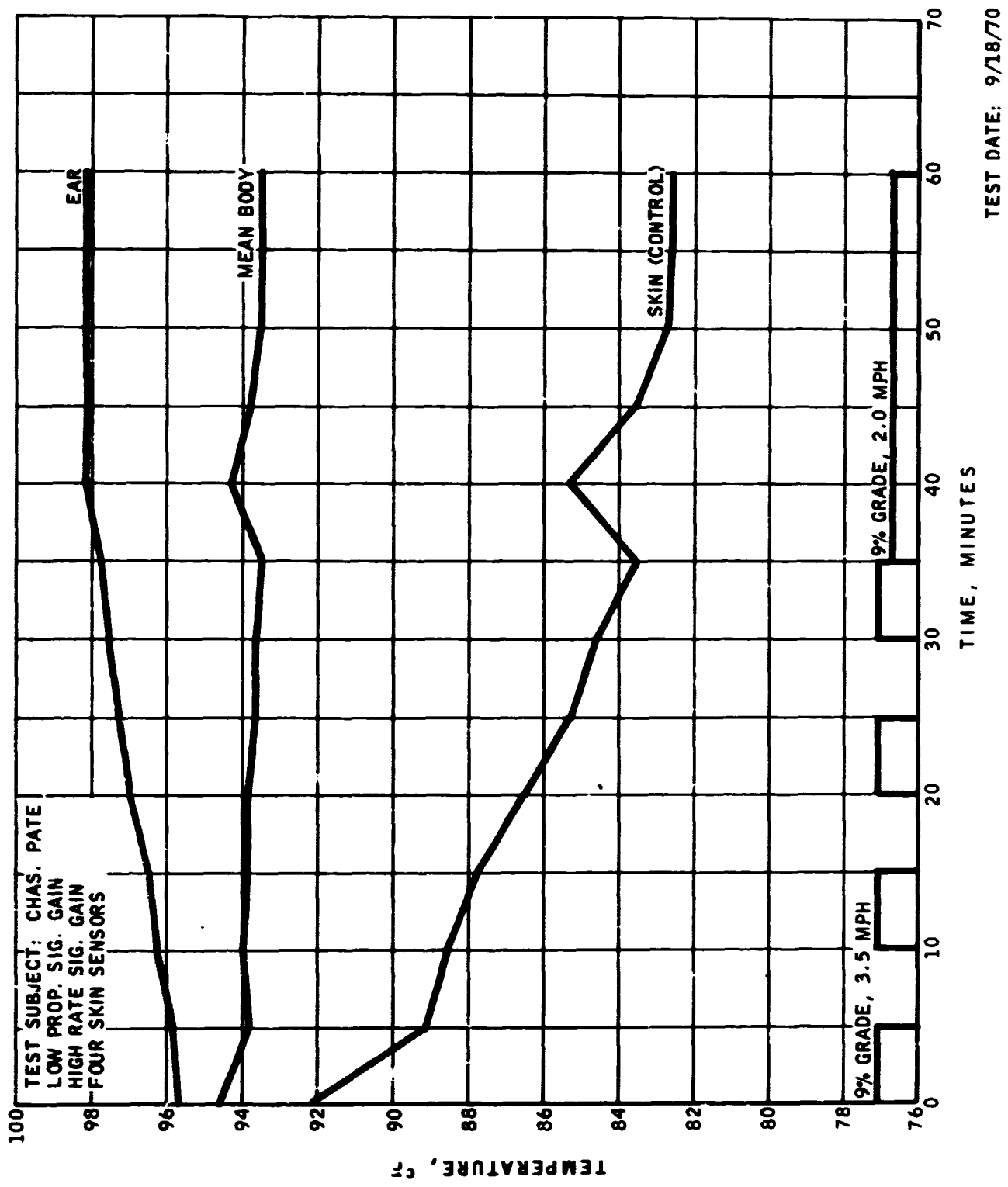

FIGURE 33. FINAL TEST DATA

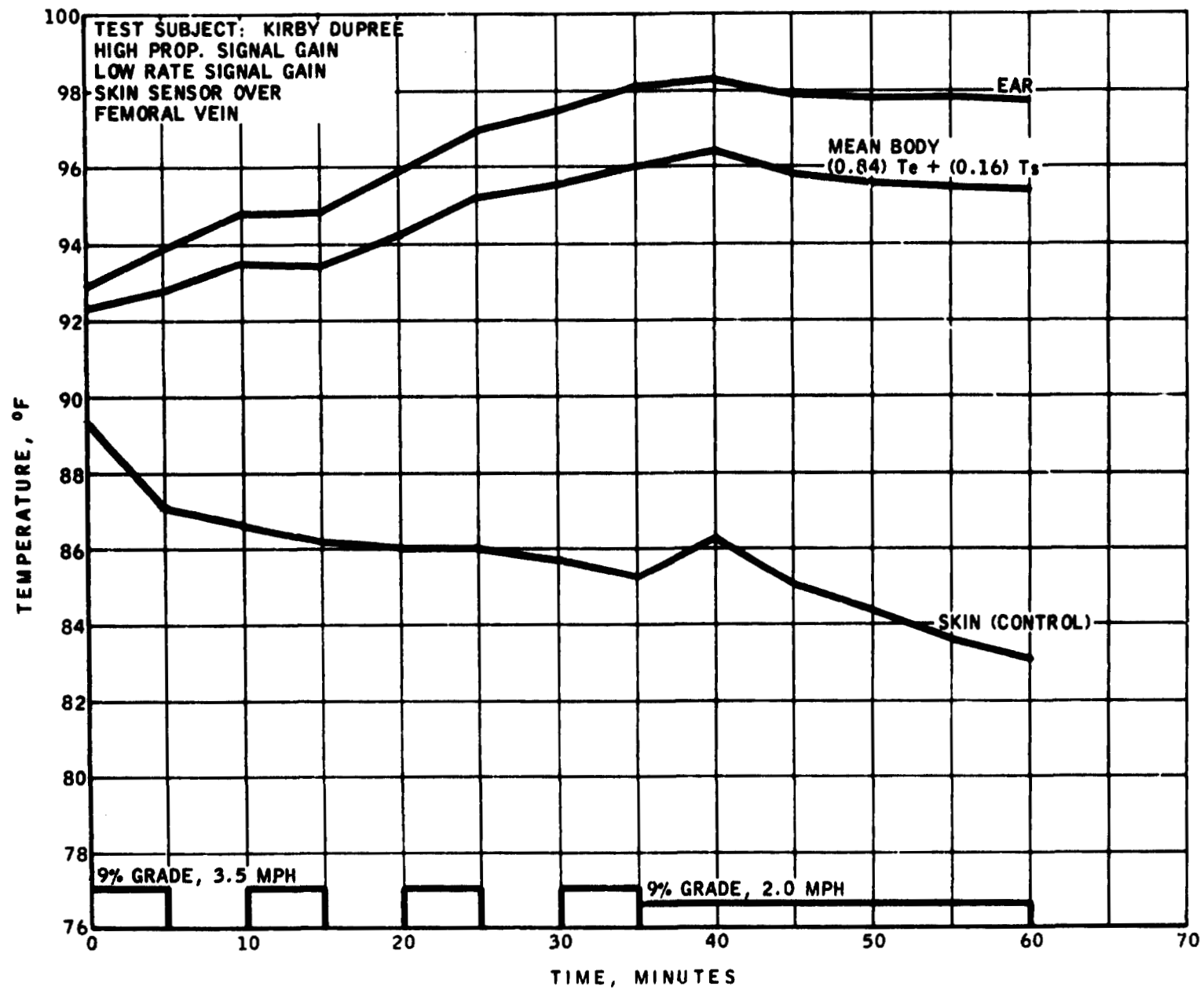

FIGURE 34. FINAL TEST DATA



TABLE 12  
TEMPERATURE DATA

Test Number	Change in Ear Canal Temperature, OF			Change in Skin Temperature Controlled Variable, OF		
	0-10 Minutes	10-20 Minutes	Maximum	To Point of Maximum Ear Temperature	Maximum	Occurring Before/After Ear Peak
1	0.5	1.2	3.3	- 3.8	- 4.2	After
2	0.4	1.0	5.0	- 5.1	- 7.0	After
3	0.5	0.9	3.7	- 6.9	- 7.2	Before
4	0.3	1.6	2.7	- 3.9	- 6.7	Before
5	0.2	0.9	2.1	-11.0	-11.0	Same
6	-1.3	0.1	-0.8	+ 2.5	+ 3.5	Before
7	0	1.1	3.8	- 7.4	- 7.5	Before
8	-0.1	0.1	0.6	- 1.7	- 1.7	Same
9	0.1	0.6	2.1	- 6.5	- 6.6	After
10	0.6	0.7	2.4	- 6.8	- 9.5	Same
11	1.9	1.0	4.9	- 3.1	- 6.2	After

Each score shown by Table 11 is the standard deviation in degrees Fahrenheit of mean body temperatures about the arithmetical mean for the test run. The lower the standard deviation, the higher the "score". Total ear temperature rise between the beginning of each test and the end of the first five minute rest period and between the end of the first and second rest periods is included in Table 12 for comparison with the scores. Discussion of results appears in Chapter VIII. Sample calculations are shown in Appendix 4. Statistical effects are tabulated by Table 13 for the main factors and the two factor interactions.

TABLE 13

## EFFECTS OF MAIN FACTORS AND TWO-FACTOR INTERACTIONS

Effects	Factors, Interactions, and Aliases
-0.420	A, -DE
0.175	B
0.475	C
0.270	D, -AE
0.400	E, -AD
0.400	BC
-0.270	BD
0.545	BE
1.055	CE
-0.045	AB
-0.195	AC
0.565	CD

The relative standings or contribution of the main effects A, B, C, D, and E are of limited interest and will not be considered further. What is of interest are the interactions having the greatest effect on system response. Of those interactions not involving the crewmen directly, BC and BD are the two with the greatest effects, i.e., the smallest absolute values, and are used to complete the design matrix. Two-way tables of interaction for BC and BD yield the combination of levels for B, C and D which should provide the best system performance.

TABLE 14  
INTERACTION BC FOR MEAN BODY TEMPERATURE  
CRITERIA OF ANALYSIS

Factor B Skin Sensor Mode	Factor C Ear/Skin Temperature Weighting	
	0.7(Ear Temperature) +0.3(Skin Temperature) (-)	0.84(Ear Temperature) +0.16(Skin Temperature) (+)
One sensor over femoral vein (-)	0.48	0.55
One sensor each on back, arm, chest, thigh (+)	0.25	1.13

TABLE 15

INTERACTION BD FOR MEAN BODY TEMPERATURE  
 CRITERIA OF ANALYSIS

Factor B Skin Sensor Mode	Factor D Proportional Signal Gain	
	10.0 (-)	5.0 (+)
One sensor over femoral vein (-)	0.52	0.51
One sensor each on back, arm, chest, thigh (+)	0.45	1.41

TABLE 16

INTERACTION SUMMARY FOR BC AND BD

B	C	D
+	-	
+		-
<hr/>		
+	-	-

Table 11 shows two tests with the combination of Table 16, i.e., tests 3 and 8. One had a high value of rate signal gain and one a low value. Test 8 was reconducted using both test subjects since it represented the better overall performance and the results of these two tests are given by the score column for tests 9 and 10.

An individually high score was also achieved in test 6 and that test was rerun as test 11 using a new test subject.

Comparisons of metabolic rates measured during the last eleven tests are given by Table 17.

TABLE 17

## COMPARISON OF METABOLIC RATES OF TEST SUBJECTS

Test Subject	Metabolic Rate, Btu/Hr	
	9% Grade, 3.5 mph	9% Grade, 2.0 mph
C. Pate	3002 3645 3144 2956 2898	1607 2131 1987 967 949
E. Scott	2298 2226 2362 2896 2054	1163 1193 1681 947 1768
K. Dupree	2878	1100

## CHAPTER VIII

## DISCUSSION

Performance Verification Test

The controller was found to have negligible drift during stability tests. In actual space operations a controller would be in continuous use for less than eight hours, and the amplifier voltage drift for that period of time would not be noticeable. Due to the feedback design, amplifier drift is automatically corrected for and special crew compensation is not required for any drift which does occur.

An error of 1.24% compared to predicted values was detected at the controller output, TP 17, during the Dynamic System Test. The error accumulated through the controller following the introduction of a simulated temperature function at TP 1, TP2 and TP 3, TP 4. The errors tend to cancel as they pass through the system and even the 8.62% error at TP 20, whose signal is summed with that of TP 13 to yield the output, TP 17, does not greatly affect the output.

Causes of the error at TP 20 are thought to be the Manual Input, which introduces a voltage into U1 if it is not calibrated, or if it drifts, and accumulative error caused by using 1.0% accuracy resistors. The drift stability test showed that the Manual Input could inject a drift error of 0.026 v/hr at the output (TP 17). Use of more accurate 0.1% resistors would improve performance although there have been no indications that propagated error is a problem. In general, the performance observed during the Performance Verification Test is considered quite satisfactory.

Preliminary Manned TestsPreliminary Test No. 1

The controller settings used for this test were based upon results of previous experiments. The test was completed in a satisfactory manner with all electronic equipment functioning properly. All mechanical components functioned properly with one exception. The heat exchanger circulating pump drive motor muffler (air driven) vibrated off during the test. The motor was adjacent to the treadmill and noisy. The immediate drop in skin temperature is believed to be related to the test subject's change in emotional state and a direct result of vasoconstriction. The period of time was so short that an increase in core temperature was not detected although the test subject felt he had "over heated" during the 40 seconds the pump was turned off. Based upon subjective comments and analysis of the data it was decided to increase controller sensitivity to change in mean body temperature slightly and decrease sensitivity to rate of change during the next test. An excessive amount of oscillation in controller output was observed and not understood during this test.

Preliminary Test No. 2

Test results for C. Dry looked very much like those for A. Behrend. The run was conducted completely "hands off" relative to controller settings and the test subject felt comfortable the entire time even though a defective amplifier caused a temporary interruption of cooling water and a rise in skin temperature during the 3.5 mph exercise. Analysis



of raw data suggested very little effect of the small changes in controller settings and it began to appear that perhaps one set of parameters could serve different test subjects. Behrend and Dry were the same size and build and were both in excellent condition. This fact, coupled with the relatively modest levels of work which were involved, led to the conclusion that the system had not really been tested regarding commonality of requirements. Oscillation of controller output was observed.

#### Preliminary Test No. 3

A more rigorous work routine was established for this test compared to previous ones and a relatively unconditioned test subject was used to exercise the system. The controller output did not oscillate as it had during previous tests but the test subject felt a requirement for more cooling than he received. Moderate sweating took place. Mechanical and electrical anomalies affected system operation and the provision of adequate cooling during this test, but the problem of chilling a test subject during rest after rigorous exercise was recognized as a potential problem.

#### Preliminary Test No. 4

The work routine and controller settings used for an untrained subject were repeated for this test using a trained subject.

System response was generally better although the subject felt warm at the end of the second work period and became chilled after work. The test subject had not worn an earmold with thermistor before and the variation in ear temperature shown by the test data is thought to be due in part to his movement and adjustment of the device during the test. It is interesting that skin temperature rose significantly during both exercise periods during intervals of time when ear temperature was dropping or was fairly steady. The test subject seemed to be very efficient in removing body heat by opening the peripheral vascular bed.

#### Preliminary Test No. 5

In general, the pretest procedures were the most effective used to date. The results are graphically illustrated by Figure 17. Shortly after the comm cap was donned, the recorded ear temperature began to climb exponentially as the ear mold temperature stabilized. Skin temperature was stable at first, and then dropped after room temperature water began circulating through the LCG.

According to test goals, the Preset was adjusted to give zero controller error signal when core temperature was  $94.5^{\circ}\text{F}$  and average skin temperature was  $91.5^{\circ}\text{F}$ .

An error was made in calculating the required Preset value, however, and the system was nulled when the core temperature was  $95.54^{\circ}\text{F}$  ( $35.3^{\circ}\text{C}$ ) and skin temperature was  $91.71^{\circ}\text{F}$  ( $33.17^{\circ}\text{C}$ ). This should have required  $(-0.62) (18) = -11.16$  volts for core and  $(0.1) (2) = 0.2$  volts for skin.

Summing gives -10.96 volts required at TP 10. From the Preset voltage curve this requires a setting of 7.15. The actual setting applied to the controller was 7.24, a 1.3% error from the setting calculated. It appears that the change in Preset was made early enough so that the results were not affected, and nulling the system at  $95.54^{\circ}\text{F}$  and  $91.71^{\circ}\text{F}$  yielded good results (Figure 17). Nulling at lower values would be expected to shift the total response downward if the capacity of the LCG and cooling system were not overtaxed.

The  $1.6^{\circ}\text{F}$  core temperature rise above baseline and  $10.9^{\circ}\text{F}$  drop in skin temperature are comparable in magnitude to the values of other investigators for comparable work levels but they are out of phase with the peaks reported by Webb. Webb drives skin temperature down much earlier and experiences a peak rectal temperature at about the time of work stoppage. For example (Webb, et al, 1970), with the test subject working for 1 hour at 2400 Btu/hr., the peak-to-peak delta for rectal temperature was about  $2.5^{\circ}\text{F}$  with the maximum occurring at the point of work stoppage. Minimum skin temperature was achieved at the same time, with a peak-to-peak difference of  $8.1^{\circ}\text{F}$ . Interestingly enough, after about twenty minutes of exercise, Webb's subject experienced a  $1.8^{\circ}\text{F}$  peak-to-peak difference in core temperature versus the  $1.6^{\circ}\text{F}$  peak-to-peak difference during this test.

Two anomaly-like trends are noted in the skin temperature curve of Figure 17. At 37.5 minutes into the test, corresponding to the end of the work cycle, skin temperature seems to level out for some

unexplained reason, and then drops. In drawing the curve that data point was neglected. Again, at about 62.5 minutes, the same thing happens but this time it extends over a fifteen minute period time frame. A dotted curve has been added to show the expected trend. It is possible that a skin thermistor came loose and due to test subject movement was intermittently in close skin contact. Note that the anomalies occurred during a period when the valve was open full and were not associated with similar variations of LCG water temperature.

#### Preliminary Test No. 6

During the previous test, average skin temperature was lowered to a minimum value of  $80.78^{\circ}\text{F}$  and ear temperature rose  $0.4^{\circ}\text{F}$  before the valve was full open. For this test it was desired to limit the minimum average skin temperature to about  $84^{\circ}\text{F}$  and to have the valve full open at the rate of ear temperature increase which occurred following onset of work during Preliminary Test No. 5. New core and skin temperature weighting factors for this test gave a mean body temperature,  $T_{mb} = 0.81 T_e + 0.19 T_s$ .

The test subject was comfortable although he perspired lightly at the end of the work period and was slightly cool later. The valve did close intermittently allowing skin temperature to rise as the ear temperature peaked and started down. All of the available rate sensitivity was used, however, and it began to appear that a design change might be required to increase the gain in the rate circuit.

Further study of skin sensor attachment techniques was initiated and the importance of avoiding overheating or cooling of test subjects before a test began to be clear.

The air-driven circulating pump did not have the capacity of the PLSS pump and steps were initiated to obtain and install an electric drive.

The short-sleeved LCG was identified as a potential cause of low skin temperatures also. The arms are efficient heat transfer surfaces and cooling them would reduce the necessity for such low body temperatures. Steps were therefore taken to obtain use of a long-sleeved LCG.

#### Preliminary Test No. 7

An illustration of the time required to stabilize earmold temperature is presented by the results of this test. Thirty minutes are required with the test subject wearing a communications cap.

The significant differences between pretest skin temperatures with the test subject in street clothes versus in the LCG and insulated garment, could be due to the difference between the temperature of the biceps where the initial readings were made, and the average temperature of the four locations measured during the work period, or it could be due to the test subject's activity in the insulated garment.

For this test a preset voltage was used so that an ear and skin temperature of  $94.5^{\circ}\text{F}$  and  $91.5^{\circ}\text{F}$  respectively would be nulled to zero. The subject had done some running before this test, and, partly because of that and possibly due to other factors, his initial, non-working ear temperature was about  $96.4^{\circ}\text{F}$  versus a  $94.5^{\circ}\text{F}$  ear temperature before the previous test. Consequently, the controller, from the very beginning, sensed an elevated body temperature and attempted to lower it by commanding full cooling as soon as it was activated. Some residual chilled water existed in the heat exchanger from pretest checkout, but chilled water circulation was not started through the heat exchanger until the test subject began to feel a need for additional cooling. At that point circulation was started and the test subject was supplied with full cooling until the test was stopped. For the next test it was proposed that core and skin temperature be nulled while room temperature water was circulating through the ICG.

It began to appear that the rises in skin temperature at the end of the heavy work periods in this and previous tests were associated with the rather steep rise in ear temperature at the same point and light secretions of sweat.

#### Preliminary Test No. 8

A long-sleeved ICG and higher capacity water pump were used in this test. During the first rest period skin temperature continued to drop prompting a reduction in proportional circuit gain. The net effect

of the change at  $74\frac{1}{2}$  minutes was to reduce system sensitivity to the deviation of mean body temperature from its baseline and to leave unchanged sensitivity to rate of mean body temperature change. (At the initial settings the relative weighting of core and skin temperature, or mean body temperature, was  $(0.71 T_e + 0.29 T_s)$ ). This change appeared to cause the valve to begin modulating and skin temperature to level out momentarily as shown by Figure 20 at  $74\frac{1}{2}$  minutes. The drop in skin temperature at the onset of the second work period is of interest since there is no increase in valve command. Similar trends can be seen in other test results as well. The drop may be due to reduction of peripheral blood flow following onset of work as muscle requirements increase.

The test subject commented that the "LCG felt cooler when he pressed it from the outside." Poor contact between the test subject's skin and garment was observed.

Both the results and test subjects' comments indicate that the long-sleeved LCG and higher cooling water flow rate resulted in a more effective system for removing body heat. During previous tests the subject had reported being uncomfortably warm, and the LCG liner and his skin were damp from perspiration following tests at this work rate. During this test the subject reported being "on the borderline of being uncomfortably warm" during the second work period only. It is of interest that the LCG used had more tubing than the present Apollo garment and does not

have a liner, i.e., the tubes can be directly in contact with skin. The tubing appeared to be coated internally with a deposit of some sort which may have affected heat transfer to some degree.

The procedure of nulling the crewman's ear and skin temperature signals after exposing him to circulating room temperature water (through the LCG) just before beginning the work cycle was satisfactory. Core and skin temperature at that point were  $94.5^{\circ}\text{F}$  and  $91.6^{\circ}\text{F}$ , very close to the  $94.5^{\circ}\text{F}$  and  $91.5^{\circ}\text{F}$  combination which had been used as a pretest, preset null in previous tests.

During previous tests in which only one work period was used, the continued rise of ear temperature after the test subject sat down, and the continued elevation of ear temperature above pretest levels for some time after work stoppage, caused full cooling to take place for quite some time after the test subject stopped work and seated himself. Usually within five to ten minutes after work stoppage the test subjects felt that they would like to reduce cooling even though ear temperature was still at a peak and not showing any downward trend. This suggests a skin temperature-work rate relationship for comfort, independent of core temperature.

Inspection of Figure 20 and Table 6 reveals some further interesting points. It is obvious, at least regarding this test subject, that there are factors other than skin temperature, which affect comfort. Some light perspiration may have occurred, for example, and the resulting



"clammy" feeling may have promoted a feeling of slight discomfort more than just temperature depression.

#### Preliminary Test No. 9

At the beginning of the second work cycle, 94 minutes into the test, there was a reduction in ear temperature with onset of work. The test subject was subcooled at the beginning of work, and it appears that with the start of work, blood may have begun flowing through certain cold regions. Blood flow to the ear canal obviously began arriving in a cooler state than before work onset, and there was a five minute time lag before skin temperature began to see the effects of increased surface flow. The test of May 27 (Preliminary Test No. 8) reveals a similar drop in ear temperature with onset of the second work period, but to a much lesser degree ( $0.1^{\circ}\text{F}$  vs  $0.6^{\circ}\text{F}$ ). Skin temperature was  $88.3^{\circ}\text{F}$  prior to work onset during the earlier test vs  $88.2^{\circ}\text{F}$  during this test. Ear temperature was  $97^{\circ}\text{F}$  vs  $96.1^{\circ}\text{F}$  during the previous test.

During the second work period valve command increases with mean body temperature in a generally proportional manner. Analysis of results indicated a requirement for faster valve opening with onset of internal heating. A decision was made to modify the controller to increase valve command sensitivity to rate of change of mean body temperature.

#### Preliminary Test No. 10

Total system performance was acceptable with valve action generally following change in mean body temperature and the test

subject remained comfortable. Rise in skin temperature during exercise was observed, and a decision was made to investigate the possibility of providing lower temperature water to the LCG inlet manifold.

#### Preliminary Test No. 11

Temperature responses are illustrated graphically by Figure 23. The controller performed very well and, despite the fact that Pate and Hansen are very different with respect to their levels of conditioning and physiological thermal control responses, the system performed in an exceptional manner with the same control settings for Pate that had proven successful for Hansen.

This was the first complete manned run using the  $\text{LN}_2$  cooled heat exchanger with insulated lines, and a need for improving operational procedures became evident. During unmanned system checkout the LCG water loop was blocked by an ice plug at a location in close proximity to an  $\text{LN}_2$  line. The water line was cleared before the manned run and start up procedures were changed so that water passed through the LCG loop during cool-down, and the water bath cool-down rate was slowed by throttling the  $\text{LN}_2$ . A net result of these procedures was a higher LCG inlet water temperature at the beginning of the manned run than was desired. In the present test rig design, inlet water temperature is a function of LCG outlet water temperature, the thermal capacity of the system, metabolic rate, valve position, or how much flow is by-passed, and other factors. The minimum LCG inlet water temperature observed on

this manned run was 55.4°F measured at the LCG inlet manifold.

The test subject was not in good physical condition for this test as evidenced by rather profuse perspiration, his comments and the rather high maximum ear temperature. He lost 1 kg of weight during the 80 minutes of test time. Six tenths of a kilogram would have been considered marginally high. His maximum work rate was measured at 3464 Btu/hr for 11.2% grade and 3.5 mph. (During a previous calibration run, he was stressed at a level of 4229 Btu/hr under similar conditions.) Hansen's metabolic rate was 1600 Btu/hr during one run under identical conditions. The 1.7°F spread on mean body temperature, though not excessive, was considered high.

The test subject was comfortable during the five minute rest periods and for about one half of each five minute work cycle. He reported that he would like to have had colder water during the latter part of each five minute work cycle.

The steep drop in skin temperature during the last five minute work period is of interest. There is nothing to indicate a failure of skin temperature sensing elements or other components, and the LCG inlet water temperature was higher on the average than during previous work periods. A slight drop in ear temperature is also noted. It appears that the test subject may have suffered a momentary circulation problem on commencement of this work period. (He commented during the previous one that due to fatigue he did not know whether he could continue, but he recovered adequately during the rest period which followed.) If

there were some circulation difficulties, it would seem logical that peripheral vasoconstriction may have taken place to maintain the blood supply to the brain. Without an adequate flow of blood to the skin, skin temperature would have dropped rather quickly in the presence of the cold LCG water. A slightly decreased supply of blood to the head would account for the drop in ear temperature as well, or since ear canal temperature is influenced greatly by skin temperature, a general vasoconstriction may have accounted for the recorded drop in ear temperature. If there were no circulation difficulties, then the physiological mechanism which prompted the apparent vasoconstriction is not understood. ECG's were not used on this run due to the low metabolic levels observed previously with Hansen, but they were used on all test subjects thereafter.

The 9-sensor skin temperature harness was operational only during the last half of the test, but its trends are comparable to those of the average skin temperature used as part of the controller input signal. The displacement of the two curves is at least partly due to the fact that 30% of the total number of sensors in the harness are situated on non-cooled skin areas, i.e., hand, foot and forehead.

### Quarter Replicate Tests

The criteria for evaluating system performance evolved from test data analysis and comments from test subjects. Tests which yielded the least test subject fatigue and perspiration and most favorable comments were those with the flattest mean body temperature response. These and other considerations led to the decision to evaluate total system response for each quarter replicate and final test according to the variance of mean body temperature. Since comparisons usually are more easily made when the measure of variation is in the same units of measurement as the data, the standard deviation, or square root of variance, is presented by Table 11 in the Results.

Inspection of Table 11 reveals that of the first eight tests, which correspond to the desired Quarter Replicate Test, Test No. 8 has the least variation of mean body temperature and therefore the "highest" score. Referring to the section Quarter Replicate and Final Manned Tests in Chapter VI reveals that Test Nos. 3, 6, and 8 were each the second of two tests conducted on the same day, and with the same test subject, i.e., Test Nos. 2 and 3 used C. Pate; Test Nos. 5, 6, 7, and 8 used G. Scott. Of Pate's four tests, Test No. 3 had the highest score. Test Nos. 6 and 8 yielded Scott's highest scores. Pate had fully recovered before starting his second test, Test No. 3, but Scott had not, as evidenced by the Results curves, Figures 28-31.

The object in conducting the tests in this manner was twofold. It was of interest to see how the system would respond to these different initial conditions. It was also of interest to see the results of the following sequence of actions:

- a. Identify the "best" controller parameters by applying the selected evaluation criteria to the Quarter Replicate Test results.
- b. Conduct a test with each test subject using the recommended controller parameters, and compare the two scores with the previous Quarter Replicate scores.

The difficulty in identifying "best" combinations of parameters by studying the data above is illustrated by Table 12. Test No. 6 yielded the least increase in ear temperature, i.e., there was a net reduction compared to the initial ear temperature, but skin temperature rose during the test. Other comparisons of data shown by Figures 24-31 leads to similar difficulties in interpretation. These difficulties were reduced by the following technique (Box, 1960).

The effects of the factors for the first eight tests were found by applying the signs of each column of Table 11 to the score column of Table 11. The results of this procedure are shown by Table 13. Some of the effects of main factors are confused with two factor interactions, e.g., A and -DE, but the relative effects of the main factors are not

of interest at this time. What is of interest are the recommended levels of the main factors, exclusive of the test subjects, viz., the object is not to identify the "best" test subject, but rather the "best" controller settings.

The two factor interactions shown by Table 13 are obtained by multiplying columns of Table 11 together row-by-row in all combinations and then applying the results to the column of scores as before. Three factor and higher interactions are not realistic for this test and are neglected.

Seven factors and interactions use all the degrees of freedom available, and subtracting the five main effects leaves two interactions capable of being considered. The interactions which include factor A, the test subject, are not of interest as mentioned. Of the remaining interactions which are not confused with main effects, BC and BD have the greatest effects, i.e., the lowest absolute values, corresponding to the least variations in mean body temperature. Two-way tables of interactions BC and BD are shown by Tables 14 and 15.

Table 11 shows that Test Nos. 1 and 5 have (-) values for factors B and C. The mean value of the scores for Test Nos. 1 and 5 is inserted in the (-)B, (-)C position of the two-way table shown by Table 11. The other values are obtained in the same manner. The lowest value in

the two-way table corresponds to the combination of factor levels which provided the least variation in mean body temperature. A summary of Tables 14 and 15 is provided by Table 16 which shows that the combinations of levels of factors B, C, and D which should provide the least variation in mean body temperature for both test subjects is (+)B, (-)C, and (-)D. There were insufficient degrees of freedom to draw a similar conclusion about factor E. Inspection of Table 11 revealed that Test Nos. 3 and 8 used the recommended levels for B, C, and D, and of the two ratings, Test No. 8 had the higher. Test No. 3 used (-)E and Test No. 8 used (+)E. It was decided to use the value of E which had yielded the higher previous rating and to conduct Tests 9 and 10 using both test subjects as shown by Table 11.

The score obtained by Scott as a result of Test No. 9 yielded a low variation in mean body temperature, second only to Test No. 8. Pate's score resulting from Test No. 10 was his best one. Both test subjects commented that the combination provided a comfortable temperature control.

Scott's second best test run, Test No. 6, was repeated using a new test subject. The results are shown as Test No. 11 results in Table 11. The combination did not prove nearly so satisfactory for the new subject, but there were probably other factors at work. The test subject was not trained for the task and previous test results have suggested that this influences a test subject's thermal regulation response.



Table 17 provides data to illustrate another dimension in the analysis of test results. Metabolic rates measured during each test showed considerable scatter in some cases. These differences occur as a result of variations in measurement techniques and equipment and test subject actions. For example, if a test subject holds on to the treadmill cross-bar while walking, less effort is required, and a lower rate is recorded. Due to the variations in metabolic rates observed for single test subjects, even when all known test factors were held constant, it was decided to keep the treadmill grade and speeds fixed and let metabolic rate vary instead of trying to maintain fixed work rates by varying treadmill grade and speed. The controller was designed to adjust to variations in cooling requirements so it was not expected that these differences, if real, would affect the final outcome.

In summary, this research found that mean body temperature can be sensed in a feedback control system, compared to a set point signal representing mean body temperature at relative thermal neutrality, and used as the actuating signal for control of water temperature entering the astronaut's liquid cooling garment. Skin temperature is lowered to a sufficient degree and with the proper time phasing so that mean body temperature, as sensed by the controller, is maintained essentially constant. Subjectively, test subjects prefer to maintain a constant or slightly reduced index of stress as represented by mean body temperature during work.

Two test subjects with significantly different physiological responses to work preferred the same controller settings and achieved their best performances with those settings. Results obtained on repeated tests with the same and different test subjects were consistent, but more testing would be required to develop statistical confidence in a "universal" set of controller gains.

One feature which would be welcomed by all test subjects interviewed is head cooling, and use of cooling hoods, such as those used by Webb (1966) and Shvartz (1970), should be investigated as more effective temperature control systems become necessary.

An interesting fact which came to light during the testing is the lack of sensitivity of the controller, relative to its proper operation, to what the test subject wears over the ICG, if anything. Early in the testing an insulated garment was worn over the ICG and concern was exercised by controlling the ambient temperature to minimize heat loss or gain from the environment. It was observed, however, that the system functioned well without the outer garment. The controller senses core and skin temperatures. If there is heat leakage into the system from the environment during a test, raising cooling water temperature, mean body temperature tends to rise causing more water to be shunted through the heat exchanger in compensation. If net heat transport is in the other direction, e.g., due to increased whole body convective transfer, mean body temperature tends to drop, other factors

being the same, and less demand for cooling results. For demonstration of conceptual feasibility nothing is gained by using an outer insulating garment and requiring close control of ambient temperature, and dispensing of these factors greatly simplifies experimentation.

The experiment design by Box (1960), partially described in Chapter VI, can be used to minimize the amount of testing required to achieve specific goals, particularly in experiments where large numbers of variables are known to affect systems' responses. Although the full power of the technique was neither needed nor involved in this research, it is clear that savings in resources can be made if an experimental program is planned well in advance and uses the principles described by Box.

## REFERENCES

1920

- HILL, L. Cooling and warming of the body by local application of cold and heat. Proc. Physiol. Soc., London 54: 137.

1935

- BURTON, A. C. Human calorimetry: II. The average temperature of the tissues of the body. J. Nutr. 9: 261.

1941

- ROBINSON, S.,  
et al Adaptation to exercise of negro and white share-croppers in comparison with northern whites. Human Biology 13: 139-158.

1947

- ADOLPH, E. F.  
et al Physiology of man in the desert. Interscience Publishers, Inc., New York.

1954

- BLOCKLEY, W. V.;  
MC CUTCHEN, J. W.;  
and TAYLOR, C. L. Prediction of human tolerance for heat in aircraft; a design guide. Wright Air Development Center Tech. Rep. 53-346.

1958

- MACPHERSON,  
R. K. Acclimatization status of temperate-zone man. Nature 182: 1240-1241.
- WYNDHAM, C. H.  
and  
MORRISON, J. F. Adjustment to cold of bushmen in the Kalahari desert. J. Appl. Physiol. 13: 219-225.

1960

- BOX, GEORGE E.P.,  
et al            The design and analysis of industrial experiments.  
                 Edited by Owen L. Davies. Published for Chemical  
                 Industries Ltd. by Oliver and Boyd, London, Hafner  
                 Publishing Company, New York.

1962

- DICKE, R. H.            The earth and cosmology. Science 138: 653-664.

1963

- BASS, DAVID E.            Thermoregulatory and circulatory adjustments during  
                 acclimatization to heat in man. Temperature - Its  
                 measurement and control in science and industry,  
                 Vol. 3. Part 3: Biology and Medicine. Edited by  
                 James D. Hardy. New York: Reinhold Publishing Co.,  
                 299-305.
- BENZINGER, T. H.  
and  
TAYLOR, G. W.            Cranial measurements of internal temperature in man.  
                 Temperature - Its measurement and control in science  
                 and industry, Vol. 3. Part 3: Biology and Medicine.  
                 Edited by James D. Hardy. New York: Reinhold  
                 Publishing Co., 111-120.
- HARDY, J. D.  
and  
HAMMEL, H. T.            Control system in physiological temperature regulation.  
                 Temperature - Its measurement and control in science  
                 and industry, Vol. 3. Part 3: Biology and Medicine.  
                 Edited by James D. Hardy. New York: Reinhold  
                 Publishing Co., 613-625.
- HERTZMAN, A. B.            Regulation of cutaneous circulation during body heating.  
                 Temperature - Its measurement and control in science  
                 and industry, Vol. 3. Part 3: Biology and Medicine.  
                 Edited by James D. Hardy. New York: Reinhold  
                 Publishing Co., 559-570.
- MINARD, DAVID  
and  
COPMAN, LOUIS            Elevation of body temperature in health. Temperature -  
                 Its measurement and control in science and industry,  
                 Vol. 3. Part 3: Biology and Medicine. Edited by  
                 James D. Hardy. New York: Reinhold Publishing Co.,  
                 527-543.

- RANDALL, W. C.      Sweating and its neural control. Temperature - Its measurement and control in science and industry, Vol. 3. Part 3: Biology and Medicine. Edited by James D. Hardy. New York: Reinhold Publishing Co., 275-286.
- ROBINSON, SID      Circulatory adjustments of men in hot environments. Temperature - Its measurement and control in science and industry, Vol. 3. Part 3: Biology and Medicine. Edited by James D. Hardy. New York: Reinhold Publishing Co., 287-297.
- 1964
- BURTON, D. R.      The development of water conditioned suits. Tech. Note. Mechanical Eng. 400. Ministry of Aviation, London.  
and  
COLLIER, L.
- COOPER, K. E.;      Temperature in the external auditory meatus as an  
CRONSTON, W. I.;    index of central temperature changes. J. Appl.  
and                    Physiol. 19(5): 1032-1035.  
SNELL, E. S.
- CROCKER, J. T.;    Metabolic heat balances in men wearing liquid-  
WEBB, P.;            cooled sealed clothing. AIAA-NASA Third Manned  
and                    Spaceflight Meeting (AIAA publication CP-10),  
JENNINGS, D. C.    111-117.
- GELINEO, S.        Organ systems in adaptation: the temperature regulat-  
ing system. Handbook of physiology, Section 4:  
Adaptation to the environment. American Physiological  
Society, 259-282.
- LADELL, W. S. S.    Terrestrial animals in humid heat: man. Handbook of  
physiology. Section 4: Adaptation to the environment.  
American Physiological Society, 625-659.
- NELSON, W. G.;      Preliminary results of the Gemini extravehicular suit  
BROWN, L.;            pressurization. AiResearch Manufacturing Company,  
and                    Los Angeles, Report No. 55-3135.  
KRUMLAND, L. R.
- WYNDHAM, C. H.      Physiological reactions to heat of bushmen. J. Appl.  
et al                    Physiol. 19: 885-889.

1965

- BURTON, D. R.  
and  
COLLIER, L.           The performance of water conditioned suits.  
R. A. F. Tech. Report No. 65004. Ministry of  
Aviation, Farnborough, Hants, England.
- STRYDOM, N. B.  
et al                 Oral/rectal temperature differences during work  
and heat stress. J. Appl. Physiol. 20(2) 238-287.
- WYNDHAM, C. H.       Role of skin and core temperature in man's tempera-  
ture regulation. J. Appl. Physiol. 20: 31-36.
- YAMAMOTO, W. S.  
and  
BROBECK, J. R.       Physiological controls and regulations.  
Philadelphia: W. B. Saunders Company.

1966

- FOLK, G. E.           Introduction to environmental physiology.  
Philadelphia: Lea and Febiger.
- WALIGORA, JAMES  
and  
MICHEL, E. L.         Application of conductive cooling for working men  
in a thermally isolated environment. (Abstract)  
Aerospace Med. 37: 206.
- WEBB, PAUL  
and  
ANNIS, J. F.         Bio-thermal responses to varied work programs in  
men kept thermally neutral by water cooled clothing.  
Contract No. NASw-1306 from Biotechnology and  
Human Research Division, Office of Advanced Research  
and Technology, NASA Headquarters, Washington, D. C.

1967

- GIBBONS, L. V.       Body temperature monitoring in the external auditory  
meatus. Aerospace Medicine 38(7): 671-675.
- WALIGORA, J. M.       Thermal comfort and tolerance design criteria.  
NASA-MSC Report No. BRO DB-57-67.
- WALIGORA, J. M.       An evaluation of flow control as a means of attaining  
comfort. NASA-MSC DB22/06/008.

1968

- CHATO, JOHN C.  
et al                   Physiological and engineering study of advanced thermoregulatory systems for extravehicular space suits. Semiannual Status Report No. 2. Contract NGR 14-005-103. Department of Mechanical and Industrial Engineering, University of Illinois, Urbana, Illinois.
- HOODES, Y.  
and  
COLIN, J.               Effects sur l'homme de l'immersion dans l'eau froide. Agard Thermal Problems in Aerospace Med., 211-216.
- MICHEL, E. L.  
and  
WALIGORA, JAMES      Private communication during meeting held at NASA Manned Spacecraft Center, Houston, Texas, November 21.
- STARR, J. B.  
and  
MERRILL, G. L.        Fluidic temperature control for liquid-cooled flight suits. NADC-AC-6818. Naval Air Development Center, Johnsville, Warminister, Pennsylvania.
- WEBB, PAUL;  
ANNIS, J. F.;  
and  
TROUTMAN, S. J.      Automatic control of water cooling in space suits. NASA CR-1085. National Aeronautics and Space Administration, Washington, D. C.
- ZOERB, EDWARD G.     Liquid fluidics controls flight suit temperature. Hydraulics and Pneumatics 21: 111-115.

1969

- BERRY, CHARLES A.    Lunar Medicine. Science J. 5: 103-107.
- DATTA, S. R.  
and  
RAMANATHAN, N. L.    Energy expenditure in work predicted from heart rate and pulmonary ventilation. J. Appl. Physio. 26(3): 297-302.
- GAGGE, A. P.;  
STOLWIJK, J. A. J.;  
and  
SALTIN, B.            Comfort and thermal sensations and associated physiological responses during exercise at various ambient temperatures. Environmental Research 2: 209-229.
- MOOREHOUSE, L. E.    Model of a system utilizing heart rate to monitor man at work in an alien environment. Conf. Inst. of Electrical and Electronic Engineers and Ergonomics Res. Soc. Int. Symposium of Man-Machine Systems, St. John's College, Cambridge, England, September 8-12, 1969, Proceedings. Volume 3: Decision Making and Mental Work Load.



## 1969 (CONTINUED)

- WURSTER, R. D.  
and  
MCCOOK, R. D.      Influence of rate of change in skin temperature on sweating. J. Appl. Physiol. 27: 237-240.

1970

- BILLINGHAM, J.      Physiological specifications for personal life support systems. Portable Life Support Systems, NASA SP-234. Ames Research Center Conference, Moffett Field, California. April 30 - May 2, 1969. Washington, D. C.: National Aeronautics and Space Administration.
- SHVARTZ, ESAR      Effect of a cooling hood on physiological responses to work in a hot environment. J. Appl. Physiol. 29(1): 36-39.
- TROUTMAN, S. J.;  
JR.; and  
WEBB, PAUL      Automatic controllers for the Apollo LCG. Contract NAS9-9778, Manned Spacecraft Center, National Aeronautics and Space Administration, Houston, Texas.
- WEBB, PAUL;  
TROUTMAN, S. J.  
JR.; and  
ANNIS, J. F.      Automatic cooling in water cooled space suits. Aerospace Med. 41(3): 269-277.

APPENDIX 1

MEAN BODY TEMPERATURE COEFFICIENTS

## APPENDIX I

## MEAN BODY TEMPERATURE COEFFICIENTS

Suppose a test subject is required to exercise at a number of work rates. Suppose also that his liquid cooling garment inlet water temperature is controlled so that he stores only the amount of heat, or less, shown by Waligora (Figure 1, 1967a) during his activity period. The questions to be addressed are what is the relationship between core and average skin temperature during this period and can coefficients C and D be determined such that mean body temperature,  $T_{MB} = C \cdot T_{core} + D \cdot T_{skin}$ , where  $C + D = 1$ .

For the ranges to be examined a scatter diagram and regression line similar to that illustrated below is obtained:

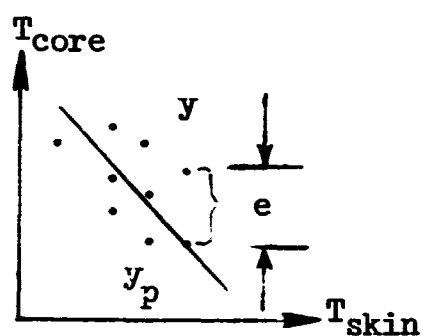

1) Let,  $T_{core} = y$

$(T_{core})_p = y_p =$  Corresponding point on regression line.

$T_{skin} = x$

Then, the regression line is

2)  $y_p = Bx + A$

3) Error,  $e = y - y_p = y - (A + Bx)$

$$\begin{aligned}
 4) \text{ Mean square error, } &= \overline{e^2} \\
 &= \overline{(y - y_p)^2} \\
 &= \overline{[y - (A + Bx)]^2}
 \end{aligned}$$

Criteria for minimum mean square error:

$$5) \frac{\partial \Delta}{\partial A} = -2 \bar{y} + 2A + 2B\bar{x} = 0$$

$$\frac{\partial \Delta}{\partial B} = -2 \overline{xy} + 2 A\bar{x} + 2B\overline{x^2} = 0$$

Solution of minimization criteria for B and A yields the following:

$$6) B = \frac{\overline{xy} - \bar{x}\bar{y}}{\overline{x^2} - \bar{x}^2} = \frac{\overline{(x - \bar{x})(y - \bar{y})}}{\sigma_x^2} = \frac{m_{xy}}{\sigma_x^2}$$

$$7) A = \bar{y} - \bar{x} \frac{\overline{(x - \bar{x})(y - \bar{y})}}{\sigma_x^2} = \bar{y} - \frac{m_{xy} \bar{x}}{\sigma_x^2}$$

8) then,

$$y_p = y + \frac{m_{xy}}{\sigma_x^2} (x - \bar{x}),$$

where,

$$9) m_{xy} = \overline{xy} - \bar{x}\bar{y} = \overline{(x - \bar{x})(y - \bar{y})}$$

$$\sigma_x^2 = \overline{x^2} - \bar{x}^2$$

$x, y$  = Variables

$\bar{x}, \bar{y}$  = Means of variables

$$\bar{x} = \frac{1}{n} \sum_{i=1}^n x(i)$$

$$\bar{y} = \frac{1}{n} \sum_{i=1}^n y(i)$$

From equation (1) and the preceding discussion,

$$10) (T_{\text{core}})_p = B \cdot T_{\text{skin}} + A, \text{ and}$$

$$T_{\text{MB}} = C \cdot T_{\text{core}} + D \cdot T_{\text{skin}},$$

$$1 = C + D.$$

Then,

$$11) C \cdot T_{\text{core}} = -D \cdot T_{\text{skin}} + T_{\text{MB}},$$

$$T_{\text{core}} = \frac{D}{C} \cdot T_{\text{skin}} + \frac{T_{\text{MB}}}{C},$$

Yielding,

$$12) B = -\frac{D}{C}, A = \frac{T_{\text{MB}}}{C}.$$

Since,

$$13) C + D = 1,$$

$$C - B \cdot C = 1, \text{ and,}$$

$$C = \frac{1}{1 - B}, D = -B \cdot C,$$

C and D thus derived provide appropriate weighting of core and skin temperatures for determination of mean body temperature during subsequent tests.

APPENDIX 2

ALGORITHM COEFFICIENT IDENTIFICATION

## APPENDIX 2

## ALGORITHM COEFFICIENT IDENTIFICATION

Let  $\Theta$ ,  $T$ ,  $\dot{T}$  represent the available variables and consider the problem of estimating the variable by means of a linear function of the other two variables. If the variable used to estimate  $\Theta$  is denoted  $\Theta'$ , the linear estimating function may be expressed as:

$$(1) \Theta' = C_0 + C_1 T + C_2 \dot{T}$$

where the C's are to be determined from available data. Geometrically, the problem is one of finding the equation of the plane which best fits, in the sense of least squares, a set of  $n$  points in  $K+1$  dimensions, where in this case  $K = 2$ .

The problem is to find the set of C's that will minimize the sum

$$\sum_{i=1}^n (\Theta_i - \Theta'_i)^2.$$

It is more convenient to work with variables measured from their sample means, hence, let

$$(2) \theta = \Theta - \bar{\Theta}$$

$$(3) r = T - \bar{T}$$

$$(4) \dot{r} = \dot{T} - \bar{\dot{T}}$$

$$(5) \theta' = \Theta' - \bar{\Theta}, \text{ thus}$$

$$(6) \Theta - \Theta' = \theta + \bar{\Theta} - (\theta' + \bar{\Theta}) = \theta - \theta'$$

Rewriting equation (1),

$$(7) \theta' = a_0 + a_1 r + a_2 \dot{r}$$

where the  $a$ 's could be expressed in terms of  $\bar{\theta}$ , the  $c$ 's and the  $\bar{T}$ 's and  $(\bar{T})$ 's. However, minimizing  $\sum(\theta - \theta')^2$  is equivalent to minimizing  $\sum(\theta - \theta')^2$  (re equation 6). Thus the  $a$ 's can be determined to minimize the latter which, using (7), is written

$$(8) \quad G(a_0, a_1, a_2) = \sum[\theta - a_0 - a_1 r - a_2 \dot{r}]^2$$

For the function to have a minimum, its partial derivatives must vanish,

hence the  $a$ 's must satisfy the equations

$$(9) \quad \frac{\partial G}{\partial a_0} = \frac{\partial G}{\partial a_1} = \frac{\partial G}{\partial a_2} = 0.$$

Differentiating (8) yields

$$(10) \quad \begin{aligned} \sum 2[\theta - a_0 - a_1 r - a_2 \dot{r}] (-1) &= 0 \\ \sum 2[\theta - a_0 - a_1 r - a_2 \dot{r}] (-r) &= 0 \\ \sum 2[\theta - a_0 - a_1 r - a_2 \dot{r}] (-\dot{r}) &= 0 \end{aligned}$$

Multiplying by 1/2, summing term by term and transposing the first terms yields

$$(11) \quad \begin{aligned} \text{a.} \\ \sum \theta &= na_0 + a_1 \sum r + a_2 \sum \dot{r} \\ \text{b.} \\ \sum r\theta &= a_0 \sum r + a_1 \sum r^2 + a_2 \sum r \cdot \dot{r} \\ \text{c.} \\ \sum \dot{r}\theta &= a_0 \sum \dot{r} + a_1 \sum r \cdot \dot{r} + a_2 \sum \dot{r}^2 \end{aligned}$$



$$\begin{aligned} \text{Since } \sum r_i &= \sum (T_i - \bar{T}_i) = 0, \\ \sum (\dot{r})_i &= \sum (\dot{T})_i - (\dot{\bar{T}})_i = 0, \text{ and,} \\ \sum \theta &= \sum (\Theta - \bar{\Theta}) = 0, \end{aligned}$$

all terms in (11a) except the first vanish; thus,  $a_0 = 0$ , leaving (b) and (c), which are reduced to

$$(12) \quad \sum r \cdot \theta = a_1 \sum r^2 + a_2 \sum r \cdot \dot{r}$$

$$(13) \quad \sum \dot{r} \cdot \theta = a_1 \sum r \cdot \dot{r} + a_2 \sum (\dot{r})^2$$

or

$$(12a) \quad \sum (T - \bar{T}) (\Theta - \bar{\Theta}) = a_1 \sum (T - \bar{T})^2 + a_2 \sum (T - \bar{T}) [\dot{T} - \dot{\bar{T}}]$$

$$(13a) \quad \sum [\dot{T} - \dot{\bar{T}}] (\Theta - \bar{\Theta}) = a_1 \sum (T - \bar{T}) (\dot{T} - \dot{\bar{T}}) + a_2 [\dot{T} - \dot{\bar{T}}]^2$$

From (7),

$$(14) \quad \theta' = a_1 (T - \bar{T}) + a_2 (\dot{T} - \dot{\bar{T}}) = \Theta' - \bar{\Theta}$$

$$(15) \quad \Theta' = \bar{\Theta} - a_1 \bar{T} - a_2 (\dot{\bar{T}}) + a_1 (T) + a_2 (\dot{T})$$

$\Theta'$  is the command  $\Theta$  desired based upon instantaneous values of  $T$  and  $\dot{T}$ .

Referring to equation (1),

$$(16) \quad C_0 = \bar{\Theta} - a_1 \bar{T} - a_2 \dot{\bar{T}},$$

$$(17) \quad C_1 = a_1, \text{ and,}$$

$$(18) \quad C_2 = a_2.$$

Rewriting equations (12a) and (13a) with the obvious substitutions yields

$$(19) \quad E = a_1 \cdot F + a_2 \cdot G$$

$$(20) \quad H = a_1 \cdot G + a_2 \cdot I,$$

from which  $a_1$  and  $a_2$  are readily obtained.

APPENDIX 3

CONTROLLER BREADBOARD OPERATIONAL DESCRIPTION

## APPENDIX 3

## CONTROLLER BREADBOARD OPERATIONAL DESCRIPTION

The breadboard, or prototype, model of the Liquid Cooling Garment Controller consists of temperature sensing bridges, amplifiers, a differentiator, and a current to air transducer. All amplifiers have null balancing circuits for stabilization and a range of gains for laboratory experimentation. A schematic is presented by Figure 4.

Thermister Bridge Circuits and Power Supply

Power for the thermister bridge circuit is obtained from negative and positive 15 v regulated power supplies and is further conditioned by  $ZR_1$ ,  $ZR_2$ ,  $R_7$  and  $R_8$ , until 10 vdc is provided to each bridge.

The temperature sensing circuit is composed of two bridges, a core bridge and a skin bridge. Core bridge output is designed to go positive if the astronaut's body temperature exceeds  $98.6^{\circ}\text{F}$  and negative if it drops below  $98.6^{\circ}\text{F}$ . Skin bridge output is designed to go positive if the astronaut's skin temperature exceeds  $91.2^{\circ}\text{F}$  and negative if it drops below  $91.2^{\circ}\text{F}$ , i.e., the core bridge is designed to balance at  $98.6^{\circ}\text{F}$  and the skin bridge is designed to balance at  $91.2^{\circ}\text{F}$ .

Bridge voltage output per degree C change is designed to be approximately the same for each bridge, (0.114 v), assuming that all four of the skin thermistors sense the  $1^{\circ}\text{C}$  change. Referring to Figure 4,  $TR_1$  (core sensing) is a single YSI 44011 thermistor and  $TR_2$  (skin sensing)

is four of the same thermistors wired in series. Outputs from the bridges are applied to the bridge and summing amplifier circuits.

#### Bridge and Summing Amplifier Circuits

U5 and U6 are high input impedance, stable, operational amplifiers used for amplifying the temperature sensing bridge outputs. Feedback controlling potentiometers R-35 and R-27 have been provided so that the gain of each amplifier can be adjusted between X5 and X15. Multi-turn helipot with high resolution dials, 0-1000, were provided for this purpose allowing gain selection within  $\pm 1\%$  accuracy.

Potentiometers R34 and R44 are used to balance the input impedance of each bridge amplifier and minimize drift. Resistance values of each have been chosen so that the circuit is balanced when their dial readings are the same as their respective gain controls, R27 and R35.

Outputs from the bridge amplifiers are coupled through R20 and R21 into summing amplifier U4. U4 is a stable operational amplifier whose output is a function of the inputs through R20, R21, R22, and the gain setting pot R19. R19 has been selected so that when there is a preset input through R22, gain may be selected from X6 to X9.33.

Preset Input through R22 is an offset adjustment to permit bridge outputs to be zeroed for each astronaut, assuming all do not have body and skin temperatures of  $98.6^{\circ}\text{F}$  and  $91.2^{\circ}\text{F}$  at ambient conditions. Negative and positive inputs are provided for both higher and lower

temperatures. This is accomplished through a voltage divider consisting of R25, R26, R45, and ZR2. Clockwise rotation of R26 provides a positive bias and counter clockwise rotation provides a negative bias.

Summing Balance pot R24 minimizes drift and should be adjusted so that

$$R24 = \frac{R19 + (R50)(R20)(R21)(R22)}{R19 + R50 + R20 + R21 + R22} .$$

Outputs from the summing amplifier U4 are fed to the circuits of U1 and U2. U2 is used as a differentiator. U1 has the capability of X1 - X6 with the present feedback/input resistance ratios.

The output of U2 is applied to a summing driver circuit, U3. U3 sums the rate of temperature signal change from U2, and a manual override input from U1 plus a temperature proportional signal from U1. The manual input provides an astronaut override capability.

U3 provides the drive current to power transistor Q1 and has unity gain between its input and the emitter of Q1. ZR4 limits the output of U3 to  $-10v_p$  and D1 clamps it to prevent a positive output.

Q1 provides the power gain necessary to drive the current to air transducer TD1 (10 ma to 50 ma). Manual input is required to set the initial conditions of 10 milliamperes. Diode ZR3 protects the transducer from extreme currents by holding a 9.1 v maximum across the load coil (170 ohms).

Table 3-1  
ELECTRICAL PARTS DATA LIST

<u>Identification Number</u>	<u>Part Name</u>	<u>Rating-Remarks</u>	<u>Qty</u>
R30	Pot. Trim	100K Bourns 3052P	1
R38	Pot. Trim	100K Bourns 3052P	1
R23	Pot. Trim	10K Bourns 3052P	1
R4	Pot. Trim	"	1
R10	Pot. Trim	"	1
R16	Pot. Trim	"	1
R35	Pot. 10 Turn	500K IRC HD150	1
R44	Pot. 10 Turn	500K IRC HD150	1
R27	Pot. 10 Turn	500K IRC HD150	1
R34	Pot. 10 Turn	500K IRC HD150	1
R39	Resistor 1/8w	499K 1% RN550 IRC CEA T-0	1
R40	Resistor 1/8w	499K 1% RN550 IRC CEA T-0	1
R31	Resistor 1/8w	499K 1% RN550 IRC CEA T-0	1
R32	Resistor 1/8w	499K 1% RN550 IRC CEA T-0	1
R36	Resistor 1/8w	249K 1% RN55D IRC CEA T-0	1
R28	Resistor 1/8w	249K 1% RN55D IRC CEA T-0	1
R33	Resistor 1/8w	255K 1% RN55D IRC CEA-T-0	1
R43	Resistor 1/8w	255K 1T RN55D IRC CEA-T-0	1
R37	Resistor 1/2w	27 $\Omega$ 1/4 5% carbon	1
R29	Resistor 1/2w	27 $\Omega$ 1/4 5% carbon	1

Table 3-2

## ELECTRICAL PARTS DATA LIST

<u>Identification Number</u>	<u>Part Name</u>	<u>Rating-Remarks</u>	<u>Qty</u>
C15	Capacitor	.033 50V 10% Aerovor MC605A 102RK	1
C16		.033 50V 10% Aerovor MC605A 102RK	1
R20	Resistor 1/4w	3010 $\Omega$ RN60 B/D IRC CEB T-0	1
R22	Resistor 1/4w	3010 $\Omega$ RN60 B/D IRC-CEB T-0	1
R25	Resistor 1/4w	750 $\Omega$ RN60 B/D IRC CEB T-0	1
R45	Resistor 1/4w	750 $\Omega$ RN60 B/D IRC CEB T-0	1
VR2	Zener diode	IN965B TI 15V 400MW	1
S1	Switch	Toggle C&K Components Inc. 7101	1
R19	Trim Pot. 10T	25K IRC-HD150	1
R24	Trim Pot. 10T	2.5K IRC HD150	1
C17	Capacitor	.01mf CR05-06 Aerovox MC51C103RK	1
C11	Capacitor	.01mf CR05-06 Aerovox MC51C103PK	1
C13	Capacitor	.01mf CR05-06 Aerovox MC51C103RK	1
C14	Capacitor	.01mf CR05-06 Aerovox MC51C103RK	1
C12	Capacitor	.01mf CR05-06 Aerovox MC51C103RK	1
C10	Capacitor	.01mf CR05-06 Aerovox MC51C103RK	1
C3	Capacitor	.01mf CR05-06 Aerovox MC51C103RK	1
C4	Capacitor	.01mf CR-5-06 Aerovox MC51C103RK	1
C5	Capacitor	.01mf CR-5-06 Aerovox MC51C103RK	1



Table 3-3  
ELECTRICAL PARTS DATA LIST

<u>Identification Number</u>	<u>Part Name</u>	<u>Rating-Remarks</u>	<u>Qty</u>
U1	Integrated Circuit	Fairchild U6E7741393	1
U2	Integrated Circuit	Fairchild U6E7741393	1
U3	Integrated Circuit	Fairchild U6E7741393	1
U4	Integrated Circuit	Fairchild U6E7741313	1
U5	Integrated Circuit	Fairchild U5B7725333	1
U6	Integrated Circuit	Fairchild U5B7725333	1
C-6	Capacitor	.01mf CK05-06 Aerovox MC51C 103RK	1
C-7	Capacitor	.01mf CK05-06 Aerovox MC51C 103RK	1
C-8	Capacitor	.01mf CK05-06 Aerovox MC51C 103RK	1
C-9	Capacitor	.01mf CK05-06 Aerovox MC51C 103RK	1
R-46	Resistor 1/8w	10K 1% 1/8w IRC CEA-	1
R-49	Resistor 1/8w	10K 1% 1/8w IRC CEA-	1
R-47	Resistor 1/8w	90.9K 1% IRC CEA T-0	1
R-48	Resistor 1/8w	90.9K 1% IRC CEA T-0	1
Dial 1	10T Dial	Amphenol 1370	1
Dial 2	10T Dial	Amphenol 1370	1
Dial 3	10T Dial	Amphenol 1370	1
Dial 4	10T Dial	Amphenol 1370	1

Table 3-4  
ELECTRICAL PARTS DATA LIST

<u>Identification Number</u>	<u>Part Name</u>	<u>Rating-Remarks</u>	<u>Qty</u>
Dial 5	10T Dial	Amphenol 1370	1
Dial 6	10T Dial	Amphenol 1370	1
Dial 7	10T Dial	Amphenol 1370	1
Dial 8	10T Dial	Amphenol 1370	1
Dial 9	10T Dial	Amphenol 1370	1
Dial 10	10T Dial	Amphenol 1370	1
R26	Pot. 10T	10K IRC HD 150	1
ICS1	Socket IC	Dual Inline Augat 314AG1A	1
ICS2	Socket IC	"	1
ICS3	Socket IC	"	1
ICS4	Socket IC	"	1
ICS5	Socket IC	TO-5 Type Augat 8058-1G32	1
ICS6	Socket IC	"	1
R7	Pot. 10T	5K IRC HD150	1
R6	Resistor 1/4w	402 $\Omega$ IRC RN60B/D 1/4w	1
VR1	Zenerdiode	IN961B	1
Dial 11	10T Dial	Amphenol 1370	1
R54	Resistor	270 $\Omega$ 1/4w Carbon 5%	1
R55	Resistor	270 $\Omega$ 1/4w Carbon 5%	1
C19(C20)	Capacitor	.001mf	2

Table 3-5  
ELECTRICAL PARTS DATA LIST

<u>Identification Number</u>	<u>Part Name</u>	<u>Rating-Remarks</u>	<u>Qty</u>
R50	Resistor	3010 $\Omega$ RN60B/D IRC	
S2	Switch	Toggle DPDT. 28, 1 amp	
R51	Resistor	10K RN55D IRC CEA-TO	
R2	Resistor	1K RN55D IRC CEA-TO	
C18	Capacitor	1.0mf Component Research Co. 03PG10511N	
R8	Resistor	10K RN55D IRC CEA-TO	
R7	Pot. 10T	10K IRC HD150	
R9	Resistor 1/8w	13.3K RN55D IRC CEB-TO	
R6	Resistor 1/4w	750 $\Omega$ RN60B/D IRC CEB-TO	
R52	Resistor 1/4w	750 $\Omega$ RN60B/D IRC CEB-TO	
R11	Resistor 1/8w	10K RN55D IRC CEA-TO	
R5	Resistor 1/8w	10K RN55D IRC CEA-TO	
R12	Resistor 1/4w	10K 1/4w Carbon 5%	
R15	Resistor 1/4w	2.5K RN60B/D IRC-CEB-TO	
R3	Resistor 1/8w	175K	
R40	Resistor 1/8w	100K	
R1	Resistor 1/8w	100K	
R41	Pot. 10T	500K IRC HD-150	
R42	Pot. 10T	500K IRC HD-150	
C1	Capacitors	2-1mf 2-5mf 2-20mf	6 ea.
C2	Capacitors	2-1mf 2-5mf 2-20mf	6 ea.

Table 3-6

## ELECTRICAL PARTS DATA LIST

<u>Identification Number</u>	<u>Part Name</u>	<u>Rating-Remarks</u>	<u>Qty</u>
D1	Diode	IN4001	1
Q1	Transistor	AN4234	1
ZR3	Diode	IN3788	1
R53	Resistor	100 $\Omega$ , 1 watt Carbon	1
Tp1-Tp17		Test Points	20
R21A	Resistor 1/8w	6040 $\Omega$ RN55 IRC CEATO	1
ZR4	Diode	IN758A	1
C21	Capacitor	.91mf Non-polarized	1
R50C	Resistor	100K	1
R40C = R40	Resistor	--	1
R41C = R41	Resistor	--	1
R51C	Resistor	10K	1
R52C	Resistor	200 $\Omega$	1
R53C	Resistor	36 $\Omega$	1
R54	Resistor	200K	1

Table 3-7

## ELECTRICAL PARTS DATA LIST

<u>Identification Number</u>	<u>Part Name</u>	<u>Rating-Remarks</u>	<u>Qty</u>
TR1	Thermistor	YS1-44011 100k @ 25°C	1
TR2	Thermistor	4 ea YSI 44011 in series ea 100K @ 25°C	4
R1	Resistor 1/8w	59K 1% RN55D	1
R2	Resistor 1/8w	59K 1% RN55D	1
R3	Resistor 1/8w	59K 1% RN55D	1
R4	Resistor 1/8w	280K 1% RN55D	1
R5	Resistor 1/8w	280K 1% RN55D	1
R6	Resistor 1/8w	280K 1% RN55D	1
R7	Resistor 1/2w	2.15K 1% RN60B/D	1
R8	Resistor 1/2w	2.26K 1% RN60B/D	1
Z1	Zener Diode	IN968B Motorola	1
Z2	Zener Diode	IN961B Motorola	1
C1	Capacitor	.01mf CK05-06 Aerovox MC51C103RK	1

Table 3-8

## ELECTRICAL PARTS DATA LIST

<u>Identification Number</u>	<u>Part Name</u>	<u>Rating-Remarks</u>	<u>Qty</u>
	Transducer	Model 69TA-2A Current to Air Transducer-Foxboro Co. Foxboro, Mass.	1
	Photo Diodes	MRL500 Motorola	2

APPENDIX 4

SAMPLE CALCULATIONS

## APPENDIX 4

## SAMPLE CALCULATIONS

1. Thermistor Bridge Circuit Voltages

Core Circuit:

- 1) Zero output - 98.15°F (Figure 35)
- 2) Output - 0.052 v/°F linear
- 3) Sign at TP2 - (+) for temperatures above 98.15°F (Figure 4)

Skin Circuit:

- 1) Zero output - 91.22°F (Figure 35)
- 2) Output - 0.0411 v/°F linear
- 3) Sign at TP4 - (+) for temperatures above 91.22°F (Figure 4)

2. Core Circuit Gain,  $G_c$ 

$$G_c = \left( \frac{R_{49} + R_{48}}{R_{49}} \right) \left( \frac{R_{35} + R_{36}}{R_{39}} \right) = \left( \frac{100.9}{10} \right) \left( \frac{R_{35} + 249}{499} \right)$$

$$\approx \frac{R_{35} + 250}{50} = X5 - X15, \text{ range}$$

3. Skin Circuit Gain,  $G_s$ 

$$G_s = G_c$$

4. Summing Circuit Gain (Core),  $G_{sc}$ 

$$G_{sc} = \frac{R_{19C} + R_{50} + 15}{R_{20C}} = \frac{R_{19C} + 18.01}{3.01}$$

$$= X6 - X9.33, \text{ range.}$$



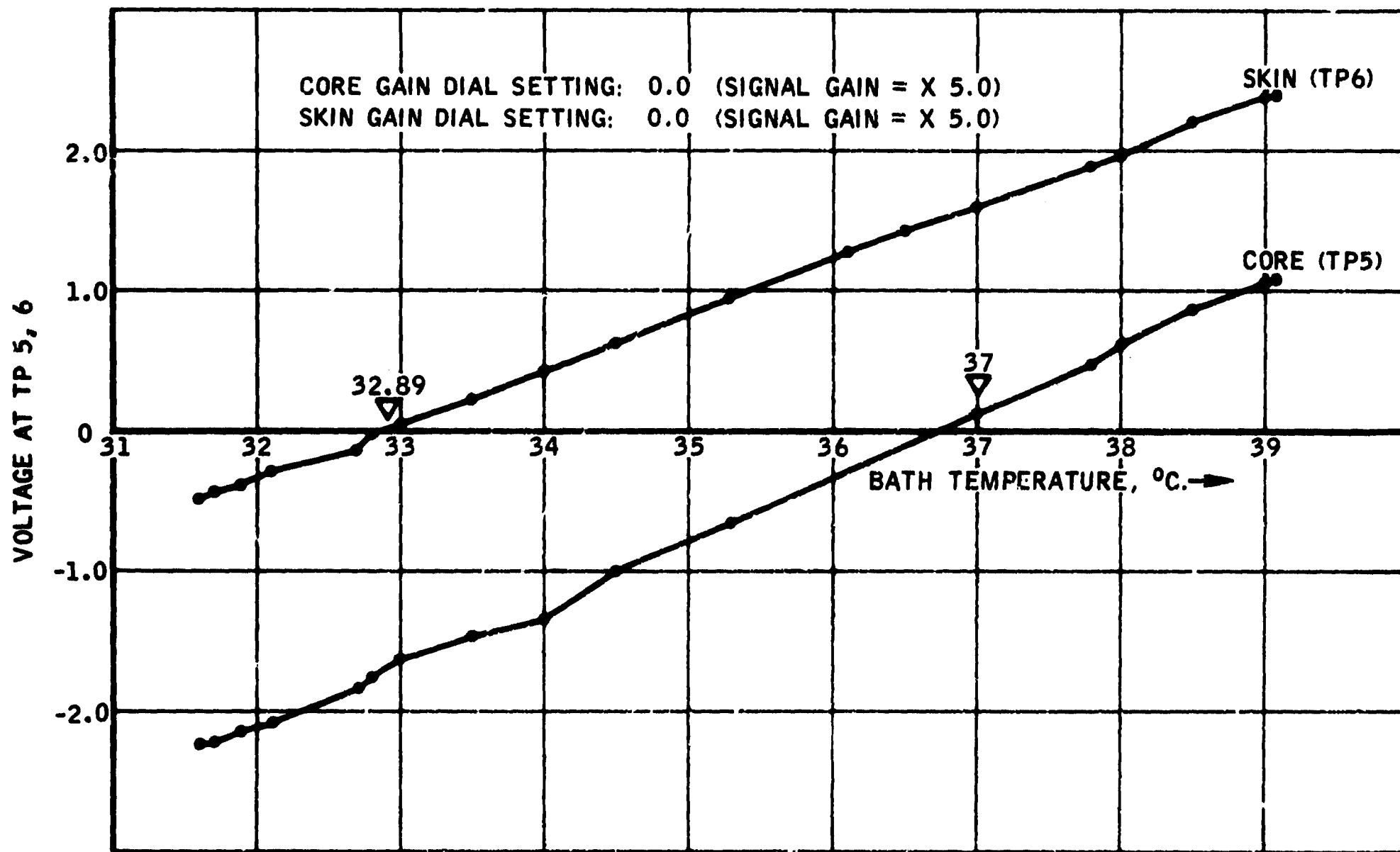

FIGURE 35. CORE AND SKIN AMPLIFIER OUTPUT VOLTAGES VERSUS WATER BATH TEMPERATURE

5. Summing Circuit Gain (Skin),  $G_{SS}$ 

$$G_{SS} = \frac{R19C + R50 + 15}{R21C} = \frac{R19C + 18.01}{9020}$$

$$= X2 - X3, \text{ range.}$$

6. Rate Circuit Gain,  $G_R$  (Rate Int)

$$G_R = (R1 + R42) \left( \left( \frac{1}{C1A} + \frac{1}{C1B} \right) + C1 \right) \left( \frac{R51C + R52C + R53C}{R52C + R53C} \right) \dot{e}_{10}$$

$$= (10^5 + R42)(15) \left( \frac{10236}{236} \right) (10^{-6}) \dot{e}_{10} = (651) (10^{-6}) (10^5 + R42) \dot{e}_{10}.$$

$$\frac{G_R}{\dot{e}_{10}} = X65.1 - X391, \text{ range. } \dot{e}_{10} = \text{volts/sec.}$$

7. Proportional Circuit Gain,  $G_p$  (Rate Diff)

$$G_p = \frac{R9C}{R41C + R40C} = \frac{600}{R41C + 100} = X1 - X6, \text{ range.}$$

8. Core and Skin Gain Settings

Suppose it is desired to have the controller respond to mean body temperature calculated from the relation

$$T_{MB} = 0.9 T_c + 0.1 T_s.$$

What settings of core and skin gain are required?

$$Ke_{10} = \frac{(e_c) (G_c \cdot G_{sc}) + (e_s) (G_s \cdot G_{ss})}{G_c \cdot G_{sc} + G_s \cdot G_{ss}}$$

where,

$Ke_{10}$  = voltage measured at  $e_{10}$  proportional to change in mean body temperature

$e_c$  = voltage change at input of core signal amplifier, U6

$e_s$  = voltage change at input of skin signal amplifier, U5

$$\frac{G_c \cdot G_{sc}}{G_c \cdot G_{sc} + G_s \cdot G_{ss}} = 0.9$$

$$\frac{G_s \cdot G_{ss}}{G_c \cdot G_{sc} + G_s \cdot G_{ss}} = 0.1$$

Iterating,

$$G_c = 15, G_s = 5$$

$$G_{sc} = 6, G_{ss} = 2,$$

yields

$$Ke_{10} = (0.9)e_c + (0.1)e_s.$$

#### 9. Core and Skin Potentiometer Settings

The gain ranges of both core and skin amplifiers are X5-X15.

For a desired core gain of X7.5, for example,

Core gain potentiometer setting = (Desired gain - Minimum gain)

$$= 7.50 - 5.00 = 2.50.$$

#### 10. Standard Deviation, s

$$s = \sqrt{\frac{1}{n} \sum_{i=1}^n (x_i - \bar{x})^2}$$

$\bar{x}$  = Mean value of mean body temperature

$x_i$  =  $i$  th value of mean body temperature.

From Test Number 7, September 15, 1970:

T<sub>MB</sub> Measured at 5.0 minute increments

93.2  
 92.9  
 93.0  
 93.2  
 94.0  
 93.9  
 94.3  
 94.5  
 94.7  
 95.0  
 95.2  
 95.2  
95.1

94.2 Mean Value.

$(x_i - \bar{x})^2$

1.00  
 1.69  
 1.44  
 1.00  
 0.04  
 0.09  
 0.01  
 0.09  
 0.25  
 0.64  
 1.00  
 1.00  
0.81

9.06

$$s = \left(\frac{9.06}{13}\right)^{\frac{1}{2}} = 0.835$$

APPENDIX 5

TYPICAL SIMULATION RESULTS

## APPENDIX 5

## TYPICAL SIMULATION RESULTS

A NASA MSC computer program, Transient Metabolic Simulation - Program J116, was modified and used in this research. The basic program simulates the heat transfer within a man and the transfer between an astronaut and his environment. The environmental mode used for this research was "suited extravehicular activity." The astronaut's work profile and environmental data are program inputs. The transient-thermal properties of the man and his environment are calculated and the output is printed at intervals selected by the program user. The output describes the reaction of the astronaut to his environmental conditions and the response of the environment to the astronaut. The analysis implemented in the program uses a 14-node concept to simulate the man.

One of the program input parameters is diverter valve position, i.e., high, medium and low flow through the sublimator. For this research the program was changed so that continuous modulation from the lowest permissible flow to full flow was simulated. A given work profile was described and the program was run. Heat storage in the man is one program output. It was monitored in the program and as it approached a specified amount, depending upon the astronaut's working level, the valve was made to open or close. Heat storage was kept within a tolerance band whose midpoint was a linear function of working rate. The relationships were proposed by Waligora (1967a) as levels of heat storage compatible with comfort.

As the simulation progressed through the prescribed work profile, a regression analysis described in Appendix 1 was performed to identify the relationship between core temperature and skin temperature for comfortable working conditions. The regression line defined a setpoint mean body temperature and coefficients to be applied to core temperature and mean skin temperature for determination of mean body temperature at any point in time.

A second regression analysis was performed to identify the relationships between the diverter valve position required to maintain thermal comfort, change in mean body temperature from a setpoint, and time rate of change of mean body temperature from the setpoint. Typical values of the coefficients provided by the program are given in Chapter V. The values of the mean body temperature and valve command coefficients changed depending upon the work profile used as a program input, but for profiles similar to those expected for lunar surface activities, there was little change.

Quantities derived from simulations of lunar surface activity were then used to verify feasibility of the proposed controller concept. The basic transient metabolic program was modified so that mean body temperature was calculated at prescribed intervals of time during the simulated extravehicular activities. The diverter valve was required to respond to changes in mean body temperature according to the control algorithm given by Chapter V. LCG inlet and outlet water temperatures, core and skin temperatures, heat storage and valve position were program

outputs. Criteria for a successful test run included whether heat storage had stayed within the desired tolerance band for each work rate, and the core temperature rise.

Simulation runs were essential for the identification of reasonable algorithm coefficient values and demonstrated controller feasibility from a theoretical point of view. Typical computer printouts are illustrated by Figures 36 - 40.



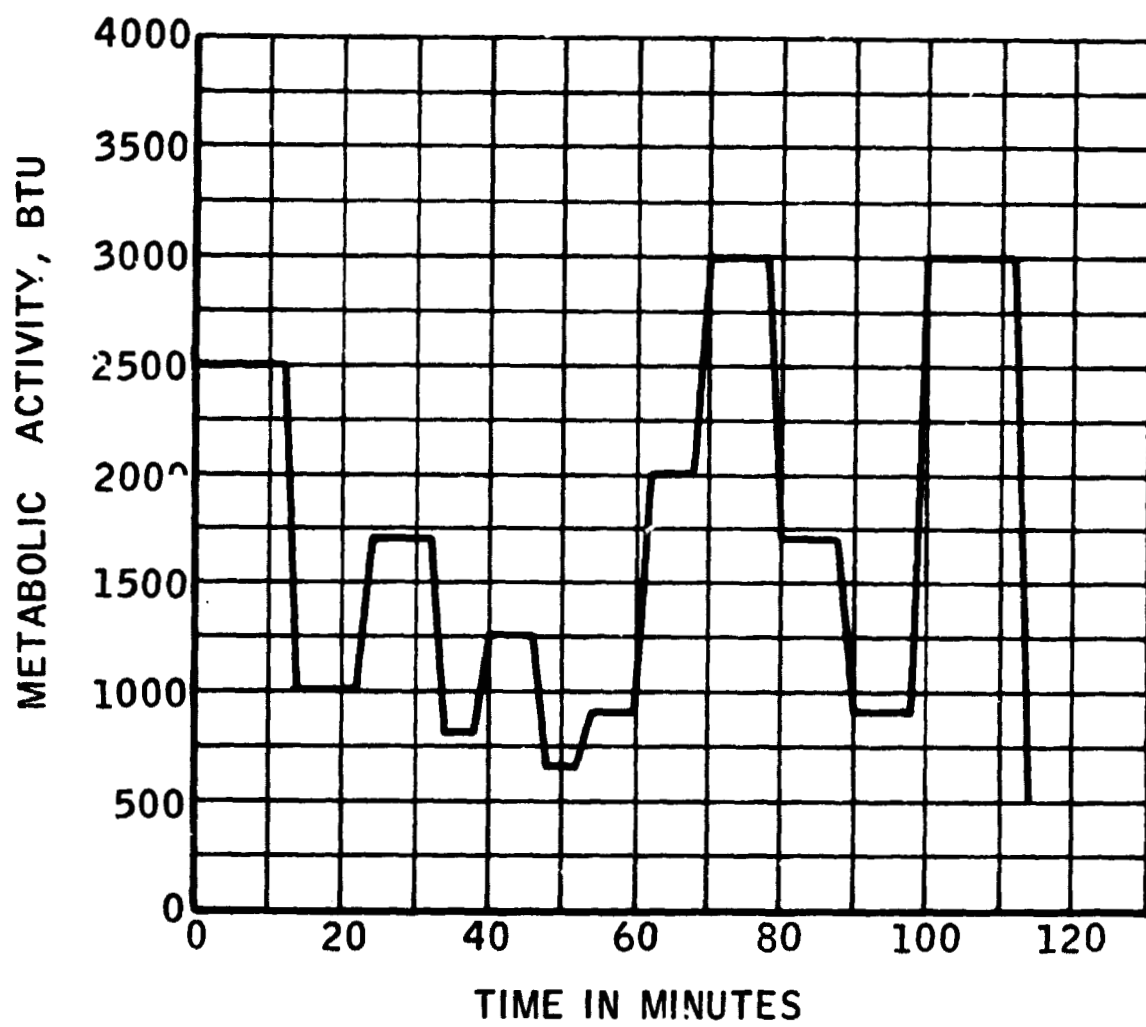

FIGURE 36. ASTRONAUT WORK PROFILE USED AS INPUT TO GARMENT CONTROLLER COMPUTER SIMULATION

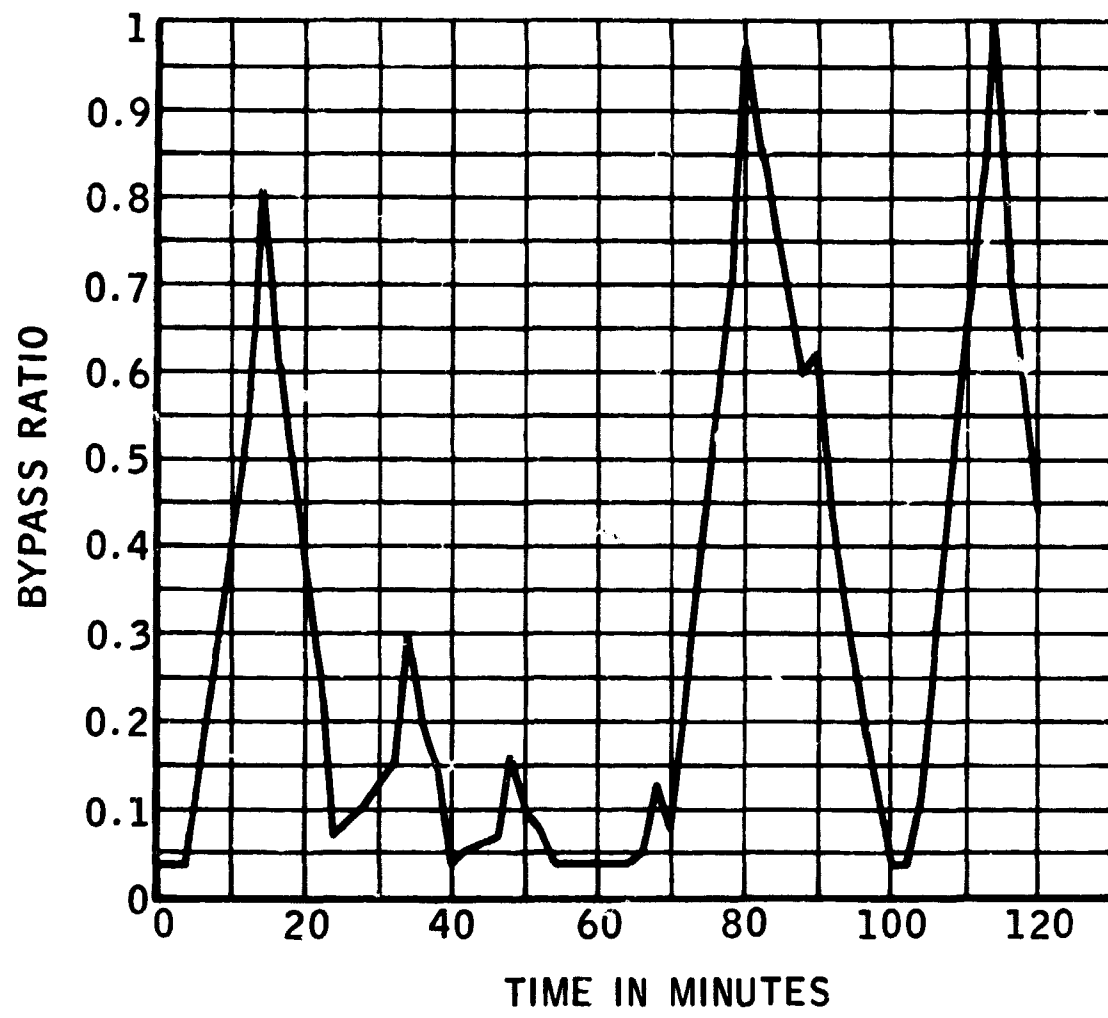

FIGURE 37. VALVE RESPONSE COMMANDED BY SIMULATED GARMENT CONTROLLER

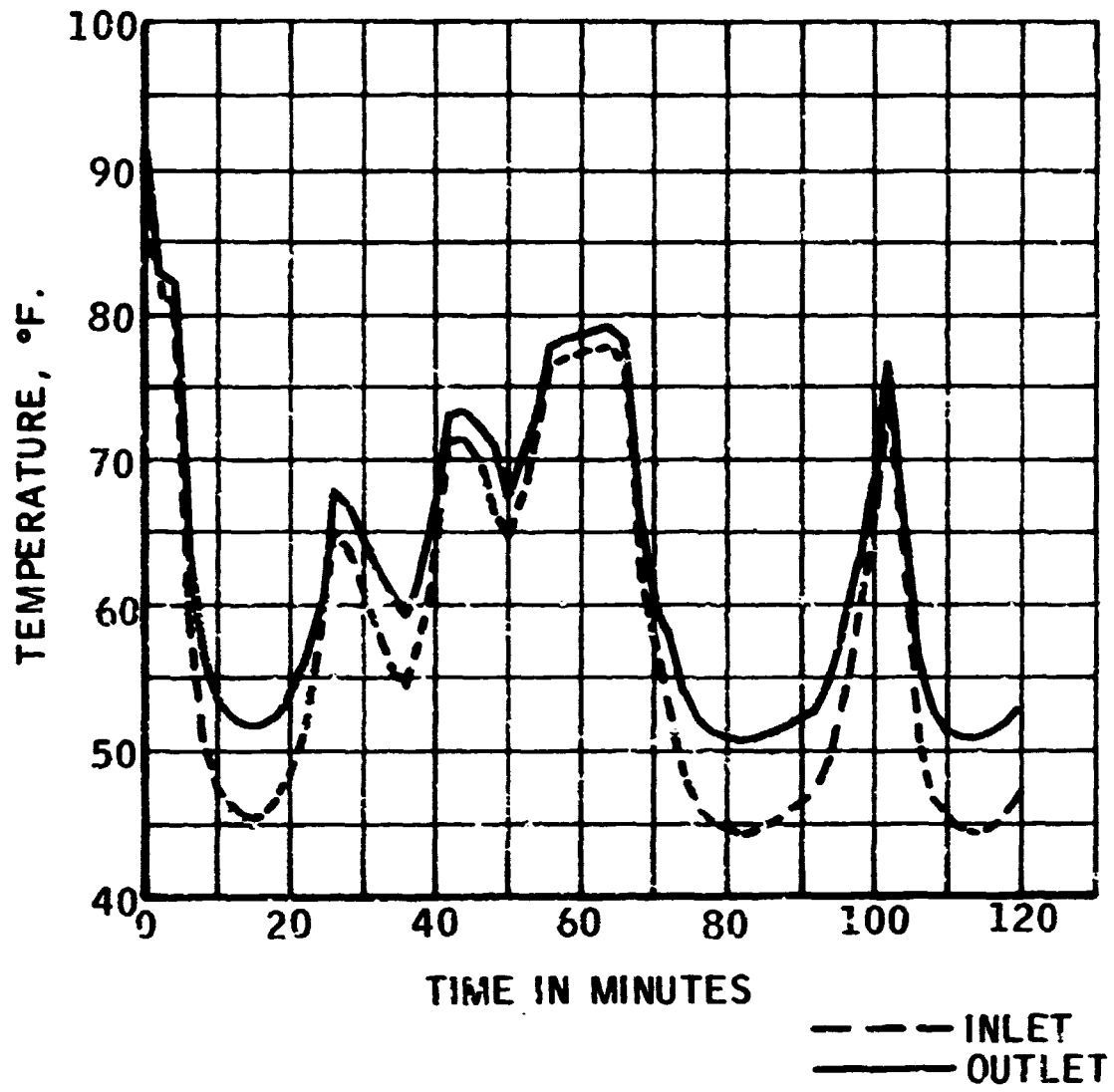

FIGURE 38. LIQUID COOLING GARMENT INLET AND OUTLET WATER TEMPERATURES PROVIDED BY CONTROLLER COMPUTER SIMULATION

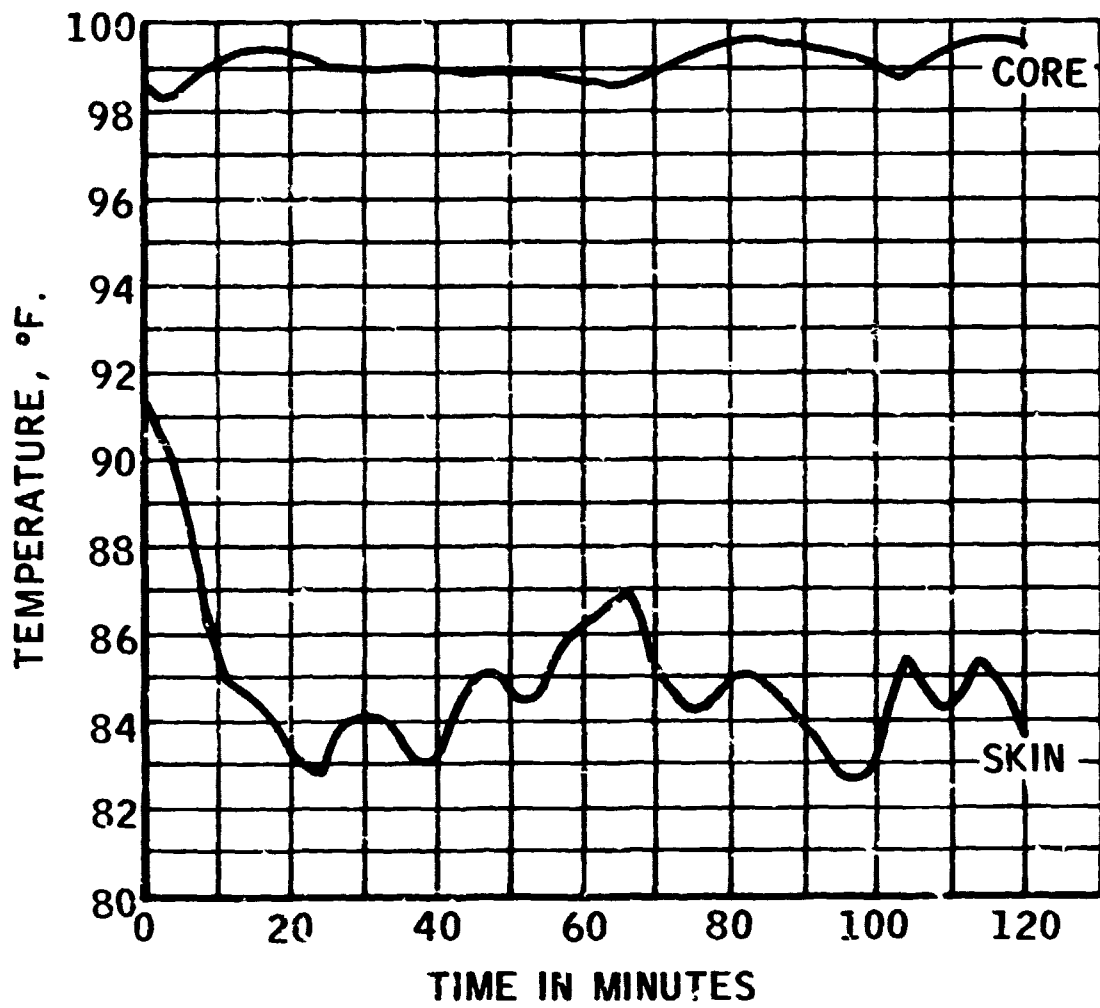

FIGURE 39. ASTRONAUT CORE AND MEAN SKIN TEMPERATURES PROVIDED BY CONTROLLER COMPUTER SIMULATION

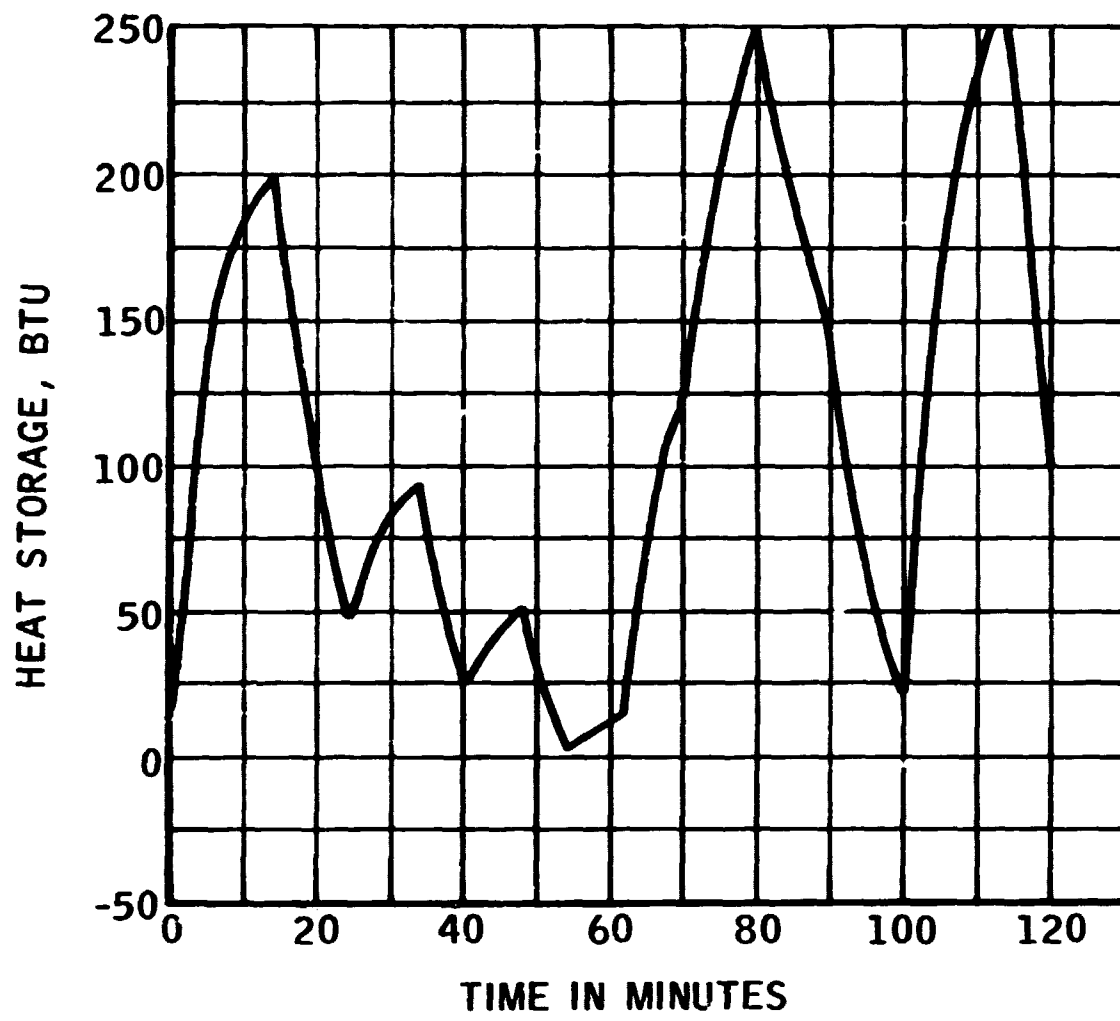

FIGURE 40. ASTRONAUT HEAT STORAGE PROVIDED BY CONTROLLER COMPUTER SIMULATION

**APPENDIX 6**

**PROCEDURES FOR PRELIMINARY MANNED TESTS**

Preliminary Test No. 1

Test Date: March 2, 1970

Location: MSC Environmental Physiology Laboratory

Test Subject: A. Behren

Test Objectives:

1. Verify test procedures.
2. Provide well-trained test subject temperature data as measure of controller performance.

Test Procedures:

1. Power supplies, recorders, and controller were energized subsequent to Preliminary Adjustments.
2. Test subject inserted ear probe. The four controller skin sensors were attached to his upper left chest. ECG electrodes were attached.
3. Test subject donned short sleeved ICG, insulated garment, and gym shoes.
4. Test subject was seated in chair on treadmill.
5. Initial System Tests were completed. The following controller settings were made:

Rate Int: 5.52

Rate Diff: 9.40

Core: 10.00

Skin: 0.00

6. Turned on cooling water circulation pumps.

7. Connected skin and core temperature sensor leads to controller.

Test subject donned wool cap.

8. Preset Input was adjusted to zero voltage at TP 10.

9. Manual Input was adjusted to yield an incipient valve opening condition.

10. Recorder was started.

11. LCG was connected to fluid system breadboard.

12. Preset Input was adjusted to zero TP 10 voltage. Manual Input was adjusted to yield an incipient valve opening condition.

13. Test subject stood up and treadmill was started. Treadmill speed was 2.0 mph with zero grade.

14. Treadmill speed was increased to 3.5 mph.

15. Treadmill was stopped. Test subject sat down on chair placed on treadmill.

16. Test subject was disconnected from cooling water. Controller was deenergized and test subject disconnected.



Preliminary Test No. 2

Test Date: March 23, 1970

Location: MSC Environmental Physiology Laboratory

Test Subject: C. Dry

Test Objectives:

1. Verify test procedures.
2. Provide well-trained test subject temperature data as measure of controller performance.
3. Study valve response to changes in controller settings.

Test Procedures:

Procedures were the same as Preliminary Test No. 1 through Step No. 13 with one exception. Controller settings were as follows:

Rate Int:	3.68
Rate Diff:	8.91
Core:	10.00
Skin:	0.00

14. Treadmill speed was increased to 3.5 mph.
15. Treadmill was stopped. Test subject sat down on chair placed on treadmill.
16. Changing of breadboard controls at intervals was initiated and valve action was observed.

17. Test subject was disconnected from cooling water. Controller was deenergized and test subject disconnected.

Preliminary Test No. 3

Test Date: April 16, 1970

Location: MSC Environmental Physiology Laboratory

Test Subject: J. Waligora

Test Objectives:

1. Verify test procedures.
2. Provide test subject temperature data from relatively untrained test subject for study of controller performance.

Test Procedures:

1. Power supplies, recorders, and controller were energized subsequent to Preliminary Adjustments. Initial Systems Test was conducted.
2. The four controller skin sensors were attached to test subject's right biceps, upper chest, thigh, and shoulder. ECG electrodes were attached. Ear probe was inserted.
3. Test subject donned short sleeved LCG, insulated garment and gim shoes.
4. Test subject was seated in chair on treadmill. Wool cap was donned.
5. Recorder zeros and sensitivities were checked. The following controller settings were used:

Rate Int:	7.57
Rate Diff:	6.80
Core:	10.0
Skin:	0.0

6. Test subject stood and treadmill was started: 3.5 mph, zero grade.

7. Began experiencing cooling water control problem.

8. Stopped treadmill. Test subject sat down on chair placed on treadmill.

9. Test subject stood and treadmill was started: 3.7 mph, 14° incline.

10. Water circulating pump was shut off for three minutes to tighten set screws on motor drive shaft.

11. Treadmill was stopped. Test subject sat down on chair placed on treadmill.

12. Test subject was disconnected from cooling water. Controller was deenergized and test subject disconnected.

Preliminary Test No. 4

Test Date: April 21, 1970

Location: MSC Environmental Physiology Laboratory

Test Subject: J. Hansen

Test Objectives:

1. Verify test procedures.
2. Provide well-trained test subject temperature data for study of controller performance.
3. Collect oral temperature data for comparison to ear temperature data.

Test Procedures:

1. Power supplies, recorders, and controller were energized subsequent to Preliminary Adjustments.
2. The four controller skin sensors were attached to the test subject's right biceps, upper chest, thigh, and shoulder. ECG electrodes were attached.
3. Test subject donned short sleeved LCG, insulated garment trousers, and gym shoes.
4. Test subject was seated in chair on treadmill.
5. Ear probe was inserted.
6. Test subject donned cap.

7. Test subject donned insulated jacket.
8. Began circulating cooling water.
9. Initial System Tests were completed. Recorder zeros and sensitivities were checked. The following controller settings were used:

Rate Int:	7.57
Rate Diff:	6.80
Core:	10.00
Skin:	0.00
Manual:	6.97
Pre-set:	4.065

10. Test subject stood and treadmill was started: 3.5 mph, 0° incline.
11. Stopped treadmill. Test subject was seated on chair placed on treadmill.
12. Test subject stood and treadmill was started: 3.98 mph, 14% grade.
13. Treadmill was stopped. Test subject sat down on chair placed on treadmill.
14. Test subject was disconnected from cooling water. Controller was deenergized and test subject disconnected.

Preliminary Test No. 5

Test Date: April 23, 1970

Location: MSC Environmental Physiology Laboratory

Test Subject: J. Hansen

Test Objectives:

1. Investigate new controller settings devised to bring test subject skin temperature back to pre-test level sooner.
2. Investigate use of astronaut communication cap instead of wool knit cap.
3. Determine effects on system response of presetting controller to have a setpoint mean body temperature equivalent to an ear temperature of 94.5°F and average skin temperature of 91.5°F.
4. Collect oral temperatures and ear temperatures measured with a Barnes Engineering Co. MT3 Infrared Thermometer for comparison with ear canal control temperatures measured by thermistors.

Test Procedures:

1. Power supplies, recorders, and controller were energized subsequent to Preliminary Adjustments.
2. The four controller skin sensors were attached as shown by Figure 6. ECG electrodes were attached.
3. Test subject donned short sleeved LCG, insulated garment, and gym shoes.

4. Test subject was seated in chair placed on treadmill. He inserted the ear probe and donned a comm cap. Core and skin sensor leads were attached to controller.

5. Room temperature water was started circulating through the LCG.

6. Water was started circulating through the heat exchanger loop.

7. Controller settings were as follows:

Rate Int: 3.68

Rate Diff: 8.91

Core: 10.00

Skin: 0.00

Preset Input: 5.58

Manual Input: 4.065

8. The test subject stood up and the treadmill was started: 3.85 mph, 14% grade.

9. Preset Input was changed to null voltage at TP 10. Dial reading was 7.24.

10. Treadmill was stopped. Test subject sat down on chair placed on treadmill.

11. Test subject was disconnected from cooling water. Controller was deenergized and test subject disconnected.



## Preliminary Test No. 6

Test Date: May 7, 1970

Location: MSC Environmental Physiology Laboratory

Test Subject: J. Hansen

Test Objectives:

1. Obtain temperature data using new proportional and rate gains and core/temperature weighting factors.

2. Study effects of presetting controller to have a null signal equivalent to an ear temperature of 94.5°F and average skin temperature of 91.5°F.

Test Procedures:

Steps 1 through 5 were identical to those of Preliminary Test No. 5.

6. Room temperature water was started circulating through the LCG.

7. Water was started circulating through the heat exchanger loop.

8. Controller settings were as follows:

Rate Int: 10.0

Rate Diff: 0.0

Core: 4.05

Skin: 6.45

Preset Input: 6.97

Manual Input: 4.065

9. The test subject stood up and the treadmill was started:  
3.75 mph, 14% grade.
10. Treadmill was stopped. Test subject sat down in chair placed  
on treadmill.
11. Test subject was disconnected from cooling water. Controller  
was deenergized and test subject disconnected.

Preliminary Test No. 7

Test Date: May 21, 1970

Location: MSC Environmental Physiology Laboratory

Test Subject: J. Hansen

Test Objectives:

1. Collect temperature data with core and skin gains set so that mean body temperature,  $T_{mb} = 0.81 T_e + 0.19 T_s$ . Other controller settings were the same as Preliminary Test No. 6.

2. Collect core and skin temperature data from test subject before donning cooling and insulating garments.

Test Procedures:

1. Power supplies, recorders, and controller were energized subsequent to Preliminary Adjustments.

2. The test subject entered the treadmill room, sat down, inserted his ear probe, donned a comm cap, took off his shirt and had the four skin sensors attached to his left biceps with tape. He sat quietly for thirty minutes while ear and skin temperature data were collected. The test subject covered the skin sensors with his free hand twice and pressed them firmly into his skin. Temperature spikes which resulted can be seen in Figure 19.

3. Controller was de-energized and sensor leads disconnected. Test subject went to dressing room, removed skin sensors, replaced them on right biceps, upper chest, thigh and shoulder, donned ICG and insulated garment, and returned to the treadmill room where he was allowed to sit down.

4. Room temperature water was started circulating through the LCG. In compliance with test goals the Preset voltage was set to null a  $94.5^{\circ}\text{F}$  ear temperature and a  $91.5^{\circ}$  skin temperature. The Preset and other potentiometer settings were as follows:

Core:	4.05
Skin:	1.45
Sum:	0.0
Rate Int:	10.0
Rate Diff:	0.0
Manual:	4.065
Preset:	6.97

5. The test subject stood up and the treadmill was started (3.75 mph, 14% grade). Chilled water circulation through the heat exchanger was initiated four minutes after the treadmill was started. Comments were requested from the test subject periodically relative to his comfort and were recorded.

6. Treadmill was stopped and test subject was allowed to sit down.

7. Test subject was disconnected from cooling water. Controller was de-energized and test subject disconnected.

Preliminary Test No. 8

Test Date: May 27, 1970

Location: MSC Environmental Physiology Laboratory

Test Subject: J. Hansen

Test Objectives:

1. Use long-sleeved ICG and new higher capacity ICG water pump drive and compare system performance and test subject comfort to previous test results.
2. Null system just prior to starting treadmill and compare system and test subject response to previous tests.

Test Procedures:

1. Power supplies, recorders, and controller were energized subsequent to Preliminary Adjustments.
2. The test subject inserted his ear probe with the sensor extended farther than it had been during previous tests, the object being to sense a higher core temperature, possibly less affected by skin temperature. He removed his shirt, had the four skin sensors attached with tape to his right biceps, upper chest, thigh and shoulder, and walked to the treadmill room and sat down. The extended ear probe was causing some pain and was withdrawn to the same position used during previous tests. The subject sat still for five minutes and then was instructed to don the ICG, insulated garment and finally the comm cap. Data collected during this period is illustrated by the first  $10\frac{1}{4}$  minutes of test time plotted on Figure 20.

3. At this point in time,  $10\frac{1}{2}$  minutes into the test, room temperature water circulation was started through the ICG. This was continued, with the subject remaining seated, for about  $8\frac{1}{2}$  minutes at which time air was supplied to the control valve. Just prior to activating the valve the ear and skin temperature signals were nulled out. Temperature at that time were  $94.46^{\circ}\text{F}$  (ear) and  $91.6^{\circ}\text{F}$  (skin).

4. At 24 minutes into the test the treadmill was started. Grade was 14% and treadmill speed was 3.7 mph. The controller operated "hands off" and exercise continued for  $21\frac{1}{4}$  minutes. At the end of that period the treadmill was stopped and the test subject sat down.

5. Initial controller settings were as follows:

Core:	4.05
Skin:	6.45
Sum:	0.0
Rate Int:	10.0
Rate Diff:	0.0
Manual:	4.065
Preset:	6.97

6. At  $74\frac{1}{2}$  minutes into the test the Rate Diff setting was changed from 0.0 to 5.0 reducing the proportional signal gain.

7. Exercise was continued for 23 minutes, the treadmill was stopped, and the test subject was instructed to sit down until the end of the test, 33 minutes later.

Preliminary Test No. 9

Test Date: June 2, 1970

Location: MSC Environmental Physiology Laboratory

Test Subject: J. Hansen

Test Objectives:

1. Study the effects of increasing the relative weighting of mean body temperature rate of change signal by decreasing the gain of the mean body temperature signal. Compare results to test of May 27.

2. Study effects of increasing skin temperature signal gain following the first work period. After the second moderately heavy work period, reduce treadmill speed to 1.0 mph and study the effect on test subject recovery and comfort.

Test Procedures:

1. Power supplies, recorders and controller were energized subsequent to the Preliminary Adjustments.

2. The test subject inserted his ear probe, removed his shirt, had the four skin sensors attached with tape to his right biceps, upper chest, thigh, and shoulder and sat down in the treadmill room. Data collected during this period is illustrated by the first 15 minutes of test time plotted on Figure 21.

3. Fifteen minutes into the test, the test subject removed his trousers and donned the ICG. A dip in skin temperature due to his disrobing

and donning the LCG containing lab ambient water in its tubing is revealed by Figure 21. Room temperature water was circulated through the LCG for about 14 minutes until core and skin temperature had stabilized fairly well. At this point, core and skin signals were nulled, the valve controller was activated, the test subject rose and took his position on the treadmill, and the treadmill was started (3.7 mph, 14%). The controller was operated "hands off" and exercise continued for 22-3/4 minutes. At the end of that period, the treadmill was stopped and the test subject sat down.

4. Initial controller settings were as follows:

Core:	4.05
Skin:	6.45
Sum:	0.0
Rate Int:	10.0
Rate Diff:	10.0
Manual:	4.66
Preset:	6.70

Just prior to the second work period, the controller setting for skin gain was changed to 10.0 (X 15.0). All other settings were left unchanged.

5. Eighty-eight minutes into the test, the controller setting for skin gain was raised to 10.0 (X 15.0). This changed the relative weighting of core and skin temperature, or mean body temperature, from  $0.70 T_c + 0.30 T_s$  to  $0.64 T_c + 0.36 T_s$ . The effect of the change upon controller input can be seen as a reduction in command for cooling in Figure 21. (See step reduction in mean body temperature.)



Preliminary Test No. 10

Test Date: August 6, 1970

Location: MSC Environmental Physiology Laboratory

Test Subject: J. Hansen

Test Objectives:

Verify the changes in controller response due to a design modification. Controller design was changed to allow greater sensitivity to variations in mean body temperature. (Capacitors ClA and ClB were added in parallel to Capacitor Cl, Figure 4.)

Test Procedures:

1. The test subject inserted his ear probe, disrobed and donned a bathing suit and had four skin temperature sensors attached to his right thigh, abdomen, biceps and shoulder. He then donned a new A6L LCG and sat down in the treadmill room. Ear and skin sensor connections were made to the controller, the test subject donned a comm cap and at 9.67 minutes into the test, cooling water circulation was commenced and the voltage at TP 10 was nulled. Sensitivity to changes in mean body temperature was set 1-1/2 times higher than was possible with the previous design. The test subject rose from his sitting position 23.6 minutes into the test and the treadmill was started (3.7 mph, 0°). Exercise continued for 14-1/2 minutes. The controller was operated "hands off" at these values for 67.4 minutes until the test ended.

2. Initial controller settings were as follows:

Core:	4.05
Skin:	6.46
Sum:	0.0
Rate Int:	4.0
Rate Diff:	10.0
Manual:	4.1
Preset:	6.75

Prior to the second work period, the controller setting for rate sensitivity (Rate Int) was changed to 5.0. All other settings were left unchanged.

Preliminary Test No. 11

Test Date: August 20, 1970

Location: MSC Environmental Physiology Laboratory

Test Subject: Charles Pate

Test Objectives:

1. Verify test subject's metabolic rates associated with specified treadmill speeds and inclination angles.
2. Verify feasibility of using 9-sensor temperature sensor harness for establishing average skin temperature independently from control system sensors.
3. Perform work profile proposed for statistical series to verify protocol and identify potential problem areas.

Test Procedures:

1. Test subject inserted ear probe upon arrival at laboratory to reduce waiting time required for thermal stabilization.
2. Water circulation was started through the heat exchanger to keep water loop from freezing during cool-down. Air circulation was started in the treadmill room to maintain laboratory ambient conditions.
3. Controller skin sensors (4) were attached to the test subject as shown by Figure 6.
4. Harness skin sensors (9) were attached to the test subject at the following locations:

- a. Back
- b. Groin
- c. Right upper chest
- d. Over right femoral artery
- e. Calf
- f. Forehead
- g. Right biceps
- h. Right instep
- i. Hand

5. The test subject donned the ICG taking care to leave the temperature sensors undisturbed, entered the treadmill room and sat down.

6. Ear and skin sensor leads were connected to the controller and recorder.

7. The test subject donned his comm cap and he stood and the treadmill was started when his ear temperature began to stabilize.

8. All controller settings were identical to those used during the previous Jens Hansen test. Settings were as follows:

Core:	4.05
Skin:	6.46
Sum:	0.0
Rate Int:	5.0
Rate Diff:	10.0
Manual:	4.1
Preset:	6.75

APPENDIX 7

LABORATORY EQUIPMENT LISTING

## LABORATORY EQUIPMENT LISTING

Liquid Cooling Garment Assembly. Model No. A6L-400000-1002A.  
Serial No. 062.

Sanborn 350 Series Eight-Channel Recorder. NASA No. 42870.

ARA SD-20 Scanner. Applied Research Austin, Austin, Texas. NASA  
Nos. 82883, 82884.

Power Supply, Constant Voltage/Constant Current, 0-40 v., 0-500 ma.  
NASA No. 48399.

Power Supply, Constant Voltage/Constant Current, 0-40 v., 0-500 ma.  
NASA No. 46397.

Tele-Thermometer, Model 46TUC, Serial No. 273, 0-40°C, Yellow Springs  
Instrument Company, Inc., Yellow Springs, Ohio. NASA No. P4148.

Tele-Thermometer, Model 46TUC, Serial No. 1149, 0-40°C, Yellow Springs  
Instrument Company, Inc., Yellow Springs, Ohio. NASA No. 76091.

Decade Resistor, 0-100 ohms. General Radio Company, Concord, Mass.  
Type 1432-Y. Serial No. 37464. NASA 36704.

Bristol Dynamaster 24-Channel Recorder. Model 24P12H13X591-51-T374X-  
T188X. Serial No. 63A 12,585. NASA No. 36155.

Power Supply, 0-36 v., 0-5 amps. Model 808A. Harrison Laboratories,  
Inc., Berkeley Heights, N.J. NASA No. 12017. (Converter)

ECG Recorder. Model 296. Sanborn Company, Waltham, Mass. NASA No. 42871.

Power Supply, 0-36 v., 0-10 amps. Model 6267A, Harrison Laboratories,  
Berkeley Heights, N.J. BRN No. 648. (Circulating Water Pump)

Digital Voltmeter. Model 4910P. Beckman. NASA No. S-14656.

Frequency to DC Converter. Input: 10-4000 CPS, 20 MV P/P to 3 Volts  
Adjustable. Output: 0-5 VDC. Power 28 VDC, 75 ma max. Model FR-320-3-5.  
Serial No. 37290. Foxboro, Van Nuys, California.

Frequency to DC Converter. Input: 10-4000 CPS, 20 MV PP to 3 Volts  
Adjustable. Output: 0-5 VDC. Power 23 VDC, 75 ma max. Model FR-320-3-5.  
Serial No. 37293. Foxboro, Van Nuys, California.

EAI 680 Scientific Computing System Analog Computer. NASA No. 65086.

Digital Flowmeter. Model LF6-1. Serial No. 9732. Cox Instrument Division, Detroit, Michigan.

Digital Flowmeter. Model LF6-1. Serial No. 9734. Cox Instrument Division, Detroit, Michigan.

Motor Speed Control. Model VT-100. Nominal HP1, 230 v., 1 phase, 6.0 amps max. Pacific Industrial Controls, Inc., Berkeley, California.

Vacuum Tube Voltmeter. Model 400H. Hewlett-Packard. NASA No. 32394.

Treadmill. A. R. Young Power Transmission Engineers, Indianapolis, Ind. NASA No. 25816.