

**Volume 15, Issue 4/2015**

**PRINT ISSN 2284-7995**

**E-ISSN 2285-3952**



# **SCIENTIFIC PAPERS**

**SERIES “MANAGEMENT, ECONOMIC  
ENGINEERING IN AGRICULTURE AND RURAL  
DEVELOPMENT”**

**Volume 15, Issue 4/2015**

**PRINT ISSN 2284-7995**

**E-ISSN 2285-3952**



# **SCIENTIFIC PAPERS**

**SERIES “MANAGEMENT, ECONOMIC  
ENGINEERING IN AGRICULTURE AND RURAL  
DEVELOPMENT”**

To be cited: Scientific Papers Series “Management, Economic Engineering in Agriculture and Rural Development“, Volume 15, Issue 4/2015

**Publishers:**

**University of Agricultural Sciences and Veterinary Medicine of Bucharest, Romania.** Address: 59 Marasti, District 1, 011464 Bucharest, Romania, Phone: + 40213182564, Fax: +40213182888, www.managusamv.ro  
**S.C. Editura Ceres S.A.,** Address:1 Piata Presei Libere, District 1, Bucharest, 013701, Phone/Fax: +40213179023, Email: edituraceres@yahoo.com  
All rights reserved

**The publishers are not responsible for the content of the scientific papers and opinions published in the Volume. They represent the authors' point of view.**

**EDITORIAL BOARD**

**Editor in Chief: Prof. Ph.D. Toma Adrian DINU**

**Executive Editor: Prof. Ph.D. Agatha POPESCU**

**Members:**

**Prof. Ph.D. Ioan Nicolae ALECU,** University of Agricultural Sciences and Veterinary Medicine, Bucharest, Romania  
**Prof. Ph.D. Manea DRĂGHICI,** University of Agricultural Sciences and Veterinary Medicine, Bucharest, Romania  
**Prof. Ph.D. Mihai BERCA,** University of Agricultural Sciences and Veterinary Medicine, Bucharest, Romania  
**Prof. Ph.D. H.C. Miguel Moreno MILLAN,** University of Cordoba, Spain  
**Prof. Ph.D. Doc. Svend RASMUSSEN,** University of Copenhagen, Denmark  
**Prof. Ph.D. Mogens LUND,** Institute of Food and Resource Economics, Copenhagen, Denmark  
**Prof. Ph.D. Pascal Anton OLTENACU,** Oklahoma State University, United States of America  
**Prof. Ph.D. Rangesan NARAYANAN,** University of Nevada, United States of America  
**Senior Lecturer Ph.D. Ove MADSEN,** Grinsted Agricultural Academy, Denmark  
**Ph.D. Patrick ANGEL,** US Department of the Interior, Office of Surface Mining Appalachian Regional Office, U.S.A.  
**Prof. Ph.D. Gerhard MOITZI,** University of Natural Resources and Applied Life Sciences, Vienna, Austria  
**Prof. Ph.D. Paolo GAJO,** University of Florence, Italy  
**Prof. Ph.D. Diego BEGALLI,** University of Verona, Italy  
**Prof. Ph.D. Mamdouh Abbas HELMY,** Modern University for Technology and Information, Cairo, Egypt  
**Ph.D. Alistair Mc CRACKEN,** Agri-Food and Biosciences Institute, Belfast, United Kingdom  
**Prof. Ph.D. Drago CVIJANOVIC,** Institute of Agricultural Economics, Serbia  
**Prof. Ph.D. Nebojsa RALEVIC,** University of Belgrade, Serbia  
**Dr. Hab. Stefan MANN,** Research Station Agroscope, Federal Office for Economics, Tanikon, Switzerland  
**Ph.D. Jonel SUBIC,** Institute of Agricultural Economics, Serbia  
**Associate Professor Ph.D. Zuzana PALKOVA,** Slovak University of Agriculture, Nitra, Slovakia  
**Acad. Prof. Ph.D. Hab. Pavel MOVILEANU,** The Agricultural State University of Moldova, Republic of Moldova  
**Senior Lecturer Ph.D. Veronica PRISĂCARU,** The Agricultural State University of Moldova, Republic of Moldova  
**Senior Lecturer Ph.D. Veronica MOVILEANU,** The Agricultural State University of Moldova, Republic of Moldova  
**Senior Lecturer Ph.D. Mariana DOGA-MIRZAC,** Moldova State University, Republic of Moldova  
**Associate Prof. Ph.D. Rashid SAEED,** International Islamic University, Pakistan  
**Senior Lecturer Ph.D. Adrian TUREK-RAHOVEANU,** University of Agricultural Sciences and Veterinary Medicine, Bucharest, Romania  
**Prof. Ph.D. Emilian MERCE,** University of Agricultural Sciences and Veterinary Medicine, Cluj-Napoca, Romania  
**Prof. Ph.D. Gheorghe MUREȘAN,** University of Agricultural Sciences and Veterinary Medicine, Cluj-Napoca, Romania  
**Prof. Ph.D. Nicoleta MATEOC-SÎRB,** University of Agricultural Sciences and Veterinary Medicine of Banat, Romania  
**Prof. Ph.D. Ion DONA,** University of Agricultural Sciences and Veterinary Medicine, Bucharest, Romania  
**Prof. Ph.D. Elena STOIAN,** University of Agricultural Sciences and Veterinary Medicine, Bucharest, Romania  
**Senior Lecturer Ph.D. Silviu BECIU,** University of Agricultural Sciences and Veterinary Medicine, Bucharest, Romania  
**Senior Lecturer Ph.D. Radu Lucian PÂNZARU,** University of Craiova, Romania  
**Senior Lecturer Ph.D. Gavrilă STEFAN,** University of Agricultural Sciences and Veterinary Medicine, Iasi, Romania  
**Prof. Ph.D. Vasile GOSA,** University of Agricultural Sciences and Veterinary Medicine of Banat Timisoara, Romania  
**Senior Lecturer Ph.D. Tiberiu IANCU,** University of Agricultural Sciences and Veterinary Medicine of Banat Timisoara, Romania  
**Senior Lecturer Ph.D. Ioan BRAD,** University of Agricultural Sciences and Veterinary Medicine of Banat Timisoara, Romania

**Publication Committee:**

**Lecturer Ph.D. Mariana Burcea, Eng. Teodora Popescu**

The papers belong to the following research fields: economic engineering in agriculture, management, marketing and agri-food trade, rural economy, agricultural policies, accounting, financial analysis, finance, agrarian legislation, durable development, environment protection, tourism, agricultural extension and other connected areas.





## C O N T E N T S

---

### **1.ANALYSIS OF ANALYSIS OF SUSTAINABLE ECONOMIC GROWTH POSITION OF EUROPEAN COUNTRIES BY ECONOMETRIC MODELING**

**Cristina BURGHELEA, Nicolae MIHĂILESCU,  
Octavian Constantin BURGHELEA, Viorel Alexandru TURCU..... 7**

### **2.ASPECTS OF SUSTAINABLE RURAL TOURISM - FARMERS' MARKETS AND FARM VISITS**

**Mirela CĂRĂTUȘ STANCIU..... 15**

### **3.E.U. FARM SUPPORT POLICY: AN ANALYSIS OF DIRECT PAYMENTS IMPLEMENTATION IN SPAIN**

**Liliana CIMPOIES..... 21**

### **4.EVALUATING THE ROLE OF THE LIQUID ORGANIC FERTILIZER, OBTAINED FROM WORM COMPOST, ON THE PHYSIOLOGICAL DEVELOPMENT, QUALITY AND THE MAIZE HARVEST**

**Larisa CREMENEAC, Tatiana BOCLACI..... 27**

### **5.SURVEY REGARDING THE CORPORATE GOVERNANCE IMPLEMENTATION IN ROMANIA**

**Raluca Florentina CREȚU, Georgeta Narcisa CIOBOTAR,  
Romeo Cătălin CREȚU..... 33**

### **6.ANALYSIS OF THE ROMANIAN RURAL AREA**

**Ada-Flavia CRISTINA, Camelia MĂNESCU, Alin Marcel POPESCU,  
Nicoleta MATEOC-SÎRB..... 39**

### **7.VISUAL COMMUNICATION IN THE RURAL AREA. STUDY CASE, LOCAL ADMINISTRATION AND THE THE LOCAL COMMUNITY OF THE BERZOVIA COMMUNE, CARAS-SEVERIN COUNTY**

**Ada-Flavia CRISTINA, Camelia MĂNESCU, Anca Gabriela HANDARIC,  
Nicoleta MATEOC-SÎRB..... 43**

### **8.DURABLE DEVELOPMENT OF COMMUNITIES UNDER ANALYSIS OF THE POTENTIAL OF WORKFORCE FROM AGRICULTURE**

**Corina CRUCERU..... 49**

## **9.TECHNICAL-ECONOMIC ANALYSIS ON FORAGE MOWERS**

**Mariana DUMITRU..... 53**

## **10.STUDY ON THE FEEDING SYSTEM OF A BIOGAS PLANT**

**Mariana DUMITRU..... 59**

## **11.LOCAL FOOD: LITHUANIAN CONSUMERS' PERCEPTIONS AND ATTITUDES**

**Ovidija EIČAITĖ, Vida DABKIENĖ..... 65**

## **12.USING SOLAR ENERGY TO PRODUCE BIOGAS FROM ANIMAL WASTES**

**Tarek FOUDA, Asaad DERBALA, Adel ELMETWALLI, M. DARWESH,  
H. KASSEM..... 71**

## **13.IMPROVING PERFORMANCE OF FORCED - AIR HEATING SYSTEM IN BROILER HOUSE**

**Mohamed GHONAME, Tarek FOUDA ..... 77**

## **14.SELECTED LEGAL ASPECTS OF STATE AID SCHEMES FOR AGRICULTURE IN POLAND IN YEARS 2015 -2020**

**Jakub GOŁAŚ..... 85**

## **15.ABOUT THE EFFICIENCY OF UKRAINIAN WINERIES**

**Anatoliy G. GONCHARUK, Natalia O. LAZAREVA..... 95**

## **16.IMPACT OF AGRICULTURAL POLICY ON GRAIN SECTOR IN BULGARIA**

**Hristina HARIZANOVA, Zornitsa STOYANOVA..... 99**

## **17.IMPACT OF THE ECONOMIC CRISIS ON EUROPEAN UNION DURING 2008 – 2015 PERIOD**

**Adelaida Cristina HONȚUȘ, Alina MĂRCUȚĂ, Cristiana TINDECHE,  
Liviu MĂRCUȚĂ..... 107**

## **18.SUSTAINABLE POSITION OF EUROPEAN COUNTRIES BASED ON LIFE EXPECTANCY AT BIRTH AND THE RISK OF POVERTY**

**Oana Camelia IACOB, Ana-Maria VOLINTIRU, Anca CRISTEA,  
Elisabeta TURCU..... 117**

## **19.ASPECTS OF GENDER EQUALITY WITHIN DOMESTIC LIFE**

**Adina Magdalena IORGA ..... 125**

<b>20.MORPHOGENESIS OF CARBONATIOUS RENDZINAS PROFILE OF THE WESTERN UKRAINIAN REGION ON DIFFERENT STAGES OF THEIR ONTOGENESIS</b>	
Andriy KYRYLCHUK.....	131
<b>21.COMPETITIVENESS OF AGRIFOOD PRODUCTION OF THE REPUBLIC OF MOLDOVA THROUGH ITS EXPORT</b>	
Aurelia LITVIN, Cornel COSER.....	139
<b>22.THE ECONOMIC GROWTH OF AGRICULTURAL SECTOR THROUGH INVESTMENT VALUES</b>	
Aurelia LITVIN, Svetlana PETRASCU.....	145
<b>23.IMPROVING ROMANIA’S GREEN COVER BY PLANTING FOREST PROTECTION CURTAINS, IN THE CONTEXT OF CURRENT CLIMATE CHANGES</b>	
Camelia MĂNESCU, Ada-Flavia CRISTINA, Teodor MATEOC, Gheorghe Sebastian SÎRB, David SAIDA, Nicoleta MATEOC-SÎRB.....	153
<b>24.RESEARCH REGARDING THE POSSIBILITIES OF EXTENSION OF THE FOREST PROTECTION CURTAINS THROUGH FINANCED PROJECTS FROM THE RDP 2014-2020</b>	
Camelia MĂNESCU, Ada-Flavia CRISTINA, Teodor MATEOC, Gheorghe Sebastian SÂRB, Alin POPESCU, Nicoleta MATEOC-SÎRB.....	159
<b>25.THE ASSESSMENT MADE BY FARMERS OF THE AGRICULTURAL CONSULTANCY EFFECTIVENESS IN OLT COUNTY</b>	
Emil Vergilius MARINESCU, Raluca-Alexandra NECULA, Diana-Maria NECULA.....	165
<b>26.EVOLUTION OF AGRICULTURAL PRODUCTION IN THE CONTEXT OF WORLD ECONOMY GLOBALIZATION (2004-2012)</b>	
Dragoș Mihai MEDELETE, Radu Lucian PÂNZARU.....	171
<b>27.STRUCTURE OF AGRICULTURAL PRODUCTION FOR NORTH - EAST REGION OF DEVELOPMENT IN ROMANIA (2009-2011)</b>	
Dragoș Mihai MEDELETE, Radu Lucian PÂNZARU .....	179
<b>28.CONSTRAINS AND CONSENSUS ON WATER USE AND LAND ALLOCATION IN MINOR SCHEME TANKS IN THE DRY ZONE OF SRI LANKA</b>	
Naoko OKA, Takeru HIGASHIMAKI, D.D.Prabath WITHARANA, Mekonnen B.WAKEYO .....	185

## **29.DETERMINANTS OF PALM OIL OUTPUT SUPPLY IN NIGERIA**

**Chigozirim Ndubuisi ONWUSIRIBE, Chibuzo Ikechukwu OKPOKIRI..... 191**

## **30.EFFECT OF QUALITY CONTROL (QC) MEASURES ON THE INCOME OF CASSAVA FLOUR BASED ENTERPRISES IN ABIA STATE NIGERIA**

**Chigozirim Ndubuisi ONWUSIRIBE, Chinedu Daniel NWOGU..... 199**

## **31.ZEA MAIS EVERTA FUNDULEA 625 – HEALTH - INCOME**

**Olimpia PANDIA, Ion SĂRĂCIN, Ștefania Eliza TĂNASIE..... 205**

## **32.METHODS OF REDUCING THE PROFOUND HYBERNATION OF CERATONIA SILIQUA SEEDS**

**Olimpia PANDIA, Ion SĂRĂCIN, Ștefania Eliza TĂNASIE..... 209**

## **33.INTERNATIONAL TRADE WITH GRAPES (2009-2011)**

**Radu Lucian PÂNZARU, Dragoș Mihai MEDELETE ..... 213**

## **34.INTERNATIONAL TRADE OF TOMATOES (2009-2011)**

**Radu Lucian PÂNZARU, Dragoș Mihai MEDELETE ..... 219**

## **35.REGRESSION MODELLING IN PREDICTING MILK PRODUCTION DEPENDING ON DAIRY BOVINE LIVESTOCK**

**Agatha POPESCU..... 225**

## **36.MULTIPLE CORRELATION AND REGRESSION IN PREDICTING MILK PRICE**

**Agatha POPESCU..... 231**

## **37.SOME CONSIDERATIONS REGARDING THE STATEMENT OF THE WORLD COMMODITY TRADE**

**Agatha POPESCU..... 239**

## **38.SOME CONSIDERATIONS ON THE WORLD AGRI-FOOD TRADE AND THE POSITION OF THE EU-28**

**Agatha POPESCU..... 247**

## **39.SOME CONSIDERATIONS ON THE ACTUAL STATEMENT OF THE WORLD TRADE IN COMMERCIAL SERVICES**

**Agatha POPESCU..... 257**

<b>40.RESEARCH ON AGRICULTURAL ASSOCIATION OF THE ROMANIAN FARMERS AND THE EFFICIENCY RECOVERY OF FOOD PRODUCTS RESULTING FROM THEIR WORK</b>	
<b>Alin Marcel POPESCU, Nicoleta MATEOC-SÎRB,     Adela NEAMȚU-POPESCU.....</b>	<b>265</b>
<b>41.THE ECONOMIC AND SOCIAL DEVELOPMENT ANALYSIS IN SYRIA FOR THE PERIOD 1980-2013</b>	
<b>Ibrahim Abdul RAHMAN, Al Mohammad JEGHAYEF, Raluca NECULA,     Diana Roxana CAPĂȚĂ.....</b>	<b>271</b>
<b>42.RELEVANT COSTS AND DECISION MAKING OF INVESTMENT</b>	
<b>Titin RULIANA, Eddy SOEGIARTO SOEGIARTO K.....</b>	<b>279</b>
<b>43.THE ESTIMATION OF TRENDS IN BUSINESS DEVELOPMENT IN THE REPUBLIC OF MOLDOVA</b>	
<b>Olga SÂRBU.....</b>	<b>287</b>
<b>44.THE DYNAMICS AND SPATIAL DIFFERENTIATION OF MUNICIPAL INFRASTRUCTURE IN 2004-2013 (EG. MALOPOLSKA REGION)</b>	
<b>Lukasz SATOLA.....</b>	<b>297</b>
<b>45.ARNICA MONTANA L. AS A MEDICINAL CROP SPECIES</b>	
<b>Camelia SAVA SAND.....</b>	<b>303</b>
<b>46.THE NON-AGRICULTURAL ECONOMIC ACTIVITY IN THE CONTEXT OF INCREASING THE COMPETITIVE BUSINESS ENVIRONMENT IN THE ROMANIAN RURAL AREA</b>	
<b>Elena SIMA.....</b>	<b>309</b>
<b>47.THE PRESENCE OF SPECIES <i>MORIMUS FUNEREUS</i> MULSANT, 1862 (LONG-HORNED BEETLE) COLEOPTERA: CERAMBYCIDAE IN A FOREST OF OAK CONDITIONS, 2015</b>	
<b>Cristina STANCĂ-MOISE.....</b>	<b>315</b>
<b>48.TRENDS IN THE DEVELOPMENT OF AGRICULTURE IN OLT COUNTY</b>	
<b>Ștefan STĂNESCU, Manea DRĂGHICI.....</b>	<b>319</b>
<b>49.STUDY CONCERNING THE CRUISES ON THE DANUBE RIVER</b>	
<b>Petrică ȘTEFAN, Mariana BURCEA, Romeo Cătălin CREȚU.....</b>	<b>329</b>

**50.PROACTIVE APPROACH FOR THE IMPACTS OF FRAUDULENT FINANCIAL INFORMATION ON ECONOMIC DECISION**

**Isa TAK..... 335**

**51.COMPARATIVE ANALYSIS OF THE LAND FRAGMENTATION AND ITS IMPACT ON THE FARM MANAGEMENT IN SOME EU COUNTRIES AND MOLDOVA**

**Elena TIMOFTI, Daniela POPA, Barbara KIELBASA..... 345**

**52.TRENDS IN EDUCATIONAL TRAINING FOR AGRICULTURE IN OLT COUNTY**

**Victor TIȚA, Raluca NECULA..... 357**

**53.STRUCTURAL CHANGES ON MEAT MARKET IN THE EUROPEAN UNION IN 2008-2014**

**Agnieszka TŁUCZAK..... 365**

**54.FARM AGRO-ENVIRONMENTAL DIAGNOSIS, A NECESSITY?**

**Camelia TOMA..... 371**

**55.CHANGES IN HIGHER EDUCATION AND THE VALUE OF EDUCATION FROM THE PERSPECTIVE OF RURAL AREAS. THE CASE OF POLAND**

**Krzysztof WASIELEWSKI..... 381**

**56.THE AGRICULTURE POTENTIAL DEVELOPMENT IN THE REPUBLIC OF IRAQ**

**Mohammed Dhary YOUSIF, Hussein Ali Hussein AL QAESI,  
Abdulmuttaleb Abbas SALIH ..... 391**

## ANALYSIS OF ANALYSIS OF SUSTAINABLE ECONOMIC GROWTH POSITION OF EUROPEAN COUNTRIES BY ECONOMETRIC MODELING

Cristina BURGHELEA<sup>1</sup>, Nicolae MIHĂILESCU<sup>1</sup>, Octavian Constantin BURGHELEA<sup>2</sup>,  
Viorel Alexandru TURCU<sup>3</sup>

<sup>1</sup>Hyperion University, 169 Calea Calarasi, Bucharest, Romania, E-mail: crystachy@yahoo.com,  
n.mihaiulescu@yahoo.com

<sup>2</sup>Printec Group Romania, 53 Putul lui Zamfir, Bucharest, Romania, E-mail:  
o.burghelea@printecgroup.com

<sup>3</sup>Politehnica University, 313 Splaiul Independentei, Bucharest, Romania, E-mail:  
b3tty\_t@yahoo.com

**Corresponding author:** crystachy@yahoo.com

### Abstract

*The economic potential of a country is consistently a primary goal of existence and sustainable development. To achieve this major goal is necessary to undertake strict complex studies to formulate a correct diagnosis and real economic situation and the rationale, on this basis, decisions economic policy and legislative decisions aimed at both time horizons immediate and for longer periods of time. In this context the significance and importance of GDP per capita as synthetic macroeconomic indicator is developed a multifactorial econometric model that includes two exogenous variables, the employment rate over 55 and resource productivity.*

**Key words:** GDP per capita, employment rate over 55, EU-28, resource productivity, econometric model

### INTRODUCTION

The growth of economic potential of a state [7] is a synthetic form of measuring the total GDP and GDP per capita. An intake defining the size and dynamics of gross domestic product it holds, from a certain point of view, the employment rate for workers aged 55+ and internal material resource productivity in the economy [11]. In the context of this economic logic states that: workers aged over 55 are considered to possess undoubted quality yield by recognized expertise and manifested in the economic process by helping to achieve economic outturn dimensioned as gross domestic product and productivity of resources built in internal gross domestic product figure measure their recovery and influence the dynamics of GDP [9].

In this context the definition of interdependent systems of variable analysis present gross domestic product per capita according to the employment rate of the population that has more than 55 years and that the productivity

of resources used in the economy by applying a rigorous methodology of econometric modeling.

This can provide support for opportunity of econometric study to obtain the information necessary to allow substantiation of macroeconomic decisions to foster real economic progress and reinforced [10].

### MATERIALS AND METHODS

The methods used to process the data contained in Table 1 are able to provide, by synthetic and analytical obtained indices, relevant information on 28 European countries on GDP per capita, rate of employment over 55 years, resource productivity, but also the mathematical relationship that expresses the interdependence of these variables. To achieve goals we are using grouping method, the relative size of the structure method, statistical modeling and viability checking method and of the model.

Table 1. GDP per capita, employment rate over 55, resource productivity in 2014 for 28 European countries

No crt.	Country	GDP per capita SER 01 = $y$ (euro)	Employment rate over 55 SER 02 = $x_1$	Resource productivity SER 03 = $x_2$
1	Belgium	33800	42.7	2.3896
2	Bulgaria	5400	50	0.2912
3	Czech Republic	15200	54	1.0018
4	Denmark	43300	63.2	2.1037
5	Germany	33200	65.6	2.0896
6	Estonia	13200	64	0.4226
7	Ireland	39500	53	1.4873
8	Greece	17000	34	1.4004
9	Spain	22700	44.3	2.7244
10	France	31100	47	2.601
11	Croatia	10200	36.2	1.0906
12	Italy	25300	46.2	2.8886
13	Cyprus	20200	46.9	1.3121
14	Latvia	10400	56.4	0.4934
15	Lithuania	11200	56.2	0.6505
16	Luxembourg	79500	42.5	4.0119
17	Hungary	10500	41.7	0.8873
18	Malta	17200	37.7	1.3444
19	Netherlands	37900	59.9	3.8225
20	Austria	36000	45.1	1.7102
21	Poland	10500	42.5	0.6125
22	Portugal	16300	47.8	1.141
23	Romania	6900	43.1	0.3217
24	Slovenia	17600	35.4	1.4331
25	Slovakia	13400	44.8	1.1966
26	Finland	34100	59.1	1.0029
27	Sweden	40400	74	1.7159
28	United Kingdom	30100	61	3.2409

Source: calculus on data from www.insse.ro

## RESULTS AND DISCUSSIONS

Based on statistical data from Table 1 we conduct a systematic distribution of European states after the three indicators considered as a group at the level of 2014.

First was drawn the group listed in Table 2 which highlights four groups of countries based on GDP per capita. Of the 28 countries included in the group, 50.00% (14 countries) have a level of GDP per capita between 0 and

20,000 euro, 39.29% (11 countries) representing states that have a GDP per capita between 20,000 and 40,000 euros and 3 states (10.71%) have a GDP per capita exceeding 40,000 euro [8].

Romania is positioned in Group 1 with a GDP per capita of 6,900 euros while Luxembourg has the highest rate of 79,500 euro.

Statistical description of the series of distribution of the 28 EU countries, the indicators presented in Table 2 highlights the significant degree of asymmetry of the series and also by the size indicator Jarque-Bera in Table 5 refuted likeness law normal distribution [4].

The average level of GDP per capita was at the end of 2014 of EUR 24,360.71 characterized by a coefficient of variation of 64.7979%. These results attest that statistical series of 28 European countries in Table 1, in terms of GDP per capita has a high degree of heterogeneity and warns that the average value is affected by non-representatively [3].

Table 2. Grouping of 28 EU states by GDP per capita in 2014

Tabulation of SER01 ( PIB/1 loc.)				
Sample: 1 28; Included observations: 28				
Number of categories: 4			Cumulative	Cumulative
Value	Count	Percent	Count	Percent
[0, 20000)	14	50.00	14	50.00
[20000, 40000)	11	39.29	25	89.29
[40000, 60000)	2	7.14	27	96.43
[60000, 80000)	1	3.57	28	100.00
Total	28	100.00	28	100.00

Source: author calculus

Regarding the employment rate of people who are aged over 55 years, the group of 28 European countries in Table 3 highlights the following: grouping identifies five types of qualitative states; the largest group is the 40-50 range is stated in the employment rate over 55 years is 42.86% (12 countries) from a total of 28 European countries; the second group in importance is entered in the range of 50-60 employment rate over 55, which includes seven states (25.00%); groups included in the intervals 30-40 and 60-70 respectively of employment rates over 55 years, equal proportions of 14.29% each, by 7 states; one country, Sweden has an employment rate of people aged over 55 have the size stated



within 70-80 respectively 74. Statistical description of the series distribution of the 28 EU countries, the indicators presented Table 3 highlights the significant degree of asymmetry of the series and also Jarque-Bera indicator of the size of Table 5 refuted likeness normal distribution law. The average employment rate of people aged over 55 years has been the end of 2014 of 49.79643 characterized by a coefficient of variation of 20.4841%. These results attest that the statistical series of the 28 European countries in Table 1, the size of the employment rate over 55 has a relatively acceptable homogeneity and warns that the average value has a degree of representativeness diminished significantly as it approaches the level of Reference 30% limit considered as acceptance of homogeneity series.

Table 3. Grouping of 28 EU states by employment rate over 55 years in 2014

Tabulation of SER02 ( Rata de angajare peste 55 ani)				
Sample: 1 – 28; Included observations: 28				
Number of categories:			Cumulative	Cumulative
5				
Value	Count	Percent	Count	Percent
[30, 40)	4	14.29	4	14.29
[40, 50)	12	42.86	16	57.14
[50, 60)	7	25.00	23	82.14
[60, 70)	4	14.29	27	96.43
[70, 80)	1	3.57	28	100.00
Total	28	100.00	28	100.00

Source: author calculus

Data presented in Table 4 systematize community of 28 European countries on five groups, depending on resource productivity. Such notice may, in summary, the following: the group is part of resource productivity 1.0-2.0 range comprises 42.86% of the total states and 12 countries; 0.0-1.0 and 2.0-3.0 group of resource productivity group has close proportions, 25.00% (7 countries) and 21.43% (6 states); groups with a significantly higher resource productivity include only three states, two states are in the range 3.0-4.0 (Netherlands and the UK) and a state within the range 4.0-5.0 (Luxembourg).

Clearly, this group also (Table 4) highlights the significance of asymmetry of the series and also Jarque-Bera through size indicator in Table 5, refuted the likeness of the normal distribution law [5]. The coefficient of

variation of this series is 63.29% distribution and explains non-representatively average value, according to information provided Jarque-Bera statistic coefficient [6].

Table 4. Grouping of 28 EU states by resource productivity in 2014

Tabulation of SER03 (Productivitatea resurselor)				
Sample: 1 – 28; Included observations: 28				
Number of categories:			Cumulative	Cumulative
5				
Value	Count	Percent	Count	Percent
[0, 1)	7	25.00	7	25.00
[1, 2)	12	42.86	19	67.86
[2, 3)	6	21.43	25	89.29
[3, 4)	2	7.14	27	96.43
[4, 5)	1	3.57	28	100.00
Total	28	100.00	28	100.00

Source: author calculus

Table 5. Main statistics that describe EU-28 series for GDP per capita, employment rate over 55 and resource productivity in 2014

Statistics	GDP per capita	Employment rate over 55	Resource productivity
Mean	24,360.71	49.79643	1.620989
Median	18,900.00	46.95000	1.372400
Maximum	79,500.00	74.00000	4.011900
Minimum	5,400.000	34.00000	0.291200
Std. Dev.	15,785.23	10.20034	1.026042
Skewness	1.520698	0.484404	0.791441
Kurtosis	6.200206	2.461715	2.801389
Jarque-Bera	22.73997	1.433064	2.969125
Probability	0.000012	0.488443	0.226601
Observations	28	28	28

Source: author calculus

Correlation analysis of GDP per capita, employment rate over 55 years, and resource productivity by applying a methodological support of an econometric nature, shall be based on data presented in Table 1, which covers 28 European countries.

The graphical representation of the correlation between variables system under study, Figure 1 and Figure 2 provides information suggestive by the arrangement of the point cloud on form interdependence both between SER 01 = y and SER 02 = x<sub>1</sub> and between SER 01 = y and SER 03 = x<sub>2</sub>. In those circumstances we opted for a multiple linear regression equation that has the general form:  $\hat{y} = a + bx_1 + cx_2$ .

By determining the equation [2] analytically formalize dependence gross domestic product per capita according to the rate of employment over 55 years, and that the resource productivity by eliminating the

influence of other factors that are considered non-essential.

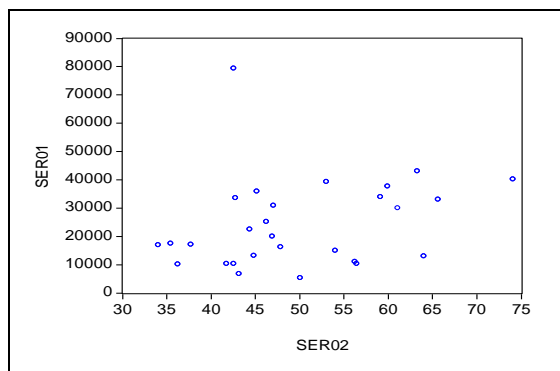

Fig. 1. GDP per capita and employment rate over 55 years cloud  
 Source: author calculus

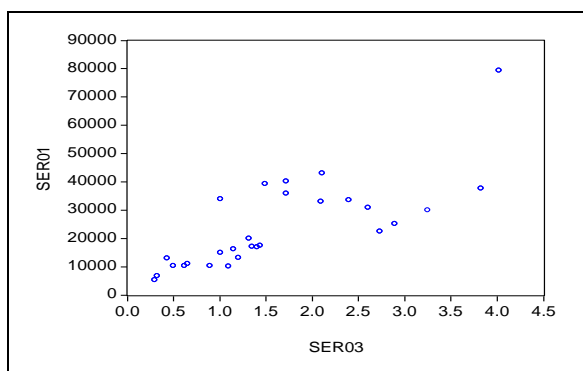

Figure 2. GDP per capita and resource productivity cloud  
 Source: author calculus

Parameter estimation of linear multiple regression equation regarded as analytical form interdependent system studied is performed using least squares method and results following system of equations [1]:

$$\begin{cases} \Sigma y = na + b \Sigma x_1 + c \Sigma x_2 \\ \Sigma x_1 y = a \Sigma x_1 + b \Sigma x_1^2 + c \Sigma x_1 x_2 \\ \Sigma x_2 y = a \Sigma x_2 + b \Sigma x_1 x_2 + c \Sigma x_2^2 \end{cases}$$

After solving the system of equations econometric model is obtained,

$$\hat{y} = -9354.584 + 302.7674x_1 + 11498.27x_2$$

The estimated values of the parameters that define the multifactor model linear gross domestic product per capita and other results information econometric are shown in "synoptic table of econometric representation indicators" that allow to appreciate the level of evidence of the viability of the econometric model, (table 6).

Table 6. Synoptic table of results that attests viability of linear multifactorial model of correlation between GDP per capita and employment rate over 55 and resource productivity

Dependent Variable: PIB/1 loc.				
Method: Least Squares				
$\hat{y} = a + bx_1 + cx_2 \rightarrow$				
$\hat{y} = -9354.584 + 302.7674x_1 + 11498.27x_2$				
Sample: 1 – 28; Included observations: 28				
Variable	Coefficient	Std. Error	t-Statistic	Prob.
Employment rate over 55 years „b”	302.7674	191.2845	1.582812	0.1260
Resource productivity „c”	11498.27	1901.644	6.046487	0.0000
C	-9354.584	9956.308	-0.939564	0.3564
R-squared (R <sup>2</sup> )	0.620533	Mean dependent var	24360.71	
Adjusted R-squared	0.590176	S.D. dependent var	15785.23	
S.E. of regression ( $\hat{\sigma}_{y; \hat{y}}$ )	10105.31	Akaike info criterion	21.38047	
Sum squared resid	2.55E+09	Schwarz criterion	21.52320	
Log likelihood	-296.3265	F-statistic	20.44096	
Durbin-Watson stat	2.211362	Prob (F-statistic)	0.000005	

Source: author calculus

Note: These indicators were obtained by using Eviews.

Actual levels (y) and the estimated ( $\hat{y}$ ) of GDP per capita obtained by applying multiple linear regression equation, residues series and their displacement is shown in Table 7. The graph of residue from the last column of the table provides a picture of their alternation in relation to the origin, which confirms the status non correlation. Statistical coefficient Durbin Watson (DW = 2.211362 - Table 6) confirms this conclusion because is positioned between 1.4 and 2.6, to accept the hypothesis of non-correlation residues. Through this statistical finding it is considered that the efficiency parameter regression equation is appropriate. It notes also that residues do not exceed framing admitted, in statistical terms, expressed by  $\pm 2.060$  estimates of standard error of regression equation

$$(\pm t_{q=0.05; f=n-k=28-3} \cdot \hat{\sigma}_{y; \hat{y}} = \pm 2.060 \cdot 10105.31)$$

under the law of Student distribution for a significance bilateral level of 5% and 25 degrees of freedom. This finding is able to justify the formation of the belief that the econometric model of the gross domestic product per capita formalized by an equation of linear multiple regression shows a construction math correct reality of statistics and therefore has utility practice to substantiate and implement measures

economic growth by considering the two exogenous variables (employment rate for those over 55 years and resource productivity).

Table 7. Actual and estimate values for GDP per capita based on employment rate over 55 years and resource productivity based on a multifactorial linear model including residual plot

Obs.	Actual	Fitted	Residual	Residual Plot
1	33800.0	31049.8	2750.16	.   *   .
2	5400.00	9132.08	-3732.08	.   *   .
3	15200.0	18513.8	-3313.82	.   *   .
4	43300.0	33969.2	9330.79	.   *   .
5	33200.0	34533.7	-1333.73	.   *   .
6	13200.0	14881.7	-1681.69	.   *   .
7	39500.0	23793.5	15706.5	.   *   .
8	17000.0	17041.7	-41.6773	.   *   .
9	22700.0	35383.9	-12683.9	*   .   .
10	31100.0	34782.5	-3682.47	.   *   .
11	10200.0	14145.6	-3945.60	.   *   .
12	25300.0	37847.2	-12547.2	*   .   .
13	20200.0	19932.1	267.921	.   *   .
14	10400.0	13394.7	-2994.74	.   *   .
15	11200.0	15140.6	-3940.56	*   .   .
16	79500.0	49642.9	29857.1	.   .   *
17	10500.0	13473.2	-2973.23	.   *   .
18	17200.0	17518.0	-318.014	.   *   .
19	37900.0	52733.3	-14833.3	*   .   .
20	36000.0	23964.6	12035.4	.   .   *
21	10500.0	10555.7	-55.7164	.   *   .
22	16300.0	18237.2	-1937.22	.   *   .
23	6900.00	7393.68	-493.681	.   *   .
24	17600.0	17841.5	-241.545	.   *   .
25	13400.0	17968.2	-4568.22	.   *   .
26	34100.0	20070.6	14029.4	.   .   *
27	40400.0	32780.1	7619.93	.   *   .
28	30100.0	46379.0	-16279.0	*   .   .

Source: author calculus

Graphic representations in Figure 3 and 4 visual attests the values of GDP per capita (real and estimate) and also residue values in Table 7.

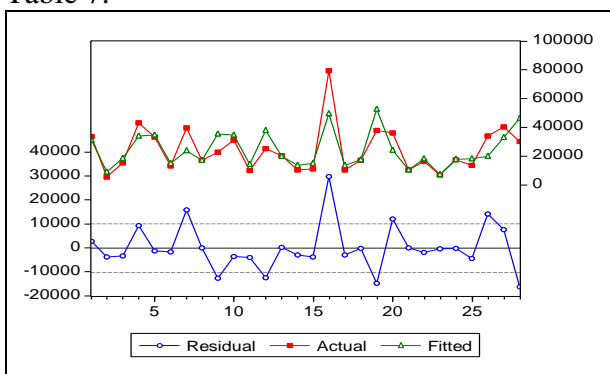

Fig. 3. Graphical representation of residual, real and estimate values for GDP per capita based on employment rate over 55 years and resource productivity  
 Source: author calculus

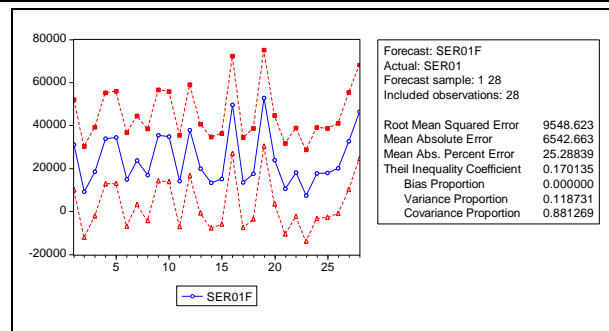

Fig. 4. Graphical representation of estimate values of GDP per capita based on employment rate over 55 years and resource productivity in the limit of  $\pm 2.060$  estimation of average error for multiple linear equation (Student repartition with significance of 5% and 25 freedom degrees)

Source: author calculus

Note: SER01F is estimate value for GDP per capita based on employment rate over 55 years and resource productivity

$$(\pm t_{q=0.05; f=n-k=28-3} \cdot \hat{\sigma}_y; \hat{y} = \pm 2.060 \cdot 10105.31)$$

Test normality of the distribution of the residual variable, Jarque-Bera leads to a rejection of this hypothesis because coefficient JB ( $JB = 8.045334$ ) is associated with a very low probability of acceptance ( $P = 1.7905\%$ ) under the law hi square distribution with two degrees of freedom (Figure 5). It is obvious that this statistical test justify the recommendation to increase the number of observations for better efficiency multifactorial linear regression model.

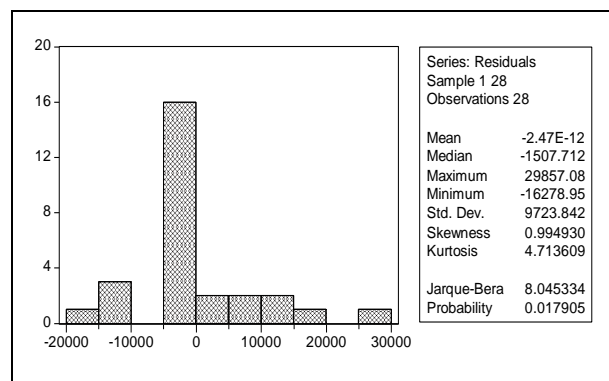

Fig. 5. Statistical description and normality test for residue variable based on Jarque-Bera criteria  
 Source: author calculus

To test the heteroscedasticity / homoscedasticity of residue we will use White test. The results entered in the Synoptic picture "White Heteroscedasticity Test"

(Table 8) was obtained by applying the software Eviews and attests that the residual variable is heteroscedastic. The conclusion is validated both under "F Criteria" and the " $\chi^2$  Criteria" thresholds of significance of 0.000025% and 0.001315% of, reasons for accepting the hypothesis of heteroscedasticity as not exceed a maximum of 5%, considered acceptance threshold.

Based on the results shown in "White

Heteroscedasticity Test" (Table 8) we concluded that the residual variable is heteroscedastic and it is assumed that between the square residual variable and exogenous variables (employment rate over 55 and resource productivity) is formed a significant interdependency relationship, confirmed statistically, and under these conditions the residual variable dispersion is not constant because:

„ F Criteria”

$$F - statistic > F - tabelar = F_{q=0.05; f_1=k-1=6-1=5; f_2=n-k=28-6=22} = 2.66$$

$$F - statistic = 10.77632 > F - tabelar = 2.66$$

$$F - statistic = \frac{\sum_i (\hat{z}_i - \bar{z})^2}{\frac{k-1}{\sum_i (z_i - \hat{z}_i)^2}} = 10.77632$$

$$n - k$$

„  $\chi^2$  Criteria”

$$n \cdot R^2 > \chi^2 - tabelar = \chi^2_{q=0.05, f=k-1=6-1=5} \rightarrow 28 \cdot 0.710075 = 19.88209 > 11.1$$

Table 8. Synoptic picture of „White Heteroscedasticity Test” for linear multifactorial model of GDP per capita

White Heteroskedasticity Test:				
F-statistic	10.77632	Probability	0.000025	
Obs*R-squared	19.88209	Probability	0.001315	
Test Equation: Dependent Variable: RESID^2				
$u^2 = z = a + b \cdot SER02 + c \cdot SER02^2 + d \cdot SER02 \cdot SER03 + e \cdot SER03 + f \cdot SER03^2$				
$u^2 = z = a + b \cdot x_1 + c \cdot x_1^2 + d \cdot x_1 \cdot x_2 + e \cdot x_2 + f \cdot x_2^2$				
Method: Least Squares				
Sample: 1 – 28; Included observations: 28, (n = 28)				
Variable	Coefficient	Std. Error	t-Statistic	Prob.
C „a”	-2.55E+08	5.46E+08	-0.466298	0.6456
SER02: $x_1$ „b”	3664964.	20001778	0.183232	0.8563
SER02^2: $x_1^2$ „c”	60923.29	192180.0	0.317012	0.7542
SER02*SER03: $x_1 \cdot x_2$ „d”	-6532731.	2463894.	-2.651385	0.0146
SER03: $x_2$ „e”	1.87E+08	1.53E+08	1.222709	0.2344
SER03^2: $x_2^2$ „f”	64808196	19242230	3.368019	0.0028
R-squared ( $R^2$ )	0.710075	Mean dependent var	91176203	
Adjusted R-squared	0.644182	S.D. dependent var	1.79E+08	
S.E. of regression	1.07E+08	Akaike info criterion	39.99693	
Sum squared resid	2.51E+17	Schwarz criterion	40.28240	
Log likelihood	-553.9570	F-statistic	10.77632	
Durbin-Watson stat	2.092041	Prob (F-statistic)	0.000025	

Source: author calculus

## CONCLUSIONS

The econometric model of GDP per capita based on employment rate over 55 years and resource productivity is shaped mathematical as regression equation

$$\hat{y} = -9354.584 + 302.7674x_1 + 11498.27x_2,$$

and is certified as a model with a limited viability as criteria for statistical testing does not confirm in all cases that the model is fully viable.

Viability interpretation is based on the following findings:

-Multiple coefficient of determination

$$R^2_{y, x_1, x_2} = 0.620533, \text{ by size, allows us to}$$

appreciate that 62.05% of GDP per capita changes is explained by employment rate over 55 and resource productivity, the gap to 100% is the influence of other variables not included in the model, or residual variable influence;

-Correlation ratio has a very high value

$$(R_{y, x_1, x_2} = 0.787739) \text{ which confirms a strong}$$

positive correlation between the model's variables.

Econometric model studied confirm the statistical significance of the correlation ratio using "F Criteria". Under this criterion we compared  $F_{\text{statistic}} = 20.44096$  with  $F_{\text{table}} = 3.39$  and we found that calculated value significantly exceeds the table value. From the table of Fisher we extract distribution function  $F_{\text{table}}$ , which corresponds to a probability of 95% and the number of degrees of freedom  $f_1 = k - 1 = 3 - 1 = 2$  and  $f_2 = n - k = 28 - 3 = 25$

$$F_{\text{statistic}} = 20.44096 > F_{\text{table}} = 3.39$$

$$F_{\text{table}} =$$

$$F_{P; f_1 = k - 1; f_2 = n - k} = F_{P; f_1 = 3 - 1 = 2; f_2 = 28 - 3 = 25} = 3.39$$

It is attested, with reasonable confidence, that correlation ratio is significantly different from zero or, in other words, the ratio validates real correlation between studied variables;

- Parameter estimator "b" ( $b = 302.7674$ ) is not significantly different from zero (for this parameter accepts null hypothesis), under "t Criteria" with the threshold of 12.60%. In these circumstances the independent variable

(exogenous)  $x_1$  – employment rate over 55 years, offers statistical information that it propagates an insignificant influence on the size of GDP per capita;

- Parameter estimator "c" ( $c = 11498.27$ ) has a statistically significant different from zero, under "t Criteria". It thus provides statistical information that the variable resource productivity has a significant role in the formation and change in GDP per capita;

- Regression coefficient "c" compared with the estimator parameter "b" also allows noting the priority order applied when policy makers will apply measures to increase GDP per capita. First will be considered and implemented measures that lead to increased resource productivity;

- Econometric model highlights the size of the regression coefficient "b" that an increase by one unit for employment rates over 55 years produces an increase in GDP per capita by 302.7674 units and an increase of one unit for resource productivity will increase GDP per capita with 11,498.27 units;

- Heteroscedasticity of residual variable is statistically confirmed and in these circumstances the "t Criteria" for the significance of the regression equation parameters is not fully conclusive and the dispersion of the residue values is not constant;

- Durbin-Watson statistic coefficient ( $DW = 2.211362$ ) has a value which is positioned in the range from 1.4 to 2.6 and we appreciate that the error term are not auto correlated, as a condition for confirming the viability complementary regression equation if used in the calculations of extrapolation. When using the table of Durbin Watson distribution, non-auto correlation residue hypothesis is confirmed for both a significance threshold of 1% and for a significance threshold of 5%, for a total of 28 observation and 2 exogenous variables;

- Relative expression to estimate the standard error of the regression equation, compared with the average value of the dependent variable (GDP per capita), 41.482%, offers information not sustain the viability of the model (regression equation) to calculate extrapolation because it has a size exceeding

the limit of 10% deemed appropriate. A statistical significance similar to that which presents the estimate of the relative standard error of the regression equation is obtained by calculating and interpreting "irregularity coefficient (inequality) of Theil" ( $Th = 17.0135\%$ ) - Figure 4. Irregularity coefficient (inequality) Theil's can take a value between zero and one (100), and is considered as a very good size for assessing the viability of the model when  $Th$  does not exceed 5%. This involves statistical unconfirmed conclusion of invalidity of the model to be used to calculate the extrapolation of estimates;

- Statistical description of the error term statistical series (residual) is shown graphically (histogram in Figure 5) as well as indicators: mean, median, maximum, minimum, standard deviation, the asymmetry coefficient (skewness), bolt-flattening coefficient (Kurtosis), Jarque-Bera statistic coefficient ( $JB = 8.045334$ ) which will form the  $\chi^2$  laws of distribution with 2 degrees of freedom and probability coefficient related  $JB$  (1.7905%). This information underlying the rejection of the hypothesis of disposition values of the error term under the law of normal distribution (test for normality of the distribution of the residual variable) because the probability associated coefficient  $JB$  is less than the critical limit of 60%, as a necessary conclusion to ensure good efficiency econometric model. Obviously testing statistical distribution of the error term, the conclusion that induces to improve the quality model, it is recommended increasing the number of observations;

In conclusion we may consider the multifactor model linear GDP per capita according to the rate of employment of persons who are aged 55+ and resource productivity has limited viability especially when intended to be carried out calculations extrapolating or interpolation. The model can be retained and is a solution of mathematical formalization of statistical regularities between variables included in the model as a source of justification of economic policy decisions.

## REFERENCES

- [1] Andrei, T., 2003, Statistică și econometrie, Economic Publishing House, Bucharest
- [2] Baron, T., Biji, E., Tövissi, L., Wagner, P., Isaic-Maniu, Al., Korca, M., Porojan, D., 1996, Statistică teoretică și economică, Didactic and Pedagogic Publishing House, Bucharest
- [3] Bacescu-Carbunaru, A., 2002, Analiză macroeconomică, Economic Publishing House, Bucharest
- [4] Isaic-Maniu, A., Mitruț, C., Voineagu, V., 1995, Statistica pentru managementul afacerilor, Economic Publishing House, Bucharest
- [5] Mihăilescu, N., Răducan, M., 2008, Analiza activității economico-financiare, Victor Publishing House, Bucharest
- [6] Mihăilescu, N., 2014, Statistica și bazele statistice ale econometriei, Transversal Publishing House, Bucharest
- [7] Petrescu, I., E., 2014, Factor analysis of labor productivity in agriculture in terms of sustainable development, Scientific Papers. Series "Management, Economic Engineering in Agriculture and rural development", Vol. 14(3), pp. 250-255
- [8] Popescu, G., H., Ciurlău, C., F., 2013, Macroeconomie, Economic Publishing House, Bucharest
- [9] Vasile, V., Stănescu, S., Bălan, M., 2013, Promoting the Quality of Life: Challenges of Innovative Models versus Payment Policies", in „The European Culture for Human Rights the Right to Happiness”, Cambridge Scholars Publishing, UK
- [10] Zaman, G., Geamănu, M., 2014, Eficiența economică în condițiile dezvoltării durabile, Editura Fundației România de Măine, București
- [11] Zaman, G., Vasile, V., Cristea, A., 2012, Provocări ale actualei crize economice în contextul cerințelor dezvoltării durabile, Conferința Academiei comerciale din Satu Mare, “Dezvoltare durabilă în condiții de instabilitate economică”-Editura A IV-a, publicat in Revista “ Calitatea-Acces la success”, Vol. 13, S3-2012, pag.13-33

## ASPECTS OF SUSTAINABLE RURAL TOURISM - FARMERS' MARKETS AND FARM VISITS

Mirela CĂRĂTUȘ STANCIU

University "Lucian Blaga" of Sibiu, Faculty of Agricultural Sciences, Food Industry and Environmental Protection, dr. Ion Ratiu str., no. 7-9, Sibiu, Romania, Phone: +40269211338, Mobile:+40744472790, Emails: mirela\_stanciu2008@yahoo.com

**Corresponding author:** mirela\_stanciu2008@yahoo.com

### **Abstract**

*Agriculture is an essential component of sustainable food tourism and there are numerous benefits to a broad range of stakeholders that can be derived from enhancing and sustaining agriculture-tourism linkages in this context. The potential to contribute to rural development and sustainable livelihoods, support for the agricultural and artisan food sectors and reduced economic leakage in the tourism sector are just a few of the potential positive outcomes. Tourists also benefit through the opportunity to experience authentic local culture and heritage, and engage in a meaningful way with local producers and suppliers. Agrotourism differs from food tourism in that agrotourism is inherently rural, while food tourism is predominantly urban, but can be rural as well. The paper shows the role of farmers' markets and farm visits like parts of sustainable tourism.*

**Key words:** agrotourism, local products, market

### **INTRODUCTION**

There is a solid business case to include agriculture in a discussion of food tourism. An increasing number of consumers and travellers alike are interested in the origins of their food. This interest has set the stage for rural economic development in the form of agricultural tourism. A central and well-known component to local food systems includes farms and farmers's markets, which is a form of agricultural tourism, also referred to as "agrotourism".

### **MATERIALS AND METHODS**

The paper is based on a bibliographic study regarding the farmers' markets and farm visits. The case study refers to farmers' markets and farmers' stores which are opened in Sibiu county.

### **RESULTS AND DISCUSSIONS**

Agrotourism can be broadly defined as any agricultural operation serving consumers that may include retail sales and provision of services involving food, fiber, flowers, trees, shrubs and any other farm products. [3]

The agrotourism is compatible with green economy. That compatibility is sustained by the idea of green tourism is tourism practiced in relation with Nature. Green tourism represents one of the three branches of tourism industry, together with travel industry and hospitality industry. [6]

Two emerging components of agrotourism are activities and events centered around farmers' markets and farms. Food tourism trends to focus on prepared food and drink, while agrotourism focuses more on the raw ingredients and the farming experience.

Farmers' markets and farm visits connect travelers to local culture while offering a wide variety of activities focused on local agriculture and cuisine. Agrotourism can also be an opportunity to build partnerships and collaborations that promote more sustainable economic development for urban and rural areas, support farm preservation and increase farmers' livelihood, while helping create diverse and memorable food tourism experiences for travelers. To fully understand the current trend of food tourism's relationship with agricultural tourism, a brief review of farms and farmers' markets is needed.

The historical story of Europe is not only about the many kingdoms and wars, but also of the lesser known lives of ordinary people. Europeans lived largely in the countryside until the last century, when more people began moving into the cities. The work of the local inhabitants was connected to nature and their products were eco-centric. Their inherited experience and expertise were passed down from generation to generation. Travel distances were far, so people were very connected on the local level. Local cuisine developed that still today distinguish countries and regions on the Old World. Most people know at least something about the historical influence on French, Italian, Greek, Spanish and Scandinavian food worldwide. The contribution aims to open the door from the local farms and farmers market into the simple kitchen that evolved in the New World. Today, there is a food movement to get back to the basics. [9]

The Old World way of eating is now becoming the mainstay in the modern countries of central Europe and America and is influencing the food culture of today on a global scale. [2]

To survive during the middle ages, villagers often worked as traders and craftsmen, while at the same time needing to harvest their gardens for food production. With the development of trade in the Middle Age, large urban clusters, also known as agglomerations, were formed. As the population grew, a growing number of villagers could no longer be fed by suburban gardens. Out of this problem grew a solution: “the fair day”. Once a week, farmers and artisans from neighboring villages would come to sell their produce and artisan products. These “fair days” or “markets” always took place in larger towns. Every today, traditional food markets are not generally held at small farms, but in towns. In the same tradition, they are open or covered outdoor marketplaces where the sellers and buyers do business. One of the oldest continuing markets in Europe is the Borough Market in London, England. [20] North America’s oldest market is located in Halifax, Nova Scotia, Canada. [21]

Along with establishment of farmer’s markets, where food is sold directly from farmer to consumer, the role of farming has also evolved.

### **Farming in Twenty-First Century**

Although the primary goal of agriculture is food production, even with government subsidies, farmers often need other gainful activities on the farm to survive. One good way for farmers to do this is through “farm tourism”, where visitors can rest or enjoy farm activities in a natural environment. A central farm activity is consuming homemade food and drink in an authentic environment, including homemade wine from the farm or from a local winery. Many farms also have their own farm store to supplement their income. In some places a tourist can spend more days on the farm and “help” in traditional tasks.

In Austria there are over 10.000 farms solely engaged in tourism activities. [11] These activities include farm and vineyard tours, farm stays and educational workshops, farm stores and stands, wine tasting and tours of vineyard, homegrown farm meals with farmers, hosting and participating in local food fairs, festivals and events. In Slovenia there are thousands of farms that engaged in these gainful agri-business activities, over 500 of which deal with daily trips and tourism.

### **Farms in Nowadays**

The structure of farms and farming has experienced many transformations during the past two centuries. Farming moved from family operated to the large corporate industrialization of mono-agriculture farming. Over time, the negative effects of commercial farming intensified, as did their negative influences on the environment and the health of farms workers and consumers. [1]

The current trend is moving away from large commercial farms in favor of small and medium sized farms working to reestablish more sustainable farming methods, coming to be known as the alternative food system. It arises out of concern for issues such as biodiversity loss, global competition, environmental degradation, economic downturns, and consumer influence. The concept is that an alternative food system is



sustainable and offers an alternate model to conventional agriculture. The overarching concept of an alternative food system is to include practices such organic farming, aquaculture, direct marketing such as community supported agriculture (CSA), farmer's market, and community based farming. Engaging in these alternative practices typically requires farmers to build or strengthen new skills sets and it encourages diversification.

Farm diversification offers farm several benefits including reducing environmental impacts, entry into niches markets, creating new agriculture industries which can strengthen rural communities, decreasing economic risks, and creating a more sustainable food system. [5]

Agrotourism fits nicely into this model. It can consist of local farms providing attractions and activities on their farm while inviting local residents and tourists to participate. In the U.S. alone there are 23.350 farms that provide some kind of agrotourism services. [12] Carlo Petrini founded the Slow Food Movement in Italy as a movement against the industrialization of food that became not only toxic to the land and the consumers, but also which created a monoculture of tasteless food. [15] He had to show consumers that they had the power to choose the type and quality of food they eat. Also he understood that the industrialization of food was standardizing taste and leading to the annihilation of thousands of food varieties and flavors. He saw that "it was imperative for an eco-gastronomic movement to exist-one that was ecologically minded and concerned with sustainability, and one that acknowledged the connection between the plate and the planet". That slow food movement can support and protect small growers and artisan producers, support and protect the physical environment, and promote biodiversity. [14]

In USA Alice Waters "is a pioneer of a culinary philosophy that maintains that cooking should based on the finest and freshest seasonal ingredients that produced sustainably and locally"[13] She created an integrated community of local farmers, ranchers, and food artisans dedicated to

sustainable agriculture practices to supply local restaurants with finest and freshest variety of ingredients available. They have created a new form of "farmers' marketing" by providing organic, sustainable, locale produce, meats, and artisanal foods directly to the restaurants. [8]

Now to international level there is a Slow Food Movement which include more than 1000.000 members from over 130 countries. [15, 19] We can say there is a real marriage of food and travel which opened up opportunities for agrotourism worldwide: travelers can readily include farm-to-fork experiences as they travel abroad.

Local farmers, ranchers, food artisans and entrepreneurs, including farmers' market associations, have a chance to tap into the agrotourism business in a creative manner.

#### **Farmers' Markets**

Farmers markets are found in shopping centers, in streets, banks, hospitals, art centers, indoor shopping centers, arenas, empty lots, and many other areas where permitted by local jurisdictions. The main purpose for farmers' markets is to provide fresh regional food to local residents and support local agriculture [7]. They can also serve as strong connectors along food tourism trails and create destinations that attract tourism in rural communities, such as the development of local and regional food festivals. Roles that farmers' markets can fulfill include providing a venue for nutritional education, cooking demonstrations, food security and social justice education, community building, supporting the local food movement, and entrepreneurial incubators for food artisans.

The new multimedia methods includes dynamic websites, social media and applications developed for smart-phones and tablets. Farmers and farmers' market managers need to stay on top of the constantly changing electronic media tools available to them to remain competitive and to be successful.

Food tourism presents of individuals and organizations that created successful farm-to-fork enterprises. These endeavors not only

help sustain the local food system, but they also have created agrotourism opportunities. Promoting a farms' market as a leisure experience for consumers is also an emerging topic in the recreation and leisure fields, but just like other forms of leisure provision, it requires thoughtful facilitation to be successful.

Some authors show that for Romania, tourism is one of the branches of the economy, which together with agriculture could contribute to increase of GDP per capita. For this purpose, there are needed innovative and sustainable strategies in these sectors. [4]

Local products and traditional products support the local economy, by selling the products the capital returns to the farmers. For the farmers, these activities are the main source of income. The local products shelled directly by the farmers maintain the cultural heritage of the rural area by preserving local traditions (local events and festivals). [10]

#### **Case study: farmers' market and farms opened for visits in Sibiu county**

At Sibiu the first store for BIO products was opened since 2004. The 10 farmers associated in this shop can also be contacted through its site. [16] Some of them allowing to visit the farm, while all these farmers and sell their products directly from the farm.

Another part of the farmers joined together and founded the Association of Producers of traditional and organic products "Marginimea Sibiului".[17]

Farmers selling local / traditional / BIO products attend weekly to the peasant market "Transylvania". From spring to autumn they can sell their products to the "Fair Country" which are opened in Open Air Museum from Dumbrava Sibiu. [18]

Some examples of farms which are opened for educational visits in Sibiu county or in surroundings are: Willy Shuster household, Moşna, Sibiu county, Cişmaş household from Albeşti, Mureş county, Călugăr Anca household from Saschiz, Mureş county.



Photo 1. William Schuster household from Moşna, Sibiu county



Photo 2– Cişmaş household from Albeşti, Mureş county



Photo 3. Products from Anca Călugăr household, Saschiz, Mureş county

## **CONCLUSIONS**

Farmers and farmers' markets have a long history of providing locally grown food to their communities. The development of industrialized mass food production and processed foods of the twentieth century

disengaged many urban people from the land and the local food production that once was part of daily family and community life. With the resurgence and growth of food movements worldwide, along with education and outreach by food producers and supporting associations, local food products are once again begin integrated into many people's daily lives.

The integration of agrotourism elements such as farm visits and farmers' markets is a necessary part of the food tourism offering. As potential for food tourism grows, it is critical for tourism and agriculture industries to build networks, partnerships, and alliances within the communities where they operate and across regions and industries to ensure sustainability of these ventures.

Traditional marketing campaign methods such as brochures, signage, radio and television, need to be enhanced with new multimedia methods.

The development of new niches for farmers' include mobile farmers markets, on-site farm stores open to the public, on-site education programs, tours and cooking demos, and commercial kitchens founded by farmers.

## REFERENCES

- [1]Altieri, M., 2009, The ecological impacts of Agrofuel Monoculture Production Systems in the America. *Bulletin of Science, Technology & Society*, 29 (3): 236-244.
- [2]Bennett Lynne M., Kim Rasto, Miller Krystal, 2014, Farms and Farmers markets, Have fork will travel. *A Practical Handbook for Food & Drink Tourism Professionals*, p. 251-261, Oregon, USA.
- [3]Che, D., Veeck, A., Veeck G., 2005, Sustaining Production and Strengthening the Agrotourism Product. *Linkage among Michingan Agrotourism Destinations. Agriculture and Human Values*, 22(2): 225-234
- [4]Crețu Romeo Cătălin, Ștefan Petrică, Gheorghe Silviu, Bibicioiu Sorin, 2015, New challenges for rural tourism. specialization of agrotourism guest houses. *Scientific Papers. Series "Management, Economic Engineering in Agriculture and rural development"*, Vol. 15 ISSUE 1, PRINT ISSN 2284-7995, 123-126.
- [5]Fritz M., Myers R., 2004, Diversifying Cropping Systems. *Sustainable Agriculture Network, USDA-SARE*. [www.sare.org/Learning-Centre/Bulletins/National-SARE](http://www.sare.org/Learning-Centre/Bulletins/National-SARE)
- [6]Gruia Romulus, 2010, "Food-Tourism - Concept Groundwork Prospective Development", *Journal of*

*EcoAgriTourism*, Brasov, Editura Universitatii Transilvania, vol. 6 (2), pp. 136-140.

[7]Lappe, France Moore, 2011. *The Food Movement: its Power and Possibilities*. The Nation. [www.thenation.com/article/163403/food-movement-its-power-and-possibilities](http://www.thenation.com/article/163403/food-movement-its-power-and-possibilities)

[8]McNamee, Th., Waters Alice, Chez Panisse, 2007, *The romantic, Impractical, Often Excentic, Ultimately Brilliant Making of a Food Revolution*. The Penguin Press, New York.

[9]Pollan Michel, 2011, *How Change Is Going to Come in the Food System*. The Nation.

See Slow Food International [www.slowfood.com](http://www.slowfood.com) and Slow Food USA [www.slowfoodusa.org](http://www.slowfoodusa.org)

[10]Stanciu Mirela, 2013, The attitude and motivation of buyers of traditional/ local/ bio products in the context of agrotourism, in Sibiu county, Romania. *Scientific Papers. Series "Management, Economic Engineering in Agriculture and rural development"*, Vol. 13(4), pp.273-278.

[11]STATcube, 2013, *Statistical Database of Statistics Austria*.

[12]U.S. Census Bureau, 2007. *National Quickfacts*. <http://quickstats.nass.usda.gov/results/203C6378-59FA-349A-99BA-C54471B7858C>

[13] [www.chezpanisse.com](http://www.chezpanisse.com)

[14] [www.slowfoodusa.org](http://www.slowfoodusa.org)

[15] Slow Food, 2013. [www.slowfood.com](http://www.slowfood.com)

[16] <http://www.biocoop.ro/>

[17] <http://www.produstraditionalesibiu.ro/>

[18] <http://www.sibiu-turism.ro/Ce-facem-Evenimente-Targuri-si-festivaluri-Targ-de-produse-traditionale-si-ecologice.aspx>

[19] [www.travelmole.com/news\\_feature.php?id=2004597](http://www.travelmole.com/news_feature.php?id=2004597)

[20] <http://boroughmarket.org.uk/the-history-of-borough-market>

[21] <http://www.halifaxfarmersmarket.com/halifax-farmers-market-to-celebrate-265-years>



## EU FARM SUPPORT POLICY: AN ANALYSIS OF DIRECT PAYMENTS IMPLEMENTATION IN SPAIN

**Liliana CIMPOIES**

State Agrarian University of Moldova, 44 Mircesti, 2049 Chisinau, Moldova, Phone: +37322432387, Fax: +37322312276, Mobile:+37379295721, Email: l.cimpoies@uasm.md

**Corresponding author:** l.cimpoies@uasm.md

### **Abstract**

*Direct payments are meant to support EU farmers being the main component of the Common Agricultural Policy (CAP) and receiving special attention during the new 2014-2020 reform. First introduced in 1992 after MacSharry reform and known as coupled payments (payments per hectare and animal head), they were designed to support farmers income. In 2003, the decoupled payments focused at encouraging farmers have been introduced in order to enhance the competitiveness and sustainability of the EU agriculture. In Spain, in 2006 the new changes in the Single Payment Scheme (SPS) were introduced, at the beginning according to the regime of partial decoupling. In 2012, the coupled payments were integrated under the SPS or transformed into additional payment. The aim of this paper is to analyze the application of direct payments, as the main support tool for EU farmers based on Spain experience. In this context, the authors have used secondary data provided by the Spanish Agrarian Guarantee Fund (FEAGA) and the Ministry of Agriculture, Food and Environment of Spain (MAGRAMA) concerning the amount of allocated direct payments in Spain, number of beneficiaries and their distribution by territorial aspect. So far, the distribution of direct payments in Spain, similarly to other member states, is unequal, as a result of CAP development, diversity of production and the use of historical references to fix the decoupled payments per farm.*

**Key words:** agriculture, direct payments, farmers, Spain

### **INTRODUCTION**

There are many contradictory opinions among economists about the role of direct payments. Many of them agree that direct payments are a needed basic income support for farmers, while others consider that the direct payments should provide a compensation for the public goods farmers deliver [4]. In the same time some economists affirm that there is no need of applying direct payments for farmers as we should not distinguish agricultural sector from other economic sectors [6,7].

Since the beginning of 90s, direct payments had been the main tool aimed to support the agricultural sector in the EU. At the beginning all direct payments were coupled to area or animals and were compensating farmers for cuts in price support [1].

Decoupled direct payments (Single Payment Scheme (SPS)) are the most important CAP instrument and accounts about 75% of total CAP budget or around 30% of EU budget [1]. The direct payments were first introduced with the MacSharry reform in 1992 as

payments per hectare and animal head for compensating farmers for the strong cut in guaranteed prices aimed at reducing the production supply and to facilitate the agreements in the Uruguay round.

Since 2003, direct payments were decoupled from farmers' production decisions and used as reference previous supports receipts in order to decide the rate of payment that must be allocated to each farmer. The new decoupled payments were aimed at encouraging farmers and enhancing the competitiveness and sustainability of the agricultural sector.

Long time was considered that direct payments are an alternative transfer mechanism and an important step to mitigate the negative effects of market price support: high consumer prices and excess supply. They are also considered as best alternative to achieve farm income goals of the Common Agricultural Policy and to avoid the regressive distribution effects of output linked support [5].

Decoupled direct payments are supposed to

have minimal or no allocative effects at all and thus are considered as almost pure income support [5].

Also, if direct payments were to fulfill the basic income function, then a consideration of relative needs, of actual farm income is needed [3].

Nowadays, many issues are discussed concerning the idea of better linking payments to the provision of specific objectives (e.g. environmental aspect) as well as their distribution between individual farms and Member States [1].

## MATERIALS AND METHODS

In the given research data provided by the Spanish Agrarian Guarantee Fund (FEGA) and Ministry of Agriculture, Food and Environment of Spain were used. In order to reach the goal and conclude the research tasks the analysis and synthesis of scientific literature, systematization of information, comparative analysis and summarizing methods were used.

## RESULTS AND DISCUSSIONS

In Spain, in 2006 the Single Payment Scheme started to apply for the first time. The selected method to calculate the value of the payments was the historical model, based on the received payments by the farmers in the previous years. As well, the charge of these payments was not linked with any production level. In order to access the payment the farmer had to have the rights on a certain number of hectares that had to be maintained in good agricultural and environmental conditions. According to the type of payment received during a certain period of time, the rights gathered are considered normal when they have as base the areas who received direct payments, and they are considered special in the case of the livestock payments without territorial base; and withdrawal in the case of payments with compulsory withdraw of land. The 2009 CAP reform eliminated the compulsory withdrawal of arable land, thus in 2010 were normalized the withdraw rights

and they started to be part of normal rights.

Nevertheless, Spain chose the regime of partial decoupling at the beginning, with the aim to maintain the payments most coupled possible. The main reason was that the abolition of coupled payments could lead to the abandon of the agricultural activity and production deployment in important areas in Spain. Thus, Spain maintained and introduced new specific payments regime which would allow keeping linked the payments to production level. As example of these are: aids for wheat durum of high quality, aid per area of crops and leguminous plants producers, specific aid for rice, aid for producing potatoes for starch, aid per area for nuts, aid for seed producers, specific aid for the cotton crop, aid for energetic crop, aid for olive growth, tobacco, aid for sugar beet and sugar cane producers, premium for the livestock sector, sheep and goats breeding, payments for cattle.

Later on, during 2006-2012 CAP reform, the payments linked to production level disappeared, being integrated under the Single Payment Scheme or transformed into additional payments (including additional payments).

The evolution of the decoupling process in Spain and the implementation of SPS by sectors are presented in Table 1.

Nowadays, in Spain are maintained coupled the payments for cotton, national assistance for nuts, sugar beet producers, as well as the suckler cow premium, in the case of assistance regime for cattle. Also, the specific assistance for compensating the disadvantages caused by the decoupled payments in particular sensitive sectors is covered and is encouraged specific types of agricultural production, important in aspects of environmental protection, animal welfare and the quality of the agricultural products. The funds used for financing this assistance come from withholding 10% of maximum national limits of the single payments scheme and are not compulsory to be utilized in the sector of origin [2].

Table 1. Model of the Single Payments Scheme implementation in Spain, according to the type of production

Types of production	% of decoupled payments (incorporated in SPS)				
	2006	2008	2010	2011	2012
Crop production:					
Arable crops, flax and hemp	75		100		
Durum wheat supplement	75		100		
Quality durum wheat			100		
Voluntary withdrawal	75		100		
Compulsory withdrawal	100				
Leguminous crops	100				
Rice	58				100
Cotton	65				
Potatoes for starch producers	40				100
Dried fodder	100				
Hops	100				
Sugar beet and cane	90				
Raw tobacco	38		45		
Olives	93		100		
Tomatoes for processing		50		100	
Fruits for processing (peaches, pears, cherries, raisins)		100			
Citrus for processing			100		
Vineyards elimination			100		
Potable alcohol distillation			100		
Protein crop premium					100
Transformations of dried forages					100
Seeds					100
Transformation of flax and hemp					100
Nuts					100
Livestock:					
Suckler cow premium and others	0				
Beef extensification payments	93				
Special premium for male bovine animals	93				
Additional payments for bovine	93				
Cattle slaughter premium	60 (adult)				100 (calves)
Prime for sheep and goats and others	50		100		
Additional payment for sheep and goat	100				
Dairy premium and additional payments	90				

Source: Bardaji I. (2014), Reflexiones en torno a la PAC, Serie Economia, CAJAMAR Caja Rural

In Spain are applied the following national assistance programs:

-National program to promote arable land rotation in drylands, with the aim to slowdown the strong tendency of the last years towards the cereal monoculture.

-National program to promote and protect the quality of the production in the vegetable sector for human consumption.

-National program to promote specific agricultural activities with large environmental benefits in certain species of nuts. Is granted specific assistance for the producers of almonds, hazelnuts, nuts and carobs that improve the administration of vegetal residues from pruning and contribute to reduce the air pollution.

-National program to promote the quality of tobacco, with the aim to improve the trade and competitiveness.

-National program to promote the quality of cotton, with the aim to facilitate its processing

and improve the crop profitability.

-National program to promote the quality of sugar beet.

-Assistance for improving the quality and trade of beef. Are allocated payments per head of slaughtered cattle under certain quality systems.

-Assistance to compensate the specific disadvantage that affects the farmers' which holds suckler cows.

-Assistance for improving the quality of sheep and goat breeding production.

-Assistance for compensating the specific disadvantage that affects the farmers from sheep breeding sector, to ensure their continuous activity.

-Assistance to compensate the farmers' specific disadvantages from goat breeding sector, particularly those who are located in less favorable areas.

-Assistance to compensate the specific disadvantages that affect the farmers from



milk beef sector with the aim to progressively eliminate the quotas regimes.

-Assistance to improve the quality of milk and milk products according to certain standards of quality [2].

The decoupling of payments in Spain had various effects. The new system of direct payments led to a higher stability of farm incomes, and to establish a more exposed and market oriented agriculture. As result, producers respond easier to prices market signals which motivates a higher intensification and concentration of high value crops production. This production specialization and higher production diversity leads to the abandon of crops and areas less profitable. As result of the CAP reform, the area of cultivated land in Spain decreased, more in dry land than in irrigated, and decreased the extensive livestock, particularly in goats breeding and suckler cows and a deeper decrease in crop diversity. From the reform the olives and vineyards growth benefited, becoming important alternatives in Spanish dry and irrigated lands. Also, detached right for the land ownership was given, associated with the availability of the resource, that involved important distortions in the land and lease market. The change in agricultural structure (except the larger size farms and more commercial oriented) and the abolition of coupled payments in labor intensive crops like cotton or tobacco led to decline in the use of agricultural labor. This decline was not so strong in the last years as a result of the economic crisis which fostered the transfer of active population in other agricultural sectors [2].

An important challenge is the equal distribution of direct payments, because in some cases farmers that cultivate the same crop can receive different payments. Similarly, like in other member states, in Spain is present an unequal distribution of payments resulted from CAP development, diversity of production and the use of historical references to fix the decoupled payments per farm.

In Spain the main institution responsible for the administration and coordination of Single Payment Scheme (SPS) is Spanish Agrarian

Guarantee Fund (FEGA). FEGA is an autonomous organization under the Spain Ministry of Agriculture, Food and Environment (MAGRAMA) aimed to ensure that CAP subsidies are strictly applied in order to achieve the objectives of the policy, reaching the beneficiaries who have met the requirements established for their concession, within the timescales laid out in the regulatory legislation, while promoting homogenous application of CAP subsidies other the whole state territory.

According to FEGA, in 2011 the 74% of beneficiaries received only 15% of total payments. This fact demonstrates the significance of small farms, an important concentration of the payments resulted from the historical payments differences. Also, regional differences in the support level can be noticed, as result of the Spain product diversity and specialization of agricultural sectors.

Table 2. Distribution of direct payments in Spain

Year	Amount, Euro	Number of beneficiaries
2000	5,480,199,244.1	957,069
2001	6,174,891,882.75	1,014,085
2002	5,938,081,669.79	967,140
2003	6,473,878,264.21	981,986
2004	6,326,401,680.03	950,121
2005	6,410,489,074.04	965,054
2006	6,656,127,478.21	962,077
2007	5,694,144,882.46	926,792
2008	5,476,876,522.21	912,956
2009	6,068,452,138.54	963,417
2010	5,933,089,314.48	947,176
2011	5,811,699,716.22	920,707
2012	5,785,117,916.91	904,343
2013	5,811,567,412.3	891,055
2014	5,493,405,777.57	878,655
Total	89,534,422,973.82	

Source: based on MAGRAMA and FEGA data

In the last fifteen years in Spain were allocated more than 89 billion euro as direct payments under CAP. The average amount was of 5,968 mio euro per year. In 2006 for Spain as direct payments was allocated the largest amount of 6,694 mio euro for 962 thousands agricultural producers. The reason was that in this year the total amount of direct



payments allocated to member countries increased as well.

Table 3. Distribution of payments in Spain, by sectors, 2014

Sector	Amount, Euros	Number of Beneficiaries
Single Payment Scheme (SPS)	4,404,727,113.81	853,261
Herbaceous crops	-97,281.09	57
Rice	17,703.29	7
Olive oil	131,093.31	69
Fruits and vegetables	183,347,791.06	829
Sugar and isoglucose	18,524,546.1	5,661
Fiber fax and hemp	139,976.29	2
Cotton	62,491,943.45	5,689
Silkworms	7,729.08	13
Wines and alcohol	191,660,324.58	9,368
Milk and dairy products	492,709.71	60
Cattle breeding	248,498,132.11	42,385
Sheep and goat breeding	41,337.62	24
Pigs breeding	8,761.6	2
Beekeeping	5,076,754.79	2,315
POSEICAN	264,547,726.71	15,547
Rural development	-22,833.49	43
Promoting measures	4,224,857.78	14
Other recovers, irregularities or fraud	-14,082,951.4	6,298
Other costs	-95,308.52	289
Compliance	-1,119,626.06	4,303
Additional payments and derivative modulation	557.3	2
Specific aid (art.68, Regulation (EC) n° 73/09)	200,556,703.51	122,449
Clearance of previous years	-75,671,983.97	7
<b>Total</b>	<b>5,493,405,777.57</b>	<b>878.655</b>

Source: based of FEAGA and MAGRAMA data

According to the distribution of payments in Spain by sectors under the Single Payments Scheme (SPS) in 2014, the largest amount was allocated for POSEICAN (compensations for sellers of seafood products from periphery regions Azores, Madeira, Canarias Islands,

French Guyana and Reunion) of 264 mio euros. It is followed by cattle breeding (248 mio euro) which also has the largest number of beneficiaries (42,385), wine and alcohol production (191 mio euro) and fruits and vegetables (183 mio euro).

The average value of the single payment right (SPR) does not reach 200 euro per hectare in regions as: Madrid, Asturias, Cantabria y La Rioja, and in the CCAA (autonomous communities) with intensive irrigated crops or olives growth, like Murcia and Andalucia is over 400 euro/ha.

Table 4. Distribution of payments in Spain in territorial aspect, 2014

Autonomous region	Amount, Euros	N° de Beneficiaries
Not territorialized	-78,026,541.03	1
Andalucía	1,594,943,969.92	267,987
Aragón	439,524,016.51	49,108
Asturias	62,096,839.8	11,081
Illes Balears	25,643,814.94	7,136
Canarias	266,868,200.96	15,623
Cantabria	40,156,216.19	5,370
Castilla-La Mancha	754,972,554.08	135,546
Castilla y León	892,216,583.82	88,286
Cataluña	294,966,839.89	55,032
Extremadura	517,077,948.73	64,858
Galicia	165,792,999.97	35,057
Madrid	43,295,781.19	6,853
Murcia	108,315,977.88	14,790
Foral de Navarra	107,382,071.09	15,804
País Vasco	55,124,170.18	10,213
La Rioja	45,383,478.1	7,882
Valencia	157,670,855.35	88,188
<b>Total</b>	<b>5,493,405,777.57</b>	<b>878,655</b>

Source: based on FEAGA and MAGRAMA data

Analysing the territorial distribution of direct payments in Spain, the leader both by amount and number of agricultural producers who benefitted is Autonomous Community of Andalucia, followed by Castilla y León and Castilla-La Mancha. Nevertheless, the amounts distributed by farm were larger in the last two regions, compared to Andalucia region were the number of beneficiaries was also higher.

Because of the high production diversity in Spain and the existence of a large area without the historical right to payment have as consequence the variability in the regional payment per hectare which is higher in Spain than in other European countries. If in Spain the average payment per hectare is 202 euro

and the average real is 285 euro, in other countries as France or UK the differences are smaller. In France the average payment per hectare is 294 euro and 300 euro the average real and in UK 212 and 229 euro [2].

## CONCLUSIONS

Since 1990s direct payments had become the main tool to support EU farmers. At the beginning all payments were coupled to area or animals and were aimed at compensating farmers for cuts in price support. Later gradually all payments became decoupled from farmers production decisions and previous supports receipts were used as reference in order to decide the rate of payment that must be allocated to each farmer.

In Spain, this process started to be applied in 2006, at the beginning with the regime of partial decoupling, maintaining the payments most coupled possible form the fear that its abolition would lead to the abandon of the agricultural activity. With the CAP reform until 2012 the coupled payments disappeared, being integrated under the Single Payment Scheme or transformed into additional payment. The new decoupled direct payments contribute to a higher stability of farm incomes and create a exposed market oriented agriculture.

Unfortunately the distribution of direct payments in Spain, similar to other member states, is unequal, being caused by CAP development and diversity of production and the use of historical references to fix the decoupled payments per farm.

## ACKNOWLEDGEMENTS

The research was supported by the EUROEAST post doctoral mobility program at Polytechnic University of Valencia.

## REFERENCES

[1] Agricultural Policy Perspectives Briefs (2011). The Future of CAP Payments.

[2]Bardaji, I., 2014, Reflexiones en torno a la PAC, Serie Economia, CAJAMAR Caja Rural

[3]Fintineru, G., Cofas, E., 2012, Distribution of the direct payments between EU member states. Scientific Papers Series "Management, Economic Engineering in Agriculture and Rural Development", volume 12(4): 78-81.

[4]Rizov, M., Pokrivcak, J., Ciaian, P., 2013, CAP subsidies and productivity of the EU farms. Journal of Agricultural Economics, Vol. 64 (3):537-557.

[5]Sinabell, F., Schmidt, E., Hofreither, M., 2013, Exploring the distribution of direct payments of the Common Agricultural Policy, Empirica, Springer, 325-340

[6]Schmidt, E., Sinabell, F., Hofreither, M.F., 2006, Direct payments of the CAP – distribution across farm holdings in the EU and effects on farm household incomes in Austria. Institut für nachhaltige Wirtschaftsentwicklung, DP-16-2006.

[7]Zhu, X., Lansink, A.O., 2010, Impact of CAP subsidies on technical efficiency of crop farms in Germany, the Netherlands and Sweden. Journal of Agricultural Economics, Vol. 61 (3):545-564

## EVALUATING THE ROLE OF THE LIQUID ORGANIC FERTILIZER, OBTAINED FROM WORM COMPOST, ON THE PHYSIOLOGICAL DEVELOPMENT, QUALITY AND THE MAIZE HARVEST

Larisa CREMENEAC, Tatiana BOCLACI

Scientific and Practical Institute by Biotechnology in Animal Husbandry and Veterinary Medicine, 6525, V.Maximovca, District Anenii Noi, Republic of Moldova, Phone: +37322359351 Fax: +37322359350, E-mail: kremeneak@yandex.ru, draganta8@gmail.com

**Corresponding author:** kremeneak@yandex.ru

### Abstract

*The purpose of work consisted in the evaluation of the role of liquid organic fertilizer obtained from crude worm compost and drinking water in a ratio of 1: 100, on the process of emergence, physiological development and maize productivity. The experiment was conducted in the field conditions of Technological and Experimental Station "Maximovca". As a material for research was used a variety of maize M-450 and liquid organic fertilizer obtained from worm compost. In the experiment were included three lots: one control (with natural background) and two experimental: experimental I - maize seeds were macerated and fertilized, in three rounds, with liquid organic fertilizer (from considerations 4t / ha); experimental II - the seeds macerated in the same fertilizer without additional fertilization. It was found that macerating of seeds in extract obtained from crude worm compost and water and its administration as additional food, in triplicate, accelerated the emergence of maize, had improved physiological development and increased maize harvest with 18.26%. On the lot where were used only macerated seeds but not performed the supplementary feeding the maize harvest surpassed that of the control lot with 10.72%. So, it was found the beneficial influence of liquid organic fertilizer obtained from crude worm compost on the process of maize development.*

**Key words:** crude worm compost, liquid organic fertilizer, harvest, maceration, maize

### INTRODUCTION

Sustainable development of agriculture aims to achieve ecological agricultural production, which is a social issue of global importance. Global ecological situation, including regional, worsened in the last century due to industrialization and chemicalization of agriculture, enlargement of the number of means of transport, storage, maintenance and irrational use of organic waste etc. These have resulted in environmental pollution and its components [4]

A special role in improving the environmental situation lies with the bioconversion of organic waste by worm cultivation and use of its products in order to solve problems in the agrarian sector industries [1].

The technology of bioconversion of organic waste by worm cultivation deserves a particular attention to fundamental research, because it solves some important problems of the zootechnical and phytotechnical sector

improving the situation of the environment, enhancing the soil fertility and improving the quality of agricultural production [8, 9].

Science and world practice had conducted researches directed towards the reduction of negative influence of harmful substances on organisms, paying particular attention to the issues of bioconversion of organic waste, a particular importance being assumed to the bioconversion technology of these by worm cultivation. The purpose of this biotechnology is to obtain ecological organic fertilizer, worm compost [3].

It is known that a serious problem in zootechny is the lack of proteins in food rations of animals and poultry, which has as a consequence the using in greater quantities of different types of forage. Therefore, this issue requires additional costs for the zootechny.

The resources of animal protein in zootechny are limited. For this reason, in recent years, in many countries increases the interest towards the technology of bioconversion of organic

waste by worm cultivation, which is an additional source for obtaining vegetable and animal protein for balancing the food rations for livestock, poultry, fish etc. [5].

Worm cultivation can become the base of the efficient production of ecological forage. Analyzing the results of previous investigations it was found that in crops fertilized with worm compost, total nitrogen content and crude protein exceeded that from the plants of control lot and the content of nitroso compounds decreased essentially [6; 7].

In the result of the research it was found that the worm compost embedded in the soil in dose 3-4 tonnes/ha increases the soil's capacity to supply plants with nutrients and growth, having a long-acting (3-4 years). The results of multiple studies have found that the use of worm compost as a fertilizer in vegetable growing leads to the increasing of vegetables harvest cultivated with 37-51%, sugar content with 15-20% sugar and vitamin C with 15-20%. It was found that worm compost shortens the phenological phases of plant development increases plant resistance to the attack of phytopathogenic agents and to the unfavourable climatic conditions, improves the quality of production and increases the productivity of crop yields [2; 7].

In the literary sources are presented data which support that from the worm compost is obtained a liquid organic fertilizer with high efficiency. The use of liquid fertilizer positively influences on the growth process, photosynthesis, increasing the productivity and quality of agricultural production [12]. This was the reason for effectuation of research in aim to determine: the technological process for obtaining liquid fertilizer, assessing his role on the process of seed germination, peculiarities of physiological development and maize harvest.

## **MATERIALS AND METHODS**

In order to assess the influence of liquid organic fertilizer obtained from crude worm compost on the process of seed germination, physiological development features and the

harvest of maize in the field conditions of Techno-Experimental Station „Maximovca” was organized an experiment in which as materials for research were used the variety of maize M-450, crude worm compost and liquid organic fertilizer obtained from it. For obtaining liquid organic fertilizer was used crude worm compost and drinking water in a ratio of 1: 100. In order to assess the role of liquid organic fertilizer on the process of emergence and increasing of maize productivity, according to the scheme of the experiment (Table 1), in it were included three experimental lots having an area of 0.5 acres (one control and two experimental). For lot I (control) were used the seeds us macerated and natural fund; lot II (experimental - I) was seeded with macerated seeds in liquid fertilizer and during the process of development was conducted a supplementary feeding (in three rounds) of maize with the same fertilizer and for the lot III (experimental - II) were used macerated seeds without affecting the supplementary feeding of the crops during the experimental period.

Before sowing the maize seeds were subjected to the maceration process, for a period of 12 hours, in the liquid organic fertilizer, prepared from worm compost, and then was conducted the sowing according to the usual technology for the mentioned crop. According to maize cultivation technology, after emergence of total plants, at each meter, were left 3 plants. During the vegetation period, in dependence on phenological stages of maize grown on the lot II, was performed a supplementary feeding with liquid organic fertilizer (from considerations of 4t / ha) obtained from crude worm compost and water. During the vegetation period supplementary feeding was carried out in three rounds (first round - the plants had 4.3 leaves, second round – before the ear emergence, the third round - beginning of the emergence of cobs.

At the initial stage and during the experiment were made observations on the physiological process of emergence and development of maize, and at the final stage by weighing was determined the obtained harvest.

Table 1. Scheme of the experiment

No	Lots	Type of crops	Investigations during the experiment
1	Lot I (control)	The seeds us macerated and plants cultivated with natural fund.	Were determined: a) the quality worm compost and liquid fertilizer; b) the development of plants in various phenological phases; c) the maize productivity.
2	Lot II (experimental I)	The seeds macerated and fertilized the maize (in three rounds) with extract obtained from crude worm compost and water, in a ratio of 1:100	
3	Lot III (experimental II)	The seeds macerated in the extract obtained from crude worm compost and water in a ratio of 1:100, without supplementary feeding	

During the vegetation period in dependence on phenological stages (ear formation, the formation of cobs in the milk phase and in the wax phase) corn samples were taken for the determination of some qualitative indicators in accordance with the usual methods [10; 11].

The duration of the experiment depended on the vegetation period of maize

## RESULTS AND DISCUSSIONS

The researches carried out regarding to the evaluation of role of the influence of liquid organic fertilizer (aqueous extract), obtained from crude worm compost on the process of emergence, physiological development, and maize harvest were conducted in order: to determine the quality worm compost the study of process of emergence and physiological development determining the quality and harvest of maize. In the results of the conducted investigations in order to determine the quality of crude worm compost and aqueous extract made from it (in the ratio 1: 100) it was found that their active acidity constituted respectively 7.20 and 7.24 conventional units and total nitrogen content - 3.14% and 0.10%. Humus content, potassium, magnesium and phosphorus in crude worm

compost constituted respectively 22.8%, 1.90%, 0.85% and 1.83%.

In order to speed up the process of germination of seeds, for 12 hours, they were macerated in the liquid fertilizer obtained from crude worm compost and water in a ratio of 1:100. After 12 hours of macerating, the seeds were incorporated into the soil.

As a result of observations carried out on the process of plant emergence it was found that the maize on the experimental lot I and II had emerged respectively with 3 days and 5 days earlier and had developed better than plants on the control lot (Photo 1).

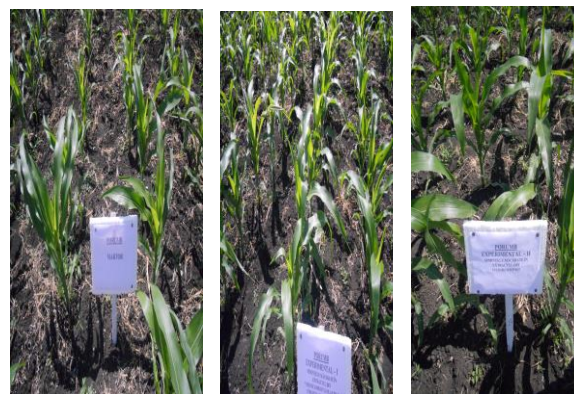

Photo 1. Physiological development of maize plants: a) the control lot; b) the experimental lot I; c) the experimental lot II

In a result of counting plants in each row during the phase of emergence there were found the following (Table 2): the number of maize plants emerged on the experimental lots I and II after 16 days from sowing had exceeded that of the control lot, respectively with 20.69% and 0.86%.

Table 2. The evaluation process of emergence of maize

No	Lot version	Period and number of emerged plants		
		16 days	19 days	25 days
		Number of plants	Number of plants	Number of plants
1	Control	11.6	18.3	35.66
2	Experimental I	14.0	23.6	42.33
3	Experimental II	11.7	22.0	41.66

After 19 days from sowing, the number of emerged plants had increased in all lots, but the ratio of emerged plants on experimental lots I and II exceeded that of the control lot, respectively with 28.96% and 20.22%. There



were noted changes in the number of emerged plants and after 25 days from sowing. But the difference, both between control and experimental lots and between the experimental lots I and II, had reduced. However, in the experimental lots I and II, the number of maize plants exceeded that of the control lot, respectively with 18.70% and 16.83%.

Therefore, the results obtained regarding to the process of the emergence of plants, the seeds of which had been macerated in liquid fertilizer made from crude worm compost demonstrate that its influence was beneficial accelerating the germination process and plant emergence.

In the experimental lot I cultivated with maize additional fertilization, was given in three rounds: I - three to four leaves appearance; II - before the advent of ear; III - after the emergence of ear. Observations on the physiological development of maize were carried out over four phenological stages. As a result of research concerning the development of phases of maize plants from the experiment was found that in the first two phenological phases, the key differences between the physiological state of the plants growing on the control lot and those experimental were not found. Some differences began to appear in the third phenological stage of the development of maize when it was found that in the experimental lot I, were kept more green plants than in the control lot and in the experimental lot II (Photo 2).



Photo 2. Physiological development of crops in the third phenological phase.

a) the control lot; b) the experimental lot I; c) the experimental lot II

This occurred under the influence of the liquid fertilizer obtained from worm compost used in three rounds for supplementary feeding of maize, which in arid climatic conditions maintained the moisture in the soil.

In early September, during the getting of maize harvest (the fourth phenological stage) it was found that on the experimental lot I the green plants constituted - 2.22%, on the experimental lot II - 1.98%, while on the control lot - 0.74 %.

Therefore, from the results of research it was found that liquid organic fertilizers used for additional fertilization of maize prolonged the phase of physiological development of maize.

Researches concerning on the evaluation of some qualitative indicators of maize from the experiment (Table 3) demonstrated that in the first two phenological stages in maize samples collected on the experimental lots I and II, the humidity reduced, respectively with 0.78% - 2.51% and 0.26% - 2.35% in comparison with plants of control lot. In the last phenological phase of maize development, the humidity value, in maize samples collected from experimental lots was more heightened with 2.37% (experimental lot I) and 1.11% (experimental lot II) than in plants of control lot. The value of total nitrogen in plants on the experimental lot I in all 3 phases exceeded the one of plants in the control lot, respectively with 65.41%; 59.40% and 66.67% and the crude protein content of the same sample increased respectively with 65.40%; 59.45% and 66.76%. The same regularity was ascertained regarding to the total nitrogen and crude protein content in the samples collected on the experimental lot II. The value of total nitrogen and crude protein in samples of this lot had exceeded, respectively with 31.45% and 31.38% (phase I); 29.09% 29, 09% (phase II), and 24.56% and 24.63% (phase III) the one from the samples of maize collected from the control lot.

In the result of researches concerning the content of nitrate in maize samples it was found that the value of nitrates in plants collected on the experimental lots had diminished in phenological phases I, II and III

respectively with 4.33%; 33.24% and 9.71% (experimental lot I) and with 1.93%; 3.08% and 6.32% (experimental lot II).

Table 3. The evaluation of the quality of maize in addition on phenological phases

Lots	Phases	Biochemical indicators			
		Humidity, %	Total nitrogen %	Crude protein, %	Nitrates, %
Cont rol	I	86.72±0.7	1.59±0.2	9.94±1.4	42.08±3.5
	II	81.80±0.3	1.65±0.1	10.31±0.7	31.52±0.4
	III	63.20±0.2	1.71±0.0	10.68±0.0	15.74±0.8
Exp erim	I	86.05±0.3	2.63±0.2	16.44±1.4	40.26±3.5
	II	79.75±0.3	2.63±0.2	16.44±1.1	21.04±0.5
	III	64.70±0.5	2.85±0.2	17.81±1.1	14.21±0.5
Exp erim	I	86.58±0.74	2.09±0.2	13.06±0.9	41.26±1.4
	II	79.90±0.2	2.13±0.1	13.31±0.5	30.55±0.4
	III	63.90±0.2	2.13±0.1	13.31±0.5	14.74±0.1

**Note:** I – ear formation; II – cobs in the milk phase; III – cobs in the wax phase; 13.31 -  $P \leq 0,001$

Therefore the quality of maize cultivated with the use of macerated seeds in the extract obtained from crude worm compost and the administration of this as additional food, in three rounds is superior to that in the control lot and to the lot in which were used only macerated seeds.

Analyzing the results concerning to the harvest of maize obtained on the surface unit (Fig. 1) it was found that the one collected on experimental lots I and II surpassed that of the control lot, respectively with 18.26% and 10.72 %.

It has also been found a difference and between the harvest of maize collected on the experimental lot I and that collected on control lot and on experimental II.

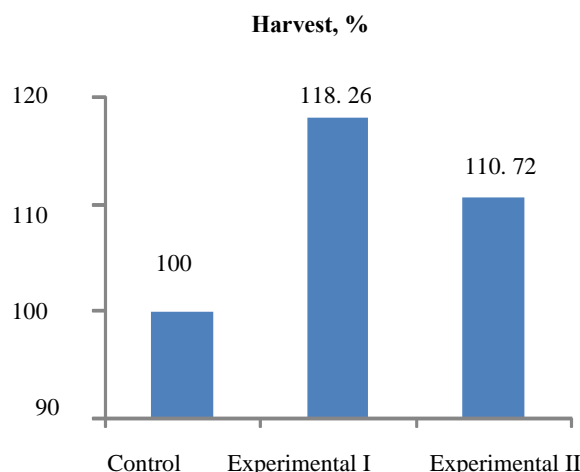
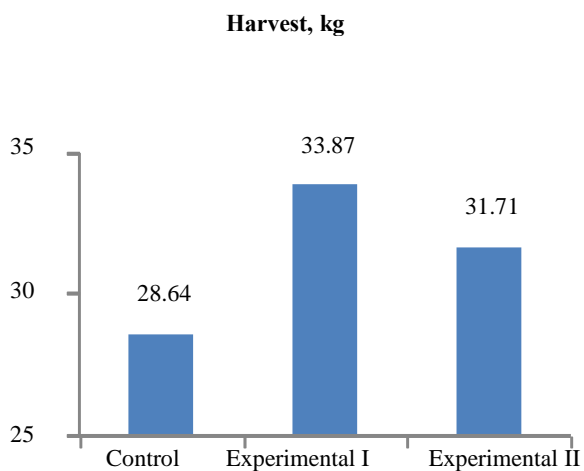

Fig.1. The evaluation of maize harvest

In this case the maize harvest collected on control lot and experimental II were respectively with 15.6% and 6.38% lower than that collected on the experimental lot I. The results presented in the table 4, shows that in comparison with harvest collected on the experimental lot II was different from the other two lots. Analyzing the obtained data it was found that the harvest on the control lot was with 8.92% lower, while the one on the experimental lot I had surpassed with 6.81% that of the experimental lot II.

Table 4. The evaluation of maize harvest used in the experiment

No	Lots	Harvest	
		kg	In a ratio with control lot, %
1	Control	28,640	100.00
2	Experimental I	33,870	118.26
3	Experimental II	31,710	110.72

Thus the analysis of obtained results demonstrates that on the lots in which the seeds before sowing had been macerated with the aqueous extract obtained from crude worm compost in a ratio of 1: 100, and the plants were fertilized with the same extract, the maize harvest was greater than that on the control lot

Therefore, analysing the results obtained in the field experiment it was found that the liquid organic fertilizer prepared from crude

worm compost and water in a ratio of 1: 100, used for macerating of maize seeds before sowing and for fertilizing with this of plants, in three rounds, during the vegetation period beneficially influenced as on the process of emergence and physiological development of plants, as well as on the maize harvest.

## CONCLUSIONS

Following the researches it was found that liquid organic fertilizer obtained from crude worm compost and drinking water in a ratio of 1: 100:

- Contributed to the early emergence of maize seed and its physiological's development;
- Prolonged the phase of the ripeness of maize;
- improved the maize qualitative indicators;
- increased the harvest of maize collected from the experimental lots I and II surpassing the one on the control lot, respectively with 18.26% and 10.72%;
- it may be used in a quality of fertilizer for macerating of seeds and supplementary nutrition of agricultural crops, in accordance with the proposed scheme.

## REFERENCES

- [1]Boclaci, T., 2012, Management of organic waste in environment protection context. Scientific papers. A. Agronomy Series. Volume LV, Bucharest, 279-282.
- [2]Boclaci, T., Cremeneac, L., 2013, Influence of fertilization of soil with worm compost on quality of peas intended. Scientific bulletin. F. Biotechnologies Series, Volume XVII, Bucharest, 39-43.
- [3]Cremeneac, L., 2003, The bioconversion of organic waste in Moldova. Information synthesis. Agroinformreclama. Chisinau 22-24.
- [4]Cremeneac, L., Boclaci, T., 2013, General aspect of management of organic waste in sustainable development of agriculture, Scientific bulletin. F.Biotechnologies Series, Volume XVII, Bucharest, 43-49.
- [5]Cremeneac, L., Boclaci, T., 2012, Technology of bioconversion of organic waste and the use of the obtained products. Recommendations. Typography "Print-Caro", Chisinau, 60-62.
- [6]Cremeneac, L., Boclaci, T., Brad, T., 2014, Evaluation of the quality and productivity of maize grown with compost worms. Book of abstract. 12-th International Symposium of Animal Biology and Nutrition. Balotești, Romania, 31.

[7]Cremeneac, L., Boclaci, T., 2015, The role of worm compost in improving the quality and increasing the productivity of maize. Magazine "Moldovan Agriculture", No. 1, 26-28.

[8]Gorodnii, N., 1996, Bioconversion of agro management systems, Kiev, p.84-103, 162-171

[9]Melnick, J., 1994, Vermiculture: the production and use, Ucr INTAI, Kiev, 36-103.

[10]Popov, A., et al., 1973, Fundamentals of Biological Chemistry and zootechnical analysis, Publisher "Kolos", Moscow, 256-266.

[11]Razumov, V., 1986, Reference of the chemist lab assistant on analysis of feed, Rosselkhozizdat, Moscow, 89-92; 144-148.

[12]Society standard, 2011, Concentrated organic fertilizer on the basis of biohumus, Chișinău, 1-9.



## SURVEY REGARDING THE CORPORATE GOVERNANCE IMPLEMENTATION IN ROMANIA

Raluca Florentina CREȚU<sup>1</sup>, Georgeta Narcisa CIOBOTAR<sup>1</sup>, Romeo Cătălin CREȚU<sup>2</sup>

<sup>1</sup>The Bucharest University of Economic Studies, 6, Romana Square, Bucharest, Romania, Emails: cretu\_raluca@yahoo.com; cnarcisa@ase.ro

<sup>2</sup>University of Agricultural Sciences and Veterinary Medicine Bucharest, 59 Marasti, District 1, 11464, Bucharest, Romania, Phone: +40213182564, Fax:+40213182888, Mobile:+40723 567 799, Email:creturomeocatalin@yahoo.com

**Corresponding author:** creturomeocatalin@yahoo.com

### Abstract

*Business world is a competitive world where only those who can adapt best to the market survive. Still, being successful from an economic stand-point does not refer to fraudulency, treacherous practice or complete exclusion of the competition. The existence of competition and need for profit does not get into conflict with accurate behaviour and respect for ethical standards. A company's value increases depending on identifying and harmonizing the conflicts of interests that occur between the social partners of the company, especially between shareholders and managers. The harmonization of these interests is ensured by the corporate governance system which aims for the global performance of the company. The present study undertakes to research the impact of the Government's emergency rule no. 109/2011 over 15 public entities/companies.*

**Key words:** competitiveness, corporate governance, evaluation, management

### INTRODUCTION

At an organization's level, the corporate governance concept refers directly to the influence of strategic decisions concerning adding value. Maximizing value relies under the managers' responsibility. The managers' behaviour regarding the wealth maximizing criterion is done by incentive levers and control mechanisms. [3]

As per classical finance theory, organization is an entity with a specific target: the maximization of the owners' wealth, which is maximizing profit due to the fact that business world is the world of profit.

For numerous economic actors, business world is a jungle where there are no rules for achieving goals. [1]

### MATERIALS AND METHODS

In ancient times, profit that now seems the only goal of entities was considered back then as something impossible as it was considered a shameful occupation. For Aristotle, trade was divided into survival trade which was done for supporting a household and the trade

done exclusively for profit. While the former type was considered essential for the existence of a quasi-complex society, the latter was regarded as a parasite.

Milton Friedman said that having profit as a goal is equally a moral duty as long as profit was obtained in legal circumstances. It was a moral duty both for business men, as well as managers, and this assumption was based on three reasons: Friedman alleges that not having profit as a main goal of the economic activity dis-respects the individuals' rights and it is unreasonable and undemocratic. [6] Coase's, Jensen's and Meckling's surveys have reached the same result, meaning that it is essential for the entity to separate management and finance or, in other words, to distinguish between ownership and control on one hand and management and control on the other hand. Ownership is represented by shareholders that have the needed resources (financing, funds) but need a specialized human capital, capable of using in an efficient way the shareholders' funds to generate profit. According to Boatright, "owner" needs to be used cautiously as it needs to be carefully separated from "investor". Unlike the true

owner, the investor does not own in every possible way an asset, but only some rights, limited by decision and options. [9]

For the Japanese cultural environment, private property is understood first as a way of promoting public interests, far from selfishness, and only last as serving the owners' selfish interests. If a company faces financial difficulties, the first measure taken by managers is to cut-down on their own salaries, followed by decreasing the shareholders' stock dividends and only then by cutting-down on the employees' revenue. If all these measures fail, the next step is to sell the company's assets, while firing employees is the last step to be taken into consideration. [4].

## RESULTS AND DISCUSSIONS

Corporate governance is based on the organization's theory and its inherent costs, as well as on the attempts to clarify the relationship between the various participants in defining the corporations' management and functioning. [2]

The main theories at the chore of corporate governance are shown in Fig.1.



Fig. 1. Theories at the chore of corporate governance

The principles of implementing corporate governance within organizations have been based on the Agency Theory. This theory refers to the relation between investor/shareholder and manager/administrator, extending further to the whole range of relations existing between those involved directly or indirectly in the activity of a company. The Agency theory has served as grounds for the way organisations manage themselves and top management acts as an

agent of the managing board, of the shareholders and it has only one task: maximizing productivity of the investment/profit. [7]

According to Stewardship theory, people with managing positions in an organization are motivated by the desire for success and get satisfaction through their work itself. In the same time, there are variations in the manager's performance depending on the structural model for managing the company. The theory describes the manager's role in maintaining and developing the organization's value.

As per the Stakeholders theory, the corporate governance reflects the way the organization is being managed and controlled. In defining this concept, the main idea is that global performance of the company is based on the theory of the interests' holders (picture no. 2). The value of the company maximizes as managers succeed in identifying and harmonizing the conflicts of interests that occur between the social partners of the company, mainly between shareholders and managers. Harmonizing these interests is ensured through the corporate governance system. Most of the times, conflict resides in dis-respecting the minority shareholders' rights and diminishing their wealth by the majority shareholders. The conflict between majority and minority shareholders usually degenerates into other conflicts between management, managing board and minority shareholders, as well as between majority shareholders and the company's business partners.

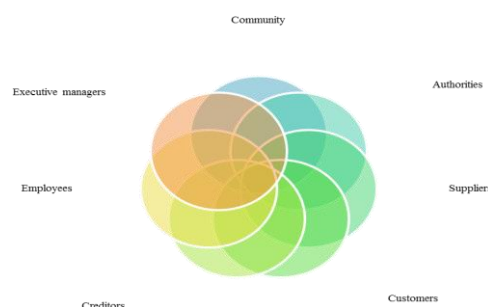

Fig. 2. The conflict of interests and the parties involved  
 There has always been a conflict of interests between shareholders and managers and it is

based on the fact that managers are poorly motivated as far as distribution of dividends to shareholders is concerned, the former preferring to re-invest the net profit even in low profitability projects in order to preserve the control over important resources. [10]

Company's policy must oriented towards: moral integrity and ethics; transparency; accounting audit; the independence of all auditors; establishing and further on checking the benefits package of the general manager and other senior managers; defining the criteria for appointing a person on a managing position, such as the Managing Board; establishing the resources that the manager has in order to run his activity, as well as defining his tasks; risk management procedures; policy regarding the distribution of dividends; equal treatment policies, elimination of discrimination; policies regarding the social responsibility of the company. [8]

In running its activity, the management of the company will have to take into account the conflicts deriving from the wide variety of interests found under "the same roof", as these might jeopardize efficiency if they are not identified and defined accordingly.

### Models of Corporate Governance used by Companies

There is no such thing as corporate governance in the under-developed countries or in countries with an economy under transition. Regardless of the governance model in discussion, corporate governance can best be observed in the developed countries (Fig 3).

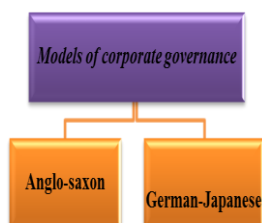

Fig. 3. Models of corporate governance

In EU member states, one can observe two general models of corporate governance with the following specific characteristics:

- The Anglo-Saxon model of corporate governance (specific for companies in UK, as

well as those in SA, Hong Kong, Australia);

- The German-Japanese model of corporate governance (specific for companies in Germany and continental Europe, as well as those in Japan).

*The Anglo-Saxon model* is based on the domination of independent persons and individual shareholders who are not linked to the corporation by business relations (the so called outsiders).[8]

As per Mayer's classification, the Anglo-Saxon model represents a system based on the external influence (outsider – based system) practiced by active capital markets through acquisitions and joint-ventures over the rated companies.[11]

The registered capital belongs to several shareholders who are mainly interested in dividends. Shareholders prove to be aggressive and revolutionary, in terms of speeding up the implementation of efficient policies, with a predisposition to quick re-organization of the un-profitable sub-divisions and re-financing new profitable activities. This is the upside of the model.

The downside of the model consists of the excessive focus over profitability to the detriment of development and implementation of development strategies. [8]

*The German-Japanese model* is a system based on internal control (by intervention), without being centred on the strong influence generated by the active capital markets, but rather on the existence of strong shareholders, such as the banks. Shareholders play the part of correcting low quality management, of stimulating economic efficiency and harmonizing the interests of the company's social partners, including their personnel. Labour plays the most important part. The main goal resides in defending the interests of the parties involved in the company. The upside of this model consists of the fact that shareholders are interested in long term strategy and business stability. [12]

### Implementation of Corporate Governance. Practical study-Public entities in Romania

There are an extremely large number of public entities in Romania. The data released by the Ministry of Public Finances at the end of June 2014 were showing that the central and local

authorities own majority shares in 1,525 companies, out of which 235 are inactive. There are 247 public active entities subordinated to various central administration institutions and 1,051 active entities in the portfolio of the local administration. The number is significantly higher than the one in the OECD countries (Table 1).

Table 1. Number of public entities

Country (year 2009)	Total number, of which	Rated on the Stock Market		Not rated	
		Majority shares	Minority shares	Entities, majority shares	Legal public entity
Austria	11	2	2	6	1
Belgium	8	1	0	7	0
Czech	124	1	0	82	41
Denmark	15	0	2	11	2
Estonia	54	0	0	32	22
Finland	45	3	9	28	5
France	60	2	9	30	19
Germany	62	0	3	57	2
Greece	82	7	3	72	
Hungary	359	0	1	346	12
Italy	28	0	3	25	0
Holland	28	0	0	28	0
Norway	51	3	5	33	10
Poland	590	13	4	573	
Portugal	93	0	0	42	51
Slovenia	37	3	1	33	
Spain	152	0	1	115	36
Sweden	50	0	3	43	4
Switzerland	4	1	0	1	2
U.K.	22	1	1	12	8
Romania (2014)	1,528	8	3	1,408	109
Romania, central authority	307	8	3	281	15

Source: Evaluation of the implementation of the Emergency Rule no. 109/2011, authors Dr. Aurelian Dochia, coordinator and main author, Dan Paulopol Necula, legal expert, Georgiana Nichita, legal assistant, 2014, page 5.

In Romania, the Emergency Governmental Rule no. 109/2011 was released in order to implement the principles and theories of the corporate governance in public entities in order to increase added value. The implementation of EGR 109/2011 started with the selection and appointment of the new administration boards and managers of 33 big entities. However, the majority of the managing boards appointed that way were soon cancelled from various reasons. The members of the managing boards that had been removed from these positions have soon been replaced by interim members and in more than 200 of the entities from the central administration portfolio the selection and appointment process hasn't even been re-

started. [5]

As presented in Table 2, the 15 entities participating to the study belong to: (i) Transports Department: 6 entities, (ii) Energy Department: 6 entities, (iii) General Secretariat of the Government: 1 entity, (iv) Department of Communications and Informational Society: 1 entity and (v) Economy Department: 1 entity.

Table 2. The entities participating to the study

	Name of the public entity	Owning/surveillance state institution
1	„CFR” SA National Railway Company (CFR Infrastructure)	Transports Department
2	„CFR Calatori” SA National Railway Passenger Transport company	Transports Department
3	„CFR Marfa” SA National Railway Commodity Transport	Transports Department
4	„METROREX” - S.A Bucharest Underground Transport Company	Transports Department
5	TAROM” SA the Romanian national air transport company	Transports Department
6	Bucharest National Company of Airports	Transports Department
7	SC Complexly Energetic Hunedoara SA	Energy Department
8	SC ROMGAZ SA Mediaş	Energy Department
9	SC OIL-TERMINAL SA Constanţa	Energy Department
10	SC Complexul Energetic Oltenia SA	Energy Department
11	SC CONPET SA Ploieşti	Energy Department
12	SC Nuclearelectrica SA Bucureşti	Energy Department
13	SN Transgaz SA	General Secretariat of the Government
14	Compania Naţională Poşta Română SA	Department of Communications and Informational Society
15	„Electrica” — S.A. Bucureşti	Economy Department

Source: Evaluation of the implementation of the Emergency Rule no. 109/2011, authors Dr. Aurelian Dochia, coordinator and main author, Dan Paulopol Necula, legal expert, Georgiana Nichita, legal assistant, 2014, page 34.

## CONCLUSIONS

A close evaluation of the activity of public entities that have tried to re-invent themselves as a result of implementing the principles of corporate governance over the past 3 years (2014-2011) shows evidence of a total failure. There are multiple reasons as presented in Fig.4.





Fig. 4. Causes of the failure in implementing EGR 109

-Unrealistic expectations: the Rule has been promoted by mass-media as offering a steady and quick remedy for solving problems in the public sector. The expectations were high, therefore the disappointment was inevitable. Obviously, it is wrong to assume that the simple change of the managing boards and managers will help the problems accumulated all along a number of years disappear. Instead of presenting OUG 109/2011 as a quick solution for solving problems, authorities should have described it as part of a more complex and long-term process of strengthening public administration.

-Problems related to assuming the Rule: This is, without a doubt, the most important and the most neglected aspect regarding the implementation of OUG 109/2011. There is no institution to be clearly held responsible for the general supervision of implementing the Rule.

There are no deadlines or penalties to be enforced in case of breach. The implementation agents are central government entities who do not have the corresponding incentives to stimulate implementation. On the contrary, it is likely that loop departments might be interested rather by preserving the current situation.

-Responsibility: The lack of assumption

generates lack of responsibility. Who is it to be held responsible if OUG 109/2011 is not adequately implemented? Given the fact that tasks have been distributed to several agents, responsibility is diluted. Since the prevailing perception is that ministers are excluded in most of the cases from the decisions regarding the governance of public entities, they cannot be held responsible. [5]

-Limits in building the institutional premises. The governance frame of public entities is not limited to the selection, appointment and remuneration of the councils which are aspects considered by OUG 109/2011. In order for the managing boards to function appropriately, there has to be counter-party, the owner/the state, and capable to establish adequate performance criteria, to supervise achieving goals, to analyse and put into practice the appropriate incentive mechanisms to empower in an accurate way the managing boards of state companies. OUG109/2011 does not attempt to define such a global system outside the company.

-Confusion with regard to the level of the exercised roles. Entities exercising ownership on state companies (loop departments or equivalent institutions) have in fact several simultaneous roles, from establishing sector strategies and macro industrial policies to privatization of a company. As a result, these can have conflicting interests with regard to various aspects and might sacrifice the goals of good corporate governance for other priorities.

In the same time, it must be admitted that OUG 109/2011 has had a significant impact over the political, corporate and social environment in Romania in so many and most often unexpected ways.

## REFERENCES

- [1]Anson, M., 2003, Corporate Governance Rating: Come of Age, IGGN Conference, Amsterdam
- [2]Avram, V., 2003, PhD study: „From separation of the property and decision functions to governing the company – the influence of the governing system on the process of wealth accumulation”
- [3]Brown Lawrence D., Caylor, M. L., 2004, Corporate Governance and Firm Performance (December )
- [4]Cretu, R.F., 2012, Corporate Governance methods

and practices, Universitară Publishing House

[5]Dochia Aurelian, coordinator, Paulopol Necula Dan, Nichita Georgiana, 2014, Evaluation of the implementation of the Emergency Rule no. 109/2011, Final report

[6]Fama, E. F., Jensen, M. C., 1983, Separation of Ownership and Control, Journal of Law and Economics, (June)

[7]Firu, F., 2009, Partner groups, Mirton Publishing House, Timișoara

[8]Ghiță, M., 2008, Corporate governance, Editura Economică, Bucharest

[9]Jensen, M. C., Meckling, W. H., 1976, Theory of the Firm: Managerial Behavior, Agency Costs, and Ownership Structure, Journal of Financial Economics (October)

[10]Morariu, A, Suciu, G., Stoian, F.,2008, Internal audit and corporate governance, Universitară Publishing House, Bucharest

[11]Robu, V., 2004, Research Project „Comparative analysis of the corporate governance system of Romanian entities and of the models used in the EU countries”

[12]Șerban, E.C., 2007, Business risk. Content and analysis methods, Infomega Publishing House, Bucharest

## ANALYSIS OF THE ROMANIAN RURAL AREA

Ada-Flavia CRISTINA, Camelia MĂNESCU, Alin Marcel POPESCU,  
Nicoleta MATEOC-SÎRB

Banat's University of Agricultural Sciences and Veterinary Medicine 'King Michael 1<sup>st</sup> of Romania' from Timișoara, Faculty of Agricultural Management, 119 Calea Aradului, Zip code 300 645, Timișoara, Timiș County, Romania, Mobile: +40726 2455577,  
Emails: ada\_flavia@yahoo.com, cameliaoborocea2004@yahoo.com,  
alin.popescu28@yahoo.com, mateocnicol@yahoo.com

**Corresponding author:** ada\_flavia@yahoo.com

### Abstract

*Rural areas are an important component of the overall evolution of the Romanian economy. The main three resources that require the agricultural restructure and rural development in our country are: the utilized agricultural area (14.8 million of hectares), the rural population (which represents around 9.24 million people, which means 46% of the population) and rural area surface (which holds 87.1% of the country surface). Therefore, the paper represents a study on rural development given the existing resources and factors, which highlights the features and functions of the rural area, insisting on these elements. At the end of the paper, there were highlighted the strengths, weaknesses, threats and opportunities of the Romanian rural area, using the SWOT analysis method.*

**Key words:** agriculture, natural resources, poverty

### INTRODUCTION

Rural area in Romania consists of the administrative area of 2,861 communes comprising 12,957 villages. [4]

The rural area surface sums up 207,522 km<sup>2</sup>, respectively 87.1% of the country surface. The rural population is currently about 9.24 million people (46% of the population). [5] The number of the rural households is 3,311 thousand (45% of the total number of the households in the country) and of housing is 3,888 thousand (46.8% of the total number of the housing in the country). [8]

The majority of the economic resources existing in our country, such as the industrial raw materials, the agricultural and forest resources, tourism and spa, are found even in the rural areas.

The main activities in the rural areas (agriculture, forestry and logging), are still holding a high share in the gross domestic product, compared with the developed countries in the EU. Employment in these industries represents over 1/3 of the entire employed population of the country. [3]

### MATERIALS AND METHODS

In order to analysis and diagnosis the Romanian rural area, were used as research method: the multi-criteria analysis (an analysis based on the statistical indicators system) and the SWOT analysis.

In the rural area diagnosis by analyzing the system of statistical indicators in Romania, the authors, first used the seven criteria for analysis, and after this, summarized the important issues found in the research, using the SWOT analysis method.

### RESULTS AND DISCUSSIONS

In the rural area there are valuable items of *potential land* (agricultural land with superior production qualities, allowing crop diversification and the achieving of some major productions; forest land, reservations and natural monuments, areas with landscaping values in particular) *human potential* (large workforce, partially qualified in the non-agricultural activities, youth reserves which ensures its regeneration) and

*heritage* (historical, cultural, architectural and ethnographic). [1]

Despite these potentially valuable items, the large disturbances which have occurred in the rural areas in the recent decades, affected all the components of the economic and the social life, have changed economic relations, system of values, individual behavior and fundamentals of life in the rural communities. Under these circumstances, the rural area experienced a regressive process.

In the following, rural area is analyzed through multi-criteria analysis, such as: physical-geographical, demographic, economic, housing, technical equipment, social and ecological criteria. [9]

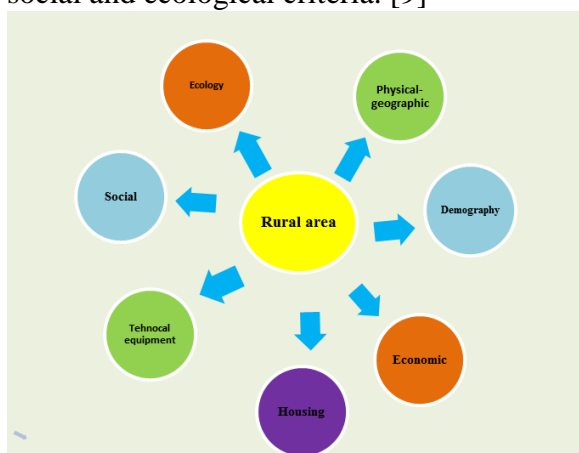

Fig. 1. Criteria for the analysis of the rural area

Regarding the **physical-geographical** aspect, the major risk factors for the rural area are floods, landslides, high seismicity, low rainfall, and reduced water sources. Although these risks are common in the rural area, only about 1/5 of the country surface is exposed to more difficult situations in this respect.

With reference to the **demographic** aspects in the rural area, it was registered a tendency of decreasing population and increasing demographic imbalances (the share of the elderly population continues to grow, which leads to a very high overall mortality).

**Economically** speaking, there is a limited diversification of economic activities, because the most rural localities have an economy based exclusively on agriculture, and where the non-agricultural activities are mainly industrial activities related to the exploitation of natural resources. Because of the contraction of the industrial activities and

construction of the cities, the job offers decreased in the rural area, which concluded to a lack of attractiveness for the youth to remain in the rural areas. [2]

The practiced agriculture is underperforming, where predominates small agricultural exploitations, without the adequate equipment, which can provide only the family subsistence.

**The rural housing criteria** is characterized by poor housing conditions for approx. 38% of the population, where the lack of equipment with plumbing inside the house was recorded in 84% of the households, which represents a high proportion of residential buildings made of materials unsustainable and an aging housing fund, with approx. 75% housing have more than 30 years. [7]

Regarding the **technical equipment** in the rural area, there is a poor state of roads (the majority of the roads are not upgraded and more than 61% of the rural population has no access to the major road and rail network). The water supply is inadequate (52 % of the population [6] are not benefiting from the public water supply system, and where the facilities exist, the amount of water supplied is usually insufficient).

With regard to the **social infrastructure and to the related services** in rural areas, the number of doctors is insufficient, (the number of people per one doctor is three times higher than in urban area). The education network is poorly diversified, the quality of the buildings is inadequate and the specialized equipment is poor, the infant mortality is high, as a direct result of the scarce living standards and health care.

On the quality of the **environment** degradation of soils predominates in the rural areas, due mainly to the human actions, thus almost 50% of the total communes are affected by powerful degradation of the soil and 37% of the communes are touched by moderate degradation of the soils. [10] Regarding the forest degradation, this is mainly a cause of uncontrolled logging, pollution and pests.

These phenomena and the processes are manifested differently in the territory, in



relation to the natural setting, the historical development and the relations with the urban industrial centers.

Following the analysis of the natural, human, economic and socio-cultural resources, the authors of the paper conducted a SWOT analysis of the Romanian rural area.

Table 1. The strengths of Romania's rural areas

<b>STRENGTHS</b>
<ul style="list-style-type: none"> <li>▪ The natural resources are generally in good state of preservation;</li> <li>▪ Romania's landforms are: mountains, hills, plains;</li> <li>▪ Biodiversity valuable;</li> <li>▪ Variety of the traditional landscapes;</li> <li>▪ Rich hydrographic network;</li> <li>▪ High percentage of the population living in rural areas (45%);</li> <li>▪ Significant agricultural and forest area (61.3%, respectively 28.3% of the country) and favorable pedo-climatic conditions for the crop diversification;</li> <li>▪ Growing number of farms and new processing units and upgraded, brought up to European standards by the RDP 2007-2013;</li> <li>▪ Positive dynamics of the organic farming in Romania and the existence of a variety of quality traditional products and foods, nationally certified and high value products given by the area of origin;</li> <li>▪ Large share of agricultural and forest lands generating eco-systems services characterized by a great biological diversity;</li> <li>▪ Rich rural heritage (large natural, material and immaterial cultural heritage);</li> <li>▪ Keeping the traditions and the customs alive;</li> <li>▪ Overall low level of greenhouse gas emissions in agriculture.</li> </ul>

As presented in Table 1, the strengths of Romania's rural areas emphasizes its potential regarding the natural resources, the variety of relief forms and traditional landscapes, the richness in hydrographical net and the biodiversity all over.

Also, regarding the social aspect, Romania is a peculiar case of the EU-28 as about 45 % of its population is living in the rural areas, where agriculture represent the main income source.

Also, the large variety of soil and climate conditions is favorable for a large range of crops. Organic farming is a niche for Romanian agriculture to produce bioproducts.

The rich cultural heritage and preserved traditions are another feature of Romania's landscape and of high attraction for tourists.

Table 2. The weaknesses of Romania's rural areas

<b>WEAKNESSES</b>
<ul style="list-style-type: none"> <li>▪ Average annual rainfall is unevenly distributed and varies;</li> <li>▪ Negative natural increase and migration of young people from rural areas;</li> <li>▪ Low levels of the education and of the further training in agriculture and forestry caused by reduced number of schools (high schools) with agricultural profile;</li> <li>▪ Underdeveloped entrepreneurial culture, there is a reduced number of rural SMEs;</li> <li>▪ High percentage of elderly farmers;</li> <li>▪ The large number of small farms, the excessive fragmentation and the small average size of agricultural and forestry lands;</li> <li>▪ Low level of association between the farmers;</li> <li>▪ Low level of the productivity in the agriculture and food industry;</li> <li>▪ Reduction of the livestock and of the quantity of organic fertilizer used;</li> <li>▪ Mostly cereals agricultural production structure;</li> <li>▪ Technical equipment is scarce and of poor quality for the agricultural, forestry and food industries;</li> <li>▪ Rural basic infrastructure underdeveloped and limited access to social services, health and culture;</li> <li>▪ Maintaining a high percentage of exported unprocessed products;</li> <li>▪ Limited and nonfunctional irrigation infrastructure;</li> <li>▪ Significant areas of agricultural exploitations and forest are affected by the adverse weather conditions (deficiency or excess water) which lead to the land erosion and landslides;</li> <li>▪ Low standard of living and high poverty rate;</li> <li>▪ Low level of development of the tourism activities and agritourism.</li> </ul>

However, despite the strengths, the rural areas of Romania have also weaknesses among which the most important are: the migration of the young people to cities and other countries looking for better paid jobs, the aging of the population and the low training level, the low living standard, the huge number of small farms and a reduced number of associative forms, the low productivity due to the low endowment, the underdeveloped infrastructure, the lack of irrigation systems, the limited access to various services ( health,

education, banking, transport, etc. as mentioned in Table 2.

Table 3. The opportunities of Romania's rural areas

OPPORTUNITIES
<ul style="list-style-type: none"> <li>▪ The existence of the National Programme for Rural Development 2014 -2020;</li> <li>▪ Favorable natural conditions for the development of the agritourism, hunting, fishing and activities which generates alternative income;</li> <li>▪ Infrastructure development (roads, potable water supply and sanitation) may generate the emergence of investors;</li> <li>▪ Access to the basic training programs and lifelong learning, for entrepreneurship development;</li> <li>▪ European Union support regarding risk management instruments and tools in agriculture (crop insurance, animals and plants insurance, setting up mutual funds, income stabilization);</li> <li>▪ Financial support through community funds for the development of the seals local network and short food chains;</li> <li>▪ The importance of the mountain areas for the production of quality food is increasing due to the effects of climate changes and to the increased population growth, globally;</li> <li>▪ Preservation and promotion of the local resources (agriculture, forestry, cultural heritage, natural heritage);</li> <li>▪ Capitalization of a range of renewable energy sources from agriculture and forestry (crop residues, energy crops, wood);</li> <li>▪ The absorption capacity of the common market for the agri-food products niche;</li> <li>▪ Local brands promotion.</li> </ul>

Table 4. The threats of Romania's rural areas

THREATS
<ul style="list-style-type: none"> <li>▪ Negative effects of the climate changes give rise to disruptive natural phenomena that can cause disasters such as: drought, floods, landslides, tornadoes, fires;</li> <li>▪ Migration of the youth from rural areas and the elder remaining population may lead in time to the depopulation of the villages (especially in the mountain areas);</li> <li>▪ Trends of intensification in agriculture, especially in the areas with agricultural potential, which implies increasing inputs;</li> <li>▪ External producers competition;</li> <li>▪ Decrease of the consumers purchasing power;</li> <li>▪ Urban and abroad migration (there is a risk that this trend will be accentuated);</li> <li>▪ The alteration and the loss of the heritage and rural traditions;</li> <li>▪ Extending the economical-financial crisis;</li> <li>▪ Negative trend in the occupied areas with orchards.</li> </ul>

## CONCLUSIONS

The rural economy has different characteristics depending on the regions, on the demographic and social features and the economic specifics. This distinction is especially visible regarding the poverty in the Romanian rural areas, reflecting a low living standard and a lack of alternative income sources.

In the national economy, *agriculture* is one of the main branches that can contribute to the relaunching of the economic growth in Romania, especially because of its role, which cannot be retrieved by any other economic activity, since the demand of food is essential and permanent for the human existence, on the one hand, and on the other hand, agriculture provides raw materials, necessary for the revival of the many other industries, such as agrifood, textile, chemical, pharmaceutical, cosmetics, handicrafts, etc.

The rural economy is poorly diversified [6] and still dependent on the agricultural activities, which leads to low-income for the rural entrepreneurs.

## REFERENCES

- [1] Bran, F., 2001, Spațiul rural – suport de curs, Editura Economică;
- [2] Iova, R. A., Crețu, D., Neagu, C., 2012, The Perception of the Life Quality of the Rural Communities. Case Study, Borcea Commune, Calarasi County, Scientific Papers Series Management, Econ. Eng. Agric. and Rural Develop., 2012, 12, (3):85-88
- [3] Mateoc-Sîrb, N., 2002, Dezvoltarea rurală și regională în România, Editura Agroprint, Timișoara.
- [4] Otiman, P.I. (coord.), 2006, Dezvoltarea rurală durabilă în România, in: Editura Academiei Române, București;
- [5] Otiman, P. I., 2012, Revista de Economie Agrară și Dezvoltarea Rurală, Editura Academiei Române, București
- [6] Programul Național de Dezvoltare Rurală 2007-2013, Guvernul României, Ministerul Agriculturii, Pădurilor și Dezvoltării Rurale;
- [7] Statistical Yearbook, Romania, 2013, Agriculture
- [8] Statistics in Brief, Romania in figures, 2014
- [9] Vincze, M., 2000, Dezvoltarea regională și rurală, Editura Presa Universitară Clujeană.
- [10] www.madr.ro;

## VISUAL COMMUNICATION IN THE RURAL AREA. STUDY CASE, LOCAL ADMINISTRATION AND THE THE LOCAL COMMUNITY OF THE BERZOVIA COMMUNE, CARAS-SEVERIN COUNTY

Ada-Flavia CRISTINA, Camelia MĂNESCU, Anca Gabriela HANDARIC,  
Nicoleta MATEOC-SÎRB

Banat's University of Agricultural Sciences and Veterinary Medicine 'King Michael 1<sup>st</sup> of Romania' from Timișoara, Faculty of Agricultural Management, 119 Calea Aradului, Zip Code 300 645, Timișoara, Timiș, Romania, Mobile: +40726 2455577, Emails: ada\_flavia@yahoo.com, cameliaoborocea2004@yahoo.com, anca\_handaric@yahoo.com, mateocnicol@yahoo.com

*Corresponding author:* ada\_flavia@yahoo.com

### **Abstract**

*In addition to the economic investment and sustainable development strategies, an organization needs to create a good communication strategy, in order to attract tourists, investors, to promote a specific area, or to improve the quality of life. This strategy should be designed to build a strong relationship between the public administration and the local community who is directly involved in the actions carried out in the area. Thus, the residents are informed about the projects developed and they can be more involved in the process and express their opinion, which is helpful for the public administration, if they take the time to listen the feedback from the community. The research aims to identify the visual means of communication used the the rural governance of Berzovia from Caras Severin county for transmission of various messages of public interest. The methodology used is based on qualitative research methods such as observation collection of the visual data and semiotics analysis. Following analysis, it was found that messages sent by means of visual communication reached faster to the receptors, which led to a participatory attitude much higher in community projects developed, than other projects which were based on non-visual communication.*

**Key words:** communication, message, prints, rural area

### **INTRODUCTION**

The critical issues that may negatively influence the promotion of an area are the lack of a strategic development plan, the poor status of infrastructure, the lack of transparency and access to the information as well as issues such as aging population, youth migration to the cities and abroad, as following the jobs deficit in the rural area.

Despite the severity of these problems, they can be overcome or at least improved, whether it will outline a communication strategy that will help public institutions to build strong relationships with the target audiences, which demonstrates that the authority cares about the its community, debunking the citizens preconception that the public officials are guided by their own interests and using illegitimate power that was given to them due to their political affiliation.

Image transfer is achieved between the political and administrative which enhances the public's distorted image of the civil servants and lead to an unconstructive relationship for the whole society. [8]

This raises *public cynicism*, according to which government policies and officials are from the start incompetent, corrupt and manipulators. A consequence of the public cynicism is distrust and a lack a belonging to the community sense. [1]

Therefore, it is of great importance to change all these preconceptions, because the lack of information and communication with the public, degrades the relationship between public institutions with the local community, and then slows down the realization of the projects for increasing the quality of life for locals. In addition, the public image of an institution aims to increase its reputation among the public, by offered services and

through the communication system used. Institutional awareness increases as its audience's needs are met.

If distortion occurs between the desired image and perceived, means that the messages or the means used were not adequate for the transmission to the public.

Public communication is a form of communication through messages sent with public information. Also, the public communication aims the knowledge of the needs and wishes of the population, so that the public institutions, can meet them. Moreover, this is the foundation of the marketing vision in the public administration. [4]

Therefore, when we want to communicate an idea, we must take into account the education, the environment and the audience experience. For an effective communication, it must be kept within a proper function, even if sometimes it is imperiled by some bottoming, barriers, which create a big problem. This is asserted by the impossibility to convey what we want to express, or by incapacity of picking-up the correct message by the receiver. For a problem to be solved is necessary to know, indentify, compliance, accept it and to pass some levels and strategies for situation optimization. [6] It must be discovered which are the familiar means of communication for the audience is and will take into account the intellectual and the emotional level to set the most effective means of communication, to send the desired messages.

## MATERIALS AND METHODS

Research in the field of communication, inquires methods and techniques used in social fields. These are notably, qualitative, of which we used for this paper, observation, documentation, visual data collection and semiotics analysis.

This research aims to identify the visual means of communication used by the rural public administration Berzovia, in Caras Severin to transmit information of public interest.

In this respect, it performed an analysis based on qualitative interpretative means using

observation, visual data collection and semiotics analysis. To interpret the results were consulted dictionaries of symbols and specialized studies.

Semiology, is considered by Saussure as a science which studies the role of signs as part of social life, in order to become aware that we live in a world of signs and we can understand this world only through codes into they are organized.[5]

The rules and the conveniences are representing the language with which we transmit sounds, words or images. The signs are bring together a sound or an image (signifier) with a concept (signified) and decrypts its relationship with other signs and the context of the dissemination.[7]

Furthermore, we will examine the means of visual communication, which are found in the form of printed materials (posters, leaflets, journal) and as an electronic means (DVD, website of the village) by which the rural public administration of Berzovia sent messages to the local community.

## RESULTS AND DISCUSSIONS

Berzovia is located in the north-western part of Caras Severin county, on DN 58 B, and is 24 km from Bocşa, 36 km from Reşiţa and 70 km from Timişoara. The area is surrounded with hills with elevations up to 230 m, is crossed by Bârzava river, having particularities of culture and architecture and making it the border between the mountain and plain areas of Banat. Following the archaeological excavations, were found the remains of a Roman legion settlement, known as the IV-th Legion Flavia Felix, whose existence is attested in the area till 119. [10]

The message is clear, concise and short, the reception will be easier. For the distribution of the information and the promotion of the community the administration of Berzovia, uses especially offline communication through prints such as: posters, leaflets, brochures, and for the online communication, they use the new official website of the commune.

The first means of visual communication in question is the emblem of Berzovia comunne.

It is displayed on the commune public institutions (city hall, community center, tourist info-center, school) and it has the function of the official logo of Berzovia's commune. Unfortunately, this logo is not used on official documents of the municipality, which would increase the visibility of the distinctive mark of the village.

The emblem is decorated with distinctive and symbolic signs, which remember the specifics and the history of the place. [3]

The emblem of Berzovia consists of three heraldic figures: on the left, there is a Roman helmet, the right, a golden bell with a cross and at the bottom, a cluster of grapes. Background colors of the shield are blue and red, and are divided into four parts: two vertical of same dimensions, and two horizontal of different sizes. On the outer shield is represented a fortress.

According to the semiotic analysis, the helmet stands for the IV-th Roman legion Flavia Felix, who was stationed on the Berzovia's territory for 20 years after the Dacian-Roman War.

The golden bell decorated with the cross illustrates the ancient occupation of the inhabitants, of workers in bronze and iron. The cross reference the membership of the Christian community.

The cluster of grapes, indicate the main category of land use (vine nurseries).

The fortress which surrounds the shield represents Berzobis, the daco-roman settlement with a long history, which reflects the millennial existence and continuity of the community in this space.

The colors used are both primary and each has a meaning, which reinforces the message sent by the heraldic figures.

Red is a symbol of vitality, action, creative masculinity, war and especially the victory. Blue is the coldest and deepest color, transcendental, which represented with red indicating the battle between heaven and earth. In ancient Rome, all gladiators were marked with red and blue when you enter the hippodrome to symbolize the sacredness of their potential sacrifice. [2]



Fig. 1. The emblem of the Berzovia Commune  
Source: personal archive

Another visual communication is to use prints for the dissemination of the information on campaigns of general interest. An example, is the national campaign „*Locul deșeurilor nu este în preajma ta*” - "The place of wastes is not around you", in areas assigned to the Berzovia commune, held on 31<sup>st</sup> of October 2015. This green campaign, aims to protect the environment by free collecting of appliances and electronics households. For the message to get better at public areas (which often is careless about the environment), were used the printed posters and leaflets with information related to the campaign.

On these posters and leaflets appeared information about the prizes that could be won at the raffle extraction.

The colors chosen for the leaflets were used to attract the eye and for ease the reading. The combination of yellow, white and green is one of the most visible and captivating. Green is the symbol of environment and of ecology. Yellow is used to highlight key words and prizes that can be won (e.g. 40 RON, 20 RON), the date, the locations and the hours of the collection (e.g. October 31<sup>st</sup>, Saturday, 9:00-16:00, Berzovia, Gherteniș, Fizeș).

The slogan and the image on the poster are slightly ironic and imperative (*Your hen eggs better on nest!*) The viewer will mentally combine both text and image with the motivation to take action and to be actively involved in this recycling campaign. However, if that still fails to reach the civic side of the audience, the call becomes irresistible as a result of the money and goods prizes prepared for the ones that will participate to the waste collection. The campaign has mobilized the community of Berzovia, so that they came in large numbers



to get rid of the items which are not needed any longer.



Fig. 2. Leaflet for a recycling campaign  
Source: own processing after campaign materials

Another example of using prints as a means of communication is to promote the area in terms of tourism. To reach a larger number of people by sending tourism information and promotion of the commune, there where built a info-center, but also a web page with general information about the community. The project was funded by the European Union and the Romanian Government through the Rural Development Fund, so that the center was built in 2014 and the official launch will take place early next year. For promoting the area were used brochures with general information and DVDs about the Berzovia commune. The brochures included representative illustrations, a short history, information on how to reach the villages, what tourism attraction exist, the number of contact of the main places and a slogan (*Enjoy the magic of history and culture in a memorable tourist destination!*). Brochure design is simple, focused on the representative places of the commune. The text is easy to read, the frequency of the word Berzovia is increased, in order to memorize easily common names, and the partners logos are positioned in the page header. The main image represents a traditional fountain,

located in heart of the village, next to the Orthodox Church of Berzovia. The fountain symbolizes perpetual rejuvenation, through the living water drunk with the clay jug, which in this case indicates the longtime existence of an old community in lands of Berzovia.



Fig. 3. Promotional brochure of the Berzovia commune  
Source: own processin after promo materiales from the public administration of Berzovia

Also, the tourism promotion was made by sharing edited DVDs with videos about the history of the commune and with other specific elements. Packaging is identical to the brochure covers used for the promotion of the tourism in the area. It distinguish the image and text unity that perpetuate the idea of sending the message: Berzovia is located on the settlement of an ancient Dacian civilization.



Fig. 4. Berzovia's promotional DVD  
Source: own processin after promo materiales from the public administration of Berzovia

For the online space, it was created a web page entitled *www.infoberzovia.ro*, where can be found information about the characteristics of the area, traditions, customs and sights, and other useful information in Romanian and in English. The site has the categories: About

Us, Geographical position and Natural environment, Local flora and fauna, Brief history, Local culture and recreation, Guest Book and Contacts. [9]

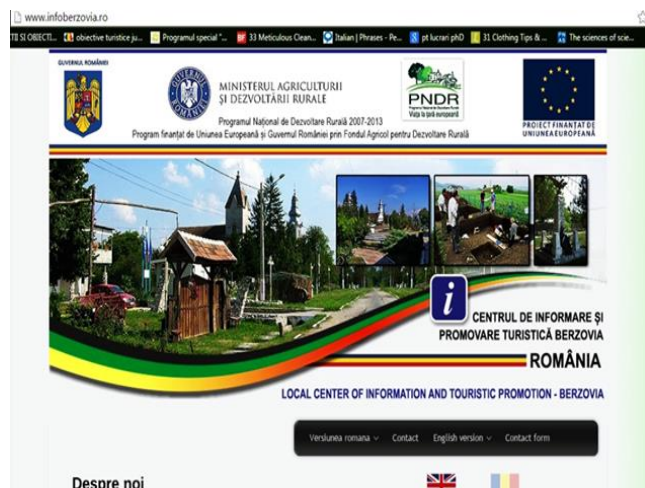

Fig. 5. Web page of the Berzovia's info touristic center  
Source: www.infoberzovia.ro

The last communication material studied is the journal of Berzovia. The journal is free distributed every month and contains four pages of general information, poems, interviews, traditions, customs and quotes of the mayor, representative images of festive events in the commune. It has the standard format of the magazines of the Journalists Union from historical Banat and comprises the emblem of Berzovia, above, on the left, next to the journal title.



Fig. 6. Jurnal de Berzovia (octombrie 2015)  
Source: Public administration of Berzovia archive

## CONCLUSIONS

A communication strategy is to create a solid relationship between the rural public administration and the local community by adapting the message through the media to its audience.

The design of the advertising materials for publications, banners, posters, leaflets, brochures, it was intended to have a unity of conception and message through the use of distinctive images (logo, slogan).

Following the development of social networking sites, an effective solution to increase awareness is by creating and managing an official fan page of the commune on social networks such as Facebook, Twitter, Instagram, for communicating the information about village life and events of general interest, to reach the youth and the urban residents, whose access and orientation towards social media is widespread.

## REFERENCES

- [1]Berman, E. M., 1997, Dealing with cynical citizens, in: Public Administration review, 1997, 57, (2): 105-112
- [2]Chevalier, J., Gheerbrant, A., 1993, Dicționar de simboluri, vol. I-III, Artemis Ed, București
- [3]Dicționar al științelor speciale ale istoriei, 1982, București
- [4]Kotler, P., Lee, N., 2008, Marketing în sectorul public, Meteor Press Ed., București
- [5]Narița, I., 2007, Semiotica, Editura de Vest, Timișoara
- [6]Sasu, S., Darii S., 2014, Particularities of Communication in Rural Tourism, Scientific Papers Series Management, Economic Eng. in Agric. and Rural Development 2014,14(2):261-264
- [7]Silverman, D., 2004, Interpretarea datelor calitative. Metode de analiză a comunicării, textului și interacțiunii, Polirom, Iași
- [8]Vigoda-Gadot, E., 2007, Citizens' Perceptions of Politics and Ethics in Public Administration: A Five-year National Study of their Relationship to Satisfaction with Services, Trust in Governance and Voice Orientations, Journal of Public Administration Research and Theory, 2007,17(2), pp 285-305
- [9]www.infoberzovia.ro
- [10]www.banaterro.eu/romana/files/berzovia\_monografie.pdf





## DURABLE DEVELOPMENT OF COMMUNITIES UNDER ANALYSIS OF THE POTENTIAL OF WORKFORCE FROM AGRICULTURE

Corina CRUCERU

University of Agricultural Sciences and Veterinary Medicine, Bucharest, Romania, Faculty of Management, Economic Engineering in Agriculture and Rural Development, Slatina Branch, 150, Strehareti Street, Postal Code: 0500, Slatina City, Olt County, Romania, E-mail: c.cruceru19@yahoo.com

*Corresponding author:* c.cruceru19@yahoo.com

### Abstract

*This work represents a studio for 5 years in the analyze of the potential of workforce from agriculture in the context of the durable development of communities. The aim of this survey is presenting the importance, of the agricultural-food sector, by the agency of indicators economic efficient. In the context of the rural development there are many resources which help this mechanism to function. One of the most important resources is the workforce, which influences the existent human capital, the quantity and the quality of this. There are many problems in this domain, which are: the efficient usage of workforce, of productivity and the growth of income, actual facts.*

**Key words:** analysis, dynamic level, regional, processing, statistics

### INTRODUCTION

According the new philosophy of rural territory has to be based on the concept of a long lasting local global development, that both supposes a solid rural component, but also an important agricultural component. From the point of view of the economic structure, agricultural activities take a large surface. Thus, agriculture stands for the "backbone of rural territory" [7].

The importance of agriculture and of the rural development in Romania is given by the fact that: the surface of the rural space is of 212.7 thousands km<sup>2</sup>, i.e. 89% of the total surface of the country; 45% of the country's population lives in the rural space [9].

From a European level, the rural space is of about 85% of the European territory, with differences regarding providing the quality of life [6]. As a result of the high range of rural population and the rural surfaces, and also the importance of rural life, the matter of rural development is does not only have a national dimension, but also an international one.

Agriculture is a basic element in the modern economy, due to its contribution to national incomes and work places in different sectors

of activity (up-stream and down-stream industries, trading, distribution, infrastructures, and tourism) [10].

It has a major implication in rural life, for it contributes to valuing the local resources and the development of small businesses in this field; it also represents an export source, by balancing the charges.

It ensures the foodstuff sector, for over 60% of the expenses are for food consumption).

### MATERIALS AND METHODS

For analyzing this phenomena, a poll was made for a period of five years (2005-2010), reflecting both dynamic and regional level. The statistic data, resulted from this poll was taken and interpreted from official publications and own investigation [1]. As work methods, the examination, the processing and the transport of data in tables were chosen, reflecting their trends at regional and national level [3].

### RESULTS AND DISCUSSIONS

At regional and national level there exists a trend of rural population to get close to the

urban one. Regarding the employment, for the social-economic stability of Romania, it was taken into account the development of this aspect, from the lack of workplaces point of view, but also from the organization in agriculture and the agrifood sector one [8].

In Romania the employment of the population in agriculture was approximately 41,4%, in 2000, decreasing in 2004 at 32,0%.

These numbers show the decrease of productivity in agricultural domain, the decrease of the efficiency and the lack of the activities diversity at rural population level. Together with the appearance of industry, the population employment in agriculture reduced [2].

The agricultural activities have a predominant share in the entire rural economy, covering, in this way, up to 63% from the total employment at rural population level.

In 2010, the agriculture represent only 28,14% from the total rural population, to 2005 when it represented 31,87%.

Table 1. The share of population in the practice of agriculture at the level of countries from Central and Eastern Europe in 2010

Country	Share (2009)	Share (2008)
Romania	29.1	28.7
Austria	5.3	5.6
Germany	1.7	2.2
Poland	13.3	14.0
Slovakia	3.6	4.0
Greece	11.9	11.3

Source: Romanian Statistical Yearbook 2011

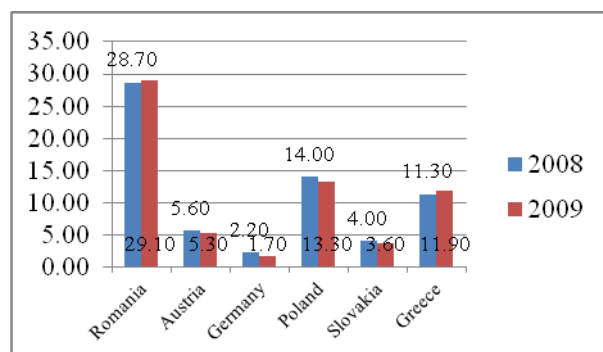

Fig. 1. The share of population in the practice of agriculture at the level of countries from Central and Eastern Europe

The evolution of workforce in agriculture was different to the European level, but in

comparison to the level from central and eastern countries, except for Poland and Lithuania has a higher level [6].

According to Table 1, the share of rural population employed in agriculture increased in 2009, keeping a growth trend.

At the European Union level, Romania still remained the first country from an employment in rural activities point of view.

Table 2. The structure of population employed in agricultural activities depending on age groups in Romania, 2009-2010

Age	Share (2010)	Share (2009)
15-24	10.2	9.4
25-34	17.7	17.3
35-44	21.1	19.7
45-54	17.4	17.6
55-64	18.9	20.1
Over 65	14.7	15.9
Total 15-64	85.3	84.1

Source: Romanian Statistical Yearbook 2011

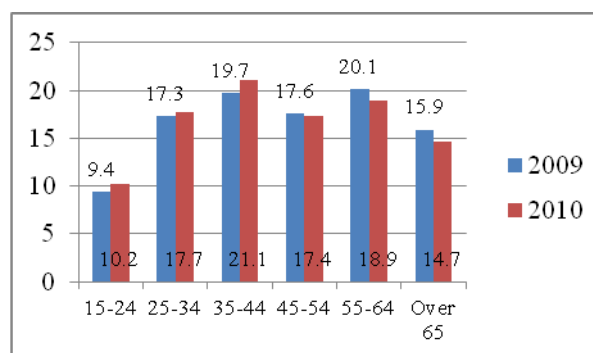

Fig. 2. The structure of population employed in agricultural activities depending on age groups in Romania

It is important to emphasize the age groups in agriculture, because we can know in this way the effects over the agricultural productivity. Before the adherence of Romania to the UE structures, the low level qualification of farmers and the lack of measures led to a low productivity.

Together with this adherence, the productivity level started to grow and the technologies started to increase it [5].

As we can see in Table 3, the younger population has started to choose agriculture as a job. This is proved by the slight increase of the groups aged between 15 and 44 years, probably due to a better quality of qualification and the possibility of European

fund accessing [4].

Table 3. The structure of the internal migration flow in Romania, 2005-2010

Flow	Number of people (thousands)					
	2005	2006	2007	2008	2009	2010
From rural to urban	60,195	75,275	80,235	78,671	70,246	96,201
	100.00 %	125.05 %	133.29 %	130.69 %	116.70 %	159.82 %
From urban to rural	80,732	93,924	118,237	124,828	96,513	133,052
	100.00 %	116.34 %	146.46 %	154.62 %	119.55 %	164.81 %

Source: Romanian Statistical Yearbook 2011

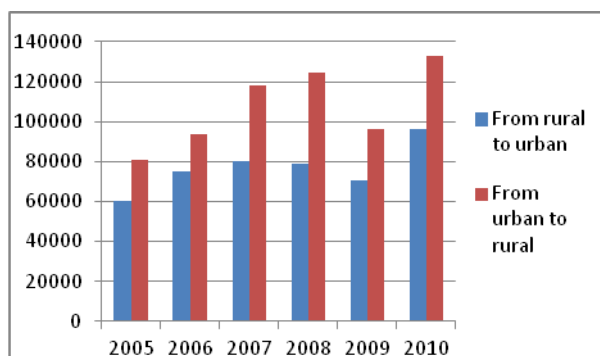

Fig. 3. The structure of the internal migration flow in Romania

The evolution of the workforce has known a growing trend, with certain oscillations. 2009 is an untypical year regarding the growth of the internal flow, because it decreased to 2008. This may be an effect of the economic crisis triggered in 2008, all the sectors from economy being affected in that period.

This approximately constant growth from urban to rural may be caused by the development of the agriculture in rural areas, being related to the growth of young population employed in agricultural activities, presented in Table 2.

Table 4. The structure of the rural population depending on the employment status, 2009-2010

Activity	Share (2010)	Share (2009)
Employee	35.7	38.1
Employer	0.6	0.7
Self-employed and member of an agricultural association	37.0	36.1
Contributing family worker	26.7	25.1

Source: Romanian Statistical Yearbook 2011

The percent values were calculated having year 2005 as base of reference.

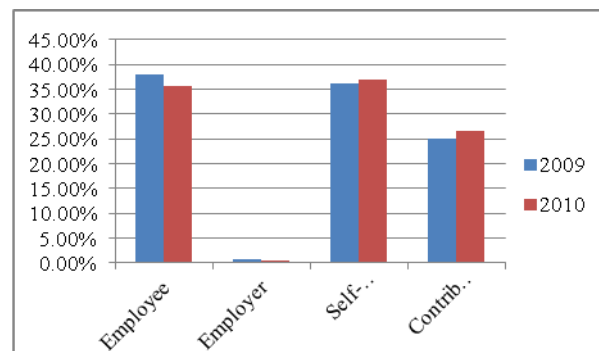

Fig. 4. The structure of the rural population depending on the employment status, 2009-2010

In 2009, the largest part of rural population developed its agricultural activity within the own household.

In 2010, the number increased slightly, also showing that this category is more willing to associate with other farmers within cooperatives and agricultural associations.

In 2010, the number of employees has decreased, as well as the employers, which means that this type of employment status is losing ground.

Table 5. The structure of the incomes regarding agricultural households, 2007-2010

	Total income (lei/month)			
	2007	2008	2009	2010
Total incomes	1,281.90	1,594.47	1,823.04	1,672.24
From agricultural income	20.6%	22.1%	23.0%	24.7%

Source: Romanian Statistical Yearbook 2011

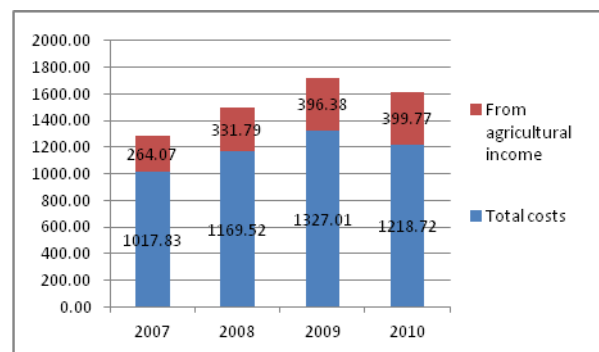

Fig. 5. The structure of the incomes regarding agricultural households, 2007-2010

The reduced dimensions of agricultural holdings, the reduced commercial character of agricultural production, the reduced costs of

the agricultural products compared to the prices on the market influence the farmers' incomes and implicitly their capacity of buy and investments in agriculture.

Table 6. The structure of the costs regarding agricultural households, 2007-2010

	Total income (lei/month)			
	2007	2008	2009	2010
Total costs	1,228.89	1,501.31	1,723.39	1,618.49
The value of consumption from own agricultural resources	49.0%	47.3%	44.6%	44.0%

Source: Romanian Statistical Yearbook 2011

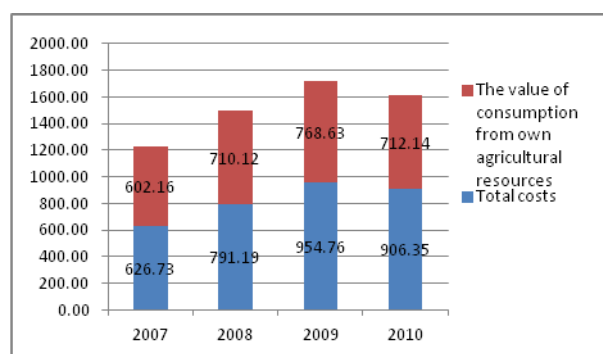

Fig. 6. The structure of the costs regarding agricultural households, 2007-2010

## CONCLUSIONS

During the analysis of the most important aspects of the population in agriculture, it was observed the fact that capacity of work has still the character of the rural economy in the rural environment.

Thus, the most part of the population in the agricultural area is employed in agricultural activities, taking into account the extension and the generalization of the aging process of the population.

Another observation refers to the low level of qualification of the population from the rural area, despite the adherence in the European structures, the traditional focus of the family members on the primary sector activities, while the youngsters are less active, a fact that leads to the decrease of rural economy development.

## REFERENCES

- [1]Arsic, S., Mijajlovic, N., Kljajic, N., 2013, Organic production and its role in environment protection, Scientific Papers. Series "Management, Economic Engineering in Agriculture and rural development", Vol. 13(3)
- [2]Barbu, C., M., 2005, Possible sustenance politics for the development of a long lasting agriculture and of the rural environment in Romania, Matrix Rom Publishing House, Bucharest
- [3]David, N., Istudor, N., 2005, Resource providing of agriculture, ASE, Publishing House, Bucharest.
- [4]Dumitru, D., Diminescu, D., Lazea, V., 2004, Rural development and the reformation of Romanian agriculture, Romanian Centre of Economic Politics
- [5]Hancu, C., D., 2004, Country-side development, Matrix Rom Publishing House, Bucharest
- [6]Manolescu Aurel, 2001, Managementul resurselor umane, Ed. Economica, Bucuresti
- [7]Otiman, I., Păun, 1997, Rural development in Romania, Agroprint Publishing House, Timisoara
- [8]Paunescu Ion, 2000, Managementul resurselor umane, ed. AISTEDA, Bucuresti
- [9]Petrescu, I., 1995, Managementul resurselor umane, Editura Lux Libris, Brasov
- [10]Walker, J.W., 1980, Human Resource Planning, Mc Graw-Hill, New York

## TECHNICAL-ECONOMIC ANALYSIS ON FORAGE MOWERS

**Mariana DUMITRU**

Lucian Blaga University of Sibiu, 10 Victoriei Boulevard, 550024, Sibiu, Romania, Phone/Fax:  
+40-(269) 21.60.62, E-mail: mariana\_dumitru2001@yahoo.com

*Corresponding author:* mariana\_dumitru2001@yahoo.com

### **Abstract**

*One of the most important stage in the agricultural process is harvesting. In this particular stage, the mower machines are some of the most important machines for harvesting forages used in agriculture, that is why we made this study. These machines are usually attached to tractors for a better efficiency. The paper presents some studies on mower machines, which are analysed after their cutting apparatus and their work width. Thus, are presented the mower with cutting apparatus through shearing, with cutting apparatus with back and forth motion of the knife, then rotary mowers. Also, in the paper are presented and analysed some technical characteristics of mowers, which influence their economic performances. From the economic point of view, considering the engine mowers, we concluded that the mowers with 2 knives have a better work capacity, at the same width of mowed furrow, compared to borne mowers.*

*Key words:* cutting apparatus, mower, technical-economic characteristics

### **INTRODUCTION**

In modern agriculture, almost all stages of production are mechanized, thus the labour productivity is much increased, so agriculture can be one of the most profitable branch of economy. In this respect, the harvesting process is one of significant importance. Mowers are some of the most important machines for harvesting forage plants, that is why their technical and economic characteristics must be competitive.

In a market economy, the correct allocation of factors of production is the basis for effective management. Analysis of the world's agricultural diversity indicates the existence of some general regularities, based on which the proportions of the factors of production are arranged, determining the level and structure of agricultural production costs. In each country there are in a particular historical moment some resources of production factors, which determine their supply and prices. This in turn affects the way the management of enterprises by the choice of the optimal production techniques. Pricing system makes the combination of factors of production in each country and in all circumstances different.[6].

Technological structure of agriculture is

expressed by farmers' access to the intensification factors referring to: the means of mechanization (tractors, machinery, equipment, facilities and equipment for mechanization of various work processes), biological means also chemical means. The means of mechanization have a direct and indirect labor productivity growth through working on the optimal time and quality (compared with simple manual means) and represent a production factor of economic growth. Quantifying the endowment level of a territory or an enterprise is achieved by analyzing the following indicators: a. structure of the tractors and agricultural machinery. Direct factors influencing the level and structure of the tractors and agricultural machines are: crop structure and the area occupied by each crop; each crop technology (optimal period of works, the possible mechanization of agricultural operations etc.); production and distance to be transported; types of existing manufacturing equipment; mechanization cost per hectare with different types of aggregates. b. degree of equipping with agriculture machinery needed for the works at the right time has the following values: tractors 58%; combine harvesting crops 94%, plows 49%, seeders 80%. [7]

The general indicators, influencing factors and economic efficiency of the tractors park and agricultural machinery, are: total production value units for a conventional tractor and physically; average annual yield per the tractor, plowing hectares, normal hours of actual use. The factors affecting the economic efficiency of mechanization are: construction and operating skills for tractors, agricultural machinery, facilities and parts; framing the optimal operating limits for the mechanical means; professionalism of exploitation; price of mechanical means - tractors, agricultural machinery, installations; the price of fuel, lubricants and spare parts. The efficiency of the tractors and agricultural machinery depends on the following factors: provision of effective technical means; rational use of technical means.[7]

To increase labour productivity, it is needed to assure a modern technical endowment, the knowledge transfer to farmers, the increase of their training level and managerial skills, the intensification of the extension system services, the stimulation of young farmers and women to develop business in agriculture and traditional activities and services, the assurance of funding for investments and modernization, the creation of jobs and new income sources for the agricultural employees and rural population. Only in this way, profitability and competitiveness could be grown in agriculture.[10]

Generally, mowers are used for harvesting through cutting of forage plants and leaving them in continuous furrows. Mowers are different by the type of cutting apparatus, the work width and the way of coupling to energy source.

If we want to classify mowers after cutting apparatus, there are the following categories:

-Mowers with cutting apparatus with back and forth motion of the knife (cutting through shearing), which are the most used in present

-Mowers with rotating cutting apparatus

The mowers are frequently made with work widths of 1,5 - 2,1 m and are laid sidewall in the back of tractor or sidewall between the front wheels and the back wheels of tractor.

## MATERIALS AND METHODS

The study was made on the existing mowers from the Agriculture machines laboratory of our department. We studied different types of mowers, concerning the cutting apparatus and functioning, after which we compared the technical characteristics of each of them. These studies were made by comparing the functioning diagram of each of mower machines presented in the paper.

## RESULTS AND DISCUSSIONS

### Mower with cutting apparatus through shearing

This type of mower consists of a frame on which is mounted the cutting apparatus and actioning mechanisms, of lifting and adjustment. The mower frame is mounted directly on tractor chassis.

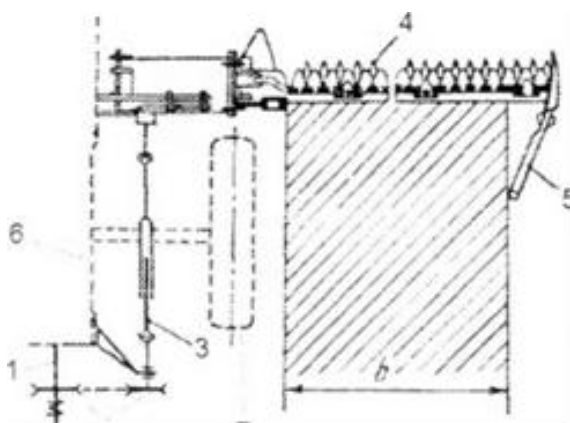

Fig. 1. Mower with cutting apparatus with back and forth motion knife

1- transmission through belt wagaş 2- straight axle ;3- cutting apparatus; 4- furrow limiter; 5- tractor transmission case; 6- tractor wheel roata tractorului; b – furrow width

Source: [3]

As it can be observed from fig.1, the working part of this mower is the cutting apparatus, which is formed of a steel support bar of trapezium shape, which has at the ends 2 supporting slides.

On the support bar are placed the fingers, which have the purpose of dividing the field in narrow slides, as well as to support plants during cutting. On the cast fingers are placed, through riveting, countercutting steel plates



[1]. The knife consists of a steel bar, on which are layed through riveting the cutting slides of trapezium shape, with side tags sharpen.

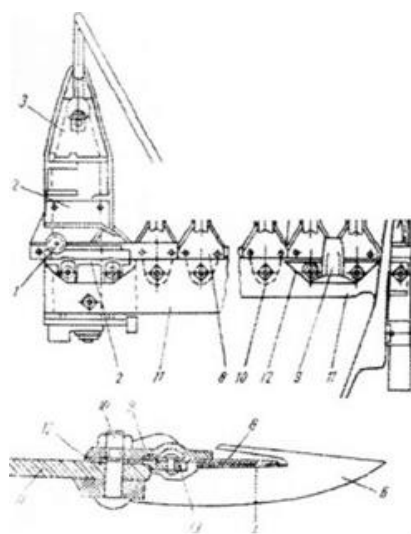

Fig.2. Mower cutting apparatus

1- the sphere joint of bear-knife bar; 2 - knife guideway; 3- interior slide; 4- cutting counter-plate; 5- fingers shoulders; 6 - fingers 7 - exterior slide; 8- knife blade; 9 - pressure plates; 10- support bar of fingers; 11 - guideway plate; 12- bear-knife bar  
 Source: [4]

The knife actioning is made from the connecting rod-crank mechanism or mechanisms with oscilation pulley. These mechanisms are acted from the power of tractor, throught some transmissions adequate to mower position toward this [11].

The work widths of the cutting apparatus depends on the energy source and the degree of land unevenness and is situated between 1,5 - 3 m.

### Rotary mowers

Rotary mowers have a rapidly rotating bar, or disks mounted on a bar, with sharpened edges that cut the crop. When these mowers are tractor-mounted they are easily capable of mowing grass at up 32km/h in good conditions. Some models are designed to be mounted in double and triple sets on a tractor, one in the front and one at each side, thus able to cut up to 6 metre swaths.

In rough cutting conditions, the blades attached to the disks are swivelled to absorb blows from obstructions. Mostly these are rear-mounted units and in some countries are

called scrub cutters. Self-powered mowers of this type are used for rougher grass in gardening and other land maintenance.



Fig. 3. Rotary mowers  
 Source: en.wikipedia.org

These type of mowers are formed by an fullcrum frame, which has actioning transmissions. On this frame are placed 2-4 rotating tambours, which have articulate knives, which rotate with peripheral speed of 60-80 m/s.

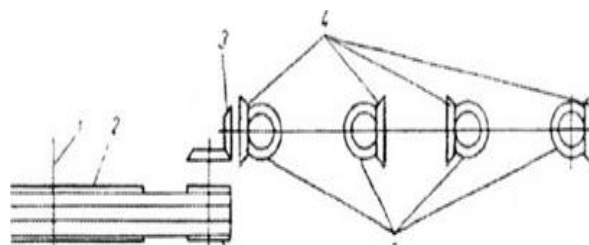

Fig. 4. Rotary mower  
 1 - power axle 2 - transmission through belt wedge; 3, 4, 5- transmissions with gear cone  
 Source: [4]

În fig. 5 a is presented the diagram of a rotary cutting apparatus with cutting blades of trapezium shape. The knives (1) (fig. 5b) are placed on disk (2), mounted straight on axle (3).

In the lower part, on axle (3), is mounted free the supporting disk (4). On disk (2) is placed a cylinder with blades (5).

The cutting apparatus cuts the plants through beating, without a counter-cutting part [2]. The absolute trajectory made by a point on the knife is an elongated cycloide (fig. 4.5, c), in which:  $r$  - the distance from the rotating axle

of the disk to the considered point;  $\omega$  – the angle speed of the disk;  $h_a$  – the space covered by the machine;  $v_m$  – machine speed. The rotary cutting apparatus functions with 3000 - 3500 rot/min and plants cutting is made with speeds of 45 - 80 m/s.

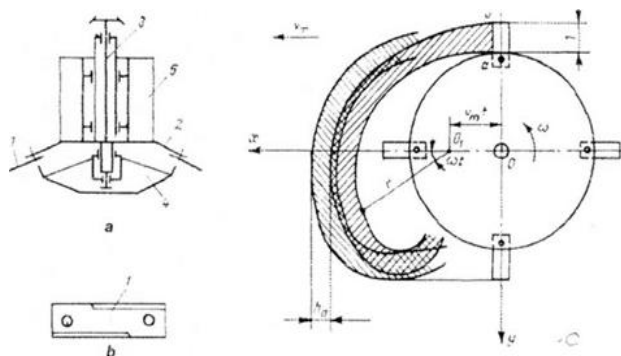

Fig.5 . Rotary cutting apparatus  
 1- knife; 2 - plate; 3 – vertical axle; 4 – supporting disk  
 ; 5 – cylinder with blades  
 Source: [5]

### Engine mowers

In order to mow plants on small surfaces or lands with an angle of elevation over 15 %, engine mowers with thermal engines are used, usually engines in 4 times, with a power of 4-10 kW [2]. The engine mowers frame is supported on small tire wheels, because the weight center is wanted to be as close to earth as possible. The cutting apparatus is the type of middle cutting, which has a widths of 0,9 - 1,6 m and is actioned from the center or by sidewall [8].

Table 1. Technical characteristics of mowers

No. crt.	Technical characteristics and work index	Types of mowers	
		Borne mower HP-40	Mowers with 2 knives CDC - 1,8
1	Work width (m)	1,8	1,8
2	Actioning	U-445	U-445
3	Knives joint (mm)	76,2	38,1
4	Knives number of motions per minute (motions/minute)	735	1035
5	Machine weight (kg)	145	156
6	Cutting height (mm)	50-60	40-60
7	The width of mowed furrow (m)	1,5	1,5
8	Work capacity (ha/day)	8,0	10,0

Source: Own calculation.

In table 1 are presented some mowers and engine mowers used in our country with their main characteristics.

From Table 1 it can be observed that from the 2 different types of mowers analised, at comparable machine weight, the mowers with 2 knives have a better work capacity, at the same width of mowed furrow, compared to borne mowers, that is why they are preferred to be used for a better efficiency.

### CONCLUSIONS

In this paper we have studied the technical characteristics of different types of mowers, considering the fact that technical characteristics are those which determin the efficiency of an agriculture machine. Thus, mower with cutting apparatus through shearing are the most used in present. They have a cutting apparatus with back and forth motion knife. The knife is actioned from the connecting rod-crank mechanism or mechanisms with oscilation pulley. This type of mower is recommended when the degree of land unevenness and is situated between 1,5 - 3 m.

Rotating mowers have a rotating cutting apparatus, which enable machine to cut plants with a with speeds of 45 - 80 m/s.



Fig. 6. Forage mower  
 Source: en.wikipedia.org

On the other hand, if we have to mow plants on small surfaces or lands with an angle of elevation over 15 %, engine mowers with thermal engines are recommended to be used. From the economic point of view, the mowers with 2 knives have a better work capacity, at the same width of mowed furrow, compared to borne mowers, that is why they are



recommended to be used in order to obtain a better productivity.

## REFERENCES

- [1]Claas „Gamme de produits”, 2003, Machines de recolte fourragere, Ed. Claas Harsewinkel, Germania
- [2]David, L., Cujbescu, I., 2003, Considerații privind parametrii optimi ai tocătorilor tip disc, Construcția de mașini (55), nr.11
- [3]Drăgan, G., Drăgan, M., 1994, Tractoare și mașini agricole, Editura Didactică și Pedagogică, București
- [4]Dumitru, M., 2004, Mașini agricole, Îndrumător pentru lucrări practice, Editura Alma Mater, Sibiu,
- [5]Dumitru, M., 2006, Tractoare agricole, Editura Alma Mater, Sibiu
- [6]Kusz, D., 2015, Changes in the relations of production factors in agriculture, Scientific Papers Series Management, Economic Engineering in Agriculture and Rural Development Vol. 15, Issue 2, 2015
- [7]Medelete, D., Pânzaru, R., 2015, Coordinates of mechanical park at Dolj county level, Scientific Papers Series Management, Economic Engineering in Agriculture and Rural Development Vol. 15, Issue 2, 2015
- [8]Moldovan, G., Tendințe în construcția combinelor de recoltat plante furajere și în special porumb siloz, Mecanizarea Agriculturii nr. 4/1999, Editura AGRIS;
- [9]Neagu, C., Utilaje pentru prelucrarea primară și păstrarea produselor agricole, Institutul politehnic, Iași, 1987
- [10]Popescu, A., 2015, Researches on labour productivity in Romania s agriculture, Scientific Papers Series Management, Economic Engineering in Agriculture and Rural Development Vol. 15, Issue 2, 2015
- [11]Toma, D., Neagu, Tr., ș.a., 1981, Tractoare și mașini agricole, Partea a II-a, Editura Didactică și Pedagogică, București



## STUDY ON THE FEEDING SYSTEM OF A BIOGAS PLANT

Mariana DUMITRU

Lucian Blaga University of Sibiu, 10 Victoriei Boulevard, 550024, Sibiu, Romania, Phone/Fax:  
+40-(269) 21.60.62, E-mail: mariana\_dumitru2001@yahoo.com

*Corresponding author:* mariana\_dumitru2001@yahoo.com

### Abstract

*This paper wants to analyse a part of a biogas plant, the feeding system. As it is known, a biogas plant is a complex installation, consisting of many components. The layout of a biogas plant depends very much on the types and amounts of feedstock supplied. As there are many different feedstock types suitable for digestion in biogas plants, there are, correspondingly, various techniques for treating these feedstock types and also different digester constructions and systems of operation. That is why, depending on the type, size and operational conditions of each biogas plant, there are various technologies for conditioning, storage and utilisation of biogas. Generally, agricultural biogas plants operate with four different process stages: transport, delivery, storage and pre-treatment of feedstock, biogas production and storage of digestate. This paper studies the feeding system of such a plant and the main pumps used in the process of transport of feedstock, such as: centrifugal pumps, pressure displacement pumps with their characteristics and components, considering that these pumps are an important part from the feeding system of the biogas plant.*

*Key words:* feeding system, pumps, transport system

### INTRODUCTION

A biogas plant is a solution for renewable source of energy, which can be used both in urban and rural communities. It is a complex installation, consisting of a variety of elements, which can be different from plant to plant. But the layout of such a plant depends to a large extent on the types and amounts of feedstock supplied. Because there are many different feedstock types suitable for digestion in biogas plants, there are, correspondingly, various techniques for treating these feedstock types and different digester constructions and systems of operation. Thus, depending on the type, size and operational conditions of each biogas plant, different technologies for conditioning, storage and utilisation of biogas are possible to implement. As for storage and utilisation of digestate, this is mainly oriented towards its utilisation as fertiliser and the necessary environmental protection measures related to it [4].

Agricultural biogas plants operate with four different process stages:

- Transport, delivery, storage and pre-treatment of feedstock
- Biogas production

-Storage of digestate, eventual conditioning and utilisation

-Storage of biogas, conditioning and utilisation [1].

After storage and pre-treatment, the feedstock is fed into the digester. The feeding technique depends on the feedstock type and its pumpability. Pumpable feedstock is transferred from storage tanks to the digester by pumps. The pumpable feedstock category includes animal slurries and many liquid organic wastes such as: flotation sludge, dairy wastes, fish oil, etc. [3]. Feedstock types which are non-pumpable (fibrous materials, grass, maize silage, manure with high straw content) can be poured by a loader into the feeding system and then fed into the digester. Both feedstock types can be simultaneously fed into the digester. In this case, it is preferable to feed the pumpable feedstock through by-passes. From a microbiological point of view, the ideal situation for a stable anaerobe digestion process is a continuous flow of feedstock through the digester. In practice, the feedstock is added quasi-continuously to the digester, in several batches during the day. This saves energy as feeding aggregates are not in continuous

operation. There are various feeding systems and their selection depends again on feedstock quality, herewith their pumpability and on feeding intervals. [2]

The key areas that determine the food and nutrition security are: availability, access, consumption and biological utilization. For this reason it is necessary to promote the health of vulnerable groups, in this case, indigenous communities, protecting and establishing conditions to ensure the human right to food. In many rural communities, the main objective of raising animals at the site is the production of animal waste, in order to implement digesters for the production of biogas, as an alternative energy source, the production of meat stays in the background, thinking only about the community consumption and helping to ensure their food source, from this perspective, the technologies applied to rural and indigenous progress are environmentally friendly, socially just, economically viable and culturally acceptable. The theme of rural and indigenous development is focused on their food security and the use of alternative energies, considering that energy is a key element in achieving sustainable development in all sectors, therefore sought from a broad perspective solidarity and actively promote greater and more rational use of energy and the environment in remote communities, through diversification of supply sources and efficient use, thereby contributing to environmental conservation and reduction of health problems through the use of appropriate technologies.[7]

The agricultural waste management is needed to maintain soil fertility through the application of methods for recovery of the resulted biomass - namely through methods such as composting and methanisation, which will have an impact on human health and on environment protection . Soil pollution leads to affect its fertility, disturbing all its physicochemical, biological and biochemical functions. The concept of sustainable development involves the application of bio-waste recycling methods to replace conventional farming. Soil conservation in its lively form is the only guarantee of the future

of every nation and of the planet as a whole [6].

In a biogas plant, a special attention must be paid to the temperature of the feedstock which is fed into the digester. Large differences between the temperature of the new feedstock and the operation temperature of the digester can occur if the feedstock has been sanitised (up to 130°C) or during winter season (below 0°C). Temperature differences disturb the process microbiology, causing losses of gas yield and must therefore be avoided. There are several technical solutions to this problem, such as using heat pumps or heat exchangers to pre-heat the feedstock before insertion in the digester.

## **MATERIALS AND METHODS**

The purpose of this paper is to identify the main stages in the developing of a biogas plant, and especially the components of the feeding system, such as: centrifugal pumps, pressure displacement pumps.

Among the most important methods used in this purpose are: studies of the existing pumps in the university laboratory of agricultural machines, SWOT analysis.

## **RESULTS AND DISCUSSIONS**

### **Centrifugal pumps**

A centrifugal pump is a rote-dynamic pump, using a rotating impeller to increase the velocity of a fluid. The fluid enters the pump impeller along or near the rotating axis and is accelerated by the impeller, flowing radially outward into a diffuser or volute chamber, from where it exits into the downstream piping system [5]. Centrifugal pumps are commonly used to move liquids through a piping system and are therefore frequently used for handling liquid manure and slurries.

### **Pressure displacement pumps**

For the transport of thick liquid feedstock, with high dry matter content, pressure displacement pumps (rotary piston and eccentric screw pumps) are often used.

The quantity of transported material depends on the rotation speed, which enables better control of the pump and precise dosing of the

pumped feedstock.

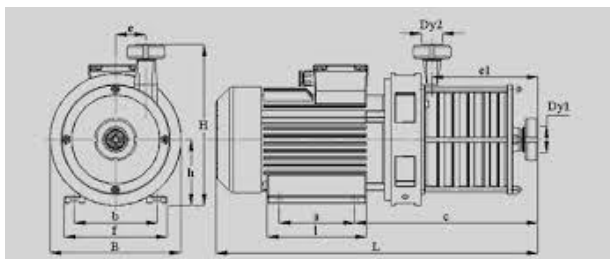

Fig. 1. Centrifugal pump  
Source [www.indpower.ro]

Displacement pumps are self-sucking and more pressure stable than centrifugal pumps. For this reason, the piping performance is less dependent on difference in height. As pressure displacement pumps are relatively prone to problems caused by high fibre content in pumped materials, it makes sense to equip them with cutters and separators, to protect them from large particle size and fibrous materials.

The selection of appropriate pumps and pumping technology depends on the characteristics of the materials to be handled by pumps (type of material, particle size, and level of preparation). Biogas plants use the same pumps that are used for liquid manure, which proved to be suitable for feeding the digester and for handling the digested substrate. Practical experience indicates that formation of plugs at inlet and outlet can be prevented by a sufficient diameter of the pipes. Pressure pipes, for filling or mixing, should have a diameter of at least 150 mm, while pressure free pipes, like overflow or outlet pipes, should have at least 200 mm for transporting manure and 300 mm if the straw content is high.

The transfer of pumpable feedstock substrate from the storage tank into the digester is done by pumps. Two types of pumps are frequently used: the centrifugal and the displacement pumps. Centrifugal (rotating) pumps are often submerged, but they can also be positioned in a dry shaft, next to the digester. For special applications, cutting pumps are available, which are used for materials with long fibres (straw, feed leftovers, grass cuttings). Displacement pumps (turning piston pumps, eccentric screw pumps) are more resistant to

pressure than rotating pumps. They are self-sucking, work in two directions and reach relatively high pressures, with a diminished conveying capacity. However through their lower price, rotating pumps are more frequently chosen than displacement pumps. All movable parts of the pumps are subjected to high wear and must therefore be replaced from time to time. This should be feasible without interrupting biogas production. For this reason, the pumps must be equipped with stop-valves (Figure 2), which allow feeding and emptying of digesters and pipelines. Pumps and pipes should be easily accessible and ensure sufficient working room, to perform the maintenance work.



Fig. 2. Stop-valves [1]



Fig.3. Pumping station in a biogas plant [1]

The function of pumps, and by this the transport of pumpable substrate, is controlled

automatically, using process computers and timers. In many cases the entire feedstock transport within the biogas plant is realised by one or two pumps, located in a pumping station ( Figure 3).

Stackable feedstock like grass, maize silage, manure with high straw content, vegetable. must be transported from a storage facility to the digester feed system. This is usually done by loaders or tractors (Figure 4) and the feedstock is fed into the digester using a screw pipe transporting system, like the one shown in figure 5.



Fig.4. Feed-in container system for dry feedstock - maize silage and solid poultry manure [1]

The feed-in system includes a container, where stackable feedstock is poured by tractor, and transport system, which feeds the digester. The transport system is controlled automatically consists of scraper floors, walking floors, pushing rods and conveyor screws. Scraper floors and overhead push rods are used to transport feedstock to the conveyor screws. They are capable of transporting nearly all stackable feedstock, either horizontally or with a slight incline, and are therefore used in very large, temporary storage containers, but they are not suitable for dosing. Conveyor screws can transport feedstock in nearly all directions. The only precondition is the absence of large stones and other physical impurities. For optimal function, coarse feedstock could be crushed, in order to be gripped by the screw and to fit into the screw windings.



Fig. 5. Conveyor screws [1]

The insertion of the feedstock into the digester has to be air-tight and should not allow leak of biogas. For this reason, the feed-in system inserts the feedstock below the surface layer of digestate (Figure 6). Three systems are commonly used: wash-in shaft, feed pistons and feed conveyor screws.

Feeding solids to the digester through wash-in shafts or sluices, using front or wheel loaders, allows large quantities of solids to be delivered any time, directly to the digester.

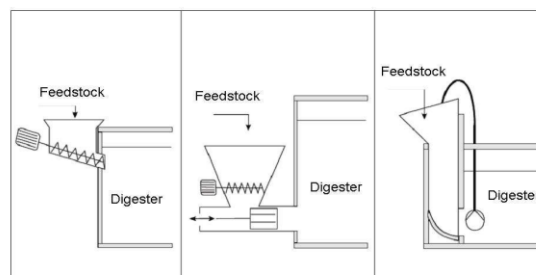

Fig.6. Wash-in shaft, feed pistons and feed conveyors system for feedstock insertion into the digester [2]

When using feed pistons, the feedstock is inserted directly into the digester by hydraulic cylinders, which push the feedstock through an opening in the wall of the digester. This ground level insertion means that the feedstock is soaked in the liquid content of the digester, reducing the risk of floating layer formation. This system is equipped with counter rotating mixing rollers, which transport co-substrates to the lower horizontal cylinders and, at the same time, crush long fibre materials.



Feeding co-substrates to the digester can be done by using feed screws or conveyor screws. In this case, the material is pressed under the level of the liquid in the digester, using plug screws. The method has the advantage of preventing gas leaking during feeding. The simplest way to do it is to position a dozer on the digester, so that only one insertion screw is necessary. For feeding the screw, temporary storage containers, with and without crushing tools are used.



Fig.7. Feed-in system for silage [3]

## CONCLUSIONS

A biogas plant is a complex installation, which is more and more used in rural areas as an alternative of bio-energy.

From all the components of a biogas plant: transport, delivery, storage and pre-treatment of feedstock, biogas production and storage of digestate, we concentrated over the transport and feeding system.

We analysed the centrifugal pumps, which are reliable and are therefore frequently used for handling liquid manure and slurries. We also analysed pressure displacement pumps, which are used for the transport of thick liquid feedstock, with high dry matter content.

The function of these pumps, and the transport of pumpable substrate, is controlled automatically, using process computers and timers. In many cases the entire feedstock transport within the biogas plant is realised by one or two pumps, located in a pumping station, as it was presented in the paper.

## REFERENCES

- [1]Al Seadi, T., Rutz, D., Prassl, H., Tobias M., Janssen, R., 2008, Biogas handbook, University of Southern Denmark Esbjerg, Denmark
- [2]Al, Seadi, T., 2001, Good practice in quality management of AD residues from biogas production. Report made for the International Energy Agency, Task 24- Energy from Biological Conversion of Organic Waste. Published by IEA Bioenergy and AEA Technology Environment, Oxfordshire, United Kingdom
- [3]Al Seadi, T., Holm Nielsen J., 2004, Utilisation of waste from food and agriculture: Solid waste: Assessment, Monitoring and Remediation; Waste management series 4; Elsevier; ISBN 0080443214, 735-754.
- [4] Al Seadi, T., Moeller, H., B., 2003, Separation of slurry - A potential option for the animal production sector. Proceedings report of European Biogas Workshop "The Future of Biogas in Europe III", October 2-4, Esbjerg, Denmark.
- [5]Dumitru, M., 2006, Tractoare agricole, Ed. Alma Mater, Sibiu
- [6]Neagu, C., 2013, Waste management generated from agriculture in Călărași county. Scientific Papers. Series "Management, Economic Engineering in Agriculture and rural development", Vol. 13 (3):171-174.
- [7]Viquez, C. S., 2013, Biogas as an alternative energy source to promote indigenous communities development. Scientific Papers. Series "Management, Economic Engineering in Agriculture and rural development", Vol. 13(1): 345-352.





## LOCAL FOOD: LITHUANIAN CONSUMERS' PERCEPTIONS AND ATTITUDES

Ovidija EIČAITĖ, Vida DABKIENĖ

Lithuanian Institute of Agrarian Economics, LAEI, V. Kudirkos St. 18–2, 03105, Vilnius, Lithuania, Phone: +370 5 262 2429, Emails: ovidija@laei.lt, vida@laei.lt

*Corresponding author:* ovidija@laei.lt

### *Abstract*

*This study aimed to identify the meaning of local food to consumers in Lithuania, to examine the interest in purchasing local food and to uncover the main drivers and barriers towards purchase of local food. Data were gathered through a survey of 415 Lithuanian residents. The analysis of collected data was performed using the methods of mathematical statistics. The results suggest that a majority of Lithuanian consumers perceived local food as being produced within more than 100 km from their home. Respondents also strongly agreed with the definitions of local food as food grown or produced in Lithuania and food sold by Lithuanian farmers directly to consumers. Three quarters of Lithuanian consumers regularly purchased local food and one fourth of respondents rarely or never purchased local food. Socio-demographic characteristics were not dominant factors in determining who purchased local food. Social conscience, health concern and shopping benefits were found to be the main drivers of purchasing local food. Alternatively, the main barriers were identified as buying inconvenience, lack of marketing, lack of trust and inadequate quality.*

*Key words:* attitudes, local food, perceptions, Lithuania

### INTRODUCTION

As a result of globalisation, the variety of food products has increased considerably. Consumers have begun to eat more food that is often produced far away from where they lived. As an alternative to the global food system, the local food movement which aims to connect food producers and consumers is often presented. In recent years, there has been a growing interest in local food in many countries.

There is no common or broadly accepted definition of local food [1, 11, 13, 17, 20, 22, 30]. Local food refers to food produced and consumed in a specific geographic area. Under this approach, the distance or political and administrative boundaries are used to define local food [1, 13, 20]. As regards the distance used to define local food, there is no consensus on the number of units of distance between production and consumption. Many distances, which have been proposed, range from 20 to 400 miles [5, 11, 13, 17, 24, 20]. As regards the political and administrative boundaries to define local food, it can be a county, region, state or whole country [4, 5,

13, 20, 24]. Local food can also refer to the types of marketing channels used between food producers and consumers. Food sold through direct marketing channels can be defined as local [16, 17]. Over time, farmers' markets, Community Supported Agriculture schemes, farm stands, sales on farms, small grocery stores have become important supply chains that provide local food [7, 9, 10, 17, 23, 24, 28, 29, 30].

A number of studies have been conducted to identify the key factors affecting consumers' purchasing behaviour towards local food. Consumers buy local food because of the freshness [3, 4, 10, 21, 22, 23], higher quality [4, 5, 6, 18, 21, 23, 29], better taste [5, 23], safety [22] and nutritional value [4, 30]. Other motivations for purchasing local food include health benefits [21, 22, 30], environmental concerns [10, 18, 22, 23, 27, 30], supporting local farmers [18, 22, 23, 26, 27, 30] and local economy [4, 22, 23], as well as social interactions with food producers [12, 28]. Consumers are also confronted with barriers to the purchase of local food [20]. The major barriers are higher prices [5, 14, 18, 21, 22], inconvenience [5, 6, 18, 21], accessibility and

availability [8, 14, 18, 21, 26], as well as difficulty in identifying local food and labelling issues [6, 8, 18, 21].

In recent years, the demand for local food in Lithuania has grown strongly. The different forms of direct sales by farmers to consumers have developed significantly. At present, Lithuanian consumers can buy local food at farmers' markets, marketplaces, special stores, supermarkets or on farms, as well as order over the internet or home delivery. Little research attention has previously been paid to examine Lithuanian consumers' perceptions and attitudes towards local food. Studies in this field are limited mainly focusing on consumers' opinions about direct marketing of agricultural and food products, organic products [19, 25].

## MATERIALS AND METHODS

This study aimed to identify the meaning of local food to consumers in Lithuania, to examine the interest in purchasing local food and to uncover the main drivers and barriers towards purchase of local food. In order to achieve this aim and collect data, a survey method was used. The survey took place from August to September in 2015. The mixed methods were used: survey online and survey in written form. A standardized questionnaire was employed as the main instrument of the survey. The questionnaire comprised four sections. The first section included a series of questions aimed at identifying how Lithuanian consumers define local food. The second section was related to the consumption of local food, i.e. frequency of purchasing. The third section incorporated questions on drivers and barriers towards purchase of local food. The questions in the last section referred to the socio-demographic characteristics of respondents (gender, age, personal income and educational level).

The data was processed with the statistical package SPSS. Cronbach alpha coefficient was employed to assess the reliability of the questionnaire. Internal consistencies using Cronbach alpha reliability statistics were calculated for total scale and subscales of the questionnaire (for the second part of the first

section referring to the definitions of local food and for the third section referring to the drivers and barriers of purchasing local food). The results of the reliability tests showed that Cronbach's alpha was 0.83 for total scale, 0.73 for definition items, 0.90 for drivers and 0.70 for barriers indicating above the minimum value of 0.70, which is considered acceptable as a good indication of reliability.

A total of 415 filled in questionnaires were received. The percentage of respondents completing the questionnaire online was 42%, while 58% completed the questionnaire in written form. Out of the survey respondents, women accounted for 62% of the sample and men 38%. In relation to residence area, 43% of respondents lived in large cities, 35% lived in towns, 21% lived in rural areas and 1% preferred not to answer this question. The distribution of respondents by age was as follows: 37% were between the ages of 18-29 years, 32% were between the ages of 30-45 years, 25% were between the ages of 46-65 years and 6% were 66 years old and over. Regarding household income, 17% of respondents indicated a household income of less than 315 EUR per month, 25% reported a household income between 316 and 500 EUR, 18% indicated a household income between 501 and 725 EUR, 21% reported a household income between 726 and 1200 EUR, 17% claimed a household income of more than 1200 EUR and 2% did not reveal a household income. As concerns educational level, 65% of respondents had higher education, 30% had secondary education, 3% had incomplete secondary education and 2% preferred not to answer this question.

## RESULTS AND DISCUSSIONS

The first part of the analysis focused on Lithuanian consumers' perceptions of local food. Respondents were presented with the definitions of local food based on geographical proximity between production and consumption, as well as distribution method. Firstly, respondents were asked to specify the distance that they thought local food could be defined. Distances that could be used to define local food ranged from 20 to

more than 100 km. A majority of respondents chose the largest proposed distance, i.e. they perceived local food as being produced within more than 100 km from their home. The percentage of respondents who considered food produced within 100 km, 50 km and 20 km as local were 17.5%, 15.6% and 12.2%, respectively (Table 1).

Table 1. Lithuanian consumers' definitions of local food based on geographical distance

Statements	Percent (%)	Cumulative (%)
Local food is grown or produced within more than 100 km of where I live	54.7	54.7
Local food is grown or produced within 100 km of where I live	17.5	72.2
Local food is grown or produced within 50 km of where I live	15.6	87.8
Local food is grown or produced within 20 km of where I live	12.2	100
<b>Total</b>	<b>100</b>	<b>100</b>

Then, respondents were asked to indicate the degree to which they agreed with each of the seven statements describing the spatial characteristics (six statements) and distribution method (one statement) of local food. Table 2 presents the mean scores of the statements.

Table 2. Mean scores of Lithuanian consumers' perceptions of local food

Statements	Mean Score
<i>Spatial characteristics of local food</i>	
Local food is grown or produced in Lithuania	4.52
Local food is grown or produced in the county that I live	3.89
Local food is or produced in the district that I live	3.63
Local food is grown or produced within the area that I live	3.63
Local food is sourced from outside the area that I live but processed in that area	2.79
Local food is sourced from outside Lithuania but processed in Lithuania	2.33
<i>Distribution method of local food</i>	
Local food is sold by Lithuanian farmers directly to consumers	4.45

The scale was scored from 1 to 5, where 1 was "Strongly disagree" and 5 was "Strongly agree". The highest mean values were for the statements "Local food is grown or produced in Lithuania" and "Local food is sold by Lithuanian farmers directly to consumers" (4.52 and 4.45, respectively). This means that respondents strongly agreed with these definitions of local food.

The second part of analysis focused on frequency of purchasing local food and socio-demographic characteristics that distinguish between local food buyers and non-buyers. All respondents were asked to indicate how frequently they purchase local food: more than once a week, at least once a week, at

least once a month, less than once a month and never. According to frequency of purchasing local food, respondents were divided into two groups: local food buyers, i.e. those who buy local food more than once a week, at least once a week and at least once a month, and non-buyers, i.e. those who buy local food less than once a month and never buy. As survey results showed, the vast majority of respondents were local food buyers (75%): 19.6% reported more than once a week buying local food, 34.9% indicated at least once a week buying and 20.5% revealed at least once a month buying. 25% of respondents were non buyers: 19.4% reported less than once a month buying local food and 5.6% indicated never buying. The significant differences between local food buyers and non-buyers were determined, using Chi-square test. A p value of less than 0.05 ( $p < 0.05$ ) was considered to indicate a statistically significant difference.

In the socio-demographic characteristics, only one of six characteristics indicated a significant difference between local food buyers and non-buyers (Table 3).

Table 3. Socio-demographic characteristics of local food buyers and non-buyers

Socio-demographic characteristics	Respondents (n)	Buyers, %	Non-buyers, %	p-value	$\chi^2$
<i>Gender</i>					
Women	254	196	58	0.222	1.49
Men	156	112	44		
<i>Residence area</i>					
Large cities	180	134	46	0.003*	11.78
Towns	144	120	24		
Rural areas	84	53	31		
<i>Age group</i>					
18-29	149	106	43	0.094	6.40
30-45	134	97	37		
46-65	102	86	16		
>66	24	18	6		
<i>Household income</i>					
<315	68	51	17	0.126	7.20
316-500	102	75	27		
501-725	74	64	10		
726-1200	87	60	27		
>1200	70	51	19		
<i>Educational level</i>					
Incomplete secondary	13	10	3	0.895	0.22
Secondary	120	92	28		
Higher	271	202	69		

Notes: All n did not add up to total number of respondents because of missing data.

\*Statistically:  $p < 0.05$  (Chi-square test).

Specifically, there was a significant difference between the two groups for residence area. There were no statistical differences in gender, age, household income and education. Significantly more respondents living in

towns (83.3%) bought local food as compared to respondents living in rural areas (63.1%) ( $p = 0.001$ ). There was no a statistically significant difference in the percentage of respondents living in towns and respondents living in large cities (74.4%) ( $p = 0.053$ ) who bought local food. The percentage of local food buyers was higher for respondents living in large cities than respondents living in rural areas, but the difference was not statistically significant ( $p = 0.190$ ).

Socio-demographic characteristics were not dominant factors in determining who purchased local food. These findings are consistence with some other studies, which have found limited relationships between socio-demographic characteristics and preferences for local food [15, 30].

The final part of analysis focused on identifying the main drivers and barriers of purchasing local food. Exploratory factor analysis was conducted using principal components extraction with varimax rotation as the estimation procedure [2]. A first factor analysis was implemented, using the scale items for drivers of purchasing local food. The initial list of variables consisted of 19 items. Corrected item-to-total correlations results revealed that correlation coefficients of variables “it tastes good”, “it has a good appearance”, “it has good value for money”, “it is GMO-free”, “it’s traditional”, “it’s authentic and original”, “it’s environmentally friendly”, “it reduces the distance food travels from producer to consumer” and “it reduces packaging” were less than 0.50, so these variables were removed from the next iteration of the principal component analysis. With parameters organised to assess solutions with eigenvalues in excess of 1.0, the analysis indicated a three-factor solution with the sampling adequacy at an acceptable level ( $KMO = 0.830$ ;  $df = 45$ ;  $p = 0.000$ ). The total variance explained in the observed items by the three-factor solution was 73.90%, indicating a well-explained factorial structure. Results of the factor analysis for drivers of purchasing local food are presented in Table 4.

Table 4. Results of factor analysis for drivers of purchasing local food

Drivers of purchasing local food	Component		
	Social conscience	Health concern	Shopping benefits
I purchase local food because it supports local farmers	0.743		
I purchase local food because it supports the local economy	0.850		
I purchase local food because it contributes to preserve rural areas	0.830		
I purchase local food because it preserves traditional production methods	0.777		
I purchase local food because it is natural		0.863	
I purchase local food because it is nutritious		0.855	
I purchase local food because it is healthy		0.838	
I purchase local food because it makes me feel good			0.777
I purchase local food because it is interesting			0.861
I purchase local food because the shopping experience is satisfying			0.785
Variance explained (%)	46.26	15.40	12.24
Cronbach's coefficient alpha	0.86	0.86	0.81

The first factor consisted of four items and accounted for 46.26% of variance in the model. These items relate to the importance ascribed to supporting local farmers and economy, preserving rural areas and traditional production methods, therefore this factor was labelled social conscience. The second factor contained three items and explained 15.40% of variance in the model. These items relate to specific quality attributes of local food that contribute to health, therefore this factor was named health concern. The final factor incorporated three items and accounted for 12.24% of variance in the model. These items relate to the pleasure, positive feelings and emotions experienced as a result of shopping for local food, therefore this factor was labelled shopping benefits. To assess the internal consistency of each of the factors within the scale, Cronbach's coefficient alpha was employed. The internal consistency of all factors was found to be above the 0.7 threshold with alpha coefficients of 0.86, 0.86 and 0.81, respectively.

A second factor analysis was implemented, using the scale items for barriers of purchasing local food. The initial list of variables consisted of 15 items. Corrected item-to-total correlations between variables were conducted and not significant variables “it is expensive”, “it is not readily available”, “it produced elsewhere is sometimes better”, “it is a fad” were eliminated from the next

iteration of the principal component analysis. The rotated solution produced a four-factor structure with acceptable sampling adequacy (KMO = 0.70; df = 55; p = 0.00). In total, 77.2% of the variance in the observed items was explained by this solution. Results of the factor analysis for barriers of purchasing local food are presented in Table 5.

Table 5. Factor analysis for barriers of purchasing local food

Barriers of purchasing local food	Component			
	Buying inconvenience	Lack of marketing	Lack of trust	Inadequate quality
I don't purchase local food because it is inconvenient	0.787			
I don't purchase local food because to do so is time consuming	0.716			
I don't purchase local food because I have to travel further to do so	0.884			
I don't purchase local food because it requires extra efforts	0.862			
I don't purchase local food because the range of products is limited		0.726		
I don't purchase local food because it is not well promoted		0.838		
I don't purchase local food because it is not clearly branded as local		0.813		
I don't purchase local food because I cannot trust it is actually local			0.910	
I don't purchase local food because I cannot trust that all of the ingredients are local			0.919	
I don't purchase local food because it is not good quality				0.816
I don't purchase local food because it has a bad appearance				0.863
Variance explained (%)	35.12	16.27	13.87	11.91
Cronbach's coefficient alpha	0.86	0.75	0.88	0.70

The first factor incorporated four items and accounted for 35.12% of variance in the model. These items relate to the non-fiscal costs involved in purchasing local food, therefore this factor was named buying inconvenience. The second factor consisted of three items and explained 16.27% of variance in the model. These items relate to inadequate marketing of local food, therefore this factor was labelled lack of marketing. The third factor contained two items and accounted for 13.87% of variance in the model. These items relate to lack of trust that the product or all of the ingredients in the product are actually local, therefore this factor was named lack of trust. The fourth factor incorporated two items and explained 11.91% of total variance in the

model. These items relate to unattractive physical properties of local food, therefore this factor was labelled inadequate quality. The internal consistency of all factors was found to be above the 0.7 threshold with alpha coefficients of 0.86, 0.75, 0.88 and 0.70, respectively.

## CONCLUSIONS

This study aimed to identify the meaning of local food to consumers in Lithuania, to examine the interest in purchasing local food and to uncover the main drivers and barriers towards purchase of local food.

In relation to the definitions of local food, several main points can be concluded. First, a majority of Lithuanian consumers perceived local food as being produced within more than 100 km from their home.

Second, respondents strongly agreed with the definitions of local food as food grown or produced in Lithuania and food sold directly by Lithuanian farmers to consumers.

As a majority of respondents considered Lithuanian made food as local food, the term local food may be understood similarly to domestic food.

Three quarters of Lithuanian consumers regularly purchased local food and one fourth of respondents rarely or never purchased local food. Socio-demographic characteristics were not dominant factors in determining who purchased local food.

The range of factors identified from this study have been categorised as three drivers and four barriers of purchasing local food: social conscience, health concern, shopping benefits, buying inconvenience, lack of marketing, lack of trust and inadequate quality. Social conscience was found to be the most important driver of purchasing local food. Alternatively, the most important barrier was identified as buying inconvenience. Understanding drivers and barriers of purchasing local food is useful to farmers, food producers and retailers in order to improve their market effectiveness and provide consumers with fresh, natural and seasonal food.

## REFERENCES

- [1] Adams, D. C., Salois, M. J., 2010, Local versus organic: a turn in consumer preferences and willingness-to-pay, *Renewable Agriculture and Food Systems*, 2010, 25 (4): 331-341.
- [2] Bilevičienė, T., Jonušauskas, S., 2011, Statistinių metodų taikymas rinkos tyrimuose, *Mykolo Riomerio universitetas, Vilnius*, p. 255-268.
- [3] Bond, J. K., Thilmany, D., Bond, C., 2009, What Influences Consumer Choice of Fresh Produce Purchase Location, *Journal of Agricultural and Applied Economics*, 2009, 41(1): 61-74.
- [4] Brown, C., 2003, Consumers' preferences for locally produced food: A study in southeast Missouri, *American Journal of Alternative Agriculture*, 2003, 18: 213-224.
- [5] Chambers, S., Lobb, A., Butler, L., Harvey, K., Traill, W.B., 2007, Local, national and imported foods: A qualitative study, *Appetite*, 2007, 49: 208-213.
- [6] Conner, D., Colasanti, K., Ross, R.B., Smalley, S.B., 2010, Locally Grown Foods and Farmers Markets: Consumer Attitudes and Behaviors, *Sustainability*, 2010, 2(3):742-756.
- [7] Darby, K., Batte, M.T., Ernst, S., Roe, B., 2008, Decomposing Local: A Conjoint Analysis of Locally Produced Foods, *American Journal of Agricultural Economics*, 2008, 90(2): 476-486.
- [8] Dukeshire, S., Garbes, R., Kennedy C., Boudreau A., Osborne, T., 2011, Beliefs, Attitudes, and Propensity To Buy Locally Produced Food, *Journal of Agriculture, Food Systems and Community Development*, 2011, 1(3): 19-29.
- [9] Feagan, R., Morris, D., Krung, K., 2004, Niagara region farmers' markets: Local food systems and sustainability considerations, *Local Environment*, 2004, 9(3): 235-254.
- [10] Gao, Z., Swisher, M., Zhao, X., 2012, A New Look at Farmers' Markets: Consumer Knowledge and Loyalty, *HortScience*, 2012, 47(8): 1102-1107.
- [11] Hu, W., Batte, M., Woods, T., Ernst, S., 2010, What is Local and for What Foods Does it Matter?, 2010, Selected Paper prepared for presentation at the Southern Agricultural Economics Association Annual Meeting, Orlando, FL, February 6-9.
- [12] Hunt, A.R., 2007, Consumer Interactions and Influences on Farmers' Market Vendors, *Renewable Agriculture and Food Systems*, 2007, 22(1): 54-66.
- [13] Jones, P., Comfort, D., Hillier, D., 2004, A case study of local foods and its routes to market in the U.K., *British Food Journal*, 2004, 106(4): 328-335.
- [14] Khan, F., and Prior, C., 2010, Evaluating the urban consumer with regard to sourcing local food: a Heart of England study, *International Journal of Consumer Studies*, 2010, 34(2): 161-168.
- [15] Knight, A. J., 2013, Evaluating local food programs: The case of Select Nova Scotia, *Evaluation and program planning*, 2013, 36(1): 29-39.
- [16] Marsden, T., Banks, J., Bristow, G., 2000, Food Supply Chain Approaches: Exploring their Role in Rural Development, *Sociologia Ruralis*, 2000, 40: 424-438.
- [17] Martinez, S., et al., 2010, Local Food Systems: Concepts, Impacts, and Issues, ERR97, U.S. Department of Agriculture, Economic Research Service.
- [18] Megicks, P., Memery, J., Angell, R.J., 2012, Understanding local food shopping: Unpacking the ethical dimension, *Journal of Marketing Management*, 2012, 28(3-4): 264-289.
- [19] Mikelionytė, D., Lukošūtė, I., Petrauskaitė, L., 2010, Tiesioginių žemės ūkio ir maisto produktų pardavimų skatinimas, atsižvelgiant į vartotojų prioritetus, 2010, *Vadybos mokslas ir studijos – kaimo verslų ir jų infrastruktūros plėtrai*, 2010, 22 (3): 22-30.
- [20] Pearson, D., Henryks, J., Trott, A., Jones, P., Parker, G., Dumaresc, D., Dyball, R., 2011, Local food: understanding consumer motivations in innovative retail formats, *British Food Journal*, 2011, 113(7): 886-889.
- [21] Penney, U., and Prior, C., 2014, Exploring the urban consumer's perception of local food, *International Journal of Retail & Distribution Management*, 2014, 42(7): 580-594.
- [22] Roininen, K., Arvola, A., Lahteenmaki, L., 2006, Exploring consumers' perceptions of local food with two different qualitative techniques: Laddering and word association, *Food Quality and Preference*, 2006, 17: 20-30.
- [23] Schneider, M.L., Francis, C.A., 2005, Marketing locally produced foods: Consumer and farmer opinions in Washington County, Nebraska, *Renewable Agriculture and Food Systems*, 2005, 20(04): 252-260.
- [24] Selfa, T., Quazi, J., 2005, Place, taste, or face-to-face? Understanding producer-consumer networks in "local" food systems in Washington State, *Agriculture and Human Values*, 2005, 22: 451-464.
- [25] Skulskis, V., Girgždienė, V., Melnikienė, R., *Ekologiškų maisto produktų tiesioginis pardavimas*, 2011, *Vadybos mokslas ir studijos – kaimo verslų ir jų infrastruktūros plėtrai*, 2011, 25 (1): 208-215.
- [26] Stephenson, G., and Lev, L., 2004, Common support for local agriculture in two contrasting Oregon communities, *Renewable Agriculture and Food Systems*, 2004, 19(04): 210-217.
- [27] Thilmany, D., Bond, C. A., Bond, J. K., 2008, Going local: Exploring consumer behavior and motivations for direct food purchases, *American Journal of Agricultural Economics*, 2008, 90(5): 1303-1309.
- [28] Thomson, C.J., Coskuner-Balli, G., 2007, Enchanting ethical consumerism: The case of community supported agriculture, *Journal of Consumer Culture*, 2007, 7(3): 275-303.
- [29] Zepeda, L., Levitien-Reid, C., 2004, Consumers' Views on Local Food, *Journal of Food Distribution Research*, 2004, 35(03): 1-6.
- [30] Zepeda, L., Li, J., Who Buys Local Food?, 2006, *Journal of Food Distribution Research*, 2006, 37(03): 1-11.



## USING SOLAR ENERGY TO PRODUCE BIOGAS FROM ANIMAL WASTES

Tarek FOUDA, Asaad DERBALA, Adel ELMETWALLI, M. DARWESH, H. KASSEM

Tanta university, Faculty of agriculture, Egypt, Phone: +20403455584, Fax: +20403455570,  
Mobile: +201228476266, Emails: tfouda @yahoo.com, derbalana@yahoo.com,  
adelra99@yahoo.com

*Corresponding author:* tfouda @yahoo.com

### Abstract

*This research work was carried out in the biogas laboratory of the Agricultural Engineering Department, Faculty of Agriculture, Tanta University at Jan. 2015. The main objectives of this research work were to study the possibility of using the stored energy from a solar panel with a heat exchanger to heat the cattle dung solution for a biogas production. Also to investigate the effect of both the temperature and the hydraulic retention time on the efficiency of anaerobic fermentation. The obtained results show that the highest biogas production was observed in horizontal digester type 12.95 L/day at mixing time of 15 minutes each four hours. and heating at 40 °C. Meanwhile the lowest was 2.39 L/day in vertical digester type in case mixing time 5min./hr. and heating at 30 °C. the total biogas productivity was increased by 0.416 from 1.126 (m<sup>3</sup> gas/m<sup>3</sup> manure) in case mixing time of 15 min. /4hr. The biogas productivity was changed by digester type from vertical and horizontal digester. the total biogas energy was increased by 201.2% by increasing temperature from 30 °C. to 40 °C. in case mixing time of 15 min. /4hr. at horizontal digester.*

*Key words:* biogas, evaluate, from vertical and horizontal digester, solar, stored energy

### INTRODUCTION

In Egypt, the annual average of global solar radiation is 5.4-7.1 kW.h/m<sup>2</sup>/day, while the annual average solar radiation on full tracking system is 7.5 -10.5 kW.h/m<sup>2</sup>/day. [8] Biogas technology is a biological process which converts organic materials such as crop and animal residues wastes by an anaerobic fermentation into useful energy. Biogas technology not supplies energy (biogas) and organic fertilizer from renewable waste materials, but also alleviates the problem of waste disposal and pollution control. Biogas system has many advantages.

[7] reported that solar energy is one of the most available forms of energy on the Earth's surface, besides; it is very promising and generous. The earth's surface receives a daily solar dose of 8E+10kW.h, which is equivalent to 500 000 billion oil barrels that is one thousand times any oil reserve known to man. [9] used the collector area about 4m<sup>2</sup> and experimented the volume of water in the storage tank between 100 and 300 l with the mass flow rate between 6 and 12 l/ min. They

found that a single solar collector can produce approximately 48-56°C hot water at an average solar radiation of 600-700 W/ m<sup>2</sup> at mass flow rate 0.2 kg/s Also, their results showed that the higher water volume exhibited lower water temperature and the mass flow rate of water had no effect on the water temperature under these conditions. [3] stated that biogas is “gas rich in methane, which is produced by the fermentation of animal dung, human sewage or crop residues in an air-tight container”. [5] described biogas as “a methane-rich gas that is produced from the anaerobic digestion of organic materials in a biological-engineering structure called the digester”. This definition suggests that biogas is only produced artificially, but this is not the case. It is believed that the scope of their definition may perhaps have been limited by their comparison of artificial production-processes, thus ignoring the natural occurrence of biogas. [4] stated that, A variety of digester types exists for the anaerobic treatment of organic wastes. The selected type depends on operational factors, including the nature of the



waste to be treated, e.g. its solid content. [11] stated that the heat requirements of digesters are used to: (i) raise the temperature of the incoming sludge to that of the digestion tank; (ii) compensate for the heat losses through the walls, floor and roof of the digester; (iii) make up the losses that might occur in the piping between the source of heat and the tank. [6] stated that, Solar water heaters are more and more used worldwide, and the evacuated-tube designs are the most popular due to their simplicity and better overall performance over their flat-plate counterparts, especially in adverse weather conditions. Many evacuated-tube designs have been developed and are being used among which the water-in-glass design is very popular because of its low cost and simple manufacturing and installation procedures. Another design uses a heat-pipe system with an intermediate fluid used to carry the heat from the heating elements to the tank. The objectives of the present research were to: Design an engineering unit to produce biogas from crop and animal wastes suit the farmer.

2- Use solar energy as a heating source during anaerobic fermentation to maximize biogas quantity under different engineering parameters.

## MATERIALS AND METHODS

The main experiments were carried out during seasons 2014 and 2015 in the biogas laboratory of the Agricultural Engineering Department, Faculty of Agriculture, Tanta University.

Animal waste (Cattle dung). The source of cattle dung obtained from the dairy farms. Table 1 showing the chemical analysis of cattle dung which was used to feed the biogas digester.

Table 1. Chemical analysis of cattle dung.

Parameter	Percentage
Total solids ( Ts %)	13.35
Volatile solids (%from Ts)	75.64
Total nitrogen (%from Ts)	1.21
Organic carbon %	36.54
C\N ratio	30.20
PH	6.65 -7.23

- **Solar heating system.** The heating required for the bioreactor was performed using a solar collector combined with a heat exchanger the bioreactor volume was 53 liters. Heating this volume of water to 40<sup>0</sup>C formed the basis for the solar collector design. Evacuated tube solar collector performance Figure (1) shows the entire system with a standard water-in-glass collector made of 20 evacuated tubes and the storage tank. A circulation pump is used to circulate the working fluid between the collector and the storage tank. The solar storage tank is a 150 liter insulated vessel.



Fig. 1. Evacuated tube solar collector



Fig. 2. The biogas digester are horizontal and vertical shape

**-A cylindrical biogas digester**

(horizontal and vertical type) are shown in Fig. 2 biogas digester were constructed Each digester was fabricated from stainless steel sheet 1.5 mm thickness, 80 cm length and 40 cm diameter with total capacity of 100 liters and it has a PVC inlet and outlet tube of 76.2 mm (3 in.) diameter for feeding by organic wastes and rejecting the digester materials.

**-Total solids (TS)** A sample of the fresh cattle dung which used in the fermentation test was oven-dried at temperature of 110 °C to the constant weight according to the American Public Health Association [1]. digested slurry was treated similarly.

**- Volatile solids (TVS)** The dried sample from the total solids determination was ignited at temperature of 550 °C in a furnace overnight to the constant weight. The loss in weight was taken as the volatile solids according to the American Public Health Association [1].

– Organic matter and organic carbon (OM & OC).

The percentage of organic matter was estimated from the percentage of ash (550-600 °C), using the following equations [2] :

$$\text{Organic matter (\%)} = 100 (\%) - \text{ash (\%)}$$

$$\text{Organic carbon (\%)} = \text{Organic matter (\%)} / 1.8$$

**- Hydrogen concentration ion (pH).**

The ph was directly measured in liquid samples using glass electrode pH meter.

**- Daily biogas production**

During the batch fermentations the released gas volume in liter everyday was measured laboratory using the wetted displacement with a previously calibrated scale in liter.

**- Methane percentage**

The daily released biogas was fractioned in a percentage i.e. methane and CO2 percentage using the potassium hydroxide 40% [10].

**RESULTS AND DISCUSSIONS**

Results of this study indicate that solar energy can be utilized for heating requirements of bio waste reactors at low cost. Heating requirements of a bioreactor are linked to increased production and decreased retention. Electric and diesel heating of such reactors

can be avoided using a combined system of solar energy and produced biogas

**-Effect of mixing and digester type on biogas production.**

Fig, 3 showing the effect of mixing on anaerobic digestion of buffalo dung was evaluated in bench

scale digester at 30 °C, 35 °C and 40 °C. Because mixing duration and intensity effect on the performance of anaerobic digestion are contradictory, we used in this study mixing system (5 minutes each one hour and 15 minute each four hours). The effect of digester type was evaluated on biogas production under the different mixing and heating treatments. The digester yield was greatly varied in both vertical and horizontal digester under mixing or heating. The effect of temperature on biogas production shown in Fig. 3. The results revealed that by increasing of temperature from 30 to 40 °C. at horizontal digester the total biogas production increased from 32.35 to 61.09 L and from 35.25 to 65.96 L. at mixing system 5 minutes each one hour and 15 minute each four hours respectively.

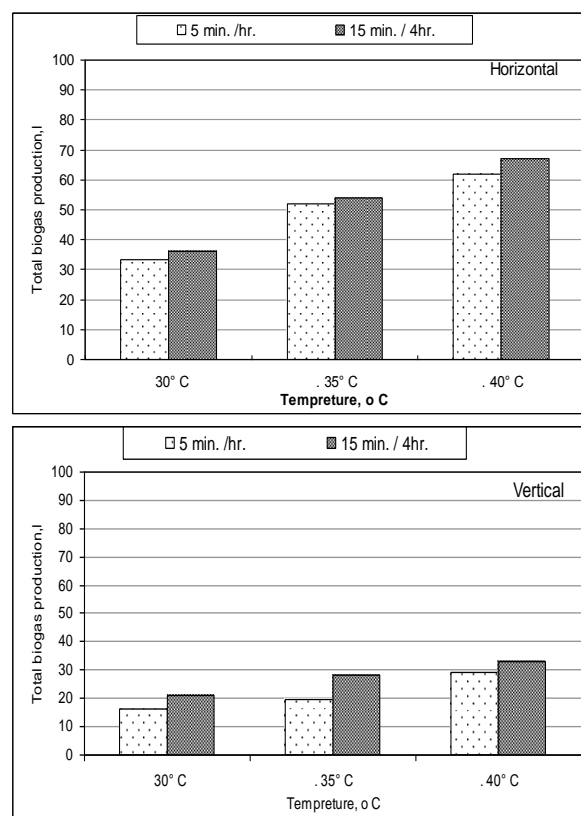

Fig. 3. Effect of temperature on biogas production under different digester type and mixing time.

The results showed that by increasing of temperature from 30 to 40 °C. at vertical digester the total biogas production increased from 15.44 to 28.15 L. and from 20.23 to 32.25 L. at mixing system 5 minutes each one hour and 15 minute each four hours respectively.

-Effect of mixing and digester type on biogas productivity.

The effect of temperature on biogas productivity shown in Fig. 4. The results indicated that by increasing of temperature from 30 to 40 °C. at horizontal digester the total biogas productivity increased from 0.364 to 1.01 m<sup>3</sup> gas/m<sup>3</sup> manure and from 0.416 to 1.126 m<sup>3</sup> gas/m<sup>3</sup> manure. at mixing system 5 minutes each one hour and 15 minute each four hours respectively. The results showed that by increasing of temperature from 30 to 40 °C. at vertical digester the total biogas productivity increased from 0.28 to 0.355 m<sup>3</sup> gas/m<sup>3</sup> manure and from 0.231 to 0.338 m<sup>3</sup> gas/m<sup>3</sup> manure. at mixing system 5 minutes each one hour and 15 minute each four hours respectively.

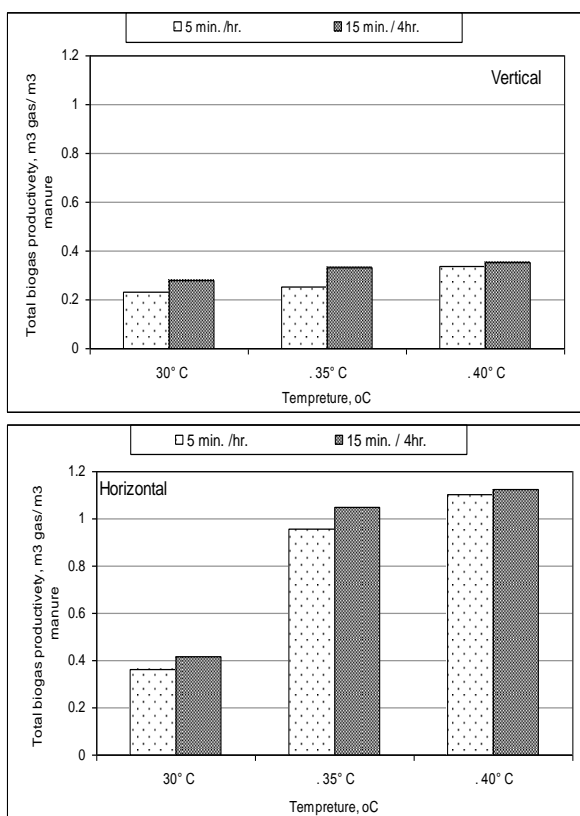

Fig. 4. Effect of temperature on biogas productivity under different digester type and mixing time.

### -Effect of mixing and digester type on biogas energy

The results in Fig. 5 showed that in horizontal digester and constant mixing time of 5 minutes each one hour the total biogas energy was 0.380, 0.631 and 0.790 (MJ/day) at 30, 35 and 40 °C respectively. While, total average biogas energy at constant mixing time of 15 minutes each four hours. 0.415, 0.655 and 0.853 (MJ/day) at 30, 35 and 40 °C respectively. However The results indicated that In vertical digester and constant mixing time of 5 minutes each one hour the total biogas energy was 0.182, 0.228 and 0.364 (MJ/day) at 30, 35 and 40 °C respectively. While, the daily average biogas energy at constant mixing time of 15 minutes each four hours. 0.238, 0.336 and 0.417 (MJ/day) at 30, 35 and 40 °C respectively.

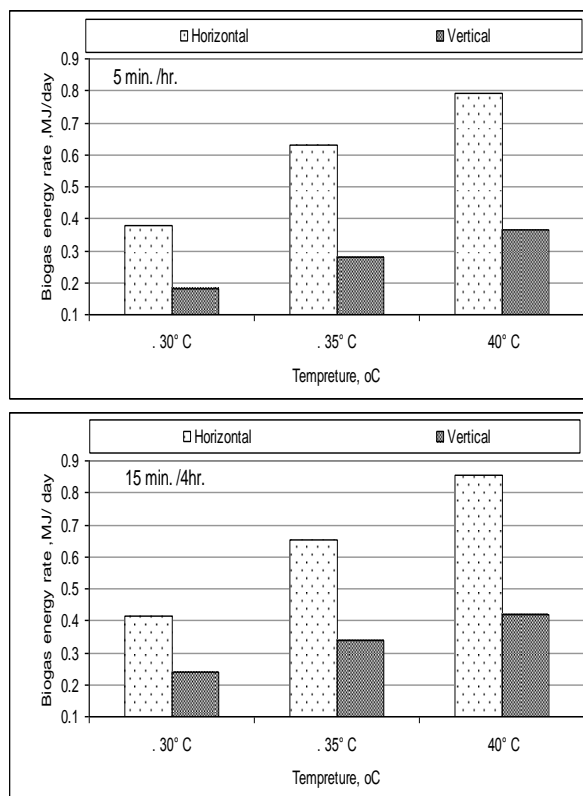

Fig. 5. Effect of temperature on total biogas energy under different digester type and mixing time.

### - Effect of mixing time and temperature on pH value

The measured PH value for the anaerobic digester of buffalo dung in vertical and horizontal digester at experimental intervals are shown in Fig. 6. pH values not greatly

affected by mixing in both vertical and horizontal digester.

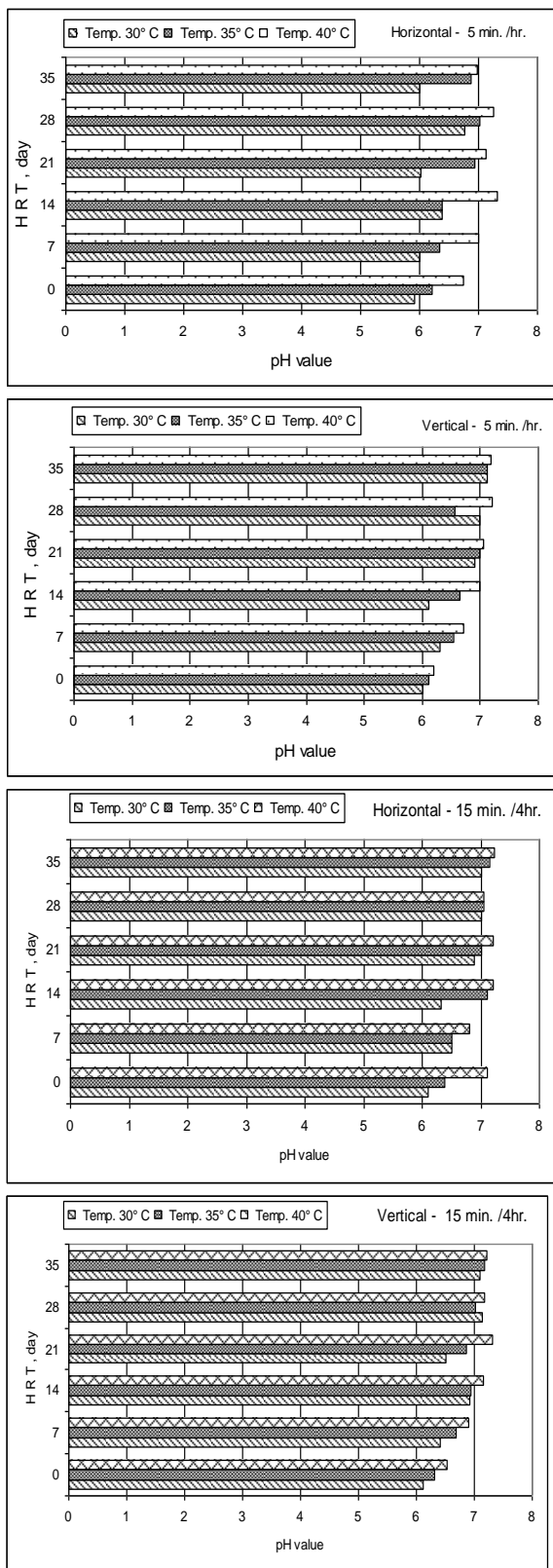

Fig. 6. Effect of (HRT) on pH values under different temperature and different digester type

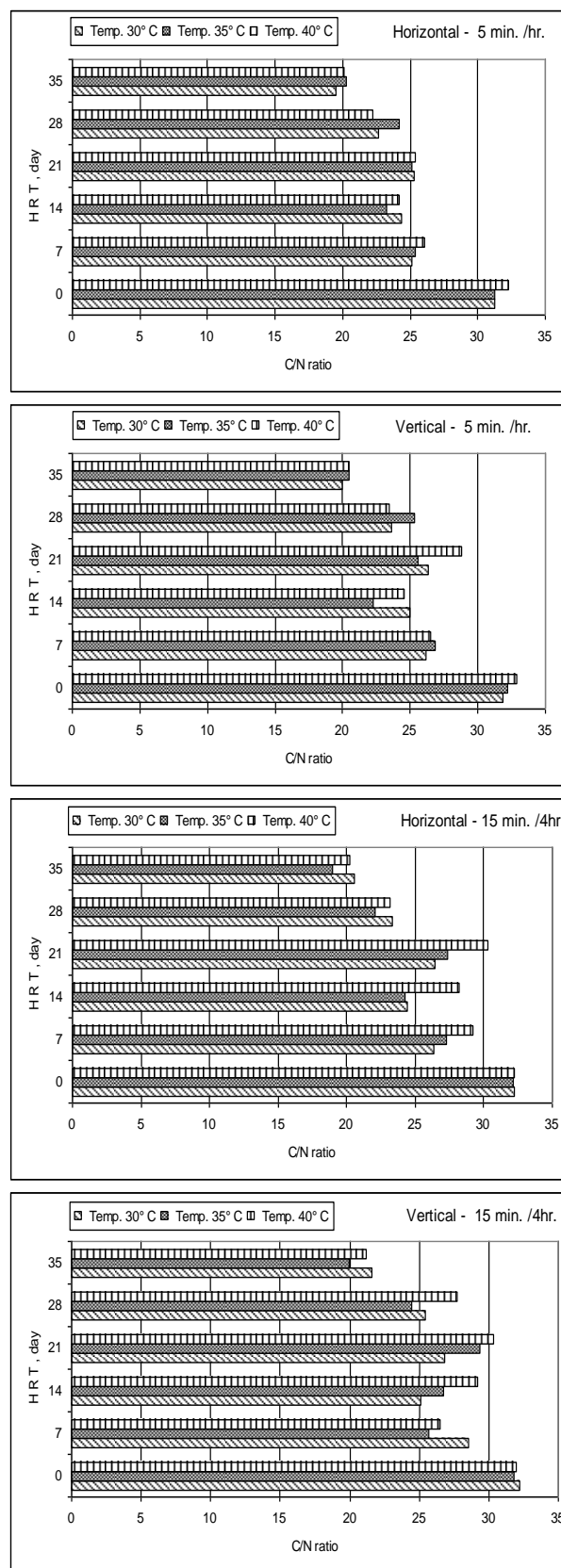

Fig. 7. Effect of (HRT) on C/N ratio under different temperature and different digester

The pH values were ranged from 5.91 to 7.23 and 6.01 to 7.21 in horizontal and vertical digester, respectively. The pH is known to influence enzymatic activity, because each enzyme has maximum activity within a specific and a narrow PH rang. The pH of the digestion liquid material and its stability as well comprises an extremely important parameter, since methanogenesis only proceeds at high rate when PH is maintained in the neutral range.

#### **- Effect of mixing time and temperature on C/N ratio**

Generally, increasing anaerobic period resulted in a highly decreasing in C/N ratio in all treatments of buffalo dung materials. The lowest C/N ratio (19.46) was recorded in horizontal digester with heating of 30 °C and mixing time of (5min. / 1h.) However The results evident that the higher C/N ratio (32.84) was recorded in vertical digester with heating of 40 °C and mixing time of (15min. / 4h.)

The results in Fig. 7 showed that there are differences in the declining of C/N ratios.

#### **CONCLUSIONS**

The highest biogas production was observed in horizontal digester type 12.95 L/day at mixing time of 15 minutes each four hours. and heating at 40 °C.

Meanwhile by increasing temperature from 30 oC. to 40 oC. the biogas productivity was increased by .069 from 0.188 (m<sup>3</sup> gas/m<sup>3</sup> manure/day in case mixing time of 15 min. /4hr. - The pH values were ranged from 5.91 to 7.23 and 6.01 to 7.21 in horizontal and vertical digester, respectively. the daily average biogas energy was increased by 106.67% by increasing temperature from 30 to 40 °C. in case mixing time of 15 min. /4hr. at horizontal digester.

#### **ACKNOWLEDGEMENTS**

The researches carried out for the elaboration of the present paper were financed by Egyptian program support from Tanta University Code: TU 04-1304 using solar

energy to produce biogas from animal wastes and agricultural contract no. 45/2012.

#### **REFERENCES**

- [1]APHA (American Public Health Association), (1989).Standard methods for the examination of water and waste water 17 th.ed. Washington, D. C. USA.
- [2]Black, C. A., Evans, D. O., Ensminger, L. E., White, J. L., Clark, F., Dineuer, C., 1965, Methods of soil analysis. II-chemical and microbiological properties. American Society of Agronomy Inc., Madison, Wisconsin, USA.
- [3]General Environmental Multilingual Thesaurus (GEMET) , 2000, Biomassresources.<<http://glossary.eea.eu.int/eeaglossary/biogas/>>.
- [4]Igoni, A. H., Ayotamuno, M.J., Eze, C.L., Ogaji, S.O.T., Probert, S.D., 2008, Designs of anaerobic digesters for producing biogas from municipal solid-waste. Application Energy 85 (2008) 430 -438.
- [5]Itodo, I.N., Phillips, T.K., 2001, Determination of suitable material for anaerobic biogas-digesters. In: Proceedings of the second international conference and 23rd annual general meeting of the Nigerian, vol. 23. Institution of Agricultural Engineers;. pp. 437–41.
- [6]Michel, H., Assaf, J., Lteif, W., 2011, Experimental Investigation of the Performance of Evacuated-Tube Solar Collectors under Eastern Mediterranean Climatic Conditions, Energy Procedia 6 (2011) 618–626
- [7]Mittal, V., Kasana, K.S., Thakur, N.S., 2005, The study of solar absorption air-conditioning systems. Journal of Energy in Southern Africa, 16(4): 59-66.
- [8]N.R.E.A. and U. S. A. I. D, 1991, Egyptian solar radiation atlas. New and Renewable Energy Authority.
- [9]Nuntaphan, A., Chansena, C., Kiatsiriroat, T., 2009, Performance analysis of solar water heater combined with heat pump using refrigerant mixture. Applied Energy, 86: 748-756.
- [10]Okeke, C. E., Ezekoye, V. A., 2006, Design, Construction and performance evaluation of plastic biodigester. The pacific journal of science and technology volume 7. No. 2. November, Nsukka, Nigeria
- [11]Tchobanoglous, G., Burton, F.L., Stensel, H.D., 2003, Waste-water Engineering: treatment and reuse. Fourth ed. New Delhi: Tata McGraw-Hill Publishing Company Limited, p. 1819

## IMPROVING PERFORMANCE OF FORCED - AIR HEATING SYSTEM IN BROILER HOUSE

Mohamed GHONAME, Tarek FOUDA

Tanta University, Faculty of Agriculture, Agriculture Engineering Department, Egypt, Phones: +201228476266, +201223558436, Fax: 0020403455570,  
E-mails: ghoname\_mohamed@ymail.com; tfouda@yahoo.com

*Corresponding author:* tfouda@yahoo.com

### *Abstract*

*The main objectives of this study were to provide thermal comfort environment, reduce heating for energy requirements and specific heating for power and maximize meat production. The air heating system performance was evaluated under with and without duct during the life cycle of 1 to 5 weeks of age. The results showed that, at first brooding stage using forced- air heating system without perforated poly -ethylene tube the air temperature at height of 0.25m above floor the air temperature close to the floor was lower than the recommended by 4.11°C and 4.64°C at 2 and 8 day of age, respectively. While, using it with perforated poly ethylene tube the air temperature close to the floor was higher than the recommended temperature by 0.12°C and lower than the recommended by 3.36°C at 3 and 8day of age, respectively. Average indoor air relative humidity through the birds' life when using heater with perforated poly- ethylene tube reduced by 12.92% comparing with using heater without perforated poly-ethylene tube. Using perforated poly - ethylene tube reduce total energy requirements and specific heating power by 17.84 and 20.82% at the end of life and increased average body weight from 1.9 to 2.1 kg at fifth week of age. Hence, it is recommended to operate forced - air heating system using perforated poly - ethylene tube to obtain thermal comfort environment, reduce heating energy requirements, and specific heating power and maximize meat production*

*Key words:* broiler, forced air heating, energy requirements, temperature

### INTRODUCTION

Broiler is a good source of fairly cheap protein comparing with the other kinds of animal protein such as beef and buffalo. Broiler has relatively high feed efficiency and the short period of capital cycle. In 2012, Egyptian production of poultry meat reached 916,597 tonnes. The total national production of chicken's meat was 800,000 tonnes in 2012 (FAO, 2014) [4]. Increasing national broiler meat production depends not only on health protection, but also on environmental control. Indoor air temperature is one of the most important environmental factors because, maintaining the correct air temperature is crucial in chicks brooding, especially during the first 7 to 10 days of the chick's life. Early in life, the chick is poorly equipped to regulate its metabolic processes to adequately control its body temperature. As a result, the young chick is dependent on environmental temperature to maintain optimal body

temperature. (Dozier and Donald, 2001) [3] reported that, forced -air furnace is more difficult to manage than pancake or radiant brooders for two primary reasons. First, furnaces produce warmth by producing heated air. This means that the floor must be warmed from hot air, which can require a long period since hot air rises, and temperature stratification can develop with hot air at the ceiling and cold air at the floor). Second, furnace heat does not allow chicks to select a comfort zone. (Lacy et al, 2003) [7] recommended that, litter moisture content should not exceed 30%. If litter moisture content exceeds this limit, ammonia is released. This means at higher moisture content leads to diffusion of ammonia. Litter moisture may affect the conversion rate of uric acid to ammonium- N. Conversion of urea to ammonia may be reduced at very dry conditions. (Czarick and Fairchild, 2005) [2, 5] conducted a trial in broiler house to measure stratification. In heating the house

with forced air furnace, and it was found that, a 10 °C differences between floor and ceiling was a problematic from a heating cost and chick performance. It is reported that, at placement floor temperatures should be at least 32°C with forced- air heating. (Cobb Broiler Management Guide, 2008) [1]. If radiant heaters/brooder stoves are used, floor temperatures should be 40.5°C under the heat source. (Fairchild, 2012) [5] recommended that, brooding should be at 34 °C floor temperature during the first week and to decreased about

3 °C every week until the cycle end reaching 24 °C . House preheating before chick's arrival is very important (Ross Broiler Management Guide, 2009) [1]. Temperature and relative humidity should be stabilized for at least 24 hours prior to chick arrival. If the air relative humidity is below 50%, litter would be too much dry, and if air relative humidity is above 70%. litter cackling can occur.

The main objectives of these study were to a) Improve the performance of forced - air heating system heating b) obtain thermal comfort zone c) reduce specific heating power and heating energy requirements d) and increase broilers average life weight.

## MATERIALS AND METHODS

The experimental work was executed in private broiler house, Egypt (latitude and longitude, 30.7°N and 30.99°E, respectively) during the winter season of 2011

### Broiler house and brooding stages

It is orientated with East-West direction. The experiment was conducted in two successive living cycles. The bird's density was 10 bird /m<sup>2</sup> at one day of age (Cobb hybrid). During the two living cycle, the chicks were brooded in three successive stages.

#### Stage 1

In the first chick brooding, all birds were brooded on small floor surface area (187.5 m<sup>2</sup>) of the house (15 m long and 12.5 m wide) for ten days of the chick's life to regulate their metabolic processes to adequately control their body temperatures.

#### Stage 2

The small floor surface area of brooding operation during the second stage was increased to 352.5 m<sup>2</sup> (15 m wide and 23.5 m long) for 10 days of age.

#### Stage 3

After 20 days of age the floor surface area of brooding was increased to be 525 m<sup>2</sup> (15 m wide and 35 m long) by removing curtains and the chick spread on all the floor surface area of the boiler house until the end of living cycle.

- In the first living cycle the house heating was executed using forced - air heating system.

- Whereas in the second living cycle the house heating was performed using forced - air heating system connected with perforated polyethylene tube.

Polyethylene tube was punched off-center (in "4 o'clock" and "8 o'clock" positions) and holes numbers was 246 circles holes with 5 cm in diameter and was distributed on both sides of polyethylene tube uniformly to give an aperture coefficient of 1.7.

The tube length was varying according to the length of brooding area.

The distances between holes vary depending on brooding space length in order to distribute the hot air inside the broiler house.

The tube situated 2.0 m above the floor surface.

The heating system was adjusted to provide a 34°C in at the first day of chicks live and was reduced gradually 3°C every week until reached 24 °C at age of five weeks.

Heating system sensor was at height of 25 cm of floor surface and was in the middle of brooding area and far 2.5 m near the house south wall.

#### Heating system

Forced air heater E 120 BABYSER consists of (furnace made of stainless steel, counter flow heat exchanger, axial fan 75 cm taken motion directly from electric motor 3 phase with 1.5 kW in power).

The fan air displacement is 11000 m<sup>3</sup> /h. and electric control box. The heating system was connected with gas burner model CIB UNIGAS (ITALY) S10 model, LPG fuel, Gas flow rate min. - max Stm<sup>3</sup> /h 6.9-12.7.



The position of heating system sensor was at the middle of every brooding area according to the brooding stage.

### **Measurements**

#### **Temperature measurements**

One data logger were 16 channels which connected by the sensors constructed from thermistors to measure inside air temperature at 15 points at height 0.25 m of floor.

One sensor was placed outside the broiler housing to measure outdoor dry bulb temperature.

#### **Relative humidity measurements**

Thermo-Hygrometer with range of 10-95% was used to measure the air relative humidity inside and outside the broiler house with  $\pm 5\%$  accuracy.

The air relative humidity during the experimental work was measured every six hours daily through the living cycle.

#### **Broiler body mass**

Broilers body mass was estimated weekly. A sample of 200 birds were taken and weighted and the total weight was used to calculate the increasing in broilers weight.

### **Calculation**

The aperture coefficient and number of circle holes were calculated using the following equation (George, 1997) [6]:

$$\text{Aperture coefficient} = \left( \frac{\text{Holes total area}}{\text{Duct cross-section area}} \right)$$

$$\text{Number of holes} = \left( \frac{\text{Holes total area}}{\text{Holes cross area}} \right)$$

### **Specific heating power**

Specific heating power was determined using the following formula:-

$$Sp = \frac{Q_{add}}{V_h}$$

$Q_{add}$  = Supplementary heating, W

$Sp$  = specific heating power, W/m<sup>3</sup>

$V_h$  = house volume, m<sup>3</sup>.

### **Energy requirements**

An energy requirement was estimated using the following equation:

$$\text{Energy requirements} = \frac{Q_{add}}{\text{Total body mass}}$$

Where:

Energy requirements = kJ/hr.kg

$Q_{add}$  = Heat energy addition, kJ/hr.

## **RESULTS AND DISCUSSIONS**

### **Indoor air temperature**

The relationship between air temperature at chick's zone and broiler age at different brooding stages when using forced air heating system with and without perforated tube inside broiler housing as revealed in (figure 1) It evidently revealed that, the average floor air temperatures at a height of 25 cm above the floor surface along the broiler house when employed the forced air heater with and without perforated polyethylene tube were varied from day to another according to the age of birds. The Fig. 1 showed the daily average air temperature at height of 0.25m with and without tube. It also showed that, during the first stage of brooding, the recommended floor temperature was 34°C at the first day of chick's life and reduced gradually until reached 30°C at the end of brooding stage. The indoor air temperatures decreased as the broiler age increased throughout the living cycle. Due to the brooding temperatures dependent on broiler age especially in the two first and second brooding stages or on their body temperature, metabolic rate, ratio of average life weight to surface area, insulation from feathering and thermoregulatory ability are all relatively low. The highest value of floor air temperature was 29.89°C at 2 day of age and the lowest value was 26.36°C at 8 day of age when using forced air heating without perforated polyethylene tube. That's mean; the air temperature close to the floor was lower than the recommended by 4.11°C and 4.64°C at 2 and 8day of age, respectively. While, using the perforated polyethylene tube the highest, value of floor air temperature was 34.12°C at 3 day of age and the lowest value was 28.64°C at 8 day of age. So, the air temperature close to the floor was higher than the recommended temperature by 0.12°C and lower than the recommended by 3.36°C at 3 and 8day of age, respectively. At the second

brooding stage the recommended floor temperature was 30°C at the 11 day of chick's life and reduced gradually until reached 27°C at the end of second brooding stage. The highest value of floor air temperature was 26.15°C at 13 day of age and the lowest value was 21.77°C at 20 day of age when using forced air heating without perforated polyethylene tube. That's mean the air temperature close to the floor was lower than the recommended by 2.85°C and 5.23°C at 13 and 20day of age , respectively. While, employing the perforated polyethylene tube the highest, value of floor air temperature was 28.8°C at 12 day of age and the lowest value was 25.92°C at 20 day of age. So, the difference between recommended temperature and air temperature close to the floor was 0.2°C and 1.08°C at 12 and 20day of age, respectively. After 20 day of age the birds were translocated from partial to all house brooding. The recommended floor temperature ranged between 26 and 24°C at this stage. When, using forced air heating without perforated polyethylene tube the highest value of floor air temperature was 23.91°C at 33 day of age and the lowest value was 20.78°C at 34 day of age. That's mean the air temperature close to the floor was lower than the recommended by 0.1°C and 3.24°C at 33 and 34day of age , respectively. While, employing the perforated polyethylene tube the highest, value of floor air temperature was 28.25°C at 23 day of age overridden the recommended temperature by 2.25°C and the lowest value was 21.06°C at 35 day of age lower than the recommended temperature by 2.94°.

The floor temperature was lower than the recommended temperature during all brooding stages when heating the house without duct. As result of that, chicks are chilled, huddle together and will not seek feed or water and nutrients that might have been used for body development are used to maintain body heat and they loose weight and not grow properly. In contrast, using duct for heat distribution the indoor temperature was close to the recommended.

#### **Relative humidity**

The ability of indoor air to hold moisture

depends upon its temperature. The level of indoor air relative humidity influences the ability of the birds to cool them through panting and influences ammonia production. In addition to, increasing the moisture adding to the house from broiler fecal. An air relative humidity level of 50 to 70% is recommended to minimize ammonia production and dust. (Figure 2) clarifies the relation between indoor air relative humidity when using forced air furnace with and without perforated poly ethylene tube during different brooding stages. At first stage of brooding the indoor relative humidity increased with increased birds in age when, using forced air furnace from 28.36 to 57.78 % at the end of the first brooding stage. While, using forced air furnace with perforated poly ethylene tube the indoor relative humidity increased from 28to 48.39 % at the end of the first brooding stage. After ten days of brooding (second brooding stage) the brooding surface area was increased to 352.5 m<sup>2</sup>. Using forced air furnace, the lowest percentage of indoor air relative humidity was 53 % at the beginning of second brooding stage and increased until reach the highest percentage at age of 15 days which is 69% and reduced to be 57% at the end of this stage. Whereas, using perforated tube for heat distribution the indoor relative humidity was 51.6 % at the first of second brooding stage and reaches the maximum percentage to be 56.36% at age of 13 days of chicks' life and was 54.67% at the end of this stage. After 20 days of age the curtain was removed and the birds spreads on the entire house until the end of living cycle. The indoor air relative humidity was 57.09% at the age of 21 days and increased gradually to overridden the maximum percentage of indoor relative humidity to be 72.65% at age of 31days and reach the 78% at 32days of age when, heating house without duct .The indoor air relative humidity increased at the end of the heating period due to the heat energy supplied during that time was insufficient to absorb more moisture from the indoor air. While performed heater with tube for heat distribution the indoor relative humidity was ranged between 52.34 % at 22 days of age to be 64.85 % the last two days of life. The

indoor relative humidity decreased compared with first treatment because of, perforated tube downward heat to house floor which was sufficient to absorb more moisture from the indoor air as shown in (Figure 2)

### Specific heating power

(Figure 3) clarifies the relationship between the specific heating power for one cubic meter of house volume and the broiler age when using forced air furnace with and without perforated poly ethylene tube. Specific heating power depends mainly upon the heat energy addition to the broiler house during heating operation and the volume of that house. As, the bird's age increased, the specific heating power was decreased. Specific heating power during the first living cycle when the forced air heating system was used without perforated polyethylene tube was  $94.6 \text{ W/m}^3$  at the first week of age and reduced gradually until reached  $26.25 \text{ W/m}^3$  at the fourth week of age, after that, it increased again until reached  $29.15 \text{ W/m}^3$  at the fifth week of age. This increasing can be almost completely attributed to the increase of house volume and the heat energy addition to the broiler house accordingly at this period (the brooded birds were translocated from a small partial area to the whole house brooding).

Thereafter, when the forced air heating system was connected to perforated polyethylene tube for uniformly distributing the hot air inside the broiler house, the specific heating power for one cubic meter of the house volume gradually decreased from  $66.38 \text{ W/m}^3$  at the first week of age until reached to  $19.9 \text{ W/m}^3$  at the end of living cycle. The previous obtained data revealed that, using perforated polyethylene tube resulted in reduced the specific heating power for one cubic meter of the house volume. Because, it was delivered the heat energy to the end of the house, increased the floor surface temperature, and decreased the total heat energy addition to the broiler house, in spite of the house volume increased particularly after three weeks of age.

### Heating energy requirements

The heating energy requirements depending mainly upon the heat energy addition to the broiler house during the heating operation and

broiler body life weight.

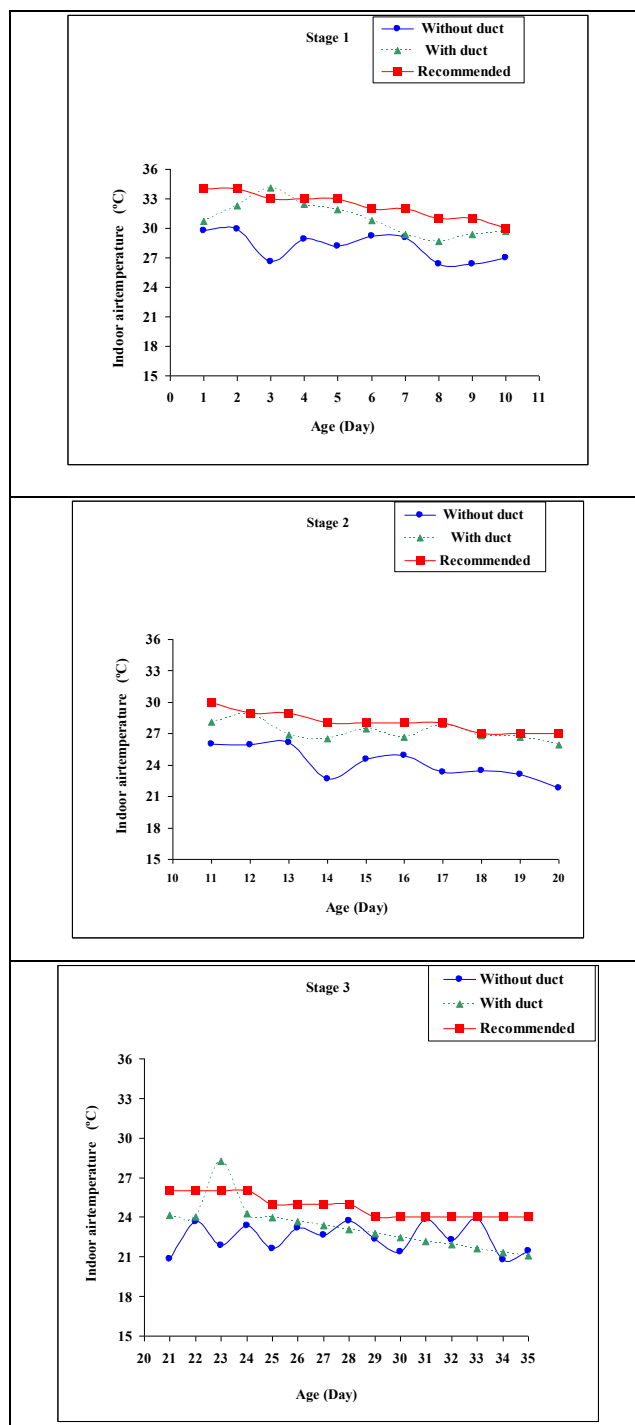

Fig. 1. Daily average indoor air temperature during different brooding stages with and without tube

As, the birds increased in age their body life weight increased and the total heat energy addition by the heating system is decreased. (Figure 4) shows the relationships between the energy requirements and the broiler age when using forced air furnace with and without perforated poly ethylene tube.

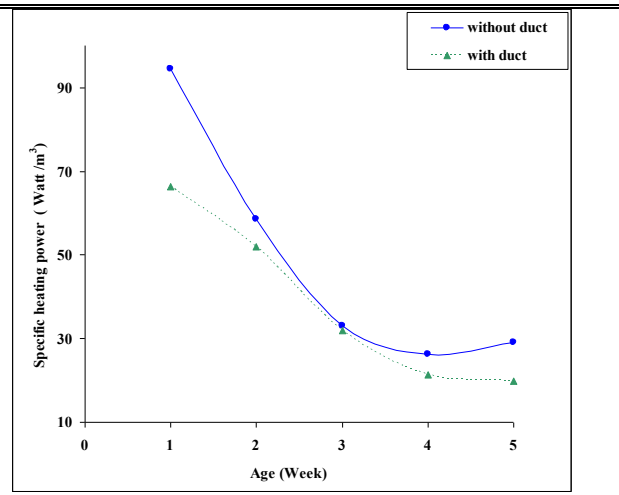
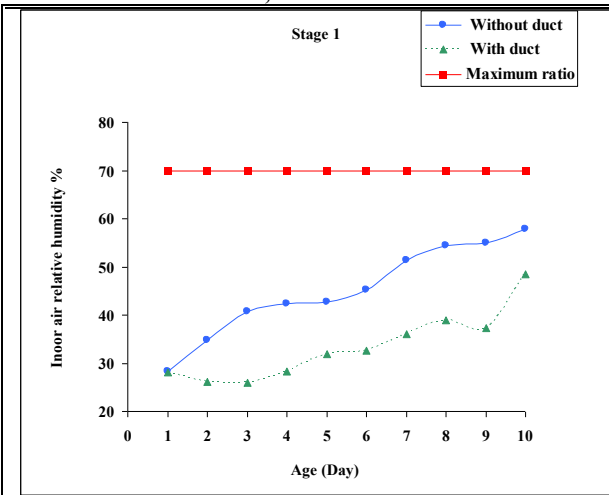

Fig.3. Specific heating power with and without Perforated polyethylene tube

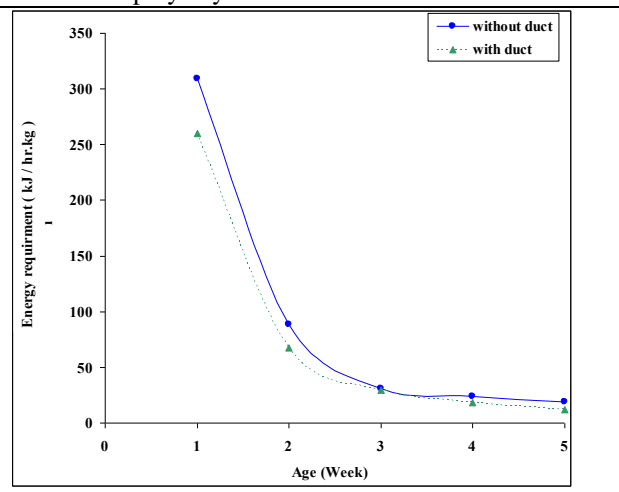
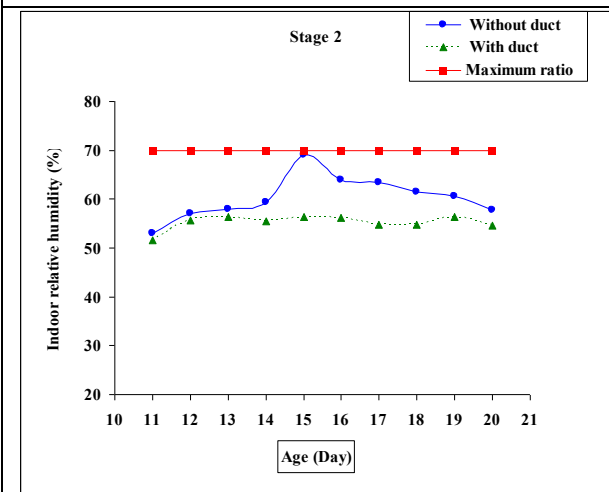

Fig.4. Energy requirements with and without Perforated polyethylene tube

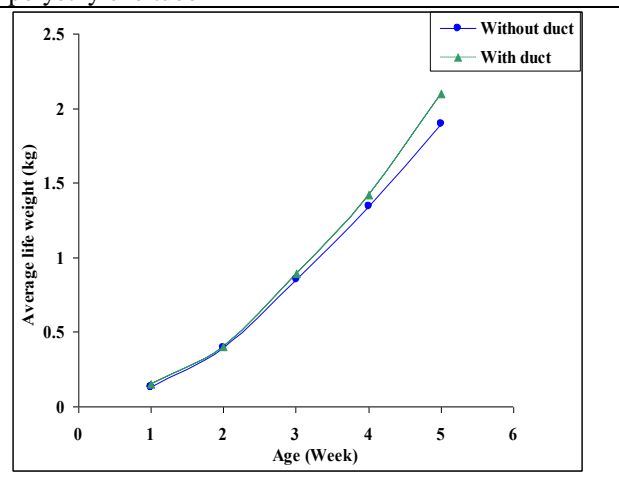
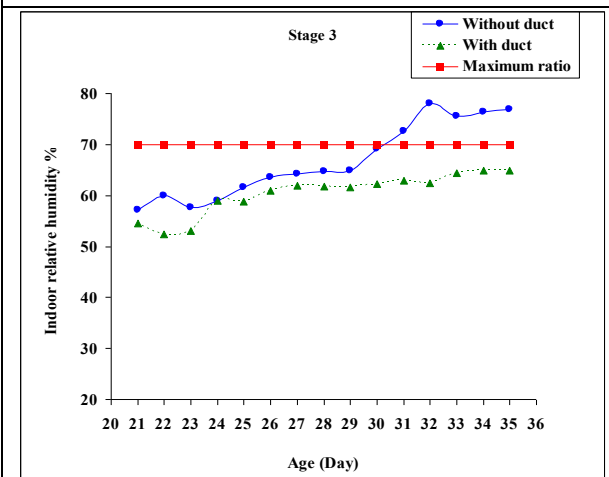

Fig.5. Average life weight with and without perforated tube

Fig. 2. Daily average indoor relative humidity during different brooding stages with and without tube

The obtained data evidently showed that, the energy requirements were namely decreased with increased the birds in age with and without perforated poly ethylene tube. When

the forced air heating system was used without perforated polyethylene tube the energy requirements reduced gradually from 308.9 to 19.25 kJ/hr. kg of broiler life weight.

While, when the forced air heating system was connected to the perforated polyethylene tube (during the second living cycle) for uniformly distributing the hot air inside the broiler house, the total energy requirements reduced gradually from 260.2 to 11.95 kJ/hr. kg of broiler life weight. It is obviously clarified that, the forced air heating system with the perforated polyethylene tube led to reduce the total energy requirements by an average of 17.84%. This reduction in heat energy requirements can be attributed to the heating system with perforated tube expelled the hot air continuously downward into the chick's zone which enhanced the chick's life weight. In addition, this heating system decreased the total heat energy addition to the broiler house. Due to the previous reasons, the total heat energy requirements were decreased when using perforated polyethylene tube for uniformly distributing the hot air inside the broiler house.

#### **Average life weight**

Due to the prevalent environmental factors which positively impact on growth and development of broiler chicken within the two successive living cycles were at or around the desired level particularly with using the developed heating system, the birds were grown well during the experimental period. When adequate broiler house temperature is obtained and chicks are well managed, they should be distributed throughout the whole house surface area and not huddling together or sitting mostly in the feed pans. The relationships between the average life weight in kilogram and the broiler's age in week during the two successive living cycles (forced air heating system was used with and without perforated polyethylene tube) are plotted in (Figure 5) for the duration of the experimental work, the average life weight was found to be directly proportional to broiler's age.

When the forced air heating system for heating the broiler house was functioned without perforated polyethylene tube, the average life weight was gradually increased with the increase of bird's age from 0.130 kg at the end of the first week until realized market average life weight of 1.90 kg at the

end of living cycle (after 35 days). It observed that, the average life weight was increased by different rates throughout the experimental period. The weekly average increasing rate of life weight was found to be 0.4425 kg. The greatest rate of increasing in the life weight (0.5544 kg). When the forced air heating system for heating the broiler house was connected to perforated polyethylene tube for uniformly distributing the hot air inside the broiler house, same trend was observed in the average life weight of broiler chickens. They were gradually increased with the increase of bird's age from 0.1505 kg at the end of the first week till achieved the market average life weight of 2.10 kg at the end of living cycle (also after 35 days). It also observed that, the average life weight was increased by different rates throughout the experimental period. The weekly average increasing rate of life weight was found to be 0.4874 kg. The greatest rate of increasing in the life weight (0.6794 kg) was achieved on the last week of living cycle as revealed in (Figure 5) Consequently, the modified heating system which was used during the second living cycle was on average 10.53% more profitable.

#### **CONCLUSIONS**

The main results of the present research can be summarized as follows:

- Using perforated polyethylene tube increased average floor air temperature through the birds' life by 7.99%.
- Using perforated poly ethylene tube reduced the average indoor air relative humidity through the birds' life by 12.92% .
- Perforated polyethylene tube reduced the total energy requirements by an average of 17.84%.
- Perforated polyethylene tube reduced the specific heating power by an average of 20.82% . .
- Using perforated tube helped in increasing broilers body mass by a 10.52%.

#### **REFERENCES**

- [1]Cobb Broilers Guide, 2008. Cobb Broiler management guide, www.Cobb.com, pp. 1-65.

[2]Czaric, M., Fairchild, B.D., 2005, Temperature Stratification during brooding, Poultry Housing Tips, February University of Georgia Cooperative Extension Service.

[3]Dozier, W.A., Donald, J., 2001, Keys to successful brooding, The Alabama Poultry Engineering and Economics Newsletter. No. 14, November. Alabama Cooperative Extension System, Auburn University, Auburn, Ala.

[4]FAO, 2014, FAO Statistics Divisio, Poultry protubeion. <http://faostat.fao.org./Site/569>.

[5]Fairchild, B. D, 2012, Environmental factors to control when brooding chicks, University of Georgia, Cooperative Extension service, Colleges of Agriculture and Environmental sciences, March, Bulletin 1287: 26-34.

[6]George, A. D., John, N .W., Lary, W.T., 1997, Poly-tube heating - ventilation systems and equipment. Cooperative Extension Service, Univ. of Kentucky.

[7]Lacy, M. P., Redwine, J. S., Parnell, C. B. Jr , 2003, Particulate matter and ammonia emissions factors for tunnel ventilated broiler production houses in the Southern U.S." Trans. ASAE, 46(4): 1203-1214.

## SELECTED LEGAL ASPECTS OF STATE AID SCHEMES FOR AGRICULTURE IN POLAND IN YEARS 2015 -2020

**Jakub GOŁAŚ**

Adam Mickiewicz University, Faculty of Law and Administration, Division of Labor Law and Social Law, Collegium Iuridicum, Św. Marcin St. 90, 61-809 Poznań, Poland; Phone: +48784566625; E-mail address: jk.golas@gmail.com

*Corresponding author:* jk.golas@gmail.com

### **Abstract**

*The main aim of the study was to analyse legal basis of state aid schemes for polish agriculture sector in years 2015 - 2020. The paper focuses mainly on the characteristics of five different state aid schemes which are regulated in four different national legal acts. Presented analysis is focused on presenting different legal instruments, which can be used to both fulfil fundamental goals of the 2015-2020 Common Agricultural Policy (the CAP) in UE and stimulate competitiveness and modernity of national agricultural sector. Polish legislator intends to assure that the state-provided financial aid schemes for national agriculture producers have clear, transparent and explicit legal frameworks. It should be also mentioned that all legal basis related to fulfilling directives of the Common Agricultural Policy have to be compatible with directly biding acts of Community law.*

**Key words:** agriculture, Common Agricultural Policy, legal aspects, state aid schemes, Poland

### **INTRODUCTION**

The Common Agricultural Policy (the CAP) of all EU Member States should not be based exclusively on the Community law. It has to be stated that in order to fulfill common goals, in addition to use of common instruments, it is also necessary to apply precise and specific legal and financial measures which are directly adapted to the realities of the given society and country. Such targets of the Common Agricultural Policy in years 2015-2020 like: increase of agriculture sector competitiveness, supporting the shift towards a low-emission agricultural economy, poverty reduction and development of rural and forest ecosystems require designing and applying specialized, unique and effective legal measures by each EU Members State. At the same time, national agricultural policy of each Member State should be compatible with basic values and principles of the European Union and should not lead to imbalance of the internal market. This is the reason why fulfilling goals of the Common Agricultural Policy may turn out to be extremely difficult and elaborate challenge for each EU member. It is an imperative to apply on national ground

such legal measures, which at the same time will both be compatible with rules of the internal market and contribute effectively to the implementation of the current objectives of the Common Agricultural Policy.

Under the CAP in years 2015-2020, polish authorities plans to spend total sum of approx. 10 -11 mld PLN for financing five different and fundamental state aid schemes earmarked for national agricultural producers. Presenting general characteristic of all indicated below public aid schemes, it should be highlighted that each analyzed legal measure both fulfills directives formed within the Community legislation and is adapted to the needs and specificity of the domestic agricultural market.

In years 2015-2020, accomplishment of the CAP in Poland regarding state aid in agriculture will be based upon five different financial aid schemes allotted for agricultural producers:

- a) aid no. SA.39562 - premium subsidies for crops and livestock insurance and partial refinancing of compensation indemnities paid to agricultural producers as a result of drought (reinsurance) [11],
- b) aid no. SA.39937 (2014/X) - refund of



excise duty included in the price of gas oil used in agricultural production including the minimum rates defined in the Directive 2003/96/EC[12],

c) aid no. SA.40223 (2014/XA) - tax advantage concerning investments in case of agricultural tax [10],

d) aid no. SA.40663 (2015/XA) - Aid for the collection, transportation and disposal of fallen stock [8] and

e) aid no. SA.40666 (2015/XA) - Young farmers — partial credit repayment [8].

## MATERIALS AND METHODS

The study presented in the article was based on the analysis of polish legal provisions fulfilling different directives and directions defined in the Common Agricultural Policy for years 2015 – 2020. The author, by the analysis of national legal basis of state aid schemes intends to present, how on the polish example, it is possible to effectively influence such desired features like progress, modernization and competitiveness of national agriculture sector through application of varied legal and financial measures.

## RESULTS AND DISCUSSIONS

### The characteristics of the selected state aid schemes for agriculture in Poland

#### *1. Aid no. SA39562 (2014/N) - premium subsidies for crops and livestock insurance and partial refinancing of compensation indemnities paid to agricultural producers as a result of drought (reinsurance)*

The state aid scheme no. SA.39562 (2014/N) has been granted by the European Commission's decision C(2015) 741 of 17 February 2015 [1]. The Commission (EU) did not raise any objections regarding presented scheme, highlighting that the scheme should be considered as compatible with the internal market with accordance to Article 107(3)(c) of the Treaty on the Functioning of the European Union [1, 9]. The state aid scheme will be functioning in years 2015 – 2020, its overall budget is fully state-founded and the total planned expenditure is 2,6 mld PLN (200,7 mln in 2015 and 480 mln for each

following year of scheme)(art.3(2) of the Act) [11]. As it was mentioned in the Commission's decision, the scheme has the task to encourage agricultural producers to insurance their farms, crops and livestock. Effective fulfillment of aid's objectives expressed in the higher proportion of insured farmers shall contribute to strengthening insurance protection of both crops and stocks [6]. The national legal basis of the presented state aid scheme is the Act on subsidies to crop and livestock insurance of 7 July 2005 [11].

As the scheme's name indicates, it is consisted of two types of aid measures:

a) premium subsidies for crops and livestock insurance and

b) partial refinancing of compensation indemnities paid to agricultural producers as a result of drought (reinsurance).

At the beginning of presentation of the first state aid scheme's characteristic, it should be highlighted that the objective scope of eventual premium subsidies is directly limited. Only specific types of crops and livestock species, which are directly defined within the Law, may be the object of the insurance contract qualified to obtain financial resources from the state's budget (art.3(1) of the Act) [11]. As the statutory exhaustive list provides, the state aid in the form of premium subsidies can be granted only when the insurance contract insures:

a) defined types of crops: cereals, maize, rape, agrimonies, hops, tobacco, field vegetables, fruit trees and bushes, strawberries, potatoes, sugar beetroots and grain legumes and

c) defined livestock species: cattle, horses, sheep, goats, pigs and poultry (art. 3(1)(1)and(2) of the Act) [11].

In the process of forming objective scope of the state aid scheme, the legislator also limited its different aspect which relates to the insured events and risks within insurance contract. The insured risk or event of qualified insurance contract may only comprise:

a) for defined crops – from time of sowing or planting to harvest and from the risk of - hurricanes, flood, heave rain, hail, thunderbolt strikes, landslides, avalanches, droughts and negative effects of winter time or spring frost;

b) for listed livestock species from the risk of – hurricanes, flood, heavy rain, hail, thunderbolt strikes, landslides and avalanches (art. 3(1)(1)and(2) of the Act) [11].

It is also worth mentioning that not every insurance contract and every insurance company shall be qualified to function under the state aid scheme. It results from the fact that the legislator has limited access to state aid by creating the precondition in the form of conducting pre-agreement on insurance subsidies between the Minister of agriculture and selected property insurance companies (art. 13 of the Act) [11]. As the consequence, only insurance companies – parties of the ministerial contracts – are entitled to act within the aid scheme and conduct actual insurance contracts with agricultural producers [6]. In order to participate in the scheme as the party of subsidies agreement, each interested entity has to submit its bid to the Ministry of agriculture by the 15<sup>th</sup> November of year preceding the year of participation in the scheme (art.9(2) of the Act) [11]. The bid submitted by the insurance company is the basis of the subsequent subsidies agreement (art.9(2) of the Act) [11]. The subsidies agreement are concluded with property insurance agencies ensuring rightful and effective use of the scheme's funds. Each subsidies agreement between Minister of agriculture and insurance company have to be concluded by 31 December of the year of the bid (art. 9(3) of the Act) [11]. The agreement is concluded for a period of the year following the bid year (art. 9(3) of the Act) [11].

In order to obtain premium subsidies for insurance, each agricultural producer has to file formal application addressed to insurance company, which participates in the scheme as the party of the ministerial subsidies agreement (art. 4(1) of the Act) [11]. Approval of the application results in concluding actual insurance contract between agricultural producer and insurance company. Each insurance agreement within the scheme is concluded for the period of 12 months (art. 4(3) of the Act) [11]. Moreover, the insurance company is not entitled to conduct unlimited number of actual insurance contracts with farmers as each insurance agency

participating in the scheme is legally bound by provisions of subsidies agreement with Minister of agriculture, where parties agreed for specified limit for awarding subsidies (art. 4(2) of the Act) [11].

According to the art. 7(1) of the Act, subsidies have form of partial insurance premiums which are to be paid by the agricultural producers to insurance companies for insurance services [11]. Thus the awarding of the financial aid directly results in reduction of premiums paid by the agricultural producers participating in the scheme.

The Minister of agriculture is sole competent authority entitled to pay out the premium subsidies (art. 5(1) of the Act) [11]. The payout is performed quarterly – up to 30<sup>th</sup> day of month following given quarter[11]. It also need to be stressed here that, according to the art. 7(2) of the Act, in order to obtain the subsidies for given insurance contract, each property insurance company participating in the scheme is legally obliged to file formal application in the term up to 20<sup>th</sup> day following given quarter [11]. The tardiness or different form of formal disobedience of entitled insurance company will result in the loss of substantial subsidies. Thus legal procedure of awarding subsidies for insurance premiums is not automatic and requires specific activities form participating entities.

The legislator has also introduced maximum possible subsidies within the scheme, which value depends on tariffs and insurance premium rates set by the insurance companies (art. 5(2) of the Act) [11]. The insurance contract insuring crops will be qualified to the scheme (up to 65% of insurance premium value) providing that the insurance premium rates set by the insurance company are not exceeding :

a) 3,5% of insured value for cereals, maize, swede rape, agrimony, potatoes or sugar beetroots and

b) 5% of the insured value for winter oilseed rape, field vegetable, hops, tobacco, fruit trees and bushes, strawberries or grain legumes (art. 5(2)(1)(a)(b) of the Act) [11].

For the insurance of livestock, the possible subsidies amount to maximum of 65% value of the premium paid within the insurance

contract providing that the premiums rates set by the insurance company are not exceeding 0,5 % of insured value (art. 5(2)(2) of the Act) [11]. In the cases of exceeding maximum insured value up to 6%, the subsidies will be conditionally awarded in the above value (art. 5 (2b) of the Act) [11]. However, exceeding conditional maximum insured value (6)% will result in not granting the subsidies (art. 5(2c)(2) of the Act) [11].

The insurance companies qualified to the scheme by conducting specified contract with the Minister of agriculture are also entitled to benefit from second legal state aid measure in the form of partial refinancing of compensation indemnities paid to agricultural producers as a result of drought (reinsurance)(art.10a (1) of the Act) [11]. The value of refinancing subsidies depend on two aspects:

- a) total amount of paid out indemnitees in given calendar year and
- b) total amount of premiums paid to given insurance agency by agricultural producers in order to insure crops or livestock in given calendar year (art. 10a (2) of the Act) [11].

Provisions of the Act constitute also additional precondition which has to be met by the insurance company in order to obtain partial refund. Each insurance company entitled to the refinancing is legally obliged to file formal application in the specific term. The Act constitutes three different and legally binding prescription periods:

- a) up to 30 June of given year – in order to receive refinancing for period from 1 January to 31 May of given year,
- b) up to 30 September of given year – in order to receive refinancing for period from 1 July to 31 August of given year and
- c) up to 30 January of given year – in order to receive refinancing for period from 1 September to 31 December of previous year (art.10b (2) of the Act) [11].

The application should include data sufficient to identify applicant and data necessary to estimate amount of entitled refinancing (art.10b (3) of the Act) [11]. It also needs to be stressed out here that each insurance company – the beneficiary of the refinancing measure, is legally obliged to both regularly

account obtained subsidies and systematically present to the Minister of agriculture precise financial records regarding the payout of compensation indemnities paid to agricultural producers resulted from drought. (art. 10b (4a) of the Act) [11].

The Minister of agriculture is also the sole competent authority entitled to both grant the refinancing and study reports and accounts of the scheme's beneficiaries (art. 10b (1) of the Act) [11]. The Minister expresses its standpoint in the form of decision. The authority has 14 workdays (since the day of application) to issue the granting decision and 10 workdays (since delivery of the decision) to payout granted refund (art. 10b (3a) of the Act) [11].

***2. Aid no. SA.39937 (2014/X) - refund of excise duty included in the price of gas oil used in agricultural production including the minimum rates defined in the Directive 2003/96/EC***

The state aid scheme no. SA.39937 (2014/X) in the form of refund of excise duty included in the prices of gas oil used in agricultural production has been granted by the European Commission under Commission Regulation (EU) No 651/2014 of 17 June 2014 declaring certain categories of aid compatible with the internal market in application of Articles 107 and 108 of the Treaty [2].

The presented state aid scheme both is compatible with provision of art. 44 of Commission Regulation (EU) No 651/2014 and the minimum rates of excise duty and refund defined in the Directive 2003/96/EC are provided for in [2, 4, 12]. Notified aid scheme has been granted for years 2015 – 2020, and its annual overall planned budget amounts to 1.450 mln PLN (7.250 mln PLN in 5 years). The national legal basis of the presented state aid scheme is the Act on the refund of excise tax on gas oil used in agricultural production of 10 March 2006 [12].

The primary aim of the Act is to define basic principles and design the procedure of excise duty's refund to beneficiaries (art. 1 of the Act) [12]. It should be stress out at the beginning that only agricultural producers can be beneficiaries of the analyzed scheme.

According to art. 3(2) of the Act, the agricultural producer should be defined as natural person, legal person or non-corporate entity being a possessor of agricultural holding within the meaning of the Act on the agricultural tax definition<sup>1</sup>[10, 12]. In the cases when given agricultural holding is possessed by both owner-like possessor and dependent possessor, only the dependent possessor shall be entitled to be beneficiary of the analyzed scheme (art. 3(3) of the Act) [12]. The same rules are applied in the cases of agricultural holding co-ownership, when only one of co-owners can be appointed as the beneficiary to the scheme (all co-owners have to express written consent) (art.3(4) of the Act) [12]. It should be also stressed that the objective scope of the scheme is limited as the legislator has introduced specific limitations regarding agricultural producers operating in the corporate form (companies, partnership etc.). According to art. 3a (1) of the Act, the state aid scheme cannot be granted to agricultural producers:

- a) operating in the form of limited liability company, when its more than half of registered share capital had been lost, including loss of over  $\frac{1}{4}$  share capital in last 12 months directly predating the application day or
- b) operating in different form of company, when over half of share capital had been lost including loss of over  $\frac{1}{4}$  share capital in last 12 months directly predating the application day or
- c) operating in any legal form, when there are reasonable presumptions for declaring bankruptcy [12].

In order to obtain return of excise duty, each agricultural producer meeting legal criteria has to file proper application form. According to the Act, the procedure of granting public aid is not automatic and it requires certain activity from potential beneficiaries. The Act constitutes two different prescription periods for aid application, which are:

a) from 1<sup>st</sup> February to the last day of February and

b) from 1<sup>st</sup> August to 31<sup>st</sup> August of given year (art. 6(1) of the Act) [12].

It should be also highlighted that eventual aid in form of return of paid excise duty can be granted for maximum period of 6 months directly predating month of filing application [12]. Taking the above into account, it should be noted that it is in the direct interest of agricultural producers to file required applications forms in systematical and timely manner.

Provisions of the Act also provides for both structure and content of required application form. In order to fulfil formal requirements of granting aid procedure, each agricultural producer shall provide the authorities with substantial personal data: identification of applicant<sup>2</sup>, taxpayer identification number and personal identity number (natural person) or company register number (legal person) [12]. Each applicant shall also attach to the application form following documentation: written declaration indicating area of possessed agricultural land, written consent of another co-owners of the land (in the case of co-ownership), account number (in case of aid payment via bank transfer) and VAT invoices (or its copies), which are sole acceptable evidence of acquiring certain quantity of gas oil (art. 6(2)(3) of the Act) [12]. It should be clearly stressed out here that failure to fulfill any of abovementioned formal requirements results in exclusion of given agricultural producer from the scheme [7].

In order to determine worth of granted excise duty refund, both amount of the potential refund and its yearly value limit have to be estimated before. To this end, the legislator has introduced under the Act two crucial and universal formulas, which shall be the sole basis of determining actual worth of the due refund (art. 4(2) of the Act) [12]. The amount of potential refund shall be calculated by multiplying the quantity of gas oil acquired by agricultural producer (validated with VAT

---

<sup>1</sup> According to art. 2(1) of the Act on the agricultural tax, the agricultural holding should be defined as the agricultural land exceeding area of 1 hectare or 1 conversion hectare [10].

---

<sup>2</sup> Name, surname and place of residence for natural person and company name and registered office of legal person[12].

invoices) by the refund rate existing in the day of application<sup>3</sup> [12]. At the same time, the maximum yearly limit of the admissible duty return is calculated by multiplying excise duty rate for 1 liter of gas oil, number 86 and area of agricultural land<sup>4</sup> possessed by the applicant (in hectares)<sup>5</sup> [12]. In this regard, the actual worth of due refund is directly dependent on three different elements – quantity of acquired gas oil, its unit price and agricultural land area possessed by given agricultural producer[7].

The competent authority, as defined in art. 5(1) of the Act, is the village mayor, mayor or city president with jurisdiction over the location of agricultural land possessed by applicant [12]. The competent authority acts within government administration and financial resources necessary for the scheme are transferred to given local government unit by the form of the targeted subsidies from state budget (art. 8(1) and (2) of the Act) [12]. Granting of partial excise duty return shall be proceeded in the form of decision, where the competent authority indicates maximum yearly return rate, worth of granted return and remaining return rate in given year (art. 5(3) of the Act) [12]. According to art. 5(4) of the Act, the decision has to be issued within 30 days from the application day [12]. It should be also highlighted that the return shall not be granted for longer period than 6 months preceding the application month (art. 5(2) of the Act) [12].

The Act provides that there are only two periods in year when the financial aid shall be paid out:

- a) from 1<sup>st</sup> April to 30<sup>th</sup> April – for beneficiaries filing application between 1<sup>st</sup> and last day of February and
- b) from 1<sup>st</sup> October to 31<sup>th</sup> October – for beneficiaries filing application between 1<sup>st</sup> and 31<sup>th</sup> August of given year (art. 7 (1)(1) of the Act) [12].

---

<sup>3</sup> Quantity of gas oil (liter) x return rate ( for 1 liter of gas oil) = potential return of excise duty.

<sup>4</sup> Excluding agricultural land which is not cultivated or is used for non-agricultural purposes [12].

<sup>5</sup> Excise duty rate (for 1 liter) x 86 x agricultural land area (in ha) = maximum limit of admissible return.

It is also important to stress that transparent consequences of obtaining unduly return or obtaining aid in exceeding value are provided for in the Act. In the considered case, the beneficiary shall be legally obliged to reimburse undue aid with proper interest (art. 9(1) of the Act) [12]. The interest rate shall be estimated in accordance with provisions of the tax arrears regulation, thus the ineligible beneficiary will face substantial inconvenience of obtaining unduly aid. Furthermore, in the case of reimbursement evasion, the competent authority shall be entitled to pursuit due reimbursement by administrative enforcement proceedings, which in turn both accelerates and facilitates the procedure of reimbursement recovery (art. 9(6) of the Act) [12].

### ***3. Aid no. SA.40223 (2014/XA) - tax advantage concerning investments in case of agricultural tax.***

The state aid scheme no. SA.40223 (2014/XA) in the form of tax advantage concerning investments in case of agricultural tax has been granted by the European Commission under Commission Regulation (EU) No 702/2014 of 25 June 2014 declaring certain categories of aid in the agricultural and forestry sectors and in rural areas compatible with the internal market in application of Articles 107 and 108 of the Treaty on the Functioning of the European Union [3, 9]. The aid scheme has been granted for years 2015 – 2020 and its budget has been estimated to aprox. 288 mln PLN. The principal purpose of the aid in the form of tax advantage in agricultural is to support general agricultural progress and modernization of infrastructure used in agricultural production. It should be certainly stated that the scheme meets all legal requirement defined in the art. 14 of Commission Regulation (EU) No 702/2014 in respect of stimulating desired investments in agricultural holdings<sup>6</sup> [3].

The national legal basis of introduced state aid scheme is the Act on the agricultural tax of 15

---

<sup>6</sup> The art. 14 of the Commission Regulation No 702/2014 regulates the issue of accepted aid for investments in tangible assets or intangible assets on agricultural holdings linked to primary agricultural [3].

November 1984 [10]. According to art. 13 (1) of the Act, solely agricultural tax tax-payers can be awarded with the tax advantage [10].

Presented investment tax advantage has transparently defined objective scope. As the art. 13 (1) of the Act indicates, the tax advantage shall be granted for investment expenses incurred in connection with:

- a) construction or modernization of livestock building or construction works with environmental protection function and
- b) acquisition and installation of sprinklers, drainage or water supply installations and natural source energy-producing installations[10].

It also needs to be stressed here that in order to obtain proper aid, the beneficiary shall not finance the abovementioned investments with public funds participation (art. 13(1) of the Act) [10]. As it appears, there are several transparent requirements and restrictions regarding access to the analyzed state aid scheme – the tax advantage granting can be linked with only legally defined investments, which will have direct contribution to improvement of both environmental protection and rational water management [5].

The taxpayer can apply for the aid only after finalizing any of statutorily defined investments. The tax advantage is granted in the form of investment costs deduction (up to 25% of its value) from the due agricultural tax (art. 13(3) of the Act) [10]. The provisions of the Act also introduce maximal period of enjoying granted tax advantage which is 15 years (art. 13(3) of the Act) [10]. It should be also highlighted here that according to art. 13(4) of the Act, the sale of defined buildings or constrictions will result in deprivation of the state aid [10].

Finally, it is worth mentioning that the procedures of both estimating the worth and granting the tax advantage in agriculture tax are directly automatic. The value of payable tax advantage is automatically deducted from due agricultural tax in the form of the competent authority's decision estimating value of due tax (art. 13(3a) of the Act) [10]. The sole legal obligation of the potential beneficiary is to indicate the tax advantage usage in the tax declaration (art.13(3a) of the

Act) [10].

**4. Aid no. SA.40663 (2015/XA - Aid for the collection, transportation and disposal of fallen stock and aid no SA.40666 (2015/XA) - Young farmers — partial credit repayment.**

Both, aid no. SA.40663 (2015/XA) as well as aid no. SA.40666 (2015/XA) have been granted by the European Commission under Commission Regulation (EU) No 702/2014 of 25 June 2014 declaring certain categories of aid in the agricultural and forestry sectors and in rural areas compatible with the internal market in application of Articles 107 and 108 of the Treaty on the Functioning of the European Union [3, 9]. The abovementioned aid schemes have been granted for years 2015 – 2020, and its budgets have been estimated to 643 mln PLN (for aid no. SA.40663) and 600 mln PLN (for aid no. SA.40666).

The national legal basis of introduced state aid schemes is the Regulation of Government of 27 January 2015 on the detailed scope and methods of fulfilling certain functions of the Agency for Restructuring and Modernization of Agriculture [8]. It should be stressed out here that the Agency for Restructuring and Modernization of Agriculture is the only competent authority to grant financial aid under analyzed state schemes (sec. 2(1) of the Regulation) [8].

The basic goal of the aid scheme „Young farmers – partial credit repayment’ is to introduce state financial support focused on encouraging young farmers to found or enlarge owned agriculture holdings (sec. 2(1)(2) of the Regulation)[8]. Indicated financial scheme and its legal basis shall be considered as national expression of directives expressed in art. 18 of the Commission Regulation (EU) No 702/2014 in respect of stimulating progress in agricultural activities of the young generation of farmers[3].

The legislator has introduced under the scheme two different financial measures dedicated to young farmers:

- a) partial bank credit repayment, where credit has been employed to finance the purchase of agricultural area and
- b) granting credit guarantees or credit warranties regarding payment of credit used for the abovementioned purpose (sec. 4 (1) of

the Regulation) [8].

The beneficiary, besides from having required professional qualifications in the area of agriculture (confirmed with proper documentation), is also legally obliged to draw up complete investment plan regarding the undertaking requiring state aid and later attach it to the credit application (sec. 4(2) of the Regulation) [8]. The investment plan have to fulfil formal requirements and its content should include crucial data indicating current agriculture activity of applicant, his plans regarding intended activities on purchased land and area of possessed agricultural land after the purchase (sec. 4(4) of the Regulation) [8]. The beneficiary shall also submit written obligation of becoming active farmer within 18 months since the day on which the chargeable event related to agricultural tax has occurred on possessed agricultural holding.

The legislator has also limited eventual maximum value of financial aid, which shall not exceed both 60% of bank credit's value and the amount of 70.000 EUR (sec. 4(5) of the Regulation) [8]. The aid payment is proceeded in two installments, where the first – paid immediately after granting aid - amounts to 80% of granted aid and the second is paid within 5 years after concluding the bank credit contract (sec. 4(6) of the Regulation) [8]. It should be also highlighted that according to sec. 4(7) of the Regulation, bank credit shall never exceed both the amount of 5 mln PLN and 90% of agricultural holding's investments costs [8]. At the same time, the state aid scheme SA.04663 has more pragmatic nature and is purposed on financing and facilitating the process of collection, transportation and disposal of fallen stock (sec. 2(2)(4) and sec. 10(1) of the Regulation) [8]. The scheme should be considered as a national measure realizing goals defined in art. 27 of the Commission Regulation (EU) No 702/2014 [3].

The scheme has clearly defined subjective scope as only the micro, small and medium agricultural enterprises<sup>7</sup> are entitled to be aid

<sup>7</sup> Within the meaning of definition presented in Commission Regulation (EU) No 702/2014.

beneficiaries (sec. 10(1) of the Regulation) [8]. The financial aid has the form of state cost covering of collection, transportation and disposal of fallen stock and its grating is dependent on the value of utilization services<sup>8</sup> (sec. 10(4) and (6) of the Regulation) [8].

The agricultural producers enjoy the scheme through affordable or free services of enterprises dealing with utilization process of fallen stock, with which the Agency for Restructuring and Modernization of Agriculture has earlier concluded defined contracts within the scheme (sec. 10(2) of the Regulation)[8]. It should be also stressed out that according to sec. 10(3) of the Regulation, each utilization enterprise acting within the scheme, in order to obtain and preserve desired state financial resources, has to meet certain legal obligation – to notify each case of utilizing the fallen stock [8].

## CONCLUSIONS

Having regard to presented above legal basis of polish state aid schemes for agriculture in years 2015 -2020 as a whole, it should be regarded as both transparent and proportional measures to original objectives of the current Common Agricultural Policy. It can be reasonably assumed that individual aid schemes might support both progress and modernization of national agricultural sector. Appropriately designed system of tax advantages and state subsidies can be considered in long-term perspective as effective measures of stimulating competitiveness in agriculture, achieving sustainable development of rural economy and strengthening tendency of using low-emission technologies in agriculture. It also seems that targeting specific aid schemes on young farmers might have crucial influence on popularizing agricultural production among young generation.

<sup>8</sup> According to the Regulation, granting of aid is conditional on value of transportation and utilization services, which value shall not exceed clearly defined stakes dependent on both species and weight of fallen stock [8].



In turn, in view of legal instruments analyzed in the article it is difficult to draw definite conclusion concerning its effectiveness in both strengthening desired tendencies and curbing negative habits in national agriculture. Currently binding legal provisions should be treated with a certain degree of caution, as its factual influence and effectiveness will become visible not earlier than after next five years.

tax on gas oil used in agricultural production of 10 March 2006)

## REFERENCES

- [1] Commission Decision C(2015) 741 final of 17<sup>th</sup> February 2015, C116.
- [2] Commission Regulation (EU) No 651/2014 of 17 June 2014 declaring certain categories of aid compatible with the internal market in application of Articles 107 and 108 of the Treaty, L 187/1
- [3] Commission Regulation (EU) No 702/2014 of 25 June 2014 declaring certain categories of aid in the agricultural and forestry sectors and in rural areas compatible with the internal market in application of Articles 107 and 108 of the Treaty on the Functioning of the European Union, L 193/1
- [4] Council Directive 2003/96/EC of 27 October 2003 restructuring the Community framework for the taxation of energy products and electricity, L 283
- [5] Etel, L., Podatek rolny. Podatek leśny. Komentarz, LEX, 2012/el
- [6] Nawracała, J., 2010, Komentarz do ustawy o ubezpieczeniach upraw rolnych i zwierząt gospodarskich, [w:] Prawo ubezpieczeń gospodarczych. Tom I, Komentarz, LEX, 2010/el
- [7] Presnarowicz, S., Procedury zwrotu podatku akcyzowego producentom rolnym. Komentarz. Wzory pism. Przepisy, ABC, 2009/el
- [8] Rozporządzenie Rady Ministrów z dnia 27 stycznia 2015 r. w sprawie szczegółowego zakresu i sposobów realizacji niektórych zadań Agencji Restrukturyzacji i Modernizacji Rolnictwa, Dz. U. z 2015 r, poz. 87. (Regulation of Government of 27 January 2015 on the detailed scope and methods of fulfilling certain functions of the Agency for Restructuring and Modernization of Agriculture)
- [9] Treaty on the Functioning of the European Union, C 326/4.
- [10] Ustawa z dnia 15 listopada 1984 r. o podatku rolnym, Dz. U. z 2006 r. Nr 136, poz. 969 ze zm. (The Act on the agricultural tax of 15 November 1984)
- [11] Ustawa z dnia 7 lipca 2005 r. o ubezpieczeniach upraw rolnych i zwierząt gospodarskich, Dz. U. z 2005 r., Nr 150, poz. 1249 ze zm. (The Act on crop and livestock insurance of 7 July 2005)
- [12] Ustawa z dnia 10 marca 2006 r. o zwrocie podatku akcyzowego zawartego w cenie oleju napędowego wykorzystywanego do produkcji rolnej, Dz. U. z 2006 Nr 52, poz. 379 ze zm. (The Act on the refund of excise



## ABOUT THE EFFICIENCY OF UKRAINIAN WINERIES

Anatoliy G. GONCHARUK, Natalia O. LAZAREVA

International Humanitarian University, Department of Business Administration and Corporate Security, 33 Fontanskaya doroga str., Odessa 65009, Ukraine,  
E-mails: agg@ua.fm; 5929155@gmail.com

*Corresponding author:* agg@ua.fm

### Abstract

*This study highlights the dynamic, regional and structural aspects of winemaking in Ukraine. The authors identified the level of efficiency of the Ukrainian wineries using three-criteria approach. The study found that Crimean wineries are at the top of the ranking for all efficiency indicators. The study did not identify a single leader by efficiency, but it detected ineffectiveness of small business in the Ukrainian wine industry.*

**Key words:** efficiency, evaluation, ranking, Ukraine, winery

### INTRODUCTION

Winemaking is the production of wine, starting from the selection of the grapes or other produce and ending with bottling of finished wine. The science of wine and winemaking is known as oenology [12]. A person who makes wine is traditionally called a winemaker. Traditionally known as a vintner, a winemaker is a person engaged in making wine. They are generally employed by wineries or wine companies.

There are all necessary conditions for the development of wine-making in Ukraine: the land, the climate, human resources and technologies. Viticulture and winemaking here unite the various forms of ownership, organizational and legal statuses, sectoral and geographical origin in an integrated system of production of the final product – the wine. This system covers all stages of the value chain – from growing raw materials, development of innovations and training of relevant personnel to the production and sale of the final product, servicing its customers. Today, in Ukraine annually more than 200 thousand tons of grapes process into wine materials (Fig. 1).

If in 2006-2013 the volume of grape processing was quite high and ranged from 300 to 450 thousand tons per year, in 2014, after the annexation of Crimea, they were down to 229 thousand tons.

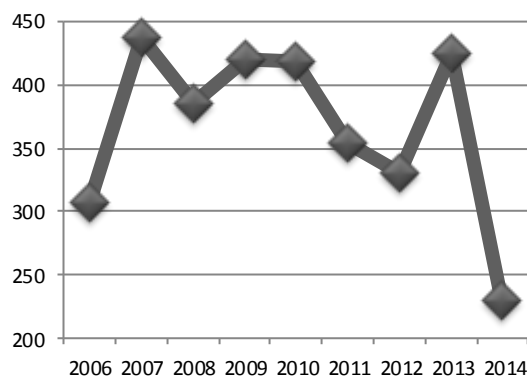

Fig.1. Grape processing in Ukraine in 2006-2014, thousand tons

The dynamics of wine production in Ukraine for the past nine years is presented on Fig. 2.

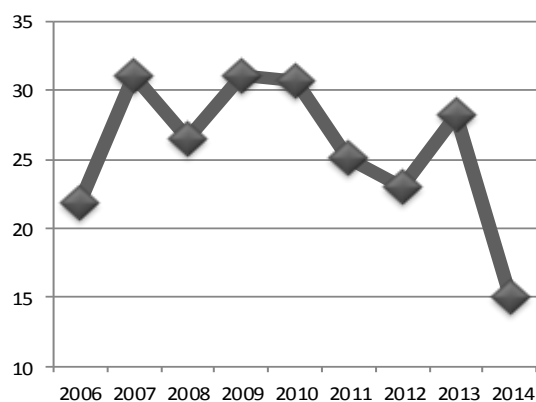

Fig.2. Wine production in Ukraine in 2006-2014, thousand tons

Like the volume of processing of grapes, wine production volumes in Ukraine in 2014

decreased significantly.

Odessa, Mykolaiv, Kherson regions and Crimea are traditionally the largest wine-producing regions in Ukraine. During the period 2010-2013 the shares of these regions in total grape processing have been relatively stable and changed between 3-7% per year. However, in 2014 with the loss of substantial refining capacity in the Crimea, the structure of grape processing has changed significantly: over 61% of grapes are now processed in the Odessa region, about 20% - in Mykolaiv, about 16% - in Kherson, and only 3.7% in other regions of the country.

Similar changes were in the structure of wine production in regions of Ukraine. If until 2014 there was not a sole region-leader in the production of wine, in 2014 more than 97% of wine industry is concentrated in three regions: the Odessa area - more than 60%, Nikolayev – 21.4% and Kherson - 15.6%.

Thus, we can assume that the wine industry of Ukraine in the part of grape processing and wine production is now concentrated in the three neighbouring southern regions of the country, among which Odessa region is the undisputed leader that accounts for almost two-thirds of the entire wine industry.

The largest shares in the total volume of grape processing in Ukraine are held by seven varieties: Aligote, Rkatsiteli, Cabernet Sauvignon, Muscat, Chardonnay, Sauvignon and Riesling. Their total share in the total volume of grape processing in 2011-2014 was 59-62%. Among the leading seven varieties for the whole period (2010-2014) the share of Chardonnay (from 5% to 11%), Cabernet Sauvignon (from 6% to more than 9%), Riesling (from 3.6% to nearly 6 %) and Sauvignon (from 4.2% to 7%) significantly increased due to reduction of Rkatsiteli share (from 11% to 5.5%) and other varieties. The traditional leader - Aligote remains the highest share (12-13%).

Despite of some difficulties of doing business and the impact of other negative factors that take place in the country, the wine industry in Ukraine is developing. This concerns primarily the production of wine materials for champagne and sparkling wines.

There are many studies of various aspects of

winemaking in different countries. Some of them explore the consumer properties of wine, e.g. tastes and aromas [7, 15]. The others examine quantitative and qualitative changes in consumption and production of wine in different countries, e.g. Italy [2], Spain [4], Germany [9], Romania [10], Australia [14], Armenia [8] and Moldova [17]. However, only a few of them address issues associated to Ukrainian wine industry [13, 16]. Still none of them identifies the efficiency of wineries in Ukraine.

Therefore, to identify the level of efficiency of wine industry it is necessary to make the appropriate evaluation, the results of which are set out in this study.

## MATERIALS AND METHODS

While wine industry enterprises (wineries) of Ukraine work in a competitive environment, to evaluate the efficiency of their work we used three-criteria methodical approach for evaluating the efficiency of the company that operates in a competitive environment, the essence of which is described in [11].

According to this methodical approach we calculated three key performance indicators for each company, including:

- 1) an indicator of structural efficiency;
- 2) annual productivity index as an indicator summarizing the dynamic efficiency of enterprises;
- 3) indicator of relative economic efficiency that is performed using the method of Data Envelopment Analysis (see [5]) and DEA Frontier software.

The sample includes the data on activity of 11 Ukrainian wine companies, which total volume of output in 2012-2013 has made over 50% of all wine production of Ukraine.

All companies of the sample are small and medium enterprises, which is proper for the Ukrainian wine business in general. Five of them are located in the Odessa region, two – in the Mykolaiv region and the Crimea and by one – in Kyiv and Donetsk regions.

Considering that results of DEA are sensitive to errors in initial data, the annual reports of wine companies for 2012 and 2013, reliability of which is confirmed by the auditor

conclusions, were used as a source of information.

## RESULTS AND DISCUSSIONS

The results of three-criteria evaluating the efficiency of the wineries in Ukraine are shown at Figure 3.

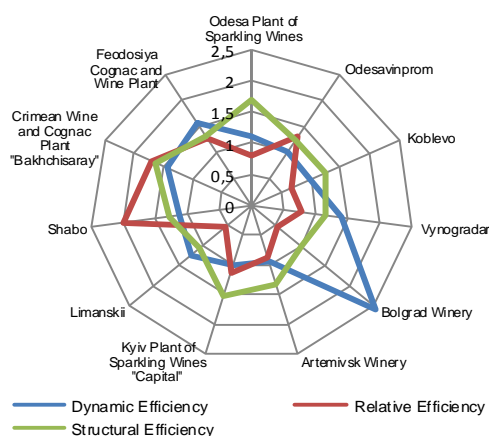

Fig.3. Evaluating an Efficiency of Ukrainian Wineries in 2012-2013

Comparing the wineries by three efficiency criteria, we can testify that none of them is a single leader. However, there are companies that are at the top of the ranking for all indicators, including:

Crimean W&C Plant "Bakhchisaray" is the second by structural and relative efficiencies and the third by dynamic efficiency;

Feodosiya C&W Plant is the second by dynamic efficiency and the fourth by relative efficiency and the fifth by a structural efficiency.

However, there are wine companies that by one criteria are the leaders, but by the other criteria still far behind its competitors, in particular:

Shabo is a leader by relative economic efficiency, but by dynamic and structural criteria it is only the sixth in a sample;

Odesavinprom has the best structural efficiency, but by relative efficiency it is the seventh and by dynamic efficiency it is only the eighth in a sample;

Bolgrad Winery is a leader by dynamic efficiency, but it is the loser by the other criteria.

Among the wineries Vynogradar and

Limanskii are the most losers for all criteria. These wineries are the smallest in the sample by the number of employees (less than 100 people). This may indicate the ineffectiveness of small business in the Ukrainian wine industry.

The correlation coefficient between the evaluated relative economic efficiency scores and the size of wineries is about 0.5 that according to the Chaddock's scale [3] demonstrates significant, but negative relationship (correlation). This means that the larger wine companies often have a higher efficiency than small companies.

A deeper analysis of the factors of winery inefficiency found that a significant burden for small wineries like Vynogradar is too high amount of annual license fee that winemakers have to pay each year for wholesale trade of wine. Its amount is 500 thousand UAH (that in 2013 equals almost 50 thousand euros) for any wine company. So, while for the big wine companies these are relatively small funds, for a small winery they reach dozen percent of annual turnover.

Hence the reduction or cancellation this fee for small wineries could give boost to small business development in this prospective sector of food industry of Ukraine.

For identifying the key performance factors, the nature and magnitude of their impact on the efficiency of Ukrainian wineries it is necessary to analyse their efficiency. The results of such analysis should be made appropriate management decisions to address the weaknesses that hamper the growth of efficiency. Benchmarking [5] and other performance management methods [1] can be useful to reach efficiency growth.

## CONCLUSIONS

Using three-criteria approach we identified the level of efficiency of the Ukrainian wineries. The results of study enable to conclude that:

- Crimean wineries are at the top of the ranking for all indicators;
- there is not a single leader by efficiency in wine industry of Ukraine;
- there is ineffectiveness of small business

in the Ukrainian wine industry.

The future research will be devoted to identifying the key performance factors for Ukrainian wineries and finding the appropriate management methods to reach their efficiency growth.

## ACKNOWLEDGMENTS

This paper is a part of research work no. 0115U001935 entitled "Improving the mechanisms of performance management and intensification of business processes on enterprises of manufacturing and non-manufacturing sectors of the economy" developed on order of the Ministry of Education and Science of Ukraine.

## REFERENCES

- [1]Alsharf, I.A.M., 2015, Performance Management in Healthcare, *Journal of Applied Management and Investments*, 4(1):45-52.
- [2]Barisan, L., Boatto, V., Rossetto, L., Salmaso, L., 2015, The knowledge of Italian wines on export markets: A nonparametric methodology to analyze promotional actions, *British Food Journal*, 117(1):117-138.
- [3]Chaddock, R.E., 1925, *Principles and Methods of Statistics* (1st Edition), Houghton Mifflin Company, The Riverside Press, Cambridge.
- [4]Gil, A.J., Garcia-Alcaraz, J.L., Mataveli, M., 2015, The training demand in organizational changes processes in the Spanish wine sector, *European Journal of Training and Development*, 39(4):315-331.
- [5]Goncharuk, A.G., 2013, About the Influence of High Gas Price on an Efficiency, *Journal of Applied Management and Investments*, 2(1):58-67.
- [6]Goncharuk, A.G., Lazareva, N.O., Alsharf, I.A.M., 2015, Benchmarking as a Performance Management Method, *Polish Journal of Management Studies*, 11(2):27-36.
- [7]Hanf, J.H., 2014, Literature Survey on New Participative Pricing Mechanisms for Wine Tastings, *Journal of Applied Management and Investments*, 3(4):201-213.
- [8]Hanf, J.H., Marquardt, V., 2012, Armenian Wine Business and its Interplay with Foreign Influence, *Journal of Applied Management and Investments*, 1(4):406-417.
- [9]Hanf, J.H., Gagalyuk, T., Schweickert, E., 2013, Problems of Goal Alignment for German Wine Cooperatives, *Journal of Applied Management and Investments*, 2(4):244-252.
- [10]Lădaru G. R., Beciu S., 2015, Trends of Wine Market in Romania: Competitiveness and Development Opportunities in the Context of Markets Globalization, *Scientific Papers. Series "Management, Economic Engineering in Agriculture and rural development"*, 15 (2):189-192.
- [11]Lazareva, N.O., 2015, The Methodical Approach to Evaluating the Efficiency of the Modern Enterprise, *Scientific Herald of International Humanitarian University, Series: Economics and Management*, 8:103-109.
- [12]Lorenzo, C., Pardo, F., Zalacain, A., Alonso, G.L., Salinas, M.R., 2005, Effect of red grapes co-winemaking in polyphenols and color of wines, *Journal of Agricultural and Food Chemistry*, 53(19):7609-7616.
- [13]Oleynik, A.A., 2012, Strategic aspects of achieving competitive advantages in the business of wine industry on the example of "Odesavynprom", *Journal of Applied Management and Investments*, 1(1):126-136.
- [14]Orr, S.C., 1997, Technology and process management in the Australian wine industry, *Benchmarking for Quality Management & Technology*, 4(1):18-33.
- [15]Rinaldo, S.B., Duhan, D.F., Trela B., Dodd, T., Velikova, N., 2014, Evaluating tastes and aromas of wine: a peek inside the "black box", *International Journal of Wine Business Research*, 26(3):208-223.
- [16]Samofatova, V.A., Gerus, E.V., 2012, Factors of influence on the investment attractiveness of wine enterprises in Ukraine, *Journal of Applied Management and Investments*, 1(2):238-242.
- [17]Timofti E., 2013, Trends in the Wine Sector Efficiency in Agricultural Enterprises in Moldova, *Scientific Papers. Series "Management, Economic Engineering in Agriculture and rural development"*, 13(2):421-426.

## IMPACT OF AGRICULTURAL POLICY ON GRAIN SECTOR IN BULGARIA

Hristina HARIZANOVA, Zornitsa STOYANOVA

University of National and World Economy, Natural resources economic department, “8<sup>th</sup> of December” Street, Office 1065, UNWE main building, Sofia, Bulgaria 1700, Phone: 003592/8195460, E-mails: hharizanova@unwe.bg, h.harizanova@gmail.com, zstoyanova@unwe.bg

**Corresponding author:** hharizanova@unwe.bg

### Abstract

*The paper aimed to evaluate the impact of agricultural policy in Bulgarian grain sector between 2007-2020. The analysis is based on data by Annual Agricultural Reports, farmer survey, experts of branch organizations and state structures. The grain sector is crucial for Bulgarian agriculture because it cultivates around 50% of utilized agriculture area (UAA) in the country. The agricultural policy in the sector has rapidly amendment and the new period faces the sector with major challenges. Implementation of parameters of new agricultural policy is a challenge for all EU Member States. Through direct payments Common agricultural policy (CAP) will continue to be an important factor for the development of agriculture in Bulgaria, but it will not support the grain sector as before. According the main findings are proposed some optional policy recommendations..*

**Key words:** grain sector, funding, financial mechanisms, impact, policy recommendations

### INTRODUCTION

Generated gross added value (GAV) by economic activities in Bulgaria in 2007 was 46,401 million BGN at current prices, and in 2012 amounted to 66,642 million BGN (34,073 million euros) at current prices (1 Euro=0.511292 BGN)[9]. Agricultural sector accordingly constitutes 6.2% and 6.4% of total GAV. The value of gross production from agricultural sector for 2012 amounted to 8,875.1 million BGN, of which 60% is formed by crop production. The largest contribution to the formation of the value of the final production of the sector in 2012 has the grain sector with 29.1%, followed by oilseeds with 10.1 % [6].

Agricultural areas for 2012 were 5,481,222 ha, or 50% of the territory and the utilized agricultural area (UAA) amounted to 5,122,983 ha, which is 46.2% of the territory of Bulgaria. Arable land in the same year was 3,294,685 ha, an increase of 2.1% compared to 2007[7]. According to data and the analysis of Agricultural Statistics[8], this is due to the increased area of wheat, corn and sunflower. Grain crops occupy 59% of the arable land in

2012 and 58% for 2007. That data shows the importance of these crops for the development of agriculture in the country.

The grain sector is characterized by uncertainty and instability, since agricultural activities are subject to weather conditions, the spread of diseases and pests etc.[11, 12]. Bulgarian grain farmers can hardly influence the market mechanisms of supply and demand [2,11,12,13].

This determines the development of a special policy aimed at the agricultural sector with specific measures, levers and mechanisms that make agriculture sustainable and profitable. These policies are implemented through economic levers, instruments (measures) which serve to achieve the objectives of agricultural policy. They are very diverse, and combine different tools that are grouped into the following types of agricultural policy suitable for grain producers [1, 4, 14,15]

- 1)Price Agricultural Policy - a policy to maintain and stabilize the prices of agricultural products.
- 2)Income agricultural policy - a policy to stabilize the income of farmers.
- 3)Policy to restrict the supply of agricultural



products.

4) Political intervention on the markets for agricultural resources (agricultural inputs).

5) Marketing policy.

6) Structural policy.

7) Food policy.

8) Regional policy and the stabilization of rural areas.

9) Ecological Agricultural Policy.

The main levers and mechanisms that are applied can be summarized as:

- System of deficit and payment.
- System of production subsidies.
- Subsidies on agricultural resources.
- Investment grants.
- Production quotas.
- Required minimum requirements for state contracts.
- Limiting the use of agricultural land for crops.
- Land reform.
- Etc.

## MATERIALS AND METHODS

The main aim of the paper is to evaluate the impact of agricultural policy in Bulgarian grain sector between 2007-2020. Reaching the aim is based on the following tasks:

(i) Analysis of Grain Agricultural policy 2007-2020 based on strategy documents as Annual Agricultural Reports [8, 10, 3]

(ii) Analysis of Grain Agricultural policy 2007-2020 based on own survey of Bulgarian grain producers

(iii) Policy recommendations.

According to the knowledge of the Agricultural policy in Bulgaria directed to the grain sector are formed three main periods. The first period includes the policy in the grain sector before Bulgaria to become NMS of EU. Based on the current policies this year (2007) will be drawn a framework of activities and opportunities for application of grain farms. This year is chosen (2007) because is a transitional year and although Bulgaria is officially in the EU effects of the policy is "expected".

The second period evaluates the first measurements adopted in the grain sector after accession in EU in few years after

accessing in EU (2012). In 2012 Bulgaria actively applies the implemented agricultural policy. Compared to 2007, the grain producers have a wide range of measures and policies of which their activity benefits. On this base is made assessment of the available policies appropriate to the grain structures.

The third period is focused in the newest agricultural policy and stress on future development of the sector. The new programming period will undoubtedly change the scope of the agricultural support. Redirecting cash resources of some other measures is also an interest of research. The paper will identify the measures that would be suitable for farms of grain sector in Bulgaria.

The collected and analyzed information is based on a survey held in two periods - 2007 and 2012. In the sample of the survey in 2007 and 2012 are researched the same grain producers. In 2015 the same producers were questioned for the new program period, before it arises officially [5]. The survey was organized by developed special questionnaire with open and closed questions and supporting interview with the owner/managers of the grain farms. The analysis is based as well on opinion of expert branch organizations and state structures. Researched sample of agricultural grain structures cultivates more than 5% of the UAA of Bulgarian grain. According to the collected data are used descriptive statistics methods which are the basis for an in-depth analysis for disclosure of the essential characteristics of grain farms in Bulgaria. As well are used qualitative methods, which refer to the adequacy of the current Bulgarian grain policy. On that base are made some optional policy recommendations.

## RESULTS AND DISCUSSIONS

### **Analysis of grain agricultural policy 2007-2020 based on strategical documents**

#### *Analysis of agricultural policy of the grain sector before the accession of Bulgaria to EU*

State support in 2007 is implemented through the State Fund "Agriculture" carried out in accordance with the Law on Support of

Agricultural Producers, The Law for implementation of the common organization of agricultural markets of the European Union and is aimed to achieve the main policy priorities in agriculture sector in accordance with the Government Programme of European integration, economic growth and social responsibility such as strategic objectives and measures in Agricultural report on the state and development of agriculture [8].

To achieve the strategic goal of "stabilization and sustainable development of the crop production" in accordance with the requirements of European quality standards in 2007 were used the following state support schemes suitable for grain sector:

-Target subsidy for the needs of agricultural institutes and regional applied centers for scientific service at the National Center for Agricultural Sciences for the production of pre-basic and basic seeds of wheat and barley. Regional centers, which are registered as farmers and implement reproductive activity, are subsidized under the terms and conditions of the existing state support. The total paid grant is 603 040 BGN for 3769 ha;

-Target credit for the purchase of seeds for wheat production - under the measure 169 grain producers were supported. The paid credit funds amount 760 077 BGN to plant 76 000 ha of wheat;

-Target credit for the purchase of fertilizers for wheat production - under the existing state support was contracted the amount of 7 623 086 BGN. The number of contracts were 432, covering 1 905 772 ha wheat;

-Funds provided under the measure "Agricultural equipment". In 2007 under this measure were bought 26 grain harvester and 84 tractors. Used funds amount 32 028 367 BGN.

-Target subsidy to assist farmers affected by floods during the production of cereal, grain, root, tuber and oilseed crops. Under the terms and conditions of the existing state support 9 farmers used this measure. The paid subsidy amounts 13,140 BGN for 131 ha totally destroyed areas.

-State support to compensate the farmer's losses for totally ruined crop due to natural disasters or inconvenient weather conditions.

Under this measure are compensated 402 farmers.

The main form of support for farmers with direct payments is Single Area Payment Scheme (SAPS). Conditions of the scheme are unchanged during the first eight years of the implementation of the CAP in Bulgaria. Eligible for direct payments are all kinds of crops, irrespective the type of produced agricultural products. The number of farmers supported by SAPS in 2007 was 78 596[10].

#### ***Analysis of agrarian policy of grain sector in 2012 in Bulgaria***

Since the beginning of Bulgaria's membership in the European Union (EU) the rules of the CAP are applied by implementing the European requirements and distribution of agricultural subsidies financed by the EU budget [10].

In 2012 the following state support schemes which are suitable for grain were:

**SAPS.** After 2007 a particularly strong impact has SAPS on the development of production structures and sub-sectors in agriculture. It provides different levels of support leading to increase of the differences in the development of agricultural structures - production, productivity, profitability, opportunities for restructuring and modernization. Grain sector and oilseed particularly are privileged because they handled the largest share of the UAA of Bulgaria. In 2012 through SAPS are administered 84,078 applications for support. From the total budget amounted to 923 560 thousand BGN, 905,975 thousand BGN are authorized. The area declared under the scheme is over 3.6 million ha and the amount of support per single area was 264.44 BGN / ha.

#### **Rural development program (RDP) measures suitable for grain sector:**

-Measure 111 "Vocational training, information and diffusion of knowledge" .

- Measure 112 "Setting up of young farmers". The analysis of progress in achieving the objectives shows that the number of young farmers supported under measure 112 to 2012 represents 95% of the target. Grain producers supported under the measure were 16%.

- Measure 121 "Modernization of agricultural holdings". Measure 121 was applied very

successfully in terms of investments in crop production - 71% of the eligible public expenditure and 80% of paid project funds. Sub sector "Field crops" has the highest share - 60% of the eligible public expenditure and 71% of the paid funds.

- Measure 141 "Semi-subsistence farms undergoing restructuring". This measure can help small farm to become market oriented, as well in the grain sector.

- Measure 142 "Setting up of producer groups." This measure has a low interest and no grain producer used it in the studied period.

- Measure 214 "Agro-ecological payments" in the section "Entering crop rotation". In 2012 under this measure were used 21 256 thousand BGN.

**State support.** According to different condition of Bulgarian agricultural sector and subsectors MAF is trying to implement such state support schemes, which will make Bulgarian farm sustainable and profitable. In 2012 were developed nine new state schemes implemented in the following areas:

- Support for investments in agricultural holdings linked to the primary production of agricultural products;

- Support aimed at the conservation of genetic resources, local animal breeds and plant varieties adapted to specific natural conditions;

- Support related to risk management and crisis aimed at countering and compensation of damages in case of natural disasters or inconvenient weather conditions, and in diseases of animals and plants;

- Support aimed at encouraging the participation of farmers in national and international agricultural exhibitions and exchange of experience;

- Support from the type of "de minimis" to cover operational costs in a relatively small size.

**Other support mechanisms.** Another mechanism for support of the sector is through "Market intervention support," which aims to ensure stability on the markets. The intervention procedure is consistent with the rules of financial support for CAP and applies a common and durum wheat, barley, maize

and sorghum. In 2012 producers were not interested in the applied schemes "Purchase of grain" and "Grain storage" and they are with no funding till the end of the programming period [10].

#### *Analysis of agricultural policy of grain sector in Bulgaria in the new programming period (2014-2020)*

There will be significant changes in the next programming period, both in terms of the policies and in refining the measures, which are included.

One of the changed parameters is connected with support schemes. It will be introduced multi-layered structure of direct payments in the period 2015-2020. The main part of the direct payments will be allocated on the basis of agricultural area eligible for conditions and used for agricultural activity. This will be implemented through the application of the basic payment scheme. Member States which have implemented SAPS have the opportunity to continue to apply temporary of the scheme until 2020.

The basic principle of subsidizing for both alternative schemes is the same and does not depend on the type of crops cultivated, but on the size of agricultural area. The main difference is that under the Basic payment scheme except agricultural area should be provided also appropriate number of payment entitlements, which are distributed mainly in the first year of the scheme. Green component is included in direct payments and it increases the environmental contribution of the CAP[10].

Farmers who are eligible to receive payment under the basic payment or single area payment scheme are required to comply such agricultural practices that are favorable for the climate and the environment (green requirements). Green requirements are:

- Crop diversification,

- Maintenance of permanent grassland and availability of environmentally focused areas,

- Member States must allocate 30% of their direct payments to finance green payment.

Implementation of new parameters of direct payments is a challenge for all EU Member States. Through direct payments CAP will continue to be an important factor for the

development of agriculture in Bulgaria.

New scheme (redistributive scheme payment) for direct payments is created as a result of CAP reform 2014-2020. The scheme is voluntary for states and sets a higher single payment per hectare for the first hectares of each farm, eligible for support under the basic payment scheme or SAPS. The size of these first hectares is determined by each state, but cannot be larger than 30 hectares of the average farm size.

MAF concept provides in addition to the implementation of the Redistributive payment scheme to be applied also progressive reduction and ceiling of the subsidy that could receive a farmer. It will be applied a tool to reduce payments and subsidy ceiling to one beneficiary. Reduction is 5% of the amounts between 150,000 EURO and 300,000 EURO and 100% for the payments over 300 000 EURO. The aim of this reduction is to avoid disproportionate amounts to go to a small number of large beneficiaries.

This kind of change will affect the grain producers as they are the main beneficiaries of the program, and many of them have enough large UAA to be affected by the change of the CAP. A large number of grain and oilseed farms will be adversely affected. The payments for "small" farms are also changed. Small farmers applying for this support may receive a subsidy which amount of 500 to 1,250 EURO per farm/per annum.

The other measures in the new programming period are almost the same like these in the previous with small differences in names and allocations, such as the new measure called "The scheme for small farmers" in the previous period was called "Semi-subsistence farms undergoing restructuring", the new measure "Young farm holders" in the previous period was called "young farmer" etc.

#### **Analysis of grain agricultural policy 2007-2020 based on own survey of Bulgarian grain farmers**

Agricultural support in 2007 and 2012 differs due to Bulgaria's membership in the EU. That is why the periods are presented separately and compared. As well in this part of the paper the focus is directed to the coming new programming period 2014-2020 and opinion

of the stakeholders of the policy implementation and the impact of it on the grain sector.

#### **Survey results - received funding**

In 2007, 24% of farms have applied for "Target credit for the purchase of seeds for wheat production". The funds were received by 83% of the farmers or 20% of survey sample.

The received amount is 100 BGN per hectare. The total volume is 2,000 hectares or 20,000 BGN. For receiving fund under measure "Target credit for the purchase of fertilizers for wheat production" have applied 13% of holdings and received 100% of them. The funds received were 3.90 BGN per hectare, total 4790 BGN. There is no grain farmer during this period who applied to target subsidies "to assist farmers affected by floods" even there were evidence of flooding. The explanation why they did not apply was pointed mainly that on one hand the too long and sophisticate procedure and on the other hand the funding is insufficient.

During 2007 the government compensated 7% of grain holdings for losses of totally ruined crop due to natural disasters or adverse weather conditions. UAA which is compensated amounted to 35 ha, and farmers received 9,150 BGN.

Farms in the survey have received under the program "Agricultural equipment" during 2007-2012 equipment as follow: 2 grain harvesters, 6 tractors and 1 tool equipment with a total investment value of 348,565 BGN, of which funding amounted 94,545 BGN. Compared with all farmers received agricultural equipment the farms in the sample respectively received 7.1 % of all tractors and 7.6 % of the grain harvesters.

SAPS are the most common instrument of the agricultural policy in Bulgaria. Studied farms received in 2007 - 15,405,959 BGN, and in 2012 - 24,140,595 BGN. Two of the farms had to return part of the received funds (7,589 BGN), due to inaccuracies in the cadastral maps of the crop land.

The funds of SAPS, according to respondents are used for payment of land rent and purchase of raw materials and fertilizers. Received amount is double between the

surveyed periods (2007-2012), which is due on one hand of the increased area for the period and on the other hand, the increased payment per hectare to 264 BGN for 2012.

The interviewees were asked to revise the SAPS in the period 2014-2020 from their point of view as grain producers. The farmers evaluated the policy change possibilities for grain sector as shown in table 1.

Table 1. Scenarios of possible policy change of SAPS in Bulgaria

Possible change	Positive impact	Negative impact
The payment per ha of SAPS to be linked with rental payment	82.5%	17.5%
The payment per ha of SAPS to be linked with current fuel price	65%	35%
The payment per ha of SAPS to be linked with UAA and to be decreasing with increasing of UAA	0%	100%
The payment per ha of SAPS to be linked with UAA and to be increasing with increasing of UAA	92.5%	7.5%

Source: Own survey; Sample: farmers which cultivated 5% of UAA of grain in Bulgaria.

The opinion of the grain farmers for future change of distribution of SAPS 2014-2020 is facing positive reaction of 3 of 4 proposed scenarios. The most positive reaction is directed to SAPS- increasing payment linked with increasing of UAA (92.5% of respondents). The explanation is that this will come as a natural stimulus to decrease the abandon land and increase the land consolidation. On the other hand negative impact of the sector would be if the payment is decreasing with increasing of UAA. Although the negative assessment of the farmers the government implements in 2015 redistributive payment scheme, with a progressive reduction of the SAPS. Calculations show that each farm of the survey for 2015 will receive 700,000 BGN less than the previous periods if they hold the same UAA. According to the opinion of farmers that redistribution of way of payments

of SAPS is “not encouraging but discriminatory against the grain sector”.

## CONCLUSIONS

### Main findings

Grain crops occupy 59% of arable land in Bulgaria in 2012 and they are holding sustainable levels through recent years up to date.

The largest contribution to the formation of the value of the Agricultural sector of final production in 2012 has the grain sector with 29.1%.

State support schemes suitable for grain producers in 2007 cover target subsidy for the needs of agricultural institutes and regional applied centers for scientific service at the National Center for Agricultural Sciences for the production of pre-basic and basic seed of wheat and barley, target credit for the purchase of seeds for wheat production, target credit for the purchase of fertilizers for wheat production, funds provided under the measure "Agricultural equipment", target subsidy to assist farmers affected by floods, state support to compensate the farmers losses for totally ruined crop due to natural disasters or inconvenient weather conditions, direct payments through SAPS.

The purpose of providing support is to increase the competitiveness of Bulgarian agricultural sector through measures focused on investments aimed to improve the efficiency of farms and the production of higher quality products, insurance and compensation of damages caused by natural disasters and adverse weather events, helping to prevent plant's and animal's diseases, protection of genetic resources in plant and livestock production, promoting animal welfare, stimulating participation in exhibitions to promote Bulgarian agricultural production and exchange of experience etc.

State support schemes suitable for grain producers in 2012 cover SAPS, part of RDP measures, state support and other support mechanisms.

In 2007-2012 is accounted double amount of funds received from the grain sector, which is due to the increased area for the period and

increased payment per hectare of the pursued policy in Bulgaria.

In the new programming period MAF concept provides to be applied also progressive reduction and ceiling of the subsidy that could receive a farmer. The aim of this reduction is to avoid disproportionate amounts to go to a small number of large beneficiaries. This kind of change will adversely affect the grain producers as they are the main beneficiaries of the program, and many of them have enough large UAA.

Grain producers in Bulgaria are well informed farmers who actively take advantage of the possible financing funds.

According to respondent's opinion for scenarios of possible policy change of SAPS in Bulgaria, if the payment per ha of SAPS is linked with rental payment, this will have positive impact on the grain sector (82.5%). At the same time they consider that if the payment per ha of SAPS is linked with UAA and is decreasing with increasing of UAA, this will have negative impact (100%).

Despite increased awareness of farmers on measures for funding in the new programming period, they will receive lower subsidies due to a change of direct payments. The concept of Bulgarian Ministry of Agriculture and Food in the new programming period provides implementation of redistributive payment scheme with a progressive reduction of the subsidy ceiling and SAPS. This kind of change will have a negative impact on grain sector as they are the main beneficiaries of the program. A large number of grain and oilseed farms will be negatively affected.

#### **Policy recommendations**

During the new program period 2014-2020 grain sector will face major changes. It will be underestimated due to the shifting the policy to other sectors. The policy recommendation is instead to apply redistributive payment scheme, with a progressive reduction of the SAPS to keep it solidary equally to all producers irrespective of the type of production and size of the farm. Other possible change is payment of SAPS (especially of the payment per ha) to be linked with current price of land under rent.

#### **REFERENCES**

- [1]Ackrill, R., 2000, Common Agricultural Policy. Sheffield: Sheffield Academic Press Ltd.
- [2]Alexiev, A., 2012, Competitive opportunities of grain sector. Plovdiv: Academical publishing of Agrarian university .
- [3]Atanasov, A. et al., 2013, National Strategy for Sustainable Development of Agriculture in Bulgaria 2014 – 2020. Ministry of agriculture and food.
- [4]Godden, D., 2006, Agricultural and Resource Policy: Principles and Practice. Sydney: University Press.
- [5]Harizanova, H., 2015, State and perspectives for development of agricultural structures in grain sector. Sofia: ATL publishing. ISBN: 978-619-71-94-05-0.
- [6]Ivanov, B., Sokolova, E., Kirovski, P., 2013, Development trends of major crops in grain sector. Project: Creation of Centre for economic analysis in agriculture.
- [7]MAF, 2005-2013, The Farm Accountancy Data Network - agro-statistical handbook. Sofia: MAF.
- [8]MAF, 2008, Annual report for the state and development of agriculture 2008. Sofia: MAF.
- [9]MAF, 2012, Annual report for the activity of National Grain Service 2012. Sofia: MAF.
- [10]MAF, 2015, Rural development program 2007-2013, 2014-2020. Sofia: MAF.
- [11]Metodieva, Ts. Harizanova, Dairy business: the case of bulgarian dairy cattle farmers, Scientific Papers Series Management, Economic Engineering in Agriculture and Rural Development, Vol. 14, Issue 3, 2014:95-101
- [12]Mishev, P., Ivanova, N., 2006, The influence of the common agricultural policy on production after Bulgarian accession to EU. Year Book - UNWE .p 221-258. Sofia: Publishing complex UNWE.
- [13]Mishev, P. et al., 2008, CAP and production structures in Bulgarian agriculture. Changes in CAP and Bulgarian position. p. 55. Sofia: Publishing complex UNWE.
- [14]Schmitz, A., 2010, Agricultural Policy, Agribusiness, and Rent-seeking Behavior. Toronto: University of Toronto Press.
- [15]Zheteva Ivelina Petkova, 2015, European regulations for rural development 2014-2020, Agribusiness and RD, Proceedings of International Conference, Publisher: Gea Print Varna





## IMPACT OF THE ECONOMIC CRISIS ON EUROPEAN UNION DURING 2008 – 2015 PERIOD

Adelaida Cristina HONȚUȘ, Alina MĂRCUȚĂ, Cristiana TINDECHE, Liviu MĂRCUȚĂ

University of Agronomic Sciences and Veterinary Medicine of Bucharest, 59 Mărăști, District 1, Zip Code 11464, Bucharest, Romania, Phone: +40213182564, Fax: +40213182888,  
Emails: adelaidahontus@yahoo.com, alinamarcuta@yahoo.com, tindecche\_cristina@yahoo.com, liviumarcuta@yahoo.com

**Corresponding author:** adelaidahontus@yahoo.com

### Abstract

*This study presents the origins and manifestations of the economic crisis that started in 2008 at both world level and in the European Union. In both cases the study analyzes also some of the measures undertaken in order to overpass the crisis and their results. During the same year, 2009, the European Union witnessed a decline of its GDP by 4.4 %, while the Euro zone had a decline of 4.5 %. Only from this synthetic data results a conclusion that the European Union and the Euro zone were more affected by the economic crisis than the rest of the world. This situation remained true in 2013 and 2014. In 2013 the world economy had a growth rate of its GDP of 2.3 % while European Union had a growth rate of 0.1 % and the Euro zone of - 0.5 % (World Bank Data). In 2014, according to the forecasts of the World Bank the world economy had a growth rate of 2.6 % while the Euro zone of only 0.9 % (World Bank Data) and the European Union as a whole of 1.3 % (Forecast for European Union for 2014 from Eurostat). A second part of the study is focused on the situation of European Union from the perspective of the current year, 2015, as well as from the point of view of the prospects for 2015 and the coming years.*

**Key words:** economic crisis, European Union, GDP, slower growth, recession

### INTRODUCTION

The impact of the economic crisis on the European Union has been particularly strong. This is why the speed of the recovery from this crisis has been unusually long and slow. This slow recovery may be understood as a symptom of a permanent decline in GDP of the European Union member countries following the economic crisis [10]. This may also mean that for some member countries the economy have not yet recovered completely as of 2015 from the initial recession. The estimated long term output losses from the economic crisis are ranging from almost none in Germany to almost 20% in Italy and Spain. In this work we present some factors that explain the long and slow recovery and also the long term side effects of the crisis.

### MATERIALS AND METHODS

In this work, in order to meet the need of information to be used a bibliographical research and a statistical research have been performed, through which data for the

conclusions regarding the performed study were collected, processed and analysed. Statistical tables have been used by which data were presented in a tabular way. This is a method which allows the description of indicators on which the performed analysis is based, and the establishing of the existing connections between its component elements. Graphical representations have been used to emphasize the extent and/or variation of data subject to the statistical research in view of showing their evolution in time.

### RESULTS AND DISCUSSIONS

**The economic crisis on the European Union**  
The factors of the economic crisis on European Union are: The economic crisis made the economies more vulnerable to other negative external shocks (like global competition, economic effects of sanctions imposed on Russian Federation, etc.); The trend of economic growth in the European Union have been slowing down long before the onset of the crisis; The economic crisis has lead to big reductions in labor

productivity and this phenomenon takes a long time to reverse.

In Figure 1. below there is a graphic presentation of this slow and differentiated recovery in some of the European Union member countries. In this graph the level of GDP from 2007 was considered as being 1 and the next years reflect the increase of GDP per working age person.

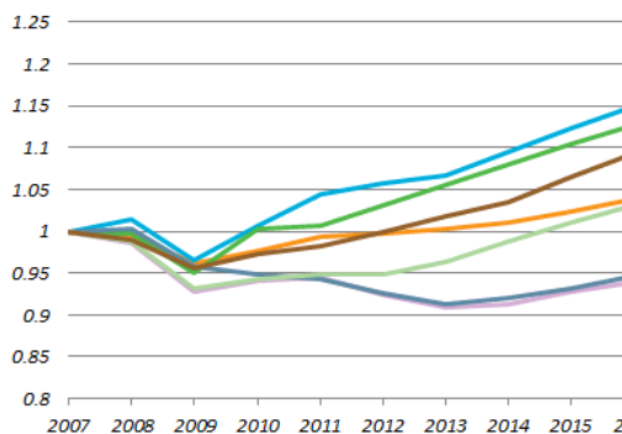

Fig. 1. GDP per Working Age Person in Advanced Economies since 2007  
 Source: Euromonitor Macro Model and International Statistics.  
 Note: 2007 level normalized to 1 for all countries. [22], [23]

From Figure 1. results that some countries (especially Germany, France and Great Britain in Europe and United States and Japan outside of Europe) had a sustained recovery although at low growth rates with a maximum of 1.2. At the same time other European countries, such as Spain and Italy remained under the level of 2007 for the whole period 2008 – 2015.

Economic growth has been disappointing in comparison to past recoveries. One significant factor in the growth slowdown of recent years has been the faster than normal of the population aging phenomenon. The decline in the growth rate of the working age population (ages 15 - 64) on its own can account for a decline in the annual GDP growth rate of advanced economies of 0.7 percentage points [17].

The recovery was so slow because the financial crises in general usually cause large permanent damage to economic activity

levels. Some researchers analyzed the effects of financial crises over a 10 year horizon using a panel of 190 countries from 1960 to 2001 [1]. The peak estimated output loss from a financial crisis in their sample is almost 8%, with output losses of around 7% at a 10 year horizon. Such results have been criticized for some of their statistical assumptions, in particular not taking into account differences in the length of crises across countries. More robust methods still find a significant long run impact of financial crises, with 10 year output losses ranging from 5 to 10% [13]. Following these researches the question arises as to why do financial crises lead to slow recoveries. In this respect in the following are presented some of the key factors behind the slow recoveries after the 2008 crisis.

One of the clear factors is that the financial crisis made the economy more vulnerable to other negative shocks. For example, the costs of bailing out banks and the decline in tax revenues due to lower economic activity or fiscal stimulus attempts affects in a negative way the government finances.

In the case of Southern European countries, such as Italy and Spain, the initial crisis led to growing concerns about the sustainability of public finances. The result was a sovereign debt crisis on top of the original recession. The increase in sovereign debt risk premia then fed back into further increases in private sector costs of financing and more economic uncertainty. Fiscal cutbacks attempting to stabilize sovereign debt risk premia caused even bigger contractions in economic activity in the short run. The compound effect of two financial crises with a few years delay has contributed to output losses in Southern Europe of a magnitude matching the great depression of the 1930's. Such a huge implication can explain in itself the long time needed for recovery.

#### Slower long term growth in the Euro zone

If we analyze the economies in a broader sense we can say that not all decline of GDP is related to the crisis. The trend towards slower growth was present in European Union long before the crisis. This aspect is particularly relevant for the Eurozone, where productivity growth slowed down

significantly starting in 1995. According to European Commission estimates productivity growth in the Eurozone had already dropped below 1% in the early 2000's. But even if we assumed a trend growth of 1% instead of 1.7% in the Euro zone the estimate of the peak output loss since 2007 is still 14.2% in Spain (compared to an initial estimate of 18.7%) and 14.8% in Italy (compared to the initial estimate of 20%) [24]. Pre-crisis declines in potential growth rates matter, but they cannot explain most of the deviation of output from trend after 2007.

#### **Impact of the economic crisis on the employment rates**

The crisis has had also a persistent negative effect on employment rates. In the United States the employment to population ratio has gone down from 63.3% in the beginning of 2007 to 59% in July 2014.

The European Union experience varies significantly across countries. The employment rate of the 20 - 64 age population in 2013 was less than 0.5 percentage points below that in 2007 in France and Great Britain. The German employment rate actually increased in the same period by more than 4 percentage points. But in Italy, there was a similar decline in the employment rate as in the United States, and in Spain the employment rate declined by more than 10 percentage points over the 2007 – 2013 period [3]. Usually, employment can respond more quickly to economic conditions than capital so a faster recovery is more likely.

There are anyway several factors that could slow down this process or even lead to a long-term decline in employment:

Part of the reduction in employment rates is due to accelerating population aging. People of 55 - 64 years are less likely to participate in labor markets, though recent years have seen significant increases in labor force participation rates of this age group.

Lower labor productivity reduces the profitability of hiring. As a result, demand for labor declines. The decline in labor productivity below trend is likely to be quasi-permanent, due to the factors discussed above. As a result, this mechanism should depress employment for many years after the crisis.

The recession has created a large number of long term unemployed (without a job for more than six months). Job finding rates for these long term unemployed are typically lower for reasons ranging from bad image (being a longer time in unemployment sends a bad signal that the job seeker may be a lower quality employee) to faster depreciation of job skills.

The good news in the United States is that since 2010 the number of long term unemployed has dropped by more than 50%, though much of this decline is due to lower labor force participation.

#### **The economic crisis in the European Union led to long term declines in the capital stock and total factor productivity**

Investment in European Union and other developed economies declined in 2009 and had only a very partial recovery in the following years. In 2013, the investment to GDP ratio was still almost 3 - 4 percentage points below its pre-crisis level in the United States, France, Germany and Great Britain. In Italy the investment to GDP ratio is still 5 percentage points below its 2007 level, while in Spain it has declined by almost 13 percentage points.

The Spanish case is extreme and mostly represents lower residential investment. But there is little doubt that business investment has also suffered tremendously. The effect of many years of low investment is a lower capital stock available for workers in the economy, making them less productive. Reversing the loss of capital would require several years of an investment boom, but such a boom is highly unlikely according to current forecasts.

Even if the capital stock recovers, labor productivity can stay depressed if the financial crisis reduces the overall efficiency with which the economy uses both capital and workers - that is if the crisis lowers the Total Factor Productivity (TFP) of the economy below the normal trend.

Using European Commission estimates some researchers [11] determined that lower labor productivity accounted for 57% of the decline in potential output growth over the 2008 - 2013 period relative to average growth in

1998 – 2007 period, with a roughly equal decomposition between lower capital accumulation and lower Total Factor Productivity.

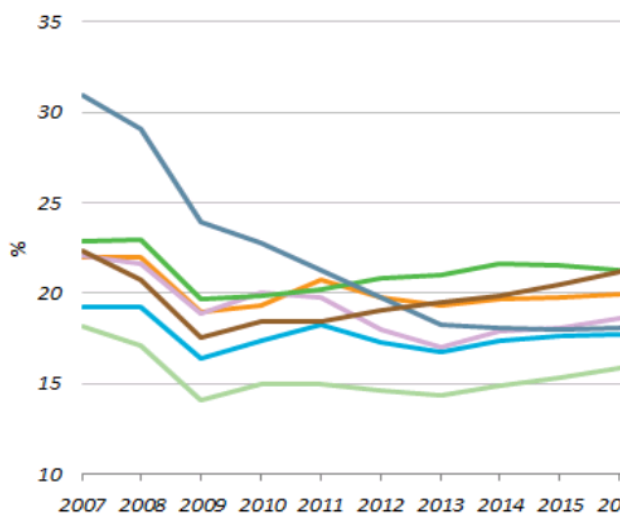

Fig. 2. Investment to GDP Ratios in a number of developed countries after the beginning of the crisis in 2008

Source: IMF World Economic Outlook, April 2014. Note: [7], [5]

At the same time a Stanford University study [6] provided a detailed decomposition of the slow recovery in the United States. The study finds that below trend labor productivity growth is responsible for 62% of the output losses in the United States in 2007 – 2013 period. Of this proportion, the decline in capital is responsible for 33% of the output loss while below trend TFP growth accounts for 29% of the output loss.

According to the studies there are several factors underlying the decline in capital and **Total Factor Productivity**:

**First**, the crisis seems to have led to a long-term reduction in the supply of credit in developed economies, due to a combination of stricter financial regulation and an increase in the risk aversion of financial institutions. While interest rates have declined, this compensates only partially for the tightening in collateral requirements and other lending standards.

Looking at the Federal Reserve’s bank lending conditions survey, credit standards have tightened during the initial phase of the

crisis, and have yet to recover to pre crisis levels.

In the Eurozone, the ECB’s bank lending conditions survey indicates that credit standards on business loans tightened each quarter since mid-2007, and have only started easing in the second quarter of 2014. Again, there is a large dispersion in performance across different Eurozone members, with Italian and Spanish firms much more financially constrained than German firms. Continued restrictions on access to external financing discourage capital investment, research and development and other productivity enhancing expenditures. Therefore, labor productivity is likely to underperform as long as the credit crunch continues.

**Second**, as the result of some research suggests that even if lending standards recovered completely, negative effects on capital investment and Total Factor Productivity would continue for many years through several channels.

For example, reductions in research and development spending and new business entry during the financial crisis reduce the growth rate of innovation over several years, cumulating into permanent declines in the efficiency of the economy. In the United States for example, the number of business startups (firms less than one year old) declined by more than 25% in 2007 – 2010 period, leading to a “missing generation“ of new firms [15].

A recent Federal reserve study [14] tried to quantify the effect of lower innovation due to a financial crisis in a macroeconomic model with bank capital constraints and new business entry. The study finds that for plausible model parameter values, even if the initial financial shock dissipates after a few years the reduction in business entry and innovation can generate permanent declines in labor productivity exceeding 6%, leading to permanent declines in GDP of more than 10%.

**And third**, the financial shocks cause long lasting distortions in the allocation of capital, a key source of loan collateral, across firms. The misallocation of capital across firms hurts

in particular small and medium enterprises with high return investment opportunities and high dependence on external financing, constraining their ability to get loans and to expand. This again leads to persistent declines in investment and productivity. In a model calibrated [8] to the United States great recession, Khan and Thomas (2013) find that this effect can significantly slow down the recovery.

### **Some aspects related to the establishment of the Euro zone**

In the 1992 Treaty on the European Union also known as the Maastricht Treaty in addition to outlining the current form of the European Union as a single market for goods, services, labor it was also provided the legal foundation and design of the euro currency by setting the so called “convergence criteria” that European Union member states would have to meet to become members of the European Monetary System (EMU).

The criteria specified in Article 104c of the Maastricht Treaty mentioned that that a nation’s actual government deficits would not exceed 3% of GDP, and that its government debt would be below 60% of GDP. The criteria also set limits on inflation, long-term interest, and national currency exchange rates. While the criteria for joining the common currency were well defined, in reality the implementation levels were more flexible. As a result, the process involved making political compromises and sidestepped critically important economic membership criteria. For example, political necessity held that the six European Union founding members would also be original Euro zone members, despite their inability to meet agreed-upon economic criteria.

Furthermore, Europeans’ unwillingness to pay direct taxes to fund an European Union budget sufficiently large to counteract regional imbalances and economic shocks led to an absence of a central fiscal authority, essential for well functioning currency unions. When the euro was implemented in 1999, the Euro zone nations were less integrated than prescribed and moreover the European Union leaders further weakened the financial and macroeconomic rules of the Stability and

Growth Pact. The latter provides a framework for coordinating national fiscal policies in the European Union and serves to safeguard sound public finances, based on shared European Union interest. In this way while the political goal of implementing a common currency was achieved, there was no central fiscal agent, no effective budget discipline enforcement, and no clearly defined path toward further economic convergence.

### **The manifestation of the economic crisis in the Euro zone**

From its beginnings, the flaws in the design of the Euro as a common currency were pointed out by a number of economists, but its inherent problems were not fully exposed until soon after the beginning of the global economic crisis that started in 2008.

Some researchers [12] presented structural design issues of the common currency. Since then, it has become increasingly clear that the problems affecting the Euro zone are not only structural and multilateral, but also country specific as a result of the existing differences and gaps between the member countries. The specific problems related to member states are at the same time highly interconnected due to the policies built around the common currency [19]. In the manifestation of the crisis in the Euro zone there are in fact several distinct but inter-connected and mutually reinforcing crises [9]. One of these crises relates to the design of Euro area institutions. The second crisis refers to the excessive debt levels among some Euro zone member states made it impossible to service their sovereign debt without further increasing their financial obligations to their bond holders.

The combined problems of euro-denominated sovereign debt and the inability of the European Central Bank to guarantee the sovereign debt led to concerns that regional financial instability would be transferred to other nations, closely linked asset markets, and financial institutions within and outside of the Euro zone. To limit such “contagion” effects, financial rescue packages collectively supported by other Euro zone members and the International Monetary Fund, combined with sovereign bond purchases by the European Central Bank and domestic policy

reforms (as well as debt restructuring in the case of Greece), temporarily enabled the most deeply affected nations of Greece, Portugal, Ireland, Italy, and Spain to fulfill their international financial obligations.

The third crisis is that the Eurozone faced a banking crisis initiated by real estate booms in Ireland and Spain. The global financial crisis created a “sudden stop” of the private capital inflows once private investors recognized that risks had been underestimated and interest rates increased, which led to a collapse of real estate markets. The large size of the Euro zone banks relative to their home nations’ economic output made it impossible for the heavily indebted home nations to guarantee the debt. Moreover, the banks were already highly leveraged, and much of the bank debt was issued by their home governments.

While the banking crisis had appeared to be somewhat under control, it also manifested itself in the case of Cyprus, whose main banks had assets far exceeding that nation’s annual economic output, but a significant part of the assets consisted of previously restructured Greek sovereign bonds. As in previous cases of over leveraged financial institutions, policy makers were faced with a difficult choice of either rescuing the banks and thereby jeopardizing sovereign solvency, or refusing rescue and risking severe economic downturns. While Cyprus’ economy is very small relative to that of the Euro zone as a whole, this manifestation of the crisis may have far reaching consequences, in that bank creditors may be expected to bear part of the costs of bank recapitalization in addition to or instead of the European Stability Mechanism.

A fourth crisis was in the balance of payments due to competitiveness disparities and “asymmetric shocks” internal to the Euro zone. That is, Eurozone countries faced country-specific shocks, including fiscal and current account imbalances in Greece, a surge in credit and banking crises in Ireland and Spain, and productivity growth in Portugal and Italy.

Over a decade before 2008, current account balances of both the European Union, as a whole, and the Euro zone in particular obscured rising deficits of Greece, Ireland,

Italy, Portugal, and Spain, which were offset by increased German surpluses. While core nations - such as Austria, Finland and Germany - improved their asset positions, countries in the periphery - Greece, Ireland, Italy, Portugal, and Spain - accumulated large net foreign liabilities.

According to a study the current account imbalances within the Euro zone were made worse by the common currency because it eliminated exchange risks, provided incentives for investors to ignore country-specific investment risks, and created unrealistic expectations about economic convergence between core and periphery nations [16]. The artificially low interest rates in the periphery attracted capital movements from the core, and resulted in current account deficits accompanied by rapidly rising prices and so undermined these nations’ competitiveness.

In their efforts to improve their competitive position without exiting the Euro, periphery nations were unable to devalue their currency for the purposes of improving their current account imbalances and enhancing their competitiveness. Instead, they were forced to bring about devaluation by decreasing prices and costs (including wages) using deflationary macroeconomic policies.

Such policies not only lead to long and painful periods of recession and budget deficits, but are also prone to extended periods with high unemployment, protracted deflationary spirals, possible additional sovereign debt and banking crises, and social unrest [4]. On the other side, cost and price competitive core nations (such as Germany) that had experienced high productivity growth over the decade prior to the crisis were unable to appreciate their currency to help restore internal trade competitiveness and balance within the Euro zone.

Perhaps more important than economic aspects are the political ones of the Euro zone crisis. European member states and people neither agree on the causes of the crisis nor on the path forward. The prevailing view in core nations (predominantly in northern parts of the Euro zone) links the crisis to a lack of enforcement of rules, whereas the

predominant view in the periphery is that the crisis is the result of systematic flaws.

Further, the core nations' dominant view is that austerity measures are the preferred policy response to the complex economic crisis, whereas the view of the periphery nations is that such policies are counterproductive and cannot be supported by the limited availability of political capital. In other words one can say that the crisis of the common European currency appears to reflect a search for a common European purpose.

#### **Main responses related to the Euro zone crisis**

The decision makers have mainly focused their responses to the Euro zone crisis on efforts to develop solutions for sovereign debt and banking crises and to strengthen the institutional framework of the European Union and Euro zone.

Increased funding for and the consolidation of temporary institutions into the permanent European Stability Mechanism in 2012 have improved the financial stability of the most indebted Euro zone nations. Another important decision was to establish a banking union and in this way the European Central Bank has a new supervisory role over Euro zone banks.

One of the most important decisions for dramatically reducing the fear of a Euro zone collapse was the European Central Bank's long - anticipated decision to commit itself to supporting sovereign bond markets [20]. By announcing itself as a lender of last resort, bond yield spreads (the interest rates on a government bond compared to that of very solid status benchmark bonds, such as German bonds) among Euro zone member states that had emerged since the start of the Euro zone crisis dramatically reduced.

One of the most intractable problems - the large, internal imbalances within the Euro zone - has thus far not been dealt with in an adequate manner. Efforts to regain competitiveness have focused on devaluing through lowering prices, wages, and production costs in periphery nations and less on conducting the reverse in core nations. These policies have had only minimal effects

on bridging the competitiveness gap between periphery and core nations.

Based on several years of experience and analysis after the start of the crisis in 2008 there appears to be an increasingly widespread realization that the controversial austerity policies consisting of spending cuts and tax increases may have worsened and prolonged the Euro zone crisis by dampening economic growth and causing historically high unemployment levels in many Euro zone member states, and thereby further increased debt burdens among households, firms, and governments.

Some economists have proposed alternative solutions to the austerity policies and have suggested ways to enable nations in the periphery to regain competitiveness. Among these alternative solutions it was proposed a combination of prioritizing economic growth, restoring the banks' ability to lend, and replacing the current austerity policies [21].

#### **Effects of the economic crisis in the Euro zone on other regions**

International institutions such as the International Monetary Fund [7] and researchers indicated that if it is contained the Eurozone crisis may have limited effects on areas outside of the Euro zone as well as outside Europe.

Anyway, without consistent economic growth, the crisis will not only affect the Eurozone but it will also affect the economic growth in other areas of Europe and areas outside Europe that are linked to Europe by trade and investment flows [10].

Due to the intensity of such linkages, spillover effects of a possible Euro collapse would have the most severe impacts on Europe's emerging markets, followed by the advanced economies in Europe, and nations of the Commonwealth of Independent States, while impacts on the United States and Canada would be relatively minor.

The implications of the Euro zone crisis for the United States and for the United States – European Union cooperation are difficult to assess. Anyway, the United States exposure to economic events in Europe, while less than for the European Union's regional trading



partners, is considerable due to the level of economic integration of the two areas.

A possible Euro depreciation relative to the US dollar might increase the United States trade deficit with the European Union. At the same time the uncertainty in the Eurozone may create a flight to safety of investors and businessmen which might further appreciate the US dollar relative to the Euro, and as such decrease the U.S. Treasury yields and increase the U.S. stock market volatility.

### **European Union in 2015: still affected by the economic crisis**

The European Union crisis is much more comprehensive than the economic and financial sides. The crisis affects the economy, politics and social conditions in European Union member countries and puts under a question mark even the foundations of this organization of economic integration.

In 2015, after 7 years since the start of the crisis there is a much broader perspective of the crisis in Europe, particularly in European Union. Things are no longer related only to economic aspects and a larger, history based approach is more and more used. This perspective can be found with Stratford Global Intelligence. Another perspective has been determined at the beginning of June 2015 by Pew Research Center that analyzed six major European economies.

From the perspective of Stratford Global Intelligence Europe as a continent is facing with two interconnected crises [3]. The first is the crisis of the European Union as organization. The organization began as a project of economic integration, but it was also intended to be more than that. It was an organization that aimed to create Europeans, that is European citizens. The national distinctions between European nations is real and has proved destabilizing, since Europe has been filled with nations with diverging interests and historical inheritances.

The European Union did not intend to replace these nations; the characteristics of the nation states were too deep and based on millennia of history. The European Union project was intended to add to the national identities a European identity. There would be nations and they would keep their sovereignty, but the

citizens of these nations would increasingly come to see themselves as Europeans. That European identity would both create a common culture and diminish the particularity of states. The inducement to all of Europe was prosperity and peace. The European Union would create ongoing prosperity, which would eliminate the danger of conflict.

The challenge to Europe in this sense was that prosperity is at best cyclical, and it is also regional. Europe is struggling with integration because without general prosperity, the seduction of Europeans away from the socio-cultural identities of nations will fail. Therefore, the crisis of the European Union, focused on the European Peninsula, is one of the destabilizing forces.

The second crisis rests in the strategic structure of Europe and is less clear than the first. Leaving aside the outlying islands and other peninsulas that make up Europe, the Continent's primordial issue is the relationship between the largely unified but poorer mainland, dominated by Russia, and the wealthier but much more fragmented peninsula. Between Russia and the peninsula lies a borderland that at times as has been under the control of Russia or a peninsular power or, more often, divided.

As for the study carried out by Pew Research Center and published at the beginning of June 2015, the findings are rather positive [18]. The report examined the public opinion in six European Union countries: France, Germany, Italy, Poland, Spain and the United Kingdom.

The findings are based on 6,028 face-to-face and telephone interviews in these European Union member states with adults 18 and older and conducted from April 7 to May 13, 2015.

The main findings are presented in Figure 3. According to the survey this revival in pro-European Union sentiment is closely related to the public's economic mood, meaning that better economic conditions in certain countries led to more favorable attitude towards the European Union.

As of early June 2015 most European publics surveyed still think economic conditions in their countries are not encouraging. But the economic downturn appears to have bottomed out in most places, and there are signs of

recovery, particularly in Spain and the United Kingdom.

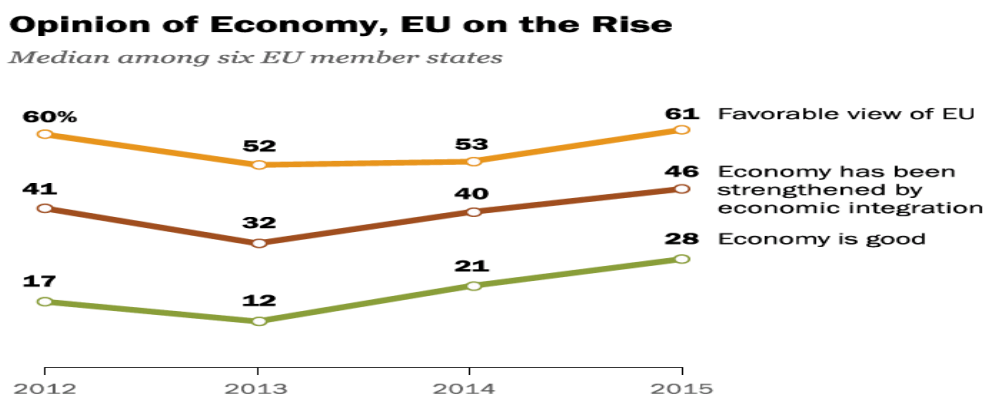

Fig. 3. A more positive opinion on economy and European Union in six major member states  
Source: [18, pag. 3]

Public assessment of the current economic situation has correspondingly improved across Europe in the past two years, even while publics remain fairly pessimistic about the future. And those who now think economic conditions are good are much more likely to favor the European Union and European economic integration than those who see their economy as doing poorly. At the same time, in some nations there are quite significant differences between the higher level of trust in the European Union as an institution and the lower public confidence in the European project.

## CONCLUSIONS

The impact of the economic crisis in the European Union revealed and made more clear than before the existence of significant differences among the member countries. They have different levels of development, different levels of competitiveness and labor market flexibility and, as result, different problems that may require different solutions. Maybe one consequence of the economic crisis for the European Union will be to decide an improvement of the functioning mechanisms so that each member country can find its specific and useful solutions.

At the same time the severe impact of the economic crisis on the Euro zone raised numerous questions on the possibility of the Euro mechanism to adapt to the crisis and provide solutions for overpassing the crisis.

Several times the very existence of Euro was put under a question mark. And despite some relaunch of the economy in the Euro zone in 2014 - 2015, the Greek economy problem, as well as the problems of other Euro Mediterranean countries, maintain some incertitude at least on the effectiveness of the Euro mechanism.

At a global level the crisis was a proof of the interconnectedness among participants confirming that the global system is both dynamic and inter-active: a phenomenon taking place in one large market will disseminate very fast in the majority if not all the other markets.

The conclusion of this proof of interconnectedness is that the world economy really needs a global governance mechanism. If the problems are global and interconnected, then the decision making system should also be global in scope and reaction. Discussions on a global governance system have been present for a long time, maybe even starting with the founding of the United Nations. But one consequence of this crisis is that it creates the real need for designing and implementing an effective system of global governance, at least in the banking and financial sector.

## REFERENCES

- [1]Cerra, V., Saxena, S.C., 2008, Growth Dynamics: The Myth of Economic Recovery, American Economic Review, pag. 456
- [2]De Grauwe, P., 2012, The Governance of a Fragile Eurozone. The Australian Economic Review, Issue

45(3), pag. 255-268.

[3]Eurostat, at page <http://ec.europa.eu/eurostat/tgm/table.do?tab=table&init=1&language=en&pcode=tec00115&plugin=1>

[4]Forecast for European Union for 2014 from Eurostat, at page <http://ec.europa.eu/eurostat/tgm/table.do?tab=table&init=1&language=en&pcode=tec00115&plugin=1>

[5]Friedman George, 2015, A Net Assessment of Europe, Stratford Global Intelligence, May 26

[6]Hall Robert, 2014, Quantifying the Lasting Harm to the US Economy from the Financial Crisis, working paper

[7]International Monetary Fund, 2012, World Economic Outlook.

[8]Khan Aubik, Thomas Julia K., 2013, Credit Shocks and Aggregate Fluctuations in an Economy with Production Heterogeneity, Journal of Political Economy

[9]Kirkegaard, J.F., 2011, The Euro Area Crisis: Origin, Current Status, and European and US Responses. Peterson Institute for International Economics, Testimony before the U.S. House Committee on Foreign Affairs Subcommittee on Europe and Eurasia, 27 October.

[10]Mărcuță Alina, Mărcuță Liviu, Tindecu Cristiana, Honțuș Adelaida C., Angelescu Carmen, 2013, Influence of economic growth on Romania's sustainable development 2007-2012, International Business Information Management Conference (IBIMA) 22nd IBIMA Conference – „Creating global competitive economies: 2020 Vision Planning & Implementation” on 13-14 November 2013 in Rome, Italy, pp. 1172 – 1178

[11]McMorrow Kieran, Roeger Werner, 2013, The Euro Area's Growth Prospects over the Coming Decade, Quarterly Report on the Euro Area

[12]Mueller Hannes, 2012, Growth Dynamics: The Myth of Economic Recovery – Comment, working paper

[13]Papadimitriou, D.B., Wray, L.R., Nersisyan, Y., 2010, Endgame for the Euro? Without Major Restructuring, the Eurozone is Doomed. Levy Economics Institute of Bard College, Public Policy Brief No. 113.

[14]Queralto Albert, 2013, A Model of Slow Recoveries from Financial Crises, working paper

[15]Siemer Michael, 2014, Firm Entry and Employment Dynamics in the Great Recession, working paper

[16]Sinn, H.W., 2013, Valentinyi A., European Imbalances. Vox EU, March 8.

[17]Solomon Daniel, 2013, The Recovery from the Global Financial Crisis of 2008: Missing in Action, Euromonitor International, November 20

[18]Stokes Bruce, 2015, Faith in the European Project Reviving, Pew Research Center, June 2

[19]Veron, N., 2012, Challenges of Europe's Fourfold Union. Peterson Institute for International Economics, Congressional Testimony to the U.S. Senate Committee on Foreign Relations Subcommittee on European

Affairs hearing on The Future of the Eurozone: Outlook and Lessons, August 1

[20]Wolf, M., Be Bold Mario, 2011, Put Out that Fire, Financial Times, October 25

[21]Wyplosz, C., 2013, Happy 2013? Vox EU, January 4

[22]World Bank Data bank at page <http://data.worldbank.org/indicator/NY.GDP.MKTP.KD.ZG/countries/1W-EU-XC?display=graph>

[23]World Bank (June 2015), Global Economic Prospects, at page <https://www.worldbank.org/en/publication/global-economic-prospects/summary-table>

[24]World Bank Data bank at page <http://data.worldbank.org/indicator/NY.GDP.MKTP.KD.ZG/countries/1W-EU-XC?display=graph>, <https://www.worldbank.org/en/publication/global-economic-prospects/summary-table>

## SUSTAINABLE POSITION OF EUROPEAN COUNTRIES BASED ON LIFE EXPECTANCY AT BIRTH AND THE RISK OF POVERTY

Oana Camelia IACOB<sup>1</sup>, Ana-Maria VOLINTIRU<sup>2</sup>, Anca CRISTEA<sup>1</sup>, Elisabeta TURCU<sup>3</sup>

<sup>1</sup>Hyperion University, 169 Calea Calarasi, Bucharest, Romania,  
E-mails: oanacamelia.i@gmail.com, lcancacristea@yahoo.com

<sup>2</sup>Valahia University, Targoviste, Romania, E-mail: anavolintiru@gmail.com

<sup>3</sup>Politehnica University, Bucharest, Romania, E-mail: b3tty\_t@yahoo.com

**Corresponding author:** crystachy@yahoo.com

### Abstract

*The level and growth of GDP per capita has a role and effect in all areas of life in society. Life expectancy at birth for each person and the risk of poverty or social inclusion are dependent on the economic strength of the State expressed by GDP per capita. Under these circumstances, practical utility for explicit reasons and justification of economic policy decisions, an analysis of the interdependence between life expectancy and the risk of poverty with GDP per capita, by applying a rigorous econometric modeling methodologies.*

**Key words:** *econometric model, GDP per capita, life expectancy at birth, poverty risk, social inclusion*

### INTRODUCTION

Economic potential and level of economic development of a country is the synthetic form of measuring the total gross domestic product and per capita.

The potential effects of level and GDP growth are found in all areas of the company's [5]. In the context of this economic logic states that: life expectancy at birth of each person is dependent on economic potential of the state expressed by GDP per 1 inhabitant [12].

It is believed that a certain level of economic development creates the material conditions necessary for life expectancy reflects this potential [11]; the risk of poverty or social inclusion is a direct relationship determining the value of gross domestic product. A certain lower level of economic development will inevitably produce a proportional phenomenon of poverty [10].

In the framework of interdependent variables defining system presents analysis of life expectancy and risk of poverty according to GDP per capita, by applying a rigorous econometric modeling methodology.

This can provide the opportunity for econometric study support to obtain the information necessary to allow substantiation of macroeconomic decisions to promote a real

and sustainable economic progress.

Note: It is noted that life expectancy at birth is defined as the average number of years a person will live if subjected rest of his life to the current mortality conditions.

The indicator that expresses social inclusion or poverty risk refers to the people who are at risk of poverty or living in households with very low work intensity.

Risk of poverty is affected by people with a disposable income below the risk equivalent of poverty, which is set at 60% of the national median equivalent disposable income (after social transfers).

The Europe 2020 strategy promotes social inclusion, in particular through the reduction of poverty. The aim of the strategy is to decrease by at least 20 million people affected by the risk of poverty and social exclusion.

### MATERIALS AND METHODS

The methods used to process the data contained in Table 1 are able to provide the resulting analytical indices and relevant information about the interdependence of life expectancy and the risk of poverty with GDP per capita.

To achieve the objective using appropriate methods of statistical modeling and

verification of sustainability models based on the data presented in Table 1 which covers 30 European countries in 2013.

Table 1. Life expectancy, poverty risk, GDP per capita in 2013 for 30 European countries

No.	Country	Life expectancy Y <sub>1</sub>	Poverty risk Y <sub>2</sub>	GDP/ capita x
1	Belgium	63.7	20.8	33,500
2	Bulgaria	66.6	48	5,200
3	Czech Republic	64.2	14.6	15,000
4	Denmark	59.1	18.9	43,000
5	Germany	57	20.3	32,800
6	Estonia	57.1	23.5	12,800
7	Ireland	68	29.5	37,600
8	Greece	65.1	35.7	16,800
9	Spain	63.9	27.3	22,300
10	France	64.4	18.1	31,200
11	Croatia	60.4	29.9	10,200
12	Italy	60.9	28.4	25,400
13	Cyprus	65	27.8	20,500
14	Latvia	54.2	35.1	10,000
15	Lithuania	61.6	30.8	10,800
16	Luxembourg	62.9	19	77,100
17	Hungary	60.1	33.5	10,100
18	Malta	72.7	24	16,800
19	Netherlands	57.5	15.9	37,600
20	Austria	60.2	18.8	36,100
21	Poland	62.7	25.8	10,100
22	Portugal	62.2	27.5	16,000
23	Romania	57.9	40.4	6,700
24	Slovenia	59.5	20.4	17,100
25	Slovakia	54.3	19.8	13,100
26	Sweden	66	16.4	39,800
27	United Kingdom	64.8	24.8	29,500
28	Iceland	66.7	13	33,100
29	Norway	68.6	14.1	66,600
30	Switzerland	58.4	16.3	56,900

Source: calculus on data from [www.eurostat.ro](http://www.eurostat.ro)

## RESULTS AND DISCUSSIONS

Econometric studies of the system variables listed in Table 1 envisage the elaboration of the following models: a model of interdependence life expectancy with GDP per capita and a model of interdependence risk of poverty with GDP per capita [3].

The graphical representation of the correlation between variables system under study, Fig. 1 and Fig. 2 by the arrangement of the point cloud on form interdependence both between Y<sub>1</sub> - life expectancy at birth; x - GDP per capita and between Y<sub>2</sub> - the risk of poverty; x - GDP per capita allows us to appreciate that

there is a significant gap between the two forms graphs [8].

The graph in Fig. 1 point cloud does not formalizes, obviously, a certain statistical regularity because the points are distributed in whole representation and they have a high dispersion.

Fig. 2 suggests a certain group of points in a hyperbole shape.

In those circumstances opting for two regression equations simple simultaneous with the same independent variable (exogenous) [1], GDP per capita, which formed different general:  $\hat{y}_1 = a + bx$  to express the correlation between life expectancy at birth and GDP per capita respectively  $\hat{y}_2 = a + b/x$  to express the correlation between risk of poverty and GDP per capita.

### The linear model of interdependence life expectancy at birth with GDP per capita

The graphical representation of the correlation between endogenous variable  $\hat{y}_1$  - life expectancy at birth, with exogenous variables, x - GDP per capita in Fig. 1 by the arrangement of the point cloud can be justified option for a simple linear regression equation that has the general form:

$\hat{y}_1 = a + bx$ . It is obvious that this model has minimal support for full visual but building statistical representation calculate key indicators and econometric will appreciate, therefore, the viability of the model.

The results presented in a synoptic picture of econometric representation indicators (Table 2) do not support, in statistical terms, that there is a real dependence between life expectancy at birth and GDP per capita [2].

The bases for this conclusion are the following results:

#### -Correlation report

(  $R = \sqrt{R^2} = \sqrt{0.033664} = 0.183477$ ) by its size close to zero attests that the variables studied system does not form a real interdependence.

This conclusion is supported statistically by "Criterion F" which denies the significance of the correlation ratio as zero, with a significance level of 33.1787%;

- Parameter estimator "b" of simple linear model is not confirmed as significant in statistical terms, based on "t criteria" (Student), with a significance threshold of 33.18% [7].

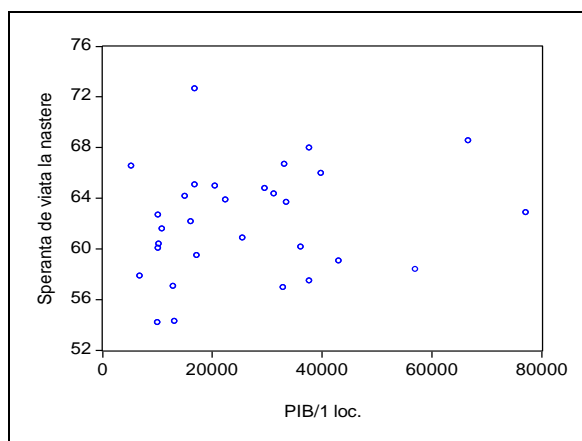

Fig.1. Life expectancy and GDP per capita correlogram  
Source: author calculus

The results and conclusions confirm the theoretical support that the life expectancy at birth is likely to be higher as the economic strength of a country is higher.

Table 2. Synoptic table of results that attest viability of simple linear model for correlation between life expectancy and GDP per capita

Dependent Variable: Life expectancy ( $\hat{y}_1$ )				
Method: Least Squares				
Sample: 1 – 30; Included observations: 30				
$\hat{y}_1 = a + bx \rightarrow$				
$\hat{y}_1 = 61.00907 + 0.0000446 \cdot x$				
Variable	Coefficient	Std. Error	t-Statistic	Prob.
PIB/1 loc. „b”	4.46E-05	4.52E-05	0.987640	0.3318
C „a”	61.00907	1.432797	-42.58041	0.0000
R-squared (R <sup>2</sup> )	0.033664	Mean dependent var		62.19000
Adjusted R-squared	-0.000848	S.D. dependent var		4.321985
S.E. of regression	4.323816	Akaike info criterion		5.830494
$\hat{\sigma}_{y_2; \hat{y}_2}$				
Sum squared resid	523.4709	Schwarz criterion		5.923908
Log likelihood	-85.45742	F-statistic		0.975434
Durbin-Watson stat	2.000752	Prob (F-statistic)		0.331787

Note: These indicators are obtained using Eviews software.

Source: author calculus

This logic is based on the size of financial and material potential for social protection and assistance and therefore a certain life expectancy at birth.

Data provided by the statistics on life expectancy at birth for the 30 European countries, can be inconclusive in terms of production methodology in these conditions

and econometric study results are marked by infidelity.

Invalidation developed model does not cancel, but real possibility of a relationship between two general causal variables. In these circumstances it may recommend reconsideration observation data and statistical modeling procedures replay.

### Hyperbolic model for risk of poverty and GDP per capita

Correlogram correlation between endogenous variable  $\hat{y}_2$  - the risk of poverty, with exogenous variables, x - GDP per capita in Fig. 2 by the arrangement of the point cloud is justifying the option for a simple regression equation hyperbolic which has the general form:  $\hat{y}_2 = a + b \cdot 1/x$ .

It is noted that as GDP per capita increases the risk of poverty is reduced by an obvious tendency to stabilize at a level as low.

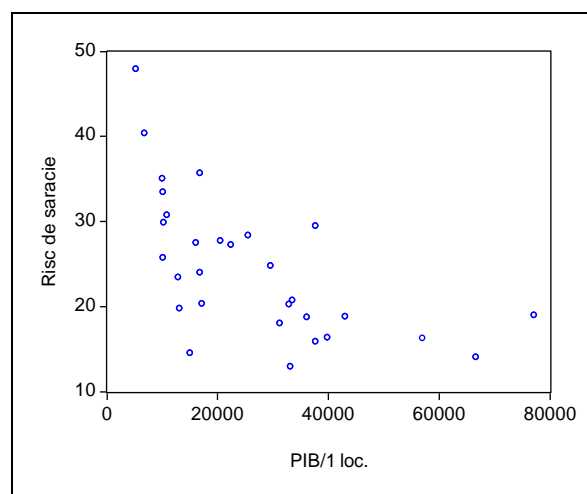

Fig. 2. Correlogram for poverty risk and GDP per capita

Source: author calculus

Estimated parameters of simple hyperbolic regression equation regarded as interdependent system studied are performed using least squares and results following system of equations:

$$\begin{cases} \Sigma y_2 = n \cdot a + b \cdot \Sigma 1/x \\ \Sigma y_2 \cdot 1/x = a \cdot \Sigma x + b \cdot \Sigma 1/x^2 \end{cases}$$

After solving the system of equations econometric model is obtained,

$$\hat{y}_2 = 15.16229 - 161492.4/x$$

Table 3. Synoptic table that attest viability of simple hyperbolic model for poverty risk and GDP per capita

Dependent Variable: Poverty risk ( $\hat{y}_2$ )				
Method: Least Squares				
Sample: 1 - 30; Included observations: 30				
$\hat{y}_2 = a + b/x \rightarrow$				
$\hat{y}_2 = 15.16229 - 161492.4/x$				
Variable	Coefficient	Std. Error	t-Statistic	Prob.
PIB/1 loc. „b”	161492.4	22520.04	7.171053	0.0000
C „a”	15.16229	1.606907	9.435699	0.0000
R-squared - ( $R^2_{y_2 .x}$ )	0.647462	Mean dependent var		24.61333
Adjusted R-squared	0.634871	S.D. dependent var		8.333180
S.E. of regression	5.035399	Akaike info criterion		6.135203
$\hat{\sigma}_{y_2; \hat{y}_2}$				
Sum squared resid	709.9467	Schwarz criterion		6.228616
Log likelihood	-90.02804	F-statistic		51.42400
Durbin-Watson stat	1.485043	Prob (F-statistic)		0.000000

Note: These indicators are obtained using Eviews software.

Source: author calculus

The estimated values of the parameters defining the unifactorial hyperbolic model for risk of poverty according to GDP per capita and the main results of information econometric are shown in "synoptic table of econometric indicators" (Table 3), allowing attesting to assess the viability of the econometric model.

Actual levels ( $y_2$ ) and the estimated ( $\hat{y}_2$ ) for risk of poverty obtained by applying simple hyperbolic regression equation, residues series and their arrangement are presented in Table 4.

The residue graph from the last column of the table, provide a picture for alternation between them in relation to the origin, which confirms the status non autocorrelation.

Statistical coefficient Durbin Watson (DW = 1.485043 - in Table 3) confirms this conclusion because it considered appropriate positions within the range 1.4 - 2.6, to accept the hypothesis of non-correlation residues.

Through this statistical finding it is considered that the efficiency parameter regression equation is appropriate [6].

It notes also that residues do not exceed framing admitted, in statistical terms, expressed the estimates by  $\pm 2.048$  standard error of regression equation

$$(\pm t_{q=0.05; f=n-k=30-2} \cdot \hat{\sigma}_{y_2; \hat{y}_2} = \pm 2.048 \cdot 5.035399)$$

under the law of Student distribution for a significance level of 5%, bilateral, and 28 degrees of freedom.

This finding is able to justify the formation of the belief that the econometric model of the risk of poverty formalized through a regression equation simple hyperbolic shown a construction math correct reality of statistics and therefore has utility practice to substantiate and implement economic policy measures and by taking into account social exogenous variable GDP per capita.

The plots presented in Fig. 3 and Fig. 4 shall be evidence of the viewing position of the series of values related to the risk of poverty [4], actual and fitted, and residues in Table 4.

Table 4. Actual values, fitted values for dependent variable (poverty risk) based on GDP per capita using a uni factorial hyperbolic model; residual values and residual plot

No.	Country	Actual	Fitted	Residual	Residual Plot
1	Belgium	20.8000	19.9830	0.81704	.   *   .
2	Bulgaria	48.0000	46.2185	1.78148	.   *   .
3	Czech Republic	14.6000	25.9284	-11.3284	*   .   .
4	Denmark	18.9000	18.9179	-0.01793	.   *   .
5	Germany	20.3000	20.0858	0.21416	.   *   .
6	Estonia	23.5000	27.7789	-4.27888	*   .   .
7	Ireland	29.5000	19.4573	10.0427	.   .   *
8	Greece	35.7000	24.7749	10.9251	.   .   *
9	Spain	27.3000	22.4041	4.89590	.   *   .
10	France	18.1000	20.3383	-2.23833	.   *   .
11	Croatia	29.9000	30.9949	-1.09488	.   *   .
12	Italy	28.4000	21.5203	6.87974	.   .   *
13	Cyprus	27.8000	23.0400	4.76003	.   *   .
14	Latvia	35.1000	31.3115	3.78847	.   *   .
15	Lithuania	30.8000	30.1153	0.68471	.   *   .
16	Luxembourg	19.0000	17.2569	1.74313	.   *   .
17	Hungary	33.5000	31.1516	2.34837	.   *   .
18	Malta	24.0000	24.7749	-0.77493	.   *   .
19	Netherlands	15.9000	19.4573	-3.55730	.   *   .
20	Austria	18.8000	19.6358	-0.83576	.   *   .
21	Poland	25.8000	31.1516	-5.35163	*   .   .
22	Portugal	27.5000	25.2556	2.24444	.   *   .
23	Romania	40.4000	39.2656	1.13437	.   *   .
24	Slovenia	20.4000	24.6063	-4.20629	.   *   .
25	Slovakia	19.8000	27.4900	-7.68995	*   .   .
26	Sweden	16.4000	19.2199	-2.81989	.   *   .
27	United Kingdom	24.8000	20.6366	4.16339	.   *   .
28	Iceland	13.0000	20.0412	-7.04121	*   .   .
29	Norway	14.1000	17.5871	-3.48710	.   *   .
30	Switzerland	16.3000	18.0005	-1.70047	.   *   .

Source: author calculus

Normality test of the distribution of the residual variable, Jarque-Bera leads to a secure acceptance of this hypothesis because coefficient JB = 0.070358 is associated with an acceptance probability P = 96.5432% under the law of division hi square with two degrees of freedom (Figure 5).

Obviously, in this case we have to accept statistical basis normality assumption which



confirms good efficacy estimators simple regression equation hyperbolic.

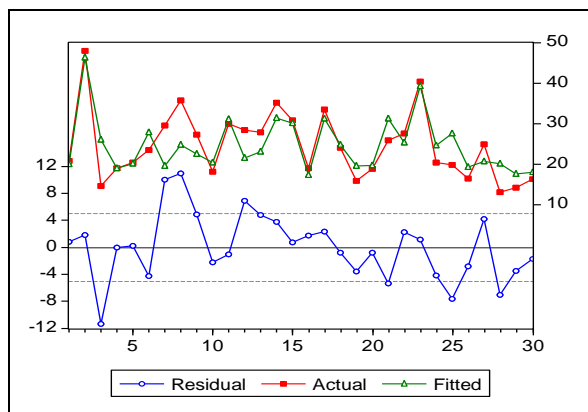

Fig. 3. Graphical representation of Residual, Actual and Fitted values for poverty risk based on GDP per capita  
Source: author calculus

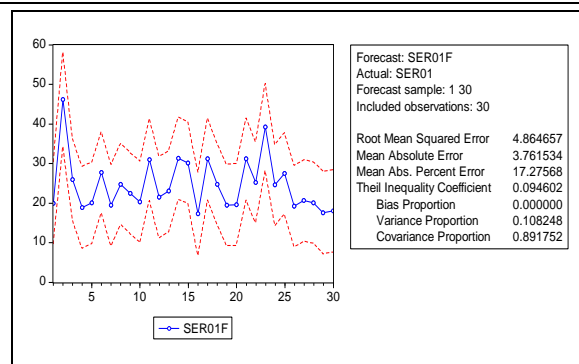

Fig. 4. Graphical representation of fitted values for poverty risk based on GDP per capita (SER01F) and  $\pm 2.048$  estimation for errors on simple hyperbolic regression equation with 5% threshold and 28 freedom degrees;  
Source: author calculus

„F Criteria”,

$$F - \text{statistic} = 0.909824 < F - \text{tabelar} = F_{q=0.05; f_1=k-1=3-1=2; f_2=n-k=30-3=27} = 3.35$$

„ $\chi^2$  Criteria”,

$$n \cdot R^2 = 30 \cdot 0.063139 = 1.894175 <$$

$$\chi^2 - \text{tabelar} = \chi^2_{q=0.05, f=k-1=3-1=2} = 5.99$$

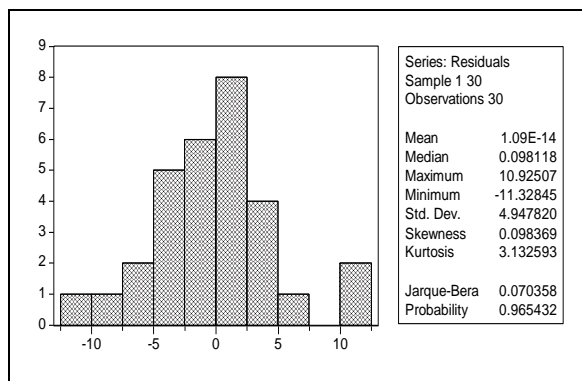

Fig. 5. Statistics and normality test for residual variable based on Jarque-Bera Criteria  
Source: author calculus

Verification of the hypothesis of heteroscedasticity of residual variable for the correlation between risk of poverty and GDP per capita (econometric model unifactorial hyperbolic) is performed using "Test White", which consists of applying two statistical criteria for verifying hypotheses "criterion F" and " $\chi^2$  criteria".

This test is based on statistical characteristics of the equation squared residual variable auxiliary according to the independent

variable and the results are shown in Table 5. In the case of the poverty risk is assumed statistical basis needed to be refuted hypothesis of heteroscedasticity and thus, the model is homoscedastic, the error term has a value equal to the scattering with respect to the independent variable (x).

Table 5. Synoptic table for "White test" for simple unifactorial hyperbolic model for poverty risk based on GDP per capita

F-statistic	0.909824	Probability	0.414585		
Obs*R-squared	1.894175	Probability	0.387869		
Test Equation: Dependent Variable: RESID^2					
Auxiliary regression equation:					
$u^2 = (y_2 - \hat{y}_2)^2 = z = a + b/x + c/x^2$					
Method: Least Squares					
Sample: 1 - 30; Included observations: 30					
Variable	Coefficient	Std. Error	t-Statistic	Prob.	
C	„a”	8.696374	18.13529	0.479528	0.6354
(1/x)	„b”	564997.1	506822.2	1.114784	0.2748
(1/x)^2	„c”	-3.55E+09	2.74E+09	-1.295774	0.2060
R-squared	0.063139	Mean dependent var	23.66489		
Adjusted R-squared	-0.006258	S.D. dependent var	35.14958		
S.E. of regression	35.25939	Akaike info criterion	10.05798		
Sum squared resid	33567.06	Schwarz criterion	10.19810		
Log likelihood	-147.8697	F-statistic	0.909824		
Durbin-Watson stat	1.513376	Prob (F-statistic)	0.414585		

Source: author calculus

## CONCLUSIONS

Analysis of the results in Table 3 and based on other tests and statistical calculations performed provides an opportunity to make the following conclusions:

- Correlation between risk of poverty and GDP per capita registered in 30 European countries in 2013 is hyperbolic regression equation expressed by:

$$\hat{y}_2 = 15.16229 - 161492.4/x;$$

- Between system variables correlation study, the risk of poverty and GDP per capita is interrelated significant in statistical terms, and strong intensity, since the ratio of correlation has a size positioned at the lower limit 0.8-1,  $R_{y_2..x} = 0.80465$  and is significantly different

from zero, meaning "Criterion F" in this case, is very close to zero.

- Coefficient of determination  $R^2_{y_2..x} = 0.620533$ , certifies that 62.0533% of

the variance of the endogenous variable -  $Y_2$  - (risk of poverty) is explained by the variation of exogenous variable -  $x$  - (GDP per capita), the difference up to a hundred percent is the proportion of residual components or the proportion determined by the influence of other factors not considered in the analysis studied the correlation system;

- Two estimators of the model parameters, "a" and "b" are significantly different from zero, meaning "Criterion t" because the threshold of significance of the test statistics of these is close to zero (Table 3);

- "Durbin-Watson statistic coefficient"  $DW = 1.485043$ , of a size large enough to appreciate it confirms the non-existence of autocorrelation between levels of the error term (residual). The information obtained is attested by the arrangement residues plot showing some alternation to the original (residues in Table 4). In these circumstances it is considered that the model is sufficiently viable model ensures good efficiency parameters to be used in calculations by extrapolation or interpolation;

- Residues within the permitted maximum estimates  $\pm 2.048$  of error average regression

equation based on the law of distribution Student arrangement of bilateral materiality threshold of 5% and 28 degrees of freedom, which confirms the correct statistical modeling system correlation studied by simple hyperbolic regression equation;

- Description of the error term statistical series (residual) is shown graphically (histogram in Fig. 5) and by indicators: mean, median, maximum, minimum, standard deviation, the coefficient of asymmetry (Skewness), Bolt flattening coefficient (Kurtosis), Jarque-Bera statistic coefficient ( $JB = 0.070358$ ) which will form the laws of distribution  $\chi^2$  with 2 degrees of freedom and probability coefficient related JB ( $P = 96.5432\%$ ). This information underlying hypothesis acceptance of the values of the error term disposition under the law of normal distribution, a finding necessary to ensure good efficiency econometric model;

- The results shown in the picture synopsis of "White Heteroskedasticity Test" (Table 5) confirms that the residual variable is homoscedastic, the error term shows an equal dispersal relative values of the independent variable ( $x$ ), ensures the possibility to conclude that viable model to calculate the estimate of the risk of poverty if they produce expected changes in GDP per capita [9];

The conclusion of the study is based on the results of calculations and it certifies the sustainability of the equation hyperbolic shape modeling statistical correlation between risk of poverty and GDP per capita. Economic growth and the economic potential of a state dimensioned by GDP per capita ensure durable and sustainable support to minimize the risk of poverty.

## REFERENCES

- [1] Andrei, T., 2003, Statistică și econometrie, Economic Publishing House, Bucharest
- [2] Baron, T., Biji, E., Tövissi, L., Wagner, P., Isaic-Maniu, Al., Korka, M., Porojan, D., 1996, Statistică teoretică și economică, Didactic and Pedagogic Publishing House, Bucharest
- [3] Bacescu-Carbutaru, A., 2002, Analiză macroeconomică, Economic Publishing House, Bucharest

[4]Burghilea, C., Gheorghiu, A., Tindeche, C., Gheorghiu, A., 2014, The Global Crisis and the Opening of a New Paradigm, Theoretical and Applied Economics, Volume XXI, No. 3(592), pp. 103-114

[5]Burghilea, O., C., Burghilea, C., 2011, Implementation status of environmental policy in Romania in the context of sustainable economic development, Scientific Papers. Series "Management, Economic Engineering in Agriculture and rural development", Vol. 11(3), pp.29-34

[6]Isaic-Maniu, Al., Mitruț, C., Voineagu, V., 1995, Statistica pentru managementul afacerilor, Economic Publishing House, Bucharest

[7]Mihăilescu, N., Răducan, M., 2008, Analiza activității economico-financiare, Victor Publishing House, Bucharest

[8]Mihăilescu, N., 2014, Statistica și bazele statistice ale econometriei, Transversal Publishing House, Bucharest

[9]Petrescu, I., E., 2014, Factor analysis of labor productivity in agriculture in terms of sustainable development, Scientific Papers. Series "Management, Economic Engineering in Agriculture and rural development", Vol. 14(3), pp. 250-255

[10]Popescu, G., H., Ciurlău, C., F., 2013. Macroeconomie, Economic Publishing House, Bucharest

[11]Vasile, V., Stănescu, S., Bălan, M., 2013, Promoting the Quality of Life: Challenges of Innovative Models versus Payment Policies”, in „The European Culture for Human Rights the Right to Happiness”, Cambridge Scholars Publishing, UK

[12]Zaman, G., Geamănu, M., 2014, Eficiența economică în condițiile dezvoltării durabile, Editura Fundației România de Măine, București



## ASPECTS OF GENDER EQUALITY WITHIN DOMESTIC LIFE

**Adina Magdalena IORGA**

University of Agricultural Sciences and Veterinary Medicine Bucharest, 59 Marasti, District 1, 11464, Bucharest, Romania, Phone: +40213182564, Fax:+40213182888, Mobile:+40721 649215, Email:iorga\_adinam@yahoo.com

*Corresponding author:* iorga\_adinam@yahoo.com

### *Abstract*

*Gender equality within private life defines a family and social model of development in which the rights and responsibilities of individuals are not influenced by their birth as male or female but by egalitarian interaction in terms of making the maximum out of their own potential. In the social construction of genders (be it male or female), the family background and social environment in which character develops has a significant role. The research aims to identify students' perceptions of USAMV Bucuresti on the attributes of a happy marriage and alternative forms of family structures, the perception that respondents have related to domestic work and the responsibilities of each member regarding its implementation. The research results reveal the option of switching the marital kind of rational criteria (money, property) to the psycho-affective and relational type. In the distribution of domestic activities a primal role is manifested through the distribution of work on gender criteria.*

*Key words:* gender equality, social basis of gender roles

### INTRODUCTION

According to UNPFA Organization, gender equality is defined as follows: "Gender equality is a human right. Women are entitled to live with dignity and with freedom from want and from fear. Gender equality is also a precondition for advancing development and reducing poverty: Empowered women contribute to the health and productivity of whole families and communities, and they improve prospects for the next generation". [6] Gender equality is a goal of family life. Egalitarian relationships involve the participation of both partners in making decisions and implementing them within their families. An important role in the perception of family roles is carried by the socialization process through which individuals internalize various models of interaction. [3]

The mechanisms and socialization agents know a great variety and they ensure, taken together or individually, stability and functionality to social structures, internal cohesion, subsequently maintaining social order. The family is one of the major institutions of society socializing, defining social as a "fundamental social process through which any society is projecting,

reproducing and establishes its legal and cultural model through the proper conduct of its members".[5]

The family influences the child's development in so many ways, thus we consider it the "building block" of primary socialization, **that can not be rivaled by any other social institution.** [4]

The character of relations within the family (dominated by tradition or opened to novelty) decisively influences through primary socialization process values, the individual's decision making patterns and relating skills towards others. That is why the family is the social group of paramount importance in ensuring harmonious development of its members in relation to biological, emotional, psychological, financial protection, proper socialization and education of children. [5]

The role of each subject is to overcome any traditional patterns and to form their own interaction model that emphasizes skills of adapting to the current situation and to others beyond gender stereotypes. [2]

### MATERIALS AND METHODS

The research aims to identify aspects of gender equality manifested in the privacy of

domestic life of students from the Veterinary Medicine University of Bucharest. In order to identify the attributes of a happy marriage we have used the following items: "to have a place of their own", "to have good living conditions", "to have money", "to have the same education," "to support one another", "being faithful", "to love each other", "sexual compatibility", "to trust each other", "small age gap". Perception of respondents regarding marriage and alternative forms of family life (cohabitation, single-parent family) was studied by using the items listed below: "it is a good idea for a man and woman to live together before getting married", "there is nothing bad in the fact that a man and a woman live together without wanting to get married", "a single parent can raise a child just as well as both parents", "it is better to have a bad marriage than not be married at all", "the main advantage of marriage is security / financial security", "generally, married people are happier than unmarried people". I sought to identify the perception that respondents have related to domestic work and the implied responsibilities of each member, by reference to its realization. Common couple participation in decisions is an indicator of gender equality in the family. [1]

The research was conducted at the University of Agronomic Sciences and Veterinary Medicine Bucharest on a research group consisting of 375 respondents. The research group includes young people aged between 20 and 25 years old, as they are the promoters of modern family values based on democracy

and gender equality. The data collection period was June 1<sup>st</sup> to July 31<sup>st</sup> 2014. The group comprises 161 female students and 213 male students, with a distribution representative across the faculty components (Agriculture, Zoology, Veterinary Medicine, Horticulture, Biotechnology and Management).

## RESULTS AND DISCUSSIONS

### 1. The attributes of a happy marriage

In the questionnaire we wanted to identify which are the attributes of a happy marriage by considering the following items: "to have a home of their own", "to have good living conditions", "to have money", "to have the same education" "to support each other," "to be faithful", "to love each other", "be a sexual match", "trust each other", "of close age".

Respondents revealed that in order to have a happy marriage partners must "trust each other" (80.53%), "love each other" (80.00%), "to support one another" (79.20%), "be faithful" (78.13%), „to have a home of their own"(66.93%), "sexual compatibility" (56.53%). Less important are considered: "close age" (22.93%), "have the same education" (24.00%), "have money" (27.20%). The partnership realized through marriage is based on mutual valuing of the other through trust, love, support, loyalty and only then, owning their own home. We note in passing the change in views from the marital kind of rational criteria (money, property) to the psycho-affective and relational type (Table 1).

Table 1. The frequency of answers to the statement of „In your opinion, what is important to a happy marriage?"

	Very important (%)	Important (%)	Not important (%)	Not important at all (%)	NA/DK (%)
Have a place of their own	66.93	26.67	4.00	1.60	0.80
Have good living conditions	48.53	47.20	2.67	0.80	0.80
Have money	27.20	60.27	10.93	0.80	0.80
Have the same education	24.00	45.33	27.73	1.60	1.33
To support each other	79.20	18.93	1.07	0.27	0.53
To be faithful	78.13	20.00	1.33	0.27	0.27
To love each other	80.00	18.13	1.07	0.53	0.27
Sexual compatibility	56.53	35.20	6.13	0.27	1.87
Trust each other	80.53	17.07	1.87	0.27	0.27
Be of close age	22.93	37.07	36.27	2.67	1.07

Source: Own SPSS analysis

To have a happy marriage, female students appreciate to a greater degree than male

students that partners must "have the same education" (+ 9.27%), "have a home of their

own" (+ 5.81%), "have money" (+ 5.70%), "to be close age" (+ 4.52%).

Respondents residing in rural areas considered to a higher extent than those in urban areas that the partners "must have money" (+ 3.40%), "have a home of their own" (3.02%). "Having the same education" is more valued in urban than in rural environments (+ 3.49%) as well as "to trust one another" (+ 1.66%). Respondents from rural backgrounds significantly value the rational aspects, such as the financial ones, while in urban areas the educational and symbolic aspects are highly appreciated.

## 2. Perception on marriage

The perception of respondents regarding marriage and alternative forms of family life (cohabitation, single-parent family) was studied by using the following items "it is a good idea for a man and woman to live together before getting married", "there is nothing bad in the fact that a man and a woman live together without wanting to get married", "a single parent can raise a child just as well as both parents", "it is better to have a bad marriage than not be married at all", "the main advantage of marriage is security / financial security", " generally, married people are happier than unmarried people" (Table 2).

Respondents had a positive and concurring view that "a man and a woman should live together before getting married" (88%), that "there is nothing wrong with a man and woman living together without wishing to marry" (65.60%). Such cohabitation before marriage and as an alternative to marriage is accepted. A neutral opinion is noticed on: "in general, married people are happier than unmarried ones" (37.33%).

Personal happiness can be achieved both in marriage and outside it. Negative opinions refer to "it is better to have a bad marriage than not be married at all" (79.20%), "a single parent can raise a child just as well as both parents" (42.40%), "the main advantage of marriage is financial security / safety" (46.13%).

Table 2. Perception on marriage

Do you agree with the following statements	Totally agree (%)	Agree (%)	Neither agree or disagree (%)	Disagree (%)	Completely disagree (%)	NA/DK (%)
Is it a good idea that a man and a woman live together before marriage?	44.00	44.00	9.33	1.60	0.80	0.27
There is nothing wrong with a man and a woman living together without considering marriage	26.93	38.67	22.67	9.60	1.87	0.27
A single parent can raise a child just as well as both parents	14.93	17.87	24.80	31.73	10.67	0.00
It is better to have a bad marriage than none at all	2.40	6.40	11.20	40.80	38.40	0.80
The main advantage of marriage is financial security/safety	6.40	15.73	31.20	35.20	10.93	0.53
Generally, married people are more happy than unmarried people	12.80	21.07	37.33	21.60	6.93	0.27

Thus the quality of marriage is very important, respondents will more likely appreciate the value of relational and affective bonds over the financial aspects. The single-parent family is not accepted as an alternative to the conjugal family in terms of the fulfillment of parental roles.

## 3. Structure of daily house work activities

Housework in the respondents' families is strictly distributed by gender.

Women especially do the washing / ironing clothes (82.13%), prepare the food (73.87%), clean house (70.67%), wash the dishes (64.80%), daily care of the child / children (43.73%), household care (31.47%) while men are inclined to house installations repair (taps, faucet, light socket, plumbing, etc) (80.27%) etc. The activities that women and men do alike are daily care of the child / children (41.33%) and household care (43.13%) (Table 3).

## 4. Deciding on daily expenses

The decision on spending money for everyday needs belongs: to both partners equally (76.80%), only to the females (13.6%), only to the males (7.2%) (Fig. 1).



Table 3. Frequency of answers to the „Usually, who does the following daily activities within your household?“ question

	More often the females (%)	More often the males (%)	Females and males alike (%)	Hiring someone (%)	Not the case (%)	NA/DK (%)
Takes care of the household	31.47	20.00	34.13	1.87	11.47	1.07
Repairs the house installations	2.93	80.27	6.93	7.47	1.60	0.80
Prepares meals	73.87	3.73	21.33	0.53	0.53	0.00
Cleans house	70.67	3.20	24.27	1.33	0.53	0.00
Washes / Irons clothes	82.13	2.93	13.60	0.80	0.00	0.53
Wash the dishes	64.80	5.33	28.53	0.53	0.80	0.00
Takes daily care of the child/children	43.73	2.13	41.33	1.87	9.87	1.07

Source: own SPSS analysis

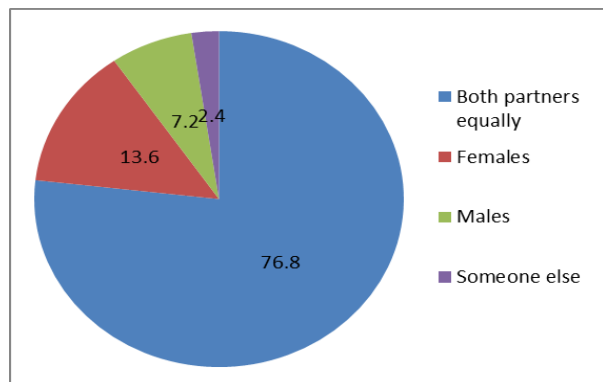

Fig 1. Frequency of answers to "Who decides how to spend the money in your household for daily needs?"

Female students rather than male students appreciate that both partners equally or just the females should decide on household spending (+ 3.3%) and (3.79) (Fig. 2).

Male students consider that decisions on spending are taken usually by the males (5.04) (Fig. 3).

Urban area respondents consider that these decisions should be taken by both partners equally or by the females, when compared to rural area upbringing respondents (+ 0.02%).

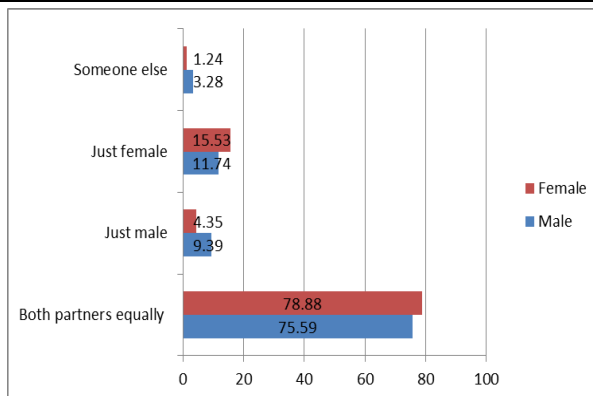

Fig. 2. Frequency of answers to the „Who decides how money is being spent, for daily basics, in your household?“ question, according to gender

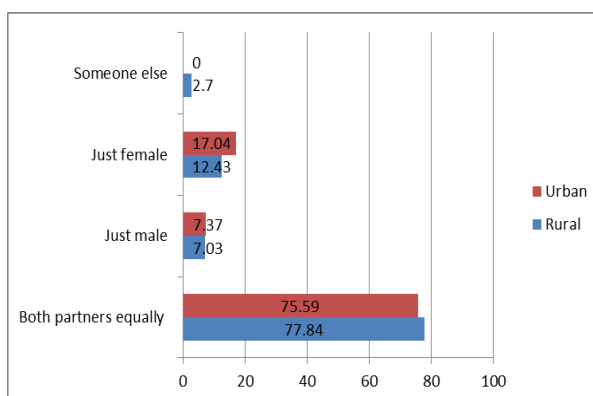

Fig 3. Frequency of answers to the „Who decides how money is being spent, for daily basics, in your household?“ question, according to residency

Source: own SPSS analysis

### 5. Deciding on major expenses

Decisions on important family expenses are taken by both partners equally (76%), just the males (14.67%) or just the females (6.93%).

Female students to greater extent than male students (+9.06%) claim that the important decisions are taken by both partners, while male students respond that males take important decisions to an even greater extent (+ 9.46%). In rural areas important decisions are taken rather both partners (+0.03%) or by the females (+ 0.02%), compared to urban areas where they are taken mostly by men (+ 0.04%) (Fig. 4).

We note that unless both partners equally make daily decisions or important ones (aprox. 76%) the daily decisions related to basic necessities shopping are taken mostly by the females, while decisions relating to significant expenses are taken by the males.

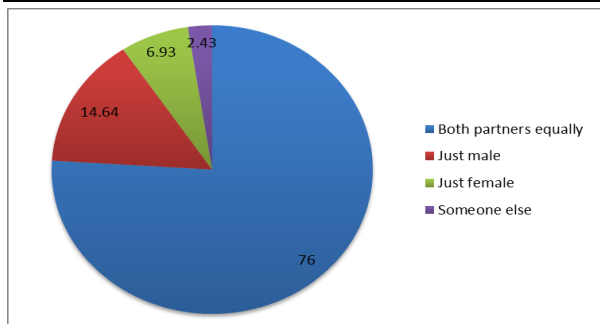

Fig 4. Frequency of answers to the „Who decides how money is being invested in important expenses (car, tv, etc.)” question

Source: own SPSS analysis

## 6. Perception on housework

Domestic responsibilities are a much debated topic within the family and beyond. An important role in shaping their own gender prescriptions is played by the perception that family members have about household work. Thusly, respondents believe that domestic work is not the easiest work (54.40%), a high percentage of them have not thought about it (30.67%), while 13.87% believe that domestic work is pretty light (Table 4).

Table 4. Frequency of answers to the „Do you agree that housework is one of the easiest forms of work?” question

	(%)
Yes	13.87
No	54.40
Didn't think about it	30.67
Na/Dk	1.07

Source: own SPSS analysis

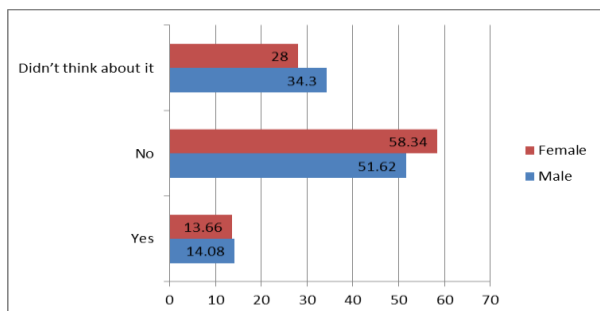

Fig. 5. Frequency of answers to the „Do you agree that housework is one of the easiest forms of work?” question, according to gender

Source: own SPSS analysis

From a gender perspective, especially female students respond that housework is not the easiest work (+6.74%) while the male students to a greater extent than female

students respond that they have not thought about it very much (+6.63%) (Fig. 5).

One possible answer would be the different family socialization levels of girls and boys, especially in the private sphere of the first, leading to an inadequate knowledge of household responsibilities by the boys.

From the perspective of residency, we find that mostly urban respondents consider that household chores are the lightest work (7, 10%) while for the most part, those in rural areas have not thought about it (7.75%) (Fig. 6).

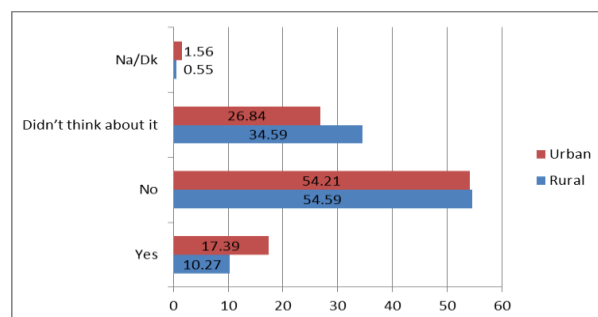

Fig. 6. Frequency of answers to the „Do you agree that housework is one of the easiest forms of work?” question, according to residency

Source: own SPSS analysis

As regards to **viewing domestic work as equal to any other type of paid work**, a very high percentage have not thought about it (41.07%), others consider it an activity that is not equal to any other type of work that is payable (24.27%). Only a third of respondents (32.53%) consider domestic work like any other work which can be paid (Table 5).

Table 5. Frequency of answers to the „Generally, do you think housework is equal to any other kind of paid work?” question

	(%)
Yes	32.53
No	24.27
Didn't think about it	41.07
Na/Dk	2.13

Source: own SPSS analysis

From a gender perspective, mostly the female students have not thought about it (5.6%), while a bigger percentage of male students consider it an activity equal to any type of paid work (2.75%)(Fig. 7)

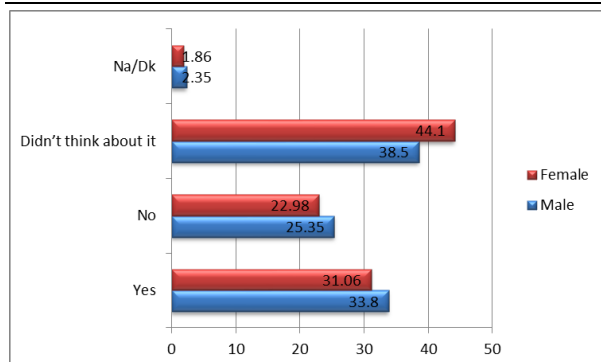

Fig. 7 Frequency of answers to the „Generally, do you think housework is equal to any other kind of paid work?” question, according to gender

Source: own SPSS analysis

Respondents from rural areas consider that household activities are equal to any other type of paid employment (+ 6.20%), while in urban areas, most have not thought about it (6.37%) (Fig. 8).

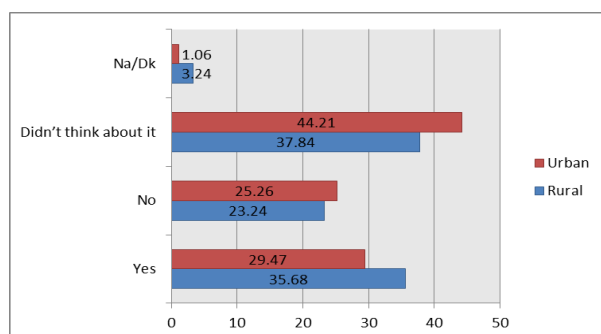

Fig 8. Frequency of answers to the „Generally, do you think housework is equal to any other kind of paid work?” question, according to residency

Source: own SPSS analysis

The high percentage of those who do not consider housework equal in importance with any type of paid work and those who have not thought about it shows that the traditional model of distributing household activities is taken up uncritically and unquestioned by the students. As shown, especially female students conform to this model, to the traditional role prescriptions, with little chance of change.

## CONCLUSIONS

Respondents revealed that in order to reach a happy marriage status, partners must "trust each other" "love each other", "support each other," "be faithful", „have a home of their

own", „sexual compatibility". Less important are perceived items such as: "close age", "having the same education," "having money". The partnership realized through marriage is based on mutual valuing of the other through trust, love, support, loyalty and only then home ownership. We note in passing the switch in choices from the rational criteria marital sphere (money, property) to the psycho-affective and relational type.

The single-parent family model is not regarded as an alternative to the conjugal family in terms of fulfilling all of the parental roles and functions.

Housework inside the families from which respondents come from are strictly distributed by gender.

The high percentage of those who do not consider housework equally important to any type of paid work and those who have not thought about it reveals that the traditional model of household activities distribution is taken up uncritically by students.

## REFERENCES

- [1] Balica, M., 2004, Perspective asupra dimensiunii de gen în educație. Ed. MarLink, București
- [2] Grunberg, L., 2002, Revoluții în sociologia feministă. Repere teoretice, contexte românești, Publirom,
- [3] Mihăilescu, I., 2003, Sociologie Generală. Concepte fundamentale și studii de caz. Ed. Polirom, Iași,
- [4] Mitrofan, I., 1998, Incursiune în psihosociologia și psihosexologia familiei, Editura Press Mihaela SRL, București
- [5] Voinea, M., 2005, Familia contemporană: mică enciclopedie, Editura Focus, București
- [6] UNPFA.org, News on Gender equality, <http://www.unfpa.org/gender-equality>

## MORPHOGENESIS OF CARBONATIOUS RENDZINAS PROFILE OF THE WESTERN UKRAINIAN REGION ON DIFFERENT STAGES OF THEIR ONTOGENESIS

**Andriy KYRYLCHUK**

Ivan Franko National University of Lviv, Department of Soil Science and Soil Geography, Doroshenka St. 41/104, Lviv, 79000, Ukraine, Mobile: +380673672698, E-mail: kyrylandrij@gmail.com.

**Corresponding author:** kyrylandrij@gmail.com

### **Abstract**

*The characteristic feature of Rendzinas (Rendzic Leptosols, WRB) is the surface and profile evidence of the residual carbonate inclusions fragmented in different size and form of the initial soil rock, amorphous coarse products of eluviogenesis in the form of farinose carbonaceous dusting and, also, new formations – the fine carbonaceous material, which is not morphologically defined in solid phase of soil. The article justifies the expediency of the macromorphological research parameter usage and carbonaceous admeasurement to identify the character and development direction of the decarbonation processes and the peculiarities of carbonaceous Rendzinas profile morphogenesis on different stages of their ontogenesis.*

**Key words:** residual carbonate inclusions, amorphous coarse products of eluviogenesis, new formations of the fine carbonaceous material, decarbonation processes, carbonaceous profile morphogenesis, stages of ontogenesis

### **INTRODUCTION**

Rendzinas (Rendzic Leptosols, WRB) development on carbonaceous soil rocks is mainly defined by the influence of Calcium and Magnesium carbonates. Most of Rendzinas properties depend on the quantity of carbonaceous inclusions, the character of carbonaceous rocks, their mineralogical composition, the quantity and composition of insoluble impurities, peculiarities of weathering [3].

In the process of soil formation on eluvium weathering crust of the massive crystalline or carbonaceous rocks the Rendzinas profile is imposed on the profile of the weathering crust, which is understood as an accumulation of weathering zones that develop under the influence of such physical processes as disintegration, hydration, leaching, oxidation and hydrolysis [4].

It is known that the weathering crust of the carbonaceous rocks has three characteristic layers: fractured, detritus and dispersive. The last layer mentioned is not common everywhere, and only in the shape of separate

areas of sand and silty, silty and clay-sand material. The most common combinations seen more often are the detritus and dispersive layers, in which the last one is a filler between the detritus of the carbonaceous rock fragments. Being affected by soil formation, these layers are transformed into genetic Rendzinas horizons, where the processes of weathering and soil formation occur simultaneously. The uniform thickness at the beginning of the hypergenesis process is divided into two dissimilar formations: the soil and the weathering crust or eluvium of the rock [3], [4], [8], [9].

The presence in the genetic profile of petrous soils, broken stone and gravel granulometric elements presented by detritus of initial soil rock, comparatively high content of foreign material of fluvioglacial or eolian origin, consistent water conduction, a large CaCO<sub>3</sub> content in solid phase – all this largely reflects the specificity of character and direction of soil forming processes, in particular, the decarbonation and differentiation of carbonaceous Rendzinas profile [10], [11]. In the weathering process of detritus of the

soil carbonaceous rocks, dissolution and leaching of carbonates take place, moreover, the main mass goes away from the Rendzinas profile and, partially, is deposited on a specific depth in the fractures and cavities of the rock in the form of occluding formations. It is exposed most clearly in soils with the wash type of water regime in the forest-meadow zone. Thus, Rendzinas are characterized by carbonates only in the form of the deposited formations, and their accumulation in the profile should be reviewed as the intrazonal phenomenon [1], [5], [6], [11].

## MATERIALS AND METHODS

The question of carbonaceous Rendzinas profile formation and their decarbonation, as a result of dissolution and leaching of carbonates, is highlighted in many of academic works (Duchafour, 1970; Kask, 1970; Targulyan, 1985; Samoylova, 1986, 1991; Sokolov, 1997; Reyntam, 2001; Zagursky, 2003; Gagarina, 2004, 2012 and others). At the same time, it should be mentioned that the number of academic works dedicated to the problem of differentiation of carbonaceous Rendzinas profile on different stages of their ontogenesis in various natural and natural-anthropogenic conditions of the Western Ukrainian Region is insufficient.

The research carried out by Kask [7] shows that the main process of chemical weathering of carbonaceous rocks is dissolution, in the process of which carbonates are transformed into bicarbonates and are taken out of soils if the water regime is of a wash type (the process of decarbonation). This process is followed by physical weathering, which leads to grinding of tight sedimentary rocks into smaller pieces. According to the data given by the author during 2-3 years, coarse fragments are grinding into 1-5 cm and an average 300-350 kg of  $\text{CaCO}_3$  are washed away annually from 1 ha area within Estonia. The dissolution of carbonate rocks leads to a residual accumulation of the insoluble residue on the surface. The intensity of such accumulation depends on the composition of carbonate rocks, filtration rate of seeping water, on its

aggressiveness and  $\text{CO}_2$  concentration in the water. The most intensive accumulation occurs in acidic environment under not very high infiltration water rate and increased  $\text{CO}_2$  concentration [7], [12], [14].

Very interesting is Gagarina's publication which shows the mechanism of detritus weathering of carbonate parent rocks [3], [4]. The author notes that in the process of limestone weathering the destruction of structural links occurs due to dissolving, in the first place of cryptocrystalline carbonate substance between carbonate crystals. This increases access of aggressive solutions to carbonates and accelerates their dissolution. As a result, rocks porosity increases, their density decreases and surface roughness enlarges. In neutral conditions carbonate dissolution process slows down and the initial stage of forming weathering product takes place. In case of weathering of the same carbonate rocks in different environments various products are formed. The degree of carbonate rocks conversion depends on their structural and textural features: weathering increases with the decreasing of particles size that make up the rock, the presence of micro and cryptocrystalline calcite mass in intergranular space and increasing of sedimentation links. Since carbonate particles are the least resistant components, they represent a kind of microgeochemical barrier, which deposits substance brought by soil solution, resulting in claying and ironing of carbonate particles [3], [4], [15]. As a result of dissolution carbonate rocks change their appearance: colour changes (brown colour appears), volume decreases and porosity increases. Accordingly, chemical and mineralogical composition of carbonate particles changes.

The aim of this work is to substantiate advisable macromorphological research parameters and carbonation values in order to establish the nature and direction of decarbonation processes development and peculiarities of carbonate Rendzinas profile morphogenesis on different stages of their ontogenesis and in different natural and natural-anthropogenic conditions of the Western region of Ukraine.

For the analysis of morphogenesis

peculiarities of carbonaceous Rendzinas profile on different stages of their ontogenesis we used comparative-geographical, morpho-geological and cartographical methods.

Expedition and semi stationary methods were used in field investigations.

Analytical work was performed according to standard procedures, CO<sub>2</sub> carbonates - according to the method of Gejsler-Maksymjuk, bulk density - by the method of cutting the ring (size 50 cm<sup>3</sup>) from the laboratory of Lytvinov, carbonate stocks and differentiation factor of carbonate content - by the calculation method.

## RESULTS AND DISCUSSIONS

According to physical-geographical zoning (Marynych et al., 2003) Western region of Ukraine is located within the two countries: East European Plain and the Ukrainian Carpathians. The research comprises the mixed forests zone of Polisia, where two regions of Volynian and Maly Polisia are differentiated, and also the zone of broadleaf forests of the Western Ukraine, which is divided into five regions: Volyn', Western-Podil's'k, Central Podil's'k, Prut-Dnistrovs'k heights and Rostots'k-Opils'k region (Roztochia and Opilya) [13].

The climate of the research territory is characterized as moderately continental, with long hot summers, short mild winters and adequate moisture. The average annual precipitation – 600–700 mm. Hydrothermal coefficient is 1.43–1.74. Currently, the natural vegetation (mixed and deciduous forests with well-developed grass cover) under which the studied soils were formed is almost entirely transformed by human activity. Arable lands dominate in the structure of agricultural land. The plow - 79.5% [17].

During 2003–2013 eleven modal plots were laid, which represent the chronological rows of Rendzinas that correspond to different space-time stages of their ontogenesis and are formed on the products of eluviogenesis of different carbonate rocks. Every modal plot is represented by 10 supporting soil profiles (Fig. 1).



Fig. 1. The research territory

Source: Author's map

Elements of chronological rows which were studied, were not separate soils, but the collection of Rendzinas varieties which according to the profile capacity are divided into: poorly-developed (< 25 cm), short-profiled (from 25 to 45 cm), fully-profiled (> 45 cm) which are confined to different relief elements (denudation undulating plains, upland interfluves, plain-tuberous and hilly-upland areas, remnants of limestone hills, steep (> 10<sup>0</sup>) and very declivous slopes of rivers, etc.), types of parent rock (eluvium of Turon-Senon chalk and chalk-marl deposits, eluvial-diluvial Turon-Senon chalk marl deposits, eluvium cluster, chemogenic and lithothamnium limestones of upper Badenian) and vegetation (associations of perennial grasses, pine woodlands, beech and pine forest, associations of perennial grasses with moss impurities, zonal cultural vegetation, and without vegetation), that is, chronological rows can be defined as pedotopocaten, pedolithocombinations and pedophitocombinations [12], [17].

The predominant parent rocks within Volynian Polisia, Maly Polisia and north-western part of West-Podil'sk highland region are the products of eluviogenesis of Turon-Senon deposits of the upper cretaceous system, lithologically represented by chalk and chalk marl. At the same time within



Roztochya-Opilsk highland region and the central part of Western Podilsk highland region the predominant parent rocks are products of eluviogenesis of upper Badenian deposits lithologically represented by cluster, chemogenic and lithothamnium limestones.  $\text{CaCO}_3$  content in presented rocks changes in a wide range. The highest  $\text{CaCO}_3$  content is present in the products of eluviogenesis of chalk which makes from 75 to 98%.  $\text{CaCO}_3$  content in the products of eluviogenesis of chalk marl is also quite high, ranging from 40 to 95%. Somewhat lower  $\text{CaCO}_3$  content presented in the products of eluviogenesis of cluster, chemogenic and lithothamnium limestones, in which it varies from 54 to 92%. Rendzinas formation on the products of eluviogenesis of carbonate parent rocks causes significant  $\text{CaCO}_3$  content in the soil profile. Almost all investigated soils are medium and strongly carbonate on the surface and within the profile. According to Gogolev [6]  $\text{CaCO}_3$  content in humus accumulative Rendzinas horizon in Western region of Ukraine ranges from several to several tens of percent, preferably 30-40%.

A characteristic feature of Rendzinas is the presence of eluvium of original parent rock as fragments of various size and shape in the profile, as well as finely dispersed carbonate material which is not morphologically identified in the solid phase [9], [10], [11].

The basis of Rendzinas evolution is a gradual leaching of  $\text{CaCO}_3$  rocks. According to Kask's investigations such characteristic features of carbonate leaching process from soil have been highlighted [7]:

- reducing of quantity and the size of initial carbonate rock fragments and carbonation of solid phase in the upper horizons;
- corrosion of carbonate particles surface;
- appearance of yellow-brown iron hydroxide covering on the surface of carbonate particles;
- decreasing of fragments strength in carbonate rocks;
- appearance of silicate particles carbonate crusts and covering on the bezel surface, which were formed due to precipitation of secondary carbonates from  $\text{Ca}(\text{HCO}_3)_2$  solution by evaporation of the latter;
- appearance of terrigenous material dusting

powder on the surface of carbonate broken stone.

In the classification the stages of this process define the subtypes of Rendzinas, where one of the main diagnostic features is the presence of morphologically expressed or unexpressed carbonate accumulations, in some form or other, at a certain depth which is detected by 10% HCl. Typical Rendzinas react on the surface under the influence of 10% HCl, leached only at the bottom of the profile, ashed (according to new terminology lessivage), have signs of colloids redistribution in the profile and react only within the parent rock [8].

Significant content of carbonates within the whole profile determines the formation of many important soil properties: porosity, soil connectivity, bulk density, structure, fractional humus composition, composition and concentration of soil solution. Carbonates play an extremely important role in alkalinity soil formation. Moderate  $\text{CaCO}_3$  content promotes the formation of well-defined structure, provides stable buffering, causes close to neutral (or weakly alkaline) reaction of soil solution. High level of carbonate accumulation usually degrades physical and physical-chemical soils properties [14].

To study the features of carbonate Rendzinas profile formation chronological rows which are associated with the presence of various carbonate forms, and identification of possible changes in distribution and forms of their manifestation within perfect and permanent stages of their ontogenesis (depending on developed profile), detailed macromorphological studies and determination of  $\text{CaCO}_3$  content and stocks have been conducted (Table 1).

For Rendzinas on the investigated territory carbonates are mainly in the forms of residual formations. The residual carbonates are:

- carbonate inclusions in the forms of fragments of various size and shape of the initial parent rocks;
- amorphous solid phase coarse and finely dispersed weathering products in the form of powdered carbonate dusting and carbonate residual neoplasms (whitish-grey or whitish-brown "saturated" halos around detritus of the

original carbonate rocks) and also not morphologically expressed in solid phase as carbonate impregnation.

Carbonate content in the investigated soil profile naturally varies with depth, forming several specific strips (zones) of prevailing forms of residual carbonate formations, indicating carbonate differentiation of their profile. Based on macromorphological studies of soil sections three strips are selected.

The *first strip* – from the soil surface to a depth of 25-30 cm with the presence of a small amount of carbonate parent rock fragments, 80-90% of which having diameter from 20 to 7 mm; 20-10% for pieces with a diameter less than 7 mm. It has been stated that the number of visible carbonate parent rock fragments (d=20-7 mm) in the column of 10 cm wide within this strip varies from 16 to 23 units. Carbonate inclusions undergo severe weathering and mechanical destruction (in cultivated variants), testifying modified close to the oval shape, slight bulk density and the formation on their surface of friable weathered layer with the thickness of about 2-3 mm. In addition, the presence of finely dispersed solid carbonate material is observed in the form of powdered dusting on bezels of structural units, on the walls of root passages and mesofauna. The presence of residual carbonate neoplasms in the form not expressed morphologically (carbonate impregnation) is permitted, which indirectly indicates rapid and continuous reaction of 10% HCl with total solid phase.

The strip is characterized mainly by low CaCO<sub>3</sub> content and its significant variability (4.48 – 41.0%). This indicates the trend of dissolution process development and carbonate leaching (Table 1).

The *second strip* – at the depth of 30 to 45 (50) cm. There is visible in the upper part and quite significant in the lower part increase of size and content of carbonate parent rock fragments, 70-80% of which are over 20 mm, 30-20% from 20 to 7 mm or less; the column of 10 cm within the strip contains from 17 to 24 units of carbonate visible inclusions, which due to larger size take a significant strip capacity.

Table 1. Carbonate content and stocks in Rendzinas and differentiation factor of their profile

Horizon	Depth, cm	Db <sup>a</sup> , Mg/m <sup>3</sup>	CaCO <sub>3</sub> <sup>b</sup> , %	S <sub>CaCO<sub>3</sub></sub> <sup>c</sup> , t/ha	Sk <sup>d</sup>
Fully-profiled Rendzinas MP №1, "Kupychyv"					
Ap <sub>Ca</sub>	0-16	1.34	17.98	240.93	4.38
ACp <sub>Ca</sub>	16-32	1.48	16.34	241.83	
A/C <sub>Ca</sub>	32-42	1.36	77.63	1055.77	
C <sub>Ca</sub>	52-62	-	82.54	-	
Fully-profiled Rendzinas MP №2, "Radekhiv"					
Ap1 <sub>Ca</sub>	0-22	1.50	23.05	345.75	2.45
Ap2 <sub>Ca</sub>	23-33	1.48	25.83	382.28	
AC <sub>Ca</sub>	35-45	1.43	45.15	645.65	
A/C <sub>Ca</sub>	50-60	1.30	65.10	846.30	
C <sub>Ca</sub>	65-75	-	81.30	-	
Short-profiled Rendzinas MP №3, "Radyvyliv"					
Ap <sub>Ca</sub>	0-10	1.37	9.24	126.59	1.22
ACp <sub>Ca</sub>	21-30	1.52	10.16	154.43	
C <sub>Ca</sub>	30-40	-	90.82	-	
Fully-profiled Rendzinas MP №4, "Bilyj Kamin"					
Ap1 <sub>Ca</sub>	0-25	1.52	12.35	187.72	2.86
Ap2 <sub>Ca</sub>	25-31	1.57	13.50	211.95	
AC <sub>Ca</sub>	32-45	1.53	28.51	436.20	
A/C <sub>Ca</sub>	55-65	1.45	37.00	536.50	
C <sub>Ca</sub>	70-75	-	78.90	-	
Fully-profiled Rendzinas MP №5, "Khvativ"					
Ap1 <sub>Ca</sub>	0-17	1.23	12.26	126.28	3.26
Ap2 <sub>Ca</sub>	17-30	1.38	13.08	180.50	
AC <sub>Ca</sub>	32-42	1.42	28.60	406.12	
A/C <sub>Ca</sub>	42-52	1.36	30.24	411.26	
C <sub>Ca</sub>	65-75	-	40.04	-	
Anthropogenically-violated Rendzinas MP №6, "Jaseniv"					
Ap <sub>Ca</sub>	2-30	1.23	12.67	155.84	2.91
ACp <sub>Ca</sub>	30-49	1.36	15.53	211.21	
Ab <sub>Ca</sub>	49-58	1.35	13.89	187.52	2.42
ACb <sub>Ca</sub>	58-68	1.27	29.42	373.63	
A/Cb <sub>Ca</sub>	73-83	1.48	30.65	453.62	
C <sub>Ca</sub>	90-100	-	40.08	-	
Poorly-developed Rendzinas MP №7, "Bila Hora"					
AC <sub>Ca</sub>	0-13	1.01	27.62	278.96	1.76
A/C <sub>Ca</sub>	13-20	1.31	37.55	491.90	
C <sub>Ca</sub>	40-50	-	47.82	-	
Fully-profiled Rendzinas MP №8, "Voronjaky"					
Ap <sub>Ca</sub>	0-20	1.35	31.65	427.28	1.85
AC <sub>Ca</sub>	30-40	1.45	41.00	448.63	
A/C <sub>Ca</sub>	42-52	1.32	59.80	789.36	
C <sub>Ca</sub>	60-70	-	92.51	-	
Short-profiled medium leached Rendzinas MP №9, "Ivano-Frankove"					
A <sub>Ca</sub>	4-21	1.02	-	0	-
A/C <sub>Ca</sub>	35-45	1.32	31.14	411.05	
C <sub>Ca</sub>	65-75	-	92.85	-	
Fully-profiled Rendzinas MP №9, "Ivano-Frankove"					
A <sub>Ca</sub>	3-19	1.01	4.48	45.25	15.22
AC <sub>Ca</sub>	19-32	1.19	32.28	384.13	
A/C <sub>Ca</sub>	42-52	1.36	50.64	688.70	
C <sub>Ca</sub>	65-75	-	92.85	-	
Fully-profiled Rendzinas MP №10, "Bererzany"					
Ap1 <sub>Ca</sub>	0-17	1.12	19.59	219.41	2.42
Ap2 <sub>Ca</sub>	17-34	1.36	23.68	547.48	
AC <sub>Ca</sub>	41-51	1.30	29.12	378.56	
A/C <sub>Ca</sub>	55-65	1.38	38.55	531.99	
C <sub>Ca</sub>	85-95	-	54.11	-	
Fully-profiled Rendzinas MP №11, "Boryshkivtsi"					
Ap1 <sub>Ca</sub> <sup>+</sup>	0-27	0.95	10.21	97.00	3.97
Ap2 <sub>Ca</sub>	27-47	1.34	20.76	278.18	
AC <sub>Ca</sub>	47-62	1.40	27.50	385.00	
C <sub>Ca</sub>	65-75	-	57.50	-	

Note. a – average values of bulk density, Mg/m<sup>3</sup> (n=5); b – average values of CaCO<sub>3</sub> content, % (n=10); c – carbonate stocks, t/ha; d – differentiation factor of carbonate content; e – modal plot.

Source: Own calculation



A characteristic feature of this strip is the formation of “saturated halo” around carbonate inclusions in the form of coarse carbonate amorphous mass of whitish-grey or whitish-brown colour, about 3-4 mm thick, being the result of intensifying process of carbonate dissolution and leaching under the influence of favorable hydrothermal conditions and fulvic acid (FA-1a) fraction, the content of which is significantly growing within the strip. Along with carbonate inclusions the presence of morphologically expressed coarse carbonate material occurs in solid phase, testified by a whitish hue. Considerable number of inclusions in the form of amorphous products of eluvium weathering occurs, to a lesser extent, due to weathering of carbonate parent rock fragments “in situ” and to a bigger extent – due to migration of salts in the form of carbonate  $\text{Ca}(\text{HCO}_3)_2$  from the upper strip and their precipitation, as a result of  $\text{CaCO}_3$  excess. As Samoylova [15] and coauthors state, after dissolution and removal of free carbonates from the top of the profile, the carbonates of deeper horizons almost do not dissolve, as solutions coming from the top are saturated by bicarbonate and cannot dissolve them.  $\text{CaCO}_3$  content compared with the upper strip increases significantly and is 20.70–72.69% (Table 1).

Samoylova and Tolchelnikov [16] believe that capacity growth of Rendzinas genetic horizons (hence the second strip capacity) is in direct proportion to the capacity growth of alkali thickness.

The *third strip* – lies at the depth of 45 (50) to 60 (65) cm, sometimes deeper, composed mainly by coarse fragmental carbonate material; detritus size ranges from 30 to 50-70 mm. This carbonate material is surrounded by clay-humus mass, which is marked by uneven greyish-white colour, sometimes with a brownish hue, due to uneven mixing with weathering products of the initial parent rock, as stones, gravel, sand and dust. Carbonate coarse detritus is characterized by a quite significant density (hardly destroyed), square shaped with a relatively well-defined clear bezel. On the surface of inclusions traces of initial dissolution in the form of greyish-white

powder dusting not more than 1-2 mm thick can be seen.  $\text{CaCO}_3$  content is somewhat lower than in the parent rock and ranges from 27.50 to 77.63% (Table 1).

The feature of profile carbonate content distribution in Rendzinas is their quite gradual growth in the upper part of soil profile to a depth of 10-20 cm in underdeveloped and low profiled and 20-40 cm complete profiled and also rapid growth of their content in lower and middle parts. Distribution curve has a clear concave shape, indicating almost uniform removal of carbonates under the influence of dissolution and leaching. According to the classification by Kovda and Rozanov [8] soils under study are characterized by regressive-eluvia type of the profile carbonates content distribution, approaching to uniformly eluvia in some cases.

Morphologically expressed differentiation of visible carbonate formations and inclusions in Rendzinas (Rendzic Leptosols, WRB) profile are combined with the gradual growth of their content down the profile. On this basis poorly-developed Rendzinas relate to strongly differentiated ( $Sk=1,76$ ), short-profiled to weak and medium differentiated ( $Sk=1.22 - 1.44$ ) and fully-profiled mainly to sharply differentiated ( $Sk=2.11-15.22$ ). Fully-profiled Rendzinas (MP №9, “Ivano-Frankove”) which were formed on the eluvium cluster limestones of upper Badenian, under beech and pine forest with developed grass cover have the highest carbonate profile differentiation ( $Sk=15.22$ ) (Table 1).

For complex assessment of carbonation variability in Rendzinas you have to take into consideration that the bulk density of genetic structure in different soil horizons is different. Therefore, carbonate content data have been listed in their stocks (t/ha) for each genetic horizon of soils under study and separately for a layer 0-20 cm (Table 1).

Comparative analysis of indexes of carbonates content and stocks in Rendzinas of defined chronological rows enables to note the following:

- the largest carbonate reserves in 0-20 cm layer are in poorly-developed Rendzinas which were formed on the eluvium of Turon-Senon chalk-marl deposits are on the modal

plot №7 “Bila Hora” (770.86 t/ha) (Table 1);

- the least carbonate reserves in 0-20 cm layer are in fully-profiled Rendzinas which were formed on the eluvium cluster limestones of upper Badenian are on the modal plot №9 “Ivano-Frankove” (45.25 t/ha);
- carbonates in short-profiled medium leaching Rendzinas of modal plot №9 “Ivano-Frankove” in 0-20 cm layer are completely absent. This is primarily due to the fact that the soils are under forest. As Duchafour [2] states, in similar soil forming conditions the process of carbonate leaching under the forest is 4 times faster than under meadow and steppe vegetation;
- in case of transition of poorly-developed Rendzinas into short-profiled (modal plot №7 “Bila Hora”) carbonate reserves in the latter slightly increase due to higher bulk density of upper horizons of short-profiled Rendzinas;
- in case of transition of short-profiled Rendzinas into fully-profiled, carbonate reserves in their profile increase;
- carbonates content and stocks in fully-profiled Rendzinas increase almost uniformly down the profile to a parent rock (modal plots №1, 2, 4, 5, 8, 9-11) (Table 1);
- carbonates content and stocks in anthropogenically-violated Rendzinas (modal plot №6, “Jaseniv”) change unevenly down the profile to a parent rock (Table 1).

## CONCLUSIONS

Analysis of macromorphological and laboratory-analytical research data indicates certain morphogenesis features of carbonaceous Rendzinas (Rendzic Leptosols, WRB) profile on different stages of their ontogenesis. It has been discovered that the formation of investigated Rendzinas carbonate profile, the present state of which corresponds to perfect and permanent stages of ontogenesis in different natural and natural-anthropogenic conditions of Western region Ukraine is characterized by a predominance of carbonates in the form of residual formations, domination of decarbonation processes, the intensity of which increases in accordance with the above stages and the degree of

differentiation of their profile from low and medium to sharply differentiated.

## REFERENCES

- [1]Andrushchenko, G.O., 1970, Grunty Zahidnyh oblastey URSS, “Vil’na Ukraina”, T.1., L’viv-Dubljany, p. 28-48.
- [2]Duchafour, F., 1968, Fundamentals of Soil Science. Evolution of soil (experiment to study the dynamics of soil formation), Paris, p. 502–511.
- [3]Gagarina, E. I., 2004, Litologicheskij faktor pochvoobrazovaniya (na primere Severo-Zapada Russkoy ravniny), SPb, Izd-vo S.-Peterb., Un-ta, Sankt-Peterburg, p. 87–91.
- [4]Gagarina, E. I., Abakumov, E. V., 2012. Počvoobrazujuščie porody s èlementami četvertičnoj geologii, Učeb., Posobie, SPb, Izd-vo S.-Peterb., Un-ta, Sankt-Peterburg, p. 100–108.
- [5]Gogolev, I. N., 1952, K voprosu o genezise tëmnocvetnyh (rendzynnyh) počv pod lesom. Počvovedenie, Vol. 3: 241–250.
- [6]Gogolev, I. N., 1958, Rendzinnye (peregnojno-karbonatnye) počvy Zapadno-Ukrainskogo Polesja i ih genezis, Prirodnye uslovija i prirodnye resursy Polesja, Kiev, 114–123.
- [7]Kask, R. P., 1976, Dernovo-karbonatnye vyščeločennye i opodzolennye počvy ili, burozëmy. Počvovedenie, Vol. 7: 17–27.
- [8]Kovda, V. A., Rozanov, B. G., 1988, Pochvovedenie. Pochva i pochvoobrazovanie, Vyssh. shkola, T.1., Moskva, p. 34 – 45.
- [9]Kyrylchuk, A. A., Poznjak, S. P., 2004, Dernovo-karbonatni grunty (rendziny) Male Polissja, Vyd. Centr, Lvivs’koho nacional’noho universytetu im. Ivana Franka, Lviv, p. 114–124.
- [10]Kyrylchuk, A. A., 1999, Osoblyvosti formuvannya karbonatnogo profilyu v dernovo-karbonatnyx gruntax /rendzyny/ Malogo Polissya, Visn. L’viv un-tu, Seriya geografichna, Vol. 25: 11–15.
- [11]Kyrylchuk, A. A., 2004, Shhebenyuvatist` i karbonatnist` rendzyn Malogo Polissya, Agrarnyj visnyk Prychornomorja, Vol. 21: 150–156.
- [12]Kyrylchuk, A. A., 2013, Peculiarities of Rendzic Leptosols distribution in Western region of Ukraine, Geografija, Vol. 49. (2): 105–113.
- [13]Marynych, O. M., Šyščenko, P. G., 2003, Fyzyčna geografija Ukrainy, Znannja, KOO, Kyiv, p. 48–58.
- [14]Orlov, D. S., 1992, Himija počv, Izd-vo Mosk. Un-ta, Moskva, p. 74–92.
- [15] Samoylova, E. M., 1991, Pochvoobrazuyuschie porody, Izd. MGU, Moskva, p. 93–114.
- [16] Samoylova, E. M., Tolchelnikov, Yu. S., 1981, Evolyutsiya počv, Izd. MGU, Moskva, p. 32–38.
- [17]Vernander, N. B., 1986, Pochvy lesostepnoj zony. Pryroda Ukrainskoj SSR, Počvy, Naukova dumka, Kiev, 82-92.



## COMPETITIVENESS OF AGRIFOOD PRODUCTION OF THE REPUBLIC OF MOLDOVA THROUGH ITS EXPORT

Aurelia LITVIN, Cornel COSER

State Agrarian University of Moldova, 42 Mircesti street, MD-2049, Chisinau, Republic of Moldova, Phone: +37322432432, Email: a.litvin@uasm.md, c.coser@uasm.md

*Corresponding author:* a.litvin@uasm.md

### *Abstract*

*Latest developments demonstrate that the constantly imposed barriers to Moldova's agrifood export by the Russian Federation highlighted the most vulnerable points of the foreign economic activity, especially the relatively low share of exports of processed products, low diversification of the markets, the large number of traditional products in traditional markets. Refocusing on the European Union market has a slower pace than the loss of East markets and the prospect of alternative destinations (Middle East, for example) is very difficult. Based on price and non-price competitiveness, the agri-food exports of the country are much less advanced than those of competitors, which further complicates the dynamics of foreign trade.*

**Key words:** agri-food, competitiveness, export, Moldova, trade

### INTRODUCTION

A country can not be considered truly competitive, using such instruments as cheap labor, grant instruments, currency depreciation or economic development based on external borrowing.

At one point, cheap labor can boost the penetration of new markets, devaluation of national currency - to stimulate exports, gaining price relative advantages, borrowing – budget expenditures financing.

But these instruments do not contribute to increasing of production factor total productivity and can not ensure the sustainable development of the economy. Following the assurance of national competitiveness, the tools used must be aimed at increasing productivity that would provide higher real income, in other words, big salaries.

Also, the productivity can only be ensured through the use of skilled labor, implementation of modern technologies and innovations: of process, product, management system etc.

And these are in contradiction with development of performance on external market based on cheap labor.

### MATERIALS AND METHODS

In order to elucidate the agri-food export competitiveness of Moldova, there were used data from international organisations, national statistics and analysis reports. The methodology used allowed the analysis, synthesis and comparison of various indicators related to agri-food export and competitiveness.

### RESULTS AND DISCUSSIONS

National competitiveness can be ensured by exporting products requiring high added value that ensures profits increase, respectively, allow to increase wages. Also, emphasis should be placed not only on aspect - price but on quality parameters that would allow the exported products to maintain sales market even under a strong national currency. Currency appreciation lead to increased prices of exports relative to imports. In those circumstances, the revenue collected from the export may be increased volume of imports, including modern technologies, and thus having a positive effect on the trade balance, even under reduced exports.

Distribution of domestic exports was influenced by a number of factors/events,

most of which we consider to be influential:  
 -numerous embargoes imposed by the traditional and important partner of Moldova - Russian Federation, during the period 2006-2014, to major products in the structure of national export - wine, fruit, vegetables, their products, meat and meat products etc.

-gradual granting by the European Union of various instruments to facilitate trade between Moldova and this entity, namely the Generalized System of Preferences (2006), the Autonomous Trade Preferences (2008), signing the Association Agreement with the EU and hence the creation of the Deep and Comprehensive Free Trade Area (DCFTA) in 2014.

-the accession of Romania, Moldova's important trade partner, to the European Union (2007), which "enhanced" statistics of trade relations with the EU.

Structured according to a top, statistical data [3] argue exposed developments - Russia's position in attracting Moldovan exports decreased significantly in 2014 compared to 2012, from over 655 mln. USD to 312 mln., namely more than 2 times (Fig.1.).

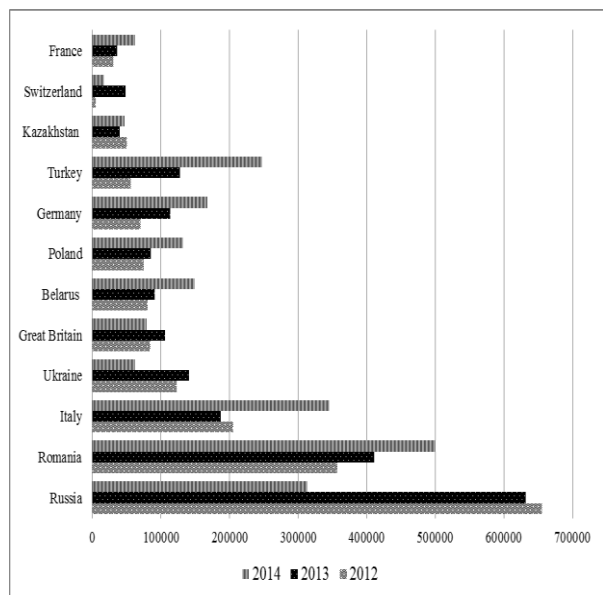

Fig. 1. Top export partners, years 2012-2014, thousand USD

Source: developed by the author based on data from International Trade Centre

Other significant reductions our exports registered in Ukraine (-49%) and Kazakhstan

(-7.5%). Thus, practically all Moldovan exports to CIS partners recorded significant decreases. In synchronism, they increased exports to destinations in Europe, which replaced into the top the traditional partners - Russia and Ukraine. Romania became the main partner in the absorption of our exports in 2014, with a value of 500 mln. 130 thousand USD, defeating Russia and thus registering an increase of 40.2% in 2012-2014. Turkey recorded significant growth (340.5%), also Germany (138.8%), France (102.7%), Belarus (84.9%), Poland (78.8%), Italy (68.3% ).

Pedo-climatic conditions and economic history of the Republic of Moldova relies on the argument that, traditionally, Moldovan exports are dominated of agrifood products. Although over the last decade (2005-2014), agrifood products decreased their share gradually in the country's export, from 53.4% in 2005 to 45.5% in 2014, they continue to be an important category, taking into consideration the real potential of export, related industries but also that the Compound Annual Growth Rate (CAGR) of these is quite high: 15.3% for the vegetable products and 13.2% for the animal products. However, amid the situation in the region [9], the share of agrifood products in total exports is much higher in Moldova (figure 2), and in the case of the analyzed countries, it is much smaller, but growing in the years 2000-2014, due modernizing in the agrifood industry.

Detailing the sections of agrifood commodities [1], we can note that during 2012-2014 years only item "Livestock and animal products" records negative trade balance (Fig. 3), which causes that trade balance of agrifood products to be positive as a whole, increasing ( USD 135.5 million in 2012, USD 231.7 million in 2013, USD 346.0 million in 2014).

The most constant trend, but also the highest value is observed, traditionally, in "Vegetable products", with a trade balance of USD 354,265 thousand in 2014, followed by "Food, beverages and tobacco", with an export of USD 378435 thousand in 2014.

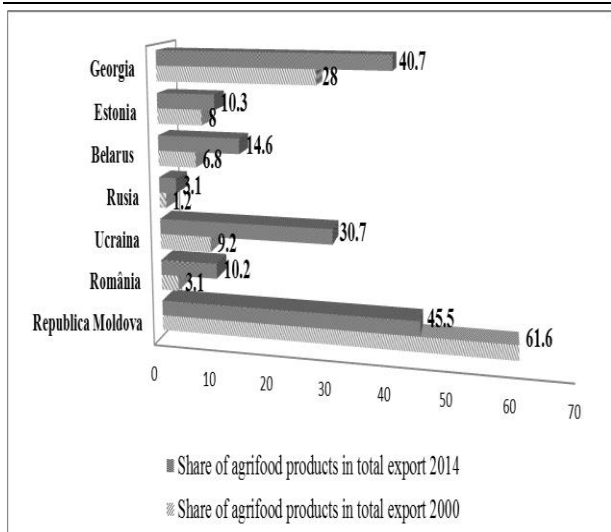

Fig. 2. The share of agrifood export in total exports, compared with countries in the region, the years 2000-2014, %

Source: developed by the author based on data from World Bank. World Development Indicators: Structure of merchandise exports

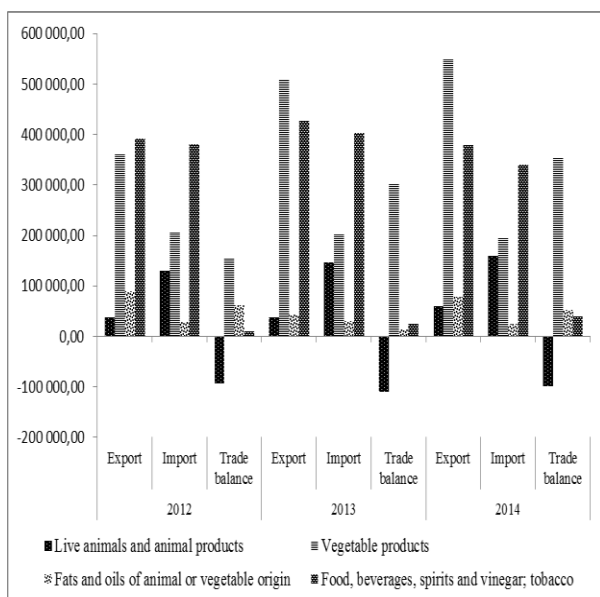

Fig. 3. Export, import and trade balance of agrifood sections, period 2012-2014, thousand USD

Source: developed by the author based on data from National Bureau of Statistics

Agrifood exports structure suffered major changes in period 2005:2014 (Fig.4), especially focusing on the export of processed products – "Food, beverages and tobacco", which has declined from 68% of total exports of agrifood goods in 2005 to 35% in 2014, which attests significant shortcomings of adapting the industry to various shocks/external embargoes, but also the lack of significant processing capacities. Thus

"vegetable products" increased their share from 23% (2005) to 52% (2014), "animal products" - from 3% to 6%, and "fats and oils" had the most constant trend of the share - around 6-7% in both periods.

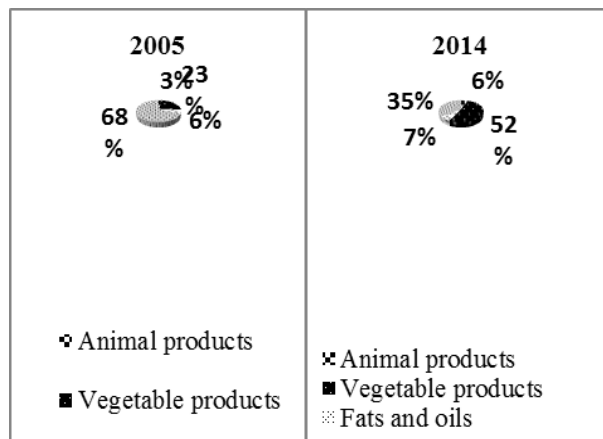

Fig. 4. Structure of Moldova's agrifood exports on sections, years 2005, 2014

Sursa: developed by the author based on data from National Bureau of Statistics

Moreover, a detailed analysis reveals that first 6 positions exported in 2014, of the total agrifood export value that equals to USD 1,065,357 thousand: oilseeds, cereals, fruits, beverages, oils and fats, fruit preparations and vegetables, sum up more than 95.96% of the total agrifood export, and of these, 4 positions are products that have a degree of processing. A breakdown at 4 digits (HS) of tariff headings in the last 2 years - 2013 and 2014 elucidates the actual structure of agrifood exports (table 1). Animal products are steadily declining in export ranking, except natural honey (0409). Tomatoes (0702) have greatly diminished their share in export in favor of potatoes (which increases in ranking from 67 to 38) and in particular due to the significant increase in the share of frozen vegetables (0710), which recorded exports of USD 5.673 million and occupied position 22, for the first time. Nuts (0802) were traditionally kept in third position, and apples, pears and quince lost a position (from 7 to 8). Exports of grapes (0806) has advanced significantly, from USD 17,028 thousand in 2013 to USD 31799 thousand in 2014, i.e. 1.8 times. Among cereals, maize (1005) recorded the most significant increases (from 9 to 2), worth over 111 million USD in 2014, exceeding in value

the sum of exports of major fruits and vegetables and ranking on second position. Position 1 was occupied in 2014 by sunflower, which had a positive continuous development, with export value of over 192.5 million USD. Sugar (1701) also had a rising trend (from 12th place to 9th). A modest but positive dynamic had pastries (1905), as well as canned vegetables (2005). At the same time, significantly decreased, with 4 positions, the exports of fruit and vegetable juices (2009), with 3 positions the wine exports (in 2204), up to USD 105.7 million as well as tobacco (2401), with nine positions in the ranking.

Table 1. Breakdown of agrifood exports of the Republic of Moldova, period 2013-2014

Indicator s	Product				
	Beef	Wine	Apple	Nuts	Sunflower
2013					
Export value, thousand USD	11,875	149,590	48,015	97,522	136,153
The trade balance, thousand USD	11,674	147,651	46,668	88,644	123,218
% of total export	0.49	6.16	1.98	4.02	5.61
Rank in the sector export	18	1	7	3	2
2014					
Export value, thousand USD	5,066	105,717	47,620	109,686	192,541
The trade balance, thousand USD	4,671	103,768	47,126	100,727	176,758
% of total export	0.19	3.88	1.75	4.02	7.06
Rank in the sector export	24	4	8	3	1

Source: developed by the author based on data from International Trade Centre

Sparling and Thompson [7] explains the agrifood sector competitiveness as being an indicator influenced by the costs, while some authors [5] and [4] explain the importance of the quality framework.

Also, there are studies that link competitiveness to sustainable development [8] and the literature indicates the existence of a multitude of factors that determine the competitiveness.

At the same time, the understanding of the complexity of the factors that push this process took scientists a long time - comparative advantage over other countries is explained by the provision of inputs on classical theory, investment in fixed capital and infrastructure at neoclassical approach. Already talking about competitive advantage, M. Porter [6] highlights five fundamental factors, which he structured into National Diamond - factors of production, domestic demand, related industries, business strategy and competitors, government policies.

Currently, there are studies on the comparing the performance of business environment in different countries and national competitiveness, analyzed under a variety of drivers. National competitiveness is directly determined by the domestic economic environment. Therefore a first exercise in determining the level of national competitiveness is related to internal economic environmental quality analysis. The following is a brief analysis of the national economic circumstances.

The long process of transition and the high vulnerability of the national economy to shocks, both internal and external, reveal the deficient model of development of the Republic of Moldova and indicates the low level of national competitiveness.

The unfavorable circumstances of the factors influencing the competitiveness of Moldovan economy is confirmed by the results of studies prepared by international organizations, Global Competitiveness Report (World Economic Forum) [10] and Doing Business Report (World Bank) [2] which focus on assessing the global competitiveness and performance of business environment in different countries.

**Doing Business Report** is an annual study conducted by the World Bank since 2003 and aims the comparison of regulatory framework for business in different countries, in other words, the cost of doing business. In this



report, all countries are categorized in a rating according to the degree of ease of doing business. The first report was published in 2003, analyzing the business environment in 133 countries after 5 criteria. In its latest report, Doing Business 2011, there are summarized regulations of 11 important stages of the business environment in 183 countries:

1. *Starting a business;*
2. *Obtaining building permits;*
3. *Property registration;*
4. *Obtaining credits;*
5. *Protecting investors;*
6. *Payment of fees;*
7. *Foreign trade;*
8. *Signing contracts;*
9. *Business contracting;*
10. *Access to electricity;*
11. *Employing workers.*

Ranking of countries in Report 2011 opposed to the previous one was based on first 9 criteria and supporting for two changes:

- Category "Employing workers" was analyzed in the report, but was not included as a performance criterion in ranking;
- In study there was also included the analysis of regulatory reforms in the field of energy access, considered a very important factor in doing business, but which also was not included as a performance criterion in the ranking.

According to the report, the most favorable climate for business development is in high-income OECD countries, followed by countries in Eastern Europe and Central Asia, and at the bottom of the ranking there are South and sub-Saharan African countries. The ranking is opened two consecutive years by such countries as Singapore, Hong Kong, New Zealand, UK, USA and Denmark and is closed by Chad, Central African Republic and Burundi.

In list of countries that registered the greatest performances in facilitating doing business in the previous year and that introduced policy changes in three or more areas are: Kazakhstan, Rwanda, Peru, Vietnam, Cape Verde, Tajikistan, Zambia, Hungary, Brunei.

And finally, an important role for local business development and national

competitiveness is the regulation of foreign trade operations. Facilitating international trade transactions has become an imperative condition for business development. In terms of external transactions, Moldova records the worst performances on building permits - position 141. This is a characteristic problem for most countries in post-Soviet space.

For handling export (import) operations an economic agent from Moldova needs a file consisting of 6 (7) acts, 1765 (1960) USD for the export of a cargo container, of which 1300 USD are required only to ensure expenses for domestic transport and the operation is conducted in at least 32 (35) days of which 20 days are required only to prepare the necessary documents.

Taking into account the best examples of conducting export/import operations in international practice, Moldova is still very far from such performance:

- Documents needed - 2 days - France;
- Days needed - 5 at export in Denmark and 4 at import in Singapore;
- Cost to export a container with goods - 450 USD at export in Malaysia and 439 USD at import in Singapore.

At the same time Republic of Moldova could at least tend to the example of the Baltic States - Estonia, Latvia.

## CONCLUSIONS

To achieve the primary endpoint - **ensuring national competitiveness** - the efforts of all actors of the economy should be aimed at creating a favorable climate for business development. A favorable climate would mean acting and improving all the factors - economic, political, social - that in some way influence the environment in which the economic entities operate and support within a nation the competitive advantages. These factors are very diverse and one of the most complex calculation methodology of the national competitiveness of the world's countries that tried to include most of them, is considered IGC (index of global competitiveness), developed by the World Economic Forum in Global Competitiveness Report. This indicator takes into account

many factors of competitiveness, classified into 12 categories - called "pillars of competitiveness". These pillars form the basis of development of any economy, but at different stages of development they have a different role. Depending on their importance to the economic development levels these pillars can be divided into three categories:

- essential factors: institutional system, infrastructure, macroeconomic stability, health and primary education;
- efficiency factors: higher education, goods market efficiency, labor market efficiency, financial market sophistication, technological degree of readiness, market potential;
- innovation and sophistication factors: business sophistication and innovation.

For example, the leverages used to increase national competitiveness in a developed country won't be the same as in a poor country. Also, the tools used to increase the efficiency of foreign trade, labor market etc. won't bring the expected results as long as there is not ensured the proper functioning of institutional system, developed infrastructure, basic conditions for a satisfactory level of health and primary education of the population of this nation.

## REFERENCES

[1] Biroul Național de Statistică al Republicii Moldova, 2015. <http://www.statistica.md/>

[2] Doing Business Report, 2011. <http://www.doingbusiness.org/reports/global-reports/doing-business-2011>

[3] International Trade Centre, 2015. <http://www.intracen.org/>

[4] Litvin, A., Coșer, C., 2014, Competitiveness and quality of agrifood products – key factors for the success of export promotion, Scientific Papers. Series "Management, Economic Engineering in Agriculture and rural development", vol. 14, issue 3: 147-154.

[5] Munteanu, L., 2013, International trade with agrifood products of Romania, as a consequence of the European quality conformity level, Scientific Papers. Series "Management, Economic Engineering in Agriculture and rural development", vol. 13, issue 1: 235-238.

[6] Porter, M.E., 1998, Competitive Strategy: techniques for analyzing industries and competitors, The Free Press, New York.

[7] Sparling, D., Thompson, S., 2011, Competitiveness of the Canadian Agri-Food Sector, Series II: Addressing Issues and Perspective on Policy Options, Canadian Agri-Food Policy Institute, Canada, 20.

[8] Stoeva, T., 2015, Competitiveness of Bulgarian vegetable production after the EU enlargement, Scientific Papers. Series "Management, Economic Engineering in Agriculture and rural development", Vol. 15, Issue 2: 391-396.

[9] World Bank. World Development Indicators: Structure of merchandise exports, 2015. <http://data.worldbank.org/indicator/TX.VAL.AGRI.ZS>. UN

[10] World Economic Forum, Global Competitiveness Report, 2011. [http://www3.weforum.org/docs/WEF\\_GC R\\_Report\\_2011-12.pdf](http://www3.weforum.org/docs/WEF_GC R_Report_2011-12.pdf)

## THE ECONOMIC GROWTH OF AGRICULTURAL SECTOR THROUGH INVESTMENT VALUES

Aurelia LITVIN, Svetlana PETRASCU

State Agrarian University from Moldova, 44 Mircesti Str., Chisinau, MD 2049, Phone: +37322432432, Emails:aurelia\_litvin@mail.ru, s.sasu@uasm.md

**Corresponding author:** aurelia\_litvin@mail.ru

### Abstract

*Any economic transformation, including the transformations in the agricultural sector, aims to develop the national economy. The market economy places the enterprise in the center of the economic activity of any branch of the economy. The obtained results, positive or negative, determine the entire national economy. The national economy is viable if it manages to stimulate the creation and development of a profitable business. Economic development, the increase of the population's living standards, investments attraction, exports promotion have become frequent subjects of primary interest for the agrarian sector of the Republic of Moldova. The reform process, implemented in the past decade, is difficult and has little progress. The results are mixed, and the tasks within the sector are huge, taking in consideration the challenges concerning EU accession.*

**Key words:** credits, financial services, grants, investments, young farmers

### INTRODUCTION

In the Republic of Moldova food sector has always been the basis of the national economy. At the time when this sector is going through a deep crisis, linked to domestic economic transformations, as well as the lack of sustainable sources of growth, the weight and impact of foreign investment sources emphasized. The research has shown that the most important part of foreign investment is allocated to this sector. Investments in agriculture should lead to larger capital stock, which will result in increased yields of the capital. It is obvious that, when the economy advances towards "steady state", investments give lower yields and growth rates remain constant. [10]

The need to increase investment in agriculture is dictated mainly by the growing demand for food and the need to develop sustainable agriculture. At the same time, these investments should not seek to promote industrial agriculture, but to use technologies that will promote environmental protection, resources, agro-ecological and social balance. The undertaken research and analysis have shown that investment plays a dominant role in the agricultural sector, particularly for the

Republic of Moldova, a country with low and middle incomes.

### MATERIALS AND METHODS

The material used for the undertaken survey consisted in research, data analysis and specialty literature interpretation. There were used such research methods as: analysis, comparison, deduction, monographic method. The information was gathered from the sources published by the National Bureau of Statistics, National Agency for Employment, the reports of the program IFAD and others.

### RESULTS AND DISCUSSIONS

In the economic life the investment activity has central place both in the production of goods and services sphere and in the sphere of consumption, being the factor that influences demand and supply simultaneously.

The rationale of this statement is given by the training processes and the multiplication of the effects that any investment project generates, regardless of the activity sector in which it is implemented.

Any investment project in the production of goods and services has the effect of increasing

and diversifying supply and, if this is validated on the market, increasing incomes of economic agents. Simultaneously, however, the level of labor employment growth will be influenced directly or through training effect. But the increase in the number of employees and / or their wage gains lead, ultimately, to the increase of the demand for goods and services. On the other hand, there will be an increase in household savings and in the available funds of economic agents that will lead to more efficient structures in line with the investment options.

Foreign investment has become the largest, most stable source of funding and implementation of a country's economic policies. International investment resources constitute important components of national economy restructuring, premises for relaunching production growth and social improvement. [1]

The problem of attracting foreign investments is not typical only for developing countries or for the countries in transition, such as Moldova, but also for developed countries. This leads to a competition among recipient countries, the factor of investment attractiveness of the country as an object for investments becoming increasingly important. The process of investments attraction in the economy of any country is a kind of a competitive game in order to offer more favorable conditions to foreign investors. [8]

The first element in attracting foreign investments is the legislation and basic economic investments. International experience has shown that to ensure minimal conditions for attracting foreign investors, investment and legislative sphere in economy should exist, function, and be transparent, stable and predictable. This is a necessary but not a sufficient condition. At the same time the capacity of attracting foreign capital is represented by the degree of economic openness to foreign investors, and the attitude of the population and political parties towards foreign investments.

A study made by the World Bank shows that foreign investment flows were directed towards those countries where there is a trade regime and a payment system according to

international standards, a system of liberal exchange, transparent and automatic incentive schemes, and favorable climate for business, where there are no barriers for investors. Foreign investment is discouraged in countries where the State plays the major role in the economy and in countries where corruption is high.

Attracting direct foreign investments involves the prior existence of political, economic, legislative conditions, without which any policies are meaningless.

The first element is represented by the basic legislation and economic investment: it is necessary to assure at least a minimal framework concerning companies, competition, bankruptcy, insurance, accounting system and others. The existence of these regulations is a necessary, but not a sufficient condition. [4]

The complementary aspect refers to the degree of effective implementation of the law and how economic institutions function in the market economy. International experience has shown that only the countries that have created a functional framework of the market economy were attractive to foreign investors.

So, to ensure minimal conditions to attract foreign investors, the institutional and legislative framework in economy must exist, operate, and be transparent, stable and predictable.

The second aspect of the capacity of attracting foreign capital is the degree of economic openness to foreign investors. It's absolutely natural that the countries, that fully opened their economy, allowed with the compliance with technical regulations, environmental protection, etc., access to investors in all fields, have attracted more foreign investors. On the other hand, the countries that excluded from the access area considerable strategic branches, or those that have allowed the privatization of public utilities (telecommunications, energy, water) had lower levels of foreign investment. [7]

Another general issue is the attitude of the population and political parties towards foreign investments. It is obvious that if there exists the manifestation of a hostile and xenophobic attitude to foreign investors,

among the population and at the level of political parties, foreign investors will be discouraged and will avoid to act on that market.

In general, the factors influencing investment decisions are of 3 types:

a – factors specific to the investing firm

b - locational factors;

c – political-administrative and legislative factors. [9]

To adjust the Republic of Moldova to EU standards related to phytosanitary requirements, product quality, environmental protection, competition issues, public procurement, and markets, besides financial resources, knowledge is needed. [11]

A large number of investment programs and projects help farmers in rural areas. In our opinion, the increase of investments in agriculture is due primarily to the fact that the private land area of agricultural destination constitutes over 86% and secondly, the number of landowners, who want to develop a business namely in this section, grows.

Also, there is increased lending to farmers by commercial banks with financial institutions and state subsidies.

At the same time, these programs and projects mobilize resources, providing opportunities for rural entrepreneurs to start and manage their own businesses.

The aid is mainly offered to young people aged between 18 and 35 years old who want to start or expand a business, to develop entrepreneurial skills.

In order to solve the problems in financing young entrepreneurs the Ministry of Agriculture and Food Industry negotiates with a number of external bodies.

According to the information on Investment Projects, from the beginning of Investment Projects Implementation for the development of small and medium enterprises there were financed about 6,773 sub-projects of beneficiaries, mostly in rural areas, totally amounting MDL 2,113.2 million, USD 88.96 million USD and Euro 38.08 million (or the equivalent of about MDL 3.82 Billion). [3]

In 2007-2013 there were invested in agriculture Lei 19,900 million lei from various investment sources and global agricultural production was obtained Lei 81,738.11 Million worth (Table 1).

Table 1. The investments value in agriculture in 2007-2013

	National Programs	State Subventions	Loans from Commercial banks	Foreign Investments	Total
Investments value, Lei Million	371.11	3,600	12,200	3,820	19,990
Investments value per 1 ha of agricultural land, Lei thousand/ha (2007-2013)	185.2	1,797.1	6,090.2	1,906.9	9,934.1
Investments value per 1 farmer, Lei/pers.	7,422.2	72,000	244,000	76,400	398,000
Investments value per 1 leu of Agricultural production (2007-2013) Lei	0.0045	0.044	0.15	0.046	0.24

Source: Elaborated on the basis of the information from AIPA, MF and commercial banks.

The main source of investment for the agricultural sector were loans obtained from commercial banks amounting to MDL 12.200 Million.

The fewer investments were made from the National Program, their value being of MDL 185,200 per 1 hectare of agricultural land in 2007-2013.

The data from Table 2 show that the largest number of loans in agriculture was offered by Moldova Agroindbank worth USD 961.7

Million.

Currently the most important international programs and projects in agriculture are: Portfolio of International Fund for Agricultural Development (IFAD, Program for Rural Financial Services and Marketing (IFAD-IV), Project for Rural Financial Services and Agribusiness Development (IFAD-V), Program for Rural Economico - Climatic Inclusive Resilience (IFAD VI); So far, with the help of this fund there were

conducted 133 training courses attended by over 50,000 young entrepreneurs; there were organized 72 days of field involving over 460 young farmers; there were made 16 study visits abroad involving 120 farmers; assistance was offered for the participation in specialized exhibition "Farmer", FruitLogisitca-2010 Berries of Ukraine, INDAGRO Interagro, Agro Animal Show Competitive Agriculture Pproject - MAC P Sponsor: World Bank IDA AIDS; The first grant program on facilitating access to markets is conducted by MAIA and has a budget of about \$ 7 mln. The second grant on increasing productivity through sustainable management of soil will have a budget of 3 million dollars. The beneficiaries of these projects can receive grants of 50% of total investment (up to 350 thousand US dollars) for the purchase of technological equipment and post-harvest equipment (sorting, washing, grading, packing, drying lines etc.). The sources are available through the AIPA.

Table 2. Credits value in agriculture

Bank name	Amount , MDL	Amount , USD	Total, USD
Moldova Agroindbank	782.5	179.2	961.7
Moldinconbank	250.4	158.7	409.1
Victoriabank	74.6	252.1	326.7
ProCredit Bank	282.3	20.0	302.3
Energbank	113.6	57.1	170.7
Eximbank-Gruppo Veneto Banca			
Banca Socială	111.8	20.6	132.4
Fincombank	117.7	8.5	126.2
BCR Chişinău	8.0	82.8	90.8
Banca de Economii	70.5	2.0	72.5
Mobiasbanca- Groupe Societe Generale	9.3	40.0	49.3
Unibank	27.5	0	27.5
EuroCredit Bak	6.3	4.0	10,3
Comerţbank	5.0	1.1	6.1
<b>TOTAL</b>			<b>2,852.2</b>

Source: prepared by the author based on the raports of the NBM.

The portfolio of the projects financed by the Japanese Government constitutes: Assistance Project for unprivileged farmers 2KR, which has been taking place since 2000. The

program for the development of small-scale irrigation system, which has been taking place since 2006. The project "Efficient use of solid fuel from biomass", which has been implemented since 2013 under the Grant Agreement, drawn up by an exchange of notes between the Government of the Republic of Moldova and the Government of Japan. The overall objective of these projects is to increase food production in Moldova by reducing crop loss and improving the quality of basic measures in the preparation of the soil.

Assistance for the General Agricultural Census, donor: the Government of Romania; TCP Facility, the Land Code of the Republic of Moldova. Donor: United Nations Organization for Food and Agriculture; Twinning Project "Support to Moldova in the field of food safety rules and standards for products of plant origin," Funder: European Commission.

Wine Sector Restructuring Program. Funder: European Investment Bank; Loans amounting to minimum 25 thousand euros (for any viticultural and vinicultural activity) and maximum 5 mln. euros (for upgrading the enterprise). EIB financing sources is 50% of the investment project, the rest 50% of the investment project in the form of cash and / or material goods.

Project "Orchards of Moldova". Funder: European Investment Bank.

At the same time agriculture is very actively financed by Poland in 2014-2015, Poland's Government has granted a loan of 100 ml. euros, the same amount was received from the European Investment Bank for the development of vegetable and fruit growing.

The main goal of these projects is to modernize agriculture and increase agricultural production quality up to European standards, and also to improve the quality of life in rural areas. External assistance is focused on four aspects: institutional development, policy development in agriculture, improving competitiveness of agriculture and the implementation of quality standards, and also increasing the access of farmers to financial resources to develop all types of agricultural business.

With the signing of the agreement on the liberalization of trade with the European Union, domestic farmers begin to face a very strong competition with the farmers from the European Union and will have to comply with new requirements regarding business development in agriculture. At European level, in terms of the technologies used in agriculture and current agricultural production, Moldova is far exceeded. In order to industrialize agricultural production and to increase the share of processed raw materials of the quality required on international markets it is necessary re-equip agricultural units with modern technique and equipment, and to change traditional methods of farming methods and agricultural raw materials. This is possible only having considerable investments. At the same time for the development and improvement of entrepreneurship skills there are organized training courses for young entrepreneurs, supported by the Ministry of Agriculture and a number of other bodies.

The main reasons for young entrepreneurs who start their own business, are the challenge to control their own destiny and to put ideas into practice, but not financial gains. Successful young entrepreneurs have talent in identifying the issues that will contribute to business success and willingness to take business niches that other entrepreneurs have ignored or they were sceptical about. The interest and potential of young people to become entrepreneurs should be supported strongly by encouraging entrepreneurial mind-sets and attitudes in education and training systems

Thus, during the years 2012-2015 within investment projects "Rural Financing and Small Enterprises Development," "Revitalising agriculture", "Development of rural business", "Rural Financial Services and Business Development" of the International Fund for Agricultural Development (IFAD) there were trained about 500 attendees in the initiation and development of business in agriculture. Free courses were organized by the Centre for Education and Rural Development. [2] The groups were each formed of 25 people aged 18-30. The main

condition was that all those participating in the courses should be from rural areas. Analyzing the data in Figure 1 we can mention that coverage area is varied from practically all districts of the Republic of Moldova.

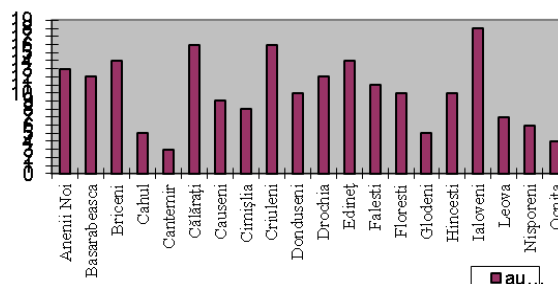

Fig. 1. Number of courses attendees by geographical area.

Source: Own calculation.

It is a good fact that in order to enhance entrepreneurship the entrepreneurs who have already established businesses are also very active. According to data in Figure 2 we can see that 55% are entrepreneurs with legal form of peasant households; 28% - joint-stock companies and only 17% haven't founded businesses.

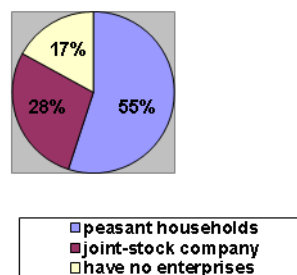

Fig.2 Organizational – legal form of the businesses that attended training courses

Source: Own calculation.

According to the information presented in the figure above, we can see that most entrepreneurs have registered peasant households.

The training courses are based more on the study of practical material. Trainees were able to develop a business plan by themselves, applying the database received from experts. The training program allowed young entrepreneurs to gain knowledge in the following areas:



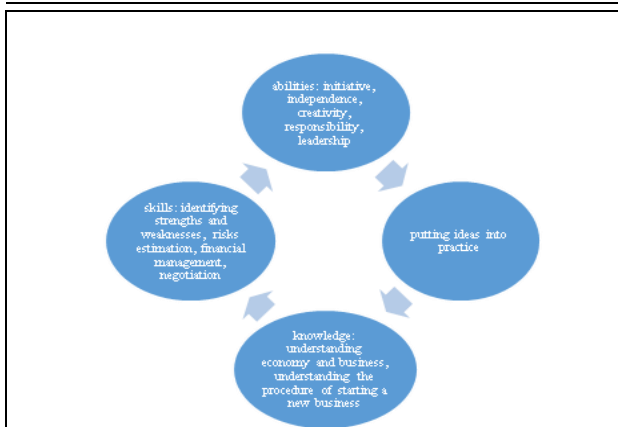

Fig.3. Skills formed after attending training courses.

Source: Own calculation.

Figure 3 illustrates the skills, knowledge and abilities, which were obtained after training courses.

## CONCLUSIONS

Agriculture in the economy of the Republic of Moldova is one of the branches of great importance, designed to contribute significantly to relaunch of the economic development of the country. It is necessary to carry out fundamental changes in agrarian structure, on the material and technical basis, in organizing and reorganizing agricultural enterprises, which would provide a modern agriculture oriented to market economy. But to ensure modern agriculture special efforts are needed in order to create a favorable investment climate as investments are the main source of economic growth. Attracting foreign investments in the Moldovan economy is a major requirement of the time and it is needed to relaunch entrepreneurial activity until own market mechanisms will begin to operate well and domestic investors will appear. Thus for the successful implementation of a strategy promoting investments the support of an effective institutional framework is necessary. Many countries have created institutions - national investment promotion agencies - with a mandate to attract foreign investments and to place the country opportunities to foreign investors.

The process of investments attraction in the economy of any country is a competitive

game led to offer more favorable conditions to foreign investors. (The strategy of the Republic of Moldova for attracting investments and promoting exports approved by the Government Decision no. 234 of 13.10.2006. Published in: the Official Gazette of the Republic of Moldova nr.43-45 of 30.10.2006)

So, in order to choose the country, in which the investor will place his investments, he will consider not only the investment legal framework, but also a number of factors such as the degree of infrastructure development and of the financial system, criminality, etc.

The achievements of our country are already recognized and appreciated abroad concerning the economy reforming, especially creating the legal and economic framework, the privatization of the State heritage, economic liberalization and creating favorable conditions for the development of entrepreneurship, attracting foreign investments. Financial stabilization has been reached, inflation decreased, efforts are being made to return to sustainable economic growth.

## REFERENCES

- [1] Certan, I., Banari, M., 2015, What are European investments for the rural development in the Republic of Moldova, Scientific Papers Series "Management, Economic Engineering in Agriculture and rural development", Vol. 15(1): 87-94
- [2] International Fund for Agriculture Development Official web site <http://www.ifad.md>
- [3] Impactul investițiilor straine directe asupra economiei Republicii Moldova, 2010. Studiu economic, Chisinau
- [4] Litvin Aurelia, Sasu Svetlana, 2014, Credit projects impact on agricultural individual sector development in Moldova. Series "Management, Economic Engineer" Vol. 14(2)
- [5] Moldova Agroindbank, Official web site: <http://www.maib.md/ro/credite-agricultura/>
- [6] National bank of Moldova. Official web site <http://www.bnm.md>
- [7] Radu Despa, Daniela Zirra, Andreea Munteanu, 2010, Eficiența investițiilor, Ed. Universitară, Bucuresti.
- [8] Petrascu, S., 2015, The impact of investment management of the evolution of the agri-food export in Republic of Moldova, Scientific Papers. Series "Management, Economic Engineering in Agriculture and rural development", Vol. 15(2): 255-258.



[9]Romănu, I., Vasilescu, I., 1997, Managementul investițiilor, Editura Mărgăritar, București

[10]Sargo, A., 2013, Stimulating investment in Moldova Agriculture through subsidies, Scientific Papers. Series Management, Economic Engineering in Agriculture and rural development, Vol. 13 (3):263-266

[11]Strategia Națională de Dezvoltare Agricolă și Rurală pentru anii 2014-2020



## IMPROVING ROMANIA'S GREEN COVER BY PLANTING FOREST PROTECTION CURTAINS, IN THE CONTEXT OF CURRENT CLIMATE CHANGES

Camelia MĂNESCU<sup>1</sup>, Ada-Flavia CRISTINA<sup>1</sup>, Teodor MATEOC<sup>1</sup>,  
Gheorghe Sebastian SÎRB<sup>2</sup>, David SAIDA<sup>1</sup>, Nicoleta MATEOC-SÎRB<sup>1</sup>

<sup>1</sup>Banat's University of Agricultural Sciences and Veterinary Medicine „King Michael I of Romania” from Timișoara, Department of Management and Rural Development, 119 Calea Aradului, Zip code 300645, Romania, Emails: cameliaoborocea2004@yahoo.com, ada\_flavia@yahoo.com, mateocnicol@yahoo.com

<sup>2</sup>University of Oradea, Faculty of Environment Protection, 1 University Street, Oradea, Romania

*Corresponding author:* cameliaoborocea2004@yahoo.com

### *Abstract*

*In Romania, the area covered by forest has decreased in the last period of time (28%), is currently below the average of developed countries in the European Union (40%). Meanwhile, a series of extreme weather phenomena have increased, representing the greatest threat facing humanity and the environment. In the current paper the authors analyse the distribution of Romania green cover on geographical areas, trying to find solutions to minimize the existing imbalances. Expanding forest areas should be a priority for ecological restoration because Romania has low forest coverage areas. Research shows that there is an unbalanced distribution of green coverage of Romania in the current climate change, which requires the plantation of protective forest curtains.*

*Key words:* climate changes, forest, protection curtains

### INTRODUCTION

Global climate changes, the greenhouse gas emissions and reduced sources of traditional fossil fuels are one of the most serious environmental problems of present time. [6]

In Romania 28 % of the area is covered with forests (about 6.43 million hectares), of which 3% (200 thousand hectares) recorded as remaining primary forests and 97 % as secondary forests and forest land, if considered only functional ecological forests, the degree of forestation is only 23 % .

In our country, the percentage of forestation is below that of other European countries with similar natural conditions ( Slovenia 57 % , Austria 47 % , Bosnia 53% , Slovakia 41%), representing about half of the optimal proportion for Romania (40-45 %).[3]

In this context, for Romania, expanding forests is a priority for ecological restoration because there are still too many hilly areas (Transylvania Plateau, Dobrugea and Moldavia Highlands) with low forest coverage. [9]

In the plains, deforestation has caused excessive dryness, excessive steppization and here and there, even desertification and massive erosion in hilly soil.

### MATERIALS AND METHODS

The research methodology consisted in a thorough study of bibliographical resources (Romanian literature, Internet sites on the topic), carried out in several steps: information on sources, observation, collection of data and information, analysis, and evaluation. The research is carried out as postdoctoral studies, part of a project for human resources development at BUASVM from Timisoara.

### RESULTS AND DISCUSSIONS

One of the main ways of ecological reconstruction and creation of a natural balance is long-term regional greening through reforestation and the creation of the national system of forest protection curtains.

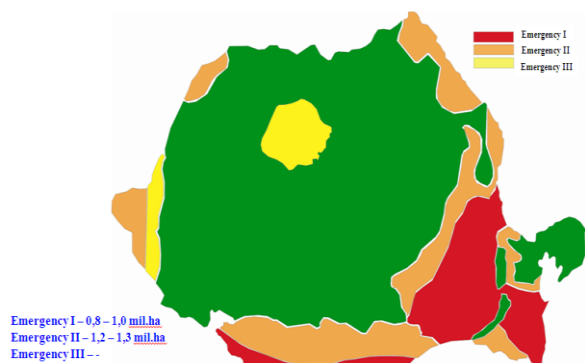

Fig.1. Areas that require forest curtains for the field protection, on emergencies  
 Source: Păun Ion Otiman, 2011

The protection curtains are established by forest vegetation formations planted in various lengths and widths relatively narrow, placed at a certain distance from an object in order to protect it from the effects of the harmful factors. This reduces the wind speed over a distance of 5 to 10 times their width. Thus, the wind speed is reduced and there are made some local changes of the wind direction, especially to those near the ground and the curtain.

Curtains determine the retention and even the distribution of the snow on the land surface, so that it increases the soil water reserve, it improves daily temperature through the reduction of the daily amplitude, and fights against flooding effect by lowering the groundwater level. The forest curtains protect the settlements, the ways of communication, the crops and they are sources of wood in the regions with rare forests.

The complex of measures and technologies regarding the conservation and the increase of eroded soils fertility includes: the antierosion organization of the territory; the formation of forest framing, including the protection curtains against the erosion provoked by waters and winds; recovering of the hardly eroded soils by grassing and foresting etc. [8, 10]

In Romania, this solution of protecting the soil and crops by using forest curtains was initiated in 1861 and developed in the great disasters, excessive drought, dust storms (1890, 1935, 1946), and it was materialized until 1962, when there were deforested once

with the forced land merger for collectivization. Following this approach it was destroyed the main network of protection curtains in Romania. After 1990, concerns arose about the reestablishment of forest protection curtains.

In 2002, Romanian Parliament adopted the Law no. 289 (republished in 2014) on implementation of a national system of protection curtains. According to this law, beyond the protection of communication routes against heavy snowfall, the forest curtains were and are a shield against landslides, erosion, as a defense of settlements, dams and river banks against climatic factors.

These last years, on the background of global warming, the frequency and intensity of extreme climate phenomena has increased globally, regionally and locally. These phenomena can have a catastrophic effect on the population both short term (large numbers of victims and material damage) and long term (land degradation and, implicitly, diminution of their productive potential. [1]

In general, global warming is caused by the greenhouse effect of the gases from human activities. The sectors that generate a considerable increase of greenhouse effect gases are industry, transport, and energetic consumption, while the increase caused by residential and commercial buildings, by deforestation and agriculture is slower. [7]

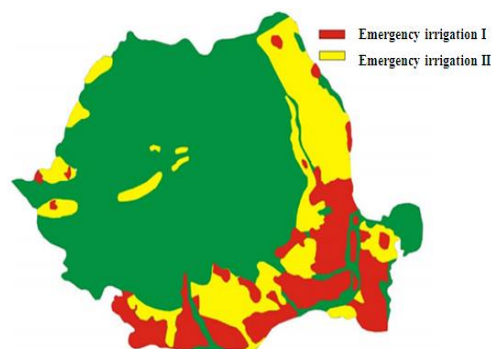

Fig.2. Drought-affected areas requiring irrigation  
 Source: Păun Ion Otiman, 2011

Late climate changes, frequency of increasingly sharp and dry periods of severe

drought and temperature extremes, determined the appearance and extended the high risk (12%) and medium (35%) of desertification, which requires development/rehabilitation of irrigation systems in drought affected areas and the establishment of forest curtains to mitigate these negative phenomena. (Fig. 2) [4]

The efficiency of the protection curtains is recognized in the fight against drought and other climate adversities and topography: storms, torrents, blizzards, landslides, for prevention and combat the massive processes of soil degradation, etc.

The forest curtains have a decisive role in protecting crops, through direct effect on the microclimate, and it stops landslides and local torrents, helps the growth and the conservation of the soil fertility. All these effects of the action of the forest curtains, contributes to safeguarding and promoting the diversity of flora and fauna.

The agriculture system with protection curtains is a part of the development strategy and is suited to the country's modern legislation. According to the requirements of European integration, integrated environmental management for sustainable agricultural development includes conservation and sustainable use of bio-resources and biodiversity, agro-ecosystems reconstruction, goals that can be achieved by planting forest protection curtains. [2]

The main benefits of setting up the protection curtains are primarily on the environment by increasing carbon storage, reducing air temperature and humidity raise, by capturing the dust and air filtration, stimulating exchanges of air, reducing noise and gaseous pollution, having positive effects on biodiversity and farm land by improving the conditions of agricultural land for growth and development for adjacent crops, by increasing fertility conditions and soil conservation (maximizing humidity and humus formation conditions and reducing erosion and deflation) and last but not least, by increasing production.

Unbalanced distribution of green coverage of Romania and the need for storm-water retention and preservation, the reduction of

snow and wind strength, requires the achievement of the protective forest curtains in the Romanian Plain (Bărăgan), in southern Moldova and to a lesser extent in the Western Plain. (Fig. 3) [4]



Fig. 3. Map coverage on ecological macro-regions of Romania

Source: Păun Ion Otiman, 2011

In the plains with small areas of forest, the protection curtains have a particularly favorable influence on the environment, serving as climate protection. This aspect reduces the wind speed over a distance of 5 to 10 times their width. This way, is reduced wind speed and it has some local changes over direction, especially next to the curtain.

The protection curtains causes the retention and even distribution of snow on the land surface, thus increases soil water reserves, improves daily temperature by amplitude reduction and combats flooding effect by lowering the groundwater level .

Trees and shrubs of the forest curtains attenuate noise. The specialty literature, it shows that the protective curtains have the ability to reduce noise up to 10 decibels. In the United States, was recorded that about 30 m a strip of forest placed along a road vehicles reduce 8-11 % of the traffic noise.

The protection curtains have decontaminated role. Regarding the phenomenon of chemical pollution, is noted that a stream of air pollution with sulfur dioxide at a concentration of 0.1 mg / m<sup>3</sup> can be completely de-polluted by slowing the transit of more than one hectare of forest. The protection curtains composed of conifers performs a microbial treatment. The forest

curtains serves as a form of recreation for the bordering population, provides an environment for developing wildlife, creates a favorable microclimate for the summers with high temperatures.

The protection curtains is a rich source of industrial and food products (fruits, mushrooms, medicinal and bee products), improves living conditions, purifies the air, tame the climate, beautifies the landscape and improves the water regime. [5]

In the context of climate change, improving the green coverage of Romania requires the establishment of protective forest that will potentially increase green surfaces and which will have an important role in the sustainable development of rural communities, contributing to a better microclimate, by reducing wind speed, improving conditions for growth and development of crops, reducing erosion etc.

## CONCLUSIONS

The objectives of rural development programs and planning must relate to the expansion of forests through the establishment of the new plantations and the forest protection curtains. Nowadays, in sustainable agricultural development schemes, it is strongly emerged the need of establishing the forest curtains with their numerous protective effects on crops, causing stability and ecological balance, biodiversity and pesticides pollution prevention, etc.

Under the current legislation, protection curtains may be set up for different utilities, thereby:

- farmland protection against harmful climatic factors and weather conditions to improve protected area;
- erosion control, soil protection which is the subject to erosion;
- communications and transport protection, especially against heavy snow;
- dams and riverbank protection against currents, floods, ice and others;
- protection of the localities and of the different economic and social goals.

The forest curtains created for the protection

of the agricultural land, aims to mitigate the effects of drought on crops, notably in:

- regions with low rainfall or with sufficient rainfall for crop development, but irregular distributed in time;
- dry climate regions, taking into account soil types;
- areas subject to periodic drought;
- regions where winds are provided with high frequency during the growing season and annual precipitation values below 400 mm or between 400 and 700 mm, but are irregular distributed in time.

The areas needing protective forest curtains identified in Romania are: Romanian Plain, Tisa Plain, Danube and Dobrogea Plateau, affected by frequent droughts. Location is done based on technical documentation, usually on rectangular networks, in stages and in emergency order, giving priority to the most arid lands.

The forest curtains against erosion can be achieved in all areas of the country, on lands with different degrees of degradation. The identification procedure and forestation of degraded lands is provided in Government Ordinance no. 81/1998 on measures to improve through forestation of the degraded lands, approved with amendments by Law no. 107/1999. In this category are covered even lands with mobile sands, which require forestation works to fix them.

The forest curtains for the communication and transportation lines protection can be established by one side or the other of them, on the portions affected by frequent heavy snow deposits.

The forest curtains for the communication lines protection are reduced height curtains (max 8 m) compact, impenetrable, with the aim of snow accumulation in the curtains area or in their immediate vicinity, at a width of 10-15 m.

Depending on the degree of intensity of the snow and winds, there will be:

- Snow-trap forest curtains* - in areas with high intensity winds and strong snow blocking;
- Hedges* - in forest areas with winds of less intensity and less snow.

Forest curtains to protect dams and riverbanks against currents, floods and ice flows, can be

achieved along them with rectangular alignments, on different widths and lengths, according to the orography of the land, water flow velocity, wave height and the thrust of ice.

These protective curtains are installed as obstacles as ice blocks for breaking the waves in case of flooding, leaving behind them, close to the dam or shore, a quiet area, without destructive power.

Typically, there are used forest species with strong root system, resistant to flooding and with great sprig power.

Forest curtains to protect localities and the various economic and social goals are set up around the urban and rural areas, near the polluting industrial units, close to the economic, social, cultural and strategic targets in order to protect them from pests or climatic factors excessive pollution. They also have a creative role for human communities.

## ACKNOWLEDGEMENTS

This paper was published under the frame of European Social Fund, Human Resources Development Operational Programme 2007-2013, project no. POSDRU/159/1.5/S/132765.

## REFERENCES

- [1]Ardelean, F., Colda, I., 2008, Cauzele schimbărilor climatice – un subiect controversat [Climate change causes - a controversial topic], A XV-a Conferință Confort, eficiență, conservarea energiei și protecția mediului, Universitatea Tehnică de Construcții București.
- [2]Government Emergency Ordinance 195/2005 on environmental protection, Law no. 289/2002 on protection curtains, Law no. 46/2008. Forest Code
- [3]Law No 289/2002 on forest protection curtains. Romanian Official Gazette nr. 338/21 May 2002
- [4]Leah, T., 2013, Soil degradation and assessment of land pretability for organization of organic farming system in the Rep. of Moldova, Scientific Papers Series "Management, Economic Engineering in Agriculture and rural development", Vol. 13(1)209-214.
- [5]National Strategy for Sustainable Development of Romania Horizons 2013-2020-203, Bucharest, 2008
- [6]Oțiman, P. I. et al., 2011, Alternativele economiei rurale a României: Dezvoltarea agriculturii sau insecuritate alimentară și deșertificare rurală severă, (Romanian rural economy alternatives: Development of

agriculture or rural food insecurity and severe desertification], Editura Academiei Române, București.

[7]Palkova, Z., Hatzilygeroudis, I., Ionițescu, S. 2014, Analysis of the training needs in renewable energy sources for agricultural sector. Scientific Papers Series "Management, Economic Engineering in Agriculture and rural development", Vol. 14(2), 201-206.

[8]Protection curtains and their importance for Timisoara, [http://www.dmmr.ro/uploads/files/Workshop%202008/perdea\\_forestiera.pdf](http://www.dmmr.ro/uploads/files/Workshop%202008/perdea_forestiera.pdf)

[9]Săndulache, C., Săndulache, I., 2011, Hazarde și riscuri naturale în România [Natural hazards and risks in Romania], Editura Universitară, București.

[10]Steriu, V., Oțiman, P.I., coord., 2013, National Strategic Sustainable Development of agri-food sector and rural areas in the period 2014-2020-2030. The national strategic areas, Romanian Academy Press, Bucharest, 2013





## RESEARCH REGARDING THE POSSIBILITIES OF EXTENSION OF THE FOREST PROTECTION CURTAINS THROUGH FINANCED PROJECTS FROM THE RDP 2014-2020

Camelia MĂNESCU<sup>1</sup>, Ada-Flavia CRISTINA<sup>1</sup>, Teodor MATEOC<sup>1</sup>,  
Gheorghe Sebastian SÂRB<sup>2</sup>, Alin POPESCU<sup>1</sup>, Nicoleta MATEOC-SÎRB<sup>1</sup>

<sup>1</sup>Banat's University of Agricultural Sciences and Veterinary Medicine „King Michael I of Romania” from Timișoara, Department of Management and Rural Development, 119 Calea Aradului, Zip code 300645, Romania, Emails: cameliaoborocea2004@yahoo.com, ada\_flavia@yahoo.com, mateocnicol@yahoo.com

<sup>2</sup>University of Oradea, Faculty of Environment Protection, 1 University Street, Oradea, Romania

**Corresponding author:** cameliaoborocea2004@yahoo.com

### Abstract

*Lately, the forest surface was reduced from about 19 million hectares, as it was in the distant past, to 6.4 million hectares, while the Romanian geographical environment is increasingly subject to natural and anthropogenic hazards. Regarding the distribution of the forests by main landforms, there is a major imbalance, were is noticed a striking deficit of woodlands in the plains. Given the unbalanced distribution of the green coverage of Romania, in the context of climate changes, the authors point out that is of great importance to establish protective forest curtains. The authors highlight the need of reconstruction of the country's land patrimony, mainly through reforestation, by establishing more protective forest curtains. Thus, we consider that the need and desirability of setting the forest protective curtains on the Romania's surface, are two particularly important factors in the sustainable development of the rural communities, for which RDP 2014-2020, through the funds allocated for the Measure M8 - 105 mil. Euro, is helping to achieve these objectives.*

**Key words:** forest, measure, protection curtains

### INTRODUCTION

Taking into consideration that over 56% of the population in the 28 Member States of the European Union is living in rural areas, which cover over 91% of the territory, rural development has become a vital policy. Moreover, Europe possesses a great regional diversity of landscapes ranging from mountains to plains, from impenetrable forests to steppes. Also at budgetary level there is a shift from Market support policy to the rural development aiming at diminishing the intervention mechanisms and stirring the economic, social and environmental development in the countryside. [5]

Starting from the Romanian rural settlements need to adapt to EU requirements, by promoting efficient sectors in rural and economically viable and socially strategies established the main directions for development of rural infrastructure. [4, 9]

The total area of the National Forest Fund and

of the forest vegetation outside the National Forest Fund in 2012 comprised 6,746,906 hectares, which represents about 28.3% of the total national land fund, which is below the European average of 37.6% and suboptimal for our country, (35%) identified by the Institute of Forest Research. [8]

In comparison with the relatively equal proportional distribution of the main landforms at the national land fund level; at the level of Forest National Fund there is an obvious imbalance in terms of their distribution on the main land forms, with the majority of the forests located in the mountain areas (52%) and in the hill areas (37%) and a striking deficit of surfaces covered with forest in the plains (11%). [6, 7]

The counties where the forests represent less than 16% of the total area of the land fund are considered deficient in forest areas.

To increase the area with forests is one of the main objectives of the National Strategy for Sustainable Development of Romania,

Horizons 2013-2020-2030 and the Romanian National Strategy on Climate Changes 2013 - 2020, as well as an obligation and national priority defined in the Forest Code. [10,11]

Afforestation of agricultural and non-agricultural lands is a measure designed, primarily, to help the reduction of the concentration of the greenhouse gases in the atmosphere by capturing CO<sup>2</sup>, to reduce the soil erosion, to increase the water retention in the soil, and to adapt Romanian agriculture to the climate changes, characterized by increasing average annual temperatures and decreasing the precipitation. Therefore, the forests, the protective forest curtains and cordons newly created on the agricultural and on the non-agricultural lands, especially in the plains, will have positive effects on the local climate, helping to fight the effects of excessive droughts, will improve the local climate and the water and edaphic regimes, will reduce the plant evaporation and transpiration. [6]

## MATERIALS AND METHODS

The paper is based on a deep documentation by studying a large variety of important publications belonging to well known personalities along the time who had the courage to present their opinions in order to support the development of agriculture and rural areas and the possibilities of extension of the forest protection curtains. Analysis and synthesis, logical deduction and critical approach are the main instruments used by author who tried to present in his manner and logical thinking his own opinions on role of forest protection curtains for sustainable development of agriculture and rural areas in Romania.

## RESULTS AND DISCUSSIONS

In 2007-2013, the contribution of the Measure 221 "First afforestation of agricultural land" in the National Rural Development Programme (RDP), aimed to increase the forest area of Romania.

The beneficiaries of the Measure 221 - "First afforestation of agricultural land", within the

National Rural Development Programme (RDP) 2007-2013 could obtain the grant for the establishment of the protective forest curtains.

The purpose of this measure was to increase the national forest area by afforestation of the agricultural lands. This measure was intended to compensate. The support through this measure was to establish an amount of money for the forest plantations (standard costs), according to the technical project, an annual amount of money for the completion works and the maintenance of the plantation for a period of five years, and an annual fixed amount of money (standard) as an income for the income loss due to afforestation, per year and per ha for a period of 15 years.

This type of investments could be applied to agricultural areas, at least 0.5 hectares, on which they could establish a forest plantation. The established forest had to be preserved until the age of exploitation, which could reach up to 40 years.

The problem of sustainable agri-zoo-forest development belongs to the state authorities and scientists. [1]

Table 1. The indicative allocation for rural development measures RDP 2007-2013 (Euro)

Measure	Public expenditure	Private expenditure	Total cost
221 First afforestation of the agricultural land	3,226,656	482,144	3,708,800
Total RDP	9,324,804,232	2,635,436,614	11,960,240,846

Source: Own research based on the RDP 2007-2013, September 2014 version

In the RDP 2007-2013, 52 projects were submitted under the Measure 221 First afforestation of the agricultural lands, of which 40 were selected and contracted only 20. Altogether, up to 01.10.2015, were made the payments of Euro 447,299 from which Euro 11,452 million are payments made for the transferred SAPARD Programme projects. The RDP 2007-2013 programming period finished at the end of 2013 and later, followed in 2014 to operate a new program, the RDP 2014-2020.

Table 2. The situation on the projects within the RDP session recorded in the monitoring tables on 10.01.2015 (Euro)

Measure		Submitted projects		Selected projects		Contract / financing of decisions concluded		Payments made
		No.	Public value	No.	Public value	No.	Public value	
221	RDP	52	4,354,839	40	3,775,661	20	1,494,204	447,299
	Transferred from SAPARD	-				3	13,796	11,452
Total RDP		150,944	18,533,168,276	98,249	7,363,836,852	84,507	5,658,386,655	7,830,993,770

Source: Own research based on AFIR, the RDP 2007-2013 implementation stage

In the RDP 2007-2013, 52 projects were submitted under the Measure 221 First afforestation of the agricultural lands, of which 40 were selected and contracted only 20. Altogether, up to 01.10.2015, were made the payments of Euro 447,299 from which Euro 11,452 million are payments made for the transferred SAPARD Programme projects. The RDP 2007-2013 programming period finished at the end of 2013 and later, followed in 2014 to operate a new program, the RDP 2014-2020.

Based on the analysis conducted by the Ministry of Agriculture and Rural Development it was decided to keep the RDP 2007-2013 successful measures. Thus, in the 2014-2020 programming period will be supported the following measures:

**Modernizing and increasing the viability of the agricultural exploitations by strengthening them and by opening them to the markets and to the processing of the agricultural products**

In order to develop the Romanian agriculture to the European standards, MARD plans to fund further investment measures on farms. Increasing the competitiveness of the agriculture will allow covering the necessary food products and will increase the exports, especially of the manufactured products. Encouraging the niche agriculture will also lead to the increased competitiveness of the agriculture.

**Encouraging younger farmers into agriculture**

The support given in 2007-2013 will be continued in the future, in order to rejuvenate the rural population and to facilitate the process of modernization of the farms. From this perspective, young farmers who want to develop their business in the agriculture, will make an important contribution to the

modernization and refurbishment of this sector, as well as, to the introduction of the innovative technologies in thagriculture. Therefore, it was proposed the increasing to the maximum amount of support, at Euro 50,000/farm.

**Rural infrastructure**

It was acknowledged the need for basic infrastructure to attract the investment in the rural areas and to lead to the creation of new jobs and, thus, to the development of the rural areas. Therefore, the priority will be to create/develop local infrastructure, including irrigation infrastructure as a precondition for economic development of the rural areas.

**Promoting the creation and the development of micro and small non-farm businesses**

A priority for future rural development policies is to promote the creation and the development of non agricultural micro and small enterprises in rural areas.

**LEADER**

It is another measure which will continue in 2014-2020 with the local development objective.

**The financial allocation whitin the RDP 2020**

EU financial allocation from the European Agricultural Fund for Rural Development (EAFRD), granted to Romania for the implementation of the National Rural Development Programme 2014-2020, the sum of Euro 8,015.6 million.

The proposals of the intervention and indicative EAFRD allocations target a **first set of investments in farm and rural businesses**, as follows:

Euro 2,057 billion for investments in physical assets;

Euro 800.36 million for the development of the farms and the businesses;

Euro 1.1 billion for the basic services and village renewal in the rural areas

A **second set** of measures for funding in the new RDP is relating to the environment and the climate, with a total allocation of Euro 2,387 billion.

This series of measures includes:

- afforestation and creation of the woodlands and forest curtains - Euro 105 million;
- agri-environment and climate measure - Euro 850 million;
- ecological farming - Euro 200 million;
- delimitation of the areas which are faced with natural or other specific constraints - Euro 1,232 billion.

The last proposed set:

- measures regarding the knowledge transfer and the information actions with an allocation of Euro 25.40 million;
- counseling services with Euro 25.40 million allocated;
- cooperation with an allocation of Euro 28.01 million;
- risk management (mutual fund) with Euro 200 million.

For LEADER programme will be allocated Euro 625 million, and for the technical assistance, including the National Network for Rural Development, is prescribed an amount of Euro 178 million.

#### **New measures introduced in the RDP 2020**

The National Program for Rural Development for the 2014-2020 focuses on a limited number of measures that meet the identified needs on the basis of the sectoral analysis, of the socio-economic and of the environmental, as well as, of the SWOT analysis of the rural areas which reflect the courses of action in the agriculture and in the Romanian village development.

The focusing on the interventions in the 2014-2020 programming period aims to maximize the impact, to simplify the accessing process and to address the structural issues on the agriculture exploitations.

Hence, RDP 2020 is both a priority and a need identified by the socio-economic analysis of the rural areas. European funds assigned for this programming period helps the management of the sustainable irrigation

systems and the promotion of the harvesting patterns which are using water efficiently, and also the creation and the management of protective forest curtains against erosion.

The RDP for the 2014-2020 (financed by the European Agricultural Fund for Rural Development) supports the strategic development of the rural areas through the strategic approach of the following objectives: restructuring and increasing the sustainability of the agricultural exploitations, sustainable management of the natural resources and combating the climate changes, economic diversification, creating jobs, improving the infrastructure and the services to develop the quality of life in the rural areas.

The National Rural Development Programme for the 2014-2020, includes 14 measures for rural development, amounting to Euro 9,363 billion (Euro 8,015 billion EAFRD and Euro 1,347 billion national contribution).

The list of the measures from the National Rural Development Programme for the 2014-2020:

- Measure 1. Knowledge transfer and information actions

- Measure 2. Counseling Services

- Measure 4. Investment in physical assets

- Measure 6. Development of the farms and the businesses

- Measure 7. Basic services and village renewal in the rural areas

- Measure 8. Investments in the forest area development and improving the viability of the forests

- Measure 9. Support for the producer groups

- Measure 10. Agro-environment and climate

- Measure 11. Organic agriculture

- Measure 13. Payment for the areas facing natural or other specific constraints

- Measure 15. Forest - environmental and climate services and forest conservation.

- Measure 16. Cooperation

- Measure 17. Risk management

- Measure 19. LEADER local development (Art. 42-44) [2]

Within the National Programme for Rural Development for the 2014-2020, the forestry sector benefits from an allocation of over 105 million euros in the measure M08 **Investments in forest area development and**

**improved viability of forests.** Through this measure, it can provide funding for afforestation, both on agricultural lands and on the non-agricultural lands, and also, to create protective forest curtains. [2]

According to the situation of the sessions for the RDP 2014 – 2020 projects, until 10.02.2015, on the measure M8 was not filed any project, because this measure has not been released yet.

## CONCLUSIONS

Given the unbalanced distribution of the green coverage of Romania, in the context of nowadays climate changes, the authors underline the importance of establishing the protective forest curtains.

Thus, we consider that the need and desirability of setting the forest protective curtains on the Romania's surface, are two particularly important factors in the sustainable development of the rural communities, for which RDP 2014-2020, through the funds allocated to the Measure M8 - 105 mil. Euro, is helping to achieve these objectives.

## ACKNOWLEDGEMENTS

This paper was published under the frame of European Social Fund, Human Resources Development Operational Programme 2007-2013, project no. POSDRU/159/1.5/S/132765.

## REFERENCES

- [1] Drăganescu, C., 2013, Some problems regarding the agricultural and sustainable development of Romania, Scientific Papers Series "Management, Economic Engineering in Agriculture and rural development", Vol. 13(4)83-96.
- [2] Evaluarea Strategică de Mediu, Raport De Mediu, 2015.
- [3] Iacob Dănuț, Achim Dan, Daia Mihai, 2008, Stadiul actual și perspectivele realizării Sistemului Național al Perdelor Forestiere de Protecție, 2008;
- [4] Otîman, P. I., Steriu, V., 2013, Cadrul Național Strategic pentru Dezvoltare Durabilă a Sectorului Agroalimentar și a Spațiului Rural în perioada 2014-2020-2030, Cadrul Național Strategic Rural [National Strategic Framework for Sustainable Development of agri-food sector and rural areas in the period 2014-

2020-2030, National Strategic Rural], Editura Academiei Române, București.

[5] Păun, F., 2014, Studies regarding the situation of Rural Development in Prahova County and the managerial measures which need to be taken. Scientific Papers Series "Management, Economic Engineering in Agriculture and rural development", Vol. 14(1): 273-276.

[6] PNDR pentru perioada 2014-2020, Versiunea aprobată 26.05.2015.

[7] Revista Finantare.ro, 20 ianuarie 2015 in PNDR Masura 8 – Investitii in dezvoltarea zonelor forestiere si ameliorarea viabilitatii padurilor 2014-2020

[8] Romanian Statistical Yearbook, 2013

[9] Stoian Remus, Anghel Claudia 2014, Ways for development of rural communities in Valcea County. Scientific Papers Series "Management, Economic Engineering in Agriculture and rural development", Vol. 14(4): 293-298.

[10] Strategia Națională pentru Dezvoltare Durabilă a României, Orizonturi 2013-2020-2030

[11] Strategia Națională a României privind Schimbările Climatice 2013 -2020





## THE ASSESSMENT MADE BY FARMERS OF THE AGRICULTURAL CONSULTANCY EFFECTIVENESS IN OLT COUNTY

Emil Vergilius MARINESCU<sup>1</sup>, Raluca-Alexandra NECULA<sup>1</sup>, Diana-Maria NECULA<sup>2</sup>

<sup>1</sup>University of Agricultural Sciences and Veterinary Medicine Bucharest, 59 Marasti, District 1, 11464, Bucharest, Romania, Phone: +40213182564, Fax:+40213182888, Mobile:+40744 6474 10, Emails: ev.marinescu@yahoo.com, raluca\_nec@yahoo.com

<sup>2</sup>The Research Institute for Agriculture Economy and Rural Development, Bdul Marasti, nr. 61, sector 1, cod 011464, E-mail:necula.diana@iceadr.ro

**Corresponding author:** raluca\_nec@yahoo.com

### Abstract

*The study undertaken showed some pragmatic conclusions concerning how the consulting activity evolves in Olt County, in terms of farmers benefiting from agricultural advice. Through its quality, consultancy seeks through its specific methods, to be equally appreciated by the beneficiaries. Normally, agricultural consultancy, should be assessed, approximately equally by farmers, i.e. that there may not be no significant differences of appreciation over the areas analyzed, namely: projects preparation (Sapard and others), plants protection, chemical fertilizer procurement, procurement of pesticides, purchase of agricultural equipment, purchase of seeds and planting, animal husbandry, in various forms. From the analysis of the responses showed that farmers in Olt County, the geographical shape of the County is of particular importance to the ways of the consultancy evaluation, resulting in appreciations of significant differentiation from all areas, excluding the purchase of seeds and planting material, where appreciation was similar.*

**Key words:** agricultural production, chi square test, consultancy, consultancy efficiency, Olt County

### INTRODUCTION

In Romania the need for consultancy in all areas of activity, from industry, commerce, banks, education, health, and to agriculture. The economic and social changes require documentation and also consultancy with someone who has some experience and that you can make you to get a decision to take a risk as low, for the work which you think to be taking or improve. Since the early part of the twentieth century, the consultancy has continued to grow, becoming a profession. The consultants began to be seen as important persons able to give solutions for saving time and resources[7].

The agricultural consultancy in our country, after 1989, was formed on the fly, i.e. to chance, with dismissed specialists from the former structure of Agricultural Production Cooperatives or Agricultural enterprises. In 1998, on the basis of Decision No. 676/1998, was established A.N.C.A. Through law 77/2005 and GD 1609/2009, was reorganized as a specialized institution of central public

administration, which has in its technical-methodological coordination the agricultural Chambers County, to which it provides support and advice in order to achieve the objectives. The agriculture consultancy is characterized as a professional service and advice, upon request, of involvement, made free or a fee, by specialists aimed at supporting farm managers.

### MATERIALS AND METHODS

The analysis indicators and assessment of consultancy services management can be structured into three categories and can be play through the following form: indicators for measuring the development of consultancy services, at the territorial level and in time, the indicators used for assessment of the effectiveness of consulting methods used in order to assess efficiency indicators; consultancy services at the level of farm management.

The data collection was done with the help of a questionnaire, at which has answered a

number of 398 farmers from 6 municipalities (two for each area: Plains, Meadow, Hill).

The questionnaire was developed through the interview and addressed directly to individuals who were involved. In assessing the survey data was used, chi square test of Association ( $\chi^2$ ) and the significance of the result from the comparison Chi calculated with Chi theoretically. The test applies in the areas of socio-economic issues and is given by the composition of some contingency tables, the data are classified by one, two, or several variables of segmentation [5]. In comparing results[4], there is the following situation: If you reject the null hypothesis, and so there is a potential relationship between variables or if it admits the existence of a null hypothesis, and so there isn't a potential relationship, or association between the variables studied. Concrete, the degrees of significance were: very significant ( $p = 0.001$  \*); distinctly significant ( $p = 0.01$ , \*\*); significantly ( $p = 0.05$ , \*) and insignificant (calculated value is less than the theoretical value for  $p = 0.05$ , N).

## RESULTS AND DISCUSSIONS

In the Olt County, the landscape includes rolling hills in the Center and North and in South Plains and terraces. Olt County actually belongs to those two major relief units: the Getic plateau in the North, which occupies one third of the surface and the Romanian Plain in the South, which has two-thirds that can be structured (three main parts: the Cotmeana Plateau, to the North, in the Centre, Boianu Plain ; Danube terrace to the South)[8].

From the total of 98 villages, 73.47% are located in the lowlands, which is predominant the agricultural area, 76.6% of the total for agriculture ( Table 1). Regarding the number of farms from the total of 90,170, the predominant share is in plain (81.1%), followed by Hill area (14.4%) and meadow (4.5%).

Analyzing the surface on agricultural holding, it becomes apparent that it is in the meadow of 8.37 ha and 4.83 ha in the plain and 4.31 ha in the area of Hill.

Table 1. The villages, surfaces and agricultural holdings distribution in Olt County area, in 2012

Relief Area	Total common		Agricultural area		No. holdings		Surf./ Hold.
	No	%	HA	%	No.	%	ha/hold.
Meadow	9	9.18	33,753	8.20	4,033	4.50	8.37
Hill	17	17.35	62,588	15.20	12,971	14.40	4.83
Plain	72	73.47	315,131	76.60	73166	81.10	4.31
Total	98	100.00	411,472	100.00	90170	100.00	4.56

Marinescu Emil, 2013, Agricultural advisor's questionnaire, Olt County[1]

**The Consultancy areas appreciation, by geographical areas** includes activities which starts with the design (accessing projects), plant protection, the main inputs (chemical fertilizers, agricultural equipment and seeds), raising livestock, forms of Association and cooperation.

**The consultancy appreciation through the drawing up of projects**, which was concerned principally with the SAPARD system.

Depending on the area of geographical relief consultation concerning the preparation of projects (Sapard) in Olt County in showed in table 2 from which emerges a major implication (79.35%), with predominance of plain area (49.12%).

Concerning the significance threshold through interpretive form of calculated theoretical Chi is relevant the differentiation correlative between the importance of the granting of advice in drafting projects on the relief zone.

The calculated value of Chi is greater than the theoretical value (73.03 calculated Chi versus Chi theoretical 22,46), which means that *the geographical relief area has an influence very significant (\*\*\*) in the drawing-up of projects.*

In the period 2008-2013, in the County of Olt, were implemented 593 projects for the procurement of equipment, 708 projects for setting up greenhouses, solaria, plantations of vineyards and fruit trees, 511 breeding projects and 140 projects for production.

It is believed to have been awarded a number of consultations of 1,200 on this theme. [3].

*The appreciation of the manner in which consultations have covered the needs in the field of plant protection, depending on the geographical relief area (table 3), delineating the appreciation much with 53,77%, and middle with 36,43%.*

Table 2. The consultancy appreciation concerning *the establishment of Sapard projects (and others)* in the County of Olt, depending on *geographical area relief*

Relief Area	Drawing up projects (Sapard)					Total	
	MU	Much	Middle	Little	At all	No	%
Plain	No	145	49	1	0	195	49.12
Meadow	No	110	8	3	1	122	30.73
Hill	No	60	4	5	11	80	20.15
Total	No	315	61	9	12	397	100.00
	%	79.35	15.37	2.27	3.02	100.00	x
CHIINV (Chi calculated) =		73.03	significance threshold		0.001	22.46	***

Table 3. Appreciation of consultations relating to *plant protection* in the County of Olt, depending on *geographical area relief*

Relief area	Plant protection					Total	
	MU	Much	Middle	Little	At all	No	%
Plain	No	95	80	17	4	196	49.25
Meadow	No	90	25	7	0	122	30.65
Hill	No	29	40	8	3	80	20.15
Total	No	214	145	32	7	398	100.00
	%	53.77	36.43	8.04	1.76	100.00	x
CHIINV (Chi calculated) =		33.57	significance threshold		0.001	22.46	***

The threshold is considered to be very significant (\*\*\*), the difference between the calculated Chi-square (33.57%) and theoretically Chi (22.46), for a risk to which  $p < 0.001$ , whence it follows that advice on the assessment of distinctness relief areas is very significant. +

In the period 2010-2014, in the County of Olt, areas treated with insecticides have dropped from 168,612 ha to 96,898 ha, surfaces treated with fungicides have dropped from 118,183

ha to 113,471 ha, and areas treated with herbicides have increased from 157,781 ha to 168,764 ha. [1].

The consultations assessment concerning the availability of chemical fertilizers in the Olt County, according to the geographical relief area, appear in table 4, is different on the three areas of relief because the threshold significance is framed in a very significant assessment (\*\*\*), the calculated Chi (64.65) vs. theoretically Chi (22,46).

Table 4. The consultations appreciation concerning the procurement of chemical fertilizers in the Olt County, depending on *geographical relief area*

Relief area	The chemical fertilizers procurement					Total	
	MU	Much	Middle	Little	At all	No	%
Plain	No	52	114	24	6	196	49.25
Meadow	No	28	87	7	0	122	30.65
Hill	No	55	21	3	1	80	20.15
Total	No	135	222	34	7	398	100.00
	%	33.92	55.78	8.54	1.76	100.00	x
CHIINV (Chi calculated) =		64.65	significance threshold		0.001	22.46	***

In the period 2010-2014, the fertilized area with chemical fertilizers, in the Olt County has grown from 219,890 ha to 272,027 ha, while the area fertilized with natural fertilizers decreased from 18,640 ha to 13,245 ha, amid the decline in livestock (INSSE 2015). At the country level the amount of fertilizers and amendments increased with 134.78% from

2,479 million lei in 2008 to 3,341.12 million lei in 2013. [6].

The consultancy appreciation concerning the purchase of seeds, planting material, depending on the geographical relief area, for Olt County is illustrated in table 5. The threshold is insignificant, given the very close levels between the calculated Chi-square

(11.02) and Chi theoretically (12.59), for a risk in which  $p < 0.05$ .

Table 5. The consultancy appreciation concerning the *purchase of seeds, planting material* in the Olt County, according to the *geographical relief area*

Relief area	The <i>purchase of seeds, planting material</i>					Total	
	MU	Much	Middle	Little	At all	No	%
Plain	No	128	56	8	4	196	49.25
Meadow	No	97	16	7	2	122	30.65
Hill	No	56	18	5	1	80	20.15
Total	No	281	90	20	7	398	100.00
	%	70.6	22.61	5.03	1.76	100.00	x
CHIINV (Chi calculated) =		11.02	significance threshold		0.05	12.59	N

The agricultural machinery procurement of is an actual issue related especially to the demands of agricultural production capacity restructuring of farm (of the territorial area) through a correlation to the three dimensions of the characteristics of agricultural holdings envisaged (embossed area, size of the farm and farmer training). In the structure (table 6) the maximum share of this appreciation situation of consultations in the procurement of agricultural machines is at the middle level

(32.75%), followed by the level of little (27.96%) and much (21.41%). Noting that at the country level the value of seeds and planting material has increased from 3,416.3 million lei in 2008 to Lei 4,353.45 million in 2008, representing an increase of 127.43% [2]. The significance threshold is framed at very significant, justification given by the huge difference between the calculated Chi-square (122.00) and Chi theoretically (22.46).

Table 6. Appreciation of consultations concerning the procurement of agricultural machines in the County of Olt, depending on geographical area relief

Relief area	The agricultural machines procurement					Total	
	MU	Much	Middle	Little	At all	No.	%
Plain	No	31	41	79	45	196	49.37
Meadow	No	24	81	13	4	122	30.73
Hill	No	30	8	19	22	79	19.90
Total	No	85	130	111	71	397	100.00
	%	21.41	32.75	27.96	17.88	100.00	x
CHIINV (Chi calculated)		122.00	significance threshold		0.001	22.46	***

In the period 2010-2014, the number of physical tractors increased in Olt County from 6,527 at 6,658, number of mechanical drills has increased from 3,730 to 3825, and the self-propelled combines increased from 1,274 to 1,318. [2]

**The consultancy appreciation relating to animal breeding, depending on geographical area, it follows trends similar to the agricultural machines procurement.** It outlines the fact, in table 7, that are distinctly significant differences on relief areas. The threshold is distinctly significant (\*\*), represented by the amplitude of calculated Chi (19.84) versus the theoretical Chi-square

(8.56).

In the period under review, 2006-2011, the livestock in Olt County decreased to cattle from 60,938 heads to 32,326 to heads, at swine from 217,559 heads to 178,800 heads and at sheep from 130,238 heads to 88,218 heads [2].

**The consultations concerning the association tendency of** represents a new shape with totally different, for the rural dweller who needs to see through the consultant arguments, the differences and also consultant the benefits of possible association.

Table 7. The consultancy appreciation relating to animal breeding, depending on geographical area, in the County of Olt

Relief area	Animal breeding					Total	
	MU	Much	Middle	Little	At all	No.	%
Plain	No	67	50	39	40	196	49.25
Meadow	No	33	41	37	11	122	30.65
Hill	No	29	26	21	4	80	20.15
Total	No	129	117	97	55	398	100.00
	%	32.41	29.40	24.37	13.82	100.00	x
CHIINV (Chi calculated)		19.84	significance threshold		0.01	16.81	**

The hard part is the arguments one, because the inhabitants of rural areas, remember the constraint shapes that occurred in the former CAPs, abolished in 1991. From the questionnaires was outlined the appreciation

at a middle level (41.21%), followed by little (28.39%), much (25.38%) and at all (5.03%). Between these appreciations, on relief area, there are differences that are very significant statistically, table 9 (\*\*\*)

Table 9. The consultancy assessment concerning *the Association in various forms*, in the County of Olt, depending on *geographical area relief*

Relief area	Association in various forms					Total	
	MU	Much	Middle	Little	At all	No.	%
Plain	No	36	89	66	5	196	49.25
Meadow	No	65	40	16	1	122	30.65
Hill	No	0	35	31	14	80	20.15
Total	No	101	164	113	20	398	100.00
	%	25.38	41.21	28.39	5.03	100.00	x
CHIINV (Chi calculated)		111.02	significance threshold		0.001	22.46	***

From the data of the OJCA Olt appears that during the period 2008-2013, were implemented a total of 58 projects in various forms [5] To point out that CAJ OLT has supported the establishment of the following associative forms at the county level and had

continuously cooperation relations with them: agricultural cooperatives = 12, producer group = 1, professional associations= 16, authorized persons by the OUG No. 44/2008 = 710[6].

Table 10. Developments in agricultural production value, according to branches of production in Olt County during the period 2008-2013

Agricultural branch	UM	2008	2009	2010	2011	2012	2013
Total	Th. lei	1,931,732	1,779,899	1,875,620	2,315,761	1,981,842	2,344,424
	%	100.0	92.1	97.1	119.9	102.6	121.4
Vegetal	Th. lei	1,322,404	1,174,546	1,348,345	1,756,239	1,384,574	1,789,013
	%	100.0	88.8	102.0	132.8	104.7	135.3
Animal	Th. lei	600,902	593,920	523,449	556,960	592,330	545,837
	%	100.0	98.8	87.1	92.7	98.6	90.8
Services	Th. lei	8,426	11,433	3,826	2,562	4,938	9,574
	%	100.0	135.7	45.4	30.4	58.6	113.6

Processed by: INSSE, 2015, statistical database, Tempo-Online [7]

In the period 2008-2013, the total agricultural output value of Olt County increased from 1,931.7 million lei to 2,344.4 million lei (121.4%). We note the increasing of the vegetal production value 135.3% and the decrease in livestock production value with 90.8 in the same period of time. Agricultural

services had an increase of 113, 6%. (Table 10)

In the structure of the agricultural output value it is presented a huge transformation during this period 2008-2013, in the sense of increasing the share of crop production from 68.46% in 2008 to 76.31% in 2013 (table

11). In the same period it is found a decrease 33.37% in 2009 to 23.28% in 2013. in the share of animal production value from

Table 11. The structure of agricultural production value by branches, in the County of Olt, during the period 2008-2013

Agricultural branch	UM	2008	2009	2010	2011	2012	2013
<b>Total</b>	%	100.00	100.00	100.00	100.00	100.00	100.00
<b>Vegetable production</b>	%	68.46	65.99	71.89	75.84	69.86	76.31
<b>Animal</b>	%	31.11	33.37	27.91	24.05	29.89	23.28
<b>Services</b>	%	0.44	0.64	0.20	0.11	0.25	0.41

Processed by: INSSE, 2015, statistical database, Tempo-Online [7]

These changes were the result of the decrease in livestock. These transformations have the effect of lowering the population engaged in agriculture and the increase of imports of agricultural products of animal origin.

## CONCLUSIONS

The differences, on area, concerning the assessment way of the consultancy activities demonstrates the need for guidance specific to each area in part.

All questions relating to the level of appreciation of the Consultancy domains, on geographic areas, can be found through: the existence of a very significant correlation for geographical relief area (in Olt County is predominant the plain where it finds a very significant assessment of consultancy).

The effective applicability of agricultural consultancy depends on the consultancy quality, but also on the degree of interest of the beneficiaries.

In conclusion, the work of consultancy is very necessary, although still setting goals, the beneficiaries remain in a fairly large proportion confident in this activity.

We believe that the consultancy results at the County level will influence positively the future average yields and the increase of management activities of agricultural holdings.

## REFERENCES

[1]Anuarul Statistic al județului Olt, INS, Direcția județeană de Statistică Olt, Ediția 2012

[2]INSSE, 2015,Baze de date statistice, Tempo-Online,<http://statistici.insse.ro/shop/>

[3]Marinescu Emil Vergilius, 2014, Teză de doctorat, Cercetări privind dezvoltarea consultanței agricole în județul Olt, USAMV, București

[4]Merce, E., et al., 2010, Prelucrarea statistică a datelor, Editura Academic Pres, Cluj-Napoca.

[5]Mihăiță, N. V., et al., 2013, Relațiile statistice puternice, ascunse, false și iluzorii <http://www.biblioteca-digitala.ase.ro/biblioteca/carte2.asp?id=388&idb=>, accesat 22.03.2013.

[6]Raport privind starea economico-socială a județului Olt în anul 2013, <http://www.prefecturaolt.ro/comunicate/2014/raport2013.pdf>

[7]Sin, G., 1998 , Asistență și consultanță agricolă, Ed. Agris-Red. Revistelor Agricole, București

[8]Vrabete Mihaela, et al., Proiect “Elaborarea planului de amenajare a teritoriului județean Olt, Faza I Documentare și studii de fundamentare”, Proiectanți, URBAN INCERC, SC HALCROW SRL

## EVOLUTION OF AGRICULTURAL PRODUCTION IN THE CONTEXT OF WORLD ECONOMY GLOBALIZATION (2004-2012)

**Dragoş Mihai MEDELETE, Radu Lucian PÂNZARU**

University of Craiova, Faculty of Agriculture and Horticulture, 19 Libertăţii, 200421, Craiova, Romania, Phone: +40 727 712 967, Fax: + 40 251 418 475,  
E-mails: medelete@yahoo.com, rlp1967craiova@yahoo.com

*Corresponding author:* medelete@yahoo.com

### **Abstract**

*This paper seeks to present the evolution of agricultural production worldwide in circumstances of globalization for international trade in the present stage of socio-economic development, which amplify the structural interdependence for economies of different regions. For this purpose it starts from presenting the evolution of total agricultural production, after which the situation shall be liable for vegetable production and livestock production sector. The phenomena are emphasized through fixed-base indices which highlights their evolution, operating with a dynamic range of five terms: the average 2004-2006 (for comparison, in 2010, 2011 and 2012 and average 2010-2012.*

*Key words:* evolution, crop production, livestock production, total production

### **INTRODUCTION**

Globalization has become a concept used routinely at international meetings, this being determined by global integration of markets of goods, services and markets for all types of capital.

At least from a theoretical standpoint, globalization offers the possibility of larger markets - size - the possibility of a very wide range of products and services that are attracted onto the market and the possibility of attracting - in the less developed areas of economic strong inflows of financial capital [2].

General premises of globalization and globalization of markets mainly consist of: increasing the level of culture, while refining and standardizing consumer tastes; general access to global information as a result of the diffusion of technological progress and large telecommunications (Internet, e-commerce, etc.); the progressive reduction of trade barriers and tariffs; especially infrastructure development and all forms of international transport; regulating markets, as for instance the telecommunications and the aviation until recently constrained by restrictive laws on zonal operators work on these [3].

Agriculture is a strategic sector, vital and very important activity for Romanian economy [10].

It remains a huge resource comparative advantage potential of Romanian agriculture [8].

EU states have significant natural resources, human and capital to produce nearly all agricultural products needed by the population, and significant surpluses for export [9].

In this context it is worth noting that the role of agriculture in the modern economy is underlined by the functions carried out: to satisfy the food needs of the population; contribute to the employment of labor resources; contributing to better use of primary resources (natural and labor) and capital; supplying industry with raw materials; consuming industrial products contributing to industrial development; It helps to ensure ecological balance and preservation of the environment embellishment; help balance national balance of payments exports; helping to educate members of rural society; farmers as an important socio-economic force [7].

Unlike other activities of the national economy, agricultural production has a wealth of features, knowledge of which is essential

for organizing the work in this branch [4]. Agricultural output is influenced by its particularities: the earth acts as object of labor and means of labor; the disparity between labor time and production time; carrying out the production process in some natural conditions; combining economic reproduction process, the natural breeding process; Secondary production existence alongside the main production; reintroduction of part of the production obtained, into a new economic cycle; technological processes on large surfaces; how to advance production and cost recovery [1].

In the structure of agri-food, agriculture is the main provider of agricultural products food (eggs, fruit, and vegetables), raw materials for food processing [6].

## MATERIALS AND METHODS

For paper, the authors called for adequate documentation using the indicator system proposed by FAO [11].

The study refers to the total agricultural production, crop production and livestock agricultural production. The indicators were analyzed overall and per capita, using as reference points situations recorded at continental level (Africa, the American continent called generic America although it includes both South America, North America and the Caribbean; Asia; Europe, Oceania includes Australia, New Zealand, Micronesia, Polynesia etc.) and in addition they finally analyze data on specific situations of the European Union (EU generic noted) and Romania.

Conducting the analysis covers the period of time between the years 2010 and 2012, to which was added the average period and a reference level represents the average of 2004-2006, thus creating a dynamic series consists of 5 terms.

The indices represent synthetic sizes which render variability - in time and space - of economic phenomena, being expressed - always - in relative units [5].

The paper did not use expression of absolute indicators, only their relative expression based

on indices (those with fixed base used most effectively), which highlights changes from the comparison period.

## RESULTS AND DISCUSSIONS

Table 1 contains data related to the development of world agricultural production, which are presented data of total and per capita level.

**a. Total production.** In Africa in the year 2010, compared to term of reference, total agricultural output increased by 15.91 %, a trend that was maintained for the remaining terms of the dynamic series - + 18.58% in 2011, + 23.17 % for + 19.22 % in 2012 and for the period average. Therefore it can be appreciated the upward evolution of total agricultural production in the case of Africa.

The situation in America highlights strict values above par compared to term of reference in 2010, 2011, 2012 and period average (111.10, 111.72, 111.01 and 111.28 respectively %). As a result, for American continent, it is estimated that there is an oscillated total agricultural production over time.

At the level of Asian continent total agricultural production has surpassed the comparison term in a higher rates than for Africa and America, as follows: 1.18 times in 2010, 1.22 times as the average of the period 1.23 times for 2011 and 1.25 times for 2012.

In Europe we can talk about subunit values in the years 2010 and 2012 (98.93 % and 99.76% respectively) and above par values for 2011 and period average (5.17 % and 1.29% compared with the term of reference). The downward trend of the evolution for agricultural production is oscillating.

When referring to the situation recorded in Oceania can be observed the upward evolution of total agricultural production from 2010 to 2012 (102.05 %, 107.97 % and 115.73% beside the basis of comparison), then for average term, the reference value is exceeded by 8.58%.



Table 1. Agricultural production - Dynamics

No.	Specification	Y E A R				Average 2010-2012**
		Average 2004-2006*	2010*	2011*	2012*	
1.	Total production	-	-	-	-	-
1.1.	Africa	100	115.91	118.58	123.17	119.22
1.2.	America	100	111.10	111.72	111.01	111.28
1.3.	Asia	100	118.60	123.45	125.20	122.42
1.4.	Europe	100	98.93	105.17	99.76	101.29
1.5.	Oceania	100	102.05	107.97	115.73	108.58
1.6.	World level	100	112.80	116.69	116.94	115.48
1.7.	E U	100	98.73	101.17	96.27	98.72
1.8.	Romania	100	90.97	100.29	78.98	90.08
2.	Production per capita	-	-	-	-	-
2.1.	Africa	100	102.53	102.31	103.67	102.84
2.2.	America	100	105.26	104.75	103.03	104.35
2.3.	Asia	100	112.28	115.64	116.05	114.66
2.4.	Europe	100	97.95	104.00	98.56	100.17
2.5.	Oceania	100	93.61	97.52	103.01	98.05
2.6.	World level	100	106.26	108.63	107.60	107.50
2.7.	E.U.	100	96.99	99.12	94.09	96.73
2.8.	Romania	100	92.03	101.69	80.28	91.33

\* <http://faostat3.fao.org/faostat-gateway/go/to/download/Q/QI/E>

\*\* own calculation

General worldwide agricultural production evolves upward comparison level is exceeded by 12.8% in 2010, 16.69 % in 2011, 16.94 % in 2012 and 15.48 % for the average of the period.

For the EU total agricultural output has evolved unevenly, decreasing in the years 2010, 2012 and for period average beside comparison term (-1.27 %, -3.73 % and -1.28% respectively), but exceeding the reporting based only in 2011 (+ 1.17%).

For Romania, there is a fluctuating trend indicator level (compared to term of reference): -9.03 % in 2010, + 0.29 % for 2011, -21.02 % in 2012 and -9,92 % for the average of the period.

**b. Production per capita.** Total agricultural production per capita in Africa, known an uneven upward trend, the term comparison being exceeded by 2.53 % in 2010, 2.31 % in 2011, 3.67 % for 2012 and 2,84% for the average of the period.

The current situation in America highlighted above par values of this indicator during dynamical series (103.03 %, 104.35 % , 104.75 %, and 105.26 % in 2012, the average of the period 2011 and 2010 respectively). In this context we may mention that evolution is

one upward and uneven compared to term of reference.

If we consider to the situation in Asia, evolution of total agricultural production per capita is one similar to that recorded in Africa. So for comparison term has been exceeded, as follows: + 12.28 % in 2010, + 14,66 % for period average, + 15.64 % for 2011 and + 16.05 % in 2012.

In Europe, total agricultural output per capita is evolving unevenly decreases in 2010 (2.05 %), followed by growth in 2011 (+ 4.0%) and decreases in 2012 (-1.44%) and increases for average period (+ 0.17%).

At the level of Oceania, total agricultural production per capita recorded a maximum in 2012 (when the term of reference is exceeded by 3.01%) and minimum in 2010 (-6.39% over the reporting basis), the remaining terms of the series dynamical is smaller than the reference value. The overall situation highlights the global total agricultural production growth per capita over the period analyzed, exceedances of the reporting base being 1.06 times in 2010, 1.07 times in 2012 and for the period average, 1.08 times 2011. For the EU it is found that the comparison term was not even achieved during the period

analyzed, the differences compared to this being: -0.88 % in 2011, -3.01 % in the year 2010, -3, 27 % for average and -5.91 % for 2012.

If we analyze the specific situation of Romania is found that total agricultural output per capita has evolved unevenly. So, the basis for reporting is exceeded by 1.69 % in 2011, but this is not achieved for dynamical series remaining terms (-7.97 % in 2010, -8.67 % in the period average and -19, 72 % for 2012).

World agricultural evolution of production recorded in the vegetable sector is shown in the Table 2.

**a. Total production.** For Africa, crop production has evolved strictly upward, exceeding the comparison term being 1.14 times in 2010, 1.17 times for 2011 and 1.23 times in 2012. The average period exceeded 18.39 % the base of reporting.

When referring to the situation in America, we can say that based of reporting has been exceeded throughout the dynamical series, but

indicator has evolved descendant as follows: 12.89, 12.59, 10.82 and 12.10 respectively in the years 2010, 2011, 2012 and for period average.

At the level of Asian continent, the term of comparison is exceeded during the entire dynamical series (from 18.13 % to 25.54 % in 2010 and 2012), and the average exceeded 1.22 times the comparison term. As a result there is a continuous increase of the total plant production level.

Crop production in Europe have a different uneven time evolution, relative to the term of reference were registered both subunit levels and levels above par as follows: 94.29 % in 2010, 95.17 % for 2012, 98.37 % in the period average and 105.66 % in 2011.

Oceania, knows a minimum crop production in the year 2010 (105.37 % over the comparison base) and a maximum at the level of 2012 (134.27 %), its evolution over time can be regarded as one upwards.

Table 2. Crop production - Dynamics

No.	Specification	Y E A R				Average 2010-2012**
		Average 2004-2006*	2010*	2011*	2012*	
1.	Total production	-	-	-	-	-
1.1.	Africa	100	114.57	117.54	123.05	118.39
1.2.	America	100	112.89	112.59	110.82	112.10
1.3.	Asia	100	118.13	124.37	125.54	122.68
1.4.	Europe	100	94.29	105.66	95.17	98.37
1.5.	Oceania	100	105.37	119.80	134.27	119.81
1.6.	World level	100	113.06	118.37	117.78	116.40
1.7.	EU	100	95.27	99.57	90.79	95.21
1.8.	Romania	100	90.24	104.98	72.31	89.18
2.	Production per capita	-	-	-	-	-
2.1.	Africa	100	101.34	101.42	103.57	102.11
2.2.	America	100	106.94	105.55	102.84	105.11
2.3.	Asia	100	111.84	116.50	116.36	114.90
2.4.	Europe	100	93.36	104.48	94.02	97.29
2.5.	Oceania	100	96.59	108.13	119.45	108.06
2.6.	World level	100	106.50	110.20	108.37	108.36
2.7.	UE	100	93.59	97.55	88.72	93.29
2.8.	Romania	100	91.29	106.46	73.51	90.42

\* <http://faostat3.fao.org/faostat-gateway/go/to/download/Q/QI/E>

\*\* own calculation

The time evolution of global crop production is one oscillating, it increases in 2010 and 2011 by 13.06 % and 18.37 % compared to reporting term, and for 2012 growth is

reduced to 17.78 % and the average ahead 1.16 times the comparison base.

EU has an uneven evolution for the indicator, net unfavorable compared to term of

reference. Compared with it notes decreased by 4.73 % in 2010, 0.43 % for 2011, 9.21 % in 2012 and 4.79 % for the period average.

Romania is characterized by an uneven development levels of total crop production. So indicator decreased in 2010 by 9.76 % compared to reporting term, increased by 4.98 % in 2011, decreased by 27.69 % for 2012 and decreasing with 10.82 % for the average of the period.

**b. Production per capita.** In terms of crop production per capita at the African continent, that knows an upward trend in time, the term of comparison being exceeded during the entire dynamical series, as follows: + 1.34 % in 2010, + 1.42 % for 2011 + 3.57 % for 2012 and + 2.11 % in the period average.

America recorded above par values of the indicator in 2010-2012, but by decreasing trends (106.94 %, 105.55% and 102.84% respectively for 2010, 2011 and 2012). In these conditions there is an outrun for the period average of 1.05 times compared to the base of reporting.

If we refer to the situation in Asia, crop production per capita was higher to basis of reporting, during the entire dynamical series: 11.84% in the year 2010, 114.90% for the period average, 116.36% for the year 2012 116.50% for 2011. As a result, appear an indicator increase from 2010 to 2011, after which it drops to the level of 2012.

In Europe the crop production per capita have a different evolution unevenly over time - compared to the reference term - from 93.36% in 2010 to 104.48% in 2011, the average being 2.71 % lower base reporting.

Oceania is characterized by fluctuated over time crop production per capita, term of reference was exceeded in 2011, 2012 and period average (by 8.13 %, 19.45 % and 8.06% respectively), while the remainder, were recorded sub-par values (96.59% if 2010).

Overall global crop production per capita has registered just above par value (demotions of 1.06, 1.08 and 1.10 times the comparison term in 2010 and 2012 period average, respectively in 2011). Given this situation it can be concluded that there is recorded a fluctuations during the period.

EU crop production per capita has registered only subunit levels compared to reporting term - 93.59 %, 97.55 %, 88.72 % and 93.29% for the years 2010, 2011, 2012 and for period average (strictly downward trend).

Romania has an uneven evolution of the indicator, being characterized by the prevailing existence of indices below par levels (73.51% in 2012, 90.42% in the period average, 91.29% in 2010), except specific situation of 2011 (+ 6.46% over the reporting basis).

In the table 3 are shown the evolution of livestock production globally and per capita, for the period under review.

**a. Total production.** Animal production in Africa, known an upward trend over time during the period under review, compared to the reference term, recording annual rates from 119.82% to 123.52% in 2010 to 2012, average period being supra-unitary (+ 21.65%).

Romania has an upward trend of the indicator, the benchmark was not achieved, though, by any term of the dynamic series. Decreases beside the base of reporting were 7.83% in 2010, 7.45% for 2011, 10.03% for 2012 and 8.44% in the period average.

**b. Production per capita.** Livestock production per capita in Africa, known, versus term of reference values above par during the whole dynamic series. Advancing the reporting base were higher in 2010 (1.05 times), after which they decrease with the advancement time (1.04 times for 2011, 1.03 times the level of 2012).

America recorded regarding animal production level per capita, superior values beside the basis for comparison terms for all components of dynamical series. It is noteworthy that the exceedances were grouped within 0.64%, as follows: 3.07% for 2010, 3.27 % for 2012, 3.35 % in the period average and 3, 71% in 2011.

For Asia, the situation is similar to that mentioned above, except that the excedent of reference terms ranged from 1.13 times for 2010 to 1.15 times the level of 2012 (1.14 times average of the period) .

Table 3. Animal production - Dynamics

No.	Specification	Y E A R				Average 2010-2012**
		Average 2004- 2006*	2010*	2011*	2012*	
1.	Total production	-	-	-	-	-
1.1.	Africa	100	119.82	121.60	123.52	121.65
1.2.	America	100	108.77	110.59	111.25	110.20
1.3.	Asia	100	119.70	121.29	124.42	121.80
1.4.	Europe	100	104.04	104.64	104.83	104.50
1.5.	Oceania	100	100.14	101.15	105.04	102.11
1.6.	World level	100	112.35	113.78	115.47	113.87
1.7.	EU	100	102.34	102.84	102.00	102.39
1.8.	Romania	100	92.17	92.55	89.97	91.56
2.	Production per capita	-	-	-	-	-
2.1.	Africa	100	105.97	104.91	103.96	104.95
2.2.	America	100	103.07	103.71	103.27	103.35
2.3.	Asia	100	113.33	113.61	115.33	114.09
2.4.	Europe	100	103.02	103.47	103.56	103.35
2.5.	Oceania	100	91.88	91.39	93.52	92.26
2.6.	World level	100	105.84	105.93	106.26	106.01
2.7.	EU	100	100.54	100.76	99.70	100.33
2.8.	Romania	100	93.23	93.84	91.44	92.84

\* <http://faostat3.fao.org/faostat-gateway/go/to/download/Q/QI/E>

\*\* own calculation

The situation of livestock production per capita within Europe highlights exceedances levels compared to comparing base grouped into a tolerance of 0.54 %, as follows: 3.02 % in case of 2010, 3.35 % for period average, 3.47 % for 2011 and 3.56 % in 2012. As a result of these values can appreciate that indicator knows a continuous upward trend.

Oceania is characterized by a per capita livestock production, decreasing from 2010 to the average of the period - compared with the reporting term as follows: 8.12 % in 2010, 8.61 % in 2011, 6.48 % in 2012 and 7.74 % for period average.

Regarding the global situation of livestock production per capita, we can say that it is - on the whole - one upper reference limit (values above par being in all terms of dynamical series: 105.84 %, 105.93 %, 106.26 % and 106.01 % for 2010, 2011, 2012 and for the period average).

If we analyze the evolution of the indicator at EU level it appears both above par value and unitary values of dynamic indices as follows: 99.70 % in 2012, 100.33 % for the period average, 100.54 % in 2010 and 100.76 % for 2011. it is estimated that the indicator presents uneven developments in time.

Romania is characterized by strict upward trend of indicator, negative differences compared to reporting base being 6.16 % in 2011, 6.77 % for 2010, 7.16 % for average of the period and 8.56 % in 2012.

## CONCLUSIONS

Total global agricultural production and per capita had an upward trends over time, a phenomenon mainly based on increases in America, Asia, Africa and Oceania, but also negatively influenced by declining characteristic of Europe. The largest increases are recorded in Asia in the year 2012 (+ 25.2 %) and lowest values are 98,93 % in Europe in 2010 - the total output.

In the EU and Romania, the evolutions are uneven, with the prevailing values of the sub unitary indices in dynamics. The two entities, not necessarily copying specific situation of the European continent, but neither presents a contrasting situation.

Concerning the total vegetable production, it can be seen that it is evolving similar to total agricultural output, kept aspect for obtained crop production per capita. Extreme limits are 94.29 % of variation for Europe in 2010 and

134.27 % for Oceania in 2012 - when referring to total crop production, while for crop production per capita, the variation limits are established at the same years and the same continents - 93.36 and 119.45 % respectively. If we look at specific situations for Romania and EU developments can be similar to those of the total production. Differences arise in the EU in 2011, where is recorded an indication below par.

For livestock production worldwide - overall and per capita, it is noted the positive developments general in time from 2010 to 2012, across all continents, except the situation recorded for total production and per capita in Romania.

## REFERENCES

- [1]Barbu, C., Pânzaru, R.L., 1992 Agrarian Economy, course, part I, University of Craiova, Chapter 2, p. 7-18
- [2]Bari, I., 1997, The world economy, Ed. Didactic and Pedagogic, Bucharest, Part IV, p. 465-616
- [3]Dumitru Camelia, 2000, International Management and International Economic Relations, Ed. Polirom, Iași, Chapter 2, p. 22-60
- [4] Nica, S., Glăman Gh., Fântâneru A., Rural economy compendium, Ed. Artprint, Bucharest, Chapter 2, p. 21-26
- [5]Pânzaru, R.L., Medelete, D.M., 2005, Agrarian Economy - Applications, Ed. Universitaria Craiova, Paper 2, p. 11-18
- [6]Stefan, G., Toma, A.D., Pânzaru, R.L., 2006, Economic and political agri-Ed. Alfa, Iasi, Chapter 1, p. 6-21
- [7]Stefan, G., Bodescu, D., Toma, A.D., Pânzaru, R.L., 2007, Economy and agri-food chain, Ed. Alfa, Iasi, Chapter 2, p. 23-52
- [8] Zahiu Letitia, et al., 2004, Policy and agricultural markets and integration, Ed. Ceres, Bucharest, Chapter 2, p. 86-249
- [9]Zahiu Letitia et al., 2006, EU Agriculture under the impact of the Common Agricultural Policy, Ed. Ceres, Bucharest, Chapter 1, p. 19-47
- [10]Zahiu Letitia et al., 2010 Agriculture in the Romanian economy, Ed. Ceres, Bucharest, Chapter 1, p. 19-47
- [11] <http://faostat.fao.org>



## STRUCTURE OF AGRICULTURAL PRODUCTION FOR NORTH - EAST REGION OF DEVELOPMENT IN ROMANIA (2009-2011)

**Dragoş Mihai MEDELETE, Radu Lucian PÂNZARU**

University of Craiova, Faculty of Agronomy, 19 Libertăţii, 200421, Craiova, Romania, Phone: +40 727 712 967, Fax: + 40 251 418 475,  
E-mails: medelete@yahoo.com, rlp1967craiova@yahoo.com

**Corresponding author:** medelete@yahoo.com

### **Abstract**

*The paper aims to specify the structure of agricultural production for the counties of the North - East Region, with its main industries specific to agriculture: crop production, livestock production and service sector. The study aims to give a sense of the relative importance of each type of activity and each administrative territorial units (county) - regionally. It starts from the presentation of regional issues and then it presents the analysis of the specific situation of the six counties parts of the region: Bacau, Botosani, Iasi, Neamt, Suceava and Vaslui.*

**Key words:** crop production, livestock production, total production, services, structure

### **INTRODUCTION**

In all countries, irrespective of social order, agriculture has always been an essential component of production materials. The progress of all countries was and is closely linked to the achievements in agriculture. Most developed countries are economically managed countries to develop their agriculture and which directly influenced the development of other sectors of national economy [2].

For Romania's national economy, agriculture is a key industries, serving to satisfy the population's agri-food consumption, materials manufacturing, export availabilities, etc.

Even for developed countries from economic point of view (USA, Canada, Germany, France etc.), agriculture is characterized by high levels of modernization and economic efficiency, special situations being encountered in US and Canada, countries that are large exporters of agricultural products.

Romanian Agriculture is a branch of goods producing - plant and animal - with a long tradition and has favorable natural conditions. Place of agriculture in the economy of a country can be assessed by two categories of parameters: endogenous and exogenous [1].

Production Branch groups relatively homogeneous activities, running to obtain

certain goods or services, characterized by the joint nature of the products produced, specialization of labor, community and technology inputs.

Production branch is part of the production activity of the agricultural unit, which are characterized by communion, the finished product, the means used and the qualifications of the workforce.

Specific features that define a particular branch of production and which individualize it are: the finished product obtained and its economic destination; the means of production used and applied technology; determinant of labor specialization [4].

### **MATERIALS AND METHODS**

Preparation of the study called for the comparison method and the method of documentation. Besides temporal sequences included in the analysis, it was also used their average.

**Comparison method.** This method considers and compares them with the results of bases of reference to which they can appeal. The comparison can be done in time, in space, or may be a mixed one.

Correct use of comparison method involves certain conditions that ensure data comparability: the presentation of results

using the same system of indicators; ensure the unitary character of the contents, methodologies and metrics of the indicators used.

The comparison shows a general trend in researched processes and phenomena, this is based on their analysis of the terms of reference parallel.

If technical and economic analysis deals with the issue in terms of cause-effect relationship, the comparison is oriented towards examining the effects.

For the present study we used the value of agricultural production, expressed in thousand Lei current prices for the period 2009 - 2011. The level of the indicator is presented both as a whole and for the three component sectors of agriculture: crop production, animal production and nature of services agricultural (regional and district values) [5,6,7,8,9,10,11]. For perform the work, it appealed on determination of the structure of total production, taking into account the three components: crop production, livestock production and services.

Simultaneously were used dynamic indices: indices with fixed base and mobile base indices or chain.

The indices represent synthetic sizes which render variability - in time and space - of economic phenomena, they being expressed - always - in relative units [2].

## RESULTS AND DISCUSSIONS

Table 1 presents data for agricultural production structure during 2009-2011 for the North - Eastern Romania [3].

For 2009, total agricultural production has reached a level of Lei 10,573,936 thousand, of which vegetable sector held a share of 57.21%, followed - downward - by the livestock sector with 42.27% and providing services such as agricultural 0.52%.

Afferent of the weights afore mentioned three sectors recorded absolute values of total production: Lei 6,050,339 thousand, Lei 4,470,524 thousand and Lei 53,073 thousand - crop production, livestock and provision of services respectively.

For 2010, the area is characterized by total sector production of Lei 48,374 thousand to services, Lei 3,821,656 thousand for industry of animal breeding and Lei 6,934,858 thousand in plants production, values that determine a general level of the indicator Lei 10,804,888 thousand.

Based on the data above, it was determined the structure of the indicator showing shares of: 0.46 % services, livestock 35.36 %, 64.18 % vegetable production sector.

The year 2011 is characterized by a total agricultural production of Lei 12,639,425 thousand, of which the plant has achieved Lei 8,585,793 thousand, the manufacturing sector Lei 4,006,369 thousand animal breeding and services supplied only Lei 47,263 thousand. In this case the share descendant of sectors in total is 67.92 %, 31.69 % and 0.39 % - crop production, animal husbandry, and service charges.

Data for the years 2009, 2010 and 2011 led to an average period of Lei 11,339,416.3 thousand - general level of the indicator - in whose structure can be found, in descending order: vegetable production sector - Lei 7,190,330 thousand, 63.41%; livestock - Lei 4,099,516, thousand 36.15%; the providing services for agriculture - 0.44% and Lei 49,570 thousand.

Based on existing values in the table was determined the share of the region at the national level, leading to the following position: 16.93% for total production; 16.17% for plant production; 18.74% for livestock production; 8.02% for services.

The data included in Table 2 presents the evolution - in dynamics - of total agricultural production and of the indicators across the three sectors, constituting this branch of economic activity.

In the case of total agricultural production, time development is strictly upward. In this sense testify mostly, the above par values of fixed based indices and mobile, making up the dynamic (except those with base mobile to the average period - 89.7% compared to term of reference).



Table 1. North - East Romania. The structure of agricultural production (2009-2011) \* -Lei thousand current prices.

Year	Total *	Vegetal		Animal		Services	
		Lei thou *	% from total**	Lei thou *	% from total**	Lei thou **	% from total**
2009	10,573,936	6,050,339	57.21	4,470,524	42.27	53,073	0.52
2010	10,804,888	6,934,858	64.18	3,821,656	35.36	48,374	0.46
2011	12,639,425	8,585,793	67.92	4,006,369	31.69	47,263	0.39
Average 2009 - 2011 **	11,339,416.3	7,190,330	63.41	4,099,516.3	36.15	49,570	0.44
Share at the national level (%) **	16.93	16.17	-	18.74	-	8.02	-

\* [http://www.neamt.insse.ro/cmsneamt/rw/resource/42r\\_productia.htm](http://www.neamt.insse.ro/cmsneamt/rw/resource/42r_productia.htm)

\*\* own calculation

Table 2. North East Romania 's agricultural production dynamics (2009-2011)\*

Year	Total		Vegetal		Animal		Services	
	Ibf	Ibm	Ibf	Ibm	Ibf	Ibm	Ibf	Ibm
2009	100	100	100	100	100	100	100	100
2010	102.2	102.2	114.6	114.6	85.5	85.5	91.1	91.1
2011	119.5	117.0	141.9	123.8	89.6	104.8	89.1	97.7
Media 2009 - 2011	107.2	89.7	118.8	83.7	91.7	102.3	93.4	104.9

\* own calculation

The first category of indicators - those with fixed base - exceeding base of the reporting - 2009, the increase was 2.2 %, 19.5 % and 7.2% in 2010, for the year 2011 and for the average period. For the mobile base indices, annual overruns of comparison terms were 1.02 times and 1.17 times in 2010 for 2011.

Referring to the situation of vegetable production sector, it is noted the outrunning of reporting base of 1.14 times in 2010 compared to 2009, bringing forward of terms of comparison to 1.41 and 1.23 times in 2010. For average of the period, fixed base indices are above base - 118.8 %, while mobile base indices are lower with 83.7 % than the reporting term.

If we refer to the specific situation of livestock sector, sequentially we see: for 2009, a decreased compared to baseline by 14.5%; 2010 an exceeding by 1.04 times of the situation in the previous year and a decrease of 10.4% compared to the first term of the dynamical series; period average is superior to the previous term of the dynamical series and decreased by 2.3 % compared to 2009 by 8.3 %.

In the case of service sector, the achieved production value decreases in 2010 and 2011 compared with all reporting databases.

The fixed base indices are strictly below (91.1% and 89.1% respectively in 2010 and 2011), as well as those with mobile basis - 91.1 % and 97.7% (for the years mentioned above).

The average period is lower by 6.6% compared to the first point of reference, but exceeds of 1.04 times the second term of comparison.

Table 3 presents a summary of the regional structure of total agricultural production value (average of reporting period) and by sector (crop production, animal husbandry and agricultural services) [5], [6], [7], [8], [9], [10].

The existing situation for total output value, has the following structure: 12.49 % Vaslui; 13.51 % Neamt County; 14.39 % Bacau County; 17.59 % Botosani County 18.84 % of Iasi County; 23.18 % Suceava (fig. 1).

Regarding the structure of crop production dominates the counties of Suceava and Iasi with shares of 23.0 % and 20.51% respectively, followed by 17.86 % Botosani County, with 13.44 % Bacau, Neamt County with 13.01 % and 12.18 % in the final Vaslui - situation is similar as order to that shown above (Fig. 2.).

Table 3. Region North - East Romania. Structure of agricultural production by county. Average 2009 - 2011

Specification	Production							
	Total		Vegetal		Animal		Services	
	Effective* -Lei thou Current prices	Str. ** -%-	Effective* Lei thou current prices	Str. ** -%-	Effective* Lei thou current prices	Str. ** -%-	Effective* Lei thou current prices	Str. ** -%-
Bacău	1,631,531.7	14.39	966,686.7	13.44	661,659.0	16.15	3,186.0	6.43
Botoșani	1,994,930.3	17.59	1,284,178.3	17.86	707,221.7	17.25	3,530.3	7.12
Iași	2,136,116.0	18.84	1,474,855.7	20.51	634,651.3	15.48	26,609.0	53.68
Neamț	1,531,206.7	13.51	934,830.4	13.01	589,870.0	14.39	6,506.3	13.12
Suceava	2,629,165.6	23.18	1,654,073.3	23.00	973,180.3	23.73	1,912.0	3.86
Vaslui	1,416,466.0	12.49	875,705.6	12.18	532,934.0	13.00	7,826.4	15.79
Total regional	11,339,416.3	100	7,190,330.0	100	4,099,516.3	100	49,570.0	100

\*<http://www.bacau.insse.ro/main.php?lang=fr&pageid=422>,<http://www.botosani.insse.ro/main.php?lang=fr&pageid=499>,  
<http://www.iasi.insse.ro/main.php?lang=fr&pageid=499>,  
[http://www.neamt.insse.ro/cmsneamt/rw/resource/42\\_productia%20ramurii%20agricultura.htm](http://www.neamt.insse.ro/cmsneamt/rw/resource/42_productia%20ramurii%20agricultura.htm),  
<http://www.suceava.insse.ro/main.php?lang=fr&pageid=422>,  
<http://www.vaslui.insse.ro/main.php?lang=fr&pageid=422>

\*\* own calculation

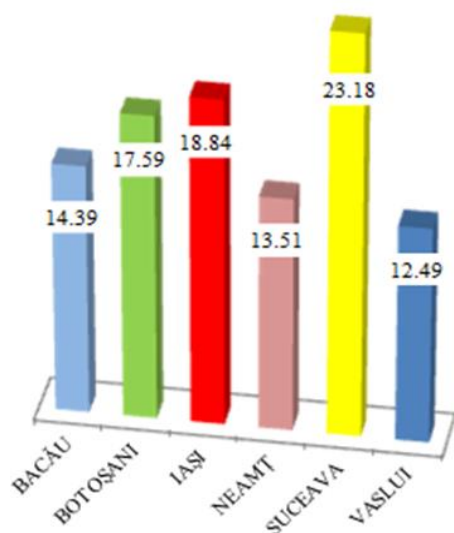

Fig. 1. North-east. Agricultural production - the county structure (%)

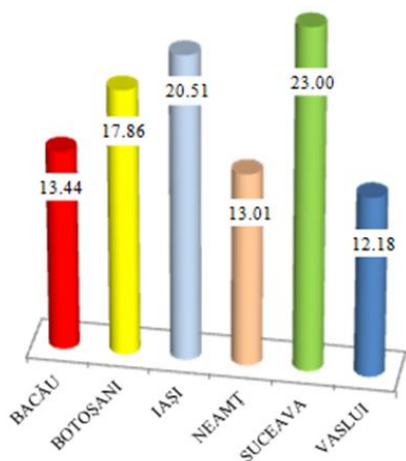

Fig. 2. North - East. Crop production - county structure (%)

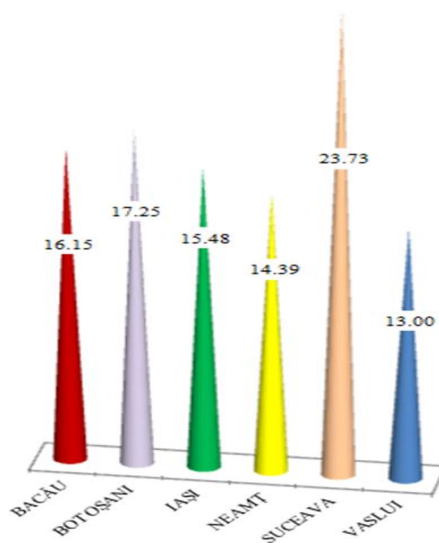

Fig. 3. North - East. agricultural production livestock - county structure (%)

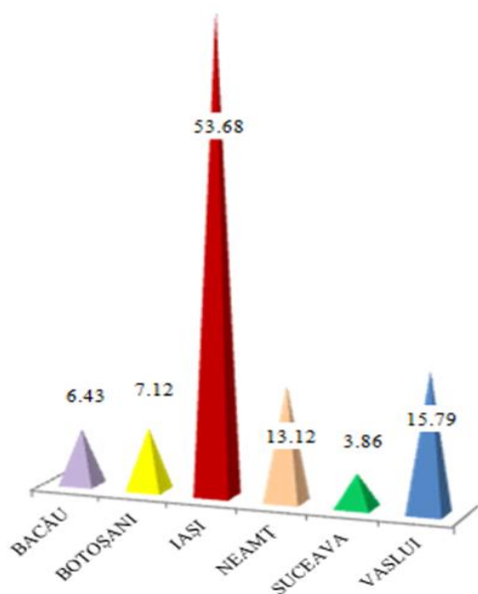

Fig.4. North - East. Agricultural production services - county structure (%)

## CONCLUSIONS

North - East Romania region stands out in all components, of dynamic series, the preponderance of vegetable production sector (over 57 % - 57.21 %, 64.18 % and 67.92 % respectively in 2009, 2010 and 2011), followed at considerable distances from farm animals (42.27 %, 35.36 % and 31.69 % for 2009, 2010 and 2011), while services supplied exceeded the 0.5 % only in 2009 (0.52 %);

The dynamics is one similar to that encountered at national level (overall upward trend for crop production, swing for animal farming and downward on services);

At the regional level, stands out three administrative units prevailed (Suceava, Iași and Botoșani exceeding the average share of 16.66 % - 23.18 %, 18.84 % and 17.59 % respectively), the remaining counties are below average share (14.39 %, 13.51 % and 12.49 % - Bacău, Neamț and Vaslui respectively).

Suceava County is ranked first in terms of the share in the case of the plant sector and livestock (23.0 % and 23.73 %), while the level of the services it ranks last (3.86 %).

The county with the lowest share is Vaslui (12-18 % for crop and livestock production 13.0 %).

Iași County, it is noted especially by the share

of service activities - 53.68 % of the region; it should be stressed the need to reinvigorate level livestock production, at the regional especially for Bacău, Neamț and Suceava that have significant potential (hills and mountains), but also of service sector for all counties.

It should not be neglected the related potential of crop production which is not used properly, in most of the cases (smallholding, poor technical equipment, limited financial resources, the need to apply a differentiated agro technical large areas of land, etc.).

## REFERENCES

- [1]Barbu, C., Pană, D., Pânzaru, R.L., 1992, Agrarian Economy, course, part I, University of Craiova, Chapter 2, p. 7-18
- [2]Nica, S., Glăman, G., Fântâneru, A., Rural economy compendium, Ed. Artprint, Bucharest, Chapter 2, p. 21-26
- [3]Pânzaru, R.L., Medelete, D.M., 2005, Agrarian Economy - Applications, Ed. Universitaria Craiova, Paper 2, p. 11-18
- [4]Pânzaru, R.L., Medelete, D.M., Stefan, G., 2007, Elements of management and marketing in agriculture, Ed. Universitaria Craiova, Chapter 3, p. 49-73
- [5][http://www.neamt.insse.ro/cmsneamt/rw/resource/42\\_r\\_productia.htm](http://www.neamt.insse.ro/cmsneamt/rw/resource/42_r_productia.htm)
- [6]<http://www.bacau.insse.ro/main.php?lang=fr&pageid=422>
- [7]<http://www.botosani.insse.ro/main.php?lang=fr&pageid=499>
- [8]<http://www.iasi.insse.ro/main.php?lang=fr&pageid=499>
- [9][http://www.neamt.insse.ro/cmsneamt/rw/resource/42\\_productia%20ramurii%20agricultura.htm](http://www.neamt.insse.ro/cmsneamt/rw/resource/42_productia%20ramurii%20agricultura.htm)
- [10]<http://www.suceava.insse.ro/main.php?lang=fr&pageid=422>
- [11]<http://www.vaslui.insse.ro/main.php?lang=fr&pageid=422>



## CONSTRAINS AND CONSENSUS ON WATER USE AND LAND ALLOCATION IN MINOR SCHEME TANKS IN THE DRY ZONE OF SRI LANKA

Naoko OKA<sup>1</sup>, Takeru HIGASHIMAKI<sup>1</sup>, D.D.Prabath WITHARANA<sup>2</sup>,  
Mekonnen B.WAKEYO<sup>3</sup>

<sup>1</sup>Japan International Research Center for Agricultural Sciences, 1-1, Owashi, Tsukuba-shi, Ibaraki-ken, Japan, Phone: 81-29-838-6679; Fax:81/29-838-6682; Email: okanaoko@affrc.go.jp

<sup>2</sup>Water Management Division, Department of Agrarian Development, No.42, Sir Marcus Fernando Mawatha, Colombo 07, Sri Lanka, Phone/Fax: 94/114379728; Email: watmngcolombo@yahoo.com

<sup>3</sup>Ethiopian Development Research Institute/EDRI, Addis Ababa: E-mail. mwakeyo@gmail.com

**Corresponding author:** okanaoko@affrc.go.jp

### **Abstract**

*In the dry zone of Sri Lanka, climate change is predicted to exert a severe impact on paddy cultivation. Paddy is cultivated with irrigation water from reservoirs called “tanks”, and decisions regarding water distribution from tanks are made by farmers in cultivation meetings which are held before cultivation seasons. In this study we focused on the bethma practice and other field crops cultivation which are potentially adaptation measures to climate change, but are not actively applied. This study tries to find constraints on applying bethma practice and other field crops (OFC) cultivation for better adaptation to climate change. We investigated the current status of bethma practice and of OFC cultivation, the reasons for the decline of bethma, and the manner in which farmers arrive at a consensus on water and land use. For the investigation we used survey data and observation of a cultivation meeting in a study area. We found that bethma is rarely applied at present and the reason is largely based on human perception of dislike of bethma, due to the unfairness in sharing responsibility in land use. This results in not only the decline of bethma but also disagreement on cultivating OFC with tank water. The lack of mechanism to arrive at a consensus between owners of suitable land and land users is a key constraint to practicing OFC using tank water. When farmers try to adapt climate change through water and land management or OFC cultivation, a new mechanism is necessary to ensure fairness in sharing responsibility for land use.*

**Key words:** bethma, irrigable land, water management and land allocation, small-reservoir, Sri Lanka

### **INTRODUCTION**

In the dry zone of Sri Lanka, climate change is predicted to exert a severe impact on agriculture. Particularly for paddy cultivation which is the dominant crop of the country, irrigation water requirements are predicted to increase due to climate change [2] [3]. In this area, paddy is cultivated with irrigation water from reservoirs called “tanks”. Among these tanks, those serving less than 80 ha (1 ha =2.47 acres) are classified as minor scheme tanks. Minor scheme tanks are managed by farmers and decisions regarding water distribution are made by farmers in cultivation meetings which are held before cultivation seasons. These decisions are made basically according to the customary water rights. In the customary water rights, the service area of

a minor tank is divided into Puranawela (old paddy fields) and Akkarawela (new leasehold paddy fields), and the Puranawela gets priority in terms of water issues. The extent of Akkarawela to be cultivated would be decided in a cultivation meeting according to the amount of rain and runoff water that would be collected in the tank [9]. In case that no agreement is reached in a cultivation meeting, water may not be used for agriculture as water is considered as a communal property. In water shortage season, water and land management practice known as “bethma” may be applied to use limited water equitably among farmers. The United Nations Educational Scientific and Cultural Organizations defines bethma as a practice that temporarily redistributes plots of land

among paddy landowners in part of the command area of a tank during drought periods. It is practiced when enough water is not available to cultivate the entire command area or Puranawela. In some cases, the land distribution in bethma practice is proportional to the landholding size, but in most cases, the same size of land is distributed to each land owner [11].

Although it is considered that bethma practice can be a key feature to adapt to climate change through utilizing limited water resource in equitable manner, it has been reported that the number of villages practicing bethma has gradually declined over the years influenced by water use insufficiency caused by population growth and expansion of irrigated area, or changes in farming activities from paddy to cash crops caused by diffusion of agro-wells [6] [10].

Another adaptation measure to climate change is crop diversification with other field crops (OFC) cultivation because OFC such as chili, soybean, finger millet, green gram, consume less water and generally increase farmers' income. Sri Lankan government has developed a "National Climate Change Adaptation Strategy" that specifies adaptation measures including crop diversification to ensure that food production meets nutritional demands and promotion of water-efficient farming methods to ensure adequate water availability for agriculture [8]. In minor scheme tanks, one major crop diversification strategy is to cultivate rice in one cropping season and other field crops or vegetables in another cropping season instead of double cropping rice [5], or promote third cropping season cultivation as seen in "Accelerated OFC production program [7]".

If, water insufficiency and change of farming activities from paddy to cash crops is the main reason for not applying bethma, there can be wider OFC expansion which consumes less water and create more income. However, self-sufficiency rate of OFC is lower than the national development goal [1]. It is assumed that there are other factors or relations between not applying bethma and not cultivate OFC instead of rice. Knowing these factors and relations can give important

insight on how to build adaptation strategy to climate change in dry zone of Sri Lanka.

Thus, this study aims to find constraints on applying bethma practice and OFC cultivation for better adaptation to climate change. For this purpose, we looked into the current status of bethma practice and of OFC cultivation, the reasons for the decline of bethma, and the manner in which farmers arrive at a consensus on water and land use, by conducting survey and observing a cultivation meeting.

## MATERIALS AND METHODS

### Study area

The study area is Thirappane Division, Anuradhapura District, North Central Province in Sri Lanka. This area belong to the dry zone, the dry season extending from May to September (Fig. 1).

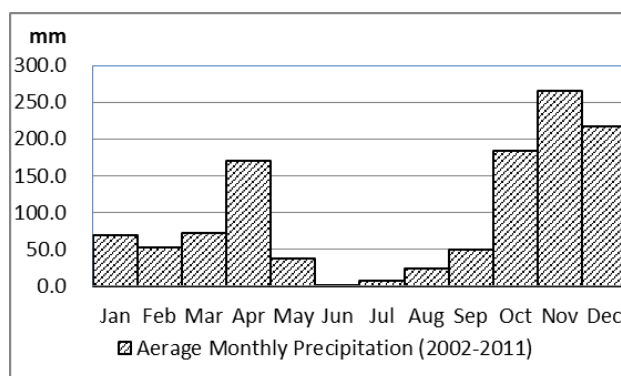

Fig. 1. Average monthly precipitation in Anuradhapura District

Source: Nachchaduwa meteorological station in Anuradhapura District, Department of Meteorology, Sri Lanka.

In the study area, two major cropping seasons exist. One is "maha" cropping season which extends from October to March, with relatively abundant rainfall. The other is "yala" cropping season which extends from April to September, with relatively small amount of rainfall and cultivation is heavily dependent on tank water. In addition to these, farmers cultivate the third cropping season "meda" which is from March and April under certain conditions including some remaining water in a tank.

### Questionnaire Based Survey on bethma and OFC

A survey was conducted from June to July 2012. Respondents to the questionnaire are representatives of Farmers Organizations (FOs) on minor scheme tanks in Thirappane Division. FOs are organizations established pursuant to Agrarian Development Act No. 48, 2000, and are registered with the Department of Agrarian Development (DAD). A questionnaire was prepared in local language and asked respondents about each tank. "Agriculture Research and Production Assistants (ARPA)" of Thirappane Agrarian Service Center (ASC), DAD, administered interviews to representatives of FOs and filled out the questionnaire. According to Thirappane ASC, there are 120 minor scheme tanks and in total, 87 questionnaire sheets were collected.

### Observing a cultivation meeting

To identify the manner in which farmers arrive at a consensus on water distribution and land reallocation, we observed a cultivation meeting for one tank in Thirappane Division in March 2014.

In usual case, FO organizes a cultivation meeting that is held before the beginning of each cropping season. In this meeting, decisions are made regarding matters including the area to cultivate, the variety of rice, the cultivation calendar, the period for distribution of water, the maintenance of irrigation infrastructure schedule, and the penalty for violations.

Observed cultivation meeting was held to decide on the cultivation of an OFC, green gram, for the meda cropping season. As usual for cultivation meetings, an ARPA observed the meeting. Along with the ARPA, an "Agricultural Instructor (AI)", an extension workers of the Department of Agriculture attended the meeting to explain the cultivation method of green gram and support that would be provided from the government.

## RESULTS AND DISCUSSIONS

### Result of questionnaire survey

The overview of respondents are presented in Table 1. It was known that there are many cases that one respondent answers for several tanks. In addition, it was known that on

average, one FO covers 2 tanks and range was from 1 to 5 tanks.

Table 1. Overview of respondents

	Number
Number of tanks	87
Number of respondent farmers	44
Number of respondent FOs	40
Number of respondents belonging to Grama Niladhari* units	22

Source: computed from the data

\*Grama Niladhari is an administrative unit under the Division

In question 1, respondents were asked to choose the implementation status of bethma from three choices. Results are shown in table 2.

Table 2. Implementation status of bethma

Choice	number of response
1-a, Bethma was applied within the past 5 years (from 2008 to 2012)	1
1-b, Bethma was applied up to some year; but it is not applied at present	37*
1-c, Bethma have never applied	73*

N=79, \*includes 32 double answers including both b and c

Table 2 shows that for most tanks, bethma is not applied at present or has never been applied. The rate of applying bethma in the past 5 years (2008 – 2012) is only 1 %. The rate is much lower than that in other surveys, for example, 34% of villages implemented bethma during 1990 – 2001, and 25% of villages implemented bethma during 1995 – 2001 among 44 traditional villages in the two Divisions of Ipalogama and Kekirwa in Anuradapura District [6], or 34% among the 32 Grama Niladhari in Mahowa division of Kurunegara District [4]. It can be inferred that the use of bethma continues to decline as existing studies [6] [10] shows.

Next, respondents were asked to choose answers based on their answer to Question 1.

Those who chose "Bethma was applied within the past 5 years (from 2008 to 2012)" were asked to explain the detailed method of implementation of bethma, such as number of participating farmers, means of redistribution

of farm land and means of water distribution. Unfortunately, no detailed information was collected from a respondent who had chosen 1-a. However, additional field observation and informant interview found that bethma was applied in Chili cultivation.

Those who chose “Bethma was applied up to some year; but it is not applied at present”, were asked to choose the reasons for not applying bethma. Those who chose “Bethma have never applied” were asked to describe the reasons. Authors tried to find out the reasons why farmers stopped applying bethma at some point.

Responses to these questions are summarized in table 3, 4 and 5. Table 3 presents the result of multiple-choice question and Table 4 and 5 present the results of descriptive answers in Question 2-b and 2-c. Table 4 shows the reasons for not applying bethma which are related to recognitions of responding person thus summarized based on responding person. Table 5 shows the reasons for not applying bethma which are related to tank conditions, summarized based on tank.

Table 3. Reasons for not applying bethma, multiple choices

Choice	Rate and number
1) Water is no longer accumulated in the tank during yala	48% (21)
2) Entre cultivation is canceled when water is not sufficient	41% (18)
3) Sufficient labor chance is available other than cultivation	36% (16)
4) No willingness to help people who are in trouble without farmland	30% (13)
5) Population has increased	27% (12)
6) Area of agricultural land per person has decreased	25% (11)
7) Farmers become annoyed to work together	25% (11)
8) Time is lacking for works increased in area other than agriculture	18% (8)
9) Fields were irrigated by agro-wells	14% (6)
10) Crops were grown without using much water	2% (1)
11) Water could be obtained from Mahaweli	0% (0)

\*N=44

Table 4. Reasons for not applying bethma, presenting perception of respondent person

Reasons	Rate and number (multiple count)
1) Farmers dislike bethma, have no will to apply it	54%(22)
2) Farmers who own large area of land dislike bethma, have no will to apply it	17%(7)
3) Farmers are not willing to help landless people, coexist	7%(3)
4) Dividing paddy lands causes trouble	5%(2)
5) No description on recognition toward bethma but on condition of tanks	27%(11)

\*Number of responded person=41

Table 5. Reasons for not applying bethma, presenting condition of tanks

Reasons	Rate and number
1)Water is insufficient to apply bethma	22% (17)
2) There are no need to apply bethma because enough water is collected	7% (5)
3) Failure experience exists	5% (4)
4) Puranawela is cultivated in water shortage	4% (3)
5) Tank has few users or is privately owned	4% (3)
6) Plot is too small in bethma	3% (2)
7) Salinity problem in yala	1% (1)
8) No description on condition of tanks but on recognition toward bethma	53% (39)

\*Number of tank with response=74

As shown in Table 3, half of the tanks reported that water is insufficient and as a result they stopped using bethma. This result is in line with the finding of Kono et al. [6], that water insufficiency caused by population growth and expansion of irrigated area influences bethma application. However, the descriptive answers presented in Table 4 indicate that 54% of farmers dislike the issues in bethma, and some respondents used the word “strong dislike” as a major reason for not applying bethma, and the rate is higher compared with the first reason in Table 5, water insufficiency which is expressed in 22% of the tanks. These means that reasons based on human perception are more dominant than reasons based on tank conditions. The fact



that among respondents, 73% of them mentioned human perception but tank condition were mentioned in only 47% of tanks support this point.

In addition, dislike may occur by landownership situation; 17% of respondents pointed that large land owners dislike bethma as shown in the second reason in Table 4.

Responses on OFC implementation were shown in Tables 6 and 7. OFC cultivation is not extensive, with the cultivation area very small compared to that of rice (Table 6), and implementation rate is only 24% of tanks (Table 7).

Table 6. Area of cultivation in yala in 2012

	Area (ac)	Proportion of tank beneficiary area (%)
Paddy	1,098	17
OFC	349	7
Total beneficiary area	5,092	100

Table 7 Number of tanks corresponding to cropping patterns in yala of 2012

Cropping pattern	Number of tanks	Rate(%)
Cultivated paddy only	17	21
Cultivated paddy and OFC	4	5
Cultivated OFC only	15	19
No cultivation	45	56

\*Number of tank with response=81

### Result of observation of cultivation meeting

The observed cultivation meeting is held to decide whether farmers should cultivate green gram in the meda cropping season with tank water. Chaired by the president of the FO, AI explained the merits of green gram cultivation in the meda cropping season: it can be cultivated in a short period of time, water supply is needed only twice, and the Department of Agriculture is ready to subsidize seed purchases if farmers decide to cultivate green gram.

The major point of the discussion was how to use or distribute the land suitable for green gram, which comprises only part of the command area considering the soil type, ground water condition and canal network. Because tank water is their common property, usage of tank water must be agreed upon by all farmers.

Farmers who do not own suitable land for green gram supported to apply bethma, because with bethma, they have right to use some portion of the suitable land. On the other hand, farmers who had suitable land for green gram cultivation did not want to lend their land because in their experiences, the borrower did not clean the land or “show their appreciation” after cultivation as promised. In their opinion, allowing others to borrow and use their land free of charge would free those farmers from responsibility.

The officers encouraged farmers to cooperate for the benefit of all, even suggesting that borrowers should pay some fee after harvesting. However, farmers who lacked land suitable for green gram cultivation did not want to agree on tank water use until landowners agreed to apply bethma and guarantee the use of suitable land. Farmers who had land suitable for green gram did not agree to apply bethma. The meeting ended in disagreement regarding green gram cultivation with tank water.

It can be said that farmers with suitable land do not want to share land without sharing responsibility to maintain land, and farmers without suitable land do not have will to share that responsibility in addition to that they do not want others gain from tank water use.

This observation made it clear that the lack of mechanism to arrive at a consensus on sharing responsibility between owners of suitable land and land users is a key constraint to practicing OFC using tank water.

### CONCLUSIONS

Bethma is rarely applied at present. The reason for this situation is largely based on human perception especially dislike of bethma by farmers who own land for bethma. The perception of dislike comes from sense of unfairness in sharing responsibility on land use. This results in not only the decline of bethma but also disagreement on cultivating OFC with tank water. The lack of mechanism to arrive at a consensus between owners of suitable land and land users is a key constraint to practicing OFC using tank water.

When farmers try to adapt climate change through water and land management or OFC cultivation, a new mechanism is necessary to ensure the fairness in sharing responsibility for land use. For example, introducing a clear compensation system or rental fee on land sharing or developing institutional system are options for future trial as adaptation measures for minor scheme tanks in the dry zone of Sri Lanka.

## ACKNOWLEDGMENTS

The authors wish to thank farmers and officers in Thirappane Division, and we also like to express our special thanks to Mr. Z. Ali. M. Mowlana for his assistance to this survey.

## REFERENCES

- [1]Asian Development Bank, 2014, Sri Lanka: Water Resources Development Investment Program, Technical Assistance Consultant's Report
- [2]De Silvia, C.S., Weatherhead, E.K., Knox, J.W., Rodriguez Diaz J.A., 2007, Predicting the impacts of climate change – A case study of paddy irrigation water requirements in Sri Lanka. *Agr Water Manage* 93:19-29,
- [3]Eriyagama, N., Smakhtin, V., Chandrapala, L., Fernando, K., 2010, Impacts of climate change on water resources and agriculture in Sri Lanka: a review and preliminary vulnerability mapping. IWMI, Colombo, Sri Lanka.
- [4]Hiraiwa, M., 2009, Analysis on the Bethma System in the Huruluwewa Irrigation Scheme in Sri Lanka. *Water, Land and Environmental Engineering* 77:477-481.
- [5]Jayawardane, S.S.B.D.G., Weerasena L.A., 2001, Crop diversification in Sri Lanka. In: Papademitriou M.K., Dent F.J. (ed) *Crop diversification in the Asia-Pacific- region*, FAO regional office for Asia and the Pacific, Bangkok. pp. 112-129.
- [6]Kono, H., Somarathna, H.M., 2003, Theoretical analysis of transforming of Bethma custom in Sri Lankan traditional village. *Research Bulletin of Obihiro University, Humanities and Social Sciences* 11:32-36.
- [7]Ministry of Agriculture, Sri Lanka, 2014, Accelerated other Field Crop Production Programme, <http://www.agrimin.gov.lk/web/index.php/project/12-project/67-accelerated-other-field-crop-production#>, accessed 8 July 2015.
- [8]Ministry of Environment Climate Change Secretariat, 2010, National Climate Change Adaptation Strategy for Sri Lanka 2011 to 2016, Final draft. In: *Climate Change Secretariat Sri Lanka*, Ministry of

Environment and Renewable Energy. [http://www.climatechange.lk/adaptation/Files/Strategy\\_Booklet-Final\\_for\\_Print\\_Low\\_res%281%29.pdf](http://www.climatechange.lk/adaptation/Files/Strategy_Booklet-Final_for_Print_Low_res%281%29.pdf).

Accessed 2 July 2013.

[9]Panabokke, C.R., Sakthivadivel, R., Weerasinghe Asoka Dias, 2002, *Evolution, Present Status and Issues Concerning Small Tank Systems in Sri Lanka*. IWMI, Colombo, Sri Lanka

[10]Somaratna, H.M., Kono, H., 2005, *Indigenous Institutions for irrigation water management and sustainable agriculture: a case study from Sri Lanka*. *JASRAD* 15:69-76.

[11] UNESCO, 1994-2003, *The bethma practice: promoting the temporary redistribution of lands during drought periods*.

<http://www.unesco.org/most/bpik21.htm>. Accessed 18 Nov 2013

## DETERMINANTS OF PALM OIL OUTPUT SUPPLY IN NIGERIA

Chigozirim Ndubuisi ONWUSIRIBE, Chibuzo Ikechukwu OKPOKIRI

Michael Okpara University of Agriculture Umudike, Department of Agribusiness and Management,  
Abia State, Nigeria, Phone: +2348063724608, Email: ndubuisichigo@gmail.com

**Corresponding author:** ndubuisichigo@gmail.com

### Abstract

*This study analyzed the determinants of palm oil output supply in Nigeria. A time series data, from the period of 1970-2014 were collected from the Food and Agricultural Organization data base and other sources. Trend analysis, ADF unit root test, co-integration test and error correction model were used to analyze the data. The trend in the output supply of palm oil shows significant growth rate based on the coefficient of the time trend ( $b_1$ ). The unit root test using Augmented Dickey Fuller test (ADF) shows that all the variables have constant mean except for palm oil yield which led to the Autoregressive Distributed Lag (ARDL) co-integration test which reveals the presence of long run relationship existing between the variables and short run relationships with error correction term. Imports of palm oil has negative significant short run and long run impacts on the output supply of palm oil while in the short run palm oil exports has a significant negative impact on the palm oil output supply and a significant positive impact in the long run. The error correction model (ECM) suggests a high speed of adjustment of the dependent variable to changes in the independent variables. The import of palm products affects the output supply of palm oil negatively as this impedes the local production of palm oil. Export of palm oil was positively signed indicating that export of palm oil encourages the farmers to increase their output supply. This study therefore, recommends the promotion of export and formulation of export promotion policies to stimulate international market for our palm oil and encourage our farmers to boost their output.*

**Key words:** determinants, oil, output, palm, supply

### INTRODUCTION

Oil Palm (*Elaeis guineensis*) is one of the most commonly grown fruit crop and the number one vegetable oil crop. Palm oil which is extracted from the palm fruit is a major global commodity used for food and raw material [12]. Oil Palm cultivation is a source of livelihood for millions of people around the world especially in the southern part of Nigeria which is characterized by tropical forest, watersheds, and biodiversity. The palm oil belt in Nigeria includes the states of Abia, Anambra, Bayelsa, Akwa-Ibom, Cross River, Delta, Eboniyi, Ekiti, Enugu, Ondo, Ogun, Osun, Oyo, Imo and Rivers. Over the years, the country's palm oil capacity has even expanded beyond these traditional palm oil belts. Indeed as a result of extensive research in inputs and good ecology, oil palm is widely grown in over 24 states of the country in both wild grove and small holder farm plantations [3]. No part of the oil palm is a waste. The residue after oil has been extracted is called palm kernel cake,

which is useful in feeding livestock. The leaves of palm oil are used for making brooms, roofing and thatching, basket and mats. The thicker leaf stalks are used for walls of village huts. The bark of the palm frond is peeled and woven into baskets [10].

Nigeria was a leading exporter of palm kernel, and largest producer and exporter of palm oil accounting for 43 percent of global palm oil production [1]. Export of cash crops such palm oil contributed significantly to the economy of Nigeria prior to the crude oil boom of the late 1960's [5, 2]. But due to over-reliance on traditional production techniques, excessive tapping of palm tree for palm wine and the civil war in 1967-70 which were more intense in areas where oil palm cultivation activities were predominant, hampered Nigeria's output supply of palm oil. Nigeria is now a net importer of palm oil. The domestic palm oil produced totalled 930,000 MT in 2014. The growth in palm oil has stagnated at 930,000 MT since 2013. The consumption of palm oil in Nigeria amounts to 2.0 million MT per annum [1].

According to Emeifele, there have been many narratives over the years and in recent times on what led to this downward trend, with blames being apportioned by different parties along the palm oil value chain [5]. This poses a very precarious situation for the manufacturing sector that depends largely on palm oil as a major source of raw material. Nigeria today produces only 1.7 per cent of the world's consumption of palm oil which is insufficient to meet its domestic consumption which stands at 2.7 per cent [1]. The output supply of palm oil in Nigeria has been affected by some factors which may include the import and export of palm oil, the producer price, climatic variables as well as area harvested. Hence, there is the need to study the determinants of palm oil output supply in Nigeria.

#### Objectives of the study

The main objective of the study is to analyze the output supply response of palm oil in Nigeria. The specific objectives are to:-

- (i) Analyze the trend and growth in the output supply of palm oil.
- (ii) Analyze the determinants of output supply of palm oil in Nigeria.

#### Research hypothesis

**Ho1:** producer price, rainfall and area harvested have no significant impact on the output supply of palm oil.

**Ho2:** import and export have no significant impact on the output supply of palm oil.

## MATERIALS AND METHODS

Nigeria is a country located in West Africa along the Atlantic Ocean's Gulf of Guinea, its land borders are with Benin to the West, Cameroon and Chad to the East and Niger to the North. It is between latitudes 4°N and 14°N and longitudes 3°E and 15°E Meridian. It has a tropical climate with relatively high temperatures throughout the year, annual average temperature varying from 35°C in the North to 31°C in the south. Temperature is highest from February to April in the South and from March to June in the North, and lowest in July and August over most states in the country.

It is the most populous nation in Africa, and

has one of the fastest growing populations in the world. Currently, the population of Nigeria is being put at 167,000,000 people.

The land area is 923,768 km<sup>2</sup> (356,667 square miles).

#### Sources of Data

Data were obtained from the Food and Agriculture Organization data base and UNDP (United Nations Development Programme) database for a period of 1970 - 2014.

#### Analytical Technique

Unit Root Test using the ADF test technique to test if the time series data were stationary, Autoregressive Distributed Lag (ARDL) co-integration and error correction tests were also used.

#### Model Specifications

##### Unit Root Test: Augmented Dickey-Fuller (ADF) Test (for stationary test)

The ADF test consists of estimating the following regression

$$\Delta Y_t = \beta_1 + \beta_2 + \delta Y_{t-1} + \sum_{i=1}^m \alpha_i \Delta Y_{t-i} + e_t$$

Where

$y$  is the series  $t$  is trend factor,

$e_t$  is the stochastic error term

$t_{-1}$  is the lag length.

It is a one-sided test whose null hypothesis is  $\delta=0$  versus  $\delta<0$  (hence large negative values of the test statistics lead to the rejection of the null) and  $\Delta$  is the difference operator. Under the null,  $Y_t$  must be differenced to achieve stationarity; under the alternative  $Y_t$  is already stationary and no differencing is required.

The Augmented Dickey-Fuller (ADF) unit root test was employed to test the integration level and the possible integration among the variables.

#### Trend Analysis

However, for measuring the acceleration or deceleration in the growth rate, trend equation was fitted and stated thus.

$$Y = a + b_t + U_t$$

Where

$Y$  = output supply of palm oil (tonnes)

$a$  = constant

$b$  = coefficient

$t$  = trend

$U$  = error term

Positive significant value of  $c$  indicates

acceleration while a negative significant value implies a deceleration. A non significant value shows stagnation in the growth process [13].

### Co-integration Test and error correction estimates

The Autoregressive Distributed Lag (ARDL) model developed by Pesaran et al is deployed to estimate our model because of three reasons. First, Pesaran *et al.* advocated the use of the ARDL model for the estimation of level relationships because the model suggests that once the order of the ARDL has been recognised, the relationship can be estimated by OLS [15]. Second, the bounds test allows a mixture of I(1) and I(0) variables as regressors, that is, the order of integration of appropriate variables may not necessarily be the same. Therefore, the ARDL technique has the advantage of not requiring a specific identification of the order of the underlying data. Third, this technique is suitable for small or finite sample size [15].

Following Pesaran *et al.*, we assemble the vector autoregression (VAR) of order  $p$ , denoted VAR ( $p$ ), for the following growth function:

$$Z_t = \mu + \sum_{i=1}^p \beta_i z_{t-i} + \varepsilon_t \quad (1)$$

where  $z_t$  is the vector of both  $x_t$  and  $y_t$ , where  $y_t$  is the dependent variable defined as palm oil output,  $x_t$  is the vector matrix which represents a set of explanatory variables According to Pesaran *et al.*, the dependent variable  $y_t$  must be I(1) variable, but the independent  $x_t$  can be either I(0) or I(1).

The vector error correction model (VECM) is specified as follows:

$$\Delta z_t = \mu + \alpha t + \lambda z_{t-1} + \sum_{i=1}^{p-1} \gamma_i \Delta y_{t-i} + \sum_{i=1}^{p-1} \gamma_i \Delta x_{t-i} + \varepsilon_t \quad (2)$$

$$\lambda = \begin{bmatrix} \lambda_{YY} & \lambda_{YX} \\ \lambda_{XY} & \lambda_{XX} \end{bmatrix}$$

The diagonal elements of the matrix are unrestricted, so the selected series can be either I(0) or I(1). If  $\lambda_{YY} = 0$ , then  $Y$  is I(1). In contrast, if  $\lambda_{YY} < 0$ , then  $Y$  is I(0).

The VECM procedures described above are

imperative in the testing of at most one cointegrating vector between dependent variable  $y_t$  and a set of regressors  $x_t$  [6, 7].

To derive model, we followed the postulations made by Pesaran *et al.* in Case III, that is, unrestricted intercepts and no trends [15]. After imposing the restrictions  $\lambda_{YY} = 0, \mu \neq 0$  and  $\alpha = 0$ ); the error correction model of the ARDL model is specified as follows

$$\Delta(\text{output})_t = \beta_0 + \sum_{i=1}^p \beta_1 \Delta(\text{output})_{t-i} + \sum_{i=0}^q \beta_2 \Delta(\text{exp ort})_{t-i} + \sum_{i=0}^r \beta_3 \Delta(\text{import})_{t-i} + \sum_{i=0}^q \beta_4 \Delta(\text{price})_{t-i} + \sum_{i=0}^r \beta_5 \Delta(\text{rainf all})_{t-i} + \sum_{i=0}^r \beta_6 \Delta(\text{areaharvested})_{t-i} + \sum_{i=0}^q \beta_7 \Delta(\text{yield})_{t-i} + \text{ECM t-i}$$

Where  $\Delta$  is the first-difference operator and ECM t-i is a Error correction term.

Output = supply of palm oil ( in tonnes)

Area harvested = area harvested ( hectares )

Price = producer price ( naira)

Import = import quantity (in tonnes)

Export = export quantity ( in tonnes )

rainfall = rainfall (mean rainfall value)

yield = yield of palm oil ( in tonnes)

t= time

ECM =error correction term

## RESULTS AND DISCUSSIONS

### Output supply trend of palm products

The trends was of palm oil area harvested, yield, output, price, import value and export value, where presented in chart 1 to chart 7. The trend of area harvested for the palm oil continued increasing after experiencing fluctuation from 1970-1984, this may be as a result of the policy of Structural Adjustment Program (SAP) prevailing in that era coupled with some agricultural enhancement programs prevalent in the era that led to the expansion of agriculture land especially for the cultivation of cash crops such as oil palm [8, 9].

The yield was constant from 1970 to 1974 but with the increase in the area harvested the yield increased as well.

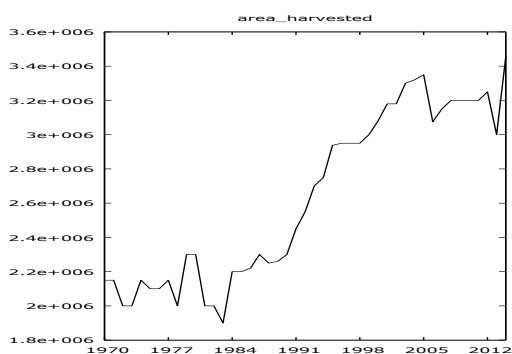

Chart 1. Trend of area harvested  
 Source: Food and Agriculture Organization data base

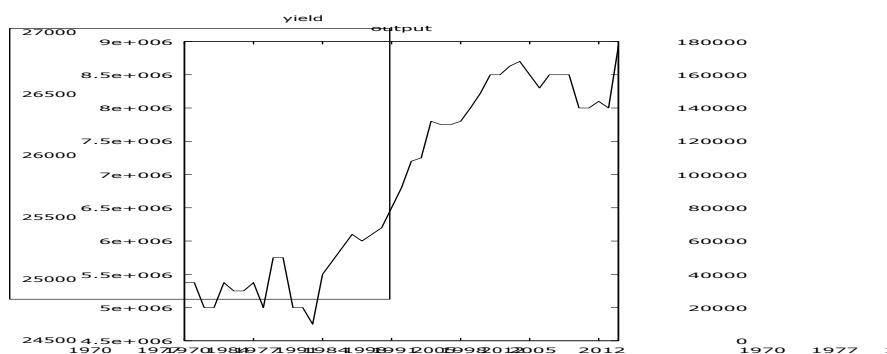

Chart 3. Trend of output of palm oil.  
 Source: Food and Agriculture Organization data base

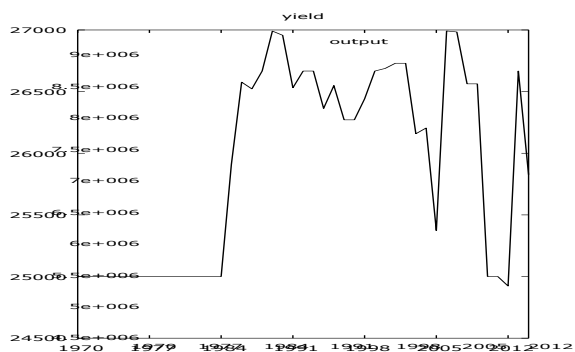

Chart 2. Trend of yield.  
 Source: Food and Agriculture Organization data base

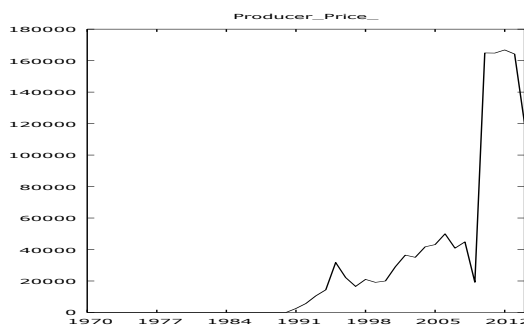

Chart 4. Trend of producer price of palm oil.  
 Source: Food and Agriculture Organization data base

But from 2000-2014 the yield has continuously dwindled despite policy efforts to improve agricultural production especially palm oil production. Though there were intense policy efforts in the area of cassava production.

The output supply of palm oil experienced significant increase from 1984 with the increase in area harvested and yield. The price of palm oil experienced a significant increase from 2008 to 2013 as a result of the dwindling output and yield.

The importation of palm oil very insignificant from 1970 to 1991 though there was a slight increase around 1977 to 1984. Nigeria is noted for the production of palm oil but with recent reduction in yield and output Nigeria has increased the importation of palm oil. As presented in chart 3 below export of palm oil has been fluctuating with a significant increase in 2005.

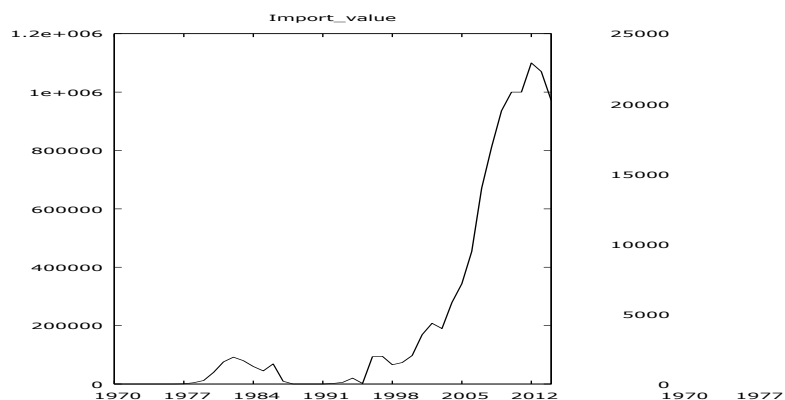

Chart 5. Trend of palm oil import  
 Source: Food and Agriculture Organization data base

The result of the palm oil output supply trend analysis estimate was presented in Table 1. The coefficient of the time trend was positive and statistically significant.

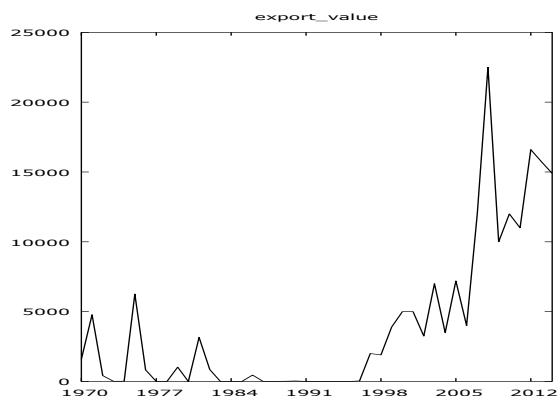

Chart 6. Trend of palm oil export Source: Food and Agriculture Organization data base

This means that time was a positive determinant of the variations in the output of the palm oils. This significant coefficient suggests that the output supply of palm oil grows over time. The model had a good fit with  $R^2$  value of 0.867 and a significant F value of 279.976. Since the coefficients are positive, palm oil output recorded growth during the period under study.

Table 2. Analysis of Growth in the output supply of palm oil

	b0	b1	R <sup>2</sup>	F STAT
OUTPUT SUPPLY	4.55E+06 (29.1024)***	99115.6 (16.7325)***	0.87	279.98

Source: Food and Agriculture Organization data base  
 Values in parenthesis are t-value and \*\*\* means that the data are statistically significant at 1%

### Unit Root Test of the variable in output supply model

The Augmented Dickey Fuller Unit root test was conducted for the variable with constant, and trend. The results revealed that all the variables were integrated at difference except for palm oil yield. With the result we now difference the affected variables.

Since all the variables are not integrated in the same order, there is a need for a co-integration test. This implies that some linear combinations of the series must be co-integrated, such that even though the individual series may be integrated in the order I (1), the series may drift apart in the short-run, and then follow a common trend which permits stable long-run relationship between them.

Table 3. Unit Root Test of the variables

	Level Tau	p-value	Difference Tau	p-value	Order of integration
Area harvested	-2.742	0.4229	-7.786	1.59E-06	I(1)
Yield	-3.842	0.0486	-3.078	0.26	I(0)
Output	-1.485	0.9475	-4.515	0.006151	I(1)
Producer Price (LCU/tonne)	-3.774	0.0764	-5.655	5.10E-05	I(1)
Import value	-0.636	0.9958	-4.476	0.007029	I(1)
Export value	-6.208	0.0001	-4.421	0.00847	I(1)
Mean rainfall	-3.115	0.244	-3.611	0.0872	I(1)

Source: Computations from the data obtained from UNDP and FAOstat various issues.

Note: I(0) and I(1) are integrated at level and first difference

### Autoregressive distributed LAG (ARDL) Model Co-Integration Test and Error correction estimates

Table 3 displays the calculated F-statistics (F-statistic = 27.861), showing that the null of no cointegration can be rejected at 1.0 percent level. This implies that there exists a long-run relationship or cointegration between output supply of palm oil and its determinants. Having established the cointegration relationship, the next step is to estimate the long-run coefficients by estimating an ARDL. The result indicates that the long run overall model is well fitted as the independent variable explained over 95% ( $R^2$ ) movement in the dependent variable.

Table 4. Estimated Long-Run Coefficients ARDL

Variable	Coefficient	Std. Error	t-Statistic	Prob.
C	-1.26E+08	22060320	-5.70442	0.0002
(SUPPLY(-1))	12712898	1773358	7.168826	0.000
(EXPORT(-1))	71156.56	27181.45	2.617836	0.0257
(IMPORT(-1))	-218902	57403.74	-3.81338	0.0034
(PRICE(-1))	320994.4	78626.45	4.082524	0.0022
(RAINFALL(-1))	760711.1	660055.7	1.152495	0.2759
(AREAHARVESTED (-1))	-5584171	1816927	-3.07342	0.0118
(YIELD)	1031147	1191392	0.865498	0.4071
R-squared	0.951225	Mean dependent var		8208444
Adjusted R-squared	0.917083	S.D. dependent var		377354.6
S.E. of regression	108660.2	Akaike info criterion		26.33094
Sum squared resid	1.18E+11	Schwarz criterion		26.72666
Log likelihood	-228.979	Hannan-Quinn criter.		26.38551
F-statistic	27.86073	Durbin-Watson stat		2.276116
Prob (F-statistic)	0.000009			

Source: Computations from the data obtained from UNDP and FAOstat various issues

The long-run coefficients show that export of palm oil exhibits a positive significant relationship with output supply of palm oil so does the lag of output supply of palm oil itself. Imports of palm oil and area harvested are inversely related to output supply of palm oil. The coefficient of importation of palm oil was statistically significant at 5% and negatively influencing the output supply of palm oil in Nigeria. This implies that importation of palm oil has negative impact on the output of palm oil in Nigeria. Since the imported products are known to be cheaper and affects domestic production negatively. Most of the manufacturers that use palm oil as a major raw material will go for the imported palm oil leaving the domestic output to suffer. But the export of palm oil had a positive significant impact on the output supply of palm oil in Nigeria. The increase in the level of exports motivates the farmers to produce more output. Price was a positive significant determinant of palm oil output supply; this means that the increase in the price of palm oil results to corresponding increasing the supply of palm oil. Area harvested has negative impact on the output supply of palm oil. As the population grows the area harvested shrinks due to the effect of urbanization and this will reduce output supply of palm oil.

According to the Granger representation theorem, when variables are cointegrated, there must also be an error correction model (ECM) that describes the short-run dynamics or adjustment of the cointegrated variables towards their equilibrium values. The result of the ECM is presented in Table 4. The error term is negative and highly significant. The coefficient of -5.705 indicates an evidence of fast adjustment towards long-run equilibrium. Exactly saying 57.1 percent of disequilibrium is corrected in the long-run level for equilibriums to be re-established. Both the short run and long run results gave the same sign for the selected variables except exports and yield, which takes negative sign in the short run. Export

and yield of palm oil had a short run negative impact on the output supply of palm oil.

Table 5. Error Correction Estimates of the ARDL Model

Variable	Coefficient	Std. Error	t-Statistic	Prob.
C	-997175.2	138254	-7.212632	0.0001
D(SUPPLY)	6.864844	1.227962	5.590435	0.0003
D(SUPPLY(-1))	4.560429	1.315715	3.466123	0.0071
D(SUPPLY(-2))	5.162884	1.226117	4.210758	0.0023
D(SUPPLY(-3))	-0.110299	0.071532	-1.541967	0.1575
D(AREAHARVESTED)	-15.22084	3.173964	-4.795531	0.001
D(AREAHARVESTED(-1))	-8.962561	3.381184	-2.650717	0.0264
D(AREAHARVESTED(-2))	-10.33207	3.140098	-3.290367	0.0094
D(AREAHARVESTED(-3))	13.33217	3.164022	4.213678	0.0023
D(EXPORT)	-28.5339	11.16626	-2.55367	0.0309
D(EXPORT(-1))	-13.77047	11.75166	-1.17179	0.2714
D(EXPORT(-2))	-3.027679	14.07584	-0.215098	0.8345
D(EXPORT(-3))	-4.931221	13.07068	-0.377274	0.7147
D(IMPORT)	-0.703292	0.490502	-1.433823	0.1854
D(IMPORT(-1))	-0.714521	0.493713	-1.447241	0.1817
D(IMPORT(-2))	0.044152	0.480294	0.091927	0.9288
D(IMPORT(-3))	-0.001639	0.566694	-0.002892	0.9978
D(PRICE)	5.639327	1.530769	3.683984	0.005
D(PRICE(-1))	4.062636	1.387681	2.927645	0.0168
D(PRICE(-2))	3.310468	1.625302	2.036833	0.0721
D(PRICE(-3))	6.66184	4.525607	1.472032	0.1751
D(RAINFALL)	1088.896	2391.247	0.455367	0.6596
D(RAINFALL(-1))	2264.22	2574.735	0.879399	0.4021
D(RAINFALL(-2))	-3084.705	3368.531	-0.915742	0.3837
D(RAINFALL(-3))	-3260.259	3069.707	-1.062075	0.3159
D(YIELD)	-1561.162	341.7433	-4.568231	0.0014
D(YIELD(-1))	-779.9873	339.6494	-2.296448	0.0473
D(YIELD(-2))	-1119.707	320.7522	-3.490879	0.0068
D(YIELD(-3))	69.42599	56.17636	1.235858	0.2478
ECM	-5.704776	1.097454	-5.198192	0.0006
R-squared	0.999438	Mean dependent var		6918000
Adjusted R-squared	0.997626	S.D. dependent var		1347325
S.E. of regression	65645.18	Akaike info criterion		25.09404
Sum squared resid	3.88E+10	Schwarz criterion		26.3737
Log likelihood	-459.3338	Hannan-Quinn criter.		25.55317
F-statistic	551.6715	Durbin-Watson stat		1.933627
Prob(F-statistic)	0.000			

Source: Computations from the data obtained from UNDP and FAOstat various issues.

### Impulse response of palm oil output supply

This means to test track the time path of the sudden changes that can be exposed to different variables of the model and how other variables respond to any sudden change in any variable included in the model. And chart 4 Shows Impulse Response Function of palm oil supply output to a sudden change rate of one standard deviation in each of the area harvested, yield, import, export, price and rainfall.

It is clear from chart (4) that output supply of palm oil is affected negatively by the previous output supplies of palm oil. The continuous harvest of the oil palm reduces the subsequent



output. The impulse response of palm oil output supply clearly shows a negative shock. Changes in the yield of palm oil, results to moderate increase in the output supply in the initial five years before a subsequent significant positive response in the palm oil output supply. Shocks in the producers' price of palm oil will result to positive response in the output supply of palm oil within the initial six years before a negative response sets in.

Changes in the export of oil palm results to a positive response of palm oil output from the first year to the third year before a slight decrease from the fifth to the sixth years. But a positive response will follow immediately. Changes in importation of palm oil results to a negative response of output supply in consonance with the long run regression coefficients. Shocks in the area harvested had a negative effect on the supply of palm oil in the short run while changes in rainfall had a positive impact on the output supply of palm oil.

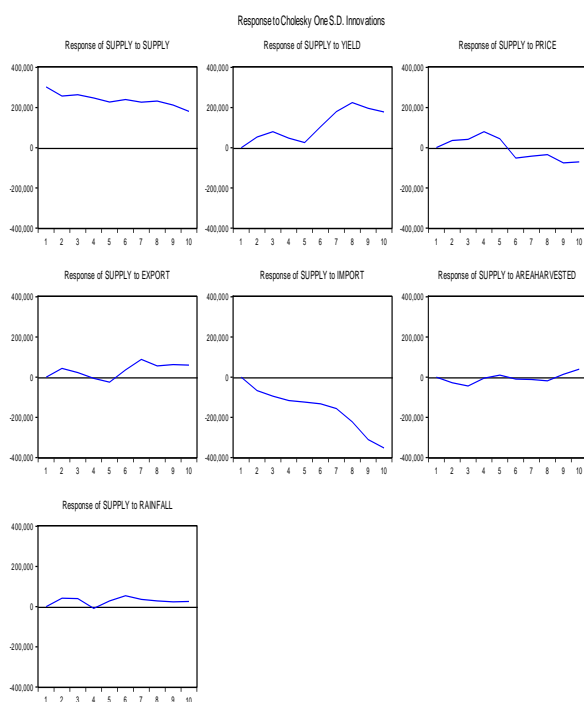

Chart 7. Impulse response of palm oil output supply  
 Source: Computations from the data obtained from UNDP and FAOstat various issues

## CONCLUSIONS

This study provides evidence in the nature of output supply response of palm oils in

Nigeria. It was found that the trend in the output supply of palm oil shows significant growth rate based on coefficient of time trend which was significant at 1% and positive. The study also found that all the variables have constant mean except for palm oil yield using the Augmented Dickey Fuller test (ADF) unit root which led to the Autoregressive Distributed Lag (ARDL) model co-integration test. The co integration test revealed that there exist a long run relationship between output supply of palm oil and its determinants. The independent variables with significant long run coefficients were imports, exports and area harvested. The error correction term shows high level of adjustment towards long run equilibrium. In the long run the impact of export was positive while in the short run it was negative. By implication in the short run exports of palm oil affects the output supply inversely while in the long run it results to the increase in the output supply palm oil. The impulse response shows the response of the palm oil output supply to its determinants, which was in line with the findings of the short run and long run coefficients.

Based on the findings of the study, the trend indicated the growth in the output supply of palm oil over the years. Also the import of palm oil revealed that the consumer will go for the imported product leaving the output supply of our farmers to suffer. The export of palm oil indicated that exporting of palm oil encourages the farmers to increase their output supply in the long run.

The following solutions become necessary for the objectives of supply response of palm oil to be achieved.

- (i) The promotion of exports and formulation of export promotion policies to create interaction market for our palm oil and encourage our farmers to boost their output.
- (ii) There is need for government to restore palm oil production in Nigeria through replanting programs and producer price supports.
- (iii) Farmers and growers should adopt technological driven production to enhance the yield of palm oil.

(iv)The need for collaborations between industries and research institution should be encouraged to boost palm oil production.

(v)With the short run and long run coefficients of price were positive, this suggest a serious policy concern for the price regularization and stabilization measures to promote the output supply of palm oil.

## REFERENCES

- [1]Adetola, S., 2015, Oil Palm Importation: A strategic Stabilizer for Palm Oil industry in Nigeria. ThisDay Live Newspaper 06/01/2015
- [2]CBN, 2000, Central Bank of Nigeria statistical bulletin 2000. Central Bank of Nigeria, AbujaNigeria.
- [3]Emefiele, G., 2015, Speech by Governor Godwin Emefiele during a Meeting with oil Palm Value Chain Stakeholder. Held at GCC Meeting Room Central Bank Of Nigeria (CBN) Headquarters, Abuja on July 10, 2015.  
<http://www.cenbank.org/Out/2015/CCD/speech-at-oil%20palm%20stakeholders%20meeting.pdf>
- [4]F.A.O, 1991, 'Food and Agriculture Organization of the United Nations.
- [5]Idachaba, F.S., 1994, The second coming of commodity board in Nigeria: curse orn blessing? in Proceedings of the national workshop on commodity board in a liberalized economy. Nsukka; Fulladu publishing company.
- [6]Johansen, S., 1988, Statistical Analysis of Cointegration Vectors, Journal of Economic Dynamics and Control, Vol. 12, No. 2–3, pp. 231–254.
- [7]Johansen, S., 1991, Estimation and Hypothesis Testing of Cointegration Vectors in Gaussian Vector Autoregressive Models, Econometrica, Vol. 59, No. 6, pp. 1551– 1580.
- [8]Kasidi, F., Mwakanemela, K., 2010, Impact of inflation on economics growth: A case study of Tanzania. Asian Journal of Empirical Research 3(4):363-580.
- [9]Kei, K., Mywish, M., Duncan, B., 1997, Transformation Versus Stagnation in the Palm oil Industry: A Comparison between Malaysia and Nigeria. Staff Paper 97-5. Department of Agricultural Economics Michigan State University, East Lansing, Michigan 48824 P. 19
- [10]Komolafe, M. F., Joy, D. C., 1990, Agricultural Science for Senior Secondary Schools, Book One. Ibadan, Nigeria: 1990 University Press Ltd.
- [11]Kwanashie, M.,Ajilima, I., Garba, A., 1998, The Nigeria economy response of agriculture to adjustment policies. Research paper No 78. African economic research consortium, Nairobi.
- [12]O'Brien, R., 2008, Facts and Oils formulating and processing for Application, Third Edition, December 5, 2008.
- [13]Onyenweaku, C.E., 2004, Stagnation, Acceleration and Declaration in Agricultural production in Nigeria, 1970-2000.
- [14]Oyejide, T.A, 1990, Supply response in the context of structural adjustment in Sub-Sahara Africa. Special paper No 1. African economic research consortium, Nairobi.
- [15]Pesaran, M.H., Shin, Y., Smith, R., 2001, Bounds testing approaches to the analysis of level relationships, Journal of Applied Econometrics, 16,+ 289-326.
- [16]Ssekuma, R., 2011, A study of Co-integration Models with Applications. University of South Africa, South Africa.

## EFFECT OF QUALITY CONTROL (QC) MEASURES ON THE INCOME OF CASSAVA FLOUR BASED ENTERPRISES IN ABIA STATE NIGERIA

Chigozirim Ndubuisi ONWUSIRIBE<sup>1</sup>, Chinedu Daniel NWOGU<sup>2</sup>

Michael Okpara University of Agriculture Umudike, <sup>1</sup>Department of Agribusiness and Management, <sup>2</sup>Department of Agricultural Economics Abia State, Nigeria, Phone: +2348063724608, Email: ndubuisichigo@gmail.com

**Corresponding author:** ndubuisichigo@gmail.com

### Abstract

*This study evaluated the level of progress in QC adoption of cassava flour based enterprises in Abia State. A random sampling technique was employed in the selection of 90 enterprises from the study area. Descriptive statistics and inferential (probit and Z-test) were used in analyzing the data collected through well structured questionnaires. About 82% of the cassava flour based enterprise' users adopted quality control measures in the manufacture of their products while 16% did not. The use of photographic aids, use of standard descriptions, system quality assurance and good manufacturing practices constituted 11%, 45%, 22% and 22% respectively of the quality control measures adopted by the enterprises. Level of education, qualified personnel and profit positively influenced the choice of quality control adoption at 1%, 10% and 5% significant levels respectively while cost of operation and government policies negatively influenced the choice of quality control adoption at 1% significant levels respectively. Result of the Z-test analysis reveals that there is a distinct difference between the mean incomes of cassava flour based enterprises who adopted quality control measures and those who did not. This study recommended that the Quality control regulatory bodies should be empowered to enforce the adoption of these measures among relevant enterprises; Government should support the growth of these enterprises by the supply of important machineries and equipment at subsidized rates; A synergy among firms on improving their level of QC utilization is recommended.*

**Key words:** cassava, control, income, quality

### INTRODUCTION

Cassava known as *Manihot esculenta* or *Manihot utilissima* was introduced into Central Africa from South America in the 16th century by the early Portuguese exporters [1]. It is estimated that 250 million people in Sub-Saharan Africa derive half of their daily calories from cassava being the second most important food staple and supplier of calories after maize [1]. Recently, production figures ranked Nigeria as the leading producer of cassava in the world [3;7] and puts ready money and food in the very vulnerable segments of society of the country. Nigeria is the largest producer of cassava in Africa. The tubers are mostly processed into cassava flour (lafun), gari and fufu in Nigeria. It can also be cooked or eaten, pounded and consumed in its raw form, most especially the sweet variety [5].

Cassava flour based enterprises are the

enterprises that use cassava flour as their major raw material. The cassava flour based enterprises may be involved in the farm production of cassava, processing of cassava flour and use of cassava products and by products for the manufacture of other products.

Owing to the policy focus of the transformation agenda to encourage the production of cassava and usage of cassava flour in Nigeria. This had led to the promotion of cassava flour exports and the birth of numerous cassava flour based enterprises mainly on a small scale basis. Cassava flour based enterprises are found in every nook and cranny in the urban and rural areas of Nigeria. The issue of quality control becomes imperative; because of most these enterprises are not registered with the government and therefore may not be controlled by government agencies.

The link between quality control and income

especially among small cassava flour enterprises makes this study exceptional. Quality is a situation where the customers are satisfied [4]. Control is the process employed to meet standards thereby, leading to a decision dependent on the observed to increase in performance [4]. Quality Control (QC) is the action taken throughout the production of a product to prevent and detect product deficiencies and product safety hazards [2;4]. Quality controls measures are adopted by the cassava flour enterprises to ensure the safety of the products, since majority of their products are mainly edible. Food safety is an increasingly important public health issues. Governments of all over the world are intensifying their efforts to improve food safety. Food safety and hygiene are very crucial for the food enterprises. This work is an attempt to determine the level of adoption of quality control by cassava flour based enterprises as well as the effect on the performance and income of the enterprises in Abia State. In line with the aim of this work, the following questions will be answered:

- a) What is the level of adoption/usage of quality control among the cassava flour based enterprises?
- b) What are the factors affecting the adoption of quality control measures among cassava flour based enterprises?
- c) Does quality control affect the performance/profitability of the enterprises?

## MATERIALS AND METHODS

The study location is Abia State of Nigeria. Random sampling technique was adopted for this study in selecting a total of 90 respondents. Primary data were collected via the administration of well-structured questionnaires while secondary data were collected from journals and important literatures. Simple descriptive tools like tables, percentages and frequencies as well as other econometric tools like probit and Z-test models were used to analyze the data for this study.

### Model Specification

The t-test is given as:

$$Z_{cal} = \frac{\bar{X}_1 - \bar{X}_2}{\sqrt{S_1^2 \frac{X_1}{n_1} + S_2^2 \frac{X_2}{n_2}}}$$

Where,

$\bar{X}_1$  = Mean net returns from cassava flour based enterprises Quality control users

$\bar{X}_2$  = Mean net returns from cassava flour based enterprises non Quality control users

$S_1^2 \bar{X}_1$  = Variance of net returns from cassava flour based enterprises Quality control users

$S_2^2 \bar{X}_2$  = Variance of net returns from cassava flour based enterprises non Quality control users

$$\text{Probit (Y*)} = X_i \beta + u$$

Where  $\mu \sim N(0,1)$

$Y^* = 0$  or  $1$

$Y$  = prob. (Quality control usage) = yes or no

Where yes=1 stands for adoption of quality control and no=0 stands for non-adoption of quality control

$X_i$  = vector of the independent variables

$X_1$  = educational level of the enterprise owners (number of years spent in school)

$X_2$  = Availability of Qualified Personnel (Yes = 1, No = 0)

$X_3$  = Size of firm (Output in Kg)

$X_4$  = Perception of quality control (1 = Relevant, 0 = Irrelevant)

$X_5$  = Capital (₦)

$X_6$  = cost of operating quality control (₦)

$X_7$  = Profits/income from the enterprises (₦)

$X_8$  = Number of customers

$X_9$  = Government policies on quality control (Operational = 1, Otherwise = 0)

$U$  = error terms.

## RESULTS AND DISCUSSIONS

### Level of Quality Control Adoption among Cassava flour based Enterprises

The extent to which the cassava flour-user enterprises adopt quality control measures is presented in the Table 1 below and discussed.

The distribution of the enterprises by level of quality control adoption shows that 82% of the cassava flour based enterprise' users adopted quality control measures in the manufacture of their products while 16% did not.

Table 1. Frequency Distribution of Quality Control Adoption by Cassava flour User Firms

Quality Control Adoption	Frequency	Percentage
Yes	74	82
No	16	16
Total	90	100

Source: Field Survey, 2015.

This implies that the entrepreneurs adopted one or more of the measures stated below.

**Quality Control measures Adopted by the Cassava flour based Enterprises**

The various quality control measures adopted by the cassava flour based enterprises are presented in Table 2 below.

Table 2. Frequency distribution of enterprises according to the adopted quality control measures during manufacture

QC measures	Frequency	Percentage
Use of photographic aids	10	11
Use of standard descriptions	40	45
System quality assurance	20	22
Good manufacturing practices	20	22
Total	90	100

Source: Field Survey, 2015.

The use of photographic aids, use of standard descriptions, system quality assurance and good manufacturing practices constituted 11%, 45%, 22% and 22% respectively. Majority (45%) adopted the use of standard descriptions. This is a major concern for regulatory agencies to avoid sub-standard products and maintain uniformity in manufacturing. System quality assurance and good manufacturing practices were relatively adopted signifying an improvement in the quality control practices of these enterprises.

**Quality Standards and Labeling systems used by the Enterprises**

The quality standards and labeling systems used by the cassava flour based enterprises in the study area is presented in table 3 below.

A multiple response system was employed in presenting the data.

Table 3. Frequency distribution of enterprises according to quality standards and labeling systems used

Labeling systems	*Frequency	Percentage
A best before date	30	33
The ingredients	70	78
The nutritional content	50	56
The manufacturers' name and address	90	100

Source: Field Survey, 2015.

\*Multiple Responses

The distribution of the enterprises according to quality standards and labeling systems employed shows that 100% (all the enterprises) had the manufacturers' names and addresses on their labels. 78% of the enterprises had the ingredients' composition of their labels. 56% had the nutritional contents of the ingredients on their labels while 33% had a best before dates. This result indicates that the labeling system of the cassava flour-flour based enterprises was moderately efficient with lots of improvement.

**Annual income distribution of the cassava flour-flour based enterprise owners**

The distribution of the cassava flour-flour based enterprise owners' income is presented in Table 4 below.

Table 4. Distribution of the cassava flour-flour based enterprise owners' income

Annual income (₦)	Quality control users		Quality control non-users	
	Frequency	Percentage	Frequency	Percentage
1,000 – 300,000	10	14	5	31
301,000 – 500,000	14	19	8	50
501,000 – 700,000	30	40	3	19
701,000 – 1,000,000	20	27	0	0
Total	74	100	16	100

Source: Field survey, 2015.

The result shows that majority of the QC users and non-users earned a minimum of N 500,000 and 301,000 respectively. 27% of the QC users earned at least 701,000 while nobody of the non QC users earned up to this amount. It therefore shows that a great disparity existed between the income of QC users and non-users.

### Factors affecting the adoption of quality control measures among cassava flour-flour based enterprises

The probit regression model was used to examine the effect of certain explanatory variables on the choice of adopting quality control measures among cassava flour-flour based enterprises in the study area. The result is presented in table 5.

The model Chi square value of 43.401 implies that the probit regression model is statistically fit at 1% level. Level of education, qualified personnel and profit positively influenced the choice of quality control adoption at 1%, 10% and 5% significant levels respectively while cost of operation and government policies negatively influenced the choice of quality control adoption at 1% significant levels respectively.

The level of education of the enterprise managers/owners positively affected their choice to adopt quality control measures in the manufacture of their products implying that as they advanced in education, they increased their chances of adopting QC measures.

Table 5. Probit Regression Result for Factors Affecting the Adoption of Quality Control measures among Cassava flour based Enterprises

Parameter	Estimate	Std. Error	Z
$x_1$ =Level of Education (Years)	1.264	0.334	3.780***
$x_2$ =Qualified Personnel (1=Available, 0=Otherwise)	1.328	0.801	1.658*
$x_3$ =Size of firm (Output)	0.0001	0.001	0.1
$x_4$ =Perception of QC (1=Effective, 0=Otherwise)	0.063	0.231	0.272
$x_5$ =Capital (₦)	0	0	-0.1
$x_6$ =Cost of operating QC (₦)	-0.056	0.014	-4.000***
$x_7$ =Profit (₦)	0.2651	0.089	2.652**
$x_8$ =Number of Customers	0.001	0.007	0.143
$x_9$ =Government Policies (1=Favourable, 0=Otherwise)	-0.122	0.021	-5.810***
Intercept	-2.606	0.521	-5.002
Chi	43.401***		

Source: Field Survey, 2015

\*\*\* = Significant at 1%, \*\* = Significant at 5%, \* = Significant at 10%

The availability of qualified personnel to manage the QC section of the enterprises also positively influenced the decision to adopt

QC. This entails that enterprises will adopt QC measures provided they can employ or have employed qualified personnel.

The profit level of the enterprises also influenced their choice of adopting QC measures. Since some costs are incurred in this section, an enterprise with an unstable profit level will find it difficult to implement the QC measures.

Conversely, cost of operation and poor/unfavourable government policies negatively influenced the adoption of QC measures. This is because while operating cost added burden on the firms, unfavourable policies provided the firms with harsh environment to operate.

### Z-Test Analysis of Mean Income Differences between Quality Control Users and Non-users among Cassava flour-based Enterprises

The Z-test result for differences in the mean income of adopters and non-adopters of cassava flour-flour based quality control enterprise' users is presented in table 6 below and discussed.

Table 6. Z-Test Result of Mean Income Differences between Quality Control Users and Non-users among Cassava flour-based Enterprises

	N	Mean	Std. Deviation	Std. Error Mean	z	df
NONUSERS of QC	16	335,711.1	32899.725	4904.401	7.281	15
USERS of QC	74	702,822.2	38407.674	5725.478	7.479	73

Source: Field Survey Data, 2015.

Result in Table 6 revealed that there is distinct difference between the mean income of cassava flour-flour based enterprises who adopted quality control measures and those who did not. A mean income of ₦335, 711.13 and ₦702, 822.24 for non-adopters and adopters of quality control measures was estimated. Z-calculated for users of quality control (7.479) was higher for the non-users of quality control (7.281). This difference was statistically significant.

### CONCLUSIONS

The adoption of Quality Control (QC) measures among food based enterprises have become a major issue for discussion among service-sector economists and policy makers.



This gave rise to this study which tried to evaluate the level of progress in QC adoption among cassava flour-flour based enterprises in Abia State. A multi-stage sampling technique was employed in the selection of 90 enterprises from the study area. Descriptive (tables, frequencies and percentages) and inferential (probit and correlation models) were used in analyzing the data.

Quality control measures were well adopted by the cassava flour based enterprises though level of utilization was still below expectation. Adoption was influenced by such variables as level of education of the managers/owners of the enterprises, availability of qualified personnel, profit level, cost of operation and government policies. A distinct difference between the mean income of users and non-users of Quality Control practices was estimated and the result showing that the difference was statistically significant. It is therefore recommended that Quality control regulatory bodies should be empowered to enforce the adoption of these measures among relevant enterprises; a synergy among firms on improving their level of QC utilization is recommended. Such integration will reduce to a certain extent the costs incurred in managing the QC section of the firms; standards should also be enforced uniformly among the firms so as to avoid the undue exploitation of the ignorant and reduce sharp practices associated with standard discriminations; timely checks and monitoring of these recommendations will go a long in enforcing the adoption and continuity of QC measures among the firms concerned.

## REFERENCES

[1]Anyaeibunam, H. N., Okoye, B. C., Asumugha, G. N., Ogbonna, M. C., Madu, T. U., Nwakor, N., Ejechi M. E., 2010, Labour productivity among Small- holder Cassava flour Farmers in South East agro Ecological zone, Nigeria African Journal of Agricultural Research Vol. 5(21) (2010), pp. 2882-2885.  
[2]Bentely, J., 1999, Introduction to Reliability and Quality Control Engineering, Addison Wesley, Harlow.  
[3]Food and Agricultural Organisation (FAO), 2004.Fact sheet No 5 on International Year of Rice <http://www.rice2004.org/>

[4]Gryna, F.M., 2001, Quality Planning and Analysis. McGraw-Hill, New York

[5]Ogundari, K., Ojo, S. O., 2007, An Examination of Technical, Economic and Allocative Efficiency of Small Farms: The Case Study of Cassava flour Farmers in Osun State of Nigeria. Bulgarian Journal of Agricultural Science, Vol. 13/2007:185-195

[6]Ohadike, D.C, 2007, The influenza pandemic Of 1918-19 and the spread of cassava flour cultivation on the lowest Niger. A study in Historical linkages. Journal. Africa: History, Vol. 22 (2007), pp. 379- 391.

[7]Yakasi, M.T., 2010, Economic Contribution of Cassava flour Production (A case study of Kuje Area Council Federal Capital Territory Abuja), Nigeria. Department of Agricultural Economics and Extension, Kano State University of Science and Technology, Kano State, Nigeria. 2010.





## ZEA MAIS EVERTA FUNDULEA 625 – HEALTH - INCOME

Olimpia PANDIA<sup>1</sup>, Ion SĂRĂCIN<sup>2</sup>, Ștefania Eliza TĂNASIE<sup>3</sup>

<sup>1</sup>University of Agricultural Sciences and Veterinary Medicine, Bucharest, Romania, Faculty of Management, Economic Engineering in Agriculture and Rural Development, Slatina Branch, 150, Strehareti Street, Postal Code 0500, Slatina City, Olt County, Romania,  
E-mail:olimpia\_pandia@yahoo.com

<sup>2</sup>University of Craiova, Faculty of Agriculture / Romania, E-mail:ion\_saracin@yahoo.com

<sup>3</sup>University of Medicine and Pharmacy of Craiova, E-mail:elyzuk\_elly@yahoo.com

**Corresponding author:** olimpia\_pandia@yahoo.com

### Abstract

*After the wheat culture, the corn is on the second place as the most important cereal plant, having the benefits resulted from grains consumption and being a medicinal remedy for certain diseases or for the completion of the necessary essential amino-acids for our organism. The paper presents the crop technology of the pop corn crop on the sandy soil from the western part of Oltenia, its importance as a food crop, determination on expansion degree at different moistures and temperatures for the wide consumption capitalization.*

**Key words:** consumption, capitalization, expansion, popcorn

### INTRODUCTION

The popcorn was discovered by Amerindians in the pre-Columbian era. The year 1948 marks the discovery of the popcorn, with an existence of 5600 years. In 1885, the first commercial machine for producing popcorn is created [7,10].

By their content in some active principles like phytosterols, mineral salts, saponins, vitamins C, E, K and volatile oil, the corn grains has a pharmacological action, being a good diuretic, energetic and bland, consumed in the form of various products, accessible for humans [6,9]. Proteins are essential constituents of the body in their turn being formed of the essential amino acids, cannot be produced by the organism and must be brought by food in various combinations and non-essential amino acids a body which can be produced, and caloric needs can be filled from vegetable or animal food with complete and incomplete biological values [4, 5].

Lysine, is an essential amino acid that is found in almost all proteins in the body, having a major role in increasing the molecular weight and calcium absorption, hindering the elimination of urine, so, lysine prevents osteoporosis, positively influence the

central nervous system, helps collagen production and participating in the production of enzymes, antibodies and proteins [3].

By eating foods of plant and animal origin, those amino acids can be found naturally on corn seeds which are rich in lysine and can cover the daily requirement of lysine for the body [1].

Because most essential amino acids are in different quantities in the food composition of a group where some nutrient factors are in large quantities, while others are in small quantity or missing, therefore in order to have a balanced diet it is necessary to eat food from different groups.

Thus, in this paper, we study two of these essential amino acids taken from corn grains, besides other existing therein and required for the daily ratio supplement of amino acids useful to humans, such as tryptophan and motioning [2, 8].

### MATERIALS AND METHODS

The results presented in this work are acquired by research effectuated within **country Dolj**, Dobrotești village, where the evert co variety Fundulea 625 of crop was studied.

Within this co variety the beans are yellow-orange, shining, little, and have the bean's apex rounded. The endosperm has corneous texture (glassy), excepting a small region around the embryo, and MMB is of 70-81 grams.

50,000 plants/ha were sowed on a sandy soil, using a non-irrigated system, resulting a production of 820 kg beans/ ha.

**Studied parameters:**

Parameter A: sowed plant;

1 – Fundulea 625 popcorn

Parameter B: fertilizer dose;

1 – Using the reserve that exists in the soil

Parameter C: irrigation system;

1 – Non-irrigated system

**RESULTS AND DISCUSSIONS**

Before establishing the corn culture, soil analyses were made for each variant.

Because of the unfavorable conditions during the studied year, an 820kg/ha production was obtained, without using chemical fertilizers and within a non-irrigated system.

Table 1. Characteristics of the soils where the experiments took place

Soil type	pH	Ah Me/100g/soil	Sb Me/100g/soil	H %	N <sub>2</sub> %	P <sub>2</sub> O <sub>5</sub> Mg/100g/soil	K <sub>2</sub> O Mg/100g/soil
V1.sandy	6.72	0.56	16.20	2.19	0.054	3.7	13.6
V2.sandy	6.65	0.48	2.7	1.95	0.055	3.4	14.8
V3.sandy	6.70	1.03	16.11	3.15	0.051	5.8	14.3

Source: authors

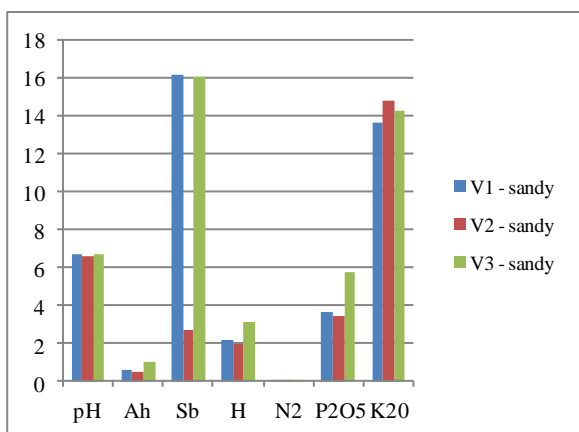

Fig. 1. Characteristics of the soils where the experiments took place

**Analysis of expansion within the laboratory**

After the maize beans were ingathered (100 beans), they were subjected to determinations of expandability at 60°C and 23% humidity. In this way it is performed the first determination, using gas flame, and, after a period of 3 minutes, it results: 33 very well expanded beans, 31 medium expanded beans and 36 unexpanded beans. If the exposure time increases the beans are burnt.



Photo 1. Maize beans subjected to determinations at a 23% H to corn cobs ingathered at 15.1% humidity  
 Source: authors

The determination is taken again but an electric stove is used this time. The expansion period is of 5 minutes and the results are the following: 64 expanded beans, 16 medium expanded beans and 20 unexpanded beans. For the ingathered beans in these humidity conditions which return to consumption, a slower and longer heating (5 minutes), but:

Table 2. The expansion results of popcorn beans depending on Humidity (H) and Temperature (T)

Quantity	H %	T°C	Time of exposure	Source of heating	Degree of expansion		
					Very well	Medium	Unexpanded
100 beans	23%	60°C	3 minutes	Gas flame	33	31	36
100 beans	23%	60°C	5 minutes	Electric stove	64	16	20

Source: authors

For acquiring better results, it is recommended that the corn cobs are

ingathered when they reach their physiological maturity and the humidity of beans is of 11.9%.

The same determinations are effectuated, using an electric stove and the following results are obtained: For a quantity of 100 beans at 11.9% humidity, using gas flame, after a period of 1 minute, the following results are obtained: 87 very well expanded beans, 11 medium expanded beans and 2 unexpanded beans. The determination is repeated, but this time an electric stove is used and the following type of beans are obtained: 78 very well expanded beans, 10 medium expanded beans and 12 unexpanded beans.



Photo 2. Maize beans subjected to determinations at a 23% H to corn cobs ingathered at 15.1% humidity  
 Source: authors

The same determinations are effectuated, using an electric stove and the following results are obtained:

For a quantity of 100 beans at 11.9% humidity, using gas flame, after a period of 2 minute, the following results are obtained: 87 very well expanded beans, 11 medium expanded beans and 3 unexpanded beans.

The determination is repeated, but this time an electric stove is used and the following type of beans are obtained: 78 very well expanded beans, 10 medium expanded beans and 12 unexpanded beans.



Photo 3. Maize beans subjected to determinations at a 11.9% H

Source: authors

Table 3. The expansion results of popcorn beans depending on Humidity (H) and Temperature (T)

Quantity	H %	T°C	Time of exposure	Source of heating	Degree of expansion		
					Very well	Medium	Unexpanded
100 beans	11.9%	60°C	2 minutes	Gas flame	88	12	2
100 beans	11.9%	60°C	3 minutes	Electric stove	79	11	10

Source: authors



Photo 4. The process of Fundulea 625 beans expansion at different temperatures

Source: authors

## CONCLUSIONS

Using the popcorn on a large scale in order to obtain financial advantages.

For acquiring better and more economical results, the maize ingathering and preserving until it reaches the value of 13% humidity within beans production.

The use of natural gas or other high caloric power sources as a source of expansion.

In order to obtain a better result, it is recommendable to use a certain dose of fertilizers and an irrigated crop system.

Determination of differentiated protein content and amino acids existing in corn grains, lead to establishing the biological value of the protein in the two hybrids that are recommended for planting being representative for the high protein content.

It is recommended for the popcorn to be consumed safely, without fat additions which can become harmful for the human body.

The home-made popcorn frequent consumption contributes to the improvement of the health status by preventing some heart and vascular diseases, because of the presence of an anti-oxidant in these grains.

## REFERENCES

[1]Ailincăi, B., 2008, Influence of organo-Mineral fertilization on wheat and maize crops and the evolution of soil fertility under long-term experiments in the Moldovian Plain, Vol. XLI, No. 3

[2]Goian, M., Sala, F., Berbecea, A., Radulov, I., Gherban, C., 2000, The effect of mineral fertilizers upon the bean production of maize, on cambic chernozem within the Timisoara Didactic Research Station, between 1997 and 1999, Scientific research U.S.A.M.V. Timisoara, Agriculture Category, volume XXXII, part I, Agroprint Publishing House, Timisoara

[3]Hera, C., 1972, The influence of fertilizers upon certain maize hybrids sowed on different types of soils in Romania, An. ICCPT, Fundulea XXXVII.

[4] Manea, N.D., 2009, Effect of tillage on soil physical features, weed control and yielding winter wheat and maize. Research Journal Science, 41

[5]Pandia Olimpia, 2006, Research Regarding the Effect of Fertilizers upon Maize Production and Quality, Doctoral dissertation, Timisoara.

[6]Pîrșan, P., David, G., Imbrea, F., 2006, Phytotechny – cereals and legumes for grains, Eurobit Publishing, Timișoara.

[7]Pirvulescu, L., et al., 2008, Comparative statistic studies concerning the nutritious value of some groups of food, Bulletin UASVM, Agriculture 65(2)/2008.

[8]Rusu, M., Marghițaș, M., 2005, Agrochemical treaty, Ed. Ceres, Bucuresti

[9]Sima, E., 2002, Ecological Agriculture and Changing Perception in the Case of Quantity and Quality, The Information and Economic Reference Material Center, Bucharest

[10]Sărăcin Ion, 2008, Resesarch regarding the factors that influence the physico-chemical properties of the soil. Bulletin USAMV Cluj Napoca, Vol 65(1)



## METHODS OF REDUCING THE PROFOUND HYBERNATION OF CERATONIA SILIQUA SEEDS

Olimpia PANDIA<sup>1</sup>, Ion SĂRĂCIN<sup>2</sup>, Ștefania Eliza TĂNASIE<sup>3</sup>

<sup>1</sup>University of Agricultural Sciences and Veterinary Medicine, Bucharest, Romania, Faculty of Management, Economic Engineering in Agriculture and Rural Development, Slatina Branch, 150, Strehareti Street, Postal Code: 0500, Slatina City, Olt County, Romania,  
E-mail:olimpia\_pandia@yahoo.com

<sup>2</sup>University of Craiova, Faculty of Agriculture / Romania, E-mail:ion\_saracin@yahoo.com

<sup>3</sup>University of Medicine and Pharmacy of Craiova, E-mail:elyzuk\_elly@yahoo.com

**Corresponding author:** olimpia\_pandia@yahoo.com

### Abstract

*The fact that the seeds of some forest species after maturation become profoundly dormant, leading to germination and emergence in the second year after planting, requires some investigation undertaken in order to reduce profound dormancy, considering that mechanical degrading of seminal coatings is a difficult operation which can lead to injuring the endosperm. In their turn, mechanical treatments can provide fast germination imbibitions, but done incorrectly, they can reduce germination potency. This paper presents a mechanical method for reducing profound dormancy by degradation of the per carp and seed coat permeability for rapid penetration of water into the seed, the method to apply the mechanical treatments under various conditions of time, temperature and humidity.*

**Key words:** *Ceratonia siliqua*, dormant, forest seed, scarification

### INTRODUCTION

*Ceratonia siliqua* (carob) seeds have been studied, which have been harvested from isolated trees which have been grown in the Southern area of Craiova, i.e. in the sandy area on the left side of river Jiu [2,4,6]. Multiple qualities of the species: content of simple and complex carbohydrates, mucilage, pectin, starch and vitamins, using powders against diarrhoea, dysentery, gastritis and enterocolitis, as well as the importance of wood for furniture, constructions and fire, and also for harnessing sandy soils by harvesting it, increased requests of seedlings [7,8,9].

Since it is a tree which originates from the Mediterranean basin from the family of Fabaceae, it has adapted very well to geographic conditions and climate of our South-West part of the country in terms of climate and humidity [3,5].

Practical difficulties to obtain seedlings of this species have lead to conducting certain studies and research in order to find possibilities of seeds imbibitions until ensuring the necessary level of humidity in order to germinate and undergo attempts to interrupt deep sleep (Dormans) in various conditions of temperature and humidity [1].

Actually the two represent the proposed objectives in order to achieve the paper.

### MATERIALS AND METHODS

In terms of material, we used *Ceratonia siliqua* pods, harvested at full maturity. Harvesting included the following organisational measures:

- the number of seeds was established;
- the source of seeds was established;
- the phonological chart was drawn in order to establish correctly the date of beginning harvesting.



a.



b.



c.



d.

Fig. 1. Sample preparation for work, (a, b, c, d)  
 Source: authors

After harvesting: pods were weighted and humidity was determined.

Dehiscent dry fruit, glad pods after dry were treated by mechanical crushing with the help of certain equipment which also separated seeds from pods by fanning. MMB was determined by obtaining the value of 206,7 grams.

Table 1. Seed rating in processing pods

Sample	Total weight (g)	The Yield (g)		Nr. seeds
		Seeds	Peabody	
P1	15.78	3.95	11.85	21
P2	14.94	3.74	11.21	19
P3	16.16	4.04	12.12	22
P4	19.58	4.89	14.69	25
P5	16.84	4.21	12.63	22
P6	16.62	4.16	12.47	22
P7	17.46	4.37	13.09	23
P8	14.46	3.62	10.85	18

Source: authors

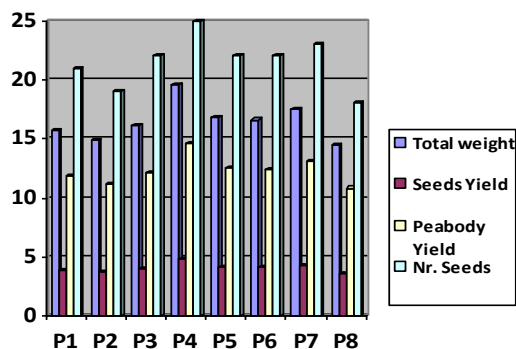
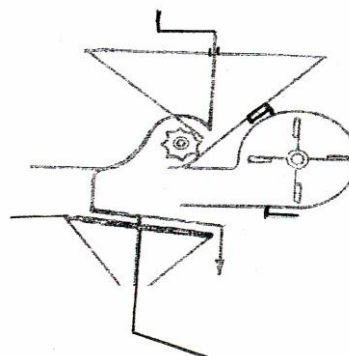
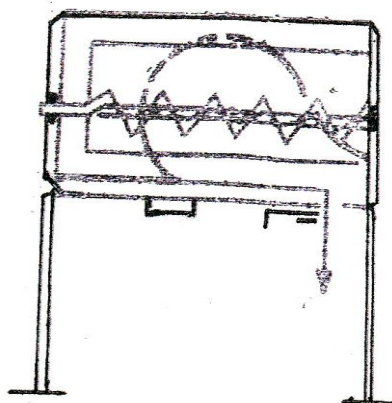

Fig.2. Seed rating in processing pods for each sample

In order to assess changing humidity under mechanical action (pericarp degradation) the studied mass of seeds was weighted, before the mechanical action of scarification, followed by placing it into water at room temperature of 22-24°C, then they were weighted every 12-24-36-48 hours. Scarification was carried out with the help of a machine of selecting, removing and sensitising seeds pericarp from forest species.





a.

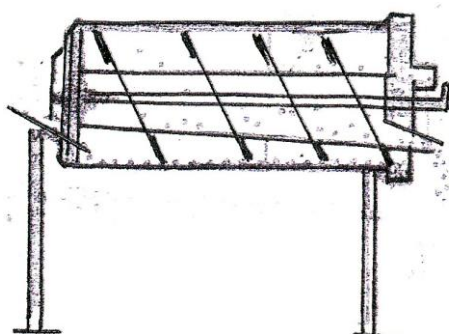
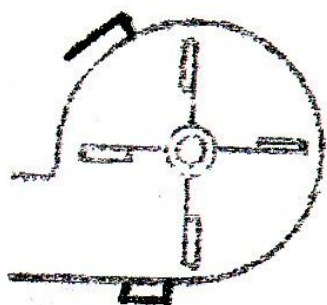

b.

Fig. 3. For the selected machine, the pericarp of the seeds of sensitized forestry species.

a. power supply system and the air flow separation; b. decorticator; c. radial-axial fan; d. conveyor with metal mesh trays for sorting and destruction of seed pericarp

## RESULTS AND DISCUSSIONS

After scarification, seeds are under supervision and determination which are meant to establish their influence on seminal coatings and viability.

In order to achieve this, 100 grams of seeds were put in small bags and placed in glass cylinders with 200 ml of water at room temperature.

Table 2. Tegument permeability according to the level of humidity after scarification

Initial state %	Humidity % at the time of immersion in water (h)			
	12	24	36	48
10.21 – 13.70	21.65 – 29.05	35.64 – 47.82	57.88 – 77.69	67.61 – 90.70

Source: authors

Laboratory determination of the level of imbibitions with scarified seeds established that generally, while germinating, their humidity is 5-6 higher than their humidity while harvesting.

Moreover, laboratory determinations performed with seeds in natural state (not scarified seeds) showed the fact that after a long period of time of approximately 120 hours, their initial state did not change, and with certain seeds the process of alteration was observed.

## CONCLUSIONS

Degradation of the pericarp and tegument, drop resistance shall be carried out for the purposes of ingress of water into the seed and shortening the period of rest.

Degradation of the pericarp will appreciate after his resistance to mechanical crushing action (compression) measured in the Laboratory for Mechanics and Strength of Materials.

-Drop resistance skin will be determined in the laboratory, depending on the degree of humidity of the seeds after a period of immersion in water.

-The proposed Car can achieve separation of seeds by setting afloat speed, selection and destruction of the pericarp.

## REFERENCES

- [1]Daia, M, 2003, Realizări și perspective ale protecției pădurilor în România, Revista pădurilor, Nr.3
- [2]Daia, M, 2011, Silvicultură, Curs litografiat, USAMV București
- [3]Florescu, I. I., 1981, Silvicultura, Editura Didactică și Pedagogică, București

[4]Florescu, I. I., Nicolescu, V.N., 1998, Silvicultura, Vol II Silvotehnică, Editura Universității Transilvania, Braşov

[5]Georgescu, F., Daia, M., 2002, Regenerarea pădurilor în România, Seminarul Internațional „Împădurirea în contextul managementului durabil al pădurii”, ENNIS, Irlanda

[6]Nicolescu, N.V., 1995, Silvicultura. Îndrumar de lucrări practice, Reprografia Universității Transilvania, Braşov

[7]Petrescu, L., et al., 1984, Tehnologii îmbunătățite de îngrijire a arboretelor, de fag, stejar și de șleau în condițiile exploatării mecanizate a lemnului, ICAS, Seria II, București

[8]Rusu, M., Marghitaș, M., 2005, Agrochemical treaty, Ed. Ceres

[9]Sima, E., 2002, Ecological Agriculture and Changing Perception in the Case of Quantity and Quality, The Information and Economic Reference Material Center, Bucharest

[10]Technical Standards for forest management, Ministry of Forestry, Bucharest, 1986



## INTERNATIONAL TRADE WITH GRAPES (2009-2011)

**Radu Lucian PÂNZARU, Dragoş Mihai MEDELETE**

University of Craiova, Faculty of Agriculture and Horticulture, 19 Libertăţii, 200421, Craiova, Romania, Phone: +40 727 712 967, Fax: + 40 251 418 475,  
E-mails: rlp1967craiova@yahoo.com, medelete@yahoo.com

**Corresponding author:** rlp1967craiova@yahoo.com

### *Abstract*

*Study activities relates to international trade situation for the grapes, 2009-2011. It starts from the presentation of the situation at the continental level (Africa, America, Asia, Europe and Oceania) after which are specifies the indicators for Romania and the European Union. The main importer (in terms of quantity) is represented by Europe (more than half), followed by America and Asia - 56.60, 23.45 and 18.77% respectively. Regarding of exports (in terms of quantity), the main actors are represented by America, Europe and Asia. They dominated the world market, achieving 40.93, 29.68 and 18.58% respectively of world exports quantitatively. Africa and Oceania recording share below 10.0% (9.67 and 1.14% respectively). The trade balance has deficient character (-856.6 million dominant phenomenon. \$). Analyzing the situation in each continent stands out strict surplus situations specific to America, Africa and Oceania (773.5, 619.1, respectively 38 mil. \$). Unfortunately they could not offset the decisive continuously deficits for Europe and Asia (-368.7 -1918.2 and mil. \$).*

**Key words:** commercial balance, grapes, export, import

### INTRODUCTION

Plantations, depending on the species (trees, vines, hops) form independent branches of plant production [6].

Like the fruit growing, vine growing is a branch of agriculture with a high level of intensity and high production efficiency [4].

Important area of wine production activity in some farms in Romania is a matter of food, industrial, agricultural technology - technological, environmental, export and source of profit [5].

The grapes are perishable products, which requires stringent measures of transport, storage and processing [7].

Total grape production fluctuates from year to year, influenced by the specific weather conditions which increase or decrease the yields. These adverse climatic conditions affecting the quality of grapes [9].

For grape wine as the main product, you can demarcate several capitalization directions (wine and its derived, table grapes, for juice, raisins, etc.), but these are related to the types of existence and / or varieties that have some specific quality [2].

Export has as content the sale or investing the

foreign goods or values, processed products, filled or repaired in a country.

Regarding the export of agricultural products, it should be understood as the total of commercial operations, in which plant and animal products - unprocessed or processed in various degrees - are sold on the external market.

Agricultural exports is a component of overall exports which engages national economy, targeting the following objectives: participation in international division of labor; attract hard currency or currency ratio required of all businesses in agriculture.

Factors that influence on exports of plant and animal products are: domestic market supply and demand of agricultural products - directly and indirectly for population in the industrial processing; trends in demand and supply in the global market of agricultural products [1].

International trade with grapes are influenced by a number of issues related to supply and demand mechanism.

The offer is given by production capacity viticulture and wine that reflects the actual production possibilities that can be achieved. The notion of " viticulture potential 'means the territorial area (areas) planted with vines

in bearing, productive, growers property rights, rights reserves and plantations authorized but still unrealized. Certainly there are correlations between the two concepts, which are the boundaries and different interpretations over historical stages. [3].

The most important marketed products are cereals, oilseeds, dairy products, beverages, vegetable oils and fats. The biggest exporters are the US and EU, who own a 19% share of global exports [8].

## MATERIALS AND METHODS

Documentary made to conceive and drafting of the work was based on the system of indicators proposed by FAO [10].

Were used information relating quantitative volume and value of imports and exports of grapes, information on which was determined the trade balance.

The paper presents Romania's position in the global market in terms of trade with grapes.

The information used relates to the period 2009-2011, and using period average. Average was calculated by the formula:

$$A = \frac{X_1 + X_2 + \dots + X_n}{n}$$

## RESULTS AND DISCUSSIONS

Table 1 shows the evolution and structure of imports worldwide.

Worldwide, in 2009, total export value was USD 6,632,610 thousand, which based on the continent contributions was: USD 26,673 thousand from Africa, USD 67,989 thousand Oceania, USD 907,417 thousand Asia, USD 1,800,760 thousand the American continent, USD 3,829,770 thousand Europe. Following these values, the indicator structure is as follows: 0.40% Africa, Oceania 1.02%, 13.68% Asian, 27.16% and 57.74% America and Europe.

If we analyze the specific situation of 2010, are obvious limits of variation of the indicator, from USD 28,503 thousand Africa (0.40%) to USD 3,905,330 thousand in Europe (54.99%). Taking into question the indicator values for rest of continents - USD

2,113,060 thousands America (29.75%), Asia USD 1,004,200 thousand (14.14%), Oceania USD 51,070 thousand (0.72%) – leads to a global total import of USD 7,102,170 thousands.

For 2011 there was a total world imports of grapes, which reaches USD 7,747,250 thousand. The constitution of this value is reached by sequential values contribution of the continents: Africa USD 41,303 thousand (0.53%), Oceania USD 78,877 thousand (1.02%), Asia USD 1,409,940 thousand (18.20%), USD 1,914,230 thousand America (24.71%), USD 4,302,890 thousand Europe (55.54%).

The average of the value of world imports was USD 7,160,676.7 thousand, based on the following structure: 56.04% Europe (USD 4,012,663.3 thousand; 27.13% America (USD 1,942,683.3 thousand ); 15.46% Asia (USD 1,107,185.7 thousand); Oceania 0.92% (USD 65,978.7 thousand); Africa 0.45% (USD 32,159.7 thousand ).

At the EU level there was an average value of imports of USD 3,263,583.3 thousand, which led to an average share in the global imports of 45.58%.

For Romania the value of grapes imports averaged USD 9,902.7 thousand, which represented 0.14% of the global level of the indicator.

Sequentially, we are talking about Romanian weights at global of 0.14% in 2011- USD 10,081 thousand, 0.16% for the year 2010- USD 7,982 thousand and 0.18% for the year 2009- USD 11,645 thousand.

Table 2 discloses the information on value of world exports of grapes, their structure and their evolution over time.

In 2009, the five continental units have recorded the following values of exports: USD 152,754 thousand Oceania, USD 619,242 thousand Asia, USD 652,132 thousand Africa, USD 1,902,550 and USD 2,339,870 thousand Europe and America. These values have led to a general global level, for the indicator of USD 1,477,770 thousand, which registered percentage contributions (in the structure) of: 41.29% America, 33.58% Europe, 11.51% Africa 10.93, 2.69% Asia and Oceania %. Under

these circumstances, the global level of the indicator reached USD 5,666,548 thousands. For 2010, the total value of exports was USD 6,219,704 thousands at which the five continental units contributed as follows: 1.23 % Oceania, Africa 9.73%, 12.00 % Asia, 33.15 % Europe and 43.89% Americas.

Corresponding to these weights, the actual continental indicator values were USD 76,249 thousands for Oceania, USD 605,073 thousands for Africa, USD 746,562 thousands for Asia, USD 2,061,870 thousand and USD 2,729,950 thousand in Europe and America.

Table 1. Grapes - World Imports (2009–2011)

Specification	2009		2010			2011			Average 2009 – 2011		
	USD Thou. *	Str. ** %	USD Thou. *	Str. ** %	2010/2009**	USD Thou. *	Str. ** %	2011/2010**	USD Thou. *	Str. ** %	Average/2011**
Africa	26,673	0.40	28,503	0.40	106.86	41,303	0.53	144.90	32,159.7	0.45	77.86
America	1,800,760	27.16	2,113,060	29.75	117.34	1,914,230	24.71	90.59	1,942,683.3	27.13	101.48
Asia	907,417	13.68	1,004,200	14.14	110.66	1,409,940	18.20	140.40	1,107,185.7	15.46	78.52
Europa	3,829,770	57.74	3,905,330	54.99	101.97	4,302,890	55.54	110.17	4,012,663.3	56.04	93.25
Oceania	67,989	1.02	51,070	0.72	75.11	78,877	1.02	154.44	65,978.7	0.92	83.64
Total	6,632,610	100	7,102,170	100	107.07	7,747,250	100	109.08	7,160,676.7	100	92.42
UE	3,165,830	47.73	3,106,780	44.58	98.13	3,518,140	45.41	113.24	3,263,583.3	45.58	92.76
Romania	11,645	0.18	7,982	0.16	68.54	10,081	0.14	126.29	9,902.7	0.14	98.23

\* <http://faostat3.fao.org/faostat-gateway/go/to/download/T/TP/E>

\*\* own calculations

Table 2. Grapes - World Exports (2009–2011)

Specification	2009		2010			2011			Average 2009 – 2011		
	USD Thou. *	Str. ** %	USD Thou. *	Str. ** %	2010/2009**	USD Thou. *	Str. ** %	2011/2010**	USD Thou. *	Str. ** %	Average/2011**
Africa	652,132	11.51	605,073	9.73	92.78	696,517	9.91	115.11	651,240.7	10.33	93.49
America	2,339,870	41.29	2,729,950	43.89	116.67	3,078,580	43.81	112.77	2,716,133.3	43.08	88.22
Asia	619,242	10.93	746,562	12.00	120.56	849,442	12.09	113.78	738,415.3	11.71	86.92
Europa	1,902,550	33.58	2,061,870	33.15	108.37	2,319,270	33.01	112.48	2,094,563.3	33.23	90.31
Oceania	152,754	2.69	76,249	1.23	49.91	82,774	1.18	108.55	103,925.7	1.65	125.55
Total	5,666,548	100	6,219,704	100	109.76	7,026,583	100	112.97	6,304,278.3	100	89.72
UE	1,477,770	26.07	1,741,690	28.0	117.85	2,119,980	30.17	121.71	1,779,813.3	28.23	83.95
Romania	282	0.005	672	0.011	238.29	487	0.007	72.47	480.3	0.008	98.62

\* <http://faostat3.fao.org/faostat-gateway/go/to/download/T/TP/E>

\*\* own calculations

If we analyze the situation, specific of 2011 reveals variations in the indicator from USD 82,774 thousands for Oceania, to USD 3,078,580 thousands on the American continent, while the global level of the indicator reached USD 7,026,583 thousands. The structure of indicator is as follows: 1.18% Oceania, Africa 9.91% - USD 696,517 thousands, 12.09% Asia - USD 849,442 thousands, 33.01% Europe - USD 2,319,270 thousands and 43.81% America.

The period average is characterized by a total global exports of USD 6,304,278.3 thousands and the continents share was: 43.08% America (USD 2,716,133,3 thousands), 33.23% Europe (USD 2,094,563,3 thousands); 11.71% Asia (USD 738,415.3 thousands); 10.33% Africa (USD 651,240.7 thousands); Oceania 1.65% (USD 103,925.7

thousands).

Regarding the position of the European Union in the context of world export value are found annual sequential weights as follows: 26.07% for 2009- USD 1,477,770 thousand, 28.0% for the year 2010- USD 1,741,690 thousand, 28.23% to the average period - USD 1,779,813.3 thousand and 30.17% for the year 2011- USD 2,119,980 thousand.

Referring to Romania's situation may be observed the following: Romanian grape exports amounts ranged from USD 282 thousand in 2009 to USD 672 thousand in 2010, and the average was USD 480.3 thousand; Romania held the following share in global export (Fig. 4.15.): 0.005% in 2009, 0.007% for 2011, 0.008% for period average and 0.011 % for 2010.

Table 3 shows the trade balance of global

exchanges made for grapes.

In 2009 the global trade balance was poor - USD 966.3 million, an aspect which is based of trade deficits: - USD 1,906.3 million Europe, - USD 288.2 million Asia. But there are surpluses in America, Africa and Oceania: USD 539.1 million, USD 625.5 million and USD 84.8 million.

In 2010 the global trade balance registered -

USD 882.8 million, due to the deficits from Europe and Asia (-USD 37.3 million and, respectively, - USD 257.7 million). The surpluses appeared to reduce the overall deficit for the same continents as in 2009 (Oceania, Africa and America. USD 25.2 million, USD 576.5 million and USD 616.9 million respectively).

Table 3. Grapes - The trade balance of global exchanges - USD Mil. (2009–2011)

Specification	2009			2010			2011			Average 2009 – 2011		
	export*	import*	±**	export*	import*	±**	export*	import*	±**	export*	import*	±**
Africa	652.1	26.6	625.5	605.0	28.5	576.5	696.5	41.3	655.2	651.2	32.1	619.1
America	2,339.8	1,800.7	539.1	2,729.9	2,113.0	616.9	3,078.5	1,914.2	1,164.3	2,716.1	1,942.6	773.5
Asia	619.2	907.4	-288.2	746.5	1,004.2	-257.7	849.4	1,409.9	-560.5	738.4	1,107.1	-368.7
Europa	1,902.5	3,828.8	-1,906.3	2,061.8	3,905.3	-1,843.5	2,319.2	4,302.9	-1,983.7	2,094.5	4,012.7	-1,918.2
Oceania	152.7	67.9	84.8	76.2	51.0	25.2	82.7	78.8	3.9	103.9	65.9	38
Total	5,666.3	6,632.6	-966.3	6,219.4	7,102.2	-882.8	7,026.3	7,747.3	-721	6,304.1	7,160.7	-856.6
UE	1,477.7	3,165.8	-1,688.1	1,741.6	3,106.7	-1,365.1	2,119.9	3,518.1	-1,398.2	1,779.8	3,263.5	-1,483.7
Romania	0,28	11.6	-11.32	0.67	7.98	-7.31	0.48	10.08	-9.6	0.48	9.90	-9.42

\* <http://faostat3.fao.org/faostat-gateway/go/to/download/T/TP/E>

\*\* own calculations

If we analyze the specific situation of 2011, we see that it is still deficient (-USD 721 million) Worldwide, which was determined by specific negative state of affairs from Europe and Asia (-USD 1,983.7 million and respectively - USD 560.5 million). For America, Africa and Oceania, appear a surplus balance: USD 1164.3 million, USD 655.2 million and USD 3.9 million.

Determining the average period it can be seen (Fig. 1) the deficient trade balance (-USD 856,6 mil.), determined by the following state of affairs:

- USD 1,918.2 million Europe; - USD 368.7 million Asia; USD 38 million Oceania; USD 619.1 million Africa; USD 773.5 million America.

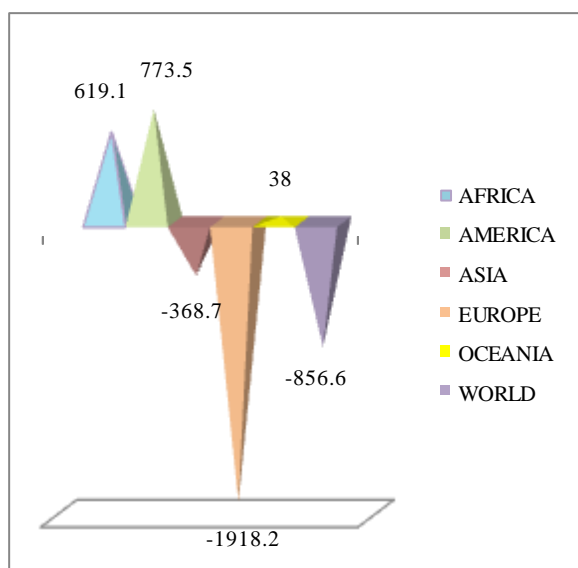

Fig. 1. Global trade balance - the average period (USD million)

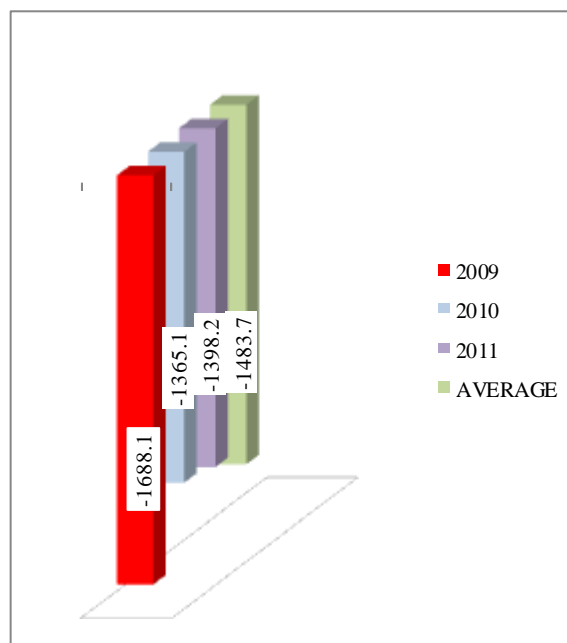

Fig. 2. The EU trade balance - annual evolution (USD million)

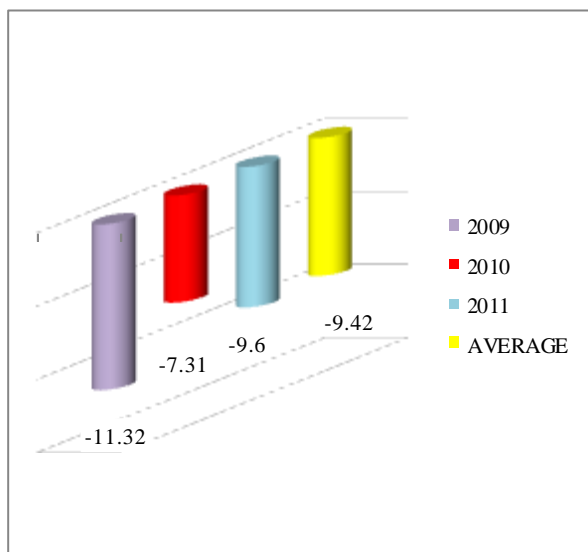

Fig. 3. Romania's Trade Balance (USD million)

At EU level the trade balance of grapes is strictly deficient, as follows (Fig. 2):

- USD 1,365.1 million in 2010;
- USD 1,398.2 million for 2011;
- USD 1,483.7 million average of the period;
- USD 1,688.1 million for 2009.

In Romania's case (Fig. 3), it can be seen that the trade balance of external commercial exchanges, with grapes, is strictly poor: - USD 7.31 million in 2010; - USD 9.42 million for period average; - USD 9.6 million in 2011; - USD 11.32 million in 2009.

## CONCLUSIONS

Regarding the import situation conclusions appear as follows:

- The value of imports was dominated by the transactions carried out in Asia, Africa and Europe with the weights of 36.69 %, 27.24 % and 21.19% respectively (the weights increased in Asia and Africa, and decreased in Europe compared to the imported quantities). As a result, it can be concluded that African and Asian markets trading unit prices are higher than in the European markets;
- The dynamic value of wheat exports was uneven in the world, similar to the situation in Asia. For other continents indicator ranged upward;
- Romania does not constitute an important actor in terms of exports for the world market, with weights of 0.44 % and 0.35%

respectively of the quantities imported values - a less beneficial aspect. Indicators variation was an uneven one, - at quantitative level, and ascending during analyzed period.

If we consider the export situation, there are a number of outstanding issues, such as:

- Global exports was dominated by Europe and America (43.33 % and 41.86%), with a downward trend share for Europe and increasing the share for Americans (compared to the quantities exported specific situation);
- the evolution over time of the indicator is upward, the essential difference manifested for Europe (non-uniform trend points upward);
- as in the case of imports and exports Romania is not an important actor in the global market (average weights of 1.45 % and 1.23% respectively for quantities and values exported) - favorable situation.

In terms of trade balance for commercial exchanges, the situation existing worldwide and national sequentially is characterized by:

- the level of world balance deficient, prominent phenomenon (- USD 4,745.9 million);
- analyzing the situation in each continent is distinguished the surplus situations specific to Oceania, Europe and America. Unfortunately they could not offset the annually decisive deficits from Africa and Asia;
- Romanian trade in surplus balance is strictly, something which highlights our country's ability to ensure the consumption of own production. There are, however, often problems with the quality of production and sales prices which in some cases make the market level to be difficulties an ensuring adequate domestic consumer demand.

## REFERENCES

- [1]Barbu, C., Pânzaru, R. L., 2000, Agrarian Economy, Hyperion Publishing, Craiova, Chapter 8, part I, p. 110-123
- [2]Constantin, M. et al., 1999, Agro marketing, Didactic and Pedagogic Publishing, Bucharest, Chapter 12, p. 263-328
- [3]Constantin, M. et al., 2009, Marketing food production Agrotehnica Publishing, Bucharest, Chapter 15, Part II, p. 341-402

[4]Nica, S., Glăman, G., Fântăneru, A., 1995, The rural economy, Compendium Artprint Publishing, Bucharest, Chapter 16, p. 169-174

[5]Pânzaru, R.L., Medelele, D. M., Ștefan G., 2009, The economy of crop production Publishing. Universitaria Craiova, Chapter 4, p. 189-209

[6]Ștefan, G., Bodescu, D., Toma, A.D., Pânzaru, R. L., 2006, Economics and agri-food policy, Alfa Publishing, Iasi, Chapter 5, p. 181-226

[7]Zahiu Letiția et al., 2005, Policies and agricultural market reform and European integration, Publisher. Ceres, Bucharest, Chapter 3, p. 250-465

[8]Zahiu Letiția et al., 2006, EU Agriculture under the impact of the Common Agricultural Policy, Publisher. Ceres, Bucharest, Chapter XII, p. 330-352

[9]Zahiu Letiția et al., 2010, Agriculture in the Romanian economy, between expectations and reality Publishing. Ceres, Bucharest, Chapter 3, p. 58-96

[10]<http://faostat.fao.org>

## INTERNATIONAL TRADE OF TOMATOES (2009-2011)

**Radu Lucian PÂNZARU, Dragoş Mihai MEDELETE**

University of Craiova, Faculty of Agronomy, 19 Libertăţii, 200421, Craiova, Romania, Phone:  
+40 727 712 967, Fax: + 40 251 418 475,  
E-mails: rlp1967craiova@yahoo.com, medelete@yahoo.com

**Corresponding author:** rlp1967craiova@yahoo.com

### *Abstract*

*The study reveals the commercial activities related to international situation for tomatoes, during 2009-2011. It aims to highlight the level of imports and exports value worldwide in general and the situation by continents (Africa, Asia, the two Americas, Asia, Europe and Oceania). Based on the indicators mentioned above (determined by multiplying the physical volume of imports and exports respectively with average selling prices), was established international commercial exchanges balance for tomatoes. There are highlighted specific situations of continental units as well as two particular cases - Romania and the European Union - having regard to the realities of our country reporting at regional and continental levels. In terms of world imports and structure stands out: the preponderance of Europe in the quantities imported - 57.61 %, shares quite low for Africa and Oceania - 0.62 % and 0.08 %, the rest of the continental units not exceeding 30.0 % (respectively 26.42 % and 15.27 % America and Asia); imports accounted for about 4 % of total world production of tomatoes (average 2009-2011); The European Union is a leading brands worldwide, surpassing the situation of most continents - 43,76 % (17,06 % of total production); Romania constitutes a "normal" operator, achieving 0.75 % of total worldwide imports. When analyzing the export situation can be observed the following: Europe remains, as in the case of imports, the main player on the market (39.13 %), but the situation is balanced in favor of Asia 28.12 %, while for America - 25.88 % the situation is similar (as a percentage) with the existing imports (same observation applies to Oceania - 0.08 %); Africa manages to significantly increase the share in the exports (6.79%) for imports compared to the situation; the world's total exports is about 4.5 % of the total tomato production; European Union held 37.0% of total world exports of tomatoes amount representing approximately 12 % of their production; Romania achieved 0.02% of world exports of tomatoes and the indicator has an upward trend for analyzed period, something beneficial - especially given that oscillating evolves of imports (approximately 1.81 % of the national total production - negative aspect);*

**Key words:** commercial balance, commercial exchanges, tomato, value

### INTRODUCTION

Vegetables grown in the open, industrial greenhouses, glasshouses - solar and other shelters and are important for food industry, as a factor intensifying land use and the use of labor resources, feed, export and source of profit [4].

In a rational diet, fresh or processed fruits and vegetables covering about 15% of human energy.

Industrial processing for consumption or fruits, leaves, flowers, buds, roots, rhizomes, seeds, tubers or stems of varieties of plants, shrubs, trees or trees [5].

1. Market activity is not conducted in a vacuum, but in a competitive environment. However, there are two types of competition: perfect and imperfect [6].

Development of international trade has experienced an intensity and different stages. The longest period of uninterrupted growth in world trade relative were the years 1820-1914; in the interwar period growth rates were significantly lower, particularly under the influence of economic crisis.

The largest rate of growth for world trade is recorded in the decades that followed the Second World War. Main characteristic of this period is the faster growth of world trade relative to world production [3].

International economic relations are imperative to know the characteristics of the foreign market of agricultural products as their base should be based on the work of foreign trade operators represented by companies and private entrepreneurs [2].

Worldwide agricultural trade holds a small share in total agricultural production (approx. 15%), most of which is intended, primarily, to domestic consumption. The main reason is that countries of the world exporting what they abound over domestic demand, with a strong agricultural trade waste.

The most important marketed products are cereals, oilseeds, dairy products, beverages, vegetable oils and fats. The biggest exporters are the US and EU, who own a 19% share of global exports [8].

Although the share of vegetables in area under cultivation at EU level is about the same as in our country, given that consumption needs cannot be provided from internal resources, it is necessary to organize routes for internal capitalization and trading to limit imports of vegetables and canned from EU Member States or with third countries [9].

Under the conditions our country's horticultural recovery paths are pointing in three different directions: fresh consumption; export delivery; raw material for food industry [1].

In this context it seems interesting to present the evolution of international trade with tomato (2009 - 2011), worldwide.

## MATERIAL AND METHODS

Drawing up the paper was used documentation by using statistical data [10]. Following this we used a nomenclature system of indicators specific to highlight some agricultural trade approved by the

United Nations Food and Agriculture Organization - FAO.

They were selected quantitative information on volume and value volume of imports and exports of tomatoes to worldwide at the five continental units (Africa, America, Asia, Europe and Oceania).

The study carried out Romania's position in the global market in terms of foreign trade with tomato.

## RESULTS AND DISCUSSIONS

Table 1 shows the evolution and structure of imports worldwide.

The year 2009 is characterized by a total export value of 7,128,098 thousand \$, which amount is based on continental contributions, punctual as follows: 9,462 thousand \$ Oceania (0.13 %), Africa 13,249 thousand \$ (0.19 %) 351,497 thousand \$ Asia (4.93%), 1,820,340 thousand \$ America (25.54%), Europe 4,933,550 thousand \$ (69.21%).

For 2010 there is a total value of world imports of 8,383,299 thousand \$, whose structure is based on the percentage contribution of 65.47% Europe – 5,488,550 thousand \$, 27.16% America – 2,276,900 thousand \$, 7.03% Asia - 589,661 thousand \$, 0.21% African – 16,892 thousand \$, 0.13% Oceania – 11,296 thousand \$.

If we analyze the situation of 2011 it appears that in each continent were recorded different values of the indicator, from 15,249 thousand \$ for Oceania (0.18%) to 5,389,510 thousand \$ for Europe (62.72%).

Table 1. Tomatoes - World Imports (2009-2011)

Specification	2009		2010			2011			Average 2009 – 2011		
	Th. \$ *	Str. ** %	Th. \$ *	Str. ** %	2010/2009**	Th. \$ *	Str. ** %	2011/2010**	Th. \$ **	Str. ** %	Average/2011**
Africa	13,249	0.19	16,892	0.21	127.49	25,687	0.30	152.06	18,609.3	0.23	72.44
America	1,820,340	25.54	2,276,900	27.16	125.08	2,616,050	30.44	114.89	2,237,763.3	27.85	85.53
Asia	351,497	4.93	589,661	7.03	167.75	546,879	6.36	92.74	496,012.3	6.17	90.69
Europa	4,933,550	69.21	5,488,550	65.47	111.24	5,389,510	62.72	98.19	5,270,536.7	65.60	97.79
Oceania	9,462	0.13	11,296	0.13	119.38	15,249	0.18	134.99	12,002.3	0.15	78.70
Total	7,128,098	100	8,383,299	100	117.60	8,593,375	100	102.50	8,034,923.9	100	93.50
EU	4,063,890	57.01	4,478,410	53.42	110.20	4,304,340	50.09	96.11	4,282,213.3	53.29	99.48
Romania	42,211	0.59	58,288	0.70	138.08	40,271	0.47	69.08	46,923.3	0.58	116.51

\* <http://faostat3.fao.org/faostat-gateway/go/to/download/T/TP/E>

\*\* own calculation



The rest of the continents have experienced levels of the indicator 25,687 thousand \$ Africa (0.30%), Asia 546,879 thousand \$ (6.36%) and 2,616,050 thousand \$ America (30.44%). The total value of the indicator was 8,593,375 thousand \$.

The average period stand out with a total value of world imports of 8,034,923,9 thousand \$, from which can be found in each continent effective contributions, variables: 12,002.3 thousand \$ Oceania (0.15%); 18,609.3 thousand \$ Africa (0.23%); 496,012.3 thousand \$ Asia (6.17%); 2,237,763.3 thousand \$ America (27.85%); 5,270,536.7 thousand \$ Europe (65.60%).

The European Union has made sequential contributions worldwide on the indicator, of 57.01%, 53.42%, 50.09 % and 53.29% for 2009, 2010, 2011 and period average - values 4,063,890 thousand \$, 4,478,410 thousand \$, 4,304,340 thousand \$ and 4282213,3 thousand \$.

Romania has contributed in varying proportions to achieving global level of indicator: 42,211 thousand \$ for 2009 - 0.59% 58,288 thousand \$ for the year 2010- 0.70%, 40271 thousand \$ for the year 2011- 0.47%, 46,923,3 thousand \$ for the period average - 0.58%.

Tomato export value level is shown in the Table 2, both in terms of its structure and in terms of time evolution.

For 2009 the indicator varied from 11,569 thousand \$ in Oceania, to 3,772,680 thousand \$ in Europe, and the overall level on the indicator reached 7,009,064 thousand \$. As a result there are continental variable weights in total as follows: 0.17% Oceania, Africa 5.03% - 352,595 thousand \$, 14.70% Asia - 1,030,610 thousand \$, 26.27% America - 1,841,610 thousand \$ and 53.83% Europe.

If we analyze the specific situation of 2010, it may be noted that the overall level for the indicator was 8,251,085 thousand \$, to which continents brought their contributions: 4,220,310 thousand \$ Europe - 51.15% 2,353,060 thousand \$ America - 28.52% 1,312,680 thousand \$ Asia - 15.91% 350,491 thousand \$ Africa - 4.24% 14,544 thousand \$ Oceania - 0.18%.

For 2011 we can see the variation, level of the indicator, from 13,290 thousand \$ for Oceania (0.16%) to 4,039,790 thousand \$ at European level (47.52%). The remaining continents recorded 449,635 thousand \$ Africa (5.29%), Asia 1,157,370 thousand \$ (13.61%), 2,841,480 thousand \$ America (33.42%). These values have made the world's total exports to record 8,501,565 thousands \$.

Table 2. Tomatoes - World Exports (2009-2011)

Specification	2009		2010			2011			Average 2009 - 2011		
	Th. \$.*	Str.** %	Th. \$.*	Str.** %	2010/2009**	Th. \$.*	Str.** %	2011/2010**	Th. \$.**	Str.** %	Average/2011**
Africa	352,595	5.03	350,491	4.24	99.40	449,635	5.29	128.28	384,240.3	4.85	85.45
America	1,841,610	26.27	2,353,060	28.52	127.77	2,841,480	33.42	120.75	2,345,383.3	29.61	82.54
Asia	1,030,610	14.70	1,312,680	15.91	127.36	1,157,370	13.61	88.16	1,166,886.7	14.73	100.82
Europa	3,772,680	53.83	4,220,310	51.15	111.86	4,039,790	47.52	95.72	4,010,926.7	50.64	99.28
Oceania	11,569	0.17	14,544	0.18	125.71	13,290	0.16	91.37	13,134.3	0.17	98.82
Total	7,009,064	100	8,251,085	100	117.72	8,501,565	100	103.03	7,920,571.3	100	93.16
EU	3,686,590	52.60	4,126,180	50.01	111.92	3,932,130	46.25	95.29	3,914,966.7	49.43	99.56
Romania	1,351	0.02	2,125	0.03	157.29	1,918	0.02	90.25	1,798	0.02	93.74

\* <http://faostat3.fao.org/faostat-gateway/go/to/download/T/TP/E>

\*\* own calculation

Discussing the average period it is found that global indicator reached a level of \$ 7,920,571.3 thousand \$, a level which is based on Continental contributions percentage - variables: 0.17% Oceania (13,134.3 thousand \$); 4.85% Africa (384,240.3 thousand \$); 14.73% Asia (1,166,886.7 thousand \$); 29.61% America (2,345,383.3 thousand \$);

50.64% Europe (4,010,926.7 thousand \$). Reporting the specific situation of the European Union to world situation can be found in the structure of world exports variable weights as follows: 46.25% in 2011 (3,932,130 thousand \$), 49.43% for period average (3,914,966.7 thousand \$), 50.01% for 2010 (4,126,180 thousand \$) and 52.60% in

2009 (3,686,590 thousand \$).

In Romania's case we can see an average of the 1,798 thousand \$ indicator (0.02% versus the global index), which is based on average annual contribution: 1,351 thousand \$ in 2009 (0.02%), 2,125 thousand \$ in 2010 (0.03%), 1,918 thousand \$ for 2011 (0.02%).

On the export of fresh vegetables, Romania can boost the European and world market by forming commercial farms, especially those producing organic [7].

Table 3 shows the trade balance of global exchanges achieved by the tomatoes.

The trade balance world exchanges with tomato has been deficient in 2009 (-118.9 Mil. \$), This situation is due to the surpluses recorded for Africa, America, Asia and Oceania - 339.4 million \$, 21.3 million \$, 679.1 million \$ and 2.1 million \$, especially

the specific deficit for European continent: -1,160.8 million. \$.

2010 maintains the weak trade balance (-132.2 mil. \$), Something determined in the previous year mostly by European deficit (-1,268.2 million. \$), which could not be offset by surpluses of other continents 333.6 million \$, 76.2 million \$, and 723. \$ - specific values for Africa, America, Asia and Oceania.

If we refer to the situation in 2011 it can be seen that deficient trade balance only appear in two continents - Europe and Oceania (-1,349.7 and 1.9 mil. \$), While the surplus character is specific to America, Africa and Asia - 225.5 million \$, 423.9 million \$ and 610.5 million \$. Therefore we can talk of a deficient global trade balance (-91.7 mil. \$).

Table 3. Tomatoes - The trade balance global trade - Mil. \$ (2009-2011)

Specification	2009			2010			2011			Average 2009 - 2011		
	export*	import*	±**	export*	import*	±**	export*	import*	±**	export*	import*	±**
Africa	352.6	13.2	339.4	350.5	16.9	333.6	449.6	25.7	423.9	384.2	18.6	365.6
America	1,841.6	1,820.3	21.3	2,353.1	2,276.9	76.2	2,841.5	2,616.0	225.5	2,345.4	2,237.8	107.6
Asia	1,030.6	351.5	679.1	1,312.7	589.7	723	1,157.4	546.9	610.5	1,166.9	496.0	670.9
Europa	3,772.7	4,933.5	-1,160.8	4,220.3	5,488.5	-1,268.2	4,039.8	5,389.5	-1,349.7	4,010.9	5,270.5	-1,259.6
Oceania	11.6	9.5	2.1	14.5	11.3	3.2	13.3	15.2	-1.9	13.1	12.0	1.1
Total	7,009.1	7,128	-118.9	8,251.1	8,383.3	-132.2	8,501.6	8,593.3	-91.7	7,920.5	8,034.9	-114.4
EU	3,686.6	4,063.9	-377.3	4,126.2	4,478.4	-352.2	3,932.1	4,304.3	-372.2	3,915.0	4,282.2	-367.2
Romania	1.3	42.2	-40.9	2.1	58.3	-56.2	1.9	40.3	-38.4	1.8	46.9	-45.1

\* <http://faostat3.fao.org/faostat-gateway/go/to/download/T/TP/E>

\*\* own calculation

In the period average (fig. 1) there is a deficient trade balance (-114.4 mil. \$), a situation which is based on continental levels of: 1.1 mil. \$ Oceania; 107.6 mil. \$ America; 365.6 mil. \$ Africa; 670.9 mil. \$ Asia; -1,259.6 Million. \$ in Europe.

The European Union is characterized by a strictly deficient trade balance for tomatoes, averaging -367.2 million. \$, While extreme values recorded were -352.2 million. \$ in 2010 and -377.3 million \$ in 2009 - fig. 2.

At national level it can be seen that the tomatoes trade balance is strictly deficient, unfavorable aspect. The weak are manifested throughout the analyzed period (Fig. 3): -40.9 million. \$ in 2009; -56.2 million. \$ 2010; -38.4 million. \$ in 2011; -45.1 million. \$ for period average.

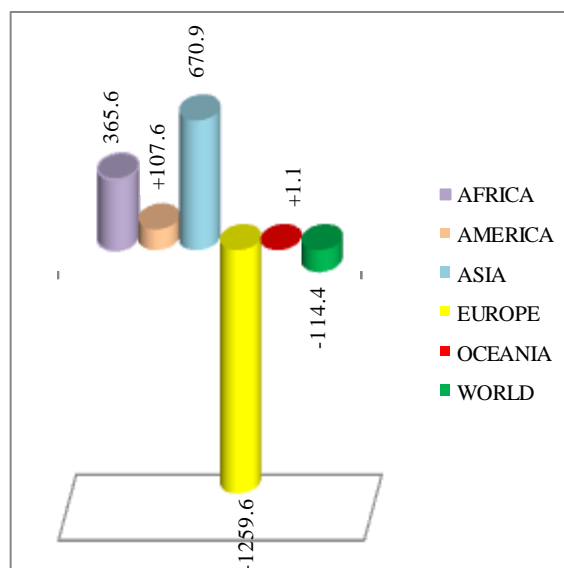

Fig. 1. World trade balance - the period average (mil. \$)

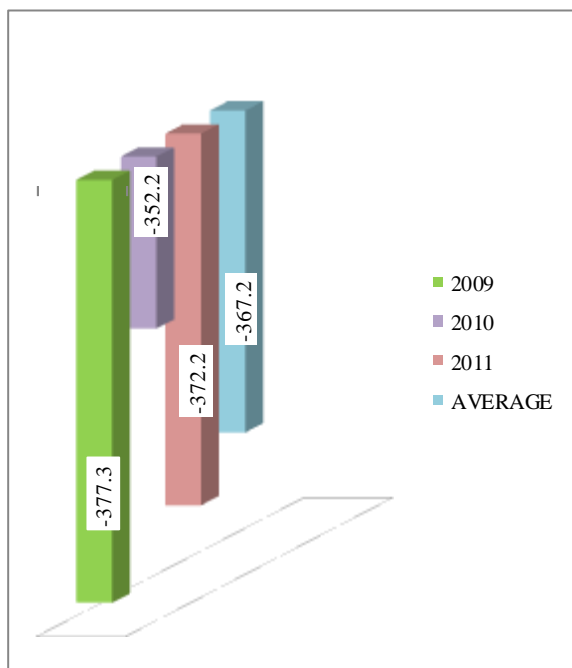

Fig. 2. EU. The trade balance - annual evolution (mil. \$)

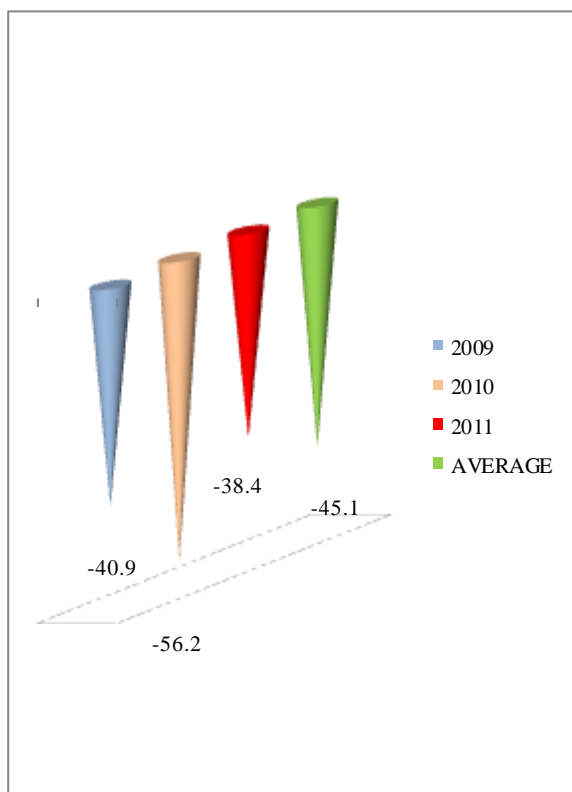

Fig. 3. Romania's commercial balance (mil. \$)

## CONCLUSIONS

-The European Union has made imports exceeding half of the world - 53.29% (almost 10% higher than the quantitative imports share registered) being the main player in the European market;

- Romania has a share of 0.58% lower than the existing quantitative imports (-0.17%);
- Global imports dynamics is upward, a trend which is respected in African, American and Oceania continents. Rest of the analyzed areas present an oscillating evolution for 2009-2011;
- For the value of exports, Europe remains the main global player, followed at a considerable distance by America - 50.64 % and 29.61% respectively (increases compared to the share at the quantitatively level of the expressed indicator).
- The dynamics of exports is an ascending one worldwide and for the American continent, otherwise the evolutions being uneven;
- Global balance is strictly deficient, both average and sequentially. This situation is caused by the deficit for Europe - decisive actor the global market for tomatoes rest of the world registering excess balances;
- The European Union is characterized by a deficient balances, being able to affirm that it decisively influenced the European situation;
- At national level, we can say that the situation is unfavorable, the weak balance being a permanent one.

## REFERENCES

- [1]Constantin, M., 1992, Marketing in agriculture, Didactic and Pedagogic, Bucharest, Chapter 9, p. 126-144
- [2]Constantin, M. et al., 2009, Food production Marketing, Ed. Agro Engineering, Bucharest, Chapter 9, Part I, p. 201-256
- [3]Crețoiu, G., Cornescu, V., Bucur, I., 2008 Economics, Second Edition, Ed. Beck, Chapter 21, p. 426-461
- [4]Pânzaru, R.L., Medelete, D.M, Ștefan, G., 2009, The Economics of vegetable production, Ed. Universitaria Craiova, Chapter 3, p. 141-188
- [5]Ștefan, G., Toma, A.D, Pânzaru, R.L, 2006, "Economy and agri-food policy" Alfa Publishing, Iasi, Chapter 6, p. 155-208
- [6] Ștefan, G., Bodescu, D., Toma, A.D, Pânzaru, R.L., 2007, Economy and chain food products, Alfa Publishing, Iasi, Chapter 10, p. 326-446
- [7]Zahiu Letitia et al., 2005, Police and agricultural market reform and European integration Ed. Ceres, Bucharest, Chapter 3, p. 250-465
- [8]Zahiu Letitia et al., 2006, EU Agriculture under the impact of Common Agricultural Policy, Ed. Ceres, Bucharest, Chapter 12, p. 330-352

[9] Zahiu Letitia et al., 2010 Agriculture in the Romanian economy, between expectations and reality, Ed. Ceres, Bucharest, Chapter 3, p. 58-96

[10] <http://faostat.fao.org>

## REGRESSION MODELLING IN PREDICTING MILK PRODUCTION DEPENDING ON DAIRY BOVINE LIVESTOCK

Agatha POPESCU

University of Agricultural Sciences and Veterinary Medicine Bucharest, 59 Marasti, District 1, 11464, Bucharest, Romania, Phone: +40213182564, Fax:+40213182888, Email: agatha\_popescu@yahoo.com

**Corresponding author:** Email: agatha\_popescu@yahoo.com

### Abstract

*The goal of the paper was to chose the best regression model for milk production, the dependent variable, Y, and dairy bovine livestock, the independent variable, X, testing two polynomial regressions: linear regression and quadratic regression. The data were collected from the National Institute of Statistics for the period 2007-2014. The discrimination between models was based on the standard error of each type of regression, choosing the one which assured the highest accuracy of the prediction. As a conclusion, between milk production and dairy bovine livestock, it is a strong and positive correlation,  $r=0.884$ , and about 78.30 % of milk production is determined by the milked livestock. As long as the Regression Standard Error was smaller in case of the Linear Regression,  $\sigma_{est} = 2,286.028830$  than in case of the Quadratic Regression,  $\sigma_{est} = 2,336.915726$ , the linear regression having the formula  $y = 23.974 x + 13,527$  proved to better fit the data.*

**Key words:** dairy bovine livestock, milk production, regression modelling, standard error

### INTRODUCTION

Milk production depends on the milked livestock and average milk production per animal. The main part of the milk production, more exactly 87.40 % of milk produced in Romania comes from dairy cows and buffalos. [9]

As long as in Romania milk yield is still very small, just about 3,364 liters per year and cow, it is obvious that the dairy bovine livestock has an important contribution to milk production.

The evolution and the relationship between milk production and dairy livestock could be studied using the statistical descriptive analysis and also the regression functions, because they are two variables closely connected, milk production being the dependent variable and dairy livestock the independent one.

Regression modeling and the value of the regression standard error is a useful tool to establish more accurately which is the most suitable regression type for a pair of variables. [4]

Polynomial regressions are most commonly used in such a case, and the calculation of

standard error for each type of regression could discriminate them, and finally the researcher to chose that regression type whose standard error is the smallest one, because it assures the highest precision. [6]

In this context, the purpose of this paper was to test the most suitable polynomial regression, in two variants: linear regression and quadratic regression, for the pair of variables: milk production, the dependent variable Y, depending on dairy bovine livestock, the independent variable, X, using as discrimination tool the standard error of each regression type.

### MATERIALS AND METHODS

The main indicators considered in this study have been: milk production coming from dairy cows and buffalos, the predictor Y, and the number of dairy bovine livestock, X.

The data were collected for the period 2007-2014 from Romania's Statistical Yearbook, provided by the National Institute of Statistics. [8]

For each variable, there were calculated the following statistical parameters: mean, median, variance, standard deviation,

coefficient of variation, minimum and maximum value, according to the well known mathematical formulas. [1]

For the pair of variables taken into consideration, there were designed the scatter plots and determined two types of polynomial regressions: the linear regression and the quadratic regression, with their specific parameters, a and b in case of linear regression and a, b and c in case of the parabolic fit, the coefficient determination and standard error, using the facilities offered by Excel Data Analysis.

The regression functions had the well known formulas:  $y = a + bx$  in case of the linear regression and  $y = ax^2 + bx + c$  in case the quadratic regression. [3, 7]

For each type of regression it was calculated the correlation coefficient, r, which measures how well a regression type or another fits the data. The interpretation was given depending on the r value as follows: if r value is close to 1, it indicates a good fit of the regression model, if r value is small, it is consider that the regression model is not appropriate.

The Regression Standard Error was used to measure the accuracy of the predicted Y, reflecting how much is the deviation of the Y observed values from the theoretical values  $Y_i'$  are situated on the regression line.

The calculation of the standard error supposed: (i) to give values to X in the linear regression formula in order to obtain the predicted Y', (ii) to make the difference between the observed values of Y and the predicted values Y', that is to determine the errors of prediction,  $Y - Y'$ , (iii) to calculate the squared errors of prediction,  $(Y - Y')^2$ , because the regression line is the one which minimizes the sum of squared deviation of prediction, also called the sum of squared errors.

The standard error was calculated using the formula:

$$\sigma_{est} = \sqrt{\frac{\sum(Y - Y')^2}{N}}$$

where  $\sigma_{est}$  is the standard error of the prediction, Y is the observed values of the variable Y, Y' is the predicted value of Y, and

N is the number of pairs of variables. The numerator is the sum of squared errors, reflecting the differences between the actual scores and the predicted scores. [2, 5]

## RESULTS AND DISCUSSIONS

### The statistical parameters of the number of dairy bovine livestock and milk production.

The number of dairy livestock including cows and buffalos registered a decline from 1,732 thousand heads in the year 2007 to 1,307.3 thousand heads in the year 2012, de reduction accounting for 24.53 %.

The average number of dairy bovine livestock was 1,419.538 thousand heads with a standard deviation of 193.6376 and a coefficient of variation of 13.64 %. The maximum livestock was noticed in the year 2007 and the minimum level was registered in the year 2012.(Table 1).

Table 1. Descriptive statistics of Number of dairy livestock and Milk production, Romania, 2007-2014

Year	Milk production (thousand hl) Y	No. of dairy cows and buffalos (Thousand heads) X
2007	54,875	1,732
2008	53,089	1,639
2009	50,570	1,569
2010	42,824	1,299
2011	43,947	1,266
2012	42,036	1,265
2013	42,593	1,279
2014	50,535	1,307.3
Mean	47,558.63	1,419.538
Median	47,241	1,303.15
Standard Deviation	5,246.208	193.6376
Variance	27,522,700.84	37,495.51
Coefficient of variation (%)	11.03	13.64
Maximum	54,875	1,732
Minimum	42,036	1,265

Source: National Institute of Statistics, 2015. [9] Own calculation.

The milk production obtained from dairy cows and buffalos also registered a decline,

from 54,875 thousand hl in the year 2007 to 50,535 thousand hl in the year 2014, the reduction accounting for 7.91 %. In the analyzed period, the maximum production was noticed in the year 2007 and the minimum one in the year 2012. The average milk production was 47,558.63 thousand hl,

with a standard deviation of 5,246.208 and a variation coefficient of 11.03 % (Table 1).

#### Testing the Linear Regression.

Firstly, it was established a scatter plot of the empirical data, using the linear regression function.(Fig.1.)

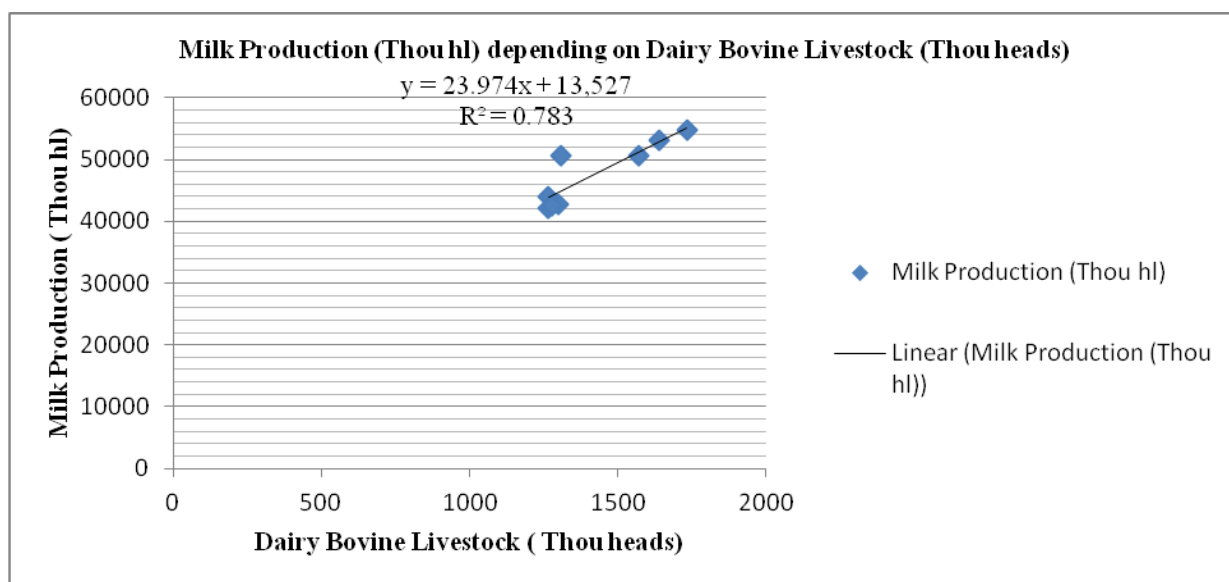

Fig.1.Milk Production evolution depending on Dairy Bovine Livestock, Linear Regression Line. Own design.

**The linear regression** resulting from the use of Excel Data Analysis facilities was:

$$y = 23.974x + 13,527$$

where Y is the predicted milk production, the dependent variable, depending on milk production, X, the vector of the independent variable, a = 13,527 is the intercept, a constant, and b=23.974 is the regression slope.

**The Multiple R**, that is the coefficient of simple correlation between X, the dairy bovine livestock and Y, the milk production is R= 0.884871581, reflecting a strong positive relationship between the two variables.

**The R<sup>2</sup> or R Square** value was R<sup>2</sup>= 0.782997716. The determination coefficient reflects that 78.30 % of the variation of milk production is determined by the dairy bovine livestock.

**The standard error** of the linear regression was  $\sigma_{est} = 2,286.028830$ , being calculated as the square root of the ratio between the sum of

the squared errors of the prediction and the number of variables as presented in Table 2.

The diagram from Fig.2. shows that between the independent variable, Dairy Bovine Livestock and Residuals, that is the errors of prediction, there is no correlation. Therefore, the regression model is good.

#### Testing the Polynomial Regression or Parabolic Fit

Firstly, it was established a scatter plot of the empirical data, using the parabolic fit regression function.(Fig.3.)

**The polynomial regression** of the 2nd degree or the Parabolic Fit, resulting from the use of Excel Data Analysis facilities was:

$$y = -0.0237x^2 + 93.997x - 37,392$$

where Y is the predicted milk production, the dependent variable, depending on milk production, X, the vector of the independent variable, a = - 13,527 is the intercept, a constant, b=93.997, c = - 0.0237.

**The Multiple R**, that is the coefficient of

simple correlation between X, the dairy bovine livestock and Y, the milk production is R= 0.8880, reflecting a strong positive relationship between the two variables.

Table 2. The calculation of the Linear Regression Standard Error

Observed Y	Predicted Y'	The errors of prediction, Y -Y'	The squared errors of prediction (Y -Y') <sup>2</sup>
54,875	55,049.52562	-174.5256	30,459.185055
53,089	52,819.96605	269.03395	72,379.266252
50,570	51,141.80293	-571.8029	326,958.556448
42,824	44,668.88804	-1,844.888	3,403,611.732544
43,947	43,877.754	69.2459	4,794.994666
42,036	43,853.78024	-1,817.78	3,304,324.1284
42,593	44,189.41287	-1,596.413	2,548,534.466569
50,535	44,867.87024	5,667.1298	32,116,360.170048
			$\sum (Y -Y')^2 =$ 41,807,422.499982
The linear Regression Standard error			$\sigma_{est} = 2,286.028830$

Source: Own calculation.

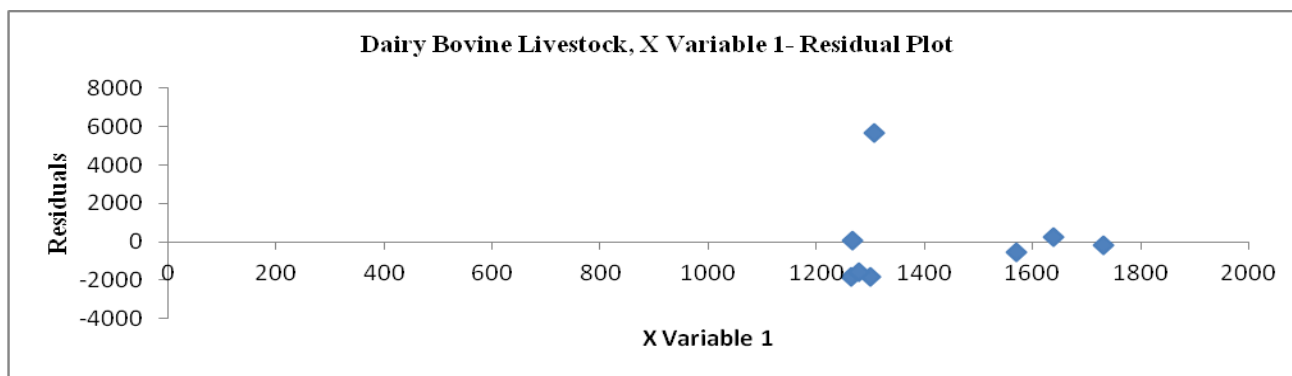

Fig.2. The diagram of the independent variable X, Dairy Bovine Livestock, and Residuals. Own design.

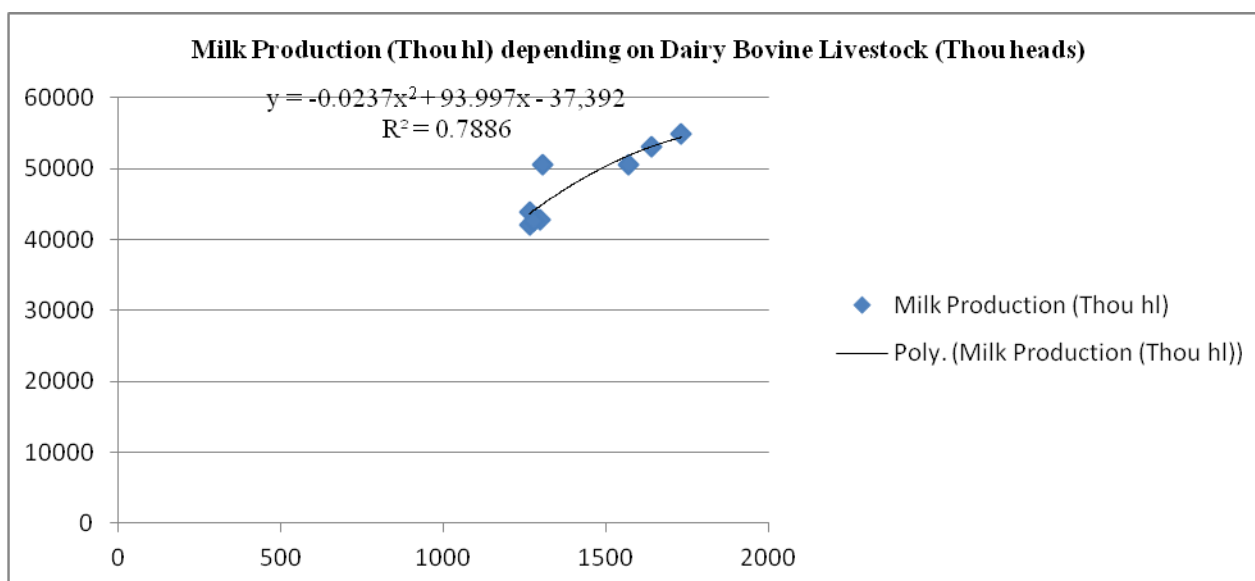

Fig.3. Milk Production evolution depending on Dairy Bovine Livestock, Parabolic Regression Line. Own design.



The  $R^2$  or  $R$  Square value was  $R^2 = 0.7886$ . The determination coefficient reflects that 78.86 % of the variation of milk production is determined by the dairy bovine livestock.

The standard error of the linear regression was  $\sigma_{est} = 2,336.915726$ , being calculated as the square root of the ratio between the sum of the squared errors of the prediction and the number of variables as presented in Table 3.

Table 3. The calculation of the Quadratic Regression Standard Error

Observed Y	Predicted Y'	The errors of prediction, Y -Y'	The squared errors of prediction (Y -Y') <sup>2</sup>
54,875	54,314.9752	560.0248	313,627.776615
53,089	53,003.2753	85.7247	7,348.724190
50,570	51,745.5573	-1,175.5573	1,381,934.965583
42,824	45,378.6993	-2,554.6993	6,526,488.513420
43,947	43,622.8848	324.1152	105,050.662871
42,036	43,588.8725	-1,552.8725	2,411,413.001256
42,593	44,060.7313	-1,467.7313	2,154,235.168999
50,535	44,986.189127	5,548.810873	30,789,302.104323
			$\sum (Y -Y')^2 =$ 43,689,400.917258
The Quadratic Regression Standard error			$\sigma_{est} = 2,336.915726$

Source: Own calculation.

## CONCLUSIONS

The study pointed out the importance to comparatively analyze the standard error of various regression models, and finally to decide to chose the regression type whose standard error is the smallest one, as the standard error is a measure of the accuracy of the prediction.

Taking into account that the Regression Standard Error was smaller in case of the Linear Regression,  $\sigma_{est} = 2,286.028830$  than in case of the Quadratic Regression,  $\sigma_{est} = 2,336.915726$ , the conclusion is that the linear regression fits better to the evolution of milk production depending on the number of dairy bovine livestock.

Therefore, for the period 2007-2014, the linear regression function reflecting the dynamics of milk production depending on the dairy bovine livestock was:  $y = 23.974 x + 13,527$ .

## REFERENCES

- [1]Anghelache, C, 2008, Treatise of Theoretical and Economic Statistics, the Economic Publishing House, Bucharest
- [2]Frost Jim, 2014, Regression Analysis: How to Interpret S, the Standard Error of the Regression,

<http://blog.minitab.com/blog/adventures-in-statistics/regression-analysis-how-to-interpret-s-the-standard-error-of-the-regression>

[3]Emerson, E, 2015, Quadratic Regression Calculator, <http://www.had2know.com/academics/quadratic-regression-calculator.html>

[4]Everitt, B.S., 2003, The Cambridge Dictionary of Statistics

[5]Jianqing, F, 1996, Local Polynomial Modelling and Its Applications. Monographs on Statistics and Applied Probability. Chapman & Hall/CRC

[6]Kennedy, J. B. , Neville, A.M., 1986, Basic Statistical Methods for Engineers and Scientists, 3rd Ed., Harper and Row

[7]Lane, D.M., Introduction to Linear Regression, <http://onlinesstatbook.com/2/regression/intro.html>

[8]National Institute of Statistics, 2015, Romania, Statistical Yearbook, Chapter 14, Agriculture.

[9] National Institute of Statistics, 2014, Animal Production 2013, Press Release No.152, June 30, 2014



## MULTIPLE CORRELATION AND REGRESSION IN PREDICTING MILK PRICE

Agatha POPESCU

University of Agricultural Sciences and Veterinary Medicine Bucharest, 59 Marasti, District 1, 11464, Bucharest, Romania, Phone: +40213182564, Fax:+40213182888, Email: agatha\_popescu@yahoo.com

**Corresponding author:** Email: agatha\_popescu@yahoo.com

### Abstract

*The purpose of the paper was to analyze the relationship between milk production and dairy bovine livestock and milk price, using the multiple correlation and regression models. The reference period is the 2005-2014 decade in dairy sector of Romania and the data were provided by the National Institute of Statistics. The simple correlation coefficient  $R_{XZ} = -0.477$  reflected a negative relationship between milk production and milk price, and the coefficient of correlation  $R_{YZ} = -0.676$ , also reflected a negative relationship between the dairy livestock and milk price. While, the total coefficient of linear multiple correlation,  $R_{ZXY} = 0.771$ , reflected a significant positive relationship between milk price, milk production and the dairy livestock, the partial coefficient  $R_{ZX.Y} = -0.537$  reflected a negative middle link between milk production and milk price, when the dairy livestock is constant. Also, the partial coefficient of multiple correlation,  $R_{ZY.X} = -0.709$ , reflected a strong negative influence of milk production on the pair milk price and dairy livestock. The linear multiple regression had the formula:  $Z = -0.00349X + 0.08305Y + 165.68$  and the width of the confidence interval,  $\delta_{\alpha/2}$ , was 29.08. In 2015, for  $X_e = 50,025.45$  thousand hl milk production and  $Y_e = 1,251.23$  thousand heads dairy livestock, the predicted milk price was 95.01 Lei/hl. Therefore, the multiple correlation and regression are important mathematical tools to describe the relationships between milk production, the dairy bovine livestock and milk price and predict milk price based on the other factors.*

**Key words:** dairy bovine livestock, milk price prediction, milk production, multiple correlation, multiple regression

### INTRODUCTION

Milk production should be analyzed in close connection with milk price and the dairy livestock, because it depends on the milked animals and their milk yield, and milk price is determined by demand/supply ratio. However, dairy farmers are complaining that farm gate milk price is frequently very small, affecting profitability [12].

For this reason, the applied statistics is helpful to better understand the relationship between milk production, dairy livestock and milk price. In this respect, multiple correlation and multiple regression are mathematical tools which allow to identify the linear simple correlation between the variables as well as the multiple correlation coefficients which may reflect the influence of one or the combined influence of two factors on the 3rd one. [1, 8, 9, 10]

The significance of the coefficient of correlation is tested using Fisher's test, and

also Student's test, which involve to compare the determined values with the quantiles presented in tables, for specific probabilities and degrees of freedom and finally to decide to accept or not the H hypothesis [2, 3, 4,7].

The multiple regression allows to predict the estimated values of a dependent factor based on the values of the independent factors. [5, 6] In this context, the paper aimed to make an analysis of the relationship between milk production, dairy bovine livestock and milk price in Romania, based on the empirical data provided by the National Institute of Statistics [11] and using the multiple correlation and multiple regression as processing methods and basic tools in predicting milk price.

### MATERIALS AND METHODS

The economic indicators taken into account were: milk production obtained from dairy cows and buffalos (thousand hl), the X variable, the number of dairy bovine livestock

(thousand heads), the Y variable, and milk price( lei/hl), the Z variable.

The data were collected from the National Institute of Statistics for the period 2005-2014 [ 11]

The following statistical parameters were determined for each variable: mean, standard deviation, and coefficient of variation according to the formulas:

Mean:

$$\bar{X} = \frac{\sum_{i=1}^n X_i}{n}$$

Standard deviation,

$$s = \sqrt{\frac{\sum(x - \bar{x})^2}{n - 1}}$$

Coefficient of variation,

$$V\% = (S / \bar{X}) * 100.$$

Also, for each pair of variables, there were calculated: the covariance, and coefficients of simple linear correlation, according to the formulas:

Covariance:

$$\text{Cov}(X, Y) = \frac{\sum_{i=1}^n (X_i - \bar{X})(Y_i - \bar{Y})}{n - 1}$$

Coefficient of correlation,  $r_{xy}$ :

$$r = \frac{n(\sum xy) - (\sum x)(\sum y)}{\sqrt{[n\sum x^2 - (\sum x)^2][n\sum y^2 - (\sum y)^2]}}$$

The coefficients of multiple linear correlation have been determined as follows:

-The total coefficient:

$$R_{z,xy} = \sqrt{\frac{r_{xz}^2 + r_{yz}^2 - 2r_{xz}r_{yz}r_{xy}}{1 - r_{xy}^2}}$$

-The partial coefficients:

$$R_{ZX.Y} = \frac{R_{ZX} - R_{ZY}R_{XY}}{\sqrt{(1 - R_{ZY}^2)(1 - R_{XY}^2)}}$$

$$R_{ZY.X} = \frac{R_{ZY} - R_{ZX}R_{XY}}{\sqrt{(1 - R_{ZX}^2)(1 - R_{XY}^2)}}$$

The correlations were tested using Fisher Test, according to the formula:

$$F_{(XY)} = \frac{R_{Z.XY}^2}{1 - R_{Z.XY}^2} \cdot \frac{2}{n-3}$$

where F is Fisher variable with the degrees of freedom [ 2; n-3 ] DOF.

The significance of correlation was established comparing F calculated values with F from tables  $F_{0.05}$ ,  $F_{0.01}$  and  $F_{0.001}$ .

The testing of the hypothesis H compared to the alternative hypothesis,  $\bar{H}$  was based on the comparison t Student Test, the calculation of t being made using the formula:

$$t_x = \frac{R_{ZX.Y}^2}{\sqrt{1 - R_{ZX.Y}^2}} \sqrt{n - 3}.$$

The calculated t was compared to t values from tables for 7 DOF for  $t_{0.025}$ ,  $t_{0.05}$  and  $t_{0.005}$ .

The A variation contribution X, Y, the X.Y interaction and E to the Z variation are:

$$A_{(X,Y)} = R_{Z.XY}^2$$

$$A_X = A_{(X,Y)} - A_Y = R_{Z.XY}^2 - R_{ZY}^2$$

$$A_Y = A_{(X,Y)} - A_X = R_{Z.XY}^2 - R_{ZX}^2$$

$$A_{(X,Y)} = A_{(X,Y)} - A_X - A_Y = R_{ZX}^2 + R_{ZY}^2 - R_{Z.XY}^2$$

$$A_E = 1 - A_{(X,Y)} = 1 - R_{Z.XY}^2$$

The linear multiple regression was determined using the formula:  $Z = B_0 + B_1 X + B_2 Y$ , where  $B_1$  and  $B_2$  are the solutions of the system of linear equations:

$$B_1 S_X^2 + B_2 S_{XY} = S_{XZ}$$

$$B_1 S_Y + B_2 S_Y^2 = S_{YZ}$$

$$\text{and } B_0 = \bar{Z} - B_1 \bar{X} - B_2 \bar{Y}.$$

The width of the confidence interval was calculated according to the formula:

$$\delta_{\alpha/2} = \sqrt{(n - 1)(1 - R_{Z.XY}^2) / [n(n - 3)]} \cdot S_Z$$

.  $t_{\alpha/2}$  for (n-3) DOF.

## RESULTS AND DISCUSSIONS

The basic data for the variables taken into account are presented in Table 1.

The statistical parameters: means and standard deviations for the three variables are presented in Table 2.

The covariance and coefficients of simple linear correlation are given in Table 3.

As one can see, the simple correlation coefficient between Milk production (X) and Milk price (Z), registered a negative value,

$R_{XZ} = - 0.477$ , reflecting that between the two variables is not a positive relationship, meaning that when milk production is higher, milk price will decline, and the lower milk production, the higher milk price.

Also, between the Dairy bovine livestock (Y) and Milk price (Z), the correlation coefficient

had a negative value,  $R_{YZ} = - 0.676$ , signifying that when the livestock declines, the milk price will increase, and, the higher the livestock in close connection with a higher production, the lower the milk price.

Table 1. Milk production, Dairy Bovine Livestock and Milk Price, Romania, 2005-2014

Year	Milk Production (thou hl) X	Dairy Bovine Livestock (thou heads) Y	Milk Price (Lei/hl) Z
2005	55,121	1,812	64
2006	58,307	1,810	67
2007	54,875	1,732	75
2008	53,089	1,639	88
2009	50,570	1,569	90
2010	42,824	1,299	94
2011	43,947	1,266	108
2012	42,036	1,265	111
2013	42,593	1,279	211
2014	50,535	1,307.3	209

Source: National Institute of Statistics, 2006-2015 [11]

Table 2. The average values, the standard deviations and the coefficients of variation for milk production, dairy bovine livestock and milk price

Statistical parameter	Milk production, X	Dairy bovine livestock, Y	Milk price, Z
Mean	$\bar{X} = 49,389.7$	$\bar{Y} = 1,497.83$	$\bar{Z} = 111.7$
Standard deviation	$S_X = 6,072.22$	$S_Y = 237.50$	$S_Z = 54.06$
Coefficient of variation	$V_X\% = 12.29\%$	$V_Y\% = 15.85$	$V_Z\% = 48.39$

Source: Own calculations.

Table 3. The values of covariance and the simple correlation coefficients between milk production (X), dairy bovine livestock (Y) and milk price (Z)

Statistical parameter	Milk production(X) and Dairy bovine livestock (Y)	Milk production(X) and Milk price (Z)	Dairy bovine livestock (Y) and Milk price (Z)
Covariance	$S_{XY} = 1,202,354.99$	$S_{XZ} = - 140,855.89$	$S_{YZ} = 7,815.24$
Correlation coefficient	$R_{XY} = 0.926$	$R_{XZ} = - 0.477$	$R_{YZ} = - 0.676$

Source: Own calculations.

**The vector of the means, the matrix of covariance and the matrix of the linear correlations** between the variables are presented below.

The vector of the means is:

( $\bar{X} = 49,389.7$  ;  $\bar{Y} = 1,497.83$  ;  $\bar{Z} = 111.7$ ).

The matrix of the covariance is:

$S^2_X = 36,871,855.72$   $S_{XY} = 1,202,354.99$   $S_{XZ} = - 140,855.89$

$S_{XY} = 1,202,354.99$   $S^2_Y = 56,406.25$   $S_{YZ} = 7,815.24$

$S_{XZ} = - 140,855.89$   $S_{YZ} = 7,815.24$   $S^2_Z = 2,922.48$

The matrix of the linear correlation is:

1	$R_{XY} = 0.926$	$R_{XZ} = - 0.477$
$R_{XY} = 0.926$	1	$R_{YZ} = - 0.676$
$R_{XZ} = - 0.477$	$R_{YZ} = - 0.676$	1

**The coefficients of linear multiple correlation** are presented in Table 4. The total coefficient of linear multiple correlation,  $R_{Z,XY}$ , reflects the intensity of the statistical connection between Z, milk price, and the other two variables, XY, milk production and dairy livestock. One can notice that its value,  $R_{Z,XY} = 0.771$ , is enough high and positive, therefore milk price is influenced by the both variables.

The partial coefficient of linear multiple correlation,  $R_{ZX,Y}$ , reflects the intensity of the statistical link between Milk production, X

and Milk price, Z, when the dairy livestock Y= constant. The value of  $R_{ZX.Y} = -0.537$  shows that, when the dairy livestock is constant, between milk production and milk price is a negative middle correlation.

The partial coefficient of linear multiple correlation,  $R_{ZY.X}$ , gives information about the statistical relationship between Milk price, Z., and the Dairy Livestock, Y, when Milk production X= constant. One can see that its value was  $R_{ZY.X} = -0.709$ , reflecting a strong negative influence of milk production on the pair milk price and dairy livestock.

Table 4. The coefficients of linear multiple correlation

The total coefficient of linear multiple correlation $R_{Z.XY}$	The partial coefficient of linear multiple correlation $R_{ZX.Y}$	The partial coefficient of linear multiple correlation $R_{ZY.X}$
$R_{Z.XY} = 0.771$	$R_{ZX.Y} = -0.537$	$R_{ZY.X} = -0.709$

Source: Own calculations.

**The testing of the coefficients of linear multiple correlation.**

The total coefficient of linear multiple correlation,  $R_{Z.XY}$ , varies from a sample to another around the total unknown coefficient of correlation,  $p_{Z.XY}$ .

According to its formula, the value of  $F_{(XY)} =$

$$\frac{R_{Z.XY}^2}{1 - R_{Z.XY}^2} \cdot \frac{2}{n-3} = 5.12$$

From the Fisher's tables, for (2:n-3) DOF, the found values for  $F_{(XY)}$  are:  $F_{5\%} = 4.74$ ,  $F_{1\%} = 9.55$  and  $F_{0.1\%} = 21.69$ . The interpretation is the following one:  $F_{5\%} = 4.74 < F_{(XY)} = 5.12 < F_{1\%} = 9.55$ , therefore the hypothesis H is not accepted,  $p_{Z.XY} \neq 0$ , and Z and the pair (X,Y) are significantly linear correlated.

The partial coefficients of linear multiple correlation,  $R_{ZX.Y}$  and  $R_{ZY.X}$ , varies from a sample to another around the unknown partial coefficient of correlation,  $p_{ZX.Y}$  and  $p_{ZY.X}$ .

Using the formula given below, it was calculated  $t_X$ :

$$t_X = \frac{R_{ZX.Y}^2}{\sqrt{1 - R_{ZX.Y}^2}} \sqrt{n-3}, \text{ and it was obtained } t_X = 0.901.$$

From the Student's tables, for (n-3=7) DOF, the found values for  $t_X$  are:  $t_{0.025\%} = 2.365$ ,

$t_{0.0025\%} = 3.499$  and  $t_{0.0005\%} = 5.408$ . The interpretation is the following one: Because  $t_X = 0.901 < t_{0.025\%} = 2.365$ , the hypothesis H is accepted,  $p_{ZX.Y} = 0$ , and Z and X are not linear correlated, when Y= constant.

Using the formula given below, it was calculated  $t_Y$ :

$$t_Y = \frac{R_{ZY.X}^2}{\sqrt{1 - R_{ZY.X}^2}} \sqrt{n-3}, \text{ and it was obtained } t_Y = 1.879.$$

From the Student's tables, for (n-3=7) DOF, the found values for  $t_Y$  are:  $t_{0.025\%} = 2.365$ ,  $t_{0.0025\%} = 3.499$  and  $t_{0.0005\%} = 5.408$ . The interpretation is the following one: Because  $t_Y = 1.879 < t_{0.025\%} = 2.365$ , the hypothesis H is accepted,  $p_{ZY.X} = 0$ , and Z and Y are not linear correlated, when X= constant.(Table 5).

Table 5. Testing the coefficient linear of multiple correlation

	$F_{(XY)}$	$t_X$	$t_Y$
	5.12	0.901	1.879
Tabled values	$F_{5\%} = 4.74$ , $F_{1\%} = 9.55$ $F_{0.1\%} = 21.69$	$t_{0.025\%} = 2.365$ , $t_{0.0025\%} = 3.499$ $t_{0.0005\%} = 5.408$	$t_{0.025\%} = 2.365$ , $t_{0.0025\%} = 3.499$ $t_{0.0005\%} = 5.408$
Decision on the H hypothesis	H hypothesis can not be accepted, $p_{Z.XY} \neq 0$	H hypothesis must be accepted, $p_{ZX.Y} = 0$	H hypothesis must be accepted, $p_{ZY.X} = 0$
Conclusion	Z and the pair (X,Y) are significantly linear correlated.	Z and X are not linear correlated, when Y= constant.	Z and Y are not linear correlated, when X= constant

Source: Own calculations.

**The contribution of X,Y, the X.Y interaction and E, error due to other factors to the Z variation** is presented in Table 6.

Therefore, the total contribution of the variation of the pair of factors milk production and dairy livestock,  $A_{(X,Y)}$ , on milk price, Z, is 59.44 %.

The partial contribution  $A_{(X)}$  of the variation of milk production, X, when the dairy livestock Y= constant on Z, was 13.80 %.

The partial contribution  $A_{(Y)}$  of the variation of the dairy livestock, Y, when milk production, X=constant was 36.7 %.

The partial contribution  $A_{(X,Y)}$  reflecting the interaction of milk production, X, and the dairy livestock, Y, on Z, was 8.90 %.

The contribution of the error, E, representing other factors of influence on milk price, Z, was 40.60 %.

Table 6. The contributions  $A_{(X,Y)}$ ,  $A_X$ ,  $A_Y$ ,  $A_{(X,Y)}$ , and  $A_E$  to the variation of Z, Milk price

$A_{(X,Y)}$	$A_X$	$A_Y$	$A_{(X,Y)}$	$A_E$
$=R^2_{Z,XY}$	$=R^2_{Z,XY} - R^2_{ZY}$	$=R^2_{Z,XY} - R^2_{ZX}$	$=R^2_{ZX} + R^2_{ZY} - R^2_{Z,XY}$	$= 1 - R^2_{Z,XY}$
0.594=59.44 %	0.138=13.80 %	0.367=36.7 %	0.089=8.90 %	0.406=40.60 %

Source: Own calculations.

**The linear multiple regression** was determined because the coefficient  $R_{Z,XY}$  had a significant value.

The formula of the linear multiple regression is:

$$Z = B_0 + B_1X + B_2Y,$$

where  $B_0$ ,  $B_1$  and  $B_2$  are the solutions of the system of linear equations:

$$B_1 \sum x_i^2 + B_2 \sum x_i y_i + B_0 \sum x_i = \sum x_i z_i$$

$$B_1 \sum x_i y_i + B_2 \sum y_i^2 + B_0 \sum y_i = \sum y_i z_i$$

$$B_1 \sum x_i + B_2 \sum y_i + n B_0 = \sum z_i$$

The formulas used to calculate  $B_0$ ,  $B_1$  and  $B_2$  were:

$$B_1 = R_{zx.y} (S_{z,y}/S_{x,y})$$

$$B_2 = R_{zy.x} (S_{z,x}/S_{y,x}) \text{ and}$$

$$B_0 = \bar{Z} - B_1\bar{X} - B_2\bar{Y}$$

Therefore, solving the system of normal equations, we found the following solutions:

$$B_1 = -0.00349$$

$$B_2 = 0.08305 \text{ and}$$

$$B_0 = 165.68.$$

The  $B_1$  value could be interpreted as follows: milk price will decline by - 0.00349 Lei per 1 hl less of milk production, when dairy livestock is constant.

The  $B_2$  value could be interpreted: milk price will increase by 0.08305 Lei/hl per an increase of one thousand heads of dairy livestock, when milk production is constant.

Therefore, the linear multiple regression will have the formula:

$$Z = -0.00349 X + 0.08305 Y + 165.68.$$

**The prediction of Milk Price.** Taking into account the average annual gain/loss of milk production  $\Delta X = -509.55$  thousand hl, and the average annual gain/loss of dairy bovine livestock  $\Delta Y = -56.07$  thousand heads, registered in the period 2005-2014, we are expecting that in the year 2015, the milk production to be  $X_e = 50,025.45$  thousand hl (50,535 thousand hl registered in the last year of the analysis, that is in 2014 - 509.55 thousand hl), and the dairy bovine livestock to become  $Y_e = 1,251.23$  thousand heads (1,307.3 thousand heads in 2014 - 56.07 thousand heads).

Replacing X and Y in the formula of the linear multiple regression, we will obtain the expected milk price ( $Z_e$ ), as follows:

$$Z_e = -0.00349 * 50,025.45 + 0.08305 * 1,251.23 + 165.68 = 95.01 \text{ Lei/hl in the year 2015.}$$

**The width of the confidence interval**,  $\delta_{\alpha/2}$ , was 29.08, according to the formula:

$$\delta_{\alpha/2} = \sqrt{(n-1)(1-R^2_{Z,XY})/[n(n-3)]} \cdot S_z \cdot t_{\alpha/2}$$

for  $(n-3=7)$  DOF. For  $\alpha = 5\%$ , in the Table it was found  $t_{0.025} = 2.36$  for 7 DOF, so that  $\delta_{2.5\%} = 29.08$ .

**The regression plan with its width of the confidence interval** will be:

$$Z = -0.00349 X + 0.08305 Y + 165.68 \pm 29.08.$$

Therefore, the maximum value of milk price will be  $95.01 + 29.08 = 124.09$  Lei/hl, and its minimum value will be  $95.01 - 29.08 = 65.93$  Lei/hl.

In Table 7 are given the values  $x_i$ ,  $y_i$ , and  $z_i$ , the expected values  $z_e$  and the differences  $\Delta z_i = z_i - z_e$ .



Table 7. The  $x_i$ ,  $y_i$ , and  $z_i$  values, the expected values  $z_e$  and the differences  $\Delta z_i = z_i - z_e$

$x_i$	$y_i$	$z_i$	$z_e$	$\Delta z_i = z_i - z_e$
55,121	1,812	64	112	-48
58,307	1,810	67	105	-38
54,875	1,732	75	110	-35
53,089	1,639	88	109	-21
50,570	1,569	90	114	-24
42,824	1,299	94	116	-22
43,947	1,266	108	117	-9
42,036	1,265	111	118	-7
42,593	1,279	211	113	+98
50,535	1,307.3	209	103	+106

Source: Own calculations

## CONCLUSIONS

Between Milk production and Milk price, the correlation coefficient,  $R_{XZ} = -0.477$ , reflected a negative relationship, that is, the higher the milk production, the lower the milk price.

Between the Dairy bovine livestock and Milk price, the correlation coefficient  $R_{YZ} = -0.676$ , also reflected a negative relationship, meaning the lower the dairy livestock declines, the higher milk price.

The total coefficient of linear multiple correlation,  $R_{Z.XY} = 0.771$ , reflected that between milk price and milk production and the dairy livestock is a significant positive relationship.

The partial coefficient of linear multiple correlation  $R_{ZX.Y} = -0.537$  showed that, when the dairy livestock is constant, between milk production and milk price is a negative middle correlation.

The partial coefficient of linear multiple correlation,  $R_{ZY.X} = -0.709$ , reflected a strong negative influence of milk production on the pair milk price and dairy livestock.

The total contribution of the variation of the pair of factors milk production and dairy livestock,  $A_{(X,Y)}$ , on milk price, Z, was 59.44 %.

The partial contribution  $A_{(X)}$  of the variation of milk production, X, when the dairy livestock  $Y = \text{constant}$  on Z, was 13.80 %.

The partial contribution  $A_{(Y)}$  of the variation of the dairy livestock, Y, when milk production,  $X = \text{constant}$  was 36.7 %. The

partial contribution  $A_{(X,Y)}$  reflecting the interaction of milk production, X, and the dairy livestock, Y, on Z, was 8.90 %. The contribution of the error, E, representing other factors of influence on milk price, Z, was 40.60 %.

The linear multiple regression had the formula:  $Z = -0.00349 X + 0.08305 Y + 165.68$  and the width of the confidence interval,  $\delta_{\alpha/2}$ , was 29.08, resulting  $Z = -0.00349 X + 0.08305 Y + 165.68 \pm 29.08$ .

In 2015, for  $X_e = 50,025.45$  thousand hl milk production and  $Y_e = 1,251.23$  thousand heads dairy livestock, the predicted milk price is 95.01 Lei/hl.

As a conclusion, the multiple correlation and regression could be successfully used to analyze the relationships between the milk production, the dairy bovine livestock and the milk price. Milk price could be easily predicted using the linear multiple regression function.

## REFERENCES

- [1] Abdi, H., 2007, Multiple Correlation Coefficient, In: Neil Salkind (Ed.) (2007). Encyclopedia of Measurement and Statistics. Thousand Oaks (CA): Sage
- [2] Aldrich, J., 2005, Fisher and Regression, Statistical Science 20 (4): 401-417
- [3] Anghelache, C., 2008, Treatise of Theoretical and Economic Statistics, the Economic Publishing House, Bucharest
- [4] Armstrong, J. S., 2012, Illusions in Regression Analysis, International Journal of Forecasting (forthcoming), 28 (3): 689.
- [5] Draper, N.R., Smith, H., 1998, Applied Regression Analysis (3rd ed.). John Wiley.
- [6] Ene, D., 2012, Applied mathematics and statistics in agriculture, Bucharest, pp.184-193
- [7] Frost Jim, 2014, Regression Analysis: How to Interpret S, the Standard Error of the Regression, <http://blog.minitab.com/blog/adventures-in-statistics/regression-analysis-how-to-interpret-s-the-standard-error-of-the-regression>
- [8] Higgins, J., 2005, Introduction to multiple regression, Chapter 4, pp.111-115, [http://www.biddle.com/documents/bcg\\_comp\\_chapter4.pdf](http://www.biddle.com/documents/bcg_comp_chapter4.pdf)
- [9] Kennedy, J. B., Neville, A.M., 1986, Basic Statistical Methods for Engineers and Scientists, 3rd Ed., Harper and Row
- [10] Montgomery, D.C., Runger, D.C., 1994, Applied statistics and probability for engineers, J.Wiley



[11]National Institute of Statistics, 2015, Romania, Statistical Yearbook, Chapter 14, Agriculture.

[12]Popescu Agatha, 2014, Research on profit variation depending on marketed milk and production cost in dairy farming, Scientific Papers Series Management, Economic Engineering in Agriculture and Rural Development, Vol.14(2):223-229



## SOME CONSIDERATIONS REGARDING THE STATEMENT OF THE WORLD COMMODITY TRADE

Agatha POPESCU

University of Agricultural Sciences and Veterinary Medicine, Bucharest, 59 Marasti, District 1, 011464, Bucharest, Romania, Phone: +40 21 318 25 64/232, Fax: + 40 21 318 28 88, Email: agatha\_popescu@yahoo.com

*Corresponding author:* agatha\_popescu@yahoo.com

### *Abstract*

*The paper aimed to present a statistical overview on the world trade of goods in term of export, import and balance value by geographical region and product, the top "players" in the commodity export and import and their market share at global level. Also, it aimed to emphasize the position of the EU-28 in the global trade of goods. In 2013, the world commodity export accounted for USD 18,301 Billion and import value was USD 18,498 Billion. The export growth rate was 3.5 % exceeding the global GDP growth rate of only 2% in the period 2005-2013. The top countries in the world commodity export based on the export value and their market shares are: China ( 12 %), USA (8.6 %), Germany (8 %), and Japan (3.8 %). The top countries in the global import of goods and their market share are USA (12.3 %), China (10.3 %), Germany (6.3 %), and Japan (4.4%). Three biggest economic "players": the EU-28, the USA and China have created a new distribution of the economic powers. In the prospect of 2030, these three economic poles will carry out more than 50 % of the global output. Europe is the most powerful economic region and player in the international trade of commodities. The emerging economies have a faster development and are more involved in the international trade of goods. The commerce with commodities will continue to grow at a lower rate than before because of the slow growth of the global GDP. As a conclusion, the policy makers both in the emergent and non emergent economies should take the best decisions at national, regional and international levels on the participation at the international trade and evaluate their impact on the economic development.*

**Key words:** commodity export, commodity import, geographical distribution, top countries, world trade

### INTRODUCTION

International trade is compulsory for the economic development both at the global, regional and national level, because of the immobility of the production factors, the differences regarding the geographical and climate conditions, the unequal distribution of the natural resources, the various market conditions, currency systems and transfer expenses (Popescu Agatha, 2012) [9]

The importance of trade has deeply increased during the last 25 years. Since 2002, it was anticipated that the liberalisation of the WTO accession commitments and the Doha Round of multilateral trade negotiations will bring new "actors" in the international market. (Edwards, 2002) [9]

The fast economic development of the emergent economies and the distinguished presence of three biggest economic "players" represented by the EU-28, the USA and China

have created a new distribution of the economic powers.

The global financial and economic crisis starting from 2008 affected the global output and international trade as well, the commodity trade being significantly contracted compared to the world output. Despite that the international trade has recovered quickly since 2010, and it is expected to continue to expand in the future but at lower rates than in the previous decades. [4]

In the prospect of 2030, this situation is expecting not to change, the forecast provides that these three economic poles will continue to carry out more than 50 % of the global output (Gros et al., 2013) . [3]

The ratio between the world exports to the global GDP increased from about 20% in the early 1990s to over 30% the year 2008 and after a slight decline to 27 % it increased again to 30 % in 2014[6].

The fast trade growth has deeply influenced

manufactured goods. The ratio between commodity exports and manufacturing output for the strongest economies: the US, the EU and Japan reached 80 %, being higher than the ratio between commodity exports and GDP. [3, 8]

One of the major trends of the global economy is the shift of economic power from the USA and the EU to the large developing economies. China, India, and Brazil are continuously growing economic powers facing challenges and opportunities for the USA economic interest and leadership of the world economy. (Ahearn, 2011). [1]

Economic growth is slower in the developed economies which still keep the most important opportunities. Europe is the most powerful economy and player in the international trade, followed by the North and Latin America, as well as by the emerging Asian economies (Ip et al., 2014) [5].

The weak points of the international trade are the low demand and the demand structure of the world GDP for a long run and as a result the low world trade growth rate. Even thou, the global GDP will recover and this will be done at a lower rate with a deep impact on the global trade which will also grow at a lower rate than before. [10]

In this context, the paper aimed to present the statistical overview on the world trade of goods in term of export, import and balance value by geographical region and product, the top "players" in the commodity export and import and their market share. Also, it aimed to emphasize the position of the EU-28 in the global trade.

## MATERIALS AND METHODS

The study is based on various information sources such as WTO, OECD, IMF, WB Reports and statistical data bases where the data were collected from and then processed using the usual methods available to point out the dynamics of the trade items in terms of value, annual percentage change, and market share, both at global level and at regional level. The main players in the field of commodity export and import were ranked based on their contribution to the global trade.

The statement of the global trade is presented in figures for the year 2013, as a final year of statistical information available on WTO date bases.

## RESULTS AND DISCUSSIONS

**The world commodity export** accounted for USD 18,301 Billion in the year 2013.

**The 160 WTO member states** registered USD 17,800 Billion export value, representing 97.26 % of the world commodity export value. Among these WTO member states, a number of 10 large exporting countries accounted for 52 % of the world commodity export value and 43 % was achieved by the developing economies.

**The geographical distribution of the world commodity export value** has pointed out that the world leader is Europe which carried out 36.3 % of the world export. It is followed by Asia with 31.5 % market share and North America with 13.2 %. (Table 1, Fig.1.)

Table 1. The world commodity export by geographical region in 2013

Geographical region	Commodity export value USD Billion	Share (%)
WORLD	18,301	100.0
North America	2,418	13.2
Central and South America	736	4.0
Europe	6,646	36.3
Middle East	1,347	7.4
Asia	5,773	31.5
CIS	779	4.3
Africa	602	3.3

Source: World Trade Development, 2014, www.wto.org [12]

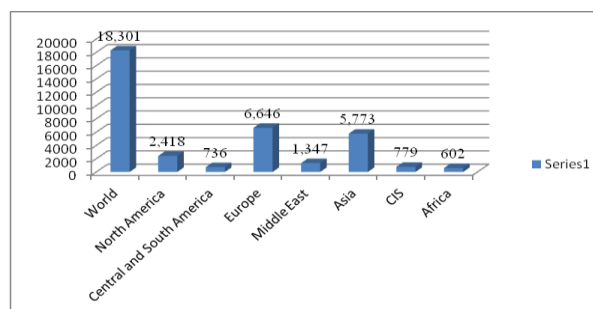

Fig.1. World commodity export by geographical region in 2013 ( USD Billion)

Source: Own design

**The top countries by geographical region in the world commodity export value** are: in North America: USA, Canada and Mexico, in Central and South America: Brazil and Argentina, in Europe: Germany, France, Italy and United Kingdom, in Asia: China, Japan, India, Australia and New Zealand, and in Africa: South Africa.(Table 2)

Table 2. The top countries by region in the world commodity export value in 2013 ( USD Billion)

Region	Country/Commodity export value USD Billion	Share in the world commodity export value (%)
<b>WORLD</b>	<b>18,301</b>	<b>100.0</b>
<b>North America</b>	<b>2,418</b>	<b>13.2</b>
	1.USA	8.6
	2.Canada	2.5
	3.Mexico	2.1
<b>Central and South America</b>	<b>736</b>	<b>4.0</b>
	1.Brazil	1.3
	2.Argentina	0.4
<b>Europe</b>	<b>6,646</b>	<b>36.3</b>
	1.Germany	7.9
	2.France	3.2
	3.Italy	2.8
	4.United Kingdom	3.0
<b>Middle East</b>	<b>1,347</b>	<b>7.4</b>
<b>Asia</b>	<b>5,773</b>	<b>31.5</b>
	1.China	12.1
	2.Japan	3.9
	3.India	1.7
	4.Australia and New Zealand	1.6
<b>CIS</b>	<b>779</b>	<b>4.3</b>
<b>Africa</b>	<b>602</b>	<b>3.3</b>
	1.South Africa	0.5

Source: World Trade Development, 2014, www.wto.org, [12]

**The distribution of the world commodity export value by country group depending on the economic development** is the following one: 55.5 % countries with developed economies, 39 % countries with developing economies and 5.3 % LDC -least developing countries ( Table 3).

**The distribution of the world commodity export by product group** pointed out that in the top there are the manufactured

commodities, with 64.73 % share in the total world export value. Machinery and equipments represented 32.41 %, fuels and mining products represented 21.84 %, and chemical products 10.93 %. Agricultural products represented 9.53 %, and food products 7.96 %. Clothing products accounted for 2.51 %.(Table 4).

Table 3. The world commodity export by country groups depending on the economic development in 2013

Economic development group	Commodity export value ( USD Billion)	Share in total world (%)
<b>WORLD</b>	<b>18,301</b>	<b>100,0</b>
Developed economies	10,195	55.7
Developing economies	7,138	39.0
LDC-Least developing economies	264	5.3

Source: World Trade Development, 2014, www.wto.org

Table 4. The world export value by main products in 2013 ( USD Billion)

Product group	Commodity export value ( USD Billion)	Share in total world (%)
Manufactured products	11,848	64.73
Machinery and transport equipments	5,932	32.41
Fuels and mining products	3,997	21.84
Chemicals	2,001	10.93
Agricultural products	1,745	9.53
Food products	1,457	7.96
Other semiindustrialized	1,153	6.30
Clothes	460	2.51

Source: World Trade Development, 2014, www.wto.org [12]

According to World Trade Organisation, **the classification of the countries by class of commodity export value** in 2013 was presented as follows:

**-Over USD 1,000 Billion:** USA, China, Japan, France, Germany, United Kingdom and the Netherlands.

**-Between USD 500 and 1000 Billion:** Canada, Mexico, Russia, India, Spain, Italy

and the Arabian Emirates.

- **Between USD 250-500 Billion:** Australia, Indonesia, Brazil, Turkey, Sweden, Poland, Austria, Switzerland.

- **Between USD 0-250 Billion-** the rest of the world.

**The developing countries** accounted for 52 % of the world commodity export value. Of these percentages, 10 % is exported to China, 4 % to India, 2 % to Brazil, 2 % to the LDCs, 1 % to Russia and 1 % to South Africa, and 32 % to others.

In addition, 30 % of the developed countries export is directed to the developing countries.

**The commodity export growth rate.** In 2013 compared to 2012, the world commodity export value increased by 2.5 % compared to the GDP growth rate, which accounted just for 2 %.

In the period 2005-2013, the growth rate of the world commodity export was 3.5 %, compared to 2 % in case of the world GDP.

The highest growth rate of the world commodity export value was registered in the year 2006, accounting for 8.5 % compared to 2005.

In the year 2009, at the beginning of the world economic crisis, the growth rate was a negative one, -12 %, regarding the world commodity export, but even the world GDP recorded a negative growth rate of -2,5 %.

Table 5. The growth rate of the commodity world export compared to the world GDP growth rate in the period 2005-2013 (%)

Period/Year	Growth rate (%)	
	World commodity export	World GDP
2005-2013	3.5	2.0
2005	6.5	3.5
2006	8.5	4.0
2007	6.5	4.0
2008	2.5	1.5
2009	-12.0	-2.5
2010	14.0	4.0
2011	5.5	2.5
2012	2.5	2.0
2013	2.5	2.0

Source: World Trade Development, 2014, www.wto.org [12]

Since 2010, the world economy started recover and the commodity export as well, but it was not reached the level registered before the crisis so far.(Table 5, Fig.2.).

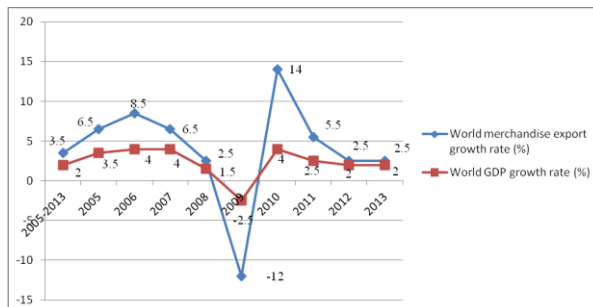

Fig.2. World commodity growth rate compared to World GDP growth rate in the period 2005-2013 (%)

Source: Own design.

Asia is in the top, having a growth economic rate of 4.5 %, and North America recorded 3 % increase compared to 2012.

The highest growth rate for the commodity import was recorded by Middle East, 6 %, in 2013 compared to 2012. Asia registered 4.5 % growth rate.

**The top countries in the world commodity export,** considered separately and also cumulating their commodity export and value, are China, USA, Germany, Japan, France and the Netherlands (Table 6).

Table 6. Top countries in the world trade based on their commodity export and import value in 2013

Country	Commodity export value USD Billion	Commodity import value USD Billion	Export + Import Value USD Billion
1.China	2,209	1,950	4,159
2.USA	1,570	2,339	3,909
3.Germany	1,470	1,150	2,620
4.Japan	700	848	1,548
5.France	570	700	1,270
6.The Netherlands	670	600	1,270

Source: World Trade Development, 2014, www.wto.org, [12]. Own calculation.

**The share of the commodity export in the GDP** positioned 4 countries in the top as follows: Germany (7.3 %), USA (4.5 %), China (2.8 %), and Japan (2.4 %)(Table 7).

**The top countries in the world commodity export based on the export value and their**

market shares are: China ( 12 %), USA (8.6 %), Germany (8 %), Japan (3.8 %), The Netherlands (3.7 %), France (3.1 %), Rep. Korea (3 %), United Kingdom (2.9%), Hong Kong China (2.8 %), Russian Fed. (2.8 %), Italy (2.8 %), Belgium (2.5 %), Canada (2.5 %), Singapore (2.2 %) and Mexico (2.1 %). (Table 8).

Table 7. The commodity trade, the trade balance and the weight of the trade in GDP: China, USA, Germany and Japan- World leaders in the world commodity trade in 2013

Country	Export + Import USD Billion	Trade balance USD Billion	The share of the trade in GDP %
China	4,159	+259	2.8
USA	3,909	-750	4.5
Germany	2,620	+264	7.3
Japan	1,548	-118	2.4

Source: World Trade Development, 2014, www.wto.org, [12]. Own calculation.

Table 8. Top 15 countries in the world commodity export in 2013

Crt.No.	Country	Commodity export USD Billion	Market share (%)
0	WORLD COMMODITY EXPORT	18,301	100.0
1	China	2,209	12.0
2	USA	1,570	8.6
3	Germany	1,470	8.0
4	Japan	700	3.8
5	The Netherlands	670	3.7
6	France	570	3.1
7	Rep. Korea	560	3.0
8	United Kingdom	542	2.9
9	Hong Kong China	536	2.8
10	Russian Fed.	523	2.8
11	Italy	518	2.8
12	Belgium	469	2.5
13	Canada	458	2.5
14	Singapore	410	2.2
15	Mexico	380	2.1

Source: World Trade Development, 2014, www.wto.org, [12], Own calculation.

The value of the world commodity import accounted for USD 18,409 Billion in 2013.

The distribution of the commodity export by geographical region was the following one: Europe 35.8 %, Asia 31.8 %, North

America 17.4 %, Central and South America 4.2 %, CIS 3.1 %, Africa 3.4 % and Middle East 4.3 % (Table 9).

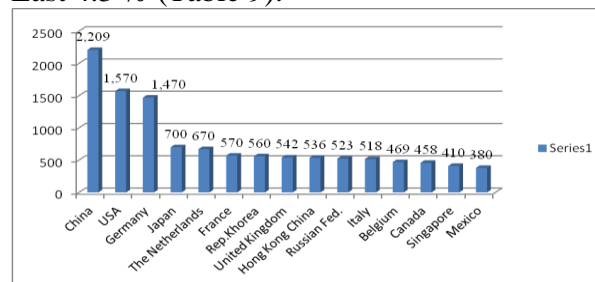

Fig.3. World top countries exporting commodities in 2013 ( USD Billion)

Source: Own design.

Table 9. The world commodity import by geographical region in 2013

Region	Commodity import value USD Billion	Share %
WORLD	18,409	100.0
North America	3,203	17.4
Central and South America	773	4.2
Europe	6,590	35.8
CIS	571	3.1
Middle East	792	4.3
Africa	626	3.4
Asia	5,854	31.9

Source: World Trade Development, 2014, www.wto.org [12]

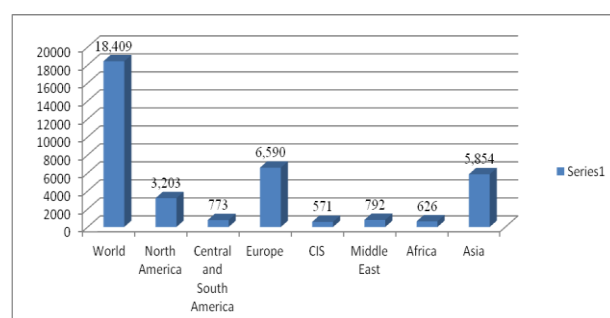

Fig.4. World commodity import by geographical region in 2013 ( USD Billion)

The main importing countries of commodities by geographical region are: in North America: USA, Canada and Mexico, in Central and South America: Brazil and Argentina, in Europe: Germany, France, Italy, United Kingdom, in Africa: South Africa, in Asia: China, Japan, India, Australia and New Zealand (Table 10).

The world classification of the top 15 countries based on the commodity import value and their market share included, in

the decreasing order: USA, China, Germany, Japan, France, United Kingdom, Hong Kong China, The Netherlands, Rep. Korea, Italy, Canada, India, Belgium, Mexico and Singapore ( Table 11).

Table 10. The distribution of the commodity import value by region and main importing countries in 2013 (%)

Region	Commodity import value/ Country	Share in the world commodity import value (%)
<b>WORLD</b>	<b>18,409</b>	<b>100.0</b>
North America	<b>3,203</b>	17.4
	1.USA	12.7
	2.Canada	2.6
	3.Mexico	2.1
Central and South America	<b>773</b>	4.2
	1.Brazil	1.4
	2.Argentina	0.4
Europe	<b>6,590</b>	35.8
	1.Germany	6.5
	2.France	3.7
	3.Italy	2.6
	4.United Kingdom	3.6
CIS	<b>571</b>	3.1
Middle East	<b>792</b>	4.3
Africa	<b>626</b>	3.4
	1.South Africa	0.7
Asia	<b>5,854</b>	31.8
	1.China	10.6
	2.Japan	4.5
	3.India	2.5
	4.Australia and New Zealand	1.5

Source: World Trade Development, 2014, www.wto.org [12]

**The EU-28 is the world leader in the commodity trade.** Its export accounted for USD 6,076 Billion, representing 33.20 % of the world commodity export and its import accounted for USD 6,004 Billion, representing 31.70 % of the world commodity import.(Table 12 and 13).

**The distribution of the EU-28 export by geographical region.** The EU-28 exports mainly in Europe, 69.2 % and at world level, in Asia 9.9 %, in North America 7.5 %, in CIS 3.7 %, in Africa 3.3 %, in Middle East 2.9 % and in Central and South America 2.0 %.(Table 12).

Table 11.Top 15 countries in the world commodity import in 2013

Crt. No.	Country	Commodity import value USD Billion	Market share (%)
0	<b>WORLD COMMODITY IMPORT</b>	<b>18,890</b>	<b>100.0</b>
1	USA	2,329	12.3
2	China	1,950	10.3
3	Germany	1,189	6.3
4	Japan	833	4.4
5	France	681	3.6
6	United Kingdom	655	3.5
7	Hong Kong China	622	3.3
8	The Netherlands	590	3.1
9	Rep.Korea	516	2.7
10	Italy	477	2.5
11	Canada	474	2.5
12	India	466	2.5
13	Belgium	451	2.4
14	Mexico	391	2.1
15	Singapore	373	2.0

Source: World Trade Development, 2014, www.wto.org, Own calculation.

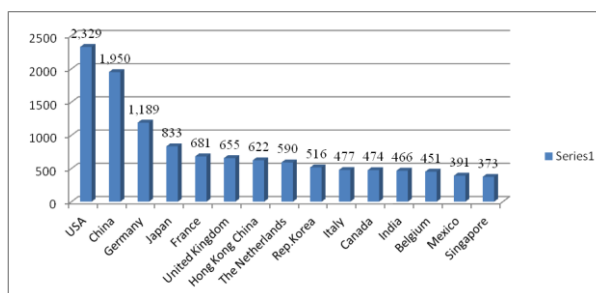

Fig.5. Commodity import in the top importing countries in 2013 ( USD Billion)

Source: Own design.

Table 12. The EU-28 commodity export by geographical region in 2013

Region	The EU-28 commodity export USD Billion	Share in the world commodity export (%)
World	6,076,450	100.0
Europe	4,206,096	69.2
Asia	603,492	9.9
North America	457,502	7.5
CIS	226,612	3.7
Africa	201,550	3.3
Middle East	177,151	2.9
Central and South America	118,525	2.0

Source: World Trade Development, 2014, www.wto.org [12]



**The distribution of the EU-28 imports by origin.** The EU-28 E imports mainly from Europe 67.9 % of its import or at world level, from Asia 12.6 %, from North America 5.3 %, from CIS 5.8 %, from Africa 5.7 %, from Middle East 1.8 % and from Central and South America 1,8 %.(Table 13).

Table 13.The EU-28 commodity import by origin in 2013

Region	The EU-28 commodity importul USD Billion	Share in the world commodity import (%)
World	6,004,045	100.0
Europe	4,079,390	67.9
Asia	756,466	12.6
CIS	345,424	5.8
North America	316,593	5.3
Africa	221,649	3.7
Middle East	108,322	1.8
Central and South America	100,200	1.8

Source: World Trade Development, 2014, www.wto.org [12]

## CONCLUSIONS

The dynamic trade flows after 1980 have been determined by the growth of manufactured goods. The world trade dynamics proved a faster growth than the global GDP influenced by the increased importance of the international supply chain in the world economy.

The balance in the world economy and trade is hold by some important players the EU-28, the USA and China, despite that the emerging economies are more and more evident protagonists in the world market.

China has become the largest exporter in the world and also it still keep an important position among the importers of goods.

Despite that the international trade looks to be more regionalized, the diversification of trade structure is a new feature both in the developing and developed countries, and has become an important incentive for the development of the emerging economies and their increasing contribution to the world trade.

This supposes the intensification of the multilateral commercial relationships as a need to grow the international trade.

The "picture" of the global trade is very important to be analyzed by the policy makers both in the developing and developed economies, as they should be the best informed to draw the right decisions and measures at national, regional and international levels on the commercial activities and to evaluate their impact on the economic development.

The strength of the global coherence imposes the development of a strong link between the sustainable development of the world economy and the international trade.

## REFERENCES

- [1]Ahearn Raymond J., 2011, Rising Economic Powers and the Global Economy: Trends and Issues for Congress, Congressional Research Service 7-5700, www.crs.gov
- [2]Edwards Leonard J., 2002, Emerging Trends in World Trade and Development, 4th World Conference of Trade Promotion Organizations: TPOs in a Turbulent New Business Environment, Beijing, China, May 15-17, 2002
- [3]Gros Daniel, Alcidi Cinzia, Behrens Arno, Blockmans Steven, Busse Matthias, Egenhofer Christian, Fontagné Lionel, Fougeyrollas Arnaud, Koleda Gilles, Maselli Ilaria, Ramos Maria Priscila, Sessa Carlo, Zagamé Paul, 2013, The Global Economy in 2030: Trends and Strategies for Europe,
- [4] Has the crisis left a lasting mark on global trade? 2012, Quarterly Report on the Euro Area
- [5]Ip Chris, Istace Florent, Lal Akash, Masanam Pavan Kumar, Natale Tommaso, Tiwari Shailesh, 2014, Insights into the dynamics of new trade flows
- [6]IMF, World Economic Outlook
- [7]International Trade Statistics 2014, WTO, www.wto.org/statistics
- [8]OECD and World Bank databases
- [9]Popescu Agatha, 2012, Domestic and International Trade, Comunicare.ro and RawexComs Publising Houses, Bucharest, pp.126-129
- [10] Understanding the weakness in world trade, 2915, Economic Bulletin Issue 3 / 2015,
- [11]World Economic Situation and Prospects 2015, Unted Nations, New York
- [12]World Trade Development, 2014, www.wto.org
- [13]World Trade Report 2013, B. Trends in international trade



## SOME CONSIDERATIONS ON THE WORLD AGRI-FOOD TRADE AND THE POSITION OF THE EU-28

Agatha POPESCU

University of Agricultural Sciences and Veterinary Medicine, Bucharest, 59 Marasti, District 1, 011464, Bucharest, Romania, Phone: +40 21 318 25 64/232, Fax: + 40 21 318 28 88, Email: agatha\_popescu@yahoo.com

**Corresponding author:** agatha\_popescu@yahoo.com

### *Abstract*

*The purpose of the paper was to present the actual statement of the agri-food trade at world level and by geographical region, the top exporters and importers and the role of the EU-28 in the global trade. The world agricultural trade accounted for USD 3,419 Billion of which 48.31 % export and 51.69 % import in 2013. The annual percentage change was 2.5 % for export and 4 % for import, explained by the low demand in the emergent countries, and increased competitiveness and changes in the international market. The Americas are the top exporting regions of agricultural products with 40.5 % market share. The EU-28 is the top world exporter of agricultural products having 40.01 % market share and also the top world importer with 37.57 % market share. It registered Euro 18.6 Billion surplus in its trade balance due to the contribution of China, Saudi Arabia, and the USA. About 2.8 % of the EU-28 import value came from the least developed countries, representing more than 0.4%, the average of other main suppliers USA, Canada, Japan, New Zealand, and Australia. Besides the top positions occupied by The EU-28 and the USA, Brazil, India and Argentina have a faster growth rate with a deep impact on the structure of the world agri-food market.*

**Key words:** actual statement, agricultural products, food products, export, import, world trade

### INTRODUCTION

The evolution of the global economy, consumers' s income and food demand have had a deep impact on the dynamics of the agricultural production and international trade with agri-food products. [5]

Also the climate conditions, mainly drought and freezing weather and other extreme phenomena, as well as the conflict areas like in the Arabian countries, and Ukraine and the Russian Federation have affected the global agricultural and food output and prices. [8]

The international flows has recorded a fast development in the last decades because of disparities regarding food consumption and food production in various geographical regions. While some high developed countries are important producers and exporters, other countries belonging to the emergent economies have become important exporters of agri-food products.

The top 6 agricultural exporters in the world are EU28, USA, Brazil, China, Canada, Argentina. [5]

The CAP has substantially contributed to the creation and enlargement of the common agricultural market of the EU and to the foundation of the top supplier of agri-food products in the world.

The EU-28 has important commercial relationships and concluded bilateral agreements with over 120 countries and takes part to 30 international conventions. About 80 % of its Extra and Intra-trade with agri-food products is represented by the intra-community trade. The most important EU suppliers of agri-food products on the internal market belong to the EU-15 block whose deliveries represent about 72 % of the total intra community export. It is about the Netherlands, Germany, France, Belgium, Spain and Italy. France is the most important exporter and importer of the EU-28 both on the intra and extra EU markets. [7]

The Uruguay Round (1994) stimulated the trade with agricultural products eliminating the protectionist measures on the internal markets transforming them in customs taxes, limiting the subsidies which created

distortions in the international markets. The EU reduced the number of guaranteed prices and the aids destined to support the market, and decided to offer direct subsidies per surface unit or animal capita and decoupled aids for agricultural producers.

The EU-28 and the USA having the highest number of agricultural holdings in the world are in a continuous competition for the 1st position in the world export with agricultural products. Also they compete with Canada, New Zealand and Australia, the main exporters as well as with Brazil, which is in the top among the developing countries, and India and China.

Various scenarios and simulations achieved by international organizations and research institutes were involved in finding solutions for customs taxes reduction and internal aids within preferential agreements. As a result, the EU and the USA, as well as Brazil and Argentina have benefited of the import growth at lower prices advantaging consumers, but the poor Caribbean and African countries have lost their preferential access on the European and American markets. In the future, it is needed an agreement where all the countries from various geographical regions of the world to be advantaged. [2]

In this context, the paper goal was to present the actual statement of the world trade with agricultural and food products by geographical region, the top exporting and importing countries and the role of the key player- the EU-28 in the international trade with agri-food products.

## MATERIALS AND METHODS

In order to set up this paper, the empirical data were collected from the WTO data bases. The specific indicators reflecting the dynamics and structure of the world agricultural trade and food trade were used to identify the main trends and also the market share allowed to establish the hierarchy of the top exporting and importing countries in the world.

The EU-28 position in the world agri-food trade was analyzed based on its market share

in the global export and, respectively global import, also by means of the weight of extra and intra EU-28 trade, the agri-food trade structure by product and the main trade partners.

## RESULTS AND DISCUSSIONS

**The world export of agricultural products** accounted for USD 1,652 Billion in 2013, being by 2.5 % higher than in 2012, and having the highest growth rate compared to 2 % registered by other commodities. The share of the export of agricultural products in the world export of commodities was 9.53 %.

**The world import of agricultural products** recorded USD 1,767 Billion in 2013, being by 4 % higher than in 2012. The weight of the agricultural products import in the world commodity import was also 9.5 %.

**The annual percentage change** of the export with agricultural products was 3.5 % in the period 2005-2013, 2.5 % in 2012 and 2.5 % in 2013. The import of agricultural products recorded an annual percentage change of 9 % in the period 2005-2013, 22 % in 2012 and 4 % in 2013.

**The agricultural production** registered an average annual percentage change of 2.5 % in the period 2005-2013, 1.5 % in 2012 and 5.5 % in 2013.(Table 1).

Table 1. Annual percentage change of world agricultural products exports and imports and of world agricultural production (%)

Specification	Value in 2013 USD Billion	Annual percentage change		
		2005-2013	2012	2013
World exports of agricultural products	1,652	3.5	2.5	2.5
World imports of agricultural products	1,767	9	22	4
World agricultural production	-	2.5	1.5	5.5

Source: World Trade Development, 2014, www.wto.org. [9]

**The share of agricultural products in the world commodity export by geographical region** has been the following one: Central and South America on the 1st position with a share of 29.5 %, on the 2nd position North America 11 %, on the 3rd position Europe 10.7 %, followed by Africa with 10.3 %.(Table 2).

**The share of agricultural products in the world commodity import by geographical region** reflected that: on the 1st position came Africa with 15.9 %, on the 2nd position was the Middle East with 13 %, on the 3rd position CIS with 12.6 %, on the 4th position Asia with 9 % and Central and South America with 9 %.(Table 2).

Table 2.The weight of agricultural products in the world commodity export and import by geographical region in 2013

Region	The share of agricultural products in the commodity export (%)	The share of agricultural products in the commodity import (%)
In Total World	9.5	9.5
North America	11.0	6.7
Central and South America	29.5	9.0
Europe	10.7	10.5
CIS	8.9	12.6
Africa	10.3	15.9
Middle East	2.5	13.0
Asia	6.7	9.0

Source: WTO Secretariat, Oct.2014, 2014, www.wto.org [10]

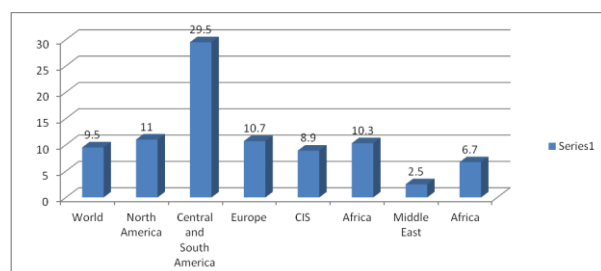

Fig.1.The share of agricultural products in the world commodity export by geographical region in 2013 (%) Source: WTO Secretariat, Oct.2014, 2014, www.wto.org. [10]. Own design.

**The top 10 countries exporting agricultural products are:** EU-28 on the 1st position with a market share of 40.01 % in the world export of agricultural products, USA on the 2nd position with 10.62 %, Brazil on the 3rd

position with 5.49 %, China 4.23 %, Canada 3.98 %, India 2.83 %, Indonesia 2.57 %, Argentina 2.50 %, Thailand 2.43 % and Australia 1.82 %.

All these 10 countries exported agricultural products whose value accounted for USD 1,264.2 Billion in the year 2013, representing 76.52 % of the world export with agricultural products.(Table 3)

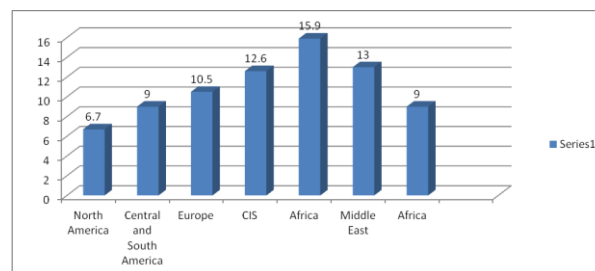

Fig.2.The share of agricultural products in the world commodity import by geographical region in 2013 (%) Source: WTO Secretariat, Oct.2014, 2014, [10]www.wto.org.Own design.

Table 3.Top 10 countries exporting agricultural products in 2013

Crt.No.	Country	Export USD Billion	Market share (%)
0	World export of agricultural products	1,652	100.0
1	EU-28 Extra EU-28 exports	661 175.3	40.01
2	USA	175.5	10.62
3	Brazil	90.7	5.49
4	China	70	4.23
5	Canada	65.7	3.98
6	India	46.9	2.83
7	Indonesia	42.6	2.57
8	Argentina	41.4	2.50
9	Thailand	40.3	2.43
10	Australia	30.1	1.82
	<b>TOTAL TOP 10</b>	<b>1,264.2</b>	<b>76.52</b>

Source: WTO Secretariat, Oct.2014, www.wto.org, [10]Own calculation.

**The main countries importing agricultural products** are: EU-28 with 37.57 % market share, China 9.36 %, USA 8.29 %, Japan 4.86 %, Russian Fed. 2.52 %, Canada 2.19 %, Rep. Korea 1.89 %, Mexico 1.65 %, Kingdom of Saudi Arabia 1.43 %. All these 10 countries accounted for 71.37 % in the world import of agricultural products (Table 4).

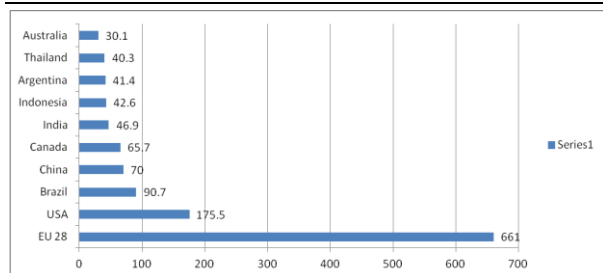

Fig.3. The top 10 countries in the world export of agricultural products in 2013 ( USD Billion)

Source: WTO Secretariat, Oct.2014, www.wto.org, [10]Own design.

Table 4. Top 10 countries importing agricultural products in 2013

Crt.No.	Country	Import USD Billion	Market share (%)
0	World import of agricultural products	1,767	100.0
1	EU-28	664	37,57
	Extra EU-28 imports	178	
2	China	165.5	9.36
3	SUA	146.5	8.29
4	Japan	86	4.86
5	Russian Fed.	44.7	2,52
6	Canada	38,7	2.19
7	Rep. Korea	33.4	1.89
8	Mexico	29.2	1.65
9	Hong Kong China	27.8	1.57
10	Kingdom of Saudi Arabia	25.4	1.43
	TOTAL TOP 10	1,261.2	71.37

Source: WTO Secretariat, Oct. 2014, www.wto.org, [10]Own calculation.

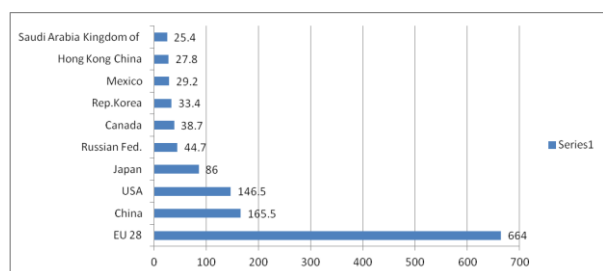

Fig.4. The top 10 countries in the world import of agricultural products in 2013 ( USD Billion)

Source: WTO Secretariat, Oct. 2014, www.wto.org, [10]Own design.

**Europe is the main world supplier of agricultural products**, the value of its export being USD 708 Billion in 2013, representing 40.57 % of the world export of agricultural products.

The distribution of the Europe's export of agricultural products by geographical area pointed out that most of the products, more exactly 75.9 %, are exported in the European countries, and the remaining in Asia 7.41 %, in North America 4.2 %, in Africa 4 %, in CIS 3.8 %, in the Middle East 3.4 % and in the Central and South America 1 %.(Table 5).

Table 5. Europe's export of agricultural products in 2013

Region	Export USD Billion	Share by region (%)
<b>World</b>	<b>1,745</b>	-
<b>In Total world</b>	<b>708</b>	100.0
Europe	537	75.9
Asia	52	7.41
North America	29	4.2
Africa	29	4.0
CIS	27	3.8
Middle East	24	3.4
Central and South America	7	1.0

Source: WTO Secretariat, Oct.2014, www.wto.org, [10]Own calculation.

**The EU-28 is the world leader in the export of agricultural products.** In the period 2000-2013, its export with agricultural products increased 2.86 times from USD 230.9 Billion in the year 2000 to USD 661 Billion in 2013. The extra UE-28 export of agricultural products increased 3.17 times from USD 55.2 Billion in the year 2000 to USD 175.3 Billion in 2013, and the intra EU-28 export raised 2.76 times from USD 175.7 Billion in the year 2000 to USD 486 Billion in the year 2013 (Table 6).

Table 6. The EU-28 export of agricultural products (USD Billion)

Specification	2000	2013	2013/2000 %
EU-28	230,985	661,002	286.16
-Extra EU-28	55,286	175,332	317.13
-Intra EU-28	175,699	485,650	276.41
Total World Export	550,868	1,652,780	300.03
The EU-28 contribution to the world export (%)	41.93	37.88	-

Source: WTO Secretariat, Oct.2014, www.wto.org, [10]Own calculation.

**The share of the EU-28 export with agricultural products in the world export** declined from 41.93 % in the year 2000 to 40.01 % in the year 2013.

**The European Union is also on the top position regarding the import of agricultural products.** In the period 2000-2013, the import of agricultural products of the UE-28 increased 2.6 times from USD 254.5 Billion in the year 2000 to USD 663.9 Billion in 2013.

The extra EU-28 import of agricultural products increased 2.26 times from USD 78.8 Billion in the year 2000 to USD 178.2 Billion in 2013. The intra EU-28 imports increased 2.76 times from USD 175.6 Billion in 2000 to USD 485.6 Billion in 2013 (Table 7).

Table 7. The EU-28 import of agricultural products in 2000 and 2013 ( USD Billion)

Specification	2000	2013	2013/2000 %
EU-28	254,480	663,904	260.88
-Extra EU-28	78,865	178,246	226.01
-Intra EU-28	175,615	485,658	276.54

Source: WTO Secretariat, Oct.2014, www.wto.org. [10]Own calculation.

**The world export of food products** accounted for USD 1,457 Billion in 2013.

**The distribution of the export of food products by geographical region** is presented in Table 8.

**Europe is the world leader in the export with food products**, its export value reaching USD 610 Billion in 2013, representing 7.6 % of the world export with food products. Asia is on the 2ns position contributing to the world export by 6.2 %. On the 3rd position is North America 4.4 %, followed by Africa 4 % and CIS also with 4 %, the Middle East 3.1 % and Central and South America 1.1 %.(Table 8).

**The main countries exporting food products are:** The EU-28 with 36.9 % market share, the USA with 9.7 %, Brazil 5.6 %, China 4.1 %, Canada 3.2 %, Argentina 2.8 %, India 2.6 %, Indonesia 2.2 %, Australia 2.1 % and Thailand 2 %. All these 10 countries achieved 73.16 % of the world export with food products (Table 9).

Table 8. Europe's export of food products in 2013

Region	Export of food products USD Billion	Share by region %
<b>Total world</b>	<b>1,457</b>	-
<b>Europe at world level</b>	<b>610</b>	100.0
Europe	466	7.64
Asia	38	6.2
North America	27	4.4
Africa	25	4.0
CIS	25	4.0
Middle East	23	3.7
Central and South America	6	1.1

Source: WTO Secretariat, Oct.2014, www.wto.org, [10] Own calculation.

**The main countries importing food products are:** The EU-28 with 36.9 % market share, the USA 8 %, China 6.4 %, Japan 4.6 %, Russian Fed. 2.7 %, Canada 2.2 %, Rep. Korea 1.6 %, Mexico 1.6 %, Kingdom of Saudi Arabia 1.6 % and the Arabian Emirates 1.1 %. All these 10 countries carried out 66.70 % of the world import of food products (Table 9).

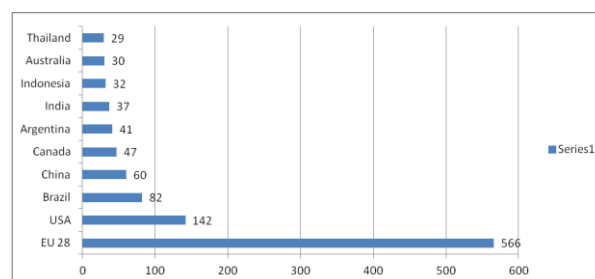

Fig.5.The top 10 countries in the world export of food products in 2013 ( USD Billion)

Source: WTO Secretariat, Oct.2014, [10] www.wto.org, Own design.

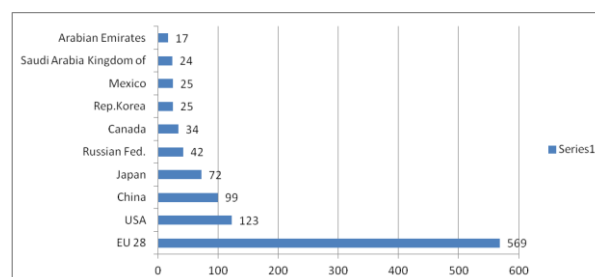

Fig.6.The top 10 countries in the world import of food products in 2013 ( USD Billion)

Source: WTO Secretariat, Oct.2014, www.wto.org, [10] Own design.

Table 9. Top countries exporting and importing food products and their contribution to the world trade with food products in 2013

Crt.No.	Country	Export of food products USD Billion	Market share %	Crt.No.	Country	Import of food products USD Billion	Market share %
1	UE-28	566	36.9	1	UE-28	569	36.9
2	USA	142	9.7	2	USA	123	8.0
3	Brazil	82	5.6	3	China	99	6.4
4	China	60	4.1	4	Japan	72	4.6
5	Canada	47	3.2	5	Russian Fed.	42	2.7
6	Argentina	41	2.8	6	Canada	34	2.2
7	India	37	2.6	7	Rep.Korea	25	1.6
8	Indonesia	32	2.2	8	Mexic	25	1.6
9	Australia	30	2.1	9	Arabia Saudita	24	1.6
10	Thailand	29	2.0	10	Emiratele Arabe	17	1.1
	Total	1,066	73.16		Total	1,030	66.7

Source: WTO Secretariat, Oct.2014, www.wto.org, [10] Own calculation.

**The EU-28 is the leader in the world export of food products.** In 2013, the value of its exported food products was USD 566.4 Billion, 2.98 times higher than in the year 2000 when the value of its export was USD 189.7 Billion.

The extra EU-28 export value of food products increased 3.15 times from USD 45.9 Billion in 2000 to USD 144.6 Billion in 2013.

The value of the intra EU-28 export increased 2.93 times from USD 143.8 Billion in the year 2000 to USD 421.7 Billion in 2013. (Table 10).

Table 10. The EU-28 export of food products in 2000 and 2013 ( USD Billion)

Specification	2000	2013	2013/2000 %
EU-28	189,781	566,461	298.48
-Extra EU-28	45,921	144,699	315.10
-Intra EU-28	143,860	421,761	293.17
World	431,141	1,456,682	337.86
The EU-28 share in the world export (%)	44.01	38.88	-

Source: WTO Secretariat, Oct.2014, www.wto.org. [10] Own calculation.

The share of the EU-28 in the world export with food products declined from 44.01 % in the year 2000 to 38.88 % in the year 2013.

**The EU-28 import of food products** increased 2.53 times in the interval 2000-

2013. In 2013, it accounted for USD 509.4 Billion compared to USD 200.6 Billion in the year 2000.

The extra UE-28 import increased 2.58 times from USD 57.2 Billion in the year 2000 to USD 147.6 Billion in 2013.(Table 11).

Table 11. The EU-28 Import of food products in 2000 and 2013 ( USD Billion)

Specification	2000	2013	2013/2000 %
EU-28	200,685	509,446	253.85
-Extra EU-28	57,224	147,684	258.08
-Intra EU-28	143,461	361,762	252.16

Source: WTO Secretariat, Oct.2014, www.wto.org., [10] Own calculation.

### The EU-28 agri-food trade.

**Agrifood export.** The EU-28 agricultural products account for 7 % of the total commodity export value in 2013, coming on the 4th position after machinery, chemicals and pharmaceuticals.

With agri-food exports reaching €120 Billion in 2013, the EU-28 became the top exporter of agricultural and food products in the world. However, the growth is slower, just 5.8 % than in previous years.

The EU export growth was stimulated by demand for particular commodities in the developing countries.

The EU growth of export in 2013 is due to the sold amounts of cereals, mainly wheat and barley, accounting for over 2/3 of the total export gain. The EU export deeply increased to China, and slowly declined to the USA.



Among the EU-28 agricultural exports, final products for direct consumption account for 2/3, and commodities for 10%. Their growth was about 3-4%.

More than 50 % of the EU exports are represented by six product categories, mainly final goods for direct consumption, except cereals.

Of the total Euro 120.1 Billion export value registered in 2013, the share of various products in the EU-28 agricultural export was the following one: Spirits and liqueurs 7%, Wine and vermouth 7%, Bakery products, pasta, infant food, etc. 6%, Wheat 4%, Non-specific food preparations 4%, Chocolate, confectionery and ice cream 3%, Pork meat (fresh, chilled or frozen) 3%, Cheese 3%, Fruit and vegetable preparations 3%, Raw hides, skins and fur skins 3%, and Remaining agricultural products 57% (Fig.7).

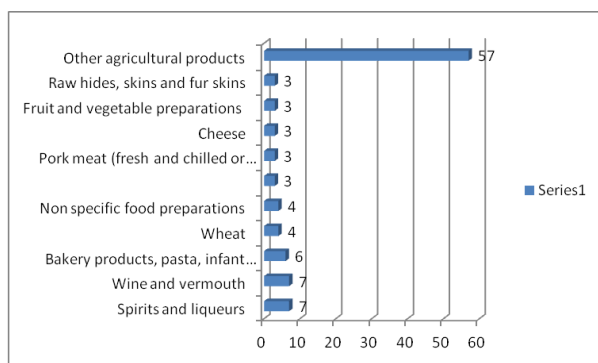

Fig.7. The share of various agri-food products in the EU-28 export value in 2013 (%)

The main products contributing to the increase of EU agricultural exports in 2013 were: Sowing maize Euro 103.2 Mil., Tobacco Euro 111.1 Mil., Dog food Euro 115.7 Mil., Frozen pig meat Euro 135.8 Mil., Ethyl alcohol Euro 172.9 Mil., WMP Euro 179.4 Mil., Malt extract Euro 181.4 Mil., Maize Euro 191.9 Mil., Sunflower seeds Euro 215.6 Mil., Rape oil Euro 256.5 Mil., Fur skins & mink Euro 431.8 Mil., Food preparations Euro 462.9 Mil., Infant food prep. Euro 495.6 Mil., Barley Euro 674.8 Mil., Wheat Euro 1,736.3 Mil. All these products contributed by 85 % to the absolute gain in the EU-28 exports.

In 2013, the USA continued to be the top destination of the EU-28 agricultural

products, with 13 % market share. On the 2nd position is Russia with 10 % market share, and on the 3rd position came China with 6.1 % market share, Switzerland with 5.9 %, Japan with 4.2 %, Hong Kong China 3.9 %.

The top market for spirits and liqueurs supplying 60% of export revenues came from the top 5 destinations: USA, Canada, South Africa, China.

The top market for wine continued to be: the USA, Switzerland, Canada, Japan and China, all these countries accounting for 63% of the EU sales.

The top markets for wheat were the Middle East and the North African countries, accounting for 66 % of the EU wheat sales.

Infant food was exported mainly in China and Hong Kong with 17 % market share and 38 % the main top five destinations.[1]

**Agri-food import.** The top 6 agricultural importers in the world are EU-28, USA, China, Japan, Russia and Canada.

The EU remains the top importer of agricultural goods totalizing Euro 101.5 Billion in 2013.

The structure of the EU-28 imports includes: Final products 50 %, Intermediate products 30%, Commodities 19%, and other products 1%.

In more details, by products, the import structure is the following one: Tropical fruits and spices 9%, Oilcakes 8%, Coffee, tea and mate 8%, Fats and oils, other than butter and olive oil 8%,

Soybeans 6 %, Fresh and dried fruits 5%, Other agricultural products 56% (Fig.8).

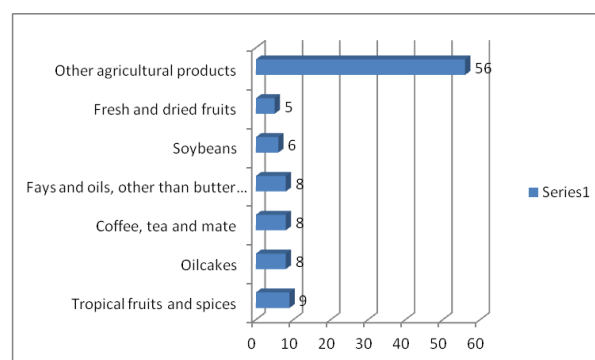

Fig.8. The share of various agri-food products in the EU-28 import value in 2013 (%)

The main suppliers of agricultural products for the EU market are Brazil (soya and soya meal, coffee, meat), which remained the EU-28 top import partner in 2013 (13%), the USA (10%), Argentina (5%) and China (5%), Indonesia 4% (palm oil, coffee, tea, industrial alcohols), Switzerland 4%, Turkey 4% (nuts, dates and figs, olive oil) and Ukraine 4%, South Africa ( for fruit and wine), Chile (wine, fruit, nuts, maize).

The EU-28 is also the top importer of agricultural products from the least developed countries (LDCs). Its import value of agricultural products from LDCs accounted for Euro 2.8 Billion in 2013, being 4 times higher than from Canada, US, Australia, New Zealand and Japan taken together.

The main agricultural products imported from LDCs in 2013 were Raw tobacco with 17% market share, Beet and cane sugar 14%, Cut flowers and plants 7%, Fresh and chilled 5%, Tropical fruits and spices 5%, Rice 5 % and other agricultural 47%. [1]

**Agri-food trade balance.** After being a net importer in 2009, the EU became a net exporter of agricultural products since 2010. In 2013, The EU-28 trade balance surplus increased to Euro 18.6 Billion, because the export value exceeded the import value. [3, 4, 9]

## CONCLUSIONS

The world trade value with agricultural products totalized USD 3,419 Billion of which 48.31 % export and 51.69 % import in 2013. While the world export increased by 2.5 %, import value increased by 4 %.

The year 2013 recorded a slight increase of the world trade performance of just 2.5 % due to the slow demand in the developing countries, the stagnant economy, export and import of many traders.

The top exporting regions of agricultural production in the world are the Americas with 40.5 % market share.

The EU-28 is the top world exporter of agricultural products having 40.01 % market share and also the top world importer with 37.57 % market share. This was due to the increased quantity of cereal exports and the

higher prices for meat and dairy products which are the key export products.

Since 2010, the EU became a net exporter of agricultural products, the trade balance surplus reached the record of Euro 18.6 Billion in 2013.

The EU agricultural imports stagnated in 2013, because the demand has not recovered after the economic crisis and the low prices of the commodities which maintained the import value down.

The export gain was due 90 % to the sold quantities and 10 % to the price driven.

Wheat is top export product contributing with the highest percentage to the export gain, while the beverages had a negative impact on export value.

To the export gain of the EU-28 contributed China, Saudi Arabia, and the USA.

Chinese demand for agricultural products recorded a fast growth, but the growth rate in imports value slowed down because of lower prices.

However, China has become the world's third exporter and importer of agricultural products coming on the 4th position in 2013.

The EU continued to be the top importer of products from LDCs, whose share in its agricultural imports was only 2.8%, but more than the average of 0.4% of the other main suppliers like USA, Canada, Japan, New Zealand, and Australia.

## REFERENCES

- [1]Agricultural trade in 2013: EU gains in commodity exports, European Commission, [http://ec.europa.eu/agriculture/publi/map/index\\_en.htm](http://ec.europa.eu/agriculture/publi/map/index_en.htm)
- [2]Botanoiu Daniel, 2011, Trade with agricultural products, <http://www.agro-business.ro/comertul-cu-produse-agricole/2011/12/15/>
- [3]D'Avino Alberto, 2013, Overview on EU agricultural exports by main destinations Market Access Working Group on SPS, Issues 04, July 2013, Directorate General for Agriculture and Rural Development, <http://www.gpp.pt/GlobalAgriMar/acesso/docs/PComercialUE/2013EUexportsByDestination.pdf>
- [4]Extra-EU trade in agricultural goods, [http://ec.europa.eu/eurostat/statistics-explained/index.php/Extra-EU\\_trade\\_in\\_agricultural\\_goods](http://ec.europa.eu/eurostat/statistics-explained/index.php/Extra-EU_trade_in_agricultural_goods)
- [5]FAO Statistical Pocket book, World Food and Agriculture, 2015

[6]The EU- a world leader in the export with agri-food products in 2013, <http://www.recolta.eu/actualitate/international/ue-lider-mondial-al-exporturilor-de-produse-agroalimentare-in-2013-25552.html>

[7]Toader (Țeveloiu) Janina Diana, Relations with the EU member states in the field of agri-food market. The role of the Common Agricultural Policy. Ph.D.Thesis Summary, University of Bucharest, pp.13-14

[8]World Economic Situation and Prospects 2015, United Nations New York, 2015.

[9]World Trade Development, 2014, [www.wto.org](http://www.wto.org).

[10]WTO Secretariat, Oct.2014, 2014, [www.wto.org](http://www.wto.org)



## SOME CONSIDERATIONS ON THE ACTUAL STATEMENT OF THE WORLD TRADE IN COMMERCIAL SERVICES

Agatha POPESCU

University of Agricultural Sciences and Veterinary Medicine, Bucharest, 59 Marasti, District 1, 011464, Bucharest, Romania, Phone: +40 21 318 25 64/232, Fax: + 40 21 318 28 88, Email: agatha\_popescu@yahoo.com

**Corresponding author:** agatha\_popescu@yahoo.com

### Abstract

*The paper aimed to present the current statement of the global trade in services and also by geographical regions, emphasizing the top exporting and importing countries. A special attention was given to transport and travel services. The global export in services accounted for USD 4,645 Billion and the world import in services was USD 4,390 Billion in 2013. The share of the export services in the global trade with commodities and services is 20 %. Compared to the previous years, in 2013 it was noticed a decline in various regions regarding the annual change. However, the highest growth rate of the export in services belongs to the Netherlands, France, Germany, China, the USA, India, Japan and United Kingdom. The top exporting countries of services are: USA 14.3 % market share, United Kingdom 6.3 %, Germany 6.2 %, France 5.1 %, and China 4.4 %. The top importing countries of services are: the USA with 9.8 % market share, China 7.5 %, Germany 7.2 %, France 4.3 %, and United Kingdom 4 %. The EU-28 is the top exporter of services with USD 891 Billion export value, representing 25 % of the world export and also the top importer with USD 668 Billion import value of services. It was followed by the USA, China, India and Japan. The travel services and transport services represent about 25 % and, respectively 22 % in the global trade with services.*

**Key words:** actual statement, commercial services, tourism and travel, transportation, world trade

### INTRODUCTION

Services are defined as the result of a production activity that changes the conditions of the consuming units (transformation services), or facilitate the exchange of products or financial assets (margin services). They are of a large variety including: transport, telecommunication and computer services, construction, financial services, wholesale and retail distribution, hotel and catering, insurance, real estate, health and education, professional, marketing and other business support, government, community, audiovisual, recreational, and domestic services. [4]

The commercial services have become an important sector of the world economy with high contributions to the growth of the global GDP, employment and international trade.

The high growth rate of the services was stimulated by the globalization process, the development of knowledge based society, the advancement in information and

communication technologies, the liberalization of service exchange at global level according to GATT and WTO and the intensification and increased complexity of the relationships between organizations. [1]

At present, the commercial services contribute by more than 68 % to the world GDP and even by about 73 % in the high developed countries. The share of services in the total employment is the highest in the USA (78%), 72 % in the high income economies, 70 % in the EU and lower in the emergent economies, for instance in China about 17 %. [3]

The share of the global export with services in the global export is about 20 %, but the international trade with services is more dynamic than the trade with commodities. Thus, in the year 2011, while the international trade with services was 10.7 times higher compared to the year 1980, the international trade with commodities was only 9 times higher. [1, 6]

As in case of commodity trade, the services liberalization requires both the elimination of the discriminatory barriers, and specific nontrade measures to protect health, environment, public order, and morals, and other issues related to competition and consumer protection. [2]

In this context, the purpose of the paper was to present the statement of the international trade in services regarding its volume at world level and its distribution by geographical region and also a special attention was paid to transport and travel services. Also, there were presented the top exporting and importing countries of commercial services in the world.

## MATERIALS AND METHODS

The purpose of the paper was to identify the main development trends of the commercial services at world level. It presents the most important issues regarding the dynamics of the services volume at world level and also their geographical structure by region, pointing out the main changes especially in the field of transport and tourism and travel services.

The data were collected from WTO World Trade Development 2014. [5]

## RESULTS AND DISCUSSIONS

**The export value of commercial services** accounted for USD 4,645 Billion in the year 2013, having 6 % growth rate in 2013 compared to 2012, especially due to the development of services in the EU.

In 2013, the 160 WTO member states carried out USD 4,6 Trillion commercial services export value, representing 99.03 % of the world export with commercial services.

About 50 % of the world export of services is achieved by 10 exporting countries and 34 % is carried out by 34 % of the developing economies.

**The distribution of the world export by category of commercial services** was the following one: 25.51 % tourism and travel services, 19.48 % transport services and 54.89 % other commercial services.(Table 1).

Table 1.The world export with commercial services by category of service in 2013

Commercial service	Export value of commercial services ( USD Billion)	Share in the world export (%)
WORLD	4,645	100.0
Tourism and travel	1,185	25.51
Transport	905	19.48
Other services	2,550	54.89

Source: World Trade Development, 2014, www.wto.org, [5] Own calculation.

**The value of the world import of commercial services** was USD 4,380 Billion in the year 2013.

**The distribution of the world import by category of commercial services** was: 24.42 % services of tourism and travel, 27.73 % services of transport and 48.97 % other services.(Table 2, Fig.1.).

Table 2.The world import of commercial services by category of service in 2013

Commercial service	The import value of commercial services (USD Billion)	The share in the world import (%)
WORLD	4,380	100,0
Tourism and travel	1,070	24.42
Transport	1,165	27.73
Other services	2,145	48.97

Source: World Trade Development, 2014, www.wto.org, [5] Own calculation.

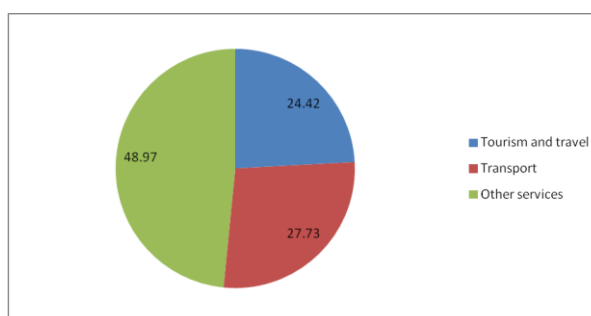

Fig 1. The share of services in the world export of commercial services in 2013 (%)

Source: World Trade Development, 2014, www.wto.org, [5] Own design.

**The annual percentage change of the export of commercial services** in 2013 compared to 2012 was 6% at world level, 2 % in the transport services, 7 % in the tourism and travel services and 6 % for other services. But, the most dynamic branch of the

commercial services has been tourism and travel, and taking into consideration the whole world trade, tourism and travel is also on the top position.

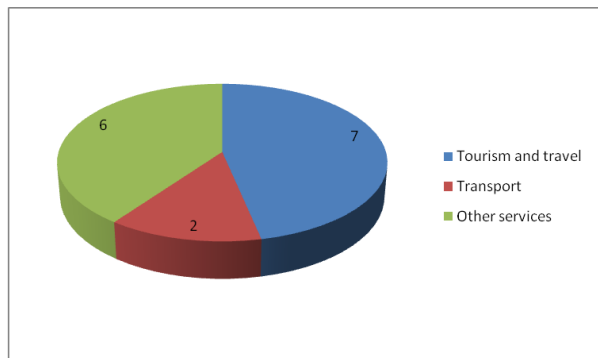

Fig.2. The annual percentage change of the commercial services in 2013 versus 2012 (%)

Source: World Trade Development, 2014, www.wto.org. [5] Own design.

**The growth rate of the export with commercial services by geographical region** was the following one in 2013 compared to 2012: 9 % in CIS, the highest growth rate, 7 % in Europe, 5 % in North America and 5 % in Asia, 4 % in the Middle East, 3 % in Africa and 2 % in Central and South America. (Fig.3.).

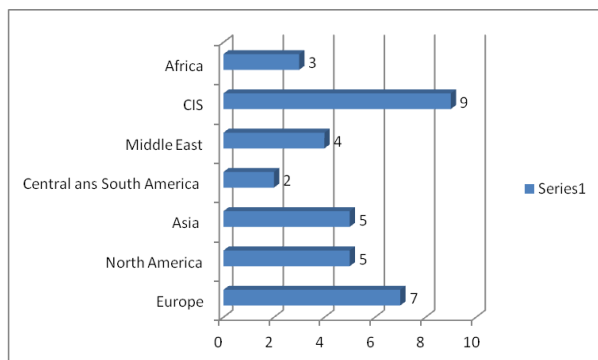

Fig.3. The annual percentage change of the commercial services by geographical region in 2013 versus 2012 (%)

Source: World Trade Development, 2014, www.wto.org. [5] Own design.

Europe registered a recover of the services, while in Asia the growth rate of services is in decline compared to the previous years.

**The main countries with the highest growth rate of the export with commercial services are:** The Netherlands, France, Germany, China, the USA, India, Japan and United Kingdom (Fig.4.).

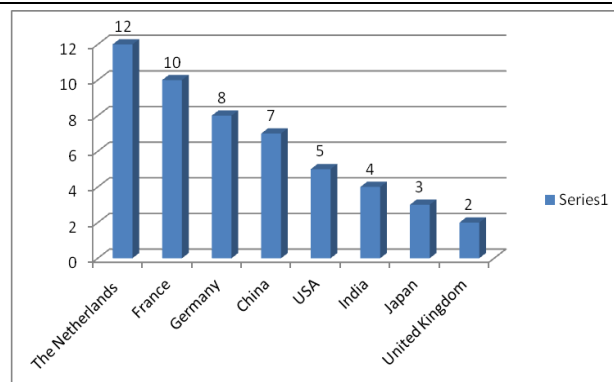

Fig.4. The growth rate of the export with commercial services in the main countries in 2013 compared to 2012

Source: World Trade Development, 2014, www.wto.org. [5] Own design.

**The share of various geographical regions in the world export with commercial services** was the following one: Europe 47.2 %, Asia 26.2 %, North America 16.4 %, Central and South America 3.1 %, Middle East 2.7 %, Africa 2.5 % and CIS 1.9 % (Table 3).

Table 3. The weight of various geographical region in the world export of services in 2013 versus 2005 (%)

Region	The share of various regions in the world export with services (%)	
	2005	2013
Asia	21.7	26.2
North America	17.3	16.4
Central and South America	2.8	3.1
Middle East	2.6	2.7
Africa	2.2	2.5
CIS	1.6	1.9
Europe	51.8	47.2

Source: World Trade Development, 2014, www.wto.org, [5]

**The distribution of the countries by size classes of export value with commercial services:**

**-Over USD 100 Billion:** USA, Canada, Brazil, Australia, China, Russia, India, Japan, Sweden, Germany, United Kingdom, France, Italy, Austria, Spain and the Netherlands.

**-Between USD 50 and 100 Billion:** Turkey, Finland, Poland, Arabian Emirates, Indonesia.

**-Between USD 25 and 50 Billion:** Mexico, Argentina, Chile, South Africa, Portugal, Hungary, Czech Rep., Egypt and Romania.

**-Between USD 0-25 Billion:** the rest of the

world.

**The main countries exporting commercial services** are: USA, with 14.3 % market share, United Kingdom 6.3 %, Germany 6.2 %, France 5.1 %, China 4.4 %, India 3.2 %, The Netherlands 3.2 %, Japan 3.1 %, Spain 3.1 % and Hong Kong China 2.9 %. All these 10 countries achieved 51.73 % of the world export of commercial services (Table 4).

**The main countries importing commercial services** are: USA with 9.8 % market share, China 7.5 %, Germany 7.2 %, France 4.3 %, United Kingdom 4 %, Japan 3.7 %, Singapore 2.9 %, The Netherlands 2.9 %, India 2.8 % and Russian Fed. 2.8 %. All these 10 countries achieved 48.08 % of the world import with services (Table 4).

Table 4. Top 10 countries in the world export and import of commercial services in 2013

Crt. No.	Country	Export of commercial services USD Billion	Market share %	Crt. No.	Country	Import of commercial services USD Billion	Market share %
0	<b>World export of commercial services</b>	<b>4,645</b>	<b>100.0</b>	0	<b>World import of commercial services</b>	<b>4,380</b>	<b>100.0</b>
1	USA	662	14.3	1	USA	432	9.8
2	United Kingdom	293	6.3	2	China	329	7.5
3	Germany	286	6.2	3	Germany	317	7.2
4	France	236	5.1	4	France	189	4.3
5	China	205	4.4	5	United Kingdom	174	4
6	India	151	3.2	6	Japan	162	3.7
7	The Netherlands	147	3.2	7	Singapore	128	2.9
8	Japan	145	3.1	8	The Netherlands	127	2.9
9	Spain	145	3.1	9	India	125	2.8
10	Hong Kong China	133	2.9	10	Russian Fed.	123	2.8
	Total	2,403	51.73		Total	2,106	48.08

Source: World Trade Development, 2014, www.wto.org. [5] Own calculation.

**The world trade with transport services by geographical region in 2013.**

**The export of transport services** had the following geographical distribution: Europe 47.84 %, of which EU-28 43.53 %, Asia 27.29 %, North America 11.5 %, Central and South America 3.31 %, CIS 4.53 %, Middle East 2.98 %, Africa 2.98 %.(Table 5).

**The import of transport services** had the following geographical distribution: Asia 33.99 %, Europe 32.27 %, of which EU-28 29.95 %, North America 11.24 %, Middle East 9.44 %, Africa 5.57 %, Central and South America 4.80 %, CIS 2.66 %, (Table 5).

Table 5. The world trade with transport services by geographical region in 2013

Region	Export of Transport services		Import of transport services	
	USD Billion	%	USD Billion	%
<b>WORLD</b>	<b>905</b>	<b>100.0</b>	<b>1,165</b>	<b>100.0</b>
North America	100	11.5	131	11.24
Central and South America	30	3.31	56	4.80
Europe	433	47.84	376	32.27
EU-28	394	43.53	349	29.95
CIS	41	4.53	31	2.66
Africa	27	2.98	65	5.57
Middle East	27	2.98	110	9.44
Asia	247	27.29	396	33.99

Source: World Trade Development, 2014, www.wto.org. [5] Own calculation.



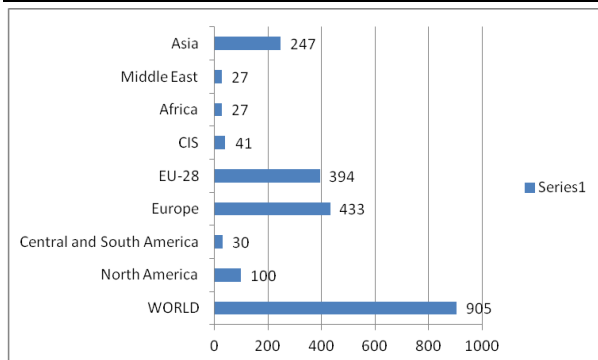

Fig.5. The world export of transport services by geographical region in 2013 ( USD Billion)

Source: World Trade Development, 2014, www.wto.org. [5] Own design.

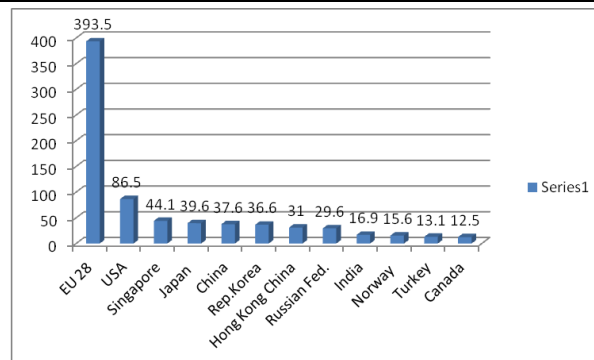

Fig.7. The top countries exporting transport services in 2013 ( USD Billion)

Source: World Trade Development, 2014, www.wto.org. [5] Own design.

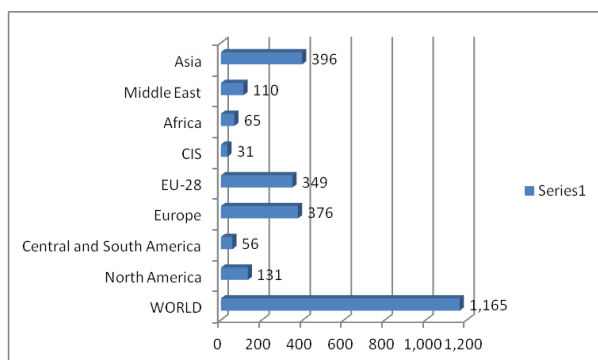

Fig.6. The world import of transport services by geographical region in 2013 ( USD Billion)

Source: World Trade Development, 2014, www.wto.org. [5] Own design.

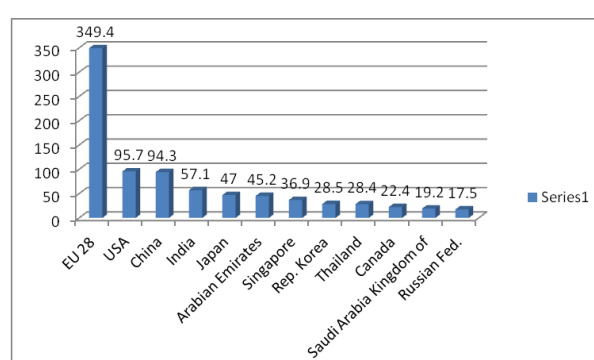

Fig.8. The top countries importing transport services in 2013 ( USD Billion)

Source: World Trade Development, 2014, www.wto.org. [5] Own design.

**The main countries exporting transport services are:** the EU-28 with 43.4 % market share, USA 9.5 %, Singapore 4.9 % Japan 4.4 %, China 4.2 %, Rep. Korea 4 %, Hong Kong China 3.4 %, Russian Fed. 2.3 %, India 1.9 %, Norway 1.7 %, Turkey 1.4 and Canada 1.4 %. All these 12 countries registered USD 756.6 Billion export value of transport services with 83.60 % share in the world transport services.(Table 6)

**The main countries importing transport services are:** the EU-28 with 30 % market share, USA 8.2 %, China 8.1 %, India 4.9 %, Japan 4 %, Arabian Emirates 3.9 %, Singapore 3.2 %, Rep. Korea 2.4 %, Thailand 2.4 %, Canada 1.9 %, Saudi Arabia Kingdom of 1.6 %, Russian Fed. 1.5 %. All these 12 countries registered USD 841.6 Billion import value of transport services, representing 72.24 % of the world export of services.(Table 6)

**The distribution of the world export with tourism and travel services by geographical region** in 2013 was the following one: Europe 38.8 %, the EU-28 34.1 %, Asia 30 %, North America 17.3 %, Central and South America 4.4 %, the Middle East 4 %, Africa 3.3 %, and CIS 2.2 % (Table 7).

**The distribution of the world import with tourism and travel services by geographical region** in 2013 was as follows: Europe 37.2 %, the EU-28 33.2 %, Asia 29.4 %, North America 13.1 %, the Middle East 7.1 %, CIS 6.3 %, Central and South America 4.5 %, and Africa 2.4 %. (Table 7).

**The top countries exporting tourism and travel services** in 2013 were the following ones: EU-28 with 34.1 % market share, USA 14.6 %, Macao China 4.4 %, China 4.4 %, Thailand 3.6 %, Hong Kong China 3.3 %, Australia 2.6 %, Turkey 2.4 %, Malaysia 1.8 %, and Singapore 1.6 %. All these 10 countries recorded USD 859.7 Billion

tourism and travel services value in 2013, representing 72.54 % of the world export with this kind of services (Table 8).

Table 6. The top countries exporting and importing transport services in 2013

Crt. No.	Country	Export of transport services USD Billion	Market share %	Crt. No.	Country	Import of transport services USD Billion	Market share %
<b>0</b>	<b>World export of transport services</b>	<b>905</b>	<b>100.0</b>	<b>0</b>	<b>World import of transport services</b>	<b>1,165</b>	<b>100.0</b>
1	EU-28 Extra EU-28 export	393.5 187.1	43.4 20.7	1	EU-28 Extra EU-28 import	349.4 154.8	30.0 13.3
2	USA	86.5	9.5	2	USA	95.7	8.2
3	Singapore	44.1	4.9	3	China	94.3	8.1
4	Japan	39.6	4.4	4	India	57.1	4.9
5	China	37.6	4.2	5	Japan	47.0	4.0
6	Rep. Korea	36.6	4.0	6	Arabian Emirates	45.2	3.9
7	Hong Kong China	31	3.4	7	Singapore	36.9	3.2
8	Russian Fed.	29.6	2.3	8	Rep. Korea	28.5	2.4
9	India	16.9	1.9	9	Thailand	28.4	2.4
10	Norway	15.6	1.7	10	Canada	22.4	1.9
11	Turkey	13.1	1.4	11	Saudi Arabia Kingdom of	19.2	1.6
12	Canada	12.5	1.4	12	Russian Fed.	17.5	1.5
	Total	756.6	83.60		Total	841.6	72.24

Source: World Trade Development, 2014, www.wto.org. [5] Own calculation.

Table 7. The world trade with tourism and travel services by geographical region in 2013

Region	Export of tourism and travel services		Import of tourism and travel services	
	USD Billion	%	USD Billion	%
<b>WORLD</b>	<b>1,185</b>	<b>100.0</b>	<b>1,070</b>	<b>100.0</b>
North America	204	17.3	140	13.1
Central and South America	51	4.4	48	4.5
Europe	459	38.8	398	37.2
EU-28	403	34.1	356	33.2
CIS	26	2.2	68	6.3
Africa	39	3.3	26	2.4
Middle East	48	4.0	76	7.1
Asia	356	30	315	29
	6		5	.4

Source: World Trade Development, 2014, www.wto.org. [5] Own calculation.

The main countries importing tourism and travel services in 2013 were: EU-28 with 33.2 % market share, China 12 %, USA 9 %,

Russian Fed. 5 %, Canada 3.3 %, Australia 2.5 %, Brazil 2.3 %, Singapore 2.3 %, Japan 2 % and Rep. Korea 2 %. All these 10 countries registered USD 789 Billion tourism and travel services value in 2013, representing 73.73 % of the world import with this sort of services.(Table 8)

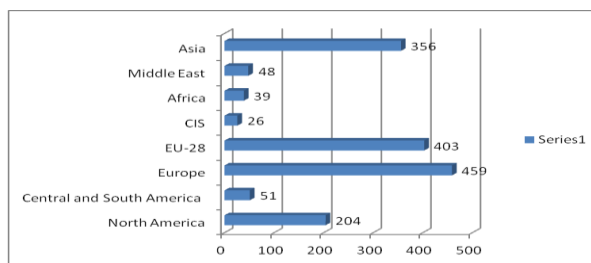

Fig.9. The world export of tourism and travel services by geographical region in 2013 ( USD Billion)

Source: World Trade Development, 2014, www.wto.org. [5] Own design.

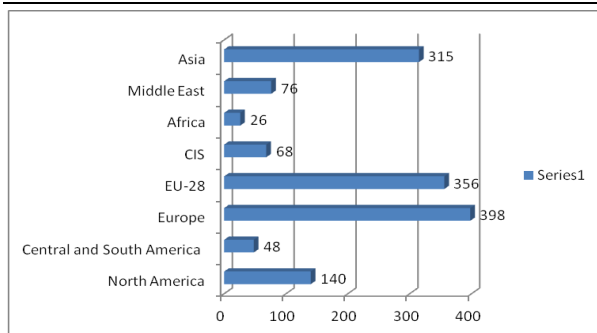

Fig.10. The world import of tourism and travel services by geographical region in 2013 ( USD Billion)  
Source: World Trade Development, 2014, www.wto.org. [5] Own design.

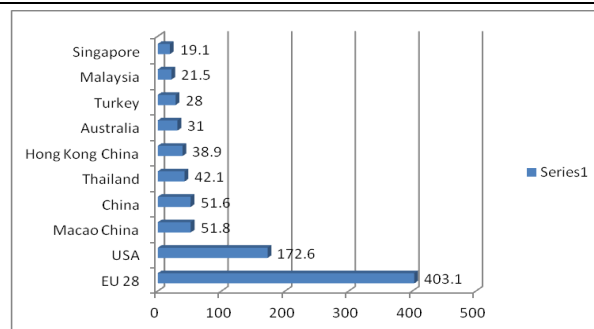

Fig.11. The top countries exporting tourism and travel services in 2013 ( USD Billion)  
Source: World Trade Development, 2014, www.wto.org. [5] Own design.

Table 8. Top 10 countries exporting and importing tourism and travel services in 2013

Crt.No.	Country	Export of tourism and travel services USD Billion	Market share %	Crt.No.	Country	Import of tourism and travel services USD Billion	Market share %
<b>0</b>	<b>World export of tourism and travel services</b>	<b>1,185</b>	<b>100.0</b>	<b>0</b>	<b>World import of tourism and travel services</b>	<b>1,070</b>	<b>100.0</b>
1	EU-28 Extra EU-28 export	403.1 134.8	34.1 11.4	1	EU-28 Extra EU-28 import	355.8 116.4	33.2 10.9
2	USA	172.6	14.6	2	China	128.7	12.0
3	Macao China	51.8	4.4	3	USA	95.9	9.0
4	China	51.6	4.4	4	Russian Fed.	53.5	5.0
5	Thailand	42.1	3.6	5	Canada	35.2	3.3
6	Hong Kong China	38.9	3.3	6	Australia	26.6	2.5
7	Australia	31	2.6	7	Brazil	25.1	2.3
8	Turkey	28	2.4	8	Singapore	24.6	2.3
9	Malaysia	21.5	1.8	9	Japan	21.9	2.0
10	Singapore	19.1	1.6	10	Rep. Korea	21.7	2.0
	Total	859.7	72.54		Total	789	73.73

Source: World Trade Development, 2014, www.wto.org. [5] Own calculation.

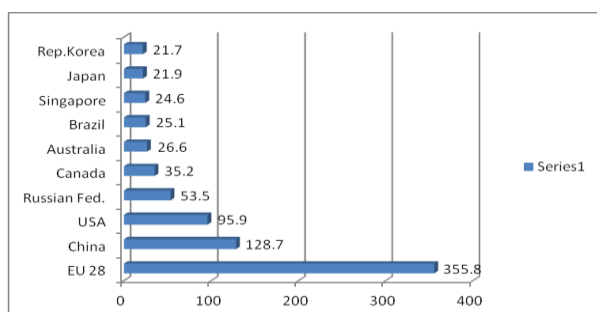

Fig.12. The top countries importing tourism and travel services in 2013 ( USD Billion)  
Source: World Trade Development, 2014, www.wto.org. [5] Own design.

**The highest growth rate of the export with tourism and travel services in 2013 versus 2012 were registered by the following countries: Hong Kong China 18.18 %, Macao China 18 %, Thailand 24 %, EU-28 8 %, Turkey 7.7 %, USA 7 %, Malaysia 5 % and China 4 %.**

## CONCLUSIONS

Commercial services are a more and more important sector in the global economy contributing to the world GDP, employment

and international trade. They represented 20 % of total world trade in goods and commercial services in 2013.

Compared to the previous years, both the exports and imports of commercial services declined sharply in the most geographical regions.

The European Union is the top exporter of commercial services in 2013, as its exports accounted for USD 891 Billion in 2013, representing 25 % of the world export. It was followed by the USA 18.7 %, China 5.8 %, India 4.3 % and Japan 4.1 %.

The European Union was also the leading importer of services. It registered USD 668 Billion import value of services representing 19.7 % of the world import. It is followed by the USA 12.7 %, China 9.7 %, Japan 4.8 % and India 3.7 %.

The development of the commercial services will depend on how the policy makers would manage all the aspects involved in the cross-border trade in services regarding the dissolution of the discriminatory barriers, the assurance of corresponding to protect health, environment, public order, and consumers.

## REFERENCES

- [1]Bombińska Elżbieta, 2013, Development trends in international trade in services in 2000-2011, The School of Banking and Management in Krakow
- [2]International Trade in Services, New trends and opportunities for developing countries, 2010, The World Bank.
- [3]The manual on Statistics of International Trade in Services 2010.
- [4]WTO Measuring trade in services. November 2010.
- [5] World Trade Development, 2014, [www.wto.org](http://www.wto.org)
- [6]World Trade Report 2014 Trade and development: recent trends and the role of the WTO

## RESEARCH ON AGRICULTURAL ASSOCIATION OF THE ROMANIAN FARMERS AND THE EFFICIENCY RECOVERY OF FOOD PRODUCTS RESULTING FROM THEIR WORK

Alin Marcel POPESCU<sup>1</sup>, Nicoleta MATEOC-SÎRB<sup>1</sup>, Adela NEAMȚU-POPESCU<sup>2</sup>

<sup>1</sup>Banat University of Agriculture Sciences and Veterinary Medicine, Faculty of Agricultural Management, 119, Calea Aradului, Timișoara, România, Zip code 300635, E-mails: alin.popescu28@yahoo.com, mateocnicol@yahoo.com,

<sup>2</sup>Polytechnic University, Faculty of Mechanical Engineering, 1, Mihai Viteazu Boulevard, Timișoara, România, Zip code 300222; E-mail: adelaneamtu@yahoo.com

**Corresponding author:** alin.popescu28@yahoo.com

### **Abstract**

*The paper aimed to present the results of a meeting and discussion with many farmers about their business and the agricultural association they are dealing with. These discussions were focused mainly on the agricultural association of the Romanian farmers, about its objectives, activities, production and agricultural products and food products and economic efficiency. The research work was based on a Field Survey, using the questionnaires designed in advance including a list of questions destined to identify the situation of farmers between whose age was between 25 and 45 years. The two young farmers have been the interviewees included in the target group who answered the questions. The conclusions presented in this study emphasized the aspects regarding the collaboration within the association in order to achieve the production and products, how problems are solved and performance is achieved.*

**Key words:** agriculture, association, capitalization, farmer, tax

### **INTRODUCTION**

All time, the intermediaries located between the farmer and the final consumer, were considered a useless parasite responsible for dear life and suspected scandalously enriched at the expense of people.[12]

However, urbanization is inseparable from economic development, because the association of many people in one place allows to take advantage of economic differences, generated by jumps in productivity that would not occur if the production would be fully dispersed territorially.

Furthermore, agriculture needs space because production per unit area is low, compared to the one achieved in the industry.[4]

It follows that urban nutrition keep the farmers away from the places of consumption, and therefore inevitably the intermediaries are involved. They deal with transport and store.

All such operations performed in a modern economy by the agri-food are as important as

the very agricultural production is.

They ensure food security and nutrition of population [5].

For this reason, the associative forms the farmers are interested to set up are a solution to avoid the losses produced by intermediaries to farmers.

In this context, the goal of the paper was to present the results of a field survey within the Romanian Association of the Farmers, based on questionnaires focused on the objectives, activities, agricultural production and agri-food products and economic efficiency.

### **MATERIALS AND METHODS**

The research work was run within a POSDRU training project where one of the authors were involved as trainers on entrepreneurial skills.

The research area was represented by Alba Iulia, Timisoara, Abrud, Sebes, Aiud, Lopadea Noua, Bozovici, etc. where the target group included, among other students, some

farmers who were involved in discussions about their agribusiness and problems within their association.

These discussions led to the conclusion that our country needs more associative forms for farmers in order to enable them to face the competition with the farmers from the more developed countries.

Many of farmers, only expect help from the state but are not willing to associate. But, also, within the target group there were farmers who are part of an association, and keen to receive grants and European funds.

Also, in the locality Lopadea Noua, at Biomilk Factory, specialized in cheese paste scalded and fermented cheese in brine, cream cheese, cream and butter, there were run several discussions with the decision makers of the firm, who explained the policy of the company regarding the traditional agricultural potential of the specific geographical area in the foothills Apuseni.

Nowadays they accomplished an integration of agroindustrial elements beginning with a link chain of farming and ending with finished products production and distribution to shops. Using its own machinery and equipment, the farm produce fodder for the livestock of the dairy farm. The milk produced in the farm and the milk produced by the farmers in the area is collected and processed in the factory located in the same locality. The dairy products obtained are distributed using its fleet of trucks in the country and abroad (Hungary, Italy, Spain). Biomilk own stores are currently under construction in Alba.

The farmers from Biomilk are part of the Association of Sheep and Goats in the Alba County, one of the strongest associations in the country. The farmers are satisfied with the association because it helped them with information and animal medicines. However, they have not too much activity with the association, but more on their own[16].

Shortly after these discussions at Biomilk, the questionnaires were designed in order to identify the situation of the 25-45 years farmers who are part of an agricultural association.

Two farmers, one a beginner and the other one with a long experience in agriculture,

answered the questionnaires for getting information about how they cooperate with the associations to which they belong, how they value their products and what issues they raise. The questions that we used are:

1. The social situation.
2. Education, training of adults.
3. What kind of agriculture rendered?
4. Land on lease?
5. The assets of the firm? (Stables, annexes ...)
6. Do you own or rent equipment?
7. What made you to enroll in an agricultural society? What is it called?
8. How you meet the income you currently have in agriculture?
9. What are you willing to invest in an association? (time, money, goods, etc.)
10. How do you see your revenue growth in agriculture in the future?
11. Do you think that being part of an association will increase your income?
12. What are the main needs that you identify as farmer now?
13. How to get your products to the final consumer?
14. The market regulates the price of your products?
15. Do you received grants?
16. Some words about agricultural tax, vama tax and tariffs in agriculture.
17. SWOT analysis of your farm. (Strengths, Weaknesses, Opportunities, Threats) [1, 2, 6, 7, 8, 9, 10, 11].

## RESULTS AND DISCUSSIONS

Regarding the social situation, the first farmer, who is at the beginning of his career, answered that he is unmarried and dealing with sheep raising. His profession is agricultural engineer and has 22 years. He replied to questions and informed that he is a part of the Association of livestock farmers in the locality, as its chairman and founder member. He explained that he is doing agriculture with his own financial resources but he also get APIA subsidy for pasture area that he owns. The area of land he owns is between 150 and 200 hectares leased from the municipality. He also has the necessary equipment to work his land and gets to a level

of self-sustaining farm.

When we asked if he thinks that being part of an association will increase farmers' incomes, he replied that first he does not want to increase his revenue, but to develop the association buying meat sheep and accessing European funds to build a milk and meat processing plant. This young farmer explained that people are keen to gather in order to get European funds and not to develop the association.

To the question "How to get your products to the final consumer?", he farmer replied that because of high taxes they have to pay, and because of the rules (cold room and slaughter) he works predominantly with a closed loop with friends. All these because of the fear of controls, although all the animals were vaccinated.

The farmer has not missed the opportunity to expose some problems he was facing with: the trouble with the local mayor in the town framing favored area when it actually is not because they have no infrastructure, no gas, water, etc. As the village is part of the favored area it is assigned with fewer funding programs. He told us that the decision makers are not good in the local administrative management.

He also mentioned that in Europe the subsidy is Lei 60, equivalent in Euros per head of sheep and in Romania is only 32 lei. There were also substantial differences between the money paid for grassland (Lei 360/ha), equipping wells, a granary in the field, cleaning, for overseeding management and APIA subsidy paid of EUR 100/ ha.

He also said that there is no interest from the authorities and that farmers are not well informed, and because they are busy all the time with their work, they have no time to inform. Here he wants to intervene with the association. He wants to try to change something by the active involvement, but he encounters the lack of interest in gathering the farmers. They prefer to work on their own closed circuit. The only area where there is common ground between farmers is the price setting. It is the same for all farmers.

At the last question, the SWOT analysis allowed to identify many aspects which are

presented in the tables given below.

Table 1. The SWOT Analysis results for the 1st farmer, the beginner

<p><b>Strengths</b></p> <ul style="list-style-type: none"> <li>- River walk by village</li> <li>- Pasture is in the vicinity of the river</li> <li>- Help from young people who remain in the village</li> </ul>	<p><b>Weaknesses</b></p> <ul style="list-style-type: none"> <li>- Lack of infrastructure, electricity, gas</li> <li>- Corruption</li> </ul>
<p><b>Opportunities</b></p> <ul style="list-style-type: none"> <li>- Visits by foreign tourists in the area</li> <li>- 9% VAT</li> <li>- Natural potential of certain areas</li> <li>- Potential market and increasing demand for certain products</li> </ul>	<p><b>Threats</b></p> <ul style="list-style-type: none"> <li>- Imposing major manufacturers prices</li> <li>- The fear of monopolization revenue percentage decreases</li> <li>- Late spring frosts and other restrictive environmental factors that determine the quantity and quality of production cuts</li> <li>- Imports of similar products</li> <li>- Competition</li> </ul>

Finally the farmer said it should be encouraged working 100 % legal, informing small farmers and also that the State should intervene to prevent monopoly.

The second farmer operating as a commercial society of SRL type is registered in cattle breeders association, dealing with agriculture and animal husbandry, cultivating plants like corn, wheat, barley for beer, triticale ( feed wheat ), sunflower and alfalfa. Also he owns cows and pigs. He works his own land and also has leased land, totalizing 300 ha. He owns the farm stables, garages, meat processing, milking and bottling milk and dependencies.

The equipment consists of a tractor, plow, baking powder, wheat and corn seed, mowers, loaders, trailers, rake , etc.

For the European funds joined the association but they do not meet the revenue they currently have in agriculture. The farmer said that he is willing to invest in equipment and in association. He also mentioned the problem of infrastructure (roads, because you can not

move machinery on highways but there are no other roads), selling at low prices because they are small farmers and the prices are imposed by large consumers and exporters in the region ( Transavia, etc ).

Another issue raised by this farmer is preparing his colleagues for facing the market: on the one hand they need training in agriculture which provides work and also they need training in trade to assert effective products. The farmer believes that being a part of an association this will help you to increase your revenue.

When asked about identifying needs, he answered he needs a combine. Also he believes that holdings below 5 ha will not help because, in this case, small farmers do not want to associate. They have grants received from the state and are happy with them. From what this farmer said, most small farmers do not work as the state receives it, namely: there are exchanges of land with farmers more developed, for compaction, and small farmers are forced by digitizing land and by property, to declare for grants land that they actually are not working.

He added that there is no difference between producers, growers, vendors and those who make all the three.

The tax is a big problem because all products are taxed separately, namely: once the animal is taxed as a being, then it is taxed the resulting meat, milk, eggs, and also it is taxed the food produced in the farm as food for animals.

Another issue raised by our farmer is taxation of the seed holds for the next year and here again begins the chain of taxation.

The farmer has a gas station and explained that the price of diesel is Lei 2.5 ,the rest of the price (Lei 5.10) is represented by other taxes.

The subsidy on diesel is Lei 1 and the remaining Lei 1.5 per liter of diesel tax is not justified as long as the machines are not used on public roads and highways.

A new method was found to use oil for tractors in order to escape to pay charges for diesel.

The farmer has his own distribution net for eggs, milk and milk preparations, meat and

meat products. He owns a shop where he sell his products.

He declared that about 80 % of production is sold, and the remaining 20% is kept for seeding and animal feeding. Like other farmers, he is forced to do this to get away from taxes and over taxes.

When asked if the market adjusts prices, the farmer answered that there is a producers' association, and the market does not regulate the price, only the producers establish the same price. Here it came another the question: why do you not associate to make other things and the answer was that the farmers are individualistic and do not want to associate.

Our farmer also gets subsidies from the state.

Table 2.The SWOT Analysis results for the 2nd farmer, the more experienced farmer

<p><b>Strengths</b></p> <ul style="list-style-type: none"> <li>-Good tech and implementation</li> </ul>	<p><b>Weaknesses</b></p> <ul style="list-style-type: none"> <li>-Lack of irrigation systems</li> <li>-Lack of sales of certain products</li> </ul>
<p><b>Opportunities</b></p> <ul style="list-style-type: none"> <li>- Irrigation systems</li> <li>- Little investment in fleet</li> <li>- Cheap labour</li> <li>- Background and experience of the farmers</li> </ul>	<p><b>Threats</b></p> <ul style="list-style-type: none"> <li>- Stronger emergence of other investors</li> <li>- Increased demand for competing products</li> <li>- Excessive humidity</li> <li>- Financial blockage</li> </ul>

## CONCLUSIONS

In Romania, some farmers' associations are not used in their true sense. The idea is that many farmers are individualists and many of them have no idea about what an association does really mean.

The establishment of various forms of farmers' association could open new opportunities for the economic development using the collective power so that the association members, their family and the community they belong to become more prosperous.

If the population dealing with agriculture, representing 37% of the whole population, would join the forces to modernize agriculture, farmers' incomes would raise and their standard of living would increase significantly.



Also, taxation legislation should be designed in other ways for agricultural associations so that the population not to resort to various tricks in order to avoid paying the state.

The poor infrastructure does not allow the farmers to operate productively.

Farmers are associated when we talk about the starting price of some products, which is not created by the market, but by producer [3], [13], [14].

Having the example of Germany, it is about BayWa system, it could be applied in Romania.

BayWa is a German company operating in sectors such as agriculture, building materials and energy sector. BayWa was founded in 1923 and has headquartered in Munich, Germany. It has a turnover of around € 8 billion, approximately 2,700 retail locations and approximately 16,000 employees. Most of the group's profits comes from agricultural division.

BayWa makes business with agricultural resources and agricultural products in the food supply. It is one of the largest companies in this area and some of its products are exported worldwide.

Agriculture is divided into three units: Agriculture – Trade, Agriculture Equipment and Fruit. Agriculture segment makes about 45 % of company revenue. Products and services provided to farmers including seeds, fertilizers, pesticides, animal husbandry etc. also stores and selling the harvest for farmers. In Germany, BayWa has approximately 500 locations, 16 of them with their harbors.

Even if the distribution of resources and agricultural products is essential, this is not just a trader. Rather, this is in a global partnership, directly with farmers, accompanying and supporting them in all stages of seeding, fertilizing, plant protection and harvesting.

This is true for livestock farms, helping them with the best feed supply and advising them regard to animal health. BayWa provides services such as collection, storage, packaging and marketing of crop, close the gap between producers and consumers on the one hand and the processing industry on the other.

Agriculture Business Unit sells machinery and

equipment, buildings and facilities. High standards of service are guaranteed by a dense network of garages.

Through a nationwide network of workshops, complemented by a mobile repair service, maintain the highest standards of quality. They also provide renting and leasing of machinery and equipment. BayWa offer complete technology. BayWa is the largest supplier seed fruit retail.

BayWa takes, stores, grades and packs the products named WOG and sells on the domestic and foreign markets.

With about 150 fruit-cider collecting points, 16 BioIndustry fruit collecting points and 8 cherries and blackberries collection points, the company is a competent partner for the processing industry.

The production area is approximately 3,300 hectares with more than 600 growers which produce mainly apples and pears and berries. About 15% of fruit came from organic farming.

At BayWa market, the fruits are inspected and then sorted with the latest technologies at the central production class, size and coloring. In more than 200 different packaging and under several trademarks, goods are then shipped only with its own logistics.

BayWa also provides building materials. This segment provides products and services for new construction, renovations and modernization, both in urban and rural areas. It also has two subunits, building materials and DIY and garden centers. BayWa has its sales centers in Germany. It also works through franchises in Germany, Austria and Italy.

Energy

This segment is particularly involved in the sale of oil. In addition, there are also traded other fuels and lubricating oils. This is the third most revenue BayWa and generates about 25% of total revenue. The main items of interest are oil, diesel, lubricants and solid fuel generally as pellets[15].

## ACKNOWLEDGEMENTS

The authors addresses their thanks the farmers who agreed to answer the questions

included in the Field survey and analysis and also for the discussions that we have with them. We'll also keep the anonymity of people who participated in our study.

## REFERENCES

- [1] Alecu, I. N., Merce, E., Pană, D., Sâmbotin, L., Ciurea, I., Bold, I., Dobrescu, N., 2001, Management în agricultură- Editura Ceres.
- [2] Burja Camelia, Burja Vasile, 2008, Performanta economica a exploatațiilor agricole in sistemul dezvoltării durabile, Casa cărții de știință.
- [3] Burja Vasile, 1998, Analiza economica si gestiunea financiara a exploatațiilor agricole, Editura AGRIS, Redacția Revistelor Agricole SA București.
- [4] Hinescu Arcadie, Ludusan Nicolae, Bele Ioan, Burja Camelia, Cocoli Larisa, 2005, Managementul si gestiunea exploatației agricole, Risoprint Cluj Napoca.
- [5] Lagrange Louis, Montigaud Jean-Claude, Oferro Ottone, Floricel Constantin, Persona Renzo, Requillard Vicent, 1997, Marketingul producției agroalimentare Editura Didactică și Pedagogică, R.A. București.
- [6] Lăpușan Alexandru, 1995, Cooperația agricolă, condiție fundamentală pentru dezvoltarea agriculturii românești.
- [7] Mateoc Sirb Nicoleta, 1995, Asocierea și cooperarea în agricultura țărilor cu economie de piață și în România, Lucrări științifice, Editura Agroprint Timișoara.
- [8] Otiman Păun Ioan, 2000, Restructurarea agriculturii și dezvoltarea rurală a României în vederea aderării la Uniunea Europeană, Ed. Agroprint, Timișoara Dezvoltarea rurală în România- Editura Agroprint.
- [9] Otiman Păun Ioan, 1995, Restructurarea agriculturii României - un punct de vedere, USAB- Timișoara.
- [10] Otiman Păun Ioan, Mateoc Sirb Nicoleta, 1994, Gospodăriile țărănești din România în perioada interbelică și astăzi, Comunicare - Simpozionul șt. internațional "Atelierele democrației", Timișoara.
- [11] Popescu, M., 1997, Exploatația familială, Tipologie și perspectivă, Economistul nr. 907
- [12] Samochis, B., 1997, Managementul muncii în agricultura, Risoprint, Cluj Napoca
- [13] Țiclea Alexandru, Toma Mircea, Bârsan Corneliu, 1992, Societăți agricole și alte forme de asociere în agricultură, Editura Ceres, București.
- [14] Vincze Măria, 2002, Economie agroalimentară, teorii și realități, Editura Risoprint, Cluj-Napoca.
- [15] [www.baywa.de](http://www.baywa.de)
- [16] [www.biomilk.ro](http://www.biomilk.ro)

## THE ECONOMIC AND SOCIAL DEVELOPMENT ANALYSIS IN SYRIA FOR THE PERIOD 1980-2013

Ibrahim Abdul RAHMAN<sup>1</sup>, Al Mohammad JEGHAYEF<sup>1</sup>, Raluca NECULA<sup>1</sup>,  
Diana Roxana CAPĂȚĂ<sup>2</sup>

<sup>1</sup>University of Agricultural Sciences and Veterinary Medicine Bucharest, 59 Marasti, District 1, 11464, Bucharest, Romania, Phone: +40213182564, Fax:+40213182888, Mobile:+40744 6474 10,Emails: ibrahimabdallahman@hotmail.com; hagihagi93@yahoo.com; raluca\_nec@yahoo.com;

<sup>2</sup>Lund University, Master Program International Development and Management, Paradisgatan 2, Lund, Sweden, SE-221 00, Tel: +46 (0)46 222 0000, Email: diana\_capata@yahoo.com

**Corresponding author:** raluca\_nec@yahoo.com

### Abstract

*Within this work we wanted to emphasize the level of social and economic development reached by Syria until the year 2013, Syria presenting as a country with outstanding prospects for development. There were analyzed one by one, the main demographic indicators through the active population and rural population evolution, life expectancy, and there have also been analyzed the indicators that demonstrate the access to culture and education, the indicators relating to urban facilities, namely the network of public roads and the evolution of the number of internet users. Our analysis was completed by indications that show the level of Human Development Index. As a result of this analysis was the progress made by Syria in recent years, both in terms of economic and social progress that at the level of the year 2012 has been stopped by the regional and local events that have had a significant impact on the country, as it emphasizes the reports of the Syrian authorities.*

**Key words:** average life expectation, free education, human development index (HDI), internet users, rural development, rural population

### INTRODUCTION

Syria, with the official name Al-Jumhuriya Al-Arabia Al-Suria, the Arabian Republic Syria, has an area of 185,180 Km<sup>2</sup>, being reported an East-West extension of 829 km and for North and South of 748 km.

In 2009, an article about Syria underscore that is a country with an average economic force, based on agriculture, oil, industry and tourism. In the same year 2009 Syria was very close to cooperate economically with the EU. Callings to bring Syria into the ENP (European Neighborhood Policy) are part of the strategy of the Western countries of Europe to keep away from the Baathist regime in Iran and to foster cooperation with Iraq and Lebanon[4]. The study tries to bring out the rural development in Syria by the year 2012, when regional and local events had a strong impact on economic and social development of the country. The indicators analyzed highlight the country efforts for rural

development and poverty alleviation that during 1997-2007 has improved from 14.26% only 11.39% [2].

In the study *The humanity degradation in Syria* prepared by the Syrian Centre for research policy and PNUD, points out that by the end of 2013, the total economic losses since the start of the conflict have been estimated at \$ 143.8 billion, which is equivalent to 276% of GDP in constant prices of the year 2010 [7].

### MATERIALS AND METHODS

In the study on analysis of rural development were used a set of indicators including: demographic indicators (total population, average life expectancy, rural population); access to education; the number of internet users; the length of the roads; the size of the HDI (Human development index).

As statistical indicators were calculated: on certain time periods, indicators of comparison

with a fixed base and in chain base and growth rhythm of the year [7]

$$= r_{2000-2012} = 12 \sqrt{\prod (p_1/p_0) - 1};$$

where:  $\prod p_1/p_0$  = the chain indicators product during the analyzed period.

## RESULTS AND DISCUSSIONS

### 1. The main demographic indicators development analysis

This analysis was focused by extracting the data and their interpretation with reference to the total active population, life expectancy, the rural population and its share in the total population. Table 1 presents the total active population developments analysis, as follows:

-At the level of 1980, the population of Syria's record 2030 thousand people, reaching out in 1990 at 3204 thousand persons, with 35.9% more and 4818 thousand in 2000, with a percentage of 137.3% higher relative to the base year 1980. The average population for this period is of 3294 thousand persons, and the annual average rhythm of growth it's 4.42 percent;

- With regard to the period from 2001 to 2012, we can also observe significant increases, from 5250 thousand persons in 2001 to 7271 thousand in 2012, with 31.6 percent more people. The average period is located at 4811 thousand persons, with an average annual rate of 3.49%.

Table 1. The evolution of the total active population at the country level and in agriculture in Syria during he period 1980-2011

7	MU	1980-2000				Specification	2000-2012				Average /Rhythm	Dif(2000-2012)-(1980-2000)
		1980	1990	2000	Average /Rhythm		2000	2005	2010	2012		
Total active population	thousands	2,030	3,204	4,818	3,294	thousands	4,818	5,754	7,088	7,271	4,811	1,517
	% compared to 1980	100	157.8	237.3	x	% compared to 2000	100	119,4	147,1	150,9	x	x
	% in chain		1.05	1.03	4.42	% in chain		1.05	1.03	1.01	3.49	-0.93
	% total pop.	22.7	25.7	29.4	x	% total pop.	29.4	31.5	34.4	33.2	x	x
Active population from agriculture	thousands	680	966	1,143	939	thousands	1,143	1,240	1,408	1,390	1,056	1,174
	% compared to 1980	100	142.1	168.1	x	% compared to 2000	23.7	25.7	29.2	28.9	x	x
	% in chain		1.04	1.01	2.63	% in chain		1.03	1.01	0.99	1.64	-0.99
	% tot econ active pop.	33.5	47.6	56.3	x	% tot econ active pop.	56.3	61.1	69.4	68.5	x	x
	% total pop.	14.25	15.19	14.53	x	% total pop.		14.77	14.75	14.58	x	x

The World Bank, 2014, Indicateurs du développement dans le monde, <http://data.worldbank.org/data-catalog/world-development-indicators>[10]

In agriculture, we can observe a constant growth throughout the period examined, with the exception of the last year, when decreases slightly, reaching out in 2012, at 1390 thousand.

As regards the life expectation of Syria and the neighboring States, the data in Table 2 presents the following situation:

-Syria has a hope of life, on average for this period of 74.5 years, data showing small oscillations between 45.5 years (2000) and 75 years (2007-2008); the coefficient of variation demonstrates the data homogeneity, its value being of 0.77%, indicating a very low

threshold of change;

-The most of the studied countries presents an average life hope with oscillations between 68 and 73 years, in the year 2012 in Egypt is recorded a life hope of 73.8 years, and in Iran and Turkey 74.9 years;

-The global life expectancy oscillates around 69.28 years with a small variation of 1.47%, while the Arab world has a hope of 68.82 years, with a 1.08 percent;

-It can be inferred that the hope of life meets the highest in Arab countries with greater economic development.

Table 2. The evolution of life expectancy in Syria and the neighboring States during the period 2000 to 2012

Country	UM	2000	2005	2007	2008	2010	2012	Average / Annual growth rhythm	Standard Deviation	Variation coef. (%)
Egypt	years	42.6	43.1	43.4	70	70.5	44.1	69.68	0.74	1.07
	%		1.00	1.00	1.00	1.00	1.00	0.28	X	X
Iran	years	69.6	44.4	44.9	72.5	73.1	73.8	71.77	1.35	1.88
	%		1.01	1.01	1.00	1.00	1.01	0.49	X	X
Iraq	years	70.8	43.1	42.8	42.7	42.8	43.0	69.51	0.78	1.12
	%		0.99	1.00	1.00	1.00	1.00	-0.19 per	X	X
Jordan	years	71.8	72.6	73	73.1	45.6	45.8	72.78	0.63	0.86
	%		1.00	1.00	1.00	1.00	1.00	.22	X	X
Syria	years	<b>45.5</b>	<b>74.7</b>	<b>75</b>	<b>75</b>	<b>74.9</b>	<b>74.7</b>	<b>74.50</b>	<b>0.57</b>	<b>0.77</b>
	%		1.00	1.00	1.00	1.00	1.00	0.16	X	X
Turkey	years	70	72.4	45.5	45.7	74.2	74.9	72.67	1.56	2.14
	%		1.01	1.01	1.00	1.00	1.01	0.57	X	X
Arab world	years	42.1	42.6	69	43.0	69.6	43.4	68.82	0.74	1.08
	%		1.00	1.00	1.00	1.00	1.00	0.27	X	X
World	years	42.1	69	69.6	43.4	70.3	70.8	69.28	1.02	1.47
	%		1.00	1.00	1.00	1.00	1.00	0.37	X	X

Source: Banque Arabe Syrienne, République, <http://donnees.banquemondiale.org/pays/republique-arabe-syrienne>

Table 3. The evolution of the rural population of Syria and of neighboring countries during the period 2005-2013

Country	MU	2005	2006	2007	2008	2009	2010	2011	2012	2013	Average/Rhythm
Egypt	Th. Pers.	40,894	41,551	42,253	42,987	43,732	44,488	45,254	46,010	46,752	43,769
	%		1.02	1.02	1.02	1.02	1.02	1.02	1.02	1.02	1.02
Iran	Th. Pers.	22,759	22,543	22,359	22,192	22,030	21,873	21,722	21,575	21,437	22,054
	%		0.99	0.99	0.99	0.99	0.99	0.99	0.99	0.99	0.99
Irak	Th. Pers.	8,551	8,751	8,946	9,145	9,357	9,588	9,814	10,042	10,272	9,385
	%		1.02	1.02	1.02	1.02	1.02	1.02	1.02	1.02	1.02
Jordan	Th. Pers.	1,019	1,027	1,036	1,044	1,052	1,060	1,068	1,076	1,084	1,052
	%		1.01	1.01	1.01	1.01	1.01	1.01	1.01	1.01	1.01
Turkey	Th. Pers.	21,825	21,698	21,561	21,417	21,272	21,125	20,981	20,842	20,704	21,269
	%		0.99	0.99	0.99	0.99	0.99	0.99	0.99	0.99	0.99
Syria	Th. Pers.	8,396	8,621	8,895	9,174	9,403	9,544	9,649	9,753	9,857	9,255
	%		1.03	1.06	1.02	1.01	1.01	1.01	1.01	1.01	0.94

\*World Development Indicators: Agricultural inputs,2014, <http://wdi.worldbank.org/table/3.2> [10]

The table 3 presents the evolution of the rural population from Syria and certain neighboring Arab States, for the period from 2005 to 2013, such that:

- in Syria, the rural population presents variations around the mean of 9254.7 thousand people, since 2005-8396 thousand persons, until 2013, when it reached at 9857 thousand persons with 10.8% more people;
- Jordan recorded a small number of people from rural areas, with small oscillations

around the average of 1051.6 thousand people, showing a steady growth on years since 2005-1019 thousand people by 2013-1084 thousand persons;

- at the opposite pole, with a large population is Egypt with a rural population of 46752 thousand persons, presenting also the constant increase along the studied period from 40894 thousand persons in 2005.

Table 4. The rural population share evolution of Syria and neighboring States, for the period from 2005 to 2013

Country	MU	2005	2006	2007	2008	2009	2010	2011	2012	2013	Average/Rhythm
Egypt	%	57	57	57	57	57	57	57	57	57	57
	%		1.00	1.00	1.00	1.00	1.00	1.00	1.00	1.00	1.00
Iran	%	32	32	31	31	30	29	29	28	28	30
	%		1.00	0.97	1.00	0.97	0.97	1.00	0.97	1.00	-1.66
Irak	%	31	31	31	31	31	31	31	31	31	31
	%		1.00	1.00	1.00	1.00	1.00	1.00	1.00	1.00	1.00
Jordan	%	19	19	18	18	18	17	17	17	17	17.9
	%		1.00	0.95	1.00	1.00	1.00	0.94	1.00	1.00	-1.38
Turkey	%	32	32	31	30	30	29	29	28	28	29.9
	%		1.00	0.97	0.97	1.00	0.97	1.00	0.97	1.00	-1.66
Siria	%	46	46	45	45	45	44	44	44	43	44.7
	%		1.00	0.98	1.00	0.98	1.00	1.00	0.98	1.04	-0.84

\* World Development Indicators: Agricultural inputs,,2014 <http://wdi.worldbank.org/table/3.2> .[10]

As regards the share occupied by the rural population both in Syria and in the other countries studied for the period 2005 -2013, table 4 presents the situation as follows:

- in Syria, the rural population has a share of about 27.8% (period average), with values between 43 (2013) and 46 (2005), the share being dropping at an annual rate of-0.84 percent;
- Egypt has a constant value along the studied period, 57%, alongside Iraq 31%;
- We see declines in Turkey, Jordan and Iran, with the annual loss of-1.66%,-1.38% and - 1.66% respectively.

**2.The indicators analysis regarding the access to education and culture**

The access to education and culture (the total number of pupils and teachers from rural schools, the purchasing power, the communal libraries, the number of health services given by the number of pharmacies, medical clinics, family dentistry, etc.) The share of net enrolment in primary education has declined from 98.4% in 2011 to 70% in 2013. In a few years, it is estimated that the rate of enrolment in primary education will fall by up to 50% for the age group of between 6-11 years, and 30% among pupils in the first and the last grade of primary education. This low rate of coverage will have a negative impact on the country for the coming decades. Experts estimate that today's generations of children who are under 15 years of age will increase the illiterate.

Table 5. Trends in the percentage of young people who have completed primary school, youth group, in Syria and neighboring countries during the period 2005-2012

Country	2005	2008	2009	2010	2011	2012	Average /Rhythm
Egypt	101	101	103	106	105	107	102.4
		1.01	1.02	1.03	0.99	1.02	0.83
Iran	107	98	103	104	104	102	101.8
		1.02	1.05	1.01	1.00	0.	-0.68
Iraq	...	...	...	...	...	...	...
Jordan	104	105	95	93	93	93	98.8
		0.99	0.90	0.	1.00	1.00	-1.58
Turkey	102	100	100	100	103	101	100.4
		1.02	1.00	1.00	1.03	0.	-0.14
Siria	110	106	105	104	106	107	106.9
		0.99	0.99	0.99	1.02	1.01	-0.39

\* World Bank, 2014, Indicateurs du développement dans le monde, <http://data.worldbank.org/data-catalog/world-development-indicators> (... the absence of data).[10]

Despite expectations for the near future that the literacy rate among the age group 15-24 will be 94.3%, it is certain that this percentage will decline sharply in the coming years due to the current decline and the one estimated in the future as regards the enrolment rates in tertiary education. The estimated ratio between girls and boys in 2015 is 90.8 in primary education, 92.5 in secondary education, 53.6 in the professional education and at university level will be reduced to 76.1[9].

Table 5 outlines the situation of young people who have completed primary school, (more than 100% percentages, because the groups originally formed, were added over the years, the percentage of young people who, thanks to the not finalizing the school in the schedule, were joined by groups of young people from the years considered in the analysis), as follows:

- in 2005, Egypt had a 101% of young people who finished school, percent maintained until the year 2008, and increases by the year 2012 to 107%;
- Turkey presents a greater stability of the variation so that between the years 2008-2010, the percentage is 100, and in 2012, with 1% up 101%;
- Syria is the country that has larger fluctuations, showing a higher rate of youth who remain repeaters in previous years, so that in the year 2005, when the percentage was 110%, decreases through 2010 at 104% and increases the next two years up to 107%.

**3.The indicators analysis in respect of facilities**

The network of roads in Syria, as shown in table 6, had a positive trend throughout the period analyzed from all categories of roads:

- Syria held in 2012, on country's total area, a total of 74342 km, of which 8266 km leveled roads and paved roads 19758 km, the increases relative to the base year being impressive;
- The paved roads increased from 8,096 km in 1970, at the 23,779 km in 1990, with 37.4% larger. The increases for asphalt surface continues also in the year 2000, registering 32,028 km asphalted and until 2012 to get to

46,318 km asphalt roads about 5 times more kilometers towards 1970.

Table 6. The evolution of the network of roads in Syria during the period 1970-2012

Roads	UM	1970	1980	1990	2000	2005	2010	2012
Asphalt roads	km	8,096	12,969	23,779	32,028	37,554	45,345	46,318
	%	100.0	160.2	293.7	3,395.6	463.9	560.1	572.1
	%				100.0	117.3	141.6	144.6
Paved roads	km	1,500	4,172	7,305	9,405	9,999	17,625	19,758
	%	100.0	278.1	487.0	627.0	666.6	1,175.0	1,317.2
	%				100.0	106.3	187.4	210.1
Roads leveled	km	2,189	2,678	2,129	3,142	2,424	6,903	8,266
	%	100.0	128.1	101.8	150.3	115.9	330.1	395.3
	%				100.0	77.1	219.7	263.1
Total roads	km	11,687	19,819	33,213	44,575	49,977	69,873	74,342
	%	100.0	169.6	284.2	381.4	427.6	597.9	636.1
	%				100.0	112.1	156.8	166.8

\* Central Bureau Of Statics, accessed September 2014, Syrian Arab Republic, [www.cbssyr.sy/index-EN.htm](http://www.cbssyr.sy/index-EN.htm)

It is very interesting to note the development of the number of internet users (Table 7) both in Syria and at the global level and in the

Arab world, known being the fact that the Internet is an important means of information, personal development as it can be also a means of lifting the standard of living.

Table 7. The annual rate evolution of the internet users number increase in Syria during the period 2000 to 2012

Country	UM	2000	2005	2010	2011	2012	Average
Syria	No inter/ 100 pers	0.2	5.	20.	14.0	15.1	10.3
	Chain indices (%)		1.30	1.20	1.09	1.08	49.18
The Arabian world	No inter/100 pers	1.1	5.2	26.	18.5	34	8.7
	Chain indices (%)		1.20	1.16	1.11	1.14	33.10
World	No inter /100pers	6.	9.8	18.2	32	22.1	12.1
	Chain indices (%)		1.11	1.14	1.09	1.11	14.79

World Bank, 2014, Indicateurs du développement dans le monde, <http://data.worldbank.org/data-catalog/world-development-indicators>

In Syria, the number of users has grown much since 2000, when there were 0.2 users to 100 persons, at 12.9 users/100 persons in 2010 and reaches at 15.1 users /100 people in 2012.

The total level of the countries of the Arab world, the number of users is higher in relation to Syria so that log also important increases in the period studied, from 1.1/100 pers, at 16.6 int/100 pers in 2010 and 34 users/100 pers in 2012.

Global data reflects a number of internet users higher towards the Arab world, 2012 a 22.1 average users/100 pers.

#### 4.The indicators analysis that show the level of Human Development Index for Syria and in the regional context.

In the comparative appreciation of the living level we used the human development index, which is calculated for the majority of ONU Member States, and is updated every year and published in the human development Report [6]. HDI was created to highlight the fact that

people and their capacities should be the ultimate criterion for assessing a country's development, not just the economic growth.

Following the calculation of the HDI, in the framework of World Development Report were introduced new measures to assess progress in poverty reduction and the empowerment of women.

Human development index (HDI) measures the average level of human development achieved in a country in three fundamental dimensions: health and longevity, access to education and decent standard of living.

The classification level of human development: countries included in the World Report are divided into 4 groups according to the HDI: very high human development (HDI over 0.900), high (HDI between 0.800-0.89), medium (HDI between 0.500-0.799) and low (HDI less than 0.500)[5].

Human development index is one, if not the most important instrument in the context of

the analysis undertaken, bringing major contributions to the determination of the standard of living, the evolution of which is presented in the tables below, as follows:

- It can be seen from table 8, that, for some of the studied countries (Turkey, Iran and Egypt), in 1990, the HDI was below the threshold value of 0.500, indicating a low human development;
- since 1990, and by the year 2013, the Report shows all countries considered in the analysis, an average level of

development (HDI between 0.500-0.799), but with significant increases over the years;

- Turkey is the country at which we observe a significant increase, from 0.496 in 1980 to 0.653 in 2000 and reaches in 2013, at a value of 0.759, which indicates an average human development, however, being much closer to the high threshold of human development, at the same time reflecting the country's economic development, raising living standards and sustained efforts of the country for social and economic development.

Table 8 The HDI size for Syria and some countries for the period 1980-2013

Country	HUMAN DEVELOPMENT INDEX(HDI)									Rank 2012	Rank dif 2013/2012	Average annual increases		
	1980	1990	2000	2005	2008	2010	2011	2012	2013			1980-1990	1990-2000	2000-2013
Turkey	0.496	0.576	0.653	0.687	0.71	0.738	0.75	0.76	0.759	69	0	1.5	1.27	1.16
Iran	0.49	0.552	0.652	0.681	0.711	0.725	0.73	0.75	0.749	73	-2	1.19	1.69	1.07
Jordan	0.587	0.622	0.705	0.733	0.746	0.744	0.74	0.74	0.745	77	0	0.58	1.26	0.43
Egypt	0.452	0.546	0.621	0.645	0.667	0.678	0.68	0.68	0.682	108	-2	1.91	1.3	0.72
Siria	0.528	0.57	0.605	0.653	0.658	0.662	0.66	0.66	0.658	114	-5	0.76	0.6	0.65
compared to Turkey	0.032	-0.006	-0.05	-0.03	-0.05	-0.076	-0.1	-0.1	-0.101	45	-5	-0.74	-0.67	-0.51
Iraq	0.5	0.508	0.606	0.621	0.632	0.638	0.64	0.64	0.642	120	0	0.17	1.77	0.45
Arab States	0.492	0.551	0.611	0.644	0.664	0.675	0.68	0.68	0.682	-	-	1.14	1.05	0.85
Worldwide	0.559	0.597	0.639	0.667	0.685	0.693	0.7	0.7	0.702	-	-	0.66	0.67	0.73

Human Development Reports,

[http://hdr.undp.org/fr/content/table-2-human-development-index-trends-1980-2013\[6\]](http://hdr.undp.org/fr/content/table-2-human-development-index-trends-1980-2013[6])

- Syria is located for the entire period at a medium level of human development, in the 1980s was calculated at 0.528, end up in 1990 at 0.570, grows up in 2000 to 0.605 and reaches the end to swing around the 0.66. The rank 114 for year 2012, the row difference between 2013 and 2012 being -5. Syria presents increases for this indicator, however, far from being a high threshold in human

development, although the annual increases are 0.65% for 2000-2013;

- The Arab States, 2013 (table 9) indicates a level of human development of 0.682, being the year with the highest value, while worldwide, HDI is 0.702, levels (both Arab and world countries) lower than Iran and Turkey and Jordan, but higher than Syria and Iraq.

Table 9. The size of HDI, by component elements in Syria and some other countries for 2013

Rank 2013	Country	HDI 2013	Life hope at birth	Average years of schooling	Expected schooling years	Gross National Income/capita	HDI 2012	Rank change
			years	years	years	\$/capita		
69	Turkey	0.759	75.3	7.6	14.4	18,391	0.756	0
75	Iran	0.749	74	7.8	15.2	13,451	0.749	-2
77	Jordan	0.745	73.9	9.9	13.3	11,337	0.744	0
110	Egypt	0.682	71.2	6.4	13	10,400	0.681	-2
119	Siria	0.658	74.6	6.6	12	5,771	0.662	-4
	compared to Turkey	-0.101	-0.7	-1	-2.4	-12,620	-0.094	
120	Iraq	0.642	69.4	5.6	10.1	14,007	0.641	
	Arab States	0.682	70.2	6.3	11.8	15,817	0.681	-
	Worldwide	0.702	70.8	7.7	12.2	13,723	0.7	-

\* Human Development Reports, [http://hdr.undp.org/fr/content/table-2-human-development-index-trends-1980-2013.\[6\]](http://hdr.undp.org/fr/content/table-2-human-development-index-trends-1980-2013.[6])

Further are examined the components of the HDI, to the year 2013, from where results the following:

- at the global level, life expectancy is of 70.8

years, average years of schooling 7.7 years, those preconized are 12.2 and GNI/pers. lies at USD 13,723/pers. while for Arab countries, the same indicators indicate a hope of life



lower, 43.6 years, 6.3 years of schooling average and 11.8 years preconized, while the GNI is increased USD 18,517/pers.

- Syria, whose HDI ranks in 2013 at 0.658 level, with an exchange of rank-4, has a hope of 74.6 years increased in comparison with the average of Arab countries and world level,

but less with 0.7 years in relation to Turkey, the years of schooling have averages of 6.6 and 12 for the preconized ones, while the gross income is by 5,771/pers, having the lowest value, in comparison with the countries studied.

Table 10. Inequality-adjusted human development index, Syria and some other countries for 2013

HDI Rank 2013	Country	HDI	IHDI	dif HDI-IHDI	Dif Rank IHDI	Human Ineq. Coef.		Life hope ineq.		Education ineq.		HDI Ineq.		GINI coef.
		val	val	%		2013	%	2013	%	2014	%	2013		
69	Turkey	0.759	0.639	15.8	-3	15.6	11	0.757	14.1	0.56	21.8	0.616	40	
75	Iran	0.749	0.498	33.6	-34	32.1	12.5	0.728	37.3	0.429	46.6	0.395	38.3	
77	Jordan	0.745	0.607	18.6	-5	18.5	11.9	0.73	22.4	0.543	21.1	0.564	35.4	
110	Egypt	0.682	0.518	24	-5	22.8	13.4	0.682	40.9	0.339	14.2	0.602	30.8	
119	Siria	0.658	0.518	21.2	4	2.8	12.6	0.734	31.5	0.379	18.3	0.5	35.8	
120	Iraq	0.642	0.505	21.4	0	21.2	17.6	0.626	29.8	0.328	16.1	0.626	30.9	
	Arab States	0.682	0.512	24.9	-	24.2	17.4	0.639	38	0.334	17.3	0.629	-	
	Worldwide	0.702	0.541	22.9	-	22.8	17.3	0.647	27	0.433	24.1	0.564	-	

\* Human Development Reports, <http://hdr.undp.org/fr/content/table-2-human-development-index-trends-1980-2013>[6].

Alongside the HDI is analyzed also the IHDI, (human development index adjusted inequalities) that aims to correct the HDI, taking into account the disparities among the population. IHDI is the current level of human development (which take account of inequalities), while the HDI can be considered as a "potential" human development (or the maximum rate of IHDI) that it would be possible to achieve in the absence of any inequalities.

In other words, the data in table 10 reflect the following situation:

- the loss suffered by the human development because of inequalities is 24.1% at the global level, because it is calculated at a IHDI level of 0.541, a coefficient of human inequality of 22.8%, inequality relating to the life expectancy is 17.3% and 27% for education;
- IHDI at Turkey's level has a value of 0.639, with a loss of 21.8%, and a difference of -3 to our ranking. Inequalities are set at a rate of 11% for life expectancy and 14.1% for education. The Gini coefficient has a value of 40 in 2013;
- in Syria, the IHDI value reflects a loss of 18.3% for human development, the difference between HDI and IHDI being of 21.2. This means an inequality at the education level of 315%, and at the level of life hope of 12.6%, the human inequality coefficient being of

20.8%. At the Syria level, Gini coefficient reaches a value of 35.8;

## CONCLUSIONS

1. Syria at the level of the year, had a population of about 22 million people, of which 6 million, concentrated in the area of Damascus, from which the total active population was of 7271 thousands (2012), of which 1390 thousand in the agricultural field. The population of the rural area is located in 2013 at 9857 thousand persons, with increases for 2005-2013.
2. The hope of life to Syria was lying around 74.5 years, having the highest value in the Arab countries, as well as above the world level.
3. In terms of economy, Syria was a country with an average economic force, based on agriculture, oil, industry and tourism. Compared to many countries of the third world, Syria has a very good infrastructure for trade and transport.
4. The analysis undertaken on the Human Development Index highlight the fact that Syria is situated for the period 1980-2013 at a medium level of human development. Syria presents increase for the level of this indicator, however, far from the high threshold in human development, although the

annual increases are 0.65% for 2000-2013;

5. Syria, whose HDI ranks in 2013 at 0.658 level, with an exchange of rank of -4, has a life hope of 74.6 years, increased from the Arab countries and world level average;

6. Before the crisis, and in the latest report of year 2010, Syria, was placed third among Arab countries in achieving the Millennium development goals. Currently lies second last position of Arab countries being exceeded only by Somalia. Thus by 2010, Syria has managed to reduce the proportion of people with income less than \$ 1.25 per day in total population from 7.9% to 0.2%;

7. As pointed out, the economy and development of Syria was average, at the level of the years 2009-2012, but reports on the impact of conflict in Syria, highlight the economic development gap, both economic and social being regarded as an extraordinary period of involution, damage to this development being considered invaluable.

[10]The World Bank, 2014, Indicateurs du développement dans le monde, <http://data.worldbank.org/data-catalog/world-development-indicators>.

## REFERENCES

- [1]Abdul Rahman Ibrahim, 2015, Research on rural development in order to improve the quality of life in the Syrian Arab Republic and the Republic of Romania, Doctoral thesis, Library-UASVM Bucharest
- [2]Khalid Abu-Ismaïl, Ali Abdel-Gadir and Heba El-Laithy, 2007, Poverty and Inequality in Syria (1997-2007), Arab Development Challenges Report, Background Paper 2011/15
- [3]Central Bureau Of Statics, accessed September 2014, Syrian Arab Republic, [www.cbssyr.sy/index-EN.htm](http://www.cbssyr.sy/index-EN.htm)
- [4]Closer to Syria, august 27, 2009 THE GUARDIAN LONDON <http://www.presseurop.eu/ro/content/article/85771-tot-mai-aproape-de-siria>
- [5]Human development index (HDI Human Development Index, accessed Jan. 15, [http://ro.wikipedia.org/wiki/Indicele\\_dezvolt%C4%83rii\\_umane](http://ro.wikipedia.org/wiki/Indicele_dezvolt%C4%83rii_umane)
- [6]Human Development Reports, <http://hdr.undp.org/fr/content/table-2-human-development-index-trends-1980-2013>
- [7]Population growth, [http://www.dictsociologie.netfirms.com/\\_IndDem/IndReproducer.htm](http://www.dictsociologie.netfirms.com/_IndDem/IndReproducer.htm)
- [8]Syria, 2014, Squandering Humanity Socioeconomic Monitoring Report on Syria, UNRWA and the UNDP Country Office in Syria
- [9]Syrian Conflict Impact on Macro-economy and the Millennium Development Goals, ESCWA, SEPTEMBER 2014

## RELEVANT COSTS AND DECISION MAKING OF INVESTMENT

**Titin RULIANA, Eddy SOEGIARTO K.**

University of August 17<sup>th</sup>, 1945 Samarinda, Jl. Ir. H.Juanda No.80 Samarinda City, postcode no.1052, Phone: (0541) 761113, East Kalimantan, Indonesia, Email: titin.ruliana15@gmail.com

**Corresponding author:** titin.ruliana15@gmail.com

### **Abstract**

*The activity of running a cultivation oyster mushroom, farmers faced with the decision of several alternative fuel to generating baglog and fresh white mushrooms, which use LPG fuel or wood fuel. Thus required an appropriate decision of some of the most favorable alternative. The study was conducted at Enterprises of White Oyster Mushroom in Samarinda City, East Kalimantan, Indonesia. Data were analyzed using financial ratios to assess and calculate the revenues, expenses, and investment decisions. This research aims to: 1) Analyze and calculate a more favorable alternative between to the use of fuel than the fuel LPG compared fuel timber on white oyster mushroom cultivation in Samarinda City based on: (1) Costs and revenues; (2) Break even point (BEP); 2) Analyze and calculate investment decisions on White Oyster Mushroom cultivation in Samarinda by: (1) Payback Period; (2) Average Return On Investment (ROI); (3) Net Present Value (NPV). Results of the study of white oyster mushroom cultivation in Samarinda City showed that: the decision to use wood fuel more profitable than using LPG fuel.*

**Key words:** *alternative, decisions making, investment*

### **INTRODUCTION**

Indonesia as an agricultural country with the potential to develop the production of mushrooms, because natural resources are owned and can be used as an ingredient mushroom production. Mushroom is a plant that is often found in the wild. The Mushrooms can grow easily on a log or plants and organic waste. White oyster mushroom or known by the scientific name *Pleurotus ostreatus*, [2] is one of the wood mushrooms and cultivated widely consumed by the public. White oyster mushroom more easily cultivated. This Mushroom has a high nutritional content, the relatively higher protein and fat are relatively lower than other vegetables and mushrooms. White oyster mushroom is a commodity that can be developed to cultivated of society, increase incomes and improve nutritional status [17].

One white oyster mushroom producers in East Kalimantan is Samarinda City, Indonesia. White oyster mushroom production in Samarinda city is managed by farmers scattered in the regions and districts in the city of Samarinda. The spread of farmers are joined in the Association of Employers' White Oyster Mushroom in Samarinda city.

This association is a medium for deliberation, determine and set the selling price of white oyster mushroom (equity production of mushrooms and mushrooms price stability).

The activity of running a white oyster mushroom cultivation, farmers faced with the decision making of some of the most profitable option for business. Farmers faced with the choice of using LPG (liquid Petroleum Gas) fuel and the fuel of wood. The choice of this fuel to used to produce baglog and fresh white mushrooms. Baglog [17] is a planting medium that will be given seeds (inoculated) mushrooms. Manufacture of baglog (growing media) and white mushrooms are ready to harvest are the business activities of the Employers' Association of White Oyster Mushroom in Samarinda city.

An attempt should be able to manage their business properly, because the market still has room for white mushrooms. Thus required an appropriate decision making of some of the most favorable alternative of income and expenses. Decision-making [11] [16] is the process of choosing an alternative, how to act in an efficient method according to the situation. The process of finding and resolving organizational problems. This statement

confirms that the decision-making requires a series of actions, requires several steps. Decision-making [16] is to choose one among several alternative measures available. Decision-making is describe the process of a series of activities chosen as the settlement of certain problems.

All forms of decision-making by the management must consider all the factors that can influence decision-making, one of the factors that influence the decision making is the cost factor is called the relevant costs. Relevant costs [8] is the cost of future expected to be different or be affected by an election decision making among various alternatives. Relevant costs [5] is the cost of a future that is different for each alternative. All decisions relating to the future so that future costs is only that may be relevant to a decision. The relevant cost [7] is the estimated future costs and revenues relevant is the expected future income, which differ among alternative actions that are being considered by a manager. Costs and revenues that are relevant to decision making depends on the context of the decision and the alternatives available. In the final stage of the decision-making process, managers compare two or more series of alternative actions [7]. Costs and revenues that are relevant to the alternative of investment decisions generate costs, revenues and profits are different.

The decision making process of several alternatives [1], the management must choose the alternative most favorable to the company. To choose one of these alternatives, the management need information about costs.

Information on the costs need to be considered by every company because it is used in pricing, efficient use of resources, and even the evaluation of the most profitable product line. The amount of charge needed to monitor support various functions in the business, including decisions concerning the selection of various kinds alternatif. Management often face uncertainty in selecting the most favorable alternative. Therefore, management requires cost information that can reduce uncertainty, thereby enabling them to determine a good choice. One of the important information for

planning and decision-making is information of the cost analysis of relevant [15].

Identification of a charge is relevant or irrelevant to a decision, then the manager approach in analyzing costs should take steps according to [12] as follows:

- 1) Collect all the expenses to be incurred related to each alternative to be considered.
- 2) Elimination of costs sunk.
- 3) Elimination of expenses that do not differ among various alternatives.
- 4) Make a decision based on the remaining charge. These costs will be the relevant costs or expenses inevitable, therefore, relevant costs to consider in making decisions that will be taken.

The activity of running the business, the company's management faced with the decision making of the most profitable investment. Investments [10] that is capital expenditures or funds invested every related assets in the hope that funds will be received back in both the short and long term. Investment decision [4], it is important for management, as relates to the source of corporate funds in the amount of relatively large, relatively long investment period and a future filled with uncertainty. Therefore, the accuracy required management in making investment decisions.

Investment planning can be done through analysis of capital budgeting. Capital budgeting is the process of evaluating, selecting capital which can provide revenue for the company [13]. In the capital budgeting process there are three things that must be considered by decision-makers are the type of project, the availability of funds, and approaches to decision making. One of the barriers of capital budgeting process is the limited amount of money available. The amount of funds the company to carry out investment activities greatly influence the decisions taken as acceptable or not related to the investment proposal.

This research aims to:

- 1) Analyze and calculate a more favorable alternative between to the use of fuel than the fuel LPG compared fuel timber on white oyster mushroom cultivation in Samarinda City based on: (1) Costs and revenues; (2) Break even point (BEP);

2) Analyze and calculate investment decisions on White Oyster Mushroom cultivation in Samarinda by: (1) Payback Period; (2) Return On Investment (ROI); (3) Net Present Value (NPV).

## MATERIALS AND METHODS

This study was carried in units of oyster mushroom cultivation Samarinda city in the Association of Employers of Oyster Mushroom Samarinda. Locations were selected includes all the data of white oyster mushroom farmers enrolled in the association. The research location in Samarinda city, East Kalimantan, Indonesia. This study was conducted in June-October 2015, to obtain preliminary data through surveys, interviews from the chairman of the Employers' Association of Mushroom Samarinda. This study uses a formulation ratios as follows:

1) Alternative of fuel is more profitable between LPG fuel compared with wood fuel on white oyster mushroom cultivation in Samarinda city use:

(1) Revenue and Cost Ratio (R/C Ratio): is the ratio to see revenues per unit costs incurred, use indicator of Revenue Cost Ratio (R/C ratio) [15], namely:

$$R/C \text{ Ratio} = \frac{\text{Total Revenues}}{\text{Total Costs}}$$

Decision-making is: (a) If the  $R/C > 1$ , then the cultivation of oyster mushrooms which done profitable, because the reception is greater than the total cost. (b) If the  $R/C < 1$ , then the oyster mushroom cultivation which is done not profitable, because the reception is smaller than the total cost. (c) If the  $R/C = 1$ , then the oyster mushroom cultivation which is done is break even.

(2) Benefit and Cost Ratio (B/C ratio), is the ratio between profit or revenue generated from any cost incurred in the production process [10] namely:

$$B/C \text{ Ratio} = \frac{\text{Net Revenues}}{\text{Total Costs}}$$

Decision-making is:

(a) If  $B/C > 0$ , then the cultivation of oyster mushrooms which done profitable, because the income is greater than the total cost.

(b) If the  $B/C < 0$ , then the oyster mushroom cultivation which done not profitable, because the income is less than the total cost.

(c) If the  $B/C = 0$ , then the oyster mushroom cultivation which done is break even.

(3) Analysis of Break Even Point (BEP) within the unit and IDR [6] is the point where total revenues equals total costs, the point where the profit is equal to zero.

(4) Break Event Point (BEP) formulated [1] as follows:

$$\text{Breakeven in IDR} = \frac{\text{Total Fixed Costs}}{1 - \frac{\text{Total Fixed Costs}}{\text{Total Selling Price}}} \text{ or } \frac{\text{Total Fixed Costs}}{\text{Contribution Margin Ratio}}$$

$$\text{Breakeven in Unit} = \frac{\text{Fixed Cost}}{\text{Selling price per unit} - \text{Variable costs per unit}}$$

2) The investment decision on Cultivation White Oyster Mushroom in Samarinda city based:

(1) Payback Period, [4] analyzes the payback period is a time period / period required investors to pay back all the costs that have been incurred to invest in a project with the formula:

$$\text{Payback Period} = \frac{\text{Invested capital}}{\text{Operating Cash Flow}}$$

(2) Return On Investment (ROI) is also called accounting rate of return method, which measures the rate of profit ability (profitability) which ignored in the payback period method [4], the formula:

$$ROI = \frac{\text{Profit}}{\text{Total Costs}} \times 100 \%$$

(3) Net Present Value (NPV) that is calculates cash receipts (cash inflows) in the future for ongoing investments, calculated based on the present value [4], using the formula:

$$NPV = PV (\text{Present Value}) - I (\text{Initial investment costs})$$

Criteria for assessment of investment decisions using the NPV is an investment proposal will be accepted, if the present value of cash inflows is greater than the present value of its cash outflows.

## RESULTS AND DISCUSSIONS

### Results

#### Profit, R/C Ratio and B/C Ratio Baglog and Fresh Mushrooms

The feasibility analysis of white oyster mushroom cultivation with target of baglog sales and target of fresh oyster mushroom sales, the business analysis is made assuming the use of LPG fuel and wood fuel for the following:

Table 1. Profit, R/C Ratio and B/C Ratio Baglog and Fresh Mushrooms

Description	Unit	Alternative Fuel	
		LPG	Wood
Total Revenue :			
Baglog Revenue+ Mushrooms Revenue	IDR	41,974,134	42,025,800
Total Operating Costs	IDR	23,853,733	23,027,900
Profit Per Period	IDR	18,120,401	18,997,900
R/C ratio = Revenue Total / Total	%	1.76	1.82
B/C ratio = Net Revenue / Total Costs	%	0.76	0.82

Source: Result research.

Analysis of calculation of receipts over costs or R/C ratio in the cultivation of oyster mushrooms White with fuel use LPG or firewood obtain the number over 1. Decision-making criteria in the analysis of the acceptance of charges or R/C ratio, if the R/C ratio > 1, then the effort profitable because the reception is greater than the total cost, if the R/C ratio < 1, then the work done is not profitable, because the revenues is smaller than the total cost.

The cultivation of oyster mushrooms white which are run by farmers in Samarinda city with fuel use LPG or firewood "beneficial" because of the amount of revenue is greater than the total cost to the value of R/C ratio > 1 fuel use LPG with a value of 1.76 when using wood fuel with a value 1.82.

Analysis of the calculation of net revenue over expenses or B / C ratio in the cultivation of oyster mushrooms White with fuel use LPG or firewood obtain a value > 0. Decision-making is: If B/C > 0, then the cultivation of oyster mushrooms which done efficiently. If the B/C < 0, then the oyster mushroom cultivation which done is not efficiently.

The cultivation of white oyster mushrooms which are run by farmers in Samarinda with fuel use LPG or firewood "efficiently"

because the amount of net income is greater than the cost of the total value of B/C ratio > 0, using the fuel of LPG with a value of 0.76 and using fuel wood with a value of 0.82.

#### Analysis Break Even Point on the cultivation of White Oyster Mushrooms

Break even point analysis on the cultivation of White Oyster Mushrooms is done on the production activities by comparison calculations on fuel used.

Table 2. Break Event Point (BEP) on The Cultivation of White Oyster Mushrooms

Description	Unit	Alternative Fuel	
		LPG	Wood
BEP Baglog Production:			
= Total Cost of Production/ Sales Price Baglog	baglog	2,385	-
= IDR14,312,240 / IDR6,000	baglog	-	2,303
= IDR13,816,740 / IDR6,000			
BEP Mushroom Production:			
= IDR9,541,493 / IDR30,000	Kg	318	-
= IDR9,211,160 / IDR30,000	kg	-	307

Source: Result research.

Here is presented BEP picture for BEP production and fresh mushrooms with a comparison using LPG fuel and wood fuel.

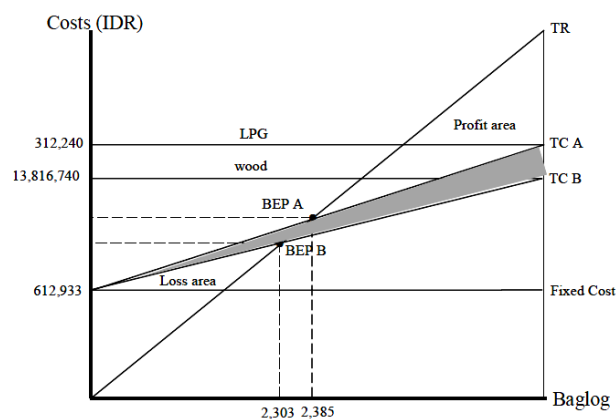

Fig.1: BEP of Baglog Production with Fuel LPG and Wood

Source: Own calculation.

Description for Figure 1:

TC A is Total Cost of baglog production using LPG fuel. TC B is Total Cost of baglog production using wood fuel. BEP A is break-even point of baglog production using LPG fuel. BEP B is break-even point of baglog production using wood fuel.

The shaded area above the point coordinates BEP indicate differences BEP of baglog production with LPG fuel and wood. The shaded area below the coordinates of BEP

shows production loss baglog with different fuels.

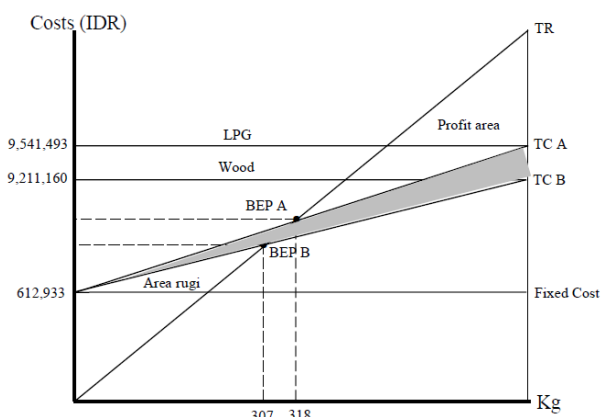

Fig.2. BEP of Mushroom Production with Fuel LPG and Wood

Source: Own calculation.

Description for Figure 2:

TC A is Total Cost of mushroom production using LPG fuel. TC B is Total Cost of mushroom production using wood fuel. BEP A is break-even point of mushroom production using LPG fuel. BEP B is break-even point of mushroom production using wood fuel.

The shaded area above the point coordinates BEP indicate differences BEP of mushroom production with LPG fuel and wood. The shaded area below the coordinates of BEP shows production loss mushroom with different fuels.

### Analysis of investment decision in Cultivation White Oyster Mushroom in Samarinda

The following of analysis of investment decisions Cultivation white oyster mushroom in Samarinda City based on aspects Payback Period, Return on Investment, and Net Present Value.

Table 3. Payback Period, and Return On Investment.

Description	Unit	Alternative Fuel	
		LPG	Wood
Payback Period: = (Investment Costs / Profits) x 1 Period = (IDR60,016,800 / IDR18,120,401) x 1 Period = (IDR57,666,800 / IDR18,997,900) x 1 Period	Period	3.32	-
	Period	-	3.04
Return On Investment: = (Profits / Total Costs) x 100% = (IDR18,120,401 / IDR23,853,733) x 100% = (IDR18,997,900 / IDR23,027,900) x 100%	%	75	-
	%	-	82

Source: Own calculation.

The time difference payback (payback period) on the white oyster mushroom cultivation is influenced by factors costs and profitability. The payback period using wood fuel more quickly than using LPG fuel.

Production period of oyster mushroom cultivation is 5 months in one period, the time is the early period of production from the breeding and preparation production until the end of the period of production namely the harvest and post-harvest.

Return On Investment using LPG fuel has rate of 75%, it is lower rate when using wood fuel by 82%.

The return on investment returns using fuel wood yield greater profits than using LPG fuel.

Table 4. Net Present Value

Year	Interest Rate **	Alternative LPG Fuel		Alternative Wood Fuel	
		Cash Flow* (IDR)	Present Value (IDR)	Cash Flow* (IDR)	Present Value (IDR)
1	0.835	18,120,401	15,100,334	8,997,900	16,812,301
2	0.783	19,620,401	15,365,652	20,497,900	16,052,862
3	0.693	21,120,401	14,637,497	21,997,900	15,245,648
4	0.613	22,620,401	13,873,516	23,497,900	14,411,702
5	0.543	24,120,401	13,091,587	24,997,900	13,567,859
Total Present Value			72,068,586		76,090,372
Original Investment			60,016,800		57,666,800
Net Present Value			12,051,786		18,423,572

Description :

\* Projections Estimated net Cash Flow

\*\* Rate of Return required is 13%.

Source: Own calculation.

Table 5. Results of Investment Analysis White Oyster Mushroom Cultivation.

No	Analysis Tools	Alternativ LPG Fuel		Alternativ Wood Fuel	
		Result	Description	Result	Description
1	R/C ratio	1.76%	Profitable	1.82%	Profitable
2	B/C ratio	0.76%	Efisien	0.82%	Efisien
3	BEP Baglog	2,385Log	Total production of 2,700 baglog	2,303Log	Total production of 2,700 baglog
4	BEP Mushrooms	318kg	The total harvest of 900 kg	307kg	The total harvest of 900 kg
5	BEP Baglog	IDR5,301	Selling price of IDR6,000	IDR5,117	Selling price of IDR6,000
6	BEP Mushrooms	IDR10,602	Selling Price IDR30,000	IDR10,235	Selling Price IDR 30,000
7	Payback Period	16.6	3.32 Period	15.2	3.04 Period
8	ROI	75%	IDR1 generate profits of 0.75	82%	IDR1 generate profits of 0.82
9	NPV	IDR 12,051,786	Estimated of cash flows 5 years	IDR 18,423,572	Estimated of cash flows 5 years

Source: Own calculation.

Estimated of cash flow (cash flow) based on the rate of return in 2015 for 5 years, the total NPV generated is greater when using wood fuel compared using LPG fuel.

### **Discussions**

#### **Profit, R/C Ratio, B/C Ratio Baglog and Fresh Mushrooms**

Investment white oyster mushroom using wood fuel have a total investment of less than the investment using LPG fuel with the difference in the cost of investment of IDR1,550,000. The difference occurs because the investment costs using LPG fuel and wood fuel. The operational costs of white oyster mushroom cultivation using wood fuel cheaper than the cost of operational use LPG fuel, difference costs of IDR825,833.

Revenue from white oyster mushroom cultivation using wood fuel is more profitable compared to income using LPG fuel with the difference in revenue amounted to IDR51,666. Gains in the period oyster mushroom cultivation using LPG fuel is less than the revenue using wood fuel with a profit margin IDR877, 499.

Advantage over the cost or called with Revenue Cost Ratio (R/C Ratio) and analysis of net income on fees or so-called Benefit and Cost Ratio (B/C Ratio) using wood fuel is greater than the use of LPG fuel of 0.06. Analysis of R/C ratio and B/C ratio of white oyster mushroom cultivation in Samarinda city has been feasible because both the value of R/C ratio > 1 and the value of R/C ratio > 0.

#### **Break Even Point of White Oyster Mushroom Cultivation**

Break even point baglog production using wood fuel at lower than breakeven levels using LPG fuel with the difference in the number of 82 baglog. Breakeven fresh mushroom production using wood fuel is also lower than the breakeven point using LPG fuel with the difference in the number of break-even point of 11 kg of income of fresh mushrooms.

#### **Payback Period, Return On Investment, and Net Present Value White Oyster Mushroom Cultivation.**

Period of time or the required period (payback period) for the return on investment of oyster mushroom using wood fuel more rapidly

compared with payback periods using LPG fuel with a difference of 0.28. Calculation Return On Investment using LPG fuel is less than the Return On Investment by using wood fuel. Return On Investment using wood fuel more profitable by a margin of 7%.

Net Present Value received by using wood fuel is greater than the Net Present Value which is accepted by the LPG fuel with the difference in acquisition cost of IDR6,371,786.

### **CONCLUSIONS**

White oyster mushroom cultivation using two fuels are LPG fuel and wood fuel. Selection alternative of the fuels have a positive value to the value of R/C ratio > 1 which is 1.76 for the R/C ratio is using LPG fuel and 1.82 for the R/C ratio is using wood fuel, while for B/C ratio has a positive value with numbers > 0 which is 0.76 for the B/C ratio is using LPG fuel and 0.82 for B/C ratio is using wood fuel.

White oyster mushroom cultivation conducted by farmers who are members of the Employers' Association of Mushroom Samarinda City produces a product that feasible to be implemented considering the revenue that tends to benefit.

This is also supported by some of the results of the analysis of the business, namely the analysis of income / receipt business, the ratio of revenues over expenses (R/C ratio), the ratio of profit over cost (B/C ratio), the analysis of Break Event Point (BEP) and investment decisions consisting of (Payback Period, Return on Investment, Net Present Value) that the business is profitable and beneficial for future periods so that it can be used as one indicator to implemented the investment.

### **REFERENCES**

- [1]Andry, 2011, Application of Analysis Relevant Costs for Accept or Reject Special Orders at PT. Adinata In Makassar, Skripsi, Faculty of Economics, Department of Accounting, University of Hasanuddin Makassar, page 1.
- [2]Editors Trubus, 2010, Mushroom Two nature; Lowlands and Highlands, Publisher Trubus. Jakarta, page 7.



- [3]Halim Abdul, Supomo Bambang, 2005, Managerial Accounting, First Edition, Yogyakarta: BPFE, page 52-53.
- [4]Halim Abdul, 2011, Financial Management of Business, Publisher Ghalia Indonesia, Bogor, page 134, 138, 141.
- [5]Hansen and Mowen, 2009, Managerial Accounting, The second book, Eighth Edition. Indonesian translation edition, Publisher Erlangga, Jakarta, page 70.
- [6]Hansen Don R., Mowen Maryanne M., 2006, Cost Accounting, Seventh Edition, Volume 2, Indonesian translation edition, Publisher Salemba Four, Jakarta, page 274.
- [7]Horngren Charles, Foster George, Datar Srikant M, 2008, Cost Accounting: A Managerial Emphasis, Volume I, Editon 12, Publisher Erlangga, Jakarta, page 446.
- [8]Mulyadi, 2001, Management Accounting: Concepts, Benefits and Engineering, Third Edition, Jakarta: Publisher Salemba Four, page 13.
- [9]Rahardi, F., Hartono Rudi, 2003, Husbandry Agribusiness, Jakarta: Penebar Swadaya, 2003, page 69.
- [10]Rosyida, Ifa, 2000, Maximizing Tools Business Feasibility Analysis, National Journal, October 5, 2007, page 11.
- [11] Salusu, J., 2003, Decision Making of Strategic For Organizations Non Profit, Publisher Grasindo, Jakarta.
- [12]Samryn, L.M., 2001, Managerial Accounting: An Introduction, Jakarta: King Grafindo Persada, page 281.
- [13]Syamsuddin Lukman, 2009, Corporate Financial Management. Jakarta: PT. Raja Grafindo Persada
- [14]Soekartawi, A., Soeharjo, JL., Dilton, JB. Hardaker, 1994, Farming Science and Research for Development of Small Farmers, (Jakarta: UI-Press, 1994).
- [15]Sugiri Slamet, 2001, Management Accounting, Revised Edition, Publisher UPP AMP YKPN, Yogyakarta.
- [16]Sugiri, Slamet, Bogat Abgus Ryono, 2004, Accounting Introduction 1, Yogyakarta: UPP AMP YKPN, page 84.
- [17]Zulfahmi Muhammad, 2011, Analysis of Cost and Revenue White Oyster Mushroom Cultivation, Model Training Centre for Rural Agriculture Non Governmental "Nusa Indah", Skripsi, Department of Agribusiness, Faculty of Science and Technology - Syarif Hidayatullah State Islamic University Jakarta, page 2.



## THE ESTIMATION OF TRENDS IN BUSINESS DEVELOPMENT IN THE REPUBLIC OF MOLDOVA

Olga SÂRBU

State Agrarian University of Moldova, 42 Mircesti Str., District Rascani, Chisinau, MD-2049, Republic of Moldova, Phone: +373 22432387, Email: o.sarbu@uasm.md

**Corresponding author:** o.sarbu@uasm.md

### **Abstract**

*For the advancement and prosperity of an economy a highly developed and innovated business environment is required. In this respect the State must issue some regulations in order to establish certain standards that would allow the opening of new opportunities for business environment, encouraging entrepreneurs. The current study highlights modern trends in business development of the Republic of Moldova and exposes some recommendations for its improvement. During the research there have been used traditional research methods of quantitative and qualitative analysis, comparative analysis and logic. Preference was given to monographic study method applying the elements of observation, selection, induction and deduction. The investigations allow us to conclude that the basic pillar for development and advancement of a State under different aspects is business environment. There are many problems and constraints that hinder business development in the Republic of Moldova, but in spite of them the positive dynamics is observed in this sector. In order to increase business efficiency there must be a joint collaboration between the government, the civil society and business owners.*

**Key words:** *businesses, business environment, competition, constraints, entrepreneurs, regulations*

### **INTRODUCTION**

One of the basic pillars for the development and advancement of a State under different aspects is the business environment. It is the driving force of the prosperity and economic growth of the country and its analysis is extremely important in order to strengthen the efforts of businesses. At the national level, strengthening the business environment is a priority. In order to overcome barriers to entrepreneurial activity, to make changes and to improve the situation a detailed and comprehensive analysis of the business climate is required. Current business environment is characterized by unreasonable financial and time costs that considerably exceed the costs in developed countries, directly influencing the national economic growth, which is based on the export of production with high added value, and discouraging loyal competition oriented towards productivity and innovation. Today the business environment is very dynamic, due to the changes that occur within it, especially under the impact of the development of science and technology. A

company may engage in normal and efficient activities only if it knows the environmental factors and the changes involved, continuously adapting to their requirements. The national activity involves a degree of uncertainty due to certain factors that can be found out with difficulty because of the presence of a series of uncontrollable elements.

In economic literature there were conducted multiple studies on the dynamic and change of business environment, highlighting its structural, branch and financial aspect.[3,6,7,9,10]

According to the National Development Strategy Moldova 2020, our country aims to improve the business environment so that by 2020 the costs and risks associated with each stage of the life cycle of the business to be lower than in the countries in the region, which is governed by free competition.[5] The impact of improving the business environment will be expressed by investments increase, exports increase, increasing number of reliable companies motivated to implement innovations, able to create quality jobs, to ensure high productivity and competitive

export-oriented production, which is supported by the advancement of Moldova in international rankings Doing Business, Global Competitiveness Index, Economic Freedom Index and Logistics Performance Index, exceeding the average level in the region. Optimizing the procedures and the time necessary for an economic operator to launch, conduct and close a business through the implementation of innovational approach to business regulation, such as digitization process of providing public services, and shifting emphasis from inspections to counseling, inspections being made on the basis of perceived risk, will significantly improve the business environment, reducing at the same time unnecessary administrative costs and thus ensuring economic development. Besides direct stimulation of business, investment and foreign trade, process optimization through innovative approaches in public service provision will create a base and a significant impetus for innovation and new jobs in the private sector.[4]

## MATERIALS AND METHODS

As theoretical support there were used publications in journals in the field and the materials from national and international conferences. In order to reveal the studied matter there were conducted researches based on the data of the National Bureau of Statistics. This statistical information was used for the quantification of the evolution of the number of enterprises by types of activities, highlighting changes in the dynamics of the number of employees in companies, the analysis of sales revenues and of the financial results of all types of enterprises as well as of small- and medium-sized enterprises from our country. In order to investigate the actual conditions and the specificity of the business environment various methods of economic analysis were used.

## RESULTS AND DISCUSSIONS

The Republic of Moldova is an agrarian-industrial country. Agriculture is one of the traditional pillars of Moldovan economy. But a study made by the World Bank shows that

agriculture in Moldova is inefficient, the sector records low productivity, investments in the field are small and the costs are exaggerated. The sector's productivity is two times lower than the European average.

World experience and the practices of forming powerful national economies show that innovative businesses are the main structural element that contributes to the economic development of the country through the implementation of innovations, promotion of technical and scientific progress and strengthening national competitiveness in the international market.

Entrepreneurs are those who boost the economy through their active and innovative behavior. Only entrepreneurial spirit of a person, namely his determination, perseverance, desire to win, initiative, responsibility, orientation towards opportunities, optimism, persistent problems solving, creativity, innovation, teamwork, management skills and many other qualities, develop a business and a respectively a sector of the country.

Based on the mentioned arguments, innovation and entrepreneurship in the agricultural sector of the Republic of Moldova remain one of the most important and current studied topics.

Being geographically close to the heart of Europe, Moldova is still far from European values, including the business environment. Although, in general lines our country has progressed over the years in ensuring favorable conditions for an incentive entrepreneurship, it remains far behind concerning the ease with which a profitable business can be developed, maintained and closed, to be able to attract entrepreneurial people from other countries to launch in our country. Moreover, we lose our national talents, some Moldovans, who decide to emigrate from the country, put in motion successful business projects later.

The Report of World Bank Group "Doing Business 2016, which draws great attention from the public and authorities, with each issue, and that exposes the totals at what has been done until now and what remains to be done in the future for business environment,

tells us once again how much Moldova has to work to be at least at a level close to Georgia, Latvia, or even Macedonia, in ensuring a favorable environment for business. [2]

According to the report, Moldova is on the 52th position of 189 countries included in the ranking according to the annual report "Doing Business 2016". Situated between the Russian Federation (51st) and Israel (53rd), our country has climbed 11 positions since the previous year. The good thing is that our country ranks 21<sup>st</sup> in chapter registering property and 26<sup>th</sup> in starting a business. And the worst position of Moldova is in chapter issuance of a building permit (170<sup>th</sup>). To get it a person must go through 27 legal procedures within a period of 276 days. Also in our country it is difficult to get electricity connection (104<sup>th</sup>), it requires seven procedures within 113 days. According to the conclusions of the World Bank, this year,

Moldova has been marked by two reforms that have positively impacted the business. Thus, our country has facilitated the process of starting a business by eliminating mandatory inspection of the territorial State Tax Inspectorate. The Republic of Moldova has improved insolvency proceedings by introducing a licensing system for insolvency administrators. The first positions in the ranking belong to Singapore, New Zealand and Denmark and the bottom of the ranking there are Eritrea, Libya and South Sudan.[2]

In order to explore the entrepreneurship at the country level, especially in Moldova, we need to identify the number of business companies that operate throughout the country in a given period of time. Thus in the following table there are the data on the number of economic agents registered in Moldova, depending on the types of activities they carry out, during the years 2009-2014 (table 1).

Table 1. Number of enterprises in Moldova by types of activities

Types of activities	Years					
	2009	2010	2011	2012	2013	2014
Total activities	44,633	46,704	48,541	50,681	52,246	53,738
Agriculture	2,325	2,384	2,464	2,538	2,715	2,956
Fishery	80	79	76	84	83	81
Mining and quarrying industry	104	115	116	112	116	115
Manufacturing industry	5,254	5,135	5,039	5,069	5,102	5,010
Electricity, gas and water	190	221	225	287	336	348
Constructions	2,595	2,614	2,686	2,788	2,770	2,923
Trade, transport and machinery repairing	18,330	19,095	19,837	20,494	20,867	20,991
Hotels and restaurants	1,311	1,424	1,516	1,667	1,711	1,745
Transports and communications	3,040	3,173	3,281	3,373	3,465	3,559
Financial activities	701	800	857	934	977	1,041
Real estate transactions	6,727	7,422	7,985	8,627	9,134	9,759
Public administration	-	-	-	14	14	14
Education	304	331	352	366	387	400
Health and social care	661	723	782	876	969	1,070
Other activities	3,011	3,188	3,325	3,452	3,600	3,726

Source: developed by the author based on NBS.

During 2009-2014 the total number of enterprises in Moldova increased from 44000 to 54000, which demonstrates the improvement of the business environment and the increase of entrepreneurship. We can see that in the given period there increased the number of enterprises that practice such activities as agriculture, from 2,300 in 2009 to 2,900 in 2014; fishery - from 80 enterprises to 81;

mining and quarrying - from 104 to 115 companies; electricity, gas and water - from 190 to 348 companies; the entities that are engaged in construction and trade, from 2,500 and respectively 183,300 in 2009 to 2,900 and respectively 21 thousand. The number of hotels and restaurants has also increased from 1.3 thousand to 1.7 thousand businesses; the entities dealing with transport and

communications and practicing financial activities from 3,000 and respectively 701 entities in 2009 to 3,600 and respectively 1,041 in 2014; the entities dealing with real estate transactions - from 6.7 thousand to 9.4 thousand in the period under review; the number of entities in the education sector and the health and social assistance sector has increased from 304 and respectively 661 businesses in 2009 to 400 and respectively 1,070 in 2014.

In 2014 Moldova 40% of the total number of enterprises are appointed in the wholesale and retail trade, repair of motor vehicles,

motorcycles, household and personal goods, followed by 17% of entities dealing with real estate transactions, 10% are in the field of manufacturing, transport and communications and mining -7% each; 5% for enterprises with agricultural activities and construction and 3% for hotels and restaurants.

According to the company size, the enterprises may be divided into 4 categories: large enterprises, medium, small and micro - enterprises. According to the territorial aspect and the size the total number of enterprises registers growth rates in the Republic of Moldova (table 2).

Table 2. The total number of businesses in the Republic of Moldova by regions by their size

Years	Enterprise's size	Total on the Republic	Chisinau Mun	North Region	Centre Region	South Region	T.A.U. Gagauzia
2009	Large	975	647	131	108	62	27
	Medium	1,589	835	305	246	134	69
	Small	8,264	5,033	1,228	1,202	545	256
	Micro	33,805	22,861	3,828	4,581	1,623	912
	Total	44,633	29,376	5,492	6,137	2,364	1,264
2010	Large	1,073	725	137	126	56	29
	Medium	1,587	856	306	233	124	68
	Small	9,132	5,542	1,365	1,337	615	273
	Micro	34,912	23,717	3,867	4,843	1,593	892
	Total	46,704	30,840	5,675	6,539	2,388	1,262
2011	Large	1,204	831	137	141	64	31
	Medium	1,502	841	269	214	115	63
	Small	9,194	5,653	1,350	1,329	585	277
	Micro	36,641	24,802	4,120	5,072	1,717	930
	Total	48,541	32,127	5,876	6,756	2,481	1,301
2012	Large	1,237	867	142	137	58	33
	Medium	1,538	897	249	233	108	51
	Small	9,570	5,890	1,410	1,378	602	290
	Micro	38,336	25,926	4,190	5,396	1,813	1,011
	Total	50,681	33,580	5,991	7,144	2,581	1,385
2013	Large	1,356	965	146	141	60	44
	Medium	1,557	902	262	236	105	52
	Small	9,874	6,037	1,432	1,476	632	297
	Micro	39,459	26,602	4,320	5,670	1,858	1,009
	Total	52,246	34,506	6,160	7,523	2,655	1,402
2014	Large	1,403	990	162	151	57	43
	Medium	1,621	964	258	240	103	56
	Small	10,099	6,133	1,464	1,570	643	289
	Micro	40,615	27,342	4,484	5,864	1,961	964
	Total	53,738	35,429	6,368	7,825	2,764	1,352

Source: developed by the author based on NBS.

During the analyzed period the biggest part of enterprises is of micro size, also we can conclude that most of the businesses are located in Chisinau municipality, followed by the Central Region, then by North, South and ATU Gagauzia. We can also see that in all

regions micro-businesses predominate, followed by small businesses, medium and the large ones are the last. Analyzing the structure of enterprises by their size in Chisinau in 2014 we can notice that most of the economic agents that operate within the capital are

micro enterprises that form 77% of the total number of enterprises, followed by 17% of businesses of small size. We can also note that medium-sized businesses and large businesses registered in Chisinau in 2014 constitute 3% each of the total number of enterprises in the region.

The SME sector plays an important role in ensuring the stability of economic development, increased mobility and adaptability of the national economy to the changing conditions of both internal and external character; it is also a diversification factor of the economy. The presence of a well developed SMEs sector in the economy is particularly important in terms of the structural reform of the economy and the increased structural unemployment which accompany this process. [8]

Small and medium enterprises sector represents about 97.4% of total enterprises. In 2014, the number of small and medium enterprises was 52,300, with 1,400 businesses (2.8%) more than in 2013. Mostly, small and medium enterprises operate in trade, constituting in 2014 about 20,500 companies, or 39.2% of small and medium enterprises. In manufacturing industry 4,800 of small and medium enterprises operated or 9.1% of all small and medium enterprises.

The competitiveness of the SME sector depends to a large extent on the implementation of innovative and creative activities. The innovation policy is currently implemented with a minimal impact on the SME sector development due to the weak cooperation contacts between public authorities that are responsible for the innovation policy, the private sector, universities as well as other factors in the Republic of Moldova. SMEs need to cover 50% of the costs associated with the innovation development. Their support structures in the innovation implementation are insufficient. The Republic of Moldova continues to face a number of issues related to the intellectual property. Intellectual protection costs and SMEs managers' insufficient awareness of the way the intellectual property system functions are the main factors that hinder its capitalization. The

ongoing free supply of the pre-diagnosis service type, which is an intellectual property audit, will enable SME managers to optimize the use of the available intellectual potential. [8]

However, the ability of SMEs to cope with the competitiveness at the European level is still limited. According to the Global Competitiveness Report 2015-2016, Moldova is at the first stage of development (there exist three of them). According to the Global Competitiveness Index 2015-2016, Moldova took place 84 (out of 140 countries), having improved its position by two points compared with the Global Competitiveness Index 2014-2015. [11]

Optimizing the procedures and the time required by an economic operator to launch, conduct and close a business through the implementation of some innovational approach in business regulation, such as digitization of the process of delivering public services, and by shifting the emphasis from inspections to counseling, the inspections being made on the basis of perceived risk will significantly improve the business environment, reducing at the same time unnecessary administrative costs and implicitly will ensure the economic development. In addition to direct stimulation of business, investment and foreign trade, the optimization process through innovative approach in public service provision will create a base and a significant impetus for innovation and new jobs in the private sector.

The main barriers for SMEs in standardization are the following: difficulties in accessing relevant information, problems with standards understanding and application, high costs of the standardization process and, as a result, limited participation in standardization activities. The available certification capacity is insufficient, which provides exporting companies with little choice and external certification services are very expensive.

The most outstanding "asset" of a company is the human resource. The other resources of the organization can be used only by means of human resource.[1]

In the period 2009-2014 the total number of employees in all types of enterprises of

Moldova registered by statistical bodies, marked a pronounced downward trend (Fig. 1). In the years 2012-2013 there was a slight annual increase in the number of employees per total enterprises as a result of positive developments attested in large enterprises. The number of employees who worked in the small and medium enterprises during the reference period was 291,700 people, constituting 56.2% of the total number of employees of enterprises.

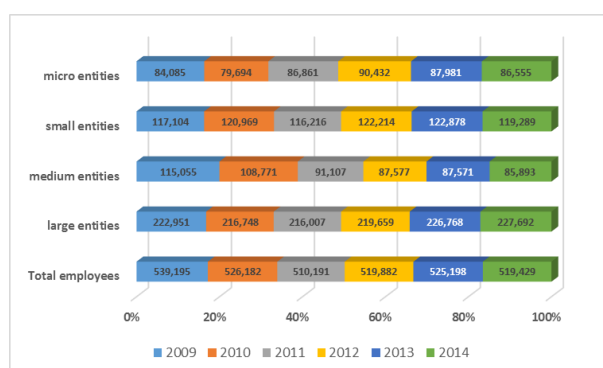

Fig. 1. Evolution of the number of employees in Moldovan enterprises, individuals  
 Source: developed by the author based on NBS

The small and medium enterprise sector in 2013 had a decrease in the number of employees compared to 2012 by 0.6 pp. 2014 was noted by lowering by 1.1% in the number of employees in all types of enterprises, only large enterprises stating a slight increase of 0.4% in the number of employees over the previous year. The number of employees on average per enterprise in 2014 was 6 people, as in the years 2012 and 2013.

The distribution of the number of employees in companies of various sizes showed that the highest share of employees is engaged in small enterprises (40.8%); 29.4% in medium-sized enterprises, 29.6% in micro enterprises - of all the employees of small and medium enterprises sector. In 2014 all types of businesses from small and medium enterprises sector have registered a decline in employment. When referring to the evolution of the number of employees by types of activities in the years 2013-2014, most enterprises have registered a decline of employees, except such sectors as: electricity, gas and water; real estate transactions and

other activities.

Between the years 2010-2014 the sales revenues of enterprises are characterized by upward trend after the decline in 2009 (Fig. 2). So, in 2014, sales revenues increased by 13% over the previous year. At the same time, small and medium enterprises sector in 2014 compared to 2013 charged 8.1% higher revenue.

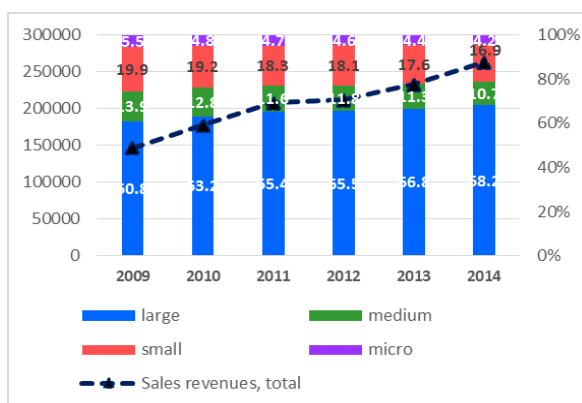

Fig. 2. The dynamics of sales revenues in Moldovan enterprises, millions MDL

The revenues in the average enterprise in 2013 amounted to 1,521 million lei or by 43 thousand lei (2.9%) more than in 2012. In 2014 the sales revenues of small and medium enterprises totaled 83,650 billion lei or 31.8% of total sales revenue in the economy. The average enterprise sales revenues in 2014 amounted to 1,599 million lei. Sales revenues in the small and medium enterprises on average per an employee in 2013 amounted to 259,400 lei or by 16 thousand lei (6.6%) more than in 2012. In 2014 sales revenues of small and medium enterprises on average per an employee reached 286,8 thousand lei, which exceeds by 27,4 thousand lei (or 9.5%) the level reached in 2013.

The economic activity of the company is completed when it obtains useful effects materialized in a number of goods and services able to satisfy social needs after having passed the stage of the exchange by currency. In terms of value the economic activity effectiveness is the difference between cash income and expenses within a given period. In 2014 the financial result before taxation (profit, loss) of the enterprises of the Republic of Moldova registered the



lowest level during the past five years, indicating values below 2009 (table 3). Since the beginning of 2012 the amount of profits before taxation has reduced considerably if compared with the period 2007-2011, except 2009. The evolutions in the last three years have coincided with changes in the tax code, which, since 2012, have canceled 0% rate on reinvested profit tax in economic activity for businesses and have established a new rate of 12% but with certain exceptions for some businesses.

Table 3. The analysis of the financial result before taxation of the enterprises of the Republic of Moldova, millions MDL

	2009	2010	2011	2012	2013	2014
The financial result before taxation (profit (+)/losses (-), total	3,666.9	13,169.8	14,427.5	4,706.6	4,131.0	3,660.8
including by the types of enterprises:						
large	1,423.7	7,712.9	9,247.3	3,622.0	2,122.5	648.0
medium	725.6	1,931.5	1,972.1	393.6	657.1	1,045.0
small	1,357.5	2,842.4	2,697.7	715.9	1,267.3	1,765.7
micro	160.1	683.0	510.4	-24.8	84.2	202.1

Source: developed by the author based on NBS

In 2014 small and medium enterprises achieved a profit before taxation increased by one billion lei compared to 2013. The largest profit was obtained from trade, while hotels and restaurants have worked in loss during the last two years.

The amount of obtained profit before taxation of small and medium enterprises in 2014 amounted to 3,0127 billion lei, or by 1,0042 billion lei (49.9%) more than in 2013. The highest profit was obtained from trade activity, while hotels and restaurants have worked in loss over the past two years. The companies operating in wholesale and retail trade are the most profitable in the country. According to the National Bureau of Statistics, small and medium enterprises active in this field had the highest sales revenue last year – 36,3 million lei, which represents 46.9% of total sales of small and medium enterprises.

The economic activity of enterprises has a

direct impact on the environment. Simultaneously, rigid regulations aimed at protecting the environment in the Republic of Moldova also require some compliance costs for doing business. Although in terms of sustainable development such costs are justified, however, there is a risk for the business environment to perceive them as excessive. In this respect, the new regulations will be focused on environmental impact assessment by ensuring that the administrative burden is distributed equitably on businesses without distorting market mechanisms and without creating preconditions for unfair competition.

Competition is a vital factor for boosting the Moldovan economy, improving the business environment and increasing its attractiveness for both launching new businesses and developing them. In order to ensure effective and fair competition, the Republic of Moldova aims to develop and implement a national program on competition and state aid by taking the European best practices to prevent, suppress and limit the anti-competitive activities of operators and public authorities. Creating new enterprises should be ensured by promoting success stories in the field of entrepreneurship, by supporting the entrepreneurial spirit.

The efforts should be focused on developing the capacity of quality infrastructure meant to facilitate exports and encourage domestic enterprises to implement advanced technologies, inclusively in agriculture, so as to ensure consumption safety. The implementation of reforms in healthcare regulation and management can improve the yield and efficiency in the Republic of Moldova.

The quality of the business environment affects investment activity and economic development through administrative and compliance costs and risks associated with opacity regulations and discretionary application of sanctions. Promoting smart regulation and a horizontal approach, with the establishment of interoperable standards in the field, will create conditions to seize all opportunities for business development.

## CONCLUSIONS

The analysis of the business environment in the Republic of Moldova allows us to conclude that lately there has been a positive dynamics of development, but the quality of the sector remains low. The business environment is very vulnerable to the political situation in the country. The most important problems and constraints that hinder business development in Moldova can be eliminated through joint efforts of the government, the civil society and business owners.

In order to increase the efficiency of business environment are required: - depolitization and accountability of government institutions through their systematic monitoring by civil society; - the eradication of corruption in the state institutions through the transparency of procedures for issuing permissive documents for business, implementing ICT solutions in providing various public services; - ensuring a transparent regulatory framework for private initiatives so that the greatest burden is not be carried in the legal business; - simplification of fiscal and customs administration, which will lead to boosting business environment; - ensuring of free and fair competition in all sectors of economy by removing barriers of entering to new markets for large and innovative companies, full and efficient functioning of the Competition Council, reducing the share of informal economy; - modernization of physical infrastructure through the efficient use of the road fund, increasing budget allocations for upgrading the local infrastructure which will stimulate both foreign and domestic private investment growth; - development of vocational education and training system by a better correlation of it with the economic realities and the demand for labor; - simplification of company restructuring and the replacement of the most unproductive employees with the best, and it would boost investment and business environment of our country; - increasing the efficiency of the system of public procurement by improving the prioritization procedures of public expenditures, removing barriers of participation in tenders and ensuring an optimal balance between price and quality by eliminating legal stipulation that offer significant advantage to bidder with the lowest

price; - improving access to finance through development of innovative financing schemes, ensuring the efficient transfer of remittances, attracting long-term credit lines from international financial institutions, credit guarantee system development and facilitating small and medium enterprises access to public procurement; - facilitating the development of small and medium enterprises in the regions by stimulating their balanced and sustainable development throughout the Republic of Moldova, ensuring of infrastructure support the development of small and medium enterprises in the regions, promoting those participation in regional and cross-border cooperation;

## REFERENCES

- [1] Condei Reta, Mocuta Dorina, Popescu Agatha, Turek Adrian, 2015, The importance of assessing human resources for the sustainable development-a study case, South West Oltenia Region. Scientific Papers. Series "Management, Economic Engineering in Agriculture and rural development", Vol. 15 Issue 1: 105-118.
- [2] Doing Business, The World Bank <http://www.doingbusiness.org/reports/global-reports/doing-business-2016>
- [3] Marinescu, E., 2013, The business environment and the current level in educational formation for Olt county agriculture. Scientific Papers. Series "Management, Economic Engineering in Agriculture and rural development", Vol. 13 Issue 3: 131-136.
- [4] National analysis, The United Nations – Moldova, 2011. [http://www.un.md/un\\_res\\_coord\\_sys/docs/Country%20Analysis%2020UN%20Moldova\\_ROM.pdf](http://www.un.md/un_res_coord_sys/docs/Country%20Analysis%2020UN%20Moldova_ROM.pdf), [Accessed on: 17th october 2015]
- [5] National Development Strategy Moldova 2020. [http://particip.gov.md/public/files/Moldova\\_2020\\_ENG1.pdf](http://particip.gov.md/public/files/Moldova_2020_ENG1.pdf) [Accessed on: 17th october 2015]
- [6] Otepka, P., Haluska, J., 2012, Entrepreneurship in rural area with real example of the agritourism facility in slovak republic. Scientific Papers. Series "Management, Economic Engineering in Agriculture and rural development", Vol. 12, Issue 3: 135-142.
- [7] Rumanovská, L., Kováčik, M., 2014, evaluation of the impact of agricultural enterprises on development of agricultural land market in Slovakia. Scientific Papers. Series "Management, Economic Engineering in Agriculture and rural development", Vol. 14 Issue 4: 243-252.
- [8] Sârbu, O., Corețchi, B. 2014, Opportunities and challenges of the development of small and medium enterprises in the agricultural sector from the Republic of Moldova. Scientific Papers. Series "Management, Economic Engineering in Agriculture and rural development", Vol. 14, Issue 2: 265-272.
- [9] Sima, E., Efficiency of resources utilization in the

sustainable development of rural entrepreneurship. Scientific Papers. Series "Management, Economic Engineering in Agriculture and rural development", Vol. 15 Issue 3: 279-282.

[10] Soare, E., David, L., Piciu, C., Dobre, I., 2014, study on the economic development of Romania's West Region. Scientific Papers. Series "Management, Economic Engineering in Agriculture and rural development", Vol. 14 Issue 4: 259-264.

[11] World Economic Forum The Global Competitiveness Report 2015-2016. <http://www.weforum.org/reports/global-competitiveness-report-2015-2016>, [Accessed on: 11 november 2015]



## THE DYNAMICS AND SPATIAL DIFFERENTIATION OF MUNICIPAL INFRASTRUCTURE IN 2004-2013 (EG. MALOPOLSKA REGION)

Lukasz SATOLA

Institute of Enterprises Economics and Management, University of Agriculture in Krakow, 21, Mickiewicza Street, 31-120 Krakow, Poland, Phone 48 12 662 43 87, Fax. 48 12 662 43 71, E-mail: lsatola@ar.krakow.pl

*Corresponding author:* lsatola@ar.krakow.pl

### *Abstract*

*The article deals with the issues of spatial diversity network of technical infrastructure in Poland. Research objects were the counties forming the Malopolska Voivodeship, as a region with rich internal diversity and specific structural problems in rural areas. The length of the water and sewage networks and the participation of residents served by these facilities infrastructure were evaluated. Comparative analysis methods and statistical measure of the dynamism and diversity were used. The analyzes carried out that there is a high spatial differences in access to basic infrastructure. Definitely more residents of Malopolska were equipped with access to water supply than sewerage. While the sewage system showed a much higher growth rate compared to the water supply. The highest values of variation coefficients were recorded for the length of the sewerage network and the percent of inhabitants equipped it.*

**Key words:** *infrastructure, municipal economy, self-government units*

### INTRODUCTION

The essence of communal economy is to achieve the objectives of a public utility and the scope designate the public tasks defined by the law [1]. Municipal services management is a vital area of operations of territorial self-government units. To the greatest degree it is realized by basic level self-governments, i.e. *gminas*, as, according to the Self-government Act, an important part of public tasks falls within the competence of that level of territorial self-government units [13]. Pursuant to art. 7 of the said Act, *gmina's* own tasks include satisfying collective needs of its inhabitants. The statutory list of *gmina's* competencies is, in this case, extensive and includes a dozen or so types of tasks.

Activities performed in the area of municipal services management mainly involve completing works related to the construction and maintenance of technical and social infrastructure facilities. Public sector's engagement in the development of components of such infrastructure and their use in the process of rendering public services has a tradition of many years [4]. At present

uninterrupted satisfaction of various needs of local communities and the entire society is so natural that it would be difficult to imagine individual communities efficiently functioning without them [8].

Municipal services management includes, in particular, the completion of public utility tasks by territorial self-government units aimed at current and uninterrupted satisfaction of collective needs of the population by rendering commonly available services [14].

The term "municipal services management" also evolved in relation to the perception of the role of the territorial self-government in Poland. Before the transformation of the political system it had been understood in a relatively narrow way and referred to the satisfaction of basic, current financial and material needs of mostly inhabitants of towns and cities. After the political system's transformation and reactivation of the territorial self-government at the level of *gminas*, the term was broadened to include any and all forms of economic activities of *gminas* both in towns and cities and in rural areas. The municipal services management came to be understood as maintaining facilities and institutions satisfying needs

related to the inhabitancy of a specific area by a population [3].

## MATERIALS AND METHODS

Statistical data acquired from the Local Data Bank Central Statistical Office (LDB CSO) accounted for source material. Nineteen local government units having the status of a county (NUTS-4), comprising the area Malopolska Region were enrolled to the analysis.

The analysis excluded 3 largest cities in the region (Krakow, Tarnow and Nowy Sacz) having the status of independent city due to their different characteristics and economic conditions. The study uses comparative method and dynamic analysis. To assess the level of volatility of equipment in infrastructural objects were also used statistical measures (eg. interval, standard deviation, variation coefficient).

The purpose of this paper is to analyze and assess transformations of basic components of the municipal infrastructure. Due to its size only selected components of the infrastructure were analyzed (those for whose condition *gmina* authorities are to the largest degree responsible). In terms of the area under analysis the paper was limited to territorial self-government units of the Malopolska Voivodeship whereas the time span under analysis was a period of 10 years (2004-2013).

## RESULTS AND DISCUSSIONS

Infrastructure is described as a set of facilities and investments creating bases for the proper functioning and development of the national economy and ensuring proper conditions for the existence of population and the possibilities of their improvement [6]. It is a basis that allows entities of the national economy to efficiently and effectively function [9], hence the purpose of its existence can be demonstrated through the prism of people and economic entities relying on it.

The importance of the infrastructure to the economic development in economic analyses

is mostly demonstrated in the context of the theory of an enterprise's location. The influence of infrastructure on the economic development is also presented from the perspective of decreasing enterprises' overheads [2]. According to such statement, a given region's attractiveness for investments depends on overheads which are inherent in order to establish a company there. Territorial units may affect decisions on location venues of enterprises first of all by equipping a given area with infrastructural facilities and then by using it as a serious asset presenting their offering to investors and convincing entrepreneurs to invest in that area [5].

Apart from a direct contribution of infrastructural components to the functioning of economic entities, also indirect influence is important which, in the economy, takes the form of externalities. Currently direct effects are repeatedly treated as more important than the direct contribution to the volume and structure of a social product which is particularly strongly stressed in new models of the economic growth. It is shown that externalities created by the infrastructure may lead to the acceleration of a long-term economic growth rate. One of such effects is the diffusion of innovations and the so-called spillover effects in the R&D sector [10].

The said analyses prove that infrastructural elements are quite important to the initiation and dynamization of the local and regional growth processes. It should also be stressed that the infrastructural facilities are a measure of the advancing civilization, to a certain degree determining the level of the economic growth of states or regions. We can see an interrelation whereby "a degree of the development of the infrastructure is related to the level of a country's economic development as a feedback. Economic development creates demand for the infrastructure's services and contributes to its development. At the same time the infrastructure whose development advances thanks to externalities creates reasons for the development of the economy's production-related sectors" [11].

In the situation of a decentralized model of the state and the resulting objectification of

the self-government, issues related to the functioning of the network and infrastructural facilities become a subject of interest of units of local administration which initiate conditions for economic activation in a given area by determining rules of the development of the policy of the infrastructural development.

An important task of the technical infrastructure is the location function which is mainly reflected in influencing the placement of a settlement network and manufacturing facilities [12]. The level of the development of basic infrastructural facilities is thus an important determinant in the process of taking location-related decisions by entrepreneurs.

Table 1. The length of the water supply system in the Malopolska Voivodeship in 2004-2013 (km/100 km<sup>2</sup>)

County	Year			
	2004	2007	2010	2013
Bochenski	92.2	104.6	114.9	130.6
Krakowski	182.8	188.4	198.3	209.8
Miechowski	126.8	127.2	129.5	137.4
Myslenicki	88.0	94.1	97.8	107.1
Proszowicki	170.9	172.8	170.4	188.1
Wielicki	243.5	263.1	271.4	278.0
Gorlicki	16.8	20.9	21.9	27.9
Limanowski	43.9	53.3	67.8	64.7
Nowosadecki	39.9	41.4	71.1	78.7
Nowotarski	39.5	37.9	29.3	25.4
Tatrzański	57.6	58.7	71.2	57.1
Chrzanowski	190.4	192.2	193.0	199.6
Olkuski	112.4	114.2	115.8	116.5
Oswiecimski	217.6	220.3	232.1	236.1
Suski	30.0	33.4	45.4	46.2
Wadowicki	147.5	157.5	166.0	173.2
Brzeski	78.6	98.7	109.6	124.4
Dabrowski	173.1	174.9	186.8	187.7
Tarnowski	76.3	81.6	86.4	94.8
Malopolska Voivodeship	102.2	107.8	116.1	121.9

Source: own elaboration based on LDB CSO.

Table 1. presents the density of the water supply system expressed as the length of the distribution network per 100 km<sup>2</sup> of the area by *counties*. During the 10 year period under the analysis (2004-2013) nearly each *county* managed to develop its water supply system with the exception of the Nowotarski and Tatrzański *Counties* where a reverse tendency was observed, nevertheless, the above can be

attributed to group or individual systems of supplying water to inhabitants in those *gminas* (the so-called water supply companies) which the municipal services management statistics do not account for.

The most dynamic increase of the water supply facilities was recorded in the Brzeski *County* and in the Nowosadecki and Bochenski *Counties*. It is worthwhile to stress that these were also the areas with the relatively lowest rate of equipping with the water supply system [7] which, in a way, forced local authorities to take efforts to reduce the existing related infrastructural gap. On the other hand, the relatively lowest rate of the increase of the network density was characteristic of the best equipped areas at the beginning of the analysis (2004), which, in consequence, meant that there was no important pressure to develop such element of the infrastructure. The above mostly referred to the western part of the region (the Olkuski, Chrzanowski and Oswiecimski *Counties*) which are, at the same time, the most industrialized areas of the voivodeship.

In the course of the process of assessing how municipal services management functions, apart from the presented rates illustrating the density of the water supply and sewerage systems, it is also important to show the population of the inhabitants who are able to rely on such services (Tables 2 and 4).

Average percentage of the inhabitants of the Malopolska region benefiting from the collective water supply rose from 71.4% in 2004 to 76.4% in 2013. The result is below the national average by approximately 14-12 percentage points. They are formed at the level of average values calculated for the population of rural municipalities in Poland (71.1% and 76.7% respectively). However, it should be stressed that the Malopolska Voivodeship is considerably internally diversified in that respect. There are *counties* where nearly all inhabitants have access to the water supply system (Chrzanowski, Olkuski and Oswiecimski *Counties*), whereas in the case of the Suski, Gorlicki and Limanowski *Counties*, the situation with access to water supply is the worst (35.4%, 36.6% and 43.8%, respectively).

Table 2. The population using the water supply system in the Malopolska Voivodeship in 2004-2013 (% of a total population)

County	Year			
	2004	2007	2010	2013
Bochenski	60.7	63.5	65.3	67.7
Krakowski	81.4	83.0	85.1	86.3
Miechowski	76.5	77.4	78.2	79.7
Myslenicki	55.6	56.9	59.2	60.9
Proszowicki	75.0	75.7	76.6	78.3
Wielicki	79.5	81.6	83.6	84.8
Gorlicki	31.9	33.2	35.7	36.6
Limanowski	36.4	39.9	42.9	43.8
Nowosadecki	32.2	36.2	43.3	44.8
Nowotarski	42.1	42.3	47.0	46.7
Tatrzański	78.6	79.7	80.5	83.8
Chrzanowski	97.5	97.6	97.6	97.6
Olkuski	96.8	96.8	96.9	96.9
Oswiecimski	95.9	96.0	96.1	96.2
Suski	26.1	29.6	33.8	35.4
Wadowicki	71.0	72.6	74.5	75.5
Brzeski	50.9	56.3	60.0	62.7
Dabrowski	85.0	85.3	85.7	86.1
Tarnowski	49.4	54.8	56.1	58.1
Malopolska Voivodeship	71.4	74.2	75.7	76.4

Source: own elaboration based on LDB CSO.

Located peripherally to the administrative center, those areas are mostly agricultural and have relatively low local entrepreneurship rates. Their economic structure is reflected in low abundance of budgets of local self-governments and, consequently, limited possibilities of financing the development of the water supply network using own funds.

Despite the fact that the highest increases of the percentage of the collective water supply system users were recorded for areas which were initially the least equipped, still the dynamics of changes was not high enough to allow the considerable advancement of *gminas* characterized by the greatest infrastructural gap. They still lag behind *gminas* which are better managed in that respect.

It is worthwhile to note that the dynamics of the increase of the percentage of the population serviced by the water supply system was lower compared to the dynamics of the growth of the length of the system itself (compare Table 1). Such discrepancy proves

that the areas with the highest population density were equipped with the water supply systems in the first place, while currently the system is developed mostly in non-urbanized areas with scattered buildings and low population density. From the perspective of the efficiency of the provision of municipal services, such situation is not advantageous both owing to high unit costs of the construction of new infrastructural systems and high expenditure related to their use, especially per single service customer.

The development of the sanitary sewerage should follow the construction of the water supply system so that conditions could be created for the protection of natural environment by treating sewage from households.

Table 3. The length of the sewerage system in the Malopolska Voivodeship in 2004-2013 (km/100 km<sup>2</sup>)

County	Year			
	2004	2007	2010	2013
Bochenski	45.9	53.5	63.5	78.1
Krakowski	42.1	62.4	84.6	106.8
Miechowski	11.0	13.2	14.3	18.5
Myslenicki	36.3	41.7	52.9	94.0
Proszowicki	16.6	23.7	34.2	52.8
Wielicki	54.6	69.4	90.7	93.6
Gorlicki	26.3	35.5	47.2	77.2
Limanowski	23.0	32.2	43.9	57.6
Nowosadecki	22.5	31.8	35.0	47.1
Nowotarski	38.8	40.9	55.1	66.9
Tatrzański	57.1	67.1	75.9	77.0
Chrzanowski	65.6	67.8	113.4	121.3
Olkuski	21.0	23.9	27.6	31.0
Oswiecimski	68.1	98.2	107.0	135.4
Suski	11.2	14.5	27.9	38.6
Wadowicki	55.9	69.6	79.0	92.1
Brzeski	23.0	53.5	46.5	60.4
Dabrowski	37.1	45.4	50.6	60.7
Tarnowski	34.8	52.5	66.2	83.0
Malopolska Voivodeship	42.7	53.9	65.9	81.5

Source: own elaboration based on LDB CSO.

Development of the water supply infrastructure leads to the increased water consumption which, in the case of the absence of the sewerage system in a given area, causes increased pollution of water mostly. However, based on many data, frequently there occurs a



considerable discrepancy between water supply and sewage systems present in individual territorial units. Even though there are many reasons for such a situation, nevertheless, the most important ones should be stressed at this point with the first one being high costs of the construction and use of the sewerage systems. The second reason is the necessity to have a given territorial unit equipped beforehand with the sewage treatment facilities of proper efficiency.

The development of the sewerage system in the Malopolska Region in 2004-2013 was intensified vis-à-vis the development of the water supply infrastructure. The above is naturally due to a diversified initial status of these components. The level of the equipment with the water supply system vis-à-vis the sewerage system is much lower (compare tables 1 and 3). *Gminas* from the Suski and Proszowicki *Counties* were the ones that developed their sewerage systems in the most dynamic manner (at the end of the period the density rate was in such case more than two times higher than in 2004). In the other seven *counties* the length of the sewerage system per area unit in the period under analysis (10 years) increased at the rate between 100-200%. In this case, just like in the case of the water supply system, high rates of the dynamics resulted from a low base back in 2004. It is worthwhile to stress that even despite a high initial level of the sewerage system infrastructure, it was regularly developed in the entire area of the region. The high dynamics of the system's development in a few cases contributed to the level of the density of the sewerage system in 2014 exceeding the level of the density of the water supply system (e.g. Gorlicki, Nowotarski and Tatrzański *Counties*.)

Definitely fewer inhabitants of the Malopolska Region have access to the sewerage system than to the water supply system. The differences in individual *counties* range from a few to 51.7 percentage points (in the Miechowski County).

With regard to the rate of the equipment of the population using the sewerage system, the following interrelation was observed: the higher the speed of its increase, the lower the

initial percentage of the inhabitants whose households were serviced by the collective sewerage treatment systems facilities (eg. Suski and Limanowski Counties with respectively 1.776 and 1.691 dynamics rates).

Table 4. The population using the sewerage system in the Malopolska Voivodeship in 2004-2013 (% of the total population)

County	Year			
	2004	2007	2010	2013
Bochenski	37.7	40.9	44.7	48.8
Krakowski	25.7	30.4	34.3	40.2
Miechowski	22.9	23.6	25.8	28.0
Myslenicki	26.9	29.2	34.0	42.7
Proszowicki	19.9	21.4	23.1	27.7
Wielicki	29.3	33.0	37.4	41.8
Gorlicki	34.3	38.0	41.2	47.6
Limanowski	17.5	20.2	23.6	29.6
Nowosadecki	19.4	24.2	25.8	29.7
Nowotarski	39.4	42.0	46.7	50.6
Tatrzański	71.4	74.0	74.9	82.0
Chrzanowski	52.6	53.2	62.1	66.3
Olkuski	46.4	47.8	48.1	49.6
Oswiecimski	49.3	53.1	54.3	57.8
Suski	15.6	19.1	25.1	27.7
Wadowicki	36.1	38.8	41.3	42.9
Brzeski	20.7	28.3	29.6	31.9
Dabrowski	31.4	33.7	36.1	39.6
Tarnowski	19.6	25.6	29.6	35.6
Malopolska Voivodeship	47.6	50.1	52.7	56.0

Source: own elaboration based on LDB CSO.

The Suski *County* was characterized by the highest dynamics of the share of the population using the sewerage system infrastructure, however, it should be added that in 2004 only 15.6% of its inhabitants discharged sewage to municipal sewage facilities, which was the lowest result recorded among all 19 Malopolska *counties*. The rate of the percentage of the sewerage system users was quite diversified both in terms of space (*counties*) and time (in individual years). The calculated values of standard deviations and variation coefficients were recorded in such case only for [units with] top scores. The above evidences that the region's territory is considerably diversified in such regard. Despite considerable progress in that area made by less equipped *gminas*, still

many years will have to pass and much investment expenditure will be required in order for them to reach the same level as that recorded in the case of the largest cities in the region.

## CONCLUSIONS

Changes in the level of the infrastructural equipment are, as a rule, a result of the development or modernization of the facilities and the system rendering specific public services. Increased access to individual components of the infrastructure leads to better satisfaction of the inhabitants in the area of their living conditions. In this way contributing to their improved living standards. Technical infrastructure being a basis for the provision of services in the area of the municipal services management must be subject to ongoing transformations adjusting its level to current standards.

In 2004–2013 in the Malopolska Voivodeship changes occurred affecting basic infrastructural systems which were not uniform. The increase of the length of the sewerage system was definitely faster as compared to the increase of the length of the water supply system which can be logically justified with differences in the initial density of both systems. Growth rate of the sewage network was particularly high in the period 2010–2013, while the water supply network dynamics explicitly slowed. However, an unquestionable majority of the inhabitants already has access to the water supply system, yet there are also areas where only every third inhabitant is the system user. It should be stressed that despite the progressing development of the water supply system, water consumption in households declined.

Despite more dynamic development of the sewerage system over the past 10 years, the level of the equipment of the area with such infrastructural component is still unsatisfactory. Only in four *counties* more than half of their inhabitants have access to the sewerage system. In seven others the respective rate is between 40–50%. With regard to the low level of the equipment with the sewerage treatment facilities, the above is

mostly true in the case of rural areas predominantly engaged in agriculture.

## ACKNOWLEDGMENTS

This paper was supported by the project nr DS-3105/KZiMA/2015 co-funded from the University of Agriculture in Krakow.

## REFERENCES

- [1] Banasiński, C., Kulesza, M., Szafranski, D., 1997, Ustawa o gospodarce komunalnej. Komentarz i przepisy towarzyszące. Wyd. ABC. Warszawa.
- [2] Biehl, D., 1986, The contributions of infrastructure to regional development. Office for Official Publications. Luxembourg.
- [3] Byjoch, K., Redel, S., 2000, Prawo gospodarki komunalnej. Wydawnictwo Prawnicze PWN. Warszawa
- [4] Cenkier, A., 2011, Partnerstwo publiczno-prywatne jako metoda wykonywania zadań publicznych. Wyd. SGH. Warszawa.
- [5] Egger, H., Falkinger, J., 2006, The role of public infrastructure and subsidies for firm location and international outsourcing. *European Economic Review*. 50 (8): 1993–2015.
- [6] Goleń, M., (Ed.) 2011, *Ekonomika gospodarki ściekowej na wsi*. Wyd. SGH. Warszawa.
- [7] Górz, B., Kurek, W., 1998, Variations in technical infrastructure and private economic activity in the rural areas of Southern Poland. *GeoJournal*. 46 (3):231–242.
- [8] Jastrzębska, M., 2012, *Finanse Jednostek Samorządu Terytorialnego*. Wyd. Wolters Kluwer Business.
- [9] Kozłowski, W., 2012, *Zarządzanie gminnymi inwestycjami infrastrukturalnymi*. Wyd. Difin. Warszawa.
- [10] Rosik, P., 2006, *Transport Infrastructure. Public Capital and Regional Policy – Review of Studies* [In:] *Shaping EU Regional Policy: Economic, Social and Political Pressures*. University of Leuven. Leuven.
- [11] Sadowy, M., 1995, *Elementy teorii i polityki rozwoju infrastruktury* [In:] *Gospodarka miejska – Część II. Wybrane zagadnienia gospodarki samorządu terytorialnego*. Dźbik E. (Ed.). Wyd. SGH. Warszawa.
- [12] Sadowy, M., 2006, *Zarządzanie funkcjonowaniem i rozwojem infrastruktury komunalnej* [In:] *Zarządzanie gospodarką i finansami gminy*. Sochacka-Krysiak, H. (Ed.). Wyd. SGH. Warszawa.
- [13] Ustawa z dnia 8. marca 1990 r. o samorządzie gminnym. Dz. U. z 2015 nr 0 poz. 1515.
- [14] Ustawa z dnia 20. grudnia 1996 r. o gospodarce komunalnej. Dz. U. z 2011r. Nr 45. poz. 236.

## ARNICA MONTANA L. AS A MEDICINAL CROP SPECIES

Camelia SAVA SAND

Lucian Blaga University from Sibiu, Faculty of Agricultural Sciences, Food Engineering and Environment Protection, 5-7 Dr. Ioan Ratiu, Sibiu, Sibiu County, Romania  
Email: camelia.sand@yahoo.com

*Corresponding author:* camelia.sand@yahoo.com

### Abstract

*The increased demands on the market for pharmaceutical plants from the wild put a high pressure for their future conservation and therefore they need protection. Thus, species such as Arnica montana L well known for their medicinal effects in a range of human diseases became for long time a target for being collected from the wild. Still, since 1977 the species is declared as nature monument and later on it is protected under the current legislative framework for nature protection. However the transfer of the plant into the crop field my further support the access to this genetic resource without any harm on the wild species. The scope of this article is to analyse if Arnica montana may change the profile of volatile oil if it is transferred from the wild into the crop field. Based on morphometry and biochemical analysis it can be considered that arnica may become a medicinal crop plant as no changes in their volatile oil composition was observed.*

**Key words:** *Arnica montana, crops, field cultivation, pharmaceuticals, Romania*

### INTRODUCTION

The drug market is fast heading toward the replacement of common drugs of chemical synthesis with those of natural origin and in particular derived from plants. But it is necessary to pay special attention to the origin of plant extracts especially when the species are to become endangered and therefore new conservation measures should be in place. Thus, *Arnica montana* L., a species quite common in Romania until recent years they have been recognized that it was a drastic reduction in their population [4, 10, 15, 18, 19, 20, 23, 24]. As a consequence this species was included in Annex 5 of the Governmental Emergency Ordinance GEO 57/2007 [1]. Therefore in order to cover the current market demands it is necessary to establish in vitro micropropagation protocols [13, 16, 25] and specialized farms for medicinal crops, especially in areas where climatic conditions are most favourable to the species, in our case the mountain region.

Arnica is a herbaceous plant that belongs to the Asteraceae family, that is particularly prevalent in sub-alpine region, through hayfields and wet pastures throughout the Carpathians and recognized as a acid-

neutrophil species [3]. The rhizome is cylindrical, thick, from which fibrous roots are forming. The stems is erect, cylindrical, simple, high up to 60 cm rarely branched, with short hairs, finished with an inflorescence. Yellow flowers are arranged in a head, ligulae are marginal, and tube shape are central [3].

The flowers are rich in active pharmaceutical compounds such as volatile oil, arnidiol, arnisterina, faradiol, astragalin and carotenoids; the roots contain, in addition to volatile oil and caffeic acid, fumaric acid and succinic also inulin and thymol, etc. The most important feature, in terms of therapeutic compounds are Sesquiterpene lactones (especially helenalin) [17].

Flowers extracts are used in human and veterinary medicine, including homeopathy [6]. The active principles have antiseptic (e.g. treatment of burn), inflammatory (e.g. rheumatic, anti-hemorrhoidal) anti-sclerotic, choleric, cholagogue, diuretic, blood pressure regulator, etc [24]. Although some studies have shown a potential for toxic side effects even at high doses of alcohol extraction, a recent study has disproved these claims, however recommending the use of Arnica preparations based on only for external

use [3] Besides flowers of pharmaceutical interest are roots and rhizomes [8, 14, 15].

The scope of this research is to study the behaviour of arnica as a crop plant during the first year after transplanting from the wild in the field and to identify valuable genotypes. Peculiarities such as the optimum momentum for transplanting or factors controlling the growth and multiplication were studied as important for developing the agricultural technology in order to obtain plants as well as seeds. Also, chemical analysis of volatile oil extracts originating from flowers were realized in order to reveal if the cultivation of the species may affect its pharmaceutical qualities.

## MATERIALS AND METHODS

**Plant material** consisted of *Arnica montana* L. seeds harvested from native plants from the wild namely Valea Frumoasei (Alba) genotypes G1 - G3 and Cindrel Mountains (Sibiu) genotypes G4 - G6 (Figs. 1 and 2). The seedlings were obtained in heated seedbeds, and in the phase of 1-2 true leaves, they have been transferred in pots under controlled conditions [3, 7].

**Planting method** The experimental plots consists in row at a distance of 1m between rows and 0.5 m between seedling into the row. The working scheme consist in 3 variants (accounting for propagation method) located in three repetitions. Each variant included 10 plants.

**Plant extracts** have been obtained from dried flowers after harvesting [22]. It was prepared a mixture of ligulate and tubular flowers, dolls predominantly bulky. This extract was submitted to volatile oil analysis.

**The extraction method of volatile oil** Only Arnica flowers have been used following the method of Bergonzi et al. 2005 [2, 21, 22]. Upon harvesting flowers were washed under tap water for 3 min and dry up to constant weight, chopped and submitted to volatile oil extraction. 50 g of dry plant material of Arnica were introduced to the distilling flask of 2 l with 700 ml of distilled water. Subsequently the flask was adapted to a distillation device. The oil collecting tube,

with an graduated increment of 0.01 ml, and the bottom of the water separator was filled with a deviation above the separator, which is then closed with a cork traversed by a channel. It was further allowed the free water flow into the refrigerator and the balloon was heated to boiling distilled at moderate speed. After completion of the distillation the vapours were allowed to run for a few minutes in order to wash traces of oil. After about 30 minutes the oil layer tube slowly descended gradually by opening the drain valve. The extraction duration was 4-5 hours /sample. At the end obtained volatile oil was measured in ml/100 g plant tissue. The resulting oil was supplemented with 1 ml benzene. The fraction oil with benzene was trapped in glass vials carefully for each rhizomes sample individually. The glass bottle included a small amount of anhydrous sodium sulphate to remove water traces. The volatile oil was extracted from the glass vial, benzene has evaporated and the oil was kept in a vial to be kept in optimal conditions until analysis without changing its properties.

**The identification of compounds of pharmaceutical interest** was performed using standard thin-layer chromatography (TLC) and gas-chromatography [9, 12]. During the determination of the temperature of the chromatographic column must remain constant, or, if necessary, to increase by a given program.

## RESULTS AND DISCUSSIONS

### *Arnica montana* as a crop plant

*Arnica montana* L. proved to maintain in the crop filed the same characteristics like in the wild. Thus the species developed well rhizomes and during the spring time emerge a rosette of oval leaves. In their midst emerge a cylindrical hairy stem, which ends in the inflorescence of 4-8 cm in diameter [11]. On the stem, 1-2 pairs of opposite leaves appears, smaller than the basilar. The stem is slightly branched, with opposite branches and ending each with one flower. The flowers are yellow-orange, sitting surrounded by bracts capital, often reddish-brown, glandular hair cells. At the edge the capitulated female flowers are in

the shape of ligule, ending with three teeth and are found only in the centre of blossom tubular flowers hermaphrodite. Both the flowers and the tubular ligule are surrounded by a papus of 8 mm long, made of stiff hairs, slightly toothed. It blooms in June up to August.



Photo 1 *Arnica montana* L.– The Cindrel Massive



Photo 2. *Arnica montana* L. – The Valea Frumoasei - 2007

Regarding the morphometry of the plant it was found that the rhizome is thick, horizontal, with numerous fibrous roots, less branched.

The stem is erect, cylindrical, 15-55 cm high, solitary, occasionally single or 1-2 branches, one anthodium, often up to 5 anthodia with a basal rosette leaves and one, often two pairs leaf stems, opposite, small bottom (rarely up under anthodium) glandulous often reddish brown.

Basal leaves are elliptical, rarely wider or lanceolate, sessile, slowly attenuated obtuse, whole or very small and spaced denticulate, hairless or rough because short hairs, with glandular cells (Table 1).

**Chemical analyses** The flowers (*Arnicae flos*) have to be harvested in June July at the beginning of flowering by cutting or tearing

inflorescences. Drying is done in the shadows in a thin layer. The artificial drying is realized at 40-50 °C [5, 6, 9].

Table. 1. Morphometry results on *Arnica montana* L. in the experimental field

Genotype	Plant no.	Rhizome lenght (cm)	Stem height (cm)	Leaves no
G1	6	5.5	45.2	6
G2	4	6.7	46.3	6
G3	9	5.3	44.8	6
G4	7	7.2	55.8	8
G5	7	7.6	58.2	10
G6	6	6.9	55.9	8

For these analyses were used dried flowers after harvesting. It was prepared a mixture of ligule and tubular flowers, dolls predominantly bulky.

The extract was performed at the end of the growing season, the volatile oil content in the organs generative (flower). The volatile oil extracted from all samples of yellow-orange inflorescences, semi-solid consistency, smells as fragrance.

This extract was reported in ml per 100 g vegetable oil. Based on these results the flowers of species *Arnica montana* L. may contain volatile oil between 0.2 and 3.8 g /100 dry plant.

Qualitative analysis performed with gas - chromatography aimed to elucidate the composition and among these compounds we are mentioning the following: terpenes, fatty acids and alcohols triterpenes (Fig.1.).

It can be concluded that there was thus identified the following structure of the essential oil arnica composition with no change between cultivated and wild plants:

- monoterpenes oxygenated compounds: thymol, moldo-hydroquinone dimethyl ether, thymol and methyl ether thymil iso-butyrate.

- compounds other m-ethyl phenol, fatty acids representing almost 50% of the composition, including palmitic acid, linoleic, myristic acid, caffeic acid and angelic; triterpene alcohols of which have been identified arnidol, faradiol, carnaubilic alcohol;

- lactone sesqui-terpenes belonging to the class of pseudo-guaianolidic: arnisterine, astragaline, izo-quvereitine;

- carotenoids: xanthophyll, xanthophyll-epoxy, zeaxanthine.

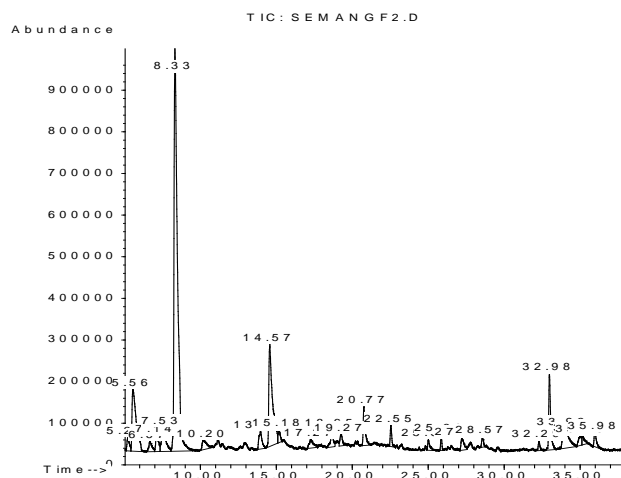

Fig. 1. Gas-chromatography diagram representing the volatile oil components in dry flowers of *Arnica montana* L. which is the same in control and cultivate plants

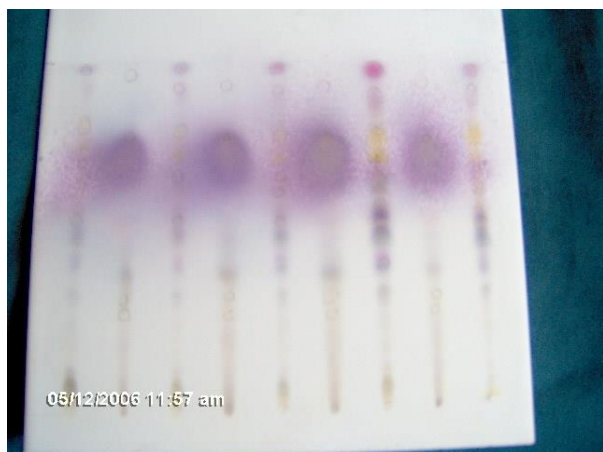

Fig.2. Thin -layer Chromatography for volatile oil extracts in *Arnica montana* L. The control is the first in the left of the series of extracts on the figure.

Thin-layer chromatography and gas - chromatography allowed the identification and quantification of all volatile oil compounds in arnica for comparing them with the control plants from the wild (fig 4). Thus it can be mentioned: mono-terpenes oxygenated compounds thymol 12%, dimethyl ether of hydroquinone 15.7%, the ether of methyl-thymol and thymol -iso-butyrate 11.3% in similar concentrations and proportions both in the wild and as a crop plant [17, 21, 22, 26, 27].

## CONCLUSIONS

The transfer from the wild into the crop field of *Arnica montana* proves to not alters the composition in volatile oil extracts in the dried flowers. The Arnica plants cultivated in the crop filed proved to maintain their botanical characteristics as well no change was identified between the control from the mountain and the cultivated plants. As a consequence the final conclusion of this study is that *Arnica montana* may be transferred into the crop field, treated as a crop plant without any negative effect on the composition of volatile oils.

## REFERENCES

- [1]Antofie, M.M., 2012, Conservarea biodiversității - considerații politice și legislative, Ed. Universității Lucian Blaga din Sibiu 275 p.
- [2]Bergonzi, M.C., et al., 2005, Evaluation of skin permeability of sesquiterpenes of an innovative supercritical carbon dioxide Arnica extract by HPLC/DAD/MS. *Pharmazie*. 60(1):36-8.
- [3]Biroul de Presa al Ministerului Agriculturii, Padurilor si Dezv. Rurale, 2004, Comunicat din data de 12.5.2004.
- [4]Bobit, D., Sand Camelia, Drumea, V., 2002, Rezultatele cercetarilor privind identificarea genotipurilor valoroase la specia *Angelica archangelica* L., pp. 200 - 209, *Lucrarile Conferintei cu Participare Internationala Studii, Procese si Tehnologii Agro-Alimentare*, Ed. Universitatii Lucian Blaga din Sibiu, Vol. I., 2002
- [5]Bown, D., 2001, *Herbal: the essential guide to herbs for living*. Pavilion, London.
- [6]Butiuc-Keul, A. L., Suteu, A., Keul, M., Deliu, C., 2002, The role of natural extracts on the in vitro multiplication of *Arnica montana*. *Contrib Bot, Cluj-Napoca*, 37, 183-190
- [7]Coroiu I, 2005, Cartarea speciilor protejate si rare din Muntii Biharia, Batrana, Ariesului, Metaliferi, Trascau si Muntele Mare, Grant CNCIS, *Revista de Politica stiintei si scientometrie*, Numar special 2005.
- [8]Doring, G., 2001, *Wolfskräfte-Arnika ist die Arzneipflanze des Jahres 2001*; *Frankfurter Rundschau*
- [9]Douglas, J. A., Smallfield, B. M., Burgess, E. J., Perry, N. B., Anderson, R. E., Douglas, M. H., Glennie, V. L., 2004, Sesquiterpene lactones in *Arnica montana*: a rapid analytical method and the effects of flower maturity and simulated mechanical harvesting on quality and yield. *Planta medica*, 70(2), 166-170
- [10]Ellenberger, A., 1998, (June), Assuming responsibility for a protected plant: WELEDA's endeavour to secure the firm's supply of *Arnica montana*. In *Medicinal plant trade in Europe*:



- conservation and supply: proceedings of the first international symposium on the conservation of medicinal plants in trade in Europe, pp. 22-23
- [11]Fisher, P., 2003, Arnica and induction. Homeopathy, 92(4):175-176.
- [12]Istudor, V., 2001, Farmacognozie, Fitochimie, Fitoterapie, Ed. Medicala, Bucuresti
- [13]Kaliniak, P.P., et al., 1999, Arnica montana and Arnica foliosa: in vitro culture and production of secondary metabolites, Proceedings of the XVIth International Botanical Congress, Hamburg.
- [14]Klass, C.A., et al., 1999, Studies on the anti-inflammatory activity of phytopharmaceuticals prepared from Arnica flowers. Planta Med. 6, 8(5):385-91.
- [15]Lange, D., 1998, Europe's medicinal and aromatic plants: their use, trade and conservation. TRAFFIC International, UK, Cambridge.
- [16]Le, C.L., 1998, In vitro clonal multiplication of Arnica montana L. ISHA Acta Horticulturae 457, Proceedings of the Symposium on plant biotechnology as a tool for the exploitation of the mountain lands.
- [17]Merfort, I., 2002, Review of the analytical techniques for sesquiterpenes and sesquiterpene lactones. J. Chromatogr A., 967(1):115-30.
- [18]Michler, B., Reif, A., 2001, Ecology, value and sustainable use of medicinal plants in the Apuseni Mountains: The case study of Arnica Montana, Buletinul USAMV Cluj Napoca, 55-56.
- [19] Parvu, C., 2002, Enciclopedia plantelor, vol. 1, Ed. Enciclopedica, Bucuresti.
- [20]Parvu, C., 1997, Universul plantelor, Ed. Enciclopedica, Bucuresti.
- [21]Pop, M. R., Sand Camelia, Barbu C.H., 2008, Studies regarding quality analysis of oil extracted of Arnica montana L. species, Cercetări științifice, Seria a XII-a, Horticultură / Inginerie Genetică, Editura Agroprint, Timișoara
- [22]Pop, M. R., Sand Camelia, Barbu, C.H., 2008, Determination of genetic variability and polymorphism for some families to Gentiana lutea L. species by RAPD, Buletinul Universității de Științe Agricole și Medicină Veterinară, Cluj-Napoca, Seria Agricultură, Vol. 65 (1-2)
- [23]Rotar, I. 2005, Cercetari privind pajistile naturale din Muntii Apuseni (zona Garda Ghetari) in vederea elaborarii unui sistem de agricultura ecologica, Grant CNCISIS, Revista de Politica stiintei si scientometrie.
- [24] Rotar, I., 2005, Conservarea plantelor medicinale in Europa de Est: Arnica montana – Romania, grant 007.01.
- [25]Sand, C., Barbu, C.H., Pop, M.R., 2004, Posibilitati de multiplicare in vitro a plantelor din specia Arnica montana L si de cultivare in teren, Acta Universitatis Cibiniensis – Seria Agricola, 1.
- [26]Smalfield, B.M., et al., 2002, Investigations towards the production of Arnica Montana in New Zealand, Proceedings of the XXVIth International Horticultural Congress, Toronto, Canada.
- [27] Tekko, I. A., Bonner, M. C., Williams, A. C., 2003, Transdermal delivery of bioactive agents from Arnica Montana, J. Pharm. Pharmacol. 55, 28-31.





## THE NON-AGRICULTURAL ECONOMIC ACTIVITY IN THE CONTEXT OF INCREASING THE COMPETITIVE BUSINESS ENVIRONMENT IN THE ROMANIAN RURAL AREA

Elena SIMA

Institute of Agricultural Economics, INCE, Romanian Academy, 13, Calea 13 Septembrie, District 5, Bucharest, Phone/Fax:021/3182411, E-mail: elena.sima2008@yahoo.com

*Corresponding author:* elena.sima2008@yahoo.com

### *Abstract*

*The paper makes an inventory of the rural non-agricultural activities, which can be classified into two categories depending on the time allocated to the respective activities: independent ones, those that are practiced in exclusivity, using the entire working time, and the complementary ones, those that are carried out to complete the available working time, by those involved in agriculture. To increase the relevance of the analysis, the paper attempts to quantify the most important methods for increasing the rural business environment competitiveness on the basis of documentation, analysis and processing of statistical data. In general, no rural development program can be conceived in the absence of the essential role played by agriculture, but the rural economy is more developed and more dynamic if it has a more diverse structure, with a higher share of non-agricultural economy.*

**Key words:** competitiveness, non-agricultural activities, rural business, rural development

### INTRODUCTION

In the sector of agriculture, forestry and food, competitiveness increase leads to performance improvement, revitalization of the rural areas and the creation of new jobs; this aspect was mentioned in paragraph 1 “The development challenges” of the Partnership Agreement, which is the national document that describes the way in which Romania has in view to use the European Union funds in order to reach the goals of the Common Agricultural Policy in the period 2014-2020. [1]

In order to promote labour force employment in the rural area, the European Commission has proposed a series of measures to stimulate the economic activities in the countryside and to encourage the local development initiatives through support to projects targeting the establishment of micro-enterprises and consolidation of local action groups.

The business environment development in the rural area, according to the principle of activity field prioritization, contributes to:

- diversification of agricultural and non-agricultural activities in the rural area;
- job creation;
- increase of rural population's incomes;

-narrowing the disparities between the rural and the urban areas;

-facilitating the supply and utilization of renewable energy sources, of by-products, of wastes, residuum and other non-food raw materials for bio-economy purposes;

-fostering the maintenance and development of traditional activities. [6]

Thus, the diversification of rural activities in the rural area contributes to the creation of new alternative or additional income sources for the rural population, as the main possibility to increase the utilization of available time in the rural areas. The non-agricultural economy consists of extractive and processing industry, food and light industry, wood and forest products harvesting and processing, cottage industry, agro-tourism activities and services. [4]

Given the potentials and rural environment diversity, most business ideas are based on a structure that has a high diversification degree (requires smaller or larger investment, depending on the nature and work extent). [3]

By diversification we understand any income gain activity that does not depend on any agricultural work, yet it is connected to the farm. This refers, among others, to: agro-

processing, wood processing, aquaculture, energy production from renewable sources for the market, contracts for hiring working equipment, tourism, housing and other leisure activities, craftsmanship. [2]

By the diversification of the farm activity, an equilibrium could be reached between the agricultural activity, other forms of rural development and the preservation of natural resources, while the multifunctional role of farmers could acquire other dimensions – that of food or non-food producers, suppliers of services, rural entrepreneurs. [9]

In a modern economy, starting from the principle that labour movement is much more expensive than the movement of materials and products, most countries modified their policy with regard to enterprises location, and they moved the enterprises towards the labour force and not inversely. The displacement of labour implies massive investments and complex social phenomena. On the contrary, the location of small and medium-sized companies in the rural area means economy diversification, labour employment, increase of the economic power of rural localities and their overall development. [8]

Long-term sustainability can be reached by encouraging the establishment or development of profitable non-farm business and improving the quality of human resources in rural areas/countryside. Investing in human capital and social infrastructure represents the most important concern for the great entrepreneurs in Romania, aiming to use the complete potential of women and men. [11]

## MATERIALS AND METHODS

In recent years, the European Union has been supporting entrepreneurship, becoming untenable to formulate policies for economic development without taking into account the improvement of the business environment by removing barriers or direct actions for supporting entrepreneurship. The purpose of this research is to quantify the current situation of the development level of business environment in Romanian rural area.

The whole volume of information present in this article was obtained through scientific

research specific methods, while respecting all its stages from the methodological point of view: identification of the investigated problem, research framework delimitation, information collection, data processing, analysis and interpretation and drawing up the conclusions.

An important place for the purpose of the paper is held by office research, which consisted of the identification of other studies and articles that addressed the same theme, as well as of the processing of certain statistical data. As a result, the information sources used can be classified into governmental sources (statistical, ministerial and from research institutes) and non-governmental sources (independent publications).

The statistical data were completed with information from the articles and studies published in specialty journals as well as in Government documents.

## RESULTS AND DISCUSSIONS

Business environment development in the Romanian countryside, by contributing to the preservation and development of traditional activities, also leads to the diminution of rural-urban disparities.

In Romania, at present, most rural people are working in agriculture, forestry and fisheries. In the year 2011, both the activity rate (62.6%) and the employment rate (58.8%) of the population in the rural area (calculated in relation to the working-age population: 15-64 years) had lower values compared to previous years (Figure 1).

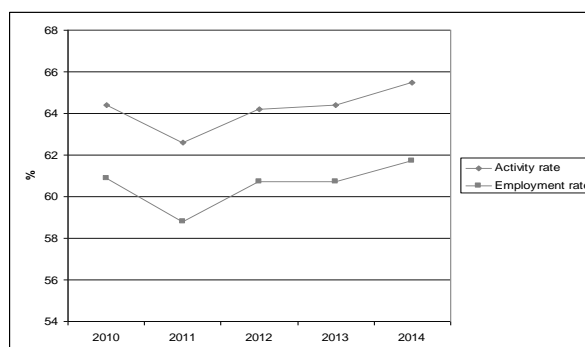

Fig. 1. Activity rate and employment rate in the rural area, in the period 2010-2014

The creation of new enterprises had been proceeding well up to 2008 (Table 1) but stalled during the recession and has yet to fully recover.

Table 1. Number of active economic and social operators of national economy, in the period 2004-2008

Type of operators	2004	2005	2006	2007	2008
Enterprises	410,383	450,666	480,910	520,228	555,128
Agricultural holdings	11,794	12,510	13,347	14,221	14,407
Non-agricultural enterprises*	394,519	433,030	461,812	499,857	533,976
Private entrepreneurs	410,642	381,468	324,700	330,438	306,879
Total	901,414	928,225	911,662	957,524	1,002,879

\*Enterprises from industry, construction, trade and other services

Source: Romania's Statistical Yearbook, 2004-2012 data series, NIS.

However, the number of agricultural enterprises increased across the years in the investigated period (Table 2).

Table 2. Number of active economic and social operators in national economy, in the period 2009-2012

Type of operators	2009	2010	2011	2012
Enterprises	541,836	491,956	452,171	472,342
Agricultural holdings	15,112	15,240	15,152	16,080
Non-agricultural enterprises*	519,441	470,080	430,608	449,482
Private entrepreneurs	307,777	290,960	280,377	278,078
Total	942,876	876,225	826,170	850,113

\*Enterprises from industry, construction, trade and other services

Source: Romania's Statistical Yearbook, 2004-2012 data series, NIS.

In rural area, most of the non-agricultural enterprises are involved in trade activities due to the fast recovery of investments and minimum necessary expertise in the organization of such activities; at the same time, the industry and services are not developed in conformity with the market demand. Except for two branches, i.e. food industry and timber industry, there are no other industrial activities in the proper sense of the word in the rural area.

Only about one quarter of the communes in Romania have non-agricultural economic

activities on their territory, organized under the form of SMEs in the extractive, processing, cottage industry and agro-tourism activities. In 2011, only 18.1% of the active SMEs with non-agricultural profile were listed in the rural area, which reveals a low share of SMEs involved in carrying out these activities (industry, services and rural tourism). Yet, in the period 2005-2011, the number of rural non-agricultural SMEs increased by 16%, but the effects of the crisis from the last years led to a decrease in number of these. [10]

The decrease of the number of workshops providing services and handicraft cooperative units generated severe compression of the social economy from rural areas. In 2010, out of the 2,017 cooperatives, 42.5% were craft cooperatives where traditional activities were carried out (crafts, handicraft). [10]

Business development in the rural areas features great differences across regions, as an effect of the insufficient material resource exploitation, of the deficient education, of the low level of utilities, as well as of the massive rural-urban migration or out-migration to foreign countries.

Romanian businesses proved to be less resilient during the recession. The most problematic factors for doing business in Romania are corruption, tax rates, government bureaucracy and inefficiency, access to finance, tax regulations, inadequate infrastructure, inflation and an inadequately educated workforce.

The access of SMEs to finance remains a problem. In terms of territoriality, financial services are generally less accessible to rural areas enterprises and to the agricultural sector, due to high credit costs. Although financial mechanisms (guarantee schemes) were in place, some of the beneficiaries who signed financing contracts under the 2007-2013 National Program for Rural Development did not succeed to access credits for investments. The main reason consisted in the non-existence of an agricultural credit adjusted to the specificity of agriculture.

The requirements imposed by the banking institutions for accessing funds (e.g. for guarantees) are similar to the ones applied for

any other company or SME, being impossible to fulfill. The insufficient specialization of crediting services was directly reflected in the guarantee system for agriculture, which was not used to its planned capacity, and, implicitly, in the limited level of accessing the program and the high level of project cancellations among selected beneficiaries.

Small-scale business development is an important source for employment/income earning, and the analysis of rural SMEs shows a low ability to provide jobs for population.

**The diversification of the non-agricultural utilization of available resources in the rural area** makes it possible to develop an entrepreneurial environment oriented towards:

-*Productive non-agricultural activities*, such as:

- light industry (leather-made items, footwear, woolen and fur items, knitware, household appliances, odor control products, etc.);
- industrial processing of wood products (e.g. furniture), starting from the timber stage;
- industrial processing of meat and milk products;
- fine mechanics, assembly of machines, tools and household appliances, production of packages, etc.

-*Craftsmanship activities*, handicraft and other non-agricultural traditional activities with local specificity (processing of iron, wool, pottery, embroidering, manufacturing traditional musical instruments, etc.), as well as their marketing (small shops selling own products obtained from these activities).

-*Services for the rural population*, such as:

- tailoring, barbers' shop, shoemaking;
- private kindergartens;
- internet connection and diffusion;
- mechanization, transport (others than the purchase of transport means), phyto-sanitary protection, sanitary-veterinary services and artificial insemination of livestock;
- repair of machines, tools and home appliances.

-*Renewable energy production* by the procurement of equipment for producing energy from renewable sources other than the bio-consumable sources;

-*Commercial activities* (small shops for the

sale of own products obtained from agricultural and non-agricultural activities, as well as of those of local, regional, national or global origin, with agricultural or industrial character);

-*Financial-banking and advisory services*;

-*Rural tourism activities, green tourism etc.*

The development of micro-enterprises as well as of small and medium-sized enterprises plays an essential role in the European economy, where these represent a significant source of incomes, while promoting entrepreneurial, innovation skills and job creation.

In Romania, for the period 2007-2013, the main programs for stimulating the business environment in rural areas are:

-The program for stimulating the creation and development of micro-enterprises by young entrepreneurs,

-The START Programme, and the

-Measure 3.1.2 of National Program for Rural Development – „Support to creation and development of micro enterprises”. [6]

The low rate of absorption of European funds on this measure is caused by strong bureaucratic character. It appears so, another reason for the lack manifestation of entrepreneurship in rural areas: the inefficiency and ineffectiveness of programs to stimulate entrepreneurship.

For the period 2014-2020, the National Program for Rural Development (PNDR) provides support to the non-agricultural enterprises in the rural area under the measure **M6 – “Farm and business development”** with two sub-measures - 6.2 “Support to the establishment of non-agricultural activities in rural areas” and 6.4 “Investments in the creation and development of non-agricultural activities”. [7]

The goal of the support granted under the measure M6 will stimulate the business environment in the rural area, contributing to the increase in the number of non-agricultural activities in the rural areas, as well as to the development of the already existing non-agricultural activities, job creation and increase of the rural population's incomes. At the same time, the support targets the farmers or members of agricultural holdings who wish

to diversify their economic activities by the practice of non-agricultural activities in order to increase their incomes and create occupational alternatives.

**The sub-measure 6.2 “Support to the establishment of non-agricultural activities in rural areas”** has in view: *the diversification of the rural economy* through the increase of the number of micro-enterprises and small enterprises in the non-agricultural sector, development of *services* and creation of jobs in the rural area and encouraging the maintenance and development of *traditional activities*.

**Under the sub-measure 6.4 “Investments in the creation and development of non-agricultural activities”** support is provided for the micro-enterprises and small enterprises in the rural area that create or develop new activities in the countryside.

The modern approaches from the governmental strategies prioritize the actions and measures, having in view to remove the constraints to private initiative in the rural areas through:

- Support to the private sector in the identification of investment opportunities;
- Strengthening the existing labour force and support to its re-qualification in order to meet the requirements of private investors in the rural areas;
- The adjustment of the education curricula in the rural areas to the specific conditions of the communities or regions, so that the young people can get jobs more easily;
- The increase of the quality of public administration in the rural areas;
- The public infrastructure improvement in the rural areas;
- Supply of technological assistance at the level of communities for the identification and coordination of public investments efforts.

The Governments have always recognized the problems in the rural area and the lower living standard compared to that in the urban area.

At the same time, the problems generated by the fewer opportunities to find jobs in the rural area have been included on the governmental agenda, together with the support to job creation and environment protection. Several governmental strategies

existed and still exist, trying to coordinate the efforts and resources of different ministries and governmental agencies (agriculture, labour and social protection, administration and environment), so as to generate a critical mass necessary for rural area development.

Yet these strategies have not generated the expected results, not even with regard to the increase of competitiveness of agricultural activities and to rural area development. The causes of failures are, in general, the top to bottom approach of the different strategies, the non-involvement of the authorities and of the rural communities, the systematic non-allocation of the funds that have been initially foreseen and the absence of certain priorities to be maintained for a long time period.

## CONCLUSIONS

For the quality of life growth and the diminution of negative social and economic phenomena with medium and long-term impact, it is necessary to increase the living standard of the population, by increasing the entrepreneurship opportunities in rural areas. Specifically, investments are needed in the development of human resources in rural areas and in supporting its entrepreneurial efforts and activities in order to generate profitable activities that can ensure motivating financial and social rewards on the medium and long term.

In a modern economy, starting from the principle that labour movement is much more expensive than the movement of materials and products, most countries modified their policy with regard to enterprises location, and they moved the enterprises towards the labour force and not inversely.

The location of small and medium-sized companies in the rural area means economy diversification, labour employment, increase of the economic power of rural localities and their overall development.

In Romania, the rural economy is by tradition associated to agriculture. This situation explains the need to create alternative jobs in the rural area, mainly by orienting the small farmers or the members of their families towards the non-agricultural sector.

The statistical data reveal that agriculture, food industry and forestry are of primordial importance for the rural economy. The presence of non-agricultural activities in the Romanian rural area, related to the primary sector, and mainly to the exploitation of natural resources and their processing, are non significant in economic terms.

The analysis of SMEs in the rural area reveals their low capacity to respond to the need to supply jobs for the rural population. Small-scale business development is recognized as the most important source of jobs and incomes in the European rural area.

In the present socio-economic context, the creation and promotion of entrepreneurial initiatives put into operation a viable mechanism for the rural communities' development. In order to obtain good results in the entrepreneurial activity in Romania, the following aspects should be taken into consideration:

-Infrastructure improvement to support business through the creation and development of industrial parks and businesses incubators;

-The continuation of the bureaucracy diminution process in the establishment and operation of the new enterprises;

-Better information of population on the governmental programs for private initiative stimulation;

-The promotion of successful business stories of the Romanian entrepreneurs on a larger scale.

The business environment development in the rural area, according to the principle of activity field prioritization, contributes to:

-Diversification of agricultural and non-agricultural activities and job creation in the rural area;

-Increase of rural population's incomes and narrowing the disparities between the rural and the urban areas;

-Fostering the maintenance and development of traditional activities.

In the future, with the continuation of the reform in education, the conditions of entrepreneurial spirit development could be changed. The success of such changes depends on how fast and how much the

administrative and managerial capacity of local authorities will be improved.

The investments in the non-agricultural and food economy in the countryside, besides adding value to products through the processing of agricultural and non-agricultural raw products from local resources, has another great advantage, in the sense of creating new jobs, through the utilization and stabilization of the local (rural) labour force, the revitalization of the rural localities, mainly of those localities from the less-favoured and remote areas.

## REFERENCES

- [1]European Commission, 2010, EUROPE 2020. A strategy for smart, sustainable and inclusive growth, COM(2010), 2020 final, [www.ec.europa.eu](http://www.ec.europa.eu)
- [2]Feher, A., Goşa, V., 2011, Dezvoltarea activităților neagricole. Alternative pentru agricultura cu timp parțial, în revista Economie agrară și dezvoltare rurală, nr.1, Editura Academiei Române, București: 47-58
- [3]Marinescu, E. 2013, The business environment and the current level in educational formation for Olt county agriculture, Scientific Papers. Series "Management, Economic Engineering in Agriculture and rural development", Vol. 13(3): 131-136
- [4]Mateoc-Sârb, N., Otiman, P., I., 2011, Considerații generale cu privire la dezvoltarea satelor și diversificarea economiei rurale românești, Economie agrară și dezvoltare rurală, nr.1, Editura Academiei Române, București: 13-22
- [5]National Institute of Statistics, [www.insse.ro](http://www.insse.ro)
- [6]National Rural Development Program 2007-2013, [www.madr.ro](http://www.madr.ro)
- [7]National Rural Development Program 2014-2020, [www.madr.ro](http://www.madr.ro)
- [8]Otiman, P.I., 2008, Sustainable Development Strategy of Agriculture and Rural Area in Romania on Medium and Long Term – Rural Romania XXI, Journal of Agricultural Economics and Rural Development, no.1-2, Publishing House of the Romanian Academy: 3-20
- [9]Popescu, M., 2001, Lecții ale tranziției – agricultura 1990-2000, Editura Expert, București
- [10]Steriu, V., Otiman P.I. (coord.), 2013, Cadrul național strategic pentru dezvoltarea durabilă a sectorului agroalimentar și a spațiului rural în perioada 2014-2020-2030, Cadrul național strategic rural, Editura Academiei Române, București
- [11]Tița, V., 2014, Analysis regarding the theoretical knowledge of management held by rural entrepreneurs in South-west Oltenia Region, Scientific Papers. Series "Management, Economic Engineering in Agriculture and rural development", Vol. 14(2): 307-310

## THE PRESENCE OF SPECIES *MORIMUS FUNEREUS* MULSANT, 1862 (LONG-HORNED BEETLE) COLEOPTERA: CERAMBYCIDAE IN A FOREST OF OAK CONDITIONS, 2015

Cristina STANCĂ-MOISE

“Lucian Blaga” University of Sibiu, Faculty of Faculty of Agricultural Sciences, Food Industry and Environmental Protection, Sibiu, Romania, Phone: 0040269234111, Fax: 0040269234111, E-mail: cristinamoise1@yahoo.com

**Corresponding author:** cristinamoise1@yahoo.com

### Abstract

*In this paper I present the species *Morimus funereus* Mulsant, 1862 (Coleoptera: Cerambycidae) which was reported in 2015 in the oak forest Dumbrava Sibiului. The samples were collected using soil traps mounted inside the forest. The material was added to the entomological collections along with other species of beetles caught in 2015. Studies on species of beetles were conducted by the author over several years, and this study complements the list of species caught in this ecosystem.*

**Key words:** *Cerambycidae, Morimus funereus, species*

### INTRODUCTION

*Morimus funereus* Mulsant, 1862 (Coleoptera: Cerambycidae) inhabits a relatively narrow geographical zone (forests of south-eastern Europe), and infests deciduous and coniferous trees [16].

The distribution of the species is in: Spain, France, Italy, Austria, Germany, Croatia, Bosnia and Herzegovina, Cehia, Macedonia, Moldova, Bulgaria, Slovakia, Serbia, Slovenia, Hungary, Romania, Montenegro, Ukraine, etc.

*Morimus funereus* (long-horned beetle) is a species stenotope, forestry, xylo-detriticole, xylophagous, saproxilyc. It prefers oaks and beech forests, but occasional occurrences of the species have been observed in coniferous forests [5].

The biology of the species is poorly known. Females lay eggs under the bark of logs and thick, dry branches. Larval development lasts 3-4 years; the larvae developed under the bark of dead tree and subsequently in the their wood. The larval stage lasts no longer than 2 years. The larvae pupate in spring or early summer. After completion of development, the larvae penetrate deeper into the wood, which prepares the room for metamorphosis. Adults appear autumn, but do not leave the pupal chamber until next spring. Adults can be

observed during the period from May to July on tree trunks. Adult activity begins quite early in April and continues until September. They have two maximum period of mating: the first half of May, respectively, the last half of June and a peak of activity between 8 p.m. and 3 a.m. Adults have longevity up to two years. Inability to fly leads to a small dispersion of population, and the increased habitat fragmentation[6]. **Morphology:** The head has a strong punctuation, more dense forehead (fig.1). The eyes are bordered with little hairs lying, yellow. The antennas have non rings articles. Pronote is dotted roughness has numerous irregularities and a side tooth, strong and sharp. Bandannas are granulated with fine glossy grains and stronger at the base.

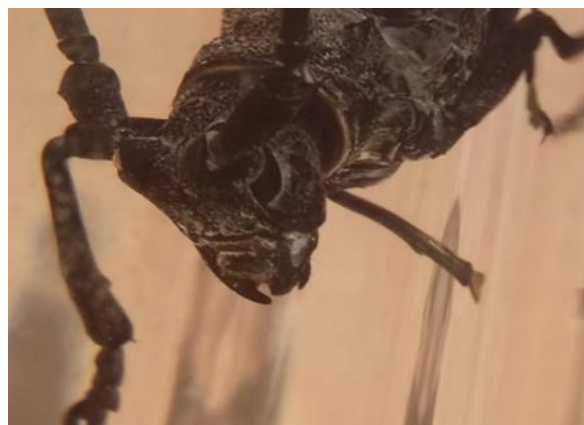

Photo 1. The head ( Original photo)



The body is black, his dorsal side shows a very dense pubescent lying, gray-silver, which completely covers the background (fig.2). Bandannas have two soft spots, black, one located in the front third and the other is postmedian; under these spots the bandannas fund is not grainy. The antennae of males are 1-1.5 times longer than bandannas and females have approximately the same length as bandannas. Body length - 18-38 mm.



Photo 2. *Morimus funereus* Mulsant, 1862 (Coleoptera: Cerambycidae) (Original photo)

Suitable habitat is the forests over 45 years, which may be present dry trees, which ensures optimal conditions for development (fig.3). Low dispersion capacity of individuals segmenting the area. So that, during the period of the adults activity, who seemed favorable habitats within the site, the species has not been found. The existence of the slopes in a ratio of about 80% in the SCT's influences the density and size of the population.

This cerambycid beetle develops on host plants of the families *Tiliaceae*, *Fagaceae*, *Corylaceae*, *Salicaceae*, *Fabaceae* and *Pinaceae*, using either physio-logically debilitated trees, tree stumps or recently cut

logs. The larvae are inner bark (phloem) feeders, found in the first stage of decomposition of trees [6].

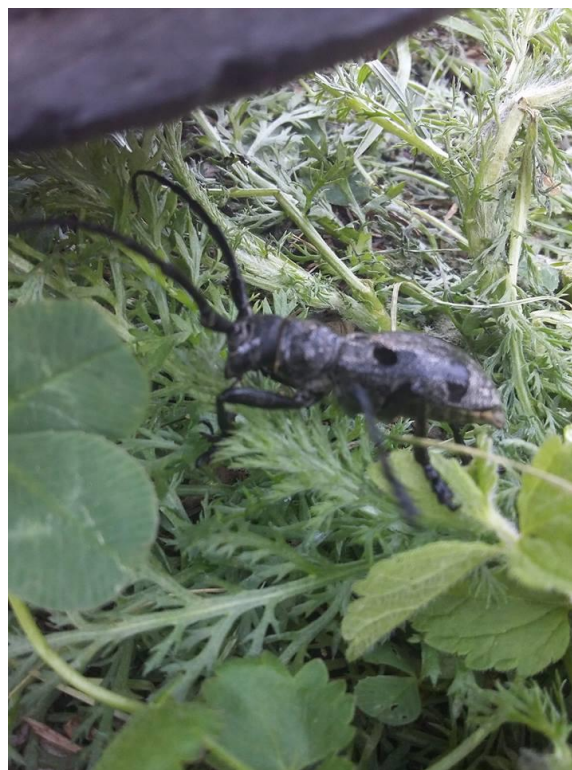

Photo 3. *Morimus funereus* Mulsant, 1862 in habitat (Original photo)

The larva develops in thick trunks and branches of trees dried or partially dried. Neonate larvae initially feed on the bark after consuming wood in order to perfection their development. Adults feed, it seems, with bark and leaves (fig.4.). The captive adults were fed with oak bark, leaves and stems of field plants.



Photo 4. Adult *Morimus funereus* Mulsant, 1862 (Original photo)



## MATERIALS AND METHODS

In the studied sylvo-cenosis they were made field studies [3,7,8,9] about epigeous entomofauna in the period between March-August 2015 [14].

In the first moment it was exactly established the place and it was dugged a pit in the ground of the size of the collection box [12,13,14]. It was important, by inserting into it in such a way that the hole funnel to be exactly at ground level. The funnel was covered with soil and plant debris to be well camouflaged. Along his way long-horned beetle fell into the trap 5 on 01.06.2015, as shown, along with other species of beetles (Photo 5, 6).

## RESULTS AND DISCUSSIONS

The list of species collected is presented in [14]. Each species is accompanied by data on the microclimate, eco-geography, trophic spectrum and floor (sublevel) where vegetation was collected [10,15,16]. There were collected 32 species of beetles belonging to six families: *Carabidae* (14 species), *Scarabeidae* (5 species), *Cerambycidae* (1specie), *Silphyidae* (6 species), *Elateridae* (2 species), *Staphylinidae* (4 species) [14].

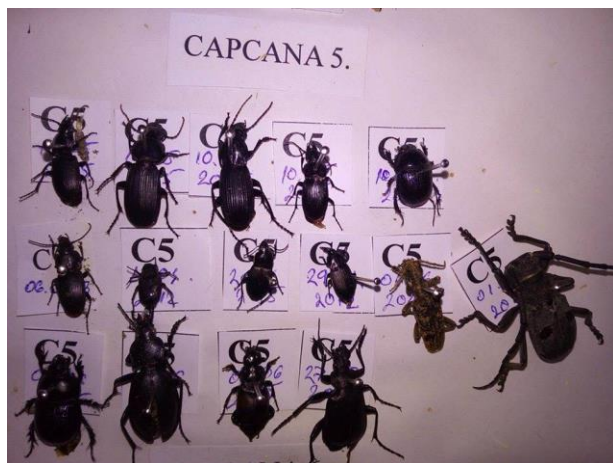

Photo 5. Trap 5 (Original photo)

## CONCLUSIONS

*M. funereus* is listed as vulnerable by the IUCN Red list of threatened species [17] and is an Annex II Species of the EU Habitats and

Species Directive [17] and also by the Decree on designate and protect the strictly protected and endangered species of wild plants, animals and fungi [18].

*Measures of protection and conservation.* The protection of the old trees of deciduous forests [1,2]; especially by prohibition of the actions amateur collectors; reducing toxic chemicals treatments in forest ecosystems[11]; preserving and protecting the characteristics biotopes [4].



Photo 6. *Morimus funereus* Mulsant, 1862  
(Original photo)

## REFERENCES

- [1]Antofie, M. M., Pop, O. G., Gruia, G., 2010, Resilience of ecosystem—A target of assessing the implementation of the Rio Convention Synergy. *Environmental Engineering and Management Journal*, 9(12), 1629-1635.
- [2]Antofie, M. M., 2014, Needs and gaps in the conservation of wild plant genetic resources for food and agriculture in Romania. *Genetic Resources and Crop Evolution*, 1-19.
- [3]Antonie, I., Manole, T., 2013, The structure of the agricultural entomologic fauna in corn culture Ocna Sibiu (Sibiu County), Romania, *Hydrology and water resources. Soil. Forest ecosystems. Marine and Ocean Ecosystems*. Albena Co. Bulgaria. pp: 771-748.
- [4]Antonie, I., 2015, Study upon the species *Ips typographus* L. (Coleoptera, Curculionidae) in the Raşinari Forestry Ecosystem, Sibiu County, *Scientific*

Papers. Series "Management, Economic Engineering in Agriculture and Rural Development", Vol. 15 (1): 45-49.

[5]Bozic, N., Vujcic, Z., Nenadovic, V., Ivanovic, J., 2003, Partial purification and characterization of midgut leucyl aminopeptidase of *Morimus funereus* (Coleoptera: Cerambycidae) larvae. *Comp Biochem Physiol* 134B:231-234.

[6]Dojon, B., Vujcic, Z., Bozic, N., Margentic, A., Vujcic, V. N., Ivanovic, J., 2012, Adaptations to captive breeding of the longhorn beetle *Morimus funereus* (Coleoptera: Cerambycidae); application on amylase study, *J. Insect Conserv* 2012, 16:239-247.

[7]Ciochia, V., Stancă-Moise, C., 2000, Contribuții la studiul structurii și activității entomofaunei epigeice într-o pădure de stejar Dumbrava Sibiului, *Lucrările Celei de-a 5-a Conferințe Naționale Pentru Protecția Mediului Prin Metode Și Mijloace Biologice Și Biotehnice și a celei se a 2-a Conferințe Naționale de Ecosanogeneză* 26-27 Mai 2000, Brașov, p:320-328.

[8]Ciochia, V., Stancă-Moise, C., 2002, *Artropodograf*, Institutul de Cercetare Dezvoltare Pentru Pajiști-Brașov, Cercetări Privind Producerea și Valorificarea Furajelor Pe Pajiști, p: 139-144.

[9]Moise, C., Tanase M., 2013, Researches on the epigeous entomofauna in the Dumbrava Sibiului oak forest (Sibiu, County, Romania) *Analele Universității din Oradea - Fascicula Biologie*, 19(1):89-96.

[10]Moise, C., 2013, Macrolepidoptera species with vulnerable status and their impact on the protected area of Dumbrava Sibiului, *Scientific Papers. Series "Management, Economic Engineering in Agriculture and Rural Development"*, Vol. 13(3): 273-276.

[11]Moise, G., 2014, Promotion of ecologic product certification as instrument to speed up the ecologic agriculture. *Scientific Papers. Series "Management, Economic Engineering in Agriculture and rural development"*, Vol. 14(1): 241-244.

[12]Stancă-Moise, C., 2014, Diversity and the main ecological requirements of the epigeic species of forest ecosystems in the Sibiu county, in the years 2013-2014, *Scientific Papers. Series "Management, Economic Engineering in Agriculture and Rural Development"*, Vol.14 (3):323-326.

[13]Stancă-Moise, C., 2015, Contributions to (Coleoptera: Staphylinidae) in Dumbrava Sibiului forest, Romania in terms of the years 2013-2014, *Scientific Papers. Series "Management, Economic Engineering in Agriculture and Rural Development"* Vol. 15 (1): 301-305.

[14]Stancă-Moise C., 2015, Observations on Coleoptera fauna from the Dumbrava Sibiului forest (Sibiu, Romania) in the 2015 year, *Scientific Papers. Series "Management, Economic Engineering in Agriculture and Rural Development"*, Vol.15(3):289-292.

[15]Stancă-Moise C., 2014, Method of analysis for population limitation of the lepidoptera pest in fruiterers (Lepidoptera: Tortricidae) in Sibiul village, Sibiu city in conditions of year 2013, *Scientific Papers. Series*

"Management, Economic Engineering in Agriculture and Rural Development", Vol.14(1):333-336.

[16]Stancă-Moise C., 2014, Observations on the biology of species *cydia pomonella* (worm apple) in an orchard in the town Sibiul, Sibiu county in 2014 year, *Scientific Papers. Series "Management, Economic Engineering in Agriculture and Rural Development"*, Vol 15(3):293-296.

[17]IUCN, 2009, *Morimus funereus* IUCN red list of threatened specie.

<http://www.iucnredlist.org/apps/redlist/details/13875/0>

[18]IUCN, 2010, <http://www.iucn.org/about/union/secretariat/offices/europe/activities>

## TRENDS IN THE DEVELOPMENT OF AGRICULTURE IN OLT COUNTY

Ștefan STĂNESCU, Manea DRĂGHICI

University of Agricultural Sciences and Veterinary Medicine Bucharest, 59 Marasti, District 1, 11464, Bucharest, Romania, Phone: +40213182564, Fax:+40213182888, Mobile:+40744 6474 10, Emails:dmprofesor@hotmail.com

**Corresponding author:** dmprofesor@yahoo.com

### Abstract

*The Olt County occupies a territory that is in a majority proportion intended for areas under cultivation, agriculture is one of the priority activity in this area. This paper analysed the main indicators of agriculture and the tendency manifested along the period from 2000 to 2014. Among the indicators analysed are the land fund of the County with the study of the evolution of the utilized agricultural area and arable area, the main crops and yields of these crops, the holdings endowment with machinery and agricultural equipment, the livestock devolving to 100 hectares, the active population from agriculture and the agricultural value production by sectors of activity. All these data have been analysed as physical size, value of the tournament which it occupies within the County, and in their evolution. The tendency of these indicators was assessed through the annual rhythm of growth and using polynomial equations of degree two and three. There were large variations over the period analysed, for most of the indicators analysed.*

**Key words:** agriculture, land fund, areas under cultivation, average yields, average annual rate of increase, Olt County, livestock production

### INTRODUCTION

The agriculture represents an area of prime importance in Romania, through the contribution of the national economy and its social vital role. With a contribution of 6.7% to gross value added (GVA) national [9], reported in the year 2010, agriculture has always played an important role in the economy.

The Olt County agriculture enjoys favorable conditions in terms of climate, landform and soil. Through the configuration of the relief from the northern part of the County, has a climate with a more humid tint, in the southern part being more arid. The mean monthly air temperature after the weather station in territory are 11.3 °C at Caracal and 10.9 °C at Slatina, values closely linked to the general conditions of this area where continental climate predominates. The rainfall ranges from < 500 mm in the South-Western part of the County to over 600 mm in the northern cities of the Getic Tableland [10]. As a strategy, the Landscaping Plan for Olt County, with a view to 2025, it proposes greater emphasis on diversification, increasing

agricultural holdings and ensuring superior conditions for plant growth (irrigation, curtains and massive forestry) [7].

### MATERIALS AND METHODS

As statistical indicators there were calculated: the average on certain time periods, indicators of comparison with a fixed base and chain base and annual growth rhythm [4]

$= r_{2000-2012} = 12 \sqrt{\prod (p_1/p_0) - 1}$ ; where:

$\prod p_1/p_0$  = the indicators in the chain product during the analyzed period.

**For the mean square deviation** or the standard deviation ( $\sigma$ ) is calculated as a square average from the deviations from all elements of the series from their average [11]

The mean square deviation is a basic indicator, which is used for the variation analysis, and also to estimating the errors of selection in the calculation of the correlation.

**Coefficient of variation ( $\nu$ )** shall be calculated as a ratio between the standard deviation and arithmetic average. It is expressed as a percentage:  $\nu = \frac{\sigma}{\bar{x}} \cdot 100$

*The significance* . As the value of  $v$  is close to zero so the variation is weaker, the collectivity is more homogeneous, with a high degree of representativeness. The higher the value of  $v$  is greater than the variation is more intense, the collectivity is more heterogeneous, and has a low level of significance.

It is estimated that at a coefficient over 35-40%, the average is no longer representative, and the data should be separated in a series of components, groups, depending on the variation of another grouping feature.

One of the methods most used in finding out the trend, is the adjustment of the data series. Through the adjustment operation, we obtain calculated chronological series, highlighting the trend of development and which replaces the empirical series.

A widely used method is by adjusting with an equation with respect to time: linear,  $Y = a + bt$ ; two degree,  $Y = a + bt + ct^2$ ; third degree,  $Y = a + bt + ct^2 + dt^3$  etc. As for a correlation, for regression function parameters is needed

for the adjustment of the series the appliance of the method of least squares:

$$\sum (y_i - Y_{ti})^2 = \min[2].$$

The data from this study have been extracted from the Statistical Yearbook, published by INSSE during 1990-2014[5].

## RESULTS AND DISCUSSIONS

### *The trend in use of land fund for the period 2000-2014*

The total agricultural area of South-West Oltenia Region represents an area of 1,820.1 hectares in 2000, 1,802.7 hectares in 2007 and by 1,796 thousand ha in the year 2014, with decreases of 23.5 thousand ha-vis 2000 and 6.1 thousand hectares in relation to 2007. The Olt County held in 2014, an area of 436.5 hectares, i.e. 24.2% of the land area of the region South-West Oltenia.

For the period 2000-2014 agricultural area decreased by 5.2 thousand hectares by 2007 and 1.7 thousand hectares with relation to 2007 (Table 1).

Table 1. The structure of land use of the Land Fund, in the County of Olt, period 2000-2014

How to use	Region	2000		2007		2014		2007/2000 (%)	2014/2007 (%)
		thousand hectares	%	thousand hectares	%	thousand hectares	%	%	%
Total	Southwest Reg	2,921.2	100.0	2,921.2	100.0	2,921.2	100.0	0.000	0.000
	OLT	549.8	100.0	549.8	100.0	549.8	100.0	0.000	0.000
Agricola	Southwest Reg	1,820.1	62.3	1,802.7	61.7	1,796.6	61.5	-0.594	-0.209
	OLT	440.0	80.0	434.8	79.1	436.5	79.4	-0.940	0.304
Arable	Southwest Reg	1,247.5	42.7	1,252.8	42.9	1,251.9	42.9	0.179	-0.030
	OLT	385.2	70.1	388.5	70.7	390.3	71.0	0.599	0.337
Pasture	Southwest Reg	379.7	13.0	380.4	13.0	377.9	12.9	0.024	-0.086
	OLT	34.8	6.3	31.8	5.8	33.0	6.0	-0.552	0.228
Meadow	Southwest Reg	86.2	2.9	88.0	3.0	89.1	3.1	0.063	0.039
	OLT	0.8	0.1	0.5	0.1	0.6	0.1	-0.045	0.005
Vineyards and wine-growing nurseries	Southwest Reg	51.1	1.7	38.8	1.3	38.0	1.3	-0.421	-0.027
	OLT	9.6	1.8	7.6	1.4	7.5	1.4	-0.365	-0.031
Orchards and nurseries	Southwest Reg	55.7	1.9	42.8	1.5	39.7	1.4	-0.441	0.105-
	OLT	9.6	1.7	6.4	1.2	5.1	0.9	-0.577	-0.236
Non-agricultural land	Southwest Reg	1,101.1	37.7	1,118.4	38.3	1,124.5	38.5	0.594	0.209
	OLT	109.8	20.0	115.0	20.9	113.3	20.6	0.940	-0.304

In the Land Fund structure, the agricultural area represents 80% in 2000 and 79.4% in 2014, with 17.7% and 17.9% respectively of the share occupied in the region.

As the educational level of the respondents is concerned it was found that the majority of those with secondary education (high school) with a ratio of 71.4%, followed by those with

graduate studies (college / university) with a ratio of 22.8 %, finding at the opposite pole respondents having postgraduate studies, 4.9%, as well as those with primary education (middle school) with 0.8% (Table 2).

The arable area of the County was of 385.2 thousand hectares (70,1%) in 2000 and 390.3 thousand ha (71%) in 2014, finding it an increase of 5.1 hectares. Towards the Development Region differences are in the share of 27.4% in 2000 and 28.1 % in 2014. Nationally, in 2011, the share of the arable surface was of 64,1%.

These agricultural areas increases were due to the decline in the same period, on areas of grassland with 1.8 thousand ha, meadows with 0.2 thousand hectares, vineyards with 2.1 thousand ha and orchards with 4.5 thousand hectares. (Table 1)

These developments demonstrate the agricultural character of the county but also the care for keeping arable land but also the

lack of investments for substituting the 6.6 thousand hectares of vineyards and fruit trees that have been cleared due to age or improper maintenance.

***The cultivated areas with the main crops tendency for the period 2007-2014***

Analyzing the size and evolution of cultivated areas in the Olt County during the period 2007-2014, we find the following:

-The area under cultivation had large oscillations from one year to another, which are measured by the coefficient of variation, and on the many cultures have very high values (52,26% beans, soya beans 118,3%, rapeseed 63.6% , tobacco 83.4%); high values (27,54% barley grain maize 22,54%); medium variation (sunflower 17,89%, wheat 13.3%); small values (5.75% cereal grains, total vegetables 4.26% vineyards 1,12% and orchards 7,79%)

Table 2. The cultivated surfaces evolution with the main crops in Olt County during the period 20 07-2014

No. crt	Main crops	2007	2010	2014	Min	Max	Average	Standard Deviation	The variation (%)
		HA	HA	HA	HA	HA	HA	HA	%
1	Total	292,908	336,851	347,000	292,908	351,401	331,331.0	19,664	5.93
2	Grain cereal	235,592	241,589	266,296	235,592	271,551	255,122.8	14,668	5.75
3	Wheat-total	135,983	143,087	141,652	102,202	150,006	132,281.8	17,704	13.38
4	Barley	8,980	14,189	13,807	5,865	15,906	11,602.1	3196	27.54
5	Oats	5,246	6,177	5,503	4,141	6,834	5,631.8	808	14.35
6	Grain maize	84,744	73,653	95,082	73,653	136,165	100,766.1	23,023	22.85
7	Shelling peas	161	480	462	161	1011	411.5	149	36.30
8	Beans	30	360	153	30	360	233.9	122	52.26
9	Sunflower	29,855	40,349	47,182	29,855	50,438	40,354.6	7,219	17.89
10	Rape	11,892	30,613	11,072	6,709	30,613	14,871.5	9,461	63.62
11	Soy beans	800	64	259	34	800	223.7	265	118.39
12	Sugar-beet	:	:	:	:	:	:	:	:
13	Tobacco	93	20	19	9	93	33.3	28	83.48
14	Vegetables-total	9,720	10,663	9,858	9,720	10,881	10,534.6	451	4.28
15	Orchards bearing	3,470	3,874	3,589	3,188	3,874	3,432.3	267	7.79
16	Vineyards and nurseries	7,634	7,634	7,465	7,445	7,634	7,563.88	84.73	1.12
17	Arable land at rest	13,474	50,787	8,929	4,079	50,787	21,499.4	18,518	86.13

In the Olt County structure, the share of the main crop is owned by cereal grains with 80.4% in 2007 and 71.7% in 2010 (Table 3).

Technical plants held over 17%, with sunflower seeds, which grow to 10.2% in 2007 and reaches 13.0% in 2014, and rapeseed which has a tendency to decrease from 4.1% in 2007 to 3.2% in 2014.

Vegetables have a downward trend from 3.3% (3,470 ha at 3,188 ha). At the country level, in 2011, of the 8.1 million hectares cultivated, 5.2 million hectares (64%) represents the cereals for grain, and 1.5 million hectares (18%) are oil plant[8].

Table 3. The cultivated surfaces structure evolution with the main crops in Olt County during the period 2007-2014

No. crt	Main crops	2007	2008	2009	2010	2011	2012	2013	2014
1	Total	100.0	100.0	100.0	100.0	100.0	100.0	100.0	100.0
2	Cereal grains	80.4	77.6	79.2	71.7	76.5	77.0	77.3	76.7
3	Wheat-total	46.4	41.3	42.1	42.5	32.7	31.2	42.7	40.8
4	Barley	3.1	3.1	4.7	4.2	1.9	2.7	4.1	4.0
5	Oats	1.8	2.1	1.9	1.8	1.3	1.5	1.6	1.6
6	Grain maize	28.9	30.6	29.9	21.9	40.0	39.6	25.6	27.4
7	Shelling peas	0.1	0.1	0.3	0.1	0.1	0.1	0.1	0.1
8	Beans	0.0	0.1	0.1	0.1	0.1	0.1	0.0	0.0
9	Sunflower	10.2	11.3	9.1	12.0	11.9	14.7	14.2	13.6
10	Rape	4.1	5.0	5.7	9.1	4.5	2.0	2.5	3.2
11	Soy beans	0.27	0.07	0.01	0.02		0.03	0.02	0.07
12	Tobacco	0.03	0.00		0.01	0.01	0.02	0.01	0.01
13	Vegetables-total	3.3	3.2	3.2	3.2	3.5	3.1	3.1	2.8
14	Orchards bearing	1.2	1.0	1.0	1.2	1.0	1.0	1.0	1.0
15	Live bearing	2.6	2.3	2.3	2.3	2.4	2.2	2.2	2.2
16	Arable land at rest	4.6	8.4	10.1	15.1	7.2	1.2	3.0	2.6

Overall, the trend of cultivated areas (table 4), expressed through the annual increase for three distinct periods 1990-1999, 2000-2006 and 2007-2014, but also the entire period 1990-2014, shows some features:

- in the first period, from 1990 to 1999, are noted significant declines for beans (-18.4%), barley (-10.4%), soybeans (23.4 percent), sugar beet (-25.6)  
 - increase in Sunflower (10.3%), rape (28.9%);

Table 4. The cultivated areas rate trend evolution in the County of Olt, for the period 1990 to 2014

No crt	Main crops	Rate 1990-1999	Rate 2000-2006	Rate 2007-2014	Rate 1990-2014
		%	%	%	%
1	Total	-0.75	-1.28	2.45	-0.49
2	Cereals for grain	0.43	-0.30	1.77	0.23
3	Wheat-total	1.09	2.06	0.59	1.47
4	Barley	-10.45	-6.02	6.34	-3.79
5	Oats	19.64	4.67	0.69	8.82
6	Grain maize	1.97	-2.61	1.66	-0.73
7	Shelling peas	-10.99	-22.43	16.25	-5.93
8	Beans	-18.42	-4.06	26.21	-11.70
9	Sunflower	10.32	-3.99	6.76	2.77
10	Rape	28.98	-1.51	-1.02	12.47
11	Soy beans	-23.42	-0.02	-26.71	-14.94
12	Sugar-beet	-25.65	-27.50	:	-49.78
13	Tobacco	-2.57	-24.45	-37.96	
14	Vegetables-total	-2.38	4.74	0.20	-0.69
15	Orchards bearing	-3.13	-12.89	0.48	-4.08
16	Vineyards and nurseries		-3.90	-0.32	-1.81
17	Arable land at rest	44.77	15.56	-5.71	-1.95

- in the second period, 2000-2006, are dropping further areas of beans, peas, sugar beet, tobacco, orchards, shelling peas, barley crop, labour-intensive crops and cultures for the production of feed;

- in the third period, 2007-2014, reductions in the areas are in tobacco and sugar beets, which are actually removed from the culture;

- throughout this period it is found important modifications of structures by increasing the areas in which mechanization is very large, for intensive consuming nutrients from the

soil crop, the removal of the crop of sugar beet and tobacco.

***Trends in equipping the farms with tractors and agricultural machinery, in the County of Olt, 1990 to 2014***

Between 1990-2010, Olt County in the number of tractors and agricultural machinery:

- has increased in physical tractors with 140.3% (4,744 PCs at 6,658 PCs); plows for tractor with 186,7% (3,307 to 6,174 PCs) and for the mechanical seeders 226,9% (from 1,686 to 3,825 PCs);

Table 5. The tractors and agricultural machinery number evolution in Olt County, for the period 1990-2014

No crt	Agricultural machinery	1990	2000	2010	2014			
		No	No	No	No	2010 (%)	/2000 (%)	/1990 (%)
1	Physical tractors	4,744	5,533	6,221	6,658	107.0	120.3	140.3
2	Plows for tractor	3,307	4,642	5,271	6,174	117.1	133.0	186.7
3	Mechanical cultivators	1,472	780	1,016	616	60.6	79.0	41.8
4	Mechanical seeders	1,686	2,981	3,531	3,825	108.3	128.3	226.9
5	Spraying machines and dusty with mechanical traction	542	105	34	39	114.7	37.1	7.2
6	Self-propelled combine harvesting grain	1,931	1,201	1,274	1,318	103.5	109.7	68.3
7	Self-propelled combine harvesting forage	186	27	2	5	250.0	18.5	2.7
8	Combine and machinery for harvesting potatoes	20	5	2	2	100.0	40.0	10.0
9	Baling presses for straw and hay	890	166	164	280	170.7	168.7	31.5

- it dropped to all other machines. We note the decrease of machinery for fodder and potato culture.

At self-propelled combines for grain harvester is found a decrease in at 68%, that decrease is offset by the productivity by several times greater of the current machines than those of 1990.

***Trends in the structure of agricultural holdings in Olt County.***

Within the County of Olt, it is considered that in the year 2012, there were a number of holdings of 90,170[6].

Analyzing the distribution by size classes, it is found that 69.85 % were under 5 ha, and possessed 43.85% of the area, 28.47% of holdings were between 5 and 10 ha and wielded 49.08% of surface and 1.68% of holdings of over 10 hectares of the area which possessed 7.07 % of the agricultural area (Table 6).

Table 6. The agricultural holdings structure in Romania , depending on the size of the agricultural holdings, in 2012

Area per holding	UM	Agricultural area		No. holdings		Sur. per holding	
		HA	%	No	%	ha/holding	from the average
< 3 ha	No	74,695	18.15	35,842	39.75	2.08	45.67
3-5 ha	No	105,727	25.69	27,140	30.10	3.90	85.37
5-7 ha	No	77,501	18.84	12,842	14.24	6.03	132.25
7-10 ha	No	66,509	16.16	7,909	8.77	8.41	184.28
10-15 ha	No	57,935	14.08	4,919	5.46	11.78	258.10
> 15 ha	No	29,105	7.07	1,518	1.68	19.17	420.16
Total	No	411,472	100.00	90,170	100.00	4.56	100.00

The share of agricultural holdings under 5 ha was 93.13% while at the EU level was of 69.3%, the share of holdings ranging between 5 and 10 ha, was in our country of 4.73% and EU-wide by 10.9 percent, while the holdings of over 10 hectares, were in our country of 2.14%, while in the EU were 19.8%[4].

***The average production on ha evolution for the main crops, in Olt County during the period 2007-2014***

The period under review is characterized by 2007, where unfavorable conditions have made the average yield from all cultures have a critical level, the average production being around 700kg/ha.

In the Olt County in 2011, the average grain production reaches a record-3,485 kg/ha, that

to be exceeded in the year 2015 with 3,535 kg/ha. We highlight the average production of grain maize of 4,384 kg/ha in 2010 and 4,474 kg/ha in 2013. (Table 7).

***The tendency for the animal production development.***

For the period 2007-2017, in Olt County, the livestock have had big oscillations and decreases in all species, which are evidenced by negative annual rhythms.

Thus in cattle and buffalos, cows and heifers decreased 10% annually, which occurred as the herds cows would be reduced to 18.1 head to 100 hectares in 2007 to 8.2 heads to 100 ha in 2014 (Table 8).

Table 7. Evolution of the average production per hectare, for the main crops in the Olt County during the period 2007-2014

Main crops	2007	2010	2014	Min	Max	Average	Standard Deviation	Variation (%)	Annual rate
Cereal grains	723	2840	3545	723	3545	2678.6	949	35.42	25.50
Wheat-total	832	2143	3299	832	3370	2570.6	836	32.54	21.75
Barley	730	2297	3132	730	3183	2444.3	789	32.28	23.13
Barley	722	2366	3208	722	3451	2579.1	870	33.75	23.75
Grain maize	531	4384	4112	531	4474	3037.5	1572	51.74	33.97
Sunflower	408	1689	2177	408	2177	1490.3	531	35.63	27.02
Rape	852	1667	2513	852	2513	1570.9	489	31.13	16.71
Soy beans	233	984	2097	233	2097	1162.6	594	51.05	36.87

Table 8 number of animals Evolution payable at 100 ha in Olt County during the period 2007-2014

Categories of animals	MU	2007	2010	2014	Min	Max	Average	Standard Deviation	Variation (%)	Annual rate
Cattle	No	18.1	7.7	8.2	7.7	18.1	10.7	3.9	36.60	-10.69
Buffalos and cows, heifers	No	12.8	5.7	5.8	5.4	12.8	7.5	2.7	36.53	-10.69
Swine	No	67.2	47.4	50.4	47.4	67.2	53.7	6.5	12.06	-4.03
Breeding sows	No	4.4	3	3.1	2.1	4.4	3.3	0.8	24.51	-4.88
Sheep and goats	No	51.8	34.3	41.1	34.3	51.8	41.8	5.8	13.91	-3.25
Sheep, ewe lambs and goats	No	47	31.9	36.2	31.9	47	37.4	5.0	13.39	-3.66

In swine, the herds to 100 ha of land dropped from 67.2 heads in 2007 to 50.4 heads in 2014.

The decrease in sheep was from 51.8 heads/100 ha in 2007 to 41.1 heads in year 2014.

The same rhythms of very large declines we can note in animal productions that were made during this period. So milk production decreased from 1,800 thousands hl, in 2007, at 1,028 thousand hl, in 2014 (annual rate 77.7%), production of eggs from 318.9 mil PCs in 2007 to 210 million PCs in 2014 (-5.8% rate).

Table 9. The evolution of main livestock productions in the Olt County during the period 2007-2014

Animal production	UM	2007	2010	2014	Min	Max	Average	Standard Deviation	Variation (%)	Annual rate
The milk production (including calves consumption)	thousand hl	1,800	1,284	1,028	1,028	1,800	1,352.2	845.0	62.5	-7.7
The wool production	to	322.3	230	253	230	322	258.2	80.8	31.3	-3.4
The eggs production	MIL PCs	318.9	233	210	210	319	243.1	147.4	60.6	-5.8
The extracted honey production	to	606.6	769	368	368	769	601.5	284.9	47.4	-6.9

Even at the production of honey is found a decrease from 606.6 tons in 2007 at 368 tons in 2014 (-6.9% rate) (Table 9).

***Trends concerning the evolution of the active labor force in agriculture, Olt County, during the 2008-2014***

In the Olt County, the occupied population in agricultural activities during the period 2008

to 2014, is between 48.6% in 2010 and 44.9% in 2008, compared to about 19% [9] of the total working population-wide country (Table 10).

The trend of labor used in agriculture, adjusted with a polynomial of degree two, presents a maximum in the years 2010 and 2011, and a decrease in the last three years (Table 10, Fig. 1)



Table 10. The size and share evolution of the occupied population in agricultural activities in Olt County during the 2008-2014

Activities	UM	2008	2009	2010	2011	2012	2013	2014
Total	thousand persons	169.3	161	161.6	162.6	167.4	163.5	160.8
Agriculture, forestry and fishing	thousand persons	76	76.3	78.6	78.2	80.4	76.6	74.6
	Towards 2007 (%)	100.0	100.4	103.4	102.9	105.8	100.8	98.2
	Share of total (%)	44.9	47.4	48.6	48.1	48.0	46.9	46.4

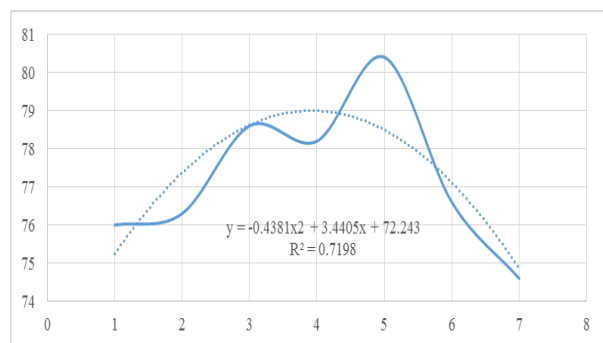

Fig. 1. The active population trend from agriculture, forestry and fishery , Olt Conty 2008-2014(th pers.)

Towards other EU countries the gap is wider and where the EU- 27 average is 4.7% and for the new Member States (e.g. Poland: 10.1%; Hungary: 5.5%; Bulgaria: 14.7%), not

to mention about countries like France (2.6%), UK (1.9%) or Germany (1.8%). This is a first indication of the low level of labor productivity and unemployment masked existing in the sector.

***Trends on the development of agricultural production in terms of value, by branch of activity in Olt County during the period 2007-2013***

The value of agricultural production for the period 2007-2014, in the County of Olt, presents an increase from 1,072.8 million lei in 2007 to 2,344.4 million lei, in 2013 (increase of 218 percent).

Table 11. Developments in agricultural production value, according to branches of production in Olt County during the period 2007-2013

Agricultural branches	UM	2007	2008	2009	2010	2011	2012	2013
Total	MIL lei	1,072.8	1,931.7	1,779.9	1,875.6	2,315.8	1,981.8	2,344.4
	%	100.0	180.1	165.9	174.8	215.9	184.7	218.5
Vegetable production	MIL lei	549.3	1,322.4	1,174.5	1,348.3	1,756.2	1,384.6	1,789.0
	%	100.0	240.8	213.8	245.5	319.7	252.1	325.7
Animal	MIL lei	515.9	600.9	593.9	523.4	557.0	592.3	545.8
	%	100.0	116.5	115.1	101.5	108.0	114.8	105.8
Agricultural services	MIL lei	7.7	8.4	11.4	3.8	2.6	4.9	9.6
	%	100.0	109.8	149.0	49.9	33.4	64.3	124.7

The vegetal production value presents a growth from 549.3 million lei in 2007 to 1,384.6 million lei in 2013 (325,7%) and livestock production from 515.9 million lei in 2007 to 592.3 million lei in 2013 (105.8%). Agricultural services in the value expression, also an increase from 7.7 million lei in 2007 at 9.6 million lei in 2013 (124,7%).

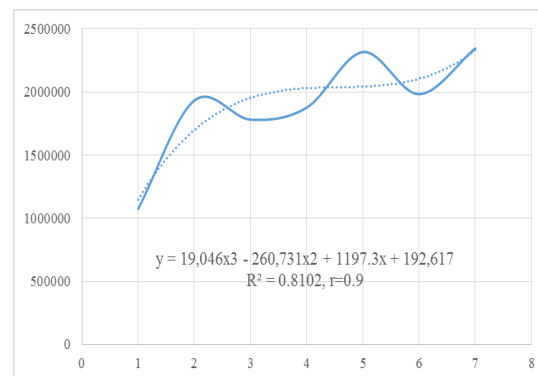

Fig 2. The total value production trend, in Olt County, 2007-2013( th. lei)

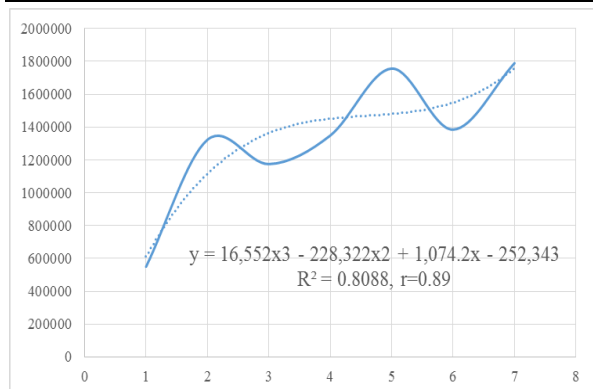

Fig.3. The vegetal value production trend, in Olt County, 2007-2013( th. lei)

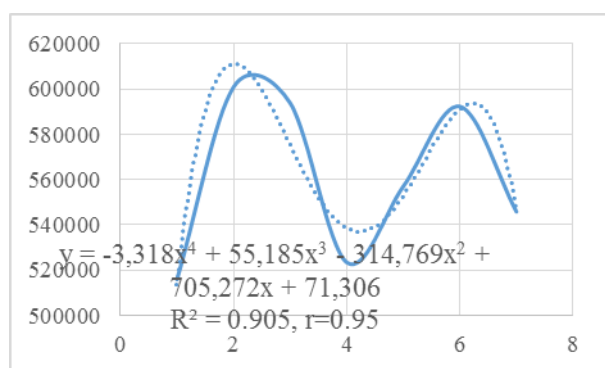

Fig 4. The animal value production trend, in Olt County, 2007-2013( th. lei)

Table 12. The agricultural production value by branches evolution, in the County of Olt, during the period 2007-2013

Agricultural branches	2007	2008	2009	2010	2011	2012	2013
Total	100.0	100.0	100.0	100.0	100.0	100.0	100.0
Vegetable production	51.2	68.5	66.0	71.9	75.8	69.9	76.3
Animal	48.1	31.1	33.4	27.9	24.1	29.9	23.3
Agricultural services	0.7	0.4	0.6	0.2	0.1	0.2	0.4

At the country level, the vegetal production sector share is predominant, holding, in 2011, a share of 70.8% from the total value of production, towards 28.5% represents by the livestock production sector and only 0.7% for agricultural services. In other countries, this share is lower. Towards 2012, in comparison, the share of crop production in total agricultural output value was 69,8% in Bulgaria, 66,6% in Hungary, respectively 51.6% in Poland. In France the vegetal production accounted 61,1%, in Germany 53,4%, while in the United Kingdom 41.8% [10].

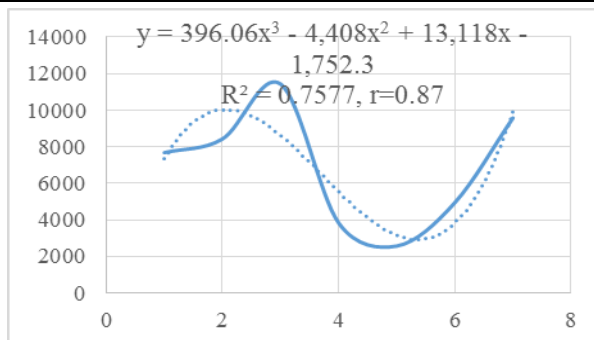

Fig 5. The agricultural services trend, in Olt County, 2007-2013( th. lei)

To plot the tendency of agricultural production by branches of activity during the period 2007-2013, we adjusted the data with the help of third order polynomial equations (Fig2, Fig 3, Fig 4, Fig 5), where it is found regular oscillations of the growth and decline of agricultural production in terms of value. The agricultural production structure for the period under review presents a strong increase in the share of vegetal production, from 51.2% in 2007 to 76.3% in 2013. This increase occurred entirely on account of the decrease in animal production, 48.1% in 2007 to 23.3% in 2013.

## CONCLUSIONS

The Olt County occupies an area that represents nearly a quarter of the area of SW development Region, namely 24.2%, to the year 2014, while agriculture occupies a surface of 11.1% of the total. In relation to the trend of the use of agricultural land fund, Olt County area has undergone major declines of about 6.1 thousand hectares in 2014 as compared with 2007.

Mainly, the arable area is occupied by cereal crops, whose surface area has increased over the period studied, significant increase also for technical plants and vegetable areas.

Throughout the period it is found important modifications of structures by increasing the areas in which mechanization is very large, intensive crop nutrients from the soil, the removal of the crop of sugar beet and tobacco. A very good growth trend for Olt County agriculture is increasing the number of tractors and agricultural machinery, whose share in late 2014 is with over 40% more tractors, ploughs, cultivators and harvesters than 1990, and over 10% more than in the year 2010.

Regarding the structure of farms in relation to size, in the year 2012, over two-thirds are holding less than 5 ha and only 1.68% of the total 90170 holdings have an area over 15 hectares.

Worrying is the fact that in relation to the livestock sector we have decreases for all livestock species, of which the deepest annual drop is noted in cattle.

The large Share of those employed in the agricultural sector over 44% of the total active population, compared with the level in EU countries is a first indication of the low level of labor productivity and unemployment masked existing in the sector.

The agricultural production value has experienced upward trends, however, for the period 2007-2013, the most important being observed in agricultural vegetal production, where increases are over 200% in the last year towards the reference year.

## REFERENCES

- [1]Agriculture, forestry and fishery statistics, 2013, Pocketbooks, ISSN 1977-2262, KS-FK-13-001-En.PDF.pdf
- [2]Anghelache Ctin, et al., 2012, Metode și procedee de ajustare a datelor pe baza seriilor cronologice utilizate în analiza tendinței dezvoltării diferitelor domenii de activitate social-economică, Romanian Statistical Review nr. 8 / 2012
- [3]Consolidarea exploatațiilor agricole, CNP, 2012
- [4]Creșterea demografică, [http://www.dictsociologie.netfirms.com/\\_IndDem/IndR eproducere.htm](http://www.dictsociologie.netfirms.com/_IndDem/IndR eproducere.htm)
- [5]INSSE, 2015, Baze de date statistice, Tempo-Online, <http://statistici.insse.ro/shop/>
- [6]Marinescu Emil Vergilius, 2014, Teză de doctorat, Cercetări privind dezvoltarea consultanței agricole în județul Olt, USAMV, București

[7]Planul de Amenajare a Teritoriului Județean Olt , accesat oct 2015, <http://www.cjolt.ro/pozearticole/documente/cjolt/gallery/stiri/faza-04.pdf>

[8]Rezultatele analizei documentare sectorul agricultură și dezvoltare rurală, 2013, Proiect cofinanțat din Fondul European de Dezvoltare Regională prin POAT 2007-2013

[9]Studiul Consolidarea Exploatațiilor agricole, Comisia Națională de Prognoză, 2012.

[10]Șerban Șerban 2010, Agricultura județului Olt, <http://agroromania.manager.ro/articole/stiri/agricultura-judetului-olt-9733.html>

[11] Wikia, Caracterizarea repartițiilor de frecvență, <http://ro.math.wikia.com/wiki/Statistica>



## STUDY CONCERNING THE CRUISES ON THE DANUBE RIVER

Petrică ȘTEFAN, Mariana BURCEA, Romeo Cătălin CREȚU

University of Agricultural Sciences and Veterinary Medicine Bucharest, 59 Marasti, District 1, 11464, Bucharest, Romania, Phone: +40.213.182.564, Fax: +40.213.182.888, Mobile: +40.743.644.744, Emails: stefanmarian2004@yahoo.com, burcea\_mariana2003@yahoo.com, creturomeocatalin@yahoo.com

**Corresponding author:** stefanmarian2004@yahoo.com

### *Abstract*

*The paper aimed to promote the cruises on the Danube River. Generally, in our mind the cruises on the Danube river mean trips of a few hours along the borders of the Danube in Budapest or in its Delta. Just a few persons know, however, that there is an extended version of these trips from 7 to 15 days of all inclusive luxury on board travel on a ship, with stops in the most historical cities which are situated along the Danube. The voyages by boat on the Danube are a very convenient and enjoyable option both for leisure and visits to the main cities from the Western Europe which are crossed by the Danube river. However, most of the cruise variants start either from Passau, and ends Budapest, or from Budapest to Passau destination. The paper presents an interesting offer of 15 days/14 nights cruise by boat along the Danube River.*

**Key words:** cruise, Danube, restaurant, Romania

### INTRODUCTION

The cruise industry is such a dynamic part of the modern tourism all over the world.

In the last decades, the cruise industry was facing new challenges caused by the high growth rate of tourists number travelling abroad whose figure reached over 1,100 billion.

It was obliged to keep pace with the extended market and the new preferences of the modern consumer keen to travel to exotic destinations, enjoy special facilities on a ship board.

Under these conditions, the cruise industry prepared and designed new cruise ships in a modern concept, it also has developed new itineraries and destinations, new on-board/on-shore activities, it diversified and included new programmes of entertainment and facilities on board and new cruise lengths according to the changes in the patterns to spend holidays. [1,5]

Europe benefits of a large variety of important interior rivers. The Danube River is the longest one with its 2,888 km from its source to the Black Sea and considered "The Queen of Europe's rivers", because it is crossing ten countries with various cultures, history and attractions.

Many tourists are keen to travel by boat along the Danube, because this the best way to admire the magnificent waterway and the attractions situated on its borders. [10]

As long as the Danube river is navigable for 2,415 km (1,500 miles), many ships are floating up and down the Danube offering pleasant voyages to the tourists. [8]

In this context, the study presents the most important attractions along the Danube river, the river cruise companies and some travel offers. Its main purpose is to promote tourism by ship.

### MATERIALS AND METHODS

This paper is based on the information collected from literature and various tourism agencies regarding their offers for cruises on the Danube River.

Also, the sites of various river cruise companies were used to promote travel offers on the Danube River.

The trip programme is presented and discussed in details and serves to the promotion of the tourism on a ship board as a modern way for relaxation, culture and travel.

**RESULTS AND DISCUSSIONS**

Among the most important places to visit along the Danube, ten are in the top. It is about: Ulm, Ingolstadt, Regensburg, Straubing and Passau in Germany, Linz and Vienna in Austria, Bratislava in Slovakia, Szentendre and Budapest in Hungary. [7]

Also the Danube Parks and especially the Danube Delta, a biosphere reserve are of high interest for tourists.

The Danube Delta has a scientific, touristic and even economic importance. It has ecosystems represented by the Danube branches, channels, floating reedbeds, floodplains, levees, sands, river meadows, and forests. Tourists are involved in specific programmes such as: leisure tours, itinerant discovery tourism, scientific trips for ornithologists, researchers, students, special youth programmes, rural tourism, ecotourism, balneary tourism, birdwatching, nautic sports, fishing, tasting traditional meals. [6]

A special attention is given to the Danube Region since June 2011 by the European Council who established a Strategy for the Danube Region. All the countries and regions situated along the River but also many other countries are involved in fulfilling this strategy. It is about Germany, Austria, Slovakia, Czech Republic, Hungary, Slovenia, Croatia, Serbia, Bosnia and Herzegovina, Montenegro, Romania, Bulgaria, Moldova and Ukraine. Among other objectives, this strategy is destined to develop and promote tourism. [2]

The cruises on the Danube river include in their itinerary the following cities: Passau, Salzburg, Linz, Melk & Dürnstein, Vienna, Bratislava and Budapest.



Photo 1. St. Stephen's Cathedral in Vienna [11]

Cruises on rivers are unique experiences, completely different from other cruises. The small boats floating on the Danube river provide access to the tourist attractions situated along the borders and to the cities.

The river cruise means a few hundred travelers instead of thousands like in the ocean cruises.

The most important cruises companies on the Danube River are: Viking River Cruises, Avalon Waterways and Tauck Tours.

Table 1. Comparison regarding the facilities offered by three cruise companies operating on the Danube River

Characteristics	Viking River Cruises	Avalon Waterways	Tauck Tours
No. of ships	2	3	3
Guests capacity	(1)Viking Danube Ship= 150 guests (2)Viking Legend= 189 guests	(1)Avalon Visionary (2)Avalon Artistry (3)Avalon Expression	118 guests/ Ship
Room types	95 deluxe staterooms	Staterooms and suites	Double room
Other facilities	-Balcony -Picture window -Sun deck	-Picture window	
Trip duration	8 to 16 days	5 to 14 days	12 days
Tourist offer	"Romantic Danube" to discover grand cities and quaint villages on this 8-day river cruise along the "Blue Danube."	"Christmastime on the Danube"- to visit the Christmas markets in the cities (I)8 days from Vienna to Budapest (II) 11 days Budapest to Prague	"Budapest to the Black Sea - Eastbound"
Price	2,056 USD	2,039 USD 3,058 USD	5,590 USD

Source: [9, 12, 13, 14]

**Study case- Cruise Star of the Danube Delta, 15 days/14 nights from Budapest- The Danube Delta-Passau-Vienna-Budapest, from Euro 1,200/person/All inclusive**

Cruise ship Star of the Delta offers a high standard of service at unbeatable value for money.

The hospitality proved by the Romanian crew is always a positive factor.

According to the ancient custom, the crew on board welcomes the guests with a small but authentic Romanian gourmet.

All the tourists are surprised by the charming landscape of the sunny deck of the boat, the chance to swim in the pool or relax in its pleasant atmosphere.

The Star of Delta Program (15 days / 14 nights) could be sometimes subject to change depending on force majeure (low waters, floods, shallow water, locks).



In this case, the tourists should pay attention to the program and the current announcements made on board by the Cruise Manager. [3]

In the cruise price are also included meals and snacks, and guide services for visiting cities where the ship stops are made [4].

In this context, the purpose of the paper was to promote the cruises on the Danube river as a chance to admire the beautiful landscapes on its borders from various countries, to enjoy living on board of a luxury ship, and to visit various cities and have contact with the historical places and cultural life of those cities and also to enjoy admiring the biodiversity of the Danube Delta as a final destination.



Photo 2. Cruise MS Delta Star 15 days/14 nights [3]

(i) The travel offer includes the following services on the ship board:

**Accommodation in the chosen cabin on the ship;** the cabin has shower/tub and toilette, air conditioned, telephone, hairdryer, TV, wardrobe, internal sound system and a safe deposit box is assured at reception.

**All inclusive** regarding the all 3 meals: breakfast, lunch and dinner.

**Lunch** has 3 versions of the main dish, and vegetarian dish.

**Dinner** consists of 2 versions of the main dish, one of them being vegetarian.

**Between the meals:** snacks.

Only breakfast is served in a buffet style and the others meals are served in an "a la carte regime".

**Bar-offer** in the all-inclusive menu: 4 non-alcoholic cocktails, Romanian house-wine, draft beer, water (still or sparkle), tea/coffee.

**Free access** on the outside deck, at the pool and sunbeds.

**Port taxes**

**Daily program:** games (tombola, karaoke) live shows, themed party watching movies from the Video Library of the ship;

**The info-desk on board** is opened 24 hours/day

**There is one tourism office** where you can get information and book excursion in each city the ship stops.

(ii) The travel offer also does not include the following services:

- Alcoholic drinks;
- Hair-dresser, laundry service, medical service;
- Optional trips (pay on the ship);
- Phone calls outside the ship;
- Shopping on board;
- Trip insurance-recommended;
- Ship transfer;
- Accommodation service before/after embarkation/disembarkation;
- Airport transfer [4].

#### **Facilities offered on the board of the ship**

All-inclusive /Bar with light alcoholic and nonalcoholic drinks /Library access /Pool access /Sunbeds / Fitness zone /Hair-dresser / Massage/Music live shows Juice, coffee, milk, tea, water, airport transfer.

#### **Cabins.**

The upper deck cabins feature large windows that can be opened (inclined) and main deck cabins feature two smaller windows that do not open.

The cabins are equipped in a practical way. Amenities include air conditioning, shower and toilet, satellite TV, telephone board, hair dryer and a wardrobe.

**The 2-bedded cabins** measuring approximately 11 square meters and all contain two beds (single-deck) of a person.

**The Deluxe Cabins 2 beds** have a size of 20 sqm and have a separate lounge and bedroom area with a double bed.

**And One bed cabins** have a space of about 10 square meters.

#### **Other Facilities on board**

Restaurant with panoramic view, bar with panoramic view, store, barber/hairdresser, sun deck with swimming pool, awning, deck chairs and tables, safe/safety deposit box at reception available in the permanent vessel customers [3].

Table 2. The Programme of Cruise Star of the Danube Delta, 15 days/14 nights from Budapest- The Danube Delta-Passau-Vienna-Budapest, from Euro 1,200/person/All inclusive

DAY	CAP SHORE	ARRIVAL	DEPARTURES	REMARKS
Monday	Budapest	08:30		EMBARKING
TUESDAY			23:00	20:30 - 22:30 Budapest night
	Mohacs	09:30	17:15	09:00 - 13:00 Pecks (facultative)
WEDNESDAY	Belgrade	08:00		08:15 - 11:45 City Tour Belgrade
			22:30	20:00 - 22:30 Night Trip Belgrade (facultative)
SATURDAY	Iron Gates			
SUNDAY	Ruse	08:30	13:30	09:30 - 13:00 City Tour Ruse (facultative)
MONDAY	Mila 35	08:30	13:30	09:00 - 13:00 Danube Delta (facultative)
TUESDAY	Oltenita	08:00	09:00	08:30 - 14:00 City Tour Bucharest (from Oltenita /to Giurgiu)
	Giurgiu	13:00	14:00	
WEDNESDAY	Iron Gates			
THURSDAY	Novi Sad	08:30	14:00	09:30 - 13:00 Novi Sad
FRIDAY	Mohacs	01:00	03:00	Revision
	Kalocs	08:30	13:30	08:45 - 12:45 Pusza-Trip- Ordas (facultative )
SATURDAY	Bratislava	14:00	19:00	14:00 - 16:30 City Tour Bratislava
SUNDAY	Melk	12:00	16:30	13:00 - 16:30 Trip "Impressions from Wachau" - Melk
MONDAY	Passau/ Engelhartzell	08:30		City tour Passau/Engelhartzell
TUESDAY	Vienna	13:00	18:00	City tour Vienna
WEDNESDAY	Budapest	08:30		DEBARKING

Source: <http://www.infinity-agency.com/en/cruises/cruise-ms-delta-star-15-days-14-nights-budapesta-danube-deltapassaubudapesta.html>[3]



Photo 3. Star of Delta cabin

#### Restaurant / Kitchen

All meals are served in the spacious panoramic restaurant. The crew of the vessel

is a professional and extremely friendly. Diversified menus contain international cuisine and traditional dishes from local regions along our route [2].

#### Program onboard

Theme evenings, quizzes, bingo (as planned) and live music are just part of the fun aboard the motor vessel portfolio. Books, board games and playing cards are also available near the library vessel (Free).

#### Payment on board

Payment on board is made in euros. At the end of the cruise you can pay your bill by the



bar / restaurant and excursions booked on board, either in cash (Euro) or by debit or credit card (Visa, MasterCard or Maestro PIN code is required, do not accept V -Pay).



Photo 4. Star of Delta boat [2].

### *Life on board*

The atmosphere on board is one of nature relaxing. We suggest smart casual attire - a sweater for cooler evenings and resistant shoes for shore excursions. Please dress more formally for dinner. Ship's crew will always be available for any questions, help and tips throughout your stay.

Please note that the smoking is allowed only in special places [2].

### CONCLUSIONS

Danube is one of the main tourist destinations in the world. Its ability to attract tourists is a driver for a much larger area and this contributes to its development.

For visitors, the Danube presents a large variety of tourist attractions and sites which can be visited from wherever the tourist is staying.

The Danube area of influence has a rich collection of tourism elements that make it a powerful international leader that also provides services to a larger area.

The Danube is much more than the river. It offers a large range of possibilities to enjoy leisure activities, culture and nature.

The Danube is a valuable asset in terms of tourism and for this reason there is a lot of effort being put into the mutual collaboration

between countries, crossed by this river, that can be beneficial for all parties.

From a customer perspective, which is well understood by tourism business owners in the cities crossed by this river, further efforts are being made to develop the competitiveness of the Danube's tourism.

### REFERENCES

- [1] Aguirre Sandra Zapata, Brida Juan Gabriel, 2011, The Impacts of the Cruise Industry on Tourism Destinations, Social science Research Network, [http://papers.ssrn.com/sol3/papers.cfm?abstract\\_id=1298403](http://papers.ssrn.com/sol3/papers.cfm?abstract_id=1298403)
- [2] Buhociu Florin Marian, Mihalcea Lucean, 2015, Tourism along the Danube River, [http://www.romanian-ports.ro/acva2015/materiale/Prof\\_Buhociu\\_Tourism%20along%20the%20Danube%20river.pdf](http://www.romanian-ports.ro/acva2015/materiale/Prof_Buhociu_Tourism%20along%20the%20Danube%20river.pdf)
- [3] Cruise MS Delta Star 15 days/14 nights Budapest-Danube Delta-Passau-Budapest, <http://www.infinity-agency.com/en/budapest-danube-delta-passau-budapest>.
- [4] Croaziere pe Dunare-Viena, <http://www.austria.ro/blog/croaziere-pe-dunare-viena/>
- [5] Dridea Catrinel Raluca, 2008, The impact of the cruising industry on local destination, Annals of Oradea University, Economic Sciences, <http://steconomiceuoradea.ro/anale/volume/2008/v2-economy-and-business-administration/112.pdf>
- [6] Exploring nature along the Danube River, Danube Parks, Network of protected area, [http://www.danubeparks.org/files/779\\_Tourism\\_Brochure\\_DANUBEPARKS.pdf.pdf](http://www.danubeparks.org/files/779_Tourism_Brochure_DANUBEPARKS.pdf.pdf)
- [7] Galvin Tom, 2004, 10 Places on the Danube, [http://www.tomgalvin.com/lists/lists\\_20030901.htm](http://www.tomgalvin.com/lists/lists_20030901.htm)
- [8] Gheorghilaş, A., 2005, Geografia turismului internaţional, Editura Universitară, Bucureşti
- [9] Plum Auvil Jennifer, Danube River Cruises, Set Sail on the Blue Danube, <http://www.travelchannel.com/interests/cruises/articles/danube-river-cruises>
- [10] Sam cel Roman, 2011, Tourism Along the Danube River, <http://kingofromania.com/2011/05/03/tourism-along-the-danube-river/>
- [11] <https://www.google.ro/search=poze+catedrale+austria+viena>
- [12] <http://www.tauck.com/river-cruises/european-river-cruises/danube-river-cruising.aspx>
- [13] <http://www.avalonwaterways.ca/>
- [14] <http://www.vikingrivercruises.com/>



## PROACTIVE APPROACH FOR THE IMPACTS OF FRAUDULENT FINANCIAL INFORMATION ON ECONOMIC DECISION

Isa TAK

Lumina - The University of South-East Europe, 64B Colentina Street, District 2, 021187, Bucharest, Romania, Phone: +40212403033, Mobile: +40756066959, E-mail: isatak23@gmail.com

*Corresponding author:* isatak23@gmail.com

### *Abstract*

*In the last decade today's world has been affected by frauds and manipulation of the financial information. An investment decision based on false financial information causes the investors to suffer losses as was experienced in Enron and WorldCom cases. For this reason financial information manipulation is as important as other types of manipulations and must be prevented so that the investors make a rational decision. Financial information has, certainly, an important positive or negative effect in economic decisions. Positive or negative effects of financial information on economic decisions depend on reliability of the financial information.*

*Key words:* decision, financial Information, fraudulent, manipulation

### INTRODUCTION

In the recent years, the financial information manipulation has been debated by many economists and researchers especially in the developed countries all over the world. If we look at the negative effects of manipulated or fraudulent financial information on the economy it seems this issue will be debated for many years. Fraudulent financial reporting has become a very problematic issue which damages today's economy. As technological developments and expectations of people have caused the inevitable changes in the economic structure, whilst trying to provide the maximum benefit with limited resources. [9]

In the literature for the financial information has been given several names: earnings management, big bath accounting, creative accounting, income smoothing and window dressing. In order to manipulate the financial information have been used these techniques using the flexibility of the Accounting Standards.

The collapse of Enron has caused about \$70 billion lost in market capitalization which is devastating for significant numbers of investors, employees and pensioners. The WorldCom collapse, caused by alleged financial statement fraud, is the biggest

bankruptcy in the United States history. [11] Loss of market capitalization resulting from the reported financial statement fraud committed by Enron, WorldCom, Qwest, Tyco, and Global Crossing is estimated about \$460 billion.

Public Company Accounting Oversight Board (PCAOB) argues that the fraud detection is among the highest priorities for the accounting profession and standard setters. Securities and Exchange Commission (SEC), Commissioner Hunt Jr Isaac C remarks in his speech in April 2002 that the transparency, reliability and accurate information allow users of the financial information such as investors, creditors to make intelligent decisions. "Audited financial statements provide the foundation for securities markets. But Securities and Exchange Commission (SEC), Chairman Harvey L. Pitt. Remarks in his speech in 2002 April 25 that the audited financial statements allow investors to make decisions on whether to buy, hold, or sell a particular security". "Accurate information also improves the quality of markets by allowing markets to discover the true price at which specific securities trade". Fraudulent financial reporting has become a very problematic issue which damages today's economy. As technological developments and

expectations of people have caused the inevitable changes in the economic structure, whilst trying to provide the maximum benefit with limited resources.

Financial scandals, indisputably, in recent years, have significant importance in the financial world. These scandals have shaken the confidence of the investors. And effects of these scandals have been felt, are being felt and will be felt all over the world. The recent reported financial statement fraud and resulting decline in the stock market show the importance of the quality of financial reports and audit functions as well as the understanding of what may have caused the occurrences of accounting scandals. [11] Scandals which took place in the beginning of the 20th century brought us the quality of financial reports and credibility of audit functions. Collapses of these big companies have raised the concern of whether the accounting standards are sufficient for producing the quality of financial information. Financial information manipulation mainly stems from the desire to influence the possibilities of wealth transfer between the various stakeholders. Active investors should be informed in time, and, properly and correctly in capital markets. The requirement of being informed is also important and necessary for money markets which consist of other financial system. However, investors' intentions of buying securities and taking decisions are based on financial information which is presented too, so this requirement of being informed is increasing the importance of financial information.

In this context, the purpose of the paper was to answer the following questions and find some solutions to satisfy the readers:

Why companies manipulate the financial information and commit the fraud in financial situation? Who benefits from the manipulated information and fraudulent financial situation? What kinds of reasons force the manipulators to commit the fraud and manipulate the financial information? If the all financial information's fraudulent can be detected? If the financial losses can be calculated in real economy? If is there any measurement which have been taken by

governors to prevent the manipulation in the financial information?

All these kind of questions have asked before and are being asked today.

## **MATERIALS AND METHODS**

The paper is a critical review of the literature on the topic and presents the author's opinions about the causes and effects of the manipulation of the financial situation, the fraudulent and manipulated financial information, the financial losses caused by manipulated financial information, and the social effects of fraud or manipulated financial information.

It presented in a critical manner why the companies manipulate the financial information and commit the fraud in financial situation, who benefits from the manipulated information and fraudulent financial situation, what kinds of reasons force the manipulators to commit the fraud and manipulate the financial information, how the fraudulent financial information can be detected, how the financial losses can be calculated, how the governors could prevent the manipulation in the financial information.

## **RESULTS AND DISCUSSIONS**

### ***(i) Causes and effects of the manipulation of the financial information***

In today's conditions, rivalry in business is at a high level and the desire of companies to present the financial information of company is rationally approached. Capital markets in which there are many companies pass the information to the investors through reports which present the activities of the companies and these reports help the investors to provide necessary funds. Companies acting this way need means and an intermediary in order to present the financial situation. Some of the causes for manipulation the financial information have been detailed below.

### ***Weakness Structure of the Company's Management***

Any weakness structure of the company management leads the manager to manipulate the financial information to show the

company's financial situation better than it is. Why the management structure is so important for any company and why the weakness structure of the company's management can be the reason to manipulate the financial information According to the Dechow, Sloan and Sweeney (1996), [1]

-CEO's influence on the board is measured as follows: a) CEO chairs the board in about 64% of the control firms. b) The CEO belongs to the founding family in 26% of the firms. So the result is that Board members are at the same time general directors and top manager.

-Most of the general directors are chairman of the board at the same time.

-Most of the general directors are founders of the company at the same time

-There are not independent audit committee in the most companies

-Shareholders from outside have not important share in the company

According to the Koch, the financial information can arise from organizational structure of the company. So we can say that the weakness management structure of the companies can be the reason for manipulation of the financial information.

#### ***Managers' Interests and the Partnership Structure of the Companies***

Behind of the financial information manipulation can be the managers' interests. Managers' interest can affect the strategic decision for the company. Normally any decision is based on interests. Especially senior managers are aware of their interests and can keep their own interest for the first point on decision. Much more, that senior managers' decisions for a strategy A or B are not (solely) based on an abstract strive for 'profit-maximization' of 'efficiency' (or whatever is portrayed as 'the interest of the organization') but on what they regard personally as in their interest. Arens and Loebbecke define fraudulent financial reporting as: "intentional misstatements or omissions of amounts and disclosures in financial statements to deceive users." Managers are always the manipulators in financial information manipulation whereas mainly the other investors are the manipulators in other types of manipulations.

According to some economists;

-Managers act for increasing their own interests

-Dividend ratio is the norm to determine the stock price causatively

-Managers' interest depends directly on the stock price of the company

Studies made by investigators indicate that companies are most likely to have fraudulent financial reporting perpetrated by top managers. These reasons above trigger the managers to manipulate the financial information in order to make stable profit. Besides this, efficiency and the size of the company is also an important factor.

#### ***Inadequate Internal Control System***

The aim of the independent audit committee is to monitor the financial reporting process which must produce the accurate, reliable financial information. Of course this monitoring process does not mean that the audit committee should stay all day in the company while controlling the accounting records. Inadequate internal control system is considered as an important cause for the financial information manipulation. Inadequate internal controls over financial reporting and accounting practices could lead to errors, which could adversely impact ability to assure timely and accurate financial reporting. On the other hand every public company must have the internal control department according to its size and should employ the experienced people who can control if the financial reports have been produced accurately and reliable.

In Ernst & Young 2007 report it is expressed that is why managers invest in internal controls, in part, to prevent and detect fraud. Because these controls are costly, and fraud prevention and detection are difficult, these controls are generally incomplete. In ACFE Report to Nation 2006 it is expressed that; consequently, managers and academics recognize that employees who become aware of wrongdoing such as fraud can play an important role in its early detection. We can get some investigation results from the survey done by the Association of Certified Fraud Examiners (ACFE) 2010 Report to Nation. These surveys also express the importance of the weaknesses of the internal control system.

According to the survey the respondents have been asked to identify which of several common issues they considered to be the primary factor that allowed the fraud to occur. The answer was as follow; a lack of internal controls, such as segregation of duties, was cited as the biggest deficiency in 38% of the cases. In more than 19% of the cases, internal controls were in place but were overridden by the perpetrator or perpetrators in order to commit and conceal the fraud. Interestingly, even though hotlines are consistently the most effective detective control mechanism, and even though less than half of the victim organizations had a hotline in place at the time of the fraud, a lack of reporting mechanism was the control deficiency least commonly cited by the CFEs who participated in study.

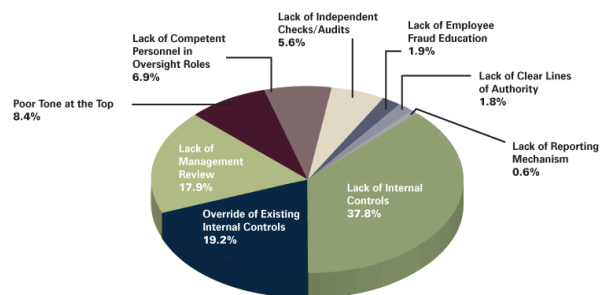

Fig. 1. Primary Internal Control Weakness Observed By CFEs  
 Source: ACFE Report to Nation

Figure 1 shows the difference between organizations according to their sizes. As we see in the chart that 47% of the small business do not have any internal control. But the number 33.7% is rather big for larger companies. Lack of internal controls shows the factor most contributed to the fraud. Small business do not override because there is nothing to override.

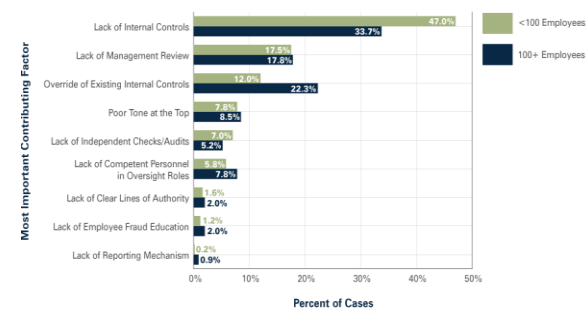

Fig. 2. Primary Internal Control Weakness by Size of Victim Organization.  
 Source: ACFE Report to Nation

Figure 2 shows the difference between organizations small and more than \$1 million. How the weaknesses of the internal control contribute to fraud.

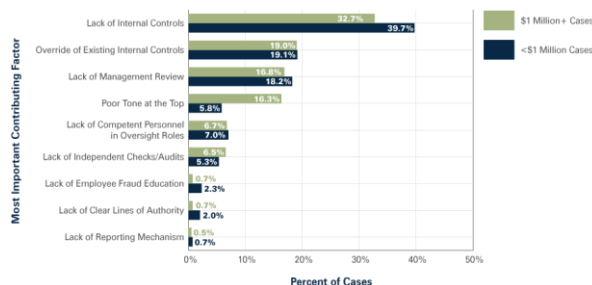

Fig. 3. Primary Internal Control Weakness in Largest Cases  
 Source: ACFE Report to Nation

### Accrual Accounting and the Flexibility of the Accounting Standards

Generally Accepted Accounting Principles (GAAP) relies on accounting accruals to provide earnings information that is useful in business decision-making. Dechow and Skinner (2000) both emphasize that fruitful areas for future research is to first, identify firms whose managers practice earnings management and focus on their managerial incentives.[2] Second, document the magnitude and frequency of specific accruals and accounting methods used to manage earnings. The impact of discretionary accruals on the information content of earnings is subject to debate. On the one hand, these manipulations could enhance the value-relevance of reported earnings by communicating a manager's private information regarding future profitability. On the other hand, the flexibility inherent in GAAP may result in opportunistic behavior that distorts reported earnings. To date, empirical research on managerial discretion and earnings in formativeness has been indirect and mixed, and the information effects of discretionary accruals in particular is relatively unexplored. [8]

Accounting principles have an international or national standard to produce the financial reports in regular and understandable mode by everyone. But as a matter of course every rules or laws can be flexible in order to adopt more easily. But ,indisputably' there are some

arguments in favor of accrual accounting and some against for accrual accounting. Models of non-discretionary accruals, i.e. Accrual models, are widely used by financial analysts to assess the level of discretionary accruals, an important indicator of earnings management practices, and, more importantly, a significant predictor of stocks returns. [4] Actually, one of the main reasons why accrual models have generated such attention in the finance literature is precisely the fact that the residuals of accrual equations carry valuable information about stock returns.<sup>4</sup>

#### ***(ii) Fraudulent and manipulated financial information***

The term fraud is defined in some dictionaries as follows; *an act using deceit such as intentional distortion of the truth of misrepresentation or concealment of a material fact to gain an unfair advantage over another in order to secure something of value or deprive another of a right. Fraud is grounds for setting aside a transaction at the option of the party prejudiced by it or for recovery of damages.* But on the other hand the term fraud has been by scholars too as follows; *in legal terms, fraud is a generic category of criminal conduct that involves the use of dishonest or deceitful means in order to obtain some unjust advantage or gain over another. In business terms, fraud is sometimes difficult to define as it extends, for example, from conduct as trivial as an employee having an extended lunch break without permission, to large-scale misappropriation of funds by a company accountant involving many millions of dollars.*

Certainly the definition may differ from person to person and from country to country but the common thing of fraud is dishonesty. Starting from the definitions we examine the problem with some real evidence.

The recent reported financial statement fraud and resulting decline in the stock market show the importance of the quality of financial reports and audit functions as well as the understanding of what may have caused the occurrences of accounting scandals. [11] Today's one of the biggest problems we face is fraudulent in the financial situation. According to the Association of Certified

Fraud Examiners (ACFE, 2008) the cost of fraud is difficult to quantify for a number of reasons: 1- not all fraud is detected; 2- of that detected, not all is reported; 3- in many fraud cases, incomplete information is gathered; 4- information is not properly distributed to management or law enforcement authorities; and 5- too often, business organizations decide to take no civil or criminal action against the perpetrator (s) of fraud.

In the survey done by Association of Certified Fraud Examiners (ACFE, 2010) given details in the "Report to the Nation on Occupation Fraud and Abuse" 2010 booklet have been declared the loss because of the fraudulent. In the survey has been asked the question to provide his or her best estimate of the percentage of annual revenues that the typical organization loses to fraud in a given year. The median response was that the average organization annually loses 5% of its revenues to fraud. The ACFE committee applying this percentage to the 2009 estimated Gross World Product of \$58.07 trillion would result in a projected total global fraud loss of more than \$2.9 trillion. But we should note that this estimation is based only on the opinions of 1,843 anti-fraud experts, rather than any specific data or factual observations; accordingly, it should not be interpreted as a literal representation of the worldwide cost of occupational fraud.

As we see above the subject „fraudulent” must be considered carefully by audit experts and should be prevented as much as possible. Otherwise the negative effects of the manipulated financial information will be bigger than previous year. This given example is just for U.S.A. but for the rest of the world cannot pass over. But we should note that the financial statements fraud is the least common but most costly form of fraud among cases investigated in the surveys.

Fraud can inflict significant damage at community, organizational or individual level and the potential consequences of fraud for organizations can be strategic, legal, financial or operational. Therefore, it must be an important issue for organizations. [10]

#### ***Fraudulent in financial situations***



Fraud consists of knowingly making material misrepresentations of fact, with the intent of inducing someone to believe the falsehood and act on it and suffer a loss or damage. [5] Every country specially developing and developed countries suffer from fraudulent and manipulated financial information. The losses from manipulated financial statements rather bigger than other types of fraud as corruption, asset misappropriation. The cost of fraudulent and manipulated financial information cannot be calculated. But some investigations show how big negative effect of the fraudulent has on real economy and undisputable because of fraud all people is effected all over the world.

An investigation study made by Committee of Sponsoring Organizations of the Treadway Commission in U.S.A. searching the „Fraudulent Financial Reporting” between 1987-1997 years has declared some of the more critical insights. They are:

-The companies committing fraud generally were small, and most were not listed on the New York or American Stock Exchanges.

-The frauds went to the very top of the organizations. In 72 percent of the cases, the CEO appeared to be associated with the fraud.

-The audit committees and boards of the fraud companies appeared to be weak. Most audit committees rarely met, and the companies' boards of directors were dominated by insiders and others with significant ties to the company.

-A significant portion of the companies was owned by the founders and board members.

-Severe consequences resulted when companies committed fraud, including bankruptcy, significant changes in ownership, and delisting by national exchanges.

The study above shows that audit committees should be stronger and the audit committees should not have any connection with the company members. If the founders of the company are members at the same time, it may encourage the directors to commit the fraud more easily. Committing fraud in the financial situations may bring to the company some benefit for short-term but consequences may be worse as bankruptcy, changes in ownership and delisting by national exchanges.

Preventing the fraud is also costly work for the companies or government agencies. As

explained in section 1 the causes of fraudulent play an important role to commit the fraudulent in the financial situations. Al Capone's bookkeeper once said that he can steal more with a pencil than ten men with machine guns—the situation is much worse today, with computers that have increased the speed, the possible scope of criminal acts and the difficulty to investigate such crimes. [5] Furthermore, money in electronic form are much easier to steal: while US\$1B in \$100 bills occupies about 15 cubic meters, and in gold would weigh about 65 tons, in electronic form is just 32 bits plus some application-dependent headers. [7]

### ***(iii) Financial losses caused by manipulated financial information***

Detecting fraud is difficult because those engaging in fraud generally attempt to conceal their behavior, fraud is not a predictable event, and auditors often have limited experience detecting fraud. [6] It is very difficult to calculate the cost of the fraud losses. ACFE „Report to Nation-2010” also expresses the danger on this issue. ACFE declares that „there is no way to precisely calculate the size of global fraud losses, the best estimate of anti-fraud professionals with a frontline view of the problem may be as reliable a measure as we are able to make. In any event, it is undeniable that the overall cost of occupational fraud is immense, certainly costing organizations hundreds of billions or trillions of dollars each year.

According to the ACFE researches there are three main types of fraud; asset misappropriations, corruption and financial statement fraud. Asset misappropriations fraud committed to steal or misuses an organization's resources. Corruption schemes involve the employee's use of his or her influence in business transactions in a way that violates his or her duty to the employer for the purpose of obtaining a benefit for him- or herself or someone else. Financial statement fraud schemes are those involving the intentional misstatement or omission of material information in the organization's financial reports. Common methods of fraudulent financial statement manipulation include recording fictitious revenues,



concealing liabilities or expenses and artificially inflating reported assets. These three types of fraud have been illustrated in charts. As we see in the chart that the asset misappropriation is most frequent but least costly form of fraud besides the financial statement fraud is less frequent but most costly form of fraud. Corruption is in the middle of two fraud types.

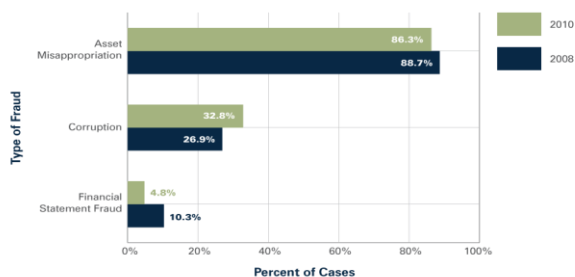

Fig. 4. Occupational Frauds by Category — Frequency  
 Source: ACFE Report to Nation

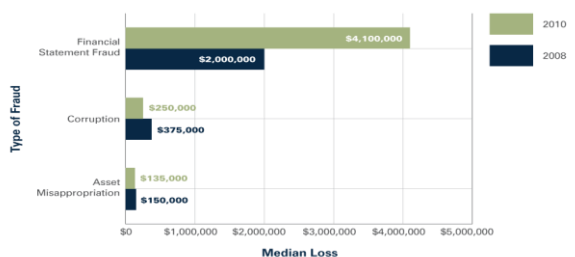

Fig. 5. Occupational Frauds by Category — Median Loss  
 Source: ACFE Report to Nation

As indicated in charts above although the percentage of cases of financial statement fraud decreases in 2010 against 2008 but the losses increased significantly. So this situation raises the question that something should be done in order to prevent the financial statement fraud. Otherwise financial crisis will be inevitable and the financial system will be fatal. On one hand the flexibility is the method unblocking the economically development on the other hand flexibility of the accounting standards encourage the perpetrators to manipulate the financial information but the flexibility of the accounting standards should not be misused in order to gain for short-term.

***(iv) Social effects of fraud or manipulated financial information***

Fraud is a serious social and economic

problem that adversely affects a broad range of stakeholders, including audit committee and board members, top managers, employees, auditors, creditors, shareholders, and pensioners [3]. Effects of fraud have been debated by financial world from point of economy. But nobody can pass over the social problem of fraud.

Expected function from taxation is to achieve the economic aims with taxes. In this situation the taxation laws have to be applied completely and correct. On the other hand, presenting the financial situation accurately the informal economy is being obstructed. Persons who evade tax can use the funds as they wish. This situation cause unfair competition and the consequences of evasion tax may affect the government plans.

Indisputable fraud has a negative effect on every human being. We can classify few consequences:

- Economic decline due to direct physical damage
- Economic decline due to losses suffered by publicly used services such as transportation, police and fire departments
- Indirect economic losses endured by prominent corporations due to losses suffered by their clients
- Physical injury or death to innocent victims caught in the middle of a scam gone wrong
- Emotional and psychological burdens placed on the fraud victims

The impact of such theft can also have a social impact on the organization. It can allow the organization to lose the confidence of the stockholders of the organization. It can also contribute to a loss of confidence in the organization by its advertisers. The negative publicity from the media can also impact how the organization is perceived and supported by the local, national or international community in which the organization operates as well as the customer base of the organization. The cumulative effect on all of the negative circumstances may also have a major impact on the organization's total reputation and stock value which could in some cases can lead to the closure of the business or an unprecedented loss of revenue (ACFE, 2007). In the ASIS (Advancing

Security Worldwide) report mentioned that due to the losses in the organization it can also have an impact on the confidence of the local, state or national economic conditions based on the size of the business affected by corporate fraud. Fraud has a negative impact on individuals, organizations, and communities. It can divide families and small communities and also has ramifications for society as a whole.

## CONCLUSIONS

The fraud is a global problem. Managers are responsible for committing the fraud in financial information. Managers' interests are playing very important role to manipulate the financial information. Company's management structure should be strong and transparent. If in any company general director is the chairman or founder of the company at the same time, so the manipulating the financial information is inevitable. Internal control system makes the financial information more confident. According to the investigation is made by ACFE express the importance of the weaknesses of the internal control system. Lack of the internal controls shows the factor most contributed to the fraud. In the last decade preventing the fraud in the financial information and manipulated financial information is an important issue. Preventing the fraud is also costly work for the companies or government agencies. As indicated in the charts the financial losses are significant and should be taken measures to prevent the fraud. Otherwise the losses will cause to collapse the real economy as experienced before. Accuracy, transparency and reliability of financial information will give the opportunity to investors to make the correct decision on their investments. Otherwise the allocation of resources will not be efficient.

Nowadays there is no developed country without an accounting and audit system. Not only national financial results but also international financial results have to show the single aspect which is called reliability. Accurate, robust, reliable and real financial

reports are provided only with audit. Reliable information has become more important as the community grows and gets more complex. From the investors' point of view, the main measurement of the investments which have been made or planned is, obviously, reliable information. If disclosed information is not reliable so decision makers cannot take measured decisions on issues. Interest groups require the financial information explained to them and need that financial information to reflect the reality. Decision makers have to investigate if the disclosed information is reliable or not. The usual method is to take advice from an independent person. Integrity, accuracy and impartiality of the audited and verified information are considered to be reliable information in the decision process.

To protect the assets which belong to investors against risks, so to provide the confidence in the capital market is quite important. Otherwise, because of the losing the confidence in the capital market will not contribute to the growing of the economy of the countries.

Committing fraud in the company and presenting an erroneous financial situation will damage the companies. Every fraud and error has a cost to the economy. The consequences of fraud and errors are that sources are not directed to the necessary and most productive areas in the economy, so allocation irregularities appear in the economy. Fraud and errors committed in financial reports lead the users of financial information to make decision wrongly, thereby not allocating resources correctly, and because of this companies could be sanctioned by official authorities. Also investors who invest on the stock exchanges will be affected by errors in the financial information. Investors will be encouraged to invest in unproductive areas and this will have the cost to the economy. Companies would like to get a profit in the short period, but this ambition could lead to fraud and errors being committed in the financial information and consequently these companies could be dragged bankruptcy. Unless this ambition of companies ends there will not be any stability in their economy. Any fraud or errors could

trigger the committing of other fraud in the financial situation. If we look at the statistical numbers there is no period in which the fraud or errors were not detected.

[11]Zabihollah, R., 2005, Causes, consequences, and deterrence of financial statement fraud, *Critical Perspectives on Accounting*, Volume: 16(3): 277-298

## ACKNOWLEDGEMENTS

This paper has been written during my PhD study degree and presented in the International Student Conference in May, 2011 in Epoka University, in Tiran, Albania but not published in any scientific journal till now. That is why in paper, readers may see the data and information from years 2008 and 2010 respectively. I'd like to thank to my coordinator Prof. dr. Ana Morariu to give me all possibility to make my PhD degree.

## REFERENCES

- [1]Dechow, P., Sloan, R., Sweeney, A., 1996, Causes and Consequences of Earnings Manipulation: An Analysis of Firms Subject to Enforcement Actions by the SEC, *Contemporary Accounting Research*, Vol: 13, No.1, pp.1-36.
- [2]Dechow, P. M., Skinner, D. J., 2000, Earnings Management: Reconciling the Views of Accounting Academics, Practitioners and Regulators, *Accounting Horizons*, 14 (2):235-250.
- [3]Dyck, I. J. A., Morse, A., Zingales, L., 2007, Who blows the whistle on corporate fraud? Working Paper No. W12882, National Bureau of Economic Research.
- [4]Hirchleifer, D., Hou, K., Teof, S.H., 2009, Accruals, cash flows, and aggregate stock returns. *Journal of Financial Economics*, 91, 389-406.
- [5]Louwers, T. J., Ramsay, R. J., Sinason, D. H., Strawser, J. R., 2007, *Auditing and Assurance Services*, New York, McGraw-Hill/Irwin.
- [6]Nieschwietz, J. R., Schultz, J. J., Zimbelman, M. F., 2000, Empirical research on external auditors' detection of financial statement fraud, *Journal of Accounting Literature*, 19, 190-246.
- [7]Parker, B.D., 1998, *Fighting Computer Crime: A New Framework for Protecting Information*, John Willey & Sons, Inc., ISBN: 0-471-16378-3
- [8]Subramanyam, K.R., 1996, The pricing of discretionary accruals, *Journal of Accounting and Economics* 22, 249-281
- [9]Tak Isa, 2010, Financial Information, Effects Of Financial Information on Economic Decision, *Annals-Economy Series*, Volume 4, pages 217-231, Publisher: Constantin Brancusi University, Faculty of Economics
- [10]Vasiu Lucian, Warren Matthew, Mackay David, 2003, Defining Fraud: Issues for Organizations from an Information Systems Perspective 7th Pacific Asia Conference on Information Systems, 10-13 July 2003, Adelaide, South Australia



## COMPARATIVE ANALYSIS OF THE LAND FRAGMENTATION AND ITS IMPACT ON THE FARM MANAGEMENT IN SOME EU COUNTRIES AND MOLDOVA

Elena TIMOFTI<sup>1</sup>, Daniela POPA<sup>1</sup>, Barbara KIELBASA<sup>2</sup>

<sup>1</sup>State Agrarian University of Moldova, 44, Mircesti St., MD – 2049, Chisinau, Republic of Moldova, Phone: +373 767 15 222, +373 795 74 780, Fax: (+373 22) 31-22-76, Emails: e.timofti@uasm.md, d.popa@uasm.md

<sup>2</sup>University of Agriculture in Krakow, 21, Al. Mickiewicza, 31-120 Kraków, Poland, Phone: (012) 662 44 00, Email: bkielbasa@ar.krakow.pl

**Corresponding author:** d.popa@uasm.md

### Abstract

*The paper presents selected problems of farm management in terms of fragmented agriculture. The problem of land fragmentation was exemplified by the three countries of Central and Eastern Europe. The main purpose of the study was to compare the effectiveness of selected indicators of agricultural production in the three selected countries. For the analysis, the data on the concentration indexes was selected: Lorenz concentration coefficient, the Gini index, and territorial concentration coefficient (Gini C and Stuck formula). In selected countries, there is a large number of small and very small farms. They represent the majority of farms managed by private owners. To a large extent, they are called semi-subsistence farms or social farms. Some of them provide a part of their products on the market. Small farms are the part of the so-called European Model of Agriculture – a model that consists of small family farms. It is difficult to indicate correct definition of „small farm”, as it may be defined differently depending on the region or country. In the EU, small farms occupy a dominant position, being a constant subject of debates and policy. The authors of the article stressed the need of strengthening of the small farms position, for example by enlarging their acreage or by initiating horizontal or vertical cooperation, however, shall not impair the role of small farms. They are important in biodiversity protection, preserving the rural landscape, as well as by cultivation local tradition, culture and heritage.*

**Key words:** European model of small farms, land fragmentation, concentration index, land productivity, farm management, the role of small farms

### INTRODUCTION

Nearly 14 million farmers manage in the EU and the average farm size is 15 hectares. The biggest agricultural holdings are located in Czech Republic (the average farm size is 90 hectares) and Denmark (60 hectares) and the lowest in Romania (3 hectares), Poland (6 hectares), Bulgaria (6 hectares), Hungary (7 hectares) and Italy (8 hectares) [Eurostat 2014] [5].

Land fragmentation and the system of small farms is known as the European Model of Agriculture (EMA) [Kowalczyk, Sobiecki 2011] [9]. Fragmented agriculture, family farms and, what should be stressed, very diverse, characterize European agriculture. There are many agricultural enterprises and organic farms, nevertheless very small and

medium-sized farms have a dominate position [Musiał, Drygas 2013] [13]. European agriculture still represents a fragmented model of agriculture and is in a large part family-managed. Very often, the land is cultivated from generation to generation: when retired owners pass the farm in the hands of their children [Poczta 2010]. The use of direct payments under the Common Agricultural Policy of European Union is for sure an incentive to keep small farms, as well as significantly affect the increase in land prices [Światły, Turnau, Majchrzak 2011] [27]. What's more, introduced modulation (reduction of direct payments for the largest farms) will cause in splitting the big farms into smaller ones [Zegar 2008] [32]. Although European Model of Agriculture is fragmented and based on family farms, the

concept of “small farm” is not very clear. For the criterion of defining the utilized agricultural area can be taken, as well as economic output, added value, allocation of production, work force, the source of income, etc. [EU Agricultural Economic Briefs: What is a small farm? 2011; The European Model of Agriculture – Challenges Ahead 2006] [5, 28]. Because of the size, the “small farm” may be the farm of 2 hectares in Poland, Romania or Moldova, while in France or Great Britain, we may consider small farm with the area of 30 or 50 hectares.

Over the years, we can observe slow increasing in the average farm size in the EU: between 2003 and 2010, the average farm size increased from 12 to 14 hectares. At the same time, the number of farms reduced between 2003 and 2010 by 20% [Eurostat 2014] [5]. However, small farms still dominate in Europe, and those above 50 hectares are only 5% of all farms. In relation to other countries in the world, e.g. the USA or Australia, these farms are still very small [Tóth 2014] [29].

In this context, the main purpose of the research was to assess the degree of the land fragmentation in three countries in the Central and Eastern Europe (Poland, Romania and Moldova), taking into account its impact on the land productivity and management.

## MATERIALS AND METHODS

The rate of land productivity was used defined as the value of agricultural production per 1 hectare of utilized agricultural area (UAA).

To assess the degree of land fragmentation the calculations of Majchrzak [2014] [10] were used: Lorenz concentration coefficient and the Gini index.

The Lorenz coefficient reaches values of  $<0,1>$ , where the closer to 0 the lower the concentration is, the closer to 1, the greater the concentration with the respect to a fixed variable is. In the paper, concentration with the respect to farms greater than 50 hectares was taken into account. In turn, the Gini index is a measure of inequality of the random variable. It also ranges from 0 to 1, but the value of zero means complete uniformity and the growth of rate represents the increase of

inequality [Statystyczne studium struktury agrarnej w Polsce, 2010] [24]. For Moldova case study, the territorial concentration coefficient (Gini C and Stuck formula) were also used.

For the calculations statistical data of Eurostat, data from the Central Statistical Office in Warsaw, the data of the Agency for Restructuring and Modernization of Agriculture and Ministry of Agriculture from Moldova Republic, National Bureau of Statistics from Republic of Moldova were used, as well as scientific publications and research results.

The study focused on the analysis of mentioned factors in relation to three selected countries: Poland, Romania and Moldova. The strong similarity can be indicated in the level of development in agriculture, and similar problems faced by these countries. They characterized by a fragmented agrarian structure, low average farm size and a high employment in agriculture [Gospodarstwa rolne w Polsce na tle gospodarstw Unii Europejskiej – wpływ WPR, 2013] [6].

## RESULTS AND DISCUSSIONS

Agriculture in Poland is very fragmented: the average farm size in 2014 amounted to less than 11 hectares (but significantly differs in different regions) [www.arimr.gov.pl] [33]. Despite a slight impact on the creation of added value this sector involves a large group of employees – about 12% (3.8 million people working in agriculture). Poland is among the countries with the large number of farms: more than 1.5 million according to Eurostat. Nearly 1.3 million farmers receive direct payments [Rolnictwo w 2014; Agricultural census, Eurostat 2010] [1, 21]. Unfavorable structure of agriculture is the result of many factors, including agrarian overpopulation, agricultural reforms (especially the reform of 1944), social conditions, the results of political transformation, as well as the current EU Common Agricultural Policy [Struktura agrarna – Land structure] [26].

As we can see in Figure 1, small farms dominate: a half of Polish farms had less than 5 hectares of agricultural land. Only 8% of all

farms have more than 20 hectares but they manage almost a half of utilized agricultural area in Poland. Farms with more than 100

hectares covered 22% of agricultural land, but they represent only 1% in the structure of all farms (Fig.1).

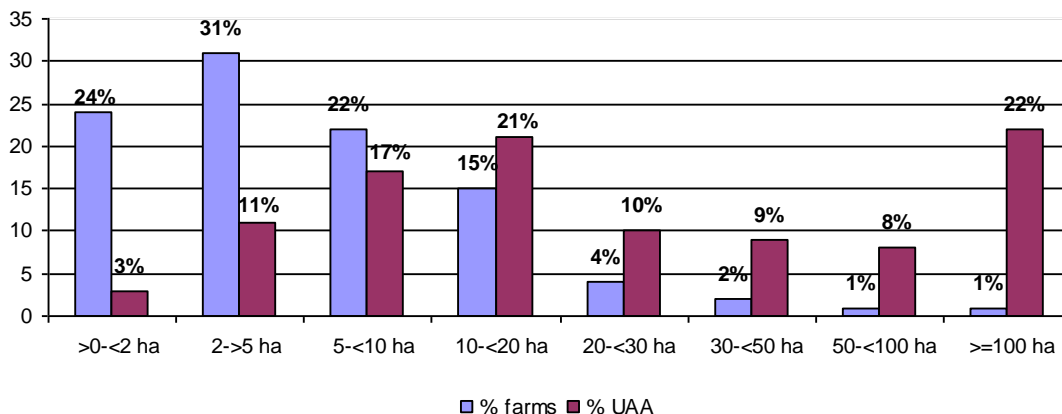

Fig. 1. Distribution of agricultural holdings and UAA in Poland in 2010 (in %) Source: Agricultural census, Eurostat 2010 [1].

Agriculture is a very important sector in Romanian economy. It covers more than 3.5 million of farms and employs over 28% of the national workforce – the first position in the EU-27, followed by Poland. Family-run and semi-subsistence farms have a dominant position [Popescu, Condei 2015] [19]. The utilized agricultural area is also very large

compared to other countries. The huge decrease can be observed in the number of farms (-14% between 2003 and 2010) but still Romania struggles with a very fragmented agriculture [Agricultural census, Eurostat 2010] [1]. Around 90% of all farms manage no more than 5 hectares, which means a huge fragmentation (Fig.2).

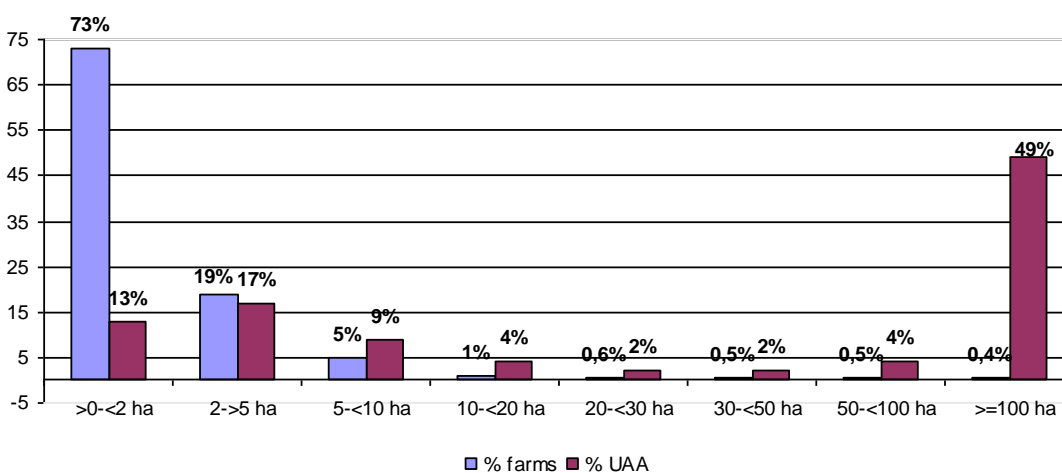

Fig. 2. Distribution of agricultural holdings and UAA in Romania in 2010 (in %) Source: Agricultural census, Eurostat 2010 [1].

The average farm size is about 3.7 hectares; what's more, farms are fragmented because they consist of many small parcels. The land fragmentation is partially the result of the land restitution from 1990s. According to Popescu [2009] [20]. due to a large fragmentation of

agricultural land, there is a need of initiating the processes of land consolidation. Agriculture in Moldova is also very fragmented. The land reform of 1991 and post-land reform development have resulted in a polarized agricultural structure with an

average land individual farm of 2 hectares, typically distributed in 3-4 parcels. Unfavorable structure of agriculture is the result of many factors, including agricultural reforms (especially the reform of 1990-1992), social conditions and the results of political transformation. In many cases, the fragmentation of land parcels has prevented the land market from developing [www.fao.org.nr] [35]. Now the average private farm size in 2014 amounted to less

than 4 hectares (but significantly differs in different regions). Farms with large acreage (more than 100 ha) are usually agricultural holdings (companies or cooperatives), and small farms with the area up to 5 hectares are run privately by farmers. Despite a slight impact on the creation of benefit, this sector in Moldova involves a large group of employees – about 361 thousand people work in agriculture [www.statistica.md] [34].

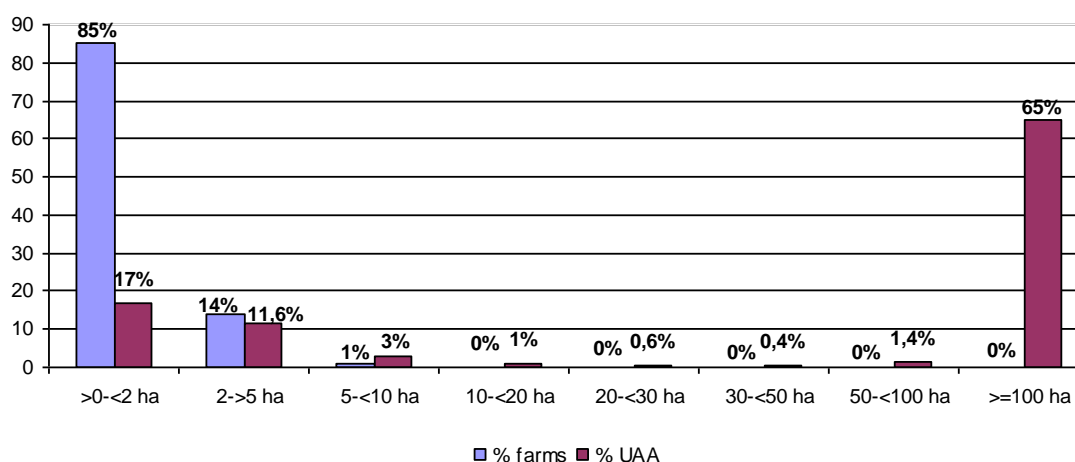

Fig. 3. Distribution of agricultural holdings and UAA in Moldova in 2010 (in %)

Source: Statistical Yearbook of the Republic of Moldova, National Bureau of Statistics 2011[23].

According to Eurostat, in 2010 in the EU were over 12 million farms and almost 30% of them located in Romania [Eurostat 2014] [5]. A significant share in the structure of the EU farms have the Polish farms, with a share of 12.3% (Table 1). Currently, Poland has about 715 thousands farms with an area of 5 hectares, in Romania over 3 million. Moldova has almost 400 thousands of peasant farms (33% of all farms). The remaining part are agricultural cooperatives (232), joint stock companies (161) and limited liability companies (36240) [www.statistica.md] [23]. In the group of Moldovan, family (peasant) farms almost all manage the area of 5 hectares or less.

A systematic decrease in the number of farms in the EU can be observed, the same in Poland, Romania and Moldova, with the largest reduction in the group of farms with the smallest area [Alexandri, Luca 2012; Poczta, Śledzińska Mrówczyńska-Kamińska 2009] [3, 15].

In the same time, the number of larger farms,

over 20-30 hectares, is growing. Despite the positive changes, in those countries there is still a very big group of small farms compared to the other European regions [Poczta 2010] [16].

The share of farms with the area of 5 hectares in the structure of all farms in Poland is 55% and in Romania 92% (Table 1), in Moldova is almost 30%. What's more almost 40% of farms in Poland and twice as much in Romania allocate a half of agricultural production for family consumption [Agricultural census, Eurostat 2010] [1]. Taking into account the number of farms (private ownership) in Moldova the changes can be seen (Table 1). Over the years, the number of farms is increasing. The effects of consolidation can be seen: the number of larger farms is growing and the number of small farms is reducing. The biggest increase is seen in the group of 5 to 50 hectares. This is the result of systematic enlargement of small farms with the area of 5 hectares. However,



still 98% of family farms in Moldova have less than 5 hectares, and these farms work on 42% of total agricultural land [Ignat, Moroz 2013] [7].

Table 1. Chosen characteristics of agriculture in the EU, Poland, Romania and Moldova

Number of farms [thousand]	EU 27	Poland	Romania	Moldova
2003	15,021	2,172	4,484	1,125
2005	14,482	2,476	4,256	1,113
2007	13,700	2,390	3,931	987
2010	12,248	1,506	3,859	902
Change (2007-2003)	-2,773	-665	-625	-223
Number of farms <5 ha [thousand]	EU 27	Poland	Romania	Moldova
2003	10,959	1,440	4,205	746
2005	10,349	1,750	3,870	427
2007	9,644	1,637	3,530	229
Change (2007-2003)	-1,314	+196	-674	-517
Number of farms 5-<20 ha [thousand]	EU 27	Poland	Romania	Moldova
2003	2,538	619	256	127
2005	2,615	608	355	158
2007	2,553	628	370	187
Change (2007-2003)	+15	+9	+113	+60
Number of farms 20-<50 ha [thousand]	EU 27	Poland	Romania	Moldova
2003	835	90	9	8
2005	825	96	16	7
2007	804	101	16	6
Change (2007-2003)	-30	+11	+6	-2
Number of farms <=50 ha [thousand]	EU 27	Poland	Romania	Moldova
2003	688	17	14	12
2005	691	20	13	9
2007	698	23	14	5
Change (2007-2003)	+9	+5	0	-7
Farm labour force [%]	EU 27	Poland	Romania	Moldova
2010	5.7	13.5	28.7	15.8

Source: Based on Eurostat 2014, BAEL data of Poland and Statistical Yearbook of the Republic of Moldova [5, 23].

The efficiency of agricultural production is largely determinate by the spatial nature of the land factor [Podstawka, Ginter 2006][17]. Efficiency of factor productivity in agriculture depends primarily on the areas of farms [Ryś-Jurek 2009] [22]. According to Nowak [2011] [14], structure of agricultural land is the basic criterion for assessing the way in agricultural land management. The farm size is influenced by many factors, including nature of agricultural production, soil quality, climate, terrain, access to market, land prices, etc. [Majchrzak 2014; Zawadzka, Strzelecka 2012] [10, 30].

Considering the analyzed countries a systematic increase in the average farm size can be observed (Table 2). For the EU, the average farm was almost 15 hectares, in Poland it was 10 hectares. The average size of a farm in Romania is still small and is almost

4 hectares, while in Moldova we can observe increase from 1 to almost 3 hectares (Table 2). Fragmentation of the land resulted in increasing of the costs of transport, it reduces labour productivity and farm income, and limits opportunities of development [Alboiu et al. 2012; Zawadzka, Strzelecka 2012] [2, 30]. Fragmentation of agricultural land can be analyzed using the Lorenz factor and the Gini index. Lorenz coefficient was determined around the farms with the area exceeding 50 hectares. The higher the ratio, the greater concentration of farms of 50 hectares or more is. In Poland and Romania, this figure falls far from the average for the EU 27. For Moldova, this figure also falls far from the EU 27 median (Table 3). In turn, inequality coefficient of random variable (Gini index) for farms shows strong disparities in the structure of farms and their significant

differences (the closer to 1, the greater the inequality is).

Table 2. Utilised agricultural area (UAA) and the average farm area in the EU, Poland, Romania and Moldova

Specification	Utilised agricultural area, UAA [thousand hectares]	Average area of farm [hectares]				
	2013	2003	2005	2007	2010	2012
EU 27	184,202.0	11.8	12.1	12.9	14.4	14.7
Poland	14,409.0	6.7	6.0	6.5	9.6	10.4
Romania	13,055.0	3.2	3.4	3.6	3.8	4.1
Moldova	378,418.8	1.9	2.2	2.5	2.6	2.9

Source: based on the data of Eurostat 2014, ARiMR Poland 2014 and National Bureau of Statistics of the Republic of Moldova 2014[5, 23, 33].

Table 3. Lorenz concentration coefficient and the Gini index for agricultural land in the EU, Poland, Romania and Moldova

Specification	Lorenz concentration coefficient around farms up to 50 hectares	Gini index of concentration of agricultural land			
	2007	2003	2005	2007	2010
EU 27	0.78	0.82	0.81	0.81	0.82
Poland	0.63	0.67	0.69	0.67	0.62
Romania	0.59	0.73	0.70	0.70	0.77
Moldova	0.48	0.57	0.65	0.66	0.67

Source: Majchrzak 2014, and own calculations based on Statistical Yearbook of the Republic of Moldova 2014 [10, 23].

Based on Gini indexes for each year, small changes can be noticed. According to Majchrzak [2014] [10] we can observe slight deconcentration processes in Poland, which means creation of the larger and medium-sized farms, and elimination of the smallest at the same time. In Romania, however, these processes occur slowly, the trend is visible even further concentration of agricultural land around the farms of small and very small size. On the other hand, in Moldova exists much more farms (holdings) with the surface over the 50 hectares [www.statistica.md] [34], and

persists, as in Poland, the process of slight deconcentration, creation of the larger and medium-sized farms, with the tendency for small size farms cooperation.

Land fragmentation hinders development; it makes achieving competitiveness impossible, as well as has a significant impact on the level of agricultural income. Table 4 shows the changes in land productivity per 1 hectare of UAA in analyzed countries and the EU 27.

Table 4. Changes in the land productivity in the EU, Poland, Romania and Moldova in 2000-2008

Specification	Land productivity per 1 hectare of UAA [euro]						
	2000	2003	2004	2005	2006	2007	2008
EU 27	1,848.9	1,904.0	1,897.7	1,907.0	1,768.2	2,084.6	2,134.0
Poland	864.6	815.5	874.0	1,020.0	1,011.0	1,288.3	1,399.2
Romania	579.1	772.5	955.2	924.2	1,017.6	1,039.9	1,326.2
Moldova	225.2	315.7	435.2	412.0	552.6	509.3	771.5

Source: Eurostat 2014, General Agricultural Census in the Republic of Moldova [1, 5]

The average land productivity in the EU is not very high, reaches values oscillating around 2 thousands euro per 1 hectare. Land

productivity in Poland and Romania is much lower than the average of the EU 27, as well as in Moldova (Table 4). Over the years 2000-

2008, a significant increase can be seen in this rate (especially in Romania). According to Eurostat [2014] in almost all countries, the rate of land productivity is increasing year-on-year, with the highest values in the Netherlands, Malta, Cyprus and Belgium. Nowak [2011] [14], on the basis of the analyzes, concluded that the highest productivity growth occurred in the new member states (e.g. Romania), which according to the author, is a result of direct

payments absorption and other aid programmes for farmers.

**The farm size versus economic efficiency: the case of Moldova**

Below the results of analyze carried out in the North Moldova districts were shown (Table 5). The study involved the analyze of agricultural land and the value of agricultural production. Next, these data were used to calculate the concentration of the variables.

Table 5. Chosen agricultural characteristics of the North of Moldova districts

Districts	In the period of 2008-2012			
	Utilized agricultural land		The value of agricultural production in the comparable prices [euro]	
	[thousand hectares]	[%]	[thousand]	[%]
Mun. Balti	836	5.0	19.9	1.0
Briceni	1,720	10.0	631.3	29.2
Dondușeni	1,123	6.8	118.8	5.5
Edineț	190	1.2	27.3	1.2
Fălești	1,322	8.0	147.1	6.8
Florești	1,002	6.0	107.6	5.2
Ocnița	3,998	24	361.2	16.7
Râșcani	444	2.6	52.0	2.4
Sângerei	2,520	15.0	367.5	17.0
Soroca	3,546	21.4	324.5	15.0
Total	16,701	100.0	2157.5	100.0

Source: Own calculations based on data specialized form T 6.1. and 9.64 in territorial T., National Bureau of Statistics of the Republic of Moldova 2014 [23]

The research shows that farms of the North of Moldova are very diverse in terms of agricultural land and global production. The Balti farms occupies only 5% by area and the volume of production and less than 1%. Briceni, occupying 10% of the surface, has the global production share at 29.2%. Farms in Edinet region occupies 1.2% of all utilized agricultural area, and in the Soroca - 21.4% (Table 5).

Based on the data in Table 5, the territorial concentration coefficient (territorial distribution) was determined using the square root of the sum of squares ratio (n) administrative (territorial) units reflecting the total amount of northern districts by formula Gini C (CG) and the ratio of the concentration Struck (Gs):

$$C_G = \sqrt{\sum g_i^2} \Rightarrow \sqrt{\frac{1}{n}} \leq C_G \leq 1$$

where:  $g_i$  – the share of agricultural land.

The second concentration ratio is calculated as:

$$C_s = \sqrt{\frac{n \sum g_i^2 - 1}{n - 1}} \Rightarrow 0 \leq C_s \leq 1$$

From calculations, the average of 2004-2006, the following results of the coefficients were obtained and shown in Table 6.

The calculations resulted in low Gini index, which indicated low uniformity of agricultural land distribution in the studied districts, and the agricultural production is even lower.

$$C_{G(s)} = \sqrt{g_i^2} = \sqrt{0.14} = 0.374$$

$$C_{G(VPG)} = \sqrt{0.17} = 0.412$$

Table 6. Gini index, Struck farmland and overall output (in comparable prices of the 2005) in farms of 50 hectares and more of UAA, in the North of Moldova, average 2008-2012

Indicator	Type of coefficient	
	$C^G$	$C_s$
Utilized agricultural land [hectares] ( $S$ )	0.374	0.209
The value of global production (in comparable prices 2005) thousand ( $VPG$ )	0.412	0.277

Source: own calculations based on data specialized form T 6.1. and 9.64 in territorial T., National Bureau of Statistics of the Republic of Moldova 2014 [23]

Struck coefficient confirms this conclusion:

$$C_{S(s)} = \sqrt{\frac{10 \cdot 0.14 - 1}{10 - 1}} = \sqrt{\frac{1.4 - 1}{9}} = \sqrt{\frac{0.4}{9}} = \sqrt{0.044} = 0.209$$

$$C_{S(VPG)} = \sqrt{\frac{10 \cdot 0.17 - 1}{10 - 1}} = \sqrt{\frac{1.7 - 1}{9}} = \sqrt{\frac{0.7}{9}} = \sqrt{0.077} = 0.277$$

The study allows concluding that the concentration of agricultural production is very low. The concentration of agricultural production of farms can be achieved by grouping the factors of production (consolidation of farms of the same profile) branches and units of various sizes, growth providing technical agricultural and professional qualification to act positively towards the concentration of production, to increase the weighted branches and crops in regions of fragmented agriculture.

#### Fragmented agriculture: new model of small farm

According to Dacko and Dacko [2014] [4], area structure reflects the state of a country's agricultural system and can change due to the impact of the components of this system, as well as external factors. Therefore, a system consists of many interacting elements. Despite the obstacles posed by fragmented system of agriculture, there are many voices supporting small, family-run farms in Europe. Small farms should have a permanent place in European agriculture [Musiał 2010; Zegar 2012] [12, 31]. The argument supporting small farms is primarily the fact that they have a social character, they are very often environmentally friendly, they help to preserve rural landscape, contribute to biodiversity, tradition and culture [Kielbasa 2015] [8]. The system of agriculture in Europe

should be changed, but it cannot be based on the elimination of small, family farms. The need to create a network of processing enterprises in rural areas is the cornerstone of sustainable development of the rural areas. The new form of small farm management should include for example cooperation between producers and processors of raw materials (Fig.1).

According to Fig.1, we can observe two directions of farm cooperation: vertical and horizontal. Vertical cooperation includes processing - supplies - transport agricultural production; while horizontal cooperation involves inter - from farming means sharing basis, applying marketing activity, providing information, with service credit, insurance and other levers of economic mechanism.

Land consolidation process is a very long operation. In Western Europe countries, it lasts for hundreds of years. This process gained momentum in EU countries in the early 50 and is continuing until today. Strengthening small and medium-sized farms provides a real opportunity to increase the effectiveness of using agricultural land on the principles of regional and erosion control, organize and implement complex necessary measures to protect the soil - the main natural wealth of the country, implementation of actual performance of agriculture and the creation of the sustainable development [Popescu 2009] [20]. Achieving this goal will

be possible by land consolidation and owners cooperation in producing a good quality and competitive production [Popa, Timofti 2009] [18].

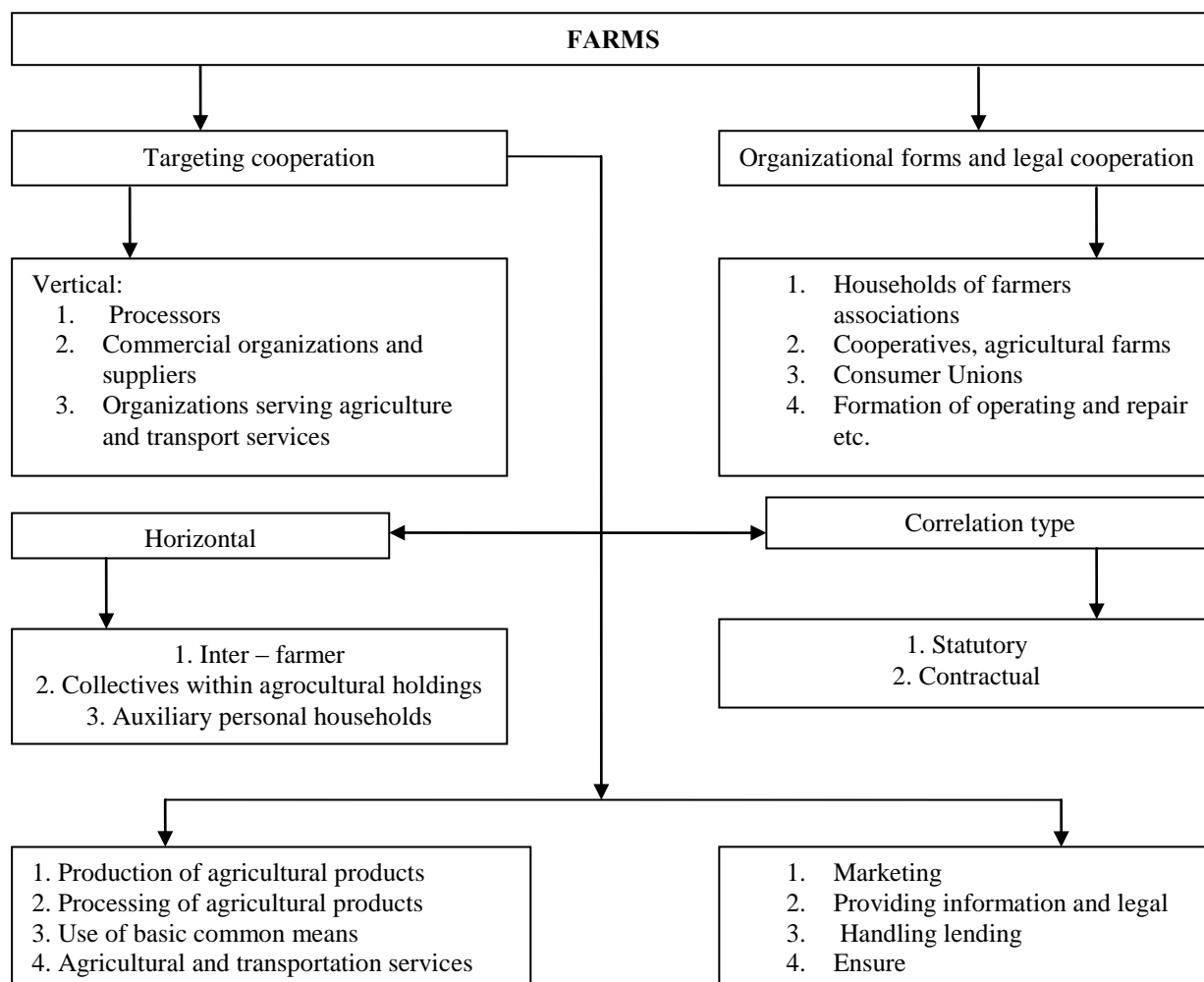

Fig.1. The forms of farms cooperation  
 Source: prepared by the authors based on their scientific researches

To address the situation in agriculture a complex of economic, legal and organizational set must be developed. These strategy envisages sustainable development of agriculture by implementing advanced technologies of cultivation, processing, packaging and marketing, etc., which ensure the country's food security and increase of farmers' income [Strategies of development of the agrofood sector in Moldova in the period 2006-2015] [25]. Therefore, the fundamental subject of farm development should contribute to economic efficiency and consolidation (Fig.2).

Achieving these basic policies would serve a solid foundation for the development of private initiative, a favorable environment for the activity of all categories of farmers to resist competition. At the same time promoting the development of rural areas as the natural, social and cultural regeneration of the economy will help rural communities in which they operate. The process of consolidation are inevitable - not only the purchase and sale, but in exchanging or leasing term, as well as by associations or unions landowners. It is building the future shape of a more rational and efficient use of land. The good example is the government programme of land consolidation in Moldova. Moldovan Ministry of Agriculture and Food Industry proposed to create the so-called

“consolidation centers” [Land Consolidation Program, Moldova] [36].

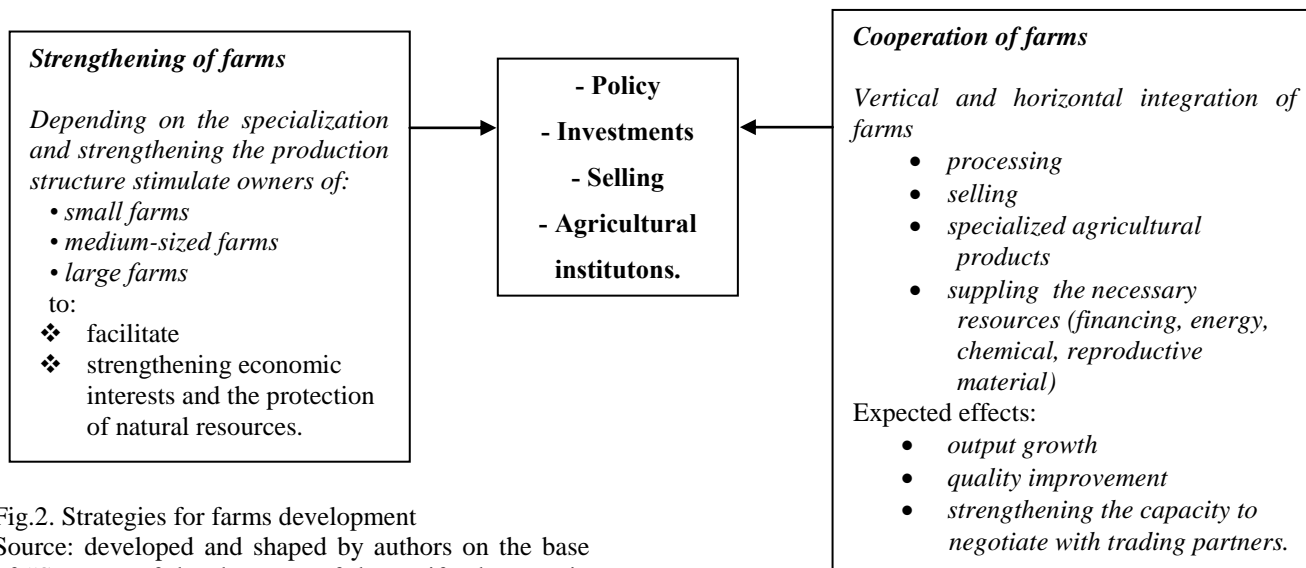

Fig.2. Strategies for farms development  
Source: developed and shaped by authors on the base of “Strategy of development of the agrifood sector in Moldova in the period 2006-2015” [25]

## CONCLUSIONS

The problem of fragmented agriculture concerns Europe for many years, especially in its Eastern parts. Analyzed three European countries: Poland, Moldova and Romania, struggle with similar problems in development of their agriculture and competitiveness. When it comes to small family farms, it can be noticed that in these countries they are very fragmented and achieve poor economic results.

The following conclusions were indicated on the basis of the analysis and discussions:

-In these countries enlargement processes can be seen. The number of small farms is reducing, and larger is increasing. There is also an increase in the average size of a farm (in Poland currently it is 10 hectares, in Romania 4 hectares and in Moldova 3 hectares). However, these processes are slow and face number of barriers (natural conditions, tradition model of farm management, the lack of funds for investments, etc.).

-Large fragmentation of the agrarian structure adversely affects the economic results and land productivity. Fragmentation contributes to a significant reduction in the small farms competitiveness.

-Indexes of land concentration indicate processes of deconcentration of a small farms and creating a greater number of larger farms in Poland. In Romania, these processes occur slowly due to the large number of very small family farms. Slightly better are indicators for Moldova, because this country has a large number of agricultural companies, however, the problem of small farms still exists.

-The case of the North of Moldova shows a large distribution of indicators within one country. The authors indicate the possibility of farms consolidation of the same profile in certain regions, which goal would be the improvement of small farm competitiveness and providing the source of income.

-The structure of farms and land structure points to a system of agriculture in Europe. This system consists of many different elements, mutually dependent and influencing each other. Increasing of the small farm effectiveness requires the cooperation of small holders, for example through cooperation between producers and processors of raw materials.

-To improve the competitiveness of small farms the processes of land consolidation are essential. However, it should be remembered that these are a long-term processes, so the effects can be seen in several years.

-The role of small farms should be emphasized especially for the environmental protection and sustainable development. Their social role is also very important: they manage small plots, which, to some extent, provide food for farmer 'families. Usually products are not sold on the market, and most consumed on the farm (semi-subsistence farm). Therefore, the European model of agriculture should not exclude small family farms.

## REFERENCES

- [1]Agricultural Census, Eurostat 2010, [http://ec.europa.eu/eurostat/statistics-explained/index.php/Agricultural\\_census](http://ec.europa.eu/eurostat/statistics-explained/index.php/Agricultural_census) (access 20.11.2015)
- [2]Alboiu, C., Alexandri, C., Grodea, M., Ionel, I., Toderiou, F., Moldovan, M., Luca, L., 2012, The main direction of the Romanian agricultural sector evolution following the UE integration: European Union Food Sector after last enlargements – conclusions for the future CAP, IERiGŻ-PIB, Warszawa: 30-62.
- [3]Alexandri, C., Luca, L., 2012, The role of small farms in Romania and their future in the face of challenges of the CAP post 2013, *Problemy Drobnych Gospodarstw Rolnych: Problems of Small Agricultural Holding*, no. 1/2013:
- [4]Dacko, M., Dacko, A., 2014, Poprawa struktury obszarowej polskiego rolnictwa – podejście systemowe, *Problemy Drobnych Gospodarstw Rolnych: Problems of Small Agricultural Holding*, no. 2/2014: 23-37.
- [5]EU Agricultural Economic Briefs: What is a small farm? Brief no 2, July 2011, European Commission, Agriculture and Rural Development, [http://ec.europa.eu/agriculture/rural-area-economics/briefs/pdf/02\\_en.pdf](http://ec.europa.eu/agriculture/rural-area-economics/briefs/pdf/02_en.pdf) (access 3.11.2015)
- [6]Gospodarstwa rolne w Polsce na tle gospodarstw Unii Europejskiej – wpływ WPR, Red. W. Poczta, Powszechny Spis Rolny 2010, GUS Warszawa 2013.
- [7]Ignat, A., Moroz, V., 2013, Agricultural land-use changes and rural transformation in the Republic of Moldova. *Scientific Papers Series Management, Economic Engineering in Agriculture and Rural Development*, vol. 13, issue 1: 181-186.
- [8]Kielbasa, B., 2015, Selected aspects of the young farmers management in the light of the fragmented agriculture in Poland. *Journal of Agribusiness and Rural Development*, Poznań.
- [9]Kowalczyk, S., Sobiecki, R., 2011, Europejski model rolnictwa – uwarunkowania ewolucji, *Roczniki Nauk Rolniczych*, seria G, t. 98, z. 3: 9-20.
- [10]Majchrzak, A., 2014, Ewolucja Wspólnej Polityki Rolnej a zmiany zasobów i struktury ziemi rolniczej w państwach Unii Europejskiej: rozprawa doktorska, Uniwersytet Ekonomiczny w Poznaniu: 97-110.
- [11]MEGA Moldova Economic Growth Moldova Analysis: Analysis of Economic Growth in Moldova / aut. Ana Popa (eds.), Valeriu Prohnițchi Alex Oprunenco [et al.] Independent Analytical Center "Expert Group". - Ch. "Offices bones" SRL, 2011. - ISBN 978-9975-80-302-1.
- [12]Musiał, W., 2010, Wyzwania wobec gospodarstw drobnotowarowych w Polsce – przyczynek do rozważań, *Zeszyty Naukowe Uniwersytetu Ekonomicznego w Poznaniu* no 150: 385-398.
- [13]Musiał, W., Drygas, M., 2013, Dylematy procesu delimitacji drobnych gospodarstw rolnych, *Wieś i Rolnictwo* no 2(159): 55-74.
- [14]Nowak, A., 2011, Zmiany wydajności rolnictwa Polski i innych krajów Unii Europejskiej. *Zeszyty Naukowe SGGW Problemy Rolnictwa Światowego*, z. 1, t. 11(26): 130-139.
- [15]Poczta, W., Śledzińska, J., Mrówczyńska-Kamińska, A., 2009, Determinanty dochodów gospodarstw rolnych Unii Europejskiej według typów rolniczych. *Zeszyty Naukowe SGGW, Ekonomika i Organizacja Gospodarki Żywnościowej*, no 76: 17-30.
- [16]Poczta, W., 2010, Gospodarstwa osób prawnych w rolnictwie Unii Europejskiej w świetle realizacji idei rozwoju rolnictwa zrównoważonego i Europejskiego Modelu Rolnictwa, *Zeszyty Naukowe Uniwersytetu Ekonomicznego w Poznaniu* no 150: 363-385.
- [17]Podstawka, M., Ginter, A., 2006, Sytuacja dochodowa gospodarstw rolniczych w warunkach różnego poziomu rozwoju rolnictwa, *Roczniki Naukowe SERiA*, t. VIII, z. 1: 145-149.
- [18]Popa, D., Timofti, E., 2009, The efficiency of the economic mechanism in agriculture. Monograph. Chisinau Complex IEFS Publishing, ISBN 978-9975-9823-3-7: 128-130.
- [19]Popescu, A., Condei, R., 2015, Research on Romania's employment in agriculture and its position in the European Union. *Scientific Papers Series Management, Economic Engineering in Agriculture and Rural Development*, vol. 15, issue 2: 281-290.
- [20]Popescu, G., 2009, Wiejskie gospodarstwa domowe na drodze od przeżycia do kapitalizmu: Przemiany strukturalne wsi i rolnictwa w wybranych krajach europejskich, nr 128, IERiGŻ PIB, Warszawa: 162-173.
- [21]Rolnictwo w 2014, Departament Rolnictwa GUS 2015.
- [22]Ryś-Jurek, R., 2009, The output, incomes and assets-capital relations in the individual farms. *Journal of Agribusiness and Rural Development*, no 1(11): 177-188.
- [23]Statistical Yearbook of the Republic of Moldova. Ch.: Statistics 2013, 2014 (I.SFE-P. "Central Painting"). ISBN978-9975-4068-4-0
- [24]Statystyczne studium struktury agrarnej w Polsce, Red. K., Kukuła, 2010, Wydawnictwo Naukowe PWN, Warszawa: 79-90.
- [25]Strategy of development of the agrifood sector in the period 2006-2015.
- [26]Struktura agrarna – Land structure. Institute of Geography and Spatial Organization Polish Academy

- of Sciences.  
[https://www.igipz.pan.pl/tl\\_files/igipz/.../06.Struktura%20agrarna.pdf](https://www.igipz.pan.pl/tl_files/igipz/.../06.Struktura%20agrarna.pdf) (access 14.11.2015)
- [27]Światły, P., Turnau, J., Majchrzak, A., 2011, Gospodarowanie gruntami rolnymi w wybranych krajach UE; wnioski dla Polskim: Rozwój rolnictwa i obszarów wiejskich w warunkach ewolucji WPR: wybrane problemy, Kujawsko Pomorska Szkoła Wyższa w Bydgoszczy, Bydgoszcz: 147-166.
- [28]The European Model of Agriculture – Challenges Ahead, 2006, A Background Paper for the Meeting of Ministers of Agriculture, 26.9.2006, Oulu, [http://www.agriregionieuropa.univpm.it/materiale/background\\_paper.pdf](http://www.agriregionieuropa.univpm.it/materiale/background_paper.pdf) (access: 10.10.2015).
- [29]Tóth, O., 2014, Farm Structure and Competitiveness in Agriculture, <http://ageconsearch.umn.edu/bitstream/139504/2/Toth.pdf> (access: 20.10.2015).
- [30]Zawadzka, D., Strzelecka, A., 2012, Analiza dochodów gospodarstw rolnych w Unii Europejskiej, Zeszyty Naukowe Uniwersytetu Szczecińskiego – Finanse, Rynki Ubezpieczeniowe, Ubezpieczenia no 690(51): 413-422.
- [31]Zegar, J.S., 2012, Rola drobnych gospodarstw rolnych w procesie społecznie zrównoważonego rozwoju obszarów wiejskich, Problemy Drobnych Gospodarstw Rolnych nr 1: 269-278.
- [32]Zegar, J., 2008, Dochody w rolnictwie w okresie transformacji i integracji europejskiej IERiŻ-PIB, Warszawa.
- [33][www.arimr.gov.pl](http://www.arimr.gov.pl) (access 14.11.2015)
- [34][www.statistica.md](http://www.statistica.md) (access 20.11.2015)
- [35][www.fao.org.nr](http://www.fao.org.nr) (access 24.11.2015)
- [36][www.eurogeographics.org/country/moldova](http://www.eurogeographics.org/country/moldova) (access 18.11.2015)



## TRENDS IN EDUCATIONAL TRAINING FOR AGRICULTURE IN OLT COUNTY

Victor TIȚA, Raluca NECULA

University of Agricultural Sciences and Veterinary Medicine Bucharest, 59 Marasti, District 1, 11464, Bucharest, Romania, Phone: +40213182564, Fax:+40213182888, Mobile:+40744 6474 10, Emails: victortita@yahoo.com, raluca\_nec@yahoo.com

**Corresponding author:** raluca\_nec@yahoo.com

### Abstract

*This article aims to analyse the indicators in terms of level of education, school dropout, school population, civilians employed and the average of lifespan, in order to determine the trends in the rural areas of Olt county. The purpose of the paper is to establish benchmarks in the formulation of strategies for the improvement of the education conditions and standards in rural areas and, therefore, in agriculture and connecting them to the socio-economic reality. Olt County, by farmland it has, by the population living in rural areas, by the share of the population employed in agriculture and by the share that the value of agricultural production in the county's economy holds requires an education which should be connected to these socio-economic realities.*

**Key words:** level of education, population growth trend equations, school dropout, school population, school units

### INTRODUCTION

In the rural area of Olt County, education issues are still limited by the available reduced possibilities, poor learning, poverty and relatively high costs of education (including regarding basic education) that rural communities cannot afford. The relatively low share of qualified teachers in rural areas, compared to urban areas, is still one of the factors that negatively influence the access to quality education in rural areas.

It was considered necessary to know the problems of the structural aspect in the analysis of indicators that could lead to the establishment of some strategies for the improvement of education in rural areas, and thus in agriculture[3].

### MATERIALS AND METHODS

As statistical indicators were calculated: average of periods of time, comparison indicators with fixed base and linked basic. Standard deviation ( $\sigma$ ), used in calculating the coefficient of variation (c%), is calculated as an mean square value of deviations of all series elements of their arithmetic mean [10]:

$$\sigma = \sqrt{\frac{\sum (x_i - \bar{x})^2}{n}}$$

The standard deviation is used for the estimation of errors of selection in calculating correlation.

**The coefficient of variation (c%)** is calculated as a ratio between the deviation of mean square value and arithmetic mean. It expresses as percentages:  $c\% = (\sigma/\bar{x}) * 100$

**Significance.** The closer to zero the value of c% is, the weaker the variation is, the collectivity of analysed data is more homogeneous, the mean having a high degree of representativeness. The higher the value of c% is, the more intense the variation is, the collectivity is more heterogeneous, and the mean has a low significance level.

It is estimated that at a rate of more than 35-40%, the average is no longer representative and the data should be separated into a series of components, per groups, depending on changes in other characteristics of the group.

In finding the tendency for some data, the indicators were used: the average rate of annual growth and the adjustment equations. Year growth rate is calculated using the

formula[4]:  $r_{2000-2014} = 13 \sqrt{\prod (p1/p0) - 1}$  ;

where:  $\prod p_i/p_0$  = the product of chain indicators for the analysed period.

Using adjustment equation of data series, time series are obtained, that highlight the development trends and that replace empirical series. The equations are used in terms of time: linear,  $Y = a + bt$ ; of second-degree,  $Y = a + bt + ct^2$ ; third-degree,  $Y = a + bt + ct^2 + dt^3$  etc. In order to find the regression function of parameters, it is applied the Method of least squares:  $\sum (y_i - Y_i)^2 = \min[1]$ .

Data from this study were drawn from Statistical Yearbook, published by National Institute of Statistics, for the period 1990-2014[5].

## RESULTS AND DISCUSSIONS

Olt county, by its agricultural land, by the population living in rural areas, by the share of the population employed in agriculture and by the share that the value of agricultural production has in economy of the county, requires an education that should be anchored in these economic realities.

Agricultural land holds a very large share of the land fund of the county, 80% (440,016 ha) in 2000 and 79.39% (436 515 ha) in 2014. (Table 1).

Table 1. The size and structure of how to use the land, in Olt county, during 2000-2014

Crt. No	Way of use	2000		2007		2014	
		ha	%	Ha	%	ha	%
1	Total	549,828	100.00	549,828	100.00	549,828	100,00
2	Agricultural	440,016	80.03	434,846	79.09	436,515	79.39
3	Arable	385,190	70.06	388,483	70.66	390,336	70.99
4	Pastures	34,819	6.33	31,784	5.78	33,038	6.01
5	Meadow	776	0.14	529	0.10	556	0.10
6	Vineyards and vine nurseries	9,643	1.75	7,634	1.39	7,465	1.36
7	Orchards and tree nurseries	9,588	1.74	6,416	1.17	5,120	0.93
8	Non-agricultural land	109,812	19.97	114,982	20.91	113,313	20.61

The analysed period, regarding the evolution of the population, is characterized by high variation coefficients of 23.43% (*high*) for data series of total population, of 34.59% (*high*) for the urban population and 10.06% (*middle*) for the rural population (Table 2).

The total population of the county has decreased over the period 2000-2015, from 511,100 inhabitants in 2000 to 485.0 thousand inhabitants on 1st of January 2015 (Mean annual rate of -0.78%) (Table 2).

Table 2. The evolution of the total population, in Olt County, during 2000-2015

Residence areas	2000	2005	2010	2015	Average	Standard deviation	Variation coefficient (%)		Annual rate
	thousands	thousands	thousands	thousands			thousands	thousands	
Total	511,1	495,2	476,6	454,7	485,0	133	27.43	High	-0.78
Urban	209,6	211,3	205,4	197,4	205,9	71	34.59	High	-0.40
Rural	301,5	283,9	271,2	257,3	279,1	28	10.06	middle	-1.05

Interestingly is that the rural population fell from 301.5 thousand inhabitants to 197.4 thousand inhabitants, with a rate of -1.05% per year.

By adjusting the data using trend equations we find that the data on the urban population are representatively adjusted (correlation coefficient  $r = 0.94$ ) by a second-degree equation, and rural population evolution by a

linear equation ( $r = 0.99$ ). Both equations show a sharp downward trend during the studied period (Fig. 1 and Fig. 2), and that will continue for the next period.

The total school population in the county of Olt is in a sharp decline, respectively, from 91,460 people in the school year 2000/2001 to 71,669 people in school year 2012/2013.

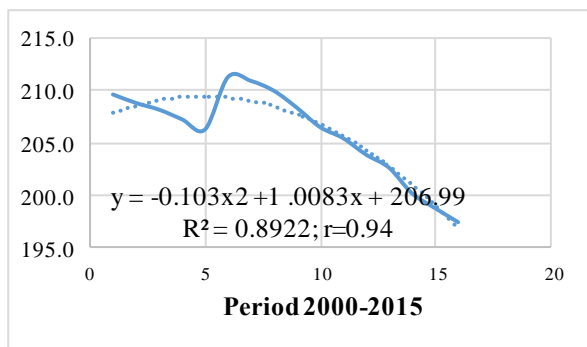

Fig.1. Evolution of total urban population in county Olt, for the period 2000-2015

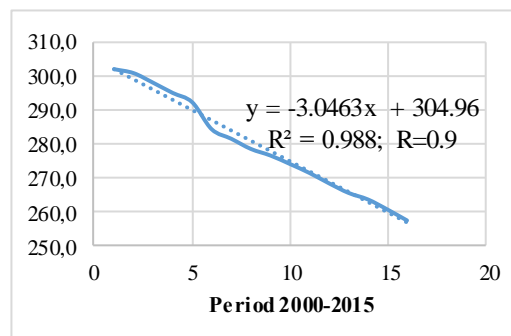

Fig.2. Evolution of total rural population of county Olt, for the period 2000-2015

The rate of decline for this period is -8.45%, much higher than the decrease of total

population of -0.78%, because most of the decline in population is for the age up to 30 year old. (Table 3).

Table 3. The evolution of the school population by level of education, in Olt County, during 2000-2013

Education levels	2000/01	2005/06	2007/08	2009/10	2012/13	Mean	Standard deviation	Variation coefficient		Annual rate
	nr	nr	nr	Nr	nr	nr	nr	%	semf	%
Total	91,460	82,809	78,303	74,625	71,669	77,934	5,259	6.75	low	-8.45
Preschool	15,161	15,425	14,288	14,052	11,864	14,135	496	3.51	low	-7.26
Elementary (Cl. I-IV)	24,386	21,347	19,247	17,666	18,026	19,216	2,238	11.65	mid	-8.80
Middle school (Cl.V-VIII)	29,283	22,248	21,637	19,969	17,559	21,179	2,967	14.01	mid	-10.22
High-school	15,604	16,229	15,896	17,672	20,068	17,458	1,358	7.78	low	-7.03
Vocational and apprenticeship	4,570	5,766	5,201	2,648	213	3,296	1,539	46.70	high	-5.02
Post-secondary and foreman	2,175	1,272	1,379	2,061	3,427	2,082	619	29.75	high	-12.7
Higher education	-	522	655	557	512	605	65	10.72	mid	-6.01

By level of education, in Olt County, we find that the school population is in a continuous decline in all categories of education: by -7.26% to preschool, by -8.80% from the elementary, by -10.22% in middle school, by -7.03% in high school, by -5.02% in vocational and apprenticeship, by -12.7% in high school and foremen and by -6.01% in higher education.

The school population structure also shows oscillations from one year to another. Pre-school education is between 16.6% in the school year 2000/2001, and 18.8% in the school year 2009/2010, 32.0% in elementary education from 2000/2001, and 24.5% in the school year 2012/2013. It is noted increase in the share of secondary education from 17.1% in the school year 2000/2001, to 28.00% in school year 2012/2013. (Fig.3)

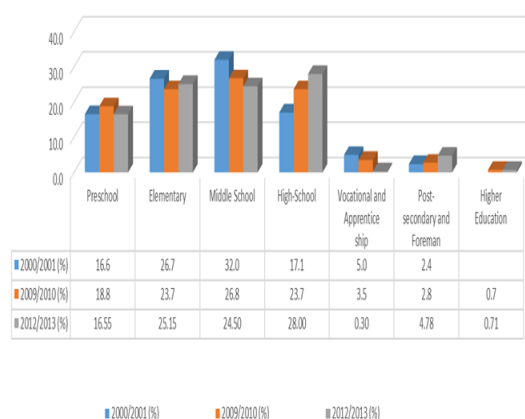

Fig. 3. Structure of School Population per Education Levels, in Olt County

Analysing the school dropout in the Development Region of South-West Oltenia, there are revealed significant differences in the component counties. The lowest dropout rates in elementary education (0.2%), middle education (0.3%) are in Gorj County in 2012.

The highest dropout rates in school year 2012 are recorded in Mehedinti County of 1.5% for elementary and 2.8% for middle school education. (Table 4).

Table 4. The level of dropout rate in elementary and middle school education, in Olt County

Crt. No.	Education levels	Elementary education			Middle school education		
		2010	2011	2012	2010	2011	2012
		%	%	%	%	%	%
1	Reg. SW Oltenia	1.3	1.3	0.8	1.6	1.7	1.5
2	Dolj	1.5	1.6	1.1	2	2.4	2.7
3	Gorj	0.7	0.9	0.2	0.6	0.8	0.3
4	Mehedinti	1.6	1.8	1.5	1.9	2.5	2.8
5	Olt	1.30	1.40	1.00	1.60	1.50	1.00
6	Valcea	1.2	0.7	:	2	1.2	0.3

Dropouts in high-school, vocational and post-secondary education, (Table 5), according to available data, shows very high values. Thus, it appears that in 2010, the dropout rate was 3.3% for high-school education, in Valcea County and of 25.1% for vocational education in Mehedinti County.

The school dropout in post-secondary education shows very high rates in all

counties, ranging between 8.6% in Olt County and 15.9% in Valcea County (Table 5).

Accentuated decrease of school population has led to a decline of schools and their equipping with specific workshops for levels of training.

Table 5. The level of dropout rate in high school, vocational and post-secondary education in Olt County

Crt. No.	Education level	High-School	Vocational	Post- secondary		
		2010	2010	2010	2011	2012
		%	%	%	%	%
1	Reg. SW Oltenia	3.2	17.3	5.5	5	9.7
2	Dolj	2.9	13.8	8.7	5.5	9.2
3	Gorj	2.8	24.4	3.6	4.2	9.3
4	Mehedinti	8.2	25.1	:	2	11
5	Olt	0.7	10.2	4.6	6.8	8.6
6	Valcea	3.3	15.9	9.7	5.6	15.9

In Olt County, the total number of units decreased to 21.3%, from 785 in 1996 to 167 in 2014 (Table 6). Important decreases that occurred during this period: from 3.8% in pre-school, to 37% in pre-university education, to 32% in high-school education and 55.7% in middle school education (Table 6).

Table 6. The evolution of schools by level of education, in Olt County, during 1996-2014

Crt. No	Education levels	UM	1996	2000	2005	2010	2012	2014
1	Total	no	785	549	480	187	176	167
		%	100.0	69.9	61.1	23.8	22.4	21.3
2	Pre-school education	no	371	270	261	31	24	14
		%	100.0	72.8	70.4	8.4	6.5	3.8
3	Pre-university education	no	414	279	219	156	152	153
		%	100.0	67.4	52.9	37.7	36.7	37.0
4	Elementary education	no	152	53	:	:	:	:
		%	100.0	35.0	:	:	:	:
5	Middle-school education	no	212	196	189	121	117	118
		%	100.0	92.5	89.2	57.1	55.2	55.7
6	High-school education	no	26	26	26	33	33	32
		%	100.0	100.0	100.0	123.1	123.1	122.0
7	Vocational education	no	12	1	1	:	:	:
		%	100.0	8.3	8.3	:	:	:
8	Post-secondary education	no	11	2	2	1	1	2
		%	100.0	18.2	18.2	9.1	9.1	18.2

Number of school workshops also presents significant decreases correlated with decreased number of schools with fewer

pupils. The total number of school workshops in the county decreased from 60.2% in 2014, compared to 1990 (from 128 to 77). (Table 7)

Table 7. Evolution of number of school workshops by educational level in Olt County, for the period 1990-2014

Crt. no	Education levels	UM	1990	2000	2005	2010	2012	2013	2014
1	Total	no	128	151	112	98	93	85	77
		%	100.0	118.0	87.5	76.6	72.7	66.4	60.2
2	Elementary and middle- school education	no	47	46	25	17	7	7	6
		%	100.0	97.9	53.2	36.2	14.9	14.9	12.8
3	High-school education	no	68	74	79	81	86	78	71
		%	100.0	108.8	116.2	119.1	126.5	114.7	104.4
4	Vocational education	no	13	30	8	:	:	:	:
		%	100.0	230.8	61.5	:	:	:	:
5	Post-secondary education	no	:	1	:	:	:	:	:
		%	:	100.0	:	:	:	:	:

A slight increase in the number of workshops is found in upper secondary school from 68 in 1990 to 71 in 2014 (104.4% increase). (Table 7)

The pre-university educational infrastructure at regional level (South-West Oltenia Region) (741 schools, 151 high-schools in 2005) is in a quite advanced state of degradation and with a highly insufficient equipment [8, 9].

Analysing the number of graduates in Olt County, during 1990-2013, we find a reduction from 12,945 people in 1990 to

9,039 people in 2013 (69.8%). In elementary and secondary education this decrease is of 54.4%, from 7,748 persons in 1990 to 4,256 persons in 2013. Important decreases in the number of graduates are in agricultural high school from 880 graduates in 1990 to 193 graduates in 2011, vocational education from 2,075 in 1990 to 56 in 2013. Increases in the number of graduates is found at high school graduates and theoretical high-school from 212 graduates in 1990 to 1,744 graduates in 2013. (Table 8)

Table 8. The evolution of the number of graduates by level of education, in Olt County, for the period 1990-2013

Crt. No	Education levels	1990	2000	2005	2010	2011	2012	2013
1	Total	12,945	12,577	12,121	10,679	8,698	9,565	9,039
		100.0	97.2	93.6	82.5	67.2	73.9	69.8
2	Elementary and middle school education	7,748	7,016	5,373	5,475	4,256	4,180	4,256
		100.0	90.6	69.3	70.7	54.9	53.9	54.9
3	High-school and theoretical high-schools	212	1,786	1,897	1,746	1,627	1,549	1,744
		100.0	842.5	894.8	823.6	767.5	730.7	822.6
4	Agricultural high-school	880	371	115	77	193	:	:
		100.0	42.2	13.1	8.8	21.9	:	:
5	Forest high-school	:	26	:	:	:	:	:
6	Agro-mountain high-schools	:	:	44	:	:	:	:
7	Veterinary High-Schools	:	122	100	42	42	:	:
8	Secondary Vocational Education	2,075	1,483	2,612	908	59	80	56
9	Post-Secondary education	:	913	464	722	878	1,052	1,182
10	Foremen schools	:	137	77	134	170	139	148
11	Higher education - bachelor	:	:	87	147	168	161	109

Table 9. The structure of graduates by level of education, in Olt County, for the period 1990-2013

Crt. no.	Education levels	1990	2000	2005	2010	2011	2013
		%	%	%	%	%	%
1	Total	100.0	100.0	100.0	100.0	100.0	100.0
2	Elementary and middle school education	59.85	55.78	44.33	51.27	48.93	47.08
3	High-school and theoretical high-schools	1.64	14.20	15.65	16.35	18.71	19.29
4	Agricultural high-schools	6.80	2.95	0.95	0.72	2.22	:
5	Forest high-school	:	0.21	:	:	:	:
6	Agro-mountain high-schools	:	:	0.36	:	:	:
7	Veterinary High-Schools	:	0.97	0.83	0.39	0.48	:
8	Secondary Vocational Education	16.03	11.79	21.55	8.50	0.68	0.62
9	Post-Secondary education	:	7.26	3.83	6.76	10.09	13.08
10	Foremen schools	:	1.09	0.64	1.25	1.95	1.64
11	Higher education - bachelor	:	:	0.72	1.38	1.93	1.21

A more detailed analysis of high-school education in the agriculture and veterinary medicine highlights the following:

- A variation in the number of agricultural high schools, but by comparing the percentage of the total of the county is a level between 2.94 and 11.53%.

The report of a yearly discrepancies between the number of students enrolled and the number of graduates, in which the number of enrolled students is increasing but the number of graduates is decreasing, a trend that is noticed for teachers, too;

- Veterinary high schools (the only one of its kind in the county) are represented by a number of annually increasing students enrolled (although, by comparison towards the total in the county is between 1.80 and 5.44 %), but decreasing on graduates (compared to the total of county level, is much lower, between 0.43 and 5.11%).

Even in this situation the teachers had an increasing trend, which in the past year was a number of 60[4]. (Table 10)

Table 10. The structure of high schools and graduates of the agriculture and veterinary profile in Olt County

Name of the indicator	M.U.	2006	2007	2008	2009	2010	2011
<b>High-school with agricultural profile</b>							
Number of high-schools	Number	3	3	1	1	2	2
	% towards total of high-school	11.53	11.53	3.84	2.94	6.06	6.06
Enrolled students	Number	385	287	363	520	898	1130
	% towards total of students	2.41	1.80	2.26	2.94	4.74	5.44
Graduates	Number	208	-	16	54	77	-
	% towards total of graduates	5.11	-	0.43	1.19	1.82	-
Teaching staff	Number	63	44	10	11	12	19
	% towards total of p. d.	5.42	4.04	0.86	1.04	0.57	1.46
<b>High-schools of veterinary profile*</b>							
Number of high-schools	Number	-	-	1	1	1	1
	% towards total of high-schools	-	-	3.84	2.94	3.03	3.03
Enrolled students	Number	-	-	166	188	168	175
	% towards total of students	-	-	1.03	1.06	0.88	0.84
Graduates	Number	-	-	-	55	42	-
	% towards total of graduates	-	-	-	1.22	0.99	-
Teaching staff	Number	-	-	40	26	64	60
	% towards total of T.s.	-	-	3.47	2.46	5.63	4.61

\* Years 2006 and 2007 are not given. Processed according to: Statistical Yearbook of Olt County, NIS, Olt Branch, Issue 2012

From what was mentioned before, it results that the structure and forms of influence of high-schools in the agriculture profile for the population have an important role in attenuation of rural problems in the training and employment of labour in agriculture. As an effect and as a result of the training, we will analyse the civilian population employed

per activities and life expectancy as living standards.

Analysing the civil population employed on economic activity in the county of Olt, there are some oscillations of variation coefficient between low and middle limits, and which falling within normal statistical limits.

Table 11. The evolution of civil population on activities, in Olt County, during 2008-2014

Crt. No	Economic activities	2008	2011	2014	Average	Standard deviation	Variation coefficient		Annual rate
		Thousands of persona	Thousands of persona	Thousands of persona			no	semf	
1	Total	169.3	162.6	160.8	163.74	3.1	1.89	low	-0.73
2	Agriculture, silviculture and fishing	76	78.2	74.6	77.24	1.6	2.06	low	-0.27
3	Extractive industry	1.30	0.9	0.9	0.99	0.1	13.98	middle	-5.12
4	Manufacturing industry	32.5	27.2	27.6	27.74	2.2	7.89	low	-2.31
5	Constructions	10.5	7.9	8.7	8.41	0.9	11.05	middle	-2.65
6	Wholesale and Retail	12.5	14.1	14.9	14.00	0.8	5.49	low	2.54
7	Public administration and defense; public social insurance	4.8	3.8	3.7	4.09	0.4	10.24	middle	-3.65
8	Education	7.6	6.9	6.9	7.11	0.3	3.70	low	-1.37
9	Health and social assistance	7.2	6.4	6.2	6.80	0.5	7.30	low	-2.11

It is noteworthy that for the entire period, the trend is of numeric declining of the employed population projecting an annual negative growth rate of -0.73% at county level, the work force is steadily decreasing, from 169.3 thousand persons employed in 2008 to 163,740 people in 2014. In the agricultural branch, there are very small variations in this

period (coefficient of variation of 2.06%) and the average work force of 77,240 people is maintained.

Economic and political crisis still have negative effects. Job reductions are found in mining and quarrying, manufacturing and construction industry. These reductions lead to increase of the number of unemployed but

also to the population employed in agriculture, because most workers live and work in these small areas of crops. For this

category of staff, retraining programs are needed because most of them are young.

Table 12. The size and structure of the employed civilian population per activities, in the Olt County, for the period 2008-2014

Crt. no	Economic activities	2008		2011		2014	
		Thousands of persons	%	Thousands of persons	%	Thousands of persons	%
1	Total	169.3	100.00	162.6	100.00	160.8	100.00
2	Agriculture, forestry and fishing	76	44.89	78.2	48.09	74.6	46.39
3	Extractive industry	1.3	0.77	0.9	0.55	0.9	0.56
4	Manufacturing industry	32.5	19.20	27.2	16.73	27.6	17.16
5	Constructions	10.5	6.20	7.9	4.86	8.7	5.41
6	Wholesale and Retail	12.5	7.38	14.1	8.67	14.9	9.27
7	Public administration and defence; public social insurance	4.8	2.84	3.8	2.34	3.7	2.30
8	Education	7.6	4.49	6.9	4.24	6.9	4.29
9	Health and social assistance	7.2	4.25	6.4	3.94	6.2	3.86

Analysing the structure of employment, it is found that the main activity is agriculture which holds 46.39% of the employed population in 2014, being double than 23.13% as they together hold in mining, manufacturing and construction industry.

The average unemployment rate in 2011 was 6.86%, in 2012 was 6.91% and in 2013 was 7.0% [6].

It is very important that education and training system to adapt to the labour market requirements in terms of training new skills. The educational and training programs have to be adapted to the needs of both the employees and population looking for a job [7].

It is required a restructuring of the entire economic activity of the county. First it is necessary to diversify farming activities, an increase in activities with higher consumption of manpower, particularly the livestock industry. It is also necessary to develop food

processing industry of primary agricultural, plant and animal production [8].

The quality of education and educational reform are affected by insufficient infrastructure and weak endowment of the existing, staff motivation (low wages) and the poor material condition of the population [8].

Among synthetic indicators that reflect human activity as a whole, we consider that the one expressing average life is significant to reflect the standard of living, of satisfaction of existence.

Despite the fact that the South-West Oltenia region is considered poor, life length is 75.18 years per region, close to the level in the country which is of 75.47 years. In Olt County is 74.33 years, being 5 years older than the average lifespan of the year 1990, which was 69.28 years. (Table 13)

Table 13. The evolution of life expectancy at country level and South-West Oltenia, for the period 1990-2014

Crt. No	Country, region, county	1990	2000	20005	2010	2012	2014
1	TOTAL of country	69.56	70.53	71.76	73.47	74.26	75.47
		100.0	101.4	103.2	105.6	106.8	108.5
2	Reg. SOUTH-WEST OLTENIA	69.33	70.61	71.62	73.24	74.32	75.18
		100.0	101.8	103.3	105.6	107.2	108.4
3	Dolj	69.08	70.2	71.22	72.83	73.8	74.82
		100.0	101.6	103.1	105.4	106.8	108.3
4	Gorj	69.39	70.94	71.96	73.54	74.3	75.02
		100.0	102.2	103.7	106.0	107.1	108.1
5	Mehedinti	68.46	70.5	71.21	72.23	73.27	74.2
		100.0	103.0	104.0	105.5	107.0	108.4
6	Olt	69.28	69.92	71.23	72.55	73.93	74.33
		100.0	100.9	102.8	104.7	106.7	107.3
7	Valcea	70.45	71.91	72.85	75.5	76.75	77.93
		100.0	102.1	103.4	107.2	108.9	110.6

## CONCLUSIONS

The rural local area of the Olt County is facing numerous shortcomings that contribute to increasing disparities between urban and rural areas through its components: rural economy, demographic potential, health, school, culture etc.

A thorough analysis of high-school education revealed that there is a variation in the number of agricultural high-schools and that annual discrepancies remain between the growing number of students enrolled and the number of graduates declining. A solution can be in adapting programmes so that they turn into one attractive educational environment and the support of a baccalaureate differentiated so as to accommodate the before and after concerns of future graduates.

By the training levels in Olt County it is found that school population is in continuous decline in all categories of education. Also dropout of high-school, vocational and post-secondary education shows very high values, both at regional and county level.

Correlated with the reduction of students and of schools, it is observed a significant decrease in the number of high school workshops. It may be noted that the abolition of a workshop on medium and long term, is more expensive than its keeping in the regime preservation. Reducing the minimum number of students who can participate in the group practice in the workshop would be a short-term solution for keeping these workshops in school circuit.

School dropout in primary school population are caused by poor conditions of living standards in rural areas. The renunciation of pupils to continue their studies after middle school are due to lack of perspective after gymnasial education.

To develop the educational system in Olt County, to increase employment of the active population, and to reduce disparities between urban and rural areas are necessary measures to implement integrated strategies for development of the education system, diversification of economic activities where to focus on agricultural activities (livestock development, development of food industry).

## REFERENCES

- [1]Anghelache, C., et al., 2012, Metode și procedee de ajustare a datelor pe baza seriilor cronologice utilizate în analiza tendinței dezvoltării diferitelor domenii de activitate social-economică, Romanian Statistical Review nr. 8 / 2012
- [2]Anuarul Statistic al județului Olt, INS, DJS Olt, Ediția 2012
- [3]Creșterea demografică, [http://www.dictsociologie.netfirms.com/\\_IndDem/IndReproducere.htm](http://www.dictsociologie.netfirms.com/_IndDem/IndReproducere.htm)
- [4]Dan Steluța, 2011, Cercetări privind implementarea și utilizarea informaticii in liceele cu profil agricol si masuri de îmbunătățire pentru perioada următoare. Teză doctorat, USAMV-București
- [5]INSSE, 2015, Baze de date statistice, Tempo-Online, <http://statistici.insse.ro/shop/>
- [6]Raport privind activitatea Agentiei Judetene pentru Ocuparea Fortei de Munca Olt, în anul 2013, Raport\_activitate\_2013\_AJOFM\_Olt
- [7]Planul de Amenajare a Teritoriului Județean Olt, accesat 9.11.2015, [www.cjolt.ro/pozearticol/documente/cjolt/gallery/stiri/faza-04.pdf](http://www.cjolt.ro/pozearticol/documente/cjolt/gallery/stiri/faza-04.pdf)
- [8]Regiunea de Dezvoltare Sud-Vest, Accesat 8.10.2015, Caracteristici demo-geografice, Oltenia 4 SW\_ro
- [9]Studiu Ministerului Educației și Cercetării (2004), relevă că 76,13% din numărul de școli la nivel regional necesită reabilitare
- [10]Wikia, Caracterizarea repartițiilor de frecvență, <http://ro.math.wikia.com/wiki/Statistică>



## STRUCTURAL CHANGES ON MEAT MARKET IN THE EUROPEAN UNION IN 2008-2014

Agnieszka TLUCZAK

Opole University, Faculty of Economics, 46 a, Ozimska Str., Opole, 45-058, Poland,  
Phone: +48 692921133, Email: atluczak@uni.opole.pl

*Corresponding author:* atluczak@uni.opole.pl

### *Abstract*

*The main aim of this paper is to classify EU countries regarding specialization and competitiveness of production of animal for slaughter in the sectors of pigs and cattle. The analysis was based on structural and geographical shift-share analysis which enabled a classification of EU countries regarding production changes and also an assessment of structures of production of animal for slaughter related to the reference space, i.e. regional area of the EU countries. The performed research also allowed the identification of animal production structures characterized by specialization and competitiveness of production of cattle and pigs.*

**Key words:** competitiveness, EU, animal production

### INTRODUCTION

The meat sector is one of the most important in European Union (EU) agriculture. Together the four main meat types: beef and veal, pig meat, poultry meat, and sheep meat/ goat meat, account for one quarter of the total value of agricultural production. Half of all EU farms have livestock. Some 90 % of farmers with ruminant animals (cattle, sheep and goats) are specialist livestock producers. Meat is a major source of protein and constitutes an important part of the European diet. EU policies in the meat sector are designed to encourage the production of safe, nutritious and affordable meats. Recent changes to the common agricultural policy (CAP) underline these aims. Policies are geared increasingly towards meeting the needs of consumers, livestock producers and the environment in a balanced way [13, 27, 32].

There have been unconsiderable structural changes in EU livestock farming since the 2008. The production of pig meat and bovine meat (based on available data for the EU-28 Member States) was lower in 2014 than in 2008: pig meat production for the EU-28 declined slightly by 1.56% to 22.2 million tonnes; bovine meat production declined by 9.8% compared to 2008.

Beef is mainly produced from cattle breeds

grown specifically for their meat but can also come from dairy cattle. Male calves from dairy cows are of no use for producing milk and most of these are used for veal production. The largest producer of bovine meat are Germany, France and Italy; They produced respectively 12.1, 15.8 and 10 million tonnes in 2008 [1, 18, 19].

European beef production in the first quarter of 2015 showed an increase of 4.8% year-on-year. It was partly related to the continuing culling of dairy cows in Poland, Italy and Estonia. Beef production was likely to rise overall in 2015, boosted by cowherd developments and export opportunities. It predicted that in 2015 total EU production could further increase by 1.4% as EU production capacity has risen and the impact of longer production cycles kicks in [13, 16, 33].

Pig meat production is expected to increase further in 2015, driven by low feed prices and a higher numbers of breeding sows. Increased production, lower meat prices, a weaker euro and a strong demand from Asia provided an opportunity for pig exports [1, 32].

Despite depressed prices at the beginning of the year, slaughter were up 5.6% in the first quarter of 2015 compared to the same period in 2014. All main producing member state contributed to this, with the biggest growth

recorded in Spain (+11.7%) and in Poland (+6.6%). In the first four months of 2015, EU pig meat exports grew by around 4% because of increased shipments towards the Philippines, China, the US and Singapore [16, 18, 19, 32].

Today's economic conditions related to the operation and regional development within the European Union make it necessary to take on new diagnostic tests for the prospects of economic development of regions [20]. In this study, one of the spatial methods was used to diagnose spatial dynamics of changes: spatial and dynamic shift share analysis. The main aim of this article was to analyze changes in the volume of animal for slaughter production in the EU countries in the years 2008-2014 by species (bovine, pig) using the shift share method. The study assesses the pace of change in the size of the phenomenon.

## MATERIALS AND METHODS

The subject of the research is agriculture production structure by two main types of meat: bovine and pigs. The adopted time range of conducted research covers the period 2008–2014. The analysis covers 27 EU countries. The necessary statistical information was obtained from Eurostat database.

Structural and geographic analysis of meat production was conducted in countries by using classical and dynamic shift-share analysis and the Esteban-Marquillas model using allocation effect [3, 5, 6, 10, 17, 20, 25, 26, 28, 29, 30]. Shift-share analysis represents a research tool that allows determining the rate of changes related to total meat production in each member countries at the background of reference area, i.e. the European Union area [2, 4, 7, 8, 9, 11, 30, 31, 33].

Shift-share analysis of meat production in the EU countries allowed for specifying structural and competitiveness the size and type of meat production changes grouped according the types of meat by positive and negative change effects values, as well as by specialization and competitiveness – the components of allocation effects [12, 14, 15, 19, 23,24].

The assessment of regional specialization and competitiveness in economy sectors requires specifying a reference structure, i.e. the one constituting the required reference basis. In the discussed framework this role will be played by meat production in the space of 27 EU countries.

## RESULTS AND DISCUSSIONS

The information provided in Table 1 indicates that in EU in the period 2008–2014, the largest average meat production share was definitely characteristic by pig meat, the other type of meat - bovine was three times smaller. The changes occurring in the course of analyzed years were insignificant, which seems natural, since economic structures are most frequently characterized by slow and evolutionary type of changes over time.

Table 1. Meat production structure in EU in the period 2008-2014 (in %).

Year	Beef	Pork
2008	26	74
2014	25	75

Source: author's own calculation based on Eurostat database.

Table 2 presents the effects of meat production structure changes which allow identifying the economy sectors exerting key impacts on the EU countries' economic growth in the period 2008–2014. Net structural effects were defined by means of decreasing gross effects in terms of agriculture production growth rate in European Union. The changes of pig meat production in 2014 resulted in higher meat production in all EU members countries, on average by +2.00%. The largest meat production rate occurred in bovine meat production sector (–6.00%). This large decrease it was due to increased slaughter of dairy cows in Poland, Italy and Estonia.

Table 3 and Figure 1 illustrate the classification of EU countries with regard to aggregated structural and competitive effects. The first class covered those countries in which sectoral meat production structure has a positive impact on agriculture production rate

growth and economic sectors are characterized by higher dynamics of meat production size fluctuations compared to other regions. This group includes five countries. In this class Germany stands out as characterized by very strong positive effects, both structural and competitive ones, definitely higher than in the other countries covered by this class.

Table 2. Results of classic shift-share analysis with regard to the effects of meat production changes in the sectors grouped according to types of meat.

Effects of meat production changes in EU countries (in %)		2014/2008
Total effect (growth rate of meat production in EU)		-3.73
Net structural effect	Pork	-6.00
	Beef	+2.00

Source: author's own calculation based on Eurostat database.

Table 3. Classification of EU countries by positive and negative aggregated effects values: structural and competitive (dynamic shift-share analysis 2014/2008).

Criterion of division	Countries	Number of countries
effects: structural (+) competitive (+)	Belgium, Germany, Spain, Netherland, Portugal	5
effects: structural (+) competitive (-)	Bulgaria, Czech Republic, Denmark, Cyprus, Hungary, Malta, Poland, Slovakia	8
effects: structural (-) competitive (+)	Ireland, Austria, United Kindtom	4
effects: structural (-) competitive (-)	Estonia, Greece, France, Italy, Latvia, Lithuania, Luxembourg, Romania, Slovenia, Finland, Sweden	11

Source: author's own calculation based on Eurostat database.

The second class characterized by a positive value only of the structural factor lists eight countries. The most favorable changes in meat production structure observed in this class in the analyzed period occurred in Hungary. This region was characterized by the highest structural effects and the lowest competitive effects.

The third class, featuring positive influence of only the competitive factor, covered four countries. In this class Ireland was characterized by definitely the least favorable changes in structure of meat production. The fourth class covers the countries in which both meat production structure and internal competitive development determinants

exerted negative impacts. This is the most numerous class including eleven countries. The most unfavorable competitive effects of meat production changes were observed in this class with reference to Romania, whereas the least favorable structural changes were recorded in Slovakia too.

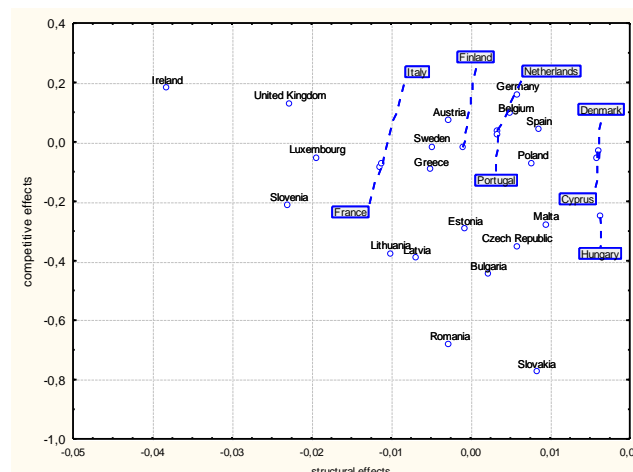

Fig. 1. Aggregated structural effects vs. aggregated competitive effects.

Source: author's own calculation based on Eurostat database.

Figure 2 presents the values of aggregated structural and competitive effects arranged according to the decreasing values calculated for 2008–2014. As it can be observed, in the analyzed period competitive factors exerted a much larger impact on meat production changes than the structural ones. The most favorable structural effects of changes occurred definitely in Denmark, Cyprus and Hungary. The largest negative influence on structure in meat production changes was observed in Ireland, Slovenia and United Kingdom.

The most favorable internal competitive factors responsible for changes in meat production occurred in Germany and Ireland. The least favorable situation was observed in Romania, Slovakia, Bulgaria and Czech Republic. Table 4 presents the classification of EU countries with regard to allocation component effects: specialization or its absence as well as the advantage or disadvantage of competitiveness.

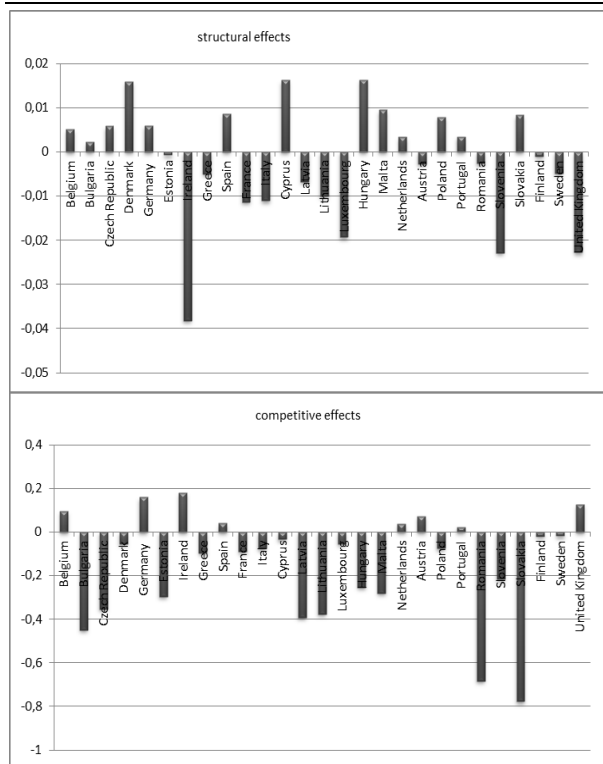

Fig. 2. Aggregated structural and competitive effects for EU countries in the period 2008-2014.  
 Source: author's own calculation based on Eurostat database.

In case of wheat in regard to all voivodships it can be concluded specialization and competitive advantage (tab. 4). The division of countries due to the advantages and disadvantages in specialization and competitiveness is varied.

Table 4. Classification of EU countries with regard to allocation component effects in meat production in 2014

	bovine meat	pig meat
Specialization and competitive advantage	Czech Republic, Denmark, France, Cyprus, Latvia, Lithuania, Malta, Poland, Slovenia, Slovakia, Finland, Sweden	Belgium, Bulgaria, Germany, Estonia, Ireland, Greece, Spain, Italy, Luxembourg, Hungary, Netherlands, Austria, Portugal, Romania, United Kingdom
Specialization and competitive disadvantage	Belgium, Bulgaria, Germany, Estonia, Ireland, Greece, Spain, Italy, Luxembourg, Hungary, Netherlands, Austria, Portugal, Romania, United Kingdom	Czech Republic, Denmark, France, Cyprus, Latvia, Lithuania, Malta, Poland, Slovenia, Slovakia, Finland, Sweden

Source: author's own compilation based on Eurostat database

All the groups of countries are numerous, the classification of the country to the group depends on the type of meat (bovine or pig) and the current weather conditions in the country. Analyzing the meat market the cyclical nature of meat production should be taken under consideration.

## CONCLUSIONS

(1) Since 2008 EU countries recorded a decrease in meat production by 3.73%. However, the changes in pig production resulted in an average production rate decrease by 6.0%. That sector turned out to be the key to responsible for economic decrease of meat production.

(2) The most favorable structural effects of changes in meat production occurred in Denmark and Hungary, in this countries characterized by a high share of pig meat production sector presenting the level of respectively about 93% and 94% in 2014. Definitely the least favorable structural effects were observed in Ireland, where pig meat production amounted to about % in 2014.

(3) The most favorable competitive effects took place in Germany and Ireland, whereas the least favorable ones in Slovakia, Bulgaria and Latvia.

(4) Production as well as consumption of meat in the EU, continues the downward trend, which is mainly due to the lower supply of pork and beef. In 2014 due to the improvement of the economic situation in most EU countries, as well as due to a decrease in grain prices, the outlook for the meat sector seem to be better. It can be observed lower profitability and the continuation of the downward trend of pig meat production and a decline in the EU. The first effects of the tense situation on the supply side was already evident in the second half of 2014 when prices on the EU market strongly rebounded. Commission experts estimate that could translate into a slowdown in exports of meat, as well as have a negative impact on consumption of pork in the EU.

(5) With regard to the beef market saw an increase in cattle numbers in 2014. Mainly due to an increase in population of dairy

cows. This implies an increase in production and a decline in beef meat imports from outside the EU. However, high prices may, as in other types of meat, limit the growth of consumption.

(4) Finally shift-share analysis proved to be a useful method in identifying changes related to structure and dynamics of size of meat production in EU countries.

## REFERENCES

- [1] Agricultural Production-Animals, [http://ec.europa.eu/eurostat/statistics-explained/index.php/agricultural\\_production\\_-\\_animals](http://ec.europa.eu/eurostat/statistics-explained/index.php/agricultural_production_-_animals)
- [2] Antczak, E., 2014, Analiza zanieczyszczenia powietrza w Polsce z wykorzystaniem przestrzennej dynamicznej metody przesunięć udziałów, *Ekonomia i Środowisko*, 2(49), s. 191-209
- [3] Barff, R.A., Knight III P.L., 1988, Dynamic shift-share analysis, *Growth and Change*, no. 19/2
- [4] Cliff, A.D., Ord, J.K., 1981, *Spatial processes. Models & Applications*, Pion, London
- [5] Dunn, E. S., 1960, A Statistical and Analytical Technique for Regional Analysis, *Papers and Proceedings of the Regional Science Association*, vol. 6, p. 98-112
- [6] Esteban-Marquillas, J.M., 1972, Shift and Share analysis revisited, *Regional and Urban Economics*, vol. 2, no. 3
- [7] Evans Garen K., 2008. Spatial Shift-Share Analysis of the Leisure and Hospitality Sector on the Gulf Coast following Hurricane Katrina, 2008 Annual Meeting, February 2-6, 2008, Dallas, Texas 6744, Southern Agricultural Economics Association
- [8] Grzybowska, B., 2013, Przestrzenna koncentracja potencjału innowacyjnego w przemyśle spożywczym, *Roczniki Ekonomii Rolnictwa i Rozwoju Obszarów Wiejskich* Tom 100, zeszyt 2, s. 53-64
- [9] Houston, D. B., 1967, The Shift and Share Analysis of regional growth: a critique, *Southern Economic Journal*, vol. 33, no. 4, s. 577-581
- [10] Malarska A., Nowakowska B., 1992, Metoda przesunięć udziałów w analizie dynamiki zmian strukturalnych [Shift-share method in the analysis of structural changes dynamics], 'Przegląd Statystyczny' ['Statistical Review'] no. 1
- [11] Marquez, M. A., Ramajo, J., 2007, Shift-share Analysis: Global and local spatial dimensions, University of Extremadura
- [12] Mayor, M., Lopez, A. J., 2008, Spatial shift-share analysis versus spatial filtering: an application to Spanish employment data, *Empirical Economics*, vol.34, is. 1, s. 123-142
- [13] Meat & Livestock Market Outlook, Autumn 2014, <http://www.bordbia.ie/industry/manufactur>
- ers/insight/publications/MarketReviews/MeatLivestock Outlook/Meat-and-Livestock-Outlook-2014.pdf
- [14] Metodyka szacowania fizycznych rozmiarów produkcji zwierzęcej (2008), Główny Urząd Statystyczny, Warszawa,
- [15] Nazara, S., Hewings, G.J.D., 2004, Spatial structure and taxonomy of decomposition in shift-share analysis, *Growth & Change*, 35(4), 476-490
- [16] Perrett Michelle, EU meat production set to increase, [http://www.globalmeatnews.com/Industry-Markets/EU-meat-production-to-grow-despite-Russian-ban?utm\\_source=copyright&utm\\_medium=OnSite&utm\\_campaign=copyright](http://www.globalmeatnews.com/Industry-Markets/EU-meat-production-to-grow-despite-Russian-ban?utm_source=copyright&utm_medium=OnSite&utm_campaign=copyright)
- [17] Perloff, H. S., Dunn, E. S., Lampard, E. E., Muth, R. F., 1960, *Regions, resources and economic growth*, Johns Hopkins Press, Baltimore
- [18] Pig Market Trends, November 2014, Issue 114, [http://pork.ahdb.org.uk/media/72648/pig\\_market\\_trends\\_-\\_november\\_2014.pdf](http://pork.ahdb.org.uk/media/72648/pig_market_trends_-_november_2014.pdf)
- [19] Polko, D., 2013, Analiza przestrzenna zmian struktury na rynku pracy absolwentów, *Logistyka*, 4/2013, s. 452-466
- [20] Rozpędowska-Matrasek, D., 2010, Badania empiryczne wzrostu ekonomicznego regionów, <http://www.ie.uni.lodz.pl/pictures/files/konfdydak175-192.pdf> (30.06.2015)
- [21] Short Term Outlook for EU arable crops, dairy and meat markets in 2014 and 2015, [http://ec.europa.eu/agriculture/markets-and-prices/short-term-outlook/pdf/2014-10\\_en.pdf](http://ec.europa.eu/agriculture/markets-and-prices/short-term-outlook/pdf/2014-10_en.pdf)
- [22] Suchecki, B., (ed.) 2010, *Ekonometria przestrzenna. Metody i modele analizy danych przestrzennych* (2010), C. H. Beck, Warszawa
- [23] Szewczyk, M., Tłuczak, A., Ruszczak, B., 2011, Potencjał województwa opolskiego w kontekście analizy zmian udziałów branż, w: *Projekcja rozwoju inicjatyw klastrowych w województwie opolskim*, red. W. Duczmal, W. Potwora, Wydawnictwo Instytut Śląski Sp. z o.o., WSZiA w Opolu, Opole 2011, s.105-119
- [24] Szewczyk, M., Zygmunt, A., 2011a, Prospects of food products manufacture sector in Opolskie region [in:] *Regional and local development: Capitals and drivers*, Krzysztof Malik (EDIT.), Faculty Economy and Management of the Opole University of Technology, Self-Government of the Opole Voivodeship, Committee of Spatial Economy and Regional Planning of the Polish Academy of Sciences, Committee Organization and Management Sciences of the Polish Academy of Sciences – Katowice, Opole 2011, s.135-156
- [25] Szewczyk, M., Zygmunt, A., 2011b, Opolskie Voivodeship: perspectives of the mining and quarrying sector [in:] *Regional and local development: Capitals and drivers*, Krzysztof Malik (EDIT.), Faculty Economy and Management of the Opole University of Technology, Self-Government of the Opole Voivodeship, Committee of Spatial Economy and Regional Planning of the Polish Academy of Sciences, Committee Organization and Management Sciences of

the Polish Academy of Sciences – Katowice, Opole 2011, s. 199-218

[26]Szewczyk, M., Łobos, K., 2011, A Comparative Study of the Economic Performance of Chemical Branch Enterprises from Opolskie and Dolnośląskie Voivodships [in:] Regional and local development: Capitals and drivers, Krzysztof Malik (EDIT.), Faculty Economy and Management of the Opole University of Technology, Self-Government of the Opole Voivodeship, Committee of Spatial Economy and Regional Planning of the Polish Academy of Sciences, Committee Organization and Management Sciences of the Polish Academy of Sciences – Katowice, Opole 2011, s. 109-134

[27] The meat sector in the European Union, 2004, [http://ec.europa.eu/agriculture/publi/fact/meat/2004\\_en.pdf](http://ec.europa.eu/agriculture/publi/fact/meat/2004_en.pdf)

[28]Tłuczak, A., 2014a, Zastosowanie modelu potencjału w analizie zróżnicowania regionalnego rolnictwa w krajach unii europejskiej, *Metody Ilościowe w Badaniach Ekonomicznych Tom XV/4*, str. 218 – 228

[29]Tłuczak, A., 2014b, Model potencjału w analizie zróżnicowania regionalnego rolnictwa w Polsce, *Acta Universitatis Lodzianis Folia Oeconomica*, 6 (308), s. 171-181

[30]Tobler, W., 1970, A computer movie simulating urban growth in the Detroit region, *Economic Geography*, 46(2), s. 234-240

[31]Trzpiot, G., Ojrzyńska, A., Szoltysek, J., Twaróg, S., 2013, Wykorzystanie shift share analysis w opisie zmian struktury honorowych dawców krwi w Polsce, *Wielowymiarowe modelowanie i analiza ryzyka*, UE Katowice, Katowice, s. 84-98

[32]UK Pig Meat Market update  
<http://pork.ahdb.org.uk/pricestats/published-reports/uk-pig-meat-market-update/>

[33]Zaccomer, G.P., 2006, Shift-share analysis with spatial structure: an application to Italian industrial districts, *Transition Studies Review*, 13(1), 213-227

## FARM AGRO-ENVIRONMENTAL DIAGNOSIS, A NECESSITY?

Camelia TOMA

Institute of Agricultural Economics, Romanian Academy, 13, Calea 13 Septembrie, District 5,  
050711, Bucharest, Romania, Phone/Fax: +4021318.24.11; E-mail: [iea@ines.ro](mailto:iea@ines.ro),  
[cameliatoma2004@yahoo.fr](mailto:cameliatoma2004@yahoo.fr)

**Corresponding author:** [cameliatoma2004@yahoo.fr](mailto:cameliatoma2004@yahoo.fr)

### Abstract

*Global warming currently implies two major problems for mankind: the need for a drastic diminution of greenhouse gas emissions on one hand, and the need to adapt to the climate change effects on the other hand. The CRESC Strategy emphasized the agricultural sector contribution to the greenhouse gas production by more than 15% of total greenhouse gases produced in our country, although in the last 25 years the greenhouse gases were down by half. In order to measure the impact of farming activities upon the environment, as well as the effects that the climate changes have upon agriculture and the sustainable development of the European rural area, sets of agro-environmental indicators were established; these indicators were tested in Romania's case as well, with regard to the relevance for policy assessment, the response capacity, analytical base, data accessibility and measurability, interpretation facility and cost effectiveness. Following these studies, the conclusion was that only part of these indicators can be calculated, the remaining indicators being estimated by mathematic modelling, due to the great diversity of physical-geographic conditions and agricultural systems, which depend on a wide range of specific local characteristics. In the last 20 years countries like France, for instance, designed methods to measure the agro-environmental indicators at farm level. Farmers' awareness and involvement is essential in the environment protection activity and the contribution that this activity can bring in the fight against climate change. The purpose of the paper is to test the DIALECT method on the Romanian farms, by a double approach, i.e. global and thematic, by the environmental components. The diagnosis has the capacity to measure the environment "value added", expressed by a better nitrogen and manure management, the way in which the conversion to organic farming takes place, which is the effect of the change in crop rotation, the way in which certain operations better optimize the use of own natural resources (soil, weather, biodiversity, etc.) and put a limit to the pressure on resources (water, energy, etc.), while other operations have a negative impact upon the local ecosystems.*

**Key words:** agro-environmental indicators, climate change, diagnosis, DIALECT method, global warming

### INTRODUCTION

As a result of human activities, the high GHG concentrations in the atmosphere (carbon dioxide, methane and nitrogen oxide in the first place) intensify the natural "greenhouse effect", resulting in the increase of the Earth's temperature. Only in the last 40 years (1970-2010) the carbon dioxide concentrations (CO<sub>2</sub>) increased by 70%.

Although divergent opinions exist among scientists, the global warming phenomenon remains a reality and it is very important to understand and explain the impact of the increasing values of certain weather parameters upon the physical-geographical systems of our planet [3]. Other researchers [7], on the basis of certain paleo-climate studies and indicators (on the ice caps, on the sediments resulting from glacier melting, etc.)

revealed that in the last 20 years out of the 600 investigated years, the indicators reveal the accelerated climate warming. The specialty studies revealed that the climate changes are differently felt depending on the latitude [5]. In this respect, it is worth mentioning that at temperate latitudes, the temperature increase is under 0.4° C, compared to Greenland, Siberia and the Arctic Peninsula, where the temperature increase reached 3° C. [8]

The global warming phenomenon, which can adversely impact the sustainable development of human society in general, and of agriculture in particular, threatening the population's food security and health, became a new science, which aroused the interest of both researchers and governments. These reached the conclusion that only by the joint efforts of the economic and political powers



of each state in part, we can initiate a collective action in order to reduce these effects.

Temperature increase has significantly impacted several physical and biological systems (water, habitats, health), which are becoming increasingly fragile.

The climate change in Romania is considered into a European context; taking into consideration the regional conditions, temperature increase will be stronger in summer time, while in the north-eastern part of Europe, the strongest temperature increase is expected during the winter.

Global warming currently implies two main problems for mankind, namely:

-on one hand, the ***need for a drastic diminution of greenhouse gas emissions*** in order to stabilize the concentration of these gases in the atmosphere – thus hindering the anthropic influence upon the climate system and making it possible for the natural ecosystems to get adapted in a natural way - and,

-on the other hand, the ***need to get adapted to the climate change*** effects, while having in view that these effects are already visible and unavoidable due to the climate system inertia, regardless of the result of actions targeting the diminution of emissions.

Even since the 1970s, the intensification of production methods contributed to pollution increase. Consequently, limiting the impact upon the environment acquired an increased importance in the agronomic research, and became a topic of great interest for researchers. These scientific concerns led to the proposal of methods and methodologies for the evaluation of agriculture impact upon the environment, such as [2]. Some of these methods utilize sets of indicators for measuring the extent to which the proposed objectives are reached.

## MATERIALS AND METHODS

From the point of view of the sustainable development of agriculture and rural areas, as well as of countering the effects of climate change, in our country different studies, methods and strategies were designed or are under the investigation, testing or

implementation stage, among which the most recent is the Strategy CRESC [6].

The strategy started from the sectoral identification of the GHG emission sources and from the quantitative estimation of these gas emissions produced by our country at present (Table 1)

Table 1. GHG emissions in Romania

GHG sources and categories of absorption basins	Total GHG emissions in 2011 (CO <sub>2</sub> equiv.)	% of total GHG emissions (without LULUCF)
Energy (transports inclusively)	86,320.46	69.98%
Out of which transports	14,577.72	11.82%
Industrial processes (solvents utilization included)	12,591.53	10.21%
Agriculture	18,941.46	15.36%
Forestry	-23,353.01	-
Other destinations of land (without forests)	-1,951.93	-
Wastes	5,366.48	4.35%
Total CO <sub>2</sub> equivalent with LULUCF	98,040.60	-
Total CO <sub>2</sub> equivalent without LULUCF	123,345.54	100%

Source: MMAP, 2015, CRESC Strategy, V2, p.25

Note: LULUCF= Land use land use change and forestry

According to CRESC Strategy, “at EU level, Romania had the greatest generalized decrease of GHG emissions in agriculture, by 53% in the period 1990 – 2011, while the GHG emissions in agriculture in EU-28 decreased by only 25% in the same period. The diminution of emissions in agriculture in EU-28 is mainly due to the diminution of livestock herds, to the improvements of good agricultural practices, to the lower utilization of nitrogen fertilizers, as well as to a better manure management”.

The Romanian agriculture is not intensive from the point of view of emissions, although it represents one of the factors that contribute to the general GHG emissions. The relatively great contribution of agriculture is the result of energy use in this sector. “For Romania, the main sources of greenhouse gas emissions are the nitrogen protoxide (N<sub>2</sub>O) based on soil nitrification and manure management, methane (CH<sub>4</sub>) resulting from the enteric fermentation of herbivores, mainly cattle, and



carbon dioxide (CO<sub>2</sub>) coming from the energy/fuels used by buildings and equipment. 50% of emissions in agriculture are represented by the nitrogen protoxide, followed by 45% methane, while only 5% of emissions are based on carbon dioxide” [6]  
 From the analysis of relevant environmental objectives for *Agriculture* it resulted that these directly respond to and are included at least in one of the strategic objectives:

Table 2. Relevant environmental objectives of agriculture in CRESC Strategy

Description of relevant environmental objectives (REO)	Diminution of GHG emissions	Adaptation to climate change
REO 1 Improving the air quality by the diminution of air pollutant emissions, of GHG emissions inclusively	YES	YES
REO 2 Sustainable management of water resources, in the climate change context	YES	YES
REO 3 Improvement and maintenance of soil quality and sustainable land use	YES	YES
REO 6 Protection and improvement of living conditions	YES	YES
REO 7 Sustainable waste management		YES
REO 8 Protection/maintenance of areas with high value landscapes and of objectives with cultural value		YES
REO 9 Increasing the information of people on the climate change effects and necessary adaptation measures		YES

Source: MMAP, 2015, CRESC Strategy

The European Environment Agency (EEA, 1999) developed the Method DPSIR (Driving Force – Pressures - State – Impact - Response), which represents an analytical framework to describe and understand the linkages between the economic and environmental activities, under the form of a set of 35 indicators integrating the environmental aspects in the agricultural, forestry and water management policies in the rural area.

The Institute for Soil Science and Agrochemistry Research proposed a research project TOGI [7] whose main objective is the adaptation and application of the DPSIR

Community methodology at local and regional level.

The evaluation criteria of agro-environmental indicators refer to the relevance for policy evaluation, response capacity, analytical base, data accessibility and measurability, interpretation facility and cost effectiveness (Table 3).

Table 3. DPSIR Method applied to agriculture and the equivalent TOGI indicators

Driving forces	
Input use	Mineral fertilizer consumption
	Pesticide consumption
	Water utilization
	Energy utilization
Land use	Land use change
	Crop/livestock structure
	Farm management activities
Tendencies	Intensification/extensification
	Specialization/diversification
	Marginalization
Pressures and benefits	
Pollution	Gross nutrient balance
	CO <sub>2</sub> emissions in atmosphere
	CH <sub>4</sub> and N <sub>2</sub> O emissions
	Soil contamination with pesticides
	Manure utilization
Resource loss	Water absorption
	Soil erosion
	Land cover change
	Genetic diversity
Environment conservation and improvement	Area with high natural value
	Alternative energy production
Specific site status	
Biodiversity	Dynamics of poultry population on farms
Natural resources	Soil quality
	Nitrates/pesticides in waters
	Ground water level
Landscape	Landscape situation
Global impact of national agriculture upon the environment	
Habitats and biodiversity	Impact upon biodiversity and habitats
Natural resources	GHG quota allocated to agriculture
	Nitrate contamination quota allocated to agriculture
	Water utilization quota for agriculture
Landscape diversity	Impact upon landscape
Responses	
Public policy	Area benefiting from agri-environment support
	Regional levels of good agricultural practices
	Regional levels of environmental targets
	Area with natural protection
Market signals	Prices for organic production and market share
	Organic farm incomes
Technology and skills	Training level of holders
Attitudes	Organic farming area

Source: ICPA, Project Cex MENER 615/2005, stage 1

The following conclusions can be drawn from the project results:

The development of agro-environmental indicators is facing difficulties in reality:

- The environmental problems are often too complex to be represented by individual parameters (such as landscape diversity),
- Romania's territory is quite diverse in terms of farm structures (crop, livestock types, etc.), soil characteristics, topographic and climate conditions, farm size and agricultural productivity,
- The relations between agriculture and environment are complex, so that a simplified description is not necessarily useful; the impact of many agricultural processes depends on a wide range of specific local characteristics,
- The lack or insufficiency of data sets prevents/constrains the implementation of the most appropriate concepts/methodologies of indicators, for instance the irrigable area must be used with approximation for water use assessment,
- The required data for state/impact indicators are often unavailable. Furthermore, several indicators from these fields should be based on modelled or approximated data,
- The causal links are not sufficiently understood so as to be represented through indicators.

In spite of these problems, the agro-environmental indicators remain key instruments for environmental reporting in agriculture (and in other fields as well). The limited resources for data collection make it necessary to select a limited set of indicators that can be maintained on long term as part of an agro-environmental information system.”[4]

Environment analysis at farm level through a diagnosis of interactions between the farming activity and the environment, in other words, a diagnosis of the negative and positive effects of the farm activity upon the environment is quite opportune and complementary in the context of the difficulty to calculate certain agro-environmental indicators at local, regional or national level.

Involving the farmers directly in making agro-environmental diagnoses in their own farms, this make them aware of the need to reduce

the greenhouse gas emissions and adapt to the climate change effects.

At the same time, at present, the environment is an important component that the agricultural policies take into consideration for conservation and financial support, as well as for the implementation of actions, such as: establishment of criteria for the selection and implementation of agro-environmental measures on the farms, providing CAP subsidies, establishment of high environmental value, recognition of high natural value agricultural systems or of those with environmental constraints, conversion to organic farming, etc.

The DIALECT method completes the weaknesses of the previous method by including the agro-environmental evaluation at farm level.

This method was developed by the research center "SOLAGRO" from Toulouse, France, in the period 1995-2015 and it is successfully applied on more than 2000 farms from France, from other different countries of the European Union and even from other regions of the world with temperate climate.[11] In the 20 years since the creation of the first version, improved versions were designed, in line with the research works in the field of agro-environment and climate change, while making available a performant interface, totally or partially transposed into the languages of the EU member states and adapted to the new online informatic technologies, so as to be used by any interested person in this field.

This analysis tool establishes the current situation of the environment and reveals the agro-ecological systems, identifies the risky practices and can suggest improvement modalities to farmers. The diagnosis has the capacity to measure the environment "value added", expressed by a better nitrogen and manure management, by the conversion modality to organic farming, the effect of a change in crop rotation, the modality in which certain operations better optimize the use of own natural resources (soil, weather, biodiversity, etc.) and limit the pressure upon resources (water, energy, etc.), while other

have a negative impact upon the local ecosystems.

The environment evaluation method at farm level is based on a double approach:

**A global approach**, which makes an analysis of farm operation, including two themes:

- farm diversity and
- rational utilization of inputs.

**A thematic approach**, measuring the impact of farm activity upon different environment components: water, soil, air, biodiversity, resource use, etc.

A specific part of the diagnosis was dedicated to the farm *energy analysis*. Energy is a necessary condition throughout the production process.

The DIALECT tool responds to 3 evaluation levels:

- 1-Selection of criteria and indicators
- 2-Scoring scale
- 3- Share of criteria and indicators.

Table 4. DIALECT method structure, approaches, criteria and indicators

Farm agro-environmental diagnosis	
Tool structure: a double approach	
Global	Thematic
System analysis and its practices	Agricultural activity impact upon different environment sectors
"System" diversity : 70 points	
-Crop production diversity: 3 indicators	Water: 9 indicators
-Autonomy of animal production and organic matters: 3 indicators	Soil: 5 indicators
-Natural infrastructures: 2 indicators	Biodiversity: 4 indicators
Indicator management: 30 points	
-Nitrogen, Phosphorous, Water, Phyto, Energy: 10 indicators	Resource utilization: 5 indicators
-Pressure indicators: 4 indicators	
-Result indicators: 4 indicators	
-Method indicators: 2 indicators	
Score from 1 to 100 points	Score 1 to 20 for each theme

Source: SOLAGRO, 2006. *Manuel d'utilisation Dialecte – Version 2. 54 p.*

**1-Selection of criteria and indicators:** The risks of impact upon the environment are evaluated on the basis of agro-environmental indicators. Each theme contains several criteria, which include indicators grouped into subcriteria. The diagnosis is based on the analysis of 8 criteria and 20 indicators. Each indicator is defined by a calculation modality using quantitative or qualitative variables.

**2-Scoring scale:** For certain indicators, it is necessary to define an evaluation scale that

includes a *minimum value* and a *maximum value* and the evaluation modality within this scale (linear or non-linear).

**3-Share of criteria and indicators:** Regrouping the indicators needs the design of a points coding, so that these can be combined within a criterion or theme (Table 4).

The instruments used by the DIALECT method are the following:

- a survey questionnaire, which makes it possible to collect information, mainly quantitative information (crop rotation, livestock herds, evolution of crops and livestock herds, products, etc.), as well as many qualitative information for the description of the environment on the territory of a given farm;
- a web platform for data inputting, which makes it possible to automatically calculate the indicators and express the results in pdf format;
- a utilization manual of the Dialect site [11].
- a database is available on the Internet for all the diagnoses made by different experts, researchers or students from different universities in this field. This enables the following: comparing the obtained results with those obtained from other similar farms or groups of farms from different countries of the European Union and ensures the development of agro-environmental benchmarks for a given type of farm and/or agricultural area.

## RESULTS AND DISCUSSIONS

The diagnosed crop production farm is located in the county Ialomita, and it was established in the year 2000. In 2011, this was taken over by the young farmer from his parents, who obtained the certification and created an Agricultural Individual Enterprise. The agricultural land is found on the Danube bank, along the Borcea branch. "The soils were formed on the alluvia deposited by the river during the repeated floods, their genesis and evolution being influenced by the flooding regime, by the depth of ground water and the relief units, etc. The climate is of excessive continental type, with hot summers and cold winters. The yearly average

temperature is 11.5 C<sup>0</sup>. The yearly average rainfall is 550.5 mm, while in the period April –October it reaches 288.1 mm. The prevailing wind is the Crivăt, which brings about drastic decrease in temperatures over the winter. Being located on the eastern migration route of birds, the territory, also including the commune Făcăieni, is visited in the transit period, being a feeding and resting area for rare and very rare water and terrestrial bird species”. [10]

“The red-necked goose is the most endangered goose species in the world, the population of this species being under decline, from a number of 60,444 birds in the period 1998-2001 to 38,500 birds estimated in the period 2003-2005. Among the main reasons for this decline, we can mention the deterioration of feeding habitats in the wintering areas.”[9]

There is also an area of 5-6 hectares on the territory of this farm totalizing 98 hectares, where the red-necked geese (*Branta Ruficollis*) feed and spend the winter.

The young farmer accessed the Measure 112, which was implemented in the period 2011-2014 and he applies the Agro-environmental Measure, package 7, which he is currently using.

He committed himself to establish at least one winter grain crop or rapeseed crop each year, after September 15. The establishment of winter crops must be completed before October 15, so as not to disturb the flocks of geese, which choose their habitat on the farm land. At the same time, the maize crops are sown until May 15, and the harvesting does not take place earlier than September 15.

Respecting these rules (and many others, according to the agro-environmental requirements), the crop structure in the year 2014 was the following: 34 ha with wheat, 37 ha with rapeseed and 27 ha with maize, the largest part of arable areas being operating under land lease system.

The wheat crop is located on 5 parcels, the rapeseed crop on 2 parcels and the maize is cultivated on 10 parcels.

In the year 2014, the average yields per hectare were 6 tons/ha for wheat, 3 tons/ha rapeseed and 10 tons/ha for maize. According

to the obligations assumed in package 7, the farmer left almost 3 tons of maize in different feeding locations for the red-necked geese.

The farm has the entire range of agricultural machinery; it applies conventional technology, with the application of fertilizers and pesticides outside the resting and wintering periods of these migratory aquatic birds.

The herbicide application is minimal, mechanical works for weed control and the “false seeding” method being used.

The direct and indirect energy consumption, expressed in “liters oil equivalent” summed up 392 leqp /ha, accounting for 31% agricultural diesel oil, 50% of the applied fertilizers, 3% of the phyto-sanitary products and 17% of the different materials used (plastic packages, baling wire/string, etc.). The produced energies (304 leqp/ha) resulted from the obtained harvests.

The ratio of output energy to input energy is very small, i.e. 0.78, while the energy efficiency coefficient specific to the system must range from minimum 5 to maximum 15, so as to be considered a sustainable, green and non-polluting system.

The CORPEN balance revealed a great application rate of chemical fertilizers (114 kg N/ha), compared to the necessary fertilizers for obtaining the respective harvests.

Thus, 102 kg N/ha and 24 kg P/ha remained unused, which can levigate by leaking into the ground waters and 623 kg N/year were volatilized, i.e. 6 kg de N/UAA ha. (Figure 1)

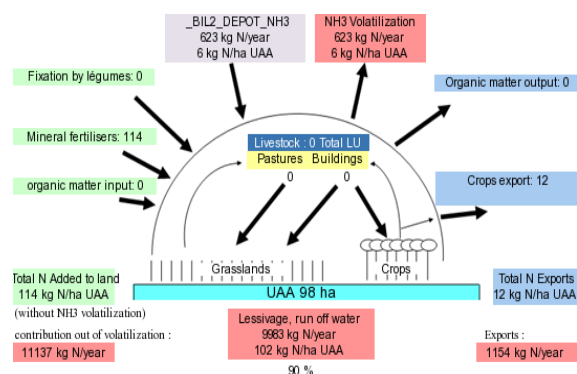

Fig. 1. Nitrogen annual flow on the farm (kg N / ha)  
 Source: Dialect appraisal, www.dialect.solagro.org, Toulouse, France, data introduced on-line by the author

At farm level, the DIALECT program estimated that **greenhouse gases** resulted from the farm activities totaling 203 tons/year, i.e. 2 tons/ha, consisting of 112 tons/year CO<sub>2</sub> and 91 tons/year N<sub>2</sub>O, under the form of direct or indirect emissions. (Table 5)

Table 5. Main sources of GHG emissions from the farm

Direct and indirect GHG	tons CO <sub>2</sub> /year	kg CO <sub>2</sub> /UAA ha	%
Direct GHG emissions from the farming activities, out of which:	120	1227	59
-Burning fuels and oils	29.1	297	14
-Direct N <sub>2</sub> O emissions from soil	53.6	547	26
-Indirect N <sub>2</sub> O emissions from soil	37.5	383	19
Indirect GHG emissions from the activities of third parties, out of which:	82.5	841	41
-purchased seeds	0.1	1	0
-manufacturing of chemical fertilizers	61.7	630	30
-manufacturing of pesticides	3.2	33	2
-manufacturing of plastic packages	1.2	12	1
-manufacturing of agricultural machinery and implements	11.8	120	6
-construction materials-buildings	4.5	46	2
<b>TOTAL GHG emissions</b>	<b>202.7</b>	<b>2068</b>	<b>100</b>

The sequestered carbon stock totalized 7 tons/year, accounting for only 4% of total GHG emissions from the farm territory.

According to the DIALECT method, the diagnosis based on the global farm approach cumulated a score of 42 points out of 100 possible points (out of which 22 points are dedicated to the livestock production). From the total score, diversification/specialization in crop production cumulated 27/70 points while input management 15/30 points. The existence of natural infrastructures (green compensation areas and the average parcel size (5.8 ha) obtained a good score (17/18 points). The global situation of the farm is considered as “medium”, both in general terms and in terms of diversification/specialization and input management. (Figure 2)

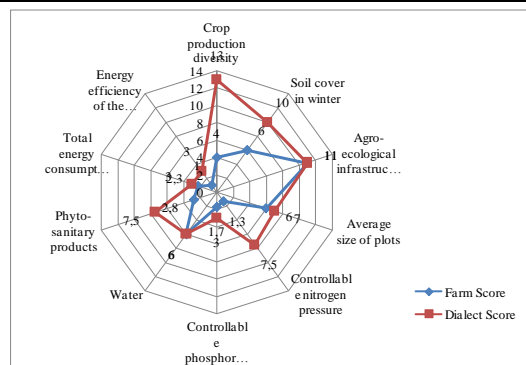

Fig. 2. Global situation of farm in relation to the optimum agro-environmental indicators

The thematic environment approaches, resulting from the Dialect Balance, qualified the farm as having a “good” impact upon water quality, with 14 points out of 20 possible points. (Table 6)

Table 6. Thematic environment approach – water quality and quantity

Thematic indicator:	% of maximum value	Farm points	Maximum ceilings
Nitrogen residues	18%	0.5	3.0
Phosphorous residues	57%	1.1	2.0
Phyto-sanitary residues	38%	1.1	3.0
Disposal of effluents from the livestock production sector	100%	3.0	3.0
Water utilization	100%	3.0	3.0
Soil cover in winter	61%	0.9	1.5
Size of parcels under different crops	85%	1.3	1.5
% of the length of protected water courses	100%	1.0	1.0
Water protection through natural elements	100%	2.0	2.0
<b>Total</b>	<b>xxx</b>	<b>14.0</b>	<b>20.0</b>

The thematic approach to the “soil” environment component revealed a “low” impact as regards the soil erosion control and natural soil fertility, with 5.8 out of 20 points (Table 7)

Table 7. Thematic approach to environment-soil (fertility, soil erosion control)

Thematic indicator: Soil	% of the maximum value	Farm scores	Maximum ceilings
Permanent grassland (% of UAA)	0%	0.0	10.0
Permanent pastures (% of UAA)	0%	0.0	8.0
Organic. fertiliz. area (% of UAA)	0%	0.0	4.0
Soil cover in winter (% of UAA)	72%	5.8	8.0
Planted area with no tillage (% of UAA)	0%	0.0	8.0
<b>Total</b>	<b>Xxx</b>	<b>5.8</b>	<b>20.0</b>



Relatively low scores were obtained for the environment component “Biodiversity”. Spontaneous flora biodiversity on the farm territory is very low due to pesticide application. A better score was obtained for the 5-6 protected hectares for the red-necked goose habitat, which is a recognized area of biological interest and a green compensation area.

Table 8. Thematic environment approach – plant and animal biodiversity

Thematic indicator: Plant and animal biodiversity	% of the maximum value	Farm scores	Maximum ceilings
Green compensation areas	100%	7.0	7.0
Productive pastures with low fertilization	0%	0.0	7.0
Recognized areas of biological interest	yes	4.0	4.0
Absence or low utilization of pesticides	no	0.0	5.0
<b>Total</b>	<b>xxx</b>	<b>11.0</b>	<b>20.0</b>

The consumption of resources is “medium”, more significant surpluses being found in the indirect energy, i.e. a too great application of chemical fertilizers compared to crop consumption and the obtained harvests, under the conditions of a dry year without irrigation utilization.(Table 9)

Table 9. Thematic environment approach – consumption of resources

Thematic indicator: Consumption of resources	Consumption from the ceiling value	Farm scores	Maximum ceilings
Direct energy	11729/25000	2.1	4.0
Indirect energy	26714/25000	0.0	4.0
Phosphorous	2940/3400	0.5	4.0
Potash	0/4800	4.0	4.0
Water	0/50000	4.0	4.0
<b>Total</b>	<b>xxx</b>	<b>10.7</b>	<b>20.0</b>

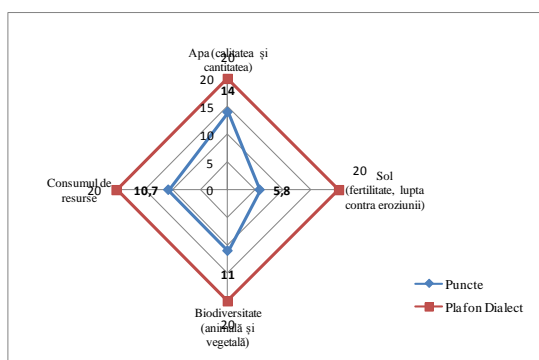

Fig. 3. Thematic approach to the farm impact upon the environment, through the optimum agro-environmental indicators

The graphical presentation of the thematic approach to the farm impact upon the environment, expressed through the optimum agro-environmental indicators, is quite suggestive. (Fig. 3)

## CONCLUSIONS

At present, the global warming implies two main problems for mankind: the need for the drastic diminution of greenhouse gas emissions and the need to adapt to the climate change effects. Agriculture is one of the most affected sectors by the global warming, as it is dependent on the weather and climate conditions; at the same time, it is also a polluting agent with chemical fertilizers, pesticides, effluents from the livestock sector and a consumer of direct and indirect energy. In order to measure the impact of human activities upon the environment, as well as to evaluate the climate change effects upon the environment and the population, different sets of indicators were established. The agro-environmental indicators partially respond to the regional and national analysis needs, as the impact of many agricultural processes depends on a whole range of specific local characteristics (heterogeneous relief units, altitude, climate, agricultural production methods, from the most simple to the most sophisticated technologies, etc. The farm agro-environmental diagnosis method, created by the French experts and made available on a free of charge basis, for online utilization, represents a very easy to apply tool, even by farmers themselves. By their direct involvement in making agro-environmental diagnoses on their own farms, farmers become more aware of the need to drastically reduce the greenhouse gas emissions and of the need to get adapted to the climate change effects.

With the 42 accumulated points, the farm from the commune Făcăieni, diagnosed through the Dialect Method, is found among the 30% of the farms from the EU sample. The diagnosis results go back to the farmer, and the role of consultancy and researcher expert is only at the beginning.

## REFERENCES

- [1] Banca Mondială, 2014, România, Program privind schimbările climatice și creșterea „verde” cu emisii reduse de carbon, Evaluare rapidă a agriculturii și a dezvoltării rurale, ianuarie 2014
- [2] Girardin, P., et al., 2000, Assessment of potential impacts of agricultural practices on the environment: the AGRO\*ECO method. *Environmental Impact Assessment Review*, 20, 227-239.
- [3] Hansen, J., Makiko, S., Reto, R., 2012, Perception of climate change, În *Proceedings of the National Academy of Sciences*, 10.1073/pnas.1205276109
- [4] Institutul Național de Cercetare-Dezvoltare pentru Pedologie, Agro-Chimie și Protecția Mediului (ICPA) București, Instrumente, Ghiduri și Indicatori pentru integrarea aspectelor de mediu în politicile agricole, forestiere și de gestiune a apei în mediul rural: de la abordările top-down la implicarea comunităților locale; Proiect Cex MENER 615/03.10.2005
- [5] Karl, T.R., Meehl, G.A., Peterson, T.C., 2009, *Global Climate Change Impacts in the United States*. Cambridge, Cambridge University Press, United Kingdom
- [6] MMAP, 2015, Strategia națională privind schimbările climatice și creșterea economică bazată pe emisii reduse de carbon (CRESC) și Planul Național de Acțiune 2016-2020 privind schimbările climatice,
- [7] Parmesan, C., 2006, Ecological and evolutionary responses to recent climate change, În *Annual Review of Ecology Evolution and Systematics*, 37, 637-669
- [8] Tang, Q., Zhang, X., Yang, X., Francis, J. A., 2013, Cold winter extremes in northern continents linked to Arctic sea ice loss. În *Environmental Research Letters*, 8, 014036
- [9] [www.apdrp.ro](http://www.apdrp.ro), 2014, Măsura de agro-mediu, pachetul 7, ultima accesare în octombrie 2014
- [10] [www.biodiversitate.mmediu.ro](http://www.biodiversitate.mmediu.ro), 2014, Clubul ecologic-UNESCO-proNatura 2000
- [11] [www.dialect.solagro.org](http://www.dialect.solagro.org), 2006, Manuel d'utilisation Dialecte – Version 2. 54 p., Toulouse, Franța, ultima accesare în 4 decembrie 2014





## CHANGES IN HIGHER EDUCATION AND THE VALUE OF EDUCATION FROM THE PERSPECTIVE OF RURAL AREAS. THE CASE OF POLAND

Krzysztof WASIELEWSKI

Nicolaus Copernicus University in Torun, Faculty of Humanistic, Institute of Sociology, Poland  
87-100 Toruń, ul. Fosa Staromiejska 1a, Phone: +48 56 611 3636, Fax. +48 56 622 4765,  
Email: kwasielewski@wp.pl

*Corresponding author:* kwasielewski@wp.pl

### *Abstract*

*The aim of this article is to present the significance of higher education for changes in the Polish countryside. These transformation are - directly or indirectly - related to changes assigned to the value of education, as well as to structural changes in the entire system of higher education in Poland. Popularization and greater accessibility to higher education has undoubtedly affected rural youth and rural areas themselves to a high degree. The rural areas that until recently had been marginalised were given an opportunity to 'catch up' in terms of educational and civilization progress. It was all possible certainly not only due to institutional changes in education system but also as a result of changes in the mentality of rural inhabitants, opening to new cultural trends and values - and last but not least - substantial aid from the European Union targeted at rural areas. The countryside has undoubtedly used this opportunity.*

*Key words:* functions of education, higher education, rural areas, value of education, youth

### INTRODUCTION

Along with the political transformation in Poland, there were significant changes both within higher education and values of education. No doubt they affected rural areas. With the changes until recently marginalized rural areas they have gained a chance to develop and catch up educational and cultural backlog. Rural youth obtained a real chance to get a university diploma and social advancement. There were mental transformation rural inhabitants, which opened up new cultural trends and values finally gained the opportunity to use EU assistance directed to rural areas. Of course, the barriers and the significant social and civilizational differences still exist (eg. in comparison with the city), however, they systematically lose its importance.

### MATERIALS AND METHODS

The aim of this article is to present the significance of higher education for changes in the Polish countryside. These

transformation are – directly or indirectly – related to changes assigned to the value of education, as well as to structural changes in the entire system of higher education in Poland. The author uses a macro-perspective and an attempt to show the changes that have taken place in Poland after the transition. Article refers to existing data, in particular the Central Statistical Office reports, the results of research centers of social research and own research on rural youth access to higher education.

### RESULTS AND DISCUSSIONS

#### **Structural changes in higher education**

Higher education in Poland (and education in general) is one of these areas which have been changing particularly dynamically in the last 25 years. What has undergone transformations are both organisational structures (among others, the network of higher education institutions, number of students, system of recruitment for higher education institutions, forms and system of studying), as well as the attitudes of the youth towards education,

including an significant increase in educational aspirations and level of education among Polish people; education came to be perceived as an important capital which is worth investing into. The change was actually of a revolutionary character, as during the entire period of Polish People's Republic higher education boasted an elite status as a result of: low value of education in the society; a small network of higher education institutions; and existing mechanisms of social selection, which limited the possibility of advancement for youth descending from lower social strata.

Critical problems before 1989 included barriers characterised by structural inequality. They stemmed mainly from an inadequate structure of the educational system with regard both to the youth's aspirations as well as to the demand of the economy. From the research of sociologists dealing with inequality in the access to education among rural youth, it seems clear that what was decisive for their fate within the educational system was the moment of leaving elementary school. The school structure was organised in such a way that a significant number of youth (about 40%) was directed to schools that did not give any chance to obtain a school leaving exam certificate, and at the same time - higher education diploma. Therefore, there was a lot of significance to the bifurcation following elementary school, as it had a major impact on the success or failure in young people's education and life. Young people who went on to schools ending with school-leaving exams, especially to one of very few and elite secondary schools, increased their chances manifold of being accepted to higher education institutions, and, thus, attaining a high social position. In turn, individuals choosing vocational schools, by doing so determined the shape of their career path leading to a low social position and working-class occupation [11]. The structural barriers were particularly severe in the case of youth living in rural areas. This stemmed from several reasons. Firstly, almost all secondary schools were located in urban areas, as opposed to vocational schools, which had a relatively strong representation in rural areas.

Secondly, rural elementary schools possessed a significantly worse infrastructure and equipment, which influenced the level of functioning and the quality of education. Thirdly, the qualifications of teachers in rural elementary schools were far from satisfactory. Structural limitations within higher education system were of no lesser importance. These were systemic, including financial factors (low expenditure), as well as political by nature. As late as in 1989 only 112 higher education institutions were in operation in Poland, and there were only 400 thousand students attending them. The Gross Enrolment Ratio in higher education did not exceed 13% in the whole of the post-war period. Higher education - just like all other sections of the economy - was public by nature. A bad situation of higher education, as well as a low level of education of the whole society, was largely a consequence of the educational policy of the state, which was clearly focused on the needs of the industry and educating low-qualified staff. What also had significant meaning was cooling down the educational aspirations through common non-meritocratic rules of professional promotion and non-competitive principles of functioning of the economic sector. This, to some extent, resulted in young people (and their parents) calculating the worthwhileness of education at higher levels. It was particularly visible in rural areas, where the dilemma of household vs school did not pose - from the point of view of the inhabitants of rural areas - a major social problem. Inheriting the household, usually after graduating from a vocational agricultural school, was a common practice [12].

While studying the mechanisms determining social inequalities in a structural dimension, factors of a social-cultural nature must also be mentioned. Without a doubt, they were the main barrier for young people from rural areas to access academic education. These factors were mostly connected to a low cultural capital of a family of rural descent along with rural poverty. Many studies in this field have shown that during the course of family socialisation in peasant (or rural) families the behavioural patterns and value system, that

were reproduced, did not favour educational advancement. It was mostly due to the fact that rural youth "inherited" a low level of educational and professional aspirations, socialised a "worse" language code and, in consequence, chose a shorter school path. They also had visible problems with going through system selection thresholds (school leaving exam, higher education institution entrance exam) [1,3,10,15,19]. This process - rooted at the foundation of the society, i.e. family and local community - could not be stopped even by actions that were structural ideological interventions by nature: introduction of preference points for social descent during higher education institution entrance exams or attempts at changing the recruitment procedure itself.

A different characteristic of the structure of the educational system appeared after the political breakthrough in 1989. Firstly - as a result of a social-political transformation – the whole philosophy of functioning of education had undergone change. On the one hand, there was a departure from the model of higher education for social elites; on the other hand, private subjects were once again (after many years of break) admitted to function on the educational services market. The first private higher education institution after the transformation was created in 1991. As late as in 1990, there were only 112 higher education institutions. Since then, their number has grown dramatically. There were 310 higher education institutions in 2000, 445 in 2005 and 460 in 2010. Currently, there are 438 higher education institutions in Poland (Table 1). Most of them are private. Since the creation of the first private higher education institution in 1991, there are as many as 306 of them at the educational services market [9]. Along with a dynamic development of educational institutions, the number of students has also increased. In the academic year 2005/06 - that is, at the peak of a population boom – the number of students reached more than 1.9 million, which is almost 5 times more than at the beginning of the political transformation. Currently, there are slightly more than 1.5 million students attending higher education institutions in

Poland (Table 1).

Table 1. Higher education in Poland in figures

Academic year	Total number of students (in thousands)	Total number of higher schools	Enrollment rate brutto
1990/91	403.8	112	12.9
1995/96	794.6	179	22.3
2000/01	1,584.8	310	40.7
2005/06	1,953.8	445	48.9
2010/11	1,841.2	460	53.8
2013/14	1,549.9	467	51.5

Source: Higher education and their finance, 1995, 2005, 2014, Warsaw: Central Statistical Office

Such a dynamic increase in the number of students was possible due to high educational aspirations of young people, but also as an effect of scientific politics, which included a conscious element of development of private education, which incorporates almost a third of the total number of students. The described changes brought with them also a whole array of unexpected or even dysfunctional phenomena. The selection threshold, which nowadays decides the fate of young people, has moved upwards to higher levels of education. Currently, it can be placed either at the turn of secondary school and higher education institution or at the turn of higher education institution and job market. This process has enhanced the phenomenon of internal differentiation within particular education levels, starting with junior secondary school and ending with higher education institutions. In consequence, the choice of type of school (e.g. a comprehensive secondary school or a technical secondary school) has lost its significance, whereas allocation in a specific secondary or higher education institution has increased in significance, where the school offers high qualifications, and in the future it improves the chances of attaining a high social position.

#### **Changes in the perception of the value of higher education**

The social-political system in dominance

before 1989 significantly determined relations in all areas of life, such as relations between individuals, but also relations between the state and the society. It was manifested in, among others, flattening of the shape of the social structure or abolishing any private property as a source of social inequality. The consequences that followed were non-meritocratic rules within the area of economy: a lack of correlation between the income gained and the level of education possessed, as well as "politicisation" of educational advancement (among others, by favouring the children of party decision-makers, supporting ideological "youth organisations" or introducing points for social descent). Within the area of education, it resulted in a relatively low value of education. Several factors were mutually responsible for that. Firstly, it was the cultural message in peasant and working-class families, which reproduced a traditional system of values, where labour was always valued more than education. Secondly, a low level of rural education in a significant way limited the possibility for young people to access higher education [11]. Thirdly, the fact that intellectual professions (mainly those requiring higher education) were relatively low-paid in comparison with working-class occupations. This, in turn, resulted in prevalence and popularity among rural youth of vocational schools or technical secondary schools.

Although education itself did not present a highly-deemed value for rural youth, it was still perceived as a means of social advancement. It was desired, as it was one of the few ways of leaving the environment where one resided, and of advancing in social hierarchy. It stemmed from the fact that the countryside was valued low as a place of residence. Therefore, for rural youth education was a tool of social mobility, which, at the same time, was always spatial mobility – road to cities [7].

The place of education within the value system of rural youth after the political transformation of 1989 is an entirely different case. Rejection of socialism was followed by a critical attitude to egalitarian ideas and slogans, too. They were replaced with

liberalism and democracy within political-economic sphere and meritocracy within the sphere of desired values and ways to achieve them. Many factors influenced this process; among others, rejection of the previous political system by the society, quick formation of liberal economy or development of private entrepreneurship [13]. They also had a significant influence on market improvement of the meaning of education and its role in the process of professional promotion.

Looking at the contemporary Polish society, it can be seen that education is now one of the most highly-deemed social values. It is so even despite mass popularisation of higher education. In 2013, a considerable majority of Polish people (82%) was of the opinion that education is worthwhile, while it was 76% in 1993 (Table 2). Almost every third person (32%) believes that education has the biggest impact on professional success.

Table 2. Is it worth it to acquire education? (in %).

Is it worth it to acquire education?	1993	2002	2007	2013
Definitely worth and worth	76	91	93	82
Probably not worth and definitely not worth	20	7	5	16
No opinion	4	2	2	2

Source: CBOS (Public Opinion Research Center), 2013.

In both cases, rural youth indicate importance of education and higher education slightly more often than urban youth [6].

#### Rural youth access to higher education

Before 1989, the countryside, as an entire social system in itself, was virtually excluded from possibility of gaining education at higher levels [21]. It was determined by structural factors (among others, a low level of rural education), social factors (among others, poverty), but also cultural factors (a relatively

low value of education). Only a handful could attend higher education institutions. A handful managed to graduate from these schools, too. This resulted in the fact that the image of an inhabitant of rural areas that was being strengthened was one of an uneducated individual destined to work in agriculture. The paradox of that situation consisted in the fact that the image commonly denoted an entire social group (inhabitants of rural areas), and not only individuals. Hence, the significance of changes that occurred after 1989. They allowed rural youth to have a possibility of education to a never-before-seen extent, and the countryside, regarded as a specific social system, received a chance to slowly rebuild its elites. Although during the period of the Polish People's Republic there were about 60-100 thousand students from rural areas at higher education institutions per academic year, now the number reaches as many as 500 thousand students. These changes mostly indicate a different attitude to education existing in the countryside; they also confirm a high level of educational aspirations of young inhabitants of rural areas [21].

Without a doubt, the positive changes within the area of access to education are indubitable, and rural youth is a direct beneficiary of these changes. Education in the countryside is improving and does not fall majorly behind education in cities, with regard to the quality of education [16]. The differences between rural and urban education stem from such factors as: a lower level of wealth among the inhabitants of the countryside, which has a significant influence on the ability to finance children's education; a low level of cultural capital (influencing specific decisions regarding education) or a poorer network of schools, and the resulting need to commute to schools located in cities. These factors significantly influence or even limit young people's educational choices.

Frequency ratios presented in available data suggest that there has been a definite progress within that field. As late as in the academic year 1999/2000, young people descending from rural areas constituted 23.9% of the total number of students attending higher education institutions [20]. At the same time, the most

recent data provided by GUS (Central Statistical Office of Poland) shows that almost a third of all students are residents of rural areas. The highest indicator of people residing in rural areas was visible in the Internal Affairs Department schools - 46.3%, agricultural schools - 43.6%, and pedagogical schools - 35.6%. The same ratio equals currently 29.6% at universities, 29.8% at higher technical schools and 27.0% at higher medical schools. The smallest amount of people residing in rural areas was found in higher art schools, that is about 16.2%. In all types of higher education institutions, excluding pedagogical schools, the frequency ratios for rural youth have increased [9]. The data included in Social Diagnosis indicates that within the age group 20-24, there are 48.0% rural youth attending education. The same indicator among urban youth, depending on the size of an urban centre, oscillates between 52% and 79%. However, what must be noted is an ongoing process of continuing differentiation of educational ratios depending on the size of the place of residence. The bigger the locality, the bigger the percentage of learning youth is. This also means that rural youth are not closing the distance to urban youth [17,18]. The increase in the frequency ratios for urban youth attending higher education institutions is particularly important in the context of popularisation of education (and "loosening" of its selection function). The results of the research show that rural youth, especially that descending from families of a lower social status and marked by worse educational characteristics, are an indubitable beneficiary of the quantitative changes within Polish higher education [21]. It must also be remembered that it was the development of private higher education that significantly influenced the access to higher education for rural youth. A considerable amount of private higher education institutions was located in smaller urban centres, giving a real chance for taking up higher education to poorer (very often rural) youth, who could not afford leaving for a bigger and more expensive urban centre. Typical academic higher education institutions (mostly public ones) are of urban

character (located mainly in urban centres with over 200 thousand inhabitants), which clearly influences their elitism. During the academic year 2012/13, in eight biggest academic centres in Poland (Warsaw, Cracow, Wroclaw, Poznan, Lodz, Lublin, Gdansk and Katowice) there were as many as 60.9% of the total number of students, and the percentage is growing systematically. Other, smaller academic centres are located evenly in the whole area of Poland, proportionally to population density [9].

Real chances of taking up higher education had a direct translation onto the increase in the level of education among the totality of the inhabitants of rural areas. Until late 1980s, Poland was considered to be a country of poorly educated people. It was particularly visible in the structure of the countryside. As late as in 1988, only 1.8% of the inhabitants of rural areas could boast a higher education diploma, and as many as 60.4% of these residents had elementary education at most, or did not have any formal education at all (Table 3).

Table 3. People aged 13 and more according to the education level (in %)

Educational level	1988		2011	
	Rural	Urban	Rural	Urban
Higher	1.8	9.4	9.8	21.4
Secondary and postsecondary	13.1	31.8	25.3	35.4
Basic vocational	24.2	23.2	26.4	18.4
Primary and without education	60.9	35.6	34.5	19.2

Source: National Census, 1988, 2011.

The results of the National Census of 2011 indicate a dramatic change in these statistics. In 2011, as many as 9.8% of the inhabitants of rural areas had higher education, which is 5 times as many as in 1988, and 34.7% of the inhabitants of rural areas had junior secondary education at most (Table 3) [14].

### The situation of rural youth in the labor market

Certainly, the consequences of social-educational conditions and specific educational choices of rural youth are only seen later, after completing education and entering the job market by these young people. According to the data of the Central Statistical Office, completion of higher education still reduces unemployment. The higher the level of education, the lower the unemployment rate in a given education category is. The unemployment rate in the second quarter of 2014 among persons with higher education was 4.3%; among persons with vocational education it was twice as high, at 8.8%; in the case of persons with secondary education it was three times as much, at 12.5%. An analogous tendency is visible in unemployment ratio among graduates. The higher the level of education, the lower the unemployment ratio among the graduates of a given level of education is. Both correlations occur regardless of the place of residence [8].

Analysing the issues of functionality of education of rural youth in the context of their allocation at the job market, what must not be forgotten is a socially important field of education in broadly perceived agricultural occupations. According to a research conducted by CBOS (Public Opinion Research Center), only 4% of parents would want for any of their children to have an occupation connected with either agriculture or environment protection. The only professions with a lower rating in this ranking were that of a politician, a scientist, and occupations connected with sports [5]. The consequence of this state of things is a decreasing demand for education in secondary-level schools of agricultural profile and higher education institutions of the same profile. In turn, a lack of interest of rural youth in education of agricultural profile and course of study may have a negative influence on the functioning of the agriculture and the countryside as a widely perceived social system. This stems from a few essential reasons. Firstly, it is mostly connected with the problem of lack of succession in

agricultural families. Rural youth, undertaking education in non-agricultural occupations (and migrating to cities), unintentionally contribute to the fall of traditional family peasant (agricultural) households. Secondly, lack of qualified staff in the field of agriculture may negatively impact the effectiveness of that area of the economy. Thirdly, the departure of the countryside from agriculture (resulting from the lack of interest in this type of activity among the young generation) may have significant consequences for the countryside as a certain comprehensive social macrosystem. When combined with a progressive urbanisation of rural areas, it can lead to a disintegration of a socially important universe, until recently based on a characteristic set of values connected, among others, to rural religiousness, attachment to the field and a peasant ethos of labour [4].

#### **Role of education in the process of destigmatisation of rurality**

One of the main functions of education and educational institutions in rural areas is their role in the process of destigmatisation of rurality. The process of stigmatisation of rurality is a consequence of the process of subjective or objective marking of rural youth with the stigma of a countryside resident - stigma which is characterised by any circulating negative connotations associated with the countryside. The countryside, as a place of residence, becomes not only an objective, external element of life, but also begins to determine individual, subjective features of an individual. In consequence, rural youth do not perceive the countryside - the place of their upbringing and residence - as an attractive and competitive environment in comparison with the city. It is quite the opposite - the countryside appears as a mark which determined life and personal failures, and is unattractive both as a place of residence and as a potential workplace. It is, therefore, a source of unpleasantness not only in an individual dimension (childhood memories), but, above all, in a social dimension determining contemporaneity. It must also be remembered that this process (of social marking) has a relatively limited and varied

power of influence. It is more powerful in relatively isolated societies - in remote villages located far from bigger urban centres. It is less powerful in suburban villages - with better communication with the city, where cultural diffusion and migration movements are relatively balanced and bidirectional. Indubitably, stigmatisation of rurality does not pose such big a problem as even 20-30 years ago [2]. A particular role in the process of destigmatisation of the countryside and rurality is played by educational institutions and educating the youth. The latter can contribute to, on the one hand, providing the social awareness with a new image of Polish countryside based on a young, well-educated generation, and to, on the other hand, acquiring, by members of the society, knowledge and competences contributing to the process of integration of the two environments. The second factor seems particularly important, as education is one of the best ways of combating marking perceived in a subjective manner and complexes deriving therefrom. Therefore, the more educated the society and the higher on the educational ladder the rural youth get, the more effective it will be to get rid of complexes resulting from social descent [21].

#### **CONCLUSIONS**

Education in Poland has passed a long and circuitous path of changes. It is, indubitably, still not finished. However, with hindsight, it is worth noticing that the processes which occurred led to very specific, measurable effects, both positive and negative ones, for the state and for the whole of the society. Without a doubt, popularisation of education at the level of higher education significantly influenced rural youth and rural areas themselves. Thanks to them, rural areas, marginalised until recently, have gained an opportunity to "catch up" with educational and civilizational backlog. Naturally, this is not simply an effect of institutional changes within the educational system, but also a change within mental residents of the countryside, of broadening their cultural horizons and opening to new trends and



values, and finally, of a substantial European Union support aimed at rural areas. Notwithstanding, the countryside has taken advantage of the arising opportunity beyond doubt. In this respect, indicators showing the dynamics of change (increase) of the level of education of rural and urban residents are the most suggestive. Thanks to higher education institutions opening their doors wide for students, youth have gained a chance of obtaining dream qualifications and higher education. This resulted in a decrease of a risk of becoming one of the unemployed. Access to education for groups that have been marginalised until now (rural youth and youth descending from families of a low social status) has significantly improved. The beneficiary of these changes is doubtless the rural youth themselves, who received a chance for development and self-realisation, and improving their qualifications.

## ACKNOWLEDGEMENTS

The article prepared within the project Youth in Transition Countries - the innovative potential, new context, new challenges and new problems, financed by the National Science Centre, (grant no. UMO-2013/08/M/HS6/00430).

## REFERENCES

- [1]Białecki, I., 1982, Wybór szkoły a reprodukcja struktury społecznej, Ossolineum, Warszawa. (School and reproduction of the social structure)
- [2]Borawska, B., 2006, Ja siebie nie widziałam na wsi (O awansie edukacyjnym młodzieży wiejskiej w okresie zmiany systemowej), UwB, Białystok. (I myself have not seen in the countryside (About educational advancement of rural youth in the period of systemic change))
- [3]Borowicz, R., 1978, Procesy selekcji w szkole wyższej. Studium wybranego rocznika studentów Uniwersytetu Mikołaja Kopernika, UMK, Toruń. (Selection processes in universities. Study of selected class Nicolaus Copernicus University students)
- [4]Bukraba-Rylska, I., 2011, Dziedzictwo kulturowe jako czynnik rozwoju obszarów wiejskich, in: Rozwój obszarów wiejskich w Polsce. Diagnozy, strategie, koncepcje polityki, Nurzyńska, I., Drygas, M., eds. Warszawa, IRWiR PAN. 219-238 (Cultural heritage as a factor of rural development (in:) The development of rural areas in Poland. Diagnosis, strategies, policy concepts)
- [5]CBOS, 2009, Aspiracje zawodowe Polaków, Komunikat z badań, 2009, No 92, CBOS, Warszawa. (Public Opinion Research Center, 2009, Poles professional aspirations. Report of research)
- [6]CBOS, 2013, Wykształcenie ma znaczenie. Komunikat z badań, BS/96/2013, CBOS, Warszawa. (Public Opinion Research Center, 2013: Education is important. Report of research)
- [7]Grzelak, Z., 1981, Inteligencja w społeczności wiejskiej, LSW, Warszawa. (The intelligentsia in the rural community)
- [8]GUS, 2014, Monitoring rynku pracy. Kwartalna informacja o aktywności ekonomicznej ludności, GUS, Warszawa. (Monitoring of the labor market. Quarterly information on the economic activity of population, Central Statistical Office)
- [9]Higher Education Institutions and their Finances in 2013, Central Statistical Office, Warsaw, 2014.
- [10]Kwieciński, Z., 1973, Poziom wiedzy uczniów a środowisko szkoły, UMK, Toruń. (The level of knowledge of pupils and the school environment)
- [11]Kwieciński, Z., 1980, Drogi szkolne młodzieży a środowisko, IRWiR PAN, Warszawa. (Paths school youth and the environment)
- [12]Łoś, M., 1972, Aspiracje a środowisko, PWN, Warszawa. (Aspirations and the environment)
- [13]Miształ, B., 2000, Prywatyzacja wyższego wykształcenia w Polsce. Wyzwania w świetle transformacji systemowej, w: Prywatyzacja szkolnictwa wyższego w Polsce, pod red. tegoż, Kraków: Universitas. (The privatization of higher education in Poland. Challenges in the light of the systemic transformation, in: The privatization of higher education in Poland, Miształ, B., (eds.))
- [14]Narodowy Spis Powszechny 2011, Warszawa: GUS. (National Census, 2011, Central Statistical Office, Warsaw)
- [15]Osiński, J., 1977, Uwarunkowania społeczno-przestrzenne selekcji młodzieży do studiów wyższych, PWN, Warszawa. (Socio-spatial selection of youth to higher education)
- [16]Raport o stanie edukacji, 2013, IBE, Warszawa. (Report on the State of Education)
- [17]Social Diagnosis, 2011, The Objective and Subjective Quality of Life in Poland, Janusz Czapiński i Tomasz Panek, eds., Warsaw.
- [18]Social Diagnosis, 2013, The Objective and Subjective Quality of Life in Poland, ed. Janusz Czapiński i Tomasz Panek, Warsaw, 2014.
- [19]Szymański, M., 1973, Środowiskowe uwarunkowania selekcji szkolnej, PWN, Warszawa. (Environmental determinants of school selection)
- [20]Świerzbowska-Kowalik, E., 2000, Wykształcenie środowisk rodzinnych i miejsce zamieszkania jako wyznaczniki szans na podjęcie studiów, Nauka i Szkolnictwo Wyższe, 2000, No 2(16):108-135. (Education environments of family and place of residence as determinants of chances to study)



[21]Wasielewski, K., 2013, Młodzież wiejska na uniwersytecie. Droga na studia, mechanizmy alokacji, postawy wobec kształcenia, UMK, Toruń. (Rural youth at the university. Road for studies, allocation mechanisms, attitudes towards education)



## THE AGRICULTURE POTENTIAL DEVELOPMENT IN THE REPUBLIC OF IRAQ

Mohammed Dhary YOUSIF<sup>1</sup>, Hussein Ali Hussein AL QAESI<sup>2</sup>, Abdulmuttaleb Abbas SALIH<sup>2</sup>

<sup>1</sup>University of Agricultural Sciences and Veterinary Medicine Bucharest, 59 Marasti, District 1, 11464, Bucharest, Romania, Phone: +40213182564, Fax:+40213182888, Mobile:+40744 6474 10, Emails: mdhj1965@yahoo.com

<sup>2</sup>University of Dhi-Qar, District Almustfawiyah, Nasiriyah, 64001, Iraq, Phone: +009647809249646, Emails: hussein\_782003@yahoo.com, abd\_mtlb@yahoo.com

**Corresponding author:** mdhj1965@yahoo.com

### Abstract

*The agricultural potential (terrestrial resources) is represented by the varieties of traditional cultures in Iraq, which has evolved over a period of over thousands of years. Agriculture in the North of Iraq depends on rain, rivers and groundwater, while the cultivation of lands in Central and Southern parts of the country is mainly dependent on only the waters of rivers. The country has a high potential for agricultural development, with reference to the total surface area of approximately 43.5 million hectares, but only 11 million hectares can be fit to the arable land.*

*This paper makes an analysis of the main indicators of the agricultural potential of the Republic of Iraq, through areas under cultivation, irrigation potential, GDP, production made, etc. As a result of this analysis, we can say that the agricultural potential of the Republic of Iraq has as the main drawback the arid land for the vegetal sector, and also the reduced rainfall and soils with salt. There are necessitates who once carried out could raise agricultural potential among which stands out the increase in the technical-material basis of agriculture.*

**Key words:** agriculture, development, Iraq

### INTRODUCTION

Raising the agricultural potential implies: ensuring the water for irrigation availability; measures to reduce the salinity of large areas of land; increase of the agricultural inputs needed for cultivation of plants and for the livestock, quantitatively and qualitatively, such as certified seeds, fertilizers and agricultural mechanization.

In the context of the reconstruction of Iraq, the FAO proposals, submitted by the Iraqi Government, include: the elimination of subsidies that distort the market prices; increasing the productivity in the agricultural sector through investment in new varieties of seeds, irrigation methods and enhanced market mechanisms; the establishment of demonstration agricultural farms along Iraq to revive the production of crops and animals, reinvigorating Iraqi agriculture in areas such as fisheries in wetlands, new varieties of plants and care towards the environment, expansion of extension services[7].

### MATERIALS AND METHODS

In the paper we used the following indicators: arithmetic mean, standard deviation, mean square deviation, coefficient of variation, confidence limits for a given risk, average annual growth rate, the limits amplitude for a given risk towards the average and statistical significance of these indicators.

The formulas used to calculate these indicators are presented,[3]

For the arithmetic mean  $\bar{x} = \frac{\sum x_i}{n}$  ;  
where:

$\bar{X}$  = the arithmetical mean;  $X_i$  = The average production values for a number of years (i);

n = number of years taken into account

The average annual rate of growth [1]

$= r_{2008-2013} = \sqrt[n]{\prod (p_1/p_0) - 1}$  ; where:

$r_{2008-2013}$  = average annual growth rate;

$\prod p_1/p_0$  = entangled growth indicators

### RESULTS AND DISCUSSIONS

Geographic location. The Republic of Iraq is situated in Southwest Asia and constitutes the

Eastern Arab region, bordered by Turkey to the North and Iran to the East, by Syria, Jordan and Saudi Arabia to the West and the Arabian Gulf, Kuwait and Saudi Arabia to the South, extends between latitudes 29°5 and 37°22 North, and between longitudes 38 ° 45 and 48 ° 45 East. The surface is by 434,924 km<sup>2</sup>, of which a large portion of the land is desert or wasteland. The mountains in the Northeast are an extension of the Alpine system that runs eastward from the Balkans, in southern Turkey, Northern Iraq, Iran, Afghanistan, and finally the Himalayas[6].

The territory of present-day Iraq is known since antiquity under the name Mesopotamia which has been the cradle of some brilliant civilizations such as the Sumerian, Akkadian, Assyrian, Babylonian. Iraq is currently made up of 18 provinces .



Fig 1. Administrative map of Iraq (source: [http://www.pecad.fas.usda.gov/highlights/2008/05/images/Iraq\\_wheat\\_barley\\_maps\\_may08.jpg](http://www.pecad.fas.usda.gov/highlights/2008/05/images/Iraq_wheat_barley_maps_may08.jpg))

About 97 percent of the country are arid lands with low precipitation. In most parts agriculture suffers from high rates of evapotranspiration that exceed the rainfall. The temperature varies greatly (10-40 ° C) during the breeding season, most notably in desert regions. The grassland covers 75 percent of Iraq and contribute a large part to the herbivore wealth. These lands which are not suitable for farming due to the dry climate, poor soils and rugged topography, and other factors, make up most of the land in Iraq.

**1. The natural potential.** The relief is characterized by 4 natural regions[11]: *a*) the plain Tigris-Euphrates, which occupies a vast lowland area drained by the Euphrates (2,800

km) and Tigris (1,850 km) that unite to form the Shatt al Arab which empties into the Persian Gulf. This plain (ancient Mesopotamia) looks dull, with arms outstretched, wasteland and wetlands; *b*) desert plains in the West are crossed by dry valleys ( Wadi Hauran, Wadi Tubal, Sha' ib Hisb), the area in question being the home of the Bedouin and camels; *c*) The north Piedmont (the ancient Assyria), the higher area, with rich deposits of oil, precipitation are richer (400 mm/an); *d*) Kurdistan National Mountains that occupy the North-East of the country, the area is traversed by valleys with deep gorges and defiles of the tributaries on the left of Tigris (Zab al Kabir, Zab of Asfal, Diyala).

**Climate.** Iraq is located in the northern region with a moderate continental climate and subtropical. Precipitation occurs in winter, spring and fall, but not in the summer season. It has a high subtropical climate aridity (summers are scorching, without precipitation, wind «shamal» raising temperatures up to 49 ° and causing in desert sand storms; the winters are milder). Actually, the pluviometric regimen for about 5.54 million hectares, is making up to 49.8% of total arable land.

Table 1. The distribution of precipitation areas by relief type in Iraq

Types of land/relief	Surface		Precipitation (mm/an)
	thousand hectares	%	
Plain	13,250.0	30.0	50-200
Hills	4,200.0	10.0	250-450
Mountains	9,200.0	21.0	400-1,000
Desert	16,855.2	24.2	50-200
Total	43,505.2	100.0	

Dost Muhammad, and colab. 2011, The profile was edited in May/June 2011[2] <http://www.fao.org/ag/agp/AGPC/doc/Counprof/Iraq/Iraq.html>

The flow irrigation areas and irrigation system are 29.9% pumps and 20.4%, respectively, of 5,575,000 ha (49.8% of total arable land), which have potential for irrigation from surface water sources. The rest of the 49.7%, it is now unsuitable for cultivation because of the lack of irrigation facility. The climate of Iraq can be divided into three types: i) Mediterranean climate, in the northern

region; II) Climate steppes, which represents a transitional climate between the mountainous region in the North; III) The desert hot climate in the South.

**Vegetation** consists of the plants in the form of bushes (North and East) and halophyte plants and xerophyte (South and West). The Woods occupy reduced surfaces (3.5%) and meet only in the Kurdistan Mountains.

**Fauna**, is adapted to the environment, including wild cats, jackals, gazelles, turtles and monitor turtles.

**Water resources.** The main sources of water in Iraq are represented by surface water and a small part the waters through the ground. Iraq's main rivers are the Euphrates, Tigris, Diyala, Shatt al Arab and their tributaries. The agriculture in the northern region depends on rain, rivers and groundwater, while the cultivation of lands in Central and southern parts of the country, is mainly dependent on only the waters of rivers.

Table 2. The classification of lands regarding the potential for irrigation

Type of land		thousand hectares	%
Suitable for agricultural production		32,970	74.2
Irrigation by flooding	Excellent for irrigation by flooding method	1,700	2.4
	Good for irrigation by flooding method	2,400	5.4
	Moderately suitable for irrigation by flooding	1,700	2.4
Non-irrigated land	Excellent land for farming	250	0.4
	Excellent for farming and production of irrigated crops where water can be provided	1,290	1.8
	Good and moderate for agriculture	1,070	2.4
Woods and pastures		3,070	4.3
Total		44,450	100.0

Source: Planning Authority, The Central Statistics Agency. 2001-2005. Annual Statistics Report.[14]

*The realization of irrigation potential in Iraq* will depend on the development of the planned irrigation in the upstream, alongside the existence of water management projects. Poor management of irrigation systems, with reference to the levels of charges, bring into question the continuation of the soils with high salinity, for which there is no effective program at national scale.[13]

**Economy.** Iraq is a country with a developing economy, but it is one of the important

producers and exporters of oil. From historical point of view, the economy of Iraq was characterized by massive dependence on oil exports, which is why the accent was placed on the development by a centralized planning. The economy of Iraq remains dominated by the petroleum sector, which currently provides about 90% of foreign exchange earnings. At the same time the country holds significant quantities of natural gas, salt, sulfur, gypsum, copper, chromium and phosphates. It is a major producing country of persimmon.

**3.The demographic potential and its influence on the national economy.** Iraq's Population, after recent data, is of 33.37 million inhabitants, from which 18.7 million (59%) aged 15 years and less, a young population, as it is specific to other countries in the area of MENA [6] (fall territory of Middle East and North Africa). It is the capital and largest city of the country, having 3,326,000 inhabitants.

The rural population presents an increase from 7,657 thousand persons in 2000 to 11,350 thousand persons in 2013, but the active population in agriculture is declining, from 535 thousand persons in 2000 at 1,408 thousand people in 2013.

Table 3. Trends in total population by area and occupation in Iraq, period 2000-2013

Population	UM	2000	2005	2011	2013	Average/Rhythm
Total population	Th. P.	23,801	27,377	31,837	33,765	28,522
	%	100.0	115.0	133.8	141.9	X
	%		1.03	1.03	1.03	2.73
Rural population	Th. P.	7,657	9,023	10,676	11,350	9,440
	%	100.0	117.8	139.4	148.2	X
	%		1.03	1.03	1.03	3.07
Active population in agriculture	Th. P.	535	479	419	408	465
	%	100.0	89.5	78.3	76.3	X
	%		0.	0.	0.99	-2.06

FAO, the State,2014,

<http://faostat.fao.org/site/459/DesktopDefault.aspx?PageID=459#ancor>[4]

The causes can be evidenced by the many forms that are specific to the rural environment, which may be by socio-economic order. Thus it can be shown that the average family consists of 6 members (7.4 in rural areas). As regards the studies ,the situation remained difficult, illiterates

representing 38%, primary and medium education provide about 50%, and 11% university studies.

Hence a knowledge of the evolution of the

GDP, is relevant. According to the figures in *table 4* on the evolution of GDP per capita and total from Iraq, we can find the following:

Table 4. Trends in total GDP and per capita in Iraq during the period 2003-2012

Specification	UM	2003	2005	2007	2009	2011	2012	Average/Rhythm
Gross Domestic Product	MIL \$	22,535	36,268	40,503	45,688	53,143	58,613	42,283.7
	%		1.04	1.01	1.06	1.10	1.10	11.21
Gross investment	MIL \$	3,453	6,917	3,245	5,561	8,140	11,450	6,673.8
	%		2.65	0.39	0.72	0.88	1.41	14.25
Population	MIL place	26.0	27.37	28.75	30.17	31.84	32.78	29.20
	%		1.03	1.02	1.03	1.03	1.03	2.62
GDP/capita	USD/capita	868.1	1325.0	1409.0	1514.6	1669.3	1788.3	1432.5
	%		1.02	0.99	1.03	1.07	1.07	8.36

Source: FAO [http://faostat3.fao.org/download/O/OA/F\[8\]](http://faostat3.fao.org/download/O/OA/F[8])

- at national level the value of GDP in 2003, from mil \$ 22535 reaches mil \$ 422,833 in 2012, with a growth rate of 11,21%, being greater than the rate of increase in the GDP per capita which is 8,36%.

**3. The agricultural potential (terrestrial resources).** Iraq is the center of primary and secondary domestication for many crops, such as wheat, barley, lentils, and chick peas. It is considered a cradle of civilization and agriculture on Earth. The variety of traditional cultures in Iraq, which has evolved over thousands of years, is not only inheritance and legal interests of Iraqi farmers, but also to the whole world. One of the trends is the increase in tracking Iraqi farmers agriculture, especially through large quantities of ancient grains and cultures.

The actual land area is about 434,000 km<sup>2</sup>.

Table 5 summarizes the structure of these lands, for which, from the analysis of the annual growth rate 1990-2009 pursuant to the following:

- areas of arable land are decreasing. In 2009, a decrease of manifest-22.4% in relation to 1990 10.0% from 2000. At the same time, it should be noted that the area under cereal cultivation has in possession approximately 95% of arable land;

- the non agricultural land is a category which, in Dynamics, is increasing, so that relative to 1990, growth in 2009 is + 7.3%.

Iraq has a high potential for agricultural development, with reference to the total surface area of approximately 43.5 million hectares, but only 11 million hectares can be fit to the arable land (commonly used)[9].

Table 5. Developments in the areas of agricultural land by category of use during the period of 1990-2012 in Iraq

Specification	UM	1990	1995	2000	2005	2010	2012	
Arable land and permanent crops	thousand hectares	5,230	5,100	4,300	5,390	4,210	4,210	
	With respect to 1990 (%)		100.0	97.5	82.2	103.1	80.5	80.5
	With respect to 2000 (%)				100.0	125.3	97.9	97.9
Total agricultural	thousand hectares	9,230	9,100	8,300	9,390	8,210	8,210	
	With respect to 1990 (%)		100.0	61.3	55.9	101.7	55.2	55.2
	With respect to 2000 (%)				100.0	113.1	98.9	98.9
Nonagricultural field	thousand hectares	34,602	34,732	35,532	34,347	35,314	35,314	
	With respect to 1990 (%)		100.0	100.4	102.7FM	99.3	102.1	102.1
	With respect to 2000 (%)				100.0	96.7	99.4	99.4
Land surface	thousand hectares	43,832	43,832	43,832	43,737	43,524	43,524	

Source: FAO, State <http://faostat3.fao.org/home/index.html> # DOWNLOAD\_STANDARD[4]

There is an economic and geographical designation " the Cornucopia", considered to be the area with the most ancient agricultural traditions in the world, where is falling also Iraq. It was the center of domestication for a remarkable range of primary agricultural

crops and animal breeding. Crops of wheat, barley, lentils, ovine and caprine species were initially brought under human control around 8000 b.c. Iraq is where wild wheat had, at a specific date his origin and many varieties of cereal from this country have been exported

and adapted into existing areas worldwide[5]. Currently, on about 2.8 million hectares is used the wetting by rain, "fed up with the rain", which is known to be structured on three different types of land, according to the areas affected by the level of annual rainfall such as[9]: the level of 450 mm/year (on approx. 0.1 million hectares); level 250-450 mm/year (for approx. 0.7 million hectares); the level of 200-250 mm/year (approx. 2 million hectares).

It can be said that Iraq has in the agricultural sector in the world, a standard of producing food of good quality.

**4. Material and its use in the agricultural system of production in Iraq**

The importance of supporting agricultural production for Iraq's agriculture is based also on the supply of materials (import), especially the seeds, fertilizers, machines. The Government of Iraq has encouraged the development of national agricultural production by paying high prices for goods produced at local level[13]. Attention has been given to *various forms of mechanization and fertilization..*

The role of fertilizers was followed by ensuring rapid growth of plants, as the main effect, but with a number of undesirable side effects,. One of the most serious effects of the excessive use of chemical fertilizers occurs due to the phenomenon of washing the nutrients in and on the soil by rain or irrigation water and infiltrating them into underground waters, contributing to enhance the process of eutrophication of water courses, along with the existence of a process of salting the soil.

Another phenomenon produced in Iraq due to the use of chemical fertilizers in excess for overeating plants, was that of the proliferation of diseases and parasites, whose development is more on excessively fattened crops with nitrogen. Effect of applying those fertilizers was looked into Iraq's agriculture through knowledge of quantities consumed of nitrogen (N) and phosphorus (P), expressed as the total amounts of nutrients active substance (s). Table 3.35 presents this situation in the dynamics of the period 2004-2010, rhythms and comparisons that can be played by the following:

Table 6. The quantities of fertilizers evolution used in agriculture in Iraq during the period 2004-2011

Specification	UM	2004	2006	2008	2009	2010	2011
Nitrogen fertilizers	thousands to a.s. N	102.7	167.0	164.1	171.8	108.0	138.3
	%	100.0	162.6	159.8	167.3	105.1	134.7
Fertilizer with phosphorus	thousands to a.s P2O5	6.9	55.0	63.6	46.4	24.4	24.4
		100.0	795.0	919.9	670.3	352.4	352.4
Fertilizer with potassium	thousands to a.s. K2O	...	...	...	46.4	4.8	5.4
					100.0	10.4	11.6

FAO State, [http://faostat3.fao.org/home/index.html#DOWNLOAD\\_STANDARD\[4\]](http://faostat3.fao.org/home/index.html#DOWNLOAD_STANDARD[4])

- in the fertilizers with nitrogen (N) application, is registered a significant increase in 2005-2006 to 2008-2009 and in years 2007 and 2010 fertilizer nitrogen consumption is declining;

- the chemical phosphatic fertilizers quantities applied (P<sub>2</sub>O<sub>5</sub>), reflects the same variation, manifests itself through a ceiling on the maximum considered in the period 2005-2008 (levels being between 55,000 to a.s., and 63,640 to a.s.), followed by a decrease in this level (who arrives in 2010 at 24,380 to a.s.).

**5. The system of agricultural production and the level of development in Iraq.** Agriculture is in Iraq the second greatest economic sector (after oil sector). However, despite its

abundant resources, earth and water, Iraq is a net importer of food.

**The cultivated area .** Constitute the potential plant production, being played in the *table7*, highlight the areas being cultivated from Iraq. For the period 1995-2010 dynamic, we have the following:

- the total cultivated land in the dynamic outlines a reduction in 2010 relative to 1990 (from 6,090.0 thousand hectares to 4,750.0 hectares, which represents a decrease by-22%);

-of the total land cultivated, the cereal crop group is preponderant (53.5%), and from these wheat (19.4%), barley (31.6%), and maize (1.1%). From these main crops in the

analysis there is a dynamic upward trend for wheat and maize crops, along with a decrease in barley.

Table 7. The crops structure in Iraq during the period 1990-2012

Specification	1990		2000		2010		2012	
	thousand hectares	%	thousand hectares	%	thousand hectares	%	thousand hectares	%
Wheat	1,180.6	22.6	1,200.0	27.9	1,383.3	32.9	1,200.0	28.5
Barley	1,922.1	36.8	1,110.0	25.8	1,005.8	23.9	600.0	14.3
Corn	69.3	1.3	72.8	1.7	113.1	2.7	130.0	3.1
Dates	123.5	2.4	110.0	2.6	123.0	2.9	124.6	3.0
Fresh vegetables	29.0	0.6	30.0	0.7	18.6	0.4	22.0	0.5
Vita de vie	18.8	0.4	13.0	0.3	10.0	0.2	11.0	0.3
Total main crops	3,355.4	64.2	2,549.3	59.3	2,683.5	63.7	2,122.7	50.4
Other cultures (pastures, meadows)	1,874.6	35.8	1,750.7	40.7	1,526.5	36.3	2087.3	49.6
Total (ha)	5,230.0	100.0	4,300.0	100.0	4,210.0	100.0	4,210.0	100.0
1990 (%)	100.0	X	82.2	X	80.5	X	80.5	X

Source: FAO, State <http://faostat3.fao.org/home/index.html> # DOWNLOAD\_STANDARD [8]

*The animal breeding.* Livestock during 1990-2011 presents a sharp decline from 10.06 LSU/ha in 1990 to 6.05 LSU/ha in 2011, when it represents only 60.10 % from the livestock.

Table 8. The structure of animals load per cultivated hectare in Iraq during 1990-2011

Specification	1990		2000		2010		2011	
	UVM	%	UVM	%	UVM	%	UVM	%
Cattle	0.18	1.8	0.18	4.48	0.23	4.13	0.23	3.83
Sheep and goats	1.21	12	0.99	25.1	1.16	21	1.19	19.65
Poultry	8.67	86.2	2.77	70.4	4.14	74.9	4.63	76.52
Total	10.06	100	3.94	100	5.53	100	6.05	100
	100.0	x	39.2	X	55.0	x	60.1	x

UVM (Vita Units); FAO State <http://faostat3.fao.org/home/index.html> # DOWNLOAD\_STANDARD [4]

The main decrease is found in birds from 8.67 LSU/ha in 1990 to 2.77 LSU/ha in 2000, to 4.14 LSU in 2010 and to 4.63 LSU in 2011. The main reason is the massive importation of poultry, favored by the political events that took place in Iraq.

**6. The national policy on the seed system structure.** In Iraq, it was recognized the importance of ensuring with seeds from the year 1927, from which was adopted a law through which it is encouraged the use of seeds of good quality especially for cotton production.

A major development in seeds have been found in 1968, when the Government established the quantity of seed used by farmers and found that the quantities of seed assured/used constitutes a necessity.

All at the same time, in the sector of agriculture and food, was initiated a project registration/insurance of seed production[11]. This was followed by a five-year plan (1969-1974), which was aimed to improve the production of seed of wheat, barley, rice,

corn, cotton and other crops. From 1975 there was a national law and regulations in order to be examined the products falling within the category of seeds, and the adoption of their registration.

In 1995, was founded the National Council of Seeds(NCS), which is chaired by the Minister of agriculture, to advise the Government on matters of grains.

Through the National Council of Seeds shall be determined the political guidelines and "Alemraaqbih", performed by agricultural research institutes such as the Institute of Agricultural Research (IPARC), State Council for Agricultural Research (SBAR) and Agricultural Research Center (ABRC)[15].

Commercial seed producers are verified are selected by the *State Council for Examination and Certification of Seeds (SBSTC)*, having a permanent collaboration with companies producing and marketing of seeds. Agricultural Research Institute (IPARC) is responsible for the improvement and development of new varieties of agricultural



crops, such as cereals (barley, wheat, rice and maize), legumes (lentils, chickpeas and beans), but also of industrial plants (nuts, soya, sunflower). State Council for Agricultural Research (SBARC) is responsible for grain, vegetables, and cotton. Center for Agricultural and Biological Research, (ABRC) pursues the development of varieties of cereals and industrial plants. Agricultural colleges play a less

important role in the amplification of seeds quantities[11].

### 7. The significant results in Iraq's agriculture between 2003 and 2012.

In the period studied the gross value added in agriculture (Table 10) has had an annual rate of increase of 2.81%, lower than the national GDP that was 11,21%.

Table 9. The Evolution of gross value added in agriculture for the period 2003-2012

Specification	MU	2003	2005	2007	2009	2011	2012	Average/ Rhythm
The added value in agriculture	MIL \$	2,230	3,440	2,595	2,329	2,745	2,862	2,701.6
	%		1.31	0.72	1.03	1.17	1.04	2.81
Share in national GDP	%	9.90	9.49	6.41	5.10	5.17	4.88	X

This made that the share of gross value added in agriculture to show a decrease from 9.90% in 2003 to 4.88% in 2012.

From the evolution analysis of certain agricultural products for the period 2003-2012, notes the following:

- the total production of wheat, with the

exception of year 2009, is maintaining a high average annual growth rate of 3.09%, mainly due to the increase in average yields level/ha;  
 - total production of barley shall be maintained at a level of 750-850 thousand tons annually, but has a tendency to decrease, with an annual rate of -0.38%;

Table 10. The evolution of the total production of certain agricultural products for the period 2003-2012

Specification	UM	2003	2005	2007	2009	2011	2012	Average/ Rhythm
Wheat	thousands to	2,329	2,228	2,203	1,700	2,809	3,062	2225.3
	%		1.22	1.06	1.35	1.02	1.09	3.09
Barley	thousands to	861	754	748	502	820	832	778.2
	%		0.94	0.81	1.24	0.72	1.01	-0.38
Grain maize	thousands to	233	401	384	238	336	503	346.5
	%		0.96	0.96	0.83	1.26	1.50	8.94
Figs	thousands to	868	404	431	507	619	655	540.9
	%		0.90	1.00	1.06	1.09	1.06	-3.07

FAO, <http://faostat3.fao.org/download/Q/QV/F>

- The corn for grains through the cultivation of more drought-resistant hybrids and the use of chemical fertilizers pose a significant increase from 233 thousand tons in 2003 to 503 thousand tons in 2012, with an annual average rate of 8.94%;

- Figs also present a decrease from 968 thousand tons in 2003 to 540.9 tons in the year 2012, with an annual average rate of -3.07%.

## CONCLUSIONS

Agriculture remains an essential part of Iraqi heritage, this even under conditions of

extreme aridity and pedo-climatic unfavorable, which are characterized by low rainfall and high soil salinity.

Natural and geographical conditions for Iraq have a particular influence on agricultural production. These conditions have influenced the diversity of traditional crops in Iraq, based on the total surface of approximately 435,200 km<sup>2</sup>, but nearly 11 million hectares can be fit to the arable land.

In Iraq, of the total cultivated land (2010), the group of cereals is prevalent (53.5%), from which one can mention the wheat (19.4%), barley (31.6%), and maize (1.1%). Of field crops crop rotation is limited to crops of

wheat, barley, grain maize and sunflowers.

Areas from arable land that can be irrigated are 49.8% or 5,575,000 hectares. The rest of areas are unsuitable for cultivation due to lack of rainfall. Irrigation is done by furrows, and areas irrigated with modern systems (aspersion and drip) is 0.58% of the irrigated area.

In Iraq the State shall ensure the necessary crop varieties and hybrids. The importance of supporting agricultural production for Iraq's agriculture is based also on the supply of raw materials (import), especially the seeds, fertilizers, machines. The Government of Iraq has encouraged the development of national agricultural production by paying high prices for local products. Attention has been given to different forms of mechanization and fertilization.

From the analysis of animal production: annual variation in the number of animals from herds of camels and goats, which retain a relatively uniform; livestock of cattle and buffaloes recorded both increases and decreases, but in birds, sheeps and goats are found decreasing trends.

The trade balance in agricultural products is characterized by imports of agricultural products, which exceed the exports. For Iraq, the importation of agricultural products is a priority. Iraq's main trading partners are the United States of America, the European Union and Syria. For this reason, the Government of Iraq has implemented new laws to strengthen its trade ties.

It is relevant the rhythm of growth of the GDP total, whose level is higher than the rate of growth of GDP per capita. With respect to these indicators for agriculture can be said that agriculture is represented currently by approximately 8% of the national GDP and 20% of the employment, the trend being in support of the rural population.

In the period studied the gross value added in agriculture has had an annual rate of increase of 2.81% annual growth rate, lower than the national GDP that was 11,21%. This has done that the share of gross value added in agriculture to show a decrease from 9.90% in 2003 to 4.88% in 2012.

## REFERENCES

- [1] Bauer Andreas, Environmental News, Issue 101 / May 2005
- [2] Dost Muhammad, si colab, 2011, The profile was edited in May/June 2011, <http://www.fao.org/ag/agp/AGPC/doc/Counprof/Iraq/Iraq.html>
- [3] Draghici, M., Mara, F., 2010, Statistical indicators characterizing meat animal production at the level country and the Virginia county during 2000-2008, ICEADR Session 2010
- [4] Fao, <http://faostat3.fao.org/download/Q/QV/F>
- [5] Fitzgerald Merry, Fitzgerald Vesel, 2009, Postat cu ocazia Zilei Internaționale a Semințelor organizat de INEAS, Excerpt of my speech at the Third Iraqi Turkmen, Media Conference in Istanbul – 10-12 April 2009 ( extras ) (<http://translate.google.ro/translate?hl=ro&sl=en&u=http://merryabla64>).
- [6] Irak, Wikipedia, enciclopedia liberă, <http://ro.wikipedia.org/wiki/Irak>
- [7] Irak crop production update, 2003, <http://reliefweb.int/report/iraq/iraq-crop-production-update>
- [8] Istorie Statele Arabe, <http://www.referate-scolare.ro/istorie/Statele-arabe--Arabia-Saudita--Afghanistan--Bahrain--Emiratele-Arabe-Unite--Iordania--Iran--Irak--Kuwait--Egipt--Qatar--Liban--Oman--Turcia--Siria--Yemen/>
- [9] Nakd A. Khamis, 2005, Agriculture in Iraq, General View, Aleoppo/Syria
- [10] Ordinul 81 care a fost transmis de către SUA pentru reconstrucția Irakului , [wordpress.com/2010/04/17/iraqs-future-implications-of-order-81-on-iraqs-](http://wordpress.com/2010/04/17/iraqs-future-implications-of-order-81-on-iraqs-)
- [11] Organizația pentru Alimentație și Agricultură FAO, 1995; National seed policy, (2008 ) Ministry of Agriculture Baghdad, Irak, pdf
- [12] Planning Authority, Central Statistics Agency. 2001 - 2005. Annual Statistics Report
- [13] Schnepf Randy, 2004, Irak Agricultură și Alimentație ( alimentare), Context și probleme, CRS Raport pentru Congres, 07.06.2004, Biblioteca Congresului ([www.nationalaglawcenter.org/.../crs/RL320](http://www.nationalaglawcenter.org/.../crs/RL320))
- [14] The World Bank, <http://web.worldbank.org/Website/External/Countries/Menaext/0,,menuPK:247619~pagePK:146748~piPK:146812~theSitePK:256299,00.html>
- [15] Yousif El-Jubouri Mohamed Dhary, 2014, "Studii privind căile tehnice (de cultură și protecția plantelor) și economice de creștere a producției de porumb boabe în republica Irak și în România", Teza de doctorat, USAMV, București

