

From: McCracken Vol. I, 1890-1899

CROSS SECTION OF TUNNEL

SECTION No. 2 NEAR UNIVERSITY HALL
1896

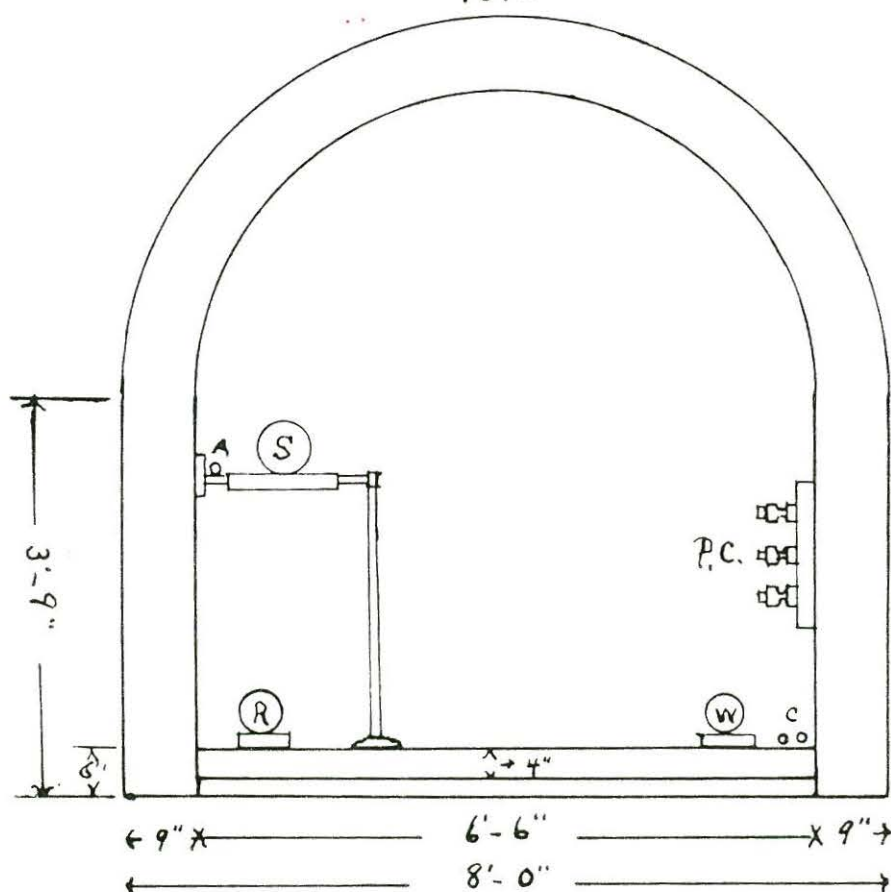

2" Sand Cushion

LEGEND

- Steam For Heating - S
- Returns From Heating - R
- Compressed Air - A
- Cold Water - W
- Lead Covered Cables - P.C.
- Power Cables - P.C.

According to the Architects for Hayes and Orton Halls, the construction of a Central Plant would save \$8,300 in the construction, and equipment of the heating plants for those two buildings. It would eliminate building a boiler house and chimney and installation of two small boilers for Hayes Hall and two Babcock and Wilcox boilers a long smoke flue and completion of the Stone Chimney at Orton Hall.

The Plan for Power to drive the machines in the Hayes Hall shops called for the installation of a small model engine to be located in the Alcove at the south end of the shop fronting the Center Hall first floor, with a large plate glass window which would give the students and visitors a view of the engine and machines in the shop.

Mr. R. B. Hayes set in motion the machinery granting authority to proceed with the plans, specifications and estimates for the construction of the new Central Heating and Power Plant by offering the resolution given below, which was adopted by the Board, May 3, 1892.

"That it is the sense of the Board that the boiler house, heating apparatus and entire steam plant be concentrated at a point north or north-east of and near the Mechanical Laboratory Building, (This is the site the Architects recommended) and that the Secretary take the necessary steps to procure proper plans and estimates for such proposed changes, the same to cost not to exceed \$30,000. That the Architects are hereby directed to change the heating plans of the new buildings so as to conform to the fore-going."

Yost and Packard were appointed Architects and proceeded with the plans, specifications and estimates and on June 2, 1892 presented them to the Board as follows:

- 1 Plans for the east half of the boiler house, with a capacity for 600 horse power of boilers of the water tube type, also, the receiver room and pit and a steel smoke stack 54 inches by 75 feet high.
- 2 Plans for two 150 Horse Power Babcock and Wilcox Water Tube boilers, hand fired.
- 3 Plans for 2,153.45 feet of Brick Tunnel, 5'-6" X 5'-6", Tunnel to extend from the Central Heating Plant to Hayes Hall, Botany Building and Orton Hall.
- 4 The necessary pipe, valves and fittings from the boilers and tunnels and an 8" sewer from the receiver pit, 22 feet deep.
- 5 A Moppes Live Steam, Boiler Feed Water Heater, a 5' X 16" Condensate receiver and a boiler feed water pump to be installed directly by the University.

The plans and so forth were referred to the Architects, Professor S. W. Robinson, the Engineer and the Secretary to make a report at the next meeting of the Board, June 21, 1892. The Board at this meeting set aside \$30,000 for the project.

It so happened Doctor Robert H. Thurston, Director of Sibley College of Engineering of Cornell University, delivered the commencement address to the Class of 1892.

While Secretary Cope had faith in the new Central Plant and tunnel project he thought it would be wise to get, if possible, Doctor Thurston's opinion on the new boiler plant and tunnels and instructed the University Engineer to meet him and explain to him on the site what the University had planned to do. Doctor Thurston very kindly and patiently listened to the University Engineer's statement and with a general view of the layout, he asked a few general questions and stated he saw no reason why the project would not be a success. And in further explanation stated; that they at Cornell would have been greatly pleased to have been able to build a tunnel system, but could not because of the rock formation of the Campus; the rock was close to the surface, in fact, was exposed in places, making the cost of tunnels prohibitive. Doctor Thurston gave the project his approval. Secretary Cope was very much gratified to receive the report from Doctor Thurston, it fortified his confidence in the project.

The plans, specifications and estimates for the New Central Heating plant and tunnels etc. were submitted to the Board for their final approval on June 21, 1892.

The plans were adopted and ordered put through the proper channels for further approval and to advertise for bids when so approved. The date for opening the bids was set for July 26, 1892. The bids were opened on that date but they were not complete.

The Board ordered a second advertising and the bids were opened on the 30th of August 1892.

Contracts were let to the following successful bidders:

L. C. Newson, Boiler House complete	\$4,098.39
L. C. Newson, Sewer	540.00
L. C. Newson, Tunnel for service lines	<u>10,109.00</u>
L. C. Newson, TOTAL	\$14,747.39

The Babcock & Wilcox Co.	6,299.00
Frank Stratton, Steam Mains, Fittings & Stack	<u>6,361.00</u>
TOTAL	\$27,407.39

The work began early in September 1892.

Henry Kanmacher who had been one of the Contractors on the old Main Building was Sup't for L. C. Newsom.

A. M. Ewart Sup't for the Babcock & Wilcox Co.

Frank Stratton for self.

Mr. Packard, Senior, Sup't for the boiler House

Wm. C. McCracken, Sup't balance of project for the University.

The Tunnels after a few difficulties had been overcome with Mr. Kanmacher were completed the latter part of December 1892 but there still remained quite a bit of cleaning up to do along the right of way of the tunnels which could not be done during the cold weather. When the weather broke the University Engineer started Mr. Kanmacher and a gang of men to make final clean up of the tunnel site. The men had just gotten a good start when Professor Thos. F. Hunt, who had just recently been given exclusive charge of the grounds came riding horsback down through the center of the Campus and demanded to know what the men were doing there. The University Engineer tried to explain to him that the men were working for Mr. L. C. Newsom the contractor and were finishing up the work on the contract, that is hauling all the old brick bats, excess dirt and debris off the Campus. Professor Hunt would not hear to it said he was in charge of the Campus and ordered the men to quit in spite of the fact that the Engineer stated to him that he had been appointed to superintend the job. The Engineer finally told Mr Kanmacher to pull off his men and consider his contract fully completed, that for a hot tempered Englishman with a little brief authority. The score was evened later.

The building, boilers and tunnel pipe work were ready for service December 31, 1892.

Regular Service to Hayes and Chemistry buildings began February 1, 1893.

Regular service to Orton Hall and Botany Buildings began October 1, 1893,

Orton Hall was not occupied till late summer of 1893.

Steam Mains in tunnels were 8", 6" and 5".

Return Mains in tunnels were 5" and 3"

Steam pressure carried on tunnels 30 pounds

Steam pressure on heating apparatus in buildings 5 pounds.

The election of Officers at the Annual Meeting of the Board November 23, 1892 resulted as follows:

R. B. Hayes, President

J. B. Schueller, Vice President

Alexis Cope, Secretary

F. W. Prentiss, Treasurer

Executive Committee:

L. B. Wing, John B. Schueller, Thos. J. Godfrey

At the April 10, meeting of the Board the condition of the stairways and other woodwork in Hayes Hall was brought up. Mr. F. L. Packard, Architect being present, made a statement concerning the condition of the woodwork and the stairs in particular and took exception to the statement made by one of the board that "you could throw a cat through some of the places." Doctor Schieller came back with the remark that, "you could throw a little one through." Mr. Packard agreed to have repairs made at his expense

The barn which was used for storing the cannon, campus tools and the east end of which had been used for the Veterinary Clinic stood on the site of the new engine room. A contract was given Mr. J. E. Dutor to move the barn to the Agricultural group of barns at the southwest edge of the Campus at his bid of \$150. The job was well done by Mr. Dutor, leaving the site clear for the new engine room.

Tunnel Extensions 1896. E. A. Kemmler and C. E. Sherman Engineers

Section No.2 of Tunnel 6'-6" by 6'-6" was built from the 5'-6" by 5'-6" tunnel at the first turn to the east approximately 225 feet from the boiler house, south 48.86 feet, thence west with a branch into the Mechanical Engineering Laboratory, thence west to a branch into University Hall, thence on west to a branch into the Electrical Engineering Laboratory. Total length of section No.2 of Tunnel system 420.78 feet.

The contract was executed by S. T. Knight and was completed in July 1896 and cost \$1,656.63.

All the pipe work in this Section of the Tunnel system was installed by the Engineer's force and consisted of:

An 8" steam main, 5" return main, 4" water main, 3" gas main and 1" vacuum line for the Paul system.

With 80% magnesia pipe covering on steam and return mains.

Section No3 of the tunnel system, same size as No.2 section was constructed during August and September 1896, and extended from the Electrical Engineering Laboratory into Townshend Hall, total length of section 461.60 feet. S. T. Knight was the contractor. The cost of section No.3 was \$2,300.00.

All the pipe work in this section of the tunnel was installed by the Engineer's force in the fall of 1896 and consisted of:

An 6" steam main, 3" return main, 4" water main, 2" gas main and a $\frac{3}{4}$ " vacuum line for the Paul System.

80% Magnesia covering for steam and return mains.

Section No.4 of the tunnel system, same size as No. 2 section was constructed in the late fall of 1896, completed about December 26, 1896, extended from west side of Hayes Hall to Armory and Gymnasium and the Biological Building, total length 1,111 feet. S. T. Knight was the contractor. The cost of section No.4 was \$5,789.33, all the pipe work in this section of the tunnel was installed by the Engineer's force in the winter and early spring 1897, and consisted of:

5" & 4" steam main, 3" return main, 4" and 2½" water main, 2" gas main and 1" and ½" vacuum Line for Paul System.

80% Magnesia covering for steam and return Mains.

Lineal feet of tunnel June 30, 1899--4,146.83 feet cost \$19,854.96.

As previously stated Yost and Packard were commissioned to make the plans for the completion of the boiler house and the new engine house.

The plans were approved by the Board, duly advertised and the bids were opened on the 19th day of May 1896, and the contracts were awarded to:

Mr. Fred Fornof of Columbus, for the buildings and chimney at his bid of	\$17,839.82
Jeffrey Mfg Co., of Columbus for Coal and Ash Conveying Machinery	3,190.74
TOTAL	<u>\$21,030.56</u>

The Boiler House was a substantial brick building the main^{Part} being 38 by 100 feet, inside, 24 feet to top of wall. Slate roof laid directly on steel Z bars; entirely fire proof.

There was room in the boiler house for 1,500 H.P. of boilers, normal rating.

The chimney was built of pressed brick was 125 feet high and 6 feet 6 inches in diameter inside at the top, it was quite ornate.

The Engine House was 40 by 60 feet inside, 20 feet to top of wall in Engine Room with an 8 foot basement, Outside of wall pressed brick, a very substantial building. Roof was slate on steel Z bars. The floor was oak on 2 by 10 inches Norway Pine joists.

The two 100 H. P. Babcock and Wilcox Co. boilers were moved from the old house and reassembled next to the two 150 H. P. boilers in the new House.

Acme Stokers were installed under the two 100 H.P. boilers.

From: Mc Cracken Vol 4, 1922-1925

THE OHIO STATE UNIVERSITY

Tunnel Data 1892 To 1925 Inclusive.

Sections	Built	Length feet	Size	Top	Kind of Top	Cost of Tunnel	Cost of Pipe, Valves &c	Cost of Cables	Total Cost
1. To Orton + Hayes H.	1892	2153.45	5'-6" X 5'-6"	Half Round	Brick	10109.00	16085.71	2510.00	28704.71
1-B	1900	21.67	" "	" "	" "	179.00			179.00
1-A	1905	74.50	" "	" "	" "	892.00	305.85	141.00	1338.85
2. To U. Hall + English B.	1896	420.78	6'-6" X 6'-6"	" "	" "	1656.63	1942.18	376.00	3974.81
3. To Townshend Hall	1896	461.60	" " "	" "	" "	2300.00	2943.94	957.00	6200.94
4. Hayes H. to Biolog. B.	1897	1111.00	" " "	" "	" "	5789.33	3678.15	857.00	10324.48
5. To Page H. from No. 4	1902	135.00	" " "	" "	" "	1337.65	764.93	93.00	2195.58
6. To Vet. Lab.	1902	163.00	" " "	" "	" "	1673.15	311.93	155.00	2140.08
7. To Brown Hall	1903	155.00	" " "	" "	" "	1479.42	381.08	186.00	2046.50
8. To Physics B.	1904	381.03	" " "	" "	" "	2521.40	3135.68	787.00	6444.28
9. To Lord Hall	1906	410	" " "	" "	" "	3713.02	1429.94	704.00	5847.01
10. To Robinson Lab. B.	1908	453.70	7'-6" X 6'-6"	" "	" "	4066.82	4617.34	3812.00	12496.16
11. Library B.	1911	347.50	6'-6" X 6'-6"	Flat	Concrete	3386.50	4069.06	2265.00	9720.56
12. To No. 12 from P. Plant	1912	568.50	" " "	" "	" "	6500.00	8764.20	1486.00	16750.20
13. To No. 2 from P. Plant	1913	321.26	" " "	" "	" "	3095.00	3813.32	1555.00	8463.32
14. Arch. Museum from 4	1913	653.50	" " "	" "	" "	6984.00	2163.95	829.00	9976.95
15. To Hort. + Forst. B.	1913	534.00	" " "	" "	" "	4995.00	4326.14	3691.00	13012.14
16. West Side of P. Plant	1913	122.50	6'-6" X 5'-6"	" "	" "	1715.00	508.78	122.00	2345.78
17. Hort + For. to B + Z. B.	1914	670.00	6'-6" X 6'-6"	" "	" "	7775.00	4555.74	3464.00	15794.74
18. B + Z. B. to 11th Ave.	1915	475.00	" " "	" "	" "	3333.00	4857.06	2691.00	10881.06
19. To Campbell H.	1916	52.71	" " "	" "	" "	443.00	304.87	146.00	893.87
20. To S. A. Hospital	1916	499.00	" " "	" "	" "	4245.00	3998.55	1539.00	9802.55
21. To Ind. Shops	1916	336.25	" " "	" "	" "	2646.00	1786.38	514.00	4966.28
22. Ext. to new Power P.	1917	436.25	10'-0" X 8'-0"	" "	" "	11573.00	16873.10	5809.50	34255.60
23. To Pomerene Hall	1921	77.50	6'-0" X 6'-6"	" "	" "	1083.00	939.12	237.00	2259.12
24. Physics to Biolog. B.	1923	166.75	" " "	" "	" "	1784.23	1570.72	173.00	3527.95
25. Brk. to Commerce B.	1924	45.00	6'-10" X 6'-6"	" "	" "	540.00	270.16	58.00	868.16
26. Vet. Clin. B. to Townsh.	1924	340.00	6'-6" X 5'-8"	" "	" "	6990.40	1319.04	2709.00	11017.94
27. To Education B.	1925	1396.00	6'-6" X 6'-6"	" "	" "	22743.00	14450.15	4623.00	41816.15
28. To Engr. Expt. Sta. B.	1925	464.00	" " "	" "	" "	12058.00	5748.57	1807.00	19613.57
29. Laundry to Garage	1925	183.00	6'-6" X 6'-6"	" "	" "	5294.83	7723.46	2028.80	15047.09
30. To Ives Hall	1925	1065.00	6'-6" X 6'-6"	" "	" "	1682.40	6201.23	3501.00	26524.23
Animal Husb. Group	1923	1070.00	5'-0" X 4'-0"	" "	" "	11848.00	3110.45	695.10	15653.55
		16058.45				171594.98	132950.85	50520.40	355086.23

Tunnels Feed OSU

23 Oct 69
By LINDA HERSHEY

Lantern Staff Writer

Ohio State is held together by a vast 4.4 mile tunnel system which carries the lifeblood of our buildings from the source to the need, according to Gordon B. Carson, vice president for business and finance.

It all started in 1906.

Prior to that time there were no central heating or lighting systems for the University. Just picture yourself curled up in front of a coal stove with a coal oil light, all ready to study for exams.

This is not the picture today due to the foresight of the University planners. Now we have light and heat without unsightly and dangerous wires blocking our skyline.

Tunnel System Started

In 1906 when the Brown Hall annex, nicknamed Rinso Hall, was the power plant and laundry, the University began its tunnel system.

The tunnels house the steam, water and gas pipes, and all electric and telephone cables.

In many areas around campus the sidewalk serves as the ceiling for the tunnels.

On cold winter mornings snow and ice will not collect on those walks. The extreme temperature inside the tunnels keeps the sidewalks warm enough to melt any snow or ice that might collect.

McCracken Main Source

The McCracken Power Plant was built in 1926 when Rinso Hall became too small to house all of the equipment necessary for the expanding University. McCracken now provides the source of all power for the

University on both sides of the river.

Most of the new buildings on North Campus are being built with self-contained boiler systems. They are not connected to the main system because there is no surplus of power available. The power plant is presently working to capacity, according to Carson.

New System Set

The modern approach to University power is through the use of gas rather than the dangerous and dirty historic use of coal and steam.

By next year the Ohio State power plant will be completely converted to this new system.

Even with the changes being made in the Power Plant the tunnel system will be vital to University life, Carson said.

It is serviced by two maintenance crews who travel under the campus through these cement holes. Some are large enough to allow a man to pass and some are inaccessible to anyone except the smallest rodent, Carson explained.

Some of the tunnels date back almost 60 years but Carson said most were still in excellent condition because of strong cement construction. They are made inaccessible to University students, however, because of the danger of steam pressure and the high electricity voltage.

Tunnels service OSU

By J. Danbridge Outland

6 August 1973

When archaeologists of some future era discover Ohio State's remains, they may conclude that we were a race of moles.

Unseen by the student eye, nearly six miles of utility tunnels stretch beneath the main campus and medical complex to pump life into University buildings, according to Glenn E. Hess, chief engineer of utilities and power systems at the physical plant.

"Altogether there are 5.85 miles of tunnels beneath campus," Hess said. "They connect many of the buildings and supply them with heat, domestic hot water (as opposed to hot water for heating), electricity and telephone wires, natural gas and city water, to name a few," he said.

First at Brown Hall

Hess said the tunnel complex was started sometime in the 1920's using prison labor. The first tunnel was built in the vicinity of Brown Hall. In 1934 the Works Progress Administration joined in the effort, and various additions to the tunnel system have been made off and on up to the present construction of tunnels in the medical complex, Hess said.

The main tunnel begins at the McCracken power plant, runs to Neil Avenue and beneath Neil Avenue to 12th Avenue, Hess said. The tunnel extends east below 12th Avenue supplying buildings on South Campus, then runs north on College Road to

the vicinity of the laboratories on North Campus. It then turns west and heads back to Neil Avenue, supplying the laboratories and other buildings on the way, Hess said.

Hess said branches of the main tunnel supply utilities to various sections of campus. Not all buildings have entrance access to the tunnels, he said.

"The main entrance to the tunnel is in McCracken Power Plant," Hess said. "Access is limited primarily to maintenance employees and the phone company," he said.

Steam clears snow

Hess said there are other entrances to the tunnels, but he's not sure how many there are or where all of them are located.

The tunnels especially serve a practical purpose in the winter. Pipes in the tunnel carrying 200 pounds of steam pressure to heat buildings generate enough heat to melt the snow off sidewalks above, according to Hess. "Many of the tunnels were built under sidewalks for this reason," he said.

Students walking on campus at night may have seen mysterious lights beaming through the gratings on sidewalks. This is from the light bulbs that glow in the tunnel every 15 to 20 feet, according to Hess.

Hess said there have been no problems in recent years with flooding in the tunnels.

Hess refuted the rumor that past University President Novice G. Fawcett used the tunnels to travel across campus.

OSU goes underground

By Sharon Sieh
Jan 1974

The Ohio State University Physical Plant is the heart of a 5.85 mile complex of veins and arteries that supplies life to the University.

This circulatory system of tunnels crisscrosses Main Campus and furnishes heat, electricity and natural gas as well as cables for closed circuit TV.

The tunnels run from Eleventh to Woodruff Avenues and from High Street to Tuttle Park Place. Tunnels also run under the entire medical school complex and West Campus.

Dallas Sullivan, an engineer at the Physical Plant said the first tunnel was installed in 1896 at a former building called Agricultural Hall.

Tunnels impressive

The oldest existing tunnels are under Brown and Lord Halls. Sullivan said he is "always impressed with these tunnels because the arches, and the masonry makes you think you're in a catacomb or a medieval castle."

What are the tunnels themselves like? Donning a hardhat, this Lantern reporter walked from the Physical Plant to the Electrical Engineering Building using the underground tunnels.

The first thing one notices about the

tunnels is that they are hot. They are hot enough to make you wish President Nixon had ordered thermostats to be set at 58 degrees. The tunnels look like sewers with pipes, and deep puddles from the rain. Some areas of the tunnels smell mouldy.

There are a maze of steps in the tunnels and some areas of the tunnels are barely wide enough for one person to get through. In some areas there is almost no lighting

Rats in tunnels

Sullivan said that rats are sometimes found in the tunnels, but the only animal I saw on the tour was one gargantuan water-bug.

For safety's sake Sullivan said the four people who work on tunnel maintenance full time are required to travel in pairs.

"People are getting lost in the tunnels all the time," he added.

Maintenance of the tunnels is an expensive operation. This year \$75,000 has been allocated for structural repair of the tunnels. Sullivan said these repairs are done "on a priority basis."

Sullivan added that adequate security is maintained to keep trespassers out of the tunnels.

Periodically the tunnels are inspected for safety. Sullivan said that a major goal is to make the tunnels "a better place in which to work."

Utilities under OSU sidewalks

Hot, crowded, dark in tunnels

By Vicki Bavetz

16 OCT 74

Some day when you are walking down Neil Avenue and feel like talking to someone, try yelling down a sidewalk grating. If you have the right grating at the right time, someone might yell back.

UNDERNEATH all those acres of campus lie six miles of underground tunnels and maintenance men keeping them in repair.

The main entrance to the tunnels on Main Campus is in the McCracken Power Plant, 2003 Millikin Rd. There are entrances to the tunnels in almost all the campus buildings, but these entrances are heavily barred and securely locked.

The tunnels on main campus are used strictly for utilities: telephone and television cables, high voltage electricity lines, and air steam, gas and water pipes which carry most of the utilities to the Main Campus buildings.

MOST OF THE tunnels were built before 1900, E. Glenn Hess, director of utility services, said. The University used labor from the state penitentiary, and bricks for the tunnels were made on the site.

"Some of the tunnels have so many pipes, you can't walk through them," Hess said. Other places are so small the men have to crawl on their

TH are lit by light bulbs every few feet, but they still are quite dark. A manhole grating lets in a little light. The tunnel is about seven feet below ground.

Hess said most of the tunnels are at least three to four feet underground, with some as deep as 14 feet.

Hess said under the Natatorium a lot of construction work had been going on. Normally two people work together in the tunnels doing maintenance work because much of the work involves carrying large pipes, he said.

Hess said much of the work done in the tunnels is "preventive maintenance." He said no accidents have occurred in the tunnels since he became director in 1966, and he had not heard of any accidents occur-

ring before then.

HESS said the men also install new pipe supports, and are in the process of cleaning up the tunnels. He said they have routine inspections.

"As of now," Hess said, "there is no communication system" in the tunnels. The men have pocket pagers, but have to leave the tunnel to make a call.

THE OLDER tunnels have arched roofs, with brick walls, floors and ceilings. The newer tunnels have brick floors with

reinforced concrete roofs.

Hess said security is maintained by requiring a key to get in and a key to get out of the tunnels. There is a locked door to every entrance to the tunnels.

But, he added, he didn't think anyone would want to go into the tunnels if they didn't have to. "If you drop down in them, I don't know how you would get out."

Also, it is extremely hot in the tunnels, because many steam and hot water pipes are in the tunnels and they are not very well ventilated.

In some places rain water from the vents comes in and some places are "close and stuffy" but the men have no problems with breathing. "It's mostly hot," said Hess.

THE TUNNELS used to be marked only with number on the pipes every 100 feet. But about a year ago, signs were put in them giving the street or building locations under which the tunnels were built, Hess said.

The tunnels are built along Neil Avenue and various buildings on Neil Avenue, east

of Neil Avenue on 17th Avenue, under the Administration building, east, south and north of the Oval and in the hospital complex.

There are also tunnels on 19th Avenue where most laboratory buildings are standing, he said. One tunnel was built directly across the Oval from Brown Hall. Another goes from the power plant to the Women's Field House.

WEST CAMPUS and University Hospitals have "dual purpose" tunnel systems. West Campus has tunnels through its five buildings, and they are used for pedestrians as well as utilities, Hess said. The most recent tunnels were completed in West Hall, which opened this summer.

The University Hospitals medical parking ramp tunnel, which leads to the hospital, was completed about four years ago. There also is a tunnel connecting the Health Sciences Library to the hospital, as well as tunnels to Means, Dodd, and Upham halls and the Ambulatory Patient Teaching Facility.

Tunnels beneath campus carry necessities to OSU

By Jack Brady

23 Oct 75

Many of the students walking around the Ohio State campus do not realize the complex system of utilities at work beneath their feet.

This system, contained in the tunnels which weave their way beneath the campus, has innumerable pipes and cables which are the focal points of much of the power on campus.

The underground passages, some which were built in the late 1800's and early 1900's, are constructed mostly of brick. The oldest ones are made totally of brick with arched overheads.

The newer tunnels are made of reinforced concrete and many are large enough for people to walk in, while

others are too small to be entered.

The tunnel system originates at the physical facilities plant on Millikin Road and weaves its way over every part of campus except the north dormitory area.

CONTAINED IN the tunnels are the pipes and cables which transport water, steam, telephone and telecommunication services and electricity.

The tunnels which are large enough for humans to travel are well lit.

University to repair tunnels

By Rich Moore

4-1-77

Formal announcement of the awarding of contracts for utility tunnel renovation at the corner of 12th and Neil avenues will be made today at the Board of Trustees meeting to be held at Wooster.

E. Glenn Hess, director of utility services for the office of physical facilities, said funds for the project totaling \$113,483 were appropriated from the Utility and Renovation budget of

the state legislature.

The project will open approximately 100 feet of existing tunnel running directly under 12th Avenue for structural repairs.

The tunnels, which were constructed in the early 1900's, consist of approximately six miles of winding passageways connecting the central campus with McCracken Power Plant. These tunnels supply campus buildings with all utility lines and pipes.

Hess said bids for the

project were taken March 2, and the Right Co. Inc. of Columbus was granted the contract and should start construction operations soon.

"Both lanes of 12th Avenue will have to remain open until June 10," Hess

said. "One lane traffic will have to be maintained after the end of Spring Quarter to allow access to the University Hospitals."

Hess blames pressure from the heavy traffic and the age of the structures themselves.

Campus underground thrives

By Frank Tsacrios

7-18-78

A six-mile system of utility tunnels which transport steam, water, gas and electricity to older campus buildings is not easy to hide. But eight years ago, university administrators attempted to guard them with secrecy.

Although the system supplies the university's power, at one time it was considered Ohio State's most vulnerable target.

During the student riots in the spring of 1970, there was a fear among administrators that students would enter the tunnels and possibly sabotage them, Dorothy Ross, keeper of the OSU archives, said.

"Some people tried to get maps to the tunnels," Ross

said. "At times, I would receive a call (from some administrators) to get everything locked up and secured."

In 1970, once a tunnel was entered, there was complete access to the entire system. Since then, security gates have been added about every 100 feet, said Martin DeLille, director of facilities maintenance.

In 1978, curiosity and fun have replaced destruction as the reason some students still sneak into the tunnels, said Charles Bennett, manager of utility services.

The system, which is more than a playground with gridiron catwalks, yellow street signs and an average temperature of 100

degrees is being partially renovated to preserve its functions. There are no new plans for expansion other than the pedestrian tunnels in the medical area

of campus, DeLille said.

"Tunnels are a pretty expensive item," DeLille said, "I'm not even sure most campuses have tunnels."



Lantern Photo by Amy Fabnestock

A sign in the second level service tunnel below the corner of Neil and 17th avenues directs utility workers to the McCracken Power Plant.

Tunnel overhauls almost complete

By Erin Anderson

4-5-79

OSU's tunnels are about half-way repaired and the other half needing repair should be finished by the end of the year, said the Director of Facilities Maintenance, Martin B. DeLille.

The tunnels contain gas, electricity, steam and some telephone lines. These lines are protected from weather by the tunnels which also make them more accessible.

OSU also has pedestrian tunnels on West Campus and at the Medical Complex which did not need repair, DeLille said.

About 300 feet of the 6¼ mile system were in need of repair.

None of the university's tunnels built in 1900 were in need of repair, DeLille said. Those repaired date from about 1910 and 1920.

Concrete was deteriorating and supports for the pipes were rusting away, he said.

In recent years stop-gap precautions have been taken, such as shoring up the most serious areas with wooden supports, according to the Capital Plan for Higher Education, which was released in February 1977 by the Board of Regents.

Four sections of repair work have yet to be finished, DeLille said. OSU will advertise for bids on that work within two

months, he added.

Some of the tunnels cross under streets and follow sidewalks, he said, but there "really wasn't a hazard to the people who use the campus." The tunnels are designed to withstand car and truck traffic, he explained.

The worst sections have been repaired, he said. The tunnel which runs below the sidewalk along Neil Avenue from Lazenby Hall to Starling-Loving Hall, was among those repaired.

The tunnels which needed repair are used to carry utility lines, he said. None were pedestrian tunnels.

The biggest problem would have been the interruption of electricity, gas and some telephone service had the tunnels collapsed, he said.

OSU will spend approximately \$375,000 to repair the tunnels.

Tunnels weave passage through OSU campus

By David M. Crawford

30 April 1980

Out of the sight of the people who pass over them daily, nearly five and one-half miles of tunnels weave their way beneath the campus.

The tunnels contain telephone lines, high voltage electric lines and steam, water and gas pipes that supply buildings on south and main campus. The north campus area has no tunnels because its utilities are supplied by a self-contained system.

The main entrance to the tunnel system is located in McCracken Power Plant on Millikin Road. Most campus buildings serviced by tunnels have an entrance but they are kept locked.

According to the University Archives, the first tunnels were constructed with labor supplied by the state penitentiary and completed about 1900. Bricks fired at the construction site by inmates are still part of the older tunnels today, said Charles Sammons, physical plant engineer.

A brief history of the tunnels is included in the book "History of the Physical Plant" by William C. McCracken. It states that "on July 2, 1924, the Elcon Engineering Co. was awarded the bid for construction of a tunnel from the Veterinary Laboratory (the present Neil-17th Building) to Townshend Hall at a cost of \$6,990." The length of the tunnel was about 400 feet.

At today's prices it costs about \$1,000 just to repair one foot of tunnel, Sammons said.

There are tunnels under University Hospitals and West Campus that also serve as

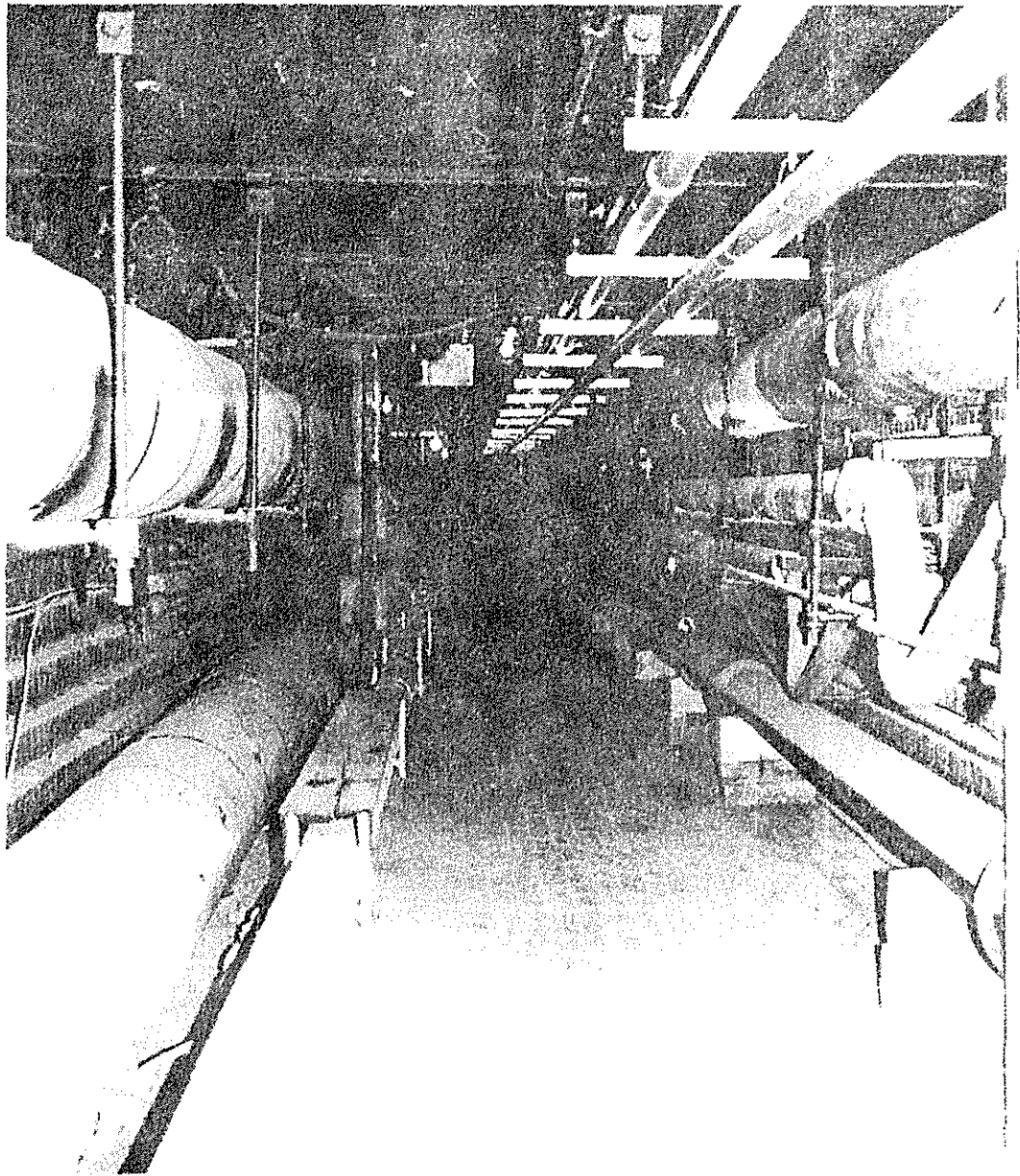

The tunnel system which lies under OSU begins near this section by McCracken Power Plant.

pedestrian walkways, but tunnels under the main campus are strictly for utilities, said Keith Byerly, OSU utilities services manager.

The tunnels are lit every few feet and Sammons said because of the steam pipes in the tunnels, he has seen the temperature rise to 145 degrees.

In winter the tunnels generate enough heat to melt the snow and ice on

the ground above.

Four workers are assigned to keep the tunnels and utility lines inside in good repair, Byerly said.

It was once rumored that past university presidents used the tunnel system to travel across the campus, but information in the University Archives discounts this since the tunnels are rather small in some places and

cause a tight fit for even the smallest people.

During the campus unrest in the early 70s there was an increased interest in obtaining the blueprints of the tunnel system, said Dorothy Ross, archives assistant.

The tunnels are named and numbered corresponding to the streets and buildings which they are under. There are gates at every entrance in the tunnels.

The Lantern Cheryl Horn

Old tunnels serve modern needs

By Lori L. Plankell

Lantern staff writer 5-6-82

The old belief that digging straight down will lead to China may be true in some places, but at Ohio State one may simply end up in a tunnel.

Since the early 1900s, there have been utility distribution tunnels under part of OSU's campus.

Originally, Brown Hall Annex, built in 1896, served as OSU's power plant. The tunnel system probably was built in the early 1900s as an economical way to distribute steam, said George N. Whicker, project engineer. When McCracken Power Plant was built in 1918, the system was extended, he said.

The tunnels contain telephone and electrical cables, and pipes for steam, water and compressed air, Whicker said.

The system is for central campus buildings, including dorms. There are some West Campus utility tunnels, but they are not hooked up to the McCracken Power Plant, he said.

Whicker said 90 percent of the telephone power in the central campus area is in the tunnels, and 30 per-

cent of the central campus buildings get their electricity from the tunnels.

Whicker said the steam pipes' pressure is 200 pounds per square inch. The super-heated steam, heated totally dry, is used for heating and cooling. Steam also is used for food-service areas.

"Most central campus buildings use water from the tunnels," he said. "Water is heated in McCracken, then distributed through the tunnels."

The tunnel system begins at McCracken and extends east under 12th, 18th and 19th avenues and North Oval Drive. The tunnels end at different places. Tunnels extend to Sullivant Hall on the east and McCracken Power Plant on the west, he said.

Tunnels extend north and south under Neil Avenue, north as far as Ives Hall and south to University Hospitals. A connecting tunnel near College Road meets the east-west tunnels.

Whicker said the tunnel system is more efficient and economical than if cables and pipes were above ground or buried.

"There is less loss into the atmosphere than if the steam pipes were outside," Whicker said. "The pipes are also easier to insulate when they are in tunnels because they don't have to be as heavily protected."

"Also, cables and pipes are more protected and are less likely to be damaged in tunnels," he said. The tunnel system allows direct access to the equipment, and there is no need to dig if repairs have to be made, Whicker said.

For example, he said on March 3 workers started installing 350 feet of insulated pipe in the 12th Avenue tunnel. "The old piping has deteriorated and is being replaced with reinforced fiberglass."

The project took about three weeks, Whicker said. "If we were dealing with buried lines, it would have

taken a lot longer." "It would have required a lot more man hours and caused disruption in the the campus community."

Whicker said, because of constant maintenance, the tunnels are in the best condition they have ever been in.

Tunnel system expansion would be unlikely because of high labor and construction costs, Whicker said.

"In the last 10 years, we've made numerous structural repairs." Around 1979 the tunnels' roof under 18th Avenue was replaced and topped with reinforced concrete, he said.

The tunnel system's newer parts are made of concrete, and the roofs are square. Older sections are made of brick and have arched roofs, Whicker said.

Most tunnels run under sidewalks, and the tunnels' tops form the actual pavement. During a light snowfall, tunnels can be identified because there will be no snow where the tunnels are, he said.

"Because of the temperature in the tunnels, heat radiates up from the ground and keeps the snow melted."

The tunnels have natural circulation. "They are ventilated by openings in the roofs. Air flows through the tunnels into McCracken, and most of that air is used for combustion air in boilers," Whicker said.

Although the tunnels are large enough for a few maintenance workers, Whicker said the tunnels could not contain many people during an emergency.

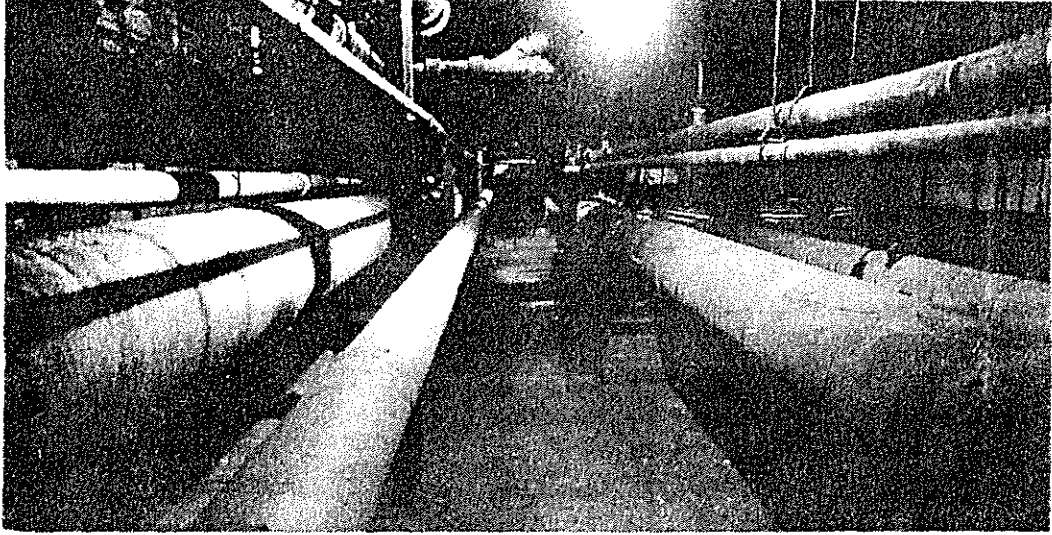

OSU's underground tunnel system

The Lantern/Larry Testa

4 students found in OSU tunnels face criminal trespassing charges

By J. Leslie Sopko and
Patrick Jackson

Lantern staff writers

2-29-84

Four OSU students went into the university tunnel system to drink a few beers, and one of them came up with five years probation.

Garth W. Lynn III, a senior from Chicago majoring in engineering, pleaded guilty Tuesday to charges of criminal trespassing before Judge Robert M. Wasylik in Franklin County Municipal Court.

The tunnels, which extend from McCracken Power Plant to almost every building on Main Campus, are used to distribute heat and electricity to the buildings.

Lynn was given probation and 30 days in the Franklin County Correctional Facility. He is also being required to perform 80 hours of community service.

However, 10 days of the jail sentence were suspended, and the remainder will be suspended following completion of the community service, Wasylik said.

Two of the three people accused of being in the tunnel with Lynn — Nicky Von Alboreo, a senior from Akron, and Todd C. Harder, a senior from Elsmore — are scheduled for hearings Thursday in Municipal Court.

The third person charged in the case, Eric D. Kruse, 22, a resident of Houck House, said his hearing date is set for Friday.

Lynn and the others were arrested Jan. 10 by OSU Police after the police were notified that people were seen entering the tunnels near Ives Hall through a manhole, said OSU Police Supervisor David Hollenbeck.

Lynn said they were sitting in the tunnel drinking beer when they found themselves surrounded by police. The four were taken to Dreese Lab where they were searched and handcuffed, he said.

Lynn said he and his friends did not realize they were

committing a crime.

"We were just down there to drink a few beers," he said. "We didn't hurt anything."

Lynn claimed he and his friends didn't think they would be arrested for trespassing because of a *Lantern* article that appeared Sept. 21.

The article quoted George Whicker, assistant director of physical facilities, who said explorers found in the tunnels would just be asked to leave for their own safety.

However, Hollenbeck said Tuesday that 'no trespassing' signs are posted in the tunnels and entering the system is considered criminal trespassing.

Hollenbeck said police are concerned about people using the tunnels because they might damage the equipment or hurt themselves. He also said the tunnels have been used in the past to enter the buildings, and in some cases, thefts have resulted.

Lynn said during the hearing, the prosecution told Wasylik that Lynn and the others had taken extensive photos of the tunnel system to plan a robbery.

Lynn claims the photos are posed shots of the group with the tunnel in the background.

Kruse, a senior from Pemberville, said, "If we were down there to make a major heist, we wouldn't have had a 12-pack of beer, and we wouldn't have been posing for pictures."

Wasylik said that the prosecution's allegations about the photographs influenced his decision to place Lynn on probation.

Lynn's attorney, Karl Sutter, asked Wasylik to consider the *Lantern* article when sentencing Lynn, Wasylik said.

Sutter told him that although the article didn't justify Lynn's actions, it may explain why Lynn didn't realize he was committing a crime, Wasylik said.

Tunnel intruders get sentences

By Patrick Jackson

Lantern staff writer 3-5-84

The last of the four OSU students charged with criminal trespassing in the university tunnel system appeared Friday in Franklin County Municipal Court.

Eric D. Kruse, a senior from Pemberton, pleaded guilty to the charge and was sentenced to 30 days in the county workhouse. Judge H. Alfred Glascor suspended the sentence and placed Kruse on six months probation.

Kruse and the other students — Nicky Von Alboreo, a senior from Akron, Garth W. Lynn III, a senior from Chicago, and Todd C. Harder, a senior from Elsmore — were charged after OSU Police arrested them Jan. 10.

The students were arrested after police were notified that a group of students were entering the tunnels through a manhole near Ives Hall.

The students said they went in the tunnels to drink beer and take pictures. The tunnels carry heat and electricity from McCracken Power Plant to the buildings

on Main Campus.

The prosecution alleged the photos were detailed and might have been used to plan a robbery, but the students claim the photos were posed shots of the group using the tunnels as a backdrop.

Each of the students charged in the case received a different judge and a different sentence.

Lynn appeared Tuesday before Judge Robert Wasylik and was sentenced to 30 days in the Franklin County Correctional Facility and five years probation.

Wasylik suspended 10 days of the 30-day sentence and will suspend the rest upon Lynn's completion of 80 hours of community service.

Alboreo pleaded no contest Thursday before Judge Bruce Jenkins and was given until March 30 to decide between paying a \$250 fine or spending nine days in jail.

Harder pleaded not guilty to the charges before Judge Marvin Romanoff Thursday and requested a jury to decide his case. Harder's trial has been set for April 25.

Tunnel invader told to guard manhole

By Mary Yost
Dispatch Court Reporter

3-5-84

An Ohio State University student who went into a tunnel as a trespasser came out of Franklin County Municipal Court a guard.

Beginning today, Judge H. Alfred Glascor ordered administrative sciences student Eric Dale Kruse, 22, of Pemberton, Ohio, to stand guard over a manhole that he entered two months ago with three others.

"I told him I'd treat him like they do in the Army," Glascor said today.

"If you're guarding a prisoner in

the Army and he escapes, you have to do his time," Glascor said.

KRUSE MUST guard the manhole cover near Ives Hall for four hours a day during the next two weeks to qualify for six months probation, Glascor ruled.

The judge placed Kruse on probation and ordered him to guard the manhole after he pleaded guilty Friday to criminal trespass, a fourth-degree misdemeanor. If he violates the probation, Kruse could be ordered to serve 30 days in the Men's Workhouse.

Kruse and the other three men he was with told police they entered the tunnel system to drink beer and explore, said OSU Police Supervisor David Hollenbeck.

Hollenbeck said authorities don't like students in the tunnels because of the potential for theft, vandalism or injury.

Two of the other three men have been found guilty of criminal trespass.

GARTH LYNN III, 21, of 49 E. Norwich Ave., Apt. A, was ordered by Judge Robert Wasylik to do 80 hours

of community service to avoid a 30-day suspended workhouse term. He was placed on five years' probation.

Nicky Von Alboreo, 22, of 127 Houck House, was given until March 30 to tell Judge Bruce Jenkins his choice between a \$250 fine plus court costs or nine days in jail.

A criminal trespass charge also is pending against Todd Harder, 23, of 39 E. Lane Ave., Apt. B.

All but Harder are current OSU students, police said.

Manhole vigil fits crime

By Richard E. Bloom
Dispatch Staff Reporter

3-27-84

Ohio State University student Eric Dale Kruse started digging himself out of a hole by standing guard over one Monday.

OSU campus police caught Kruse, 22, and three others partying inside the university's tunnel system about two months ago.

In Franklin County Municipal Court on Monday, Judge H. Alfred Glascor, out to give Kruse a whole new perspective on campus escapades, ordered him to guard the manhole outside Ives Hall they used to enter the tunnels.

"I'd rather be sleeping now 'cause I just got back from Florida late last night, but at least I get Saturday and Sunday off," Kruse said on the first day of his 10-day guard duty.

An administrative sciences student, Kruse pleaded guilty to one count of criminal trespass, a fourth-degree misdemeanor. Glascor placed him on six months probation, providing he maintains the manhole vigil four hours a day for two weeks.

"Heck, I think I got off easy," Kruse said, perched atop a towel-covered edition of the Yellow Pages. "Garth (Lynn III) got 80 hours community service and Nick (Von Alboreo) had to pay a \$250 fine."

A criminal trespass charge is still pending against a fourth man, Todd Harder, 23, who is not an OSU student.

"My sister's bringing me lunch about noon, and some friends are coming over later to play cards and backgammon," said Kruse of Pemberton, Ohio.

"Next week when I have time to put things together, I'll probably be out here with a deck chair and cooler, but my probation officer said there better not be any beer in the cooler."

Kruse said he can pick his own guard duty hours and had to jockey only one course to accommodate the watch. But he wasn't sure whether he could get a rain check if it rains.

Less than a half-hour into his opening vigil, Kruse was oblivious to student traffic along Woodruff Ave., near Neil Ave., as he read *The Universe and Dr. Einstein*. To the casual observer he looked like a student studying for a class.

"I don't feel stupid," he said, leaning against the north side of the building in front of the padlocked manhole, "but I'm supposed to tell anyone who tries to go down there they'll go to jail.

"I just wish I was on the other side of the building so I could catch some rays."



Dispatch photo by Craig Holman

Eric Kruse, lower right, kills time guarding a manhole by playing euchre with, from left, Amanda Francus, Garth Lynn

III, his sister Amy Kruse, Nicky Von Albreo and Tom Namola.

IMAGINE the challenge of providing utility services to over 300 buildings throughout 1000 acres of Ohio State's Columbus campus. Now try doing this without the average person knowing! That's exactly what the two miles of a complex network of underground tunnels do. These tunnels provide a means of distributing a myriad of utilities to the many buildings around campus.

Responsibility for these tunnels rests with Ohio State's Office of Physical Facilities, with Dean Ramsey as director. Physical Facilities is the lifeline of the university, yet as Ramsey emphasizes, "Our objective is not to be seen." Such is the case with the tunnels. The unseen tunnels distribute such basic utilities as: steam, hot and cold water, natural gas, compressed air, and electricity. More advanced utilities such as communications, fiber optics, and lines for class bells are also run through the tunnels.

The philosophy behind the tunnel system is to centralize utility distribution. The confusion and extra work of separately dug lines are avoided by having the utilities distributed through a single tunnel system. The utility lines are easier to access, maintain, and repair in the tunnels. It is also relatively easy to install new utilities, like the recently added fiber optic cables.

As Ramsey points out, the tunnels contribute to the beauty of the campus. Unlike most communities, one sees no unsightly electric lines or telephone poles at Ohio State!

The tunnels and enclosed utilities have an excellent service record. They must. Without steam for heating, electricity for lights, or communication lines for phones, the university would soon come to a grinding halt.

However there are occasional problems. The most notable incident was a water line break in a tunnel near Pomerene Hall. Water flooded the basement of Campbell Hall, damaging a historic clothing collection.

Portions of the tunnels have collapsed due to extreme loading. Such was the case when an asphalt truck driver failed to heed warnings and subsequently collapsed a section near Baker Systems Engineering Building. Less severe damage was the case when landscape workers broke into a tunnel ceiling while digging a hole for a tree.

Such accidents can be very danger-

TUNNELS IN DEPTH

By Ron Dull and Brian Thomas

ous. The high voltage lines are deadly. Eighteen inch diameter lines carry steam at 200 psi and 600 degrees. F. Leaks can shoot streams of steam powerful enough to cut through electric and communication lines. This danger is minimized by protecting electric and communication lines with conduit.

Deterioration and unusual pipe stresses can also cause failures. To reduce expansion and contraction stresses, expansion sections are placed at regular intervals. Expansion sections are made of flexible piping, placed to allow free expansion and contraction of

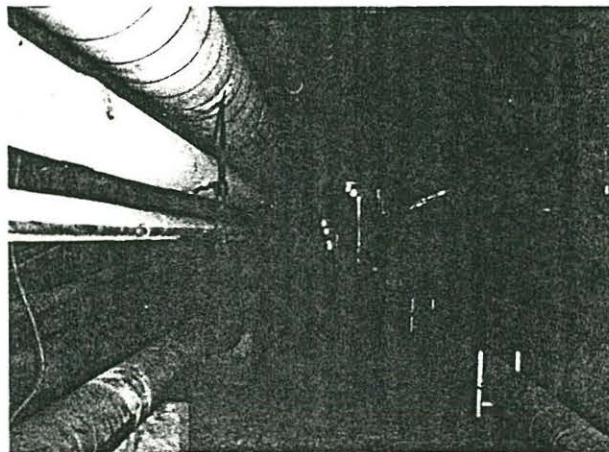

The view down one of OSU's many tunnels.

long lengths of pipe.

To deal with water line problems, alarms detecting water levels are installed periodically throughout the tunnels. Sump pumps are also in place to pump water out of the tunnels.

To assist in maintenance and problem determination, Physical Facilities plan to digitize some 40 tunnel maps over the next two years. A computer can "layer" each utility so that at any time only the utility of immediate concern can be viewed. These digital maps will be "very helpful in finding any given utility problem," says Roger Fettrow, director of utilities distribution.

Portions of the current tunnel system date back to 1912. These older tunnels are centered around the original physical facilities building, located near the present site of Brown Hall Annex. Under

Brown Hall Annex, three levels of tunnels radiate out, forming the original tunnel network. The present network stretches from Woodruff Avenue to the medical campus, encompassing almost all of main campus.

The tunnels are typically seven feet high and seven feet wide. The older tunnels are constructed of brick made by convicts from the now vacant state penitentiary in downtown Columbus. These older tunnels have arched brick ceilings.

Later constructions are similar, except the ceilings consist of concrete slabs. The tunnels range in depth from five feet, such as those that cross the Main Oval, to just below the surface, where the slab ceilings form the sidewalk above.

Utility lines are positioned along both walls of the tunnels, either supported from the ceiling or by racks attached to the walls. Air vents are at regular 200 foot intervals. Ventilation is aided by

natural suction at the main tunnel entrance in McCracken power plant. The power plant's large boiler continually draws fresh air through the tunnels.

Brown Hall Annex is scheduled to be demolished within the next two years so that an addition to Cockins Hall can be built. Engineers will face several challenges in working around the tunnel system. Due to the complexity and strength of the old foundation, it will be difficult to remove it without damaging existing tunnels. Since utilities to most of North Campus run near Brown Hall Annex, a disruption

in this local area could cut off service to many North Campus buildings. Establishing a new foundation around the existing tunnels will also prove to be difficult.

As one might expect, there are a few "stories" about the tunnels. During the student riots of the 1960s and 1970s, students found access points into the tunnels. Students were rumored to use the tunnels to come up behind lines of police and national guardsmen. To prevent such access the university installed locked gates at various intervals throughout the tunnels.

At one time a mattress was found, and people were thought to live in the tunnels. No one can vouch to seeing any hermits, though! Fettrow reports few problems with animals living in the tunnels, except for an occasional cat.

• April 13, 1995 • onCampus

Tunnel vision

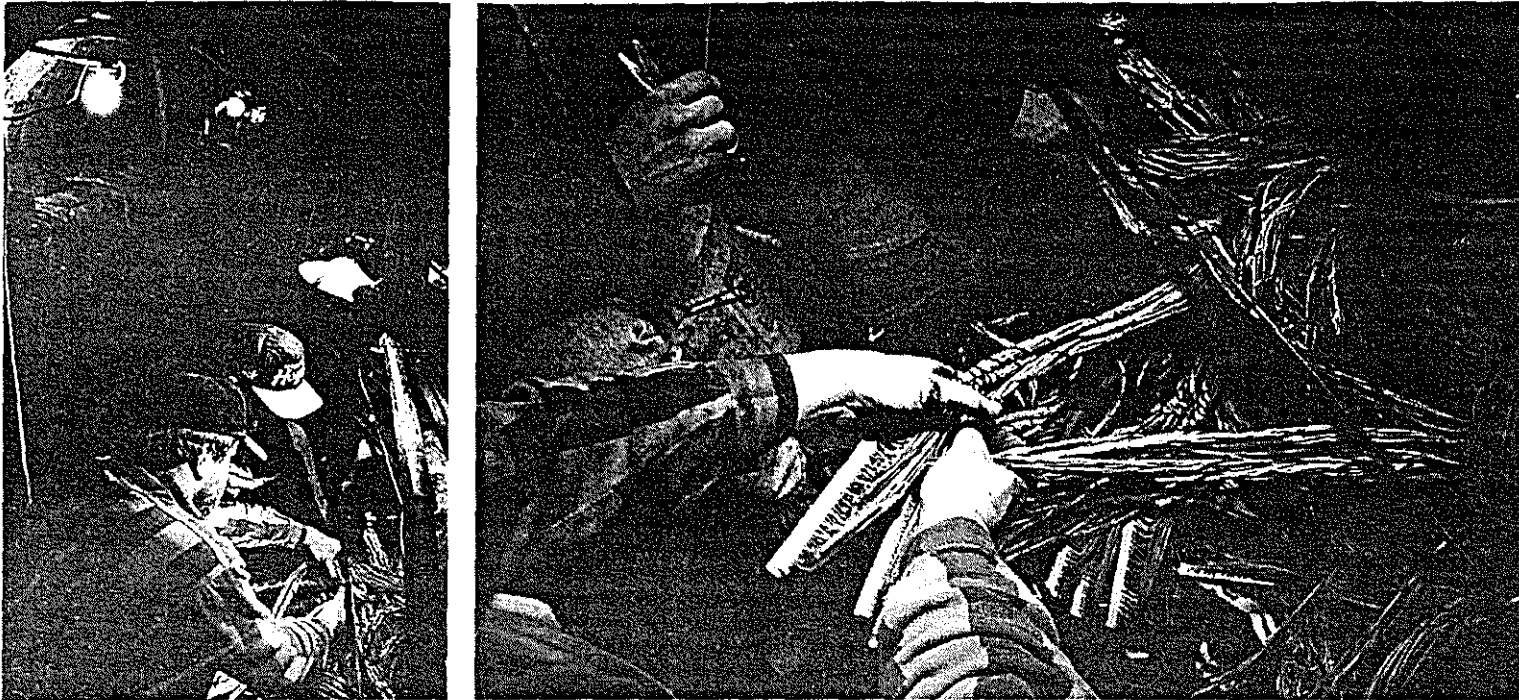

By Jo McCulty

THE UNIVERSITY UNDERGROUND keeps the world going 'round. Beneath the Columbus campus, all kinds of activities are hidden. Contractors Mark Jackson, front, and Tim Colopy splice together telephone wires in the utility tunnel under Neil and 17th avenues. The cable they are repairing normally is protected by pressurized air that is pumped through a sheath and keeps water from touching the copper wires inside. The cable, which is capable of carrying 600 phone lines, had an air leak.

This
issue:

Autumn 2011

Resources

Special B-section/pullout

onCampus

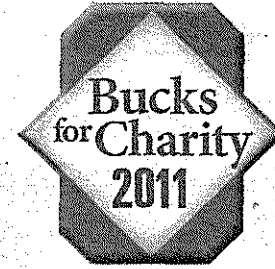

Annual guide
to giving,
4-page center
spread

The Ohio State University Faculty Staff Newspaper | oncampus.osu.edu

November 3, 2011

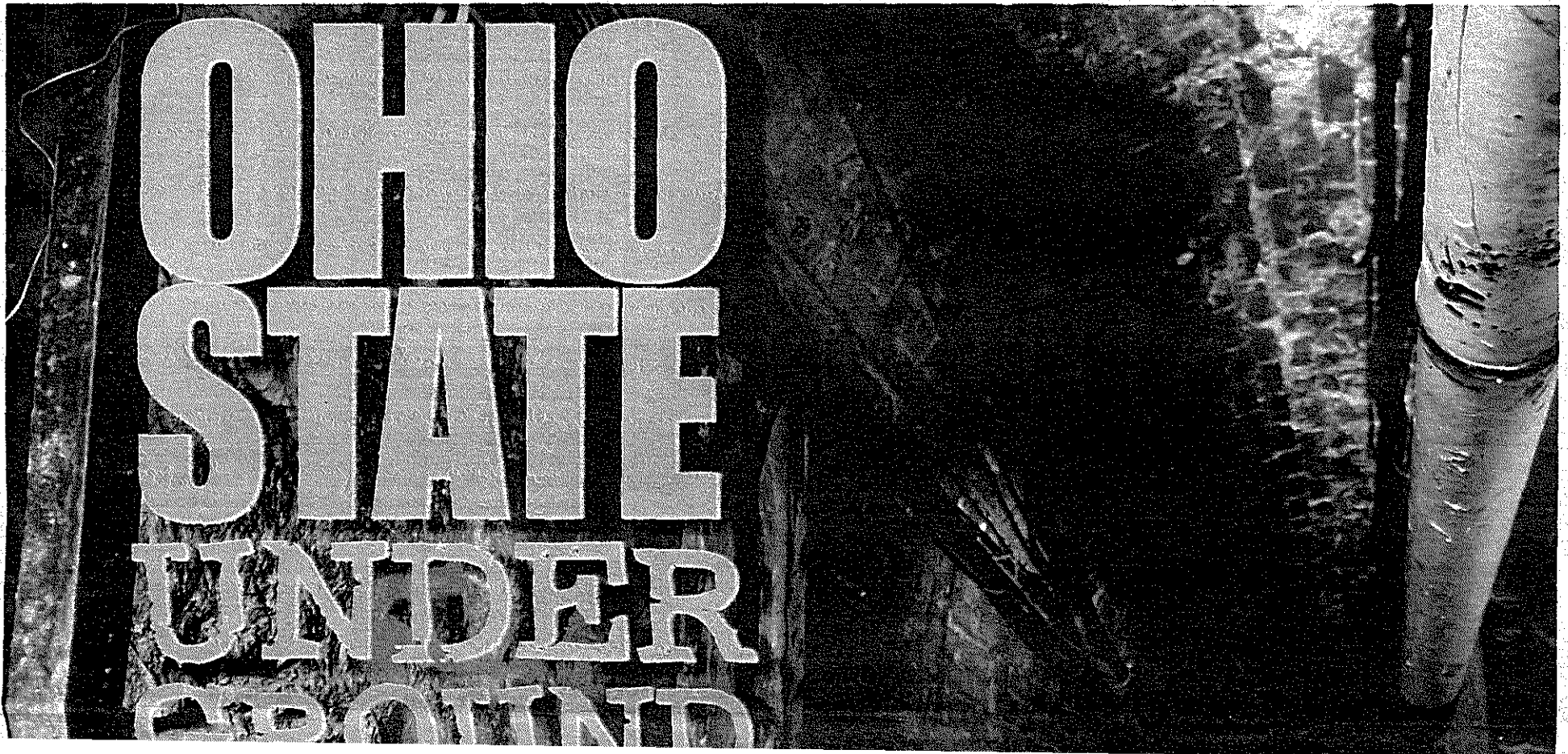

GROUND

History lurks in the tunnels that snake along beneath our feet...

See story, Pages 8-9

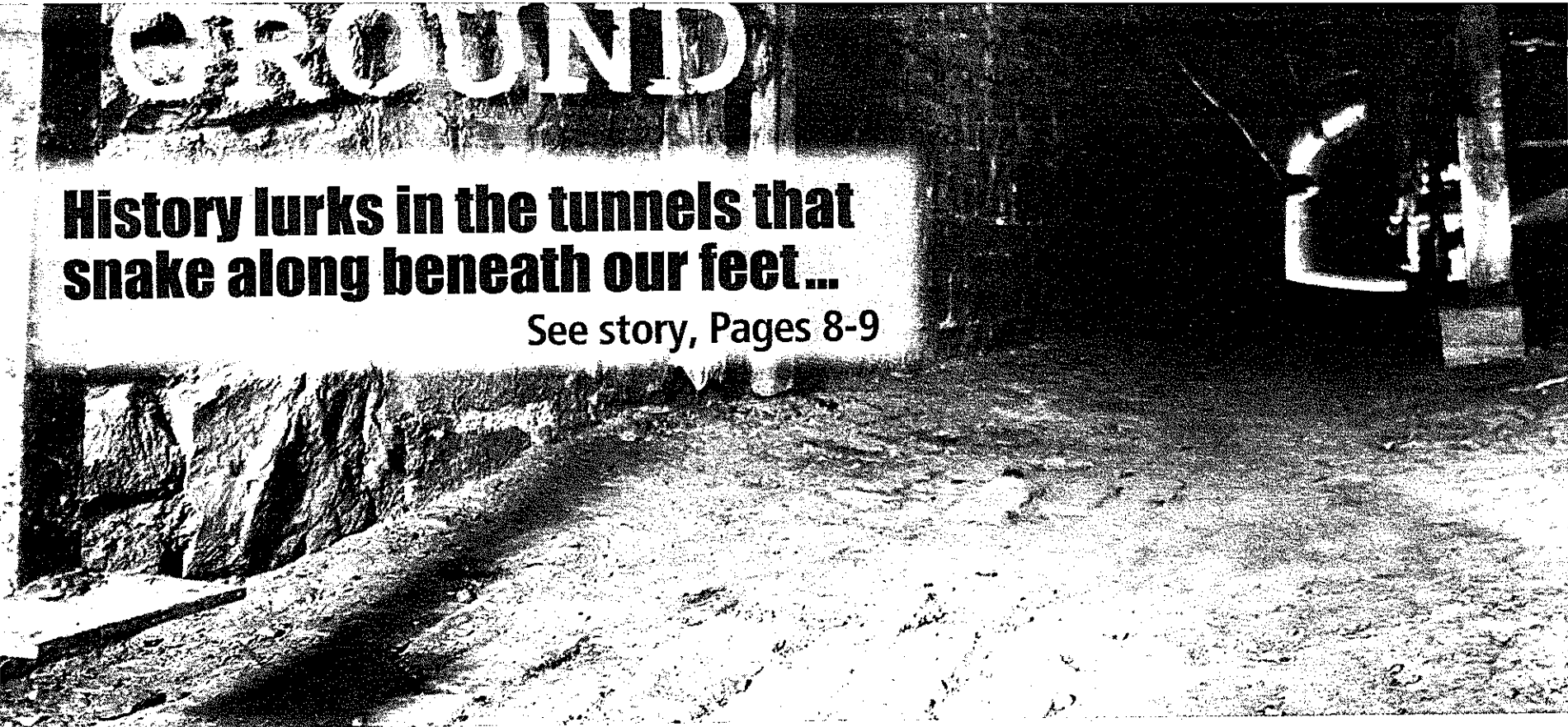

Online poll of the week

88 Percentage of staff/faculty who say the university needs more creative means of funding its programs. Visit oncampus.osu.edu for next week's question.

Inside Vol. 41 No. 7

- Program urges students to take a prof to lunch **6**
- Leaders make the case for parking, other changes **10**
- Benefits changes needed so care stays affordable **17**

This week in history

In 2001, former president George H.W. Bush visited campus to deliver the Fisher Council on Global Trade and Technology Lecture at Mershon Auditorium.



onCampus
Faculty | Staff | News
21 E. 11th Ave.
Columbus, Ohio 43201-2126

Kevlin C Haire
Librarian I
University Libraries
132 Library Book Depository
2700 Kenny Rd
Columbus OH 43210

5150

Find the latest classifieds on the Bulletin Board @ oncampus.osu.edu

In Ohio State's century-old underbelly, it's a little too

Adam King onCampus staff |

When Henry Dammeyer opened the door at the lowest level of the Math Tower, an inhospitable heat enveloped him as he descended the three-step metal staircase.

He stepped into a room that was dimly lit, with pipes that crisscrossed the alcove and extended off into the darkness. Dammeyer turned to his right, and a tunnel that had beckoned him many times before stood waiting, blacker than night.

It was a part of Ohio State few ever get to see and fewer still even knew existed beneath a campus going about its daily bustle. Dammeyer has spent thousands of hours in the Ohio State tunnels — all eight miles of them — during his nearly 17-year OSU career.

There are enough twists, turns and dead ends to disorient even seasoned tunnel dwellers, and there are no directional markers. Dammeyer, the technical director of Utilities, always tells employees new to the tunnels to be sure and bring two flashlights.

“Do you want to be standing in that dark tunnel with your batteries dying, wondering which way is out?” he chuckled. “You learn quickly.”

Dammeyer himself doesn't need any help. He's walked Ohio State's underground enough times to know his way around. He figures about eight employees in all are

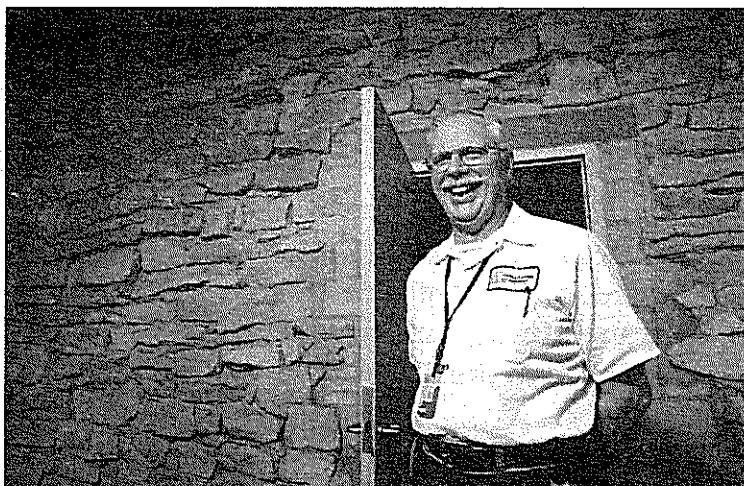

Photos by Al Zanyk

Henry Dammeyer, technical director of Utilities, stands before a fieldstone wall in the basement of the Math Tower that belonged to the old Brown Power Plant. It's the only remnant of that more than 100-year-old structure — but a testament to the durability and ingenuity of the construction of that day.

self-sufficient in the tunnels — and most of them won't be far behind him when he retires Dec. 16.

Fortunately, the newest members of the distribution maintenance crews — who work on the tunnel piping that carries natural gas, potable water, chilled water and steam and condensation — are quick studies, and Dammeyer said OSU's utility infrastructure is in good hands.

Most of the time Dammeyer's tunnel strolls have been uneventful, quiet inspections. But he'll never forget the night a water line burst.

Going beneath Ohio State means stepping into history. The walkways, walls and arches in the

oldest tunnel sections — first started in the late 1800s and constructed with heavy, red bricks made by prisoners at the Ohio State Brick Plant in Chillicothe between 1909 and 1926 — make for an excellent barrier against street-level saltwater.

But the tunnel's age was working against Dammeyer that night. The water from the burst pipe eroded the brick flooring, and Dammeyer was suddenly falling through a gaping hole filled with ice-cold water that went over his head.

“I had to swim my way out of it and climb back up,”



Dammeyer said. “I was thinking,

Archives.

THE ARTS AT OHIO STATE



A SAMPLING OF UPCOMING EVENTS

Last Days of Judas Iscariot

NOVEMBER 10 - 20

Roy Bowen Theatre, Drake Center
theatre.osu.edu

Side by Side: Mozart and Sondheim

NOVEMBER 12, 8 pm

Thurber Theatre, Drake Center
music.osu.edu



OSU Marching Band Concert

NOVEMBER 13, 3 pm

Veterans Memorial
music.osu.edu



PHOTO: STEPHANIE MATTHEWS

MFA Dance Concert

NOVEMBER 18 - 19, 8 pm

Northland Performing Arts Center
dance.osu.edu

Details and many more performances listed on our website.

COLLEGE OF ARTS AND SCIENCES
asc.osu.edu/artsandculture

"I had to swim my way out of it and climb back up,"

Dammeyer said. "I was thinking, 'Great, I'm going to drown in the tunnel. They'll just fill the hole in and I'll become another legend.'"

While the mishap makes for a great story now, Dammeyer doesn't plan on going into any tunnels once he retires.

But sharing that part of his career with others is rather fun, said Dammeyer, who has spent quite a bit of his free time researching the tunnels' history in the OSU

Archives.

Last spring his crew was boring a new electrical duct bank between the Northeast Parking Garage and Dreese Hall near Oxley's by the Numbers, when they hit what they thought was the building's foundation. But according to their map, whatever they hit shouldn't have been there.

Dammeyer pulled out the 1918 map he keeps in his office.

"It's always handy to have an old

M.T. Wellness Clinic



Columbus' leading provider of **Medical Restorative Massage Therapy**®

Reduce pain and restore physical function

www.MTWellnessClinic.com

1151 Bethel Road, Suite 302

614-273-0810

OSU Health Network Provider

easy to get lost ...



When prisoners made bricks in the Ohio State Brick Plant, they were stamped "convict made" with the date of their creation. These bricks line miles of Ohio State's tunnels, and it's believed prisoners were sent by train to build some of the tunnels in the early 1900s.

map, especially around this place," he said.

It turned out the crew had struck the foundation for the old Marconi Station, a wireless radio telegraph office the US Army used during World War I. The military was developing machine guns there and using the station to communicate weapon readiness and personnel transfer orders.

Over the years, the tunnels have acquired three distinct looks. The bricked

A hostile environment

Working in the Ohio State tunnels requires more than just stepping inside and getting busy.

During the summers, the tunnels can easily become a dangerous health risk. Temperatures in the tunnels can reach 160 degrees Fahrenheit. Heavy-duty gloves are required just to be able to grab the handrails on the tunnel ladders.

Utilities maintenance crews can only work for 10 to 15 minutes at a time in those conditions before they have to come out and cool down.

"That's why you'll see our people

Dec. 15 is deadline to change your ARP representative



Mitch Grant

- Specializing in ARP, 403b, 457 and STRS PLOP
- Efficient portfolio design
- *Comprehensive* financial and estate planning
- 20 years of experience working with OSU faculty and staff

Call Mitch Grant today at 431-4330



mitch.grant@LFG.com

mitchellgrantfinancialperformance.com

7650 Rivers Edge Drive, Suite 250, Columbus, OH 43235

Securities and investment advisory services offered through Lincoln Financial Advisors Corp., a broker/dealer and a registered investment advisor. Member SIPC. Insurance offered through Lincoln affiliates and other fine companies.

Lincoln Financial Group is the marketing name for Lincoln National Corporation and its affiliates.

7650 Rivers Edge Drive, Suite 250, Columbus, OH 43235 • (614) 431-4330 • CRN201101-2050120

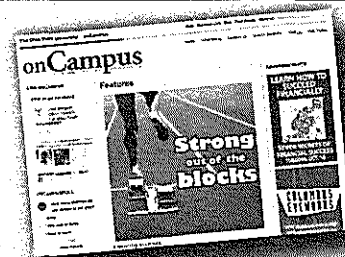

onCampus online

Advertising That Clicks

oncampus.osu.edu



business and personnel transfer orders.

Over the years, the tunnels have acquired three distinct looks. The bricked archways were the architectural style until 1914. After that, convict bricks were still used in the walls and walkways, but the ceilings became flat concrete. And by the 1960s, concrete was used completely for new additions or when older portions of the tunnel needed to be torn down and reformed to add new infrastructure.

Brick is an excellent structural material, but concrete and the labor involved to put it in are cheaper. There are still several miles of the brick tunnels, mostly below the older parts of campus as well as some on West Campus.

A little more than 10 years ago, students were known to break into the tunnels and play a live version of Dungeons & Dragons — something Ohio State vehemently discouraged for safety reasons (the students were caught and prosecuted). But around that same time, the tunnel had an uninvited guest, a raccoon the employees nicknamed Ricky. Dammeyer was worried the students would accidentally encounter Ricky.

“He was not a friendly raccoon,” Dammeyer said. “You get in a very narrow space like that and you have

work for 10 to 15 minutes at a time in those conditions before they have to come out and cool down.

“That’s why you’ll see our people sitting outside the McCracken Power Plant in 90-degree weather,” said Henry Dammeyer, Utilities technical director. “That’s cool to them. You’re looking for a sweater at that point.”

In preparation for the extreme heat, Utilities crews make certain they’re properly hydrated and have enough electrolytes in their bodies. A close eye is kept on the time spent in such conditions as well.

“We’re trained and our people are trained,” Dammeyer said, “so we avoid getting ourselves into a dire situation.”

a raccoon that’s trapped, they get a little ferocious. Ricky left on his own accord as far as we know. We’ve never found him since.”

There’s a much safer way for students, faculty and staff to see the tunnels. Students may book a tour through Student Life and faculty and staff can contact Utilities administrative assistant Darla Brewer (brewer.260@osu.edu) or Ryan Wester (wester.2@osu.edu), who will be Dammeyer’s replacement.

Dammeyer said there is at least one benefit to knowing and having access to the tunnel system. During winter while everyone else is trudging through the snow, he’s taking a warm, dry walk between buildings.

WE'RE STILL GROWING...

The more suppliers eStores has available, the more your department can save on everything from staplers to sandwiches to software. Listed here are the newest vendors in eStores. View these vendors' catalogues by visiting eStores through the eRequest site at erequest.osu.edu

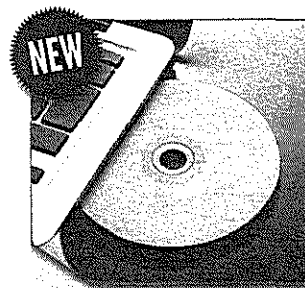

Insight Technology



Dupler Office



Cheryl's Cookies

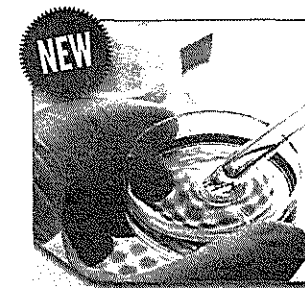

Santa Cruz Biotechnology

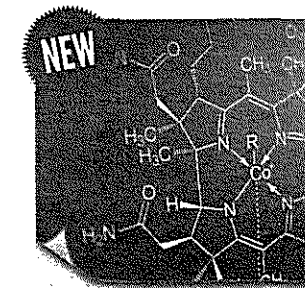

Sigma Aldrich



Schmidt's Hospitality

CEHL CONNOR, EVANS & HAFENSTEIN LLP
Attorneys and Counselors at Law

Accidents? DUI? Moving violations? We can help! Local attorneys helping those in trouble for over 40 years. Discounted fees for OSU employees and their families.

Contact Ken for a FREE CONSULTATION.

614-464-2025 • www.cehlaw.com

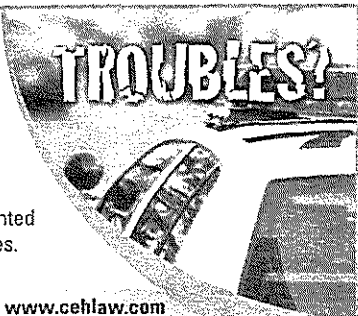

eStores

STORES SERVICE CENTER: 2-2694

CAMPUS LIFE

Once-a-year tour displays off-limits sites at Ohio State



JONATHAN QUILTER | DISPATCH PHOTOS

Tour guide Katie Holloway, third from right, leads a tour of the bell tower at Orton Hall on Ohio State's campus. It's one of 21 sites that graduating seniors and others got to see this week.

By **Encarnacion Pyle**

The Columbus Dispatch Friday May 3, 2013 8:19 AM

Many Ohio State University students have heard about the 8 miles of steam tunnels that run underneath the main campus.

But few have walked through the dark, hot corridors without getting arrested for trespassing. However, once a year, Ohio State allows graduating seniors and others to see such places.

[View a slide show of OSU curiosities](#)

The "Things You Never Got to See Tour" showcases 21 sites, including limited-opportunity tours of Ohio Stadium, OSU's **underground tunnels** and the Orton Hall bell tower.

Yesterday, OSU's utilities director, Ross Parkman, led groups of 15 students at a time through a large utility room, down a small ladder and into a narrow tunnel beneath the school's recreation center.

"Wow, it's really hot," one student said after being hit by a wave of humid air just a few steps into the tunnel.

A lot of the old tunnels on campus are constructed of bricks made by prisoners in the Ohio State Penitentiary during the 1920s, '30s and '40s, Parkman told the group. But this one is made of newer technology — cast-in-place concrete.

"We run 185 pounds per square inch of steam at 550 degrees," he said underneath a flickering light that cast an eerie glow. "That steam goes to 136 buildings on campus."

"That's incredible. This is so awesome!" said Jessica Hines, a 22-year-old

graduating accounting major from Chardon, after learning that the air temperature was 115 degrees.

"It's like getting to see the university's secrets," added Nathaniel Kralik, a 21-year-old from Hudson, about 30 miles southeast of Cleveland, who is graduating with majors in comparative studies and French.

On Wednesday night, dozens of students climbed the stairs of the castlelike tower of Orton Hall on the Oval to learn about the chimes that have serenaded the campus for more than a century.

They also heard stories about the building's namesake — Edward Orton, OSU's first president, who liked to read at the top of the tower by lamplight before the bells were installed. Some still claim to see a flickering light through the vertical slots of the turret on some nights.

"His ghost still haunts the campus," said tour guide Katie Holloway, a 21-year-old human-development and family-science major. "But he's less a scary ghost and more a teacher ghost who likes to chill the air and shush students who are acting out in class."

Although the students didn't get to climb to the upper two tiers of the tower, they learned that the building holds 14 bells: 12 E flats, an A sharp and a G sharp. The bells chime every 15 minutes.

Some of the students snapped photos of the mechanisms that run the bells. Others wrote their names in ink on the tower's bricks, a tradition that dates to the early 1900s, when the first person signed the bell-tower door.

"It brings back so many memories," said Simon Cheung, a 22-year-old consumer and family financial-services major from New Albany who had climbed the tower once before with a student volunteer group. "I will miss hearing the chimes play *Carmen Ohio* when I graduate next year."

epyle@dispatch.com

[@EncarnitaPyle](#)

Email

Ads by Yahoo!

Transportation Software

Transportation and Logistics software including accounting
(omni-info.com)

Web 2.0 Apps In Minutes

Generate database & reporting apps straight from your database! Try it
(www.ironspeed.com)

Dispatch Software

Find Providers of Dispatch Software Solutions on Business.com.
(www.business.com)

Be A MegaMillion Winner

This Is The February Surprise The Lotteriers Are Trying To Avoid...
(www.secretmasterformula.com/cn/1.1)