MEDIUM VOLTAGE DRIVES

ACS2000 AFE 1MVA

User Manual



High reliability due to proven design and low parts count

Fuseless design

Air-cooled

Application tailored design

Softstarter

Arc resistant design

Direct torque control

Power range from 250 to 800 kW

ABB Sp. z o.o.
System Drives
Placydowska 27
95-070 Aleksandrow Lodzki
Poland

Document name
ACS2000 AFE 1MVA
User Manual

Document number
3BHS297030 ZAB E01 Rev. J

Issue date
2020-07

Table of contents

8	Terms, trademarks, related documentation	132	CDP control panel
14	General information on manual and drive	150	Preventive and corrective maintenance
20	Important note on main circuit breaker		
24	Safety		
30	Power electronics and cabinet features		
48	Control system		
68	Transportation, storage and disposal		
78	Mechanical installation		
86	Electrical installation		
110	Commissioning		
114	Commissioning check list		
118	Operation		

List of figures

21	Drive system overview	41	INU - Inverter unit
22	MCB opening timing diagram	41	EMC filter
28	Safety labels	42	Terminal compartment
32	Drive overview with input transformer	44	Door locks
32	Single-line diagram of direct-to-line configuration	45	Fan unit types
34	Drive overview with input transformer	46	Example of fan group 1
34	Drive overview with input transformer	46	Example for the operating time of the fan units
35	IFU - Input filter unit	47	Air flow inside the drive
36	AFE - Active front end	47	Air pressure switches
37	Phase module	49	Block diagram of control system
38	DC-link	50	Control compartment
39	Grounding switch	51	Control compartment details
39	Grounding circuit	52	AMC circuit-boards location
40	Grounding the drive	53	Direct torque control

54	IOEC modules overview	102	Bolted busbar connection
54	IOEC modules location	103	Control cable entry
56	IOEC module terminals	104	Preparing control cables for EMC plates
57	IOEC module identification	105	Preparing control cables for sealing modules
65	Location of fieldbus and pulse encoder interface	105	Preparing control cables for cable glands
72	Lifting rails	106	Shield grounding point for encoder cable
72	Transporting the cabinet by crane	123	Local operator panel
73	Transporting the cabinet by forklift	133	CDP control panel
82	Fixing the cabinet to the floor	152	Device identification
92	Grounding the drive system and integrated transformer	153	Alarm / fault indication
93	Grounding the drive system and non-integrated transformer	156	AMC34 circuit board
94	Drive with integrated transformer	157	IOEC module
94	Heating cable connection	158	AF 100 interface
98	Preparing power cables for EMC plates	159	NETA-21 remote monitoring tool
99	Preparing power cables for sealing modules	161	Modbus RTU interface
101	Power cable entry	162	Profibus interface
		166	Four-way grounding set
		167	Connecting a grounding set
		169	Service covers

170 Replacing filter mats

171 Phase modules location

**171 Phase module – Dimensions
and weight**

List of tables

55	3-1: IOEC module configuration	62	3-11: Optional digital input signal allocation
55	3-2: 24 V internal voltage supply	63	3-12: Optional analog input signal allocation
57	3-3: IOEC module identification	63	3-13: Optional analog output signal allocation
58	3-4: Standard analog input signal allocation	70	4-1: Transport Conditions
58	3-5: Standard digital output signal allocation	74	4-2: Storage conditions
59	3-6: Standard digital input signal allocation	91	6-1: Auxiliary power terminal sizes
60	3-7: Example for digital input signal allocation	91	6-2: I/O module terminal sizes
61	3-8: Standard analog input signal allocation	119	8-1: Operating conditions
61	3-9: Standard analog output signal allocation	158	10-1: AF 100 LED description
62	3-10: Optional digital output signal allocation	159	10-2: NETA-21 LED description
		161	10-3: Modbus RTU LED description
		162	10-4: Profibus LED description

Terms, trademarks, related
documentation

Terms and abbreviations

The following table lists terms and abbreviations you should be familiar with when using the manual. Some of the terms and abbreviations used in the manual are unique to ABB and might differ from the normal usage.

Term / Abbreviation	Meaning
AMC circuit board	Application and Motor Controller The digital signal processor is the heart of the control system of the drive. A separate AMC circuit board is assigned to the line-side rectifier (AFE) and the motor inverter (INU) of the drive.
AFE	Active Front End The AFE, also referred to as ARU (Active Rectifier Unit), is the line-side rectifier of the drive that enables four-quadrant operation and reactive power compensation.
Converter	Short form for ACS2000 frequency converter
Cluster	A cluster is a synonym for a group of hardware modules of the drive control system.
DDCS	Distributed drive control system DDCS is an acronym for a serial communication protocol designed for data transfer via optical fibers.
Drive	Short form for ACS2000 frequency converter
Drive system	The drive system includes all equipment used to convert electrical into mechanical power to give motion to the machine.
DriveBus	Communication link dedicated for ABB drives
DriveDebug	DriveDebug is part of ABB's <i>DriveWare</i> [®] software tools for drives using the DDCS communications protocol. DriveDebug runs on computers with <i>Windows</i> [®] operating systems. DriveDebug is a specialist's tool used to diagnose, tune and troubleshoot ABB drives.
DriveWindow	DriveWindow is a <i>DriveWare</i> [®] product. DriveWindow is a 32 bit <i>Windows</i> [®] application for commissioning and maintaining ABB drives equipped with optical communication links.
DriveMonitor	DriveMonitor is a monitoring and diagnostics system that allows secure access to the drive via the internet from a remote location. DriveMonitor provides long-term monitoring functions that allow to infer equipment status and improve equipment performance.
Equipment	Frequency converter and related equipment
EMC	Electromagnetic compatibility All measures to suppress electromagnetic disturbances caused by different electrical equipment in the same electromagnetic environment, and to strengthen the immunity of the equipment to such disturbances.
FE	Functional earth
Ground	Earth
To ground	The conducting path (eg, conductor) between the electric equipment (eg, frequency converter) and the earth. The electric equipment is connected to the earth, eg, by a grounding set or a grounding switch.
GTO	Gate turn-off thyristor
IGBT	Insulated gate bipolar transistor
INU	Inverter unit of the drive. The INU converts the DC voltage to the required AC motor voltage and frequency.
I/O module	Term of ABB's S800 I/O system. The I/O module is an active input or output device for digital or analog signals.
Line voltage	RMS voltage of the main power supply of the drive
MCB	Main circuit breaker The MCB is a major protection device of the drive system and connects / disconnects the main power supply to the drive. The MCB is controlled entirely by the drive.
PCB	Printed circuit board
PCC	Point of common coupling. The PCC is the point in the electrical power supply system where the responsibility of the utility changes to the industrial customer. The utility is responsible to provide clean voltage and current with respect to harmonic distortion up to the PCC. The industrial customer is responsible not to distort voltage and current by its electrical systems.
PE	Protective earth

Term / Abbreviation	Meaning
Phase module	The phase module is a compact assembly of wired components including power semiconductors and circuit boards that serves as a standardized building block for the AFE and INU of the drive.
PPCS	Power plate communication system PPCS is an acronym for a serial communication protocol designed for data transfer via optical fibers between AMC circuit board and INTerface circuit boards.
RTD	Resistance temperature detector or device The RTD is a temperature sensor where the change in electrical resistance is used to measure the temperature.
Safeline	ABB synonym for uninterruptible power supply
Supervisory signal	Indicates the operating condition of a circuit or device.
SW	Software
TC	Short form for terminal compartment of the drive
Zero speed threshold	Used in the manual to indicate that the drive has reached the value "zero speed" that is set in a parameter. The value can be set in the range of 0 and maximum speed (the unit for the speed is rpm).

Trademarks

Names that are believed to be trademarks of other companies and organizations are designated as such. The absence or presence of such a designation should however not be regarded as an offence

of the legal status of any trademark. The following registrations and trademarks are used in this manual:

Term / Abbreviation	Meaning
Windows®	Registered trademark of Microsoft Corporation
Industrial IT™	Trademark of ABB
DriveWare®	Registered trademark of ABB
Advant®	Registered trademark of ABB
Advant Fieldbus™	Trademark of ABB
Ethernet®	Registered trademark of Xerox Corporation
Profibus®	Registered trademark of Profibus International (P.I.)
Modbus®	Registered trademark of the Modbus IEC organization
ROXTEC®	Registered trademark of Roxtec AB, Karlskrona, Sweden

Related documentation

The following documents are available for supplementary information:

Title	Document number
Schematics	
Layout drawing	Project-specific
Specifications, guidelines	
Retrofit guideline	3BHS301179 ZAB E01
Main circuit breaker engineering guideline	3BHS104785 ZAB E01
ABB MVD ACS Motor Specification	3BHS824803 ZAB E01
Technical project Specification Motor	3BHS824804 ZAB E01
ABB MVD ACS High Performance Motor Spec	3BHS824805 ZAB E01
ABB MVD ACS High Speed Motor Spec	3BHS824806 ZAB E01
ACS2000 power cable specification	3BHS189994 ZAB E01
Power cables engineering guideline	3BHS542290 ZAB E01
Maintenance	
Preventive maintenance schedule	4MFB005215 ZP3 E01
Drive monitoring	
DriveMonitor user manual	3BHS268039 ZAB E01
Serial communications interfaces	
AF 100 fieldbus - NAFA-01 installation and start-up guide	3BFE58919837 ZAB E01
Modbus TCP - NETA-21 remote monitoring tool user's manual	3AUA0000096881 EXT E01
Modbus RTU - NMBA-01 installation and start-up guide	3AFY58919772 ZAB D01
Profibus - NPBA-12 installation and start-up guide	3BFE64341588 ZAB D01

General information on manual and drive

Copyright notice

The information in this manual is subject to change without notice.

This manual and parts thereof must not be reproduced or copied, or disclosed to third parties, nor used for any unauthorized purpose without written

permission from ABB Sp. z o.o.

The hardware and software described in this manual is provided under a license and may be used, copied, or disclosed only in accordance with the terms of such license.

Document identification

Ownership
ABB Sp. z o.o., System Drives

Document number
3BHS297030 ZAB E01

Revision index
J

Date
2020.07

Contact information

Address
ABB Sp. z o.o.
Placydowska 27,
95-070 Aleksandrow Lodzki,
Poland

Phone
+1 479 648 5912

E-Mail
drivesupport@abb.com

Web
<http://www.abb.com/drives>

Equipment covered by the manual

This manual covers a standard drive and provides generic information on the drive. The manual does not claim to cover all variations and details of the drive, nor to consider all eventualities that may arise during installation, commissioning, operation and maintenance of the drive.

If the drive is adapted to specific customer needs or applications, and handling, installation, and operation of the drive are affected by these modifications, information on these modifications is provided in the appropriate documentation (eg, layout drawings, wiring diagrams, project-specific data, engineering notes).

If information is required beyond the instructions in this manual, refer the matter to ABB.

Target groups and required qualifications

The drive presented in this manual is part of an industrial environment where voltages are present that contain a potential hazard of electric shock and / or burn. For this reason, only personnel who have a thorough knowledge of the drive and the industrial environment and have obtained the required qualification must handle, install, operate, or maintain the drive.

The manual addresses personnel who are responsible for unpacking, transportation, installation, operation and maintenance of the drive. The personnel must carry out the below listed tasks in a manner that does not cause physical harm or danger, and that ensures the safe and reliable functioning of the drive.

—

Commissioning of the drive must only be performed by qualified and certified ABB personnel.

Handling

The personnel must be skilled and experienced in unpacking and transporting heavy equipment.

Mechanical installation

The personnel must be qualified to prepare the installation site according to the site and equipment requirements and to perform the installation accordingly.

Electrical installation

The personnel must have a sound knowledge of the relevant electrical codes and specifications covering low and medium voltage equipment, be experienced with electrical wiring principles, and know the electrical symbols typically used in wiring diagrams.

Operation

The personnel include all persons who operate the drive from the local operating panel of the drive. The personnel must know the functions of the operating panel, be adequately trained for the drive, and know the driven process. Special knowledge of frequency converter technology is not required.

Maintenance

The personnel include all persons who

- are qualified to carry out preventive and corrective maintenance on drive as described in this manual,
- are thoroughly familiar with the drive,
- have a sound knowledge of the relevant electrical codes and specifications covering low and medium voltage equipment,
- are able to assess the hazards associated with the energy sources of the drive system and act correspondingly,
- know the safe shutdown and grounding procedures for the drive system.

Responsibilities of the user

It is the responsibility of those in charge of the drive to ensure that each person involved in the installation, operation or maintenance of the drive has received the appropriate training and has thor-

oughly read and clearly understood the instructions in this manual and the relevant safety instructions.

Intended use of equipment

Those in charge of the drive must ensure that the drive is only used as specified in the contractual documents, operated under the conditions stipulated in the technical specifications and on the rating plate of the drive, and serviced in the intervals as specified by ABB.

Use of the drive outside the scope of the specifications is not permitted.

Intended equipment use also implies that only

spare parts recommended and approved by ABB must be used.

Unauthorized modifications and constructional changes of the drive are not permitted.

Quality certificates and applicable standards

The following certificates and conformity declarations are available with ABB:

- ISO 9001 / ISO 14001 certificates stating that ABB Group has implemented and maintains a management system that fulfills the requirements of the normative standards
- EC Conformity Declaration
- List of the standards the drive complies with.

Items covered by delivery

Delivery comprises the following items (see figure below):

- Drive (1), shipped either in seafreight or airfreight packaging.
- Transformer (can be integrated or non-integrated) (2)
- Fan unit(s) (3), shipped separately.
- Phase module kit (4), if selected as additional option.
- Set of door keys (5)
- T-handle screwdriver with torx bit T30 (6)
- Rating label (7)

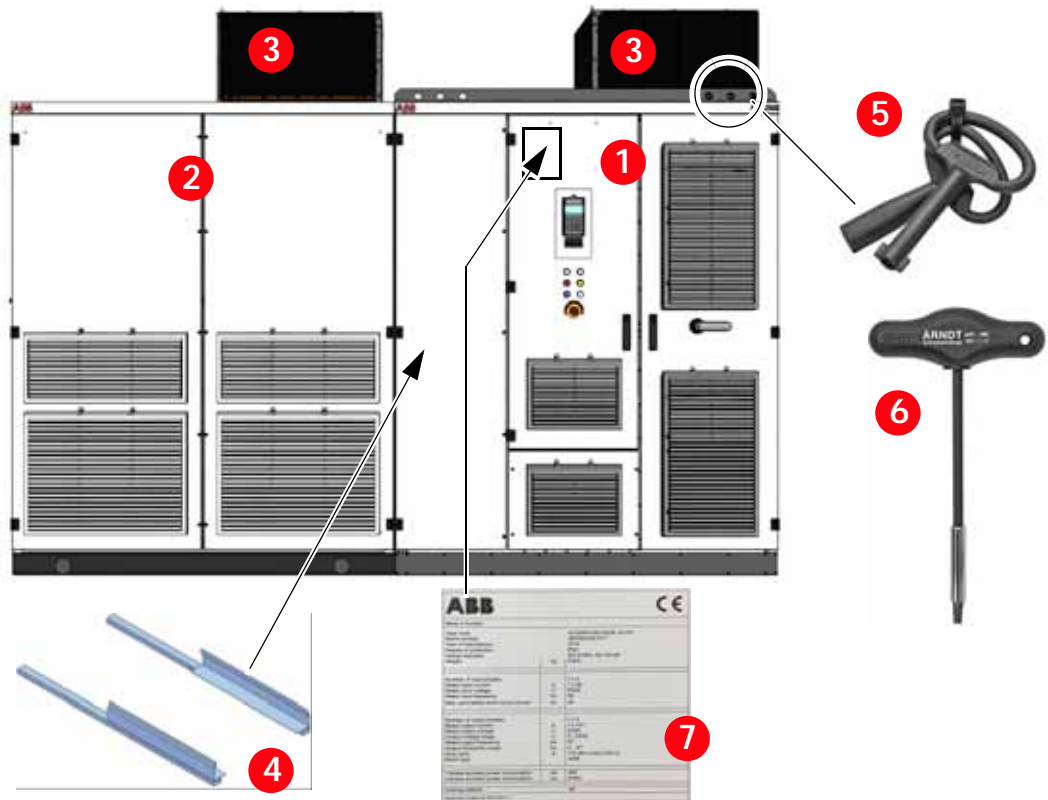

For a complete list of items supplied, see the shipping note.

Identifying the delivery

The drive and accessories are identified by the type code printed on the rating label (7).

The rating label is located on the front of the control compartment door.

The label provides information on the type of drive, the rated voltage, the frequency and the current of the main and the auxiliary power supply.

Important note on main circuit
breaker

—
References
—
0-1 Drive system overview

The main circuit breaker (MCB) is a major protection device of the drive. If a serious fault occurs in the drive, the MCB must disconnect the main power supply to the drive immediately. The main power supply must be disconnected without delay on an open or trip command from the drive to prevent hazard to the personnel and further damage to the equipment. The MCB is located on the primary side of the input transformer.

0-1 shows the conceptual single-line diagram of a typical drive system, including main power supply, MCB, input transformer, drive and electrical motor. The MCB is defined as a switching device to disconnect the power supply whenever required by the process or when a fault occurs. Typical devices used as MCBs are:

- Vacuum circuit breakers
 - SF6 circuit breakers
 - Fused contactors or motor control centers
- The overcurrent protection relay is part of the switchgear.

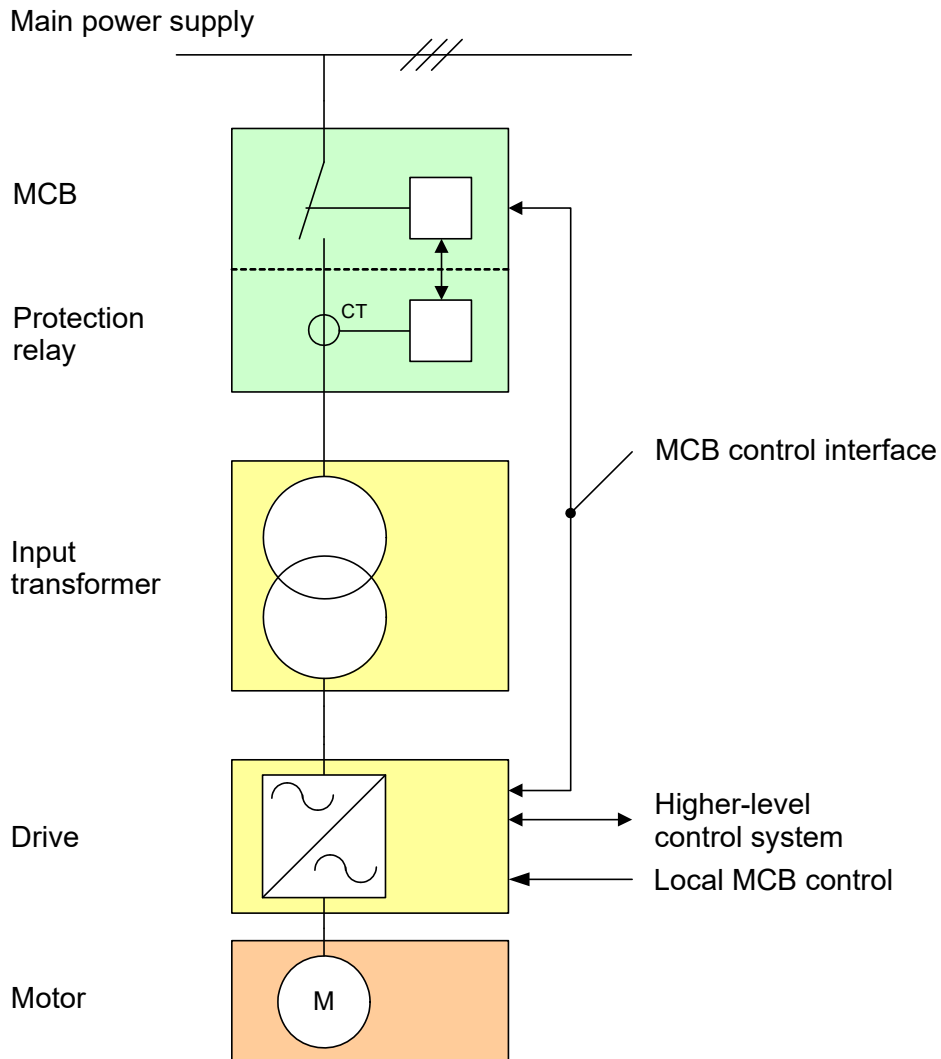

Safety and protection requirements

For safety and protection reasons, the MCB must meet the stipulated minimum requirements of the specifications of ABB MV Drives. It is the system integrator's responsibility to ensure that the minimum requirements are met. The minimum requirements for the MCB are stated in this note and in the respective MCB specifications, which are available for each medium voltage drive from ABB. The safety requirements for the drive are based on the following standards:

- ISO 13849-1 Safety of machinery - Safety-related parts of control systems - Part 1: General principles for design, section 6.2.6 Category 3
- IEC 60204-1 Safety of machinery - Electrical equipment of machines - Part 1: General requirements

Minimum requirements for MCB and MCB control

—
References
—
0-2 MCB opening timing diagram

- The MCB open and / or trip command has to be wired directly from the drive to the MCB. It is not permitted to wire the trip command through any PLC or DCS system if it is not certified to meet SIL 3 level requirements, and to fulfill the timing requirements outlined below. Opening of the MCB by the drive must be possible at any time. It is not permitted to interrupt the open and / or trip command, eg, by a local-remote switch in the MCB.
- When the MCB is in service position, the drive must have exclusive control of closing the MCB. Local closing of the MCB is not permitted.
- The maximum opening time of the MCB must never exceed the product or project-specific maximum time defined in the MCB specifications. Typical maximum values for the drive are defined as follows:
 - Maximum protection trip time: 75 ms
The maximum protection trip time is the maximum allowed breaking time (open and arcing) of the breaking device after the open command has been initiated to prevent further damage to the drive, eg, diode failures.
 - Maximum safety trip time: 250 ms
The maximum safety trip time is the maxi-

mum allowed time to ensure safe disconnection of the main power supply to prevent any hazard to personnel.

In order to meet the stipulated safety requirements, it is recommended that:

- the MCB is equipped with two independent opening coils, or
- the MCB is equipped with one opening coil and an undervoltage coil for monitoring of the control voltage, or
- an upstream protection coordination scheme is provided which uses the "breaker failure" (ANSI 50BF) signal to automatically trip the upstream breaker, in case the MCB does not open. The upstream breaker must open within the maximum safety trip time after a failure has occurred.

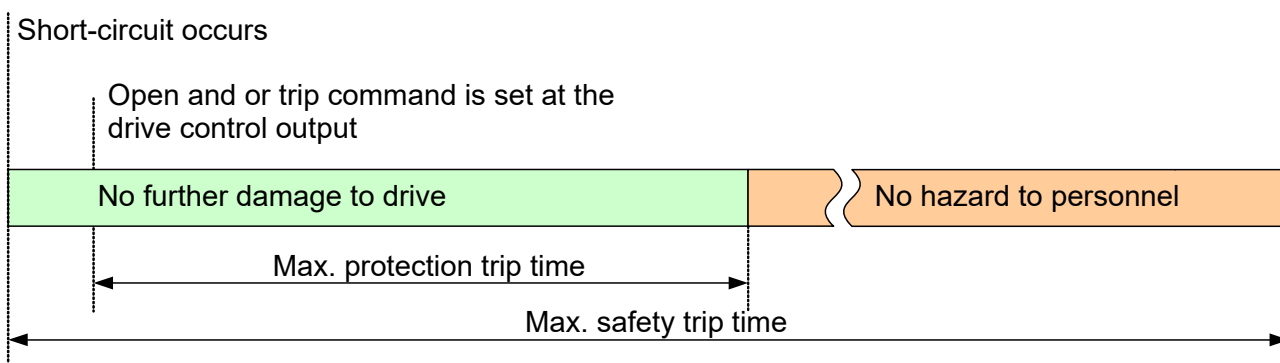

Maintenance recommendation

The MCB trip circuits should be checked once yearly.

Chapter 1

Safety

- 25 Meaning of safety instructions
- 26 General safety information
- 27 Possible residual risks
- 28 Safety labels
- 29 Cyber Security Requirements

1.1 Meaning of safety instructions

Safety instructions are used to highlight a potential hazard when working on the equipment. Safety instructions must be strictly followed! Non-compliance can jeopardize the safety of personnel, the equipment and the environment.

DANGER

DANGER indicates a hazardous situation which, if not avoided, will result in death or serious injury.

WARNING

WARNING indicates a hazardous situation which, if not avoided, could result in death or serious injury.

CAUTION

CAUTION indicates a hazardous situation which, if not avoided, could result in minor or moderate injury.

NOTICE

NOTICE is used to address practices not related to personal injury.

The safety instructions are derived from the following standards:

- ISO 3864-2:2004 (E)
Graphical symbols – Safety colors and safety signs – Part 2: Design principles for product safety labels
- ANSI Z535.6
American National Standard for Product Safety Information in Product Manuals, Instructions, and Other Collateral Materials

1.2 General safety information

To maintain safety and minimize hazards observe the following:

- Before the drive is energized, make sure that:
 - all foreign objects are removed from the drive,
 - all internal and external covers are securely fastened and all doors are closed, locked and / or bolted,
 - the manual release of the safety switches is in the locked position.
- Before starting to work on the drive, make sure that:
 - the main and auxiliary power supply to the drive is switched off, locked out, and tagged out,
 - the drive is dead,
 - safety ground connections are in place,
 - appropriate personal protective equipment is provided and used when required,
 - everyone involved is informed.
- When working near the running drive, wear protective earmuffs.
- Before work is carried out simultaneously on the drive and on other drive system equipment, make sure that:
 - the relevant safety codes and standards are observed,
 - all energy sources of the equipment are turned off,
 - lockout and tagout devices are in place,
 - barriers and appropriate covers are used on equipment which is still live,
 - everyone involved is informed.
- In case of fire in the drive room:
 - Observe the established rules and regulations for fire protection.

Only firemen with appropriate protective equipment are allowed to enter the drive room.

1.3 Possible residual risks

The following risks can arise from a drive system and pose a hazard to people. These risks must therefore be taken into account by the system integrator and / or the plant owner when assessing the risks of the machinery.

- Electric power equipment generates electromagnetic fields which can cause a hazard to people with metal implants and / or a pace-maker.
- Drive system components can move unintentionally when being commissioned, operated, or serviced due to, for example:
 - Operation of the equipment outside the scope of the specifications
 - Incorrectly assembled or installed equipment
 - Wrongly connected cables
 - External influence on, or damage of the equipment
 - Wrong parameter settings
 - Software errors
 - Faulty hardware
- Hazardous touch voltages can be present on drive system components caused by, for example:
 - Operation of the equipment outside the scope of the specifications
 - External influence on, or damage of the equipment
 - Induced voltages by external equipment
 - Condensation on equipment components, or pollution
 - Faulty hardware
- High temperatures, noise, particles, or gases can be emitted from drive system components caused by, for example:
 - Operation of the equipment outside the scope of the specifications
 - External influence on, or damage of the equipment
 - Wrong parameter settings
 - Software errors
 - Faulty hardware
- Hazardous substances can be emitted from drive system components due to, for example:
 - Incorrect disposal of components

1.4 Safety labels

Safety labels are attached to the cabinet to alert personnel of potential hazards when working on the equipment. The instructions on the safety labels must always be followed, and the labels must be kept in a perfectly legible condition.

References

1-1 Safety labels

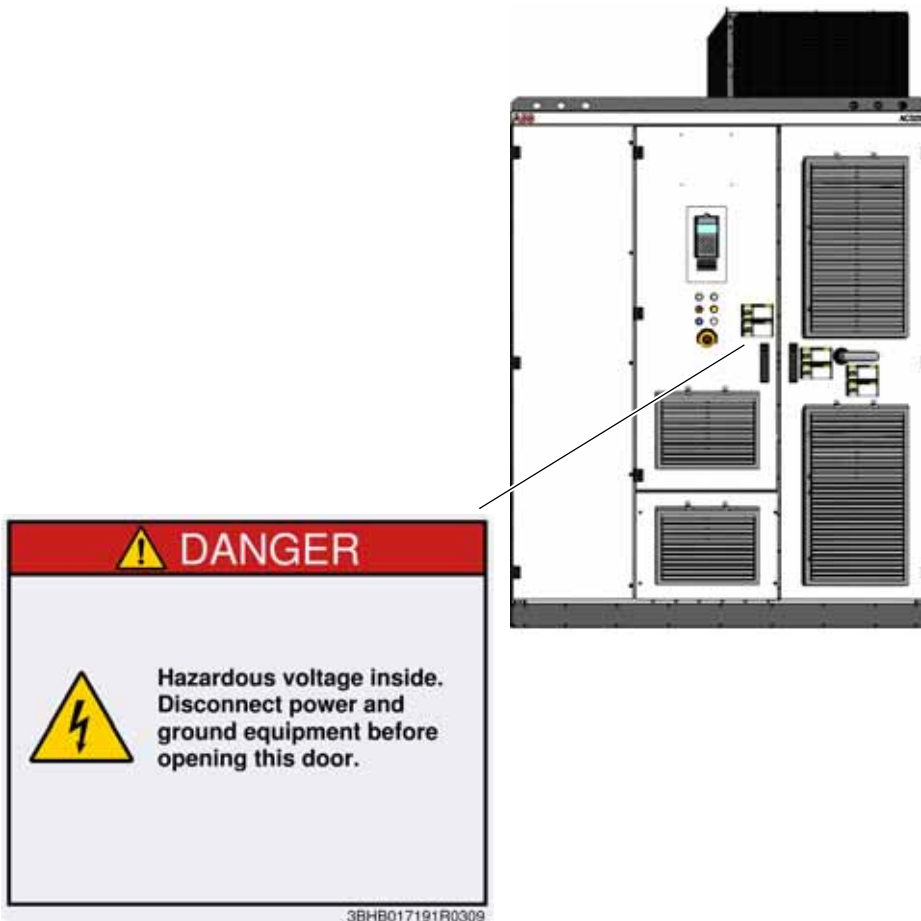

1.5 Cyber Security Requirements

1.5.1 Cyber Security Disclaimer

This product is designed to be connected to and to communicate information and data via a network interface.

It is Customer's sole responsibility to provide and continuously ensure a secure connection between the product and Customer network or any other network (as the case may be). Customer shall establish and maintain any appropriate measures (such as but not limited to the installation of fire-walls, application of authentication measures, encryption of data, installation of anti-virus programs, etc) to protect the product, the network, its system and the interface against any kind of security breaches, unauthorized access, interference, intrusion, leakage and/or theft of data or information.

ABB and its affiliates are not liable for damages and/or losses related to such security breaches, any unauthorized access, interference, intrusion, leakage and/or theft of data or information.

1.5.2 User Lock

For better cyber security, it is highly recommended that you set a master pass code to prevent e.g. the changing of parameter values.

WARNING

ABB will not be liable for damages or losses caused by the failure to activate the user lock using a new pass code. See 1.5.1 Cyber Security Disclaimer.

To activate the user lock for the first time, enter the default pass code, 358, into **16.02 Passcode**. This will make parameters **16.16**...**16.17** changeable. Then enter the old pass code to **16.16 OldUserPasscode** and change user pass code in **16.17 NewUserPasscode**. In **16.02 Parameter Lock**, the user lock functionality can now be enabled.

Chapter 2

Power electronics and cabinet features

- 31 Overview
- 32 Power supply configurations
- 34 Drive topology
- 42 Terminal compartment
- 43 Cabinet design
- 44 Door locking system
- 45 Cooling system

2.1 Overview

The air-cooled ACS2000 is a general purpose frequency converter for the control of standard induction motors.



For information on the power and voltage range of the drive, see the technical specifications and / or the rating plate of the drive.

The following drive configurations are described in this user manual:

- ACS2000 for connection to a non-integrated transformer



- ACS2000 for connection to an integrated transformer (1)

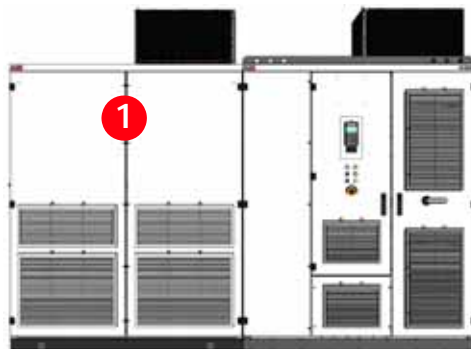

- ACS2000 for direct-to-line connection (DTL)



The following sections provide an overview of:

- the available main and auxiliary power configurations,
- the power electronic components of the drive,
- the cooling system,
- cabinet features such as the grounding switch and the electro-mechanical door interlock.

2.2 Power supply configurations

The drive requires two independent power supplies:

—
References

2-1 Drive overview with input transformer

2-2 Single-line diagram of direct-to-line configuration

- Main power supply for the power electronic components
- Auxiliary power supply for the control and cooling equipment

- Integrated
The transformer is placed on the left side of the drive. The length of the cabinet depends on drive power. For the integrated configuration, a dry-type transformer is used.
- Non-integrated
The transformer is external to the drive. The transformer can either be an oil-immersed or dry-type device. The distance between drive and transformer is determined by the maximum possible cable length for the transformer secondary cables.
Drives with a non-integrated transformer are equipped with a common mode choke.

2.2.1 Main power supply configurations

Input transformer

The main power is fed to the drive by the input isolation transformer which adapts the line voltage to the required voltage for the drive. The input isolation transformer is always part of the drive system. Two installation solutions are available for the transformer:

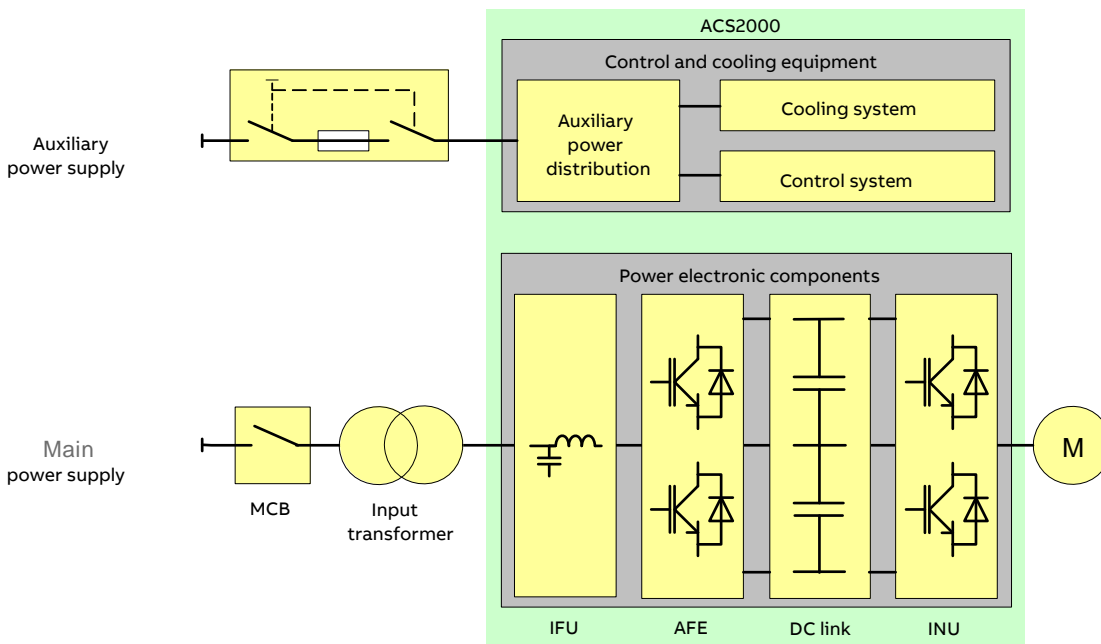

—
2-1

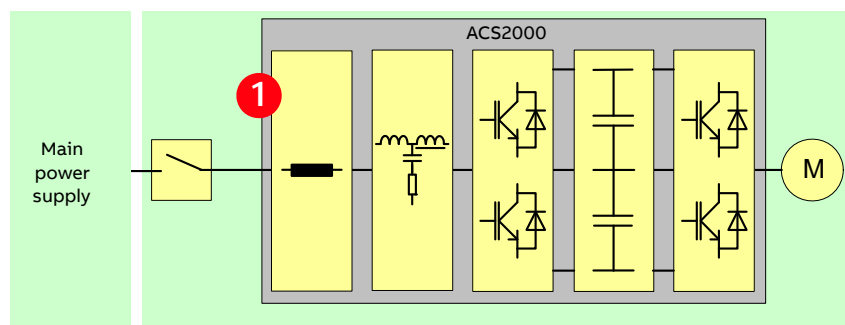

—
2-2

Direct-to-line connection

For applications where the line voltage corresponds to the motor nominal voltage, the ACS2000 can be connected direct-to-line by employing input reactors (1) instead of an input transformer. The direct-to-line (DTL) configuration is used for 6 to 6.9 KV line voltages.

2.2.2 Auxiliary power supply configurations

The drive needs auxiliary power for:

- the cooling system and a short-time power demand for the charging unit of the drive.
The power is fed by a three-phase power supply.
- the control hardware.
The power is fed by one single-phase power supply.

The drive can be equipped with the following power supply options:

- Standard power supply
The drive is equipped for one three-phase power supply that provides the total auxiliary power.
- Optional power supplies
To accommodate requirements for safe operation if the auxiliary power fails, the drive can be furnished with one three-phase power supply and one single-phase power supply.

Independent of the power supply scheme, the drive provides an internal back-up supply for 100 ms.

This safety feature enables the control system to shut down the drive in a controlled manner if the auxiliary power fails.

Optionally the drive can be equipped with an additional battery. The battery supports 15 minutes ride-through operation of the control system.



The power feed for the auxiliary supply must be protected with a suitable circuit protection rated for the inrush current.

For information, see utility consumption *list* of the drive.



For information on the configuration of the auxiliary power interface in the drive, see Appendix D – Wiring diagrams.

2.3 Drive topology

This section describes the main design features and introduces the major power electronics components of a typical ACS2000.

References

2-3 Drive overview with input transformer

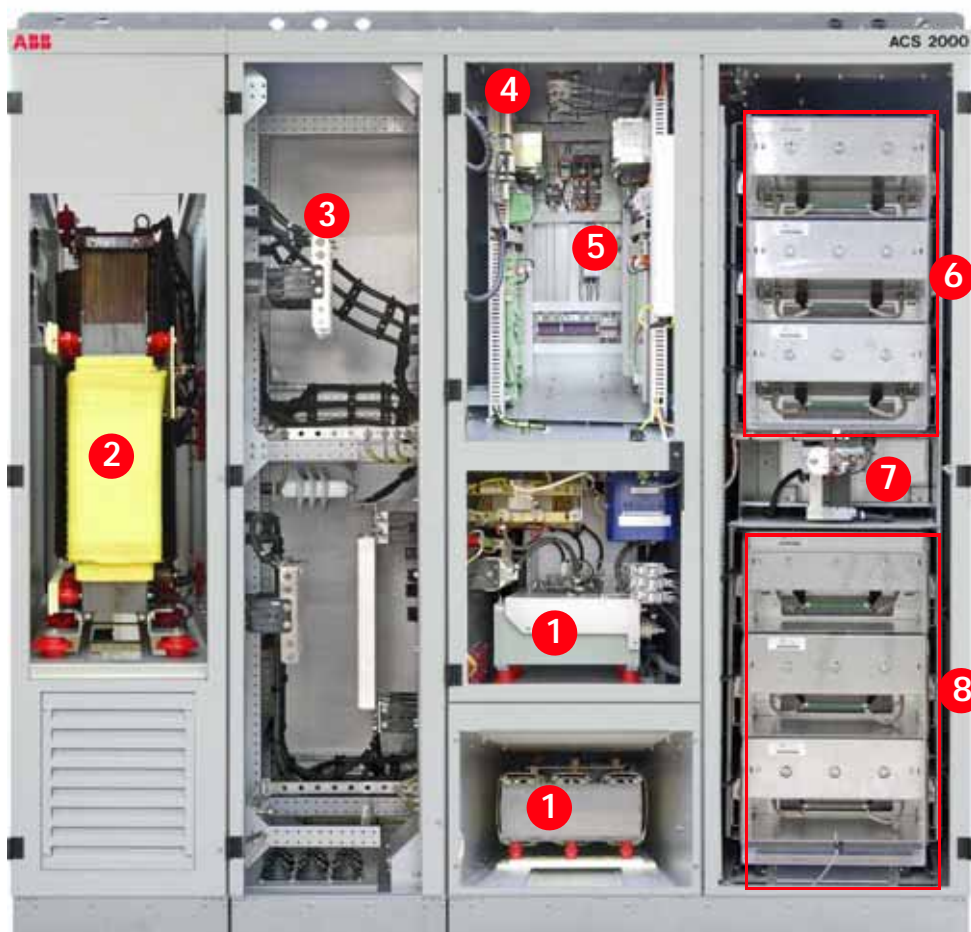

- 1 IFU - input filter unit
- 2 DTL compartment (not present in drives for connection to an input transformer)
- 3 Terminal compartment for feeder and motor cables
- 4 EMC filter (behind control compartment)
- 5 Control compartment with local operator panel
- 6 AFE - active front end
- 7 DC link
- 8 INU - inverter unit

-
- References
-
- 2-4 IFU - Input filter unit

2.3.1 IFU - Input filter unit

The IFU (2-3: 1) is located between the input transformer and the AFE. The IFU is a tuned filter that reduces harmonic voltages injected to the supply network.

2.3.2 DTL compartment

The DTL compartment (2-3: 2) is present in drives configured for direct-to-line connection. The functions of the compartment are twofold:

- It smooths the current harmonics in the power supply.
- It decouples the common mode voltages of the drive from the network.

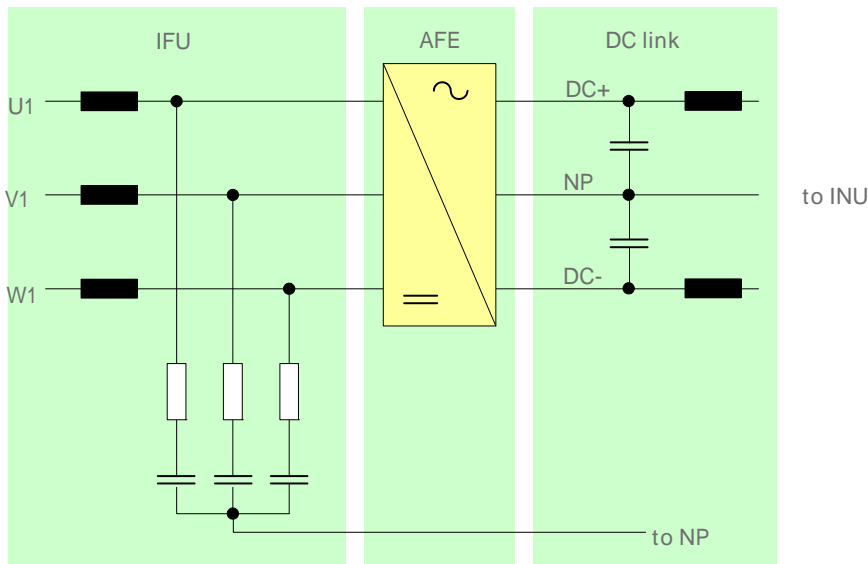

-
- References
-
- 2-5 AFE - Active front end

2.3.3 AFE - Active front end

The active front end of the drive consists of an rectifier for four quadrant operation. The AFE features the same electrical design as the INU of the drive. The AFE rectifies the AC line voltage of the main power supply and connects its output to the minus, neutral point and plus side of the DC link. The AFE maintains the DC-link voltage at the required level and provides the desired input power factor at the point of common coupling (PCC). The input power factor is adjusted by the AFE to near unity.

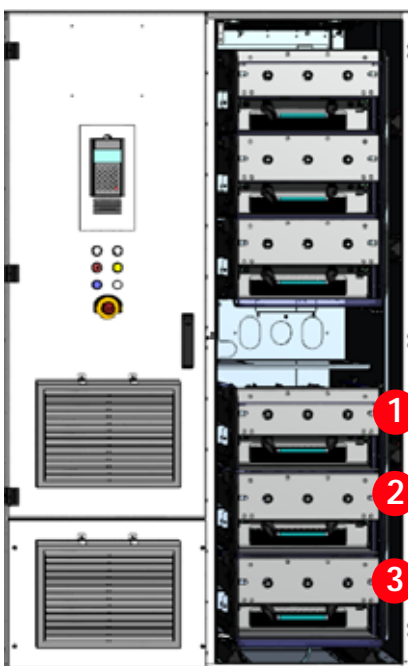
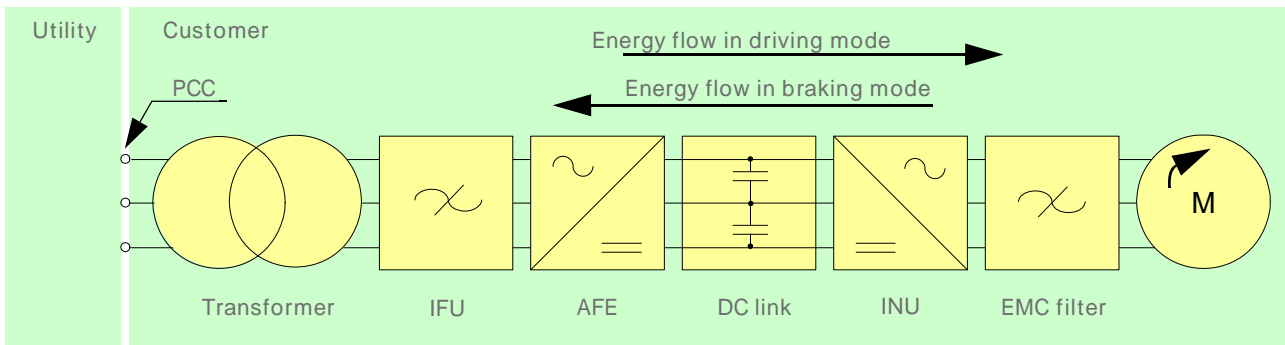

- 1 Phase module 1
- 2 Phase module 2
- 3 Phase module 3
- 4 Extracted phase module



—
References
—
2-6 Phase module

Phase module

The AFE consists of three identical phase modules each housing the series-connected IGBT semiconductors, the phase capacitor, the gate drivers, and the interface board for communication with the main control circuit board (AMC circuit board) of the AFE.

The high voltage IGBT is a power semiconductor switching device specially developed for medium voltage drives. The device is based on well-established transistor technology and combines high speed switching capabilities with high blocking voltage and low conduction losses as known from GTOs.

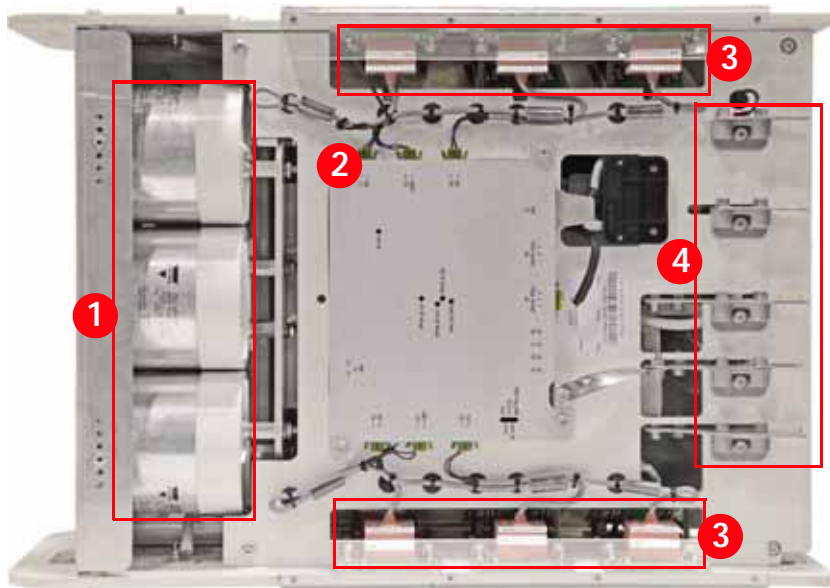

- 1 Phase capacitor
- 2 Phase-INT circuit board
- 3 Gate drivers
- 4 Connectors
- 5 IGBT module, each module contains two IGBTs
- 6 IGBT assembly on heat sink

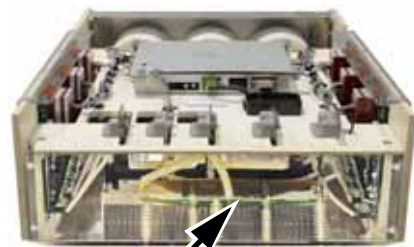

—
References
—
2-7 DC-link

2.3.4 DC link

The DC link consists of the charging unit (not shown), the capacitor (1), and the grounding switch (2).

Charging unit

Charging

The unit charges the DC-link capacitor and the phase capacitors before the MCB is closed to connect the drive to the main power supply. Thus, excessive inrush currents are prevented.

The charging unit is fed from the auxiliary power supply and charges the DC link and the phase capacitors to 90% of the steady state voltages. The charging sequence is started by pressing the SUPPLY ON pushbutton on the control compartment door. After the charging sequence has finished, the charging unit is disconnected from the medium voltage circuit, the MCB is closed and the DC link reaches its nominal level.

Stand-by mode

Once the DC link is charged, it is possible to keep the drive in this state to facilitate a more rapid start-up procedure. The losses during stand-by mode are approx. 1% of the nominal power and are caused from small losses from the AFE, the INU, and the auxiliaries.

Discharging

Discharging is initiated by pressing the SUPPLY OFF pushbutton on the control compartment door. The DC-link capacitors then discharge via the IFU. The energy stored in the DC link is dissipated in the parasitic resistors of the power part of the drive. When the DC-link voltage has decreased below a quarter of the DC-link voltage, the capacitors in the phase modules start to discharge as well.

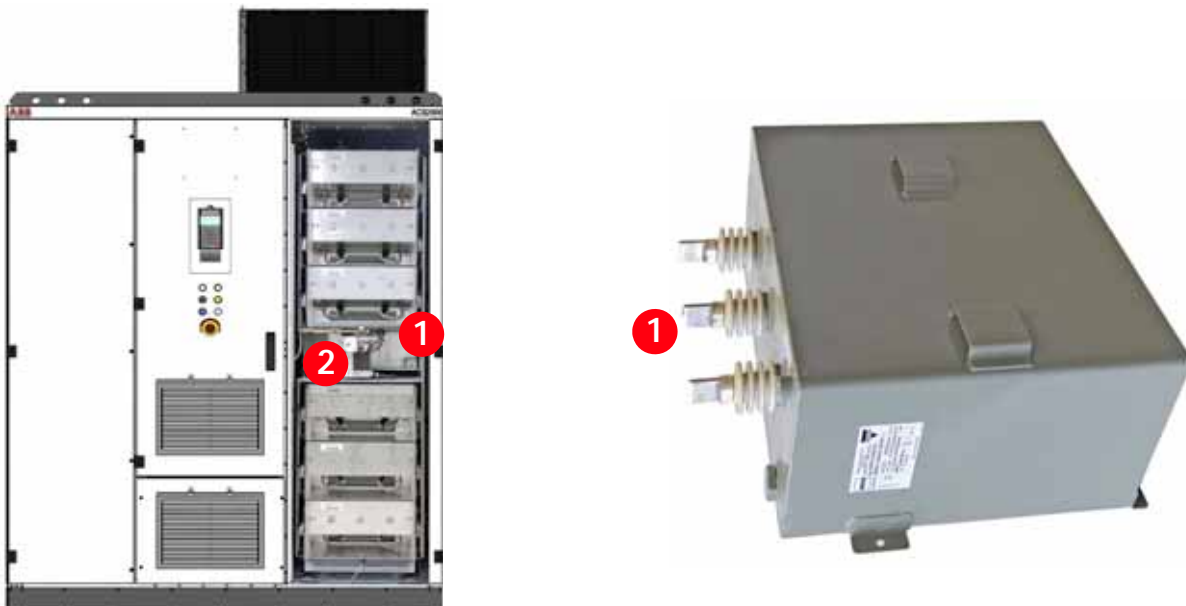

-
- References
-
- 2-8 Grounding switch
-
- 2-9 Grounding circuit

Grounding switch

The grounding switch is a safety device that enables safe access to the AFE-INU compartment of the drive.

When the switch is in position grounded, input filter (2-9: 1) AFE (2-9: 2), DC link (2-9: 3), INU (2-9: 4) and output filter (2-9: 5) of the drive are connected to the PE ground bus (2-9: 6).

The switch is electromechanically interlocked with a discharge monitoring circuit that prevents closing of the switch while the DC link capacitor is still charged.

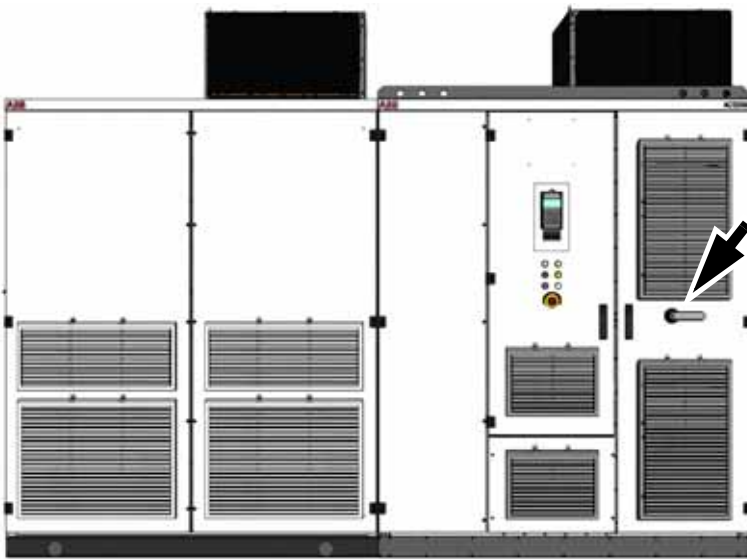

2-8

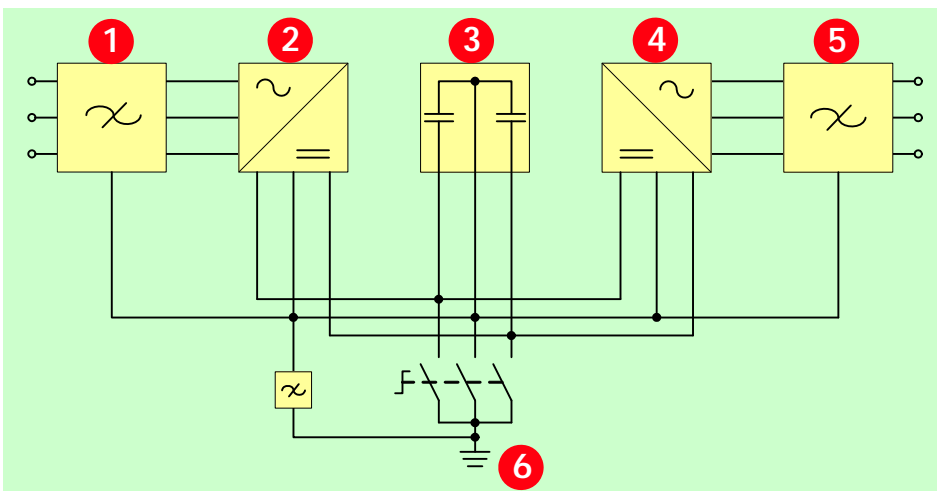

2-9

—
References

—
2-10 Grounding the drive

Grounding the drive is only possible after the main power supply has been disconnected and the DC link has discharged. When the voltage is below 50 V (DC), press the pushbutton *Grounding Switch Unlocked* (2-10: 1) located on the control compartment door (the pushbutton lights up) and - at the same time - turn the grounding switch to the position **grounded** (2-10: 2).

When the grounding switch is in position **grounded**, the door safety switch of the AFE-INU compartment will be released and the door can be opened.

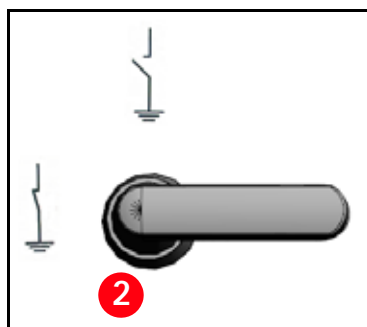

Grounding switch

-
- References
-
- 2-11 INU - Inverter unit
-
- 2-12 EMC filter

2.3.5 INU - Inverter unit

The INU converts the DC voltage to the required AC motor voltage and frequency.

Like the AFE, the INU is an active 3-phase unit with the same electrical configuration. The unit is designed as a self-commutated, 5-level voltage source inverter. As a result of the multi-level topology, the drive produces an optimum number of switching levels - nine levels, phase to phase.

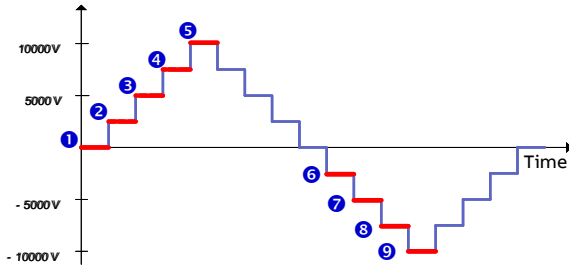

The resulting waveforms permit the application of standard motors.

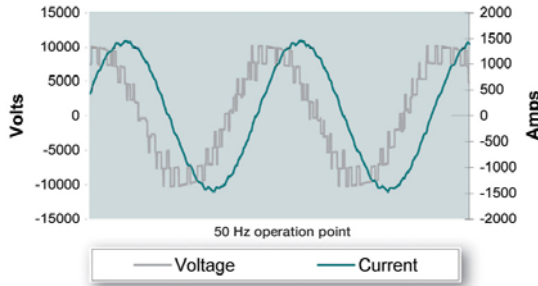

The INU is composed of three identical phase modules (see Phase module). The phase modules can be extracted from the cabinet to facilitate maintenance and service on the INU.

- 1 Phase module of phase U2
- 2 Phase module of phase V2
- 3 Phase module of phase W2

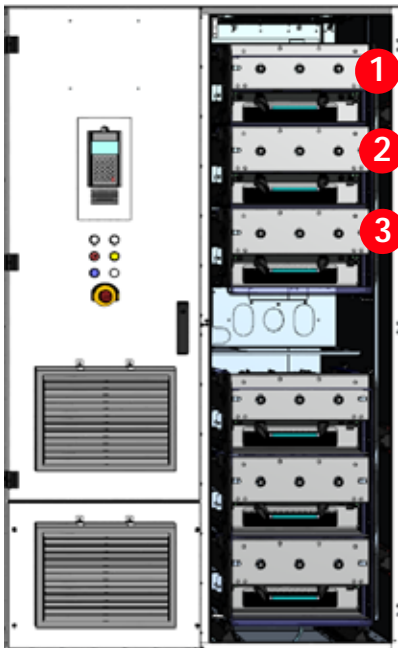

2.3.6 EMC filter

The INU includes a three-phase du/dt filter connected to its AC output. The filter chokes (2-12: 1), resistors (2-10: 2), and capacitors (2-10: 3) protect the motor against excessive voltage slopes (du/dt is limited to 500 V/?s).

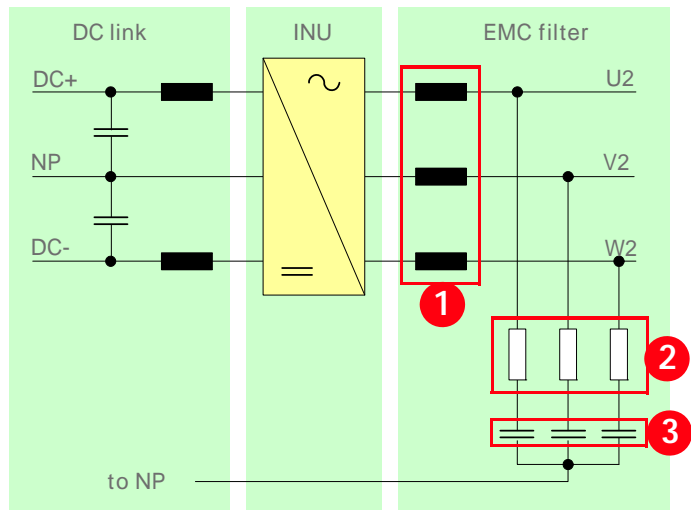

2.4 Terminal compartment

The terminal compartment provides the terminals for the feeder and motor cables and the ground bus for the termination of the ground cable and the cable screens.

—
References
—
2-13 Terminal
compartment

The cable entry is prepared in the factory for to the cable entry configuration ordered:

- Top or bottom cable entry
- Type of entry plate



- For information on the type of cable entry in the drive, see Appendix C – Mechanical drawings.
- For further information, see 6.8 Cable entries.



2.5 Cabinet design

The riveted and folded cabinet construction of the drive ensures a strong, flexible and self-supporting framework. The construction avoids the need for additional skeletal support and provides effective protection against electromagnetic emissions.

EMC has been achieved by applying a cabinet design consisting of folded, galvanized sheet metal plates (approximately 2 mm thick) and minimizing the space between the rivets. The inside walls of the cabinet are not painted, because paint tends to reduce the effectiveness of metallic bonding which is important for successful EMC. Accordingly, only the front of the cabinet is painted while all other walls are galvanized. However, the cabinet can be ordered optionally with the whole of the outside painted. EMC performance is further enhanced by the use of metal cable ducts.

2.6 Door locking system

—
References
—
2-14 Door locks

To ensure safety and to prevent the doors being opened unintentionally, all doors are lockable, and the doors of compartments where medium voltages are present during operation (2-14: 1, 2, 4) are bolted or electromechanically secured.

Additionally, the doors of the medium voltage compartments have locks with different inserts than the control compartment door. The different lock inserts ensure that these doors can only be opened by personnel authorized to do so.

The covers of the integrated transformer are bolted.

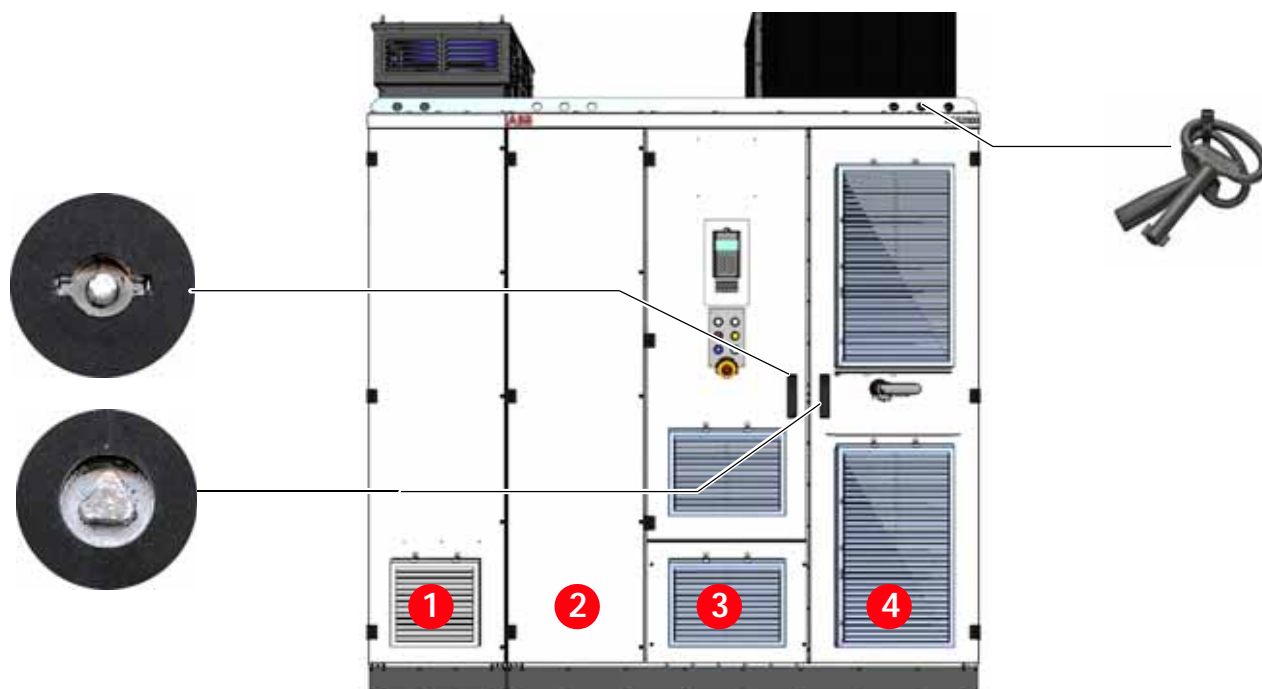

- ① Cover of DTL compartment: bolted
- ② Cover of terminal compartment: bolted
- ③ Door of control compartment: lockable
- ④ Door of AFE-INU compartment: electromechanically locked
Door cannot be opened when the drive is energized.

2.7 Cooling system

—
References
—
2-15 Fan unit types

2.7.1 Fan unit configurations
The drive and the integrated transformer are each equipped with fan units. Optionally, the drive and the integrated transformer can have a **redundant** fan configuration, ensuring full operation in the event of fan failure.
The drive can be equipped with fan units of the following types:

- ① Fan unit type 1
- ② Fan unit type 2

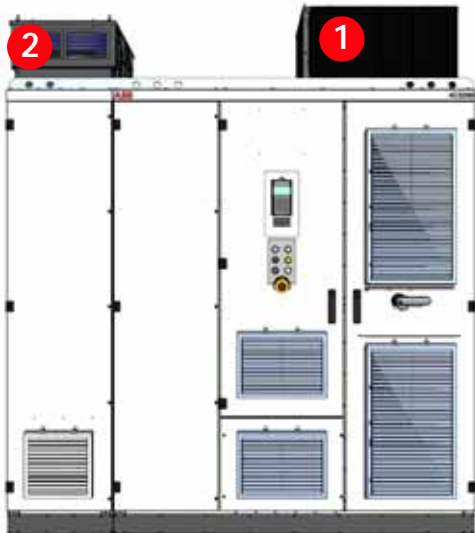
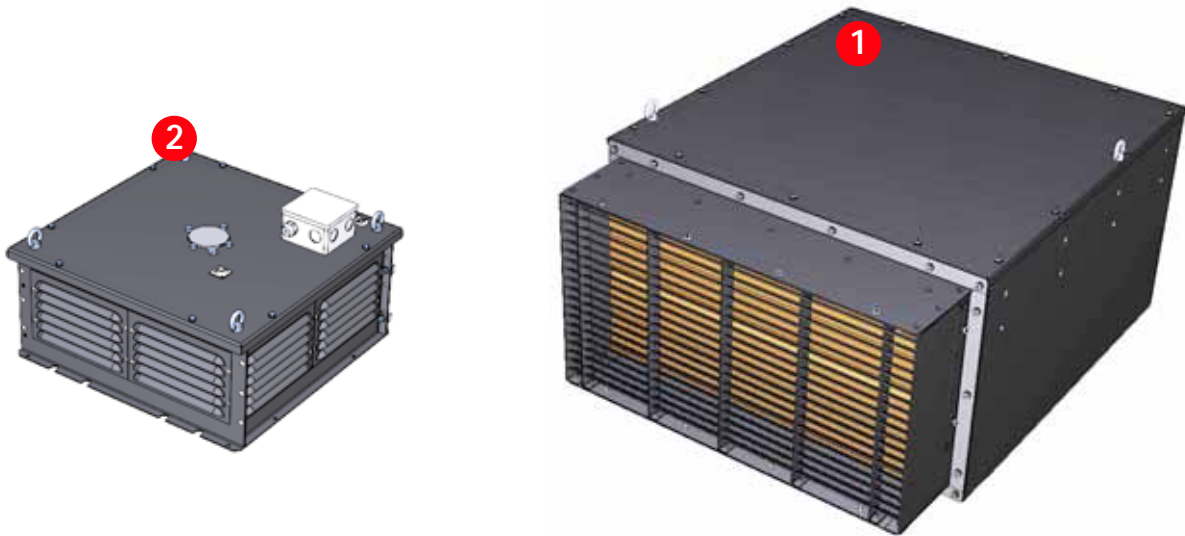

ACS2000 DTL

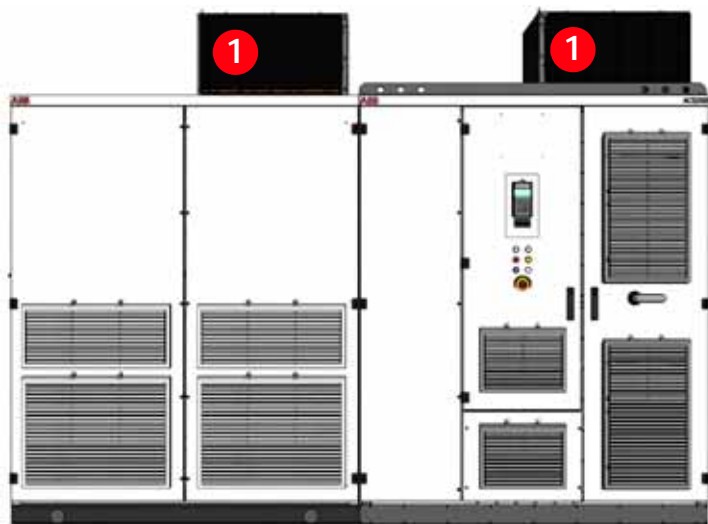

ACS2000 with integrated transformer

-
- References
-
- 2-16 Example of fan group 1
-
- 2-17 Example for the operating time of the fan units

2.7.2 Function

Fan groups

For control reasons, the fan unit(s) of the drive and the integrated transformer are combined into groups, for example:

- Fan unit 1 of the drive and fan unit 1 of the integrated transformer belong to group 1.
- Fan unit 2 of the drive and fan unit 2 of the integrated transformer belong to group 2.

The fan units of a group are always switched on and off together.

Starting, stopping

The standard fan group 1 is switched on by the control system of the drive when the charging of the DC link is initiated. When the drive is stopped, the fan group continues to run for a preset time after the main power has been switched off and the DC link voltage has decreased below a preset value.

Operating intervals

Parameter setting allows to run one of the two fans continuously, or to run the fans alternately in adjustable intervals. The intervals are set with parameters.



For further information on settings for the cooling system, see signal and parameter table, section automatic converter-fan change-over.

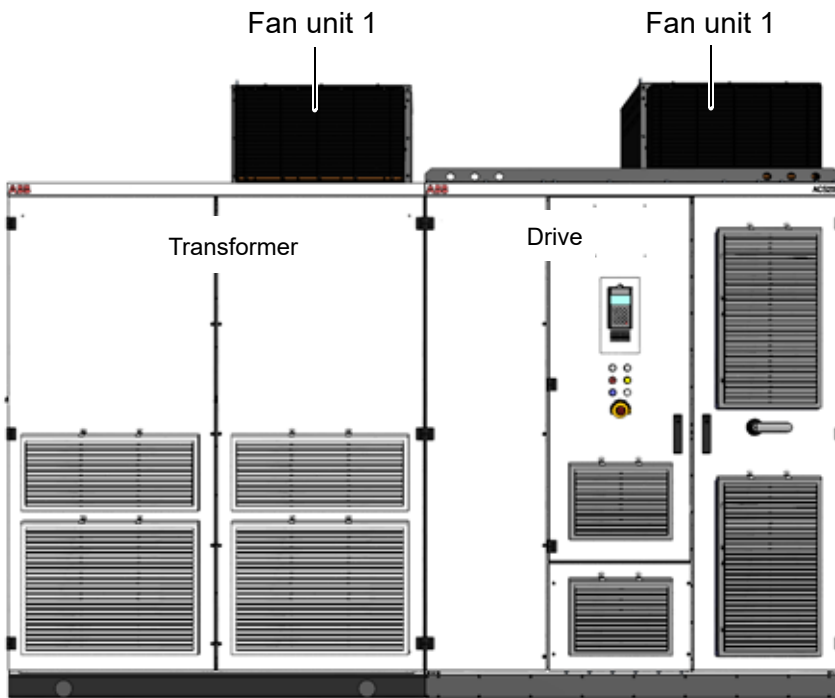

—
2-16

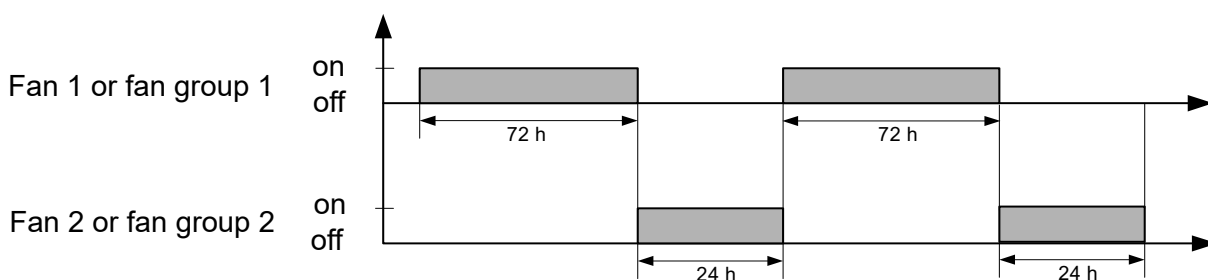

—
2-17

—
References
—
2-18 Air flow inside the
drive
—
2-19 Air pressure
switches

Air flow inside the drive

The fan group of the cabinet feeds the cooling air to the main power electronic components and transfers the heat to the outside of the cabinet.

Air flow monitoring

Air pressure switches monitor the air flow through the cabinet of the integrated transformer (2-19: 1) and the cabinet of the drive (2-19: 2).

Separate air pressure switches in each cabinet monitor the air flow through the filter mats and the air flow through the cabinets.

When the filter mats are clogged and the pressure drop reaches the specified final pressure loss, the message `Conv1CoolAirFilter` is displayed on the CDP control panel and the alarm/fault lamp lights up on the control compartment door.

When a fan of the drive or a fan of the integrated transformer fails, the control system of the drive switches on the stand-by fan automatically. The failure of a fan is indicated on the CDP control panel of the drive as follows:

- `CoolCircuit1Alm` if a fan of the drive fails
- `CoolCircuit2Alm` if a fan of the integrated transformer fails

The alarm fault lamp starts to flash.

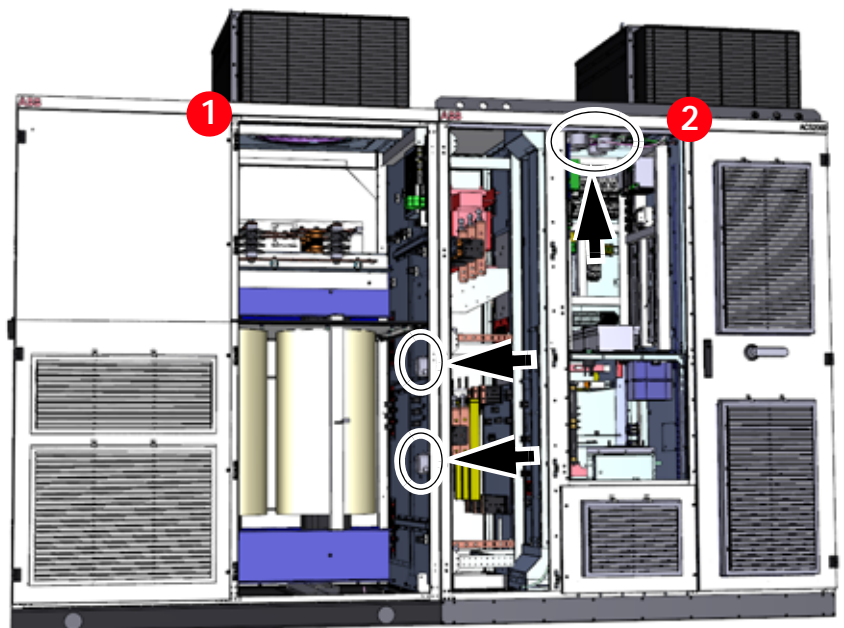

Chapter 3

Control system

- 49 Overview
- 50 Main components
- 54 I/O interfaces

3.1 Overview

The control compartment incorporates the hardware for the control, monitoring and protection functions of the drive, and the communication interfaces to the local control panel and to the remote control devices. Depending on the control concept of the drive system, the remote control devices include a higher-level control system and / or remote operator stations.

References

3-1 Block diagram of control system

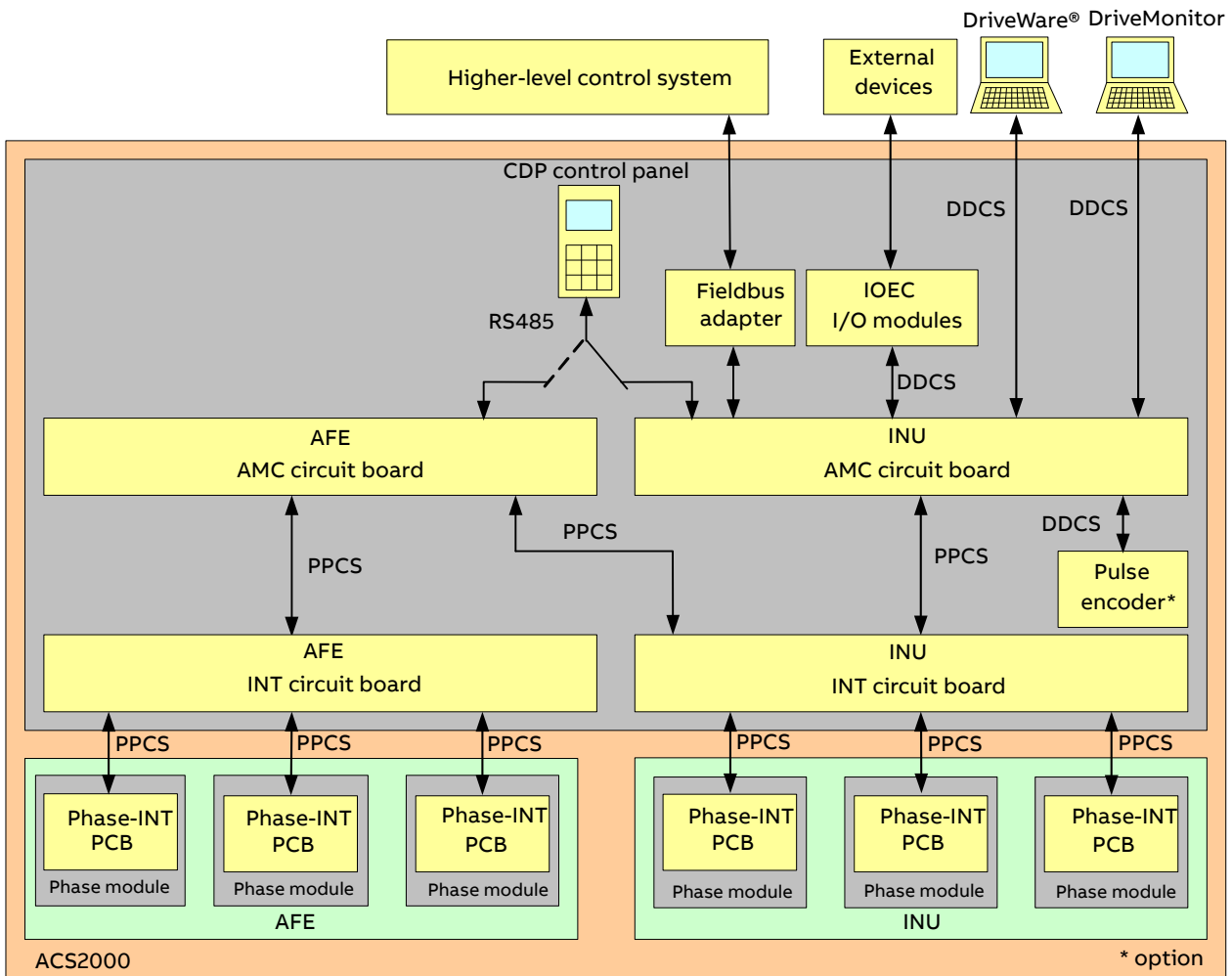

3.2 Main components

This section provides a short functional overview of the main hardware components of the control system and their interconnection.

—
References

—
3-2 Control compartment

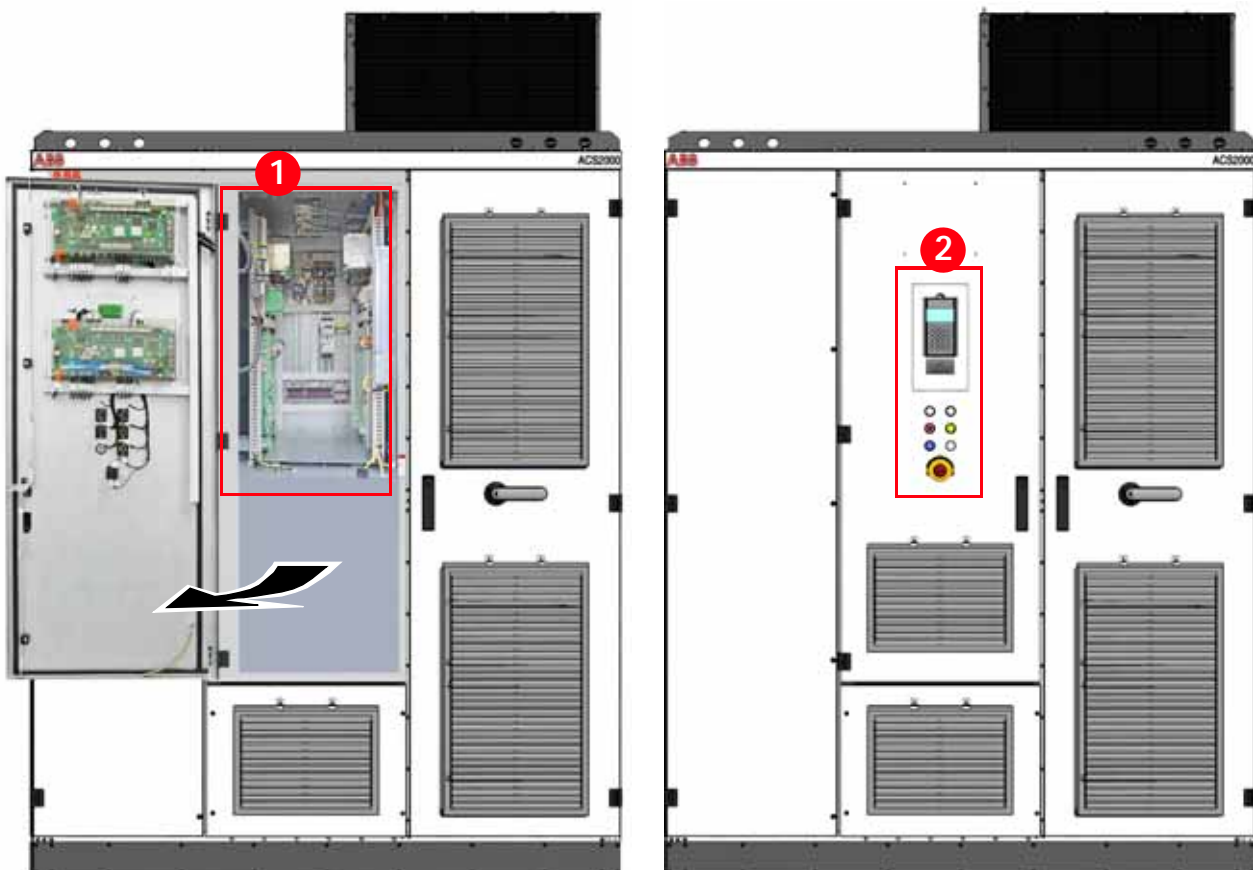

Shown is the ACS2000 for connection to an input transformer

- ① Control compartment
- ② Local control panel

References

3-3 Control compartment details



For information on the devices present in the control compartment of the drive, see Appendix D – Wiring diagrams.



For 24 V circuits the ATO style blade fuses rated 3 A, 32 V are used.

3.2.1 Local control panel

The local control panel on the door of the control compartment serves as the basic user interface for monitoring, control, operation of the drive, and setting of parameters.

For further information, see Chapter 8 - Operation and Chapter 9 - CDP control panel.

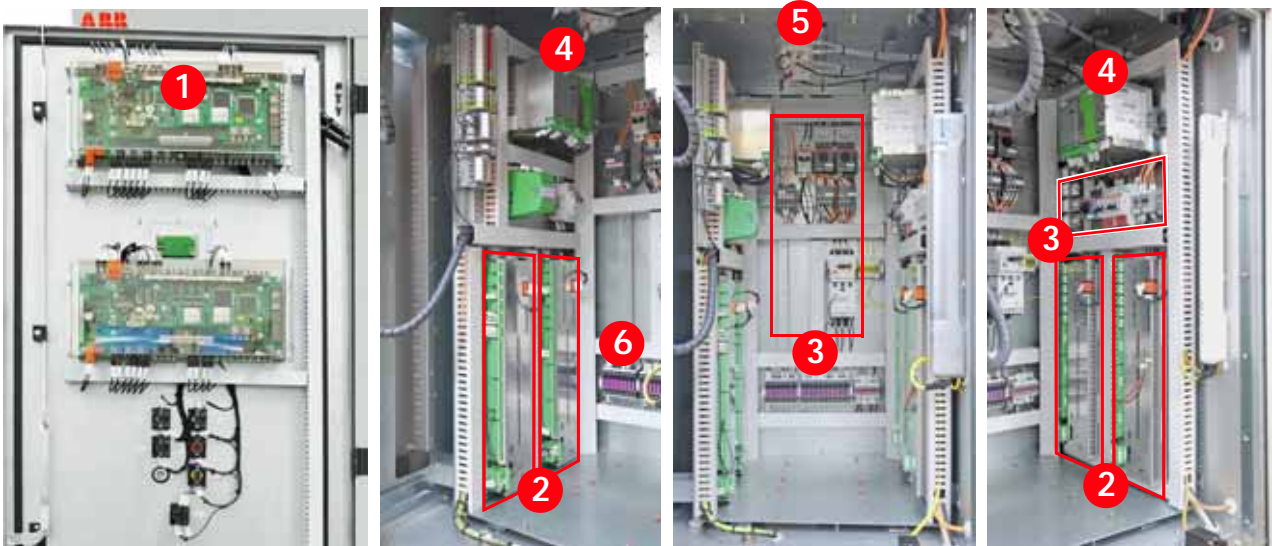

- ① AMC circuit boards
- ② IOEC modules with analog and digital inputs and outputs
- ③ Circuit breakers, auxiliary relays and contactors
- ④ Power supply units
- ⑤ Air pressure switches
- ⑥ 24 V power distribution terminals

—
References

—
3-4 AMC circuit-boards
location

3.2.2 AMC circuit board

Overview

The AMC circuit board is the major component of the control system of the drive and performs general drive, motor control, and closed loop functions. The main internal control devices and the peripheral input and output interfaces to the customer communicate with the AMC circuit board via optical fibers.

The circuit board is fitted with a Motorola DSP processor and features two PPCS and eight DDCCS communication channels. The communication channels are used for high speed data transfer via the INT circuit boards to the Phase-INT circuit boards inside the phase modules.

AFE and INU have their own AMC circuit board.

Control tasks

Each AMC circuit board has specific control and closed-loop tasks assigned to it.

- The AMC circuit board of the AFE handles all rectifier and line-related functions of the drive.
- The AMC circuit board of the INU processes drive and status information, performs the speed and torque control tasks, and monitors the operation of the drive.

The AMC circuit board continuously monitors all relevant drive variables (eg, speed, torque, current, voltage). Pre-programmed protection functions ensure that these variables remain within certain limits in order to maintain safe operation of the drive. These internal functions are not programmable by the user.

Optionally, the AMC circuit board can monitor signals from external equipment. These can be activated and adjusted with Parameters.

Other general control, protection and monitoring tasks regarding the whole drive include control and monitoring of:

- Main circuit breaker
- Grounding switch
- Door locking system
- Cooling system

These tasks are implemented in the AMC circuit board of the INU.

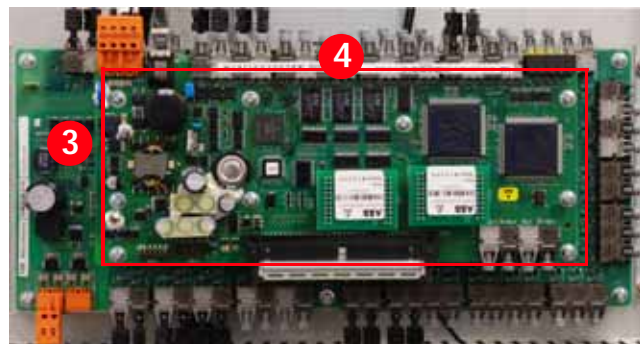
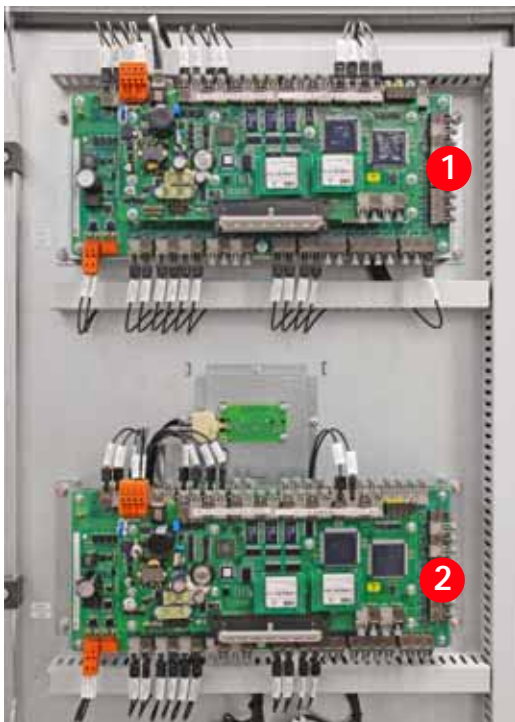

- ① AMC and main INTERface circuit board of the INU
- ② AMC and main INTERface circuit board of the AFE
- ③ INTERface circuit board
- ④ AMC circuit board

Parameters

The control system is configured, customized, and tuned with a set of application parameters. The application parameters are organized in functional groups and have factory-set default values. The default parameter values are adjusted during commissioning to the specific application of the drive to activate the specific control, monitoring and protection functions for the driven process, and to define the signals and data to be transferred between drive and external equipment. The parameters and parameter groups referred to in the signal allocation tables in this chapter are valid for drives with software version LDOI6xxx revision "-" and later versions.



For further information on the parameters for signal allocation, signal type selection, signal inversion, scaling, and filtering, see signal and parameter table.

Main circuit breaker

The main circuit breaker (MCB) is an important switching and protection device of the drive system. Therefore it must only be controlled and monitored by the drive.



For further information, see:
Main circuit breaker engineering guideline
Important note on main circuit breaker

Switching of the semiconductors in the INU is directly controlled in accordance with the motor core variables flux and torque.

The measured motor currents and DC link voltages are inputs to an adaptive motor model. The model produces exact values of torque and flux every 25 microseconds. Motor torque and flux comparators compare the actual values to reference values which are produced by the torque and flux reference controllers.

Depending on the outputs from the hysteresis controllers, the switching logic directly determines the optimum switch positions every 50 microseconds and initiates switching whenever required.

Peripheral I/O devices

The peripheral input and output devices connected to the AMC circuit board of the INU include:

- Local CDP control panel
- I/O interfaces for parallel signal transfer to external devices
- Optional fieldbus adapters for serial data transfer to a higher-level control system
- PC-based service tools comprising:
 - DriveWare® software tools
DriveWare® includes software tools such as the commissioning and maintenance tools DriveWindow and DriveDebug, and DriveOPC for data transfer between ABB drives and Windows®-based applications.
 - DriveMonitor (option)
DriveMonitor is a monitoring and diagnostics tool that allows access to the drive from any location in the world via a secure internet connection.

References

3-5 Direct torque control

Direct torque control

The speed and torque of the motor is controlled by DTC (Direct Torque Control). DTC provides accurate speed and torque control, and high dynamic speed response.

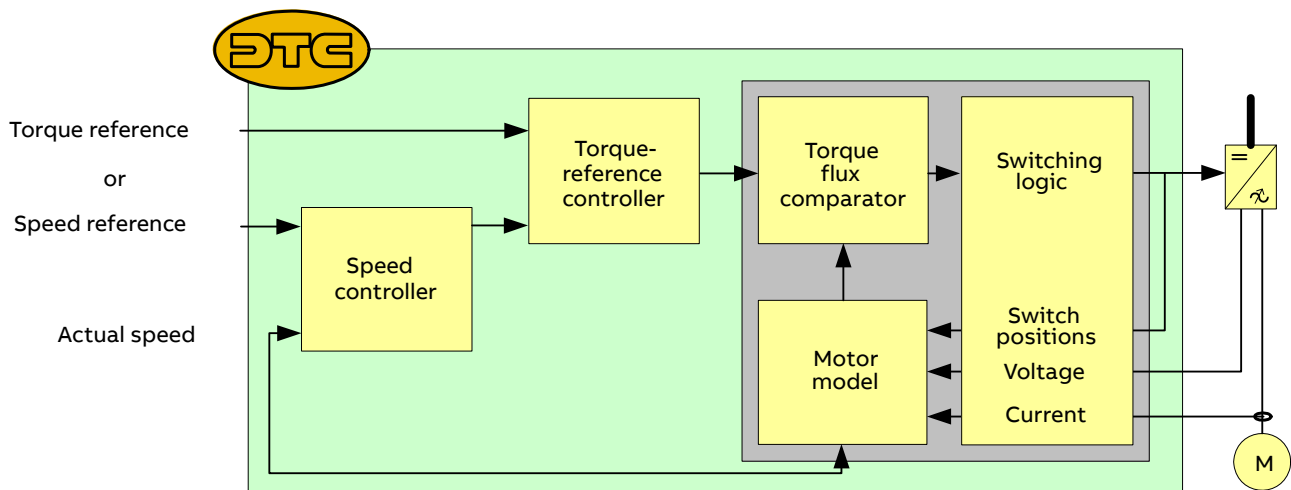

3.3 I/O interfaces

- References
- 3-6 IOEC modules overview
- 3-7 IOEC modules location

3.3.1 IOEC I/O modules

Overview

Internal and external, analog and binary I/O signals are connected to the control system by IOEC modules.

The standard I/O includes one external module (IOEC 2) and one module that is internal to the drive operation (IOEC 1). The standard I/O provides standard control and supervision functionalities sufficient for most applications.

The drive can include optional expansion I/O that includes an external module (IOEC 4) and an internal module (IOEC 3). These expansion modules provide extra inputs and outputs for control and supervision as may be required by ABB or the customer to support various control options.

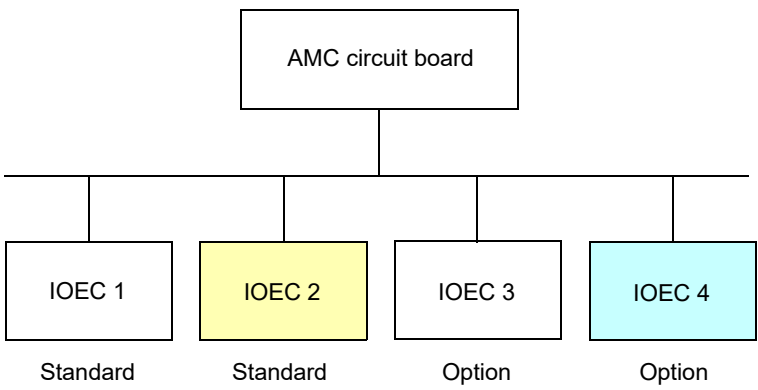

3-6



- 1 Standard internal IOEC 1 (A3401)
- 2 Standard external IOEC 2 (A3411)
- 3 Optional internal IOEC 3 (A3421)
- 4 Optional external IOEC 4 (A3431)

3-7

IOEC module configuration

Each IOEC module is configured with both analog and digital inputs and outputs as shown in

Table 3-1.

Table 3-1 IOEC module configuration

Analog inputs			
No. of I/O	4		
Resolution	10 bit		
Signal interface	Floating, galvanically isolated		
Signal level	0 - 20 mA, 4 - 20 mA, 0 - 10 V, 2 - 10 V Individually scalable by parameter		
Input resistance	$R_{in} = 105 \text{ } \Omega$ for current input $R_{in} = 250 \text{ k}\Omega$ for voltage input		
Common mode voltage	Maximum: 48 V		
Isolation level	350 V (AC)		
Analog outputs			
No. of I/O	2		
Signal range	0 - 20 mA (load impedance: max. 250 Ω)		
Resolution	12 bit		
Isolation level	350 V (AC)		
Digital inputs			
No. of I/O	14		
Signal level	22 - 80 V (DC) 22 - 120 V (DC) with IOEC Adapter - 3BHE040914R0101 22 - 250 V (AC)		
Logical thresholds	$< 13 \text{ V (AC or DC)} \hat{=} "0", > 16 \text{ V (AC or DC)} \hat{=} "1"$		
Input current	13 mA steady state (14 mA max. inrush) at 24 V (DC) 11.5 mA steady state (80 mA max. inrush) at 120 V (DC) 10.5 mA steady state (92 mA max. inrush) at 230 V (AC)		
Isolation level	1350 V (AC)		
Digital outputs			
No. of I/O	6		
Signal level	Maximum: 120 V (DC) or 250 V (AC)		
Isolation level	4000 V (AC)		
Switching capacity	Voltage	Switching current	Steady state current
	24 V (DC)	8 A	6 A
	24 V (AC)	8 A	
	48 V (DC)	1 A	
	48 V (AC)	8 A	
	120 V (DC)	0.4 A	
	120 V (AC)	8 A	
	230 V (AC)	8 A	

24 V internal voltage supply

One isolated DC/DC converter supplies an over-load protected voltage of 24 V (DC) to operate digital inputs from passive contacts. The output is protected by a PTC-resistor against short-circuit and external applied overvoltages.

Table 3-2 24 V internal voltage supply

Output voltage	24 V (unregulated)
Available output current	180 mA

- References
- 3-8 IOEC module terminals

Module terminals

The IOEC module has terminal blocks for internal wiring and indicator LEDs for diagnostic and I/O status.

IOEC DigIn adapters

The IOEC modules can be equipped with DigIn adapters U3411 and U3412 to limit the input voltage to a certain level. The detailed settings are described in the Wiring diagrams.

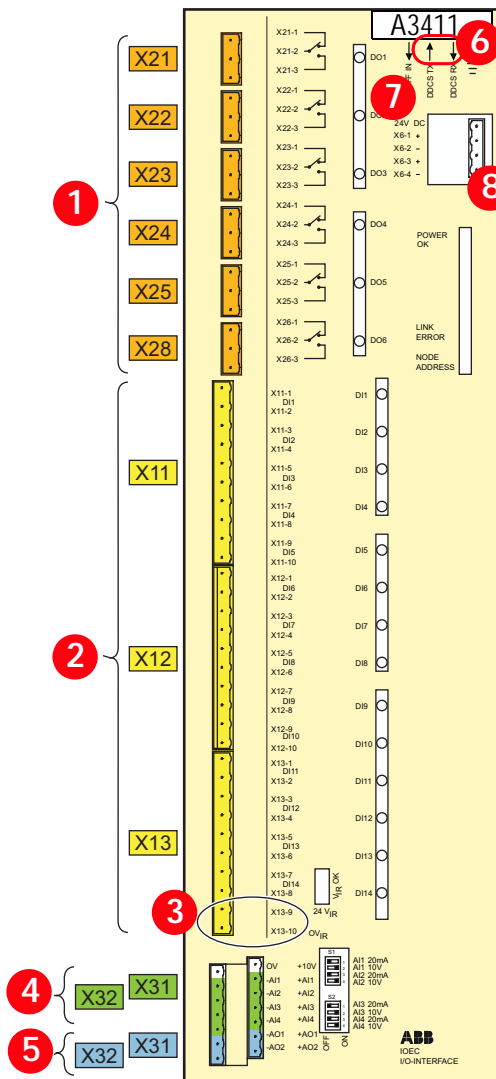

- 1 Digital outputs
- 2 Digital inputs
- 3 24 V internal voltage
- 4 Analog inputs
- 5 Analog outputs
- 6 DDCS fiber optics *
- 7 I/O Emergency OFF function *
- 8 Power supply (factory-installed wiring)

Voltage mode

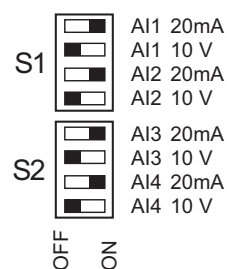

Current mode

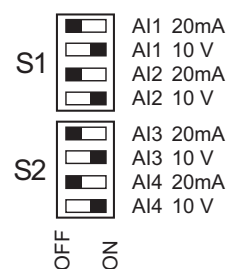

-
- References
-
- 3-9 IOEC module identification

I/O device identification

The I/O modules are identified on the part with an identification label (3-9: 1), in the wiring diagram, and in the software by the wiring diagram identification number (3-9: 2).

The way the identification number is built directly corresponds to the wiring diagram as can be seen in 3-9. The letter **A** represents the kind of part, an assembly, the next three digits are the page number the part is located on, page **340**, and the last digit, **1**, means that the part is the first assembly on the page. This identification label number is the key to track electrical devices throughout the drive and in ABB documentation.

The designation for each IOEC module is shown in Table 3-3.

Table 3-3 IOEC module identification

I/O module type	Wiring diagram designation for module identification
IOEC1	A3401
IOEC2	A3411
IOEC3	A3421
IOEC4	A3431

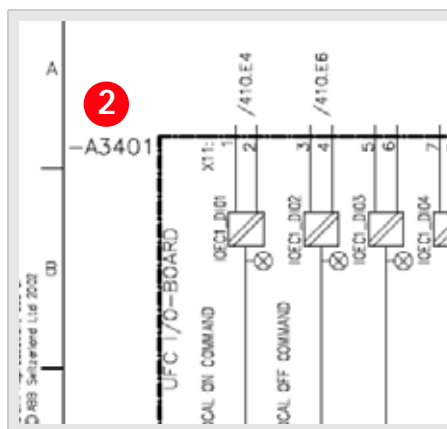
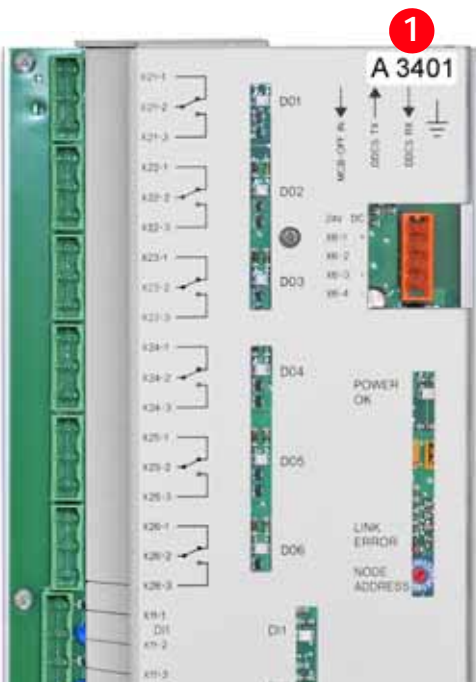

3.3.2 Standard internal IOEC1 (A3401) module

Analog inputs













Table 3-4 Standard analog input signal allocation

Terminal	Channel	Default setting	Parameter group
X31-1	+10 V	Internal supply voltage	—
X32-1	0 V		
X31-2	AI1+	Freely programmable	72
X32-2	AI1-		
X31-3	AI2+	Converter air temperature	
X32-3	AI2-		
X31-4	AI3+	Freely programmable	72
X32-4	AI3-		
X31-5	AI4+	Freely programmable	72
X32-5	AI4-		

3.3.3 Standard external IOEC2 (A3411) module

Digital outputs

Table 3-5 Standard digital output signal allocation

Terminal	Channel	Default setting	Parameter group
X21-1	DO01	 NC  NO	Ready on (drive is ready for operation)
X21-2			
X21-3			
X22-1	DO02	 NC  NO	Ready ref (drive is running)
X22-2			
X22-3			
X23-1	DO03	 NC  NO	Alarm / fault (alarm / fault is present)
X23-2			
X23-3			
X24-1	DO04	 NC  NO	Tripped (drive has shut down)
X24-2			
X24-3			
X25-1	DO05	 NC  NO	MV switchgear open command (low active)
X25-2			
X25-3			
X26-1	DO06	 NC  NO	MV switchgear close command (high active)
X26-2			
X26-3			

Digital inputs

Table 3-6 Standard digital input signal allocation

Terminal	Channel	Default setting	Parameter group
X11-1	DI01	Freely programmable	72
X11-2		Common	
X11-3	DI02	Freely programmable	72
X11-4		Common	
X11-5	DI03	Freely programmable	72
X11-6		Common	
X11-7	DI04	Freely programmable	72
X11-8		Common	
X11-9	DI05	Freely programmable	72
X11-10		Common	
X12-1	DI06	Freely programmable	72
X12-2		Common	
X12-3	DI07	Freely programmable	72
X12-4		Common	
X12-5	DI08	Freely programmable	72
X12-6		Common	
X12-7	DI09	MV switchgear open	*
X12-8		Common	
X12-9	DI10	MV switchgear closed	*
X12-10		Common	
X13-1	DI11	MV switchgear available (not tripped)	*
X13-2		Common	
X13-3	DI12	Freely programmable	72
X13-4		Common	
X13-5	DI13	Freely programmable	72
X13-6		Common	
X13-7	DI14	Freely programmable	72
X13-8		Common	
X13-9	+24 V	24 V control logic	—
X13-10	+0 V	Common	

* Not configurable

Table 3-7 Example for digital input signal allocation

Terminal	Channel	Default setting	Parameter group
X11-1	DI01	External start / stop request	72.06 – 72.09
X11-2		Common	
X11-3	DI02	Forward / reverse	72.10 – 72.11
X11-4		Common	
X11-5	DI03	Freely programmable	—
X11-6		Common	
X11-7	DI04	Ramp 1 / 2	72.41 – 72.42
X11-8		Common	
X11-9	DI05	Ext1 / Ext2	30 – 31
X11-10		Common	
X12-1	DI06	Constant speed select	24 – 25
X12-2		Common	
X12-3	DI07	External ON request (start DC link charge)	72.02 – 72.03
X12-4		Common	
X12-5	DI08	Process stop (stops drive)	72.43 – 72.44
X12-6		Common	
X12-7	DI09	MV switchgear open	*
X12-8		Common	
X12-9	DI10	MV switchgear closed	*
X12-10		Common	
X13-1	DI11	MV switchgear available (not tripped)	*
X13-2		Common	
X13-3	DI12	Remote reset	72.33 – 72.34
X13-4		Common	
X13-5	DI13	External OFF request	72.04 – 72.05
X13-6		Common	
X13-7	DI14	Disable local operation	72.35 – 72.36
X13-8		Common	
X13-9	+24 V	24 V control logic	—
X13-10	+0 V	Common	

* Not configurable

Analog inputs

Table 3-8 Standard analog input signal allocation

Terminal	Channel	Default setting	Parameter group
X31-1	+10 V	Internal supply voltage	—
X32-1	0 V		
X31-2	AI1+	Reference value 1 (speed reference)	
X32-2	AI1-		
X31-3	AI2+	Reference value 2 (speed or torque reference)	
X32-3	AI2-		
X31-4	AI3+	Motor winding V temperature	
X32-4	AI3-		
X31-5	AI4+	Motor winding W temperature	
X32-5	AI4-		

Remote speed supply output specifications
 Output voltage 10 V
 Available output current 5mA

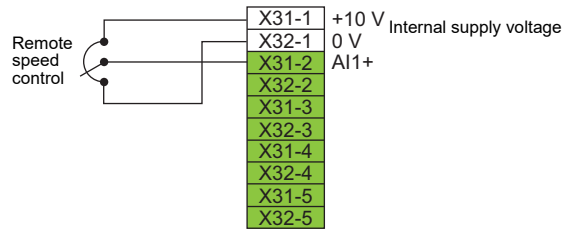

Wiring example - remote speed

Analog outputs



















Table 3-9 Standard analog output signal allocation

Terminal	Channel	Default setting	Parameter group
X31-6	AO1+	Actual motor speed	
X32-6	AO1-		
X31-7	AO2+	Actual motor torque (filtered)	
X32-7	AO2-		

3.3.4 Optional external IOEC4 (A3431) module

Digital outputs

Table 3-10 Optional digital output signal allocation

Terminal	Channel	Default setting	Parameter group
X21-1	DO01	 NC	Freely programmable
X21-2			
X21-3			
X22-1	DO02	 NC	Freely programmable
X22-2			
X22-3			
X23-1	DO03	 NC	Freely programmable (for motor space heater then motor heater OFF command)
X23-2			
X23-3			
X24-1	DO04	 NC	Freely programmable (for motor cooling fan then motor cooling fan ON command)
X24-2			
X24-3			
X25-1	DO05	 NC	Freely programmable
X25-2			
X25-3			
X26-1	DO06	 NC	Freely programmable
X26-2			
X26-3			

Digital inputs

Table 3-11 Optional digital input signal allocation

Terminal	Channel	Default setting	Parameter group
X11-1	DI01	Freely programmable	
X11-2		Common	
X11-3	DI02	Freely programmable	
X11-4		Common	
X11-5	DI03	Freely programmable	
X11-6		Common	
X11-7	DI04	Freely programmable	
X11-8		Common	
X11-9	DI05	Freely programmable	
X11-10		Common	
X12-1	DI06	Freely programmable	
X12-2		Common	
X12-3	DI07	Freely programmable	
X12-4		Common	
X12-5	DI08	Freely programmable	
X12-6		Common	
X12-7	DI09	Freely programmable	
X12-8		Common	
X12-9	DI10	Motor protection monitoring	
X12-10		Common	
X13-1	DI11	Motor vibration 2 / bearing 2 (alarm trip)	
X13-2		Common	
X13-3	DI12	Motor vibration 1 / bearing 1 (alarm trip)	
X13-4		Common	
X13-5	DI13	Ext mot trip (ovrtmp / ovrsdpd / space heater / fan)	
X13-6		Common	
X13-7	DI14	External motor alarm	
X13-8		Common	

—
Table 3-11 Optional digital input signal allocation

Terminal	Channel	Default setting	Parameter group
X13-9	+24 V	24 V control logic	
X13-10	+0 V	Common	

Analog inputs

—
Table 3-12 Optional analog input signal allocatio

Terminal	Channel	Default setting	Parameter group
X31-1	+10 V	Internal supply voltage	—
X32-1	0 V		
X31-2	AI1+	Motor winding U1 temperature	
X32-2	AI1-		
X31-3	AI2+	Motor winding V1 temperature	
X32-3	AI2-		
X31-4	AI3+	Motor winding W1 temperature	
X32-4	AI3-		
X31-5	AI4+	Freely programmable	
X32-5	AI4-		

Analog outputs

—
Table 3-13 Optional analog output signal allocation

Terminal	Channel	Default setting	Parameter group
X31-6	AO1+	Freely programmable	
X32-6	AO1-		
X31-7	AO2+	Freely programmable	
X32-7	AO2-		

3.3.5 Fieldbus communication interfaces (option)

Overview

Fieldbus communication interfaces are used for the bidirectional communication between the drive and a higher-level process control system. Typically, operational commands, status messages of the drive, speed or torque reference values, and actual values are transmitted.



For further information on data transmission and on data and signal allocation to the transmitted datasets, see:

- Signal and parameter table
- Installation and start-up guide of the installed fieldbus interface
- Engineering documents

Available fieldbusses

The drive can be equipped with one of the following fieldbus interfaces.

Fieldbus	Interface type
AF 100 fieldbus communication interface	CI810
Modbus TCP	NETA-21
Modbus RTU	NMBA-01
Profibus DP	NPBA-12

AF 100



Terminal allocation		
X1A:1	L-	0 V supply in
X1B:1	L+	24 V (DC) supply in
X1B:2	L+	24 V (DC) supply out
X1B:3	SA	Redundant power supply "A" monitoring input
X2:1	+	+ Signal
X2:2	-	- Signal
X2:3	SH	Shield
X2:4	SH	Shield

Customer connections

Modbus TCP



Terminal allocation	
RJ-45	Ethernet connection
X1:1	+24 V (DC) supply
X1:2	0 V

Modbus RTU



Terminal allocation		
X2:1	D(P)	Data positive
X2:2	D(N)	Data negative
X2:3	DG	Data ground
X2:4	SHF	Shield AC ground via RC filter
X2:5	SH	Shield ground direct
X2:6	0 V	
X2:7	+24 V	Power supply (24 V (DC) +/- 10 %)
X2:8	PE	Ground

Customer connections

Profibus



NPBA-12 terminal assignment		
X1:1	A	Data negative (conductor 2 in twisted pair)
X1:2	B	Data positive (conductor 1 in twisted pair)
X1:3	A	Data negative (conductor 2 in twisted pair)
X1:4	B	Data positive (conductor 1 in twisted pair)
X2:5	24 V	
X2:6	0 V	Power supply (24 V (DC) +/- 10 %)
X2:7	DG	Cable data ground (optional 3rd conductor) Connected to module ground via a 1MΩ / 15 nF RC network
X2:8	SH	Cable shield. Internally connected to module

Customer connections

Customer connections



To identify the adapter type installed in the drive, see the applicable Wiring diagrams.

Communication with AMC circuit board

The fieldbus adapter is connected to channel 0 of the AMC circuit board via optical fibers.

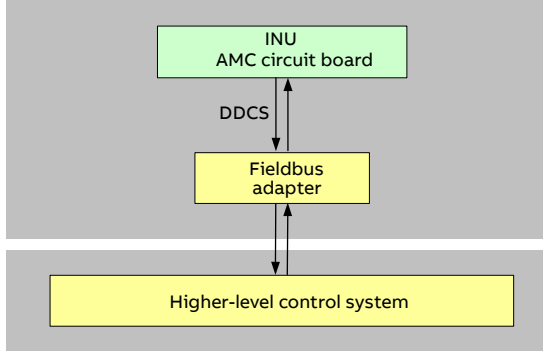

References

3-10 Location of fieldbus and pulse encoder interface

Location

The fieldbus adapter is DIN rail-mounted inside the control compartment (3-10: 1).

The indicated mounting position may vary depending on the number of optional devices present on the swing frame.

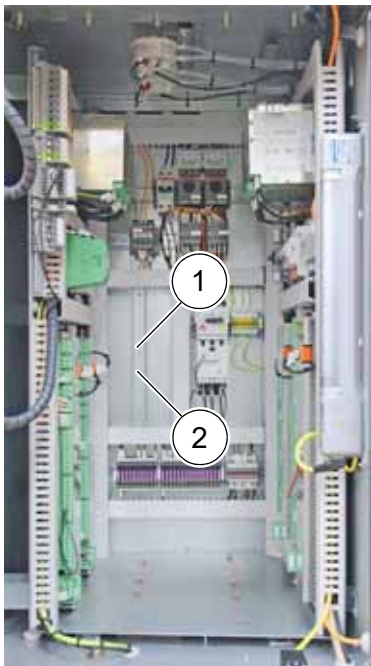

3.3.6 Pulse encoder interface NTAC (option)

Overview

The pulse encoder is required for constant torque applications.



Terminals X1			Terminals X2		
1	A+	Channel A	1	-V	0 V
2	A-		2	-V	24 V
3	B+	Channel B	3	+V	
4	B-		4	24 / 25	
5	Z+	Channel Z	5	15	
6	Z-		6	24	
7	SH	Shield	7	0 V	
8	SH		8	+24 V	

Communication with AMC circuit board

The NTAC module communicates with the AMC circuit board of the INU via a fast optical link using the standard DDCS protocol. The optical fibers are connected to channel 1 of the AMC circuit board.

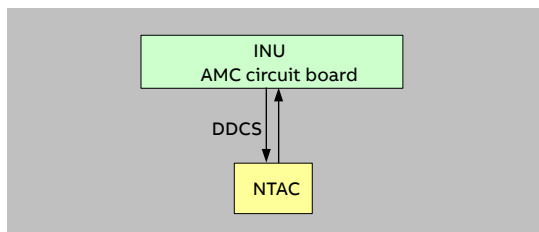

Location

The NTAC interface is DIN rail-mounted inside the control compartment (3-10: 2).

The indicated mounting position may vary depending on the number of optional devices present on the swing frame.

3.3.7 Motor temperature supervision

Motor temperature supervision is accomplished via optional PT100 input modules. These modules are suitable for connection of PT100 resistance thermometers in accordance with IEC60751 in 2, 3 or 4 conductor systems.

Chapter 4

Transportation, storage and disposal

- 69 Safety
- 70 Transport conditions
- 71 Unpacking and inspection
- 72 Lifting and transportation
- 74 Storage
- 75 Storage and handling of spare parts
- 76 Disposal of packaging materials and components

4.1 Safety

The drive must only be handled by personnel who are skilled and experienced in unpacking and transporting heavy equipment.

4.2 Transport conditions

The transport conditions for the drive are based on IEC 60721-3-2 'Classification of environmental conditions: Classification of groups of environmental parameters and their severities; Transportation'.

Table 4-1 Transport Conditions

2K12 Climatic conditions	
Low air temperature	-45 °C
High air temperature	
Unventilated enclosures	70 °C
Ventilated enclosures / outdoor	40 °C
Relative humidity	100%
Absolute humidity	60%
2B1 Biological conditions	
Flora	No
Fauna	No
2M4 Mechanical conditions	
Stationary vibration random	
Acceleration spectral density	10 m ² /s ³ (2 - 3 Hz)
	1 m ² /s ³ (10 - 20 Hz)
	0.5 m ² /s ³ (50 - 2000 Hz)
Non-stationary vibration (including shock)	
Shock response spectrum	100 m/s ² , 11 ms duration 300 m/s ² , 6 ms duration
Free fall	0.1 m
Toppling	No
Rolling, pitching	
Angle	No
Period	No
Steady-state acceleration	20 m/s ²

4.3 Unpacking and inspection

1. Remove all packaging material carefully.
2. Check the drive and accompanying equipment for damages.
3. Compare the complete delivery with the purchase order and the packing list.
4. If parts are missing or damaged, immediately inform the shipping company and the ABB service organization.

It is recommended to photograph the damages and send the photographs to ABB.

4.4 Lifting and transportation



It is recommended to have the following information at hand before transporting the cabinet:

- Appendix C – Mechanical drawings provides details on dimensions, weight, and of center of gravity of the cabinet.
- 10.6 Corrective maintenance provides instructions if the door of the AFE-INU compartment cannot be opened.

4.4.1 General notes on transportation

Observe the following points when transporting the cabinet:

- The cabinet can be transported using a crane or a forklift.
- Drive components can be damaged during transportation. Therefore, transport the cabinet in an upright position.
- When transporting the cabinet, ensure that no dirt enters. Keep the doors closed. Metallic dust in particular can cause damage and lead to malfunction when the cabinet is powered up.

4.4.2 Using a crane

- Use lifting equipment (eg, web slings, chain slings, round slings, safety hooks, shackles) that corresponds to the weight of the cabinet.
- Attach a sling to the outer holes of the rails (arrows).

The rails can be removed after the cabinet has been installed at its final location.

- Do not pass a sling through the hole. To attach a sling, use appropriate safety hooks or shackles
- Verify that the slope angle (1) is appropriate to the weight of the cabinet.
- Observe the center of gravity.
- Lift the cabinet slowly and steadily to the required clearance height maintaining the cabinet in upright position.
- Check the horizontal position of the cabinet. Reposition the slings if necessary.

—
References
—
4-1 Lifting rails
—
4-2 Transporting the cabinet by crane

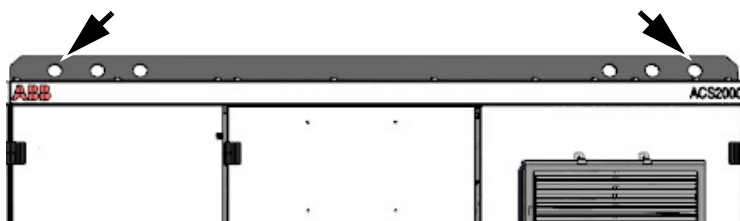

—
4-2

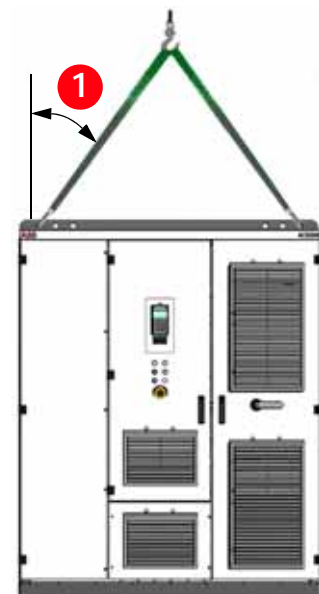

—
4-2

References

4-3 Transporting the cabinet by forklift

4.4.3 Using a forklift

Do not lift drives with DTL compartment by a forklift.

- Transport the cabinet only with the short side facing in the driving direction.
The recommended position of the forklift is on the short side of the cabinet (4-3). This is the cabinet side where the heaviest drive components are located.
- Use forks of sufficient length to ensure stable transportation and to prevent tipping.
The arrow in 4-3 indicates the minimum fork length if the forklift is positioned on the right. If the forklift is positioned on the left of the cabinet, the forks must be as long as the cabinet.
- Insert the forks fully to transport the cabinet.

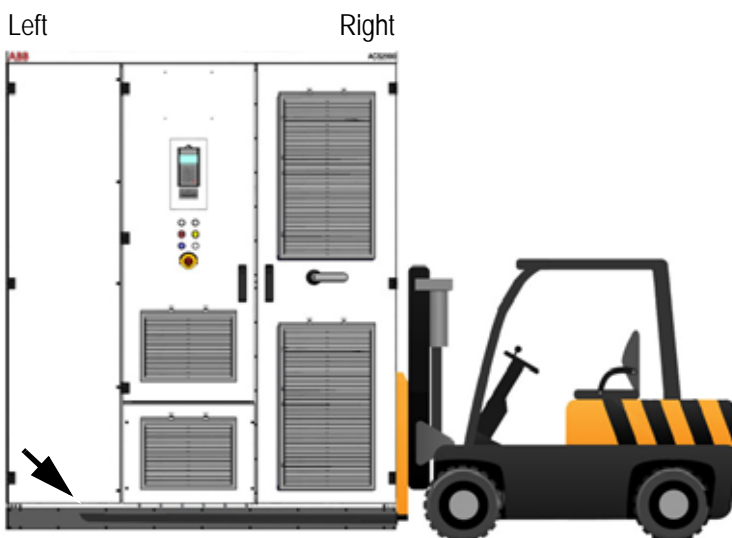

4.5 Storage

4.5.1 Storage conditions

The minimum requirements for storage are based on IEC 60721-3-1 '*Classification of environmental conditions: Classification of groups of environmental parameters and their severities; Storage*'.

Table 4-2 Storage conditions

1K22 Climatic conditions	
Air temperature	-25 – +55 °C (drive) -5 – +55 °C (spare parts)
Relative humidity	10 – 100%
Absolute humidity	0.5 – 29%
1Z3 Special climatic conditions	
Movement of surrounding air	30 m/s
1B1 Biological conditions	
Flora	Negligible
Fauna	Negligible
1M12 Mechanical conditions	
Vibration	
Acceleration spectral density	0.1 m/s ² (5 – 200 Hz)

The drive can be stored for up to one year in the original packaging as long as it is not damaged or opened. For information on longer storage periods contact the ABB service organization.

4.5.2 Storage

If the drive is taken out of service for a longer time proceed as follows:

- Cover all cable inlets and ventilation slots with an impermeable plastic or aluminum foil and a wooden panel.
- Add a desiccant of the appropriate quality:
 - 1 unit desiccant (30g) absorbs 6 g water vapor.
The following quantity is needed when using a polyethylene foil:
 - 10 units/m² foil
- Close and lock the doors of the cabinet.
- Use polyethylene or equivalent for packaging:
 - 0,3g/m²/24h water vapor diffusion
- Attach humidity indicators to the packaging. The storage conditions and the packaging should be checked regularly. Any damages that occur during the storage period should be repaired immediately.

4.6 Storage and handling of spare parts

4.6.1 Storage place conditions

- Temperature range: -5 °C – + 55 °C
- Free of vibration and shock.
- Protected against dust, sand, vermin and insects.
- Free of corrosive gases, salt or other impurities that could damage electronic equipment.
- Dry; no condensation

Relative air humidity: 5 – 85%

If in doubt whether the maximum allowed humidity is exceeded, protect the spare parts by an external heater.

4.6.2 Handling precautions

NOTICE

Electronic devices (eg, circuit boards, semiconductors) are sensitive to electrostatic discharge (ESD). ESD can damage these devices.

Apply ESD handling precautions before handling these devices.

To maintain spare parts in good condition and to keep the warranty valid during the warranty period, observe the following:

- Check the spare parts immediately after receipt for damages. Report any damage to the shipping company and the ABB service organization.
- Keep spare parts in their original packaging.
- Store printed circuit boards in antistatic bags or boxes.
- Ground yourself with a wrist strap before touching a component.
- Hold the component only at the edge.

Put the component on a grounded working surface protected against electrostatic discharges.

4.7 Disposal of packaging materials and components

Dispose of the packaging materials and the components at the end of the life time of the drive according to local regulations.

Chapter 5

Mechanical installation

- 79 Safety
- 80 Overview on installation work
- 81 General notes on installation
- 82 Fixing the cabinet to the floor
- 84 Installing fan units

5.1 Safety

All installation work must be carried out by qualified personnel according to the site and equipment requirements and in compliance with local regulations.

5.2 Overview on installation work

The installation includes the following work:

- Preparing the floor
- Fixing the cabinet to the floor
- Installing fan units

5.3 General notes on installation

NOTICE

Foreign matter and particularly metallic dust can cause failure and damage when the drive is energized.

Ensure that foreign matter cannot enter the cabinet:

Close the doors and cover openings completely when work is discontinued.

Retrieve any foreign matter which accidentally dropped into the cabinet.

5.3.1 Dimensions, clearances



For information on cabinet dimensions, clearances to be observed and mounting hole sizes, see Appendix C – Mechanical drawings.

5.3.2 Cabinet roof

The cabinet roof is not designed as a mounting base for eg, foreign devices, cable ducts. Therefore, it is not permitted to install any foreign device on the roof.

5.3.3 Fire protection

Suitable fire protection measures should be applied to prevent fire spreading into the drive.

5.3.4 Cable duct material

Cable ducts should be of non-flammable material with non-abrasive surface.

All cable entries and exits should be protected to prevent dust, humidity and animals entering into the drive.

5.3.5 Preparing the floor

Condition of the floor

- Must support the weight of the cabinet
- Overall incline across 5 m must not exceed 5 mm
- Even
- Non-flammable, smooth and non-abrasive
- Protected against humidity diffusion

5.4 Fixing the cabinet to the floor

References

5-1 Fixing the cabinet to the floor

The cabinet provides a hole in each corner of the base for floor fixings.

Insert the screws from the ends of the cabinet base (5-1: A) or via the holes inside the cabinet (5-1: B – D).

Hole number (5-1: 4) cannot be accessed from inside the cabinet.

Floor fixings are not supplied. Anchor bolts as illustrated (5-1: E), or screws and nuts of size M20 are recommended.

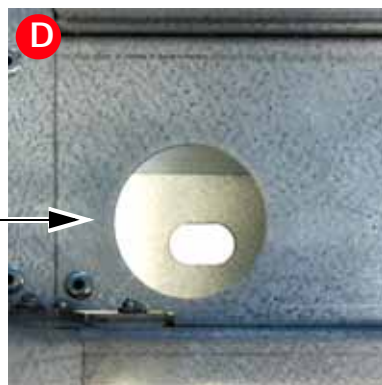
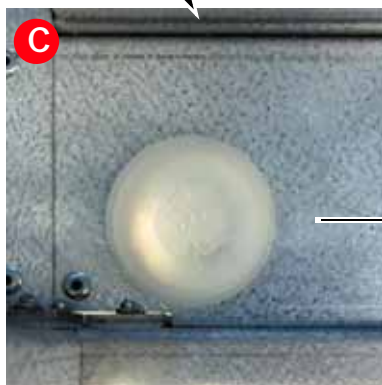

5.5 Installing fan units



For information on the number of fan units to be installed and their location on the cabinet roof, see the applicable Mechanical drawings.

Installation

1. Lift the fan unit onto the roof by means of a forklift or a crane (if using a crane, employ the lifting eyes in the fan roof).

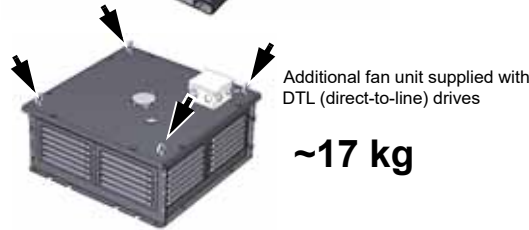

Note: The mounting position can be identified by the cutouts in the drive roof.

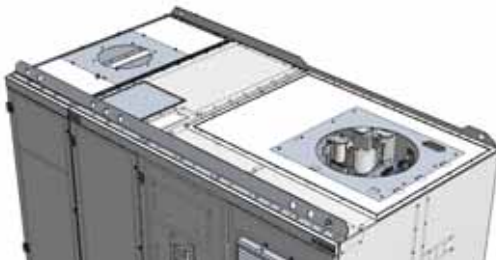

2. Use the supplied screws to fasten the fan unit(s) to the fan mounting plate(s) on the cabinet roof.

M8	25 Nm
----	-------

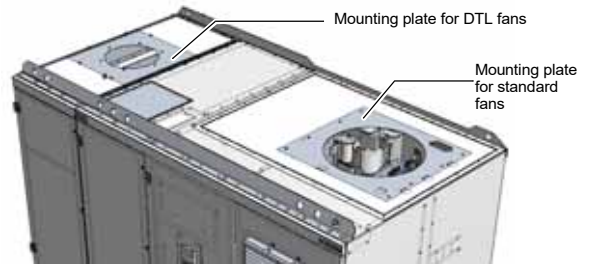

Redundant fan configurations

Redundant fan configurations require prior installation of the appropriate redundancy adaptor box on the cabinet roof.

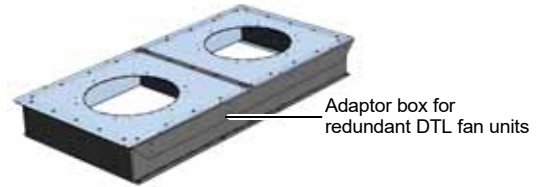

~42 kg (adaptor box for redundant standard fan units)

~17 kg (adaptor box for redundant DTL fan units)



For information on the electrical installation, see 6.11 Control and power supply cables for fan units.

Chapter 6

Electrical installation

87	Safety
88	Overview of installation work
89	Cable requirements
90	Parallel routing of power cables
91	Terminal sizes
92	Ground cable connection and cable shield connections
94	Cables between integrated transformer and drive
96	Cable entries
97	Power cables, ground cables, equipotential bonding conductor
103	Auxiliary power, control and serial communication cables
107	Control and power supply cables for fan units
109	Final checks

6.1 Safety

WARNING

Hazardous voltage!

Improper work could lead to life-threatening injury or death.

The electrical installation must be carried out by qualified personnel according to the site and equipment requirements, and the relevant electrical codes.

When the electrical installation is completed, the main and auxiliary power supply to the drive must not be switched on without the consent of the ABB commissioning personnel.

Take appropriate measures to prevent main and auxiliary power supply being switched on during installation.

6.2 Overview of installation work

The electrical installation includes the following wire and cable connections:

- Cables between integrated transformer and drive
- Power cables, ground cables, equipotential bonding conductor
- Auxiliary power, control and serial communication cables
- Control and power supply cables for fan units

6.3 Cable requirements



For information on the requirements for power cables, ground cable and equipotential bonding conductor, see:

ACS2000 power cable specification

Power cables engineering guideline

For information on the requirements for the auxiliary power cable and the control cables, see Auxiliary power and control cables guideline.

6.4 Parallel routing of power cables

Independent of the distance between the non-integrated transformer and the drive, and the drive and the motor, one single-core cable per each phase must be used. The current carrying capacity must not be increased by laying cables in parallel.

6.5 Terminal sizes

Table 6-1 Auxiliary power terminal sizes

Standard three-phase auxiliary power supply	
Terminal	Wire cross section (mm ²)
-X1:1	2.5 to 25
-X1:3	
-X1:5	
-N	
-PE	
Optional single-phase UPS	
Terminal	Wire cross section (mm ²)
-X1:11	1.5 to 25
-X1:12	
-PE	
Optional auxiliary power supply for converter space heater	
Terminal	Wire cross section (mm ²)
-X1:15	1.5 to 25
-X1:16	
-PE	

Table 6-2 I/O module terminal sizes

	Wire cross section (mm ²)
Digital inputs	0.5 to 2.5
Digital outputs	
Analog inputs	
Analog outputs	



- For information on the auxiliary supply voltage, see the rating label of the drive.

6.6 Ground cable connection and cable shield connections

The cabinet is equipped with a ground busbar (marked PE, Protective Earth) for grounding the armor and shields of the cables, and for the connection of the ground cable.

References

6-1 Grounding the drive system and integrated transformer



To identify the ground busbar, see the applicable Mechanical drawings.

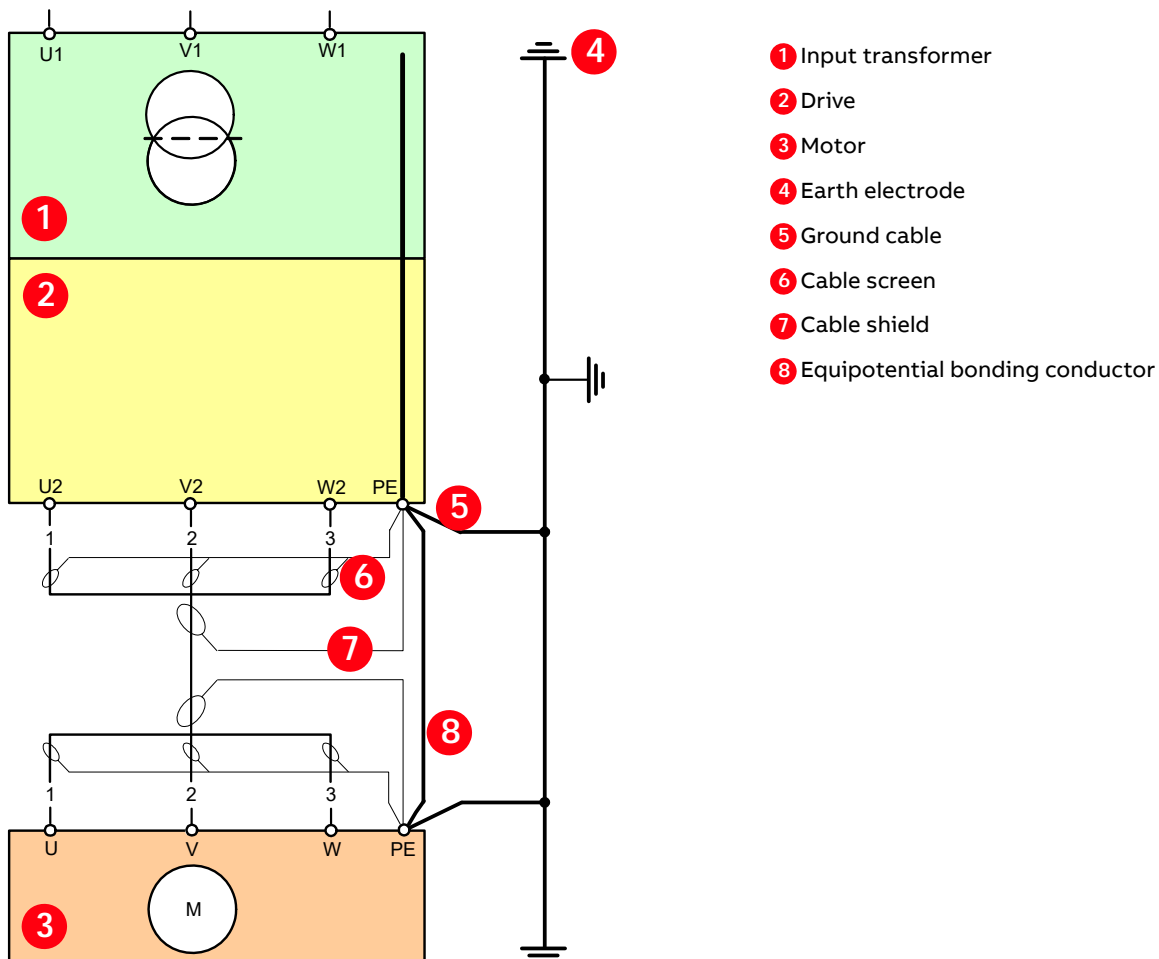

References

6-2 Grounding the drive system and non-integrated transformer

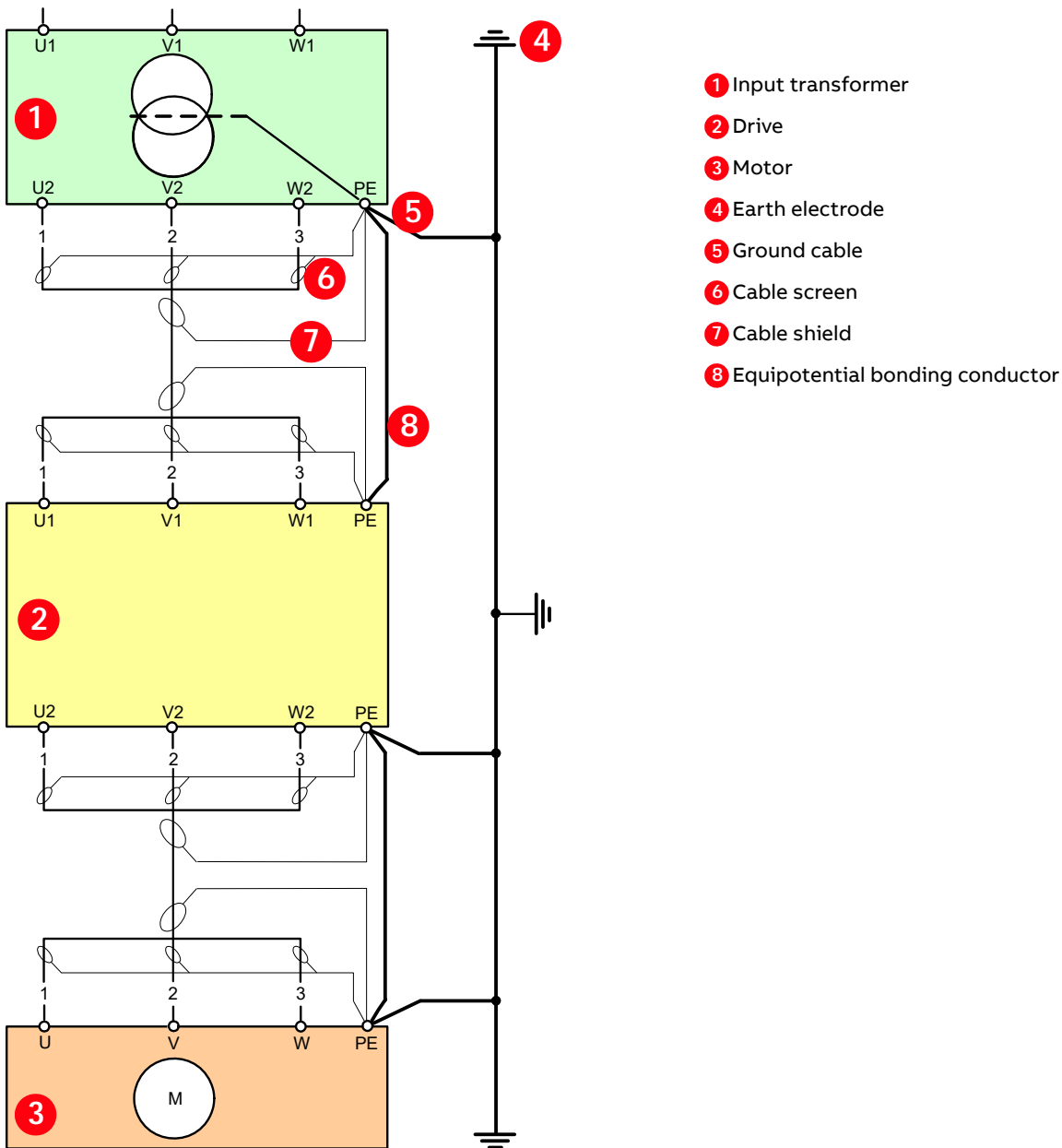

6.7 Cables between integrated transformer and drive

Cabling of a drive with an integrated transformer includes the following connections:

References

6-3 Drive with integrated transformer

6-4 Heating cable connection

- Transformer primary and secondary cables
- Temperature sensor cables
- Three-phase power supply and control cables to each of the transformer fan units
- Air filter and pressure monitoring cable
- Heating cable (option)
- Optical fiber and power supply for primary current measurement

The cables are identified by their specific number and are labeled with the designation of the terminal where they are connected to.

The cables are prepared for connection. Power cables are rolled up in the transformer cabinet,

control cables in the drive cabinet.



For further information, see Appendix D – Wiring diagrams.

6.7.1 Heating cable (optional)

This section applies to drives that are delivered in several transport units and are equipped with a heating cable.

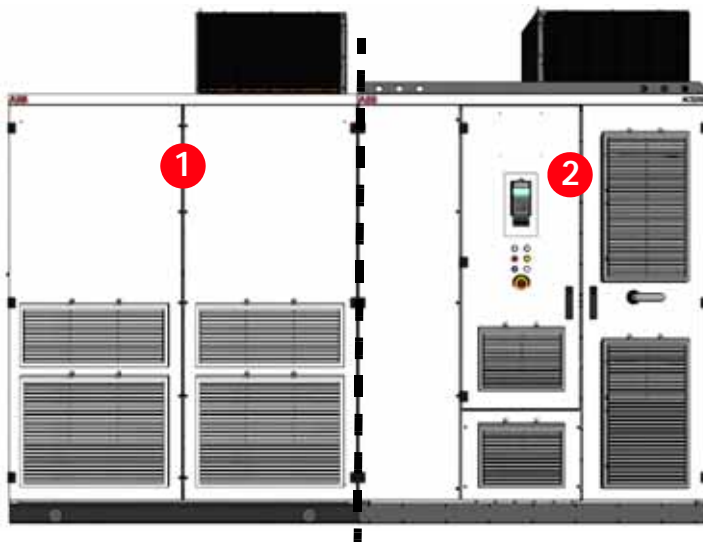

1 Input transformer

2 Drive

6-3

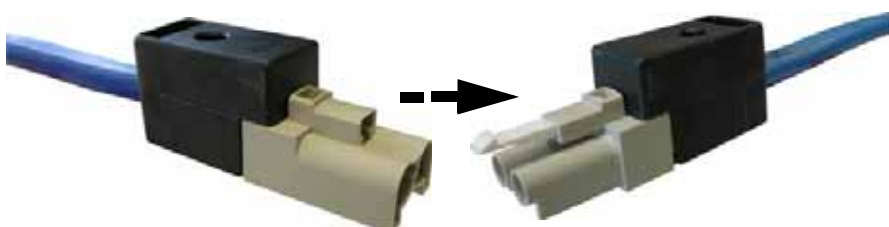

6-4

1. Connect the power supply of the heating cable.



For further information on power supply connections, see the applicable Wiring diagrams.

2. Connect the heating cables of two adjoining transport units with each other.
3. Fasten the connectors with cable ties.

6.8 Cable entries

The drive is prepared for top or bottom cable entry with one or a combination of the following cable entries:

- Cable entry with EMC plates
- Cable entry with sealing modules, type 1
- Cable entry with sealing modules, type 2



For further information, eg, location and dimensions, see the applicable Mechanical drawings.

6.8.1 Cable entry with EMC plates

Usage

Power cables, ground cables, bonding conductors
Auxiliary power cables, control cables

Included in delivery

Galvanized plate with net-like EMC sleeves (1) and sealing grommets (2)

Example



EMC cushions (1) on the underside of the EMC plate if the cable entry is used for control cables.



6.8.2 Cable entry with sealing modules, type 1

Usage

Power cables, ground cables, bonding conductors

Included in delivery

Cable entry frame (1)

Not included in delivery

Sealing modules (2), accessories, tools

Example

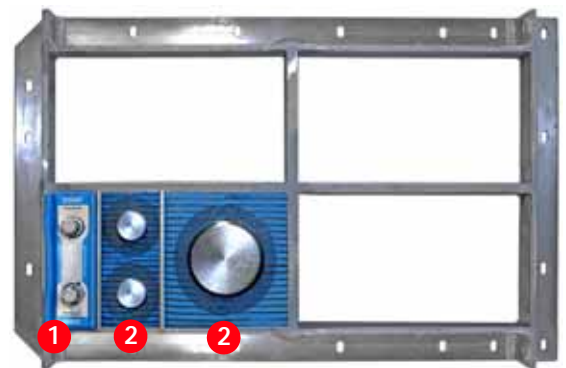

6.8.3 Cable entry with sealing modules, type 2

Usage

Auxiliary power cables, control cables

Included in delivery

Frame (1), EMC sealing modules (2)

Example



Supplier

Roxtec AB (www.roxtec.com)

Not included in delivery

Tools and accessories

6.9 Power cables, ground cables, equipotential bonding conductor

6.9.1 Further information



See the applicable Mechanical drawings for information on:

- Project-specific cable entry
- Distance between point of cable entry and terminals
- Busbar and fastening hole dimensions
- Busbar designations

See the applicable Wiring diagrams for information on:

- Conventions for cross-references and device identification
- Transformer cables and motor cables and their corresponding connections

6.9.2 Preparing the cable entry and the cables

NOTICE

Risk of damage or malfunction!

Waste inside the cabinet can cause damage or malfunction.

If possible, do not cut cables inside the terminal compartment. Retrieve any waste which accidentally dropped into the cabinet.

Determining the cable length

1. Determine the required length of a cable between the point of entry and the connection point inside the cabinet.
2. Cut the cable to the required length before connection.

Preparing the cables for EMC plates

The orientation of the EMC plates is the same for top and bottom cable entry: the sealing grommets face always upwards.

1. Remove the grommets.
2. To ensure proper sealing, cut along the marking that corresponds to the cable diameter.



3. Slide the grommet onto the cable. The grommet must fit tightly to prevent water entering the cabinet.

The grommets can be discarded if cables are entered through the cabinet floor.

4. If necessary, remove the entry plate and push the cable through the entry holes.
5. Prepare the cables as illustrated.
 - (6-5: A) illustrates how cables with an outer cable screen or shield are prepared for EMC bonding with the metal enclosure of the cabinet.
 - (6-5: B) illustrates how cables without an outer screen or shield are prepared.

References

6-5 Preparing power cables for EMC plates

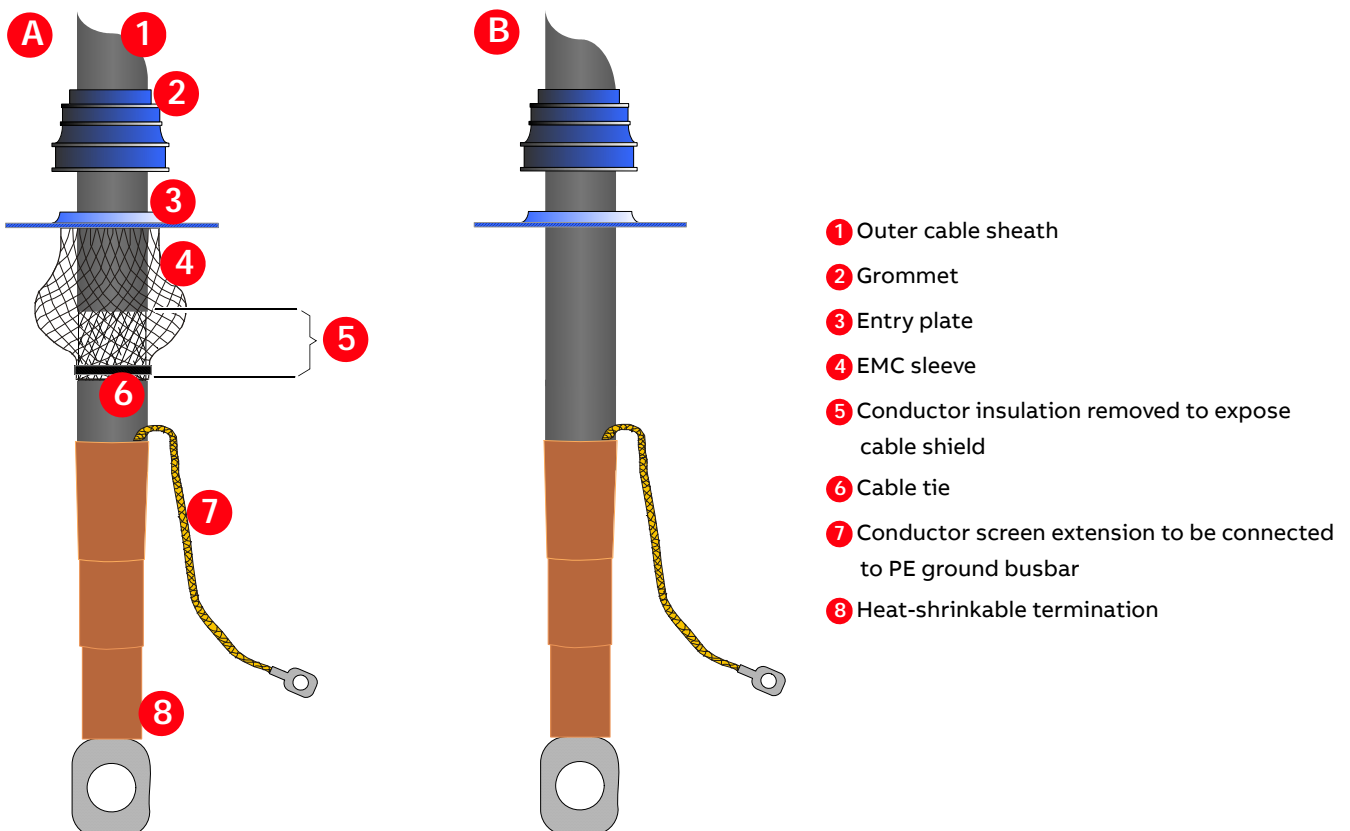

—
References
—

6-6 Preparing power
cables for sealing
modules

Preparing the cables for cable entries with sealing modules

- Prepare cables with an outer cable screen or shield for EMC bonding with the metal enclosure of the cabinet as illustrated.
- Install the sealing modules according to the instructions of the sealing module supplier.

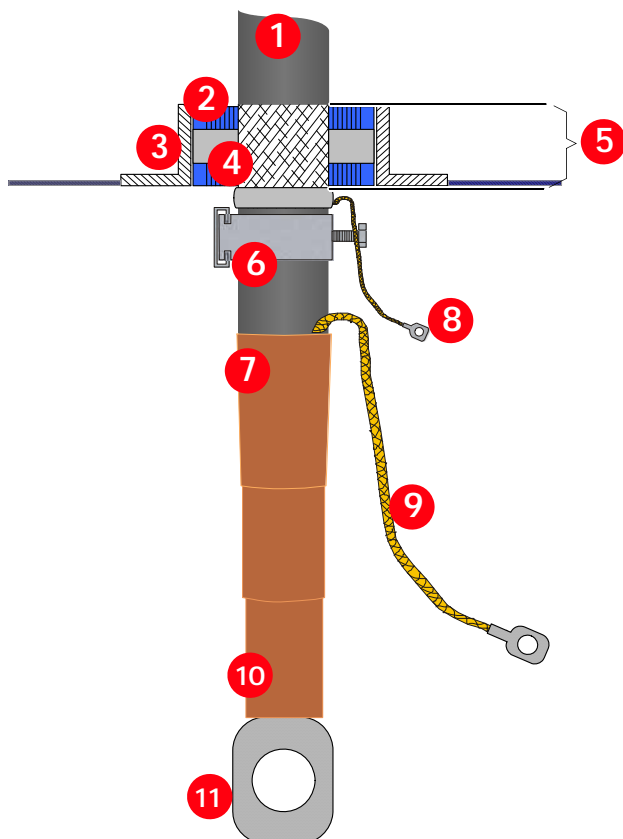

- 1 Outer cable sheath
- 2 Sealing module
- 3 Frame
- 4 Conductive foil of sealing module
- 5 Cable sheath removed to expose cable shield
- 6 Cable clamp
- 7 Shrinkable sheath seal
- 8 Shield extension to be connected to PG busbar
- 9 Conductor screen extension to be connected to the PG busbar
- 10 Heat-shrinkable termination
- 11 Cable lug as specified by the cable supplier and suitable for M12 bolt

6.9.3 Connecting the cables

NOTICE

Risk of flashover!

High voltages will be present in the terminal compartment. High voltages can cause flashover between conductors with different electric potential, and between a conductor and earth. Therefore, maintain a minimum clearance of 55 mm between a conductor and the terminals of any other conductor, and between a conductor and earth.

Checking the cable insulation

- Measure the insulation of each cable before connection and verify that the results are within the specification of the cable manufacturer.
- Leave the cable conductors unconnected at both ends until the commissioning engineer has given permission.

—
References

—
6-7 Power cable entry

Connections

Connect the cables to their corresponding busbars:

- the feeder cable conductors to busbars U1, V1, W1,
- the motor cables to busbars U2, V2, W2,
- the screen ends of all conductors and the shields of all cables to the PE ground bus,
- the ground cable to the PE ground bus (6-7: 1),
- the equipotential bonding conductor to the PE ground bus (6-7: 1).

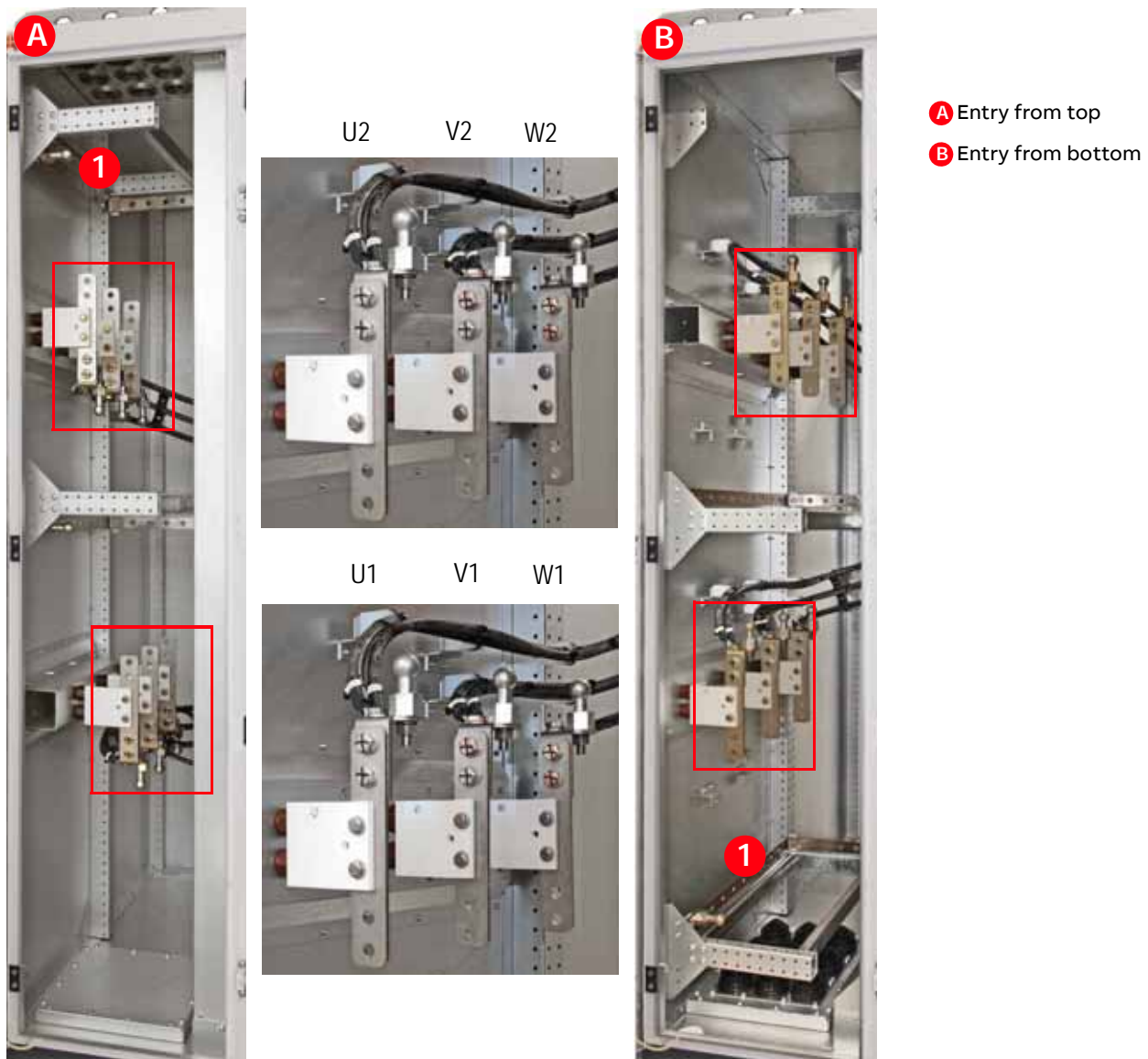

—
References
—
6-8 Bolted busbar
connection

Bolted connections

Material requirements

Use stainless steel bolts and nuts with the appropriate steel grade and property class for the connection (recommended: A2-70 [designation according to ISO 3506]).

Nuts with bonded coating can be used as an alternative to uncoated stainless steel nuts.

Connection type

The following connection type is recommended when a cable lug (6-8: 4) is connected to a busbar (6-8: 3):

- Spring washer (6-8: 1) and flat washer (6-8: 2) on each side of the busbar (6-8: 3).
- Other washers can be used, provided they maintain the required contact pressure.
- Cable lugs suitable for M12 bolts.

Lubrication

- If stainless steel bolts and nuts are used, lubricate the thread and head contact surface of the bolt using recommended pastes, eg, Molykote D paste.

—
If a coated nut (eg, with bonded molybdenum-disulfide [MoS₂] coating) is used, the connection does not have to be lubricated.

Tightening torque

- Tighten bolted connections with bolts of sizes M10 and greater with the recommended nominal torque for the bolt size used.

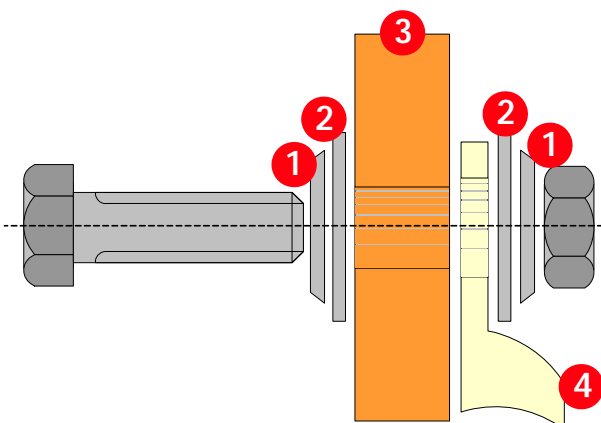

6.10 Auxiliary power, control and serial communication cables

—
References
—
6-9 Control cable entry

6.10.1 Further information



See Appendix C – Mechanical drawings for information on:

- Project-specific cable entry
- Dimensions between point of cable entry and terminals

See Appendix D – Wiring diagrams for information on:

- Conventions for cross-references and device identification
- Terminal designations

—
The power feed for the auxiliary supply must be protected with a suitable circuit protection rated for the inrush current. For infor-

mation, see utility consumption list of the drive.

6.10.2 Preparing the cable entry and the cables Determining the cable length

1. Determine the required length of a cable between the point of entry and the connection point inside the cabinet.
2. Cut the cable to the required length before connection.

Routing the cables

Top and bottom entry

- To facilitate cable routing, remove the cover above the cable transit (6-9: 1), and the cover of the cable duct (6-9: 2).
- Rout the cables as illustrated to the customer terminals in the control compartment.

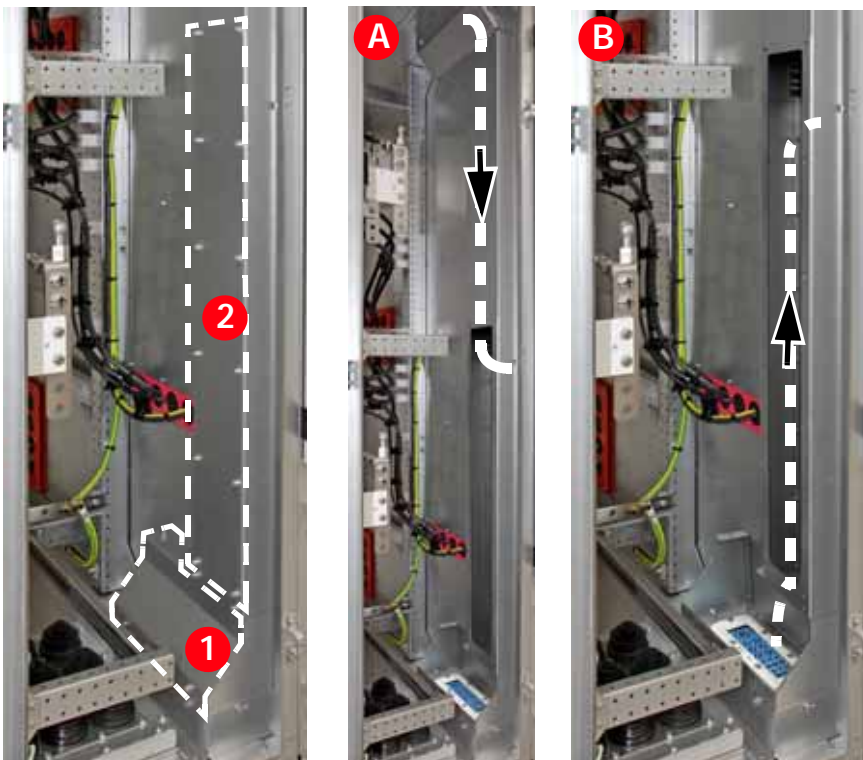

- A** Entry from top
- B** Entry from bottom

Preparing cables for EMC plates

Top or bottom cable entry

1. Remove the grommets.
2. To ensure proper sealing, cut along the marking that corresponds to the cable diameter.



3. Slide the grommet onto the cable. The grommet must fit tightly to prevent water entering the cabinet.

The grommets can be discarded if cables are entered through the cabinet floor.

4. If necessary, remove the entry plate and pull the cable through the entry holes.
5. Loosen the screws of the EMC cushion brackets and push the cushions apart.

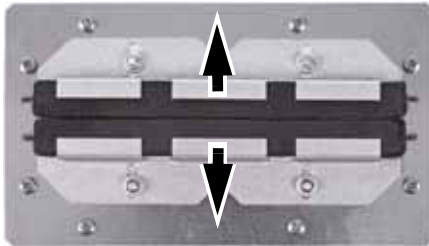

6. Remove the cable insulation at the point of entry (6-10: 1).

If the outer cable screen is non-conductive, cut open the cable screen in the middle of the stripped area (6-10: 1). To turn the conductive side inside out, pull the cable screen ends over the cable insulation (6-10: 2). Connect the screens ends with a continuous conducting foil (6-10: 3).

7. Pull the cables through the EMC cushions.

8. Push the cushions together so they fit tightly around the bare screen and tighten the screws.

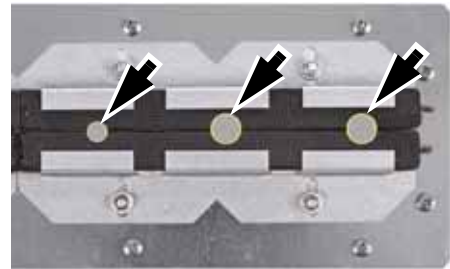

—
References

—
6-10 Preparing control cables for EMC plates

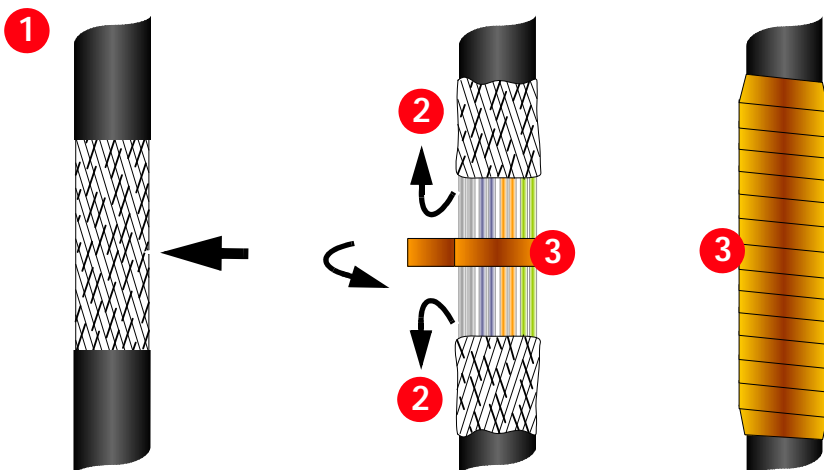

References

6-11 Preparing control cables for sealing modules

6-12 Preparing control cables for cable glands

Preparing cables for cable entries with sealing modules

1. Unscrew the frame and remove the sealing modules.



For information on removing and installing the sealing modules, see Appendix A – Additional manuals.

2. Prepare the cables with an outer cable screen for EMC bonding with the metal enclosure of the cabinet as illustrated.

Preparing cables for cable entries with cable glands

- Prepare the cables with an outer cable screen for EMC bonding with the metal enclosure of the cabinet as illustrated.

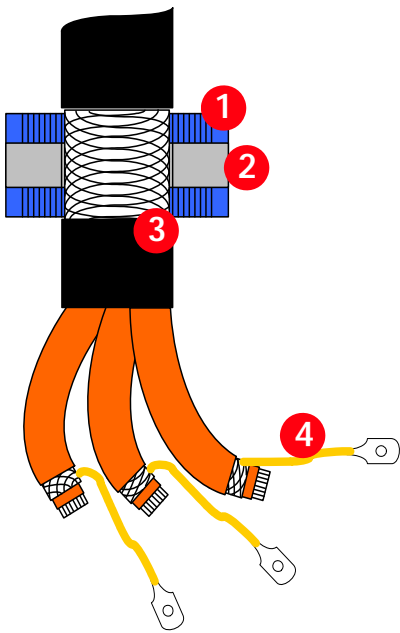

- 1 Sealing module
- 2 Conductive foil
- 3 Cable sheath removed to expose cable shield
- 4 Conductor screen extension to be connected to PE terminal

6-11

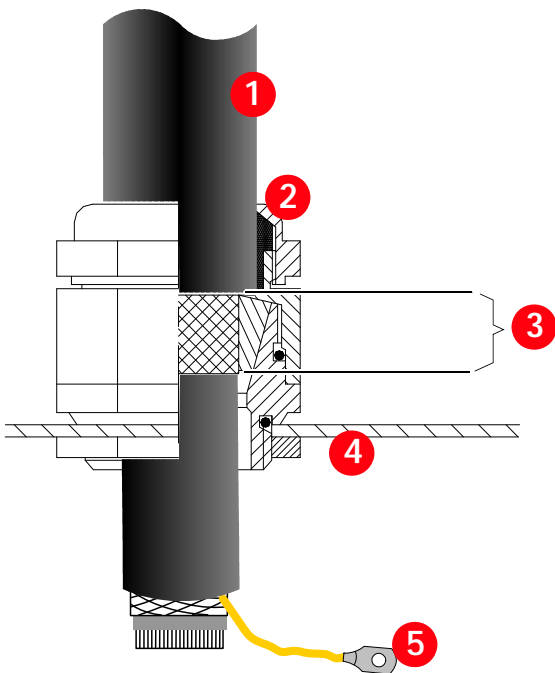

- 1 Outer cable sheath
- 2 Cable gland
- 3 Conductor insulation removed to expose cable shield
- 4 Plate
- 5 Conductor screen extension to be connected to PE terminal

6-12

References

6-13 Shield grounding point for encoder cable

6.10.3 Connecting the cables

IOEC modules

- Connect the cables for digital and analog input and output signals to the IOEC modules.

Conductors

- If a twisted pair cable is used, leave the unshielded cable ends twisted until they reach the terminals.
- Leave unshielded conductor ends as short as possible (not longer than 50 mm).

Cable shields

- Connect the shield of serial communications cables to the fieldbus adapter.
- Connect the overall shield and the individual shields of the encoder cable to the separate shield grounding bracket (6-13: 3). Do not connect the shields directly to the encoder adapter (6-13: 1).
- To accommodate encoder cables of different diameters, ground clamps (6-13: 2) of different sizes are supplied.

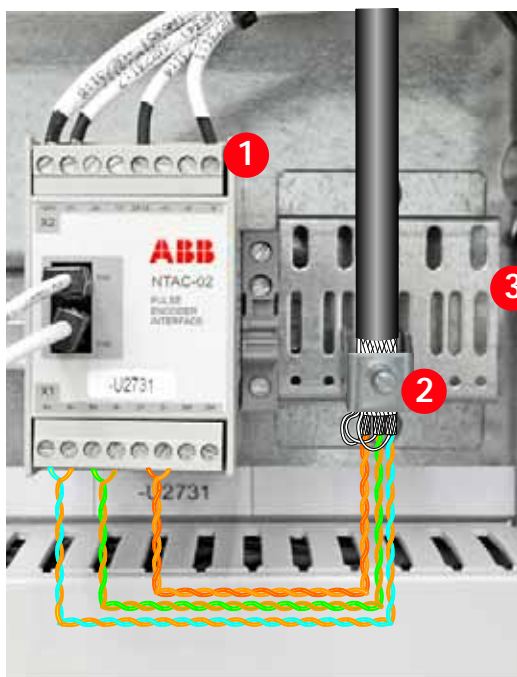

6.11 Control and power supply cables for fan units

DTL fan units

(In drives with DTL operation only) Connect the power supply cable of the fan unit to the terminals inside the corresponding terminal box (see picture below).

Standard fan units

1. Pull the control and power supply cables through the rear cable entry located in the floor of the fan unit (see picture below).
2. Route the cables through the fan cable entry on the cabinet roof and connect them to the appropriate terminals inside the cabinet.



For information on connection details, see the applicable Wiring diagrams.

Note: The control and power supply cables are already prepared in the factory for connection.

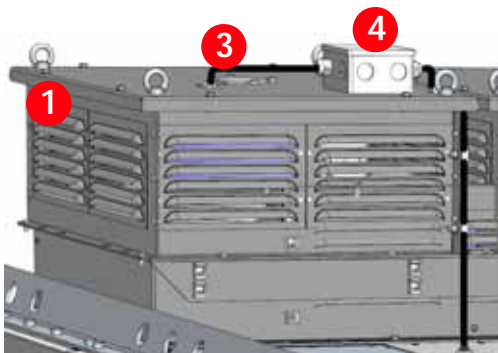

- ① DTL fan unit
- ② Standard fan unit
- ③ Power supply cable
- ④ Terminal box
- ⑤ Front cable entry
- ⑥ Rear cable entry
- ⑦ Cable entry on cabinet roof

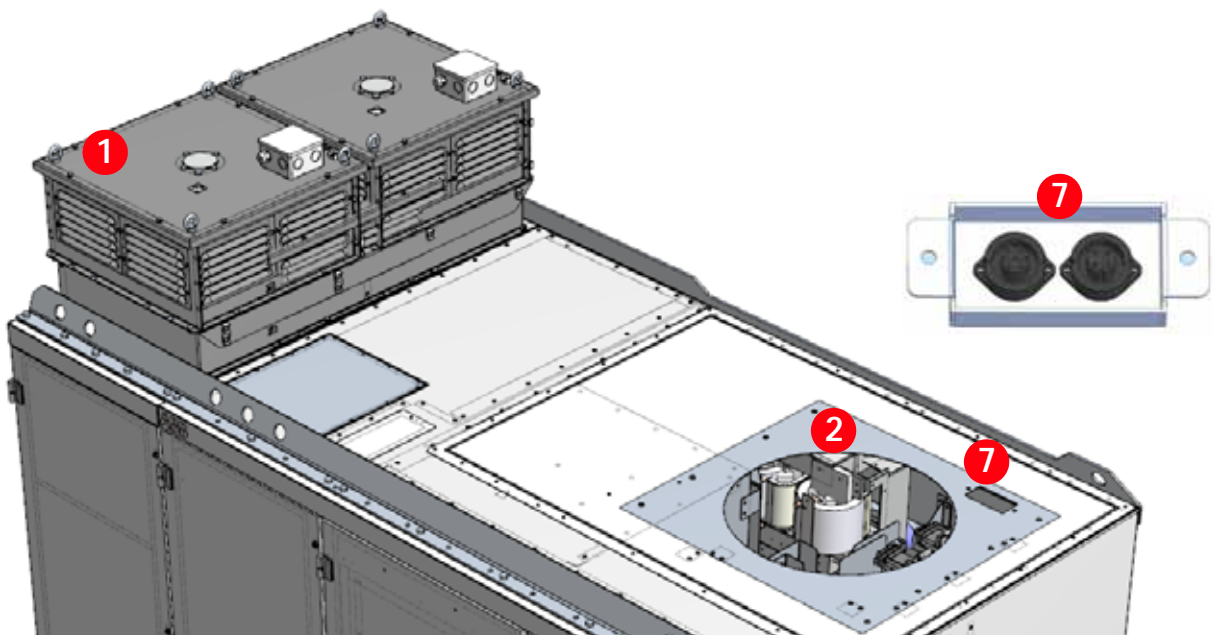
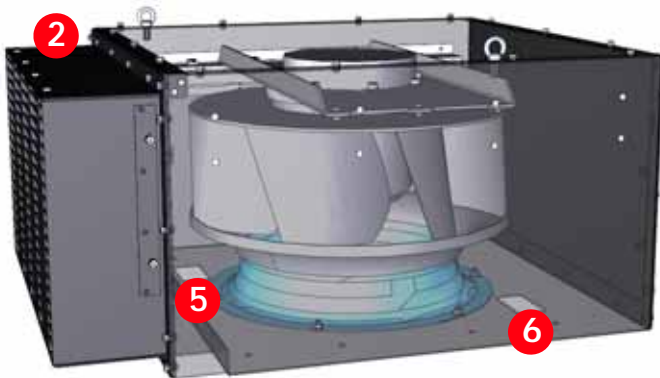

6.12 Final checks

- Check that the entry plates are properly fastened.
- If EMC entry plates with grommets are used, check that the grommets fit tightly (arrows) to prevent water entering the cabinet. If necessary, seal gaps with silicone.

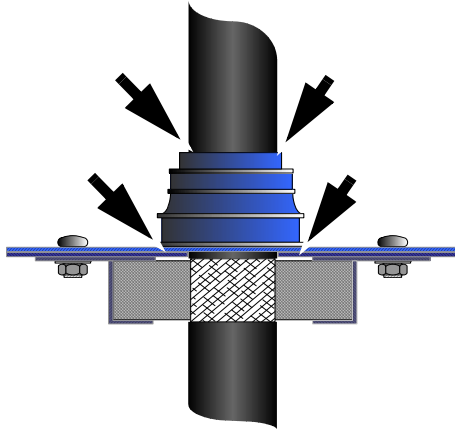

Chapter 7

Commissioning

- 111 Required qualification
- 111 Commissioning procedure
- 111 Commissioning check list
- 112 Customer assistance
- 112 Customer acceptance

7.1 Required qualification

Commissioning, parameter adjustments and functional tests of the drive must be carried out only by commissioning personnel certified by ABB.

7.2 Commissioning procedure

Information on the commissioning procedure and the start conditions for commissioning can be obtained from ABB.

To contact the ABB service organization, see [Contact information](#).

7.3 Commissioning check list

In order to ensure uncomplicated and speedy commissioning, it is important that drive and associated equipment are ready for commissioning. Reviewing and completing the items in the Commissioning check list before the commissioning personnel arrive on site will help to achieve this.

7.4 Customer assistance

During the commissioning period, the customer is requested to provide qualified personnel for assistance, who are

- experienced with medium and low voltage equipment and with the local safety regulations,
- familiar with the driven process,
- authorized to operate associated medium and low voltage equipment (eg, main circuit breaker, other low and medium voltage switchgear),
- authorized to operate the driven process for functional tests.

7.5 Customer acceptance

When commissioning has been completed, the commissioning report is signed by the responsible commissioning personnel and by the customer as a sign of acceptance. A copy of the report and a copy of the actual parameter settings are handed out to the customer.

Mechanical installation

1. Drive installed according to the instructions in the user manual
2. Drive securely fastened to the floor (if applicable)
3. Fan unit or fan units installed
4. Visual inspection:
no badly affixed or damaged components
no foreign objects inside cabinet
no dirt, dust and humidity inside cabinet

Electrical installation

1. Types and cross sections of control cables suitable for the signal type and signal level
2. Types and cross sections of power cables selected according to the power cable specification
3. Pulse encoder cable screens connected to screen **grounding point** and not connected directly to the pulse encoder interface (only applicable for drives with pulse encoder interface)
4. Cable entry prepared according to the instructions in the user manual
5. All control cable screens and conductors are connected according to the instructions of the user manual, appropriately labeled, and the customer connections are completed
6. Heating cable (if supplied) installed according to the instructions in the user manual
7. Ground cable of drive securely connected at both ends
8. Input transformer and motor cables not connected at both ends (cables and drive must be meggered before connection)

Door interlocking

1. The manual release of the safety switch is in the locked position

Main circuit breaker (MCB)

1. Type of MCB selected as per MCB specification

2. High voltage connections completed

3. MCB ready to be tested with drive

4. MCB protection relay settings tested

5. Safety devices (eg, door locks) tested and in operation

Input transformer (if applicable)

1. Ground connection completed

2. Transformer auxiliaries (eg, dehydrating breathers, cooling, protection devices) ready

3. Safety devices (eg, door locks) tested and in operation

Motor

1. Motor installed, aligned and alignment protocol available
2. Motor not coupled to driven load
3. Ground connection completed
4. Motor auxiliaries (eg, bearing lubrication, heater cooling) ready

Insulation tests

1. All power cables to input transformer, between input transformer and drive, and from drive to motor measured, measured values within the required limits.
2. Report of the megger test available

If the test is carried out by the commissioning engineer of the drive, an additional day per drive motor combination needs to be reserved. After the test, the feeder cables can be connected, except at the drive end. The test must comply with the specification.

Power supply

1. Medium voltage available for start-up of drive
2. Low voltage auxiliary power available for start-up of drive

Miscellaneous

1. Sufficient number and correct type of spare parts available
2. Air conditioning of drive room ready for load run of drive
3. Optional equipment ready

Chapter 8

Operation

119	Operating conditions
120	Safety
121	Overview
122	Overview of local operator panel
124	Status messages
128	Starting the drive
130	Stopping the drive
131	Emergency-off

8.1 Operating conditions

The operating conditions for the drive are according to IEC 60721-3-3 'Stationary use at weather-protected locations' (deviations from the standard are indicated).

Table 8-1 Operating conditions

3K3 Climatic conditions			
Air temperature	5 – 40 °C		
Relative humidity	5 – 85%		
Absolute humidity	1 – 25 g/m ³		
Condensation	No		
3B1 Biological conditions			
Flora	No		
Fauna	No		
3C2 Chemically active substances			
Sea salt and road salts	Salt mist		
	Mean value	Max. value	
Sulphur dioxide	0.3 mg/m ³	1.0 mg/m ³	
Hydrogen sulfide	0.1 mg/m ³	0.5 mg/m ³	
Chlorine	0.1 mg/m ³	0.3 mg/m ³	
Hydrogen chloride	0.1 mg/m ³	0.5 mg/m ³	
Hydrogen fluoride	0.01 mg/m ³	0.03 mg/m ³	
Ammonia	1 mg/m ³	3 mg/m ³	
Ozone	0.05 mg/m ³	0.1 mg/m ³	
Nitrogen oxides	0.5 mg/m ³	1.0 mg/m ³	
3S2 Mechanically active substances			
Sand	30 mg/m ³		
Dust (suspension)	0.2 mg/m ³		
Dust (sedimentation)	1.5 mg/m ³		
3M3 Mechanical conditions			
Stationary vibration sinusoidal			
Displacement amplitude	1.5 mm (2 – 9 Hz)		
Acceleration amplitude	5 m/s ² (9 – 200 Hz)		
Non-stationary vibration (including shock)			
Shock response spectrum	70 m/s ²		

If the operating conditions are not within the specifications, contact ABB.



For the maximum ambient temperature, see the rating label of the drive.

8.2 Safety

The drive must only be operated by qualified and authorized personnel, ie, personnel who are familiar with the operation of the drive and the hazards involved.

8.3 Overview

The chapter outlines the local operation of the drive.

Control of the drive via a PLC or a higher-level control system is not described in this chapter. If the drive is controlled from remote, see the appropriate manuals for information.

The panel messages and parameter settings used in this chapter are typical examples to illustrate the related instructions and display functions and may therefore differ from the actual messages and parameter settings in the drive.

8.4 Overview of local operator panel

The operator panel on the control compartment door enables the operator to control the drive without restrictions if all requirements for normal operation are met.

The functions of the operator panel include:

- Connecting / disconnecting the main power supply
- Setting the reference value
- Starting, stopping the drive
- Displaying:
 - Actual values
 - Status messages
 - Alarm and fault messages
- Viewing, setting parameters
- Resetting alarm and fault messages
- Activating the emergency-off circuit
- Testing lights and illuminated pushbuttons

For further information on the CDP control panel, see Chapter 9 - CDP control panel.

8.4.1 Lamp test

The lamp test is activated via the CDP control panel by setting parameter 16.7 to LAMP TEST. The lamp-test function resets itself after a set time.



1. CDP control panel

Main functions:

- Starts and stops the motor
- Displays status messages
- Displays alarm and fault messages of the drive and monitored foreign equipment
- Resets alarm and fault messages

2. Supply ON

Illuminated pushbutton. When pressed, it lights up and turns the main power supply on (the main circuit breaker closes and the DC link charges).

3. Supply OFF

Illuminated pushbutton. When pressed, it lights up and turns the main power supply off (the main circuit breaker opens and the DC link discharges).

4. Alarm / Fault lamp

- Fault: permanent light
- Alarm: flashing light

5. Grounding Switch Unlocked

Illuminated pushbutton. It lights up if the grounding-switch can be released by pushing the Grounding Switch Unlocked pushbutton.

Keep this pushbutton pressed to turn the grounding switch to the grounded or ungrounded position.

Note: This pushbutton also works as a test lamp. To test its functionality, press it and verify that it lights up.

6. Emergency Reset pushbutton (option)

Resets the emergency-off relay of the drive control system
Flashes when the auxiliary voltage is switched on, or when an emergency-off switch is pressed

7. Emergency Off

Latching pushbutton. When pressed during operation of the drive, the main circuit breaker opens immediately and the DC link discharges. When pressed at standstill of the drive, it prevents the drive from starting.

8.5 Status messages

8.5.1 Overview on status messages

The following section lists the status messages of the main operating states of the drive, the drive passes through, when it is put into operation (see 8.5.2 Start sequence of the drive), when it is stopped (see 8.5.3 Stop sequence of the drive), or when a fault condition has occurred. The status messages are sent to the higher-level control system and are displayed on the CDP control panel of the drive.



For information on other status messages, such as fault status messages in particular, see the status words in the Appendix G – Signal and parameter table of the drive.

Not ready on

NotReadyOn means that the DC link cannot be charged and the drive cannot be connected to the main power supply, ie, the main circuit breaker cannot be closed. The status message is displayed, eg, when the doors of medium voltage compartments are still open, the grounding switch of the drive is in the grounded position, or the motor starter of the fan unit is switched off.

Ready on

The status message signals that the drive is healthy and ready for the ON command. The ON command initiates charging of the DC link capacitors and closing of the main circuit breaker of the drive. Depending on the control place, the command can either be sent from the higher-level control system to the drive or be initiated by pressing the SUPPLY ON pushbutton on the control compartment door.

Charging

The status message **ReadyOn** changes to **Charging** when the DC link capacitors of the drive are being charged.

Ready run

The status message **ReadyRun** tells the operator

that the drive is energized and ready for operation. As soon as the start command is initiated, the motor is magnetized and the drive starts to modulate.

Ready ref

When the drive is in **ReadyRef** state, it is running and operating according to the set speed or torque reference value. When in remote control mode, the reference value is set by the higher-level control system. When in local control mode, the value is entered into the CDP control panel.

Stopping

Stopping indicates that the drive has received a stop command and that a ramp or coast stop has been initiated. The stopping mode depends on the parameter setting. The status message changes to **ReadyRun** when the zero speed threshold is reached.

When a start command is given while the drive is stopping, the drive resumes operation and the status message changes to **ReadyRef** again.

Tripped

The status message indicates that a fault condition has occurred that requires a shutdown of the drive. During shutdown, the status message is alternating between **Tripped** and the specific fault message.

8.5.2 Start sequence of the drive

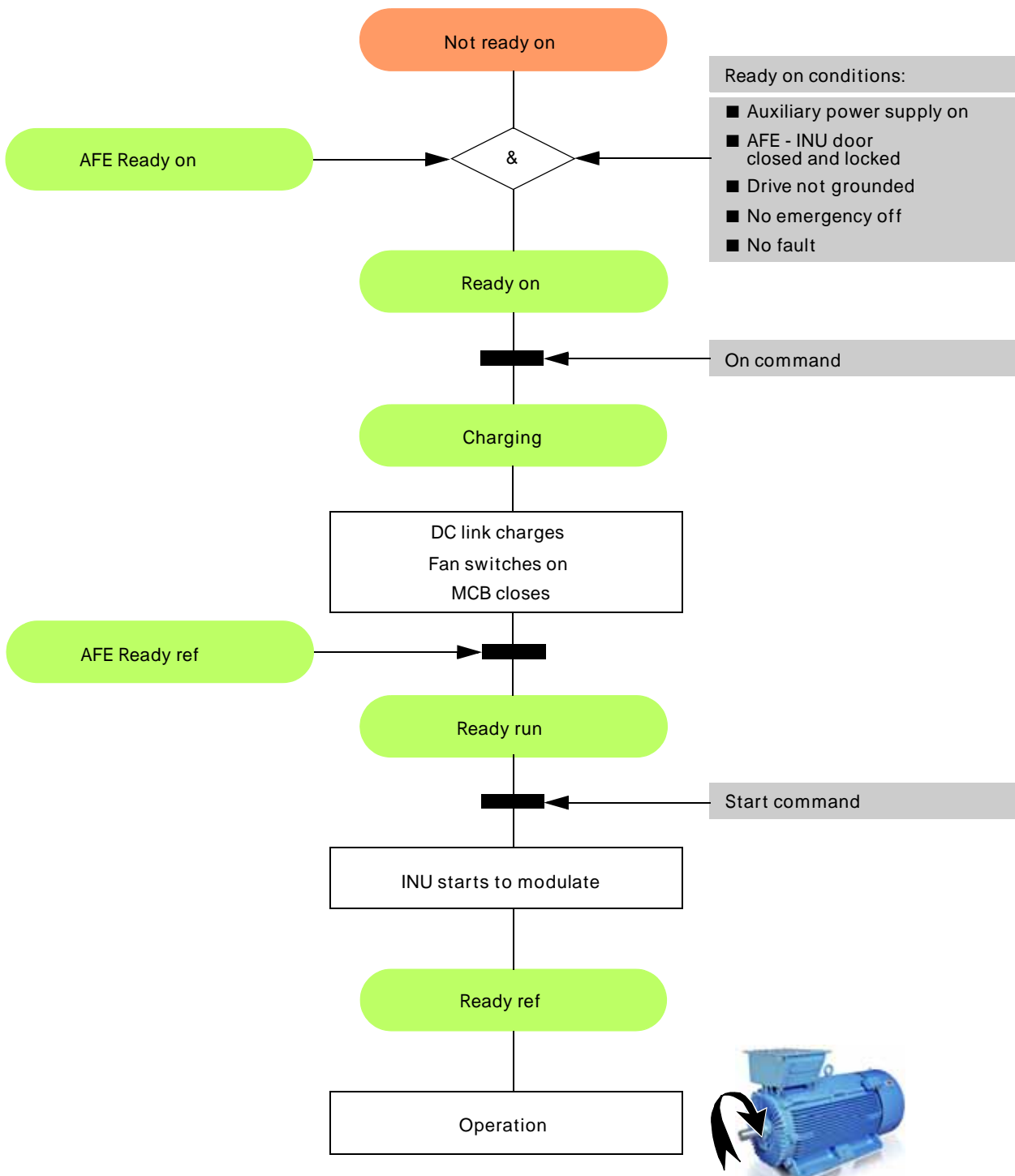

8.5.3 Stop sequence of the drive

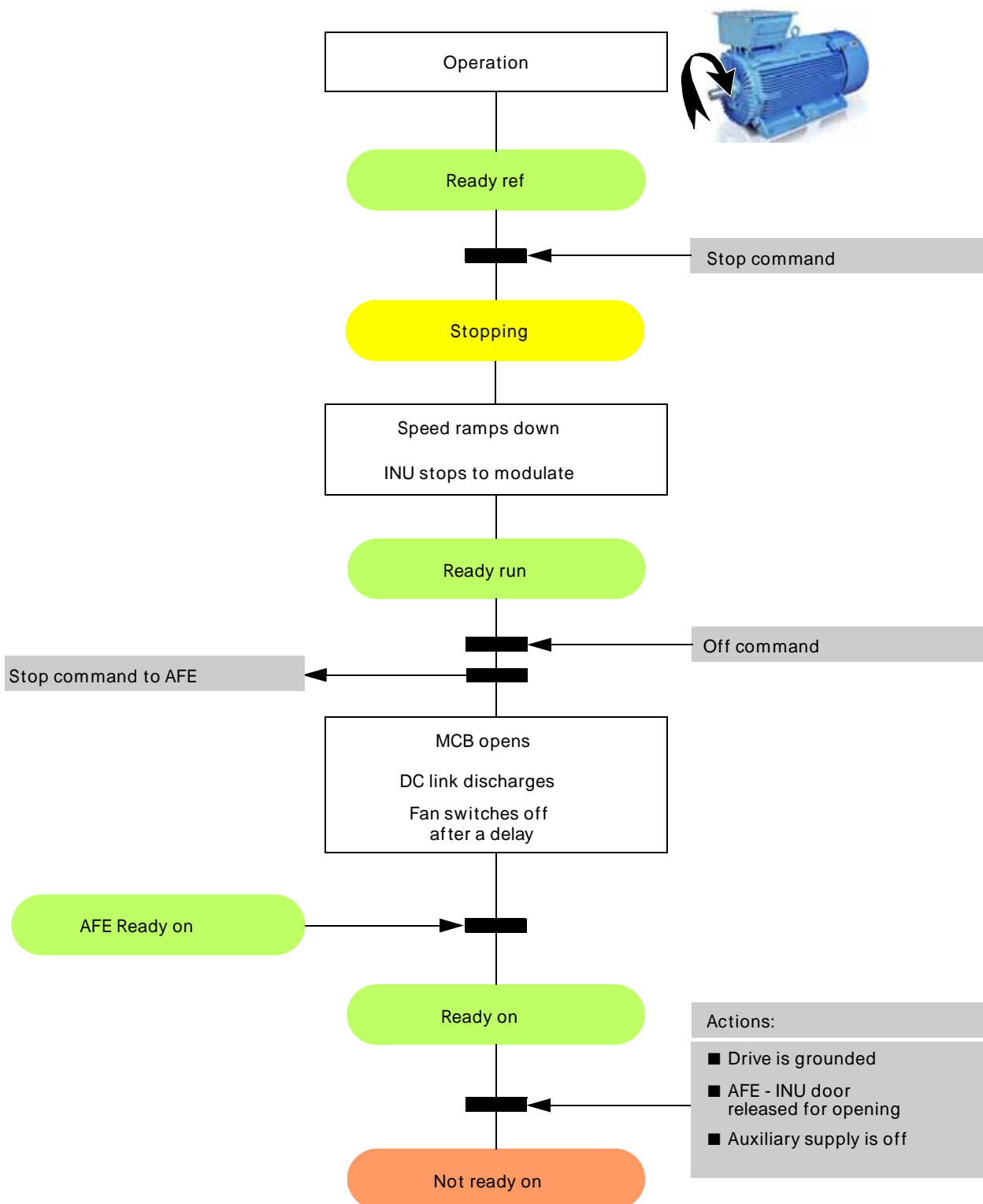

8.5.4 Emergency-off sequence of the drive

For the sake of simplicity, the flow diagrams of the AFE are omitted in the above diagrams.

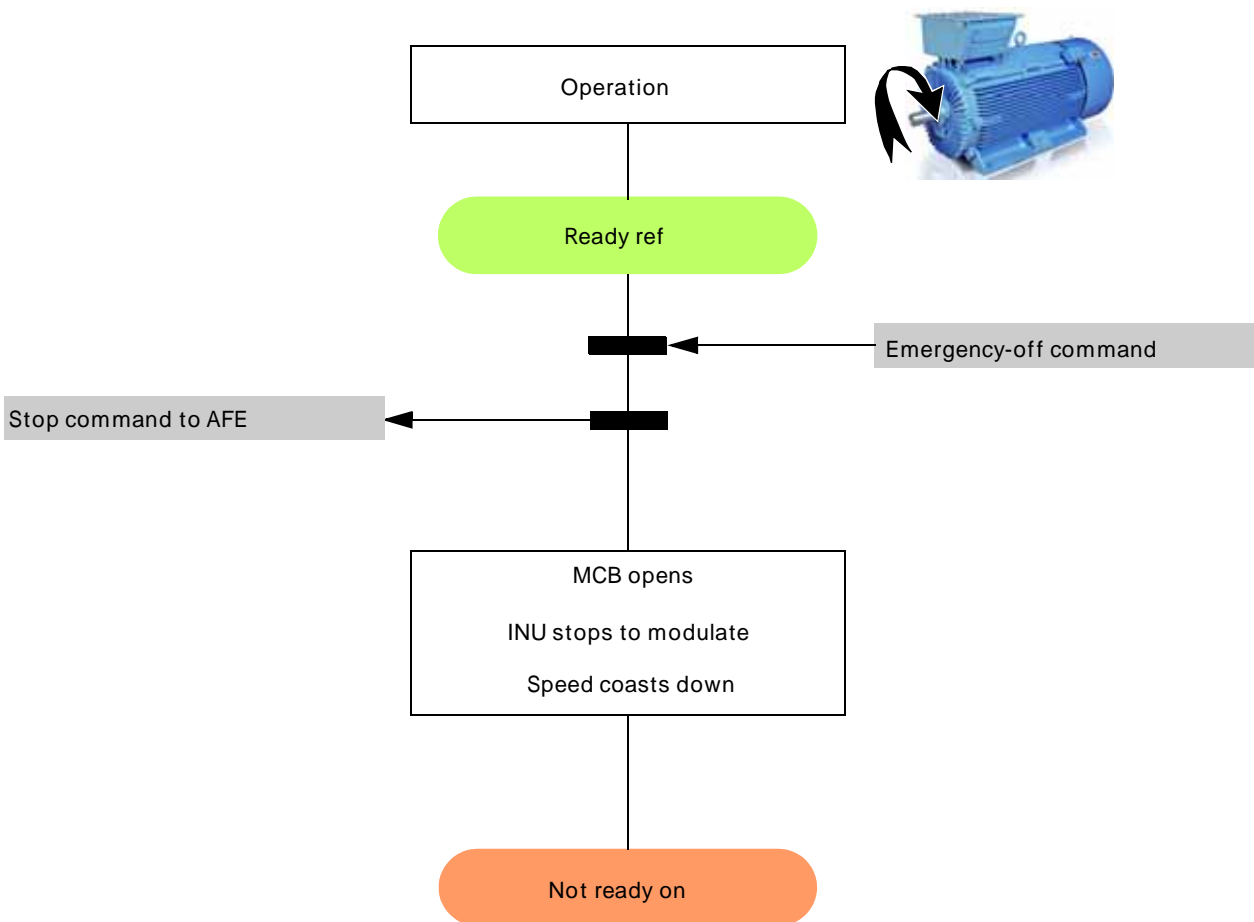

8.6 Starting the drive



It is recommended to have the following documents at hand when starting the drive locally for the first time after commissioning:

- Appendix D – Wiring diagrams to identify the circuit breakers to be switched on
- Chapter 9 - CDP control panel for information on functions and features of the CDP control panel

8.6.1 Checks before starting the drive



Hazardous voltage!

All covers must be screwed in place to prevent unintentional contact with energized components. The manual release of the safety switch must be in the locked position to prevent the door of the medium voltage compartment being opened unintentionally during operation.

When the drive is put into service after it has been commissioned, or after it has been taken out of service for a longer period, check the drive according to the following list:

- Check that no tools and foreign objects are left inside the cabinet.
- Check that all auxiliary power supplies from external sources are switched on.
- Check that all internal circuit breakers of the drive are closed.
- Check that all covers are mounted and the doors are closed, locked and / or bolted.
- Check that the grounding switch is in position **not grounded**.
- Check that the MCB is in **operating** position.
- Check that there is no run interlock active.

8.6.2 Starting the drive from remote

When the drive is operated from remote through a higher-level control system or an operator control desk, follow the instructions in the appropriate manuals.

8.6.3 Starting the drive locally

The motor is controlled by the INU of the drive. For this reason, the CDP control panel must be connected to the INU to be able to start up the drive locally. The CDP control panel is only connected to the AFE if it is required to view status and fault messages of the AFE.

When the drive is running, the CDP control panel can be connected back and forth without interrupting the operation of the drive. However, to stop the drive, the CDP control panel must be connected to the INU. Switching the CDP control panel from the INU to the AFE and back is done with the drive selection mode.

For further information, see 9.8 Drive selection mode.

1. Check that the CDP control panel is connected to the INU.
2. Enable the local control mode of the CDP control panel.



- 3.

This step only applies to drives which are equipped with the optional safety relay.

If the EMERGENCY RESET pushbutton (option) is flashing, press the EMERGENCY RESET pushbutton to cancel flashing.

Each time the auxiliary voltage is switched off and on again, the emergency-off safety relay of the drive is actuated and lets the EMERGENCY RESET pushbutton flashes.

The EMERGENCY RESET pushbutton also flashes if the EMERGENCY OFF pushbutton on the control compartment door, or any other

emergency-off switch linked to the drive, is pressed. If the EMERGENCY RESET pushbutton continuous flashing, verify that there is no emergency-off command active.

For further information, see 8.8 Emergency-off.

4. Check that no alarm or fault messages are displayed on the CDP control panel.

When a fault message is displayed on the CDP control panel, reset the fault.



If a fault cannot be reset, it must be rectified by the responsible personnel.

For further information, see 10.3 Alarm / fault indications.

When no alarms and faults are present and the drive is ready, the CDP control panel displays **ReadyOn**.

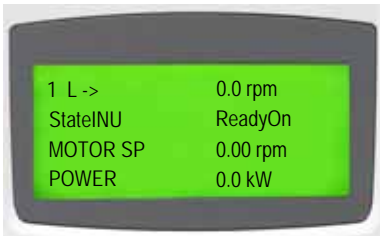

5. Press the SUPPLY ON pushbutton on the control compartment door to close the MCB and charge the DC link. The pushbutton lights up. The status line of the CDP control panel alternates between **Charging** and **AuxiliaryOn**.

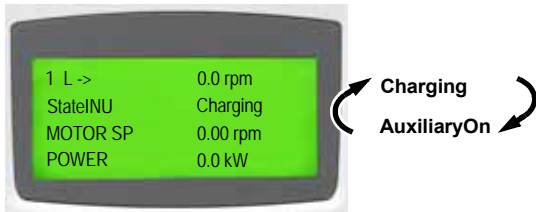

After charging has finished, the AFE starts to modulate.

If the CDP control panel was switched to the AFE, you would first see the message **Modulating** and then after a short instant the message **ReadyRef** in the status line of the display.

When the AFE is in **ReadyRef** state, the state of the INU changes to **ReadyRun** and the motor can be started.



6. Enter the reference value.

For further information, see 9.10.2 Entering a reference value.

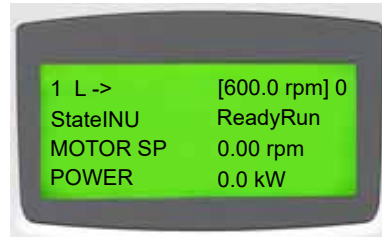

7. Start the motor.



When the motor has been magnetized, the motor speed ramps up to the reference value. While the motor is accelerating, the run status message on the display blinks. When the motor speed has reached the reference value, the run status message lights up permanently.

To indicate that the drive is operating, the display shows **ReadyRef**.

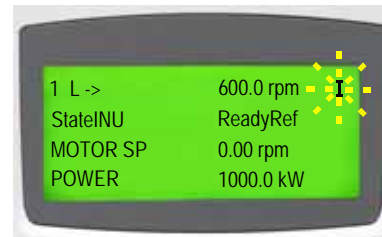

8.7 Stopping the drive

Press the STOP key on the CDP control panel.



The motor stops according to the preset stop function and the drive stops modulating. While the motor stops, the status line of the display shows **ReadyRef**. The run status message blinks during the stop sequence.

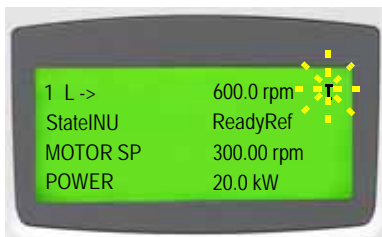

As long as the stop sequence is in progress, the drive can always be restarted by pressing the START key on the CDP control panel.



Just before the motor comes to a standstill, the CDP control panel displays shortly the message **Stopping**.



When the drive has stopped modulating, the CDP control panel displays **ReadyRun**.



As long as the MCB has not been opened, the motor can be started again.

8.8 Emergency-off

8.8.1 Function

The drive is equipped with a hard-wired emergency-off circuit. When an emergency situation occurs during operation, this safety feature ensures that the drive can be disconnected without delay from the main power supply. When the EMERGENCY OFF pushbutton has been pressed while the drive is at standstill, the main power supply cannot be connected to the drive, hence the drive cannot be started up.

The EMERGENCY OFF pushbutton of the drive is part of the operator control panel (8-1) and features a latching switch action.

Pressing the EMERGENCY-OFF pushbutton does not disconnect the auxiliary power supply from the drive.

8.8.2 Initiating an emergency-off

To initiate an emergency-off, press the EMERGENCY OFF pushbutton on the control compartment door or an external EMERGENCY OFF pushbutton (if present) linked to the emergency-off circuit.

When an emergency-off is initiated during drive operation, the following takes place:

- The MCB opens.
- The drive coasts down.
- The DC link of the drive discharges.
- The status line of the CDP control panel alternates between the message **EmergencyOff**, **NotReadyOn**.

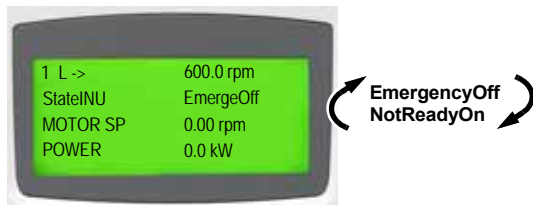

- The **EMERGENCY RESET** pushbutton flashes.
- The **SUPPLY OFF** pushbutton flashes.

8.8.3 Starting the drive after an emergency-off

1. To start the drive after an emergency-off reference value, unlatch the EMERGENCY OFF pushbutton.
2. Turn the EMERGENCY OFF pushbutton into the direction indicated by the arrows on the pushbutton to return the pushbutton to its initial position.
3. Press the RESET key on the CDP control panel to cancel the emergency-off message on the display.
4. To reset the emergency-off safety relay of the drive, press the EMERGENCY RESET pushbutton.

After resetting, the status message of the drive changes to **ReadyOn**.

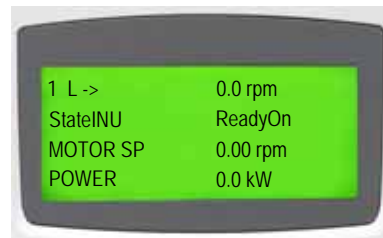

The main power supply can be connected to the drive and the drive can be started again.

Chapter 9

CDP control panel

- 133 Overview
- 134 CDP control panel functions
- 135 CDP control panel modes
- 136 Identification mode
- 137 Actual signals mode
- 140 Parameters mode
- 143 Functions mode
- 145 Drive selection mode
- 147 Local and remote control
- 148 Operational commands

9.1 Overview

The panel messages and parameter settings used in this chapter are typical examples to illustrate the related instructions and display functions and may therefore differ from the actual messages and parameter settings in the drive.

—
References

9.1.1 Display and keypad

—
9-1 CDP control panel

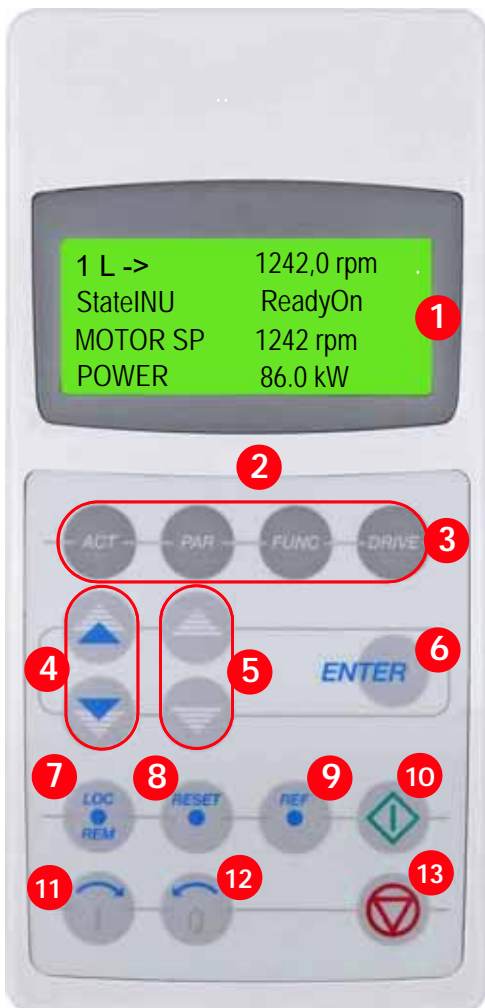

- 1 Display
- 2 Keypad
- 3 Mode selection keys
- 4 Fast navigation keys, select and / or change a value fast
- 5 Slow navigation keys, select and / or change a value slowly
- 6 Enter key, terminates a procedure
- 7 Local / remote selection key
- 8 Reset key
- 9 Reference key
- 10 Start key
- 11 Forward key
- 12 Reverse key
- 13 Stop key

9.2 CDP control panel functions

The CDP control panel serves as the basic user interface for operating and monitoring the drive when the local operating mode has been selected.

The CDP control panel can be attached to or detached from the drive without having to switch off the auxiliary power supply first.

Using the CDP control panel, it is possible

- to enter start-up data,
- to control the drive with a reference value, and start, stop and direction commands,
- to display actual values (three values can be read simultaneously),
- to display and adjust parameters,
- to display information on the most recent forty fault events,

9.3 CDP control panel modes

The CDP control panel provides the following modes:

- Identification mode
- Actual signals mode
- Parameters mode
- Functions mode
- Drive selection mode

9.4 Identification mode

The identification mode informs the user about the CDP control panel version and the ID number of the drive. The information appears on the display when:

- the power supply is switched on, or
- the CDP control panel is connected to the drive and the auxiliary voltage has been switched on already.

When the CDP control panel is initialized as described before, the display changes as follows:

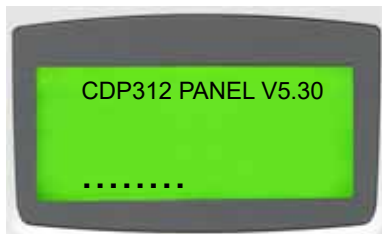

After 2-3 seconds, information on the drive (1, 2), the application software in use (3), and the drive identification (4) is displayed.



After another few seconds:

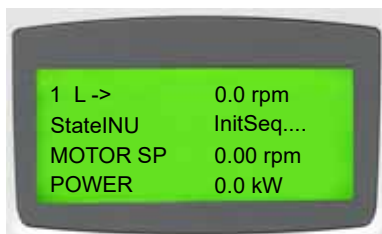

After another few seconds, the display changes to the actual signals mode. The status line of the display alternates between **DCGnd NOpen**, **NotReadyOn**.

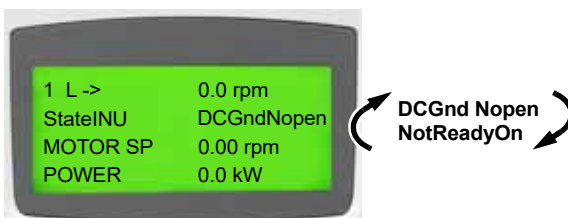

9.5 Actual signals mode

9.5.1 Overview

Two displays can be selected in the actual signals mode:

- Actual signals display
- Fault memory display

The actual signals display appears first when entering the actual signals mode. However, when the drive is in a fault condition, the fault memory display appears instead.

The actual signals display is used to monitor the drive without interfering with its operation. It continuously displays three selectable actual values.. The CDP control panel automatically returns to the actual signals display from other modes if no key is actuated within one minute (an exception from this is the fault memory display).

Actual values

The actual values are organized in groups.

Group 01	Measured or calculated motor values
Group 02	Measured or calculated drive values
Group 03	Reference values
Group 04	I/O status signals
Group 05	Communication link and MCB status signals
Group 06	Software version, drive and motor nominal values
Group 07	Control words
Group 08	Status words
Group 09	Fault and alarm words



For the complete list of selectable actual signals, see signal and parameter table.

Fault memory

The fault memory display provides information on the 64 most recent fault events that occurred in the drive. It displays the name of the fault and the time it occurred. For instructions on how to display and reset the fault memory, see 9.5.7 Displaying and resetting an active fault.

When the drive generates a fault or alarm, the corresponding message displays immediately. Changing from the fault memory mode to other modes is possible without resetting the fault first. When no keys is actuated, the fault or warning text is displayed as long as the fault is active.

Control panel overview

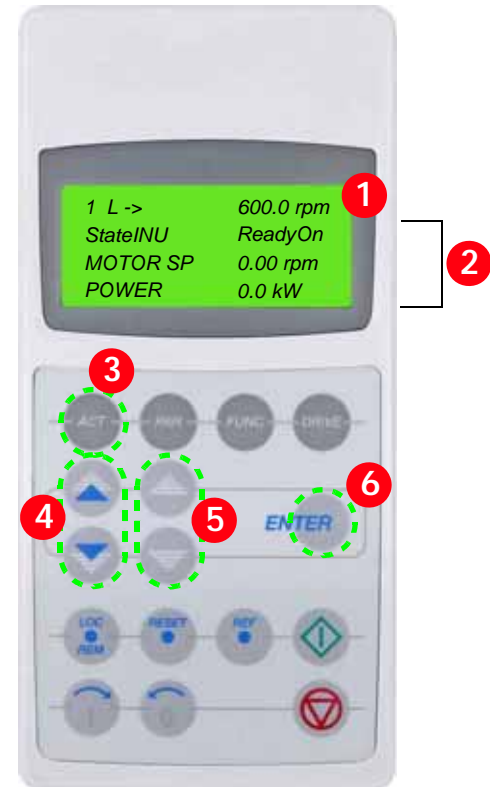

- 1 Status line
- 2 Actual signal names and values
- 3 Selection key for actual signals mode
- 4 Fast navigation key for selecting the actual signals display or the fault memory display
- 5 Slow navigation key for selecting signals or fault messages
- 6 Enter key for confirming the selection

9.5.2 Selecting the actual signals display

To open the actual signals display, press the ACT key.



3. To enter the actual signal selection function, press the ENTER key.



9.5.3 Toggle between actual signals display and fault history

To toggle between actual signals display and fault history display, press a fast navigation key.



4. To select a parameter group, press a fast navigation key.



5. To select an actual signal, press a slow navigation key.

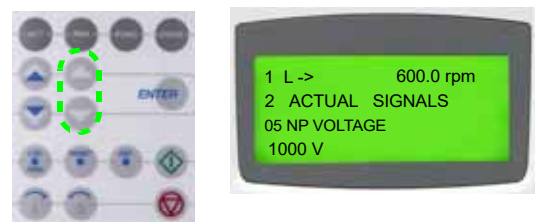

9.5.4 Displaying three actual signals

1. To display the full name of three actual signals, press and hold the ACT key.

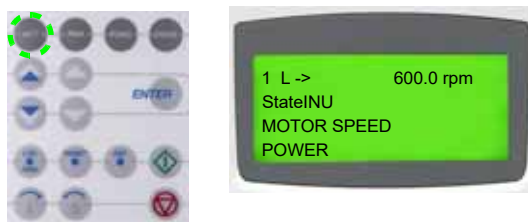

6. To confirm the selection and to return to the actual signals mode, press the ENTER key.



2. To return to the actual signals display, release the ACT key.

9.5.5 Selecting actual signals

1. To select the actual signals display, press the ACT key.



7. To cancel the selection and keep the original selection, press any of the mode selection keys. The selected CDP control panel mode is entered.



2. To select a line where the actual signal is to be displayed, press the corresponding slow navigation key. A blinking cursor indicates the selected line.

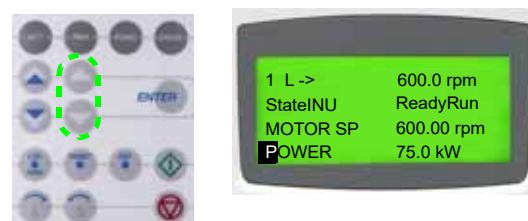

9.5.6 Displaying a fault and resetting the fault history

1. To open the actual signals mode, press the ACT key.



2. To change to the fault memory display, press a fast navigation key.



3. To display a specific fault, press the slow navigation keys. The UP key selects the previous, the DOWN key the next fault.

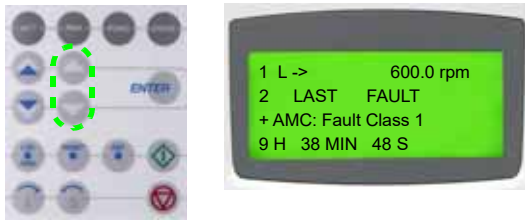

4. To clear the fault memory, press the RESET key.



5. To return to the actual signals display, press a fast navigation key.



9.5.7 Displaying and resetting an active fault

1. To display an active fault, press the ACT key.



2. To reset the fault, press the RESET key.



9.6 Parameters mode

NOTICE

Running the drive system with incorrect data can result in improper operation, reduction of control accuracy and damage to equipment. Parameters must only be set by qualified personnel. Do not change any parameter, if the meaning of the parameter and the effects of the change are not fully understood.

9.6.1 Overview

If the parameter lock is disabled or unlocked (see 9.6.3 Enabling / unlocking a parameter lock), the parameters mode allows entering the parameter settings for the required drive configuration depending on the application.

The parameters are organized in functional groups, so called parameter groups.

Group 07	Control words	21.01	Start function
Group 08	Status words	21.02	Start function
Group 09	Fault and alarm words	21.03	Off1 stop mode
Group 11	Start / stop / direction / MCB control	21.04	Process stop selection
Group 12	Reference selection	21.05	Process stop signal
Group 16	System control inputs	21.06	Process stop MCB control
Group 17	DC-link control	21.07	Process stop mode
Group 18	Utility	.	
Group 19	Data storage	.	
Group 20	Limits	.	
Group 21	Start / stop / process stop	21.17	MCB closing time limit
Group 22	Ramp functions	21.17	
Group 23	Speed reference	21.19	MCB available signal



For further information on the parameters, their settings and functions, see Appendix G – Signal and parameter table.

When entering the parameters mode for the first time after the auxiliary supply voltage of the drive has been switched on, the CDP control panel displays the first parameter of parameter group 11. The next time the parameters mode is entered, the previously selected parameter displays. Some parameter values cannot be changed while the drive is running. If tried, the following warning displays.



Control panel overview

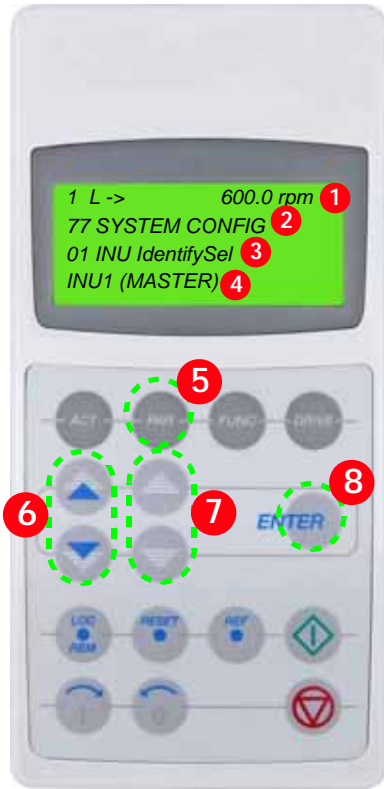

- 1 Status line
- 2 Group number and name
- 3 Parameter number and name
- 4 Parameter value
- 5 Selection key for parameters mode
- 6 Fast navigation key for selecting a parameter group (and a parameter value)
- 7 Slow navigation key for selecting a parameter (and a parameter value)
- 8 Enter key for confirming the selection

9.6.2 Selecting and changing parameters

1. To enter the parameters mode, press the PAR key.

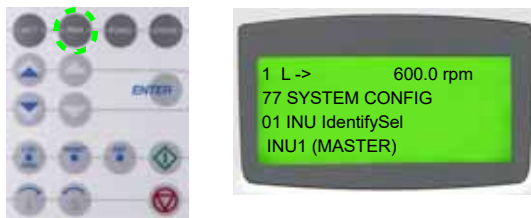

2. To select a different group, press a fast navigation key.

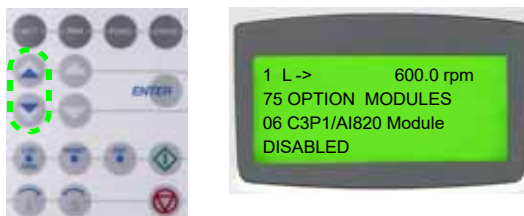

3. To select a parameter, press a slow navigation key.

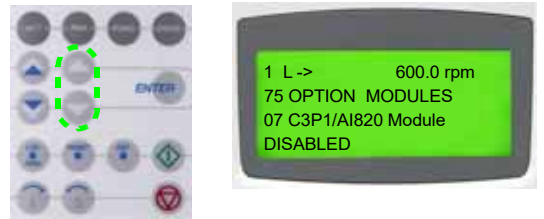

4. To enter the parameter setting function, press the ENTER key.

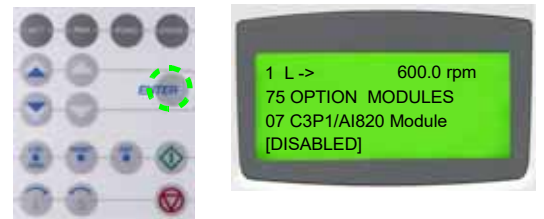

5. To change the parameter value, press:

- a slow navigation key for numbers and text,
- a fast navigation key for numbers only.

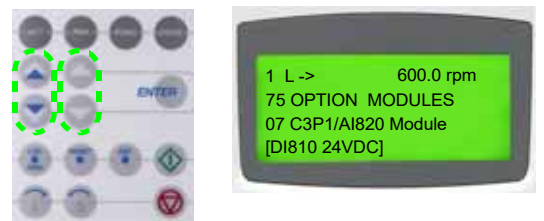

6. To confirm the setting and to return to the actual signals mode, press the ENTER key.

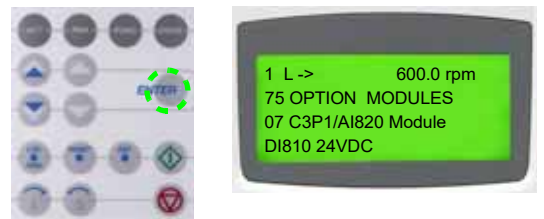

7. To cancel the setting and keep the original selection, press any of the mode selection keys. The selected keypad mode is entered.

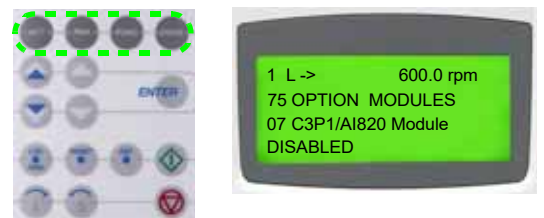

9.6.3 Enabling / unlocking a parameter lock

Unwanted parameter entry can be prevented by activating the parameter lock function.

The corresponding parameters are 16.02 PARAMETER LOCK and 16.03 PASSCODE and belong to parameter group 16 SYSTEM CTRL INPUTS.

Enabling the parameter lock

1. Select parameter 16.02.
2. Set parameter 16.02 to 1 (LOCKED).
3. Confirm the setting and exit the parameters mode.

Unlocking the parameter lock

1. Select parameter 16.03.
2. Set the correct pass code.
3. Confirm the setting and exit the parameters mode.



For further information, see Appendix G – Signal and parameter table.

9.7 Functions mode

9.7.1 Overview

The functions mode is used to set the display contrast.

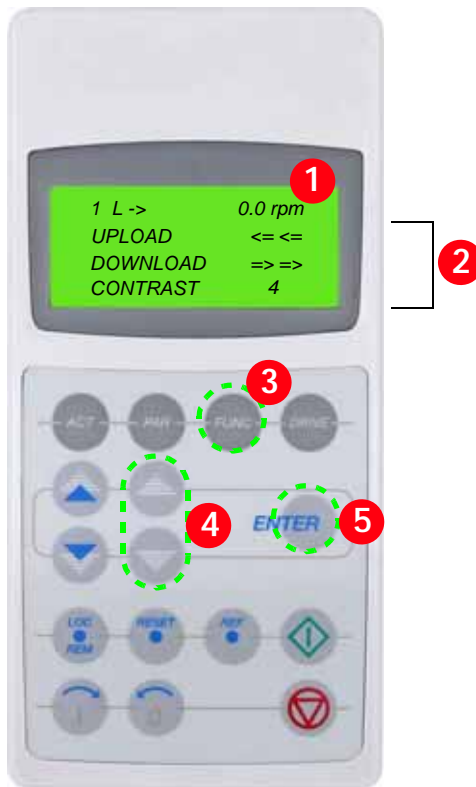

- 1 Status line
- 2 Selectable functions
- 3 Selection key for functions mode
- 4 Slow navigation key for selecting a line (and adjusting the contrast)
- 5 Enter key for confirming the selection

9.7.2 Adjusting the display contrast

1. To enter the functions mode, press the FUNC key.



2. To select the contrast adjustment function, press the slow navigation keys until the blinking cursor reaches the CONTRAST line.



3. To enter the contrast setting function, press the ENTER key.



4. To change the contrast value, press a slow navigation key.



5. To confirm the selection and to return to the actual signals display, press the ENTER key.



- To cancel the setting and keep the original setting, press any of the mode selection keys. The selected keypad mode is entered.

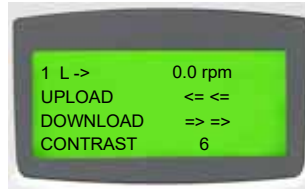

9.7.3 Upload and Download functions

The Upload and download functions of the CDP are not supported in ACS2000

9.8 Drive selection mode

9.8.1 Overview

The drive selection mode is used to connect the CDP control panel either to the AMC circuit board of the AFE or the INU of the drive.

In this context, the AMC circuit board of the AFE and INU is referred to as a drive that is identified in the control system by its ID number:

- ID number of INU: 1
- ID number of AFE: 2

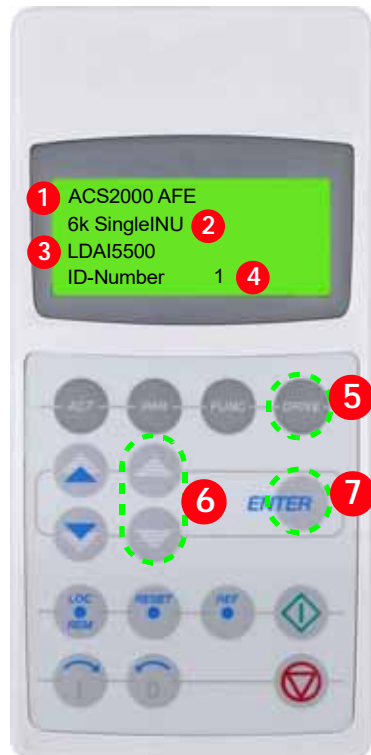

- ① Status line
- ② Device type
- ③ Application SW version
- ④ Drive identification
- ⑤ Selection key for drive mode

- ⑥ Slow navigation key for selecting the AMC circuit board (AFE or INU)
- ⑦ Enter key for confirming the selection

9.8.2 Selecting an AMC circuit board

It is assumed in the following example that the CDP control panel is connected to the INU.

1. To enter the drive mode, press the DRIVE key.

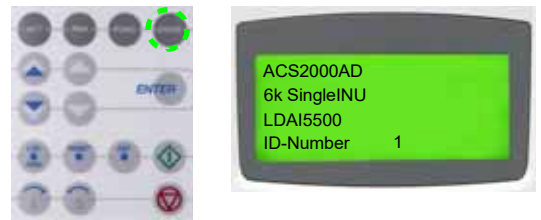

2. To select the ID number of the AFE and to connect the CDP control panel to the AFE, press any of the slow navigation keys.

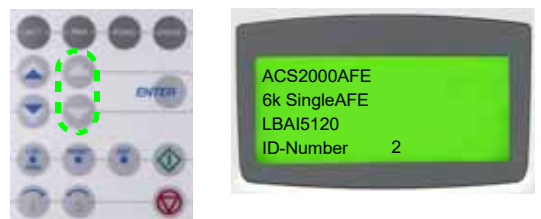

If none of the keys is pressed, the display automatically returns to the actual signals display after a while.

If the ID number of the AFE or INU is changed by accident (eg, to 3) and the ENTER key has been pressed, the new number is saved in the memory. The display still shows the old number. Only when the auxiliary voltage has been switched off and on again, the new number is shown on the display. If the ID number is changed by accident, simply change the ID number back and press the ENTER key. The ID number is restored when the auxiliary power is switched off and on the next time.

—
Do not select LOCAL by pressing the LOC-REM key (arrow) when the CDP control panel is connected to the AFE.



If the drive is in operation, the AFE stops modulating and the drive shuts down. If the drive is stopped and the CDP control panel is set to LOCAL, the drive cannot be started up.

9.9 Local and remote control

The local / remote feature of the CDP control panel allows selecting the control location of the drive. Possible are:

- Local control
- Remote control

The control location is selected by pressing the LOC-REM key on the CDP control panel.

In this context, remote control is not necessarily equivalent to higher-level control. For further information, see 9.9.2 Remote control.

9.9.1 Local control

In local control mode, full operational control of the drive is enabled from the local operator panel. Commands from remote have no effect.

To enter the local control mode, press the LOC-REM key. Local control is indicated by the letter L.



9.9.2 Remote control

In remote control mode, operational commands or reference values usually come from a higher-level control system via fieldbus or remote I/O. However, with the following parameter settings it is possible to start and stop the drive, to set the motor's direction of rotation, and to enter reference values from the CDP control panel.

- 11.01 EXT1 START/STOP/DIR = 10 (KEYPAD) or 12.03 EXT REF1 SELECT = 1 (KEYPAD) and 12.02 EXT1/EXT2 SELECT = 1 (EXT1)
- 11.02 EXT2 START/STOP/DIR 10 (KEYPAD) or 12.06 EXT REF2 SELECT = 1 (KEYPAD) and 12.02 EXT1/EXT2 SELECT = 2 (EXT2)

To enter remote control, press the LOC-REM key.

- Full remote control from a higher-level control system is indicated by a blank space.

- Partial remote control (some commands enabled locally) is indicated by the letter R.



9.9.3 Disabling / enabling local lock function

Accidental switching from remote control to local control can be prevented with the local lock function.

The corresponding parameter is 16.04 LOCAL LOCK and belongs to the parameter group 16 SYSTEM CTRL INPUTS.

Enabling the local lock

To enable the local lock, set parameter 16.04 to 2 (LOCKED).

With this parameter setting, local control (including the LOC-REM key) is disabled.

If the CDP control panel or a DriveWindow PC is in local control mode at the time that the local lock is enabled, they remain in local control mode until they are switched to remote control mode. This means that the CDP control panel displays the letter L until you press the LOC-REM key.

Disabling the local lock

To disable the local lock, set parameter 16.04 to 1 (OPEN). With this parameter setting, switching between remote and local control is enabled.

9.10 Operational commands

For instructions on how to start and stop the drive system from the CDP control panel, see 8.6 Starting the drive and 8.7 Stopping the drive.

9.10.1 Setting the direction of rotation

Setting the direction of rotation from the CDP control panel is possible in:

- Local control mode L
- Remote control mode R

The arrow on the display indicates the direction of rotation:

- When the motor is running, the arrow indicates the actual direction.
- When the motor is not running, the arrow indicates the preselected direction.

To set the direction of rotation, press the forward or backward key.

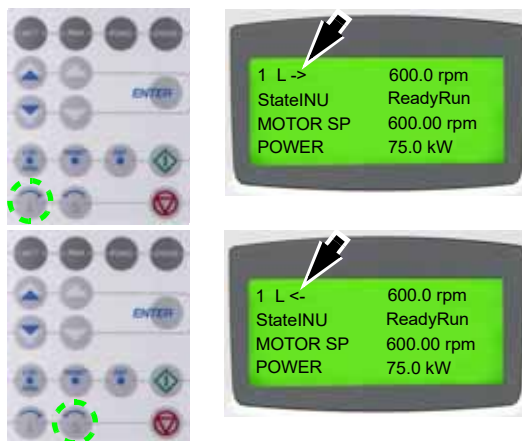

If you change the direction while the motor is running, the motor automatically ramps down to zero speed and re-accelerates in the opposite direction to the preset speed. The arrow changes at zero speed.

9.10.2 Entering a reference value

Entering a reference value from the CDP control panel is possible in:

- Local control mode L
- Remote control mode R

1. Press a mode selection key:



2. To enter the reference value input mode, press the REF key.



3. To change the reference value, press the corresponding fast or slow navigation key.



4. To exit the reference value input mode, press a mode selection key.



Chapter 10

Preventive and corrective maintenance

- 151 General information
- 152 Identifying electrical equipment
- 153 Alarm / fault indications
- 155 Removing the CDP control panel
- 156 LEDs and switches on printed circuit boards and I/O devices
- 163 Corrective maintenance

10.1 General information

10.1.1 Required qualification

During the warranty period of the drive, any maintenance must be carried out exclusively by ABB service personnel. After the warranty period, maintenance must only be carried out by certified personnel.

To maintain safe and reliable operation of the drive, ABB recommends taking out a service contract with the ABB service organization.

To contact the ABB service organization, see [Contact information](#).

10.1.2 Maintenance schedule

Carry out all maintenance tasks according to the maintenance schedule, on time and at the stated intervals in the “ACS2000 Preventive maintenance schedule”.

10.1.3 Logbook

It is recommended to record all troubleshooting and maintenance work in a logbook including:

- Date and time
- Detailed description

10.1.4 Spare parts

To ensure safe and reliable operation, use only spare parts recommended and approved by ABB.



For information on types and identification codes, see spare parts list.

10.2 Identifying electrical equipment

References

10-1 Device identification

10.2.1 Device identification

To facilitate the identification in wiring diagrams and parts lists, all devices are labeled in accordance with IEC 81346-1.

10.2.2 Cables and wires

Cables and wires in the drive are equipped with marker sleeves that carry the same identification number as in the wiring diagrams.

10.2.3 Understanding wiring diagrams



For information on item designation and cross-reference conventions, see the applicable Wiring diagrams.

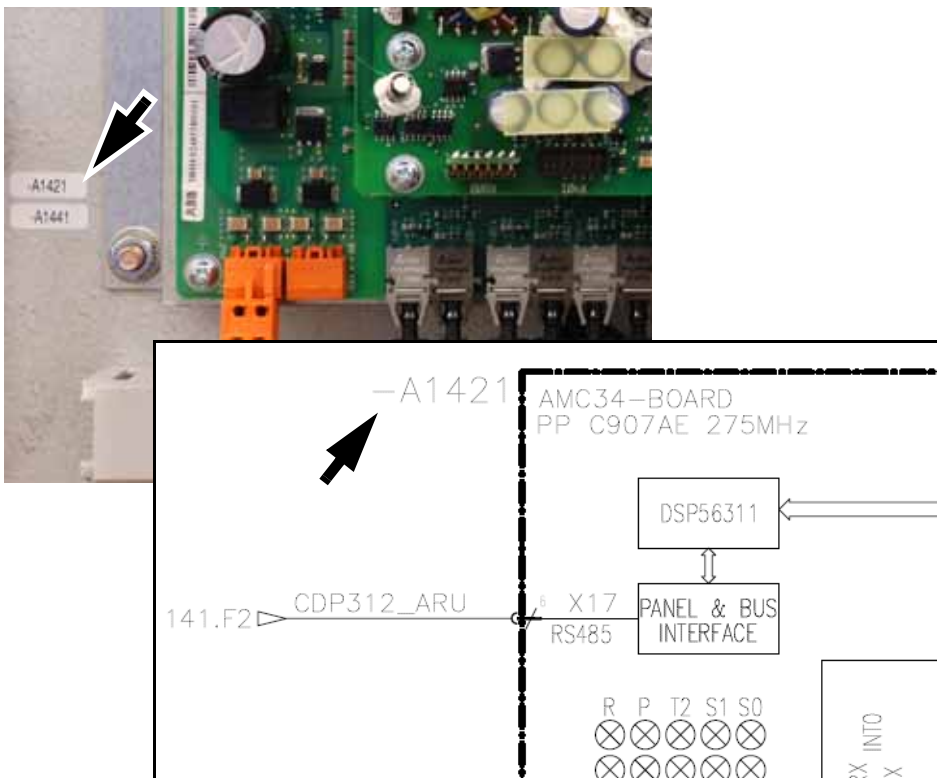

10.3 Alarm / fault indications

—
References
—
10-2 Alarm / fault
indication

10.3.1 Messages

When a failure occurs in the drive or in the equipment monitored by the drive (eg, main circuit breaker, transformer, cooling system), the CDP control panel displays a corresponding alarm or fault message and the alarm / fault lamp on the control compartment door lights up:

- Alarm: flashing light
- Fault: permanent light

The message can be saved and viewed in the fault history of the drive when a PC with DriveWindow, DriveDebug or DriveMonitor is connected to the drive. The fault history can also be called up on the CDP control panel.

10.3.2 Error message levels

Two error message levels are used in the drive:

Alarm

An alarm does not shut down the drive. If the condition causing the alarm is not corrected, a persisting alarm can often lead to a fault. An alarm cannot be reset manually. The alarm message is deleted from the display as soon as the alarm condition has been corrected.

Fault

A fault shuts down the drive. The type of shutdown depends on the origin of the fault.

Depending on the type of fault, the drive opens the main circuit breaker (MCB) or keeps it closed:

- Class 1 faults (FC 1) open the MCB
- Class 2 faults (FC 2) do not open the MCB

Since the MCB is controlled and monitored entirely by the drive, no external opening command must be given to the MCB when a fault condition occurs. A fault condition must be corrected and the fault be manually reset before the drive can be started again.

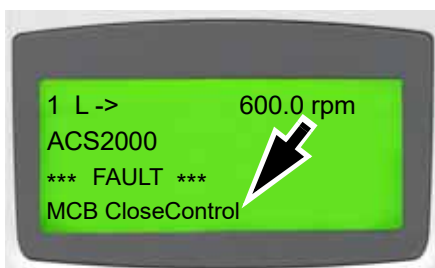

Alarm / fault messages

If an alarm or a fault occurs, a specific message is saved in the fault buffer of the drive. Information on the 64 most recent fault and alarm events are saved.

10.3.3 Fault handling

The faults are entered into the fault buffer as they occur and are numbered:

- The last fault entered has number 1.
- The first fault entered has the highest number.

Information on the fault classification (eg, FC 1 or FC 2) is also saved when the first fault of the fault class is active. Date and time stamps facilitate fault tracing, especially when a fault leads to several subsequent faults.

Example:

1. +Fault AMC: Fault Class 2 2008-01-08
16:58:24.3770
2. +Fault PPCS Communication 2008-01-08
16:58:24.3760
3. +Fault AMC: Fault Class 1 2008-01-08
16:56:02.1170
4. +Fault DC Undervoltage 2008-01-08
16:56:02.1170

In the above example,

- 4. +Fault DC Undervoltage is the reason for the failure of the drive, as it occurred first.
- 3. +Fault AMC: Fault Class 1 classifies the fault.
- 2. +Fault PPCS Communication represents a subsequent fault that occurred 2 min 22 sec later than the first fault.
- 1. +Fault AMC: Fault Class 2 classifies the fault.



For further information on alarms and faults, see Appendix G – Signal and parameter table.

10.3.4 Troubleshooting procedure

If a fault shuts down the drive, proceed as follows:

1. Do not switch off the auxiliary power supply or try to reset a fault message before all information at the time of the occurrence of the fault has been saved.
2. Select the Fault History Display on the CDP control panel.

For further information, see Chapter 9 - CDP control panel.

Do **not** clear the fault buffer now!

3. Identify the fault and make a logbook entry.
4. Save the content of the data logger when a PC is available that has DriveWindow or DriveDebug installed.

The data logger provides information (eg, waveforms of voltage, current, torque) for efficient troubleshooting.

5. Contact ABB service if a fault cannot be rectified.

When calling ABB service, it is recommended to have the following data available at the time when the fault occurred:

- Operating, ambient and load conditions
- Unusual events

After the fault has been rectified, start the drive as described in Chapter 8 - Operation.

10.4 Removing the CDP control panel

1. When the panel is removed while the drive is in operation, check the setting of parameter 31.01 PANEL LOSS SUPERVISION first. If the parameter is set to NOT USED, the panel can be removed without interrupting drive operation.



For information on setting parameters, see Appendix G – Signal and parameter table.

When the CDP control panel has been removed during operation, the drive can only be stopped by pressing the emergency-off button.



2. To remove the panel, proceed as illustrated.

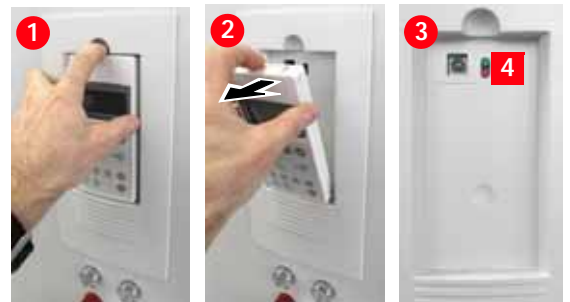

Meaning of the LEDs

The green LED [4] signals that the control voltage has been switched on.

Communication with AMC circuit board

The CDP control panel (1) is connected to the AMC circuit board of the INU (2) and the AFE (3) via an RS485-Interface.

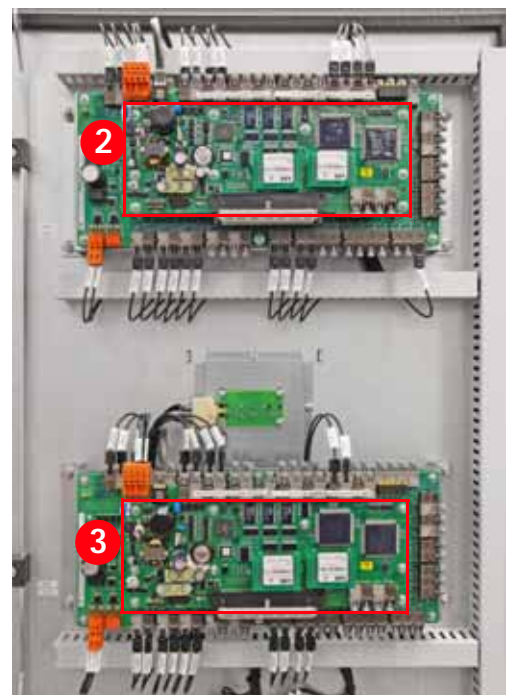

10.5 LEDs and switches on printed circuit boards and I/O devices

The following section provides an overview on the meaning of LEDs and switches of the main circuit boards and I/O devices. The LEDs presented in the following section can be checked easily while the auxiliary voltage is switched on without having to remove covers first. The LEDs provide information on the status of the devices and can be used for diagnostic purposes.

—
References

—
10-3 AMC34 circuit board

10.5.1 AMC circuit board

LED	Color	Meaning	Status when SW loaded		Status when SW not loaded	
			Booting	ON	Booting	ON
F	Red	Fault	ON	OFF	ON	ON
R	Green	Run	OFF	OFF	OFF	OFF
M	Green		ON	OFF	ON	ON
P	Green	Supply OK	ON	ON	ON	ON
T1	Yellow	Receiving data on DDCS channel 0	Flashing	ON/OFF	Flashing	ON/OFF
T2	Yellow	Receiving data on DDCS channel 3	Flashing	ON/OFF	Flashing	ON/OFF
S3	Yellow		OFF	OFF	OFF	OFF
S1	Yellow		Flashing*	OFF	Flashing*	OFF
S2	Yellow		Flashing*	OFF	Flashing*	OFF
S0	Yellow		Flashing*	OFF	Flashing*	OFF

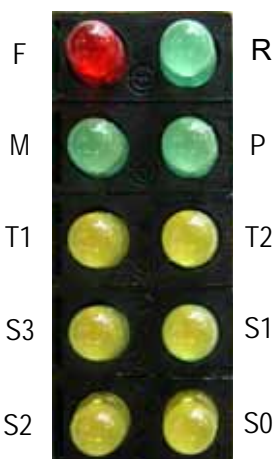

References

10-4 IOEC module

10.5.2 IOEC I/O modules

Cluster address

Each IOEC module has a unique cluster address that identifies the module in the software and links it to a parameter.

The address is set with the rotary switch on the module (10-4: 3). The factory-set value must not be changed.



For information on IOEC switch settings, see Appendix D – Wiring diagrams.

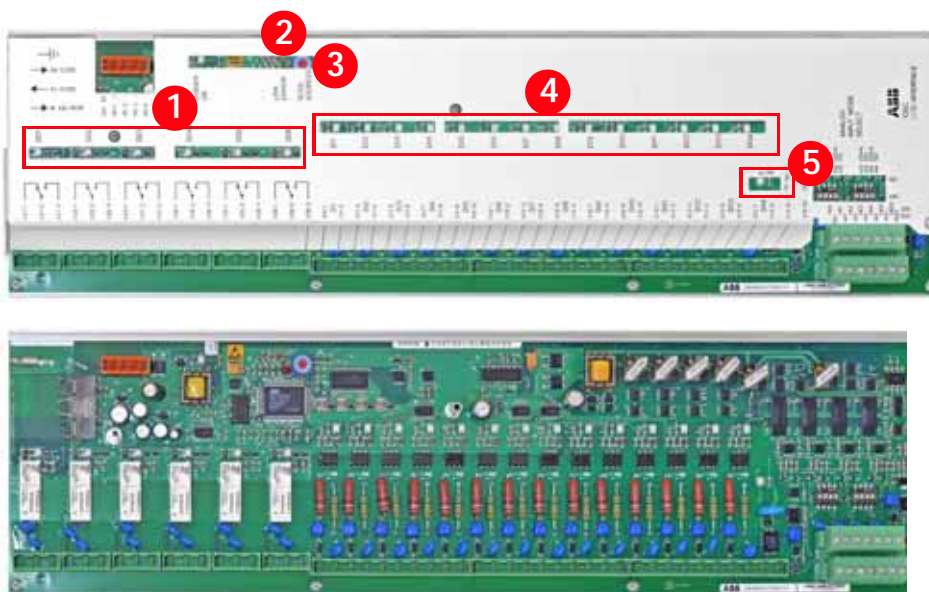

LED		Meaning
1	Status LEDs of digital outputs	On when output is energized
2	Link error light	On only when there is a problem with the optical fibers.
4	Status LEDs of digital inputs	On when input is energized
5	Status LED of the 24 V internal voltage supply	On when energized

10.5.3 Serial communication interfaces (option)



To identify the serial communication interface in the drive, see the applicable Wiring diagrams. For further information on the device, select the appropriate manual from the list below:

- AF 100 fieldbus - NAFA-01 installation and start-up guide
- Modbus TCP - NETA-21 remote monitoring tool user's manual
- Modbus RTU - NMBA-01 installation and start-up guide
- Profibus - NPBA-12 installation and start-up guide

AF 100 interface

—
References
—
10-5 AF 100 interface



1. Status LEDs
2. Service connector
3. AF 100 station address selectors
4. Power supply terminals
5. AF 100 terminals

—
Table 10-1 AF 100 LED description

LED		Meaning
F (Fault)	Red	Module fault. Also lights up during module start-up. Turns off when the self-test is successful.
R (Run)	Green	In operation
P (Power OK)	Green	Internal power OK
T1 (Traffic 1)	Yellow	Data traffic on AF 100 cable 1
T2 (Traffic 2)	Yellow	Data traffic on AF 100 cable 2

—
References
—
10-6 NETA-21 remote
monitoring tool

Modbus TCP interface

Table 10-2 NETA-21 LED description

LED	Color	Meaning
USB	Off	No USB mass storage devices attached
	Green	USB mass storage device attached and mounted
	Blinking green	Device attached, initialization in progress
	Yellow	Device can be removed
	Red	Unidentified error when settings are imported from an USB memory device
	Blinking red	Initialization failed. Unsupported file system on a USB stick.
EXT	Off	No NEXA-21 connected
	Green	NEXA-21 found and initialized
	Blinking green	NEXA-21 support is being initialized (when the NETA-21 boots up)
	Red	NEXA-21 malfunctions
	Blinking red	NEXA-21 not supported
SD	Off	No SD/SDHC card
	Green	Card attached and taken into use
	Blinking green	Card attached and initialization in progress
	Yellow	Card can be safely removed

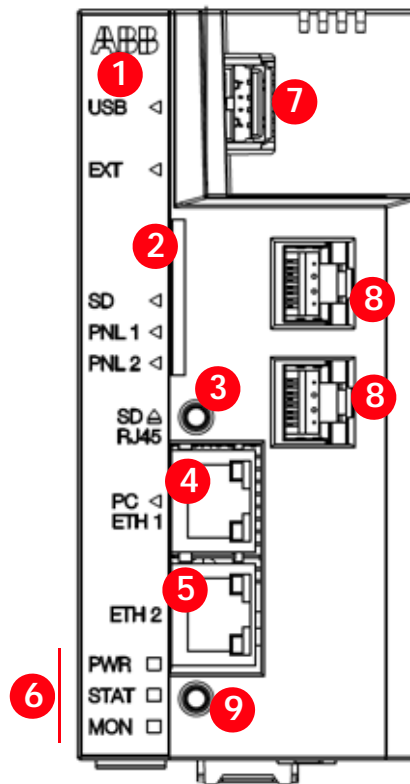

1. Front panel labeled with a black sticker and equipped with indicator LEDs.
2. SD – SD/SDHC memory card slot
3. SD RJ45 – SD button is used for removing the SD/SDHC card safely and activating a DHCP server for the first access to the user interface
4. PC ETH 1 – connector providing an Ethernet connection for a locally connected PC
5. ETH 2 – connector providing an Ethernet connection for an external Ethernet network
6. PWR, STAT, MON – power, status and monitoring indicators (see table below for LED indications)
7. USB – USB host connector for third party extensions
8. PNL 1/PNL 2 – connector providing an interface for a panel bus that can be used for communication with certain drive types
9. Reset button

Table 10-2 NETA-21 LED description

LED	Color	Meaning
	Blinking yellow	Card attached, removal in progress
	Blinking yellow	Together with the blinking red STAT LED: System waits for confirmation of reboot operation or network override
	Red	Card error, for example write protection prevents from writing data to the card
	Blinking red	Card initialization failed. Unsupported card type (eg, SDXC and MMC cards are not supported).
PNL 1 / PNL 2	Off	No devices (no wire) connected to the PNL port
	Green	All devices connected, identified and commissioned
	Blinking green	Manual or automatic discovery of devices in progress
	Yellow	Communication OK, but device connectivity limited. All devices are ready to be unplugged/disconnected.
	Red	Communication error caused the panel port network initialization to fail. Unknown device in the network, or something interfering the network and preventing proper detection of monitored devices.
	Blinking red	Unsupported device found in the network, or too many devices in the network to be monitored
PC ETH 1	Off	PC not connected. If an Ethernet cable is connected to the PC ETH 1 port but no one uses the NETA-21, the LED remains blank.
	Green	Connection set up and in operation, for example, DHCP is active and at least one PC has got an IP-address
	1/2-second blinking green	NETA-21 provides IP addresses for local devices. Activate the DHCP server mode by pressing the SD RJ45 button for five seconds. When a PC is connected and the NETA-21 has provided an IP address for it, the LED turns steady green. Note: The DHCP server functionality remains enabled until the NETA-21 is restarted or until the DHCP server is disabled in the web UI.
	1-second blinking green	At least one user has been logged on to the user interface
	Blinking yellow	Factory-level access/operation. Firmware update in progress. Note: System status (STAT LED) blinks during the firmware update.
PWR	Off	Power off
	Green	Power on
	Yellow	Timed power off or standby. NETA-21 can go to the standby mode as a protective measure (eg, if the environmental temperature is too high). To wake up the NETA-21, press the SD RJ45 button.
STAT	Green	System in operation, OK
	Yellow	System starts up, services not yet fully operational
	1/4-second blinking yellow	System waits for a confirmation of the reboot operation or network override. If you reboot the NETA-21 by pressing the reset button for 5 seconds when the NETA-21 is running, the STAT LED starts blinking. Confirm the reboot operation by pressing the SC RJ45 button. If you do not confirm the reboot operation, it stops after a 1-minute delay. You can override the network settings by pressing the SD RJ45 button for 10 seconds when the NETA-21 powers up. If you keep pressing the button for about 20 seconds, the STAT LED starts blinking, which indicates that you can release the button. If you do not release the SD RJ45 button within one minute (or if the button is locked to the "ON" position), the default network settings are not restored.
	1-second blinking yellow	Firmware update in progress
MON	Blinking red	Error occurred during the start-up of the NETA-21. If the start-up fails, the NETA-21 restarts itself automatically after a few seconds. During the reboot operation, all LEDs excluding the PWR LED flash before the STAT LED turns yellow again. If the yellow STAT LED and blinking red STAT LED alternate and the STAT LED does not turn green, the start-up of the NETA-21 fails continuously. Try resetting the NETA-21 to factory settings
	Blinking green	NETA-21 sends data (eg, email) to an external destination.
	Blinking red	NETA-21 fails to send data (eg, email) to an external destination.

—
References
—
10-7 Modbus RTU
interface

Modbus RTU interface



1. Bus-cable terminals
2. Fiber-optic connectors for communication cable to the drive
 - TXD = transmitter
 - RXD = receiver
3. Status LEDs
4. Switch for bus termination

LED		Meaning
XMIT	Flashing	Interface transmits a response or an exception
REC	Flashing	Interface receives a command from the Modbus network
ERROR	Flashing	If the received command has a parity error, or if the received command has a CRC error, or if the received command is not supported by the interface, or if the interface has detected an error

—
Table 10-3 Modbus RTU LED description

LED	Error indication	Meaning
XMIT, REC, ERROR	On	ROM checksum test failed
REC, ERROR	On	RAM test failed
ERROR	On	DDCS-ASIC-register-access test failed

—
References

Profibus interface

—
10-8 Profibus interface



1. Fiber-optic connectors for communication cable to the drive
 - TXD = transmitter
 - RXD = receiver
2. Reset button for initialization of module
3. Status LEDs
4. Bus-cable terminals

During start-up	LED		
	Master	MSG	DDCS
Power-on	Off	Off	Green then red then off
	Off	Green then red then off	Off
	Green then red then off	Off	Off
DDCS link initialization	Off	Off	Flashing green then green
Transfer-rate detection	Flashing green then green	Off	Green
Communication established	Green	Flashing green then green	Green
Operation	Green	Green	Green

Table 10-4 Profibus LED description

LED			Cause
Master	MSG	DDCS	
Red	Red	Off	RAM test failure
Off	Red	Red	ROM test failure
Last valid state	Last valid state	red	DDCS link failure
Green	Flashing red	Flashing green	Communication failure
Flashing red	Red	Flashing green	Link failure

—
10-8

10.6 Corrective maintenance

10.6.1 Overview on maintenance tasks

- Visual checks on the drive
- Cleaning
- Checking wire and cable connections
- Replacing filter mats
- Replacing a phase module
- Replacing a fan

10.6.2 Safety

DANGER

Hazardous voltages!

Before starting to work on the drive, make sure that:

the main and auxiliary power supply to the drive is switched off, locked out, and tagged out, the drive is dead, safety ground connections are in place, personal protective equipment is provided and used when required, everyone involved is informed.

Before energizing the drive again, make sure that: all foreign objects are removed from the drive, all internal and external covers are securely fastened and all doors are closed, locked and / or bolted, the manual release of the safety switches are in the locked position

DANGER

Hazardous voltages!

When a phase module is removed from the cabinet, the grounding path between grounding switch and PE ground busbar is interrupted.

For this reason, connect grounding equipment at the appropriate locations. The grounding equipment ensures that hazardous voltages cannot be fed into the drive from the main power supply or the motor

NOTICE

Foreign matter and particularly metallic dust can cause failure and damage when the drive is energized.

Ensure that foreign matter cannot enter the cabinet:

Close the doors and cover openings completely when work is discontinued.

Retrieve any foreign matter which accidentally dropped into the cabinet.

10.6.3 De-energizing the drive locally

The following section describes how to de-energize the drive using the local operator panel of the drive. If the drive is controlled from remote, follow the established shutdown procedures.

Stopping the motor

1. Check that the CDP control panel is connected to the INU.
2. Enable the local control mode of the CDP control panel.



For further information, see 9.9 Local and remote control.

3. Stop the motor..



When the motor has reached zero speed, the display shows **ReadyRun**.

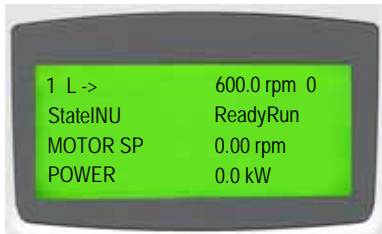

De-energizing the drive

4. To disconnect the drive from the main power supply, press the SUPPLY OFF pushbutton. The following takes place:

- The MCB opens.
- The DC link discharges.

While the DC link discharges, the display shows **OffSeqOn**.

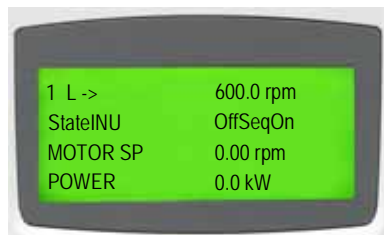

When the DC link has discharged completely, the status line displays **ReadyOn** and the SUPPLY OFF pushbutton changes to a permanent light.

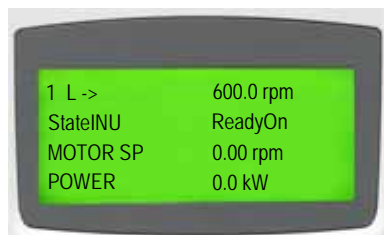

5. Rack-out, lock-out, ground and tag-out the main power feeder.

6. Wait until the yellow lamp **GROUNDING SWITCH UNLOCKED** lights up.

The lamp lights up when cooling of the drive has stopped. Cooling is stopped after a delay time (default setting: 10 min.) has elapsed. The delay time is triggered, when the main power feeder is disconnected.

CAUTION

If the **GROUNDING SWITCH UNLOCKED** pushbutton does not light up, press it: this pushbutton also works as a test lamp to verify its functionality. It is important that you do not force the grounding switch in any direction before you know the reason why the lamp does not light up. If you try, the following can happen:

The switch closes when the DC link is still energized and short-circuits the DC-link capacitors. The short-circuit manifests itself in a loud bang.

The switch is damaged because it is not released for closing.

If the lamp is on, continue with **Grounding**.

If the yellow lamp is not on, continue with 10.6.4 **Grounding switch is not released**.

Grounding

7. If the yellow lamp **GROUNDING SWITCH UNLOCKED** is on, turn the grounding switch to the grounded position.

When the grounding switch is in the grounded position, the CDP control panel shows the following:

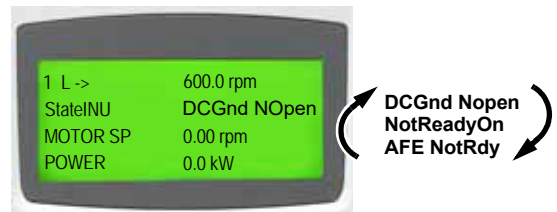

8. If necessary, open the doors of medium voltage compartments.

To open the AFE-INU compartment door, auxiliary voltage is required.

9. Switch off and lockout all auxiliary voltages from external sources.
10. Verify that the drive system is de-energized.
11. To connect a grounding set, continue with 10.6.5 **Connecting a grounding set**.

10.6.4 Grounding switch is not released

When the DC link of the drive has been discharged, the lamp GROUNDING SWITCH UNLOCKED lights up to indicate that the grounding switch is released and can be turned to the grounded position. If the lamp does not light up, proceed as follows:

1. Do not force the grounding switch in any direction.
2. To test the lamp GROUNDING SWITCH UNLOCKED, activate the lamp test with parameter 16.7.
(For information on setting parameters, see 9.6 Parameters mode.)
 - If the lamp does not light up, replace it.
 - If the lamp lights up after it was replaced, continue with step 7..
 - If the lamp does not light up after it was replaced, continue with step 3..
3. Verify that the MCB (main circuit breaker) is open.
 - a. If the MCB is open, check that it is locked out.
 - b. Check if the SUPPLY OFF lamp is lit.
If the lamp is lit, the feedback signal "main circuit breaker open" is present at digital input DI09 of I/O module A3411.
4. Check if the LED of digital output DO03 (I/O module A3401) is lit.
If the LED is lit, the grounding switch is released.
5. Check the discharging level of the DC link.
If the value of parameter 2.01 DC VOLTAGE is below 50 V, the DC link is discharged.
If the DC link is discharged, the message **ReadyOn** is displayed on the CDP control panel.



6. Verify that hazardous voltages from the motor cannot be fed into the drive.
7. Carefully turn the grounding switch to the grounded position if it has been verified:
 - that hazardous voltages cannot be fed into the drive from the main power supply or the motor,
 - that the DC link is discharged,
 - that the grounding switch is released (DO03 is energized).
 - that the drive status is **ReadyOn**.
 If you cannot turn the grounding switch, continue with 10.6.6 Releasing the door safety switch.
8. Switch off and lockout all auxiliary voltages from external sources.

9. Verify that the drive system is de-energized.
10. Ground the drive with a grounding set (option).

—
References
—
10-9 Four-way grounding
set

10.6.5 Connecting a grounding set

1. Connect the enclosure ground clamp (10-10: 1) to the ground ball stud of the cabinet's grounding frame.
2. Use the telescopic insulating pole to connect the busbar ground clamps (10-9: 3) to the ground ball studs of the busbars, and to tighten each connection.

Connect the inner most busbar first (10-10: 3), then the middle busbar (10-10: 4) and then the outer busbar (10-10: 5).

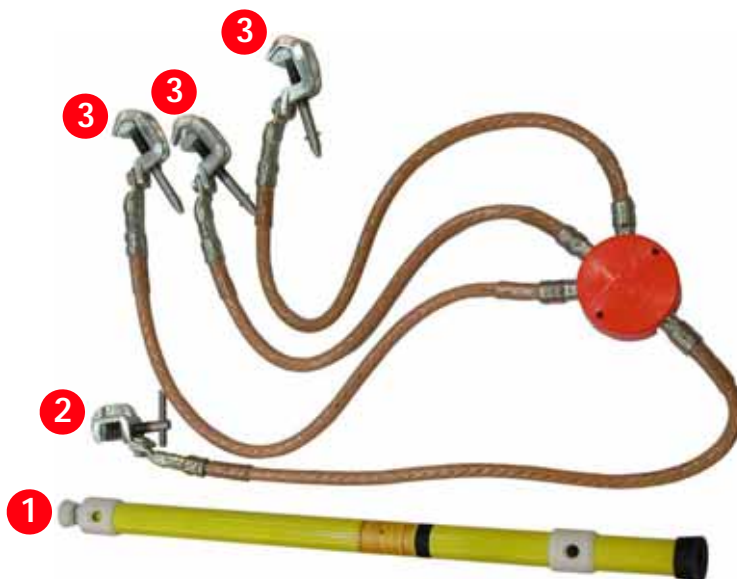

1. Telescopic insulating pole
2. Enclosure ground clamp
3. Busbar ground clamps

—
10-9

—
References

—
10-10 Connecting a
grounding set

The drive is now dead, and safe access is possible.

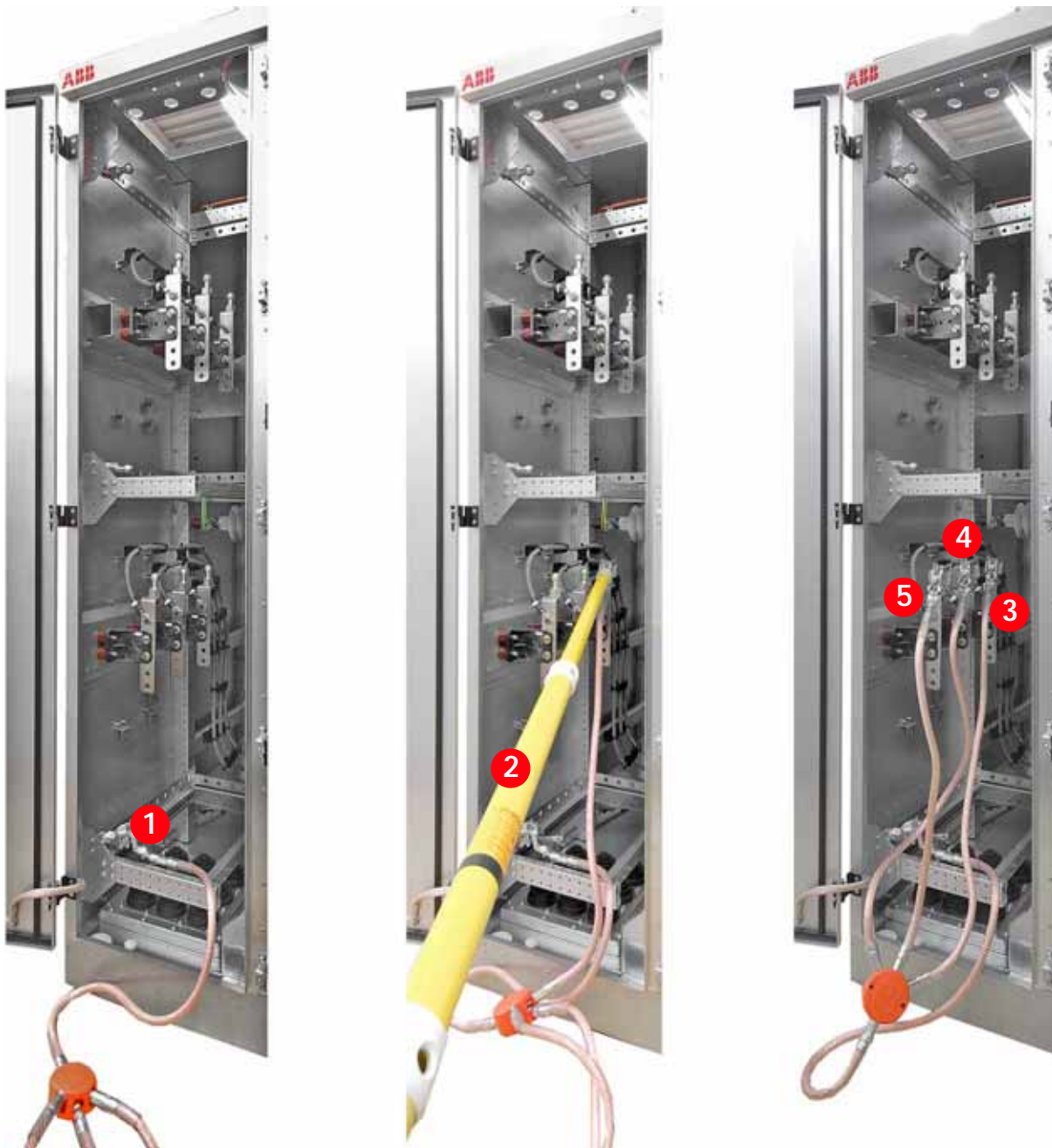

10.6.6 Releasing the door safety switch

The door of the AFE-INU compartment is secured by a safety switch. The safety switch is tied into an interlocking circuit that operates in conjunction with the grounding switch of the drive and the interlocks from the main circuit breaker of the drive. The interlocking system ensures that:

- the main power can only be connected to the drive if the door is securely closed, the grounding switch is in position **not grounded**, and the safety switch is in position **locked**.
- the door can only be opened if the main circuit breaker is open, the DC link is discharged, and the grounding switch is in position **grounded**.

The door of the AFE-INU compartment can also not be opened if

- the drive is disconnected from the auxiliary power and
- the safety switch of the door is in position **locked**.

If the auxiliary voltage is switched off and the door is locked and cannot be opened, check the position of the release dial of the door safety switch. If the release dial is in the locked position, unlock the safety switch as described in the following section.

DANGER

Hazardous voltages!

Touching energized components can be fatal.

Before you unlock the safety switch, verify that the drive is de-energized.

Do not unlock the safety switch permanently.

Safety-switch settings

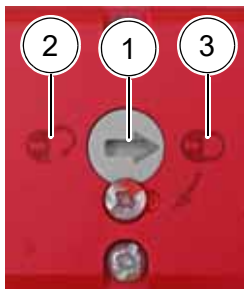

1. Release dial
2. Unlocked position
The unlocked position enables opening the AFE-INU compartment door whether the auxiliary voltage is switched on or off.
3. Locked position
Locked is the normal operating setting. To open the AFE-INU compartment door, the DC link must be discharged and the auxiliary voltage must be switched on.

Unlocking

1. To access the dial of the door safety switch, remove the cap in the control compartment.



2. Turn the release dial from the locked to the unlocked position.



5 mm

3. When the door is open, turn the release dial to the locked position.
4. Reinsert the cap.

10.6.7 Service covers

CAUTION

High temperature!
Components inside the drive can be hot.
Before taking off a service cover on the back of the cabinet, wait until the fan has stopped. To cool down the components, the fan continuous to run for a preset time after the main power supply has been switched off.

The service covers enable rear access to the NP frame (1), the resistor assembly (2) and the terminal compartment (3).

10.6.8 Visual checks on the drive

Check the drive and its immediate vicinity visually at the intervals stated in the maintenance schedule and pay attention to the following items:

- Humidity inside the drive
- Permitted range of ambient air temperature and humidity of the drive
- Dust built-up inside the drive room and inside the drive
- Appropriate fastening of cables and wires and connections of cable shields and screens
- Integrity of cable insulation
- Signs for overheated components, wires, cables or busbars
- Corrosion on circuit boards, connectors or busbars
- The outer cable sheath must not be damaged.
- Correct type of signal and power cables



For information, see the applicable cable specifications.

10.6.9 Cleaning

NOTICE

Risk of component damage!

Dust on electrical components and wiring can cause failure and damage the components. Dust and moisture can build up in loose connections and cause loss of low-level signals. Check the cabinet regularly for signs of dust and humidity and clean if necessary. Alcohol and solvents can damage the components. Use appropriate and recommended cleansing agents.

When cleaning the drive cabinet, mind the following:

- To prevent dirt falling into equipment, cover the equipment.
- The drive contains components which are sensitive to electrostatic discharge. Therefore, take electrostatic-sensitive precautions and use suitable tools.
- Clean circuit boards with special care. To prevent the components being damaged, use anti-static brushes and a vacuum cleaner with a soft nozzle.
- Remove dust on assemblies and busbars inside the cabinet with a vacuum cleaner and lint-free cleaning cloths.
- Remove water, oily or greasy deposits on assemblies, components and busbars with water- and oil-absorbing microfibers such as "3M Scotch Brite".
- Use a nylon brush or a vacuum cleaner for removing dust or deposits from recesses.
- Clean the outside of the cabinet with a vacuum cleaner and cleaning cloths.

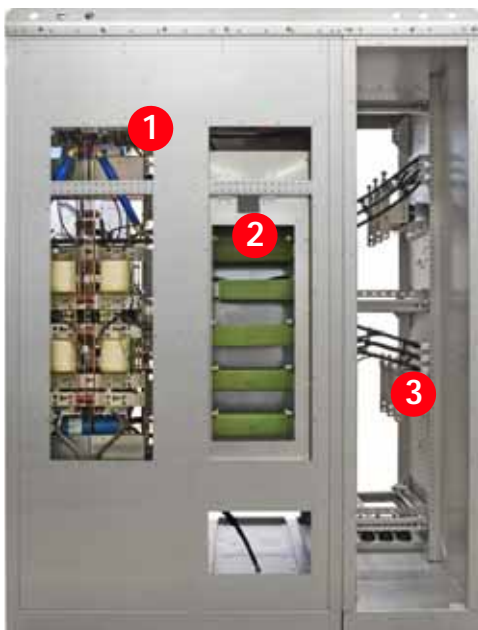

10.6.10 Checking wire and cable connections

Vibration can loosen electrical connections and cause occasional malfunction or equipment failure.

- Check all power and control cable connections and tighten them if necessary.
- Check that all plugs and connectors are tight.

	Standard	Option
Thickness	10 mm	20 mm

NOTICE

• The ACS2000 is designed to operate in a temperature range of 0°C to 40°C. If the ambient temperature is outside this range, the unit may not operate correctly. For more information, see the ACS2000 user manual.

10.6.11 Replacing filter mats

i For information on replacement intervals, see the ACS2000 preventive maintenance schedule.

To replace a filter mat:

1. Unfasten the air intake panel upper supports (1).
2. Remove the air intake panel (2).
3. Remove the filter mat (3) and clean it by using compressed air or a vacuum cleaner. Perform this operation away from the drive to prevent dust from entering.

	Standard	Option
Filter class (EN779 classification)	G3	G4
Dimensions	See layout drawing	See layout drawing

1. Supports
2. Air intake panel
3. Filter mat

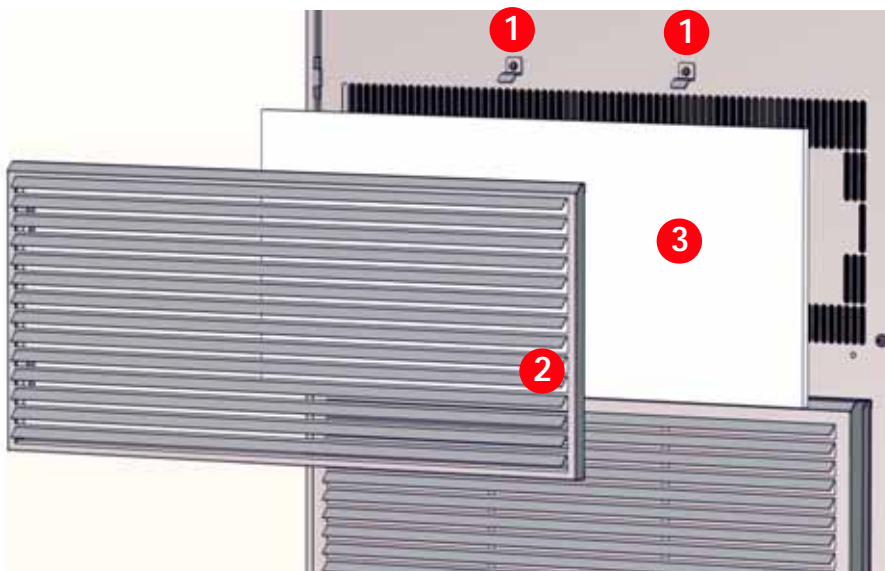

—
References
—
10-12 Replacing filter mats

- References
- 10-13 Phase modules location
- 10-14 Phase module – Dimensions and weight

10.6.12 Replacing a phase module
Phase modules location

Dimensions and weight

Tools

The following parts are required for the maintenance of the phase modules. The module tray can be order as a standard option. The rest of the tools are not included in the scope of supply.

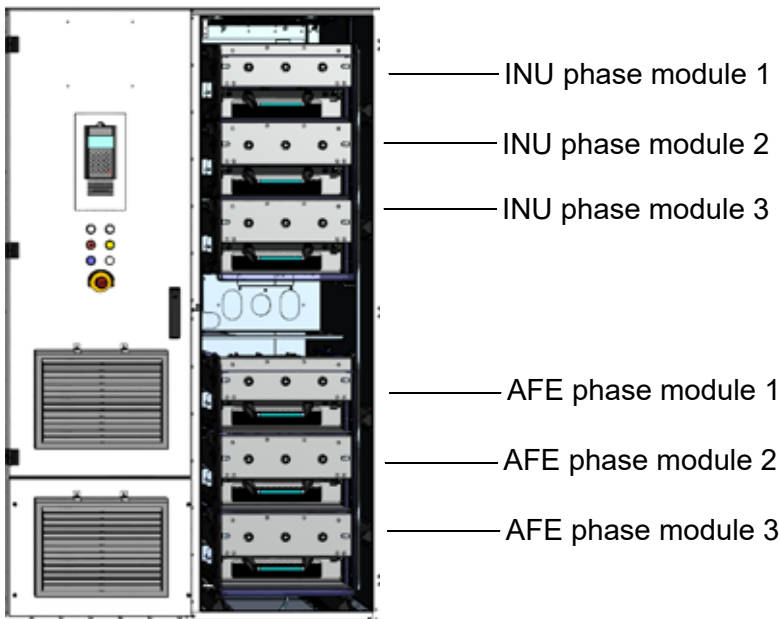

10-13

W (width)	L (length)	H (height)	Weight
490 mm	650 mm	250 mm	35 kg

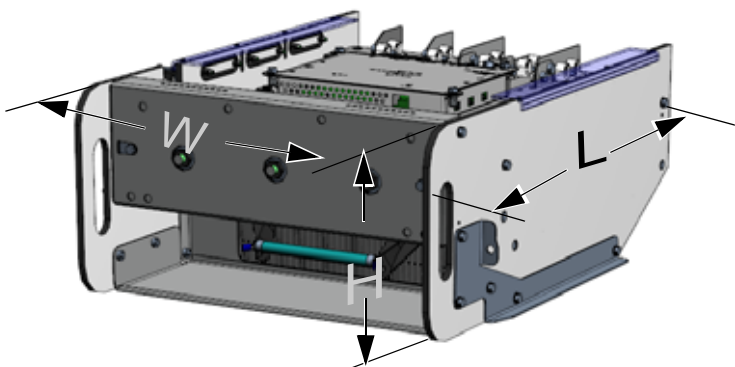

10-14

Replacing a phase module

1. Disconnect all power supplies to the drive and ground the drive.

For further information, see 10.6.3 De-energizing the drive locally.

⚠ DANGER

Hazardous voltages!

When a phase module is removed from the cabinet, the grounding path between grounding switch and PE ground busbar is interrupted.

For this reason, connect grounding equipment at the appropriate locations. The grounding equipment ensures that hazardous voltages cannot be fed into the drive from the main power supply or the motor.

2. Remove the appropriate acrylic panel.

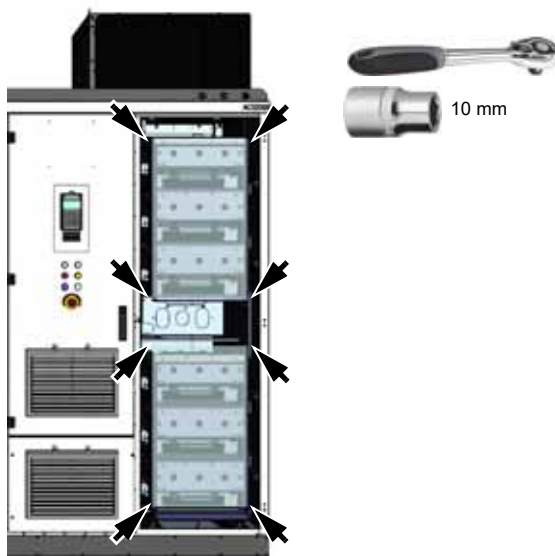

Note: When working on the AFE, pull out the air pressure tube at the bottom (see 1 in the figure below).

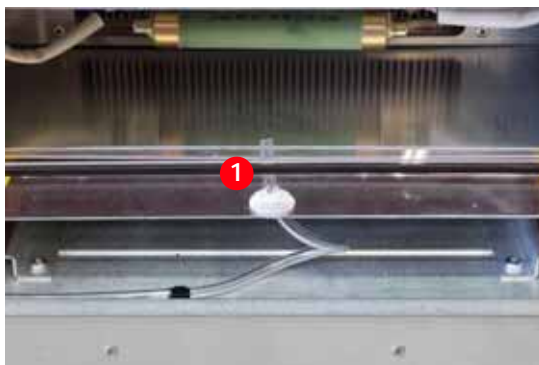

3. Remove the screws on each side of the phase module.

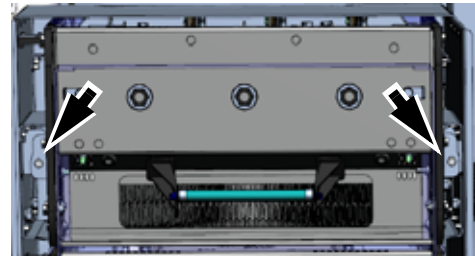

4. Slide the module rails under the phase module.

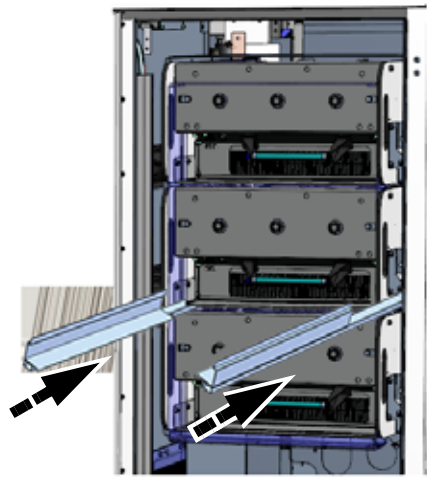

⚠ CAUTION

To prevent the phase module from dropping on you, make sure the rails are slid completely under the phase module.

5. Holding the phase module at the handles, pull it out carefully.

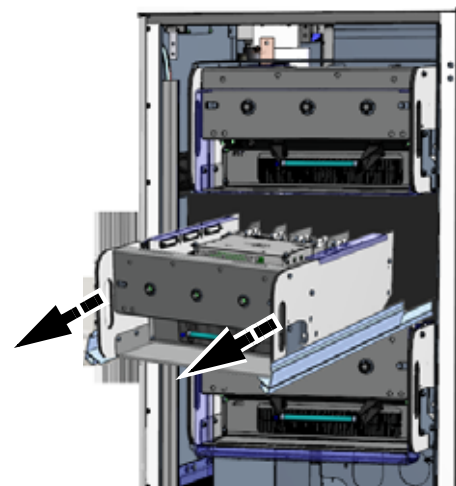

6. Disconnect all cables from the Phase-INT-circuit board (1) that are going into the cabinet:
 - Auxiliary power supply cable (2)
 - Two optical fibers (3)
 - The cables are partly concealed by the grounding strap.
 - Current transformer cable (4)

— This cable is only present in phase modules of the AFE.

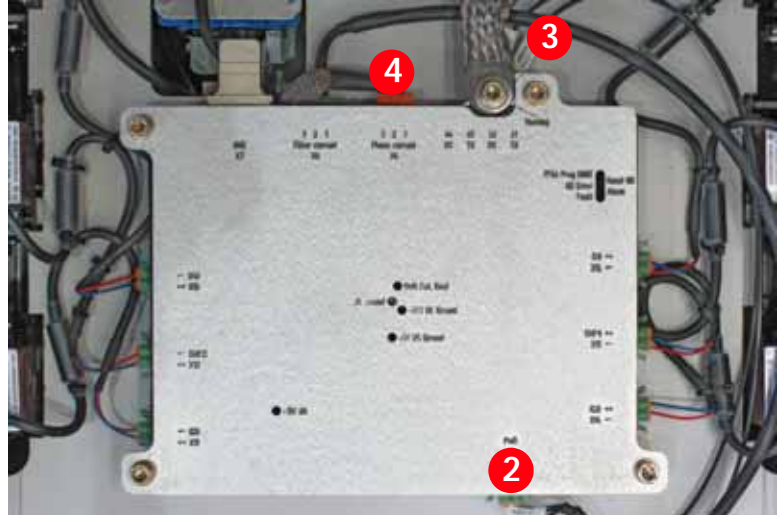
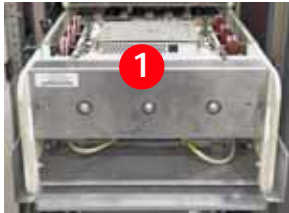

7. Detach the cable chain on the side of the phase module (1, 2). Pull down the end of the chain a little (3), and then pull it into the direction of the arrow (4) to disengage the chain from the mounting bracket.



8. Lift the phase module off the rails. Attention! Due to the weight, it is recommended that two persons, one on each side, lift the phase module off the rails. Furthermore, make appropriate arrangements for removing one of the upper phase modules.

9. Put the new phase module back into the cabinet.
10. When reconnecting the optical fibers, pay attention to connect them to their corresponding receptacles (arrows).

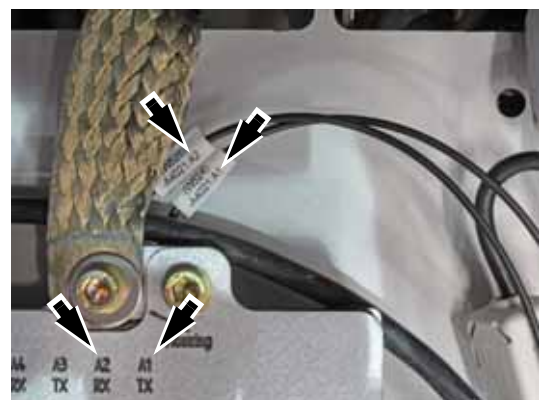

11. When all cables have been reconnected, check that the drive control system and the phase module communicate with each other. Switch on the auxiliary power supply. Check that the LEDs on the Phase-INT circuit board of the phase module are on (box).

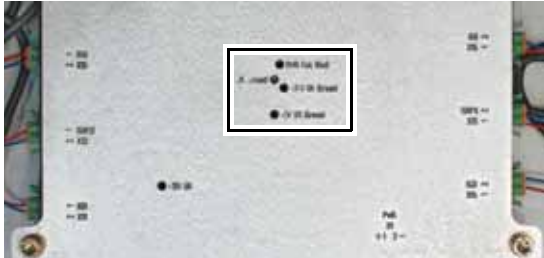

12. Push the phase module back into the rack as far as it goes and tighten the fastening bolt on each side.
13. Remove the rails and reinstall the acrylic panel.
14. Switch on all miniature circuit breakers in the control compartment.

The work is now completed, and the drive can be started again.

For further information, see 8.6 Starting the drive.

10.6.13 Replacing a fan

The fan housing can stay on the roof when only the impeller is replaced.

1. Disconnect all power supplies to the drive and ground the drive.
For further information, see 10.6.3 De-energizing the drive locally.
To isolate the fan unit from the auxiliary power supply, switch off the motor starter of the fan unit.



To identify the motor starter, see Appendix D – Wiring diagrams.

2. Continue with Standard fan units or DTL fan units as applicable.

Standard fan units

3. Remove the cover from the fan housing.

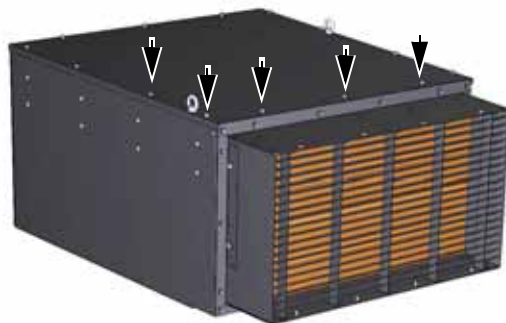

4. Disconnect the control and power supply cables of the fan.

5. Remove the fastening screws from the support plate and the duct ring.

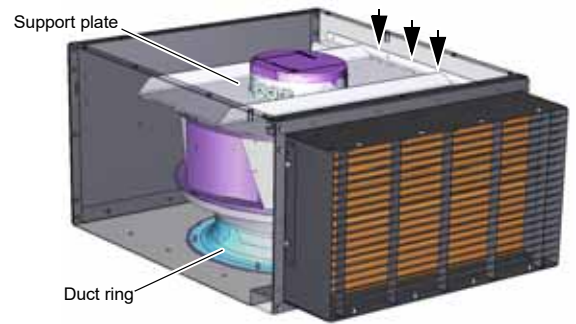

6. Using the lifting eyes in the fan housing cover and a lifting gear, lift off the support plate with the fan attached to it.

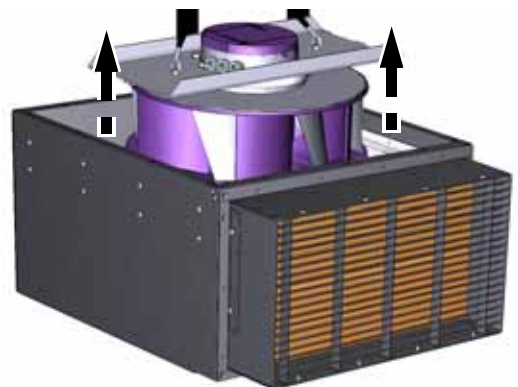

7. Unscrew the support plate from the fan
8. Replace the fan and re-assemble in reverse order of removal.

DTL fan units

9. Disconnect the power supply cable at the entry of the terminal box.
10. Unscrew the cover from the fan housing.

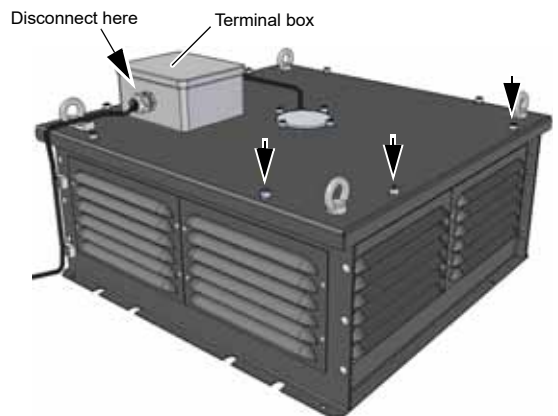

11. Lift off the cover and the fan attached to it.



12. Disconnect the cable at the exit of the terminal box, unscrew the locknut of the cable gland, unscrew the cover from the fan.

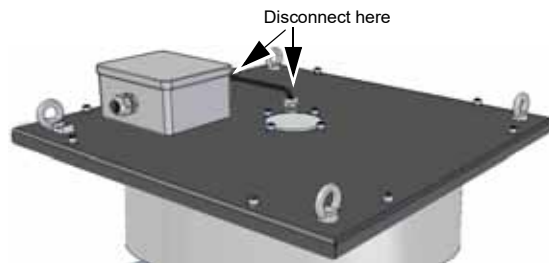

13. Replace the fan and re-assemble in reverse order of removal.



ABB Sp. z o.o.

Placydowska 27,
95-070 Aleksandrow Lodzki,
Poland

Phone: +1 479 648 5912
E-Mail: drivessupport@abb.com

www.abb.com/drives