



**System Manager III
Programming Guide**
V3.22.22

Version October 2022

Programming Guide Qbus System Manager

© **Qbus NV**

All rights reserved. No part of this publication may be reproduced in any form or by any means, graphic, electronic or mechanical, by photocopying, recording or with storage and retrieval systems, without the written permission of Qbus NV.

Despite the care taken in the preparation of this document, the publisher and the author accept no liability for errors or omissions or for damages resulting from the use of information contained in this document or from the use of associated programs and source codes. Under no circumstances will the publisher and the author be held liable for lost profits, commercial damage or any other consequential damage caused directly or indirectly or alleged to be caused directly or indirectly by this document.

Printed October 2022, Erpe-Mere.

Content

1. Introduction to the Qbus Automation System.....	7
1.1 Description of the Qbus Automation System.....	7
1.1.1 Limitations of the Qbus system.....	8
1.1.2 Planning your installation	9
1.1.3 Types of controllers.....	11
2. Installation of the Qbus System Manager	14
2.1 Where can you find the Qbus System Manager?.....	14
2.2 System Manager Hardware Requirements	14
2.3 Starting Qbus System Manager.....	14
2.4 Configure Qbus System Manager.....	15
2.4.1 Communication with the Controller	17
2.4.2 Other Setup Options	20
3. Taskbar Qbus System Manager	33
3.1 Open and Save	33
3.2 Extract data from the controller.....	33
3.2.1 Restore QDB from SD	34
3.2.2 Events	34
3.2.3 Module scanning.....	36
3.3 Send data to the controller.....	36
3.4 Programming modules	38
3.5 Outputs.....	42
3.5.1 Toggle (Bistable).....	43
3.5.2 Push button	43
3.5.3 Dimmer1B / Dimmer2B.....	43
3.5.4 Shutter1B / Shutter2B.....	43
3.5.5 Intermittent	43
3.5.6 Intelligent Thermostat	44
3.5.7 Sequencer.....	52
3.5.8 Timers	52
3.5.9 (Energy) meter	56
3.5.10 Universal function	58
3.5.11 Stepper output	58
3.5.12 Output properties	59
3.6 Editing scenes.....	62
3.6.1 Simulation	63
3.6.2 Multi-link.....	65
3.7 Setting time schedules (Clock times or Weekly program)	67
3.8 Control table selection	68
3.9 Infrared samples.....	70
3.9.1 Creating infrared samples.....	70
3.9.2 Assign outputs to the sampled infrared codes.....	71
3.9.3 Sending infrared code via the IRG04.....	74
3.10 Creating Logical Functions	76
3.10.1 Binary Logic (If – Then – Else with ON/OFF)	76
3.10.2 Analogue Logic (If – Then – Else with all values and operations x,/,+,-,<,>,<=,=)	77
3.11 Choosing an alarm	81
3.12 Grid editor (Global editing).....	85
3.13 Importing a QDB.....	90
4. Configuration of the Qbus modules	92
4.1 Configuring Input Modules.....	93
4.1.1 INP02/04	93
4.1.2 INP08/INP16	94
4.1.3 INP08/230	94
4.1.4 INA02 (module type 0013)	95
4.2 Configure output modules.....	99

4.2.1	Configuring Relay Modules (REL02SA/230, REL04(SA), REL08)	99
4.2.2	Roller shutter module with positioning (ROL02P, ROL01PSA and ROL04PSA)	101
4.2.3	Dimmer modules (DIM02SA/500U, DIM04SA/500U)	104
4.2.4	Constant Light Control (CLC01).....	106
4.2.5	Analog dimmer module (ANA04/ANR04SA).....	108
4.3	Configuring switches (SWC0X/XX and Tastu)	110
4.4	DIS02IT (Eol 2017).....	114
4.4.1	Configuring the DIS02 IT	114
4.4.2	Using the DIS02 IT.....	115
4.5	ViZiR Room Controller (Eol 08/2019).....	116
4.5.1	Configuring the ViZiR Room Controller	116
4.5.2	Using the ViZiR Room Controller.....	119
4.6	Touch Display (DIS/Gx) Module type 0008.....	121
4.6.1	Configuring the Tastu display	121
4.6.2	Using the Tastu display.....	123
4.7	Configure 5.8” touch screen (TSC5.8)	124
4.8	Configure motion detector (MDX01 or SEN04MLT)	125
4.8.1	Specifications	125
4.8.2	Configuration parameters	125
4.9	Configure SMS module – SMS01 (Eol 2017).....	127
4.9.1	Install SIM card	127
4.9.2	Install Phone Numbers.....	127
4.9.3	Configuring Commands	128
4.10.	Configuring the Audio Module - SER10 (Eol).....	130
4.10.1.	Select audio system.....	130
4.10.2.	Assign Sources and Zones	131
4.10.3.	Assigning outputs.....	131
4.10.4.	Audio outputs in scenes.....	133
4.11.	Configure the SER485/DMX module (module type 0002)	134
4.12.	The QDI01 (Dali 1): Configure module type 0006 (Eol 2021)	140
4.13.	SER485/Modbus interface: Module type 0003.....	146
4.14.	SER485/APIEN: Weather station module type 0001.....	147
4.15	SEN01X modules	148
4.15.1	SEN01T: serial numbers 700300 to 704999.....	148
4.15.2	SEN01NTC: serial numbers 705000-708999	149
4.15.3	SEN01M: Serial Numbers 710000-749999	150
4.16	Dali broadcast module QDBC02SA module type 0009	151
4.17	Constant Voltage Driver CVD04SA module type 000C.....	152
4.18	Configure Wireless Interface QWI/EW Module Type 000A	153
4.18.1	QWE-REL01/230 and QWE-REL01/230PF relay module.....	154
4.18.2	QWE-PP01/BE power plug	155
4.18.3	QWE-SWC04/55 4-way push button	155
4.18.4	QWE-INP04/bat 4-way input module.....	157
4.18.5	QWE-INP02/230 2-way input module.....	158
4.18.6	QWE-PB/button and QWE-PB/wrist and QWE-PB/neck and QWE-RC01 1- button pushbuttons	159
4.18.7	QWE-RC04/metal 4-button hand-held transmitter.....	159
4.18.8	QWE-SWC01/call and QWE-SWC01/reset 1-key pushbuttons	160
4.18.9	QWE-SEN01MW motion detector with light cell.....	160
4.18.10	QWE-MC01/white window or door contact.....	161
4.19	QDM01 Configure Dali1 and Dali2 module (Type 0011)	162
4.20	QDG04SA Configure Dali1 module (Type 0012)	163
5.	Remote connection	165
5.1.	Qbus Cloud	165
5.2.	EQOweb web server	172
5.3.	Port Forwarding.....	176
6.	Measuring (energy) via Qbus	177

6.1.	Energy Counter Module	177
	Step 1: Insert Serial Number.....	177
	Step 2: create outputs and assign them	178
	Step 3: Logic	179
6.2.	EMM03 (Module type 0017)	182
6.3.	counters	185
	Logic.....	185

1. Introduction to the Qbus Automation System

This chapter provides an introduction to the Qbus home and building automation system, a brief description of the system and its limitations, and instructions on how to plan the installation. It also describes the various controllers - the brain of the Qbus system.

1.1 Description of the Qbus Automation System

With the Qbus system, various electrical products in a home can be controlled, either manually or automatically and remotely (with an IR remote control, via SMS or on the internet). As the block diagram indicates, a central control unit (controller) communicates via a special two-wire bus with numerous input and output modules (I/O modules) in the home. The Controller:

- perpetuates the operation of the bus;
- ensures simultaneous two-way communication between the controller and the Qbus modules on the bus;
- powers the Qbus modules on the bus;
- stores the time-based input and output sequences according to the status of the input modules and sends commands to outputs to change their status based on the output sequences, remote commands, or manual commands;
- can also be a separate communication link over the ethernet with internet-based contacts for remote control and monitoring.

I/O modules monitor the communication bus for commands from the controller to change the output status and report their status and the change of status to the controller, based on operations in the I/O modules.

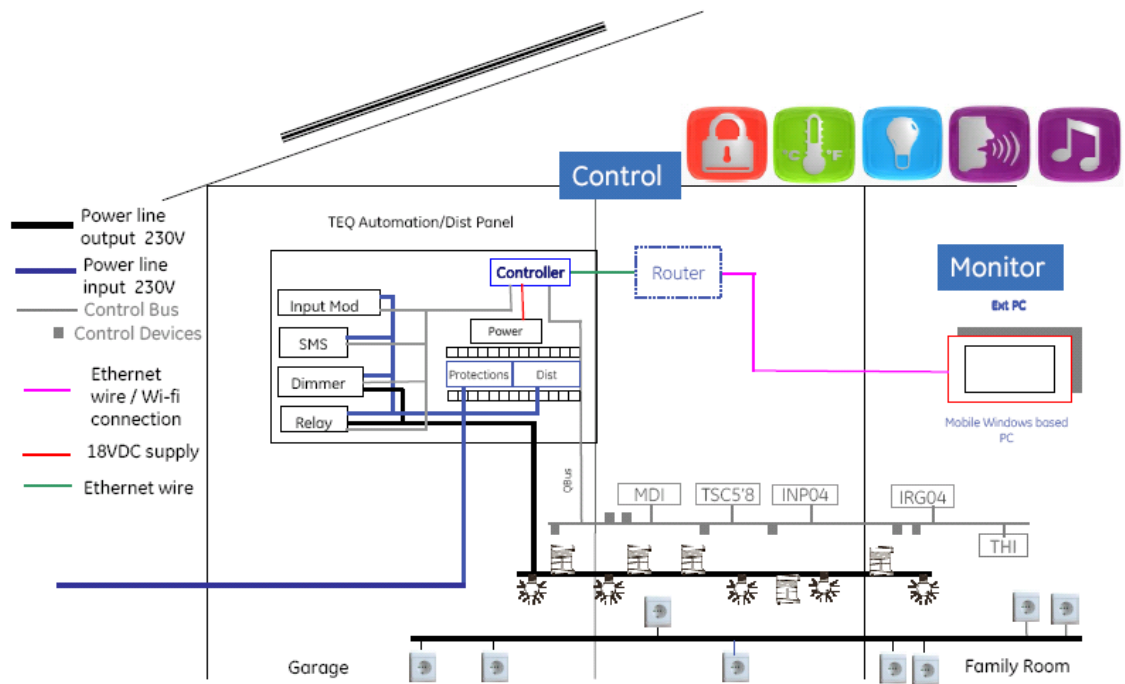

1.1.1 Limitations of the Qbus system

When installing the Qbus automation system, you must take the following restrictions into account.

- a. The size of the installation is limited by:
 - **The number of modules that can be powered by the controller** depends on the maximum power that can be delivered on the bus of the corresponding controller:
 - CTD10, CTD40, CTDMax: Maximum 1000mA per bus. The actual number of modules is limited here and can be expanded by software via an expansion card.
 - CTD01Em (with Ethernet): Maximum 100mA on the bus (~9 Qbus modules)
 - CTD01 (with and without Ethernet): Maximum 250mA on the bus (~20 Qbus modules)
 - CTD01E+ (only with Ethernet): Maximum 500mA on the bus (~40 Qbus modules)
 - CTD02E (only with Ethernet): Maximum 500mA on each bus (~40 Qbus modules per bus)
 - CTD03E (only with Ethernet): Maximum 500mA on each bus (~40 Qbus modules per bus). In order to utilize the maximum power of the CTD03E, equal to 1500mA, the CTD must be placed on a ventilated distribution board in an area where the ambient temperature is $< 25\text{ }^{\circ}\text{C}$.
 - **The number of available outputs:** Each controller has 388 available outputs, 91 scenes and 99 clock times. The Qbus system works with addresses; 1 controller has 388 addresses; Depending on the type of output, 1 or more addresses are used:
 - a monostable, bistable, timer or meter output uses 1 address
 - a dimmer and a roller shutter use 2 addresses
 - a thermostat output and HVAC output uses 4 addresses.
 - an RGB output uses a minimum of 2 addresses but can use up to 5 addresses (Using RGB outputs in the Cloud uses 2, 3 or 4 addresses)
 - The maximum length of a branch measured from the controller: The length of each bus is limited to a maximum of 200 meters, which means that the module furthest away from the controller is 200 meters. We strongly recommend laying the bus in a loop, ie: the start and end of the loop come together in the controller. In this case (with a closed loop) we can increase the total length to 400 meters. If communication on the bus is not optimal when using the maximum distance (depending on the total load on the loop), add an RC circuit (220 ohms combined with 100 nF) at the end of the bus. Normally RC circuits are not needed.
- b. Other installation requirements.
 - The wiring must be done by means of a cable with at least $2 \times 1\text{ mm}^2$ conductors as a bus cable. The green shielded EIB cable ($4 \times 0.5\text{ mm}^2$) is also allowed when the conductors are routed in pairs to obtain a cross section of at least $2 \times 1\text{ mm}^2$.
 - The bus can be mounted in any architecture (closed loop, tree, star, ...) provided the conditions in terms of distance and cross-section are met. The bus can be tapped to a length of about 30 m. Normally an RC circuit is not necessary, but you can add one (220 ohms combined with 100 nF) if you find that communication is not optimal.
 - Since the bus has no polarity, it is not possible to connect consumers incorrectly.
 - Qbus modules with a thermostat sensor (SEN01T, SEN01NTC, SWC04T, SWC04T/SU, SWC02T/SU, SWC0102T, ViZiR, DIS and TSC5.8) should not be placed close to heating or heat sinks to ensure correct thermostat operation.
 - MDI01, SEN01M or SEN04 should be placed in the best location to obtain maximum viewing angle coverage (110 degrees - 7 meters away), NOT in a location close to a heating or heat sink.

1.1.2 Planning your installation

Determine required number of outputs and inputs

Based on the building floor plan, the desired outputs (relays, dimmers, motors, valves, etc.) and input devices to control the outputs (switches, input modules, motion detectors, infrared sensors, temperature sensors, displays, touch screens, etc.) must be determined. Number each room on the floor plan and determine the required outputs and entrances for each room. We propose to use different codes and colors for the various functions of the modules: as you can see in the example below, we use red for 230 V modules, green for modules on the bus and blue for potential-free inputs.

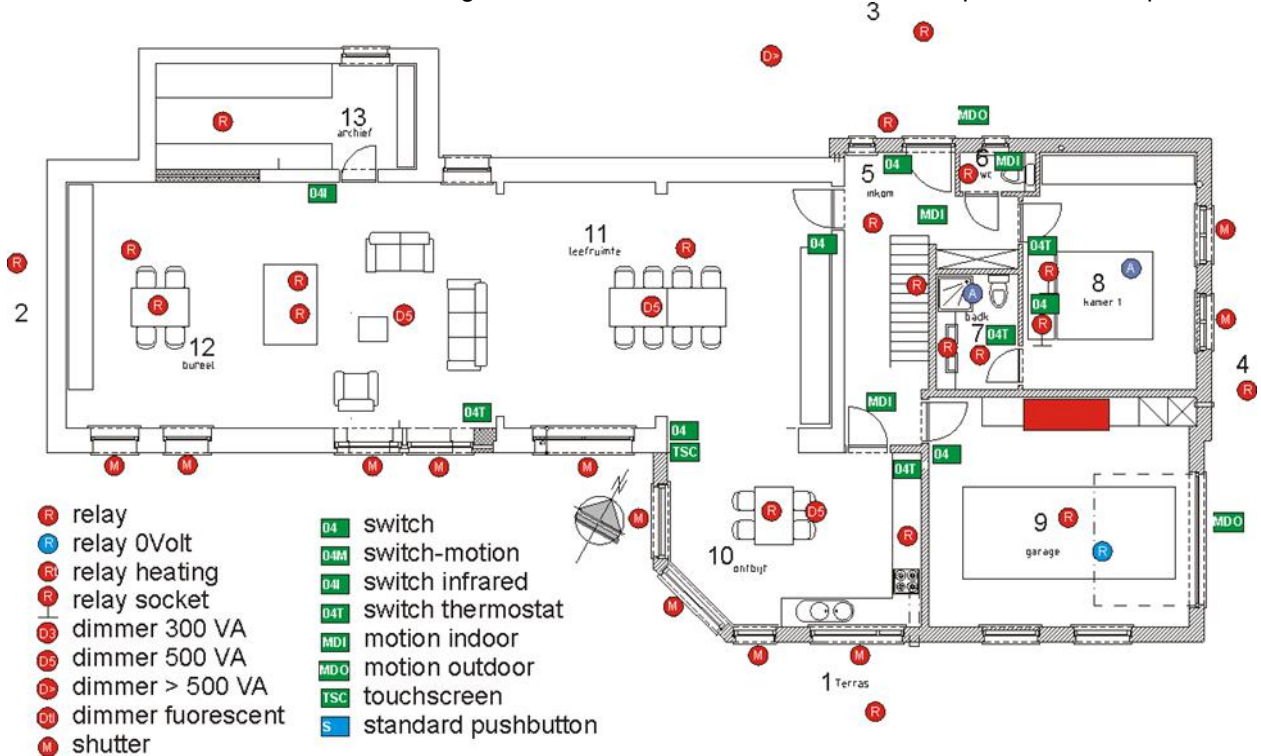

This gives you an overview of the installation requirements, which you need to order the right products and install the modules in the right places.

Determining the Wiring Method

The cabling of the installation is of the utmost importance. As indicated above, the bus can be mounted in any architecture (closed loop, tree, star, etc.), provided the conditions for distance and cross-section are fulfilled.

- The maximum length of a branch, measured from the controller, is limited to 200 meters, which means that the module furthest away from the controller is 200 meters. We strongly recommend looping the bus which means that the top and bottom of the loop meet in the controller. In this case (with a closed loop) we can increase the total length to 400 meters.
- The wiring must be done by means of a cable with at least 2x1 mm² conductors as a bus cable. The green shielded EIB cable (4 x 0.5mm²) is also allowed when the conductors are routed in pairs to obtain a cross section of at least 2 x 1 mm².

The bus can be tapped to a length of about 30 m. Normally an RC circuit is not necessary, but you can add one (220 ohms combined with 100 nF) if you find that communication is not optimal.

All individually controlled 230 V circuits must be connected separately to the appropriate output modules (dimmer, relay) on the distribution board.

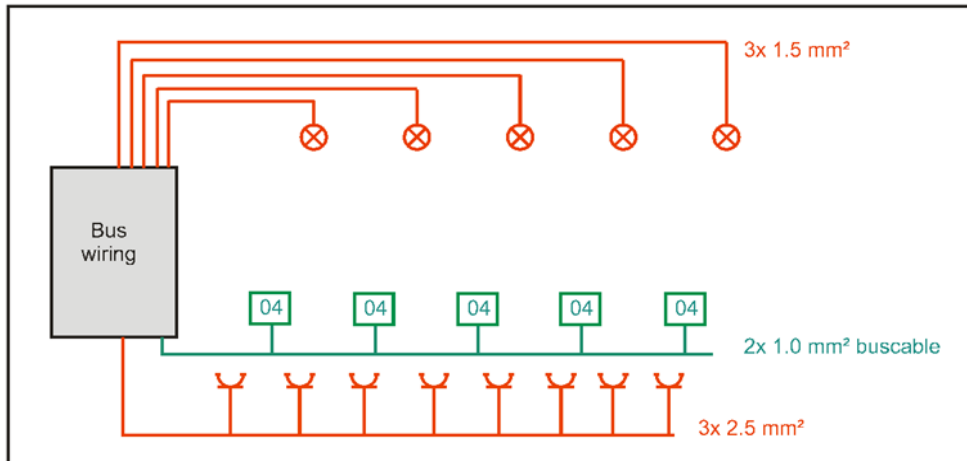

The modules on the bus must all be connected to the bus – preferably in closed loop to ensure optimal distance.

The potential-free modules must be connected in star form to the distribution board.

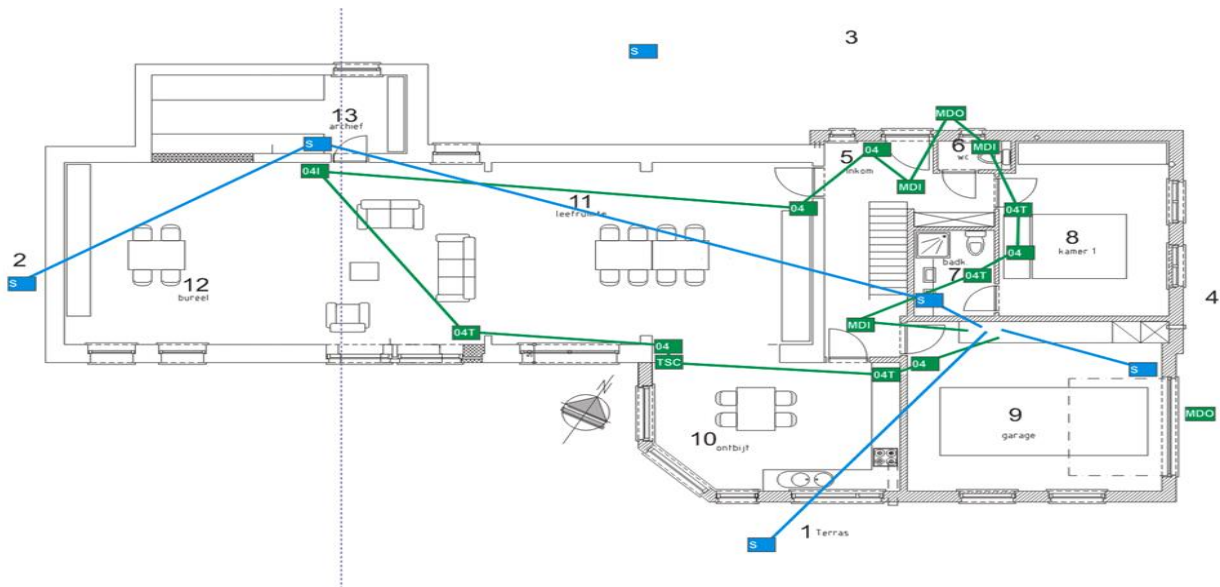

Tips

- When ordinary push buttons are to be connected to the Qbus system (instead of the Qbus SWCxx smart switches), input modules on DIN rails in the housing (INP08, INP16) or input modules on the bus (INP02, INP04) can be used.
- The DIN-rail input modules are the cheapest option in purchase price per connected input, but additional wiring and installation costs are required because all potential-free devices (ordinary push buttons, magnetic contacts for doors or windows, PIR sensors, ...) have to be star-shaped connected to the distribution board.
- In order to optimize the total cost of the installation and flexibility in the future, it is recommended to work with input modules on the bus. These INP02 and INP04 devices require less time for wiring and installation, and can always be replaced in the future by another Qbus module on the bus (motion detectors, touch screen, smart switch, ...).
- If communication on the bus is not optimal when using the maximum distance (depending on the total load on the loop), add an RC circuit (220 ohms combined with 100 nF) at the end of the bus. Normally RC circuits are not needed.
- Check for short circuits before activating the controller.

1.1.3 Types of controllers

Depending on the installation you have in mind, you can choose a different type of controller.

CTD10	<p>The controller supplies the power and data required to all connected modules.</p> <p>Characteristics:</p> <ul style="list-style-type: none"> • 2 bus connection max. 2 x 1000mA • Ethernet connection • Maximum 10 modules allowed on the bus. Expandable per 15 modules (max. 4x) up to CTDmax • 388 outputs • Boolean logic (and/or/if-then-else) and analog logic (+, -, x, /, <, >, =) • 99 clock times, each with max. 15 outputs or 1 scene • 91 scenes • Presence simulation • Astronomical Clock • 16 GB SD card with 10 memory banks available (for 10 system configurations) • Width: 4 modules (DIN) • Supplied with DIN rail power supply (4 modules)
CTD40	<p>The controller supplies the power and data required to all connected modules.</p> <p>Characteristics:</p> <ul style="list-style-type: none"> • 2 bus connection max. 2 x 1000mA • Ethernet connection • Maximum 40 modules allowed on the bus. Expandable per 15 modules (max. 2x) up to CTDmax • • 388 outputs • Boolean logic (and/or/if-then-else) and analog logic (+, -, x, /, <, >, =) • 99 clock times, each with max. 15 outputs or 1 scene • 91 scenes • Presence simulation • Astronomical Clock • 16 GB SD card with 10 memory banks available (for 10 system configurations) • Width: 4 modules (DIN) • Supplied with DIN rail power supply (4 modules)
CTDMax	<p>The controller supplies the power and data required to all connected modules.</p> <p>Characteristics:</p> <ul style="list-style-type: none"> • 2 bus connection max. 2 x 1000mA • Ethernet connection • No limitation on the number of modules allowed on the bus. • 388 outputs • Boolean logic (and/or/if-then-else) and analog logic (+, -, x, /, <, >, =) • 99 clock times, each with max. 15 outputs or 1 scene • 91 scenes • Presence simulation • Astronomical Clock • 16 GB SD card with 10 memory banks available (for 10 system configurations) • Width: 4 modules (DIN) • Supplied with DIN rail power supply (4 modules)

CTD01Em (microcontroller with Ethernet)	The controller supplies the power and data required to all connected modules. Characteristics: <ul style="list-style-type: none"> • 1 bus connection max. 1 x 100mA (for ~9 Qbus modules) • USB connection • 388 outputs • Boolean logic (and/or/if-then-else) and analog logic (+,-,x,/,<,>,<=,>=) • 99 clock times, each with max. 15 outputs or 1 scene • 91 scenes • Presence simulation • Astronomical Clock • 8 GB SD card with 10 memory banks available (for 10 system configurations) • Width: 4 modules (DIN) • Supplied with DIN rail power supply (4 modules)
CTD01 (mini controller with USB)	The controller supplies the power and data required to all connected modules. Characteristics: <ul style="list-style-type: none"> • 1 bus connection max. 1 x 250mA (for ~20 Qbus modules) • USB connection • 388 outputs • Boolean logic (and/or/if-then-else) and analog logic (+,-,x,/,<,>,<=,>=) • 99 clock times, each with max. 15 outputs or 1 scene • 91 scenes • Presence simulation • Astronomical Clock • 8 GB SD card with 10 memory banks available (for 10 system configurations) • Width: 4 modules (DIN) • Supplied with DIN rail power supply (4 modules)
CTD01E (mini controller with USB and Ethernet)	The controller supplies the power and data required to all connected modules. Characteristics: <ul style="list-style-type: none"> • 1 bus connection max. 1 x 250mA (for ~20 Qbus modules) • USB connection • Ethernet connection • 388 outputs • Boolean logic (and/or/if-then-else) and analog logic (+,-,x,/,<,>,<=,>=) • 99 clock times, each with max. 15 outputs or 1 scene • 91 scenes • Presence simulation • Astronomical Clock • 8 GB SD card with 10 memory banks available (for 10 system configurations) • Width: 4 modules (DIN) • Supplied with DIN rail power supply (4 modules)
CTD01E+ (basic controller with USB and Ethernet)	The controller supplies the power and data required to all connected modules. Characteristics: <ul style="list-style-type: none"> • 1 bus connection max. 1 x 500mA (for ~40 Qbus modules) • USB connection • Ethernet connection • 388 outputs • Boolean logic (and/or/if-then-else) and analog logic (+,-,x,/,<,>,<=,>=) • 99 clock times, each with max. 15 outputs or 1 scene • 91 scenes • Presence simulation • Astronomical Clock • 8 GB SD card with 10 memory banks available (for 10 system configurations) • Width: 4 modules (DIN) • Supplied with DIN rail power supply (4 modules)

CTD02E (Full Controller with USB and Ethernet)	<p>The controller supplies the power and data required to all connected modules.</p> <p>Characteristics:</p> <ul style="list-style-type: none"> • 2 bus connections max. 2 x 500mA (for ~80 Qbus modules) • USB connection • Ethernet connection • 388 outputs • Boolean logic (and/or/if-then-else) and analog logic (+,-,x,/,<,>,<=,>=) • 99 clock times, each with max. 15 outputs or 1 scene • 91 scenes • Presence simulation • Astronomical Clock • 8 GB SD card with 10 memory banks available (for 10 system configurations) • Width: 6 modules (DIN) • Supplied with DIN rail power supply (4 modules)
CTD03E (Maxi Controller with USB and Ethernet)	<p>The controller supplies the power and data required to all connected modules.</p> <p>Characteristics:</p> <ul style="list-style-type: none"> • 3 bus connections max. 3 x 500mA (for ~120 Qbus modules) • USB connection • Ethernet connection • 388 outputs • Boolean logic (and/or/if-then-else) and analog logic (+,-,x,/,<,>,<=,>=) • 99 clock times, each with max. 15 outputs or 1 scene • 91 scenes • Presence simulation • Astronomical Clock • 8 GB SD card with 10 memory banks available (for 10 system configurations) • Width: 6 modules (DIN) • Supplied with DIN rail power supply (4 modules)

2. Installation of the Qbus System Manager

2.1 Where can you find the Qbus System Manager?

The Qbus System Manager is the software you will use to configure the Qbus system. In the Qbus System Manager you can create outputs (on/off, timers, sequences, scenes, clock times, alarm systems, ...) and determine how those outputs will be controlled (which button on a switch/motion detector etc. activates each output) . All those settings are stored in a .qdb (Qbus DataBase) file.

The Qbus System Manager is available free of charge. You can download the latest version from our website <https://www.qbus.be/en/support/software/system-manager-iii> Click on “Download” to download the latest version of the System Manager. Once the System Manager has been downloaded and run, you will have a shortcut to the program on your desktop.

ATTENTION: the SYSTEM MANAGER III is ONLY used to program CTD controllers (CTD10, CTD40, CTDMax, CTD01Em, CTD01, CTD01E, CTD02E, CTD03E), AND IS NOT COMPATIBLE with CTL controllers (CTL16, CTL32, CTL64, CTL256). The configuration software for CTL controllers is the Serial Manager II, which can be downloaded at <https://www.qbus.be/en/support/software/serial-manager-ii>

2.2 System Manager Hardware Requirements

Before installing the software, make sure that your PC meets the following requirements.

- Supported Operating Systems: Windows 7, Windows 8, Windows 10, Windows 11
- Processor: 1Ghz Pentium or equivalent recommended
- RAM: minimum 1GB, preferably 4GB
- Hard disk: 100 MB free space
- Screen: 1024x768 (minimum) 1680x1050 or higher (recommended)
- Ports: USB or Ethernet port or WiFi available

2.3 Starting Qbus System Manager

After the first start-up of the Qbus System Manager application, the following screen appears where you can choose a language by clicking on a flag. Then click OK.



2.4 Configure Qbus System Manager

In the System Manager menu bar, click "Utilities" and then "Setup" to configure the communication between the System Manager and the Controller.

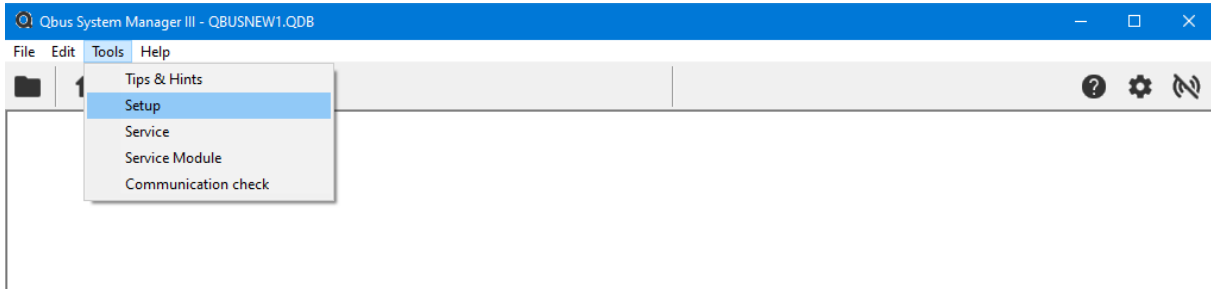

You will then see the following screen:

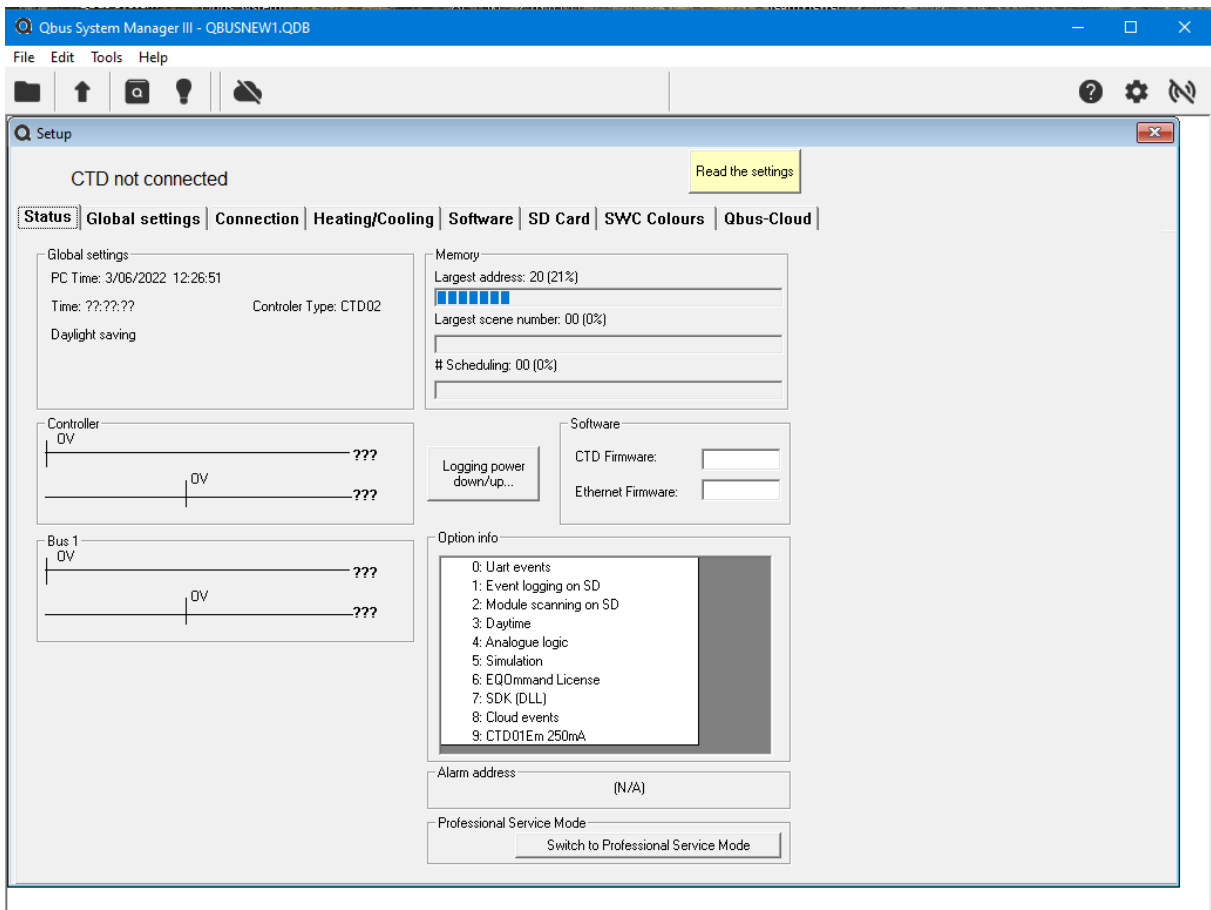

In this screen you will see several tabs – click on the “Connection” tab to be able to connect to the Controller. The following screen will then be displayed:

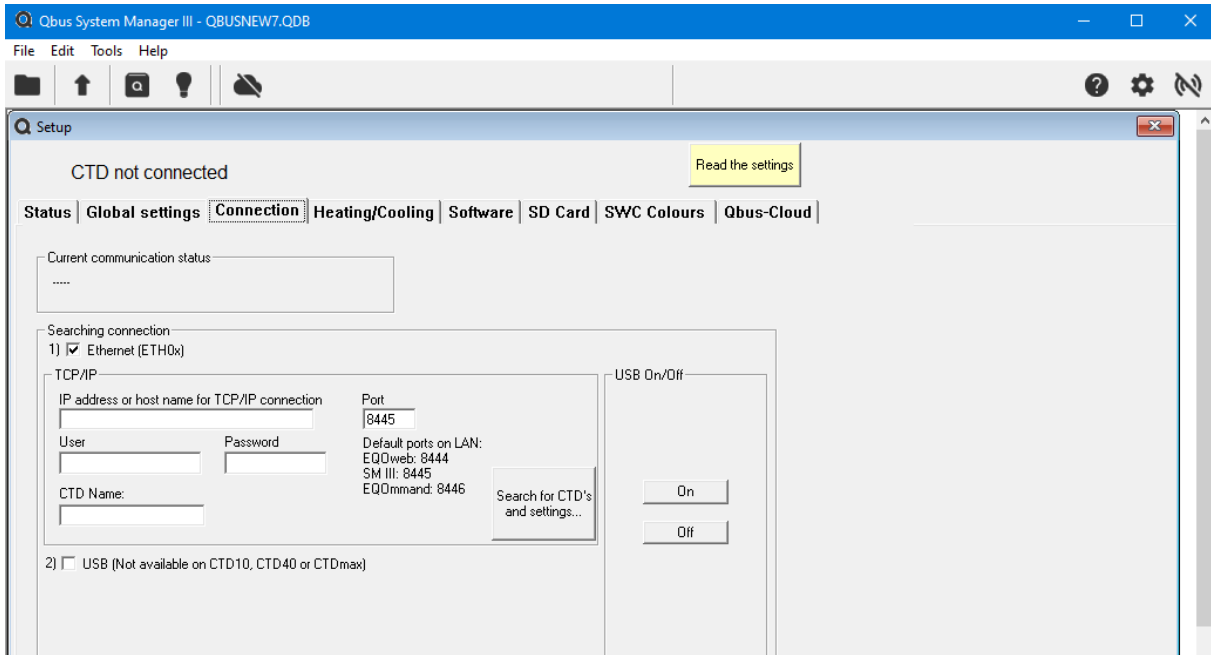

When the correct IP address has been entered, by clicking on the button “Read Settings” in this screen you can see the status of the Controller in the first tab such as the temperature of the CTD, the load on each bus, the voltage on the bus, ... If this is not visible, the correct communication method must first be chosen – see next point below.

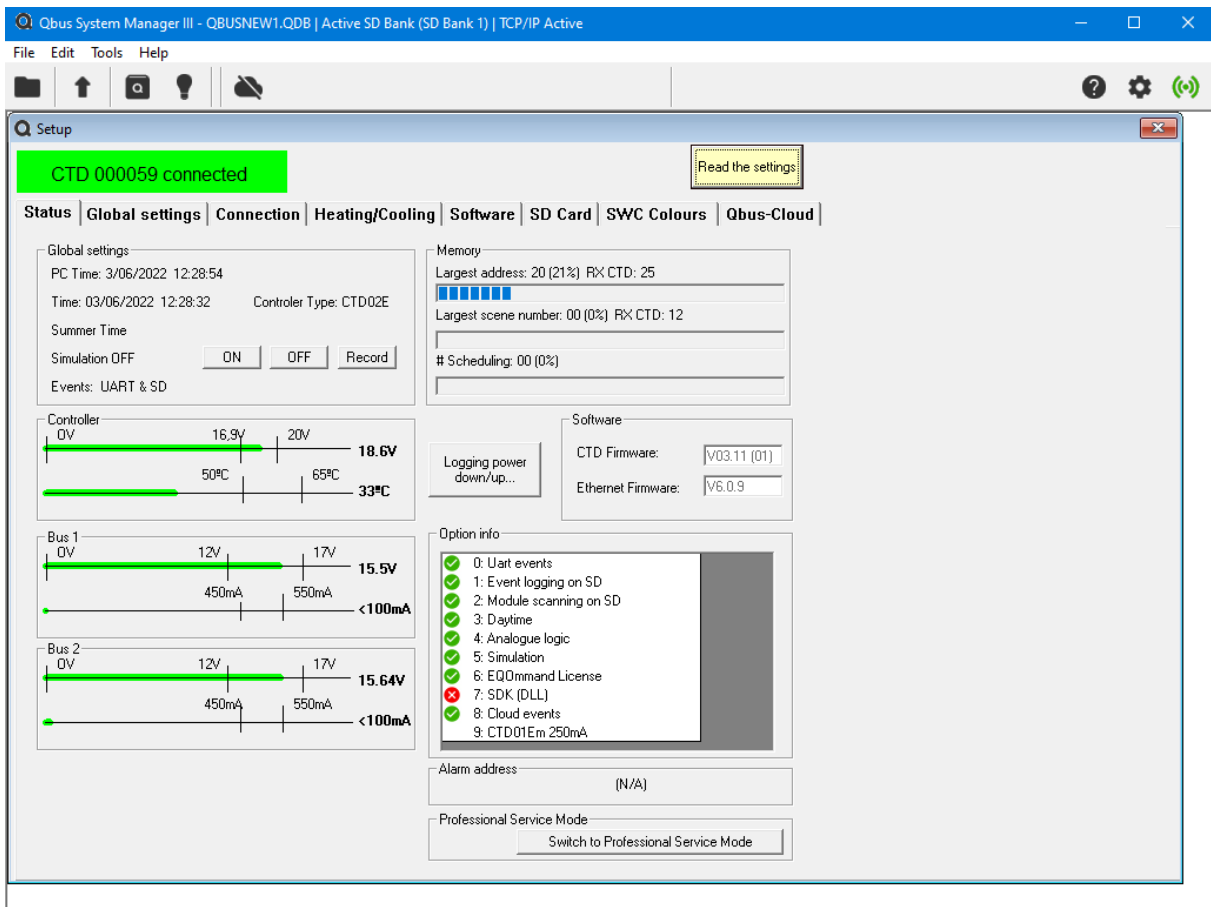

2.4.1 Communication with the Controller

Go to the “Connection” tab in the Setup screen.

There are two ways to communicate with the Controller (CTD):

1. over Ethernet: Only if the CTD has an Ethernet port – CTD10, CTD40, CTDMax, CTD01Em, CTD01E, CTD01E+, CTD02E, CTD03E.
2. via USB: possible with the following 'older' CTDs: CTD01Em, CTD01, CTD01E, CTD01E+, CTD02E, CTD03E

If you wish to communicate via USB, click on the USB option in the setup screen. Make sure that the selected communication ports are set (default from COM1: to COM8:)

There are 2 ways to connect to the CTD via an Ethernet cable:

1. If you are connecting to the CTD through a router, you must connect the controller to the router using a straight Ethernet cable (supplied with the CTD - usually yellow). **It is important that the Ethernet cable is plugged in before the CTD is powered up.** You will also need a straight cable to connect your computer to the router. If you have a wireless router, you can establish a wireless connection with your computer to this router.
2. If you connect the ethernet port of the CTD directly to your computer, a straight ethernet cable will suffice in most cases. However, if the computer is a bit older, a crossover network cable (not included) is required. **It is important that the Ethernet cable is plugged in and the computer is powered before the CTD is powered up.**

With a correct physical connection, the left LED on the Ethernet port will light up green and the right LED will flash green when there is data traffic.

To operate the device via Ethernet, an IP address must be assigned.

When a device is powered up, it will only search for an IP address if there is already a good physical connection. When the CTD is connected via a router, this router has integrated DHCP, which ensures that each connected device is given an IP address.

To assign the correct IP address to the CTD, uncheck the USB and check the Ethernet option in the setup screen, then click "Search for CTD's and settings...".

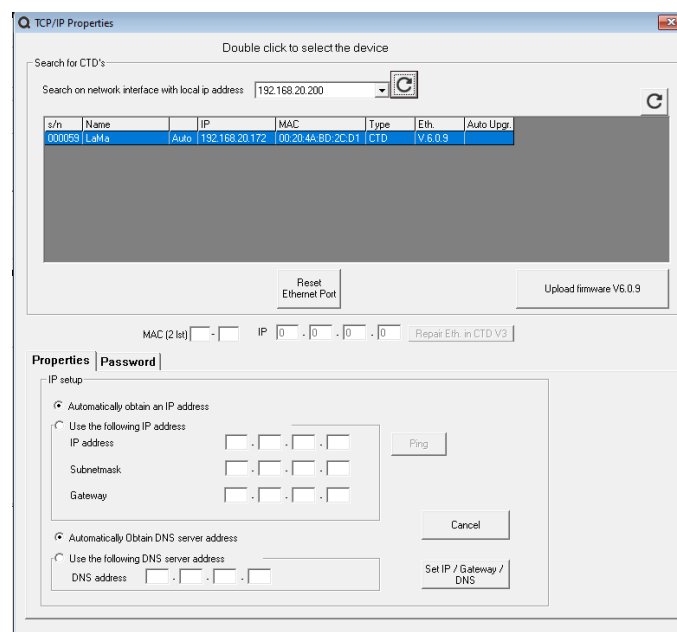

When you click on "Search for CTD's and settings...", the System Manager will search for CTD's in your network via UDP broadcast. If the table remains completely empty, select the network interface in which the controller is located. When the desired CTD has been found, double click on the desired line to establish communication. If successful, the settings screen disappears, the correct IP address is entered in the "IP address or host name" field of the setup screen and the connection is established. If you connect through a router, you will get an IP address that usually starts with 192.168. When you connect to the Controller directly from your computer (without a router with DHCP server), you will get an IP address that starts with 169.254

The (Not-)connected status is always visible at the top right. Clicking on this icon connects or disconnects the USB/Ethernet connection to the controller.

ATTENTION!!

- The local communication of the System Manager always takes place via port 8445, which is entered in the "setup" window, in the "Port" field next to the IP address.

Remark: Connect the network cable first, then power up the controller to request an IP address via DHCP. Of course, direct connection to a PC is possible, in which case a crossover cable is sometimes required (purchased separately at an IT specialist store).

Remark: you can give a fixed IP address to the Controller. In the TCP/IP Settings screen you can enter the desired IP address and then click on "Set IP / Gateway / DNS". This is usually more interesting because in the event of a power failure, the CTD and other IP address can be assigned. Be sure to use an IP address that is not yet in use. If necessary, use the "PING" button to test this.

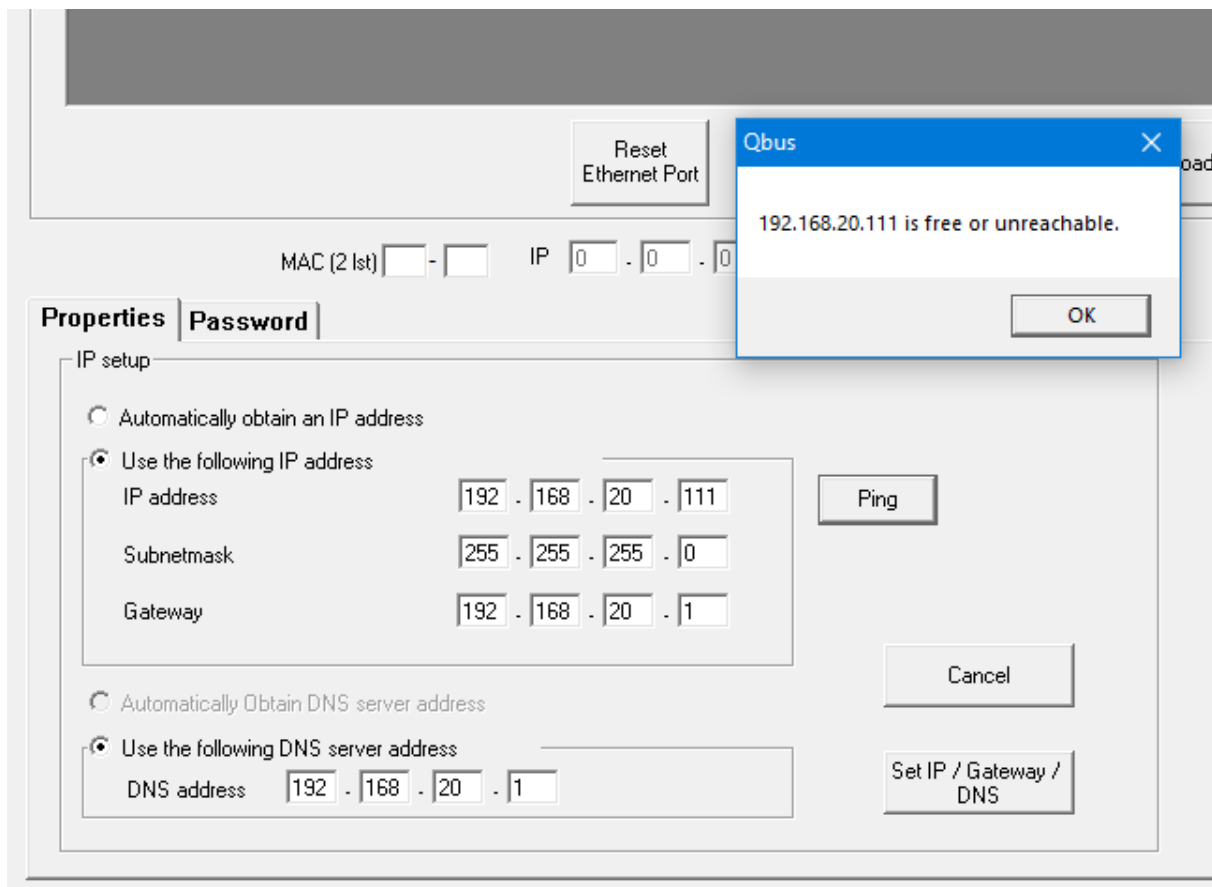

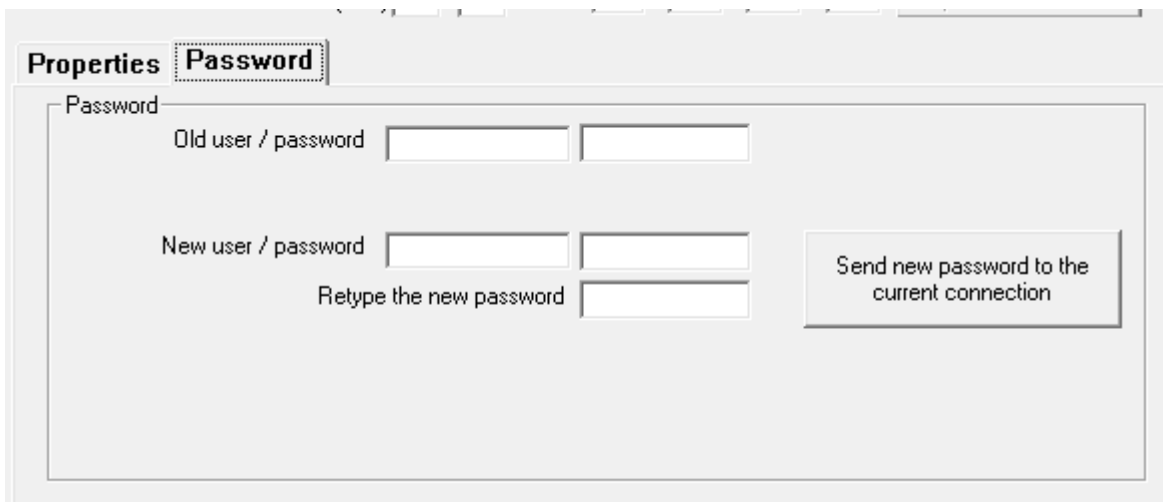
To set a password for the Ethernet connection:

The screenshot shows a dialog box titled "Properties Password". Inside the dialog, there is a section labeled "Password". Under this section, there are three rows of input fields. The first row is labeled "Old user / password" and contains two adjacent text input boxes. The second row is labeled "New user / password" and contains two adjacent text input boxes. The third row is labeled "Retype the new password" and contains one text input box. To the right of these input fields is a button labeled "Send new password to the current connection".

The devices are delivered without a password. When the devices are connected to the Internet and you want to make changes over the Internet, a password must be set for security. To set a password, enter the old password and the new password twice and send it to the interface. This is done via the screen shown above; when you have entered a password twice, click on the option "send new password to the current connection".

If it is your first time using the software, we recommend that you continue with chapter [3.4](#) and [3.3](#). Afterwards you can view the further detail of the setup screen.

2.4.2 Other Setup Options

2.4.2.1 Global Settings

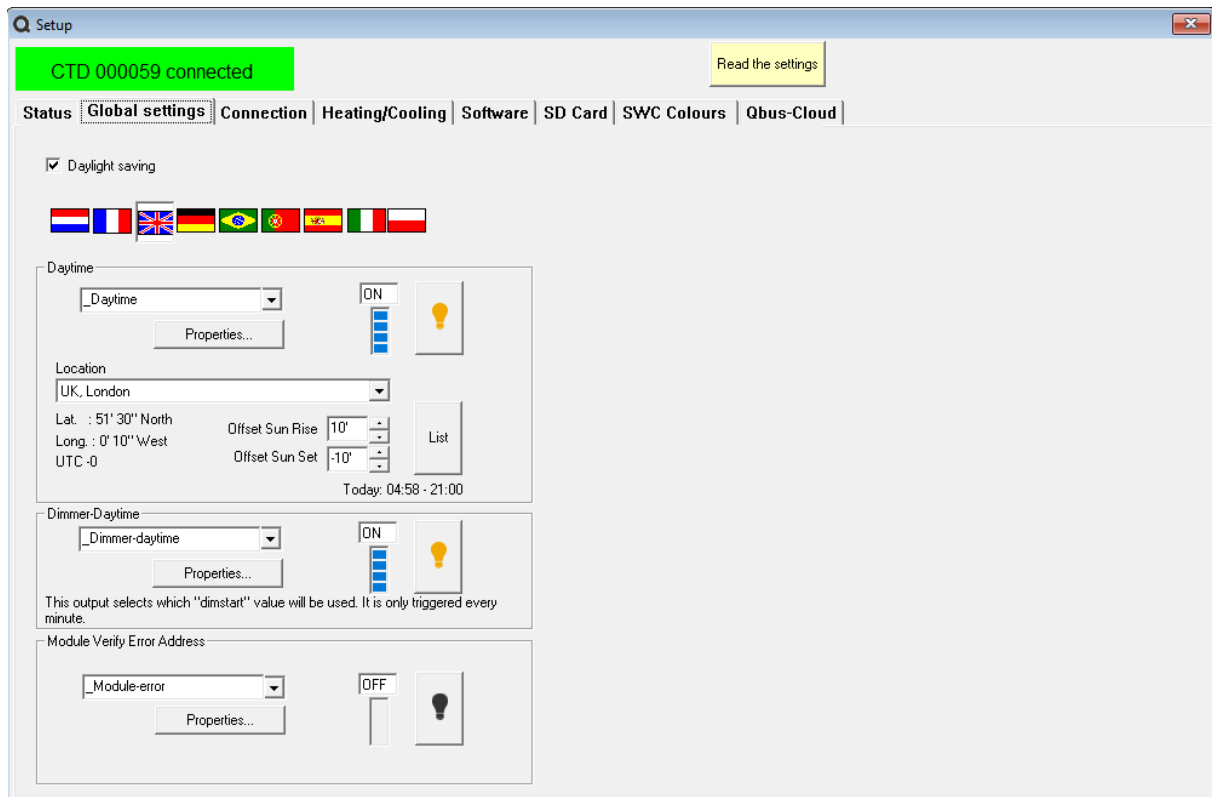

In the “General Settings” tab of the setup screen, you can specify whether you want your controller to automatically switch between summer and winter time, and initialize the System Manager III and controller in different languages (so you can read menus, instructions, etc. on e.g. a TSC5.8 or DIS02 in the corresponding language).

2.4.2.1.1. Daytime, Location

With this option you can select your place of residence. You will then get the list of sunrises and sunsets for each day of the year at the selected place (click on the "List" button to see the exact times). You can adjust these times in a range from -60 minutes to +60 minutes if, for example, you do not find your own place in the drop-down list.

You can assign an output to this time of day. If you create a fictitious output "_Daytime", this output will be active when it is actually daytime in your hometown. You can therefore use this output "_Daytime" for logic functions (e.g. if _Daytime = on then Garden_lighting = on).

ATTENTION!!

This function will only work from the next day or after the controller is rebooted, or when you reboot the controller. Via “Read settings” the current sunrise and sunset time are displayed (Today: ...).

2.4.2.1.2. Dimmer-Daytime

Here you can create or select a bistable output. This will ensure that each dimmer can have a separate start value according to the status of this dimmer daytime.

2.4.2.1.3. Module Verify Error Address

The "module verify error address" function in the setup screen is an output that will intervene if an error is detected in a module on the bus.

You can set your CTD to scan all Qbus modules that have a decimal 6-digit serial number at a certain time. You will then be warned if there is a problem with one of your modules.

You must first add analog logic to set the time of the scan. Go to the Logic button in the System Manager taskbar, click on the **+** next to the drop-down box, draw "logic" and then choose that you want to create an analogous logic.

Automatically you will get a few logical lines with outputs that you have created. When you mark the first output used (if XXXX), you can click the "Time" button to add a clock to the logic. When you click on the time, you can set a specific time on the right at which the logic should be executed.

Now you can select at what time the scan should take place - preferably at night, of course.

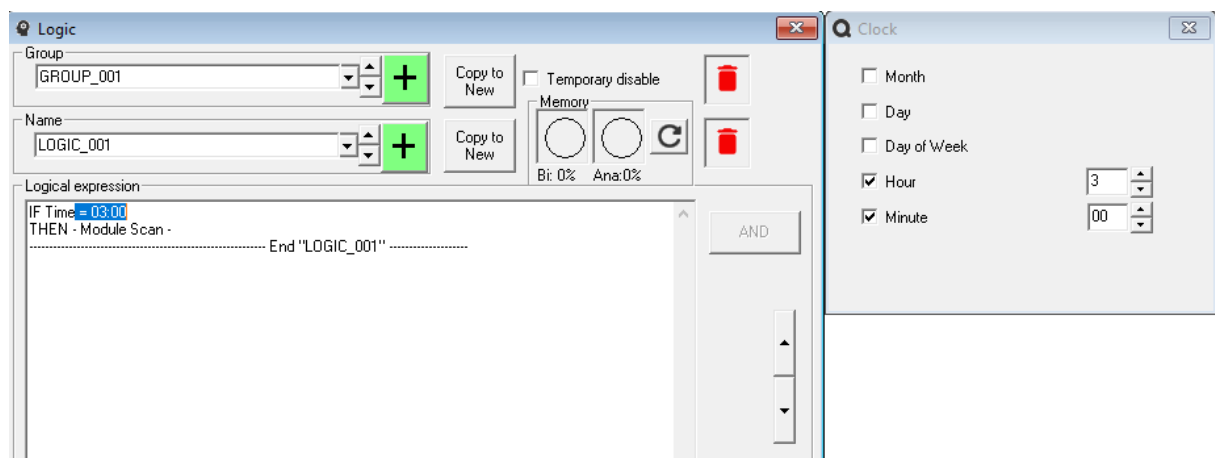

Then click on the output after the → in the "THEN" line and click on the menu "Other" in the list of outputs on the right-hand side. Here you can select the action "- Module Scan -" by double clicking on it. Clear the "ELSE" condition by clicking "ELSE" and clicking the "Delete Line" button. After transmitting the data, you programmed the controller to wake up every night at 3:00 AM to do a module scan.

You must also indicate which modules you wish to scan. In the module list, when you click on the CTD name or on a specific group of modules (relays, dimmers, ...), you can select in the grid on the right whether you want to scan it with the process described above. The default for each module is checked

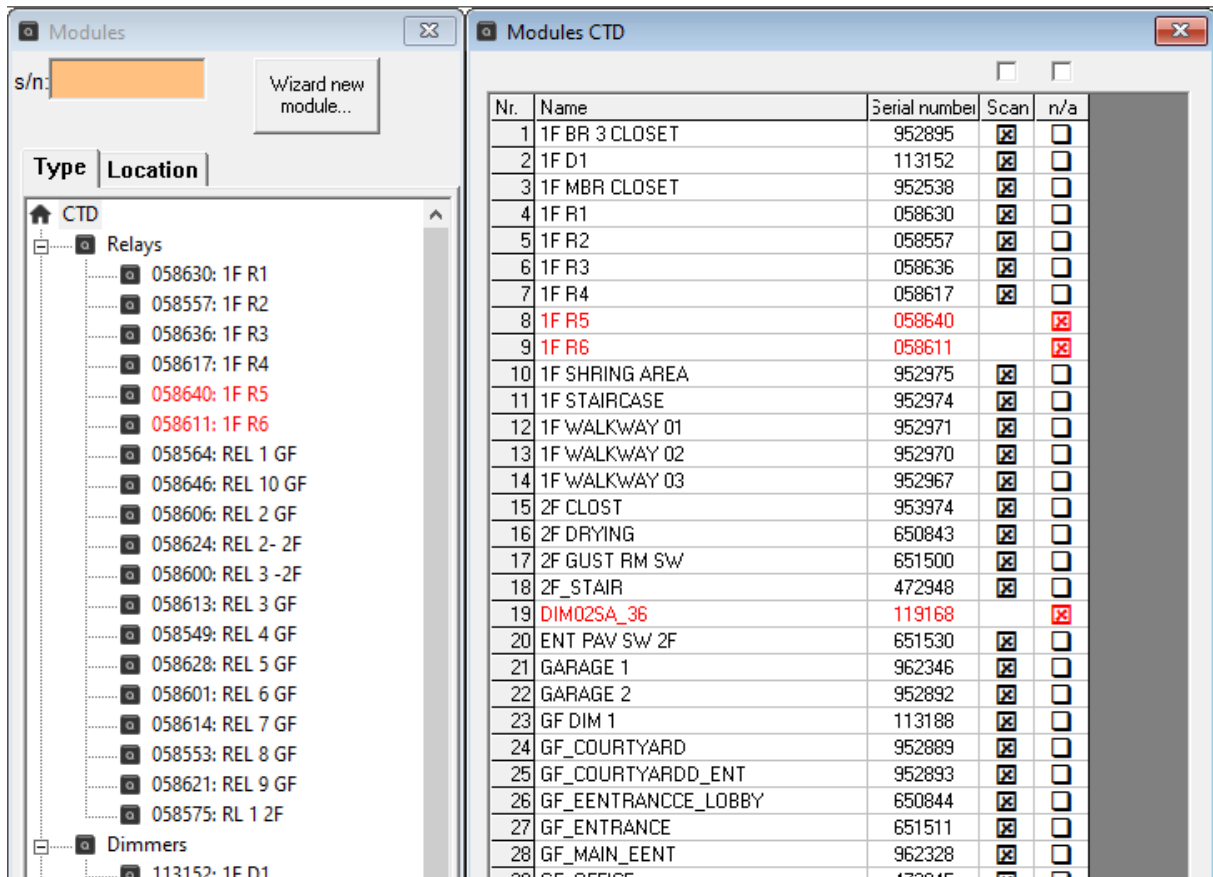

If you have selected a certain output in the module verify error address, that output will be activated when at least one problem is detected with one of the scanned modules.

If you want to know the status of your scanned module, click the download arrow in the System Manager , then click the down arrow at “Module scanning”.

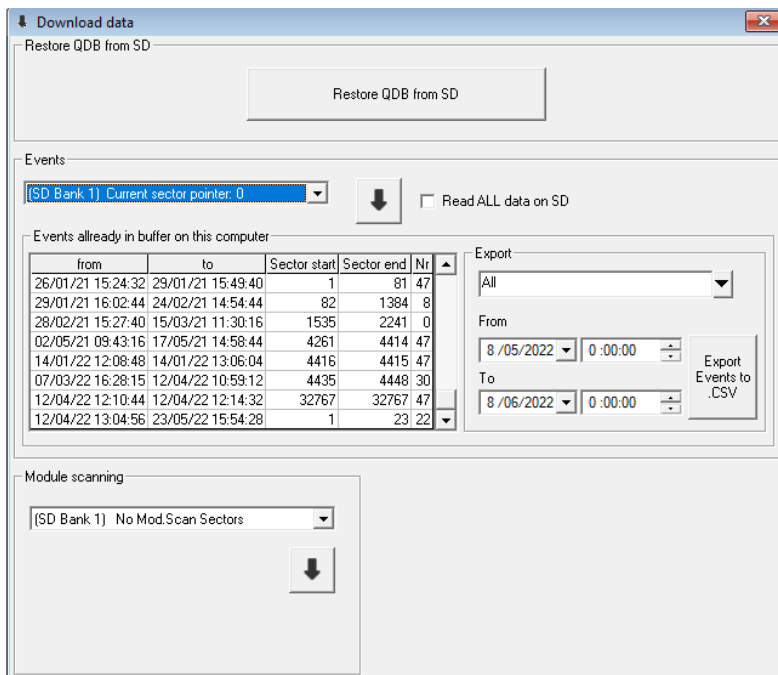

2.4.2.1.4 *Default parameters/mode*

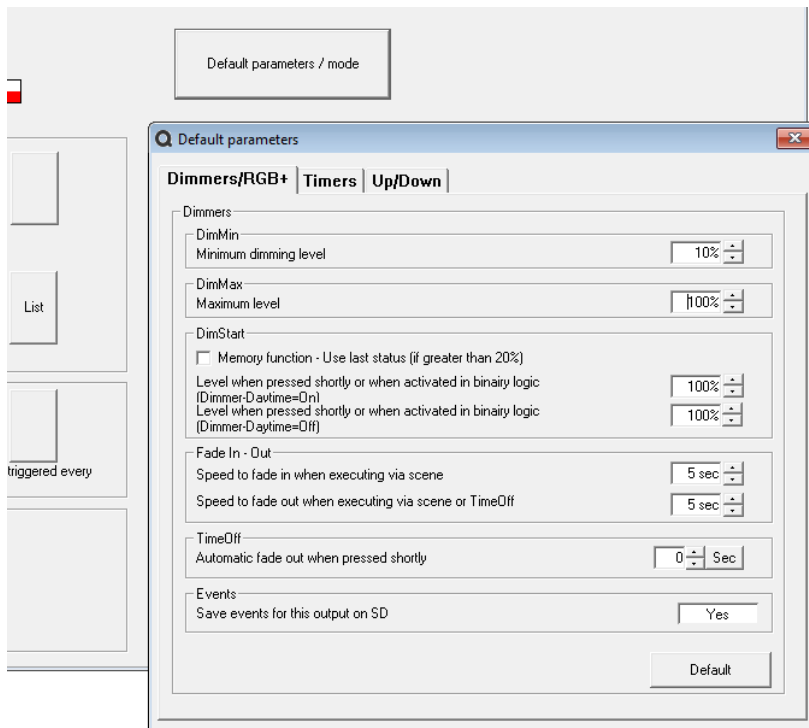

In this form it is possible to set the default values of various output types. Any new output created from now on will be created with these parameters. These settings will remain active on the computer and will therefore apply to any new configuration.

If you wish to adjust a parameter for all (or several selected) existing outputs, you can easily do this via 'grid editor'. More information about this can be found in section [3.12](#)

2.4.2.2 Heating/Cooling Settings

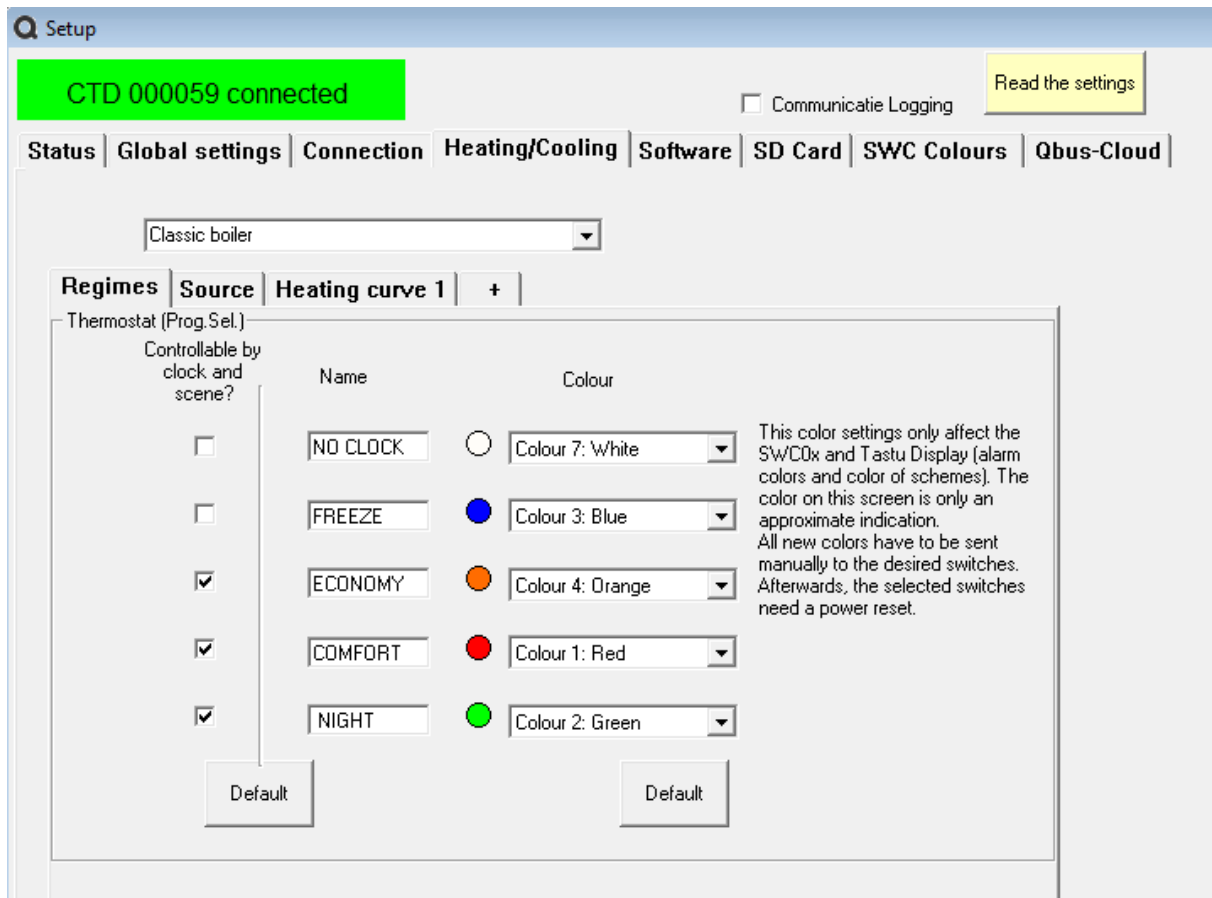

In the “Heating/Cooling” tab of the setup screen, you can change the main settings for your thermostat programs. You can set 5 thermostat programs in the Qbus system. The default settings are No Clock (Manual), Freeze, Economy, Comfort and Night. While programming a thermostat in a switch, a DIS02, a ViZiR or a TSC5.8, ... (see [3.5.6- Thermostats](#) for more information) you can set the temperature level for each program. However, in the setup screen you can define the names for each program.

If you uncheck the box “Controllable by clock time and scene”, the thermostat that is in this thermostat program will not be able to change by a call from scenes or clock times. eg. An anti-freeze program that you only activate when you are on vacation and that only switches on the heating when the room temperature falls below 5 °C. If your thermostat is set to the anti-freeze program, it will stay on that program even if you forgot to turn off a clock that always turns the heating on in your bathroom at 6:00 AM.

It is also possible to adjust the fixed color of a thermostat's regime. The changes will only take effect after the desired switches have been designated, the colors have been sent and the module is reset via the 'SWC Colours' tab.

The color settings are further explained in point [2.4.2.3](#)

In the Source tab you can already get an overview of your heating installation.

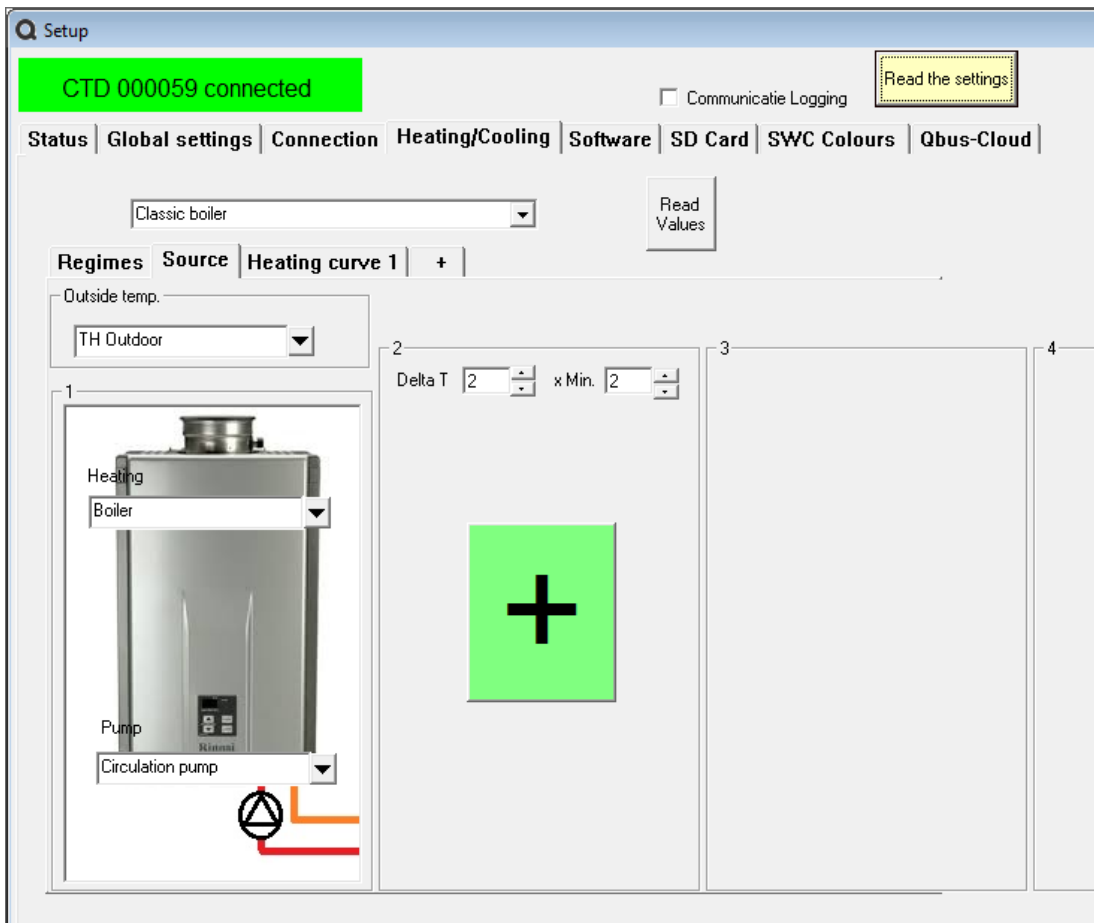

If you work with classic boilers, you can visualize with up to 4 boilers. The parameters 'Delta T' and 'x Min' are still purely informative. Later they will be used to automatically create the logic lines.

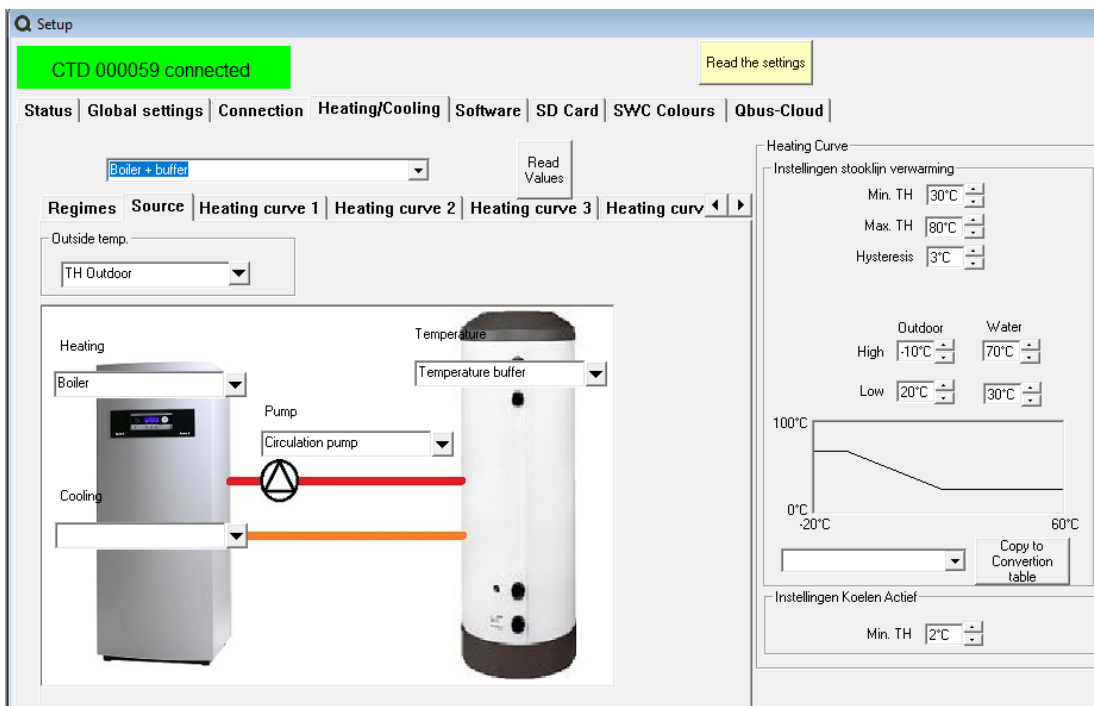

When a boiler with a buffer tank is chosen, the screen above will be displayed. The parameters of the heating curve will also be used later to automatically create analog logic.

A final visualization is that of a water-water heat pump. Here one can visualize all outputs related to such a configuration:

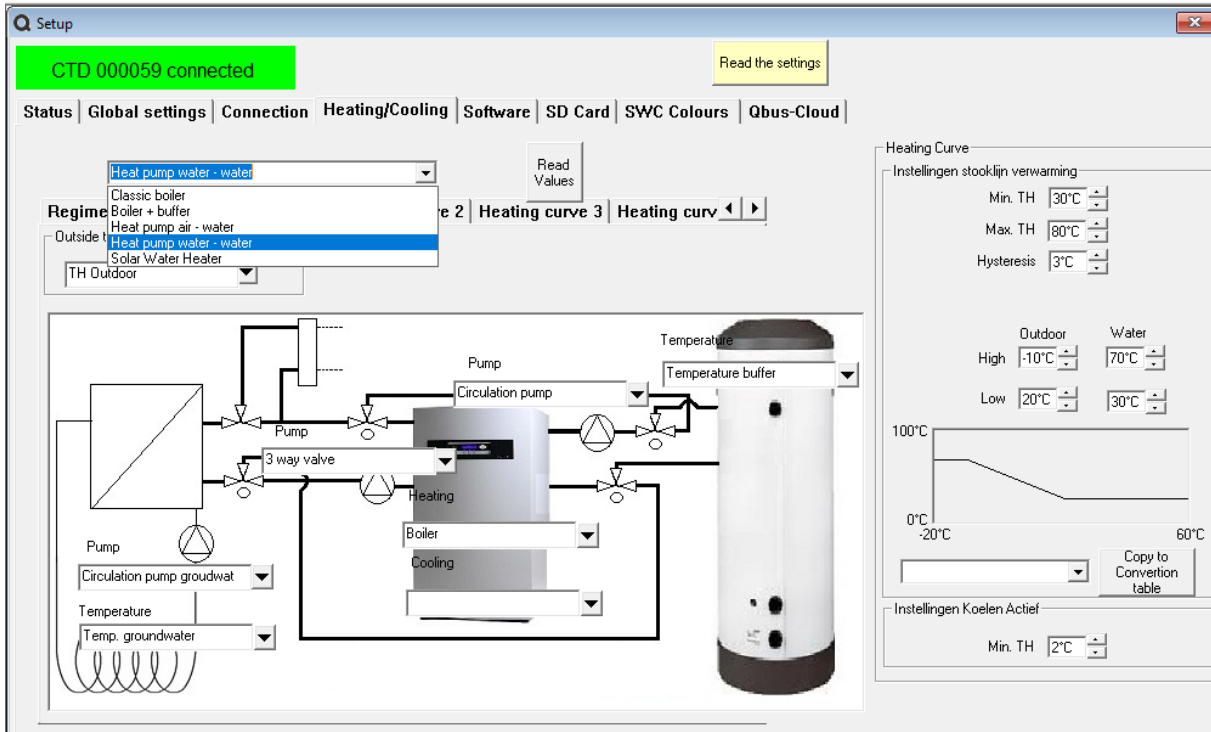

An unlimited number of heating curves can also be visualized as shown below.

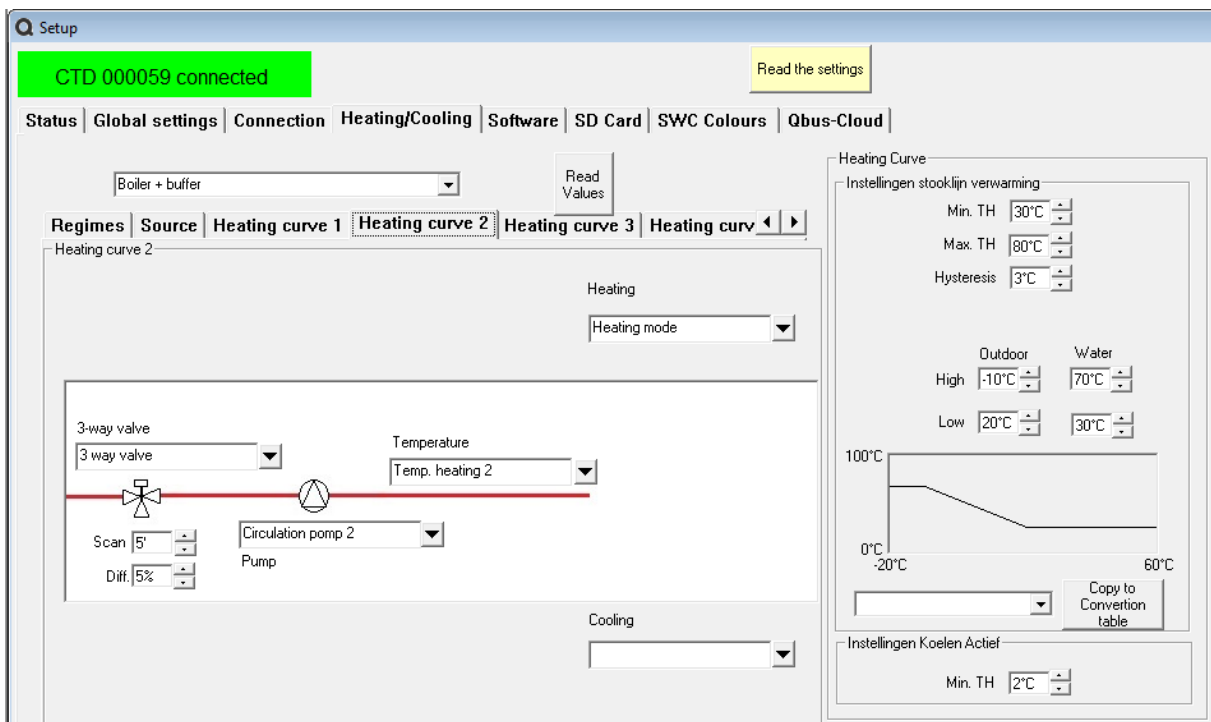

2.4.2.3 SWC colours

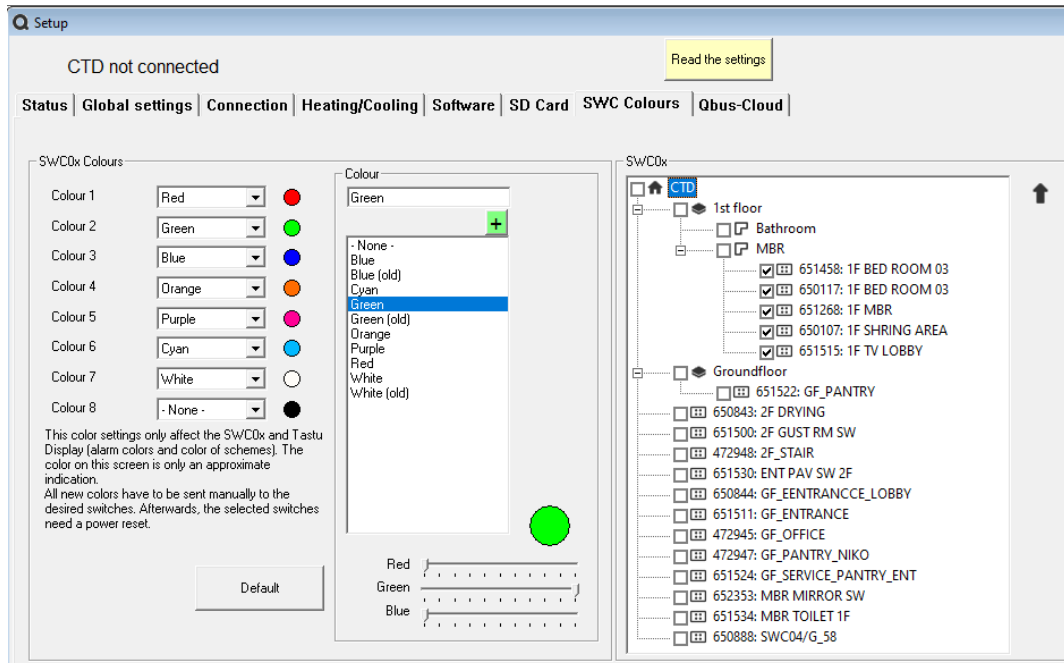

In this tab “SWC Colors” it is possible to set the 8 standard colours yourself. These 8 colours are the basic colours of the LEDs that are used on all intelligent switches in thermostat mode and as alarm code.

For older SWCs it is recommended to use 'White (old)'. For the new switches where the white is rather pink, 'White' must be selected. Only by marking the desired switches and clicking the send arrow on the right side, the switches will get the new color setting. The module must also be hard reset afterwards.

2.4.2.4 Software Upgrade

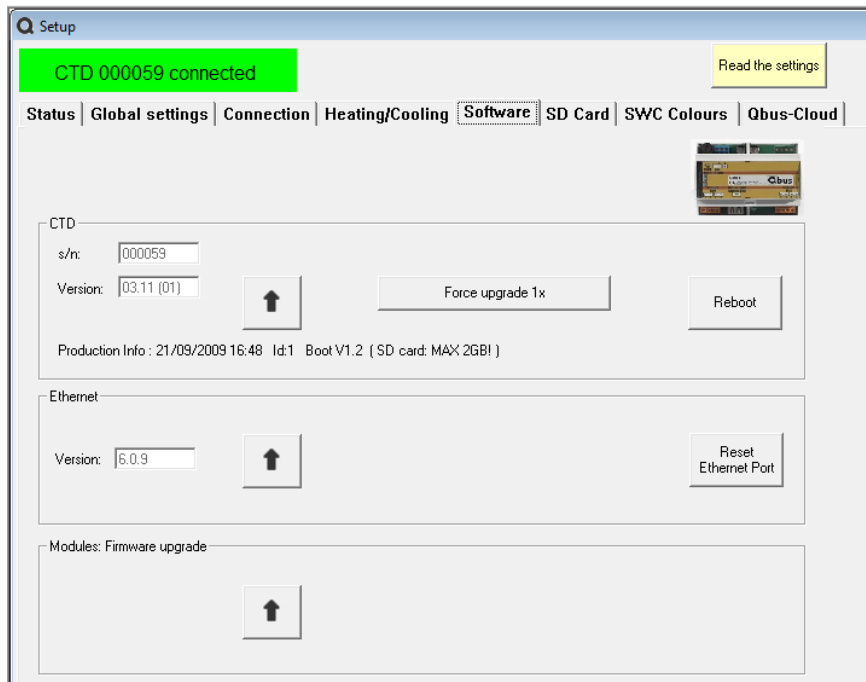

Via the first upload arrow it is possible to manually install a new Controller software. However, this will not (much) be necessary. If such new software is available, it will be added to the latest version of the System Manager. As soon as this new version is opened and you are connected to a Controller that does not yet have this latest version, an automatic message will be displayed and you can let this software upgrade.

It is now also possible to update the firmware of the modules that are connected to the bus (only new modules with a new Dual Core Chip have this function).

Via the bottom arrow a form will open, where the upgradeable modules are visible and you can optionally upload the firmware to the modules.

The most recent upgrade files are always installed with the installation of the SMIII, but every time the Module FW upgrade is performed, it will be checked online for newer versions. Any new versions are saved on the computer and can later be used offline.

Modules that have a firmware smaller than the available version will be marked for upgrade. This can be unchecked or even checked to force an upgrade. When clicking the up arrow, the upgrade procedure will start. This can take up to about 2 minutes per module.

When a module shows 'Boot' in the version, then the module only runs in bootstrap. The module will no longer perform any functions. It is still possible to upload the new firmware, so that the module will work perfectly again.

2.4.2.5. SD Bank Information

The SD card on the Qbus CTD has 10 memory banks. This means that you can save up to 10 configurations for your Qbus system on the SD card.

ALL data is stored separately for each bank. So the configuration, the list of modules, the events and the backup of the QDB file are saved separately per bank.

By clicking on the SD card tab, you can give these configurations different names – e.g. summer, winter, vacation, ...

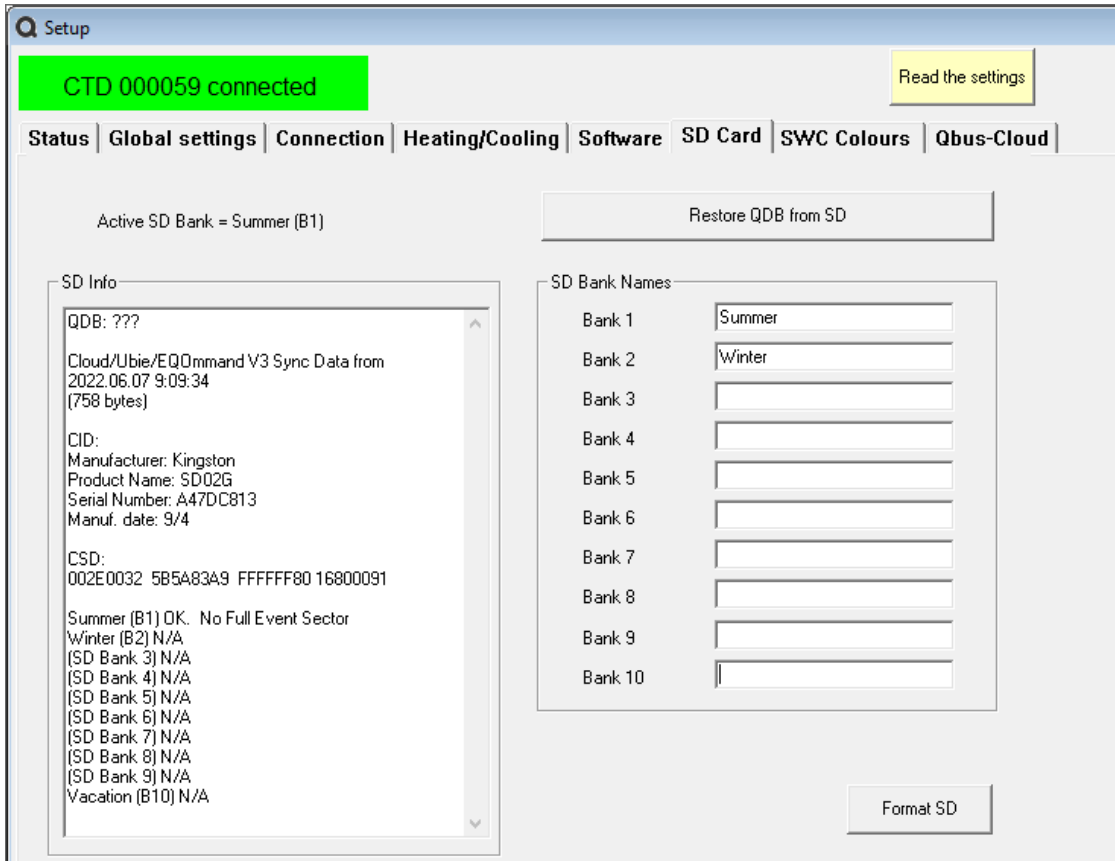

You can use analog logic (see [3.10.2](#)) to switch automatically between different SD banks, e.g. based on date and time (from summer to winter), or manually switch with a push button or by activating a scene. Note that you must have separate .qdb files with their own specific configurations to load into the various SD banks (for example, you create a "summer" configuration (e.g. summer.qdb) and a "winter" configuration (winter.qdb) and loads the summer configuration in SD Bank 1 and the winter configuration in SD Bank 2).

With the button 'Restore QDB from SD' the backup of the configuration file from the SD card can be transferred to the computer. After this action, you will be asked to unzip and open this QDB. After possibly saving the current data, the restored configuration will open immediately.

The button "Format SD" prepares a new SD card for use in the controller. This will erase all data. All recent controllers with Bootstrap V2.2 or higher support SD cards of 4GB or more. However, older controllers only support 1GB or 2GB SD cards.

2.4.2.6 Qbus Cloud

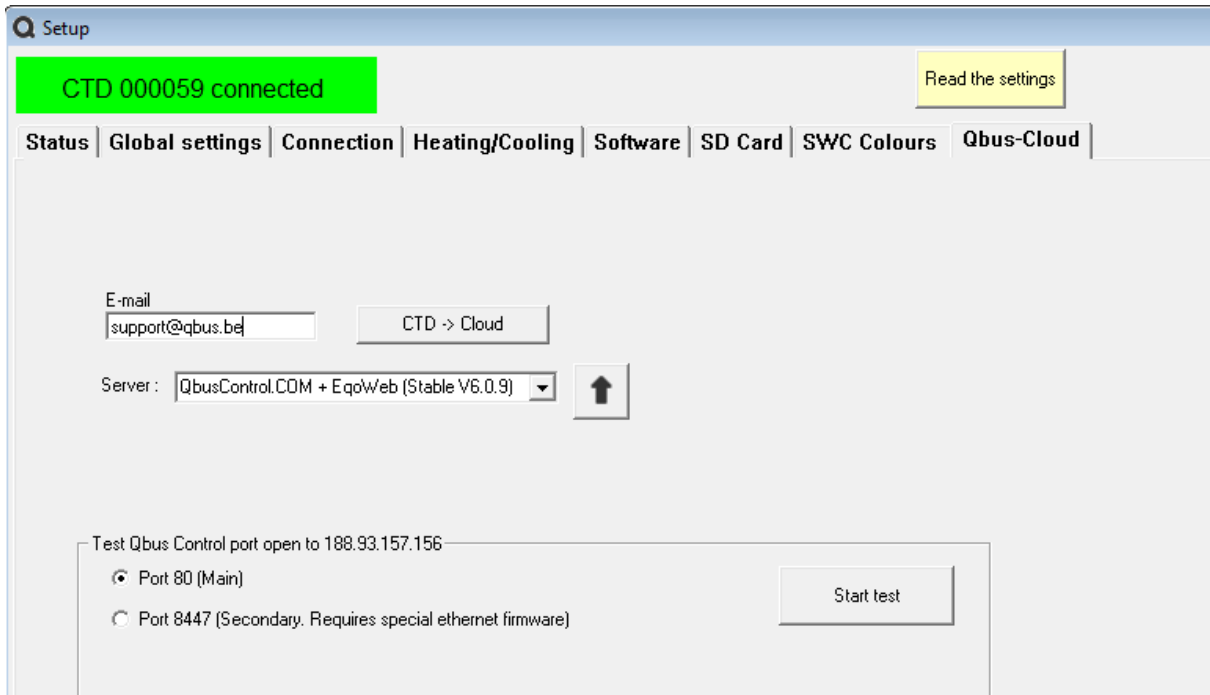

Via this tab you can activate the controller for Qbus Control, in order to control your installation from anywhere in an extremely easy way via any internet platform (Windows, Android, iOS) and to receive messages about your installation. If you also purchased a Ubie, this activation is not necessary. The Ubie will find all controllers in the local network. You can then activate a found controller via QbusControl.com. For further details see [chapter 5](#) of this manual.

2.4.2.7 Expansions for CTD10, CTD40

Unlike previous series of CTD controllers, the bus load limitation with these controller types is not measured by the power consumption on the bus but by the exact number of connected modules. The CTD is supplied as standard in 3 versions:

CTD10: maximum 10 modules

CTD40: maximum 40 modules

CTDmax: No limitation on number of modules. There is a maximum current consumption of 1000mA per bus

In terms of software, a CTD can be expanded per 15 modules. A CTD extended to 70 modules is equivalent to a CTDmax

When you have a network connection to the CTD, this can be done in two ways:

2.4.2.7.1 **Online by entering the code of a purchased expansion card (EXP15):**

You already have an account on Installer Dashboard or UbieCloud:

From the setup screen in the System Manager III, click on the “Expansions” tab
Enter the case-sensitive code of the expansion card (3 times 4 characters)

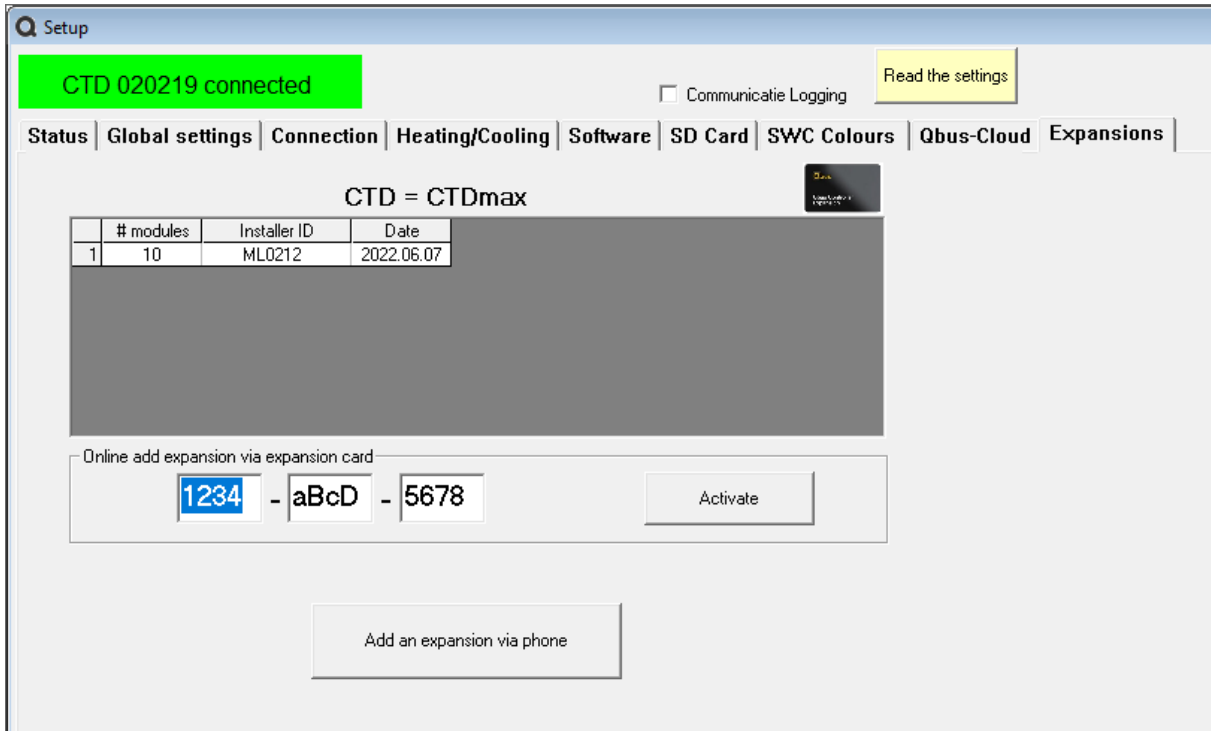

And click on “Activate”.

If you are not yet connected to the Installer Dashboard, you will first be asked for the username and password:

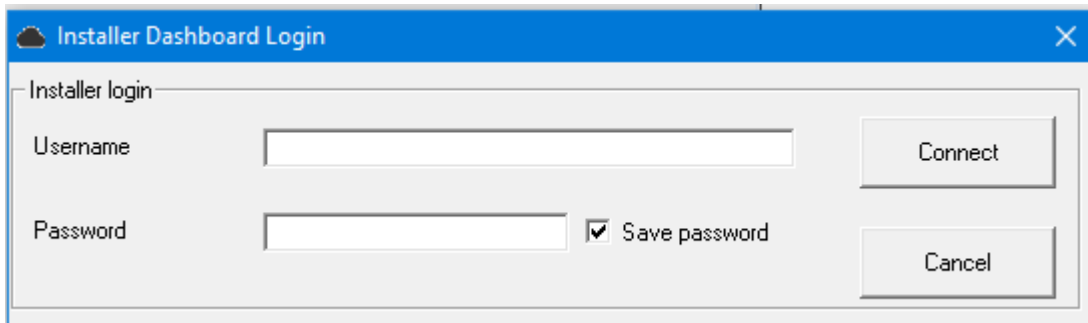

If you already have an Installer Dashboard account, the CTD will be expanded immediately.

If you do not yet have an account on the Installer Dashboard, but do have an account on Qbuscontrol.com, this approval will be requested:

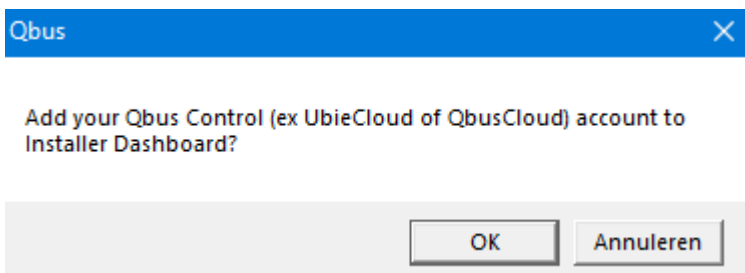

After entering your company name and VAT number, the Installer Dashboard is also activated and the CTD will also be expanded immediately.

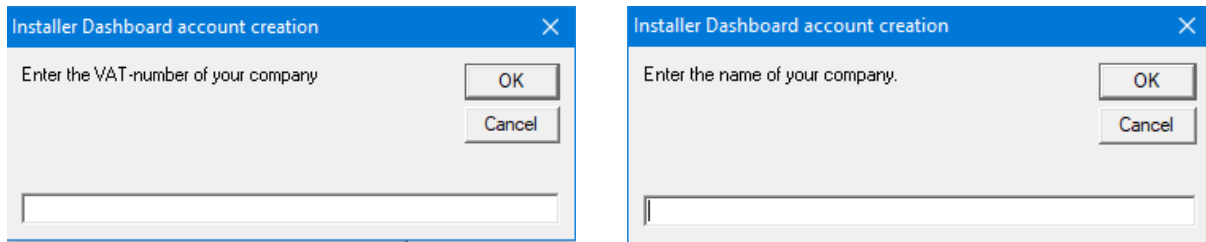

If you do not yet have an account on the Installer Dashboard nor on UbieCloud

Then you can create an account via <https://installerdashboard.qbus.be>
 Afterwards follow the steps as mentioned above.

2.4.2.7.2 Offline: via telephone contact with a QBUS service employee

From the setup screen in the System Manager III, click on the “Expansions” tab
 Click on the button “Add an expansion by phone” and the following screen will appear:

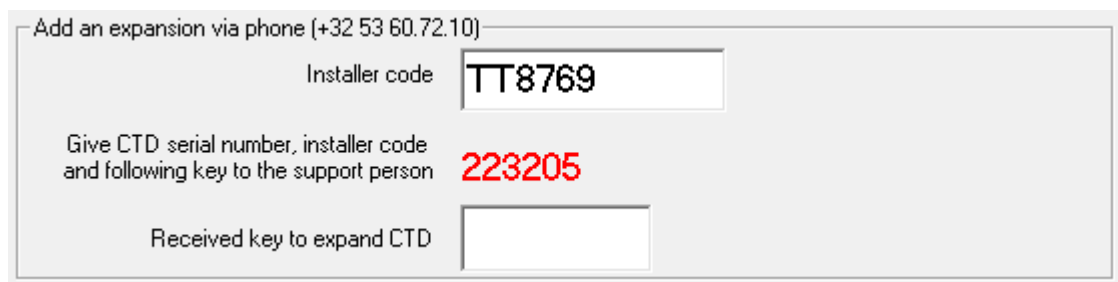

If you pass on your installer code from the Installer Dashboard together with the CTD serial number and the red key by telephone, the Qbus employee will provide you with a new 6-digit key. You will then receive an invoice for the requested number of licenses (15,30,45 or 60)



After entering the received key and clicking on “Activate”, the CTD will be expanded with the number of requested modules.

3. Taskbar Qbus System Manager

The task bar of the Qbus System Manager looks like this:



3.1 Open and Save

The first two keys on the left   serve to open and save configuration files (.qdb).

3.2 Extract data from the controller

The  key is used to read the configuration file backup, event logging or module scanning from the controller's SD card.

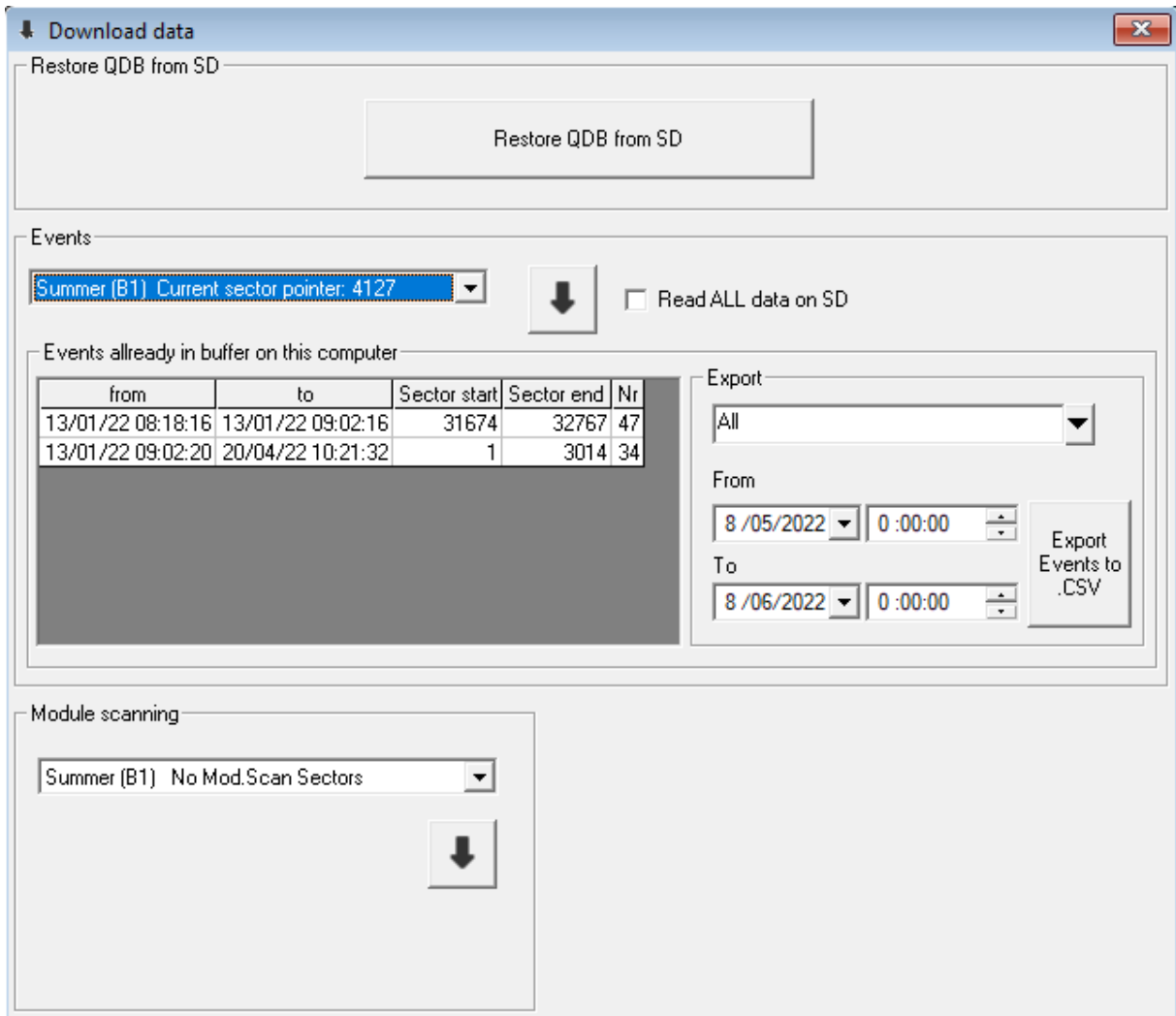

3.2.1 Restore QDB from SD

The QDB file contains all data that can be configured by the System Manager III. This data is NOT necessarily used by the controller. For the operation of the system, the controller uses the data sent with the upload arrow! When closing or saving the QDB, you are asked to save this file (as a backup) on the SD card in the CTD.

With the button 'Restore QDB from SD' the backup of the configuration file from the SD card can be transferred to the computer. After this action, you will be asked to unzip and open this QDB. After saving the current data, the restored configuration will open immediately.

3.2.2 Events

In this frame you can already see which periods have already been read from this CTD on this computer.

When you click on the Events arrow and confirm with OK, the data from the last saved sector of the SD card will be read back in time and saved in the “TEMP” folder. And this up to and including the time of the previous download. If you also want to read all previous data, you can check the box “Read ALL data on SD”.

You can follow the timestamp that is read in the frame “Connection” at the bottom right of the screen. When you have read the desired period, you can “Cancel” the download.

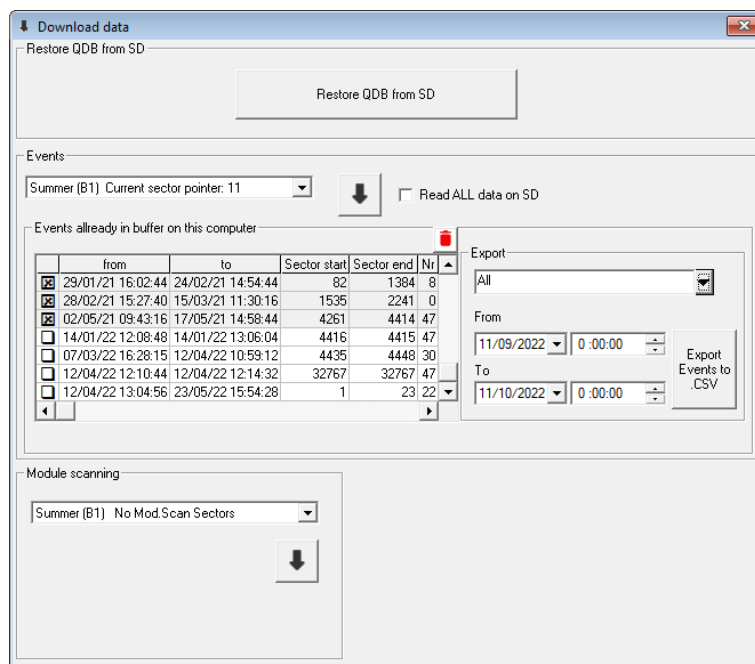

You can then “Export” the desired events from all outputs or from 1 output of the selected period to a CSV file.

Without output selection each event always contains the data of the entire address (4 sub-addresses). The status of each individual sub-address (1 to 4) can be found in the column “Status1” to “Status4” You can open this data file in a spreadsheet (e.g. MS Excel) for further processing or filtering.

Each SD sector contains 48 events. The CTD with firmware V3.10.1 or higher has a ring buffer of 32767 sectors. The old data will therefore be overwritten over time without warning.

If the firmware is still V3.10.0 or lower, the CTD will stop saving events when the last sector is reached. The “Clear ALL Events” button will then clear all events on the SD card, after confirmation. Previous saved data will be kept in the temporary folder on the computer!

More explanation about the content of the 4 statuses can be found in the following table:

Fashion	State 1	State 2	State 3	Status43	Remark
BI (Bistable, Toggle)	0 = OFF; 255 = ON	0 = OFF; 255 = ON	0 = OFF; 255 = ON	0 = OFF; 255 = ON	1 output per status
T1 - T5 (Timer 1 - 5)	Time of the Timer; 255 = ON	Time of the Timer; 255 = ON	Time of the Timer; 255 = ON	Time of the Timer; 255 = ON	1 output per status
D1 - D2 (Dimmer)	State 0-255	-	State 0-255	-	Divide by 2.55 to convert into %
L1 - L2	CLC1 Set point	CLC1 Current value	CLC2 Setpoint	CLC2 current value	Divide by 2.55 to convert into %
RO (Roller shutter with position)	Position 0-255	Slat position 0-255	Position 0-255	Slat position 0-255	Divide by 2.55 to convert into %
U1-U2 (Updown/Roller Shutter)	0 = Stop; 1 = Up; 2 = Down	-	0 = Stop; 1 = Up; 2 = Down	-	
TH (Thermostat)	1 = Heating ON 2 = Cooling ON 3 = Turbo ON 4 = Alarm ON Or combination	Set point in °C (without offset)	Current value in °C (without offset)	Regime: 0 = Manual 1 = Frost 2 = Economy 3 = Comfort 4 = Night	4 statuses for 1 thermostat
TH PID (Thermostat with PID control)	0 – 255 = analog value of heating or cooling	Set point in °C (without offset)	Current value in °C (without offset)	Regime: 0 = Manual 1 = Frost 2 = Economy 3 = Comfort 4 = Night	4 statuses for 1 thermostat
HV (HVAC)	0-4000 = CO2 value	0 – 100 = % Humidity	0 – 255: refresh value	Regime: 0 = Manual 1 = Night 2 = Boost 3 = OFF 4 = Auto	4 statuses for 1 HVAC address
EC (Energy Counter)	0 – 255 = Number of pulses measured during the last minute input 1	0 – 255 = Number of pulses measured during the last minute input 2	0 – 255 = Number of pulses measured during the last minute input 3	0 – 255 = Number of pulses measured during the last minute input 4	
UN (Universal)	0 – 7 = Sub-address of output	XH byte of the 24-bit value	H-byte of the 24-bit value	L-byte of the 24-bit value	

3.2.3 Module scanning

When you click on the 'Download Module scanning' arrow, you will see all saved logs.

The module scanning, which you can activate via analog logic, not only checks whether the module is still responding, but it also checks whether all configuration data of the module is still correct.

3.3 Send data to the controller



Whenever you change something in the .qdb file in the System Manager, the arrow for sending data to the controller will turn red. This means that you need to send the changes to the controller. If you forget this, when you close the System Manager you will receive a message that you have not sent all the changes to the controller. You can then submit the changes or ignore the changes made.

Remark: After adding modules or programming changes, ALWAYS send the information to the controller so that any changes or additions are actually implemented.

Once the components and outputs have been entered, you must also send all data to the controller, otherwise no test can be performed for the outputs.

Always make sure that you are connected to the CTD via the Ethernet or USB port when sending data to the controller.

When you click the upload arrow, the following screen appears.

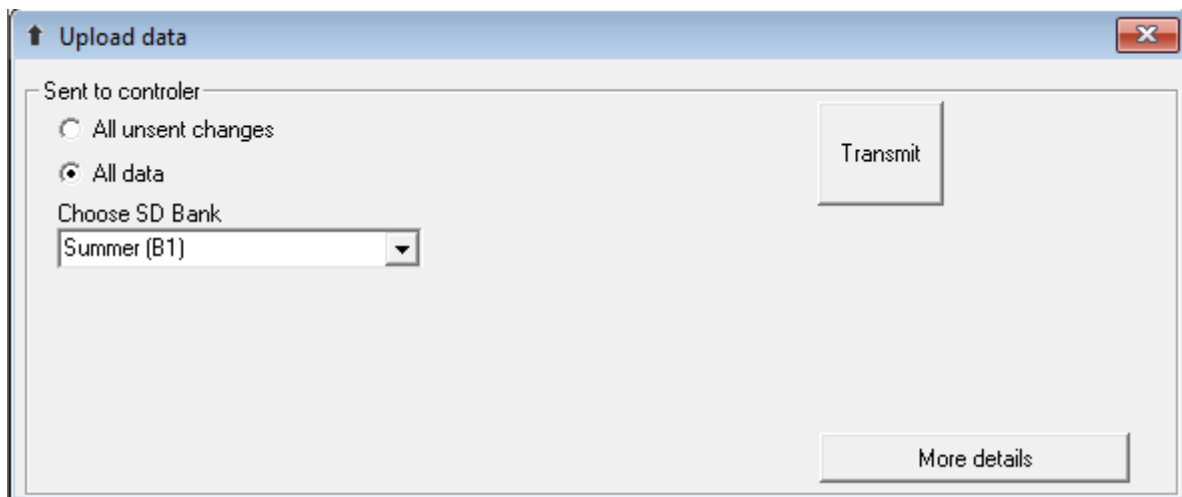

Select "All data" whenever you want to send a completely new .qdb file to the controller (e.g. when you first configure your system or when you want to send a new .qdb file to a new SD bank). After that first time, it is possible to only send "All unsent changes" after you have changed settings in your program.

With a CTD10 or CTD40 it is not possible to send data if you want to configure more modules than allowed. Following message will appear:

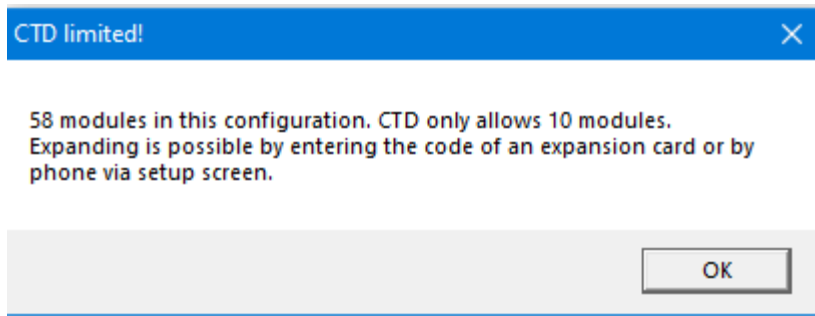

Expanding the CTD10 and CTD40 were explained in point [2.4.2.7](#)

Sending and verifying data takes place in various phases: When you click on “More detail” you can follow these steps nicely.

A first step is synchronizing the clock of the CTD with the time of the PC.

As mentioned above, you can send up to 10 configurations to different SD banks (e.g. a winter program, a summer program, a holiday program, an "early shift" program, a "late shift" program, etc.). see point [2.4.2.5](#) above for naming the various SD banks. Before pressing the "Send" button, make sure you choose the correct SD bank from the drop-down list in the window above.

After clicking the "Send" button, the data will be sent to the controller, together with the module data it will be saved to the selected SD bank and then all modules will be programmed.

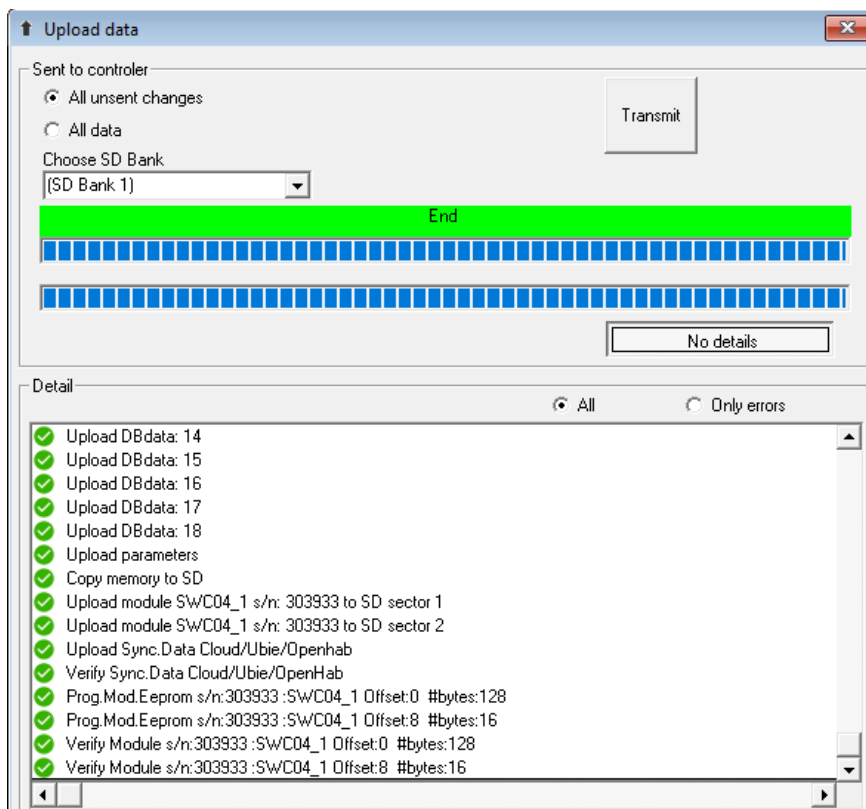

If you receive error messages, this may mean that a module was not found: possibly because the concerned module is not correctly connected to the bus or the serial number has been entered incorrectly. Try using Utilities/Communication Test to see if that module is communicating perfectly. If it still gives an error, check the connection between the module and the bus.

3.4 Programming modules



This option opens the main programming window. When you select "modules", the following screen appears.

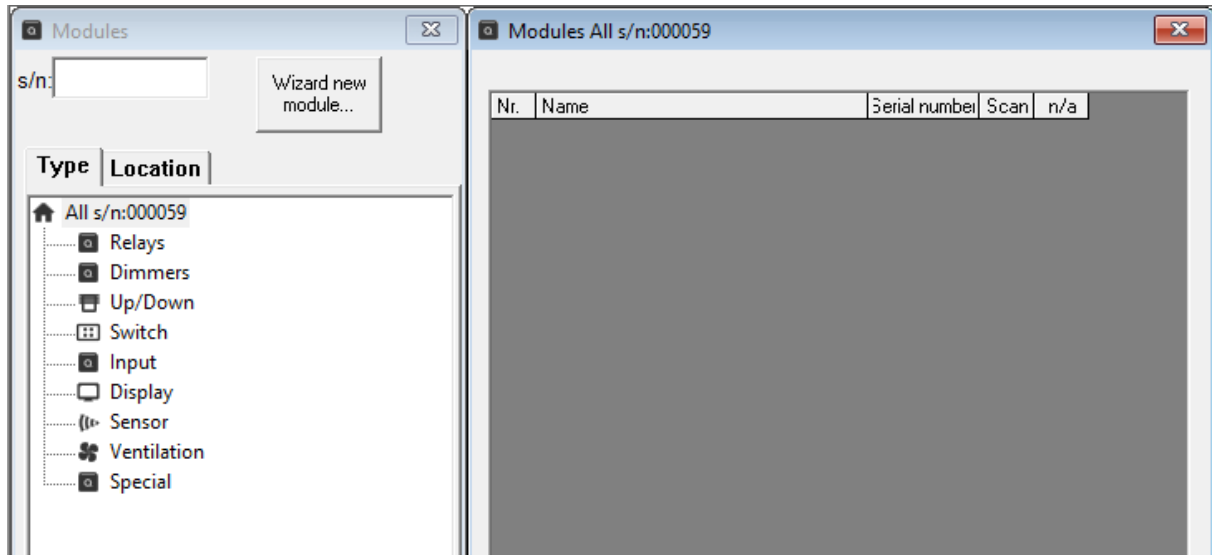

In the top left corner, type the serial number for the module you wish to program. Each module has a unique serial number consisting of either 6 digits or 10 hexadecimal characters. The "New Module Wizard" is described later.

Once you have entered the serial number, the corresponding module will appear, as shown in the following screen. The next screen contains more than one module.

It is also important that you type in ALL modules connected to the bus, even if they are not immediately used. A module can already contain a configuration. This 'old' configuration may conflict with the existing settings!

Possible modules are relay04, relay08, dimmer, thermostats, switches, etc.

If you want to delete a module, select it and click on the red "-" button (top right corner).

You can also enter the intelligent switches in a second way, without having to enter the serial numbers of the switches one by one. The "Search for modules" button in the lower left corner allows you to search for modules which, after clicking the switches one by one, are recognized and used in the program.

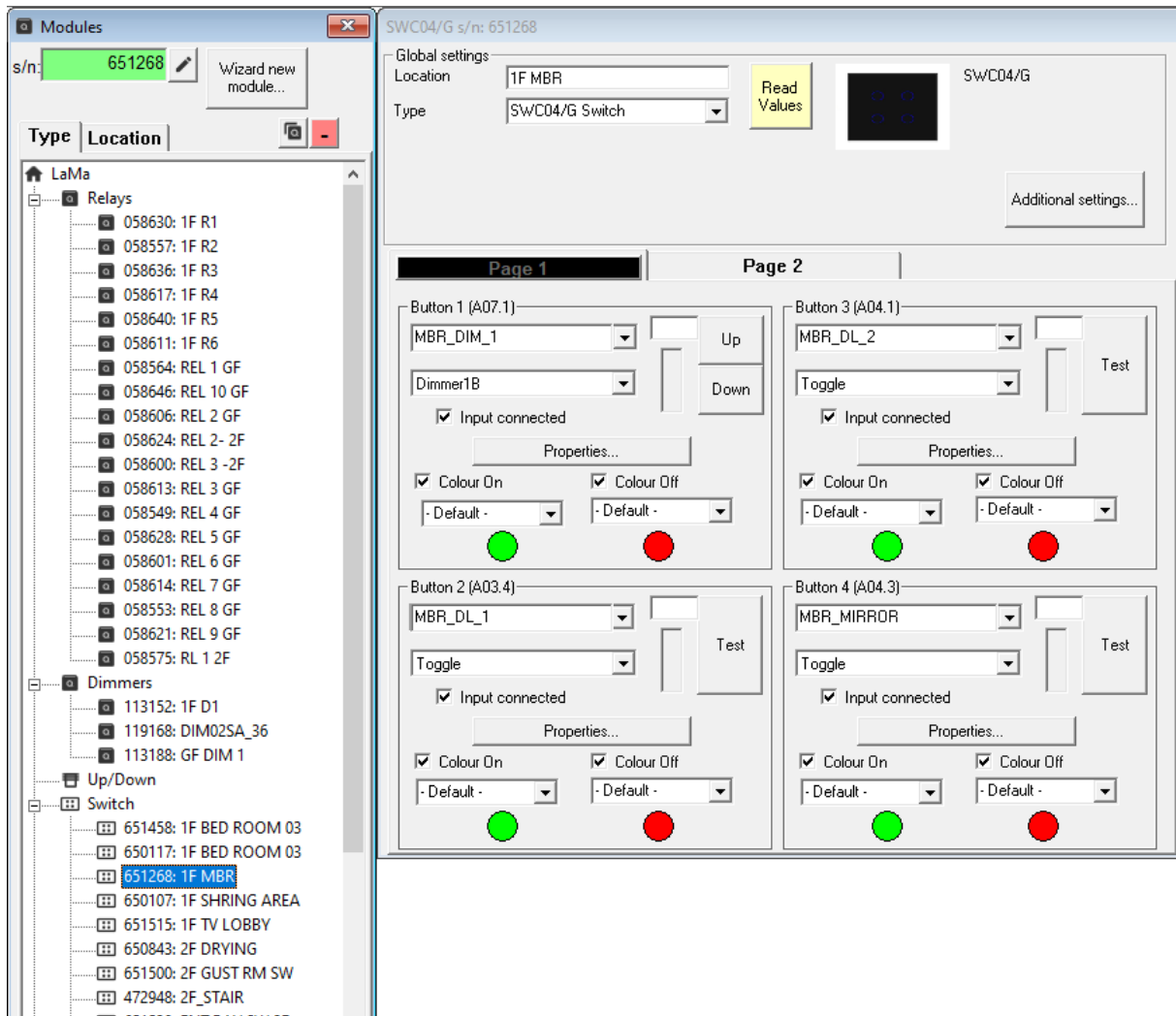

The “Wizard new module...” allows you to add a module without having to enter the serial number. The first free serial number is then chosen and the module is then set to n/a. This is shown in red in the treewiew.

And as long as a module has not yet been sent correctly, the background of the serial number field will remain highlighted in orange.

The following wizard appears:

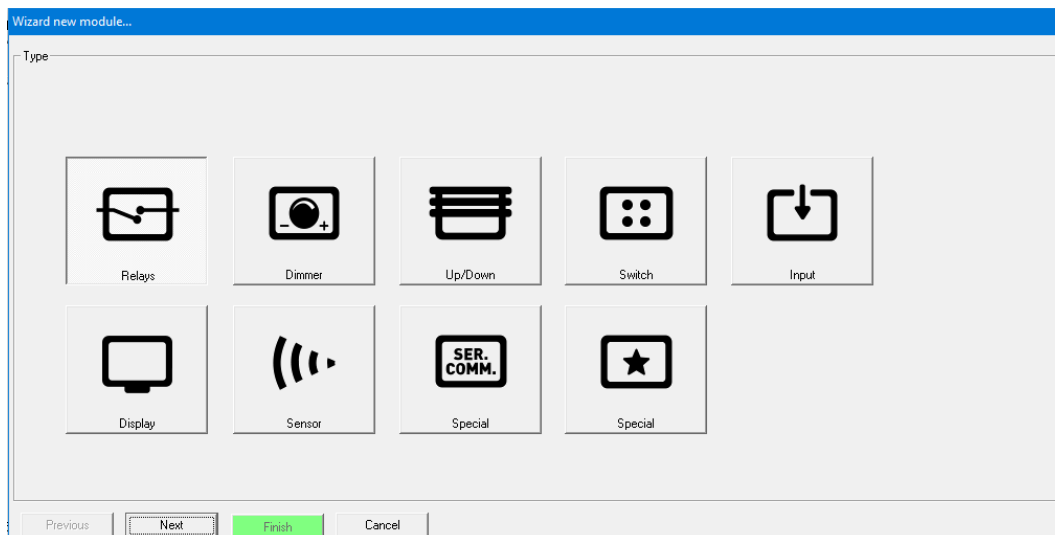

In a first screen you choose the type of module as shown in the figure above. When double clicking on the desired type, the next selection screen will appear where you can make the right choice from all possible module types. Before clicking on 'Finish', you can enter the number of modules to be created and, if desired, select the location of the modules. An example of the choice of relay modules and switches can be found in the two figures below.

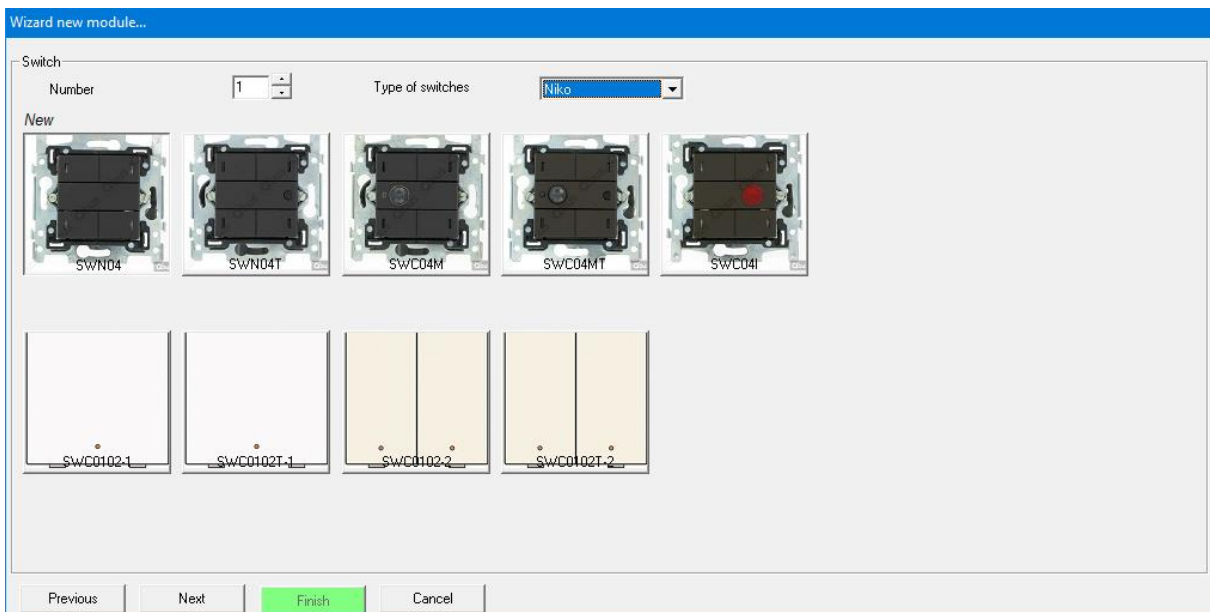
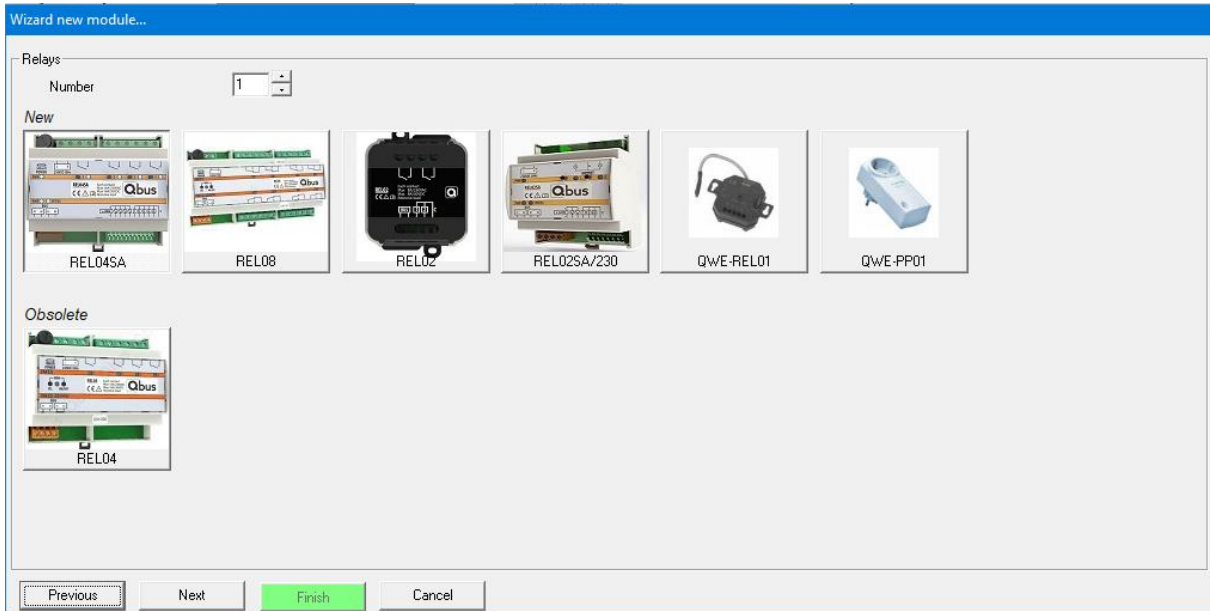

In this last screen you can select the version: Niko, Bticino, Sumum, CJC, JUNG, Lithoss, Tastu (or Easywave if your installation has a QWI/EW module)

Properly naming the module names and locations is an ideal way to quickly find the modules in the list. When the tab "Location" is selected, the treeview will be sorted on location. Locations can be added and deleted using the buttons. An example of such a list can be found below.

Modules

s/n: [REDACTED] Wizard new module... ↑

Type Location +

- 🏠 All s/n:000059
 - 🏠 1st floor
 - 🚪 Bathroom
 - 📄 650012: SWC04/G_16
 - 🚪 MBR
 - 🚪 Dressing
 - 📄 650014: SWC04/G_17
 - 📄 B00006: DIS_26
 - 📄 650016: SWC04/G_18
 - 📄 650018: SWC04/G_19
 - 🚪 Guestroom
 - 📄 650010: SWC04/G_15
 - 🏠 2nd floor
 - 📄 050020: REL04SA_10
 - 📄 650020: SWC04/G_20
 - 🏠 Groundfloor
 - 🚪 Garage
 - 📄 B00001: CVD04SA_21
 - 📄 B00002: CVD04SA_22
 - 📄 B00003: CVD04SA_23
 - 📄 B00004: CVD04SA_24
 - 📄 050002: REL04SA_1
 - 📄 050004: REL04SA_2
 - 📄 050006: REL04SA_3
 - 📄 050008: REL04SA_4
 - 📄 050010: REL04SA_5
 - 📄 050012: REL04SA_6
 - 📄 050014: REL04SA_7
 - 📄 050016: REL04SA_8
 - 📄 050018: REL04SA_9
 - 🚪 Hall
 - 📄 650008: SWC04/G_14
 - 🚪 Kitchen
 - 📄 650002: SWC04/G_11
 - 🚪 Living
 - 📄 B00005: DIS_25
 - 📄 650004: SWC04/G_12
 - 📄 650006: SWC04/G_13
 - 🏠 Outdoor

Modules All s/n:000059

Nr.	Name	Serial number	Scan	n/a
1	CVD04SA_21	B00001		<input type="checkbox"/>
2	CVD04SA_22	B00002		<input type="checkbox"/>
3	CVD04SA_23	B00003		<input type="checkbox"/>
4	CVD04SA_24	B00004		<input type="checkbox"/>
5	DIS_25	B00005		<input type="checkbox"/>
6	DIS_26	B00006		<input type="checkbox"/>
7	REL04SA_1	050002	<input checked="" type="checkbox"/>	<input type="checkbox"/>
8	REL04SA_10	050020	<input checked="" type="checkbox"/>	<input type="checkbox"/>
9	REL04SA_2	050004	<input checked="" type="checkbox"/>	<input type="checkbox"/>
10	REL04SA_3	050006	<input checked="" type="checkbox"/>	<input type="checkbox"/>
11	REL04SA_4	050008	<input checked="" type="checkbox"/>	<input type="checkbox"/>
12	REL04SA_5	050010	<input checked="" type="checkbox"/>	<input type="checkbox"/>
13	REL04SA_6	050012	<input checked="" type="checkbox"/>	<input type="checkbox"/>
14	REL04SA_7	050014	<input checked="" type="checkbox"/>	<input type="checkbox"/>
15	REL04SA_8	050016	<input checked="" type="checkbox"/>	<input type="checkbox"/>
16	REL04SA_9	050018		<input checked="" type="checkbox"/>
17	SWC04/G_11	650002	<input checked="" type="checkbox"/>	<input type="checkbox"/>
18	SWC04/G_12	650004	<input checked="" type="checkbox"/>	<input type="checkbox"/>
19	SWC04/G_13	650006	<input checked="" type="checkbox"/>	<input type="checkbox"/>
20	SWC04/G_14	650008	<input checked="" type="checkbox"/>	<input type="checkbox"/>
21	SWC04/G_15	650010	<input checked="" type="checkbox"/>	<input type="checkbox"/>
22	SWC04/G_16	650012	<input checked="" type="checkbox"/>	<input type="checkbox"/>
23	SWC04/G_17	650014	<input checked="" type="checkbox"/>	<input type="checkbox"/>
24	SWC04/G_18	650016	<input checked="" type="checkbox"/>	<input type="checkbox"/>
25	SWC04/G_19	650018	<input checked="" type="checkbox"/>	<input type="checkbox"/>
26	SWC04/G_20	650020	<input checked="" type="checkbox"/>	<input type="checkbox"/>

For more details on programming modules, see the information later in this document ([Section 4](#)).

3.5 Outputs



You can create outputs (dimmer, on/off, push button, timer, etc.) in two ways.

1. When programming switches, relay modules, dimmer modules, ... you can create outputs for each key on the switch (see "Programming Switches," later in this document).
2. You can create all outputs at once without immediately assigning them to a particular switch, detector or other module. This is what we will explain in this section.

When you click the Outputs (Lamp) button, the following screen is displayed.

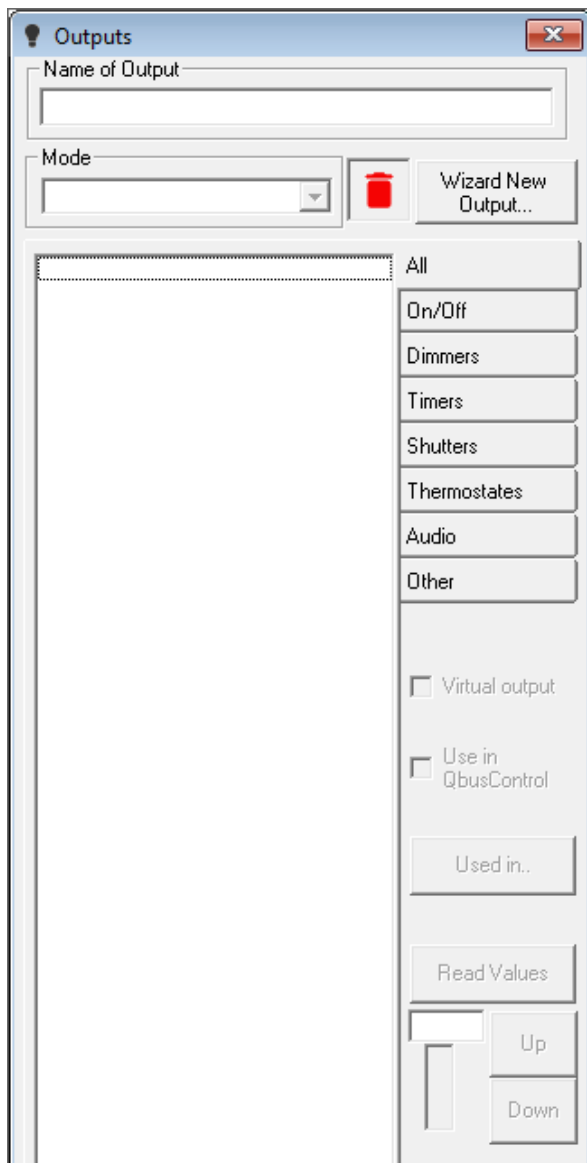

Use the "Wizard new output..." button to create a new output. The following window is displayed.

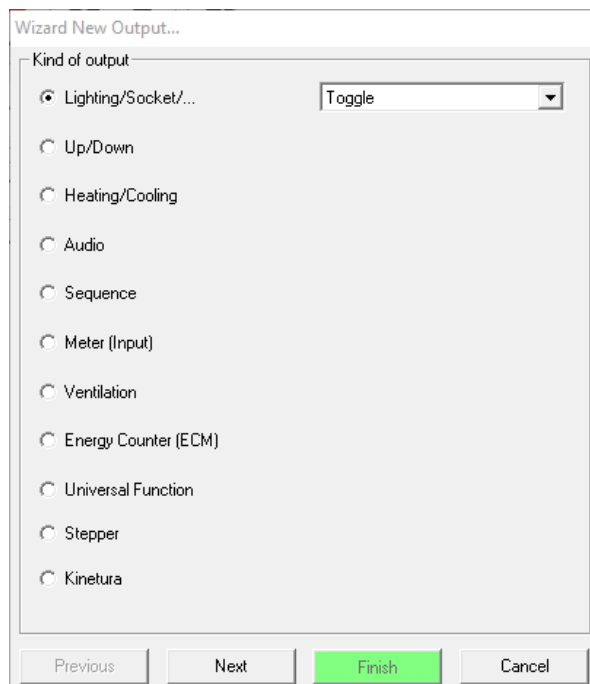

In this window, select the type of output you wish to create. To select lighting, use the first option displayed and choose the type of output. Below you will find a list of output types that you can use in your Qbus system.

After selecting the desired output type, click "Next" and give the output a name, click on "Finish". If you wish to create several outputs of the same type simultaneously, you can also enter the number here. The names are therefore numbered consecutively, starting from the entered name.

All outputs will then be visible in the screen above.

The buttons on the right side of the list of outputs (All, On/Off, Dimmers, ...) allow you to select which outputs are displayed, so that you can find the desired output more quickly. For example, the "All" key displays all outputs. With the on/off key only on/off contacts are displayed. With the "Dimmer" button, only the dimmer contacts, etc.

When you select one output and click the "Used in..." button, information is displayed about where in your program this output is used. In addition, you will be shown the serial number of the relay or dimmer component, the serial number of the switches, the scenes, clock times and logic rules where this output is used, ...

Finally, by selecting an output and clicking the "Read Values" button, you will see the current status of the output (on or off). Of course, this only works after you've also sent the changes to the system. The "Test" key can be used to (de-)activate this specific output.

3.5.1 Toggle (Bistable)

Toggle is the option called "on/off". Pressing it once switches the output on, pressing it again switches it off.

3.5.2 Push button

Only when the key is pressed is the output active - e.g. for a doorbell. Do not confuse the push button (input mode) on the switch with a push button output! The push button on the switch can be used for all modes (on/off, monostable, timer, ...), of which the push button mode (monostable) is one. Never use this type of output for long-term contacts on an input module. In that case, I would constantly occupy the bus with the input and thus put more strain on communication.

ATTENTION!!

A push button output CANNOT be controlled via the Cloud. To open a door or gate, it is better to use a Timer2 of, for example, 2 seconds.

3.5.3 Dimmer1B / Dimmer2B

Dimmer1B stands for Dimmer with one button (when the dimmer is off, press the button once to go to its start value depending on the day/night state (default 100%), press it again to go to 0%, or hold it down until the dimmer has reached the correct light level.

3.5.4 Shutter1B / Shutter2B

As with dimmers, there is a Shutter1B option (use one button) and a Shutter2B option (control the shutter/motor with two buttons – Up to open, Down to close).

For a Roller shutter 1B, you can open the roller shutter completely by pressing briefly. Pressing the button when the roller shutter is running will stop the action. Long press will lower the roller shutter.

3.5.5 Intermittent

With the "Intermittent" function you can switch an output on and off alternately (e.g. garden sprinklers). The on/off times are adjustable from 1 to 255 seconds or 1 to 255 minutes.

3.5.6 Intelligent Thermostat

When you select a thermostat in e.g.a DIS or SWC0xT or click on "properties" in a thermostat switch, the following thermostat screen will be displayed.



This screen shows 5 thermostat programs including manual control. By (un)checking the fields right below the program names, you can select which programs you want to control from the control on the switch.

The "turbo" option can be used if you have an additional valve or circuit that you can control to heat the room faster. In that case you may want to add heat from this second controlled heating unit (turbo heating = heating coming from both units) if the difference in degrees between the set value and the measured temperature is greater than e.g. 2 °C.

The "hysteresis" refers to the difference in degrees required to turn on the heating system. This prevents the heating and cooling from switching on alternately when you control both heating and cooling. For example, if you want the heating to operate when the temperature is less than 20 degrees and the cooling is activated at a temperature above 20 degrees, it will continuously switch between cooling and heating. If you set the hysteresis to 0.5 degrees, the heating will start from 19.5 degrees and the cooling from 20.5 degrees.

With the "alarm" option, set the maximum and minimum temperatures and select whether you want to close a contact (this can be done via the relay) or create an alarm that you can send via your mobile phone (if you have an SMS module) or via ethernet (if you have an ethernet port on the controller).

The “Time Off” box can be used to have the system switch automatically from Economy or Comfort to Night after a number of minutes when selecting the program manually.

From CTD FW3.09 you can also limit the set point. It is not possible to have the set point deviate further from the set point of that program. A setting of 5°C thus limits the set point between 17°C and 27°C when the Comfort regime of 22°C is active.

Intelligent Heating / Cooling (Qbus PID)

PRINCIPLE

The Qbus intelligent Heating / Cooling works on the basis of PID control. The controller calculates the difference between the desired temperature (set point) and the room temperature, and will control the heating depending on the magnitude of this difference. We call this Intelligent Heating / Cooling or Qbus PID control.

The Intelligent Heating / Cooling works as follows:

- 1) The difference between the room temperature and the desired temperature is calculated (“DIFF”);
- 2) The time to change the temperature 0.5 degrees has been calculated (TIME)
- 3) The DIFF value and the TIME value are multiplied by the GAIN (see below) to calculate the proportional value that the heating system will control.

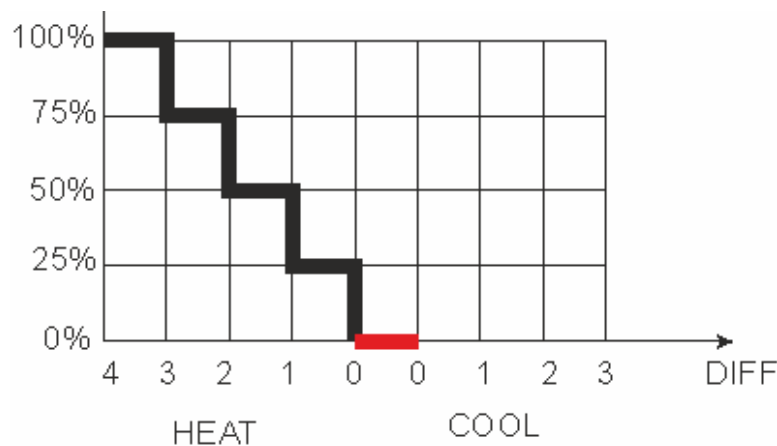

Figure 1: Representation of the proportional aspect of Qbus PID Control

During each proportional step, a fine-tuning mechanism based on the Integrator value will speed up or slow down the heating or cooling process. See below for more explanation about the integrator value.

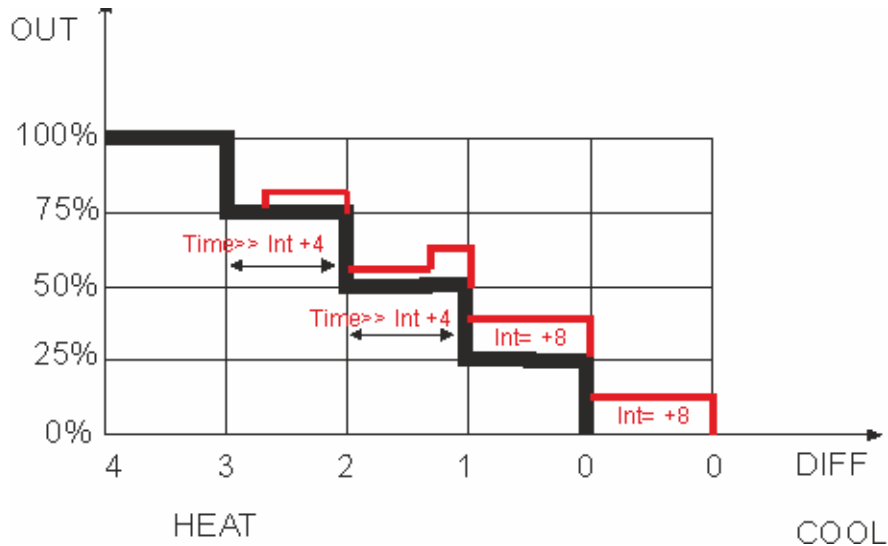
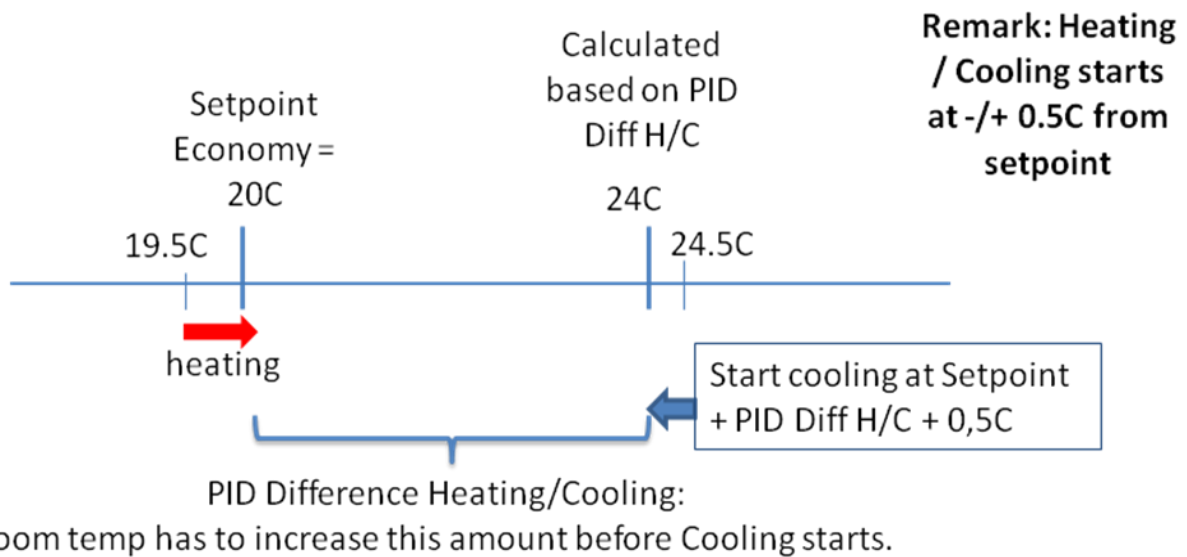

Figure 2: representation of the acceleration/deceleration mechanism of Qbus PID control

The Qbus intelligent heating / cooling works as shown below. Both heating and cooling are activated when the room temperature differs 0.5 degrees from the desired temperature. A “dead zone” between heating and cooling must avoid continuous alternating between cooling and heating: when the room is heating and the desired temperature has been reached, cooling can only start when the room temperature rises above the dead zone (adjustable via the Qbus configuration software) has increased.



Room temp. has to decrease to Setpoint -0,5C before Heating Starts.
 If new Setpoint (new program) is below minimum PID value, Cooling won't be activated

Figure 3: Principle Qbus Intelligent Heating / Cooling

CONFIGURATION OF THE QBUS PID CONTROL IN THE SYSTEM MANAGER

Once PID is selected the thermostat screen will change as shown below. CLICK THE “DEFAULT” BUTTON AT THE TOP RIGHT TO USE THE DEFAULT VALUES FOR THE QBUS PID CONTROL. IT IS RECOMMENDED TO USE THESE STANDARD VALUES DURING FIRST PROGRAMMING AND ADJUST THEM AS NECESSARY BASED ON THE EFFECTIVE RESULTS OF THE CONTROL.

The screenshot shows the 'Thermostat | (A03)' configuration window. It is divided into several sections:

- Programs:** Five programs are listed: NO CLOCK (20°C), FREEZE (5°C), ECONOMY (20°C), COMFORT (22°C), and NIGHT (15°C). Each has a vertical slider and a 'Check on display' checkbox.
- Dead zone:** A row of five input fields, each set to .5°C.
- Time Off:** A section for 'Time to switch to program 'night' after manually put to', with options for ECONOMY, COMFORT, and N/A.
- Display:** 'Short Name' is set to 'TH Bathroom'.
- SwitchTime:** A clock icon for 'Put this output in a Switchtime'.
- Events:** 'Save events for this output on SD' is set to 'Yes', and 'PID Event Time' is set to '2m'.
- Advanced Settings (Right Panel):**
 - Range (MDO01/SEN0x/RELO2T/INA02):** 0 to 63,5°C.
 - Range in Cloud:** 0°C to 35°C.
 - PID (Advanced settings):**
 - PID Heating, Integrator: 15.
 - PID Cooling, Gain: 3°C.
 - Relais Delay: 3m.
 - Button2 on DIS01: Program selector, Enable/Disable Cooling.
 - Speed 2: 2°C.
 - PID Minimum: 20°C, Maximum: 26°C.
 - Adjust. temp.: 0°C.
 - Max. Setp. Offset:** Maximum Setpoint Offset +/-: 63,5°C.

Integrator: both for the relay and 0-10V-based Intelligent Heating/Cooling. The integrator value is added to the control value (= calculated as $DIFF \times TIME \times GAIN$) to smooth the control. The higher the integrator value, the flatter the curve, causing the control process to react more slowly. We recommend that you do not change the integrator value at system start-up and only adjust this value if necessary after the system has been in operation for a while.

Gain: Used to calculate the heating/cooling proportional control value ($DIFF \times TIME \times GAIN$; see explanation above). The higher this value, the greater the jumps in the checking process will be to speed up this process). A gain that is too large can result in an overshoot. Again, we recommend using the default value of the gain in a first stage and only adjusting it after using the system for a while.

Ddelay: is only used with relay-based Intelligent Heating/Cooling. When relays are used to control heating and cooling, a 10-minute cycle is used to go through the process. Since a relay can only be

open or allowed, e.g. a relay that is 75% open is translated by opening this relay in the cycle for 75% of the cycle time (=7.5 minutes) and for 25% of that time (2.5 minutes). Since most electronic thermostatic valves have a delay from fully open to fully closed (usually about 3 minutes), the “delay” time indicated in the “delay” field is added to the 10-minute cycle time to minimize the effect of this “slow effect” to filter out thermostatic valves.

Button2 on DIS01: when the Qbus PID is active and this field is on, the second button on a DIS02IT can be used to switch the cooling off or on.

Speed 2: only when the difference between room and set temperature is higher than the number of degrees stated in “Speed 2” an extra relay can be switched on for additional heating or cooling. Speed 2 is an output that can be assigned to a relay or 0-10V control module.

PID Minimum / Maximum: describes the range that can be used for manual temperature control via touch screens or switches. When a temperature lower than the PID minimum temperature is selected in a thermostat program, the cooling will never be activated. This is to prevent, for example, the air conditioning being used to cool down a room during the night or when you are absent.

Dead zone: dead zone between heating and cooling: when cooling is off, the room temperature must be lower by at least the number of degrees stated in this field before the heating is switched on. Conversely, it should be that number of degrees warmer than the set point before cooling starts. See also figure 3 above for an example.

Events: The events are on by default. Next to this button is the interval at which these events can be forwarded. We recommend choosing an interval of no less than 2 minutes.

CONFIGURE OUTPUTS WITH QBUS PID

Configure relay outputs

By creating a Qbus PID thermostat, four outputs are automatically created: Heating, Cooling, Speed 1 and Speed 2. These outputs can be assigned to relays.

Stand Alone	All OFF	All ON
Delay before All OFF is activated	In/a	
Living spots	<input checked="" type="checkbox"/>	<input checked="" type="checkbox"/>
Output 2	<input checked="" type="checkbox"/>	<input checked="" type="checkbox"/>
Output 3	<input checked="" type="checkbox"/>	<input checked="" type="checkbox"/>
Output 4	<input checked="" type="checkbox"/>	<input checked="" type="checkbox"/>

Heating and Cooling must be assigned to the relay to which the valve, controlling them, is connected. Speed 1 and Speed 2 must be assigned to a fan if there is one present. Speed 2 will only work if the

difference between the room and requested temperature is at least the number of degrees assigned to Speed 2 in the PID screen.

Configure analog (0-10V) outputs

Since the Speed1 / Speed2 outputs are ON/OFF contacts, they can only be assigned to relays, not analog outputs. Only the Cooling / Heating contacts can be assigned to 0-10V output modules.

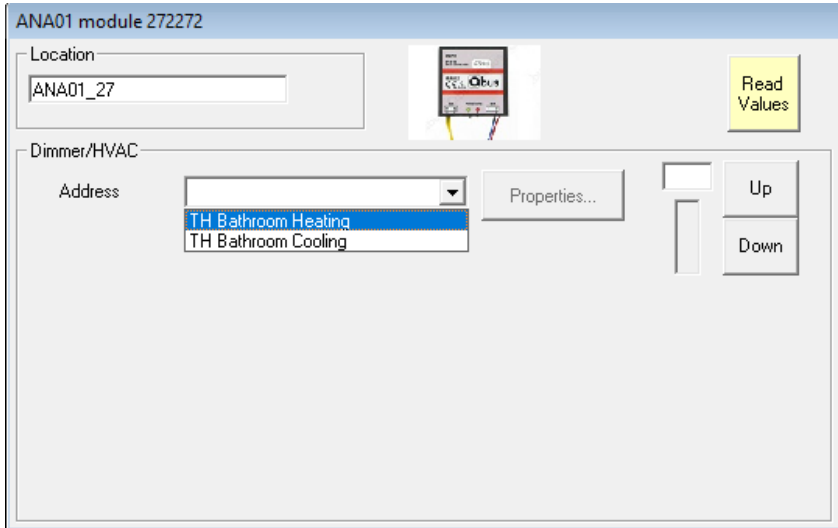

Configure an Air Quality Sensor (AIR01 with CO2 / Humidity / Temperature)

ATTENTION: INTELLIGENT HEATING AND COOLING IS SUPPORTED ONLY IN THERMOSTAT MODE, NOT HVAC MODE. WHEN THE TEMPERATURE SENSOR FROM AN AIR01 SENSOR IS USED TO CONTROL THE PID THERMOSTAT OUTPUT (AND NOT THE HVAC THERMOSTAT OUTPUT) MUST BE LINKED TO THIS AIR01 TEMPERATURE SENSOR.

This can be done via the TH Link button in the setup screen of the AIR01.

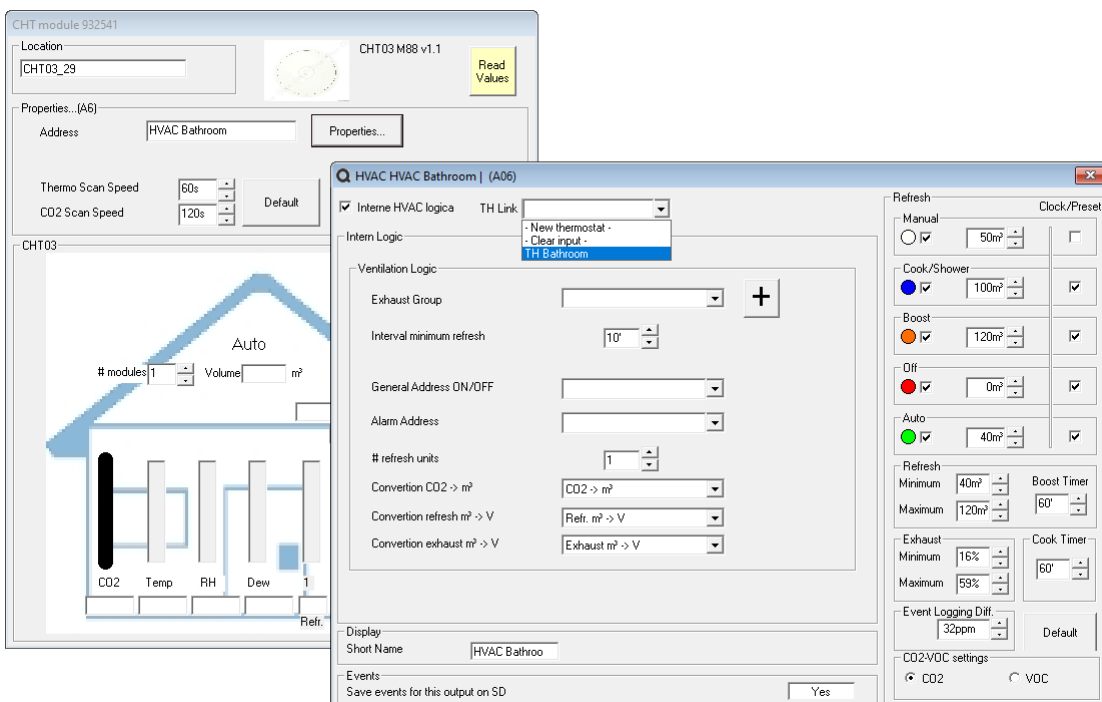

USING QBUS PID IN COMBINATION WITH ANALOGUE LOGIC

When a PID thermostat mode has been created you will find following outputs in the list of outputs that can be used in analogue logic:

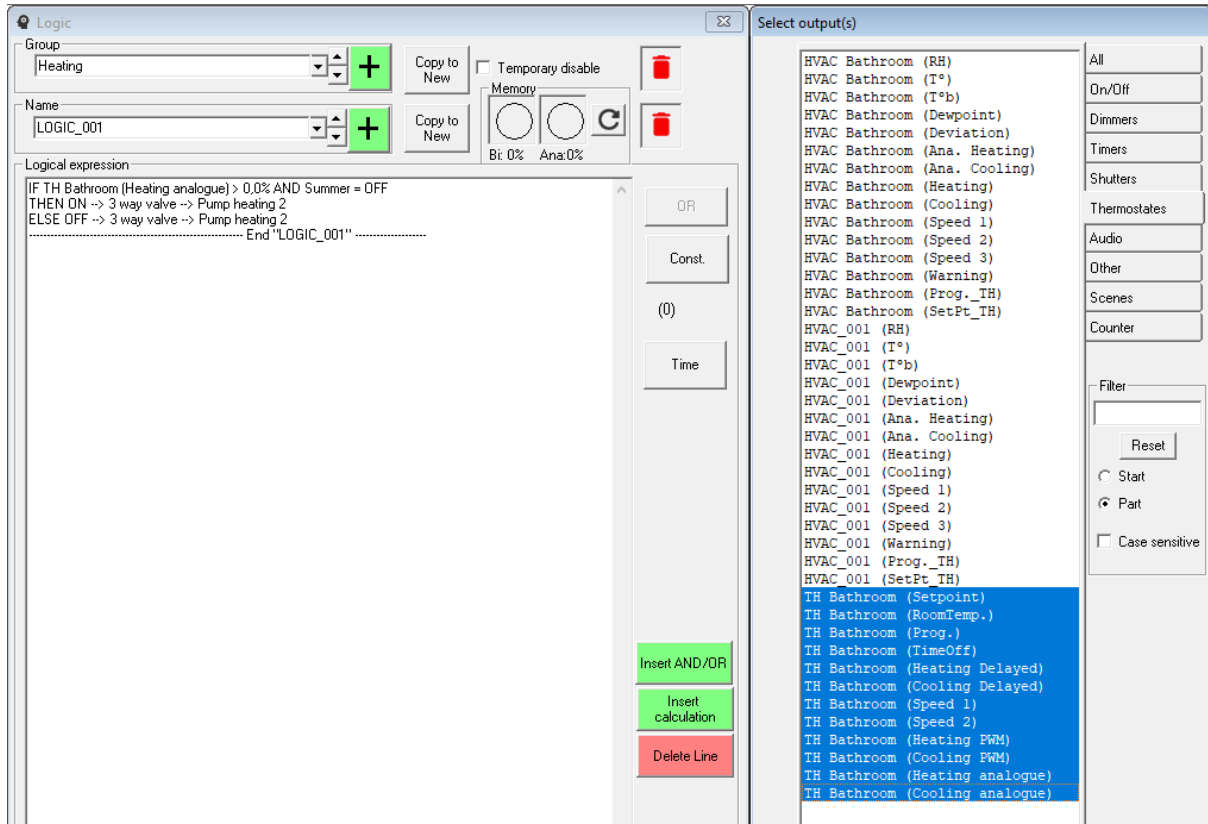

Thermostat (Setpoint): Set point (requested temperature) of this thermostat; it can be used as a condition: (IF Setpoint = X degrees, THEN...) or as a consequence (If X is ON, then set Setpoint to X degrees)

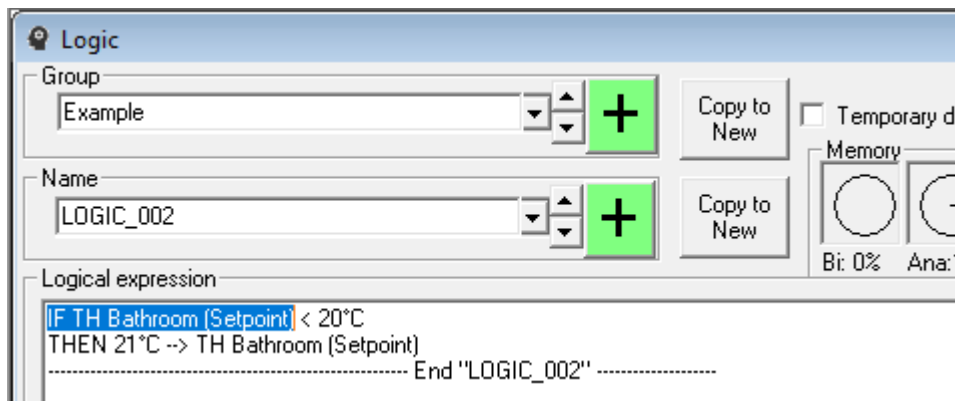

Thermostat (RoomTemp.): Room temperature measured by the thermostat sensor; can only be used as a condition

Thermostat (Prog): Respective program (Comfort, Economy, Night, No Clock,...) of the thermostat mode; can be used as a condition or as a result.

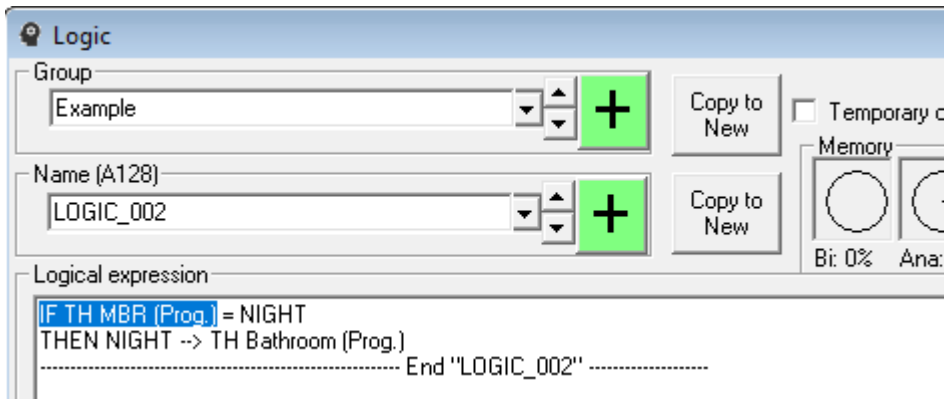

Thermostat (TimeOff): the Time-Off function of the respective thermostat program; can be used as a condition or as a result.

Thermostat (Heating): if the "Heating" output of the thermostat mode is on (too cold) or off (warm enough); used as a condition

Thermostat (Cooling): if the "Cooling" output of the thermostat mode is on (too warm) or off (cold enough); used as a condition

Thermostat (Speed1): if the output "Speed 1" of the thermostat mode is on or off; used as a condition

Thermostat (Speed2): if the output "Speed 2" of the thermostat mode is on or off; used as a condition

Thermostat (HeatingPWM): if the "PID Heating" output of the PID control via RELAY is on or off; used as a condition

Thermostat (CoolingPWM): if the "PID Cooling" output of the PID control via RELAY is on or off; used as a condition

Thermostat (HeatingAnalog): if the "PID Heating" output of the PID control via ANALOGUE MODULES (0-10V) is on or off; used as a condition

Thermostat (CoolingAnalog): if the "PID Cooling" output of the PID control via ANALOGUE MODULES (0-10V) is on or off; used as a condition

3.5.7 Sequencer

A sequencer uses scenes in a sequential order.

When you select a sequencer, the following screen is displayed.

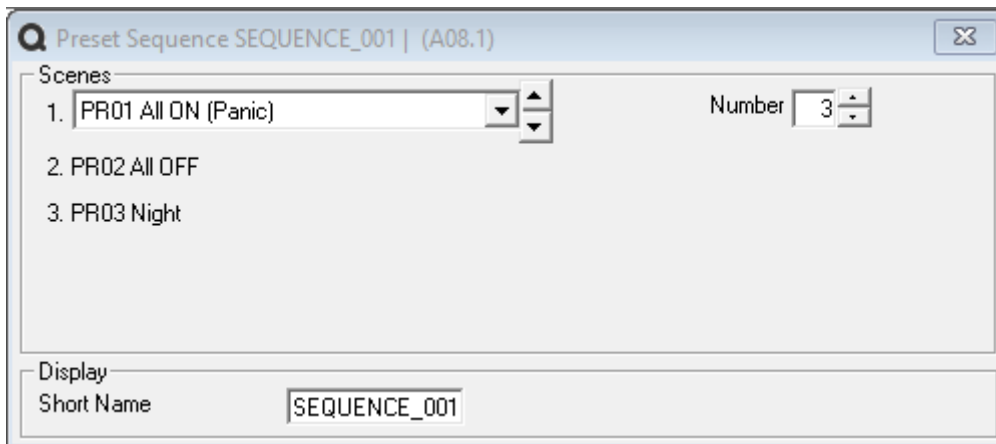

Choose the first scene for choice 1. The 2nd will follow automatically as this is the next scene in the sequence you programmed. This means that the first press will activate the scene in position 1, and the next press will activate the scene in position 2. It is a looping process.

With the option "Number" on the right side you can select the number of scenes for this scene.

Choose the first, the rest will follow the scene set as primary, based on the order in which these scenes were created. When this sequencer is assigned to a key, each press of the key will output the following scene.

When pressed for a long time, the first scene is always activated.

3.5.8 Timers

In the Qbus software you can select 5 timer modes:

Timer 1 ("Forget timer"):

Each time the button is pressed, the timer is switched on or off. For example, in a hall, the button is pressed once to turn on the light for a certain period of time (set by clicking the "Properties" button and using the "Min" or "Sec" buttons to select the time in minutes or seconds), and a second time to extinguish the lights.

ATTENTION: work as long as possible in seconds (up to more than 4 minutes) to have an accuracy of 1 second. If you set the timer in minutes, the accuracy is 1 MINUTE.

Timer 2 ("Staircase timer"):

Each time the button is pressed, the timer is reset to the set value. For example, if your timer is set to 3 minutes, the timer will run for 3 minutes each time you press the button. This timer does not work with motion detectors - motion detectors can only control toggle outputs and will continue to count down for the period set in the detector module.

From CTD FW3.08 the Timer2 has an extra parameter: When the "Automatic Reset" is turned on, this timer will be reset to its set value when it reaches 0. Such a timer can be useful for continuous testing in analogue logic.

Timer 3 ("lazy timer"):

The timer is activated the first time the button is pressed. Pressing the button a second time switches on/off mode - the value set in the timer is then no longer relevant. A third press of the button switches the output off. For the front door, for example, you can use a timer, but you also have the option of leaving the light on indefinitely without the timer turning it off automatically. If you have selected Timer 3 and set it to, for example, 3 minutes, and you press the button, the timer will be activated for 3

minutes, and the light will turn off at the end of that period. If you press the button twice, the light will stay on until you press it a third time - then the light will go out.

Timer 4:

This is a linked timer: an impulse (pressing a button, motion detection, ...) activates an output (e.g. output 1). After a certain period of time (can be set by the user), a second output is activated (e.g. output 2, selected by the user). When output 1 (the "master") is turned off, output 2 (the "slave") will also be turned off after a preset period. Example: When you come home in the evening, the motion detector outside turns on the front door lighting, and 1 minute later the hallway lighting.

To program this timer, you must assign the Timer4 master for the first output. When you click "enter", a drop-down screen will ask you to define the output that will be associated (with a certain delay) to this first output (will be defined as Timer4 slave). You can set the delay time by clicking "Properties".

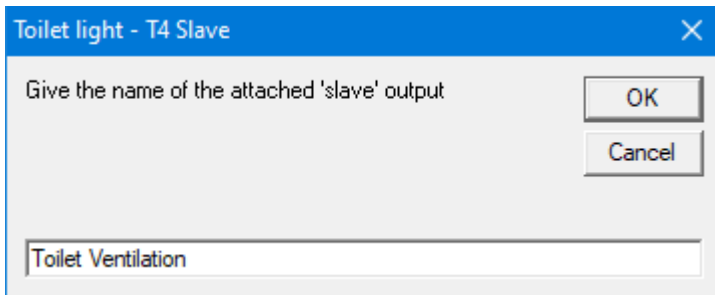

The delay time can be set by pressing the "Properties" button.



Timer 5

With this timer you can link a manual input (switch) and a detector input. A detector activates an output only when it detects movement or when the light level falls below a set threshold (see below in MDI/MDO programming). In the Qbus system, a detector has priority over a switch. If you also want to control an output controlled by a detector with a switch, the output will not respond to the command of the switch if the parameters of the detector do not match (e.g. no movement detected or light level still too high - the detector turns your output off immediately after you command the switch to turn it on).

You can avoid this problem by using a Timer 5. A timer 5 is programmed as follows:

- Step 1: Create a new output (Timer 5 Manual) on the switch you want to use to control that output. When you click "enter", you will be asked to name the output that you want to control with the detector (you will have two names for the same output, one for the manual control, the other for the detector - add the output "manual" or "detector" so you can distinguish between the two).

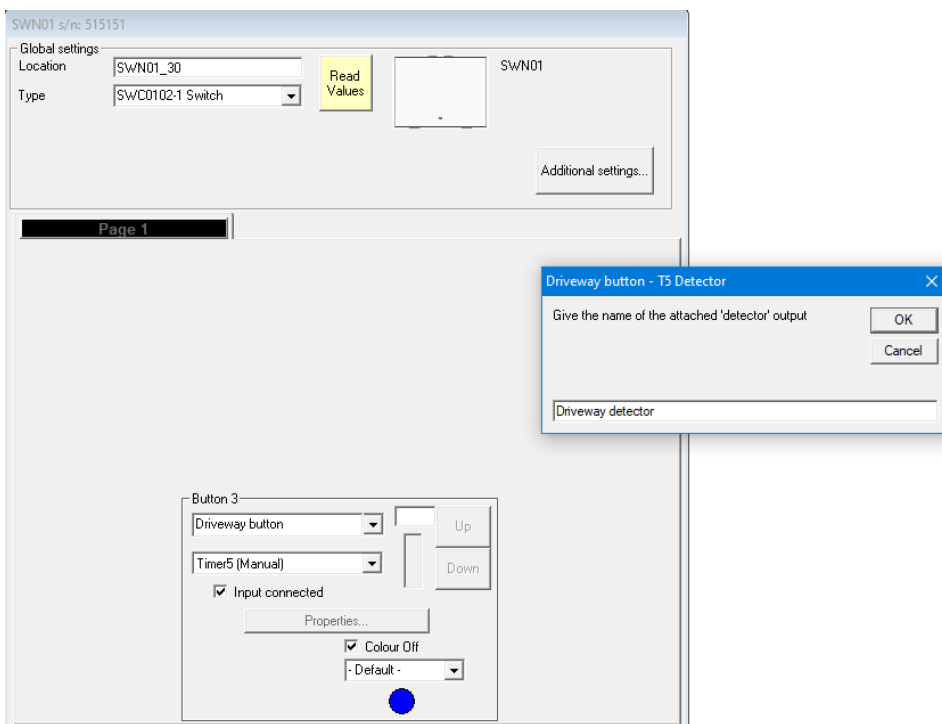

- Step 2: You must also link Timer 5 Detector to the detector you want to use to control this output. If you program a SWC04M, you can link this Timer 5 Detector directly to first input key. However, if you use an MDI01 or SEN04 as a detector, you must create a fictitious bistable output, as an MDI01 or SEN04 can only control bistable outputs (no timers). In this case, first create a fictitious bistable output, and link this fictitious output to Timer 5 Detector via logic
- Step 3: In the MDI01 or SEN04, use the fictitious output as one of the controlled outputs: when the detector now detects something, it will switch on the fictitious output, which in turn activates Timer 5 Detector (both are linked via an internal logic function).

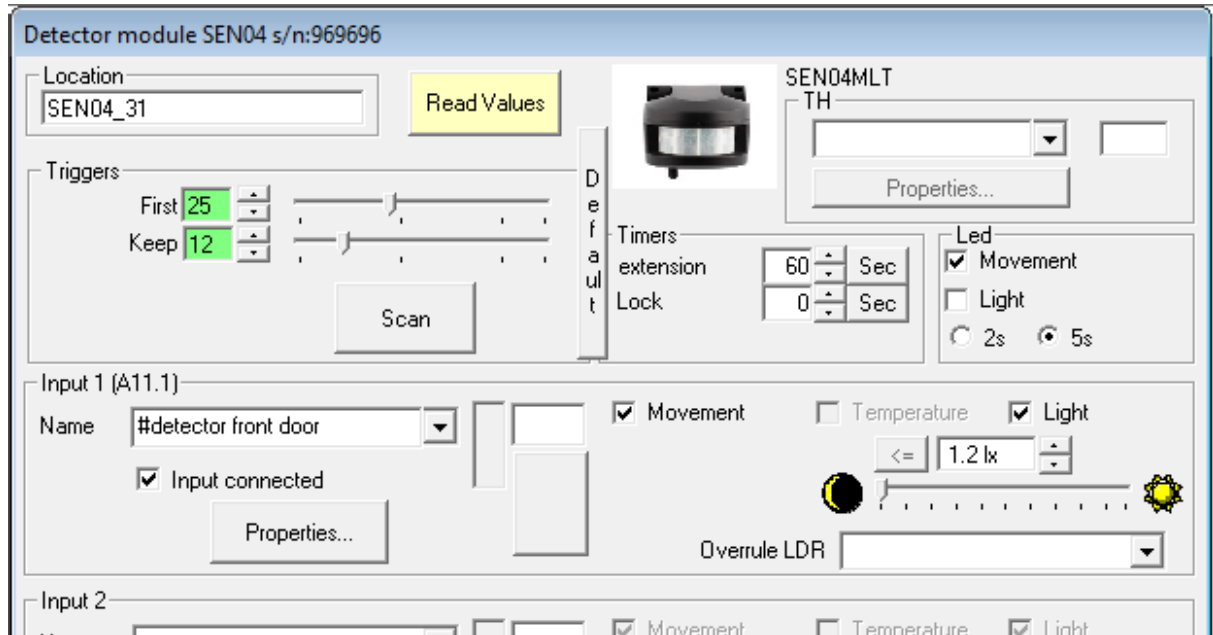

- Step 4: In order to give priority to the manual control of the output over the Detector control, you must assign the manual output to the relay to which the output is connected. Your manual operation now takes precedence over your detector.

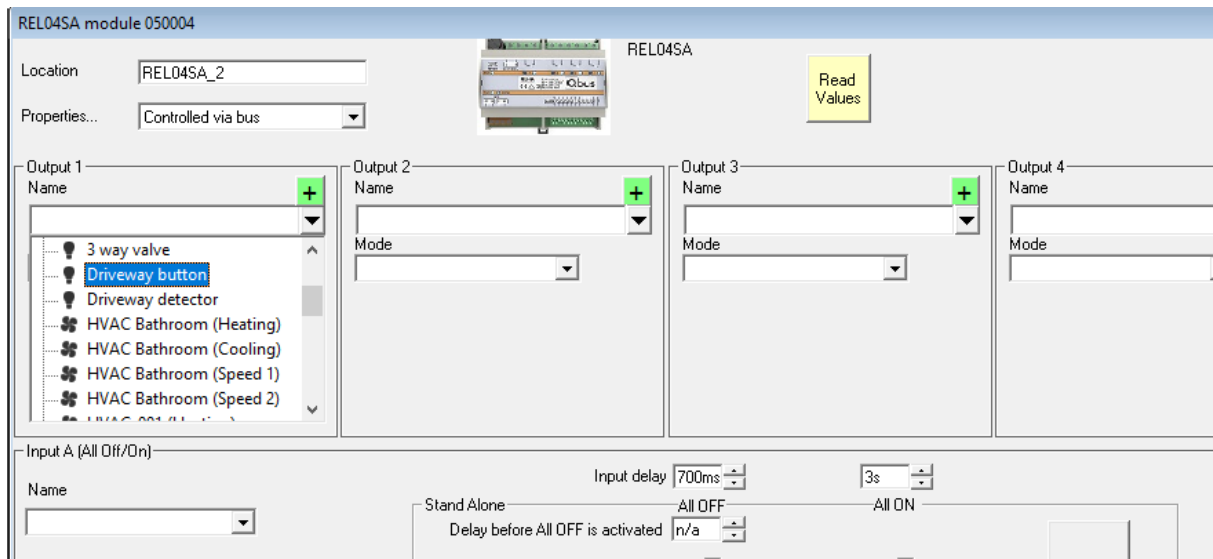

3.5.9 (Energy) meter

A meter mode can be created in different ways

1. An energy meter can be created on the ECM04 module: By clicking on the function “New output” in the drop-down menu of input 1.
2. Wizard new output: In the outputs tab you have the function “Wizard new output”, by opening this you can create an ECM04 input via the option “Energy meter” or create a normal meter mode.

If you create an ECM04 input via one of these methods, the three other inputs of the ECM04 will automatically be created as meter inputs.

In our example, we have created and named 4 entries as follows: E-meter, Solar Energy , Gas Meter, Water Meter

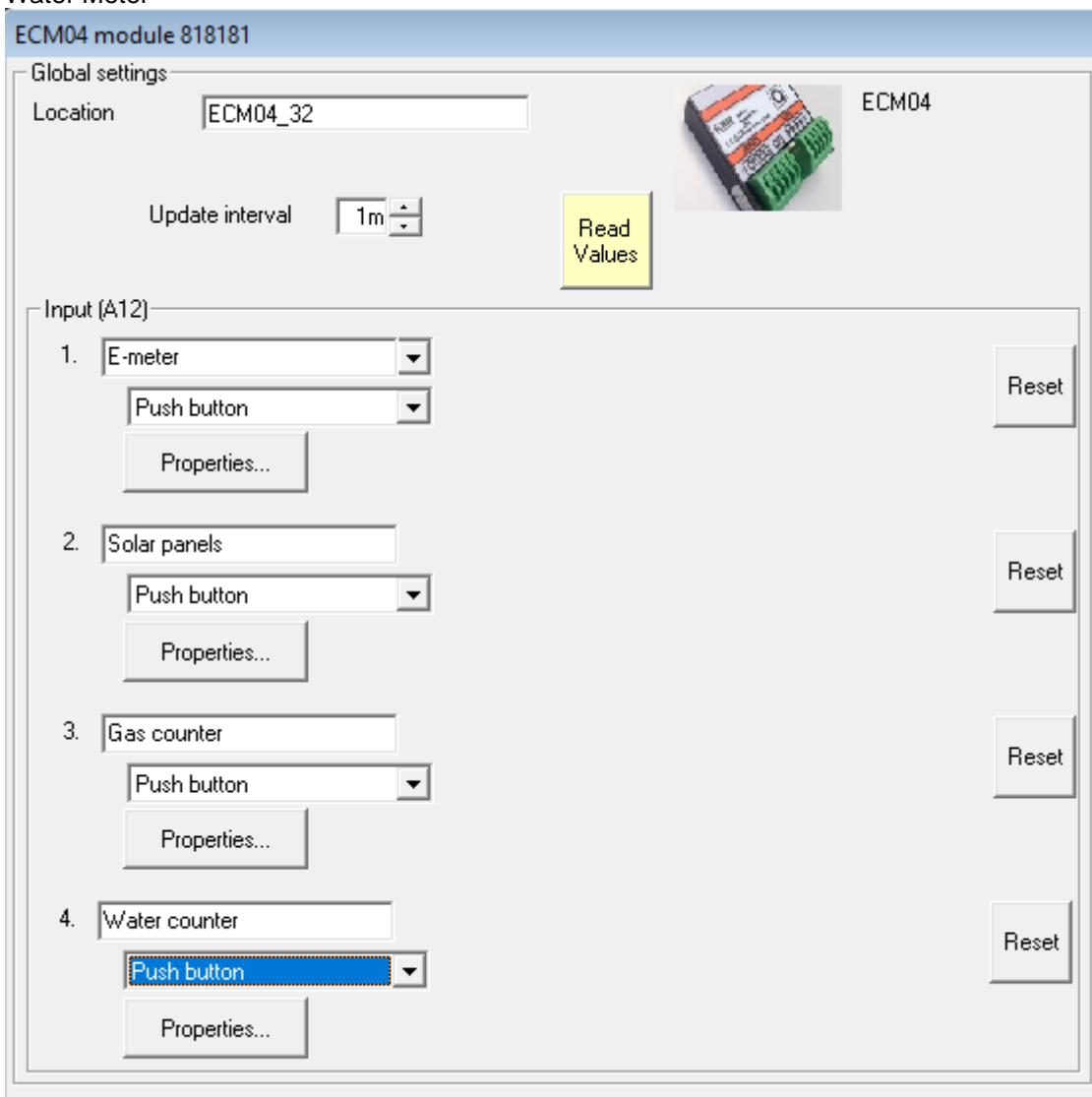

When we look at the properties of an (energy) meter input, we see several parameters:

Minimum: This is the minimum limit of the value that will be measured and can be displayed in EQOmmmand/Cloud.

Maximum: This is the maximum limit of the value that will be measured and can be displayed in EQOmmmand/Cloud.

Pulse value: This is the factor with which we have to multiply the measured pulse to get a correct value. For example, each pulse represents 100Wh, then the pulse value must also be 100 if we want to express it in Watthours, if we want to express it in kWh then the pulse value must be 0.1.

Unit: this is the unit in which we express the measured value.

Trigger: is a set point when an alarm output can be activated. The trigger can be set from 0 to 1,000,000,000 pulses.

Warning Address: This is the output that turns on when the number of pulses is equal to or greater than the trigger value.

If we want to read the number of pulses in the System Manager, it is sufficient to press the button “Read values”. This data is synchronized every minute by default, but the update interval can be set from 1 to 255 minutes. The pulses can also be reset to zero for each input by clicking the “Reset” button.

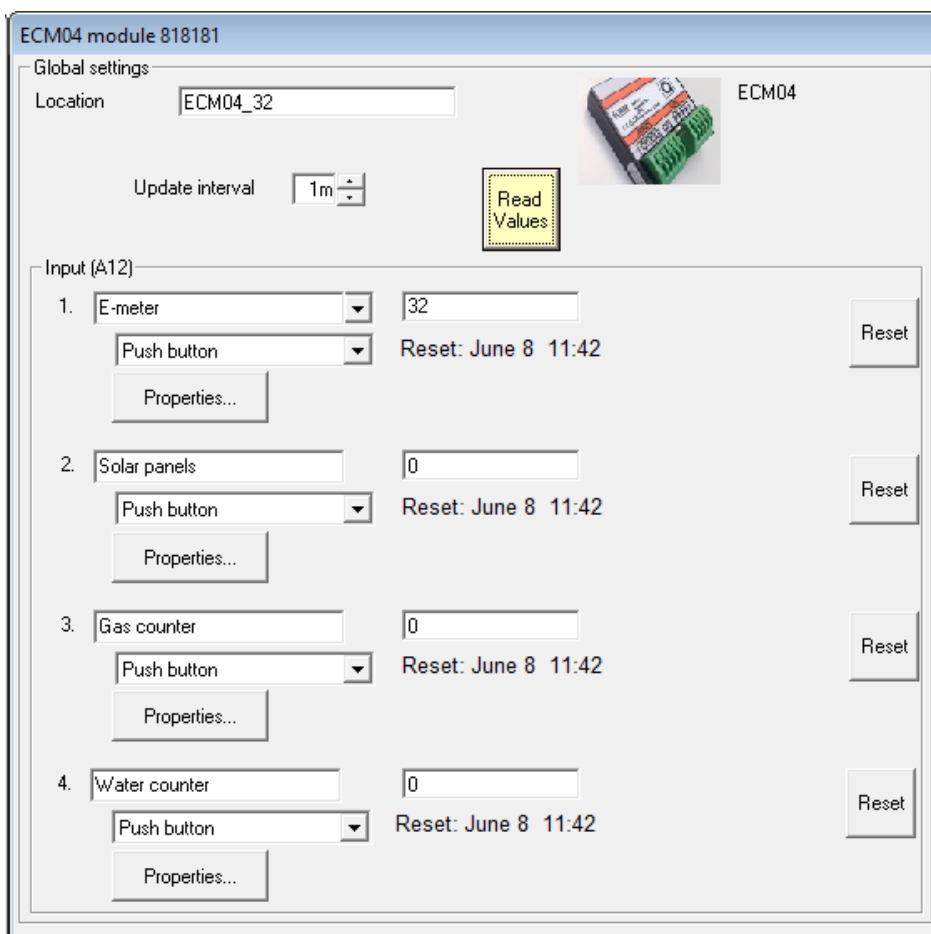

For more information about how to measure (energy) via Qbus, see [chapter 6](#) in this manual.

3.5.10 Universal function

A universal output can have a 24-bit signed value (-8,388,607 ... +8.388.607)

In the properties you can choose the type.

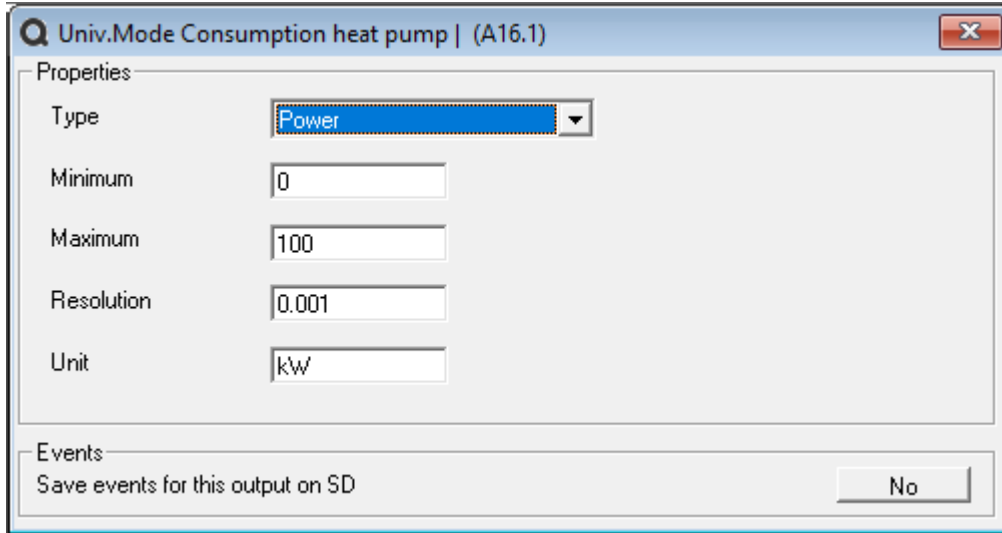

The selected type also determines the icon in EQOmmmand and Cloud.

The minimum and maximum are used in EQOmmmand and Cloud to display the gauge nicely.

3.5.11 Stepper output

A stepper output can have any value from 0 to 254.

The minimum and maximum values can be set. In the following example an output was set to display (via MODBUS) the mode of a heat pump:

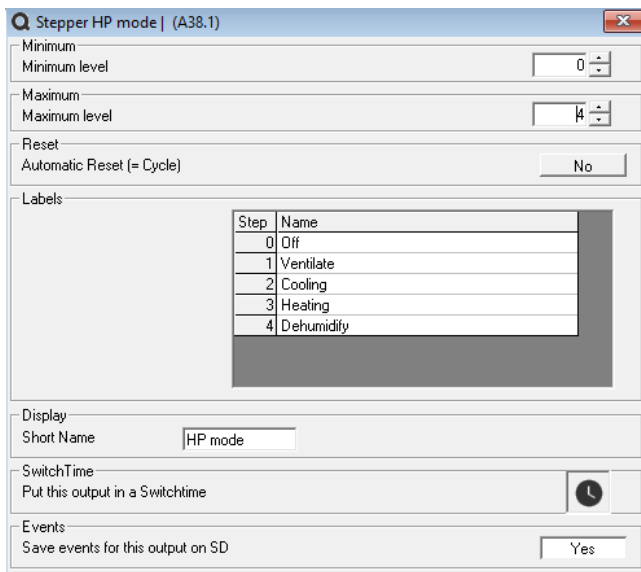

When this output is assigned to a pushbutton, each pulse will always increase or decrease the stepper by the value 1.

A long press on the up button or down button will reset it to the value 0.

If the 'Automatic Reset' was switched on, the maximum level is reached and another short pulse is given 'up', the minimum level will be selected again.
 This does not work in the reverse direction: when the output is already at the minimum, clicking the down button will NOT set it to the maximum level.
 Via a scene, any value can be set.

3.5.12 Output properties

A property window is displayed on the right side for each output.

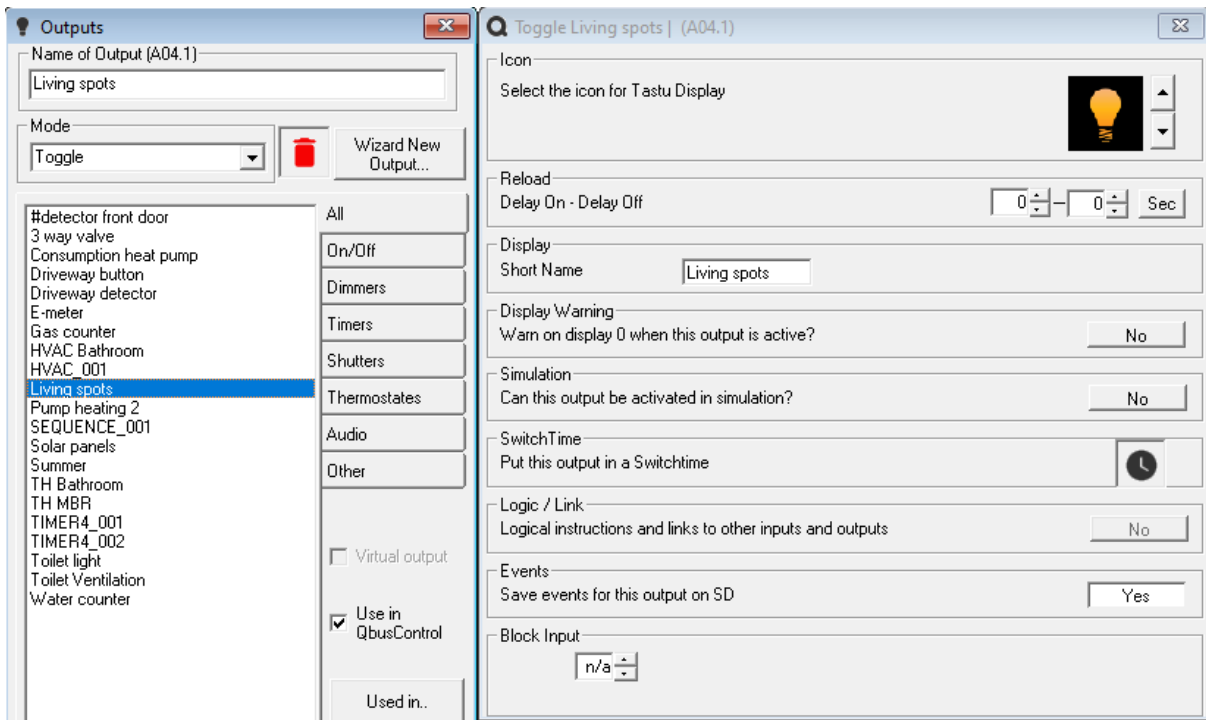

You can also reach the properties directly from the switches, relays, dimmer modules, ...

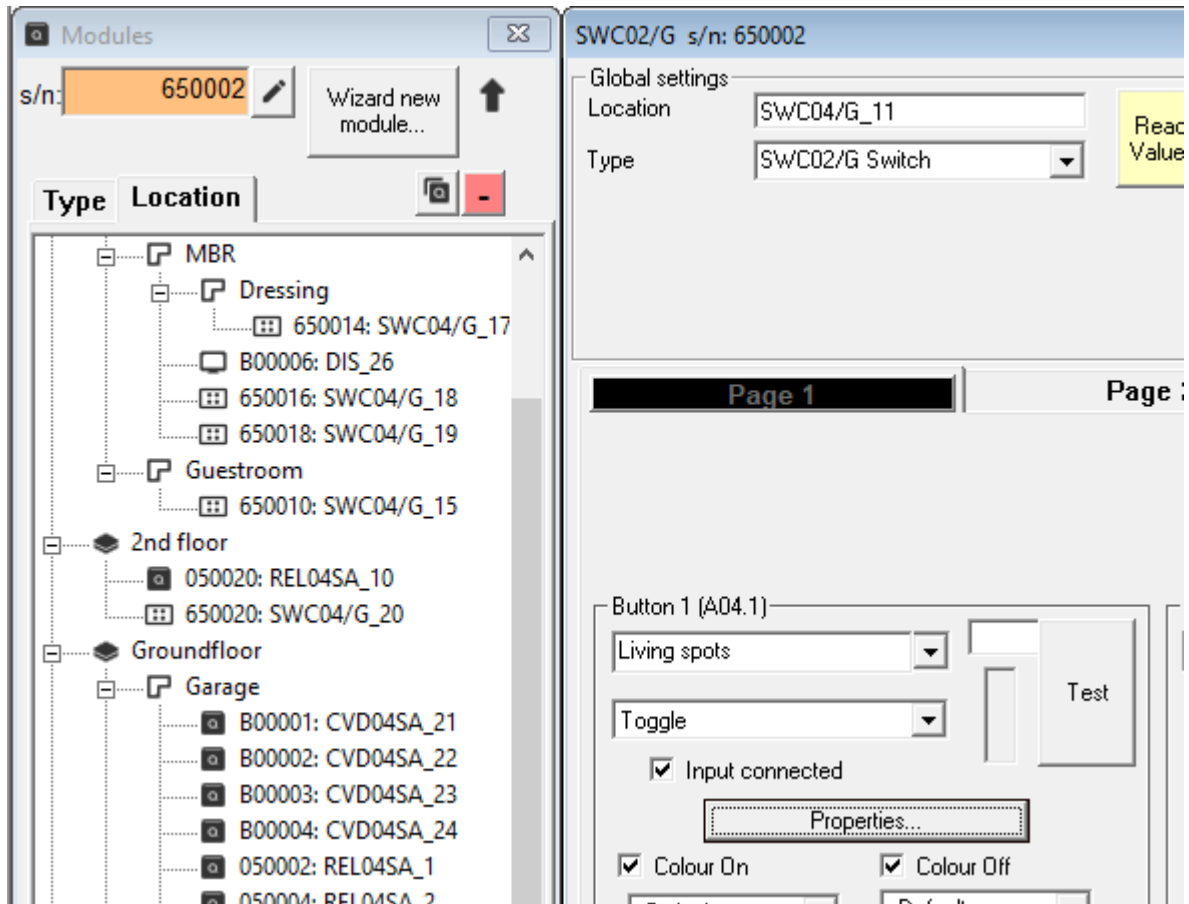

Reload: Add a delay to turn on or off the selected output (period between when you press the switch and the corresponding relay output is turned on or off).

Display: the 'short' name (max. 12 characters) that will appear on a display (e.g. TSC5.8, ViZiR, Tastu Display, ...)

Display Warning: Warning on a display when the output is still active. On a TSC 5.8, you can -check the status- and you will get an overview of all outputs that are still active and that have been selected via the properties screen

Simulation: Should this output be taken into account for the presence simulation tool, a standard part of the system? E.g. not helpful to have a thermostat outlet or a light in a hallway without outside windows as part of a simulation.

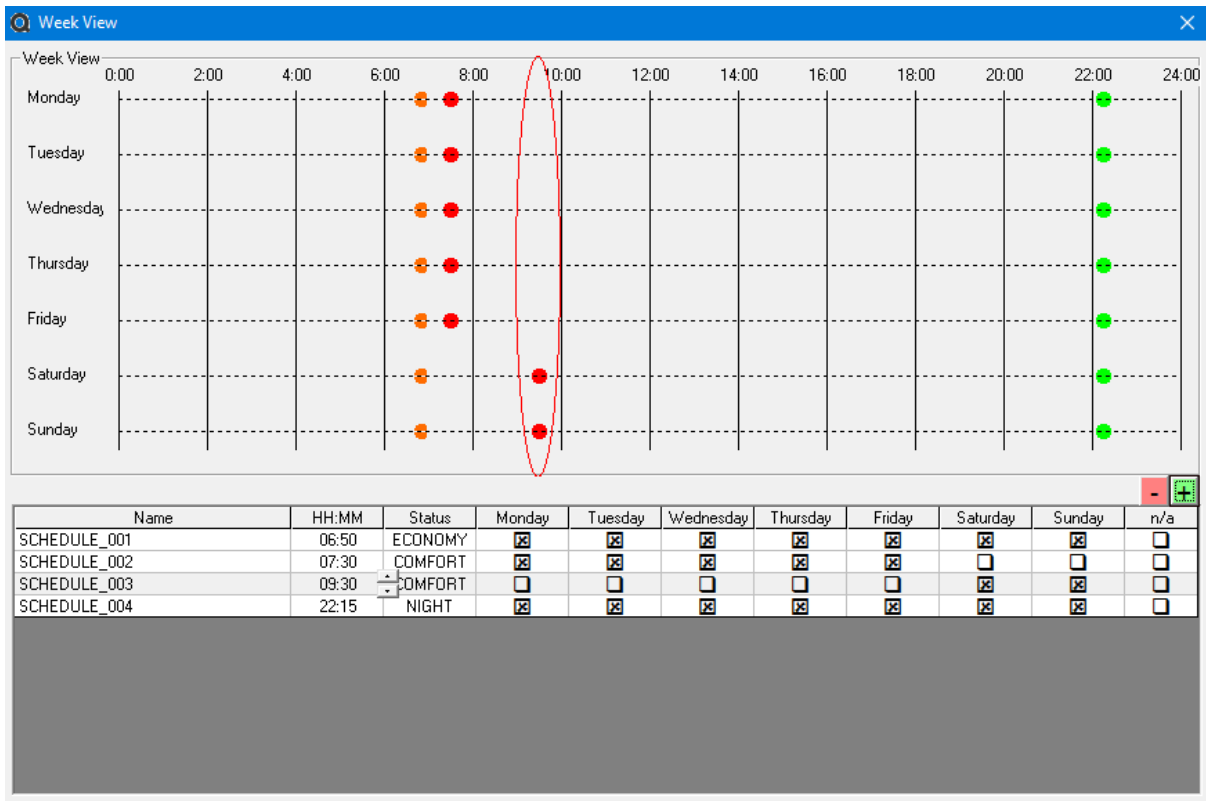

Switch Time: This graphical weekly overview provides an easy way to update the clock times of e.g. a thermostat.



An output can be turned on (Yellow) or off (Black) at a specific time. With a thermostat, the color of the regime is displayed.

Editing is possible via the grid. The name and time of the clock time can be changed. The desired status can be set, a weekday can be checked and unchecked. And in the last column, the full clock time can be temporarily switched on or off.

When a parameter is adjusted and there are other outputs in this clock time, you will be asked to adjust the entire clock time or create a new clock time, so that the time of the other outputs remains unchanged.

You can also remove or add a clock time with the   buttons, right above the table.

Logic / Link: used to create multilinks. A multilink is a setting where you can control several outputs with one switch. This is not the same as a scene - a scene allows you to set various outputs to a predetermined level. With a multilink you can control various outputs together (e.g. adjust the setting of all dimmers in your living room together; with a scene you can only set them to 1 value). See point [3.6.2](#) for more information about working with multilinks.

Events: If you set the button under 'Events' in the Properties screen to "on", all status changes will be saved to the SD card in the controller. Reading the event data is described in [3.2.2](#)

3.6 Editing scenes



Qbus offers you the possibility to create scenes. An scene is a complete situation in which lighting, shutters, dimmer, etc. are controlled together so that you get a complete result in your zone. When you click the "scenes" button, the following screen appears.

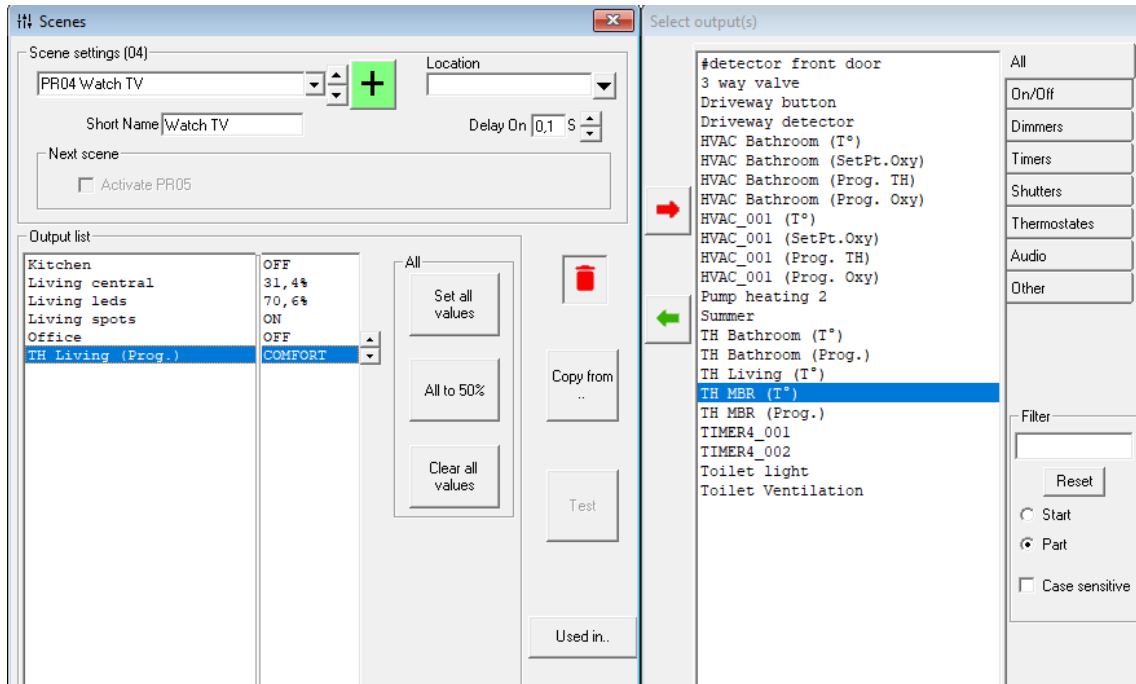

The outputs in your program are displayed on the right side of the screen. In the section on the left, select "new preset". Then, by double clicking or with the → and ← keys, move the desired outputs to the scene you are creating. Change the values based on what you want to do by selecting the appropriate output and using the up or down arrows on the right side of the list. The "Set all values" option activates all selected outputs while the "Clear all values" option places all outputs in an off state.

If you are creating two opposing scenes, complete the first scene, then create a new one with the "Copy from ..." key and copy the previous scene; then use "Clear all values", "Set all values" or use the arrows, depending on the situation you want to assign to the new scene.

Remark: If you use thermostats in your scenes, they will not change to the requested program if it is in a non-"Changeable by clock time or scene" program. These settings can be adjusted in the setup screen (Utilities – Setup – Heating/Cooling) – see also "Thermostat settings" in point [2.4.2.2](#) of this manual.

The scenes can be activated in various ways.

1. Button on an intelligent switch
2. Pushbuttons or switches connected to the INPUT modules, with INP02, INP04, INP08, INP16 & INP08/230.
3. DIS02 module (DIS02 IT)
4. Touch screen module (TSC 5.8, ViZiR, DIS, ...)
5. Also from the System Manager with the TEST button in the "Scenes" window shown above.
6. Logic
7. ...

3.6.1 Simulation



This application can be used to give the impression that someone is at home when you are away. The Qbus system can be set up to record all events that occur on the bus. These events are then repeated on a weekly basis each time the simulation program is activated.

Step 1: Select outputs

First you need to select which outputs will be part of the simulation. For example, it makes no sense to include heating outputs - after all, heating is not visible from the outside and switching them on would be a waste of energy.

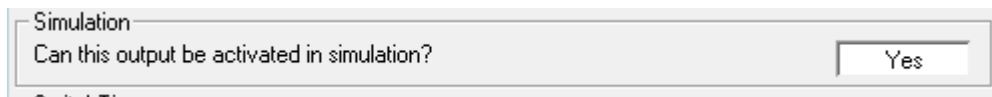

For each output you can indicate in the properties whether it may be activated during simulation. Simulation is deactivated by default.

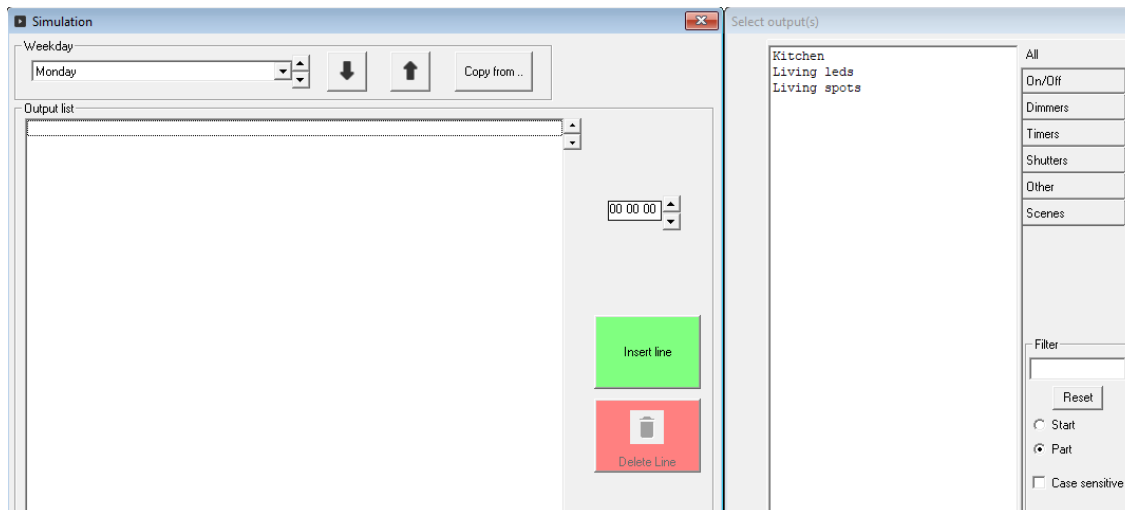

Step 2: Record Simulation

Now that you have selected all the outputs that you want to use during the simulation, you need to record the events that occur over a period of time so that they can be repeated during the simulation. To record a simulation, you must assign one key of a switch or touch screen to "Record Simulation" or you can click the "Record" via Utilities – Setup:

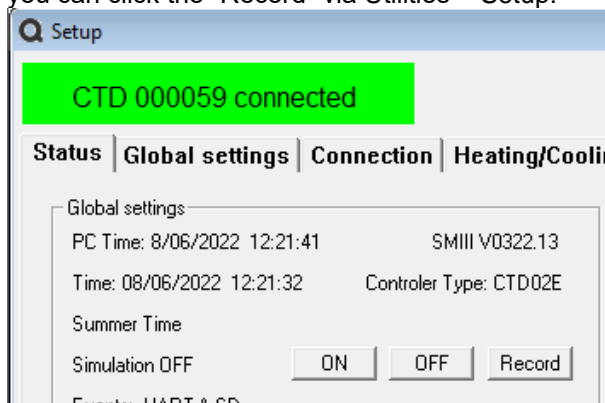

Using a Smart Switch (SWC).

Click on a button of the specific switch you wish to use, click on "- Scenes -" on top of the output list and scroll through the list until you find "- Record sim. -" at the bottom. Click that button when you want to start recording.

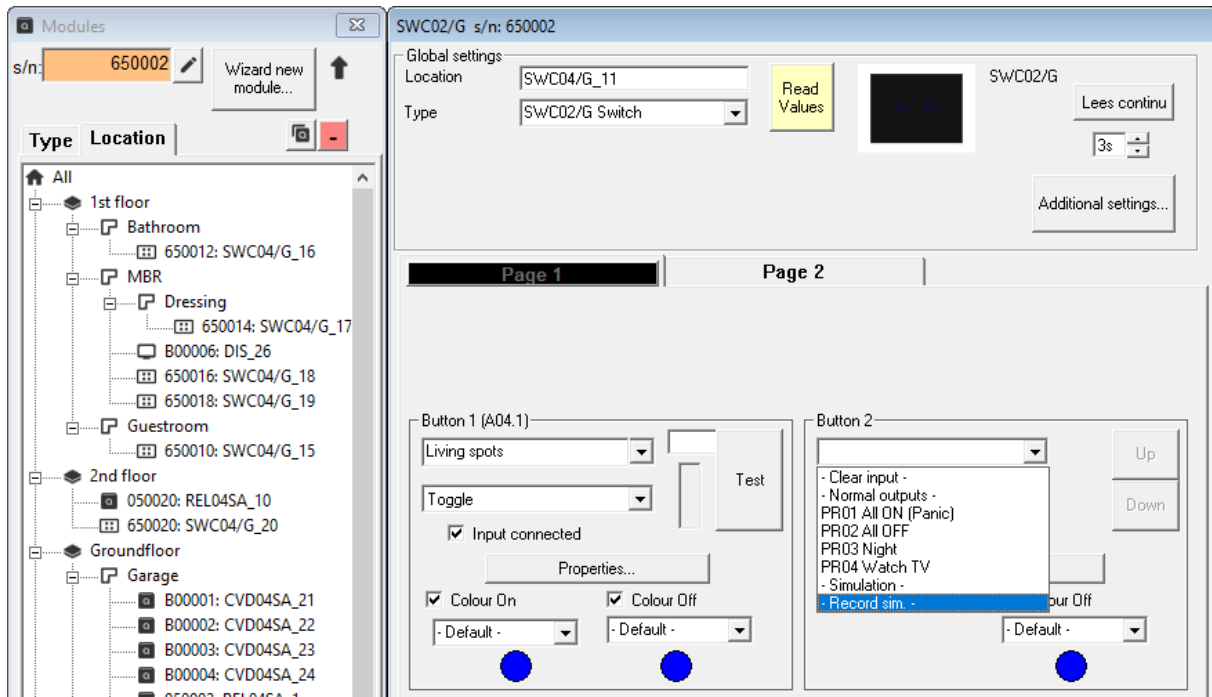

Using a touch screen

You can assign the "Simulation Record" key to the touch screen. In the Outputs list of the control table, you can select Scenes and choose the desired simulation key.

Using the switches connected to the input modules

The "Record Simulation" key can be assigned to the switches connected to the input modules, including INP02, INP04, INP08, INP16, INP08/230. The allocation procedure is the same as that described in 6.5.1.1.

Comments:

- The recording of a simulation starts immediately. The system will continue to record until you stop recording by pressing the button again. If you do not interrupt the recording, the system will continue to record - when the end of the week is reached, the events recorded during this week will be gradually overwritten.
- The system can record at a maximum speed of 1 recording per 4 seconds, and up to 90 recordings per hour. When the recording function is stopped, the system will remember all events up to 1 minute before the recording stops.
- If the recording is stopped, then turned on again during the same hour, the events that were previously recorded during that hour will be erased (activating the recording will erase the events during the hour in which the recording is activated).
- To download the recorded events to your .qdb file, go to the menu item "Edit", "Simulation", and click on the down arrow. As a result, only the recorded events of the indicated weekdays will be downloaded from the controller. ATTENTION: BEFORE DOWNLOADING THE SIMULATION, RECORDING MUST BE STOPPED (Simulation off); THE RECORDED EVENTS WILL NOT BE SAVED ON THE CONTROLLER'S SD CARD WHEN RECORDING HAS STOPPED. If you changed certain events in the simulation list, you can send the modified simulation list to the controller by clicking the red upload arrow.
- Scenes are also fully recorded, but when the Simulation is played back, only those outputs are used in a scene where those outputs were specified to be allowed to be used in simulation.

Step 3: Activate the simulation

You can activate the simulation by clicking the "Simulation" button, which you can assign to a switch or control table as you did for the "Record Sim." button (see above). When you click on "Simulation", the simulation starts playing the next hour (Simulation ON at 1:26 PM, starts simulation at 2:00 PM). The simulation repeats the events on the same day, and the same time in hours, minutes and seconds as the recording. You can check the list of events by day and time by clicking "Edit", "Simulation". In this screen, select the desired day to view the list of recorded events. You can change this list by adding events (click on "Insert line" and then on the output you wish to add). You can view the time in the list of outputs (select an output in the list of simulations and change the time with the clock on the right), and the status of the output (click the up or down arrow to the right of the list of simulations). Since the simulation program records all events per day, you must record an entire week to have a list of events for each day in the simulation program. If you have only recorded one day, the simulation will only be active during that day. However, you can add events to other days by copying days for which you have recorded events (use the button "Copy from .." in the list of simulations).

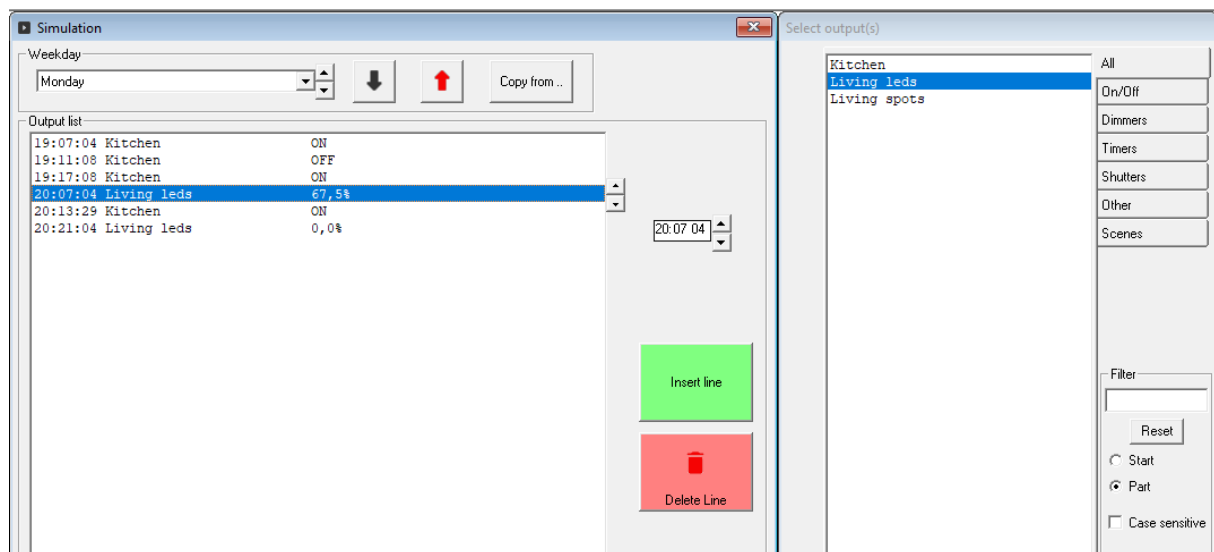

3.6.2 Multi-link

A multilink is a setting where you can control several outputs with one switch. That's not the same as a scene - a scene allows you to set various outputs to a predetermined level. With a multilink you can control various outputs together (e.g. adjust the setting of all dimmers in your living room together; you can only activate them to a certain level with a scene).

Multilinks are generally used to control all dimmers or shutters in a room/building simultaneously. Multilinks are programmed as follows.

Step 1: Select the output that will be controlled (usually Dimmer or Shutter mode) or create a fictitious address, e.g. "AllDimmers" (go to "outputs" in the System Manager and use the Wizard New Output).

Step 2: In the "properties" screen of this output, click the "Yes/No" button next to Multi-Link

You can create a new multilink - e.g. "AllDimmers Multilink", and select from the list on the right all the outputs you want to control with the same button (all the selected dimmers will follow the 1 button control - as if they were on the same circuit. Bistable outputs are switched on if the 'client' is different from 0%).

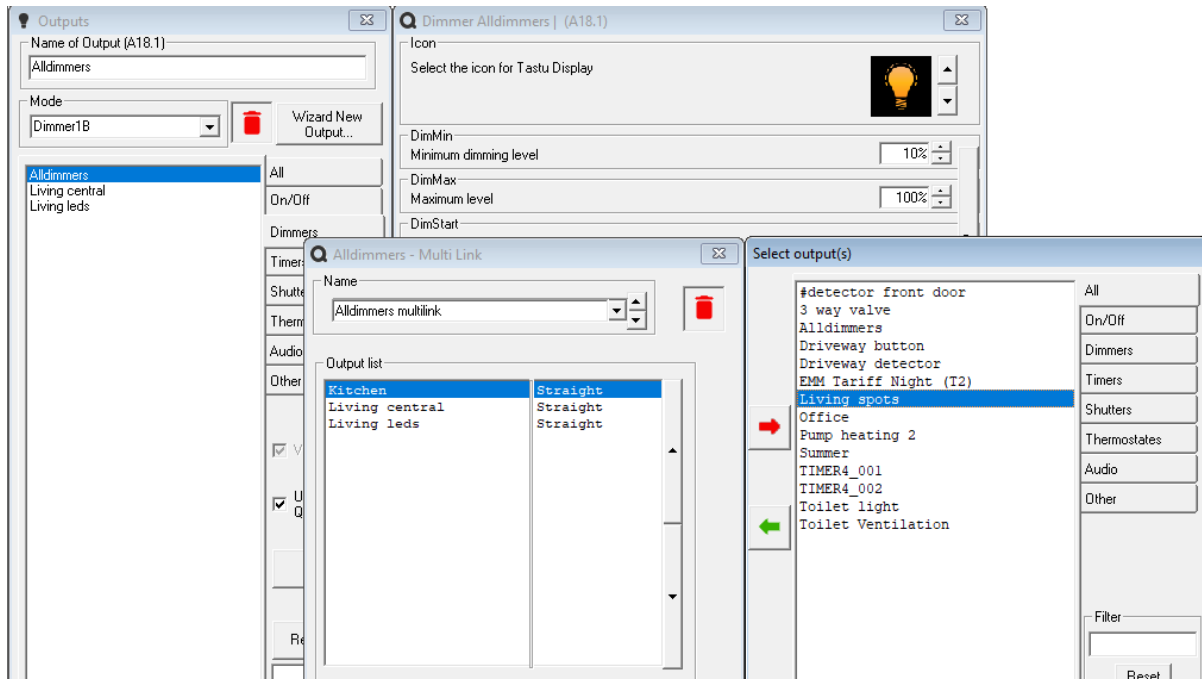

Now you only need to assign the (fictional) output “Alldimmers” to a switch - with the push buttons on that switch you will be able to control all selected outputs simultaneously.

You can also apply a similar procedure for shutters. It can let 'follow' several roller shutters of the same type in the same way.

For shutters with positioning, the control must be assigned to an effective output. You have to take into account that the PERCENTAGE value is linked and shutters that 'follow' and that are longer or shorter can follow for a while or even return!

3.7 Setting time schedules (Clock times or Weekly program)



The Qbus controller has an integrated clock. When you click this button, the following screen appears.

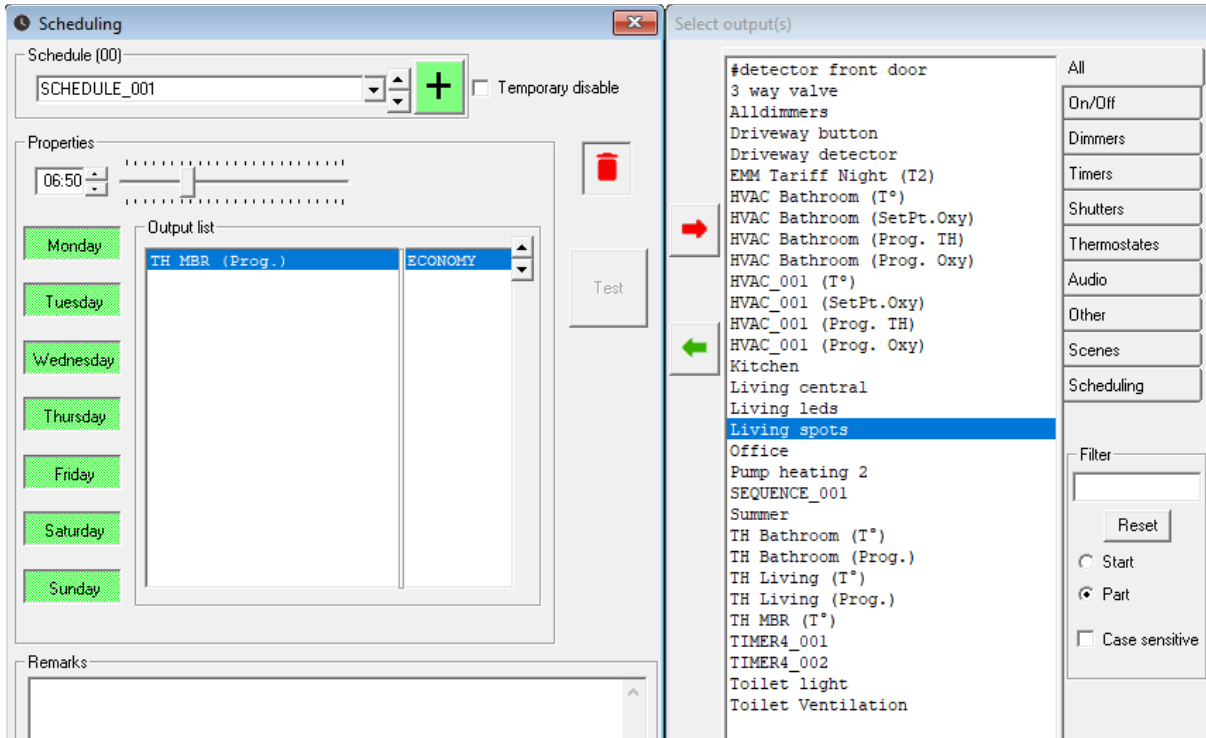

The screen with all outputs reappears on the right.

On the left you can edit (or add) a clock time and set the time and weekdays at which it should be activated. Then move all the outputs you would like to include in the schedule and set the status you

want to give them when this schedule is called, using the arrows . The days of the week in green are the selected days, these are the days on which you want to activate the program during the selected period. If you do not wish to activate the time schedule on certain days, deselect these days.

Remark: Create 2 time schedules – one for switching certain outputs on and the other for switching them off.

You will also find a nice graphic overview under 'SwitchTime' in the properties of an output; This is described in [3.5.11](#)

3.8 Control table selection



The Qbus control tables are essentially lists of outputs that you wish to control with a DIS02, TSC5.8, ViZiR or SMS module. Also, if you want to use the EQOweb web server that is standard on a Controller with Ethernet port, you must create a control table for EQOweb. When selecting a new control table, you must also select which "type" of module you wish to use to establish the connection. The following screen is displayed when you select a control table.

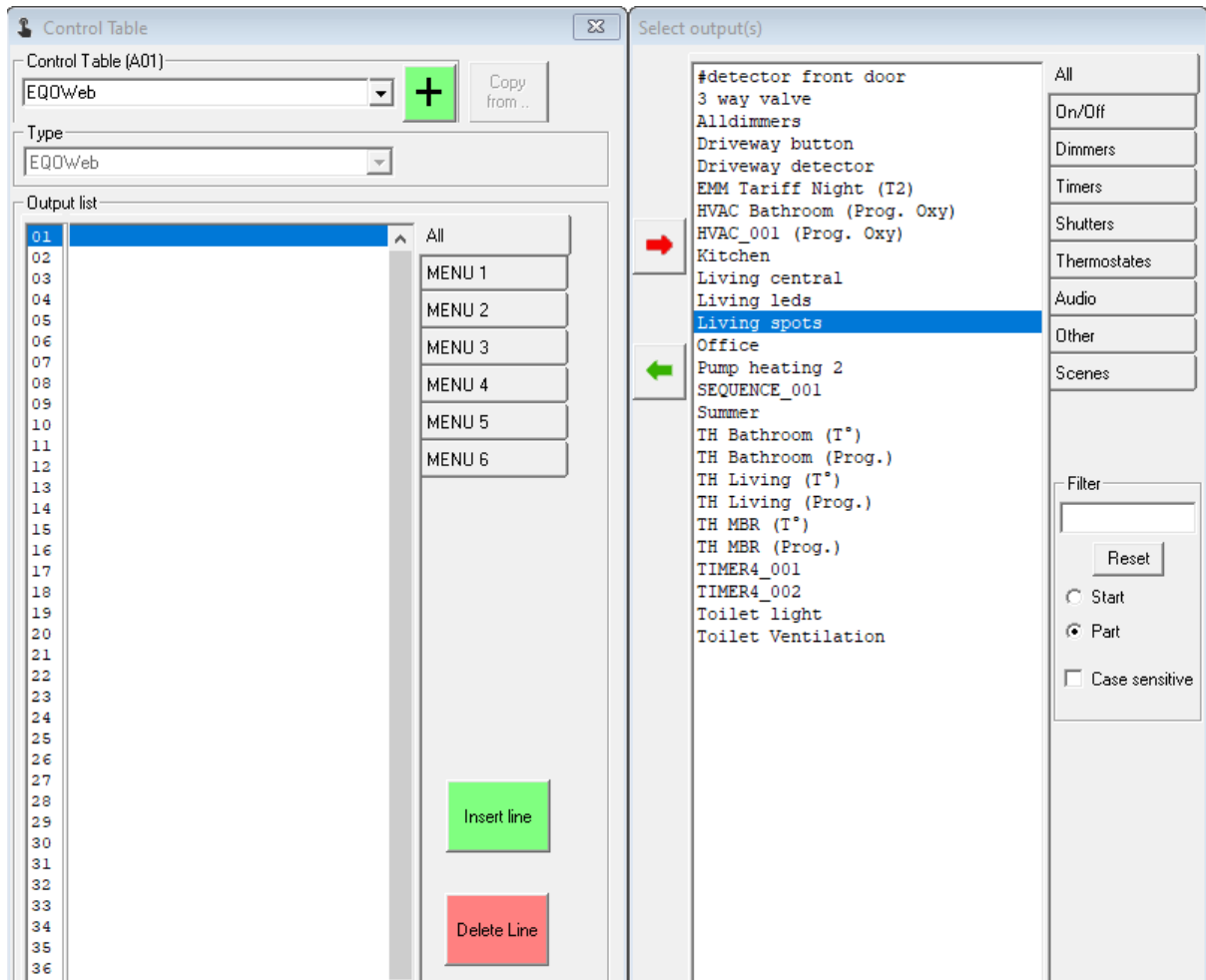

The outputs are displayed on the right side of the screen. The tables are on the left. Table on A01 is usually the first, and should always be used for the EQOweb web server if EQOweb is to be used. You can create up to 6 menus per operating table. Select Menu 1 and double click the menu key so you can change its name. When you have selected menu 1, move the desired outputs to menu 1. Select menu 2, move the desired outputs to menu 2, etc.

With the "insert line" and "delete line" keys you can insert a line between two outputs if you have forgotten outputs or delete what you will not need in the end. "Delete line" does not delete the corresponding output from the program itself, but only from the table or menu.

You also have the option of not using any menus, just the "All" list. When using menus, you must select the menu first and then the output when using the module to which the control table is linked (TSC, DIS02 , SMS). If you only use the "All" list, you can go through all the outputs directly without entering the menus first.

ATTENTION!! The EQOweb web server ONLY sees and serves the table at Address 1 (A01). This will also be marked as Type “Eqoweb” by default – the type cannot be changed here.

The EQOweb web server is NOT available on Ethernet Firmware 6.0.7! This has been replaced by the QbusCloud, UbieCloud or Qbus Control.

The EQOweb is available on each CTD10, CTD40 and CTDmax, even if you are not connected to the internet.

For these CTDs, the EQOweb is accessible via the standard HTTP port 80. For the older controllers, this control is accessible via port 8444. For more info, see point [5.2](#)

You can turn this option on or off via the setup screen. When you click on “Read settings” you can switch the EQOweb on or off in CTD10, CTD40 and CTDmax:

Searching connection:

1) Ethernet (ETH0x)

TCP/IP

IP address or host name for TCP/IP connection:

Port:

User:

Password:

CTD Name:

Default ports on LAN:
EQOweb: 80
SM III: 8445
EQOmand: 8446

EQOweb (poort 80)



2) USB (Not available on CTD10, CTD40 or CTDmax)

3.9 Infrared samples

The infrared functions in the Qbus system can be used in two ways:

- 1) You can control outputs of the Qbus system with one of your remote controls (e.g. press a number on your remote control to turn off all the lights). This is done via Qbus switches with infrared ports (SWC04I/XX or DIS02 IT).
- 2) You can use Qbus to control devices that you usually operate with a remote control (air conditioning, TV, audio,... - e.g. automatically switch on the air conditioning at a temperature higher than 24 °C.). This is done via an infrared transmitter IRG04 (Eol).

In any case, you must first "teach" your Qbus system the infrared codes of your remote control, choose a known type of code from the database or enter an RC5 or Pronto HEX code manually. You can do this by creating infrared samples as described below.

3.9.1 Creating infrared samples

With a SWC04I/XX

Step 1:

If you are using BTicino switches: Press the two upper or lower buttons on the switch simultaneously for about 5 seconds until all the LEDs on the switch are red and not flashing.

If you use Niko switches: simultaneously press the two buttons on the left side or the two buttons on the right side of the switch for about 5 seconds until all LEDs on the switch are red and not flashing.

Step 2:

Press any button on the remote control while pointing the infrared button at the SWC04I/XX. If this is a valid infrared code, the LEDs now turn yellow.

Step 3: Sampling the Codes

While sampling, you need to send the IR-signals for channels 1-12 (in that order) to the switch. On a universal remote control, you must select a "device" button (SAT2, AUX, ...) that you will only use to operate your Qbus system.

You will have to cycle through the 12 channels when sampling, even if you want to use less than 12. After you have sampled the codes, you can assign each code to a particular output (see below).

Press the button on the remote control twice for each channel. The key will henceforth be used to switch the corresponding Qbus output on and off.

e.g. Press "1" – the LEDs will turn blue, press "1" again the LEDs will turn green. Press "2" – the LEDs will turn blue, press "2" again the LEDs will turn green. Continue until you have done this for the twelve channels. When sampling is complete, the switch LEDs will blink for approximately 3 seconds.

Via a DIS02 ITX/XX

Start of sampling

1. Make sure the DIS02 ITX/XX is in channel mode (press IR button).
2. Press the "+" and "-" buttons simultaneously.
3. The display of the DIS02 ITX/XX shows "LEARN IR?". To confirm, press any key on the remote control while pointing the infrared light at the SWC04I/XX.

Procedure for sampling

Follow the instructions on the DIS02 ITX/XX

Explanation of the codes requested by the DIS02 ITX/XX:

- Press the "+" button: this will be the button on your remote that you use to turn on an output
- Press the "-" button: this will be the button on your remote that you use to turn off an output

- Press key “>”: this will be the key on your remote that you use to go to the next output in the DIS02 ITX/XX table
- Press key “<”: this will be the key on your remote that you use to go to the previous output in the DIS02 ITX/XX table
- Press button “M”: this will be the button on your remote control that you use to select the desired menu.
- Press key 0-F: corresponds to numbers 1-16. These buttons on your remote control allow you to select the desired output.

End of sampling.

After sampling the last code (key F) the bottom line of your DIS02 ITX/XX will be filled with asterisks. This indicates the end of the sampling procedure.

3.9.2 Assign outputs to the sampled infrared codes.

With a SWC04/XX

When you select the infrared switch in the Modules menu of the System Manager, go to the IR page. On this page you will see 12 IR fields. In these fields you can also select which output you want to activate with the concerned IR code. The first 4 automatically contain the 4 outputs or scenes from page one of the IR switch. You can select outputs 5-12.

Now you need to match the outputs or scenes to the corresponding IR codes of the remote you want to use. You have already entered the 12 infrared codes into the Qbus system by following the steps described above. On the IR page, click the down arrow to download the samples already entered (see screenshot below).

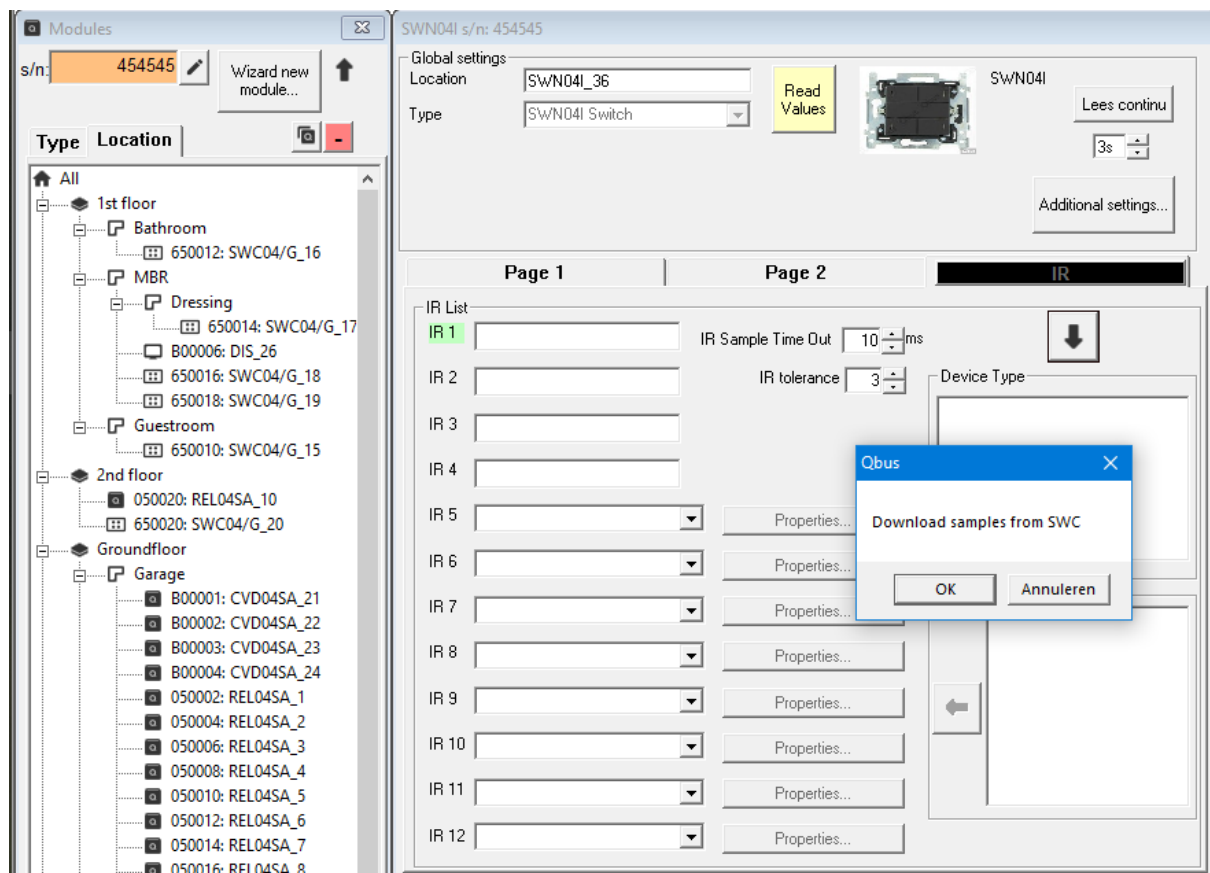

You will see the date and time of the samples created. When you click on that date and time, you will see the 12 samples each appear individually in the "Sample" box on the IR page. By double clicking on a sample, you assign it to the output in the IR list marked green.

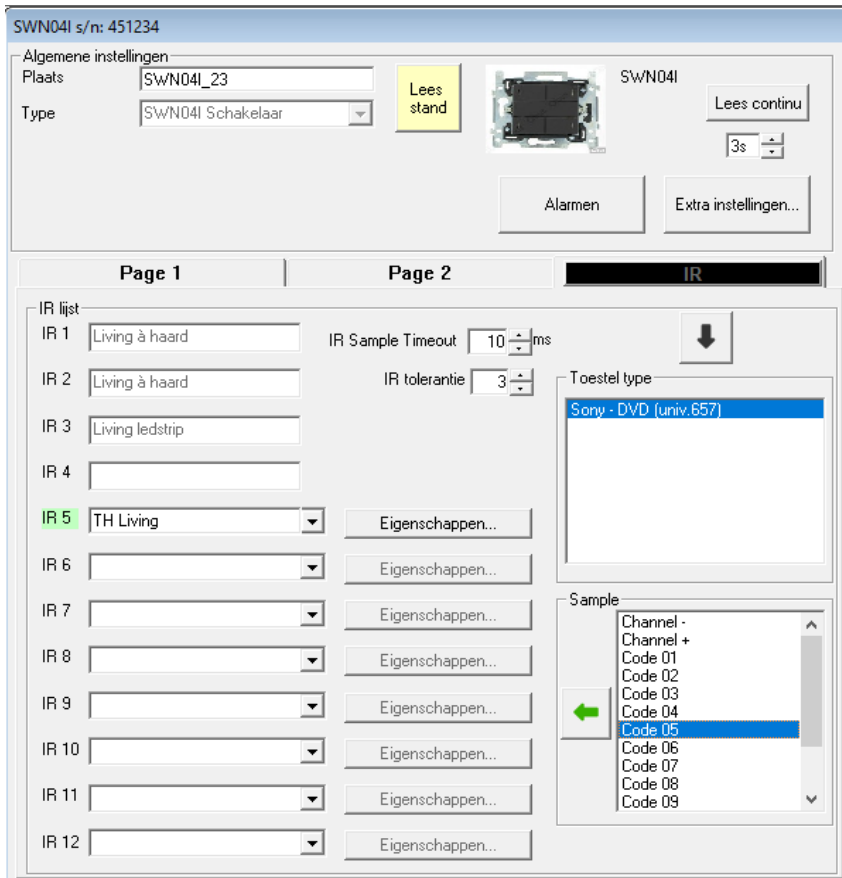

Send these new settings to the controller. You can now operate your Qbus system with your remote control.

Remark: You can name each sample (e.g. 1, 2, 3, ... FFW, Back, ...) and the range of samples by going to the Samples menu in the System Manager. If you downloaded the samples by clicking the arrow on the IR page of your IR switch as explained above, you will find the sample range "Other" in the Samples menu. Brand, Type and Sample names can be edited here.

Via a DIS02 ITX/XX

To link IR samples to outputs via a DIS02 IT module, you must first create a control table (see [section 3.8](#)). Make sure to add all the outputs you want to control with your remote to this control table; the maximum number of outputs that you can control directly via a DIS02 IT with your remote control is 16. When you work via menus, you can control ten channels per menu ('M' key + number 0-9).

On the screen of the DIS02 module, you need to select the control table that you want to associate with the DIS02.

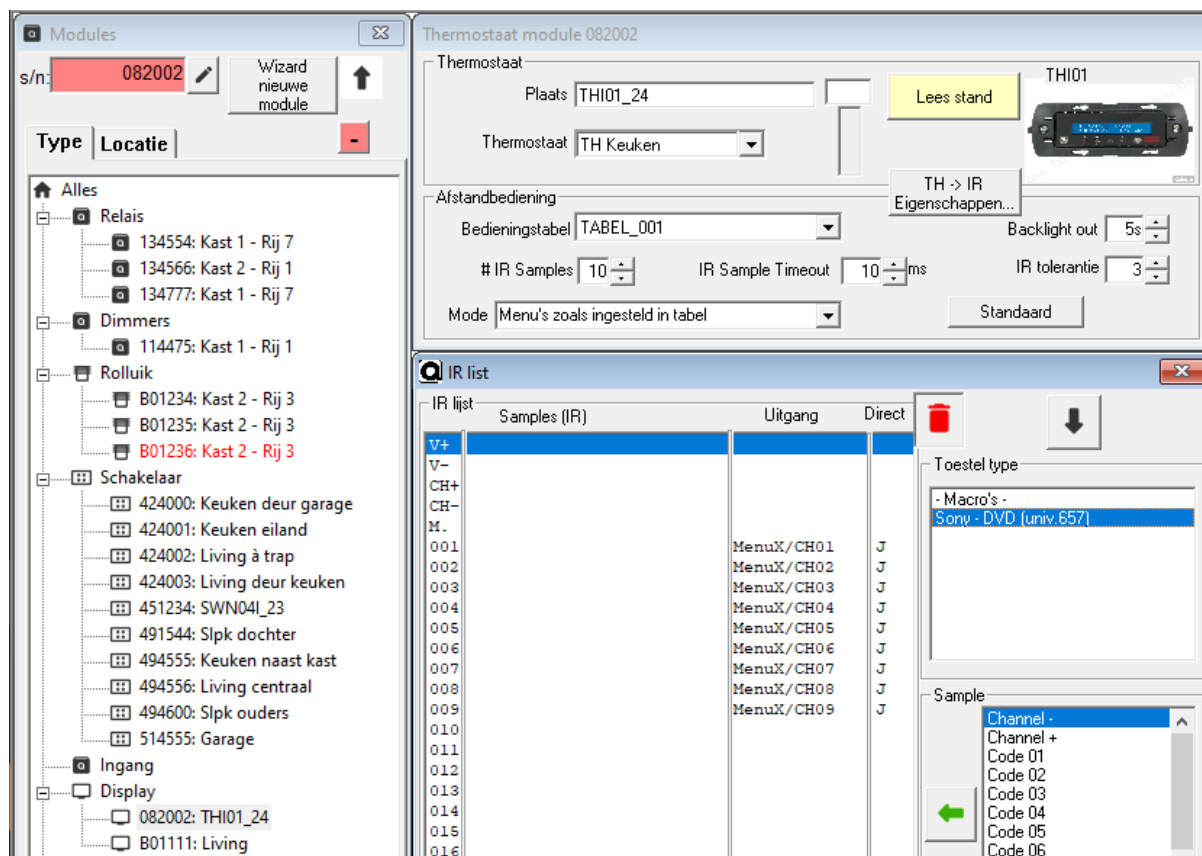

In the "mode" field you can choose how you want to operate your DIS02:

- "Menus as set in table": you can first choose between 10 menus, then between 10 outputs that you can place in each menu
- "No menus max 16 channels": you can assign 16 outputs directly to 16 channels on your remotes, and switch between all further, not directly linked outputs using the up/down arrow keys on your remote.

By clicking the down arrow, you can download the IR samples you entered on the DIS02 as we described earlier in this section". When you download this list, you will see the date and time you samples; when you click on this date and time in the Device Type Menu, you will be presented with the list of samples in the "Sample" screen shown below.

Then you need to assign each sample to the IR list on the left (highlight the function in the IR list to which you want to assign the sample and double click on the corresponding sample). Keep the following in mind:

- "V+": this will be the button on your remote control that you use to turn on an output
- "V-": This will be the button on your remote that you use to turn off an output
- "CH+": this will be the key on your remote that you use to go to the next output in the DIS02 ITX/XX table
- "CH-": this will be the key on your remote that you use to go to the next output in the DIS02 ITX/XX table
- "R" or "M": This will be the button on your remote control that you use to select the desired menu.

When you have assigned all samples to the IR list and you chose the option "No menus", then you have to assign the desired channels to the samples.

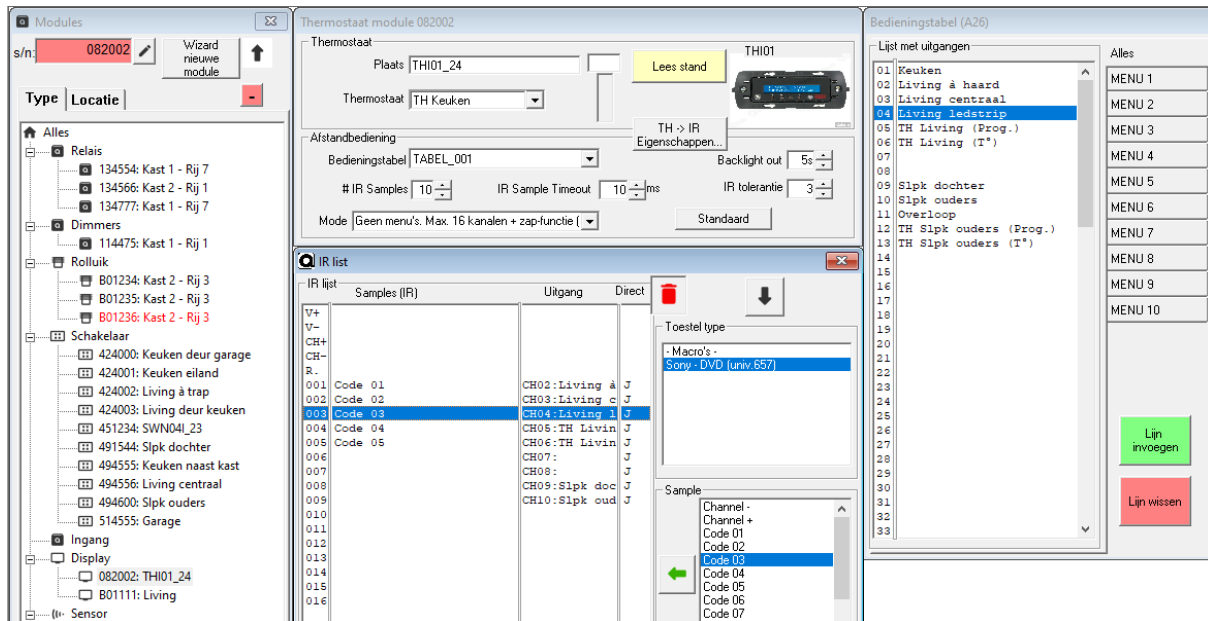

3.9.3 Sending infrared code via the IRG04

When you are in the programming screen of an IRG, select “Universal IR TX”. You can select how many ports of the IRG04 you will use (e.g. use 1 port to send 64 codes, 2 ports to send 32 codes or 4 ports to send 16 codes each). Then you must create a new address per module - an IR list will appear corresponding to the number of ports you have selected and that you will use (if 4 ports are selected, you will receive an IR list with four times 16 codes - page 1/01 to page 4/15).

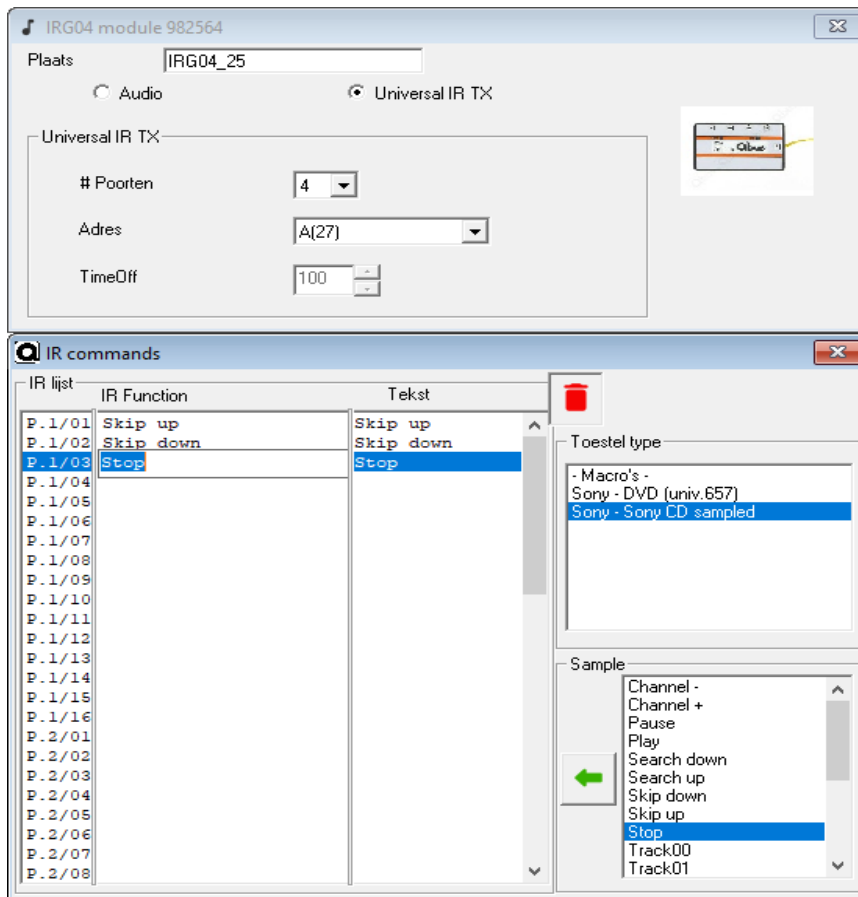

Then select the type of device you want to control (you must first sample the infrared codes to be used in the Qbus system according to the instructions in "Sampling IR codes"), and double click on the samples to assign them to a specific port and code. to link. You can enter a name in the IR function.

Now if you want to send these infrared ports through a Qbus input device, you will find these assigned IR codes at the Scenes or Clock Times button in the System Manager - under "Others" in the output selection screen. To associate these IR codes to a button on a switch or to a control table or a touch screen, you must first create a scene, select the corresponding code (play CD, next, volume up, ...), and in turn link the required scene to a switch or control table.

3.10 Creating Logical Functions



You can create logic functions in the System Manager by clicking the icon shown above in the taskbar. Before you can create logic functions, you must have available outputs.

When you click on the “+” button next to the “Group” drop-down box, you can create a new logic group and enter the desired name.

When you click the “+” button next to the “Name” drop-down box, you will see a pop-up asking if you want to create binary or analog logic.

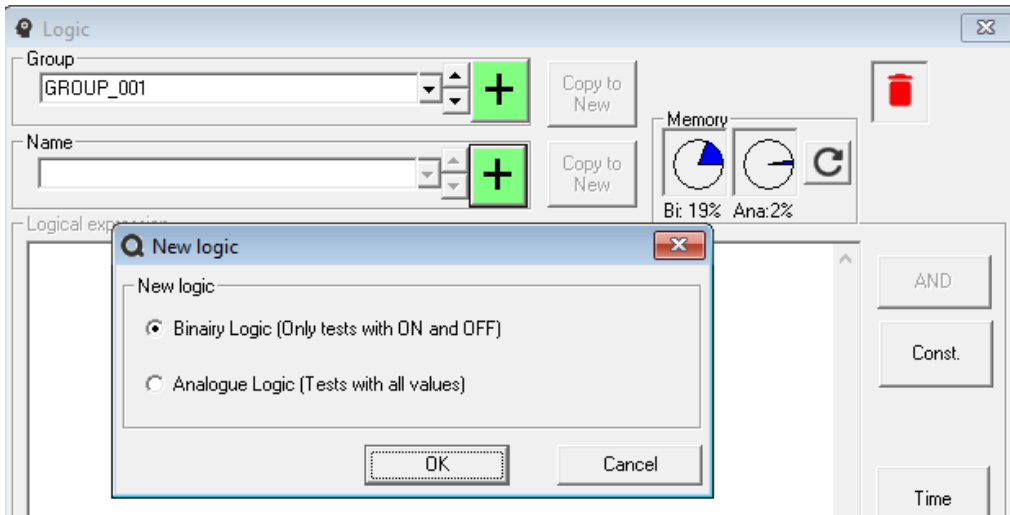

3.10.1 Binary Logic (If – Then – Else with ON/OFF)

Automatically an "if - then - else" logic will appear at random with a few outputs you have created.

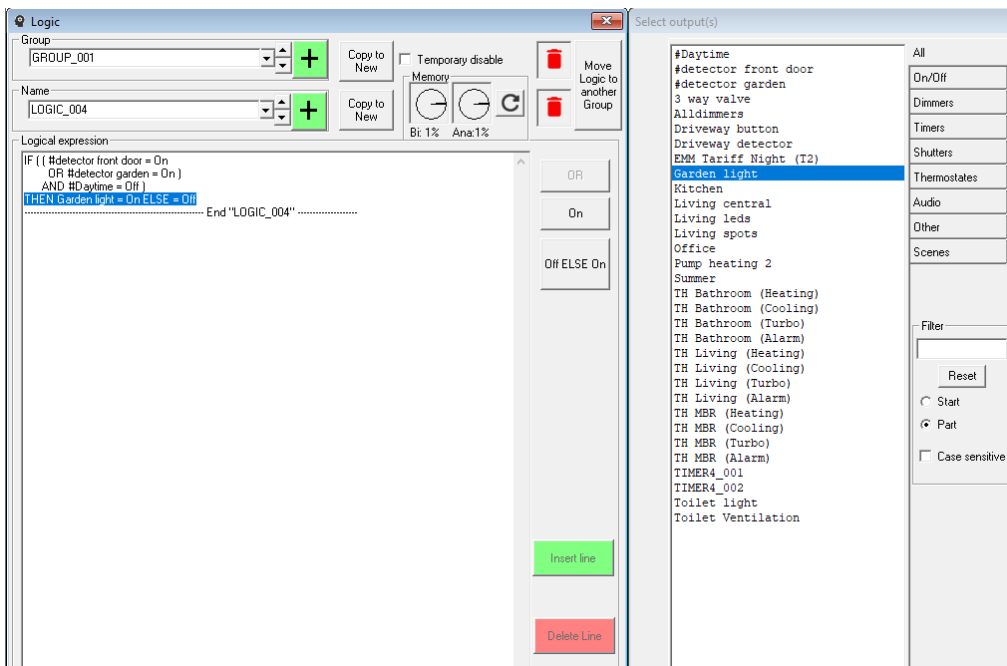

Double-clicking on the list of outputs, overwrites the output concerned in the highlighted line in the field of the logic expression. You can add or delete lines by clicking the "Insert line" & "Delete line"-button. You can switch the logic between AND and OR conditions by clicking the AND/OR button when the AND/OR line to be changed is highlighted. Every time you change from AND to OR (or vice versa), parentheses will be added automatically. The position of the brackets cannot be changed. Outputs that are at the end of a logical expression will therefore have the most influence on the result. You can also change the desired status of the selected output by clicking the On/Off button.

Remark

If you have a long list of outputs, you can use the "Filter" field in the list of outputs. Placing a name in the filter will only show you outputs that start with that name (if you marked the "Start"-option) or that have the letters involved in their names (if you marked the "Part"-key). You can also choose whether or not the word in the filter is case sensitive.

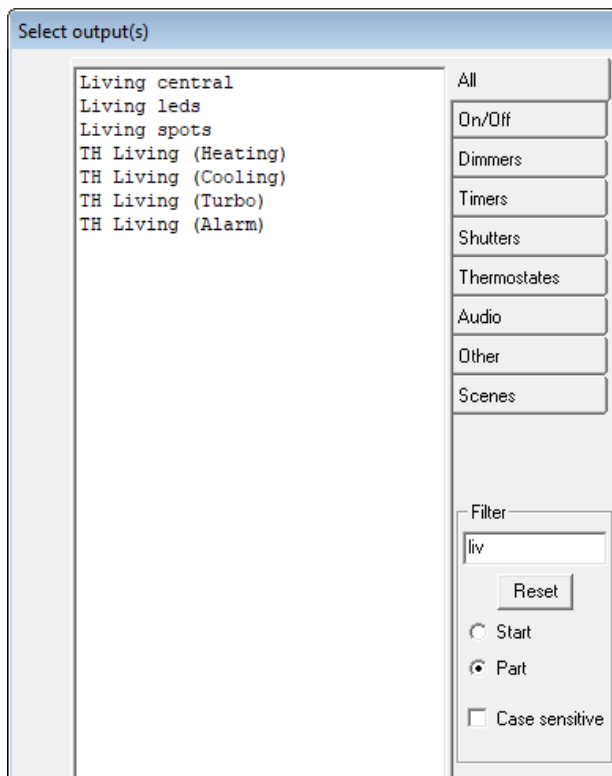

3.10.2 Analogue Logic (If – Then – Else with all values and operations x,/,+,-,<,>=)

Analog logic allows you to activate outputs based on the status of another output, more than one other output, a calculation that uses outputs as parameters or is based on time. For example, it might only be possible to switch on the heating in one room if, between two times (e.g. 7:00 AM and 9:00 AM), the temperature in another room is < or = X degrees.

By pressing the "+" key next to the drop-down window in the Logic module, you can select the creation of analog logic. You will automatically get an IF - THEN - ELSE logic, with certain outputs already created.

Remark: To create logic functions, outputs must first be created.

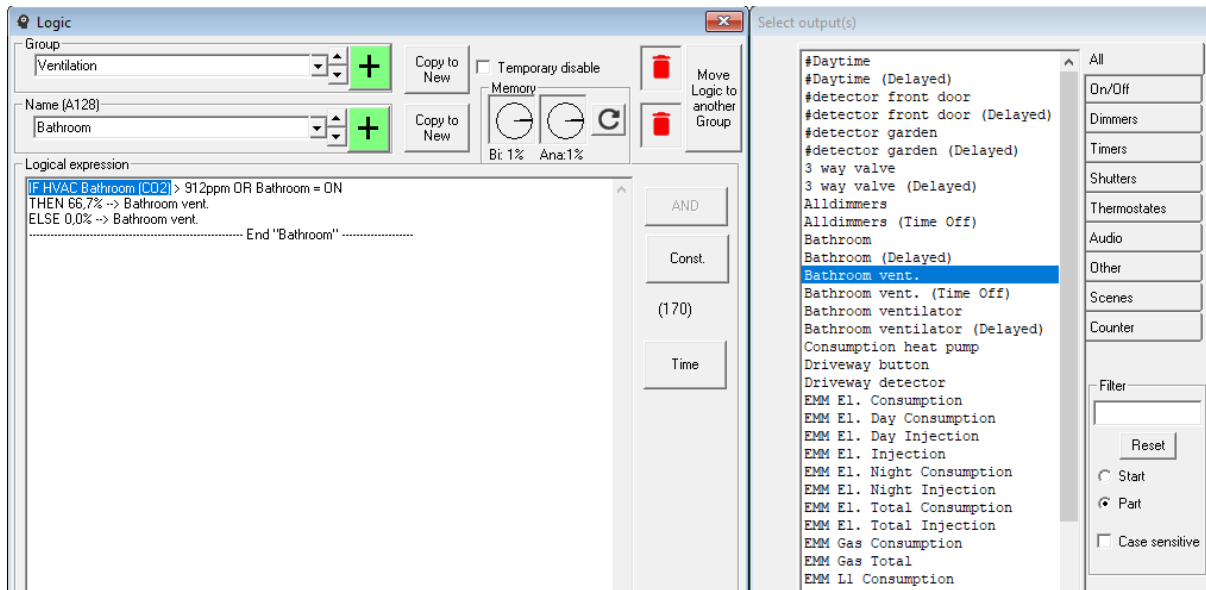

Select outputs

To use different outputs in the logic expressions, first click on the output in the logic you want to change, then double click on the desired output in the list of Outputs on the right.

Select the calculation

When you highlight the characters (<, >, =) in the logical expression, you can change them by clicking the desired character to the right of the logical expression window. You can change the value by pressing the up or down arrow on the right side of the logical expression box. By highlighting a calculation (x, /, +, -) in the logical expression, you can change it by selecting the desired calculation on the right side of the window.

Remark: use "> 0" in the logic expression to indicate that an output must be ON. If the output must be OFF, use "= 0".

The conditions change

AND/OR conditions can be changed by highlighting the AND/OR condition in the logical expression and clicking the inverse on the right. AND/OR conditions can also be deleted by clicking "Delete Line", and you can add conditions by clicking the "Insert AND/OR" button.

Any condition can also be used as a parameter in a calculation; highlight the output you want to use in the calculation and click the "Insert Edit" button.

Using the clock

Highlight an output in the logic expression, then click the "Time" button.

Highlight the value next to the clock, and select a combination of month/day/weekday/hours/minutes or any of these elements alone. In this way, an output can be activated at a specific time.

Example: Switching configuration files between summer and winter

As mentioned earlier in this document (2.4.2.3 SD banks), different configuration files (.qdb files) can be downloaded on different SD banks in the controller. Analog logic can be used to automatically switch between .qdb files based on time. For example, if you have a winter.qdb file (with heating controlled by clock times) and a summer.qdb file (without heating), you can automatically switch between winter and summer. Click on "Other" in the list of outputs to be able to select SD banks.

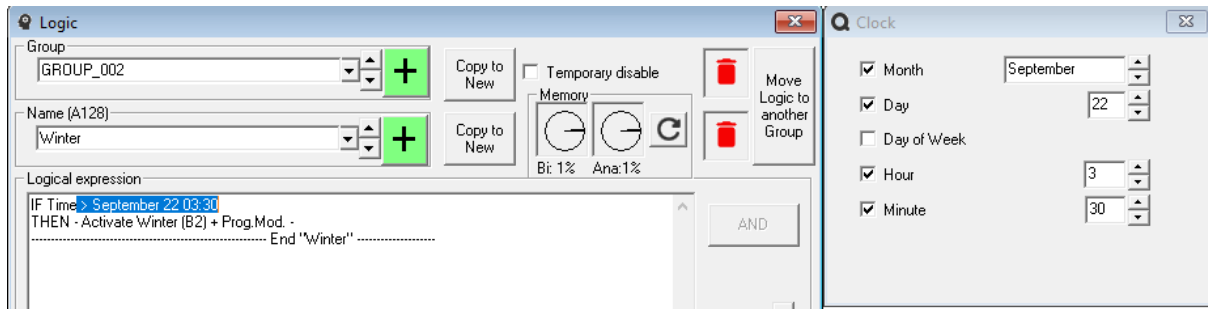

How does Qbus analogue logic work?

Syntax:

In contrast to binary logic, you first determine the value that you will send as a result to one or more outputs.

It is important to know that the calculation of the Qbus logic does NOT follow standard mathematical rules.

- In Qbus logic, all operations are calculated from left to right and everything is calculated immediately before moving on to the next operation. For example:

$1+1 \times 0$ is executed in Qbus from left to right, or $1+1 = 2$, $2 \times 0 = 0$ (mathematically, the multiplication is normally worked out first, before the addition, so that according to the mathematical operation the result would be: $1+ (1 \times 0) = 1+0 = 1$).
- Qbus logic counts within a range of 0 to 65535. But the result of any operation can never be more than 255 and never less than 0. For example:

$255+255=255$
 $255+255/4=127$
 $0-255=0$

In combination with the calculation that is done from left to right, and that every operation computed first before continuing, we get the following: $255+255/4 = (255+255)/4 = 510/4=127$.
- If one logical operation contains both analog operations (% , volts, ...) and "binary" operations (ON/OFF, UP/DOWN), then all analog operations must be listed first followed by the binary operations. E.g.:

IF $0 < 1$
 THEN analog value 1 --> analog value 2
 THEN analog value 3 --> analog value 4
 THEN analog value 5 --> binary output 1

Addition and subtraction

An output that is ON is also represented as 255. In analog logic this means that adding up two outputs that are both ON ($ON+ON = ON$) can also be shown as follows: $255+255=255$.

Multiply

Since Qbus counts between 0 and 255, all percentage values are also reduced compared to 255. A dimmer that lights up 5% is shown in the Qbus protocol as 5% of $255 = 13$ (rounded). If percentages are then multiplied, a different result is obtained than the mathematically calculated result. E.g. $5\% \times 5\%$: is first converted relative to 255 (so $13 \times 13 = 169$), and then this result is again displayed relative to 255 in percent ($169/255 = 66.3\%$).

TIP: If you wish to multiply by an analog variable equal to 1, use 0.4% to multiply (0.4% of $255 = 1$). For example, $Light\ 80\% \times Presence\ 0.4\% = 80\%$.

Also when multiplying, a value can never be less than 0 and never be more than 255. So if you multiply with an ON/OFF output, the result is always 0 (=OFF) or 255 (=ON). E.g.: Light 80% x presence ON (=255) = 100%. Light 80% x presence OFF (=0) = 0%.

The analog logic internally calculates all intermediate operations on 16 bits (0-65535) but the result is always a byte (0-255)

Depending on the mode, this is displayed correctly (dimmer 0-100%, TH 0-63.5°C +/- offset, ...)

When using universal outputs in analog logic, the values are multiplied by a fixed factor (5). This gives a range of more than 10 bits.

A maximum value up to 1275 (255 x 5) can thus be tested. In the following example, where the multiplier is set to 0.01, a power can be tested up to a maximum of 12.75 kW

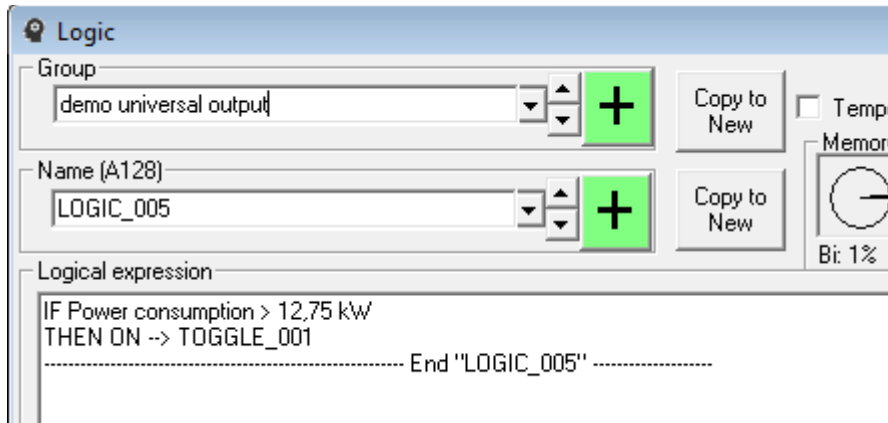

3.11 Choosing an alarm



Qbus gives you the option to receive alerts when certain situations occur. This can be done with the Alarm function. The type of warning can be virtual, e.g. by lighting up one or more LEDs, or written, in the form of a text message on a mobile phone.

When you select the Alarm menu of the program, the following screen will be displayed.

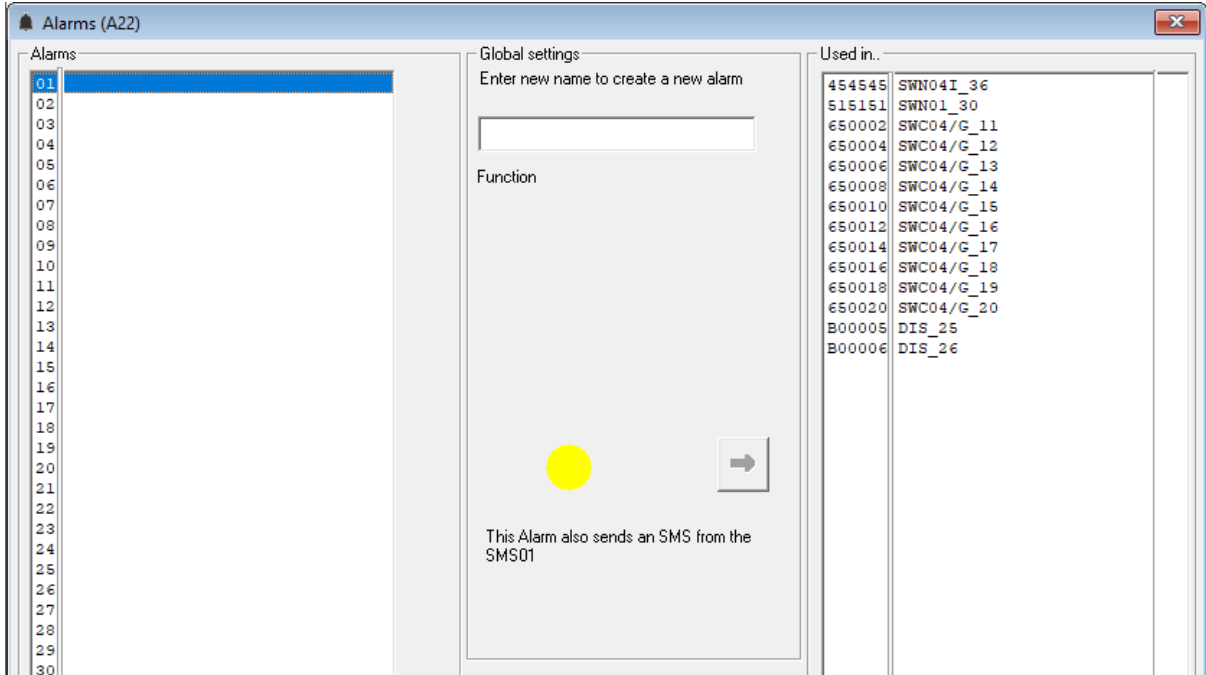

Giving a name to an alarm is essentially creating a new alarm. The screen above then takes the following form.

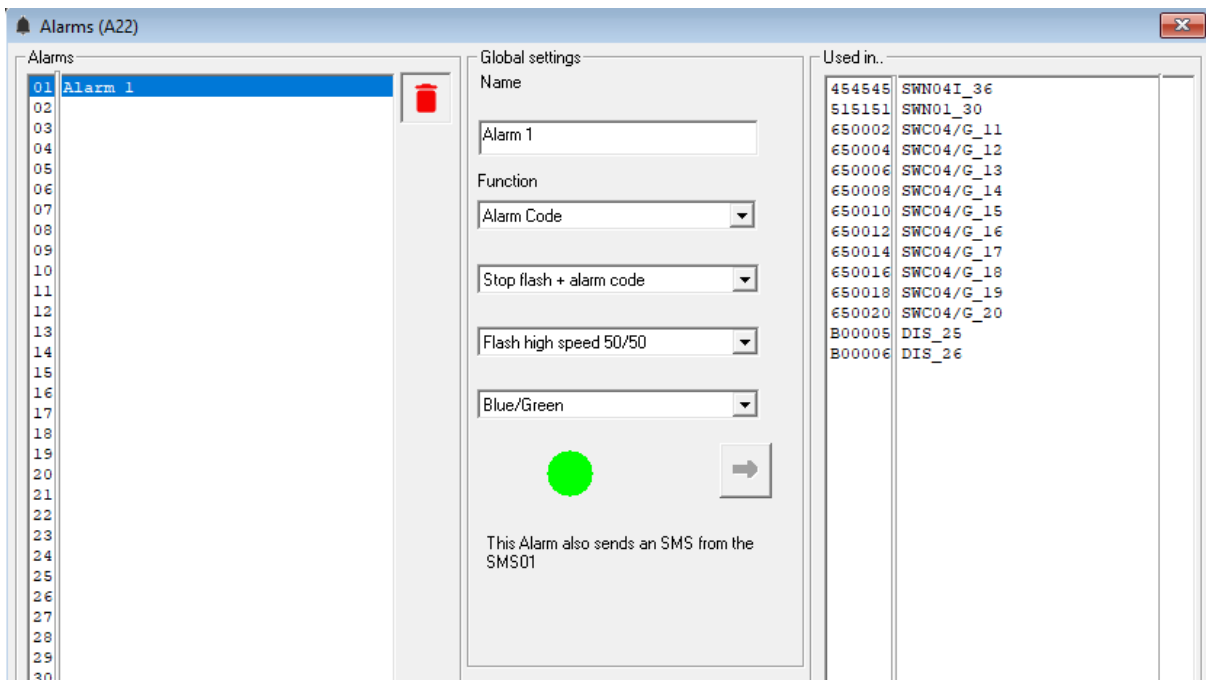

The selection used under the name is usually the one shown in the screen above.

An overview of the options depending on the priority:

Alarm code: (e.g. burglary)

It has the highest priority and will be displayed to the desired switches, regardless of their color setting, lock LEDs or pushbuttons. Flash LEDs with an adjustable rhythm and color pattern.

Blocking keys possible on one or more SWC's.

Unlock all SWC's by pressing key on unblocked SWC('s), via touch screen, logic, or PC.

The ratio of the flashing on/off can be set in the following ratios:

	Color 1	Color 2 (or off)
Slow 50/50	1.5s	1.5s
Slow 20/80	250ms	1.5s
Fast 50/50	120ms	120ms
Fast 80/20	300ms	60ms

Activating an external output: (e.g. door opener, mute audio, open garage door, etc.)

With certain actions, e.g. doorbell rings, garage door is open, heating is on with open windows, this 'alarm' can be shown to one or more SWCs in the form of flashing the LEDs. When pressing any key, one can control an output (e.g. door opener) regardless of the programming of that switch. When the button is released, the switch returns to its original functions.

Other switches, with the same alarm code, will also stop flashing.

Up to 4 arbitrary outputs (or scenes) can be defined per SWC.

ATTENTION!

Please use a timer with a short reload (e.g. max. 2s) as an external output or only use scenes without delay! A pulse is given that simulates this input. For example, if the timer1 is still on, it will be turned off when the alarm stops!

LED intensity reduction:

When going to sleep or leaving a house, it may be desirable that all switches go into a standby mode: pressing a scene, (e.g. "All lights off") can also cause some or all switches to turn off their LEDs. (small power saving up to about 5W).

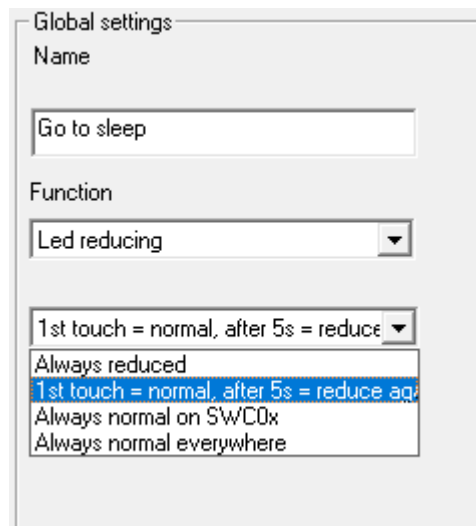

With the first options, the LEDs remain off.

With the second option, the LEDs will return to their normal functions after a pulse on one of the push buttons and the LEDs are reduced again if there is no action on that switch for 5 seconds.

With the third option, the LEDs on that switch will revert to their normal color settings.

The fourth option will stop this alarm and turn the LEDs on ALL switches, where this alarm is still active, will return to their normal color settings.

The latter also applies when this alarm is stopped via logic, scene or clock time

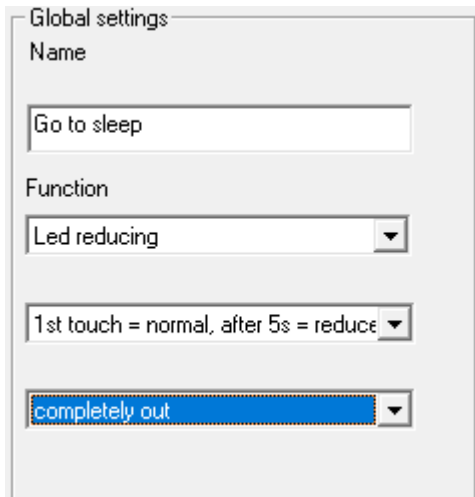

You can choose between LEDs completely off (both on and off status) or a value of 15 for the on position and 4 for the off position. These are values compared to the maximum color setting of 200

Change LED colors:

Would you like a different color on your switches without using a PC?

An evening with friends and create a different scene?

Simple: a single button on a selected switch can display different colors to all designated switches: red on/greenoff or blue on/purple off...

The composition of these 7 basic colors can be set via the SETUP screen – SWC Colours.

If you select one switch or multiple switches (via CTRL or SHIFT) in the list on the right hand side and then press the green arrow, you can transfer the selected alarm setting to the selected switches.

These settings can still be changed per switch. E.g. a useful example is to block all inputs. The alarm can then be modified in one switch to raise the alarm...

Go to modules, choose the desired switch and click on the Alarms button and adjust the desired setting. The alarm is therefore performed wherever it is set.

But the settings can have a different function per switch. In the list 'Used in...' one can see if the alarm has the general setting (=) or it has a custom setting (<>) or if the alarm is not set to that switch (blank)

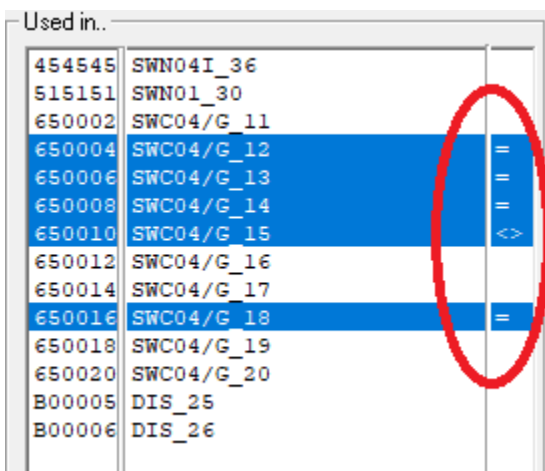

A maximum of 8 alarms and 4 external outputs can be set per switch. By double clicking on an alarm it will be added or removed. Also selecting in group and clicking on the arrows is possible.

The alarm activation setting is made by means of logic functions. By logic functions we mean that when one or more events occur, the corresponding alarm will be triggered.

Setting the alarm for SMS, where the user also receives a warning in the form of a text message, is done as follows. Go to the SMS module via the "modules" option in the program's taskbar and choose the alarms tab; the following screen is displayed.

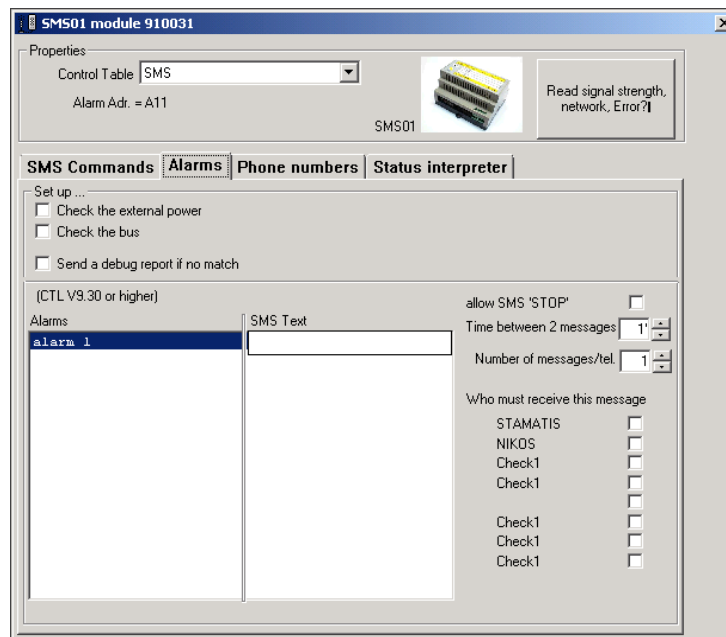

In the screen above, enter the SMS text, e.g. the text that will be sent to your mobile phone. In the right part of the screen, choose the phones for the people who should receive the notification of this particular alarm. If you create a second alarm, you will need to re-select the phone numbers of the people who should receive the message, as it may not be necessary for everyone to receive all alarms.

The options above the names allow you to set the repeat time if the alarm is not initially detected.

3.12 Grid editor (Global editing)



Global editing makes it possible to change the properties of all selected outputs simultaneously with the same action; this can range from setting the reload delay to turning the events on or off. Click on the shortcut or go to Edit – Grid editor. The following window will then be displayed:

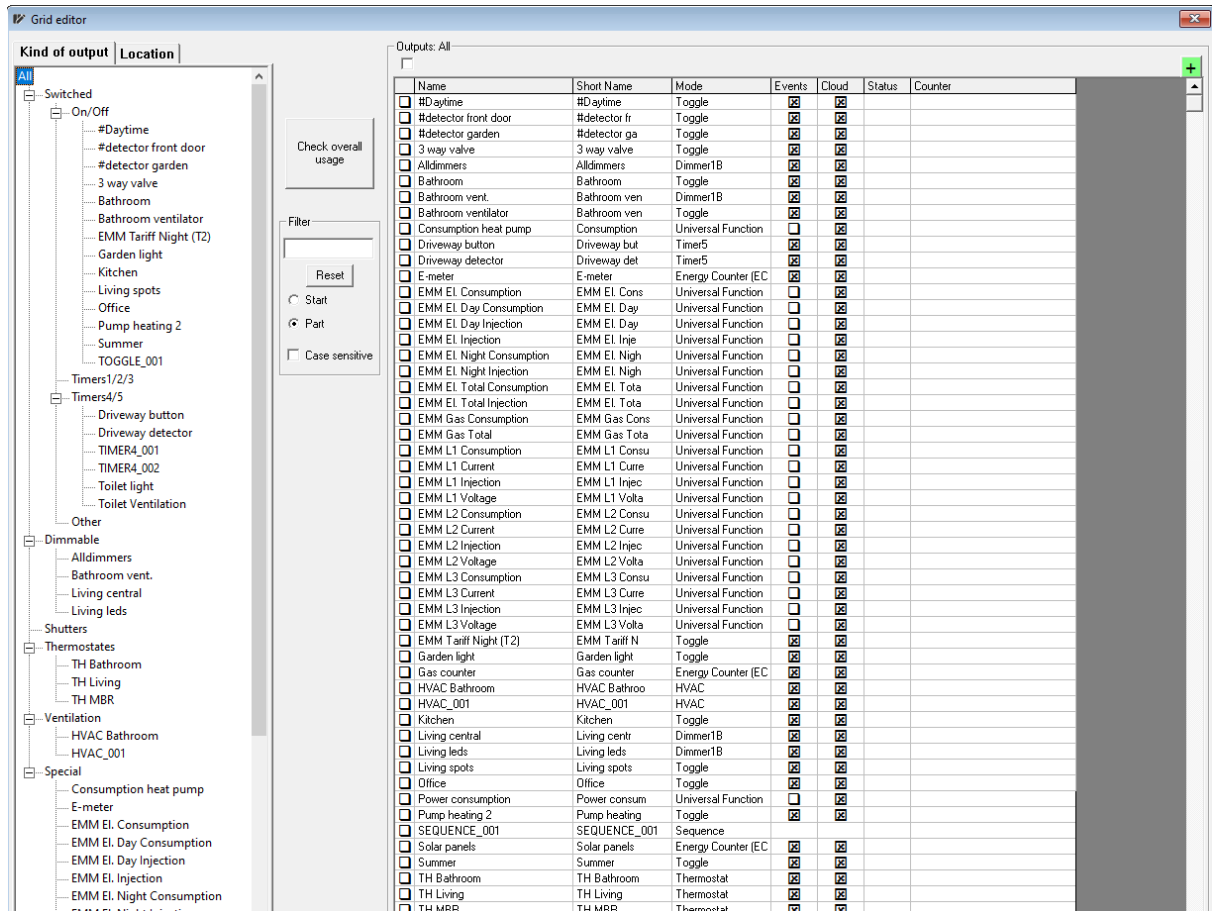

In the left column at “Kind of output” all outputs are displayed per kind, more specifically switched (bistable and timer functions), dimmers, shutters, thermostats, ventilation and other outputs.

The second tab is the tab “Location”. Locations and rooms can be added here by means of the  buttons at the top of the list. By clicking on an output or location, they can also be dragged to another location.

In this way it is possible to assign all outputs of an installation to their respective location, and to organize these spaces via a tree structure. It is perfectly possible to build an installation from this global edit screen.

By clicking on a group of outputs of the same type, the main screen will display all these outputs and their common properties.

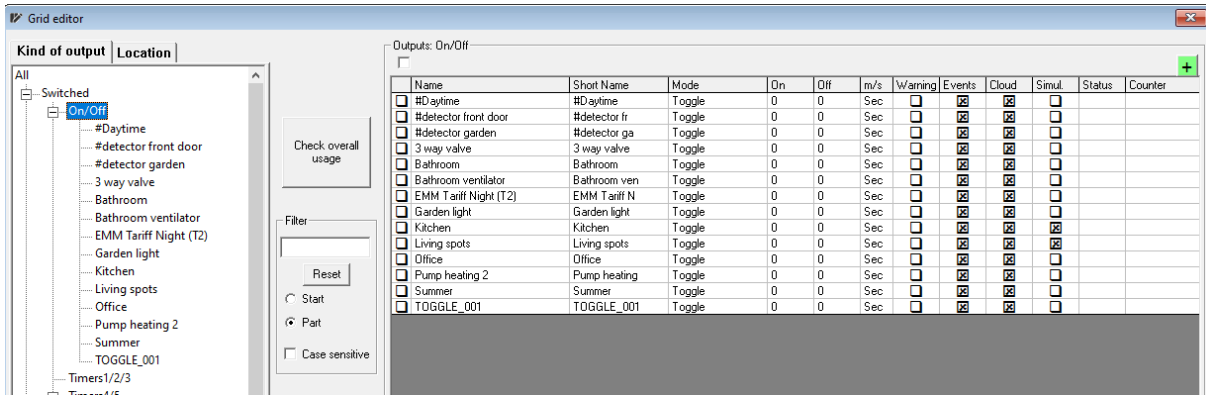

If you now want to change the switch-on delay of a few outputs, you can do this one by one or you can select and adjust the relevant outputs as explained and illustrated below:
 Step 1: Select the outputs to be changed (bathroom, kitchen, office)
 Step 2: Click on the “Overall edit” button, this button will now turn red.
 Step 3: Now change the relevant parameters at the top of the gray title bar.

Note: if several outputs are changed at the same time, this change will be carried out immediately. It is not possible to go back to the previous setting.

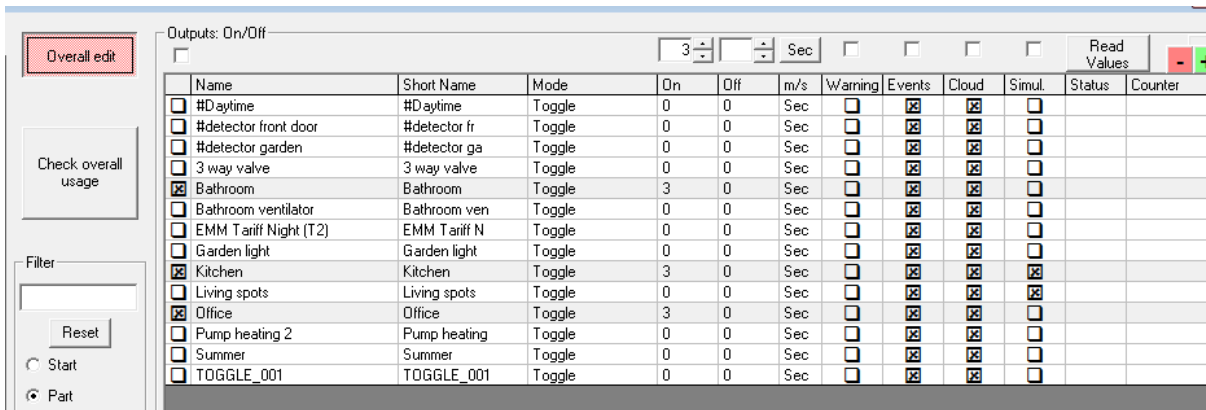

If you want to change all outputs displayed in the main screen at the same time, the check box under “Outputs: On/Off” in the gray title bar must be checked.

By clicking on the “Read values” button located in the top right corner, the status of all outputs in the main screen can be read. In the column “Counter” the number of hours that each output has been active, is shown.

Note: all outputs must be reset before using the counter. A complete reset of all outputs in the main screen can be done by clicking the Reset button in the gray title bar. More about counters can be found in the manual “Measuring (energy) via Qbus” on the Qbus website.

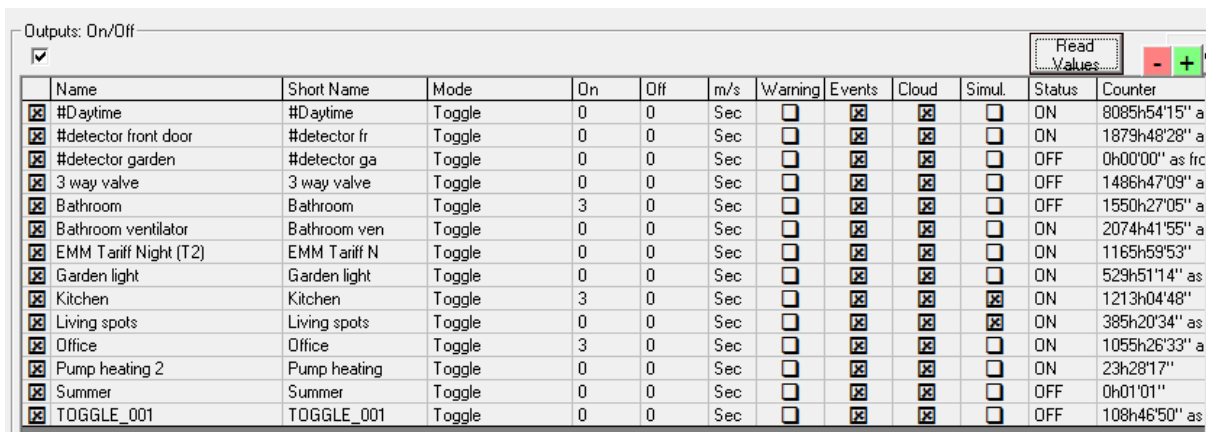

Below you will find an overview of the options that can be adjusted for each type of output

Bistable output

Uitgangen: Aan/Uit	Naam	Korte naam	Mode	Vertraging aan	Vertraging uit	Tijdseenheid van vertraging	Waarschuwing op display	Events aan/uit	Opname in simulatielijst	Status van de uitgang	Bedrijfsurenteller
<input type="checkbox"/>	Badkamer	Badkamer	Bistabiel	1	0	Sec	<input type="checkbox"/>	<input checked="" type="checkbox"/>	<input type="checkbox"/>		
<input type="checkbox"/>	Berging	Berging	Bistabiel	3	0	Sec	<input type="checkbox"/>	<input checked="" type="checkbox"/>	<input type="checkbox"/>		
<input type="checkbox"/>	Garage	Garage	Bistabiel	0	0	Sec	<input type="checkbox"/>	<input checked="" type="checkbox"/>	<input type="checkbox"/>		
<input type="checkbox"/>	Inkom	Inkom	Bistabiel	0	0	Sec	<input type="checkbox"/>	<input checked="" type="checkbox"/>	<input type="checkbox"/>		
<input type="checkbox"/>	Keuken	Keuken	Bistabiel	3	0	Sec	<input type="checkbox"/>	<input checked="" type="checkbox"/>	<input type="checkbox"/>		
<input type="checkbox"/>	Living	Living	Bistabiel	0	0	Sec	<input type="checkbox"/>	<input checked="" type="checkbox"/>	<input type="checkbox"/>		
<input type="checkbox"/>	Oprit	Oprit	Bistabiel	0	0	Sec	<input type="checkbox"/>	<input checked="" type="checkbox"/>	<input type="checkbox"/>		
<input type="checkbox"/>	Toilet	Toilet	Bistabiel	3	0	Sec	<input type="checkbox"/>	<input checked="" type="checkbox"/>	<input type="checkbox"/>		

Timer 1/2/3

Uitgangen: Timers1/2/3	Naam	Korte naam	Mode	Herlaadwaarde van de timer	Tijdseenheid van de timer	Waarschuwing op display	Events aan/uit	Opname in simulatielijst	Status van de uitgang	Bedrijfsurenteller
<input type="checkbox"/>	Deurbel	Deurbel	Timer2	3	Sec	<input type="checkbox"/>	<input checked="" type="checkbox"/>	<input type="checkbox"/>		
<input type="checkbox"/>	Timer 1	Timer 1	Timer1	60	Sec	<input type="checkbox"/>	<input checked="" type="checkbox"/>	<input type="checkbox"/>		
<input type="checkbox"/>	Timer 2	Timer 2	Timer2	60	Sec	<input type="checkbox"/>	<input checked="" type="checkbox"/>	<input type="checkbox"/>		
<input type="checkbox"/>	Timer 3	Timer 3	Timer3	60	Sec	<input type="checkbox"/>	<input checked="" type="checkbox"/>	<input checked="" type="checkbox"/>		

Timer 4/5

Uitgangen: Timers4/5	Naam	Korte naam	Mode	Naam2	Korte naam2	On	m/s	Off	m/s	Warning	Events	Simul.	Status	Counter
<input type="checkbox"/>	Timer 4.1	Timer 4.1	Timer4	Timer 4.2	Timer 4.2	60	Sec	60	Sec	<input type="checkbox"/>	<input checked="" type="checkbox"/>	<input type="checkbox"/>		
<input type="checkbox"/>	Timer 5 det	Timer 5 det	Timer5	Timer 5 man	Timer 5 man	0	Sec	60	Sec	<input type="checkbox"/>	<input checked="" type="checkbox"/>	<input type="checkbox"/>		

dimmer

Uitgangen: Gedimd

Naam	Korte naam	Mode	Minimum dimmer niveau	Startwaarde bij kort puls	Automatisch uitfaden korte puls	Tijdseenheid uitfaden	Waarschuwing op display	Events aan/uit	Opname in simulatielijst	Status van de uitgang	Bedrijfsurenteller
<input type="checkbox"/> Living Spots	Living Spots	Dimmer1T	0%	100%	0	Sec	<input type="checkbox"/>	<input checked="" type="checkbox"/>	<input type="checkbox"/>		
<input type="checkbox"/> nachthal	nachthal	Dimmer1T	0%	100%	0	Sec	<input type="checkbox"/>	<input checked="" type="checkbox"/>	<input type="checkbox"/>		
<input type="checkbox"/> Slpkmr 1	Slpkmr 1	Dimmer1T	0%	100%	0	Sec	<input type="checkbox"/>	<input checked="" type="checkbox"/>	<input type="checkbox"/>		
<input type="checkbox"/> Slpkmr 2	Slpkmr 2	Dimmer1T	0%	100%	0	Sec	<input type="checkbox"/>	<input checked="" type="checkbox"/>	<input type="checkbox"/>		
<input type="checkbox"/> Slpkmr 3	Slpkmr 3	Dimmer1T	0%	100%	0	Sec	<input type="checkbox"/>	<input checked="" type="checkbox"/>	<input type="checkbox"/>		

Blinds

Uitgangen: Rolluiken

Naam	Korte naam	Mode	Wachttijd manuele bediening	Wachttijd sfeer bij Up	Wachttijd sfeer bij Down	Tijdseenheid vertraging	Looptijd rolluik	Tijdseenheid looptijd	Events aan/uit	Opname in simulatielijst	Status van de uitgang	Bedrijfsurenteller
<input type="checkbox"/> Badkamer Rol 1	Badkamer Rol	Rolluik2T	1	2	2	Sec	30	Sec	<input checked="" type="checkbox"/>	<input type="checkbox"/>		
<input type="checkbox"/> Keuken Rol 1	Keuken Rol 1	Rolluik2T(+Pos)	1	2	2	Sec			<input checked="" type="checkbox"/>	<input type="checkbox"/>		
<input type="checkbox"/> keuken Rol 2	keuken Rol 2	Rolluik2T(+Pos)	1	2	2	Sec			<input checked="" type="checkbox"/>	<input type="checkbox"/>		
<input type="checkbox"/> Living Rol 1	Living Rol 1	Rolluik2T(+Pos)	1	2	2	Sec			<input checked="" type="checkbox"/>	<input type="checkbox"/>		
<input type="checkbox"/> Living Rol 2	Living Rol 2	Rolluik2T(+Pos)	1	2	2	Sec			<input checked="" type="checkbox"/>	<input type="checkbox"/>		
<input type="checkbox"/> Slpkmr 1 Rol	Slpkmr 1 Rol	Rolluik2T(+Pos)	1	2	2	Sec			<input checked="" type="checkbox"/>	<input type="checkbox"/>		
<input type="checkbox"/> Slpkmr 2 Rol	Slpkmr 2 Rol	Rolluik2T(+Pos)	1	2	2	Sec			<input checked="" type="checkbox"/>	<input type="checkbox"/>		
<input type="checkbox"/> Slpkmr 3 Rol	Slpkmr 3 Rol	Rolluik2T(+Pos)	1	2	2	Sec			<input checked="" type="checkbox"/>	<input type="checkbox"/>		

Thermostat

Uitgangen: Thermostaten

Naam	Korte naam	Mode	Regime temperatuur	Regime temperatuur	Regime temperatuur	Regime temperatuur	Regime temperatuur	Events aan/uit	Minimum temperatuur	Maximum temperatuur	Status van de uitgang	Bedrijfsurenteller
<input type="checkbox"/> TH Badkamer	TH Badkamer	Thermostaat	20°C	5°C	20°C	22°C	15°C	<input checked="" type="checkbox"/>	1°C	63.5°C		
<input type="checkbox"/> TH Keuken	TH Keuken	Thermostaat	20°C	5°C	20°C	22°C	15°C	<input checked="" type="checkbox"/>	1°C	63.5°C		
<input type="checkbox"/> TH Living	TH Living	Thermostaat	20°C	5°C	20°C	22°C	15°C	<input checked="" type="checkbox"/>	1°C	63.5°C		
<input type="checkbox"/> TH Slpkmr 1	TH Slpkmr 1	Thermostaat	20°C	5°C	20°C	22°C	15°C	<input checked="" type="checkbox"/>	1°C	63.5°C		
<input type="checkbox"/> TH Slpkmr 2	TH Slpkmr 2	Thermostaat	20°C	5°C	20°C	22°C	15°C	<input checked="" type="checkbox"/>	1°C	63.5°C		
<input type="checkbox"/> TH Slpkmr 3	TH Slpkmr 3	Thermostaat	20°C	5°C	20°C	22°C	15°C	<input checked="" type="checkbox"/>	1°C	63.5°C		

Ventilation

Uitgangen: Ventilatie

Naam	Korte naam	Mode	Events aan/uit	Status van de uitgang	Bedrijfsurenteller	Counter
<input type="checkbox"/> Badkamer HVAC	Badkamer HVA	HVAC	<input checked="" type="checkbox"/>			
<input type="checkbox"/> Berging HVAC	Berging HVAC	HVAC	<input checked="" type="checkbox"/>			
<input type="checkbox"/> Kookplaat	Kookplaat	Renson	<input type="checkbox"/>			
<input type="checkbox"/> Slaapkmr 1	Slaapkmr 1	Renson	<input type="checkbox"/>			
<input type="checkbox"/> Slaapkmr 2	Slaapkmr 2	Renson	<input type="checkbox"/>			
<input type="checkbox"/> Slaapkmr 3	Slaapkmr 3	Renson	<input type="checkbox"/>			
<input type="checkbox"/> Toilet ventilatie	Toilet venti	Renson	<input type="checkbox"/>			

Special

Uitgangen: Speciaal

Naam	Korte naam	Mode	Events aan/uit	Status van de uitgang	Bedrijfsurenteller	Counter
<input type="checkbox"/> E-meter	E-meter	Energimeter	<input checked="" type="checkbox"/>			
<input type="checkbox"/> Gasmeter	Gasmeter	Energimeter	<input checked="" type="checkbox"/>			
<input type="checkbox"/> Watermeter	Watermeter	Energimeter	<input checked="" type="checkbox"/>			
<input type="checkbox"/> Zonne-energie	Zonne-energi	Energimeter	<input checked="" type="checkbox"/>			

3.13 Importing a QDB

Via the main menu File / Import QDB it is possible to MERGE an existing QDB with the current database.

ATTENTION: It is recommended to save your current QDB first, so that in case of a wrong or unwanted import, you can return to the saved QDB

ATTENTION: Do not use this menu item to use a QDB of the Serial Manager !! You can simply open a configuration file of the older generation controllers via File/Open. This converts the old structure to the new one.

After selecting the file, the following selection appears:

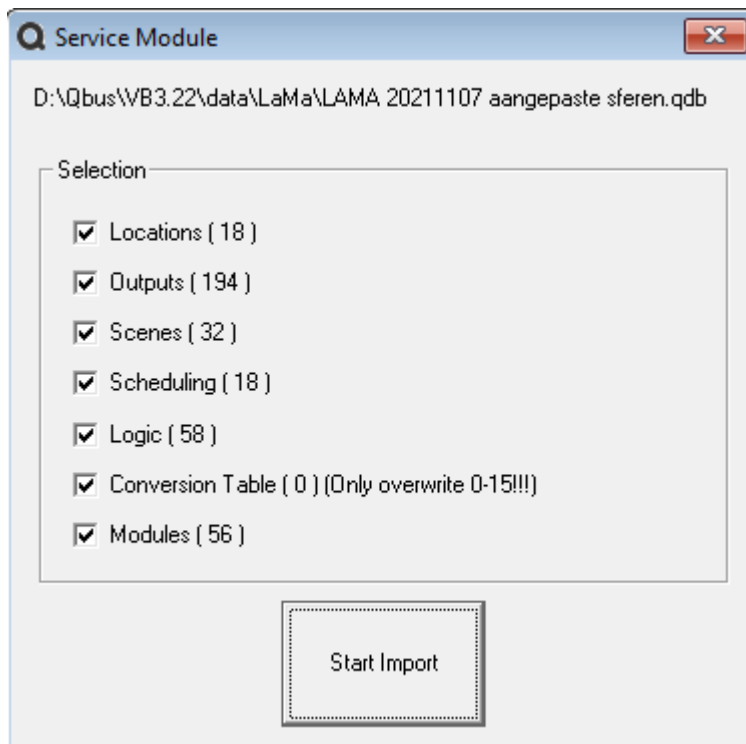

An overview is shown of how many different items of each category are present in the selected QDB and are ready to be imported.

You can uncheck the unwanted items.

When you click on "Start import" and confirm the command, all items in the current configuration will be added. The same names will be changed to a unique new numbered name, serial numbers will also be uniquely generated.

On our website you can find many examples of QDB's of specific small configurations.

These are divided into the groups BASIS, STANDARD and ADVANCED.

You can even import these QDB's multiple times if a situation occurs multiple times.

The files are stored in zipped format on <https://www.qbus.be/en/support/support-service/qdb-files-configuration-files-examples>

After importing you can then scroll through the overview of all imported data. The newly generated names, scenes, clock times, modules, addresses and sub-addresses can then be seen:

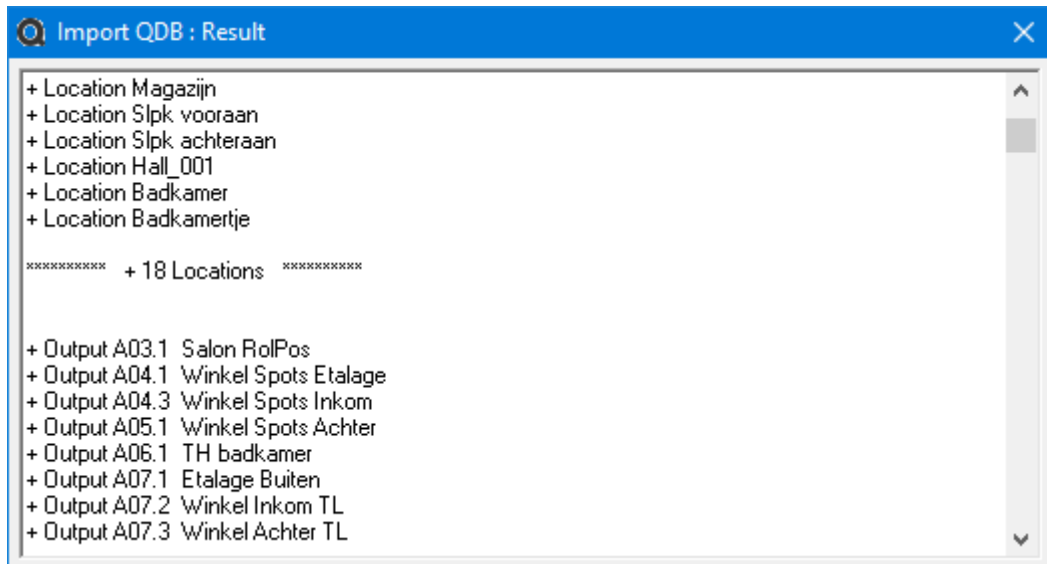

4. Configuration of the Qbus modules



The configuration principles are the same for all Qbus modules. The difference is in the operation, which does not necessarily affect the logic of the program.

The system manager takes care of configuring the modules, rather than programming. The Qbus system was developed to make programming transparent for the user of the system; the user only needs to configure the system - select which input will activate which output - and adjust the settings as necessary to suit his or her specific needs.

Remark: it is recommended that you create all outputs BEFORE configuring the modules, as this will make configuration faster and easier. See [chapter 3.5](#) to create the outputs.

To configure modules, go to the Qbus System Manager and click on the modules option on the taskbar. The following screen is displayed. In the field beside "S/N:" you must enter the serial number of the specific module you are configuring.

Remark: Each Qbus module has a unique serial number which you will find on a sticker on the module itself. A CTD also has a serial number, but should not be entered in this list. The controller is automatically read by the System Manager when a connection is established between the System Manager and the Controller.

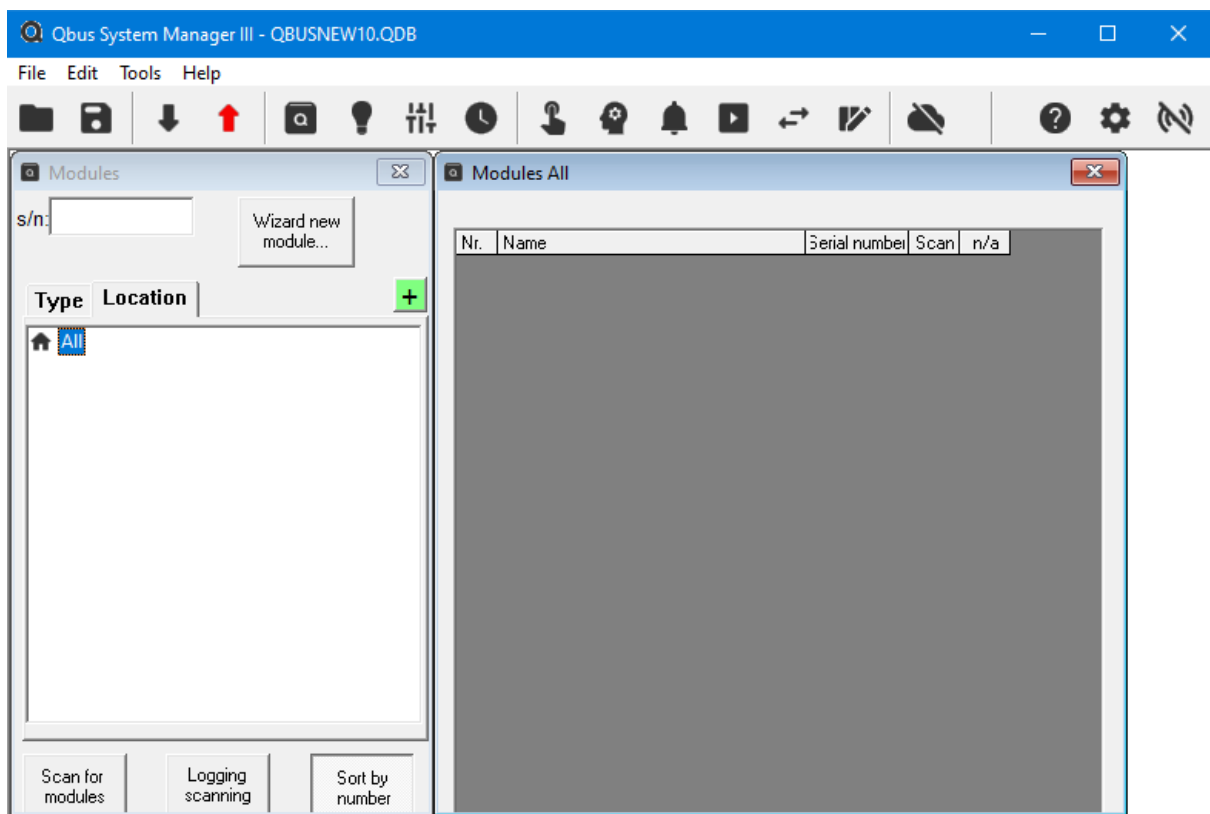

Once you type the serial number of the component in the "s/n:" field, another screen will appear on the right side of the programming screen showing this specific component.

4.1 Configuring Input Modules

In the upper part of the module programming screen, the location of the module can be entered (e.g. distribution board 2, row 1).

In each of the input fields, outputs can be selected by clicking the drop-down field next to the "Name" field. If outputs were created before, they will be listed in this drop-down list.

Selecting an existing output will automatically fill in the "mode" field (as the mode was selected when the output was created – see [chapter 3.5](#). If the "- New output -" is selected in the drop-down list of the module, a mode must be assigned; then an indicative name is immediately displayed for the concerned output, which you can change at that time. The "Properties" button next to each output allows you to check or assign the properties of the affected output.

See [chapter 3.5](#) to create an output.

4.1.1 INP02/04

This module can be used to connect an ordinary switch (without integrated Qbus PCB) or external contacts such as a solar/wind detector, a motion detector, door switches, magnetic contacts for doors and windows, etc.

4 input switches can be connected, which must be potential-free. Each module has a unique serial number for programming. After entering the serial number, the following window will appear:

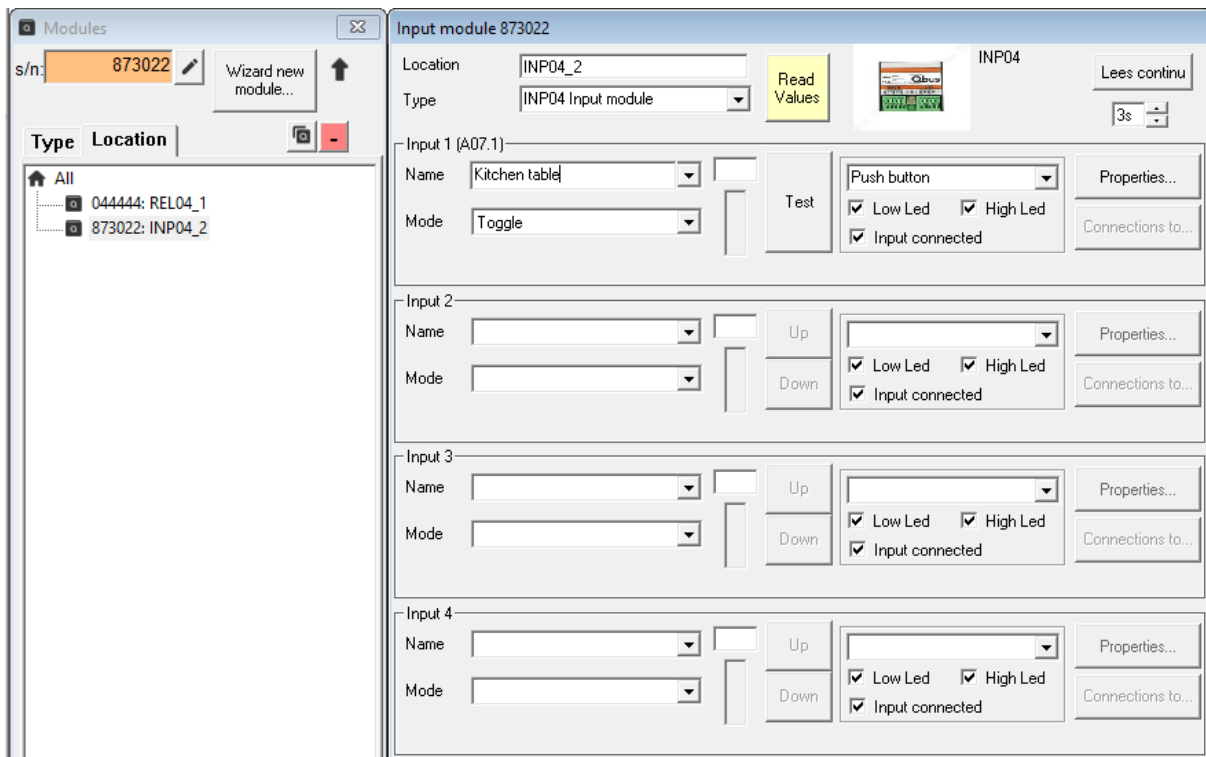

The input contacts can be selected and set with the system manager as shown below.

- Push button = when you connect a push button to the input
- Normally open = contact open when not energized (for long contacts - see below)
- Normally closed = contact closed when not energized (for long contacts - see below)
- Switch = when you connect a switch to the input (2 positions – on & off).

ATTENTION: Always use Normal Open or Normal Closed when connecting inputs that give long contacts (e.g. magnetic contact for window, motion detector, smoke detector, ...). These inputs maintain the same state for a longer period of time and only activate the output when that state changes. If you use "push button" for those inputs, the bus will continuously send the status to the controller, resulting in poor communication. Only use push buttons for short contacts (= ordinary push buttons).

One module can control up to 4 outputs, 4 scenes or 4x16 scenes via the sequencer function. The outputs can also be activated from the system manager using the Test key in the programming window. The instantaneous status of the outputs can be consulted by pressing the "Read values" key in the programming window of the INP04 module.

4.1.2 INP08/INP16

As far as programming is concerned, there is not much difference between INP04, INP08 and INP16; the only difference is the number of potential free switches that can be physically connected to the INPUT modules. INP04 provides capacity for 4 potential free switches, INP08 for 8 and INP16 for 16.

The other difference, in terms of programming, is that INP16 has 2 serial numbers. The first serial number refers to inputs 1 to 8. The second serial number refers to inputs 9 to 16.

The input contacts can be selected and set with the system manager as shown below.

- Push button = when you connect a push button to the input
- Normally open = contact open when not energized (for long contacts - see below)
- Normally closed = contact closed when not energized (for long contacts - see below)
- Switch = when you connect a switch to the input (2 positions – on & off).

ATTENTION: Always use Normally Open or Normally Closed when connecting inputs that give long contacts (e.g. magnetic contact for window, motion detector, smoke detector, ...). These inputs maintain the same state for a longer period of time and only activate the output when that state changes. If you use "push button" for those inputs, the bus will continuously send the status to the controller, resulting in poor communication. Only use push buttons for short contacts (= ordinary push buttons).

The same outputs that can be activated by INP04 in 4.1.1 are also applicable for INP08 and INP16 modules. The outputs can also be activated from the system manager by pressing the Test key, and the current status can be consulted by pressing the "Read value" key.

4.1.3 INP08/230

The INP08/230 is comparable to the INP08 module. Again, there is no difference in programming aspects. The only feature that sets this module apart from the other Input Modules is that the INP08/230 can switch up to 230 volts. (the switches do not have to be potential-free).

The same outputs that can be activated by INP04 in 4.1.1 are also applicable for INP0/230. The outputs can also be activated from the system manager by pressing the Test key, and the current status can be consulted by pressing the "Read value" key.

4.1.4 INA02 (module type 0013)

The INA02 is a module that can measure a voltage between 0 and 10V or a current between 0 and 20mA in a range of 12 bits via 2 inputs.

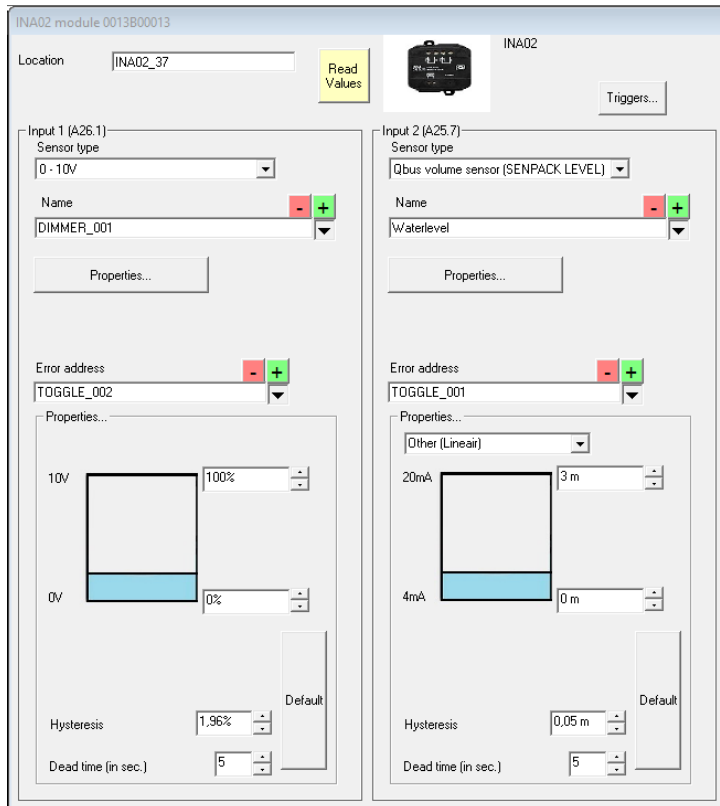

An input can be of 3 types: Dimmer (0-100%), Thermostat output (with a range of 63.5°C) or a universal output (number of 24-bit with adjustable resolution)

The latter can therefore display large values as well as decimals. However, the measurement of the module is limited to 12-bit and will therefore be able to display the complete measurement in +/- maximum 4000 steps.

After selecting (or adding) the universal output, it is important to set the parameters correctly. Choose the correct type to get a correct display. The default parameters will then be suggested. You can then adjust this to your own liking.

Then choose the mode of the sensor:

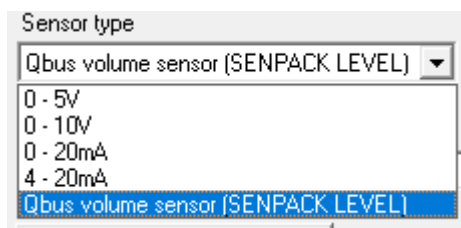

Then click on “Default” to set the default conversion.

You can configure the settings of the first four types as follows:

Especially with a universal output, it may be necessary to adjust these default values. Enter the correct value at minimum (at 0V, 0mA or 4mA) and also the desired value that the sensor should give at maximum (at 5V, 10V or 20mA)

e.g. You want to visualize a temperature between 40°C and 100°C and according to the technical documentation the sensor gives 0°C at 4mA and 100°C at 15mA. Then you will need to use the following settings:

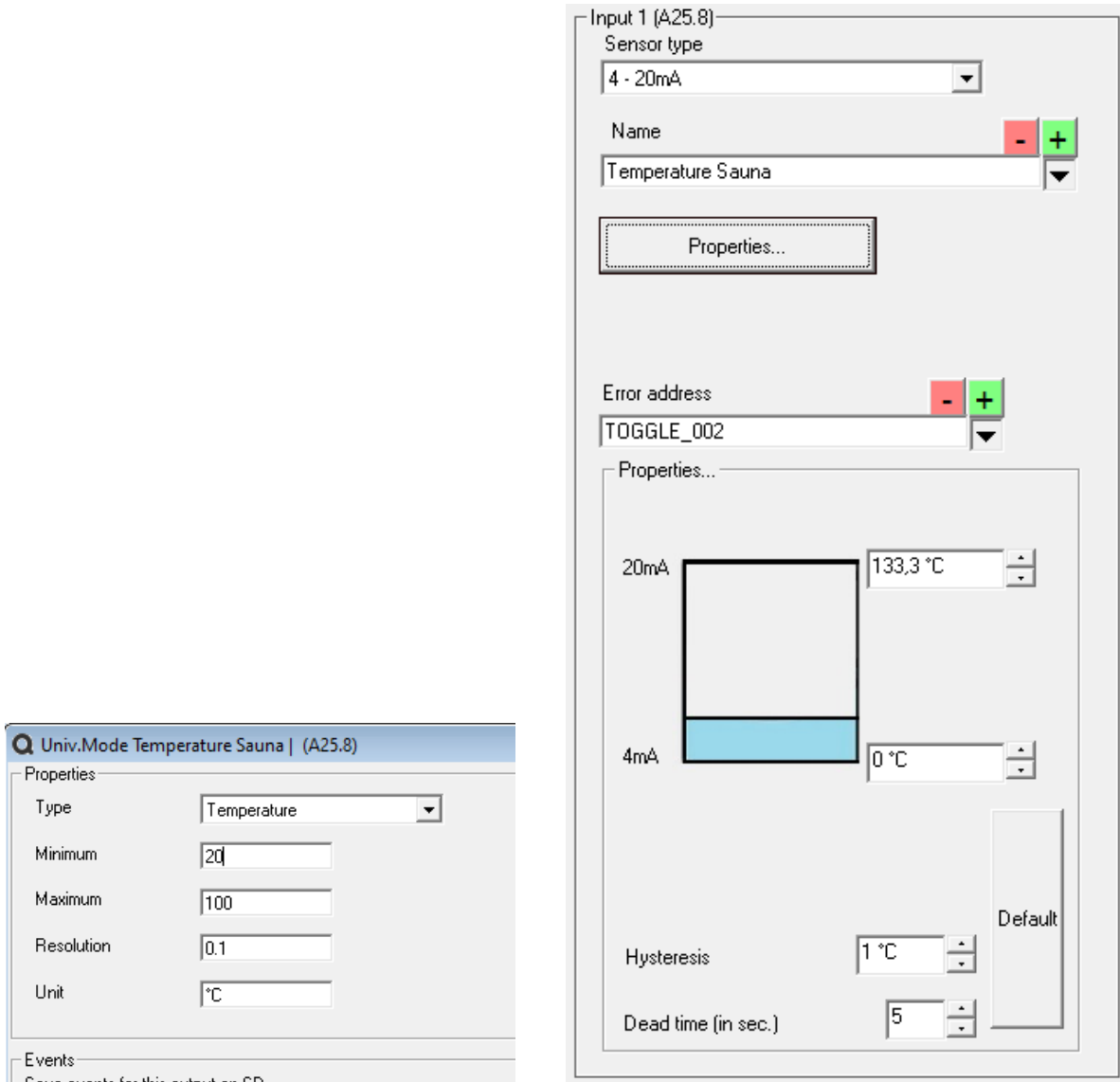

The value 133.3°C is obtained by the following formula: $100\text{ °C} / 15\text{ mA} * 20\text{ mA}$

The result of the measurement is sent to the selected output in the controller when the “hysteresis” is reached and the “dead time” has elapsed. In this example there will only be a status update if the temperature difference compared to a previous measurement is greater than or equal to 1°C and this at the earliest 5 seconds after a previous update.

If a pressure sensor from Qbus (SENPACK/LEVEL) is connected, you can easily measure the contents of a tank.

For example, the output settings look like this:

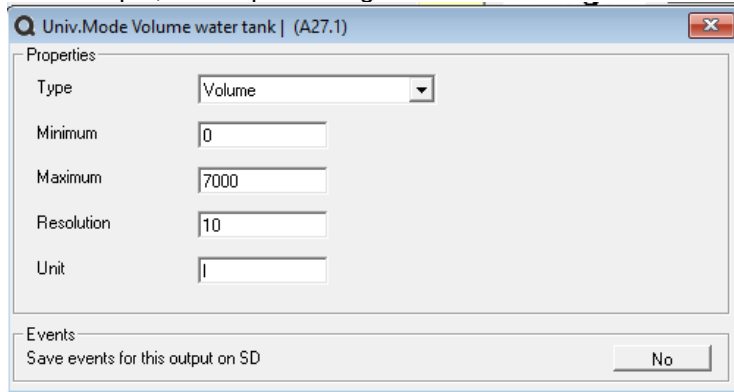

At “Properties” you can set all parameters of your tank. The choice of tank type, maximum volume, height and type of liquid will provide a correct representation of the measured contents of the tank when the sensor is just above the bottom. The pressure sensor (SENPACK/LEVEL) can handle a maximum pressure of 0.3bar (20mA at 3m maximum depth in a tank filled with water)

For other liquids with a specific weight of less than 1000kg/m³, the volume of slightly deeper vessels can therefore be measured.

The liquids offered are water, diesel (fuel oil) and petrol.

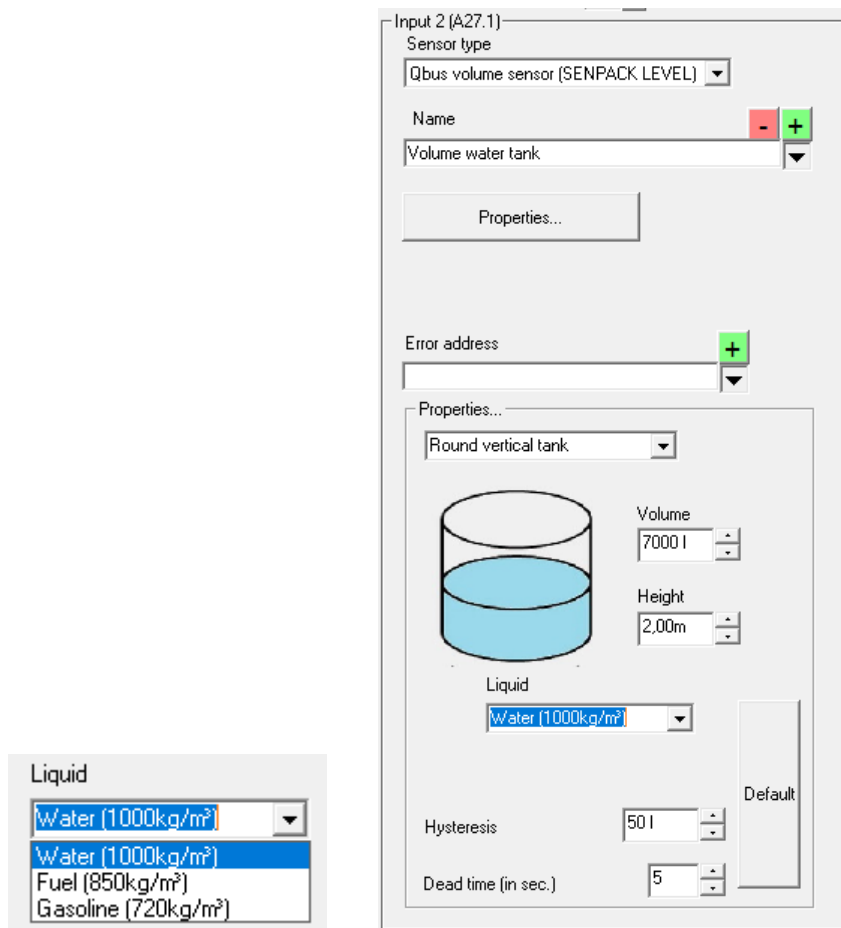

If you want to measure another kind of tank/liquid or if the height of the vertical tank is e.g. 4 m and the sensor is 1m from the bottom, you can choose “Other (linear)” and set the value from 0 bar and from 0.3bar

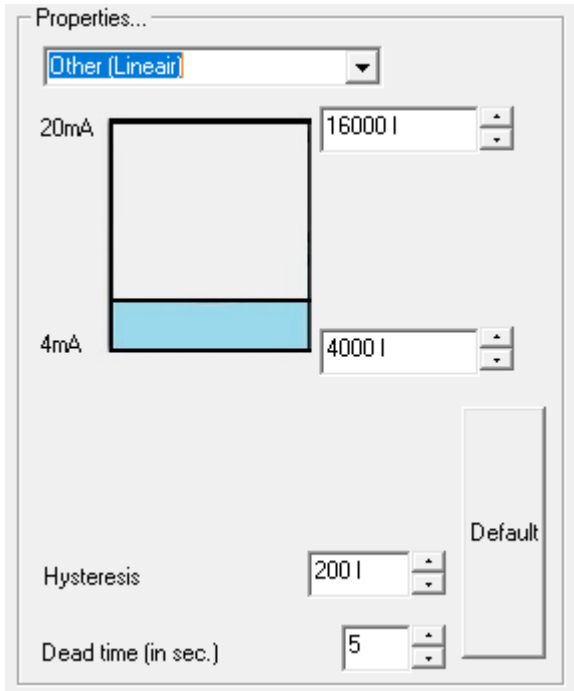

The bistable error address will be turned on if, for example, there is a sensor break. At 0-5V the output will be switched on if a voltage is measured of more than 5.25V, at 0-10V more than 10.5V, at 0-20mA or 4-20mA more than 21mA and at 4-20mA also if less than 3.5mA

If you wish to test other threshold values, you can use analog logic or, better yet, set a trigger on the module itself.

E.g.:

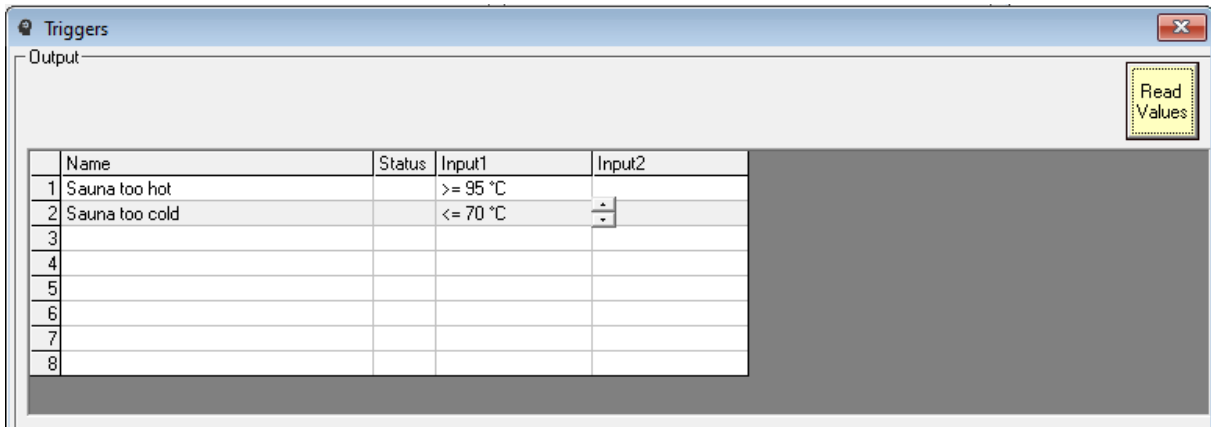

Double click on the threshold value changes the test from >= to <= and to 'do not test'.

When a threshold value is set on both inputs, the result will be calculated as an “AND” condition.

4.2 Configure output modules

In the upper part of the module programming screen, the location of the module can be entered (e.g. distribution board 2, row 1).

In each of the output fields, outputs can be selected by clicking the drop-down box next to the "Name" field. If outputs were created before, they will be listed in this drop-down list.

If the "new output" field is selected in the drop-down list of the module, a mode must be assigned; then an indicative name is immediately displayed for the concerned output, which you can change at that time. The "properties" option next to each output allows you to check or assign the properties of the affected output.

Refer to section 3 for how to create an output.

4.2.1 Configuring Relay Modules (REL02SA/230, REL04(SA), REL08)

The REL04(SA) has 4 normally open contacts, on which max. 16 A and 230 V ($\cos\phi=1$) can be connected. These are independently working contacts, each of which can be assigned a separate function by means of the system manager.

The REL08 has 8 changeover contacts (Normally open or normally closed contact can be connected as desired)

ATTENTION: The REL02SA/230, on the other hand, has two 230V outputs

These modules have 1 unique serial number by which the system manager recognizes the modules. When you have entered the serial number in the modules window, the following window will appear. The following figure shows the programming window of a REL04SA.

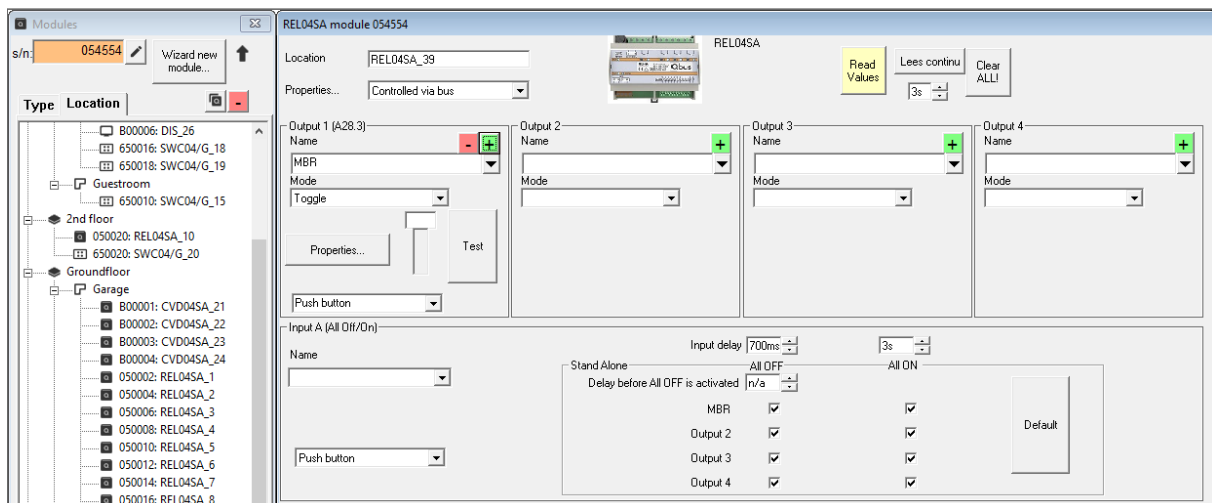

As explained at the beginning of section 4.2, the outputs can be created in the “modules” section of the System Manager or in the “Outputs” section. The Mode here refers to the various types of outputs, bistable, thermostat, timer, etc.

ATTENTION: a REL04(SA) and REL02SA/230 only have make-contacts. For safety reasons, it is NOT recommended to control electric motors (for roller shutters, curtains, etc.); this requires a REL08, ROL01PSA, ROL02(P) or ROL04PSA.

When you set the properties of the module to “SA – xx output”, you can prepare the module to work stand-alone. The following image shows these possible settings of a REL02SA/230

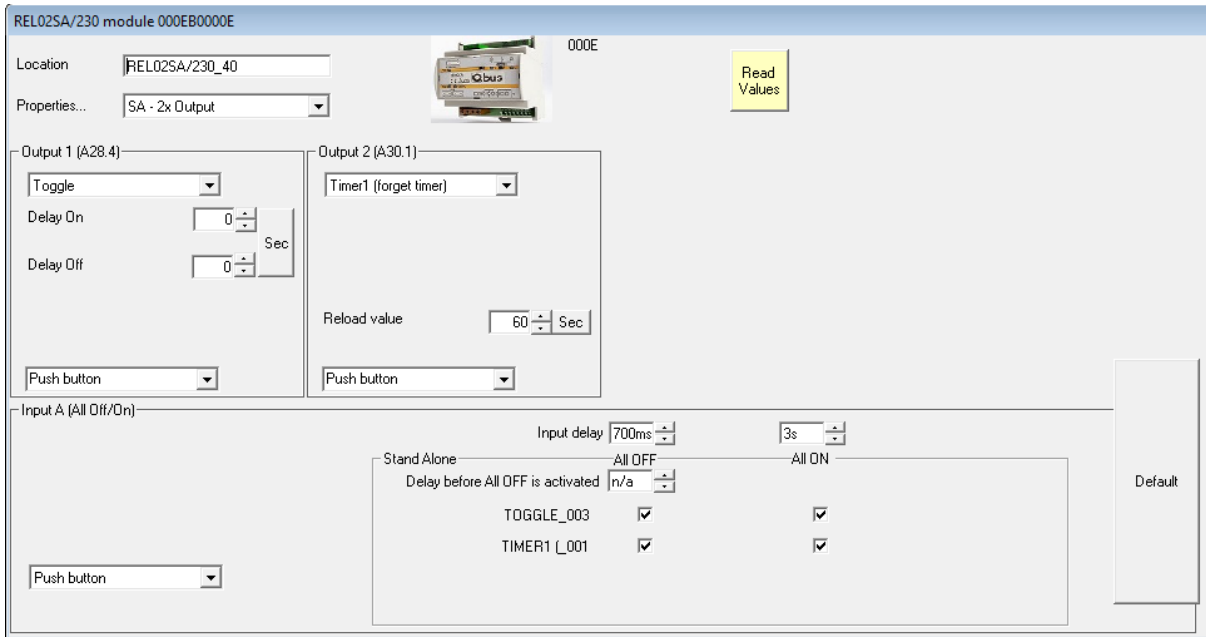

When you have entered the serial number of the REL08 modules, the following window will appear.

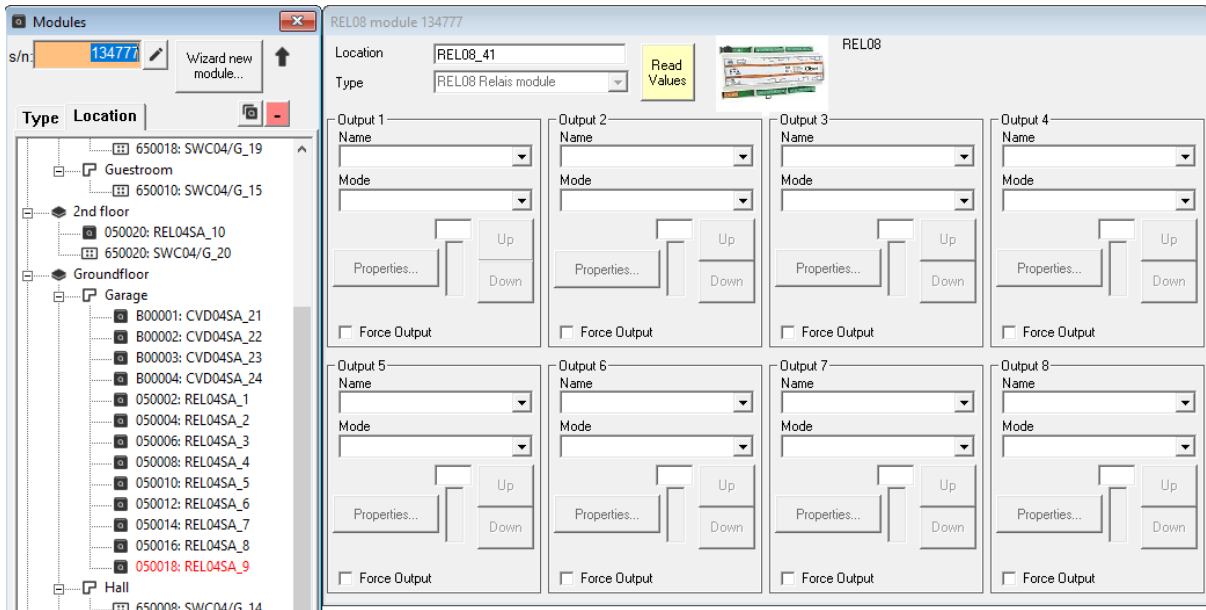

The relay module has no specific function. It can handle all switching functions: monostable (bell), bistable (on/off), timer, interval, thermostat output, etc. The outputs can also be activated from the system manager by means of the Test key, and the current status can be consulted by pressing the "Read value" key.

4.2.2 Roller shutter module with positioning (ROL02P, ROL01PSA and ROL04PSA)

This is a special relay module that is only available for controlling and positioning 230Vac electric motors (shutters/blinds/curtains).

The roller shutter motors that are connected to the roller shutter modules must be 230V AC motors, with a minimum load of 40W and a maximum load of 500W. The roller shutter motors must also have limit switches; this is important when calibrating the roller shutters. These modules do not allow controlling an Up and a Down contact of the same roller shutter at the same time.

Each roller shutter on the ROL02P can be positioned between 0% and 100% of the running time. An internal calibration mechanism will calibrate the roller shutter each time it is fully raised or lowered (each time both limit switches are activated). This ensures that the desired position of the roller shutter remains accurate over time. With a shutter module it is possible to configure the shutters so that they would go to 0% (closed) when e.g. the light level outside falls below a certain value, or to set them to 42% when the temperature in the living room is more than 22°C and the light level outside is more than 1200 lux (meaning the sun is shining inside and the room is warming up), etc.

Remark: If there is no need to position the shutters, a REL08 or a REL04SA can also be used.

When you have entered the serial number in the modules window, the following window will appear.

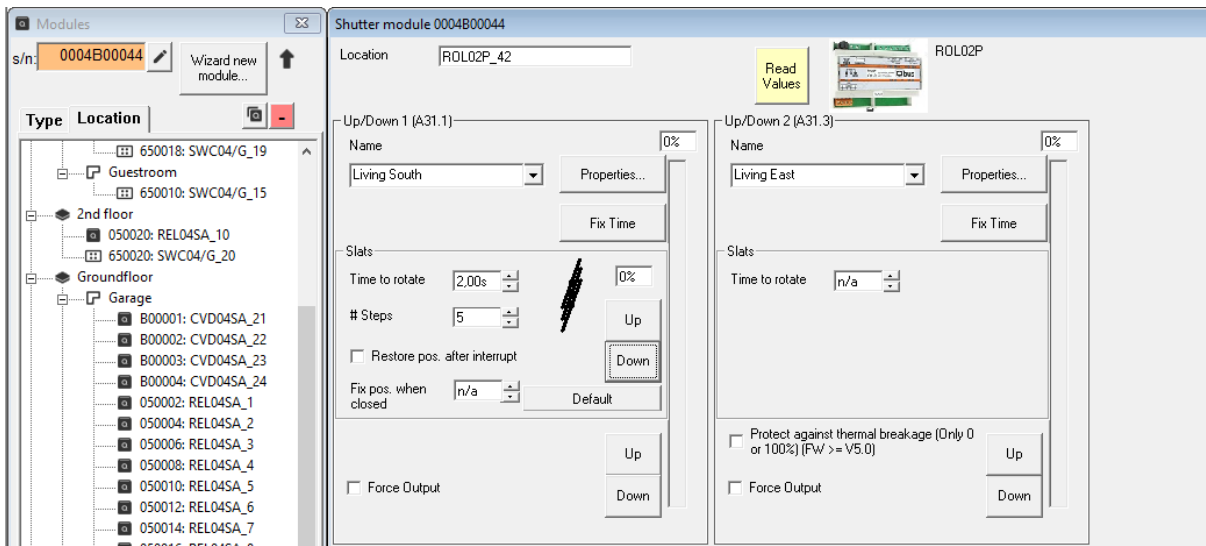

As mentioned above under 3.5.4, only the Up/Down(+Pos) can be assigned to a roller shutter module.

The outputs can be activated from the system manager by pressing the Up and Down keys, and the current status can be consulted by pressing the "Read value" key.

With the ROL02P it is possible to set your roller shutters to a desired percentage. In order to achieve this, the roller shutter must be calibrated.

Adjust the roller shutter's end of range contacts so that the upper and lower limits of the roller shutter are clearly defined. Then connect the module to the ROL02P module.

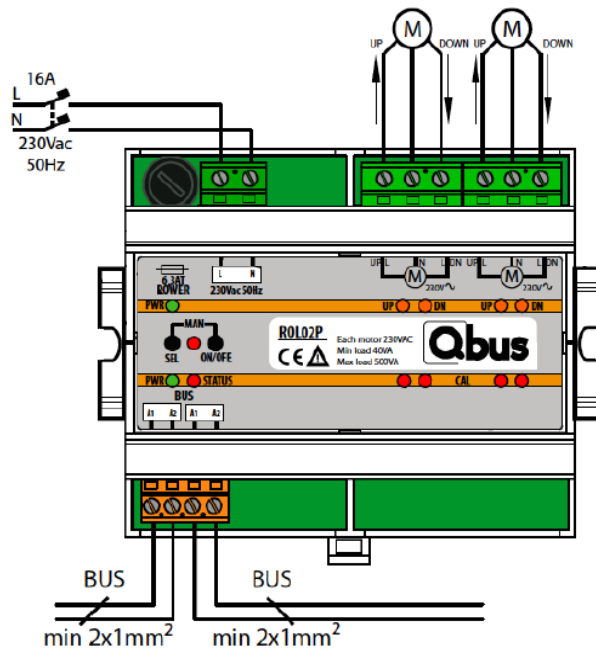

Note: Roller shutter motors may not be placed parallel to each other. This usually results in irreparable damage to the motors!

Via the module you can create a new output on the module or you can go via the output list to “Wizard New Output” (mode = “Up/Down(+Pos)”). Our output that we are going to create is called “Sun blinds”. When the output(s) have been created and placed on the module, we send this data to the controller. We then return to the shutters screen and click on the “Read value” button. The module will now indicate that it has not yet been calibrated.

You can choose either automatic calibration or the entry of fixed run times (only modules with 10-digit serial number). If automatic calibration has been selected and slats are present, you must first enter the time required to tilt the slats from 0 to 100%. Afterwards, on the first operation of the shutter, the module will move the shutter to the nearest end (0% or 100%) and then measure the time it takes from 0% to 100% and vice versa. The end of range contacts in the roller shutter motor ensure that the current is lost and the module will then reverse the direction. After the calibration is finished, the module can be operated normally.

After calibration, you can then press the "Read values" button where you can read the times. If these times differ by more than 2 seconds, it is recommended to reset the calibration and try the calibration again. If this does not help, you should check the limit switches of the motor.

When the roller shutter is sent to 0% or 100%, the up or down contact will always be activated until the power is lost. As a result, the roller shutter is synchronized with the real position every time.

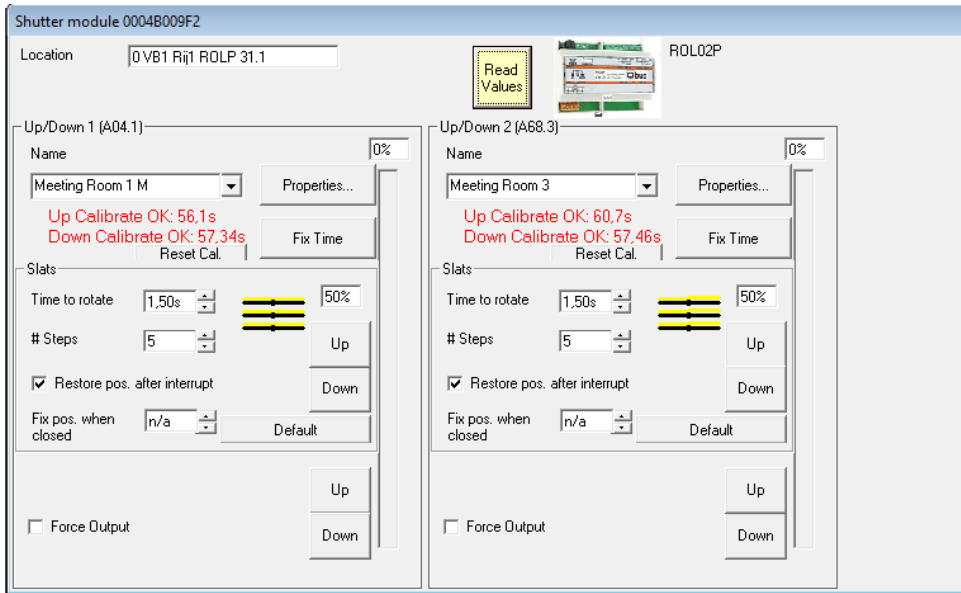

With new roller shutter modules with a 10-digit serial number starting with 0004,000F and 0010 these times can also be entered as a fixed value. This is necessary if you work with roller shutters or sun blinds with electronically controlled motors on which the current measurement does not work correctly. You can also control the position of the slats on these new modules. For these outputs it is important that the tilting time is entered as precisely as possible.

A short pulse on a key will tilt the slats 1 step further.

Both the position of the roller shutter/screen and the position of the slats can be controlled via scenes. You can then operate the roller shutter output on any Qbus-controlled control panel or switch.

4.2.3 Dimmer modules (DIM02SA/500U, DIM04SA/500U)

The Dimmer Modules are used to control the input power for incandescent or halogen lamps, 230V LED lamps and energy-saving lamps. Each dimmer can be programmed as a 1 or 2 button dimmer. The one-button version allows you to reduce the number of control buttons, but remember that the dimming cycle must always be completed, from zero to maximum and back to zero. In the two-button version, you need a "+" and a "-" button, but you do not need to complete the full dimming cycle. When you hold down a key, the run time from 0 to 100% is 5.1sec. A short pulse (< 0.3 sec.) activates the dimmer in 2.5 sec. to 0 or to 100%. The minimum and maximum value can be set within a range from 0 to 100%, the start value if the "Dimmer-Daytime" is on and off from 5 to 100%. The start value must be 5% higher than the minimum value - that margin is automatically maintained when setting the minimum and start values. The lighting can also be dimmed automatically after a programmed period of 1 sec. up to 255 minutes (TimeOff). This automatic switch-off time only starts counting after activating the dimmer via a short pulse.

If the dimmers are controlled via an scene, the rise and fall time can be set independently between 0.3 sec. and 20 min. This descent time is also used with the automatic shutdown

DIM0xSA/500U (Universal Dimmer)

The DIM02SA/500U module can switch 2 circuits and the DIM04SA/500U module can switch 4 circuits from 10 – 500VA, and are suitable for dimming incandescent and halogen lamps, capacitive and inductive loads, dimmable energy saving lamps and dimmable 230V LED lamps. Mixed loads on the same circuit are not allowed. For more information about the type of lamps and loads that can be connected to this module, see the technical data sheet of the DIM04SA/500U on www.qbus.be.

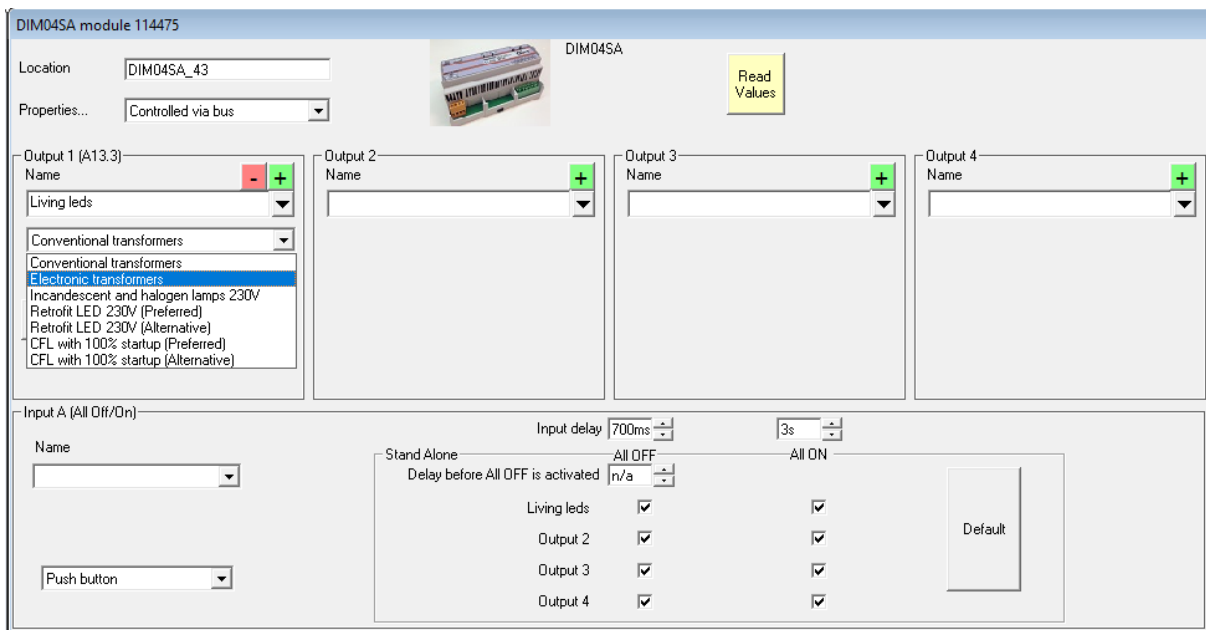

The outputs can be activated from the system manager using the Up / Down keys, and the current status can be consulted by pressing the "Read values" key.

IMPORTANT: if a circuit dims dimmable energy-saving lamps, the option “CFL with 100% startup” must be selected in this window above. This ensures that the dimmable energy saving lamp is first ignited at 100%, and then dimmed to the requested percentage.

Properties:

When you click on the properties, the following window will be displayed.

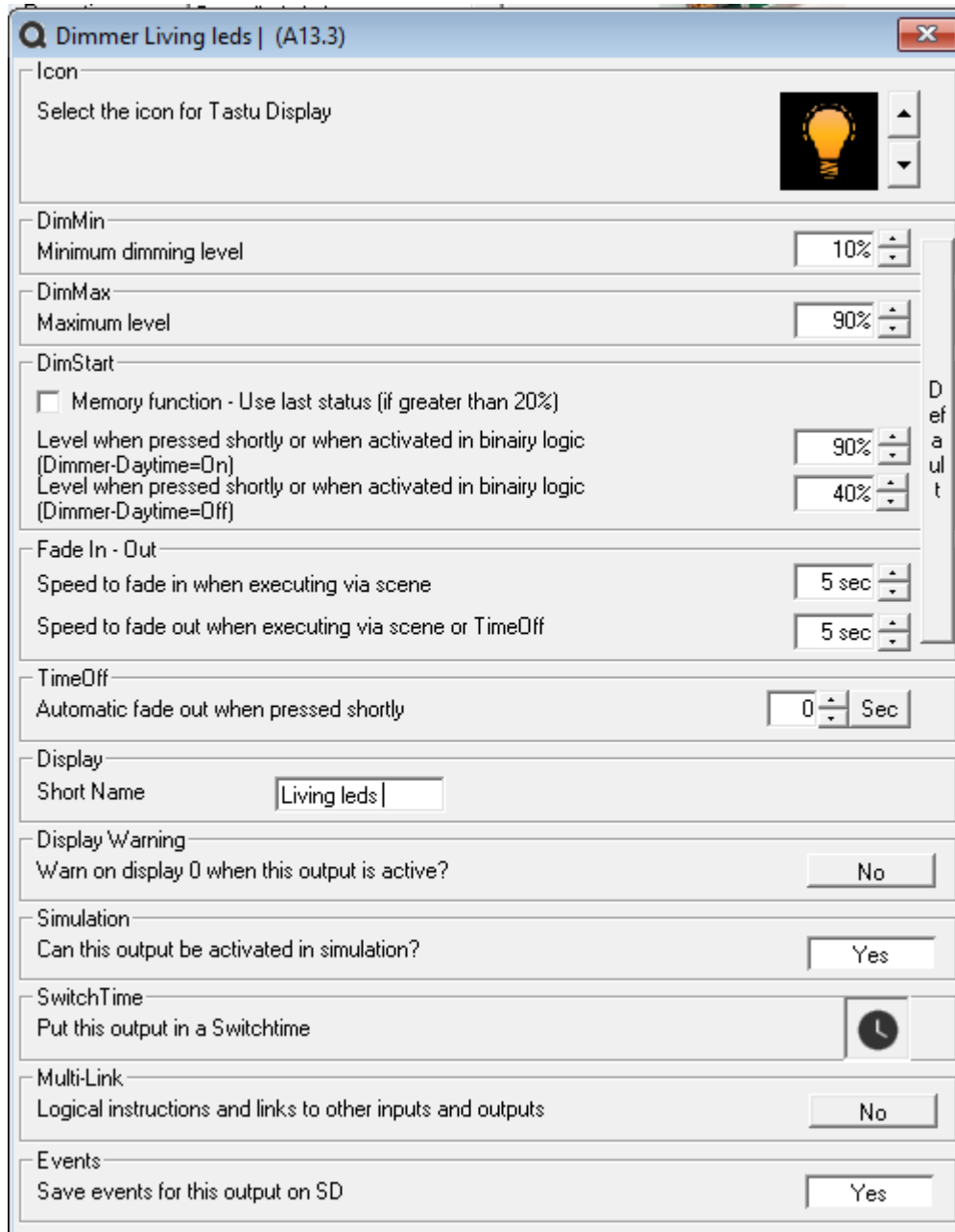

- Both the minimum, maximum and start value (If Dimmer-Daytime is ON and OFF) are adjustable. ATTENTION: SET A MINIMUM VALUE FOR DIMMABLE ENERGY LAMPS AND LED LAMPS (ADJUSTABLE FOR COLD LAMP). THIS MINIMUM VALUE DEPENDS ON THE TYPE OF LAMP AND THE WATTAGE - ENSURE THAT THE LAMP DOES NOT Flicker AT MINIMUM VALUE. TOO LOW DIMMING WILL REDUCE LAMP LIFE OR MAY CAUSE Flicker.
- Fade In / Fade Out: time it takes to go from 0% to maximum or from 100% to minimum when the dimmer is controlled via a scene or a TimeOff
- TimeOff: After briefly pressing the button, the time in seconds or minutes (click the "Sec" button to switch to minutes and vice versa) displayed under TimeOff, before the dimmer fades out (depending on the duration set for Fade Out).
- For more details on the other properties, see chapter [3.5.10](#).

4.2.4 Constant Light Control (CLC01)

The CLC01 is a decentralized module equipped with a light sensor that measures the light level in the room and which, based on the difference between the desired light level and the measured light level, dims the 0/1-10V ballast of a fluorescent fixture to achieve the desired light level. The CLC01 is connected decentrally to the bus and powered by the bus. The module has 6 wires, two yellow ones for the bus connection (no polarity), a gray (-) and a white (+) wire to connect the light sensor and a blue (-) and red (+) wire for the connection to the 0/1-10V ballast. A magnetic isolation between the bus and the output guarantees safe operation.

When you have entered the serial number in the modules window, the following window will appear.

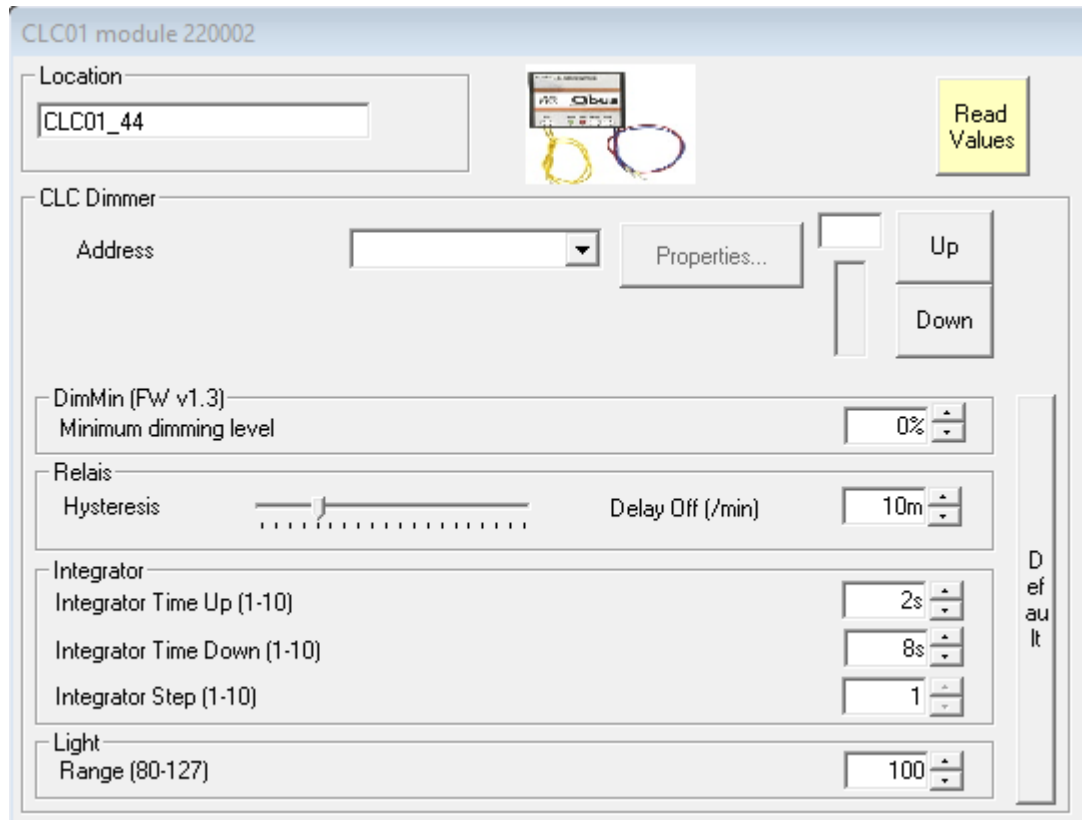

A CLC output can be created from the module screen as shown above, or from the New Output Wizard. The CLC01 can be programmed as a 1-button dimmer or as a 2-button dimmer. If the output is created via the module screen, it will default to a 1-key CLC. This can be adjusted to a two-button dimmer via the output screen.

By clicking on the “properties” button, the following screen will appear:

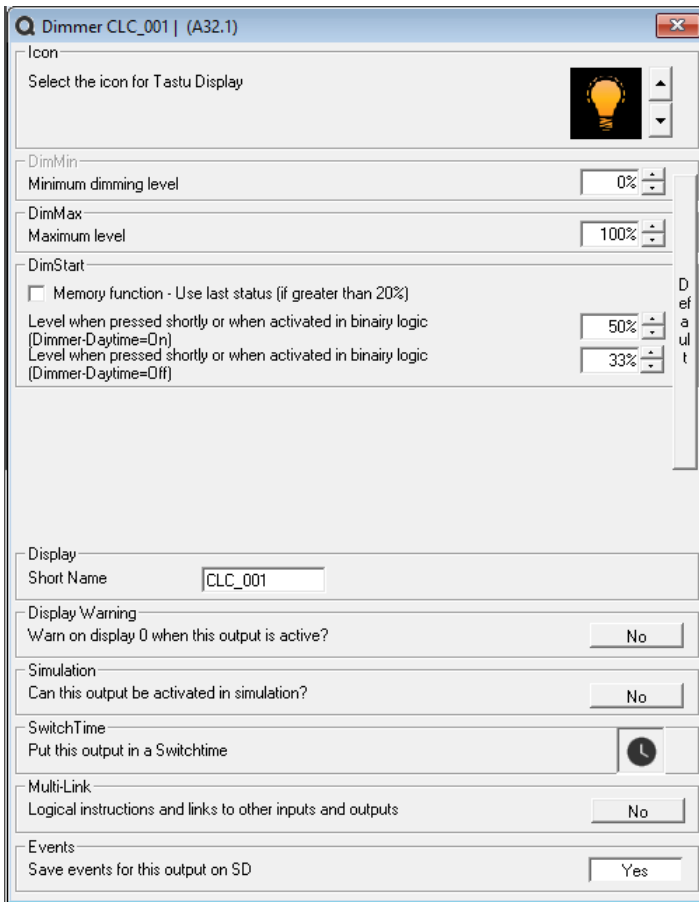

The required light level can be set via the DimStart %. Since a lux value depends on factors such as size and height of the room, color of the walls and furniture, reflection, etc., no lux values are set here, but percentages. We recommend setting a percentage of e.g. 70%, sending these settings to the controller and visually checking if the light level needs to be adjusted or not. For more light, the % should be higher, for less light, lower.

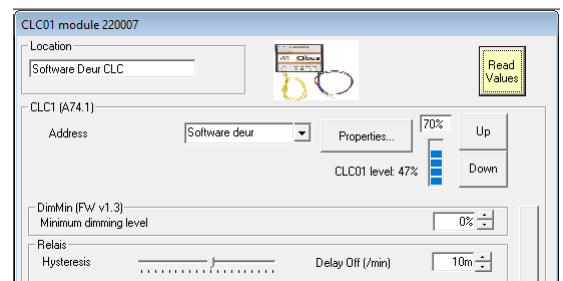

For more details on the other properties, see section [3.5.10](#).

When switching on the output linked to the CLC, the CLC will keep the value entered in the DimStart. The light sensor on the CLC will measure the light level, and the CLC will regulate the connected light circuits to achieve this requested light level. The lighting circuits in the room will therefore only be used as a complement to the available natural light.

When reading the status of the CLC, the requested value will therefore be returned on the one hand (in the example below 70%), and on the other hand the dim value of the CLC (here 47%). In this case, this means that there is sufficient natural light (or other light sources) in the room so that the lighting controlled by the CLC only needs to be on at 47% to reach the required light level of 70%.

The Hysteresis and the delay off are only used if the CLC is used in combination with a relay. The light circuit that is dimmed by a CLC must also be able to be switched on or off. This can be done by putting this circuit on a relay output: when someone is present in the room, the relay is switched on

(manually or via a detector), only then does the CLC start to dim the circuit in function of the available light.

To prevent the relay output from switching too quickly, the delay off time can be set. Only after this time will the relay be switched off if no more light is requested by the CLC module. The Hysteresis can be used to increase the enable level of the relays. For example, if the light level just fluctuates around the level at which the CLC will or will not request additional lighting, so that the relay is switched on again after each switch-off, increasing the hysteresis can also increase the requested light level. In this way a relay will only switch on again after it has been switched off if the requested light level is equal to the DimStart plus the hysteresis. This Hysteresis has a value between 0 and 19;

The CLC outputs can of course also be used on the other Qbus control modules (switches, control tables, scenes,...). The automatic CLC function that will adjust the light based on the DimStart value can always be overruled by manual control via e.g. a switch (the CLC-controlled output can be controlled via a switch as a standard dimmer output). When the CLC01 is manually overruled, the output will remain in that position; turning the output off will cancel the overrule and the output will be controlled again by the CLC01 as soon as the output is active again.

4.2.5 Analog dimmer module (ANA04/ANR04SA)

The analog dimmer modules are used to control external dimmers with input voltages 0-10V /1-10V. The only difference between ANA04 and ANR04SA is that the former type contains no relays, while the ANR04SA has relays through which the loads connected to the external dimmer can be completely isolated when the output is set to 0%. In the case of the ANA04, the lamp connected to the dimmer may still be lit, depending on the minimum output of the dimmer. Bistable outputs can also be used on the ANR04SA.

Both the ANA04 and the ANR04SA are recognized by the system manager by a unique serial number. The programming is similar. Both can be configured as a 1T dimmer or as a 2T dimmer. The following explanation of programming and operation applies to the two modules.

When you have entered the serial number of an ANA04 in the window of the modules, the following window will appear.

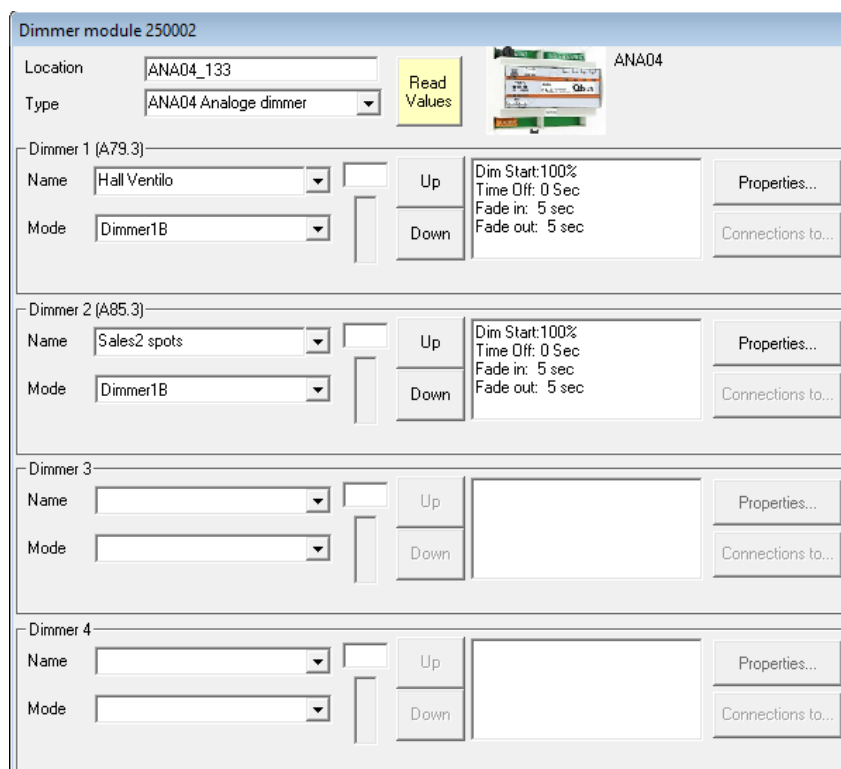

Mode: Can be a 1T dimmer or a 2T dimmer. The ANA04 can also control thermostat outputs

Properties: similar to the properties of the dimmer module, described in section 4.2.3

For an ANR04SA the screen looks like this:

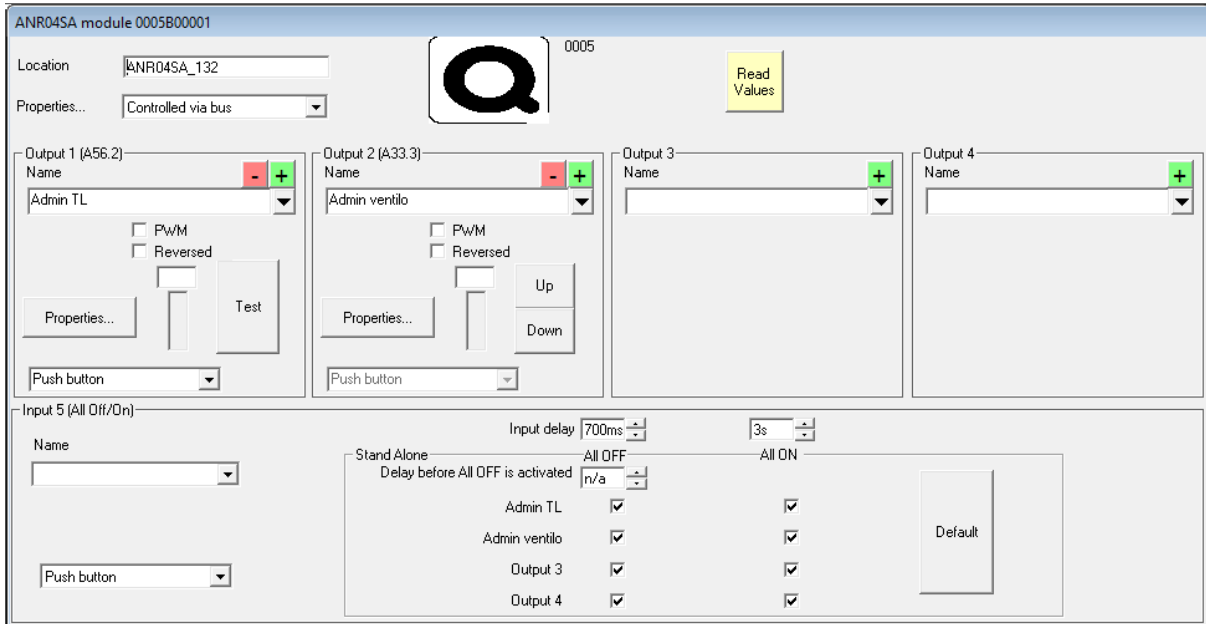

The same as the REL04SA and DIM04SA, this module can also work completely standalone. The settings as shown below are then also applied.

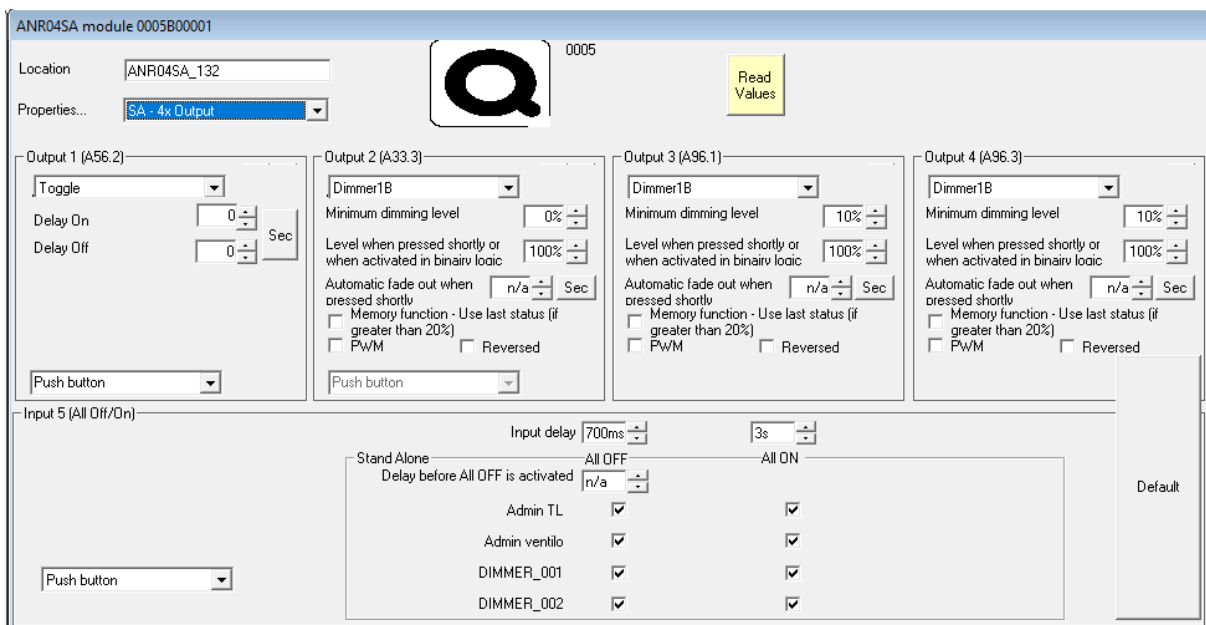

As with the other Qbus Stand-Alone modules, if the module is used in Stand-Alone mode, the fifth input (Input 5 (All Off/On)) will act as an All Off button (press briefly), and as a Panic button at long push.

As soon as the module is no longer used in Stand-Alone mode, i.e. if it is connected to a controller and is supplied with voltage via the bus, the fifth input will work differently. Now a scene must be created via the System Manager and assigned to this input (on the field "Input 5"). This scene is then executed

with a short push. PLEASE NOTE, with a long press the next scene in the list of created scenes in the Qbus System Manager is automatically executed. So make sure to take that into account!

IMPORTANT:

- if several Stand-Alone modules are interconnected on this fifth input, only 1 module may be assigned a scene – for all other connected modules the scene input (Input 5) must remain empty!
- For the scenes used in the 5th entrance of SA modules, NO DELAY TIMES may be set at the scene level itself. The delay times are entered here in the module screen.

The outputs can be activated from the system manager by pressing the Test or Up/Down key, and the current status can be consulted by pressing the "Read value" key.

See the corresponding sections on controlling the relay modules via various modules.

4.3 Configuring switches (SWC0X/XX and Tastu)

The switch is essentially the user interface of the system. As with a conventional switch, its operation is very simple.

Each switch can perform 4 + 4, so a maximum of 8 operations. These operations are simple toggles (ON/OFF), dimming, scene recall, central commands, and anything the system can handle.

To program a switch, follow this procedure:

When you have entered the serial number of a switch as mentioned above in this document, in 3.3, you will see the following screen appear:

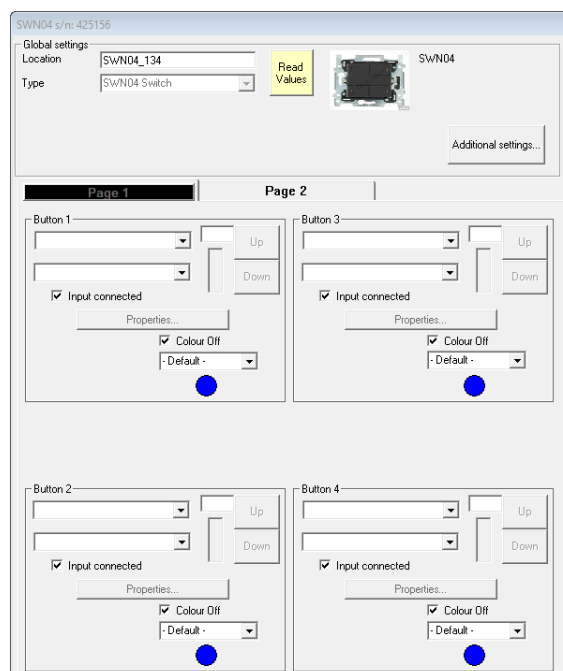

It is important that you set the correct type for the Tastu switches. In the drop-down list you can choose from SWC01/G, SWC02/G, SWC04/G or, if equipped with a temperature sensor, SWC02T/G or SWC04T/G

The screen above is the programming screen of a switch, showing the 4 commands for the switch. These commands are placed so that the top left field (Key 1) corresponds to the top left of the switch when you are in front of the switch, etc.

Remark: You can verify that the position of the switch is correct by making sure that the serial number on the back of the switch is legible (not upside down).

To program the switch, click the drop-down box next to the first key; there you can select outputs that you have already created, or create a new output. see point [3.5](#) in this document for creating outputs.

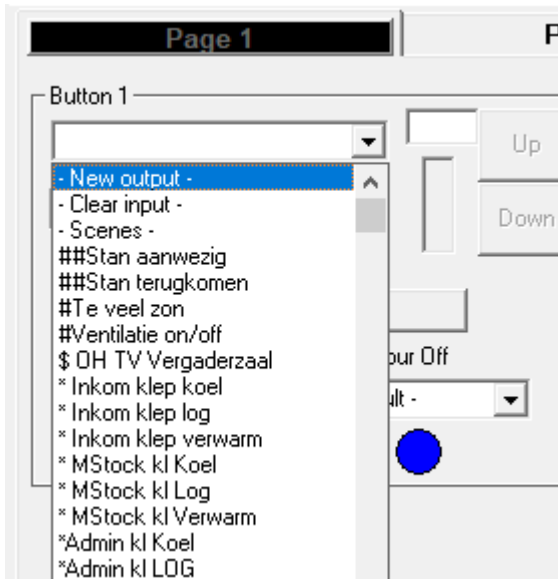

In the drop-down box below the output selection window, you can select the mode of the new output you want to create. If you have selected an existing output, the mode will already be indicated in that box. see point [3.5](#) in this document for a description of the various output types you can select.

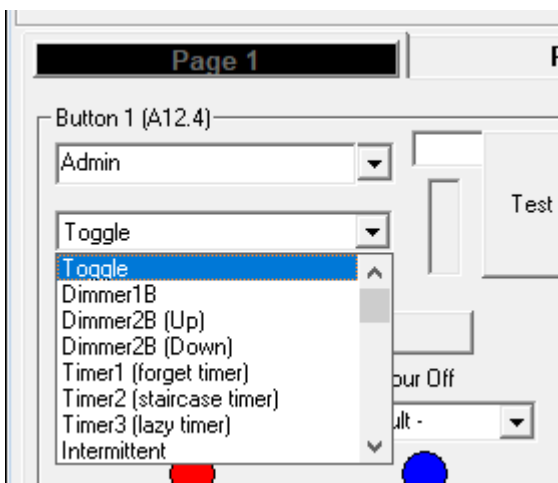

As you can see on the screen below, for each key you can choose the color of the standby LED (off color), as well as the color for the operating state (on color), or even disable all colors completely, with the option above each color. It is recommended to use different colors for different outputs - e.g. blue for on/off, yellow for dimmers, green for scenes etc. This will make your system easier to use.

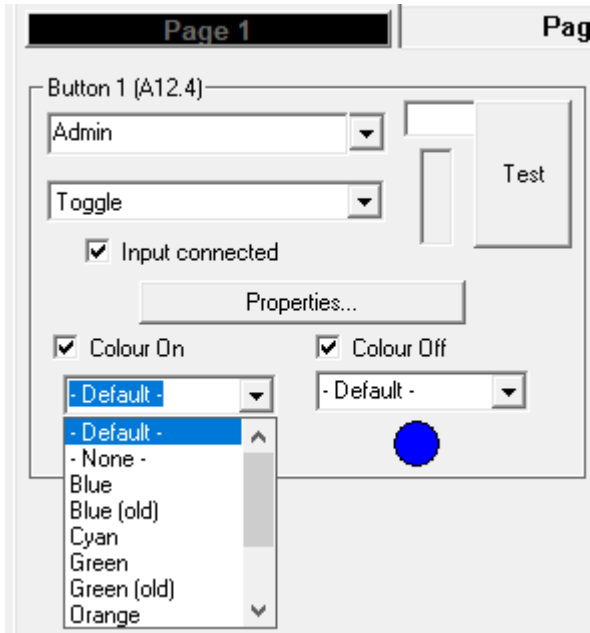

The UP/DOWN and TEST keys on each key next to the output allow you to verify that the selected output is operational and that it is indeed the one we want to illuminate on the key in question for this particular switch.

The properties option takes you to the output properties for this key. see point [3.5.10](#) - Properties - for more details about these properties.

As mentioned earlier, these switches have the capacity for 4+4 operations. The other 4 operations can be found on page 2, in the upper part of the window. When you go to this page, an identical screen is displayed with the four keys. The configuration method is exactly the same.

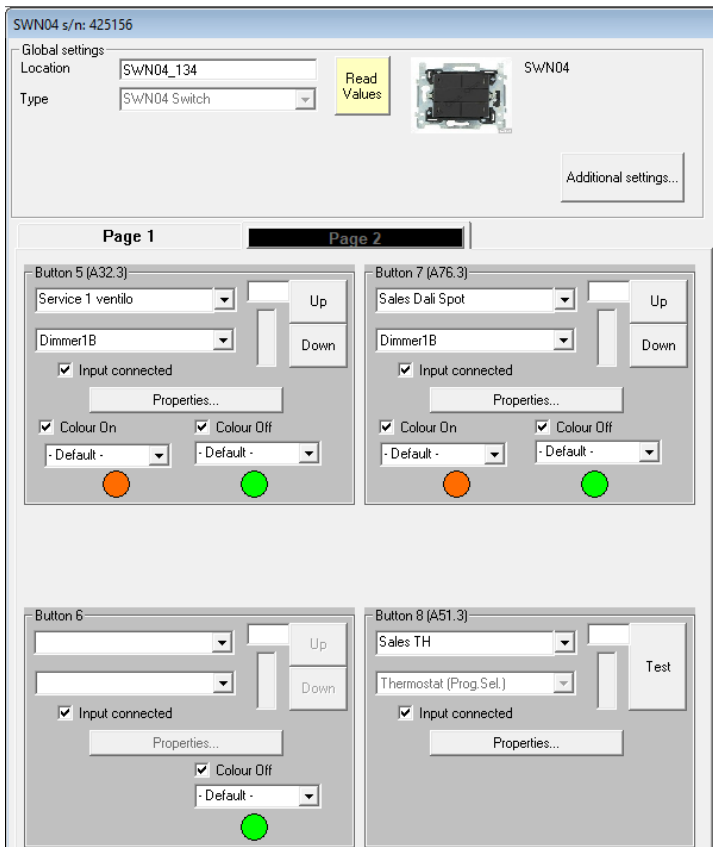

ATTENTION!!:

Switching between the pages is done by pressing 2 keys simultaneously. If you are using BTicino switches: Press the two upper or lower buttons of the switch simultaneously. If you use switches from Niko or the glass switches (Tastu): press the two keys on the left side or the two keys on the right side of the switch. Once this is done, the 4 keys on the 2nd startup page will be activated. The selection of the 2nd page takes 5 seconds, then the switch returns to the first startup page. You may want to use the second page of a switch for outputs that you do not activate regularly (e.g. shutters).

Additional settings: with this option the following screen appears.

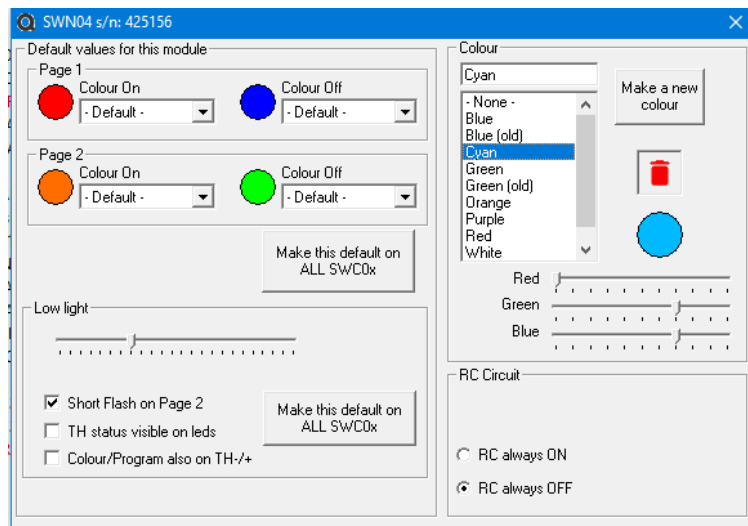

Standard colors for this SWC0x:

This option allows you to set the standby and operating colors for all LEDs on pages 1 and 2. If you click on “Use these colors as default”, the chosen colors will now be used as default. So all switches set to - Default - will use these new colors. Clicking "Make this default for ALL SWC0x" will set these colors as default AND will also be assigned to all switches under this project.

Low light

With this option the brightness of the LEDs at the OFF position can be adjusted by moving the bar left/right (position 2-10 is recommended).

With the “Short Flash on Page 2” option, when you use the 2nd page of the switch commands, the LEDs will flash to indicate that you are on page 2.

The option “TH status visible on LEDs” will reduce the brightness of the LED of the thermostat output when the requested temperature has been reached.

With the option “color/regime also on TH+/-” the color of the thermostat program (night, comfort, etc.) will also be visible on the thermostat + and - buttons.

Finally, you will be given the opportunity to select the colors of your choice and use them for the LEDs.

Thermostat switch

In addition to the simple switches, there are switches with an integrated temperature sensor, which also serve as a thermostat in addition to the normal functions. The following screen is a programming screen for such a switch.

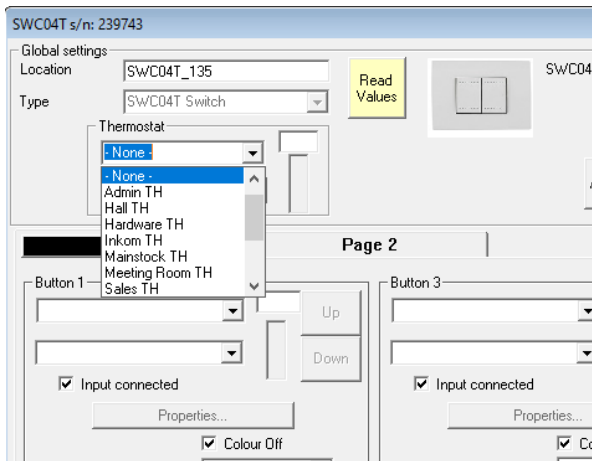

Note that, under the two fields in the upper part of the screen (for the BTicino or Tastu switches) or between Button 3 and Button 4 (for the Niko switches), an extra field has been added that relates to the thermostat. That way you can add a new thermostat or use one of the thermostats already created. The thermostat settings are the same as those listed for the DIS02 .

4.4 DIS02IT (Eol 2017)

4.4.1 Configuring the DIS02 IT

DIS02 is a central control unit with an integrated electronic thermostat. It can control a number of outputs or scenes. In addition, it has an integrated infrared receiver that can be linked to any remote control.

It is initially programmed by entering the serial number of the DIS02, which you will find on the back of the device. The following screen is displayed.

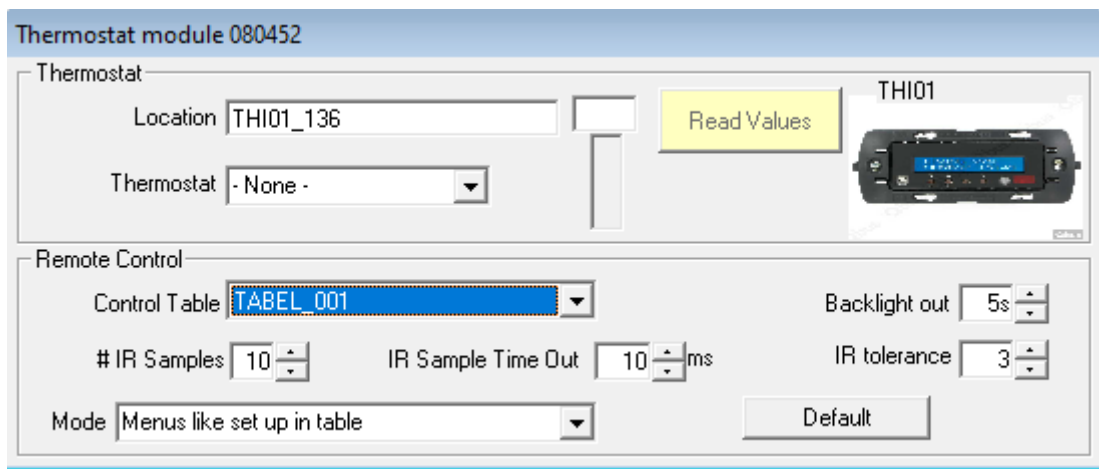

In the first field (location), type the installation location of the controller.

In the second field, select the thermostat that you want to control with the DIS02. This can be a new thermostat that is only controlled by the DIS02, or a thermostat that you have already entered (e.g. for a switch or a touch screen with thermostat function). Refer to the point about the various output modes (3.5.6) for programming thermostats.

In the “control table” field you can select a control table that you assign to the DIS02. see point [3.8](#) to create a control table.

After selecting the control table that you want to control via your DIS02, the following screen will be displayed.

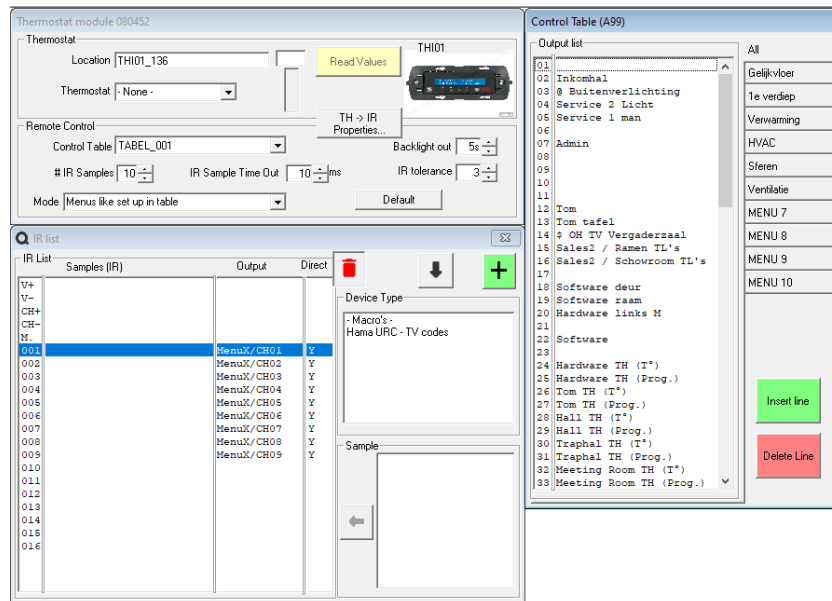

When you select the desired control table, the outputs you selected in this control table are now automatically fed into the DIS02. Note that this list serves to show the link between the outputs that you can control via the buttons on the DIS02, and the infrared samples that you have created to control your Qbus installation with your remote control. Therefore it seems that the first 4 fields of the list are empty and you can only see 20 "samples". The first 4 fields (numbers 000-003) are not empty - if you click on these fields you will see that they are assigned to Volume Up, Volume Down, Channel Up and Channel Down (functions you will need when using the remote control). From field 004 you will see the outputs you selected in the Control Table. In this specific list you only see the first 10 outputs from the control table (ie up to field 013). However, if the control table contains more than 10 outputs, the remaining outputs are also automatically entered in the DIS02 (maximum 99 outputs) and can therefore be controlled.

The other fields of the DIS02 screen (# Learn samples, IR sample timeout, Mode, ...) are required to use a remote control - see point [3.8](#) to read more about this.

4.4.2 Using the DIS02 IT

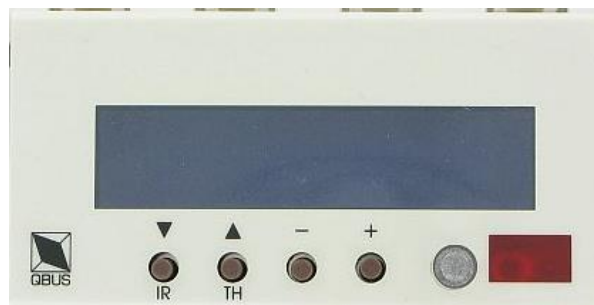

The temperature displayed on the thermostat's display in standby mode is the current room temperature, not the temperature you selected.

By pressing the IR key, you can scroll through the outputs assigned to your DIS02 via the control table (see above). When you have briefly pressed the IR button, you can use both the IR button and the TH button to cycle through the outputs, from high to low (using the IR button) or from low to high (using the TH -test). By holding down the "down" (IR) or "up" (TH) key, you scroll through the list in steps of 10 outputs (from output 1 to 10 to 10 ...). When you see an output that you want to control, you can use the + or - keys to turn this output on or off. If you are operating a dimmer, set it to 100% by pressing the + button once or to 0% by pressing the - button once. Press and hold the button if you want to dim to a certain percentage.

On channel 0 you can check the status of the system (using + or -); you will then see the outputs you have selected to be displayed on a screen when they are activated (see 3.5 Select Outputs - where we discuss the properties of the various output modes).

If you do not press the IR button again, the screen will return to the default setting (displaying the local temperature) after 5 seconds.

In the standby status of the DIS02, pressing the TH button allows you to select the programs "Manual", "Freeze", "Economy", "Comfort and "Night" You can change the requested temperature for each program in steps of 0.5oC with the +/- button of the DIS02 .

4.5 ViZiR Room Controller (Eol 08/2019)

4.5.1 Configuring the ViZiR Room Controller

The ViZiR Room Controller is a control panel for a Qbus installation consisting of an OLED screen with a capacitive cover plate around it. The screen can be operated by touching this cover plate. The ViZiR also has a digital temperature sensor on board so that this module can also serve as a thermostat. The ViZiR Room Controller is clicked into a Niko® frame (included) and is equipped with a bus connector (no polarity). The bus that is connected to the bus connector provides the ViZiR with power and control.

A control table for the ViZiR Room Controller can be compiled in the Qbus System Manager III (minimum version 3.2.22). Up to 10 menus can be used, which can be selected by sliding the finger up or down on the cover frame on the left side of the screen.

When the serial number of the ViZiR is entered in the module field, the following screen is displayed:

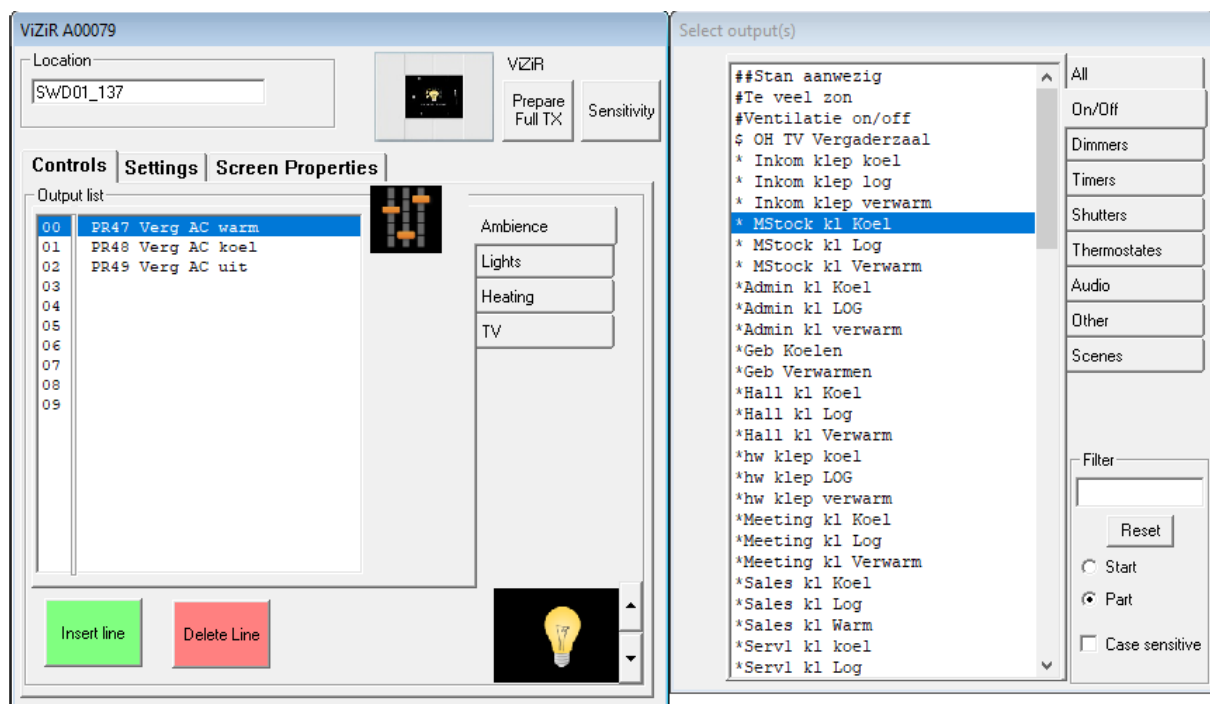

Up to 10 different menus can be created in the “Controls” field (in the example above, these are the menus “ambience”, “lights”, “heating” and “TV”), and in turn can be assigned up to 10 different outputs to each menu (in the “output list” 0 to 9).

The outputs are displayed on the right side of the screen. Select Menu 1 and double click the menu key so you can change its name. When you have selected menu 1, move the desired outputs to the list of outputs in menu 1. Select menu 2, move the desired outputs to menu 2, etc.

The "Insert line" and "Delete line" keys allow you to insert a line between two outputs if you have forgotten outputs or delete what you will not need in the end. "Delete line" does not delete the corresponding output from the program itself, but only from the table or menu.

An image can be chosen per menu that will be displayed on the ViZiR when that specific menu is selected. Click the up and down arrows next to the displayed icon at the bottom of the screen to cycle through the different images. You can also set the icon per output in the same way.

The "Settings" field displays the following screen:

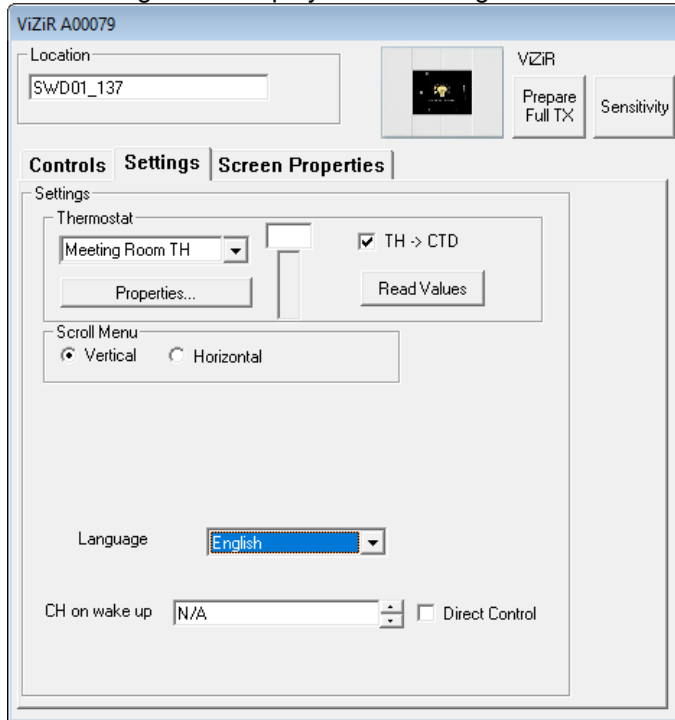

On the thermostat field you can choose which thermostat the ViZiR should function as (has built-in temperature sensor). If the ViZiR is to be used as a thermostat to control the temperature of the specific room, the checkmark next to "TH ->CTD" must be checked. If this is not checked, the ViZiR will only show the temperature measured by the temperature sensor of the ViZiR on its "home screen", but this temperature will not be sent to the Controller to be used as room temperature for the regulation of the temperature.

In the Scroll Menu you can choose whether to scroll vertically (slide from top to bottom on the cover frame to the left of the ViZiR screen) or horizontally (slide from left to right on the cover frame below the ViZiR screen) between the menus. **WE RECOMMEND CHOOSING THE VERTICAL SCROLL MENU.**

The language in which commands from the ViZiR are displayed can also be selected in this screen.

A shortcut can be programmed in the ViZiR via the "CH on wake-up" link. Touching the blanking frame on the left side of the screen with two fingers at the same time will immediately activate the output selected in the "CH on wake-up" field. To do this, the checkmark next to Direct Control must be checked.

The Screen Properties field displays the following screen:

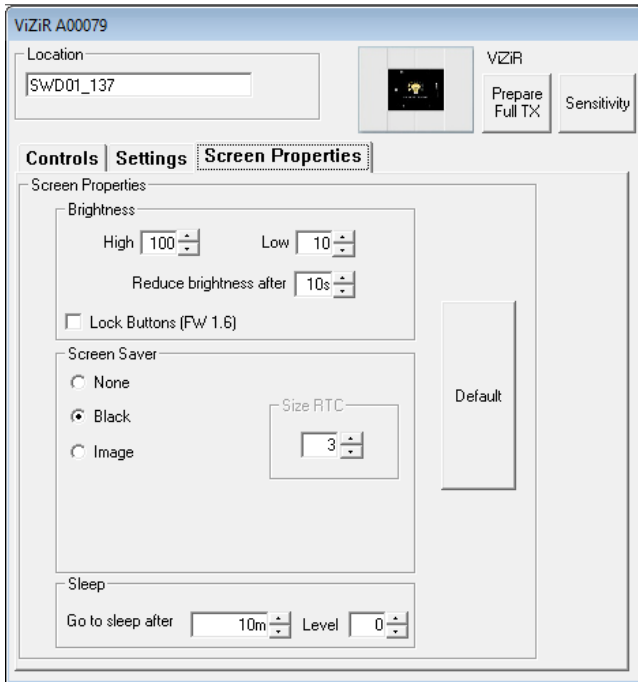

The brightness of the screen can be updated via the Brightness buttons. The Low brightness appears after the number of seconds defined in the “Reduce Brightness after” field. After the number of minutes defined in the “Go to sleep after” field, the ViZiR enters an energy-saving sleep mode.

The screen saver can also be selected:

- None = no screen saver (so completely black screen in sleep mode which may be appropriate in a bedroom)
- Black = screen saver shows date, time and temperature.
- Image = a screen saver that displays images (Images 1-8). Images can also be uploaded via the Upload button. The font size can be adjusted via the “Size RTC” buttons.

We recommend using the Default settings.

IMPORTANT: IF THE SCREENS ON THE VIZIR LOOK WRONG, CLICK ON THE “PREPARE FULL TX” BUTTON ; THE DISPLAY WILL BE FULLY REPROGRAMMED WITH THE REQUESTED CHANGES AT THE NEXT UPLOAD TO THE CONTROLLER.

Adjust control sensitivity

In the configuration screen of the ViZiR there is a button “Sensitivity”. Clicking this button displays the following screen:

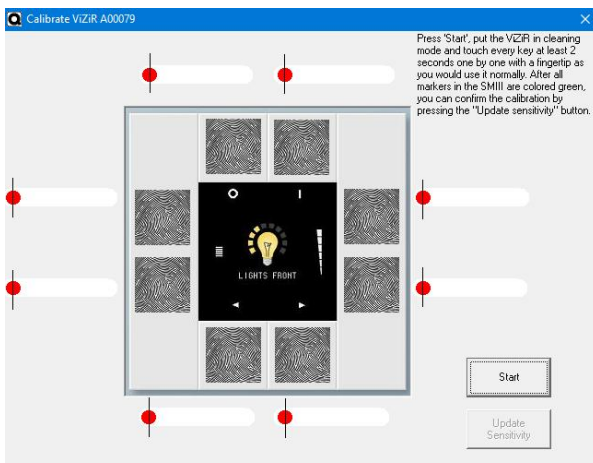

Press the “Start” button at the bottom right, then touch the eight keys of the ViZiR (on drawing 1 to 8) one by one for a minimum of 2 seconds in the same way as they will be operated. The red orb above the appropriate key will move and then turn green. After all keys have been calibrated in this way, you can confirm them by clicking on “Update sensitivity”.

4.5.2 Using the ViZiR Room Controller

The cover frame of the ViZiR is capacitive; ie by pushing or sliding the finger on the cover frame you can scroll between menus or control outputs. As indicated in the image above, 8 capacitive keys are incorporated under the cover frame; the ViZiR can only be operated by touching the places where these buttons are located; by touching the ViZiR in the corners (where there are no buttons) the ViZiR cannot be operated.

TOUCH THE COVERING FRAME WITH THE ENTIRE SURFACE OF THE FINGER - NOT JUST WITH THE TIP OF THE FINGER - TO GET OPTIMUM OPERATION.

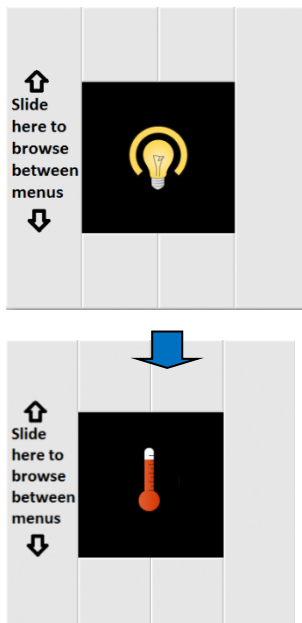

A maximum of 10 outputs can be assigned per menu. Within the same menu, you can choose between these outputs by pressing the left or right area below the screen. We recommend using the menus for functionalities (e.g. lighting, heating, ventilation, scenes,...) and grouping outputs with this functionality in these menus.

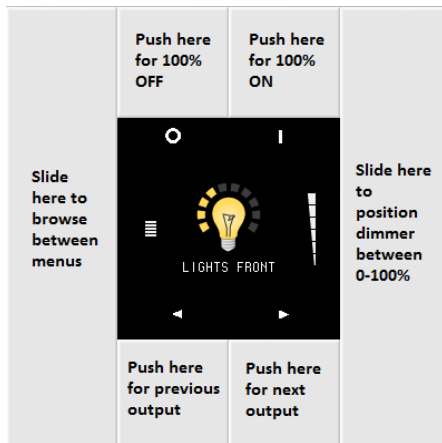

If more than one output is assigned to a menu, you can choose between these outputs by touching the areas above the on/off symbol (I / 0). The vertical area to the left of the screen can always be used to scroll between menus if more than one menu has been assigned.

All outputs that can be switched on or off (lamps, shutters, dimmers, ...) can be controlled by touching the areas above the on/off symbol (I / 0). Outputs that also can be positioned (roller shutters with positioning, dimmers) are switched on or off completely by touching these surfaces, and can be positioned by the finger up or down on the cover frame on the right side of the screen.

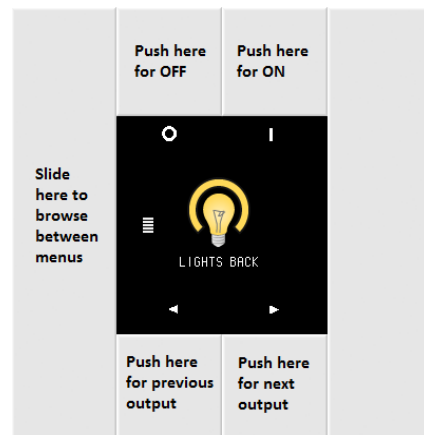

can be used to choose between these outputs by touching the areas above the on/off symbol (I / 0). The vertical area to the left of the screen can always be used to scroll between menus if more than one menu has been assigned.

the screen can

sliding side of

For heating and ventilation outputs, the areas above the screen can be used to choose between regimes. The vertical plane on the right side of the cover frame can be used to determine the regime set point (heating) or the exhaust flow rate (ventilation).



4.6 Touch Display (DIS/Gx) Module type 0008

4.6.1 Configuring the Tastu display

The Tastu Display is a control panel for a Qbus installation consisting of an OLED screen with a capacitive glass cover around it. The screen can be operated by touching this cover plate. The Tastu display also has a digital temperature sensor on board so that this module can also serve as a thermostat. The Tastu display is clicked into a Niko® frame (included) and is equipped with a bus connector (no polarity). The bus that is connected to the bus connector provides the Tastu display with power and control.

In the Qbus System Manager III (minimum version 3.16.11) 4 direct controls and a table for the Tastu display can be composed. Up to 16 channels can be used.

When the serial number of the Tastu display is entered in the module field, the following screen is displayed:

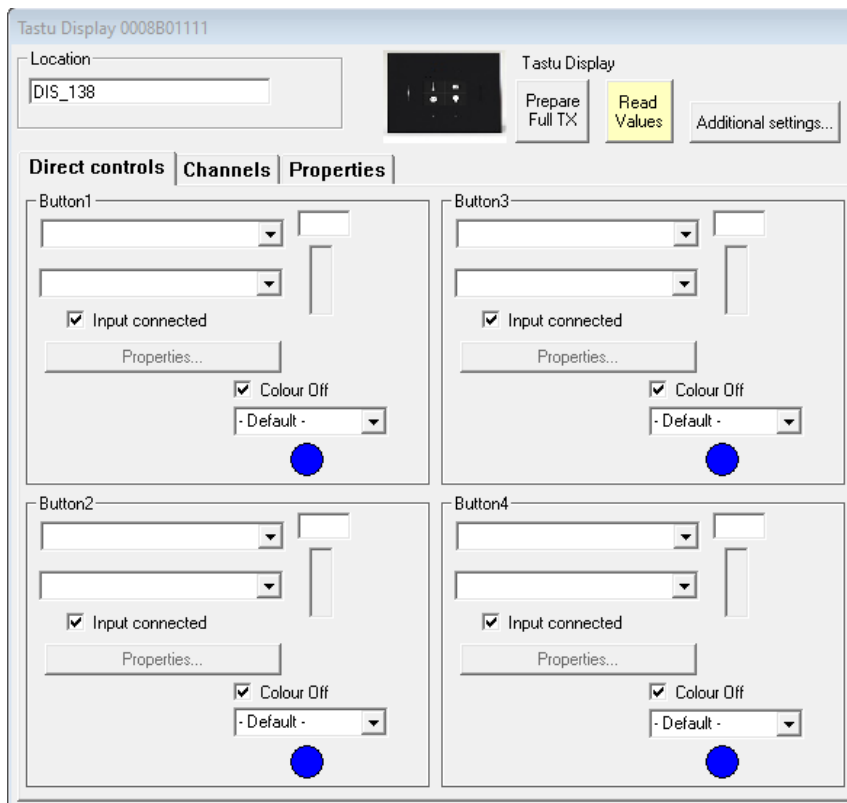

In this screen the 4 outputs or scenes can be set that will work as direct control on the Tastu display. Same configuration parameters as with an intelligent switch (SWC04) can also be set here. See section [4.3](#)

When you select the second tab “Channels”, the following screen appears:

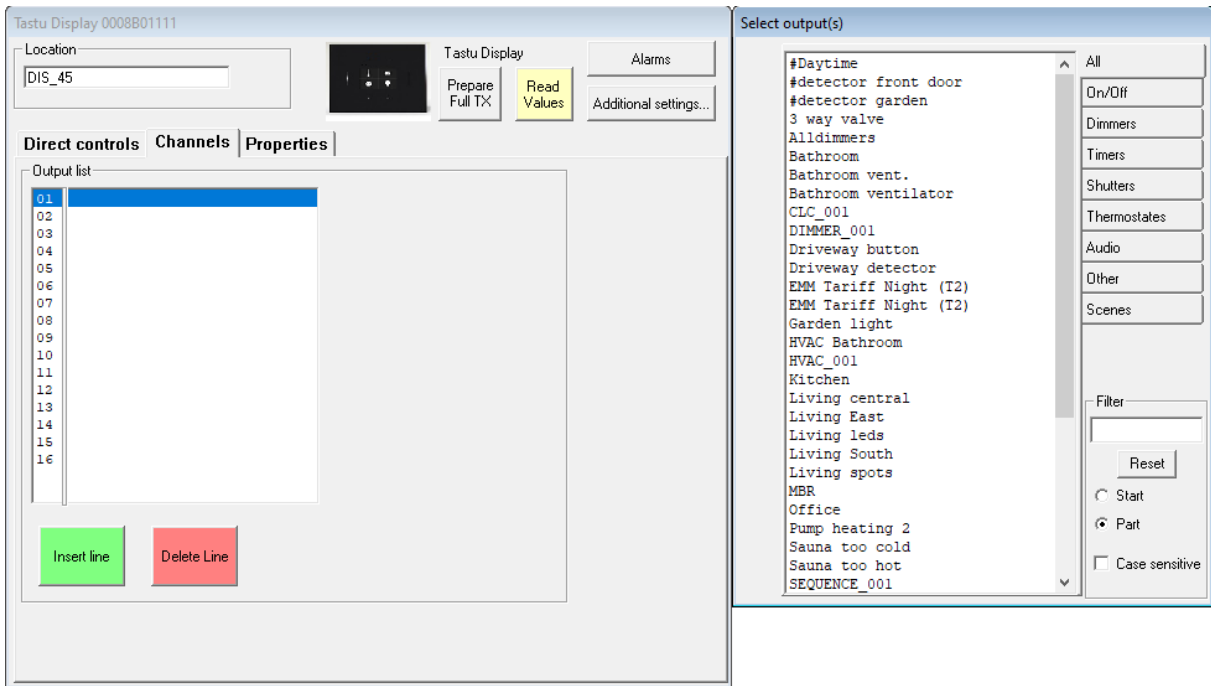

The outputs are displayed on the right side of the screen. Select the desired output line and double click the output to use it on the selected line

The "Insert line" and "Delete line" keys allow you to insert a line between two outputs if you have forgotten outputs or delete what you will not need in the end. "Delete line" does not delete the corresponding output from the program itself, but only from the table.

An image can be selected for each output that will be displayed on the Tastu display. Click on the up and down arrows next to the displayed icon to cycle through the different images.

The "Settings" tab displays the following screen:

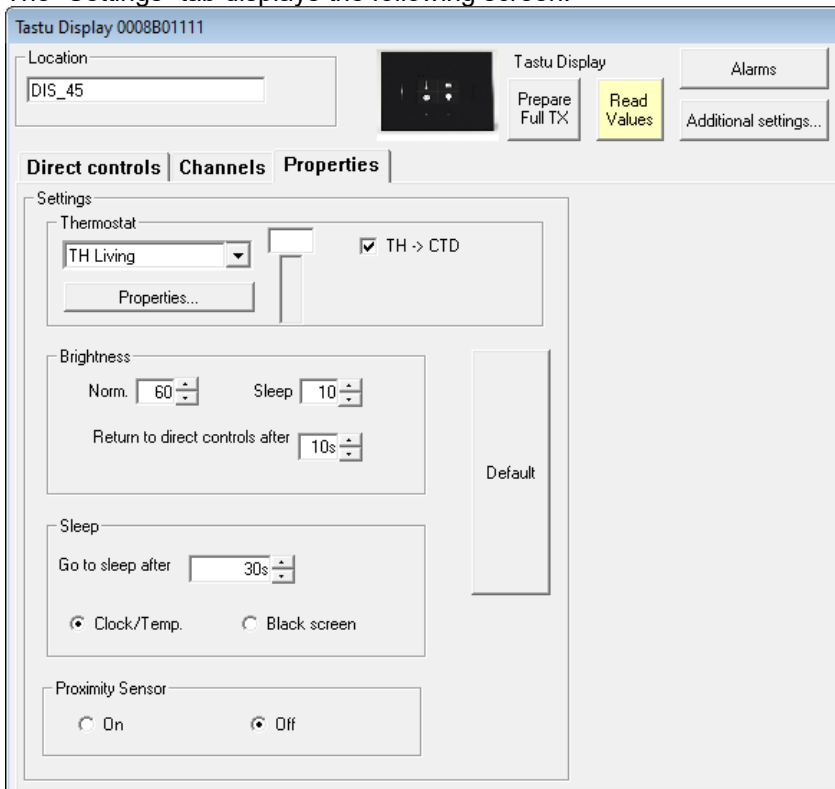

On the thermostat field you can choose which thermostat the Tastu display should be controlled (it has built-in temperature sensor). If the Tastu display is to be used as a thermostat to control the temperature of the specific room, the checkmark next to “TH ->CTD” must be checked. If this is not checked, the Tastu display on its “home screen” will only show the temperature of the selected thermostat output, but will not transmit the temperature from its own sensor to the controller to be used as room temperature for the regulation of the thermostat.

The brightness of the screen can be updated via the Brightness settings. The ‘Sleep’ brightness will appear after the number of seconds defined in the “Go to sleep after” field.

IMPORTANT: IF THE SCREENS ON THE TASTU DISPLAY LOOK WRONG, CLICK ON THE “PREPARE FULL TX” BUTTON ; THE DISPLAY WILL BE FULLY REPROGRAMMED WITH THE REQUESTED CHANGES AT THE NEXT UPLOAD TO THE CONTROLLER.

4.6.2 Using the Tastu display

The glass of the Tastu display is capacitive; ie by pushing or sliding the finger on the cover frame, you can scroll between outputs or control outputs. The keys are NEXT, BELOW, and ABOVE the screen. You can operate the direct channels by pressing the hole/led at the bottom or top. The status of the LED indicates the status of the output.

The slider on the left takes you to the channel list. You can slide up and down. You can turn an output ON and OFF by pressing the hole/led at the bottom, or dimmers can be dimmed up and down by pressing the top or bottom half on the right-hand side.

4.7 Configure 5.8" touch screen (TSC5.8)

The TSC5.8 is a monochrome touchscreen that can be connected directly to the bus (it receives all the power from the bus), or via an external power supply (so less power is drawn from the bus).

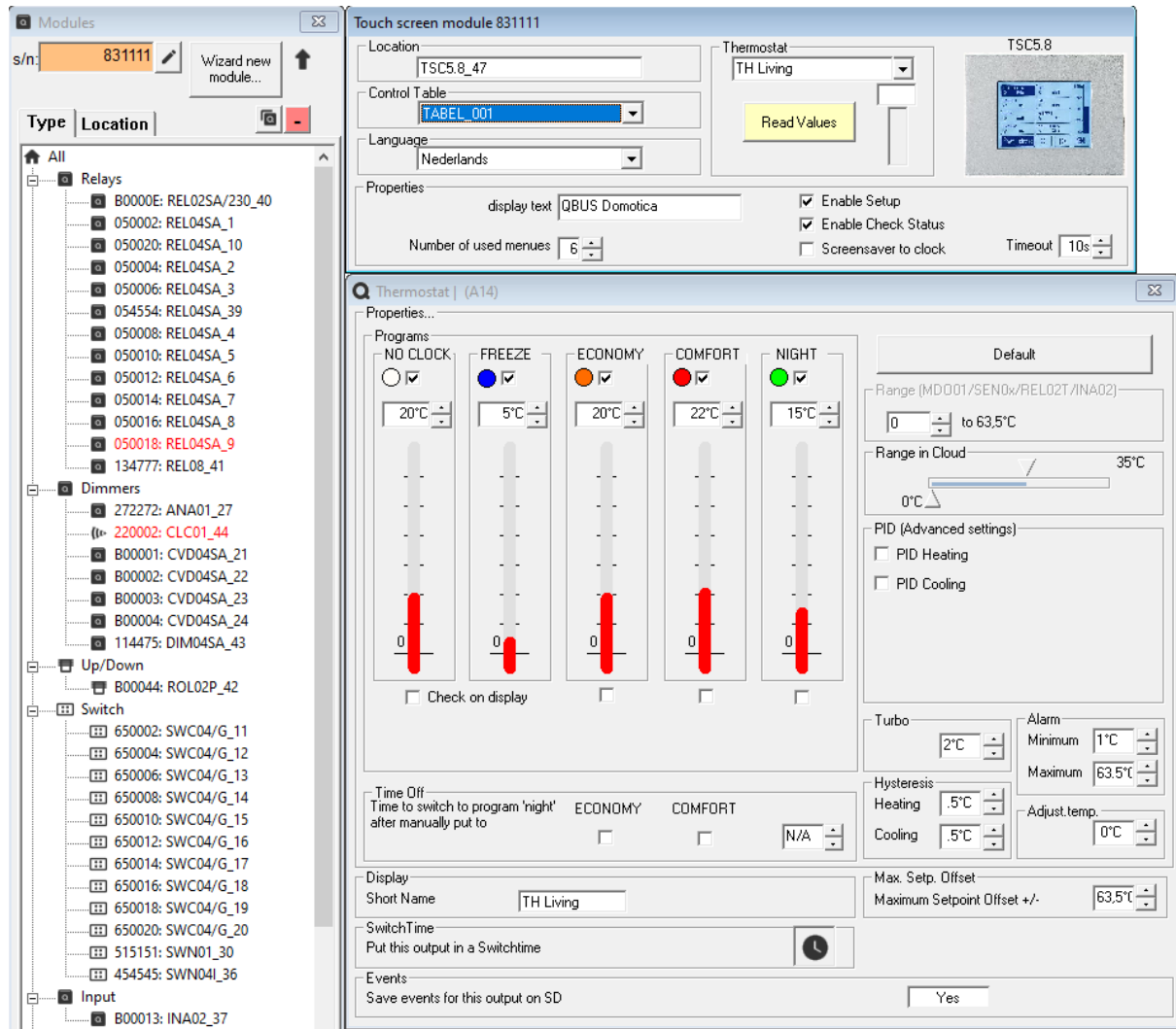

In the Location field, select what name you will give the TSC5.8 - usually the location where it is installed. As with a DIS02, a control table must be selected. This control table is the menu structure of your touch screen. See point 3.8 for how to create a control table.

On the same screen, you can select the language for the default touch screen text. Since the TSC5.8 is also equipped with a temperature sensor, you can select a thermostat to pair with the touchscreen. see point 3.5.6 for configuring thermostats.

In "Display text" you can enter the text you want to display on the bottom of the TSC5.8.

The number of menus used can be adjusted with the up and down arrows.

If the box next to "Enable Setup" is checked, you will be able to perform the following operations on the TSC.

- Enable/Disable the buzzer (buzzer may or may not work when the touch screen is used)
- The colors change from positive to negative
- Set up the touch screen
- Cleaning Mode: During this cleaning mode, the touch screen is inactive for 1 minute. During this period it can be cleaned.

If the box next to "Enable Check Status" is checked, you can check the status of certain outputs on the TSC. To select the outputs that can be monitored, go to the properties of the output and set the "Display Warning" key to Yes.

Activating "Screen saver to clock" means that after the set number of seconds, displayed on the right, the TSC will not return to the screen saver (lower power consumption by reducing the backlight), but will show the clock and measured temperature.

4.8 Configure motion detector (MDX01 or SEN04MLT)

4.8.1 Specifications

- The MDI01 is an INDOOR detector with an adjustable angle and an internal light sensor.
- The MDO01 or SEN04MLT is an OUTDOOR detector with an adjustable angle, and an internal light and temperature sensor.
- The detection range is 7 m at an angle of 110°
- Ability to recognize the origin of the movement, in particular to determine whether the movement comes from the right or the left in the detection zone.
- The MDI can be programmed taking into account the ambient light - it then only works if the ambient light is below a certain threshold value.

4.8.2 Configuration parameters

The following screen is displayed when the properties of a component are selected.

ATTENTION!!!! : Only bistable type inputs can be controlled

4.8.2.1 Triggers

The parameters of these fields are for setting the trigger sensitivity.

First: The level of motion must be higher than this set value to activate the output

Keep: The level of motion must be higher than this set value to maintain the state of the output.

Scan: A visualization of the detector is shown. The output will be activated when the level is higher than the green line and will time out if it stays below the yellow line:

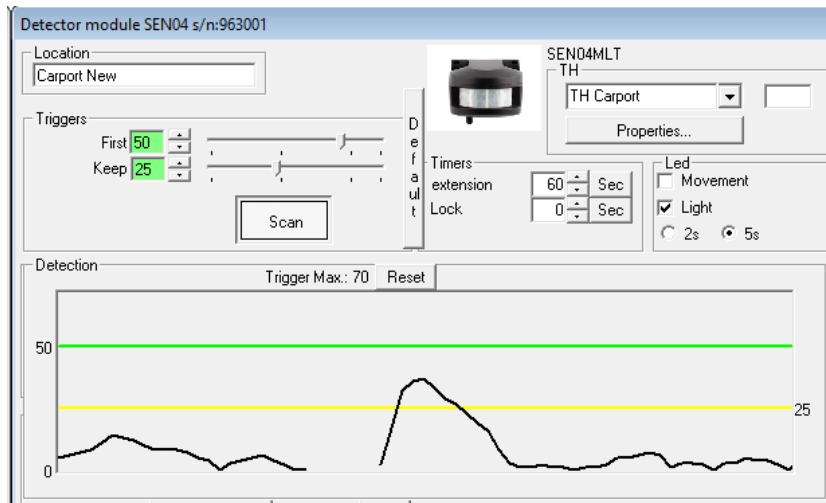

4.8.2.2 LED field

You can select when the built-in red LED will be activated, based on the motion or light level or both.

4.8.2.3 "Timers" field

Extension: Corresponds to the extension of the period during which the outputs remain activated. The smallest possible timer value is 2 seconds.

Lock: This sets the period of time the sensor will lock (and will not activate the output) after the output has become inactive.

4.8.2.4 Fields "Input x"

Movement (right/left): Activation of the sensor due to the movement reaching the detection range from the left or right side. If you choose both, the sensor will scan both the left and right sides. With the SEN04MLT/OUT there is no choice between left and right

Light: If 'Movement' is checked, this additional option "light", will only activate the output if the light level is lower than the set value. This is useful to prevent the output from being activated during the day. The threshold value can be set with the buttons or slider. When only this option is checked (without 'Movement'), the output will only be activated if the measured light value is HIGHER than the set threshold value.

The current light value will be displayed with a yellow or black bar via the "Read values" button. When the threshold value is in the colored bar, the output will be activated.

4.9 Configure SMS module – SMS01 (Eol 2017)

First connect the 230 VAC power source and the bus communication cables.

4.9.1 Install SIM card

Install the SIM card on a mobile phone and deactivate the PIN. If you are using a new SIM card, make a call and send an SMS to test the SIM card. Then insert the card into the SMS unit. **DO NOT FORGET TO PLACE THE SMS CARD IN THE SMS MODULE BEFORE PROGRAMMING.**

After installing the SIM card, go to the device properties in the Qbus program and check whether the device has a signal by pressing the option "Read signal strength, network, Error, ...". This option is displayed under the first tab of the device properties. Then you need to enter the table you want to control with the SMS unit in the option "control table" as shown below.

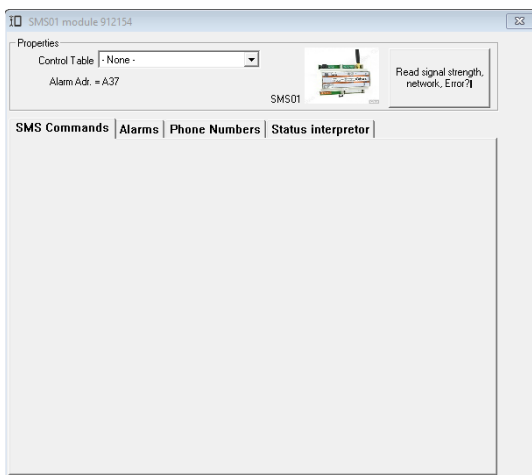

Continue if everything is in order, otherwise you will have to check that no wrong actions were taken in the previous steps.

4.9.2 Install Phone Numbers

Click on the tab "Phone numbers", and install the telephone number that can be used to control the Qbus system. **ONLY** with the installed numbers commands can be given to the system. If a third party knows the reporting number, he or she **CANNOT** give a command because the system does not recognize the number.

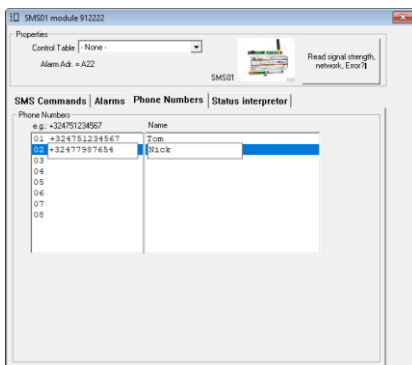

ATTENTION: For each phone number entered (mobile phones only), you must enter the country code preceded by the + sign.

4.9.3 Configuring Commands

When you're done entering phone numbers and the associated names that you want to see displayed, go back to the first "SMS Commands" tab and choose from the "Control Table" the outputs you want to control by SMS. Thus, the selection of outputs is done through the table, by double clicking, and is automatically entered in the table of SMS commands as shown above.

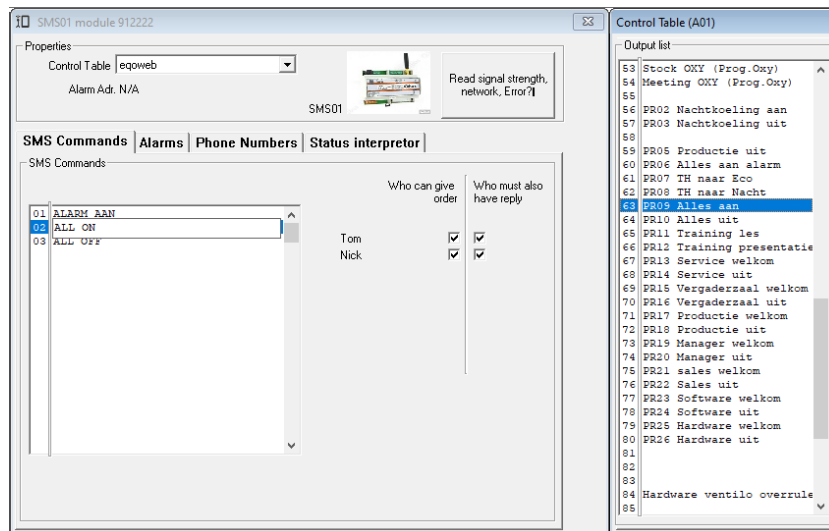

You can change the names of the commands that should be sent to the system.

In the "Who must also have reply" boxes you can select who – in addition to the sender of the message – should also receive a confirmation message that an instruction has been executed. The sender of the message will always receive a confirmation message if the instruction has been carried out correctly. If you also want to receive messages that an instruction was not executed correctly (e.g. because the instruction does not match what was written in the Status Interpreter) in the Alarm tab, check the box "Send debug report if no match".

ATTENTION: DO NOT USE SPECIAL CHARACTERS OR LETTERS (é, ã, ç,...) IN ANY TEXT CONFIGURED IN THE SMS (NEITHER IN THE NAMES NEXT TO THE TELEPHONE NUMBERS NOR IN THE MESSAGES TO BE SENT.) !!!!!

Finally, go to the "status interpreter" tab and click on "Default", so that the commands appear as shown in the following screen.

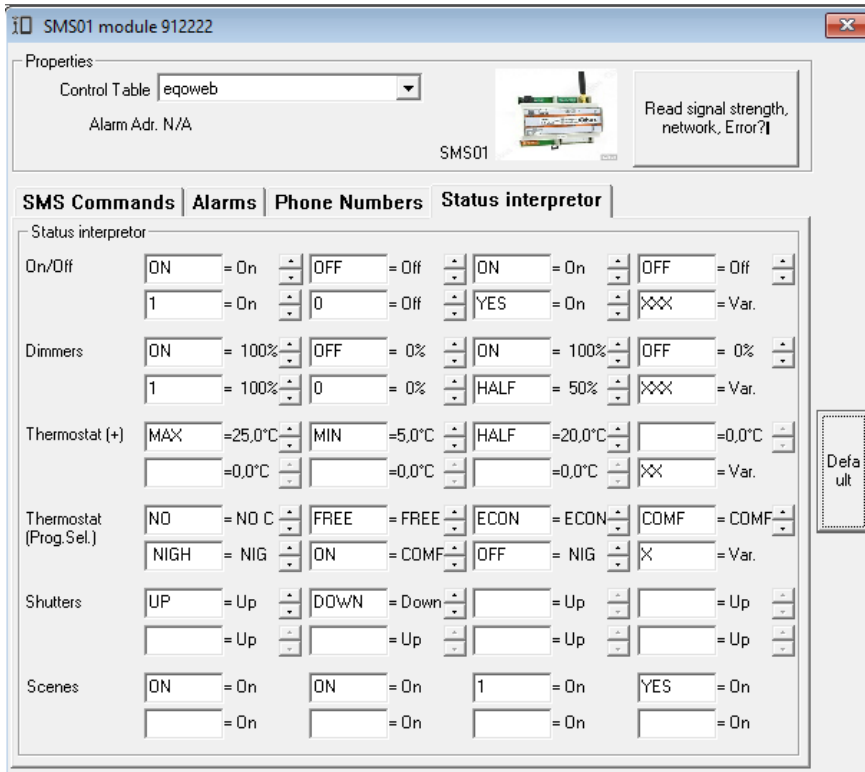

The commands shown above are defined as follows. If you want to energize a relay contact (on/off), you only need to enter the name of the contact as it was entered under the "SMS Commands" tab. Then, insert a space and type ON or 1 or YES, as shown in the previous table. Similar procedures are used for dimmers, blinds, etc. Make sure that the same instructions as listed in the Status Interpreter Tab are used when sending an instruction. If you want to request a current status of an output, you have to send a message with only the name of the output in the text (eg. TH Living) – you will then receive a feedback with the current status (e.g. TH Living Comfort).

In addition, you can be warned if there is a failure on the bus or in the event of a power failure. You can do this by going to the "Alarms" tab and selecting "Check the external power" and "Check the bus", so that the power of the system and the operation of the bus signal are checked respectively, as shown in the next screen. Via the option "Send a debug report if no match", the SMS unit informs you whether the message was not delivered or whether the command was not executed.

Setting the alarm for SMS, where the user also receives a warning in the form of a text message, is done as follows. Go to the SMS module via the "modules" option in the program's taskbar and choose the alarms tab; the following screen is displayed.

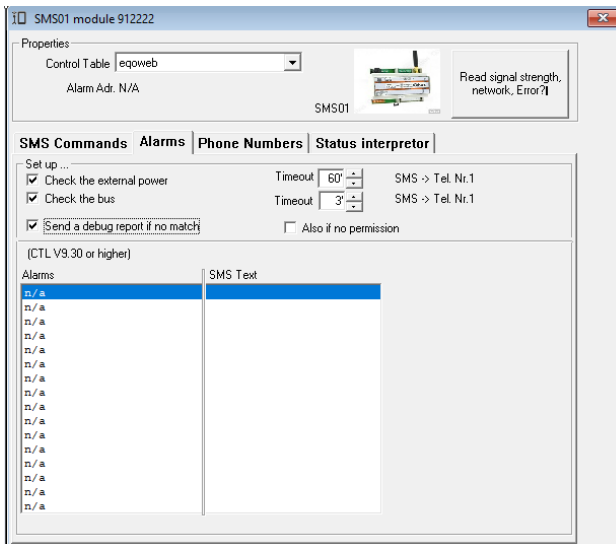

In the screen above, enter the SMS text, ie the text that will be sent to your mobile phone. In the right part of the screen, choose the phones for the people who should receive messages from this particular alarm. If you create a second alarm, you will need to re-select the phone numbers of the people who should receive the message, as it may not be necessary for everyone to receive all alarms.

The options above the names allow you to set the repeat time if the alarm is not initially detected. Please note that the SMS module can only send out two alarms at the same time.

DO NOT ACTIVATE OUTPUTS (DO NOT PRESS ANY KEY/ DO NOT ACTIVATE MOTION DETECTOR/ DO NOT ACTIVATE INFRARED PORT /....) DURING SENDING THE SMS CONFIGURATION TO THE CONTROLLER. UPLOADING WILL TAKE ABOUT ONE MINUTE. CLICK ON "TRY AGAIN" IF YOU GET A TIMEOUT (MODULE NOT FOUND).

4.10. Configuring the Audio Module - SER10 (Eol)

The SER10 is a serial port that fits into a standard built-in socket and is connected to the bus. This SER10 can be connected via the supplied cable to the serial port of one of the following audio systems:

- Apart Zone4
- artsound art2.4
- artsound art 5.4/8.8
- Niko Allegretto
- Nuvo Essentia/Grand Concerto

The SER10 is available in Niko versions (100, 101, 121, 122) and in BTicino versions (Light, Light Tech, Living).

Via a SER10 you can select up to 4 sources and configure up to 8 zones. Obviously, no more zones and sources can be used than what is offered by the respective audio system.

4.10.1. Select audio system

Open the System Manager III and enter the serial number of the SER10 in the module list. The serial number of a SER10 always starts with 99XXXX.

If desired, enter the location of the SER10 module. Then select the audio device. This can be a Nuvo Essentia or Gran Concerto, an artSound art2.4, 5.4, 8.8, Niko Allegretto or an Apart Zone4.

4.10.2. Assign Sources and Zones

Enter maximum 4 sources in the SER10 module, this can be for example “CD”, “Radio”, “MP3”.



The next step is to create the audio outputs, depending on the type of the audio module. We do this, for example, via the “Wizard new output” in the output list of the System Manager III. In the Wizard we select the Audio output. Then click on next, now enter the name of the audio zone. This can be the name of the room. Then press the finish button. Repeat this process as many times as the number of sources your audio device can handle.



ATTENTION: the order in which the audio zones are connected to the audio device will be the same as the order in which the audio zones should be created in the system manager. E.g. if on your audio device the first zone is Living and the second is Kitchen, the System Manager must also first create the Living zone and then the Kitchen zone.

4.10.3. Assigning outputs

a) on a SWC

Select the SWC where you want to control the audio outputs. For a user-friendly operation for both the installer and the customer, it is recommended to use the layout below.

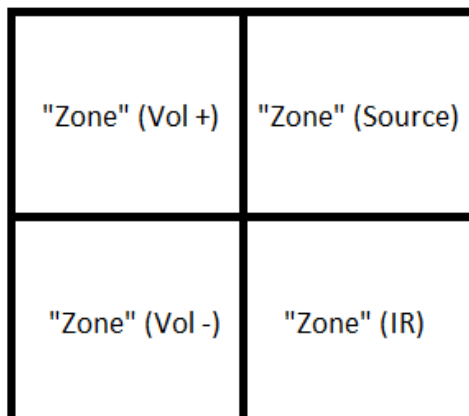

The visualization of the source selection on the SWC switch is done via LED coding visible on the two right buttons ("Source" and "IR") of the SWC.

Source 1:

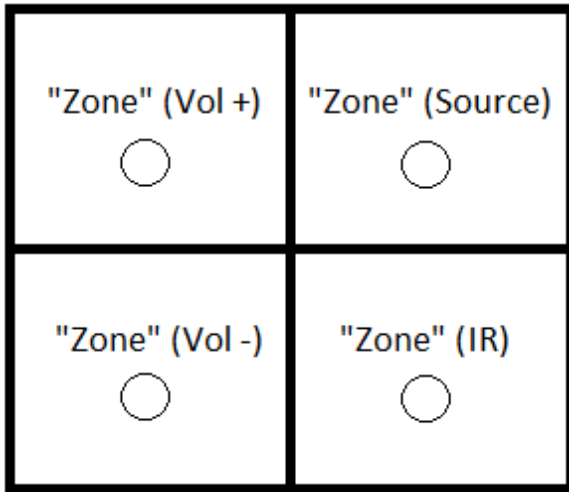

Source 2

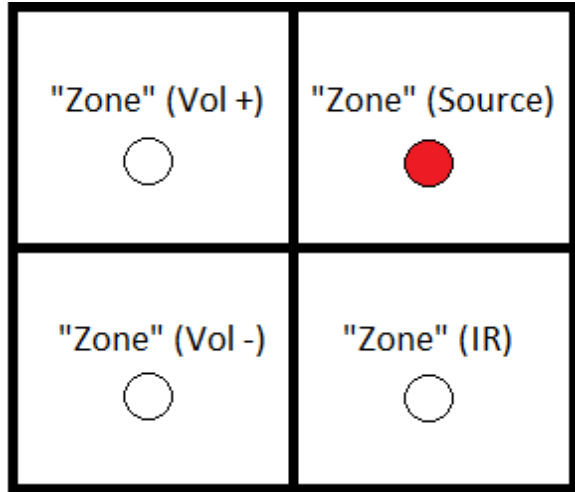

Source 3

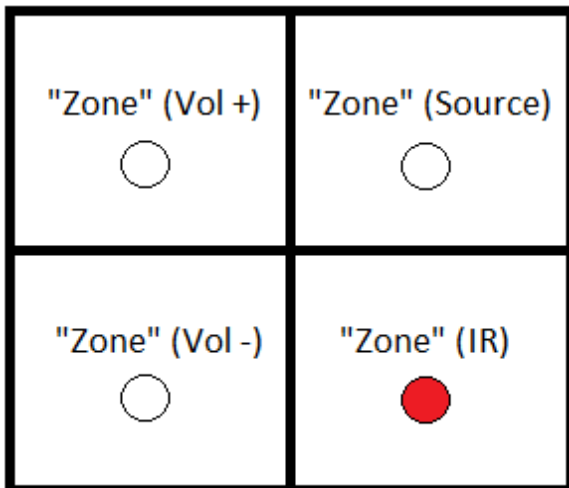

Source 4

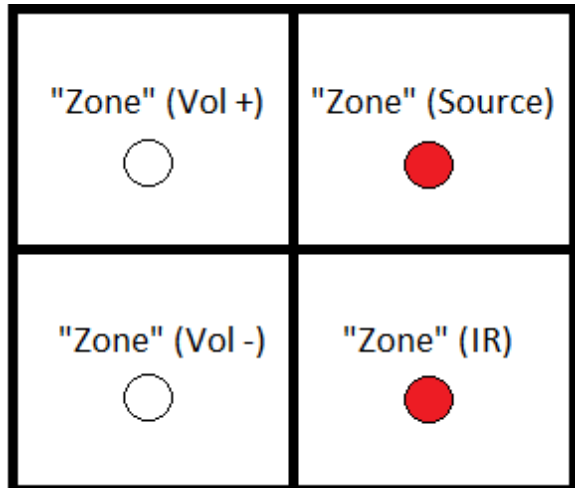

b) on a TSC5.8

Create a new control table, give the desired name to the table.
Then name one of the submenus audio, then add the audio outputs in the control table.

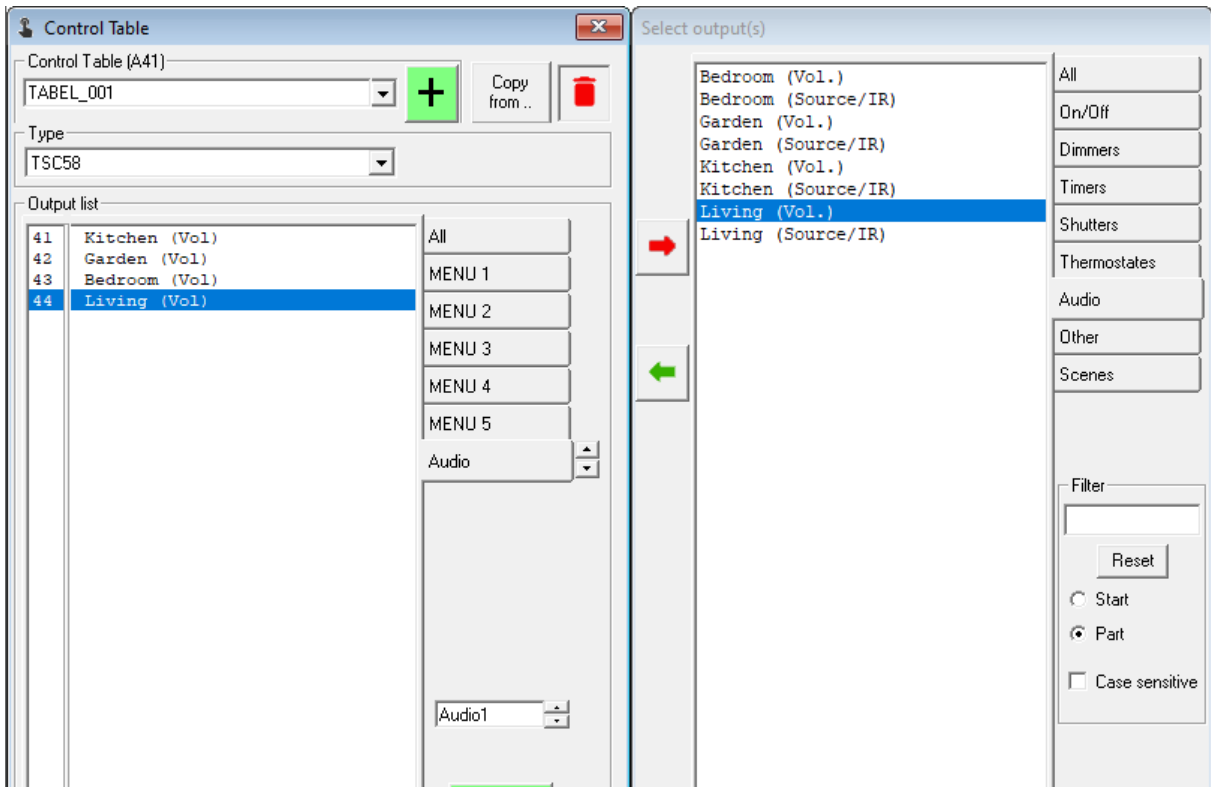

4.10.4. Audio outputs in scenes

Like all outputs that can be created in the System Manager III, the audio outputs can also be assigned in an scene. In this scene you can then choose to switch the zone on or off (IR output), change the source (Source output) and adjust the volume (Volume output).

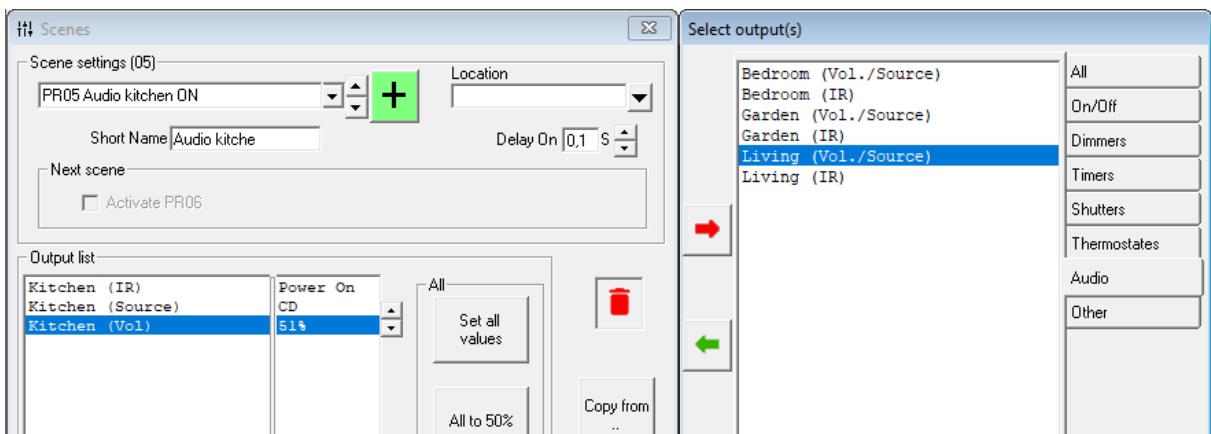

4.11. Configure the SER485/DMX module (module type 0002)

With the Qbus-DMX interface (SER485/DMX), it is possible to control DMX lighting fixtures via the Qbus control points (switches, screens, Qbus Cloud) (fixed colours, color transitions, switching via clock times or scenes, ...)

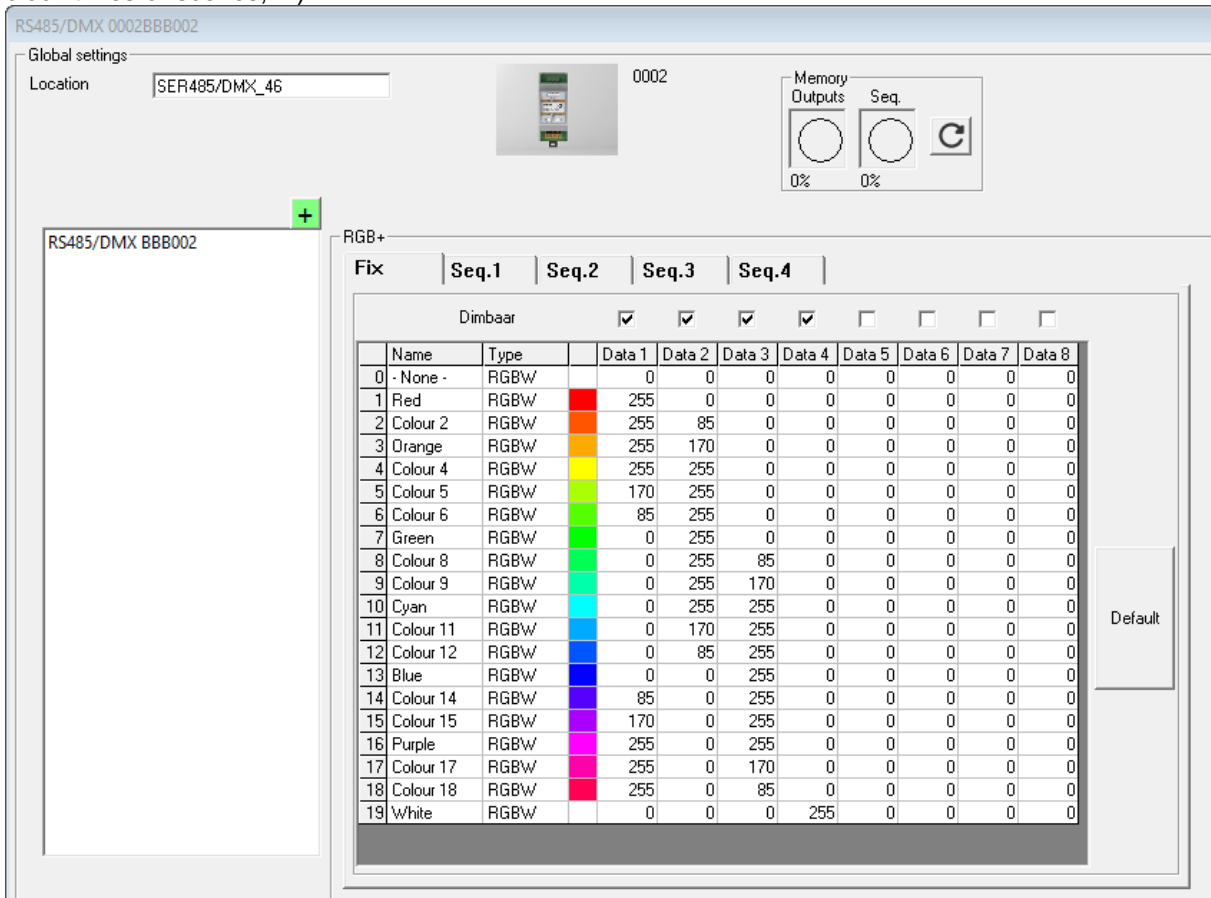

Possibility to set 20 'fixed' colors with default values as shown above.

Data1 to Data4 are the settings for RGBW

If the DMX fixture requires RGB values, Data1 to Data3 contains the R, G and B values.

Data4 to Data8 can then be used for other data for the fixture.

When WWCW is chosen, Data1 contains the red 'warm' value and Data2 contains the blue 'cold' value

The 'dimnable' box determines whether this value is dimmed linearly according to the set dimming value of the RGB(W) output. If not, the value will simply remain fixed as set.

By clicking on the checked box you can also set the desired color. See next figure:

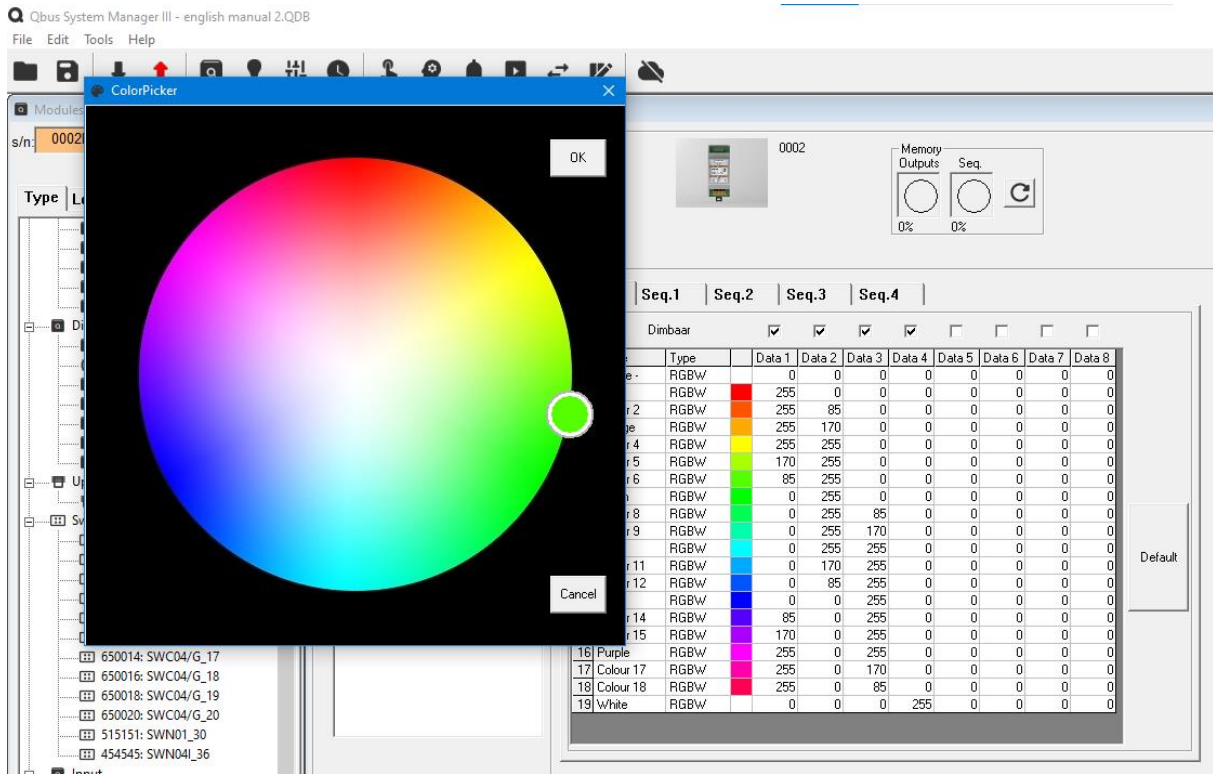

Setting a WWCW color via 'bar':

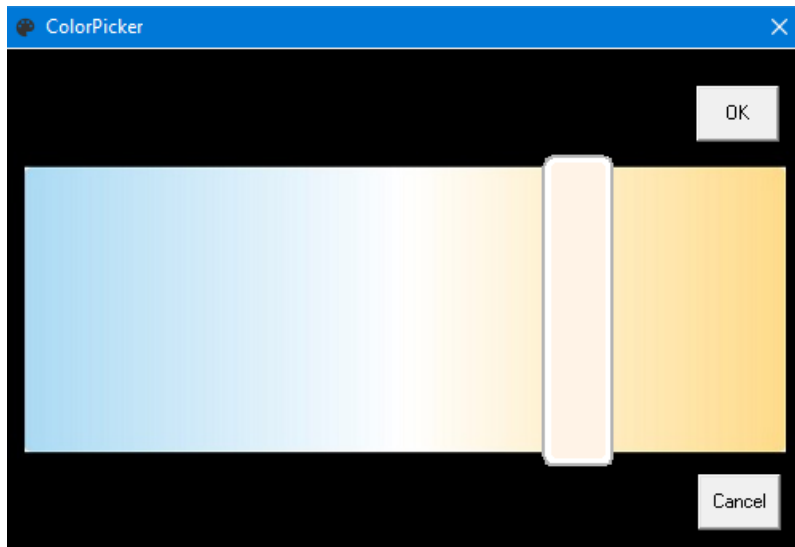

With the + and – button you can add and remove fixtures. In the right window you determine the start DMX address and the number of channels. The channel name can also be edited. The memory of the module is limited to a maximum of 48 links. For the use of an RGB+ output, 2 links are used internally. The free space can be seen at the top of the pie chart.

An output can be a QBUS output:

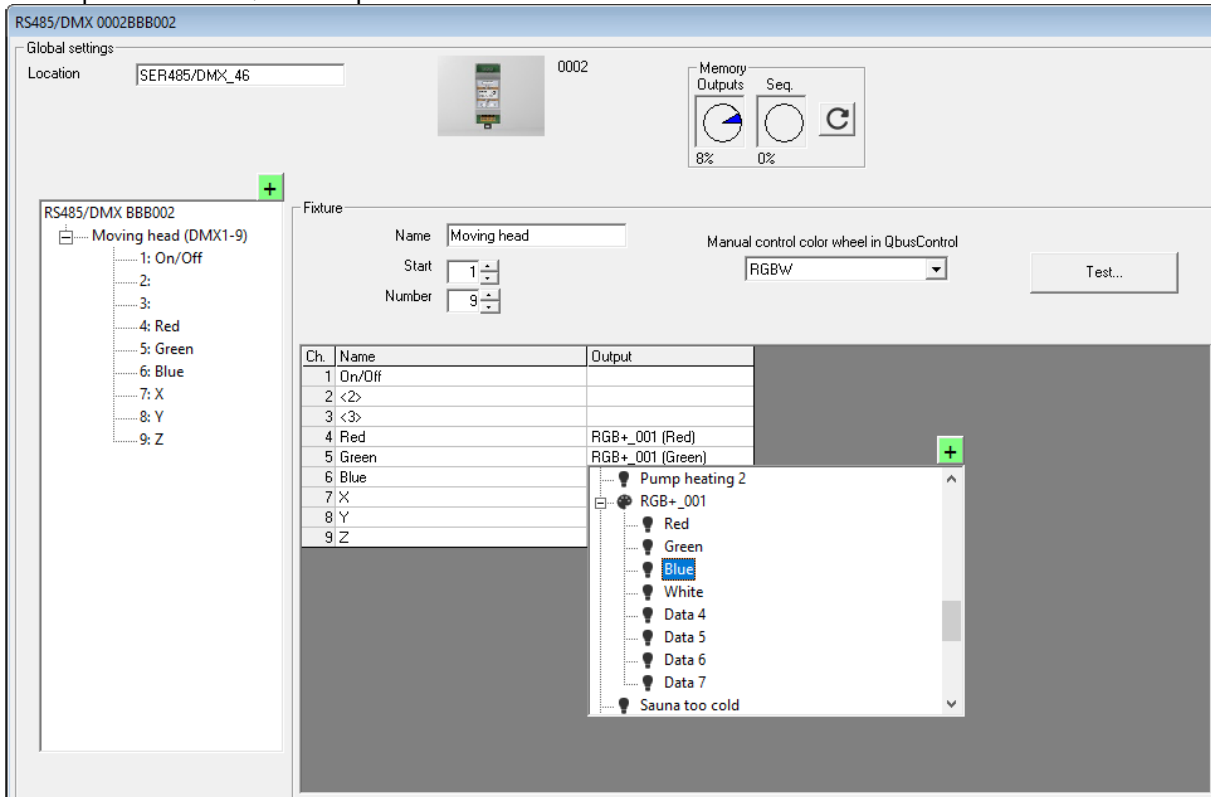

Or a fixed value (e.g. to have the lamp of the fixture give the maximum power)

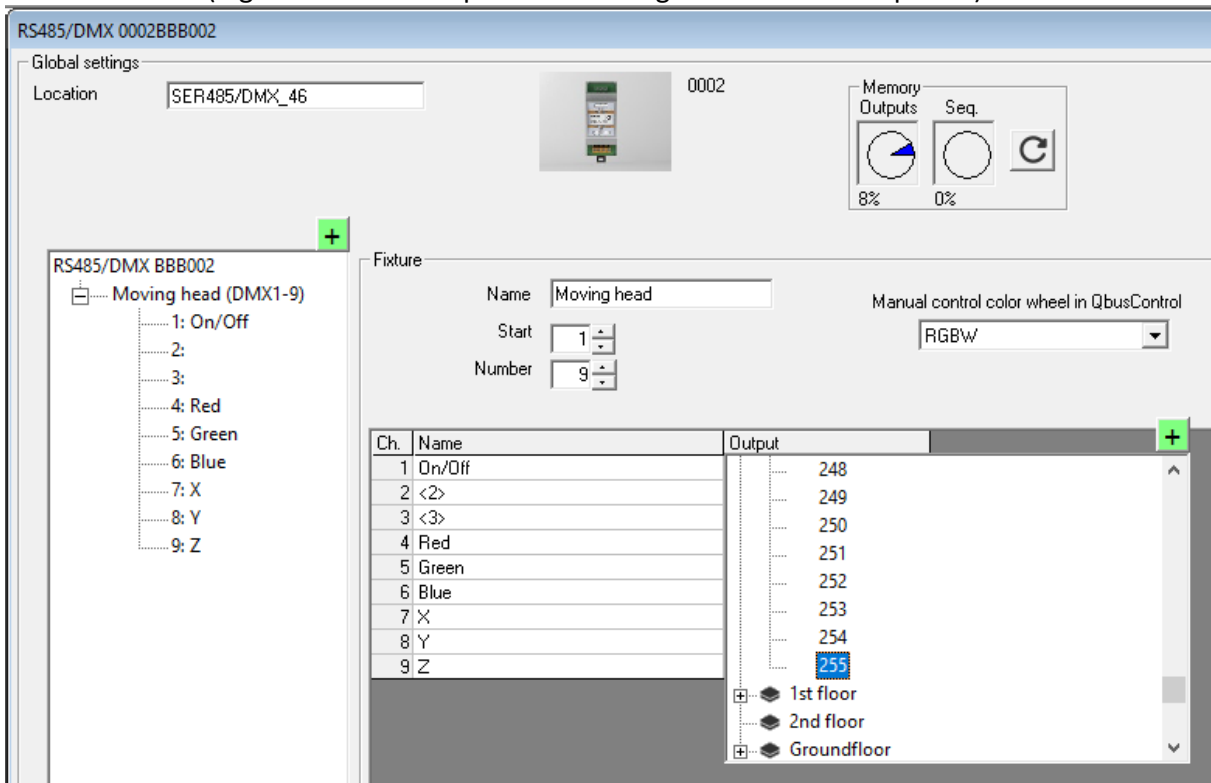

There is also a possibility to make 'Sequences'. The desired color can be set, the transition time to reach this color and also the time that this color must be maintained. Both times are adjustable from 20msec to 20min.

A maximum of 4 sequences are possible with a combined maximum of 80 color transitions. The free space in the memory can also be seen at the top in the right pie chart.

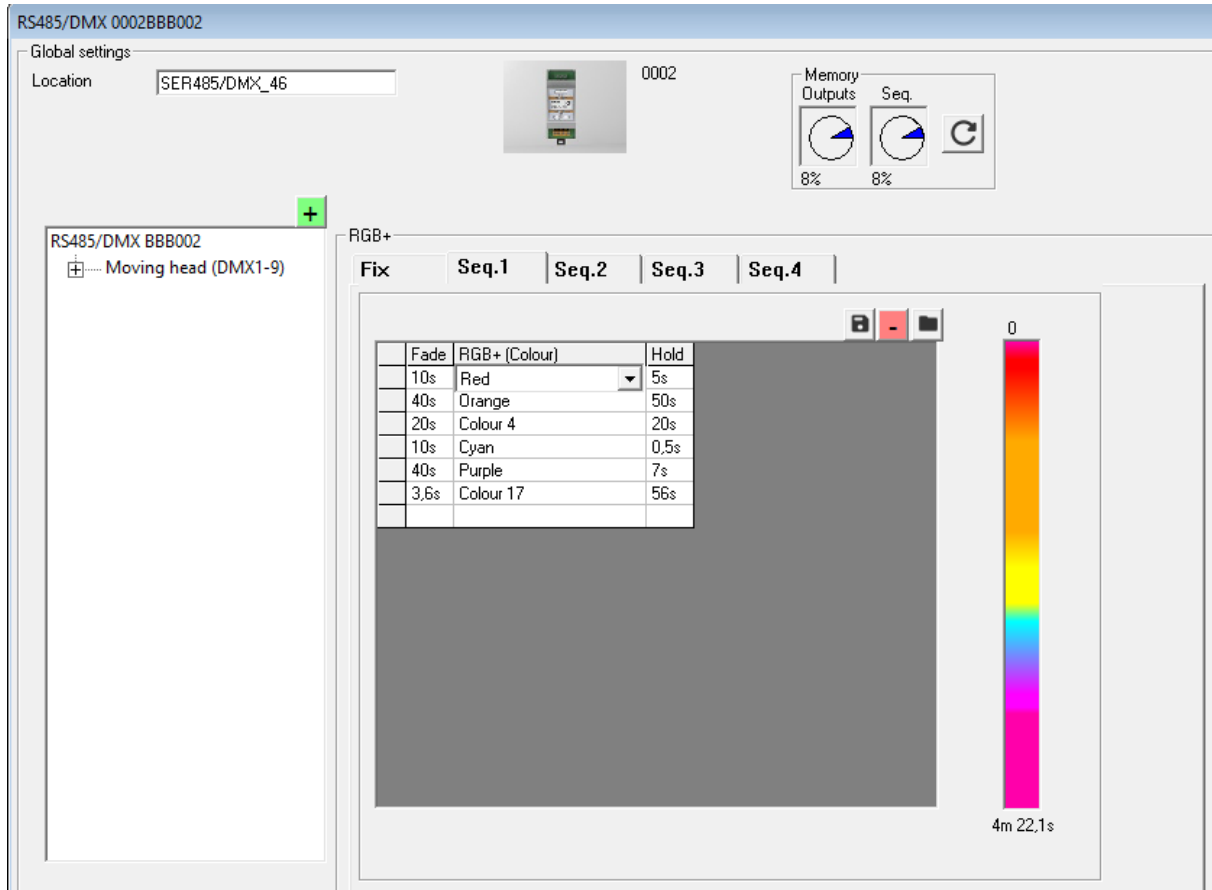

Via the diskette button you can save a sequence on the computer and via the 'open folder' icon you can add the saved sequences to the same or another sequence. By default, some examples are already supplied with the System Manager III, which you can use via the 'open folder' button. The new DMX module with new DualCore Chip (Module type 0002 – from SM 3.13) has the same function as the previous module but with an extra simple test button. Existing colors can be loaded (“Load 'color'”), with the sliders the RGB(W) values can be adjusted live and also saved to the same or a different color. The set fixed value can also be saved by clicking on “Save 'color'”.

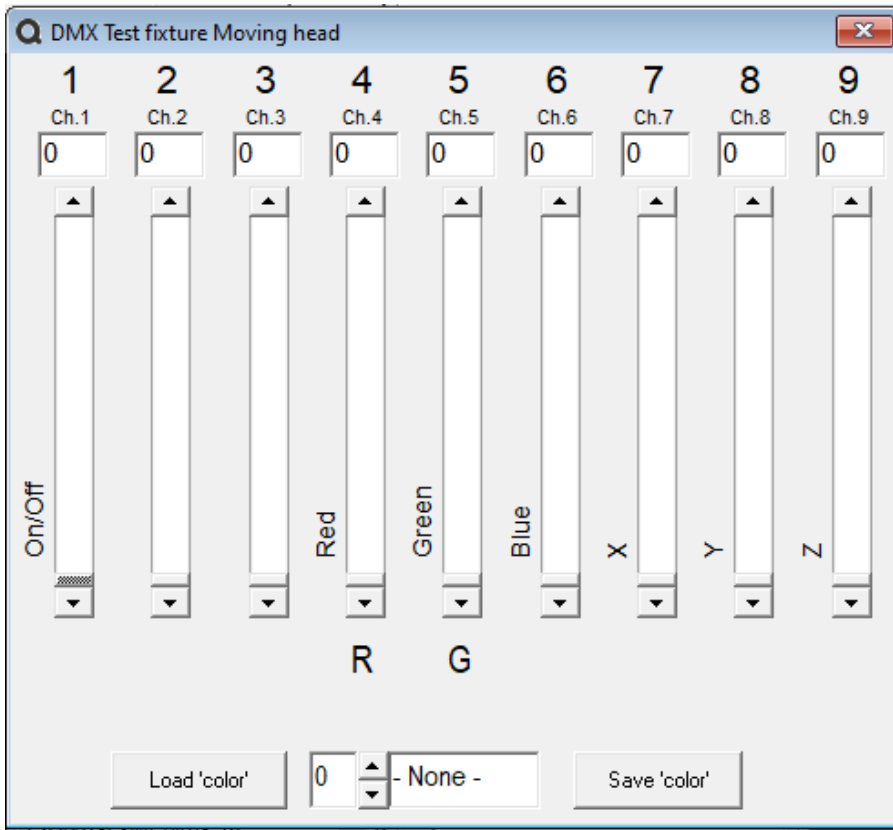

DMX controlled dimmers

In this example we are going to use a DUP-600. This is a dimmer pack with 6 channels that can be controlled via DMX. From now on we will work with 2 DMX devices.

- Device 1: DMX RGB
- Device 2: DMX Dim pack DUP600

Our RGB DMX is a lamp that continuously needs a high signal on the 4th channel to work. We can set this by selecting the output “** Value **” in the list of outputs. This is an output that is automatically created when creating a DMX output. We choose the value 255 on channel 4.

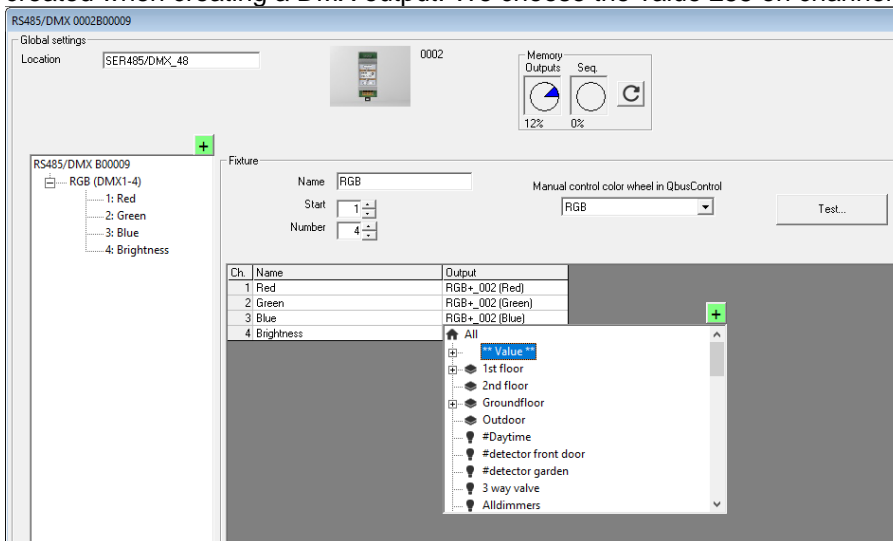

By clicking on the **+** sign we can add an additional DMX lamp to our driver. The DUP-600 has 6 dim channels, so we also create 6 channels in our software. The RGB lamp uses address 1-4, so we set the DUP-600 to work from channel 5 to 10. On the outputs we don't put DMX mode this time, but for channels 1-5 we choose a 1Button dimmer and for channel 6 a bistable output.

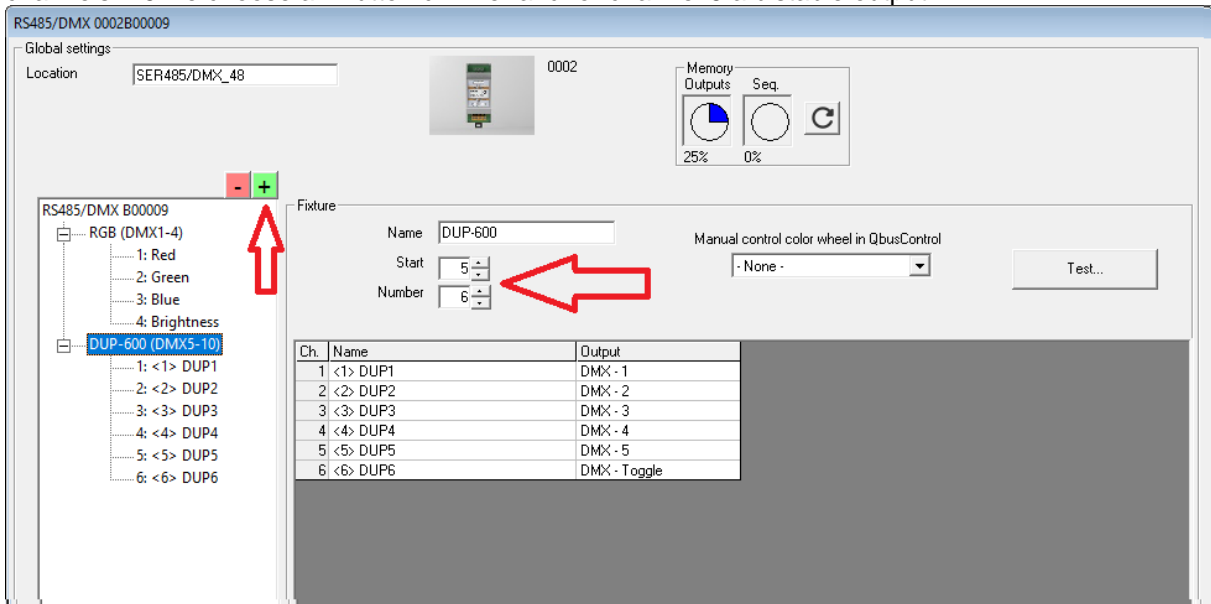

Setting the DUP-600

By pressing the “menu” button 3 times you get to the above menu. There you can set the start channel with the Up/Down button, in our example channel 5. By confirming with “Escape” you set the dimmer that Channel 1 has DMX address 5, Channel 2 DMX address 6, etc.

By assigning different addresses you can therefore control several light points with 1 DMX module.

You can see from the red color of the DMX-LED that a DMX signal is coming in.

With the sliders you can manually control each output. If you do this, the DMX signal will be overruled and you will no longer be able to control this channel. To make the output listen to DMX you have to press the CH1 button, then the output takes over the set value.



4.12. The QDI01 (Dali 1): Configure module type 0006 (Eol 2021)

This module has been replaced by the QDM01 since 2021. See [4.19](#)

These modules can configure the electronic ballasts themselves. Via the tab “Setup” one can assign addresses and change settings in the ECGs.

The button “Clear all addresses”, after confirmation, will delete all addresses in all connected ECGs! The “Assign Addresses” button first scans for the addresses that are already in use and then assigns the free addresses (from smallest to largest, 0 to 63) to new ECGs that do not yet have an address. After this command, the addresses in use are shown in **green**. Addresses set as “input” will be highlighted in **blue** and addresses to which more than 1 ECG is responding (garbled data is being received) will be displayed in **orange**. An address displayed in **red** shows a 'failure'. The same data is read when you click on the 'down arrow'. Groups that are in use somewhere are also shown in **green**. When clicking on an address, this address will flash. The commands 'go to minimum' and 'go to maximum' are then repeated every second.

The screenshot displays the Qbus System Manager interface for module 0011B03FAC. At the top, it shows 'Global settings' with 'Location' set to 'QDM01_62' and 'Error polling interval' set to 'n/a'. A 'Read Values' button is visible. Below this is a 'Dali bus' status graph showing voltage levels (0V, 16V, 19V, 17.5V) and current (250mA, 25mA). A 'Memory' indicator shows 0%. The main section is titled 'Dali 1 Dimmers' and 'Dali 1 Setup'. It features a grid of address buttons from 0 to 63. Addresses 0-31 are shown in a grid, with 28, 29, 30, and 31 being bolded. A legend at the bottom indicates: Underlined: Qbus addressed, Bold: Labeled, Italic: In group. To the right of the grid are buttons for 'Assign addresses', 'Clear Address 0', and 'Clear all addresses'. A 'Device parameters' panel on the right shows settings like 'Blink selected device' (checked), 'Type: 6: control gear for LEDs', 'Status: 0 (0000 0000)', 'Failure: 0', and 'Device random address: 0A967B'. A 'Broadcast' checkbox is also present.

The number of the address or group to which a qbus output is linked is underlined. Addresses that are added to a group are shown in italics.

A label can also be assigned to an address or group:

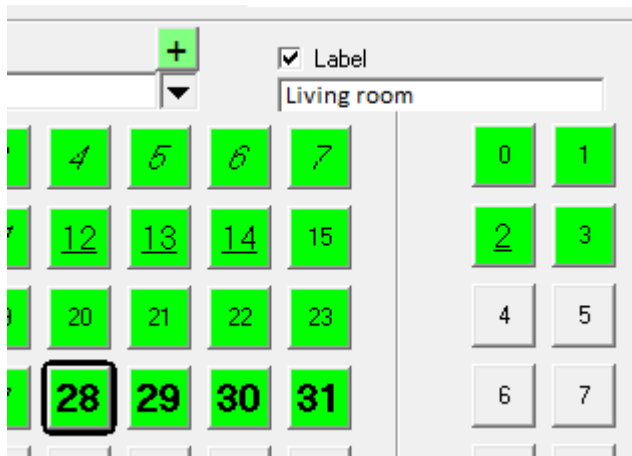

Such an address or group number is then marked in bold.

From FW V9.0 you can also read and adjust the parameters of a dimmer and detector via the System Manager.

When clicking the arrow down, all parameters will be read and, for example, the following information will be displayed for an output of the Dali Type 6 (Control Gear for LEDs):

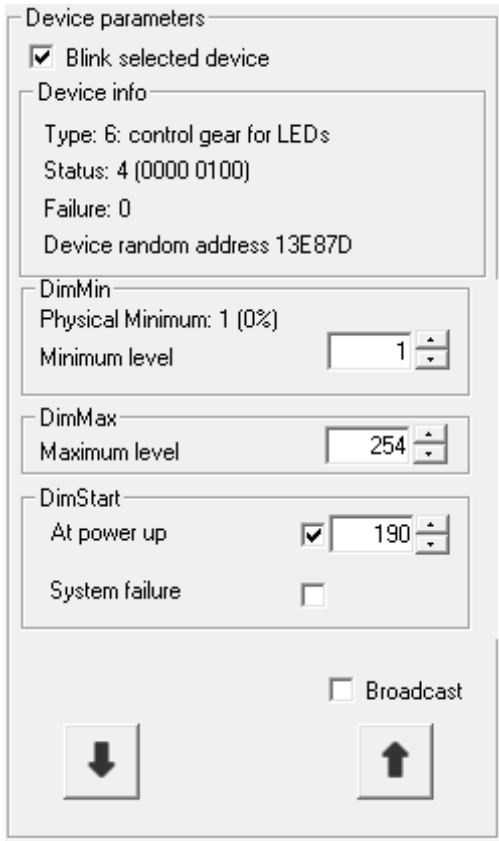

You can turn off the flashing by unchecking the first box.

The status shows more info about the ECU. When you move the cursor over this field, you will see the declaration of this status byte.

All messages that this status byte can show are:

- Control Gear Failure
- Lamp Failure
- Lamp On
- Limit Error
- Fade Running
- Reset State
- Short Address
- Power Cycle Seen

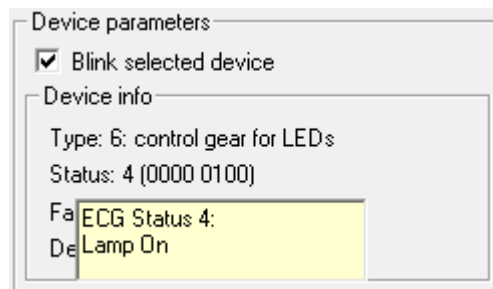

Some notifications (such as “Power Cycle Seen”) are only shown once!

The up arrow sends the parameters to the selected dali module.

The screenshot displays a software interface for configuring a DALI module. It features several sections:

- Device parameters:** A checked checkbox labeled "Blink selected device".
- Device info:** A box containing the following text:
 - Type: 128: unknown type
 - Status: 0
 - Failure: 0
 - Device random address 451864
- Sensitivity:** A section with a label "Sensitivity" and a sub-label "Detector sensitivity (0-9)". It includes a numeric input field with the value "4" and a small up/down arrow control.
- Time-out:** A section with a label "Time-out" and a sub-label "Detector Time-out". It includes a numeric input field with the value "6" and a small up/down arrow control.
- Broadcast:** An unchecked checkbox labeled "Broadcast".
- Control Buttons:** Two square buttons at the bottom. The left button contains a downward-pointing arrow, and the right button contains an upward-pointing arrow.

When "Broadcast" is checked and up arrow is clicked, all parameters will be sent to ALL connected modules!

The groups to which an address belongs are framed with a blue square. When you click on a group, this group will also blink (controlled with minimum and maximum). All set addresses (also framed with a blue square) then flash along. After this 'scan' you can link the correct Qbus output address per address. It is also possible to put the addresses in the desired order. This can be done by exchanging the addresses 2 by 2.

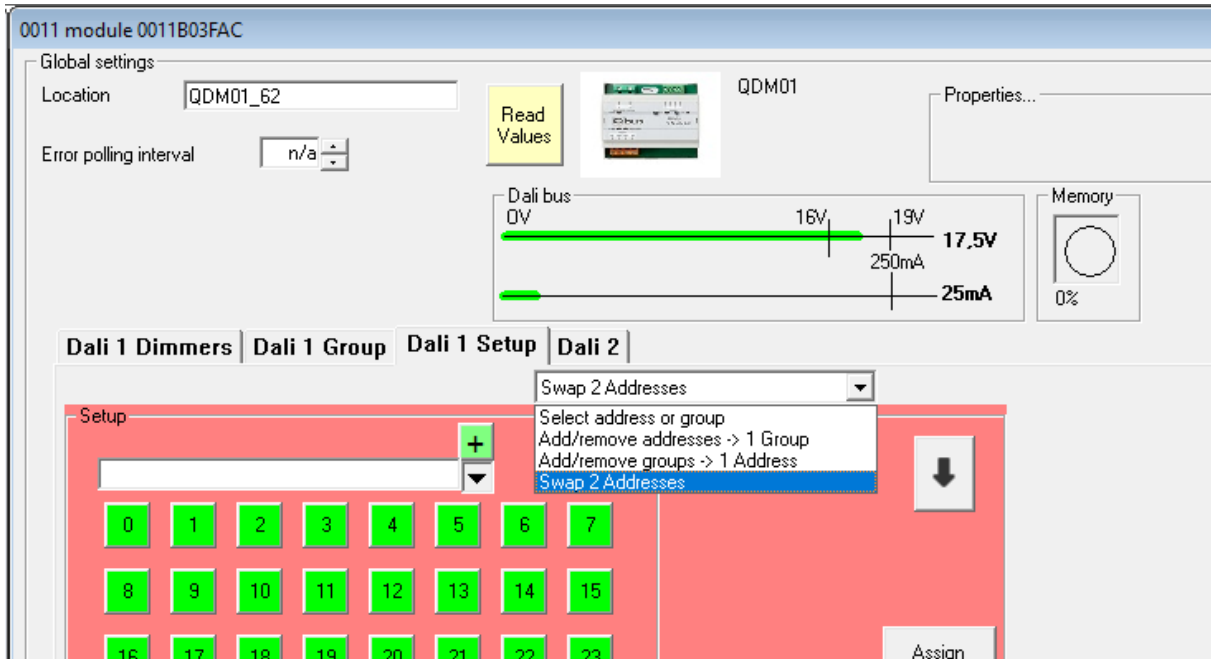

Select the first address and then the second address. After confirmation, the 2 addresses in the ECGs are swapped. In this way the ECGs can be arranged in a logical order.

In a next step you can add addresses to a group or add groups to an address.

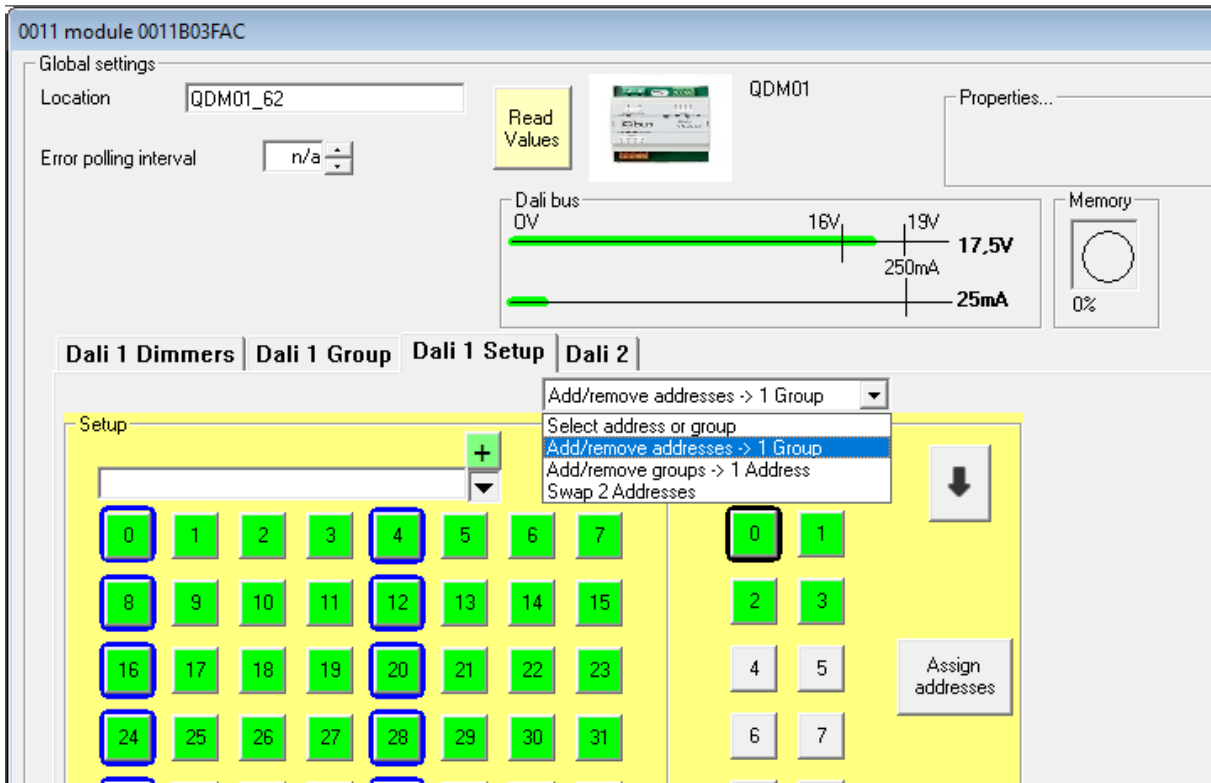

When assigning addresses to a group, it is possible to click on the first address and to indicate the last address together with the shift key. All addresses from the first to the last are added to or removed from the group according to the status of the first clicked address. Assigning addresses to a group or groups to 1 address can also be done offline. These settings take effect immediately in the ECGs. Later, when sending this module, these parameters will also be stored permanently in the QDI01 module.

At the top, you can also set a bistable output. It will scan every set time if a failure occurred somewhere. This output will turn on when a failure occurs somewhere. After clicking the download arrow, the defective address or addresses will be displayed in red. After repairing the lamp/ballast and operating that address again, the bistable output will be turned off again.

A last button is “Delete address x”. After confirmation, this address is removed from the connected ECG.

4.13. SER485/Modbus interface: Module type 0003

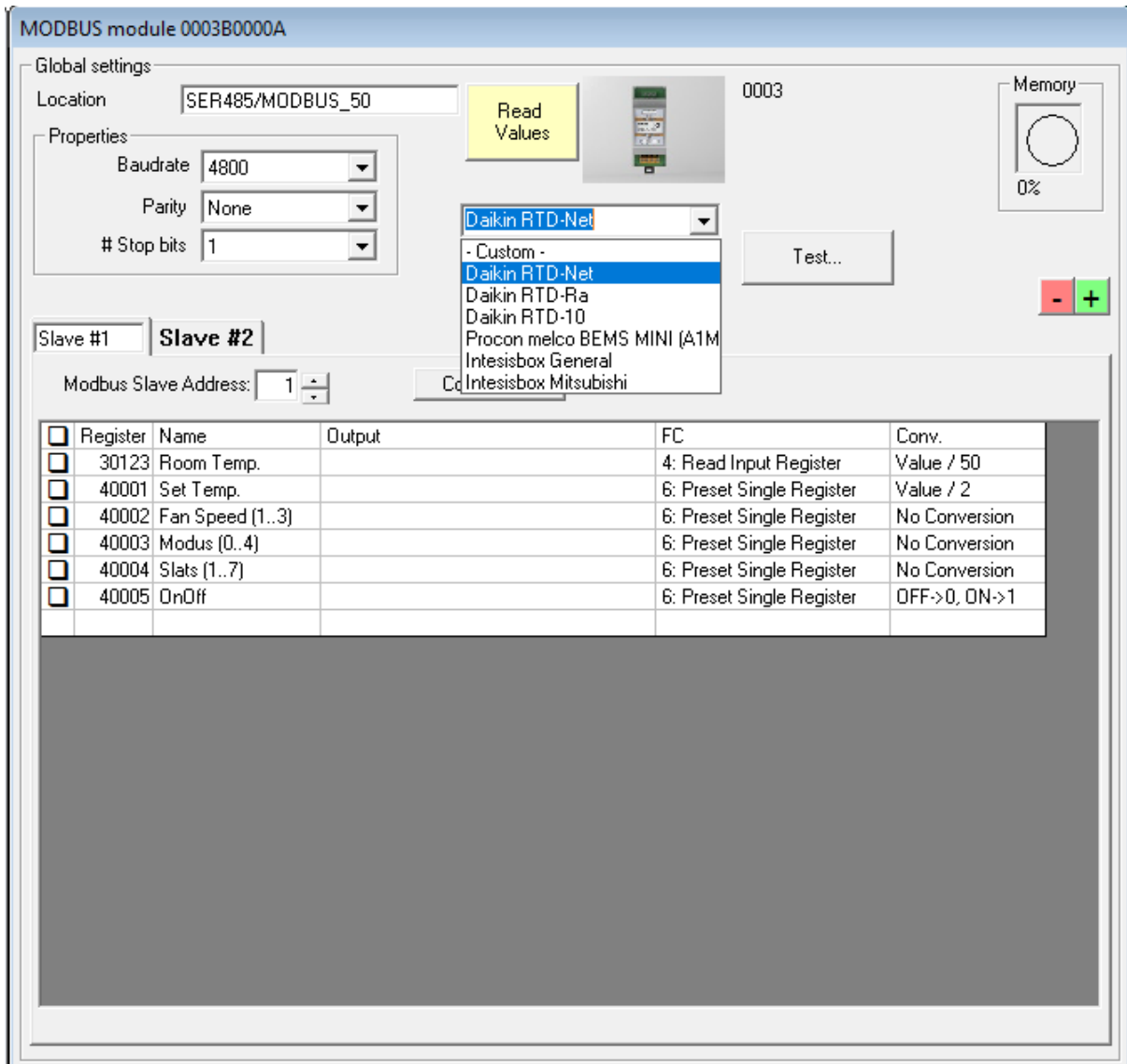

The SER485/Modbus module can link up to 127 Modbus registers at different slave addresses to a qbus output. Known types are preconfigured in the file “ModbusTypes.Json”
 This file can be customized to your preference. When one of these types is selected, the registers, function codes and conversions are fixed. Only the correct Qbus output has to be selected.
 If you choose the – Custom – all settings are completely free.

The name of the slave address can be changed at the top of the Tab, as well as copying the settings from another slave address is possible.

4.14. SER485/APIEN: Weather station module type 0001

The screenshot shows the configuration interface for a weather station module. At the top, the location is set to 'SER485/APIEN_52'. Below this, there are several output configuration options for Light, Temperature, Wind, Twilight, and Rain. At the bottom, there is a table for defining triggers based on these parameters.

	Name	Statu	Temperature	Daylight	Light (East)	Light (South)	Light (West)	Twilight	Wind	Rain
1	WS TH < 21°		<= 21°C							
2	# Too much sun				>= 20klx					
3	#Too much wind and rain								>= 40km/h	<input checked="" type="checkbox"/>
4										
5										
6										
7										
8										

The weather station can display temperature, light values, wind and rain detection. The twilight value and rain are outputs of the Bistable type. All others are 'universal' outputs. When creating the outputs, these parameters are set correctly. The daylight value ranges from 0 to 999lx. The light values per wind direction range from 0 to 99klx (= 99000lx).

In the bottom table it is possible to set different 'triggers'. For example, in the figure above, the output '#Too much wind and rain' will be on if it rains AND there is more wind than 40 km/h.

A double click on a cell changes the test from 'greater than or equal to' to 'less than or equal to' and vice versa.

Testing for 'No rain' is represented by an empty (unchecked) square. A completely empty box means this field is not checked.

The current values from the weather station are displayed via 'Read values'. The triggers are also immediately recalculated with the exact values. However, minor changes are not immediately sent to the controller (or to the Cloud).

4.15 SEN01X modules

4.15.1 SEN01T: serial numbers 700300 to 704999

This temperature sensor can trigger up to 4 separate bistable outputs. Each test can be greater or less than a selected temperature. Minimum -27°C, Maximum 100°C with a resolution of 1°C

Temperature module SEN01T s/n:700300

Location: SEN01T_54 Read Values  SEN01T

TH Sensor

TH Outdoor ▼ ▢

Properties...

Scan Speed: 60s ▲ ▼

Input 1 (A52.4)

Name: # It's freezing ▼ ▢

Input connected ▢

Properties... <= 0 °C ▲ ▼

Input 2 (A54.1)

Name: # Too warm ▼ ▢

Input connected ▢

Properties... >= 29 °C ▲ ▼

Input 3

Name: ▼ ▢

Input connected ▢

Properties...

Input 4

Name: ▼ ▢

Input connected ▢

Properties...

4.15.2 SEN01NTC: serial numbers 705000-708999

This module can switch up to 4 outputs in the same way.

But this module has a black NTC sensor as standard. If different, the parameters of this sensor can be entered at the top via the specified “B-value” or if available via the more accurate Steinhart-Hart method.

Temperature module SEN01NTC s/n:705055

Location: SEN01NTC_55 Read Values  SEN01NTC

TH Sensor: TH Outdoor Properties...

Scan Speed: 60s

NTC parameters:

- NTC Qbus White
- NTC Qbus Black (103AT)
- User NTC via Steinhart-Hart
- User NTC via B value

Beta: 3435

28704 Ohm @ 0°C

9999 ohm @ 25°C

1451 Ohm @ 85°C

Input 1 (A52.4): Name: # It's freezing Properties... <= 0 °C

Input 2 (A54.1): Name: # Too warm Properties... >= 29 °C

Input 3: Name: Properties...

Input 4: Name: Properties...

4.15.3 SEN01M: Serial Numbers 710000-749999

The SEN01 can switch a bistable output according to the set values.

Extension: is the time the output will remain on when no more motion is detected.

First: The magnitude of the movement necessary to activate the output. A larger value will therefore trigger the output a little later.

Keep: The amount of movement necessary to keep the output active. Values greater than or equal to the "First" option are excluded.

Light level: If 'Only if "Dark"' is checked, the output will be activated if the measured light value is lower than the set threshold value.

The current light value will be displayed with a yellow bar via the "Read values" button. When the threshold value is in the colored bar, the output will be activated upon movement.

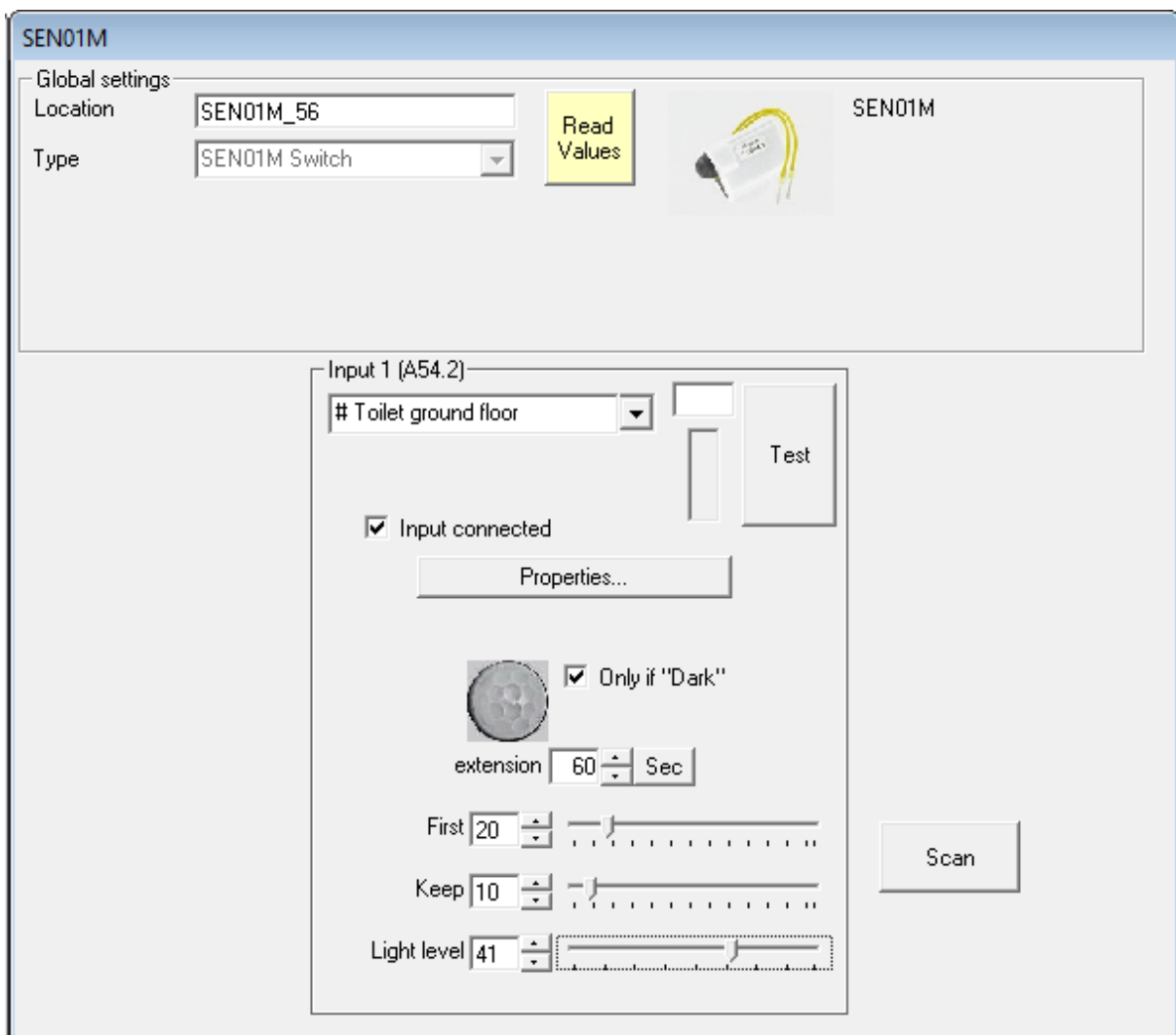

4.16 Dali broadcast module QDBC02SA module type 0009

The Dali broadcast module controls 2 Dali buses on the basis of 2 qbus outputs. All Dali luminaires, regardless of their set address, will follow the status of the Qbus output. Usually a Qbus dimmer output is used for this. All parameters of a dimmer can be found in section 4.2.3

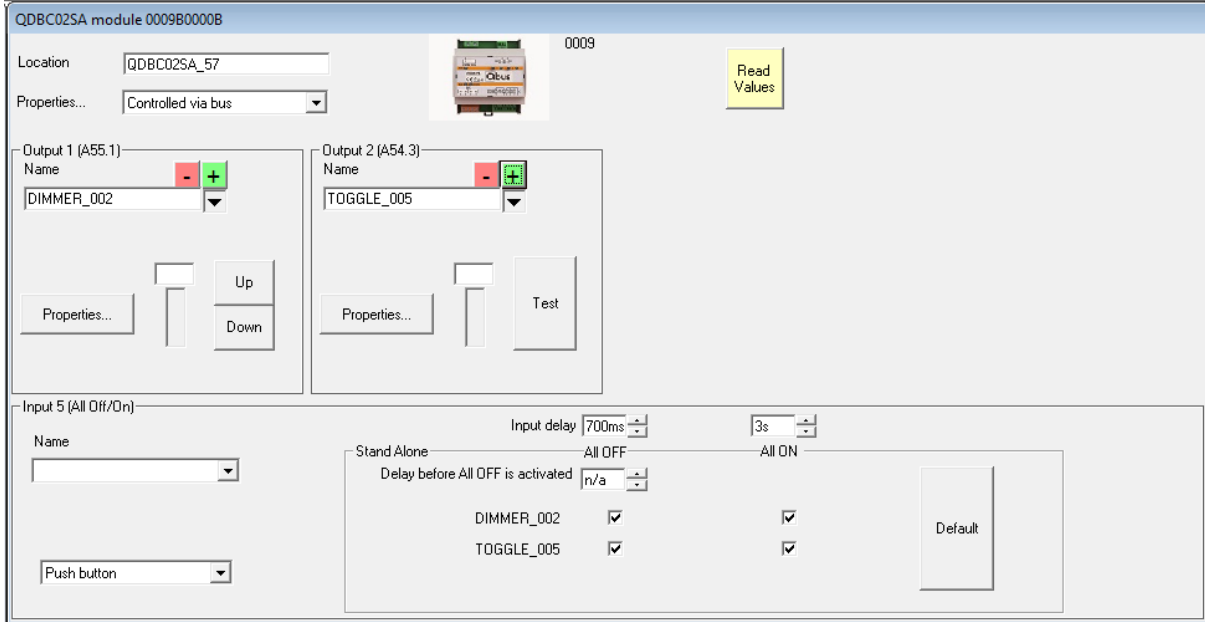

You can read the current value of the outputs via the “Read values” button. You can control the outputs online via the Up/Down buttons. A short click up or down will bring the output to the start value and off state respectively.

If you wish to pre-configure this module to work Stand-Alone, you can select this at the top of the screen. You can then easily set all parameters like this:

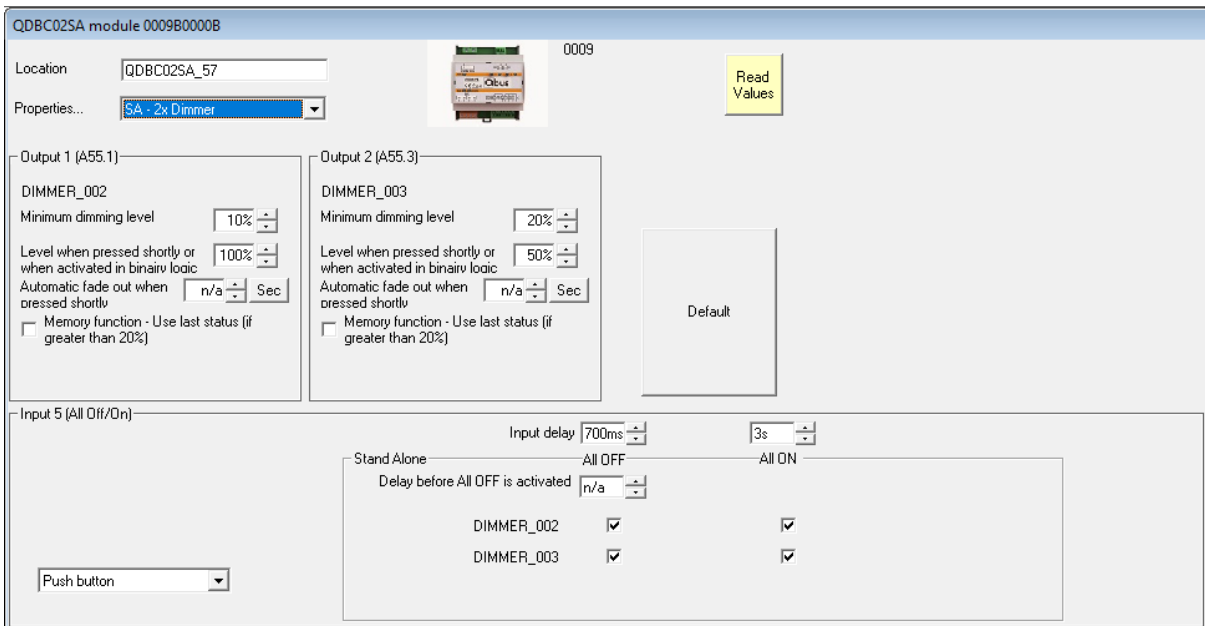

4.17 Constant Voltage Driver CVD04SA module type 000C

The Constant Voltage Driver sends a PWM signal to the 4 channels.

The module can control the following types of outputs in standalone mode:

- 4 separate dimmers
- 2 WWCW LED(strips)
- 1 RGB LED strip + 1 dimmer
- 1 RGBW LED strip

In the selection you can also indicate that the module is controlled via the QBUS bus. Other combinations of output types are also possible in this way.

In the properties it is also possible to choose the desired PWM frequency (500Hz, 1000Hz or 2000Hz. And per channel you can set whether it is dimmed according to a linear or a logarithmic curve.

The module window looks like this:

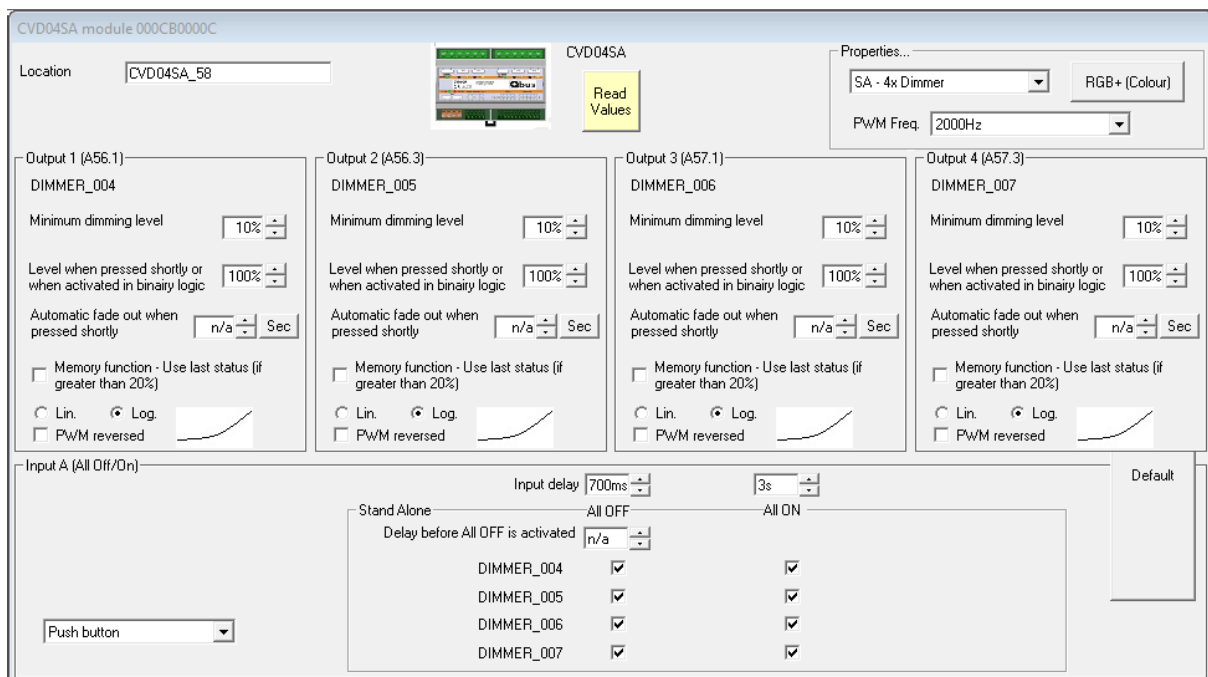

The configuration of the RGB+ colors and sequences (via the button at the top right) is done in an identical way as described for the SER485/DMX module in chapter [4.11](#).

4.18 Configure Wireless Interface QWI/EW Module Type 000A

The Qbus Wireless Interface provides wireless communication between Qbus and all wireless Qbus modules.

First of all, add the serial number of this module in the list of modules. If this module has already been programmed in another project, it is important to clear the memory of the module first. When you send the data of this (empty) module, all previously registered wireless modules will be deleted from the memory.

You can add the new wireless modules via the green + button or via the Wizard new modules. These are also divided into the categories Relay, Switch, Input and Sensor. Since each module transmits a unique transmission code, all wireless modules must be enrolled to the gateway. In order to cause the least problems, we recommend that you enroll this code before mounting it in its final location. We also recommend that you first enroll all sensors (see menu [4.18.9](#)), because they will send out their code when they detect motion. Once this code is known, it will be ignored when enrolling the next module.

You can select or add a bistable output as an error address. This will be switched on by the module as soon as an error is reported on one of the wireless modules. Any module that runs on battery will be able to report a low battery. An additional error message will also be generated if a magnetic contact has not sent its status within 24 hours.

After assigning the wireless gateway, the screen of the QWI/EW will look like this:

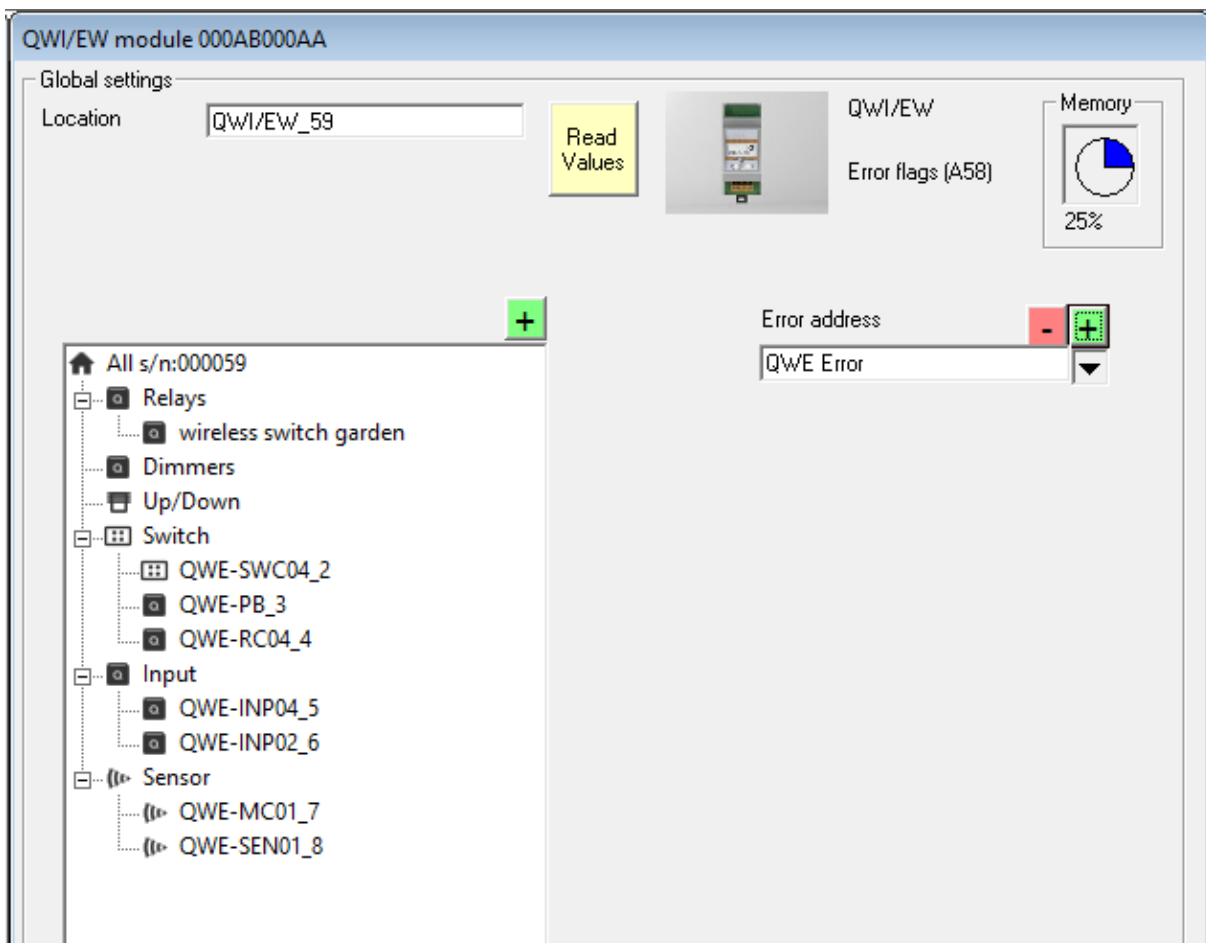

After 'Read values', when clicking on a module, the low or completely empty battery status may be shown.

If the battery has been replaced, this error will not disappear automatically. Resetting this individual error is only done by clicking the “Reset Error” button.

4.18.1 QWE-REL01/230 and QWE-REL01/230PF relay module

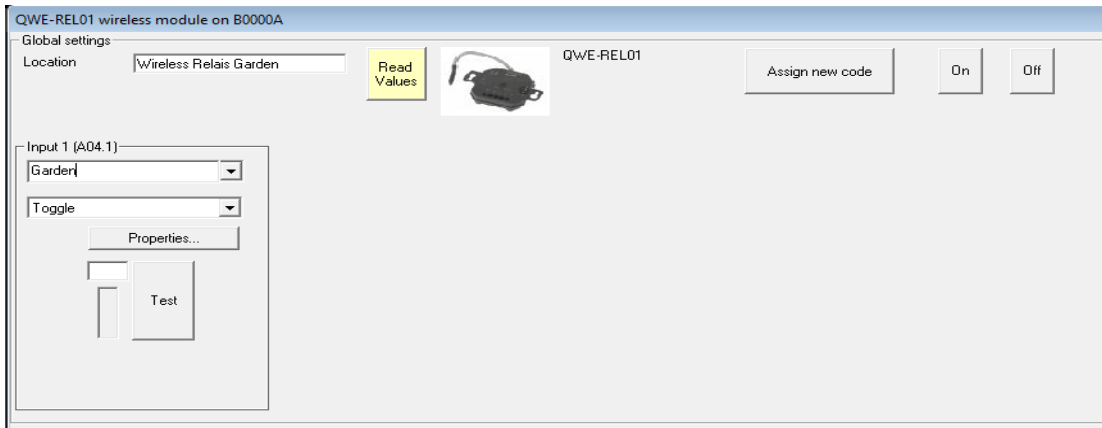

For each wireless module it is important that it is enrolled to the gateway (QWI/EW). An output module receives a code from the QWI/EW, an input module sends its code to the QWI/EW.

When you click on “Assign new code”, you will be asked to put the module in programming mode and then click on OK:

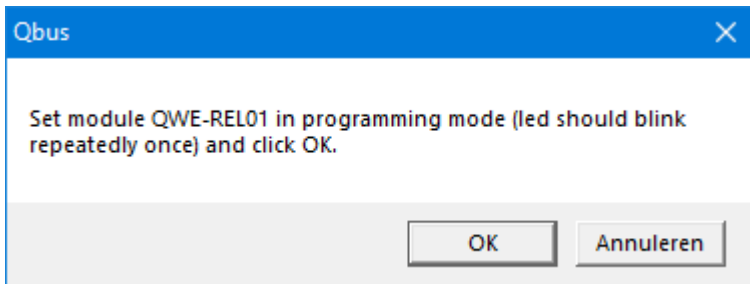

When OK is pressed, the QWE-REL01 is assigned a transmission code by the QWI/EW. The module may now return from programming mode. You can do this by briefly pressing the programming button on the module 3 more times. The programming LED will stop flashing.

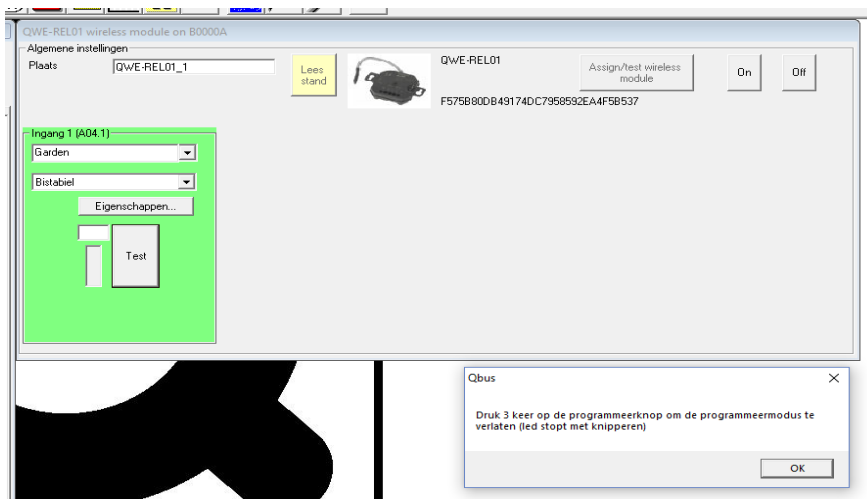

By using the “On”, “Off” buttons you can perform a first test to check if the code has been programmed correctly. To test this new module via the qbus outputs, it is important that the data is first sent to the controller via the normal way (red upload arrow).

4.18.2 QWE-PP01/BE power plug

In an identical way to the QWE-REL01 module as described in 4.18.1, you can add a QWE-PP01/BE. Unlike the QWE-REL01, this module will automatically exit programming mode after assigning the transmission code.

4.18.3 QWE-SWC04/55 4-way push button

Assigning an input module is done in a slightly easier way. When you click on the “Assign/test wireless module” button, the following screen appears:

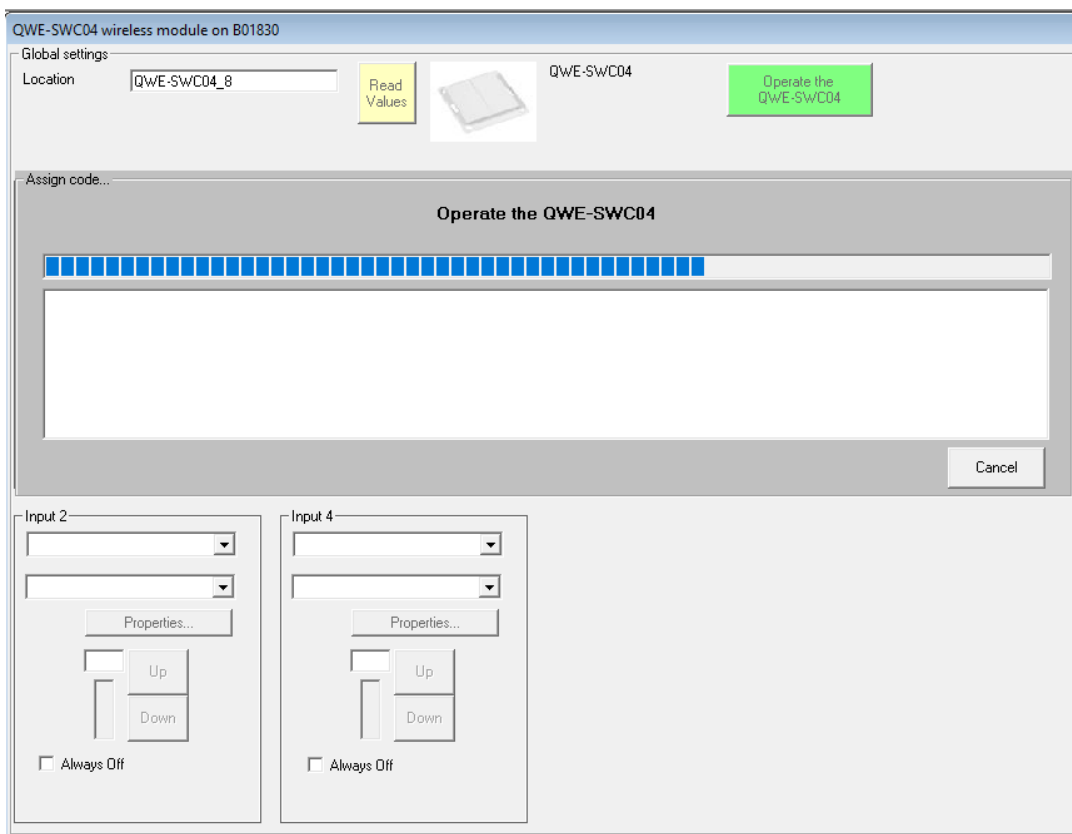

When you press one of the push buttons, it will send its transmission code and store it in a free place in the QWI. The transmission code is shown at the top and the key pressed is shown in green.

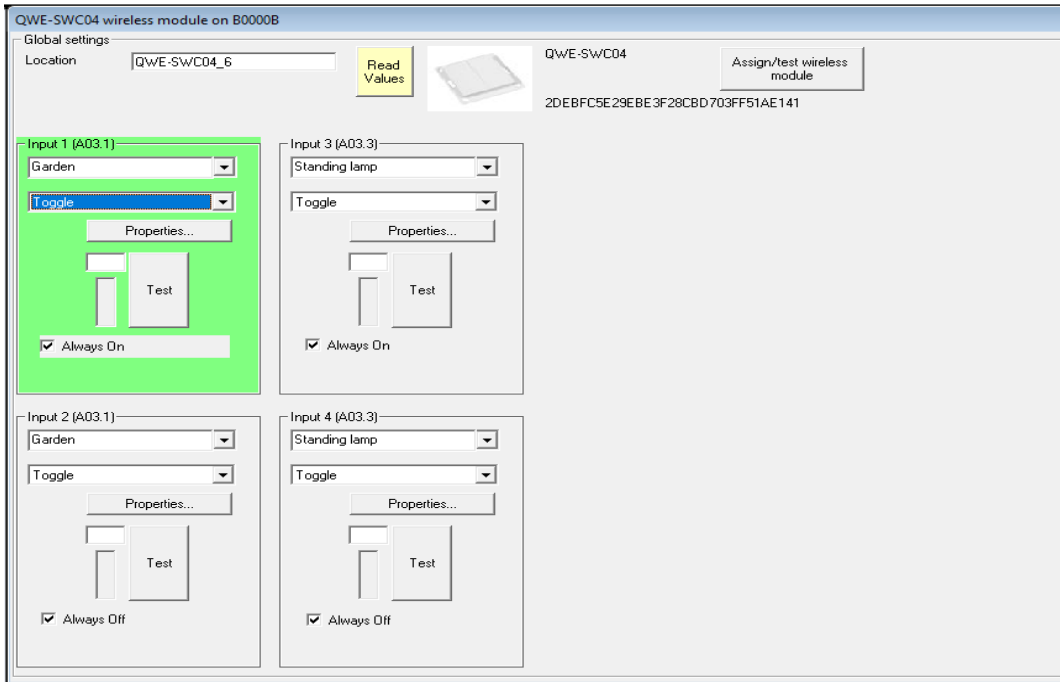

It is not necessary to teach each key separately, but you can do this to verify the operation of each key.

With the option “Always ON” and “Always OFF” you can make sure that the buttons at the top always turn on the output and the buttons on the bottom row will always turn off the selected output. If this option is not checked, these inputs will always change the status of the output like a normal Qbus Toggle output.

4.18.4 QWE-INP04/bat 4-way input module

In an identical way to the QWE-SWC04 module described in 4.18.3, you can add a QWE-INP04/bat. However, with this module you can select whether you connect 4 push buttons or 2 long-term contacts. This requires a different wiring. A long-term contact can act as “normally open” (The output follows the status of the input) or “switch” (the output reverses with every change on the input)

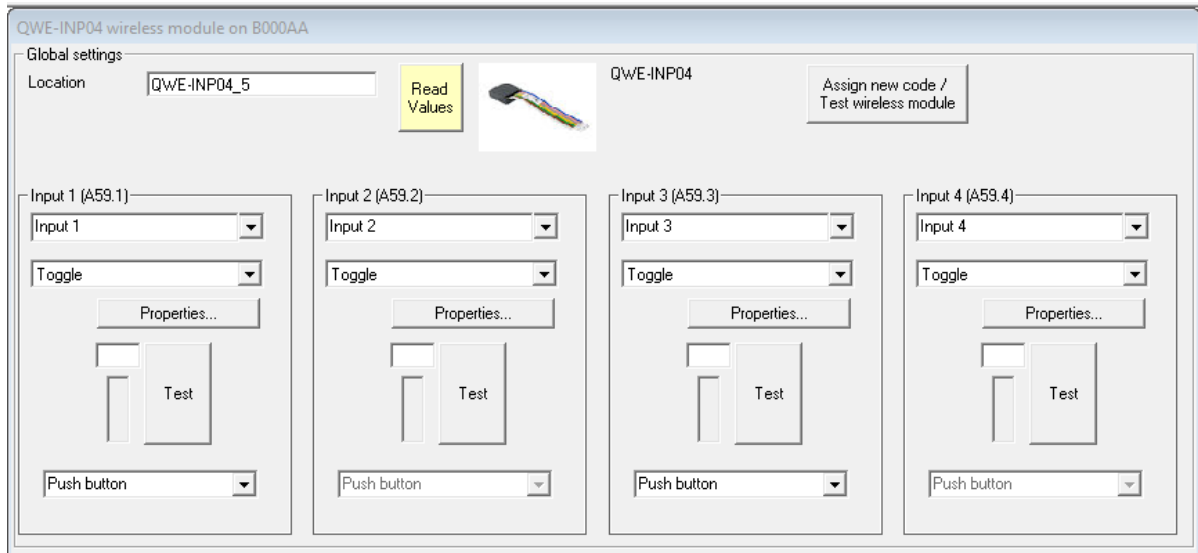

Or e.g.

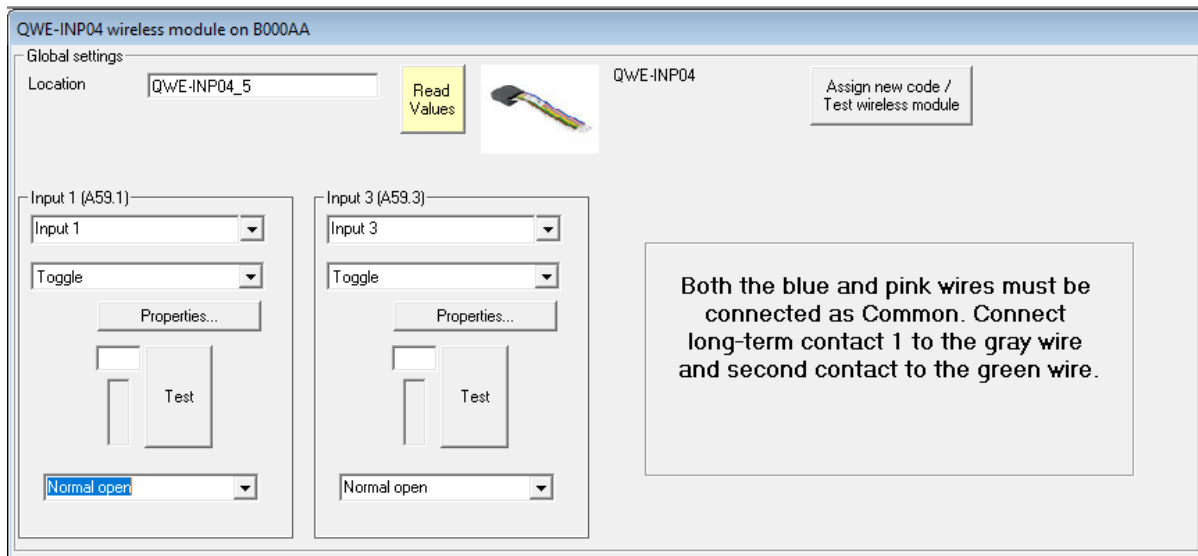

4.18.5 QWE-INP02/230 2-way input module

In an identical way to the QWE-SWC04 module as described in 4.18.3, you can add a QWE-INP02/230. However, with this module you can select whether you connect 2 push buttons or 2 long-term contacts to the 2 inputs. If long-lasting contacts are used, a wire bridge between L and F is necessary. A long-term contact can act as “normally open” (The output follows the status of the input) or “switch” (the output reverses with every change on the input)

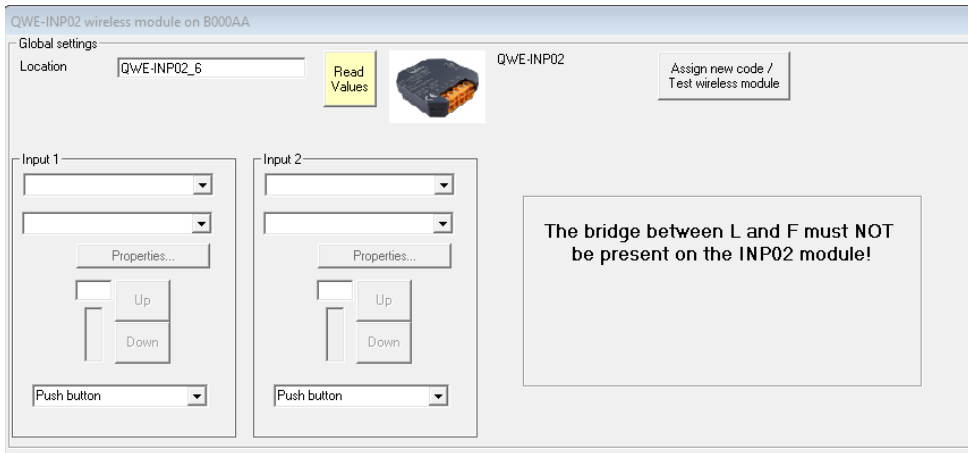

If long-term input contacts are used, it is necessary to assign the codes of both inputs with this module! The first learned code will be named as “Input 1”, the second learned code as “Input 2”

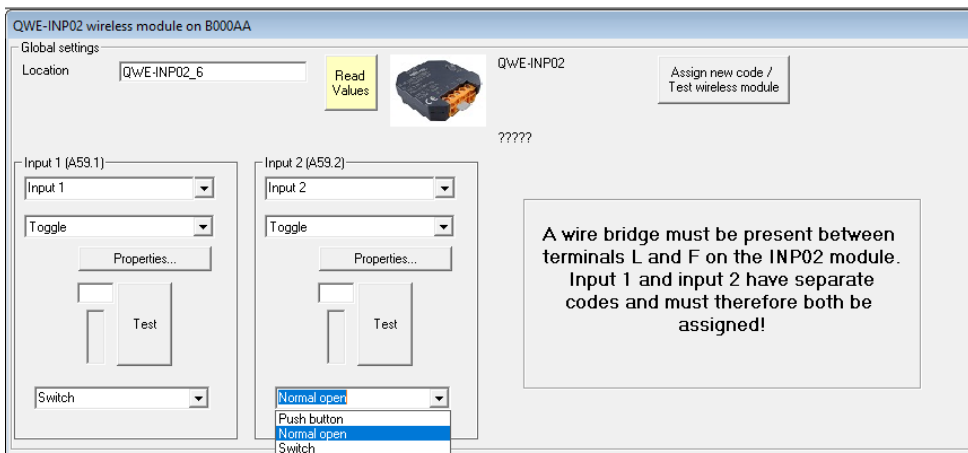

4.18.6 QWE-PB/button and QWE-PB/wrist and QWE-PB/neck and QWE-RC01 1-button pushbuttons

In an identical way to the QWE-SWC04 module as described in 4.18.3, you can assign a QWE-PB and QWE-RC01 module.

When you briefly press the push button, it will send its transmission code and store it in a free place in the QWI. The transmission code is displayed and the key pressed is displayed in green.

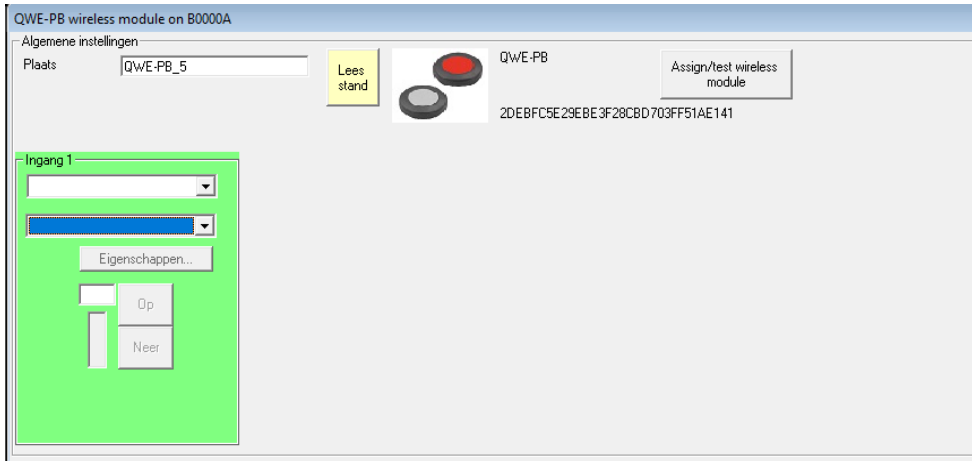

4.18.7 QWE-RC04/metal 4-button hand-held transmitter

In an identical way to the QWE-SWC04 module as described in 4.18.3, you can assign a QWE-RC04 module.

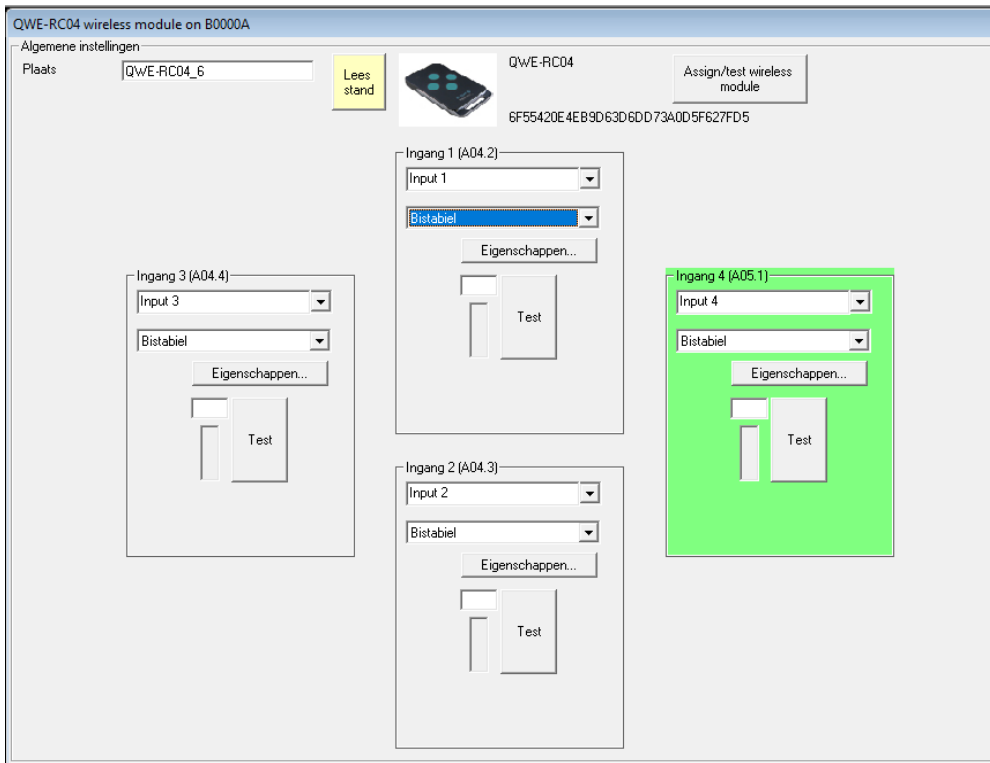

4.18.8 QWE-SWC01/call and QWE-SWC01/reset 1-key pushbuttons

In an identical way to the QWE-SWC04 module as described in 4.18.3, you can assign a QWE-SWC01 module. However, both modules have a different function. The QWE-SWC01/call module can only turn an output ON.

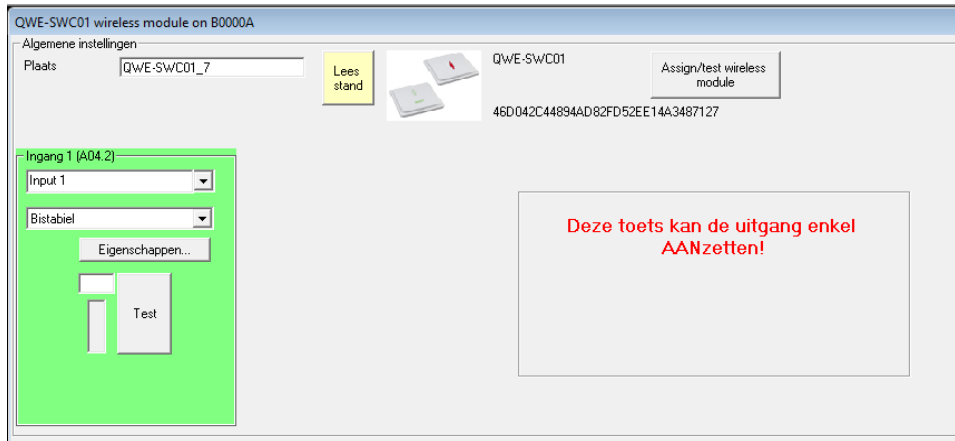

The QWE-SWC01/reset, on the other hand, can only turn an output OFF.



4.18.9 QWE-SEN01MW motion detector with light cell

Assigning a wireless motion detector can be a little more difficult. It will only enroll when there is movement and the light level is below the set value. So make sure that these settings are correct or test with a darkened motion detector. Depending on the set time, it will re-transmit the movement every 5-10 seconds so that it can register its transmission code to the gateway after clicking “Assign/test wireless module”.

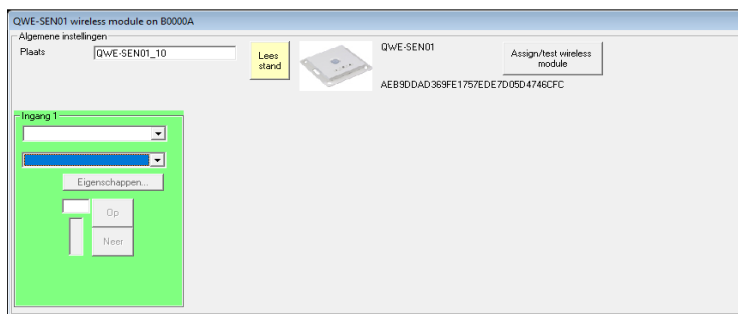

The transmission code is shown at the top and the key pressed is shown in green.

4.18.10 QWE-MC01/white window or door contact

Assigning a window or door contact is done in an identical way to the QWE-SWC04 module as described in 4.18.3,

Both when making contact and when breaking contact, this module will send its key.

In addition to reporting a low battery status, this module will also be marked as an error if it has not reported its status within 24 hours. The battery of this module is then completely empty or the wireless signal is too weak.

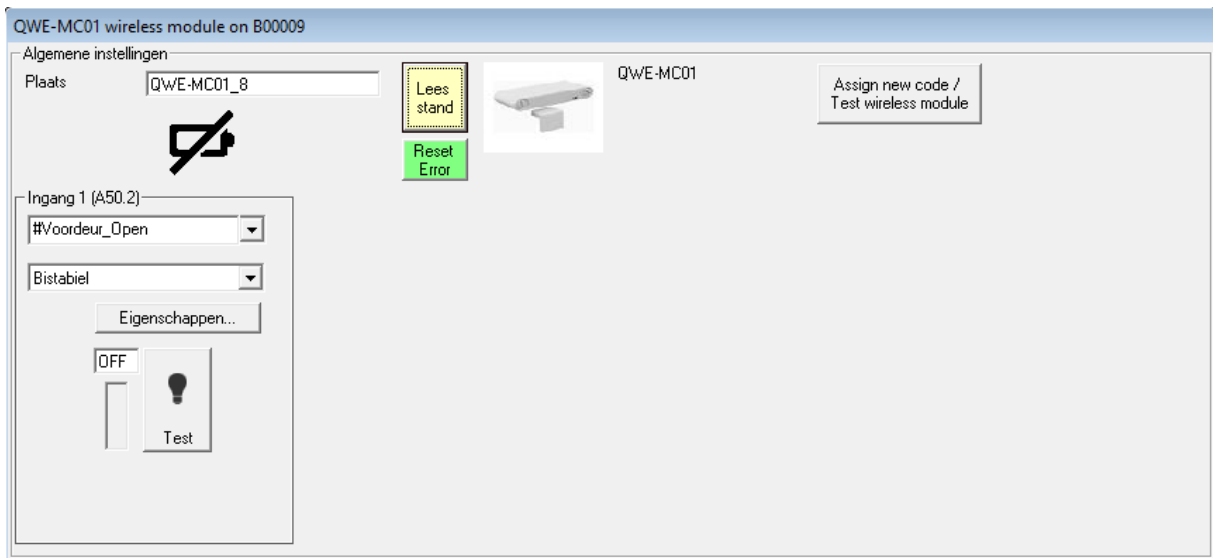

4.19 QDM01 Configure Dali1 and Dali2 module (Type 0011)

The QDM01 module has a built-in Dali power supply and can address both modules with the Dali1 protocol and the Dali2 protocol.

The Dali1 modules are configured in the same way as the QDI01. See point [4.12](#)

The configuration of the Dali2 modules is done via the fourth tab:

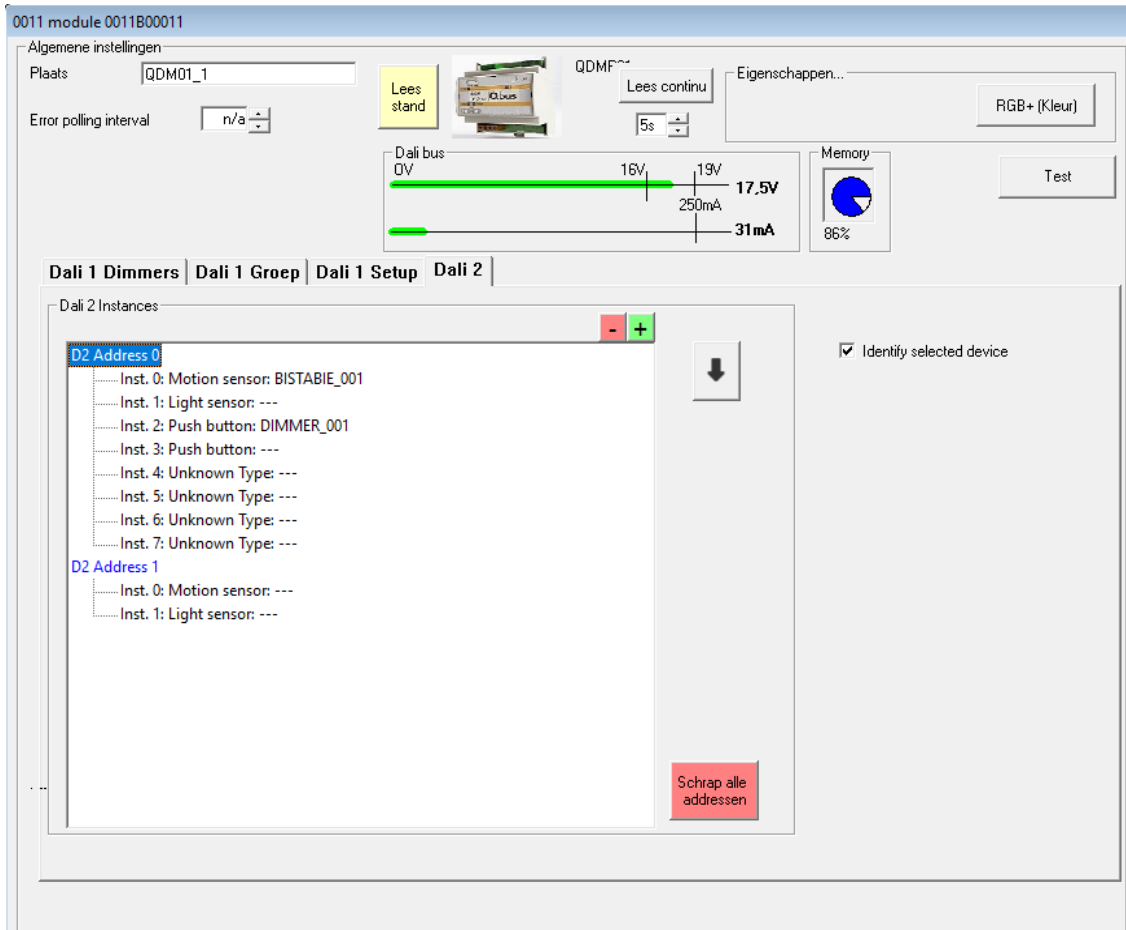

With the download arrow the Dali2 bus will be scanned. Addresses that respond will be marked green. If the address is orange, more than one module is responding. If the address is in red, the module will indicate a failure. If the address is still greyed out or not in the list, this address will no longer be found on the Dali2 bus.

Idem as on Dali1, when clicking on an address or instance, the relevant module will blink (set to minimum and maximum). Most detectors will have a built-in LED flashing on and off.

You can assign a Qbus output to the selected Dali2 instance by selecting or creating a new output on the right side of the screen.

By clicking on the plus sign above the list, the Dali2 bus is scanned for newly connected modules. After possibly assigning new addresses, the scanned bus will be shown again.

By clicking on the minus sign above the list, the selected Dali2 address will be deleted from all modules assigned to this address.

In addition to the current status of the outputs from the controller, the “Read values” button will also display the current voltage and current consumption of the Dali bus.

4.20 QDG04SA Configure Dali1 module (Type 0012)

The QDG04SA module has a built-in Dali power supply and can control up to 64 Dali1 outputs via 4 groups. This module can be controlled via the bus or Stand-alone via the inputs on the module itself. The configuration can be set via the buttons on the front panel. For this configuration we refer to the technical data sheet of the module.

The groups can also be set via the System Manager: Assigning Dali addresses to a driver, configuring groups, setting parameters, etc. is done in the same way as with the QDI01. See point [4.12](#)

When entering the serial number and assigning the outputs, you will see, for example, the following screen:

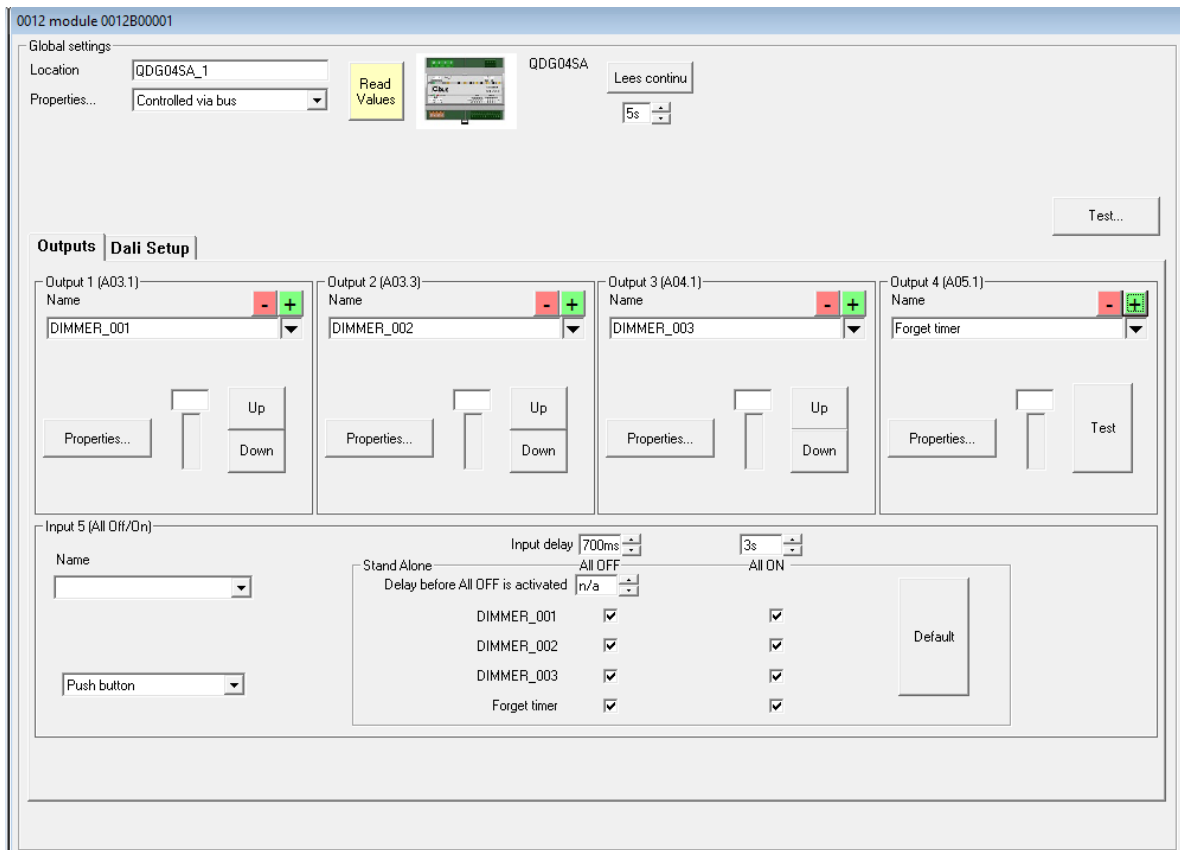

The 4 assigned outputs will control the 4 preset groups.

The same as the other SA modules, this module can also work completely standalone. The settings as shown below are then applied.

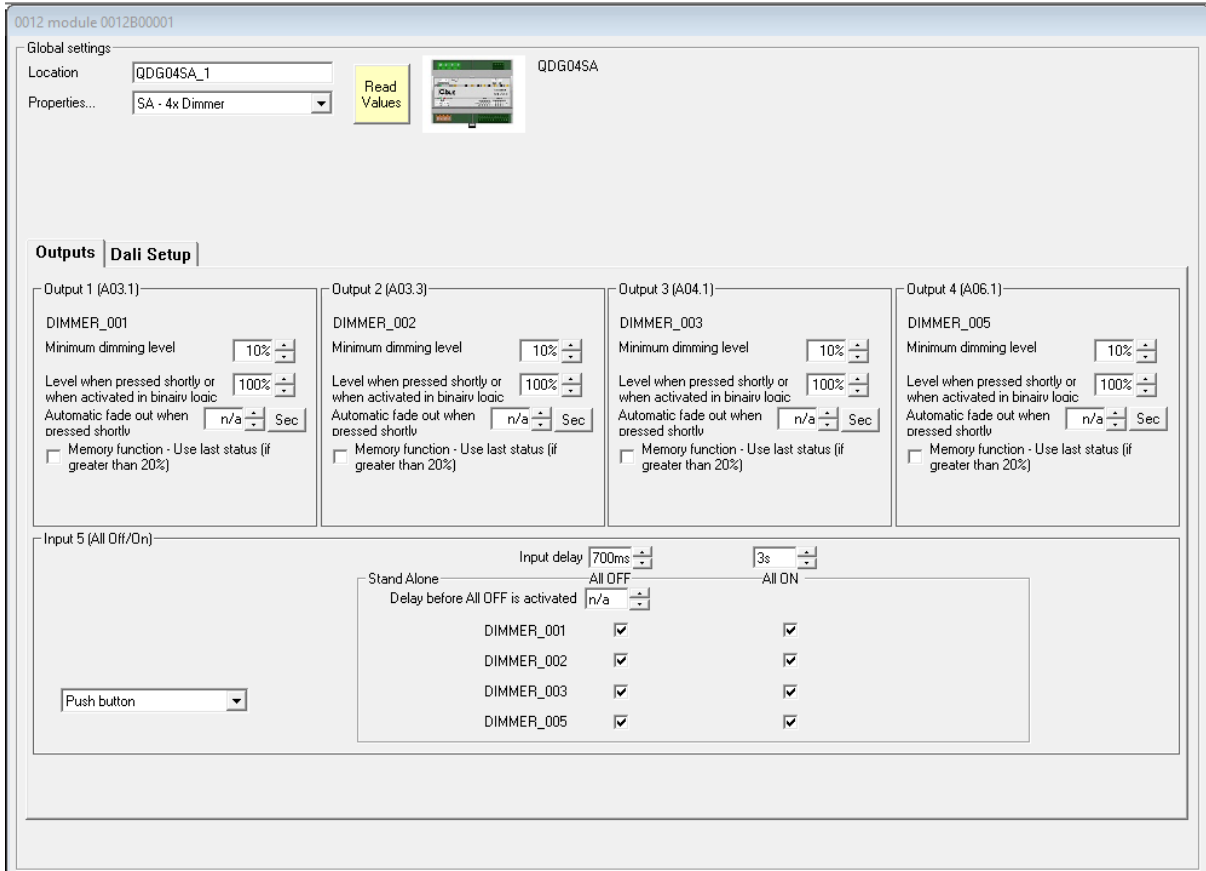

As with the other Qbus Stand-Alone modules, if the module is used in Stand-Alone mode, the fifth input (Input A: All Off/On) will act as an All Off button (press briefly), and as a Panic button at long push. As soon as the module is no longer used in Stand-Alone mode, i.e. if it is connected to a controller and is supplied with power via the bus, the fifth input will work differently. Now a scene must be created via the System Manager and assigned to this input (on the field "Input 5"). This scene is then executed with a short push. **PLEASE NOTE, with a long press the next scene in the list of created scenes in the Qbus System Manager is automatically executed. So make sure that this is taken into account!**

IMPORTANT:

- if several Stand-Alone modules are connected to each other on this fifth input, a scene may only be assigned to 1 module – the scene input (Input 5) must remain empty for all other connected modules!
- For the scenes used in the 5th entrance of SA modules, NO DELAY TIMES may be set at the scene settings itself. The delays are entered in this module screen.

5. Remote connection

5.1. Qbus Cloud

By connecting the Ethernet port of the Controller CTD01Em, CTD01E, CTD01E+, CTD02E, CTD03E, CTD10, CTD40 CTDmax to the router in the local network, this controller will connect itself to the Qbus Cloud when it is properly activated. Once logged in, the connection between the Qbus installation and the Qbus Cloud will continue to exist, so that the user can log in to the Qbus Cloud via a mobile device, tablet or PC with internet access and thus operate and visualize his installation. In the future, additional services will also be offered via the Qbus Cloud, such as SMS, e-mail, linking controllers, etc.

This manual describes how a Qbus installation can become Cloud-compatible.

Step 1: Install the correct software on the Controller.

In order to use the Qbus Cloud, at least System Manager III version 3.5.6 is required. This can be downloaded from the Qbus site:

<https://www.qbus.be/nl-be/support/software/system-manager-iii>

Install the new System Manager, click on Utilities - Setup and you will see the screen below. Click the Connection tab to connect to the Controller.

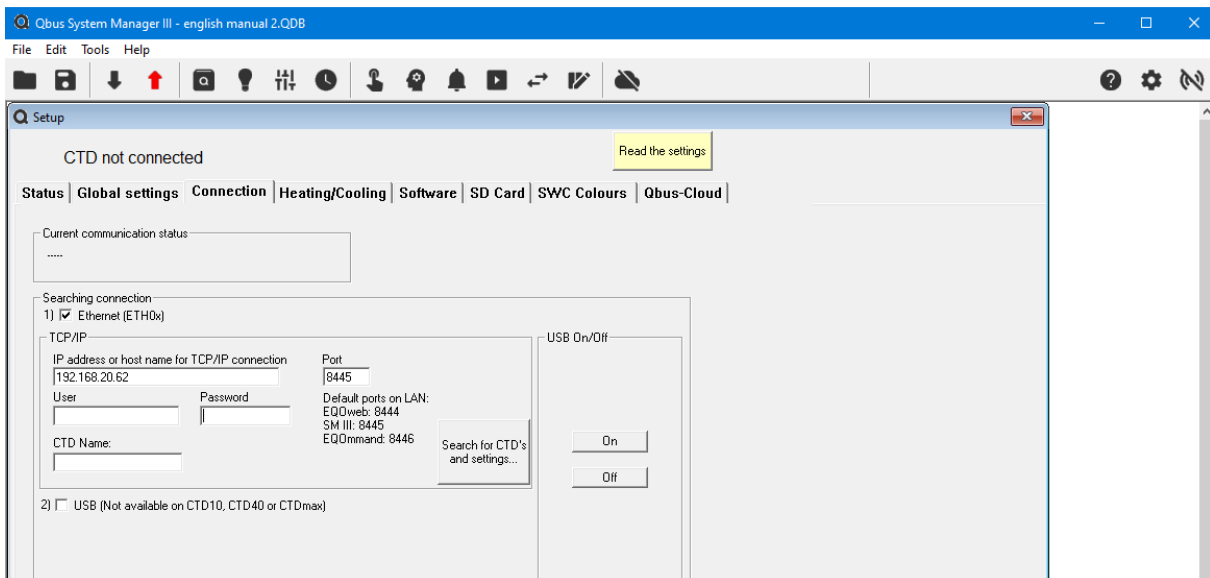

Once this upload is done, click on “Read Settings” in the Setup Screen and you will be notified that the Controller is connected to the computer.

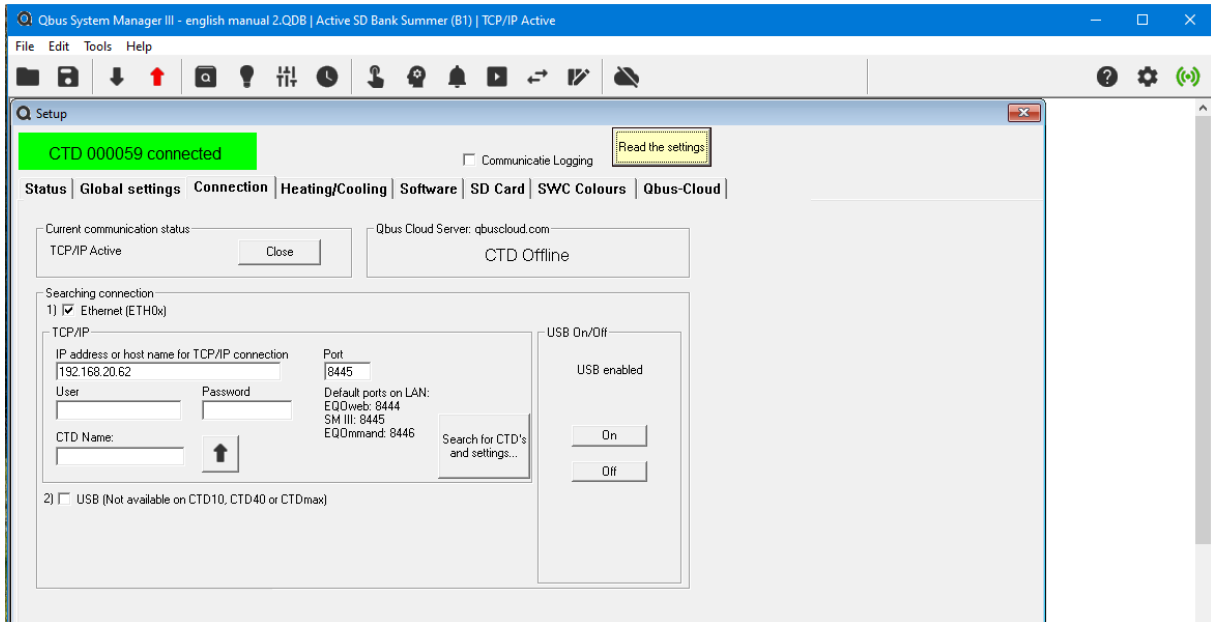

Step 2. Register the Controller to the Qbus Cloud

Now click on the “Qbus Cloud” tab. Select the stable Version 6.0.9 for older CTD’s and click the upload arrow next to it. After that you can enter an e-mail address - once this is filled in click on the button “CTD -> Cloud” and the Controller is registered in the Qbus Cloud. An activation code will now appear on the screen. You can copy this code when you add your controller in the QbusControl app or website!!! If you want to add the CTD later to the account of the customer, the activation code will also be sent by e-mail to the specified e-mail address.

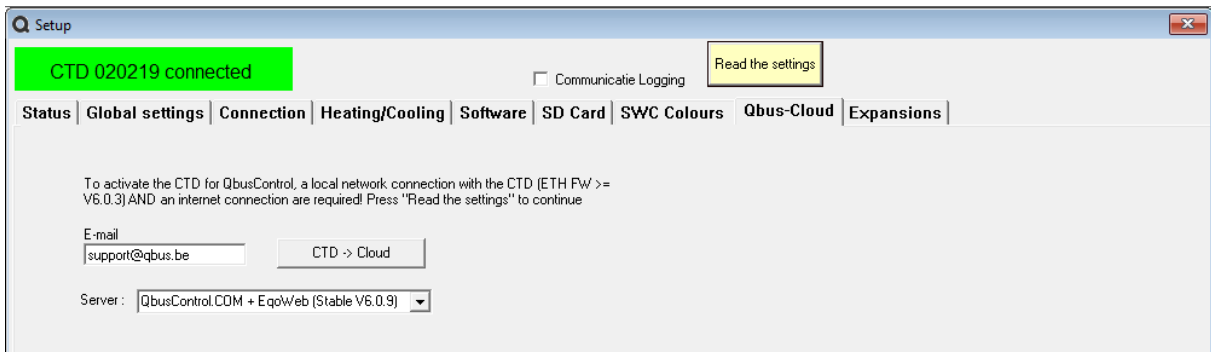

Step 3: Register yourself on the Qbus Cloud

Go to the site www.qbuscontrol.com and click the “Register” button.

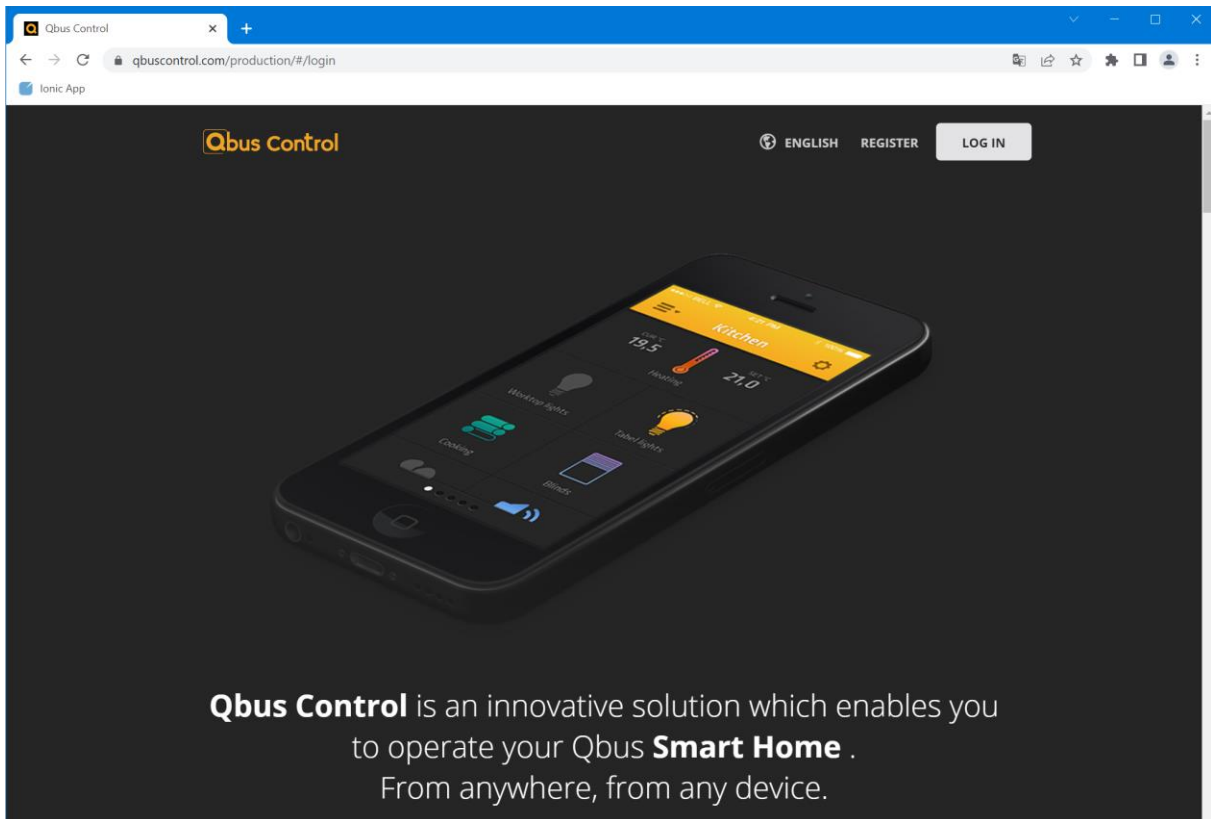

Now fill in your personal details, including the password with which you want to log in to Qbus Control. Click on “Create account”. You can now open your account on Qbus Cloud.

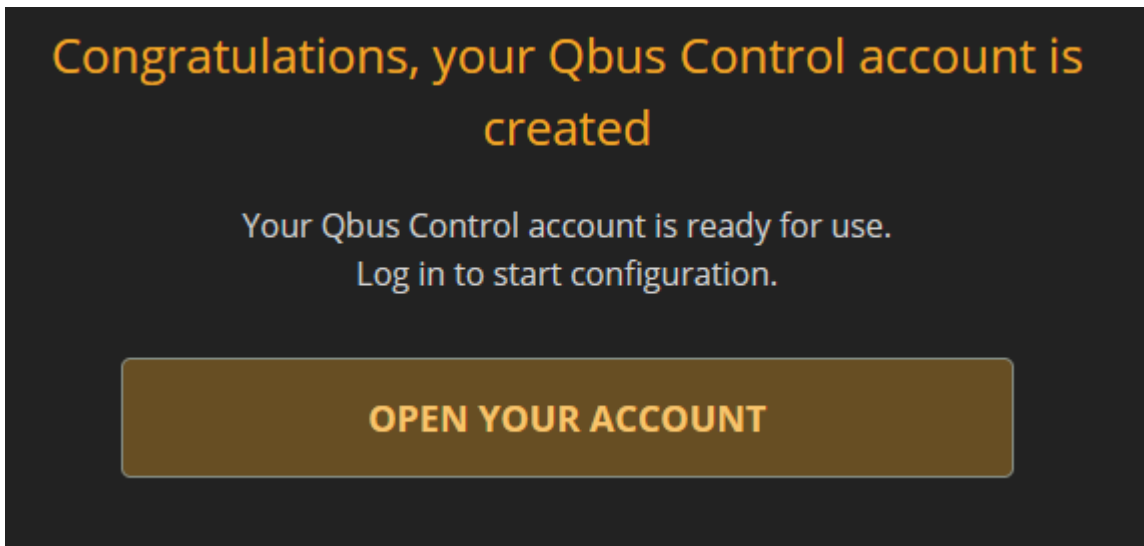

Step 4: Add your CTD to your account

In the settings screen, click on “ADD INSTALLATION” and type in the Serial number of the CTD and the activation key just just received.

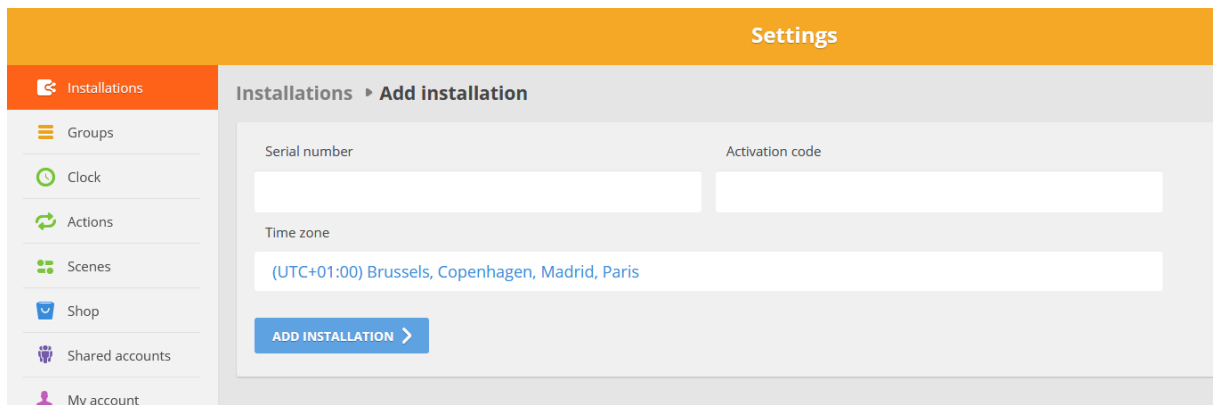

Step 5: Configure the Qbus Cloud

The Qbus Cloud still needs to be configured, press the wheel at the top left in the Menu bar

In the Controllers field, additional controllers under the same account can be added by serial number and activation code. Different outputs from different controllers can thus be displayed on the same Cloud account.

By clicking on “Groups” you can create groups. Click on “Add group”, then a choice can be made between adding a Manual or an Automatic group.

Note: To return to the previous step, click on the arrow at the top, or to exit the configuration and go to the main screen of the Qbus Cloud, click on the cross in the top left.

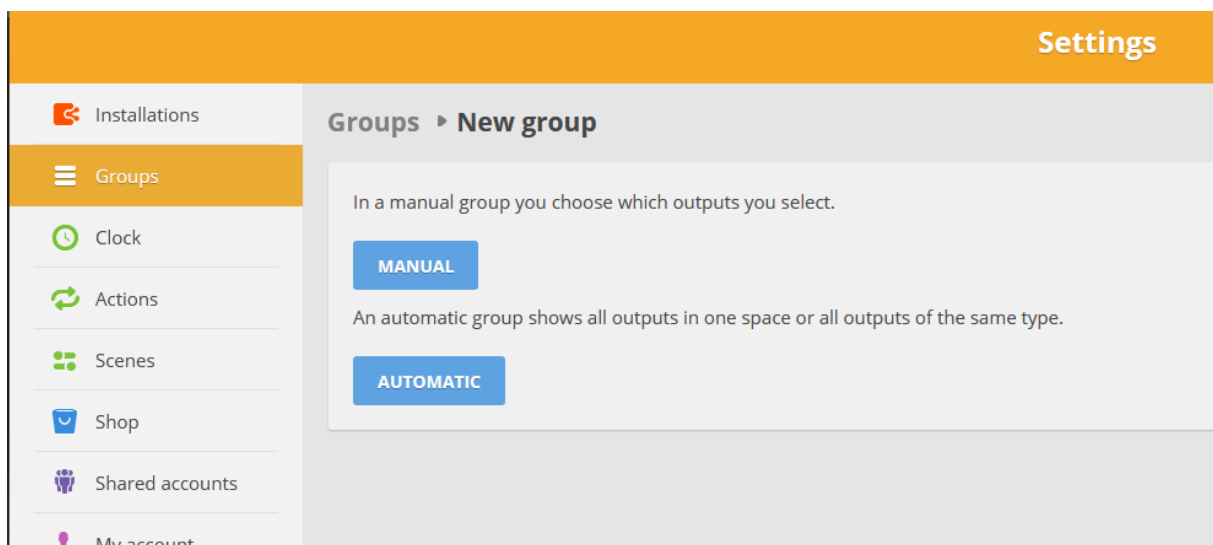
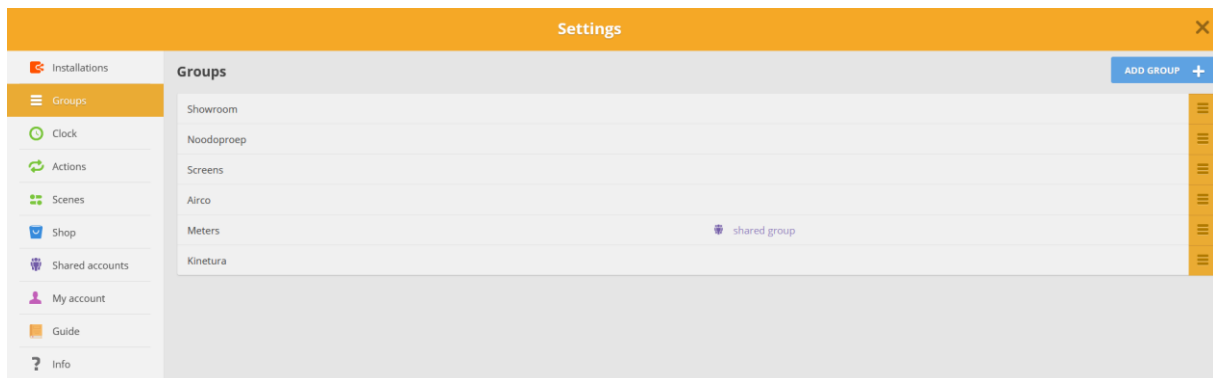

To add a manual group you first have to give the group a name, and then choose the outputs that belong to that group.

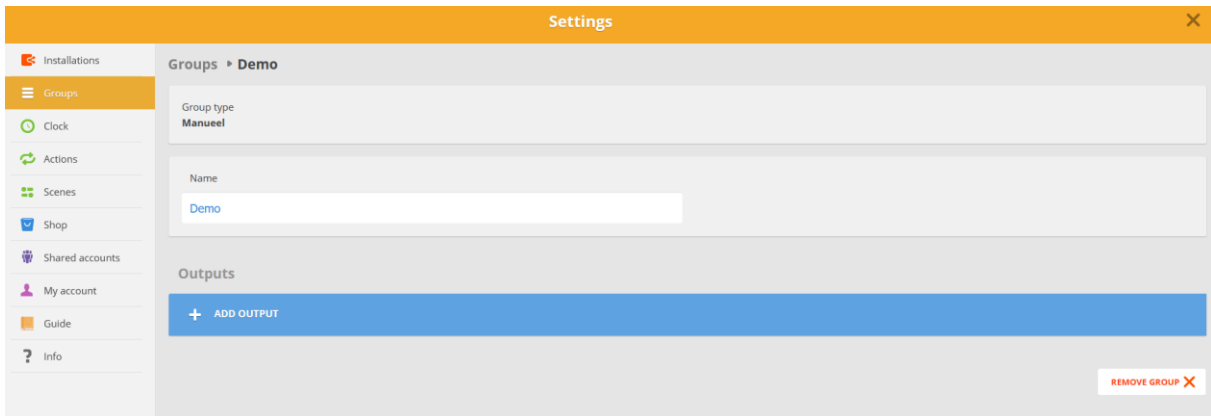

An automatic group is a group that will be created automatically based on location or based on the type of output. To create an automatic group based on location, the locations must be assigned to the outputs in the configuration of the System Manager. In the automatic group based on the type of output you can choose between the different types such as dimmers, on/off, CO2, scenes, thermostats,... The advantage of an automatic group is that, if an extra output is ever created of the same type or to which same location is assigned in the System Manager, it will automatically appear in the correct group in the Qbus Cloud.

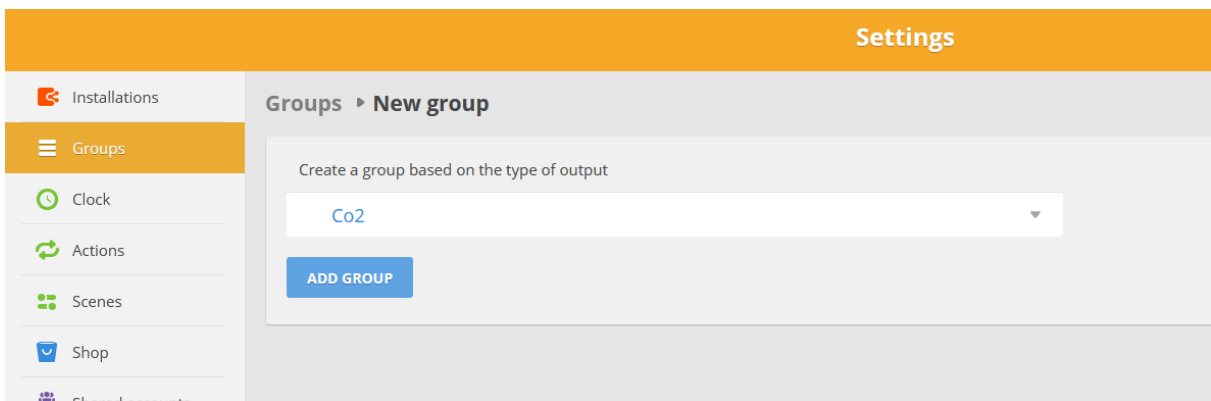

An existing group can also be modified: in a manual group, outputs can be added and removed, given a different order, or other icons can be assigned. Click on the name of the output in the group to change it. By clicking and holding on the yellow square to the right of the output, the order of the outputs can be changed.

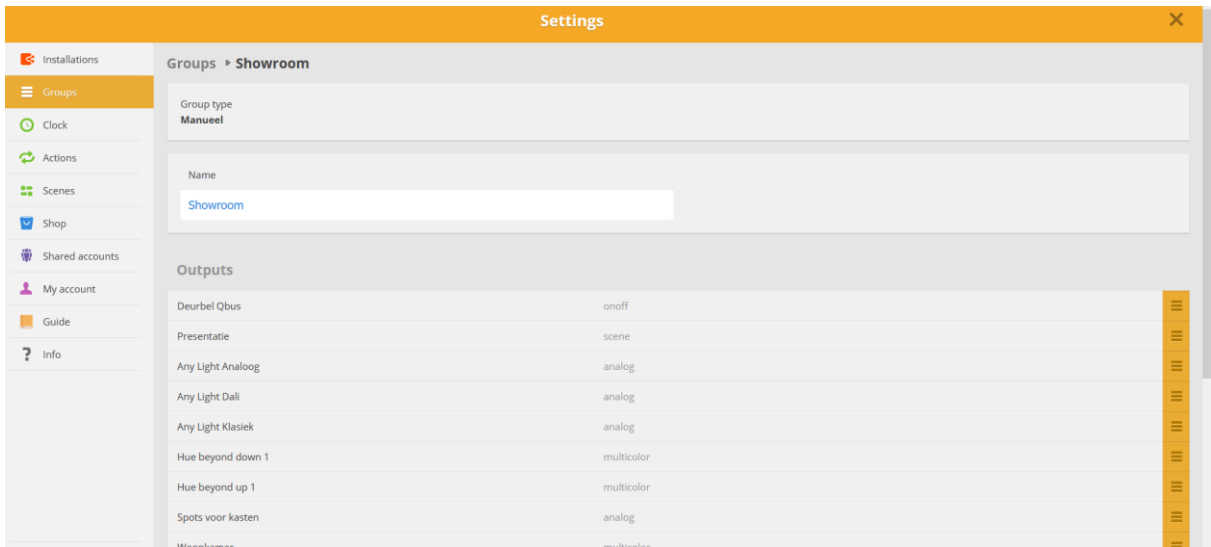

In an automatic group you cannot add or remove outputs yourself - this is automatic depending on location or type. You can change the icon to a new available icon by clicking on the output

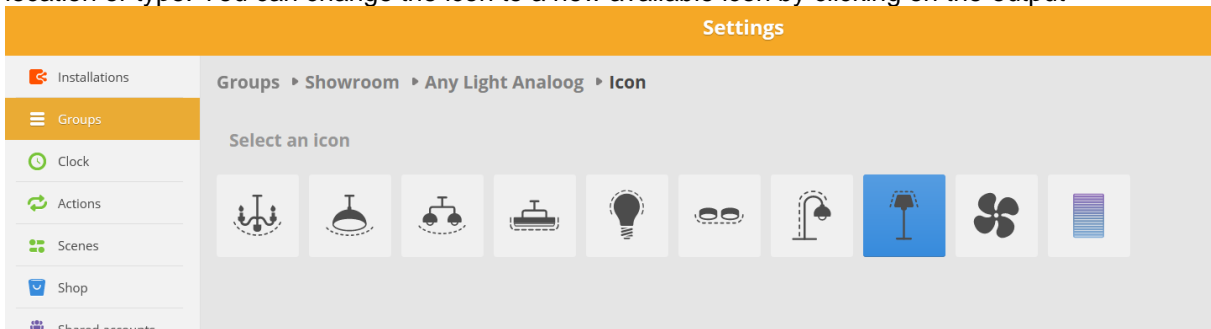

Clocks can also be set in the Qbus Cloud. These clocks are run at the selected times so that you can use the Qbus installation as an alarm clock, for example: shutters on, lights on 20%, coffee on, heating to comfort.

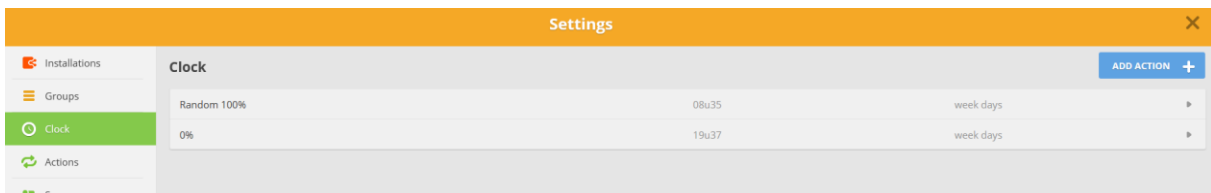

Settings

- Installations
- Groups
- Clock**
- Actions
- Scenes
- Shop
- Shared accounts
- My account
- Guide
- Info

Clock ▶ New action

A clock action will automatically execute the chosen output at the chosen time.

Output

Use the timezone of?

What Time?

When do you wish to apply this output?

[ADD ACTION >](#)

Settings

- Installations
- Groups
- Clock**
- Actions
- Scenes
- Shop
- Shared accounts
- My account
- Guide
- Info

You are logged in as
Qbus Showroom

[Log out](#)

Clock ▶ New action

A clock action will automatically execute the chosen output at the chosen time.

Output Option Option

Use the timezone of?

What Time?

When do you wish to apply this output?

Which day?

- Monday
- Tuesday
- Wednesday
- Thursday
- Friday
- Saturday
- Sunday

[ADD ACTION >](#)

A clock can easily be turned on or off by clicking on the clock and dragging between 1 and 0.

Clock ▶ Action

Output:
020012 - Random 100% (scene) ▼

Option
Status ▼

Option
On ▼

Switch on / Switch off

1

Use the timezone of?

Ubie (Romance Standard Time)

What Time?

08 : 35

When do you wish to apply this output?

Repeated

Which day?

Monday

Tuesday

Wednesday

Thursday

Friday

Saturday

Sunday

Now click on the cross at the top left, your Qbus Cloud is configured and you are ready to use it. Have fun!

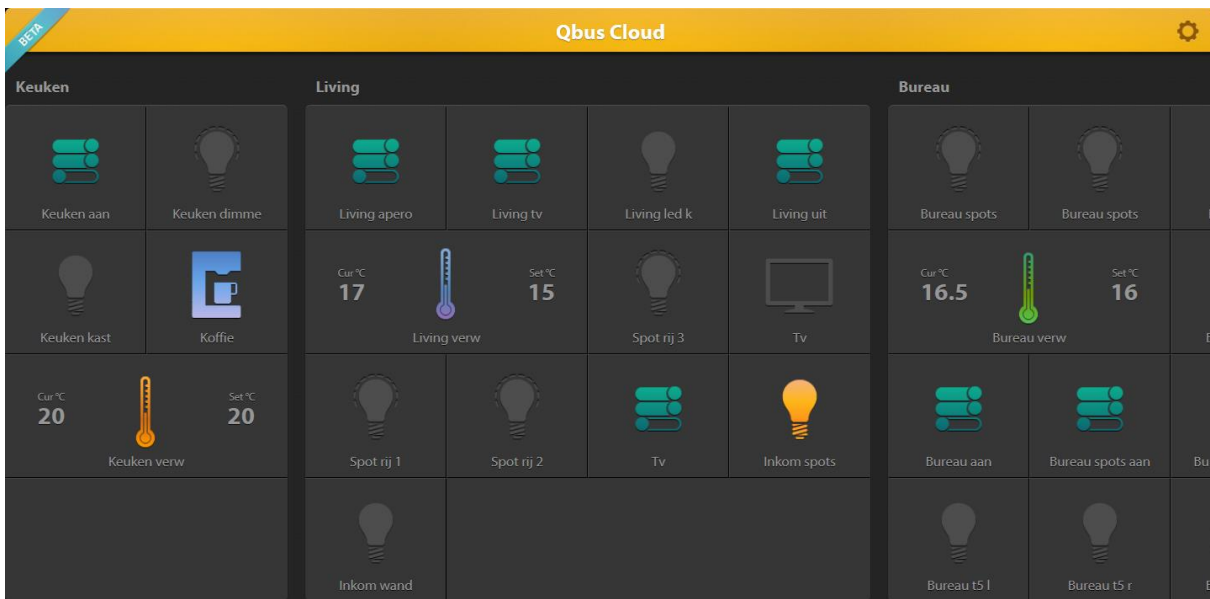

5.2. EQOweb web server

All CTD controllers with an Ethernet Port (CTD01E, CTD02E, CTD03E, CTD10, CTD40 and CTDmax) have a web server on the Ethernet interface. This means that it is possible to remotely control this CTD via a browser on an iPhone, smartphone, tablet, laptop, Mac, ...

To be able to use EQOweb you must first create a control table (see chapter 3.8.) Make sure to use the first control table (address A.01 - the type will default to "EQOweb" and cannot be modified) as the EQOweb control table.

In order to use the EQOweb web server, the firmware on the Ethernet port must be at least version 5.0.5. The version of that firmware can be checked as follows: open the System Manager III, click on Utilities, click on Setup, click on Search for CTD's and Settings...

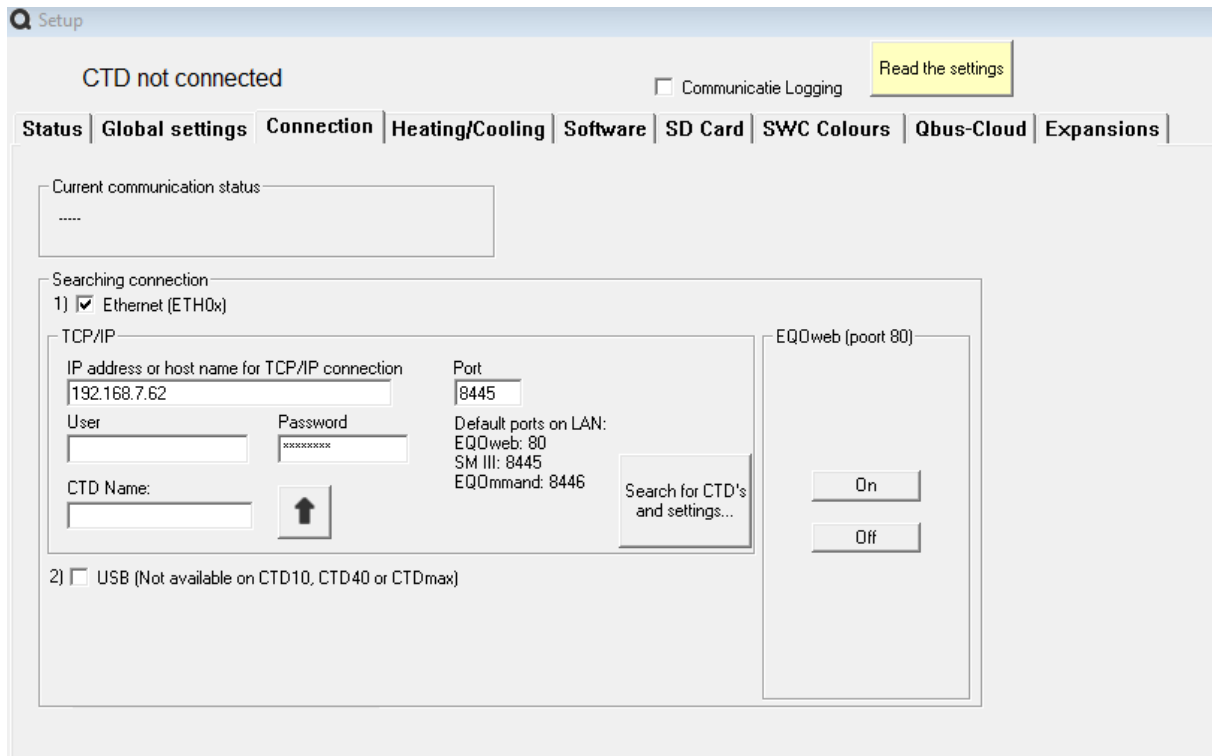

Qbus controllers are now being searched (via UDP network packets). Select your CTD controller – in the screen where your controller is located you will first see the Mac address and name (default serial number) of the controller and then the version of the Ethernet port. If you do not have minimum version 5.0.5 you need to upgrade the Ethernet port: click on “Upload Firmware V XXX”. This will upgrade the Ethernet Port firmware (differs from the Firmware of the CTD itself which can be upgraded via setup/software).

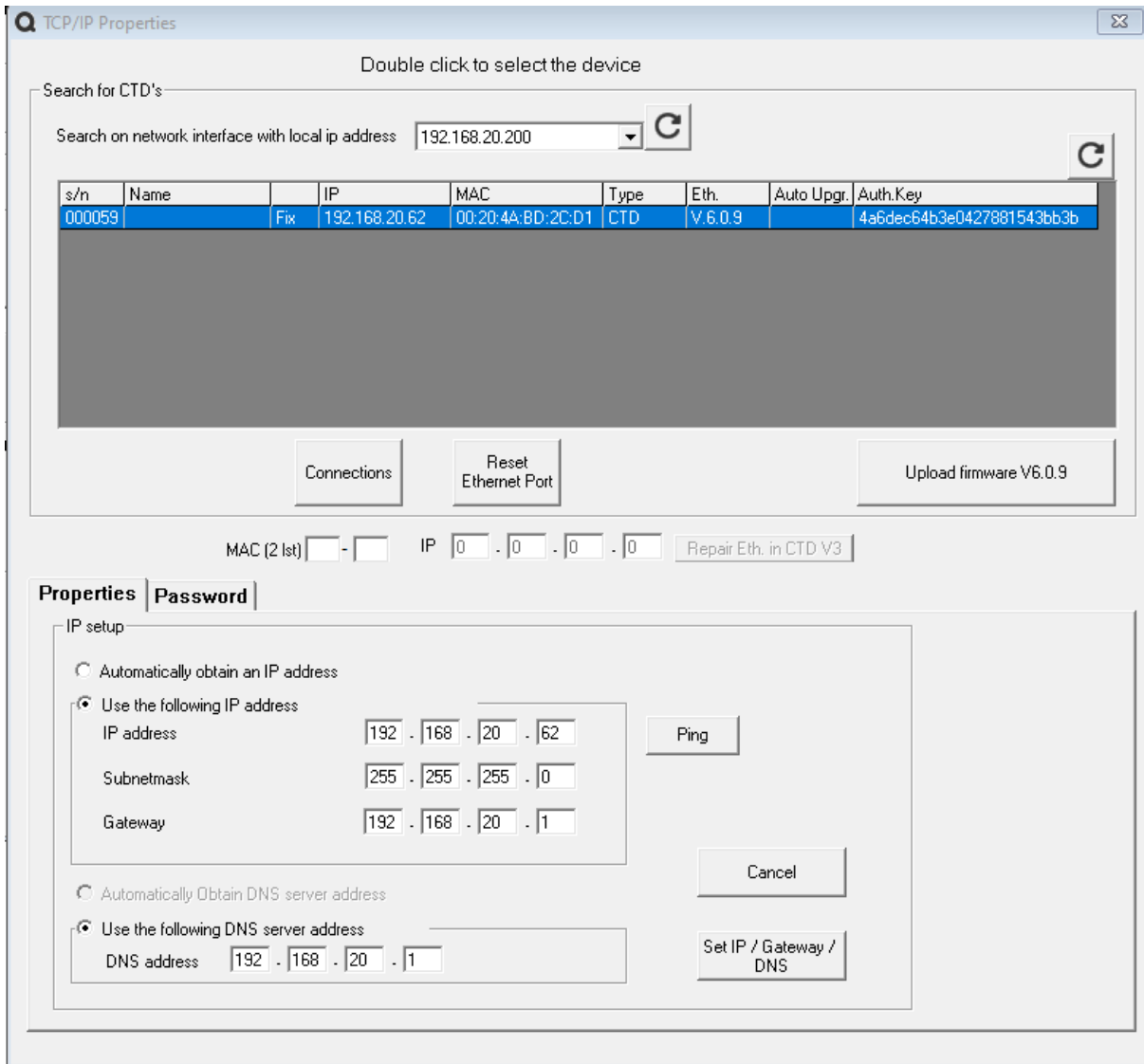

The upgrade of the Ethernet firmware at CTD0xE is done via the TFTP protocol. For this, UDP packets must also be allowed on the network (adjustment or temporary disablement of Firewall may be necessary for this). With the CTD10, CTD40, CTDmax this is done automatically via the internet. Once the EQOweb control table has been uploaded to the controller, you can control this control table via the EQOweb web server by typing the IP address of the Controller in your browser (<http://192.168.X.XXX:8444> for the older CTDs and <http://192.168.X.XXX:80> or simply <http://192.168.X.XXX> for the CTD10, CTD40 and CTDmax). See Chapter 2.4.1 to assign a static IP address to your controller.

You will now see the following login screen

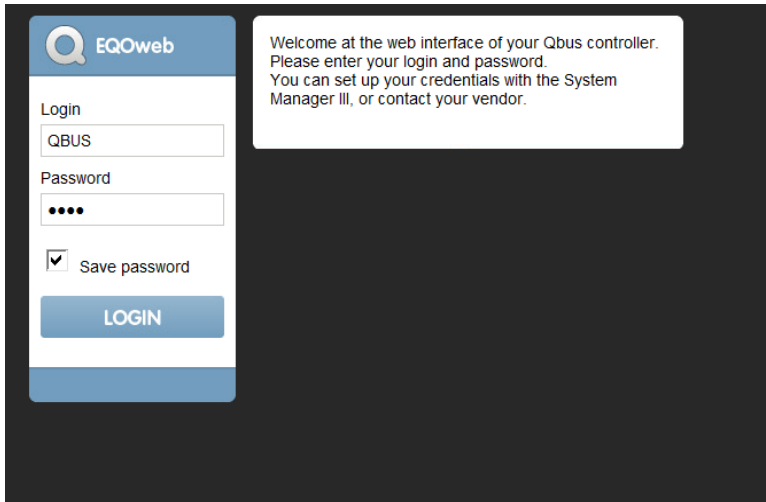

Make sure Login and Password are the same as those set through the System Manager III. For this, see the topic “Setting password for Ethernet connection” under chapter [2.4.1](#). Communication with the Controller. In the login screen you can check Save Password so that Login and Password do not have to be entered again and again.

By pressing the Login button you enter the menu of the web server that has been compiled via the operating table. Each menu now shows the different outputs that can be operated separately.

ATTENTION:

- EQOweb is a polling-based system. This means that the status must always be requested – there is no real-time feedback of changed statuses of your installation.
- Each thermostat output has two versions: an output to control the thermostat programs (OUTPUT NAME (Prog.)) and an output to adjust the set temperature per (half) degree (OUTPUT NAME (T°)) . If the latter is set in the EQOweb control table, this output will return you the room temperature of the location where the thermostat is located - so you will not be able to use this output to indicate the desired temperature. You can indicate the desired temperature by setting the Prog. to adjust the outputs (Economy, Comfort, Night...).

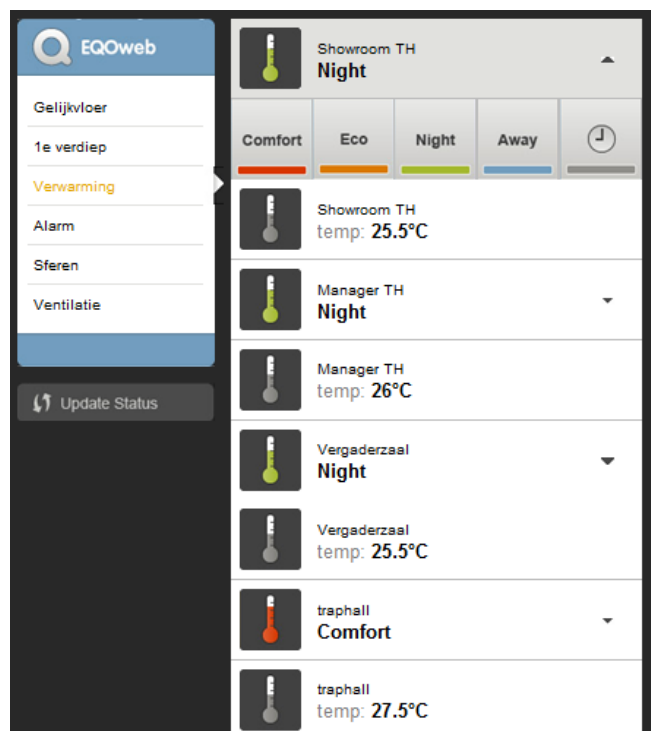

5.3. Port Forwarding

In order for the Ethernet device to establish remote connections through the router, some ports must be forwarded to the local IP address. This is called “Port forwarding” or “Virtual server”; Using an internet browser (MS Internet Explorer, Mozilla Firefox, Google Chrome, etc.), navigate to the router's address (e.g.192.168.2.1) and follow the router's instructions. Basically what you are doing is pairing the ports 8444 and 8445 of the router and entering the IP address assigned to them. From now on, the Ethernet interface can be reached via the external IP address.

Certain providers may change the available external IP (especially for ADSL users). It is not easy to remember 4 numbers. Therefore, there are certain services that can convert an IP address into a name (e.g.<http://www.dyndns.org>) By surfing to this site, you can activate a name, e.g. MYOWNNAME.DYNDNS.ORG. Of course, you need to register on the site first, so you don't need codes to sign up later. You can then link the name of your choice to the IP via the site.

6. Measuring (energy) via Qbus

All bus events are kept on the SD card of the Qbus controller: from this the average temperature in a room, how much the light has been on in the hall, how much energy, water or gas was consumed last winter, etc. can be calculated. This data is collected from the Qbus modules, or is read from a non-Qbus meter module via an input module. The data on the Qbus SD card can then be exported from the controller in Excel, or can be displayed on the Eco Dashboard (part of the Qbus EQOmmmand software).

For reading data from non-Qbus meters, we have designed the Energy Counter Module or ECM04.

6.1. Energy Counter Module

The ECM04 or energy counter module is a module that adds up the pulses it receives from a meter. It does not matter from which meter type these pulses come as long as the contacts are voltage-free. The ECM04 can receive and add a pulse every 250ms. The system can also create an alarm at a certain number of pulses, for example for a green power certificate for solar panels.

Step 1: Insert Serial Number

The ECM04 has the serial number range 81xxxx. In our example we now use 810001, the following screen will appear.

ECM04 module 810001

Global settings

Location

Update interval

Input

1.

2.

3.

4.

Step 2: create outputs and assign them

This can be done in 2 ways:

1. On the module itself: By clicking on the function “- New output -” in the drop-down menu of input 1.
2. Wizard new output: In the outputs tab you have the function “Wizard new output”, by opening this you can create an ECM04 input via the option “Energy meter”.

If you create an ECM04 input via one of these methods, the three other inputs of the ECM04 will automatically be created as meter inputs.

In our example, we have created and named 4 entries as follows: E-meter, Solar Energy , Gas Meter, Water Meter

When we look at the properties of the ECM04 input we see several parameters:

Minimum: This is the minimum limit of the value that will be measured and can be displayed in the EQOmmmand and Cloud.

Maximum: This is the maximum limit of the value that will be measured and can be displayed in the EQOmmmand and Cloud.

Type: Energy (in kWh), gas (in m³), water (in l) or 'Other'

Puls value: This is the factor with which we have to multiply the measured pulse to get a correct value. For example, each pulse represents 100Wh, then the multiplier must also be 100 if we want to express it in Watthours, if we want to express it in kWh then the multiplier must be 0.1.

Unit: this is the unit in which we express the measured value.

trigger: is a set point where an alarm output can be created. The can be set from 0 to 1,000,000,000 pulses.

warning address: This is the output that turns on when the number of pulses is equal to or greater than the trigger value.

If we want to read the number of pulses in the System Manager, we can press the button “Read value”. This data is synchronized every minute by default, but the update interval can be set from 1 to 255 minutes. Each interval the number of pulses counted is reported, but also when the counter reaches 255, this is reported to the controller.

The pulses can also be reset to zero by clicking the “Reset” button.

ECM04 module 810001

Algemene instellingen

Plaats:

Update interval:

Ingang (A20)

1.	<input type="text" value="E-meter"/>	<input type="text" value="136235"/>	<input type="button" value="Reset"/>
	<input type="text" value="Normaal open"/>	<input type="text" value="Reset: mei 25 13:47"/>	
	<input type="button" value="Eigenschappen..."/>		
2.	<input type="text" value="Zonne-energie"/>	<input type="text" value="0"/>	<input type="button" value="Reset"/>
	<input type="text" value="Normaal open"/>	<input type="text" value="Reset: mei 25 13:47"/>	
	<input type="button" value="Eigenschappen..."/>		
3.	<input type="text" value="Gasmeter"/>	<input type="text" value="0"/>	<input type="button" value="Reset"/>
	<input type="text" value="Normaal open"/>	<input type="text" value="Reset: mei 25 13:47"/>	
	<input type="button" value="Eigenschappen..."/>		
4.	<input type="text" value="Watermeter"/>	<input type="text" value="0"/>	<input type="button" value="Reset"/>
	<input type="text" value="Normaal open"/>	<input type="text" value="Reset: mei 25 13:46"/>	
	<input type="button" value="Eigenschappen..."/>		

Step 3: Logic

The ECM inputs can be used in analog logic as a condition. For each ECM input there are 4 parameters in the logic that we can use. In the Counter tab we see these outputs. We see there Last Count, Counter L, Counter H, Counter XH and Counter XXH.

The counted value on the ECM04 is divided over these 4 parameters. Each parameter can go up to 255. When Counter L(ow) becomes greater than 255 we increase Counter H(igh) by one and reset Counter L, when Counter H exceeds 255 we increase Counter XH by 1 and reset Counter H. If Counter XH is higher than 255 then we will increase Counter XXH by 1 and we will reset Counter XH. Counter L counts in multiples of 1 (0 to 255), Counter H counts in multiples of 256 (0 to 65280), Counter XH in multiples of 65536 (0 to 16,711,680) Counter XXH in multiples of 16,777,216 (0 to 4,278,190,080)

The 'Last Count' contains the number of pulses of the last measurement (default is the last minute). Note: if there are NO new pulses, this value will not return to zero, but will remain at the last value (0 – 255).

An example: We want the Alarm 1 output to turn on when the ECM has counted 3547 pulses. The 4 parameters will then have the following values as a condition: Counter L = 219 and Counter H = 3328. The logic then looks like this:

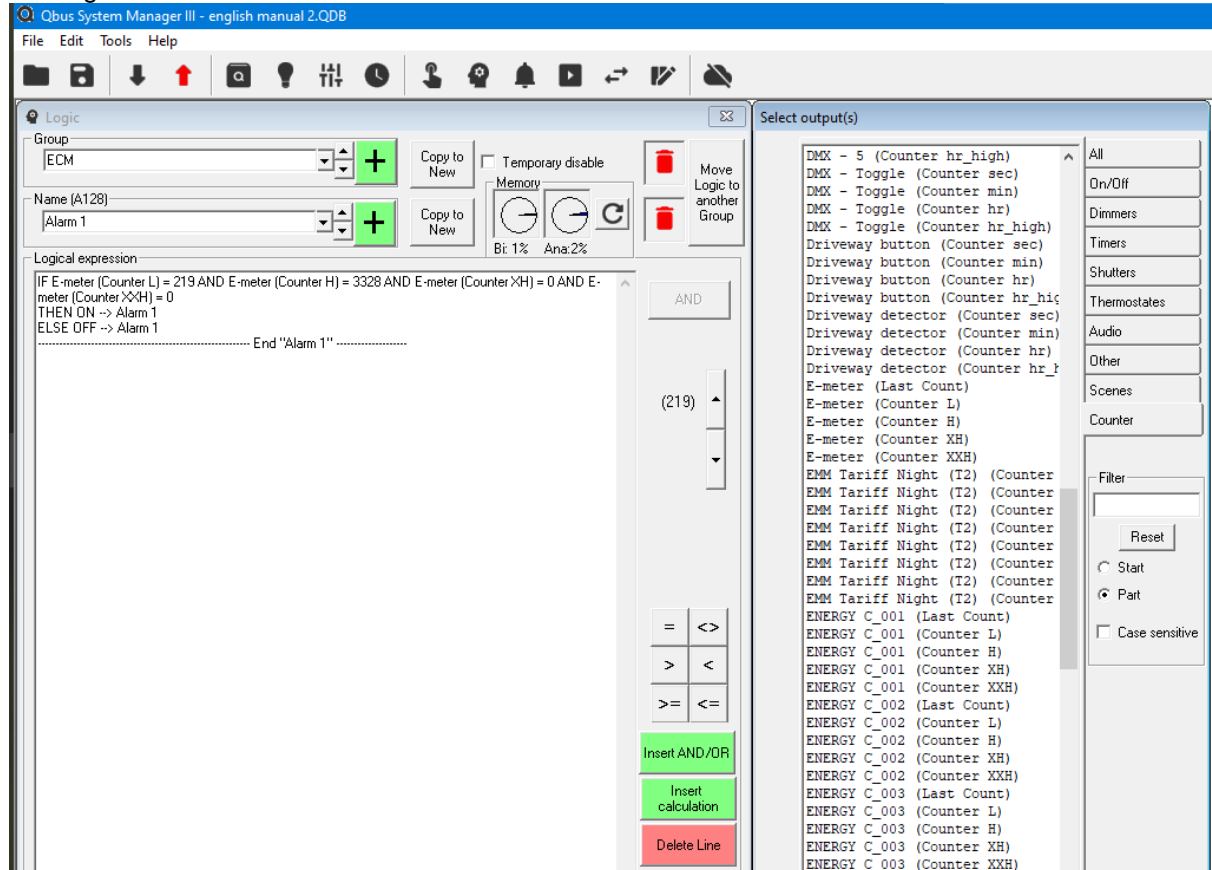

If we want to reset the counters, this can also be done via logic. We create a bistable (or timer) output (`_reset`) for this, which we set as a condition for resetting the counter.

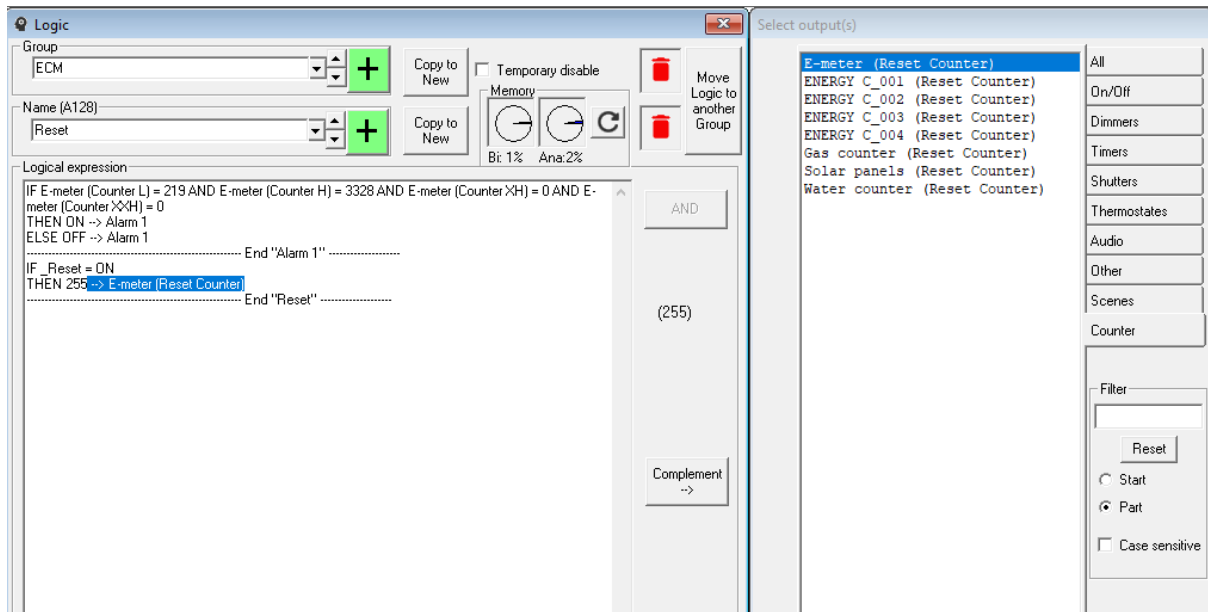

A counter value can also be used as a condition for a reset function. A practical example: A green electricity certificate is issued for every 1000 kWh; via the ECM module we can easily demonstrate this via an output. We write in the logic the following (we assume that 1 pulse represents 1kWh)

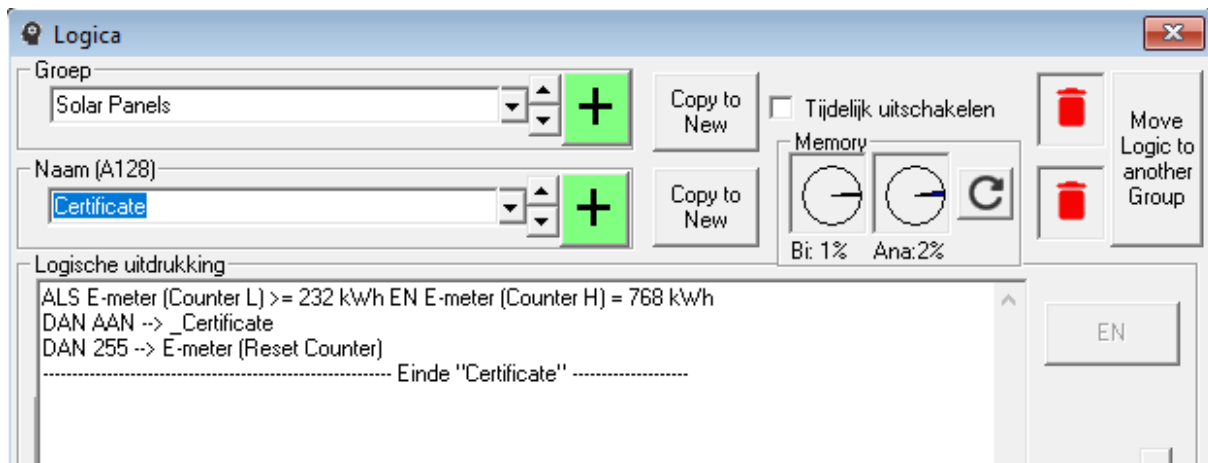

In this way an output is switched on when the number of pulses is reached and we immediately reset so that we do not miss any pulses. The output `_Certificate` can then be sent via an SMS module to a mobile phone or displayed on an EQOcommand, or to investigate further, the LEDs of the switch can flicker via an alarm.

6.2. EMM03 (Module type 0017)

The EMM03 or energy management module is a DIN rail module that can read the data from the P1 port of a digital energy meter (BE and NL) and visualize it on universal outputs. Triggers can also be set that turn an output on and off according to a certain level.

After entering the serial number (in our example 0017B00017) the following screen appears:

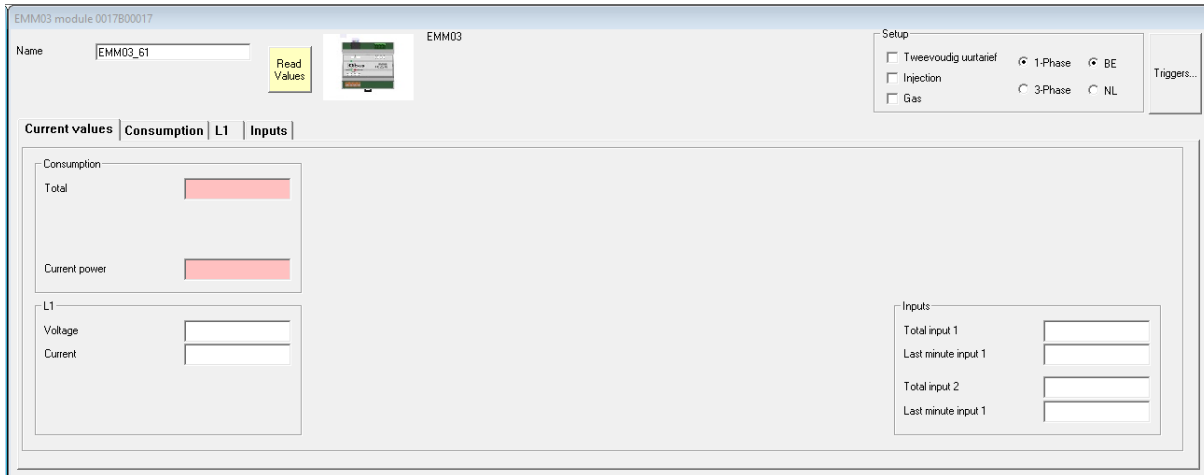

In the setup box in the top right corner you can set whether you have a single or multiple hourly rate (also called day-night rate), whether there is also injection (solar panels, battery, ...), whether there is also a gas counter is connected, whether you have a 1-phase or 3-phase network and whether the EMM03 is connected to a Belgian or Dutch P1 port.

After checking the correct parameters and clicking on the “Read values” button, you will see all the values from the smart meter. Values in red are consumptions and values in green are injections into the grid.

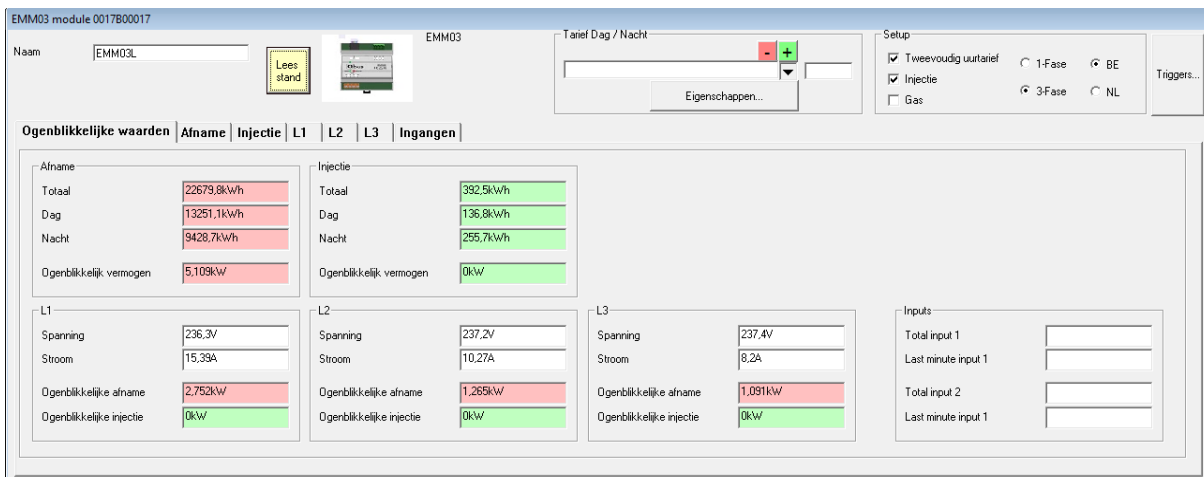

To see these values in the Cloud, you need to assign outputs to any desired parameter:

When you click on it  sign, the following question appears:

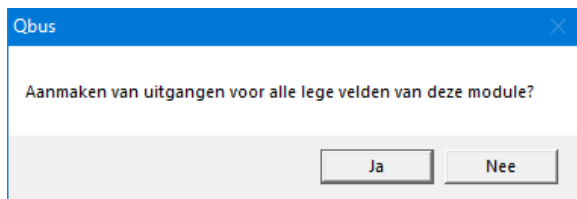

When you click on “No” you can create or assign an individual output to the selected parameter.

If you answer “Yes” here, the following window will appear:

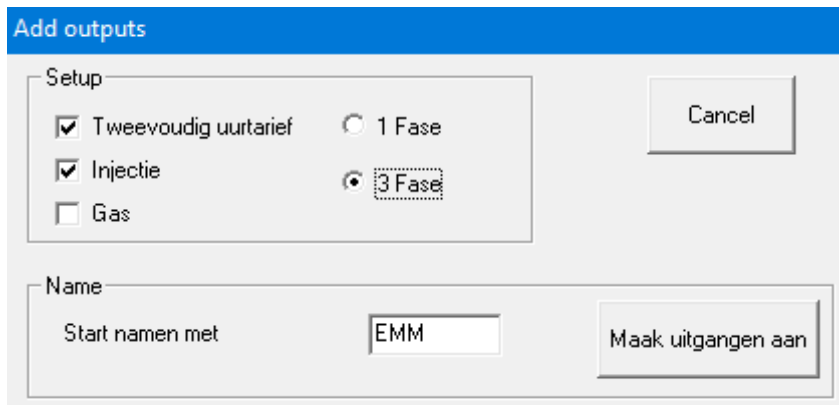

Check whether all setup parameters are correct, adjust the desired beginning of the names if necessary and then click on “Create outputs”.

All individual outputs that were not yet assigned in module will be created with the correctly set type, minimum, maximum, multiplier and unit for a normal house.

The screen of the purchase for a two-time hourly rate then looks like this:

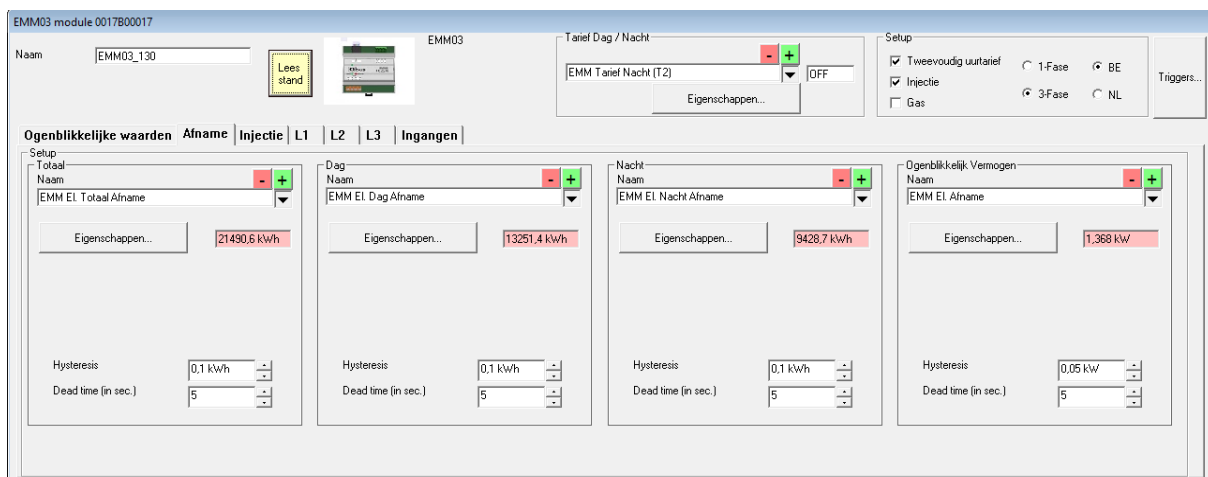

All energy values are displayed by the EMM03 with a resolution of 0.1kWh, the instantaneous power has a resolution of 0.001kW (= 1 Watt). Voltages are accurate to 0.1V and currents to 0.01A.

Every time the difference with a previously sent value is greater than the set hysteresis and the “Dead time” has elapsed, the new value will be sent to the controller. These values can also be visualized on the Cloud, EQOMmand, ...

The powers are standard set to a maximum of 10kW, the currents to 40A.

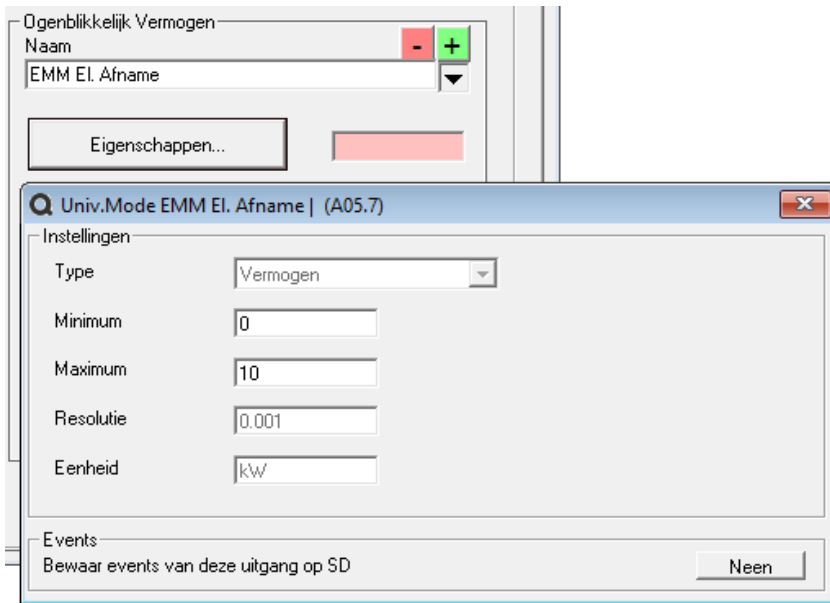

If your installation has larger (or smaller) consumers than normal, you can still adjust the minimum and maximum value for each output so that the indicator on the cloud looks better.

If you wish to switch outputs when a value reaches a certain level, you can set this by clicking the “Triggers” button. Following window appears:

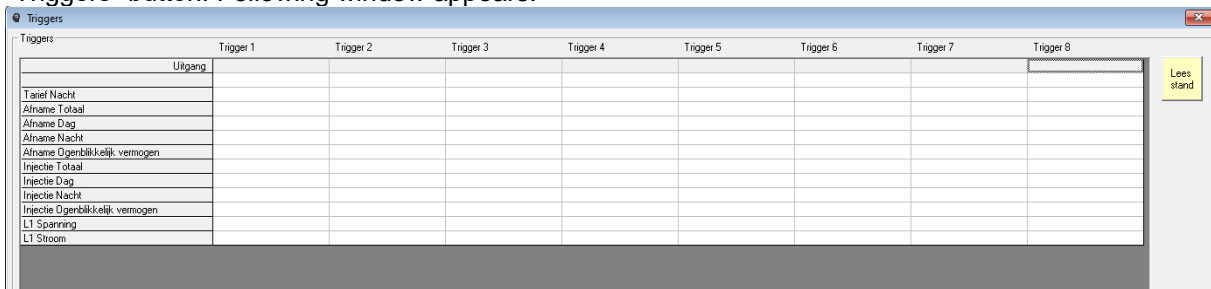

The EMM03 can internally switch up to 8 outputs and will always be triggered by the instantaneous values received from the P1 port. The “hysteresis” and “dead time” therefore have no influence on this.

In the first row you select which output should be switched. Only outputs of the type 'Bistable' can be selected here:

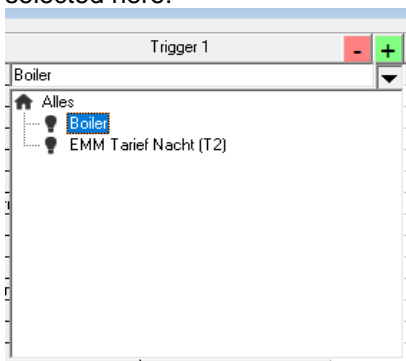

On the desired row, select the condition to turn the output ON. The condition \geq can be changed to \leq by double clicking on the cell. Double clicking again removes the full condition. You can set up to a maximum of 8 conditions per trigger that will be tested together with an AND condition.

In the following example, the output “Boiler” is turned on when there is more than 0.7kW (700W) injection.

Uitgang	Trigger 1	Trig
Tarief Nacht		
Afname Totaal		
Afname Dag		
Afname Nacht		
Afname Ogenblikkelijk vermogen		
Injectie Totaal		
Injectie Dag		
Injectie Nacht		
Injectie Ogenblikkelijk vermogen	>= 0,7kW	
L1 Spanning		
L1 Stroom		

NB! When a boiler of e.g.2kW is switched on here, the trigger will no longer be sufficient and the output will be turned OFF because the injection is less than 700W. So always set the delay on and/or off of the bistable output and/or use a fictitious output that switches on a timer via logic.

6.3. counters

From System manager 3.4.0 it is possible to visualize the operating hours of each output in the System manager. The operating hours can be viewed in the global edit tab by pressing the “Read value” button, or you can have certain actions performed via logic when a certain time is reached

Naam	Korte naam	Mode	Events	Cloud	Status	Counter
Diepwegklep	Diepwegklep	Bistabiel	<input checked="" type="checkbox"/>	<input checked="" type="checkbox"/>	DN	163h1351''
E-meter	E-meter	Energimeter (ECM)	<input checked="" type="checkbox"/>	<input checked="" type="checkbox"/>		136235 vanaf 25 mei 13:47
ENERGIE_M_001	ENERGIE_M_001	Energimeter (ECM)	<input checked="" type="checkbox"/>	<input checked="" type="checkbox"/>		
ENERGIE_M_002	ENERGIE_M_002	Energimeter (ECM)	<input checked="" type="checkbox"/>	<input checked="" type="checkbox"/>		
ENERGIE_M_003	ENERGIE_M_003	Energimeter (ECM)	<input checked="" type="checkbox"/>	<input checked="" type="checkbox"/>		
ENERGIE_M_004	ENERGIE_M_004	Energimeter (ECM)	<input checked="" type="checkbox"/>	<input checked="" type="checkbox"/>		
Gasmeter	Gasmeter	Energimeter (ECM)	<input checked="" type="checkbox"/>	<input checked="" type="checkbox"/>		0 vanaf 25 mei 13:47
Keuken	Keuken	Audio	<input type="checkbox"/>	<input checked="" type="checkbox"/>	0:	
Keuken TL	Keuken TL	Bistabiel	<input checked="" type="checkbox"/>	<input checked="" type="checkbox"/>	DN	1100h4359''
Koelen globaal	Koelen globa	Bistabiel	<input checked="" type="checkbox"/>	<input checked="" type="checkbox"/>	OFF	305h2939''
Licht parking detector	Licht parkin	Timer5	<input type="checkbox"/>	<input checked="" type="checkbox"/>	DN	12h2518''
Licht parking manueel	Licht parkin	Timer5	<input checked="" type="checkbox"/>	<input checked="" type="checkbox"/>	DN	953h4301''
Licht parking	Licht parkin	Timer5	<input checked="" type="checkbox"/>	<input checked="" type="checkbox"/>	DN	163h1411''

Logic

The operating hours counter can also be used as a condition in an analog logic. The counters can be found in the Counter tab. The 3 counters (Counter sec, Counter min, Counter hr) each go from 0 to 255, Counter hr_high goes from 0 to 65280 (in steps of 256). For example, if we have 2 groups of lighting that are allowed to turn on for 1000 hours each, we have to build such a logic.

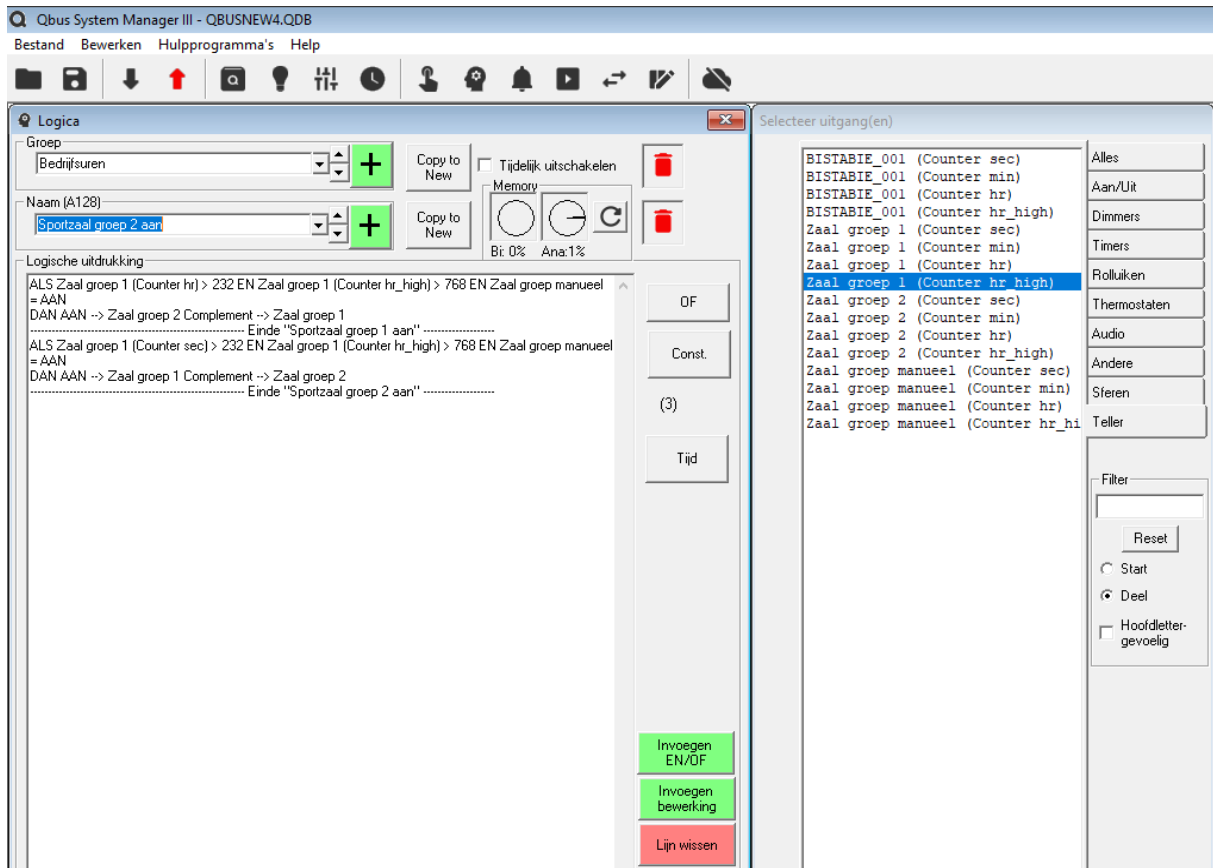

Remark:

A reset of the operating hours counter must be done manually via the System Manager, this can be done via the global Change tab, select the relevant output and then click on the Reset button.

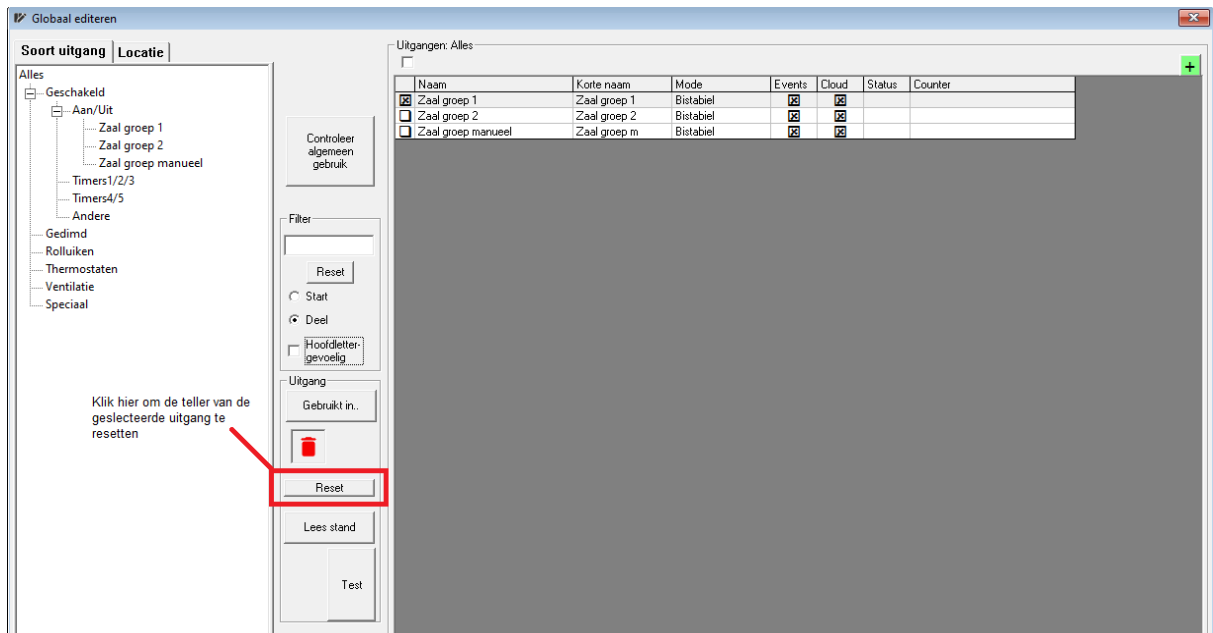

Gloobaal editeren

Soort uitgang | Locatie

Uitgangen: Alles

Naam	Korte naam	Mode	Events	Cloud	Status	Counter
<input checked="" type="checkbox"/> Zaal groep 1	Zaal groep 1	Bistabiel	<input checked="" type="checkbox"/>	<input checked="" type="checkbox"/>	ON	963h03'56"
<input checked="" type="checkbox"/> Zaal groep 2	Zaal groep 2	Bistabiel	<input checked="" type="checkbox"/>	<input checked="" type="checkbox"/>	OFF	1011h01'07"
<input checked="" type="checkbox"/> Zaal groep manueel	Zaal groep m	Bistabiel	<input checked="" type="checkbox"/>	<input checked="" type="checkbox"/>	ON	1102h07'09"

Klik hier om de tellers van ALLE geselecteerde uitgangen te resetten

Lees stand

Reset

Controlleer algemeen gebruik

Filter:

Reset

Start

Deel

Hoofdlettergevoelig